

MARCH 1957

35 CENTS

POPULAR MECHANICS

MAGAZINE

WHAT YOU CAN UNDERSTAND IT

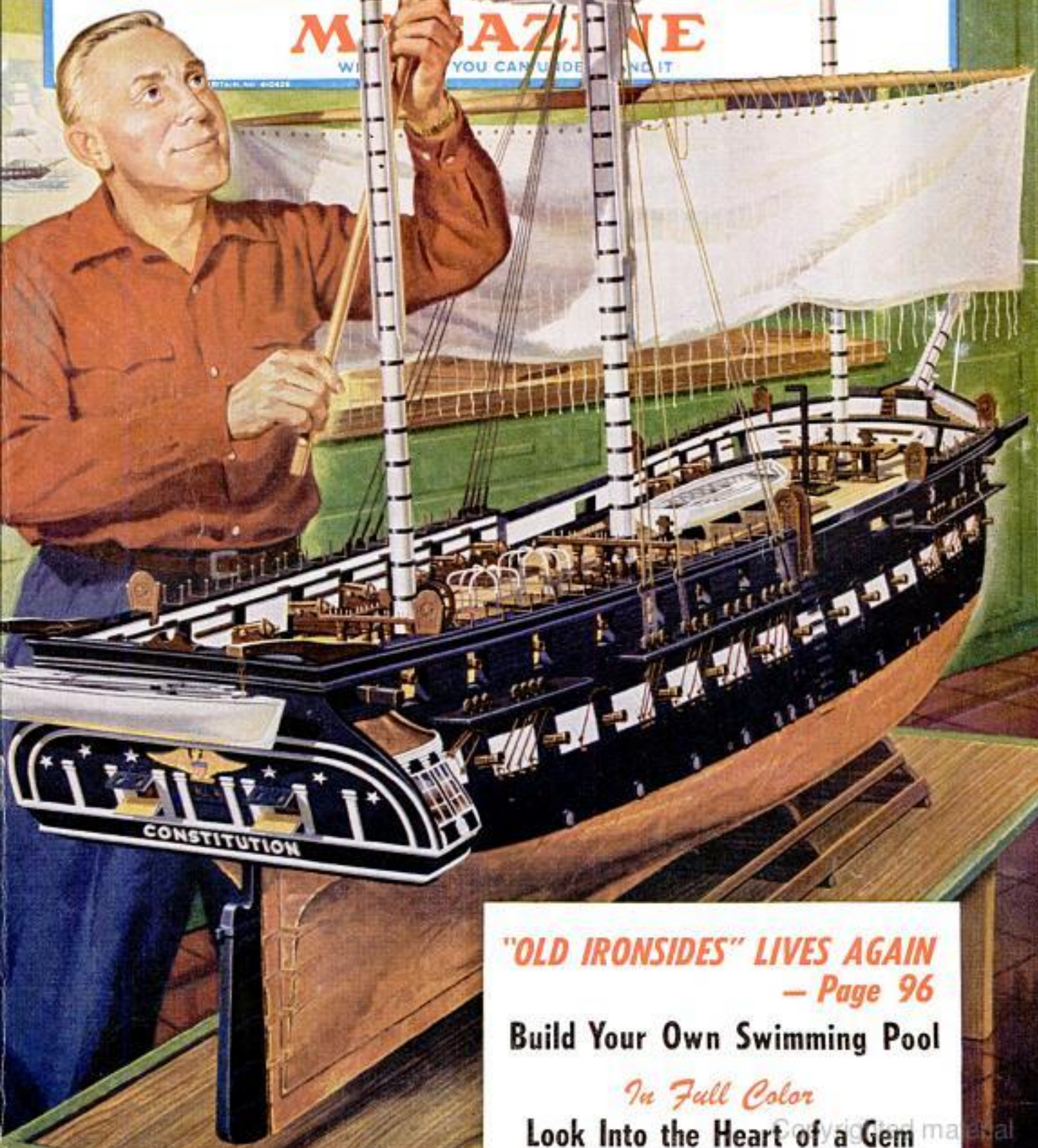

"OLD IRONSIDES" LIVES AGAIN
— Page 96

Build Your Own Swimming Pool

In Full Color

Look Into the Heart of a Gem

nine wonderful ways
to welcome spring



See them - try them -
**nine new
Evinrudes**
- tops for fishing fun!

Fishing dreams come magically true when you slip a '57 Evinrude on the stern of your boat. Nine superb new models—3 to 35 horsepower—blanket the entire range of fishing fun. Nothing on water surpasses the pleasure of their whisper-quiet operation—their smooth and steady slow-speed trolling—their blazing performance when you flick the throttle wide.

They're loaded with power—loaded for fun! New high-compression, high performance 18 and 35 horsepower models that set

new standards of big-load handling ability. New fuel economy. New 12-volt electric starting. New manual starting ease. In every popular power range they're today's most exciting, most wanted motors.

Make a date for spring with your Evinrude dealer *now*. Don't miss your best week ends on a waiting list (Evinrude demand exceeds supply every year). Now's the time for top-dollar trade-ins, too. For full-color catalog of the complete Evinrude line, write EVINRUDE MOTORS, 4412 N. 27th St., Milwaukee 16, Wis.



A Division of Outboard Marine Corporation
In Canada: Mfd. by Evinrude Motors, Peterborough



Evinrude
quiet outboard motors

TIPS FROM
TEXACO



HEAVY FOOT WASTES GASOLINE

CAR DRIVERS who watch their footwork can get up to 50% more mileage from a gallon of gasoline. Here are some ways they do it.

Smart drivers take it easy. A "swoosh" start or beating the other guy at the light takes up to 60% more gasoline. Nervous "pumping" of the accelerator pumps unneeded gas to the engine, gives an over-rich mixture, lowers performance, wastes gas.

So much for the accelerator. What about the brake? You make a gas investment to give the car momentum. Useless braking kills momentum, wastes gas. Rushing up to a red light, turn or traffic jam, and then screeching the brake wastes plenty. Look ahead, plan a smooth even pace and you'll save gas—maybe even lives.

So watch your footwork and save!

Here's another gasoline saver:

Most motor oils get "stiff" when cool—drag on the engine when starting and warming up. Not so with *Havoline Special 10W-30*. Fully fluid when cold it saves gas by lessening starting and warm-up drag, yet stays full-bodied and full-lubricating when warm. Also it guards against engine deposits for clean, power-packed performance. Switch to *Havoline Special 10W-30*, use less gas, get more power. Get this ultra heavy duty motor oil from your Texaco Dealer, the best friend your car has ever had.

STAYS "LIGHT" WHEN COLD
—LESS STARTING DRAG

KEEPS "BODY" WHEN WARM
—SAVES ENGINE WEAR



TEXACO DEALERS

IN ALL 48 STATES

Texaco Products are also distributed in Canada, Latin America, and Africa

TUNE IN ... Metropolitan Opera radio broadcasts every Saturday afternoon.
See newspaper for time and station.

THE TEXAS COMPANY



MARCH 1957

1

Copyrighted material



X-RAY ON CHEVROLET

The biggest step forward since overhead valves—FUEL INJECTION!

With Ramjet fuel injection* the auto industry enters upon a whole new era of engine performance. For this is as important an advance as overhead valves—setting new standards of gasoline economy, of *instantaneous* acceleration, of smooth low-speed running and free-breathing maximum performance.

Fuel injection used to be limited to racing

engines. But now Chevrolet offers a constant-flow port injection system that develops up to *one horsepower per cubic inch of displacement!* That's a summit of efficiency never before attained by any American production engine—and what it does for the 1957 Chevrolet you'll have to feel to believe. Try it—soon—and see! *Chevrolet Division of General Motors, Detroit 2, Michigan.*

**Optional at extra cost*

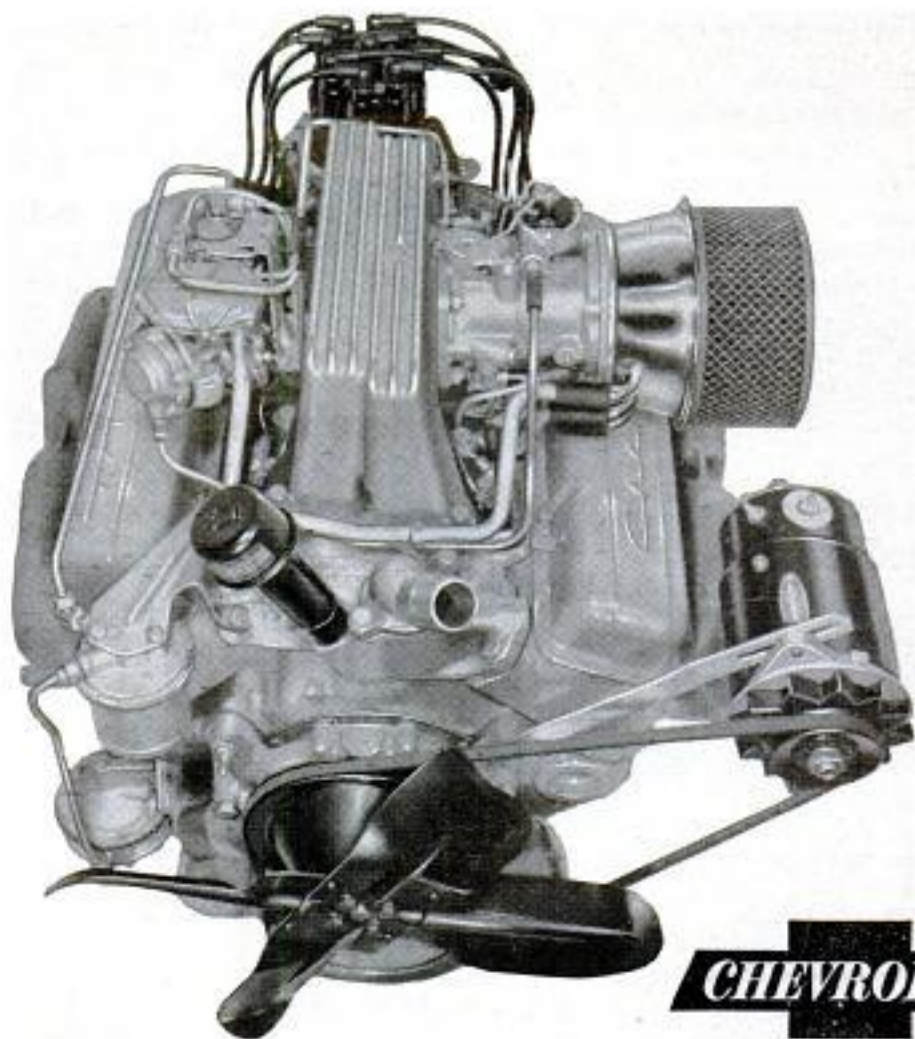

CHEVROLET

POPULAR MECHANICS

Popular Mechanics Magazine

Registered in U. S. Patent Office and Canada

H. H. WINDSOR, Founder

H. H. WINDSOR, JR., Editor and Publisher



Next Month

LANDSCAPING is a subject close to the heart of every homeowner whether his yard be large or small. Breath-taking plans for the spacious yard are plentiful—but what about the family with a 50 or 60-foot lot? In the April issue "PM's Landscaping Plan for the Small Yard" reveals the transformation of a desolate mud hole to a spot of real beauty. There are scores of ideas in the plan and photos reproduced in full color. Twenty-one pages of the April issue are devoted to outdoor living with additional articles on shading devices for the yard, outdoor furniture, an innovation called "garage porches" and a page on how to combat pesky mosquitoes

POPULAR MECHANICS INTERNATIONAL EDITIONS

Mecanique Populaire (French)
Mecanica Popular (Spanish)
Populaer Mekanik (Danish)
Popular Mekanik (Swedish)
Populare Mechanik (German)

Sources of further information not listed in the index, starting on page 74, about articles in this issue, frequently are shown in the Where-to-Find-It List prepared for each issue. A copy may be obtained by readers, without charge, from Bureau of Information, Popular Mechanics, 200 East Ontario Street, Chicago 11, Ill.

Published monthly by Popular Mechanics Company, 200 E. Ontario St., Chicago 11, Ill. H. H. Windsor, Jr., president; Wm. Harrison Feltz, exec. vice-pres.; Franklin S. Forsberg, operations vice-pres.; D. F. Windsor, vice-president and secretary-treasurer; H. H. Windsor III, vice-president; W. T. Windsor, vice-president; Joseph R. Buell, Jr., advertising manager; Alan M. Deyoe, circulation manager. Single copy in the United States and Canada, 35 cents; subscription rates in the United States and possessions, Canada and countries of the Pan-American Postal Union, 1 year \$3.50; 2 years, \$6.00; 3 years, \$8.00. To all other countries add \$1.00 a year over United States prices for overseas postage. If you plan to move, notify us at least 30 days in advance so you will not miss an issue. Give both your old and new addresses.

Entered as Second Class Matter, September 15, 1903, at the Post Office at Chicago, Illinois, under Act of March 3, 1879. Entered as Second Class Matter at Post Office Dept., Canada. Registered as Second Class Matter at the Post Office at Mexico, D. F., Mexico, June 20, 1950. Copyright 1957 by Popular Mechanics Company. Copyright under International Copyright Union. Copyright in France. All rights reserved under Pan-American Copyright Union. Printed in the United States of America.

Volume 107 MARCH 1957 Number 3

Address all communications to: 200 E. Ontario St., Chicago 11, Ill.

Managing Editor.....Roderick M. Grant
Assistant Managing Editor.....Wayne Whittaker
Shop Notes and Crafts Editor.....James R. Ward
Associate Editor.....Clifford B. Hicks
Associate Editor, Automotive.....Arthur R. Railton
Associate Editor, Shop Notes and Crafts.....Wayne C. Leckey
Associate Editor, Shop Notes.....W. Clyde Lammey
Radio-Television, Electronics Editor.....Lothar Stern
Assistant Editor, Crafts.....Jay W. Hedden
Assistant Editor, Makeup.....John C. Dolen
Art Director.....Frank Beatty

Assistant Editors

Robert E. Dorsett Robert M. Hendrickson Earl F. Wobeck
Eastern Editor.....Richard F. Dempewolf
Empire State Bldg., Room 2906, New York City 1
Western Editor.....Thomas E. Stimson, Jr.
Suite 1010, 3460 Wilshire Blvd., Los Angeles 5, Calif.
London Manager.....Douglas W. Wedderspoon
Eagle House, Jermyn St., London S. W. 1, England
Director, Bureau of Information.....Allan Carpenter
200 E. Ontario St., Chicago 11

Advertising Offices

Chicago: 200 E. Ontario St., Whitehall 4-0100; New York: Empire State Bldg., 350 Fifth Ave., Longacre 5-7580; Detroit: General Motors Bldg., TRinity 5-8711; Cleveland: Hanna Bldg., 1422 Euclid Ave., PRospect 1-0456; Los Angeles: 3460 Wilshire, DUNkirk 2-8458; San Francisco: Russ Bldg., 235 Montgomery St., YUkon 2-0823.

In This Issue . . .

You Can Build Your Own Swimming Pool	- - -	81
The Owners Report on the 1957 Ford	- - -	88
"Old Ironsides" Lives Again	- - -	96
"Beachcombers" of the Woods	- - -	102
Look Into the Heart of a Gem	- - -	112
What's New for Your Home	- - -	120
Taxi to Venus?	- - -	124
Birds Write Their Musical Score on Tape	- - -	132
House of Electric Nerves	- - -	138
You Can Have Speed With Safety	- - -	144
Science Gives You More Miles for Your Tires	- - -	154
Radio, TV and Electronics	- - -	161

For the Craftsman . . .

Modernize With a Vanity Lavatory	- - -	165
Test the Soil First	- - -	170
Solving Home Problems	- - -	178
When You Shop for a Trailer—	- - -	184
Pep Up Home Movies With Titles	- - -	190
Build "The Bug"—Part II	- - -	201
Filing Machine Fits Your Lathe	- - -	205
How Would You Do It?	- - -	210
On the Market for Do-It-Yourselfers	- - -	217
Shopping for Tools	- - -	218
Clinic for Homemakers	- - -	222

See pages 74, 76 and 78

for other items and manufacturers of available products

**"My Army Recruiter
got me just
the job training
I wanted"**

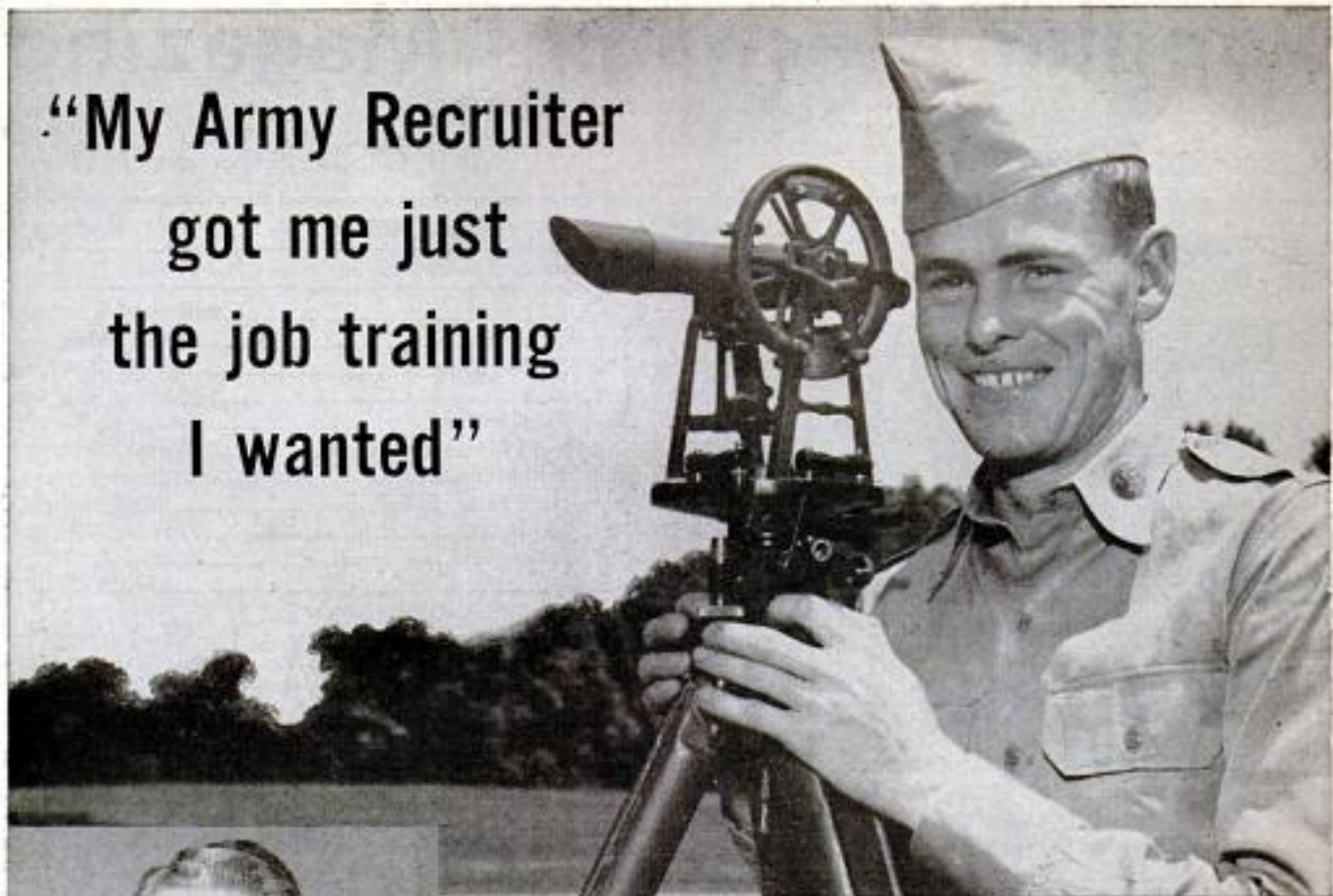

M/Sgt. James D. Kennemur
Army Recruiter
San Francisco, California

***"He helped me pick my course
before enlistment"***

"My Army Recruiter sure helped me to get the most out of service. He showed me how I could choose my job training course *before* I enlisted. Now I'm in a great course—surveying—learning to be an expert in my field. The instructors really know what they're doing, and we work with the best equipment there is. This should be a swell deal for *you*, too, because the Army has enough technical courses so that everybody can find one he really wants. And the best thing is that you're guaranteed the course *before* you enlist. I think you ought to look into this program. My Army Recruiter spent a lot of time helping me get just what I wanted, and I'm sure yours will, too."

John R. Fox

Pvt. John R. Fox
Parlieo, California
Graduate, Parlieo High School

**YOUR ARMY RECRUITER WILL GIVE
YOU THIS SAME OPPORTUNITY**

The Army Recruiter in your town will show you how to get the same deal John got. You have over 100 courses to choose from—electronics, engineering, medicine, finance, radio and TV—practically everything. And the course you *pick* is the course you *get*! You get a written

guarantee that you will be in that class. And not until after high school graduation do you actually enlist. If you're a senior, you can get in on this deal right *now*! You'll become an expert in your field. Just see your Army Recruiter and reserve the course of your choice—at no obligation!



Get choice, not chance, from your Army Recruiter



Your CARBURETOR IS DIRTY...
AND IT'S COSTING YOU MONEY!

Dirt, gum and varnish accumulate constantly in the carburetor of every car. When this happens—and it must in normal driving—you get . . .

- High gas consumption
- Rough idling
- Stalling
- Loss of power

The only cure is to CLEAN THE CARBURETOR and keep it clean!

Carburetor cleaning is easy with GUMOUT . . . inexpensive too. Simply add GUMOUT to your gas tank. It cleans as you drive. Or your service man can run GUMOUT directly through your carburetor while you wait.

You'll get smoother idling, faster pick-up, greater power, no stalling. GUMOUT will save you money in gasoline mileage AND repair bills.

Get GUMOUT today from any auto supply store, or wherever automotive products are sold. There's nothing like it!

GUMOUT DIVISION
Pennsylvania Refining Company
2671 Lisbon Road, Cleveland 4, Ohio



Send for
FREE

46-page "CARBURETOR
HANDBOOK." It's full of helpful
information about your car's
fuel system.

This One



W2NW-OET-WN2L

**New Tools for Your Needs
Further Expand PROTO's
Huge Professional-
Quality Line**

Joining the thousands of other proven standard and special tools are hundreds of *new* tools, developed to meet the exacting requirements of your job. With this extensive line you can build a complete matched set of guaranteed tools, getting time-saving designs, long service and highest quality at the right price. Make your PROTO dealer your Tool Headquarters. Send 10c for catalog of entire line to

PROTO TOOLS

2235 Santa Fe Ave., Los Angeles 54, Calif.
Eastern Factory, Jamestown, N. Y., Canadian Factory, London, Ont.

Forging Ahead
Through
Leadership,
Quality,
Service and
Understanding



ACROSS THE DESK



Who Has the Smallest Town With TV?

George Cadogan's story of "The World's Tiniest Town With TV" brings us some challenges from other hamlets. Cadogan wrote of the TV station at Wingham, Ont., which boasts a population of 2700. Here's what we hear from readers in other small towns:

☆☆☆

I think you will find Poland Spring, Me., about 2000 persons shy of Wingham's 2700, yet it has a TV station, WTMW. Right?

Alan Magary,
Phillips Exeter Academy,
Exeter, N. H.

☆☆☆

We have a TV station out here in Garden City, S. D., seven miles from our farm, and the town has a population of not over 500. It's KDLO, 100,000 watts. I believe this is the smallest TV station.

Emil C. Konvalin,
Route 3,
Clark, S. D.

☆☆☆

KOTI-TV, Klamath Falls, Ore., is located about three miles from Klamath Falls at the campus of Oregon Technical Institute. The station is not owned by the school. Oregon Tech is officially classed as being in Oretch, Ore., has its own post office, fire department, police and a total student population of around 1000.

Thomas Sternburgh,
Bend, Ore.

Credit Is Due

In our account of the steel-roofed auditorium of St. Patrick High School at Kankakee, Ill. (*PM*, Dec. 1956, page 153), we failed to give credit to the designers of the unique building: Architects Belli & Belli, 6040 W. Fullerton Ave., Chicago 39, Ill.

"Every Young Man Can Build It"

So enthusiastic is John D. Murphy about the *Popular Mechanics* ranch house that he writes us:

"I invite anyone who may read this to come to Washington Court House, Ohio, and see this home." Murphy built the house at 605 Albin Ave. It is his second *PM* house, a previous one having been built in Pennsylvania.

(Continued to page 8)

POPULAR MECHANICS

THIS FREE BOOK

will prove that you can become an expert

ACCOUNTANT...AUDITOR

OR C.P.A.

GET THIS BOOK FREE!

We offer you this free book so that you can prove to yourself that you CAN master Accounting—quickly, thoroughly—in spare time at home.

You will see exactly how LaSalle's famous "Problem Method" works...how you are led step-by-step through actual accounting work—learning by doing and not by study of theory alone. First you tackle easy problems, then more difficult ones—until soon you master them all. And at every step you have the close personal guidance of LaSalle's large staff of C.P.A. instructors.

One out of every 13 of all C.P.A.'s in the U.S. has been trained by the LaSalle Problem Method



This well-paid LaSalle-trained Accountant's success could be yours.



THIS BOOK HAS STARTED HUNDREDS OF THOUSANDS toward well-paid accounting careers—in business, government, and public practice as C.P.A.'s. Even without previous knowledge, progress is rapid—earning power climbs fast.

If you have been envying the high incomes and good jobs enjoyed by thousands of men and women Accountants today...incomes ranging from \$4,000 to \$10,000 and more per year...why not launch such a career for yourself?

Do you doubt that you can?

Then let us send you—without cost or obligation—the same book with which LaSalle has started several hundred thousand men and women toward successful accounting careers. We want you to see for yourself how this remarkable method, originated by LaSalle, makes Accounting simple, interesting, practical, and certain...how it leads you step-by-step to a complete mastery of Accounting—

and on up to the Certified Public Accountant Certificate if you so aspire.

It doesn't matter whether you've had previous bookkeeping experience, or whether you don't know a debit from a credit. Whether you wish to qualify as an expert accountant, advanced accountant, cost accountant, auditor, government accountant, income tax specialist, or public accountant...you'll find in LaSalle's Problem Method the exact plan to prepare you rapidly and inexpensively—in spare hours at home—without losing a day from your present job.

So right now, today...if you are an adult, employed, and earnestly ambitious for rapid advancement in one of the highest paying professions...send your name and address on the coupon below. We'll send you free our latest book outlining today's career opportunities and how you can qualify for them. A coupon like this has started many thousands toward greater success. It can do the same for you. Mail it today!

Member, National Home Study Council

Clip Coupon... Mail TODAY!

LaSalle Extension University... A Correspondence Institution

Dept. 364H, 417 S. Dearborn Street, Chicago 5, Illinois

YES, I want to see how LaSalle's "Problem Method" works...how I can qualify for high-pay Accounting positions. Send your book, "Accountancy, The Profession That Pays"...without cost or obligation.

Name.....Age.....

Street Address.....

City, Zone & State.....

Present Position.....



(Continued from page 6)

"I know that every young man in the United States is capable of building this house—if they would only make up their minds to do so," says Mr. Murphy. "To those whose finances are limited, such as ours, I say roll up your sleeves and go to work if you want a nice home at a minimum of cost. I have, with the help of my wife and friends, built two of *Popular Mechanics'* houses and they are everything you may want in a home . . . some 20 years ahead in design."

To those who might be discouraged by the experts, Mr. Murphy says: "Don't forget that our early settlers did not have the good tools and machinery we have today. As far as tools go, I have one eight-inch Black and Decker saw and the minimum of other tools, but it does not take a lot of tools."

Although tradesmen were hired to help with plumbing, wiring, furnace and fireplace, Murphy says he still saved over \$8000 in building the ranch house. He is a salesman with territory in southern Ohio.

(Continued to page 10)



New greaseless way to keep your hair neat all day

Bud Palmer went for a ride . . . then he used Vitalis



GIVES DRIED-OUT HAIR THE AIR . . . New Vitalis keeps hair in place and prevents dryness with V-7, the *greaseless* grooming discovery. You never have an over-slick, plastered-down look. Try it. You'll like it.



Sports car fan Bud Palmer is a Vitalis fan, too.

New VITALIS® Hair Tonic with V-7®

ANOTHER FINE PRODUCT
OF BRISTOL-MYERS

How to pass a genius



All of us can't be geniuses. But any ordinarily talented mortal can be a success—and that's more than some geniuses are.

Now, as in Aesop's time, the race doesn't always go to the one who potentially is the swiftest. The *trained* man has no trouble in passing the genius who hasn't improved his talents.

In good times and bad times, in every technical and business field, the *trained* man is worth a dozen untrained ones, no matter how gifted.

The International Correspondence Schools can't make you into a genius. For more than 60 years, however, I. C. S. has been helping its students to become *trained, successful leaders*—and it can do the same for you.

Mark your special interest on the coupon. Don't be like the unsuccessful genius who wastes his life in dreaming of what he intends to do. *Act now!*

For Real Job Security—Get an I. C. S. Diploma! I. C. S., Scranton 9, Penna. Member, National Home Study Council

INTERNATIONAL CORRESPONDENCE SCHOOLS



BOX 59953C, SCRANTON 9, PENNA.

(Partial list of 257 courses)

Without cost or obligation, send me "HOW TO SUCCEED" and the opportunity booklet about the field BEFORE which I have marked X (plus sample lesson):

- | | | | | |
|--|---|---|---|--|
| <p>ARCHITECTURE and BUILDING CONSTRUCTION</p> <ul style="list-style-type: none"> <input type="checkbox"/> Air Conditioning—Refrig. <input type="checkbox"/> Architecture <input type="checkbox"/> Architectural Interiors <input type="checkbox"/> Building Contractor <input type="checkbox"/> Building Estimator <input type="checkbox"/> Building Maintenance <input type="checkbox"/> Carpentry and Mill Work <input type="checkbox"/> Heating <input type="checkbox"/> Painting Contractor <input type="checkbox"/> Plumbing <input type="checkbox"/> Reading Arch. Blueprints <p>ART</p> <ul style="list-style-type: none"> <input type="checkbox"/> Cartooning <input type="checkbox"/> Commercial Art <input type="checkbox"/> Fashion Illustrating <input type="checkbox"/> Magazine Illustrating <input type="checkbox"/> Show Card and Sign Lettering <input type="checkbox"/> Sketching and Painting <p>AUTOMOTIVE</p> <ul style="list-style-type: none"> <input type="checkbox"/> Auto Body Rebuilding <input type="checkbox"/> Auto Elec. Technician <input type="checkbox"/> Auto-Engine Tune Up <input type="checkbox"/> Automobile Mechanic | <p>AVIATION</p> <ul style="list-style-type: none"> <input type="checkbox"/> Aeronautical Engineering Jr. <input type="checkbox"/> Aircraft & Engine Mechanic <p>BUSINESS</p> <ul style="list-style-type: none"> <input type="checkbox"/> Advertising <input type="checkbox"/> Bookkeeping and Accounting <input type="checkbox"/> Business Administration <input type="checkbox"/> Business Correspondence <input type="checkbox"/> Public Accounting <input type="checkbox"/> Creative Salesmanship <input type="checkbox"/> Federal Tax <input type="checkbox"/> Letter-writing Improvement <input type="checkbox"/> Office Management <input type="checkbox"/> Professional Secretary <input type="checkbox"/> Retail Business Management <input type="checkbox"/> Sales Management <input type="checkbox"/> Stenographic-Secretarial <input type="checkbox"/> Traffic Management <p>CHEMISTRY</p> <ul style="list-style-type: none"> <input type="checkbox"/> Analytical Chemistry <input type="checkbox"/> Chemical Engineering <input type="checkbox"/> Chem. Lab. Technician <input type="checkbox"/> General Chemistry <input type="checkbox"/> Natural Gas Prod. & Trans. <input type="checkbox"/> Petroleum Engineering <input type="checkbox"/> Plastics <input type="checkbox"/> Pulp and Paper Making | <p>CIVIL STRUCTURAL ENGINEERING</p> <ul style="list-style-type: none"> <input type="checkbox"/> Civil Engineering <input type="checkbox"/> Construction Engineering <input type="checkbox"/> Highway Engineering <input type="checkbox"/> Reading Struct. Blueprints <input type="checkbox"/> Sanitary Engineering <input type="checkbox"/> Structural Engineering <input type="checkbox"/> Surveying and Mapping <p>DRAFTING</p> <ul style="list-style-type: none"> <input type="checkbox"/> Aircraft Drafting <input type="checkbox"/> Architectural Drafting <input type="checkbox"/> Electrical Drafting <input type="checkbox"/> Mechanical Drafting <input type="checkbox"/> Mine Surveying and Mapping <input type="checkbox"/> Plumbing Drawing and Estimating <input type="checkbox"/> Structural Drafting <p>ELECTRICAL</p> <ul style="list-style-type: none"> <input type="checkbox"/> Electrical Engineering <input type="checkbox"/> Electrical Maintenance <input type="checkbox"/> Electrician <input type="checkbox"/> Contracting <input type="checkbox"/> Lineman <p>HIGH SCHOOL</p> <ul style="list-style-type: none"> <input type="checkbox"/> Commercial <input type="checkbox"/> Good English <input type="checkbox"/> High School Subjects <input type="checkbox"/> Mathematics | <p>LEADERSHIP</p> <ul style="list-style-type: none"> <input type="checkbox"/> Foremanship <input type="checkbox"/> Industrial Supervision <input type="checkbox"/> Leadership and Organization <input type="checkbox"/> Personnel-Labor Relations <p>MECHANICAL AND SHOP</p> <ul style="list-style-type: none"> <input type="checkbox"/> Gas—Electric Welding <input type="checkbox"/> Heat Treatment <input type="checkbox"/> Metallurgy <input type="checkbox"/> Industrial Engineering <input type="checkbox"/> Industrial Instrumentation <input type="checkbox"/> Industrial Supervision <input type="checkbox"/> Internal Combustion Engines <input type="checkbox"/> Machine Design—Drafting <input type="checkbox"/> Machine Shop Inspection <input type="checkbox"/> Machine Shop Practice <input type="checkbox"/> Mechanical Engineering <input type="checkbox"/> Quality Control <input type="checkbox"/> Reading Shop Blueprints <input type="checkbox"/> Refrigeration <input type="checkbox"/> Sheet Metal Worker <input type="checkbox"/> Tool Design <input type="checkbox"/> Toolmaking <p>RADIO, TELEVISION</p> <ul style="list-style-type: none"> <input type="checkbox"/> Industrial Electronics <input type="checkbox"/> Practical Radio TV Eng'ng <input type="checkbox"/> Radio and TV Servicing <input type="checkbox"/> Radio Operating | <ul style="list-style-type: none"> <input type="checkbox"/> Television Technician <p>RAILROAD</p> <ul style="list-style-type: none"> <input type="checkbox"/> Air Brake Equipment <input type="checkbox"/> Car Inspector <input type="checkbox"/> Diesel Engineer & Fireman <input type="checkbox"/> Section Foreman <p>STEAM AND DIESEL POWER</p> <ul style="list-style-type: none"> <input type="checkbox"/> Combustion Engineering <input type="checkbox"/> Diesel—Elec. <input type="checkbox"/> Diesel Eng's <input type="checkbox"/> Electric Light and Power <input type="checkbox"/> Stationary Fireman <input type="checkbox"/> Stationary Steam Engineering <p>TEXTILE</p> <ul style="list-style-type: none"> <input type="checkbox"/> Carding and Spinning <input type="checkbox"/> Cotton, Rayon, Woolen Mfg. <input type="checkbox"/> Finishing and Dyeing <input type="checkbox"/> Loom Fix'g <input type="checkbox"/> Textile Design <input type="checkbox"/> Textile Eng'ng <input type="checkbox"/> Throwing <input type="checkbox"/> Winding and Weaving <p>MISCELLANEOUS</p> <ul style="list-style-type: none"> <input type="checkbox"/> Domestic Refrigeration <input type="checkbox"/> Marine Engineering <input type="checkbox"/> Ocean Navigation <input type="checkbox"/> Professional Engineering <input type="checkbox"/> Short Story Writing <input type="checkbox"/> Telephony |
|--|---|---|---|--|

Name _____ Age _____ Home Address _____

City _____ Zone _____ State _____ Working Hours _____ A.M. to P.M. _____

Occupation _____

Canadian residents send coupon to International Correspondence Schools, Canadian, Ltd., Montreal, Canada. . . . Special tuition rates to members of the U. S. Armed Forces.



For Any Picture, Any Time...

GET A PACEMAKER

SPEED GRAPHIC®!

You can be more certain of outstanding pictures with this "big negative" camera. It was specifically designed to get any type of picture, any time, day or night. In fact, that's why better than 90% of all professional and press photographers use it! Its 4 x 5 film size permits the use of 40 different types and makes of sheet film which can produce beautiful enlargements without loss of detail. Trade in your present camera as all or part down payment at your Graflex dealer listed in the "yellow pages". Take up to 20 months to pay. Priced as low as \$286.95.

ACCESSORIES FOR

Versatility

- Riteway Sheet Film Holders — holds 2 sheets of film and unconditionally guaranteed for two full years!
- Grafmatic Sheet Film Magazines — holds six sheet films which are changed in a split-second by simple push-pull motion.
- Roll Film Holders — permit use of inexpensive 120 size roll film. Two types for 8 or 12 exposures.
- Film Pack Adapter — permits use of 12-exposure daylight-loading film packs.
- Polaroid Back — fits all Graflex Back Graphics, allows Polaroid "picture-in-a-minute" photography.

Prices include federal tax where applicable and are subject to change without notice. Prices slightly higher in Canada.

GRAFLEX®

Price-Winning Cameras and Equipment

For free booklet, write Dept. PM-37,
Graflex, Inc., Rochester 8, N.Y.

A SUBSIDIARY OF



(Continued from page 8)

Plans for the PM ranch house were first published in our May 1951 issue and later in a book, *Popular Mechanics Build-It-Yourself Ranch-Type House*.

To the Editor:

Your April 1953 issue (page 96) pictured a folding fishing-and-hunting trailer that I built. Since then I have made improvements that I believe would interest your readers.

I now have the window frames on hinges and as I raise the roof they automatically fall into position. Now when we want to take our large 14-foot boat along I simply



roll our complete rig into the camp trailer, as pictured, and take off. This was done by making a drop gate in the back of the trailer, and building the back window so it could be unfastened and raised. Boat rig is securely fastened to trailer by quick-release turnbuckles. Now when we reach our campsite we leave our camp trailer and take off with the car and boat rig for surrounding water. After our fishing trip is over we lower the roof of our camp trailer and leave it at the coast for the summer, and bring the boat rig home with us until time for the next trip.

Cecil K. Beck,
1420 McCullough Ave.,
San Antonio 2, Tex.

Edison Did Have Some Talent

Even the Russians agree that Thomas A. Edison was a great inventor, but Dr. Yuri Tolstov of the Soviet Academy of Science says a Russian engineer, A. N. Lodygin, invented the incandescent lamp. Edison, according to Dr. Tolstov, did improve on Lodygin's work by devising a bulb that was cheap, durable and suited for mass production. He also credits Edison with inventing the kinoscopic camera, sound film and rotating cement kilns.

Learn Radio-Television

or Electric Appliance Repair by Practicing at Home in Spare Time

Job and Career
Opportunities
for
**RADIO-TV
TECHNICIANS**

APPLIANCES FOR
TYPICAL TROUBLES
LESSON

Sample
Lesson
and Catalog
FREE

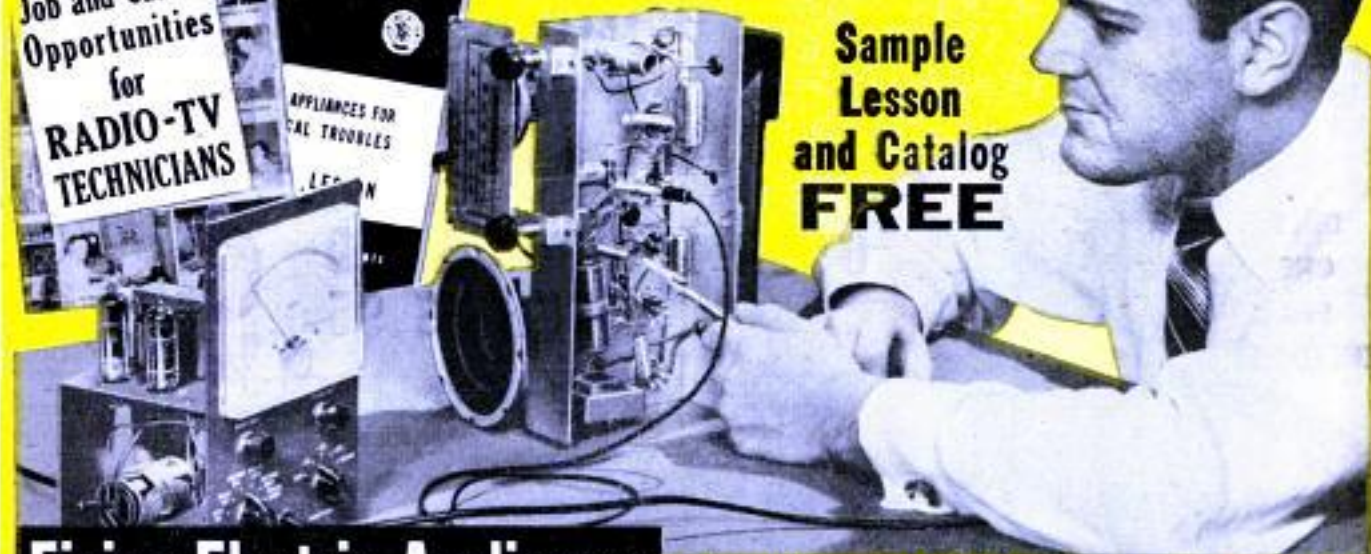

Fixing Electric Appliances Pays Good Money

Get into a field where there is important work and opportunity. Millions of Electric Appliances are sold every year. Every wired home now has an average of 8. Owners pay well to have them fixed quickly, properly. This is your opportunity for a better job, your own part time or full time business. NRI can give you the training you need, at home in your spare time.

You need proper equipment to service today's automatic appliances. With NRI course you get parts to build professional type, multi-use Appliance Tester. It takes the guesswork out of servicing. You use it to get practical experience, conduct experiments. You get easy to understand lessons, train at home as fast or as slow as you like.



Start Soon to Make \$10 to \$15 a Week Extra in Spare Time

Soon after starting many NRI men earn extra cash fixing toasters, clocks, fans, vacuum cleaners, etc., or radio and TV sets, for neighbors and friends. Keep your job while learning and earning. Work in your basement, garage, spare room.

You'll be amazed how easily, quickly you, too, can start earning many extra dollars. Find out about NRI . . . a school that for more than 40 years has been training men, through home study, for success, good pay jobs.

MAIL COUPON TODAY Find Out What NRI—Oldest and Largest Radio-Television School Offers You

Bigger than ever and still growing. That's why Radio-Television has special appeal to an ambitious man not satisfied with his job and earnings. More than 4000 Radio and TV stations on the air, 150 million home and auto radios plus 40 million Television sets to be serviced. Color TV promises added opportunities.

Training PLUS opportunity is the ideal combination for success. Plan now to get into Radio-TV. The technical man enjoys prestige. He does important work, gets good pay for it. NRI can supply training quickly, without expense of going away to school. You learn at home in spare time. NRI training is LEARN-BY-DOING. NRI sends you kits of parts for practical experience; they "bring to life" things you study.

Fast Growing Radio-TV Field Offers Good Pay—Success—Extra Income

For the trained man there are good jobs, a bright future in Radio-TV Servicing or Broadcasting. Soon after enrolling, many NRI students start to earn extra cash fixing neighbors' sets in spare time. Some pay for their training and enjoy extra luxuries this way. Some make enough to start their own full time Radio-TV shops. NRI has trained thousands for successful careers in Radio-TV. Study fast or slow—as you like. Diploma when you graduate. Mail coupon now. Paste on a postcard or mail in envelope. You get SAMPLE LESSON FREE. Also 64-page Catalog that shows opportunities, equipment you get. Cost of NRI Courses low. Easy terms. NATIONAL RADIO INSTITUTE, Dept. 7CA, Washington 9, D.C.

LESSON and CATALOG FREE

NATIONAL RADIO INSTITUTE, Dept. 7CA, Washington 9, D.C.
(CHECK ONE PLEASE—NO SALESMAN WILL CALL)

Radio-Television—Please send me FREE Sample Lesson and 64 Page Catalog on Radio-Television Servicing and Communications.

Electric Appliance—Please send me FREE Sample Lesson and Catalog on your Electric Appliance Servicing Training.

Name.....

Address.....

City..... Zone..... State.....

ACCREDITED MEMBER, NATIONAL HOME STUDY COUNCIL

AMAZING BARGAIN!

WORLD FAMOUS

Black Forest HUNTING KNIFE

OVER 100,000 SOLD FOR \$3.95

NOW ONLY

99c

PLUS POST.

ONLY ONE PER CUSTOMER

FREE! LEATHER SHEATH

- Rugged Korium Steel!
- Handsome Wall or Den Decoration!
- It's Extra Sharp!
- Lasts a Lifetime!

Over 100,000 Sportsmen paid 3.95 for this internationally famous hunting knife. Now . . . for a short time you can get one for only 99 cents plus postage. This amazing offer is made to win 20,000 new customers.

The bargain of the year! This is the original and genuine BLACK FOREST—the world's most famous hunting knife—its rugged beauty has won recognition for design thruout Europe and America. Has dozens of uses both in the field as well as at home. Very sharp—allows you to skin an animal in minutes. Use it for carving roasts too! So handsome! So practical! It's the biggest bargain! Send only 99c plus 21c postage for immediate delivery. Leather scabbard yours FREE! Sorry no COD's. No more than ONE per customer. Offer subject to withdrawal without notice. Satisfaction guaranteed or money back.

THORESEN, INC., Dept. 6-C-76, 585 Water St., New York 2, N.Y.

THORESEN, INC., Dept. 6-C-76
585 Water Street, New York 2, N. Y.

RUSH one BLACK FOREST Hunting Knife at the special price of 99c plus 21c postage, on 10 day home trial. If not satisfied I will return knife in 10 days for full refund. Payment of \$1.20 enclosed.

NAME _____

ADDRESS _____

CITY _____ ZONE _____ STATE _____

Canadian Address: 45 St. James St., West, Montreal 1, P.Q.

10 INCHES OVERALL

INVENTORS

Learn how to protect your invention. The U. S. Patent Laws provide that any new and useful art, machine, article of manufacture, or composition of matter, or any new and useful improvement thereof, may be patented if the act of invention is involved. Therefore, every inventor with a valuable invention should take advantage of the Patent Laws and proceed for patent protection in order to safeguard his rights.

A patent gives the inventor the exclusive right to prevent others from making, using, or selling the invention claimed in the patent for a period of seventeen years.

The Patent Laws were enacted for the benefit of the inventor to give him protection for the features of his invention which are patentable. These features must be properly and concisely set forth and claimed in a formal application for patent, in order to comply with the requirements of the Patent Laws. For that reason, unless the inventor is familiar with patent matters, he should engage a competent registered patent attorney or agent to represent him. We are registered to practice before the U. S. Patent Office and are prepared to serve you in the handling of your patent matters.

A specially prepared booklet entitled "Patent Guide for the Inventor", containing detailed information with respect to patent protection and procedure, together with a "Record of Invention" form will be promptly forwarded to you without obligation upon request.

CLARENCE A. O'BRIEN & HARVEY JACOBSON

Registered Patent Attorneys

71-C DISTRICT NATIONAL BUILDING
WASHINGTON 5, D. C.



IN ONLY 2 YEARS

he'll have an
ASSOCIATE of SCIENCE
DEGREE in...

AERONAUTICAL ENGINEERING DESIGN

The increasingly acute shortage of engineering talent assures unlimited opportunities in aviation and electronic fields. A 2-year intensive course at Embry-Riddle—an approved technical institute—leads to a Degree and specialization in rewarding careers such as Aerodynamic Engineer, Design Engineer, Flight Test Engineer and Materials & Process Engineer.

Embry-Riddle's constant supervision, concentration on essentials, and minimum required instruction of 25 hours per week assures you the education your future requires.

You'll enjoy Miami's perfect year-round climate for study and training.

Take your big step now. Think BIG—think Aviation! Mail coupon for pictorial brochure and complete outline of curricula.



Embry Riddle

INTERNATIONAL SCHOOL OF AVIATION

TRAINING
AUTHORIZED
UNDER
G.I. BILLS

MAIL THIS COUPON TODAY

DEAN OF ADMISSIONS, Dept. 99
Embry-Riddle School of Aviation
Miami 30, Florida

Without obligation, please send FREE and post-paid full particulars.

- AERONAUTICAL ENGINEERING DESIGN
 ELECTRONICS ENGINEERING DESIGN
 A. & P. TECHNICIAN FLIGHT

Name.....Age.....

Address.....

City.....State.....

I am a (check one) Veteran Non-Veteran

Bean's

Free Catalog

Just Off the Press
Fully illustrated; 108 pages showing three hundred and seventy-five items of interest to both men and women — special fishing tackle, footwear, clothing, leather and canvas specialties — many of our own manufacture.



L. L. Bean Inc., 66 Main St., Freeport, Maine
Mfrs. Fishing and Camping Specialties

CLEANS WALLS NEW WAY!



Amazing invention
DRY roll wallcleaner. No mess. No fuss. Simply glide over walls. Removes dirt like magic from Wallpaper, Painted Walls, Ceilings, Window Shades. Leaves beautiful lustrous finish. Take orders. *Kara memo!*

SAMPLES for TRIAL

Sample offer sent at once to all who send name. Hurry—just a postcard will do. **SEND NO MONEY—Just your name.**

KRISTEE CO., Dept. 697, Akron 8, Ohio

LEARN LOCKSMITHING



send for
**FREE
BOOKLET**

Learn this fascinating, profitable trade from experts in your spare time at home! Age or physical handicap no disadvantage. Year around, steady income. Full or part time. Practical, illustrated lessons. You can make money even while learning! All materials and special tools supplied without extra charge.
INSTITUTE OF LOCKSMITHING, Dept. P-88
15 PARK AVENUE RUTHERFORD, N. J.
Lic. by N. J. State Board of Education
Approved for Veterans

3" "PALOMAR, JR." TELESCOPE 100 or 120 Power—An Unusual Buy!



See
Stars
Close
Up!

You'll see the Rings of Saturn, the fascinating planet Mars, huge craters on the Moon, Star Clusters, Moons of Jupiter in detail, Galaxies! Aluminized and overcoated 3" diameter high-speed 1/10 ventilated mirror. An Optical Finder Telescope, always so essential, is also included. Sturdy, hardwood, portable tripod. Order by Stock No.—Send check or M.O.—Money-back guarantee! Stock No. 85,050-H. . . . \$29.50 f.o.b. (Shipping wt. 10 lbs.) Barrington, N.J.

Ask for FREE catalog H
EDMUND SCIENTIFIC CO., Barrington, N. J., U. S. A.

MY "BIG IDEA" MAKES BIGGER PROFITS FOR YOU!



I've got it!—a money-making "Shoe Selling" idea so new, so different—yet so simple! Now anyone will be eager to buy 2 or 3 pairs of my Air Cushion dress, work or sport shoes from you—while you make fat cash commissions and bonuses. No experience needed to show my beautiful men's, women's and children's styles. Have the security, independence and prestige of a big steady income. Write this minute for my "BIG IDEA", plus big Selling Outfit FREE! Write: **CHARLES CHESTER SHOE CO.**
C573 Chester Bldg., Brockton, Mass.

LET DeVRY TECH PREPARE YOU IN
SPARE TIME AT HOME AS AN

ELECTRONICS TECHNICIAN



**NO PREVIOUS TECHNICAL EXPERIENCE
OR ADVANCED EDUCATION NEEDED!**

Laborers and bookkeepers, store clerks, shop men, farmers, salesmen — men of nearly every calling — have taken the DeVry Tech program and today have good jobs or service shops of their own in Electronics. You don't have to quit your present job. If you are 17 to 55, see how you may get yourself ready for a future in the fast-growing Electronics field.

Whether you prepare at home or in our well-equipped Chicago or Toronto Laboratories, you get sound, basic training in both principles and practice. At home, you use educational movies. You build actual circuits and test equipment. You read simple directions, follow clear illustrations. When you finish, you are prepared to step into a good job in an excitingly different field. You may even start a service shop of your own. Mail coupon for free facts today.

Live-Wire Employment Service

Puts you in touch with job opportunities—or helps you toward a better position in the plant where you are now employed.

Draft Age?

We have valuable information for every man of draft age; so if you are subject to military service, be sure to check the coupon.

A SAMPLE LESSON

See for yourself how DeVry Tech trains you for real opportunities in Electronics. We'll also give you a free copy of an interesting booklet, "Electronics and YOU."

FREE



Accredited Member
of National
Home Study Council

DEVRY TECHNICAL INSTITUTE

CHICAGO 41, ILLINOIS

FORMERLY

DEFOREST'S TRAINING, INC.



**AN INDEX
to a
BETTER JOB,
A BRIGHTER
FUTURE**

Electronics

Radar

Guided
Missiles

Television

Micro-Waves

Communications

Radio

Industrial
Electronics

Computers

Automation
Electronics

Remote Control
Systems

Broadcasting

Your Own
Service Shop

MAIL TODAY FOR FREE FACTS

DeVry Technical Institute

4141 Belmont Ave., Chicago 41, Ill., Dept. PM-3-N

Please give me a FREE Sample Lesson and your booklet, "Electronics and YOU."

NAME _____ AGE _____

Please print

STREET _____ APT. _____

CITY _____ ZONE _____ STATE _____

Check here if subject to military training.

#1090

DeVry Tech's Canadian Training Center is located at
626 Roselawn Avenue, Toronto 12, Ontario

DIESEL MECHANICS IN DEMAND

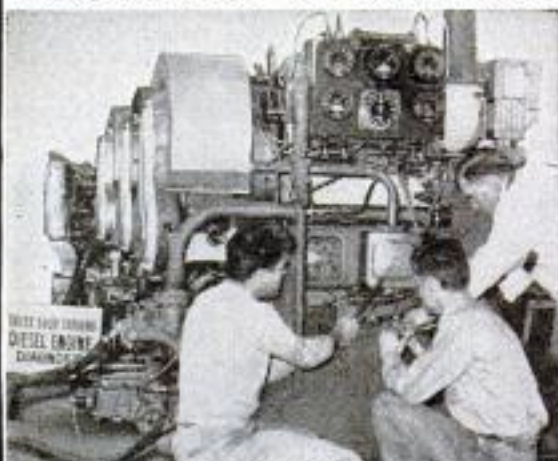

Learn to earn big pay in DIESEL in our large, modern equipped Chicago school and shop. No previous experience or training necessary. We help you find living quarters and part time job while in school. Complete, practical courses taught in the following trades, under the supervision of experienced, expert technicians.

APPROVED FOR CIVILIANS OR GI'S

— CHOOSE YOUR TRADE —

CHECK HERE	WEEKS
<input type="checkbox"/> DIESEL MECHANICS	20
<input type="checkbox"/> AUTO MECHANICS	20
<input type="checkbox"/> BODY & FENDER	16½
<input type="checkbox"/> GAS-ARC WELDING	4-12
<input type="checkbox"/> REFRIGERATION	13½
<input type="checkbox"/> AIR CONDITIONING	8½
<input type="checkbox"/> MACHINIST TRADE	30
<input type="checkbox"/> ADVANCED MACHINIST (includes tool & die)	32½
<input type="checkbox"/> PIANO TUNING & REPAIR	36

Heavy Construction Equipment Operators Training School Road Building, Terracing, Land Clearing, etc. Resurrection for starting classes now being accepted.

CHOOSE YOUR ENGINEERING COURSE

These courses are intended as terminal education for men who wish to enter the Diesel-Automotive and Refrigeration-Air Conditioning fields as technicians. These courses are designed to prepare men for supervisory positions. Students with a high school education, or equivalent, will be accepted.

<input type="checkbox"/> DIESEL AUTOMOTIVE ENGINEERING.....	2 years
<input type="checkbox"/> REFRIGERATION & AIR COND. ENGINEERING.....	18 months

FREE EMPLOYMENT HELP

Start your career with Greer by checking your interest above and mail coupon for complete information at no obligation.

NAME _____ AGE _____

STREET _____

TOWN _____ ZONE _____ STATE _____

Established 1902 — Over 50,000 Graduates.

55 years of continuous trade school experience to guide your training.

GREER SHOP TRAINING

Box C, 2236 S. Michigan Ave.
Chicago 16, Illinois



GROW MONEY AT HOME!

Buy PROOF SETS of Coins—watch them grow rapidly in value!

In 1936 you could buy a Proof Set for \$1.81. Today it is worth over \$500, an increase in value of more than 30,000%.

In July 1956, the 1956 Proof Set cost \$2.10. In December, 1956 it sold for \$5 to \$7, a 300% increase in 6 months.

Your Proof Sets are treasures as investments. Proof coins are Hand-struck by the Mint, especially for collectors, from highly-polished metal blanks and dies which give the coins a mirror-like finish. Each set contains 5 coins: 1¢, 5¢, 10¢, 25¢, 50¢.

ORDER NOW! 10-day Money-back Guarantee of Satisfaction!

PROOF SETS	Orig. Cost	Value in Dec. 1956	Our Low Price Now
1936	\$1.81	\$500.00 - 600.00	\$ ----
1950	2.10	55.00 - 65.00	55.00 ppd.
1951	2.10	37.00 - 44.00	37.00 ppd.
1952	2.10	27.00 - 40.00	27.00 ppd.
1953	2.10	15.00 - 22.00	15.00 ppd.
1954	2.10	8.50 - 14.00	8.50 ppd.
1955	2.10	7.50 - 9.00	7.50 ppd.
1956	2.10	5.50 - 6.50	6.00 ppd.
1957	3.00 ppd.

SPECIAL: Complete Set 1950-1957 Incl.—\$155.00

All Orders Postpaid and Insured. BONUS OFFER: with each \$30.00 order postmarked before March 31, 1957, we will send you FREE a Plastic Proof Set Holder, value \$1.75! ORDER NOW!

POSTAL PRODUCTS COMPANY—Fast Mail Order—Jos. Gordon ANA 11036
5614-M California Street San Francisco 21, California

LAW FREE BOOK THE LAW TRAINED MAN

Write today for a FREE copy of illustrated law book, "THE LAW-TRAINED MAN," which shows how to earn the professional Bachelor of Laws (LL.B.) degree through home study of the famous Blackstone Law Course. All necessary books and lessons provided. Moderate cost; convenient monthly terms. Write for FREE law training book today.

Blackstone School of Law, 225 N. Michigan Ave.
Founded 1890 Dept. 53 Chicago 1, Ill.

ARTHRITIS—RHEUMATISM VITAL FACTS EXPLAINED

FREE DESCRIPTIVE BOOK

How crippling deformities may be avoided. This amazing FREE BOOK explains why ordinary methods give only temporary relief —if that. Describes a drugless method of treatment successfully applied in thousands of cases. Write for this 36-page FREE BOOK today. No obligation.

BALL CLINIC, DEPT. 758, EXCELSIOR SPRINGS, MO.

FREE-U.S. STAMPS

U. S. 1943 Bi-Colored Flag of Occupied Nations (as illustrated) Airmails, Commemoratives, Regular Issues, included in this collection of 25 selected, all different, genuine U. S. stamps. PLUS VALUABLE U. S. \$5.00 STAMP. Everything for 10c to cover mailing expenses. Approvals included. Act at once.

WILLETT CO., P.O. Box 390, Dept. 707, Mount Kisco, N. Y.

AMAZON JIVARO

SHRUNKEN HEAD

Amazing replica of fabled native curios with a legend that owners have good luck. A strong stomach helps too because these 4" heads defy detection from just a few feet away, with remarkably true skin and hair. Sensational to hang in the car, den, bar. Have fun with this guy who got picked once too often.

GREENLAND STUDIOS, Dept. PM-4
5858 Forbes St. Pittsburgh 17, Pa.



INVENTORS

If you believe that you have an invention, you should find out how to protect it. The first step is to have a search made of the prior pertinent U. S. patents. If a report on this search indicates that the invention appears patentable you can apply for a patent, and the specifications and claims should be prepared.

The firm of McMorrow, Berman & Davidson, with offices in Washington, D. C., is qualified to take the necessary steps for you. We can make a preliminary search on your invention, advise you whether we think it can be patented, and prepare your application for

patent.

Unless you are fully familiar with the U. S. Patent Laws, we recommend that you engage the services of a Registered Patent Attorney to protect your interests. The patent laws are *your* laws. A patent gives you the right to prevent others from making, using or selling the invention claimed in your patent for a period of 17 years.

Use these patent laws for your protection. Investigate whether your invention can be patented. If you have what you believe to be an invention, we suggest that you have this firm make a search for you.

Send for a copy of our Patent Booklet entitled "How To Protect Your Invention," containing information about patent protection and patent procedure. Along with this we will also send you an "Invention Record" form, for your use in writing down and sketching details of your invention. We will mail them promptly. No obligation. They are yours for the asking.

McMORROW, BERMAN & DAVIDSON

Registered Patent Attorneys

PATENTS • COPYRIGHTS • PATENTS

135-B VICTOR BUILDING, WASHINGTON 1, D. C.

Superior's New Model 70 UTILITY TESTER

FOR REPAIRING ALL ELECTRICAL APPLIANCES MOTORS · AUTOMOBILES · TV TUBES



AS AN ELECTRICAL TROUBLE SHOOTER THE MODEL 70:

• Measures A.C. and D.C. Voltages, A.C. and D.C. Current, Resistances, Leakage, etc. • Will measure current consumption while the appliance under test is in operation • Incorporates a sensitive direct-reading resistance range which will measure all resistances commonly used in electrical appliances, motors, etc. • Leakage detecting circuit will indicate continuity from zero ohms to 5 megohms (5,000,000 ohms) • Will test Toasters, Irons, Broilers, Heating Pads, Clocks, Fans, Vacuum Cleaners, Refrigerators, Lamps, Fluorescents, Pans, Switches, Thermostats, etc. • Will test all TV tubes for open filaments, inter-element shorts, burned out tubes, etc. (Will not test TV tubes

for quality. An emission type tester such as the Model TV-11 described below is required to test tubes for quality).

AS AN AUTOMOTIVE TESTER THE MODEL 70:

• Tests both 6 Volt and 12 Volt Storage Batteries • Generators • Starters • Distributors • Ignition Coils • Regulators • Relays • Circuit Breakers • Cigarette Lighters • Stop Lights • Condensers • Directional Signal Systems • All Lamps and Bulbs • Fuses • Heating Systems • Horns • Also will locate poor grounds, breaks in wiring, poor connections, etc.

Handsome round-cornered molded bakelite case, 2 1/4" x 5 1/2" x 2 1/4". Complete with all test leads. Also included is a 64 page book giving detailed instructions, for testing all electrical appliances, automotive equipment, TV tubes, etc. Only

15⁸⁵

Superior's New Model TV-11 STANDARD PROFESSIONAL

TUBE TESTER



Uses the new self-cleaning Lever Action Switches for individual element testing.

Because all elements are numbered according to pin-number in the RMA base numbering system, the user can instantly identify which element is under test. Tubes having tapped filaments and tubes with filaments terminating in more than one pin are truly tested with the Model TV-11 as any of the pins may be placed in the neutral position when necessary.

The Model TV-11 does not use any combination type sockets. Instead individual sockets are used for each type of tube. Thus it is impossible to damage a tube

by inserting it in the wrong socket.

Free-moving built-in roll chart provides complete data for all tubes.

Phono Jack on front panel for plugging in either phones or external amplifier will detect microphonic tube/or noise due to faulty elements and loose external connections.

Operates on 105-130 Volt 60 Cycles A.C. Hand-rubbed oak cabinet complete with portable cover

47⁵⁰

SHIPPED ON APPROVAL NO MONEY WITH ORDER — NO C.O.D.

Try either of the above instruments for 10 days before you buy. If completely satisfied then send down payment and pay balance as indicated on coupon. No Interest or Finance Charges Added! If not completely satisfied, return unit to us, no explanation necessary.

MOSS ELECTRONIC DIST. CO., INC. Dept. D-334, 3849 Tenth Ave., New York 34, N. Y.

Please rush the unit(s) checked. If satisfied, I agree to remit the down payment within 10 days and to pay the monthly indicated rate. If not satisfactory, I will return within 10 days for cancellation of account.

Model 70. Total Price \$15.85 —\$3.85 within 10 days. Balance \$4.00 monthly for 3 months. Model TV-11. Total Price \$47.50—\$11.50 within 10 days. Balance \$6.00 monthly for 6 months.

Address _____
Name _____
City _____ Zone _____ State _____
All prices net. F.O.B., N.Y.C.

Shrinks Hemorrhoids New Way Without Surgery

Science Finds Healing Substance That Relieves Pain—Shrinks Hemorrhoids

For the first time science has found a new healing substance with the astonishing ability to shrink hemorrhoids and to relieve pain — without surgery.

In case after case, while gently relieving pain, actual reduction (shrinkage) took place.

Most amazing of all — results were so thorough that sufferers made astonishing statements like "Piles have ceased to be a problem!"

The secret is a new healing substance (Bio-Dyne*) — discovery of a world-famous research institute.

This substance is now available in suppository or ointment form under the name Preparation H.* Ask for it at all drug counters — money back guarantee. *Reg. U. S. Pat. Off.

\$6,000-\$10,000 YEARLY OPERATING AUTO RADIATOR SERVICE SHOP



World's largest radiator shop equipment mfr. will assist responsible individuals in setting up radiator shops. Opportunity to own secure profitable business. First year averages \$6,000 to \$10,000. Garage or service station can operate as dept. Over 1,000 INLAND shops now operating. As little as \$205 down for equipment starts you. INLAND will finance balance and furnish training. Write to

INLAND MFG. CO., Dept. PM-3, 1108 Jackson St., Omaha 2, Nebr.

FREE GERMAN HUNTING KNIFE



4-INCH BLADE
We give you handiest hunting and fishing knife you've ever had! Has 4-INCH LONG highly tempered steel blade—VERY SHARP! Attractive handle. We send knife FREE to acquaint you with our below-wholesale bargain. Please send 25c for handling. NO LIMIT—but send 25c handling for each knife. Order TODAY! HUNTING KNIFE. Dept. K-171, Box 881, St. Louis, Mo.

CABINET MAKING



LOW COST HOME TRAINING COURSE FOR BEGINNERS & ADVANCED CRAFTSMEN

Make money. Learn skills and secrets of fine woodworking and tool use. Professionally prepared shop method training tells and shows how. Covers everything. Easy to master.

Write for Free Booklet INTERSTATE TRAINING SERVICE DEPT. F3, PORTLAND 13, OREGON

HOW TO TURN Concrete INTO Gold

\$2.00

A MUST FOR EVERYONE CONCERNED!

This MANUAL Tells You How To Make Handsome Profits From Concrete Items YOU CAN MAKE

All you need is a mold or two and a little determination. This Manual contains large, clear pictures, gives prices and description of more than 200 different molds you can buy direct from the manufacturer. AND... priceless trade secrets that make production a snap. Take the first step Today!!!

SEND ONLY \$2.00 FOR YOUR COPY (Shipped to you by First Class Mail)

CONCRETE MACHINERY COMPANY, INC. Dept. PM Hickory, N. C.

**GREATEST
ADVANCE IN
SHOP-METHOD
HOME TRAINING**

EARN MORE MONEY...GET INTO TELEVISION ELECTRONICS-RADIO

Learn ALL 8 PHASES in ONE MODERN HOME-STUDY COURSE
At Home - In Spare Time

YOU GET ALL THIS NEWEST PRACTICAL EQUIPMENT

- Parts to build a modern TV set, including all tubes plus a large screen Picture Tube
- Parts to build a powerful Superhet Receiver, standard broadcast and short wave
- Parts to conduct many experiments and build Continuity Checker, RF Oscillator, TV Circuits, Audio Oscillator, TRF Receiver, Signal Generator
- A Valuable Professional Multitester



**19 BIG KITS
YOURS TO KEEP**

YOUR NATIONAL SCHOOLS TELERAMA COURSE COVERS ALL 8 PHASES

- | | |
|------------------------------------|--------------------------------|
| 1. TELEVISION, INCLUDING COLOR TV | 5. PREPARATION FOR FCC LICENSE |
| 2. RADIO, FM AND AM | 6. AUTOMATION |
| 3. INDUSTRIAL ELECTRONICS | 7. RADAR AND MICRO WAVES |
| 4. SOUND RECORDING AND HI FIDELITY | 8. COMMUNICATIONS |

YOU ARE NEEDED IN THE TELEVISION-ELECTRONICS-RADIO INDUSTRY!
You can build a secure future for yourself if you get into Electronics NOW! Today's shortage of trained technicians creates tremendous opportunities. National Schools Shop-Method trained technicians are in constant and growing demand for high-pay jobs in Broadcasting and Communications, Electronic Research, Servicing and Repair, and many other branches.

— many other materials and services — consultation privilege with our qualified staff, and Graduate Employment Service **EVERYTHING YOU NEED** for outstanding success in Electronics.

Let National Schools, a Resident Technical School for over 50 years train you for today's unlimited opportunities in electronics! Our Shop Method trains you to be a **MASTER-TECHNICIAN**. Completely up to date, developed by experienced instructors and engineers, your Telerama Course will teach you all phases of the industry quickly, clearly and correctly. You can master the most modern projects, such as Color TV, printed circuits — even prepare for FCC License without taking a special

course. You can handle sales, servicing, manufacturing, or make good money in your own business. **SEND FOR FACTS TODAY!**

EARN AS YOU LEARN. Many of our students earn their entire tuition and more in Spare Time jobs we show them how to do while learning.

YOU GET EVERYTHING YOU NEED — Clear, profusely illustrated lessons, shop-tested manuals, modern circuit diagrams, practical job projects — all the valuable equipment shown above

RESIDENT TRAINING AT LOS ANGELES

If you wish to take your training in our Resident School at Los Angeles, the world's TV capital, start NOW in our big, modern Shops, Labs and Radio-TV Studios. Here you work with latest Electronic equipment—professionally installed—finest, most complete facilities offered by any school. Expert, friendly instructors. Personal attention. Graduate Employment Service. Help in finding home near school—and part time job while you learn. Check box in coupon for full information.



FREE! Fully illustrated "Career" Book in TV-Radio-Electronics. PLUS actual sample lesson—yours at no cost, no obligation. **CLIP COUPON NOW... MAIL IT TODAY!**



APPROVED FOR G. I. TRAINING NATIONAL SCHOOLS

4000 S. FIGUEROA ST., LOS ANGELES 37, CALIF.
187 N. LA SALLE ST., CHICAGO 1, ILL.
IN CANADA: 811 W. HASTINGS ST., VANCOUVER, B. C.

NATIONAL SCHOOLS

TECHNICAL TRADE TRAINING SINCE 1905
LOS ANGELES 37, CALIFORNIA

GET FAST SERVICE—MAIL NOW TO OFFICE NEAREST YOU!

NATIONAL SCHOOLS, DEPT. RB-37
4000 S. FIGUEROA ST. LOS ANGELES 37, CALIF. OR 187 N. LA SALLE ST. CHICAGO 1, ILL.
Rush free TV-Radio "Opportunity" Book and sample lesson. No salesman will call.

NAME _____ AGE _____
ADDRESS _____
CITY _____ ZONE _____ STATE _____

Check if interested ONLY in Resident School training at Los Angeles. VETERANS: Give date of Discharge _____

Inventors

If you consider your invention valuable, take these necessary preliminary steps promptly to protect it by applying for a United States patent.

Sketch and describe your invention. (For convenience in starting action on your invention, use "Evidence of Invention" form offered below.)

Sign, date and have this invention disclosure witnessed by two people capable of understanding your invention.

Have us make a preliminary search among U. S. patents already granted for similar types of invention.

We then prepare a report for you on the probable patentability of your invention and recommend your further course of action.

This firm is registered to practice before the U. S. Patent Office. We are available to assist you in the preparation and prosecution of your application for patent.

We shall be glad to send you promptly and without obligation, an instructive booklet—"Patent Protection for Inventors"—and our convenient "Evidence of Invention" form.

VICTOR J.
EVANS & Co. *Merlin M. Evans*
REGISTERED PATENT ATTORNEY
330-C MERLIN BUILDING, WASHINGTON 6, D. C.



college graduates get ahead faster!

You see it in your own city. They have higher incomes . . . advance more rapidly. Grasp your chance for a better life. Industrial growth . . . automation . . . technical advances create career opportunities for engineers, accountants, management experts. Share rewards awaiting college-trained men. Important firms visit campus regularly to employ Tri-State College graduates. Start any quarter in this world-famed college. Approved for veterans.

Bach. of Science degree in 27 months

In Mechanical, Civil, Electrical, Chemical, Aeronautical, Radio (TV-Electronics) Engineering. In 26 months a B.S. in Business Administration (General Business, Accounting, Motor Transport Management majors). Superior students may accelerate, 36-weeks course in Drafting. Intensive program, technical fundamentals stressed; comprehensive courses with more professional class hours. Small classes; personalized instruction. Enrollment limited to 1550. Preparatory courses. Beautiful campus. Well-equipped, new and modernized buildings and laboratories. Enter March, June, Sept., Jan. Earnest, capable students (whose time and budget require accelerated courses and modest costs) are invited to write Jess McCarthy, Director of Admissions, for catalog and book "Your Career in Engineering and Commerce."



TRI-STATE COLLEGE

437 College Avenue • • • Angola, Indiana

FREE OUTFIT STARTS YOU IN BIG MONEY SHOE BUSINESS!

We furnish everything FREE to set you up in your own profitable full or spare time shoe business. Just Seasy sales a day brings up to \$84 a week EXTRA! Repeat orders mean big, steady profits. No experience or investment needed. You feature over 150 fast-selling styles in dress, sport, work shoes for men, including beautiful Nylon mesh shoes with Air Cushion innersoles. Also special kinds of shoes for different occupations. Amazing range of sizes and widths. Fit customers stores are unable to take care of. Start now by selling to friends, neighbors, relatives. Everyone's your prospect. Send postcard Today for FREE Selling Outfit!

MASON SHOE MFG., Dept. 584, Chippewa Falls, Wis.



WRITE TODAY!

STUDY TO BE A DOCTOR of Psychology or Metaphysics

Obtain a Ph.D., Ms.D., or Ph.D. Be a Teacher, Lecturer or Accredited Practitioner. Teach others how to achieve Health, Happiness and Contentment. Chartered by State. Correspondence Courses only. Write for FREE book telling how.

THE NEOTARIAN FELLOWSHIP

Desk 8, Pickwick Building Kansas City 6, Missouri



SELL JUST ONE KEEP/SAFE A DAY—EARN \$8,000 A YEAR!

95% of homes, farms, small businesses are prospects for KEEP/SAFE—the quality-built personal safe that undersells all others. Only safe sold direct. \$26 to \$40 profit per sale. Exclusive territory, chance to be district agent. Get details, giving address including county. JOHN D. BRUSH & CO., INC., 575 West Ave., Rochester 11, N.Y.

KING MIDGET

Drive it for 75c per week. Rider Agents wanted—earn your own car free. Also KING MIDGET JUNIOR chassis, finely engineered, ready to run and priced at a fraction of any similar car. GET THE FACTS. Send 25c for 32 page picture book giving special prices and agents proposition on both cars. Or send \$1 (refunded first order) for this plus actual assembly book and service manual.

MIDGET MOTORS CORPORATION, ATHENS 1, OHIO



World's Lowest Priced Car

POPULAR MECHANICS

Copyrighted material

WHAT Every AUTO MECHANIC Wants to Know

motor vehicle is a machine of many parts, each part designed and constructed for its own special function. All good mechanics, like good doctors, should know the working theory and operation of each part and understand what causes trouble and how to remedy it.

LET AUDELS AUTO GUIDE SOLVE YOUR PROBLEMS

Every auto mechanic, helper, serviceman and operator can use a copy of AUDELS AUTOMOBILE GUIDE. The information it gives saves time, money and worry. Highly endorsed by all users, it presents the whole subject of auto mechanics from A to Z in plain language and simple terms.

This Big Practical Book gives full information with working diagrams covering the principles, construction, ignition, service and repair of modern cars, trucks and buses.

A complete Guide of 1664 pages, with over 1500 illustrations showing inside views of the working parts, with instructions for service jobs. Diesel engines, Fluid and Hydra-matic drives fully explained.

IT PAYS TO KNOW HOW TO

How to fit pistons—How to locate engine knocks—How to fit connecting rod bearings—How to service main bearings—How to read condition valves—How to time valves—How to adjust fan belts—How to adjust carburetors & chokes—How to rebuild a clutch—How to service automatic transmissions—How to service brakes—How to adjust steering gear—How to cope with ignition troubles—How to service distributors—How to time ignition—How to "tune up" an engine.

INFORMATION IN A HANDY FORM

INTERESTING CHAPTERS—Read this partial list of subjects which practical information is fully given for quick reference under the headings as shown below. Ready Reference Index.

Parts of an Automobile—Automotive Physics—The Gas Engine—Engine Principles—Multi-Cylinder Engines—Horse Power—Automobile Engines—Stationary Parts—Moving Parts—Pistons—Piston Rings—Connecting Rods—Crank Shafts—Valves—Valve Gear—Cams and Cam Action—Valve Timing—Cooling Systems—Fuel Feed Systems—Dual Fuel Feed—Mixture—Carburetors—Carburetor Service—Automatic Choke—Super-Chargers—Transmissions—Special Transmissions—Fluid and Hydra-matic Drives—Clutches—Universals and Propeller Shafts

Ready Reference

1664 PAGES



Ask to See It!

—The Differential—Rear Axles—Rear and Front Suspension—Running Gear—Brakes—Wheel Alignment—Knee Action—Steering Gear—Tires—Lubricants and Lubrication—Automotive Electricity—Ignition Systems—Magneto Ignition—Spark Plugs—Ignition Coils—Distributors—Automatic Spark Control—Ignition Timing—Generators—Starters—Generator and Starter Testing—Lighting Systems—Storage Batteries—Charging and Testing—Diesel Engines and Trouble Shooting.

7 DAYS' FREE TRIAL TO GET THIS ASSISTANCE FOR YOURSELF SIMPLY FILL IN AND MAIL COUPON TODAY.

\$6 COMPLETE PAY \$1 A MONTH ONLY



O.K. SAY READERS.....

"Well Worth the Price" "SAVED ME \$50"
 "Most Useful and Complete"
 "It has my Highest Recommendation"
 "The Best Money can Buy"
 "Easy for the Mechanic to Understand"

Sent on 7 Days Approval

Step up your own skill with the facts and figures of your trade. Audels Mechanics Guides contain Practical Inside Trade Information in a handy form. Fully illustrated and Easy to Understand. Highly Endorsed. Check the book you want for 7 DAYS FREE EXAMINATION. Send No Money. Nothing to pay postman.

CUT HERE MAIL ORDER

AUDEL, Publishers, 49 W. 23 St., New York 10, N. Y.

Please send me postpaid for FREE EXAMINATION books marked up below, if I decide to keep them I agree to mail \$1 in 7 Days on each book or set ordered and further mail \$1 monthly on each book or set until I have paid price, otherwise I will return them.

- HOME APPLIANCE SERVICE GUIDE, 800 Pages . \$6
- AUTOMOBILE MECHANICS GUIDE, 1664 Pages. 6
- TRUCK & TRACTOR GUIDE, 1299 Pages . 5
- DIESEL ENGINE MANUAL, 575 Pages . . . 3
- MACHINISTS HANDY BOOK, 1650 Pages . . . 6
- WELDERS GUIDE, 400 Pages 3
- BLUE PRINT READING, 416 Pages 3
- MATHEMATICS & CALCULATIONS, 700 Pages 3
- SHEET METAL PATTERN LAYOUTS, 1100 Pgs. 7.50
- SHEET METAL WORKERS HANDY BOOK, 388 Pgs. 2
- MECHANICAL DRAWING GUIDE, 160 Pages . 2
- MECHANICAL DRAWING & DESIGN, 480 Pages 3
- TELEVISION SERVICE MANUAL, 434 Pages . . 3
- RADIOMANS GUIDE, 1040 Pages 5
- ELECTRONIC DEVICES, 216 Pages 3
- ELECTRIC MOTOR GUIDE, 1000 Pages 5
- WIRING DIAGRAMS (Light & Power), 272 Pgs. 2
- ELECTRICIANS EXAMINATIONS, 250 Pages. . . 2
- ELECTRIC POWER CALCULATIONS, 425 Pages. . 3
- HANDY BOOK OF ELECTRICITY, 1440 Pages. . . 5
- ELECTRIC DICTIONARY, 9000 Terms 3
- ELECTRIC LIBRARY, 7000 Pages (10 Book Set) 20
- REFRIGERATION & Air Conditioning, 1280 Pgs. 6
- MILLWRIGHTS & MECHANICS GUIDE, 1200 Pgs. 5
- POWER PLANT ENGINEERS GUIDE, 1500 Pages 5
- ENGINEERS & FIREMANS EXAMS, 525 Pages . 2
- PUMPS, Hydraulics & Air Compressors, 1658 Pgs 6
- OPERATING ENGINEERS LIBRARY (3 Books) . 12
- GARDENERS & GROWERS GUIDES (4 Book Set) 6
- CARPENTERS & BUILDERS GUIDES (4 Book Set) 8
- PLUMBERS & Steamfitters Guides (4 Book Set) 8
- MASONS AND BUILDERS GUIDES (4 Book Set) 8
- PAINTERS & DECORATORS MANUAL, 450 Pgs. . 2
- HOUSE HEATING GUIDE, 1000 Pages 5
- OIL BURNER GUIDE, 384 Pages 2

Name

Address

Occupation

Employed by

AUDEL, Publishers, 49 W. 23 St., New York 10, N. Y.



23
BIG KITS
to build
AIR CONDITIONER
REFRIGERATOR
FREEZER or
MILK COOLER

This CTI Student Is Training at Home in Spare Time for a Big-Pay Job . . .

As a CTI student, you build a complete, heavy-duty, commercial-type refrigeration high-side. You get all parts and tools without extra cost. You do 10 complete trouble shooting and service jobs. You build (and keep) an air conditioner, freezer, refrigerator or milk cooler. Only CTI sends 23 big kits—brings Shop Method training right into your home!

Be a Success—Be Secure in AIR CONDITIONING AND REFRIGERATION

Letters from Students Show Value of Training



"When I came home from the army, there was no work. Thanks to CTI training, I am now employed full time at good wages. I got 3 raises and a bonus. Have my own home."—*Daniel Stevens, Springfield, O.*

"Without the practical and theoretical training I received through CTI, I never could have started a business of my own. I have a small shop. Am financially independent."—*K. Sellman, Guthrie Center, Ia.*

"Am very glad I learned through CTI. I am now an able refrigeration technician. Am earning good wages, find my work interesting. I recommend CTI to any ambitious man."—*A. W. Heindrich, Kewanee, Ill.*



"I find the lessons very interesting and easy. Since my fifth lesson I have been working on refrigerators. I rebuild old ones and sell at a nice profit. Am planning a full time shop."—*W. O. Ward, Mich.*

"Your course proved to be very valuable to me. As a result of your training, my partner and I run our own repair shop. He is also a CTI graduate. We also employ a former CTI student as our outside repair technician."—*J. J. Giertuga, Chicago.*

"My training thru CTI has changed my life. It has changed it from working for bare necessities to my owning a business."—*J. J. Kish, E. Chicago, Ind.*

Do you really want to be a success? Then get into air conditioning and refrigeration! This old, established industry offers security. Because it's growing bigger every day, thousands of new jobs must be filled. Many pay up to \$125 a week and more. Most set the stage for you to open a shop. Find out how you can train at home in spare time. Just fill out and mail coupon for two new books that give the facts. Both are free.



R. C. Anderson
President

Over 150,000,000 Units Need Service and Repair

This is why the air conditioning and refrigeration industry needs trained technicians so badly: Over 150 million units are in use today. Each year, some 3 million refrigerators, 1 million freezers, and 2 million air conditioners are produced. Yet, experts say the surface has hardly been scratched. It takes tens of thousands of trained men to keep commercial and home units in working order.

AUTO AIR CONDITIONERS

It is estimated that this year, over 300,000 new cars will have air conditioners. Tens of thousands of older models also are in the market. Already the auto industry is seeking trained men for this exacting work. Be one!



Earn Cash as You Train

CTI training is so practical that soon after starting, many students do repair work in spare time for profit. It's no unusual for students to have a going business by the time they graduate. Assembling CTI kits, doing real repair jobs, you learn fast. No need to waste years in low-pay apprenticeship.

Training You Can Trust

CTI home training was developed in our own resident shops—thoroughly tested in the field. CTI was the only civilian school to train men in refrigeration for the U.S. Army during WWII. That CTI is way-ahead in home instruction is proved by the practical training kits that we provide. You can't get better or more complete training.

COMMERCIAL TRADES INSTITUTE

1400 Greenleaf Ave. Dept. R-344
Chicago 26, Illinois

Mail me your book *Success in Air Conditioning and Refrigeration*, and *Sample Lesson*. Both FREE.

Name _____ Age _____

Address _____

City _____ Zone _____ State _____



MAIL COUPON FOR 2 FREE BOOKS

You can have the full story on your opportunities by filling out and mailing coupon. CTI will send you two new books, just off the press. Act today.

• CTI graduates often open shops. You can start a business with a small investment. Start small, grow big!



Get the Facts First—then Decide

If You Had Mailed This Coupon

LAST MONTH— You'd Be Playing Real Music TODAY!

U. S. SCHOOL OF MUSIC
Studio A303, Port Washington, N. Y.

I am interested in learning to play, particularly the instrument checked below. Please send me your free illustrated booklet, "How to Learn Music at Home." **NO SALES- MAN IS TO CALL UPON ME.**

<input type="checkbox"/> Piano	<input type="checkbox"/> Piano, Harmond.	<input type="checkbox"/> Piccolo
<input type="checkbox"/> Guitar	<input type="checkbox"/> Reed Organ	<input type="checkbox"/> Modern
<input type="checkbox"/> Steel Guitar	<input type="checkbox"/> Tenor Banjo	<input type="checkbox"/> Elementary
<input type="checkbox"/> Violin	<input type="checkbox"/> Ukulele	<input type="checkbox"/> Harmony
<input type="checkbox"/> Piano Accordion	<input type="checkbox"/> Clarinet	<input type="checkbox"/> Mandolin
<input type="checkbox"/> Saxophone	<input type="checkbox"/> Trombone	<input type="checkbox"/> Practical Finger Control
<input type="checkbox"/> Trumpet, Cornet	<input type="checkbox"/> Flute	

Do you have the instrument? _____

Mr. _____
Mrs. _____
Miss _____

Address: _____
(Please Print Carefully)

City: _____

State: _____

If under 18, check here for Booklet A.

BUT IT'S NOT TOO LATE TO JOIN THE THOUSANDS WHO HAVE TAUGHT THEMSELVES THIS QUICK, EASY, INEXPENSIVE WAY!

YES, IT'S TRUE! If you had answered our ad a few weeks ago, you'd be playing real music **RIGHT NOW!** And you'd be well on your way toward mastering your favorite musical instrument—even if you'd never known a single note before!

Impossible? Not at all! Over 900,000 students have already taken up this famous home-study method—and even children "catch on" rapidly. Now **ANYONE** can learn to play the piano, violin, accordion, guitar, or any other instrument. And the cost is only a few cents per lesson, including valuable sheet music!

NO "SPECIAL TALENT" REQUIRED

No previous training needed, no "special talent" required. Right from the start, this amazing music discovery will have you playing real melodies instead of practicing boring scales and exercises. Clear, simple directions and show-how pictures tell you exactly what to do, so you can't go wrong. Soon you'll amaze your friends by playing your favorite songs easily, confidently, by note! No inconvenient lesson periods, no expensive hourly tuition. You learn in spare time of your own choosing.

STOP MISSING THESE JOYS

Why not let the U. S. School of Music method bring the many joys of music into your life? Good times! More confidence. New friends. Gay parties. Extra money from playing or teaching. Possibly even a brilliant musical career. Best of all, the deep satisfaction of being able to create your own music.

**SEND FOR
FREE
BOOK**

See for yourself why our method has been so successful for 59 years. Mail coupon AT TOP OF PAGE for valuable 36-page FREE BOOK. No obligation! No salesman will call. It can mean so much to you for the rest of your life—if you mail coupon today. U. S. School of Music, Studio A303, Port Washington, N. Y. (Special Reduced Prices on Instruments to Our Students.)



Lawrence Weik



Andrew Schneider



Peter Kosyra

900,000
STUDENTS
59
Successful
Years

Choose Your Favorite Instrument

Now it's easy to learn—by note—Piano, Guitar, Accordion, Violin, Steel Guitar, Mandolin, Trumpet, Cornet, Saxophone,

Tenor Banjo, Organ, Ukulele, Clarinet, Trombone, Flute or Piccolo—check your choice in coupon above. (No salesman will call upon you.)

MAIL COUPON NOW—PLAY NEXT MONTH

THOUSANDS NOW PLAY WHO NEVER THOUGHT THEY COULD!



12-Year-Old Surprises Her Friends

"I am twelve years old. Thanks to your Course, I was able to play for our church. All my friends were certainly surprised when they discovered I could play!"—Patsy Jeffrey, Sweetwater, Texas.

Now Famous Orchestra Leader Got His Start

"I got my start in music with a U. S. School Course. How easy it is to learn to read notes and play an instrument this 'teach yourself' way!"—Lawrence Weik, famous orchestra leader. (Picture at left)

Excels Friend Who Has Teacher

"I never took lessons before I started to take them from you—and still I can play better than my friends who began at the same time I did with a private teacher."—Joan Lueck, Big Stone, South Dakota.



"How Rapidly I am Progressing"

"I just want to tell you how much I enjoy your lessons for the Tenor Banjo, and how rapidly I am progressing. Lessons are so simple, anyone can understand them."—Andrew Schneider, Hanna, Wyoming. (Picture at left)

"Opened Door to Popularity"

"I was able to play many pieces in a short time. Course opened door to popularity, wider circle of friends."—Peter H. Kosyra, P.O. Brokenhead, Manitoba. (Picture at left)

Now Invited Out Lots

"It's been fun. Hasn't cost anywhere near as much as private teacher. Now invited to affairs, dances."—Howard Hopkins, E. Syracuse, N. Y. (Picture at left)

Now Plays at Church

"I had tried several times to start music lessons. I had been depending on a teacher before. Now I play at church, etc."—Mrs. P. J. Tatman, Sycamore, Illinois.



Howard Hopkins

**"TOOK IN \$217
FIRST 10 DAYS"**

Some make more, some less...

**We help you to start Your
Own All-Year Business**

Make Big Money! With our easily operated, highly efficient wall washer, Charles Stelle took in \$217 gross in first ten days. E. L. Goss took in more than \$10,000 in one year. E. C. Taber wrote, "I made \$400 gross in two weeks."

And no wonder... this machine washes walls 6 times faster and better than by hand.



Your Money-making Opportunity. We want more men to go into this profitable business for themselves and enjoy independence—freedom from bosses, layoffs. Customers everywhere—homes, offices, schools, churches, hotels, etc. How much you earn depends largely on you. What you take in is mostly profit. No need to rent shop or office; operate business from home. Can start spare time until your full time is available.

Lose no time. Get all facts without obligation

FREE BOOK! MAIL COUPON TODAY!

VON SCHRADER MFG. CO.
310 "W" Pl., Racine, Wisconsin

Send at once (no obligation) your **FREE** booklet containing information about your **WALL WASHING MACHINE** and how I can start my own permanent, profitable business.

Name _____
Address _____
City _____ Zone _____ State _____

WHOLESALE Electric Guitars - Parts - Factory to You
Solid-body Spanish, amplifiers, pedal harp-chord guitars, double-necks, single-necks, triple necks, solid-body mandolin, pickup mikes, non-electric instruments, etc. 1957 Models wholesale. **FREE CATALOG**. Free home study course with instruments. Parts & plans available to build your own.
CARVIN CO., Box 287, PM-3, Covina, Calif.

**SAVE THOUSANDS OF DOLLARS
"HOME-A-MINUTE" KIT**



Not Something To Fool Around With!

Let's be frank. Isn't it ridiculous for you to pay thousands of dollars in excess profits when you build or buy a New Home, simply because you do not know the actual cost of building it? **WHY NOT** design and build your New Home, Attic Flat, Extra Bedrooms or Remodeling—**IN MINUTES**—with dozens of fiber partitions, Doors, Windows, Kitchen Cabinets, made to 1/4 inch scale same as blueprints. **THEN, BELIEVE IT OR NOT, YOU, THE LAYMAN, who knows nothing about building, can estimate your own costs—IN MINUTES—after you adjust charts to local prices.** Don't build anything until you get this "KIT." If you want to save money, Handbook tells you how. Also financing. This information should not pass you by. Complete "KIT"—\$3.95 ppd. Money back guarantee. Return in 10 days.

B. A. HALL & CO. 2825 N. 69th St. MILWAUKEE 10, WIS.

FORTUNES IN DIVING
Train at Home in Spare Time
Write Today for Amazing Free Booklet
Here is one of the greatest opportunities of our time. Make big money fast in Skin and Lung Diving. Trained divers needed in hundreds of industries and by government. Build a successful business of your own. Hourly rates among highest paid in any field. Training program by E. R. Cross, world famous master diver. Instruction directly under supervision of former Navy frogman. Get the facts now. Write for **FREE BOOKLET TODAY!**

U. A. S. CORPORATION
Dept. PM-3 5637 W. 63rd Place, Chicago 38, Ill.

**NOW NO ONE CAN KEEP
A SECRET FROM YOU!** 20x-40x-60x only \$299
TELESCOPE postpaid

Amaze your friends... See what they're doing—without being seen! Special: Order now, get free carrying case.

Money back guarantee. Send cash, check or money order.

3-range all metal telescope magnifies up to 60 power. Watch ball games, look at the moon, stars, animals, distant buildings... up close. Bright aluminum tube, made for long use. Good on hikes, camping trips, can use either 20x, 40x, or 60x power instantly. Variable focus eyepiece. No assembling, ready-to-use, no special instructions required.

L. J. STONE, Dept. T-B-3 • 1616 Oak St. • Santa Monica, Calif.

Learn ACCOUNTING
Business Administration
Bookkeeping, secretarial and allied subjects at home in your spare time or attend nationally approved resident school. Write for **FREE Success Book** giving complete details on courses, plans, rates and employment opportunities. G.I. approved. Write Dept. A.

**Hills BUSINESS UNIVERSITY AND
EXTENSION SCHOOL**
619 W. MAIN ST. OKLAHOMA CITY 2, OKLAHOMA

BOWS—ARROWS—EQUIPMENT
Easy to make your own
Illustrated Hand-Book 84 pgs. \$1, tells you how! Large Colored Catalog 50—Send for it!
Ask your dealer for "Stemmler's Archery" (Oldest Mfr. in U.S.A.)
L. E. STEMLER CO.
Manorville (Box 1) L. I., N. Y.

500 TRICKS
MAGIC TRICKS
IT'S FUN TO DO MAGIC
Be popular! Amaze—mystify—entertain! For 30 years Douglas has satisfied customers all over the world. Now, you can enjoy this fascinating hobby. Only 10c brings our Catalog 500 Tricks, containing brand new tricks for pocket, parlor, stage. Join in the fun—send 10c today!
Douglas Magicland, Dept. A, Dallas, Texas

**I'll Send You This Handsome
SAMPLE CASE—FREE**
and Show You How to Make Up to \$30.00 in a Day
WRITE for this **FREE** Tailoring Sample Case packed with 100 beautiful, big-value suit and overcoat fabrics. Take orders from friends, fellow-workers, others, for fine quality, made-to-measure clothes. Pocket big cash profits in advance. Because wearing our suits and overcoats brings more orders, we make it easy for you to get your own clothes without a cost. No experience is needed. **SATISFACTION GUARANTEED!** SEND NO MONEY. Rush your name, address, and age—today!
**PIONEER TAILORING COMPANY, Dept. P-1116
CONGRESS & THROOP STREETS • CHICAGO 7, ILLINOIS**

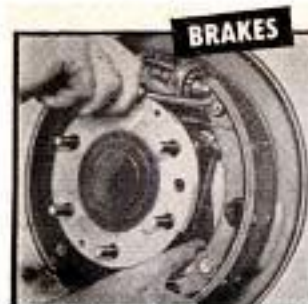

2900 photos and diagrams, plus crystal-clear directions, make every operation easy as A-B-C.



Diagrams, tables and text take the "mystery" out of all ignition systems.



You get illustrated adjustment procedures for all types of carburetors.



ALL AUTOMATIC TRANSMISSIONS are fully covered in special big section. (NOTE: All pictures shown here are greatly reduced in size. Actually, this giant book is almost a foot high!)

Here's the EASY Step-by-Step Way to FIX ANY PART OF ANY CAR

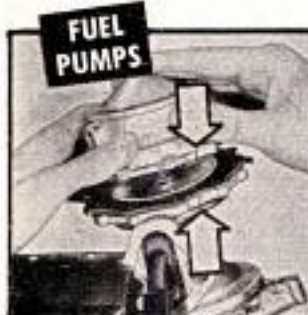

Fuel pumps can cause trouble. Pictures show exactly how to take them apart, fix them.

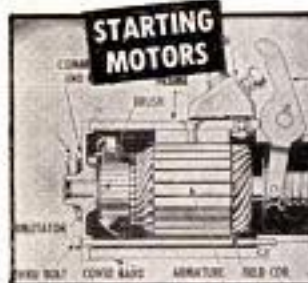

No guesswork. Clear pictures show how to fix starting motor, generator, brakes, etc.

Just 2 of the Many Letters of Praise
Does Every Job. "My MOTOR Manual is a wonderful help. It has put me in a position to do every job." — S. L. Sharpless, Los Angeles, Calif.
Amazed Self and Friends. "I amazed myself and my friends, too. Now do jobs that stumped me before." — Michael Bollesky, Newark, N. J.

Now—Whether You're a Beginner or Expert Mechanic—You Can "Lick" Any Auto Repair Job On Any Car Built from 1949 Through 1957!

in a jiffy!

NOW you can tackle any repair job, and do it quickly, easily, right—the first time! MOTOR'S BRAND-NEW AUTO REPAIR MANUAL shows you how—with crystal-clear pictures and step-by-step directions you can easily follow.

No guesswork. This giant guide tells you where to start; what tools to use. Leads you easily and quickly through the entire operation. Covers everything from a simple carburetor adjustment to a complete overhaul.

Everything You Need to Know

BIG, NEW REVISED Edition has MORE REPAIR INFORMATION THAN EVER! OVER 1,000 giant pages, 2,900 "This-Is-How" pictures—clear drawings, diagrams, cutaway photos—make every step EASY. 291 "Quick Check" charts—23,426 essential repair specifications. 225,000 service and repair facts. Instructions and pictures so complete, so clear—you CAN'T go wrong!

Even a green beginner can do a good job. And top mechanics will be amazed at the time-saving procedures.

The "Meat" of Over 160 Official Shop Manuals

The editors have put together the "Know-How" from over 160 Official Shop Manuals; "balled it down" into one handy indexed book.

Includes ALL Automatic Transmissions. Covers new Carburetors, Engines, Fuel Pumps, 12-Volt Ignition Systems, Starting Motors, Generators, Distributors, Voltage Regulators, Axles, Brakes, Power Steering, etc. PLUS new Trouble-Shooter

section that enables you to spot any car trouble in a jiffy.

Factory Specifications and Adjustment Tables. Tune-up Charts, Tables of Measurements and Clearances. Overhauling, Replacement Parts—AND MUCH MORE.

Used by Armed Forces, hundreds of thousands of auto service men! Now try it on this GUARANTEE:

Try Book for a Week FREE SEND NO MONEY

Pay nothing to postman. Test book in your own garage or shop. It's GUARANTEED to pay for itself in 7 days. If it doesn't just return the book, and owe nothing. Rush coupon for your free-trial copy of this great money-saving Manual. MOTOR Book Dept., Desk 13, 250 West 55th St., New York 19, N. Y.

USED BY U.S. ARMY NAVY MARINES



SEND NO MONEY! TRY BOOK FREE! FOR A WEEK FREE!

Some FREE 7-Day Offer on MOTOR'S Brand-New TRUCK REPAIR MANUAL
Covers EVERY job on EVERY gasoline-powered truck made since 1948—including GM and Cummins Diesels. Over 2,000 Illustrations, Check facts, Check proper box for free trial.

BRAND-NEW EDITION—COVERS ALL THESE MAKES

Buick	Ford	Packard
Cadillac	Hudson	Plymouth
Chevrolet	Imperial	Pontiac
Chrysler	Jeep	Rambler
Clipper	Lincoln	Studebaker
Continental	Mercury	Thunderbird
De Soto	Nash	Oldsmobile
Dodge	Oldsmobile	Willys

2,000,000 COPIES SOLD!

MAIL COUPON NOW FOR 7-DAY FREE TRIAL

MOTOR Book Dept., Desk 13, 250 West 55th Street, New York 19, N. Y.

Rush to me at once: (Check box opposite book you want!)

MOTOR'S New AUTO REPAIR MANUAL. If okay, I'll remit just \$2.00 in seven days, then \$2.00 monthly for two months and a final payment of 95c (plus 35c delivery charges) one month after that. Otherwise, I'll return the book postpaid in seven days. (Foreign price: Remit \$9.00 cash with order.)

MOTOR'S New TRUCK REPAIR MANUAL. (Described at left.) If okay I will remit \$2.00 in seven days, and \$2.00 monthly for three months, plus 35c delivery charge with final payment. Otherwise I will return book promptly. (Foreign price: Remit \$10.00 cash with order.)

Print Name.....Age.....

Print Address.....

City & Zone No.....State.....

SAVE 35c delivery charge by enclosing WITH COUPON check or money order for full payment of \$6.95 for Auto Repair Manual (or \$8.00 for Truck Manual). Same 7-day return-for-refund privilege applies.

Check the Kind of Body You Want



Charles Atlas

...and I'll Prove How EASILY You Can Have It!

Just tell me, in coupon below, the kind of body you want—and I'll give it to you SO FAST your friends will be amazed! "Dynamic Tension," my easy, 15-minutes-a-day method, will make your chest and shoulders bulge... arms and legs surge with power... your whole body feel "alive!"

FREE BOOK 32 pages on how "Dynamic Tension" changed me from a 97-pound weakling into "World's Most Perfectly Developed Man"—and how I'll prove it can change YOU too. Mail coupon NOW!

CHARLES ATLAS, Dept. 8C,
115 East 23rd St., New York 10, N. Y.

Dear Charles Atlas: Here's the Kind of Body I want:

(Check as many as you like)

- More Weight—Solid—in The Right Places
 Broader Chest, Shoulders
 Powerful Arms, Legs, Grip
 Slimmer Waist, Hips
 Better Sleep, More Energy

Send me absolutely FREE a copy of your famous book showing how "Dynamic Tension" can make me a new man—32 pages, crammed with photographs, answers to vital questions, and valuable advice. No obligation.

NAME _____ AGE _____

ADDRESS _____ (please print or write plainly)

CITY _____ STATE _____

MAKE \$18⁰⁰ AN HOUR WITH New



PLASTIC SANDWICH MACHINE

This new, remarkable PLASTIC SANDWICH MACHINE does a permanent, beautiful, professional, protective, plastic lamination job in exactly three minutes time! Amazing earnings possible in your own home or shop permanently sandwiching PHOTOS, SOCIAL SECURITY CARDS, IDENTIFICATION CARDS, CLIPPINGS, DIPLOMAS, etc. between sheets of clear plastic. Make PLASTIC SANDWICHES that cost you only 8c each, take 2-3 minutes time—yet sell for 50c to \$1.00 each! Laminating machines range from \$39.50 up.

FREE SAMPLE and illustrated literature, NO obligation.

PLASTICAST COMPANY

6612 N. Clark St. Dept. LM-1101 Chicago 26

INSURED TIRE SERVICE
POPULAR BRANDS

FREE INSURANCE POLICY given with each used tire sold. We guarantee the amount of service you pay for.
NOWHERE CAN SUCH QUALITY BE FOUND AT SUCH LOW PRICE!

SPECIAL! Deduct 10% on orders for two or more used tires
YOU CAN'T LOSE!!

Super Quality — Rugged Performance — 6 Months Insured Service		Supreme Quality — Nothing Finer — 12 Months Insured Service	
600x16	\$3.45 670x16	\$3.95 700x16	\$4.45 760x16
650x16	3.85 670x16	4.05 710x16	4.35 820x16
650x16	4.25 700x16	3.95 760x16	4.45 850x16
600x16	\$5.25 475x16	\$5.45 700x16 (6)	\$10.45 700x20
600x16 (6)	6.75 640x16	4.95 750x16 (8)	13.95 750x20 (8)
650x16	5.75 670x16	5.35 700x17	11.95 750x20 (10)
650x16 (6)	7.25 710x16	5.45 750x17	16.45 825x20
700x16	6.35 760x16	5.95 780x18	10.95 900x20
750x16 (6)	8.45 800x16	6.35 30x5	11.25 1000x20
880x18	4.95 820x16	6.35 600x20	10.95 1100x20
850x17	4.75 850x18	8.35 650x20	11.75 1000x22
850x15	3.25 670x16	8.15 32x8 (5)	11.95 1100x22
700x18	8.35 700x16 (6)	10.25 32x8 (10)	12.75 1100x24

Whitewalls \$1.00 extra.

MIDLAND TIRE SALES Speedy shipments on Mail Orders, F.O.B. Chicago. Insurance policy sent with each order. Deduct 10% on orders for 2 or more used tires. Send CHECK or MONEY ORDER—No COD's.
3701 S. Normal, Dept. PM-56, Chicago 9, Ill.

ME A MANAGER? Yes, if you are ambitious we will train you for a management position. The Thomas Method of Individual Instruction trains you at home under expert supervision. Business men approved. 15 thorough courses in business admin., industrial, retail, office management, advtg., personnel, salesmanship, human relations, etc. Write for FREE BOOK, "Opportunities in Business Management," and complete details. No obligation. **THOMAS SCHOOLS, Dept. A3, 1428-11th Ave., Seattle 22, Wash.**

MAKE BIG MONEY AT HOME!
INVISIBLE MENDING
Pays up to \$10 in an Hour!
Make moth holes, cigarette burns, tears, rips, disappear from all fabrics. Little-known craft pays extra spare-time profits at home. Write today for exciting details FREE!
FABRICON Dept. 323, Chicago 19, Ill.

Learn MECHANICAL DENTISTRY
A profession offering unlimited opportunities. Most modern and complete course embracing every branch from Plate to Porcelain Work which prepares you to work for Dentists or start your own business. Individual instruction—practical training in day or night school. No books—no classes. Catalog upon request.
McCARRIE SCHOOL OF MECHANICAL DENTISTRY
207 N. Broad Street Dept. 63 Philadelphia 7, Penna.

IT'S EASY... MAKE MONEY IN PHOTOGRAPHY
If you are over 17—good pay and fascinating work await you in photography! Start making money quickly in sparetime—step into your own studio or exciting career job. **LEARN-TO-DOING** method trains you at home! Write TODAY for FREE catalog. Also Resident Training. Co-ed. 47th Year. Approved for Veterans.
NEW YORK INSTITUTE OF PHOTOGRAPHY
Dept. 49, 10 West 33 Street, New York 1, New York 47th YEAR

MOTORIZE YOUR BARBECUE!
Easily rigged up by anyone. Handles whole ham or 4 small chickens. Commercial-quality thruout—2 r.p.m. gear-head motor (110V-AC)—spring-tension bronze bearing permits spit removal—

\$12.95
adjustable meat forks—heavy-duty, chrome-plated spit.
Limited time, introductory offer. Postpaid. (\$13.95 Denver and West).
B & R SALES CO. — Dept. P3-57 — Muncie, Indiana

Learn BAKING At Home
Baking is one of America's high industries in wages. Nearly depression-proof. Thorough basic home course lays sound foundation. If you have aptitude, write for FREE BOOKLET, "Opportunities in Commercial Baking."
National Baking School, 835 Diversy Pkwy., Dept. 1353, Chicago 14, Illinois

BEST JOBS ARE FILLED BY ALLIED TRAINED MEN

Yes, you can train now for the best paying jobs, and become one of the Builders of Industry! Due to the great present day industrial expansion programs throughout our country, Industry has been clamoring for Allied-trained men to fill important jobs. Shortages of Draftsmen, Designers, Tool Engineers, Machinists, Tool and Die Makers are so wide spread that you can pick one of these highly paid key jobs and then look forward to a life of security and success. Get started now—take advantage of these opportunities to earn good money—to build for your security and success.

Foundation of Industry is Built by the:

**DRAFTSMAN
MASTER MACHINIST
TOOL-DIE MAKER
TOOL-DIE DESIGNER
TOOL ENGINEER
MACHINE DESIGNER
MECH. ENGINEER**

Allied is the outstanding school of its kind—the foremost school in its field. Allied is approved by Industry, Department of Registration and Education, Department of Public Instruction, State of Illinois, Department of Justice for Foreign Students, and the Veterans Administration. Accredited by Central Schools Association.

**Train at Home in Your Spare Time
or at The Allied Institute in Chicago**



Free employment service and housing assistance all through your training period and after your graduation. Our industrial contacts cover the U.S.A.

Allied's training program permits you to study right at home in your spare time or at the Allied Institute's fully equipped shops and laboratories. You can begin your training in short courses and continue progressively to a Bachelor Degree in 26 months.

ALLIED SCHOOL of MECHANICAL TRADES

Allied Institute of Technology
1338-42 South Michigan Ave., Dept. PM-3, Chicago 5, Illinois

Gentlemen:

Mail me FREE BOOKS explaining ALLIED'S courses of instruction, and FREE SAMPLE lesson.

I am interested in resident training home study

VETS write in date of discharge _____

Name _____ Age _____

Address _____

City _____ County _____ State _____

SEND FOR **FREE BOOKS**

**ALLIED SCHOOL
of Mechanical Trades**
1338-42 South Michigan Ave
Chicago 5, Illinois

make it with 60c worth of sand & cement!

SELL IT FOR \$2000

every home a prospect for these "LIFETIME"

CONCRETE INCINERATORS

Make big profits manufacturing rust proof, fire proof, almost indestructible concrete incinerators in your own backyard or garage... full or part time. Sell to home-owners, hardware, department and garden supply stores. Phila. manufacturer doing big volume with Sears, Roebuck; large department stores. Easy to follow instructions and all needed equipment supplied. Exclusive protected franchise—No competition! Territories going fast. Write immediately for full details.



Dept. PM-37, T. C. TOR, 2113 Bellevue St., Phila. 40, Penna.

Gentlemen; Rush full information about your concrete incinerator protected franchise offer.

Name _____

Street No. or R.D. _____

City _____ Zone _____ State _____

Make \$500 an Hour CASH PROFIT THE DAY YOU START!



START YOUR OWN BUSINESS AT HOME... SHARPEN HOUSEHOLD, GARDEN AND SHOP TOOLS IN SPARE TIME

Now you can turn spare time into Big Cash Profits with new Belsaw Sharp-All. Sharpen knives, scissors, shears, snips, ice skates, mower blades, hedge trimmers, grass whips, axes, chisels, screw drivers, scrapers and saws... just about any household, garden and shop tool. Your own CASH business with no inventory. No calls to make. No experience needed.

Learn how easily you can start your own spare time business. Amazing low cost easy-payment plan. Send postcard for FREE BOOK.

BELSAW SHARP-ALL CO
717 Field Bldg. Kansas City 11, Missouri



BIG MONEY AWAITS MEN TRAINED IN

TELEVISION — RADIO — ELECTRONICS — RADAR

Only CTS offers COMPLETE TRAINING in all phases of Electronics. Why be satisfied with less? You learn by working with actual equipment. Comprehensive Training Program allows you to EARN AS YOU LEARN.

19 TRAINING KITS INCLUDED!

You receive a Multi-Tester, Oscillator, Signal Tracer, Oscilloscope, Signal Generator, Electronic Timer, Regenerative Radio, 24" TV set (optional) and other valuable testing equipment. FREE BOOK and TWO FREE LESSONS sent on request. No obligation.



Send for 3 FREE BOOKS!

CHRISTY TRADES SCHOOL, 4804 N. Kedzie, Dept. T-1103, Chicago 25

"YOU ARE UNDER ARREST!"



Help Bring Crooks to Justice Through Scientific CRIME DETECTION!

We have taught thousands this exciting, profitable, pleasant profession. Let us teach you in your own home. Learn Fingerprinting, Firearms Identification, Police Photography, Secret Service Methods thoroughly, quickly, at small cost. Over 800 of all American Bureaus of Identification employ I.A.S. students or graduates. Write stating age, for "Blue Book of Crime."

(A Correspondence School Since 1918)

INSTITUTE OF APPLIED SCIENCE, 1920 Sunnyside Ave., Dept. 1353, Chicago 40, Ill.

BUILD A BOAT AT 1/3 THE COST!



with CLEVELAND'S full size, cut-to-shape boat patterns, detailed blueprints, and specifications. All classes and styles of modern Naval Architect-designed boats from 7 1/2

to 38 ft. BIG NEW 86-PAGE ILLUSTRATED CATALOG, 50¢ (coin). "How to Build a Boat" Booklet, \$2.50.

CLEVELAND BOAT BLUEPRINT CO.

Dept. A-166 Box 1651 Cleveland, Ohio

MONEY in WORMS

Big money made raising fishworms and crickets. Billions used yearly—unlimited market—Sell by mail—We teach you how to raise and where to sell. Learn about our new, tremendous 6 to 12 inch African Redworms—in demand everywhere. Free Literature. CARTER WORM RANCH, PLAINS, GEORGIA

RHEUMATISM

NEURITIS • SCIATICA • LUMBAGO

Why continue to suffer agonizing pains when usual remedies have failed. Learn how thousands have been successfully treated by an amazing new method which is fully explained in our New FREE Book. Don't wait. Write today. No obligation.

EXCELSIOR INSTITUTE, Dept. C9806, Excelsior Spgs., Mo.



LEFAX

TECHNICAL DATA BOOKS

POCKET SIZE • LOOSE LEAF

Printed on loose leaf, 6 hole, 6 1/2"x3 1/2" bond paper, each book contains about 140 pages of technical data, condensed, accurate, essential, for engineer, technical worker, teacher, student, business man \$1.25 each

- | | | | |
|--------------------|------------------|--------------------|------------------|
| Architecture | Surveying Tables | Machine Design | Radio |
| Home Heating | Highway Eng'g. | Machinist's Data | Television & FM |
| Electrician's Data | General Math | Mech. of Materials | Electricity, AC |
| Builder's Data | Math Tables | Pwr. Trans. Mach. | Electricity, DC |
| Lumber Data | Physics | Thermo. Tbls. & | AC Motors |
| Air Conditioning | Trig-Log Tables | Charts | Conversion Tabl. |
| Building Constr. | Gen'l Chemistry | Phys. & Thermo- | Steel Forms |
| Reinf. Concrete | Chemical Tables | dynamic Data | Welding Data |
| Piping Data | Analytic Chem. | Metals | Transformers, |
| Surveying | Mech'l Drawing | Hydraulics | Relays & Meters |

Write for FREE catalogs (2000 listings). See how helpful Lefax can be to you. Send \$1.25 book, or \$6 for any five books to

LEFAX PUBLISHERS, Dept. PM-37, PHILADELPHIA 7, PA.

I call this machine "My Little Money Maker"



It can be put anywhere in the house—in the kitchen, the basement, or the attic and it goes on making money for you whether you're there or not. Three times a day—while you're at work, while you're asleep, or at the movies—it turns out a product that sells for \$6 and the cost of raw materials is only 54c. It will make 6 a day, and the profit on each is more than \$5.00. I'll be glad to tell you how to get one of these little money makers working for you.

What a fellow makes in his regular job today is hardly enough to make ends meet. Higher taxes, higher costs of food and rent and almost everything else raise hob with the savings account. And I say that what a fellow puts away is even more important than what he makes. It would worry me sick if I couldn't save a little against a rainy day.



And that makes it almost necessary to make some extra money. There are lots of ways to do it, too. The magazines and newspapers are full of ads for agents to sell things. But if I had to make a living by selling, from house-to-house, I'm afraid I'd starve to death. I like to make something with my hands and either sell it by mail or let the stores sell it for me. There are lots of people like me.

Another thing: Lots of men—and women, too—don't want to get mixed up with something that might hurt them on their jobs. They want a plan they can operate at home—in spare time—one that they can work at any time they please and one that doesn't need any rented store or hired help. And that's where my little money maker rings the bell.



Let's say you're like me. You want to make some extra money but you don't want to do any selling. All right—take a look at what you can do with this machine. I'll give you some facts that I discovered and your own common sense will tell you they're true.

If you're going to make something, it ought to be something that lots of people want—something that lots of people buy. It shouldn't be something that sells at just certain seasons—but all year round. And, it shouldn't be any flash in the pan. It's got to be steady—year after year—something that's not here today and gone tomorrow.

Well, give a thought to this: What's more permanent than babies? Ever since I can remember there's been more and more babies born every year. Last year three and a half million. This year more. Next year, more yet. Then answer this question and tie it in with your thinking: What's stronger than mother's love for her baby? And what is more powerful than love or sentiment in making people buy things. Now you've got the idea.

Every year millions of mothers want their babies' first shoes preserved as mementos. These mothers have the shoes "bronzed" as they call it—by electroplating. Electroplating coats the shoes with copper and preserves them forever. And there's no big company that has a corner on the business of metalizing baby shoes. Almost all of this work is done by little fellows in their kitchens



or basements. Lots of orders come to you by mail when you send out circulars letting mothers know you can do the work. Lots of stores take orders, but they have to turn the work over to you. There are six or seven ways to get orders without making any house-to-house calls. The big job is keeping up with them.

You see, you can clean up six pair shoes in a few minutes. In a few minutes more you can dip them in the hardening solution like you see in the picture. Then you spray them with a conductive coating and hang two pair in the tank on copper wires. Just turn the switch and walk away. The machine does the rest. Eight hours later those shoes are ready to take out of the tank, burnish and mount and ship or deliver. Two pair every eight hours, whether you are asleep, awake or at the movies. The materials cost 54c a pair.



The retail price you get for electroplating is \$6.00—so the profit is more than \$5.00 a pair. Since you can do six pair a day you can see what the profit is, and the beauty of it is that the machine doesn't cost much. Almost anyone can afford the equipment. The book tells how to run the machine and how to get orders without house-to-house selling.

If you'll just put your name and address on the coupon and mail it to me, I'll send you all the information right away by mail. After you have read all this you will know what you want to do. It will be easy to decide whether you would like to have a "Little Money Maker" of your own. Everything I send you now is free. There is no catch to it and nobody will call to try to sell you anything. I'll send everything free and postage paid. All you have to do is mail the coupon, get the facts and then decide. Mail the coupon right away so I can help you get started making money!

IRVING B. MASON, 1512 Jarvis Ave., Chicago 26, Ill.

IRVING B. MASON,
1512 Jarvis Ave., Chicago 26, Ill.

Please tell me about the seven different ways to make money at home in spare time with your "Little Money Maker." It is understood that no salesman will call and it is up to me to decide what I want to do. Everything you send me now is free and will not cost me a penny now or ever.

Name _____

Address _____

City _____ Zone _____ State _____

**FREE!
NEW
ISSUES..**

**plus new, rare
BONUS OFFER!**



RUSH COUPON TODAY for generous collection just released **NEW ISSUE** British Empire Stamps. All genuine, all different, very difficult to get. Thanks to agents all over the Empire, valuable, desirable stamps both mint and used — topicals, pictorials, bi-colors, commemoratives, many more. Due to present scarcity, we give only one packet. **ALSO FREE!** Exclusive — never before offered — **"BRITISH EMPIRE BONUS PACKET"**. Unusual out-of-the-way, seldom-seen Coronations, Jubilees, Royal Visits, Commemoratives, others. No two packets alike. **MORE!** Other offers for your free inspection plus **FREE** copy helpful **STAMP COLLECTOR'S GUIDE**. Supply limited, so we give only one of these collections. If coupon clipped, send name and 10c for postage, handling to **GARCELON STAMP CO., Dept. PM3N, Calais, Maine.**

GARCELON STAMP CO., Dept. PM3N
Calais, Maine. **RUSH** New Issues, **BONUS PACKET**, other offers. Enclosed 10¢ for postage, handling. (PLEASE PRINT)

Stamp Collector's Guide



**DO YOU EARN
\$125 PER WEEK?
Hundreds of our
GRADUATES Do**

Auto and Diesel repair shops today are short of trained mechanics. **THINK** why? More cars and trucks on the road than ever before. And the government is now starting its huge road building program—super express, coast to coast highways, making even more diesel jobs to maintain diesel road building machinery. Our graduates have been in demand by the best garages for 37 years.

WE TRAIN YOU for these top-paying jobs. Shop training on a splendid variety of both gas and diesel engines, automatic transmissions, engine analyzers, electrical testing machines, injection pumps, calibrating equipment, etc. **G. I. APPROVED.**

**Other courses:
BODY & FENDER — WELDING**
These are also top-paying trades offering good futures and often lead to your own business.

Students from all states in the union and 24 foreign countries... **NOT A CORRESPONDENCE COURSE.**

Earn While You Learn
Day & night courses—we help night students get jobs. Most courses start monthly. Write today for full particulars.

NASHVILLE AUTO-DIESEL COLLEGE

226 7th Ave., N. Dept. 75 Nashville 3, Tenn.

G2

**You Can Be a
Manufacturer
of Gardencrete**

Set of 18 Flagstones (below). Sells for \$8.25; Costs to make, \$3.00. Your markup, \$5.25.



**Bird Baths
Jars and Vases
Flower Boxes
Flagstones
Lawn Seats**

Your spare-time manufacture of Gardencrete can lead to a full-time business, with broad sales potentials and generous income possibilities. A small investment buys the Colorglazing machine and a few molds. Add more molds as your business continues to expand.

Gardencrete has wide sales appeal wherever people have pride of lawn and garden. Colors are fused on under air pressure. Stay put for years and years. Choice of 30 colors.

Your mark-up on basic costs is 200%—300%. Products easily made in shed or garage. We supply full instructions. Write for literature and information on costs and selling prices on complete line.

Colorcrete Industries, Inc.
710 Ottawa Ave., Holland, Mich.



\$ GROW HERBS FOR US!

AT HOME — IN YOUR SPARE TIME

Help fill our huge demand — used in expensive medicines. Easy to grow indoors or out—multiply rapidly. Year around Profitability! You grow 'em—we buy 'em! We supply everything you need. Free rare seeds and revealing plan is yours Free for the asking. Be one of the first to profit—rush name and address to: **NATIONAL HERB EXCHANGE: Dept. A-3 Gardens, Calif.**

SHORTHAND in

Famous **SPEEDWRITING** shorthand. 120 words per minute. No symbols; no machines; uses ABC's. Easiest to learn, write and transcribe. Lowest cost. For business and Civil Service. 350,000 graduates. Typing available. 34th year. Write for **FREE** booklet to: **SCHOOL OF**

Speedwriting
Dept. 1503-7, 55 W. 42 St., New York 36



men ... be **TALLER!**

Step up in "ELEVATORS" and others will look UP to you. The moment you slip on these height increasing shoes you add almost 2 inches to your height. The shoes look no different, but you'll see an amazing difference in your appearance. Be sure, be smart, be taller! 31 smart styles for sport, street, dress.

For **FREE** Booklet and Dealer's name write to: **STONE-TARLOW SALES CORP., Dept. PM357, BROCKTON 68, MASS.**

THE ORIGINAL AND LEADING
ELEVATORS
HEIGHT-INCREASING SHOES
"YOUR PERSONAL PROTECTIVE"
MADE BY STONE-TARLOW CO., INC.

Do You Laugh Your Greatest Powers Away?

THOSE STRANGE INNER URGES

You have heard the phrase, "Laugh, clown, laugh." Well, that fits me perfectly. I'd fret, worry and try to reason my way out of difficulties — all to no avail; then I'd have a hunch, a something within that would tell me to do a certain thing. I'd laugh it off with a shrug. I knew too much, I thought, to heed these impressions. Well, it's different now—I've learned to use this inner power and I no longer make the mistakes I did, because I do the right thing at the right time.

This FREE BOOK Will Prove What Your Mind Can Do!

Here is how I got started right. I had heard about hypnosis revealing past lives. I began to think there must be some inner intelligence with which we were born. In fact, I often heard it said there was; but how could I use it, how could I make it work for me daily? That was my problem. I wanted to learn to direct this inner voice, master it if I could. Finally, I wrote to the Rosicrucians, a world-wide frater-



nity of progressive men and women, who offered to send me, without obligation, a free book entitled *The Mastery of Life*.

That book opened a new world to me. I advise you to write today and ask for your copy. *It will prove to you* what your mind can demonstrate. Don't go through life laughing your mental powers away. Use the coupon below or write: Scribe Y.T.C.

USE THIS GIFT COUPON

SCRIBE Y.T.C.
The Rosicrucians (AMORC)
San Jose, California

Please send free copy of *The Mastery of Life*,
which I shall read as directed.

Name.....

Address.....

City.....State.....

The ROSICRUCIANS (AMORC) San Jose, Calif. (Not a religious organization)

DRAFTSMEN



**CASH BIG
PAY CHECKS!**

Train Now for
more success,
greater security

**LEARN AT HOME IN SPARE TIME
(or at college in Chicago)**

Check the want ads in any newspaper—SEE the big-pay opportunities open to you as a draftsman. What's more, you can learn this well-paid, prestige profession at home—quickly, easily! No special talent needed. Get complete, step-by-step Chicago Tech lessons in the mail, spend a few pleasant hours studying each week. In a short time you'll be a well-trained draftsman, ready to take your pick of many good jobs. Act now!



Free Information—Mail Coupon Today!

Get FREE TRIAL LESSON plus information about C.T.C. practical training. Learn what successful Chicago Tech graduates say about high pay and opportunities in drafting. No charge, or obligation.

CHICAGO TECHNICAL COLLEGE

C-215 Tech Bldg., 2000 So. Michigan Ave.
Chicago 16, Illinois

Mail me FREE lesson with facts about big opportunities in DRAFTING.

Name _____ Age _____

Address _____

City _____ Zone _____ State _____

Now—You Can Own and Play a

Famous Make Italian **ACCORDION**

Save **UP TO 50%**



Choose from famous quality makes at lowest WHOLESALE prices...

Get the facts about owning and playing the accordion... it's easy and loads of fun!

You order on NO RISK PLAN... 5 DAYS FREE TRIAL! Save up to 50% off regular price. Easy, convenient terms. You choose from the finest and most famous Italian accordion makes for which we are authorized direct factory distributors. FREE home study course included. Find out about the fun and profit in store for the accordion owner. Rush coupon for big Color Catalog and low Wholesale Prices... yours FREE. No obligation. Write TODAY!

Accordion Manufacturers & Wholesalers Outlet
2003 W. Chicago Ave., Dept. R-37, Chicago 22, Ill.

**5 DAY
FREE
TRIAL
Easy Terms**

Accordion Manufacturers & Wholesalers Outlet • MAIL COUPON!
2003 W. Chicago Ave., Dept. R-37, Chicago 22, Ill.

Send big FREE Color Catalog, best terms, lowest wholesale prices.

NAME _____

ADDRESS _____

CITY _____ ZONE _____ STATE _____

SEND FOR **Free Record**

START SPEAKING
FRENCH
OR
SPANISH ALMOST OVERNIGHT!



HERE'S the easiest way to learn FRENCH, SPANISH, Russian, German, Italian, Japanese or Brazilian. Listen to FREE 2-sided non-breakable record. Let your eyes follow words in FREE sample lesson. Almost as once you'll be chatting in a new language with a perfect accent! That's all you hear! No dull, tedious work. Just listen—imitate! It's that easy! Offer may end soon. Rush 10c to help cover cost of special packaging, shipping. State language you want. We'll also send free information on full Cortina course. CORTINA ACADEMY, Dept. 648, 136 W. 52nd St., New York 19.



**WORLD'S LOWEST PRICED
ADDING MACHINE**

Counts up to 999,999,999
IDEAL FOR BUSINESS AND PERSONAL USE—GUARANTEED ACCURATE.

Not a toy. Operates with only a finger flick. Adds, subtracts, multiplies, divides. Counts up to one billion. Pays for itself over and over. Ideal Gift—for Business, Income Tax and School use. MONEY BACK GUARANTEE. Send name and address. Pay postman only \$2.95 plus postage. Beautiful rich-looking Leatherette Case included at no extra cost. Money back in 10 days if not delighted. AGENTS WANTED.

CALCULATOR MACHINE COMPANY
P.O. Box 126, Dept. H-57, Huntingdon Valley, Penna.

Vest Pocket Size
FREE TRIAL
\$2.95

only
TOTAL COST
SEND NO MONEY

**BUILD YOUR OWN OPTICAL INSTRUMENT
"FUN with OPTICS"**



TELLS YOU HOW

Just out! 32 exciting pages! Wonderfully illustrated. Shows you how to build telephoto lenses, telescopes, microscopes, close-up camera lenses, artist drawing projectors, slide viewers, binoculars, riflescopes, etc. Plenty of diagrams—any 10-year old can easily follow the instructions. We can furnish the lenses, prisms and parts you'll need. Right now—order your copy of "FUN WITH OPTICS." Just send your name and address, along with only 50c in coin. EDMUND SCIENTIFIC CO., Barrington 30, New Jersey.

MAKE TREMENDOUS PROFITS

Have fun! Earn Big Money! Cast plaster figurines, bookends, plaques, novelties at home in your spare time with X-1, rubber molds! NO EXPERIENCE NEEDED! Molds and rubber for 3 molds, only \$1.50 ppd. Send 25c (refunded with order) for 40 page catalog now!

PLASTIC ARTS STUDIO 3403 SO. MADISON, DEPT. PM-3
MUNCIE, INDIANA



SEND FOR THIS **FREE!**

Make money. Know how to break and train horses. Write today for this book FREE, together with special offer of a course in Animal Breeding. If you are interested in Galting and Riding the saddle horse, check here () Do it today—now.

BEERY SCHOOL OF HORSEMANSHIP
Dept. 1103-D Pleasant Hill, Ohio

FALSE TEETH

That Loosen
Need Not Embarrass

Many wearers of false teeth have suffered real embarrassment because their plate dropped, slipped or wobbled at just the wrong time. Do not live in fear of this happening to you. Just sprinkle a little FAS-TEETH, the alkaline (non-acid) powder, on your plates. Holds false teeth more firmly, so they feel more comfortable. Does not sour. Checks "plate odor" (denture breath). Get FASTEETH at any drug counter.

RCA offers you the
 finest training
 at home in
Radio-TV
 electronics,
TV servicing,
Color TV

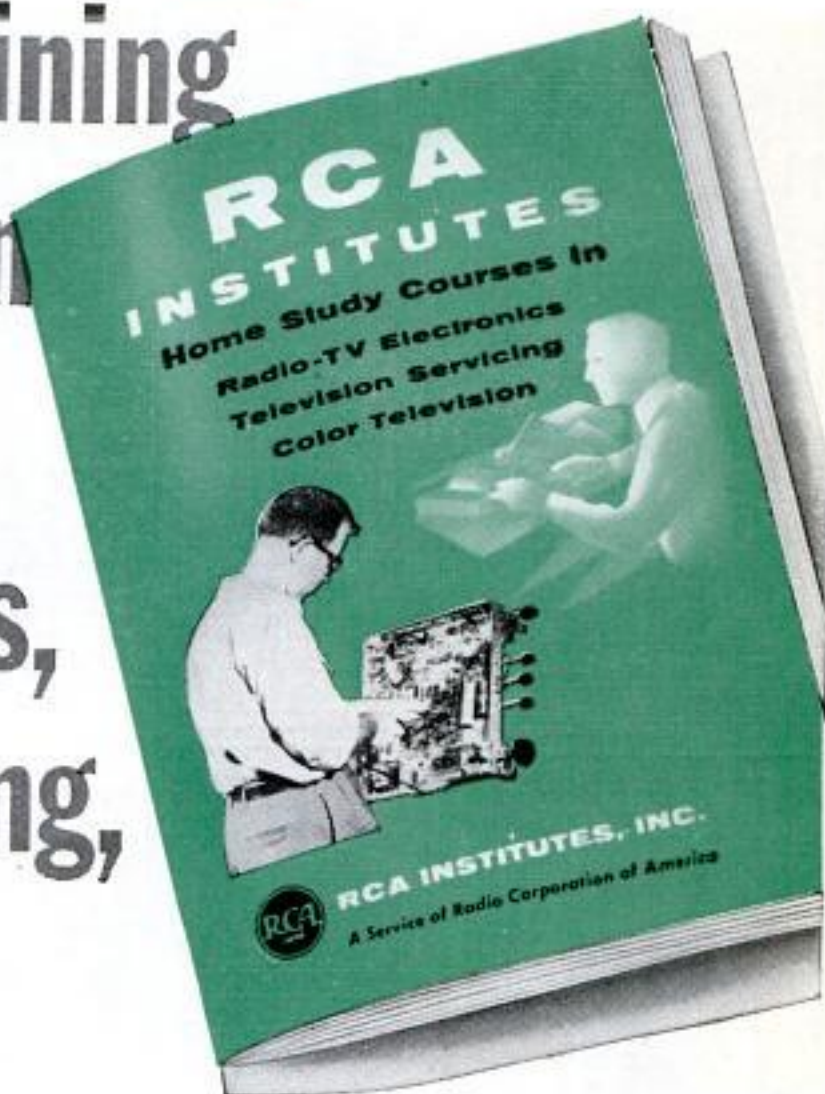

**SEND FOR THIS FREE
 BOOK NOW!**

The instruction you receive and equipment you get (and keep) will start you on your way. Pay-as-you-learn. You pay for only one study group at a time. This 52 page book contains complete information on Home Study Courses for the beginner and the advanced student.



RCA INSTITUTES, INC.

A SERVICE OF RADIO CORPORATION OF AMERICA
 350 WEST FOURTH STREET, NEW YORK 14, N.Y.

In Canada—RCA Victor Company, Ltd.,
 5001 Cote de Liesse Rd., Montreal 9, Que.

RCA Institutes, Inc., Home Study PM-37
 350 West Fourth Street New York 14, N. Y.
 Without obligation, send me FREE CATALOG
 on Home Study Courses in Radio, Television
 and Color TV. No salesman will call.

Name..... Please Print

Address.....

City..... Zone..... State.....

VETERANS
 KOREAN G. I.
 P. L. 550
 CHECK HERE

()

Free! SCARCE "TRIANGLE" COLLECTION



Start TODAY to enjoy an exciting new hobby! Get this big, valuable collection of gorgeous, multi-colored triangle shaped postage stamps . . . brought to you from strange and mysterious lands in the wilds of Africa, enchanting Europe, exotic Latin America, etc. All genuine, all different—picturing man-eating reptiles, jungle birds, action-packed sports, ancient clipper ships; PLUS scarce airmails, fabulous commemoratives, giant and midjet-sized stamps. EXTRA! Bargain Catalog, "Collector's Manual" plus other exciting offers for your inspection. Enclose 10c for mailing costs. Supplies limited. ACT NOW!

JAMESTOWN STAMP CO. DEPT. H3PM, JAMESTOWN, N. Y.

RUSH my Free "Triangle" Collection and other offers. I enclose 10c for mailing costs.

Name.....
Street.....
City..... State.....



TECHNICIANS WANTED

GAPS IN INDUSTRY MUST BE FILLED BY MEN TRAINED TO HIGH STANDARDS . . .

The man who really has the "know-how" will win the best position and highest pay. "Engineering Opportunities" lists many specialized home study courses written by world authorities in: Aeronautical, Civil, Mechanical, Mining, Petroleum, Structural, Electrical, Radio, Television and Plastics etc. Send today for your FREE copy of "Engineering Opportunities" to Canadian Institute of Science and Technology Ltd., Century Building, Washington, D.C.

Canadian Institute of Science & Technology Limited, 648 Century Building, 412, 5th Street, N.W., Washington, D.C. Please forward FREE of cost or obligation of any kind your 105-page handbook, "ENGINEERING OPPORTUNITIES".

Name.....

Address.....

Course interested in..... Age.....

Canadian Enquiries: Canadian Institute of Science & Technology, 263 Adelaide St., W., Toronto, Ont.

start a big profit business with a small investment
EARN UP TO \$200 a DAY

Manufacturing Exciting New RAINBOW ROCK Concrete Slump Brick in your back yard

Earn big building boom profits with Rainbow Rock, the colorful new building brick that's taking the country by storm. Sell all you can make to contractors, builders, building supply houses. RAINBOW ROCK CUTS LABOR COSTS BY 1/3! Amazing low cost machine makes modern slump brick 24" long (3 times the length of ordinary brick) in a variety of widths and pastel colors . . . up to 1500 bricks a day! NEEDS NO SPECIAL SKILL. Operates indoors or out. Full instructions and valuable mixing formulae supplied. YOU CAN START EARNING BIG MONEY NOW. PAY AS YOU PROFIT! A limited number of machines available on easy payment terms. NOW is the time to start. Write today for free literature and full information.

GENERAL ENGINES CO., INC.
Dept. MR-37 — Route 130,
Therofore, N. J. — Tilden 5-5401



STEEL PIER SENSATION
Luxurious RAINBOW ROCK fireplace wall in living room of the "Home of the Century" in Atlantic City, N. J.'s Steel Pier . . . acclaimed by over 500,000 Summer, 1953 visitors as the most beautiful they'd ever seen! Endorsed by the Pier's famous architect, William F. B. Koelle.



Makes beautiful, decorative fences, garden walls, garages, outside walls, room separators, etc.

REAL ESTATE BE A BROKER

PAYS BIG! SEND FOR FREE, BIG, ILLUSTRATED CATALOG NOW! Graduates report making substantial incomes. Start and run your own business quickly. Men, women of all ages, learn easily. Course covers Sales, Property Management, Appraising, Loans, Mortgages, and related subjects. STUDY AT HOME or in classrooms in leading cities. Diploma awarded. Write TODAY for free book! No obligation. Approved for World War II and Korean Veterans.

WEAVER SCHOOL OF REAL ESTATE (Est. 1936)
2020 R Grand Avenue Kansas City, Mo.



BUY IT WHOLESALE!

GET UP TO 40% OFF
Agents—Start Buying Service at Home. Get big-name merchandise for clients up to 40% off. Sales easy as you can give sizeable discounts, still make fat commissions. Postcard brings FREE COPY "The Wholesale Plan."

American Buyers Service

HERTEL STATION, DEPT. R, BUFFALO 16, N. Y.

LEARN METALCRAFT and JEWELRY MAKING

Low Cost Home Training Now Available. Make money. Learn profitable skills and arts of decorative metal and jewelry crafts. Course is complete. Professionally prepared. Easy to master. Special tools and materials furnished.

Write for Free Booklet INTERSTATE TRAINING SERVICE
DEPT. K-3 PORTLAND 13, OREGON

RUPTURED BE FREE FROM TRUSS SLAVERY

Now there is a new modern Non-Surgical treatment designed to permanently correct rupture. These Non-Surgical treatments are so certain, that a Lifetime Certificate of Assurance is given. Write today for our New FREE Book that gives facts that may save you painful and expensive surgery, and tells how non-surgically you may again work, live, play and love and enjoy life in the manner you desire. There is no obligation. Excelsior Hernia Clinic, Dept. 8305, Excelsior Spgs., Mo.

DO YOU REALLY WANT SUCCESS IN BUSINESS— —AND WILL YOU PAY THE PRICE?

Success and security come to the man who has "trained ability." Specialized ability commands promotion. Business is glad to pay—and pay well for real "know-how."

So—if you are the man who wants success in business, we urge you to immediately take stock of yourself. If an opening should occur, either in the company who now employs you or with another company—a job which would be a definite promotion with more money—could you fill it?

If so, you are fortunate. If not, you had better do something about it, or be satisfied to stay at your present salary level.

PREPARE FOR A HIGH-PAY POSITION

Fortunately, there is something you can do about it—if you will pay the price of investing leisure hours. You can, in your spare time at home, quickly, economically, and thoroughly, without interference with your present work, prepare yourself for a brighter future—more money and a better job.

For nearly 50 years LaSalle has been helping ambitious men and women help themselves. During that time we have enrolled more than 1,380,000 students—helping them on their way to more money—a better job.

We believe we can help you too. The coupon is for your convenience. We suggest that you check the career of your choice and mail the coupon today. By return mail, and without obligation, we will send you full information on that field—the opportunities, and what you must know to be successful.

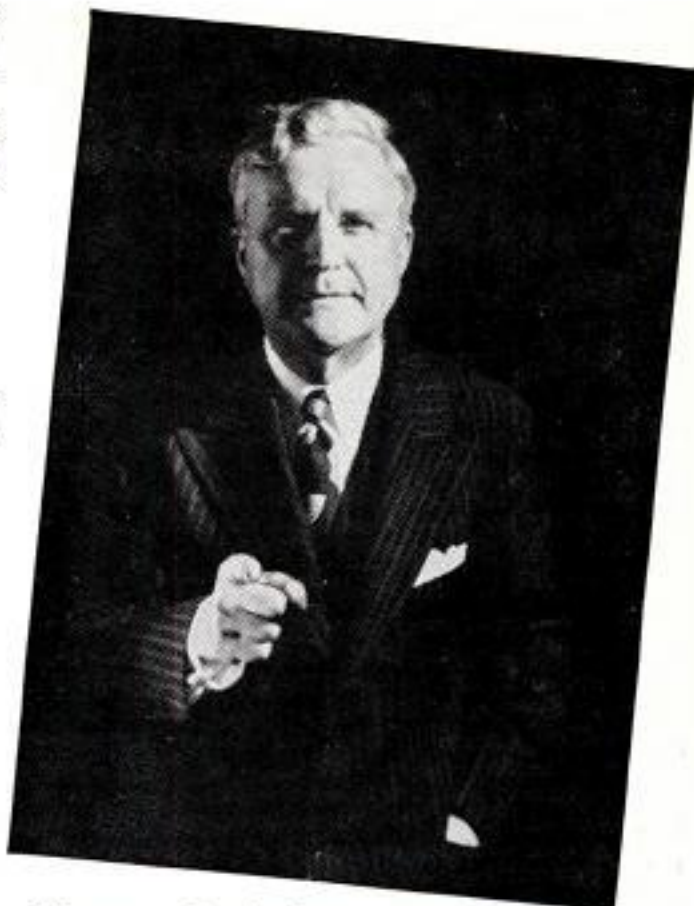

It's true—there's always room at the top for the trained man.

Don't delay. MAIL THE COUPON NOW.



MEMBER, NATIONAL HOME STUDY COUNCIL

→ SEND FOR FREE BOOK ←

- Accounting
- Law: LL.B. Degree
- Traffic and Transportation
- Business Management
- Stenotype (Machine Shorthand)
- Stenographic-Secretarial
- CPA Training
- Salesmanship

LaSalle Extension University

— A Correspondence Institution —
Dept. 364R, 417 S. Dearborn St., Chicago 5, Ill.

Please send me your FREE illustrated booklet describing the course of training I have checked.

Name.....Age.....

Address.....

City, Zone, State.....

Home Operators Take Over Huge Rubber Stamp Profits

Men and Women Everywhere Now Can Start in a Big-Pay Business at Home in Spare Time

The multi-million dollar Rubber Stamp business is now being taken over by small, home operators throughout the U.S. Men and Women who operate this inexpensive machine can turn out large numbers of Rubber Stamps with special wording of all kinds. Material costing only 27c makes a stamp that sells for \$1.80. The machine is easy for anyone to operate. It molds as many as six Rubber Stamps at a time, each with different wording such as names, addresses, notices, stock numbers, prices and other "copy" needed by offices, factories and individuals. At full capacity, it can earn as much as **\$9.20 an hour for the operator!** You don't need experience to get into this big profit business at home. We supply everything, including complete instructions and eight ways to get orders for stamps coming in fast. Start making up to \$9.20 in one hour right away. We'll mail full particulars FREE and no salesman will call. Be first in your locality. Rush coupon today to **Rubber Stamp Div., 1512 Jarvis Ave., Dept. R-2-C, Chicago 26, Ill.**

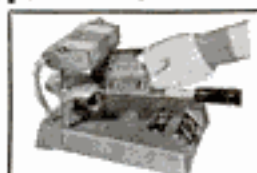

This Little Table Top Machine pays Home Workers up to \$9.20 AN HOUR.

Rubber Stamp Div., Dept. R-2-C FREE!
1512 Jarvis, Chicago 26, Ill.

Please rush full particulars about the little machine that can get me started in the profitable Rubber Stamp business at home in spare time. Everything you send me is FREE and no salesman will call.

Name

Address

City.....Zone.....State.....

Yours FOR JUST 10¢



This \$4.95 Regular Size Presto Fire Extinguisher for Letting Us Prove How YOU CAN MAKE UP TO **\$1,000⁰⁰** A MONTH!

C. Kama of Texas Making Even More—Said, "Haven't Touched Bottom Yet!"



We DARE make this amazing offer because we're certain that once you actually use a PRESTO to put out a demonstration fire in a bucket—you'll realize why it "sells on sight" to car owners, homes, stores, farms, boats, offices, factories, and to stores for re-sale. PRESTO's startling chemical is 1½ to 6 times as effective as ordinary extinguisher chemicals on equal-weight basis . . . permits light, handy extinguisher even a child can use!

Here's Our Daring 10c Offer!

Send your name and address with only 10c TODAY—and we'll send you a regular \$4.95 PRESTO at once. Then you can demonstrate this miracle fire extinguisher to yourself and friends and see for yourself. If not amazed, return PRESTO to us and we'll refund your 10c. Or keep it at this big saving when you order 6 or more. You can't lose. You risk nothing. We'll also send you FREE a complete Sales Kit to help you get started. Act now. Write to **MERLITE INDUSTRIES (Presto Div.), 114 E. 32nd St., Dept. X-157, New York 16, N.Y.** IN CANADA: Mopa, Ltd., 371 Dowd St., Montreal 1, P. Q.

INVENTORS

PROTECT YOUR INVENTION BY A U. S. PATENT. SEND FOR FREE "INVENTION RECORD" FORM AND "PATENT INFORMATION EVERY INVENTOR SHOULD HAVE."

CARL MILLER

REGISTERED PATENT ATTORNEY

WOOLWORTH BLDG., 36th FLOOR, 37A
NEW YORK CITY



INVENTORS

U. S. Patents protect your inventions. Our free book of "Instructions on Patent Procedure for Inventors," also "Certificate of Invention" form sent without obligation.

C. A. SNOW & CO.

REGISTERED PATENT ATTORNEYS

428 SNOW BUILDING WASHINGTON 1, D. C.

INVENTORS

Whether an invention is patentable can be substantially determined by a search of the U. S. Patent records. Without obligation, write for information explaining the steps you should take to secure a patent.

JOHN N. RANDOLPH

Registered Patent Attorney

201 Columbian Building, Washington 1, D. C.

INVENTIONS WANTED

If you want to market, or sell, your invention for cash or royalties, write for our Free Booklet. Send no drawings. We also welcome hearing from firms, or private capital, wishing to review inventions in any field. We will be glad to send notice of our clients' inventions.

GLOBAL MARKETING SERVICE

2420 77th Ave. Dept. PD Oakland 5, Calif.

GET THE HABIT OF READING OUR CLASSIFIED ADS.

Wonderful Opportunities Amazing Bargains

INVENTORS

Send for PATENT INFORMATION REGISTERED PATENT ATTORNEY

Book and INVENTOR'S RECORD without obligation

ASSOCIATE EXAMINER U. S. PAT. OFF. 1922-1929

GUSTAVE MILLER

Patent Attorney & Advisor U. S. NAVY DEPT. 1930-1947

37-PM WARNER BUILDING WASHINGTON 4, D. C.

PATENT LAWYER

INVENTORS

I shall be pleased to furnish you, upon request, with full information relative to patent procedure—without any obligation on your part.

PATRICK D. BEAVERS

Registered Patent Attorney

934 Columbian Building Washington 1, D. C.

AMAZING NEW PERSONAL POCKET RADIO

LISTEN IN PRIVATE WHILE YOU WALK!
 SMALLER AND LIGHTER THAN ANY TRANSMITTER "POCKET RADIO!" Wt. only 1/2 lb. Size 1 1/2" x 2 3/4" x 4 3/4" complete. Black Gold breakproof plastic case. POSITIVELY NO HOOKUPS OR WIRES NEEDED! BUILT IN 100 MILE ANTENNA! Snap in flashlight batteries lasts for months. "Listen in the Dark!" Easy to use from car (while walking, riding, etc.). Has special tiny, soft plastic almost invisible ear-plug—LETS YOU ALONE LISTEN ANYTIME. ANYWHERE without anyone else knowing you are hearing radio music, sports, news, weather, etc. GUARANTEED TO WORK ANYWHERE RADIO CANCELED. ONE YEAR SERVICE GUARANTEE.

SEND ONLY \$5.00 (ck, mol) and pay postman \$14.95 plus postage on delivery or send \$19.95 for postpaid delivery. A REAL \$25.95 VALUE! AVAILABLE NOW ONLY FROM US AT HALF PRICE WHILE OUR SUPPLY LASTS. American model You can always get repairs if ever needed. NOT AN UNWORKABLE INCOMPLETE KIT OF PARTS OR PLAYTHING. A REAL MIDGET PERSONAL POCKET SIZE RADIO. Get yours now—Listen when you want without bothering others. Price will go up soon so rush your order now for YOUR TINY TONE POCKET PERSONAL RADIO. Available only from:

WESTERN RADIO Dept. AP-3 KEARNEY, NEBR.



GIANT BALLOONS

The best! Surplus US Govt. (new over-age) Neoprene weather target balloons. **FOR FUN**—Great in backyard, at parties, picnics, fairs. Young & old enjoy 'em! **FOR ADVERTISING**—Attract big crowds to business openings, civic events, trade shows, exhibitions. Print 'em with a sales message and they'll pay off for you! **FOR PROMS**—Makes any high school or college prom more festive. Real cool! Approx. inflated sizes.

3 ft. dia., 49c—5 ft. dia., 99c

Postage paid on prepaid orders. Cal. res. add sales tax.
VOLUME SALES CO., War Assets Division
 3930 Sunset Blvd., Dept. PM-357, Los Angeles 29, Calif.



DEVELOP A HE-MAN VOICE!

Write for FREE book "How to Strengthen Your Voice for Greater Success" by Eugene Freuchlinger. No obligation. Book will be mailed at once in plain wrapper, postpaid. Just send your name and address. State age.

LOCKSMITHING
 Practical Up-to-Date Course — ONLY \$5.95
 53 Illustrated self-instruction lessons. Easy to learn. Full price only \$9.95 postpaid—or COE plus postage. Satisfaction guaranteed or full refund! **NELSON HALL CO., 210 S. Clinton St., Dept. CT-2, Chicago 6, Ill.**

Write Like This **Complete OUTLINE FREE!**

MIRACULOUS IMPROVEMENT in your Penmanship in six hours practice with Grooved Letters. No failures. Inexpensive. No charges unless you're satisfied after 6 hours practice.

WRITE OZMENT BOX 645
 34-P, ST. LOUIS, MISSOURI

BE A LANDSCAPE CONTRACTOR

Make \$20 to \$60 a day. Millions of new and old homes, estates, etc., need modern landscaping. Contracting is full time job for those who want to start own business. Start with smaller projects, and work into larger jobs. We show you how. Easy-to-follow Home Study Course. Hundreds of successful graduates. Write for FREE Book.

NATIONAL LANDSCAPE INSTITUTE
 310 S. Robertson Blvd. Dept. M-37 Los Angeles 48, Calif.

Day or Night Enjoy this HIGH-POWERED 40, 80, 120 TELESCOPE with TRIPOD

Observe stars, moon, planets. See distant ships, people, etc. appear feet away! Crystal-clear image sharpness at all powers. All images erect. Telescope, with five precision lenses and 40" long black leatherette covered tube mounted on 3 ft. hardwood tripod, cast aluminum head. Vertical and horizontal movements machined aluminum. Tension controls on each. 3X finder scope attached locates target fast. Telescope completely assembled with tripod PLUS 3 FREE GIFTS only \$12.95 postpd. Satisfaction guaranteed.

\$12.95 ppd.

GET THESE GIFTS FREE!

1. 120 pg. book "Discover the Stars"
2. Star Finder Dial
3. 200 & 400X eyepiece lenses

SUFFOLK SCIENCE SERVICE
 Dept. PM-3 Mattituck, N. Y.

Make your interest in AUTO MECHANICS & DIESEL PAY OFF!



OUR FAMOUS SHOP METHOD HOME TRAINING PREPARES YOU FOR BIG TIME PAY AT HOME IN SPARE TIME

YOU GET AND KEEP ALL THIS EQUIPMENT

<p>Complete set of professional tools and All-Metal Tool Box. Same top-quality equipment used by expert mechanics everywhere. Use them, display them proudly.</p>	<p>"Motor Analyzing Set" contains Standard Engine Vacuum Fuel Pump Tester, Remote Starter Switch, Modern Timing Light, Standard Compression Tester. Plus compact carrying case & instructions.</p>	<p>Top-quality Socket Wrench with Fittings. Real professional tools you'll use during your lifetime career in repairing all types of engines, from foreign cars to big diesel jobs.</p>
---	--	---

Nearly 60 million cars and trucks on our roads! If you could talk to owners of garages, service stations and car dealerships (as we do every day), you'd realize America's DESPERATE NEED FOR TRAINED MECHANICS.

Take your choice—One modern course prepares you for Auto-Mechanic jobs, Airplane Mechanics, Farm Machinery Repair, all Diesel Jobs, Experimental Labs, Government Work, Engine Specialties, etc. A qualified, ALL-AROUND Mechanic always has a good job.

Every phase is Shop-Tested! Streamlined lessons, diagrams, manuals are easy to understand. Earn as you learn. Free Graduate Employment Service.

FREE! VALUABLE BOOK & SAMPLE LESSON JUST SEND COUPON

RESIDENT TRAINING AT LOS ANGELES! If you wish to take Resident Training at Los Angeles, in our big, modern Shops & Labs, check special box in coupon for full information.

APPROVED FOR GI TRAINING NATIONAL SCHOOLS
 Los Angeles 37, California
 Canada: 811 W. Hastings St., Vancouver, B. C.

NATIONAL SCHOOLS
 TECHNICAL TRADE TRAINING SINCE 1905
 LOS ANGELES 37, CALIFORNIA

NATIONAL SCHOOLS, Dept. DB-37
 MAIL NOW TO OFFICE NEAREST YOU

4000 S. FIGUEROA ST. LOS ANGELES 37, CALIF. OR 187 N. LA SALLE ST. CHICAGO 1, ILLINOIS

Send for FREE Auto-Diesel Opportunity Book and Sample Lesson.

NAME _____ AGE _____

ADDRESS _____

CITY _____ ZONE _____ STATE _____

Check if interested ONLY in Resident School Training at Los Angeles

VETERANS: Give date of discharge _____

Learn ELECTRIC APPLIANCE REPAIR IN YOUR SPARE TIME AT HOME

START YOUR OWN BUSINESS

ONE BUSINESS THAT IS NOT AFFECTED BY STRIKES, DEPRESSIONS OR POLITICS

WITH A POTENTIAL MARKET OF 50,000,000 CUSTOMERS

New shop-method, home-training system gives you electrical know-how that used to take years to learn. Learn at home by building valuable testing kits, repairing your own and neighbors' appliances. It is not unusual for appliance repairmen to charge on the basis of \$5.00-\$6.00 an hour.

FREE ILLUSTRATED BOOK
Shows you how you learn every phase of electrical appliance. How to make money while you learn. Write today for your FREE copy.

CHRISTY TRADES SCHOOL
Dept. D-6403
4804 North Kedzie Ave., Chicago 25

I'll Send You This Famous TRAVIS BIKE MOTOR AT TREMENDOUS 30% SAVING

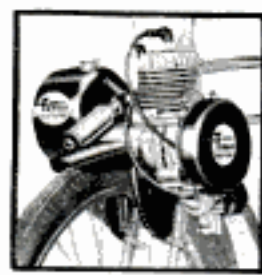

IF YOU'LL AGREE TO DEMONSTRATE TO YOUR BIKE-RIDING FRIENDS

AMAZING NEW RIDER-DEMONSTRATOR PLAN CAN PAY FOR YOUR MOTOR...AND BRING YOU EXTRA CASH, TOO!

If you'll agree to demonstrate to friends, we'll sell you a rugged, powerful 1 1/2 H.P. world-famous Travis Motor for your own bike at amazing low Demonstrator Price of 30% off! Just ride around town and see how everyone wants a Bike Motor like yours. Only 3 orders and your own Travis is paid for—costs you nothing. Then you keep on making wonderful profits in your spare time!

World's Lowest-Priced Bike Motor . . . Unequaled Features!

SAFE . . . mounts on front fork away from rider, always under control of bike brakes. **POWERFUL** . . . climbs hills, carries heavy loads. **SMOOTH-RIDING** . . . 2-cycle airplane-type multi-finned air cooled engine, ball bearing construction, direct drive to front wheel (no belts or pulleys to break). **LIGHT-WEIGHT** . . . only 17 lbs., perfectly balanced. **MOUNT IN LESS THAN 30 MINUTES** . . . anybody can do it with just pliers and screwdriver. **FITS ALL BIKES** . . . boys' or girls', balloon or lightweight. Motorcycle-type control. Unconditionally guaranteed . . . carries unique LIFE-TIME Factory Rebuilding Policy.

FREE! Rush name, address NOW for complete details of amazing Rider-Demonstrator Plan that saves you 30% and shows you how Travis pays for itself, makes EXTRA MONEY for you. Everything FREE. No obligation. Write:



TRAVIS PRODUCTS CO. 224 W. HURON, DEPT. R-3 CHICAGO 10, ILL.

DEER HUNTERS! ENFIELD RIFLE SALE

We have made a special low cost purchase of surplus British Lee Enfield Army rifles, one of the world's most accurate rifles and ideal without any further expense for deer, bear and any North American or African big game. Adjustable sights. 10 shot, bolt action, barrel 25", wt. approx. 8 1/2 lbs. British ordnance and proofhouse marks. Bore guaranteed good condition. 303 softnose ammo is made by Rem., Win., Western and Peters, available everywhere. We remove cosmoline and re-oil lightly before shipping. Sling included. Bayonet: \$1.95 additional. We have softnose ammo, 20 rds. for \$2.95; military target ammo, 100 rds., \$7.50. Pachmayr Lo-Swing Scope mount specially made for this rifle—\$20.00 extra.

JUST \$19.95



TO ORDER: Send check, cash or money order 1/2 deposit for C.O.D. Shipped express collect, Pasadena, Calif. Calif. resid. add 4% state tax. 10-day unconditional money back guarantee.

THE ELLNER COMPANY
Dept. S, 1206 Maple Ave., Los Angeles 15, Calif.

FIX OUTBOARD MOTORS

POWERMOWERS, AND ALL SMALL 2 & 4-CYCLE GASOLINE ENGINES

Repair your own equipment or MAKE EXTRA MONEY in this growing field. Fully illustrated, easy-to-understand, Home Study Course. Write for FREE information.

LINCOLN TECHNICAL INSTITUTE
SUITE 3-E, 472 MARKET STREET, NEWARK 5, N. J.

Now! TEST YOUR OWN TV - RADIO TUBES!
EVEN THE PICTURE TUBE

Checks fuses, appliances, etc. Easy, safe to use. Insert tube in socket. Pilot light instantly indicates if tube needs replacement. Rugged metal case (not plastic). AC or DC. One service call saved pays for tester. Only \$3.95 ppd. or C.O.D. plus charges. Deluxe Model \$4.95. Instructions, 3-yr. guarantee.

GEIGER ENGINEERING CORP., Dept. AB-100, 6349 N. Western Ave., Chicago, Ill.

HELPFUL BOOKS

Send post card asking for FREE catalog
Popular Mechanics Press, 200 E. Ontario, Dept. 601, Chicago 11

LEARN PLASTICS

COMPLETE LOW COST SHOP METHOD HOME TRAINING NOW AVAILABLE

Get in on Big Money opportunities in Plastic molding, casting, forming, carving, etc. Earn as you learn with Interstate's professionally prepared course. All plastic materials furnished.

INTERSTATE TRAINING SERVICE
DEPT. C-3, PORTLAND 13, OREGON

WRITE FOR FREE BOOKLET

Lightning Calculator

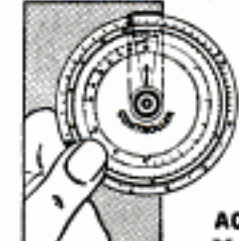

Germany's latest simplifies all calculations, multiplication of discounts, percentages and profits

JUST TURN THE DISC AND READ THE ABSOLUTELY ACCURATE RESULTS

Made of fine aluminum just three inches in diameter, it does the work of a ten-inch slide rule, fits in a vest pocket. Complete with easy to follow instruction booklet. In Plastic Case \$6.95 Prepaid. 10-day Money-Back Guarantee.

PROGRESSIVE ENTERPRISES, INC.
135 W. 20th St., N.Y. 11, N. Y., Dept. TT1

ELECTROPLATING EQUIPMENT

SUPPLIES & INSTRUCTIONS for
HOME WORKSHOPS
JEWELRY MFRS.
BABY SHOE METALIZERS
INDUSTRIAL PLATERS

Complete Assemblies of
COPPER, NICKEL, CHROME
GOLD, SILVER, Chemicals
& Anodes — small or large
quantities.

COMPLETE COPPER, NICKEL,
CHROME PLATING ASSEMBLY
ONLY \$275.00

RECTIFIERS: 10 to 1000 amps.
TANKS: Steel, Stainless,
P.V.C., Rubber-Lined

FREE
CATALOG

Complete line of metal and onyx baby shoe mountings.

HOLLYWOOD BRONZE SUPPLY
1624A East 1st St., Los Angeles 33, Calif.

BE A CLAIM INVESTIGATOR



INVESTIGATE ACCIDENTS! Many earning \$750 to \$1000 a month. Thousands of insurance companies, airlines, steamship lines and Government Offices need Claim Investigators. Also big opportunities for your own spare time business. We train you at home. National Placement Service FREE of extra charge. Bill King writes: "Your course has paid off for me with large earnings. You can quote me—your Adjuster Training Course is worth many times the cost." Write TODAY for FREE book.

UNIVERSAL SCHOOLS

University Park, Dept. PM-3, Box 8202, Dallas 5, Texas

Watch Repairing Pays Big Money Learn at home



Watch repairers in great demand. Train step-by-step in 10 easy lessons. We furnish all tools and 15 jewel watch and practice movement. Turn spare time into cash. A licensed school. Low cost. Send for FREE book today.

ILLINOIS SCHOOL OF WATCH REPAIRING
2870 Elston Ave., Dept. PM-37, Chicago 18, Ill.

RAZOR BLADE PLANES

3-WAY CURVE
PLANE



LITTLE GIANT

JUST USE
A
DOUBLE-EDGE
RAZOR
BLADE



FLAT
PLANE



FOR JOBS OTHER
PLANES CAN'T DO
For Short Curves
and Sheeps
For Long Curves
and Flat Surfaces



ADJUSTS
INSTANTLY FOR
DESIRED
DEPTH
OF CUT

ONLY 98¢ each AT HARDWARE DEALERS
If not yet available in your area, you may order by
mail. Include 25¢ additional for postage and handling.
— DEALERS WRITE FOR INFORMATION —
WILSON BROS. Dept. PM-3 SPRINGFIELD, MISSOURI

MEN - WOMEN RAISE

ORCHIDS

IN YOUR
LIVING
ROOM!

YEAR 'ROUND

No Equipment Needed

Any Climate, Maine to California

BIG PROFITS!

Spare or Full Time. Loads
of Fun for all the Family!

Fill your home with gorgeous Tropical Orchids. Thrill to the gorgeous beauty of your very own huge purple Cattleyas like those you see in nearly every flower shop. Exquisite Cymbidiums, sometimes with 30 or more blooms on each stalk. Hundreds of others—many grow without soil, getting food from the air. Yellow Orchids, greens, blues, pinks, browns, every rainbow color. No greenhouse needed. Start on card table in your living room. Any climate, Maine to California.



LOUIS SCHIRMER Orchidist

Successful Home Grower SHOWS YOU HOW

Louis Schirmer, successful home grower, shows you step-by-step how he and Mrs. Schirmer started with a few plants at home, developed a big-profit business, and grew an Orchid collection now worth a fortune. Learn how Orchids multiply — how one plant may become many, each as valuable as the first. No big investment. No overhead. Takes few minutes a week. Big-profit orders come from individuals, florists, hotels, clubs, etc. Popular year-round gift. Millions sold by Mail-Order. Schirmer shows you how!



You can grow
gorgeous Cattleya Orchids
like this in your own home!

Home Growers Count to Count
Benefit from Schirmer's Help

"A wonderful course, suitable
for anyone who understands it."
— I. G. ...
"I can't get all the Orchids I own
at home."
— A. S. ...

Complete Instructions and Living
Orchid Plants Sent for You to Examine
at Home — NO OBLIGATION
TO BUY A THING...

Complete Directions — secrets
of the experts—in simple lan-
guage jam-packed with "show-
how" drawings, gorgeous full-
color pictures of Orchids. Also a
real blooming-size Orchid plant
from the Schirmer's own Gardens.
Everything you need to start is
yours to examine at home, without
obligation to buy a thing. FREE —
full details. Learn how you may
become an Orchid grower. Send
no money! Write today. Airmail
is quicker.

TROPICAL FLOWERLAND, Dept. 313
100 So. Vermont Ave., Los Angeles 4, Calif.



MAIL COUPON NOW!

Tropical Flowerland Dept. 313
100 So. Vermont Ave., Los Angeles 4, Calif.

Rush me complete free details on your offer
of Louis Schirmer's Instructions which show
me how to grow Tropical Orchids at home.
The instructions will include a blooming-size
Orchid Plant and valuable home Profit-Plan.
This request does not obligate me in any way.

Name _____
Address _____
City _____ Zone _____ State _____

AMAZING STAMP OFFER!

Free

TO GET NAMES FOR OUR MAILING LIST

- 1 WORLD MAP**—authentic 3 ft. sq. Mercator projection map, used by air and sea navigators—yours FREE!
- 2 STAMP FINDER**—identifies stamps around the world—no matter how strange their script letters—yours FREE!
- 3 ENCYCLOPEDIA OF STAMP-ISSUING COUNTRIES**—Tells area, location, population, parent country, etc.—yours FREE!

Also FREE: 30 MUCH-WANTED FOREIGN STAMPS

NOW you can identify even the strangest stamps—at a glance—with this GIANT world map and stamp guide. Opens up to 3 SQUARE FEET to make a big handsome wall map you'll be proud to display in your room. THE PHILATELIC WORLD MAP & GUIDE is well-known among stamp fans all over the country. Complete and up-to-date. Locates the tiniest, most remote stamp-issuing countries in the world. While our supply lasts—we'll send it to you FREE. But that's not all! You also get—FREE—30 colorful foreign stamps—from exciting, far-off places like San Marino, Djibouti, etc. Included is Chi-

nese anti-Communist stamp with face value of \$10,000 in Nationalist money! Also interesting stamp offers for your inspection. No obligation. But hurry. Offer may be withdrawn at any time. Send your name and address, with 10c to cover postage and handling, to **LITTLETON STAMP CO., Dept. PM-3, Littleton, New Hampshire.**



...TURN CONCRETE INTO GOLD!

MAKE UP TO \$75 A DAY IN YOUR OWN BUSINESS

If you want to have your own business — to start a business on your own — here's your big opportunity! New high speed, low cost General block machine produces up to 1,000 concrete blocks a day. Sell all you make to builders, supply houses, and others for homes, factories, buildings, garages. Cash in on the building boom! You can make profits of 100% to 150% — up to \$75 a day! General block machine equipped with 1/2 h.p. electric motor — or can be supplied with gasoline engine — works anywhere, in little space, indoors or out. Operates from ordinary house light socket. Simple, foolproof 3 step operation — so easy a child can do it. Makes superior 3 core blocks any size from 4" to 12". Also makes chimney, sash, corner and other types. Blocks meet any building code anywhere in the country. Materials — sand, water, cement, available anywhere. Simple illustrated operating instructions and mixing formulae for cement and cinder blocks supplied with each machine. Write for FREE folder with full information.

MOTOR DRIVEN

R.L.T. of New York City reports: "MY GENERAL BLOCK MACHINE PAID FOR ITSELF IN FIRST 2 WEEKS!" Hundreds now in use the world over! Write for FREE details today!

EXTRA Amazing illustrated book gives floor plans for 6 sensational concrete block bungalows. Tells how to lay blocks, lay out building lines, mix concrete, build steps, porch and concrete floors all at great savings. Written by experts. Can save many times the cost of the machine! Get it now! No strings attached. Send \$1.

BOOK SENT FREE IF YOU BUY MACHINE, \$1 REFUNDED IF YOU BUY LATER.

GENERAL ENGINES CO.
DEPT. M-37, ROUTE 130, THOROFARE, N. J.

HOW TO BUILD YOUR OWN CONCRETE BLOCK HOME
Only \$1 Prepaid

OUR AD HAS BEEN IN THIS MAGAZINE LONGER THAN ANY OTHER TIRE CO., NEARLY EVERYONE BUYS FROM STANDARD.

23 YEARS AT THIS ADDRESS
TUBE FREE WITH EVERY PASSENGER TIRE

Our entire stock of very slightly worn EXTRA MILEAGE TOP GRADE Tires, (Written Insurance Guarantee). SEND AD

EVERYBODY 10% off ON EVERY TIRE

FREE If you buy 2 or more Passenger 4-ply tires, WE GIVE ONE tire FREE, on each order. Does not include W.W. or Truck Tires, or Snow Tires.

12 MOS. WRITTEN GUARANTEE WITH EVERY TIRE	
600-16 \$5.52	475-19 \$4.82
600-16(6) 5.92	640-15 4.22
650-16 5.72	670-15 5.52
650-16(6) 6.62	710-15 5.52
750-16(6) 7.52	760-15 5.82
850-17 3.72	800-15 5.92
650-15 5.52	820-15 5.92
700-15 4.92	700-16(6) 7.32
700-15(8) 5.72	700-15(10) 5.72
750-20(10) 15.72	750-20(8) 11.92
825-20 18.92	825-20 18.92
900-20 17.92	1000-20 17.92
1100-20 19.92	1100-22 19.92

"EXTRA SPECIAL" SOME NEAR NEW all size 4-ply pass. FREE TIRE with 2 or more of these also.—W.W. \$1.00 Extra Factory Tested Tube given—GIANT TIRE SALE.

Thousands of tires shipped all over the U.S.A. All tires shipped F.O.B. Phila. Send Check or M.O. with this ad. Dept. 2, No C.O.D.

STANDARD 834 N. Broad St., Philadelphia 30, Pa.

75 POWER TELESCOPE \$3.98

VARIABLE EYEPIECE 25X-45X-75X — BRASS BOUND NEW! Three telescopes in one, 3 different magnifications. 25 power for ultra-bright images with 45 and 75 power for extra long range. Guaranteed to bring distant objects, people, sports events, ships, moon, stars, etc. 75 times as close.

Most powerful for any where near the moon. Contains 4 ground and polished lenses. Also used as a powerful compound microscope. Directions included. Mass production enables us to offer this instrument at amazing price of \$3.98 complete. Money back guarantee. We pay postage. Get yours now.

CRITERION CO., 331 Church St., Hartford, Conn., Dept. PMB 43

TASOPE PHOTO-ENGRAVING PLANTS

Establish your own profitable PHOTO-ENGRAVING business. Make cuts for newspapers, printers, and advertisers. Make etched name plates, plaques etc. Instructions furnished, no experience necessary. Sold direct from factory since 1931. First five hundred cuts sold locally or by mail will pay for plant and pay you well for your time. Write for FREE catalog.

TASOPE, DEPT. PM-3, AURORA, MO.

\$2.95 OR 2 FOR \$5.00!

TESTED AND GUARANTEED

Write for free list on all types of telephones. Shipments F.O.B. Simpson, Pa.

TELEPHONE ENGINEERING CO., Dept. 837, Simpson, Pa.

\$10,000 REWARD

If correct use of my new body building course fails to build you a "HE-MAN" BODY The secret is in my revolutionary, exclusive Body Mould system. Yours FREE with famous

DAN LURIE BARBELLS

Scientific! Fastest, surest method known — beats all other training methods. Results guaranteed. Special low prices. 80 lb. set \$9.98 + 100 lb. set \$14.98 150 lb. set \$21.98 + 200 lb. set \$27.98 14c per lb. F.O.B. 50¢ Deposit required

DAN LURIE BARBELL CO.
52M3 Bristol St., Dept. 759C, B'klyn, 12, N. Y.

WAR SURPLUS BARGAINS

WAR SURPLUS BARGAINS

\$500,000.00 INVENTORY for QUICK LIQUIDATION

Surplus items—hundreds of them for home, shop, factory, farm and outdoor use. New items, used items, reconditioned items—all at tremendous savings—all priced for quick sale.

Page After Page of Values

This big catalog shows page after page of amazing money saving values. Write for your copy today. Send 10c to cover postage, mailing, etc. Write today! SEND TODAY FOR YOUR COPY

STARK'S 10c

212 W. Madison St.
Dept. PM-573
CHICAGO 6, ILL.

YOUR MOVE, DAD!



The first frantic months of fatherhood are over. You have time now to really enjoy the new baby—and time to really think ahead.

There's plenty to think about. And lots to plan for. What kind of a Dad will you be? What kind of a provider?

One thing's sure: now you've got to earn more money! About \$500 a year more, to start with. *But how?*

Try doing what some five thousand new fathers did last year. Start preparing yourself for a better job—at home, in your spare time. *Enroll with I.C.S.*

Most of these new fathers already have job promotions, fat pay boosts. One writes, "I've

jumped five years in one." Another reports, "I'm making \$125 more a month."

There's no magic in I.C.S. Just sound, practical, step-by-step training. And a *method* that makes it possible to master any subject as rapidly as your time and ability permit.

You have 257 courses to choose from. Business. Technical. Engineering. All job-related. All keyed to everyday problems. Let us send you a *free sample lesson* together with two valuable books—(1) opportunities in your field and (2) "How to Succeed." No obligation—except the new one you have as a father.

The famous I.C.S. coupon is right here. *And it's your move!*

For Real Job Security—Get an I. C. S. Diploma!

I. C. S., Scranton 9, Penna.

Member, National Home Study Council

INTERNATIONAL CORRESPONDENCE SCHOOLS



BOX 06953C, SCRANTON 9, PENNA.

(Partial list of 257 courses)

Without cost or obligation, send me "HOW TO SUCCEED" and the opportunity booklet about the field BEFORE which I have marked X (plus sample lesson):

- | | | | | |
|--|---|--|---|--|
| <p>ARCHITECTURE and BUILDING CONSTRUCTION</p> <ul style="list-style-type: none"> <input type="checkbox"/> Air Conditioning—Refrig. <input type="checkbox"/> Architecture <input type="checkbox"/> Architectural Interiors <input type="checkbox"/> Building Contractor <input type="checkbox"/> Building Estimator <input type="checkbox"/> Building Maintenance <input type="checkbox"/> Carpentry and Mill Work <input type="checkbox"/> Heating <input type="checkbox"/> Painting Contractor <input type="checkbox"/> Plumbing <input type="checkbox"/> Reading Arch. Blueprints <p>ART</p> <ul style="list-style-type: none"> <input type="checkbox"/> Cartooning <input type="checkbox"/> Commercial Art <input type="checkbox"/> Fashion Illustrating <input type="checkbox"/> Magazine Illustrating <input type="checkbox"/> Show Card and Sign Lettering <input type="checkbox"/> Sketching and Painting <p>AUTOMOTIVE</p> <ul style="list-style-type: none"> <input type="checkbox"/> Auto Body Rebuilding <input type="checkbox"/> Auto Elec. Technician <input type="checkbox"/> Auto-Engine Tune Up <input type="checkbox"/> Automobile Mechanic | <p>AVIATION</p> <ul style="list-style-type: none"> <input type="checkbox"/> Aeronautical Engineering Jr. <input type="checkbox"/> Aircraft & Engine Mechanic <p>BUSINESS</p> <ul style="list-style-type: none"> <input type="checkbox"/> Advertising <input type="checkbox"/> Bookkeeping and Accounting <input type="checkbox"/> Business Administration <input type="checkbox"/> Business Correspondence <input type="checkbox"/> Public Accounting <input type="checkbox"/> Creative Salesmanship <input type="checkbox"/> Federal Tax <input type="checkbox"/> Letter-writing Improvement <input type="checkbox"/> Office Management <input type="checkbox"/> Professional Secretary <input type="checkbox"/> Retail Business Management <input type="checkbox"/> Sales Management <input type="checkbox"/> Stenographic-Secretarial <input type="checkbox"/> Traffic Management <p>CHEMISTRY</p> <ul style="list-style-type: none"> <input type="checkbox"/> Analytical Chemistry <input type="checkbox"/> Chemical Engineering <input type="checkbox"/> Chem. Lab. Technician <input type="checkbox"/> General Chemistry <input type="checkbox"/> Natural Gas Prod. & Trans. <input type="checkbox"/> Petroleum Engineering <input type="checkbox"/> Plastics <input type="checkbox"/> Pulp and Paper Making | <p>CIVIL, STRUCTURAL ENGINEERING</p> <ul style="list-style-type: none"> <input type="checkbox"/> Civil Engineering <input type="checkbox"/> Construction Engineering <input type="checkbox"/> Highway Engineering <input type="checkbox"/> Reading Struct. Blueprints <input type="checkbox"/> Sanitary Engineering <input type="checkbox"/> Structural Engineering <input type="checkbox"/> Surveying and Mapping <p>DRAFTING</p> <ul style="list-style-type: none"> <input type="checkbox"/> Aircraft Drafting <input type="checkbox"/> Architectural Drafting <input type="checkbox"/> Electrical Drafting <input type="checkbox"/> Mechanical Drafting <input type="checkbox"/> Mine Surveying and Mapping <input type="checkbox"/> Plumbing Drawing and Estimating <input type="checkbox"/> Structural Drafting <p>ELECTRICAL</p> <ul style="list-style-type: none"> <input type="checkbox"/> Electrical Engineering <input type="checkbox"/> Electrical Maintenance <input type="checkbox"/> Electrician <input type="checkbox"/> Contracting <input type="checkbox"/> Lineman <p>HIGH SCHOOL</p> <ul style="list-style-type: none"> <input type="checkbox"/> Commercial <input type="checkbox"/> Good English <input type="checkbox"/> High School Subjects <input type="checkbox"/> Mathematics | <p>LEADERSHIP</p> <ul style="list-style-type: none"> <input type="checkbox"/> Foremanship <input type="checkbox"/> Industrial Supervision <input type="checkbox"/> Leadership and Organization <input type="checkbox"/> Personnel-Labor Relations <p>MECHANICAL AND SHOP</p> <ul style="list-style-type: none"> <input type="checkbox"/> Gas—Electric Welding <input type="checkbox"/> Heat Treatment <input type="checkbox"/> Metallurgy <input type="checkbox"/> Industrial Engineering <input type="checkbox"/> Industrial Instrumentation <input type="checkbox"/> Industrial Supervision <input type="checkbox"/> Internal Combustion Engines <input type="checkbox"/> Machine Design-Drafting <input type="checkbox"/> Machine Shop Inspection <input type="checkbox"/> Machine Shop Practice <input type="checkbox"/> Mechanical Engineering <input type="checkbox"/> Quality Control <input type="checkbox"/> Reading Shop Blueprints <input type="checkbox"/> Refrigeration <input type="checkbox"/> Sheet Metal Worker <input type="checkbox"/> Tool Design <input type="checkbox"/> Toolmaking <p>RADIO, TELEVISION</p> <ul style="list-style-type: none"> <input type="checkbox"/> Industrial Electronics <input type="checkbox"/> Practical Radio TV Eng'ng <input type="checkbox"/> Radio and TV Servicing <input type="checkbox"/> Radio Operating | <ul style="list-style-type: none"> <input type="checkbox"/> Television Technician <p>RAILROAD</p> <ul style="list-style-type: none"> <input type="checkbox"/> Air Brake Equipment <input type="checkbox"/> Car Inspector <input type="checkbox"/> Diesel Engineer & Fireman <input type="checkbox"/> Section Foreman <p>STEAM AND DIESEL POWER</p> <ul style="list-style-type: none"> <input type="checkbox"/> Combustion Engineering <input type="checkbox"/> Diesel—Elec. <input type="checkbox"/> Diesel Eng's <input type="checkbox"/> Electric Light and Power <input type="checkbox"/> Stationary Fireman <input type="checkbox"/> Stationary Steam Engineering <p>TEXTILE</p> <ul style="list-style-type: none"> <input type="checkbox"/> Carding and Spinning <input type="checkbox"/> Cotton, Rayon, Woolen Mfg. <input type="checkbox"/> Finishing and Dyeing <input type="checkbox"/> Loom Fix'g <input type="checkbox"/> Textile Des'gng <input type="checkbox"/> Textile Eng'g <input type="checkbox"/> Throwing <input type="checkbox"/> Warping and Weaving <p>MISCELLANEOUS</p> <ul style="list-style-type: none"> <input type="checkbox"/> Domestic Refrigeration <input type="checkbox"/> Marine Engineering <input type="checkbox"/> Ocean Navigation <input type="checkbox"/> Professional Engineering <input type="checkbox"/> Short Story Writing <input type="checkbox"/> Telephony |
|--|---|--|---|--|

Name _____ Age _____ Home Address _____

City _____ Zone _____ State _____ Working Hours _____ A.M. to P.M. _____

Occupation _____

Canadian residents send coupon to International Correspondence Schools, Canadian, Ltd., Montreal, Canada. . . . Special tuition rates to members of the U. S. Armed Forces.

Direct Factory... ...Special Offer



A Tong for "MA"

KOOL-HAND Tongs

- New positive grip with automatic spring action tension.
- Ideal for lifting hot baby bottles, fruit jars, baked potatoes, sweet corn, wieners or hot dishes.
- Handy, attractive, durable chrome with life-long action . . . easy to clean.



A Saw for "PA"

JIFFY-MASTER Hack Saw

- A necessary and handy tool for every home mechanic, plumber or electrician.
- Cuts anything . . . in restricted places where ordinary hack saws will not work.
- Adjustable, complete. High grade blade furnished. Uses any new or broken hack saw blade.

Tong 47c
Saw 97c

POSTPAID \$1.44 plus sales tax where required.

Kindly send check or money order.
Money refunded if not completely satisfied.

DIESEL POWER, Inc. P.O. BOX 72
GREENVILLE, PA.

"I DOUBLED MY INCOME— Am My Own Boss— in CUSTOM UPHOLSTERY"



**Leonard Schroeder, Former Low Paid
Accountant—Increases Earnings 110%**

"I was an accountant earning a meagre salary before UTS training in upholstery. Upon graduating, I got a much bigger paying job as an upholsterer. Now I've better than doubled my income in my own business."

WHAT DO YOU WANT? Your own Profitable Business—A Steady Job—Substantial Sparetime Earnings—A More Secure Future? They're all Waiting for YOU in the Big-Opportunity Field of Custom Furniture Upholstery.

The big nationwide housing boom has created a great demand for trained upholsterers. Prepare for this well-paid trade—easily, quickly. You can earn as you learn to make good money all year 'round at home, in your own shop, or in a well-paid job. The practical N. Y. State-approved UTS Course teaches you professional custom furniture upholstery, reupholstery, slip-covers, furniture finishing, window cornice, cushion, and drapery making. Course includes—FREE—All tools, complete frames and materials. You make 3 beautiful upholstered pieces, yours to keep or sell. **FREE ILLUSTRATED BOOK — FREE SAMPLE LESSON!**

Our FREE book, "YOUR NEW WAY TO A SUCCESSFUL CAREER" with FREE Sample Lesson shows you how. **WRITE TODAY!** Training in N.Y. School also available. Upholstery Trades School, Dept. FC-305, 721 B'way, N. Y. 3.

MAIL COUPON TODAY

APPROVED FOR VETERANS

**UPHOLSTERY TRADES SCHOOL, Dept. FC-305
721 B'way, N. Y. 3**

Please send me FREE book with FREE Sample Lesson. No obligation—no salesman will call.
 Home Study In N.Y. School Training

Name _____ (Please print plainly)

Address _____

City _____ Zone _____ State _____

Check if Korean Veteran

**MATERIALS FREE
WITH COURSE
YOU MAKE**



**SLIPPER
CHAIR**



**CLUB
CHAIR**



OTTOMAN

**PLUS SLIP COVERS
Yours to keep
or sell**



CONTRACTORS NEED MEN!

trained to operate Bulldozers, Draglines, Back Hoes, Scrapers and Motor Graders and pay high wages to skilled operators! YOU can make big pay in the construction industry if you learn these skills NOW!

Contractors WANT our graduates.

Write TODAY for FREE School Catalog to

NATIONAL SCHOOL OF HEAVY EQUIPMENT OPERATION
P. O. Box 8243, Dept. D-13 Charlotte, N. C.

WHEELS WHEELS WHEELS

7" Disc Wheel 3/4" Tire 3/4" sleeve 45c ea.
8" Disc Wheel 1 1/8" Tire 1/2" sleeve 70c ea.
7" Disc Wheel 1" Tire 1/2" ball bearing 80c ea.
8" Disc Wheel 1 1/4" Tire 1/2" ball bearing \$1.00 ea.
6" Disc Wheel 1.50 semi-pneum. Tire 1/2" B.B. \$1.35 ea.
8" Disc Wheel 2" semi-pneum. T. 1/2" B.B. \$1.50 ea.
10" Disc Wheel 1.75 semi-pneum. T. 1/2" B.B. \$1.50 ea.
10" Disc Wheel 2.75 semi-pneum. Tire 3/4" B.B. \$3.50 ea.
12" Disc Wheel 1.75 semi-pneum. T. 1/2" B.B. \$1.85 ea.
Above wheel prices includes hub caps, excepting 10 x 2 1/2".
Postage extra. C.O.D.'s accepted. Axles extra. Sizes, 5/16", 3/8", 1/2" dia. Cut to size per inch long. End holes drilled.

UNITED WHEEL STAMPING CO.

11915 S. MARSHFIELD AVE., PM-3, CHICAGO 43, ILLINOIS

Finish HIGH SCHOOL AT HOME

Complete 4 Yrs. in 12 Months

Learn More! Earn More! Enter professional or technical schools. Advance Socially. Live a Happier, Fuller Life. Individual Courses or complete schedule. **WRITE FOR SCHOOL BULLETIN.**

ACADEMY FOR ADULTS

30 W. Washington, Dept. PM-37, Chicago, Ill.



Exclusive Double-Bearing HEAVY-DUTY PUMPS

IRRIGATE • DRAIN • CIRCULATE • SPRAY
Up to 7,500 GPM. 3,000 GPM from 25' well. Use 1/2 to 1 HP motor. 1 1/4" inlet; 1" outlet. Stainless shaft.

TYPE X-2 oilless bronze bearings. **\$10.95**
Won't rust.

TYPE XB—Ball bearing model. **\$12.95**
Postpaid if cash with order. Rush your order today

MONEY BACK GUARANTEE

Centrifugal and Gear Pumps in All Sizes

LABAWCO PUMPS, Belle Mead 2, N. J.

SOLVED: MYSTERIES



The S-M is not an ordinary slide rule. Made by Acu-Bale Mfg. Co., this 30" all plastic slide rule is so simplified that a grade schooler can use it, and yet so accurate, engineers sanction it. Solve such problems as 93.75 x 1.28 or 20,196 + 204—in a matter of seconds—without paper and pencil. \$2.00 postpaid, including instructions. Money back guarantee. Sorry no COD's.

C. V. ORE DEPT. J BOX 305 HARVEY, ILL.

Enjoy the Fascinating Story
of the Horseless Carriage in



Popular Mechanics

AUTO ALBUM

166
Illustrations

The most intriguing book about the automobile ever printed. It's thrilling, fascinating and informative. From the very first gasoline-propelled buggy to the cars of today and the atomic auto of the future. The first cars—the men who made them—the scrambled start and the development of the fabulous auto industry—the story of auto racing—the growth of the Nation's highways. 166 thrilling action pictures—old-time cars—racing cars—early auto advertising—automotive oddities. Roll call of names of more than 2000 auto models in the U.S. included. Ideal gift book. Cloth bound, only \$3.00 by mail. Money back if not pleased.

**POPULAR MECHANICS PRESS, Dept. PM-357
200 East Ontario Street Chicago 11, Illinois**

Train in Great Shops of COYNE for better jobs in

ELECTRICITY - TELEVISION

ELECTRONICS

RADIO - COLOR TV



TWO TOP OPPORTUNITY FIELDS

Whether 17 or up to 45 years of age, train the Coyne way for a better job and a real future in **ELECTRICITY-ELECTRONICS** or **TELEVISION-RADIO**, fields that offer a world of opportunities. Train on real, full-size equipment at COYNE where thousands of successful men have trained for nearly 60 years—largest, oldest, best equipped school of its kind—established 1899. No advanced education or previous experience needed. Employment service to graduates. **START NOW—PAY LATER**—Liberal Finance Plans and Easy Payment Plans. Also part-time employment help for students. Training in Refrigeration and Electric Appliances can be included.

B. W. COOKE Jr., President

COYNE
ELECTRICAL SCHOOL

FOUNDED 1899

A Technical Trade Institute Operated Not For Profit
500 S. Paulina Street, Chicago, Dept. 37-72H
ELECTRICITY • RADIO • TELEVISION • REFRIGERATION • ELECTRONICS

MAIL COUPON FOR FREE BOOK

Send coupon for 48-page illustrated book "Guide to Careers in Electricity-Electronics and Television-Radio." No cost; no obligation; no salesman will call. Vets and Non-Vets get vital facts now!



B. W. COOKE Jr., President
COYNE ELECTRICAL SCHOOL
500 S. Paulina St., Chicago 12, Ill., Dept. 37-72H

Send BIG FREE book and details of your training offer. This does not obligate me and no salesman will call. I am interested in:

() Electricity-Electronics () Television-Radio

Name _____

Address _____

City _____

State _____

YOU BUILD 'EM — WE SELL 'EM EARN UP TO \$50.00 A DAY AT HOME

Participate in our national sales and sub-contract plan—spare time—full time. You assemble special luggage and cases for photographers, musicians, salesmen, and all types of portables. We supply complete instructions—materials—tools—everything. No previous experience necessary. Free details: Abarsi Cascraft, Dept. AC, 807 W. Sunset Blvd., Los Angeles 12, Calif.

Secrets of VENTRILOQUISM Now Revealed!



Easy to learn in 60 to 90 days with our Home Study Course. **RESULTS GUARANTEED.** Make Money! Be Popular! Have Fun! Big Opportunity! Radio, Television, Stage Appearances! For FREE information regarding price and terms WRITE: You must state your age. Dummy Catalog 256. **FRED MAHER SCHOOL OF VENTRILOQUISM** Box 36, Studio PM-3, Kensington Station Detroit 24, Michigan

LEARN MEAT CUTTING AT NATIONAL Pay After Graduation



The steady dependable trade of Meat Cutting taught easily in 8 short weeks. **YOU LEARN BY DOING** under actual meat market conditions in big modern school at Toledo.

For beginners or men with experience. Get a profitable store of your own. Remember, **PEOPLE MUST EAT!** Big pay jobs. Free employment help. Thousands of successful graduates.

Buying, cutting, percentage, pricing, advertising, selling, etc. A complete retail meat education. National School established 35 years. Get National training **NOW.** Pay your tuition in easy weekly payments

after you graduate. Send coupon for **FREE** 52 page school catalog — **TODAY.** G.I. approved.

National School of Meat Cutting, Inc., Dept. 50-P, Toledo 4, Ohio

Send me your **FREE** school catalog on National Training at Toledo in Meat Cutting, Meat Merchandising and Self Service Meats. No obligation. No salesman will call.

Name _____

Age _____

Address _____

City _____

State _____

Approved for training Korean Veterans



TO THE MAN LOOKING FOR A
SECURE FUTURE
Learn **OIL
BURNER
SERVICING**

AT HOME IN
YOUR SPARE TIME

Enjoy real security . . .

earn top wages . . . get ahead faster.
Learn a trade where Trained Men are always in demand.
High starting salary, plus hundreds of opportunities for
advancement in the fast-growing Oil Burner industry,
which U. S. Government predicts will double in size
in next few years. We teach you Installation, Opera-
tion, Maintenance and Servicing. Complete course. Re-
member, Trained Men command best jobs — highest
wages. Our Oil Burner graduates are 100% employed.

LEARN AND EARN IN YOUR SPARE TIME

Put your spare time to work. Learn a specialized trade.
No previous experience or special education necessary.
Act today! Cash in tomorrow! Earn while you learn,
doing repair jobs in your own area. Low tuition, only
\$5 starts you! Tools furnished. Send coupon now! No
obligation.

Mass Trades has trained thousands for success
since 1938.

RESIDENT SCHOOL — APPROVED FOR VETERANS

WRITE NOW FOR FREE SAMPLE LESSON AND BOOKLET

MASS. TRADES

161 High Street, Boston 10, Mass.

Please send me FREE sample lesson and booklet

NAME _____ AGE _____

ADDRESS _____

CITY _____ ZONE _____ STATE _____

looking for the shortest route?

SET SCALE
by turning
teeth on end



READ EXACT
MILEAGE
shown by
pointer thru
magnified
window

MEASURE
MILEAGE by
rolling
wheel along
map route

... find it in a moment with

MILE-O-GRAPH

measures mileage ... without arithmetic



Find the fastest,
shortest route your-
self, on any scaled
map, with this amaz-
ing, patented mile-
age measurer. Easy
as 1-2-3—no figuring.

Precision MILE-O-GRAPH adjusts to any
map scale, fits into pocket or purse.
Saves time, tires, temper. A welcome
gift, perfect for motorists. MILE-O-GRAPH
also adaptable for measuring air and
sea charts and blueprints.

SETS TO ANY SCALE ON ANY SCALED MAP

ONLY \$2 EACH OR 3 FOR \$5 gift
boxed
MONEY-BACK GUARANTEE.
we pay postage on prepaid orders

MILE-O-GRAPH, INC., Dept. PM-3, 117 Liberty St., N.Y. 6

Please send . . . Mile-O-Graphs at \$2 each or 3 for \$5.

Enclose find \$..... or send C.O.D. I will pay postman.

NAME _____

ADDRESS _____

CITY & STATE _____

Auto Industry Leaders Praise

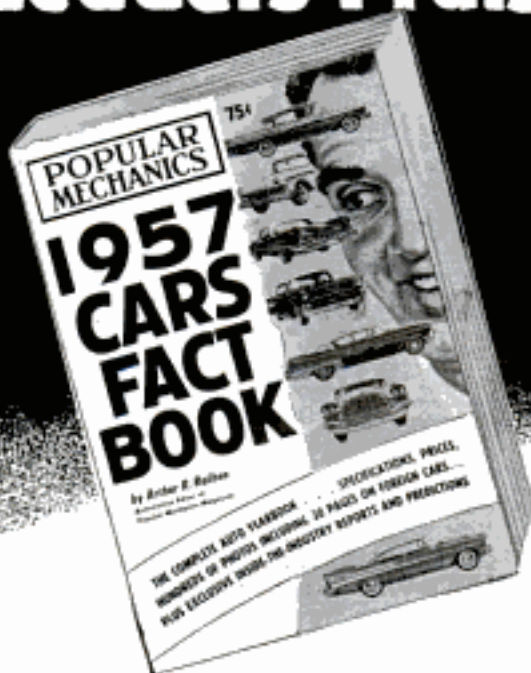

Here's what they say:

Volkswagen of America, Inc. —

“May we congratulate you on the concise way you have described the 1957 models. In so many publications today it is sometimes difficult to get to the real facts. Since you have succeeded where others have failed, we know that the book will be enthusiastically received.”

American Motors Corp., John R. Pichurski,
Press Relations Mgr., Automotive Divisions —

“I just received your ‘1957 Cars Fact Book’ and must agree it is one of the finest pieces of reference material that has come across my desk this year.”

Only 75¢

**GET IT AT YOUR
NEWSSTAND TODAY!**

POPULAR MECHANICS

Copyrighted material

Catalog of 3100 Novelties 10c



Send 10c for amazing catalog of novelties, live animals, scientific supplies, hobbies, funmakers, planes & boats, looms, magic tricks, joke articles, unusual seeds, gadget timesavers, cameras, optical goods, projectors, movies, lucky jewelry, religious novelties, disguises, musical instruments, stamps, coins, puzzles, fortune tellers, radios, auto & bike accessories, telescopes, magnifiers, compasses, banks, smokers' gadgets, artists' supplies, printing sets, engines, motors, shockers, knives, billfolds, guns, rifles, sports, books, games, plants, etc. Send 10c (3 for 25c—get for friends!).
JOHNSON SMITH & CO. Dept. 546 Detroit 7, Michigan

POWERFUL ELECTRIC GENERATOR

Cost Over \$20.00 New; While They Last, \$3.95
Generates Up to 75 Volts. Use to generate electricity, to ring bells, light up lights, as a medical battery, deliver terrific electric shock as joke, many electrical experiments, classroom uses, etc. Cost over \$20 new. Used but excellent operating condition. Hand crank or gear wheel drive. Made by leading electrical companies. Each has 3 or 4 five-inch 1-lb. bar magnets (alone worth more than total cost), generating armature, wire leads, gear crank, ready for use. Originally used in crank phones. Complete unit weighs over 5 lbs. Postpaid \$3.95.
JOHNSON SMITH COMPANY, Dept. 546, Detroit 7, Mich.



LEARN TO MOUNT BIRDS

ANIMALS, FISH, PETS

Be a Taxidermist. Save your hunting TROPHIES. Have a fine home-museum. Hunters, save and MOUNT your beautiful DUCKS, QUAIL, DEER, TAN skins. FURS. Great Fun. Spare-time PROFITS. Tells ALL about it. 100 fine wild-game pictures, 48 pages. SEND **FREE BOOK** TODAY, don't delay. Get this **WONDERFUL FREE BOOK, MEN AND BOYS.** Learn Taxidermy. Double your hunting pleasure. Rush letter or **POSTAL** today. **STATE YOUR AGE, N. W. SCHOOL OF TAXIDERMISTRY, Dept. 2503, Omaha, Neb.**



NEW! BUILD MUSCLES & HEALTH with **BODY BUILDER**
Only \$1.00 Postpaid
This new Chest Pull Body Builder develops powerful he-man muscles F-A-S-T. Ideal for the beginner to give him a real start in championship muscularity and perfect for the more advanced bodybuilder to combine with his regular training for faster, all around muscle growth. Body Builder is wonderful for developing massive arms, shoulders, chest and back. Mail your order today. Only \$1.00 postpaid. No C.O.D.
MEDFORD PRODUCTS, Inc.
Dept. PM3, P.O. Box 39, Bethpage, New York



WHOLESALE CATALOG!

30-80% Discounts! Appliances, Musical Instruments, Typewriters, Tools, Watches, Jewelry, Cameras, Housewares, etc.

CONSOLIDATED DISTRIBUTORS

1300-03 MAIN CLIFTON, NEW JERSEY

SAVE 1/2 - 3/5 THE PRICE OF FACTORY-BUILT BOATS

BOAT KIT CATALOG Free!

Write:

Runabouts, cruisers, convertibles, fishing; 43 models, 8 through 18 ft. Freight paid, \$39.25 up. Assembled and finished by experienced owners. Luger boats equal factory-built in speed, handling, style, beauty; yet save you 1/2 to 3/5. Owners say: "Fastest boat on river." "Pleasure to assemble." "Everyone admires my Luger." Thousands in use. Send for big, free boat kit catalog; also lists fiberglass, hardware, accessories, trailers, paint. Write for catalog today.



LUGER INDUSTRIES, INC. DEPT. B-3 3404 Lyndale S. Minneapolis 8, Minn.

Still dreaming about a good job and more pay?



WAKE UP TO YOUR OPPORTUNITIES IN

Auto Mechanics

PRACTICAL NEW WAY TO TRAIN AT HOME

Don't rely on *luck* to make your dreams come true! Be practical and depend on *training*. As a skilled man, you can step into a good, top-pay job—enjoy security—and even open a shop.

Your best bet is to become an auto mechanic. *That's the big opportunity field today.* Over 60 million cars and trucks are on the road, and all require maintenance. At least one-third are in the heavy-repair class. There's so much work that 50,000 mechanics are needed! It's easy to learn this trade at home. Find out *how* by mailing coupon below.

EARN MONEY IN SPARE TIME as you train. Many students repair cars for neighbors; others get jobs in local garages; some open shops by the time they graduate. You can learn-and-earn because CTI offers practical *Shop-System* training.

DIESEL MECHANICS OR BODY-FENDER REBUILDING is included at no extra cost. Only CTI offers this extra choice. Get this fully-rounded mechanic's training. *Send coupon for two free books.*



YOU PRACTICE WITH THIS TUNE-UP KIT

Kit includes a Compression Tester, a Vacuum Gauge and Fuel Pump Tester, an Ignition Timing Light, and a portable steel case. These professional instruments help you locate engine troubles, let you get useful practice. You keep this kit!

MECHANIC'S TOOLS TOO
You'll use these tools to get real experience. They'll increase your interest, stamp you as a "pro." You'll earn spare time cash with them. No extra cost for tools—you keep them.

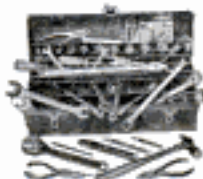

MAIL COUPON TODAY!

MAIL TODAY FOR 2 FREE BOOKS

COMMERCIAL TRADES INSTITUTE
1400 Greenleaf Ave., Chicago 26
Dept. A-489

Send your new Auto Mechanics book and Sample Lesson. BOTH FREE.

Name _____ Age _____

Address _____

City _____ Zone _____ State _____



YOUR
NEIGHBORHOOD
NEEDS AN
**ELECTRICAL
APPLIANCE**

TROUBLE SHOOTER



Men needed to repair and service all kinds of Electrical Appliances—AUTOMATIC WASHERS - DRYERS - IRONS - VACUUMS - FANS - HOME REFRIGERATORS - FREEZERS - AIR CONDITIONERS —home and industrial motors, etc., also home and industrial wiring.

Big, Year-'Round Profits!
HELP US FILL HUGE DEMAND

MODERN BIG PROFIT ONE-MAN BUSINESS
YOURS AT HOME — SPARE OR FULL TIME.

No previous experience needed. New, visual "Shop-Practice" method quickly shows you how. Hundreds of plain-as-day "How to" photos and drawings make it easy. A corner of garage, porch, attic, or basement is all the space needed. No costly leases—no big overhead. We show you how to make business come to you.

BIG MONEY, SECURE FUTURE—INDEPENDENCE.
F. V. in N. Y. says, "I made \$800 in 3 months while studying." T. E. H. in W. Va. says, "Made \$14 a day while learning."

EVERYTHING FURNISHED—Including BIG TOOL KIT
Instructions are complete and include a Tool Kit and Appliance Tester. Everything furnished to help you build your own big-profit business at home. Our new 30-day income plan shows you how to start making money almost at once. Send no money—just your name and address on coupon below. I will rush you FREE complete success plan with full details. Do it NOW—BE FIRST!

PACIFIC TRAINING SCHOOL, Dept. P-573
11029 So. Vermont Ave., Los Angeles 44, Calif.

PACIFIC TRAINING SCHOOL, Dept. P-573
11029 So. Vermont Ave., Los Angeles 44, Calif.

Gentlemen: Rush me postpaid your FREE plan for success in the Appliance Repair Business and the Free Book Entitled "The Appliance Repair Business and You" and remember I am under no obligation.

Name _____
Address _____
City _____ Zone _____ State _____

You buy better when you buy brands
advertised in POPULAR MECHANICS



KEEP YOUR... EYE ON BENJAMIN
for HIGH H.P. COMP
AIR GUNS & CO.; GAS GUNS—Top Quality at LOWEST PRICES!

BB BB or 177 or 22
BENJAMIN SUPER
CO₂ Gas Carbine
with Reg. Stock as low as **\$14.95**
Deluxe Model with Custom Stock (Shown) as Low as \$17.95

Benjamin Air Rifles and Benjamin Air Pistols are Recognized All Over the World for Finest Workmanship and Highest Quality at Lowest Prices. Adjustable Power with Amazing Optimum Force. Fully Guaranteed—Safe—Accurate—Economical. Easy to Use anywhere—12 Models for Target and Small Game BB or 177 or 22. All Models Benjamin CO₂ Carbine Gas Rifles and Benjamin CO₂ Rocket Gas Pistols Use Standard Size CO₂ Cartridges (available everywhere). 2-Stage BB-10 Jer Power—High for Small Game—Low for Target—Up to 50 Shots from each Cartridge. No Pumping—Safe—Accurate—Economical—Non Toxic—12 Models BB or 177 or 22.

FREE! Catalog All Models Benjamin Air Guns & CO₂ Guns & Supplies. Also, Money-Saving Offer on Hunting & Fishing Accessories.
Send Free Gun Catalog and Special Offer!
BENJAMIN AIR RIFLE CO., MAIL TODAY!
896 MARION ST., ST. LOUIS 4, MO., U.S.A.
Name _____
Address _____
City _____ State _____



Colorcretors are Needed Everywhere

C-9



More Colorcretors are needed to supply growing demand for the enduring, colorful beauty possible only from Colorcrete. Time-worn concrete, stucco and other old or new masonry walls are quickly transformed into clean freshness from a selection of 30 tints, tones and shades. Cementitious base—tough, tenacious, enduring. Colorcrete is applied under pneumatic air pressure by authorized Colorcretors. Machine is easy to operate and readily mobile. Opens up opportunities for men of modest capital. Broad markets with high income potentials. Write for Opportunity Book.

COLORCRETE

COLORCRETE INDUSTRIES, INC.
570 Ottawa Ave., Holland, Mich.

CANADA: 1020 Dundas Highway, Cooksville, Ont.

Build a Boat for Fun or Profit

Popular Mechanics

23 BOATS
You Can Build



Complete Patterns and Working Drawings

Build the boat you have always wanted. Build it for fun or to sell at a profit. Get Popular Mechanics 23 BOATS YOU CAN BUILD—row boats, canoes, sail boats, power boats and other craft including a 25 ft. cabin cruiser that sleeps four; 11 1/2 ft. car-top row boat; 8 ft. duck boat; 15 ft. sniling knockabout—in all, 23 of the most popular boats. Book includes more than 500 photos, plans, diagrams and working drawings, plus step by step instruction that anyone can follow. Only simple tools needed. Material list of lumber, hardware, fittings, etc. included. Order today, under money-back guarantee. Only \$2.75 postpaid.

Row Boats, Canoes
Sail Boats, Power
Boats and Others



POPULAR MECHANICS PRESS, Dept. 357, 200 E. Ontario St., Chicago 11

**Men: Get Into
AUTO MECHANICS & DIESEL**

Good jobs, high pay, security are yours as a qualified Auto-Diesel mechanic. Train NOW in the big famous Shops at National Schools in Los Angeles. Over 50 years experience, since 1905, in successfully training ambitious men. Here you work on ALL ENGINES. You master fuel injection, motor tune-up; general mechanics, automatic transmissions, all power equipment, in shortest possible time. Most complete, up-to-date equipment offered by any school. Expert, friendly instructors and engineers. Help in finding home near school. Part time job while in training. Mail coupon NOW, TODAY, for all the facts.

NATIONAL SCHOOLS

National Schools Dept. DXB-37
4000 So. Figueroa Los Angeles 37, Calif.
Send Free Auto-Diesel Opportunity Book Today.
Name _____ Age _____
Address _____
City _____ State _____

NOW IT'S
EASY
TO LEARN

DRAFTING

AT HOME - QUICKLY - IN YOUR SPARE TIME

HERE'S YOUR CHANCE! No matter where you live . . . no matter what your present job is, you too can soon be cashing big pay checks and enjoying an assured future in drafting! Never before has there been such a demand for trained draftsmen . . . the key men in all industry. No profession has a brighter future! Draftsmen get top pay . . . are in line for promotion to executive positions.

NO EXPERIENCE NEEDED! Cleveland Engineering Institute Courses are the most modern, practical, thorough, drafting courses available. They are fully illustrated; prepared especially for Home Study. If you can read this ad, you can learn drafting under C.E.I.'s guidance. Ours is a tested, proven, up-to-date course that has helped thousands of others on the road to success (many with only grammar school training).

EARN WHILE YOU LEARN! Keep your present job while learning drafting at home in your spare time at the speed that is best for YOU. Many students, as they advance, earn extra money by doing part-time drafting. Many graduates earn more in a single

CLEVELAND ENGINEERING INSTITUTE

After completing the C.E.I. course I became foreman . . . salary increased 50%.
Wm. Reichers

First job after taking C.E.I. course increased my salary from \$350 to \$820 per month.
G. T. Wiseman

Thanks to C.E.I. I was promoted ahead of 4 other men with a good pay increase.
W. K. Andersen

The drafting job I got with C.E.I.'s assistance has given me a real start.
R. Eisenbart

week, as draftsmen, than the entire cost of the course.

FREE! After you graduate, 50 hours of extra training at the Institute in Cleveland. This post-graduate training is optional.

WE HELP YOU GET THAT JOB! After you have graduated, C.E.I. will help you find a position. Our Job-Finding-Service is the only one of its kind offered by a Home Study School.



PROFESSIONAL EQUIPMENT included at no extra cost!
VETERAN APPROVED

WHAT CAN DRAFTING OFFER YOU? Find out how a C.E.I. DIPLOMA can bring you a better life — more security — the respect of your employer and people in your community. Without obligating yourself in any way, write for the Cleveland Engineering Institute Success Book and a Sample Lesson FREE. Industry needs men of action! This means YOU.

MAIL THE COUPON RIGHT NOW

CLEVELAND ENGINEERING INST., Dept. PM-3G
6300 Euclid Ave. Cleveland 3, Ohio
FREE Success Book & Sample Lesson.

Write today! Aeronautical Mechanical

My Name

Address

City.....Zone....State.....

Free! ISRAEL Stamp Collection

Usually selling for \$1.00 and more, this packet of 25 ALL DIFFERENT ISRAEL stamps is yours FREE! Your chance to own a good basic collection including the various ancient HEBREW COIN SETS, 12 TRIBES ISSUE, HIGH HOLY DAYS, RUNNING STAG ISSUE, AIRPOST, and CHILDREN'S ISSUE. EXTRA: 48 PAGE STAMP DICTIONARY & GUIDE included Free. Send 10 cents to help cover mailing costs.

STAMPEX CO., Box 47-MM, White Plains, New York



Whatever the job, you'll do it better with nationally advertised products. Ask for products advertised in POPULAR MECHANICS

PM TAG of INTEGRITY

Get into.. PLASTIC LAMINATING AT HOME!



Get ORDERS and CASH from your mailman—do work in SPARE TIME at home—or expand into FULL TIME business. Send coupon for Free facts about the newest and most fascinating of all home operated businesses. For the first time a simplified machine brings the fabulous profits of Plastic Sealing and Plastic Laminating within the reach of the small operator. Anyone can learn to operate the machine with a few minutes practice—then with our Magic Mail Plan can get mail orders pouring in daily with cash in every envelope. No canvassing—no selling. We even

Make \$20 to \$30 a Day by..
MAGIC MAIL PLAN!

supply the circulars you mail to bring back cash and orders. Don't waste a minute. Rush your name. We'll send you FREE and postpaid, pictures, prices, details, and all the facts you need to start. Mail coupon or send name on postcard. No charge. Warner Electric Co., 1512 Jarvis Av., Dept. L-10-C, Chicago 26, Ill.

Make Thousands of Beautiful Art Creations

COSTUME JEWELRY • CIGARETTE BOXES
TRAYS • CANDLESTICKS • COASTERS
LAMP BASES • BOOK ENDS...ALL IN
SPARKLING COLORED PLASTIC



THIS MAN . . . is taking out of the machine a Plastic Sealing Job—ordered by mail—only 11c in material cost brings back \$2.58 in cash by mail. Capacity of machine: \$25.00 profit per hour of operation.

WARNER ELECTRIC CO., 1512 Jarvis Av. Dept. L-10-C, Chicago 26, Ill.

At no cost to me, please rush complete details postage prepaid. I am under no obligation.

Name.....

Address.....

City.....Zone....State.....



CRAFTSMEN, HOBBYISTS, INVENTORS
 THE MOST IMPORTANT TOOL YOU CAN OWN IS THE WORLD FAMOUS
UNIMAT 10 IN 1 COMPLETE WORKSHOP

CHECK THESE FEATURES:

- **UNIMAT** is a precision electric tool that will enable you to machine an endless variety of small parts from steel, brass, wood, aluminum, plastics, etc.
- **UNIMAT** is portable and compact . . . takes up no more room than a typewriter.
- **UNIMAT** is simple to operate and converts quickly into 10 different tools . . . all operations are off one base.
- **UNIMAT** basic unit now at new low price of \$99.50. Available on budget plan at no extra cost.
- **UNIMAT** can be tried at home for 10 days with a money back guarantee if you're not completely satisfied.

MAIL COUPON FOR FREE CATALOG

Find out exactly what this amazing machine can do for you.

AMERICAN EDELSTAAL-UNIMAT DIVISION
 Dept. 337, 350 B'way., N. Y. 13, N. Y.

NAME _____

ADDRESS _____

CITY _____

STATE _____

MANUFACTURE THIS BEAUTIFUL CONCRETE OUTDOOR FIREPLACE

Right In Your Own Backyard

\$4.00 Worth of Sand & Cement produces this Attractive Fireplace.



Sells on Sight from \$60. to \$80. Easy to start your own Profitable Business.

The General Fireplace Molds and Process are the most amazing and foolproof ever invented. Simple to operate. Two men can produce five fireplaces a day.

BIG DEMAND!!

Sell all you produce to Department Stores, Homeowners, Parks, Nurseries and Picnic Groves. Fireplaces sell on sight. No experience necessary. We supply full operating instructions and equipment plus the know-how that spells **BIG PROFITS**. This is an outstanding opportunity for men of vision and small capital to get into a busy rich paying field. Don't delay, be the only exclusive manufacturer in your own home town. Mail coupon at once for full details as to how you can reserve your territory. Molds sold only on exclusive franchise.

GENERAL ENGINES CO., Inc., Dept. MF-37
 ROUTE 130, THOROFARE, N. J.

Mr. Tar of Philadelphia writes: Sold 250 in first 4 months. Selling to Sears Roebuck, John Wanamaker, and Gimbel Bros. in Philadelphia area.

Name _____
 Address _____
 City _____ Zone _____
 State _____

TROPICAL FISH
 Sell for up to \$75 A PAIR

BREED EASY-TO-SELL TROPICALS AT HOME—IN FULL OR SPARE TIME

Imagine—up to \$75 per pair paid for beautiful, exotic fish. Big demand constantly from hobbyists, stores, business offices, interior decorators, others. Earn up to \$7.50 an hour in interesting, easy, home business.

NO BIG INVESTMENT—NO COMPETITION

We supply complete instruction plus everything to get you started. Operate in living room, garage, anywhere; full or part time. No "big business" competition to worry about.

Rush name, address for free illustrated booklet, business plan, premium offer. Limited supply—act now!

FREE! VIEW-PROJECTOR & FULL COLOR SLIDE—WORTH \$4.95

TROPICAL FISH BREEDERS OF AMERICA
 Dept. D-3, 1512 S. BROADWAY
 LOS ANGELES 41, CALIFORNIA

BOTH FREE! Write!

This FREE Lesson Proves You Can Learn TV Repair in one short week!

AMAZING NEW TECHNIQUE! Make \$5 to \$10 per job without special tools or studying!

Now! Cash in on the profitable, multi-million \$888 T.V. servicing business. Start right out making \$5 to \$10 per job evenings, spare time. Big, full-time income. No studying, no experience or big expense required. Our new **SIMPLIFIED T.V. REPAIR METHOD** strips all the hokus-pokus away. Reveals how over 90% of T.V. trouble is simply caused by worn out tubes. Clear, accurate diagrams describe all possible symptoms, **LOCATES TROUBLE FOR YOU!** Tells exactly what to do on each set!! **AMAZING, but it's true!** For proof send for **FREE Troubleshooter Sample and Business Plan, Now! ALL FREE!** No salesman will call.

ELECTRONIC ENGINEERING
 Dept. A23 1038 S. La Brea Los Angeles 19, California

RUPTURED? NEW, LASTING RELIEF! (PATENTED)

FREE! Helpful new facts sent in plain wrapper. Send your name and address today.

Enjoy new freedom of action, new peace of mind, new pleasures—in place of rupture pain. Proven, new patented **MILLER** gives relief day & night, at work or play. **ENTIRELY DIFFERENT!**

FRED B. MILLER, Manufacturer
 DEPT. 1-C, Hagerstown, Maryland

WORK FOR THE GOVERNMENT

RAILWAY POSTAL CLERKS **CLERKS** **CITY CARRIERS**

START AS HIGH AS \$3,880.00 YEAR
 Prepare now for next exams. Other positions start high as \$4,080.00.
 Men—Women, 18-55
 Mail Coupon.

FRANKLIN INSTITUTE, Dept. E-93, Rochester 4, N. Y.
 (Not Government Controlled) First Rush FREE:
 (1) 36-page book with list of many U. S. Gov't. Jobs. (2) Tell me how to prepare for these tests.
 Name _____ Age _____
 Address _____

TELEPHONES, TELEPHONE PARTS and WIRE & CONSTRUCTION SUPPLIES



BATTERY OPERATED TELEPHONES

for Inter-House, House to Barn or Office to Shipping Room telephone service. Handset style or Desk Stand style.

MAGNETO TELEPHONES

for Rural telephone lines, construction jobs, factories, farms, camps or summer homes, etc.

MOTEL TELEPHONE SYSTEM — Simple economical telephone service between office and each cabin. Suitable for roadside Drive-In food service, etc.

ANTIQUE TELEPHONE CABINETS — complete with all parts except generator. Ideal for Home Hobby Shops. Make beautiful Radios, Spice Cabinets, Liquor Chests and Flower Boxes.

TELEPHONE LAMPS. Make your own. Beautiful. Different. Lamp, if you prefer.

WORM HARVESTER — Dan Mac Magneto — gathers fish-worms by electricity.

WRITE FOR ILLUSTRATED BULLETIN "AA-11"
which gives full facts on all of the above.

TELEPHONE REPAIR & SUPPLY CO.
DEPT. AA-11 1760 LUNT AVE., CHICAGO 26, ILL.
"America's Largest Independent Telephone Repair Shop"

**ENGINEERING
DEGREE IN
27 MONTHS**

B. S. Degree. Aero., Chem., Civil, Elec., Mech., & Electronic Eng. (inc. Radio & TV). B.S. degree in 36 mo. in Math., Chem., Physics. Prep. courses. Low rate. Earn board. Large industrial center. Students from 48 states, 21 countries. Demand for grads. U.I. appor. Enter March, June, Sept., Dec. Catalog. 1637 E. Washington Boulevard Fort Wayne 2, Indiana.

INDIANA TECHNICAL COLLEGE

ONLY \$399
Freight included
FREE FOLDERS

NEW 18 ft. OFFSHORE CRUISER KIT

17 Models as low as \$42.00 (freight included). Fiberglass boat covering kits, marine supplies, etc.

Top and side curtains available!

TAFT MARINE WOODCRAFT
Dept. PM-357 • 636 29th Ave. N.E. • Minneapolis 21, Minn.

FREE!

1. URANIUM TESTER! 2. CHEMICAL PUZZLE!
3. POLAROID ANALYSER KIT!

An amazing URANIUM TESTER, a fascinating CHEMICAL PUZZLE (worth \$2.50 if you can solve it) and a valuable POLAROID ANALYSER KIT, all FREE with our great new catalog of OPPORTUNITIES IN CHEMISTRY! Learn BAKING, How To Make Precious SYNTHETIC GEMS, PRACTICAL CHEMISTRY, HORTICULTURE (Flowers), TAXIDERMY, ADHESIVES, MOLDABLE & CASTING COMPOSITIONS, PLASTICS, ELECTRO-PLATING, COSMETICS, PERFUMES, MINERALOGY, CHEMICAL PRINTING, CRIME LAB., How to Convert WATER into GAS! Complete courses and instructions from \$2.00 and up! Easy payment plan. Send 25c today for CATALOG, details, Uranium Tester, Chemical Puzzle and Analyser Kit! NATIONAL SCHOOL OF CHEMISTRY, P.O. BOX 606-P, Redwood City, Calif.

I SHOW YOU HOW TO

MAKE MONEY AT ONCE

START YOUR OWN BUSINESS

IN 2 WEEKS—
AT HOME
IN SPARE TIME

**PLATE
Baby Shoes
IN
BRONZE
AND
COLORED
PEARL**

MILLIONS OF
NEW PROSPECTS
EVERY YEAR



Now is the time to cash in on this ever growing, big profit field. No previous experience needed. Baby Shoe metalizing (bronzing, some call it) is EASY to do and HIGHLY PROFITABLE. Materials cost you 50c—you get \$6. You can metalize Baby Shoes in a corner of your basement, attic, or service porch—even in your kitchen—NO BIG OVER-HEAD. Our plan shows you how to START AT ONCE spare time without quitting your present job—have two paychecks instead of one. No investment in equipment necessary. A few hours pleasant occupation can bring you more money than many make working a full week. Big profit orders come from friends, neighbors, gift shops, dept. stores. No face to face selling—you can operate by MAIL ORDER. Send for our FREE Booklet and complete money making plan. No salesman will call. MAIL COUPON below TODAY sure.

IMMEDIATE RESULTS

- Big Income
- Huge Demand
- Sales Plan
- Future Security
- Your Own Business

We will send you full details absolutely free.

KIKTAVI COMPANY, Dept. PM-573
11029 S. Vermont, Los Angeles 44, Calif.

FREE!
MONEY MAKING PLAN
Full Details Without Obligation
MAIL COUPON TODAY!

KIKTAVI COMPANY, Dept. PM-573
11029 S. Vermont, Los Angeles 44, Calif.

Send me FREE Booklet and plan for making money in the Baby Shoe metalizing business. Remember I am under no obligation.

NAME _____

STREET _____

CITY _____ ZONE _____ STATE _____

New PROFIT-PROVEN* Home-Business!

"I make \$400⁰⁰
a week!"



*Proves MR. J. T. ANDERSON, Inglewood, Calif.
(Notarized statement on file in our office and open to inspection)

Give your name and address today and we will mail you FREE COMPLETE RECALCULATING DETAILS, SAMPLES, OPPORTUNITY PLAN, "HOW TO" BOOKLET, ETC. Absolutely free to you—no obligation.

FREE!
SAMPLES &
BOOKLET



Big Money?—sure it is—because Huge Profits are waiting to be "tapped" with this **MIRACLE NEW PRINTING METHOD**. Now, you may share the exciting secrets and build a big-paying **FULL OR SPARE TIME** Screen Printing Business right in your own home. Yes, we'll teach you, too, how to turn pennies into dollars in this newest, most sensational printing method ever invented. **WHAT IS SCREEN-PRINT?** It's an exciting new printing technique—amazingly simple and fascinating. (It may soon revolutionize the entire printing industry) **NO EXPENSIVE EQUIPMENT**, no printing press, no "cuts," no art ability, no experience is necessary—yet you can print beautiful professional jobs on **PAPER, GLASS, LEATHER, CLOTH—ANYTHING!** You print in all colors—even new "glowing" **FLUORESCENT COLORS**. It's amazing—but true! **EARN PROFITS IMMEDIATELY—IN YOUR OWN HOME!** Start in your garage, basement, kitchen, spare room—anywhere! It's much easier than you think. Then expand as this new printing industry grows. **300% PROFIT** on some jobs—earn up to \$12.50 per hr. **HELP FILL THE HUGE GROWING DEMAND**. No selling because every business in your area needs Screen-Printing. You can save them up to 50% on printing, too. **WE SUPPLY EVERYTHING YOU NEED**. Never before has such a profitability been offered to anyone wishing to start a full-time or spare-time "business of his own." Don't Hesitate! **Write!**

Screen-Print Co., Dept. 23
15127 S. Broadway, L.A. 61, Calif.

MAKE STRIPES with new PAINT PEN

Straight, curved, single or double
With any color paint, stripe furniture, bikes, autos, model planes, toys, linoleum, wall-board. Clean, crisp decorative lines. Can't clog or smear. Also use with glue, tempera, textile paint or underglaze... on wood, glass plastic, ceramics, metals, fabrics and paper. Ask your dealer or order direct.

DEALERS Master paint stripping tool in display carton. Write for discounts.	HOBBY "Professional" results every time. Simple, easy to use. Order now.	MFRS Ask about heavy duty industrial stripping tools.
---	--	---

DOUBLE STRIPE MODEL \$3.25
5 COMBINATIONS. . . .

Single 1/16" stripe model \$1.25

Other single stripe models 1 ea. 1/64", 1/32", 3/64", 5/64", 3/32" & 1/8"

Complete Kit \$5.00 (all 7 tips)

Extra tips 90c ea.

Extra 1/4" tip...\$1.20

WENDELL MFG. CO. 4234 LINCOLN AVE., Dept. 327 CHICAGO 18, ILLINOIS

BUILD YOUR OWN VEE BOTTOM BOAT
SAVE TWO-THIRDS TOTAL COST

Complete, easy to follow plans with full size construction details. My designs, backed by many years experience, produce quality performers. Plywood or plank construction. 21 and 23 footers, designed for outboard, inboard, direct or V-drive. Send for information. Price per set, 21 footer sleeping 4, \$19.00; 23 footer sleeping 4, \$17.00. Prices subject to change. Order now!

6515 Earl Ave. N.W. CLAUDE W. HORST, M.A. Seattle 7, Wash.

Be an industrial designer

Combine your design abilities with technical aptitudes in Industrial Design training at Art Center School in California. Work under practicing professionals for upper level jobs as automotive stylists, product and package designers. Design offices, stores, motels, showrooms, shopping centers. Constant demand for graduates. Recent placements with Ford, G.M., Kaiser Aluminum, G.E., Raymond Loewy and other leading design studios. 700 students. Co-ed. Accredited. B.P.A. Degree. Four-year course can be completed in 2 yrs. 8 mos. by year-round training. New term Feb., June, Sept. Enroll early. Write Mr. Mead for new catalog. 5353 West 3rd St., Los Angeles 5, California.

ART CENTER SCHOOL

TRAINED MEN NEEDED!

BIG PAY!—GOOD FUTURE!

- | | |
|---------------------------------|--------------------------------------|
| <input type="checkbox"/> DIESEL | <input type="checkbox"/> ELECTRONICS |
| <input type="checkbox"/> AUTO | <input type="checkbox"/> AUTOMATION |

NEVER BEFORE has the opportunity been so good for the properly trained mechanic and technician to step into **BIG PAY POSITIONS** with rapid advancement and future security virtually assured.

YOUR SUCCESS depends on the quality of training you receive... and the reputation of the school you attend.

YOUR GUARANTEE we are giving the best in mechanical and technical training is proved by the fact... we have a waiting list of good pay positions for our graduates, with leading companies throughout the United States.

RESIDENT SHOP TRAINING is easier and costs less than you may think! We provide you with housing and part-time jobs while in school, plus free nation-wide placement service for graduates.

Check subject above in which you are interested and mail for

FREE BOOKLET

BAILEY
Technical Schools

Veteran Approved

1634 S. Grand, St. Louis 4, Mo.

Your Future
IN
ELECTRONICS
AND
AUTOMATION

Your Future
IN
DIESEL and
AUTO
MECHANICS

Name _____ Age _____
Street _____
Town _____ Zone _____ State _____

SALESMEN WANTED

Prefer men over 50. Earnings \$5000 to \$8000 per year, calling on hardware stores and lumber yards, selling and installing Popular Mechanics show windows. No window trimming experience necessary (we train you) but selling experience essential. Must have automobile. Average territory consists of about 5 counties. Salesmen have exclusive territory. Home every night.

Not a get rich quick scheme but steady dignified work by which a skilled, industrious salesman can earn a good living. This company, in cooperation with Popular Mechanics and the leading manufacturers of tools, equipment and materials, offers retailers traffic-stopping window displays to retail hardware stores and lumber yards at a nominal cost. All equipment furnished. Endorsed by many retailers, jobbers and manufacturers. Much repeat business. Extras offer additional earning opportunity. Desirable but not necessary to have knowledge of hardware and lumber lines. Personal training given.

For details write to Window Displays, Inc., giving all the facts about yourself. If your letter indicates that you might qualify, an appointment will be made for an interview.

WINDOW DISPLAYS, INC.

1609 SHERMAN AVENUE EVANSTON, ILLINOIS

Make SURE, SAFE INSULATED ELECTRICAL CONNECTIONS

The New

SUPER ~~CLAMP~~ Hand Tool

The ONE Tool for ALL Wire Sizes used in Home Wiring, Appliances, Automobiles!

DOES ALL THESE THINGS BESIDES

CRIMPS Solderless Terminals and Connectors without solder or tape for safe connections.

CUTS Wire, making clean, sharp cut through insulation and Conductor.

STRIPS Wire sizes #22-#10. Gauges assure proper length for sure, safe crimp.

SHEARS Bolts and screws without damaging threads — no filing or hack sawing.

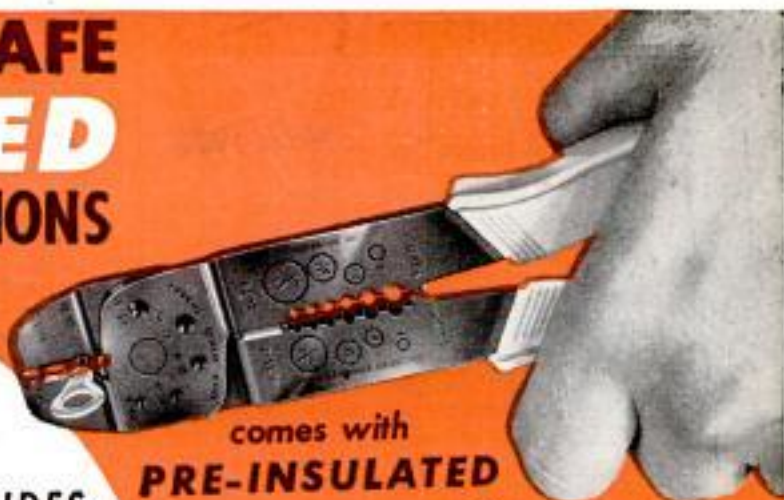

comes with
PRE-INSULATED



FREE with Each TOOL

ORDER DIRECT — USE COUPON

Satisfaction guaranteed or money back. Send check or money order for \$3.95.

T. W. Berger
National Distributor
Manufactured by
AMP INCORPORATED

Only
\$3.95
Post Paid

T. W. Berger
National Distributor Champ Tool
Room 401, 1700 Walnut St., Phila. 3, Pa.

Send me post paid the new Super Champ Hand Tool. I am enclosing \$3.95. (Incl. state sales tax where applicable)

check money order

NAME

ADDRESS

CITY.....ZONE.....STATE.....

BE A **CAMERA CRAFTSMAN...**

Send for **FREE** book!

Many are needed in this big paying field and now — YOU can learn to repair cameras using manufacturer's service methods at home... in your spare time! Instruction, tools, profit equipment — everything you need is included in this approved course! Write for big FREE illustrated booklet that tells you HOW!

national camera repair school - DEPT. V-3
ENGLEWOOD COLORADO

POWER OF WORDS

If YOU want to be —

An interesting conversationalist
Good speaker before groups
Forceful in use of words
Confident and correct in the use of written and spoken English

find out about Functional Training in English. Amazing booklet, THE POWER OF WORDS, is yours free. Write for it today.

PRINCIPLE INSTRUCTION CENTER, Dept. D-4
2956 PETERSON AVE. CHICAGO 45, ILL.

High School at Home

MANY FINISH IN 2 YEARS

No classes. No time wasted going to and from school. Progress as fast as your time and abilities permit. Standard H. S. texts supplied. Thousands enroll each year in this 60-year-old school. Send for FREE descriptive booklet.

AMERICAN SCHOOL, Dept. H345
Drexel at 58th St., Chicago 37, Ill.

Without obligation, please send FREE descriptive booklet.

Name.....

Address.....

Complete Canadian Courses available. Write American School, Dept. H345, 6083 Sherbrooke St. W., Montreal

Train at Home or in the Big Allied Shops

AIR CONDITIONING HEATING & REFRIGERATION

ALLIED offers YOU the finest training for one of the greatest industries of our time. You can be sure of the quality of **ALLIED** training—resident training on a wide variety of equipment—and Home Study training that has behind it a great resident school.

BIG KITS

ALLIED TRAINING PREPARED WITH COOPERATION OF INDUSTRY

Only a school with the established reputation of **ALLIED** could have been given the cooperation by leading industries in the Air Conditioning, Heating and Refrigeration fields which has made this training so outstanding.



You Are Supplied Shop-Work Kits if You Prefer to Train at Home

Right in your own home you do practical air conditioning and refrigeration work made possible by **ALLIED** training. You build an Air Conditioner, Freezer, or other units of your choice.

Send Today for Free Sample Lesson and Book

Air Conditioning and Refrigeration are changing the living habits of millions of people. Plan to get into this great industry now—it's your chance to go up to higher and still higher earnings or build a successful business of your own. Get the facts about **ALLIED** training and how you can be helped. Mail the coupon for free book and sample lesson—no obligation.

ALLIED SCHOOL OF MECHANICAL TRADES
ALLIED INSTITUTE OF TECHNOLOGY
1538-42 South Michigan Ave., Dept. PM-3A, Chicago 5, Ill.

Gentlemen:

Mail me **FREE** BOOKS explaining **ALLIED'S** training program in **AIR CONDITIONING, HEATING, and REFRIGERATION.**

I am interested in resident training home study

Name.....Age.....

Address.....

City.....State.....

FREE

A NEW HOME INDUSTRY

OPPORTUNITIES
UNLIMITED



Let us show you how extremely easy and PROFITABLE it is to make beautiful and useful things out of LIQUID PLASTIC, LIQUID MARBLE, LIQUID IVORY, LIQUID GLASS, CERAMICS, ETC. . . as easy as pouring water out of a glass! Make novelties, jewelry, gifts, artware, toys, tools, dies, gadgets, ceramics . . . a million useful things! We supply everything—MATERIALS and INSTRUCTIONS!—Send only 25c for big 64 page catalog of casting materials, molds and accessories and we will include free of extra cost a remarkable book, "THE WONDERS OF LIQUID PLASTICS" . . . that will open your eyes to wonders you never dreamed of! Send 25c today—this may be the lucky coin that will start the most fascinating and profitable phase of your life!

PLASTICAST COMPANY

6612 N. Clark St., Dept. PC-1302, Chicago 26, Illinois

Some make more, some less: T. THORN reports:

\$690 gross in single
MONTH
IN MY OWN BUSINESS!



Start your own business!

Here's YOUR chance to start a money-making, year-round business of your own and make the success you've dreamed about. R. O. Donnelly took in \$40 in seven hours. O. W. Ware landed a \$750 hotel job. J. S. Corbit grossed \$279.50 his first month. Homes, hotels, offices, clubs, offer you big profit possibilities. Auto upholstery also.

NO SHOP OR OFFICE NECESSARY. You clean furniture on customers' premises. No hauling. No high rents. Supplies inexpensive; operate from your home. What you take in is mostly profit.

● If you want to be your own boss—free from layoffs, strikes and bosses, we will help you to start and succeed. Don't delay . . . read the facts, then decide for yourself.

MAIL COUPON TODAY FOR FREE BOOK

VON SCHRADER MFG. CO.
E10 "D" Pl., Racine, Wisconsin

Without obligation rush your FREE booklet about how I can start my own permanent, profitable electric Upholstery Cleaning business.

Name _____
Address _____
City _____ Zone _____ State _____

PAINTING IS EASY!

with the famous **BURGESS**
electric **SPRAYER**

Just plug in and Spray:

- paint • varnish • enamel
- shellac • mothproofers
- garden sprays • water
- insecticides

PAINT 3 to 7 TIMES FASTER!

For the fastest, smoothest painting or spraying job you ever saw, try the Burgess Sprayer. Completely self-contained . . . just plug into regular household outlet, pull the trigger, and paint furniture, floors, walls, screens, cabinets, fences. Fine for mothproofing and garden spraying, too. Sapphire nozzle, handy spray adjuster, new convenient hanging hook, 25 oz. graduated jar. Easier to clean than a brush.



only **\$12.95** AT YOUR FAVORITE DEALER

If not available locally send \$12.95 for post-paid delivery. Money-back guarantee.

SEND FOR FREE BOOKLET "HOW TO PAINT THE EASY WAY"

BURGESS VIBROCRFTERS, INC.
DEPT. A-56 • GRAYSLAKE, ILLINOIS

CONCRETE BLOCK HOME PLANS

\$1900 DUPLEX



Build your own 24'x36' duplex, complete for \$1900. No block cutting necessary. Slab floor, forced air heating. Each side contains 11'x17' living room and kitchenette, 10'x11' bedroom, bath, five closets. Genuine blueprints, scale 1/4"=1'. Instructions and material cost list \$2.00 ppd. \$1150 GARAGE APARTMENT, 22'x24', Liv. room, kit., two bedrooms and bath. Double garage below. Plans \$1.00. \$2500 RANCH HOME, 25'x48', Liv. room, kit., bath, two bedrooms, den with fireplace, utility room, garage, central heating. Plans \$2.00.

MEMBER ARKANSAS HOME BUILDERS ASSOC.
BAILEY BUILDERS, 7607 Harmon Drive, Little Rock, Ark.

Print Your Own

Cards, stationery, circulars, etc. Save money. Print for Others, Good Profit; easy rules sent. Raised Printing like engraving, too. Junior press \$15; Senior \$29 up. Sold direct from factory only. We furnish everything. Write for free details. **KELSEY PRESSES, Y-37 Meriden, Connecticut**



FIX home & car APPLIANCES YOURSELF

NEW! EICO REDI-TESTER KIT \$12.95 Factory-wired **\$15.95**

Multi-range ac/dc voltmeter, ammeter, ohmmeter, wattmeter, leakage checker. Locates defects in appliances, air-conditioning, furnace control, TV, radio, car batteries, generators, etc. Easy step-by-step instruction book. Send Check or M.O., specify Kit or Wired. Or write for neighborhood distributor's name & FREE catalog P36-3 describing EICO's 50 professional kits & instruments.

Electronic Instrument Co., Inc., 81 Withers St., Bklyn 11, N. Y.



We try to ship your favorite brand (not receipts)

GOOD YEAR General, Firestone & others, worn slightly.

12 MONTH GUARANTEE I replace FAST any defective tire, frt. excl.

SPECIAL! Any 4-ply Black Tire \$3.50

If you don't want the tube take \$1 off!
GUAR. 12 MOS. AGAINST EVERYTHING!

600-16	\$5.28	670-15	\$5.18	700-20	\$7.98	600-16 (H)	\$5.68
640-15	5.68	710-15	5.38	750-20	8.88	650-16 (H)	5.78
650-16	5.68	760-15	5.38	825-20	15.58	700-16 (H)	6.88
700-16	5.78	800-15	5.68	900-20	14.58	700-15 (H)	6.88
700-15	4.98	820-15	5.68	1000-20	16.28	750-16	7.58
W.W. \$1 Extra		700-17	8.98	1100-20	16.28	750-17	11.98

TAKE OFF 20% (Send ck. or M.O. Since 1918 I've sold shipments sent a million tires & made F.O.B. Phila. a million friends!) **MIL. MUD GRIP 900-16 \$17.99 750-20 17.99**

MARVIN BLATT 6th & Spring Garden Philadelphia, Pa. **CO. ADJUSTED TIRES with NEW Tire service guaranteed \$7.95 WHITE WALLS any \$1. Ext.**

★ DRAFTSMEN! ★ MACHINISTS!
★ SKILLED MACHINE OPERATORS!

There's a
**BETTER
JOB
FOR YOU
HERE!**



JET ENGINES

There are outstanding opportunities in this expanding field. The General Electric Co. is building world famous jet engines in their Evendale Plant, near Cincinnati, Ohio.

AIRCRAFT GAS TURBINE DIVISION

GENERAL  ELECTRIC

EVENDALE PLANT,
BUILDING "A"
CINCINNATI 15, OHIO

Here you will find many excellent benefits and a chance to work in an exciting and future-filled field. Our relocation office will help you find adequate housing. Moving allowances granted.

Please write Mr. H. T. Carns, Supervisor of Employment, Dept. PM. Tell him which position you are interested in and he will send you complete information.

250 POWER.....



Complete Telescope Lens Kit only \$3.49 postpaid

Conquer Space, Explore the Universe, Planets, Moon Craters, New Stars, etc. Complete Lens Kit consists of 80 inch focal length ground and polished objective lens, eyepiece lenses for 50 POWER, 100 POWER, 150 POWER, 200 POWER, 250 POWER, and all necessary lens fittings. Easy to make from simple step by step instructions. (Tripod and mount not included.) Money back guarantee.

BUSSE SALES CO., Hartford, Conn., Dept. PM 55

Advertised products are backed by their manufacturers. Select them from POPULAR MECHANICS advertising pages



What Do 3 Out of 4
Doctors Recommend
to Relieve Pain?

A survey shows 3 out of 4 doctors recommend the famous ingredients of Anacin Tablets to relieve pain of headache, neuritis and neuralgia. Here's why Anacin® gives you better total effect in relieving pain than aspirin or any buffered aspirin:

- ➔ **ACTS INSTANTLY:** Anacin goes to work *instantly*. Brings fast relief to source of your pain.
- ➔ **MORE EFFECTIVE:** Anacin is like a doctor's prescription. That is, Anacin contains not one but a combination of effective, medically proven ingredients.
- ➔ **SAFER:** Anacin simply can not upset your stomach.
- ➔ **LESSENS TENSION:** Anacin also reduces nervous tension, leaves you relaxed, feeling fine after pain goes. Buy Anacin today.

MARCH 1957

PREPARE FOR BETTER JOB, BIGGER PAY
IN SPARE TIME AT HOME

Today, choose the job you want—and prepare for it in time you might otherwise waste. Or if you are already in the work you like best, start training now for quicker promotion and increased pay. During the past 60 years AMERICAN SCHOOL has helped ambitious people to reach higher goals. Check subject that interests you and mail coupon for full information.

AMERICAN SCHOOL, Dept. G345, Drexel at 58th, Chicago 37, Ill.

Without obligation, please send FREE and postpaid, full particulars about the subject checked below.

- | | | |
|--|--|---|
| <input type="checkbox"/> Accounting | <input type="checkbox"/> Contracting | <input type="checkbox"/> Mechanical Engineering |
| <input type="checkbox"/> Apprenticeship Courses | <input type="checkbox"/> Diesel Technician | <input type="checkbox"/> Mechanical Technology |
| <input type="checkbox"/> Architecture & Building | <input type="checkbox"/> Drafting—Building | <input type="checkbox"/> Metalworking Courses |
| <input type="checkbox"/> Automotive Technician | <input type="checkbox"/> Drafting—Machine Trades | <input type="checkbox"/> Plumbing—Practical |
| <input type="checkbox"/> Better Foremanship | <input type="checkbox"/> Electrical Engineering | <input type="checkbox"/> Retail Merchandising |
| <input type="checkbox"/> Blueprint Reading | <input type="checkbox"/> Electricity—Practical | <input type="checkbox"/> Salesmanship—Outside |
| <input type="checkbox"/> Bookkeeping | <input type="checkbox"/> Electronics—Industrial | <input type="checkbox"/> Sheet Metal Work |
| <input type="checkbox"/> Business Management | <input type="checkbox"/> HIGH SCHOOL COURSES | <input type="checkbox"/> Tool Making |
| <input type="checkbox"/> Civil Engineering | <input type="checkbox"/> Machinists | |

NAME _____ OCCUPATION _____

HOME ADDRESS _____ APT. _____

CITY _____ STATE _____

Conditions: Write American School, Dept. G345, 6083 Sherbrooke St. W., Montreal

MAIL COUPON NOW 

MUTINY ON THE MANTELPIECE

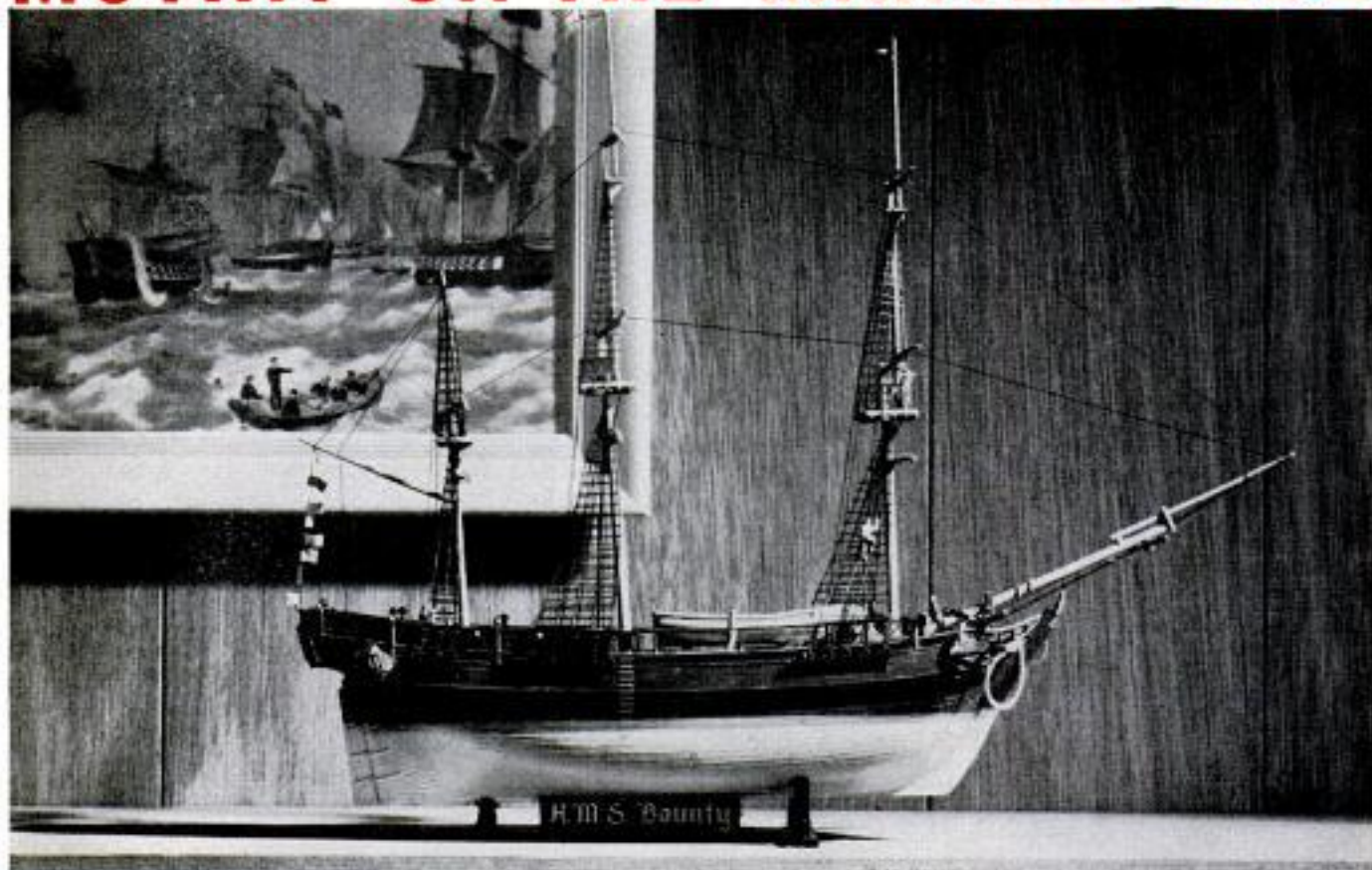

NEW H. M. S. BOUNTY MODEL KIT ONLY REVELL COULD MAKE IT SO REAL!

You can practically hear the mutinous crew snarling at Captain Bligh. . . that's how real this model of the Bounty looks when you put it together from the new Revell Authentic Kit! Every detail is shipyard accurate. Even the mounted cannon, the ship's launch, the ratlines and rig are in perfect scale. Five sculptured figures of crew and Capt. Bligh are included. Revell gives you step-by-step plans, a display stand and nameplate to mount your 14 $\frac{3}{8}$ " ship model on when it's finished. Put it on your mantelpiece. HMS Bounty Kit, \$2.98.



MCDONNELL VOODOO F-101A — Here's the mighty jet fighter that slices the sky at speeds faster than sound—scaled down from Air Force blueprints for you to put together. Swept-back wingspan, 6 $\frac{1}{4}$ ", with action-accurate details like landing gear, flaps, mounted armaments, pilot figure. With base, 89¢.



LINCOLN FUTURA — The \$250,000 experimental car of the future—yours to build now in Revell's plastic scale model. Engineered from 227" to 8 $\frac{1}{2}$ " length, with transparent canopy, chrome exterior trim, deep-hooded headlights, two driver figures. \$1.29.

HOW! SEE ALL THE OTHER MODELS YOU CAN BUILD!

SEND THIS COUPON TO GET BIG 32-PAGE REVELL CATALOG—ONLY 25¢ (Stamps or Cash)
Packed with action photos, real-life details about 89 different ships . . . planes . . . sportscars . . . trucks . . . guns . . . dozens of other models you make from Revell Authentic Kits.
Please rush by return mail the 32-page REVELL AUTHENTIC KIT CATALOG.

NAME _____

STREET ADDRESS _____

CITY _____ ZONE _____ STATE _____

SEND COUPON AND 25¢ TO REVELL INC., DEPT. BP, 4223 Glencoe, Venice, Calif.



Wherever hobby kits are sold

POPULAR MECHANICS

Copyrighted material

WORLD'S
BEST
WANT-AD
MEDIUM

CLASSIFIED ADVERTISEMENTS



Advertisements in this section \$1.25 per word, each insertion, minimum 10 words, payable in advance.

To be inserted under proper classification, copy must be in our office the

20th of the second month preceding date of issue

F. W. Johnson, Manager, Classified Advertising

Popular Mechanics Magazine, 200 East Ontario Street, Chicago 11, Illinois

YOU'LL PROFIT

By reading and answering the classified ads in this section. Hundreds of opportunities for you to make and save money

AUTOMOBILES, MIDGET CARS

JEEP Tops, American-foreign convertible tops, clear plastic seat covers. Free catalogue. Mor-Nan, Box 123, Boston 14, Mass.

BOYS' Power-driven auto. Build your own. Plans 25 cents. Sypher Co., Sta. F., Toledo, Ohio.

NEW 1957 Automobiles—Up to 25% off retail prices. Meder, 550-PM Fifth Avenue, New York City 36.

WORLD'S Lowest price children's motorized automobiles. Also fiberglass bodies, power units, parts, etc. Free literature. Sportillac Co., P.O. Box 6263, Philadelphia 26, Penna.

NON-Profit organization offers automobile literature—Old, modern and foreign; dealer books, service manuals, glossy photographs; free motor magazines. Write for free information. Auto Maniacs, Stockbridge, Mich.

REDUCE Repair costs, save time! Automobile trouble-shooting manual clearly explains everything on every car. Solves problems fast. Money-back guarantee. \$2.00 postpaid. Graham's, Box 135A, Springfield, Pennsylvania.

AUTOMOBILES, Brand new 1957, 15% discount. Literature 25¢. Auto Dwyer, Livonia Branch, Detroit, Mich.

SAVE Gasoline ten ways. Send 25¢ to Norman Summers, P.O. Box 84, Mercer Island, Washington.

VOLKSWAGEN Owner's Handbook, 144 pages, 150 photos, charts, drawings. Full details repairing, maintenance. Every owner, enthusiast needs this fabulous authentic book covering all models. Just published. \$2.00 postpaid. Floyd Clymer Publications, 1268 S. Alvarado, Dept. PM, Los Angeles 6, Calif.

AUTO SUPPLIES AND EQUIPMENT

SAVE Money on Jeep and army truck parts. Large inventory. Catalogs for Jeep or G.M.C. owners. American Auto Parts Co., 1830 Locust, Kansas City, Mo.

FREE! New catalog. Speed, power, mileage increasing equipment. Discounts! Alquist Engineering, Milford PM5, Penna.

RING-Valve job while you drive \$6.00 postpaid. Safe, proven, guaranteed. Literature. Motalov, Grantham, Penna.

NEW And used parts at savings. Complete guaranteed parts service for all models cars and trucks—1934 and later. Largest in the West. Army parts specialists. No catalog. Submit your needs for quotations. Fast mail order service. Pioneer Auto and Truck Parts Co., 734 W. 13th Ave., Denver 17, Colorado.

AUTO Accessory and parts catalog, 1957 edition, all new! 238 pages. Save up to 50%. 75,000 items, including Hollywood accessories, hi-speed equipment, rebuilt engines, all parts and accessories for all cars and trucks! Hard-to-get parts! Send 25¢, refundable. J. C. Whitney, 1919 PM Archer, Chicago 16, Ill.

\$89.50 **LONEY** Static wheel balancers \$12.50. Distributors wanted. Frost-Sales, 22060 Karl, Detroit 19, Michigan.

1909-1932 **FORD** Parts. Catalog 25¢. Huber, 15 Emerson, Clifton, New Jersey.

MOTORIST, Safety device for youngsters under 6. Free information. Tallant Co., 3639 N. 48 Terrace, Kansas City 4, Kansas.

FORD T and A parts? Try best source old car parts anywhere. Wisneski, Milwaukee 7, Wis.

SEAT Covers—Save 50%. Custom tailored fire resistant Nycar. Red, blue, green, and black-white. Regular price \$35. Send make, year, and model, and only \$17.50. Bill Booth, Wildwood, N. J.

CHAMMOIS Direct from importer. Full skins 25" x 38" finished both sides, very best service station quality. \$7.50 value. \$3.95 postpaid. Guaranteed. Jones, Importer, Box 929, Corpus Christi, Texas.

INEXPENSIVE Two-way radio for your own auto! Write: Hart, 467 Park, Birmingham, Michigan.

CHECK Your own car ignition points, coils, condensers. Free details. Norman Covington, Box 384, Hurricane, Utah.

CRANKSHAFT Grinder, hand operated. Makes bearings fit without taking engine apart. \$3.75. Literature, L. D. McGee, 719 Cascade St., Wenatchee, Wash.

100% PROFIT Service stations, garages, dealers only. Free information. Hardy's, 878 East Waterloo, Akron 6, Ohio.

NEW Concentrate motor overhaul, autos, tractors, all combustion engines, add years to old motors, insures instant start, increases compression, cuts oil and gas consumption. Certified by American Research and Testing Lab. Unconditional 30 day guarantee. Satisfaction or money refunded. \$2.98 each. General Sales Co., P.O. Box 717, Pottsville, Penna.

TRIPLE Protection for today's car, truck, tractor engines. New "Electric Reclaimo" filters, re-refines, stabilizes crankcase oil. Prevents destructive acid-sludge formation; makes oil changing unnecessary. Folder free. Reclaimo, 6251-M Touhy, Chicago 30.

SAVE On parts, accessories, gadgets, tools, dress-up items not in stores. Giant 1957 catalog—25¢ (refunded first order). Newhouse Automotive Industries, 5803-PM Beverly, Los Angeles 22, Calif.

AMAZING Turbo charger carburetion, \$8.95 up. Clean motor, keep clean. Box 12211, Dallas 25, Texas.

SAVE Hundreds of dollars when you buy a new car! Know the exact dealer cost of every American car. The book, "Auto Costs," puts you in the driver's seat when buying a new car. Money-back guarantee. Price \$10.00. Auto Costs Publications, Box 224, Department 8, New York 1, New York.

McKAY Cleaner-wax, for that glossy glass imported car look. Once over—two way action. Protects over six months. Sample \$1.00 postpaid. Oliver McKay, 208-9th Ave. So., Jacksonville Beach, Fla.

AUTO TRAILERS

TRAILER Building manual \$1.00. Booklet 30¢. Kamcraft, Box 1153, Milwaukee 1, Wis.

BUILD Expanding eight foot trailer. Accommodates five. Literature 10¢. Framar Company, Wilmington, Mass.

MOTORCYCLES, BICYCLES, MOTORSCOOTERS AND SUPPLIES

PARTS For Cushman, Doodle-Bug, Salsbury, etc. Send make, model, 25¢ for price list. Motor Scooter Parts Co., Dept. P3, Box 7211, Indianapolis 1, Indiana.

HARLEY - Davidsons — Used bargains. New, used parts, accessories for all models. Bulletin, catalog 25¢. Knuth's (Factory Dealer), 1753 Muskego, Milwaukee, Wis.

RECONDITIONED Motorcycles and motors, Chromium accessories. Complete stock Indian parts. Expert rebuilding. Past service. Indian Motorcycle Sales, Kansas City 27, Missouri.

MOTORCYCLES And supplies, all makes, new and used. Factory dealer. Tell us your needs. Wichita Cycle Co., 813 Ohio, Wichita Falls, Texas. Our 31st year.

PARTS, New, used. List 10¢. Ballak, 811 N. 9th, St. Louis 1, Mo.

ENGLISH Bicycle shock absorbers, \$5.95. Free leaflet. Thomas, Box 1873, Oakland 4, California.

MIDGET Racer \$10, motorscooter \$15, less engines. Whizzer motorbike engine \$7.50, Briggs \$4, Maytag \$3, Doodlebug \$8, (mailorder only). Send 25¢ (35¢ for first class mailing) for new 36-page, illustrated directory-catalogue 76, listing these and hundreds of other bargains, homebuilders plans, parts, etc. Midget Motors Directory, Athens, Ohio.

IMPORTED Motorcycles, 1957 models, now available. Singles, twins, square fours, BSA, Ariel, BMW, Sunbeam, NSU, Lambretta. \$399.00 up delivered. Save money. Glenn Walraven Motors, Marion 2, Ohio. Phone 2-4135.

MIDGET Auto \$25.00; 1954 Whizzer \$20.00; Cushman motorscooter \$25.00; motorcycle \$10.00. Rush 25¢ (35¢ first class mail) for new catalog #960 listing amazing bargains in motors, midget cars, motorcycles, motorbikes, construction plans. Associated, Box 534, Toledo, Ohio.

AVIATION

BUY Surplus aircraft; fuselages; accessories; engines; instruments; electronics; radiotelephones. Buy direct from U. S. government depots. List and procedure \$1.00. Brody, Box 8-PMJ, Sunnyside 4, New York.

"SMALL Helicopters" theory and guide manual. Drawings. Construction data. \$2.00. Sandhill Aircraft, Box 315, O'Neill, Nebraska.

SPECIAL Aircraft publications. Thousands of bargains in new and used airplanes \$100.00 up. Also hundreds of airplane accessories suitable for automobile use. Eighteen big issues only \$2.00. Job Sales, 247 Union Block, New Castle, Ind.

AVIATION Surplus bargain catalogue. One dime. Box 22 PM7, Thomasville, Penna.

PROPELLERS. Plans, supplies by world's oldest and largest manufacturer of special design airboat and snowplane propellers. Latest designs. Prompt delivery. Satisfaction guaranteed. 48 page catalog 25¢. Banks-Maxwell, Box 3301E, Ft. Worth 5, Texas.

NEW Lightplane circulars, illustrated 30¢. Kamcraft, Box 1153, Milwaukee 1, Wis.

BATTERIES, GENERATORS

EDISON Nickel storage batteries. Any voltage, any amperage. Unconditionally guaranteed. Power plants, generators, motors. Literature. Hawley Smith Co., Croton Falls 1, N. Y.

ELECTRICAL SUPPLIES

TELEPHONE Transmitter, hand set type and ear cap receiver inter-house phones, speakers or any communication purpose. Both only \$1.50. No cod's. Telephones, Dept. D-11, 1760 Lunt, Chicago 26.

HOME Wiring Guide. Indoor, outdoor installations. Circuits, insulation, weather-proofing, remote control—everything. Complete instructions, diagrams. Only \$1.00. Craftsman Publishing, 115-E-5 Worth Street, New York City 13.

ELECTRIC Pencil: Engraves all metals \$2.00. Beyer Mfg., 10511-H Springfield, Chicago 43.

LAMP. Electrical parts, wholesale. Thousands of items for repairing, converting. Catalog 25¢. Brown Lamp, Box 305, Clayton 5, Mo.

200 STUNTS, 110 Volts \$1.00. Kutting, 2627B Aratradero, Los Altos, Calif.

LAMPS—Parts catalog showing wiring instructions, 25¢. Gyro Lamps, 5402F Clark, Chicago 40.

WELDING, SOLDERING, PLATING

WELDERS, 110/220, \$39.50. Morris, 1670 Inner Drive, Schenectady 3, New York.

ELECTROPLATING Equipment, anodes and solutions for all types of plating. Instructions. Assemble your own plater and save. Free catalog. Ramyr, Dept. E-4, 1624 East First Street, Los Angeles 33, California.

ACETYLENE Welding outfits new \$54.50; used \$34.50; arcwelders \$56.50. Eagle Welding, Dept. PM, 5083 Broadway, Chicago 40, Ill.

FREE Electrical repair pamphlet with arc welding manual \$1.00. Marnel, Box 7642, Denver 15, Colorado.

BUY Welding supplies direct from manufacturer. Cable, welding rods, helmets, etc. Portable arc-welders and kits at tremendous savings. Free factory catalog! LeJay Mfg. Co., 2927 Emerson Ave. So., Minneapolis, Minn.

ALUMINUM Soldering, easy with "Bondit" flux and solder. \$1.00 postpaid. Money-back guarantee. Product Research Company, Box 181, Arlington, Virginia.

A.C. Welders, 4 sizes, lowest prices. Free literature. Holgeron's Service, Canton, Kansas.

"BUILD-UR-OWN" a.c. welder and a.c. power plant with a good used engine and low cost Hobart generator. Welds anywhere and supplies 5kw stand-by power for any emergency. Write Hobartweld, Box M-373, Troy, Ohio.

MACHINERY, TOOLS, SUPPLIES

"MACHINE Tool Reconditioning." Amazing manual for machinists. Simplifies preventive maintenance. Free circular. Machine Tool Publications, 362 Holly, St. Paul 2, Minnesota.

BUILD-Your-Own hydraulics. Informative plans 25¢ including catalog cylinders, valves, pumps, welders. Dunbar Manufacturing, Houston 23, Texas.

LAWNMOWER Sharpeners: New, \$80.00 to \$336.00. Other specialized equipment, Turner Cline, 430 Yellowstone, Pocatello, Idaho.

1957 ROTARY Mowers. 21 inch Chief, 2½ h.p. Lauson engine, \$109.50 value, now \$59.50. Prompt shipment. Freight prepaid 3 or more. Glenn Walraven Sales, Marion 1, Ohio.

SURVEYING INSTRUMENTS

NEW And guaranteed factory rebuilt transits and levels, sale or rent, with purchase option. We will repair, trade or buy old instruments. Write for list M-73, Warren-Knight Co. (Manufacturers of Surveying Instruments), 136 N. 12th St., Philadelphia 7, Penna.

ENGINES, MOTORS, DYNAMOS

THERMO-Nuclear hydraulic engine plans are now available in response to thousands of requests. Externally applied heat generates powerful mechanical energy via molecular thermo-nuclear explosions. Has one moving part. No special tools or materials. Not a toy. Completely safe. \$2. Novold, Box 10,133, Phoenix, Arizona.

DIESEL Injector parts wanted. GM71-110. Bares, 7120 Carnegie, Cleveland 3, Ohio.

A. C. Generators. 750 watt \$42.50; 1500 watt \$67.50. Motors, 5 horse \$110; 3 horse \$87.50; 1 horse \$36.50. Butler, 1883 Milwaukee, Chicago.

GENERATORS: Aircraft E-7A; 12V; 50 amp.; or high output for automotive, boats, battery chargers; new; \$17.50 f.o.b. Meers Sales, Box 404, Stephenville, Tex.

½ HORSEPOWER Electric motors. a.c. 110, used, good \$5.00 each, f.o.b. Plant Machinery Corp., Richmond & Norris Sts., Philadelphia 25, Penna.

REWIND Motors yourself. Complete instructions \$1.00. Lewis Mfg., Howell, Michigan.

WINDING Data. 275 motors, single and three phase, \$1.10. Data Company, Box 7631, Kansas City 28, Mo.

BOATS, OUTBOARD MOTORS

SAVE Money. New, used outboard motor parts. Send wants. Stamp appreciated. Outboard Motor Mart, 229-M State, Boston 9, Mass.

BOAT Plans. Full size patterns. Frame kits. Modern inboards and outboards for amateur builders. Complete new catalog 50¢ or specify requirements. Glen Designs, Box 566, Compton, Calif.

NEW, Used, rebuilt marine motors. Marine conversions, fittings. Free catalog. Stokes Marine Supply, Dept. 24, Coldwater, Michigan.

FIBERGLAS Permanent boat waterproofing. Special 25% winter discount. Complete kits, \$9.45 up. Guaranteed materials. Easy application. Full instructions. Free literature. Ajax Plastics, Dept. PM, P.O. Box 1323, Fort Worth, Texas.

MARINE Conversions for Ford and Jeep engines. Catalog 25¢. Lehman Manufacturing Company, 972D Broad Street, Newark 2, New Jersey.

FORDS And Jeeps 100% marine engines with famous Convo-Kits. Deluxe catalogue 25¢ coin. Oscomotors, 3627B Lawrence, Philadelphia 40, Penna.

MARINE Conversion. Willys to Cadillac engines, kits and parts. Catalogue and conversion hints free. Barr Marine, 2706 Castor Avenue, Philadelphia 34, Penna.

FIBERGLAS Boat coating. Plexiglas boat windshields—Clear, blue, green tints. Wholesale-retail. Instructive information catalog free! Gem-O-Lite, 5529 Cahuenga, North Hollywood, California.

STEEL-Wood, boat plans, cruisers—sail. 21-42 feet. Free information. Please specify size-type. John B. Clark, N.A., Box 51, Bay Village, Ohio.

BUILD Small boats. Booklet 25¢. Catalog free. Popular Mechanics Press, 633 N. St. Clair St., Chicago 11.

FREE Catalog! Boat kits, trailers, fiberglass, marine hardware. Lager Industries, Dept. M3, 3404 Lyndale South, Minneapolis, Minnesota.

NEW! "How to Make Old Boats New with Fiberglass." 10¢. Castolite Company, Marine Division, Dept. CM-101, Woodstock, Illinois.

FIBERGLAS Your boat! Complete kits including color resin. Low as \$8.50. Aqua-Glas, Box 99, Altadena, Calif.

300 PLANS, Patterns, kits. Catalog 50¢. Outboards 2.5 h.p. \$79.95! Literature. Marinecraft, Box 161-M, Brighton, Mass.

FIBER Glass—Buy direct, save 40%. Complete polyester and epoxy resin boat covering kits and supplies. Highest quality guaranteed. Send for prices and brochure. Marine Fiber Glass Corp., 6308 San Fernando Rd., Glendale 1, Calif.

ATHLETIC EQUIPMENT, BODY BUILDING COURSES

BARBELLS, Dumbbells. Courses. Free catalogue. Good Barbell Co., Reading, Penna.

DISABLE Any bully, with two fingers. Secrets, Ju-Jitsu, 98 pages, illustrations, \$1.50. Special chapter for women. Seico, Box 38, Cooper Station, New York 3, N. Y.

STRENGTH, Health, muscles, gain, reduce. All you need is a rope! Free details. Roperclise, 4834-A Art St., San Diego 15, California.

4 MUSCLE Courses 25¢. Fully guaranteed. Sid's System, Southgate, California.

BE Taller! Coach's "Inch-At-A-Time" system \$1, complete. Marty Snyder, Box 133-ME, Union City, New Jersey.

JUDO—Defeat bullies. 23 complete lessons. \$1.00. Box 1475, E.T.S.C., Johnson City, Tenn.

BIGGER Muscles, faster! Seven courses, 35 exercises, \$1.00, 30-day money-back guarantee. Buckley, Box 638, North Miami, Florida.

DUMBBELL Collars. Self-locking. No screws. Free folder. Autolock, Box 1642, York, Penna.

SPORTING GOODS, GUNS, FISHING TACKLE, ARCHERY, TRAPPING

FISHERMEN. Amazing secret Indian Fish Lure Oil attracts all fish! One drop on bait, plug, fly guaranteed to catch more fish or money back. Send \$1.00 for bottle now! King & Company, Ashville, New York.

THROWING Knives. Set of three, perfectly balanced. \$3.00. George McCarty, 3251 W. Washington Blvd., Chicago, Ill.

TENTS, Camping equipment; tremendous selection. Send 20¢ for 136 page tent, camping equipment catalogue-handbook listing all national camping sites. Morsan, 10-21R 50th Ave., Long Island City 1, New York.

GUNSMITHS! Illustrated gun parts catalog, 50¢. Shelley Braverman, Athens 2, New York.

FREE Sporting goods catalogs! Save 70%. Econ-O-Mart, Whippany 2, New Jersey.

MOLDS For fisherman's sinkers, jigs, squids, casting and spinning lures. Free catalog. Sweet's Molds, Tonawanda 1, New York.

FREE Fishing scent secrets. Johnston's, 312 Lake Avenue, Ithaca, New York.

ARROWS—Unsurpassed for speed, accuracy. 26 kinds. Accessories, raw materials. Free catalog. Marlin Archery, Ames, Iowa.

180 PROFUSELY Illustrated pages antique pistols, swords, daggers, armor, etc. 50¢. Robert Abels, M890 Lexington Ave., New York City 21.

BUILD Barbecue. Complete plans. Booklet 25¢. Free catalog. Popular Mechanics Press, 633 N. St. Clair St., Chicago 11.

BIG Money raising crickets and 12 inch African fishworms. Free literature. Carter Ranch, Plains, Georgia.

JAP Rifle altering to 30-06, \$6.00. Japshells, \$3.75. Catalog 5¢. T. P. Shop, West Branch 11, Mich.

FREE Catalog. Newest items, Bargains, Gadgets, Beads, Spinners, Lure parts, Sinkers, molds. Finnyports, MC, Toledo 6, Ohio.

5000 BARGAINS. Firearms, binoculars, war relics. Catalog 50¢. Smith Firearms, Rannemede, N. J.

SAMPLE: 25¢ Copy of "The Archery Magazine." Send 10¢. 1200 Walnut Street, Philadelphia 7, Pennsylvania.

NEW! Automatic fishhooks. Guaranteed. \$1.00 retailer. Details, sample \$1.00 refundable. Aron, 1126 Comack, Mastic Beach, New York.

FREE—Below wholesale fishing catalog. Fishing Tackle Mart, Dept. 53, Box 6737, Chicago, Ill.

GRAY Crickets: Special advertising material (limited offer) free to fishbait dealers ordering crickets. Use material for your advertising. Crickets shipped immediately, any quantity. Live delivery guaranteed. Scientifically raised. Write for free literature and price list. Owen Crickets, Farm 2, 2818 25th, Lubbock, Texas.

NIGHTCRAWLERS Raised easily anywhere. Soilless method. Charlie Morgan, Box 238D, Sheridan, Wyoming.

NYLON Rope, lines, cords. Every description for all household and sportsmen's uses. Finest made. Free catalog. Beebe Cordage Co., Inc., Cranford 8, N. J.

BUY, Sell, trade or exchange. 5000 used or new guns, knives, binoculars and ammunition. Send stamped self-addressed envelope and 50¢, refunded first order, for list and procedure. \$1.00 next three lists. Gun Exchange, 247 Union Block, New Castle, Indiana.

ANTIQU And modern firearms. Send 20¢ coin for list. Hawkeye Arms, Post Office Box 7000, Miami 55, Florida.

OLD Colts, Win. rifles, many others, 25¢ list. New stocks, Winchester T3, 66, finished, complete set \$11.75. Leather, hand tooled, finest quality, double thickness western design deluxe belt, one holster \$14.50, same, two holsters \$18.50. Holster, \$3.75 prepaid. Dealers invited. Laredo Gun Shop, 3110 San Bernardo, Laredo, Texas.

1,000,000 GUNS, Accessories, Colts, Lugers, Mausers, Kentuckies, P38's, Winchester. Catalog 50¢. Agramonte's, Yonkers 2G, N. Y.

FREE—Giant 1957 wholesale sporting goods catalog. Lowest wholesale prices. Complete line of cameras, sporting goods, appliances, outdoor items. Write today. Santa Fe Distributing Co., 1321 Main Street, Dept. PM, Kansas City, Mo.

BINOCULARS, TELESCOPES, MICROSCOPES, MAGNIFIERS

BINOCULARS, Telescopes, microscopes. Terrific values \$3.98 up. Request free money-saving catalog. Criterion, Dept. P-52, Hartford, Conn.

REFLECTOR Telescope kits \$6.25 (3") to \$175 (12"). Mirrors, cells, focusing mounts, tripods, eye systems. Anything, everything in telescopes. Free catalog. Also ready to use telescope from \$25. Esco Products, Oakridge, N. J.

AMAZING Prices precision binoculars, special slow season winter reductions. Free trial. Folder "Binocular Selections," catalog free. Prentiss Importers, Mercury Bldg., West Los Angeles 25, Calif.

BUILD Your own reflector telescope. Complete kit; mirrors, eyepieces, tripod, all other accessories. Request free illustrated literature. Criterion Manufacturing, Dept. DPM 27, Hartford, Conn.

REFLECTING Telescope, 60X, completely assembled \$29.75. Guaranteed observatory clearness. Free information. Skyscope, 475 Fifth Avenue, New York City 17.

MICROSCOPE Catalog free. Research Scientific Supplies, 60 Wall St., New York City 5.

BINOCULARS, Riflescopes, etc. Exclusive models! Tremendous selection. \$100,000.00 stock! Free 56 page illustrated catalog. United, 9043 S. Western, A-1308, Chicago 20. Dealers wanted.

WAR Surplus bargains: Millions of lenses, instruments, telescopes, binoculars, components and complete line of astronomical telescope items. World's greatest optical market place! Send only \$1.00 for beginner's 10-lens kit and big instruction booklet Stock 2-CH. Write for catalog CH, free! Edmund Scientific Co., Barrington, New Jersey.

DYNASCOPE—Sensational new reflector telescope. Send for details. Criterion Co., Dept. DP 30, Hartford, Conn.

300 POWER Reflector telescopes complete with finder scope and tripod, \$24.95. 400X telescopes easily made. Kit includes focusing tube, erector, five finished lenses, building instructions, \$3.75. Free telescope booklet. Suffolk Science, Mattituck 4, New York.

PLANTS, SEEDS, BULBS, NURSERY AND GARDEN SUPPLIES

TREES And shrubs—Raise your own from seed for shade, windbreak, snow fence, ornament, erosion control, etc. For free planting guide, price list, write Woodlot Seed Company, Norway 9, Michigan.

OPERATE Profitable garden. Write: Regal Industries, Spring Lake Road, Streator-PP, Illinois.

WORLD'S Greatest cash crop. Free information. Write Ginseng Gardens, Asheville, N. C.

GINSENG, Goldenseal, Roots bring up to \$14 pound. Full information. F. M. Collins, Viola, Iowa.

CUT Landscaping costs by half. 100 money saving tricks. Pamphlet \$1.00. Bayer Gardens, Route #1, Neenah, Wis.

PETS—DOGS, BIRDS, RABBITS, HAMSTERS, ETC.

HUNTERS! Raccoon Mountain and Short Creek kennels now combined. Large number of coonhounds, foxhounds, rabbit-hounds, beaglehounds, bird-dogs, puppies. Free literature and pictures. Trial, Dures Thomas, Owner, Box 464, Boaz, Alabama.

RAISE Rabbits successfully by knowing facts. 48 page illustrated book describing 25 breeds. Housing, feeding, breeding, marketing, etc. Plus bulletin. 25 cents. American Rabbit Association, 36 Arba Building, Pittsburgh, Penna.

STANDARD Rabbit Journal, Milton 3, Penna. Year \$1.00. Sample dime. Beginners manual 25¢.

MAKE Money raising chinchillas, mink, nutria, rabbits, cavy for us. Free catalog. Keeney Brothers, New Freedom 2, Penna.

BEAUTIFUL Pure white pedigreed police puppies. Ansonia Kennels, McHenry, N. Dak.

RAISE Rabbits on \$500 month plan. Plenty markets. Free details. White's Rabbitry, Mount Pleasant, Michigan.

ANIMALS, Birds, reptiles. List 25¢. Menagerie, 3704 So. Pecan, Fort Worth 10, Texas.

HAMSTERS—Young Golden pairs, \$2.95, breeders \$3.95. Free booklet. Jer-Pre's Hamstery, 2425 Hoyt, Muskegon Heights 13, Mich.

HAMSTERS—Golden—young, \$3.00 pair. Fully developed \$4.00 pair. Adirondack Hamstery, Prospect 10-C, N. Y.

RAISE Rabbits, nutria. Choice stock available. Bob Madsen, Lyndon 2, Illinois.

PRICE List with snake skin sample 25¢. With live chameleon or turtle \$1.00. Snake Farm, LaPlace, Louisiana.

COUNTRY'S Best dogs at wholesale prices. Dog Market Journal, Minier, Illinois. Sample dime.

GROW Mushrooms. Cellar, shed. Spare, full time, year round. We pay \$3.50 lb. We have over 25,000 customers. Free book. Mushrooms, Dept. 171, 2954 Admiral Way, Seattle, Wash.

WILD Animals, birds, reptiles, for pets and institutions. We get them direct from our foreign compound, where they are treated against diseases. Jungle World Inc., Box 947, Miami 48, Florida.

FUR BEARING ANIMALS

MINK Raising information free. Complete. Lake Superior Mink Farm, Superior, Wis. Wisconsin.

1000 BRED Mink. Booklet, plans 25¢. Lake Ontario Ranch, Gravel Road, Webster, N. Y.

RABBIT Raising booklet-magazine 10¢. Stahl, Hickman Mills 1, Mo.

AMAZING Profits converting greens into nutria fur. Nutria carcasses into mink. Voight Farms, Atlanta 2, Texas.

FARMS, FARM LANDS, REAL ESTATE

FABULOUS Opportunities! Government land, U. S., Alaska. Write Sledge Surveys, Macon, Mississippi.

OZARKS! \$8 Acre. Listings, information free. Write: Armstrongs, Shook, Missouri.

FLORIDA. Nice homesites, \$245 at \$10 monthly. Folder free. Howard Vernor, DeLand, Florida.

TEXAS Resort-site, at Falcon Lake, adjoining city. Excellent fishing! Full price \$149.50. Payments \$7.50 per month. Utilities, including city water. Ideal vacation or retirement. Write for free photos. Frank Matlock, Box 7487, Fort Worth, Texas.

STROUT Spring catalog! Mailed free! 34 states, coast-to-coast, bargains galore! Farms, homes, businesses. World's largest: 57 years service. Strout Realty, 7-MP So. Dearborn St., Chicago 3, Ill.

CANADIAN Tax sale lands for three dollars an acre and up. Small monthly payments. Farms, timber, hunting and fishing camps, minerals. Limited number of properties. Write at once for free catalogue. Tax Sale Service, Room 105, 120 Bloor St., W., Toronto 5, Canada.

FLORIDA Lakefront homesites. Easy monthly payments. Complete literature free. Write Box 1311, Eustis, Florida.

FLORIDA, California consultants, on real estate, jobs, retirement. Free questionnaire. Surveys, 36 Wendover, Kenmore 23, N. Y.

CHOICE Florida homesites. Special sale—80 by 135 feet only \$240, payable \$10 monthly. Also beautifully wooded deluxe trailer sites and fine 20-acre winter garden farms. In famous pleasure resort area. Wonderful fishing, hunting. Booklet free. Wendell Wood, Fountain, Florida.

POULTRY, FARM SUPPLIES

RAISE Turkeys the new way. Information explaining how to make up to \$3,000 in your own backyard. Literature 10¢. Address: National Turkey Institute, Dept. 3, Columbus, Kansas.

GUINEAS, Ducks, pheasants, eggs and babies; 50 varieties chicks. Low prices, gorgeous book free. Berry's Farm, Route 12, Clarinda, Iowa.

PROFITABLE OCCUPATIONS

THEY Hand him \$100! Free packet. "Secret Journal." 919 secrets-plans! Work home. Publicco, Oceanside, Calif.

HOME Mailorder sources, methods, opportunities. Literature free. Carnahan Bros., 9610-D Acacia, Fontana, Calif.

FREE! "301 Profitable Small Businesses!" Amazing shoestring plans! Work home! Start sparetime! Deumant Surveys, Kenmore 23-R, N. Y.

FOREIGN Jobs—Latin America, Alaska, Canada, up to \$1500 monthly. Up-to-date 1957 foreign service directory gives complete information; hot list of firms hiring for military and civilian construction, aircraft, oil, exporters-importers, mining, \$1.00. How-when-where to apply. 9th successful year! Global Reports, Box 883-S, Hollywood 28, Calif.

MAKE Flexible molds. Cast plaques, figurines. Free sample. Tooker, 1045-M Fairview, Hamilton, Ohio.

VENDING Machines—No selling. Operate a route of coin machines and earn amazing profits. 32-page catalog free. Parkway Machine Corporation, Dept. 25, 715 Ensor Street, Baltimore 2, Maryland.

YOUR Own wholesale business without investment. Free catalog. Norris, 487-X Broadway, New York City.

BE The Popular Mechanics representative in your neighborhood and earn big profits in your spare time. Write Popular Mechanics Magazine, Room 408M, 200 E. Ontario St., Chicago, Ill.

RAISE Pheasants on \$100 week plan. Little capital and space can make you independent. Free details. Great Central System, Columbus 1, Kansas.

MAKE New greaseless doughnuts in kitchen. Sell stores. Free recipes. Michael Ray, 3605 South 15th Ave., Minneapolis 7, Minnesota.

AUCTIONEERING—Home study course. Diploma granted. Auction School, Ft. Smith, Ark.

FREE Book "505 Odd, Successful Businesses." Work home. Pacific, Oceanside, Calif.

BUY Wholesale thousands nationally advertised products at big discount. Free "Wholesale Plan." American Buyers', Hertel Station, Buffalo 16-B, N. Y.

\$10,000 PROFITS! Your own mailorder business! No risk! Success plan free! Treasury, 709 Webster, New Rochelle L-37, N. Y.

FREE Poiso "\$5,000-\$45,000: Unlimited Vacations." No merchandise. Unknown! Work home, sparetime! Haylings, Carlsbad, Calif.

BIG Money raising fishworms and crickets. Free literature. Carter Wormery, Plains, Georgia.

BUY Wholesale! Discounts to 80%! Appliances, cameras, sporting goods, housewares, watches, tools, clothing, etc. Buy-Rite 73-03, Wagaraw, Hawthorne 2, New Jersey.

360 WEEKLY. Spare time—Easy! Home Venetian blind laundry. Free book. Burt, 2434A, Wichita 13, Kansas.

LEARN Locksmithing from licensed experts at home in your spare time. High pay. Earn as you learn. Locksmithing Institute, Rutherford 11, N.J.

BIG Profits raising—Fishworms, crickets. Free literature. Three Oaks Ranch, Dresden, Tenn.

EARN \$100.00 A day installing window air conditioners. Millions are sold each year, shortage of trained men. Simple to install after a few hours training. Complete illustrated instructions \$3.00. Anderson Installation Co., 21740 N. Tuller Ct., Birmingham, Mich.

START Your own business. Part or full time. Little or no capital needed. Many golden opportunities. 24 page catalogue free. Frank Fix, 2056 Switzer Ave., St. Louis 21, Mo.

LEARN Commercial deep sea diving from established and recognized school. Write Coastal School of Diving, 8111 MacArthur, Oakland, Calif.

WELDING Pays big money. Learn easily at best equipped school in country. Non-profit school with low cost training. G.I. approved. Write Hobart Trade School, Box M-372, Troy, Ohio.

MAGAZINE Subscriptions. Largest commissions. Bonus. Qualified Agency, 431QA Kingston, Brooklyn 25, N. Y.

SPARETIME Repeat profits taking magazine subscriptions. Special offers. Cassell Agency, Boynton Beach, Florida.

MUSHROOMS In 14 days. Preplanted trays, 3 for \$4.50 l.o.b. Spawn plus newest manureless methods, \$1.00. Literature. Luxur, 641 South 19th, Newark 3, N. J.

GROW Mushrooms. Cellar, shed. Spare, full time, year round. We pay \$3.50 lb. We have over 25,000 customers. Free book. Mushrooms, Dept. 99, 2954 Admiral Way, Seattle, Wash.

BOOKS, PERIODICALS, PICTURES, POSTCARDS

OLD West pictures gunsmoke, deadline, many others. Large picture and list \$1.00. Henry Sisson, Luray, Mo.

BRITISH Book bargains. Any subject. Catalog free. Transbooks, Box 22-PMJ, Brooklyn 26, N. Y.

SIGHT-Saving Bibles. Lincoln House of Good Books, Galesburg, Ill.

"HOME Improvement Guide." New, amazing 192 page volume. Packed with ideas, plans for remodeling, decorating, landscaping, built-in projects, \$2.50 prepaid. Popular Mechanics Press, 200-HG East Ontario St., Chicago 11.

BOOKS, Essays, lectures, plans. Experimental information. Free list. Tipp Scientific Co., Tipp City 5, Ohio.

INTENSELY Interesting Alaska magazine! True experiences on "The Last Frontier." Send \$1.00 for six back issues. The Alaska Sportsman, Ketchikan, Alaska.

NATIONAL Geographic Magazines, 1888-1936. Periodical Service, Box 465-PM, Wilmington, Delaware.

OUT-Of-Print books at lowest prices! You name it—we find it! Fast service. No obligation. International Bookfinders, Box 3003-PM, Beverly Hills, Calif.

"SCIENCE Milestones." Records march of science starting 400 years before Christ, right up to date. Amazing facts revealed. 312 pages packed with startling information that will thrill you. A real history of science. \$5.00. Literature free. Popular Mechanics Press, 200-SM East Ontario St., Chicago 11, Ill.

RARE Magazines, catalog 10¢. Nationwide Exchange, Box 1375-P, San Antonio 6, Texas.

BOOKFINDERS! All subjects. Send wants! Jaher Book Service, 183 Hazelwood Drive, Westbury, N. Y.

BOOKHUNTERS! Scarce, rare, miscellaneous books. Atlantic Book Service, Cedar Street, Charlestown 20, Mass.

JOHN Friend, bookfinder, can get the book you want. Free search service. Box 197PM, Cardiff, Calif.

BE Secure. Your own profitable business. Over 9,000 formulas, 900 pages, \$3.00 postpaid. Aunt Pat, Edinburg 59, Texas.

BOOKALOGUE. Huge discounts. 1,000 bargains. Murie's, 199 Circuit, Waterbury 8, Connecticut.

SAMPLE: 30¢ copy of "The Aquarium." Send 10¢ to 12th and Cherry Sts., Philadelphia 7, Penna.

PROVERBS (The book of Biblical wisdom) in purse or pocket size. 25¢ postpaid. Satisfaction guaranteed. Bogardus, 184-PM Cedar, Freeport, N. Y.

FREE: Exciting catalog packed with books covering most everything. Think of it—From cover to cover you will find described and illustrated hundreds of books telling how to fix and how to build almost anything. How to remodel your home; do your own decorating, plumbing, electrical work. Simplified books covering concrete work, carpentry, painting, furniture making and refinishing. How to build your own boat, home workshop tools. Best books on photography, welding, hobbies, homecraft. How to make a home freezer. Send for your free copy now. Popular Mechanics Press, 300-BC East Ontario St., Chicago 11, Ill.

MAGIC TRICKS, PUZZLES, JOKER NOVELTIES

SENSATIONAL Magician's wand 25¢. Vanishes handkerchief! Catalog included. Box 1332-PM, Philadelphia 5.

BE A magician! Large professional catalog of latest tricks. 35¢. Ireland, C-100 North Dearborn, Chicago 2, Illinois.

3100 NOVELTIES, Jokes, tricks, gadgets, funmakers, hobbies. Big catalog 10¢. Johnson-Smith, D-407, Detroit 7.

VENTRILLO, Professional voice-throwing instrument and catalog 25¢. Box 971-PM, Philadelphia 5.

WOODEN Nickels, catalog, trick, 10¢. Magico, Box 1375-P, San Antonio 6, Texas.

DOLLAR Magic set free with catalog 25¢. 4462-PM Germantown, Philadelphia.

WORLD'S Finest professional magic, Joker novelties. Giant illustrated catalog 10¢. Top Hat, Evanston 12, Illinois.

500 TRICKS, Douglas famous 120-page catalog, only 10¢. Fastest service to magicians for 30 years. Send 10¢ today. Douglas Magicland, Dept. 1, Dallas, Texas.

SMOKEBOMBS 25¢, 7 for \$1.00. Terri-lic! 4463-PM Greene, Philadelphia 44.

PROFESSIONAL Catalog, 175 pages, 25¢. Williams, 900 Plymouth, Ellwood City, Penna.

MAGIC Catalog 25¢. Eastern, P.O. Box 81, No. Westport, Mass.

WHOLESALE! Thirty 10¢ trick novelties \$1.00! Profits! 1746-W Market, Philadelphia 3.

COINS, TOKENS, CURRENCY

MORGAN Dollars; 1878-87-90-91-97s, \$2.00 ea. Coin catalogue, 25¢. Shultz, Salt Lake 10, Utah.

OLD Money wanted. Will pay \$100.00 for 1894 dime, 8¢ mint, \$50.00 for 1913 Liberty head nickel (not buffalo). Big premiums paid for all rare coins. Send 4¢ for large coin folder. May mean much profit to you. Numismatic Co., Dept. 20, Fort Worth, Texas.

WE Pay \$100.00 each for certain Lincoln head pennies. Sort all U.S. coins for us spare or full time. All coins are now in circulation and can be found by anyone. Send \$1.00 for catalog listing our paying prices. \$1.00 refunded on our first purchase we make from you. Viroqua Coin Company, Dept. F-12, Viroqua, Wisconsin.

GIANT U. S. coin catalog 25¢. Accoin, 314 So. Clark, Chicago 4.

PROTECT And glorify your proof sets. Plastic proof holder \$1.00. Skorupa Co., 7413 Argyle, Harwood Heights, Ill.

FREE! Foreign coin, banknote and coin collectors illustrated catalog to approval service applicants. Send 3¢ postage. Tatham Coinco, Springfield 30, Mass.

60 DIFFERENT Coins \$1.00. 60 different bills \$1.00. Oddehon, Box 482, St. Louis, Mo.

GIANT 80 Page bargain catalogue (only one like it in America) \$1.00. Fine \$5 gold \$10.95. Bebe's, 4514 North 30th, Omaha 11, Nebraska.

COINS From Formosa, Vatican, etc., plus foreign banknote, 10¢ with coin approvals. Littleton Coin Co., Littleton 51, New Hampshire.

38 DIFFERENT Foreign coins \$1.00. Robbins, 1007 Cleveland, Montgomery 8, Alabama.

U. S. Coin approvals. Reasonable. Hutchinson, 3463 "I" Street, Philadelphia 34, Pennsylvania.

BARGAIN Lists, Indianhead cent, 10¢. Economy Sales, 156-A Dean, Mansfield, Mass.

GET Profit and pleasure in collecting old coins. Send 10¢ for 56-page illustrated coin catalog. You'll be delighted with it. Send for it now. B. Max Mehl, 370 Mehl Building, Fort Worth, Texas. Largest rare coin establishment in U. S. Established 40 years.

FIFTEEN Different Indianhead cents \$1.00. Bargain lists free. Sayers, 1000 East Unaka, Johnson City, Tennessee.

BARGAINS, U.S. coins: 1893 Columbian world's fair half dollar, \$1.00. Ten different Indian pennies, 75¢. Two-cent piece, and 3-cent piece, \$1.00. Gold ¼ eagle, \$9.00. Gold ½ eagle, \$12.50. Beautiful coin bracelet, \$1.00. Many coins available. What do you need? Rare Coin Company, 31 North Clark, Chicago 2.

NAZI Coin, Italian banknote, lists, All-10¢. Approvals. Dwight Musser, Dunbar, West Virginia.

OLD Coins, currency bought, sold. Large list 10¢. Thos. J. Settle, Box 1173, Church Street Station, New York 8, N.Y.

LARGEST Coin magazine, 180 pages, 35¢. Scrapbook, 7320-J Milwaukee, Chicago 31.

SAN Francisco mint closed! Made only cents and dimes in 1955. In short supply and great demand. One each, brilliant uncirculated, for 25¢. Free coin lists with order. Bryson Stamp & Coin Company, 612 White, Toledo 5, Ohio.

LINCOLN Cents 1910-S, 1913-S, 1921-S, 1923-S, 1934-S, 1933-D all for \$2. Gasser's, Box 34515, Los Angeles 34, Calif.

\$4,000.00 FOR 1913 Liberty head nickel. Uncirculated dollars 1804 to 1839, 1893-S, 1895-P, 1903-O pay \$100.00-\$5,000.00. Certain dates—Small cents before 1915, \$325.00; Dimes before 1917, \$2,000.00; Quarters before 1924, \$1,000.00; Half dollars before 1905, \$1,000.00; 2¢ pieces, \$70.00; 3¢ pieces, \$90.00; Halfdimes, \$500.00. Hundreds of others worth \$10.00-\$1,000.00. Canadian coins: 1921 5¢ Silver, \$50.00. 1889 Dimes, \$25.00. 1875 Quarters, \$50.00. 1921 30¢, \$200.00. Wanted—20¢ pieces, gold coins, paper money, etc. Our large illustrated guarantee buying-selling catalogue, giving complete alloy information—Send \$1.00. Purchase catalogue before sending coins. Worthycoin Corporation, Leaders numismatic quotations, K-240-C, Boston 8, Massachusetts.

U.S. Coins! Bargain catalog! Sullivan's, 127-FF East Fourth, St. Paul 1, Minn.

CONFEDERATE And southern states currency catalogue and value list, 288 pages, finest ever printed, \$5.00 postpaid. Criswell's, Pass-A-Grille 9, Florida.

12 DIFFERENT Indian cents, coin list, \$1.00. Pounds, North Wales, Penna.

U. S. large cent and coin bargain lists, only \$1. Delmaco Products, Box 1123, Wilmington, Del.

10 DIFFERENT Indian head cents \$1.00. Coins, Box 6184, Albuquerque, New Mexico.

40 DIFFERENT Foreign coins \$1.00. Claud Denney, 3406 S. Harwood, Dallas 15, Texas.

DOLLARS 1881S, 1890S uncirculated, \$1.75 each. \$90.00 per roll. Sorensen's, Box 665, Burley, Idaho.

SWITZERLAND, Yugoslavia, Finland, Austria, Mexico—All 10¢. Jolie, 126B, Roslyn Heights, N. Y.

1921 P&D Dimes, good \$1.50, very good \$4.75, others. Send want list. Felerstein, 67-38 108 Street, Forest Hills 75, N. Y.

50,000 COINS, Medals, bills. Lists free. Collectors magazine 25¢. Nagy, 8-P South 18th, Philadelphia 3, Penna.

FOREIGN Coins, 10 diff., 23¢. Foreign bills, 20 diff., 25¢. Indian cents 10 diff., 50¢. Lists. Oliver Arnold, Macon, Mo.

STAMP COLLECTING

STAMP Finder, world map and encyclopedia of stamp issuing countries only 5¢. Approvals. Goliath Company, Bethlehem K1, New Hampshire.

NOW! 200 Different stamps including P.D.R. triangle also scarce war ration stamps. Only 10¢ to approval applicants. Avalon Stamp Co., Dept. M, Springfield, Mass.

FREE! Giant catalog offering thousands of bargains. Sent with beautiful approvals. Jamestown Stamp Co., Dept. E3PMC, Jamestown, N. Y.

U. S. stamps. Giant bargain catalog 10¢. Raymax, 35-VZ Maidenlane, New York City 38.

CANADA — Newfoundland collection including early issues, commemoratives, pictorials and high values. Plus set of fascinating triangle stamps. Plus set of unused British Colonies. Plus large stamp book. All four offers free. Send 10¢ to cover postage. Empire Stamp Corp., Dept. PM, Toronto, Canada.

100 LATIN America 25¢. Plus surprise packet. Packet list free. Econopackets, Box 168, Riverside 9, Calif.

FREE! Amazing list! Two feet long! All countries! Stampmart Company, Hartford 1, Connecticut.

IRAQ, Iran, Syria, Lebanon, Egypt, Israel, free! Popular approvals. Panorama, Box 229, Miami 2, Florida.

QUEEN Elizabeth pictorials, Fiji, Montserrat, St. Kitts, Sierra Leone, etc. 20 different colonies only 10 cents. Approvals. Vulcan, Box 9053, Birmingham 9, Alabama.

BRITISH Colonies over 100 different. Includes Egyptian soldier, King Farouk "behind bars," Ireland Marian Year, Jamaica pictorial, Sarawak butterfly, Tonga, Norfolk Islands first stamp, Nigeria silver wedding, animals, Queen Elizabeth issues. 5¢ to new approval applicants. Moulblow, 304B Lynn, East Northport, New York.

COLLECTION Monaco stamps featuring wedding of Princess Grace Kelly; also Presidents Eisenhower, Lincoln, Washington, Roosevelt and others. Only 10¢ to introduce approvals. Littleton Stamp Co., Littleton B1, New Hampshire.

500 WORLDWIDE Mixture. Big variety, 25¢. Monjar, Fairmount, Cincinnati 14, Ohio.

SUPERIOR Worldwide mission mixture. Amazing variety! Half pound \$1.50 post-paid. Baye Nielsen, 4545B Harvard, Montreal 28, Canada.

ECONOMICAL 1/4-3¢ Approvals, 33,000 varieties. Dresel, Box 128-N, West Englewood, New Jersey.

DOMINICAN Bicolored commemorative packet free! Interesting, popular approvals. Hilltop, Box 696, Havertown, Penna.

PHILATELIC Grab bags \$2.50. No approvals. Harold Mauk, Pasadena, Md.

90,000 STAMPS Sale; Bargain lot \$1. Extra special \$2. Persil, 436 N. Y. Ave., Brooklyn 25, N. Y.

WOW! 135 All different Germany 10¢. Zeppelins, semi-postals, airmails, high values. Big bargain lists and approvals included. Jamestown Stamp, Dept. A3PMC, Jamestown, N. Y.

GIANT Stamp 800 free! Snakes, leopards, rhinoceros, zebu, koalabear and other fierce jungle beasts. Approvals. Send 10¢ for handling. Free stamp magazine. Lincoln Stamp Co., St. Catherine's 518, Ontario.

MACAO, Nepal, Burma, Transvaal, Haiti, free! Satisfying approvals follow. Delval, Box 142, Palmyra, N. J.

TWENTY Different Mexico 5¢, approvals. Stampcraft, Box 935-A, Brownsville, Texas.

84 WORLD Coats-of-arms in color, 10¢. Approvals follow. Monumental, Box 3507, Baltimore 14, Maryland.

FREE! 107 British Colony stamps. All different, from Britain's farflung colonial empire. Catalog value \$2.50. Free stamp magazine, approvals. Send 10¢ for handling. Act now! Niagara Stamp Co., St. Catherine's 71, Ontario.

FREE! 50 British Colonies, 5¢ handling. Approvals included. Kensington Stamps, Buffalo 15, N. Y.

FREE Packet! Angola, Azores, Mongolia, Nepal, Palestine. Fascinating approvals. Coral, Box 7095, Ludlum, Miami 55, Fla.

SIX Triangles free to approval applicants. Rare, Box 633, Coconut Grove Station, Miami 33, Florida.

50% OFF Scott catalogue; send for bargain approvals. Catalina Stamps, Box 206-A, Avalon, California.

FREE Stamps with low-priced worldwide approvals. Postage paid. Enclose 10¢. P. Roy, 100 St. Johns Place, Brooklyn, N. Y.

PENNY Approvals; bargains for pennies. Free gifts. Penny Stamps, Orange 1, California.

UNITED States. Fine mint airmails. #C7, #C8, #C9, #C10. Only \$1.00. Approvals accompany. Whitton Paine, Westport 11, Connecticut.

125 DIFFERENT United States—\$1.00, approvals. Utechts, 1143J North Keeler, Chicago 51.

KENYA—Queen set to 1/-Free with approvals. Lee Hoover, Box 3594, Portland 8, Oregon.

UNITED States commemorative collection containing 33 different—10¢. Approvals. White, 516-A Avenue L, Brooklyn 30, New York.

TWO \$5.00 U.S. stamps plus 20 different, 10¢ with U.S. approvals. Irwin, Box 1105, Brooklyn 30, N. Y.

SELL Your surplus good grade stamps. Write, describing fully what you have. Vanroy Shirk, Lebanon, Pennsylvania.

FREE United States price list. Mark Hanna, 335 Fifth Ave., Pittsburgh 22, Penna.

50 DIFFERENT Argentine 10c. Approvals. Reuter, 611 W. 40th Pl., Los Angeles 37.

77 DIFFERENT U.S.—25¢. Approvals. Utechts, 1143D North Keeler, Chicago 51.

U. S. Classics. Over 50 yrs. old. 15 selected old-timers. Missing in biggest collections. All 15 at less than 1¢ each. 10¢ with approvals. Jaro, Box 246-T, New York City 8.

50 DIFFERENT United States 5c with bargain approvals, lists. Bookman, Box 8245-M, Madeira Beach, Fla.

AMAZING Offer! 200 United States stamps—including commemorative, airmails, high denominations to \$1.00. Only 10¢ to approval applicants! Illustrated bargain lists free. Mystic Stamp Co., Dept. 80, Camden, New York.

100 STAMPS, 10¢ With approvals. Smith, 508A Brooks, College Station, Texas.

MINT U.S. plate blocks. Bargain approvals. Kuehl, 3125 East K, Tacoma 4, Washington.

OLD Scarce U.S. seconds on approvals. Slight imperfections, lowest prices. Herfield, Clintonhill Sta., Newark 8, N. J.

100 OLD United States between 1861 and 1935, \$1.00. Roush Stamps, 51 Chestnut, Mansfield, Ohio.

UNITED States approvals. Select copies, used—mint. Kingsbury, Fairfax, Vermont.

ICELAND 10 Different beautiful stamps for only 10 cents to applicants for our good old fashioned approvals. Old Colony Stamp Co., Dept. A, Milford, Connecticut.

100 DIFFERENT China 10¢. Approvals. Coast, P.O. 2187H, Santa Ana, California.

1-2¢ EACH! Thousands of exciting worldwide stamps. Free examination. Cole, Box 223-A, Buffalo 21, N. Y.

SELL Stamps to our readers. Your ad in this space will be read by thousands of stamp buyers. I'll prove that to you. Write now for Folder "S." F. W. Johnson, Classified Advertising Manager, Popular Mechanics, 200 E. Ontario St., Chicago 11, Ill.

FREE United States illustrated catalog. Bailey, 45 Bromfield, Boston, Mass.

U.S. Flag, \$5.00 stamps, 25 different collection. Only 10¢. Approvals. Willett Stamps, Box 390-A, Mount Kisco, N. Y.

225 STAMPS For only 10¢! This mammoth value includes airmails, pictorials; stamps from strange countries cataloging up to 25¢ each! Also approvals. Mystic Stamp Company, Camden 80, New York.

PICTORIAL Packet from Antigua, Barbados, British Guiana, British Honduras, Burma, Curacao, Leewards, Rhodesia, Trinidad, Tobago, and many other hard to get countries. Bi-colors, topicals. Tremendous value. Each stamp a beauty, 10¢ with inexpensive, attractive approvals. Roseland Stamps, Spring Lake 2, Michigan.

100 DIFFERENT Austria, 10¢. Approvals. Aronson, Box F, Newton Centre 59, Mass.

GIANT Approvals, thousands different, 1¢ and 2¢ each. Wahl's Stamp Exchange, 7008P Farragut, Chicago 31, Ill.

FREE Stamp collection! 100 different stamps from Europe, Africa, Asia, Scandinavia, Balkans, etc. 3¢ to approval applicants. Tatham Stamp Co., Springfield 30, Mass.

STAMP Collecting outfit, includes packet worldwide stamps, package hinges, watermark detector, millimeter gauge. Everything 10¢ with approvals. Lorain Brown, Marlon 1, Michigan.

MINT U. S. at face value! All different older commemoratives! Send 25¢ for yours with first selection mint U. S. approvals. Western, Box 1689P, Salinas, California.

100 DIFFERENT U. S. commemoratives \$1.00. Wiggins, Box 72-P, Guild, N. H.

SELLING Out. Surprise packet 40¢. Perley Porter, West Medway, Mass.

14,000 DIFFERENT! Fascinating new club plan systematically builds your collection. Only 50¢ weekly. Details free. L. G. Ware, Baldwin 75, New York.

WONDERFUL Offer. 7 complete mint sets only 10¢ with approvals. Reich (M26), 1033 Lawrence, Chicago 40.

70 DIFFERENT U.S., included 35 commemoratives, 25¢. No approvals. Seldenberg, Appleton, Wisconsin.

U. S. Revenues on approval. El Jay Stamps, Box 236, New York 36, New York.

SOUVENIR Sheet Russia 1937 10¢ with approvals. Kingman, 30 Empire, Yonkers 4, N. Y.

WEIRD Diamond shape coffee stamps. Lovely flower triangle! First American big commemorative. Greenland, idol dancer, etc. Free with approvals. Capital Stamp Co., Ferrysburg 2, Mich.

WANT Lists filled, 100,000 varieties available. References. Downey Stamp Service, Box 70A, Bell, California.

FIVE Different sets French Colonies, 10¢ with approvals. Banner, Box 63, Park Forest, Illinois.

FREE Sample! Interesting, informative, illustrated. National Stamp News, Anderson, South Carolina.

ADEN To Zanzibar! A special collection of over 200 different stamps from Aden, Barbados, Cyprus, Dahomey, Egypt, Falkland Is., Guadeloupe, Hejaz, Israel, etc., to Zanzibar. Very unusual collection, catalog value easily \$5.00. Some really scarce ones included! Only 25¢ to approval applicants! Write today and receive free—Eisenhower, Grace Kelly and Geo. Washington stamps from Monaco! Lyle Clark, Muskegon 2, Michigan.

FREE! Your choice any volume Scott's International, Master Global albums, Scott's 1957 catalogues when you buy our sensational foreign approvals. Write for details with trial selection. Bargain Stamps, Redlands, California.

30 DIFFERENT Commemoratives 1893 up 10¢. U. S. approvals. K&B, Box 70, Brooklyn 23, N. Y.

EXCITING "Strange countries" packet. Free with approvals! Saxon, Orange, California.

FREE! 9 Armenia bi-colored, (50¢ value) with approvals. Diane, Box 70-M, Hartsville, South Carolina.

12,000 PENNY Approvals waiting for you. Many from exotic countries, pictorials, airmails, new issues. Tilbury, Box 862, Newark 1, N. J.

50 DIFFERENT Switzerland 10¢; colorful, inexpensive approvals. Elkhart, Box 33, Elkhart, Indiana.

QUALITY Approvals, 500 at 2¢ each. Hadrian, 12 East 31st, New York City 16.

BEST In '57! Fifty-seven stamps from 57 different countries. Triangles, colonials, pictorials. 25¢. Approvals. Olympic Stamp Co., 1215 20th North, Seattle 2, Wash.

FREE! Bahamas, Cayman, Fiji, St. Lucia, Honduras, Trinidad. Exciting approvals accompany. Rogers, Box 485-N, Albany 1, New York.

AUSTRALIA—Fifty different exciting commemoratives, animals, kings, queens. This valuable Australian collection only 10¢ with approvals. Viking, Great Neck 8, New York.

25 BEAUTIFUL Ceylon pictorials 25¢! Giant illustrated catalog free. James, Box 1111P, North Redondo Beach, Calif.

FREE U.S. price list, to approval customers only. New-Way Stamp, Lawrence, Massachusetts.

1500 STAMPS \$1.00 On and off paper. Good variety. World wide. Many pictorials. No approvals follow. Satisfaction guaranteed. Whalen, 1435 First Ave., Oakland 6, Calif.

MOZAMBIQUE Company set free. Approvals. Weitz, Box 83F, Orange, N. J.

135 DIFFERENT U.S. commemoratives \$1.00. 50-25¢. Request approvals. Harold Holub 18 East 198th Street, New York 68, New York.

50 DIFFERENT Bulgaria 10¢! Approvals. Ensign Stamp Company, Dept. M, Berdan Avenue, Paterson 2, New Jersey.

BUNDLE First day covers; blocks, stamps, guaranteed. \$1.00. Raders, Walnut, Richwood, West Virginia.

FIRST U.N. set. Among world's prettiest. Only 10¢. Approvals. Welles, Box 1246-R, New York City 8.

FREE! Large new profusely illustrated catalog of United States postage issues complete; 64-page Stamp Collectors' Guide; other unusual offers. Write today! Harris-co, 3781 Transit Bldg., Boston 17, Mass.

60 DIFFERENT Canadian 7¢. Box 41, Westboro, Ottawa, Ontario, Canada.

EXTRAORDINARY Antarctic set, free with approvals. Variety Stamps, 57-A Circuit, Newton Highlands 61, Mass.

83 DIFFERENT U.S., 25¢. Approvals. Edgar, Box 437M, Punxsutawney, Penna.

DEALERS. Wholesale list. Postage 3¢. Frank, 5031 Queensberry, Baltimore 15, Maryland.

300 DIFFERENT Given free with approvals. Particulars. Winsor Stamps, 8834 Cornell Ave., Chicago 17.

LOW-Cost world-wide approvals. Fine selection. Champlain Stamp Company, Isle La Motte, Vt.

U.S. Canada price list, over 100 pages, 700 illustrations stamp identification, 10¢. Thom, 4808 15th Avenue, Minneapolis 17, Minnesota.

FREE! 20 Egyptians; attractive approvals. Smith, Box 83, Brooklyn 3, (Rugby) New York.

FREE—Mint Monaco dog set with penny approvals. J. W. Harris, P.O. Box 56, Beaver Falls, Penna.

25 DIFFERENT U.S. commemoratives only 10¢ with approvals. Wm. Rice, 87 Washington Ave., Kingston 35, N.Y.

SPAIN 100 Different 10¢ to approval applicants. Morell, 203 Fenimore St., Brooklyn 25, N.Y.

FREE. 10 Different mint airmails, 10 countries, good approvals. Pan-American, Box 24, Coconut Grove, Miami 33, Florida.

WHOLESALE Foreign stamps \$100.00 catalog guaranteed \$10.00. Sample lot \$2.00. Plenty variety. Jean Husak, 342 Liberty, Syracuse 4, N. Y.

UNITED Nations. Five different 10¢. Approvals. Anderson, 1113 Harrison, San Francisco 3, Calif.

U. S. mint specials! 13 different commemoratives. 25¢; flag set, complete, \$1.00. Free price list. Brooks, 2332-P East 23rd Street, Brooklyn 29, New York.

RUSSIA, 25 Exciting gems 5¢ with approvals. Belmont Stamps, Washington 13, D. C.

25 DIFFERENT Greece only 5¢ to approval applicants. Wineholt, Woodbine, Penna.

101 DIFFERENT Including first Greenland stamp, 10¢ with approvals. Finney, Box 89, El Monte, Calif.

SIX Different colorful Roosevelts, free! Attractive, inexpensive approvals. Americana, Box 1560, North Miami, Florida.

FIVE Fiji 10¢, twelve Fiji, Papua 25¢. Levin Otis, Lewiston, Calif.

FREE Stamps. Write for bonus offer with approvals. Village Stamps, Box 111, New York City 9.

75 YEAR Old U. S., famous Americans, Flags, Presidents, commemoratives with approvals plus free premium for 10¢ handling. Metropolitan Stamps, Box 312Y, Jackson Heights, N. Y.

FREE! Seven short sets! Approvals. Gernert, 4235-X Alton, Louisville 7, Ky.

COLORFUL Set, dogs, triangles, free with approvals. Philatelic, Pennington, New Jersey.

MACAO Maps, mint, 10¢. Approvals. Security, Box 113, So. Orange, N. J.

FREE! Monaco triangle, Cameroun! Togoland! Zaragoza commemoratives! Approvals. Keating, 2530-P Boulevard, Jersey City, New Jersey.

SUEZ Canal—26 different better Egypt stamps, only 10¢ with approvals. Excello Stamp Company, Box 489, Red Bank, New Jersey.

100 DIFFERENT Greece 25¢ with approvals. Northwest Stamp Service, Box 37, Seattle 5, Washington.

MONKEYS On stamps. Free set to approval applicants. Collier, Chamber, Ga.

1957 U.S. U.N. catalogue free. Stone, 192 Washington, Boston 8, Mass.

1888 VICTORIA (Canada), mint Elizabeths, Hungarian pictorials, French colonies, all free with interesting approvals. Stamp Imports, Peterborough, Ontario, Canada.

U. S. commemoratives. 100 mixed 25¢. Ray Worth, 321 So. Cicero, Chicago 44.

CANADA—100 Different. 35¢ with bargain approvals. K. S. Holmes, London, Canada.

FREE! 20 Different U. S. commemoratives, approvals. Ludwig, 9012 Niles, Afton 23, Mo.

2 NUDES Sets 25¢ to adult stamp approval applicants. Atlas, 1326 Vilas, Madison 5, Wisconsin.

FREE Premiums for approval customers. Bengtson, Box 713A, Minneapolis 1, Minn.

UNITED States commemorative price lists free, no approvals. Frank Hutter, 468 8th Street, Brooklyn 15, New York.

50 DIFFERENT Worldwide 10¢. Attractive, exciting approvals. Senator Stamp Co., Box 1522, Arlington 3, Va.

3 ISRAEL Free, approvals. Coral, Box 224, Riverside Sta., Miami, Fla.

JAPAN Souvenir sheet 10¢ with approvals. Ralph Rice, 15 Longlane, West Hartford 7, Connecticut.

CALLING Canadian collectors. Return postage gets 108 Confederate (facsimiles). Additional dime gets 50 different British Colonials, Canadian and British Colonials approvals accompany. Gene's, 1707 Congress, Austin 1, Texas.

500 EARLY U. S. 50¢ with approvals. Connelly, Box 474, Portsmouth, N. H.

50 DIFFERENT Beautiful Switzerland, free! Interesting, inexpensive approvals. Cliffe, Box 97, Hudson Heights, N. J.

TRIANGLES, Birds, butterflies, flowers—Big packet 19¢ with approvals. Southwest Stamps, Box 117, Long Beach 1, Calif.

35 ANIMALS, Fish, maps, rulers, triangle, others, 5¢. Approvals. Tillicum Co., 6 Hyde Ave., Vancouver, Canada.

STAMP Collecting outfit 10¢! Album, stamps, gauge, stamp file, lists, surprises. Approvals. Adventure, Dept. PM, Buckland, Connecticut.

50 DIFFERENT U. S. 10¢. Approvals accompany. Standard, 10840 Woodview, Parma Hts. 30, Ohio.

FOREIGN Approvals. Free gift. Smith, 504 Water Street, Warren, Penna.

100 DIFFERENT U. S.—Stamp wallet—Perforation gauge. Only 50 cents. Thiese, 9320 San Juan Ave., South Gate, Calif.

TRIANGLES, French Colonials, 100 others 10¢ with approvals. Bennett, Candor 3, N. Y.

PANAMA Pictorials—10 different 10¢ with worldwide approvals. Moffat's, 740-A Milton, Rock Hill, South Carolina.

HUNGARY, 100 Different 10¢. Approvals accompany. William Torrance, Stony Brook, New York.

EXCHANGE Stamps. Club plan, Stamps, membership, \$1.00. LEC, 50 Lincoln, Westwood, N. J.

HOBBIES AND COLLECTIONS

COLLECTORS Matchbook covers. 100 different unused, \$1.00. Catalog 25¢. Album \$3.00. Charles Edelman, 1311-C East 84, Cleveland 3, Ohio.

INVENTING Can be an interesting and profitable hobby. Write for complete particulars. Institute of American Inventors, Dept. 40-E, 635-F St., N.W., Washington 4, D. C.

NAZI Insignia. 12 different \$1.00. Medals, patches, armbands, flags, daggers. Illustrated lists. 15 cents. Medcrafts, Box 532, Victoria, B. C. 2, Canada.

PRECIOUS STONES, MINERALS

BEAUTIFUL Collections Ceylon gems airmailed \$10.00 up. John Rajapakse, Negombo, Ceylon.

ASSAYS. \$2 Each. Reed Engineering, 620 S. Inglewood, Inglewood, Calif.

TEN Minerals \$1.50, six fluorescents \$1.00, five crystallized minerals \$1.00, fool's gold 25¢. Hartoon, Winston, N. Mex.

CUT Gems, make jewelry—For profit or fun. 100 page magazine tells how; where to get supplies. Sample 25¢ or request free literature. Lapidary Journal, Del Mar 2, Calif.

EARTH Science, the Rockhounds' national magazine. Subscription \$2.00, sample 25¢. Box 1367, Chicago 90.

SAPPHIRE, Topaz, tourmaline, garnet, peridot. Five uncut gem specimens. \$1.00. Ten polished gems, baroque shaped. \$1.00. Free bargain list jewelry, gems. Profitable, easy "do-it-yourself" projects. O'Brien's, 1116M Wilcox, Hollywood 36, Calif.

ANTIQUES, RELICS, INDIAN GOODS, CURIOS

10 ANCIENT Arrowheads \$2.00. Grooved tomahawk \$3.00. List free. Lear's, Glenwood, Arkansas.

SCALPING Knife, spearhead, thunder-bird \$4.00. Catalog free. Arrowhead, Glenwood, Arkansas.

4 PERFECT Arrowheads \$1.00. Smith, 841 N. Tacoma, Indianapolis 7, Indiana.

ILLINOIS—Gesundheit! Selling several hundred historical firearms, 50,000 Indian relics, 30,000 collectors cartridges, coins, Confederate money, oddities, Revolutionary, Mexican-Civilwar, Confederate, muskets, pistols, swords, powder flasks, bayonets. Arrowheads, spears, tomahawks, discoidal, mounted birds, steerhorns, deerheads. Violin wood, bo-wood, dagger-reotypes, Kentucky rifles, frontiers, duelling pistols. Agates, fossils, minerals, gold dollars. Send 35¢ for profusely illustrated catalog. Heike, Manson, Wenona, Illinois.

CAMERAS, PHOTO SUPPLIES

MULTIPLE Print easel. Everything on 8x10. Process efficiently. Octo Products, Inc., 376 Clay Avenue, Rochester 13, New York.

AMAZING Low cost 3-D! Details free. Consterdine's, 4844 Lakewood, Detroit 15, Michigan.

BUY Wholesale nationally advertised cameras, photo supplies, thousands other products at big discount. Free "Wholesale Plan." American Buyers, Hertel Station, Buffalo 16-E, N. Y.

FREE! Big list of 300 books on photog-raphy. Send 25¢ for new illustrated 8x10 catalog describing 600 current photo books available. Morgan & Morgan, Publishers, 101 Park Avenue, New York City.

FREE! Free! Free! Bargain book. Big savings—Still, movie camera, equipment and supplies. Photographic headquarters since 1899. Central Camera Company, Dept. 2-11, 230 S. Wabash Ave., Chicago 4, Illinois.

NEW Kodak Pony '33' \$23.95. (Regularly \$36.50.) Big discounts, photo equipment, appliances. Free catalog. Mailers Mart, Box 135-MK, Pelham, New York.

PHOTOGRAPHY For pleasure or profit. Learn at home. Practical basic training. Long established school. Free booklet. American School of Photography, 835 Diversey Parkway, Dept. 3442, Chicago 14.

PHOTO FINISHING

LIFETONE (Copyright) ultra fine grain prints. Custom developing plus overize prints on heavy portrait weight paper. Salon quality. 8 exposure 70¢, 12 exposure \$1.00; 35mm—20 exposure \$1.75, 36 exposure \$2.75. Free mailers and circulars. Send to Lifetone Prints, Post Office Box 96, Chicago 17, Illinois.

HOLLYWOOD "Starotype" enlarge-ments. Eight 5x7s or five 8x10s—\$1.00. Hargraves Lab's, Box 373, Hollywood 28, California.

8-HOUR Service on deluxe jumbo prints. 8-exposure roll developed and 8 jumbo prints 40¢, 12 exposure 55¢, 16 exposure 70¢; 35mm. 20 exposure 75¢, 36 exposure \$1.25. Jumbo deckle reprints 4¢ each. Contact prints made if specified. Bay Photo Service, P.O. Box 210, Oakland, California.

ENLARGEMENTS, Heavyweight eight 5x7s or five 8x10s, \$1.00. Jack Koons, Huntington Mills, Luzerne County, Pennsylvania.

SUPERIOR Quality. Prompt service. 8 jumbos in album 40¢, 16 contacts 50¢. Jumbo reprints 5¢. Satisfaction guaranteed. Also complete color film finishing service. Write for free circulars and mailers. Fast-X-Foto, Box A, Jersey City, N. J.

8-12 EXPOSURE Rolls 39 cents jumbo prints. Free 5x7 enlargement with each roll developed. Guaranteed work, one day service. Lincoln Studios, Dept. K, Box 13, Lincoln, Nebraska.

QUALITY Kodak finishing. 8 exposure roll 40¢; 12 exposure 60¢; 16 exposure 70¢. Reprints 5¢. Fast service. Guaranteed quality. 40 years continuous operation. Be a satisfied customer. We do color. Send for mailers. Mail Order Photo Service, Box 297, Watertown, Wisconsin.

EKTACHROME, Anscochrome, Processed \$1.00. Fast Kodachrome, Kodacolor service. National Color Corporation, Box 55P, Northside, Atlanta, Georgia.

NEW Kolourchrome color prints. White borders. 2½x3¼, 29¢. 3¼x3¼, 39¢. 3¼x4¼, 49¢. 5x7, 99¢. Anscochrome—Ektachrome processing \$1.00. Kolour Labs, Inc., Box 333, Boise, Idaho.

THREE 5x7's Mounted, \$1.00. Send negative. Harwell, 319-37, Byrdstown, Tennessee.

EKTACHROME—Anscochrome processed. Mounted \$1.00. National Color Corporation, Box 55E, Northside, Atlanta 5, Georgia.

KODACOLOR—5 Days. Save 30% on lovely, sparkling color pictures. Write for discount coupon or send roll with this ad. 8 exp. \$2.43, 12—\$3.32. Introductory special. Delco Color, Box 362 PM, Darby, Penna.

SAVE Dollars on color. 20 exposure Ektachrome \$1.00; 20 exposure Anscochrome \$1.00; 8 exposure Kodacolor \$2.75; 12 exposure Kodacolor \$3.75; 16 exposure Kodacolor \$4.75. Fast Confidential Services, Box 128, Spokane 10, Washington.

MOTION PICTURES AND SOUND EQUIPMENT

5,000 8-16MM. Movie films. Free catalogue. International, Greenvale, N. Y.

TAPE Recorders, tape. Unusual values. Free catalog. Dressner, 69-02M 174 St., Flushing 65, N. Y.

MOVIE Camera film: 8mm. roll \$1.50, 16mm. 100' \$3.00. Free processing. Better Films, 742 New Lots, Brooklyn, N. Y.

RECORDERS, Tapes; wholesale. Free catalogue. Carstan, 215 E. 88, New York City 28.

8-16MM. Films. Free catalogue, with sample film 10¢. Garden, 690 Howard Avenue, Brooklyn, N. Y.

FREE! Blackhawk's big sale catalog new and used 16mm., 8mm. films; 2"x2" color slides; used 16mm. sound projectors. Biggest stock in U.S.A. Blackhawk Films, 1700 Eastin, Davenport, Iowa.

SAVE 50%! Guaranteed-fresh color, b.&w. movie film! 8mm., 16mm. Free catalog! Eco-R, 47th Holly, Kansas City 12, Missouri.

16 MM. Sound films. Large selection. Bedner, 5300 So. Talman, Chicago.

FREE Catalog. Save dollars. Fresh 8mm., 16mm. b&w and color film. Home processing equipment. Superior Bulk Film Company, 448 No. Wells, Chicago 10.

1957 MISS Universe Pageant. Eight color slides \$1.00. 32—\$4.00. Eddings, R-3, Corning, N. Y.

MUSIC AND MUSICAL INSTRUMENTS

POEMS, Songs wanted! Recording, publishing. Bengol, 93 Jefferson, Chelsea 50, Massachusetts.

PLAY Piano the first day! Copyrighted secret. Details free. Miracle Method, Box 5203P, Phoenix, Arizona.

ACCORDIONS. Wholesale to everyone. Save up to 60%. All national known brands. Free catalogue. Del Principe, 29 South Cicero, Chicago 44.

WRITE Songs. Big money and reputation. Write for information. J. Gordon Pub. Co., 4700 South California Avenue, Chicago.

SONGPOEMS And lyrics wanted. Mail to: TinPan Alley, Inc., 1630 Broadway, New York 19, N. Y.

SONGS Into dollars. Share \$29 million dollars yearly for new songwriters, song-poets. Songs composed, published, promoted by famous firm. Information, appraisal free. Send to Nordyke Publishing, 6050 Sunset, Hollywood 28PM, California.

POEMS Wanted for new songs. Send poems. Free examination. Immediate consideration. Songcrafters, 2724 Arcade Station, Nashville, Tenn.

SONG Poems wanted. Five Star Music Masters, 630 Beacon Building, Boston.

POEMS Wanted for new songs. Send poems. Immediate consideration. Crown Music Company, 49-C West 32 Street, New York City.

BEAUTIFUL, Lovely toned harps direct from the manufacturer for only \$59.50. Learn music, write songs, be popular! Harp Co., Baird, Texas.

ACCORDIONS—Direct from importer. Save 50% and more! Free trial. Lifetime guarantee. Trades accepted. Free catalog. Write Accordion Manufacturers, Dept. 37R, 2003 Chicago, Chicago 22, Illinois.

SWISS Musical movements, \$1.90. Helax, 218 West 72nd Street, New York 23.

SONGWRITERS: Recording company wants new songs. Royalty basis. National sales, promotion if selected. Send material. Music Makers, Dept. E-31, Box 2507, Hollywood, Calif.

MARVEL Piano course. Play in one half hour! Send postcard for your free first lesson. Empire Music School, Box 1332, Denver, Colorado.

VIOLIN-Making supplies for the home craftsman. Free catalogue of quality imported woods, tools. Fred Artindale, Box 71992, Los Angeles, California.

PHONOGRAPH Records. Collectors items. 6 rare internationally renowned instrumentals hi-fi 78 r.p.m. only (no title choice). Limited quantity \$10.00. Paul Bennie, 1252 63rd Street, Oakland, Calif.

ACCORDIONS Wholesale—10 day trial. Free catalog. American Accordion Center, 5329-PM-3 Belmont, Chicago.

SONGWRITERS—Professionally arranged printed song copies made very reasonably. Write M. Kahn, 134 W. 58 St., New York City.

SONGPOEMS. Music for your words. Information. Hudson Music Service, Happy Valley Rd., Chattanooga 9, Tenn.

DISCOUNTS—Instruments, accessories. National brands. Tempo Music, 37 Cutler St., New London, Connecticut.

ELECTRIFY Reed organs. Instructions \$1.00. Galloway, 301 Central, New Port Richey, Fla.

VIOLINMAKERS. Repairers. Fine tone wood, and all violin supplies. Send for free wholesale price list. International Sales, 414-MPM E. Baltimore St., Baltimore 2, Maryland.

SONGPOEMS, Songs wanted. Independent Songwriters Agency, P.O. Box 16-A, New York City 19.

RADIO, TELEVISION AND ELECTRONICS

CRYSTAL Radio experimenters write to Hulet, 305 Hope, Lakewood, N. J.

GOVERNMENT Surplus radio gear. Astounding picture list 5¢. Meshna, Malden 48, Mass.

MINIATURE Wireless broadcaster kit. Transistorized. Literature. Amerilabs, 471 Clifton Ave., Newark 4, N. J.

FREE! Newark's 1957 catalog. A postcard will bring you 23 pages full of the latest releases and largest selections of the world's finest radio, TV, amateur, electronics and high fidelity equipment. Write today to: Newark Electric Company, 223 W. Madison St., Dept. PM-3, Chicago 6, Ill.

CRYSTAL Radio kit \$1.00, preassembled \$1.25, phone \$1.75; catalogue. Clearco Crystal Company, 2966 North 4th, Milwaukee 12, Wisconsin.

ENJOY 3-Color television now! Screens for every black-white set. Complete details free. Zingo Products, Johnstown, New York.

BUSINESS OPPORTUNITIES

PROFIT From casting. Detailed information on casting, mold making and the sale of finished casts. A profitable and enjoyable part time hobby. Send for complete catalog—25¢. Plastic Arts Studios, 3403 So. Madison Street, Dept. 5, Muncie, Indiana.

START Your own business on credit. Your own boss. 1598 dealers sold \$5,000 to \$32,000 in 1955. We supply stocks, equipment on credit. 200 home necessities. Sales experience unnecessary. Pleasant profitable business backed by world-wide industry. Write Rawleigh's, Dept. C-U-PPM, Preport, Ill.

BECOME Tax consultant. Graduates earn \$3,000 every tax season preparing returns evenings. State approved, Union Institute, 68 Hudson, Hoboken 2V, N. J.

START A buying service, buy wholesale thousands nationally advertised products. Make big profits selling at sizable discounts. Postcard brings details. American Buyers, Hertel Station, Buffalo 16-C, New York.

MAKE Extra money. Cash commissions. Everybody buys easy-to-sell advertising book matches. Union Label. All sizes. Cuts for all businesses. Powerhouse selling kit free. Steady repeat business. No experience necessary. Superior Match Co., Dept. MX-357, 7526 S. Greenwood, Chicago 19.

IMPORT-Export opportunity, profitable, world-wide, mail-order business from home, without capital; or travel abroad. Established world trader ships instructions for no-risk examination. Experience unnecessary. Free details. Meilinger G703, Los Angeles 24.

NEWEST Spare, full-time home business \$5 to \$10 hour possible. Paint with suede—The finish with touch and eye-appeal. Beautify auto dashboards, signs, radios, toys, figurines, lamps—1001 others. Complete, step-by-step instructions sent for no-risk examination. Free details. Coast MH, Los Angeles 61.

SHINE Cars without polish. New invention. Lightning seller. Cars gleam like mirror. Samples sent on trial. Kristee 108, Akron, Ohio.

\$50, \$75 WEEKLY at home. Spare time. Repairing electric motors. Easily mastered. Free trial. Lincoln School, Box 52, Hempstead, N. Y.

NOW! Amazing, unique, profitable business at home. Part or full time. No selling, stock or experience needed. Request information. General Associated, 119-A South Western, Los Angeles 4, Calif.

PRINT Without a printing press! Amazing new method! Print colorful signs, banners, cards, posters, glassware; anything at home. Big profits. Moneymaking opportunity! We supply everything. Beautiful sample, home-business plan free! Write Screen-Print Company, MH, Los Angeles 61, California.

WANTED: Home producers, to be subcontractors. Cast plastic products for manufacturers in our clearing house service. Thousands of easily made items required. Cash in at home, without previous experience. Plastic Service Associates, Dept. 3-PM, East Boston 28, Massachusetts.

WANTED! Home workers to assemble luggage and cases for ready market. Instructions, materials, tools, everything supplied. Free details. Abaral, 807-BC Sunset, Los Angeles 12.

GROW Expensive herbs for us! Big profits home-business of your own. Year around profitability! We supply everything necessary! Send for free rare seeds and revealing plan. National Herb Exchange, Dept. MH, Gardena, Calif.

"HOW To Start a Business" booklet sent free! If you know any trade, go into business for yourself! Learn the 9 easy steps to follow. We've guided 5,000 others to success. Revealing free booklet yours for the asking! Write! National Business Consultants, Office MH, Los Angeles 61, Calif.

\$5000.00 YEARLY, Part time. In one of these businesses: Mail order; real estate; photography; insurance; bookkeeping; collection. Write today. Nationwide, 618 Savannah, Columbus 4, Ohio.

MAKE Attractive, durable, building plastic, easily. 800% profit. Exclusive district. Bays Laboratory, Oklahoma City 9.

MAKE Flexible molds. Cast plaques, figurines. Free sample. Tooker, 1045-R Fairview, Hamilton, Ohio.

WANT To make big money at home? \$10.00 profit in an hour possible with invisible reweaving. Make tears, holes disappear from clothing, fabrics. Steady year-round demand from cleaners, laundries, homes. Details free. Fabricon, 8334-S Prairie, Chicago 19, Illinois.

NATURAL Molding rubber, extra thick. Free sample. W. Woolley, 1016-A Donald, Peoria, Illinois.

INTERNATIONAL Mailorder business. Complete setup service—Not just instructions. Hermes, 152 West 42, New York City 36.

YOU Can make money at home in spare time taking magazine renewal subscriptions. No capital or experience necessary. All supplies furnished. Write today! McGregor Magazine Agency, Dept. 500B, Mount Morris, Illinois.

BIG Money raising fishworms and crickets. Free literature. Carter Farms, Plains, Georgia.

INTERESTED Mail order? Samples leading mail order magazines 10¢. Palm, Box 1221, Baton Rouge, La.

START Home business making statuary, plaques, novelties, garden furniture, artificial marble flooring, liquid marble. Make your own flexible molds. Amazing profits. Only \$1.98. Free literature. Popular Mechanics Press, 631 No. St. Clair St., Chicago 11.

UNUSUAL Mailorder opportunity. Tested. We supply everything. Girard's, Azusa, Calif.

\$60 WEEKLY. Spare time, easy! Home Venetian blind laundry. Free book. Burtl, 2434A, Wichita 13, Kansas.

YOUR Own mailorder business. Manual 234. George McCutcheon, 638 W. Creighton, Fort Wayne, Ind.

WHOLESALE—Thousands nationally advertised products. Buy, sell. Amazing profits. New, free plan. Associated Wholesalers, 1016-D Starr, Burlington, Iowa.

WANT More business? Here's an amazing opportunity to increase your sales. Talk to thousands of interested readers of "Mechanica Popular." Our Spanish Edition covers the Latin American countries like a blanket. They're real mailorder buyers. Classified rate 75¢ per word. Try an ad in our next issue. Classified Advertising Department, Popular Mechanics Magazine, 200 East Ontario Street, Chicago 11, Ill.

PLATE Baby shoes, jewelry, gifts, bronze and colored pearl. Free booklet. Platex, 11029 South Vermont, Los Angeles 44.

VENDING Machines—No selling. Operate a route of coin machines and earn amazing profits. 32-page catalog free. Parkway Machine Corporation, Dept. 26, 715 Ensor Street, Baltimore 2, Maryland.

GROW Orchids at home—Profitable, fascinating. Year 'round, Maine to California. No greenhouse. Gorgeous cacti, cymbidiums, etc. Successful home grower shows you how. Full details free. Flowerland, 100 So. Vermont, Los Angeles 4.

HOME Workshop books. Free catalog. Popular Mechanics Press, 631 N. St. Clair St., Chicago 11.

LIQUID Rubber, make flexible molds. Free sample. Chaney, 1130 E. 16th St., Jacksonville 6, Fla.

MONEY In saw and lawnmower sharpening sparetime at home. Free book. Virgil Foley Company, Columbia Heights, Minnesota.

FREE Folio "85,000-\$45,000. Unlimited Vacations." No merchandise, equipment. Unknown! Work home, sparetime! Haylings, Carlsbad, Calif.

\$250 WEEK Cleaning venetian blinds. Patented machinery. Free literature. Robinson, 7213B, Indianapolis 1, Indiana.

FIX Typewriters. Inexpensive home course teaches factory secrets. Free booklet. Write, Typewriter, Tarentum 1, Penna.

\$70 WEEKLY—Home, spare time. Simplified mail bookkeeping. Immediate income—easy! Auditax, 34757A, Los Angeles 34.

BRUSH Plating outfits for plating articles in the home and shop. No tanks necessary. Good income spare or full time. Free particulars. Gunmetal Co., Ave. H, Decatur, Illinois.

50% PROFIT Baking new greaseless doughnuts in kitchen. Grocers buy daily. Free recipes. M. Ray, 3605 South 15th, Minneapolis 7, Minnesota.

\$1,000 MONTHLY Possible in collection agency business. Free details. Write Cole Associates, Syracuse 2, N. Y.

TO \$100.00 Weekly. Sparetime, home operated mailorder business. Successful beginner's plan. Everything supplied. Lynn, 10429-M National, Los Angeles 34.

FREE Book "505 Odd, Successful Businesses." Work home. Expect something odd! Pacific, OceanSide, Calif.

PLASTERCRAFT Molds, liquid rubber, plasters, flocks, candle supplies. Catalog and manual free. Blue Rapids Supply, Blue Rapids, Kansas.

EARN \$10,000 Yearly raising Angora rabbit wool for us. Information 25¢ coin. American Angora Company, Malta 12, Montana.

BREED Rare tropical fish at home. Earn big money! Learn secrets! Help fill huge demand. Amazing opportunity! Free plan. Tropical Fish Breeders, Los Angeles 61, Calif.

MINK Raising information free. Complete. Lake Superior Mink Farm, Superior, EEl, Wisconsin.

COPUBLISH Mail Sale Advertiser. Leading mail order paper. Details. Latest copy, dime. Vanroy Shirk, Lebanon, Penna.

HIGHEST Commissions all magazines. Free catalogue, supplies, prizes, exclusive extras. Subscription Service Co., Box 2070, Birmingham, Alabama.

LEARN Real estate by listening to records. Lee Institute, Brookline 46, Mass.

I Want to send you proof of the wonderful pulling power of Popular Mechanics classified pages. What's your proposition? Write me today. Include literature if possible. F. W. Johnson, Manager Classified Advertising, Popular Mechanics Magazine, 200 E. Ontario St., Chicago 11, Ill.

POPCORN And potato chip equipment. Eakins, Box 933 A7, Springfield, Ohio.

FREE "Franchise Profit Letter" describes nationwide opportunities. Exclusive distributorships, dealerships, agency operations. Write today. National Franchise Reports, 333 North Michigan, Chicago 1.

DO Drain cleaning by electric machine. Highly profitable, non-competitive business. Full details and prices. Electric Sewer Cleaning Co., Allston 34, Mass.

LEARN Sewing machine repairing. To \$125.00 weekly. Sparetime. Supplies. "Add to present business." Write today! Taylor Service, Box 2126, San Bernardino, Calif.

LEARN Photo-negative portrait retouching. Men, women. \$5 hour possible spare or full time at home. Easy, glamorous. Work for photographers by mail order. Full details sent free. Duval, 100 So. Vermont, Los Angeles 4.

PROFITABLE Mail order methods, ideas, opportunities. Clearly, authentically revealed in amazing new publications now available. Free details. Write: Wellington Publishing, Box 4157, Austin 51, Texas.

YOUR Own name brand business. No investment; no inventory. Part time or full time. Sell famous brands of appliances, housewares, silverware, radios, vacuum cleaners, lamps, tools, clocks, watches, jewelry, etc., etc., over 1000 items. Join thousands of successful independent dealers. Send for free catalog and dealer price list. H. B. Davis Corp., Dept. 11, 145 W. 15 St., New York City.

GUARANTEED—Profitable. Sparetime. Home. Mailorder business, \$1.00. AAA, 100 Airport, San Antonio 12, Texas.

\$5,000 YEARLY. Spare time at home. Nothing to buy. No local selling. Dignified. Guaranteed. Home Harvest, Rt. 3, Box 3491-A, Albuquerque, New Mexico.

BUY Wholesale! Discounts to 30%! Appliances, cameras, sporting goods, housewares, watches, tools, clothing, etc. Buy-Rite 73-01, Wagaraw, Hawthorne 2, New Jersey.

FREE! "301 Profitable Small Businesses!" Amazing shoestring plans! Work home! Start sparetime! Deamant Surveys, Kenmore 23-R, N. Y.

EXPERIENCE Unnecessary. Earn big money bookkeeping. Copyrighted "5 Minute System." Complete instructions \$1.00. Cooke's, Seaside, California.

WHOLESALE Catalogue! Appliances, cameras, watches! Cam Company, 6806PM 20th Ave., Brooklyn 4, N. Y.

AMAZING Profits in local mimeographing! Start on shoestring. Merritt Mimeo, Basking Ridge, N. J.

NEW Method for overhauling car motors pays up to \$25 a day. 125% profit. Write, Stephens Enterprises, Hartstown 1, Penna.

HIGH Profits selling trailer awnings, carpets. Canvas Center, Tampa 10, Fla.

DISCOVERY Makes \$1,500 in three weeks! Free packet. "Secret Journal." 819 secrets—plans! Work home. Publicos, OceanSide, Calif.

SPECIALIZED Magazines—5,165 publications—current copies. Also 1,148 self-help books. All trades, professions, sports, hobbies, etc. List free. Publications, 34C North Ritter, Indianapolis 19, Indiana.

PROFITABLE Home mail-order business. Big profits. Details free. Gryder, Box 187, Barberton, Ohio.

\$20-\$50 WEEKLY With local mimeographing plans. Moezel Mimeo, Bonham, Texas.

11,000 NEW Prospects daily. Baby record books, shoes, albums. Sell mailorder. Use our literature. Write: No-Co-Ro, Capitola, California.

COLORGLAZED Concrete pottery made without molds. Patented method. Cemetery products, novelties, tiles. Basement leak-sealing. Money-making projects. Booklet, details free. Men only. National Potteries Company, Grand Rapids, Minnesota.

FREE Cadillac, \$10,000 yearly. Cars, appliances wholesale. Strateway, 6228E, Charlotte 7, N. C.

MOLD Rubber latex. \$5.00 gallon, red, yellow, green, orange, blue, white. Duplicate china-plaster objects. Instructions furnished. Send cash with order. Specify color. Marshall, Box 67, Forney, Texas.

MADE \$10,000.00 Typing at home. Guaranteed profit. Amazing information 10¢. Lenore Felgen, Box 1125-PM, Oak Park, Illinois.

MAKE Mailorder pay handsomely, I do. Close contact with patent office enables me to offer original sources of several novelties, specialties, etc., new to mail-order. Will furnish name and address of manufacturers or suppliers who drop-ship your label. Excellent mail sellers. Ask about this month's articles. McClain's, Box 471, Detroit 4, Mich.

OPERATE Profitable mailorder business! Splendid opportunity. For details write: Thomas Bond, 1637H West Vernon, Phoenix, Arizona.

MAIL Order advertising agency executive reveals sensational no-risk advertising and merchandise methods. Start in office or home; minimum capital; positive profits. Free details: Impact! 3407 Prospect Avenue, Dept. 11-3, Cleveland 15, Ohio.

COLOR Concrete with chemicals. Marble-glaze cement benches, pottery. Home-shop. Hundred beautiful designs, made without molds. Birdbaths to waterfalls. Your chance for fame, fortune, 10¢ brings sample, pictures. Hollywood Cementcraft, 8527-R Wonderland, Hollywood 46, Calif.

"MAILORDER Laws and Regulations." Explains necessary licenses, taxes, legal requirements, etc. Only \$1.00 postpaid. Tasker, 1603 Peach Street, Alexandria, Va.

GREATER Opportunities may be waiting you in Florida. Interesting information free. Herco Industries, Box 382, St. Petersburg, Florida.

FREE Plan: "\$3,000 Yearly Sparetime, Backyard, Raising Earthworms!" Oakhaven-P, Cedar Hill, Texas.

MAKE Perfumes, cleaners, polishes, cosmetics. Sell mailorder. International, 6347 Parnell PM-37, Chicago 21, Illinois.

CASH From sawdust, seventy methods. Tin-cans, thirty methods. Newspapers, eighteen methods. Instructions 50¢ each. All three \$1.00. Charles Company, 12-DXT, Norwood, Ohio.

DON'T Buy just any business opportunity plan. Be classified according to abilities, finances, personal requirements. Free questionnaire. Opportunities, 131 Parkhurst, Kenmore 23, N. Y.

HIGHEST Profits all magazines. Sure success plan. Free catalogue, supplies, prizes. Subscription Service Co., Box 2070, Birmingham, Ala.

WORLD-Wide! Profitable mail-order business from home without capital or experience. Free details! World Importer, P-163, 939 Vanderhoeven, San Antonio 9, Texas.

START Your own business. Part or full time. Little or no capital needed. Many golden opportunities. 24 page catalogue free. Frank Fix, 2056 Switzer Ave., St. Louis 21, Mo.

MAKE Money in a business of your own in Latin America. Others have done it, so can you. Write airmail. Thomas, Apartado 2988-N, San Jose, Costa Rica.

OPERATE Home mailorder (folio) bookshop. Write Ballard's, 425 East Catherine, Louisville 3, Ky.

SELL Books by mail. 400% profit. Royal, Box 368-X, Cleveland 27, Ohio.

MAKE Money in landscaping. Start your own business, part or full time. Many good paying positions open. Earn while learning. Send for free book, National Landscape Institute, Dept. M-37-C, 310 S. Robertson Blvd., Los Angeles 48, Calif.

FINEST Mailorder manual in the field! Contains thousands of supply sources, plans, and tips. Guaranteed satisfaction. Only \$2.00 postpaid. W. Adams, Box 5415, Chicago 80, Illinois.

1957 WHOLESALE Buyers directory, 7000 wholesale supply sources, manufacturers, importers, giant directory \$3.00. Victor Publications, Box 944B, Kingsport, Tenn.

AMAZING Sign system. Earn while learning. Straley, 410 S. Western, Springfield, Ohio.

IMPORT Your own fast selling products in small lots. Also, start highly profitable mail-order business using international drop shipment method. Capital unnecessary. Free details. Georgia Overseas Trading Co., Dept. W, 715 Persons Bldg., Macon, Georgia.

YEAR'S Subscription. Four top mail magazines, \$2.00! 1,000 names, \$1.00. Bassett, 16-A6 Fernwood, Larchmont, N. Y.

ENGRAVE Crystal plastic personal nameplates! Everyone wants! New engraving attachment "DupliScaler." Details, sample 25¢. Desco Distrib., 5262-M Van Nuys, Van Nuys, California.

MONEY Comes easy to owners of Acme saw sharpeners. Send for free literature. Max Mfg. Co., 138 Stockton Ave., San Jose 25, Calif.

IMPORT Mailorder business opportunities! Details. Warner, Box 6, Fort Scott, Kansas.

PIANO Tuning learned quickly at home. Tremendous field! Musical knowledge unnecessary. Free information. Empire School of Piano Tuning, Champaign 4, Ill.

BE Appointed state notary public now. Write, Stationers, Boerne, Texas.

OPERATE Your own mailorder business. Everything furnished at small cost. Mann, Woodcliff Lake, New Jersey.

10,000 WORD Booklet "How To Build Own Mail Business." 25¢. Hamm, 3001 North Spaulding, Chicago 18, Illinois.

MAKE \$46 From square foot plywood; jig saw necessary. Free information. Woodart, Bridgewater, Mass.

BUSINESS Of your own. Manufacture concentrated rug and upholstery cleaner, wonderful wool soap, liquid detergent, oven cleaner. Formulas \$1.50 each, all four \$4.00. Burns, 509 Ellicott, Buffalo, N. Y.

67 EASY, Inexpensive ways for men, women—town, country—to make money home! Details sent free with wholesale catalog! \$1.00! Refundable! Carcion, 8970 Newport, Fontana, Calif.

GROW Mushrooms. Cellar, shed. Spare, full time, year round. We pay \$3.50 lb. We have over 25,000 customers. Free book. Mushrooms, Dept. 173, 2954 Admiral Way, Seattle, Wash.

BIG Profits raising earthworms. Literature free. Lund's Hatchery, Olathe, Kansas.

BOOKKEEPERS, Accountants. Operate a bookkeeping service. Part or full time. Amazing simplified system. Wonderful money-making opportunities. Complete information free. National Bookkeeping Publishing Co., Suite 307, 3435 Broadway, Kansas City 11, Mo.

SELL By mail. Free book shows how. John Shrager Advertising, 2 W. 46 St., New York City 36.

DO It with "Floating-Henryburgers." 20 million sold, 3 years. Start home or increase business any eating place 50%. Meat markets, food brokers, franchise operators—investigate this goldmine. State which. P.O. Box 936, PM1, Wichita, Kans.

OPERATE Money-making international "drop-ship" business. Western Activities, 1512-P2 Wilton, Los Angeles 19, Calif.

BRICKLAYERS Literature, opportunities, layoff plans, retirement. Information 25¢. Pretlo Services, Box 114, Durham, N.C.

COSMETICS, Perfumes, your label, local, mailorder. Farrand Chemical, Tyrone, Penna.

MAKE Money fast! Buy nationally-advertised products at factory prices—sell for up to 500% profit! Bi-monthly publication tells all. Write now for sample copy details. Home Business Digest, G.P.O. Box 972-PM, New York 1, N. Y.

WE Love our mailman—He leaves over \$1000.00 monthly in our rural mailbox. My college professor husband drafted a scientific home mailorder method. We bought a Texas ranch, live as we always wanted. Now we sell the Ranch Mailorder Method. Operates anywhere. Inquire: Eveningshade Ranch, Boerne, Texas.

MONEYMAKING OPPORTUNITIES

"HOME Business Digest" has money-making opportunities galore. Sample 25¢. Donovan, 79-PM Greenbelt, Levittown, New York.

EARN \$50.00 Daily making mats, shoes and mud guards from old tires. S and S Patents Inc., 1307 North Clark St., Chicago 10, Ill.

100% PROFIT. No investment. Stamp brings details, samples. Miller, Box 584, Brooklyn 1, New York.

ATTENTION Typewriter owners. Make handsome profits. Write today. Groves Company, 682, Hastings 8, Nebraska.

DOLLARS Every day! Amazing new magic mail plan. Set-up free. Miller, Box 584X, Oshkosh, Wis.

GENERAL Contest Bulletin. Lists contests monthly. Sample, 25¢. 1609 1/2 East 5th, Duluth, Minn.

READ Progressive Mailtrade, the magazine that tells how to make money by mail. Dime brings sample and special offer. Progressive Mailtrade, Box 357, Sheboygan, Wisconsin.

FREE! "361 Profitable Small Businesses!" Amazing shoestring plans! Work home! Start sparetime! Deumant Surveys, Kenmore 23-R, N. Y.

SELL Nothing—Yet have a reserve! Free packet. "Secret Journal." 918 secrets—plans! Work home. Publica, Oceanside, Calif.

OWN Collection agency office. Pays big. Free details. Franklin Credit, Roanoke 4, Virginia.

MONEY Making opportunities. Copper Hill Sales Service, Copper Hill, Va.

RAISE Rabbits on \$500 month plan. Plenty markets. Free details. White's Rabbitry, Mount Pleasant, Michigan.

\$45.00 PROFIT From one bag of cement. Complete instructions and formula \$1.00. McComb & Son, Hometown, Indiana.

BIG Money raising, fishworms and crickets. Free literature. Carter Hatchery, Plains, Georgia.

EARN Money evenings copying and duplicating comic cartoons for advertisers. Adservice, Argyle 1, Wisconsin.

\$60 WEEKLY, Spare time—easy! Home Venetian blind laundry. Free book. Burt, 2434A, Wichita 13, Kansas.

SELL Titania gems. Far more brilliant than diamonds. Catalog 10¢. Diamonite, 2420-M 77th, Oakland 8, California.

VENDING Machines—No selling. Operate a route of coin machines and earn amazing profits. 32-page catalog free. Parkway Machine Corporation, Dept. 27, 715 Ensor Street, Baltimore 2, Maryland.

FREE Book "365 Odd, Successful Businesses." Work home. Pacific, Oceanside, Calif.

PRIZE Contests provide fabulous and confidential home income opportunities! Here's how and where to win your share! Send stamp! National Contest Bulletin, Box 2885-P, Miami 16, Florida.

NEW Way to make money in automotive service! A wanted service, needed by one out of every three cars on the road. Minimum capital investment. Equipment pays for itself out of profits. Our accredited school will train you and issue diploma; no prior automotive experience necessary. Write for Profit Facts today. No obligation. Address Box No. 607, Rock Island, Illinois.

START Big-pay business at home in spare time. No experience needed to operate little table-top machine for bronzing baby shoes. Make \$5.46 profit on every pair. Full particulars free. Send postcard to Mason, 1512 Jarvis, Room 7-C, Chicago 26, Ill.

MAKE \$5,000 Yearly sparetime raising mink, chinchillas, nutria, etc. Free booklet reveals proved plans. Write Furs, 588 Mt. Pleasant Road, Toronto 1, Canada.

START A buying service, buy wholesale thousands nationally advertised products. Make big profits selling at sizable discounts. Postcard brings details. American Buyers, Hertel Station, Buffalo 16-D, New York.

MAKE Money writing short paragraphs! No tedious study. I tell you what to write, where and how to sell; and supply list of editors buying from beginners. Many small checks add up quickly. Write to sell, right away. Send for free facts. Benson Barrett, Dept. C-27-C, 7484 Clark, Chicago 26.

MEN And women wanted to start home business in spare time with little table-top rubber stamp machine. Easy to earn up to \$9.80 an hour without previous experience. Full particulars free by mail. Send postcard to Roberts, 1512 Jarvis, Room 7-C, Chicago 26, Ill.

WE Pay \$100.00 each for certain Lincoln head pennies. Sort all U.S. coins for us spare or full time. All coins are now in circulation and can be found by anyone. Send \$1.00 for catalog listing our paying prices. \$1.00 refunded on our first purchase we make from you. Viroqua Coin Company, Dept. F-11, Viroqua, Wisconsin.

RECEIVE Money-making opportunity packed big mails, 50¢ year. Alex, 212 Meadville Pike, Franklin, Penna.

BUY Wholesale! Save 88%!! Appliances, furniture, jewelry, toys, sporting goods, tools. Free details. National Buyers Service, Box 338EB, San Francisco.

MEN—Women! Start money-making plastic laminating business at home in spare time. Material that costs 11¢ brings back \$2.58. No canvassing or selling but mail orders bring in \$20 a day. Write for full particulars free. Rush name on postcard to Warner, Room 7-C, 1512 Jarvis, Chicago 26, Ill.

KILL Pests for profit! New shortcut methods. Rid homes, farms, resorts, businesses of termites, roaches, rodents, etc. Ideal spare, full time business. Nationwide need. Huge profits! Free business plan. Contrex, Dept. D, 429 South Western Avenue, Los Angeles 4, Calif.

PLEASANT Profits—Let us show you how to start your own complete scissors and tool sharpening business. Free details. Serr-Edge Inc., 9729 Lorain, Cleveland 2, Ohio.

PRINTING Office supplies wholesale. Save 80%. Royal, Box 386-A, Cleveland 27, Ohio.

START Your own business. Part or full time. Little or no capital needed. Many golden opportunities. 24 page catalogue free. Frank Pix, 2056 Switzer Ave., St. Louis 21, Mo.

LEARN Baby shoe bronzing. Formula, instructions \$1.00. (Bronze included \$2.00.) Beachcraft, 115 Springfield, Lawrence, Massachusetts.

CONTESTANTS! Contests, helps. Write. Contests, 166 Catherine St., Red Bank, New Jersey.

PROSPERITY Plans, schemes, money-making mailorder ideas. Valuable formulas, educational information. 25¢ for list. Con-Mar Sales Company, 1945 N.W. 9, Oklahoma City, Okla.

AMAZING Successes through franchises! Become exclusive franchise holder your territory. Information rushed. National Franchise Reports, 333 North Michigan, Chicago 1.

EXCEPTIONAL Opportunity, home work spare time. Daugherty's Service, Lincoln, Illinois.

\$100.00 WEEKLY Spare room. Raise redworms soilless way. Odorless. Charlie Morgan, Box 258E, Sheridan, Wyoming.

FREE Folio "\$5,000-\$45,000. Unlimited Vacations." No merchandise. Unknown! Work home, sparetime! Haylings, Carlsbad, Calif.

INCREASE Your income. Free details. Bercher, Box 500, Shreveport, Louisiana.

GROW Mushrooms. Cellar, shed. Spare, full time, year round. We pay \$3.50 lb. We have over 25,000 customers. Free book. Mushrooms, Dept. 173, 2954 Admiral Way, Seattle, Wash.

GET A protected territory for building grease, smokeless barbecue grills according to patent pending Great Outdoors Co. plans. Leads furnished by national advertising. Make 300% to 400% over costs on every job. Earnings unlimited. Rush name and 10¢ for details to Great Outdoors Co., 16261 Northlawn, Detroit 21, Mich.

MAKE Top money collecting snakes, lizards, turtles, toads, frogs. We pay guaranteed prices. Details 25¢. Biological Exchange, Dept. 11b, Box 5302, El Paso, Tex.

200% PROFIT. Guaranteed new, different. PCO, 322 1/2 Brady, Davenport, Iowa.

EARN Easy money! Cash in advance! Adventure, Dept. PM, Buckland, Conn.

INTRODUCE Profitable window weather-stripping. E-Z-On-11, 1009 Harvard, Evanston, Ill.

"HOW Fortunes Are Made in Uranium." Atomic power comes from uranium. This illustrated book is a guide on the twelve ways to make big money in uranium. May be worth many thousands of times the purchase price. \$2 postpaid. Dolphin Press, 1753 Grant, Denver, Colorado.

WANT Sweet money-making sideline? Operates anywhere, anytime. Start small, soon snowball! Secret \$2.00. Write: Knobow, Box 897, Ardmore, Okla.

BUY Without money. American Swappers' Journal. Miner, Ill. Sample dime.

BE Your own boss! Many lines of endeavor that pay big. Details 25¢. E. B. Justice, 474 Blackthorne, El Cajon, Calif.

AMAZING New fascinating electric plastic drawing desk with easy instructions in animated cartooning for television, movies. Per-C-A Products, 950 Barry Pl. N.W., Washington 1, D. C.

EXPORT — IMPORT

FREE, Free, free! Foreign import's catalogue. Hershey Mail Mart, Box 543, Hermosa Beach, Calif.

FOREIGN Imports—World trade. Dealers' samples, 100 selected manufacturers \$1.00. Millen, Cozumel-Q-R-Mexico.

FORMULAS, PLANS, ETC.

PRODUCT Analysis, manufacturing formulas, processes developed. Moderate fees. Plastics, Box 1574, Boston 4, Mass.

PRACTICAL Formulas. Lists free. Cummings, Chemist, Gordon Ave., Syracuse 4, N. Y.

LATE, Modern manufacturing formulas. List free. Moon Chemical, Marville, New York.

FORMULAS For latest money-making discoveries. New! Good! Valuable literature free! Miller, Chemist, 1517-D, Tampa, Florida.

FORMULAS: All kinds, latest, best. Literature free. Kemikal, Park Ridge, Ill.

MONEY-Making formulas. 900 pages, 9,999 formulas. \$3.00 postpaid. Aunt Pat, Edinburg 99, Texas.

FREE Formula catalog. Anything analyzed \$35.00. Western Chemical, Salem, Oregon.

LEARN Successful formula business methods. Latest information book only \$2.00. Formuco, 4015 So. Lincoln, Englewood, Colorado.

CHEMISTRY

ILLUSTRATED Catalog: Chemistry, mineralogy, biology 20¢. Tracey Laboratories, Evanston, Illinois.

CHEMICALS And apparatus for industrial, analytical, and private laboratories. Catalog 25¢. Dept. M-50, Biological Supply Co., 1176 Mt. Hope Ave., Rochester 20, N. Y.

60 PAGE Booklets! "Beginners Chemistry," "Chemistry," "Physics," "Relativity," "Light," "Astronomy," "Electricity," "Radio," "Useful Tables," "Scientific Oddities." 10¢ each. Franks, 3121 South Racine, Chicago 8.

CHEMICALS, Glassware. Catalog 25¢. Laboratory Sales, Box 161-E, Brighton, Mass.

PLASTICS

CASTING And embedding course. Easy method with liquid plastic, flexible molds. Details free. Plastic Arts, 416 El Camino, San Carlos, California.

FLEXIGLAS. Square foot cost. 1/16", \$1.18; 1/8", \$1.52; 3/16", \$1.86; 1/4", \$2.21; 3/8", \$3.23; 1/2", \$4.36. Colors add 10%. Send 15¢ for postage. Aristocrat Plastics, 23-25 Sussex Avenue, Newark, N. J.

LAMINATING Supplies. Free price list. Solomonson, 46 Cornhill, Boston 8, Mass.

LEARN Plastics fabrication for spare time income. Low cost home training now available. Write for free booklet. Interstate Training Service, Dept. D-3, Portland 13, Ore.

Plexiglas, Fiberglass, polyester, acetate. Instructive wholesale-retail catalog free! Gem-O-Lite, 5529 Cahuenga, North Hollywood, California.

WALLET Cards, photos, plastic sealed by machine. 50¢. Sample free. Box 516, Davenport, Oklahoma.

CREATE Colorful tiles, mosaics, jewelry with new Castoglas for yourself, gifts, profit. No tools, heat, experience needed. Manuals 10¢ each. All three only 25¢. Castolite, Dept. CI-101, Woodstock, Ill.

BOXES, Plastic. Free list. Althor, 170 Bay 23 Street, Brooklyn, N.Y.

PLASTIC, Sheet, rod, tubing. Catalog 10¢. Coleman Sales, 5926 Cornell, Dearborn, Michigan.

NEW Liquid casting plastic, clear, colors. Embed real flowers, coins, photos. New manual shows fine things you can make at home and sell at big profit. Send 25¢. Castolite, Dept. C-101, Woodstock, Illinois.

AGENTS WANTED

MYSTIC—Terrific demonstrator! Glasses gleam. Samples on trial to selected territories. Metro, Dept. B, Box 151, Oak Park, Illinois.

GREETING Cards—\$50.00 cash from 40 boxes sensational all-purpose assortment. Big money all year from special occasion cards—Mother's, Father's day, birthdays, Eastern Star. Best all-occasion assortments, stationery, gifts. Bargain specials. Color catalog. Samples on approval. Midwest, 1113 Washington, Dept. 707-C, St. Louis 1, Mo.

IF You want to earn money fast, I'll send you free sample stocking of newest stretch DuPont nylons to sell at only \$1 a pair. American Mills, Dept. 665, Indianapolis 7, Ind.

BUY Wholesale! 100,000 name brand products! Save 66%! Big profits selling others spare time! Free details! National Buyers Service, Box 3338EE, San Francisco.

60% PROFIT On cosmetics—Famous nationally advertised Hollywood cosmetics pay 60%. Make \$25 day up. Hire others. For free samples, details, write Studio Girl, Glendale, Calif., Dept. 12790.

CLEANS Windows without mess. Strange dry cleaning-cloth. Replaces liquids. Windows gleam. Samples sent on trial. Kristee 64, Akron, Ohio.

\$1,000.00 A Month for making dramatic 3-second demonstration of amazing lightweight Presto fire extinguisher. New chemical used by Airforce snuffs out fires instantly. Only \$4.95. Terrific commissions. Millions want it. Free kit. Merlite, 114 E. 32nd, Dept. P-727, New York City 16.

BUY Wholesale thousands nationally advertised products at big discount. Free "Wholesale Plan." American Buyers, Herlet Station, Buffalo 16-A, N. Y.

IF You're interested in making money in selling, see the hundreds of exceptional opportunities in Salesmen's Opportunity Magazine. Send name for your copy, absolutely free. Tell us what you're selling now. Opportunity, 848 N. Dearborn, Dept. 51, Chicago 10, Illinois.

WAXES Floors without wax. New invention. No more floor wax to buy. Sensational seller. Samples sent on trial. Kristee 63, Akron, Ohio.

YOU Can make money at home in spare time taking magazine renewal subscriptions. No capital or experience necessary. All supplies furnished. Write today! McGregor Magazine Agency, Dept. 500A, Mount Morris, Illinois.

RUN Spare-time greeting card and gift shop at home. Show friends samples of our wonderful new 1957 all-occasion greeting cards and gifts. Take their orders and earn up to 100% profit. No experience necessary. Costs nothing to try. Write today for samples on approval. Regal Greetings, Dept. 33, Ferndale, Michigan.

AGENTS—300% Profit selling genuine gold window letters; stores and offices. Free samples. Metallic Sign Letter Co., 1217-D West Newport, Chicago.

WHOLESALE Comedy cards! Samples, \$1.00. Sebastian, 10934-B Hamlin, North Hollywood, California.

YOUR Ad in this space will get some good agents for you. Yes, I'll prove it. Write for Folder "A" right now. F. W. Johnson, Classified Advertising Manager, Popular Mechanics Magazine, 200 E. Ontario St., Chicago 11, Ill.

GOLDMINE Of 600 money makers. Copy free. Specialty Salesman Magazine, Desk 5-B, 307 N. Michigan, Chicago 1.

GOLD Or silver letters, numbers. Windows, doors, trucks. 1" to 6". 500% profits. Free samples. Atlas-T, 544 West 79th, Chicago 20.

PRINTING, Advertising salesmen—Excellent moneymaking sideline selling decalcomania name plates, small quantities. Automobile initials, sign letters. Free samples. Ralco, XL, Boston 19, Mass.

EXCLUSIVE Line of personal initialed buckles, belts, cap badges, 3,000 emblems, etc. Hook-Fast, Dept. PM, Roanoke, Va.

YOUR Own business—Used suits \$1.50, overcoats 85c, mackinaws 35c, shoes 12½c, ladies coats 30c, dresses 15c. Enormous profits. Catalog free. Nathan Portnow Associates, 605-AA West 12th Place, Chicago 7.

CALIFORNIA Sweet smelling beads. Sensational sellers. Particulars free. Mission, 2328-PM W. Pico, Los Angeles 6, California.

SCHOOL Seniors—Be popular with classmates. Have spending money galore. Details free. Craftcards, Box 235-L, Pittsburgh 19, Pennsylvania.

EASY Handwork makes fast-selling articles. Sample free. Sunmade Company, Brockton 64, Massachusetts.

NEW Type bath sponge uses soap scraps! Home Products Co., 399 Main St., Metuchen, N. J.

BIG Profits. Sell merchants Daygo signs for all occasions. Sample kit \$2.00. Refundable. Ovenglo Sales, 4729 Lincoln Ave., Chicago 25, Illinois.

1" DEVICE Eliminates curb parking difficulty. E-Z-Park, Box 148, Falmouth, Mass.

TERRITORIES Open. Low cost English chamois. Babrok Tannery, Hudson Falls, New York.

AGENTS And dealers wanted. Operate from your home. Make \$75.00 on every Merlin electronic garage door operator. M. J. Fitzgerald Co., 2815 West Vliet Street, Milwaukee 8, Wisconsin.

RETRACTABLE Ball pens 5 for \$1.00. Refills 5 for 50¢. Guarantee. Bonomo, 54 Jefferson St., Brooklyn 6, N.Y.

BIG, Easy commissions taking orders for beautiful door name plates! Home owners buy like mad! Sure-fire, money-maker! Sample plate and details, 25¢. Zax Corporation, Box 401-C, Nashua, N.H.

MAKE Extra cash—Quickly! Show newest big value \$1, \$1.25, \$1.50 assortments of birthday, get well, Easter greeting cards, gift wrappings, stationery, gifts, in spare time. Big profits, bonus. Friends, others buy on sight. Write for samples on approval, free gift offer, details. Hedenkamp, 361 Broadway, Dept. PM-47, New York City.

BIG Profits selling amazing liquid. Mends fabric without sewing. Free details. Seal-Rite, 355 Imperial, Youngstown 9, Ohio.

MEN, Women, make money spare time plus new car as bonus for encouragement. Amazing hosiery guaranteed to wear without holes, snags, and runs, or replaced free. For example, lovely 60 gauge nylons guaranteed for as long as 1½ years or replaced free. Write Wilknit, 1773 Wash., Greenfield, Ohio.

CURB Parking. Backing single space behind auto easy. 1" steering wheel attachment. Sample \$1.00. E-Z-Park, Box 148, Falmouth, Mass.

SOMETHING New. Vogue book-form paneled business and calling cards with case. Big profits. Anderson Printers, 213 W. 63rd St., Chicago.

HAVE Agents work for you. \$3,000 per month possible. Electric shavers, razor blades, etc. Free samples. Mfg. Outlet, 370 Alabama Ave., Brooklyn 7, N. Y.

"SUNBOW Sun Shields" replace sunglasses everywhere. Sell on sight to millions. Enormous profits. Write immediately. Houston Co., Box 1413-P, Fairmont, W. Va.

BIG Profit selling new fire extinguisher at \$1.98. Full or part time. Send \$1 for sample extinguisher and sales kit. Edconco, Dept. 242, 155 East 44, New York City 17.

"SUPER Glo" signs. Earn \$25.00 day. Magic flashlight test. Advance profits. Prospects everywhere. Sample kit and catalog help you sell on sight. Active Display Advertising, 1702 West 19th Street, Chicago 8, Illinois.

FREE! Beautiful feather pictures. 200% profit! Apartado 9036, Mexico 1, D. F.

EARN To \$4 hour writing orders for appliances, gifts, housewares, etc., at big discounts. Confidential wholesale prices and details free. Bond Specialties, 1637B West Vernon, Phoenix, Arizona.

BUY IT WHOLESALE

BUY Wholesale! Discounts to 80%! Appliances, cameras, sporting goods, housewares, watches, tools, clothing, etc. Buy-Rite, 73-04 Wagaraw, Hawthorne 2, New Jersey.

WHOLESALE Catalog! Appliances; housewares; jewelry! Postcard! Midwest, 156-M, Pontiac, Illinois.

1001 WHOLESALE Items. Brand names. 25¢ gets \$1.50 credit and discount list. United Plan, 450 Broad, Newark, N. J.

TRACTORS And parts wholesale prices. International, Caterpillar AC. Free giant list. Send your requirements. Write today. General Corp., 555 Northside, Atlanta, Ga.

BIG Multicolor wholesale catalog! Housewares, appliances, clothing, silverware, cookware, luggage, binoculars, radios, phonographs, cameras, recorders, projectors, typewriters, shavers, sporting goods, toys, tools, sewing machines, watches, jewelry. Name brands. Huge discounts. Postcard: Selbyco, Decatur 154, Ill.

AUTOMOBILES—Unbelievable 40% discounts! Purchase locally! Jakiela, 2644-NNO Western, Chicago 47.

TYPEWRITERS, Televisions, appliances, outboards, watches, nylons, neckties, rugs, handbags. Simms, Warwick, New York.

WHOLESALE Catalog! Appliances, cameras, watches, Distributors, Box 106A, Hudson, New York.

USED And new watches \$2 up. Free list. Southern Watches, Gray, Georgia.

BUSINESS Gifts, wholesale. J. J. Davis Co., Englewood Ave., Englewood, New Jersey.

SALESMEN—DISTRIBUTORS

MONEY-Making opportunity! Take big profit orders for world famous patented varieties fruit trees. Also flowering shrubs, roses, vines. Big sales outfit free. Stark Bros, Desk 30137, Louisiana, Missouri.

CALENDARS, Advertising novelties, matches. All styles, including religious, varnished. 12 sheet, girls. Hundreds of advertising novelties, book matches, etc. Fleming Calendar Co., Sales Division, 6539 Cottage Grove, Chicago 37, Ill.

MAKE Extra money. Cash commissions. Everybody buys easy-to-sell advertising book matches. Union label. All sizes. Cuts for all businesses. Powerhouse selling kit free. Steady repeat business. No experience necessary. Superior Match Co., Dept. M-357, 7528 S. Greenwood, Chicago 19.

CLEAR Glass washes outside windows in 1/2 time. No wiping. Make 100%, sample 25¢. 419 Vilet, Milwaukee 12.

FAMOUS French perfume. 200% profit. Martin, Colgate, North Dakota.

WILL You wear new suits and topcoats without one penny cost and agree to show them to friends? You can make up to \$30.00 in a day even in spare time, without canvassing. Stone-Field, 532 South Throop Street, Dept. F-926, Chicago 7, Illinois.

\$1,000.00 A Month for making dramatic 3-second demonstration of amazing lightweight Presto fire extinguisher. New chemical used by Airforce snuffs out fires instantly. Only \$4.95. Terrific commissions. Millions want it. Free kit. Merlite, 114 E. 32nd, Dept. P-727, New York City 16.

GET New shirt outfit free. Make \$90.00 weekly on 5 average orders a day. Famous quality made-to-measure dress and sport shirts at \$3.95 up sell fast to all men. No experience needed. Full or part time. Write: Packard Shirt Co., Dept. 452, Terre Haute, Ind.

NEW Advertiser, needs salesmen, salesladies. Merchants, doctors, buy quickly. No investment. Nationwide, North Madison 1, Ohio.

AD Matches! Sell amazing designs—10, 20, 30, 40 and 240-light book matches. Bigger spot cash commissions: every business a prospect. Low prices for high quality. Repeats. Start without experience; men, women; full, part time. Buy nothing! Sales kit furnished. Match Corp., Dept. PM-67, Chicago 32, Illinois.

SELL "Grease that won't melt," including moly products in a complete line of heavy duty lubricants. Our leading salesmen now earning over \$12,000 in a year. Write immediately to E. J. Baker, Dept. P-7, P.O. Box 676, Dayton, Ohio.

ONE Monument sale weekly earns \$200 or more. Jones Monumental Works, St. Cloud, Minn.

INCREASE Present income \$75-up weekly. Dealers, farmers, agents—demonstrate nationally known Gro-Green liquid fertilizer nutrients. Results guaranteed. Full-part time. Samples free. Campbell Co., Rochelle 209, Illinois.

NEW Jobs open in selling! Send name, address for five free issues of Opportunity Magazine's money-making guide, listing hundreds of companies who'll pay you well, full or part-time. No experience needed. Opportunity, \$50 N. Dearborn, Dept. 17, Chicago 10, Ill.

WE Are the world's largest manufacturer of portable adding machines. Highest grade. Best service, highest profit. You are sure to win. Lightning Adding Machine Sales Co., 2306-C W. Slauson Ave., Los Angeles 43, Calif.

GET Into big money. Steady profits, stainless tableware. Mann, Woodcliff Lake, New Jersey.

HIGH Paying jobs; Foreign, USA. All trades. Travel paid. Information. Application forms. Write Dept. 21H, National, 1020 Broad, Newark, N. J.

DEPENDABLE Carded leather item. Proven, good profit. Write The "Red" Wolf, Box 304, San Angelo, Texas.

CASH In on Chestlite, successor to flashlight. Profit over 100%. Protected territories still open for this patented money-maker. Write for details right now. Chestlite, 620 W. Anaheim, Long Beach, Calif.

FACTORY Salesmen. Steady work. No evenings, no car. Sell patented comfort feature shoes direct. Highest comm., bonuses. Paid vacations. Write: Charles Chester Shoes, 309 Brockton, Mass.

BUSINESS Kit free! Postcard puts you in business! Complete line. 160 shoe styles, also jackets. New discoveries pay big commissions. No investment. Send for free kit. Mason Shoe, Dept. C-47, Chippewa Falls, Wisconsin.

BALL Pens retractables, colors \$25.00 gross. Samples 5-\$1.00. Pencil type \$5.00 gross, 15-\$1.00. Postpaid. Plastic wallets, \$4.50 dozen. Samples 3-\$2.00. New owner—Crescent Sales Co., 150 Broadway, New York City 38.

EMPLOYMENT INFORMATION

THOUSANDS Needed. Highest pay. Booming Ohio valley's major industrial centers. Classified job listings. 3-\$2.00 airmailed. Box P1706, Parkersburg, W. Va.

UNLIMITED Job opportunities. Details free. Personnel Associates, Box 889, Wheeling, W. Va.

COPYRIGHTED Reports on best paying jobs with travel, adventure, promotions. Construction, aviation, shipping, laborers, clerical, trades, supervisory, factory, unusual opportunities. Many types of work. Skilled and unskilled. Foreign and state-side openings for men and women. Only \$2.00 (\$2.25 airmail), including registration-advisory service. Satisfaction guaranteed. Included absolutely free: Special reports on Alaska, Spanish airbase construction. South American opportunities and husband-wife foreign jobs. Research Services, Suite 207-PMN Brown Building, St. Louis 5, Missouri.

ALASKA, Overseas, U. S., California jobs! Men, women. Free applications. Information. International, Box 16, San Diego 18, Calif.

SOUTHERN California. Thousands of good jobs. Ads airmailed \$1.00. Vandenburg, 310 S. Hesperian, Santa Ana, Calif.

COUNTRY Salesmen. Automatic fire extinguisher. Huge profits. Out-O-Matic Co., 1737 E. 31st, Dept. 280, Denver, Colo.

FOREIGN, Alaskan, U.S.A., jobs! To \$15,000 monthly! Million Americans employed overseas. Copyrighted reports. Who to contact for highest paying jobs. Laborers, trades, truck drivers, office, engineers, many others. 52 countries—St. Lawrence project, Spain, Latin America, Northern project, Europe. Year registration-advisory service. Application forms. Unconditional money-back guarantee! \$2.00 (airmailed \$2.25). C.O.D.'s accepted. International Reporter, St. Louis 1-PR, Missouri.

EDUCATIONAL AND INSTRUCTION

WANTED: More new writers for TV-radio, magazines, business publications, motion pictures. Learn at home for extra income or exciting full time career. Many students earn while learning. Professional instruction. Send today for free lesson and book. Palmer Institute of Authorship, Desk TM-37, 1680 N. Sycamore, Hollywood 28, Calif.

COMPLETE Your high school at home in spare time with 60-year-old school. Texts furnished. No classes. Diploma. Information booklet free. American School, Dept. X345, Drexel at 58th, Chicago 37, Illinois.

FINISH High school at home, spare time. No classes. Diploma awarded. Write for free catalog. Wayne School, Catalog HF-73, 2527 Sheffield, Chicago 14.

LEARN Camera repair. Easy, complete, approved home-study course. Free illustrated booklet. National Camera Repair School, Dept. L-3, Englewood, Colo.

USED Radio-TV correspondence courses sold. Money back guarantee. Free list. Courses bought Nafziger, 3566-AA Diamond Ave., Oakland 2, Calif.

IT'S Easy learning a language by Linguaphone's World Standard Conversational Method. At home, quickly, easily learn to speak French, Spanish, German, Japanese, Modern Greek—any of 34 languages. It's like living in another country. Save time, work, money. Send for free book. Linguaphone Institute, 83-037 Radio City, New York 20.

HELP Yourself! Solve personal problems by self-mastery. Free information. The Leavitt Science, Clinton, Illinois.

BOOKS. Free 1957 catalog. 100 pages. Text, vocational, educational, instructional subjects. Millions of volumes, new and used. Bargain prices. Books bought, Est. 1902. Long's College Book Co., Dept. PM, Columbus 1, Ohio.

INVESTIGATORS Trained, men-women. Learn fascinating, profitable profession, spare time study. Big pay. Important details on how to open your own agency in any state. Free booklet. Investigator, Box 450, Times Square Station, New York 36, N. Y.

IMMEDIATE Continuous monthly earnings operating your own simplified book-keeping, control analysis service. Amazing details free. Vanderdrift, 35E Franklin Street, East Orange, New Jersey.

LEARN While asleep! Details free. Research Association, Box 610-MC, Omaha, Nebraska.

REFRIGERATION, Air conditioning. Extension course. Free booklet. Mechanics School, 11029-PX South Vermont, Los Angeles 44.

PIANO Tuning pays. Learned easily at home. GI approved. 50th year. Free booklet. Niles Bryant School, Dept. P, 3731 Stockton, Sacramento 20, Calif.

SPEAK, Sing with power, personality. Home self-training method on records. Amazing details free. Canfield, 2018-A 5th Ave. South, Minneapolis 4, Minn.

PIANO Tuning pays. Big money in spare time. Learn at home in 30 days. No musical knowledge necessary. Phonograph, records, tools and instructions furnished. Personal instructions available. Free catalog. Capital Tuning School, 16 Southwest Second, Fort Lauderdale, Fla.

EXCEPTIONAL Home study plan. F. Woodworth, Box 4867, Detroit 19, Mich.

STUDY For Doctor's degree of psychology, metaphysics and divinity. Correspondence courses only. College of Divine Metaphysics, Dept. P-M, 2811 North Illinois, Indianapolis 8, Indiana.

LEARN Mineralogy at home. Diploma course. Fortunes now being made in uranium and other minerals. Free catalog. Mineral Science Institute, Desk 2, 199 East Ontario, Chicago 11.

HIGH School diploma at home. Licensed teachers—Approved materials. Southern States Academy, Box 144-MX, Station E, Atlanta, Georgia.

BE A real estate broker. Study at home. Write for free book today. GI approved. Weaver School of Real Estate, 2018P Grand, Kansas City, Missouri.

USED Correspondence courses and books sold and rented. Money back guarantee. Catalog free. (Courses bought.) Lee Mountain, Pisgah, Alabama.

EARN While you learn. Auto and diesel mechanics master this top paying trade. Many graduates earn \$100 a week and up. Approved for Korean veterans. For free information write Dept. No. 256, Nashville Auto-Diesel College, Nashville 3, Tenn.

HELP Yourself to abundant living. Our courses have aided students to richer fuller lives. Learn secret of contentment, happiness. Earn degrees Ps.D., Ms.D. Write for free book. College of Universal Truth Correspondence School, 23-C E. Jackson, Chicago.

SECRET Investigation. Experience unnecessary. Investigators particulars free. George Wagner, M125 West 86th, New York 24.

BOOKKEEPERS! Increase your earnings! Operate your own simplified "Dollar-A-Week" bookkeeping and tax service. Full or spare time. Details free. No obligation. Ellis, Box 200, Cedar Grove, North Carolina.

WANT A diesel job? New opportunities to increase income. Higher pay. More money. We can help you qualify. Tools. Shop method home training. Write today! Diesel, Tractor, Heavy Equipment Division, Interstate Training Service, Dept. B-3, Portland 13, Oregon.

I want to send you proof of the wonderful pulling power of Popular Mechanics classified pages. What's your proposition? Write me today. Include literature if possible. F. W. Johnson, Manager Classified Advertising, Popular Mechanics Magazine, 200 E. Ontario St., Chicago 11, Ill.

INVESTIGATOR Training. Phillips Secret Service System, 1917-B North Kenneth, Chicago 39.

HANDWRITING Analysis now accepted in college, business, industry. Our men, women who use grapho analysis spare, full time earning more money, getting prestige, success, happiness. Uncrowded, fascinating field for intelligent men, women anxious to get ahead. We need more members. Investigate this growing field where you give a real service to your fellow man. Opportunities unlimited. Free sample lesson and information to all over 21. Write today! Igas, 2307 National Station, Dept. 613, Springfield, Missouri.

GAIN New knowledge, perspective. Revolutionary easy way learn decimal equivalents common fractions without memorizing. Fun, Practical. Details free. Val Palmer, 1322 12th St., Rockford, Ill.

ENGINEERING, Home study. Midwest Engineering School, 10923 Hillcrest, Hickman Mills, Missouri.

PHYSICAL Therapy and massage. We train you at home. Earn big profits from your own private practice or work with hospitals and doctors. Free catalogue. National Institute, Desk 4, 159 E. Ontario, Chicago, Ill.

MECHANICALLY Inclined men needed for careers in jet industry as jet mechanics, overhaul, maintenance, service, with opportunities for bigger pay, better jobs, security. For information on first all-jet home training: United Jet Schools, Dept. PM, International Airport, San Francisco.

MEMORIZING Made easy. Booklet \$1.00. Memoraid, 1424 Emerson, Salt Lake City, Utah.

LEARN To sing at home. Money-back guarantee. Spanish instructions only. Academia "Novo," Apartado 1894-L, Monterrey, Mexico.

STUDENTS—The Maxwell Simplified Method of Study will help you get better grades. Simple, efficient, proven. Only one dollar. Study Methods, Box 419, Pacific Grove, California.

MEMORY Education. Additional mental power. Memorology, lesson one free. Memorology Studio, 2018-M Bunnyside, Chicago 25, Ill.

EARN University degree by correspondence. Golden State University, 6715 Hollywood Blvd., Hollywood 28, Calif.

SIMPLIFIED Analytics teach algebra clearly. \$1; guaranteed. Ziemba, H-6123 Orchard, Dearborn, Mich.

U.S. Civil service tests! Training until appointed. Men-women, 18-55. Start high as \$340.00 month. Experience often unnecessary. Get free 36-page book showing jobs, salaries, requirements, sample tests, benefits. Write today: Franklin Institute, Dept. E-24, Rochester, N.Y.

EARN Degree. Free bulletin. Homestudy only. Bible School, 1060 Broadripple, Indianapolis.

ENGINEERING Degrees earned by home study. (Residential courses also available.) Pacific International University (American College of Engineering), Box 27724-B, Hollywood 27, California.

WELDING Training pays at Hobart Welding School, Box M-371, Troy, Ohio. VA contract. Best equipment. Catalog free.

ABACUS And instructions, \$2.50. Literature free. Money, 45 E. 28, New York City 16.

TRANSFORM Yourself via subconscious. Free brochure. Box 847, H-3, Ocean Park, Calif.

GROW Mushrooms. Cellar, shed. Spare, full time, year round. We pay \$3.50 lb. We have over 25,000 customers. Free book. Mushrooms, Dept. 174, 2954 Admiral Way, Seattle, Wash.

EARN College degree. Remain employed. Fremont College, 5625 Melrose Ave., Los Angeles 38, Calif.

BLUEPRINT Reading — Train at home. Learn to read blueprints with confidence in 10 easy lessons. Write today Belton School, 1059-K North Lawndale, Chicago 51.

WANTED! Men, women train for real estate appraisers. \$500 month up. Seavy, 429 So. Western, Los Angeles 5, Calif.

PLAYS, STORIES, MANUSCRIPTS

WANTED: Book manuscripts, all subjects considered. Greenwich Book Pub., Attn. Mr. Zealand, 489 Fifth Ave., New York City.

WRITERS! There is a strong demand in the New York market for all types of material. We offer honest appraisal and placement. Write for terms today! Daniel S. Mead, Literary Agent, 419 Fourth Avenue, New York.

WANT Your book published? Learn how we publish, advertise, promote, distribute. Many successes. Free booklet PM. Vantage, 120 West 31, New York City.

SPECIAL SERVICES

INFORMATION Where to get any product or manufacturing facility \$1.00 with inquiry. Refunded if I fail. Watts, Box 375, Statesville, N. C.

INFORMATION On anything. Ferguson Research Specialists, 116-14 141 St., South Ozone Park 36, N.Y.

CARTOONING, COMMERCIAL ART, SHOWCARD & SIGN PAINTING, TATTOOING

TATTOOING Outfits, licensed course. Brochures 25¢. Zels, 728 Leslie, Rockford, Illinois.

BASIC Art training at home. New plan. Free talent test. Students' Art Club, Kennebunkport, Maine.

CARTOON Your way to fame. Minimum age seventeen. Write Cartoons-of-the-Month, Roslyn, New York.

YOU Can entertain with chalk talks. Catalog 10¢. Balda The Cartoonist, Oshkosh, Wis.

LEARN Sign painting at home. Free talent test. Ben Kerns, Box 812-PM, Greenville, S.C.

"HOW To Make Money With Simple Cartoons." A book everyone who likes to draw should have. It is free; no obligation. Simply address Cartoonists' Exchange, Dept. 93, Pleasant Hill, Ohio.

SIGN Letters, Masonite cutouts, all sizes. Catalogue free. Eyerly Co., Newton, Iowa.

ADVERTISING AGENCIES, LETTER WRITERS, FOR ADVERTISERS

ADVERTISING Ratebook leading newspapers, magazines, free. Chicago Advertising Agency, Chicago 4.

ADVERTISE: 24 Words, 100 Canadian newspapers \$5.50. Lists free. Advertising Bureau, 10511-C Springfield, Chicago 43.

FREE! 1957 Advertisers Rate and Data Directory. 52 pages! E. H. Brown Advertising Agency, 20 N. Wacker, Chicago 6.

WANT More business? Here's an amazing opportunity to increase your sales. Talk to thousands of interested readers of "Mechanica Popular." Our Spanish Edition covers the Latin American countries like a blanket. They're real mailorder buyers. Classified rate 75¢ per word. Try an ad in our next issue. Classified Advertising Department, Popular Mechanics Magazine, 200 East Ontario Street, Chicago 11, Ill.

ADVERTISING, Result-getting ads prepared, placed newspapers, magazines, radio, anywhere! Lowest rates. Catalogue free. Baker Advertising Agency, 189 W. Madison, Chicago 2.

MAILING Lists most any classification \$5.00 1000. Your circulars mailed with ours \$4.00 1000. Write for our literature. Dixie Mailers, King, N. C.

RUBBER STAMPS AND OFFICE SUPPLIES

3 LINES, \$1.00. Cushioned — Indexed. Satisfaction guaranteed! Campfield, 14 Beaufort Circle, Springfield 4, Mass.

THREE Line pocket stamp or regular with free pad \$1.00. Barber, Marengo, Ohio.

TYPEWRITERS, DUPLICATORS, OFFICE DEVICES

REMINGTON Portable typewriters. New, no down payment, dollar weekly. Sent on 30 day trial; prepaid. Send for application. Oscar Chahine, 909 Forsyth, Carnegie, Pennsylvania.

RECONDITIONED Typewriters, duplicating, printing devices, \$25.00 up. Supplies. Appliances. DixieGraph, King, N. C.

IBM Electric typewriter \$59.95. Albin, 423 Broome St., New York City 13.

PORTABLE Mimeograph! Uses no stencil, no ink. The newest, cleanest, smallest, lightest and cheapest. Weight 15 pounds. DuPont Distributors, P.O. Box 695, Dept. A, New York 1, N. Y.

PRINTING, MULTIGRAPHING, MIMEOGRAPHING, GUMMED LABELS

100 LETTERHEADS 5 1/2 x 8 1/2. 100 Envelopes both printed three lines same \$2.25. Sheldon, 115 Ninth, Philipsburg, Penna.

500 NAME And address printed gummed labels, 3 lines \$1.00. No c.o.d.'s. Print clearly. Addison, PM-3, 1840 Addison, Chicago 13.

750 TU-Tone address labels \$1.25. Orwat Howe, 927 Walnut, Philadelphia 7.

ECONOMICAL Printing of books, catalogs, publications. Catalog free. Adams Printery, 30 West Washington, Chicago 2, Illinois.

BUSINESS Cards, 1000 flat black \$2.50, engraved \$3.50. Samples. Sales, 1333 Orchid Ave., Winter Park, Fla.

100 BUSINESS Cards \$1.00. (300-\$2.00.) Print Shop, 1418 Broadway, Rockford, Ill.

MIMEOGRAPHING—Letters, pricelists, formulas, instructions. Lowest prices. Lem's Letter Shop, 5710 Stanton, Detroit 8.

CIRCULARS, Booklets, letterheads, statements. Estimates, anything! Lonelm Printers, Paulding, Ohio.

FREE Catalog business, personal printing. D.M. Press, Sebastopol, California.

OFFSET Printing — \$6.50 1000, 8 1/2 x 11, 16 lb. National Letter, 251 W. 42 St., New York City 36.

SAVE On quality printing! Samples, price list by return mail. Print-Rite Service, Box 674, Pottstown, Penna.

BUSINESS Printing. Samples, prices free. Howprint, 723-G Eunice, Webster Groves 19, Missouri.

QUALITY Letterpress, offset printing. Economical. Catalog. DeLuxe, 518-PM West 79th, Chicago 20.

150 8 1/2 x 11 LETTERHEADS, 150 6 3/4 Envelopes, neatly printed your copy, \$3.00. Brookside Press, Wonder Lake, Illinois.

1000 BUSINESS Cards. Nice work. Only \$3.95. Robinsons, Sebastopol, California.

RAISED Process business cards, 1,000 postpaid \$3.45. Samples. Royal Press, Box 161, Waltham 54, Massachusetts.

TOP Quality printing, mimeographing. Free literature. Carrier, PM, New Lebanon Center, N. Y.

FREE Samples, printing, mimeographing, offset. Reasonable. Stark Press, Capitola, Calif.

LETTERHEADS 500 8 1/2 x 11 \$2.95. Envelopes \$2.95. Schroeder, 218 Ellington, Peoria, Illinois.

100 PERSONALIZED Correspondence post cards, \$1.00. Namecraft, Box 13, Arlington 74, Massachusetts.

1000 RAISED Letters business cards \$3.50. Samples. Pioneer, Island Park 10, New York.

500 STATEMENTS \$3.55. Agent's discount, Dick Anderson, Box 183, Romeo, Mich.

TAGS Of every description printed, die cut, strung. Samples, estimates. Fitz, 347 Worthington St., Springfield, Mass.

SELF-Sealing "no lickum—just stickum" labels, your name and address printed on 500 labels, size 2"x1 1/2", \$1.95 postpaid. Sticks to any surface. Other sizes too. Eric Andrews, Box 865P, Allentown, Penna.

LETTERHEADS 8 1/2 x 11. Envelopes 6 3/4, 100 each, \$2. Postpaid. Security Press, Box 344-PM, Oskaloosa, Iowa.

CATALOG Free. Distinctive printing. Reasonable prices. Vosacek Printing, 4444 A Ute, San Diego 17, Calif.

PLAIN And embossed business cards in raised letters, 1,000, \$3.50. The National Distributors, 5020 2nd Ave., North, Birmingham, Alabama.

PRINTING OUTFITS AND SUPPLIES

RUBBER Stamp making presses, hydraulic operated, electrically heated. Sizes 5"x8", 8"x12", 10"x15" starting outfits. All kinds supplies. Custom Manufacturing, 601 N. Jefferson, Springfield, Missouri.

DO Your own printing. Save money. Simple rules. We supply everything. Print for others; good profit. Raised printing like engraving too. Have home shop. Details free. Kelsey Presses, V-11, Meriden, Connecticut.

PRINTING Presses, type, supplies, lists 3¢. Turnbaugh Service, Mechanicsburg, Penna.

MAKE Your own self-molding rubber stamps and printing cuts. Flexirubber, Argyle 1, Wisconsin.

PRESSES, Type cabinets, supplies. List for stamp. Lincoln Press Company, 230-C Hartwell, Fall River, Mass.

PATENT ATTORNEYS

INVENTORS: Without obligation, write for information explaining the steps you should take to secure a patent. John Randolph, Registered Patent Attorney, 203 Columbian Bldg., Washington 1, D. C.

INVENTION Record form free and "Patent Information Every Inventor Should Have." Carl Miller, Registered Patent Attorney, Woolworth Building, New York.

C. A. Snow & Co.—M427, Snow Building, Washington 1, D. C. Registered Patent Attorneys. Write for information.

INVENTORS: When you are satisfied that you have invented something of value write me, without obligation, for information as to what steps you should take to secure a patent. Write Patrick D. Beavers, Registered Patent Atty., 835 Columbian Bldg., Washington 1, D. C.

PATENTS. "Proof of Invention" free. E. E. Vrooman, Registered Patent Attorney, 507 McKim Building, Washington 5, D. C.

"INVENTOR'S Guide" and "Record of Invention" free on request. Frank P. Ledermann, Registered Patent Attorney, 154 Nassau Street, New York City.

REGISTERED Patent attorney offers services. Sanders, 6430 Evans, Chicago 37, Illinois.

INVENTORS: Learn how to protect your invention. Unless the inventor is familiar with patent matters, he should engage a competent registered patent attorney or agent to represent him. We are registered to practice before the U. S. Patent Office and prepared to serve you in handling your patent matters. "Patent Guide for the Inventor" containing detailed information concerning patent protection and procedure with "Record of Invention" form will be forwarded to you upon request—without obligation. Clarence A. O'Brien & Harvey Jacobson, Registered Patent Attorneys, 71B-A District National Building, Washington, D. C.

INVENTORS—If you believe you have an invention, you should find out how to protect it. The firm of McMorrow, Berman & Davidson with offices in Washington, D. C., is qualified to take the necessary steps for you. Send for copy of our patent booklet "How to Protect Your Invention." We will also send you an "Invention Record" form. No obligation. They are yours for the asking. McMorrow, Berman & Davidson, Registered Patent Attorneys, 134-F Victor Building, Washington 1, D. C.

PATENTS—Irving L. McCathran, 315 McLachlen Bldg., Washington 1, D. C. Registered Patent Attorney.

MECHANICAL Skill alone is not enough to entitle you to patent protection; your invention must clearly show your exercise of the inventive faculties. As patent attorneys we feel better qualified than the inventor to recognize patentable invention. Sketch and describe your invention. Sign date and have this disclosure witnessed by two people who are capable of understanding your invention. Have us make a preliminary search among U. S. patents already granted for similar types of invention. We report on the probable patentability of your invention and recommend your further course of action. Write for our instructive booklet, "Patent Protection for Inventors" and convenient "Evidence of Invention" disclosure form. Victor J. Evans & Co., 331-C Merlino Building, Washington 6, D. C.

FOR INVENTORS

INVENTORS—If you believe you have an invention, you should find out how to protect it. The firm of McMorrow, Berman & Davidson with offices in Washington, D. C., is qualified to take the necessary steps for you. Send for copy of our patent booklet "How to Protect Your Invention." We will also send you an "Invention Record" form. No obligation. They are yours for the asking. McMorrow, Berman & Davidson, Registered Patent Attorneys, 134-M Victor Building, Washington 1, D. C.

INVENTORS—This firm is registered to practice before the United States Patent Office and available to assist you in the preparation and prosecution of your patent application. "Patent Protection for Inventors" booklet containing detailed information and steps to take toward patent protection sent promptly upon request. No obligation. Victor J. Evans & Co., 332-C Merlino Building, Washington 6, D. C.

WE'LL Buy giftware inventions if suitable mail order. Lowry-Johnston, Wolverine Bldg., Ann Arbor, Mich.

INVENTORS. Don't sell your invention patented or unpatented until you receive our offer. Write Cowgill, Box 298, Marion, Ohio.

INVENTORS: Learn how to protect your invention. Unless the inventor is familiar with patent matters, he should engage a competent registered patent attorney or agent to represent him. We are registered to practice before the U. S. Patent Office and prepared to serve you in handling your patent matters. "Patent Guide for the Inventor" containing detailed information concerning patent protection and procedure with "Record of Invention" form will be forwarded to you upon request—without obligation. Clarence A. O'Brien & Harvey Jacobson, Registered Patent Attorneys, 71A-A District National Building, Washington, D. C.

PROTECTION For your invention or idea. Send \$1.00 for instructions on how to protect your interests. Don't send your secrets or models. Your dollar entitles you to limited analysis of costs, development, merchandising, etc., after your ideas are secured to your satisfaction. We will patent, copyright, promote, merchandise your ideas on percentage basis if you lack financing. Arizona Patent Research Laboratory, Inc., Box 2468, Phoenix, Arizona.

INVENTORS! Have you good, patentable ideas? Write Mr. Metzler, 11 West 42nd Street, New York City.

INVENTORS—Send for free patent information book and inventor's record. Registered Patent Attorney, Associate Examiner. Patent Office 1922-29, Patent Attorney & Advisor, Navy Department 1930-47. Gustave Miller, 37A Warner Building, Washington 4, D. C.

PATENT Searches \$5.00. 48-hour service. Free invention protection forms. Write Raymond L. Smith, Patent Searcher, 820 Sheraton Building, Washington 5, D. C.

IDEAS Developed for products and your profit with effective patent protection at low definite cost. Foreign patents: Canadian patents filed \$100.00. Patent development costs now deductible from tax payments. 30 yrs. in business. Joseph O'Brien, Patent-Development Engineer, 132 Nassau St., New York 38, N. Y.

PATENT Searches \$5.00. 48-hour airmail service. Invention protection forms free. Write Patent Engineering Service, 711 14th Street N. W., Washington 5, D. C.

INVENTION Record form free and "Patent Information Every Inventor Should Have." Carl Miller, Registered Patent Attorney, Woolworth Building, New York.

SEARCHES—Put your patent searches in the hands of a registered patent attorney or agent, as he qualifies to give a worthwhile patentability report. Record of invention form upon request and information on patent protection. Patrick D. Beavers, Registered Patent Attorney, 835 Columbian Bldg., Washington 1, D. C.

INVENTORS: Information on patent procedure furnished on request, without obligation. John Randolph, Registered Patent Attorney, 202 Columbian Building, Washington 1, D. C.

"INVENTOR'S Guide" and "Record of Invention" free on request. Frank P. Ledermann, 154 Nassau Street, New York 38, N. Y.

INVENTORS: Test the commercial value of your patented or unpatented inventions, quickly and inexpensively. Write for free information. Institute of American Inventors, Dept. 40-B, 635-F St., N.W., Washington 4, D. C.

PATENT Searches, including copies of nearest patents, \$6.00. Reports airmailed within 48 hours. More than 100 registered patent attorneys use my service. For free invention protection forms, write Miss Ann Hastings, P.O. Box 178, Washington 4, D. C.

INVENTIONS WANTED

INVENTIONS Wanted. Patented or patent pending. 26 years experience promoting inventions. National Service Bureau, 3120 Meramec, St. Louis 18, Mo.

INVENTIONS Wanted. Patented; unpatented. Tremendous manufacturers lists. Global Marketing Service, 2420 77th, Oakland 5, California.

SUPERIOR Promotions. Patented; unpatented inventions. Information booklet, free. Superior, 338-344 North Rodeo, Beverly Hills, Calif.

CASH Buyers for inventions. Write National Inventors Institute, Box 7007, Cleveland 28, Ohio.

INVENTORS. Give us the opportunity to explain our selling plan for your invention, gadget or device, patented or unpatented; free particulars available upon request. Demarest and Demarest, Box 95, Battle Creek, Michigan.

INVENTORS: Hundreds of manufacturers have requested our assistance in locating marketable new products. Complete information free. Institute of American Inventors, Dept. 40-D, 635-F St. N.W., Washington 4, D. C.

INVENTORS. Don't sell your invention patented or unpatented until you receive our offer. Write Cowgill, Box 298, Marion, Ohio.

INVENTIONS Wanted now by my manufacturer-clients. Patented, unpatented. Write Adams, Patent Broker, 80-S Wall Street, Financial District, New York City.

INVENTIONS Needed immediately for manufacturers. For additional information write Kessler Corporation, 581W, Fremont, Ohio.

HIGHEST Cash and royalties. Inventors having patented, patent pending inventions for sale write Inventors Creative Service, 354 South Spring Street, Los Angeles 13, California.

MANUFACTURERS Will consider any invention. Deal direct. Colburn, 920 So. Robertson, Los Angeles 35, California.

INVENTORS! Free book. "Selling Your Invention." Inventors Exchange-D, Hartford 1, Connecticut.

100 IDEAS For inventions: Products described have large market potential. 81. Research Surveys, Box 3891, Columbus 13, Ohio.

PATENTS FOR SALE

REALIZING U. S. patent protection unreliable, sacrificing 2,589,013 "Head Rest." Cost or best offer. Lewis W. Martin, R. 3, Manheim, Penna.

MODELS, MODEL SUPPLIES

POWER Models. Unusual steam gasoline and traction engines, fittings, metals. Comprehensive catalog \$1.00. Chas. Cole, Ventura, Calif.

BUILD Miniature passenger hauling live steam locomotive with file and drillpress. We do machine work, you bolt it together. Catalog 50¢. Little Engines, Lomita, Calif.

SHIP And yacht model fittings; blueprints. Send 35c for illustrated catalog listing hundreds of items. A. J. Fisher, 1002-1 Etowah Ave., Royal Oak, Mich.

SHIP Models. Most complete line in New England. Kits, fittings, plans, books, tools, engines, motors. Illustrated catalog 30¢. James Bliss & Co., Inc., Dept. SM, 342 Atlantic Ave., Boston 10, Mass.

BALSA Wood and model aircraft. 40-page catalog 25¢. Sig Co., Montezuma, Iowa.

SHIP Model kits and fittings including clippers, trawler, fishermen, frigates, privateer, radio control tug, etc. Send 25¢ for 1957 catalog. Model Shipways, Box 83, Bogota, N. J.

GIANT New 1957 "O" Gauge catalog for scale—Tintplate model railroaders. 92 pages 8 1/2 x 11, 2600 items, 180 car kits, 46 locomotives, hard-to-find model building parts. Price \$1.00 (refundable on \$10.00 order). All-Nation Hobby Shop, 178 N. LaSalle, Chicago 1.

SHIP Models—Authentic scale. Complete kits with tapered wood masts and spars, carved mahogany hulls, perfectly detailed wood blocks and dead-eyes, cast metal parts, all keyed and numbered. Even mahogany base boards with brass pegs. Simplified instructions cut building time. Send 10¢ for new catalog of 22 ships and 4 guns. Dept. 650, Marine Model Co., Halesite, Long Island, New York.

SHIP Models and yacht supplies complete. Large 68 page catalogue 50¢. Bill Wild's, 510 East 11 St., New York City 9.

MANUFACTURING

MODELS—Small lot manufacturing. Metals, plastics, etc. Milburn, Burlington, Kentucky.

HOME CRAFTSMEN

QUALITY Leathercraft and 16 other crafts at big savings. Send 10¢ for large catalog. Russo Handicrafts, Box 29-D, Los Angeles, California.

100 **JIGSAW** Patterns 75¢. Full size. Plus alphabets. Barebo, O'Fallon 1, Mo.

LEATHERCRAFT. Copper enameling, mosaic tile, shellcraft, metal tooling, beadcraft, many more crafts. Free big catalog. Kit Kraft, Dept. 223, Studio City 1, Calif.

FREE. Complete illustrated catalog, leathercraft kits, supplies. J. C. Larson Co., 820 S. Tripp, Dept. 6927-LA, Chicago 24.

BUY Wholesale nationally advertised power, hand tools, thousands other products at big discounts. Free "Wholesale Plan." American Buyers', Hertel Station, Buffalo 16-F, N. Y.

STYLECRAFT Sure fire hits. "Pre-traced" leather kits. Handbags, billfolds, filigree belts, over fifty other projects. Patterns on leather. Why trace? Just carve, assemble and lace. Large assortment "precarved" kits also available. Send 25¢ for catalog, free folder. Refunded first order. Apache Leather Company, 2804 E. Washington St., Phoenix, Arizona.

DO-It-Yourself booklets 25¢. 24 subjects. Free catalog. Popular Mechanics Press, 631 N. St. Clair St., Chicago 11.

ALL Crafts, supplies. Large free catalog. National Handicraft, 199 William Street, New York City 38.

WOODWORKING And cabinetmaking course for beginning and advanced home craftsmen. Only complete low-cost home training program available. Write for free booklet. Interstate Training Service, Dept. G-3, Portland 13, Ore.

I want to send you proof of the wonderful pulling power of Popular Mechanics classified pages. What's your proposition? Write me today. Include literature if possible. F. W. Johnson, Manager Classified Advertising, Popular Mechanics Magazine, 200 E. Ontario St., Chicago 11, Ill.

129 **FULL-Size** jigsaw patterns. Artist-drawn. \$1. Craftplans, 1321-A Michigan, Chicago 5.

LEARN Art metalcraft and jewelry making. Complete, inexpensive, home training course now available. Special tools and materials furnished. Write for free booklet. Interstate Training Service, Dept. L-3, Portland 13, Oregon.

LEATHERCRAFT. Kits, copper, artist's supplies. New catalog. Midas, 7705 State, Huntington Park, California.

KNOCKDOWN Cedar chests. Lumber and veneers. Free price list. Giles & Kendall Company, Huntsville, Ala.

FREE. New catalog, 1,668 patterns, designs. Craftplans, 1321-A Michigan Ave., Chicago 5.

FREE "Do-it-yourself" leathercraft catalog. Tandy Leather Company, Box 791-019, Fort Worth, Texas.

OVER 900 Woodworking projects. Books and patterns. Free catalog. Craftsman, 115-C Worth St., New York City 13.

KNOCKDOWN Cedar chests and lumber. Free price list. Bedford Lumber Company, Shelbyville, Tennessee.

LAMP Size cypress knee with nipple installed \$2.00. Cy Products, Dept. 2-F, Lafayette, La.

DRIFTWOOD—All kinds. Finest for homecrafters. Free details. Beachcomber, Rt. 1, Box 3250, Florence, Oregon.

101 **FULL** Size patterns. Smart, new, gifts, novelties, lawn figures, shelves, action windmills, alphabets. Plus "Make Money Jig Sawing." Only \$1.00. Mastercraft 35M, 7041 Olcott, Chicago 31, Illinois.

LEATHERCRAFT. Send 10¢ for new 76-page catalog of tools, supplies, kits, including metalcrafts, enameling, ceramics, all other crafts. Complete stock. Reasonable. Since 1910. Sax Bros., Dept. PM-3, 1111 N. 3rd, Milwaukee, Wis.

16 **NEW** Lawn chairs, 22 picnic tables, benches, trellises, etc. All 38 plans with necessary full size patterns, \$1.00. Mastercraft 33M, 7041 Olcott, Chicago 31, Ill.

NEW Woodworkers begin with four proven easily made useful plans, \$1.00. Workman's, 723 N. Main St., Burlington, N. C.

HANDY. All metal glue injector forces any liquid glue into loose joints. Quick repairs for chairs, tables, picture frames. Use on models and other new work, too. \$2 prepaid. Satisfaction or money back. Drumcliff Company, Dept. M-75, Towson, Maryland.

CONCRETE. Bond or repair it permanently with Free-Mix concrete glue. Fast, easy, for broken steps, cracks. Quart \$3.45; gallon \$11.45; prepaid. General Material Company, 650 Rosedale Ave., St. Louis 12, Mo.

DO IT YOURSELF

GRANDFATHER Clock movements, blueprints, kits. Wholesale catalog 25¢. Mason-Sullivan, Noroton, Conn.

BUILD Your own optical instrument! New book—"Fun With Optics" tells you how! 32 exciting pages. Full diagrammed instructions on how to build telephoto lenses, telescopes, microscopes, slide viewers, artist drawing projectors, binoculars, magnifiers, riflescopes, etc. We can furnish the lenses, prisms and parts you'll need. To get this terrific book send your name and address and only 50¢, full price. Request Stock No. 9000-CY. Edmund Scientific Company, Barrington, New Jersey.

MELT Cast iron, brass, aluminum. Make castings for profit. Free literature. Urtsutz Burner Co., Box 566-M, Tempe, Arizona.

AWNING Prices fractured! You install! Aluminum, roll-up. Free literature. Fifth Avenue Awnings, 210 Fifth Avenue, New York 10-A.

NEW Amazing sprinkler system. Eliminates hand watering. Reaches hard-to-water areas. Saves time. Saves water. Make it yourself in 20 minutes. Free details. Prix, 353 Hull Ave., San Jose 25, Calif.

PERMAPILM Seals photographs, cards, four 8x5's 50¢. Press-O-Matic, 111P Branch, Arroyo Grande, California.

WATCHES, OLD GOLD, JEWELRY

COPPER Enameling supplies, rhinestones, pearls, jewelry settings. Catalog 10¢. J & M Novelties, Dept. CC-3, Griffith, Indiana.

WATCH And clock repairing books. Free catalog. North American, 2320-AC Milwaukee, Chicago 47, Ill.

PREFERRED Source for quality settings and stones. Manufacture costume jewelry at home. Extensive catalog 25¢. A. V. Cuff Co., 210-F Fifth Ave., New York 10, N. Y.

COSTUME Jewelry supplies. Catalog and samples. 35¢. Largest line in America. Milady-Fair Co., G.P.O. Box 1328, New York City 1.

HIGHEST Cash for old gold, broken jewelry, gold teeth, watches, diamonds, silverware, spectacles, platinum, mercury. Free information. Rose Refiners, Heyworth Bldg., Chicago 2.

WATCHMAKERS'—Jewelers', machinists' tools. Watchmaking course. Catalog 25¢. Bengale, Culver City, California.

WATCHMAKERS' Tools, materials, supplies, watches. Catalog. Oales, Box 1000, Chicago 90, Illinois.

10 **WATCHES** \$18.00. Minor repairs. Catalog 30¢. Berkwit, 1150 Castle Hill, New York City 62.

WHOLESALE Quality jewelry findings, chains. Fraternal, religious emblems. Catalog 10¢, refundable. PM3-7 Caraday, Box 22, West Hempstead, New York.

FOR THE HOME

SWEDISH Modern furniture. Save 50%. Descriptive folder, material swatches free! Barone Furniture, 114 Main St., East Orange, N. J.

NEW Type bath sponge uses soap scraps! \$1.00 postpaid. Home Products Co., 399 Main St., Metuchen, N. J.

"**HOME** Improvement Guide." New, amazing 192 page volume. Packed with ideas, plans for remodeling, decorating, landscaping, built-in projects. \$2.50 prepaid. Popular Mechanics Press, 200-HQ East Ontario St., Chicago 11.

FOAM Rubber furniture cushions. Factory seconds. 50% discount. Free catalog. Perma-Foam, 236C Rhode Island Ave., East Orange, New Jersey.

BE Your own plumber. You can. Few inexpensive tools and our instructive book, "Home Plumbing Guide," shows and tells you how. Hundreds of photographs and diagrams. Easy to follow. 160 pages. \$3.50. Catalog free. Popular Mechanics Press, 200PG East Ontario St., Chicago 11, Ill.

OF INTEREST TO WOMEN

GOOD Money in weaving. Weave rugs at home for neighbors on \$89.50 Union loom. Thousands doing it. Booklet free. Carcraft Co., Polk St., Boonville, N. Y.

WANT To make big money at home? \$10.00 profit in an hour possible with invisible mending. Make tears, holes, disappear from clothing, fabrics. Steady year-round demand from cleaners, laundries, homes. Details free. Fabricron, 8332-S Prairie, Chicago 19, Illinois.

SELL Fine fabrics. Get yours wholesale. Box 863, Norwalk, Conn.

BOOKS: Hundreds of subjects. Big catalog free. Popular Mechanics Press, 200-BC East Ontario St., Chicago 11.

MAKE New greaseless doughnuts in kitchen. Sell stores. Free recipes. Morgan Ray, 3605 South 15th, Minneapolis 7, Minn.

"**3 MISTAKES** Parents Make." Every parent should have this new book about child training. It is free; no obligation. Simply address Parents Association, Dept. 673, Pleasant Hill, Ohio.

RAISE Money! Making, selling artificial flowers, corsages, novelties. Big illustrated catalog 25¢ (refundable). Profitkrafts, 4513C21 Lorain, Cleveland 2, Ohio.

READY—Cut dresses! Sew 'em yourself! Save! Sizes 1-12! Feeling, looking old! Unattractive! Getting fat! Write today! Carcion, 8970 Newport, Fontana, Calif.

GROW Mushrooms. Cellar, shed. Spare, full time, year round. We pay \$3.50 lb. We have over 25,000 customers. Free book. Mushrooms, Dept. 176, 2954 Admiral Way, Seattle, Wash.

JERSEY Loop pot holders 29¢. Four for dollar. Johnson's, 139 Tower St., West Sacramento, Calif.

EARN Money throughout the year. No selling, no canvassing, no telephoning, no samples to buy, no investment. It's new! Write for sensational details! MacPherson Manufacturing, 8974 St. Charles Road, St. Louis 14, Mo.

PERSONAL

MAKE Your own will! Legally drawn, copyrighted form. \$1.00. Conlon, 1331P Osage, Bartlesville, Oklahoma.

BUY Vitamins direct. Amazing savings. Catalog free. Matoska, White Bear, Minn.

"HOW Can I find out?" You can! Information confidentially developed. Any matter, person, problem. Worldwide. Officially licensed. Established 1922. William Herman, 170 Broadway, New York City.

BOOKS: Hundreds of subjects. Big catalog free. Popular Mechanics Press, 200-BC East Ontario St., Chicago 11.

SASKATCHEWAN The oil province. Regina newspaper classified airmailed \$1. Stenseth, Box 231, Regina, Sask., Canada.

DYNAMIC Booklet reveals difference between synthetic and natural vitamins and minerals. Free. Bonnie, 1605 N. W. 79th St., Miami 47, Florida.

YOUR Private Connecticut address mail received and forwarded \$3.00 month. Specialties, Box 5304, Mount Carmel, Conn.

BILLS! Bills! Bills! Pay them quickly with cash loan by mail, \$100.00 to \$500.00. Repay in small monthly installments over 20 months. Your payments may run 1/2 less than now; have money left over to spend. Loan order blank mailed free in plain envelope. Advise amount you need. State Finance Co., 323 Securities Bldg., Dept. K-227, Omaha 2, Nebr.

SIMPLE Television repairs. Marvelous booklet 25¢. Free catalog. Popular Mechanics Press, 633 N. St. Clair St., Chicago 11.

REMAILING SERVICE

HONOLULU Remailing 25¢. Receiving-forwarding available! Write: Fobel, 3132-M George Street, Honolulu.

AIR Remails 35¢. Confidential mailings \$3 month. Ross, 83 Bellhaven Rd., Toronto 8, Canada.

LAS Vegas: Remails 35¢. J. William Post, 1479 S. 7th St., Las Vegas, Nev.

LETTER Remailing, receiving-forwarding address for rent. Details free. William McLaughlin, 800 Stewart, Columbus 6, Ohio.

SECRET Mail receiving, forwarding system. \$3 month. Hedgpeh, Box 830, Alhambra 23, California.

REMAILING 25¢: Receiving-forwarding, monthly rates. Enterprises, Box 184, Hialeah, Florida.

ALASKA Remails — 25¢. View cards. Mae Armstrong, Box 491, Ketchikan, Alaska.

SAN Fernando, California: remails 25¢. Mail received, forwarded \$3.00 month. 5 scenic cards \$1.00, remailed free. Los Angeles Sunday classified \$1.00. Homer, 13247 Sayre Street, San Fernando, Calif.

REMAILING Miami, Miami Beach 25¢. Shay, 103 Marion Rd., Miami Gardens, Hollywood, Florida.

LETTERS Retailed from Kansas City, 25¢ each. Korst, Box 7652, Kansas City 28, Missouri.

TREASURE FINDERS

FIND Buried treasure, gold and silver; with Goldak's sensational 3 1/2 lb. "find-it" locator, only \$49.50. Write for free literature on complete line of mineral, metal locators; Geiger and scintillation counters. Goldak, 1541 W. Glenoaks Blvd., Glendale, Calif.

LITHIUM. The wonder metal. Free booklet describes prospecting information, uses, etc. Nu Age, Box 142, North Battleford, Sask., Canada.

TREASURE. Metal, mineral detectors. M-Scope. Used worldwide for treasure hunting. Mineralights, Geiger, scintillation counters. Prices from \$14.75. Fully guaranteed. Use our time payment plan. Free booklets on treasure hunting, uranium prospecting. Free catalog. Fisher Research Lab, Inc., Dept. PM-C1, Palo Alto, Calif.

GOLD. Silver, metal detectors. Geiger counters for uranium, Violites. Sensational new fully guaranteed models. None finer. Information free. Detectron Corp., 5523 Vineland Ave., North Hollywood, Calif.

NEW Scintillation counters. 51% discount. Literature free. Box 943, Billings, Montana.

FIND Uranium, valuable metals and minerals, buried treasures! One of the world's oldest and most reliable suppliers offers a complete line of equipment—Geiger counters, assay and test kits, metal detectors, etc. All instruments traded and repaired. Write for free literature on profitable prospecting. The Radiac Co., Inc., 489 Fifth Ave., Dept. PM-3, New York 17, N. Y.

FORTUNES For the taking. Gold, silver treasures. Light weight, guaranteed, power-packed metal detectors. Kits and assembled models from \$39.90. Geiger counters and mineralights. Free literature. Electronic Applications, Dept. M, Box 8, Arlington 10, Virginia.

FOR SALE—MISCELLANEOUS

ENGLISH Steel upholstery needles. Curved and straight assortment \$1.00. Jubin Upholstery, Uniontown, Penna.

HEARING Aid batteries, wholesale. Free list. Habs, Box 51, York, Penna.

BOOKS: Hundreds of subjects. Big catalog free. Popular Mechanics Press, 200-BC East Ontario St., Chicago 11.

WANTED—MISCELLANEOUS

SCRAP Mercury (quicksilver) containers supplied — Tantalum, tungsten, silver, platinum. Metallurgical Products Company, Established 1909, 35th & Moore Sts., Philadelphia 45, Penna.

QUICKSILVER. Sterling, silver solders, precious metals. Wholesale Terminal, Norwood, Massachusetts.

BOOKS: Hundreds of subjects. Big catalog free. Popular Mechanics Press, 200-BC East Ontario St., Chicago 11.

MISCELLANEOUS

EARN Up to \$25.00 daily! Make lamps, furniture, novelties from old, unused articles. Free circular. P. Warman Publications, Uniontown, Penna.

SELL! Buy! Trade! Anything. In "Trading Post Magazine." Sample 25¢. Information free. 525 Dewey, Jackson 30, Michigan.

REMAIL 25¢. 12 Assorted California scenic postcards \$1.00. Retailed free. Los Angeles Sunday classified \$1.00. Wynn's Mailing Service, Box 218, Mira Loma, California.

FREE: "43,000 Yearly Sparetime, Backyard, Raising Earthworms!" Oakhaven-M, Cedar Hill, Texas.

ENGLAND Re-mails, London, 25¢. European hotel baggage labels, 50¢. Picture post cards, any city, "Sempex" Irby, Wirral, England.

LEARN While asleep! Details free. Research Association, Box 810-MC, Omaha, Nebraska.

FREE Vitamin catalogue. Quality capsules for better, healthier living. Feel younger, more vigorous. Buy direct, save! Vitamin-Center, Drawer 2318P, Detroit 31.

DRESSES 24¢; Shoes 39¢; men's suits \$4.95; trousers \$1.20. Better used clothing. Free catalog. Transworld, 164-S Christopher, Brooklyn 12, N. Y.

VIOLINS Repaired. Bows repaired. A. E. Rice, Box 1627, Baird, Texas.

INTERESTED In puzzle contests? Valuable information free. Unique, Box 99, Mt. Vernon, Ill.

HOW To remodel, basement, attic. Booklet 25¢. Free catalog. Popular Mechanics Press, 633 N. St. Clair St., Chicago 11.

DO It yourself. What? Repair TV, build furniture, make barbecue, plumbing repairs, build boats, do house wiring, remodel home, lay tile, modernize kitchen, repair home, and scores of other things you can do yourself. Books covering each subject, only 25¢. Send for descriptive list. It's free. Popular Mechanics Press, 200-LB East Ontario St., Chicago 11, Ill.

RECEIVE Magazine samples, mails, catalogues, offers from everywhere. Get listed 25¢. Rorick, Cincinnati 26, Ohio.

YOUR Name wanted. We'll send 1000 publishers, mailers, wholesalers your name, on our list one year 25¢. Dixie Mailers, King, N. C.

HOUSE Wiring—Electrical repairs. 32-page booklet 25¢. Popular Mechanics Press, 633 N. St. Clair St., Chicago 11.

CESSPOOLS, Septic tanks, outhouses, clogged drains, cleaned, deodorized without digging, pumping. Sursolvent reduces contents. Reclaims leachability. Old systems work like new. Free details. Electric Sewer Cleaning, Allston 34, Mass.

HOW To read blueprints. Amazing booklet 25¢. Free catalog. Popular Mechanics Press, 631 N. St. Clair St., Chicago 11.

STUPENDOUS Mental power. Adults. Details 3¢. Delmar Wisdom, 846 Sunnyside, Chicago 40.

BUY Wholesale! Discounts to 80%! Appliances, cameras, sporting goods, housewares, watches, tools, clothing, etc. Buy-Rite 73-02, Wagaraw, Hawthorne 2, New Jersey.

I want to send you proof of the wonderful pulling power of Popular Mechanics classified pages. What's your proposition? Write me today. Include literature if possible. F. W. Johnson, Manager Classified Advertising, Popular Mechanics Magazine, 200 E. Ontario St., Chicago 11, Ill.

SHARPEN And service lawnmowers \$10.00 hour possible, build your own grinder, small cost, 26th year. Wirt's, 2419 Gnahn, Burlington, Iowa.

WANT More business? Here's an amazing opportunity to increase your sales. Talk to thousands of interested readers of "Mechanica Popular." Our Spanish Edition covers the Latin American countries like a blanket. They're real mailorder buyers. Classified rate 75¢ per word. Try an ad in our next issue. Classified Advertising Department, Popular Mechanics Magazine, 200 East Ontario Street, Chicago 11, Ill.

CIGARETTES. Make 20 for 9¢. Facts free. Moberly, Box 810, Owensboro, Ky.

FREE Wood preserving guide. What and where to use for home and yard. Rot Stoppers, 978 Ellicott, Buffalo 9, N. Y.

REMOVE Paint, grease, printing ink from hands. Lanolised waterless cream \$1.25 postpaid. Relisa Company, 21 Ravine Rd., Great Neck, N. Y.

4 RETRACTABLE Pens, \$1.00. 4 refills — free. Imprinted pens \$21.00 per 100. Robbins Sales, 1565 24th N.W., Canton 9, Ohio.

FRESH Kodak film. 3 rolls \$1.00. Sizes 620, 120, 127. PicSure Service, Box 899-M, Philadelphia, Penna.

FREE! Mammoth mail. Special offer! Hoyer, 36-11 Raven, Levittown, New York.

100 NIGHTCLUB-Restaurant jokes \$1. Eddie Gay, 242 West 72nd St., New York 23, N. Y.

SUPER Memory overnight! Success guaranteed! Bijou, Box 1727-M5, Hollywood 28, California.

RECEIVE Mails, magazines, samples. Your name in numerous mailing lists 25¢. Greenwood, Box 1116-W, New York City 8.

GILHOOLIE Opens and seals every jar and bottle tops to 1 gal. Stainless steel \$2.95. Money-back guarantee. Allens Sales, Box 303, Mims, Brevard Co., Florida.

BE Your family barber. Send \$1.00 for complete illustrated manual to: Barber, Box 586, Minneapolis, Minn.

PAY Nothing. Get beautiful complete set stainless steel tableware. Most amazing free offer. Write quick. Lamont, 824 Eleventh St., Huntington 1, West Va.

GROW Mushrooms. Cellar, shed. Spare, full time, year round. We pay \$3.50 lb. We have over 25,000 customers. Free book. Mushrooms, Dept. 175, 2954 Admiral Way, Seattle, Wash.

ANY Sign, painted and lettered, your copy. Reasonable. List free. Arcade Signs, 77 E. 35th, Chicago, Ill.

WASHING Machine parts. New-used for all makes. Send stamp for price quotation, listing parts needed. American Service, 9 Broad Street, Demarest, New Jersey.

LEATHER Jackets repaired. Suede mending our specialty. Write. Weissman Jacket Service, 4659 N. Kedzie, Chicago 25, Ill.

MEXICAN Imports, handbags, jewelry, car blankets, etc. Information 25¢. Imports Warehouse, Box 365, Selmer, Tenn.

WANTED: Folks now using vitamins. Mail us your formula (label, carton). We will send you free samples and catalogue. Savings of 40%. Vitamin Specialty, Philadelphia 46, Penna.

BUY Gifts direct from Japan. Kimono, lighters, organs, jackets, slides, novelties, etc. Business information fee \$1.00. Clarence Yamagata, 202 Naka 7 Bldg., Marunouchi, Tokyo, Japan.

LIKE Swapping? Read American Swappers' Journal, Minier, Illinois. Sample dime.

GENERATE Ideas? Don't waste them, sell them! "How to Sell Ideas" guides you; legal forms to protect you included. \$1. Research Ad Service, 600 W. 161 St., New York, N. Y.

BUILD IT YOURSELF

This **EASIER** way with
CONCRETE BLOCKS
and **SAVE!**

Shows every step from how-to-plan to how-to-build all kinds of things with one of the most economical materials known. Over 150 pictures and cutaway diagrams show exactly what to do. Tells how to mix mortar, how to set blocks; even covers painting concrete! A complete picture manual that any man can follow with ease. Washable cloth binding.

FREE 5-DAY EXAMINATION

Send no money. Pay nothing to postman on delivery. If delighted we bill you later, plus shipping costs. Or return book, owe us nothing.

ONLY
\$3.60
If you keep it



HOW TO BUILD

GARAGES
WALLS
FIREPLACES
SWIMMING
POOLS
CHIMNEYS
FOUNDATIONS
TERRACES

AMERICAN TECHNICAL SOCIETY
Dept. AG-3, 848 E. 58th St., Chicago 37, Ill.

AMERICAN TECHNICAL SOCIETY, Dept. AG-3
848 E. 58th St., Chicago 37, Ill.

Please send me **CONCRETE BLOCK CONSTRUCTION** for 5 Days **FREE EXAMINATION**. If I decide to keep the book, I will send you \$3.60, plus shipping costs. Otherwise I will return it and owe you nothing.

NAME.....

ADDRESS.....

CITY.....ZONE.....STATE.....

Check here if you prefer to send \$3.60 with coupon. We then pay all shipping costs. Same refund guarantee.

World
Wide



OWN a Business!

Even if now employed, we'll personally train you, furnish all equipment & supplies, and show you how to clear **\$8,750** the first year on **2 jobs a day**.

- **NATIONALLY ADVERTISED**
- **NO SHOP NEEDED**

Enjoy the prestige and financial independence of your **OWN** business. You will be locally trained to help you get quickly established. Just 2 average jobs a day earns **\$8,750 NET** profit first year. Employ others. **MULTIPLY** profits. You become an expert in the care of rugs and upholstery. Easy to learn. Start part-time from home. We provide 25 regular benefits. **National Advertising, Publicity Program, Conventions, Monthly Magazine, Insurance, Advertising Kit.** Many others. You offer 3 different services: 1. **Duraclean:** Famous **ABSORPTION** process for cleaning rugs, upholstery. Commended by Parents'. **NO** scrubbing, soaking, shrinkage. Aerated foam removes dirt, grease. 2. **Durashield:** Soil-retarding treatment **KEEPS** furnishings clean **MONTHS** longer. 3. **Duraproof:** Protects against damage by moths, carpet beetles.

Moderate payment establishes your business... pay balance from sales. We furnish portable machines, complete sales material, enough supplies to return **TOTAL** investment. Send for **FREE** booklet explaining Dealership Program today.

"OWN a Business" Coupon

DURACLEAN CO., 7-163 Duraclean Bldg., Deerfield, Ill.
Please rush free booklet with full details of how I may **OWN** a growing, lifetime business.

Name.....

Address.....

City.....State.....

Hone-sharpens everything —

LECTRO-HONE'S gentle honing action makes all cutting edges "surgically sharp". Perfect for every home, hobby and commercial sharpening chore. A rugged electric motor turns LECTRO-HONE'S quality oilstone at ideal speed for best sharpening action... never damages tempered steel or leaves "saw" edges like old-fashioned sharpeners. Smart modern styling. Buffing attachment also available for polishing fine silver, etc. Priced at \$19.95.

from
Awl
to
Zax*

LECTRO-HONE



For
Knives,
Scissors,
Tools

*Zax: a tool for cutting and punching shingles.

ORDER BY MAIL under money back warranty.

WARREN SALES CO. Box 161A, Cranford, N. J.
Manufactured by E. F. Britten & Co., Cranford, N. J.

Big Mail Order Profits

FREE BOOK



[from] **IMPORTS**

Men, women, coast to coast making money now on small imports with plan based on our 30 yrs. experience. We show you how to import at bargain prices for friends, stores and **MAIL ORDER**, also how to get free mail order ads. We give you names of foreign suppliers who ship direct, so no stocks to carry. Write for **FREE BOOK**. Air mail reaches us overnight. **Mellinger Co., Import-Export,** Dept. 0253, 1717 Westwood, Los Angeles 24, Calif.

Do a Real Professional-Like Job
Yourself and **SAVE**

HOW to PAINT

With Brush and Spray

Covers All Painting Methods and
Materials

You can do professional-like painting and finishing jobs yourself and save about two-thirds of the cost. Sam Brown, noted craft authority, makes it so easy for you in his book, **HOW TO PAINT WITH BRUSH AND SPRAY**. Order your copy now and enjoy this tremendous saving. It covers exterior painting, wall and interior decorating, furniture finishing, concrete painting — every type of painting with brush, spray gun, roller and other methods. Tells what finish is best; what materials to use, etc. No previous experience needed. Fully illustrated. Order by mail. Only \$2.50. Money back if not pleased.

POPULAR MECHANICS PRESS, Dept. PM257
200 E. ONTARIO ST., CHICAGO 11, ILL.



EASILY APPLIED IN LESS THAN AN HOUR

Full Color Handprinted Canvas Mural for \$29.50



absolutely scrubbable
and grease resistant
11 feet wide, printed
on four 33 inch panels
available wherever
good wallpaper is sold.

other designs to \$39.50
including Grandma Moses mural.

for free full-color brochure write us at dept. PM

"Easy Apply" CORP. 134-12 Atlantic Ave.,
Richmond Hill 19, N. Y.

SAVE \$ ON U\$ GOV'T \$URPLUS\$

Our publication "Government Surplus Sales" lists hundreds of items for sale by the U. S. Government at tremendous savings, as low as 1c on a \$1.00.

These are samples of the savings that are being made:

LIFE BOAT \$12.00	GRINDER \$4.69	SHAPER \$15.00	DUMP TRUCK \$76.77
TRACTOR \$75.00	TYPEWRITER \$7.51	FREEZER \$30.00	SPRAY PAINTER \$15.25
	MOTOR \$4.00		

Hundreds others listed in our bulletin "Government Surplus Sales" and may be purchased direct from U. S. Government. Hunting, Fishing, Camping, Sporting Equipment, Photographic Equipment and Supplies, Radio and Electronic Equipment, Amphibious Trucks, Jeeps, Boats, Motors, Binoculars, Plumbing, Electrical Equip., Cars, Power Tools, Machinery, Chemicals, Furniture, Office Equipment, Supplies, Scrap, Etc.

How may you receive our bulletin "Government Surplus Sales?" By sending \$1.00 to
GOVERNMENT SURPLUS SALES, P. O. Box 169, Department 8-5, East Hartford 8, Conn.

AMAZING NEW "LIFETIME" RADIO



GUARANTEED TO WORK FOR YOUR LIFETIME! USES NO TUBES, BATTERIES OR ELECTRICAL PLUG-INS. Never runs down! SMALLER THAN A PACK OF CIGARETTES! RECEIVES LOCAL RADIO STATIONS MOST ANYTIME ANYWHERE WITHOUT EXTRA ANTENNA. Uses perma-crystal diode H-Q Tuner - Built-in SPEAKER-PHONE. Beautiful Black gold plastic case.

Send only \$2.00 (bill, ck, mo.) and COD on arrival or send \$8.99 for post-paid delivery. SENT COMPLETE READY TO LISTEN—NOTHING EXTRA TO BUY EVER! (Extra long distance serial kit included free to receive stations up to 1,000 miles away!) Available only from:

MIDWAY COMPANY DEPT. WPM-3 KEARNEY, NEBR.

Whatever the job, you'll do it better with nationally advertised products. Ask for products advertised in POPULAR MECHANICS



Top Pay Jobs in TV-ELECTRONICS-RADIO

High pay, opportunity, prestige, security ... all yours, as a qualified Electronics Technician!

Get your training NOW in the big, recognized shops, Labs, and TV-Radio Studios at National Schools in Los Angeles, foremost since 1905. Here you work with latest Electronics equipment—professionally installed—finest, most complete facilities offered by any school. Expert, friendly instructors. Personal attention. Graduate Employment Service. Help in finding home near school. Part time job while you learn. Mail coupon NOW, TODAY... for full information.

NATIONAL SCHOOLS

National Schools Dept. RKB-37
4000 So. Figueroa Los Angeles 37, Calif.
Send Free Electronics Opportunity Book Today

Name _____ Age _____
Address _____
City _____ State _____

Earn Better Money



Learn Scientific Engine Tune-up and Service! In just four weeks you can become a tune-up expert, using the most modern test and tune-up equipment • Good jobs open all the time in this growing field, paying *real money* for men who have learned how to handle the up-to-date electronic testing methods which 1957 high-efficiency auto engines call for • You don't need to have finished school to learn how to

handle every aspect of auto testing • Automotive electricity, learn everything you need to know about how the electric system of a car works • How to find troubles, how to adjust to manufacturers' specifications • Carburetors, how to check their working, how to fix them quickly, accurately • You work on modern, late model engines, step-by-step, learning where breakdowns happen and what to do about them • Not a correspondence course, a fully-equipped school to teach auto engine testing and tune-up • Classes start first Monday in each month at SUN Electric headquarters on Chicago's beautiful northwest side • Full cost \$35.00 a week for four weeks including use of tools and textbooks • 1st week: Modern Tune-up Methods • 2nd week: Automotive Electricity • 3rd week: Test Equipment Operation • 4th week: Service Merchandising • Classes limited to 12 men each so you get what amounts to individual instruction • SUN'S cafeteria is open to you for tasty low-cost meals • Living quarters can be arranged for you if you wish, at an attractive price • G.I. Bill approved • Take this quick way to better income now!

Mail in Coupon
for complete
information,
brochure free

Sun Electric Corp., Dept. P-2
6323 N. Avondale, Chicago 31, Ill.

Please send free brochure.

Name _____

Address _____

City _____ Zone _____ State _____

Make Money

in ART

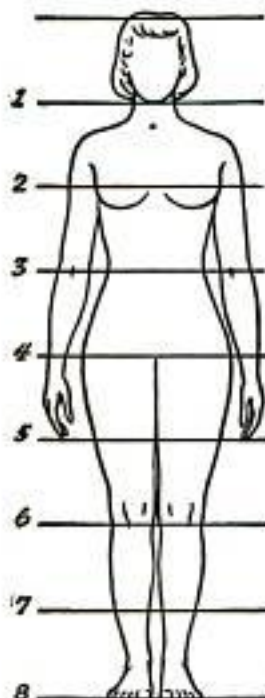

**It's EASIER
Than You Think!**

DRAWING at left shows how to proportion average human figure, 8 heads tall. General art instruction has been simplified same way in our famous home study course. With it, you can develop artistic ability you never dreamed you had—train for top pay in Illustrating, Cartooning, Design, Fashion Art, Lettering, Portraits, TV. Low cost. Individual supervision.

SEND FOR FREE BOOK. Describes our methods. Quotes students. Talent Test also sent free. No obligation. No salesman will call. Mail coupon now. **Washington School of Art, Studio 143, Port Washington, N. Y.**

WASHINGTON SCHOOL OF ART (Estab. 1914)
STUDIO 143, PORT WASHINGTON, N. Y.

Send me —FREE— illustrated book, "Art for Pleasure and Profit," plus free talent test. No obligation. No salesman will call.

Name _____ (Please Print)

Address _____

City _____ State _____

DRAFTING and BLUE PRINTING pay BIG MONEY



LEARN AT HOME IN SPARE TIME.
You will be sent professional drafting instruments, drafting equipment, drafting lesson manuals, portable drafting table, etc. You learn by making actual drawings. Everything furnished on a **PAY AS YOU LEARN PLAN.**

REVOLUTIONARY NEW METHOD
Teaches you quickly the hows and whys of Mechanical, Machine, Structural, Architectural, Electrical Drafting, etc.

LIGHT PLEASANT WORK
and Drafting and Blue Printing in addition to paying good wages often lead to top managerial positions.

MAIL COUPON for FREE BOOK

CHRISTY TRADES SCHOOL, Dept. DB-3303
4804 N. Kedzie Ave., Chicago 25, Ill.

Mail me at once your big FREE book on Drafting and Blue Printing. Tell me how I can get your Home Training and Professional Drafting Instruments, Drafting Table, Drafting Equipment, etc., on a **PAY AS YOU LEARN PLAN.**

Name _____ Age _____

Address _____

City _____ Zone _____ State _____

**GRINDS • CARVES • ENGRAVES
DRILLS • ROUTS • SHARPENS**
**DREMEL Electric
MOTO-TOOL**

The handiest tool you can own for household jobs, your workshop, or hobby projects. Handles like a pencil. It saves time—makes all jobs easier—gives the finished product a professional look.

The Dremel Moto-Tool has an excellent record as a precision tool in industry. Fastest, most powerful tool of its kind—27,000 rpm. Buy a Moto-Tool—it will pay for itself in no time. See your dealer today.



MODEL No. 2 (Wgt. 1.3 oz.) **\$17.85**

MODEL No. 1 **\$12.85**

Moto-Tool Kit No. 2

Includes Model No. 2 Moto-Tool, 23 accessories (high-speed-steel cutters, grinders, polishers, etc.) in a steel case. **\$25.95**

Kit No. 1 **\$21.50**

SEE YOUR DEALER. If he cannot supply you, order direct from factory on a 5-day trial, money back guarantee. Send full amount and we pay postage or send \$2.00, and pay postman balance plus C.O.D. charges and fee.

DREMEL MFG. CO., Dept. 117C, Racine, Wisconsin



YOU CAN BUILD A VIOLIN FOR PLEASURE OR PROFIT

Now you can build a rich toned mellow violin modeled after a famous "Strad." **YOU CAN MAKE A STRADIVARIUS VIOLIN** contains 8 full scale plans plus complete instructions. You work directly from the plans with no confusing scale of dimensions to translate. Detailed instructions for each step including varnishing and stringing—even shows how to build your own tools. Cloth bound. Order today from

POPULAR MECHANICS PRESS **\$3.50**
Dept. 357, 200 East Ontario Street, Chicago 11, Illinois

FREE AMAZING NEW BOOK "HOW TO ANSWER ADS"



Never before have you seen anything like this. Tells you in simple language the correct way to answer ads. Gets you quicker replies—better results, and greater satisfaction. Will save you time and money and it's **ABSOLUTELY FREE.** No obligation whatever. Every reader of advertising should have this booklet. Send a postcard for your copy NOW. **F. W. JOHNSON, Popular Mechanics Magazine, Room 600-A, 204 East Ontario Street, Chicago 11, Ill.**



POPULAR MECHANICS

Copyrighted material

FROM ALL OVER THE WORLD...

news you want to hear with a



hallicrafters Model S-38D—Only **\$49.95**

It's a fascinating, exciting hobby to listen in on the whole wide world by short wave with Hallicrafters S-38D radio. With this exceptional receiver you enjoy not only standard broadcasts . . . but can choose from the 3 international short wave bands. You, too, will praise the performance of Hallicrafters S-38D radio . . . the choice of countless governments as well as radio experts the world over. Hear the S-38D at your nearest Electronic Parts Distributor today—\$49.95 . . . or write

hallicrafters

CHICAGO 24, ILLINOIS

TWO WAYS TO BUY BETTER

Your dealer knows the right products for your needs—quality products that are nationally advertised. POPULAR MECHANICS brings you a monthly roundup of valuable "how to" information and product advertising. Read POPULAR MECHANICS every month—then talk to your dealer.



Handiest Adhesive

for all

Household Jobs



Pliobond

by **GOODYEAR**
"Bonds Anything to Anything"



Available at chain, hardware and hobby stores everywhere.

Pliobond—T. M. The Goodyear Tire & Rubber Company, Akron, Ohio

NEW MAGIC RADIO WALKIE TALKIE!

YOUR OWN POCKET SIZE RADIO STATION!

BROADCASTS TO ANY HOME OR CAR RADIO WITHOUT WIRES OR HOOKUPS! Wt. only 5 oz. Size, 1 1/2 x 2 1/2 x 4 1/2". Built-in telescoping antenna. Powerful Transistor-sensitive microphone, frequency setter, break-in switch! Runs for weeks on self-contained flashlight batteries. Durable plastic case. With this Radio Talkie you CAN TALK TO YOUR FRIENDS UP TO A BLOCK OR MORE AWAY! Talk up to 1 mile or more between two automobiles. INSTANT OPERATION! Just push button to talk! No license needed. Uses inductive field magnetic radiation. Useful and real fun in a million ways! GUARANTEED TO WORK. 1 YEAR SERVICE GUARANTEE.
SEND ONLY \$2.00. (cash, ck, too) and pay postman \$1.50 COD postage or send \$11.98 for prepaid delivery. COMPLETE READY TO OPERATE with instructions and hundreds of ways and tricks for broadcasts thru any radio you desire. Price may go up soon, so get your NEW POWERFUL RADIO-VOX WALKIE TALKIE NOW. Available only from WESTERN RADIO, Dept. RPM-3, KEARNEY, NEBR.



R-1 GENERATORS



Aircraft Type 300 Amps, 24 Volt D.C., 4 to 10,000 RPM. Makes handy arc welder. Cost Gov'l. \$400. SPECIAL \$29.80. Good Serviceable Used. F.O.B. York. Diagram Incl. Free. NEW '57 catalogue with 1000's Big Bargains—10c.
KARL ORT, Dept. PM3, York, Pa.

HELPFUL BOOKS

Send post card asking for FREE catalog

Popular Mechanics Press, 200 E. Ontario, Dept. 601, Chicago 11

7MM MAUSER CARBINES

GUAR. GOOD CONDITION

\$19.95

Guaranteed VERY

GOOD COND. \$27.50

FOR HINGED

FLOOR PLATE

ADD \$5.00

6 SHOT BOLT

ACTION MOD. '95

One of the world's most popular hunting carbines in a powerful military carbine. Light, fast, extremely accurate with the famous trouble free Mauser action. SOFTNOSE HUNTING AMMO, available everywhere—made by Rem., Win., Peters, Western. Bore and outside guar. good. This model, seldom seen on the market, is a bona fide collector's item. Our exclusive import. 10-day money back guarantee. All milled parts. TO ORDER: Send check, cash or M. O. 1/2 dep. for C.O.D. Calif. resid. add 4% state tax. Shipped R.R. Exp. F.O.B. Pasadena.

GOLDEN STATE ARMS CORP. 406 Army Bldg., 386 W. Green St., Pasadena, Calif.

FREE! 1957 ALLIED ELECTRONIC SUPPLY CATALOG



356 value-packed pages

SAVE ON EVERYTHING IN ELECTRONICS

Everything for Experimenters, Builders & Amateurs, Servicemen, Engineers & Hi-Fi Hobbyists

Send for ALLIED's money-saving guide to *everything* in Radio, Hi-Fi and Electronics! Select from the world's largest stocks: High Fidelity systems and components; latest builders' kits (see the famous KNIGHT-KIT line); recorders and phono equipment; TV tubes, antennas, accessories; Amateur station equipment; P.A. Systems; test instruments; industrial electronic supplies—plus *everything* in parts, tubes, transistors, tools and books. Get more for your money—send for your FREE 1957 ALLIED Catalog!

Everything in Electronics from One Reliable Source OUR 36TH YEAR

Send for FREE CATALOG

ALLIED RADIO

ALLIED RADIO CORP., Dept. 5-C-7
100 N. Western Ave., Chicago 80, Ill.

Rush FREE 1957 ALLIED 356-Page Catalog

Name _____

Address _____

City _____ Zone _____ State _____

WHERE-TO-BUY-IT INDEX

Source of supply appears after items commercially available

AUTOMOTIVE

- Desert trailer carries 200 tons (Eidal Mfg. Co., Albuquerque, N. Mex.)106
Four-seater midget car has doors in front and rear.....108
"Hold 'er, Cowboy!".....110
Secret car signal opens garage door (Anthony Machine and Engineering Service, Inc., San Jose, Calif.).....119
Utility trailer can fold for storage like an ironing board (J. G. Mfg. Co., Plymouth, Wis.).....142
Trick cord for trunk (G. G. Sales and Mfg. Co., 5038 W. Wolfram St., Chicago 41).....158
Captain's custom car combines parts of many automobiles...159

AVIATION

- Swedish jet fighter intercepts supersonic enemy bombers.... 86
Plane's intercom is transistorized (Goldak, Inc., 1544 Glenoaks Blvd., Glendale 1, Calif.)..... 92
Mineral "diving rod" prospects from plane..... 93
"H" mark at heliport means "hospital near"..... 95
New whirlybirds 100
Wing on latest intercontinental Super Constellation is 27 feet longer 119
Scorpion's sting is rockets in wing pods..... 129
Hypersonic wind tunnel..... 152
Transport planned for small airports (Frye Corp., P.O. Box 1375, Fort Worth, Tex.)..... 159
CAA men help Italy..... 160
Four Navy jet fighters refueled simultaneously..... 160

BOATS

- Paddle wheeler 93
Motor is used to inflate rubber boat prior to propelling it..... 123
Steamboat comin'—all 16 feet of it..... 153

CONSTRUCTION

- Control holds grader blade at precise angle (Caterpillar Tractor Co., Peoria, Ill.)..... 123
3800-degree oxygen-kerosene flame carves granite blocks (Coggin Granite and Marble Ind., Elberton, Ga.)..... 131
Trussless steel roof spans 31,200-foot area (Wonder Bldg., Corp. of America, 30 N. LaSalle, Chicago)..... 135

FARM

- Tandem tractor 119
Mobile irrigator depends on wells (W. W. Fox, Detroit Diesel Engine Div., General Motors Corp., Detroit 28, Mich.)..... 130
Suspended sprayer kills barn flies (W. R. Brown Corp., 2701 N. Normandy, Chicago 35)..... 148

MISCELLANEOUS

- Dog's life? It's great!..... 86
"Ski Skoot" goes 50 m.p.h..... 86
No need to wind this watch (Hamilton Watch Co., Lancaster, Pa.) 87
Puckered tent 92
Roll-out unit for drawing board (Spiroll Products Co., 1 Concord Rd., South Sudbury, Mass.)..... 92
Water scooter thrills bathers..... 93
Glass fertilizes soil..... 95
Jeep mine-finder 107
Lightweight rifle (Fairchild Engine and Airplane Corp., Hagerstown, Md.) 108
Transportation bill 108
GI can blast own foxhole..... 109
20-axle freight car carries 220-ton load..... 109
Canada "main street" to cross continent 118
Compressed-air bubbles keep shipping lane ice-free in Swedish lake 122
Artificial ship launches missiles..... 122
Cool combine 130
Suspension bridge with single pillar planned in Germany..... 130
Gas air conditioner-heater for air or water systems (Rheem Mfg. Co., 7600 S. Kedzie, Chicago 29)..... 131
Subway cars in Paris to have rubber tires..... 131

(Continued to page 76)

**NEW 1957 GEOPHYSICAL YEAR MODEL OF
GENUINE 135-POWER
ACHROMATIC TELESCOPE**

with Achromatic Lens and
4-POWER FINDER attached

ONLY
\$18.95
PREPAID

EXTRA BONUS GIFTS:

- 273 page book, "Handbook of the Heavens"
- Magic Star Finder Dial
- 220X & 400X Eyepiece lenses

5 Magnifications 18X-35X-65X-85X-135X

Never before has an ACHROMATIC 135X telescope with range finder and tripod sold for anywhere near this amazing low price. **POSITIVELY SHOWS** planets, stars, craters, people and all distant objects. Compound Achromatic coated lens guarantee performance. Adjustable 18X-35X-65X-85X-135X for any condition of brightness, greater range of powers, color free needle-sharp views only possible with Achromatic corrected lens. Trimmed with gleaming brass extends to 43" 4X finder scope (30MM LENS) gives brilliant clear views. Brings difficult objects on target before viewing. 5 ft. folding tripod with heavy cast iron head fitted with Criterion's famous universal 360 degree aluminum mount assures stability, locks in any position. Remote controls. This amazing 135X Achromatic obtainable only from Criterion. Shipped ready for use together with 4 bonus gifts: 273 page "Handbook of Heavens," Magic Star Finder, also 220X & 400 eyepiece lenses free for experiments. Shipped complete, nothing else to buy at amazing price of \$18.95, without tripod \$14.95.

ALSO SPECIAL 40X-80X-120X \$11.95
TELESCOPE WITH TRIPOD POST PAID

5 section telescope with 5 precision lenses, opens to 36" closes to 12", 5 ft. hardwood tripod, cast head, aluminum 360 degree mount. Erect clear images. Bonus gifts: 273 page Handbook of Heavens, Star Finder. You must be completely satisfied with these instruments or money promptly refunded. Send cash, check or money order today.
Dept. PMA12, CRITERION MFG. CO., 331 Church St., Hartford, Conn.



Become an
**Electrical
Engineer at
MSOE**
in Milwaukee

Electronics Communications
Electrical Power
Industrial Electronics

Join the Engineering team! Over 50% of the nation's industrial leaders began their careers with engineering training. Jobs are waiting for well-trained men.

Milwaukee School of Engineering's educational program of technical institute and collegiate engineering courses offers you step-by-step advancement. Save a valuable year through MSOE's optional year-round study system. Prepare yourself for the opportunities ahead in one of these MSOE courses:

Engineering
(Bachelor of Science degree in Electrical Engineering)

Engineering Technician
(Associate in Applied Science degree)
MSOE also offers courses in mechanical engineering and technology.

MSOE's complete, modern facilities include specialized technical laboratories and equipment, visual aid theater, and amateur radio station. Courses approved for veteran training. 50,000 former students. Excellent placement record for graduates.

4 TERM OPENINGS YEARLY
OCTOBER, JANUARY, APRIL, JULY

Clip and Mail Today!



MILWAUKEE
School of Engineering

Dept. PM-357, 1025 N. Milwaukee St. MS-36
Milwaukee 1, Wisconsin

I am interested in: (Please print)

- Electrical Engineering course
- Engineering Technician course
- Mechanical Engineering

Name.....Age.....

Address.....

City and State.....

If veteran, date of discharge.....

**E-ZEE Water Powered
TWIN SPIN**

Aerated Action
Brush



EVERY CAR OWNER
EVERY HOME NEEDS THIS
WORK SAVING BRUSH

Connects directly to garden hose. Twin spinning center brushes do aerated cleaning and rinsing. Soft, mar-proof, quality brushes for finest car finishes. Perfected, swivel action, leak-proof valve regulates water flow and prevents hose kinkage. 36" rubber covered handle. Brush head detaches for insertion of detergent cartridges (sample with each brush) Extension handle available (\$1.75 extra) to lengthen unit to 6 ft.

for washing cars,
windows, siding,
screens, etc.

\$6.95

Available at Hardware, Auto Supply and Dept. Stores. If your dealer cannot supply — send check or money order direct to factory. We pay shipping cost.

LAITNER BRUSH COMPANY
2000 Brooklyn Ave. • Detroit 26, Mich.

TURN BLACK ASPHALT INTO YELLOW GOLD!

MAKE UP TO
\$100 PER DAY
IN A BUSINESS
OF YOUR OWN!



OUR HELPING HAND

You can start your own big profit paving business. Cash in on the tremendous demand in this fast growing field. The General Giant heavy duty, power operated roller lets you pave asphalt driveways and walks, parking lots, service stations. Roll lawns, tennis courts, playgrounds, parks and municipal properties. Your customers are everywhere. Home owners, builders, contractors, landscapers. This is a real professional contractor's roller that enables you to take ANY JOB — time tested and job proven — built to take a beating and withstand years of rugged service. Wonderful new automatic transmission with full reverse gives you complete maneuverability in tight spaces. Simple, footpedal adjustable weight control lets you roll anything from blacktop driveways to highways with equal ease. With your roller you get full operating instructions and complete accessories — everything you need to get started the day your equipment arrives. This is a once-in-a-lifetime opportunity for men with an eye to the future and small capital to get into a booming, high paying business. Don't delay — get rolling right away. Write for free, fully illustrated details.

You can call on us at any time. Our engineering department is always at your service. We show you how to enter this booming business. Whether you can work full or part time, we supply the know-how and equipment that spells big profits. Don't delay. Act now. Write for full details.

J. H. from N. Y. writes, "What a money maker this is! I'm loaded down with jobs. Working with a new housing developer — have all the driveways and patios—140 of them!"

DEALERS WANTED!

GENERAL ENGINES COMPANY

Dept. R-36, Route 130, Thornfare, N. J.

WANT HIGH PAY and STEADY WORK?

Get into

DIESEL AND HEAVY EQUIPMENT

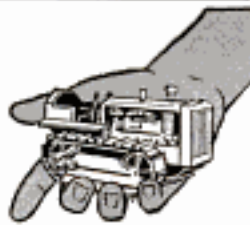

Men are now being selected to train for the Diesel and Heavy Equipment industry. High pay and future security are the benefits of a trained and qualified Diesel man. If you are mechanical minded, write to us for free information without obligation as to how you may become a part of this rapidly expanding industry in . . .

- DIESEL MECHANICS
- DIESEL PARTS
- DIESEL OPERATION
- DIESEL SALES

MAIL THIS COUPON TODAY!

We will give you complete details about possibilities for you in the Diesel and Heavy Equipment field, without cost or obligation. Fill in the information below, or write at once to:

TRACTOR TRAINING SERVICE, INC., Dept. PM-12

1525 E. 53rd St., Chicago 15, Illinois or
3334A Bloor St., West, Toronto 18, Canada

Gentlemen:

I would like all the facts about opportunities for me in Diesel.

NAME _____ AGE _____

ADDRESS _____

CITY & STATE _____

TV monitors needs of hospital patients (Sperti Paraday, Inc., Adrian, Mich.)	135
Converted tenders	136
"World wonders" in Ohio	136
Plastic-lined lake (Dowell, Inc., P. O. Box 536, Tulsa, Okla.)	137
Portable railroad-cargo carrier (Minnesota Mining and Mfg. Co., St. Paul, Minn.)	142
Tractor furnishes water by boom-mounted irrigation pump	149
Camera features three film cases	149
World's largest dump trailer can carry 100 cubic yards (Marion Metal Products Co., Marion, Ohio)	149
German-built diesel coaches cut 1½ days from mountain trip	152
Ship model seems wingless aircraft	159
Engineer makes fly trap	226
No more fish, but much more comfort (Niagara Mfg. and Dist. Co., Adamsville, Pa.)	236
Swimming-pool guard (Supertron Corp., Los Angeles 65, Calif.)	246

SCIENCE

Blind "see" through their ears with electronic eye	95
Atomic-bomb detectives pinpoint explosion 3000 miles away	107
Sterilizer kills viruses of polio	129
Alcohol slows evaporation	131
Automatic weather station broadcasts data from remote buoy	148
Men to live underwater beneath radar tower	158
Satellite sees weather	158
Weekly blood donations	158
Telescopic tracker lens "eyes" weather, missiles	160
Antibiotic injections	246

WHAT'S NEW FOR YOUR HOME

Rotary mower operator adjusts height with toe	120
Portable electric ice crusher	120
Double-bottom shortening cup	120
Take-apart portable grill	120
Floor-hugging rubber duct	121
Women's hose drier	121
Automatic garbage can	121
Lock set does not require a doorknob	121
Can opener can be handled by disabled persons	121

Radio-Television, Electronics

The prospector's partner—a combination geiger counter and portable radio	161
--	-----

Craftsman and Shop Notes Index

CONSTRUCTION

Chimney "screwed" to building	175
Lean-to-workshop provides needed storage and workspace	181
Cement-roughening "trowel" made from block and shingle	182
Compass traces corner deviation on wallboard panel for good fit	182

HOUSE AND HOME

Trellis made with coat hangers	175
Solving Home Problems—	
Protect edges of linoleum	178
Pipe flange makes low candle holder	178
To store crochet hooks	178
One-drop oil for typewriter	178
Sanding block made from shoe-polishing block	178
Loose handle of plumber's suction cup made secure	179
Foot scraper from discarded broom	179
Friction lids made easy to remove	179
How to store safety razor blades for sewing kit	179
Handy doorstop from sheet metal	179
Favorite recipes kept in file	179
Pivoted crane adds character to your fireplace	189
Sheet-metal angles support shelves in wall cabinet	198

(Continued to page 78)



ATOMOTRON

First Model Atom Smasher

Now in use in hundreds of America's leading High Schools and Colleges

See and learn wonders of Nuclear Physics and Electricity with miniature high-voltage generator. Make artificial lightning... pitb balls defy gravity, propellers turn at a distance. Only 7" high. Produces 75,000 volts on a 2-inch

diameter sphere, yet is absolutely safe for the youngest child. Operated by sturdy 110 volt A. C. motor... comes complete with Smog Control Unit, Field Reaction Rotor, Plastic-encased Pitb-Ball, Paper Strand Cluster, Electric Wind Unit, Neon Light Wand and Illustrated Experiment Manual. Price assembled, \$19.95, post paid; in kit form, \$14.95, post paid.

NEW 3-IN-1 ELECTROMAGNET

Insert D. C. coil, suspend 100 lbs. with only 1 flashlight battery. Insert A. C. coil, push switch and levitate aluminum ring 3 inches. Light bulb included to demonstrate transformer action. Magnet & keeper precision-machined of low carbon steel. Long-life coils wound with Formvar-insulated copper wire. Complete with all accessories & experiment manual, \$14.95 post paid.

Cash, check or money order. (In California, 4% Sales Tax.)

ATOMIC LABORATORIES
P. O. Box 343-B, Berkeley, Calif.
World's Leading Manufacturers of new low-cost Educational Scientific Equipment



GLIDE TO THE HAUNTS OF THE BIG ONES

• Smoothly and quietly you reach the best spots when your canoe is an easily handled Old Town. Strong yet light, Old Towns are built to give years and years of pleasurable, reliable service. Every canoe is backed by half a century of skilled experience in building water-wise craft.

FREE CATALOG shows all kinds of canoes for paddling, for sailing, for outboards. Also sailboats, outboard boats, dinghies, rowboats.

OLD TOWN CANOES

Old Town Canoe Co. 443 Middle St., Old Town, Maine
PLEASE SEND ME FREE CATALOG

Name _____
Address _____
City _____ State _____

MARCH 1957

HULA POPPERS

BORROWED BAIT MAKES NEW FAN

"I wanted to fish, but didn't have a casting bait," says Mrs. W.H. Hathcock, Memphis, Tenn. "I'm very happy that I was able to borrow a black Hula Popper!" With it, she caught these three swell bass—total wt. 14-1/2 lbs. at Horsehoe Lake, Ark. Action-packed Hula Popper obeys your slightest wrist command. You make it pop, plunk, twitch or jerk at will under perfect control.



NEW REFLECTOR FINISHES

—now available on both Spinning (1/4 oz.) and Casting (5/8 oz.) sizes. Sparkling non-fade gold and silver inserts reflect light to attract big fish. Choice 6 Reflector Finish and 6 Standard Colors, \$1.35 ea. Fly-rod (1/16 oz.) 5 colors, 75c ea.—weedless, 85c ea. Midget (1/32 oz.) 6 colors, 80c each.



RED-HOT SURFACE POPPER

MAIL FOR BIG FREE CATALOG

FRED ARBOGAST CO., INC.
2253 W. North St., Akron 3, Ohio
Please send my FREE copy of the NEW Arbogast Color Catalog of baits—full of pictures of catches.

Name _____
Address _____
City _____ State _____



You can make money in



WATCH REPAIR

Learn at home the low cost Swezey Way

Watch repairing pays up to \$6 an hour, part time watch makers report on survey. Unique and modern Swezey home study System starts you making repairs right away on Swiss and American watches. Professionally prepared training. No previous experience needed. Special tools provided for practice. Tuition only \$5 a month. Free sample lesson and opportunity book give all facts. Write today. No obligation.

CHICAGO SCHOOL OF WATCHMAKING

2330 N. Milwaukee Ave., Dept. 137, Chicago 47, Illinois

FREE BOOK and SAMPLE LESSON

CHICAGO SCHOOL OF WATCHMAKING
2330 N. Milwaukee Ave., Dept. 137, Chicago 47, Illinois
Please rush FREE BOOK and Sample Home Study Lesson.

Name _____ Age _____
Address _____
City _____ Zone _____ State _____

Plan your VACATION in TENNESSEE



send for **Free Color Book**

Treat your family to a 3-way vacation that includes mountains, lakes, and history. They'll ride highways into the sky in the Great Smoky Mountains National Park; fish, boat and swim in Tennessee's 20 Great Lakes; see the homes of three presidents, historic battlefields, TVA dams, and the world's only Atomic Energy Museum at Oak Ridge. Yes, for three vacations in one, see Tennessee. Send now for free 40-page color book.

MAIL COUPON TODAY

Tennessee Division of Information
1564 Cordell Hull Bldg., Nashville, Tennessee
Please send Free Color Book on Tennessee

NAME _____

ADDRESS _____

CITY & STATE _____

ENGINEERING DEGREE IN 27 MONTHS

B. S. DEGREE IN

**Aeronautical, Chemical, Civil, Electrical, Mechanical
and Electronic Engineering (inc. Radio and TV)**
Big Demand for Graduates

Hundreds of young men are earning B. S. ENGINEERING DEGREES annually in this recognized institution—year around classes optional. Also B.S. in 36 mo. in Mathematics, Chemistry, Physics. New terms start quarterly. Many students earn a major part of their college expenses in this large industrial center. Low tuition. Competent instruction.

Thorough, intense practical program. Modern, well-equipped laboratories including new physics laboratory and modern wind tunnel. Individualized instruction emphasized. Government approved for G.I.'s. Engineering Science preparatory courses.

Students from 48 states and 21 foreign countries. Enter March, June, September and December. Send coupon for free catalog and full information. Enroll now.

INDIANA TECHNICAL COLLEGE

537 E. Washington Boulevard, Fort Wayne 2, Indiana

Please send me free information on 27 MO. B.S. DEGREES in:

Aeronautical Chemical Civil Electrical
Mechanical Electronics

on 36 MONTH B.S. DEGREES in:

Mathematics Chemistry Physics

Name _____

Address _____

(Continued from page 76)

HOUSEHOLD HINTS

Fingers from rubber gloves "leakproof" bottles.....	180
Simple way to keep lampshades clean.....	196
Color-tinting kitchen foil.....	198
Salt spout fitted on fruit jar dispenses powdered soap.....	200

MISCELLANEOUS

Improvised lettering "brush" made from cloth and cotton...	169
Old wheels roll again.....	174
Auto registration certificate carried on identification tag.....	175
"Pinto" rocking horse.....	176
Road-map distance measured by use of pipe cleaner.....	176
Imitation inlay stenciled.....	180
Beads grouped between knots simplify restringing task.....	182
Box top is notched to open easily.....	182
Shoehorn used as gardening tool for transplanting seedlings.....	182
Salad-bowl novelties.....	183
Safety release on crossbar of pole-vaulting hurdle.....	189
Birdhouse roof "shingled" with strips of adhesive tape.....	198
Special-effects lens shades.....	199
Sounding block locates joists.....	200
Punch cuts blind holes in cardboard for coin collection.....	200
Moth balls protect hen.....	207
Drawing dimensions converted by dividers set with micro- eter.....	208
Geared windlass on transport lifts disks for hauling.....	208
Envelope flap guides carbons into typewriter.....	214
Suede-shoe brush cleans carvings.....	214
Truck parked on hoist to provide additional storage space.....	216
"Hook on" chute on silo keeps waste at minimum.....	216
On the Market for Do-It-Yourselfers.....	217

PHOTOGRAPHY

Mirror background for photographing flowers.....	180
Trimming photoprints without cutting board.....	214
Wet cloth cools developer.....	214

WORKSHOP HINTS

Bent hinge screw tightens self in oversize hole.....	169
Fasteners support shelves.....	169
Pocket cigarette lighter converted to miniature blowtorch.....	169
Putty used as sanding block.....	169
Broom clamp on ladder rail keeps hammer handy.....	176
Emergency hose clamp from wire and bolt.....	180
Improvised fluting plane.....	189
Nail in stick is depth gauge.....	189
Gauge cut from sheet metal measures various diameters.....	196
Spaced lines ruled quickly with this perforated disk.....	196
Wood scrap prevents splitting when boring hole with brace.....	196
Two-piece holder for machining screws.....	197
Sill cock made rigid.....	198
Micrometer mounted on base for checking duplicate parts.....	207
Scale and drill press utilized to measure valve-spring tension.....	208
Removing generator pulley.....	209
Sanding freshly glued joint seals and finishes it.....	209
Try-square jig for quick milling-machine setup.....	209
How would you do it?.....	210
Adjustable depth stop for arbor press clamps to ram.....	212
Holding a bolt in sheet metal.....	212
Milling machine set up to make 45-deg. cuts.....	212
Thin-wall pipe nipple plugged to prevent crushing with wrench.....	212
Almost anything can be soldered.....	213
Ferrule replaced on tool handle with solder-wire wrapping.....	215
Metal fasteners have "self locking" action.....	215
Valves and tappets left in place when changing engine cam- shaft.....	215
Cutting hole in plaster.....	216
Round stock cut on bandsaw clamped to prevent rolling.....	216

NOTICE—It is the intention of this magazine to provide its readers with information regarding the latest developments in the mechanical arts. Except where otherwise indicated, this magazine has no information as to any unexpired patents in respect of the developments reported herein. In the event that commercial use is to be made of any of the developments reported herein, it is suggested that legal counsel be consulted to avoid liability for patent infringement. It is not the purpose of this magazine to encourage patent infringement but, as indicated, it is the intention of this magazine to report on the latest developments in the mechanical arts.

Everyone GETS TO USE...



THE SIOUX POLISHER SANDER

The car, the floors, the furniture, everything will shine like new when this SIOUX Electric Polisher Sander joins your family. It arrives ready to work, complete with Wool Polishing Pad, Polishing Wax, and Abrasive Discs. A handle for polishing floors and a drill chuck with 7 drills are optional extras.



Look for SIOUX in the yellow pages under "Electric Tools"

Write for Free Catalog



ALBERTSON & CO. INC. SIOUX CITY, IOWA, U.S.A.

How to sharpen tools

cutlery, sports equipment, garden implements... from an axe to ice skates

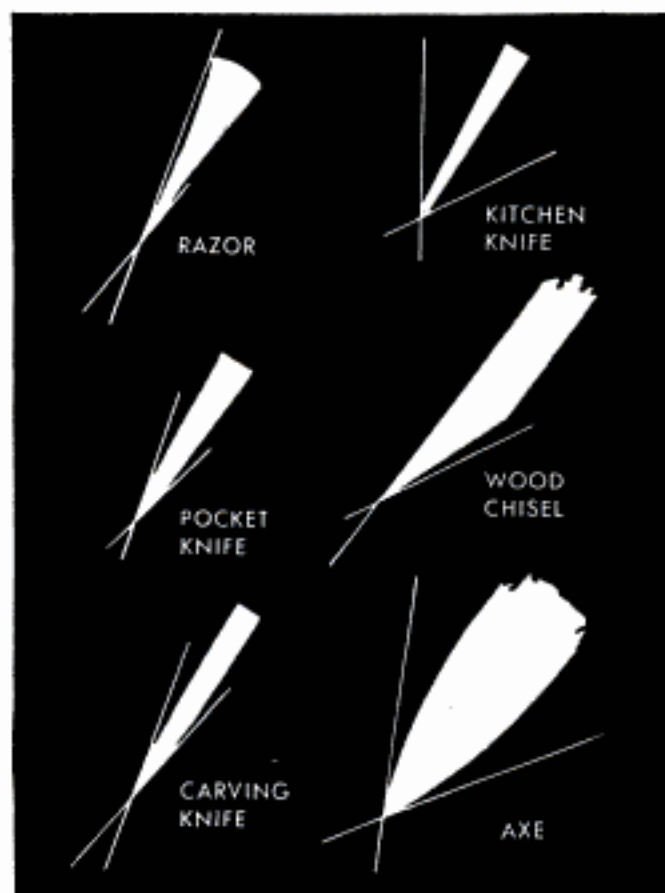

Sharp tools make work easier. The right angle is important... and so is the *right sharpening stone*. Ask for NORTON manufactured and natural stones... the best you can buy.



Handy 32-page book tells all about sharpening tools, sporting equipment, cutlery, etc. It's yours FREE at your dealer's when you purchase a NORTON stone. Or send 10¢ with the coupon below to

BEHR-MANNING CO.

Troy, N. Y.



TIDY TRASH INCINERATOR

Consumes all burnable trash in a matter of minutes.

*Durable, Convenient,
Safe, Economical.*

**THE HOUSE YOU SAVE
MAY BE YOUR OWN**

Made of Aluminized Steel — molten aluminum applied to steel. This coating and steel team up to resist a combination of heat and corrosion which destroys ordinary metals. Will withstand 900° of heat.

Ash receptacle retains all ashes and non-burnables. Screen top minimizes fly ash.

The Tidy eliminates fire hazards and is the answer for the householder with pride in his home and yard. Capacity approximately 3 bushels. Accept no substitute—ask for it by name. If not available at your favorite store send check or money order for... **\$13.95**

West of Denver \$15.95. We pay delivery charge.

SUPERIOR SHEET METAL WORKS CO., INC.
3201 ROOSEVELT AVE. INDIANAPOLIS, IND.

BEHR-MANNING CO., Troy, N. Y.

PM-3

A Division of NORTON Company

Enclosed is 10¢. Please send "How To Sharpen" book.

Name _____

Address _____

City _____

Zone _____

State _____

Is your
engine
tired



out,
too?

... see your **Doctor of Motors**

Wake up the "sleeping" power of your car! See your Doctor of Motors—your skilled mechanic—for a thorough engine analysis that will reveal the cause of your car's sluggish behavior. In no time at all, your Doctor of Motors can put new life into your car—bring back that satisfying "new car feel."

One of the sure ways to restore full-power pep and performance is to have your

mechanic install Perfect Circle 2-in-1 Chrome piston rings. Perfect Circles are plated with thick, solid chrome that resists wear, more than doubles the life of cylinders, pistons and rings—assures responsive power with positive oil control for thousands of extra miles. Perfect Circle Corporation, Hagerstown, Indiana; The Perfect Circle Co., Don Mills, Ont.



You'll be surprised how quickly and economically your Doctor of Motors can bring back a "New Car Feel" to your car!

PERFECT CIRCLE

2-IN-1 CHROME PISTON RINGS... restore that *New Car Feel*

Yard Fibre Pools:
PARADISE Pools, Inc
12955 BISCAYNE Blvd., North Miami, Fla.



Back-yard pool with a separate wading area changed the recreational habits of residents of a Texas village

YOU CAN BUILD YOUR OWN SWIMMING POOL

By Shirley P. English

IN APRIL, Mr. and Mrs. Gerald McAfee of Tucson, Ariz., came down with a "malady" that is hitting increasing thousands of American families each year—swimming-pool fever.

They had wanted a back-yard pool for several years but knew in a vague way that the type they wanted would pulverize their budget.

That year they decided at least to plan a pool. With the help of a friend studying engineering at the University of Arizona, they drew up sketches for what many pool builders consider the ideal size—36 feet long, 18½ feet wide and a depth ranging from 3 to 7½ feet.

Then they called in various professional pool builders to bid on the job. The estimates threw them into a mild state of shock.

Possibly they were still in this condition a week later for, although neither of them was experienced in any type of construc-

tion, they decided to build their own pool, using concrete blocks for the walls.

On May 1 they hired a man with a small bulldozer to rough out the hole for \$110, and started to work. Both had jobs and various social and civic obligations which took up most of their spare time. Their pool work was done on Sunday mornings. For five months during the winter, they didn't touch the project.

Even so, 13 months after the man with the bulldozer appeared they took that long-anticipated first swim.

"Believe me, it was worth every hard hour of sweat and labor we put into it," says McAfee. "That first plunge made it all worthwhile. After one season we knew we'd be lost without our pool."

To put it in operation they spent a total of \$1715.98 which included all materials, a \$375 filter, tools (including a secondhand concrete mixer), labor and even a paid-up three-year liability-insurance policy

TIPS FROM POOL BUILDERS

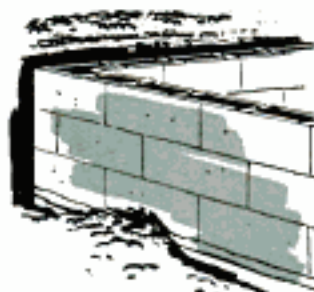

CONCRETE-BLOCK POOLS

Least expensive type, but likely to crack or leak within a few years unless extreme care is used in constructing walls. Pour floor first and have steel-rod

uprights firmly anchored in concrete. Uprights should have threaded tops so clamping plates can be bolted against the top blocks to give the wall greater strength. When wall is finished, fill the blocks completely with semiliquid concrete and let cure for several weeks.

POURED CONCRETE VS. GUNITE

Decide before you start excavation. Guniting takes rounded pool bottom, poured concrete takes vertical walls with bottom at right angle.

Compare local cost of concrete for five or six-inch bottom, eight to ten-inch walls and form lumber against cost of hiring man with Guniting equipment to come out and spray cement on walls and bottom. The Guniting process takes less cement because it is applied under pressure and gives greater strength per inch. If there is no great price advantage to poured concrete, choose Guniting; it will make an excellent pool and be done in one day. For either method, don't skimp on reinforcing steel rods.



EXCAVATION

Amateur builders say that unless you have an exceptionally strong back and a strong urge to work, hire a man with equipment to excavate.



CLEANING POOL

Bottom and walks will need vacuum cleaning twice a week. Buy an underwater vacuum cleaner for \$60 to \$80; a swimming pool service company will charge \$35 to \$50 a month.

LOCAL ADVICE

If you are going to spend several hundred dollars on a filter, you may as well buy it from a dealer or pool builder who will help you plan your pool and overcome construction problems.



FILTER

Costs money but definitely worth it. Owners of pools without filters say they wish they'd spent the extra money and installed one. Without filter, water will look dingy much of the time, you'll run up a heavy water bill refilling the pool every week or so, you'll have to scrub the pool between fillings and your pool will be out of use during draining, scrubbing and refilling. An automatic skimmer is helpful in taking care of leaves and debris, costs about \$20 extra.

PAINT

Not necessary if interior of pool is properly finished. Most paints will not hold up more than two or three seasons. Finish interior with cement plaster made with silicate sand. This off-white finish will give filtered water a sparkling blue appearance. A single row of blue tiles around top of walls will intensify the blue.



WALKWAY

Build it three or four feet wide clear around the pool; prevents bathers from tracking grass and dirt into water.

COST OF OPERATION

Figure \$5 a week for chemicals, filter sand and electricity during the swimming season.

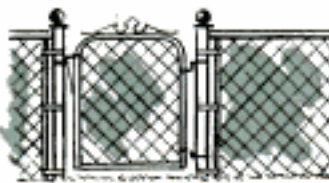

FENCE

Considered absolutely essential; may keep a child from drowning in pool.

against pool accidents.

Contractor-built, they estimate the pool would have cost \$6000.

In a Hurry for a Swim

About a month after the McAfees started their pool in sun-drenched Arizona, Alvin Gottschalk of Wichita, Kans., also came down with pool fever. But he was in a hurry for a swim. He hired a man with a bulldozer to rough out the hole for a pool 50 by 20 by 8 feet and started on a poured-concrete pool.

Working evenings, week ends and holidays, he finished the pool in 10 weeks. Then, to keep from wasting his form lumber, he used it to build a 60 by 15-foot covered shed, left half of it open as a barbecue patio and enclosed the other half for dressing rooms. His total cost, including filter, underwater lights, diving board, ladder and building came to \$3900. He estimates the layout would have cost \$10,500 if built by a contractor.

The Gottschalk pool, completed in '54, was one of an estimated 15,000 private pools built that year; the McAfee pool was one of about 25,000 completed in 1955. Fifty to sixty thousand private pools were built last year.

The owner-built Gottschalk and McAfee pools are examples of an important trend in the rapidly expanding pool business—do-it-yourself.

Only a few years ago the words "private swimming pool" conjured up a vision of the estate of a millionaire or movie star. Today, in any fair-sized city, private pools are found not only in expensive residential sections but also in the back yards of \$8000 to \$12,000 homes.

The swimming-pool boom has many causes:



Here are steps in construction of B. F. Aldredge pool. It is a concrete-block, do-it-yourself package. Above, floor is poured concrete, reinforced

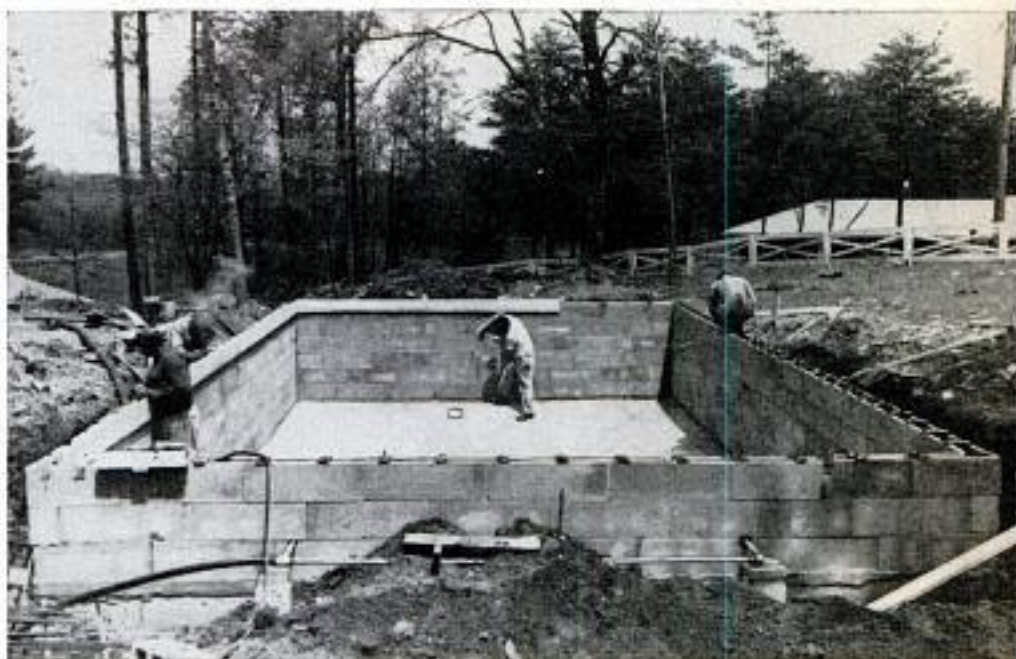

Wall blocks interlock and require no mortar. Instead, concrete is poured down hollow centers of the blocks. Uprights are threaded so clamping plates can be bolted over blocks. Below, real enjoyment on a hot afternoon





One day Frank Bernard decided to build a back-yard pool. This enticing photo was taken just 10 months later

Prosperity, more leisure time and the fact that many families in various income brackets are tired of reading about that wonderful world of the future when the average family will enjoy 3D color television, a private swimming pool and a helicopter—all for a 30-hour work week.

They've decided that until 3D TV and inexpensive helicopters come along, they will at least enjoy a private pool.

Feeling of Accomplishment

And many men who could easily afford a professionally built pool have decided to invest their own labor in the project.

They like the feeling of accomplishment.

In commenting on the pool situation in San Diego, Calif., D. P. Asquith of the Rain Beau Water Equipment Company, points out:

"We are finding that more and more the trend is toward owner-built pools or do-it-yourself installations. I do not believe by any means that this is always a result of the over-all cost of a contracted pool, but is a personal desire on the part of the owner to create a luxury item for his family's own use."

No one knows what percentage of the total number of private pools are at least

About \$1700 and 13 months of work went into McAfees' pool. Contractor would have charged about \$6000





Molded glass-fiber pool arrives on the site in four sections. This is the easiest type of do-it-yourself pool

partially built by the owners. Estimates vary widely in different parts of the country. Probably, for the nation as a whole, about a third of the private pools are built at least in part by the homeowner.

His effort may be only supervision of hired labor or it may include personally heaving out every shovel of earth, pouring concrete, handling plumbing and electrical installations and plastering and tile-setting.

Few Kind Words by Professionals

For the owner-built pools, most professional builders have few kind words. One says, "Ninety-nine out of a hundred will do a miserable job; it's like giving a layman

a pile of parts, and expecting him to come up with an automobile of factory quality."

But most owner-builders, even when they realize they've made mistakes and would do things differently next time, remain sold on their pools.

In South Orange, N. J., John Barkhorn hired a contractor, not a professional pool builder, and put in a nonfiltered, poured concrete 40 by 20 by 7-foot pool in a day and half for \$485. He estimates the job would have cost \$2000 if done by a professional pool builder.

But if he had it to do over, he says he would make his walls thicker to avoid

(Continued to page 238)

Sections of the glass-fiber pool are joined with screws and self-curing resins. Pool rests in a bed of sand





Swedish Jet Fighter Intercepts Supersonic Enemy Bombers

To intercept enemy bombers flying at supersonic speeds, Sweden has developed a one-man, all-weather jet aircraft called the Dragon. With a double-delta form, the fighter can travel more than 1000 miles per hour. Equipped with navigation and armament radar, the plane can carry cannons, rockets and air-to-air guided missiles.

Wingspan is 35 feet. Length is 50 feet. Gross weight, loaded for action, is under 20,000 pounds. Combined elevator and ailerons are fitted to trailing edges of wings, leaving the aircraft without a conventional tail plane. Landing gear includes tricycle and braking parachute. The plane has a large space for equipment and fuel.

"Ski Skoot" Goes 50 M.P.H.

Thrill-seekers may now zoom down nautical pleasure paths at 50 miles per hour on motor scooters mounted on skis. These craft sit on two separate in-line skis between which is mounted a 25-horsepower outboard motor.

Right, outboard motor sits →
between two in-line skis



Dog's Life? It's Great!

Man's best friend can now enjoy the best seat in the car. A cover that buttons over the rear seat of a convertible provides protection from wind and sun, if the dog wants to sleep. And, should he want to sit up and take notice, there's an opening on one side through which he can look at the world passing by. The cover provides peace of mind for the owner, too, as it keeps the dog from jumping out of the car.

←Pampered pet pokes head
through "window" in cover



Electric wrist watch receives its power from energizer that is no bigger than the button on a shirt



Manually wound watch is at left. Electric watch is at right, with energizer in circle at top center

No Need to Wind This Watch

ELECTRIC WRIST WATCHES that need no winding or periodic agitation are a recent result of the first basic change in watchmaking in 500 years, Hamilton Watch Co. officials have announced. Chemical energy, stored in a tiny "battery" energizer the size of a shirt button, provides electrical power to run this watch, which is no larger than a conventional timepiece.

Secret of this development is a precise miniature power plant built around a balance wheel, according to Dr. John Van Horn, director of research and development at Hamilton. Chemical energy from the energizer is converted to electrical power, which releases a flood of electrons through a miniature coil on the balance wheel. This microcurrent, interacting with magnetic fields set up by a pair of midget platinum-alloy magnets, spins the balance wheel first toward one magnet, then back toward the other. The oscillating wheel turns gears that turn the watch hands.

"Combining the power with a balance wheel permits the flow of energy to be

controlled and the speed of the hands to be held to an accuracy of better than 99.995 percent," Doctor Van Horn said.

Windings on the balance-wheel coil are made with wire .0006 inch in diameter. Each wire is one fifth the thickness of a human hair, and three or four strands can be easily threaded through a hole drilled in a human hair. Enough wire for 1000 watches weighs only two ounces but would stretch across the English Channel from Dover to France. Screws holding some parts of the watch together are so small that it takes 80,000 such screws to make one ounce. The platinum magnets in the watch contain less metal than in a paper clip yet, ounce for ounce, these magnets are the most powerful known.

Power stored in the energizer would not run a 100-watt light bulb for more than three seconds, but in one year that power will open and close electrical circuits in the new wrist watch 75,000,000 times and will operate the balance wheel 150,000,000 times.

This balance wheel will operate 150,000,000 times in one year with power from the tiny "battery" energizer

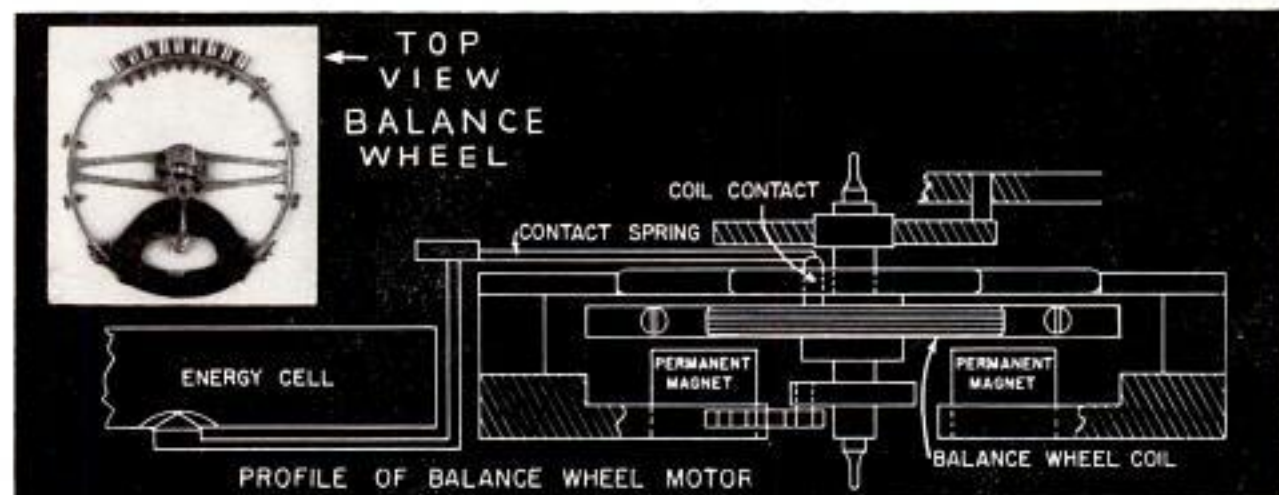

OWNERS REPORT:



How Good Is the 1957 Ford?

We asked owners in these 38 states that question

HERE IS WHAT WE LEARNED:

- What the 1957 Ford owner likes most about his new car is its styling. Handling ease, comfortable ride and flashy performance are next on his best-liked list.
- But he complains about the workmanship in the body. And he doesn't like the rattles and other body noises, nor does he like the poor gasoline economy.
- He does not have seat belts in his Ford (only 6.2% do), but he does have a padded dash (60.5%).
- He does not want any more top speed, nor any faster pickup. It goes fast enough now, he says.
- He traded in a Ford to buy this new Ford (24.2% traded some other make) and he probably will buy a Ford next time (only 12.1% say they definitely will not).

That's a Brief Summary—Read the Whole Story, the Good and the Bad, as Told by the Ford Owners Themselves →

Handling and roadability are among the best-liked features of the 1957 Ford and this photograph shows why



Ford Is Long, Low And Owners Love It

By Owners of 1957 Fords

FORD FOR 1957 is longer, lower and more powerful than ever before and the owners love its length, lowness and power!

That's what our nationwide survey of Ford owners disclosed. We asked the owners to tell us frankly what they thought about their cars and this article is their reply.

(For road test and performance data on the 1957 Ford, see the January 1957 issue of *Popular Mechanics*, page 109.)

You read lots of articles about cars getting too long and too low and too powerful. Certainly they are getting longer and lower and faster, but the people who buy them overwhelmingly approve of these changes.

Only 2.3 percent of the Ford owners object to the length of the new models. Only 11.8 percent object to the lowness and only 9.1 percent object to the power and speed (although another 14.4 percent did not answer).

Best-Liked Features

First on the list of best-liked features is styling with 42.1 percent mentioning it.

"It has wonderful lines. Inside the car is beautiful, also."—Illinois trucker.

"Everyone turns to look at the '57 Ford. I am proud to own one."—Florida clerk.

Next comes handling ease with 34.6 percent of the owners putting it on the best-liked list.

"Excellent over-all handling on all roads. I have driven 2000 miles in past three weeks over mountain roads and was able to maintain average speed of nearly 50 miles per hour."—Colorado contractor.

"So easy to handle in traffic."—Texas truck driver.

The following describe other best-liked features in order of frequency of mention:

"It rides very nice."—Michigan papermaker.

"Good soft stable ride at all speeds."—Idaho cheesemaker.

"Fast acceleration for passing."—New Jersey welder.

"Has so much energy and it's always ready to go with lots of reserve power."—Illinois farmer.

"Ford is no longer a Ford. It's a big car with a big-car look."—Kansas construction worker.

"Looks like a big car instead of one of the low-price three."—Wisconsin teacher.

Most-Frequent Complaints

But owners have complaints too. Some are very articulate about the faults of the new Ford. However, 39.1 percent of the owners make no complaints at all—they're completely satisfied.

Among those who complained, the most frequently mentioned fault is poor workmanship in assembly (22.6 percent).

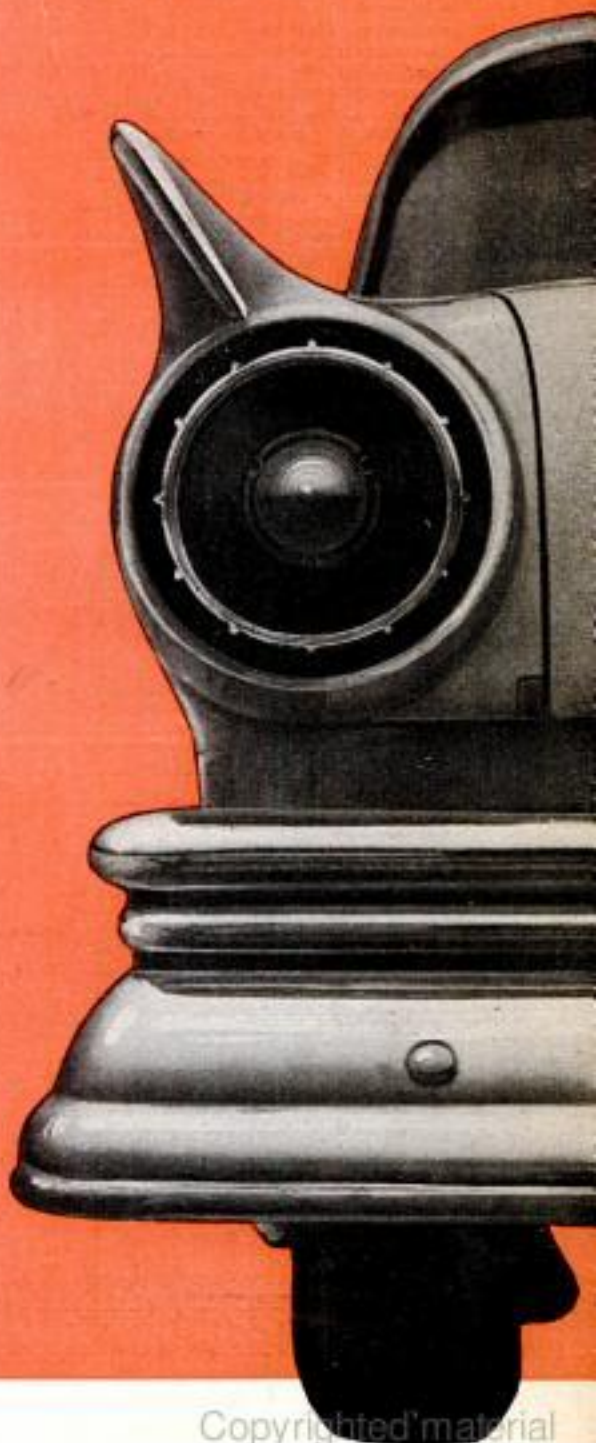
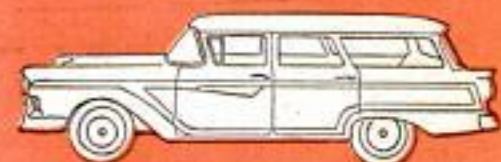
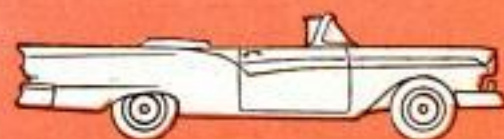
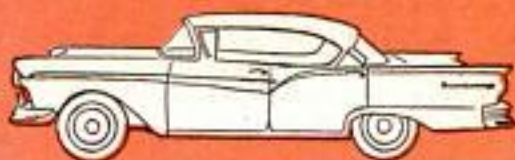

THE OWNERS' OPINION OF THE '57 FORD

Had trouble with engine?

No trouble	79.8%
Some trouble	16.3%
Considerable trouble	3.9%

What was engine trouble?

Valves, tappets	10.9%
Carburetor, choke	7.0%
Oil leaks	2.3%

Performance

Would like faster acceleration?

Yes, would	25.0%
No, would not	65.9%
Undecided, no answer	9.1%

Would like more top speed?

Yes, would	6.1%
No, would not	65.9%
Undecided, no answer	28.0%

What is car's horsepower?

Knew correct horsepower	68.9%
Did not know	31.1%

Styling

Did styling influence choice?

Yes, did influence	68.2%
No, did not influence	27.1%
Undecided, no answer	4.7%

Best-liked exterior feature?

Lowness of body	30.2%
Tailfin design	10.9%
Rear-opening hood	9.3%
Side-trim design	8.5%

Least-liked exterior feature?

Front grille	13.2%
Headlight styling	7.0%

Best-liked interior feature?

Dashboard design	28.7%
Seat styling	14.0%
Color treatment	13.2%

Least-liked interior feature?

Ash-tray design	20.2%
-----------------	-------

OVER-ALL RATING OF THE FORD

Excellent	Average	Poor
73.6%	17.6%	8.8%

Floor humps, wells	19.4%
Seat covering	3.9%

Safety

Have safety belts in car?

Yes, have belts	6.2%
No, do not	93.8%

Have padded dash, visors?

Yes, have padding	60.5%
No, do not	39.5%

Miscellaneous

Will buy a Ford next time?

Yes, will	59.1%
No, will not	12.1%
Undecided, no answer	28.8%

How is dealer service?

Excellent	50.0%
Average	28.0%
Poor	22.0%

Would buy from him again?

Yes, would	53.8%
No, would not	21.2%
Undecided, no answer	25.0%

What make of car was traded?

Ford	61.4%
Mercury	1.5%
Other makes	22.7%
No trade, no answer	14.4%

Why did they pick Ford?

Exterior styling	35.3%
------------------	-------

Previous ownership

.....	24.8%
Handling, performance	5.3%
Price	3.0%

What should be changed?

Nothing at all	41.4%
Ash-tray design	9.8%
Front grille	6.1%
Floor hump, wells	5.3%
Improve bodywork	5.3%
More gas mileage	3.8%
More room inside	3.0%

Best-Liked Features

Exterior styling	42.1%
Handling	34.6%
Riding comfort	24.1%
Performance	23.3%
Bigness of exterior	12.8%
Road holding	9.8%
Roominess, big trunk	8.3%

Most-Frequent Complaints

No complaints at all	39.1%
Poor workmanship	22.6%
Rattles, body noises	14.3%
Noisy engine	7.5%
Poor gas mileage	7.5%
Inconvenient ash tray	6.8%
Dust and water leaks	6.0%
Too big, too low	5.3%

Ford is longer than ever

Like this length	97.7%
Don't like it	2.3%

Ford is lower than ever

Like this lowness	88.2%
Don't like it	11.8%

Ford is faster than ever

Like this speed	76.5%
Don't like it	9.1%
Don't know, no answer	14.4%

"Body poorly assembled. Window over tailgate (on wagon) will not stay latched."
—Georgia banker.

"Workmanship is very poor on some de-

tails. Trim has a fast rusting rate. Rear window of wagon is set in such a way that road spray is deposited on it by the airflow."
—Illinois electrical engineer.

As these drawings show, the small Custom is roomier than the big Fairlane. All dimensions are in inches

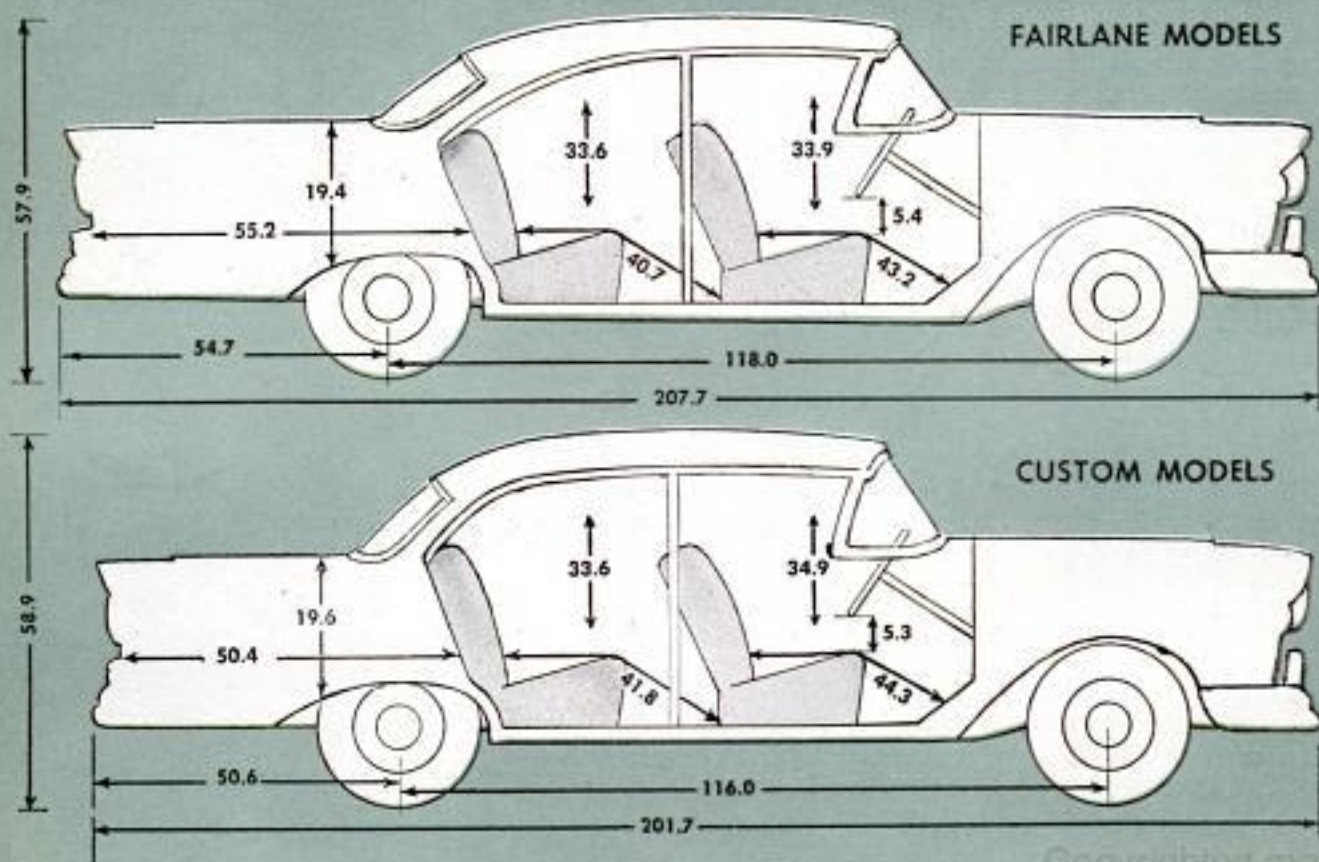

"There should be a law against putting together a car like this and selling it for \$3000."—New Jersey engineer.

Second most-frequently mentioned complaint is body noises and rattles (14.3 percent mention these).

"I was rather disappointed to find, after paying \$3200 for the car, it developed rattles and wind noises which my garage says can't be helped."—Iowa insurance man.

Next on the complaint list are engine noise and poor gasoline mileage with 7.5 percent mentioning each of them.

"After about 25 miles the engine sounded like a truck. They said it was a soft tappet."—California surgeon.

"The 1957 Ford gives fewer miles per gallon than any Ford I have owned (and I've had about 15). Next year I will buy another Ford and hope the miles per gallon is back to normal."—Maryland real-estate broker.

Small things can be very annoying and apparently the Ford ash tray in the dashboard is such an item. Its poor design and location are mentioned by 6.8 percent of the owners.

"It has an ash tray on the dash that you have to reach inside to put the ashes in."—Connecticut apprentice.

"Ash tray not a bit convenient, especially at night."—Illinois businessman.

"Ash tray rattles constantly."—Missouri salesman.

Last year, Ford put a lot of attention on safety in its sales promotion. This year,

(Continued to page 262)



Owners praise front-hinged hood for safety and engine accessibility; others say it's hard to close



High on list of most-wanted changes is the ash tray. It requires smoker to poke cigarette into small hole

Three can't sit comfortably in the front seat. Center passenger has to have knees doubled up in this manner

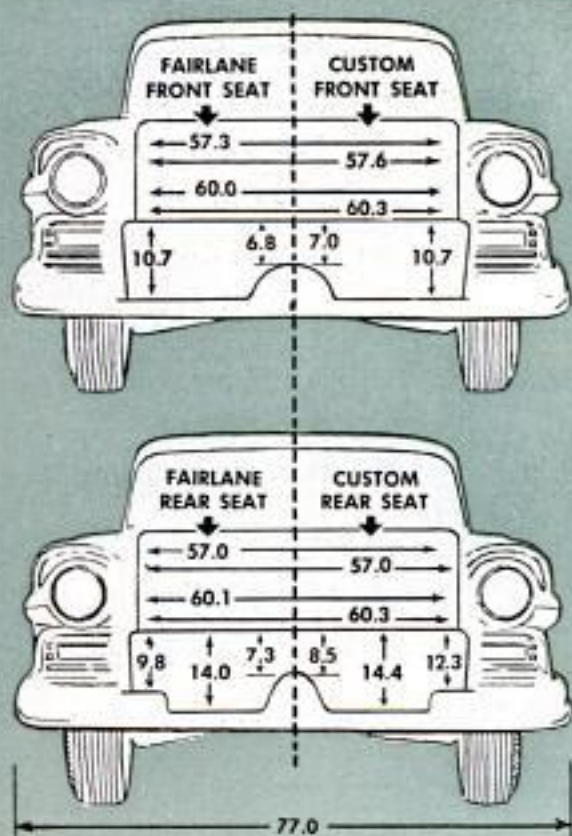

Copyrighted material



Plane's Intercom Is Transistorized

Appropriately named "Plane Talk," a low-priced transistorized intercom for use between the instructor and his student in a light plane has become available. The unit, housed in a plastic tube 6½ inches long and one inch in diameter, is powered by a self-contained miniature battery that provides 100 hours of use between changes. The entire set consists of a microphone, the tiny amplifier and sensitive, rubber-cushioned earphones.

Puckered Tent

Looking like a partially erect umbrella, an unusual grooved tent is large enough to sleep eight persons yet weighs only 80 pounds. The tent is made of canvas triangles, and the valleys or corrugations allow for rapid water runoff in heavy rains. With a pulley arrangement, one person can raise or lower the tent. A metal dome over the opening at the top of the tent prevents water from entering and also acts as an outlet for the hot air.

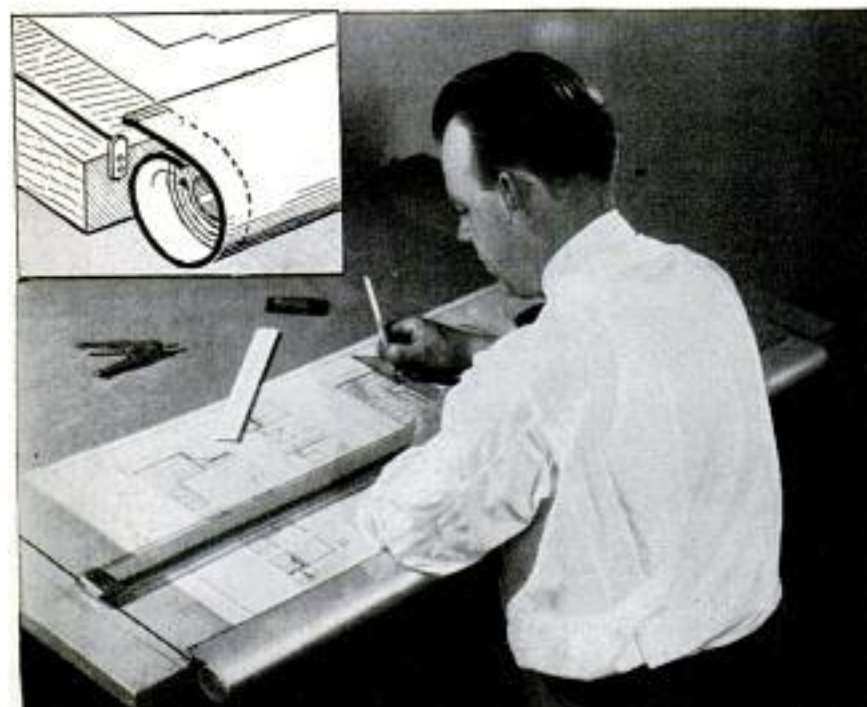

Roll-Out Unit For Drawing Board

Draftsmen work more comfortably with less fatigue on large drawings by using a spiral-roll/attachment. The attachment fastens to the edge of the drawing board and permits the draftsman to pull the drawing in and out of the sheet-metal enclosure. In this way, the work is directly in front of the draftsman and eliminates stretching and eyestrain. The device also prevents smudges and keeps the drawing from tearing. The roll-out unit is available in four different lengths.

Water Scooters Thrill Bathers

Swimmers at a beach in England have found excitement in riding water scooters that skim along at 15 miles per hour. The little scooters are powered by gasoline engines. Should the rider topple off, the scooter automatically turns in a tight circle so it can be recaptured by the bather.

Doused swimmer tries to→
corral water scooter which
automatically circles her



Mineral "Divining Rod" Prospects From Plane

That time-honored picture of the bearded prospector with his pickax and mule is vanishing, its place taken by the aerial laboratory hunting ore deposits from the sky. British-built for the Spanish government, the flying lab is a plane equipped with electronic equipment to enable it to spot likely deposits of minerals in hundreds of square miles of countryside daily. This equipment will reveal the presence of iron, nickel, titanium, oil, copper, zinc, lead and uranium in a single flight.



Paddle Wheeler

Paddle wheelers, once a glamorous segment of American river folklore, now fight for survival in British shipyards. The Royal Navy finds these tugs suitable for moving aircraft carriers and warships in confined waters of dockyard basins. Seven new diesel-electric models have been ordered by the British Admiralty to replace seven of ten paddle-tugs currently in service.

☐ Plywood paneling with porcelain-coated steel facing is being produced for use on store fronts, gas stations, kitchen and bathroom walls.



Detroit Listening Post



By Art Railton

WHAT SELLS CARS? Styling? Of course. But the industry apparently has not counted out horsepower despite expensive style changes. How else can you explain the rash of superpowered options now available?

When the 1957 Fords were announced last fall a special high-performance V8 engine was listed as optional. It put out 245 horsepower with a four-barrel carburetor (standard Ford V8s had 212 and 190 horsepower).

Next Ford announced an optional 285-horsepower V8 with two four-barrel carburetors. But that wasn't enough.

Now it offers a 300-horsepower supercharged V8 as optional. It discontinued the 285-horsepower option. Suggested list price on the new engine is \$447.40 plus taxes, making it about \$500.

Plymouth offers a high-performance V8 with 290 horsepower as optional. Its price tag is \$245 plus taxes (this includes, by the way, considerable chassis modification).

Chevrolet is yet to be heard from, but it started the whole spiral with a fuel-injection 283-horsepower V8 which has a price tag of \$480.

Yes, horsepower does seem important—especially around the time of NASCAR's annual Daytona Speed Week. A hot hassle resulted during the writing of rules!

NASCAR puts supercharged cars in the next higher displacement class for flying-mile and acceleration runs. Fuel-injection Chevrolets have Class V almost to themselves. Fury-engined Plymouths compete in Class VI. Supercharged Fords are in Class VII along with Chrysler 300C and other giants. In the 160-mile race, though, all run against each other. Mighty confusing to a prospective car buyer!

Chevrolet is having trouble delivering fuel-injection engines. Ford won't deliver supercharged engines until summer at least. Plymouth says you can get the 290-horsepower engine any time you want.

Situations like this make so-called stock-car racing "so-called."

People and Gloveboxes

Despite the power propaganda, folks who buy cars still go into the showroom to investigate such old-fashioned features as glove compartments. And they're shocked to learn that as the cars get bigger, glove compartments get smaller.

There is a mystery about seating room, too. The six-passenger car is gone—killed by a combination of low seats and high tunnels. You just can't sit comfortably for very long in the middle of either front or back seat. Yet cars are wider than ever.

About the only thing that gets bigger and more useful is the trunk and it can now be called voluminous.

If you want evidence that this is not just an academic discussion read what the buying public has to say about these 1957 models on page 266 of this issue. These letter writers are fighting mad!

Will It Be "GoPower?"

Look for some new word to replace the word "horsepower" in Edsel advertising. The new Edsel (Ford's entry in the medium-price class) will brag about power at normal road speeds, but its advertising men are looking for a new word. Horsepower is frightening; torque is confusing.

According to a top Edsel executive, the car's styling is distinctive. The aim, he says, was to style it so it could be recognized from the top of a 10-story building. That wouldn't be hard to do—but would it sell? The real trick is to make it distinctive from a rooftop yet attractive on the street.

Incidentally, if you think you have problems—the Edsel top brass has just okayed final styling changes for its 1959 models! And the 1958 Edsel hasn't been built yet. That's the big gamble in this business—without knowing how the public will take the 1958 styling, they have to risk millions on the 1959 changes. It's great for ulcers.

Mercury is looking at Buick and rolling up its sleeves. The reports are that Mercury will introduce another series in 1958 to give it four separate price levels to compete with Buick's highly successful four.

Continental is the big question mark at the moment. Will it or won't it? At present, it is doing poorly. Sales are down. There are plenty of guesses as to why. Nobody really knows, of course. Some industry experts say it was doomed because it didn't offer anything that was new, anything that looked ahead. It was built on the idea that it could succeed by lush conservatism.

The industry doesn't work that way. If the Mark II is to survive, the concept of unchanging classic styling will have to go, the experts say, and be replaced by an up-to-date body with advanced engineering.



Blind "See" Through Their Ears With Electronic Eye

Not much larger than a fountain pen, a new instrument permits the blind to "see" through their ears. The instrument differentiates between light and dark objects focused through its lens on a photoelectric cell. Depending upon the amount of light it "sees," it emits a variable sound signal through an earpiece similar to the receiver of a hearing aid. Dark areas produce a low signal; bright objects a high one. Using four different lenses, a blind person can

locate doorways, windows and lamps. He can determine the time by scanning the face of a watch or clock to locate the hands. He can locate the letterhead on stationery, find the level of milk in a baby's bottle and read many types of gauges or dials. The first 50 of the "eyes" are under test. The instrument is an adaptation of an invention by the late Dr. Clifford M. Witcher, a blind research physicist at Massachusetts Institute of Technology.

"H" Mark at Heliport Means "Hospital Near"

Marked heliports near hospitals and in small towns will increase efficiency of rescue operations, pilots say. Such a landing spot is the inlaid white stone triangle with 32-foot sides and an "H" in the middle near the Public Health Hospital on Staten Island, N. Y. Helicopters will operate from such designated spots in carrying rescue teams, equipment, supplies and patients in time of emergency.

Glass Fertilizes Soil For Long Periods

Ground-glass fertilizer furnishes potassium to plants at a low rate for prolonged periods. Known as potassium frit, this finely ground substance does not wash away rapidly under heavy rainfall. Thus, potassium frit is effective in areas growing ornamental, cut flowers and vegetable crops which are stimulated by readily draining, well-irrigated soil mixes.



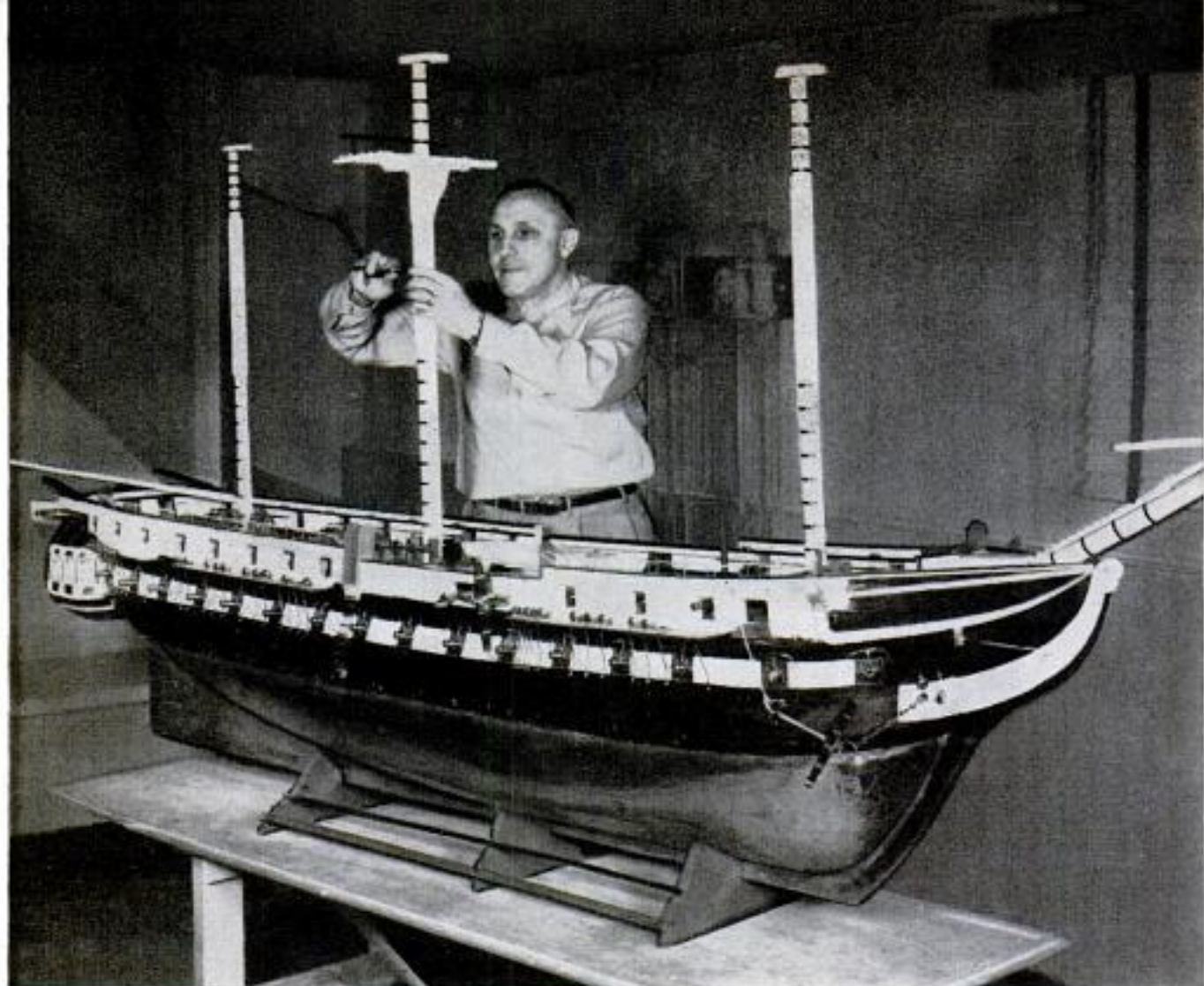

Tops of the model's masts are missing because the basement workshop has a low ceiling. Rigging comes later

TWENTY-FIVE YEARS AGO in Berwyn, Ill., they laid the keel *again* for "Old Ironsides," more properly known as the United States Ship *Constitution*. This year, more than 20,000 man-hours later, this shipbuilding task is coming to an end. Soon to be ready for display is probably the most faithful and accurate model of the frigate *Constitution* ever built.

Back in 1932 the late Dr. William Lange of Berwyn saw an announcement of a forthcoming model-shipbuilding contest in connection with the Chicago world's fair of 1933. He teamed up with Louis Kuebler, a friend, to produce an authentic model of the *Constitution* for that competition. For reasons now forgotten, the contest was called off, but the two amateur shipwrights continued with their project.

Christened in 1933, the completed hull was launched in a local lagoon. A miniature custom-blown bottle of champagne was broken across the bow of the vessel by daughters of the two men, thus making the event official. Then the hull was carried back to the workshop and the real job of building began.

Concern for accuracy and realism explains the length of time it has taken to reproduce the famous old ship. Kuebler

has kept on with the construction since the death of Doctor Lange in 1949. John Palko, another friend, has joined him and has become an expert on Old Ironsides, too. Mr. and Mrs. Kuebler visited the reconstructed hull of the *Constitution* in Boston Navy Yard in 1951; at that time he was asked if the ship—restored by contributions from school children in the 1920s—was fitted out correctly. He replied that, with one or two exceptions, it was the same Old Ironsides.

Size of the model was determined by how large the smallest fittings could be made for true reproduction. This attention to detail has resulted in a hull 8½ feet long with a 6-foot bowsprit and 11½ feet between the keel and the top of the highest mast. Every tiny piece of the model has been painstakingly handmade. Galley, crew's quarters and the commodore's cabin near the stern are all reproductions of the original, including made-to-scale tables, chairs, and a "hot shot" stove (a bucket suspended from the ceiling by a chain and holding a hot cannon ball). Even the commodore's copper bathtub is present.

All 52 cannons in the ship's batteries are built to correct scale, accurate to $\frac{7}{1000}$ inch. Each can be fired. Muskets, bayonets, powder horns and officers' swords hanging

"Old Ironsides"

LIVES AGAIN

A quarter century in building, this is probably the most faithful copy of the famous ship ever constructed. Its tiny cannon will really fire!

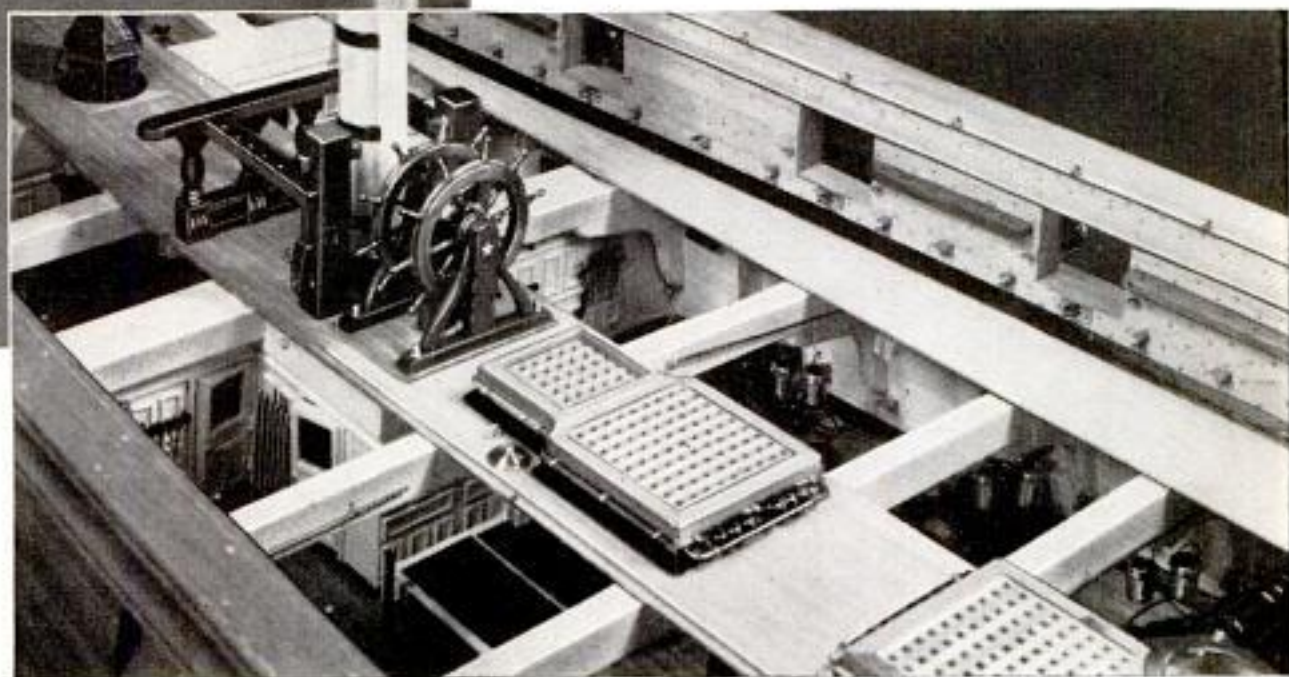

Above, decking has been removed to show the ship's interior. The steering helm is an exact-scale miniature of the original Constitution. Below, wooden blocks for fastening working lines are installed by Kuebler

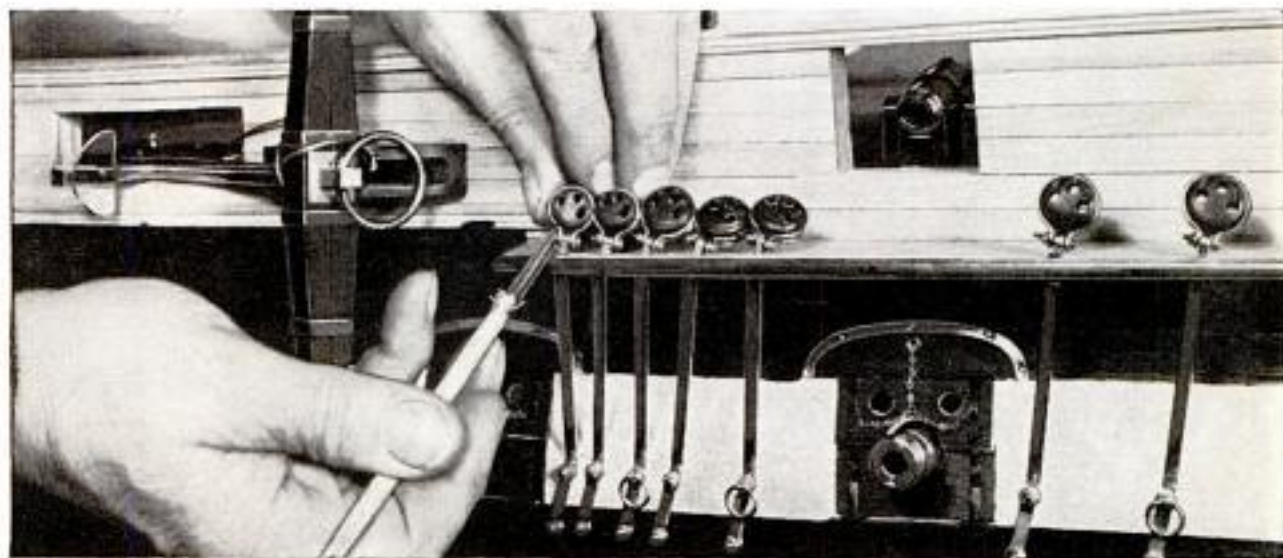

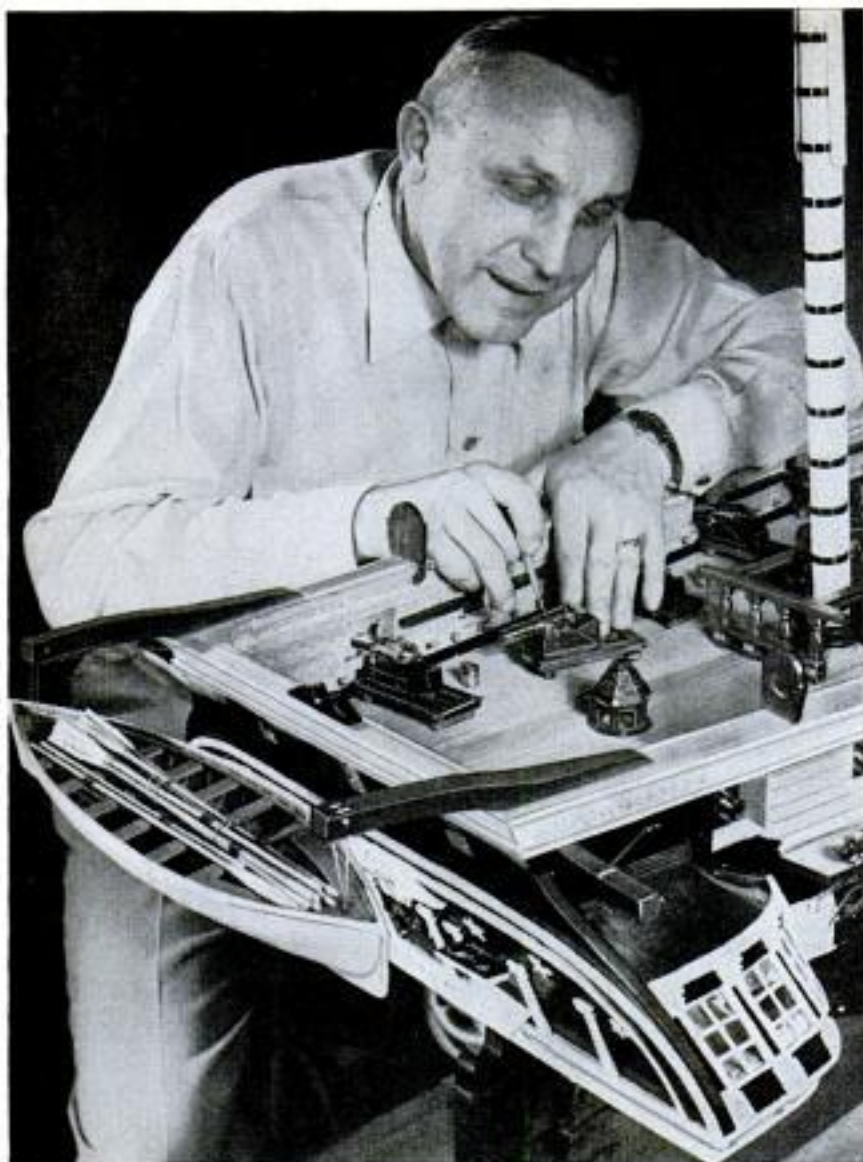

Kuebler installs a small cannon next to the ship's boat hanging over the stern. The mast is bound with metal strips just as on the actual frigate

outside the wardroom are working models and exact copies of the originals.

Two bilge pumps have been duplicated from the big ship, one two-cylinder and one four-cylinder pump. Each of these can take water from flooded holds. About 1500 pulley blocks are mounted on the ship. Anchor chains have been fashioned link by link. Three anchors required 90 hours each of workmanship, and their castings were handled by a Detroit foundry.

Thirteen different woods are used in this construction. The bottom of the original *Constitution* was covered with copper furnished by Paul Revere's firm, when the ship returned to Massachusetts in 1803 for repairs after battle with Barbary pirates. One hundred and thirty years later, Kuebler used copper sheeting made by the same company for the bottom of his model. Fully rigged and outfitted with sails on completion this year, Kuebler expects to take Old Ironsides on tour throughout the United States. ★ ★ ★

Planning of the model's construction involved making this cutaway section with bilge pumps and cannon

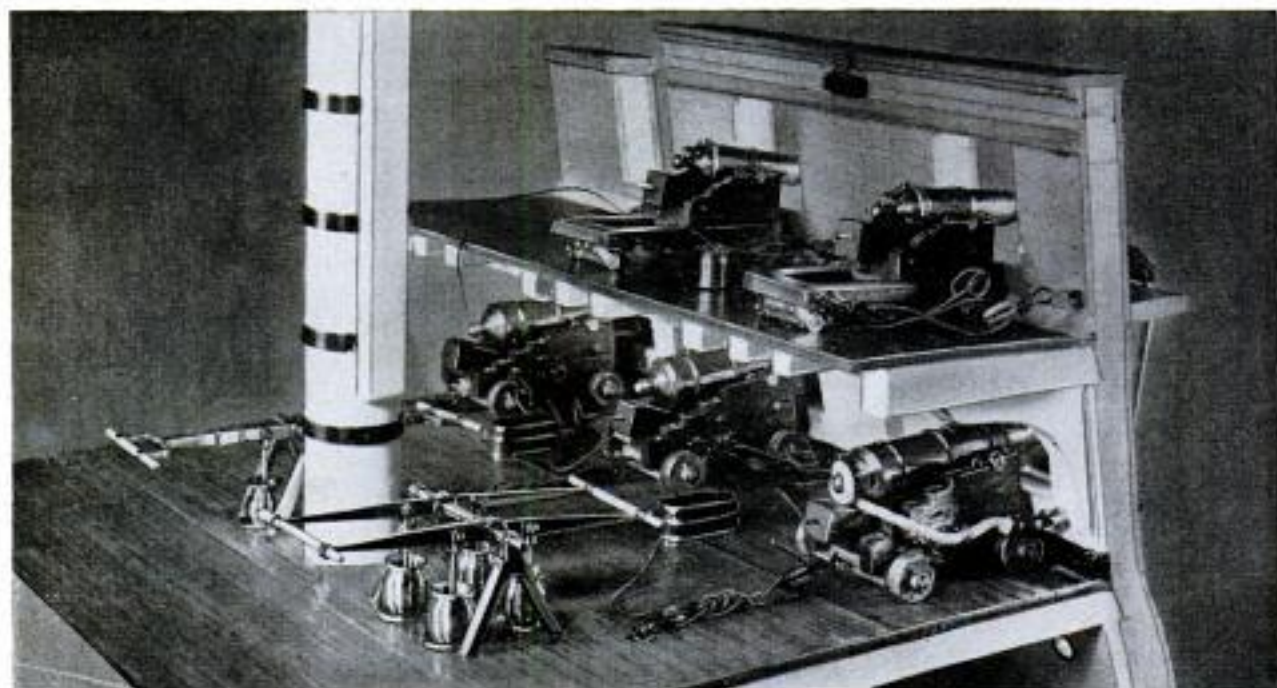

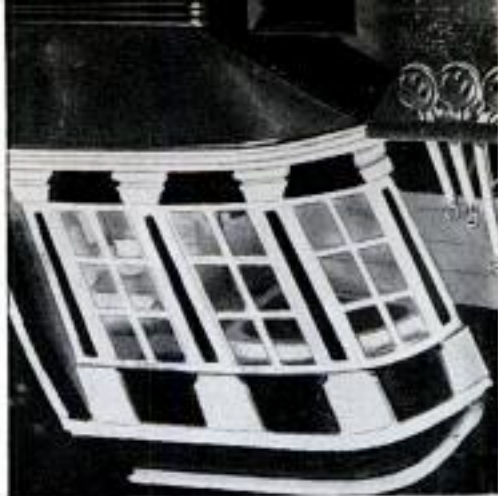

Above, the commodore's copper bathtub and his washstand sit in a bay window with a copper roof . . . sunny but public

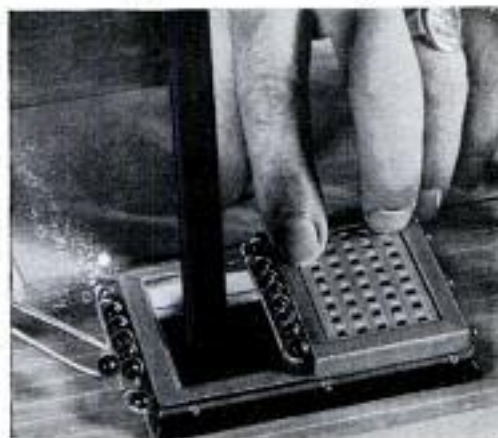

Above, Kuebler, with tweezers, places tiny cannon balls at the side of an open hatch

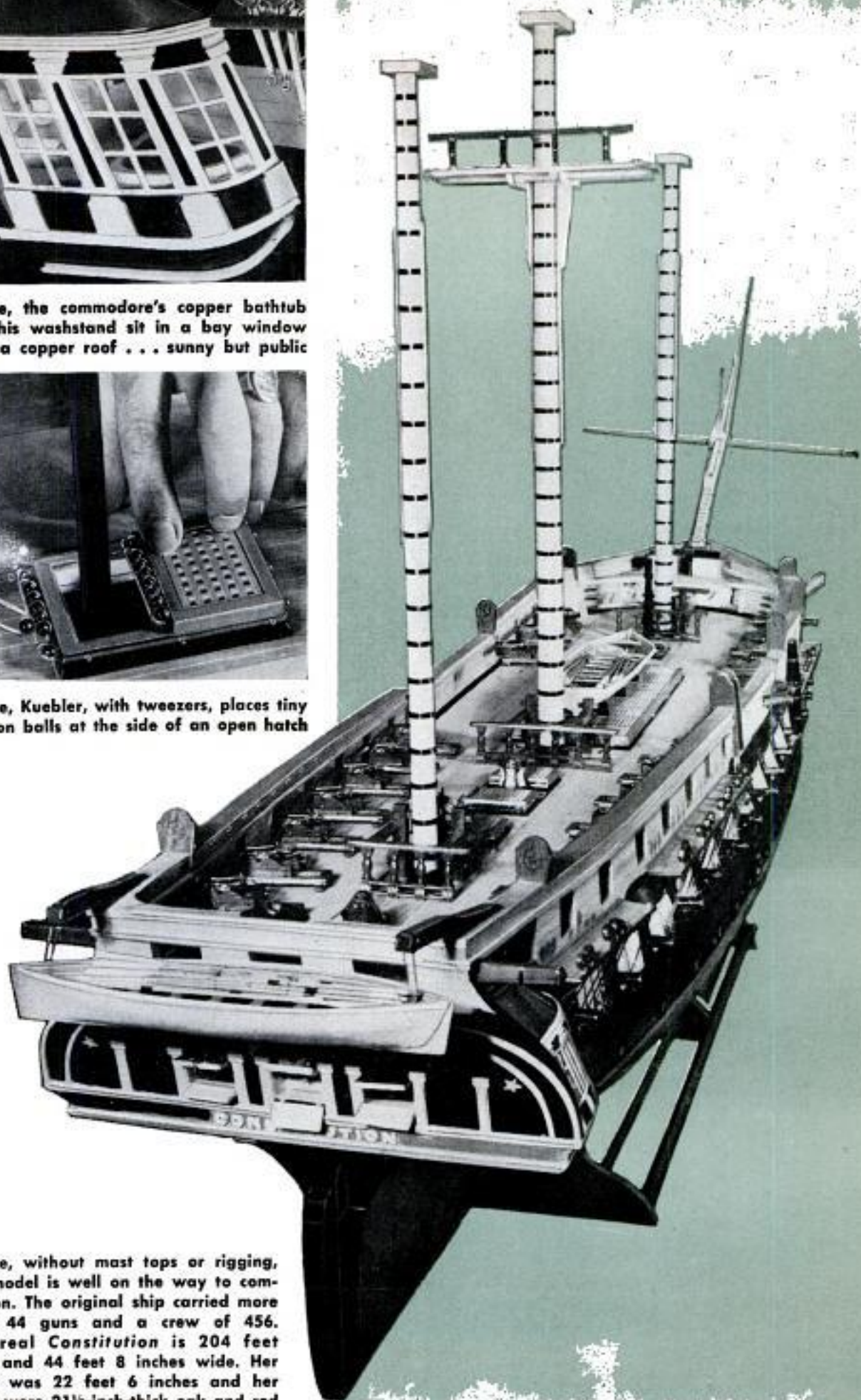

Above, without mast tops or rigging, the model is well on the way to completion. The original ship carried more than 44 guns and a crew of 456. The real *Constitution* is 204 feet long and 44 feet 8 inches wide. Her draft was 22 feet 6 inches and her sides were 21½-inch-thick oak and red cedar. Her guns could shoot cannon balls 1200 yards into the enemy



Hughes' two-man copter is 8½ feet high, 19 feet 5 inches long, and can climb at rate of 1400 feet per minute

New Whirlybirds

*a \$15,000 bargain from Hughes
and a one-man kit from Hiller
for the Marines*

By Ewart Thomas

Rotor blades extend 25 feet in diameter. Engine and V-belt drive are under the seat in the "two man"



IT WILL BE a long time before most people can afford a helicopter. A two-place whirlybird just introduced by Hughes is listed at half the average price, but you still need to write a check for \$15,000 to buy one.

No price tag has been put on a one-man helicopter being developed for the flying Marines by Hiller Helicopters, Palo Alto, Calif. This collapsible job weighs less than 250 pounds and folds up into a neat package for air drops. These aircraft aren't for sale to the public and probably would cost as much as an expensive automobile if they were. Stan Hiller explains that helicopters are still too complicated to sell for a cheap price. A big breakthrough in design is needed to simplify the structure before prices come down. This new Marine one-man copter can be assembled in 10 minutes, after which the pilot fires up its four-cylinder air-cooled engine with a pull-cord, sits on the bicycle-type seat attached to one of the landing struts and operates conventional helicopter controls for flying.

Priced at \$15,000 is the new two-place copter made by Hughes Tool Company, Culver City, Calif. The vehicle weighs 850 pounds empty and has a lifting capacity of 900 pounds. The "two man" can carry a pilot, passenger and 350 pounds of cargo 170 miles at 75 miles per hour. Power comes from a four-cylinder, air-cooled, 170-horsepower engine mounted under the seat to drive the main rotor by a simple arrangement of V-belts. ★ ★ ★



Hiller's one-man helicopter is designed to be collapsed into compact unit for easy transportation or air drop

Pilot reaches just above head to pull small lever which brakes rotor for quick slowdown of machine

Simple snap-out pins are used to connect components in typical joint in the base of the one-man copter



"BEACHCOMBERS"



Trimming Christmas trees by the half-dozen is easier than preparing single trees for shipment to the market

This man is not hanging yuletide ornaments. He is extracting cones from the noble fir tree. Cones in this particular species grow only in the treetops

By Robert H. Forbes

WITHOUT TOUCHING the timber crop, many Pacific Northwesterners are building a bonanza out of tree seeds, wild berries, Christmas greenery and medicinal forest by-products. Sharing this spare-time woods-combing are housewives, school children, oldsters, farmers, ranchers and even passers-by.

For example, Roy Chapman, a rancher from Eureka, Mont., netted \$1000 for one month's labor in rounding up 4000 small Christmas trees, which he sold at a buyer's station in the forest.

Take Montana as a case history. Annual yuletide tree harvests mean clothes and groceries to many western Montanans. The Treasure State reportedly leads the country in furnishing Douglas fir trees to points as distant as Cuba. In fact, Doug firs are to the western U.S. as balsam fir is to the eastern part of our country at Christmastime.

The Forest Service in 1952 estimated the returns of Washington and Oregon brush-pickers at \$6,000,000 or \$7,000,000 per year. Around Puget Sound and on the Oregon coast these gatherers go into the forests for Christmas greens and floral decorations, coming up with salal and evergreen-huckleberry shrub sprays, cedar foliage and swordfern fronds by the bale. Such



of the WOODS

workers receive up to \$35 for a day's harvest. And the mild Pacific Coast climate permits similar forest sideline work almost all year, with only a six-week vacation for pickers when their source of income is in bloom. Landowners' permission for gathering is inexpensive, and National Forests require but a small-fee permit, which local rangers issue.

Supplementing this picture are tree-farm owners and food-crop farmers. Tree farmers want to get maximum production from their land and yet have to wait long periods for their slow-growing tree crops to mature; these businessmen welcome an opportunity for added income from forest by-products. The food-crop farmer, also seeking means to make the woodlot pay, turns happily to profitable sidelines.

Ethel Mae McConnell, lady tree farmer of Goldendale, Wash., started in the forest-incidentals business selling decorative pine cones, "winter bouquet" materials, "pine drops" and other "wildcraft" articles to a New York City firm. "Then I got so many customers of my own that now I sell only to individuals," she says. "In 1954 I added to my woodland wares a line of grasses for lamp shades and am finding it well received."

Winter bouquets have been sought by American clubwomen, who stage contests for unique color effects and unsuspected ingredients of their art. Pine drops are the above-ground portions of plants growing on rotting matter on the ground of Western forests. Their urn-shaped pods appeal to those with an eye for beauty.

Everyone Picks Berries

When wild berries are ripe, many rural Northwesterners, their children and vacationers take to the forests to lay in supplies for preserves. A few enterprising berrypickers have gone into the business of buying huckleberries, blackberries and other natural sweets from neighbors. These buyers then sell the berries wholesale for resale in cities. M. E. Mercer of Vaughn, Wash., saw these possibilities and now handles 350 tons a year of tiny huckleberries in his Puget Sound country.

This semimechanical cone-stripping device, used here by Merle Mosar, has lightened the job of helping squirrels collect seeds from hemlock trees





Above, Ethel Mae McConnell makes up a winter-bouquet door charm from forest by-products. Below, workers use a 1000-pound hydraulic press to put a bale of evergreen huckleberry in a packing case for shipment

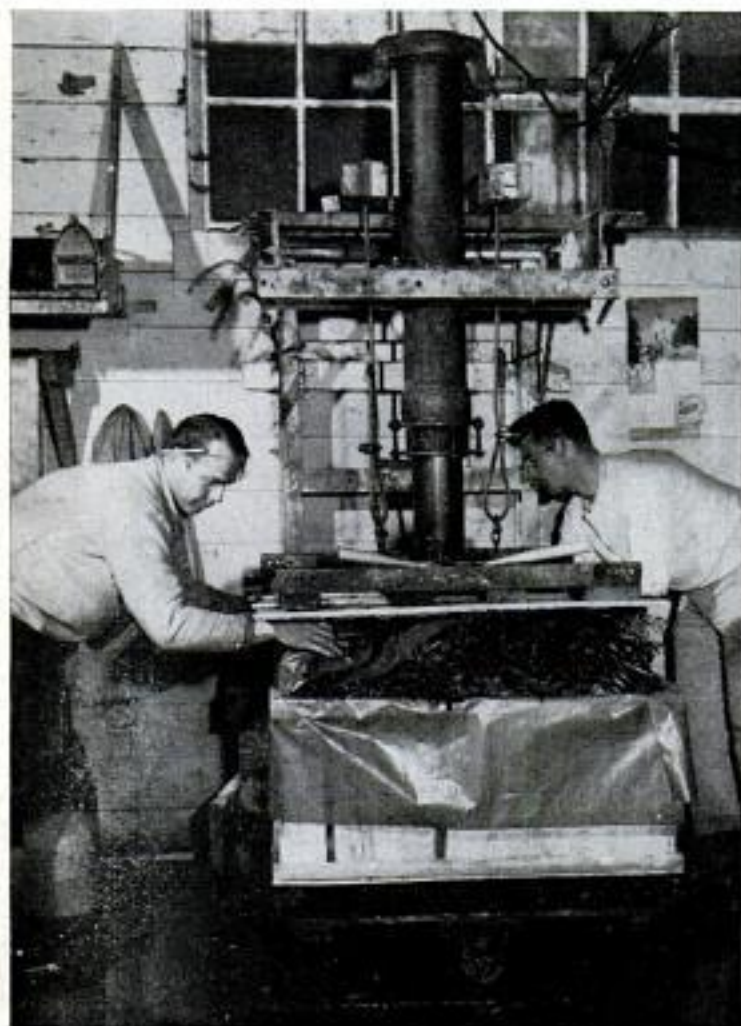

Lud Esses of Montesano, Wash., has built a fortune by marketing blackberries by the ton, and selling cascara bark and other forest by-products. Esses' bark, from which a laxative is made, comes from the cascara buckthorn tree, identified by tiny leaves in place of fall-winter leaf buds. Bark-peeler pay varies from 20 to 30 cents an air-dry pound, and good peelers can take in 140 to 175 pounds daily. The region ships almost two million pounds of cascara bark yearly.

Cascara bark has been cut for years, until now a tree trunk more than six inches in diameter is rare. The sprout growth from a properly cut stump will often produce a far greater bark-growing surface in a few years than originally. Cascara plantations are gambles, but some of them have been started in our country's Northwest.

Another money-maker, the quinine fungus of living larch trees grows a fruiting body, or "conk," loaded with agaric acid. Europeans like a dash of agaric acid in top-caliber wines and patent medicines, so Northwestern conks have risen in market price to as high



Machine knocks off the prickles from cone scales. Independent gatherers have collected these cones



Fern pickers gather 65 to 70 bunches of fern fronds every day. Below, man holds 20-pound fungus

as two dollars per pound. Conks contain no quinine drug. The name was given for their bitter taste. They grow out from the sides of larch trunks at spots as high as 100 feet in the air. Ted Hay, ranger of the Kootenai National Forest in Montana, secured conks at a "profit" when they sold for only 25 to 75 cents per pound. With his rifle he shot them from trees.

Robbing Squirrels' Nests

Second largest forest sideline in Idaho and Montana is the systematic robbing of squirrels' nests. Some caches, forgotten by bushy-tailed owners, contain quantities of seed worth as much as \$90 to collectors. E. C. Moran, forest tree seed dealer of Stanford, Mont., once purchased seeds from a 70-year-old gatherer who grossed more than \$12,000 in one year.

Hooks, threshing machines for cones and seed driers have been designed but squirrel hoards still provide the best seed yield for tree raisers. Yet, such devices as the 1000-pound hydraulic press that fits evergreen in packing cases play vital roles in shipping from the forest to the customer.

Data on income possibilities for forest sidelines is available at the Extension Service in Pullman, Wash.; Moscow, Idaho; Corvallis, Ore., or Bozeman, Mont.; and at regional offices of the U.S. Forest Service located in Portland, Ore., and Missoula, Mont. ★ ★ ★



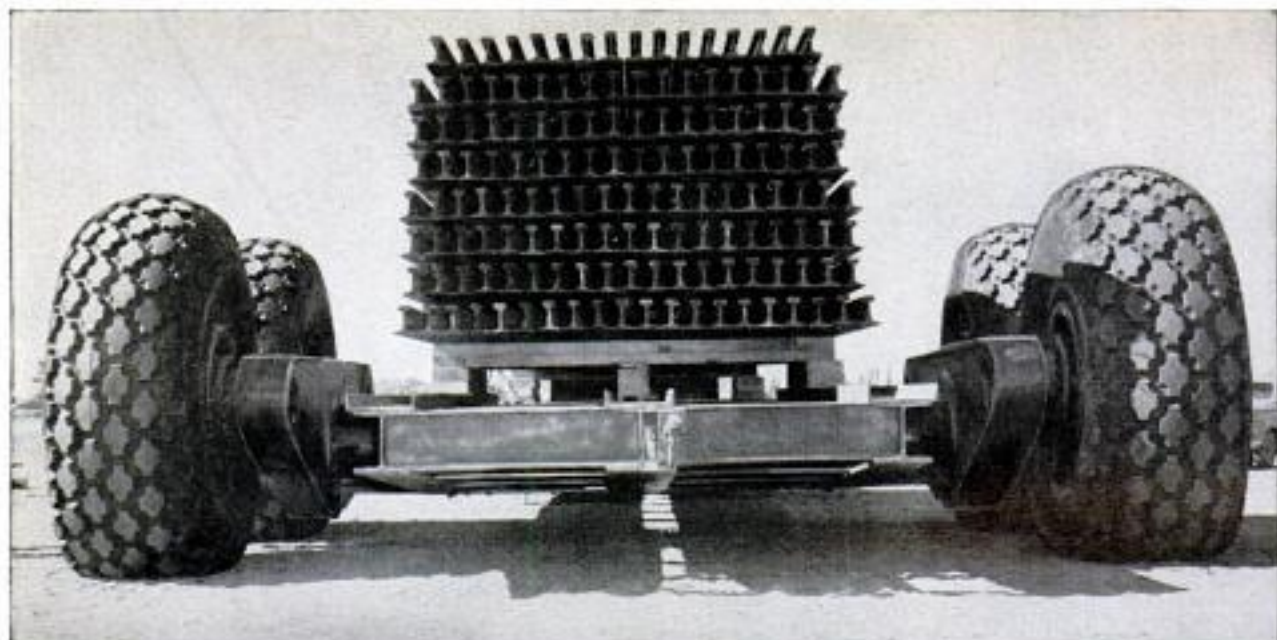

This desert trailer can carry a gross weight load of 200 tons and weighs 75 tons when there is no cargo

Desert Trailer Carries 200 Tons

CARRYING a weight equivalent to three railroad carloads of oil-field equipment, the world's largest known low-bed trailer traveled 570 miles across Arabian desert from Dammam toward Sidon in 3½ days. Made of steel and pulled by a 320-horsepower tractor, the trailer alone is 82 feet long, 26 feet wide and weighs 75 tons empty. Gross weight loaded can be 200 tons. A single wheel and tubeless-tire assembly of the trailer weighs 9300 pounds and has a diameter of 9 feet 6 inches. This vehicle was developed for the Arabian American Oil Company by Eidal Manufacturing Company of Albuquerque, N. Mex. To haul equipment through vast expanses of highwayless desert, the Eidal firm developed a trailer unit with an extremely low ground pressure.

Each tire is equipped with a specially designed assembly. Diameter of a tire is 9 feet 6 inches

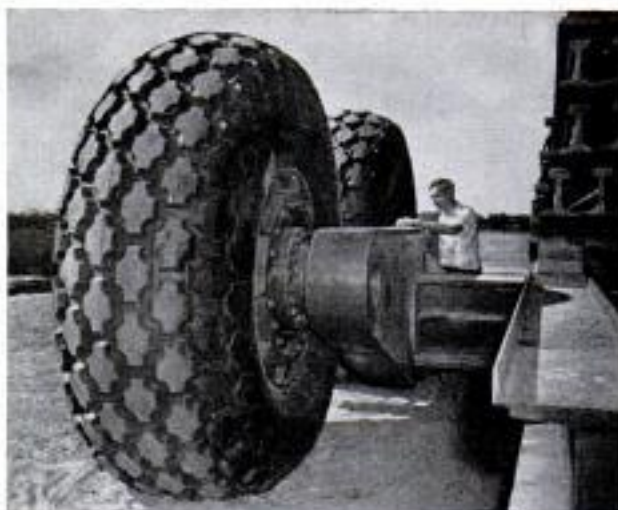

Length of the "big boy" of trailer classes is 82 feet without tractor. Width of the vehicle is 26 feet

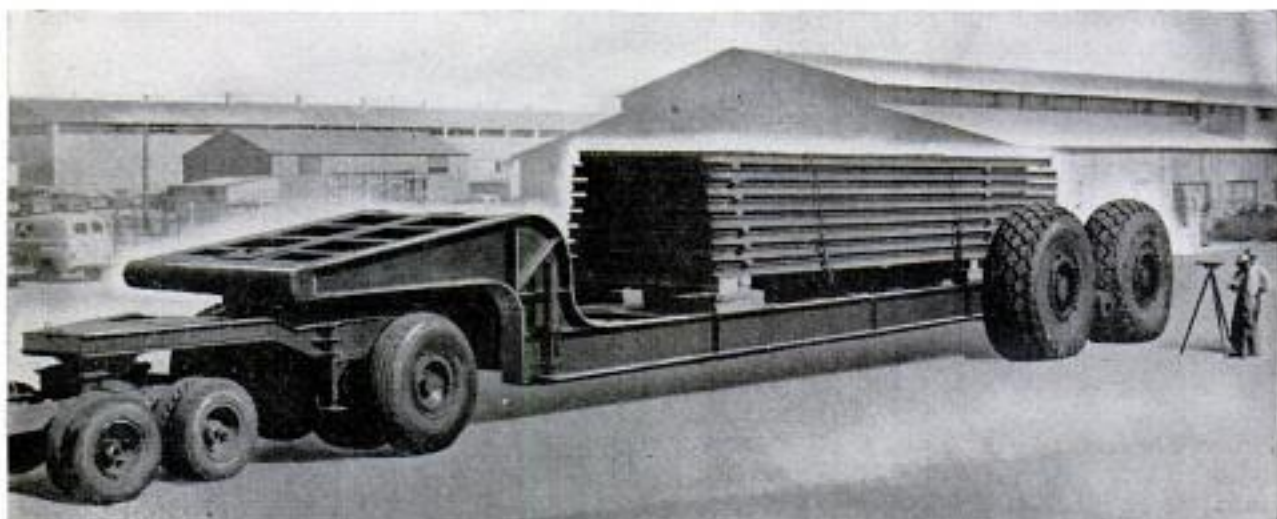



Zigzag lines on charts tell Japanese scientist that someone set off an A-bomb near Lake Baikal, Siberia

Atomic-Bomb Detectives Pinpoint Explosion 3000 Miles Away

Although Japan has no atomic weapons, its scientists have perfected a system of nuclear sleuthing that may make it hard for any other nation to conduct future test explosions in secrecy. Soon after the A-bomb and H-bomb detectives went to work, they revealed that the Soviet Union conducted tests in the Lake Baikal region of Siberia. The U.S.S.R. denied this, but the Japanese still stand back of their evidence. The Central Meteorological Observatory in Tokyo is responsible for the global detection system. Checks are made with three basic weather instruments: The seismograph, which records ground waves; the microbarograph, which records atmospher-

ic pressure, and the tidal gauge. These instruments record disturbances caused by atomic and hydrogen explosions 2000 to 3000 miles away. When the readings of a full network of instruments are correlated, they point right to the spot where the blast went off. They also reveal the time it took place and, to some extent, the size of the device tested. The C.M.O. has specially designed microbarographs spotted at 13 of its key weather stations scattered over the four main islands. An extremely sensitive seismograph is located in central Honshu. One main tidal gauge is located on the eastern coast of Honshu and six others are spotted elsewhere.

Jeep Mine-Finder

Jeep-mounted detection gear automatically stops the vehicle when a land mine is located. As the search coil passes over a mine, a spring-loaded, hydraulically operated piston disengages the clutch and sets the brakes. Panel and meter lights, plus an audible signal in the driver's earphones, indicate the mine. Wheels keep the search assembly at a constant height above the ground to cover an arc six feet wide.





Lightweight Rifle

Under test by the Army as a possible successor to the Garand M1 is a new fully automatic rifle that weighs only 6.85 pounds, almost three pounds less than the M1. Made of aluminum alloy and plastics, the new rifle fires a .308-cal. bullet. Instead of a drilled-steel barrel it has a barrel liner made of stainless-steel tubing.

Transportation Bill

Transportation costs take 27 cents out of every sales dollar in the United States each year, according to Chester C. Thompson, president of the American Waterways Operators, Inc. The nation's annual transportation bill is \$15,000,000,000.

Four-Seater Midget Car Has Doors in Front and Rear

Passengers sit back-to-back in a German midget car, named "Janus," with doors in front and rear and its engine in the center. This auto has a two-stroke, 248-cubic-centimeter, 14-horsepower engine and can go 50 miles per hour. The vehicle weighs 880 pounds. Its motor is suspended to minimize

vibration. Brakes are hydraulic and cooled by compressed air. Main advantages of the Janus are reported to be its space-saving compactness, convenient access to the engine, and its ability to hold the road due to distribution of weight. The car holds four persons.





GI Can Blast Own Foxhole

Ground troops can dig defensive foxholes in 90 seconds with a recently developed rocket-explosive device. Inserted in a vertical launching tube on a tripod, the unit (fuse, bazooka rocket motor and charge) is fired two feet into the ground. The resulting explosion creates a crater four feet wide and four feet deep.

20-Axle Freight Car Carries 220-Ton Load

With 20 axles a new railroad freight car in Germany can carry 220 tons. This car, first viewed publicly at Nuernberg, has a dead weight of 110 tons and is 135 feet long.

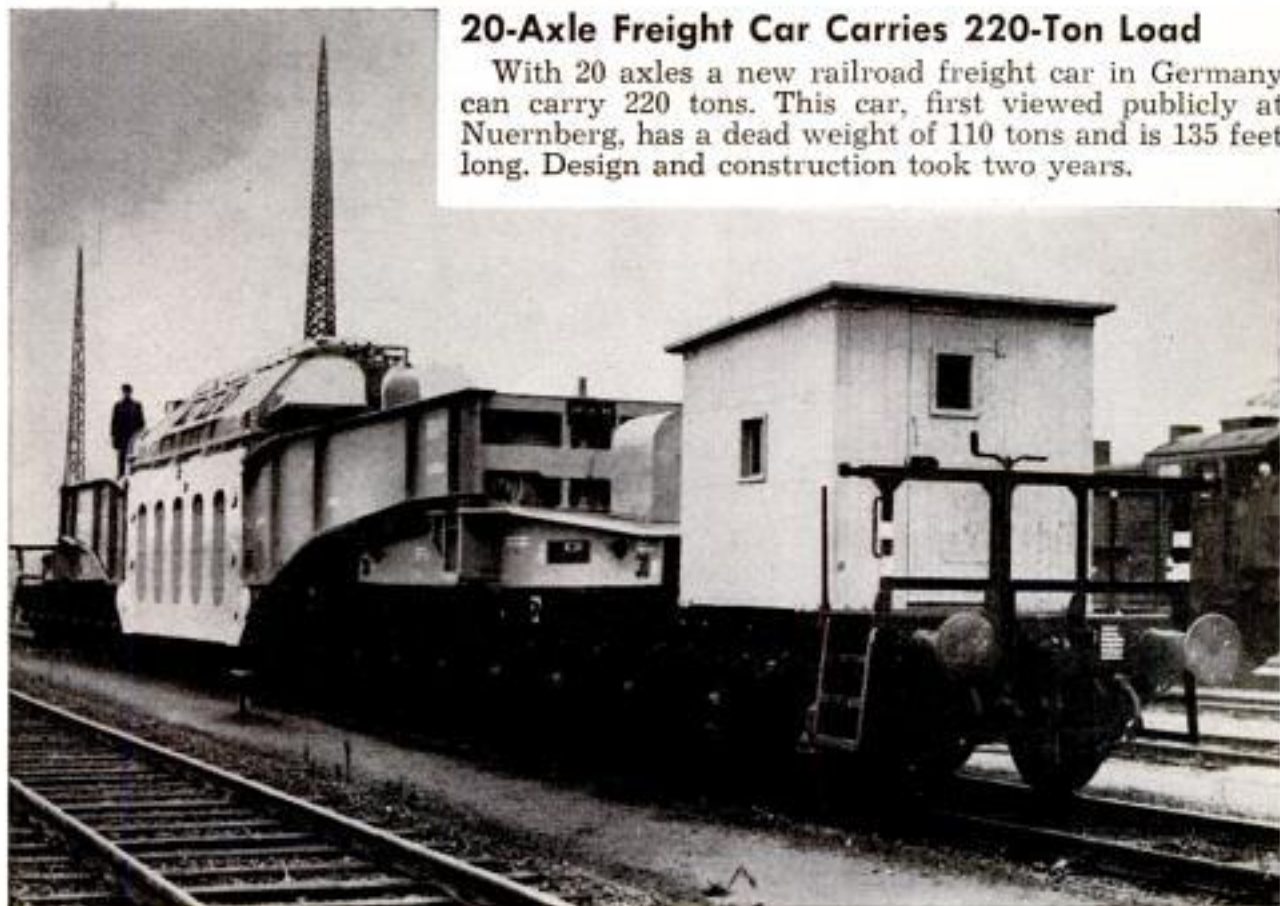

JEEP JAMBOREE



Winner of the broad jump at the jamboree was this Jeep shown here making a leap of 23 feet 8 inches

HOLD 'ER, COWBOY!" And the cowboys did—but they were holding steering wheels, not reins and their mustangs were mechanical, not animal.

It was an exciting, rip-snorting Jeep jamboree held on South Padre Island in the Gulf of Mexico off Texas as part of a campaign to publicize the place as a winter resort for sun-worshipping Northerners.

Every entry in the jamboree was a Jeep

driven by a rough-and-tough Texan in the best rodeo tradition. The competition included such unlikely vehicular events as a slalom race in the surf, a broad jump, an obstacle course and a treasure hunt.

The winner? It doesn't really matter. What the jamboree did prove was that the car may yet replace the horse after all—especially if the car is as acrobatic as a Jeep! ★ ★ ★

Spectators dotted the five-mile obstacle course to watch the motorized "sand fleas" roar over the dunes

One wet event required the drivers to speed down the beach and retrieve a pennant 50 feet out in the surf

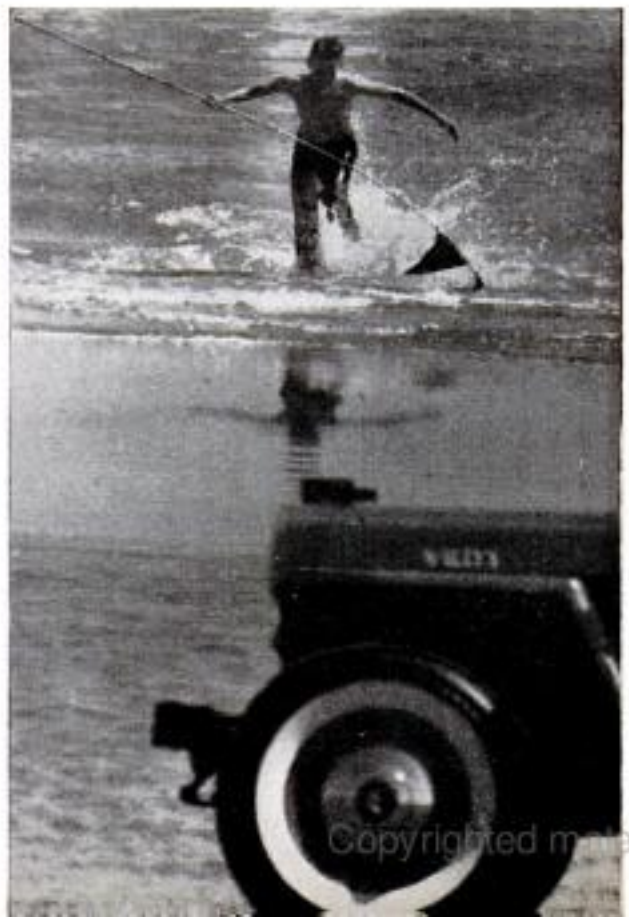



Late in the day Jeeps rested as contestants dug up the beach with bare hands looking for buried treasure



Above, that's not a landing craft coming ashore, it's a Jeep trying to win the slalom in the surf. Here it appears as though the surf is winning! Below, a flat front tire forced this Jeep to retire from the race



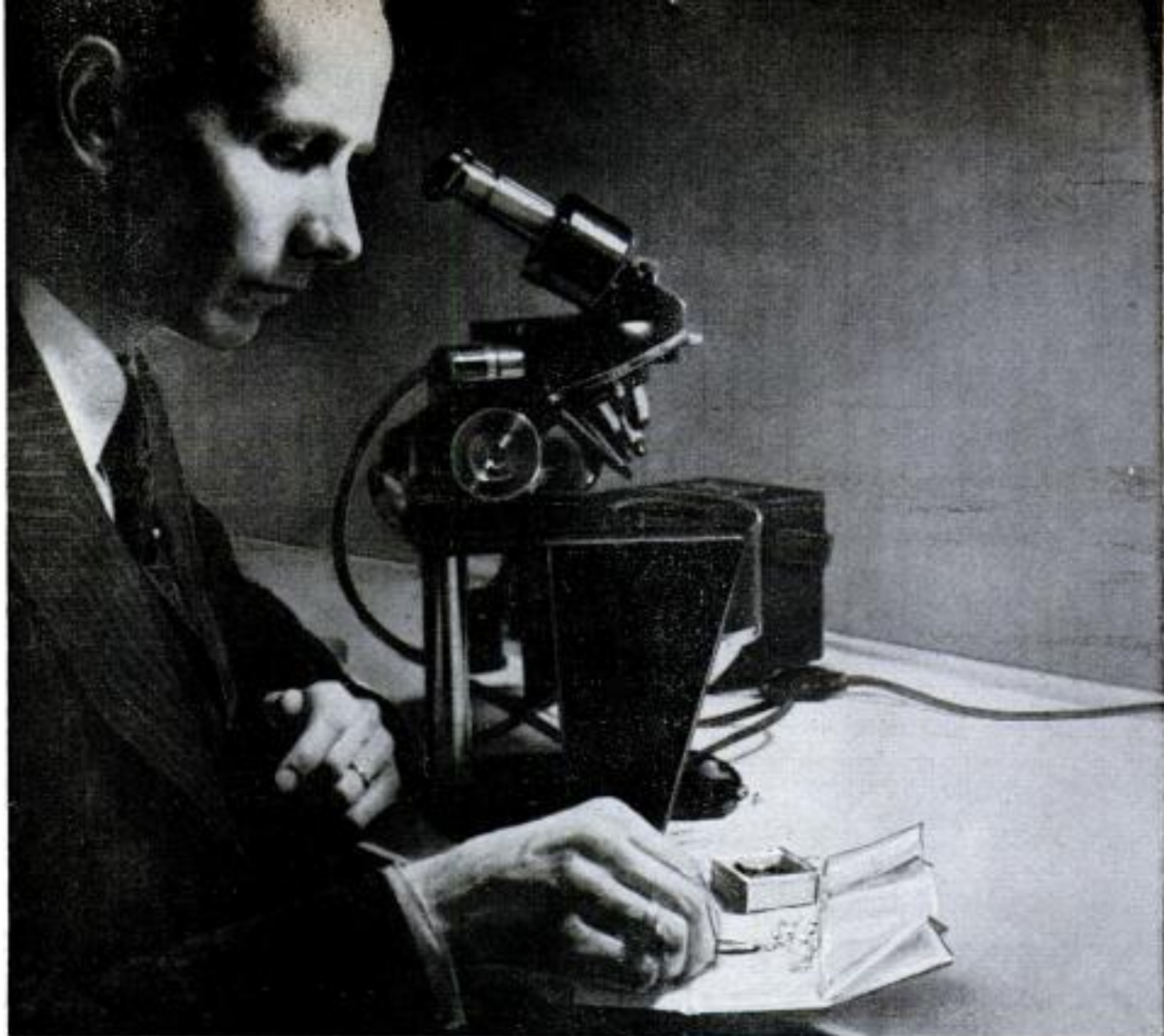

Dr. Edward Gubelin, authority on gem inclusions, provides photomicrographs of each stone to the buyer

Look into the Heart of a Gem

Invisible to the unaided eye are telltale "fingerprints" that identify nearly every jewel. It may be a tiny gem within a gem or a bubble. Here's how the gemologist fingerprints precious stones.

By Creighton Peet

Erwin Harvey has elaborate set-up for photographing heart of gem. Examples of his photos appear on the following pages



DEEP WITHIN almost every precious stone and fully visible only with a microscope are fantastic, brilliantly colored identifying marks and structures. In every case they are as different and individual to each stone as are fingerprints of a man.

A lost—or stolen—diamond, ruby, amethyst or sapphire, for example, may turn up in the market recut so it appears to the naked eye to be an entirely different stone. But a gemologist familiar with a particular stone's internal "fingerprints" or, better yet, having a photograph of its inclusions as these microscopic formations are known, can quickly make positive identification.

To date, no court has formally recognized this means of identification, but for almost two years now the New York City Marshal's Office has kept impounded some \$60,000 worth of assorted gem stones whose ownership is in doubt. A specialist in a wholesale jeweler's office from which such a batch of stones was stolen believes he has definitely identified stones from this firm's stock among those held by the police. But in this case he has only his own memory to back him up—not photographs. The grand jurors were impressed by his identification—but not sufficiently to hand over



It isn't theoretically possible for a star spinel to have six rays, but here it is. Internal construction dictates that the star have only four rays. This is a rarity, probably the only one in existence

these gems. On the other hand, the dealers in whose possession the stones were found could show no bills of sale. So for the present they belong to nobody.

Dr. Edward Gubelin of Lucerne, Switzerland, a dealer in precious stones and one of the world's leading authorities on inclusions, believes a study of these internal markings is essential in the positive identification of a stone. For this reason, his firm some years ago started the practice of presenting the purchaser of every jewel

Harvey sorts out a fortune in gems. The long stones are synthetics, identical to real ones except for inclusions

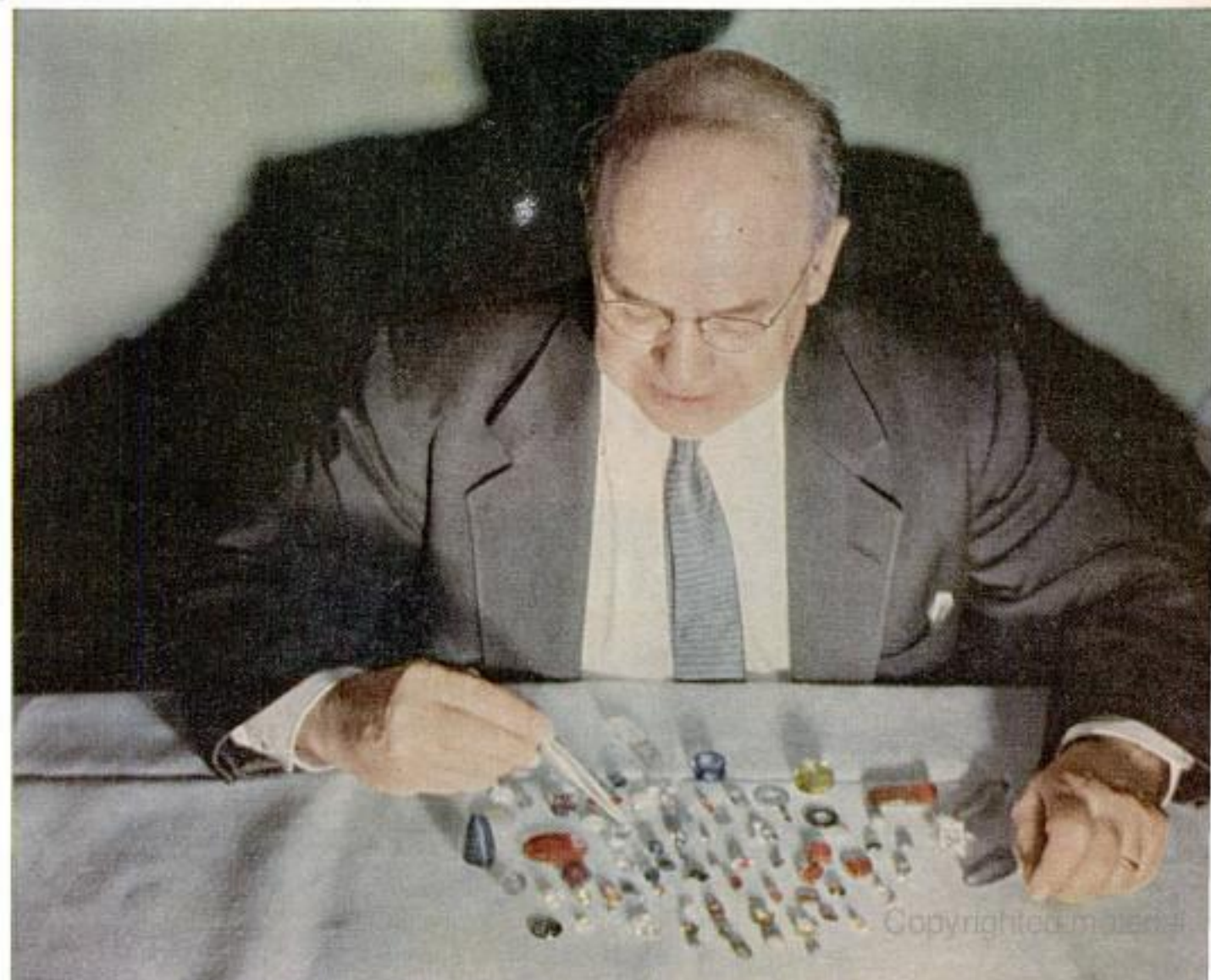



GARNET has one inclusion inside another



AMBER has a real insect imprisoned in it



TOURMALINE with graceful tube inclusions



DIAMOND, above, and GARNET, below



with a photomicrograph that shows its inclusions.

In America some leading jewelers have for years made photographs of all diamonds sold of a certain size. These show reflections from the diamond's facets and identify it quite accurately—so long as the stone is not recut. But recutting is one of the first tricks of the gem thieves to make stolen stones safely salable.

Some years ago the Gemological Institute of America, which does research in this field, established a sort of central file of information on diamonds over a certain size, sold by member jewelers all over the United States.

Since inclusions in diamonds are extremely hard to photograph because these stones transmit so much light, the Gem Society's files consist of pen and ink sketches of each stone's inclusions as observed through a microscope and recorded on special blank forms.



You might call inclusions flaws or defects in a stone. In a sense they are, for they are bits of other stones or structural markings left as the stone was being formed millions of years ago. Garnet or zircon crystals may be found deep inside diamonds. Liquid-filled cavities called "feathers," looking a little like rain streaking down a window, are characteristic in Ceylon sapphires.

In some cases dark holes are found surrounding inclusions, the result of radioactivity—now long extinct—in these specks of foreign material. In particular, once-radioactive zircons occasionally appear in sapphires, always surrounded by the tell-tale black halo. Today we produce radioactive materials which have a half-life of 5000 years, but in the life of a stone which may have been formed five million years ago the fragment of radioactivity has long since become ancient history.

More fantastic, in many stones such as emeralds, topazes and sapphires there are inclusions which

Certificate given with purchase of an expensive diamond gives highly accurate description of the stone

Certificate of Diamond

Model No. _____

This Certificate is given to the holder of the diamond described in the following table as being a natural diamond of the highest quality and of the weight and color described in the following table.

The diamond is guaranteed to be a natural diamond of the highest quality and of the weight and color described in the following table.

Color	Weight	Clarity	Cut
_____	_____	_____	_____

Drawings of the diamond are shown on the right side of this certificate.

By the Gemological Institute of America, Inc., New York, N. Y.

are liquid-filled cavities in which small bits of other stones are suspended. Occasionally these "floating" inclusions have been observed to change position as the gem was turned about.

Doctor Gubelin has in his collection a stone containing a liquid inclusion in which is a bubble of what he believes to be carbonic gas. After being heated to 31 degrees C. for several minutes, this bubble becomes absorbed by the liquid and disappears. Then, back at room temperature, the bubble reappears.

The Federal Trade Commission says that if an inclusion can be seen under a 10-power microscope, a stone cannot be sold as "perfect." However, in actual practice very few stones are entirely free from inclusions, and there are some inclusions which make a stone more valuable. The "star" sapphire, for example, is a stone in which three sets of minute "rods" crossing each other at an angle of 60 degrees produce the star effect when seen from above. In many cases a few very small inclusions which do not detract from the outward appearance of the stone can be proof that a stone is genuine. Artificial stones are amazingly good today, and very often the only way a gemologist can decide whether a stone is real or synthetic is by the inclusions. While synthetic stones often have inclusions, they are not the same as those in natural stones.

Photographing gem inclusions is among the more remote and expensive hobbies, but here and there all over the United States jewelers and dealers in precious stones have cameras and microscopes set up in apartments, spare rooms or the backs of shops.

One of the most able of these gemological photographers is Erwin Harvey of East Paterson, N. J., who has made a handsome collection of 35-mm. color slides of literally hundreds of gem stones. These photographs are not of stones he owns, but of unusual stones friends in the trade have loaned him for a few days, knowing his deep interest and his skill. To the outsider this seems a strangely casual business. A stone worth many thousands of dollars will be left with him at the jewelry shop where he works or sent to him through the mails. No receipt or other formal document is involved.

Making a single inclusion photograph may involve a tedious setting-up of apparatus and careful study of the stone to decide precisely the angle to which it should be turned on the microscope slide. Then, since the inclusion or inclusions in a single stone are at some depth from the surface, the photographer must decide where his plane of focus inside the stone should be for maximum effect. In nearly all photographs of inclusions the focus is on the major or most interesting formation. But this usually results in showing other inclusions in the same stone, which are at different depths, out of focus. For a complete "fingerprinting" job, other pictures must be made at these other depths. Precious stones were formed untold ages ago by the tremendous forces of nature. For a comparatively brief span in their unbelievably long life they may adorn our womenfolk. During this period they need never lose their identity if they are properly "fingerprinted" by experts. ★ ★ ★

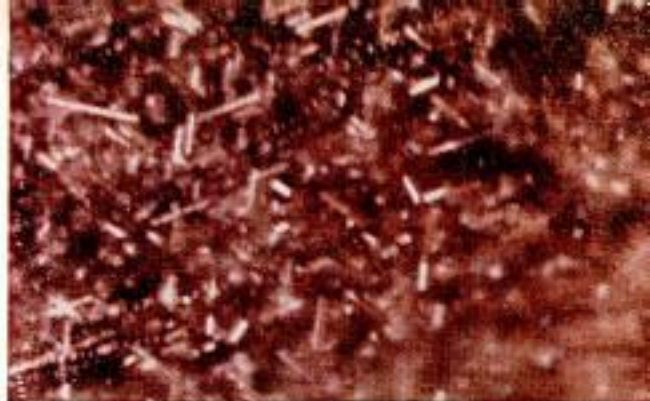

SPINEL has millions of inclusions



DIAMOND with star formed by inclusions



SAPPHIRE contains "fingerprints" of liquid



SPINEL with halo, and below, TOPAZ

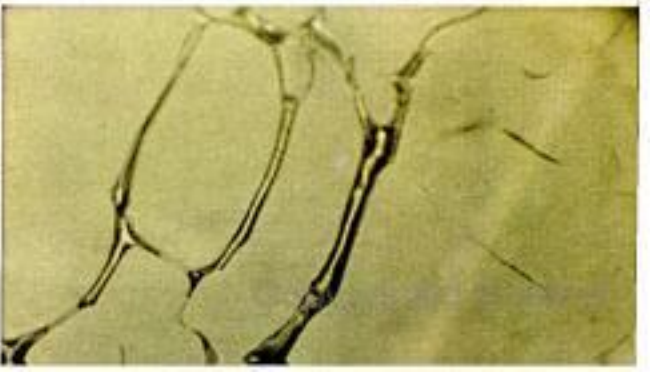

"Flying Girder" Crop Duster



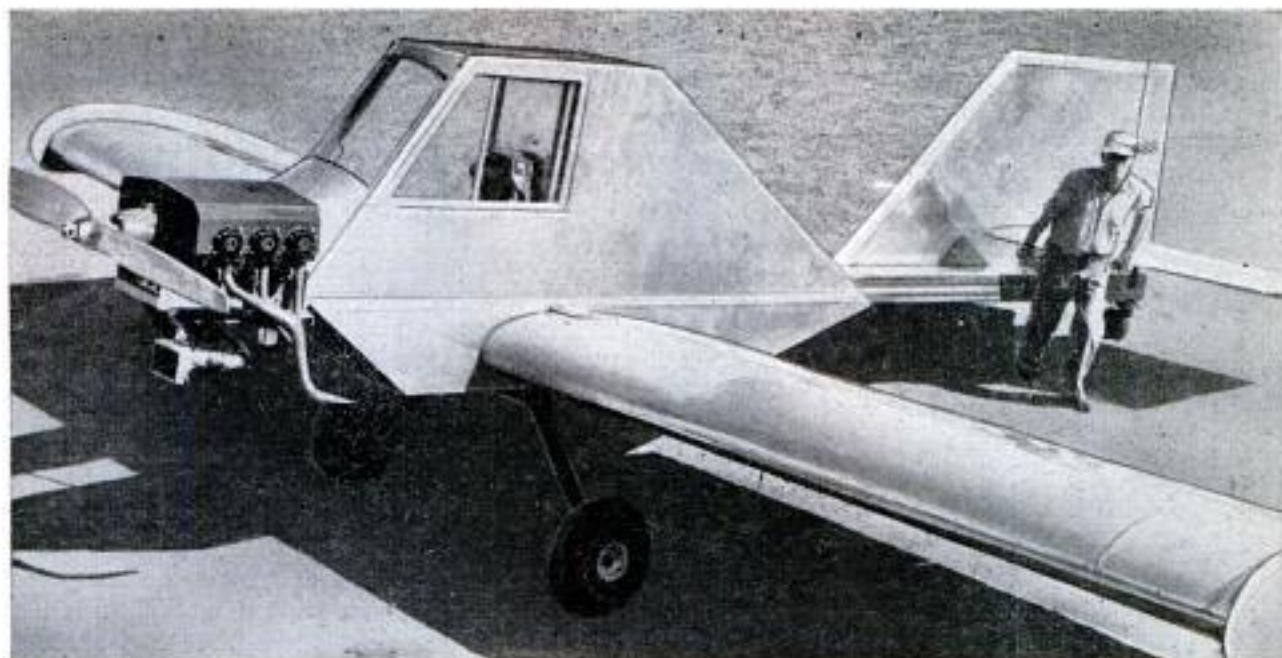

Fashioned around a 20-foot girder, flying spray-duster (above and opposite page) cruises at 120 m.p.h.

DUBBED the "Flying Girder," an aircraft that can dust crops or spray them, or do both simultaneously, has been built around twin six-inch aluminum channels bolted together to form a single 20-foot rigid box fuselage. Controls and other vital parts are set between these channels. William Marlman, Colorado airport operator, created the "Girder" to eliminate costly welded-aluminum-tubing construction common to most commercial aircraft. This ruggedly simple airborne hunk of metal has 14-inch-thick wings to give the high lift and "flyability" necessary to crop spraying and dusting. Fifty-gallon spray tanks are in the wings. A 20-cubic-foot hopper carries dust behind the pilot's skintight compartment. In flight, the Girder rests on a large cushion of lift provided by out-sized wings and flap areas. Liquid sprays and insecticides mist over the fields from pipes concealed in wings; atomized vapors emerge from trailing edges of these wings. Dust sifts from the hopper bottom to drift evenly on fields below, assisted by the plane's slip stream. A four-foot vertical tailfin gives the Girder directional stability. With its 260-horsepower Lycoming engine, the aircraft cruises 120 miles per hour and has a stalling speed of less than 40 miles per hour. The CAA has approved the safety design and performance of the Girder. ★ ★ ★

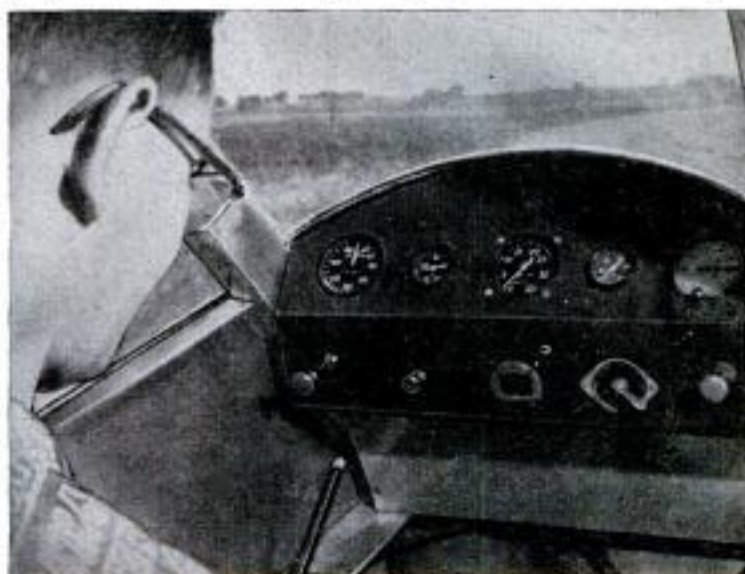

Above, the aircraft's controls are set between the rigid channels of bolted, twin, six-inch aluminum metal pieces. Below, the "girder's" creator, William Marlman, points to the box fuselage



Canada "Main Street" To Cross Continent

IN A FEW YEARS you'll be able to drive all the way across Canada on the new Trans-Canada Highway that is now being pushed to completion.

Only a few gaps remain in the new southerly route, known as Canada's ocean-to-ocean "Main Street," and most of these can be detoured. In some areas the route has been completed by joining stretches of existing road, in other districts the road is being driven through virgin country. In Newfoundland, for instance, 600 miles of road and 200 bridges are at present under construction.

The distance between the eastern and western terminals of the route is 5100 miles. Officially, the 520 miles of route through Quebec will not be part of the federal-provincial project. Travelers will pass through the province on the existing paved highways. Of the other 4580 miles of route, 30 percent is paved according to Trans-Canada Highway standards: hard-surfaced, two or more lanes in width, with gentle grades and wide shoulders. An additional 33 percent is paved. The remaining 37 percent is not paved.

Included in the latter total are 250 miles where there is no route of any kind. A gap of 65 miles exists between Clarenville and Gambo Pond, Newfoundland. Between Chapleau and Marathon in Ontario is an impassable gap of 185 miles that at present requires an immense detour. One hundred miles may eventually be clipped off the route in western British Columbia by short-circuiting a horseshoe section of route.

The route begins at St. Johns, Newfoundland, crosses to Nova Scotia by means of an ocean-going ferry, and uses other ferries to cross to Prince Edward Island and then to New Brunswick. On the mainland the route connects many of the large cities across the continent, including Montreal, Ottawa, Winnipeg and Calgary. Farther west the highway passes through portions of Banff and Yoho National Parks and continues to Vancouver, from where Victoria and Nanaimo on Vancouver Island are reached by ferry. Total cost of the route is estimated at close to \$500,000,000.

Map shows route of transcontinental road. It is now possible to drive almost the entire length of it, although only 30 percent now meets Trans-Canada Highway standards and 37 percent is not hard-surfaced

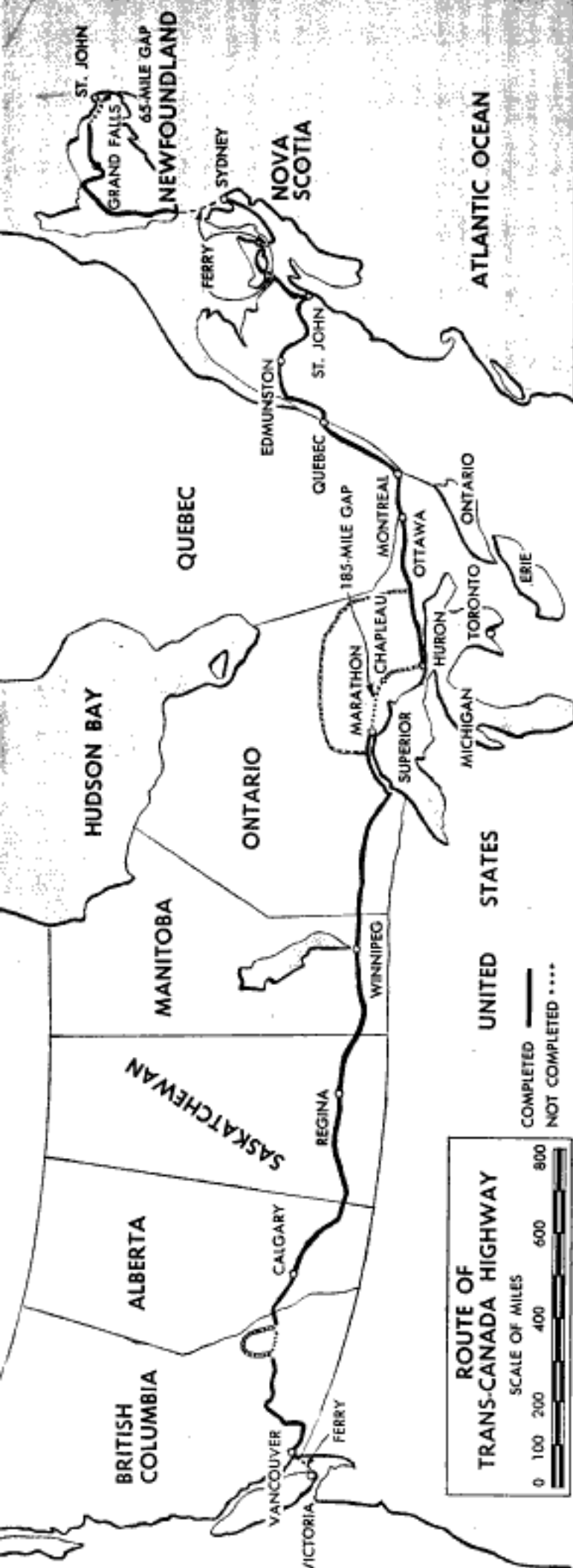

Secret Car Signal Opens Garage Door

Radio-controlled garage doors equipped with a new actuating device will open only in response to a certain coded radio signal from the owner's car. No other transmitter can open the door, so this equipment solves the biggest problem which has faced the owners of electronically operated doors. The manufacturer has over a million of the secret codes available, so there is little chance of repetition from other actuating units.



Tandem Tractor

Engineers at Iowa State College are perfecting a tandem arrangement with which two medium-size tractors can be hooked together to do the work of one large machine. The obvious advantage is that the farmer could buy two smaller tractors which would do most of the farm work; then, when a big tractor was needed, he would simply hook the two together.

Wing on Latest Intercontinental Super Constellation Is 27 Feet Longer

Wingspan is 150 feet on the new Model 1649A Super Constellation slated for intercontinental airline duty in April. The huge wing is 27 feet longer than in previous Super Constellations and holds fuel for nonstop flights of 6300 miles without con-

suming reserves. Future nonstop runs may include San Francisco to London, New York to Rome, and Rio de Janeiro to New York. The aircraft has three-bladed propellers, each measuring 16 feet 10 inches, for its 3400-horsepower engines.



WHAT'S NEW FOR Your Home



1. ROTARY MOWER operator can adjust the cutting height by light toe pressure on a foot pedal without stopping the mower. Blade and mower deck rise horizontally up to four inches. Mounting a 3.6-horsepower engine, this unit cuts a 25-inch path. Geared transmission allows forward and backward movement. A safety clutch can stop the blade.
Midland Company, South Milwaukee, Wis.

2. PORTABLE ELECTRIC ICE CRUSHER breaks ice into fine, intermediate and coarse sizes. Dial can be set while the unit is in operation. Ice cubes are fed into the safety opening with an inward swinging gate at the top of the crusher. Stainless-steel talons smash the ice and drop it into a seamless steel drawer with the capacity of an average ice tray.

Hival Manufacturing Co., 304th and Bennington, Kansas City 20, Mo.

3. DOUBLE-BOTTOM SHORTENING CUP allows housewife to measure shortening without touching it. This plastic cup, divided into quarter-cup sections, has its double bottom connected to a push rod. When filled with shortening from a can, the cup is inverted; shortening sufficient for the recipe is pushed out, cut off and placed directly in mixing bowl.

Lowry-Johnston Co., 301 Wolverine Bldg., Ann Arbor, Mich.

4. TAKE-APART PORTABLE GRILL for outdoor cooking fits into a pocket or a fishing-tackle box. Measuring 1 by 3½ by 13 inches, this steel grill weighs 2½ pounds. It can be assembled in 15 seconds. The circular grill-top area accommodates two pots and a skillet at the same time and keeps them concentrated over center of fire for quick, convenient cooking.

Multi Products Co., 2052 Grove Ave., Racine, Wis.

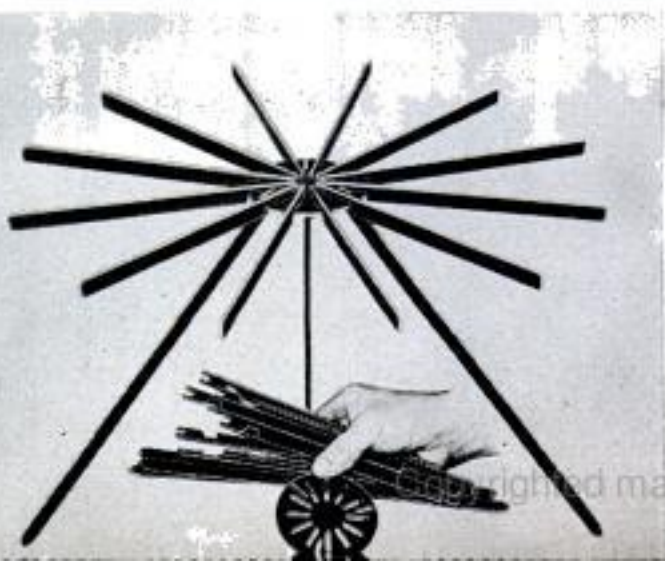

5. FLOOR-HUGGING RUBBER DUCT permits extension wire to run from a wall outlet to the center of a room without hampering traffic or cleaning. The extension is rated at 15 amperes and 125 volts and includes two outlet units. The duct is available in four, five, six and ten-foot lengths. Beveled, it can be cemented to floor, without danger of coming loose unexpectedly

CMG Industries Inc., 615 South Second, Laramie, Wyo.



6. WOMEN'S HOSE DRIER holds stockings by the toes. Less than five inches in diameter, this Bakelite polyethylene holder is a flat disk with eight slots around the edge to pinch and hold the toes of four pairs of stockings or other hand-laundered items. A chain attached to the center of the holder has a small hook at one end to form a loop for hanging

Cosom Industries, Inc., 6012 Wayzata Blvd., Minneapolis 16, Minn.



Cross-section view shows compact rubber duct

7. AUTOMATIC GARBAGE CAN, enclosed in enameled steel cabinet, moves forward on shelf to receive waste when foot pedal on cabinet is pressed. The can moves back into the cabinet when foot pressure is stopped. A regular can cover is unnecessary, as the cabinet keeps out flies and animals. Housewife does not have to handle this garbage can at any time during disposal

Automatic Window Co. of America, 1753 N.W. 20th St., Miami, Fla.

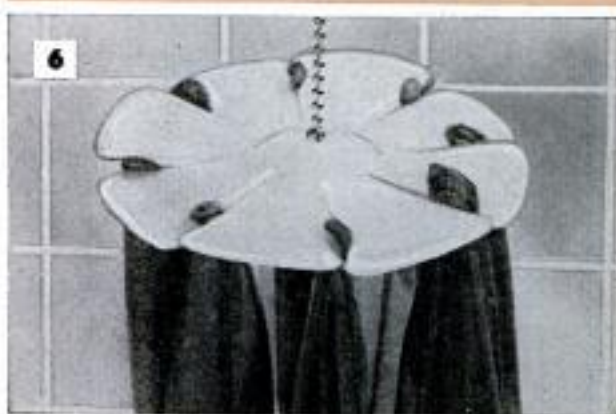

8. LOCK SET does not require a doorknob for turning to unlatch the door. Plates that are pushed or pulled to open the door actuate the latch and release it so the door swings free. Bottoms of the plates are fastened to the door. Tops of the plates are movable. The door can be locked in the usual manner. This lock set can be installed horizontally, if need be

Screw Machine Products Co., 7737 N.E. Killingsworth Ave., Portland 20, Ore.



9. CAN OPENER that can be handled by disabled persons has a vacuum base which firmly locks the opener to any flat, smooth, nonporous table surface. The unit opens round, oval and square cans by left or right-handed operation. Cans are placed on an elevator platform, which raises them to proper height for opening. A magnet holds lids severed from the can

Rival Manufacturing Co., 36th and Bennington, Kansas City 29, Mo.

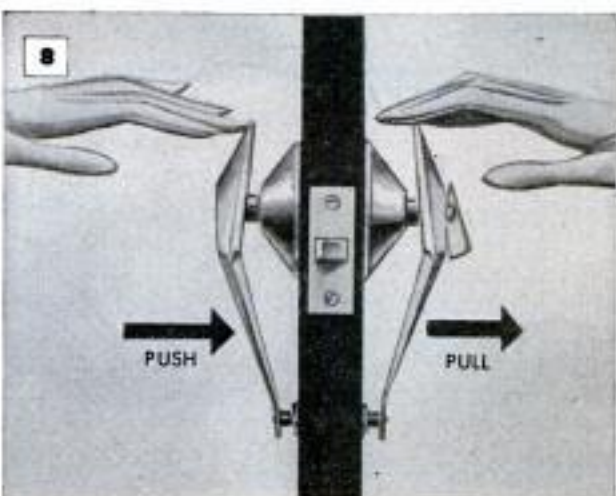

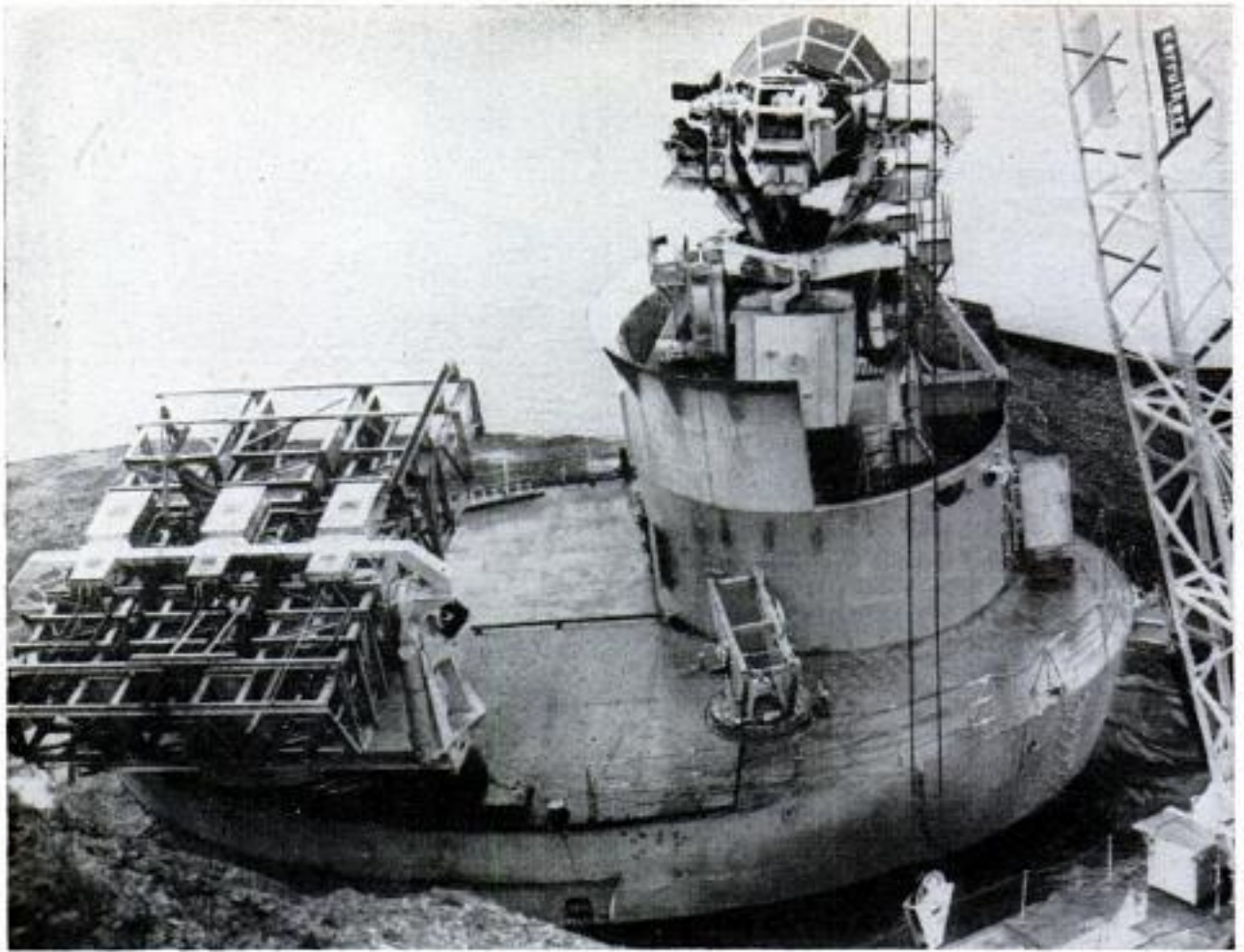

Platform duplicates any movement of ship, permitting tests of naval missiles. Left, tracking camera follows the missiles

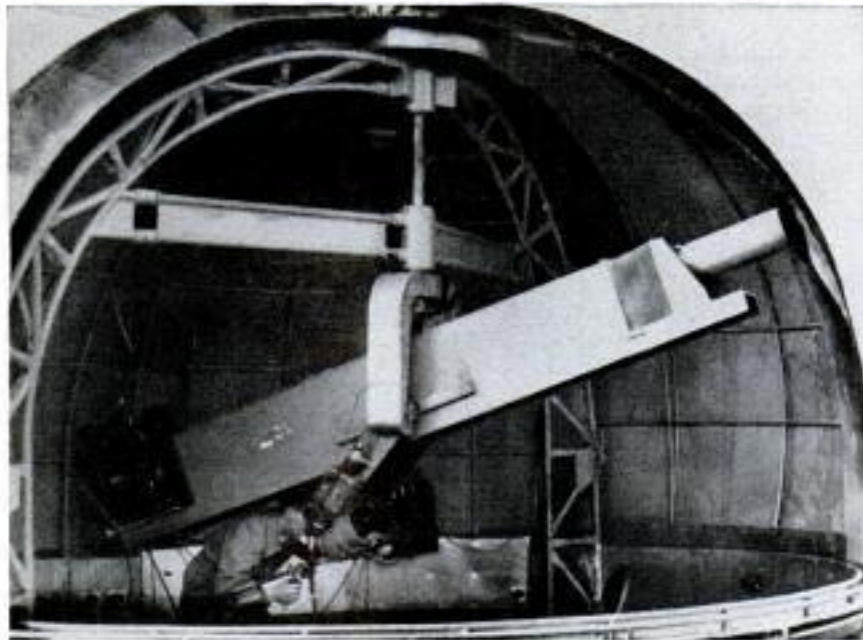

Artificial Ship Launches Missiles

Missiles roar skyward from a strange platform in Wales. The platform is used by the British Ministry of Supply to flight-test guided missiles designed for ships. The platform can duplicate any movement of a ship at sea. Nearby is a 100-inch tracking camera which follows the flight of the missiles.

Compressed-Air Bubbles Keep Shipping Lane Ice-Free in Swedish Lake

Compressed-air bubbles kept a shipping lane ice-free last winter in Lake Malar, Sweden. Perforated Neoprene-plastic tubing was laid on the lake bottom along the shipping route between Vasteras and Sodertalje. Air bubbles from the tubing lighten the lower layer of water, which rises to displace the colder water sink-

ing to the bottom. This technique was applied on a large scale in the United States in 1917 to keep water open before the gates of a hydroelectric dam across the Mississippi River at Keokuk, Iowa. The method also has been effective in providing ice-free lakes for migratory waterfowl and in keeping water open in sawmill log ponds.



Motor Is Used to Inflate Rubber Boat Prior to Propelling It

Using a 2.3-horsepower outboard motor which has a built-in air compressor, a collapsible rubber boat made in Germany is easy to inflate. Once the boat has been in-

flated, the specialized motor is attached to the boat and used to propel it. The boat is divided into seven separate compartments to prevent sinking from a puncture.

Control Holds Grader Blade at Precise Angle

Precise grading of a slope with one pass of the grader is possible with a new automatic control. The attachment, designed to speed the grading of highways, holds the grader blade at the desired slope regardless of how uneven the terrain may be. The operator simply sets the desired slope on a dial mounted within easy reach. He raises or lowers the blade to control the depth of cut, but the slope of the blade always remains the same, even when the grader frame is tilted by uneven terrain.

Operator of grader sets desired slope on dial. Blade remains at this angle even if grader frame is tilted

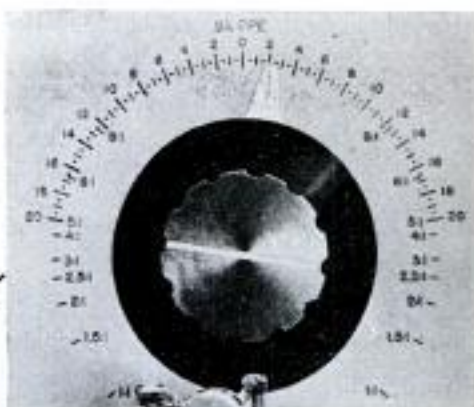

TAXI TO VENUS?

Maybe—if you have time for a year's round trip. But here are some of the problems our aeronautical engineers face as they head into the space-ship business

By Thomas E. Stimson, Jr.

Rocket motors produce tremendous surge of power in test stand. Water on deflection plate turns to steam

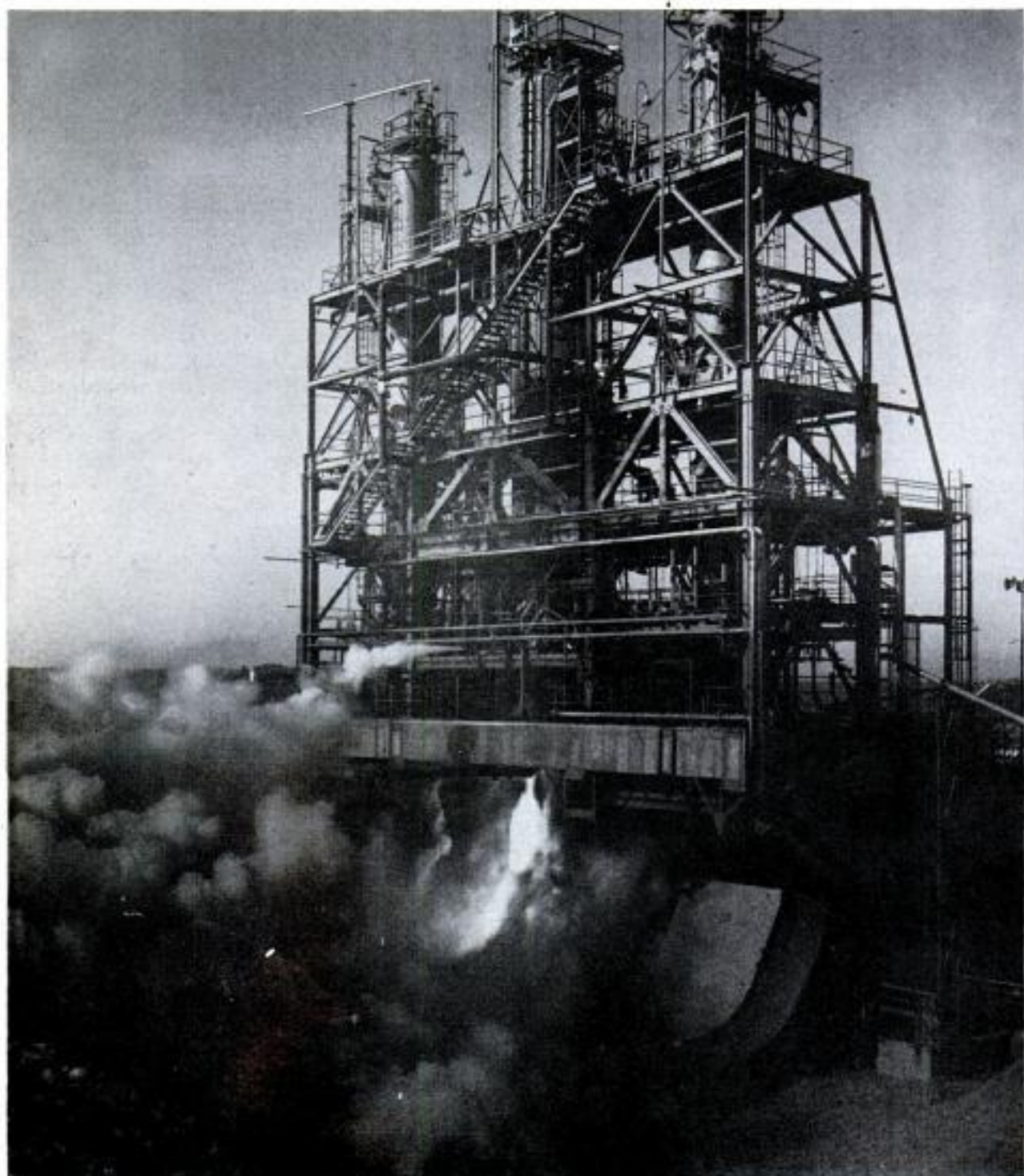

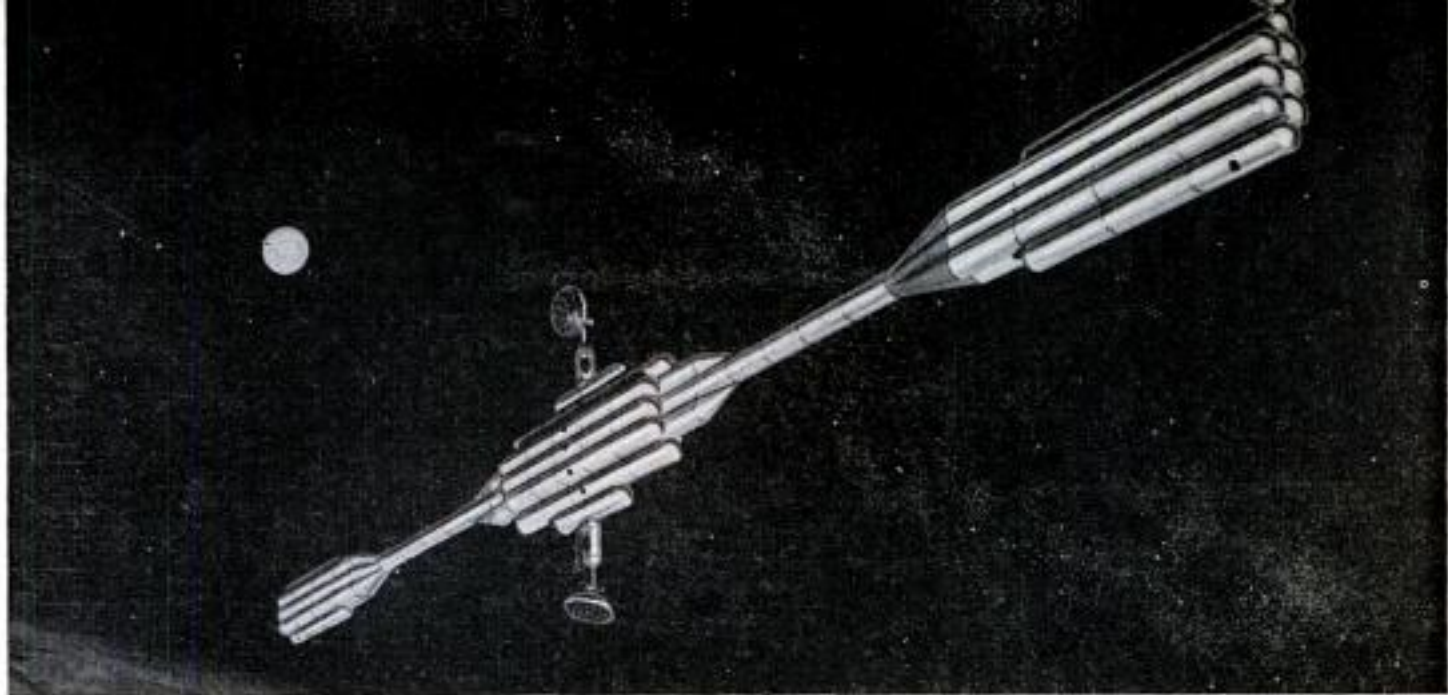

Dumbbell-shaped satellite envisioned by Ehricke would have a crew. Rotation would create artificial gravity

WHAT'S THIS RUMOR about Convair getting into the space-flight business? Is it true?" a friend recently asked Krafft A. Ehricke, chief of preliminary design of Convair's astronautics division.

"It certainly is," Ehricke told him. "We are studying advanced instrument satellites and are thinking about space ships that could travel to the moon. And we are considering the sun as a source of power for space propulsion."

Convair is one of the giants of the aviation industry; what is it doing in a field that sounds like science fiction? Why does it have a \$40,000,000 astronautics division?

One reason is that the company is building the "Atlas" intercontinental ballistic missile. This long-range weapon is designed

to fly a quarter of the way around the earth in half an hour. En route it will climb some 500 miles above the surface and for a time will be a true space vehicle. Everything that can be learned about conditions in space is affecting the design of the ICBM.

Ballistic Missile

The Atlas is known as a ballistic missile because its trajectory is like that of an artillery shell. It can be guided only during the time its rocket motors are blasting. During the rest of the missile's flight its trajectory is governed by the known laws of ballistics plus a number of new factors such as the effect of the virtual vacuum at extremely high altitude.

The ICBM has been called the ultimate

Ehricke shows how space ship for circling moon would actually be an earth satellite on long elliptical orbit

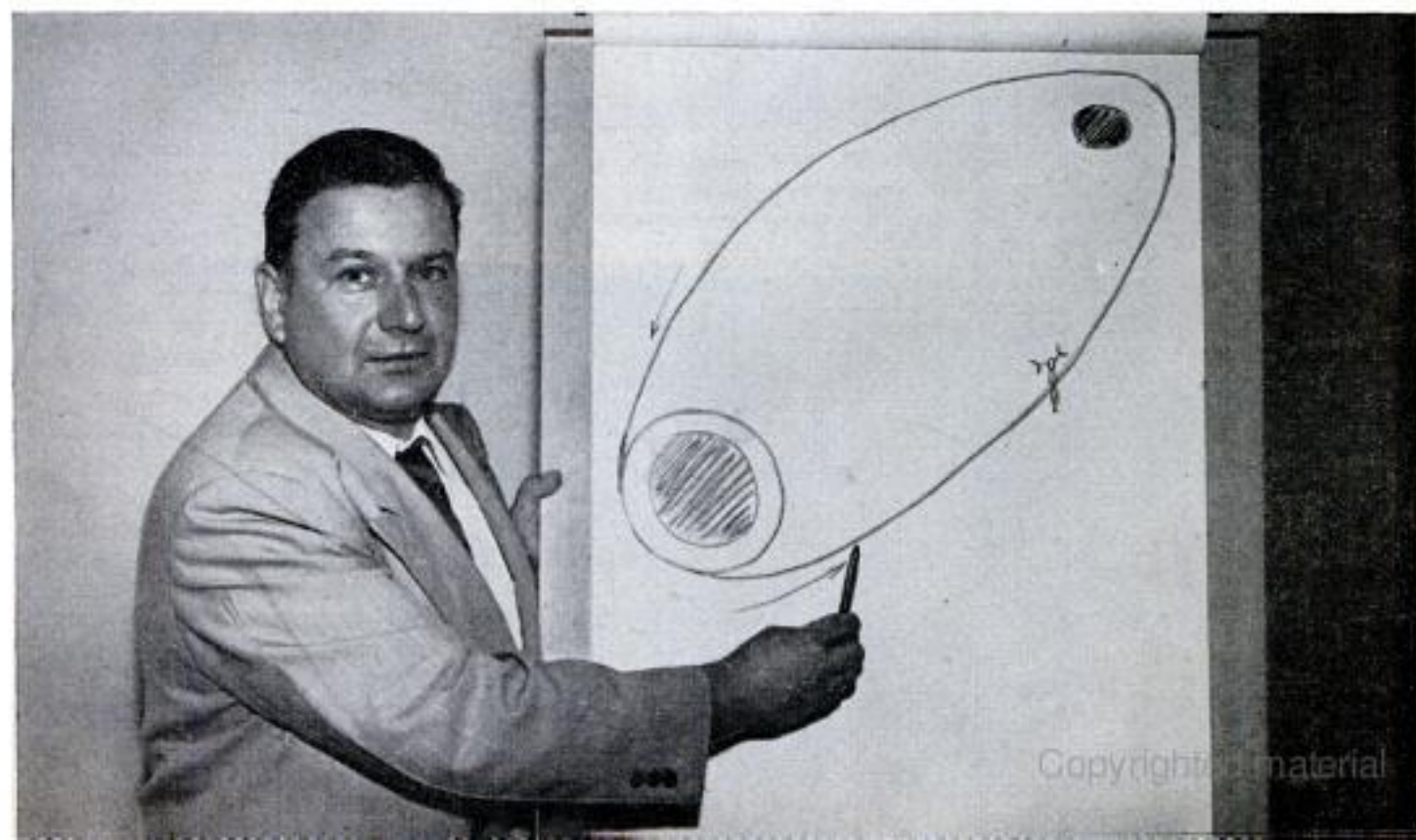



Shuttle craft would transport personnel to satellite at 600-mile altitude. Lower rocket portion detaches after take-off

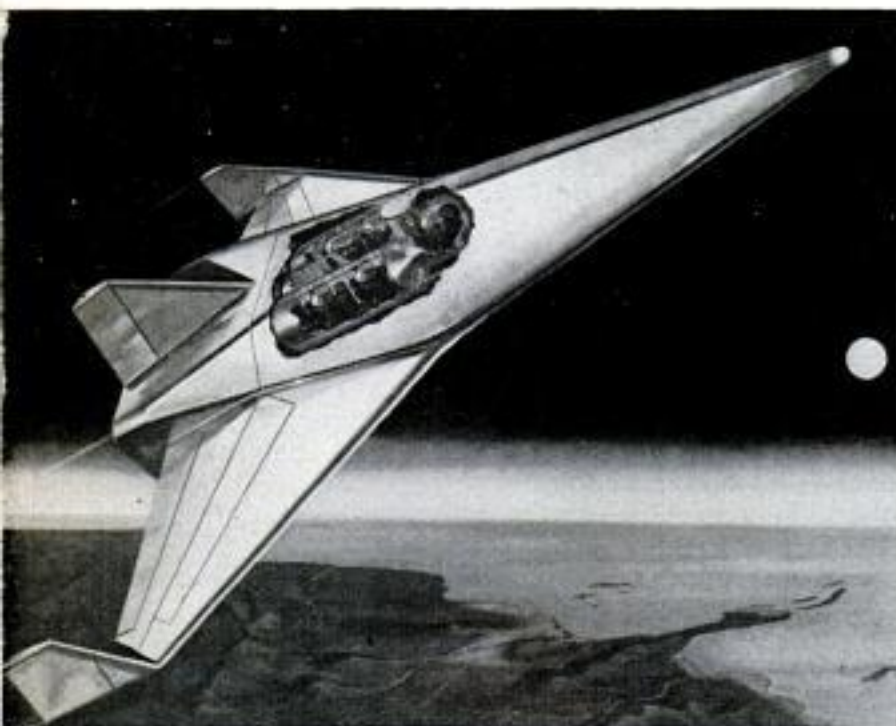

During the return trip, craft stalls with nose high as it settles into dense atmosphere. Pointed nose glows from aerodynamic heat. Below, should anything go wrong, power section could be detached and the craft flown to earth as a glider



weapon. It is designed to carry a thermonuclear warhead that is at least 100 times more destructive than an ordinary atom bomb. Once launched, it is believed to be unstoppable—unlike the winged cruise missiles that are powered with jets or ramjets and that fly at aircraft altitudes and at speeds of around Mach 2. The Atlas will have a hypersonic speed of about Mach 20, some 15,000 miles per hour.

Some perplexing problems must be solved before the first of these multistep rockets is tested. One concerns guidance. During the half hour that the missile is flying, its target will have moved some 500 miles because of the rotation of the earth. If the missile is fired toward the west, the target will move 500 miles toward it during the time the missile is in the air. If the missile is fired in an easterly direction, the target will travel 500 miles away during the half hour. Automatic controls for cutting off the rocket motors at precisely the right times must be adjusted to compensate for the direction in which the missile is fired.

Another problem is that of getting the missile back down through the atmosphere intact. During the plunge to earth its nose will heat up to 5000 degrees and will glow like a meteor. The rocket could disintegrate if the nose melted or if it broke up under thermal stress. It might even ignite with the oxygen in the atmosphere and burn. To prevent any such occurrence the engineers must, in effect, design a better meteor.

One solution they have considered is a very thick nose cone. The molten metal on the surface of the nose would stream away, carrying the heat with it. The rest of the structure would remain relatively cool. Another possibility is some kind of insulation between the outer skin and the warhead itself.

Heat Affects the Air

Even the air that surrounds the missile during its plunge is affected by the heat. The molecules of air collide with so much energy that some of them are broken down into atomic form. The missile is actually surrounded by a new gas, and this could influence its trajectory.

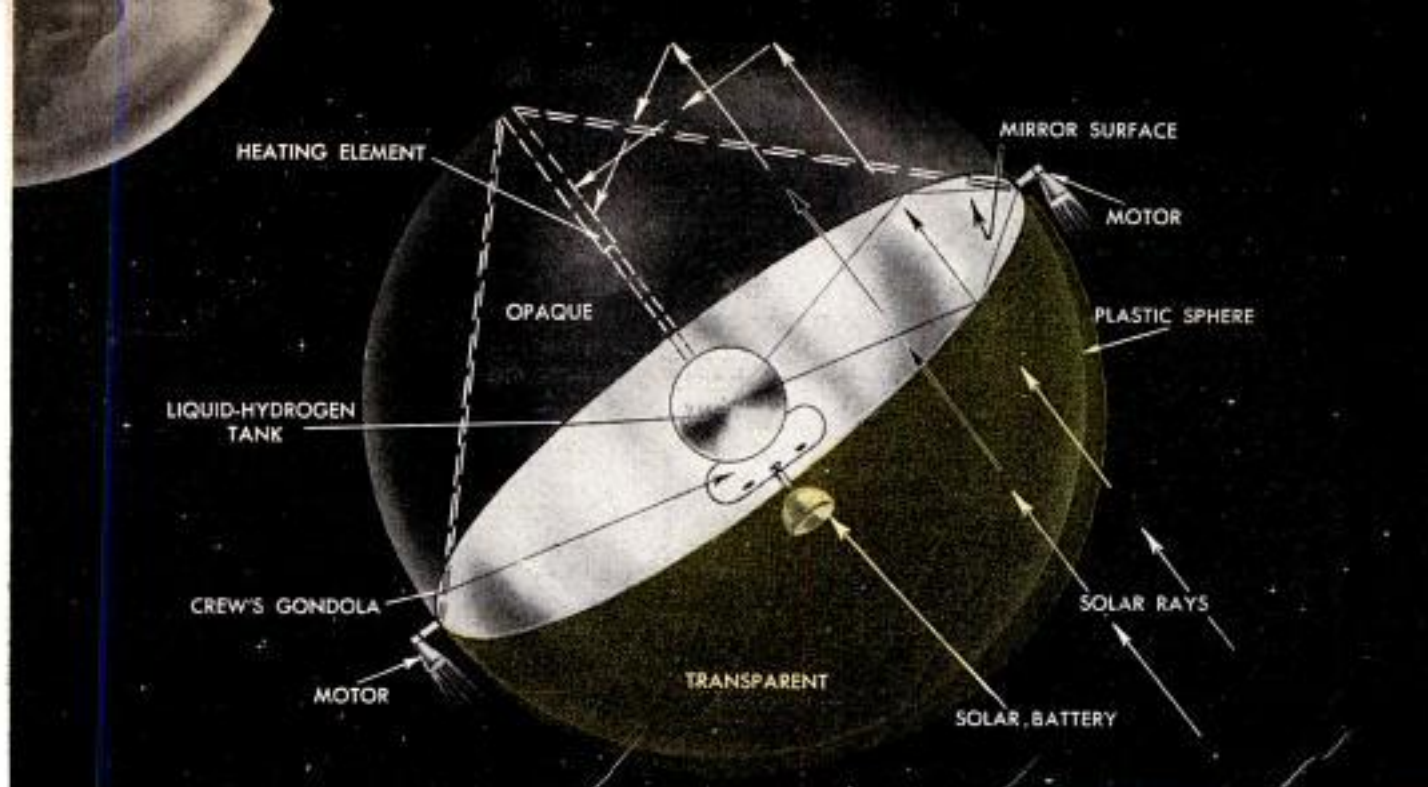

Ehricke suggests space ship made of huge plastic bubble. Solar rays would heat liquid hydrogen to power craft

The whole re-entry problem is so vast that many agencies are studying it. The National Advisory Committee for Aeronautics, for instance, is working with a "light gas" gun in which compressed helium is used to shoot $\frac{1}{4}$ -inch projectiles at speeds of up to 10,000 miles per hour. When fired into the open air these projectiles burn white-hot from friction with the atmosphere. A larger gun now being built will propel $\frac{3}{4}$ -inch projectiles at a speed of 16,000 miles per hour. This speed will be made inside a flight-test chamber where the atmospheric density can be varied to simulate successive portions of a missile's re-entry through the atmosphere.

Space-flight studies are aiding in the design of the Atlas and, in turn, research on the long-range missile is helping solve some of the problems of space vehicles. The small terrestrial satellites to be launched in the next 18 months are only the forerunners of the larger satellites that will follow.

Already contemplated are noninhabited instrument satellites that will be as large as an ordinary room. These will be sent around the earth on long elliptical orbits. They will carry instruments to measure such quantities as magnetic fields in space, pressures, temperatures and the different kinds of solar radiation. All this information will be transmitted to earth by radio.

The Moon on Television

Kraft Ehricke and his fellow engineers expect that large modified instrument satellites will be able to swing close to the moon, including its other side, and will be able to transmit close-up views of the lunar surfaces to earth by television.

"Eventually noninhabited vehicles will be sent far out into interplanetary space," Ehricke predicts. "There the distances are so vast that tracking them is going to be difficult. One idea is to equip such a vehicle with a few small A-bombs that would be released and detonated at regular intervals.

Diagram shows suggested zones for various satellites, and altitudes and ranges of existing or proposed missiles

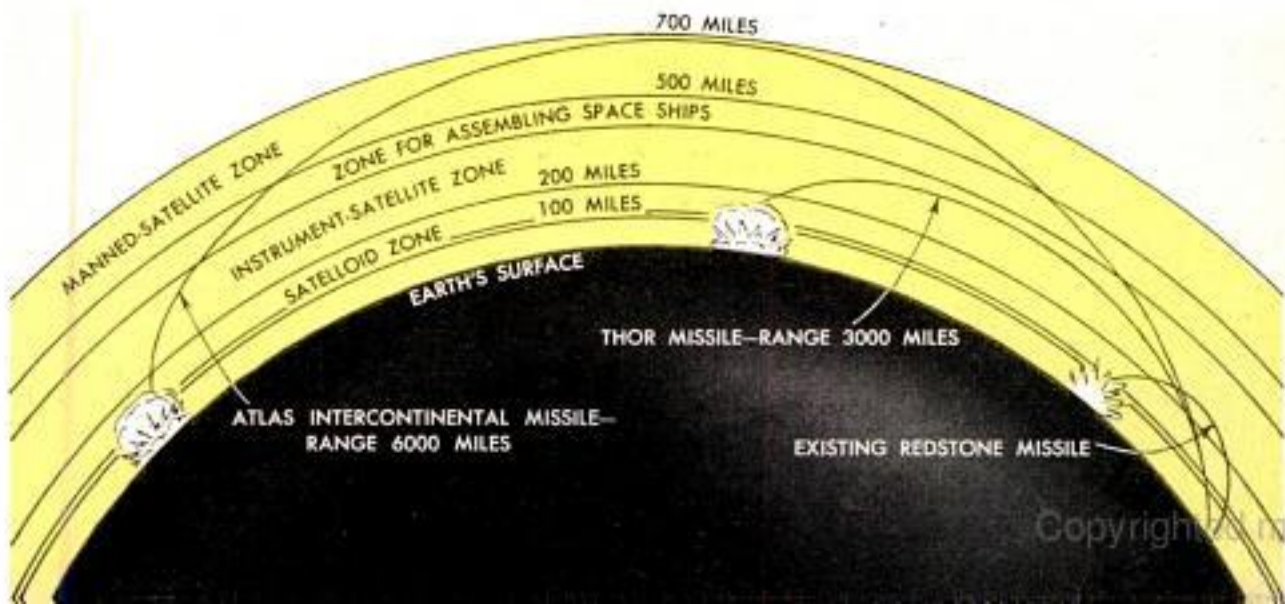

The light from these explosions would be recorded by cameras on astronomical telescopes and would show the locations of the manmade bodies.

"Probably some of the vehicles will be used as solar probes and will be aimed at the sun. Their radios will telemeter information back to earth right up to the instant when they are consumed in the sun's heat."

In all, the engineers foresee a number of different kinds of space vehicles, each type designed for a special job. The list includes satelloids, satellites, shuttle craft for transferring personnel to the satellites, automatic supply rockets from earth to the satellites and, eventually, huge bubblelike interplanetary cruisers.

"One of the first man-carrying craft may be a satelloid, not a true satellite," Ehrlicke says. "This is a low-altitude craft designed to explore the region from 20 to 100 miles up. The air there is too thin for ordinary aircraft, too dense for a satellite."

"The satelloid would be a rocket-launched hypersonic glider that would circle the earth at 17,500 miles per hour, completing an orbit every hour and a half. It would require some power for staying aloft, possibly the equivalent of five gallons of gasoline for making one revolution around the earth."

Ready for launching, the satelloid would be a three-stage rocket, with the third stage having a deltalike wing and a sealed cabin outfitted for flights of up to a week. After the first and second stages were fired and dropped, the third stage would take up its orbital path. To return to earth the satelloid would be stalled down through the atmosphere at a very high angle of attack to reduce forward speed and prevent excessive aerodynamic heating. Even so, skin temperatures of around 2000 degrees would be experienced and a multiwalled cabin would be required to keep occupants cool.

"Not only is the satelloid a useful vehicle for upper-air research," explains Ehrlicke, "it will be an ideal training ship for the crews of the somewhat similar shuttle craft that will carry personnel out to the large manned satellites stationed on orbits some 600 miles out."

Dumbbell—A Home in Space

"Today we believe these manned satellites will be smaller and simpler than previously supposed. Instead of the huge doughnutlike structures that were suggested earlier, a shape like an elongated dumbbell now seems more practicable. The satellite would be set in rotation by small rockets to provide an artificial gravity. The crew would live and work in the rooms at each end of the dumbbell and could move from one end of the structure to the other by climbing half way up the hollow stem and falling the rest of the way.

"Such a satellite would be
(Continued to page 232)

Redstone is a medium-range (several-hundred-mile) missile shown here in test stand. It is 60 feet tall, 70 inches in diameter

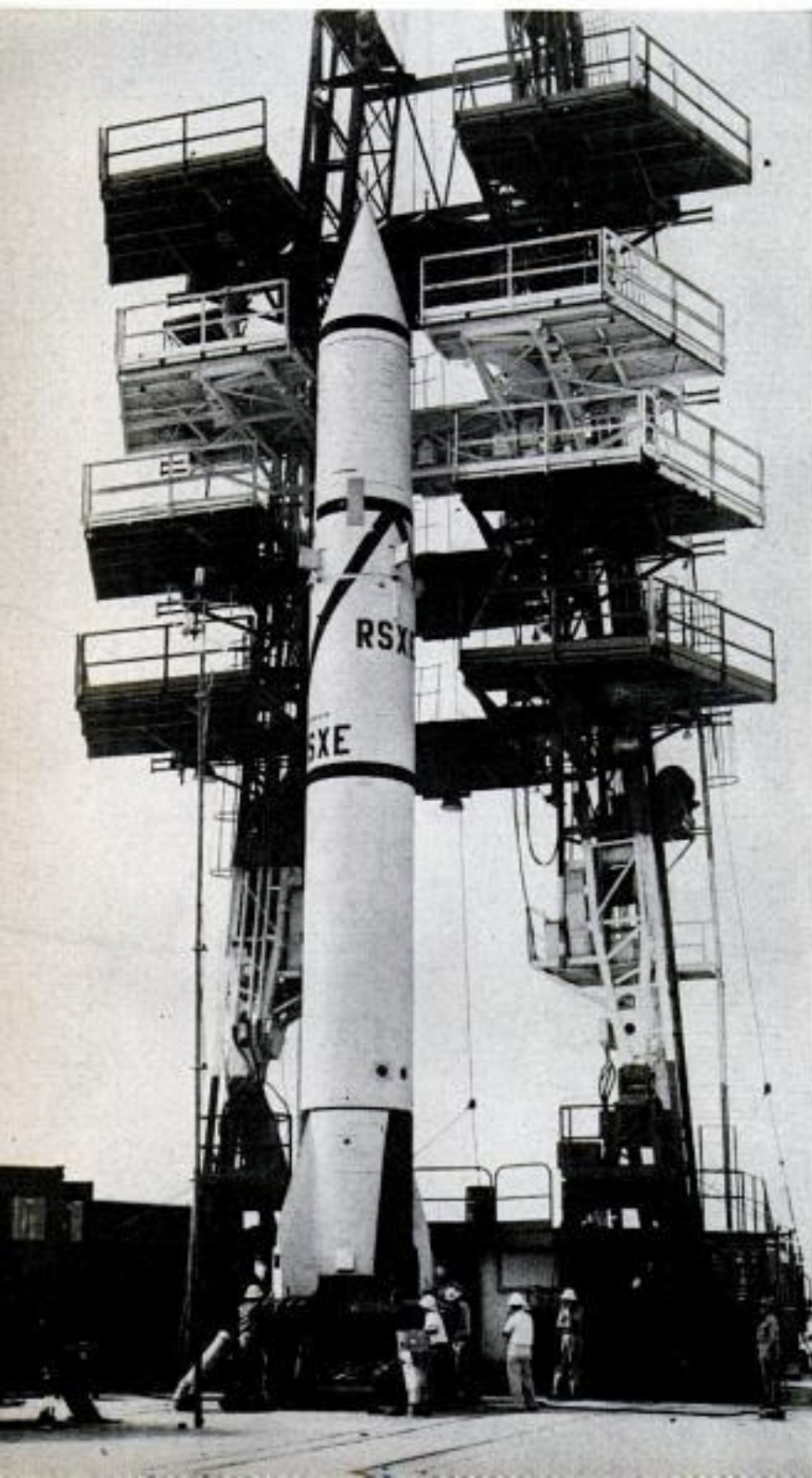



Scorpion's Sting Is Rockets in Wing Pods

Recently released photographs show for the first time how the Northrop F-89H Scorpion, America's most heavily armed operational fighter plane, carries its weapons. Each wing-tip pod contains three Falcon guided missiles, which are carried within the pod until firing time, then are extended. Also inside of each pod are 21 air-to-air rockets, which are fired through breakable fairings in the nose of the pods.



Sterilizer Kills Viruses of Polio

Live polio viruses being processed into vaccine are dealt a fatal blow by a mechanical sterilizer. The unit spins the vaccine into a film $\frac{1}{10,000}$ inch thick, while tubular quartz lamps inside the centrifuge kill every particle of virus with ultraviolet light. The vaccine enters a perfectly balanced 15-inch vasselike cup that spins at 1800 revolutions per minute. Centrifugal force pushes a film of the liquid up the walls of the cup to the top rim, where the liquid is drawn off by a special collector. Parke, Davis Co. applies the method.



Mobile Irrigator Depends on Wells

Water shoots from the revolving nozzle of a mobile irrigation unit to drench a circle of land 520 feet in diameter. Three of the diesel-powered units, often working day and night, furnish water to a 300-acre tomato farm near Homestead, Fla. Wells are spotted throughout the acreage. Each unit consists of a centrifugal pump and a diesel engine mounted on a truck.

← Each irrigator has a centrifugal pump and diesel engine mounted on a truck to work from a well

Cool Combine

Any farmer would envy the Cardiff brothers, Charles and John, of Katy, Tex., who ride in their combine in cool comfort. The brothers decided one day to air condition the big machine, sketched their ideas on the floor of their shop and then went to work. They enclosed the cab in aluminum and glass. The two-ton air-conditioning unit, which once had cooled an office, was installed behind the seat and cools the cab about 20 degrees below outside air.



Suspension Bridge With Single Pillar Planned in Germany

Now in the planning stages, a modernistic suspension bridge using only a single tower has been designed to extend across the Rhine River at Cologne, Germany. The tower will be built as a triangle, with the

roadway suspended between the two arms which meet at the peak to support the cables. As now planned, an observation tower and a restaurant will be built into the top of the bridge pillar.



3800-Degree Oxygen-Kerosene Flame Carves Granite Blocks

Utilizing oxygen and kerosene to generate a flame of 3800 degrees, a machine for cutting granite blocks from a quarry throws hot burning gases and flame at 6000 feet per minute from a 10-foot blowpipe. Three times as fast as the old drill method used for cutting the four by eight by ten-foot blocks, the jet flame causes a thin surface layer of the granite to expand and break away from the main body as a result of thermally induced stresses. Each pass with the blowpipe flakes one quarter to one half an inch of the granite, and the harder the rock the faster the flaking takes place.

Gas and flame, thrown at 6000 feet→ per minute from a 10-foot blowpipe, cause granite flakes to break off

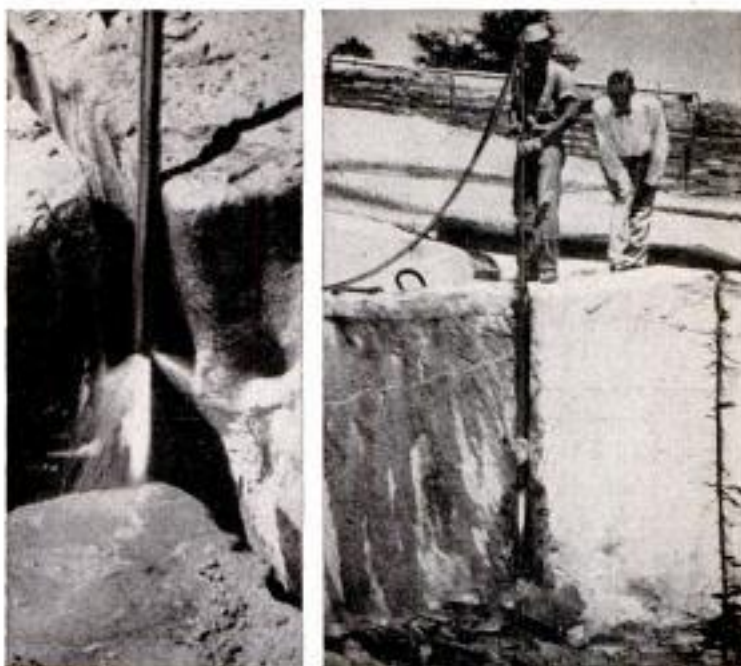

Subway Cars in Paris To Have Rubber Tires

Built by the Renault Works, a subway car employs rubber tires to provide its passengers with a softer, more comfortable ride. The car is scheduled to be put into service on the Paris Metro (subway) soon.

Alcohol Slows Evaporation

Experiments in this country and abroad indicate that evaporation from reservoirs may be retarded by 50 or even 70 percent by covering the pool with a molecule-thick film of cetyl alcohol, derived from sperm oil.

Gas Air Conditioner-Heater For Air or Water Systems

Air conditioning and heating by a gas-fired unit is being investigated for application to either new or existing warm-air or hot-water heating systems. For the warm-air heating systems, a heat-exchanger coil and blower is installed instead of a furnace arrangement. A pump circulates chilled or heated water from the evaporator chamber of the gas-fired unit to the heat-exchanger coil. For hot-water systems, old-fashioned radiators must be replaced with finned coils through which chilled or heated water is pumped. Convector fans circulate air over these coils.

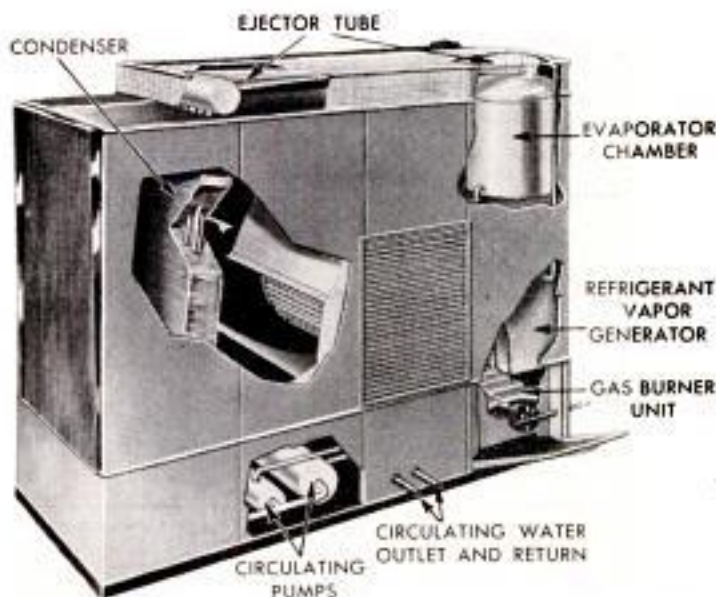

BIRDS WRITE

Their Musical Score

By William F. Rounds, Jr.

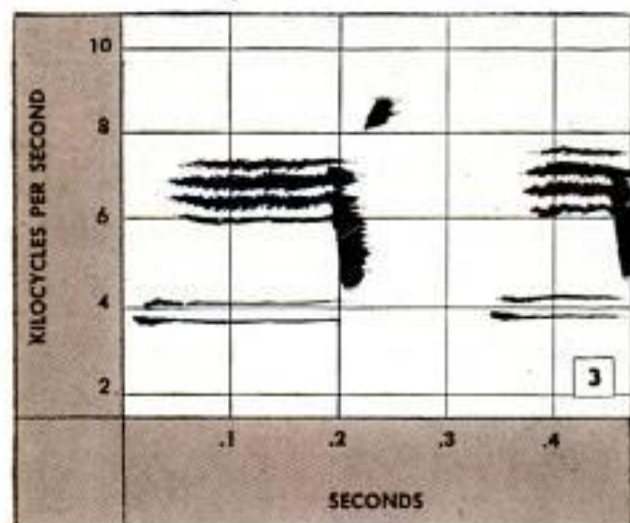
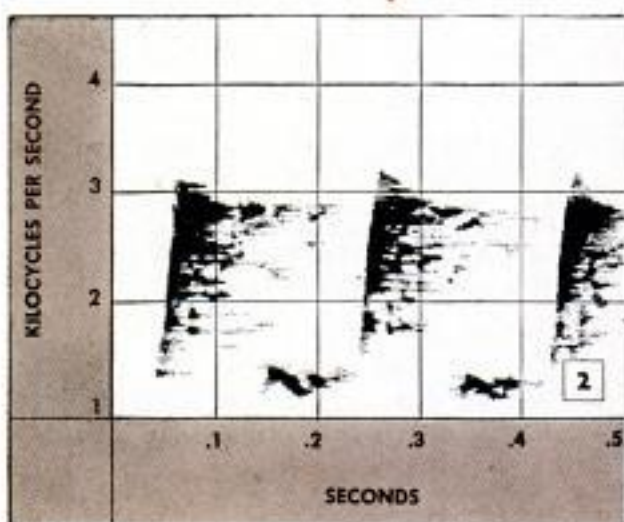
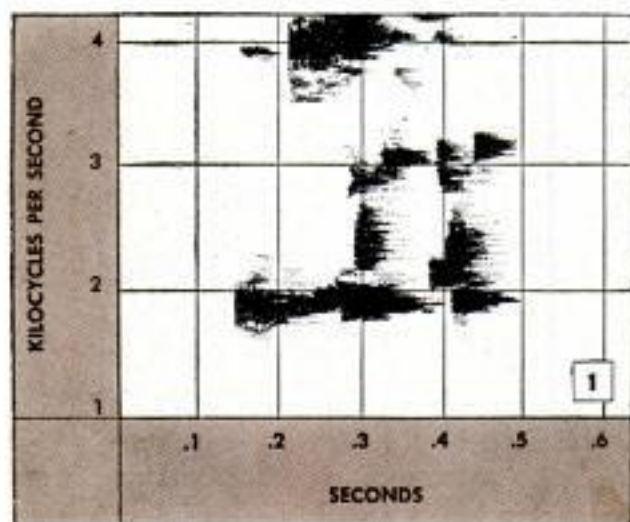

POETS AND NATURALISTS have tried for centuries to describe accurately the intricate sounds that birds produce. Now science has taken a hand, using the magnetic-tape recorder and a device known as the audiospectrograph as research tools. Collected data supports one conclusion—as a sound-generating instrument, a bird's throat is unparalleled in nature.

"Birds are vocal gymnasts," say Profs. Donald J. Borror and Carl R. Reese of Ohio State University. These men began

Top left, blue jay sings "squeakily." Top right, cardinal slurs note up an octave in 1/100 second. Left center, song sparrow sings eight notes at once. Below, wood thrush sings 100 pulses per second.

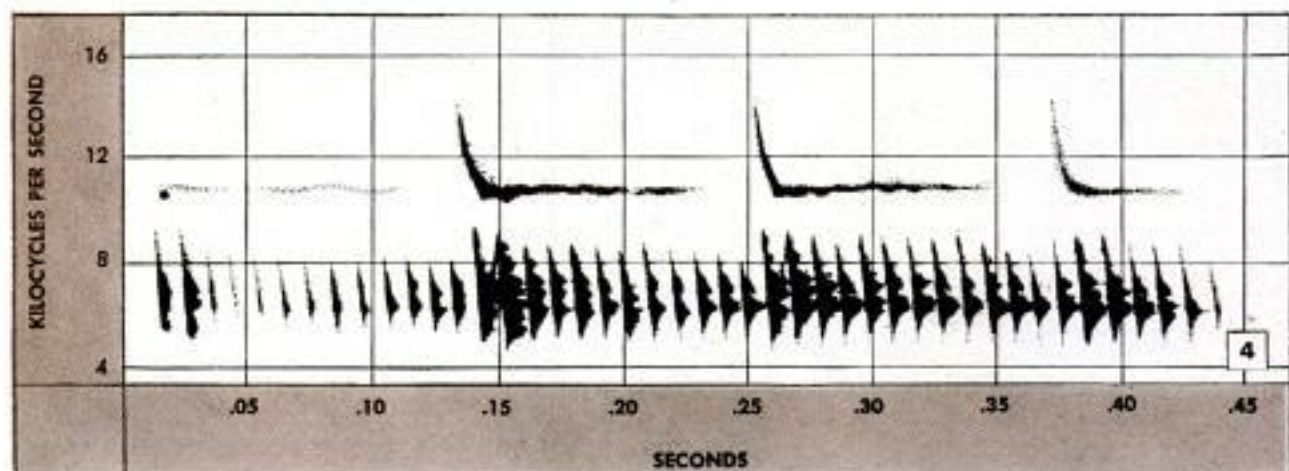

on Tape

studying bird songs four years ago. They used tape recordings and a new visual-research method that charts out the sounds on paper, revealing pitch and timing of each twitter with extreme accuracy. Today their campus library contains 1700 individual bird recordings and is one of the largest in the world. Represented are 200 species recorded in 12 states—ample proof that the complex song of a bird often outstrips the hearing capacity of the human listener. The visual-analysis method, first proposed in 1949 by C. E. G. Bailey, British engineer, should outmode all earlier procedures used to describe birds' vocalizing. Early techniques have included written syllables (like "to-whit to-whooo"), musical notes and line graphs—all inaccurate because they rely chiefly on the limited hearing ability of the observer.

"We soon learned that the human ear registers only a part of most bird songs," Berror says. Obviously, no means of depicting a song can be accurate if it depends on man's imperfect hearing."

The all-electronic method employs high-fidelity recordings, then sets the recorded songs down on paper in easily studied form. As "written" by the audiospectrograph, most bird music looks like a series of smudge marks. Analyzed by experts, these marks disclose in great detail all of the vocal quirks of the singers. For example, many birds have been found capable of uttering individual notes with great rapidity—100 or more per second are not uncommon. This is the rate of pulses the researchers found in a portion of the chart of a wood-thrush song. On tape, it sounds like a high-pitched buzz, but the individual notes show up distinctly on the chart.

Split-Second Timing

Containing many elements is the brief, squeaky song of the blue jay, and the graph shows that these elements are uttered with split-second timing. On the basis of his chart, the cardinal earns the title of vocal acrobat; visual examination of his song



Prof. Carl Reese (left) carries battery-operated tape recorder, as Prof. Donald Berror adjusts parabolic reflector

shows that he can slur a note upward an octave or so in $\frac{1}{1000}$ second. One of the most baffling things discovered by Berror and Reese is that a number of songsters can sing more than one note at a time. The experts have a chart of a song sparrow, recorded in Maine, in which the bird sings all parts of an octet, momentarily holding eight notes simultaneously. How this is done remains unknown.

Mockingbird Is Versatile

The mockingbird has received special attention because of his reputation as a mimic. The professors studied not only his songs but also those of the birds he imitated. One of these was a Carolina wren which, like several species, has numerous song patterns. Scientists concluded that the mockingbird reproduces not just a generalized song pattern of a species but duplicates the actual notes as sung by a particular bird. In 20 minutes of tape-recorded singing, this airborne mimic imitated 47 birds and 2 mammals!

First step in studying any bird's song is to get it on tape. The researchers make



Audiospectrograph makes a chart of a bird's song, which later will be analyzed as part of this research project at Ohio State University

Binoculars and a bird manual may be needed for identifying the songsters. Noise interference from street, rail and air traffic will be hard to escape in city areas, but noise is a problem almost anywhere. After you get a recording, play it back at half-speed and some of the intricacies of the song may become noticeable.

In the second phase of this research, visual analysis by the audiospectrograph is required. The Ohio State men use a \$2500 commercial model. Only at Cornell University and in England is similar equipment being applied to extensive bird-song research, although the audiospectrograph has

their recordings in the field, using a small battery-operated recorder easily carried on a shoulder sling. Their crystal microphone is mounted over a 24-inch aluminum parabola to make it directional. They "aim" it by listening through a headset. Occasionally, they use a 40-inch parabola set on a photographer's tripod. For good fidelity at high frequencies, they prefer a tape speed of 15 inches per second.

Recording at Home

Although Borrer and Reese may travel 50 or 60 miles through the countryside to add 2 or 3 minutes of edited tape to their library, they point out that good recordings can be made at home. If you have a tape recorder, take it into your yard or set it up near an open window, and get those early morning singers. Most true songbirds have "singing perches," locations from which they like to vocalize. A cone formed from a piece of cardboard can take the place of the parabolic reflector.

been used by engineers for years in sound analyzing and by speech experts in studying human voices. The song being studied is re-recorded on a magnetic disk in the audiospectrograph. Facsimile paper is wrapped around a cylindrical drum, which revolves as a variable-frequency oscillator "scans" the recorded signal. A marking stylus, mechanically linked to the oscillator, moves across the paper, making a mark when activated by frequencies contained in the recorded song. This results in a "sheet music" graph of the sound.

Charts Highly Accurate

These charts are highly accurate, showing pitch in cycles or kilocycles per second along the vertical axis, and time in seconds along the horizontal axis. Researchers now evaluate the singing of particular birds. Eyeing new horizons in sound, these electronic naturalists are glancing toward the ground, where insects are soon to be investigated acoustically.

Below left, the mockingbird imitates a Carolina wren

Below right, the original Carolina wren is singing

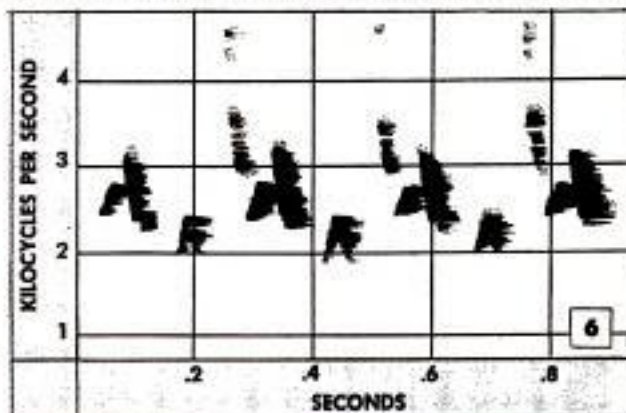
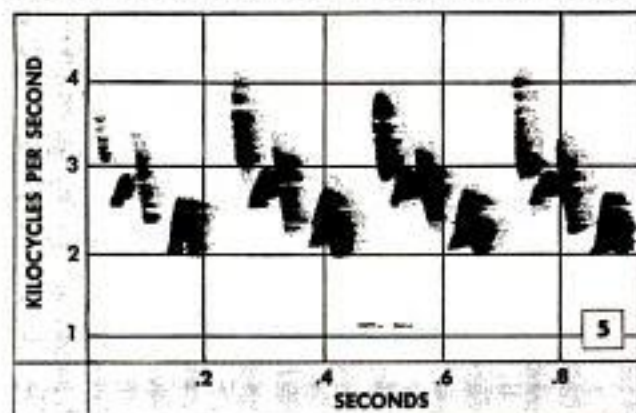

TV Monitors Needs Of Hospital Patients

Television has come to the rescue of the over-worked hospital nurse. Now a supervisor seated before a television screen can check on a dozen or more rooms at once. Pictures from camera units installed in the rooms appear in rotation on the monitor. Pressing a switch, the nurse can hold the image and talk with a patient. When visitors come, the patient can switch off camera and speaker. If desired, patient's name and room number appear on screen.

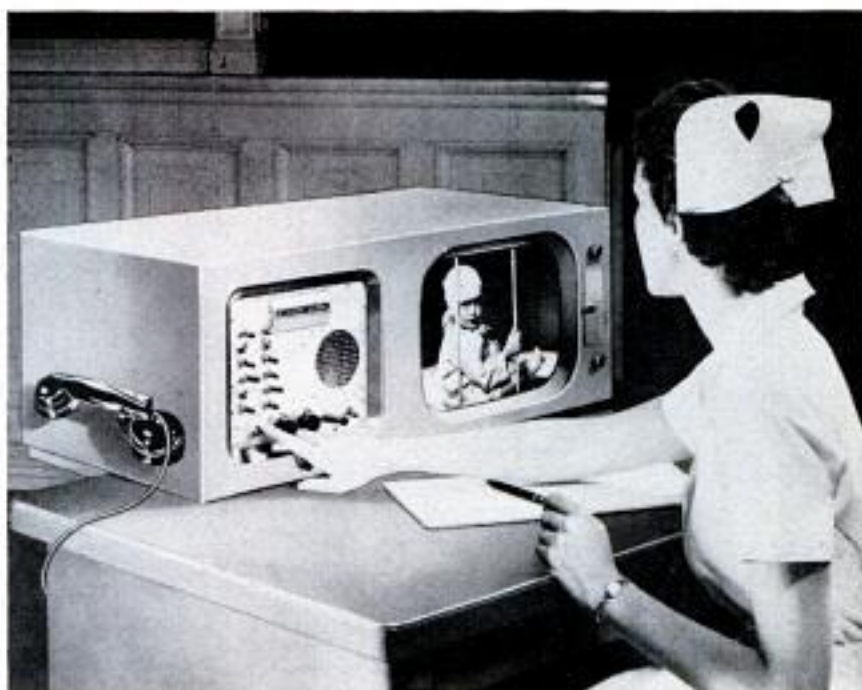

Trussless Steel Roof Spans 31,200-Foot Area

One of the world's largest trussless steel roofs, with a clear span 120 feet wide and 260 feet long, extends over the Phoenix Coliseum, Phoenix, Ariz. Erected in 7½ days, the roof consists of curved 18-gauge galvanized corrugated steel sheets, two feet wide and from six to ten feet long, fastened together by nuts and bolts to form self-supporting arches. Eliminated is need for pillars, posts, horizontal raft braces, trusses or supports of any kind. This roof will withstand winds of more than 113 miles per hour and will not crumple under loads up to 42 pounds per square foot (equivalent to 5½ feet of snow).



Above, curved 18-gauge galvanized corrugated steel sheets are hoisted into position in trussless roof. Below left, roof spans area 120 feet wide and 260 feet long. Below right, sheets are bolted together by workers prior to final assembly in roof





"World Wonders" in Ohio

Few schoolbooks or maps show the Eiffel Tower or Pyramid of Cheops as located in Columbus, Ohio. Yet, such is the case. Side by side with these marvels are Niagara Falls and Carlsbad Caverns, the Taj Mahal, Parthenon, Grand Canyon, Leaning Tower of Pisa, the Sphinx and Trevi Fountain of Rome. These 10 "wonders" may be seen—in scale models—in an area 700 feet long and 60 feet wide outside a Columbus shoppers' mart. The project was built without blueprints and is dedicated to the education and culture of all people.



Converted Tenders

What can be done with the tenders when steam locomotives are scrapped? The Milwaukee Road came up with some answers when it converted entirely to diesel and electric power. The old tenders made a trip through the shops and emerged as snowplows, cabooses, water carriers for track-maintenance forces and fuel-oil and sand carriers. The cabooses were made by stripping the tenders to their underframes, then erecting small steel cabs. The cabooses are intended for use only around railroad terminals, not for road service. They are expected to stand up well under the buffeting of such service because of the rugged underframes of the old tenders.





Near Hominy, Okla., this polyethylene-lined storage pit contains 2200 barrels of water for oil-well use

Plastic-Lined Lake

Polyethylene-lined water-storage pits substitute for steel storage tanks during hydraulic fracturing of oil wells near Hominy, Okla. Water from these pits is combined with sand under pressure to create crevices in the oil well to improve the flow. A bulldozer excavates the pit, which is lined with plastic film up to 80 by 400 feet in area.



Intake hoses carry water to truck for blending with sand. Mixture goes to high-pressure pump trucks for transfer to oil well

Polyethylene-lined pits may replace steel tanks such as those at left holding 21,000 gallons of water

Courtesy of Dowell Incorporated



NEAL BEAR RUNS A

HOUSE OF



Neal Bear operates the master intercom-station switch in the communications center located in his kitchen

By **Walter E. Burton**

WHEN HE DRILLED for water in his yard and struck gas at 300 feet, Neal Bear started a series of events that resulted in two more electronic systems for his already thoroughly electrified home. If you were looking for a practical example of how push buttons and electronics can work wonders in everyday living, you would need go no farther than this house, which nestles in a wooded valley about halfway between Akron and Cleveland, Ohio. It probably contains more wire, switches, and relays, and a greater complexity of electrical circuits, than almost any score of conventional homes lumped together—circuits which are used for lighting, entertaining, protecting, controlling, communicating, testing and laborsaving purposes.

The house evolved into its present state of electrification within a decade. Bear, a manufacturers' representative specializing in electronic equipment, used to have his headquarters in a downtown Cleveland building. Some years ago he got the idea that he might be able to conduct his work from his home in the country, so he erected a small work building between house and garage. The idea proved sound and soon it became necessary to provide more space. He combined the three units into one and

built additions, ending with a sizable two-story house. The first-floor level is devoted to work areas for himself and several others, and the second floor is occupied by living quarters. On a hill near the house is a tenant building that started out as a tower for testing television equipment and working out problems of TV reception.

Well Drillers Get Surprise

After the well drillers struck gas instead of water, Bear learned that there were other shallow gas wells in the vicinity that had been producing for many years. He piped the gas to the boiler of his hot-water heating system. This looked like an easy way to solve the fuel problem—but difficulties developed. A heavy rain came, choked off the gas supply and it turned out that water entered the well at the 290-foot level whenever there was a severe or prolonged rain or melting of much snow. When the weight of the water column in the pipe exceeded the 55-pound pressure of the gas, the gas flow stopped and Bear's house went heatless. If service was to be restored immediately without waiting for natural draining of the well, it was necessary to bail out the well, a tedious job through the 2-inch pipe.

ELECTRIC NERVES

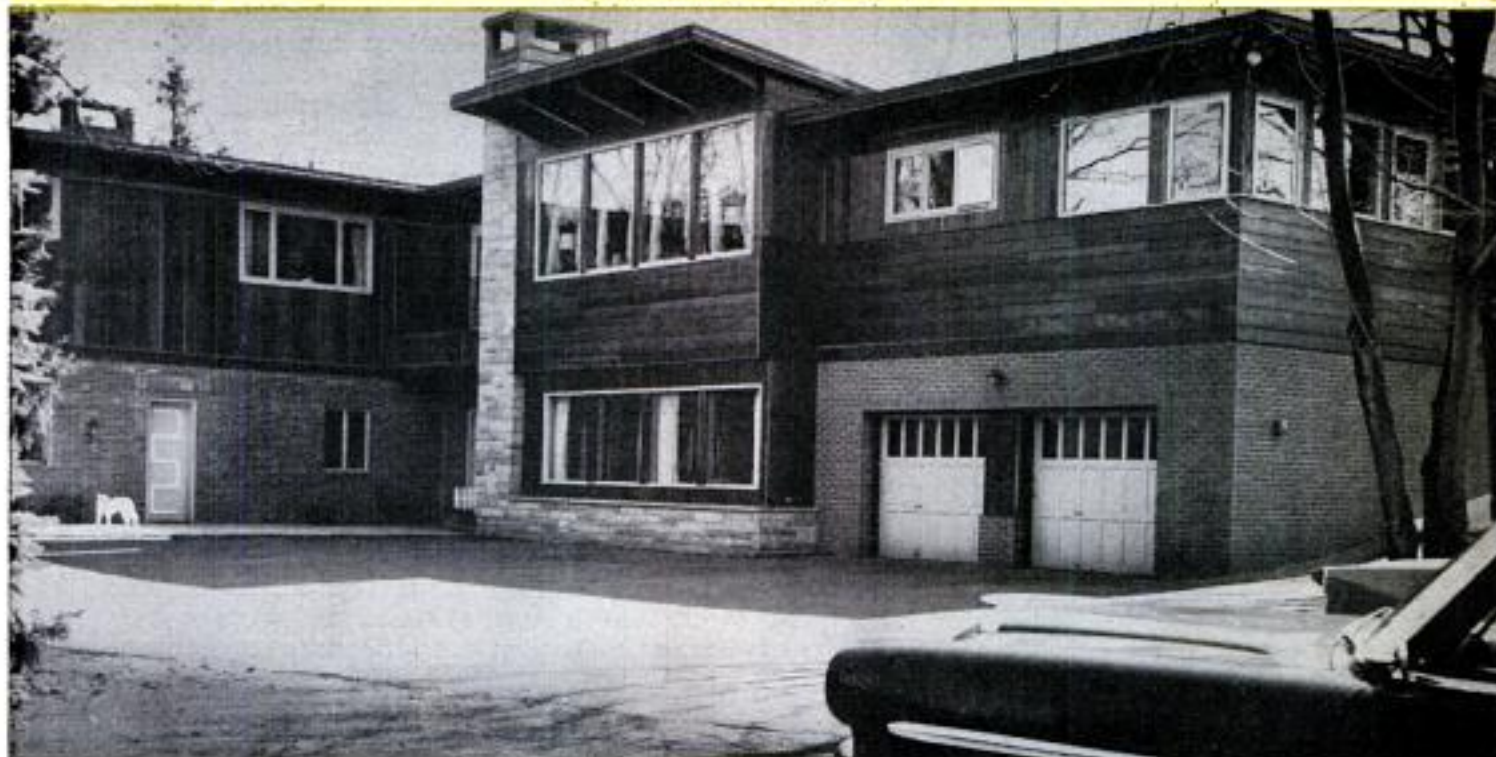

One of several floodlighting units is visible at the corner of the Bear house (upper right) above the garage

To prevent prolonged heating-plant shut-downs during his absence, Bear installed a conventional oil burner in the center of the fire pot. In the line feeding the gas burner, which encircles the oil unit, he placed a "sensing" valve that responds to small changes in gas pressure. When the furnace water-jacket temperature falls enough to operate a thermostat, this valve measures the gas pressure and feeds its finding into an electronic circuit. If the gas pressure is adequate, the circuit operates controls that turn on the gas burner; but if the pressure has fallen below the minimum point for proper operation, the circuit disconnects the gas burner and turns on the oil unit. Thus there always is heat, whether from gas or oil. In a heating season, the boiler operates about 80 percent of the time on gas, Bear says.

Electric Eye Watches Soot

This, however, did not end his heating-system control problems. He found that, with the two types of burners working in the same firebox, the flame sometimes would contain an excess of carbon, causing heavy soot deposits and resulting loss of heating efficiency. He solved this with another tailor-made electronic system. In the front of the firebox, he drilled a hole and inserted a metal tube finned on the outside

for cooling and equipped with a head containing a photoelectric cell protected from products of combustion by a window of heat-resisting glass. This cell is connected into a circuit that merely stands by so long as light from the furnace flame reaches the cell. But if excessive soot blocks the passage of light through the tube and glass while the burner is operating, the photocell circuit shuts down the furnace completely and rings a bell. Operation is restored after cleaning out the soot and adjusting the burner for proper mixture. With these two electric systems, plus six heating-zone thermostats each controlling a water-circulating pump and a main thermostat regulating burner operation with respect to water-jacket temperature, Bear's heating plant is well equipped to run itself with almost no attention. Routine maintenance includes lubrication of the pump motors, and here Bear uses a system that many other homeowners might copy with profit. He has, in the boiler room, a chart on which every lubrication date is noted, so that no motor is likely to go unoiled.

The complexity and much of the cost of Neal Bear's house are not apparent to anyone merely walking through it, for the wiring and many of the relays and other electrical devices used in the numerous circuits are concealed from normal view.

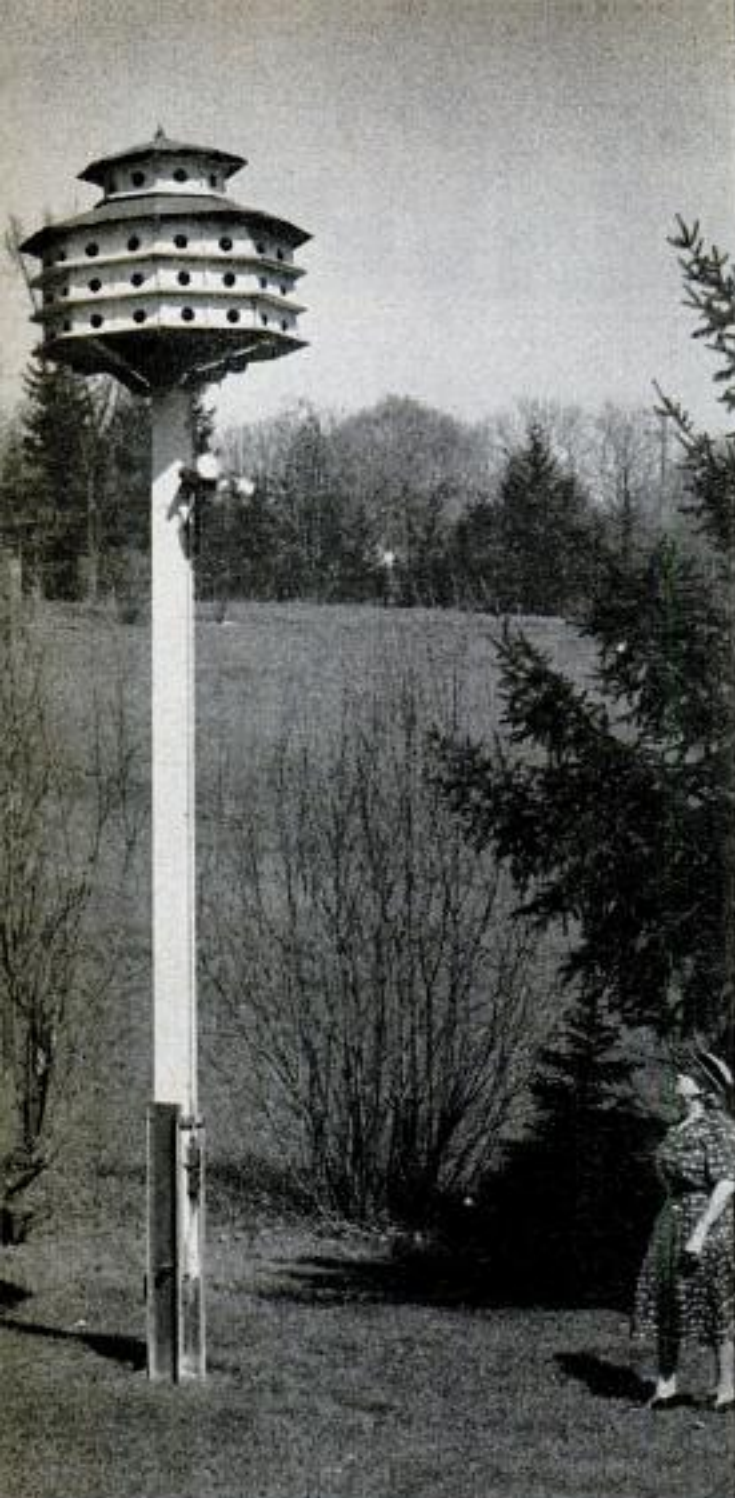

Above, on this birdhouse pole are mounted floodlights and an intercom unit to serve a lawn area. Below, the terminal board can be swung down to provide access to wires behind it for a major circuit change



A feature of the building is a crawl space, of 2½ feet minimum height, which runs, somewhat like an intermediate floor, between first and second stories. In its chief function, it might be likened to the spinal column of a highly developed organism. Through this space run the wires, ducts and pipes of the building's electrical, heating, air-conditioning and plumbing systems. This crawl space, all parts of which are accessible and can be well-lighted by touching switches, simplified the original installing of the facilities and it makes easy any necessary repairs and modifications.

Lights Have Remote Control

Shortly after Bear built his original home in the valley, he installed several outdoor lights controlled remotely by low-voltage relays. In such an arrangement, all switches are connected directly only to 24-volt circuits by wires much like those used in doorbell and chime systems. These circuits control relays that switch the 120-volt lamps and other equipment on and off. The relay system, relatively new when Bear first tried it, proved so convenient that, when he began plans for expansion, he decided to use it throughout his home.

It took him a month to work out the remote-control-lighting and outlet circuits for the entire house. They were designed for extreme flexibility. For example, his plans called for nine outdoor-lighting circuits — lamps to illuminate drives, floodlight the buildings and even a group on a birdhouse pole to light a lawn area. All these lights were to be controlled from six exterior doors in the main house and two in the building that is now the tenant house. These control stations must be capable of turning any one circuit, any group, or all of them on and off. The indoor circuits he planned were even more intricate.

When Bear had completed his wiring diagrams, he discovered that contractors would have nothing to with them. Too complex, they said—and cost of doing the work would have been prohibitive. So Bear persuaded his oldest son, Barton, to leave his electronics work in Toledo for four months and supervise electricians installing the wiring.

At practically every doorway and at some points in between, there are groups of push-button switches. In the remote-control system of wiring, each switch is a momentary-contact type requiring only a light pressure to operate it. Ceiling lights and base outlets of each downstairs room are controlled simultaneously by a single switch. This is to prevent plugged-in devices from being left connected overnight.



Radio, phonograph, tape and microphone sound are piped from this music panel to main and tenant houses

These outlet and ceiling-light circuits are so wired that a short circuit in one will not interrupt the other.

In a typical three-button doorway-switch installation, one button controls lights and outlets of the room in which the switch is located, another button controls those in the next room to the right, and a third controls those to the left. When there is no left or right-hand choice, only two buttons are needed. At each exterior door is another push-button switch combined with a knob adjustable to nine positions. This unit controls the nine outdoor-lighting circuits, one at a time or, at a twirl of the knob, all together. At some entry doors a third switch is used to control lights in other nearby rooms.

In the second-floor living area a similar switching arrangement is used, but base outlets are on separate switches. One button near each door controls ceiling lights and another handles base outlets of the room in which the switches are located, and a third button controls lights in the room being entered. Two plug-in receptacles in each outlet are switch-operated, one is unswitched so it can be used for continuously operating clocks or various appliances.

The house has an intercom system whose two dozen stations make it as complete as the telephone service in a small community. One important function is to keep track of Bear's younger sons and their playmates. One microphone-speaker is mounted on a birdhouse standard in the east lawn, another in a play yard on a hill behind the main house, still another by a creek that runs through the property, and so on. The children are trained to answer

any call that is sent out for them. At night, when the Bears are out, the occupants of the tenant house can check on the children merely by flipping a switch and eavesdropping through bedroom intercom units.

Intercom on Mailbox

An intercom speaker-microphone mounted on the mailbox standard beside the highway operates in conjunction with a colored-light signal system that has proved to be one of the most useful of Bear's electric gadgets. A green light informs the school-bus driver that no one will be coming to board his vehicle at the Bear drive that morning, so he does not stop. When the red light burns, one of Bear's employees, whose morning chore is to drive to a Cleveland-Akron highway to meet a bus bringing other employees, stops at the mailbox and, over the intercom, inquires about special instructions. Maybe the people came from the bus stop by other means, or something is needed from a store.

Signals at the mailbox can be operated from a main control station in the kitchen. This center also includes a master unit of the intercom system and a special telephone-switching arrangement. There are several telephone lines coming into the property, many of which are used for daytime calls. At night, when the family does not want to be bothered with nonpersonal calls, a flick of a switch disconnects all the daytime phones. While someone attempting to call on these lines hears a normal ring, the Bears hear nothing. The regular residence phone remains operative. On special occasions, as when a guest is expecting a call from his home, one of the

(Continued to page 254)

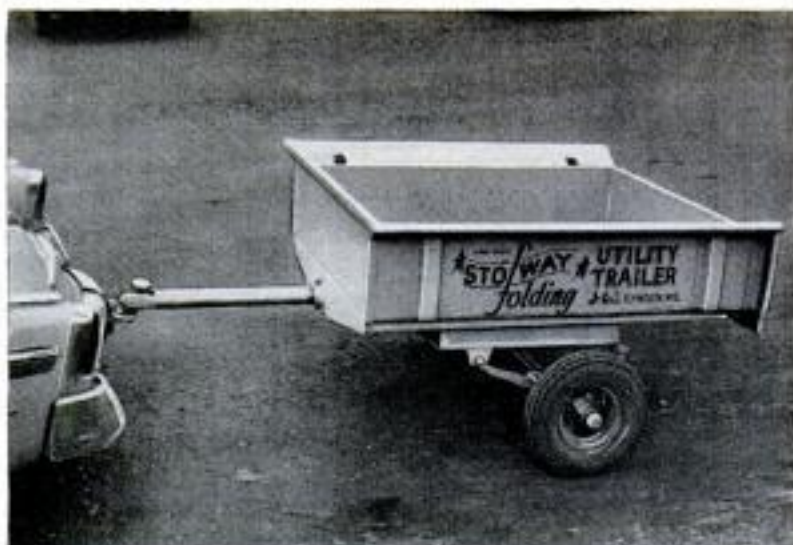

Utility Trailer Can Fold for Storage Like an Ironing Board

Storage space for a utility trailer is reduced to a minimum by a model that folds like an ironing board. The box of this trailer is mounted on a frame which slides backward for the storage operation. Two

choices are available, one in which the sides of the trailer box fold, and one in which they do not fold. These units are for farmers, contractors, field workers and families who need a trailer for vacation.

Portable Railroad-Cargo Carrier

Railroad freight-car bodies made of plastic fasten to lightweight flatcars for transport on the Rock Island Line. Fork lifts or cranes later transfer these demountable cargo carriers to loading docks or flatbed trailer trucks. Refrigerator cars have special adhesive bonding seals at



the joints and are cooled by a thermostatically controlled dry-ice circulating system. Other demountable cargo carriers include closed-box units, open-top gondolas, covered hoppers, tank-car sections, flat-bed pallets for carrying steel, and automobile carriers.

KEEPING UP WITH THE ATOM

EVEN THE SIMPLE flashlight may become something far different in the age of the atom. Atomic flashlights now are producing light which will last for 12 years or more without batteries or external power sources. The flashlight contains radioactive chemicals which give off light. Various chemicals produce white, green, yellow or blue light. The lights are designed to illuminate map boards, instrument dials, diving-gear markings and emergency direction signs in buildings.

☆☆☆

NOW IT SEEMS to be only a matter of time, brains and dollars until scientists tame the power of hydrogen bombs for peaceful use.

Scientists both here and in Russia seem to be lifting the curtain of secrecy just enough to show progress in the search for power from fusion reactions. The basic problem is one of confining heat. To wrest power from fusion, it is necessary to heat a nuclear fuel to a temperature of 100,000,000 degrees or more and confine it long enough for fusion to take place.

One suggested answer is use of a magnetic field as a container for the reaction.

The code name for the United States research program in this field is Project Sherwood. It seems destined to become even more famous than the Manhattan Project, which first achieved a chain reaction and produced the atom bomb.

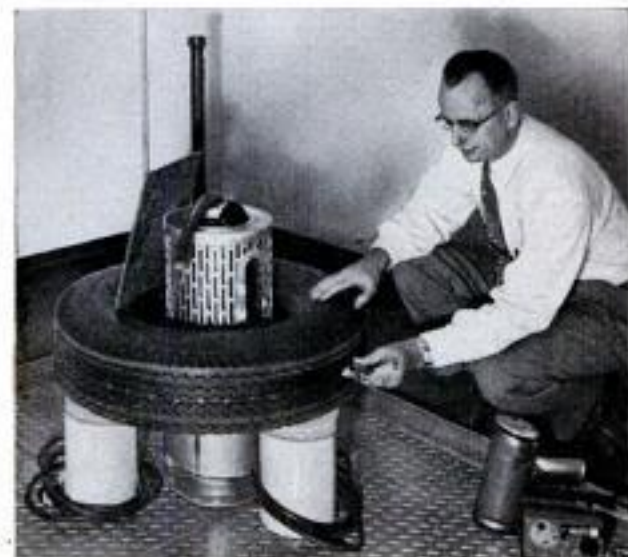

MARCH 1957

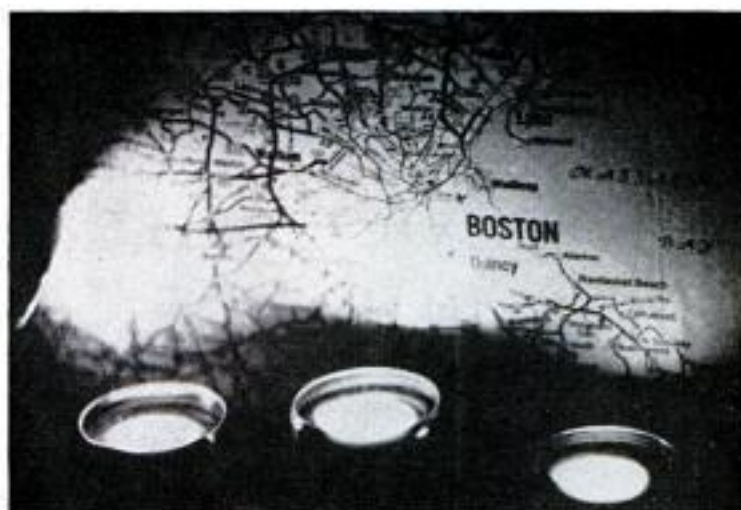

Early next year work will be started on what is claimed to be the world's largest atomic-power station, at Hunterston, near Glasgow, Scotland. Costing some \$98,000,000, it will begin generating 360,000 kilowatts of electric power by 1961. Twin reactors with 500 tons of natural uranium metal will provide the power. The atomic-power station is expected to save about one million tons of coal per year.

☆☆☆

RESEARCH APPARENTLY is under way to solve some of the detailed problems of building the atom plane. Admiral Corporation recently announced a research program to determine the effect of radioactivity on electronic gear of the type required by aircraft. Now Goodyear has built a new laboratory—the first of its kind in the rubber industry—to find out the precise effects of radiation on rubber. In announcing the laboratory, the company stated that "one of the more important projects contemplated is development of radiation-resistant airplane tires which could be used on atomic-powered aircraft of the future."

The Goodyear facility has a heavily shielded area known as the "cave" for housing the radioactive source, which is cobalt 60. This source is raised from the bottom of a 17-foot well into the center of the cave. It can be raised right up through the center of a tire. After the tire has been exposed to the high-energy gamma rays, it is inspected for damage. Rubber is particularly susceptible to radiation damage.

The laboratory also will be used to investigate the vulcanization of rubber and improvement of plastics by irradiation.

143

Copyrighted material

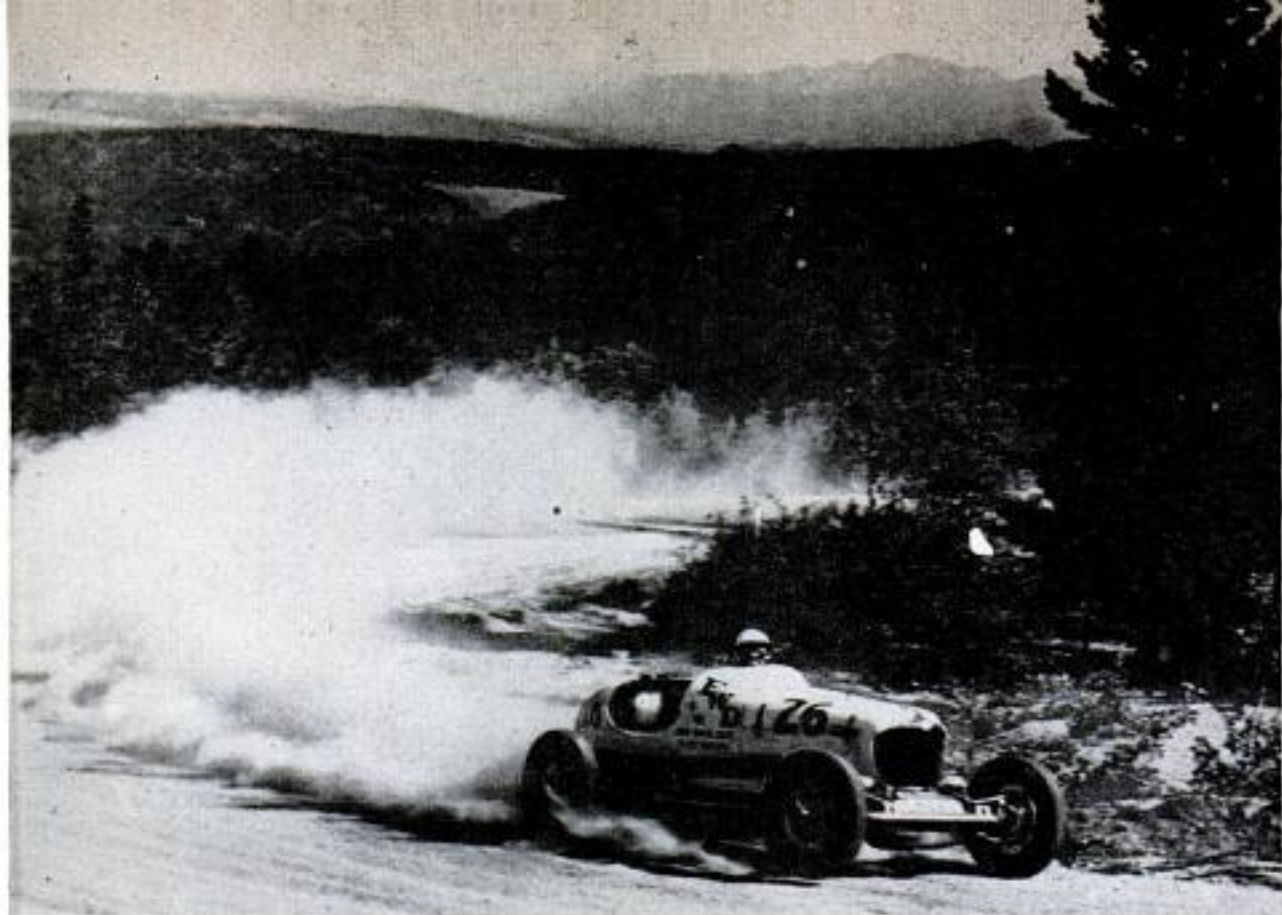

Cornell Aero Lab photos

Milliken is no armchair scientist. Here's a shot of him speeding up Pikes Peak in a four-wheel-drive racer

William F. Milliken is "Mr. Safety" of the Cornell Aeronautical Laboratories. At home in airplane or racing car, he is working toward this goal:

YOU CAN HAVE SPEED WITH SAFETY



By William Gilman



Left, Cornell Lab's Bill Milliken, is as much at home in a jet airplane as in a fast car. At right is the "rubber airplane" he helped develop to provide a way of pretesting flight characteristics before the new design is built. It is all done by electronic controls



Knobs in front of pilot give plane differing characteristics, making it feel longer, stubbier, wider-tailed

DRIVING THE highways near the Buffalo airport is an odd-looking version of the tail that wags the dog. It's a truck that took two years and \$140,000 to build. Its function? Simply to tow a wheel properly in the safety testing of new tires.

The tester fills an old need. While engineers have added power and beauty to the modern car, Cornell Aeronautical Laboratory engineers felt too little was known

about what actually goes on at the wheels. It is there that, among other things, tire traction fights centrifugal forces when a car screeches around a curve.

The truck's cost is due to complicated electronic instrumentation and safeguards for accuracy. Its towed wheel can be set for different slip angles and cambers. Electronic pickups measure the various forces on tire and axle and relay them to recorders.

Several tiremakers have tried, unsuccessfully, to buy this rig. However, C.A.L. allows them to take turns using it when it's not needed for testing plane tires (actually it was designed for the Air Force).

How to travel fast with safety is the





Above, four-wheel-drive racing car driven by Milliken has its tachometer mounted over the engine so driver can read it without lowering his eyes dangerously. Below, another of his cars is filled with special instrumentation to measure its stability

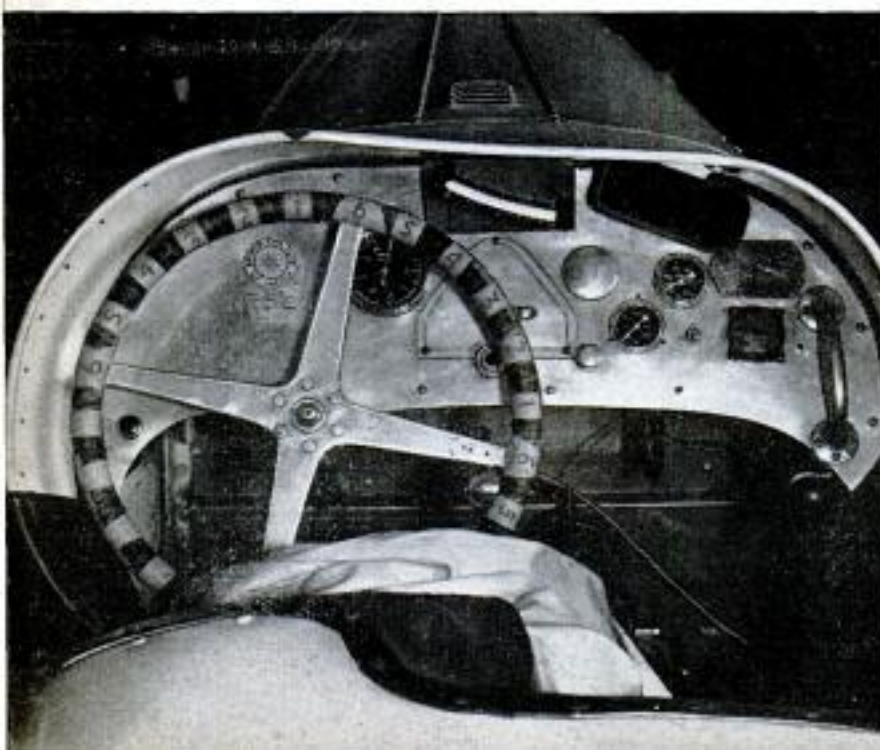

chief goal at this research laboratory which Cornell University took over from Curtiss-Wright in 1944 and now runs on a nonprofit basis. That's why experts in its Flight Research department see nothing odd about testing ideas for both the planes and cars of tomorrow.

They're headed by William F. Milliken, a fast-thinking aeronautical engineer who is right at home in racing cars. He is a pioneer in the modern sports-car era in America. "Milliken's Corner" at Watkins Glen, N. Y., is named after a rollover he survived in the first running of the Grand Prix.

But accidents haven't slowed his pace. His current enthusiasm is a special four-wheel-drive job that he races. Powered by the engine from a light tank, it accelerates in 12 seconds from standstill to 138 miles per hour.

However, Milliken points out that not merely speed, but *safe* speed is his business and hobby both. A few years ago, he began parking and rebuilding his racing cars at C.A.L.'s hangar. Out of that grew Flight Research's automotive section where engineers are as interested in why a car skids on wet pavement as in why a plane goes into a tailspin.

The air world knows Milliken for his big specialty—stability and control. His first tussle with these factors came when he was a high-school youngster in Old Town, Me. That's when he cracked up in his homemade airplane powered by a motorcycle engine.

He knew *how* it happened, but didn't start finding out *why* until he was taught the theories of stability and control at the Massachusetts Institute of Technology. From there, he went into practical aviation. He became chief test engineer on those risky first flights of such early big bombers as the B17 and B29.

It took years of engineering experience to evolve his "rubber airplane" idea for improving test flying. Before coming to Buffalo, Milliken had worked with the hush-hush XP79, an all-magnesium jet fighter that was abandoned after killing its test pilot.

Such tragedies had convinced him that the basics of plane design ought to be dug into deeper. He



Photographer snapped Milliken at start of his rollover in the Watkins Glen race. Safety belt saved his life

wanted a variable-stability plane whose flying characteristics could be changed in mid-air.

The "rubber plane" he worked out with colleagues at C.A.L. accomplishes this. It takes new-plane ideas up for test without the need for building such planes or risking test crews in them.

Engineers point out this helps solve aviation's oldest problem. Ever since Orville Wright's first flight, in which he complained of rudder troubles, designers of new planes

have been fighting the problems of pitching, sideslip, rolling and yawing.

C.A.L.'s quick-change planes use a servo-mechanism solution for the old problem. The trick is done by a "little black box"

(Continued to page 248)



Here's the back end of the \$140,000 tire-testing truck. Mechanic puts needle into tire to get temperature reading. With this rig, much is being learned about wheel stability

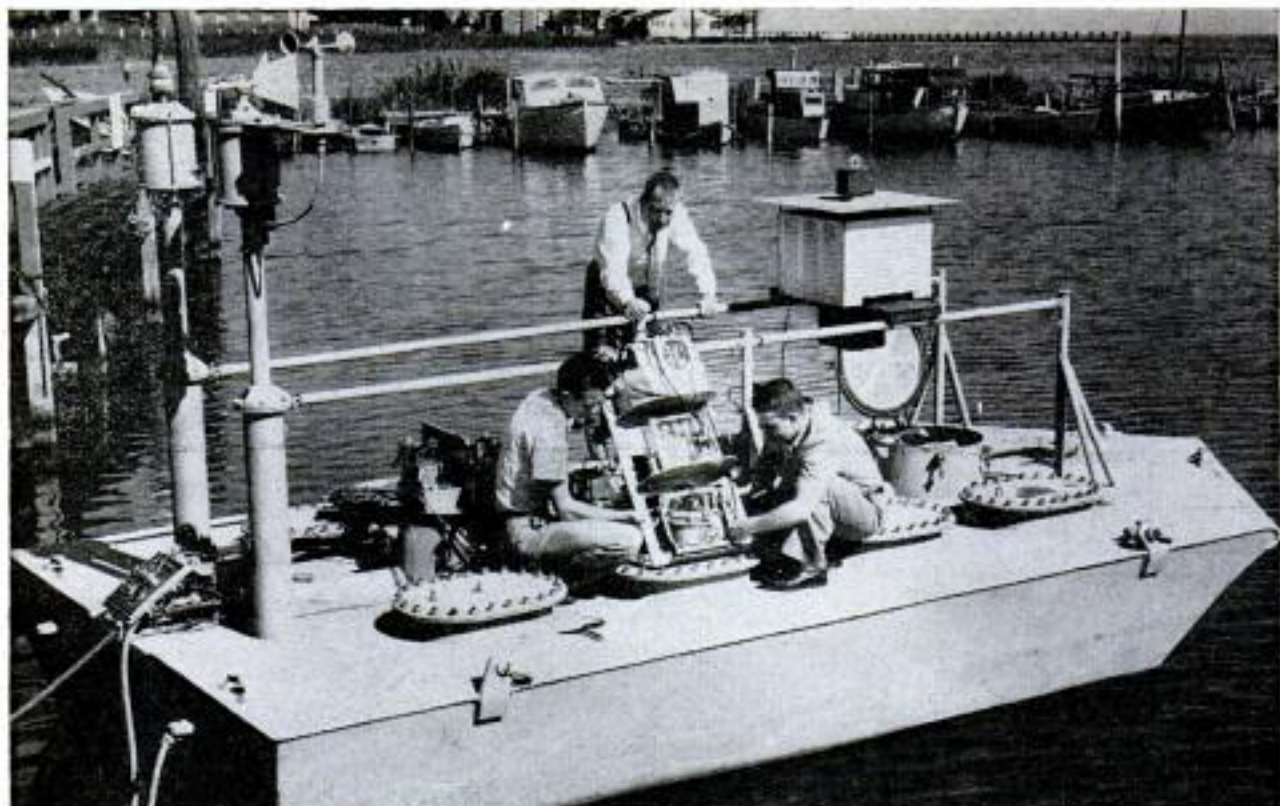

With an 800-mile radio range, this buoy will broadcast periodic information on local marine-weather conditions

Automatic Weather Station Broadcasts Data From Remote Buoy

Local marine-weather data is regularly reported by radio apparatus in a buoy that can be anchored in remote areas and left unattended up to six months. At intervals daily the station broadcasts in code the exact air temperature, water temperature, barometric pressure and wind speed and

direction. Tests show the station to have a radio range of more than 800 miles. Developed by the National Bureau of Standards, this automatic unit is 20 feet by 10 feet in area. It is made of aluminum and other nonmagnetic alloys and can be anchored in waters as deep as 3600 feet.

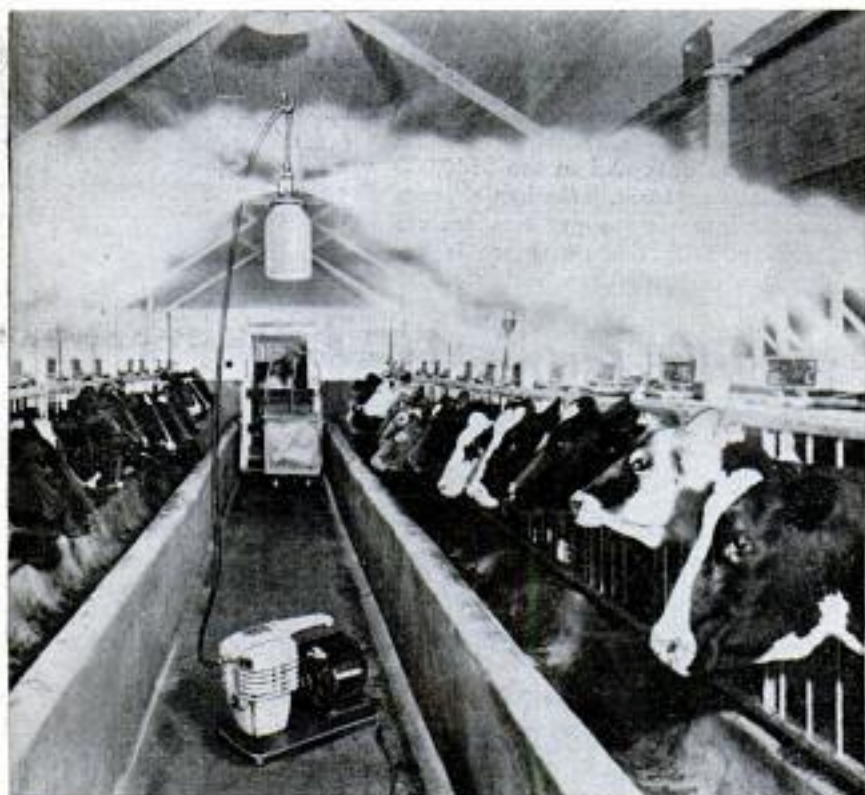

Suspended Sprayer Kills Barn Flies

Farmers can rid their dairy barns of flies automatically, without endangering their livestock, by using a spraying unit that fills the barn with a fog of insecticide vapor. Spraying lasts only five minutes. Insecticide is ejected in a mist from the nozzles of a half-gallon plastic bottle suspended from the ceiling. Air pressure to operate the fogging bottle comes from an air compressor that can be purchased with the unit. Any $\frac{1}{4}$ -horsepower electric motor can be used to power the compressor, which is adaptable for paint spraying and similar work.



World's Largest Dump Trailer Can Carry 100 Cubic Yards

Built to carry coal down mountainsides in West Virginia, a hopper dump trailer will convey more than 100 cubic yards. Towed by a special tractor, the trailer has

a struck level of 95 cubic yards of coal and carries more when heaped. The unit weighs 100,000 pounds when empty and is nearly 70 feet long.



Camera Features Three Film Cases

Interchangeable film cases are featured on a small German camera that permits use of color film for one shot, fast black-and-white for the next and slow black-and-white for the third shot. Replacement of the case can be made in a moment. Three film cases suitable for any kind of film are included with each AD-GX 300, made by the Dr. Schleussner Works in Frankfurt, Germany.

Tractor Furnishes Water By Boom-Mounted Irrigation Pump

Enough liquid to cover $4\frac{1}{2}$ acres hourly with an inch of water is furnished by an irrigation pump boom-mounted on a tractor. Operated from the tractor's power take-off, the unit works by backing the tractor to a water source, clamping a plastic tubing to a discharge outlet and submersing the pump. A 12-foot boom enables the operator to work from steep banks.

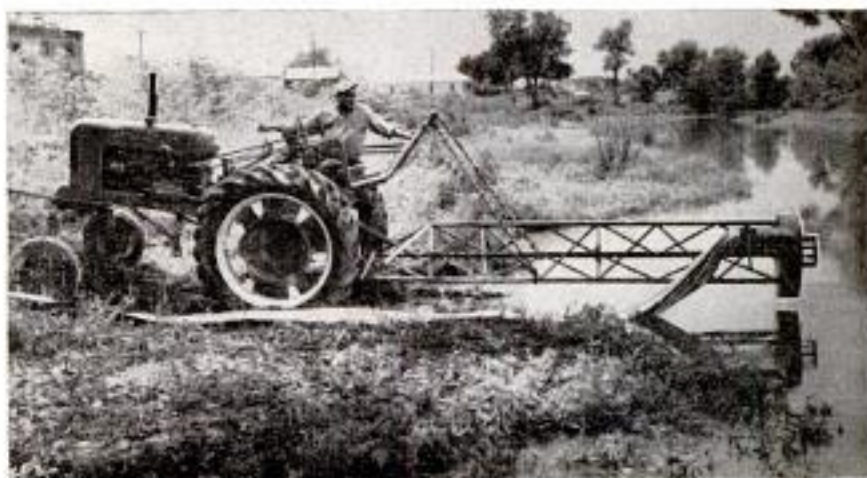

Tap the Hillside for WATER



By Leland Elam

THE OLD FARMER who hauled water instead of drilling a well supposedly said, "Water is closer sideways than it is straight down." California farmers who live in areas such as the foothills along the Coast Range Mountains know the statement is true.

Many a Western farmer has taken a tip from the old-timer's remark and is now taking water out of a hillside through a horizontal well. The method was developed after World War II. Farmers get the water from what they call "perched water levels" by drilling a hole into a hillside, sloping it slightly upward so the water will drain down.

Although these wells are not gushers, in many places they produce enough water to turn dry-land ranches into good dairy ranches with irrigated pastures.

These horizontal wells can never be plugged. The pressure that builds up blows out any plug yet devised, so they flow all the time. Some wells produce a trickle, others up to 100 gallons per minute. Most flow at the rate of 30 to 50 gallons per minute.

One feature the farmer likes is that it takes no power to keep the water flowing.

Roland Matteri in Sonoma County is using several hillside wells to good advantage. In 1946 this farmer, who had been operating his ranch as a dry-land pasture for beef cattle because there was not even a flowing spring on the property, heard about horizontal drilling for water.

He drilled several wells into the hillsides and got enough water to start a milking herd of 60 cows. He expanded to 100 head in 1949 and 162 in 1952. Besides watering the cows and giving water for use in the milkhouse, the hillside wells feed into a storage reservoir which irrigates 40 acres of pasture.

Another example is seen on the Bert Allenby ranch in Napa County. It cost him just \$200 to slant a 100-foot well into the hillside to get enough flow to keep a reservoir full so a 500-acre livestock and fruit ranch could be improved.

The farmer has to use these hillside wells because water is not available from any other source.

In many of these lower mountain and foothill areas the farmers have found it impossible to drill straight down and find water, for under the soil there is a blue rock which is simply too thick to drill through.

Such a rock formation prevents farmers from drilling straight down for water except in a few instances where they do find faults in the rock or find it is shallow in depth. Farmers have had to depend on springs and rainwater caught in reservoirs during the summer, or get along without water.

When a farmer has a spring on his ranch which gives water, or which used to give water but has closed up over a period of years, he usually has a good site for a hillside well. If there is no spring on his property, a scout goes up in an airplane and flies over the ranch. From the air he can spot where the vegetation is the greenest. Such a green spot generally will produce a flow of water when drilled.

Horizontal rigs are used to drill the wells. A gasoline engine powers a two-inch drilling bit. The bit is mounted on the end of a one-inch pipe, and as the drill digs into the hillside more pipe is added.

The bit has a hole in the center so that water can be forced through it by a pump to flush out the borings. Water is brought to the scene in tank trucks.

Two hundred feet of drilling is seldom more than a day's work, for in most cases rock is not encountered because drilling is above the blue stone.

Once the water is flowing freely a length of two-inch pipe can be driven into the hole to eliminate cave-ins. ★ ★ ★



Flow is continuous from hillside wells, which can't be capped because of the high pressure. Below, workmen fasten pipe extension on drill bit





German-Built Diesel Coaches Cut 1½ Days From Mountain Trip

German-built twin diesel rail coaches have reduced travel time on the mountainous, 280-mile Guayaquil-Quito run in Ecuador from two days to 10½ hours. When six coaches being built in Western Ger-

many arrive to supplement four coaches now in service, the trip will be scheduled daily. Each coach has a snack bar and can seat 36 passengers. The hostess, engineer and his assistant form the crew.

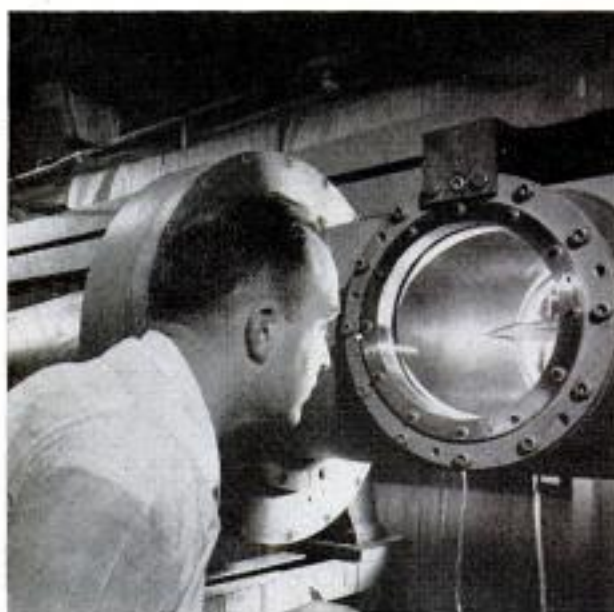

Hypersonic Wind Tunnel

Long-range missile and aircraft models, mounted in a 16-inch-diameter hypersonic wind tunnel, "fly" 11,000 miles per hour in 15,000-degree heat under 20,000 pounds' pressure per square inch. Operated by the U. S. Air Force in Tullahoma, Tenn., the tunnel's 1/100-second flights, photographed at high speed, may solve the problem of destructive heat met by ballistic bodies re-entering the earth's atmosphere after outer-space flight. Air is pumped into a storage chamber and sealed by a light plastic diaphragm from the downstream tunnel "vacuum area." An electric charge is sent into the upstream air-storage chamber, pushing heated, high-pressure air through the plastic seal. Stabilized, high-speed air flashes through a conical nozzle, which increases air velocity before it hits the model.

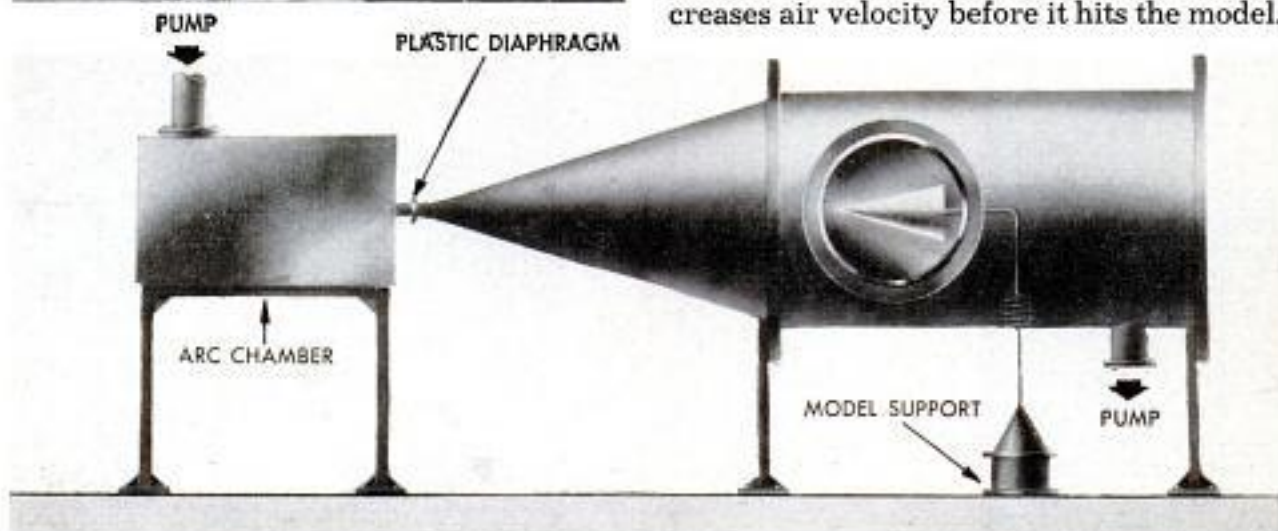

Steamboat Comin'— All 16 Feet of It!

UNWILLING to permit steamboating to pass silently from the American scene, a Wisconsin farmer has rebuilt his 16-foot, flat-bottom vessel into a steam-driven river craft. Skipper of this contrivance is Delmar Kolbe, who raises crops in Marathon County for a living and pilots his nautical brain child when chores permit.

"Captain" Kolbe first altered his boat to hold a steam engine. He then fitted the vessel with a propeller, rudder and four-spoke steering helm. The engine is mounted on a two by four-foot frame for carrying to and from the boat. When the engine has been put in place, a chain drive couples the sprockets on the motor flywheel and the propeller drive shaft. By varying the size of the sprockets, crewmen control speed.

Fuel consists of wood scraps which are fed into the small steam boiler. Power comes from the 120-pound pressure generated in this boiler. The engine operates economically and cost of operation is rock bottom. In addition to supplying the motive power, the engine also provides steam for the boat's twin whistles. Usually, in case of emergency, a supply boat loaded with extra passengers and fuel follows in the wake of Kolbe's craft. Much to the surprise of captain, crew and guests, few emergencies arise.

Like its more illustrious forebears on the Mississippi, Ohio and Missouri Rivers, Kolbe's boat has received formal christening. His four-year-old daughter, Jean, broke a bottle over the bow.

All-aboard whistles sound as the craft is readied for an eight-mile trip down Big Rib River in Wisconsin

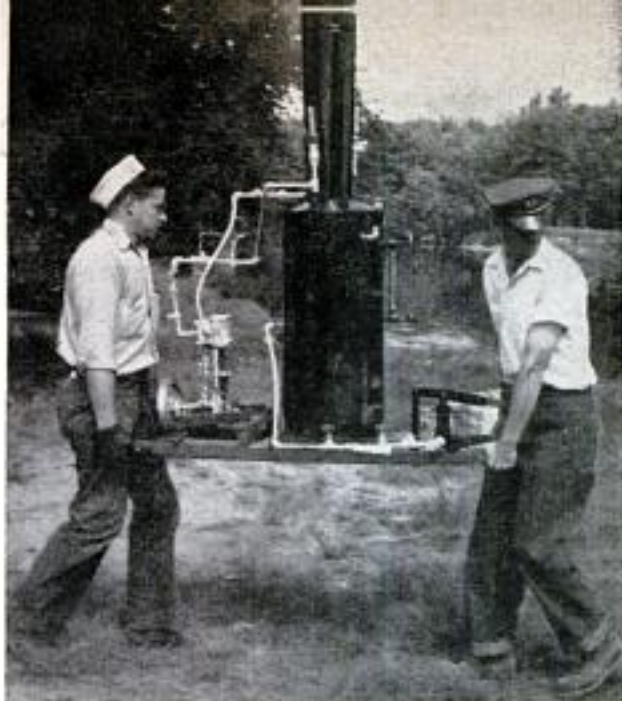

Above, two crew members carry the steam engine from a truck to its place in Kolbe's craft. Below, the stoker pushes scraps of wood fuel into the steam boiler, which can generate 120 pounds of pressure

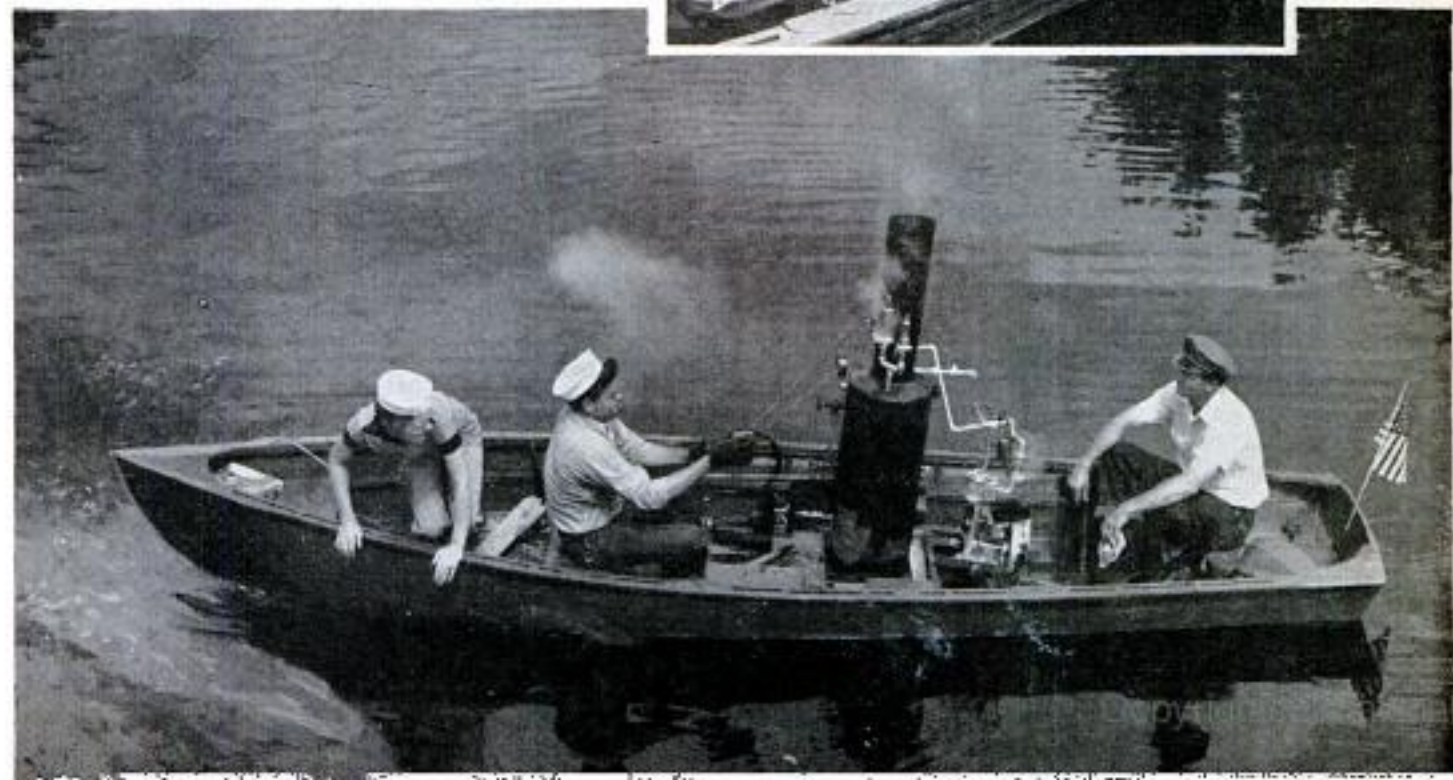
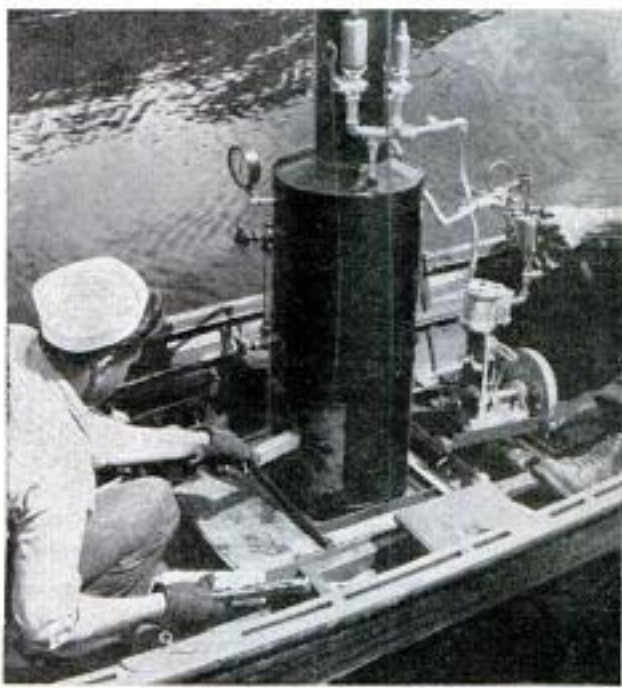

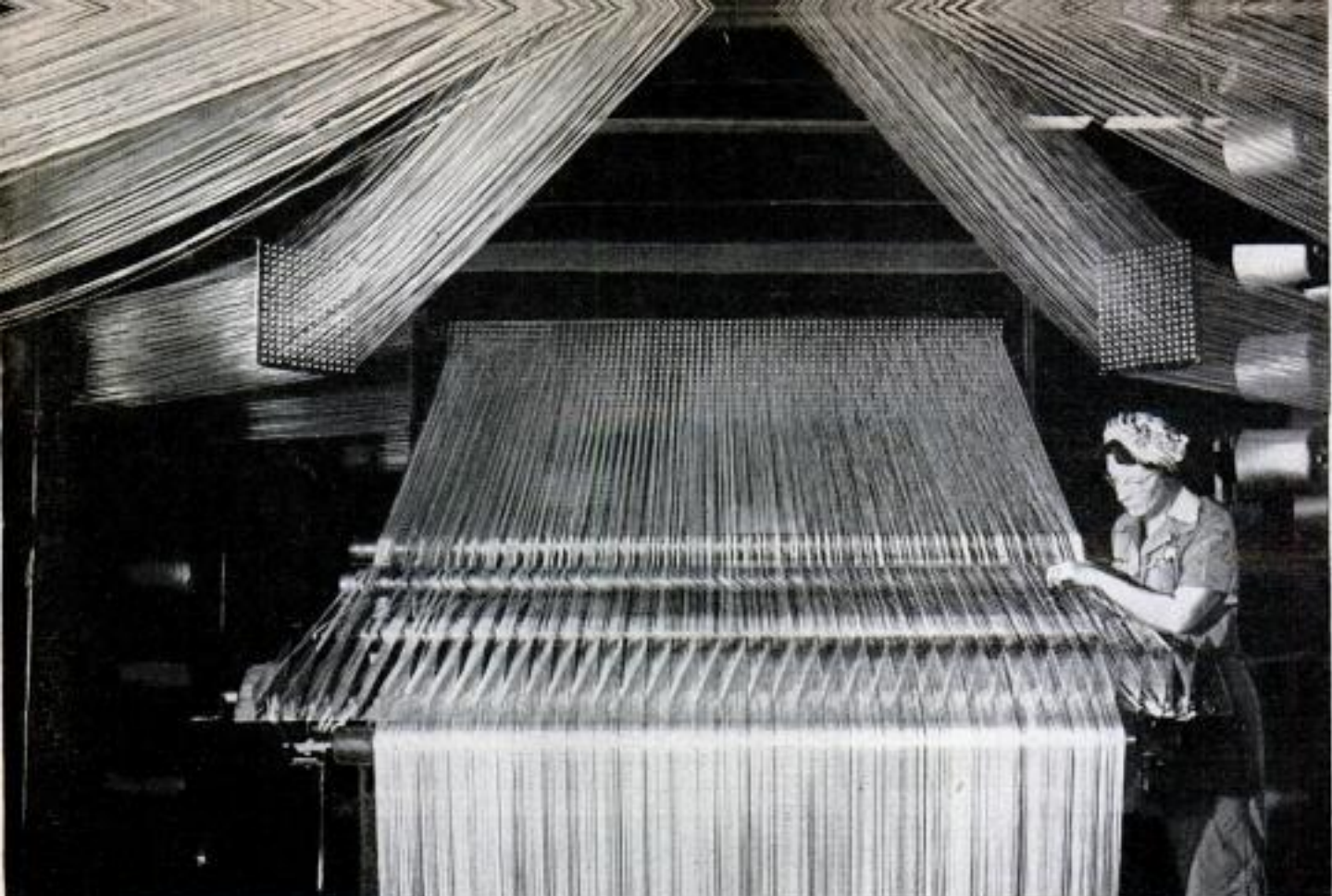

Textile cords—millions of miles of them—pass through the creel room where they are processed for tires

Science focuses on textile fibers to give you **MORE MILES ON YOUR TIRES**

High-speed camera shows how waves travel around a tubeless aircraft tire under severe shock of landing

By **Walter E. Burton**



YOU ARE ROLLING along at turnpike speed when there is a sudden "whomp" that makes the car shudder and waver for an instant. Instinctively you know that your right wheels struck one of those unexpected chuckholes that blossom on so many highways in the spring. Visualizing the sharp edges of concrete gouging into your tires, you slow down, waiting for something to let go. But nothing happens, and the car rolls merrily along as if it never had been jounced. Even days and weeks later you don't get a delayed-action flat. With some luck, plus a lot of science that has gone into your tires, you have escaped a blowout—one which, not too many years ago, would have been considered inevitable. Oh, sure—you can have blowouts today from hitting chuckholes and bricks; but as a result of constant research on tire construction, such mishaps are not as common as they used to be.

If you go far enough behind the scenes, you will find an instrument that deserves a considerable portion of your thanks for preventing that chuckhole blowout. That instrument is the compound microscope. Often teamed with a camera, the microscope has done key work in giving the motorist and the trucker tires that wear longer and are safer than the best yesterday had to offer. While the motorist has been listening to talk about improvements in rubber compounding, researchers have been quietly directing their skills and their lenses on another, no less important, part of the modern tire—the skeleton composed of textile cords.

"Shock Shield" for Truck Tires

Typical of this work are the studies by microscope of tire cords carried on by R. H. Judson and others in the B. F. Goodrich laboratories at Akron and Brecksville, Ohio. From thousands of photomicrographs, long hours of tedious peering and a seasoning of imagination have come such improvements as a nylon "shock shield" incorporated into truck tires.

The average motorist gives little thought to the "dry goods" part of his tires. In a typical truck tire there is enough rayon cord—14½ miles of it—to make a good many shirts for him or dresses for his lady. Each cord has 1500 fibers, which makes 21,750 miles of rayon fibers in each truck-tire casing. In a typical (7.60-15) passenger-car tire there are fewer potential shirts or dresses, but still nearly 2½ miles of cord, or 3880 miles of fibers. The manner in which these fibers hold together and behave under such influences as compression and tension has much to do with the tire's behavior and length of life.

The bundle of 1500 fibers in a tire cord measures about .028 inch in diameter, so it is necessary to magnify the fibers greatly—each is smaller than a human hair—in order to discover what they are doing. Tires are sliced into paper-thin sections to reveal how well the cords have united with surrounding rubber, to show the depth of penetration of the adhesive dip, and so on. Individual

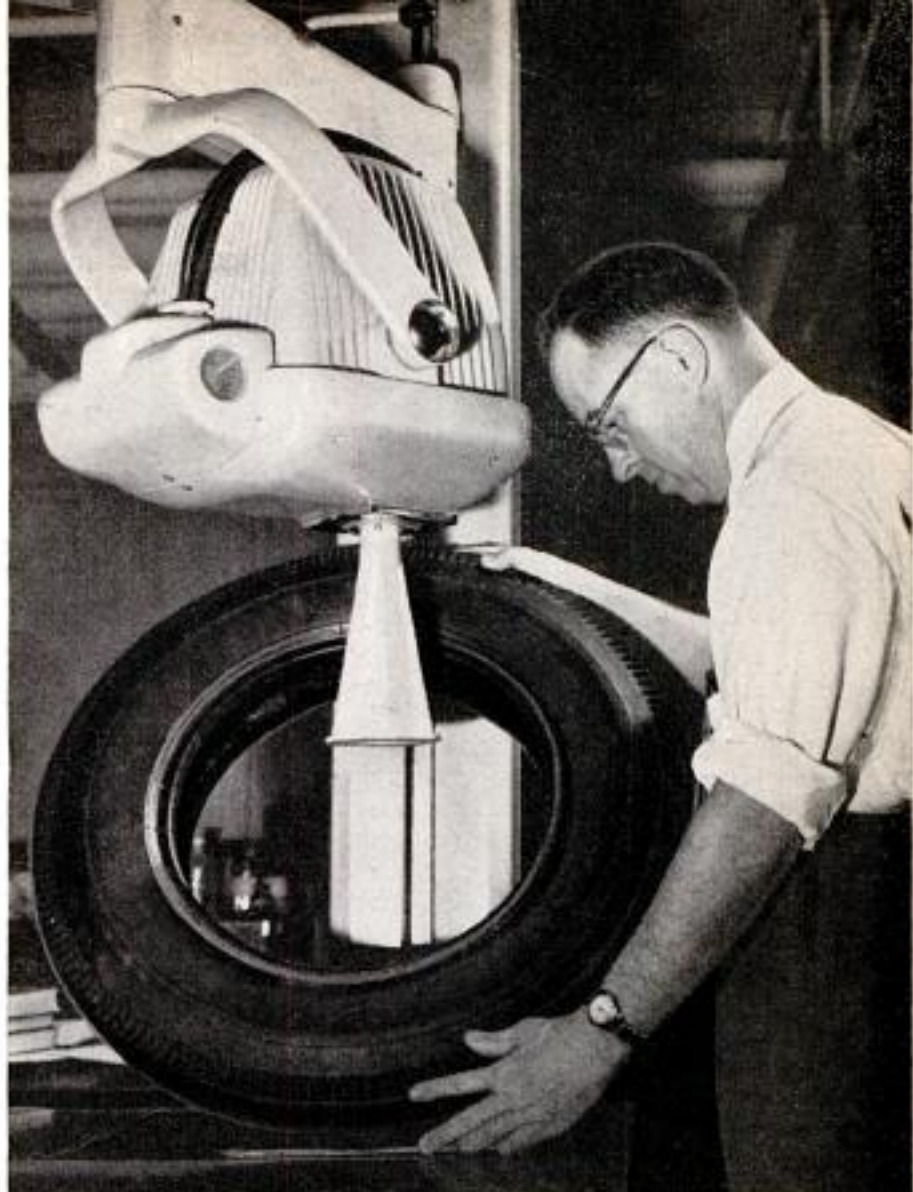

X-ray machine can reveal arrangement and damage to cords in a test tire without cutting or otherwise disturbing them. Below, cross section shows layers of rayon-cord plies that build up the body of truck tire, with nylon "shock shield" around them
B. F. Goodrich Co. photo

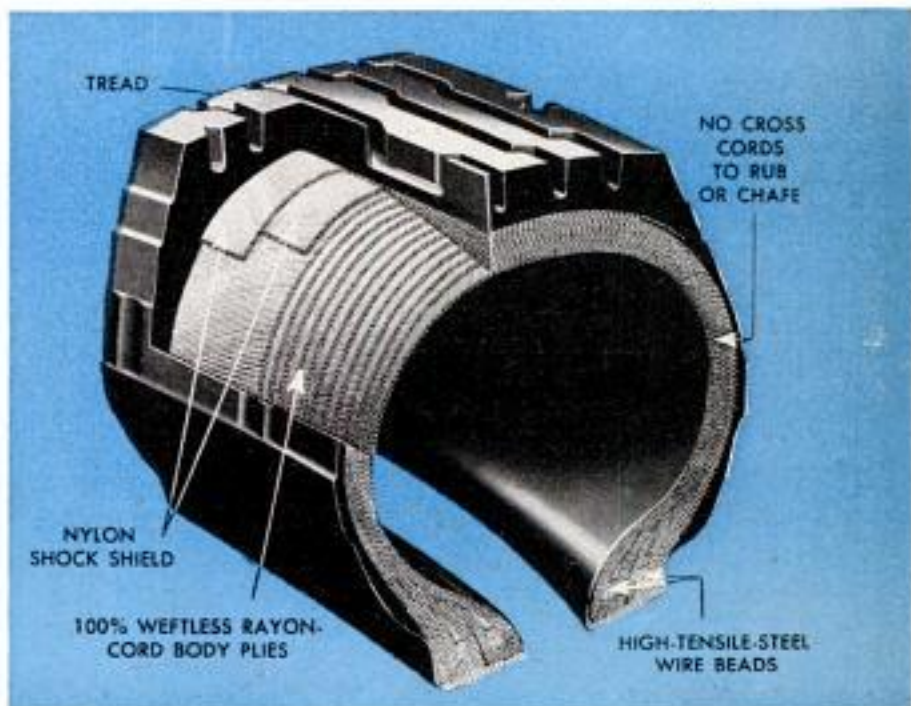

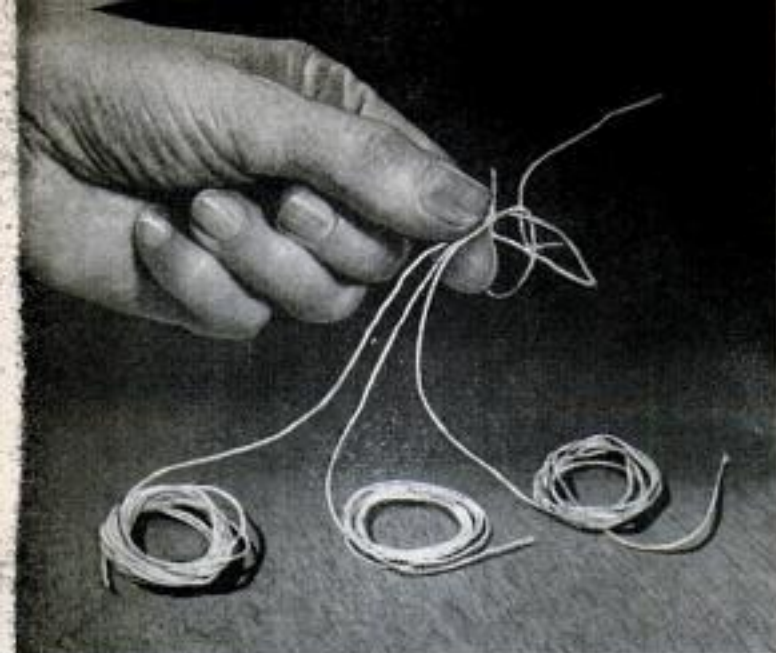

Three kinds of tire cord are, left to right, cotton, nylon and rayon. Other synthetics may be used soon

cords are jammed into slots in thin metal plates, with nylon fibers packed around them to hold them in place, and the cords and packing fibers are cut crosswise at plate surfaces to provide cross sections that can be examined under the microscope.

Spotting Failures

Before World War II, tire bruising was a common form of tire failure. Today bruising is less common, largely because manufacturers have learned how to use rayon and nylon cord in tires, and such cords are stronger than the cotton ones formerly employed. When a tire does fail, studies with a microscope may reveal what part the cords played in the failure. Because stresses on cords may leave permanent marks, a trained observer, by examining a tire, often can spotlight the cause of failure.

When a plane lands, its tires take a tremendous beating. Cords are compressed six to ten percent, then quickly subjected to tension. Microscopic examination of such a tire reveals numerous tiny cracks in the rubber, each one beginning at a cord. In a section obtained when the tire is sliced parallel to one of these cords, the thin rubber over the textile material shows a regular series of breaks, each coinciding with a twist in the cord and each being in alignment with the twist angle of the cord. Such breaks are caused by the compression-tension-compression cycle.

Judson has made considerable use of color photography in his micro-explorations of tire cords. Color film records the images of textile fibers and other tire elements illuminated by polarized and other types of light. Such pictures reveal many things about the tire—for instance, the depth of penetration of the dip into the cords.

This dip is an adhesive that unites cords

with the surrounding rubber compound. An example is a resorcinol-formaldehyde resin, similar to that used as a glue in making waterproof plywood. It is mixed with latex to serve as a cord-to-rubber adhesive. Action of the dip is controlled so it penetrates only the first few outer layers of fibers forming a cord. Thus at any point along the cord, the outside fibers become anchors to hold the cord in place, while the inner fibers are free to move and adjust themselves to the stresses. Because of the way in which the cord is twisted, fibers that are "inner" at one point have, at a point farther along, changed places with outer fibers. The microscope is used as a means of keeping check on fiber arrangement during manufacture.

Studies by Radiography

Of course, microstudies of tire fibers are supplemented by other research involving the textile parts of a tire. Thus radiography is employed in studying cord position, failure and other conditions within the tire.

Tire cords are composed of strands twisted together. The number of twists per inch is important. A cord twisted too much or not enough will not behave satisfactorily under such influences as compression. In studying the effect of vibration on blocks of tire rubber containing cords, researchers have watched low-twist cords actually "unthread" themselves, crawling out of the rubber like so many worms.

A tire in use must withstand vibratory flexing which can tear the textile skeleton apart. One of the goals of the tire maker is to put rubber and textile fibers together in such a way that vibrations are made less destructive. The typical tire in service experiences compression and tension where it touches the roadway, but the resulting vibrations travel in waves completely around the wheel. In fact, in laboratory tests, tires

NYLON FILAMENTS shown under microscope in cross section. Each nylon cord contains 240 filaments

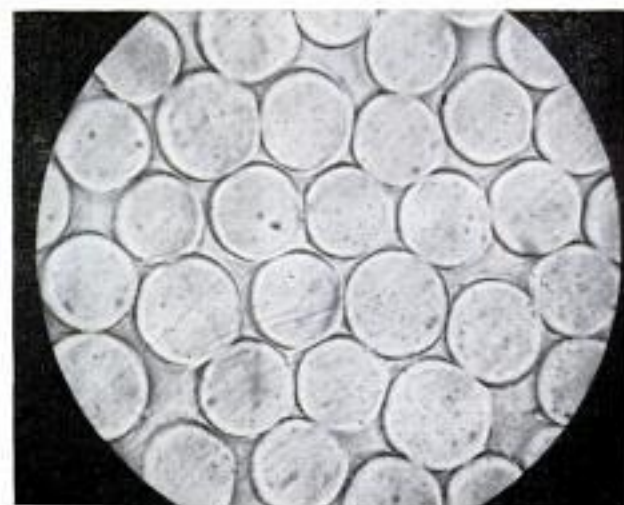

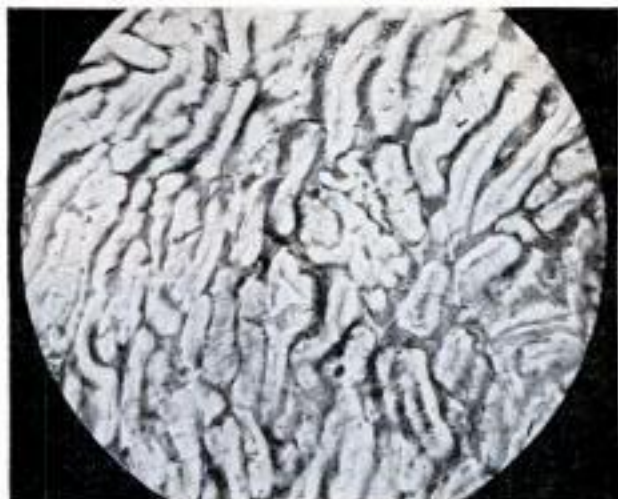

RAMIE FIBERS: Ramie is one of the strongest of natural fibers, but it will not withstand repeated flexing

subjected to vibration have been made to blow out *on top* instead of where they contact the "road."

Tire scientists explain that vibration limits the kinds of textile fibers that can be used successfully in tire cords. So far, the only natural fiber that has been satisfactory is cotton, in which each fiber is a single cell. Two manmade fibers, rayon and nylon, form, with cotton, the trio of cord materials used in tires in recent years. Some wire is employed, too, but is not classed as a textile. Other fibers, including a percentage of hush-hush ones, are constantly being investigated, and something even better than nylon may come out of the laboratories in the future. Natural fibers such as those of linen and ramie are unsatisfactory because each fiber is composed of many cells separated by cross membranes, and vibration of the tire causes breaks at these joints between cells.

At one time cotton was used as the cord material in all tires, but now it is out almost entirely and rayon is reported to be in the lead, while nylon is rapidly catching

COTTON FIBERS: Cotton is the best natural fiber for tire cord because it combines strength and flexibility

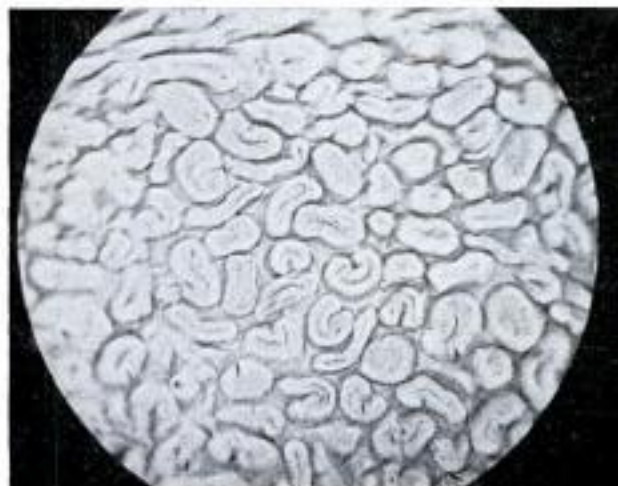

MARCH 1957



HUMAN HAIRS: For comparison purposes. The diameter of each hair is more than twice that of tire fibers

up. One tire scientist pointed out that in 1955 eight pounds of rayon were used for every pound of nylon in making tire cords. There have been important improvements in the rayon available for tires. It used to be thought that only rayon made from cotton was satisfactory; now most of it is made from wood pulp and is said to be better than ever. More and more kinds of wood are being utilized, ranging from Florida pine and Mississippi hardwoods to Canadian hemlock.

Tire to Outwear Car?

From scientific studies of tire cords and cord materials comes promise of the "perfect" fiber that will do much to make possible a tire that will outwear the car. If researchers could pick out the best characteristics of experimental fibers now known, and combine them into one fiber, such a tire might soon become commonplace.

The tedious business of studying tire cords with the microscope may not be as spectacular as driving tires over rows of

(Continued to page 228)

RAYON FILAMENTS: Each rayon cord contains 1500 individual filaments, each as long as the cord

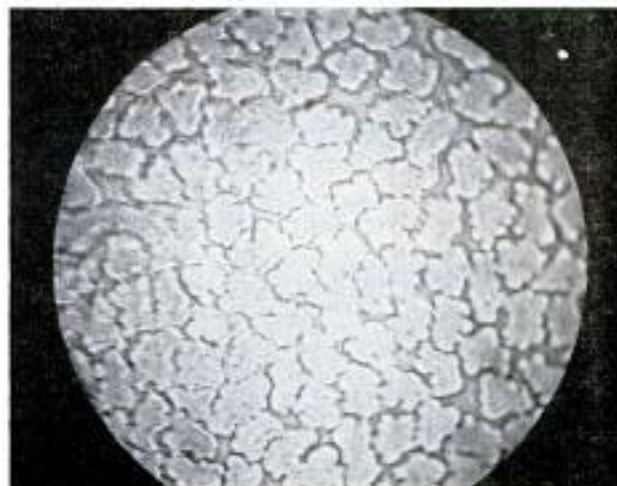

157



Men to Live Underwater Beneath Radar Tower

Operators of a newly designed floating radar warning tower are to live 115 feet beneath the surface of the ocean in a 70-man "doughnut" installation. Elevators inside pillars will rise to a helicopter deck and radar units 65 feet above water level. A centrally located atomic reactor will supply electric power and work a small engine to prevent the station from drifting out of position. Towed to mid-ocean, the tower could remain in one spot for three years before being returned for reconditioning. This tower has been created by Northwestern University engineering students to supplement fixed Texas Tower radar structures off the coast of New England.

Weekly Blood Donations

Two Philadelphia physicians report that a blood donor can safely give a pint of blood every week by a method of separating the plasma from the red blood cells and returning the red cells immediately to the donor.

Trick Cord for Trunk

When you can't close the car trunk lid on a bulky object, you can tie the lid down firmly with an adjustable Neoprene rubber cord. Two hooks at the top slip into holes in the under edge of the trunk lid. Clamps on either end of the cord grasp the bottom of the bumper. The 8½-foot cord can be slipped through holes in the bumper clamps to secure proper tension.

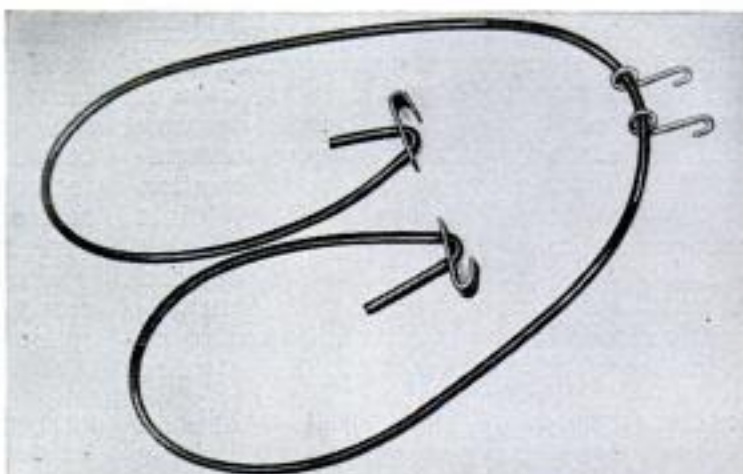

Satellite Sees Weather

Weather predictions, based on daily observations of the sun from an earth-circling satellite, might be routine in five or ten years, scientists say. Instruments will measure visible and invisible solar radiation affecting long-term climate and day-to-day weather. Behavior of radio waves in the earth's upper atmosphere is to be studied. Weather patterns evaluated by electronic computers and data gathered during the International Geophysical Year may clarify these solar relationships.





Captain's Custom Car Combines Parts of Many Automobiles

Starting with the chassis of a Willys car, Capt. Paul Jones of Eglin Air Force Base, Fla., built himself a custom car that excites envy wherever it goes. Included in the car

are the front-suspension system of a Hudson, the rear end, transmission and engine of a Ford, plus many parts from Studebakers. Wheels were taken from a Crosley.



Transport Planned For Small Airports

Planned for operation from small airports, a new transport, the F-1 Safari, is now on the drawing boards. The Safari is to be built by the Frye Corporation of Fort Worth, Tex., in the hope that it will prove versatile enough to replace that venerable workhorse, the DC-3, which for 20 years has done the heavy, short-haul lugging for both the military and the airlines.

Ship Model Seems Wingless Aircraft

What appears to be a mixed-up airplane shorn of wings is a ship model designed by Dieter Jansen, a refugee from the Soviet zone of Germany. It scoots along on top of calm water at 60 miles per hour. Six miniature diesel engines, three mounted in a row on each side, turn the ship's airplane-type propellers. A rudder takes care of steering, which is done by remote control.





Four Navy Jet Fighters Refueled Simultaneously

Four Navy jet fighter planes are refueled at the same time by a Convair R3Y-2 Tradewind. Refueling time for the planes was less than five minutes, with the fuel coming from the R3Y's own wing tanks, which hold enough fuel to service eight fighters. The R3Y is a turboprop built to serve as a transport and a tanker.



Telescopic Tracker Lens "Eyes" Weather, Missiles

Tracking and photographing weather balloons, locating airborne missiles, and evaluating radar systems is the job of a new telescopic tracker now under test. The apparatus weighs 1½ tons, is equipped with a 400-pound lens of 160-inch focal length, and can trace objects 300 miles distant on its scope in natural color. Able to automatically photograph targets in black and white, this unit can be remotely controlled to record impact of missiles in danger areas. Experimentation is being conducted by the Army Signal Corps Engineering Laboratories, Fort Monmouth, N. J.

CAA Men Help Italy

Eight Civil Aeronautics Administration specialists have assisted Italy in setting up airway aids and an adequate air-traffic-control organization from methods utilized in the United States.

RADIO



ELECTRONICS



THE PROSPECTOR'S PARTNER— A COMBINATION GEIGER COUNTER-PORTABLE RADIO

By Otto Fried

WITH SPRING just around the corner, thousands of modern prospectors will again try their hands at finding that hidden fortune. It's not gold they'll be looking for, but rather a far more useful and vital mineral—uranium.

The old forty-niner would view with suspicion the tools used by today's prospectors. The panning dish of old has been replaced with a scientific instrument, called a geiger counter which, by a series of rapid clicks, indicates the presence of radioactivity, the "paydirt" of modern prospecting.

But treasure hunting, now as in bygone days, can be a lonely, monotonous business. This project, therefore, was designed to provide not only a sensitive geiger counter, but also an entertaining companion; one who will not ask for a cut of the "take" in the event of a strike—a portable radio.

The versatility of the project is increased by the fact that the experimenter can use the schematic diagram, Fig. 6, to build either a radio or a geiger counter alone,

merely by omitting the undesired portion of the circuit. Or, if a suitable portable radio is already on hand, the counter portion may readily be added to the unit.

Construction Is Simple

To eliminate the most tedious part of construction, the original model was designed to fit into a commercially available cabinet and built on a prepunched chassis. Both of these parts (see parts list) can be purchased at a relatively low cost, but if you prefer to make your own chassis, you can do so by closely following the chassis layout details shown in Fig. 1. In either case, you'll still have to make the necessary brackets, but this is a comparatively simple matter.

Note: If you use the prepunched chassis you will have to add the three small holes which are shown in solid black on the left side of the chassis diagram.

Buy the parts first. Before doing any work at all, you should obtain all the

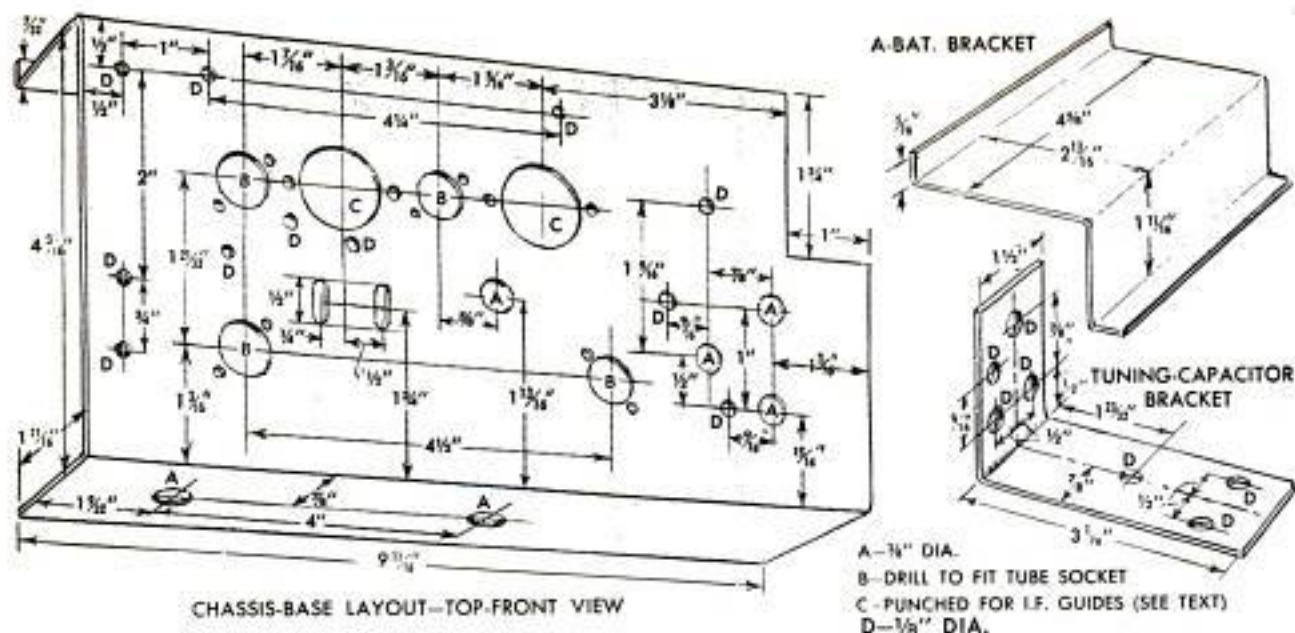

Fig. 1. Chassis and bracket layout showing critical dimensions. Punched chassis is commercially available

required parts. In the event that these are not identical to the ones originally used in the model, you can easily change the location of any mounting holes to fit the parts you have. The recommended i.f. transformers are supplied with mounting plates which fit into standard miniature-tube-socket cutouts. These will not be needed if you use the prepunched chassis, but they will greatly simplify chassis drilling if you intend to do this job yourself.

Special care is needed in making the

mounting bracket for the variable capacitor, Fig. 1. Note that the four holes in the bottom of the bracket must line up with similarly placed holes in the chassis base, and the three holes in the top portion correspond with the tapped mounting holes in the base of the capacitor itself.

Another homemade part is the spark gap detailed in Fig. 5. This can be made of any nonmetallic material which will not absorb moisture. Nylon rod, $\frac{3}{4}$ in. in diameter, is readily available from hardware stores

Fig. 2. Top-view pictorial of completed model. 1B85 and switches S1 and S3 will mount on side of cabinet

TUNING-CAPACITOR-MOUNTING DETAILS

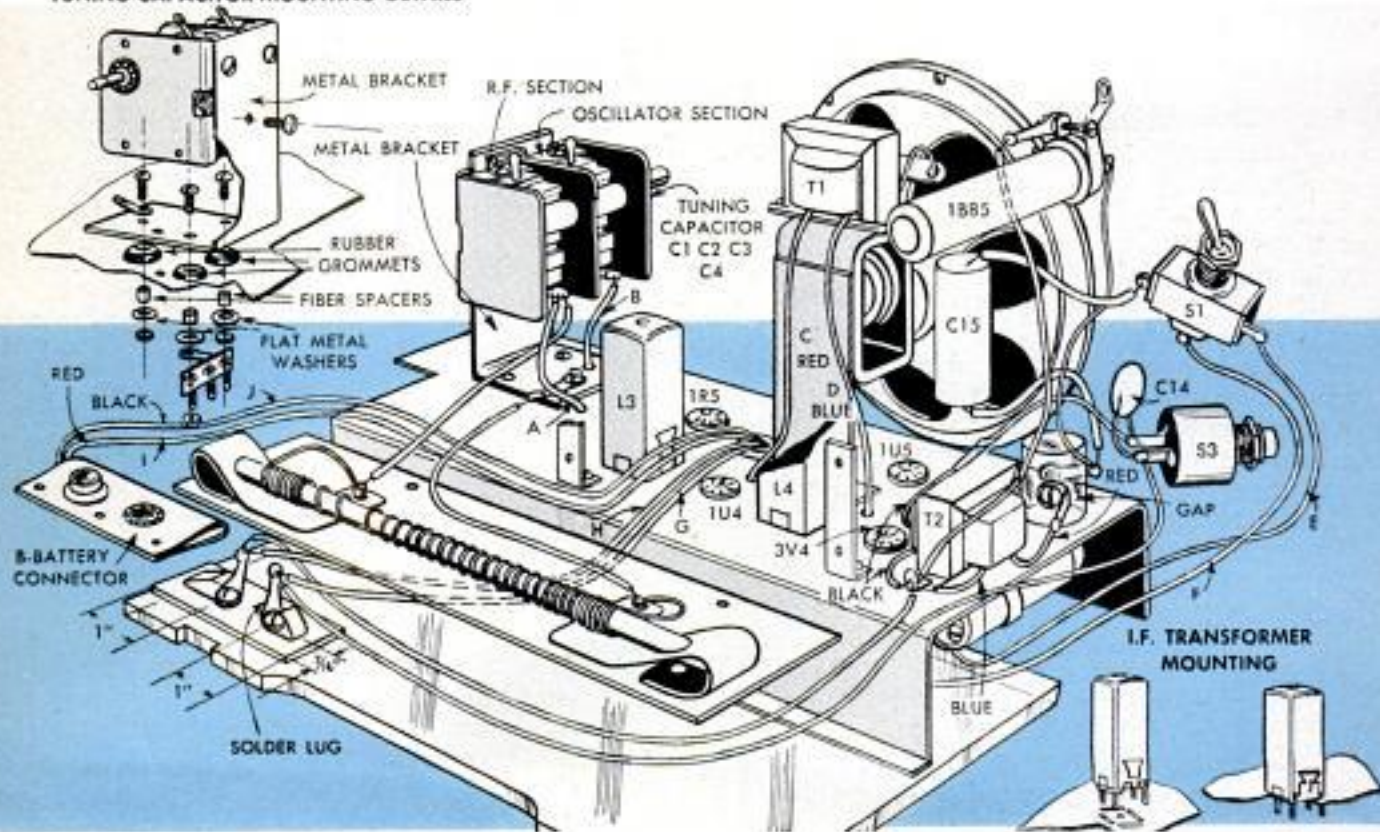

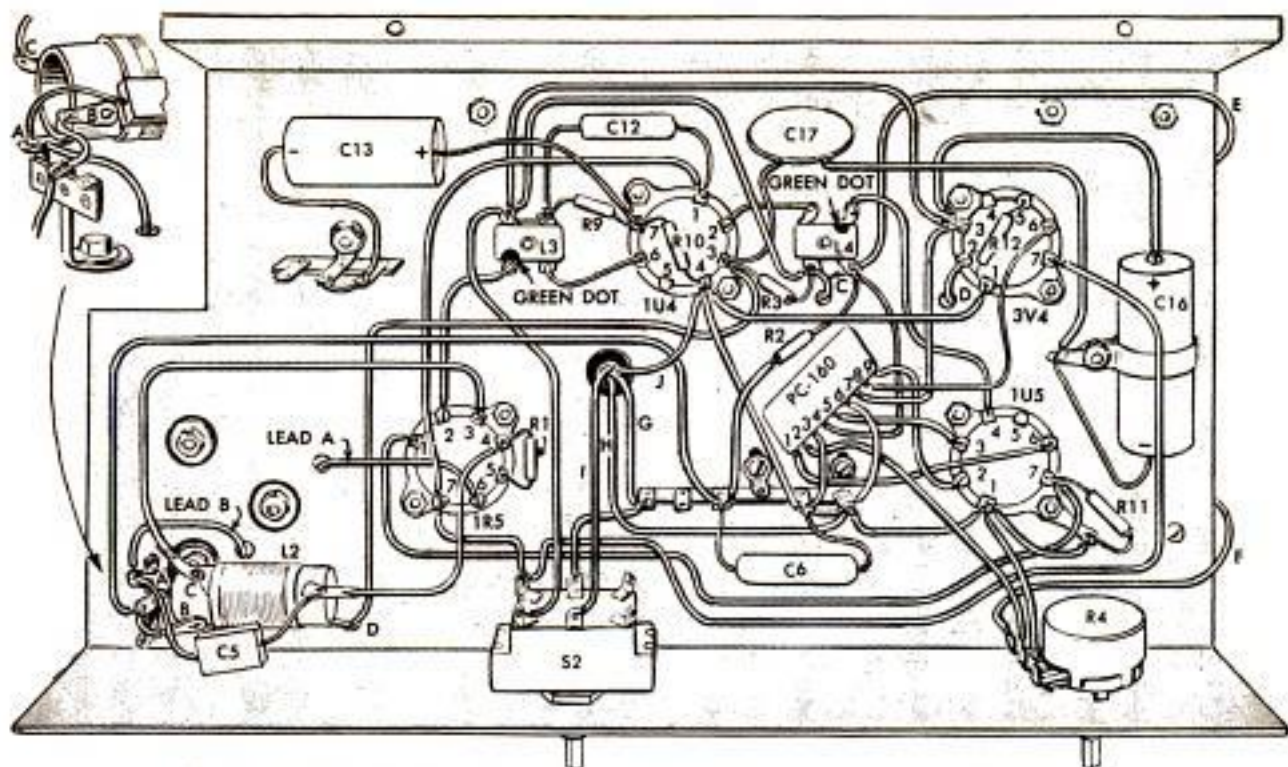

NOTE: TERMINATIONS OF CODED LEADS (A,B,C, ETC.) ARE SHOWN IN TOP-VIEW PICTORIAL

Fig. 3. Wiring pictorial, bottom view. Method of mounting oscillator coil is shown clearly in inset

and is not expensive. But if you happen to have a square block of Bakelite or phenolic material, go ahead and use it—it will work very well. This material merely serves to hold the two self-tapping screws which actually form the gap. Connections to the gap are made to two ground lugs which are soldered to the heads of the gap screws.

This should be done before the screws are inserted in the gap to prevent melting the plastic material during soldering.

Mounting the parts. Now, carefully study the top and bottom-view pictorials, Figs. 2 and 3, and note how the various parts are mounted on the chassis. Pay particular attention to mounting of i.f. transformers

Fig. 4. Final assembly. Wood screws fasten chassis to bottom of cabinet. Ready-made cabinet is available

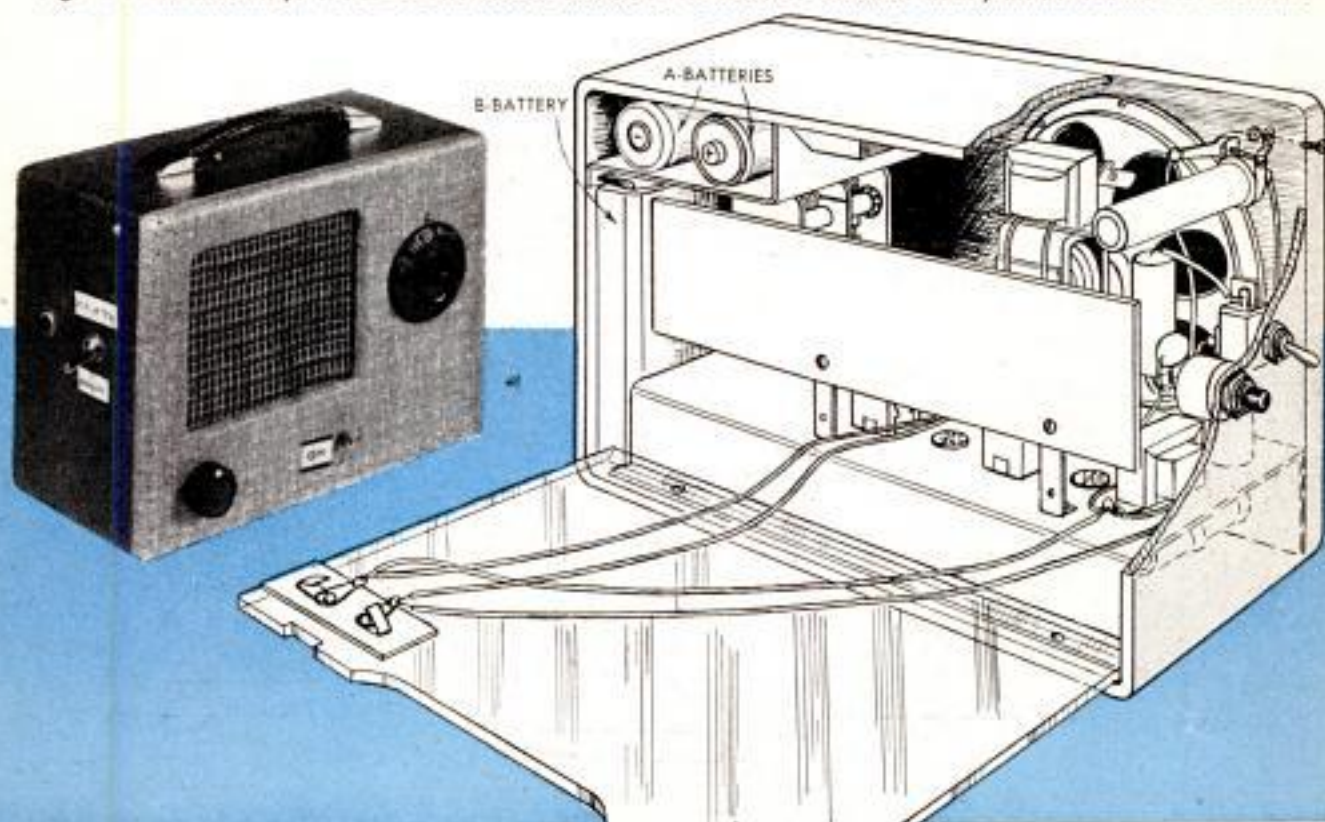

THE

**POPULAR
MECHANICS**

CRAFTSMAN

Corner Installation

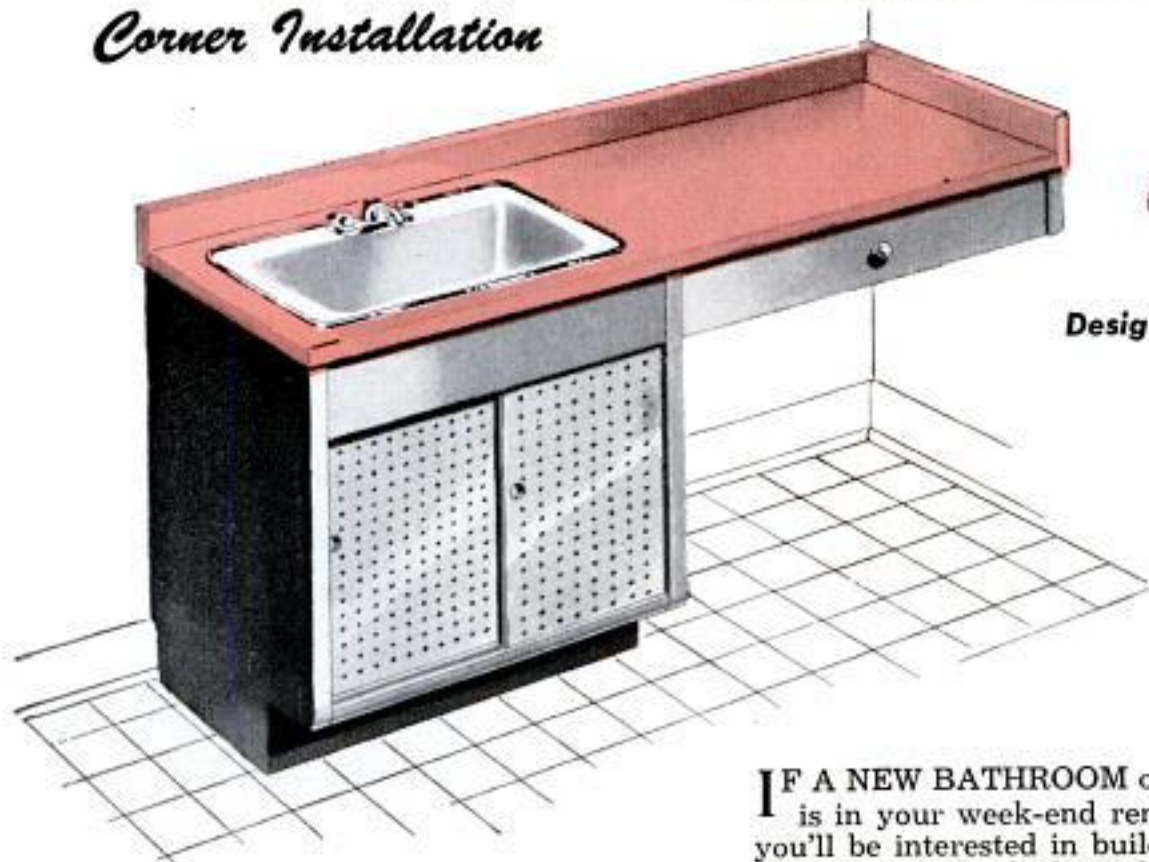

WTM 58

Designs by John Bergen

MODERNIZE WITH A VANITY LAVATORY

IF A NEW BATHROOM or powder room is in your week-end remodeling plans, you'll be interested in building this smart vanity lavatory which can be tailored to fit practically any room, large or small. Basically, the unit consists of a plastic-top sink-storage cabinet with bypassing doors which can be expanded, where space permits, to include a powder-room counter and drawer. In all cases, the basic unit is built the same—you simply increase the size of the top to suit your requirements. For a wall installation a leg is added, while for a corner installation a leg is omitted.

Basic Unit



Wall Installation



Copyrighted material

The basic unit will take a standard rim-type sink.

The Basic Unit

The cutaway drawing in Fig. 1 details the basic unit. Start with the 1 1/4-in.-thick piece across the front which is grooved for two sliding doors. Note in detail D that the lower front edge is rounded and that the back edge is rabbeted to house the bottom plywood shelf. Both front corners of the grooved piece are notched for 1 1/4 x 2 1/2-in. posts as in detail B. Note that these notches are made only 1 in. deep to let the cabinet sides set flush in 1/4-in. rabbets in the posts. In detail D you'll see that the front piece is attached to a 5 5/8-in. kickboard with nails driven in the rabbet. The kickboard is 24 in. long and has a 1/4-in. rabbet cut across each end. These extend

1/4 in. at each side. Now the bottom shelf can be glued and nailed in the front rabbet and the two sides of the base added. If the unit is to fit against an existing baseboard, the lower corners of the side members will first have to be cut to fit snugly around it.

Set aside the front posts for the moment and make the back frame. This is made of 3/4 x 2-in. pieces which are half-lapped at the corners. Notice that the frame rests on top of the bottom shelf. Gains are cut in the sides, 10 1/2 in. up from the bottom, to house shelf rails. The back frame can now be nailed and glued to the bottom shelf, keeping it even with the back edge. Shelf-rail notches are now made in the front posts 11 3/4 in. up from the bottom. Note in detail A that a shallow saw cut, 1/16 x 1/8-in., is run alongside the side-panel rabbet in the posts so that when the sides are in

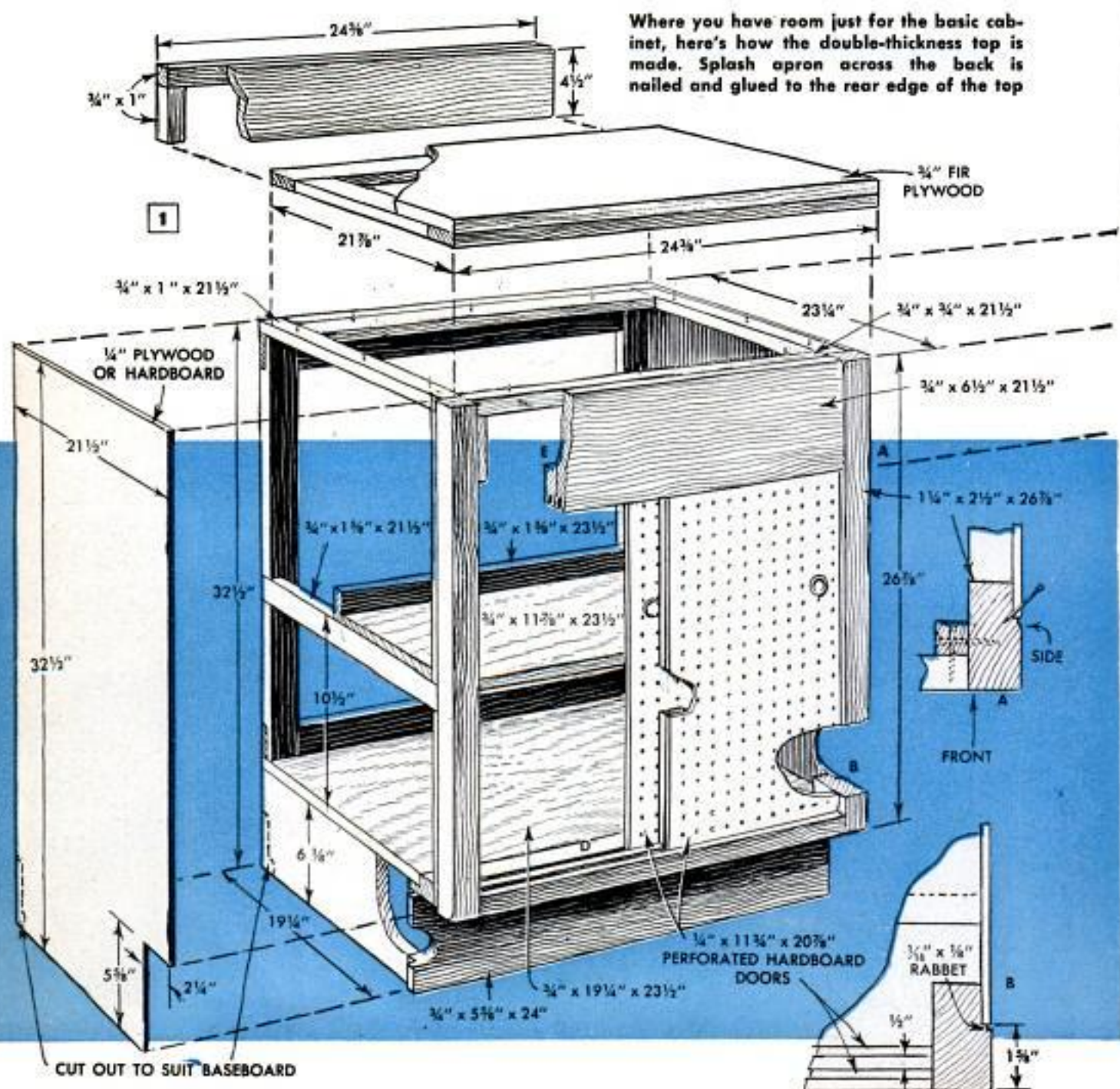

place a decorative groove is formed along each joint. Before the posts can be added to the assembly they must be joined together at the top with a 6½-in. member. As shown in detail E, this is backed up with a ¾ x 1½-in. piece across the bottom and a ¾ x ¾-in. cleat across the top, after which the lower edges are grooved for the sliding doors, spacing them ½ in. apart to match the lower grooves. After notching the upper ends of the posts for the top side rails, you can join the front member to the posts at the top and in turn fasten the lower ends of the posts to the rest of the assembly. Remember that the perforated-hardboard doors must be set in the grooves at the same time. The top side rails, as well as the one across the back, are predrilled for screws which are used later to anchor the top in place. When these pieces are installed, the side panels finally can be added.

Notice that they are notched at the back to fit over the baseboard and at the front to fit the rabbets in the kickboard. Use glue and small finishing nails to hold the sides in place and set and putty the heads on sides that are exposed. The left-hand



Perforated hardboard for the doors is both decorative and practical as it ventilates the interior. Saw the material slowly to avoid chipping the edges

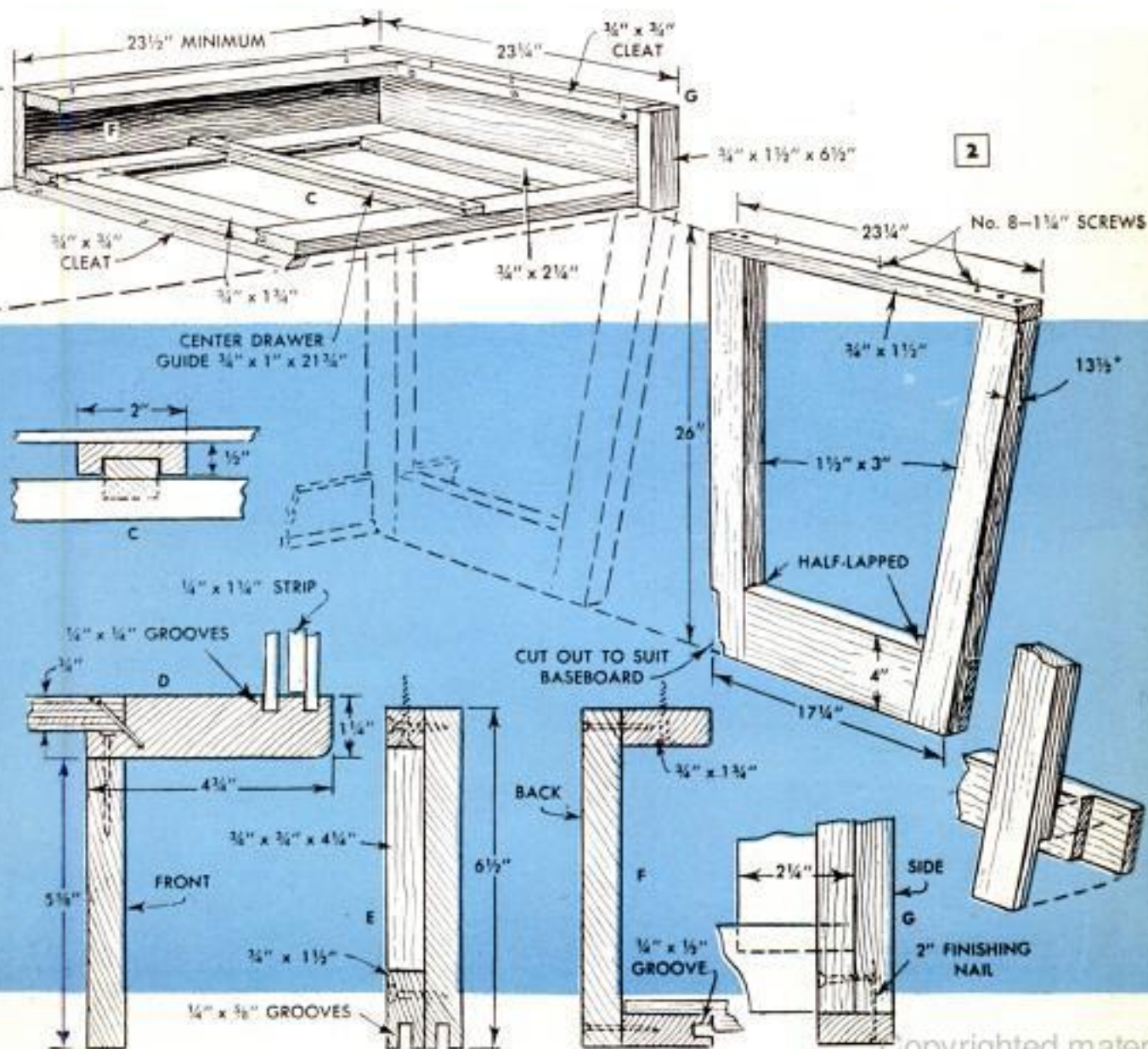



The opening for the rim sink is cut after the counter is covered with sheet plastic. Use a keyhole saw for this

edge of the front sliding door is stiffened on the back with a $\frac{1}{4} \times 1\frac{1}{4}$ -in. strip. Glue and clamp this rather than nail it. The grooves for the bypassing doors should be wide enough to allow for finish and possible shrinking of the wood which would cause the doors to bind. It might be best to paint the doors before they are installed to make final finishing less tricky. Regular recessed finger pulls are used, pressing them in holes centered $1\frac{1}{4}$ in. in from the outer edges of the doors.

The $1\frac{1}{2}$ -in.-thick top consists of a $\frac{3}{4}$ -in.-plywood top piece glued and screwed to an open frame of $\frac{3}{4} \times 2$ -in. material.

Adding Drawer Compartment

The drawer compartment and its supporting leg are detailed in Fig. 2. The compartment is built as a separate unit and is attached to the basic unit with screws passing through a $\frac{3}{4}$ -in.-sq. cleat. Fig. 3 details the drawer which is made to fit the opening. It rides in a guide which slides in a grooved strip attached to the bottom of the drawer. Construction of the tops, Figs. 1, 4 and 5, differs only in size. Where the vanity is to be installed in a corner, the splash apron is carried around the corner. The opening for the sink is made after the top is covered with plastic counter-top material. Cover the edges first and then the top surfaces, using contact cement made for the purpose. ★★★

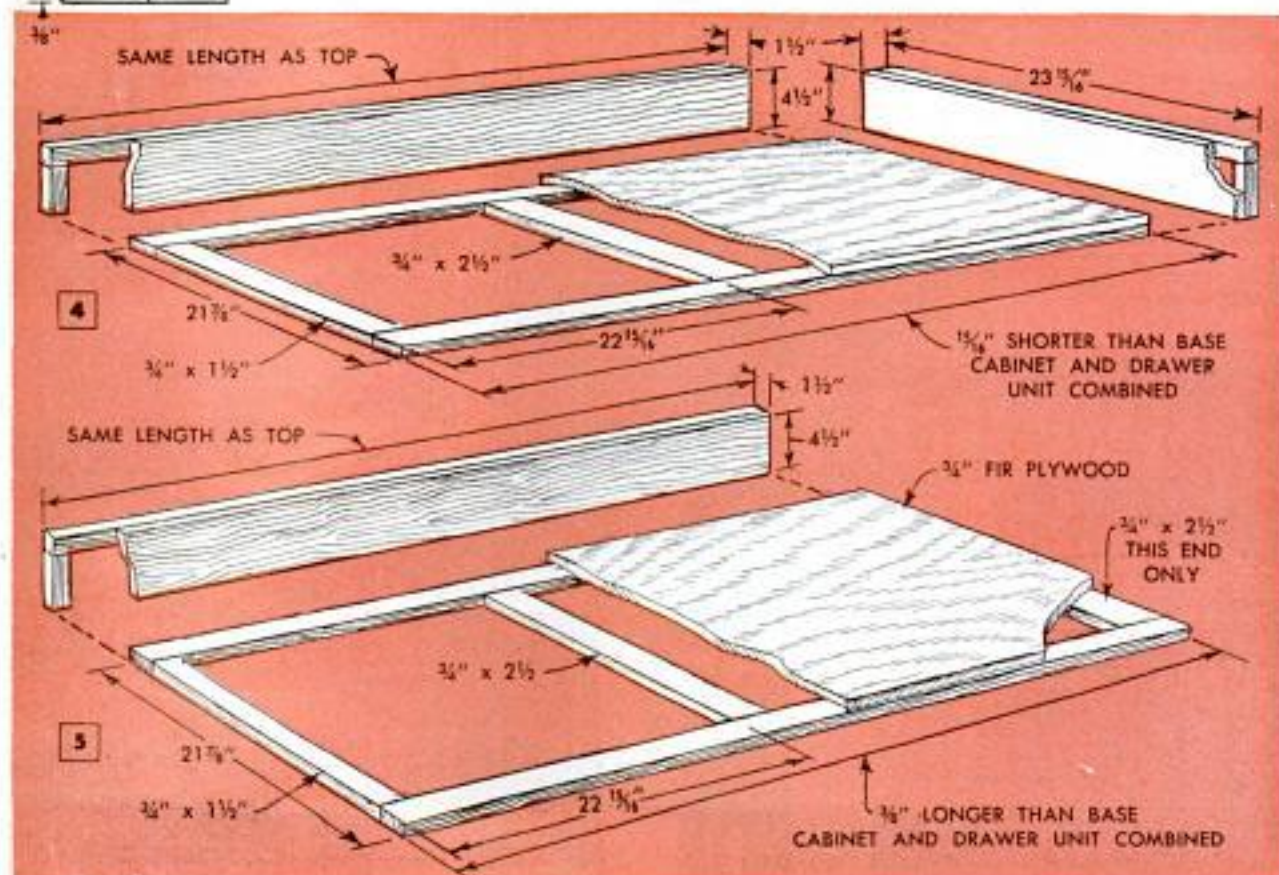
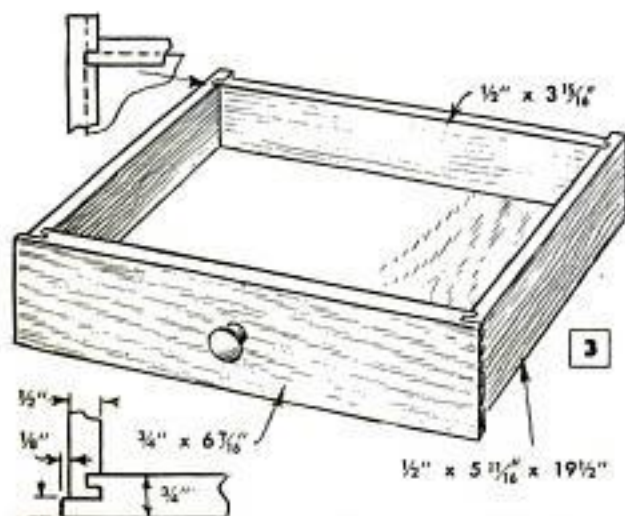

Pocket Cigarette Lighter Converted to Miniature Blowtorch

Pocket cigarette lighters of the type shown that have wind guards can easily be modified for use as miniature soldering torches. A metal tube $\frac{1}{8}$ -in. dia. or less is soldered in a hole punched in a metal clip formed from a $\frac{3}{8}$ x 1-in. strip of sheet brass folded in half. The clip then is slipped over the wind guard and adjusted so the tube will direct your breath against the flame to control it.



Putty Used as Sanding Block



When sanding odd-shaped pieces of wood a ball of putty or modeling clay will provide a "sanding block" that will shape itself to the contour of the work. Held against the abrasive paper as indicated your fingers are protected from sharp splinters.

Allyne Smith, Syracuse, N. Y.

Fasteners Support Shelves

An easy way to build rough shelving is to support the ends of each shelf on corrugated fasteners driven part way into the vertical framework. After the shelves have rested on the fasteners for a while, they will become indented sufficiently to keep from slipping off the supports.

Ken Murray, Colon, Mich.

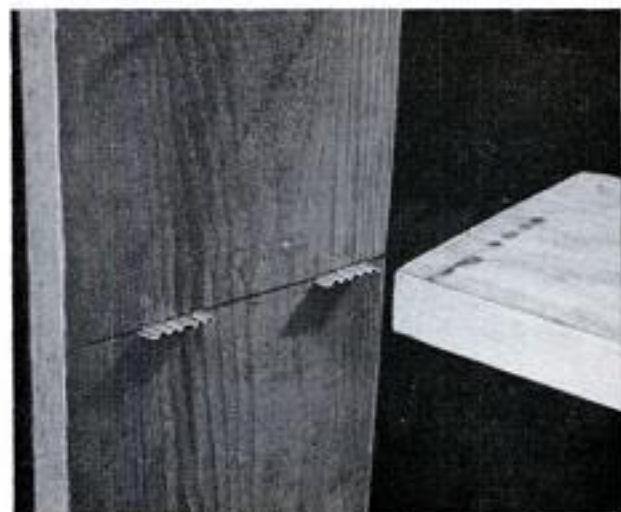

Bent Hinge Screw Tightens Self In Oversize Hole

Emergency repair of a loose hinge screw due to oversize screw holes is possible by removing the screw and bending it at a slight angle as indicated. When driven back into the hole, the screw will tighten itself sufficiently to hold the hinge in place until a more permanent repair can be made.

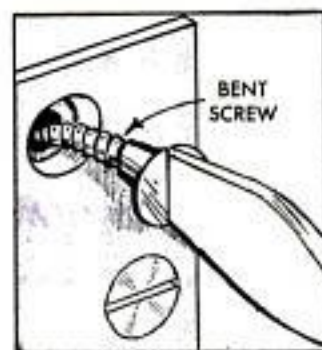

Improvised Lettering "Brush" Made From Cloth and Cotton

There is no need to invest in special brushes to do an occasional job of sign or poster lettering. Just wrap a bit of clean cloth around a cotton ball and tie this to the end of light dowel or wooden skewer. This inexpensive "brush" need not be cleaned, but simply is discarded after being used.



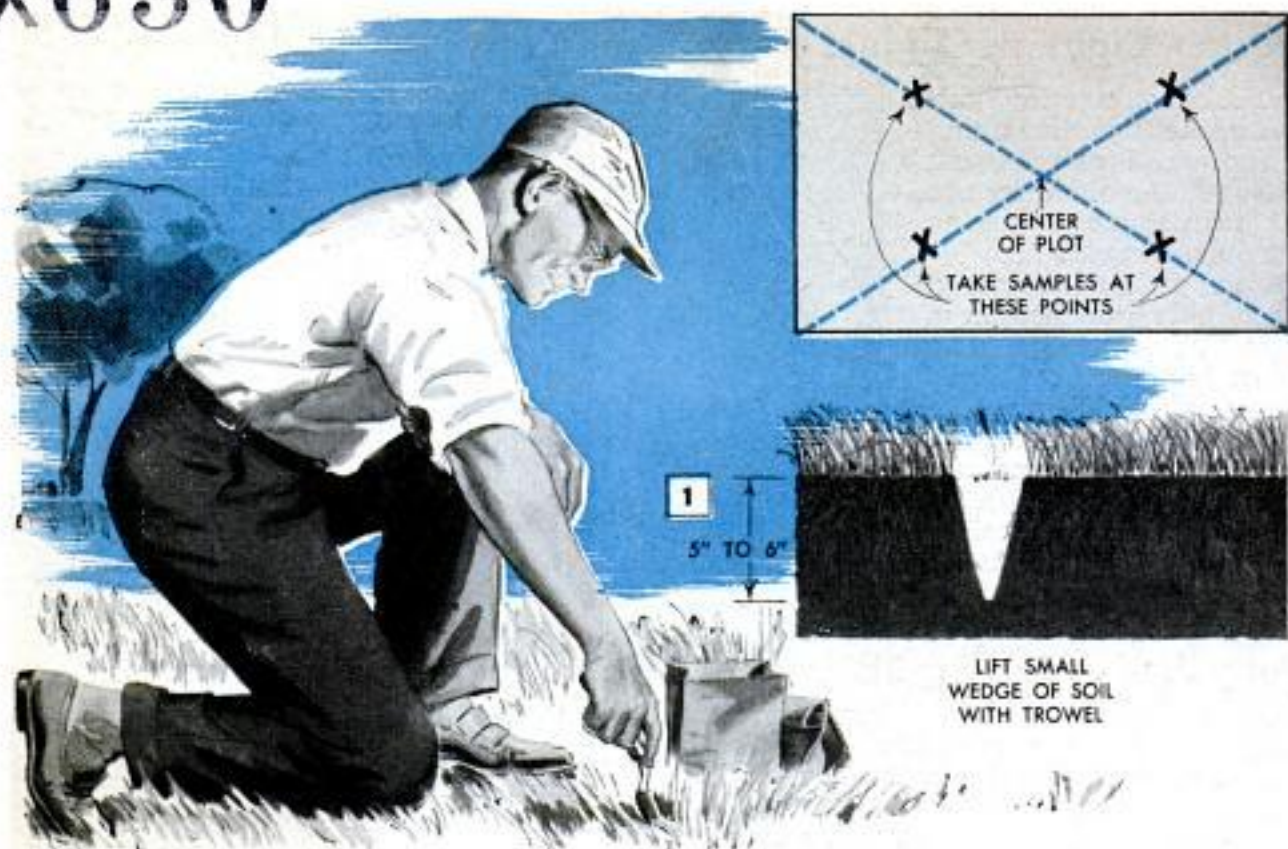

TEST THE SOIL FIRST

By John B. Mullen

ROUTE 1, BARRINGTON, ILL.

WHEN YOU ARE planning to bring your garden plot up to full production of either vegetables or blooms, a soil test is the first step. This will tell you what available plant foods the soil already contains and also determine what amounts of the primary plant-food elements—nitrogen, phosphorus and potassium—must be added for maximum plant growth and yield. Soil acidity and possible lime requirements also can be estimated closely. In small plots soil samples for testing should be taken from the positions shown in Fig. 1. Use a sharp trowel and lift a wedge of soil as indicated. Place the samples in a paper bag and allow to dry overnight. Then remove all roots, gravel and any other foreign matter. Mix the samples thoroughly.

Soil acidity is measured in what are known as pH units, which designate acid, neutral and alkaline conditions by numbers 1 to 14. Note the chart on the opposite page. Acid conditions from strong to weak generally are rated from 1 to 7. A pH of 7 usually is considered neutral. Most plants grow best in a neutral or slightly acid soil with a pH value between 5.5 and 7. However, plants do have definite pH preferences as will be noted from Table III. When testing, the pH is found by adding to the soil sample an indicator solution, Table V,

which changes color, depending on the pH. Note that there are two solutions to cover the normal pH range. When checking colors it is best to place a drop of the solution on a white surface, such as a china plate, where the true color can be more accurately judged. Use only a small portion of the soil sample, about $\frac{1}{4}$ in. in a test tube, and add indicator solution No. 1 to a depth of about $\frac{1}{2}$ in. Cork the tube, shake rather vigorously, and then allow the solids to settle. After an hour or so, check the color of the liquid layer. Then find the pH value in Table VI, column 1. If the liquid is yellow, indicating a pH under 6, repeat the test, using solution No. 2 and find the pH from the color as given in the last column of Table VI.

If the pH value is low (soil too acid) for the plants you want to grow, it will be necessary to lime the soil. Table VII shows how much limestone or hydrated lime to add per 1000 sq. ft. to raise the pH one unit. On the other hand if the pH is too high, add 18 lb. of sulphur per 1000 sq. ft. to lower the pH one unit.

Testing the sample for the primary plant foods—nitrogen, phosphorus and potassium—requires the preparation of a soil extract which is made by dissolving these three elements out of the soil sample with

SOIL ACIDITY CHART

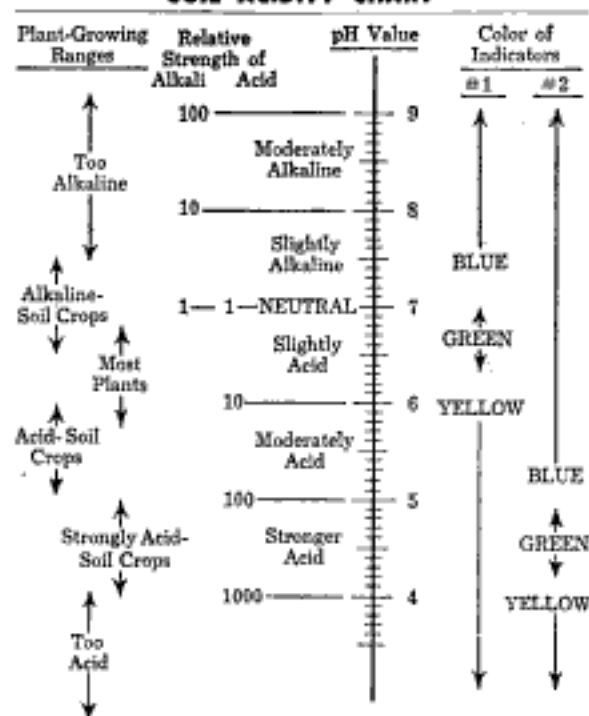

Tests with indicator solutions show pH value of soil, which tells its acidity or alkalinity. pH preferences of various plants are given in Table III.

**TABLE I
CONSUMPTION OF PRIMARY PLANT FOODS**

(Table shows the weight of nitrogen, phosphorus and potassium consumed from an area of 1000 sq. ft. by a growing crop.)

Element	Pounds Consumed	Equivalent Amount of Fertilizer	Effect on Plant of Lack of Element
Nitrogen	3	30 lb. of 10% nitrogen fertilizer	Yellowish-green color. "Firing" or drying of leaves. Slow growth.
Phosphoric acid (P ₂ O ₅)	1 1/4	12 1/2 lb. of a 10% phosphorus fertilizer	Purplish leaves. Slow growth. Low yield of grain or fruit.
Potassium oxide (K ₂ O)	3	30 lb. of 10% potash fertilizer	Curling leaves, ragged edges. Poor roots (plants may fall down). Spotted or streaked leaves.

**TABLE II
SOIL-TESTING CHEMICALS**

Chemical	Used for	Quantity Required
Bromthymol blue indicator	Acidity test	1 gram
Bromocresol green indicator	Acidity test	1 gram
Sodium hydroxide (C.P. pellets)	Acidity test	1/4 lb.
Sodium acetate	Extraction	1/4 lb.
Acetic acid (C.P. Glacial)	Phosphorus, Potassium	1 lb.

**TABLE II—Continued
SOIL-TESTING CHEMICALS**

Chemical	Used for	Quantity Required
Ammonium molybdate	Phosphorus	1 oz.
Tin wire (or foil)	Phosphorus	1 oz.
Sodium cobaltnitrite	Potassium	1 oz.
Sodium nitrite	Potassium	1/4 lb.
Isopropyl alcohol (99%)	Potassium	1 lb.
Diphenylamine	Nitrogen	1 oz.
Sulphuric acid	Nitrogen, Phosphorus	1 lb.

**TABLE III
PREFERRED SOIL pH RANGES FOR VARIOUS PLANTS**

Strongly Acid Soil pH below 5		
Cranberries	Azaleas	
Blueberries	Rhododendron	
Moderately Acid Soil pH 5 to 6		
Eggplant	Hydrangea (Blue)	
Potatoes	Ferns	
Watermelon	Pine, Firs	
Parsnips		
Slightly Acid Soil pH 5.75 to 6.75 (Most plants prefer this pH range)		
Beans	Rye	Hydrangea (Pink)
Broccoli	Wheat	Iris
Brussels	Grasses	Larkspur
Sprouts	Aster	Narcissus
Onions	Carnation	Pansy
Peas	Chrysanthemum	Rose
Peppers	Dahlia	Snapdragon
Squash	Daisy	Tulip
Tomatoes	Delphinium	Zinnia
Turnips	Gladiolus	
Corn		
Neutral or Slightly Alkaline Soil pH 6.5 to 7.5		
Apples	Cineraria	
Asparagus	Clematis	
Cabbage	Geranium	
Carrots	Ivy	
Cauliflower	Morning Glory	
Celery	Nasturtium	
Lettuce	Petunia	

**TABLE IV
EQUIPMENT REQUIRED FOR SOIL TESTING**

Test tubes—3" x 3/8" or 4" x 1/2"
Corks to fit test tubes
Glass filtering funnel
Filter paper to fit funnel
Graduated cylinder—10 ml. or 25 ml.
Medicine droppers

**TABLE V
INDICATOR SOLUTIONS**

	Indicator No. 1	Indicator No. 2
(A) Bromthymol blue (powder)	.01 gram	
Bromocresol green (powder)		.01 gram
Pure grain alcohol (or isopropyl alcohol)	5 ml.	5 ml.
Distilled water	95 ml.	95 ml.
(B) Sodium hydroxide (C.P. pellets)	2 pellets (1/4 gram)	2 pellets (1/4 gram)
Distilled water	1 pint	1 pint

Dissolve powder in alcohol, add distilled water to complete (A); then add solution (B), drop by drop, until color is yellow-green.

TABLE VI
COLORS AND pH VALUES FOR INDICATORS

Indicator No. 1	Color of Solution	Indicator No. 2
pH over 7.5	Blue	pH over 5.25
pH 7 to 7.5	Blue-Green	pH 4.75 to 5.25
pH 6.5 to 7	Green	pH 4.25 to 4.75
pH 6 to 6.5	Yellow-Green	pH 4 to 4.25
pH under 6	Yellow	pH under 4

TABLE VII
USE OF LIMESTONE OR HYDRATED LIME TO RAISE pH OF SOIL

(Table shows number of pounds of crushed limestone or hydrated lime required per 1000 sq. ft. to raise the soil pH one pH unit.)

Type of Soil	Crushed Limestone	Hydrated Lime
Light sandy soil	35 lb.	26 lb.
Sandy loam	45 lb.	33 lb.
Loam soil	70 lb.	52 lb.
Clay loam	80 lb.	60 lb.

TABLE VIII
EXTRACTION SOLUTION

Sodium acetate	20 grams
Acetic acid (C.P. Glacial)	6 ml.
Distilled water	175 ml.

TABLE IX
STANDARD SOLUTION OF PLANT-FOOD ELEMENTS

Stock Solution	
Monosodium phosphate	2 grams
Potassium nitrate	1 gram
Distilled water	1000 ml. (1 liter, or 1.056 qt.)
Standard Solution	
Stock solution	10 ml.
Extraction solution	90 ml.

TABLE X
REAGENT SOLUTION FOR PHOSPHORUS

Phosphorus Reagent A	
Ammonium molybdate	10 grams
Distilled water	40 ml.
Phosphorus Reagent B	
Acetic acid (Glacial)	10 ml.
Distilled water	100 ml.
Sulphuric acid	5 ml.
Mixed Phosphorus Reagent	
Add all of Phosphorus Reagent A to Phosphorus Reagent B and stir to mix well.	

TABLE XI
PHOSPHORUS-TEST COLORS AND REQUIREMENT FACTORS

Color of Test Solution	Amount of Phosphorus in Soil	Phosphorus Requirement Factor
Faint blue or clear	Very low	900
Lighter than standard	Low	750
Like standard	Medium	600
Deeper than standard	Medium high	450
Very deep blue	High	350

TABLE XII
REAGENTS FOR POTASSIUM

Potassium Reagent No. 1	
(A) Sodium cobaltinitrite	5 grams
Sodium nitrite	30 grams
Distilled water	50 ml.
Acetic acid (Glacial)	5 ml.
Distilled water— to make a total volume of	100 ml.
Potassium Reagent No. 2	
(B) Sodium nitrite	15 grams
Water	100 ml.
1. Dissolve the chemicals for (A) in the order listed, and let stand in an unstoppered bottle for a few days.	
2. Prepare solution (B).	
3. Add 5 ml. of (A) to all of (B) to complete Potassium Reagent No. 1.	
Pure isopropyl alcohol	

TABLE XIII
POTASSIUM-TEST COLORS AND REQUIREMENT FACTORS

Appearance of Test Solution	Amount of Potassium in Soil	Potassium Requirement Factor
Trace of cloud	Very low	700
Less cloud than standard	Low	600
Like standard	Medium	400
More cloud than standard	Medium high	200
Dense cloud	High	100

TABLE XIV
REAGENT FOR NITROGEN

Diphenylamine	.05 gram*
Sulphuric acid (C.P. Concentrated)	25 ml.
* Amount the size of a small pea	

TABLE XV
NITROGEN-TEST COLORS AND REQUIREMENT FACTORS

Color of Test Solution	Amount of Nitrogen in Soil	Nitrogen Requirement Factor
No blue	Very low	400
Lighter than standard	Low	300
Like standard	Medium	250
Darker than standard	Medium high	200
Very dark blue	High	100

TABLE XVI
CALCULATING FERTILIZER REQUIREMENTS (EXAMPLE)

Food Element	Fertilizer Material	Anal. No.	Food-Element Requirement Factor	Lb. Req'd. per 1000 sq. ft.
Nitrogen	Sodium nitrate	15	250	250 ÷ 15 = 17 lb.
Phosphorus	Super-phosphate	20	450	450 ÷ 20 = 23 lb.
Potassium	Potassium chloride	52	100	100 ÷ 52 = 2 lb.

an extraction solution, Table VIII. To prepare extract, fold filter paper as in Fig. 4 and place in a glass funnel. Place a level teaspoonful of soil on the filter. Place a clean test tube (or a small glass tumbler) under the funnel spout. Pour 10 ml. (milliliters) of extraction solution on the soil sample and when the liquid has passed through the filter, lift the latter and squeeze it lightly to force out the remaining extract. Portions of this extract are used in all remaining tests. Now, make a stock solution and a standard solution as in Figs. 2 and 3, also Table IX.

Tables X to XVI inclusive outline the tests for the primary plant foods and show how to calculate fertilizer requirements, Table XVI. Using as an example the test for phosphorus, Table X, pour soil extract into a test tube to a depth of about $\frac{1}{2}$ in., then add an equal amount of the phosphorus reagent (solution). Stir with a pure-tin wire, or add two $\frac{1}{4}$ -in. squares of tin foil and stir with a glass rod, until a full blue color results. Now, in a second test tube mix equal amounts of standard solution and phosphorus reagent and stir with a bright tin wire. Compare the colors and judge the amount of phosphorus present by referring to Table XI. The phosphorus requirement will be used later in estimating the amount of fertilizer needed. Note that two reagents are required for the potassium test, Tables XII and XIII, but that only one reagent is needed to test for nitrogen, Table XIV.

Note that in preparing the nitrogen reagent it will be necessary to handle concentrated sulphuric acid, Table XIV. This acid is extremely corrosive and must be placed in a glass-stoppered bottle, or one with a paraffined cork. Take every precaution against having any of this solution containing sulphuric acid come in contact with the skin, clothing, workbench or any metal object. Protect the eyes against splatters. Wear rubber gloves. In carrying out the test, lay a small pane of glass on a sheet of white paper, Fig. 5, and place four drops of nitrate reagent in the center. Follow with one drop of soil extract. Immediately a blue ring will form, Fig. 6. After allowing three minutes, compare the color with that of a nitrogen standard, prepared in the same way except using one drop of standard solution instead of soil extract. Refer to Table XV for the values. ★ ★ ★



MARCH 1957

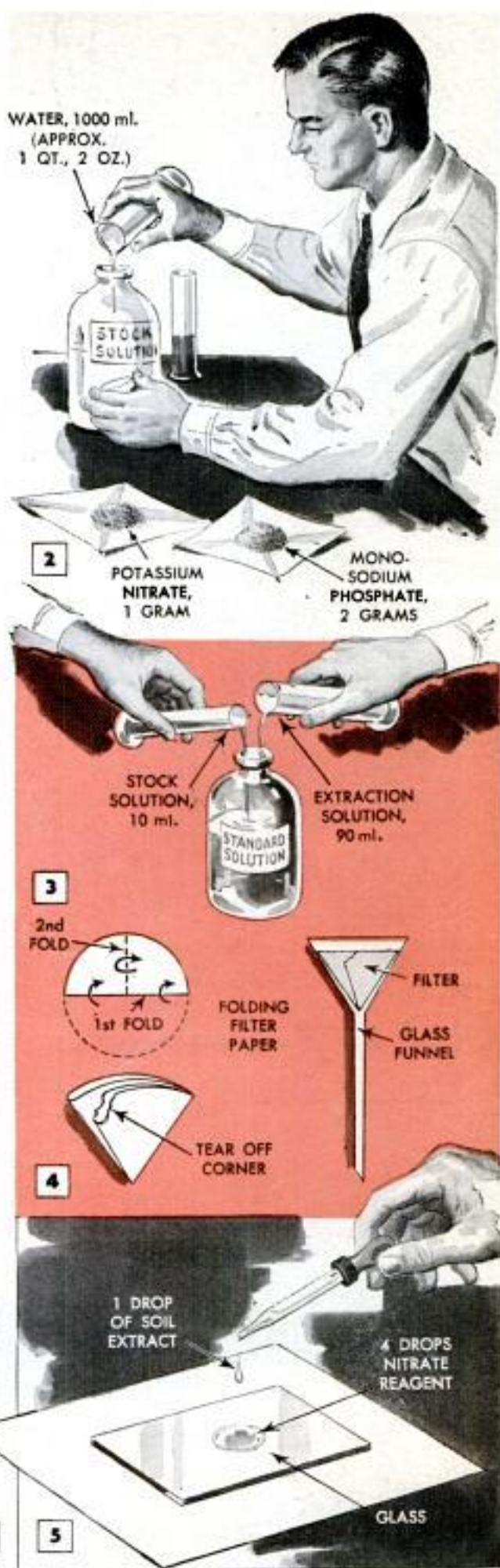

OLD WHEELS "ROLL" AGAIN

WHAT GOOD is an old wheel? Leland Elam of Sacramento, Calif., found that a wheel doesn't have to be on a wagon or buggy to be useful. A tour of the countryside with his camera showed that Western farmers have put these relics of the horse-and-buggy days to dozens of practical and decorative purposes. Rather than relegate them to the junk pile they have put them back to work in a variety of ways, ranging from serving as decorative windows to supporting rural mailboxes. As this group of photos shows, there are almost endless uses for one or several of these old wooden wheels. For instance, look what three farm-wagon-wheel windows can do to make a plain brick wall really attractive. Such windows can be mortared in a fence-wall for mere decoration or they can be backed with glass to serve as real windows. A single buggy wheel placed flat on the ground makes a novel flower bed, while another mounted on the wall of a building will provide an unusual trellis for a climbing vine. Several large farm-wagon wheels can be leaned against a split-rail fence to add further rustic decoration. A buggy wheel will make a unique vegetable-display rack at a county fair. The wheel is backed with a sheet of plywood and supported at a slant. Place grain between spokes and nest vegetables in grain. ★★



Above, a buggy wheel makes a unique window-trellis for a barn. Below, wheels help decorate rail fence



Below, mortared in walls of an "adobe" structure, three wagon wheels make unusually appropriate windows

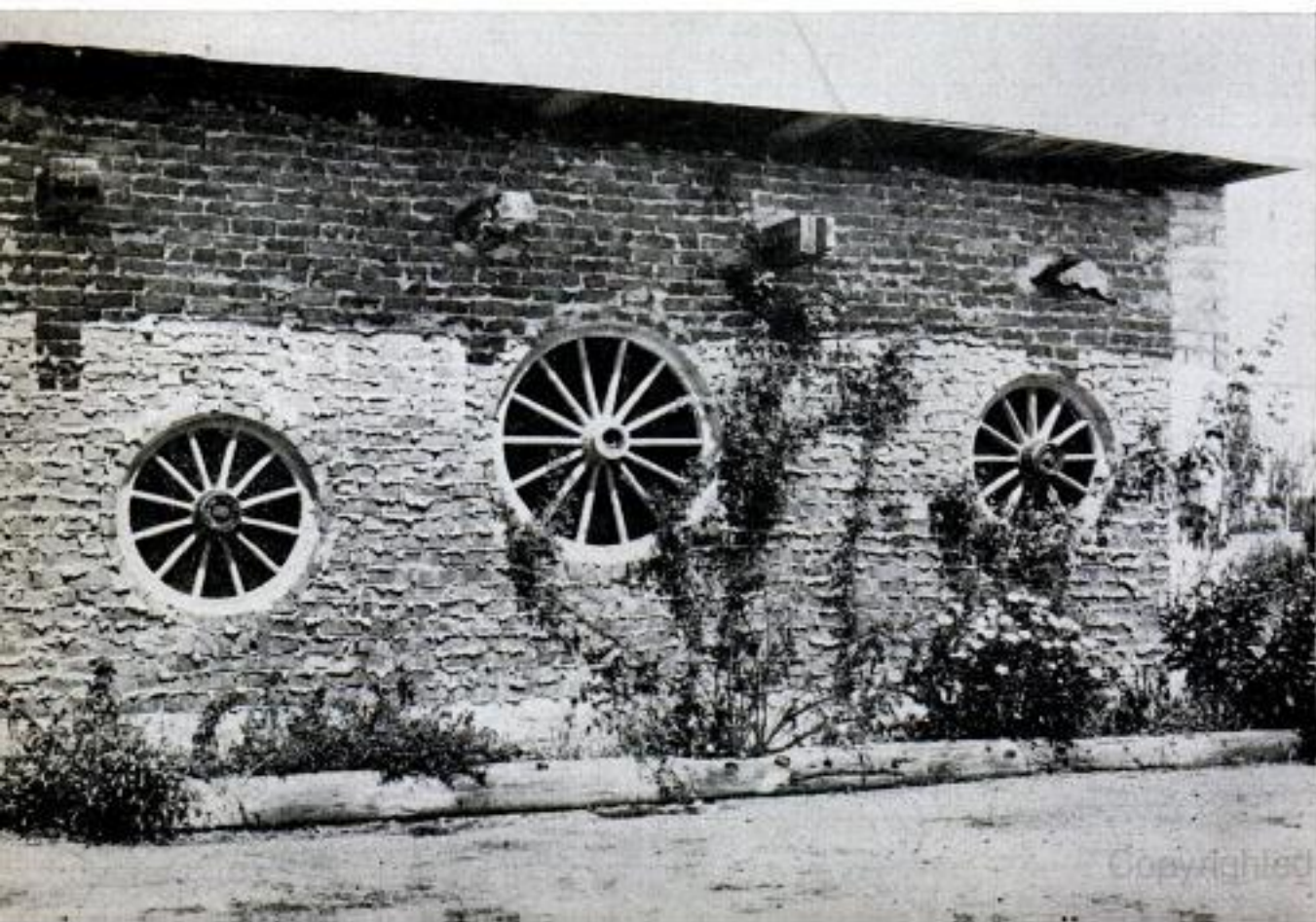



As a sturdy farm-mailbox support, a wagon wheel is hard to beat. Here a most unique box rests on a platform of angle iron which is welded to the steel tire



Above, two farm-wagon wheels set in concrete add a decorative touch to an entrance walk. Below, buggy wheel painted white and laid on ground makes novel flower bed. Dirt is poured between the wheel spokes



Auto Registration Certificate Carried on Identification Tag

A luggage identification tag containing the auto registration certificate and attached to a key chain as shown in the photo is used by one car owner to assure presence of the certificate on the vehicle whenever it is driven, as required in most states. The key chain and tag are kept on a hook inside the house for the convenience of other members of the family.



Chimney "Screwed" to Building

Instead of using unsightly iron bands to hold a cement-block chimney to a building, try lag screws, placing them about every 5 ft. as the chimney is built. It is necessary to notch the top of the block slightly to form a bed for the lag screw and prevent it from interfering with the next course. Locate the screws so they enter the studs.

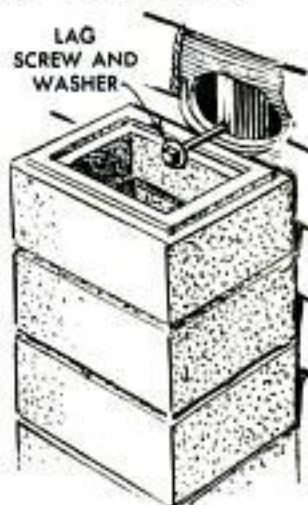

Locate the screws so they enter the studs.

Trellis Made With Coat Hangers

Three or four wire coat hangers nailed one above the other on a discarded broom handle or other wooden upright as shown provide an excellent trellis for small climbing plants. Use poultry-wire staples to fasten the hangers and apply wood preservative to the part of the upright that is to go underground. Paint the completed trellis with outdoor paint to prevent the metal hangers from rusting.



Victor H. Lamoy, Upper Jay, N. Y.

X342C "PINTO"



Broom Clamp on Ladder Rail Keeps Hammer Handy

If you are doing a job on a ladder for which a hammer occasionally is needed—such as nailing down loose boards while calking—keep the hammer in a broom clamp attached to one of the side rails of the ladder. The hammer will be more easily reached than if it were carried shoved under a belt, and will definitely be more secure than if the claws were hooked over one of the ladder rungs where it easily can be knocked to the ground.

Road-Map Distances Measured By Use of Pipe Cleaner

Want to know how far you will drive to reach a specific destination without adding up all the small mileage figures on a road map? Bend a pipe cleaner along your proposed route, then straighten it and measure the indicated distance on the scale-of-miles diagram at the corner of the map.



HERE IS A sturdy rocking horse designed for the enjoyment of any lively youngster four to seven years of age. The base on which the horse is mounted is made of 1-in. pine lumber nailed together and reinforced with steel braces bent from $\frac{1}{8}$ x $\frac{3}{4}$ -in. stock. The parts for the horse are scrollsawed from $\frac{1}{2}$ -in. plywood, the head and foreleg being in one piece, while the hind legs and body are cut in pairs according to the squared pattern shown for each.

After assembling the horse and base, the hoofs are fastened to small wooden platforms with inside corner plates and the entire unit then is clamped to two U-shaped rods by wooden blocks notched to fit over the rods and screwed to the platforms as shown in one of the details. A length of brass tubing slipped on each of the rods before bending serves as a bearing, permitting a rocking motion when the rider pushes forward on the dowel handle bars.

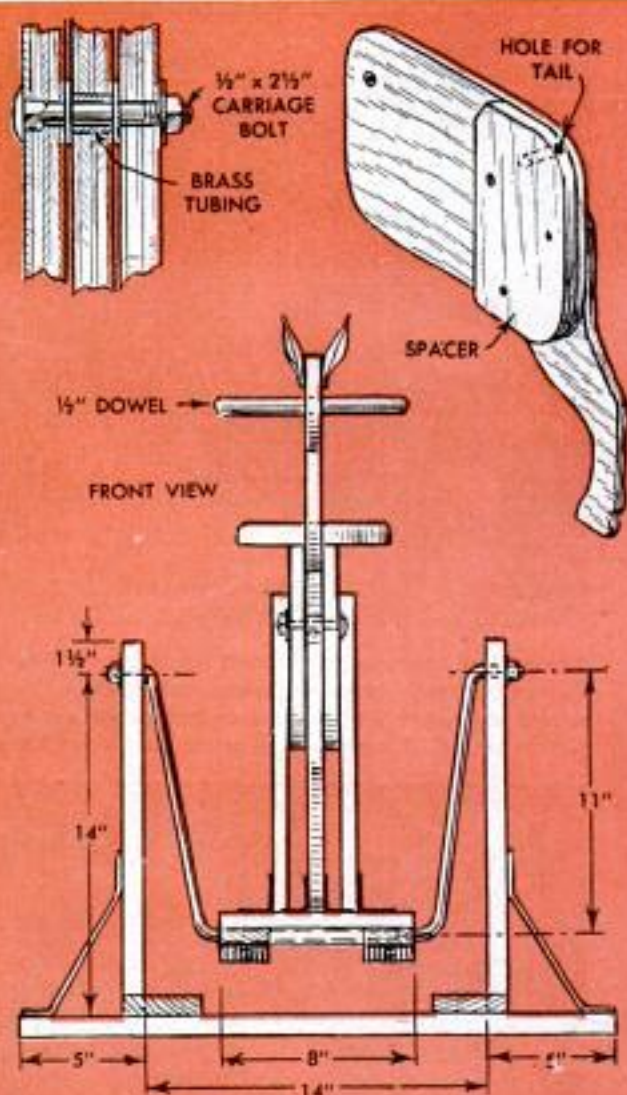

WTM 58

ROCKING HORSE

fitted in the horse's head. Short lengths of brass tubing inserted in holes drilled in the upper ends of the base uprights provide bearing surfaces for the rods. A small hole drilled vertically in the top of each upright, as shown in the detail on the right side of the drawing, provides a means of lubricating the bearing surfaces to reduce wear and noise.

To complete the rocking horse, the base is painted red, the rods green and the horse large irregular black spots on white, for a pinto. The tail is simply unraveled Manila rope bound at one end so that it can be glued in a hole drilled in the body spacer block as shown. The halter, mane and hoofs are painted on the horse in black. The ears are cut from the uppers of discarded leather shoes and glued and nailed on the head.

Hi Sibley, Nuevo, Calif.

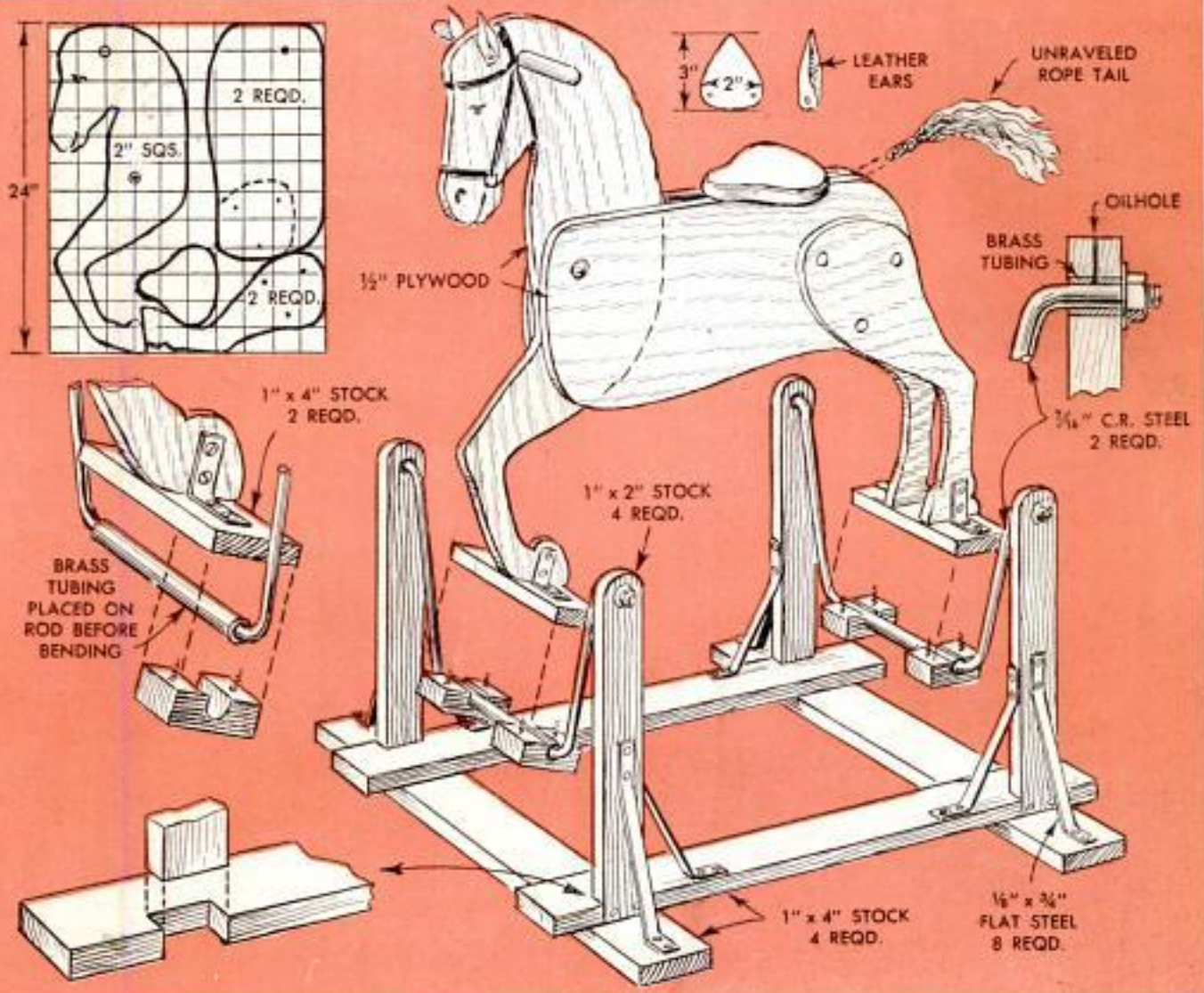

SOLVING

Home Problems

NEWSPAPERS turned into ends of a roll of linoleum will protect edges against damage. When rolling, place papers as shown



PIPE FLANGE makes the low candleholder you need when necessary to improvise a floral centerpiece. Be sure to get right size so threads hold candle

CROCHET HOOKS stored in a toothbrush holder won't snag delicate fabrics or injure fingers. Apply strips of adhesive tape over holder ends to close vents

ONE-DROP OILER for typewriter, guns and fishing tackle can be made by filling an old fountain pen with light lubricating oil. Reaches hard-to-get-at places

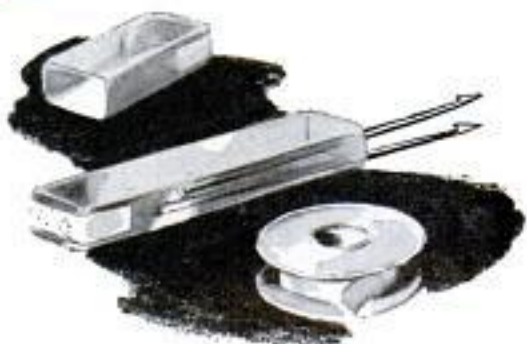

SHOE-POLISHING BLOCK faced with lamb's wool makes an ideal padded sanding block for finish-sanding both flat and slightly curved surfaces. Soft, springy padding causes abrasive to conform to surface





LOOSE HANDLE of your plumber's suction cup can be anchored securely with an ordinary bottle cap. Remove the handle from the rubber cup, screw the bottle cap to the end as pictured and then force handle back in place

FOOT SCRAPER is improvised from a discarded broom and a short length of pipe. The latter is driven into the ground near the stoop. Then bristles of the broom are cut off square and handle is inserted in the pipe



FRICTION LIDS on paper containers which are to be reused are easier to remove if you cut uniformly spaced slits in the cover rim before replacing. Cut the slits the full width of rim with sharp knife

AN EMPTY MATCHBOOK is the safest place to store that safety-razor blade you keep in your sewing kit. Slide edge of blade behind match stubs, then wrap cover tightly and hold securely with a rubber band

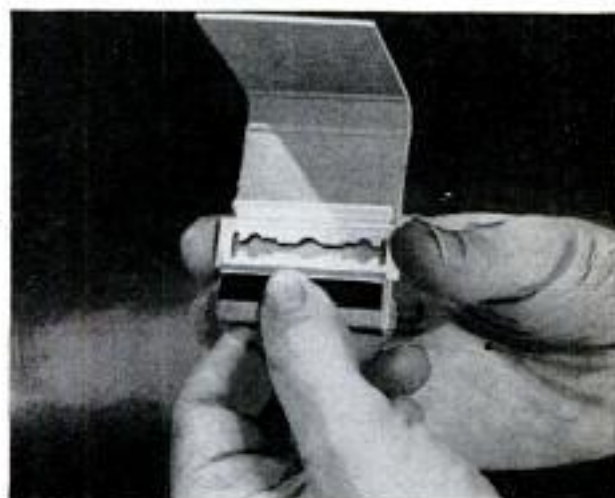

HANDY DOORSTOP made from a length of sheet metal holds the door securely when partially or fully open. Bend the metal to the shape indicated and fit pads of sponge rubber or felt to prevent slipping

FAVORITE RECIPES have a way of getting mislaid unless you keep them in this special file pocket attached to the back of a kitchen-cabinet door. Make file of colored plastic or plywood, attach with screws

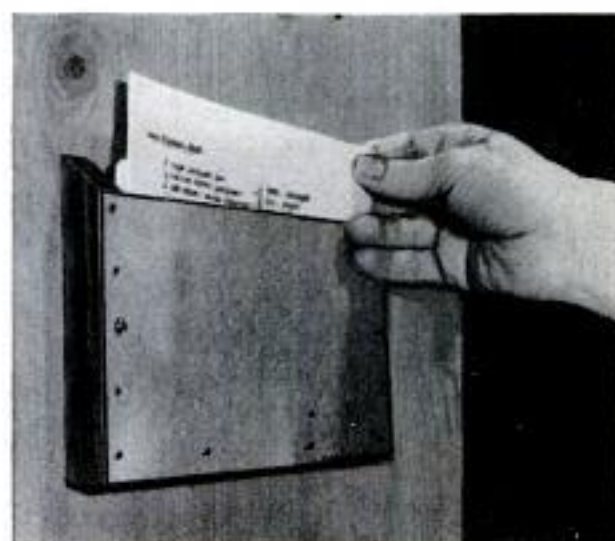
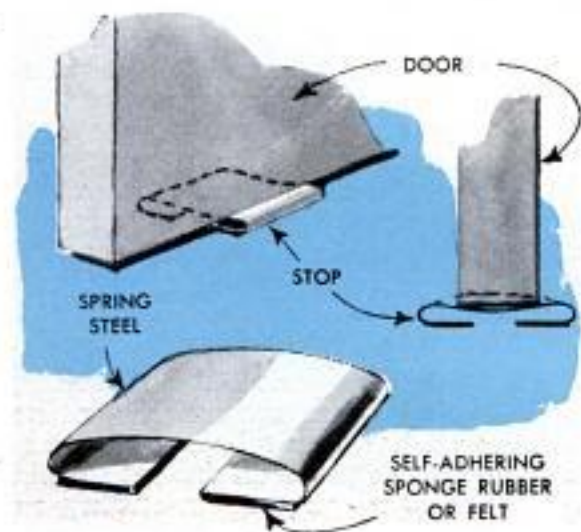

Mirror Background for Photographing Flowers



The problem of photographing wild flowers surrounded by other vegetation is solved by propping a mirror back of the blooms being photographed. The mirror provides an artificial background, which isolates the subject and catches sky and cloud reflections that sharpen the detail and improve composition.—H. Beatty, New York City.

☐ Fewer insects will be attracted to fresh paint during warm weather if a small amount of a good insect repellent is added when mixing it.

Imitation Inlay Stenciled On Table Top

Beautiful "inlay" patterns are easy to apply on table tops, doors and other woodwork with shellac and a stencil of the desired design. Simply place the stencil on the unfinished wood surface and brush thin, clear shellac over it. After the shellac has dried, stain and finish the work. Only the surface that is not protected by the shellac will receive the stain. Since no two woods take stain alike, experiment on a sample piece.



Emergency Hose Clamp From Wire and Bolt

When you need a hose clamp in a hurry and none is available, try winding two turns of wire around the hose and drawing it tight with a bolt passed through eyes formed in the ends of the wire as shown in the photo.



Fingers From Rubber Gloves "Leakproof" Bottles

Fingers cut from old rubber gloves are ideal for slipping over cosmetic bottles to prevent any possibility of leakage should the caps loosen. These fingers also may be used as guards over the caps of bottles containing poison kept around the home. To apply a finger, first roll it around the edge almost to the end and then stretch it over the cap, rolling it down over the neck of the bottle. To open the bottle, simply roll up the finger to the cap, leaving the rolled finger on the cap. The rubber fingers can be rolled inside out for easy cleaning.

Mrs. Michael Fey, New York City.

☐ Watch television without disturbing other individuals who are reading in the same room by having a television serviceman install phone jacks on the set so that earphones may be plugged in, cutting off the speaker sound.

WTM 58 + SN 58

LEAN-TO WORKSHOP

Provides Storage and Workspace

IF YOU NEED extra storage and workspace at low cost, this lean-to shed will provide it. Built against any existing structure, the shed provides storage for bicycles, garden tools and similar articles, as well as having space for a small workbench. The shed is built on a 4-in. concrete-slab floor, and its roof can be blended into the roof of the adjoining structure for neat appearance if desired. In this case, matching roofing material would be used. The original shed was roofed with roll roofing and the window openings were covered with plastic-laminated screening nailed in place and attached to the siding below the openings as indicated in the circular detail. No doors were used in the shed, and the end walls were left open. Hand tools can be accommodated in racks fitted between the 2 x 4 studs over the bench and beside it. Drawers under the bench will provide storage for tools that cannot be kept in racks.

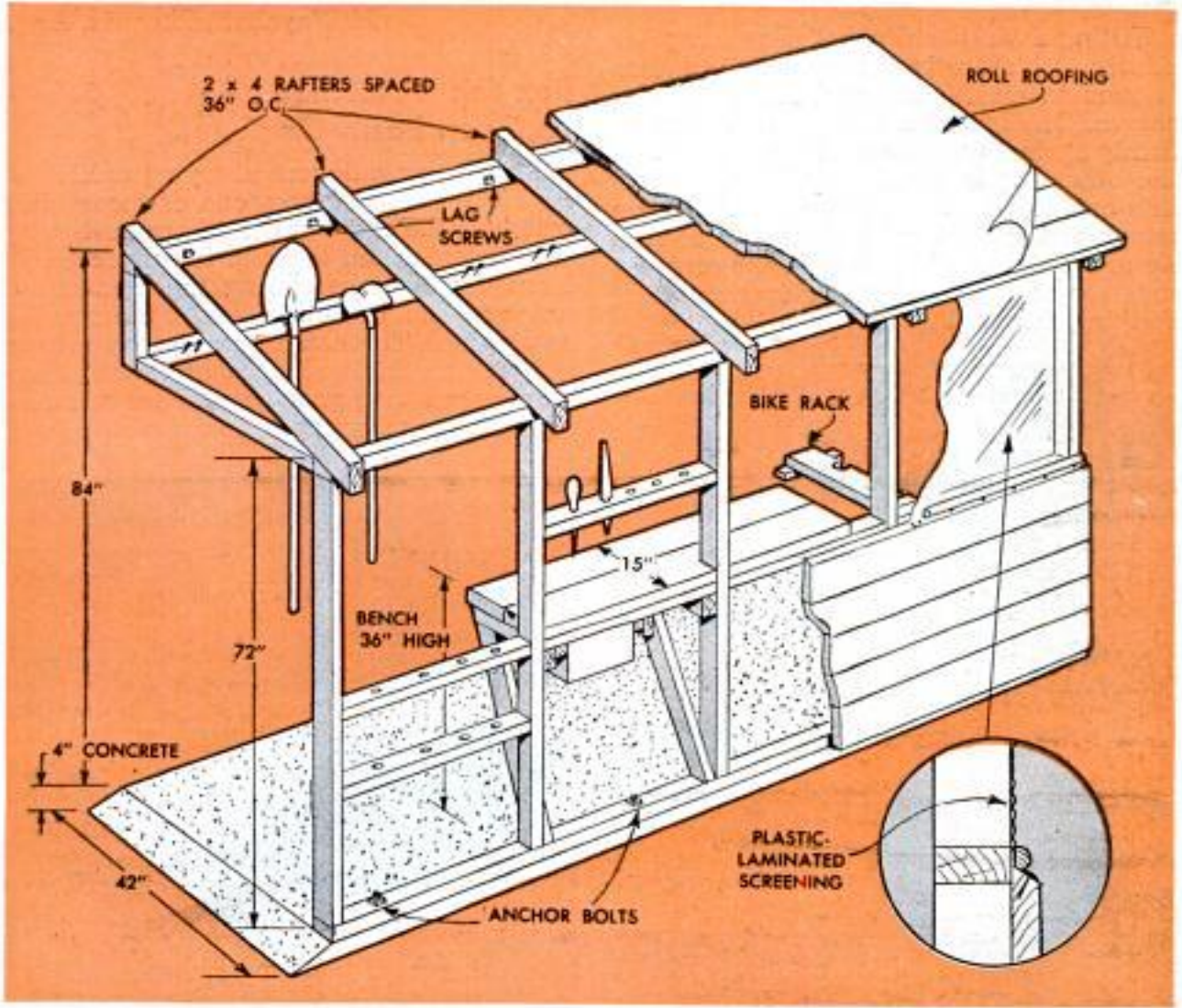

Cement-Roughening "Trowel" Made From Block and Shingle



A roughening "trowel" for finishing a concrete floor or walk may be made by tacking a gravel-surfaced asphalt shingle to a wooden block of suitable size

Compass Traces Corner Deviation On Wallboard Panel for Good Fit

Fitting a wallboard panel in an irregular corner of a room is easy when a compass is used to mark the panel for cutting as shown. One leg of the compass is pressed firmly against the corner of the room while the other leg is used to scribe a vertical line on the wallboard reproducing all the irregularities that exist along the corner. To prevent error, both legs of the compass must be held at the same elevation while scribing the line.

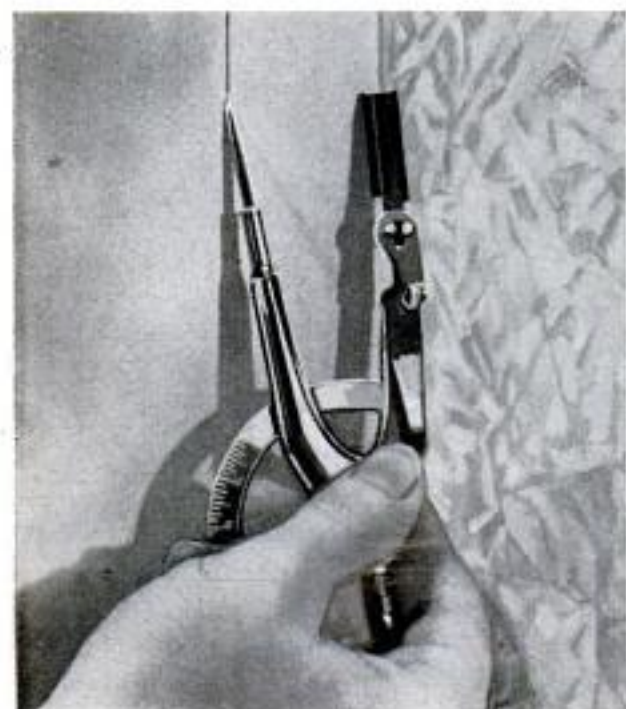

182

Shoehorn Used as Gardening Tool For Transplanting Seedlings

Transplanting seedlings and delicate plants with a minimum amount of damage can be done with a shoehorn. The concave body and rounded edge of the shoehorn permit lifting the plants gently with just the right amount of soil, and the curved top of the horn provides a firm grip.—Charles Carroll, Marion, Ohio.



Beads Grouped Between Knots Simplify Restringing Task

Accidental breaking of a necklace is less trouble if the majority of the beads remain on the string, held by a series of knots. A suggested pattern would be to string six beads at a time tying a knot in the string between each group of six, large enough to retain them. In case of breakage, only six beads will fall off.

A. H. Waychoff, Phoenix, Ariz.

Box Top Is Notched To Open Easily

Ever break a fingernail trying to lift the lid of a cardboard box, one of those kind on which the edges of the lid are flush with the bottom when the box is fully closed? Next time, before closing the box, cut a notch in one, or both, sides of the box lid as pictured. The notch permits you to grip the box while the lid is lifted off. Also works well with gross-size boxes containing screws, screw eyes and hooks.

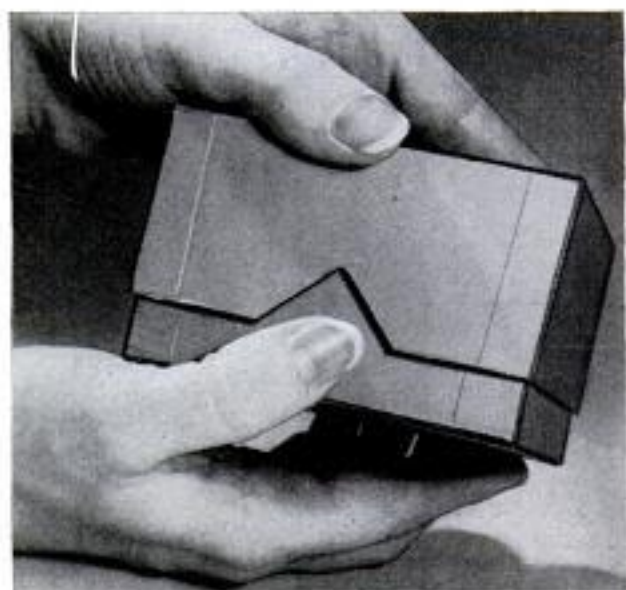

POPULAR MECHANICS

WTR 58

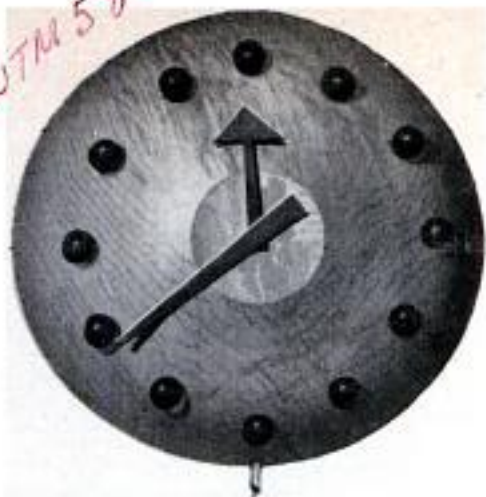

Salad-Bowl Novelties

By Ron Anderson

WOODEN SALAD BOWLS become interesting and attractive novelties simply by adding legs, a cover, handles, or making other minor changes or additions as shown in the examples illustrated on this page. Twelve cork balls, a pair of hands cut from copper sheet metal and the works from an old clock are used in making the modernistic wall clock shown above. The dome-shaped birdhouse has a hardboard bottom with a perch attached to the rim of the bowl and an entry cut in one edge.

The bowls are available in various sizes in waxed natural-wood finish, making it easy for anyone to turn out work with a professional appearance. If a painted finish is desired, it is necessary to remove the wax before refinishing.

To make this handy knitting basket, drill three $\frac{3}{8}$ -in. holes nearly through the bottom of large-size bowl and insert dowels 20 in. long for legs



Above, for snack server, glue 8-in. length of $\frac{3}{8}$ -in. dowel in hole drilled in bowl, add leather thong. Below, wheelbarrow fruit bowl is made from four lengths of $\frac{3}{8}$ -in. dowel and 3-in.-dia. wooden wheel

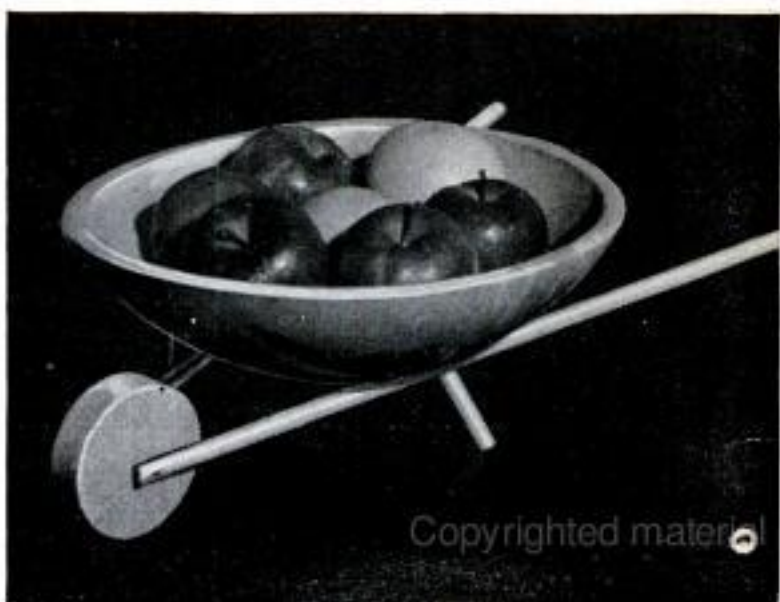



Courtesy Car Bros. Products

WHEN YOU SHOP FOR

Important fittings for comfort and safe travel are overload springs and hitches that stabilize the load.

REQUIREMENTS for safe, trouble-free travel in a trailer are much the same whether you choose a fully equipped mobile home, Fig. 1, or settle for a light job like that pictured in Fig. 4. The smaller unit will trail better on the highways and back roads when equipped with a weight-distributing hitch and big mobile homes will require both the special hitch and helper (overload) springs on the car for maximum safety and driver comfort while on the road. Special hitches on the trailer and overloads on the car keep both units on an even keel, prevent sway and roll on curves and level out dips on secondary roads that may otherwise cause the car frame to bottom on the axle due to uncontrolled weight on the trailer drawbar. Extreme deflection of the car's rear springs under unstabilized trailer weight has the effect of lightening the front wheels, causes uncertain and hazardous steering, accelerates front-tire wear and at night tilts even the headlight down beams to a point somewhere above the horizon.

Helper Springs

Helper springs, or overloads as they are commonly called, generally are weight-rated and from these ratings it is possible to determine the capacity required as most manufacturers of trailers give the approximate drawbar weights, which usually range from 6 to 12 percent of the total weight. Of course, it should be remembered that the actual drawbar weight, with the

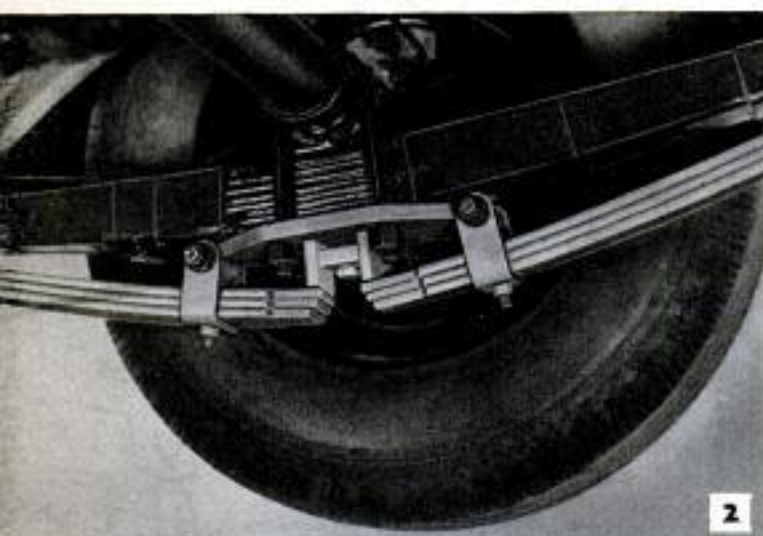

Courtesy Duo-Control Spring Co.

Above, heavy-duty helper spring (overload) attached to rear car spring. Can be released when not in use.

Below, weight-distributing hitch attached to car

Courtesy Reese Products, Inc.

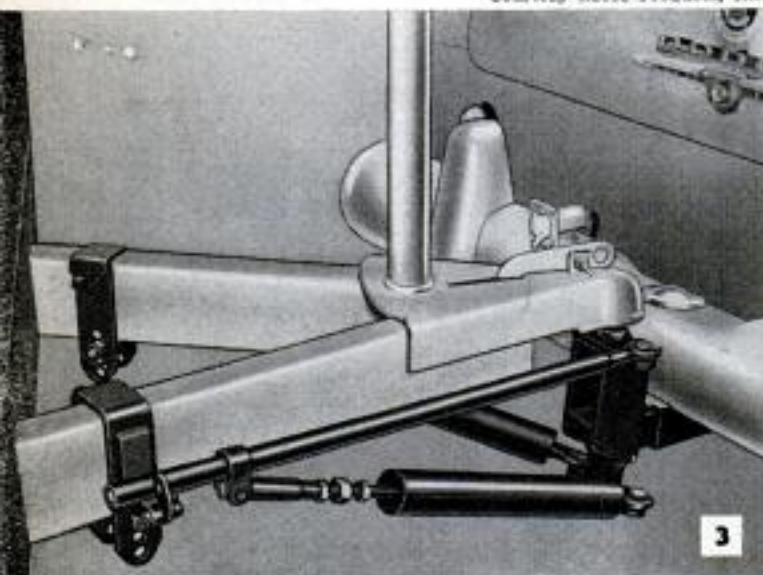

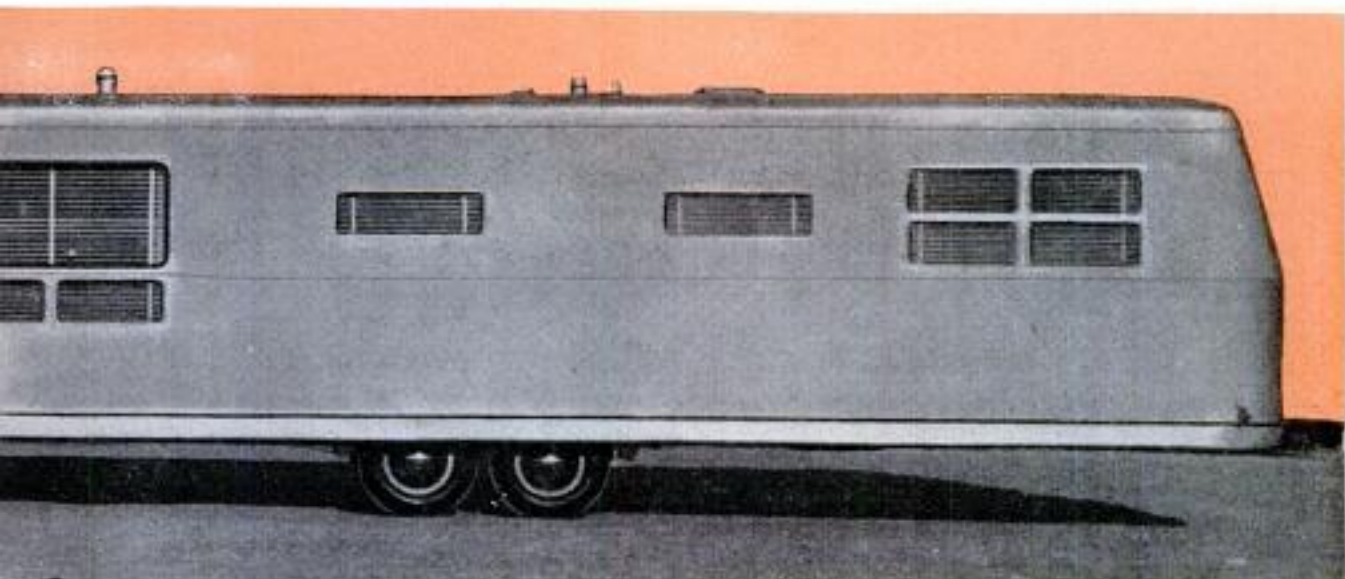

A TRAILER—

By Clinton R. Hull

trailer loaded for the road, depends to a considerable extent on proper distribution of the load.

Representative types of overloads are shown in Figs. 2, 5, 6 and 10, but there are other types not pictured. These include half-length overloads, for light trailers, which clamp onto the rear halves of the car springs. There also are pneumatic overloads of several types and of varying capacity. Nearly all overloads throughout the capacity ranges ordinarily supplied are designed to be removed or released easily when not in use. Note as an example, the load-adjusting and releasing devices on the high-capacity overloads in Figs. 5 and 10.

The important consideration in selecting a trailer hitch of the weight-distributing, or compensating, type is to obtain a unit exactly suited to the trailer, the car and the type of service you are going to require.

In a general way, weight-distributing hitches are of two types, those that bolt to the car bumper with extensions that extend back to a cross member of the car frame, and those that attach to the bumper and extend back to the rear axle of the car. Weight-distributing hitches of several types are illustrated in Figs. 7, 11 and 12. Hitches shown in these views are of the type that attach to the car frame, or to the frame and body, but not to the rear axle of the car. In some instances these hitches are attached to the car-frame members by welding, but as a rule manufacturers of hitches of this type recommend that the parts be bolted in place. Figs. 13, 14 and 16 picture hitches of the type that attach to the rear axle of the car by means of heavy saddles. On some variations of this special type the hitch ball is mounted directly on the saddle, the trailer being fitted with a

Many trailerists prefer weight-distributing hitches on smaller trailers for maximum safety and driving ease



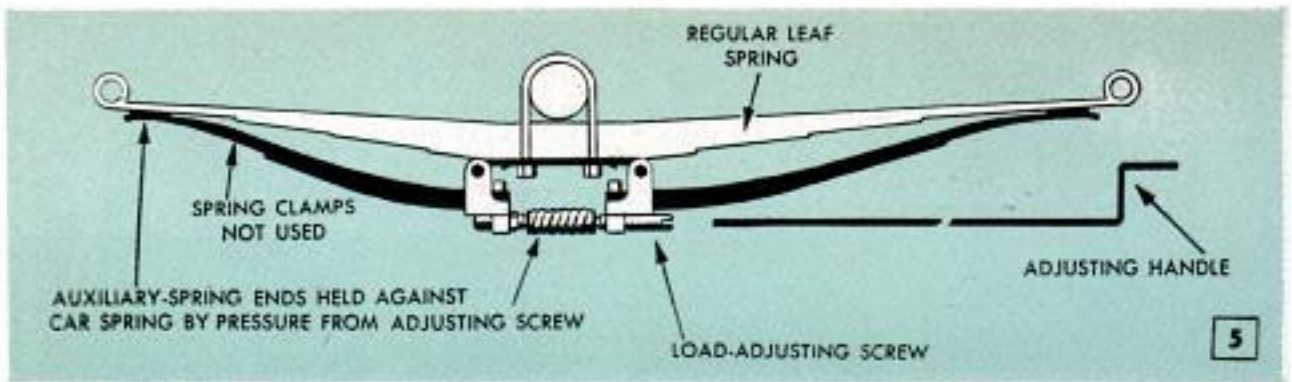

Overload spring of type that can be adjusted or released by means of handle which projects beyond bumper

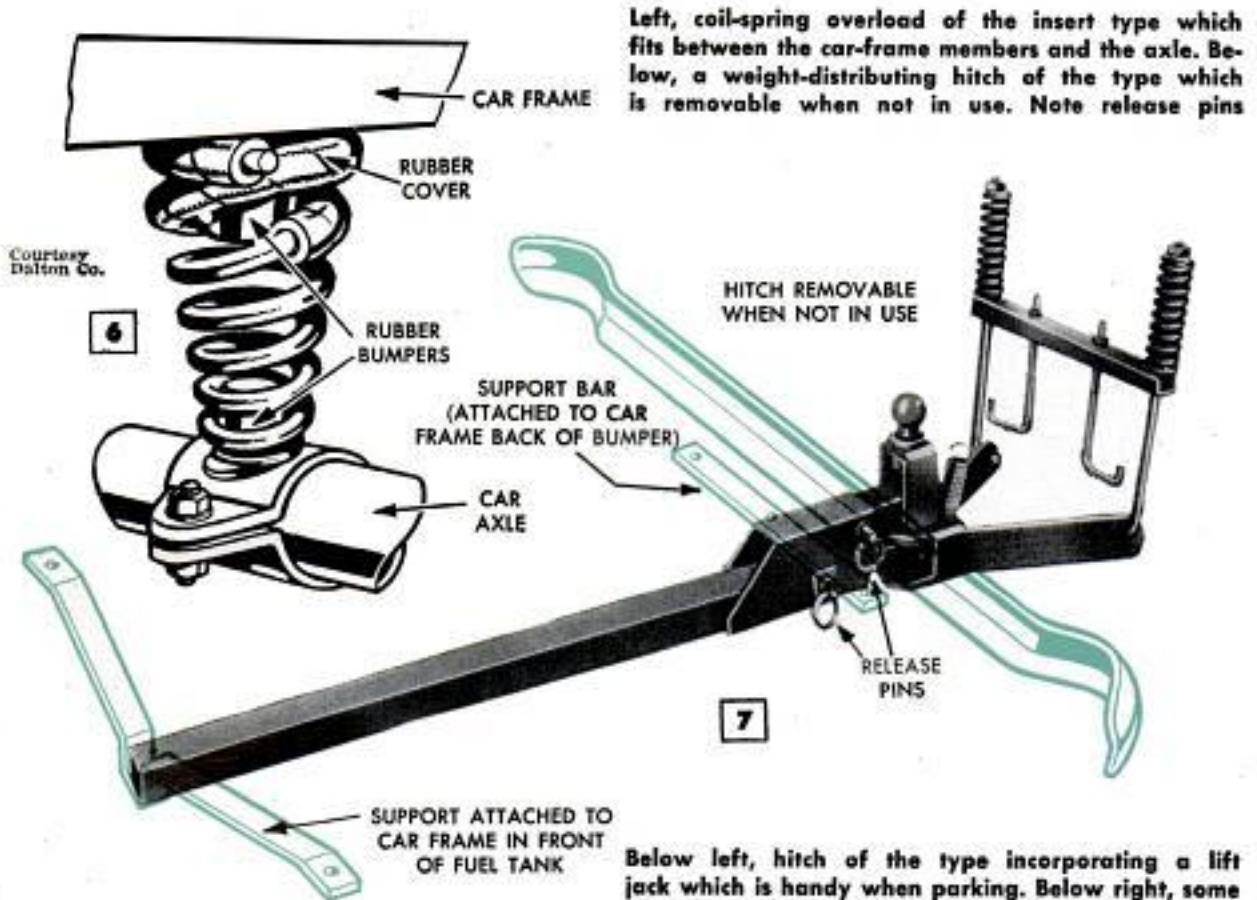

Courtesy Ear-Lift Spring Corp.

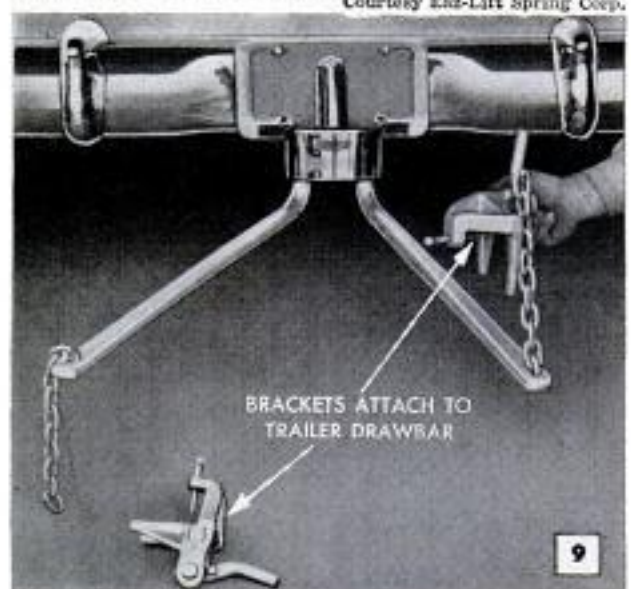
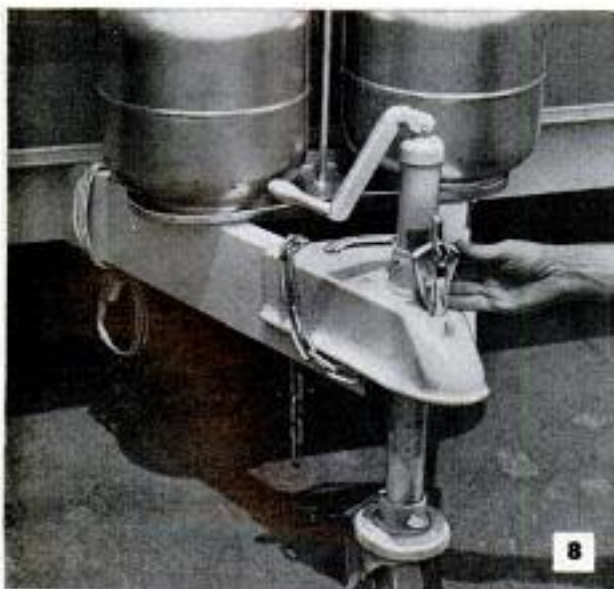

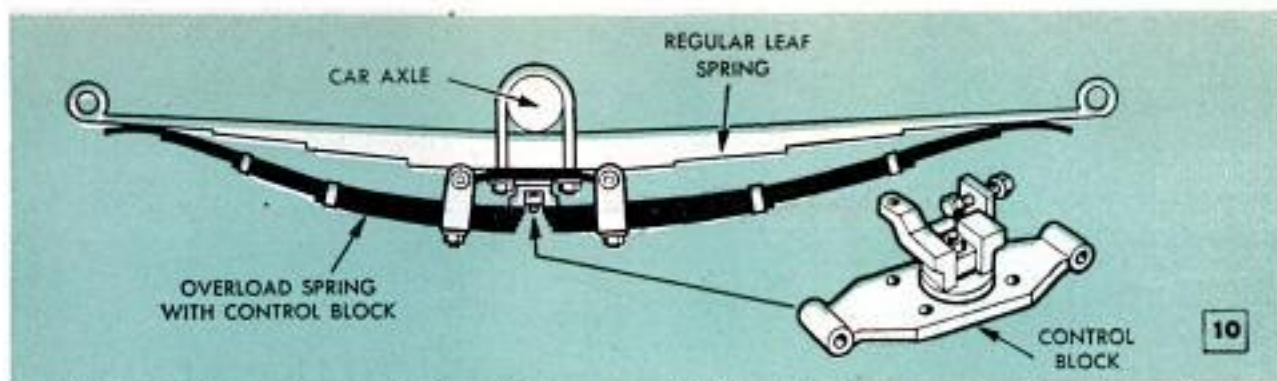

Another type of heavy-duty overload employing a control block rather than a screw and crank for adjustment

special extension drawbar. Such hitches require no overloads as drawbar weight is carried directly to the rear wheels of the car. Manufacturers design hitches to fit nearly all makes and models of cars and supply any special parts necessary for attaching. Complete instructions are furnished. In the illustrations of the general types of hitches it should be noted that in several instances not all parts are shown.

Safe Towing

In addition to providing a safe means of towing the trailer, the special hitches are designed to prevent sideways and to distribute both towing and load stresses in such a way that car and trailer ride level. Various types of equalizing mechanisms are pictured in Figs. 3, 7, 9, 14, 15 and 16, all being designed to distribute total weight of car and trailer uniformly over the four car wheels and the two or four wheels carrying the trailer. This weight distribution, or equalized weight return to the car and trailer wheels, is accomplished by means of coil springs, tension bars or pneu-

matic cylinders, all of which are adjustable.

Weight-distributing trailer hitches call for uniform inflation of tires, on both trailer and car, a general recommendation being an increase in tire pressures from 3 to 5 lb. above those specified for a given tire size. Underinflation of the tires or varying pressure in the tires on either car or trailer can cause uneven braking and hazardous swaying under certain driving conditions. On long trips it's advisable to check the air pressure in all tires once a day.

For light and medium-sized trailers 4-ply tires on the trailer and towing car are usually considered adequate for average service. For the heavier jobs having either single or dual axles (four wheels) most experienced trailerists recommend 6-ply tires on both car and trailer. Some use 6-ply tires on the car when towing any type of trailer with drawbar weight sufficient

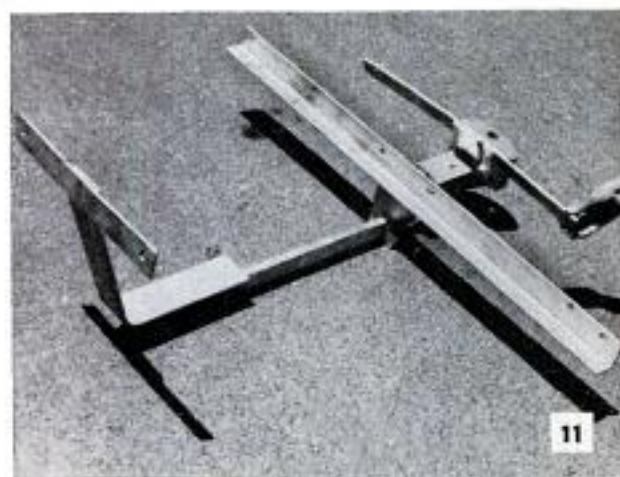
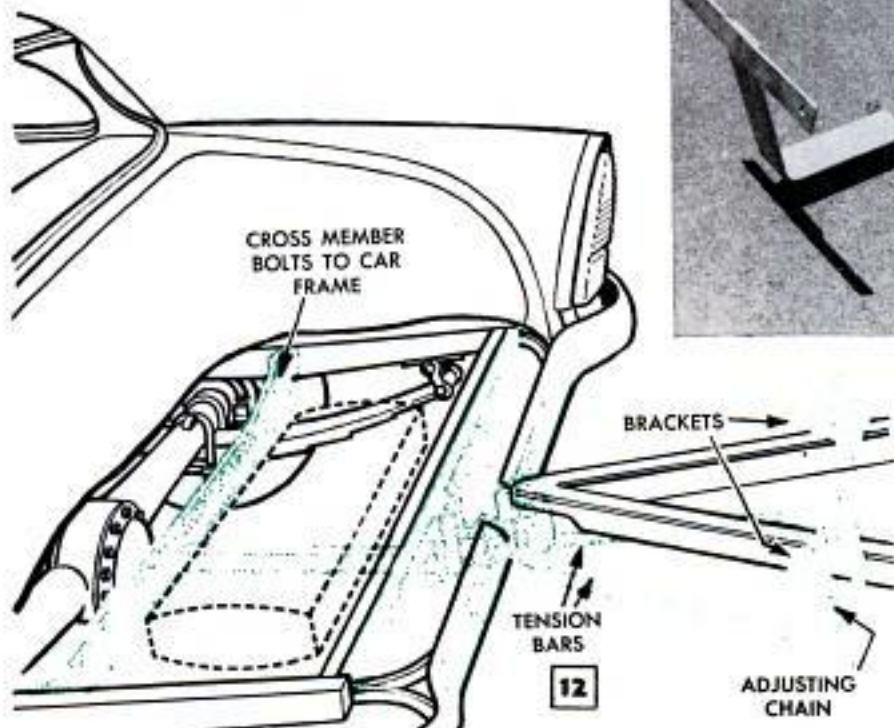

Above, principal parts of a typical weight-distributing hitch designed to be attached to the bumper and car frame back of the fuel tank. Left, the same general type of hitch with a wide angle-steel cross member which bolts to the side frames of the car, to the rear crossframe and also to the bumper. Note the use of tension bars. See also Fig. 9



13

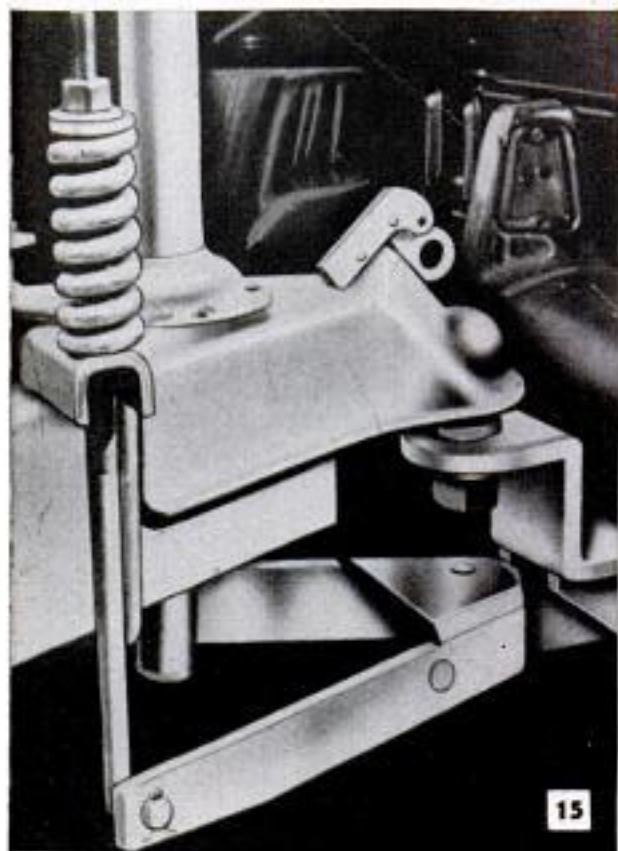

15

Above, types of hitches which attach to rear axle of car by means of saddles. Below, saddle-attaching hitches and one type of self-steering front axle

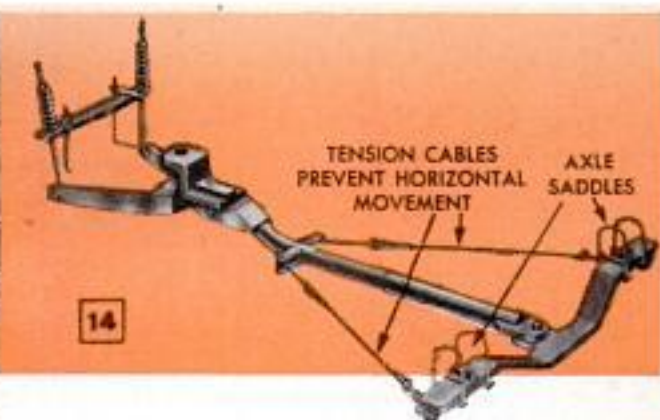

14

Courtesy Mobile Equipment Co.

to require overloads on the car springs. For heavy-duty service, or unusual conditions it is probable that the extra initial cost of 6-ply tires is offset by the added safety factor.

Front Axle

For towing a heavy mobile home, and especially one in which it is not always possible to distribute the load equally, many owners like a self-steering front axle such as that shown in Fig. 17, the right-hand detail. This axle is designed to relieve the car of all stresses except the towing effort, making overloads unnecessary. The hitch from axle to car is so arranged that the axle faithfully follows every movement of the towing vehicle. In this action it differs from the conventional dolly and also the casters which are designed to support the trailer drawbar when at rest and are usually furnished with the drawbar jack as in Figs. 8 and 17, the left-hand detail. ★ ★ ★

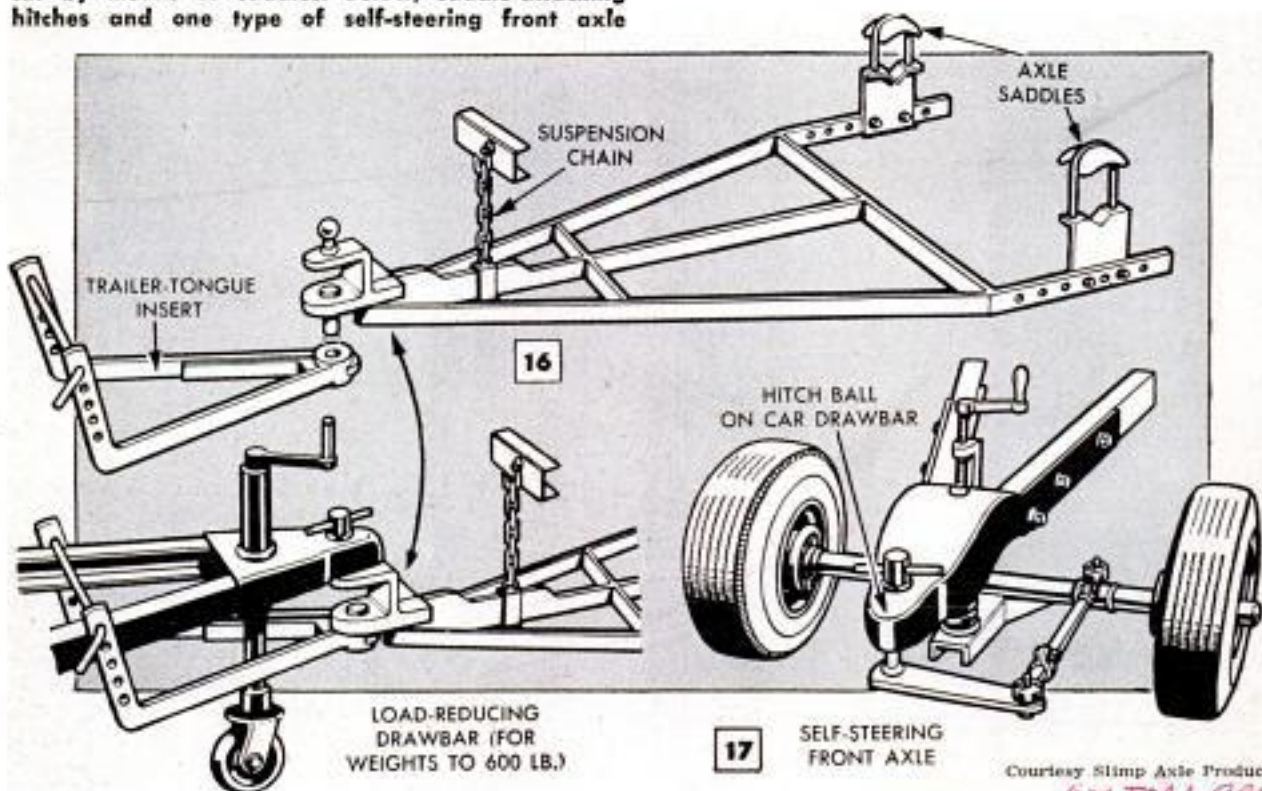

16

17

Courtesy Sling Axle Products

COLTON, CALIF.

POPULAR MECHANICS

Pivoted Crane Adds Character to Your Fireplace

Instead of just setting an iron kettle on the fireplace hearth, create an authentic atmosphere by hanging it on a hinged crane. A flat-steel bracket with its ends bent outward and drilled is bolted to the fireplace wall by means of lag screws turned into steel expansion sleeves, as indicated in the detail. The swinging part of the crane consists of two pieces of square $\frac{1}{2}$ -in. steel rod of sufficient length to locate a hook-shaped end of the upper cross piece in the center of the fireplace.

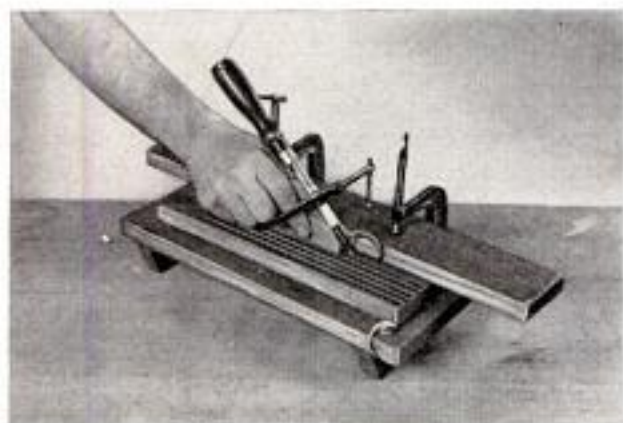
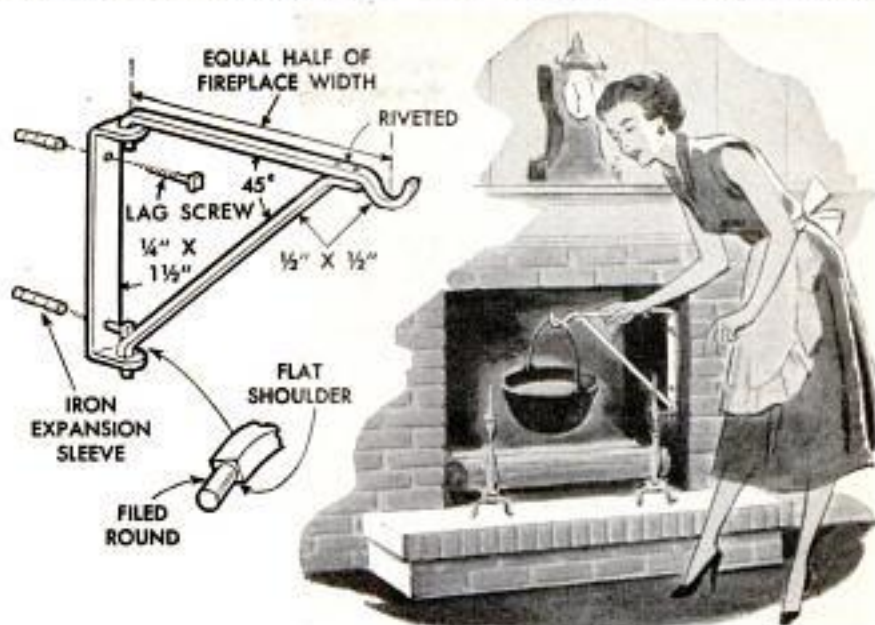

Improved Fluting Plane

If you have only occasional need for a fluting plane, one can be improvised from a gouge and a block of wood. Cut off the end of the block at an angle of about 45 deg. and clamp the gouge to that end with a C-clamp. Drill a hole through the side of the block to receive the fixed pad of the clamp. To assure a straight cut, clamp a straightedge to the work piece and hold the "plane" against it. Make several shallow cuts, adjusting the gouge to cut more deeply into the wood each time.

Safety Release on Crossbar Of Pole-Vaulting Hurdle

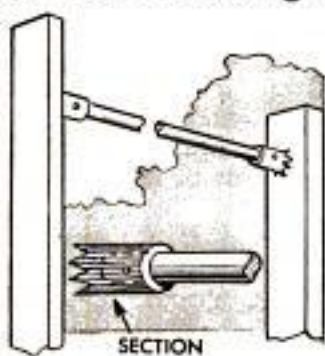

One method of assuring that the crossbar of a pole-vault hurdle becomes dislodged easily if a contestant strikes it when making an unsuccessful jump is to fit a section of serrated rubber hose over each end of the bar.

The friction of the hose will hold the bar in place, but a slight blow from any direction will dislodge it. Hose sections without serrations are not as efficient, because the bar might be inserted so that a blow against it from a certain angle or direction could wedge it firmly in place.

☞ Strong black tea, diluted to provide the desired color, makes antique stain for white pine.

Nail in Stick is Depth Gauge

A nail driven into a block of wood and allowed to project the required distance serves as an improvised depth gauge when cutting lap joints or making notches where the depth of the cut must be uniform. Use a nail having a flat head.

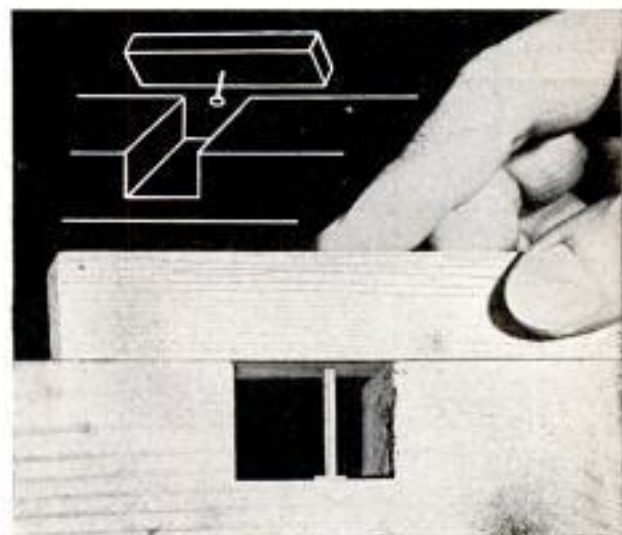

Pep Up HOME MOVIES

By E. R. Haan



Above, colorful wallpaper in simple pattern appropriate to subject provides attractive, unobtrusive background for movie title. Also, carpeting, yard goods, tablecloth and wrapping paper can be used



Scenic background is colored picture which can be cut from calendar, magazine, illustrated travel folder

Plywood suitably stained to bring out wood grain produces simulated aquatic background for rope title



UNLESS YOU'RE a born master of ceremonies, both you and your friends may prefer silent titles spliced into home movies to a running commentary explaining the film and apologizing for its faults. Titles should be used only to convey information that is not evident or readily apparent in the pictures. This article tells how you can make simple titles that are neat and effective, without spending a great deal of time, effort and money.

Use titles sparingly. Make them clear and concise. They should not distract attention from the film story. Lengthy information can be divided into two or three short titles presented in sequence on background boards, Fig. 3, or they can be presented on a scroll, Fig. 18, for continuous filming of the sequence. At times the need for a special title can be avoided by letting some detail in the scenery serve the purpose, such as a signboard giving the name of a park, hotel, city, state or mountain. Such title substitutes should be kept in mind on trips and vacations and worked into the scenery or surroundings for title material. When these opportunities have been missed, it is still possible to insert close-up shots of souvenir decals, pennants, maps (Fig. 7) and illustrated travel folders.

Conventional Titles

Usually, the most attractive printed titles are made with the aid of commercially available letters for titling. These come in kits, some of which also include colored background cards. Also available are letters of different sizes and colors stamped out of paper, cardboard, felt or sheet plastic. Some have gummed backs for repeated use on glass or celluloid backgrounds. Block letters shown in Figs. 1, 2, 4 and 6 produce interesting three-dimensional effects that can be intensified with shadows.

Although the cost of manufactured letters is very low, you may want to make your own. Block letters are easy to cut out on a scrollsaw, from wood, plywood, plastic or soft metal such as aluminum. Rough edges should be sanded smooth and the letters given a coat of flat-white paint.

Novel Titles

The simplest kinds of titles that cost practically nothing are printed or written on suitable backgrounds as in Figs. 8 and

With Titles

Part I

9. Anyone can letter neatly with the aid of a lettering guide obtainable at art stores. You can use chalk on rough surfaces of contrasting color, Fig. 10; black or colored grease pencils on glass or other smooth surfaces such as the script part of the title shown in Fig. 11. Titles can be made using show-card techniques and colors, or "finger paint" used in schools. Also, letters can be formed with colored tape as shown in Figs. 11 and 12. Matches, small twigs, Fig. 17, sea shells, and rope and yarn letters, Fig. 3, produce interesting and novel effects. Letters from alphabet soup and children's blocks can be arranged to spell words. You can scratch titles in damp sand at a beach, Fig. 14, or in snow, and then photograph them, using a strong side light for the contrasting shadow effects necessary for good reproduction. For small titles, typewritten words can be used, but for this an auxiliary lens may be needed to magnify the letters sufficiently.

Selection of Backgrounds

White block letters contrast well with colored backgrounds, but if you wish to use colored letters, be sure that they are complementary to the main background color. Often it is preferred to use one color combination for all the subtitles in a film since radical changes in title technique tend to distract from the film story.

There's no end to the variety of materials available for making distinctive artificial backgrounds. The materials include textured carpeting; patterned wallpapers, Fig. 1; wood, Fig. 12, and plywood, Fig. 3; cloth and yard goods; sheet plastic and glass; corrugated paper, Fig. 6, and decorative wrapping paper; pictures, Fig. 2, and photos. Rough, textured surfaces can be given contrast by side lighting. When positioning letters over rough, uneven backgrounds, place a pane of clean transparent glass on the background, and arrange the letters on it. This method, used in Figs. 4 and 6, permits using household and clothing fabrics with a minimum risk of soiling them. Also, the glass serves to hold the background material flat. Solid letters on the glass will seem to stand out from the background because of the shadows they cast. Sketches and thin-line lettering or writing should not be done on the glass since their shadows on the background will



Fig. 4, photographing background on table is easier than on wall, eliminates gluing title to background. Fig. 5, fabric background and sketch on cellophane protected under glass used for title. Below, strong side light on corrugated paper accents vertical lines





Substitute for title consists of photographing moving hand that traces route of entire trip on map with pencil using colored lead

be confusing. If a sketch is desired, this is put on a sheet of cellophane with a grease pencil and the cellophane laid on the background and under the glass as in Fig. 5.

Title making is considerably easier if all the lettering and background cards are of uniform size throughout a film. However, title sizes often vary. Perhaps the texture of a background material is too fine for a shot taken at 36 in. but requires a close-up of 15 or 20 in. Sometimes only a small area of wallpaper can be used as a title background, or the size of a picture used for a background may be the determining factor. If possible, avoid getting backgrounds that are too small in proportion to the size of the lettering.

Titling Equipment Needed

A titling stand that holds the camera, title and two lights is a great convenience.

Title hand-lettered with charcoal on rough wallpaper easy to do but lacks neatness of printed title



You can buy one for \$20 to \$300, or make one as shown in Fig. 15. When titles can be shot outdoors where illumination is adequate, no separate lights are needed. An auxiliary lens is required only for close-ups taken at distances less than the minimum focusing distance of a camera. A film viewer on an editing board is convenient but it is possible to use the projector instead—simply stop the film, open the projector and apply a small piece of masking tape over selected frames.

For splicing title strips into a film as well as other editing work, a splicer and two geared rewinds are needed. These units are mounted on a single base, the splicer midway between the rewinds. Some of the latest-model projectors are equipped

with splicers that are very handy for this work. A splicer has a built-in knife to cut the film and a scraper to remove a narrow strip of emulsion along one of the cut edges, to which another strip of film is to be cemented. Often water is applied to the edge to soften the emulsion before scraping it off. However, the film must be absolutely dry when the cement is applied or it will not stick. The splicer holds the joined ends of the film together firmly while the cement dries.

Aligning Camera With Title

Titles can be arranged horizontally with the camera above, Fig. 4, or they can be set vertically in front of the camera. The first arrangement usually is the most convenient. Letters can be laid on horizontal backgrounds but must be secured in some way on vertical ones. In either case the

Green script title on panel of red wallpaper in oatmeal pattern is more decorative than printed one





10 Title lettered in chalk on sidewalk utilizes readily available materials appropriate to subject of movie

camera should be mounted rigidly as on a tripod or titling stand. The lens of the camera should be aligned with the center of the background card, with the lens axis at right angles to it.

Getting close-up titles properly positioned on the film is easy if your camera takes pictures in good focus at distances of 36 in. or less and if the view finder is accurate—field of view as seen through the view finder is the same as that transmitted by the lens. If the field of view is not the same for the view finder and lens, a parallax condition may exist and part of the subject might not be recorded on the film. Some cameras are equipped with view finders having parallax correction for distances less than 6 ft., but very few have this correction for distances as close as 18 in. On some cameras using film magazines instead of rolls, accurate close-up focusing is done through the camera lens by means of a special viewer which is momentarily substituted for the magazine.

If your camera does not have provision for close-up focusing of titles, it will be necessary to take careful measurements when aligning the camera with the subject. A great deal of measuring is eliminated when a titling stand is used since it keeps the camera lens centered and aligned with the background. The distances between the camera lens and the titles vary according to the title sizes. In view of this, you should know the exact field of view of your camera at various distances under 4 ft. These figures for 8 and 16-mm. movie cameras equipped with $\frac{1}{2}$ and 1-in. lenses, respectively, are given in Fig. 16. You can determine them for your own camera by making a few test exposures at various distances from a 15 x 20-in. cardboard marked off in 1-in. squares, after centering and aligning the camera with the card.

When no titling stand is used, you can



11 Photo of car, block letters of tape on plastic tabletop background. Script written with grease pencil

Title made of colored tape on mahogany background with scissors—object associated with childhood



center and align a camera lens and a title background card as follows: Take measurements with a string from the center of the lens (after covering it with a lens cap) to each of the four corners of the background. When these distances are identical, centering and alignment are correct. A T-square or suitable straightedge clamped to one leg of a try square may be helpful when obtaining alignment. When a camera is mounted above a horizontal title, a plumb bob may be found useful for centering. Whether a title is square with the camera or not generally can be seen through the view finder.

The background card should be a little larger than the field of view so that the edges of the card will not show on the film if there should be a slight discrepancy in alignment. Ample space should be provided between titles and the edges of the field of view to prevent a crowded effect.

Titling Stand You Can Make

The titling stand shown in Fig. 15 consists of a beam, preferably hardwood,

with a tapped, metal plate at the balancing point, for attachment to a tripod. A sturdy holder at one end supports the camera, which must be centered and properly aligned with the background. A felt-covered plate bent at right angles keeps the camera from turning. A shoulder rest may be added for "panning" scenic backgrounds through a transparent glass background on which a title is mounted.

Title background cards are set in a grooved holder which can be moved back and forth, or tightened at any point on the beam. Smaller backgrounds are cemented to a sheet of hardboard that slips in the holder. A crossarm holding two lamps may be attached to the beam just ahead of the camera (optional). The cross piece can be located behind the camera if the beam extends far enough on both sides of the camera. Also, lamps can be held on separate floor stands.

Correct Timing for Titles

Titles should be timed to give the slowest readers enough time to finish them. About one second per word is sufficient. This does not include the time required for a title fade or other similar effect. When titles are shot against a photo or picture background, extra time should be allowed for viewing the artwork. When preparing titles, don't forget a suitable one at the end, in order to give spectators a smooth, pleasant transition from the movie to reality, instead of ending the picture abruptly.

Scroll Winder for Long Titles

When a great deal of information must be conveyed, this can be done by using a scroll winder, Fig. 18, using two or three separate background cards for presenting the information. The scroll-winder frame can be used in place of the background holder for holding cards, simply by removing the cranks and scroll. In operation, the lines of a title on a scroll move upward

Important element of scenery such as signboard photographed on trip is excellent title material



194

and out of view after sufficient reading time, and new lines appear from below. The simplest kind of scroll is a typewritten one on paper 4 or 5 in. wide, which must be shot at a distance of 10 or 12 in. and may require an auxiliary lens. To avoid the latter, a larger scroll can be made and worked on the same principle. For lettering, use the "stick on" type, or print the titles with rubber type of suitable size.

Lighting Suggestions

The amount of illumination required for photographing titles varies with the type of film used, the distance between the camera and the title, and the light reflectivity of the title and background. Check the illumination with a light meter or use an exposure guide. Daylight usually is sufficient to shoot titles outdoors. A title background should be lighted uniformly unless strong shadow effects are wanted for block letters or textured backgrounds. For title lighting indoors, a single lamp, either regular or flood, may be sufficient, but this should not be less than 3 ft. from the title to avoid uneven illumination. Two lamps set at an angle of 30 to 45 deg. from the axis of the lens, equidistant from the title and not closer to it than 2½ ft., as indicated by the dotted lines in Fig. 15, are preferable to a single lamp. Check the uniformity of the lighting with an exposure meter. Avoid placing lamps close to the lens axis or in other positions where strong light might be reflected directly into the lens. For shadow effects with block letters or textured backgrounds, one lamp is set closer than the other, or lamps of different sizes are used.

Translucent backgrounds, such as decals and some kinds of ornamental glass, may be lighted from the rear. When doing this, the light intensity must be checked with an exposure meter at a point immediately in front of the camera for the correct exposure. To prevent glare on the lens when

Title scratched in damp sand at beach or in snow photographed with side light for shadow effect



POPULAR MECHANICS

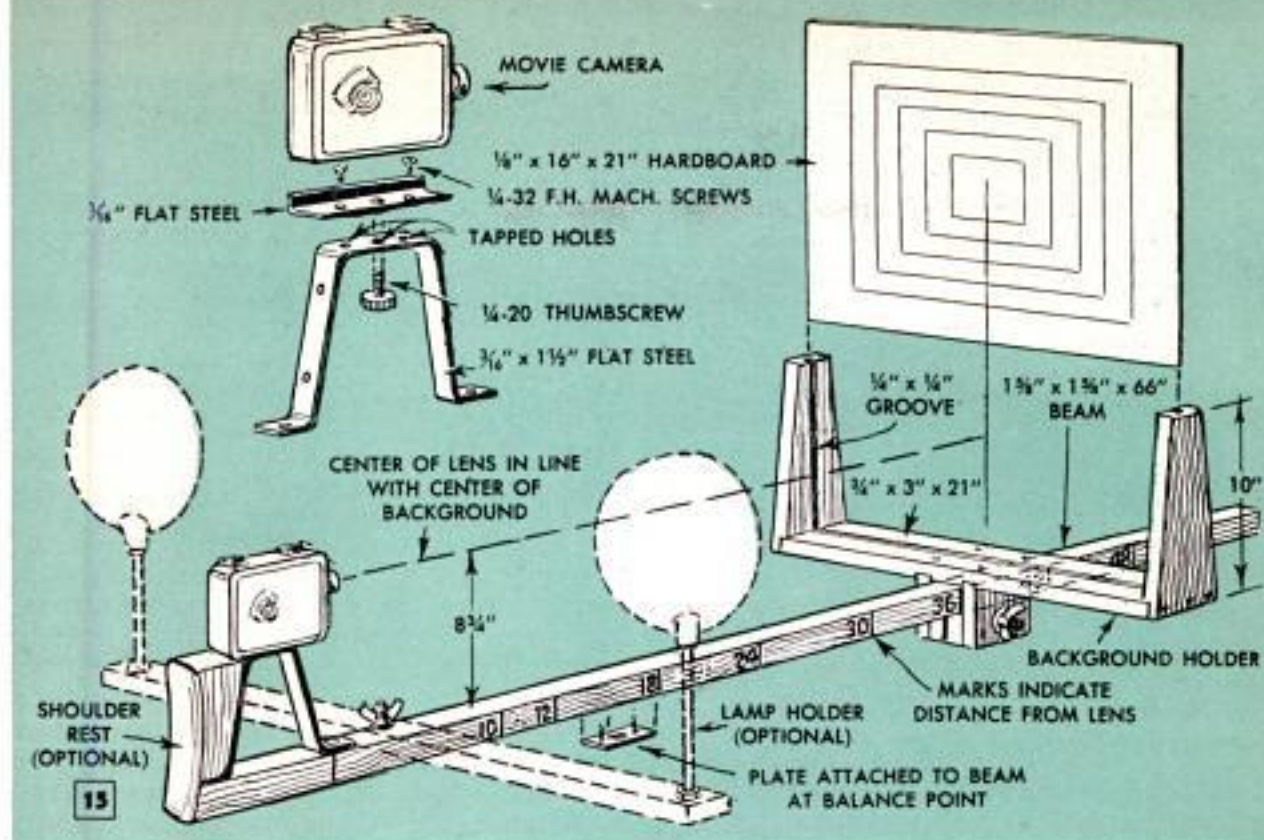

Scroll winder, Fig. 18, can be used as background holder on tiling stand above, after removal of hand cranks

employing this method, a diffusing screen such as tracing paper or opal glass may be needed between the background and the lamp. Avoid placing paper too close to a lamp because of the fire hazard.

In the second half of this article you will be shown how to superimpose titles on real scenery backgrounds, how to fade titles before and after processing film and an easy way of producing wipe-ons and wipe-offs.

16 CAMERA FIELD OF VIEW AT VARIOUS DISTANCES FROM BACKGROUND BOARD
(All dimensions in inches)

Distance from lens to title	8-mm. cameras having $\frac{1}{2}$ " lens	16-mm. cameras having 1" lens	Recommended size of background card
48	12 $\frac{3}{8}$ x 16 $\frac{1}{2}$	13 $\frac{3}{8}$ x 18	16 x 21
42	10 $\frac{3}{8}$ x 14 $\frac{1}{2}$	11 $\frac{3}{8}$ x 15 $\frac{1}{2}$	14 x 18
36	9 $\frac{3}{8}$ x 12 $\frac{3}{8}$	10 x 13 $\frac{1}{2}$	12 x 15
30	7 $\frac{3}{4}$ x 10 $\frac{1}{4}$	8 $\frac{3}{8}$ x 11 $\frac{1}{4}$	10 x 13
24	6 $\frac{1}{4}$ x 8 $\frac{1}{4}$	6 $\frac{1}{4}$ x 9	8 x 11
18	4 $\frac{3}{4}$ x 6 $\frac{1}{4}$	5 x 6 $\frac{3}{4}$	6 x 8
12	3 $\frac{1}{2}$ x 4 $\frac{1}{2}$	3 $\frac{1}{2}$ x 4 $\frac{1}{2}$	4 x 5
10	2 $\frac{1}{2}$ x 3 $\frac{1}{2}$	2 $\frac{1}{4}$ x 3 $\frac{3}{4}$	4 x 5

Fig. 16, table gives field of view for $\frac{1}{2}$ and 1-in. camera lenses at various distances from background board and sizes of background card required for each distance. Below, lengths of twigs arranged on beach present movie title interestingly



MARCH 1957

195

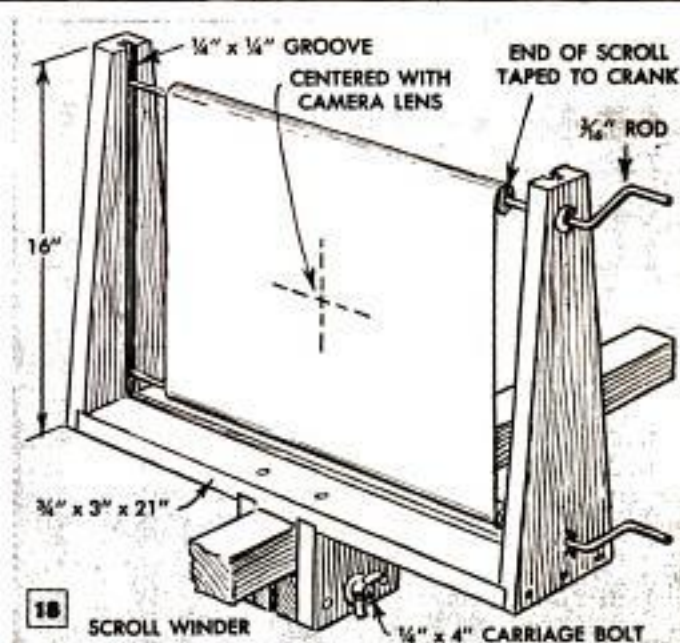

Spaced Lines Ruled Quickly With This Perforated Disk

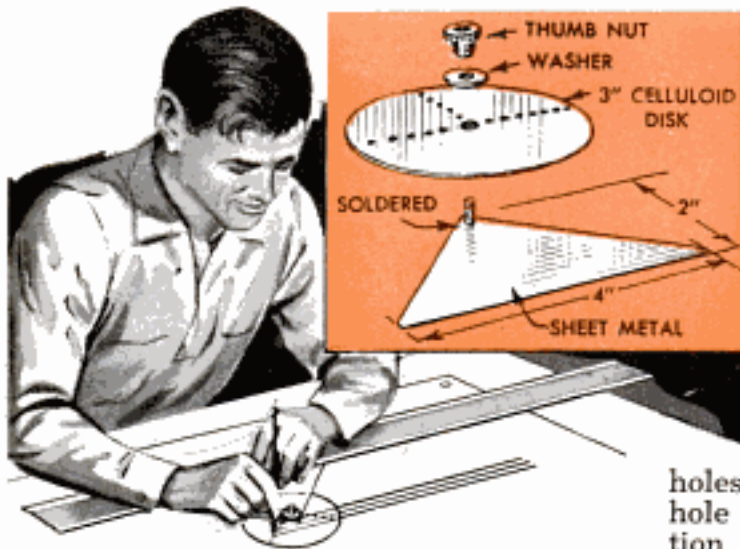

Gauge Cut From Sheet Metal Measures Various Diameters

Cut from sheet metal to the shape shown, a gauge can be used to measure outside diameters of round stock, inside diameters of pipe and tubing, and diameters of screw sizes. One side of the gauge is marked in sixteenths of an inch for diameters of pipe, tubing and round stock, while the opposite side of the pointed end is marked in wire-gauge sizes of measuring the diameters of

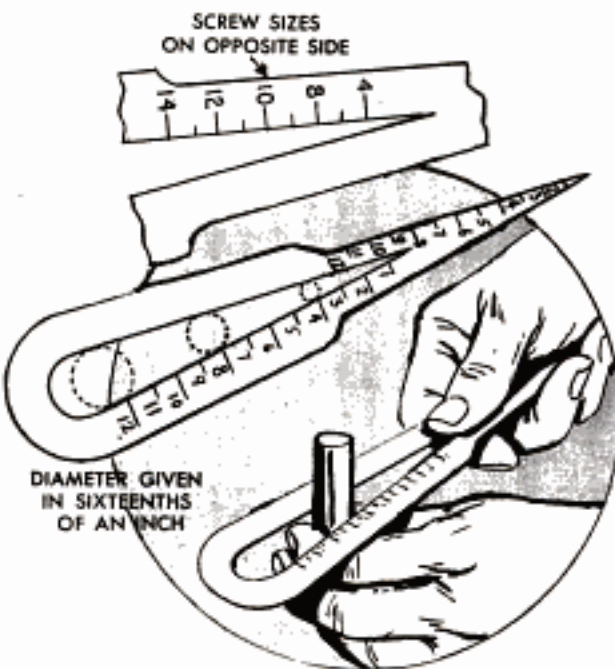

drill bits and screw stock. The method of using the gauge for measuring the outside diameter of round stock is shown in the lower detail in the illustration.

☛ Paint the frayed outer covering of electric cord with shellac to help insulate it against possible short circuits.

Parallel lines can be ruled accurately at any desired spacing with this perforated celluloid disk. It pivots on a screw soldered to a sheet-metal base, but is locked in position with a thumb nut after it has been adjusted. Radial rows of tiny countersunk holes admitting a sharpened pencil point without play are drilled in the disk at equidistant spacing of $\frac{1}{4}$, $\frac{1}{2}$ and $\frac{3}{4}$ in., or as desired. In use, the device is moved back and forth along the T-square by means of the pencil engaging successive

holes in the disk. Starting in the outermost hole of a row, the first stroke in one direction rules the top line. Then the pencil point is inserted in the next hole and the return stroke is made, ruling the second line. Spacing of lines is maximum when a row of holes used is at right angles to the T-square, but becomes less as the row approaches the point of being parallel with the T-square.

Wood Scrap Prevents Splitting When Boring Hole With Brace

When boring with a bit and brace, splitting of the wood around the hole can be avoided by first clamping a scrap of wood behind the work. The point of the auger bit will penetrate the wood scrap and allow smooth cutting of the hole, since the back surface of the work cannot split out because of the block.

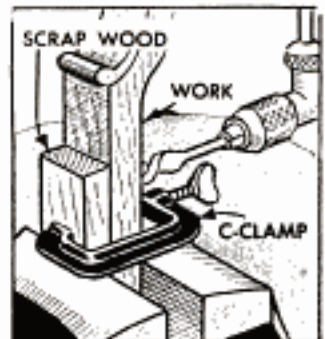

Simple Way to Keep Lamp Shades Clean

To keep lamp shades clean longer, try self-adhering kitchen wrap. Cut the material into strips about 3 in. wide. Use a sharp knife or razor blade and cut through the cardboard tube too. Anchor the first strip to the cross wire at the top of the shade by simply tying a single knot. Then start wrapping from top to bottom on the outside and back up on the inside. When one strip is used up attach the next one with a common pin. The edges of the strips will adhere and completely enclose the shade in a transparent cover.

Veryl Le Masters, Le Mars, Iowa.

SN 58

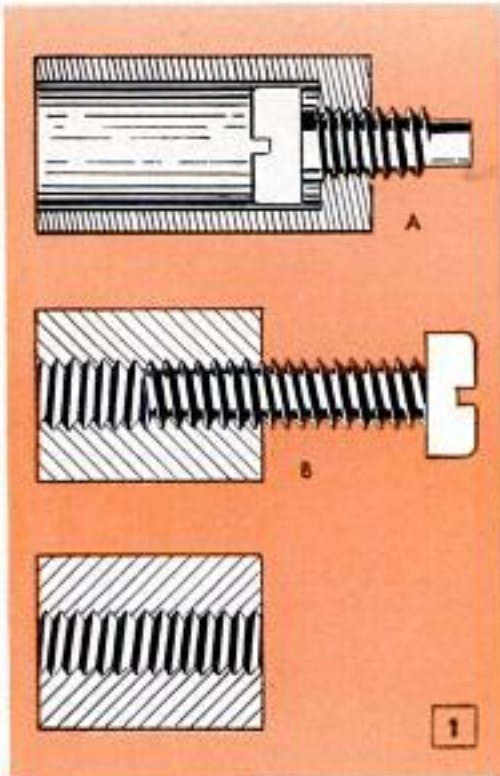

Two-Piece Holder For Machining Screws

HERE ARE TWO TYPES of holding devices for protecting the threads on screws when it is necessary to chuck them in a lathe or drill press for machining or polishing of either end. Differing from the conventional one-piece manufactured types, these holders are cut in half as shown in details A and B, Fig. 1, so that work can be positioned between the halves and chucked in a lathe in only a few seconds, Figs. 2 and 4. The one shown in detail B is designed for screws requiring work on the head only. The type in detail A has threads at one end with the remaining length drilled to receive the head of a screw to permit machining on the end of it.

The holders can be made of brass or steel in a length suitable for the size of chuck used and in a range of sizes ordinarily used. For use in a chuck they are made of round stock. While round holders can be clamped in vise jaws, square ones will work better. When making a holder, chuck a length of stock in a lathe, square one end, machine the circumference to fit the chuck it is to be used in, and drill-tap the thread size the holder is to accommodate, as shown in Fig. 3. Next, the holder is cut to the desired length and sawed lengthwise entirely through one side and about two thirds of the way through the other. After the two halves of the holder are forced apart it is ready for use.

Fig. 1, two types of holders permit modifying screw without damaging threads gripped by lathe chuck

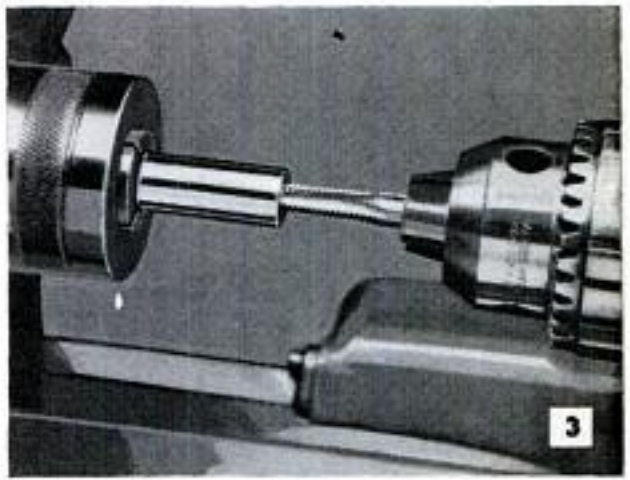

Above, for accurate results, machine surface of holder and drill-tap threads with lathe. Below, screw holder should be long enough to permit positive grip in chuck and sufficient working space

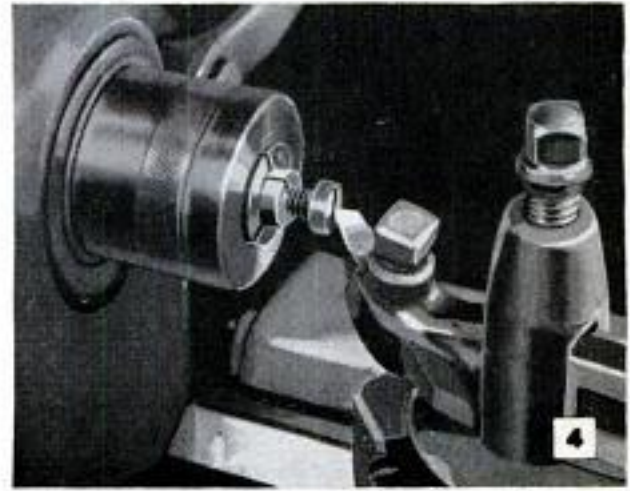

Sheet-Metal Angles Support Shelves in Wall Cabinet

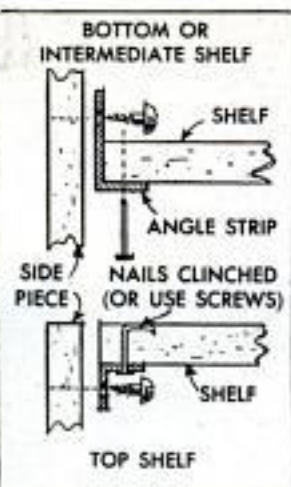
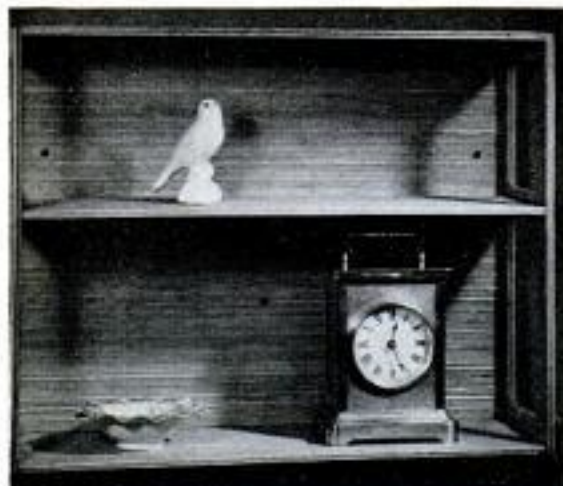

One home craftsman installed plywood shelves in a wall cabinet by nailing thin sheet-metal angles on the ends of the shelves and screwing them to the sides of the cabinet as shown in the detail. The angles were bent from 1-in.-wide strips cut from metal food containers. Additional support for the shelves was provided by gluing and nailing the back panel to the shelves.

Birdhouse Roof "Shingled" With Strips of Adhesive Tape

Before you paint that birdhouse you just finished, "shingle" the roof attractively with strips of tape. Use black tape or any color that suits your fancy. Lay the first strip flush with the eaves, making sure that it is straight. Each succeeding strip should overlap the preceding one about $\frac{1}{8}$ in. at the lower edge. The final strip, which forms "ridge boards," straddles the ridge as pictured. If desired it can be a contrasting color for a novel effect.

David Farkell, White Bear Lake, Minn.

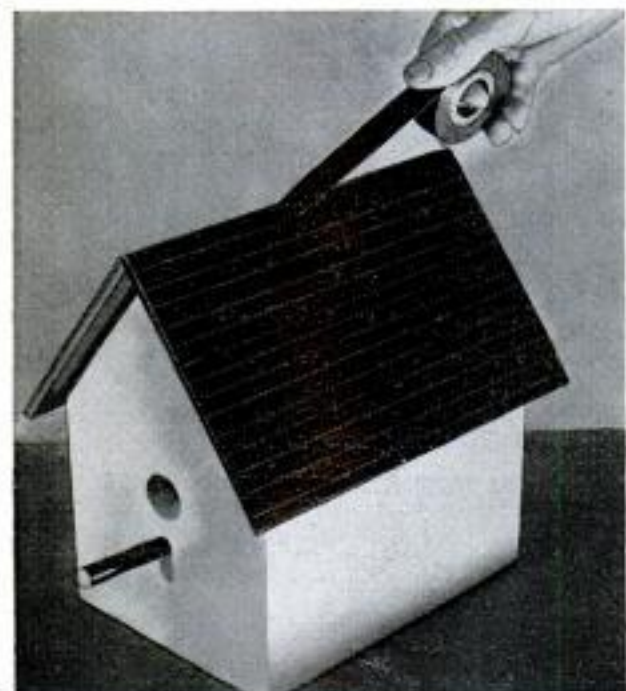

Let's Go "Water Cycling"

Have even more fun on your beach outings with the "Water Pedd," a seagoing bicycle propelled by a paddle wheel. Complete plans for building this unique boat are in next month's issue

Sill Cock Made Rigid

When a sill cock is installed on copper tubing as shown in the detail, it is usually not sturdy and tends to twist when turned on or off. By drilling several holes through the wall flange and screwing the latter to the wall as shown, the entire assembly is made rigid for a more satisfactory installation.

Oliver C. Grant, Springfield, Mass.

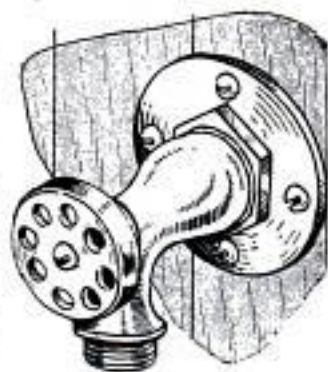

Color-Tinting Kitchen Foil

If you use kitchen foil for decorative purposes, make it even more eye-appealing by tinting the shiny side with a transparent color. Spray the sheets, or float them in a shallow tray, using an application of thin shellac colored with alcohol-soluble dye. Add alcohol occasionally to replace that lost by evaporation.

Ken Murray, Colon, Mich.





Special-Effects Lens Shades

ALTHOUGH an ordinary camera-lens shade is adequate for normal conditions, more protection is required when making studio shots where brilliant highlighting is employed. One photographer improvises a more effective shade by using a cylinder of dull-finish black paper, as in the lower right-hand photo. For an ethereal effect, in which the subject seems to be rising out of a mist, a partial cylinder of translucent paper is fitted around the lower two thirds of the lens, as in the middle right-hand photo, and a small spotlight is focused on it. For a full vignette effect, a complete cylinder of the translucent paper is used, as on the portrait camera in the upper right-hand photo and the reflex-type camera in the lower left-hand photo. The portrait of the pretty girl was taken with this latter method, showing the "halo light" result.—Graphic House, Inc., New York City.

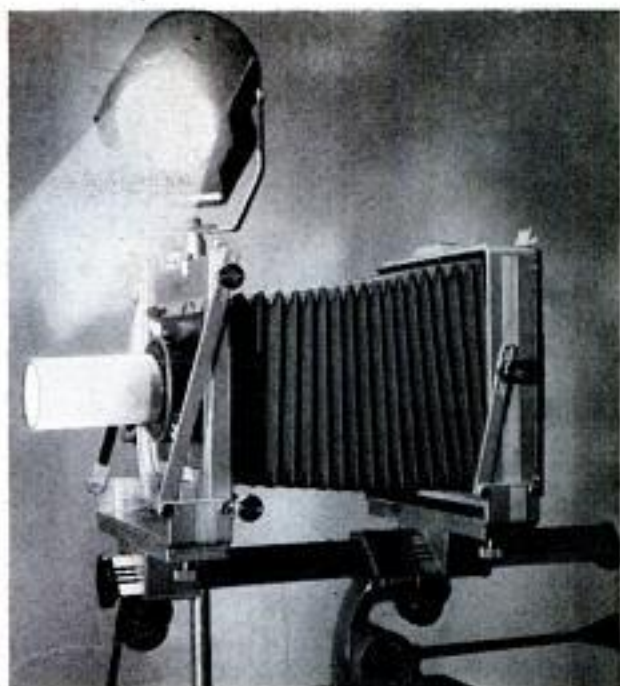

Light on lens shade of translucent paper produces "halo effect" as in portrait of pretty girl at left

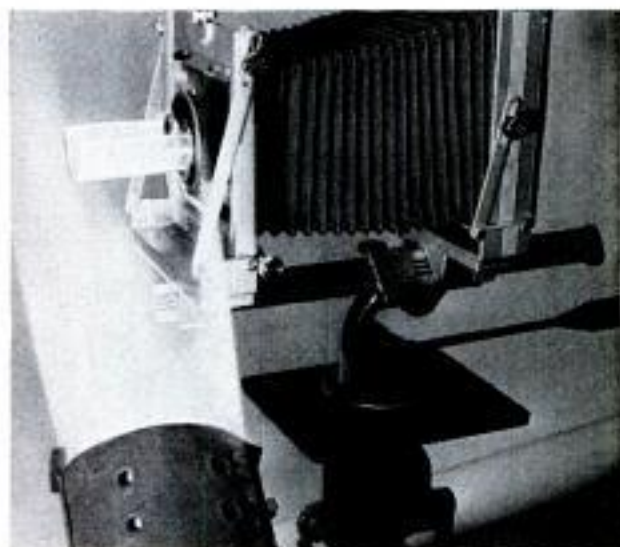

Above, partial cylinder of translucent paper provides "ethereal" effect. Below, cylinder of black paper shields camera lens against studio lights. Below, left, reflex-type camera needs two cylinders

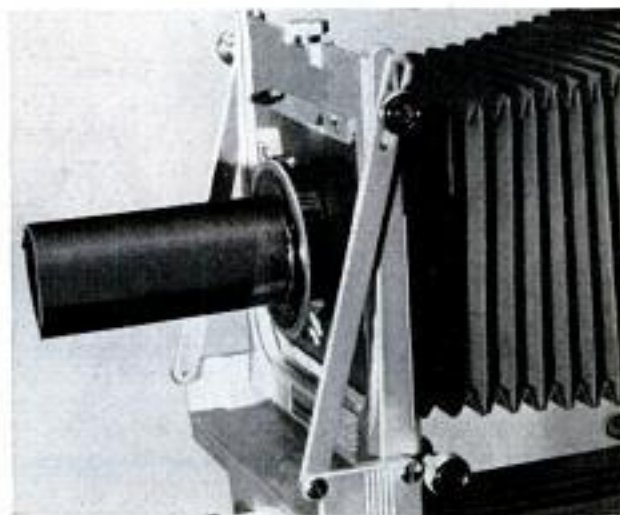
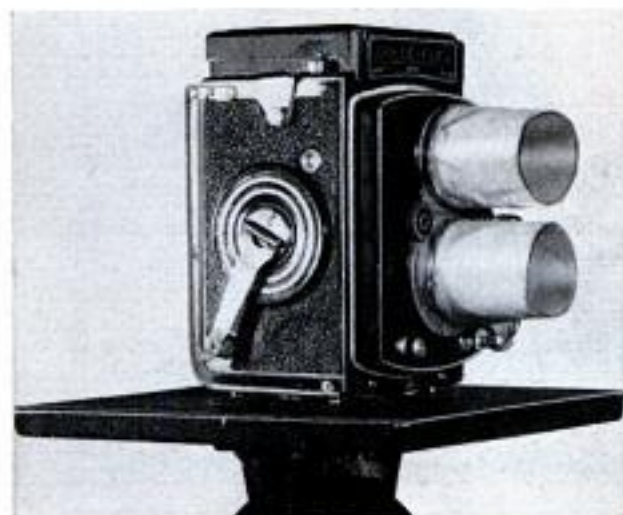

Punch Cuts Blind Holes in Cardboard for Coin Collection



DOWEL ABOUT
3" LONG



Holes cut in the cover ply on one side of a square of corrugated cardboard, as shown in the photo, provide an excellent means for storing a coin collection. Punches for cutting the holes, similar to the one shown in the detail, can be made by nailing strips of thin sheet metal to 3-in. lengths of dowels of selected diameters, depending upon the sizes of the coins to be inserted. Sharpen the projecting edge on each punch with a stone.—Burl Knutson, Bismarck, N. D.

Sounding Block Locates Joists

Floor joists are easy to locate when repairing a section of flooring covered on the underside. Just slide a small hardwood block across the floor in the general area to be repaired and tap it with a hammer. Reduced vibration or damped sound usually indicates a supporting timber.

Salt Spout Fitted on Fruit Jar Dispenses Powdered Soap

For a waterproof powdered-soap dispenser, cut the top from a salt box having a metal pouring spout and secure it to a fruit jar with the screw band of a two-piece cap. Use the metal insert for a pattern when cutting the box top.



Enrich Your Life with the Marvels of HI-FI! Thrill to a Pocket-Size Transistor Radio . . .

Have you been wanting a Hi-Fi set for your home . . . a portable transistor radio no bigger than your hand . . . and any of the other pieces of electronic equipment that are adding so much enjoyment to modern living? Then here's how you can have them, at merely a fraction of the usual purchase price. Using Popular Mechanics new book—*Electronics Made Easy*—

You Can Make These Electronic Devices Yourself!

This unusually practical book enables you, without any previous experience, to enter the amazing field of electronics for fun or profit. In 192 pages of simple step-by-step instructions and hundreds of illustrations, you learn all about Hi-Fi—exactly what it is and how to build your own Hi-Fi system. You discover how to make the "miracle" transistor radio, how electronic tubes work, how to do radio

servicing, how to use test instruments and make your own, and how to convert old radios into inter-com systems and other devices. It's fun and easy to build your own electronic equipment with the help of this book which contains numerous do-it-yourself projects. Send for your copy of *Electronics Made Easy*. It's your key to the most fascinating hobby of these times **\$2.95** for just.....

Send your order to

POPULAR MECHANICS PRESS, 208 East Ontario Street, Chicago 11, Illinois



Build "THE BUG"

PART II—Conclusion

AFTER ALL WORK described in Part I of this article has been completed, including frame, running gear, suspension, brake and fuel lines and installation of the fire wall and a heater, if one is to be used, construction of the sheet-steel body can be started. On the prototype, 20-ga. sheet steel was used and tools for bending the metal consisted of two steel angles from a bed-spring frame, a number of C-clamps, a hammer and a wooden mallet. Although each builder will have his own ideas and methods, Figs. 1 through 6 detail a method that was worked out on a trial-and-error basis as being the simplest and strongest one of assembling the body.

The width of each body panel should be such that, whenever possible, the $\frac{1}{2}$ -in. flanges of adjacent panels are not only screwed together but also to a vertical frame member, Figs. 6 and 7. Where a vertical member is not located conveniently, the two flanges screwed together provide a stiffening rib in the body covering. Patterns can be employed when making the panels, but it is almost as simple to use the sheet steel itself as a pattern. After bending a $\frac{1}{2}$ -in. flange on each edge of a panel, cut away the flanges wherever necessary to clear the frame tubes. Then wrap the lower two inches of the panel around the lower horizontal frame member and clamp it. Drill through the sheet metal and tubing and drive in sheet-metal screws about every 3 in. Lift the panel upward and press it against the vertical members of the frame and the horizontal top members. Start at the bottom of the panel and drive sheet-metal screws about every 3 in., pressing the metal inward and upward to

force out any distortion. At the top, repeat the process used for the bottom of the panel, wrapping the metal around the frame tube and fastening it with sheet-metal screws. When the top frame member is at an angle to the bottom member, repeat the preceding steps, except that just before fastening the top, mark it and cut it off parallel to the frame tube, allowing $1\frac{1}{2}$ to 2 in. for wrapping. After all body panels have been screwed to the frame and together, they can be tack-welded together and to the frame. Screws are removed and the holes plug-welded. The final result is a type of unit body-and-frame construction.

When making the horizontal panels for the cowl, headlight shrouds and top of the grill, bend flanges on them to support the hood. The hood should be flanged to form a channel cross section along its edges. The hood flange should be about $\frac{1}{8}$ in. less in depth than the body flange to permit insertion of rubber strips that prevent the hood from rattling.

Trunk Lid

Trunk lids will vary in design, according to each builder's ideas. For the prototype, the rear portion of the top of the original car body was used. Compound curves at the rear corners were cut out and replaced with flat pieces of sheet metal cut and bent to shape and welded in place. A flange was bent along the front and rear and along both edges, using the steel bed angles. It is much simpler to use new metal, fitted over a frame of light steel angles and flats as indicated in Fig. 4. A piano-type hinge, butt hinges or offset hinges from the trunk lid of the original car can be installed. Hinging is at the rear in Figs. 4, 13 and 14, so the folding hard top can be swung back



1

WINDSHIELD ASSEMBLY

RUBBER GLASS



TOP CONSTRUCTION AND METHOD OF FOLDING

2



COVER FOR RADIATOR CAP

3



HOOD



TRUNK LID

TRUNK LID

TRUNK FLOOR

4



COWL

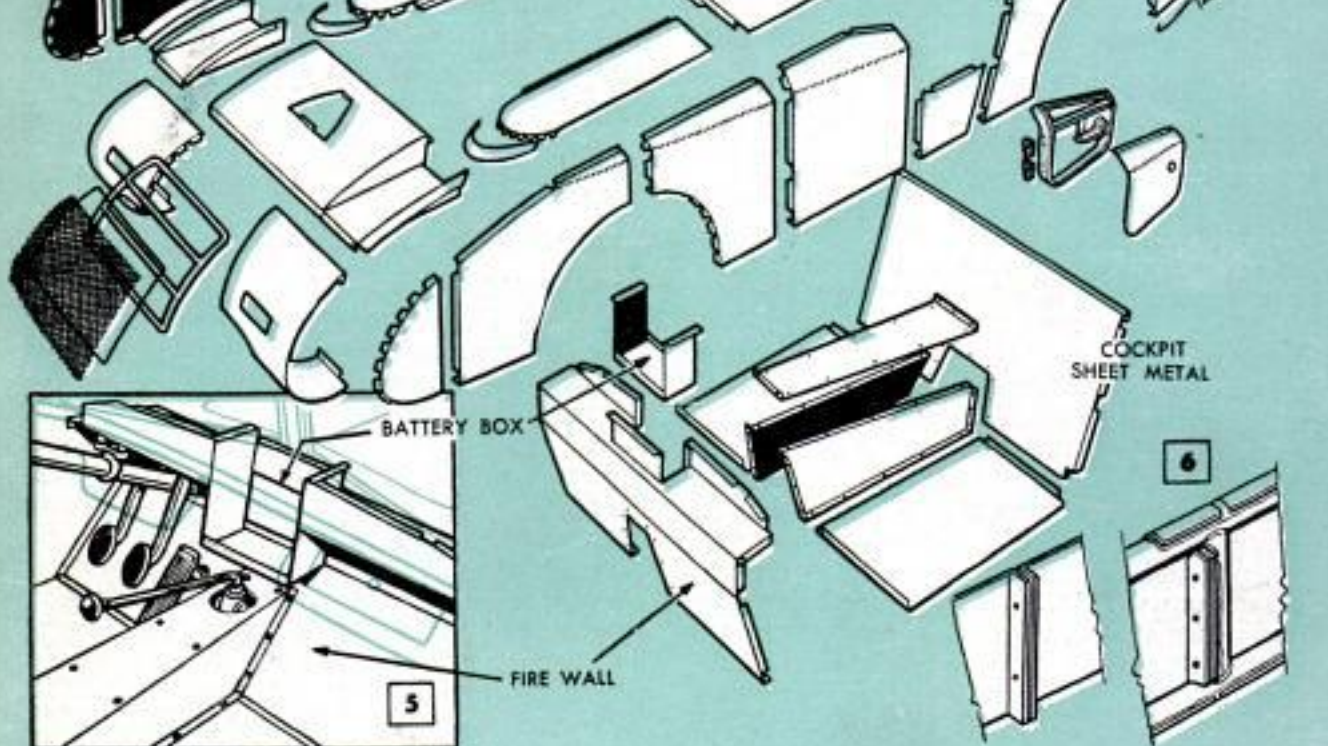

COCKPIT SHEET METAL

BATTERY BOX

FIRE WALL

5

6

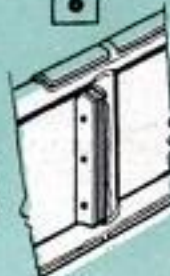

and accommodated in the trunk, Fig. 2. If a different type top is used, the trunk can be hinged at the front edge in a more conventional manner.

Top Design

In many cases, construction of the inside of the trunk will be such that there will be no room for a folding top of the design shown in Fig. 2. Ingenuity and imagination take over at this point. A solid top with gull-wing doors, such as is used on some European sports cars can be formed. Or the doors can be designed so that a portion of the roof also swings out when the vertically hinged doors are opened, somewhat like the "dream cars" shown at auto shows. Another method is to use two tops, one a folding canvas top for mild weather, the other a steel top that clamps in place.

Skillful fitting is required for the construction and installation of the folding, one-piece hardtop detailed in Fig. 2. Sheet steel is used in its construction and heavy transparent plastic is used for two roof panels and the rear window. Three hinges are fitted at the rear of the top as indicated with a space cut out between the hinges so the top clears the two angles that form the front flange of the trunk. As shown in Fig. 16, when the top folds down into the trunk, the trunk lid fits down over two steel dowels welded to the angle flange in the same manner as when the top is up.

If maximum frame strength is desired, doors can be omitted entirely. A "cockpit" step is fitted into the sides of the body to permit stepping up and onto the drive-shaft cover, then sliding down under the wheel.

Assembly of the windshield is detailed in Fig. 1. Tubing is used for the three main vertical members and light channel is



welded or screwed to it and to the cowl. Rubber channel then is fitted in the metal channel and the glass is inserted from the top of the frame. Screwing the top channel in place secures the glass. Notched steel dowels welded to the tops of the windshield tubes accommodate a drilled strip of wood that is fitted to the front edge of the top as shown in Fig. 15, when a folding hardtop is used, or some types of soft tops.

Radiator and Grille

Because of the position of the radiator, the filler tube quite likely will project above the curved portion of the front of the car. Fig. 3 shows one method of disguising the filler tube with an attractive air scoop. The main part of the scoop folds down over the filler tube first, then the front, smaller part folds down and wedges

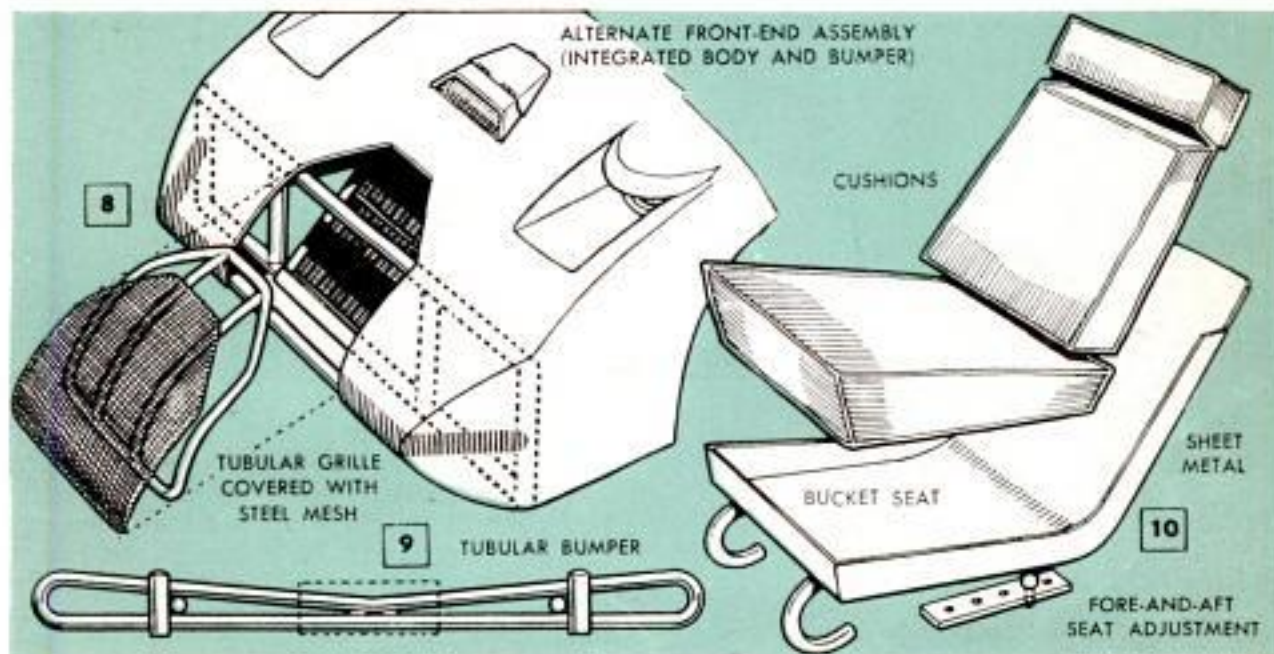



Photos show application of glass fiber and spray painting



TWO METHODS OF MOUNTING SPARE WHEEL

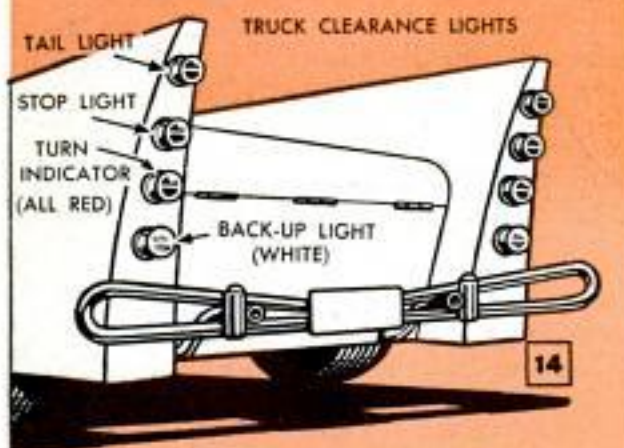

METHOD OF FASTENING TOP TO WINDSHIELD

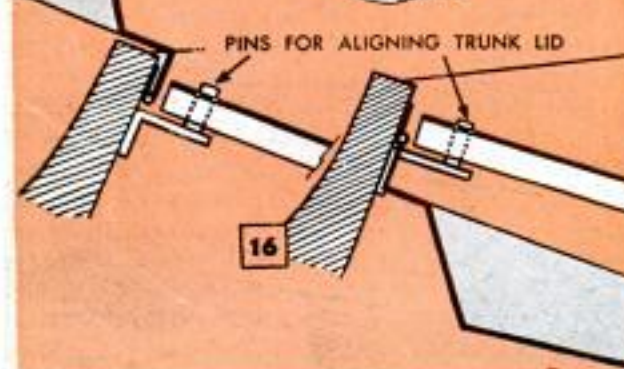
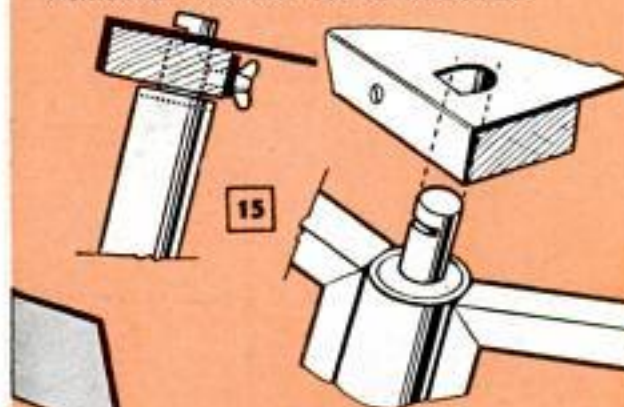

against the filler tube to keep the air scoop locked in position. Many variations of this system can be devised.

Steel tubing used for the frame also can be used to make bumpers for the sportster, Fig. 9, or the bumpers from the original car can be modified for use. An alternate design of the front end of the car, Fig. 8, shows a method of incorporating body and frame to form an integrated bumper-and-body. The grille for the car can be fabricated from $\frac{3}{4}$ or $\frac{1}{2}$ -in. electrical conduit and wire mesh, Figs. 4 and 8, or in some cases, a stock grille can be modified and installed to simplify the job.

Tailfin and Spare Wheel

Rear-end treatment of the sportster, Fig. 14, depends solely on the builder of the car. Truck-clearance lights can be used as indicated, or any one of a number of stock tail-light assemblies can be used. It is best to choose the taillight before shaping the fins, since they then can be bent, wrapped or angled to fit any type or size of light or combination of lights.

In some instances moving the spare wheel forward or back will aid in making the car handle better by changing the front-to-rear weight distribution, so it should be installed last. The wheel can be mounted inside the trunk, on the trunk lid or at the rear of the body, Fig. 13. Location of the gasoline tank also will have a definite effect on weight distribution, since when full it weighs a considerable amount.

Seat Construction

Bucket seats for the sportster can be bus or truck seats picked up at an auto graveyard, or they can be fabricated from sheet steel as shown in Fig. 10. Cushions for the seats will require the services of an upholstery shop. One method of attaching the seats to the floor, so they can be adjusted fore and aft, is shown in Fig. 10. The rear legs are bolts on which are fitted lock washers and nuts. Seat belts anchored to a frame cross member will aid in keeping both driver and seat in position in case of a sudden stop or collision.

Glass-fiber cloth and resin, and glass-fiber putty are the products that make your body job look professional. All joints, seams and mistakes are covered by glass fiber, which is sanded down, primed and painted as in Figs. 11 and 12. Glass-fiber cloth and resin also can be used to form panels with compound curves that can be inserted between the steel panels of the body. Headlight shrouds, taillight housings and air scoops can be shaped from glass material and cemented to the steel body by using epoxy resin that forms a bond almost as strong as a weld. ★ ★ ★

SN 58

SHOP NOTES



FILING MACHINE FITS YOUR LATHE

By C. W. Woodson

CUSTOM tool-and-die shops having only infrequent use for a die-filing machine can save time and money by making this filer to fit one of the smaller lathes in the shop. The unit is specially designed to mount on the lathe bed and is driven from the lathe spindle through a flexible coupling. Utilizing the lathe as a drive permits a selection of file speeds to meet almost any requirement. The table of the filer is designed to tilt a few degrees to permit filing drafts and tapers. As detailed, the table is only 9 in. square, making it suitable only for work of small size. It can, of course, be made larger to meet your individual requirements.

No castings are necessary as the filer is built up entirely from cold-rolled-steel flats and rounds which are readily available cut to the sizes required. Bronze bushings carry the pitman shaft and the file spindle.

The pitman block also is made from bronze. The dimensions given in the details on the following pages adapt the filer for use on a 9-in. lathe with flat ways, but by making slight changes in the sizes of certain parts and filing or milling vees in the base supports, the unit can be adapted for use on a lathe with V-ways as pictured above.

Although materials lighter than those specified for the table and end plates (all three of which are of 1/2-in. stock) can be used, the weight of the machine, when assembled from the parts specified, reduces vibration to the minimum, making extremely accurate work possible. Note in the lower left-hand detail on the following page that the lower ends of the side plates fit between the lathe-bed ways. When the unit is made to fit on a lathe with V-ways the end plates will have to be located in a

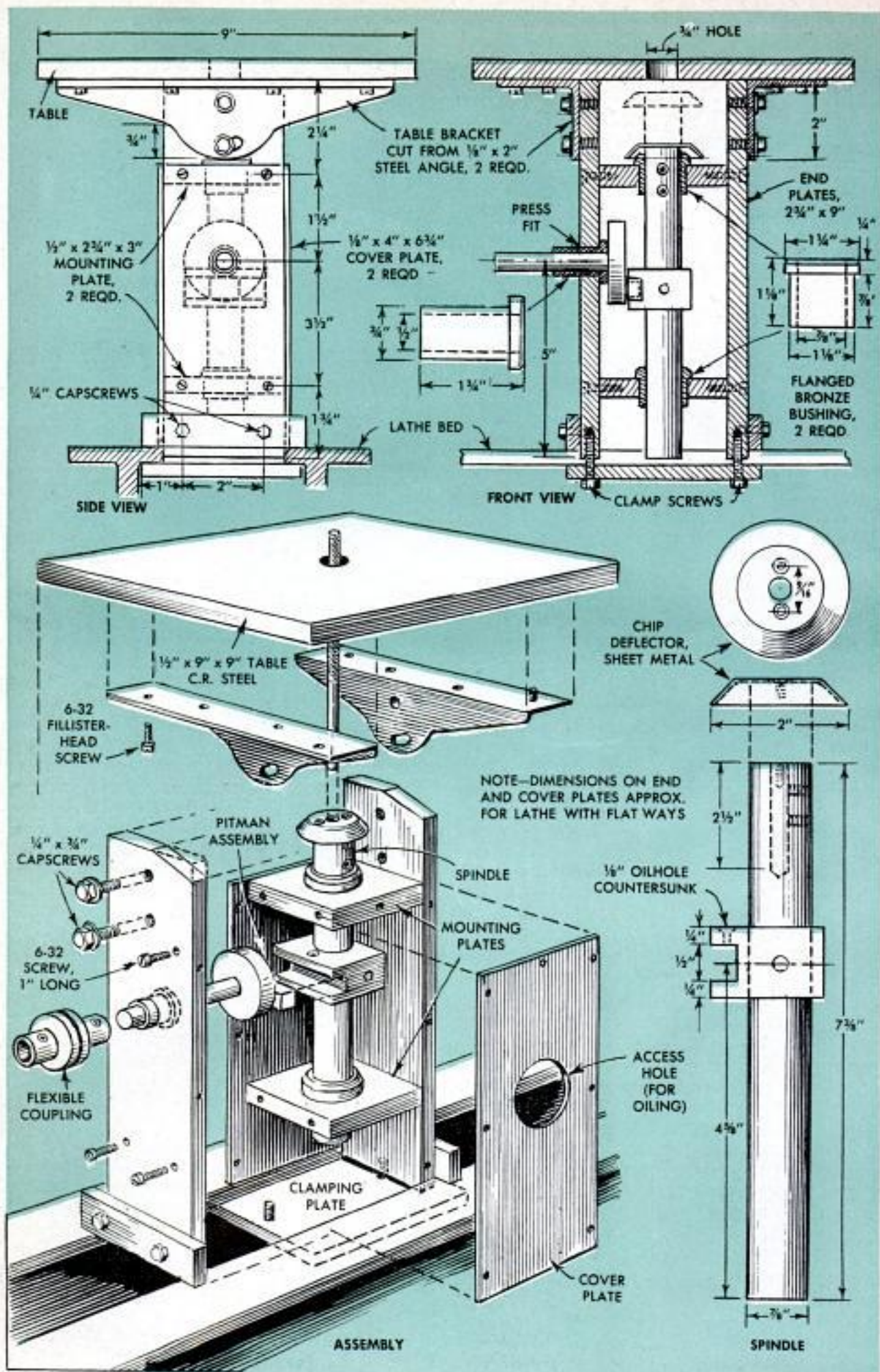

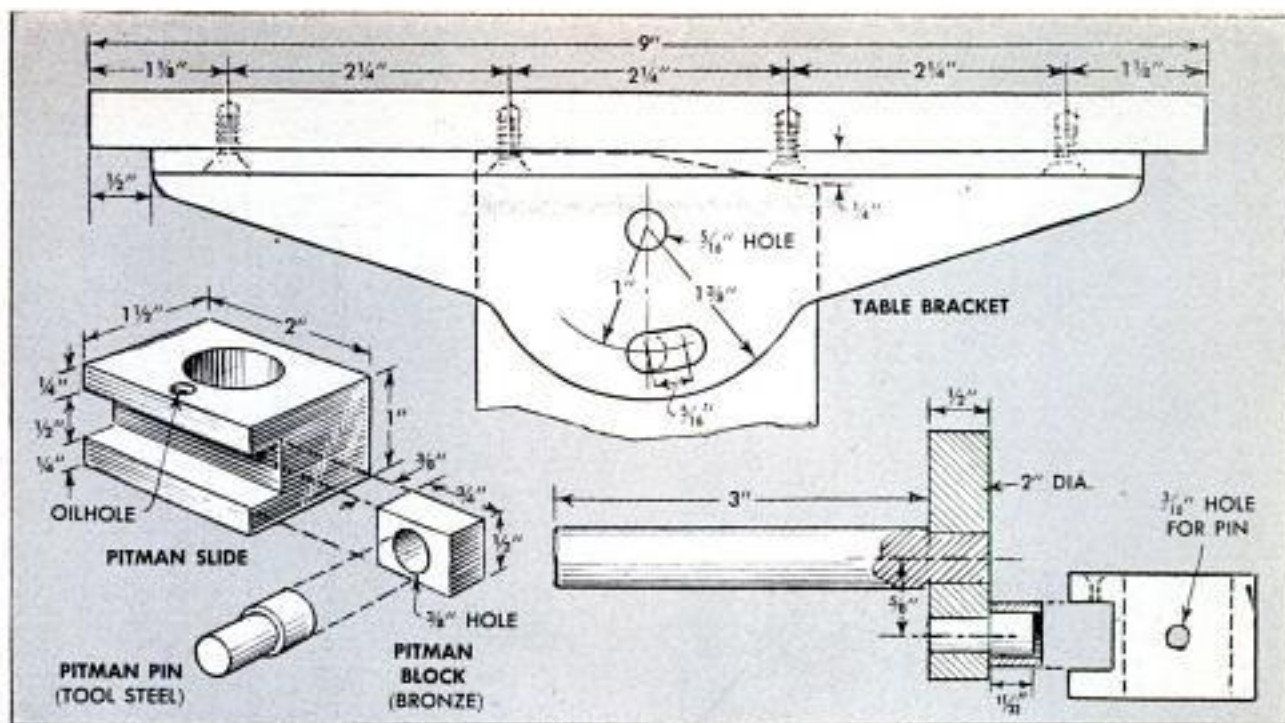

somewhat higher relative position, and corresponding changes must be made in the dimensions in order to bring the pitman spindle to correct height. The hole in the table is given as $\frac{3}{4}$ in. in diameter. To give added support to small parts the hole can be drilled only slightly larger than the diameter of the file to be used, or the table can be set up in a lathe and the hole step-machined from the top surface so that several inserts can be used, each with a different hole diameter.

To drive the filer it generally is best to use a drill chuck or a collet chuck in the lathe headstock. Clamp a short length of $\frac{1}{2}$ -in. shafting in the chuck and connect to the filer with flexible coupling as pictured

in the lower left-hand detail on the opposite page and also on page 205. When laying out the height of the pitman spindle care must be taken to center it at the correct height so that it will be in line with the lathe spindle when the filer is clamped in position. This height will vary with lathes of different makes. Note the variations in dimensions for the spindle height on the side and front views, opposite page. Be sure to check the height carefully before drilling the hole for the pitman-spindle bushing. Any appreciable change in dimensions also will affect the location of the mounting plates and the pitman slide. The required dimensions may vary considerably from those given. ★ ★ ★

Micrometer Mounted on Base for Checking Duplicate Parts

Duplicate parts can be checked faster if the micrometer is mounted on a base as shown to leave both hands free to handle the work. Setting of the micrometer is easily read so that discrepancies can be noted with little delay. Jaws of the base are adjustable.

Moth Balls Protect Hen

Since it is difficult to dust insect powder into the feathers of a setting hen, one poultryman avoids any disturbance of the fowl by merely dropping a couple of moth balls into the nest. These, he claims, discourage mites and other insects that would often cause the hen to give up the job.



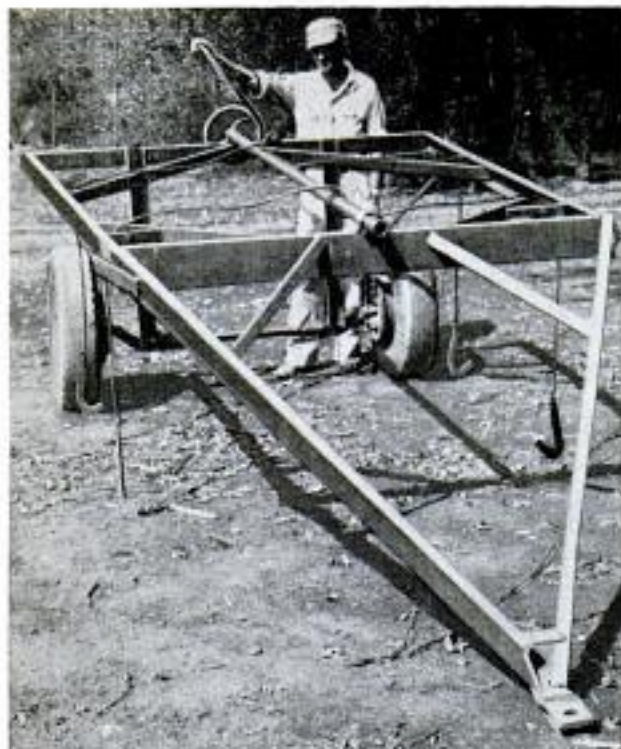

Geared Windlass on Transport Lifts Disks for Hauling

Turning a crank raises 8 and 10-ft. tandem disks clear of the ground for easy hauling under this farm-built transport. An automobile front axle provides the running gear and two lengths of $1\frac{1}{2}$ x 3-in. steel channel welded and braced to the axle locate the transport frame the correct height above the ground. The main frame, welded of the same size channel, measures 6 x 8 ft. Extensions of the frame locate the trailer hitch 6 ft. ahead of the transport. Cables with end hooks wind on a heavy pipe winch to raise the disks. A 10-in. gear on the pipe meshes with a 3-in. gear on the crank to permit easy lifting of the heavy disk units.

A. M. Wettach, Mt. Pleasant, Iowa.

☐ When through taking cellophane tape from a roll place a button under the loose end so that it will be easy to find the next time tape is needed.

Scale and Drill Press Utilized To Measure Valve-Spring Tension

To make certain that an overhauled engine runs as smoothly as possible, it is good practice to use valve springs that are close to uniform in tension. For measuring the tension of springs removed from the engine, make a setup with a bathroom scale and drill press as shown. Fit a spring under the drill-press chuck and apply pressure with the feed lever until a reading of about 50 lb. is obtained on the scale. Set the feed stop at this point to assure that all springs will be compressed the same amount, then check each spring. Those that vary more than 5 lb. from the average should be replaced with new springs, or special shim washers can be used to increase the tension of weaker springs.

Ed Packer, Oak Park, Ill.

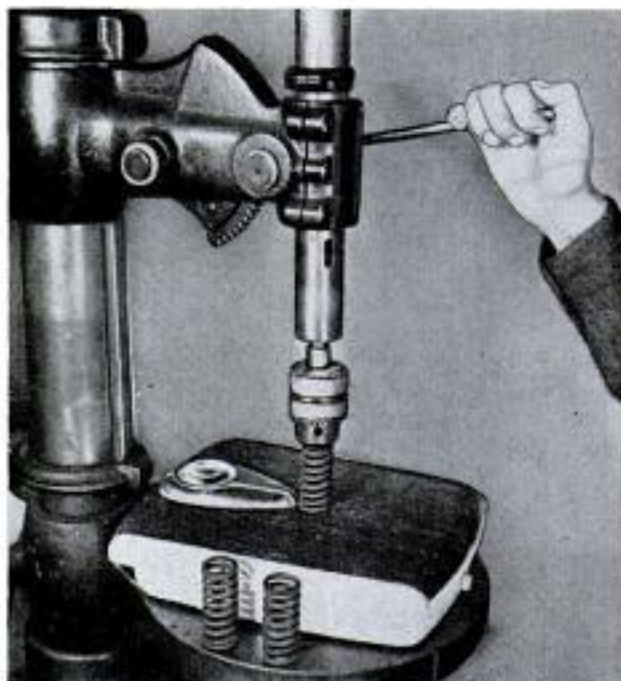

Drawing Dimensions Converted By Dividers Set With Micrometer

In mechanical drawing or layout work where dimensions are given as decimals, it is often difficult to convert the dimensions to fractions. For a quick and accurate method of determining exact divider settings set a micrometer on the particular dimension called for and adjust the dividers in the gap.—H. Hanscom, Elmhurst, Ill.

☐ If you have a power failure in the dark-room, a safelight can be improvised by slipping a flashlight into an amber or ruby-colored drinking glass.

Try-Square Jig for Quick Milling-Machine Setup

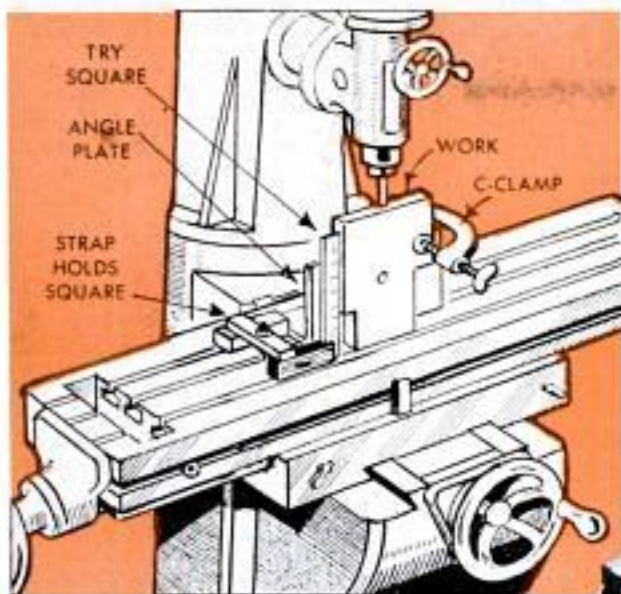

When using a vertical milling machine for drilling, reaming or jig-boring a single piece of work, a try square or machinists' square strapped to the table and an angle plate clamped to the work and bolted to the table as shown will permit a quick and accurate setup without making an elaborate jig or fixture for the work. The jig enables the operator of the machine to square the work vertically and acts as a registering point for measuring to a given dimension for drilling, reaming and other machining operations. To make a setup by this method, simply clamp the work loosely against

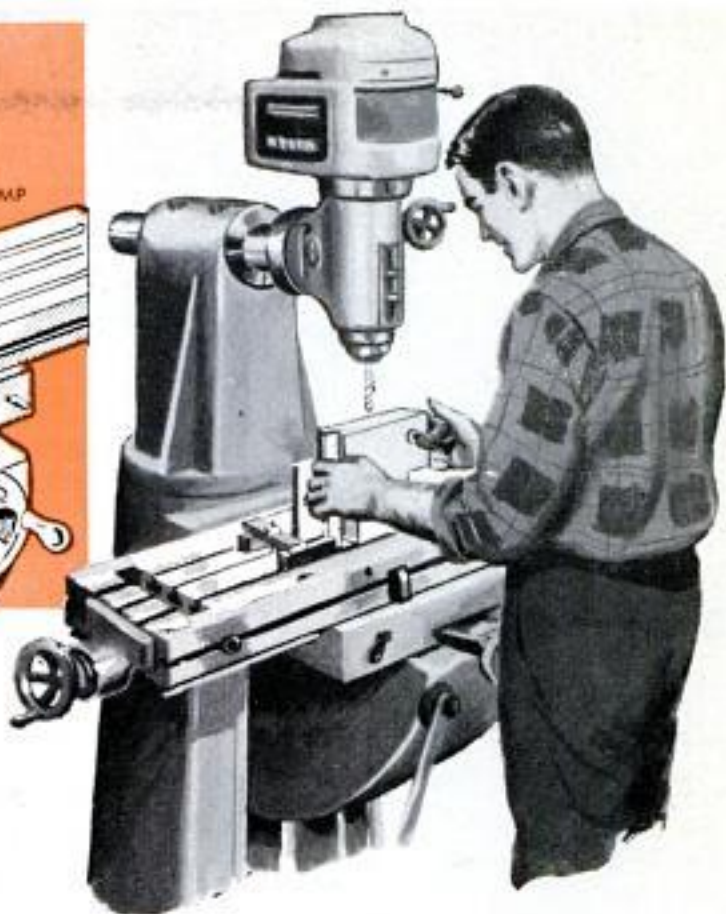

the angle plate, then align the work vertically against the try square, bolt the latter to the table as shown in the drawing and secure the angle plate to the table and the work to the angle plate.

Frank LaSaracina, New York City.

Sanding Freshly Glued Joint Seals and Finishes It

To make a joint in a glued-up wooden workpiece less conspicuous, sand the surfaces before the glue has set firmly. Wood dust will mix with the glue to provide a filler that matches the wood. The sanding block assures that the joint is flush with the other surfaces.



Removing Generator Pulley

To remove the pulley from an auto generator without disassembling it, wrap the fan belt around the pulley and grip it in a vise as indicated. While held in this manner the pulley and armature will not turn when a wrench is applied to the nut. Two screwdrivers then are inserted under the pulley to pry it from the shaft.

SN 58

HOW WOULD

By Chris Nelson



1. Q—To turn a bowl with a thin base, how do you mount it on the faceplate so screws do not go through?

A—Screw the faceplate to a block of wood that has been glued to the bowl stock. When gluing bowl stock to block, wipe both surfaces with glue, then insert a piece of newspaper in the joint before clamping. After turning, work and block can be split apart readily and dried glue sanded off base of bowl

2. Q—To prevent the dead-center end of work being turned in a lathe from smoking, what can be done?

A—Squirt a drop or two of oil onto the center to lubricate it as shown in the left-hand photograph. Or, better still, obtain a live cup-center as shown in the right-hand photograph. This type of center rotates on ball or roller bearings and requires only occasional lubrication or none, if the sealed type



3. Q—Where should your left hand be placed when holding a tool against stock that is rotating in the lathe?

A—Hold the wood-turning tool as indicated in the photograph. Let the tool rest support your left hand which is used to grip the tool near the end. Held against the tool rest this way the left hand controls angle and depth of cut easily. When held farther back on the tool, hand has little control

4. Q—When making a roughing cut on wood 6 in. in diameter, at what speed should the lathe be rotating?

A—Lathe speed should be about 650 r.p.m. for making a rough cut on a piece of stock that is more than 4 in. in diameter. For proper cutting and longer life for a cutting tool, lathe speed should be controlled. Speeds for cutting wood, plastic and nonferrous metals are indicated in the chart

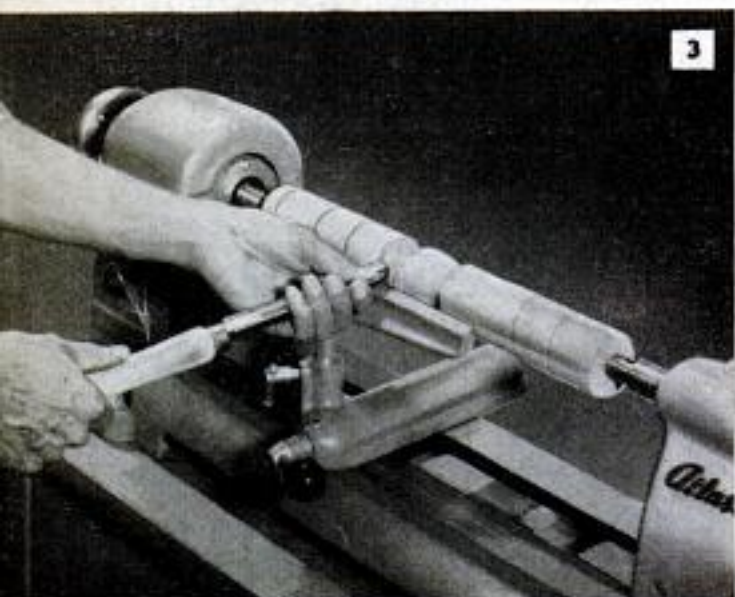

4

LATHE-SPEED GUIDE

Material and Diameter	Roughing Cut (r.p.m.)	Shaping Cut (r.p.m.)	Finishing Cut (r.p.m.)
Wood up to 2"	910	2590	4250
Wood 2" to 4"	810	2375	3380
Wood 4" to 6"	650	1825	2375
Wood 6" to 8"	650	1200	1825
Wood 8" to 10"	650	910	1025
Wood over 10"	650	650	650
Plastics up to 3"	2200	3125	3875
Plastics over 3"	1025	1200	1680
Nonferrous metals up to 3" (with carbide-tipped tools)	650	1300	3125

YOU DO IT?

5. Q—What kind of chisel is used to turn brass, and what is indicated when the chisel starts to chatter?

A—A carbide-tipped chisel is used for turning soft metals or plastics. Because it stays sharp much longer than a regular chisel, a carbide-tipped tool also is ideal for wood turning. If the chisel starts to chatter when turning brass it means that the work is rotating too fast or too deep a cut is being made

6. Q—How far should the lathe tool rest be positioned from the work for best control and maximum safety?

A—As a general rule for all work turned on the lathe, the tool rest should be positioned as close to the stock as is practicable. This practice is both for safety and to assure better control of the chisel as described in answer 3. Stop the work frequently and move in the rest as stock is cut away

7. Q—Of the four common lathe tools, skew, roundnose, gouge and parting tool, which are used for rough cuts?

A—A gouge can be used for most cuts except where a portion of the work is to be left square. In this case, many turners prefer to use a skew chisel inverted on the tool rest to turn a shoulder from the square to the round. When properly beveled and sharpened, a skew chisel produces a cleaner cut

8. Q—In what manner can work neatly be cut off the waste portion of stock while still held in the lathe?

A—Do it as shown, always at the headstock end of the lathe. Use a skew chisel to remove as much stock as possible, then place the skew on the tool rest so the point will go through the remaining bit of stock. While making this last cut through the wood, support the rotating work lightly with your right hand

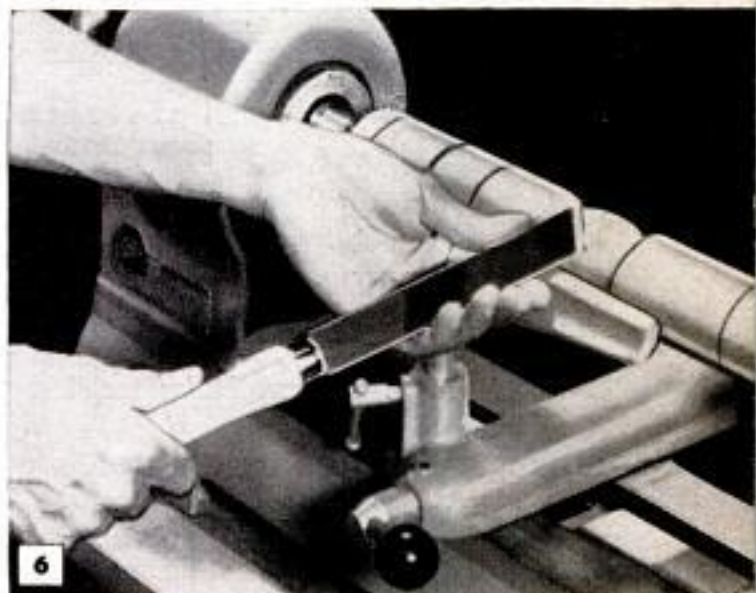

Adjustable Depth Stop for Arbor Press Clamps to Ram

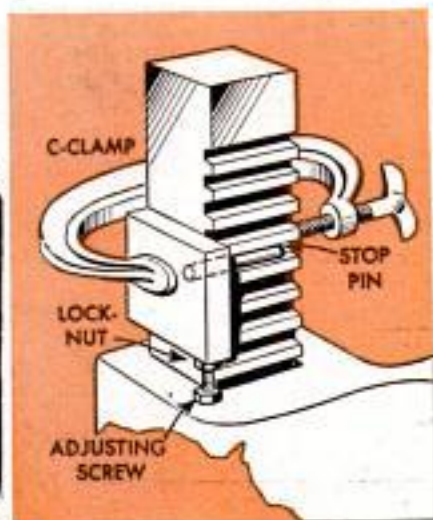

Accurately pressing pins, bushings and other items to a predetermined depth is no problem when an arbor press is fitted with this stop. Since it is held on the arbor ram with only a C-clamp, the stop can be removed, but will not slip when in use because of a steel stop pin that fits between the teeth of the ram. Pin diameter is such that it fits snugly between the teeth. Fine adjustments of the stop are made by means of a $\frac{3}{16}$ or $\frac{3}{8}$ -in. machine

screw turned in a tapped hole on the lower edge of the stop and held in position by a locknut. Suggested size of the steel plate used for the stop is $\frac{1}{2} \times 1\frac{1}{2} \times 1\frac{1}{2}$ in.

Thin-Wall Pipe Nipple Plugged To Prevent Crushing With Wrench

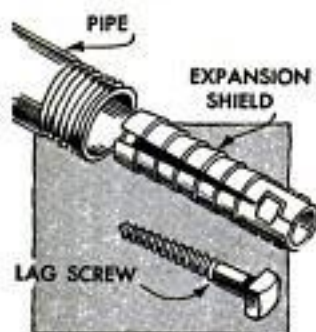

An expansion shield and lag screw installed in the end of a thin-wall pipe nipple will prevent it from being crushed or distorted when clamped in a vise or wrench. Keep a number of shields in various sizes

available for use in pipe nipples of diameters commonly used.

H. J. Gerber, Stillwater, Okla.

Holding a Bolt in Sheet Metal

To hold a bolt or machine screw in sheet metal and keep it from turning, straddle the head with a staple, seating the staple firmly in the screw slot. The points of the staple go through two small holes drilled near the hole that receives the screw. Clip the ends of the staple short on the other side of the metal and hammer them flat.—Bertram Brownold, Cedarhurst, N.Y.

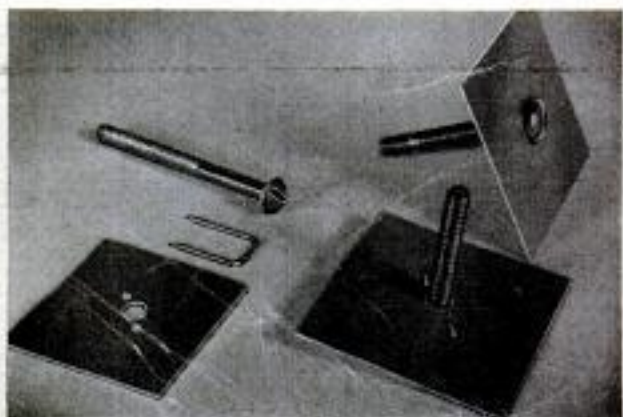

Milling Machine Set Up To Make 45-Deg. Cuts

When a small production job required making 45-deg. angle cuts, one machinist used this simple setup on a vertical milling machine. A machine vise and two V-blocks were bolted and clamped to the machine table and carefully located as indicated. A small capscrew turned into a hole tapped in one block acts as a positive stop. Excess material on the workpieces is first cut away with a metal saw or abrasive wheel. Then the first of the pieces is machined and the setup checked for accuracy. Once accuracy is established within the limits required the operation is simply repeated on each workpiece.

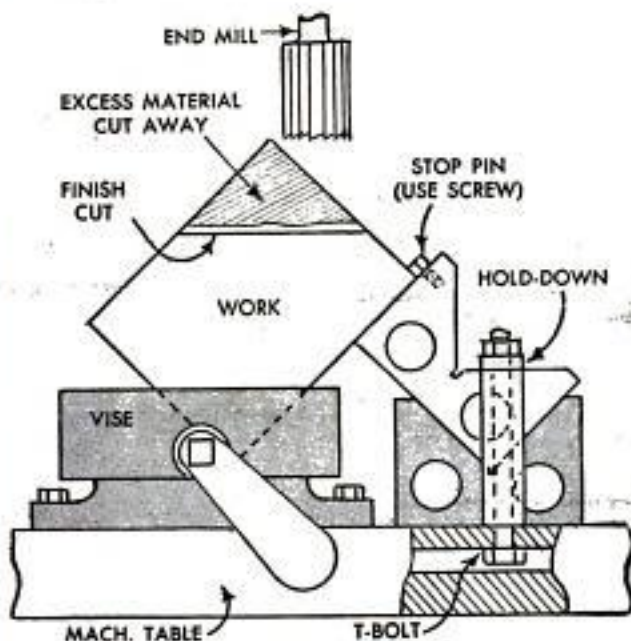

POPULAR MECHANICS

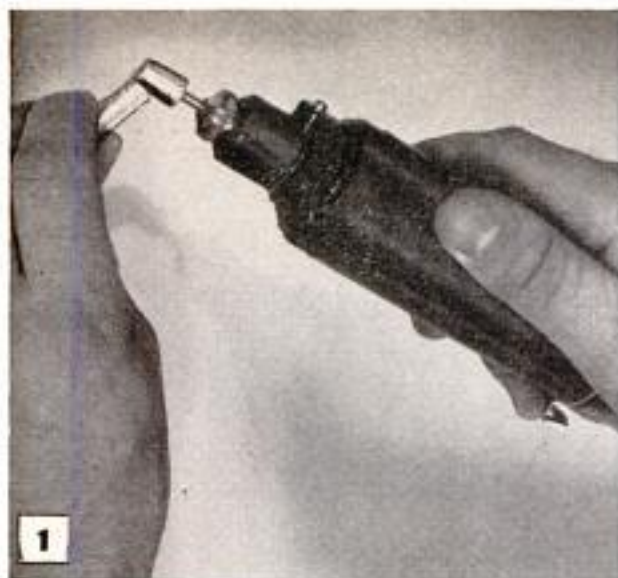

Almost Anything Can Be Soldered

SOLDERING such materials as aluminum, glass and ceramics, which until recently has been either extremely difficult, or impossible without special equipment, now can be done in any home workshop. A technique developed at the Los Alamos laboratory of the University of California requires only the addition of a small hand grinder and 60-40 solder. A medium-grit wheel in the grinder is preheated and rotated against the soft solder, Fig. 1, until it is "loaded" with the metal. The wheel then is rotated against the surface to be soldered, Fig. 3, until a slight abrasion occurs. Heat of friction again melts the solder which flows onto the abraded surface. After this tinning operation, soldering is done with 50-50 solder, Fig. 4.

After wheel is loaded with solder, as in Fig. 1, it is rotated against work to be soldered, as below

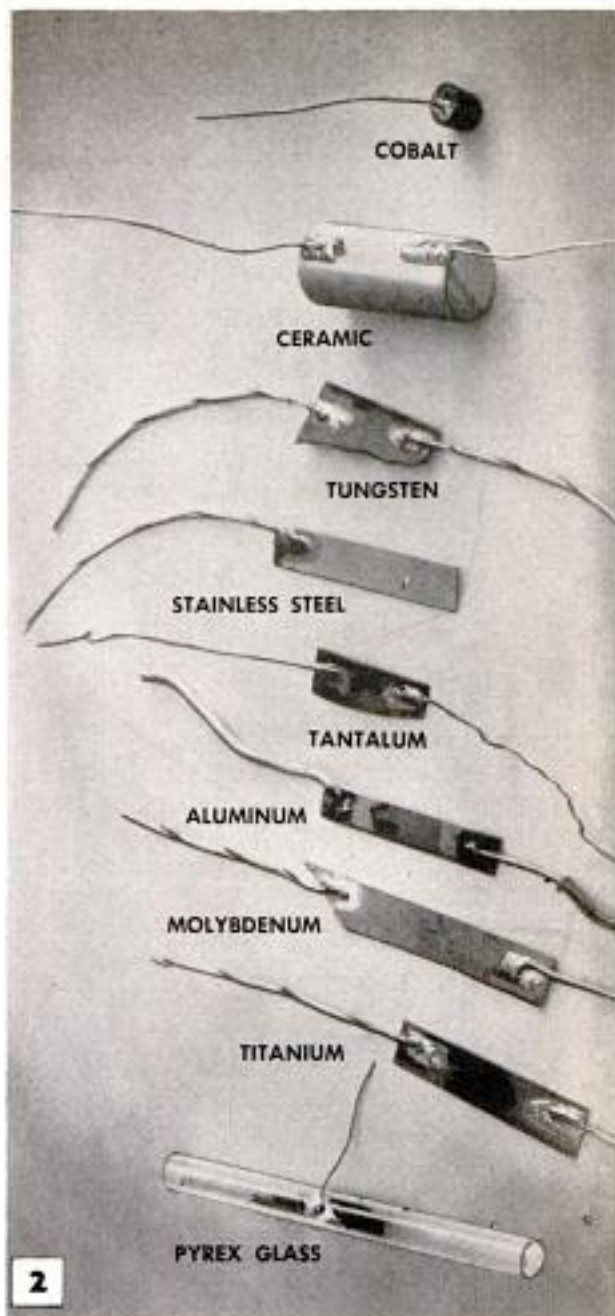
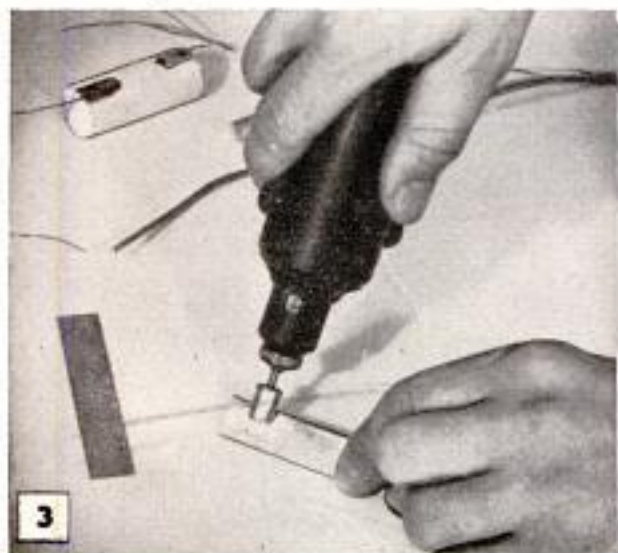

Above, various materials soldered with new technique. Below, after tinning, work is soldered in usual way

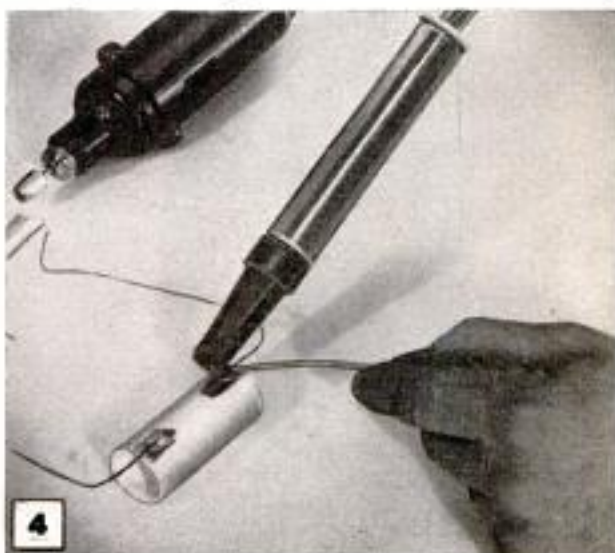



Trimming Photoprints Without Cutting Board

In the absence of a cutting board, a transparent ruler can be used as a guide for trimming photoprints. Paint a black line on the underside of the ruler at the appropriate distance in from the edge. Align this mark with the exposed area of the print and trim off the excess margin.

O. A. Nelson, Seattle, Wash.

Wet Cloth Cools Developer

When ice or other means of cooling photo developer is not available, it can be cooled to the recommended 68 deg. F. by wrapping the container in a wet cloth and setting it where a draft of air will evaporate the water rapidly. The container should be placed in a shallow pan containing enough water to keep the cloth wet for the ½ to 1 hr. usually required to lower the temperature of the developer to 68 deg. F.



214



Envelope Flap Guides Carbons Into Typewriter

Feeding more than one carbon sheet into the typewriter at a time is a neat trick at the best. When you're pressed for time, or when the typewriter is somewhat worn or out of adjustment, the tendency of the sheets to come through with the edges uneven can be rather trying to one's patience. It's always easier and faster if you slip the edges of the sheets under the flap of an envelope as pictured.

Suede-Shoe Brush Cleans Carvings

When preparing old furniture for refinishing you are almost sure to encounter the problem of removing softened varnish or paint from carvings after the varnish remover has done its work. A suede-shoe brush is handy for this job as the brass bristles have just the right tension, or degree of stiffness, to reach into the grooves and depressions of the relieved surfaces and clean out the softened finish without damaging the wood.



POPULAR MECHANICS

Copyrighted material

Metal Fasteners Have "Self Locking" Action

Sheet-metal "nuts," that can be made in almost any size and shape, are ideal for emergencies when the standard types are not available, and in some cases may be even more suitable for the job at hand. As a screw is turned into a sheet-metal nut, the edges dig into the threads and provide a "self locking" action. Also, where there is a minimum of space, the extreme thinness of the sheet-metal nuts permits easy installation. A large nail with the head removed, or a length of steel rod ground to a square point is used as a "forming tool" for the nuts. The tool can be chucked in a drill press as indicated in the upper detail and forced through the sheet metal by pulling down on the drill-press feed lever, with a wooden block under the sheet metal. On jobs, the tool can be used manually and struck with a hammer. In this method, as indicated in detail A, the sheet metal itself is "tapped" to permit insertion of machine screws that have had their tips filed or

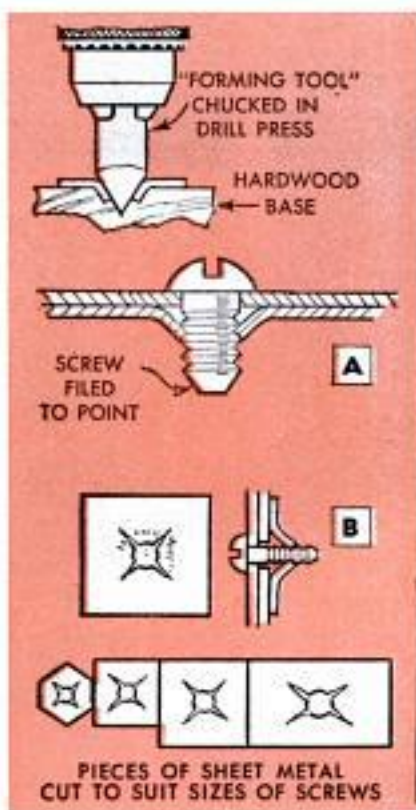

ground to a slight point to assure easier starting. A block of wood is used to back up the metal under the tool, as shown in the illustration. Detail B indicates the manner in which sheet-metal nuts pull against the threads of a screw.

Carl S. Bates, Chicago.

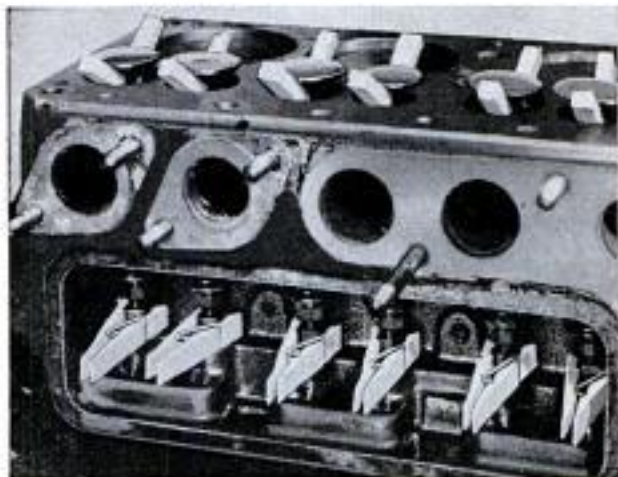

Valves and Tappets Left in Place When Changing Engine Camshaft

It is not necessary to remove valves and tappets to change a camshaft on a valve-in-block engine if the following method is used: Hold the valves up by slipping small wooden wedges under the heads as the engine is turned. Then lift each tappet and clamp it up with a spring-type clothespin.

Ferrule Replaced on Tool Handle With Soldered-Wire Wrapping

To repair a tool handle from which the ferrule has been lost, wrap it tightly with several turns of wire as shown and secure the wrapping with solder. The starting end of the wire can be anchored in a small hole drilled in the handle. Another method of repairing or reinforcing a handle is to coat it with shellac, apply a wrapping of strong cord and brush more shellac over the cord.



Truck Parked on Hoist to Provide Additional Storage Space



To provide additional storage space in the garage for equipment and material left outside during the day, one service-station operator lifts the station pickup truck on the hoist and leaves it up all night. The floor space under the hoist then can be used for storage, as well as the area adjacent to the hoist where the truck normally would be parked.—Bruce D. Stewart, Winder, Ga.

Cutting Hole In Plaster

To prevent breaking the wood lath away from plaster when cutting a hole for the receptacle box of an electrical outlet, use a hacksaw blade, holding it in the reversed position. Saw with an easy motion, exerting pressure on the cut only on the stroke toward you.

Round Stock Cut With Bandsaw Clamped to Prevent Rolling

When round stock is cut on a bandsaw it should be held in a wood clamp or an inverted drill-press vise to prevent it from rotating by the downward force of the blade. Stock which rolls while being cut may bind against the blade and break it, or the stock may be thrown free of the saw. Either action can cause injury to the operator.

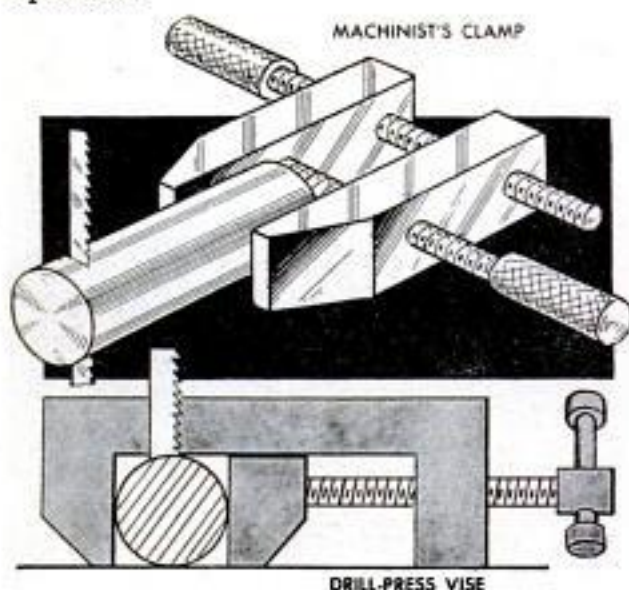

"Hookon" Chute on Silo Keeps Waste at Minimum

Sheet-metal roofing bolted to a steel-angle frame is used to make this chute that directs silage from the silo into a feed wagon with a minimum of waste. The angle frame of the chute hooks over the silo hoops and is lowered to the proper door as the silo is emptied. Sheet metal of fairly heavy gauge should be used for the chute.

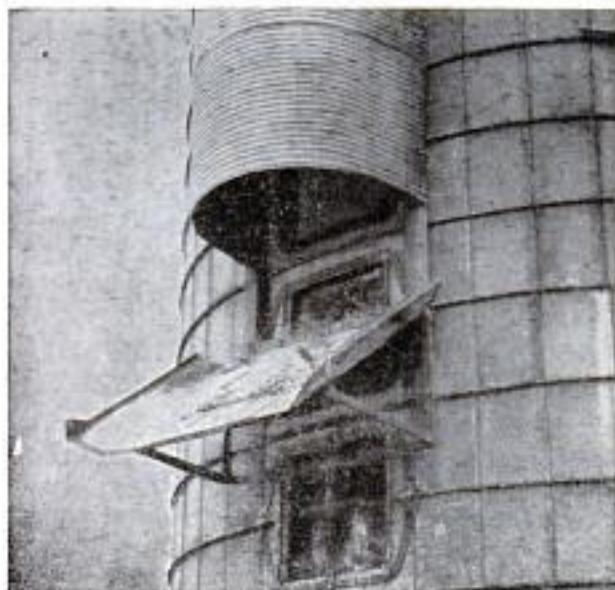

On the
MARKET
for Do-It-Yourselfers

1. WIRE BRACKET makes a screen-painting easel of your stepladder. Holds the screen at just the right height for painting the stiles and rails. Suitable for screen frames of any length as bracket can be fitted over the ladder steps at a convenient height.

Max Salisbury Mfg. Co., 2038 Biedmiller, Fort Wayne, Ind.

2. SURFACE-STAIN REMOVER takes off stains and discolorations without dulling the finest finish. Easy to use. Merely wipe it on the surface with a soft cloth. Then wipe off with a very light pressure. Stains, discolorations come off with the material.

Renewize Products, Minneapolis 4, Minn.

2105 4th Ave. S.

3. RUST-PREVENTIVE COATING for metal sash, pipe, outdoor furniture, tanks, gutters and downspouts contains a specially processed sardine oil which bonds to the metal, resists rust and the action of other corrosive agents which may attack the metal.

Rust-Oleum Corp., 2799 Oakton St., Evanston, Ill.

4. ALUMINUM PAINT in decorator colors is now available in 1-pt. pressurized containers which greatly enlarge its applications. Two types of paint are furnished, regular type, and another having an asphalt base giving exceptional durability for exterior use.

Duncan-Stewart Industries, Ltd., 715 Fifth Ave., New York City 22

5. DOOR HINGE requires no flush mortising in door or jamb. Hinges are simply located and then screwed to edge of door and to surface of jamb. Hinges have flat-button tips, nonrising pins and staggered screw holes. Available in three finishes.

McKinney Mfg. Co., 1715 Liverpool St., Pittsburgh 33, Pa.



1



2



3



4



5

SHOPPING FOR TOOLS



1

1. UNIVERSAL VISE serves as a vise, clamp and holding fixture for use on bench or on machine tables. Two jaws, each consisting of a pivoted arm carrying a swiveling link and pad at each end, can be arranged to hold work of almost any shape, pressure being exerted equally in all directions. Has counter-threaded spindle which moves the jaws in or out simultaneously

Firearms International Corp.,
6521 Keeby Hill Rd., Washington 22, D.C.

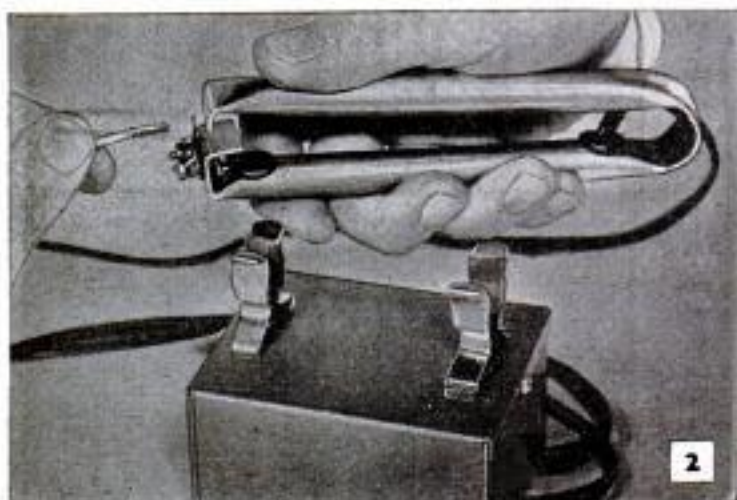

2

2. STRIPPER removes insulation without damaging the wire, as it has no blade. A chrome-nickel wire, heated electrically, cuts insulation without nicking the wire and a slight turn of tool removes severed portion. May be used to strip either solid or stranded wire. Requires no adjustment for different sizes of wire

Western Electronic Products Co.,
655 Colman St., Altadena, Calif.

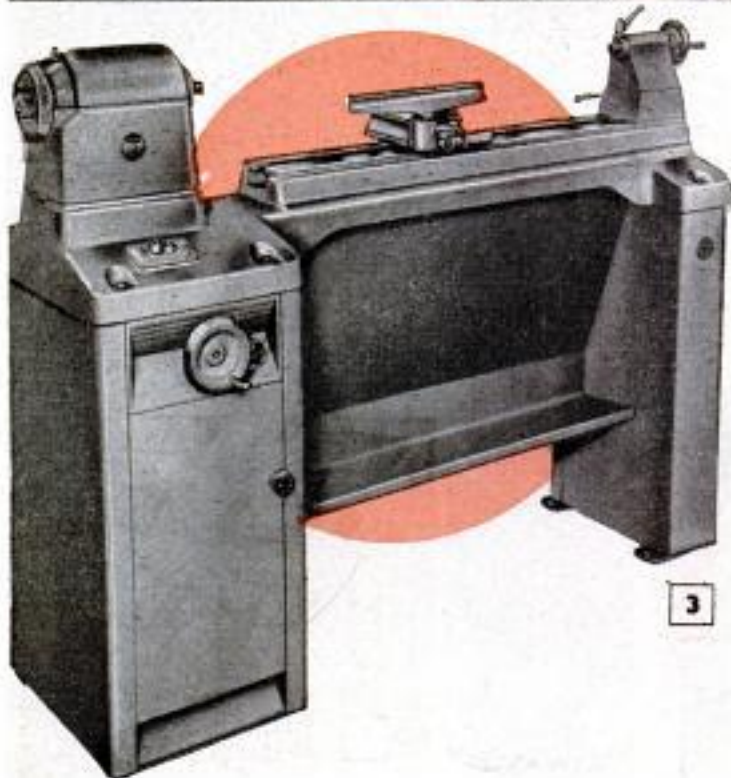

3

3. VARIABLE-SPEED LATHE for wood turning, metal spinning and light turning of metals has 12-in. swing over bed, 16½-in. swing over gap and takes 38 in. between centers. Comes complete with variable-speed drive having a range of 340 to 3200 r.p.m. Tailstock has quick-acting cam-type clamp for positive positioning on bed

Delta Power Tool Div., Rockwell Mfg. Co.,
457 N. Lexington Ave., Pittsburgh 8, Pa.

4. STRAP-TYPE CLAMP can be placed at any angle up to 45 deg. to hold work securely on machine tables. Requires no block. Curved ends bear on table and surface of work, and single bolt and floating washer equalize pressure when nut is tightened. Curved ends, or pads, require very small space on surface of work

Custanite Corp., 1228 Utica Ave., Brooklyn 3, N.Y.



4

5. ONE-MOTOR WORKSHOP is available with accessories which convert it to a saw, grinder, drill, hedge trimmer, lawn edger, rotary garden cultivator and twin-head floor polisher with counter-rotating polishing brushes. Motor unit weighs 10 lb., has power to handle cultivator-tiller unit, drill and table saw up to full capacity. Small size of saw table and blade makes tool especially suited to modelmakers

Iron Fireman Mfg. Co., Cleveland 11, Ohio

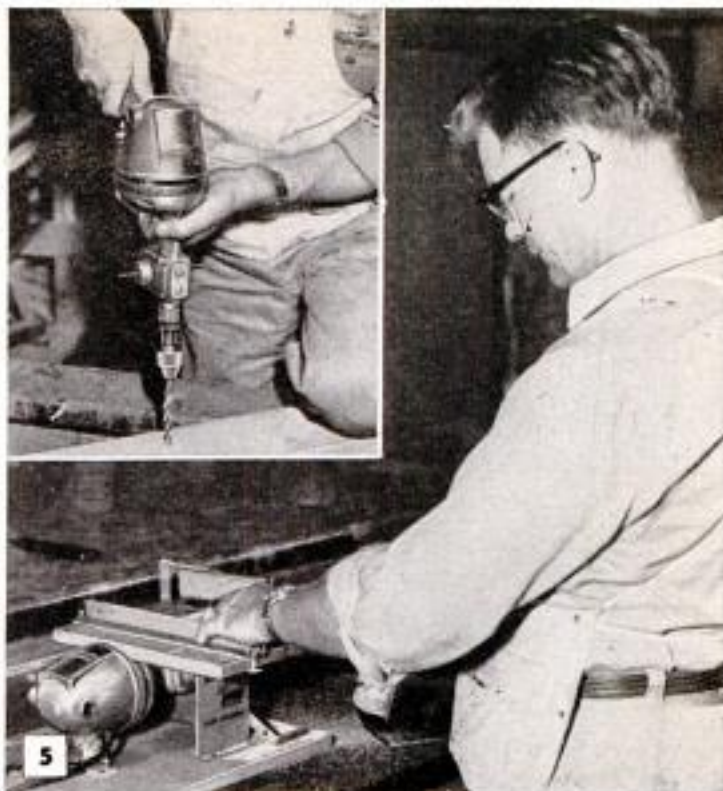

6. NEW CUTTING TOOLS in the familiar form of hand plane and rasp utilize filelike blades each having 450 individual cutting edges set at a 35-deg. angle. Blade is provided with an opening through which chips pass, preventing any tendency to clog. Blades are interchangeable on rasp and plane body, both of which are of lightweight aluminum. Blade will cut wood, fiber, plastic and common nonferrous metals

Stanley Tools, Div. of Stanley Works, New Britain, Conn.



7. WIRE TIGHTENER can take up as much as 30 in. of slack in light wires and cables such as metal clotheslines, TV-antenna guy wires, any type of metal line which cannot be placed under tension conveniently while attaching the ends to anchors or other supports. Consists of a winding drum 2½ in. in dia. and having projecting lugs so that it is easily rotated with a screwdriver in the manner pictured. Locks at any position

BMS Enterprises, 4826 Greenville Ave., Dallas 6, Tex.

8. KIT for attaching solderless terminals consists of a combination cutting, stripping and crimping tool, a plastic-handled screwdriver and an assortment of solderless terminals. Jaws of the tool are specially formed for crimping the terminals. Wire cutters and stripping slots are cut into the meeting edges of the handles between the inner ends of the plastic grips and the pivot. Handles wire from No. 10 to 22

Vaco Products Co., 317 E. Ontario St., Chicago 11

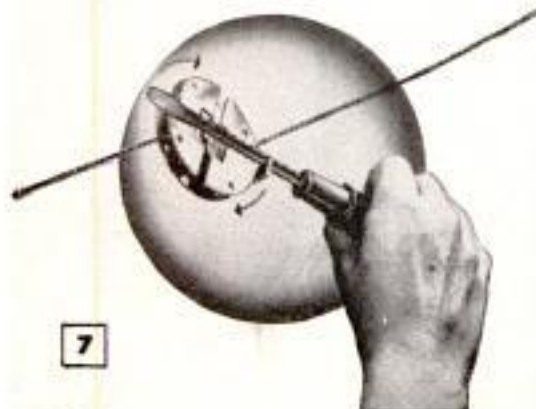

7

8



SHOPPING FOR TOOLS

(Continued from preceding page)

9. BAND CLAMP for assembling and gluing chair frames and columns features an exceptionally strong, stretchproof nylon band and a pawl and ratchet for tightening and loosening. Flexible band exerts uniform pressure, assures tight joints

Eagle Products, Meriden, Conn.

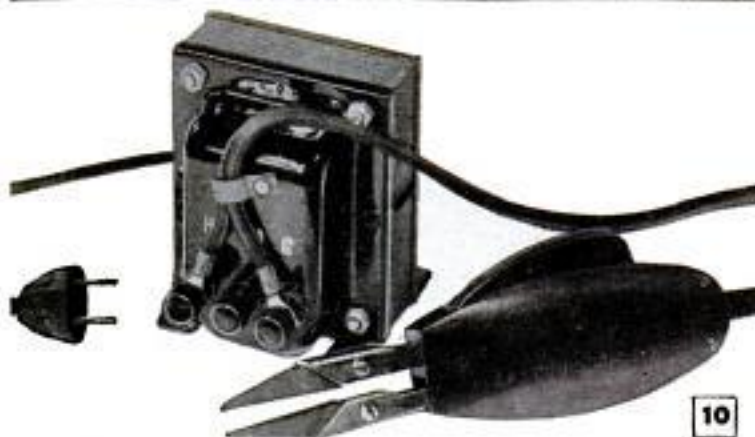

10. ELECTRIC SOLDERING TOOL comes with a two-heat transformer and plier-type electrodes which generate almost instantaneous heat when switch in hand piece is closed by light pressure. Electrodes grip work in the same manner as pliers

Triton Mfg. Co., Inc., East Haddam, Conn.



11. JIGSAW has built-in motor with take-off fitted with a chuck for standard 1/4-in. accessories for grinding, drilling, sanding and polishing. By removing over-arm, unit can be operated as a saber saw. Unit is lightweight, easily moved to work

Burgess Vitrocrafters, Grayslake, Ill.

12. WOOD-SCREW HOLDER permits one-hand placement of screws in hard-to-reach locations. Slides over screwdriver bit and grips screw firmly with bit engaging screw slot. Sliding coil spring locks into notches to hold the screw firmly

Cade & Holt, Mfg. Engineers, Millview Works, Barham, Kent, England

13. STORAGE CABINET for tools is designed to hang on the wall. It is fitted with a drawer and six sliding tool panels providing 24 sq. ft. of tool-storage area. Doors nest into sides of cabinet when opened and are equipped with built-in lock

Huot Mfg. Co., 550 N. Wheeler Ave., St. Paul W4, Minn.

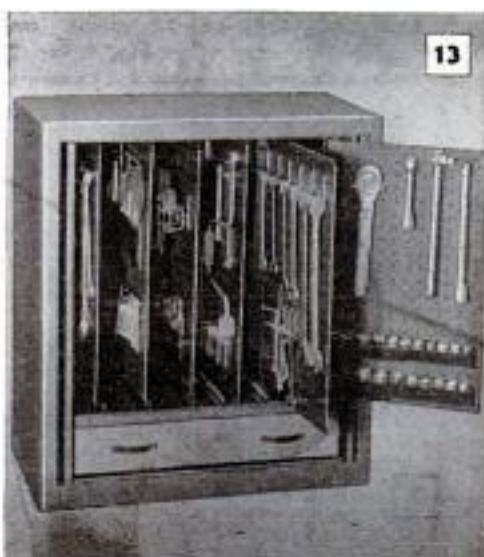

THERE'S LONGER
ENGINE LIFE IN **MOPAR**
MICRONIC OIL FILTERS

WOW! OVER
10 FEET OF FILTER
ELEMENT!

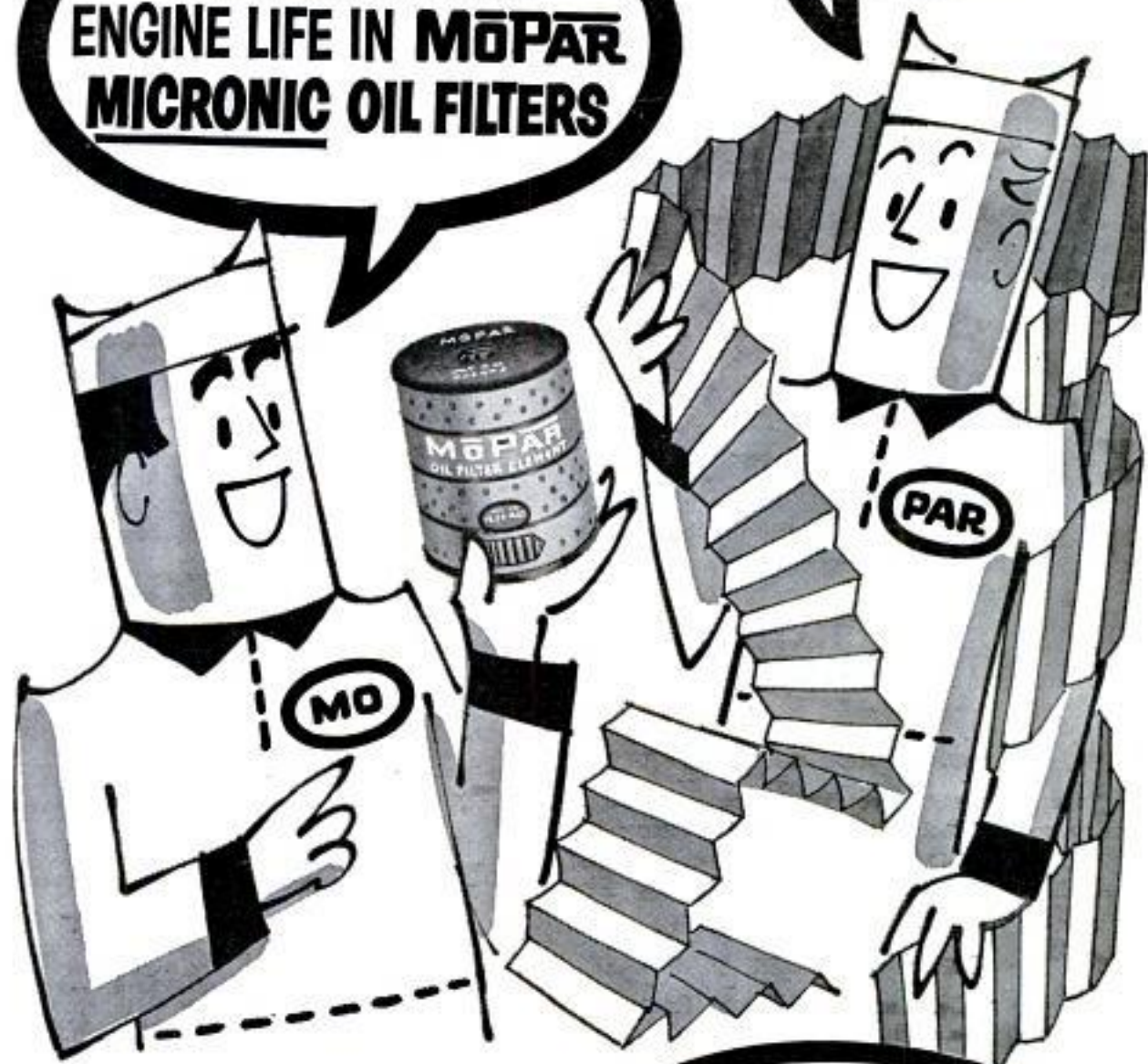

Here's the oil filter that invites you to keep careful tab yourself. MoPar Micronic Oil Filters keep engines purring longer because they trap corrosive, abrasive particles down to .000039 of an inch . . . take out one third more dirt per square inch of filtering surface . . . offer a surface over 8 times that of conventional types. MoPar Filters fit most makes of cars. Make sure you get MoPar Parts — official, authentic Chrysler Corporation Parts, available from your local Plymouth, Dodge, De Soto, Chrysler or Imperial dealer.

MOPAR

PLYMOUTH · DODGE · DE SOTO · CHRYSLER · IMPERIAL
PARTS & ACCESSORIES

CHRYSLER CORPORATION  PARTS DIVISION
DETROIT 31, MICHIGAN

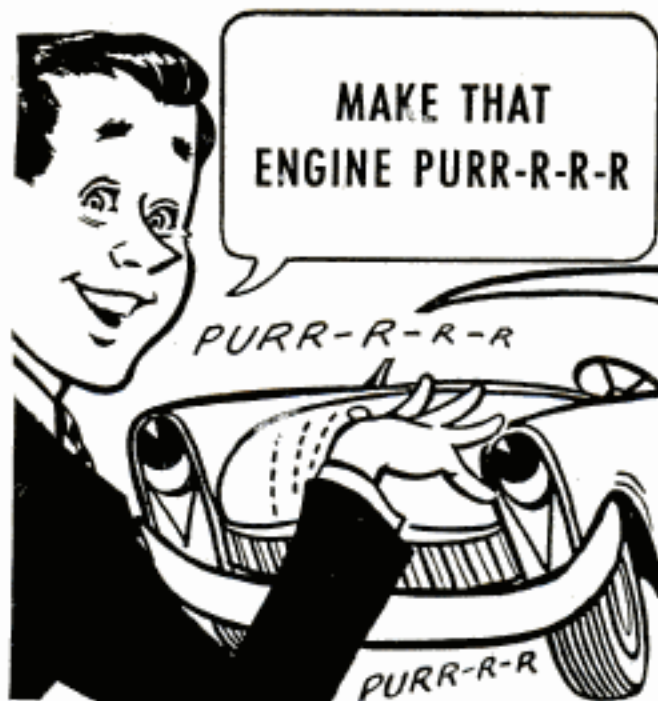

YOUR CAR DESERVES A Sealed Power KromeX Ring Set

Piston rings wear out before cars do. When your car begins to smoke, and labors on a hill, and acts tired—give it the best piston rings on the market—Sealed Power KromeX. Sealed Power rings are used by every major engine builder in America! What's best for original equipment is best for replacement!

SAVE OIL! SAVE GAS! GAIN POWER!

You'll be amazed at the way your engine will purr happily along, with a new Sealed Power KromeX Ring Set! Your oil and gas bills will be lower—power will be higher. And driving will be so much more fun!



SEND FOR FREE MANUAL

"Care and Feeding of Engines" is an illustrated manual of engine care which is yours for the asking. It may save you a lot of money. For your free copy, address Sealed Power, Dept. G-3, Muskegon, Mich.

Sealed Power

PISTON RINGS

BEST IN NEW CARS! • BEST IN OLD CARS!

Clinic for Homemakers



As a service to our readers in solving the hundreds of problems pertaining to a home—inside or out—the editors of *Popular Mechanics* invite you to present your problems to The Clinic Editor for help and advice. Address your questions to The Clinic Editor, *Popular Mechanics Magazine*, 200 East Ontario Street, Chicago 11, Ill.



Hilling Plants

Q—Is it always a good gardening practice to hill such growing plants as potatoes, carrots and beets? I'm told that it is, but I don't quite see the reason for hilling vegetables. No one I know of carries out this procedure. It seems to me that the practice may cause the soil to dry out rapidly to a considerable depth, especially between the rows where the soil is taken for hilling. Am I right?
H. L., Ga.

A—We assume you are referring to gardening practice in small plots and not to general field practices. One of the main reasons for hilling root crops, particularly potatoes, is to prevent the tubers from being discolored by exposure to the direct rays of the sun. This would be true of other root crops such as beets and carrots, although to a lesser degree. Some experienced gardeners make a regular practice of hilling potatoes, also carrots, beets, salsify, and some others, in heavy soils. The hills, or ridges, tend to promote drainage of moisture to a lower level, the soil dries and aerates faster after heavy rains and generally remains in a more friable condition. In the lighter, sandy or gravelly soils, level cultivation is generally the best practice. If necessary, low ridges or hills can be built up around the plants to protect the tubers from the sun.



Removing Oil Finish

Q—I have removed the finish from an old table and due to the rather lifeless appearance of the bare wood, I was advised to apply a coat of linseed oil as a first step in refinishing. I was much disappointed in this, as the oil darkened the wood. Now I want to remove the oil, but how? Sanding seems to have little effect.
S. A., Mass.

A—You do not say what kind of wood was used in the construction of the table. This tends to limit our answer to generalities. If the oil has been applied recently, it is just possible that it can be washed out of the wood by using a lacquer reducer, or thinner, which will act as a solvent to remove at least a portion of the oil which has been absorbed. A wash-off type of paint and varnish remover

(Continued to page 224)

ROCKWELL-BUILT

the all new dust collector

DELTA



New Delta Dust Collector shown with Delta Saw-Jointer. It can be attached to any other workshop power tool quickly, easily.

... for dozens of home workshop uses!

The only industrial type dust collector priced for the home workshop!

POWERFUL, BUILT TO LAST—Picks up small screws, nuts, bolts—even a 1" steel ball—without damaging suction mechanism.

ATTACHES TO ANY TOOL—Mounted on casters, rolls where you want it.

GET ALL THE FACTS:—See how this great new Delta Dust Collector picks up sawdust, chips, metal filings, converts for paint spraying and does dozens of other jobs. Visit your Delta Dealer—he's listed under "TOOLS" in the Yellow Pages of your telephone book. Or see it at leading department or hardware stores.

Send Coupon Today!



another product by
ROCKWELL



Delta Power Tool Division, Rockwell Manufacturing Co.
502C N. Lexington Ave., Pittsburgh 8, Pa.

- Please send complete information on new Delta Dust Collector.
 Please send name of my nearest Delta Dealer.

Name _____

Address _____

City _____ County _____ State _____

Aluminum Living

is maintenance-FREE

with
nichols
NEVER-STAIN

ALUMINUM trellis

to accent the Beauty of your flowers



- RUSTPROOF — lasts indefinitely
- Never requires painting — maintenance-free
- Attractive "LUSTRE-BRITE" silver-like finish accents beauty of flowers and vines
- Reflects sun's heat and provides numerous surfaces for vines to grip
- Easy to put up — complete instructions in each package
- Ideal for interior treatments such as room dividers, etc.
- Available in 10 ft. and 25 ft. packages complete with hardware. Look for the red-white-blue displays at your favorite store.



ALUMINUM grass stop

for the neatest lawn in your neighborhood



- RUSTPROOF—lasts for years and years
- NEW "safety edge" makes installation easy — no sharp edges. No joints or clips.
- Ideal for use around trees, shrubs, sidewalks and driveways
- Substantially reduces tedious lawn work
- Won't interfere with mowing
- Available in 40 ft. coils in 4" and 8" girth



ALUMINUM clothesline



- RUSTPROOF — lasts indefinitely
- Once up — always up, summer and winter
- Will not rot, rust, chip or crack
- Solid or stranded in 50 ft. and 100 ft. coils

nichols WIRE & ALUMINUM COMPANY
DAVENPORT, IOWA



(Continued from page 222)

might do the trick. We hesitate to recommend use of an oxalic-acid bleach without knowing the kind of wood that was used in the construction of the table. However, you might try a mild solution on a small inconspicuous area and note the results. If it works satisfactorily, then it may be safe to use the solution on all parts. **Caution:** Lacquer thinner (reducer) is highly flammable. If you use it as a wash, take every precaution against the fire hazard. Handle oxalic-acid solution only with rubber gloves. Avoid inhaling the fumes. Destroy any unused portion.



Damp Basement

Q—I partitioned my basement and built a playroom at one end. I laid a floor of asphalt tile and finished the walls in knotty-pine plywood. Now dampness seems to be loosening the tile and the plywood plies are separating at several points. What can I do to stop the damage?—E. H., Ill.

A—Preventive steps should have been taken at the time the work was done. About the only suggestion we would consider practical now is to install an electric dehumidifier to reduce the humidity of the air in the room to a low level. However, this may not prove a complete cure, as a certain amount of moisture comes through the concrete, both the walls and floor, unless it has been waterproofed. Waterproofing the basement walls from the outside will, of course, prevent this but the cost may be prohibitive. It may well be that after the dehumidifier has been operated a sufficient length of time to dry the walls and floor the dampness will be minimized to such an extent that it will no longer be damaging.

Damaged Tree

Q—I have a young tree about 8 ft. in height. A foot or more of the top end of the trunk has been broken off. I just noticed the damage recently and have no idea what caused it. What will happen now? Will new branches start at the break, and is there danger of insects causing damage where the wood is splintered?—I. L., Conn.

A—You did not say what kind, or variety, of tree you are referring to as being damaged in the manner you describe. This makes it rather difficult for us to outline what we would consider a practical procedure. In general, it sometimes is possible to train a branch, which is located just below the break, to take the place of the missing leader. Although the tree you describe must be fairly well along in growth, it may still be practical to carry out this suggestion. First, cut the trunk below the break, taking special care to make a clean cut at an angle. Protect the cut surface with a coating of asphaltum or other similar coating made for the purpose. Then attach a 1 x 1-in. strip of soft wood to the trunk, the top end extending a foot or more above the break. Pad the strip at all points where it touches the trunk with sponge rubber or some other soft material. Then bend the branch to be trained as a replacement upward as far as it will go without danger of breaking and tie loosely to the strip. After a time repeat the bending process, drawing the branch a little closer to the strip. This may have to be done several times in order to train the branch to grow straight upward. Once this is accomplished, remove the wooden strip.

Condensation in Water-Heater Vent

Q—My gas water heater is installed in the kitchen. When the burner is on, the vent pipe to the chimney drips water onto the floor. Can you tell me what causes this, and how to remedy it?—M. H., Va.

A—One of the products of the combustion of concentrated fuels is water vapor. This tends to condense on the inner surface of the metal vent pipe which is cooler than the gases passing through it. Usually pitching the horizontal run of vent pipe at a somewhat steeper angle minimizes or entirely cures the trouble.



Lee

DUNGAREES

**Lee's "Jelt" Denim
takes the jolt of
the toughest jobs
you can name!**

As hard-working a pair as you'll ever wear! Lee Dungarees are made of Lee's exclusive "Jelt" Denim, rugged as rope. Sanforized. Lee Dungarees have triple-stitched seams, one of 20 Tough-Tailored Extras that give you unmatched endurance. Tailored sizes make sure that they fit perfectly no matter how you're built! Lee must look better, fit better, wear longer than any you've ever worn or your money back or a NEW GARMENT FREE!

H. D. LEE COMPANY, INC.
KANSAS CITY, MO. WORLD'S LARGEST
MAKER OF UNION-MADE WORK CLOTHES

SET YOUR SIGHTS ON THE SAVAGE 340

It's always "open season" with the Savage 340 . . . chambered for 2 great varmint cartridges and America's most popular deer caliber. Stock has medium-high comb and trim lines for steady handling, fine balance and streamlined appearance.

This rugged bolt action repeating rifle has a ramp front sight and rear sight with elevation adjustment . . . drilled and tapped for popular receiver sights and 'scope mounts. Available in 3 great calibers:

.222 Remington 50 grain bullet

The advanced design of the 340 brings out the ballistic potential of this high velocity, flat-shooting cartridge.

.22 Hornet 45 grain bullet

An economical cartridge that delivers peak accuracy in the Savage 340.

.30-30, 150 and 170 grain bullets

For more than 50 years it has proved its effectiveness on deer and medium-sized game.

The 340's exclusive head space control and specialized Savage manufacturing methods give you extreme accuracy at a price so low you can buy the 340 complete with 'scope for less than you might expect to pay for the rifle alone. See it at your dealer's now.

There is a complete line of Savage, Stevens and Fox shotguns and rifles for every shooter and every kind of shooting. Write for free rifle or shotgun catalog. Savage Arms Corp., Chicopee Falls 18, Mass.

\$57⁵⁰



Savage

TRADEMARK
SAVAGE • STEVENS • FOX FIREARMS



ALL PRICES SUBJECT TO CHANGE . . . SLIGHTLY HIGHER IN CANADA



Captured flies in the bottle are emptied into one of Wright's zoociliariums for smaller reptiles to feed on

Engineer Makes Fly Traps

Flies and the reptiles that eat them are a full-time business with Ralph Wright of Walnut Creek, Calif. Formerly a mechanical engineer at the University of California radiation laboratory, Wright has switched to production of fly traps and reptile "zoociliariums." The fly trap has three parts: A quart glass bottle, a wood "sandwich" with an internal labyrinth of screen funnels and baffles and a discarded coffee can with fly bait inside. The overturned bottle sits on an opening into the sandwich, which rests on the can of fly bait. Flies, trapped in the screen chamber over the bait, crawl into the glass jar seeking escape.

Fly trap, with bottle replaced by tube to zoociliarium, supplies continuous insect food to caged reptiles



GRAVELY

New **EASE** for
Country Living!

Now!
30 Tools

CULTIVATE
GROWING CROPS

POWER CULTIVATE
YOUR GARDEN

PERFECT SEEDBED
WITH ROTARY FLOW

MOW LAWN
AREAS

MOW TALL GRASS,
WEEDS, CROPS

BLOW
SNOW
AWAY

MOVE SNOW,
DIRT

HAUL
HALF-TON
LOADS

GRAVELY gets the Job done Better, Faster!

An amazing new experience in *easy, efficient mowing* is yours with the Gravelly, its Steering Sulky and Rotary Mower attachments.

Whether you are mowing the front lawn in riding comfort, or a steep slope bristling with tough grass and weeds, the Gravelly turns in the finest performance of any tractor.

The reason is **POWER**. Gravelly has the *extra* power you need for the tough jobs, plus the versatility that is yours with 30 performance-proved attachments. A year-around choice of tools for every lawn and garden job.

More For Your Money!

You get more power, more performance, more for your money when you buy Gravelly. The cut-away view of the tractor on the right shows you the clean, compact design which is the reason for the remarkable performance of the Gravelly Tractor.

- ALL-GEAR DRIVE
- POWER REVERSE
- Power Attachments Securely Mounted by Only 4 Bolts

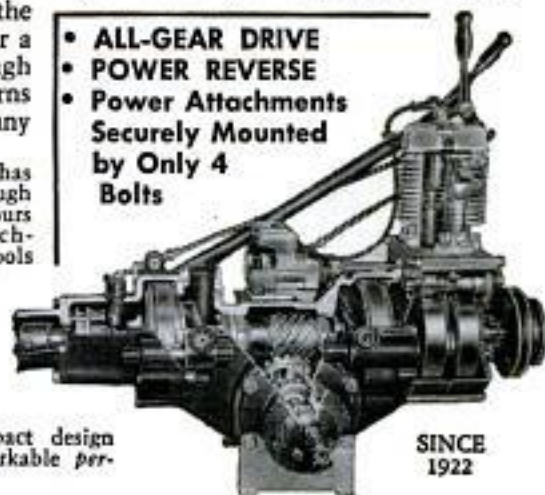

SINCE
1922

New Rotary Cultivator

Now, power-cultivate your garden with the new Gravelly Rotary Cultivator—one of seven **NEW** attachments for the Gravelly. Never before have you been offered such versatility, such power for your jobs!

Send coupon today for "Power vs. Drudgery", the big booklet that shows how Gravelly equipment solves your upkeep and gardening problems . . . *faster, easier, better!* (EASY PAYMENT PLAN)

GRAVELLY TRACTORS, INC.
BOX 363, DUNBAR, W. VA.

Please send me "Power vs. Drudgery" Booklet and dealer's name.

NAME _____

ADDRESS _____

CITY _____ STATE _____

FIELD-TESTED SINCE 1922

More Miles on Your Tires

(Continued from page 157)

spikes to demonstrate their puncture resistance; but work such as that being done by Judson and others will continue to keep tiremaking costs down and to increase tire safety and service life.

What does all this mean to the average motorist? Better, stronger tire skeletons made from miles of textile cord mean greater highway safety. Blowouts resulting immediately from hitting a bad rut or large stone, as well as those occurring days or weeks after the tire is subjected to such abuse, are less likely. Improved tire cords and better ways of uniting them with rubber compound make it possible to build a tire that can outlast more than one tread.

Motorist's Responsibilities

With all the improvements in tires and the materials that go to make them, the passenger-car or truck driver still has some responsibilities. For one thing, he must keep his tires properly inflated.

"Underinflation is particularly bad in high-speed tire performance," Judson explained. "The pressure that is built up in tires by fast driving, as a result of friction that heats air in the tires, never should be let out. In fact, a little higher pressure,

which would cut down flexing, is considered to be actually safer. Higher pressure increases slightly the tendency to bruise, but modern tires are so much stronger than prewar ones that the driver can forget about this effect. On the other hand, low pressure permits increased flexing, and this quite rapidly increases heat buildup and the possibility of failure at high speed. This will be especially true with the lower-pressure tires on some of the 1957 cars.

"Lower operational tire pressures are made possible by improvements in such things as cord dip and adhesion. The pressures at which some modern tires can be run would, 10 years ago, have put them in the semiflat class, and might have resulted in frequent failure of the casing caused by cord separation."

Besides keeping his tires properly inflated, the motorist should drive with reasonable care and—even though his tires are stronger than ever—try to avoid hitting sharp-edged ruts, stones and other obstacles. He should be careful not to pinch his tires or rub their sidewalls against the curb. And he should strive to avoid other tire abuses. Microscopes are wonderful tools in tire-development work, but so far they haven't revealed fibers or anything else that can completely neutralize careless driving habits. ★★★

New *Black & Decker*® Saws . . .

**Board for board—
job for job—
Black & Decker Saws
outcut 'em all!**

On-the-job tests prove new Black & Decker Saws outcut, outperform, outlast other saws with power to spare.

They're designed with you in mind—to give you more power, better visibility, easier handling, extra ruggedness!

Four heavy-duty models. #63 model which cuts 2 x 4's at 45° to #93 with maximum cutting depth of 3¼".

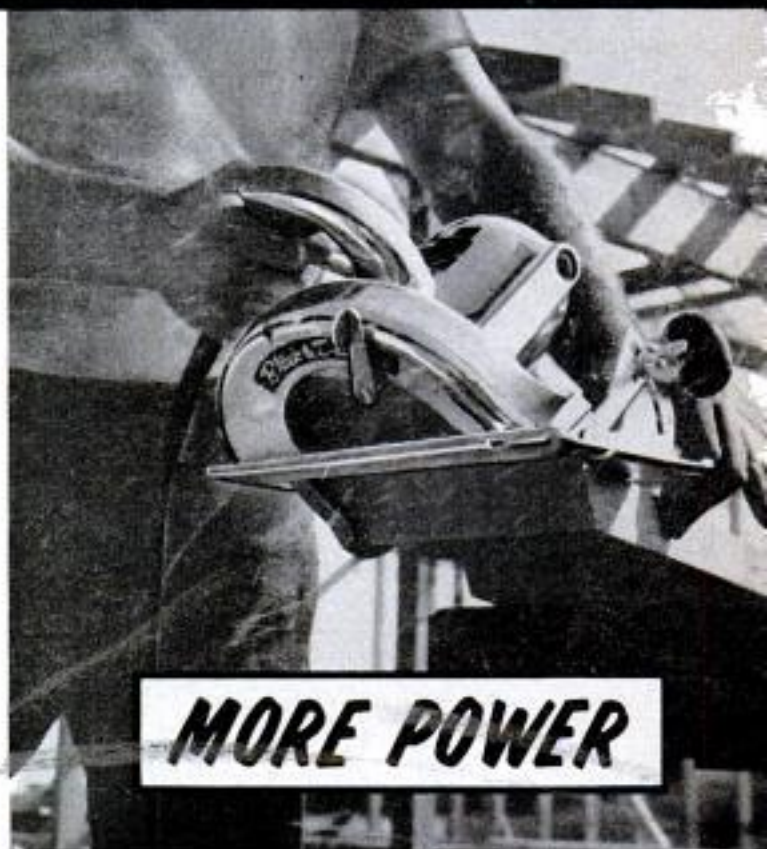

MORE POWER

Geiger Counter-Portable Radio

(Continued from page 164)

you're wise, you'll tape a piece of heavy cardboard over the speaker cone to prevent accidental damage to this unit during construction. Also, keep the plates of the variable capacitor fully closed. Remember that bent plates can be the cause of considerable trouble.

The mounting detail for the variable capacitor shows three fiber spacers to be inserted in the rubber grommets. Such spacers are often included with a kit of radio hardware, but they may be omitted if not readily available. Note also the solder lug fastened to the capacitor-mounting bracket beneath the head of one of the mounting screws. This lug must make good electrical contact with the bracket and should, therefore, be soldered to the bracket after the screw has been tightened.

Wiring. Under-chassis wiring is simplified through the use of a printed circuit plate, PC-160, which replaces a number of individual resistors and capacitors. Of course, the individual parts may be used, if desired, by following the schematic diagram.

Wires which lead from under the chassis to components mounted above the chassis, or on the cabinet, are coded with capital

letters for easy identification. These leads should consist of flexible, stranded wire.

Fasten the oscillator coil, L2, in place by soldering its terminal, A, to the end lug of the indicated 3-lug terminal strip. The inset in Fig. 3 and the oscillator-coil diagram in Fig. 5 will help you identify the coil terminals.

Final assembly. Fig. 4 shows the completed unit assembled in its cabinet. The battery bracket holding the A-batteries in place fits into two grooved blocks which are already glued to the top and side of the cabinet. The cabinet also contains a metal jumper plate riveted to the inside front panel. This plate is so positioned that when the A-batteries are inserted in the compartment the positive terminal of one is automatically connected to the negative terminal of the other, thus connecting them in series. Two Fahnestock (spring) clips and solder lugs fastened to the wood block on the cabinet back, as illustrated, press against the other terminals of the batteries when the back cover is in place. This wires the batteries into the circuit.

Caution: The solder lugs under the Fahnestock clips must be so positioned that they do not touch the metal battery bracket when the cabinet back is in place. Otherwise, the batteries will be short-circuited.

(Continued to page 230)

designed with *YOU* in mind!



Sawdust is blown clear of work!

New B&D picture window design makes line-of-cut and cutting edge of the blade visible at all times. Ideal for angle cuts . . . perfect for ripping. New cooling fan is so powerful it keeps the line-of-cut clean and blows sawdust clear of the job, clear of your eyes!

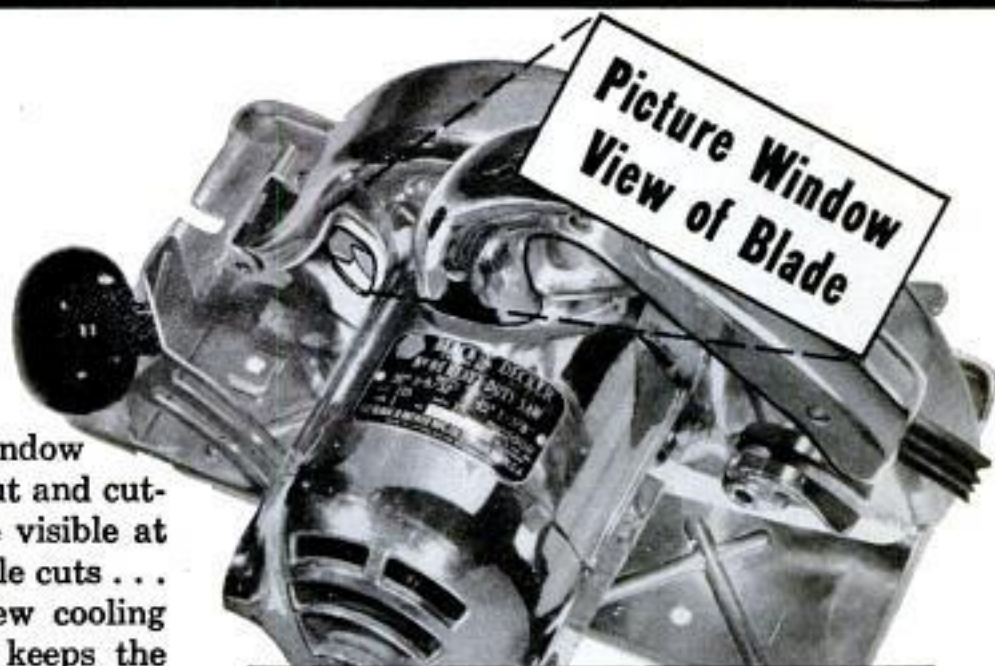

BETTER VISIBILITY

The selector switch, S1, and push-button switch, S3, as well as the 1B85 detector tube are fastened to the side of the cabinet. Mounting holes for these will have to be drilled, but their exact positions are not critical.

Testing

With the set completely installed and the back cover in place, turn the unit on and set the selector switch to the "radio" position. Turn volume control to maximum and rotate the tuning knob. You should be able to tune in some of your strong local stations.

Now, set the selector switch to the "counter" position and rapidly "pump" the push-button switch in and out several times. This should produce a slow, intermittent "pop, pop" in the speaker, indicating that the detector circuit is functioning properly.

If you happen to have a wrist watch with a fluorescent dial, bring the watch close to the part of the cabinet housing the detector tube. This should produce a very noticeable increase in the frequency of the "clicks" emanating from the speaker. A stronger source of radioactive material, such as an inexpensive radioactive sample, available from most radio-parts distributors, will literally make the detector "go

crazy," producing a continuous noise similar in sound to static in a radio during a thunderstorm.

Adjusting the Radio Circuit

Although the loopstick, oscillator coil and variable capacitor have been especially selected to provide proper tracking and the i.f.s are factory aligned, some adjustment may still be required to obtain best results. This involves removal of the unit from the cabinet and, in some manner, connecting the A-batteries to the circuit. This can be done by actually wiring the two batteries in series and temporarily soldering leads G and H (see Fig. 2) directly to the open battery ends. Alternatively, at an additional investment of less than 50 cents, you can buy a separate 3-volt battery with screw terminals (Burgess No. 422 or equiv.) and connect these to the proper Fahnestock clips with clip leads.

Once power is applied to the set, attach the calibrated knob to the variable capacitor shaft so that, with the plates fully closed, the number 55 appears at the top. Now, tune in some station near the center of the band and, with a thin, nonmetallic screwdriver, slightly rotate the slugs through the top and bottom of the i.f. cans (in both directions) to determine the point

(Continued to page 231)

New Black & Decker® features . . .

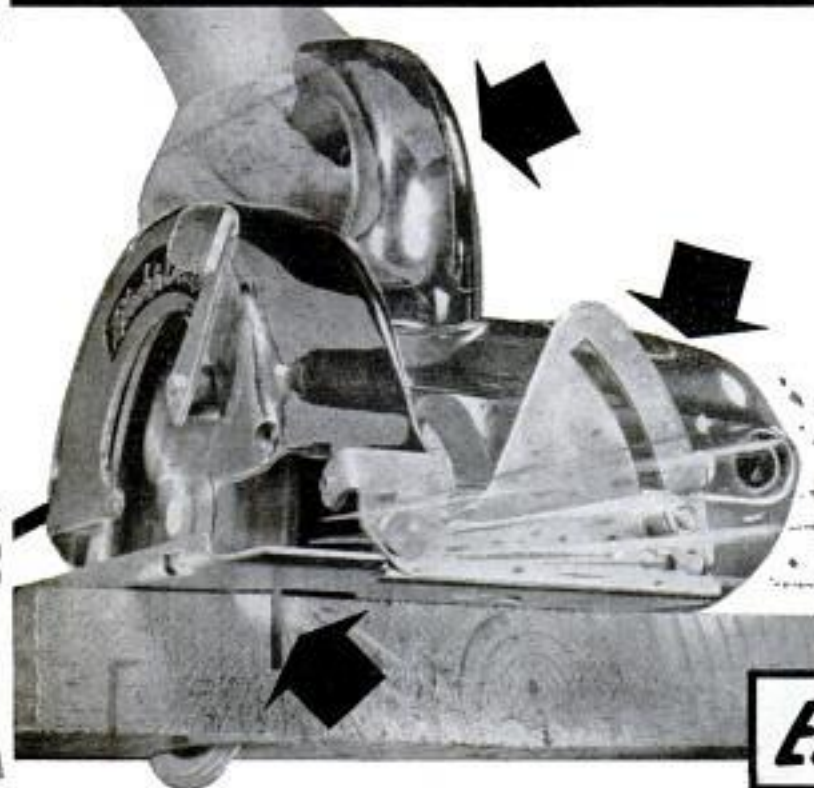

Better control in the wood!

As you rip down a board, you'll be amazed how this new B&D Saw won't walk away from the line-of-cut . . . won't nose in or drag. Open-end handle allows for easy handling, even with heavy gloves. Big wing nuts and fast-grip levers make depth and bevel adjusting a snap. And you'll like the overall lightness and balance.

EASIER HANDLING

of maximum volume. Then, tune in the highest-frequency station in your area and notice if the tuning-dial number now appearing at the top corresponds with the station's frequency. If not, rotate the dial until that number does appear at the top and adjust the small screw of the tuning capacitor's oscillator section until the station comes in at that point. Adjust the trimmer screw of the capacitor's r.f. section for maximum volume to complete the radio alignment.

Operating the Geiger Counter

While the radio portion of this project is completely conventional, a short explanation of the geiger-counter circuitry, shown in red on the schematic diagram, may help you to interpret the results.

When push-button switch S3 is suddenly depressed and released, a surge of current flowing through the low-impedance winding of T2 produces a voltage pulse across this winding. Through transformer action this voltage is greatly stepped up, so that in the secondary transformer winding it is great enough to break the spark gap and permit capacitor C15 to charge up. Rectifier action of the spark gap prevents the capacitor from discharging back through the transformer, with the result

that the voltage across C15 appears at the anode of the 1B85. The more rapidly S3 is pumped (depressed and released) the more quickly the voltage across C15 will become high enough to operate the detector.

In the absence of radiation, the 1B85 represents an open circuit. But, each time a parcel of radioactive energy strikes the tube, the latter conducts and causes a pulse of voltage to appear across the volume control, R4. This voltage pulse is amplified in the audio portion of the radio and produces a pop or click in the speaker.

In actual use, the push-button switch should be pumped rapidly for a period of about 30 seconds. The slow popping sound then heard through the speaker is caused by cosmic radiation from the sun which is present at all times. This is called the "background count." When a radioactive sample is brought near the part of the cabinet housing the detector, the frequency of the count increases until the sound from the speaker resembles that of continuous radio static.

A single charge of the capacitor C15 may last from 3 to 20 minutes, depending on the intensity of the radiation, the quality of the components and the humidity in the air. When the background count is no longer audible, the capacitor must be recharged, as outlined earlier. ★ ★ ★

found only in these saws!

EXTRA RUGGED

Power-Built to Last!

Black & Decker Saws are famous for their extra rugged, dependable motors—B&D-designed-and-built to last! And you'll find that same outstanding construction throughout your new B&D Saw. Added safety features, sturdy shoe. Write: THE BLACK & DECKER MFG. CO., Dept. M-037, Towson 4, Md.

Look in the Yellow Pages under "TOOLS-ELECTRIC" for nearest dealer.



Black & Decker

World's Largest Maker of Portable Electric Tools

MARCH 1957

231

Copyrighted material



NEW Starrett No. 167 RADIUS GAGES



- Rustproof Stainless Steel
- No-Glare Satin Finish
- Handy Individual Gages
- Each With Five Gaging Surfaces
- Six Convenient Sets

MECHANICS, MACHINISTS, INSPECTORS... here's why you'll go big for these new Starrett No. 167 Radius Gages:

Stainless steel with no-glare satin finish — to make them rustproof and stainproof, easy on the eyes in any light. *Individual gages* — easier to use, less chance of errors. *Five gaging surfaces on each* — to handle any concave or convex radii. *Sizes from 1/64" to 1/2"* — in your choice of six convenient sets. Available with handy gage holder.

New No. 167 is only one of many new Starrett Tools you'll want for your kit. Your distributor or tool store will gladly demonstrate them or write for big, new illustrated catalog.

BIG NEW CATALOG — FREE

Describes and illustrates over 3000 Starrett Tools. Write for it. Address Dept. AP



THE L. S. STARRETT CO., ATHOL, MASS., U. S. A.
Since 1880 — World's Greatest Toolmakers



MECHANICS' HAND MEASURING TOOLS AND PRECISION INSTRUMENTS • DIAL INDICATORS • STEEL TAPES
PRECISION GROUND FLAT STOCK • HACKSAWS, BAND SAWS and BAND KNIVES

Taxi to Venus?

(Continued from page 128)



Electrical leads are attached to body of airman in altitude chamber. They report changes during test

assembled in space from parts that are sent aloft by rockets. In fact, the fuel and oxidizer tanks of the supply rockets would be the principal building blocks of the structure."

A smaller vehicle rebuilt from rocket components could be used for exploring the moon, though not for landing on its surface, Ehrlicke says. The craft could consist of three tanks, one of them a gondola for crew and instruments, one an oxidizer tank containing oxygen or fluorine, and the third a tank of hydrogen to which a thrust chamber is attached. The tanks would be square, for there is no air resistance in space and so no need for streamlining.

Chemically fueled rocket motors of the type used today seem adequate for short space flights such as to the moon, but some new kind of power plant must be devised for true interplanetary travel.

One propulsion system that has possibilities for trips to Mars and Venus is solar drive. In this system, heat from the sun would be used to change liquid hydrogen into a high-temperature gas which would be expelled through nozzles to provide thrust.

A space ship using solar drive might well

(Continued to page 234)

*Why users expect
(and get!) more
from
Eclipse mowers*



IT CAN BE assumed that almost any mower will cut grass. But folks who buy an Eclipse expect more than this minimum performance. They expect — and get — low cost, trouble-free mowing year after year. That's why Eclipse is recognized as the standard of comparison . . . the brand most mower users plan to buy "the next time" for sure. User experience quickly points up the need for the kind of built-in quality only Eclipse offers.

The Eclipse extras

Feature for feature and dollar for dollar, you get more value from Eclipse. This is a direct result of the factory policy of building up to performance standards instead of paring quality down to meet a price. It stands to reason that skilled craftsmen — specializing in quality mowers — can provide a master touch not possible in factories where mowers are only a "sideline" product.

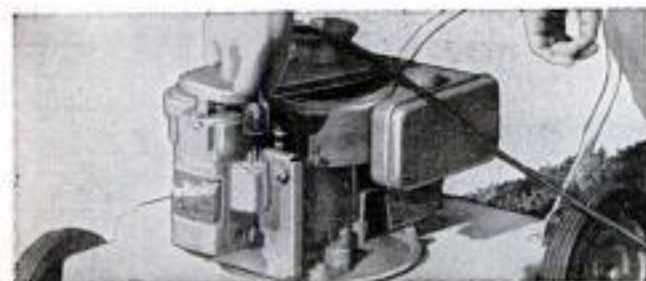

Easiest starting

Most people prefer the rope or recoil starter. But for those who prefer (or for health reasons require) completely effortless starting, an electric starter is available on many models. A gentle touch of the plug starts the engine: no work, no strain!

Easy Terms! Low as

\$850 per month

(Based on average dealer finance plan — 10% down.)

Lowest "per year" cost

It may cost just a few dollars more when you first buy an Eclipse. But user reports prove conclusively that the total cost of owning an Eclipse is less than for ordinary mowers. Eclipse mowers are built to last years longer and it's not at all uncommon for families to use an Eclipse for 15, 20 or even 30 years with very little maintenance expense. The rugged construction, the craftsmanship that is acquired only by half a century of specialized manufacture pays off for the user.

A typical letter reported a total expense of 87¢ for maintenance of an Eclipse power mower over a period of 5 years. When you consider ALL your costs, you see why we say, "Eclipse costs you less to own per year."

Free check list to help you choose your power mower

Many families have been confused by mower claims and are not certain as to what type of mower they should buy. Some people insist that a rotary mower is best, while others just as emphatically say the reel type can't be beat. Eclipse makes both kinds — has no special "ax to grind." A check list of 8 easily answered questions will indicate the type of mower that's best for you. Write for your free copy of the folder, "How to select your power mower." The Eclipse Lawn Mower Co., Div. of Buffalo-Eclipse Corporation, 3714-A Railroad St., Prophetstown, Ill.



Now it's **EASY**
to have modern
oak floors



Your choice of Block, Strip or Ranch Plank design

Just lay prefinished Bruce oak flooring right over your old floors...no sanding or finishing

You can give your home new beauty at low cost with a prefinished Bruce Hardwood Floor. Completely finished—even waxed—at the factory, this highest quality oak flooring can be nailed right over old floors. No sanding or finishing...no mess or smell. Ready for use as soon as laid. Made in Strip, Ranch Plank or Block (parquet) design.

"Scratch Test" Finish — The Bruce factory-applied finish is baked into the pores of the wood. The "Scratch Test" (left) will prove to you that this durable finish does not scratch or chip or mar like an ordinary floor finish.



Moderate in cost — A new Bruce Hardwood Floor will cost you less than a good rug or carpet. Easy to keep clean and beautiful, too. It's just the thing to use in fixing up or adding a room. Let your lumber dealer give you an estimate. Mail coupon below for colorful literature.

MAIL FOR FREE LITERATURE

E. L. Bruce Co., Box 397-L, Memphis 1, Tenn.
Send complete information on prefinished Bruce Hardwood Floors.

Name.....

Address.....

City..... State.....



Bruce Hardwood Floors

Product world's largest hardwood flooring maker



Machine outside the altitude chamber records effects of altitude on brain waves of the subject inside

consist of a huge bubble of transparent polyester plastic, Ehrlicke suggests. "The bubble could be some 300 feet in diameter with a skin only a thousandth of an inch thick," he says. "It would be slightly pressurized to give it a spherical shape. Half the inside surface would be silvered to create a hemispherical mirror that would concentrate the sun's rays on a heating element. In this element the hydrogen would be vaporized.

"Piped to directable nozzles, one at each side of the sphere, the gas would provide thrust for acceleration, braking and maneuvering. The crew's gondola and associated equipment including solar battery for auxiliary power would be supported by a framework in the center of the big sphere.

"It should be remembered that a space ship uses power only during its initial acceleration. The vehicle coasts the rest of the trip. Nevertheless it should carry large reserves of propellant.

"Here the solar drive has real advantage. Its heat-collecting device, the hemispherical mirror, weighs possibly 1000 pounds as compared to a much greater weight of oxidizer that would need to be carried in a comparable chemical rocket. This saving in weight permits additional hydrogen to be carried.

"Solar drive provides low thrust as compared to the very high thrust of a chemical rocket. This is a good thing, for the fragile plastic bubble will tolerate only low accelerations. It will be necessary to remain under power for hours to achieve the acceleration obtained in minutes by a chemical power plant."

Obviously a solar-driven space ship

(Continued to page 236)

TORO



\$129⁵⁰*... *the best you can buy*

Extra-heavy steel castings . . . mirror-polished working surfaces . . . years-ahead design features (like the single out-in-front control that either tilts—accurate to 1/10 degree—or raises the blade) . . . all these are yours in the Toro 8-inch Deluxe Tilt-arbor Saw—the *best* table saw you can buy.

Other professional-quality machines in the Toro home power tool line include: a 10-inch Deluxe and an 8-inch Standard Tilt-

arbor saw, a 12-inch drill press, 10-inch band saw, 18-inch jig saw, 4-inch belt sander, 4 and 6-inch jointer-planers.

You can see them all and get all the specifications in the latest full-color Toro Power Tool Catalog. For your free copy, mail coupon below.

*Table extensions and stand extra. Prices higher in the West and Canada; subject to change.

TORO MANUFACTURING CORP.

3015 Snelling Ave.
Minneapolis 6, Minn.



Yes! I'd like a free copy of your new, full-color Power Tool Catalog.

Name _____

Address _____

City _____ Zone _____ State _____



**Car owners who understand motors
get years-ahead Quaker State
for protection, performance, oil mileage!**



Super-refined from Pure Pennsylvania Grade Crude Oil, world's finest. Famous for performance, protection, economy! Try it!

QUAKER STATE OIL REFINING CORP., OIL CITY, PA.
Member Pennsylvania Grade Crude Oil Association

can't be assembled on earth and then shot out into space. After manufacture it must be disassembled, taken out to a satellite station, and there carefully put together and inflated.

Patches for the Space Ship

One thing that isn't known is how long a large bubble can remain in good condition under the bombardment of cosmic dust and tiny meteors that undoubtedly exist in space. Since a round trip to Venus would take nearly a year, engineers are sure they will need to make provision for patching numerous holes in the plastic membrane during the trip.

Convair is not the only group that is studying the vehicles that will be used in conquering space. A score or more of other agencies are all doing research on portions of the problem. These range all the way from the Air Force's Department of Space Medicine at Randolph Field, that is learning how man can live away from the earth, to the metallurgical concerns that are testing new metals from which the space ships will be built. ★ ★ ★

No More Fish, But Much More Comfort

It may not tempt any fish, but it relaxes the fisherman. A new massager keeps cramps out of the angler's legs while he tries for hours to boost his catch. The massager is attached to a foam-rubber pad. Built-in motors provide a gentle rubbing action. It can be operated on alternating current or batteries.



POPULAR MECHANICS

Copyrighted material

THE MIGHTY CHRYSLER 300⚡C



FOR SPORTS CAR THRILL . . . AND LIVING ROOM COMFORT

A tough, no-nonsense car is this latest version of the NASCAR Grand National Champion. 375 h.p. with the get-away, balance and split second control of the finest sports car. But you don't have to be an acrobat to get in, a midget to be comfortable, or an eskimo to keep warm. Here is all the spacious comfort you want, richly finished in

sports car leather. Convertible or hardtop models and choice of colors.

SPECIFICATIONS—375 h.p., 9:25 to 1 compression ratio. 2 four-barrel carburetors. Special high output camshaft. Torsion bar anti-dip front suspension. High spring rate—low deflection. Length 219.2 in. Height 54.7 in.

America's Most Powerful Car—375 H.P.

help yourself
to the
handiest
plier
ever
designed

CHAN NEL LOCK

No. 420

GRIPS LIKE
A PIPE
WRENCH



No other plier does so many jobs so well as a Channellock No. 420. Grips anything from a small cotter pin to a 1 1/4" hex nut. And what a grip! Just like a pipe wrench. What's more, Channellocks are streamlined . . . easy to use in hard-to-get-at places. Ask your hardware man for a Channellock plier. You'll soon agree with thousands of other craftsmen . . . Channellock is the handiest plier of them all.

BE SURE IT'S A GENUINE CHANNELLOCK



CHAMPION DEPARTMENT TOOL Co. MEADVILLE, PA.

You Can Build Your Own Swimming Pool

(Continued from page 85)

cracks, would put in more patio paving to cut down the grass clippings kids track into the pool, would put in a filter system and would pay the contractor extra to take time to get the edges of the pool perfectly level and flush with the patio paving.

In spite of its faults, Barkhorn remains an enthusiastic pool owner and maintains, "For family pleasure, it's been more than worth the trouble and expense."

Many amateur builders, however, work like fury and come up with pools which would be a credit to the best professional builders in the country.

In Dallas, Tex., Frank P. Bernard built a 28 by 12 by 7-foot pool which would come under this classification. Guided by many suggestions from a friendly professional builder, John A. Corrick of Corrick-Paddock Pools, Bernard ended up with a poured-concrete pool with strong, eight-inch walls, a heavy-duty filter system, automatic skimmer, tile edging and nicely plastered interior. Including the \$325-filter system, the pool cost him \$1400; he estimates a comparable pool by a professional builder would have cost \$4000.

Tough Luck

Bernard built his pool the hard way and ran into tough luck which cost him extra time and money. He personally removed about 70 tons of earth and rock; when he got down 2 1/2 feet he found solid limestone and spent several spine-jarring week ends with a rented air hammer breaking his way down to the desired depth.

Working mostly on week ends, he spent 10 months on the pool; of this period, five months were spent in digging the hole. Bernard didn't skimp on materials; he used 2500 feet of reinforcing steel and poured 24 yards of ready-mix concrete.

If he had it to do over, Bernard says he would definitely pay a man with machinery to rough out the excavation.

That is one point on which all amateur pool builders seem agreed: Hire someone to dig your hole.

They'd Do It Again

In general, about seven out of eight pool builders say that with some changes in procedure they'd do it over again, that the pool is worth the money and work.

H. D. Dobson of Wichita, Kans., is probably typical of the eighth man who says, "I strongly recommend a professional builder

(Continued to page 240)

SMALL INVESTMENT PUTS YOU IN GOOD PAYING BUSINESS OF YOUR OWN

ROGERS MANUFACTURING CO.
Dept. M-37, Lindsey, Ohio

Gentlemen: Please rush complete details about
the big-profit possibilities of the Universal
Lawn Mower Grinder.

FREE

Name _____

Address _____

State _____

City _____

SHARPENING LAWN MOWERS IN SPARE OR FULL TIME . . . AT GOOD PROFIT.

Thousands are successfully earning good money with the Universal plan of a spare or full time business in their garage or basement. Previous experience not necessary. Age no handicap. C.H.R. of Ohio made \$3,688.20 working part time, in one season. The new Universal is the only grinder in the world that enables you to grind both the bed knife and reel blades . . . **IN A SINGLE SET-UP**

. . . without removing them from the mower. Just put the mower in the grinder, follow a few simple instructions and you can do an expert job sharpening hand or power mowers without removing engine, handle, or roller. **SEND COUPON** today for success plan of this low investment big pay business of your own.

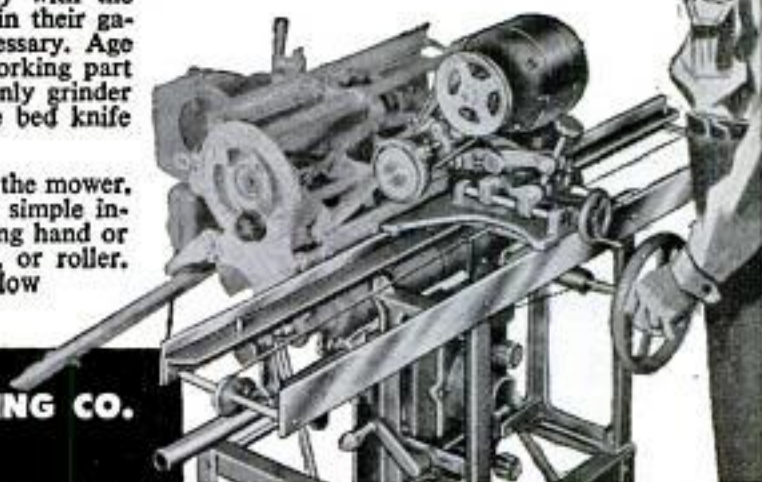

ROGERS MANUFACTURING CO.
LINDSEY, OHIO



BUY GREAT NECK HAND TOOLS

. . . for long-lasting performance



CHROME PLATED ADJUST-
ABLE TUBULAR HACK SAW

GREAT NECK SAW MFRS., Inc.
MINEOLA, N. Y. — SEE YOUR LOCAL STORE

FIRST IN THE FLEET



FOR '57 IT'S
WOLVERINE

Seamate 14

New ideas in design . . . comfort . . . styling.
Seats arranged for extra comfort & convenience.
Choice of Boat-A-Ramic color combinations.
Many models in molded plywood and aluminum.

FREE LITERATURE

WAGEMAKER COMPANY

Dept. 27-57

Grand Rapids, Michigan

it's NEW! it's ALL IN ONE LEVEL · SQUARE · TAPE

IT'S A LEVEL!
Built-in, accurate unbreak-
able Level.



IT'S A TAPE!
10 ft., replace-
able WYTEFACE®
Tape.

IT'S A SQUARE!
Accurate Square.
Easy to use.

Only \$1.98

at your hardware store



KEUFFEL & ESSER CO.
Hoboken, N. J.



**the mower
that's built
to ride**



Makes kids eager to cut the grass

Teen agers actually beg for the chance to ride that comfortable seat, manipulating clutch, gear shift and throttle while *MOW Cycle* speedily tames the grass. Grownups too find lawn chores really pleasant with *MOW Cycle* to eliminate heavy exertion. Twin rotary blades beneath strong steel platform do the mowing; cut 24" swath. Attachments pulled behind offer complete lawn care without walking. On the market since 1950; thousands now in use. Safe for even inexperienced operators. All moving parts shielded. Unique 3-point suspension allows travel across 30% slopes without tipping. Husky 3½ hp engine with recoil starter; speeds to 5 mph. Available also with electric starter. See improved 1957 models at nearest dealer.



MOW Cycle '24'
\$289.50

**MOW Cycle
'Cadet'**
\$219.50

Prices F.O.B. factory. Dealer adds freight and local taxes. Slightly higher in far west.

Mail the coupon TODAY

Musgrave, Inc., Dept. 137, Springfield, O.

You may send free circulars on the latest *MOW Cycle* models and attachments for same.

Name _____

Address _____



to do the whole job from beginning to end."

Dobson, although he bulled his way through to completion of a fine pool, ran into unforeseen troubles from the beginning. He planned a circular pool, 30 feet in diameter with a maximum depth of 5½ feet. The first trouble was the pool site. While still steamed up with enthusiasm, he discovered that the layout of his house, lot and neighbor's shrubbery was such that it was impossible to get any sort of earth-moving machinery to the pool site.

"We had to dig it by hand," says Dobson, "put the dirt in a wheelbarrow, wheel it to the front of the house and dump it in a truck. As you can imagine, this took considerable time and effort." After a couple of days of this, Dobson discovered he needed a firm base for his wheelbarrow so he suspended pool operations while he put in a patio and sidewalk.

He had wanted a concrete-block pool but then began to doubt his ability as an amateur to put in the steel uprights properly and to bind down the blocks and fill them well enough to make his walls strong and watertight. He switched plans, put in the complex system of steel bracing necessary for Gunitite and hired an operator to come out and spray the concrete for the floor and walls.

No Filter System

Dobson built his pool without a filter and tried chlorine as a purifying agent, but 10 days after he filled the pool it began to bloom with tremendous amounts of algae. He emptied the pool, tore up some of the completed work and installed a \$400 filter system.

Finally, when everything was working properly, he hired a fence contractor to put a circular fence around the pool. But, it seems, fence contractors who can put in a large, circular fence are rare creatures; after many experiments and arguments Dobson settled for a 12-sided fence.

Back-yard swimming pools are, of course, popular not only with the owner's family but with friends, neighbors and relatives. Each pool owner has to work out his own policy on use of the pool by outsiders.

Any person who helped build the pool usually has swimming rights; almost always close neighbors and their children are welcome—if an adult is present while children are using the pool—and many owners establish "open" days and hours for friends and neighbors to drop by for a swim without invitation.

Mr. and Mrs. B. F. Aldredge, Jr., of Florence, Ala., bought a package do-it-yourself pool. Then they decided they

(Continued to page 242)

**Rare opportunity for a
"LIVE-WIRE" MOTORCYCLIST**
Move ahead at high speed as
a Harley-Davidson Dealer

"Greatest ever." That's one of the milder compliments motorcyclists the country over pay the great 1957 Harley-Davidson line. Their enthusiasm is your big opportunity to enjoy good profits this year and for years to come . . . the added rewards of being in a business that deals with dynamic, energetic young people. If you're the right man—there's a big future for you as a Harley-Davidson Dealer. You'll be selling the world's finest motorcycles . . . be backed by a strong national advertising program . . . get plenty of local sales and promotion helps . . . the kind of full cooperation that practically assures success. Why not write now and tell us about yourself, your sales experience, how much you can afford to invest? For prompt reply, address Dept. P, HARLEY-DAVIDSON MOTOR CO., MILWAUKEE 1, WISCONSIN.



with
Master
LAMINATED
Padlocks



Layer on layer of solid steel for the powerful laminated protection that gives you peace of mind.

25¢ to \$4.00, in a variety of sizes, at locksmiths and hardware stores everywhere.

Master Lock Company

MILWAUKEE 45, WISCONSIN

World's Largest Padlock Manufacturers

Free!

Good Luck Key Chain plus illustrated booklet, "The Story Behind Your Master Padlock".



MASTER LOCK CO. PM-3
2600 N. 32nd St., Milwaukee 45, Wis.
Please send me free key chain and booklet on Master Padlocks.

Name
Address
City State

Drive with Confidence

DINSMORE Auto Compasses
Shows you the right way—the short cuts. Saves time, money. Write for new compass history folder, "Pants—Knives—Compasses," and name of nearest dealer.

ONLY COMPASS APPROVED BY AUTO MAKERS

DINSMORE INSTRUMENT CO., 1802-25 Kelso St., Flint 1, Mich.

New Long Lasting Combination Blade
Roc-Edge 6" SAW \$1.49
BLADE ^{7" \$1.59} ^{8" \$1.99}
Fits any power saw. At all Hardware Stores

FOR BETTER REFINISHING JOBS USE

Klean-Strip
PAINT REMOVER

• Non-inflammable
• Removes any finish
• Fast • Non-messy
• Needs no neutralizing

"Peels Off Paint"

Protect your home against power interruptions with an...

ONAN Emergency ELECTRIC PLANT

Provides dependable stand-by electricity for heating system, pumps, freezer, lights, appliances. Keeps home safe, livable. Automatic start and stop. Find out how little it costs!

Write for Folder!
D. W. ONAN & SONS, INC.
3243 University Ave. S. E. • Minneapolis 14, Minnesota

A SIZE FOR EVERY NEED
500 to 75,000 watts.
Compact, quiet-running.
Gasoline-powered.
Priced from \$269.00



high-quality hand tools for finer workmanship

Do the job easier and better with GREENLEE tools. Auger bits, electric-drill bits, other boring tools, chisels, gouges, spiral screw drivers, push drills, and many more. All expertly made of top-quality materials for long life, fine results. At leading hardware and building supply dealers. Write for folder, Greenlee Tool Co., 2103 Columbia Avenue, Rockford, Illinois.



would rather supervise the job and let hired labor do it. However, they personally poured the concrete for the deck and put in the fence. They consider the fence an absolute necessity to reduce the possibility of some child accidentally falling in the pool.

During the first summer their pool was a novelty in the neighborhood and was so popular Mrs. Aldredge was forced to limit uninvited neighbors and their children to three hours in the afternoon. During their second summer however, there was less traffic and regular hours weren't necessary—neighbors merely called to see if they could use the pool during certain hours.

In at least one instance, a private pool has changed the recreational habits of a whole town and become a community recreation center.

"Kitty" for Donations

L. L. Brown of the village of Friendswood, Tex., population 500, built a large poured-concrete pool, 55 by 25 by 8 feet, in the spring of 1955. He opens the pool to all comers three afternoons a week and has a "kitty" for donations toward the cost of operating the pool. During a typical summer afternoon, about 10 percent of the entire population will drop by for a swim.

Brown did none of the actual work himself but hired and supervised local labor. Exclusive of \$1400 for a covered patio, dressing rooms and fence, his pool cost about \$4400 and he believes it would have cost \$10,500 if built by a professional builder.

A large part of his total cost, \$2749 went for an elaborate filter and underwater-lighting system. Excavation cost \$225; concrete \$1365; hired labor \$300, and trim \$870. Total construction time was six weeks.

Children Dig the Hole

Not all pools are major projects. Mrs. Edward Grant of Manchester, Conn., decided it would be nice if her children had a back-yard pool; not a big one, but just a place to splash and learn to swim. She asked her children and some of the neighborhood kids if they would dig a hole and help with construction if she would buy the materials for the pool and hire necessary outside labor.

The kids thought it a fine idea and began to dig. Three weeks later they had a fine swim-splash pool measuring 12 by 9 by 3½ feet. August didn't seem as hot as July.

Total cost of the pool was \$143.32; cement \$23.30; 160 concrete blocks \$32.40, and hired labor \$70. The pool has no filter

(Continued to page 244)

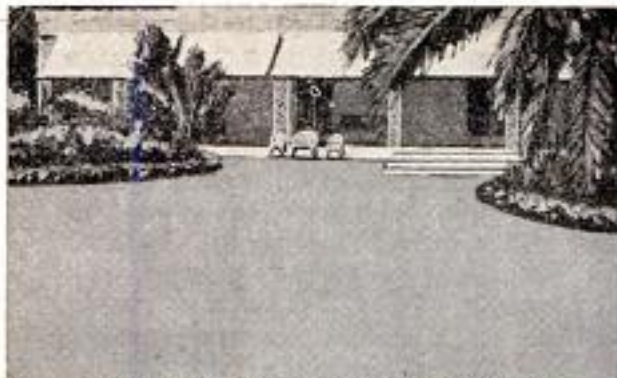

NOW IS GOOD TIME TO PLANT BLUE-GREEN MONDO "GRASS"

Trade Mark Registration applied for
U. S. Patent Office

This entire lawn planted in Mondo "Grass"

REQUIRES NO MOWING - MAKES WORLD'S MOST BEAUTIFUL LAWN

Our Blue-Green Mondo "Grass" is described by the U. S. Department of Agriculture as "Ophiopogon Japonicus (formerly called Mondo Japonicus)," is native to Northern China and should withstand severe degree of freezing; drought tolerant, evergreen, commonly called Mondo "Grass."

It is a "grass" relative to the lily with paper thin blades 1/16" wide. This sod-forming EVERGREEN, low-growing oriental genus is currently used by many owners of distinctive homes in America for lawn grass. Now we can offer this exclusive Blue-Green Mondo "Grass" at popular prices.

SO HARDY IT CAN BE PLANTED ANYTIME, it is recommended for beautiful lawns where mowing is not desired. Blue-Green Mondo "Grass" retains its color the year-round; thrives in shade or sun; extremely hardy, rarely requires watering; fantastically beautiful, drooping low to the ground in weeping style year after year. **REQUIRES NO MOWING AND SHOULD NEVER BE MOWED.**

Guaranteed to withstand severe freezing or money refunded. Ideal for heavy shaded areas, dry or wet. FREE folder of testimonials and many photos of Mondo "Grass" lawns sent on request.

Mondo is resistant to diseases; insects and animals will not feed on it. Stops erosion; grows compactly, crowding out other grass and weeds; multiplies rapidly, approximately 100 times (10,000%) first year. Enhances property value. So sensational we expect to revolutionize lawn-making. For good coverage first year plant 4" to 12" apart. Numerous rooted blades to sprig.

Planting and culture instructions with each order. Shipped now or when desired. Remittance with order. Shipped prepaid. **MONEY-BACK GUARANTEE:** if not completely delighted you may return at once for refund. Open account to A-1 rated firms buying 1,000 sprigs or more. FOB. Biloxi. Distributors wanted everywhere.

ORDER TODAY - YOU CAN'T LOSE!!

Sprigs packed in damp moss. Guaranteed to grow or we will replace.

25 SPRIGS \$2.98

50 Sprigs.....\$ 5.00	1,000 Sprigs.....\$79.00
100 Sprigs..... 9.00	5,000 Sprigs or more
500 Sprigs..... 40.00	per 1,000..... 50.00

MONDO GRASS & NURSERY CO.

DEPT. PM, BILOXI, MISS.

Please send prepaid _____ Sprigs of Mondo "Grass," for which I enclose \$ _____.

NAME _____

ADDRESS _____

CITY _____

STATE _____

NEW WAY TO CUT PERFECT GROOVES WITH CIRCLE SAW!

Just dial any of 40 cuts. Parallel, clean, no sanding! Only \$4.95 per set. Leave on saw for regular cuts. For 1/8", 3/8", 1/2" and 1" arbors. At dealer's or order direct! Send for free booklet

WARREN DADO WASHERS CO.

Dept. #23 P.O. Box 98, Detroit 2, Mich.

Only SHOPSMITH lets you complete the job!

Let us send you our free Catalog! It gives you the full story on SHOPSMITH, the original complete home workshop in one unit, five major power tools in one! Write Dept. 503-M, MAGNA POWER TOOL CORPORATION Box 2808, Ft. Wayne, Indiana, OR Menlo Park, California



132 PAGES

Many in full color

packed with rare, fancy & imported woods... veneers, plywoods, patterns, tools, ornaments, hardware... everything for the woodworker.

Get This NEW Catalog of WOOD & WOODWORKING EQUIPMENT

WORLD'S LARGEST SELECTION OF FINEST DOMESTIC AND IMPORTED WOODS... MOULDINGS, HARDWARE, TOOLS... ALL AT LOW MONEY SAVING PRICES!

Your complete wood buying guide and project book. Craftsman is your best, most complete source of finest kiln-dried domestic and rare imported woods, beautiful wood inlays, colorful handings, matched plywoods, embossed mouldings, carved ornaments, newest woodworking tools, "hard to find" cabinet hardware and fittings... more than 1,500 items! Packed with newest scroll saw patterns, project ideas & money making plans. Enclose 25c (refunded with first order) to help pay mailing, handling cost. Write now! Craftsman Wood Service Co., Dept. A-3 2729 S. Mary Street - Chicago 8, Ill.



IT'S HERE... the ALL-NEW, YEARS-AHEAD

Cushman ROAD KING

Designed for tomorrow body lines in two-tone colors. Ruggedly built. Greater comfort and riding ease. Powered by Cushman Husky 4-cycle engine. Up to 50 miles per hour, up to 100 miles per gallon. Ride it anywhere, everywhere for just 3/4 cent per mile.

- Sold and serviced nationally; replacement parts available immediately
- Ask your Cushman dealer for FREE demonstration
- Dealer inquiries invited.

Write for new FREE booklet today
CUSHMAN MOTOR WORKS, INC.
907 No. 21st, Lincoln, Nebraska

MARCH 1957

243



1. Steel Back
2. Copper-alloy lining
3. Brass barrier
4. Lead-tin overplate
5. Pure tin flash plate

You see why Fleets call Sintered Copper-Leads "Mileage" Bearings!

Step by step fleet mileage is built in to Federal-Mogul sintered copper-lead engine bearings. The wonders of powder metallurgy provide the strength of copper, the "softness" of lead, in perfect balance. The brass barrier assures lining stability. Lead-tin overplating assists break-in. Pure tin flash plating adds corrosion resistance. The result—a heavy-duty mileage bearing without equal! We produce millions of them for original equipment and service.

FEDERAL-MOGUL SERVICE

Division of

Federal-Mogul-Bower Bearings, Inc.

Mechanics Know...

that the black and red Federal-Mogul box identifies the service bearing line as modern as today's engines.

RESEARCH • DESIGN
METALLURGY • PRECISION
MANUFACTURING • SERVICE



system. Mrs. Grant empties it in the winter, puts her lawn furniture in it for storage and covers it with a wooden lid.

New Developments

Literally dozens of materials and techniques have been used for pools, including stone, steel, aluminum, inflated plastic, tar paper, plywood, poured concrete, concrete blocks, Gunite and vinyl.

Of these, most professionals recommend only two—poured concrete and Gunite. Concrete-block pools, though seeming easiest to most amateurs, are really the most difficult to handle properly, according to the builders. They point out that "unless they are very carefully reinforced, filled and tied to the floor of the pool (by steel uprights embedded in the poured-concrete floor), there is danger of cracking and leaking."

Vinyl shells, according to some builders, can be punctured, do not have sufficient rigidity and "are sometimes eaten by field mice."

Glass-Fiber Pools

In 1955 something new hit the swimming-pool industry: Glass-fiber pools made of four or more molded sections which join together.

Pool suppliers and contractors not financially wedded to one of the older methods of pool construction are downright enthusiastic about the glass-fiber pools. D. C. Siminson of American Pool Company of Briarcliff, N. Y., which sells chemicals, filters and miscellaneous equipment such as ladders and diving boards, says, "Until the glass-fiber pool appeared on the market there was not a truly satisfactory do-it-yourself pool that would stand up in all climates and yet be simple to install. This material is very strong, is impervious to acids and pool chemicals and has the color impregnated into it so it never has to be painted."

A pool contractor who represents several companies and builds pools by any of the standard methods says, "We feel the new glass-fiber pools will become the leader for all types of pools installed. This particular pool has all the necessary structural requirements along with many other advantages not found in concrete pools."

One popular make of glass-fiber pools comes in four sizes, 30 by 15 by 5 feet (too shallow for diving) up to 35 by 15 by 7 feet.

The pools, shipped in four sections from the California factory, vary in price according to freight charges. In central Texas, for example, the small pool costs

(Continued to page 246)

**BIND JOINTS
STRONGER
WITH
ROGERS
GLUE**



**ROGERS GLUE IS CLEARER, STRONGER,
ALWAYS UNIFORM**

Prove it yourself —
SPECIAL OFFER: Send only 15 cents for a full-size jar of Rogers Glue. Get, **ABSOLUTELY FREE:** The new 1955 edition of "Rogers Book of Woodworking Shop Notes", jam-packed with ideas and helpful tips on setting up a shop at home, how to equip a workshop, workshop procedure, and other valuable information for the accomplished craftsman and for the beginner. In addition, you will receive a set of new woodworking project plans, also free. Write, Rogers Inslglass & Glue Co., Gloucester, Mass. Ask for Rogers Glue at Your Local Hardware Store.



Over 3,885
lbs. Actual
Tensile
Strength per
Square Inch.

ROGERS

the best LIQUID FISH GLUE
GLOUCESTER, MASS.



**COUNTRY
SQUIRE
TRACTOR**

with
ROTARY,
REEL TYPE
or SICKLE
MOWER

**CUT GRASS
THE EASY WAY**



ALSO plows, harrows,
cultivates, plants, rakes,
hay, sprays, bulldozers,
plows, stumps, saws, cord-
wood. Write for FREE
CATALOG

**COUNTRY SQUIRE
TRACTOR CO.**

P.O. Box 107, K-3A
Muskego, Wisconsin

GO Unerringly WITH HULL AUTO COMPASS

Only a Hull Auto Compass can give you, behind the wheel, the unerring sense of direction of a homing pigeon. Know the right way at every turn, anywhere. No more guesswork, mistakes!

At your dealer's or write for literature.
**MOST COMPASS DRIVERS \$4.95 and
USE HULL \$6.50**



HULL MFG. CO. P.O. Box 246-D-3, Warren, Ohio

DIGS 2" TRENCHES to 18" DEEP

New Model B DITCH WITCH digs 2-in. trenches to 18-in. deep. Perfect for lawn sprinkler systems, utility service lines. Digs straight, curved and cornered trenches in all soils, even rocky and frozen. Low Cost! Write for new Bulletin. **THE CHARLES MACHINE WORKS**
620 B Street Perry, Oklahoma



**NOW—THE QUICK-WAY TO SHARPEN
ALL CIRCULAR SAWS**



Model
PG-12
Complete
No
extras
to buy.
\$16.50
Postage
Paid

NEW
Model PG-12 sharpens joints, gums, and retools all cross cut, rip, combination, miter, and planer blades up to 12" in diameter. Two precision index plates give versatile, accurate sharpening. Guarantees precise spacing of teeth. New safety rest prevents tilting and gouging of blade. Save time and money. Special \$3.00 grinding wheel also included for use on your own power table. Fits regular or radial swing tables.

Order today. Send check, cash, or money order. We pay postage. **FREE Booklet—"How To Sharpen Saws."**

QUICK-WAY SAW CO.

136 TOMPKINS ST. CORTLAND, N. Y.

have fun with electronics BUILD YOUR OWN knight-kit

**IT'S EASY—
AND YOU SAVE!**

KNIGHT-KITS are famous for their clear "step-and-check" instructions. You'll marvel at how easy they are to assemble. You'll be thrilled with their performance—proud of your work. You can't miss—and you save money!

Transistor Radio Kit

Experiment with the marvel of transistors! Printed circuit mounting board simplifies assembly—just make a few solder connections. Delivers fine broadcast reception. Fits in palm of your hand; powered by penlight cell that lasts for months. Complete with all parts, transistor, penlight cell. Shpg. wt., 2 lbs.

\$3 Y 765. Transistor Radio Kit... \$4.35
\$3 Y 266. Headset & Antenna Kit... \$3.15



Famous 2-Band "Space-Spinner"

Thrilling new bandswitching receiver. Selects exciting short wave on 6 to 18 mc (foreign, amateur, aircraft, police, marine); and full regular broadcast. Sensitive regenerative circuit; 4" PM speaker; beam-power output. Easy to build. All parts supplied (less cabinet). 4½ lbs.

\$3 Y 243. "Space-Spinner" Kit... \$15.95
\$3 Y 247. Cabinet for above... \$2.90



Transistorized Electronic 10-in-1 Lab Kit

Sensational—work with transistors! Assemble the basic parts, then complete project after exciting project (10 of them in all) just by plugging leads into proper jacks on printed-circuit board—no wiring changes needed. Make the following: AM radio, amplifier, wireless broadcaster, code practice oscillator, electronic timer, switch, flasher, or any of 3 other electronic relays. Includes all parts, 2 transistors, battery, headphones and instructions for each project. Shpg. wt., 3 lbs.

\$3 Y 299. Electronic Lab Kit... \$15.45



2-Way Intercom Kit

It's easy and inexpensive to build your own 2-station intercom! Use it in home or office. Makes ideal "baby sitter". Extra high gain—delivers full output from only a whisper. Complete with 50 ft. cable (up to 200 ft. may be added), antique-white cases, tubes and all parts. For AC-DC. 7 lbs.

\$3 Y 295. 2-Way Intercom Kit... \$14.75



**Dozens of other
knight-kits
available**

**GET THE BIG
356-
PAGE 1957**

FREE

ALLIED CATALOG

See our complete selection of **KNIGHT-KITS**—plus the world's largest stocks of Hi-Fi systems and equipment, recorders, Amateur equipment, test instruments, TV components, parts, tubes and tools. **FREE—send for it!**



**World's Largest
Electronic
Supply House**

Our 36th Year

ALLIED RADIO

**ALLIED RADIO CORP., Dept. 5-CC-7
100 N. Western Ave., Chicago 80, Ill.**

Send **FREE** 356-Page **ALLIED** Catalog

Send the following **KNIGHT-KITS:** _____

_____ \$_____ encl. Prices Net F.O.B. Chicago

Name _____

Address _____

City _____ Zone _____ State _____

Atlas GIVES YOU GREATER VALUE PER DOLLAR

Atlas

15" DRILL PRESS

The most useful tool for your shop — and America's greatest drill press value! With accessories, it gives you a whole shop full of tools . . . for mortising, carving, routing, sanding, and buffing as well as drilling. And Atlas is built to last you a lifetime — with exclusive "floating-drive", six-splined spindle and drive sleeve, 4 sealed-for-life ball bearings and extra-heavy construction throughout for maximum rigidity and accuracy! See it — compare it before you buy.



Atlas
12" WOOD LATHE

The new ATLAS 12" is a heavy-duty lathe built for professional workmanship and efficiency in the complete range of turning operations . . . inboard and outboard . . . light or heavy. Has new massive bed with ground ways. 60-hole indexing mechanism. 4 speeds. One movement of lever loosens tool support for instant positioning, or anchors it to bed. Headstock spindle is turned from a solid bar of tough, fine-grained steel, accurately ground. Sealed-for-life ball bearings. New Functional Cabinet stand is a massive foundation for accurate work. Your shop isn't complete without this fine lathe.

WRITE FOR ILLUSTRATED LITERATURE



Atlas Press Company

3-24 N. Pitcher St., Kalamazoo, Mich.

QUALITY MACHINE TOOLS SINCE 1911

\$2000 for a do-it-yourself kit including filter and about \$2700 installed. The largest pool costs \$2500 on a complete do-it-yourself basis, \$2700 if the dealer furnishes tools, equipment and supervision, and about \$3600 completely installed.

The glass-fiber pools appear excellent for the amateur pool builder in that they are practically foolproof. Their cost, however, is still high compared to owner-built pools of blocks, poured concrete or Gunite.

Enthusiastic dealers, who now install poured concrete, Gunite or glass-fiber pools for about the same price, predict mass production of glass-fiber pools may bring their price way down. They hope to see the day when an adequate glass-fiber back-yard pool will cost about \$1000 installed—and less if you do it yourself. ★ ★ ★



Swimming-Pool Guard

If a child accidentally falls into a swimming pool, a new alarm system sounds a loud bell. The system is touched off by water displacement; only a body entering the water will activate it. Surface disturbance or turbulence will not cause false alarms. The sensing unit automatically compensates for evaporation.

Antibiotic Injections

Norwegian whaling companies halt decay of whale meat and oil by injecting antibiotics into the whale's stomach after it has been killed or by harpoon shell during the chase. This process may extend the world's supply of whale meat and oil.

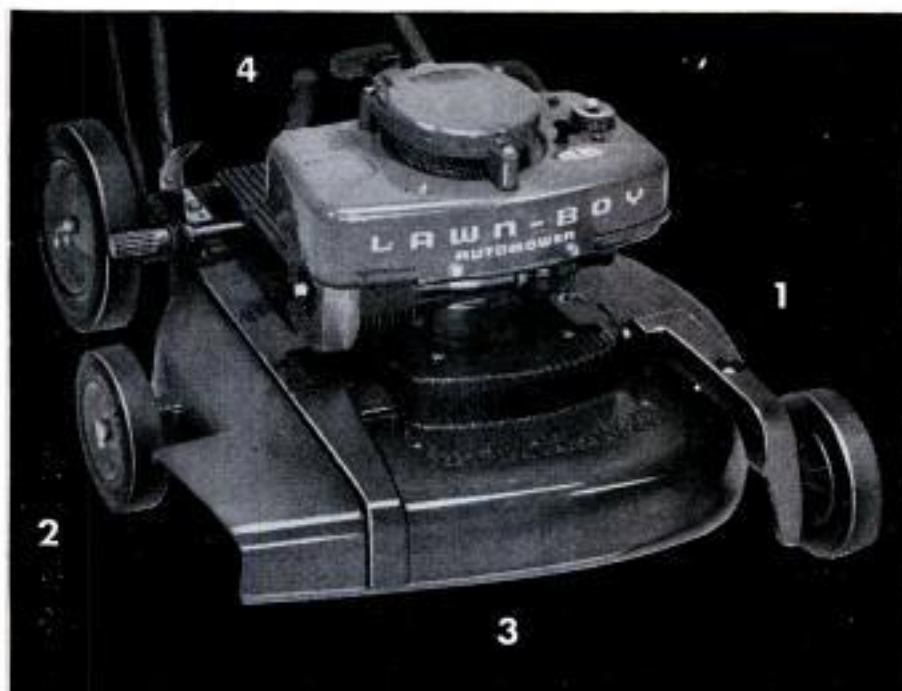

① Exclusive "Activated" Pilot Wheel keeps LAWN-BOY level . . . even on rough turf grass surface is cut level.

② Staggered Front Wheels let LAWN-BOY go right up and over high spots without leaving scalped patches.

③ Aluminum Die-cast Housing and specially close-machined blade with stabilizer lets LAWN-BOY trim to $\frac{3}{8}$ ".

④ *Lightweight Automower* . . . it's self-propelled! With the surest, simplest control ever . . . no oily chains, no clanking gears . . . a forward roll of the wrist starts LAWN-BOY out at a steady even pace . . . a backward roll—it stops.

LAWN-BOY "KNOW-WHY" DESIGN GIVES THAT FAMOUS **LEVEL-CUT** TO LAWNS

Every detail of LAWN-BOY is designed to give that LEVEL-CUT. To make absolutely sure each detail is right LAWN-BOY makes almost all their parts and assemblies.

"KNOW-WHY" DESIGN DEMANDED THE LAWN-BOY 2-CYCLE ENGINE

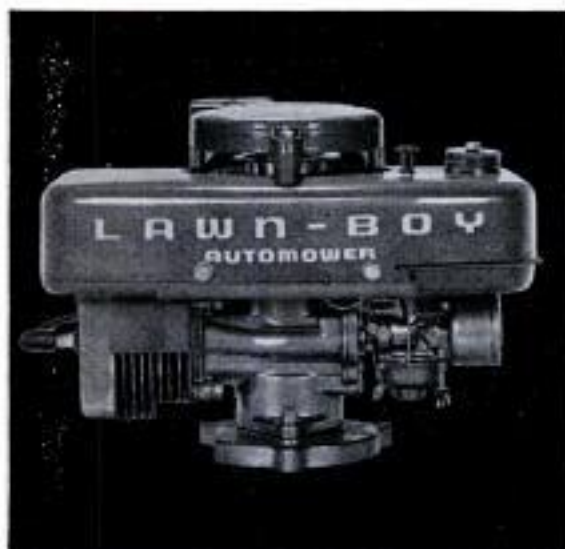

Created and made for LAWN-BOY by LAWN-BOY

Naturally efficient. . . LAWN-BOY operates at 3200 r.p.m. . . . the truly efficient speed for rotary mowing. No adjustments needed! Ideal mowing speed is LAWN-BOY's natural speed.

Power on every stroke gives instant response to additional loads . . . starts quicker with twice as many firing chances.

Rugged, Lightweight . . . fewer moving parts means lighter weight, less friction, less maintenance. LAWN-BOY aluminum die-casting gives great strength and wear to all parts.

No lubrication problems . . . pre-mixing fuel and oil eliminates messy crankcase drain and refill . . . you never have to worry about proper lubrication with LAWN-BOY.

Easier to start . . . because LAWN-BOY 2-cycle has fewer moving parts, there is less friction, lighter weight, more firing chances; easier pull through and more revolutions per pull.

LAWN-BOY IS DESIGNED IN EVERY DETAIL TO LEVEL-CUT LAWNS—EASILY!
Prove it to yourself—try a LAWN-BOY today!

LAWN BOY

LAWN-BOY, Lamar, Mo. • Division of Outboard Marine Corp., makers of *Johnson* and *Evinrude* Outboard Motors • In Canada: LAWN-BOY, Peterborough, Ontario

LAWN-BOY dealers are listed in the yellow pages under Lawn Mowers, or call Western Union, by number, and ask for Operator 25.



REPLACE YOUR

OLD WOOD CELLAR DOOR



WITH A MODERN ALL-STEEL BILCO DOOR

DO IT YOURSELF

IN JUST 3 TO 4 HOURS

Think of it! Only a few hours of pleasant work to replace your unsightly, troublesome wood hatchway with a lifetime, weathertight BILCO . . . the door installed on tens of thousands of new homes.

PAYS FOR ITSELF! Cost so little, yet never needs repair or replacement. Operates at a touch. Smooth, trim appearance adds amazing new beauty to your home.

Rush coupon TODAY for free folder "How to replace your wornout wood hatchway" showing sizes and prices.

Bilco®

**AMERICA'S FINEST
BASEMENT DOOR**

THE BILCO CO.
DEPT. 930C
NEW HAVEN, CONN.

Gentlemen: Please send me free folder and name of nearest dealer.

Name _____

Street _____

City _____ State _____

You Can Have Speed With Safety

(Continued from page 147)

mounted in the plane. Its electronic circuits are complicated, but the basic idea is simple.

When mounted in a conventional plane like F94 Starfire jet or B26 attack bomber, this box can make the craft act like it's been rebuilt in a split second while in flight. Working on the plane's automatic controls, it makes the plane seem to have been given a longer fuselage, wider tail, stubbier wings, and so on.

Control knobs in the cockpit set the robot to do the jobs wanted. Dual controls allow the human pilot to cut out this electronic "interference" when he wishes.

Working with Milliken are other old hands at safety research. As far back as 1929, C.A.L.'s present head, T. P. Wright, won the Guggenheim \$100,000 safe-aircraft award.

Milliken says a pressing task is to provide safe-driving controls for the radically new kinds of planes being invented. "Jets are becoming old hat. We're now dreaming up flying platforms, convertiplanes, tail sitters and so on."

Even the safe helicopter, he points out, isn't as simple as many believe, "because it has the worst controls imaginable." He concedes its future is great since here's a craft that rises vertically, hovers, flies sideways, backward and forward.

But it's not easy on the pilot. The tail surfaces of a fixed-wing plane are virtually useless to a copter when it hovers or comes straight down. To overcome pilot fatigue, C.A.L. is working for the Navy and other clients to put more stabilizing devices into helicopters and to improve operation in bad weather.

With his twin interests in flying and auto racing, Milliken is convinced there will eventually be a really practical combination of auto and plane. He points out many ideas one craft can borrow from the other. A simple example is the ordinary car's steering wheel, which Milliken sees as one answer to easier and safer flying.

"We take it for granted," he explains, "but it's a magnificent engineering device. It allows two cars going 50 miles per hour to pass each other neatly, almost fender to fender. Compare that to the first cars, which were steered by the buggy-tongue principle. And that's just about where airplanes still are. Aviation concentrated on things like wings and speed, and left the rest up to plenty of room in the wide-open spaces.

"But those spaces are getting crowded.

(Continued to page 250)

now, in power tools, too,
if it's Remington, it's right!



powerful enough
to drill
through steel...

light enough
for a woman to
wax fine furniture!

*the famous 149 B Power Drill has 5
great features that make it right for you!*

only
\$28.50*

- Precision geared chuck for greater accuracy!
- Heat treated gears for longer life!
- Balanced armatures for smoother running!
- Anti-heating fan for cooler operation and longer wear!
- Die cast aluminum alloy housing for light weight...longer life!

MODEL 149B. 3/4-inch drill; AC-DC 25 to 60 cycle; 115 volts; 2500 rpm. free speed; 1500 rpm. load speed; 3 lbs.; U.L. approved.

Remington Mall[®]

MALL TOOL COMPANY
 Division of Remington Arms Company, Inc.
 25000 South Western Avenue • Park Forest, Illinois



Electric Saws for every carpentry job.



Bell and Orbital type sanders.

*Prices and specifications subject to change without notice.

Here's the answer to the tough ones—the jobs that defy ordinary drills! Yes, now you can have power tools by Remington, the newest name in power tools...the greatest name in sporting firearms and ammunition for 141 years.

Model 149B has the power of drills costing twice as much! And it's built for superior performance on the most rugged jobs—as are *all* of Remington's famous Mall power tools.

With its attachments, this drill can be used as a saw, planer, sander, polisher, paint mixer, hedge trimmer, screw driver, and in many other ways. Saves hours of work.

There's a power tool by Mall Tool Company, Division of Remington Arms Company, Inc., for every need. For further information just fill out the convenient coupon.

• **MALL TOOL COMPANY, Division of Remington Arms Company, Inc. Dept. C-6**
 • 25000 S. Western Avenue, Park Forest, Illinois

• Please send free catalog on Portable Electric Tools.

• NAME _____

• STREET _____

• CITY _____ ZONE _____ STATE _____

arc welding pays BIG!

... with these
easy-to-use
**HOBART
WELDERS**



Cash in on the big demand for
emergency repair work. Requires low
investment, costs little to operate.

In or out of the shop this "Husky Boy" arc welder can earn big profits for you and will quickly pay for itself out of increased earnings. Welds anywhere. Lightweight and easy to use without special training. Cash in on the big demand for arc welding. Get into the bigger paying jobs now.

INVESTIGATE these MONEY MAKERS

200 amp. TRANSFORMER AC Welder for operating on single phase 220 volt power. Ideal for shops for production and repair work.

200 amp. lightweight, low cost "Bantam Champ" is specially designed to let you do production and repair work in your own shop.

200 amp. AC Power-AC Welder Combination. Four cylinder air-cooled engine. Furnishes current for welding—power for running tools, lights, etc. Mounts easily on truck or trailer. HOBART BROTHERS CO., Box M-37, Troy, Ohio, Phone FEderal 2-1223.

HOBART TRADE SCHOOL . . . learn arc welding quickly by actual on-the-job experience. Complete or partial courses. G. I. approved. Non profit.

Hobart
"One of the world's
largest builders of arc
welding equipment"



TRANSFORMER



BANTAM CHAMP
AC WELD
AC POWER



BANTAM CHAMP
AC WELD
AC POWER

BANTAM CHAMP
AC WELD
AC POWER

BANTAM CHAMP
AC WELD
AC POWER

BANTAM CHAMP
AC WELD
AC POWER

BANTAM CHAMP
AC WELD
AC POWER

BANTAM CHAMP
AC WELD
AC POWER

HOBART BROTHERS CO., Box M-37, Troy, Ohio

Without obligation, send complete details on:

200 amp. "Husky Boy" 200 amp. "Bantam Champ"

200 amp. AC Transformer AC Power-AC Welder Combination

Endorsed is \$1.00 for lessons book. welder's vest pocket guide

NAME _____

ADDRESS _____

CITY _____ STATE _____

() Send Free Welder's Vest Pocket Guide.

Welding LESSONS book

200 pages
self-teaching
only
\$1.00

Use the
handy coupon!



TRANSFORMER



BANTAM CHAMP
AC WELD
AC POWER



BANTAM CHAMP
AC WELD
AC POWER

BANTAM CHAMP
AC WELD
AC POWER

BANTAM CHAMP
AC WELD
AC POWER

BANTAM CHAMP
AC WELD
AC POWER

BANTAM CHAMP
AC WELD
AC POWER

BANTAM CHAMP
AC WELD
AC POWER

Planes can't continue roving in the air and waddling all over runways like awkward ducks. Adapting the steering wheel to plane controls looks like a fine answer. Besides, most everybody can handle one, so it will make plane flying much easier to teach."

The experts don't always agree on details. Where Milliken praises the steering wheel, E. R. Dye, head of C.A.L.'s industrial division, considers it a "harpoon" that can be fatal in an auto crash and wants it banished in favor of side levers.

These researchers have many new ideas on the griddle. One thing they're working on is highway black top that you can see at night, especially at curves. To cut down the danger and cost of crashes, they're planning rubber highway guards, plastic fenders—and also very different instrumentation for tomorrow's cars. It would go with a wrap-around dashboard and result in fewer distractions for the driver.

"Our idea is that the driver is a navigator," says Dye, "and things should be made easier for him. An older person has trouble adjusting his vision from far to near. Even the younger driver risks an accident every time he shifts his glance from the bright highway 50 feet ahead of him to the dashboard's comparative darkness only a couple feet away."

To overcome this, C.A.L. is working on a substitute for today's lineup of instruments. Everything except speed would be handled by a row of color panels staying green when the car is running right. In case of something like generator or temperature trouble, the appropriate panel would flash red, and the driver could pull off the road to study the situation.

The only instrument for him to watch would be the speedometer. It's planned for mounting almost at hood level, and will announce only your current speed—in large numbers (Studebaker has a similar speedometer on its cars now.)

Milliken uses somewhat the same idea on racing cars when he mounts a tachometer on top of the hood, so he doesn't have to take his eyes off the track.

He claims that, as far as safety is concerned, he'd rather pilot a fast plane or drive a racer than be the average motorist. The latter is less prepared for sudden accidents, and is packaged badly—more like a delicate vase loose inside a large packing case.

That's why, borrowing an air idea, the lab worked out its most popular idea—safety belts for the motorists. The result is the estimated 80,000 seat belts per month now being manufactured.

But the lab isn't entirely happy over the
(Continued to page 252)

Valuable new DeWalt® Manual shows

"Easy Ways to Expert Woodworking!"



Information-packed new woodworking manual shows how to get the most out of your Power Shop®—how to do everything in woodworking, easily, safely, expertly! Chapter after chapter of the facts you need to know for home modernizing, hobby projects, with over 300 easy-to-follow illustrations. How to install and operate your Power Shop. Use of attachments. Special decorative cuts and shapes. Tricks of disk, belt, and drum sanding. Sharpen your own tools, make your own jigs, mix your own bleaches. How to choose woods, hardware, and finishes. Easy-to-use charts and formulas. And much more!

Just \$3.95! Send check or money order today!

DeWalt Inc., Dept. PM-703, Lancaster, Pa.



KATO A.C. GENERATORS

A WIDE VARIETY FOR ANY ELECTRICAL APPLICATION!

Adaptable to all well-known makes of engines. 350 Watts through 500 KVA and larger. To 600V. Odd frequencies from 15 to 1000 cycles. Also, Rotary Converters, High Frequency Changers, Motor Generator Sets.

KATO Engineering Company
1402 First Ave., Mankato, Minn.

FREE FOLDER

Guaranteed original equipment
Replacement Auto Parts . . . at
Western Auto

make your own Gems 32.50

The Gem Maker comes complete with all necessary equipment, including a super-charged diamond blade for sawing, and all wheels for grinding, shaping and polishing; also complete instructions. The complete equipment as shown, less motor and belt, for only \$32.50, f.o.b., Burlington, Wisconsin. Write today for information and literature.

B & I MANUFACTURING CO.
Dept. P, Burlington, Wis.

SENSATIONAL NEW HIGH SPEED DRILL MASTER

NOW turns the ordinary shop drill into HIGH SPEED DRILL PRESS at a big saving. When DRILLMASTER is used on a 5,000 rpm drill press its top speed will be 20,000 rpm. Does the work of expensive high speed drill presses on brass, aluminum, plastics and cast iron where high speed drilling is necessary. Available for work of any size runs. Fits any 1/2" chuck, holding drills from 5/32 to #80. Shafts are heat treated and ground. Ball bearings and oil impregnated bearings and gear train are housed in cast aluminum. Precision made throughout. **\$62.50** Feb. MAIL ORDER TODAY only. **27** Chgo. Wt. ON C.O.D. ORDERS WE REQUIRE A 10% DEPOSIT. 27 DIRZIUS MACHINE SHOP "L", 1423-25 So. 52nd Ave., Cicero 50, Ill.

GENUINE ALNICO MAGNETS

AMAZING, PERMANENT, NON-ELECTRIC, HIGHLY PRACTICAL. Conduct interesting experiments. Hundreds of uses. Retrieve valuable steel items such as guns, tackle from fresh or salt water; tools from tanks & drains. **GUARANTEED.** Try any magnet one week. Money back if you are not well-pleased.

No. M-710 (Wt. 53 oz.) Has pull of 225 lbs. on steel block . . .	\$16.50
No. M-625 (Wt. 70 oz.) Has pull of 125 lbs. on steel block . . .	\$9.50
No. M-575 (Wt. 18 oz.) Has pull of 75 lbs. on steel block . . .	\$6.50
No. M-500 (Wt. 13 oz.) Has pull of 50 lbs. on steel block . . .	\$4.50
No. M-300 Kit of Flat Bars 5 Pairs (10 Magnets)	\$3.00
No. M-250 Kit of Round Rods 5 Pairs (10 Magnets)	\$3.50
No. M-47 Hot Pad Magnets, 10 for \$1.00	\$1.00
No. M-35 Hobbyist assortment of 8 small magnets	\$1.50

Send M.O. or check. We pay postage. Sorry no C.O.D.'s.
MIAMI MAGNET COMPANY, 3240 N.W. 27th Ave., Miami 42, Fla.

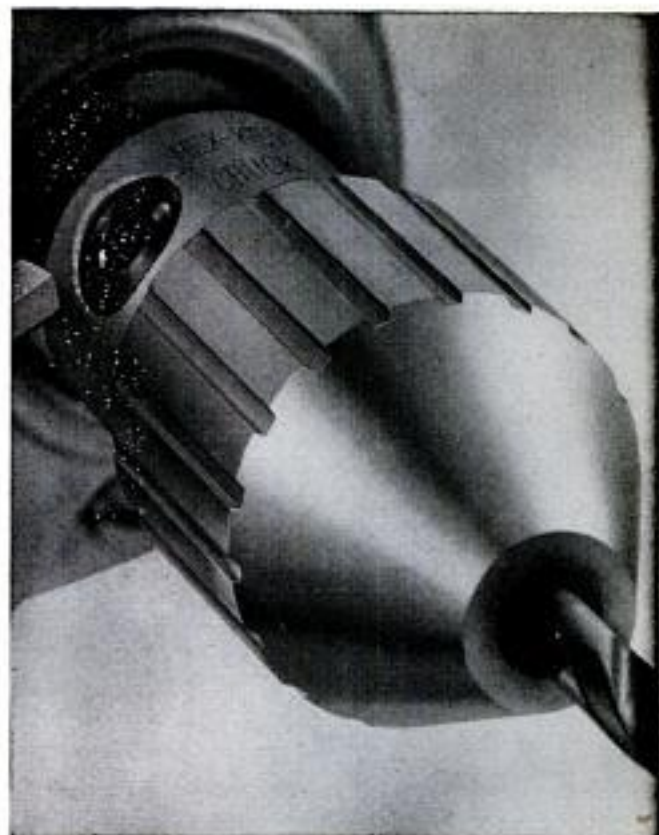

There's power in this end, too!

Electric drill power isn't all in the motor. There's another kind of power — just as important to you — in the business end of a portable electric drill. It's the gripping power that has to be in the chuck, particularly when you are using sanding and screwdriver attachments that must be chucked on the drill.

Take the drill shown here. It is equipped with a Jacobs Model 6141 Rubber-Flex Hex-Key Chuck. You cannot buy a more powerful grip on a portable electric tool. It is compact, light in weight, and easy to operate. Buy the drill and buy the chuck. Jacobs is a name men go buy!

This Jacobs Hex-Key Chuck *looks* different because it *is* different. A quarter turn of a standard Allen key produces tremendous holding power. It actually produces a gripping leverage ratio of 1000 to 1! Another quarter turn easily releases the twist drill.



Reg. U.S. Pat. Off.

The Jacobs Manufacturing Company
West Hartford 10, Connecticut

4 NEW SKIL POWER TOOLS

A new standard in $\frac{1}{2}$ " drills. Now, a full 2.5 amps. Helical gears smoothly deliver increased power. Cool-running. Compact. Rugged. Model 549—\$28.95.



A brand-new $6\frac{1}{2}$ " saw. Makes every cut required—even 2" lumber. Power-packed motor—over 1 horsepower. Save \$5.00. Regular \$54.95 value. Model 536 now only \$49.95.



All new SKIL Jig Saw. Full $\frac{1}{2}$ " stroke; maximum cut 2" lumber. Powerful motor. Cuts straight lines, curves, irregular shapes. Model 511—\$42.50.



New, ball-bearing professional-type $6\frac{1}{2}$ " saw. Extra powerful motor. Exclusive "Vari-Torque" slip clutch guards against motor burn-out, reduces wear. Model 552—\$64.95.



NOW—PROFESSIONAL QUALITY at POPULAR PRICES

Why buy less when you can have the best? For over 30 years, SKIL has been the standard for professional craftsmen. Now, you too can have this same high quality at attractive prices. Put a SKIL in your workshop. Enjoy the fun of building with the finest power tools made.

Made only by SKIL Corporation
5033 Elston Avenue,
Chicago 30, Illinois.
In Canada:
3601 Dundas Street West,
Toronto 9, Ontario.

SKIL
PORTABLE TOOLS

outcome of this project. Dye warns too many belts give false security because they're weakly made, or aren't installed properly.

Milliken is an old campaigner to put safety belts into racing cars. When he helped write the rules for first running of the Grand Prix in 1948, belts were required.

In the 1948 Watkins Glen race, while driving a Bugatti, Milliken had a close call at "Milliken's Corner." It's a sharp turn at the bottom of a hill. On the last lap, his car went into a skid, slammed into some hay bales serving as guard rail and rolled over.

"If I hadn't had a safety belt on," he comments, "I probably wouldn't have walked away from there."

He was wearing one when he drove the Pikes Peak Race with a borrowed four-wheel-drive. Built by Harry Miller, it had been raced several times by Mauri Rose, three-time winner at Indianapolis Speedway. A sprint car rather than road racer, it had "only the barest excuse for brakes."

Halfway up, its transfer-drive casing broke, leaving the engine no longer connected to the wheels. Milliken got out of that without damage, but concedes, "That's a time I could understand why most of the Pikes Peak racers were against safety belts. It's a tough decision to make out there, faced with going over the edge of a high cliff. Nevertheless, you can do better driving with a seat belt, and it has been proven time and again that you can make better time."

Even when driving his own Austin-Healey along highways for a relaxing hobby, Milliken is thinking of safety at a fast pace, and is an outspoken crusader against speed traps. They're no solution, and even dangerous, he contends, because they give "false security." For example, their speed limits don't take into account the driving difference between night and day or wet and dry conditions.

He concedes that slowing down in towns makes sense. But on the open highway, his solution is safer-built cars and better-trained drivers for them.

He feels that speed-with-safety would put lots more pleasure into driving an auto which he looks on as one of the nicest "toys" man has yet invented. ★ ★ ★

Frozen Milk Kept for Year

Milk frozen in plastic bags and melted a year later cannot be distinguished from pasteurized milk, according to Britain's National Institute for Research in Dairying.

Professional Mechanics' TOOL CHEST FOR YOUR HOME WORKSHOP



This may be the lowest cost full-sized chest in America! 4 sliding drawers in blue-gray rugged steel cabinet. 26" x 12 1/2" x 12 1/4". Keep your valuable tools safe, clean and always at your fingertips.

\$25⁹⁰

F.O.B. ST. PAUL

FREE BULLETIN

HUOT MFG. CO.
555 No. Wheeler St., St. Paul 4, Minn.



HOME REPAIR TIP NO. 21



Mend auto seat covers. Cover split seams, tears, with tough, stretchy "Scotch" Colored Plastic Tape. Tight-sticking tape is waterproof, washable. Choose red, yellow, green, white, blue, black, brown or clear. 3/4" width 25¢—1 1/2" width 50¢—at stores everywhere. Made by Minnesota Mining & Mfg. Co., St. Paul 6, Minnesota. © 1957, 3M Co.

at stores everywhere. Made by Minnesota Mining & Mfg. Co., St. Paul 6, Minnesota.

SMALL! POWERFUL!

ECONOMY TRACTOR

Unequaled value! Low price! America's finest tractor. Ruggedly built. Easy to operate. 790 lbs. Borg-Warner clutch, trans. and diff 140 to 1 reduction. 40% more drawbar pull than ordinary tractors 8-1/4 H. P. engine. 20 quick change implements. HOOD, FENDERS.

Thousands In Use Write for complete details.

Engineering Products Co.
915-K-3 Niagara Ct.
Waukesha, Wisconsin

THE ORIGINAL PACKAGED BOAT KITS Made ONLY by *Custom-Craft*

Top Performance, Design, Styling! Over 70 Models 8 to 21 ft

World's largest line! Over 200 Boats: Kits, Formed-Hulls, Semi & Custom-finished! All types: Prams -Cruisers! Easy to build! Flying stem, Tredonic bottom, Bulkhead construction!

Send 35¢ for KIT CATALOG
52 pages; Includes Victory Series, hardware, paint accessories, Fiberglass! Send \$1.00 for Catalog Plus "Boating Handbook". DEALERS-AGENTS INQUIRE

BOAT PLANS & PATTERNS Frame-Pac Kits World's largest selection; over 200 plans, full-size patterns, frame-pac kits! Designed strictly for amateurs! All types: prams, kayaks, racers, runabouts, catamarans, houseboats, cruisers - Inboard-outboard 6-40' wood-plywood-steel!

Send 35¢ for PLAN CATALOG
Catalog PLUS "Boatbuilding Handbook" \$1.00

DEPT. PM CUSTOM-CRAFT - BUFFALO 7, N. Y.

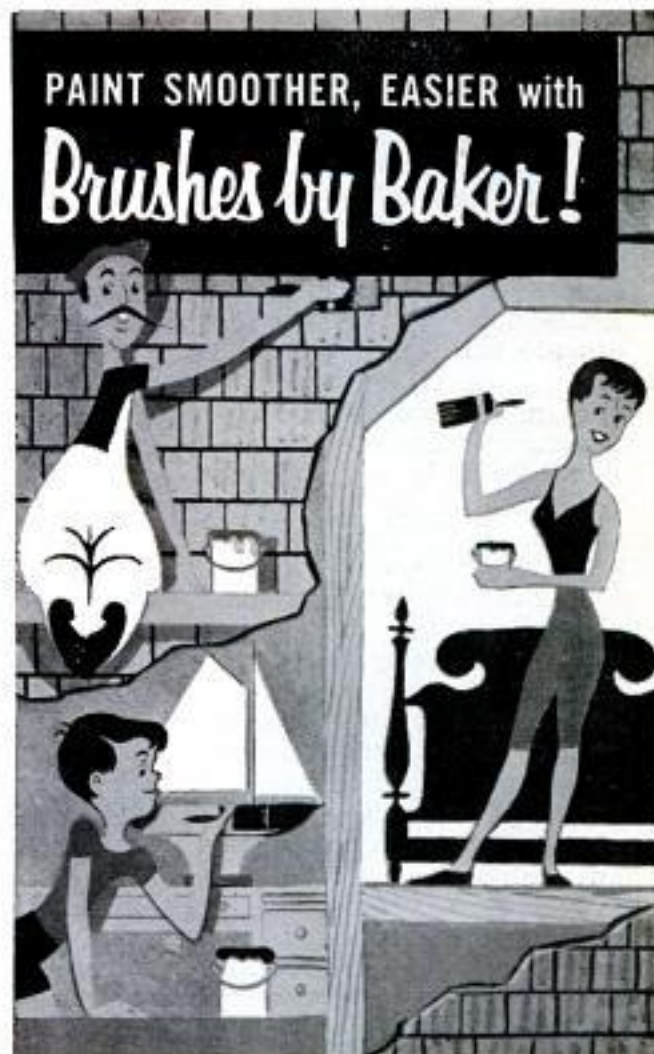

PAINT SMOOTHER, EASIER with **Brushes by Baker!**

Use Baker Brushes and paint easier, faster, better! Enjoy smoother painting, use fewer strokes, get more coverage. Next time you paint choose the right Baker Brush size most practical for the job.



learn to paint like an expert...

Free booklet tells "HOW TO DO A GOOD PAINT JOB." Today, send card to Baker Brush Co., Inc., 83 Grand Street, New York 13.



BRUSHES BY BAKER

AMERICA'S FINEST PAINTING TOOLS

House of Electric Nerves

(Continued from page 141)

daytime numbers can be used, and the call switched directly to the guest room. Bear worked out special circuits in cooperation with the local telephone company.

In Bear's private study is one terminus of his "traffic control" system. This consists of three switches operating colored lights in the study and at a prominent point outside the room. When he flips on the green light, others know that he is in and will see anyone. An amber light indicates that he has time only for important callers. A red light warns that he does not want to be disturbed.

Hi-Fi Network in House

Before hi-fi became a household expression, Bear did considerable pioneering work on audio equipment and installations. So naturally, when he enlarged his house, he planned a built-in sound-distributing network of majestic proportions. There are two sound centers containing record players, tape recorders and players, microphones and radio receivers, plus elaborate switching facilities. One of these centers is in his private study, the other is on the second floor in a room he calls the hi-fi den and library. Music from either room can be

heard through speakers in all parts of the house, and the systems can be operated

(Continued to page 256)



Robert Bear works remote-control-lighting switch. The switches at the top are for lights in other areas

AS A TUNE-UP*

- frees sticky valves
- increases pick-up
- improves performance

*through air intake or add to gasoline



ADDED TO MOTOR OIL

- cleans out engine
- increases power
- gives quick starts

☆ At your service station, garage or accessory store

SATISFACTION GUARANTEED OR DOUBLE-YOUR-MONEY-BACK

HASTINGS MANUFACTURING CO.
HASTINGS, MICH.

Also makers of H-W-R, Piston Rings, Oil Filters, Spark Plugs

With This Book

Here is a 96-page bargain! 18 projects you can build—all with plenty of pictures and illustrations, full material lists and complete step-by-step directions. Build cabinets, toys, games, built-ins! You can even remodel your kitchen. And this book—a regular 50¢ value when it goes on general sale—is yours with the coupon below for only 25¢! Send today!



and Weldwood Pine

This is Weldwood Old Craftsman Pine Plywood—the easiest working, easiest painting plywood ever! And that's because Old Craftsman combines all the advantages of top pine lumber with all the advantages of rugged plywood construction. What's more, Old Craftsman Pine Plywood comes already sanded and made with a special mold-resistant agent. See it at your lumber dealer's soon!



you can build projects like these



48"-long sliding-door cabinet with adjustable shelves.

Sturdy duck pull-toy with nodding head and wagging tail.

29"-high storage cabinet with adjustable shelf, swinging door.

Early American hutch cabinet with built-in decorative planter.

2'-high play school-bench with large storage shelf.

Convertible table that adjusts to coffee- or card-table height.



Weldwood®

**OLD CRAFTSMAN
PINE PLYWOOD**

A product of

UNITED STATES PLYWOOD CORPORATION
Weldwood—The Best Known Name in Plywood

SEND TODAY!

United States Plywood Corporation
Box 61, New York 46, N. Y.

GENTLEMEN: Send me a copy of your 96-page book "Projects You Can Build With Weldwood Old Craftsman Pine Plywood." I enclose 25¢. PM-3-57

NAME.....

ADDRESS.....

CITY.....STATE.....

Easy Does It!

when you ride a

BOLENS

RIDE-a-matic TRACTOR

with AUTOMOTIVE STEERING

VERSA-MATIC VARIABLE
SPEED DRIVE

TIME-SAVING ATTACH-
MENT HITCHES

ADJUSTABLE COMFORT-
SPRING SEAT

ALL-AROUND, YEAR-
AROUND UTILITY



Plow, disc, seed and cultivate . . . mow lawns, cut weeds, grade land and plow snow . . . you'll ride through these jobs and many more—with a Bolens RIDE-a-matic, America's finest small riding tractor. Two powerful models (don't miss the brilliant new 6.6 hp "Super") take 16 basic attachments. *Easy time payments.*

SEND POSTCARD FOR CATALOG

BOLENS PRODUCTS DIVISION

Food Machinery & Chemical Corp.
Port Washington 4, Wisconsin

CUT THE BOLT YOU NEED TO ANY LENGTH

HEAT AND BEND TO ANY SHAPE

24" and
36" lengths

7 SIZES

$\frac{1}{4}$ " $\frac{3}{16}$ " $\frac{1}{2}$ " $\frac{3}{8}$ " $\frac{7}{16}$ "
 $\frac{1}{2}$ " $\frac{3}{8}$ " $\frac{3}{4}$ "

REDI-BOLT

THREADED STEEL RODS

Ask Your Hardware Dealer or Write

REDI-BOLT, Inc., 5330 Indianapolis Blvd., East Chicago, Ind.



Mailbox-post supports signal lights for school bus as well as floodlight and an intercom unit to house

from a number of remote-control points.

The upstairs hi-fi installation is capable of feeding three distinct programs of music to three different parts of the house, though this is a result of necessary isolation of speaker systems rather than a desire for triple programming. Of three 60-watt high-fidelity amplifiers, one drives a single speaker in either the dining, living or hi-fi room; and a duplicate amplifier feeds directly to a second speaker in the same room. Thus the two can be operated together for binaural reproduction, or they can feed "pure" hi-fi sound simultaneously to two rooms. The third amplifier normally picks up the program going into either of the other amplifiers and distributes it to other parts of the house. All sound-system circuits are brought to a patch board in the hi-fi den, and switching to various speakers, including matching of impedances, is done by changing connections at this board. Sounds complicated? It merely seems so, Bear explains, and adds, "My four-year-old son can operate the hi-fi system as well as he does the lights."

Outlets for television receivers are scattered throughout the house. A coaxial distribution system enables each receiver to function as if it had its individual antenna. Auxiliary electronic equipment is used wherever necessary to isolate signals so that any connected receiver can get all channels.

Located in the kitchen and other rooms

(Continued to page 258)

POPULAR MECHANICS

Copyrighted material

Now's the time to
trade-in
that
old saw!



**Get an extra big trade-in allowance
 on a famous Porter-Cable quality saw!**

Here's a wonderful opportunity to get any famous Porter-Cable saw illustrated here, at a saving! Trade-in your old saw and get a liberal allowance toward the purchase of a Porter-Cable saw that best fits your cutting needs and requirements. No matter what model you choose, you're getting Porter-Cable quality that can't be beaten for design, construction, versatility and solid value. Check the yellow pages of the telephone book and see these professional quality saws at your Porter-Cable dealer—or use coupon to get complete information. (Offer expires May 31, 1957.)

SEE YOUR DEALER — OR MAIL COUPON TODAY!

PORTER-CABLE MACHINE CO.
 7143 N. Salina St., Syracuse 8, N. Y.

Please send me complete information on your Saw trade-in offer and name of my nearest dealer.

Name _____

Address _____

City _____ Zone _____ State _____

Porter-Cable

Quality Electric Tools

saws • routers • finishing sanders
 belt sanders • drills • planes

In Canada: write Porter-Cable, Ltd.,
 Box 5019, London, Ontario.
 Canadian prices slightly higher.



SAVE \$5 ON MODEL 125 SAW!
 A standard duty 6" saw featuring Kickproof Clutch, instant depth and bevel adjustments and a safe telescoping guard. Regularly \$49.50 — with any saw trade-in \$44.50.



SAVE \$20 ON MODEL 528 SPEEDMATIC!
 World's finest professional saw. Big capacity 8 1/4" blade with new telescoping guard, Kickproof Clutch and many more features. Regularly \$135 — with electric saw trade-in . . . \$115.



SAVE \$15 ON MODEL 521 SAW!
 Famous Speedmatic saw with 7 1/2" blade, Kickproof Clutch, depth and bevel adjustments, and other professional features. Regularly \$117.50 — with electric saw trade-in . . . \$102.50.



SAVE \$15 ON MODEL 108 SAW!
 Rugged 8 1/4" saw for the builder who needs extra speed and power on all cutting jobs. Features Kickproof Clutch. Regularly \$99.50 — with electric saw trade-in \$84.50.



SAVE \$15 ON MODEL 157 SAW!
 Heavy duty 7 1/4" saw with blade on left. Weighs only 13 lbs. Professional features throughout include exclusive Kickproof Clutch. Regularly \$95.00 — with electric saw trade-in . . . \$80.00

Soldering is Easy

with

INSTANT STARTING

Lenk

LIQUEFIED LP PETROLEUM
Torch

only **\$2.95**

THE ONLY THROW-AWAY FUEL-CONTAINER WITH SELF-SEALING SAFETY VALVE.

Here's what you can do:

- regular soldering,
- sweat fittings,
- silver soldering,
- refinish furniture,
- remove paint and putty.

Available at Hardware Counters Everywhere

Write for FREE
Soldering Instructions

THE *Lenk* MFG. CO.
BOSTON 15, MASS.

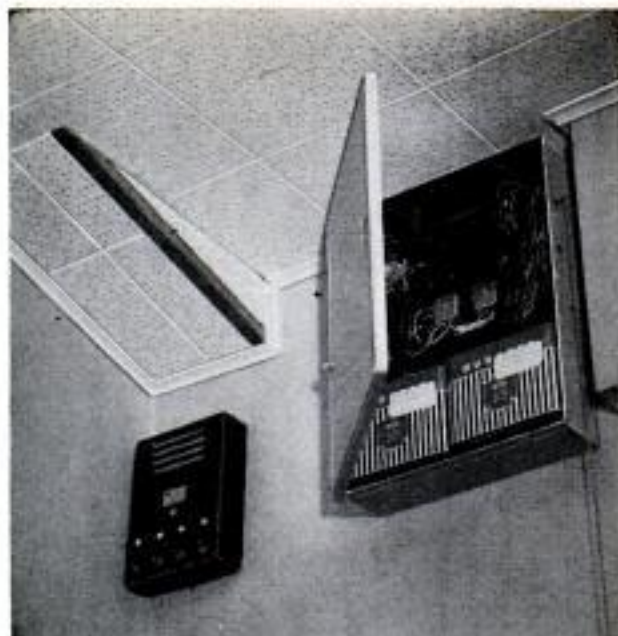

At left is control box for four fire-alarm circuits. Right, cabinet holds rectifiers, stand-by batteries

where a TV receiver is not installed are extension speakers that can be turned on to bring in the audio portion of TV programs. These are of particular convenience during baseball seasons. Listeners can follow the games without neglecting work and, for particularly interesting plays, can dash into a nearby room to watch the action on the screen. When maximum audio fidelity is desired, the sound portion of a TV program can be switched to one of the hi-fi amplifiers.

A Pioneer in Television

In TV as in hi-fi, Bear has been a pioneer. Back in the days when the only video signals available in northern Ohio came from WWJ-TV in Detroit, he began experimenting with receivers and antennas. On the hill behind his house he erected a 99-foot tower. He and his engineers used it to experiment with ways of picking up weak signals. Bear formed a company for the development of community-antenna systems to bring TV programs to areas screened by hills and mountains. The organization made numerous installations in Pennsylvania, West Virginia and Ohio. The coaxial system in Bear's home might be likened to such an antenna system.

Mrs. Bear, who assists her husband in his electronics work, objected to the appearance of the TV tower and the shed that had been built at its base. So her husband agreed to construct a more substantial-looking tower building. It was found that a normal structure could not be squared with the tower and at the same time properly oriented with respect to the residence.

(Continued to page 260)



'Tugit' GETS YOU GOING AGAIN!

When snow or mud imprisons your car, 'Tugit' gets it out fast! This powerful lever-operated hoist works smoothly at any angle. A 40 lb. pull on the handle lifts or shifts a ton! Compact 'Tugit' operates where a standard hoist would be too big. You get action when the handle end moves only 3½". In placing a heavy part in a tight spot, you can move the load ½" at a time. A finger-tip control makes it simple to change from "up" to "down" or into "free wheeling." 'Tugit' Makes 1,000's of Jobs Easy. Get a 1 or 2-ton 'Tugit' for your tool box, car trunk or truck. Small size weighs only 16½ lbs. In building a home or fence, fixing a tractor or clearing a woodlot, portable 'Tugit' saves time, trouble, expense. \$63.50 up. See your Shaw-Box Distributor or write us for Bulletin 388.

- Hauls rocks, logs
- Tightens guy wires
- Moves wreckage
- Positions parts
- Lifts boats, motors
- Shifts machinery
- Squares frames
- Spots trailers
- Hoists tanks, vats
- Pulls out posts
- Handles pipe, concrete slabs



578-3

MANNING, MAXWELL & MOORE, INC.
SHAW-BOX CRANE & HOIST DIVISION
354 W. BROADWAY MUSKEGON, MICHIGAN

**MASTER & SLAVE
HYDRAULIC
REMOTE CONTROL SET**

ITEM #415—Designed for remote operation of controls on engines, boats, special machinery, etc. Eliminates complicated mechanical linkages, cables, pulleys, etc. The master unit connects to the slave unit with a single 1/4" tube.

When master control lever is moved, slave lever follows exactly. Light, compact, aluminum alloy construction.

Dim. of both unit: 5 1/4" W, 9" H, 1 3/4" D. (exclusive of handle) Ship. Wt. 8 lbs. **27.50** pair
F.O.B. Chicago.
(Note — tubing not supplied.)

**VICKERS
HYDRAULIC PUMP
PISTON TYPE
COMPACT — POWERFUL**

ITEM #39

For direct or pulley drive. Rated 8 Gal. per min. at 3750 R. P. M. Delivers 1000 lbs. per sq. in. Ball bearing construction. Standard foot mounting, 1/2" shaft, 1/2" pipe thread ports.

U. S. Air Force cost \$136.00 Our low price **24.95** Postpaid.

**SAVE \$30.30 ON THIS PESCO
HYDRAULIC CONTROL VALVE**

ITEM #371V

FOR SAFE POSITIVE CONTROL OF HYDRAULIC CYLINDERS AND MOTORS

• FULLY-INSULATED RELIEF VALVE — ESCALATOR SET AT 1200 P.S.I. • FOUR-WAY VALVE — to operate one double acting cylinder • OPEN CENTER — with valve in neutral, cylinder is locked in position and pump is unloaded. • SPRING RETURN TO NEUTRAL • FULLY BALANCED PLUNGER • EASILY STACKED INTO 2, 3, or 4 valve combinations for multiple cylinder operation. • 8 gal. per min. capacity, at 1500 P.S.I. — 3/4" pipe ports • CONNECT PUSH RODS TO HANDLE FOR REMOTE CONTROL • EASY MOUNTING • LIST PRICE — \$46.80. • YOU SAVE \$30.30. • DIMENSIONS — 9"x4 1/2"x 2 1/2" — Ship. Wt. — 8 lbs. F.O.B. Chicago. **16.50**

**SELECTED
TOP VALUE SPECIALS!
SURPLUS ITEMS AT FRACTION OF ORIGINAL GOV'T. COST
AT GROBAN'S**

1 1/2 H. P. HYDRAULIC SPEED REDUCER

ITEM #115 — 1 1/2 H.P. Output rotation reversible. Ship. wt. 31 lbs. Complete with 2 qts. of oil and full instructions. F.O.B. Chicago. **72.50**

with **FINGERTIP CONTROL**

USE FOR: • Reamer Drives • Midget Cars • Feed Mills • Canning Machines • Conveyors • Lathes • Milling Machines • Motor Boats • Cream Separators • Garden Tractors • Pumps.

Variable output speeds from 0 to input speed available by moving control handle. Locking handle maintains setting. Use input power of 1/4 to 1 1/2 H.P. Shafts 3/8" diam. Input rotation counter-clockwise facing shaft. Input speed 750 R.P.M. 7/8"x7 1/2"x 1 1/2". Output rotation reversible. Ship. wt. 31 lbs. Complete with 2 qts. of oil and full instructions. F.O.B. Chicago. **72.50**

**DOUBLE ACTION
HYDRAULIC CYLINDERS**

ITEM #31C — 3 1/2" bore, 11" stroke. Alloy steel cylinder wall. Micro-Honed and all steel 1 1/2" diameter piston rod. 19 1/2" overall length closed. Clevis mounting at base and shaft. Will lift 9625 lbs. with 1000 PSI Pump Pressure. Uses 3/8" tubing fittings. (Fittings to pipe thread: two 3/8" MPT @ 35c.) A \$102.00 value. Shipping weight 11 lbs. FOB Chicago. **25.00**

ITEM #16-C — 1 1/2" bore, 26" stroke. Will lift 1760 lbs. with 1000 lbs. pump pressure. Great for hay loaders, etc. 1" stainless steel piston rod. Postpaid **16.95**

**16-TON "SIMPLEX"
SCREW JACKS
BRAND NEW**

ITEM #505 • For house movers, railroads • Construction Equipment • Machinery, rigging.

16-Ton Simplex screw jacks, 1 3/4" x 16", 4-way head type, with malleable iron base, and heat-treated steel handle. Shipping Wt. 35 lbs. F.O.B. Chicago. EA. **9.50**

Set of 4 - \$35.
F.O.B. Chicago

FREE — 1957 CATALOG — JUST OUT!

60 PAGES — Chuckfull of unsurpassed War Surplus and newly manufactured Equipment Bargains for farm, home, factory, workshop. Write letter today.

ORDER DIRECT FROM AD — SATISFACTION GUARANTEED

Send Payment Or Purchase Order Today
For Phone Orders Call **WEBSTER 9-3793**

GROBAN SUPPLY CO. Dept. **PM-3**
1139 S. WABASH AVE., CHICAGO 5, ILL.

**A. C. ELECTRIC
GENERATOR**

ITEM #G-75-D 7 1/2 K.W. (7500 WATTS) single phase, 110/220 volt output. 3 wire system. 2 bearing construction. 5 groove 8" V belt pulley included. Self-excited. Foot mounted. Drive generator from tractor or stand by engine. Ample power for 6 room house. Dimensions: 34" x 11 1/2". Shipping Wt. 420 lbs. **295.00**

Complete control box for these generators includes A.C. rheostat, automatic voltage regulator, field rheostat, and voltmeter, already wired and ready to connect to generator. List price \$167.00. Our Price **56.45**

**G.E. SEALED BEAM
300 WATTS 110 VOLTS
SPOTLIGHTS**

ITEM #418
General Electric "Mazda" 5 1/2" Sealed Beam

Uses conventional 110 Volt current A.C. — D.C. Fine for lighting up driveways, signs, parking lots, displays, garages. Built for use as Flashing Signal for U.S. Navy — to stand heavy surge loads. Shipping Wt. 2 lbs. U. S. Govt. Cost \$12.68 ea.

Now Each. **2.50** Postpaid

Lots of 3 — 6.00 Postpaid

**BRAND NEW 1 H.P.
12 Volt Electric Motor**

ITEM #308

Rated 1 H.P. — 100 amps., 5000 R.P.M., 12 volts, D.C. — This double shaft motor of ball-bearing construction may be run on 6 volts for lower horsepower requirements. — Standard 3/8" shafts, flange mounting. — Dimensions: 2" x 4 1/2" x 4 1/2". Ship. wt. 19 lbs. A real value at **12.50** Chicago

- For electric wheel chairs (Pop. Mech. design — Mar. — 1953)
- For electric golf carts
- For self-propelled scooters, children's mid-gt cars.

**2 H.P.
ELECTRIC MOTOR**

24 Volts, 90 Amps, 4000 RPM. Splined shaft both ends. Style similar to above. Mfgd. by Hobart or Diehl. **ITEM #315** **13.00**
F.O.B. Chicago.

NEW SPEED PROPELLERS

for JOHNSON AND EVENRUDE 18 & 35 HP OUTBOARDS, SCOTT ATWATER 20 & 40, AND FAGEOL 35 HP.

If you own one of these great motors by all means investigate MICHIGAN'S new, style SMC, 3-blade propellers engineered specifically for them, to provide more speed, better skiting, more fun. Send postcard for FREE 1957 catalog. Also contains outstanding bargains in skis, speedometers, boat accessories. .

Dept. P-3, Michigan Wheel Co., Grand Rapids 3, Mich.

**DO EVERY FASTENING JOB
10 TIMES FASTER!**

Amazing one-hand operation, 10 times faster than hammer & nails. Can't jam.

ARROW
DO-IT-YOURSELF
TACKER, No. T-50

for ceiling tile, insulation, wire fence & every home job

At your local hardware dealer or lumber yard

Arrow Fastener Co., Inc., 1 Junius St., Brooklyn, N. Y.

**Bore 35 standard holes
with just one tool**

New IRWIN Expansive Bit

lets you dial your size

Just turn the dial and you're set to go with this new Irwin Expansive bit. No hunting for the size you need. Fits all hand bit braces. Clean, fast, accurate boring action from $\frac{3}{8}$ " to 3"—35 standard hole sizes in all!

And what a really fine precision tool to own. It's drop-forged from special bit steel, heat treated full length, machined for accuracy and sharpness, highly polished, too. Two cutters supplied with each bit. Model No. 21 with $\frac{5}{8}$ " to $1\frac{3}{4}$ " boring range also available. Ideal for home handyman, professional woodworker, or farm. See your independent hardware dealer soon.



IRWIN

Wilmington, Ohio

the original solid
center auger bit
•
screw drivers
screw driver bits

PAINT Comes off FAST!



Apply Wonder Paint Remover to *any* finish. In a few minutes, wash it off with water. Then when surface is dry, refinish. You're through in half the time! Paste-like—stays put on up-rights. **NON-FLAMMABLE**. Ideal for furniture, woodwork, walls, boats, etc.

At paint and hardware stores.

● Write for free Wonder Remover folder or send 25¢ for illustrated Manual on Refinishing. Wilson-Imperial Co., 119 Chestnut St., Newark 5, N. J.

WONDER

water wash off Paint Remover

So a large central chamber, designed as a laboratory and conference room, was aligned with the tower, and the outer walls of the building with the house. Between these walls and the inner chamber, odd-shaped guest rooms were built. Not long ago, when his TV-antenna studies had been completed, Bear dismantled the entire tower and converted the building into a tenant house.

Running through the crawl space and thence to various parts of the main house are other electrical circuits whose purpose is to increase convenience and safety. About the simplest of these is an alarm system that warns of too-high temperature in the deep-freeze room. Another is an elaborate fire-alarm network.

Because of the country location, special attention was given to fire-alarm facilities. The house is divided into four alarm zones, each with its fire-detecting circuit. Heat-sensitive elements are spotted at every point where a blaze might conceivably start. The circuits are brought to a control panel centrally located in a hallway on the ground floor and parallel to a duplicate panel in the living quarters.

Fire Alarm Also Works on Batteries

When Bear was developing the system, he decided that it should operate normally from an alternating-current circuit, but should be arranged to switch automatically to stand-by batteries in case the a.c. power failed. But the equipment he acquired for this proved to be somewhat short of perfect; whenever a switchover was made, the alarm bells and siren would sound. So he had to redesign equipment and circuits so that, at no time during a switchover, would the relays be fooled. The batteries have a rated shelf life of one year and are replaced every nine months. The system is tested periodically. If a fire should break out, the control panels on the two floors would indicate, by pilot lights, in which of the four zones it is located. Bells in various parts of the house and a siren on the roof would go into action, and continue to operate until someone pulled a chain dangling from the battery and rectifier box in the ground-floor hall. Normally, by means of various signal lights, a glance will reveal whether the fire-alarm system is operating on a.c. or batteries, and whether someone has inadvertently pulled the cut-off switch.

The conveniences that Neal Bear has developed have one thing in common: They were created by the use of generally available parts and equipment, and anyone sufficiently skilled in such work could reproduce them on a scale suitable for his particular requirements. ★ ★ ★

NEW! MODEL 400 SIMPLEX Lawnmower Sharpener

Many Exclusive Features . . .

The NEW SIMPLEX is the fastest, most accurate straight-line lawnmower grinder ever built . . . gives you all these advantages:

- Grinds all mowers—reel type, rotary, hand or power, any size.
- No dis-assembly needed, gas and oil remain in engine, support bar rotates.
- Grinding head feeds both horizontally and vertically, turns 90° for bed knives.
- Fast, positive adjustments, 4-point support on steel base with leveling screws.
- Rugged, long life construction and many other features.

THE FATE·ROOT·HEATH COMPANY

Dept. PM-3 • Plymouth, Ohio

Small investment
returns
Big Profits!



Get the facts on the new Simplex 400
before you buy any sharpener.

Send for free brochure today!

Find HIDDEN TREASURES

GOLD, SILVER, PRECIOUS METALS with the Famous Model 27 Metal Detector. Lightweight, ultra-sensitive, low cost. None finer. Also GEIGER COUNTERS for uranium and the VIOLITE for tungsten. INFORMATION FREE

THE *Detectron* CORP.
5528 Vineland Ave., No. Hollywood, Calif.



ARE YOU SURE YOU NEED A DEEP WELL WATER SYSTEM?



See Why
**BURKS
PUMPS**
LIFT FARTHER

DECATUR PUMP CO., 61F ELK ST., DECATUR, ILL.

FUN-WORK YARD TRACTOR WHEEL-HORSE RIDE-AWAY



SENSATIONAL
LOW PRICE

Turn work into FUN! Do a dozen back-breaking jobs in a jiffy. Yard-size tractor with 5 forward speeds and 1 reverse. 3 1/2 hp (or 2 1/2 hp) engine. Heavy channel steel chassis. Mow 5-foot swath at 5 mph. Plow snow, cultivate, haul compost, pull any of 22 attaching tools for yard and garden. Write for details, and name of dealer.

WHEEL-HORSE PRODUCTS

2644-D Dixieway North

South Bend, Indiana

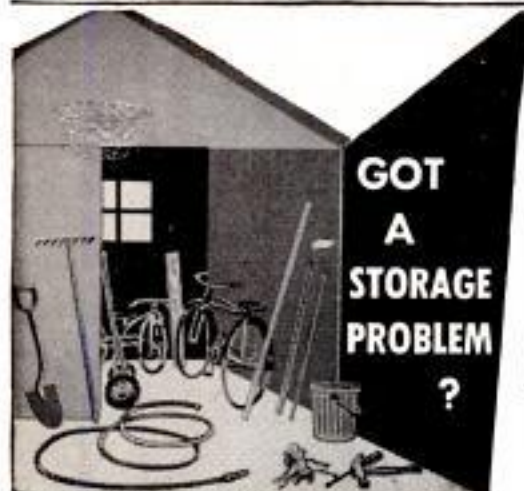

GOT
A
STORAGE
PROBLEM
?



When you need TURNBUCKLES Perforated Board fixtures to end space-wasting clutter and to keep everything neatly in place until needed. TURNBUCKLES do-it-yourself fixtures come in a wide variety of shapes and sizes . . . fit easily into any wall-hung perforated board . . . and hold everything from clothing and kitchen utensils to hand tools and garden equipment. Send for your free copy of space-saving suggestions for home, farm and workshop.



TURNBUCKLES, Inc.

BOX 333, MICHIGAN CITY, INDIANA

NAME _____

ADDRESS _____

CITY _____

STATE _____

MARCH 1957

261

you know
this means
quality*...

PET
POWER TOOLS

NOW LET'S TALK PRICE!

- YOU:** Can I get a better 6½" power saw at any price?
- US:** Not to our knowledge, or to the knowledge of a famous research institute.
- YOU:** Well, how much do I save?
- US:** Anywhere from \$10 to \$20! And it has ball bearings for smooth running, a full horsepower motor and the exclusive Automatic Safety Clutch, which increases the work life of the Pet saw up to 15 times.
- YOU:** How?
- US:** It eliminates motor burnout, the major cause of saw damage, and kickback, the major cause of accidents. This Pet saw is really the best buy on the market. Only \$49.95. At your hardware dealer's.

* report by a famous research institute proves that this Pet saw equals or exceeds any other make, regardless of price!

NEW!

Exclusive Automatic Safety Clutch adds up to 15 times more work life!

NEW!

1 h.p. Universal ac/dc motor develops 4850 r.p.m.!



NEW!

Retracting lever on automatic blade guard!

NEW!

Exclusive Tru-Guide for right, left or on-line sawing—stops guesses!

*Those who depend
on their tools depend on*

**JOB
TESTED**

T.M.

PORTABLE ELECTRIC TOOLS, Inc.
Chicago 20, Illinois

PET
POWER TOOLS

Ford Is Long, Low And Owners Love It

(Continued from page 91)

the emphasis is on styling and performance. As a result, perhaps, the sale of seat belts has dropped sharply.

In the 1956 Owners Report on the Ford, (PM, July 1956), 15.7 percent of the Ford owners had seat belts in their new cars. This year only 6.2 percent have seat belts.

However, there has been an increase in the percentage of Fords with padded dashboards and visors from 48.0 percent in 1956 to 60.5 percent in 1957.

As previously, only a small fraction of the owners who have seat belts wear them all the time. Most of them say they wear them only during high-speed highway driving.

Apparently Ford is having trouble stocking belts for its 1957 models:

"I ordered seat belts and was told they weren't available for 3 or 4 months."—Ohio assembler.

What Should Be Changed?

In each questionnaire we ask the owner what changes he would like to have made in his new car. Many owners of the Ford are fully satisfied, 41.4 percent answering that nothing need be changed.

Those who are not altogether satisfied mention suggested changes in the following order: Ash-tray design, front grille, eliminate floor humps and rear-seat floor wells, improve body work, increase gasoline economy and provide more room inside the car.

More Best-Liked Features

Here, in order of frequency of mention, are quotations describing other best-liked features (for percentages see page 90):

"Holds the curves well. Gives you the feeling of belonging."—Nebraska trucker.

"Doesn't throw you when you round a bend."—Florida teacher.

"Enjoy the spacious trunk, but the length makes it harder to park. Don't care for cutaway seats."—Kansas investigator.

"Most economical car in its price range. Drives longer without trouble."—North Carolina superintendent.

"It isn't using as much gas as I was led to believe it would."—New York teacher.

"I like its lowness. Radiator cap is on side and I can't see fluid."—Illinois owner.

"I can see over the steering wheel and don't sink to the floor."—Utah steelworker.

"Easy starting in winter."—New York steelworker.

"I like the low hood and the way it opens

(Continued to page 264)

GIGANTIC
SAVE-TO-70%

MAIL SALE

WAR SURPLUS
EXCESS INVENTORY
BANKRUPT STOCK

GOLF CAR BATTERY MOTOR

● Precision built, powerful ball bearing unit. Operates on 6, 12, or 24-v DC. Reversible 100-300 rpm output. For golf car, midget auto, motorized wheel chair, automatic feeders, etc. Wt. 31 lbs. Cost \$245. SALE.....\$19.46 FOB

TRACTOR WEED SPRAYER

● Latest design, 5-row (17') outfit. Complete outfit using ball bearing high pressure roller pump. T-jet nozzles, relief valve, hoses, controls. List \$175. SALE.....\$97.65 Ppd.

SURPLUS BARGAINS

- Hyd. Cyl. 3 1/2"x24" S.A. 9021 push FOB \$27.95
- Fuel Rotary Hand Pump..... FOB \$19.32
- Burglar-Fire Alarm System..... Ppd \$13.95
- Tree & Pole Climbers (pair)..... Ppd \$1.79
- New Heavy Tarpaulin 8x10'..... Ppd \$6.80
- 200 Amp Welding Generator..... FOB \$17.91
- Portable Elec. Saw (clutch) 6 1/4" Ppd \$25.05
- Pneumatic Tree Trimmer..... FOB \$6.59
- 1000-Lb. Hand Winch..... Ppd \$6.25
- Contour Survey Level, tripod, rod Ppd \$47.00

SPEED REDUCER

● Wonderful 80-to-1 gear reduction unit. Contains 8 roller bearing, multiple gears. Decreases speed—increases torque. Reduces standard motor to 21 rpm. Shafts 3/4" input, 1 1/4" output. Many uses—power winches, revolving signs, door openings, etc. Gov't. cost \$66. SALE.....\$7.49 Ppd.

HYDRAULICS—PUMPS—AIR COMPRESSORS

● Bargains in finest quality surplus and new factory items. 3" Cyl. 6" stroke, \$14.95; 2" Cyl. 9" stroke, \$12.95; 1500 16-gauge \$3.49; Control Valve \$12.95; Air Compressor \$19.95; Gauge 160-lb. \$1.89; Air Regulator \$3.29; Air Compressor Kit \$39.49; 2 1/2" 270 gpm Pump \$44.37; Automatic Sump Pump \$42.95; Plastic Pipe 1/2" 8c, 3/4" 12c, 1" 20c. All prepaid. Many other items in each line. Write for our catalog.

STAINLESS STEEL TANKS

● Brand new 12"x24" 400-lb. capacity air corps tanks. 100s uses—air storage, air horn port, tire inflating tank, etc. Two 1/4" pipe thread openings. Last chance to get these popular tanks. Air-filling valve furnished free. Wt. 17 lbs. Gov't. Cost over \$30. SALE.....\$16.95 FOB

SPECIAL OF THE MONTH!

GEARED AC MOTOR

● Powerful A-C motor with fully enclosed gear reduction drive. Gear ratio 334-1, output 8 1/2 rpm, clockwise. Motor rated 90-w AC. Runs on 115-v using from 60 to 300 watt light bulb in series. Motor is fan cooled for continuous operation. 100s uses, window display, coil winding, etc. Motor 3 1/4" dia. with 1/16" dia. shaft. Original Cost \$12.50 SALE.....\$2.86 Ppd.

GEAR REDUCTION MOTOR

● Multiple gear, ball bearing motor with enclosed 42-to-1 reduction gear box. High torque, 10 to 200 rpm output, reversible. Runs on 6 or 12 v DC or 110 AC through series resistors. Many uses. Cost \$35. SALE.....\$4.97 Ppd.

ARMY POWER PLANTS

● Amazing buys surplus Army and factory-to-you plants and generators. Save to 60%.

- 1000-w, 115-v, 60-c \$179.50 Ppd.
- 2000-w, 115-v, 60-c \$269.95 Ppd.
- 3000-w, 115-v, 60-c \$299.50 Ppd.
- 5000-w, 115-v, 60-c \$497.50 Ppd.

Many other plants, generators. Get catalog.

ORDER FROM AD or write for big new FREE CATALOG 1000s items at tremendous savings. We pay frt. except where FOB.

BURDEN SALES COMPANY

805 "O" St., LINCOLN, NEBRASKA



START A BUSINESS this Quick Way

"I have taken in 100 mowers in 5 weeks since I got my Foley," says George C. Wise.

FOLEY LAWN MOWER SHARPENER

Start in spare time and make a quick CASH PROFIT. The Foley handles up to 3 or 4 mowers per hour—prices run \$1.50 to \$3.00 for hand mowers, \$5.00 to \$8.00 for power mowers. You make 99% profit!

FREE VALUABLE ILLUSTRATED BOOK shows how to sharpen all leading makes of power mowers. Foley prices are low—easy payments available. FREE PLAN tells how to start. Write today—no salesman will call.

FOLEY MFG. CO., 307-7 Foley Bldg., Mpls. 18, Minn.



KEY-BAK KEY-REEL

Carry your keys on a KEY-BAK key-reel. Keeps keys handy! Safe! Keeps clothing neat. 24" long stainless-steel chain reaches all locks. Pocket-watch size. Sturdily constructed to last for years. GUARANTEED. For all who use and carry keys. Dealers Wanted!

LUMMIS MFG. CO., Pasadena 8, Calif. CTL CO., Wausau, Wis. **\$2.95 Ppd.**

HELPFUL BOOKS

Send post card asking for FREE catalog

Popular Mechanics Press, 200 E. Ontario, Dept. 601, Chicago 11



WELD IT YOURSELF IN A JIFFY!

Weld, Cut, Braze, Solder; Iron, Steel, Brass, Bronze, Aluminum and other metals safely and easily. Make your wrought iron furniture, porch railings, fences, knick-knacks and other metal specialties. With this fine equipment anyone can do professional-like work with little practice. Tool and equipment breakdowns are annoying and costly. Don't let them bother you. The Dynamic will pay for itself quickly in both time and money and is designed to operate from any properly wired 110 volt AC line.

Order your Dynamic Industrial type transformer Arc Welder for Workshop or Industrial use today. Order from this ad.

Literature on larger equipment available on request.

DYNAMIC WELDER COMPANY, 1808 S. Federal Street, Dept. D2-C, Chicago 16, Illinois

BUILD YOUR OWN POWER TOOLS—With GIL-BILT PARTS-PLAN KITS

10" TILT/ARBOR SAW

Sturdy wood, steel, and aluminum construction, NEW DEPARTURE ball bearings. Capacity and performance of floor saws selling for \$150.00 and up. Plans, all metal parts in kit with 10" comb. blade \$25.90, less blade \$22.95, F.O.B. St. Louis.

12 IN. and 18 IN. BAND SAWS

(12" only illustrated)

Ball bearing drive, rigid cast aluminum wheels, rubber tires. Rigid cast aluminum tilt and tension mechanisms. 18 inch saw handles stock to 6" thick, cuts to center of 36" circle. Extra large tilting tables. Capacity and performance of hand saws selling for \$80 to \$300. Plans and all metal parts for 12" band saw \$25.95. Plans and all metal parts for 18" band saw \$39.95.

For shipments up to 600 miles, add 1% over 500 add 10%. Amount in excess of actual postage will be refunded.

Also Build-it-yourself 6" Belt Sander, Shaper, 8" Tilt-Table Saw. Simplified plans, build easily with hand tools only. Advertised and sold for 10 years, over 33,000 units in use. Money back Guarantee. FREE CATALOG.

GILLIOM POWER TOOLS DEPT. 80-C, LAMBERT FIELD ST. LOUIS 21, MISSOURI

STOP DON'T THROW ME OUT



IMPERIAL Rapid Brush Cleaner

cleans hard-caked paint brushes in a jiffy. No long soaking. Bristles stay springy—never flabby. At paint and hardware stores.

Wilson-Imperial Co., 119 Chestnut St., Newark 5, N.J.

BUY with confidence! BUY products advertised in POPULAR MECHANICS

EASY PAY PLAN

Low down-payment. Pay as you weld. Money back guarantee. Send for details. Complete outfit.

Only \$38.50

F.O.B. Factory

NEW!



EDGE PLYWOOD...



DECORATE THINGS...



with new Flexible

Weldwood® Wood-Trim*

No more exposed edges when you make things of plywood—things like tables, desks, cabinets or other projects. Wood-Trim covers the edge with real wood veneer . . . gives a real "pro" finish. Apply it in minutes—without clamping, ironing, sawing, nailing, using Weldwood Contact Cement or Weldwood Presto-Set® Glue. Countless decorative uses too; trim lamp shades and picture frames, decorate coffee tables, clocks, waste baskets, etc.

At hardware, paint and lumber dealers or write for free leaflet. Dept. PM3-7WT For perfect wood finishing jobs, use Firzite® and Satinlac®. *TRADEMARK

Box 525, UNITED STATES PLYWOOD CORP., N.Y. 46

8 Ft. rolls
1" wide,
89¢ each.
Oak,
African
Mahogany,
Walnut,
Birch, Fir,
Korina®



You buy better when you buy brands advertised in POPULAR MECHANICS



FREE! COLORFUL 32-PAGE SHOOTIN' BOOK



Family fun!
Target games!
Regulation shooting
tips by a world champion!

"Do-It-Yourself" tips on building an indoor and outdoor range and many other tips on shooting. Real shooting indoors or close-to-home, all year 'round—the safer, accurate, quiet, odorless, "power without powder" way.

WRITE today for "Shootin's Three Times More Fun With A Crosman Pelgun"—supply limited. Crosman Arms Co., Inc., Dept. PM-3, Fairport, N.Y.

toward the front. It is a safety feature."—Massachusetts housewife.

And More Complaints

Ford, like all cars, has faults and the owners mention them frankly in our survey. Here are more quotations describing their complaints in order of frequency.

"My convertible leaks so much I might as well leave the top down."—Louisiana juke-box mechanic.

"It's too low. I am a farmer and have to go places I can't with a low car. I also am substitute mail carrier and find the low Ford is not for dirt roads."—North Carolina farmer.

"Three persons can't sit in the front seat. The one in the center has knees too high."—Kansas contractor.

"Seats too low and entry too difficult. Too long. Too heavy."—Minnesota teacher.

"Rear floor with its three different levels makes it unpleasant at times."—Michigan bookkeeper.

"Don't like two holes in back floor."—Alabama hospital attendant.

"Front vent windows are hard to open. Wind noises from vents too great."—Michigan welder.

"Like everything about the Ford but the dealer's service."—Ohio factory worker.

"Ford sure has a poor dealer in my town."—Wisconsin scale clerk.

"Front-fender shape throws mud on top of hood."—Washington postmaster.

"Loop-twist mats hard to clean."—Maryland factory worker.

"Have hard time closing hood. Service attendants reach over fenders and scratch them and mark hood with rings on fingers as they try to get it closed."—New York owner.

"No padding on top of seats."—West Virginia millworker.

"I own two 1957 Fords. Radios on both cars are no good. Have had them in three different shops and have been told they cannot be improved."—Colorado salesman.

"Gas gauge always incorrect."—Washington, D.C., embassy secretary.

"Don't like headlights. Look like a round plug in a square hole."—California owner.

"Upper door in rear of wagon requires two hands to fasten in open position."—California executive.

"Should add handle to rear door of wagon. It's hard to open when frozen shut."—Illinois salesman.

There you have it—the good and the bad as described by the owners themselves. These quotations are the true test of a car. They describe the cars that are delivered to the buyers—as, in fact, one would be delivered to you. ★ ★ ★



Spare time income — or full-time business

CASH FILING SAWS

make up to \$3-5 an hour in home workshop
with FOLEY SAW FILER

Here is a steady CASH business you can start at home in your basement or garage, while you are working at your regular job. No experience is necessary to turn out perfect cutting saws—"the first saw I sharpened came out 100%," writes Clarence E. Parsons. Every saw you sharpen will bring you new customers. You will find you can make up to \$3 or \$5 an hour—\$20 to \$30 a week in your spare time as a starter.

With a Foley Saw Filer you can file all hand saws, also hand and cross-cut circular saws. It is easy to operate—simple adjustments—no eye-strain. Patented jointing principle evens up all irregular teeth and makes an old saw cut just like new.

This Free Book Shows How To Start Your Own Cash Business →

"MONEY MAKING FACTS" shows you how to get plenty of saws to file without canvassing, and how you can develop into a general repair shop that will be your own business. This is a helpful, practical book that tells just what to do—send for your free copy today. No salesman will call.

**FOLEY MFG. CO., 316-7 Foley Bldg.
Minneapolis 18, Minn.**

Send me free book "MONEY MAKING FACTS."

Name _____

Address _____

City _____ State _____



Easy-On Trailer Hitch

ON OR OFF
IN SECONDS

Only two simple adjustments. No Welding—No Brackets—No Bolts. Fits virtually all truck and car bumpers. Rugged, big load construction. Cadmium plated for maximum protection.

**SPECIAL
INTRODUCTORY
PRICES**

Single (for cars with
no center
obstruction) . . . **\$7.95**

Double (as shown) **\$10.95**

Deluxe Double
(36" spdn) . . . **\$13.95**



Ball Not furnished.
Prices F.O.B. New Orleans, La.

UNIVERSAL PRODUCTS, INC.

1137 Annunciation Street • New Orleans 13, La.



5-BOX DrawRacks
STACK WITHOUT SLIPPING
OR FASTEN TO WALL
The newest, cleverest, most
convenient method of
keeping your screws and
bolts handy for quick use!

stock your shop

SCREWS • BOLTS • NUTS



**59¢
PER BOX**

Look in your hardware store for the revolving display rack that contains all 40 of the most-wanted types and sizes of screws, bolts, and nuts. You get generous quantities in clear plastic boxes, brilliantly labeled for fast, accurate selection. Start to "Stock your Shop" today!

ELCO TOOL & SCREW CORP., Rockford, Ill.

IT'S HERE!

Darra-James

Motor Tools



...Power Packed Beauties
with BUILT-IN-MOTORS

CONVENIENT: Darra-James Motor Tools take the guesswork out of choosing the proper motor. They come complete with Timing Belt, Pulley and G. E. Motor with Cord, Plug and Switch. Nothing to buy! TIME-SAVING: Nothing to set up! No time lost! Simple to Operate: Just plug in, flip the switch and operate. MOVABLE: Each Motor Tool is compact—can be carried quickly and easily from one place to another. RUGGED: Entire tool is constructed of heavy-duty cast-iron to assure many years of trouble-free service. CHOICE OF COLORS: Available in Slate Grey or Woodland Green. ECONOMICAL: Cost less than similar tools and motors purchased separately. GUARANTEE: All Darra-James Power Tools are guaranteed against defects for a full five years.



8" Tilted Arbor Saw (Model 825)
A quality saw at a minimum price.



8" Tilted Arbor Saw (Model 815)
An economy saw that performs all operations of high-priced models.



4 1/2" Jitter (Model 845) Featuring Parallel Motion to maintain constant distance between table and blades at all depths of cut.

All Darra-James Power Tools
can now be purchased for
only 10% down
on convenient Credit Plan

Write today for free
folder on Motor Tools and
free folder of complete
line of Darra-James
Standard Power-Tools.

TOOLKRAFT CORPORATION

400 PLAINFIELD ST., SPRINGFIELD, MASS.



Can't read it?



next time,

say **STANLEY!**

It's not your eyes, it's those invisible markings. If you can't see 'em, you can't read 'em! Next time get a rule with markings you *can* read. Ask for a rule that lasts longer. Be precise . . . say Stanley, it's a *good* rule.

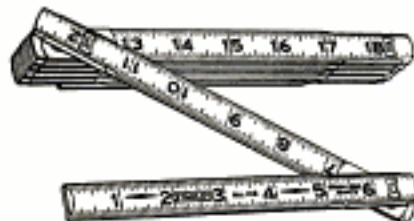

Take this Stanley 6 ft. No. 106. No comparable rule reads easier longer. It never shows early symptoms of "outside stick fadeout." The numbers are bold, black Gothic. The graduations are sharp, clear indentations. And all markings are protected with a long-wearing plastic finish. The joints are smooth working, too, and they stay that way. They have been *permanently lubricated*. Don't get your eyes checked, get a new rule, and this time say Stanley when you buy.

Have you seen the new Stanley Glide-O-Matic? This smooth acting tape rule locks blade in place, marks work with metal scribes and retracts automatically. The best in tape rules. 8, 10 and 12 ft. lengths. Try one yourself and see.



For free booklet "Measuring Tools and How To Use Them" write Stanley Tools, Division of The Stanley Works, 623 Elm Street, New Britain, Conn.

STANLEY

The Tool Box of the World

Readers Sound Off

IN THE "Detroit Listening Post" last December we asked you what you think of the '57 cars.

It's human nature that the satisfied customers don't talk as loudly as the unsatisfied. The people who like American cars buy them at a rate of 125,000 cars per week. As a sample of those who disagree with the Detroit automobile makers, here are some random excerpts from our mailbag, written to us in answer to our December question:

For years the characteristic "tails" of the Cadillac radiated aristocratic grandeur, not unlike the headlights on the front fenders of the Pierce-Arrow. I truly mourn that Cadillac is now a peon, peasant in looks.

A.W.S., Pennsylvania

☆☆☆

This year's cars, with a few notable exceptions, have too many unnecessary frills which do not make sense to the sensible. Those artificial wrinkles, nooks, crevices and fins add air resistance as well as areas to be cleaned and polished, gather dust unduly (being somewhat inaccessible), obstruct the rear view and are an eyesore (the rear end of the average 1957 car looks at you like a pig-eared donkey). The "wing" or "flight" motif is not mindful of an airplane but of the little birdie in the designer's head.

H.L., Florida

☆☆☆

What do I think of the 1957 cars? For the person who has no financial worries they may be fine, but for the person in the low-income bracket like myself and buying a house or paying high rent, well stand back—here it comes:

1. They are much bigger than necessary.
2. They cost too much.
3. They depreciate too fast.
4. Gasoline consumption too high.
5. Engineering and designing poor (other than body); steer hard, so power steering is extra; brake hard, so power brakes are extra.
6. Poor workmanship, body squeaks and rattles.
7. Some parts made to last only one or two years (mufflers and tailpipes, batteries and brake linings) could and should be improved greatly.
8. Service on new cars is very poor in most cases.

POPULAR MECHANICS

About '57 Cars

9. Wrap-around windows on some cars are hideous when door is open and dangerous getting in and out of car.

10. Engines too great horsepower, unnecessarily wasting fuel.

11. Weight distribution should be closer to 50/50 front and back wheels for better traction on snow and ice and for better handling.

My family needs transportation at low cost, trouble-free operation and ease of handling, not flashy colors and body design which is outdated in one year anyway. The cheapest full-sized car here (Ontario) costs \$2600, but after a five-minute talk with a salesman drops to \$2200. Why do these dealers fool around with this "fake list price" so much?

My 1951 Ford dropped in 5½ years from \$2300 to \$400—\$350 per year, plus repairs, maintenance, insurance, etc. . . . too much to lose.

J.H.G., Ontario, Can.

Editor's note: This Canadian reader solved his particular problem by buying a small European car which, he says, "will do everything the bigger cars do, and then some, at half the cost of operation and depreciation. We were very sorry, however, to see our money going to a foreign land instead of to Windsor, Detroit or Oshawa."

☆☆☆

There are many important and useful developments in today's cars. Perhaps most important is automatic transmissions.

The bodies are much too long and too wide. They have far too much overhang at the rear (I have seen many of them drag on sidewalks when leaving sloping driveways). What those hideous fins are for is something far beyond me. . . . The general idea of the Rambler strikes me as being just about right.

A.R.H., Connecticut

☆☆☆

The following are the features I do not approve of:

1. The added length and width since 1950 make parking and driving in congested traffic much more difficult.

2. The oversized rear fins on some models are downright unsightly and only add extra weight.

3. The over-wrapped windshields on some do not add any more to driver's visibility while making the protrusions into the front door quite objectionable.

4. Wider doors are very impractical to

(Continued to page 268)

MARCH 1957

Wonderful things happen when you put

Gold Bond TWININSULATION in your attic



- Upstairs rooms stay up to 15° cooler in summer
- Your whole house keeps warmer in winter
- You save as much as 25% in fuel bills



... and you can do it yourself in one afternoon!

Did you ever dream that just by insulating your attic with Gold Bond TWININSULATION you could make your *whole house* more comfortable?

TWININSULATION is actually *two* insulations in one. Rock wool to block heat (there's nothing better) and aluminum to reflect heat (invaluable in summer).

You just tuck the blankets of TWININSULATION® between studs or rafters and staple them in place. The Gold Bond® dealer in your town will show you how. He'll lend you a stapler, too. You can increase your home comfort by seeing him soon. And ask him for your free copy of Gold Bond's Do-It-Yourself Book. It tells why, where and how to insulate.

National Gypsum Company, Buffalo 2, N. Y.



Gold Bond

BUILDING PRODUCTS

NATIONAL GYPSUM COMPANY

267

LUBRIPLATE LUBRICANTS



Make Sports Equipment Work Better...Last Longer!

LUBRIPLATE IN HANDY TUBES is a waterproof, semi-fluid lubricant. It's white and clean, will not wash off nor run out. Reduces friction and wear, prevents rust and corrosion. Belongs in every tackle box, gun case and car glove compartment. Nothing like it . . . nothing as good.



**YOUR SPORTS EQUIPMENT
DESERVES THE BEST...USE
LUBRIPLATE...YOU'LL SEE
THE DIFFERENCE IMMEDIATELY**

At Hardware, Sporting Goods and Marine Stores

OTHER LUBRIPLATE PRODUCTS

- LUBRIPLATE 2-C MOTOR OIL for outboards
- LUBRIPLATE OUTBOARD GREASES for underwater gears
- LUBRIPLATE H.D.S. MOTOR OIL for cars, trucks and tractors
- LUBRIPLATE AUTO-LUBE "A" for general automotive lubrication
- LUBRIPLATE Industrial Lubricants for every application

LUBRIPLATE DIVISION, Fiske Brothers Refining Co.
Newark 5, N. J., Toledo 5, Ohio.

AUTOMATIC TRANSMISSION at LOW, LOW COST!

Here's the way to get low-cost, truly automatic transmission on your midget racer, power mower, garden tractor or any gas driven machine. There's no load on your engine when starting—no stalling possible. Step on the gas and this Mercury Automatic Clutch picks up the load smooth as silk. Engines do bigger jobs on less gas. Easily installed with 1 screw. 1/2", 3/8", 3/4" bores—standard 3" x AB pulley assembly. For engines to 3 1/2 HP. Send check or MO, specifying bore. **MONEY-BACK GUARANTEE!**

MERCURY CLUTCH DIVISION **ONLY \$7.95**
1201 Camden Ave., S.W., Canton 6, Ohio

open in close quarters such as garages, parking lots, at the curb, etc.

5. The oversized headlamp hoods have no practical value and only catch dirt and offer more wind resistance.

6. I do not like the hood opening from the rear on some makes.

7. I do not like the all-metal drive-selector levers; a plastic knob is easier to handle, especially in freezing weather.

8. Brake pedals on some makes with "automatics" are too small.

9. Hooded taillights on one make, and too small on others, are not in the best interests of safety.

10. Bumpers have no "give" to them and are simply massive ornaments.

11. Too much dazzling chrome trim, especially in front of the driver.

Since we are not living in a dream world why doesn't Detroit wake up and build more practical cars again instead of "dream cars."

E.M., Arizona



I've ordered a small German car.

W.W.M., California



I have never been so thoroughly disgusted as I was after looking at these new monstrosities. . . .

The way Detroit believes that style is all-important and engineering is secondary is nauseating. I, for one, am revolting against this trend.

G.F.S., New York



All the cars are becoming more and more alike. Each year they become more and more V8. Each year more power, more speed and more deaths. There is surely some other way to sell cars.

The public may turn to Europe so as to get something different in their automobiles. I along with many thousands of others have already done that.

For some time I have had features just being announced on American cars. Fuel injection, step-down floors, a frame even ahead of Cadillac's and an engine with only five moving parts. Smooth running is accomplished with only two cylinders. Cruising speed is faster than most states permit. Ride is excellent. In fact we can ride farther without tiring than in our American cars.

J.R.H., Kansas



What choice does the auto buyer have? He wants a new car and has to take what

the industry rams down his throat, and if Detroit brings out new cars with flapping wings instead of stationary ones, he has to buy them or look to the foreign market.

General Motors still has the best-balanced-looking and conservatively styled cars, without going overboard with excessive frills like exaggerated fins (except Cadillac), wagon-wheel taillights and so forth. I am thinking less of this year's Chevy whose fins I dislike, but the Olds, Pontiac and Buick still look like automobiles, not Halloween jet planes or space rockets, and GM still sells most cars. The independents have also some well-designed cars and out of principle I will always give the little guy who fights for his existence the preference. I have always liked Chrysler products but 1955 is as far as I can go with them. After that their crazy styling just hurts my self-respect. I still drive a '51 Imperial and I will stick to it because I like its conservative styling in addition to the magnificent engine and performance. Incidentally the 1956 Imperial looks good also. I have not yet seen the '57.

H.L., Florida

☆☆☆

When the auto manufacturers switched to the 12-volt battery for the electrical system it was announced as the greatest thing for the cold-morning "no start" motorist. . . . Now that the motorist has that extra six volts to play with, what do the auto boys do—you guessed it, they put two extra headlights on the front to double the current drain on the poor 12-volt battery (not to mention the air conditioners). Seems to me that this puts the motorist right back where he started as far as battery efficiency is concerned—and guess who pays for this "improvement"?

Can someone give me just one logical reason why the auto makers insist on mounting the front (and sometimes rear) license plate bracket where it is a cinch to be mangled on the first parking attempt?

K.G., Illinois

☆☆☆

Why don't they open their ears to the demands of the growing minority and give us a small car that is efficient, economical and minus all the useless trim, ultrasonic, supermatic and automatic devices that only add to the cost of the product? Give us a car that can really be called a low-priced car, one that can be handled easily without needing power steering and power transmission. There are still many of us who still have energy to shift gears.

H.S., Washington, D. C.

MARCH 1957

Fitting out your boat?



Let these 2 Weldwood Wizards work their magic for you!

Granted, you need no magic to conjure a vision of gliding downstream in a canoe . . . put-putting across a mountain lake . . . or sailing crosswind in a heeling sailboat. And frankly we hate to break the spell! But it's time to get her scrubbed, ship-shape and shiny for the season ahead. That's where these two Wizards with Wood can help you do a lasting professional job.

FIRZITE® (The beauty treatment undercoat)

Many a "see-" worthy craft owes its smooth, grain-free, paint or stain job to Firzite. Because Firzite tames that wild, unsightly, wavy grain, keeps it from showing through the paint or stain . . . practically eliminates hair-line checking . . . helps achieve a smooth-as-glass, sure-to-last finish. Don't let wavy grain spoil your paint job. Start with Firzite. Two types: Clear Firzite and White Firzite in pints, quarts and 1 gallon cans.



WELDWOOD® WATERPROOF RESORCINOL GLUE (Laughs at water and weather)



This is Weldwood's all-purpose glue for the boat owner. It is absolutely 100% waterproof. Withstands cold or boiling water . . . moist or dry heat . . . mold or fungus . . . mild acids or alkalis. Meets the most exacting government standards for marine work. So strong, it's widely used for everything from constructing hulls and decks . . . to installing cabinets and repairing windshields. No pre-heating or other materials are required. Simply mix and apply. In handy 1/4 pints, pints, quarts, gallons.

At boat yards, paint, lumber or hardware dealers or mail coupon for free leaflets.

UNITED STATES PLYWOOD CORPORATION

Box 525 - New York 46, N. Y.

FMD-75

Send me leaflets on:

Firzite Weldwood Waterproof Resorcinol Glue

NAME _____

ADDRESS _____

CITY _____ ZONE _____ STATE _____

269

The Familiar *Southern* Symbol



means Satisfaction!

When you plan your next home-shop project, or make repairs or revisions around the house, be sure you have on hand plenty of Southern Screws . . . Southern Screws are famous for Quality and Permanence—they start right, drive right and hold tight. Available at your hardware or lumber dealer's in any popular head style: in steel, brass, silicon bronze, aluminum, stainless steel. All standard plated finishes. Write today for your free copy of Southern's TC-4 Folder for home craftsmen showing how to select proper wood and sheet metal screws, drill correct size of pilot holes, etc.

SOUTHERN SCREW COMPANY

Box 1360-37 Statesville, N. C.

WOOD SCREWS • MACHINE SCREWS & NUTS • TAP-
PING SCREWS • DOWEL SCREWS • DRIVE SCREWS •
STOVE BOLTS • CARRIAGE BOLTS • HANGER BOLTS

Warehouses:

NEW YORK
CHICAGO
DALLAS
LOS ANGELES



Sold Through Leading Wholesale Distributors



A Nose for Action

...Yes, there's real action in UTICA's® Long Chain Nose Cutting Pliers.

No. 654-6

They're specially designed for year in, year out service on those hard-to-get-at jobs. And they stay sharp!

They'll cut tempered steel wire in a snap—will even cut paper like a pair of scissors.

See your hardware dealer today. Just ask for UTICA® No. 654 Pliers—they'll make your work easier!

UTICA®
Tools

UTICA DROP FORGE & TOOL CORP., UTICA 4, N. Y.

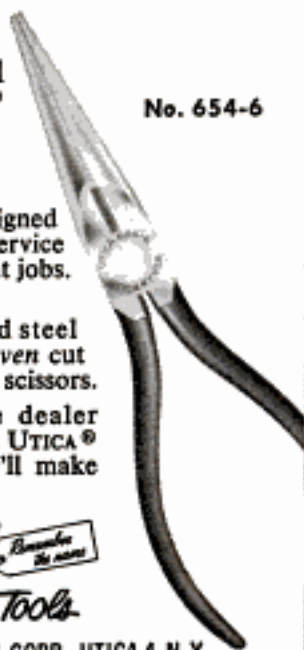

SAW SHARPENING IS EASY

Super Filer No. 11 joints and sharpens hand and circular saws 6" to 10" with all teeth correct in height, depth, pitch, bevel. When file hits steel roller, teeth are finished. Saw runs true with no side pull. Includes 8" file. **\$9.95** PPD.



"TRU-CIRCLE" saw set automatically sets teeth at 10° or more. **\$2.95** PPD.



SUPER SAW FILER No. 6

Automatically controls depth, angle, pitch for all saws. Precision made and calibrated. Use in any vise or clamp. Includes 6" file. **\$6.50** PPD.



DOWEL CENTERS

Centers inscribe exact location for opposite holes. Pairs for 1/4", 3/8", 1/2" holes. **\$1.00** PPD.

MONEY BACK GUARANTEE—CATALOG FREE

A. D. McBURNEY, 5908 Hollywood Blvd., Hollywood 28, Cal., Dept. A-37

YOUR DEALER CAN HELP YOU

He makes it his business to know the right equipment and materials for you. They're advertised in POPULAR MECHANICS



FURNITURE FOR YOUR BEDROOM

YOU'LL BE THE ENVY of your neighbors with this beautiful bedroom suite in honey maple, oak or walnut! Here's a bed with storage space . . . a three-piece vanity with cosmetic compartment and makeup mirror . . . a Mr. and Mrs. dresser . . . twin night stands with drawers!



Send for Complete PLANS Only **\$2.00**

YOU MAKE IT YOURSELF! Only two power tools, a saw and a jointer, are needed to turn out this modern bedroom furniture. No other project of Popular Mechanics Magazine in recent years has captured the fancy of home craftsmen as has this easy-to-build suite. Letters demanding detailed plans poured in after the suite was pictured in Popular Mechanics. And now the plans are ready! They're detailed scaled drawings—a complete set of 4. Send for them today!

POPULAR MECHANICS PRESS, Dept. 357
200 East Ontario Street, Chicago 11, Illinois

I enclose _____ for a complete set of plans for making the modern bedroom suite illustrated above.

Name _____

Address _____

City _____ Zone _____ State _____

WOODWORKERS CONSTANTINE'S CRAFT SUPPLY CATALOG...



CONSTANTINE has supplied woodworkers, craftsmen and industry for over 145 years at America's lowest prices. This manual is new from cover to cover. Tells how to veneer, make inlays and inlay pictures. Lists over 1,000 hard-to-get hardware and craftsman items. Section on hand and power tools. Invaluable do-it-yourself book. Send 50¢ now to pay mailing and handling (refunded on first order).

126 pages — shows rare and fancy woods and inlays in full color. Carving, hardwood, veneer, mouldings, plywood, plans, inlay pictures, projects, hardware, upholstery items, finishing materials. Everything for any hobbyist.

50¢

ALBERT CONSTANTINE AND SON, INC.
2056-I EASTCHESTER ROAD, NEW YORK 61, N. Y.

the finest
GLASS CUTTERS

are

Red Devil Tools.

ROAD TO RICHES

You can be the next uranium millionaire! Government guarantees huge bonus! PRI instruments from \$29.95. See your local dealer today! FREE CATALOG!

Write PRI, 4223 PM W. Jefferson
Los Angeles 16, California
DEALERS WANTED



Get More
Fun from
Your Home
Workshop
With

**POWER
TOOLS**
and How
Use Them



If you have a home workshop of any kind — if you are thinking of starting one — get **POWER TOOLS AND HOW TO USE THEM** by W. C. Lamme, Popular Mechanics Shop Editor. This vital book tells you how to select and how to use all types of power tools; what you can do with the tools, in the form of exciting projects, using all types of materials. One half of the book is pictures — photos, drawings and working diagrams. It covers woodworking power tools — metal working power tools — dual purpose power tools. Special "Where-to-buy-it" directory gives supply sources for all workshop equipment. 375 pictures. Send only \$2.50 with name, address and this ad. Money back if not pleased.



POPULAR MECHANICS PRESS, Dept. PM357, 200 E. Ontario St., Chicago 11

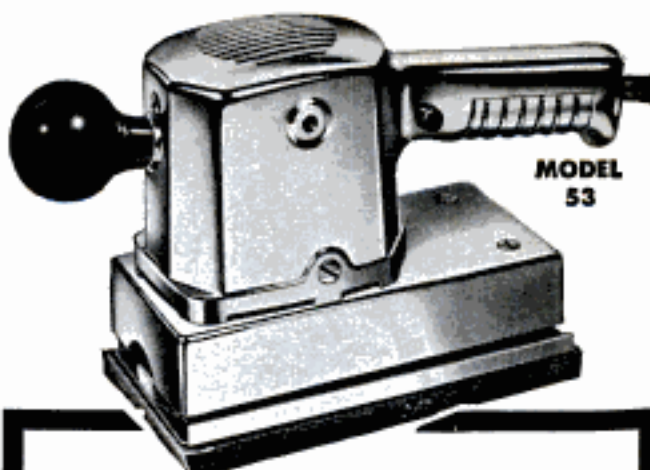

MODEL
53

The Secret of Scratch-free Sanding!

Ask any expert—the secret of a perfect finish is to sand with the wood grain! The old-time craftsman did when he sanded by hand. And so do you, when you use a Dremel Straight-Line Action Sander—except that a powerful motor does all the work.

With Dremel Straight-Line Action, you leave no cross-grain scratches or orbital swirl marks to mar the finish of your project. Three models to choose from.

Get a Dremel from your local power tool dealer. If he can't supply you, order direct from factory on 5-DAY TRIAL, money back guarantee. We ship postpaid. Write for free power tool catalog.

DREMEL Straight Line Action POWER SANDERS

Model B.....	\$14.85
Model 2000.....	\$19.95
Model 2000 Deluxe kit.....	\$24.50
Model 53.....	\$34.85



DREMEL MFG. CO.

DEPT. 117C RACINE, WIS.

MAKE \$10-\$20 AN HOUR

Full or part time, work anywhere.

Serrate and sharpen table, steak knives. Every restaurant, hotel, etc., repeat customers. Write today for proven daily profit plan. Guaranteed.



58-H So. Raymond
Pasadena, Calif.

CUTTER-CRAFT

BUILD WELDER OR LIGHT PLANT

Instruc. Incl. TYPES AMPS VOLTS PRICE
Delco FI 200 24 \$12.95
J. & Helitz or G. E. R1 300 24 \$24.50
J1, 160-250 amps, 30V. New \$15.50 used \$9.95

V-BELT PULLEY KIT. To fit R-1, P-1, G-1 or AC-DC Generators: has 2 bearing block plates, 2 bearings, V type, triple groove pulley, drive shaft & flexible coupling \$17.90.

AC-DC WELDER KIT G.E. #511. Makes ideal light plant, D.C. Welder and Battery charger. Consists of New generator rated 1250 Watts A.C., 800 cy. & 200 amps. 30V D.C., including 1 voltage regulator, 1 reverse current relay, 1 voltmeter 0 to 30 volts, 1 electrode holder, 1 toggle switch, 1 welders shield and instructions. Complete \$38.50. (AC-DC generator if bought separate \$24.50)

R-1 GENERATOR KIT. J & Helitz or G.E. 300 Amps. including same kit as above \$38.50.

GEAR REDUCTION MOTOR BARGAIN
54:1 ratio, reversible 10- to 200 RPM, runs on 6- or 12V D.C. & ppl. for 110V/A.C. \$4.50, 2 for \$7.95.

General SALVAGE CO. SALE

WATER PUMP WITH MOTOR 1/4 H.P. runs on 6-12- or 24V. D.C. Adj. pressure, 1" ports, 200 G.P.H. \$12.95, with 1/4 H.P. motor, 400 G.P.H. \$14.95

DRAINS BASEMENTS pump water, oil or gasoline with Rotary Pump #107 self priming, 400 G.P.H. 3/4" pipe ports, Adj. pressure to 100 P.S.I. approx. 5 1/2" x 11 1/2" x 7", reversible, incl. mounting base, use 1/4 H.P. motor. A \$50.00 value \$12.95.

HYDRAULIC LIFT KIT New 3 Ton cap. for hyd. press, hyd. jack, snow plow, etc. Has new weaver hyd. hand pump, 2000 P.S.I. with relief, 20" handle, 1 hyd. D.A. cylinder, 2 1/2" bore x 11" stroke, hose fittings & 1 gal. hyd. fluid complete \$28.95.

ROMEC HYD. PUMP & Motor. Positive displacement, 900 G.P.H., .28 H.P., 2500 RPM for 12- or 24V. D.C. 3/4" ports. New \$12.95.

NEW HYDRAULIC CYLINDERS

Air or Oil	Bore	Stroke	Shaft	D.	Action	Price
HH500	1 1/2"	6"	3/8"	1 1/2"	2"	\$6.50
HH500	1 1/2"	7 1/2"	3/8"	1 1/2"	2"	\$8.50
HH512	2 1/8"	4"	3/8"	2"	2"	\$6.50
HH107	4 1/2"	10 3/4"	1-5/16"	2 1/2"	2"	\$27.50
HH511	3 1/8"	2 1/2"	1 1/4"	1 1/2"	2"	\$22.50
HH111	3"	2 1/4"	1-3/16"	2 1/2"	2"	\$27.95

(7) **HYDRAULIC PUMP BARGAINS** 1500 P.S.I. MFG. TYPE R.P.M. G.P.H. NEW
Pesco Gear 1500 198 \$12.95
Pesco Gear 4900 360 \$14.50
*Pesco Gear 447 cu. in. 270 \$15.50
*Stratopower .450 cu. in. 3750 400 \$17.50
* with built in pressure control & reversible
Vickers .297 cu. in. rev. \$18.50, 410 cu. in. rev. \$16.50

NEW FOUR WAY OPEN CENTER CONTROL VALVE has built in adj. relief for 1 to 4 D.A. cylinders, 3/4" ports, 16000 \$14.50. 24W11 four way with 1 handle for 1 D.A. cyl. \$8.95.

BARGAIN HYDRAULIC MAKE UP KIT #500. Consists of 1 Bosch motor, 24V. D.C., 1 1/2 H.P. & hyd. pump 360 G.P.H., cap. 1500 P.S.I., 2 ea. hyd. D.A. cylinders, 1 1/2" bore x 7 1/2" stroke, 1 ea. four way valve, 1 ea. pressure gauge 2000 P.S.I. dial, 1 ea. purulator oil filter. Ship wt. 40 lbs. Govt. C. #500. New \$27.50. Write for bargain list.

GENERAL SALVAGE CO. CHECK OR M.O.
2922 E. 27 St., Dept. 83, Kansas City 27, Mo.

Save that PAINT BRUSH

— now more valuable than ever

Perfect
for
NYLON BRUSHES

BEFORE



AFTER

10c
25c

KEEP
BRUSHES
LIKE
NEW
WITH
DIC-A-DOO



At Paint,
Hardware, Dept.,
and 5 & 10¢ Stores

Patent Cereals Co.

Geneva, New York

Special Introductory Offer
\$5.00 OFF!

WALTCO'S

NEW

ny-o-lite

nylon
SPINNING REEL



Regular Price
\$13.50

Now Only
\$8.50

Limited Orders To The First 5 From Any County

For the easiest, most enjoyable fishing of your life, get a NY-O-LITE Spinning Reel. Needs no lubrication, nothing to rust or corrode, impossible to backlash, weighs only 5 oz., tougher than steel. 5-year warranty.

Try NY-O-LITE at our risk. Once you've proved it's the greatest reel, you'll rave about it to your friends, creating a demand for NY-O-LITE reels that WALTCO Dealers everywhere are ready to fill. For this favor from you, we'll send you this \$13.50 reel at \$5.00 OFF! . . . you send only \$8.50 postpaid (No C.O.D.'s). This offer limited to the first 5 orders from any County in U.S.A. You'll have 30 days to use it on our money back Free Trial Offer. Order Today!

WALTCO PRODUCTS, Dept. G-1
4501 S. Western Ave., Chicago 9, Ill.

SOAK 'EM

THEY
DRY OUT
SOFT



Only Wolverine's triple tanning make tough horsehide to soft—so flexible. Even dries out soft. Withstands rough wear to outlast other gloves — saves you money — Triple tanning makes it really soft.

feel that tanned-in softness

rockford, michigan

WOLVERINE GLOVES

don't say glue . . . say "Yoo-Hoo"

UHU®

GLUES
EVERYTHING
BETTER!

At variety, hardware, magazine & newspaper stores

BRONZE FOUNDRY



Schools • Home Workshops • Inventors

Make your own castings of aluminum, copper, bronze, silver. Foundry sets are available in three sizes including 2400 Deg. F. blast Furnaces. \$26.50; \$33.50; and \$46.00 f.o.b. Marysville or Lakewood. Free Circular.

KANSAS CITY SPECIALTIES CO. Dept. Box 6023, Marysville, Kans. P-3 or Box 7543, Lakewood, Colo.

HOLD-F-ZEE®

the Original AUTOMATIC GRIP
SCREWDRIVERS

FINEST
MATERIALS
AND
WORKMANSHIP



LOK-BLOK® makes blade twist and impact proof.

GRIPPER recedes deep into handle, giving full blade use.

SPECIAL BIT fits both types cross-point screws.

—YET COST NO MORE THAN
ORDINARY SCREWDRIVERS!

At Leading Dealers Everywhere

UPSON BROS., INC., ROCHESTER 14, N. Y.

POPULAR MECHANICS

Copyrighted material

WAR SURPLUS AND OTHER BARGAINS **SAVE UP TO 90%**



ARC WELDER KIT \$27.95 — build your own Complete make-up package consisting of 1 Aircraft DC Generator, Electric Auto-Lite 160-240 Amps. 24 Volt. RPM from 2600 up. 1 Rheostat, 1 Giant Toggle Switch, 1 Ammeter, 1 Shunt, 0 to 240 Amps. 1 Voltmeter, 0 to 30 Volts, 1 Electrode Holder, 1 Welder's Shield, 1 Voltage Regulator. Wiring diagram for hookup as welder. Wt. under 100 lbs. Approx. GOVT. COST \$475. Like new, perfect . . . \$27.95.

DC Generator (only) — same as above . . . if purchased separately \$12.50.

R1 GENERATOR KIT Jack & Helms or GE. Rated 300 Amps. 24-32 Volts. With same items as above incl. 300 Amp Ammeter. Approx. GOVT. COST for kit \$600. Complete kit only \$39.95. Wt. 60 lbs.

DUPONT EXPLOSIVE RIVETS! A must for the man who works with sheet metal. A hot soldering iron placed on the head of the rivet will explode and mushroom the other end of the rivet self-bucking itself. 1/8" x 5/32" x 3/16". Round and flat heads. Approx. GOVT. COST \$50.00 a 1,000. NEW, 1,000 assorted, \$5.00 pzd.

AUXILIARY POWER PLANT Mfd. by Lawrence Model C-2, Navy type 1. Engine comes complete with spark plugs, generator self starter, voltage regulator, reverse current relay, silencer case, dual scintilla magnets, Stromberg carburetor. Use as portable welder. Devolves 300 amps & more. Capacity up to 7 1/2 KW. Engine 14.5 HP. Up to 7500 Watts. Terrific as standby power supply, in boats, to power small cars, as a complete lighting system. Operates all DC equipment. Like NEW, all engines checked & run before shipment. Wt. cased 360 lbs.; wt. net 130 lbs. Approx. GOVT. COST \$4590. Now only \$187.75.

BENDIX PUMP & MOTOR Can be used for pumping fuel, oil or where-ever hydraulic pressure is required. Pump has 1" connections, built-in relief valve, adjustable up to 1500 lbs. Max. capacity 6 GPM. 1 1/2 H.P., 24 volt motor, 4000 RPM. Can be used on 12 to 36 volts. Approx. GOVT. COST \$350. NEW — \$10.95.

140-1 REDUCTION GEAR! Make your own winches, hoists, wagon unloaders, stump pullers or fence stretcher. Sturdy Aircraft quality. Built-in (removable) 24 V. AC. motor & clutch. High torque. Low speed. 100's of uses. Wght. 42 lbs. Approx. GOVT. COST \$300. Like New only \$12.00

PRECISION GROUND SQUARES Production engineer's squares. Accuracy guaranteed. Mfd. by Wright & Moore, Sheffield, Eng. Square blades, hardened & tempered. Brand NEW. Fraction of original cost. 2"—\$2.75, 3"—\$3.00, 4"—\$3.25, 6"—\$3.75, 9"—\$7.00, 12"—\$8.75.

BENDIX AIRCRAFT COMPASS For boats, trucks, cars. By Pioneer Instrument Co., div. Bendix. Mark VIII. Graduated in increments of 1°; 360°. Major graduations every 5°. Magnetic. Can be lighted with 6, 12 or 24 volt standard bulb. Flush panel mounting. Approx. GOVT. COST \$230. Perfect . . . \$10.95 pzd.

MICROMETERS Chrome plated, precision engineered, carefully tooling to give long life. All new 0-1" cap. \$2.25 ea., 1-2" cap. \$3.50.

LONG-FLUTE, HIGH SPEED DRILLS 15 assorted sizes. Up to 1 1/2". Like NEW. Approx. GOVT. COST \$25. Only \$2.50.

HIGH SPEED HAND TAPS 10 assorted, precision-ground thread. National Mfr. Like NEW. Up to 1/2". Approx. GOVT. COST \$25. Only \$2.50.

HEAVY-DUTY RHEOSTAT Designed for heavy-duty use with Air Force heated suits. Ideal for regulating voltage on electric welders, model trains, lights, generators; controls soldering irons, etc. Rated 5.75 ohms, 100 watts with double windings and dual female 25 amp, 125 volt receptacles. Size: 7" H x 3 1/4" W x 1 3/4" D. Shpg. Wt. 2 1/2 lbs. Approx. GOVT. COST \$25. Brand new, only \$1.95.

OFFSET DRIVE (180 DEG.) For use where tremendous power at low take-off RPM is desired. This unit drives through a chain of 6 steel gears rotating on 8 self-lubricating hi-speed roller bearings. Take-off shafts are 1 1/4" diameter and 3/4" diameter. Gear housing is forged, machined aluminum. Approximate GOVERNMENT COST \$75.00. NEW. \$10.95.

REVERSIBLE RACHET WRENCH For diesels, ships, farm machinery, trucks, bridges, oil fields, all heavy equipment. Terrific leverage. 4" Lowell, safety steel, sockets for 2 3/8", 2 9/16" & 3 1/8" hexagon nuts. Navy surplus. Approx. GOVT. COST \$215 a set. Wt. 50 lbs. NEW! Now \$10.95 per set.

NEW IMPROVED MAUSER-TYPE VERNIER CALIPERS Quick, handy, accurate. 6" Vernier Calipers. Glass hardened, lapped measuring surfaces. Fine engraved scales—1/1000" and 1/1000" for inside, outside & depth measurements. Friction thumb release. Larger capacity. 2 giv. adjustments. Neg. \$25. Now only \$7.95. Leather case \$1 extra.

NEW! BIG CATALOG Largest ever . . . just out . . . new low prices. Send 25c for your copy today. Prices F.O.B. Culver City unless otherwise stated. Check, cash or money order. 50% deposit for C.O.D.

AIRBORNE SALES CO., INC. DEPT. PM357
8501 Stellar Drive, Culver City, Calif.

MONEY MEN ALL FREE DATA

THE PLASTEX Industry needs manufacturers on small scale and for big production of Lamp and Clock Stands, Art Goods and Novelties in Plastex and Marble Imitation. Experience unnecessary. Use material makes regular 10c store sellers. Rubber moulds furnished for speed production. Small investment brings good returns. We are now placing big Chain Store Orders with manufacturers. Ambitious men have chance for real prosperity. Our Free booklet will interest and benefit you.

PLASTEX INDUSTRIES, Dept. A
3400 Third Ave. New York 56, N. Y.

ESHELMAN TRACTORS LOW AS \$99

Plows-Cultivates-Saws
Dzer-Harrows-Rolls
Hauls-Snow Plow
Eshelman Tractors,
Mowers for Better
Lawns and Gardens
Advertised in GOOD
HOUSEKEEPING. Thousands of
satisfied users.
Write for Free Literature.
Dept. 59, ESHELMAN, Balto, 2, Md. \$453.75

New 1957 SPORTABOUT CARS and GOLF CARS. Write for literature.

Shipping Points: BALTIMORE - CHICAGO - RENO

BUY with confidence! BUY products advertised in POPULAR MECHANICS **PM TAG of INTEGRITY**

SAVE MONEY on LUMBER with the LOW-COST BELSAW PLANER

Convert Rough and Random Size Lumber Into Cabinet Finished Stock

Now anyone can make perfect cabinet finished stock from low-cost rough lumber . . . any size up to 12 1/4 inches wide and 6 inches thick. Turn out high grade finished material at a fraction of the cost you pay lumber yards. Big 42-inch-long bed makes it easy to plane heavy, wide and long pieces . . . BELSAW self-feeds at 14 to 34 feet per minute.

USE THIS ONE LOW-COST MACHINE for Planing, Jointing, Sawing, Milling, Tongue and Groove.

You can easily make flooring, siding and many other popular patterns with your Belsaw. Your Belsaw quickly pays for itself with savings on raw materials and profits on finished stock . . . a highly profitable machine for custom work. Compare Belsaw with any 12-inch planer on the market . . . Belsaw gives you more essential features—yet costs you \$50 to \$125 less than others.

Send Today for Free Literature on the Belsaw Multi-Duty Planer.

BELSAW MACHINERY CO 2057 Field Bldg. Kansas City 11, Mo.

"DO IT YOURSELF" IT'S EASY WITH KESTER SOLDER

Soldering's really a "cinch" . . . when you use time-tested, reliable KESTER . . . available everywhere.

FREE! "Soldering Simplified" . . . 16-page how-to-solder booklet. At your dealer or write direct.

KESTER SOLDER COMPANY
4251 Wrightwood Avenue Chicago 39, Illinois

NEW! *Evans*
POWER-TAPE



**No More Pushing Blade
Back Into Case!**

Here's the greatest single mechanical advance in steel tape history! Press the button gently with your thumb — blade returns smoothly. You control the speed. Release the button—blade stops instantly. No "creep," no lost measurements! Chrome-plated case, GIANT sliding end hook — for inside-outside measuring. White steel blade, marked in inches and feet-and-inches—no figuring! Free Tenite carrying case with magnifying lens.

Only
\$7.69
(10 ft.)

Unconditionally Guaranteed
6, 8, 10, or 12 ft. lengths
Get POWER-TAPE today!
Available only at hardware stores

Evans RULE CO. Elizabeth, N. J.
Montreal, Que.



CREATE EXTRA ROOMS. Anyone can install these handsome PELLA WOOD FOLDING DOORS. Close for privacy—open for free flowing space. Ideal closures for closets, utilities, extra sleeping areas. Handsome veneers of natural pine, oak, birch and Philippine mahogany. Order unfinished and save. Factory assembled. Complete with hardware.

Pella WOOD FOLDING DOORS

FREE IDEAS—MAIL COUPON

ROLSCREEN COMPANY, Dept. 1-35, Pella, Iowa
Send free 6-page folder on PELLA WOOD FOLDING DOORS.

NAME _____
ADDRESS _____
CITY _____ ZONE _____ STATE _____



The Modern PLASTIC
for lasting Home Repairs

PERMANENTLY mends cracks or holes in wood, tile, stone or plaster. Sticks and stays put—Does not chip, shrink or fall out. Easy to use. Economical. Mold it, chisel it, polish or paint it. The big 4-lb. can is obtainable from your lumber, paint or hardware dealer at \$1.25; or will be shipped direct postpaid (in U. S.) for \$1.50. Complete satisfaction guaranteed or your money refunded.

DONALD DURHAM CO.
Box 804-T Des Moines, Iowa



**FIND THE WOOD STUD IN YOUR WALL
WITH A FORD DOWSER BALL**

Indispensable when hanging pictures, mirrors, shelves; and when making alterations. The Original Stud Finder.

YOU MAY NEED ONE TOMORROW!
The roll of the ball finds the actual STUD in the wall.

NO MAGNETS!
Only \$2.00 post. Money-back guarantee; no C.O.D.'s please. Usual trade discounts to dealers.



\$2.00
POST PAID

FORD PRODUCTS Dept. P-6
PORT CHESTER, N.Y.

NEW! PLUMB BOB REEL



PLUMBS, CENTERS, ALIGNS EXACTLY!

You can't miss with Line-Master! No re-sets! Unbreakable point drives into wood, mortar, holds fixed distance from vertical surface. Suspends perfectly from overhead line. Non-fouling reel, adjustable line drag, cast alloy case, beaded aperture, 50' nylon line. \$3.25 postpaid. Guaranteed. Send cash, check, M.O. today. No C.O.D.

LINE-MASTER, Box 3821-A3, Seattle 24, Wn.



**Heavy Duty Bench Type
ALLEN PUNCH PRESSES**

Model B-5
5 ton
\$199.50
fab
less motor

Many Popular Models
1 to 5 ton capacities
Moderate in price
Fully guaranteed

See your supply dealer
or write for free catalog
showing all models with
descriptions and prices.

ALVA ALLEN INDUSTRIES, Dept. PM, Clinton, Mo.



**BIRCH TABLE LEGS—TOPS
PLYWOOD—FURNITURE KITS**

Build attractive, modern furniture pieces with highest grade selected birch table legs. Choice of turned, tapered or bent laminated. Smoothly sanded with brackets, ready to attach and finish, 15" high. Set of 4, only \$3.75 post. Also Aluminum Folding Legs, 30" high, \$9.95 set of 4. Order now. Write for FREE CATALOG of quality furniture kits, legs, tops, plywood.

BIRCHWOOD INDUSTRIES
DEPT. 14 FITCHBURG, MASS.

**SPARE-TIME MONEYMAKING OPPORTUNITIES
READ OUR CLASSIFIED ADS**

HUNDREDS OF BARGAINS AMAZING OFFERS



Loosens Rusted Bolts
nuts, screws, "frozen" parts!

LIQUID WRENCH

The super-penetrating rust solvent that quickly loosens rust and corrosion.

AT HARDWARE STORES, GARAGES
SERVICE STATIONS, EVERYWHERE
RADIATOR SPECIALTY CO.
Charlotte, N. C.

3 OZ. CAN
30c

BRAND NEW!
"ARCO HOLE-SAW"
 with AUTOMATIC
SLUG-EJECTOR



Fits any Electric Drill, Lathe, Drill-Press or Motor. Exclusive "Slug-Ejector" pops out discs immediately—therefore works 3-times faster than other hole saws selling for twice as much. 7 shatterproof blades easily exchanged to cut 1", 1 1/4", 1 1/2", 1 3/4", 2", 2 1/4" & 2 3/4" holes thru any 3/8" stock. Safety-lock screw prevents blades from "jumping out." Incl. 3/4" drill bit. **\$7.95**

No. 600 "ARCO HOLE-SAW"—as above, but with 4 blades to cut 1", 1 1/4", 2" & 2 1/4" holes. **\$5.95**

At your dealer or order direct on our 10-day Money Back Guarantee. Send check, M.O. (ppd), C.O.D. plus post.

ARROW METAL PRODUCTS CO.

Dept. PM-3, 140 WEST BROADWAY, NEW YORK 13, N. Y.

ONE-MAN SAWMILL LOW \$50.00 AS... **50.00** DOWN



Take BELSAW Portable Sawmill right to the trees—turn out valuable lumber for home and farm—sell to local yards—make up to \$50 a day custom sawing for neighbors. BELSAW lasts a lifetime. No crew needed. Power with tractor or auto engine. Beginners get excellent results. Send today for **FREE BOOK**.

BELSAW MACHINERY CO.
 3457 Field Bldg., Kansas City 11, Missouri

G E A R S



In Stock - Immediate Delivery
 Gears, speed reducers, sprockets, thrust bearings, flexible couplings, pulleys, etc. A complete line is carried in our Chicago stock. Can also quote on special gears of any kind. Send in your blueprints and inquiries.

Send for Complete Catalog No. 10
CHICAGO GEAR WORKS
 440-50 N. Oakley Blvd., CHICAGO 12, ILL.

ELECTRIC WELDER AC or DC 110 Volts



The "Little Marvel" all-metal welder, 5-year written guarantee. Welds 1/8" metal or money back. Repairs tanks, tools, fenders, machine parts, etc. Complete with everything—rods, unit, eye shield, directions. \$7.95 plus 50c postage. Flame torch necessary for soldering, cutting, brazing \$3.95 complete with carbons, brass rods, flux. \$2.00 deposit on C.O.D. 75 ampere 1/4 inch Transformer Welder \$24.95 F.O.B.

\$7.95 Complete

ESSAY MFG. CO., Dept. 51, Quincy 69, Mass.

A BETTER DOCK
 without working in water

with
PERMA-DOCK
METAL
BRACKETS



Here's a quick, low cost way to erect and take down a stronger dock. You build wooden dock in sections, attach "Perma-Dock" Brackets, float into place on boat, drive steel pipes thru brackets, lock with set screws. "Perma-Dock" Mooring Bars safely hold boats near dock.

Write for circular on all "Perma-Dock" Marine Specialties
CENTRAL MACHINE WORKS CO. 1235 Central Avenue
 Minneapolis 13, Minn.

BOLENS

Mustang...

**THE TILLER THAT
 BUILDS
 YOUR SOIL**



- WEEDS
 - TILLS
 - MULCHES
 - CULTIVATES
- row widths up to 36" with Select-O-Width Tines

Tine action that builds soil Nature's way . . . rugged power that makes your gardening easy . . . good reason why the Bolens Mustang is today's best buy by far in rotary tillers. Three models from \$129.50. Easy time payments.

Ask your Bolens Dealer for Details

SEND POSTCARD FOR CATALOG

BOLENS PRODUCTS DIVISION
 Food Machinery & Chemical Corp.
 Port Washington 4, Wisconsin

U-MAK-IT BOAT KITS



SAVE 1/2 THE COST

Now added to the famous U-Mak-It Boat Kit line—Easy to assemble

LAPSTRAKE SKIFF KITS

Greatest line of kits in our 29 years of boat kit pioneering. 30 models — prams, row-boats, runabouts, cabin cruisers and the new lapstrake skiffs.

SEND FOR ILLUSTRATED CATALOG showing all models 8' to 23', prices, construction details, accessories, hardware, trailers, motors, all you need to build your own!

SEND 35¢ (coin) for postage & handling
U-MAK-IT products 703P Whittier St., Bronx 59, N.Y.



WARN HUBS on your

Patented



Jeep

STOP FRONT DRIVE WEAR
in 2-Wheel Drive!



Over 100,000 now in use!

That is real proof of their many advantages and rugged dependability. Warn Hubs on 4-wheel drives make steering easier, increase power, speed in high; add life to gears, tires, because the front drive stands still in 2-wheel drive—there is no drag! Use free-wheeling 2 w.d. or tractive 4 w.d. as needed, automatically,

as you shift, with Warn Lock-O-matics, through fingertip controls with Warn Locking Hubs. Factory approved. Iron-clad guarantee. Models for all 4 w.d.s. to 1½ tons. See your dealer now! Write for free literature.

WARN MFG. CO.

Riverton Box 6064A-3
Seattle 88, Wash.

THE CHOICE OF TOP CRAFTSMEN

LUFKIN WHITE CLAD MEZURALL TAPE RULES

ADD 2 INCHES FOR INSIDE MEASURE

467

YOU SHOULD EQUIP YOUR TRAILER WITH

why... BULL DOG

- AXLE ASSEMBLIES
- JACKS • COUPLERS

Straight or drop axles in single or tandem—capacity up to 10,000 lbs.—any width. Also Torq-Less Axles for all types of trailers.

JACKS—Bull Dog Jacks make hitching and parking a one-man job.

COUPLERS—Bull Dog Couplers hitch or unhitch to trailer in a moment.

Write today for FREE Descriptive folder 13C.

HAMMER BLOW TOOL COMPANY
WAUSAU, WISCONSIN

JEEP OWNERS

RE-POWER NOW with your choice of three famous V-8 engines

FORD • CHEVROLET • MERCURY

CONVERSION KITS now available to fit ALL 2 and 4 Whi-Drive Willys Jeeps. . . Priced \$43.25 to \$64.75 . . . If you want fast action tell us which V-8 engine you wish to use . . . give us the gear . . . 2 or 4 Whi-Drive . . . body style of your vehicle. Send min. \$15.00 dep. and we will ship correct kit, bal. C.O.D. Send full amount for prepaid shipment. Wire, phone or write for FREE details.

HOOSIER MACHINE PRODUCTS CO.
312 S.E. 8th St. Phone 676 Pendleton, Oregon, U.S.A.

Wholesale!

TOOLS! GUNS! CAMERAS!

AGENTS — BUY TOOLS, PHOTO EQUIP., SPORTING GOODS, JEWELRY AND THOUSANDS OTHER NATIONALLY ADVERTISED PRODUCTS AT BIG DISCOUNTS. BIG PROFITS SELLING TO OTHERS.

POSTCARD BRINGS FREE COPY "THE WHOLESALE PLAN"

AMERICAN BUYERS SERVICE

HERTEL STATION, DEPT. 15, BUFFALO 16, NEW YORK

Get up to 40% off

FIND HIDDEN RICHES!

NOW—find buried treasure, gold, silver, and metal objects, with sensational 3½-lb. locator—GOLDAK'S "FIND-IT" . . . only \$84.50 complete with earphones, batteries, instructions.

Manufacturers of metal detection devices since 1933.

Write for FREE literature full line metal, mineral locators, geiger and scintillation counter.

GOLDAK CO. 1542A-3 W. Glenoaks Blvd., Glendale, Calif.

IMPORTERS LOSS

Precision Vernier Calipers 9.50 REG. \$19.00

M.Z.B. One of the World's Finest Precision Tool Craftsmen

(2202) STAINLESS 6" 5¼" CAP. 001 & 17128"

Extreme accurate measurements with fine micrometer adjustments for measuring outside, inside & depth. For root dividing, measuring grooves, moldwork. Toolmakers, each caliper has 2 accurately divided scales and verniers. Full visibility in all positions. Clear cut markings, special chrome steel spring. Tempered throughout glass hard on all surfaces. Unconditionally guaranteed.

JOB LOT TRADING CO., Box 351, Church St. Station, N.Y. 8, N.Y.

BOAT KITS

28 MODELS—8 to 19 ft.
\$39 up—FREE FREIGHT

SAVE 2/3! Easy-to-build MAHOGANY FRAMES-DECKS

19' CRUISER KIT \$499.50!

SEND 10¢ for KIT CATALOG! Includes Hardware -Trailers-Fiberglass

BOAT PLANS-Patterns-Frame Kits

Build over 50 modern boats from large scale plans, available with FULL-SIZE patterns, new PRE-FAB frame kits! All types: prams to cruisers, 6 to 25 ft. Best buy for Amateurs! SEND 10¢ for CATALOG.

Craig Craft
Tanawanda, N. Y.

MODERN

IMPROVED LAWN MOWER SHARPENER AND BED KNIFE GRINDER

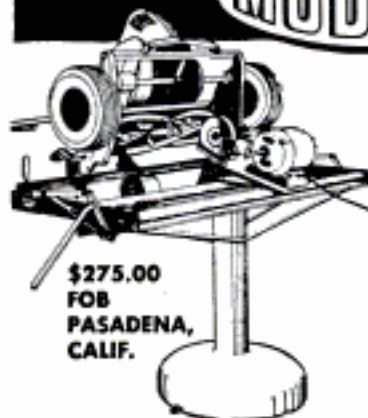

\$275.00
FOB
PASADENA,
CALIF.

Grinds any reel type mower. Hollow grinds or flat grinds bed knives. New micro feed grinding head. Sharpens hand and power mowers. No disassembly of wheels, roller, handle or gasoline engine. No draining of gasoline or oil. Precision sharpens more mowers per hour. Costs less. Compare before you buy. If it isn't a MODERN it can't be MODERN.

WRITE FOR FREE BOOKLET 10A

The Modern Lapping Machine is designed to fit the needs of any large user of mowers and the lawn mower shops. Laps any reel type mower. 1/2 H.P. motor, \$67.95 fob, Pasadena, Calif.



MODERN MFG. CO., 160 N. FAIR OAKS, PASADENA, CALIFORNIA

WELD **BRAZE**
SOLDER **CUT**



4WAY
ONLY
\$14.75
f.o.b. factory

WELDER
Complete with
Twin Carbon Arc
Torch and ac-
cessories... to
handle all metal-
craft work.

Acclaimed by thousands of Homeowners, Mechanics and Hobbyists as the welder of 1001 uses. Easily operated from properly wired 110 volt AC or DC line. The ideal gift with a life-long use... Order today on 10 day money back guarantee.

FOUR-WAY WELDER CO., Dept. F2-C
1810 S. Federal St. • Chicago 16, Ill.

GARDEN TILLERS at LOWEST COST



3 models
light weight
deep tillage
EASY gardening with 1 power tool.
EASY to assemble Model 5K only \$50.00 less engine.
EASY to operate 8" and 12" models—powerful engines.
EASY to order by mail—immediate delivery.

Also riding tractors, 2-wheel garden tractors, riding and power mowers. **SEE CATALOG.** Buy direct from:

RED-E TRACTOR CO.
RICHFIELD 9, WISC.

The NEW Hi-torque

HANDEE®

The Newest of all Hand Tools



A COMPLETE
WORKSHOP IN
YOUR HAND

The perfect power tool for model building, wood carving, costume jewelry making, plastics engraving, gift initialing, etc. Grinds, polishes, cuts, saws, routs, engraves, cleans and burnishes. Packed with speed (25,000 r.p.m.) and power.

Perfectly balanced, cool running, fits the hand for pencil point precision in delicate work. 110 volt or 220 volt (if specified) 25 to 60 cycles AC or DC.

with 6 accessories
\$23.95

With every type of cutting tool in metal case—\$32.95
Unconditionally Guaranteed

SEND ORDER TODAY!

Chicago Wheel & Mfg. Co., 1101 W. Monroe St., Chicago 7 PM-3
Rush Postpaid the following:

- Handee with every type of cutting tool in metal case @ \$32.95
- Handee with 6 Accessories @ \$23.95
- Check Money Order Enclosed Send COD
- Send Literature

Name.....
Address.....
City..... Zone..... State.....

24-Page Illustrated DO-IT-YOURSELF PROJECTS BOOK

Describes attic finishing, built-in cabinets, add-a-room, recreation room, kitchen remodeling, summer cottage and farm projects. Helpful information on how to get started, planning, cost estimating, materials purchasing, proper procedures, nail charts, moulding designs, etc. Send 25c and also receive 52-PAGE POWER TOOL CATALOG.

BOICE-CRANE CO., 943 Central — Toledo 6, Ohio



Metal Turning Lathe for Model Makers



SEND FOR FREE FOLDER describing the new Lathe for Model Makers. 15 1/4" bed with 4 1/2" swing; 7" between centers. Guaranteed. Only **\$35.00** f.o.b. Lansing.

Rosemoor Manufacturing Co.,
2501 Bernice Rd., Lansing, Ill.

Short Cuts

with **WILHOLD WHITE GLUE**
with Ortkneal



MAKE BOOK CASE without dowels or screws

You'll like it better. Simplifies woodworking. Sets quick, dries clear.

holds permanently. Illustrated, one of many Wilhold shortcuts. **FREE BOOKLET.**

Paint, Hardware, Lumber, Variety Stores. Or write **WILHOLD PRODUCTS** Los Angeles 31, Calif.; Chicago 44, Ill.

READY CUT HOMES DO-IT-YOURSELF \$AVE! \$\$\$

BUY DIRECT FROM MILL & SAVE ON LABOR COSTS

You can assemble any of the 57 designs from easy-to-follow plans. Every piece marked, easily identified, ready to erect. You don't have to measure, or cut. It's all done economically by precision production machinery (not prefabricated). Save high skilled labor costs and material wastes. Save contractor's profits and overhead. Complete with all hardware, paint, nails, roofing, glass, etc. Sterling Homes are mod-

ORDER TODAY - SAVE UP TO 40%

PRICED FROM
\$2150.00 AND UP

Send 25c

Color Catalog including Floor Plans



INTERNATIONAL MILL & TIMBER CO., BAY CITY, MICH. DEPT. PM37

ern designed for comfort and convenience. Plans sold separately.
FIVE EASY PAYMENT PLANS INCLUDING MONTHLY PAYMENT

2 WAY PORTABLE RADIO SET SENDS - RECEIVES UP TO 10 MILES AS SHOWN

with built-in antenna or hundreds of miles with outside antenna. Works on 80 and 40 meter amateur radio bands—also Aircraft and overseas broadcast bands (3 to 8 mc.) PORTABLE SELF-CONTAINED RADIO BATTERIES. NO AC PLUG-INS NEEDED! Take it with you everywhere you go—on trips, vacations, camping—Keep in contact with home, friends, Has 5 watt crystal controlled transmitter—



Sensitive Regenerative Receiver. Talk-listen switch. Wt. only 3 lbs. Size, only 6 7/8" x 4" - TESTED - PROVEN - SIMPLIFIED - PRACTICAL - Full information given on quick easy to get license. SEND ONLY \$3.00 (bill, ck, mo) and pay postman \$11.95 COD postage on arrival or send \$14.95 for postpaid delivery. Complete kit includes all parts, tube, coils, plastic cabinet, easy instructions. (Set of batteries \$2.75; crystal \$1.25). COMPLETELY WIRED AND TESTED POSTPAID \$19.95. A regular \$49.95 value—Order now before price goes up. GUARANTEED - AVAILABLE ONLY FROM:

WESTERN RADIO Dept. BNM-3 KEARNEY, NEBR.

BUY with confidence! BUY products advertised in POPULAR MECHANICS



SUPREME Versamatic

REVERSIBLE SCREW DRIVER
AND SPEED REDUCER

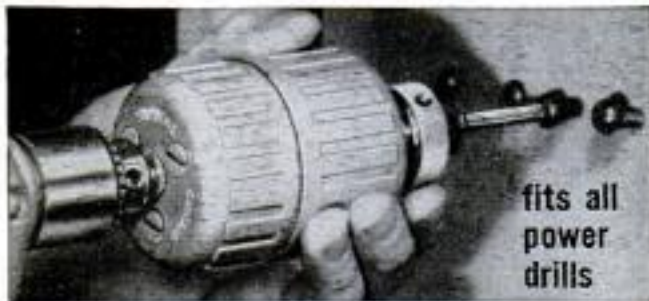

fits all
power
drills

First time ever! It REVERSES!



Drive and remove screws with Supreme Versamatic. Versamatic reduces speed 7 to 1, increases power 7-fold. Reverses with one twist. Handles even the largest screws with ease. Also for nut running (adapter furnished); tapping; and all heavy duty drilling where speed reduction is needed. Fingertip control means safe, fast work. Complete set \$14.95.

(1/2" chuck extra). At hardware stores or direct from

SUPREME PRODUCTS Corp., 2222 S. Calumet, Chicago 16

100 BEST Woodworking Projects

Selected by Popular Mechanics Editors

Enjoy the fun of making things. Revel in the pride of the craftsman when neighbors and friends admire your handiwork. Get 100 BEST WOODWORKING PROJECTS, complete with simplified instruction, plans, diagrams and more than 400 how-to-do-it pictures. Make all kinds of furniture—chairs, tables, desks, bed room furniture. Make baby carriages, clock cases, lamps, book shelves, fireplaces, attic ladder, folding screen, kitchen accessories, games, swings, storage bins, garden sets, etc., at little or no cost. Send only \$2.00 with name and address today. Money back if not pleased.

POPULAR MECHANICS PRESS, Dept. 357
200 E. ONTARIO STREET CHICAGO 11, ILL.

The "Must" for All
Home Workshops



BUILD YOUR OWN ARC-WELDER

WE SHOW YOU HOW to build powerful D.C. Welders from surplus aircraft generator. Light or heavy work. Easy to build at low cost. Worth hundreds of dollars. PLANS 35c. SEND TODAY. Includes FREE Surplus, Welder, Electrical catalogs.



LEJAY MFG. CO., 2907 EMERSON AVE. 50., MINNEAPOLIS, MINN.

BUILD YOUR OWN AUTOMATIC AIR COMPRESSOR

K-33 Complete Automatic Air Compressor Unit: Knocked Down, 3 CFM Air Compressor 1/2 HP AC Motor 5x20 Tank on Wheels: Pressure Switch, Air Regulator, Gauge, Check Valve, Safety Valve, Hose & Tire Chuck. UNIT COMPLETE (\$100 Value) ONLY \$67.50. Same as above 3/4 HP Unit 5 CFM Twin Cylinder Compressor 12x24 Stainless Tank on Wheels, All Accessories, You Assemble = \$K-75. SPECIAL LOW PRICE ONLY \$99.00.



Order from THIS AD. GUARANTEED. FOB Chicago

C. MARSHALL SALES, 3546 Fullerton Ave., Dept. P-3, CHICAGO 47

BIGGER! BETTER! FINER! FASTER!

PENN YAN boats

... this year's line of leaders includes luxury outboard runabouts, Trailboats, Cartops® and canoes. Types for cruising, fishing, skiing, racing. New work-free, leak-proof constructions, new treatment with germicide under pressure that proof-tests, adds years to boat life.

FREE
CATALOG:
44 pages, color
illustrations.

Write Today!
PENN YAN BOATS, Inc.
34th St., Penn Yan, N.Y.



POPULAR MECHANICS

**CHROME VANADIUM 60 Pc. Set WIRE GAUGE
29 Pc. DRILL SET CHROME VANADIUM DRILLS**

Special made for speed drilling. In sturdy plastic tool roll. Finest alloy steel drills hardened and precision ground to the sharpest, longest lasting cutting edge obtainable; will easily and cleanly bite through hardwoods, plastics, aluminum, iron and the toughest steels. Unconditionally guaranteed for thousands of drillings. Full jobber length. Sizes by 64ths from 1/16" to 1/2". NOW... **\$6.49** ppd. Also available with Turned Down Shanks to fit all 1/4" drills. In individual pocket roll... **\$8.95** ppd.

Top quality German import high test Chrome Vanadium Drills designed for speed drilling through toughest steels, woods, plastic, iron and aluminum. Precision ground, long-lasting cutting edges. Guaranteed to give years of satisfaction. A full 60 pc. set, Nos. 1 through 60. A \$14.95 value—**\$5.40** NOW ONLY... **\$5.40** PLUS 35c PP. & HDLG.

Name set above available with Huet Metal Index container. Only... **\$6.65** PLUS 35c PP. & HDLG.

**Also Available
20 Pc. Set - Nos. 61-80
WIRE GAUGE DRILLS**

Finest steel! Tops for precision work in woods, plastic, iron, aluminum, etc. Includes plastic kit with marked pocket for each drill. **\$2.50** ppd.

7 POWER Illuminated Loupe



A precision-built 7 power magnifier with built-in light so every detail stands out clear regardless of outside light! Coated lens. Opening in housing permits use with other instruments. For stamp collectors, banks, textile field, photo retouching, model work, students, lathes, machine shops, auto mechanics, jewelers, etc. Lens diameter 1-3/16". Removable linen tester plate for counting threads. Worth **\$4.95** ppd.

Also Available - 5 x 50 Power Illuminated Loupe - Same features as above except lens dia. 1 1/4". Use where wider field of vision less magnification is needed. Black and silver finish. Batteries not included. Worth **\$10.95!** NOW only... **\$4.95** ppd.

Send Check or M.O. C.O.D. fee extra. **MONEY BACK GUARANTEE**

SCOTT-MITCHELL HOUSE, INC. DEPT. M-327, 611 BROADWAY NEW YORK 12, N. Y.

ESHELMAN ELECTRIC STARTER GENERATOR

Push-Button Starting For Small Engines
Generator Charges Battery As Engine Runs

Electric starter ends pull cord or crank starting. For tractors, pumps, mowers, etc. Powered by 12 volt car battery. Trouble free, V-belt drive. Battery operates lights, radio. Generator recharges battery as motor operates. Write for free literature. State engine make. Dept. 385, **ESHELMAN**, 109 Light St., Balto. 2, Md.



Shipping Points: BOSTON BALTIMORE - CHICAGO

NEW CARPENTER'S SQUARE WITH INSTRUCTIONS

VISIBILITY • NO-RUST • LIGHTWEIGHT
EASY-TO-USE • NEW ANGLE MEASUREMENTS **\$3.25** ea. only

48" NON-RUST STRAIGHT EDGE FAIRGATE METAL RULE

BE EFFICIENT - WORK BETTER - QUICKER - NEATER - WITH FAIRGATE. LOOK FOR THE FAIRGATE NAME. 36"\$2.25 60"\$4.50 72"\$6.50 **only \$3.50** ea. SEND FOR CIRCULAR

The FAIRGATE RULE COMPANY
Cold Spring On-The-Hudson, New York Dept. P.M.
SEE YOUR DEALER

MARCH 1957



HERE'S YOUR COMPLETE POWER TOOL WORKSHOP

FOR ONLY **\$7995**

FACTORY TO YOU

8" SAW

- TRY SUPERSHOP FREE
- WE PAY FREIGHT
- YOU BE THE JUDGE
- EASY PAY PLAN

• Why does Power Tools Inc. make such an unusual offer? Our business is manufacturing and selling power tools direct to people like yourself. We have had experience with hundreds of thousands of people regarding their home workshop requirements. Supershop meets these requirements. This has been proven.

The combination of direct selling, advanced design and efficient manufacturing enables us to give the greatest power tool value in America today. That is why we have the courage to make you this offer.

This free trial is truly free. The machine is prepaid to your door and if it does not satisfy you, you return it at our expense. If you keep Supershop you pay the low factory-to-you cash price — or easy payments to fit your budget.

Write for free information. Mail the handy coupon — or send a postcard. We'll mail you colorful brochures on Supershop — and full details on the FREE TRIAL HOME OFFER. Absolutely no obligation.



1/2" DRILL PRESS



8" SANDER



30" LATHE



8" GRINDER

POWER TOOLS INC. 193 YATES AVE. BELOIT, WISCONSIN

POWER TOOLS INC • BELOIT, WIS.

Send me your FREE brochures on Supershop and complete information about the Free Home Trial Plan. I am under no obligation.

NAME _____
ADDRESS _____
CITY _____ STATE _____



Just pull the trigger...
spray paint!

The easier, better way to paint! Job's done in minutes. Finish is smooth, flawless. Speedy Sprayer is a real professional tool, favorite of craftsmen for over 35 years! At stores everywhere. \$90 Outfit, including gun, hose, less motor, only \$39.95

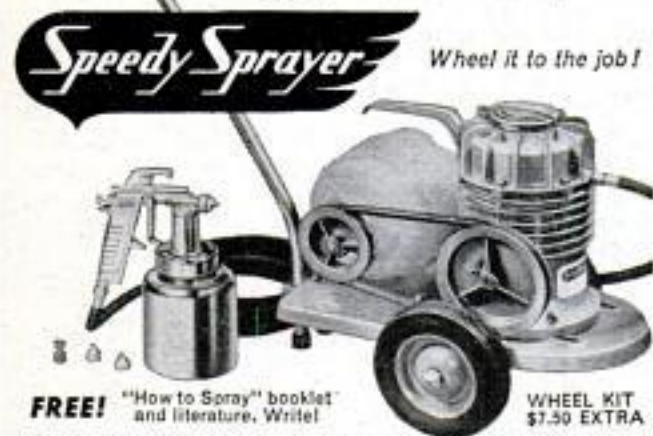

FREE! "How to Spray" booklet and literature. Write!
WHEEL KIT \$7.50 EXTRA

W. R. BROWN CORP., 2635 N. Normandy, Chicago 35

Jet King
POCKET-SIZE
BUTANE
BLOW
TORCH

SOLDERS!
BRAZES!
FIXES LEAKS!

ONLY
\$1.95
WITH CHARGER

Every do-it-yourself and hobby fan needs this **Kidde JET KING** butane Blow Torch. Just the tool you've been looking for to do dozens of jobs in home or hobby... TV, appliance, lamp, radio or plumbing repairs... precision soldering, brazing or metal craft. Useful, too, for starting charcoal fires. A tiny, clean, safe charger does the job.

Each charger gives 30 minutes of intense 3500° pinpoint flame; turns on and off. Extra chargers, 39¢ per box of 2. Money back guarantee. At leading hardware and hobby stores... or send check or money order, we pay postage.

Kidde KIDDE MANUFACTURING CO., INC.
Dept. PM-3
42 Farrand Street, Bloomfield, N. J.

Please send me _____ JET KING BLOW TORCHES plus: _____ boxes extra chargers (limit 2 boxes per torch). My check , money order for \$_____ is enclosed.
Name _____
Street _____
City _____ State _____

115 Volt, A. C., ELECTRIC GENERATORS

60 Cycle, Single Phase, Continuous Duty



750 Watt Cost \$115.00 **\$59.50** PPD.
1000 Watt Cost \$150.00 **\$79.50** PPD.
2000 Watt Cost \$235.00 **\$133** PPD.

BRAND NEW SURPLUS FULLY GUARANTEED

Ideal as a permanent or stand-by unit for electricity IDENTICAL to house current. Perfect for farms, camps, aboard ship, oil fields, mines, etc. Easily handles lights, refrigerator, deep freeze, oil burner, radio; power for saws, floodlights, drills, pumps, etc.

All ball bearing. Operates at 3600 R.P.M. Drive with 2 HP to 3 1/2 HP or larger engine—or use power take-off. Voltage self regulating. Standard base mounting. Two outlets. Modern, compact design. Tremendous overload capacity. Operates in either direction!

SUPPLY LIMITED! WE PAY SHIPPING! ORDER FROM AD FREE CATALOG OF OTHER SURPLUS, HYDRAULICS

ROBERTS ELECTRIC CO., Dept. PM-578, 849 W. Grand, Chicago 22, Ill.



SAVE 60% ON SAW BLADE COST

WITH HEINEMANN'S **HARD-TIP** SAWS

HEINEMANN SAWS
STA. 8, CANTON, OHIO



DRAINS cellars, cisterns, wash tubs; **\$7.95**
IRRIGATES - CIRCULATES - SPRAYS

Up to 3,000 GPH; 450 GPH 80' high; or 1800 GPH from 25' well. Use 1/6 to 3/4 HP motor. Coupling included free. 1" inlet; 3/4" outlet. Stainless steel shaft. Won't rust or clog... Type P—\$7.95.
CELLAR DRAINER KITS (less motor)
"Low Boy"—15" high, 1500 GPH..... \$12.95
"High Boy"—32" high, 3,000 GPH..... \$15.95
Postpaid if cash with order. **MONEY BACK GUARANTEE**
LABAWCO PUMPS, Belle Mead 7A, N. J.

LIFE-LONG DURABILITY



They last and last. Trouble-free service year in and year out. Free catalog to toolmakers and machinists.

GERSTNER TOOL CHESTS
457 Columbia St., Dayton 7, Ohio



SURPLUS SALE

\$39.50 NEW TOOL POST GRINDERS
REGULAR PRICE \$125.00
1-6 H.P. MOTOR
Less Grinding Wheel
TAKES WHEELS UP TO 1 1/2"x4"
EXTRA GRILL EXTERNAL OR INTERNAL \$19.50
MONEY BACK GUARANTEE
EDWARD J. NOLAN, PULASKI, NEW YORK

HELPFUL BOOKS

Send post card asking for **FREE** catalog

Popular Mechanics Press, 200 E. Ontario, Dept. 601, Chicago 11

NOW! It's EASY To REMOVE STUMPS With "MAGIC" STUMP REMOVER

All you do is pour "Magic" Stump Remover—a new, quick-acting chemical compound—into hole drilled in center of stump. Wood fibres soon decompose all way to root tips, making removal easy... even for women and youngsters!
SPECIAL TRIAL OFFER: 8-oz. Can (enough for one stump)—\$1.50; 16-oz.—\$2.50; 3 lbs. \$5.00. Send no money! Pay postage and 10¢ p.p.s. (Or send full amount with order for postpaid delivery.)



No Digging! No Chopping! No Blasting!

FREE! Generous sample of "GRO-GREEN," new liquid lawn fertilizer, with each Stump Remover order.
H. D. CAMPBELL CO. Rochelle 43, Ill.

POPULAR MECHANICS

3400 RPM 1/2 HP. POWER SAW



RIPS - CROSSCUTS

CUTS A FINISHED 2x4 LIKE A KNIFE THROUGH BUTTER

COMPARES TO SAWS SELLING UP TO \$49.50 **1998** Complete with 5-1/2" Blade

A rugged, professional type, adjustable saw. Will cut any angle from 0 to 45°. Has an adjustable (0 to 6") rip fence. Safety-trigger switch on handle. Full 1/2 HP Universal AC-DC, 110-120 Volt, 60 cycle motor. Weighs only 6 1/2 lbs. Thousands already sold. Your satisfaction guaranteed.

EXTRA SAW BLADES - Available in Rip, Crosscut or Combination. Please Specify **235EA.**

NEW POWER SAW BENCH TABLE

This sturdy, precision made bench-saw table converts our famous power saw (above) to a handy bench saw. Permits angle and level cuts, rip, crosscut & comes with rip fence and mitre guide. 14" x 16" table, 6" high.



NEW ONLY 995

GENUINE SELECT PHILIPPINE MAHOGANY PLYWOOD

For Paneling Dens, Offices, etc. Use in Cabinets, Furniture, etc. Rotary cut. Both sides sanded. Bonded with the finest resin adhesive. Face side unjointed. Shipped at lowest, truck rates.

SAVE 50%

3mm (1/8") x 3FT. x 6FT. **179 PER SHEET**
\$500 VALUE
MINIMUM ORDER 8 SHEETS

FREE SAMPLE ON REQUEST
1/2" x 4FT. x 8FT. **950 VAL.**
MIN. ORDER 4 SHEETS **449 PER SHEET**

SAVE 50% ON TRANSLUCENT FIBERGLAS PANELS

Finest quality. Available in many widths and lengths. Excellent color selection. Ideal for home, office, etc. FREE sample and booklet. **49.50 85c VAL.**

NEW 9 INCH NAVY SURPLUS PROJECTOR LENS

Originally used as Motion Picture Projector Lens. Contains the very finest coated optical lens in a precision machined, stainless steel barrel. Has 9" focal length. 1-1/2" lens diam. Ideal for use on a 35mm Slide Projector or for 2 1/2" x 2 1/2" to 4" x 5" transparencies. **1595**

NEW 10" f/4.5 EYEMAX TELEPHOTO LENS

Made for Bell & Howell Eyemo Camera but easily adapted to any single lens camera with a 25mm (or larger) lens diameter. 10" focal length with fastos from 4.5 to 22. Makes a terrific telephoto lens for all cameras up to 5" x 7" size. Overall length 10". Comes with built-in sunshade. Brand NEW! Guaranteed Perfect! **6750**

HARDWOOD LEGS WITH BRASS TIPS

Of selected, seasoned hardwood. Beautifully turned and smoothly sanded. Complete with brushed brass tips and steel mount plate. Unfinished or finished in Blonde, Silver Fox, Mahogany or Charcoal. Please specify when ordering. . . . Price per set of 4 with brass tips

SIZE	FINISHED	UNFINISHED
4"	\$2.65	\$2.15
6"	3.00	2.45
8"	3.55	3.00
12"	3.95	3.55
14"	4.40	3.95
16"	4.75	4.40
18"	5.35	4.75
20"	6.25	5.35

FREE CATALOG !!
BUILDING SUPPLIES, Foam Rubber, Fibreglass panels, Plywood panels and hundreds of Housewares and Home Repair Items of SAVINGS to 85%.

SAVE UP TO 85% ON GOVT SURPLUS



U. S. CORPS of ENGINEERS
SPECIAL ONLY 295 12.95 VALUE
CLINOMETER
Ideal for preliminary survey work. Reads approximate elevation or depth of any point on the horizon. Also gives the degree of incline or decline. Only 2-3/8" in diameter by 3/8" thick - easily fits in a pocket. Internal scale reads negative and positive level. When reading has been obtained, internal scale may be locked in position for reference. Depressing a button on top of case locks scale. When pressed again, scale is free to move.

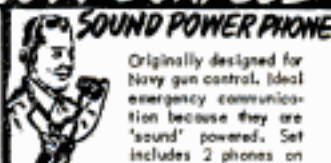

SOUND POWER PHONE
Originally designed for Navy gun control. Ideal emergency communication because they are 'sound' powered. Set includes 2 phones on chest plate, 2 headset & approx 35 ft. of wire. **995 PER SET**

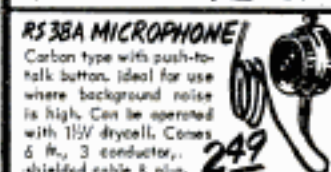

RS 38A MICROPHONE
Carbon type with push-to-talk button. Ideal for use where background noise is high. Can be operated with 115V drycell. Comes 6 ft., 3 conductor, shielded cable & plug. **249**

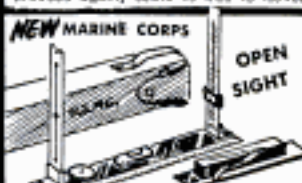

NEW MARINE CORPS ALIDADE & COMPASS
Base rule is made of solid brass with an etched 10" scale divided in mils. Designed to mount on plotting board. Has a vertical elevation scale of one end with cross-hair adjustable alignment and is divided in 10 mil segments. Base has built-in bubble level. Comes with a precision magnetic N-S compass. Open sighting type with notched sights. Comes in a genuine Leather Case. **995**

SURPLUS HOISTS

5 TON HOIST
\$100.00 VALUE **69.95**
A real heavy duty Hoist, Mfg. by the Seattle Chain & Mfg. Co. Crank operated. Has two speeds one for rapid lift - other for heavy duty. Drum size: 3-3/8" x 5" diameter. Complete with hand brake and handle.
3 TON WINCH HOIST - With crank type handle and ratchet brake. In excellent condition. Ideal for truck or jeep mounting. **3995**



CONVERTED NYLON PARACHUTE CAR COVERS
Protects your car from all kinds of weather. Converted to give snug fit and goes on easily and quickly.
For Ford, Chevy, Plymouth, Nash Rambler, etc. **ONLY 795**
For Dodge, Buick, Chrysler, Cad. and other large makes. **895**

SAVE ON HYDRAULICS

40,000 PSI THRUST HYDRAULIC CYLINDER
A Gov't Surplus Bargain! Produces up to 40,000 lb. thrust with a 3000 PSI line pressure. May also be used as a low pressure AIR OPERATED cylinder. Has a 4" bore and 18" stroke. Overall length is 30". These are all new. **4995**

SAVE ON METAL WORKING CARBON STEEL TWIST DRILLS

Made by Cleveland, Morse, etc. All are unused and in excellent cond. 3/16" Aircraft, threaded shank - 74¢
1 1/16" with tapered shank - 89¢
5/16" with tapered shank - 99¢
Hundreds more in stock. Write for our complete list of sizes and prices.

10,000 PSI HAND PUMP & RESERVOIR

For use with a short stroke press or as a static pressure booster pump. Reservoir mounts vertically and has capacity of 45 cu. inches. Has two position handle. **1975**

SEND FOR HYDRAULICS CATALOG OF PARTS & EQUIPMENT - FREE!

Palley's

2260 E. VERNON AVE. DEPT. PM-3
Los Angeles 58, California

Order From This Ad. Pay by M.O. or check. P.O.'s except from D&B firms. 3 deposit with C.O.D.'s. All Prices FOB Los Angeles.

"FIRE UP"

YOUR ENGINE AT ALL SPEEDS WITH AUTO-LITE RESISTOR SPARK PLUGS WITH

POWER TIP

LOOK FOR THE PROTRUDING TIP!

earn BIG PROFITS



Sharpening Hand Saws

The Foley Saw Retoucher cuts perfect new teeth right over old ones in less than 1 minute, without removing saw handle. Makes filing easy. Takes all hand saws 4 to 16 points per inch. Relieves eye-strain. No experience needed.

FREE Foley Price Guide of saw sharpening charges. A valuable chart of actual prices. Send coupon today. No salesman will call.

FOLEY MFG. CO. 370-7 Foley Bldg., Minneapolis 10, Minn.
Send FREE Price Guide and Foley Retoucher circular.

Name _____
Address _____



ESHELMAN TRACTORS

For Better Lawns and Gardens Investigate Eshelman Riding Rotary Mowers, Tillers, Tractors. Advertised in GOOD HOUSEKEEPING. Thousands of Satisfied Users. Write for Free Literature.
Dept. 60, ESHELMAN, Balto. 2, Md.
Riding Mower \$187.50

Shipping Points: BALTIMORE - CHICAGO - DENVER

24 Drilling Combinations with Parker No. 4 Wood Screw COUNTERSINK BIT SET



Drills and countersinks to flush, putty or plug depths for 8 most popular screw sizes. Depth-a-dapter adjusts easily on all 4 bits.

At your
hardware
Dealer's
Only
\$1.70
per set

PARKER MANUFACTURING CO.
WORCESTER 1, MASS., U.S.A.

MODERNIZE WITH MARLITE



...takes years of wear, minutes of care!

Easy-to-handle Marlite paneling—in luxurious wood finishes, distinctive marble and plain-color patterns—will give any room in your home an exciting new personality. Quickly installed over new walls or old, Marlite eliminates plastering, painting, papering. And the melamine plastic finish shrugs off scuffs, grease, moisture; cleans with a damp cloth. This weekend, finish a room with Marlite. See your lumber dealer, or send 10c for 16-page, full-color decorating book to Marlite Division of Masonite Corporation, Dept. 342, Dover, Ohio.



Marlite

plastic-finished
WALL and CEILING PANELING

ANOTHER QUALITY PRODUCT OF MASONITE® RESEARCH

STOP SAGGING REARS!



with
LOW-COST

AIR LIFT PNEUMATIC SPRING BOOSTERS

Car got that "middle age spread" look? Even new cars need help for overloads of luggage, equipment or extra passengers. AIR LIFTS fit between leaf springs and frame — inflate with air to support overloads up to 1000 lbs! Perfect for vacation trips, and so easy to install. See your dealer or write for his name.



FREE . . . tip-packed literature on Air Lift remedies for sagging rears. Write Dept. 413.



AIR LIFT COMPANY,
LANSING, MICHIGAN

FREE

WHOLESALE CATALOG

get up to
50%
off

MAKE MONEY!! SAVE MONEY!! Buy Tools, Hardware, appliances, photo equipment, sporting goods, power tools, paints and thousands of other nationally advertised products at WHOLESALE COST TO YOU.

SEND FOR FREE 1957 WHOLESALE CATALOG TODAY

SILVO HARDWARE COMPANY
Dept. PM3, 106 Market St., Philadelphia 6, PA.



PAGE FOR TILLING
PLOWING
MOWING

FULL LINE
2 to 6 HP
with complete
gear drive
and reverse.

Free Catalog
LOW PRICES
EASY TERMS
Over 30 Years
Experience

FULLY GUARANTEED!
Over 60
attachments
available!

PAGE 1904-M 5.81st STREET
MILWAUKEE, WIS.

AUTOMATIC

MAKES NEW
PROFITS

RETOOTHER

for HAND SAWS

Cuts new teeth in 50 seconds — only size 4 to 16 points. Old teeth fall off or chip. Easy to operate. A perfect job.



BURR MFG. CO.

8933-M VENICE BLVD. LOS ANGELES 34, CALIFORNIA

POPULAR MECHANICS

PORTABLE LIGHT PLANTS

1500 WATT PLANT
115v. 60 cyc. AC Push Button Start. Powered by a 3 1/2 HP. Clinton engine. Combines big output with easy portability. Provides emergency power for operating any oil burner, sump pump, freezer, television, lights, communications systems, etc. which require up to 1500 watts. (Item 22) Wt. 110 lbs. Reg. \$475 value, Factory price... **\$239.50**



1750 Watt Plant Powered by 4.5 Briggs engine. Electric starting & battery. Charging built-in. Factory price... **\$279.50**

MASTER-LITE 2500 Watt Plant
110/120 v. 60 cyc. AC. A powerful plant, ruggedly constructed and yet designed for easy portability. Can be started by rope or built-in 12 v. electric push button starter. Built-in winding to charge battery. Powered by a big 8-10 HP Briggs engine, complete with all accessories. Includes control box, voltmeter, and handy plug-in power receptacle. An ideal plant for permanent or stand-by service. Wt. 225 lb. Reg. price \$648.00 (Item 21) Factory Price... **\$329.50**



(Item 21)

DUAL VOLTAGE 110/220 — \$30 additional.

EXTENSION CORD

Heavy duty and very flexible. Neoprene 14-2 cable, 20 year quality. Wt. 12 lbs. (Item 185) 100 ft. Complete with rubber plug and outlet. A terrific buy at only **\$8.95**



No. 10-2 Power Cable. Heavy duty, very flexible, 20 ft. with male and female fittings. Wt. 4 lbs. (Item 818b)..... **\$5.15**
20 ft. without fittings (818a)..... **\$4.15**
50 ft. (Item 502) with fittings..... **\$13.45**
100 ft. (Item 135) with fittings..... **\$25.95**

No. 12-2 Power Cable. Very flexible rubber covered, special outside shield for grounding power tools, etc. 50 ft. (Item 199) Wt. 8 lbs. **\$6.95**. 100 ft. (Item 200)..... **\$12.95**

No. 8-2 Conductor Power Cable. 30 ft. heavy duty, very flexible rubber covered with male & female plug (Item 817)..... **\$12.95**

"RIGID" PIPE STRAP WRENCH

This new, unusual strap wrench grips pipes, nuts, and large fittings vise tight without tearing. Ends all marring and slipping on polished or chrome pipes and fittings. Takes all the sweat out of cleaning sink traps, handling nuts, large unions, fittings, etc. where ordinary wrenches are not big enough. The harder you pull, the tighter it grips. Big 12" handle and 1 1/2"x24" heavy web strap will last a lifetime! Wt. 3 lbs. (Item 382) Reg. \$3.95. Our special... **\$1.95**
Super 15" model—larger for more leverage and bigger fittings. (Item 383A)..... **\$2.95**



MASTER DC ARC WELDERS

Now! a portable rugged, industrial type welder with terrific performance, yet at a price hundreds of dollars less than you'd expect. Senior model made for years of trouble-free, continuous service. High capacity DC welding unit enables you to tackle any job with confidence—easily welds anything up to 2" plate using from 1/16" to 1/4" rods. Built-in stabilizer and cooling system makes are easy to strike and hold. Dual control rheostat provides low heat soldering, brazing and welding from 30 to 300 amps. Complete with instructions, guarantee and triple V-belt or flat pulley. Easy to hook up and easy to operate. **WELDER ONLY — DUAL CONTROL MODEL.** Same as above, but drive with your tractor, jeep or gas engine of 14 HP or more. (Item 386) Wt. 110 lbs. \$450 value... **\$119.50**

WELDER ONLY — 400 AMP. MODEL same as above but with ceramic rotary type rheostat providing 74 different heat settings for all types of welding (Item 388) \$500.00 value... **\$139.50**

COMPLETE POWER MASTER (illustrated above) powered by a 14.6 hp., air cooled Wisconsin engine. Wt. 480 lbs. (Item 280) Complete with welder costing \$1200. Factory Special... **\$449.50**

WELDING KIT Two 10 ft. leads, welding helmet, electrode holder, ground clamp. Sold only with welder at... **\$10.50**

BUY
at dealer prices

direct from
MASTER MECHANIC'S
factory
700 WATT PLANT

(Item 24)

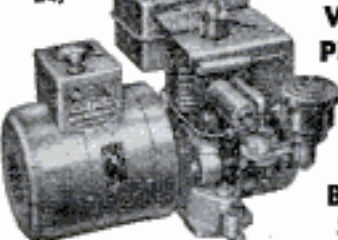

PUSH BUTTON START

115 v. 60 cyc. AC Powered by a rugged 2.2 HP. easy starting Briggs engine. No wiring necessary! Just plug in and operate. Plenty of current for any oil burner, freezer, brooder, emergency lights, etc. which require up to 700 Watts. Ideal for television and radios. Complete with voltmeter and built-in winding to charge 6 v. auto batteries. (Item 24) Wt. 75 lbs. Easily fits in car trunk. Be prepared if storm knocks out power lines. Regular \$275.00 value... **\$143.50**
1200 Watt Plant (Item 45) same as Item 24 but larger generator and engine with 50% greater output... **\$199.50**

Double Acting Hydraulic Cylinder



A powerful cylinder mfr'd. by Massey Harris which develops both a pushing and a pulling action. Will push 8,100 lbs., with a 1000 PSI pump pressure. Cylinder in 3 3/4" O.D. with 6 1/2" stroke—standard heavy duty clevises on both ends. Has standard 1/2" pipe thread openings. Can be used for tilting buckets or blades, raising or lowering implements, hydraulic presses, etc. Can also be used as an air cylinder. (Item 802) Wt. 17 lbs. Reg. \$68 value, Special... **\$14.95**

OTHER DOUBLE ACTING CYLINDERS

8" stroke — 3" bore	\$34.00
10" stroke — 3" bore	34.80
12" stroke — 3" bore	43.00
24" stroke — 3" bore	47.50

HYDRAULIC CONTROL VALVE — 4 way open center valve with built-in adjustable relief. Controls 1 double, or 2 single acting cylinders. Equalizing feature permits easy control even under heavy loads. 3/4" pipe thread on inlet & outlet. 1 1/2" mounted, finger tip control. Wt. 16 lbs. (Item 822)..... **\$21.50**

SCREW-TYPE PRESS

A tremendously powerful press capable of exerting nine tons of pressure. Pays for itself straightening bent parts, or pushing out bearings and bushings. Ideal for manufacturing and assembly operations because of precise control. Massive 1 1/2" screw permits precise control over vertical travel. Extra heavy ribbed yoke has a throat 2 1/2" high—depth capacity for working to the center of an 11" object. Includes 8" x 15 1/2" vise-type table and two pushing arbors. Wt. 150 lbs. (Item 797) Reg. \$149.50. Special... **\$49.50**

HYDRAULIC PRESS. Nine ton capacity. See Feb. Pop. Mech's ad for details—or write, Complete, Wt. 110 lbs. (Item 464)..... **\$69.50**

RUBBER HOSE

Genuine Neoprene Hose — outlasts ordinary rubber 3 to 1. Reinforced with super tough cotton cord plies—yet completely flexible. Equipped with standard thread male and female fittings. Pump water for irrigation, stock tanks, home, barn, fire fighting, etc.—or pump gas. Factory prices—save more inside! Dia. Length Price

1"	10 ft.	5.95
1 1/4"	10 ft.	8.95
1 1/4"	25 ft.	12.95
1 1/4"	50 ft.	24.75
1 1/2"	100 ft.	49.95
1 1/2"	10 ft.	10.95
1 1/2"	25 ft.	14.75
2"	10 ft.	16.50
2" (no cord plies)	10 ft.	9.50
2" (suction)	14 ft.	21.50
2 1/2" (discharge)	10 ft.	21.75
3"	10 ft.	25.50

TERRIFIC VALUES!

and fuel oil. Volume factor 60%.

LESS THAN WHOLESALE

GIANT 2500 WATT PLANT

110-120 v. 60 cyc. AC. absolutely the best made — exclusive dynamically balanced armature; heavy windings develop up to 1000 watt overload for motor starting. Skid mounted — portable. Powered by an easy starting Briggs or Wisconsin 6 HP engine—complete with all accessories; engine easily disconnected for other uses. Big outlet box, voltmeter, no wiring necessary. Ample current for all purposes. Factory warranty. (Item 31) Wt. 210 lb. Reg. price \$585. Special at... **\$299.50**

Same plant with electric self starter (Item 31a)..... **\$359.50**

Generator only and control box.... **\$169.50**



DIESEL LIGHT PLANT

(Item 1660) Diesel Master—11-12 kw. 110/220 v. AC single or 3 phase. 1800 rpm direct connected. Electric self-starting. Engineered for permanent power where continuous low-cost, heavy duty service is important. Wt. 1350 lb. Reg. list \$3650.00. Factory Price... **\$1995.00**

We make every type and size of light plants —Write, giving us your requirements!



(Item 1660)

Rugged, ball bearing WINCH

Sturdy ball bearing winch—super tough aluminum alloy construction. Powered by an easy starting 2 1/2 HP Briggs gas engine thru gear reduction drive — it exerts up to 3000 lbs. of terrific force for hoisting materials or pulling. Combination gear and pulley reduction results in tremendous multiplication of engine power. Idler pulley clutch arrangement and built-in drum brake (with ratchet hand lever) enables operator to ease loads down gently and lock at any point desired. Drum handles 400 ft. of 3/4" cable or 600 ft. of 1/2" cable. Ideal for contractors, farm implement trailers and unlimited other uses! (Item 795) Wt. 125 lbs. Only... **\$149.50**

HAND WINCH—Same winch with large crank handle for extra leverage and 2 speed drive. (Item 794) Wt. 80 lbs... **\$59.50**



(Item 795)

HI-FLO Centrifugal PUMP

Completely self-priming! No foot valve required. Tremendous capacity—100 gal. per min. 1" — Special impeller enables pump to handle muddy or sandy water. Simple to operate—simply start engine and watch the water go. Powered by a rugged, easy-starting 2 HP Briggs engine. Pre-lubricated, sealed bearings for years of heavy low-cost service. Big 1 1/2" Model, Item 502, Wt. 70 lbs. Factory price... **\$134.50**

2" Model (150 gal. per min.) with 2 1/2 HP engine. Item 502a, 90 lbs. Fact. Spec. **\$154.50**



MASTER AIR COMPRESSOR

COMPARE! This is the only compressor built with a NO RUST stainless steel tank. Safe up to 500 lbs. (Item 209) High pressure type (4 c.f.m.) large volume of air for heavy duty service. For paint spraying, inflating truck & auto tires, greasing, sand blasting, etc. Piston type 2 1/2 horse compressor with built-in air filter. Master built with high strength alloys and precision bearings. Tank, 12"x24", 3100 cu. in. cap. Equipped with automatic switch that starts and stops motor to maintain desired pressure (up to 150 lbs.) and check valve, safety valve, gauge, shut-off valve, 20 ft. air hose and tire chuck. Beautifully balanced on ball bearing wheels and rubber tires. Don't take chances with used or surplus equipment. Our compressors are factory new and are guaranteed SAFE. Low factory prices. 1 1/2 HP Model (cap. 85 lbs.) Reg. \$175. (Item 209)..... **\$109.50**

1/2 HP heavy duty model, Reg.-Ind. motor & unloader switch (Item 209a) **\$129.50**

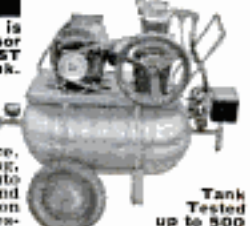

Tank Tested up to 500 lbs. per sq. in.

Send check or M.O. Prices f.o.b. Factory. 10 Day Money back guaranteed. SEND 10c for... **BIG 1957 Catalog**

MASTER MECHANIC MFG. CO., DEPT. EM-3

Burlington, Wis.



CENTERS AND DRILL PADS



STEEL AND BRASS COLLETS



BALL BEARING LIVE CENTER



HANDWHEEL COLLET ATTACHMENT



FOLLOWER AND STEADY RESTS

YOU CAN DO MORE WITH SOUTH BEND LATHES because of the very complete line of practical attachments available. Only a few are shown here. Send for complete catalog.



SAFETY and STANDARD LATHE DOGS



ADJUSTABLE COLLET BUSHING CHUCK



HANDLEVER BED TURRET

South Bend Attachments will enable you to do more and better lathe work. Write for your copy of our new catalog 5700.

SOUTH BEND LATHE
BUILDING BETTER TOOLS SINCE 1906 • SOUTH BEND 22, INDIANA



TELESCOPIC TAPER ATTACHMENT



EXTERNAL GRINDER

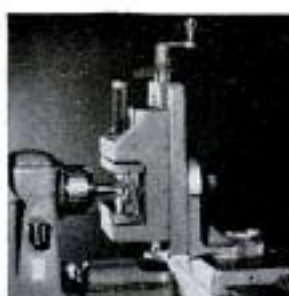

MILLING ATTACHMENT

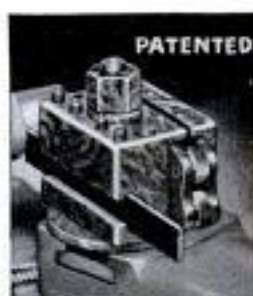

PATENTED
10 in 1 TOOL BLOCK



PLEASE SEND INFORMATION CHECKED:

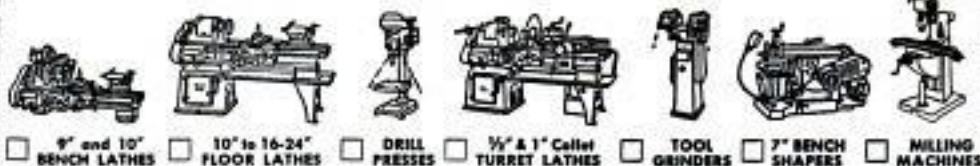

9" and 10" BENCH LATHES 10" to 16-24" FLOOR LATHES DRILL PRESSES 1/2" & 1" Collet TURRET LATHES TOOL GRINDERS 7" BENCH SHAPERS MILLING MACHINES

Name _____ Street _____
City _____ State _____

Building Better Tools Since 1906 • SOUTH BEND LATHE • South Bend 22, Indiana

When the
refinery finishes,
your AC Oil Filter
begins...

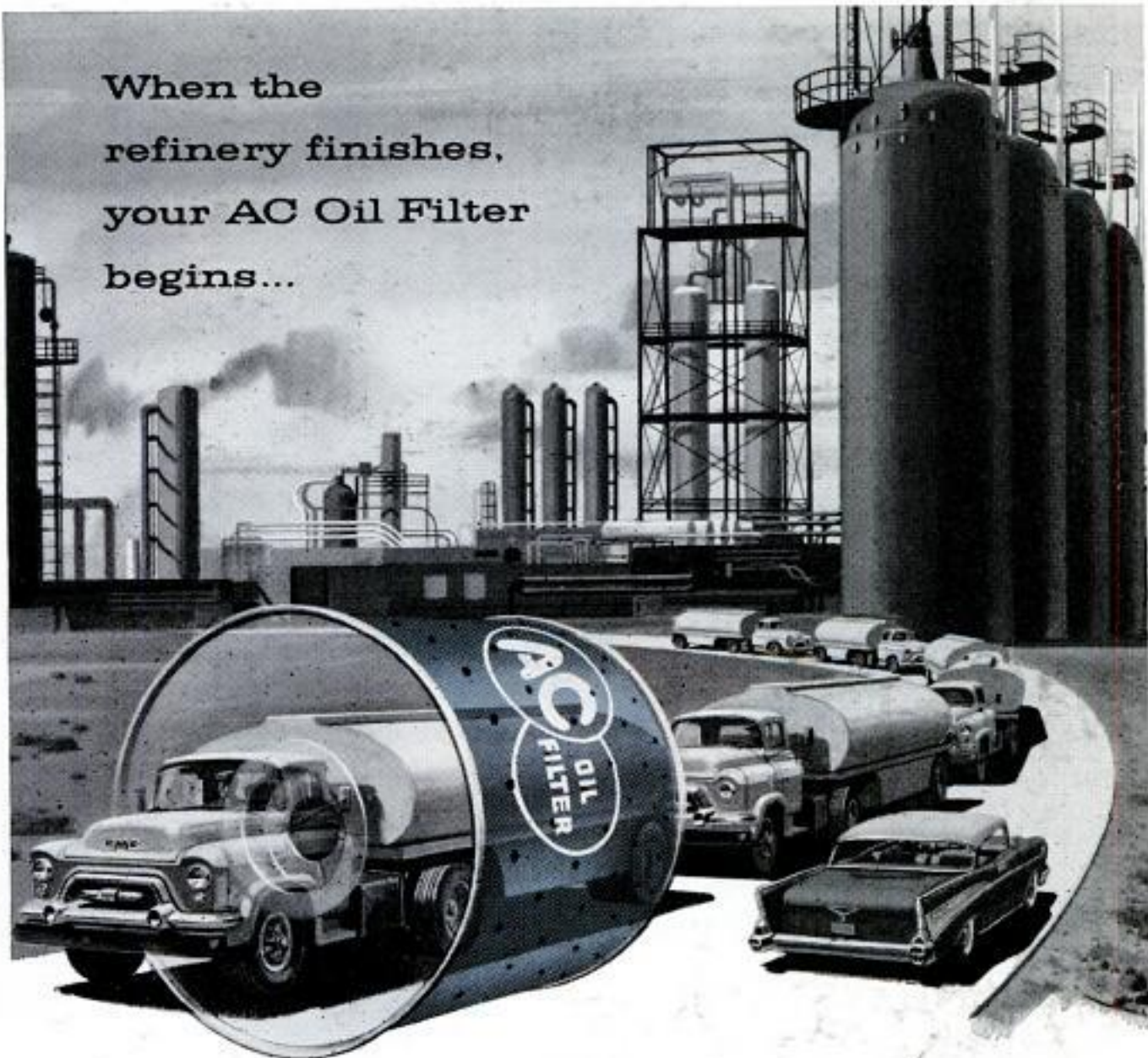

...cleaning 36,000 gallons
of oil every 5,000 miles!

Change your



**OIL
FILTER**
every
5,000 miles



Mark MADE WIDE WORLD-NBC-TV

An almost unbelievable volume of oil recirculates through your AC Full-Flow Oil Filter in 5,000 miles of driving—as much as 36,000 gallons.

Your oil filter is faced with the job of cleaning that vast quantity of oil in six months or less of average driving . . . a full six quarts for every 30 seconds at normal speeds.

That's why it's so important for you to change your AC Oil Filter regularly. A fresh AC Filter takes out dirt and bits of metal as small as 1/100,000 of an inch. It keeps your oil clean and on the job . . . protects the vital engine parts in your car from the damage dirt can do.

When you change your oil, check the mileage since your last filter change. For your engine's sake, change to a new AC Oil Filter at least every six months or every 5,000 miles your car is driven.

AC SPARK PLUG  THE ELECTRONICS DIVISION OF GENERAL MOTORS

Copyrighted material



Taste is what folks talk about
— *and like about* **WINSTON**

People keep saying how really good Winstons taste! And...how the exclusive Winston filter—*snowy-white and pure*—lets that rich flavor come through! Try today's most talked-about flavor-filter combination. Latch onto a pack of Winstons — for flavory filter smoking!

R. J. REYNOLDS TOBACCO CO., WINSTON-SALEM, N. C.

Smoke **WINSTON**...enjoy the snow-white filter in the cork-smooth tip!