

# ANNUAL AUTO ISSUE

50 PAGES ABOUT CARS - PLUS ALL REGULAR FEATURES

FEB.  
1957

LANCOLN

# POPULAR MECHANICS

## MAGAZINE

WRITTEN SO YOU CAN UNDERSTAND IT

BEST TRADE MARK, GREAT DESIGN, NO. 40434

REG. U.S. PAT. OFF.

DODGE



CHRYSLER 300C



MERCURY



PLYMOUTH



BUICK



CHEVROLET



CORD



PACKARD



IMPERIAL



PONTIAC



CHRYSLER



OLDSMOBILE



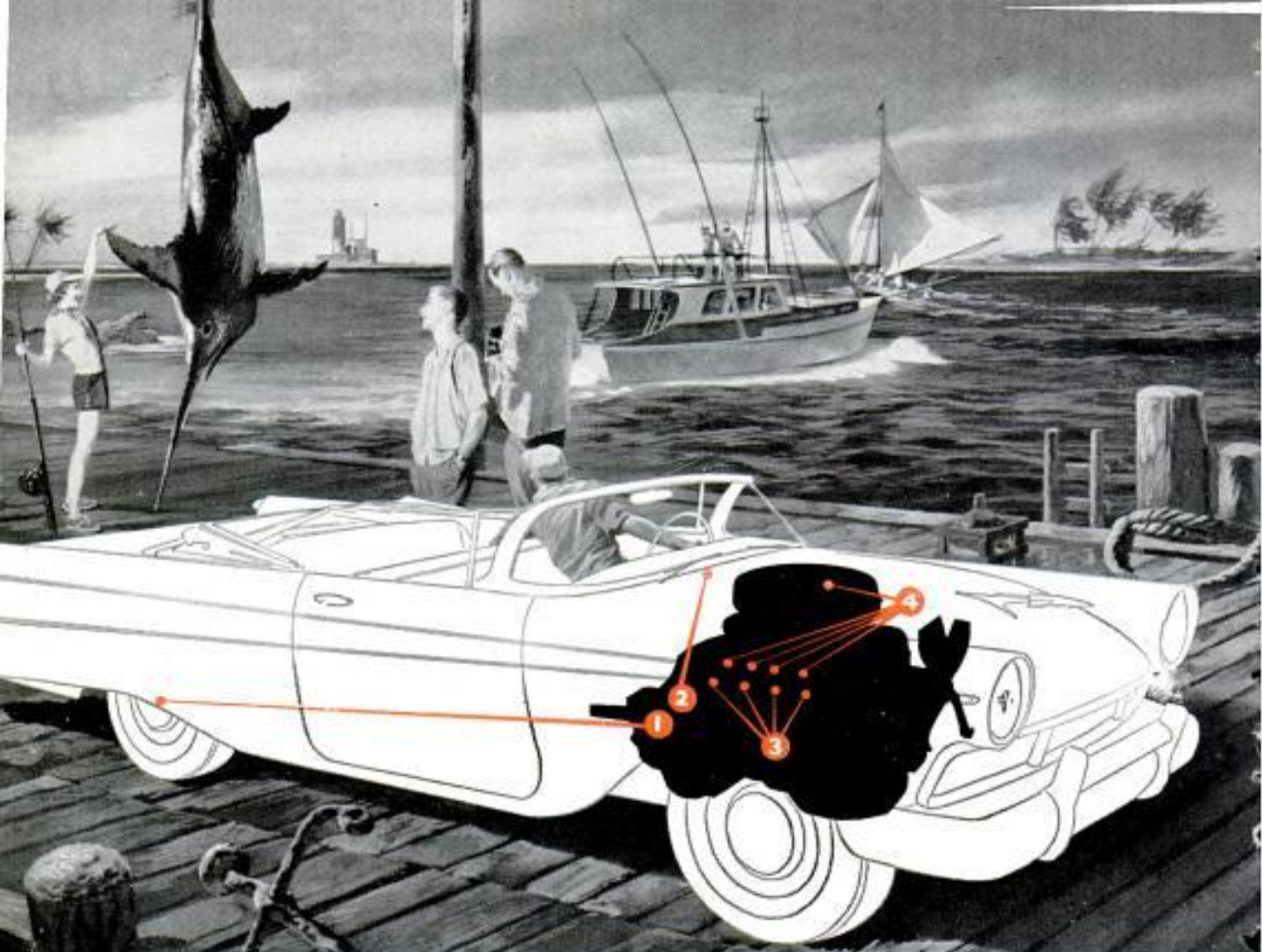

**1 More road horsepower**—If you haven't changed your spark plugs recently, new 5-rib Champions can give you an *immediate* increase in road horsepower—the actual power delivered at your rear

wheels. Independent tests prove most cars get an increase of 6% to 31%—for better hill climb and *safer passing!* No wonder 9 out of 10 racing drivers—men who really know cars—insist on Champions!

If you haven't changed your plugs in about 10,000 miles—

## You can make your car 4 ways newer with Champion spark plugs!



**2 Quicker starts**—New 5-rib Champions cut starting time 39% on the average—in tests with cars whose regular plugs had gone 10,000 miles or more. New Champions will give you quicker starts...

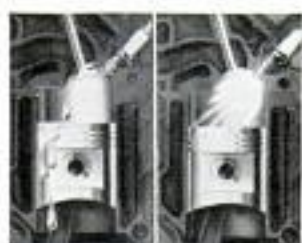

**3 Less engine wear**—When old plugs misfire (left), raw gasoline drains into the crankcase... dilutes engine oil. New full-firing Champions (right) in your car will protect oil from dilution... help



**4 Lower cost-per-mile**—Champion's great new Powerfire electrode stands up better than ordinary types under identical use... gives top power and gas economy for life of plug. Always insist on



**CHAMPION**

# How a man of 35 can retire at 55 with \$300 a month



**N**EVER knew I was a born craftsman until I retired. But, believe me, nothing has ever given me more satisfaction than the first shelves I built with my own two hands. Today I'm working on our hi-fi set. I've been turning out some really beautiful furniture in my basement workshop. But if it weren't for that \$300 check each month, I'd still be at the plant worrying about production figures.

"In a way, I have my father to thank that I'm retired at 55. Twenty years ago we were right in the middle of the depression. My father had always hoped to retire at 65, but when the time came, he hadn't saved enough. I was 35 then. My job promised a good financial future, so I went from day to day without thinking ahead.

"Then one day my father pointed out that he had had the same kind of promising job when he was my age. He and my mother lived comfortably, sent us children through

college, traveled. Somehow the money went as fast as it came in.

"I began to think seriously. With a wife, two children and a third on the way, I hadn't saved much. As the children grew older, expenses would go up. And even if I were able to save, I might outlive my savings.

"I read everything I could on ways to retire. One day I saw an ad for a plan that seemed different—the Phoenix Mutual Retirement Income Plan. Provided I started young enough—and I was definitely young enough—this plan could provide an income from \$10 to \$300 a month for life.

"I clipped the coupon and sent for the booklet. I discovered I'd be able to retire at 55, ten years earlier than the age my father had suggested. That fact was enough to make me decide on Phoenix Mutual, but I carefully compared it with other plans. It was still Phoenix Mutual for me.

"That was only twenty years ago—twenty short years of feeling secure about my future. When my first check for \$300 came, I retired. I've started a new career in my workshop—my secret ambition for years."

## Send for Free Booklet

This story is typical. Assuming you start at a young enough age, you can plan to have an income of \$10 a month to \$3,600 a year or more—beginning at age 55, 60, 65 or older. Send the coupon and receive, by mail and without charge, a booklet which tells about Phoenix Mutual Plans. Similar plans are available for women. Don't delay. Send for your copy now.

ESTABLISHED 1891

## PHOENIX MUTUAL

*Retirement Income Plan*

**GUARANTEES YOUR FUTURE**

OVER 100 YEARS OF LIFE INSURANCE PROTECTION  
FOR BUSINESS AND FAMILIES

COPYRIGHT 1956, BY PHOENIX MUTUAL LIFE INSURANCE COMPANY

FEBRUARY 1957

PHOENIX MUTUAL LIFE INSURANCE CO.  
205 Elm Street, Hartford 15, Conn.

Please send me, without obligation, your free 28-page book showing new retirement income plans.

Plan for Men  Plan for Women

Name \_\_\_\_\_

Date of Birth \_\_\_\_\_

Business Address \_\_\_\_\_

Home Address \_\_\_\_\_

**This One**



9YNH-NP1-F6A4

# ANNOUNCING THE MIGHTY CHRYSLER 300-C



## AMERICA'S MOST POWERFUL CAR! 375 HP!

Chrysler's proud engineers poured all their high-performance know-how into the Chrysler 300-C, the car that out-seats, out-corners, out-controls, and out-powers anything on wheels in this hemisphere. This car is really a bomb!

The Mighty Chrysler 300-C has all the spacious comfort of any of the 1957 Chrysler models. But this is no souped-up stock car; it is built from the ground up to handle the mightiest force ever put under an American hood.



The 300-C's mighty airplane-type engine boasts two four-barrel carburetors and exclusive Chrysler aircraft-type hemispherical combustion chambers. It generates 420 ft. lbs. of torque at 4,000 rpm.



A magnificent leather interior carries out the sports car theme of the Chrysler 300-C—is compatible with choice of body colors. Controls are skillfully arranged for maximum driving ease and safety.

**SEE YOUR CHRYSLER DEALER ABOUT THE 300-C**

*Hardtop and Convertible body types... five new colors to choose from.*

# Popular Mechanics Magazine

Registered in U. S. Patent Office and Canada

H. H. WINDSOR, Founder

H. H. WINDSOR, JR., Editor and Publisher



## Next Month

"OLD IRONSIDES" lives again on the pages of next month's issue. A product of 25 years' effort by two men, this scale model of the USS Constitution is 14½ feet long and 11 feet high. Its tiny cannon really fire. The ship's pumps actually draw water. Make this true sea story "must" reading for yourself and family.

### POPULAR MECHANICS INTERNATIONAL EDITIONS

Mecanique Populaire (French)  
 Mecánica Popular (Spanish)  
 Populaer Mekanik (Danish)  
 Popular Mekanik (Swedish)  
 Populare Mechanik (German)

Sources of further information not listed in the index, starting on page 106, about articles in this issue, frequently are shown in the Where-to-Find-It List prepared for each issue. A copy may be obtained by readers, without charge, from Bureau of Information, Popular Mechanics, 200 East Ontario Street, Chicago 11, Ill.

Published monthly by Popular Mechanics Company, 200 E. Ontario St., Chicago 11, Ill. H. H. Windsor, Jr., president; W. M. Harrison Ferridge, exec. vice-pres.; Franklin S. Forsberg, operations vice-pres.; D. F. Windsor, vice-president and secretary-treasurer; H. H. Windsor III, vice-president; W. T. Windsor, vice-president; Joseph B. Buell, Jr., advertising manager; Alan M. Deyoe, circulation manager. Single copy in the United States and Canada, 35 cents; subscription rates in the United States and possessions, Canada and countries of the Pan-American Postal Union, 1 year \$3.50; 2 years, \$6.00; 3 years, \$8.00. To all other countries add \$1.00 a year over United States prices for overseas postage. If you plan to move, notify us at least 30 days in advance so you will not miss an issue. Give both your old and new addresses. Entered as Second Class Matter, September 15, 1903, at the Post Office at Chicago, Illinois, under Act of March 3, 1879. Entered as Second Class Matter at Post Office Dept., Canada, Registered as Second Class Matter at the Post Office at Mexico, D. F., Mexico, June 20, 1950. Copyright 1957 by Popular Mechanics Company. Copyright under International Copyright Union. Copyright in France. All rights reserved under Pan-American Copyright Union. Printed in the United States of America.

Volume 107

FEBRUARY 1957

Number 2

Address all communications to: 200 E. Ontario St., Chicago 11, Ill.

Managing Editor.....Roderick M. Grant  
 Assistant Managing Editor.....Wayne Whittaker  
 Shop Notes and Crafts Editor.....James R. Ward  
 Radio-Television, Electronics Editor.....Lothar Stern  
 Associate Editor.....Clifford B. Hicks  
 Associate Editor, Automotive.....Arthur R. Railton  
 Associate Editor, Shop Notes and Crafts.....Wayne C. Lecky  
 Associate Editor, Shop Notes.....W. Clyde Lamney  
 Assistant Editor, Crafts.....Jay W. Hedden  
 Assistant Editor, Makeup.....John C. Dalen  
 Art Director.....Frank Beatty  
 Assistant Editors—Robert E. Dorsett, Emily M. Rice, Earl F. Wobeck  
 Eastern Editor.....Richard F. Dempewolff  
 Empire State Bldg., Room 2906, New York City 1  
 Western Editor.....Thomas E. Stimson, Jr.  
 Suite 1010, 3460 Wilshire Blvd., Los Angeles 5, Calif.  
 London Manager.....Douglas W. Wedderspoon  
 Eagle House, Jermyn St., London S. W. 1, England  
 Director, Bureau of Information.....Allan Carpenter  
 200 E. Ontario St., Chicago 11

### Advertising Offices

Chicago: 200 E. Ontario St., Whitehall 4-0100; New York: Empire State Bldg., 350 Fifth Ave., Longacre 5-7580; Detroit: General Motors Bldg., TRinity 5-8711; Cleveland: Hanna Bldg., 1422 Euclid Ave., PRospect 1-0456; Los Angeles: 3460 Wilshire, DUnkirk 2-8458; San Francisco: Russ Bldg., 235 Montgomery St., YUkon 2-0823.

## In This Issue . . .

The Tricks He Plays on Trees	- - - - -	113
Backstage Wizardry of the TV Commercials	- - - - -	121
Canada's Copter King	- - - - -	137
What's New for Your Home	- - - - -	146
Farm Equipment on Parade	- - - - -	152

<b>Special</b>	The History of Speed	- - - - -	160
	Parade of the '57 Cars	- - - - -	170
<b>Auto</b>	Where Do the Horses Go?	- - - - -	182
	World's Toughest Car Test	- - - - -	187
<b>Section</b>	Do Small Cars Make Cents?	- - - - -	190
	I Race in the Big Leagues	- - - - -	196
Build "The Bug"—Your Personal Sportster—			
	Part I	- - - - -	201
Automatic Chokes	- - - - -	205	
And Many Other Special Items			

## For the Craftsman . . .

Solving Home Problems	- - - - -	214
New Look for Interior Walls	- - - - -	222
Auto-Powered Arc Welder	- - - - -	241
Shopping for Tools	- - - - -	246
How Would You Do It?	- - - - -	256
On the Market for the Do-It-Yourselfer	- - - - -	259
Radio, TV and Electronics	- - - - -	261
Clinic for Homemakers	- - - - -	268

See pages 106, 108 and 110

for other items and manufacturers of available products

FEBRUARY 1957



# Tubeless Tires *can* be safely repaired

# IF

*... your tire repairman  
has proper equipment  
and materials*

**M**any car owners have had "sad" experiences with tubeless tire repairs. This has been true because the repairman did not recognize that you cannot use old methods and materials for tubeless tire

repairing. It just can't be done that way.

Remember, it's the tire that has to hold air now . . . not the tube and this means that new methods and materials had to be developed.

## For SURE, SAFE Tubeless Tire Repairing

*look for the*

# BOWES

*Tubeless Tire  
Repair Expert*



As the largest manufacturers of tire repair materials in the world it follows that Bowes would start, long before the actual announcement of tubeless tires, on exhaustive research and tests.

Today, the Service Station or Tire Dealer equipped with Bowes Tubeless Tire repair materials, equipment and "Know How" offers you the sure safe results of these several years of research and exhaustive highway testing.

Leading Tubeless Tire Manufacturers use and approve Bowes Tubeless Tire repair equipment and materials.

BOWES "SEAL FAST" CORP., INDIANAPOLIS 7, INDIANA • HAMILTON, ONTARIO, CANADA • LONDON, ENGLAND  
BOWES PACIFIC CORPORATION, RIVERSIDE, CALIFORNIA

**IF YOU** "like to get under the hood . . ."



*you can get a great training . . . and  
start a great future . . .*



*in the* **U.S. AIR FORCE!**

Your talent with engines—or any mechanical ability—can pay big dividends, when it is backed up with solid training. And that's what you get when you serve in the U. S. Air Force. The Air Force offers you opportunities to learn one of over 40 career fields—training that will stand you in good stead, wherever your future may lie.

Start developing your valuable talents today—and go places *faster*—in the U. S. Air Force. See your local Air Force Recruiter—or mail the attached coupon.

M-79-PM

**Paste Coupon on Postcard and mail to:**

Airman Recruiting Information Branch  
Box 2202, Wright-Patterson AFB, Ohio

Please send more information on my opportunities for enlisting in the U. S. Air Force. I am between the ages of 17-34 and reside in U.S.A. or possessions.

NAME \_\_\_\_\_

ADDRESS \_\_\_\_\_ AGE \_\_\_\_\_

CITY \_\_\_\_\_ ZONE \_\_\_\_\_ STATE \_\_\_\_\_

# Shakespeare SPIN-WONDEREEL



SO EASY  
SO SIMPLE  
YOU CAN OPERATE IT  
BLINDFOLDED



No. 1755L



**"Made Me a Better  
Fisherman"**  
SAY VETERAN  
SPIN-FISHERMEN

*"I switched because, with  
cone design, it's trouble-  
free at night and in the  
wind," says John Cook,  
of Minneapolis.*

When experts switch, the reasons are important! With Shakespeare's SPIN-WONDEREEL, the line is always at your fingertip; you simply pick up the line, back up the crank, and cast. So easy . . . so simple, you can operate it blindfolded. Even beginners can make long, effortless casts right from the start. No groping for a bail or knob; nothing exposed to foul the line. Smooth, adjustable drag. No. 1755 L (above) latest non-reverse crank model, factory-filled with 150 yards new, extra-limp 6-lb. test Tynex monofilament line . . . **\$18<sup>95</sup>**

(Other models from \$13.50 to \$27.50.)



LOOK FOR THIS DISPLAY AT YOUR DEALERS

See how easy and simple it is to operate a Spin-Wondereel or the Wonder-Spin . . . easiest-to-use of all open-face reels.

**5 BRAND NEW  
FISHING BOOKLETS  
AND CALENDAR FREE**

Latest in fishing tips and tricks by the experts. Covers spinning, bait casting, push-button, fly and salt water fishing. Send today!



**SHAKESPEARE COMPANY**  
Dept. PM-2, Kalamazoo, Michigan

Please send your 5 brand new fishing booklets and calendar, Free!

NAME \_\_\_\_\_

ADDRESS \_\_\_\_\_

CITY \_\_\_\_\_ ZONE \_\_\_\_\_ STATE \_\_\_\_\_

## ACROSS THE DESK



### Camping in a VW

J. R. Bruman of 5055 Westslope Lane, La Canada, Calif., sends us these photographs of his Volkswagen "Kombi" as converted



for family camping expeditions. One picture shows its interior arranged for daytime use, with a "dinette" table installed. The large drawer pulls out from beneath the middle seat. The bed shown in the other photograph can be used while traveling if desired. The total sleeping space in the car accommodates two adults and three children—the seats permitting anyone up to five feet tall to lie down comfortably.

### To the Editor:

For many years now I have been a reader of your excellent magazine and always look forward to receiving each issue.

During the last six months here in Australia, television has received the okay

(Continued to page 8)





If...

YOU WANT TO ENJOY AN

# ACCOUNTANT'S CAREER

## INVESTIGATE THIS OPPORTUNITY TODAY!

**IF** you're that person, here's something that will interest you.

Not a magic formula—not a get-rich-quick scheme—but something more substantial, more practical.

Of course, you need something more than just the desire to be an accountant. You've got to pay the price—be willing to study earnestly, thoroughly.

Still, wouldn't it be worth your while to sacrifice some of your leisure in favor of interesting home study—over a comparatively brief period? Always provided that the rewards were good—a salary of \$4,000 to \$10,000 and up!

An accountant's duties are interesting, varied and of real worth to his employers. He has *standing!*

Do you feel that such things aren't for you? Well, don't be too sure. Very possibly they can be!

Why not, like so many before you, investigate LaSalle's Problem Method of training for an accounting position?

Just suppose you were permitted to work in an accounting firm under the personal supervision of an expert accountant. Suppose, with his aid, you studied accounting principles and solved problems day by day—easy ones at first—then more difficult ones. If you could do this—and could turn to him for advice as the problems became complex—soon you'd master them all.

That's the training you follow in principle under the LaSalle Problem Method. You cover accounting from Bookkeeping and Basic Accounting right through Accounting Systems and Income Tax Procedure. As you go along, you absorb the principles of General Accounting, Auditing and Basic Cost Accounting. Then you may choose Commercial Accounting, Industrial Accounting or Public Accounting and prepare for the CPA examinations.

Your progress is as speedy as you care to make it—depending on your own eagerness to learn and the time you spend in study.

Will recognition come? The only answer, as you know, is that success *does* come to the man who is really *trained*. It's possible your employers will notice your improvement in a very few weeks or months. Indeed, many LaSalle graduates have paid for their training—with increased earnings—before they have completed it! For accountants, who are trained in organization and management, are the executives of the future.

### Send today for Free Book "Accountancy, The Profession That Pays"

For your own good get all the facts about this completely new and modern accounting training. Write for free book "Accountancy, The Profession That Pays," which will prove that accounting offers brilliant futures to those who aren't afraid of serious home study, and will show the wide range of opportunities that exist today. No cost or obligation. If you want a position of higher income, greater prestige, **MAIL THE COUPON NOW!**

**Over 4,200 Certified Public Accountants  
among LaSalle alumni**

**Member, National Home Study Council**

**LASALLE EXTENSION UNIVERSITY**  
A CORRESPONDENCE INSTITUTION  
417 S. Dearborn St. Dept. 264H Chicago 5, Ill.  
*I want to be an accountant. Send me without obligation,  
Free Book, "Accountancy, The Profession That Pays."*

Name.....Age.....  
Address.....  
City, Zone & State.....

**GO**  
*places*

**with more power  
...less fuel**

**CLEAN YOUR  
CARBURETOR**

*with*



- Gum can be clogging the carburetor of your car right now—causing high gas consumption, loss of power. Clean it out with GUMOUT!
- GUMOUT gets rid of carburetor gum deposits quickly . . . completely. No more stalling, rough idling, high gas consumption.
- Just add GUMOUT to your gas tank. It cleans the carburetor while you drive.
- Buy GUMOUT at auto supply stores, or wherever automotive products are sold. There's nothing like it!

**send for FREE**

46-page "CARBURETOR HANDBOOK"  
It's loaded with helpful information  
about your car's fuel system.



**GUMOUT DIVISION**

Pennsylvania Refining Company  
2671 Lisbon Road, Cleveland 4, Ohio

from the federal government and one station in Melbourne and one in Sydney [have been] providing two hours a day test programs prior to commencement of regular transmissions [which began] Nov. 4, 1956. Present programs are of films imported from the United States and England. They are of an educational nature. Only black-and-white TV will be seen here during the next few years, but the programs will be up to world standard. Many top United States TV shows are listed for showing here.

In Melbourne, where I live, station HSV, channel 7, is the first local station to commence telecasting. It broadcasts 12 hours a week, six hours of which are test pattern for the use of manufacturers and service men installing sets. The sets use the 525-line method and use FM sound. Seventeen-inch sets are very popular, the price ranging from 205 to 250 Australian pounds. Larger types, 21 and 24 inches, cost from 250 to 300 pounds.

All three Melbourne stations will have their aerials built on the same mountain, Mount Dandenong, some 25 miles east. This means that only one aerial will be required per home, as all signals will come from the same direction, a considerable saving in the cost of installing a set. Aerials are simple folded dipoles in most places in the suburbs. Studios are in and around the city and signals are beamed by microwave to the main transmitters for general broadcast. The Melbourne stations are HSV7, GTV9 and one government-controlled.

Mount Dandenong is about 2500 feet high. HSV7 has a mast of some 450 feet.

Although operating on only 1/10 its actual power HSV7 has been received 150 miles away; 1000 watts is the permissible output. Present frequencies are all VHF, but UHF will be available in several years for use in inland areas.

G. J. Wilson,  
1327 Nepean Highway,  
Cheltenham S. 22,  
Victoria, Australia

**To the Editor:**

Enclosed is a picture of an interesting stunt we used in dismantling some Butler huts, later to be assembled in a new location. The side walls were removed in large panels while the roof was merely rolled up like a carpet. (The roof panels are of thin-gauge aluminum.) This saved lots of time.

I am a supervisor teaching Arabs to be craftsmen and this one (at left in photo) Saleh bin Mohammed, is an avid reader of *Popular Mechanics*. We both are with

(Continued to page 10)

# Can you profit by their mistakes?

## "Not getting enough education"

You needn't make that mistake. You can get that better job, those big promotions, the regular raises that so many I. C. S. students report. And you can do it without

"going to school," without interfering with your present job or your social life.

**YOU can study with I. C. S. at home, in your spare time!**



## "Wrong choice of career"

When you study with I. C. S. you have 256 courses to choose from. And part of our job here at I. C. S. is not only giving you instruction

but making sure you pick the course that's right for you!

**YOU get expert guidance FREE from I. C. S.!**



## "Failed to seize opportunities"

Your opportunity is right here on this page. Don't pass it by. Don't put it off. Mail the coupon now and let us send you our 3-book career kit.

**YOU get 3 FREE books if you mail the coupon today!**

1. 36-page gold mine of information, "How to Succeed."
2. Career Catalog outlining opportunities in your field.
3. Sample I. C. S. lesson (Math.).



For Real Job Security—Get an I. C. S. Diploma! I. C. S., Scranton 9, Penna. Member, National Home Study Council

## INTERNATIONAL CORRESPONDENCE SCHOOLS

65<sup>TH</sup> YEAR

BOX 70953B, SCRANTON 9, PENNA.

(Partial list of 256 courses)

Without cost or obligation, send me "HOW TO SUCCEED" and the opportunity booklet about the field BEFORE which I have marked X (plus sample lesson):

### ARCHITECTURE and BUILDING CONSTRUCTION

- Air Conditioning—Refrig.
- Architecture
- Architectural Interiors
- Building Contractor
- Building Estimator
- Building Maintenance
- Carpentry and Mill Work
- Heating
- Painting Contractor
- Plumbing
- Reading Arch. Blueprints

### ART

- Cartooning
- Commercial Art
- Fashion Illustrating
- Magazine Illustrating
- Show Card and Sign Lettering
- Sketching and Painting

### AUTOMOTIVE

- Auto Body Rebuilding
- Auto Elec. Technician
- Auto-Engine Tune Up
- Automobile Mechanic

### AVIATION

- Aeronautical Engineering Jr.
- Aircraft & Engine Mechanic

### BUSINESS

- Advertising
- Bookkeeping and Accounting
- Business Administration
- Business Correspondence
- Public Accounting
- Creative Salesmanship
- Federal Tax
- Letter-writing Improvement
- Office Management
- Professional Secretary
- Retail Business Management
- Sales Management
- Stenographic-Secretarial
- Traffic Management

### CHEMISTRY

- Analytical Chemistry
- Chemical Engineering
- Chem. Lab. Technician
- General Chemistry
- Natural Gas Prod. & Trans.
- Petroleum Engineering
- Plastics
- Pulp and Paper Making

### CIVIL, STRUCTURAL ENGINEERING

- Civil Engineering
- Construction Engineering
- Highway Engineering
- Reading Struct. Blueprints
- Sanitary Engineering
- Structural Engineering
- Surveying and Mapping

### DRAFTING

- Aircraft Drafting
- Architectural Drafting
- Electrical Drafting
- Mechanical Drafting
- Mine Surveying and Mapping
- Plumbing Drawing and Estimating
- Structural Drafting

### ELECTRICAL

- Electrical Engineering
- Electrical Maintenance
- Electrician  Contracting
- Lineman
- HIGH SCHOOL
- Commercial  Good English
- High School Subjects
- Mathematics

### LEADERSHIP

- Foremanship
- Industrial Supervision
- Leadership and Organization
- Personnel-Labor Relations

### MECHANICAL AND SHOP

- Gas—Electric Welding
- Heat Treatment  Metallurgy
- Industrial Engineering
- Industrial Instrumentation
- Industrial Supervision
- Internal Combustion Engines
- Machine Design-Drafting
- Machine Shop Inspection
- Machine Shop Practice
- Mechanical Engineering
- Quality Control
- Reading Shop Blueprints
- Refrigeration
- Sheet Metal Worker
- Tool Design  Toolmaking

### RADIO, TELEVISION

- Industrial Electronics
- Practical Radio TV Eng'ing
- Radio and TV Servicing
- Radio Operating

### TELEVISION TECHNICIAN RAILROAD

- Air Brake Equipment
- Car Inspector
- Diesel Engineer & Fireman
- Section Foreman

### STEAM AND DIESEL POWER

- Combustion Engineering
- Diesel—Elec.  Diesel Eng's
- Electric Light and Power
- Stationary Fireman
- Stationary Steam Engineering

### TEXTILE

- Carding and Spinning
- Cotton, Rayon, Woolen Mfg.
- Finishing and Dyeing
- Loom Fix'g  Textile Des'ing
- Textile Eng'g  Throwing
- Warping and Weaving

### MISCELLANEOUS

- Marine Engineering
- Ocean Navigation
- Professional Engineering
- Short Story Writing
- Telephony

Name \_\_\_\_\_ Age \_\_\_\_\_ Home Address \_\_\_\_\_

City \_\_\_\_\_ Zone \_\_\_\_\_ State \_\_\_\_\_ Working Hours \_\_\_\_\_ A.M. to P.M. \_\_\_\_\_

Occupation \_\_\_\_\_

Canadian residents send coupon to International Correspondence Schools, Canadian, Ltd., Montreal, Canada. . . . Special tuition rates to members of the U. S. Armed Forces.

# Looking for Something?



**POWER  
TOOLS**

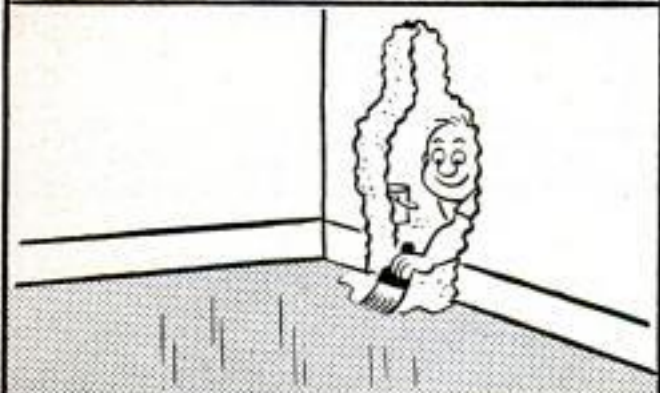
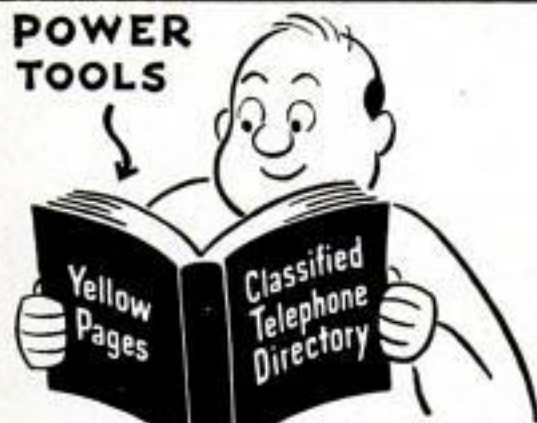

**FROM PAINT  
TO POWER TOOLS  
WHATEVER YOU NEED**

**Find It Fast  
In The  
Yellow Pages**



Ads with this emblem make your shopping easier

(Continued from page 8)



Bechtel International working for Aramco in the Arabian oil fields.

M. V. Bailey,  
International Bechtel Builders  
Arabian Division,  
Dhahran, Saudi Arabia

### To the Editor:

The enclosed snapshot is of my portable "boat." Its over-all dimensions are nine feet by three feet six inches . . . two rubber



pontoons attached to plywood top. I fitted the seats and fixed the bicycle wheels to either side; also the shafts that protrude out the front end and the motor mounting.

Wheeling to the water is easy with the boat inverted. The outboard is just slipped between the seats; petrol, camping gear, etc., ride between pontoons. At the water's edge, the outfit is lowered onto shaft ends and turned completely over to ride in water.

J. Armstrong,  
Panania, N.S.W.,  
Australia

### Float Planes

Single-engine planes with wheels cannot legally take off from Canada to fly across the Atlantic or Pacific Oceans. But planes having pontoon floats instead of wheels can make these trips with the law's blessing.

More than 400,000 air travelers pass through the northern terminal of Gander, Newfoundland, every year.



**J. E. SMITH**  
President, National Radio Institute. 40 years' experience training men at home for Radio-TV.

*I Will Send You A*  
**SAMPLE LESSON FREE**  
*to show you how easy, practical it is to*  
**Train at Home for Good Radio-Television Jobs**



**America's Fast Growing Industry Offers You Good Pay Plus a Bright Future**

TRAINING plus OPPORTUNITY is the PERFECT combination for ambitious men. Let me send you a sample lesson from my course to prove you can keep your job while TRAINING at home in your spare time for better pay and a brighter future. I will also send my 64-page book to show you that Radio-Television is today's field of OPPORTUNITY for properly trained men.



**Make \$10, \$15 a Week Extra**

Many men I train fix neighbors' Radios, make extra money, soon after they enroll. Actual equipment you build gives you practical experience.



**Television's Growth is Making More Jobs, Prosperity**

Radio is bigger than ever and television is growing fast. Government, Aviation, Police, Ship, Microwave Relay, Two Way Communications for buses, taxis, railroads are other growing fields for Radio-Television trained men.

**Mail Coupon—Find Out About This Tested Way to Better Pay**

Take NRI training for as little as \$5 a month. Many NRI graduates make more in two weeks than the total cost of my training. Mail coupon today for Actual Lesson and 64-page Book—Both FREE. J. E. SMITH, National Radio Institute, Dept. 7BA, Washington 9, D. C. Our 40th Year.

**I Trained These Men**



"I have a regular job as a police captain and also have a good spare time Radio and Television service business. Just opened my new showrooms and shop."—C. W. LEWIS, Pensacola, Florida.

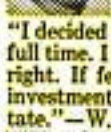

"I decided to quit my job and do TV work full time. I love my work and am doing all right. If fellows knew what a wonderful investment NRI is, they would not hesitate."—W. F. KLINE, Cincinnati, Ohio.



"Thanks to NRI, I operated a successful Radio repair shop. Then I got a job with WPAQ, later WBOB and now am an engineer for WHPE."—VAN W. WORKMAN, High Point, N. Carolina.

**You Learn by Practicing with Equipment I Send**

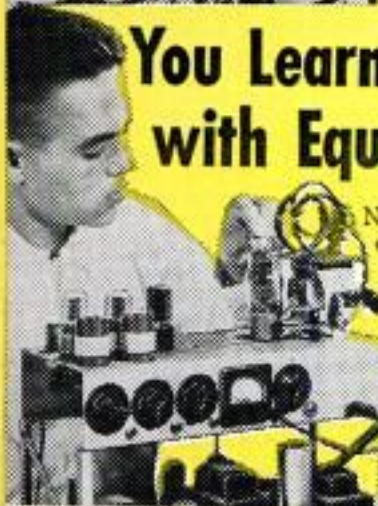

Nothing takes the place of practical experience. That's why NRI training is based on LEARNING BY DOING. My training includes kits of parts which you use to build equipment and get practical experience on circuits common to both Radio and Television. Shown at left is the low-power Broadcasting Transmitter you build as part of my Communications Course.



AVAILABLE TO **VETERANS** UNDER G.I. BILLS

**Good for Both—FREE**

Mr. J. E. Smith, President, Dept. 7BA  
National Radio Institute, Washington 9, D. C.  
Mail me Sample Lesson and 64-page Book, FREE.  
(No salesman will call. Please write plainly.)

Name \_\_\_\_\_ Age \_\_\_\_\_  
Address \_\_\_\_\_  
City \_\_\_\_\_ Zone \_\_\_\_\_ State \_\_\_\_\_  
**VETS** write in date of discharge \_\_\_\_\_  
Approved Member, National Home Study Council

# Our 3 Best-Sellers Now at BIG DISCOUNTS!

50,000 SOLD  
AT \$3.95

NOW \$1.98  
ONLY

10 TOOLS IN ONE

- Saw • File • Scissors
- Jackknife • Screwdriver
- Awl • Can Opener • Corkscrew
- Small Knife • Bottle Opener



IMPORTED  
SWISS ARMY  
TYPE KNIFE

SAVE 50%! SAVE \$2.00! Famous, authentic, imported SWISS ARMY Type Knife—\$3.95 value—yours at HALF PRICE! Made famous by the Swiss Army because it's virtually a lifesaver in many emergencies. 10 practical, quality tools. Each tool is separate; easy to open and close. No jamming! No slipping! Replaces multitude of tools you can never find when you need them. Lifetime of rugged use. Ideal for home handymen, sports enthusiasts, or just plain Mrs. Housewife! (Tip: Lots of men keep extra knife in car glove compartment.)

No. 18.....now \$1.98

## FAMOUS MONTE CARLO STEAK KNIVES

Nationally Advertised at \$2.00 each

Our greatest cutlery bargain ever! Same Monte Carlo steak knives advertised in *House Beautiful* at \$2.00 each—now yours for only 33c (in lots of 3). All brand-new, first-quality! Bargain possible because we import direct from Continent by the boatload, sell direct by mail, eliminate needless distribution costs, high middlemen's profits! Stainless steel knives, hollow ground, like a barber's razor. Serated edges. Never need sharpening or polishing. Handles in beautiful design of autumn leaves in color of Gold, embossed on pastel Ivory styrene. Breathtaking! Ideal for every setting. Over ONE MILLION sold! 10-Year Replacement Guarantee IN WRITING!

No. 89.....3 for 99c; 6 for \$1.98; 12 for \$3.96 (Plus Free Cake & Pie Server)

NOW ONLY

33c

each

FREE!

Cake & Pie Server  
with order of 12



MORE THAN 100,000  
SOLD AT \$3.95!

## Black Forest HUNTING KNIFE

NOW  
SLASHED  
TO

99c

SAVE \$3.00! This is the original, the famous, the genuine Black Forest—the world's most popular hunting knife. Its rugged beauty has won highest recognition for design throughout Europe and America. Hand-forged by old world steelsmiths famed for their high standards of craftsmanship. Precision-tempered high carbon steel. 10 full inches long. Blade is sharp enough to shave with!

You'll use the Black Forest on every hunting, fishing and outdoor trip you take! Use it to skin moose, rabbit, deer, bear, any wild animal! Use it to cut hemp, wire, underbrush, branches, etc. To hunt small game—it makes a silent, accurate, deadly weapon! Use it to dig holes when your shovel can't penetrate cold, frost-hardened earth. Use it in a hunting emergency—when seconds really count! No matter how, when or where you use the Black Forest you can trust it to come through with flying colors! It's a real champion! You can even use it to carve turkey, roasts, etc. at the table. And it even makes a handsome wall decoration—over the mantelpiece, in your den, etc.

Over 100,000 Sportsmen gladly paid \$3.95 for their Black Forest. Now—for a limited time—we have SLASHED the price way down to only 99c—yours almost as a gift. You SAVE 75%! You SAVE \$3.00! Here's one bargain you can't afford to pass up. Hurry. This offer is subject to withdrawal without notice. (Limit: Two knives to a customer)

No. 76.....99c



10  
inches  
overall

FREE!  
Deluxe Leather  
SHEATH

### MONEY-BACK GUARANTEE!

THORESEN, INC., Dept. 6-B  
585 Water Street, New York 2, N. Y.

RUSH items checked below on 10-day free home trial. If not delighted, I shall return the merchandise for prompt refund—no questions asked!

- Check, cash, money order enclosed. Send prepaid.

Send C.O.D. plus postal charges.

- No. 18—Swiss Army Type Knife (\$1.98)     No. 76—Black Forest (99c)  
 No. 89—Monte Carlo Steak Knives     3 for 99c     6 for \$1.98  
 12 for \$3.96 (Plus Free Cake & Pie Server)

Name \_\_\_\_\_

Address \_\_\_\_\_

City \_\_\_\_\_

Zone \_\_\_\_\_ State \_\_\_\_\_

CANADIANS:  
Address 45 St.  
James St.  
West, Montreal  
1, P.Q.



# INVENTORS

**L**earn how to protect your invention. The U. S. Patent Laws provide that any new and useful art, machine, article of manufacture, or composition of matter, or any new and useful improvement thereof, may be patented if the act of invention is involved. Therefore, every inventor with a valuable invention should take advantage of the Patent Laws and proceed for patent protection in order to safeguard his rights.

A patent gives the inventor the exclusive right to prevent others from making, using, or selling the invention claimed in the patent for a period of seventeen years.

The Patent Laws were enacted for the benefit of the inventor to give him protection for the features of his invention which are patentable. These features must be properly and concisely set forth and claimed in a formal application for patent, in order to comply with the requirements of the Patent Laws. For that reason, unless the inventor is familiar with patent matters, he should engage a competent registered patent attorney or agent to represent him. We are registered to practice before the U. S. Patent Office and are prepared to serve you in the handling of your patent matters.

A specially prepared booklet entitled "Patent Guide for the Inventor", containing detailed information with respect to patent protection and procedure, together with a "Record of Invention" form will be promptly forwarded to you without obligation upon request.

**CLARENCE A. O'BRIEN & HARVEY JACOBSON**

*Registered Patent Attorneys*

**71-B DISTRICT NATIONAL BUILDING**

**WASHINGTON 5, D. C.**

These great minds were Rosicrucians . . .



Francis Bacon Benjamin Franklin Isaac Newton

## WHAT SECRET POWER DID THEY POSSESS?

### Why were these men great?

How does anyone—man or woman—achieve greatness? Is it not by mastery of the powers within ourselves?

Know the mysterious world within you! Attune yourself to the wisdom of the ages! Grasp the inner power of your mind! Learn the secrets of a full and peaceful life!

Benjamin Franklin, statesman and inventor . . . Isaac Newton, discoverer of the Law of Gravitation . . . Francis Bacon, philosopher and scientist . . . like many other learned and great men and women . . . were Rosicrucians. The Rosicrucians (NOT a religious organization) have been in existence for centuries. Today, headquarters of the Rosicrucians send over seven million pieces of mail annually to all parts of the world. Address: Scribe Y.M.L.

**THIS BOOK FREE**

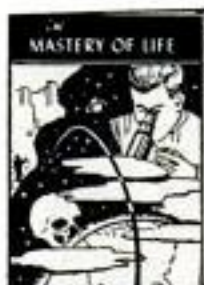

## The ROSICRUCIANS

San Jose (AMORC) California, U.S.A.

SEND THIS COUPON

Scribe Y.M.L.  
The ROSICRUCIANS  
(AMORC)  
San Jose, California, U.S.A.

Please send me the free book, *The Mastery of Life*, which explains how I may learn to use my faculties and powers of mind.

Name \_\_\_\_\_

Address \_\_\_\_\_

City \_\_\_\_\_

State \_\_\_\_\_

**Earn \$217 a Month EXTRA With My FREE SHOE OUTFIT!**

**Just 2 Sales a Day Does It!**

Rush a postcard today for my powerful FREE Shoe Selling Outfit. It contains everything you need to start a steady profit, repeat-order shoe business! Just 2 sales a day earns you up to \$217 a month EXTRA! It's amazingly easy! Just show friends, relatives Mason's famous shoes with comfortable Air-Cushion innersoles. People like buying the Mason way because they choose from over 160 dress, sport, work styles for men and women—including Nylon mesh, Cush-N-Crepe and Safety Toe work shoe styles. Because you draw from stock of 200,000 pairs in an amazing range of sizes and widths, customers get the exact size, width and style they order! Our shoes are not sold in stores . . . people must buy from YOU! Start making BIG MONEY now . . . send for your FREE Special Outfit TODAY!



**Write TODAY!**

**MASON SHOE MFG. CO.**  
DEPT. 582  
CHIPPEWA FALLS, WIS.

## TELEPHONES



**Desk Stand Style**

*Slightly used but in excellent condition*

Many Valuable Uses  
Inter-House Phones House to Barn, etc.  
Loud Speakers Microphones  
Educational Purposes, Toys, etc.

Come complete, ready to use with wiring diagrams included. **\$2.75** Postpaid in U.S.A.

Two complete for only \$5.00

**TELEPHONE LAMP KIT** — with illustrated instructions for making Desk Telephone Lamp including all parts (lamp, nipples, push switch, cord, plug, etc.) \$6.50 Ppd. (Shade is not included).

**MICROPHONE**, Dept. X-4702, 1760 W. Lunt Ave., Chicago 26, Ill.

YOU CAN COUNT on the quality of products advertised in POPULAR MECHANICS



**\$6,000-\$10,000 YEARLY OPERATING AUTO RADIATOR SERVICE SHOP**



World's largest radiator shop equipment mfr. will assist responsible individuals in setting up radiator shops. Opportunity to own secure profitable business. First year averages \$6,000 to \$10,000. Garage or service station can operate as dept. Over 1,000 INLAND shops now operating. As little as \$295 down for equipment starts you. INLAND will finance balance and furnish training. Write to

**INLAND MFG. CO.**, Dept. PM-2, 1108 Jackson St., Omaha 2, Nebr.



**PLAY GUITAR IN 7 DAYS OR GET MONEY BACK**

**SURPRISE FRIENDS, RELATIVES, HAVE POPULARITY AND FUN GALORE!**

In this introductory offer you get TOP RADIO GUITARIST ED SALE'S famous 66 page secret system worth \$2.75 which positively teaches you to play a beautiful song the first day and any song by ear or note in seven days! Contains 52 photos, 87 finger placing charts, etc. Shows how to tune, keep time, build chords, bass runs, dance chords, swing, etc., plus 110 popular and western songs, words and music; a \$1.00 Chord Finder of all the chords used

in popular music; a \$2.00 Guitarist Book of Knowledge—TOTAL VALUE \$5.75—ALL THREE for only \$2.98. SEND NO MONEY! Just name and address, pay postman \$2.98 plus C.O.D. postage. (Or send \$3.00 with order and I pay postage.) Same Guarantee. (Sorry, no C.O.D. to A.P.O., F.P.O. or outside U. S. A. Canada and Foreign \$3.00 with order.) Rush your order now

**ED SALE • STUDIO 802-A • BRADLEY BEACH, N. J.**



# HOW WOULD YOU LIKE TO BREAK INTO ENGINEERING STARTING NEXT MONTH?

Your start in Engineering could mean higher pay, more interesting work, a real chance for advancement. Here's how to do it—fast!

A career in Engineering may be closer than you think, whatever your age or education or present job.

You know about the tremendous demand for engineers and technicians. But do you know how easy it is to get the training that will qualify you for this vital work, and how quickly you can advance?

## First Step Wins Job Consideration

The moment you enroll for a course in Engineering you're in a position to change your job. I.C.S. Engineering Courses, for example, start you off with Basic Mathematics and Drafting. Most employers are quick to accept men who start technical training.

## Your Advancement Is Rapid

Your interest, your determination, your willingness to spend free hours improving your-

self all work in your favor. But your mastery of engineering subjects is what wins you the biggest boosts.

The I. C. S. method makes it possible for you to learn while you earn, to qualify yourself for upgrading step by step—from Draftsman to Detail Designer to Engineering Technician to full-fledged Engineer. It's a plan fitted to your needs, with personalized instruction and guidance, and, if you like, regular progress reports to your employer.

## Mail Coupon for Free Books

If you are seriously interested in a fresh start in an opportunity-packed field, then mark and mail the coupon today. We'll send you *three* free books—(1) the 36-page career guide "How to Succeed," (2) Opportunity outlooks in your field of interest, (3) sample lesson (Math) demonstrating I. C. S. method.

For Real Job Security—Get an I. C. S. Diploma!

I. C. S., Scranton 9, Penna. Member, National Home Study Council

## INTERNATIONAL CORRESPONDENCE SCHOOLS

65<sup>TH</sup> YEAR

BOX 14953B, SCRANTON 9, PENNA.

(Partial list of 256 courses)

- Without cost or obligation, send me "HOW TO SUCCEED" and the opportunity booklet about the field BEFORE which I have marked X (plus sample lesson):
- |  |   |  |  |  |
|--|---|--|--|--|
| <p><b>ARCHITECTURE and BUILDING CONSTRUCTION</b></p> <ul style="list-style-type: none"> <li><input type="checkbox"/> Air Conditioning—Refrig.</li> <li><input type="checkbox"/> Architecture</li> <li><input type="checkbox"/> Architectural Interiors</li> <li><input type="checkbox"/> Building Contractor</li> <li><input type="checkbox"/> Building Estimator</li> <li><input type="checkbox"/> Building Maintenance</li> <li><input type="checkbox"/> Carpentry and Mill Work</li> <li><input type="checkbox"/> Heating</li> <li><input type="checkbox"/> Painting Contractor</li> <li><input type="checkbox"/> Plumbing</li> <li><input type="checkbox"/> Reading Arch. Blueprints</li> </ul> <p><b>ART</b></p> <ul style="list-style-type: none"> <li><input type="checkbox"/> Cartooning</li> <li><input type="checkbox"/> Commercial Art</li> <li><input type="checkbox"/> Fashion Illustrating</li> <li><input type="checkbox"/> Magazine Illustrating</li> <li><input type="checkbox"/> Show Card and Sign Lettering</li> <li><input type="checkbox"/> Sketching and Painting</li> </ul> <p><b>AUTOMOTIVE</b></p> <ul style="list-style-type: none"> <li><input type="checkbox"/> Auto Body Rebuilding</li> <li><input type="checkbox"/> Auto Elec. Technician</li> <li><input type="checkbox"/> Auto-Engine Tune Up</li> <li><input type="checkbox"/> Automobile Mechanic</li> </ul> | <p><b>AVIATION</b></p> <ul style="list-style-type: none"> <li><input type="checkbox"/> Aeronautical Engineering Jr.</li> <li><input type="checkbox"/> Aircraft &amp; Engine Mechanic</li> </ul> <p><b>BUSINESS</b></p> <ul style="list-style-type: none"> <li><input type="checkbox"/> Advertising</li> <li><input type="checkbox"/> Bookkeeping and Accounting</li> <li><input type="checkbox"/> Business Administration</li> <li><input type="checkbox"/> Business Correspondence</li> <li><input type="checkbox"/> Public Accounting</li> <li><input type="checkbox"/> Creative Salesmanship</li> <li><input type="checkbox"/> Federal Tax</li> <li><input type="checkbox"/> Letter-writing Improvement</li> <li><input type="checkbox"/> Office Management</li> <li><input type="checkbox"/> Professional Secretary</li> <li><input type="checkbox"/> Retail Business Management</li> <li><input type="checkbox"/> Sales Management</li> <li><input type="checkbox"/> Stenographic-Secretarial</li> <li><input type="checkbox"/> Traffic Management</li> </ul> <p><b>CHEMISTRY</b></p> <ul style="list-style-type: none"> <li><input type="checkbox"/> Analytical Chemistry</li> <li><input type="checkbox"/> Chemical Engineering</li> <li><input type="checkbox"/> Chem. Lab. Technician</li> <li><input type="checkbox"/> General Chemistry</li> <li><input type="checkbox"/> Natural Gas Prod. &amp; Trans.</li> <li><input type="checkbox"/> Petroleum Engineering</li> <li><input type="checkbox"/> Plastics</li> <li><input type="checkbox"/> Pulp and Paper Making</li> </ul> | <p><b>CIVIL, STRUCTURAL ENGINEERING</b></p> <ul style="list-style-type: none"> <li><input type="checkbox"/> Civil Engineering</li> <li><input type="checkbox"/> Construction Engineering</li> <li><input type="checkbox"/> Highway Engineering</li> <li><input type="checkbox"/> Reading Struct. Blueprints</li> <li><input type="checkbox"/> Sanitary Engineering</li> <li><input type="checkbox"/> Structural Engineering</li> <li><input type="checkbox"/> Surveying and Mapping</li> </ul> <p><b>DRAFTING</b></p> <ul style="list-style-type: none"> <li><input type="checkbox"/> Aircraft Drafting</li> <li><input type="checkbox"/> Architectural Drafting</li> <li><input type="checkbox"/> Electrical Drafting</li> <li><input type="checkbox"/> Mechanical Drafting</li> <li><input type="checkbox"/> Mine Surveying and Mapping</li> <li><input type="checkbox"/> Plumbing Drawing and Estimating</li> <li><input type="checkbox"/> Structural Drafting</li> </ul> <p><b>ELECTRICAL</b></p> <ul style="list-style-type: none"> <li><input type="checkbox"/> Electrical Engineering</li> <li><input type="checkbox"/> Electrical Maintenance</li> <li><input type="checkbox"/> Electrician <input type="checkbox"/> Contracting</li> <li><input type="checkbox"/> Lineman</li> </ul> <p><b>HIGH SCHOOL</b></p> <ul style="list-style-type: none"> <li><input type="checkbox"/> Commercial <input type="checkbox"/> Good English</li> <li><input type="checkbox"/> High School Subjects</li> <li><input type="checkbox"/> Mathematics</li> </ul> | <p><b>LEADERSHIP</b></p> <ul style="list-style-type: none"> <li><input type="checkbox"/> Foremanship</li> <li><input type="checkbox"/> Industrial Supervision</li> <li><input type="checkbox"/> Leadership and Organization</li> <li><input type="checkbox"/> Personnel-Labor Relations</li> </ul> <p><b>MECHANICAL AND SHOP</b></p> <ul style="list-style-type: none"> <li><input type="checkbox"/> Gas—Electric Welding</li> <li><input type="checkbox"/> Heat Treatment <input type="checkbox"/> Metallurgy</li> <li><input type="checkbox"/> Industrial Engineering</li> <li><input type="checkbox"/> Industrial Instrumentation</li> <li><input type="checkbox"/> Industrial Supervision</li> <li><input type="checkbox"/> Internal Combustion Engines</li> <li><input type="checkbox"/> Machine Design-Drafting</li> <li><input type="checkbox"/> Machine Shop Inspection</li> <li><input type="checkbox"/> Machine Shop Practice</li> <li><input type="checkbox"/> Mechanical Engineering</li> <li><input type="checkbox"/> Quality Control</li> <li><input type="checkbox"/> Reading Shop Blueprints</li> <li><input type="checkbox"/> Refrigeration</li> <li><input type="checkbox"/> Sheet Metal Worker</li> <li><input type="checkbox"/> Tool Design <input type="checkbox"/> Toolmaking</li> </ul> <p><b>RADIO, TELEVISION</b></p> <ul style="list-style-type: none"> <li><input type="checkbox"/> Industrial Electronics</li> <li><input type="checkbox"/> Practical Radio TV Eng'ing</li> <li><input type="checkbox"/> Radio and TV Servicing</li> <li><input type="checkbox"/> Radio Operating</li> </ul> | <ul style="list-style-type: none"> <li><input type="checkbox"/> Television Technician</li> </ul> <p><b>RAILROAD</b></p> <ul style="list-style-type: none"> <li><input type="checkbox"/> Air Brake Equipment</li> <li><input type="checkbox"/> Car Inspector</li> <li><input type="checkbox"/> Diesel Engineer &amp; Fireman</li> <li><input type="checkbox"/> Section Foreman</li> </ul> <p><b>STEAM AND DIESEL POWER</b></p> <ul style="list-style-type: none"> <li><input type="checkbox"/> Combustion Engineering</li> <li><input type="checkbox"/> Diesel—Elec. <input type="checkbox"/> Diesel Eng's</li> <li><input type="checkbox"/> Electric Light and Power</li> <li><input type="checkbox"/> Stationary Fireman</li> <li><input type="checkbox"/> Stationary Steam Engineering</li> </ul> <p><b>TEXTILE</b></p> <ul style="list-style-type: none"> <li><input type="checkbox"/> Carding and Spinning</li> <li><input type="checkbox"/> Cotton, Rayon, Woolen Mfg.</li> <li><input type="checkbox"/> Finishing and Dyeing</li> <li><input type="checkbox"/> Loom Fix'g <input type="checkbox"/> Textile Des'ing</li> <li><input type="checkbox"/> Textile Eng'g <input type="checkbox"/> Throwing</li> <li><input type="checkbox"/> Warping and Weaving</li> </ul> <p><b>MISCELLANEOUS</b></p> <ul style="list-style-type: none"> <li><input type="checkbox"/> Domestic Refrigeration</li> <li><input type="checkbox"/> Marine Engineering</li> <li><input type="checkbox"/> Ocean Navigation</li> <li><input type="checkbox"/> Professional Engineering</li> <li><input type="checkbox"/> Short Story Writing</li> <li><input type="checkbox"/> Telephony</li> </ul> |
|--|---|--|--|--|

Name \_\_\_\_\_ Age \_\_\_\_\_ Home Address \_\_\_\_\_

City \_\_\_\_\_ Zone \_\_\_\_\_ State \_\_\_\_\_ Working Hours \_\_\_\_\_ A.M. to P.M. \_\_\_\_\_

Occupation \_\_\_\_\_

Canadian residents send coupon to International Correspondence Schools, Canadian, Ltd., Montreal, Canada. . . . Special tuition rates to members of the U. S. Armed Forces.



**Want better pay,  
steady work and  
a way to make  
extra money?**

# Learn at Home IN YOUR SPARE TIME to Fix Electrical Appliances

To build a better future, get into a field where there's much important work and the security that comes from knowing a good trade. Servicing electrical appliances offers that OPPORTUNITY. Every wired home has an average of 8 electrical appliances. Up to 10 million new appliances are sold every year and owners pay well to keep them in repair. That's making a fast-growing need for trained men.

## Start Soon to Earn \$3, \$4, \$5 an Hour Extra in Your Spare Time

Start soon to fix electric toasters, clocks, fans, vacuum cleaners and other appliances for neighbors and friends. Work in your basement, garage or spare room. Pick up \$3 to \$5 an Hour extra that way. It's easy to increase your earning power—to pay for this training many times over with your spare time earnings.

## Learn and Earn with Multi-Use Tester Built with Parts We Send

This course includes the parts to build a portable, sturdy Appliance Tester that helps you locate electrical defects quickly and easily. You use it to learn and do actual electrical appliance repair jobs. If you want better pay learn this good

trade. No need to give up your present job. You can train at home in your spare time for only \$2.50 down and \$5.00 a month. A small price to pay for increased earnings, a more secure future. Paste coupon below on a 2c postal or mail in envelope for free book and sample lesson. Address National Radio Institute, Dept. AB7, Washington 9, D. C.

**2c TO MAIL THIS  
COUPON MAY START  
YOU TO SUCCESS  
LESSON AND BOOK  
FREE**



**NATIONAL RADIO INSTITUTE  
Dept. AB7, Washington 9, D.C.**

Please send me Electric Appliance Training lesson and book free. (No salesman will call.)

Name \_\_\_\_\_ Age \_\_\_\_\_

Address \_\_\_\_\_

City \_\_\_\_\_ Zone \_\_\_\_\_ State \_\_\_\_\_

APPROVED MEMBER NATIONAL HOME STUDY COUNCIL

# INVENTORS

If you believe that you have an invention, you should find out how to protect it. The first step is to have a search made of the prior pertinent U. S. patents. If a report on this search indicates that the invention appears patentable you can apply for a patent, and the specifications and claims should be prepared.

The firm of McMorrow, Berman & Davidson, with offices in Washington, D. C., is qualified to take the necessary steps for you. We can make a preliminary search on your invention, advise you whether we think it can be patented, and prepare your application for

patent.

Unless you are fully familiar with the U. S. Patent Laws, we recommend that you engage the services of a Registered Patent Attorney to protect your interests. The patent laws are *your* laws. A patent gives you the right to prevent others from making, using or selling the invention claimed in your patent for a period of 17 years.

Use these patent laws for your protection. Investigate whether your invention can be patented. If you have what you believe to be an invention, we suggest that you have this firm make a search for you.

*Send for a copy of our Patent Booklet entitled "How To Protect Your Invention," containing information about patent protection and patent procedure. Along with this we will also send you an "Invention Record" form, for your use in writing down and sketching details of your invention. We will mail them promptly. No obligation. They are yours for the asking.*

**McMORROW, BERMAN & DAVIDSON**

*Registered Patent Attorneys*

**PATENTS • COPYRIGHTS • PATENTS**

**1359 VICTOR BUILDING, WASHINGTON 1, D. C.**

# Genuine DIAMONDS Direct from N.Y. Leading Specialist



**In Latest Style Mountings  
From \$25 to \$5,000  
Remarkable Savings**

## BUY FOR CASH OR ON EASY CREDIT TERMS

Diamonds never get old! Kaskel's, New York's leading diamond specialist since 1882, have originated a novel plan for you to enjoy great savings on diamonds reset in brand new 14Kt. gold or platinum mountings. Kaskel's plan is simple. They fine-comb the many outlets where diamonds can be secured at much lower than regular wholesale prices. These markets uncover first grade diamonds at amazingly low bargain prices. Kaskel's resets them into beautiful diamond rings, diamond bracelets, diamond pins, diamond earrings, diamond watches . . . AND . . . Kaskel's grades them for you according to nationally accepted standards. These unusual beauties are yours for a fraction of the usual market cost. You take no risk. You are 100% protected by a written bond and a money back guarantee. You can see your selection before you buy. Any size genuine diamond can be yours on a pay as you like lay-away plan. There are no extra charges.

## FREE BIG CATALOG Diamond Advice FREE!

Send today for the big illustrated catalog just off the press. It illustrates many wonderful diamond bargains. All in most fashionable, up to the minute mountings, of 14Kt. gold or platinum. You also get important advice about diamonds that is in itself a diamond buying safeguard and education. Send coupon below for your copy today and learn all the facts which includes Kaskel's special pay as you like lay-away plan. There's no obligation. SEND COUPON TODAY.

References: Your own bank,  
or any mercantile agency

KASKEL'S, Dept. 707-B  
KASKEL Building  
41 West 57th St.  
New York 19, New York

(Diamond  
Specialists  
since 1882)

Send FREE CATALOG and advice about DIAMONDS without obligation.

Name \_\_\_\_\_

Address \_\_\_\_\_

City \_\_\_\_\_ State \_\_\_\_\_

### INSURED TIRE SERVICE POPULAR BRANDS

**FREE** INSURANCE POLICY given with each used tire sold. We guarantee the amount of service you pay for.

NOWHERE CAN SUCH QUALITY BE FOUND AT SUCH LOW PRICES!

SPECIAL! Deduct 10% on orders for Two or More used tires

YOU CAN'T LOSE!!

---

**GOODYEAR SUBURBANITE TYPE SNOW TIRES**  
New Tire Guarantee—Factory Rebuilt  
BEST WINTER TRACTION OF ALL!

670x15	\$9.95	710x15	650x16	650x15	
600x16		760x15	800-820x15	\$10.90	

---

**Super Quality — Rugged Performance — 6 Months Insured Service**

600x16	\$3.65	670x15	\$3.95	700x16	\$4.45	760x16	\$4.75
650x15	3.85	670x16	4.05	710x15	4.35	820x15	4.95
650x16	4.25	700x15	3.95	760x15	4.45	850x17	4.65

---

**Supreme Quality — Nothing Finer — 12 Months Insured Service**

600x16	\$5.25	475x19	\$5.45	700x15(6)	\$10.45	700x20	\$12.50
600x16(6)	6.75	640x15	4.95	750x16(8)	15.95	750x20(8)	18.50
650x16	5.75	670x15	5.35	700x17	11.95	750x20(10)	17.50
650x16(6)	7.25	710x15	5.45	750x17	16.45	825x20	21.50
700x16	6.35	760x15	5.95	750x15	10.95	900x20	19.95
750x16(6)	8.45	800x15	6.35	30x5	11.25	1000x20	20.45
850x15	4.95	820x15	6.35	600x20	10.95	1100x20	21.25
850x15	4.75	850x15	8.35	650x20	11.75	1000x22	21.95
880x15	5.25	870x16	8.15	32x8(5)	11.95	1100x22	22.75
700x15	5.35	700x16(6)	10.25	32x8(10)	12.75	1100x24	25.95

Whitewalls \$1.00 extra.

---

**MIDLAND TIRE SALES** 3701 S. Normal, Dept. PM-55, Chicago 9, Ill.

Speedy shipments on Mail Orders. F.O.B. Chicago. Insurance policy sent with each order. Deduct 10% on orders for 2 or more used tires. Send CHECK or MONEY ORDER.—No COD's.

## LAW FREE BOOK

**THE LAW TRAINED MAN**

Write today for a FREE copy of illustrated law book. "THE LAW-TRAINED MAN," which shows how to earn the professional Bachelor of Laws (LL.B.) degree through home study of the famous Blackstone Law Course. All necessary books and lessons provided. Moderate cost; convenient monthly terms. Write for FREE law training book today.

**Blackstone School of Law, 225 N. Michigan Ave.**  
Founded 1890      Dept. 52      Chicago 1, Ill.

Grow authentic, LIVE dwarf trees!  
Fascinating hobby! Profitable business!

## GROW MINIATURE TREES

SEND FOR FREE SEED & INFORMATION!

**MINIATURE NURSERY CLUB**  
Dept. J-2, P.O. Box 8794,  
Los Angeles 8, Calif.

## MONEY in WORMS

Big money made raising fishworms and crickets. Billions used yearly—unlimited market—sell by mail—We teach you how to raise and where to sell. Learn about our new, tremendous 6 to 12 inch African Redworm—in demand everywhere. Free Literature. CARTER WORM RANCH, PLAINS, GEORGIA

## REAL ESTATE

BE A BROKER

PAYS BIG! SEND FOR FREE, BIG, ILLUSTRATED CATALOG NOW! Graduates report making substantial incomes. Start and run your own business quickly. Men, women of all ages, learn easily. Course covers Sales, Property Management, Appraising, Loans, Mortgages, and related subjects. STUDY AT HOME or in classrooms in leading cities. Diploma awarded. Write TODAY for free book! No obligation. Approved for World War II and Korean Veterans.

**WEAVER SCHOOL OF REAL ESTATE (Est. 1936)**  
2020R Grand Avenue      Kansas City, Mo.

**FREE BOOK TELLS HOW**

## RUPTURED?

Write for New Relief FACTS FREE!

**ENJOY NEW FREEDOM**

of action, peace of mind and comfort at work or play. Proven, patented MILLER holds your rupture back Day & Night—will bring you lasting relief! Has helped thousands of others!

For FREE facts in plain wrapper—  
Send Name and Address to

**FRED B. MILLER, DEPT. 1-B**  
Manufacturer, HAGERSTOWN, MARYLAND

ENTIRELY DIFFERENT

**NOW...from DTI's MILLION DOLLAR TRAINING CENTER**

Learn to master

# TELEVISION AUTOMATION

**RADIO - ELECTRONICS**

by getting **EVERYTHING YOU NEED!**

America's amazing multi-billion dollar Television field offers a chance of a lifetime to get started toward a good job or your own business. With over 400 TV stations in operation and more than 30 million receivers in use, Television is one of today's most promising fields. Mail coupon today. See how you may prepare to cash in on this grand opportunity.

Get **ALL** of your training  
**AT HOME!**...including setting  
up your own **HOME LABORATORY**

See how you may now get one of today's most complete, effective combinations of major home training aids—including (1) well illustrated lessons, (2) the wonderful aid of HOME TRAINING MOVIES and (3) 16 big shipments of electronic parts for setting up your own HOME LABORATORY. You work over 300 construction and test procedures to get the practical experience you need. This includes building and keeping a 5 INCH "SCOPE", Vacuum tube VOLTMETER, and a big 21 INCH TV SET. (DTI offers another home training in Television-Radio-Electronics, but without the TV set.) Mail coupon today for exciting facts.



**NOW—  
get training  
to suit your NEEDS**

**TAKE YOUR  
CHOICE**

Come to  
DTI's  
great **CHICAGO  
LABORATORIES**

...one of the Nation's **FINEST!**

Now, in the heart of the nation's TV Center, you can get all of your preparation in DTI's big, modern, wonderfully equipped training laboratories. Loads of commercial equipment and ample, well qualified instructors help you get a thorough, practical preparation in the **SHORTEST POSSIBLE TIME**. Part time student Employment assistance can help you pay your work while in training.

**EMPLOYMENT SERVICE**

As soon as you complete either the Chicago Laboratory or Home Training, you'll find DTI's grand Employment Service ready to help you start earning real money. Get full facts. Mail coupon today.

**MILITARY SERVICE:** If subject to military service, the training information we have for you should prove very helpful. Mail coupon today.

**89 WAYS  
TO  
EARN  
MONEY  
IN TELEVISION  
RADIO ELECTRONICS**

**ACT NOW! MAIL COUPON TODAY**  
**Get this publication FREE!**

**DEVRY TECHNICAL INSTITUTE** Accredited Member of National Home Study Council  
4141 BELMONT AVE., CHICAGO 41, ILL. DEPT. PM-2-N

I would like your Opportunity News Bulletin showing "89 Ways to Earn Money in Television-Radio-Electronics"; also, complete facts about the training opportunity made possible by your organization.

Name \_\_\_\_\_ Age \_\_\_\_\_  
Address \_\_\_\_\_ Apt. \_\_\_\_\_  
City \_\_\_\_\_ Zone \_\_\_\_\_ State \_\_\_\_\_

DTI's Training is available in Canada 999



**ABOVE:** You build and keep this big 5 INCH commercial-type oscilloscope—one of the most useful test units used in TV today.



Build and keep this **BIG DTI** Engineered TV set—easily converted to U.H.F. (DTI offers another home training, but without the TV set.)



**Use 16 mm. MOVIES** Only DTI provides you with the loan of visual training movies at home to help you master important basic points faster... easier... better!



"One of America's Foremost Electronics Training Centers"



**DEVRY TECHNICAL INSTITUTE**  
CHICAGO 41, ILLINOIS  
FORMERLY  
**DEFOREST'S TRAINING, INC.**

# Inventors

If you consider your invention valuable, take these necessary preliminary steps promptly to protect it by applying for a United States patent.

Sketch and describe your invention. (For convenience in starting action on your invention, use "Evidence of Invention" form offered below.)

Sign, date and have this invention disclosure witnessed by two people capable of understanding your invention.

Have us make a preliminary search among U. S. patents already granted for similar types of invention.

We then prepare a report for you on the probable patentability of your invention and recommend your further course of action.

This firm is registered to practice before the U. S. Patent Office. We are available to assist you in the preparation and prosecution of your application for patent.

We shall be glad to send you promptly and without obligation, an instructive booklet—"Patent Protection for Inventors"—and our convenient "Evidence of Invention" form.

**VICTOR J. EVANS & Co.** *Merlin M. Evans*  
REGISTERED PATENT ATTORNEY  
330-B MERLIN BUILDING, WASHINGTON 6, D. C.

**SAVE 75%**

ON

**WORK CLOTHES!**

SURPLUS STOCK FROM MIDWEST SUPPLY FIRM!  
Terrific values you've got to see to believe!



**SHIRTS 79c**

Made to sell for 2.99! Now only 4 for \$2.99

What a buy! 4 for the price of one! These shirts, though used, are washed, sterilized and ready for long, tough wear. In blue, tan or green. Send neck size, 1st and 2nd color choice.

**PANTS to match Unbelievable 99c**

Bargains! Sold for 3.95. Now only 4 for \$3.75

Send waist measure and inside leg length.

**COVERALLS . . . wear 'em used and save \$2.29**

plenty! Originally 6.95. Now only 3 for \$6.75

Send chest measurement.

**SHOP COATS . . . fully reconditioned. \$1.79**

Take advantage of this rock-bottom price. Send chest measurement. Now only 3 for \$5.00

SATISFACTION GUARANTEED! Your money back if you can beat these bargains anywhere! You can't lose so order TODAY for immediate delivery! Send \$1.00 deposit on C. O. D. orders. Add 25¢ postage and handling on prepaid orders.

**GALCO SALES CO. Dept. 132**

7120 Harvard Ave. • Cleveland 5, Ohio

**FREE OUTFIT STARTS YOU IN BIG MONEY SHOE BUSINESS!**



Run your own profitable shoe store business from home! Represent fast growing million dollar firm in spare or full time. We give you — FREE — complete Starting Outfit that makes you \$217.00 EXTRA each month for just 2 easy orders a day. You feature 195

fast-selling dress, sport, work shoe styles for men and women. Air-cushion shoes, many other special features! Sizes 2 1/2-15—widths AAAA to EEEE. Draw on 200,000 pair stock. Also horsehide jackets. Start now selling to friends, folks where you work. Rush postcard for FREE Outfit!

**MASON SHOE, Dept. 583, CHIPPEWA FALLS, WIS.**



See Stars Close Up!

**ASSEMBLE A BIG 100 POWER 3" REFLECTING TELESCOPE**

. . . with this complete 87 piece "Do-It-Yourself" Kit. See the moon, stars close up, or view terrestrially. Kit includes: 3" f/10 aluminized and over-coated, Spherical Mirror—60X Eyepiece and 100X Barlow Lens—Optical Finder Telescope, 40" Tripod—fork type Equatorial Mount. Complete instructions furnished. Order by Stock No. Send check or M.O. Money back guarantee. Shipping

Weight 10 lbs. Stock No. 85,025-H. \$29.50 f.o.b.

Ask for FREE catalog H Barrington, N. J.

**EDMUND SCIENTIFIC CO., Barrington, N. J., U.S.A.**



Full Color—Wall Size International

**WORLD or U.S. MAP**

It's wall size! 33 inches x 50 inches. Heavy duty durable stock in 8 full colors with clear type to instantly identify any corner of the globe. All in precision detail. Smart as a mural. Educational for children's rooms, den, office, civic, schools, etc. Order Direct today. Send \$1.00 each prepaid or 3 for \$2.75. Your choice. Any selection. Same price. Guaranteed.

**TERRY ELLIOTT CO., Dept. MP-74**  
135 East 44th St. New York 17, N. Y.

**\$1**

**GREATEST  
ADVANCE IN  
SHOP-METHOD  
HOME TRAINING**

# EARN MORE MONEY...GET INTO TELEVISION ELECTRONICS - RADIO

**Learn ALL 8 PHASES in ONE MODERN HOME-STUDY COURSE**

At Home - In Spare Time

## YOU GET ALL THIS NEWEST PRACTICAL EQUIPMENT

- Parts to build a modern TV set, including all tubes plus a large screen Picture Tube
- Parts to build a powerful Superhet Receiver, standard broadcast and short wave
- Parts to conduct many experiments and build Continuity Checker, RF Oscillator, TV Circuits, Audio Oscillator, TRF Receiver, Signal Generator
- A Valuable Professional Multitester



**19 BIG KITS  
YOURS TO KEEP**

## YOUR NATIONAL SCHOOLS TELERAMA COURSE COVERS ALL 8 PHASES

- |                                    |                                |
|------------------------------------|--------------------------------|
| 1. TELEVISION, INCLUDING COLOR TV  | 5. PREPARATION FOR FCC LICENSE |
| 2. RADIO, FM AND AM                | 6. AUTOMATION                  |
| 3. INDUSTRIAL ELECTRONICS          | 7. RADAR AND MICRO WAVES       |
| 4. SOUND RECORDING AND HI FIDELITY | 8. COMMUNICATIONS              |

## YOU ARE NEEDED IN THE TELEVISION-ELECTRONICS-RADIO INDUSTRY!

You can build a secure future for yourself if you get into Electronics NOW! Today's shortage of trained technicians creates tremendous opportunities. National Schools Shop-Method trained technicians are in constant and growing demand for high-pay jobs in Broadcasting and Communications, Electronic Research, Servicing and Repair, and many other branches.

Let National Schools, a Resident Technical School for over 50 years train you for today's unlimited opportunities in electronics! Our Shop-Method trains you to be a MASTER-TECHNICIAN. Completely up to date, developed by experienced instructors and engineers, your Telerama Course will teach you all phases of the industry quickly, clearly and correctly. You can master the most modern projects, such as Color TV, printed circuits - even prepare for FCC License without taking a special

course. You can handle sales, servicing, manufacturing, or make good money in your own business. SEND FOR FACTS TODAY!

**EARN AS YOU LEARN.** Many of our students earn their entire tuition and more in Spare Time jobs we show them how to do while learning.

**YOU GET EVERYTHING YOU NEED** - Clear, profusely illustrated lessons, shop-tested manuals, modern circuit diagrams, practical job projects - all the valuable equipment shown above

- many other materials and services  
- consultation privilege with our qualified staff, and Graduate Employment Service. EVERYTHING YOU NEED for outstanding success in Electronics.

## RESIDENT TRAINING AT LOS ANGELES

If you wish to take your training in our Resident School at Los Angeles, the world's TV capital, start NOW in our big, modern Shops, Labs and Radio-TV Studios. Here you work with latest Electronic equipment - professionally installed - finest, most complete facilities offered by any school. Expert, friendly instructors. Personal attention. Graduate Employment Service. Help in finding home near school - and part time job while you learn. Check box in coupon for full information.



**FREE!**

Fully illustrated "Career" Book in TV-Radio-Electronics. PLUS actual sample lesson - yours at no cost, no obligation. CLIP COUPON NOW... MAIL IT TODAY!



MEMBER



APPROVED FOR G.I. TRAINING

## NATIONAL SCHOOLS

4000 S. FIGUEROA ST., LOS ANGELES 37, CALIF.  
187 N. LA SALLE ST., CHICAGO 1, ILL.  
IN CANADA: 811 W. HASTINGS ST., VANCOUVER, B. C.

## NATIONAL SCHOOLS

TECHNICAL TRADE TRAINING SINCE 1905  
LOS ANGELES 37, CALIFORNIA

GET FAST SERVICE - MAIL NOW TO OFFICE NEAREST YOU!

NATIONAL SCHOOLS, DEPT. RB-27  
4000 S. FIGUEROA ST. OR 187 N. LA SALLE ST.  
LOS ANGELES 37, CALIF. CHICAGO 1, ILL.  
Rush free TV-Radio "Opportunity" Book and sample lesson. No salesman will call.

NAME \_\_\_\_\_ AGE \_\_\_\_\_

ADDRESS \_\_\_\_\_

CITY \_\_\_\_\_ ZONE \_\_\_\_\_ STATE \_\_\_\_\_

Check if interested ONLY in Resident School training at Los Angeles.  
YES/NO: Give date of Discharge \_\_\_\_\_

## Make Big Pay-Feel Secure-Work Steady

# New Shop-Method Way To Learn AUTO MECHANICS At Home In Your Spare Time



2 FREE BOOKS  
MAIL COUPON

**A** NATIONAL MAGAZINE reports that an auto mechanic has the "brightest future". . . that his prospects for success are "very good". . . that he has "opportunity to open his own shop." This is no surprise because Auto Mechanics ranks as America's No. 1 trade. *It offers you good pay, lifelong security and steady work.* Here's why: There are 600,000 auto repair shops and supply stores in the U. S. These shops need thousands of trained mechanics to keep the 50 million cars and 10 million trucks on the road in operation. As a leading automotive magazine said: "About two-thirds of all cars in use are in the heavy repair age classification." It adds, "Aside from the prosperity generated by the huge flood of new cars, the service potential they create is tremendous." If YOU are a man of action—if you want to earn up to \$125 a week and more—we suggest you mail coupon below for two new, free books. These books tell you about the good jobs now waiting . . . show you how to qualify at home in spare time in just a few months.

## Start Earning Spare Time Cash Soon After You Start Training



CTI Shop-Method training is so practical that many students do repair work for profit in spare time. Some do repairing soon after enrolling. Their earnings help pay tuition, buy equipment. Graduates often start in business this way. You, too, may want to earn as you learn, and get valuable experience besides.

## You Get Practical Experience Using Tools and Tune-Up Kit

### YOURS—THIS FINE SET OF MECHANIC'S TOOLS

As part of your training, CTI sends you this set of fine quality mechanic's tools. You'll soon be using these tools—getting practical experience and earning spare time dollars, just as many students do. Tools make you proud of your craft, keep your interest high, develop your skill. CTI's illustrated, easy-to-understand lessons show you *when and how* to use your tools. You will put action into your training—see your knowledge "come alive."



## Start A Business - Be The Boss

If you like independence, Auto Mechanics offers you an opportunity to make your dream come true—to start small and grow big. Many students start repairing in their own back yards. By doing good work, they develop a list of satisfied customers. Then, when they're ready, they open shops.



## Diesel or Body-Fender Training Also

So complete is CTI training in Auto Mechanics that you become not just a mechanic but a *specialist* in tune-up; overhaul; automatic transmissions; power steering; power brakes; clutches; electric, cooling and lubricating systems; etc. And that isn't all! If you wish, CTI will send you instruction on either Diesel Mechanics or Body & Fender Rebuilding at no extra cost.

## High Praise From Industry

One of the largest auto trade associations in America said: "CTI has the best school in the U.S.A." Another association reported: "Your graduates are making excellent progress . . . are highly thought of."

## FREE BOOKS TELL HOW

COMMERCIAL TRADES INSTITUTE Dept. A-478  
1400 Greenleaf Ave., Chicago 26, Ill.

Mail me your book *Big Money In Auto Mechanics* and Lesson Sample. Both FREE.

Name \_\_\_\_\_ Age \_\_\_\_\_

Address \_\_\_\_\_

City \_\_\_\_\_ Zone \_\_\_\_\_ State \_\_\_\_\_



## MAKE GOOD LIKE THESE CTI MEN



"Without CTI training, I would not have the job I hold today. When I showed my CTI diploma, I was given a chance to work as a mechanic."  
—W. O'NEIL, PA.

"Went to work in a garage repairing generators, starters, other electrical equipment. Training is complete and thorough."  
—J. EDWARDS, ILL.

"After completion of training, I started as a full-fledged mechanic in a Buick garage."  
—W. CARTWRIGHT, IND.

"Have bettered myself nearly 100%. Am in partnership with another fellow and we have 24 cars of our own."  
—A. H. CAYES, ME.



"Have had 3 pay raises in 8 months. Before I took the course, I knew very little about a car engine."  
—W. LONG, PA.



# AMAZING MUSIC DISCOVERY

## Has You Playing Real Music The Very First Time You Try!

**Thousands Now Play Who  
Never Thought They Could  
— Requires No Teacher — No  
Boring Practice of Scales  
and Exercises . . .  
QUICK, EASY, INEXPENSIVE!**

**I**F you are one of the many thousands who have always wanted to play music, yet hesitate to learn because "it takes too long," or "it costs too much"—here's wonderful news! Now, with this modern home-study method, you can actually play your favorite instrument *the very first time you try*—and you can go on to master that instrument in a much shorter time than you'd ever imagine possible!

### NO "SPECIAL TALENT" REQUIRED

No previous training needed — no "special talent" required. Right from the start, this amazing music discovery will have you playing *real melodies* instead of practicing tedious scales and exercises. Earliest lessons consist of delightful songs, hymns, waltzes, etc. Clear, simple directions and large, show-how pictures teach you exactly what to do, so you can't go wrong . . . even if you don't know a single note of music now! Soon you'll be playing ALL your favorite songs and compositions *by note!*

### EVEN CHILDREN LEARN QUICKLY

Over 900,000 people the world over have taken up this easy-as-A-B-C way to learn music. It's all so clearly explained, so easy to understand that even children "catch on" quickly. Yes, ANYONE can learn to play piano, violin, accordion, guitar or any other instrument. No inconvenient lesson periods—no expensive hourly tuition. You learn in spare time of your own choosing. *You become your own music teacher . . .* and progress as rapidly or as leisurely as you wish. And lessons are only a few cents each, including valuable sheet music you'll keep always! The whole family can learn for the price of one.

### STOP CHEATING YOURSELF OF THESE JOYS

Why not let this U.S. School of Music method bring the many pleasures of music into YOUR life? Popularity! New friends. Gay parties. Good times. More self-confidence and poise. Extra money from playing or teaching. Possibly even a brilliant musical career. Best of all, the deep *personal satisfaction* of being able to create your own music—provide your own entertainment!

**WHICH MUSICAL INSTRUMENT DO YOU WANT TO PLAY?**

 <p><input type="checkbox"/> <b>PIANO</b> Miss Mildred Cude of Houston, Texas and her friends are so enthusiastic about this method that they've started a music circle.</p>	 <p><input type="checkbox"/> <b>GUITAR</b> "It's been fun. Hasn't cost anywhere near as much as a private teacher. Now invited to affairs, dances."—HOWARD HOPKINS, E. Syracuse, N. Y.</p>
 <p><input type="checkbox"/> <b>ACCORDION</b> "I got my start with a U. S. School of Music Course. How easy it is to play this 'teach yourself' way!"—LAWRENCE WELK, Famous Orchestra Leader</p>	 <p><input type="checkbox"/> <b>VIOLIN</b> "I have played for dances, and am now studying Heifetz's 'Hora Staccata' and a couple of concertos." — IVAN W. DAYLEY, Lisco, Nebr.</p>

**... OR ANY OF THESE OTHER INSTRUMENTS:**

<input type="checkbox"/> Saxophone	<input type="checkbox"/> Tenor Banjo	<input type="checkbox"/> Flute
<input type="checkbox"/> Trumpet, Cornet	<input type="checkbox"/> Ukulele	<input type="checkbox"/> Steel Guitar
<input type="checkbox"/> Pipe, Hammond, Reed Organ	<input type="checkbox"/> Clarinet	<input type="checkbox"/> Piccolo
<input type="checkbox"/> Trombone		

900,000 STUDENTS  
59 Successful Years

### SEND FOR FREE BOOK

Let us SHOW you why our way to learn music is so EASY—and so much FUN! See for yourself why our method has been so successful for 59 years. Clip and mail coupon for our valuable 36-page FREE BOOK. No obligation, no salesman will call on you. It can mean to *every* *winch* to you for the rest of your entire life — if you will mail the coupon at right **TODAY!** U. S. School of Music, Studio A302, Port Washington, N. Y. (Special Reduced Prices on Instruments.)



**U. S. SCHOOL OF MUSIC**  
Studio A302, Port Washington, N. Y.

I am interested in learning to play, particularly the instrument checked below. Please send me your free illustrated booklet, "How to Learn Music at Home." NO SALESMAN IS TO CALL UPON ME.

- |  |   |   |
|--|---|---|
| <input type="checkbox"/> Piano           | <input type="checkbox"/> Pipe, Hammond, | <input type="checkbox"/> Piccolo        |
| <input type="checkbox"/> Guitar          | <input type="checkbox"/> Reed Organ     | <input type="checkbox"/> Modern         |
| <input type="checkbox"/> Steel Guitar    | <input type="checkbox"/> Tenor Banjo    | <input type="checkbox"/> Elementary     |
| <input type="checkbox"/> Violin          | <input type="checkbox"/> Ukulele        | <input type="checkbox"/> Harmony        |
| <input type="checkbox"/> Piano Accordion | <input type="checkbox"/> Clarinet       | <input type="checkbox"/> Mandolin       |
| <input type="checkbox"/> Saxophone       | <input type="checkbox"/> Trombone       | <input type="checkbox"/> Percussion     |
| <input type="checkbox"/> Trumpet, Cornet | <input type="checkbox"/> Flute          | <input type="checkbox"/> Finger Control |

Do you have the instrument?.....

Mr. }  
Mrs. }  
Miss } (Please Print Carefully)

Address .....

City ..... State .....

(Insert Zone Number, if Any)

If under 18, check here for Booklet A

# INCREASE YOUR PAY THROUGH HOME STUDY TRAINING



Do you want a better job—more money? Of course you do. They are within your reach—now. LaSalle experts will train you—guide you step-by-step to acquire the business training which can lead to greater earnings.

The time-saving, interesting LaSalle Problem Method is used to prepare you at home without interference with daily work.

Just mark on the coupon below the career in which you desire success, and we will mail you at no obligation a valuable booklet describing the opportunities in that field. Let us show you how we have helped to start thousands of other ambitious men and women on the high road to success and more money.

Check and mail the coupon NOW!

## LASALLE EXTENSION UNIVERSITY A Correspondence Institution

417 So. Dearborn St., Dept. 264R, Chicago 5, Ill.

Send me FREE, complete information about the field I have checked, and the opportunities in that field.

- |   |  |
|---|--|
| <input type="checkbox"/> LaSalle Accounting       | <input type="checkbox"/> CPA Training        |
| <input type="checkbox"/> Law: Degree of LL.B.     | <input type="checkbox"/> Business Management |
| <input type="checkbox"/> Traffic & Transportation | <input type="checkbox"/> Stenotype           |
| <input type="checkbox"/> Stenographic-Secretarial |  |

Name.....Age.....

Address.....

City, Zone & State.....

## BIG PAY JOBS for men who qualify in DIESEL



**TRAIN NOW FOR A DIESEL FUTURE.** Steady, high-pay jobs await men qualified in Diesel, Tractor, and Heavy Equipment. Are you qualified for job and advancement opportunities in this fast-growing field? You can qualify!

**COMPLETE DIESEL COURSE NOW AVAILABLE.** If you are ambitious and want to get ahead in this big money field, you'll want to know about the complete Diesel home training course now offered by Interstate Training Service. Covers all phases of operation, repair, service. Easy to master in spare time. No interference with present job. Up-to-the-minute. Regularly revised to cover new developments. We invite comparison of material offered. Advisory placement service for our students.



**YOU OWE IT TO YOURSELF** to investigate Interstate Training Service Diesel Training. Thousands agree it has helped them to better jobs...better pay. It can do the same for you!

**WRITE FOR FREE INFORMATION TODAY**

INTERSTATE TRAINING SERVICE, Portland 13, Ore.  
Please see that I receive FREE 24-page book,  
"Getting Ahead in Diesel." (A-3)

NAME.....AGE.....  
ADDRESS.....  
CITY.....ZONE.....STATE.....

## AMAZING! Secret Spy CAMERA



It's a  
CAMERA!  
It's a  
LIGHTER!  
ONLY

**\$2.98**

Complete  
with roll film

**TAKE PICTURES UNDETECTED!!** Now you can take pictures while lighting your own or someone else's cigarette—WITHOUT BEING SUSPECTED! Others think you're just using the lighter, BUT ACTUALLY YOU'RE TAKING PICTURES WITHOUT THEIR KNOWLEDGE! Patterned after the long-secreted spy camera used by secret agents, it's a dependable lighter in addition to being a precision-made camera that takes 20 clear, detailed pictures at a moment's notice. Same size as an ordinary cigarette lighter; fits vest pocket.

**SATISFACTION GUARANTEED OR MONEY BACK**  
High quality lens takes close-ups or distance photos that enlarge beautifully. Allows you to get natural, unposed pictures at parties, home or out-of-doors. No complicated adjustment necessary; easy to operate camera takes 20 photos per roll, that can be developed anywhere. Comes to you complete, ready to operate. Send check, money-order or cash. Add only 20¢ to each order for postage and handling. No C.O.D.'s please. **\$1.00 SPECIAL** — Extra Film, 4 rolls for only.....

DOBB'S PRODUCTS CO., 1255 So. Wabash Ave., Dept. 472, Chicago 5, Ill.

## MAKE MONEY WRITING

.. short paragraphs!

You don't have to be a trained author to make money writing. Hundreds now making money every day on short paragraphs. I tell you what to write, where and how to sell; and supply big list of editors who buy from beginners. Lots of small checks in a hurry bring cash that adds up quickly. No tedious study. Write to sell, right away. Send for free facts. **BENSON BARRETT, Dept. 27-B, 7464 Clark St., Chicago 26, Ill.**

## \$ GROW HERBS FOR US!

AT HOME— IN YOUR SPARE TIME

Help fill our huge demand—used in expensive medicines. Easy to grow indoors or out—multiply rapidly. Year around Profitability! You grow 'em—we buy 'em! We supply everything you need. Free rare seeds and revealing plan is yours Free for the asking. Be one of the first to profit—rush name and address to: **NATIONAL HERB EXCHANGE, Dept. A-2, Gardena, Calif.**

**FREE SEEDS Write!**

## 500 TRICKS MAGIC TRICKS

IT'S FUN TO DO MAGIC

Be popular! Amaze—mystify—entertain! For 30 years Douglas has satisfied customers all over the world. Now, you can enjoy this fascinating hobby. Only 10¢ brings our Catalog 500 Tricks, containing brand new tricks for pocket, parlor, stage. Join in the fun—send 10¢ today!

Douglas Magicland, Dept. A, Dallas, Texas

## FOR BIG MEN ONLY!

SIZES 10 to 16 WIDTHS AAA to EEE

We specialize in LARGE SIZES ONLY—sizes 10 to 16; widths AAA to EEE. Dress, sport, casual and work shoes, golf shoes; insulated boots; socks; slippers; rubbers; overshoes; shoe trees. Also... sport shirts in your exact, extra-long sleeve length. Enjoy perfect fit in your hard-to-find size at amazingly low cost. Satisfaction Guaranteed. Sold by mail only. Write for FREE Style Book TODAY!

**SEND FOR FREE CATALOG**

KING-SIZE, INC., 149 Brockton, Mass.

POPULAR MECHANICS

Copyrighted material

Here's the **EASY, Step-by-Step** Way to

# FIX ANY CAR IN A JIFFY!

Engines, Brakes, Transmissions, Rear Ends, Generators—Yes, Any Part

**BRAND-NEW  
EDITION!**



ALL AUTOMATIC TRANSMISSIONS are fully covered in special big section.

Diagrams, tables and text take the "mystery" out of all ignition systems.

You get step-by-step adjustment procedures for all types of carburetors.

Now—Whether You're a Beginner or Expert Mechanic—You Can "Lick" Any Auto Repair Job on Any Car Built from 1946 Thru 1956

YES, now you can fix ANY part of ANY car—quickly, easily, and right! From carburetor adjustment to a complete overhaul, it's easy when you have MOTOR's famous Auto Repair Manual. It's like having a staff of factory experts and MOTOR's field-trained engineers beside you, guiding you every step of the way. No wonder so many thousands of beginner and expert mechanics alike use this step-by-step, illustrated giant manual.

MOTOR's Manual "starts from scratch"—leads you through entire job with easy step-by-step directions, clear "how-to" pictures. Tells you WHERE to start, what TOOLS to use. You just CAN'T go wrong!

**2,900 Pictures! So Complete  
So Simple, You CAN'T Go Wrong!**

NEW, REVISED edition covers everything you need to know to repair any car. Over ONE THOUSAND giant pages, 2900 "This-Is-How" pictures lead you every step of the way. 291 "Quick-Check" charts—23,436 essential repair specifications. Over 225,000 service and repair facts on ALL 737 chassis models from 1946 thru 1956. Instructions and pictures so clear you can't go wrong! Even a green beginner mechanic can do a good job. And if

you're a top-notch mechanic, you'll be amazed by the time and labor-saving methods!

**The "Meat" of Over 160  
Official Shop Manuals**

**OVER  
2 MILLION  
COPIES  
SOLD!**

The editors have put together the "know-how" from over 160 Official Shop Manuals and "boiled it down" into one fully-illustrated easy-to-understand guide.

Here's ILLUSTRATED step-by-step guidance on Automatic Transmissions, Tune Up, Ignition, Carburetors, Fuel Pumps, Axles, Steering Gears, Rear End, Brakes, PLUS MUCH MORE.

**SEND NO MONEY**

**Try Book for a Week FREE**

Send no money. Pay nothing to postman.

Test book in your own garage or shop. It's **GUARANTEED** to pay for itself in 7 days. If it doesn't, just return the book, and owe nothing. **MOTOR Book Dept., Desk 12, 250 West 55th St., New York 19, N. Y.**

**USED BY U. S. ARMED FORCES**

**Covers 737 Models—All These Makes**

Buick	Ford	Nash
Cadillac	Fraser	Oldsmobile
Chevrolet	Henry J	Packard
Chrysler	Hudson	Plymouth
Clipper	Imperial	Pontiac
Continental	Jeep	Rambler
Crosley	Kaiser	Studebaker
De Soto	Lincoln	Thunderbird
Dodge	Mercury	Willys

Try Book for a Week **FREE**

Beginner Raves About

"Never knew anything about repairing cars until I got this wonderful book. Easy to see close-up pictures of every part. Has paid for itself time and time again."

—P. Pemper, Wis.

So Does Expert

"Have been a mechanic for 23 years. MOTOR'S Manual still takes me out of the tight spots. And it's simple enough to be understood by average person."

—V. Lauria, Nev.

**MAIL COUPON NOW FOR 7-DAY FREE TRIAL**

**MOTOR BOOK DEPT.  
Desk 12, 250 W. 55th St., N. Y. 19, N. Y.**

Rush to me at once (check box opposite book you want):

**MOTOR'S New AUTO REPAIR MANUAL.** If O.K., I will remit \$2 in 7 days, \$2 monthly for 2 months and a final payment of 50¢ (plus 35¢ delivery charges) one month after that. Otherwise I will return the book postpaid in 7 days. (Foreign price, remit \$9 cash with order.)

**MOTOR'S New TRUCK REPAIR MANUAL.** If O.K., I will remit \$2 in 7 days, and \$2 monthly for 3 months, plus 35¢ delivery charges with final payment. Otherwise I will return book postpaid in 7 days. (Foreign price, remit \$10 cash with order.)

Print Name..... Age.....

Address .....

City..... State.....

Check box and save 35¢ shipping charge by enclosing WITH coupon entire payment of \$6.00 for Auto Repair Manual (or \$8 for Truck Repair Manual.) Same 7-day return-refund privilege applies.

**Some FREE Offer on  
MOTOR'S New  
TRUCK MANUAL**

Covers EVERY job on EVERY popular make gasoline truck as well as GM and Cummins Diesels 1946 thru 1956 For FREE trial, check coupon.

# DRAFTSMEN

## CASH BIG PAY CHECKS!

Train Now for more success, greater security

LEARN AT HOME IN SPARE TIME (or at college in Chicago)

Check the want ads in any newspaper—SEE the big-pay opportunities open to you as a draftsman. What's more, you can learn this well-paid, prestige profession at home—quickly, easily! No special talent needed. Get complete, step-by-step Chicago Tech lessons in the mail, spend a few pleasant hours studying each week. In a short time you'll be a well-trained draftsman, ready to take your pick of many good jobs. Act now!

Free Information—Mail Coupon Today!

Get FREE TRIAL LESSON plus information about C.T.C. practical training. Learn what successful Chicago Tech graduates say about high pay and opportunities in drafting. No charge, or obligation.



## CHICAGO TECHNICAL COLLEGE

B-215 Tech Bldg., 2000 So. Michigan Ave. Chicago 16, Illinois

Mail me FREE lesson with facts about big opportunities in DRAFTING.

Name \_\_\_\_\_ Age \_\_\_\_\_

Address \_\_\_\_\_

City \_\_\_\_\_ Zone \_\_\_\_\_ State \_\_\_\_\_

You can make money in

## WATCH REPAIR

Learn at home the low cost Sweazey Way

Watch repairing pays up to \$6 an hour, part time watch makers report on survey. Unique and modern Sweazey home study System starts you making repairs right away on Swiss and American watches. Professionally prepared training. No previous experience needed. Special tools provided for practice. Tuition only \$5 a month. Free sample lesson and opportunity book give all facts. Write today. No obligation.

## CHICAGO SCHOOL OF WATCHMAKING

2330 N. Milwaukee Ave., Dept. 127, Chicago 47, Illinois

FREE BOOK and SAMPLE LESSON

CHICAGO SCHOOL OF WATCHMAKING  
2330 N. Milwaukee Ave., Dept. 127, Chicago 47, Illinois

Please rush FREE BOOK and Sample Home Study Lesson.

Name \_\_\_\_\_ Age \_\_\_\_\_

Address \_\_\_\_\_

City \_\_\_\_\_ Zone \_\_\_\_\_ State \_\_\_\_\_

## Shrinks Hemorrhoids New Way Without Surgery

Science Finds Healing Substance That Relieves Pain—Shrinks Hemorrhoids

For the first time science has found a new healing substance with the astonishing ability to shrink hemorrhoids and to relieve pain—without surgery.

In case after case, while gently relieving pain, actual reduction (shrinkage) took place.

Most amazing of all—results were so thorough that sufferers made astonishing statements like "Piles have ceased to be a problem!"

The secret is a new healing substance (Bio-Dyne\*)—discovery of a world-famous research institute.

This substance is now available in suppository or ointment form under the name Preparation H.\* Ask for it at all drug counters—money back guarantee. \*Reg. U. S. Pat. Off.

## SHORTHAND in 6 WEEKS

Famous SPEEDWRITING shorthand, 120 words per minute. No symbols; no machines; uses ABC's. Easiest to learn, write and transcribe. Lowest cost. For business and Civil Service. 350,000 graduates. Typing available. 34th year. Write for FREE booklet to: SCHOOL OF

*Speedwriting*  
Dept. 1502-7, 55 W. 42 St., New York 36

IT'S EASY...

## MAKE MONEY IN PHOTOGRAPHY

If you are over 17—good pay and fascinating work await you in photography! Start making money quickly in spare time—step into your own studio or exciting career job. LEARN-BY-DOING method trains you at home! Write TODAY for FREE catalog. Also Resident Training. Co-ed. 47th Year. Approved for Veterans.

NEW YORK INSTITUTE OF PHOTOGRAPHY  
Dept. 49, 10 West 33 Street, New York 1, New York  
47th YEAR

## CABINET MAKING

LOW COST HOME TRAINING COURSE FOR BEGINNERS & ADVANCED CRAFTSMEN

Make money. Learn skills and secrets of fine woodworking and tool use. Professionally prepared shop method training tells and shows how. Covers everything. Easy to master.

Write for Free Booklet

INTERSTATE TRAINING SERVICE  
DEPT. F3, PORTLAND 13, OREGON

2011 Offers... 88 Pages

YOUR COPY FREE!

1106 pictures illustrate 2011 offers!—in our new 88 page 1957 catalog. FREE TO YOU from America's largest direct-to-you seed and nursery house. Over 60 years in business. Mail card today!

HENRY FIELD Seed & Nursery Co.  
7164 Oak St., Shenandoah, Iowa



# FREE

## A NEW HOME INDUSTRY



GEARS



FISHING LURES



JEWELRY GEMS

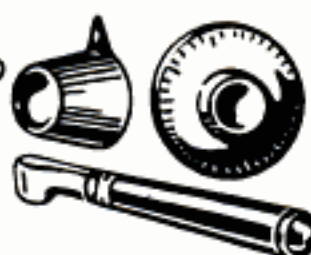

HANDLES  
KNIVES - DIALS



STATUES  
FIGURINES

Let us show you how extremely easy and **PROFITABLE** it is to make beautiful and useful things out of **LIQUID PLASTIC, LIQUID MARBLE, LIQUID IVORY, LIQUID GLASS, LIQUID EBONY, LIQUID PORCELAIN, LIQUID GEMSTONE, CERAMICS, ETC.** . . . . as easy as pouring water out of a glass! Make tools, dies, gadgets, novelties, jewelry, gifts, artware, ceramics . . . . . a million useful things! Valuable products that sell themselves on sight because of their exciting beauty and practical utility.

For years we have been teaching and guiding ambitious people in how to acquire profitable and fascinating occupations, starting at home or in your own shop (with only a few dollars investment), how to make more money than ever before! We now offer **YOU** the same unlimited opportunities!

### MANUFACTURE WITHOUT TOOLS OR MACHINERY!

No previous experience or special ability is needed in order to manufacture with **PLASTICAST Liquid Plastics**. Our special book the "**WONDERS OF LIQUID PLASTICS**" reveals all. Our Liquid Plastics serve so many diverse and useful functions, and can so easily be converted into beautiful and attractive products that thousands of our customers are now actively engaged in a wide variety of pride giving and profitable businesses established with the aid of our products and instructions!

**FREE** Catalog 19 is devoted exclusively (108 pages) to the art of manufacturing **EVERYTHING** without tools or machinery! Send for it today! We will include valuable book **THE WONDERS OF LIQUID PLASTICS** absolutely **FREE**. Catalog No. 19 — 25c.

**PLASTICAST CO., Dept. PC-1202**  
6612 N. Clark St. Chicago 26, Ill.

### WE BUY THOUSANDS OF PLASTICAST ITEMS ANNUALLY

Let us start you in business! We always need **GEMCRAFT** stones, made from **PLASTICASTINGS**, for our regular customers. We guarantee to buy your output too, when made from **PLASTICAST MATERIALS**.

### MATERIALS and INSTRUCTIONS

We can supply you with everything you need. **MATERIALS** in single or gross lots. As much or as little as you want. **INSTRUCTIONS** included with all shipments. In addition, we carry a complete library of beginners and advanced technical books on the manufacture and sale of plastics, from which you can select.

Send only 25c for big, giant-sized catalog of Casting Materials, Molds and Accessories and we will include **FREE** our remarkable book "The Wonders of Liquid Plastics."

**PLASTICAST CO., Dept. PC-1202**

6612 N. Clark St., Chicago 26, Ill.

I am enclosing 25c for **PLASTICAST** Catalog No. 19 and include **FREE** of extra cost the book "**THE WONDERS OF LIQUID PLASTICS.**"

Name \_\_\_\_\_ Age \_\_\_\_\_

Address \_\_\_\_\_

City \_\_\_\_\_ Zone \_\_\_\_\_ State \_\_\_\_\_

# BUY DIRECT and SAVE UP TO 1/2 on ITALIAN ACCORDIONS EASY TERMS

Accordions of famous makes and breath-taking beauty now can be yours! Mail coupon for FREE Color Catalog and amazing Wholesale Prices.



**TRY BEFORE YOU BUY**  
World's largest selection direct from Importer to you! 30 models to choose from. **SATISFACTION GUARANTEED** or your money back. Trade-ins accepted. Terms as low as \$10 monthly. Write today!

Accordion Manufacturers & Wholesalers Outlet  
2003 W. Chicago Av., Dept. R-27, Chicago 22, Ill.

**5 DAYS FREE TRIAL**  
•  
**MONEY BACK GUARANTEE**  
•  
**MAIL COUPON NOW**

**Send For FREE Color Catalog**

Accordion Manufacturers & Wholesalers Outlet  
2003 W. Chicago Av., Dept. R-27, Chicago 22, Ill.  
Send me Free Color Catalog—full details.

Name \_\_\_\_\_  
Address \_\_\_\_\_  
City \_\_\_\_\_ State \_\_\_\_\_

## ENGINEERING DEGREE IN 27 MONTHS

**B. S. DEGREE IN**  
Aeronautical, Chemical, Civil, Electrical, Mechanical and Electronic Engineering (inc. Radio and TV)  
**Big Demand for Graduates**

Hundreds of young men are earning B. S. ENGINEERING DEGREES annually in this recognized institution—year around classes optional. Also B.S. in 36 mo. in Mathematics, Chemistry, Physics. New terms start quarterly. Many students earn a major part of their college expenses in this large industrial center. Low tuition. Competent instruction.

Thorough, intense practical program. Modern, well-equipped laboratories including new physics laboratory and modern wind tunnel. Individualized instruction emphasized. Government approved for G.I.'s. Engineering Science preparatory courses.

Students from 48 states and 21 foreign countries. Enter March, June, September and December. Send coupon for free catalog and full information. Enroll now.

### INDIANA TECHNICAL COLLEGE

527 E. Washington Boulevard, Fort Wayne 2, Indiana

Please send me free information on 27 MO. B.S. DEGREES in:

Aeronautical  Chemical  Civil  Electrical   
Mechanical  Electronics

on 36 MONTH B.S. DEGREES in:

Mathematics  Chemistry  Physics

Name \_\_\_\_\_  
Address \_\_\_\_\_

## 315 Different STAMPS - 25¢ GUARANTEED \$6.95 CATALOG VALUE

Grace Kelly - Rainer  
Royal Wedding  
Monaco U. S.  
President Set—  
F.D.R., Lincoln,  
Washington,  
Eisenhower.

You also get Bulgaria Complete Motor Show; St. Thomas Explorer; San Marino Airmail Triangle; Dutch New Guinea 1st Stamp Issued and hundreds more! Grand total of 315 all-different stamps. Catalog value \$6.95—yours for 25¢ to introduce our Bargain Approvals. Included FREE, Midget Encyclopedia of Stamps.

Send 25¢ Today. ASK FOR LOT FO-26  
ZENITH CO., 81 Willoughby St., Brooklyn 1, N. Y.

## If Your Child Is a Poor Reader

See how The Sound Way To Easy Reading can help him to read and spell better in a few weeks. New home-tutoring course *drills* your child in phonics with records and cards. Easy to use. University tests and parents' reports show children gain up to *full year's grade* in reading skill in 6 weeks. Write for free illustrated folder and low price. **Bremner-Davis Phonics, Dept. E57, Wilmette, Ill.**

## MEN WANTED

Earn \$100 Per Week and up  
**AUTO DIESEL MECHANICS**

Master a trade with a future—learn Auto-Diesel mechanics in our shops. You learn with tools on real equipment. Earn while you learn. Many of our graduates earn \$100 per week and up. No previous experience necessary. Day and night courses. Approved for veterans. Write for free bulletin.

**NASHVILLE AUTO-DIESEL COLLEGE**  
226 7th Ave., N., Dept. 75  
Nashville 3, Tenn.

## Secrets of VENTRILOQUISM Now Revealed!

Easy to learn in 60 to 90 days with our Home Study Course. **RESULTS GUARANTEED.** Make Money! Be Popular! Have Fun! Big Opportunity! Radio, Television, Stage Appearances! For FREE Information regarding price and terms WRITE. You must state your age. Dummy Catalog 25¢.

**FRED MAHER SCHOOL OF VENTRILOQUISM**  
Box 36, Studio PM-2, Kensington Station  
Detroit 24, Michigan

## It's NEW! It's DIFFERENT!

### 40, 80 & 120 POWER TELESCOPE WITH TRIPOD \$1295 ppd.

Observe stars, moon, planets. See distant ships, people, etc. appear feet away! Crystal-clear image sharpness at all powers. All images erect. Telescope, with five precision lenses and 60" long black leatherette covered tube mounted on 3 ft. hardwood tripod, cast aluminum head. Vertical and horizontal movements machined aluminum. Tension controls on each. 3X finder scope attached locates target fast. Telescope completely assembled with tripod PLUS 3 FREE GIFTS only \$12.95 postpd. Satisfaction guaranteed.

**SUFFOLK SCIENCE SERVICE**  
Dept. PM-2  
Mattituck, N. Y.

**GET THESE GIFTS FREE!**

1. 120 pg. book "Discover the Stars"
2. Star Finder Dial
3. 200 & 400X eyepiece lenses

# Check the Kind of Body YOU Want! RIGHT IN THE COUPON BELOW

...and I'll Prove How EASILY You Can Have It!



Valuable Trophy Given Away Be the envy of friends! Win this strikingly handsome "Atlas Champion's" trophy, over 1 1/2 ft. high! All entries eligible.



*Charles Atlas*

Awarded the title of "The World's Most Perfectly Developed Man" in an international contest.

JUST tell me where you want it — and I'll add **SOLID INCHES** of powerful new muscle **SO FAST** your friends will grow bug-eyed with wonder!

Do you want me to broaden your shoulders—put trip-hammer power in your arms—make your legs pillars of strength? Then just check what you want in the coupon below. I'll prove you can get it in just 15 minutes a day — in your own home—or it won't cost you a penny!

I don't care if you are 15 or 50 years old—or how ashamed of your physical condition you may be. I can give you a "barrel chest" and a vise-like grip. I can shoot new strength into your backbone, exercise those inner organs — help you cram your body full of pep, vigor and red-blooded vitality! I'll wake up t h a t sleeping energy of yours

and make it hum like a high-powered dynamo! You'll feel and look different. Man, you'll begin to LIVE!

ling I was at 17 to my present superman physique! Thousands of fellows are becoming marvelous physical specimens — my way. I give you no gadgets or contraptions to fool with. When you develop your strength through "Dynamic Tension" you can laugh at artificial muscle-makers. You simply utilize the dormant muscle-power in your own God-given body—watch it increase and multiply double-quick into real solid LIVE MUSCLE.

My method — "Dynamic Tension" is so easy! Spend only 15 minutes a day in your own home. From the very start you'll be using my method of "Dynamic Tension" almost unconsciously every minute of the day—walking, bending over, etc.—to BUILD THE MUSCLE and VITALITY you want. And you'll be using the method which many great athletes use for keeping in condition — prize fighters, wrestlers, baseball and football players, etc.

## ARE YOU

Skinny, Weak and run down?  
Always tired?  
Nervous?  
Lacking in confidence?  
Suffering from bad breath?  
Fat and flabby?  
Do you want to lose or gain weight?  
**WHAT TO DO ABOUT IT is told in my FREE BOOK**

**FREE** Illustrated 32-Page Book. Just Mail the Coupon.

SEND NOW for my famous book describing my famous method. (Over 3 1/2 MILLION fellows have sent for it already.) 32 pages, packed with photographs and valuable advice. Shows what "Dynamic Tension" has done for others, answers many vital questions.

This book is a real prize for any fellow who wants a better build. Yet I'll send you a copy absolutely FREE. Rush coupon to me personally! Charles Atlas, Dept. 8B, 115 East 23rd St., New York 10, N. Y.



## Here's The Kind of Results I Give:

"I gained 11 lbs. and 4 1/4 inches on my chest, 3 inches on my arms. I am never constipated."  
—Henry Neven, Canada

"I gained 34 lbs. and increased my chest 6 inches."  
—Stanley Lynn, Calif.

"What a difference! Have put 3 1/2 inches on my chest (normal) and 2 1/2 inches expanded."  
—F. S., New York

"Gained 29 pounds. When I started your

course I weighed only 141. Now I weigh 170."  
—I. K., New York

"The benefits are wonderful. The first week my arm increased one inch, my chest two inches."  
—E. M., Conn.

"You changed me from a weakling to a real he-man. My chest has gone up 6 inches. I am a solid mass of muscle. Friends and doctors have noticed a great change in me."  
—J. W., Montana

## WHAT'S MY SECRET?

"DYNAMIC TENSION"! That's the ticket! The identical natural method that I myself developed to change my body from the scrawny skinny chested weak-

CHARLES ATLAS, DEPT. 8B  
115 East 23rd St., New York 10, N. Y.

Dear Charles Atlas: Here's the kind of Body I want:

(Check as many as you like)

- More Weight—Solid—In The Right Places
- Broader Chest and Shoulders
- More Powerful Arms and Grip
- Slimmer Waist and Hips
- More Powerful Leg Muscles
- Better Sleep, More Energy

NAME.....AGE.....  
(please print or write plainly)

ADDRESS.....

CITY.....STATE.....

**RUSH COUPON FOR FREE BOOK**

YOUR  
NEIGHBORHOOD  
NEEDS AN  
**ELECTRICAL  
APPLIANCE**



# TROUBLE SHOOTER

Men needed to repair and service  
all kinds of Electrical Appliances—  
**AUTOMATIC WASHERS - DRYERS  
IRONS - VACUUMS - TOASTERS  
REFRIGERATORS - FANS - HOME  
FREEZERS - AIR CONDITIONERS**  
—home and industrial motors, etc.—  
also home and industrial wiring.

**Big Year-'Round Profits!**  
HELP US FILL HUGE DEMAND

MODERN BIG PROFIT ONE-MAN BUSINESS  
YOURS AT HOME — SPARE OR FULL TIME.

No previous experience needed. New, visual "Shop-Practice" method quickly shows you how. Hundreds of plain-as-day "How to" photos and drawings make it easy. A corner of garage, porch, attic, or basement is all the space needed. No costly leases—no big overhead. We show you how to make business come to you.

**BIG MONEY, SECURE FUTURE—INDEPENDENCE.**

*P. V. de N. Y. says, "I made \$500 in 3 months while studying." T. E. H. in W. Va. says, "Made \$11 a day while learning."*

**EVERYTHING FURNISHED—Including BIG TOOL KIT**  
Instructions are complete and include a Tool Kit and Appliance Tester. Everything furnished to help you build your own big-profit business at home. Our new 30-day income plan shows you how to start making money almost at once. Send no money—just your name and address on coupon below. I will rush you FREE complete success plan with full details. Do it NOW—BE FIRST!

**PACIFIC TRAINING SCHOOL, Dept. P-572**  
11029 So. Vermont Ave., Los Angeles 44, Calif.

**PACIFIC TRAINING SCHOOL, Dept. P-572**  
11029 So. Vermont Ave., Los Angeles 44, Calif.

Gentlemen: Rush me postpaid your FREE plan for success in the Appliance Repair Business and the Free Book Entitled "The Appliance Repair Business and You" and remember I am under no obligation.

Name \_\_\_\_\_  
Address \_\_\_\_\_  
City \_\_\_\_\_ Zone \_\_\_\_\_ State \_\_\_\_\_

## "YOU ARE UNDER ARREST!"

Help Bring Crooks to Justice Through Scientific  
**CRIME DETECTION!**

We have taught thousands this exciting, profitable, pleasant profession. Let us teach you in your own home. Learn Finger Printing, Firearms Identification, Police Photography, Secret Service Methods thoroughly, quickly, at small cost. Over 800 of all American Bureaus of Identification employ I.A.S. students or graduates. Write stating age, for "Blue Book of Crime."

(A Correspondence School Since 1918)

**INSTITUTE OF APPLIED SCIENCE, 1920 Sunnyside Ave., Dept. 1355, Chicago 40, Ill.**

## High School at Home

**MANY FINISH IN 2 YEARS**

No classes. No time wasted going to and from school. Progress as fast as your time and abilities permit. Standard H. S. texts supplied. Thousands enroll each year in this 60-year-old school. Send for FREE descriptive booklet.

**AMERICAN SCHOOL, Dept. H245**  
Drexel at 58th St., Chicago 37, Ill.

Without obligation, please send FREE descriptive booklet.

Name \_\_\_\_\_  
Address \_\_\_\_\_

Complete Canadian Courses available. Write American School, Dept. H245, 6083 Sherbrooke St. W., Montreal

## EAT ANYTHING WITH FALSE TEETH

If you have trouble with plates that slip, rock and cause sore gums—try Brimms Plasti-Liner. One application makes plates fit snugly without powder or paste, because Brimms Plasti-Liner hardens permanently to your plate. It relines and refits loose plates in a way no powder or paste can do. No need to pass up your favorite foods. With plates held firmly by Plasti-Liner, **YOU CAN EAT ANYTHING!** Simply lay soft strip of Plasti-Liner on troublesome upper or lower. Bite and it molds perfectly. *Easy to use*, tasteless, odorless, harmless to you and your plates. Removable as directed. Money back guarantee. At your drug counter. Only \$1.50. Plasti-Liner, Inc. Dept. GG, Buffalo 9, N. Y.



**BRIMMS PLASTI-LINER**  
THE PERMANENT DENTURE RELINER

## GIANT BALLOONS

The best! Surplus US Govt. (new overage) Neoprene weather target balloons. **FOR FUN**—Great in backyard, at parties, picnics, fairs. Young & old enjoy 'em! **FOR ADVERTISING**—Attract big crowds to business openings, civic events, trade shows, exhibitions. Paint 'em with a sales message and they'll pay off for you! **FOR PROMS**—Makes any high school or college prom more festive. Real cool!

Approx. inflated sizes.

3 ft. dia., 49¢—5 ft. dia., 99¢

Postage paid on prepaid orders. Cal. res. add sales tax.

**VOLUME SALES CO., War Assets Division**  
3930 Sunset Blvd., Dept. PM-257, Los Angeles 29, Calif.

## A TEXAS OIL COMPANY Wants a Man Over 45

WE NEED a good man at once and we are willing to pay top earnings. We prefer someone between 45 and 65... who can make short auto trips... and can call on small town industrial and rural property owners.

**WORTH \$12,500.00**

Our top men in other parts of the country draw exceptional earnings from \$12,500 to \$18,000 in a year. This opening is worth just as much to the right man. We pay earnings in advance. Write a confidential letter to Oscar F. Swallow, President, Box 789, Fort Worth 1, Texas



SEND FOR THIS **FREE!**

Make money. Know how to break and train horses. Write today for this book FREE, together with special offer of a course in Animal Breeding. If you are interested in Galting and Riding the saddle horse, check here ( ) Do it today—now.

**BEERY SCHOOL OF HORSEMANSHIP**  
Dept. 1102 Pleasant Hill, Ohio

## LEARN TO BE AN EXECUTIVE!

BOOK  
SENT  
FREE

Qualified, trained men are needed now to fill big pay management positions in business and industry. The Thomas Method of Individual Correspondence Instruction trains you at home under expert supervision. Business men approved. 15 thorough Management Courses—in Business Administration, Industrial, Retail, Office Management, Advertising, Personnel, Salesmanship, Human Relations, other business fields. Write for FREE BOOK, "Opportunities in Business Management," and complete details. No obligation.

**THOMAS SCHOOLS, Dept. A2, 1428-11th, Seattle 22, Wash.**



The famous ALLIED School  
**LEARN-BY-DOING-METHOD**  
 Will Prepare You for  
 Great Opportunities in  
**AIR CONDITIONING**  
**HEATING & REFRIGERATION**



**FREE Sample Lesson and Book**



**BIG KITS**

**Train at Home in Your Spare Time or at the Allied Institute in Chicago**

Here is the finest training for one of the greatest industries of our time. Here is preparation for high pay made possible only because of ALLIED'S extensive resident training facilities—the "know how" that has won the co-operation of industry. You can be sure of the quality of Allied training—resident training on a wide variety of equipment—and home study training that has behind it a great resident school. That is why it means so much more to you when you enroll for Allied Home Study training—or whether you come to the big Allied training shops.

**You are Supplied Shop-Work Kits if You Prefer to Train at Home**

Right in your own home you do the practical air conditioning and refrigeration work made possible by ALLIED training. You are given actual Work-Shop kits, and right at home have the opportunity to build an Air Conditioner, Freezer, or other units of your choice. ALLIED Home Study Work-Shop training right in your own home on actual equipment is made possible only because of ALLIED'S resident facilities. That is why you can progress so much faster, begin to earn so much sooner. Even in your spare time while learning your hourly pay can be really big!

**Send for Free Books at Once—Tell How to Get Ready for Good Jobs or Business of Your Own**

ALLIED gives you the comprehensive all-around training you need—Air Conditioning, Heating, Refrigeration. Here is your chance to get into a great industry now while so many are growing rapidly with it—and making more and more money. Vast expansion is taking place in home air conditioning, auto air conditioning, increasing uses of industrial air conditioning. The need for trained men in Air Conditioning, Heating and Refrigeration points the way to success for you. Get the facts—find out what makes ALLIED training so superior. Send for free books today—no obligation!

**ALLIED SCHOOL of Mechanical Trades**  
 1338-42 South Michigan Avenue  
 Chicago 5, Illinois

**ALLIED SCHOOL OF MECHANICAL TRADES**

*Allied Institute of Technology*  
 1338-42 South Michigan Ave., Dept. PM-2A, Chicago 5, Ill.

Gentlemen:

Mail me FREE BOOKS explaining ALLIED'S training program in AIR CONDITIONING, HEATING, and REFRIGERATION.

I am interested in resident training  home study

Name \_\_\_\_\_ Age \_\_\_\_\_

Address \_\_\_\_\_

City \_\_\_\_\_ County \_\_\_\_\_ State \_\_\_\_\_

not everyone does as well, but E. O. Lockin, who started a business of his own, reports...

for 12 months I've averaged  
**\$800 PER MONTH**  
**INCOME** —  
 most of it clear profit for me!

• Mr. Lockin expresses his grateful thanks for the opportunity to make a decent living on his own. Many men have discovered how to be independent, to be free of bosses and layoffs. L. A. Eagles grossed more than \$200 his first week. R. E. Traynor says, "I made \$62 gross in one day." Others report gross up to \$12,000 per year.

How much you make depends largely on you. You need no special skill, no large investment. Can start part time until you have full time.

**No shop necessary**  
 Our *Electric Rug Washer* cleans rugs, carpets right on floor... helps to show their natural color and beauty. So efficient and safe, used by largest hotels and railroads.

You take no risk. Machines fully guaranteed. Mail coupon today for complete information including how to start making big profits in *your own* business.

**VON SCHRADER MFG. CO.**  
 RACINE, WISCONSIN

You, too, can start your own business. No special skill, no large investment required. Mail coupon today for interesting **FREE** book.

**VON SCHRADER MFG. CO.,**  
 210 "R" Pl., Racine, Wisconsin

Send at once (no obligation) your **FREE** booklet containing information about your *Electric Rug Washer* and how I can start *my own* permanent, profitable business.

Name.....

Address.....

City.....Zone.....State.....

**SAVE HUNDREDS OF DOLLARS**  
 with **HOME-A-MINUTE "KIT"**

This is not something to fool around with.



**A Hard Hitting System of Saving Big Money**

Design and build your New Home. Any design. Attic, Flat, Extra Bedroom or Remodeling — **IN MINUTES** — with dozens of fiber partitions, Doors, Windows, Kitchen Cabinets, made to 1/4 inch scale same as blue-

print. THEN, BELIEVE IT OR NOT, YOU, THE LAYMAN, who knows nothing about building, can estimate your own costs — **IN MINUTES** — after you adjust charts to local prices. Tells how to get your loan. Don't build anything until you get this "KIT" if you want to save money. Handbook tells you how. This information should not pass you by. Complete "KIT" \$3.95 ppd., if COD plus postage and \$1 deposit required. Handbook without "KIT" \$1.95 or free literature. Money back guarantee. Return in 10 days.

**SPECIAL NOTICE!** — As a builder, controlling over 3 million dollars worth of home construction, we will ATTEMPT, but not promise, to obtain a special discount to you for your building materials on your new project, thru your favorite, local, Lumber Dealer. Details with "KIT."

**R. E. HALL & CO.** 2825 N. 69th St. MILWAUKEE 10, WIS.

**Get Yourself FIXED**  
**FOR LIFE in the Big Pay**  
**Shoe Business!**

I'LL PUT UP  
 THE MONEY  
 TO GIVE YOU  
 A FLYING  
 START!



It's no trick at all to make big money—FULL OR SPARE TIME—with America's most comfortable shoes! Amazing new "Spring-Step" cushion invention proves it by actual demonstration. Only ORTHO-VENT has it! There is no other shoe in the world like it. Repeat orders are sure, steady. One try and a customer is sold for life. Profits are BIG. Orders are sure and easy with the most amazing 2-minute demonstration in the history of the shoe business. No experience needed. No investment to make. Everything, including actual cut-a-ways, furnished free! Be the big-pay ORTHO-VENT man in your territory. Write TODAY! E. C. Brand, Sales Manager.

**ORTHO-VENT SHOE COMPANY**  
 1172 College Ave. SALEM, VIRGINIA

I GIVE  
 PRODUCERS  
 THEIR OWN  
 SHOES AS A  
 BONUS!

Money in **SHELLCRAFT**

Trained Commercial Shellcrafters earn big money. Elderly lady reports \$7,000.00 a year.



Ohio couple boasts \$1,800.00 in ten weeks while wife holds secretarial job. **GET PROOF** there is money in this fascinating trade. Write today for **FREE SHELLS** and information on Training Plan.



**NATIONAL SHELLCRAFT SCHOOL**  
 5666 34th St. No. St. Petersburg, Fla.

**"ROLL" WALL CLEANER**



**DRY** roll wallcleaner. No mess. No muss. Simply glide over walls. Removes dirt like magic from Wallpaper, Painted Walls, Ceilings, Window Shades. Leaves beautiful lustrous finish. Take orders. **Korn money!**

**SAMPLES FOR TRIAL**

Sample offer sent at once to all who send name. **Hurry** — just a postcard will do. **SEND NO MONEY** — just your name.

**KRISTEE CO., Dept. 696, Akron 8, Ohio**

**MINK \$25.00 EACH**

BRED FEMALES FOR SPRING DELIVERY  
 BOOK "DOMESTIC MINK" \$1.00  
**HARRY SAXTON'S MINK RANCH, Bemus Point, N. Y.**

**LEARN LOCKSMITHING**

Learn this fascinating, profitable trade from experts in your spare time at home! Age or physical handicap no disadvantage. Year around, steady income. Full or part time. Practical, illustrated lessons. You can make money even while learning! All materials and special tools supplied without extra charge. **INSTITUTE OF LOCKSMITHING, Dept. P-87**  
 15 PARK AVENUE RUTHERFORD, N. J.  
 Lic. by N. J. State Board of Education  
 Approved for Veterans

Now Many Wear  
**FALSE TEETH**  
 With More Comfort

**FASTEETH**, a pleasant alkaline (non-acid) powder, holds false teeth more firmly. To eat and talk in more comfort, just sprinkle a little **FASTEETH** on your plates. No gummy, gooey, pasty taste or feeling. Checks "plate odor" (denture breath). Get **FASTEETH** at any drug counter.

**RCA** offers you the  
 finest training  
 at home in  
**Radio-TV**  
 electronics,  
**TV servicing,**  
**Color TV**

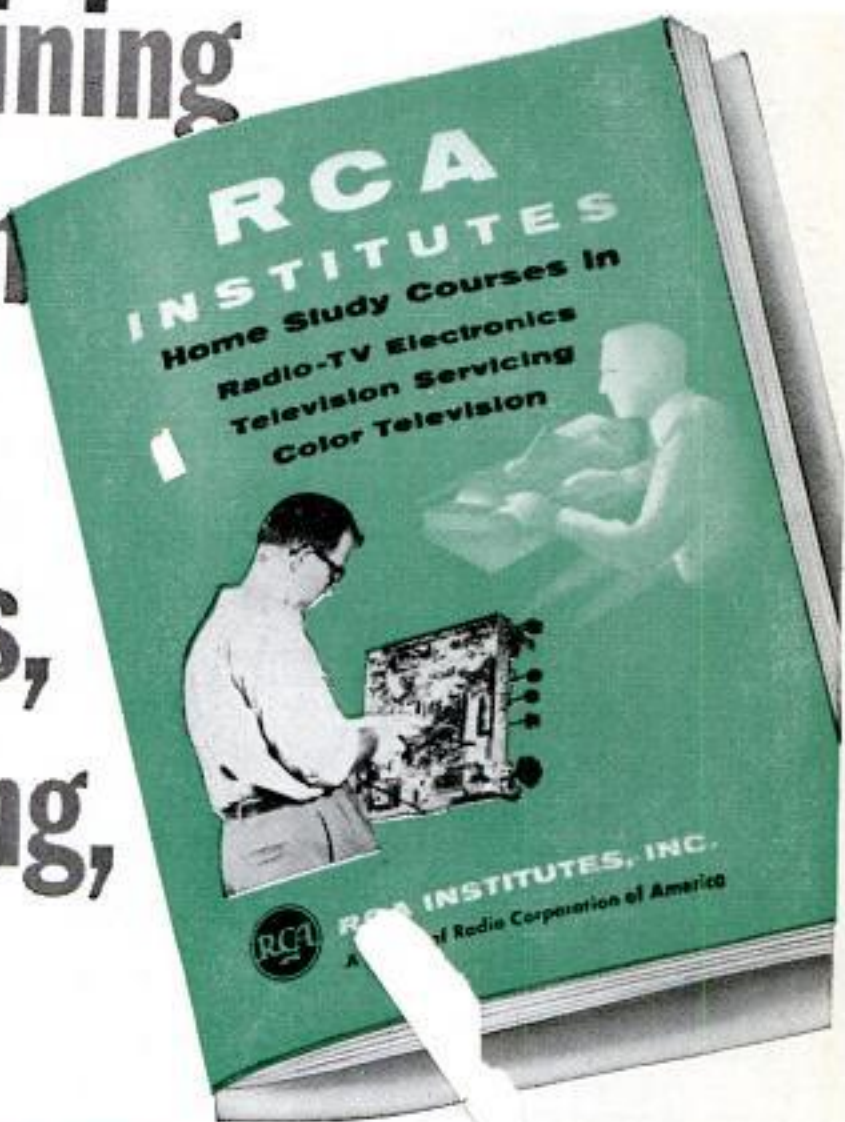

**SEND FOR THIS FREE  
 BOOK NOW!**

The instruction you receive and equipment you get (and keep) will start you on your way. Pay-as-you-learn. You pay for only one study group at a time. This 52 page book contains complete information on Home Study Courses for the beginner and the advanced student.



**RCA INSTITUTES, INC.**  
 A SERVICE OF RADIO CORPORATION OF AMERICA  
 350 WEST FOURTH STREET, NEW YORK 14, N.Y.

RCA Institutes, Inc., Home Study PM-27,  
 350 West Fourth Street New York 14, N. Y.  
 Without obligation, send me FREE CATALOG  
 on Home Study Courses in Radio, Television  
 and Color TV. No salesman will call.

Name.....  
 Please Print  
 Address.....  
 City..... Zone..... State.....

VETERANS  
 KOREAN G. I.  
 P. L. 550  
 CHECK HERE  
 ( )

FEBRUARY 1957

Copyrighted material 33



**YOU**  
can  
acquire

## LAW NIGHTS AT HOME! LL. B. DEGREE

LaSalle's famous Law Library—used as reference in many Law libraries and Law offices—has enabled thousands to master Law surprisingly fast, in spare hours at home, for business and professional advancement.

These 14 remarkable volumes, compiled by leading professors and lawyers, cover the whole basic field of Law in condensed, orderly, simplified manner.

You advance rapidly with this great library, plus special lectures furnished. We guide you step-by-step with personalized Problem Method of instruction . . . you learn by doing—handling legal problems—not by memorizing rules.

Send for two FREE booklets, "Law Training for Leadership," and "Evidence," answering questions about Law and its value to you, and telling how LaSalle Law graduates are winning rapid advancement in business and public life. Mail coupon below. No obligation.

### LA SALLE EXTENSION UNIVERSITY A Correspondence Institution

417 S. Dearborn St. Dept. 264L Chicago 5, Ill.

Send me your two FREE booklets described above, without obligation.

Name.....Age.....

Street.....

City, Zone & State.....

*Write Like This*

MIRACULOUS IMPROVEMENT in your Penmanship in six hours practice with Grooved Letters. No failures. Inexpensive. No charges unless you're satisfied after 6 hours practice.

WRITE OZMENT BOX 665  
34-P, ST. LOUIS, MISSOURI

Complete  
OUTLINE  
FREE!

## MAKE BIG PAY!

in the construction industry as an operator of Bulldozers, Draglines, Back Hoes, Scrapers and Motor Graders. Learn these skills NOW! Contractors need operators of earth-moving machines and pay high wages to our graduates. Don't be satisfied with just a job . . . learn a career!

Write TODAY for FREE School Catalog

**National School of Heavy Equipment Operation**  
P.O. Box 8243 (D-12) Charlotte, N. C.

## Let Me Show You How I Made \$20,000 a Year Buying Junk Jewelry

Learn at home in one evening



No selling. Pay friends and neighbors good prices for old rings, watches, chains and bridges. U. S. Gov't pays you \$35 an ounce for the gold this junk contains.

THERE'S gold to be picked up on any street in any town any day of the year if you know my secrets. I teach you how to find it, how to buy it, what to pay for it, how to test and how to ship to Uncle Sam for cash. I supply you with testing outfit and weighing scale. Takes only one evening to learn at home. Next day you are ready to fill your pockets with gold at junk prices. I'll teach you the secrets by which I made \$20,000 a year. No charge for facts. Send name on postcard—no money. **Leslie Patton**, 335 W. Madison Street, Dept. P-92, Chicago 6, Illinois.

## LEARN TO MOUNT BIRDS



ANIMALS, FISH, PETS

Be a Taxidermist. Save your hunting TROPHIES. Have a fine home-museum. Hunters, save and MOUNT your beautiful DUCKS, QUAIL, DEER, TAN skins, FURS. Great Fun. Spare-time PROFITS. **FREE BOOK** Tells ALL about it. 100 fine wild-game pictures. 48 pages. SEND TODAY, don't delay. Get this WONDERFUL FREE BOOK, MEN AND BOYS. Learn Taxidermy. Double your hunting pleasure. Rush letter or POSTAL today. STATE YOUR AGE. **N. W. SCHOOL OF TAXIDERMISTRY**, Dept. 2502, Omaha, Neb.

## FREE GERMAN STEEL HUNTING KNIFE



4-INCH BLADE

We give you handiest hunting and fishing knife you've ever had! Has 4-INCH LONG highly tempered steel blade—VERY SHARP! Attractive handle. We send knife FREE to acquaint you with our below-wholesale bargains. Please send 25c for handling. NO LIMIT—but send 25c handling for each knife. Order TODAY! **HUNTING KNIFE**, Dept. K-149, Box 881, St. Louis, Mo.

## LEARN METALCRAFT and JEWELRY MAKING



Low Cost Home Training Now Available

Make money. Learn profitable skills and arts of decorative metal and jewelry crafts. Course is complete. Professionally prepared. Easy to master. Special tools and materials furnished.

Write for **INTERSTATE TRAINING SERVICE**  
Free Booklet DEPT. K-3 PORTLAND 13, OREGON

## RUPTURED

BE FREE FROM TRUSS SLAVERY

Now there is a new modern Non-Surgical treatment designed to permanently correct rupture. These Non-Surgical treatments are so certain, that a Lifetime Certificate of Assurance is given.

Write today for our New FREE Book that gives facts that may save you painful and expensive surgery, and tells how non-surgically you may again work, live, play and love and enjoy life in the manner you desire. There is no obligation. **Excelsior Hernia Clinic**, Dept. 8305, Excelsior Spgs., Mo.

# BARGAINS

IS THE ONLY BIG TABLOID PUBLICATION in  
Existence That Tells You WHERE & HOW  
—EVERY MONTH—



- To Buy Bankrupt, Closeout, Surplus Bargains!
- To Buy Items at Wholesale! ● At Below Wholesale!
- To Buy Many New & Unusual Items!
- To Obtain Information on Rare Money Making Offers!

**TOYS, BOOKS, JEWELRY, GREETING CARDS,  
COSMETICS, HOUSEHOLD MERCHANDISE,  
APPLIANCES, INDUSTRIAL MATERIALS,  
MACHINERY, TOOLS, ETC.**

**Often as Low as 10c-25c on the Retail Dollar!!**

ONE issue of this Sensational NEW publication can save you MORE MONEY than the cost of the entire subscription! You can BUY BETTER, CHEAPER, NEWER THINGS EVERY MONTH OF THE YEAR! Today, when your dollar buys so little, you absolutely need every single issue of BARGAINS in order to get the MOST FROM EVERY PENNY YOU SPEND. Each issue carries HUNDREDS of bargain offers . . . many times SO EXTRAORDINARY that it's hard to believe that they're GENUINE! Buying at WHOLESALE, BANKRUPT, SURPLUS, CLOSEOUT PRICES can save you from 40c to 80c or more on every dollar you spend! THIS MAY BE HARD TO BELIEVE, BUT IT IS THE TRUTH!

**YOU Can make FANTASTIC PROFITS Buying Up Bargain Merchandise CHEAP and Selling It CHEAP**

Thousands of Agents, Salesmen, Dealers are subscribers to "BARGAINS." They want to know where to buy BEST in order to sell at low prices for BIG PROFITS. NO REASON why you CAN'T DO THE SAME! Special articles in BARGAINS give you valuable tips on HOW to sell these bargains for BIG PROFITS. And you know, EVERYBODY is looking for bargains these days . . . in fact, this is the only kind of merchandise that is being sold in tremendous volume. Ask any big businessman!

**Unique "Subscribers Shopping Service" Enables You to Buy Big Name Merchandise at TREMENDOUS SAVINGS**

You won't find this feature in ANY OTHER MAGAZINE. ONLY "BARGAINS" has it. For subscribers ONLY, each month it negotiates bargain offers in famous merchandise at LOW WHOLESALE PRICES and then offers them to subscribers AT NO PROFIT! Enables you to buy in small lots—singly or in quantity at the same prices (sometimes even lower) than dealers are paying! This SINGLE FEATURE OF BARGAINS IS WORTH THE LOW SUBSCRIPTION PRICE A DOZEN TIMES OVER. Yet, it's only ONE feature among many to be found! Yes, just one!

**"Bargains" Is the ONLY Publication of Its Kind in Existence!**

Search your newsstand high and low. You won't find another publication like it! BARGAINS is available by subscription ONLY. Read the glowing letters by subscribers who received their first copies and WERE AMAZED by this sensational publication! You will be, too!

**SAVE Up to \$1,000 — EARN Up to \$3,000**

We honestly believe that it's possible to SAVE up to \$1,000—and EARN up to \$3,000 within a year by reading "BARGAINS" EVERY MONTH! WHY NOT PROVE THIS FOR YOURSELF!

Your subscription will automatically include the BIG 1957 CHRISTMAS SPECIAL ISSUE . . . jam full of terrific, eye opening holiday BARGAINS! JUST \$2.00—17c per month gives you 12 great money saving issues of BARGAINS!

**\$2.00 Per Year — 12 Big Issues**

(Regular price, \$3.00 per Year)

Special Limited Time Offer to Get 10,000 New Subscribers!

**Your Money Back IN FULL if the First Issue Doesn't Please You!**

LET'S FACE IT . . . Claims, promises are easily made on paper. You may or may not believe all we say here. BUT can you go wrong in subscribing to "Bargains" on this iron-clad MONEY BACK GUARANTEE . . . Your money back IN FULL if the first issue that you receive doesn't please you! Can any offer be more POSITIVE, more FAIR than this POWERFUL guarantee?

**TOWER PRESS, INC., P.O. Box 591-ZO, Lynn, Mass.**

**Here's a FEW Samples of the Bargains Usually Found in "BARGAINS"!**

- PENCILS, 57½c per Gross!
  - 25c Rudolph the Reindeer Brooches, 2c each!
  - Plastic Toy GUNS, 2c each!
  - \$1 Mufflers, Scarfs, 12½c each!
  - Double edge razor blades, \$1.50 per 1000!
  - LADIES APRONS, 6¼c each!
  - \$2.50 WALLETS, 30c each!
  - \$1 val. BILLFOLDS, 15c each!
  - \$1 Kiddies handbags, 3c each!
  - CIGARETTE HOLDERS, 1c each!
  - BUTTONS, 144 for 25c!
  - NEW Phono records, 78 & 45 r.p.m. 7c each!
  - 69c Insect Repellent, 5c each!
  - New 20" T.V. Pic. tubes, \$21.95 each!
  - Famous brand \$18.75 perfume, \$1 each!
  - 49c Xmas window decorations, 10c per set!
  - \$1-\$3 Hard cover books, 20c each!
  - \$200.00 Surplus typewriters, \$23.00 each!
  - 50c Everyday greeting cards, 7c per box!
  - \$1.95 Men's Silk Ties, 12½c each!
  - \$1 val. personal cloth name tapes, 40c for 72!
  - 39c Under arm deodorant, 2c jar!
  - \$1 Automatic card shufflers, 9c each!
  - NEW HAIRNETS, ½c each!
  - \$15.00 Electric Percolators, \$5.00 each!
  - \$1.75 Rudolph Reindeer kiddies toiletry sets, 35c each!
  - \$5.50 Lucite Hairbrushes, 65c each!
  - New Bobby Pins, 70c per 700 pins!
  - \$10 Men's Toiletry Sets, 60c each!
  - Calendar Wrist Watches, \$5 each!
  - Christmas Seals, 25c per 1000!
  - \$2.98 Horserace game records, 30c each!
- PLUS HUNDREDS OF OTHER SENSATIONAL BUYS!**

(Above list merely illustrates type of bargains usually found in this paper. Lists naturally change from month to month.) Pre rate prices based on quantity buys.

—"Tear out Coupon. Mail NOW—at once!"—

Tower Press, Inc., P.O. Box 591-ZO, Lynn, Mass.  
O.K. Here's my \$2.00 for 1 year subscription. Rush me 1st copy!

Name \_\_\_\_\_

Address \_\_\_\_\_

City \_\_\_\_\_ State \_\_\_\_\_

Remember! Your Money Back IN FULL if the 1st issue you receive doesn't please you!

Some make more, some less; T. THORN reports:

**\$690** gross in single  
**MONTH**  
IN MY OWN BUSINESS!



**Start  
YOUR OWN  
Business!**



• Here's YOUR chance to start a money-making, year-'round business of your own and make the success you've dreamed about. R. O. Donnelly took in \$40 in seven hours. O. W. Ware landed a \$750 hotel job. R. Traynor grossed over \$450.00 in five days. Homes, hotels, offices, clubs, offer you big profit possibilities. Auto upholstery also.

**NO SHOP OR OFFICE NECESSARY.** You clean furniture on customers' premises. No hauling. No high rents. Supplies inexpensive; operate from your home. What you take in is mostly profit.

• If you want to be your own boss—free from layoffs, strikes and bosses, we will help you to start and succeed. Don't delay... read the facts, then decide for yourself.

**MAIL COUPON TODAY FOR FREE BOOK**

**VON SCHRADER MFG. CO.**  
210 "D" Pl., Racine, Wisconsin

Without obligation rush your **FREE** booklet about how I can start my own permanent, profitable electric Upholstery Cleaning business.

Name \_\_\_\_\_

Address \_\_\_\_\_

City \_\_\_\_\_ Zone \_\_\_\_\_ State \_\_\_\_\_

**Top Pay Jobs in  
TV-ELECTRONICS-RADIO**

High pay, opportunity, prestige, security... all yours, as a qualified Electronics Technician! Get your training NOW in the big, recognized shops, Labs, and TV-Radio Studios at National Schools in Los Angeles, foremost since 1905. Here you work with latest Electronics equipment—professionally installed—finest, most complete facilities offered by any school. Expert, friendly instructors. Personal attention. Graduate Employment Service. Help in finding home near school. Part time job while you learn. Mail coupon NOW, TODAY... for full information.

**NATIONAL SCHOOLS**  
National Schools Dept. RKB-27  
4000 So. Figueroa Los Angeles 37, Calif.  
Send Free Electronics Opportunity Book Today

Name \_\_\_\_\_ Age \_\_\_\_\_  
Address \_\_\_\_\_  
City \_\_\_\_\_ State \_\_\_\_\_

**INVENTORS**

PROTECT YOUR INVENTION BY A U. S. PATENT. SEND FOR FREE "INVENTION RECORD" FORM AND "PATENT INFORMATION EVERY INVENTOR SHOULD HAVE."

**CARL MILLER**  
REGISTERED PATENT ATTORNEY

WOOLWORTH BLDG., 36th FLOOR, 27A  
NEW YORK CITY

**INVENTORS**

I shall be pleased to furnish you, upon request, with full information relative to patent procedure—without any obligation on your part.

**PATRICK D. BEAVERS**  
Registered Patent Attorney

934 Columbian Building Washington 1, D. C.

**INVENTORS**

Send for **PATENT INFORMATION** REGISTERED PATENT ATTORNEY

Book and **INVENTOR'S RECORD** without obligation

ASSOCIATE EXAMINER  
U.S. PAT. OFF. 1922-1929

**GUSTAVE MILLER**

Patent Attorney & Advisor

27-PM WARNER BUILDING WASHINGTON 4, D.C.

U. S. NAVY DEPT. 1930-1947  
PATENT LAWYER

**INVENTORS**

U. S. Patents protect your inventions. Our free book of "Instructions on Patent Procedure for Inventors," also "Certificate of Invention" form sent without obligation.

**C. A. SNOW & CO.**

REGISTERED PATENT ATTORNEYS

428 SNOW BUILDING WASHINGTON 1, D. C.

**INVENTORS**

Whether an invention is patentable can be substantially determined by a search of the U. S. Patent records. Without obligation, write for information explaining the steps you should take to secure a patent.

**JOHN N. RANDOLPH**

Registered Patent Attorney

201 Columbian Building, Washington 1, D. C.

**MAKE TREMENDOUS PROFITS**

Have fun! Earn Big Money! Cast plaster figurines, bookends, plaques, novelties at home in your spare time with K.L. rubber molds! NO EXPERIENCE NEEDED! Models and rubber for 3 molds, only \$1.50 post. Send 25c (refunded with order) for 40 page catalog now!

**PLASTIC ARTS STUDIO** 3403 SO. MADISON, DEPT. PM2 MUNCIE, INDIANA



**WORLD'S LOWEST PRICED  
ADDING MACHINE**

Counts up to 999,999,999 IDEAL FOR BUSINESS AND PERSONAL USE—GUARANTEED ACCURATE. Not a toy. Operates with only a finger flick. Adds, subtracts, multiplies, divides. Counts up to one billion. Pays for itself over and over. Ideal Gift—for Business, Income Tax and School use. **MONEY BACK GUARANTEE.** Send name and address. Pay postpaid only \$2.95 plus postage. Beautiful rich-looking Leatherette Case included at no extra cost. Money back in 10 days if not delighted. AGENTS WANTED.

Vest Pocket Size  
**FREE TRIAL**  
**\$2.95**

TOTAL COST  
SEND NO MONEY

**CALCULATOR MACHINE COMPANY**  
P.O. Box 126, Dept. G-57, Huntingdon Valley, Penna.



# BOTH OF THESE MEN ARE MECHANICS...



Earns \$3,000 a Year

Earns \$10,000 a Year

The Difference is SKILL!

## EARN MORE PAY the Audel Way!

### AUDELS AUTO MECHANICS GUIDE. \$6

A practical quick ready reference book for auto mechanics, service men, operators & owners. Explains theory, construction & servicing of modern motor cars, trucks, buses & auto type Diesel engines. 1800 pages, fully illustrated, 73 chapters. Indexed. A standard book for mechanics. New Hydraulic & Fluid drive covered.

### AUDELS MACHINIST & TOOLMAKERS HANDY BOOK. \$6

Covers modern machine shop practice in all its branches. Tells how to set up & operate lathes, screw and milling machines, shapers, drill presses & all other machine & hand tools. 1600 pages, fully illustrated. Indexed. 5 sections. 1—Modern Machine Shop Practice. 2—Blue Print Reading & How to Draw. 3—Calculations & Mathematics for Machinists. 4—Shop Physics. 5—How to Use the Slide Rule. 60 chapters. Easy to read and understand. A shop companion that answers your questions.

### AUDELS WELDERS GUIDE. \$3

A concise, practical text on operation & maintenance of all welding machines for all mechanics. Over 400 pages, illustrated. Covers all methods of electric and acetylene welding including airplane work.

### AUDELS BLUE PRINT READING. \$3

For Mechanics & Builders. Covers all types of blue print reading including ship & airplane. 416 pages, fully illustrated.

### AUDELS MATHEMATICS & CALCULATIONS FOR MECHANICS. \$3

Mathematics for home study or reference. 700 pages, 550 illus. Practical mathematics from beginning. How to figure correctly. Easy, correct methods covering complete review. 111us. & Indexed.

### AUDELS SHEETMETAL HANDY BOOK \$2

Practical inside information. Fundamentals of Sheet Metal Work. 388 pages. Illustrated. 11 sections. Clearly written. Essential & important facts, figures, pointers in everyday language. Ref. Index.

### AUDELS PLUMBERS & STEAMFITTERS GUIDES—(4 Book Set) \$8

A Practical Trade Assistant & Ready Reference. Explains in plain language & by clear illustrations, diagrams, charts, graphs, pictures principles of modern plumbing practice including Pipe Fitting and Air Conditioning. 4 Vols.—1670 Pages—3642 Diagrams & Illustrations. Each Vol. Sold Separately, \$2 a vol.

### AUDELS OIL BURNER GUIDE. \$2

384 Pages Covering Installation, Servicing & Repairs All Types Domestic & Industrial Burners. Illustrated. Highly Endorsed.

### AUDELS CARPENTERS & BUILDERS GUIDES—(4 Book Set) \$8

A practical illustrated trade assistant on modern construction for carpenters, joiners, builders, mechanics and all woodworkers. 4 vols., 1600 pages, 3700 illustrations. Fully indexed. Each volume Sold Separately, \$2 a Vol.

### AUDELS ELECTRIC MOTOR GUIDE. \$5

Practical Information Covering Construction, Control, Maintenance & Wiring Hookups of All Types Electric Motors also Armature Winding. 1000 Pages Fully Illustrated & Indexed.

### AUDELS PRACTICAL ELECTRICITY. \$5

A key to a practical understanding of Electricity. For maintenance engineers, electricians & all electrical workers. 1440 Pages, 2600 illus. Covers important electrical information in handy form—including wiring for Light & Power. Indexed.

### AUDELS RADIOMANS GUIDE. \$5

A key to the practical understanding of radio including Frequency Modulation, Television, etc. Aircraft & Marine Radio. For radio engineers, servicemen, amateurs. 914 Pages, 633 Illustrations & Diagrams. Photos. Review Questions & Answers. Reference Index.

### AUDELS TV SERVICE MANUAL. \$3

Tells How to Solve T.V. Troubles. 384 Pages on Installing, Trouble Shooting & Repairing. Shows Good Receiver Adjustment—How to Install Aerials—Explains Color Systems. 225 illus. & Diagrams covers Operating Principles of Modern T.V. Receivers.

AUDEL, Publishers, 49 W. 23 St., N. Y. 10, N. Y.



Learn more to earn more! Step up your income with an Audel Guide. Increase your skill with the practical facts and figures of your trade. Get the facts about the right methods, short cuts, labor saving ideas and new materials. Check the box below now! Yours to examine FREE in your own home. Start the easy payments only if completely satisfied.

CUT HERE

## MAIL ORDER

AUDEL, Publishers, 49 W. 23 St., NEW YORK 10, N. Y.

Please send me postpaid for FREE EXAMINATION books marked (x) below. If I decide to keep them I agree to mail \$1 in 7 Days on each book or set ordered and further mail \$1 monthly on each book or set until I have paid price, otherwise I will return them.

- HOME APPLIANCE SERVICE GUIDE, 800 Pages \$6
- AUTOMOBILE MECHANICS GUIDE, 1664 Pages. 6
- TRUCK & TRACTOR GUIDE, 1299 Pages . . . 3
- DIESEL ENGINE MANUAL, 575 Pages . . . 3
- MACHINISTS HANDY BOOK, 1650 Pages . . . 6
- WELDERS GUIDE, 400 Pages . . . 3
- BLUE PRINT READING, 416 Pages . . . 3
- MATHEMATICS & CALCULATIONS, 700 Pages 3
- SHEET METAL PATTERN LAYOUTS, 1100 Pgs. 7.50
- SHEET METAL WORKERS HANDY BOOK, 388 Pgs. 2
- MECHANICAL DRAWING GUIDE, 160 Pages . . 3
- MECHANICAL DRAWING & DESIGN, 480 Pages . 3
- TELEVISION SERVICE MANUAL, 434 Pages . . 3
- RADIOMANS GUIDE, 1040 Pages . . . 5
- ELECTRONIC DEVICES, 216 Pages . . . 3
- ELECTRIC MOTOR GUIDE, 1000 Pages . . . 5
- WIRING DIAGRAMS (Light & Power), 272 Pgs. 2
- ELECTRICIANS EXAMINATIONS, 250 Pages . . 2
- ELECTRIC POWER, CALCULATIONS, 425 Pages. 3
- HANDY BOOK OF ELECTRICITY, 1440 Pages. . 5
- ELECTRIC DICTIONARY, 9000 Terms . . . 3
- ELECTRIC LIBRARY, 7000 Pages (10 Book Set) 20
- REFRIGERATION & Air Conditioning, 1280 Pgs. 6
- MILLWRIGHTS & MECHANICS GUIDE, 1200 Pgs. 5
- POWER PLANT ENGINEERS GUIDE, 1500 Pages 5
- ENGINEERS & FIREMANS EXAMS, 525 Pages . 2
- PUMPS, Hydraulics & Air Compressors, 1658 Pgs 6
- OPERATING ENGINEERS LIBRARY (3 Books) . 12
- GARDENERS & GROWERS GUIDES (4 Book Set) 6
- CARPENTERS & BUILDERS GUIDES (4 Book Set) 8
- PLUMBERS & Steamfitters Guides (4 Book Set) 8
- MASONS AND BUILDERS GUIDES (4 Book Set) 8
- PAINTERS & DECORATORS MANUAL, 450 Pgs. 2
- HOUSE HEATING GUIDE, 1000 Pages . . . 5
- OIL BURNER GUIDE, 384 Pages . . . . . 2

Check NOW!

Audels List Of Time Tested Practical Handy Books

MAIL THIS TODAY

Name .....

Address .....

Occupation .....

Employed by .....

**MAKE  
\$18<sup>00</sup>  
AN HOUR  
WITH**



**New  
PLASTIC SANDWICH MACHINE**

This new, remarkable PLASTIC SANDWICH MACHINE does a permanent, beautiful, professional, protective, plastic lamination job in exactly three minutes time! Amazing earnings possible in your own home or shop permanently sandwiching PHOTOS, SOCIAL SECURITY CARDS, IDENTIFICATION CARDS, CLIPPINGS, DIPLOMAS, etc. between sheets of clear plastic. Make PLASTIC SANDWICHES that cost you only 8c each, take 2-3 minutes time—yet sell for 50c to \$1.00 each! Laminating machines range from \$39.50 up.



**FREE  
SAMPLE**  
and illustrated  
literature, NO  
obligation.

**PLASTICAST COMPANY**

6612 N. Clark St. Dept. LM-1001 Chicago 26

**FREE!**

TO SECURE NAMES FOR OUR MAILING LIST

**Treasure Chest  
OF PRIZED  
STAMPS**

FROM  
PIRATE STRONGHOLDS



IMAGINE! You receive FREE this whole "treasure chest" of valuable stamps from countries and islands famous in history as PIRATE hideouts! Your imagination will be carried back to the days of Jean La Fitte, Blackbeard, Captain Kidd, by these colorful stamps from the Bahamas, Barbados, Haiti, Trinidad, Liberia, Madagascar, St. Pierre and Miquelon . . . etc. You may want to sell them to envious friends. Or start a priceless "pirate country" stamp collection. ALSO FREE - Stamp Collector's MAP OF THE PIRATE WORLD and helpful, informative "How to Collect Stamps." Other interesting offers included for your inspection. Mail this ad now (with your name and address and 10¢ to help cover handling, mailing) to:  
**LITTLETON STAMP COMPANY,**  
Dept. PM-2, Littleton, N. H.

**RAZOR BLADE PLANES**



**JUST USE  
A  
DOUBLE-EDGE  
RAZOR  
BLADE**

FOR JOBS OTHER  
PLANES CAN'T DO  
For Short Curves  
and Shaping  
For Long Curves  
and Flat Surfaces

Adjust Here

ADJUSTS  
INSTANTLY  
FOR  
DESIRED  
DEPTH  
OF CUT

ONLY 98¢ each AT HARDWARE DEALERS  
If not yet available in your area, you may order by mail. Include 25¢ additional for postage and handling.  
- DEALERS WRITE FOR INFORMATION -  
**WILSON BROS. Dept. PM-2 SPRINGFIELD, MISSOURI**

**GET LATEST OFFICIAL AIRCRAFT PHOTOS**

NOW, FIRST TIME ANYWHERE  
exclusive official, sharp photos of advanced  
Supersonic Rockets, Jets, Historical planes.  
All makes, hundreds from which to choose.



**SPECIAL OFFER**

with your name and address. Send 25c . . .  
get four 2 1/2 x 5 photos, world's fastest jets.  
Illustrated catalog, with order.  
Money back Guarantee. Mail today.

**AVIATION PHOTO EXCHANGE** DEPT. PE BOX 75084  
LOS ANGELES 5, CALIFORNIA

**STUDY TO BE A DOCTOR**

*of Psychology or Metaphysics*

Obtain a Ph.D., Ms.D., or Ph.D. Be a Teacher, Lecturer or Accredited Practitioner. Teach others how to achieve Health, Happiness and Contentment. Chartered by State. Correspondence Courses only. Write for FREE book telling how.

**THE NEOTARIAN FELLOWSHIP**  
Desk B. Pickwick Building Kansas City 6, Missouri

**SEND ME**



every month so I am sure to  
see each new issue. Here's

- \$3.50 for 1 year
- \$8.00 for 3 years

name \_\_\_\_\_

address \_\_\_\_\_

city \_\_\_\_\_

zone \_\_\_\_\_

state \_\_\_\_\_

Hand this order to your newsdealer or send it to

**POPULAR MECHANICS**  
200 East Ontario St. Chicago 11, Ill.



# Get "The Most" in Pay and Job Security— LEARN AIR CONDITIONING

## MAKE HOME YOUR TRAINING SHOP

## & REFRIGERATION



BUILD A REFRIGERATOR,  
AIR CONDITIONER,  
FREEZER or  
MILK COOLER

### A GOOD JOB, MORE MONEY, BRIGHT FUTURE

—all three can be yours in the Air Conditioning & Refrigeration field! Thousands of mechanics are needed to repair and service the 150 million units in use—and the six million air conditioners, freezers and refrigerators that are produced each year. You can earn more money in a better job—if you are trained. For information on how to get this training, just fill out and mail coupon below. No obligation!



R. C. Anderson  
President CTI

### A New, Easy Way to Learn in Months

CTI training is quick and effective because it is *practical*. You learn by doing. During the course of your training, you receive 23 big kits, including tools. You practice with these kits, get valuable experience. For instance, you do 10 complete service and trouble-shooting jobs with CTI kits. You assemble a heavy-duty, commercial type, ¼ h.p. high side (illustrated at left). You build an air conditioner, refrigerator, freezer or milk cooler—and you keep and use this valuable unit! Only CTI sends you these fine tools and kits—helps you get real *on-the-job* training! And all this fine equipment is yours at *no extra cost!* With CTI training you can *start out* as a mechanic and avoid years of work as a lower-paid apprentice.

### You Practice with 23 Kits

You learn fast because CTI sends you 23 kits. Illustration shows heavy-duty ¼ h.p. refrigeration high-side which you will build—and keep. *Only CTI sends these kits.*



### You Get Professional Tools

Here are tools included in just one kit. You get other tools, tubing, much equipment. Tools develop your interest and skill, speed up training.



### You Learn in Easy Stages

Another kit, which includes motor, fan, pulley, service tools. Kits are sent on a planned schedule to help you learn in easy stages. There's no other training like this!

### Earn Good Income as You Train, too

CTI training is so practical that students often work in spare time repairing air conditioners and refrigerators. *They add to their income this way.* Some get jobs with local dealers; others work on their own. Many students go in business on graduation. A number get full-time jobs while they're students.

### A Wonderful Opportunity to Be the Boss

If you want to own a business, Refrigeration offers you opportunity for success. Since most jobs are service calls, you can build up a list of potential customers. Very little capital is needed to start.



### Mail Coupon For Two FREE Books

Mail coupon below for two books which give you complete information. One is entitled *Success in Air Conditioning and Refrigeration*. The other is a *Lesson Sample*. Both FREE.

**DO NOT DELAY—MAIL THIS TODAY**

Mr. R. C. Anderson, President  
COMMERCIAL TRADES INSTITUTE  
1400 Greenleaf Ave., Chicago 26, Ill.

Dept. R-341

Mail me SUCCESS BOOK and LESSON SAMPLE. No cost or obligation.

Name \_\_\_\_\_ Age \_\_\_\_\_

Address \_\_\_\_\_

City \_\_\_\_\_ Zone \_\_\_\_\_ State \_\_\_\_\_



# LEARN UPHOLSTERY

in your spare time  
run your own  
business  
AT HOME



**FREE BOOK**  
with  
sample  
lessons

## BE YOUR OWN BOSS

Earn more from the start! Set up your own profitable business, in your own home, enjoy steady income, independence for life—in the booming field of Custom Furniture Upholstery. Right off you start learning with tools, complete frames, fabrics and materials, included **FREE** with your UTS course. You learn skilled professional custom upholstery, reupholstery, furniture finishing, repairs, how to make beautiful slip covers, window cornices, cushions and draperies. **EARN WHILE YOU LEARN**, in your spare time . . . the UTS easy way.

**FREE ILLUSTRATED BOOK—FREE SAMPLE LESSON**  
Get ready for well-paid job and big profits, from steady work, as your own boss, running your own business. Mail coupon NOW! Training in N. Y. School also available.

## APPROVED FOR VETERAN TRAINING

### UPHOLSTERY TRADES SCHOOL

Dept. FB-310, 721 8<sup>th</sup> way, N. Y. 3, N. Y.

Please send me **FREE** book "Your New Way to a Successful Career," and **FREE** sample lesson. No obligation—no salesman will call.  
 Home Study  N. Y. School Training

Name \_\_\_\_\_ (Please Print Plainly)  
Address \_\_\_\_\_  
City \_\_\_\_\_ Zone \_\_\_\_\_ State \_\_\_\_\_  
 Check if Korean Veteran

- with course YOU MAKE
- SLIPPER CHAIR
- CLUB CHAIR
- OTTOMAN

PLUS SLIP COVERS  
Yours to Keep or Sell

# WHY YOU NEED AUTO-TIMER...

ADJUSTS SPARK PERFECTLY

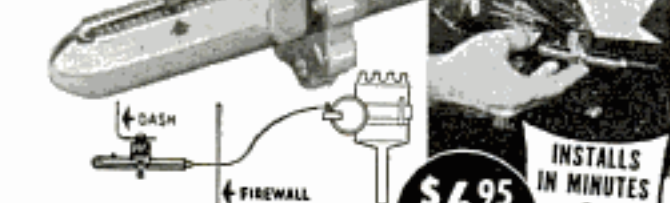

## RIGHT SPARK—RIGHT NOW

Don't let so-called "automatic" spark timing ruin your mileage economy. The **AUTO-TIMER** lets you adjust your spark instantly to compensate for heat, altitude, speed, load, gas octane, etc. You advance or retard your spark with a simple flick of your finger... for city traffic, heavy pulling, cheaper gas, high speeds, cold starting, etc. New indicator button shows exact spark setting, can't get out of adjustment. **AUTO-TIMER** supplements the factory installed spark advance, does not interfere with its operation at all. **AUTO-TIMER** is a tested and approved engineering advance, yours for only \$6.95.

**NEWHOUSE AUTOMOTIVE IND.**  
5805 E. Beverly Blvd.  
Dept. 667, Los Angeles 22, Calif.

**\$6.95**  
PPD.  
INSTALLS IN MINUTES  
• FITS ALL CARS

**AUTO-TIMER** installs simply and quickly - do it yourself. It is triple-chromed for lasting beauty, designed for that "years-ahead" style. The increased performance, power, mileage and satisfaction will more than pay for **AUTO-TIMER** in a few wks. **MONEY-BACK GUARANTEE** Satisfaction is guaranteed, or your money back. **AUTO-TIMER** may be found at leading Automotive Supply Stores everywhere, or order direct from us. Send \$6.95 full payment and we'll pay postage - or send \$1.00 and pay balance plus postage C.O.D.

# Want to pass a U. S. CIVIL SERVICE TEST?



**MEN — WOMEN, 18-55.** Thousands of positions open. Prepare **NOW** for next examinations. Write immediately for free 36-page book, with list of many positions and particulars telling how to prepare. Grade school education often sufficient. Veterans get preference.

## FRANKLIN INSTITUTE

(Not Government Controlled)

Dept. D-93, Rochester 4, N. Y.

**SELL SUITS!** **MAKE \$90 a WEEK** On Only One Sale a Day!

**YOUR OWN SUIT WITHOUT COST!** Salesmen! Make "top" money with the nation's "top" direct-selling tailoring line! Show customers and friends, outstanding selection fine suiting fabrics, tailored to measure, and pocket cash profits. Your own suit to wear and show supplied as bonus without cost!

**Sales-Winning Sample Outfit — FREE!** Everything needed to start making good money—a prosperous business of your own. Write fully about yourself, age, etc.

**GREAT WESTERN TAILORING CO.** Since 1895  
Dept. B-2 841 W. Jackson Chicago 7, Ill.

**250 POWER . . . .**

**Complete Telescope Lens Kit** only **\$3.49** postpaid

Conquer Space, Explore the Universe, Planets, Moon Craters, New Stars, etc. Complete Lens Kit consists of 80 inch focal length ground and polished objective lens, eyepiece lenses for 50 POWER, 100 POWER, 150 POWER, 200 POWER, 250 POWER, and all necessary lens fittings. Easy to make from simple step by step instructions. (Tripod and mount not included.) Money back guarantee.

**BUSSE SALES CO., Hartford, Conn., Dept. PM 54**

**MAKE BIG MONEY AT HOME!**

## INVISIBLE MENDING

Pays up to \$10 in an Hour!

Make moth holes, cigarette burns, tears, rips, disappear from all fabrics. Little-known craft pays extra spare-time profits at home. Write today for exciting details **FREE!**

**FABRICON 8342 S. Prairie Avenue**  
Dept. 322, Chicago 19, Ill.

## HELPFUL BOOKS

Send post card asking for **FREE** catalog

Popular Mechanics Press, 200 E. Ontario, Dept. 601, Chicago 11

**BUY IT WHOLESALE!**

**GET UP TO 40% OFF**

Agents-Start Buying Service at Home. Get big-name merchandise for clients up to 40% off. Sales easy as you can give sizeable discounts, still make fat commissions. Postcard brings **FREE** COPY "The Wholesale Plan."

**FREE! "THE WHOLESALE PLAN"**

**American Buyers Service**

**HERTEL STATION, DEPT. R, BUFFALO 16, N. Y.**

## RUPTURE!

An amazing Air-Cushion Invention allows body freedom at work or play. Light, neat, cool, sanitary. Durable, cheap. Day and night protection helps Nature support weakened muscles gently but surely. No risk. **Send on Trial!** Write **NOW** for free Booklet and **Proof of Results**. All correspondence confidential.

**Brooks Company, 373-F State St., Marshall, Mich.**

Train in Great Shops of COYNE for better jobs in

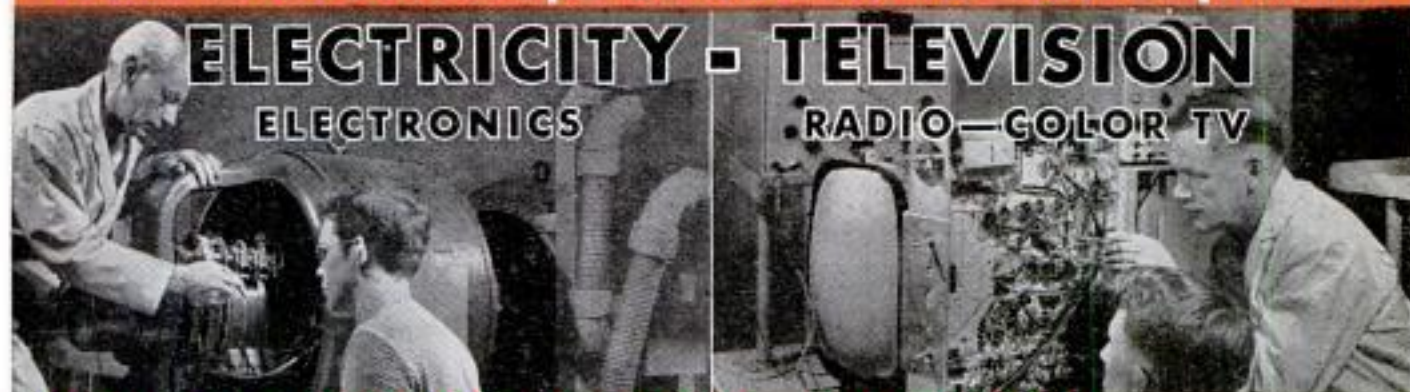

# ELECTRICITY - TELEVISION

ELECTRONICS RADIO—COLOR TV

## TWO TOP OPPORTUNITY FIELDS

Whether 17 or up to 45 years of age, train the Coyne way for a better job and a real future in **ELECTRICITY-ELECTRONICS** or **TELEVISION-RADIO**, fields that offer a world of opportunities. Train on real, full-size equipment at COYNE where thousands of successful men have trained for nearly 60 years—largest, oldest, best equipped school of its kind—established 1899. No advanced education or previous experience needed. Employment service to graduates. **START NOW—PAY LATER**—Liberal Finance Plans and Easy Payment Plans. Also part-time employment help for students. Training in Refrigeration and Electric Appliances can be included.

B. W. COOKE Jr., President

**COYNE**  
ELECTRICAL SCHOOL

FOUNDED 1899

A Technical Trade Institute Operated Not For Profit  
500 S. Paulina Street, Chicago, Dept. 27-72H

ELECTRICITY • RADIO • TELEVISION • REFRIGERATION • ELECTRONICS

## MAIL COUPON FOR FREE BOOK

Send coupon for 48-page illustrated book "Guide to Careers in Electricity-Electronics and Television-Radio." No cost; no obligation; no salesman will call. Vets and Non-Vets get vital facts now!



B. W. COOKE Jr., President  
COYNE ELECTRICAL SCHOOL  
500 S. Paulina St., Chicago 12, Ill., Dept. 27-72H

Send BIG FREE book and details of your training offer. This does not obligate me and no salesman will call. I am interested in:

( ) Electricity-Electronics ( ) Television-Radio

Name \_\_\_\_\_

Address \_\_\_\_\_

City \_\_\_\_\_

State \_\_\_\_\_

# Draw Me...

You may win \$375.00  
Scholarship in Professional Art

Winner gets a complete art course—free training for a money-making career in commercial art, illustrating or cartooning. You are coached, individually, by professional artists on the staff of world's largest home study art school. Many top artists have studied with this school, founded over 40 years ago. As winner you also get a drawing outfit and valuable art textbooks. Try for this free art course!



(PLEASE PRINT)

ART INSTRUCTION, INC., STUDIO 2137

500 South 4th Street, Minneapolis 15, Minnesota

Please enter my attached drawing in your "Draw Me" contest.

Name \_\_\_\_\_ AGE \_\_\_\_\_ Phone \_\_\_\_\_

Address \_\_\_\_\_ City \_\_\_\_\_ Zone \_\_\_\_\_

County \_\_\_\_\_ State \_\_\_\_\_ Occupation \_\_\_\_\_

**DRAW THIS GIRL'S HEAD**  
5 inches high. Use pencil. Drawings for March 1957 contest must be received by March 31. None returned. Winner notified. Amateurs only. Our students not eligible. Mail your drawing today!

# ENGINEERING



**Thousands of  
Engineers Needed  
for Hard Pressed  
Industry  
BACHELOR OF  
SCIENCE DEGREE,  
27 MONTHS**

**Degree Courses:**

- Electronic Engineering
- Electrical Engineering
- Highway Engineering
- Mechanical Engineering
- Structural Engineering
- Civil Engineering
- Architecture

**Diploma Courses:**

- TELEVISION  Color TV
- Tool & Die Design
- Architectural Drafting
- Mechanical Drafting
- Structural Drafting
- Surveying
- Estimating
- Master Electrician

Approved for Veterans

Photo of Heald Electrical Laboratory  
Enroll Now for New Term

Heald College Ranks **FIRST**  
West of the Mississippi  
in "Who's Who" in America

Send for **FREE** Information  
**Heald Engineering College**  
Van Ness at Post, Dept. PM-1  
San Francisco, California

NAME \_\_\_\_\_  
STREET \_\_\_\_\_  
CITY \_\_\_\_\_  
STATE \_\_\_\_\_

# Yours FOR JUST 10¢



**This \$4.95 Regular Size  
Presto Fire Extinguisher  
for Letting Us Prove How  
YOU CAN MAKE UP TO  
\$1,000<sup>00</sup> A MONTH!**

C. Kama of Texas Making Even More—  
Said, "Haven't Touched Bottom Yet!"



We DARE make this amazing offer because we're certain that once you actually use a PRESTO to put out a demonstration fire in a bucket—you'll realize why it "sells on sight" to car owners, homes, stores, farms, boats, offices, factories, and to stores for re-sale. PRESTO's startling chemical is 1½ to 6 times as effective as ordinary extinguisher chemicals on equal-weight basis. . . permits light, handy extinguisher even a child can use!

**Here's Our Daring 10c Offer!**

Send your name and address with only 10c TODAY—and we'll send you a regular \$4.95 PRESTO at once. Then you can demonstrate this miracle fire extinguisher to yourself and friends and see for yourself. If not amazed, return PRESTO to us and we'll refund your 10c. Or keep it at this big saving when you order 6 or more. You can't lose. You risk nothing. We'll also send you **FREE** a complete Sales Kit to help you get started. Act now. Write to **MERLITE INDUSTRIES (Presto Div.)**, 114 E. 32nd. St., Dept. X-155, New York 16, N.Y. **IN CANADA:** Mopa, Ltd., 371 Dowd St., Montreal 1, P. Q.

SAVE ½ - ¾ THE PRICE OF FACTORY-BUILT BOATS

**BOAT  
KIT  
CATALOG  
Free!**

Runabouts, cruisers, convertibles, fishing; 43 models, 8 through 18 ft. Freight paid, \$39.25 up. Assembled and finished by experienced owners. Luger boats equal factory-built in speed, handling, style, beauty; yet save you ½ to ¾. Owners say: "Fastest boat on river." "Pleasure to assemble." "Everyone admires my Luger." Thousands in use. Send for big, free boat kit catalog; also lists fiberglass, hardware, accessories, trailers, paint. Write for catalog today.



Write:

**LUGER INDUSTRIES, INC.** DEPT. 3404 Lyndale S.  
B-2 Minneapolis 8, Minn.



**Now! TEST YOUR OWN  
TV - RADIO TUBES!**

**EVEN THE PICTURE TUBE**

Checks fuses, appliances, etc. Easy, safe to use. Insert tube in socket. Pilot light instantly indicates if tube needs replacement. Rugged metal case (not plastic). AC or DC. One service call saved pays for tester. Only \$3.95 ppd. or C.O.D. plus charges. Deluxe Model \$4.95. Instructions. 5-yr. guarantee. **GEIGER ENGINEERING CORP.**, Dept. G-1110, 6349 N. Western Ave., Chicago, Ill.

**TASOPE PHOTO-ENGRAVING PLANTS**



Establish your own profitable **PHOTO-ENGRAVING** business. Make cuts for newspapers, printers, and advertisers. Make etched name plates, plaques etc. Instructions furnished, no experience necessary. Sold direct from factory since 1931. First five hundred cuts sold locally or by mail will pay for plant and pay you well for your time. Write for **FREE** catalog.

Material Cost  
Of This Cut 31c  
Selling Price  
\$1.00 And Up

**TASOPE, DEPT. PM-2, AURORA, MO.**

**Learn MECHANICAL DENTISTRY**

To make Crowns, Plates, Bridgework, etc., for Dentists. Easy practical way to learn mechanical dentistry at home in spare time. **FULL EQUIPMENT OF TOOLS AND MATERIALS INCLUDED WITH COURSE.** Low tuition. Easy terms. Write for **FREE** BOOK about this money-making profession that is not affected by machine age.

**McGARRIE SCHOOL OF MECHANICAL DENTISTRY**  
207 N. Broad St., Dept. 62, Philadelphia 7, Pa.

**Learn ACCOUNTING  
Business Administration**

Bookkeeping, secretarial and allied subjects at home in your spare time or attend nationally approved resident school. Write for **FREE** Success Book giving complete details on courses, plans, rates and employment opportunities. G.I. approved. Write Dept. A.

**Hills BUSINESS UNIVERSITY AND  
EXTENSION SCHOOL**  
629 W. MAIN ST. OKLAHOMA CITY 2, OKLAHOMA

Enjoy the Fascinating Story  
of the Horseless Carriage in



Popular Mechanics  
**AUTO ALBUM**  
166 Illustrations

The most intriguing book about the automobile ever printed. It's thrilling, fascinating and informative. From the very first gasoline-propelled buggy to the cars of today and the atomic auto of the future. The first cars—the men who made them—the scrambled start and the development of the fabulous auto industry—the story of auto racing—the growth of the Nation's highways. 166 thrilling action pictures—old-time cars—racing cars—early auto advertising—automotive oddities. Roll call of names of more than 2000 autos made in the U.S. included. Ideal gift book. Cloth bound, only \$3.00 by mail. Money back if not pleased.

**POPULAR MECHANICS PRESS, Dept. PM-257**  
200 East Ontario Street Chicago 11, Illinois



# We'll train & establish you in Your Own Business ... even if now employed

We are enlarging this 26-year-old world-wide chain of Duraclean dealerships. Many excellent locations are still available in the U.S.A., Canada, and other countries. If you are reliable and diligent, this is an opportunity to increase your income . . . and have the freedom, financial independence, and prestige of YOUR OWN business.

These are full time dealerships . . . but you can start

in spare time and have a profitable, lifetime business when your present job ends. A Duraclean dealer will train and assist you. He'll reveal his successful, proven methods and sales plans. He'll work with you.

Alert dealers can average \$5 hourly gross profit on service they render plus \$3 on EACH service-man at National Price Guide charges. This business is easy to learn . . . quickly established.

World-wide Service



**FREE Booklet** tells how!

## You Become an Expert in cleaning and protecting Rugs and Upholstery

**DURACLEAN** cleans by absorption. It eliminates scrubbing . . . soaking . . . shrinkage. Aerated foam, created by electric Foamovator, restores natural lubrication in rugs and upholstery. Dirt, grease and many unsightly spots vanish. Fabrics and floor coverings are cleaned with a new consideration for their life and beauty.

This modern process avoids strong soaps and machine scrubbing, eliminating unnecessary wear and breaking of fibers. Fabric life is increased. **DURACLEANING** is done in the home. Customers like this convenience. Fabrics dry in a few hours. Rug pile again stands erect and even. Brilliant colors revive. Furnishings become clean, fresh and enlivened.

**DURAPROOF** is another year 'round service rendered in the home, office or institution — without removing furnishings. It protects upholstery, rugs, furs, clothing and auto interiors against damage by moths and carpet beetles. U. S. Government says "Moths are present in practically every household . . . No section of country seems free from such infestations." **DURAPROOF** kills moths and carpet beetles. It makes materials non-eatable to both. **DURAPROOF** is backed by an International 6-Year Warranty.



## Easy to Learn • No Overhead Expense

### Permanent, Growing Market

Service is rendered in homes, offices, hotels, theaters, institutions and to revive used-car upholstery for auto dealers. There is need for these services in almost every building. Duraclean dealers operate from their home, an office or shop, as they prefer. It's easy to learn . . . we quickly train you. Rendering service yourself, at first, prepares you to train and supervise service men.

### Repeat and Voluntary Orders

Demonstrations win new customers. **DURACLEAN** Dealers find REPEAT and VOLUNTARY orders a major source of income. Customers, enthused with results, tell friends and neighbors. Furniture and department stores and others turn over rug and upholstery cleaning and mothproofing to **DURACLEAN** Dealers. We show you 27 ways to get new customers.

### We Help YOU Grow

Our **MUTUAL COOPERATION** program gives you many unique and continuous advantages: National Advertising in Life, McCall's, House & Garden, Canadian Homes & Gardens and a dozen others. Copyright and trademark protection. Certificate approves equipment and materials. Products Insurance. Six-year Warranty. Pocket Demonstrators. Sales Book. Advertising Folders & Cards. Tested Ads. Ad Cuts & Mats. Store Display Cards. Radio & TV Musical Commercials. Home Show Booth Display. Publicity Program gets FREE local newspaper stories. Prizes. Laboratory research and development. Monthly magazine. Resale Service. Annual Conventions. Behind all this is a 26 YEAR OLD headquarters interested in YOUR personal success. If you want to become the owner of a **DURACLEAN** Service business, you should inquire now, TODAY, while territory is still available.

### What Dealers Say

- W. Lookbill: We've had 20 years of pleasant dealings. I'm 65 but am getting my sights for 20 more years.
- Gerald Merriman: \$700 cleaning . . . only 13 working days.
- P. D. Freidinger: 70% of our business is repeat.
- A. Ullman: Every demonstration has been a sale.
- Ellsworth: Your advertising certainly has paid dividends.
- M. Lascakas: Original investment returned in two months. Not sorry I started 'em on a shoe string.
- R. Kimbrough: Finished First White House of Confederacy and am to Duraclean the Governor's Mansion.
- Margaret Turner: Took in \$106 in 15 or 18 hours.
- L. Johnson: Each customer leads to 3 or 4 more.

### FIRST PROCESS IN THE FIELD TO WIN THIS IMPORTANT HONOR!

As a Duraclean dealer, your services are backed by this famous seal of quality . . . proof that Duraclean has passed rigorous tests. No competitor in your town can boast this seal. Duraclean has also been tested and certified by the American Research & Testing Laboratories. No wonder it's so easy to get business!



### FREE Booklet

Our first letter and illustrated booklet will explain everything — the two modern, urgently needed services, waiting market, how business grows, your large profit, easy terms and PROTECTED territory. Clip and mail coupon today! Get all the facts . . . no obligation.

**Duraclean Co.** 7-162 Duraclean Bldg., DEERFIELD, ILLINOIS

### EASY TERMS

A moderate payment establishes your own business—pay balance from sales. We furnish electric machines, folders, store cards, introduction slips, sales book, demonstrators and enough material to return your TOTAL investment.

### "OWN a Business" Coupon

**DURACLEAN CO., 7-162 Duraclean Bldg., Deerfield, Illinois**

Without obligation to me, send booklet and letter giving full details. Tell me how I may OWN a growing business of my own built upon satisfied customers.

Name \_\_\_\_\_

Address \_\_\_\_\_

City \_\_\_\_\_ State \_\_\_\_\_

# EARN MORE THAN EVER BEFORE IN HOME BUILDING AND CONSTRUCTION

You can earn top hourly wages — or make big profits in your own building business. Skilled men are needed everywhere—over 300,000 newly-trained men needed yearly. Five out of 10 homes need some repairs. More than \$20 billion will be spent for remodeling this year. Get set now for a better job or big profits in your own business!



## TRAIN AT HOME IN SPARE TIME

Learn building construction at home in just a few months. The new, HBTI Job-Applied Method is practical, makes every step easy, teaches every phase of building. Add extra dollars to your weekly income as you train. Build dormers, stairs, garages, etc. For full details on both opportunity and training, mail coupon.

### MAIL TODAY • 2 FREE BOOKS

HOME BUILDERS TRAINING INSTITUTE, Dept. HB-138  
1400 Greenleaf Ave., Chicago 26, Ill.

Send free Home Building Success Book and Sample Lesson. No cost or obligation on my part.

Name \_\_\_\_\_ Age \_\_\_\_\_

Address \_\_\_\_\_

City \_\_\_\_\_ Zone \_\_\_\_\_ State \_\_\_\_\_

**\$2.95 OR 2 FOR \$5.00!**

TESTED AND GUARANTEED

Write for free list on all types of telephones.  
Shipments F.O.B.

TELEPHONE ENGINEERING CO., Dept. B27, Simpson, Pa.

start a big profit business  
with a small investment  
EARN UP TO  
\$200 a DAY

Manufacturing Exciting New

## RAINBOW ROCK

Concrete Slump Brick  
in your back yard

Earn big building boom profits with Rainbow Rock, the colorful new building brick that's taking the country by storm. Sell all you can make to contractors, builders, building supply houses. RAINBOW ROCK CUTS LABOR COSTS BY 1/3! Amazing low cost machine makes modern slump brick 24" long 13 times the length of ordinary brick in a variety of widths and pastel colors . . . up to 1500 bricks a day! NEEDS NO SPECIAL SKILL. Operates indoors or out. Full instructions and valuable mixing formulae supplied. YOU CAN START EARNING BIG MONEY NOW. PAY AS YOU PROFIT! A limited number of machines available on easy payment terms. NOW is the time to start. Write today for free literature and full information.

GENERAL ENGINES CO., INC.  
Dept. MR-27 — Route 130,  
Theriot, N. J. - Tilden 5-5401



STEEL PIER SENSATION

Luxurious RAINBOW ROCK fireplace wall in living room of the "Home of the Century" in Atlantic City. N. J.'s Steel Pier . . . acclaimed by over 500,000 Summer, 1953 visitors as the most beautiful they'd ever seen! Endorsed by the Pier's famous architect, Wilton F. B. Koelle.



Makes beautiful, decorative fences, garden walls, garages, outside walls, room separators, etc.



## college graduates get ahead faster!

You see it in your own city. They have higher incomes . . . advance more rapidly. Grasp your chance for a better life. Industrial growth . . . automation . . . technical advances create career opportunities for engineers, accountants, management experts. Share rewards awaiting college-trained men. Important firms visit campus regularly to employ Tri-State College graduates. Start any quarter in this world-famed college. Approved for veterans.

### Bach. of Science degree in 27 months

In Mechanical, Civil, Electrical, Chemical, Aeronautical, Radio (TV-Electronics) Engineering. In 36 months a B.S. in Business Administration (General Business, Accounting, Motor Transport Management majors). Superior students may accelerate. 36-weeks course in Drafting. Intensive program: technical fundamentals stressed; comprehensive courses with more professional class hours. Small classes; personalized instruction. Enrollment limited to 1550. Preparatory courses. Beautiful campus. Well-equipped, new and modernized buildings and laboratories. Enter March, June, Sept., Jan. Earnest, capable students (whose time and budget require accelerated courses and modest costs) are invited to write Jean McCarthy, Director of Admissions, for catalog and book "Your Career in Engineering and Commerce."



## TRI-STATE COLLEGE

427 College Avenue • • • Angola, Indiana

### YOU BUILD 'EM — WE SELL 'EM EARN UP TO \$50.00 A DAY AT HOME

Participate in our national sales and sub-contract plan—spare time—full time. You assemble special luggage and cases for photographers, musicians, salesmen, and all types of portables. We supply complete instructions—materials—tools—everything. No previous experience necessary. Free details. Abaris Casecraft, Dept. AB, 807 W. Sunset Blvd., Los Angeles 12, Calif.

### WHEELS WHEELS WHEELS

- 7" Disc Wheel 3/4" Tire 3/4" sleeve . . . . . 45c ea.
  - 8" Disc Wheel 1 1/4" Tire 1/2" sleeve . . . . . 70c ea.
  - 7" Disc Wheel 1" Tire 1/2" Ball bearing . . . . . 80c ea.
  - 8" Disc Wheel 1 1/4" Tire 1/2" ball bearing . . . . . \$1.00 ea.
  - 6" Disc Wheel 1.50 semi-pneum. Tire 1/2" S.B. . . . . \$1.35 ea.
  - 8" Disc Wheel 2" semi-pneum. T. 1/2" S.B. . . . . \$1.50 ea.
  - 10" Disc Wheel 1.75 semi-pneum. T. 1/2" S.B. . . . . \$1.50 ea.
  - 10" Disc Wheel 2.75 semi-pneum. Tire 3/4" S.B. . . . . \$3.50 ea.
  - 12" Disc Wheel 1.75 semi-pneum. T. 1/2" S.B. . . . . \$1.85 ea.
- Above wheel prices include hub caps, excepting 10" x 2.75". Postage extra. C.O.D.'s accepted. Axles extra. Sizes: 5/16", 3/8", 1/2" dia. Cut to size per inch long. End holes drilled.
- UNITED WHEEL STAMPING CO.  
11915 S. MARSHFIELD AVE., PM-2, CHICAGO 43, ILLINOIS

### DRAW The First Day! NO LESSONS! NO TALENT!



New Amazing Invention—"Magic Art Reproducer." You can draw Your Family, Friends, Anything From REAL LIFE—Like An Artist Even If You CAN'T DRAW A Straight Line! Anything you want to draw is automatically seen on any sheet of paper thru the "Magic Art Reproducer." Then easily follow the lines of the "picture image" with a pencil for an original "professional looking" drawing. Also reduces or enlarges. SEND NO MONEY! Free Trial! Pay Postman on delivery \$1.98 plus postage. Money Back Guarantee.

NORTON PRODUCTS, Dept. 120, 296 Broadway, N. Y.

WAR  
SURPLUS  
BARGAINS

# WAR SURPLUS BARGAINS

**\$500,000.00 INVENTORY  
for QUICK LIQUIDATION**

Surplus items—hundreds of them for home, shop, factory, farm and outdoor use. New items, used items, reconditioned items—all at tremendous savings—all priced for quick sale.

Page After Page of Values

This big catalog shows page after page of amazing money saving values. Write for your copy today. Send 10c to cover postage, mailing, etc. Write today! SEND TODAY FOR YOUR COPY

# 10c

**STARK'S** 212 W. Madison St.  
Dept. PM-572  
CHICAGO 6, ILL.

# "HOME SWEET HOME" vs. FACTORY BLUES

**I'm beat Jim!**

RUSHING FOR THE BUS - FIGHTING CROWDS - BOSS IS UPSET - NOISY MACHINERY CLANGING ALL DAY - I'VE REALLY HAD IT. BUT YOU LOOK FRESH AS ALL GET-OUT AFTER WORKING AT HOME ALL DAY, TOO. HOW DO YOU DO IT? WHAT'S THE SECRET?

AFTER THE FACTORY CLOSES, BOB MEETS HIS FRIEND JIM...



LATER AT JIM'S HOME...

I HAVE THE KIKTAVI BABY SHOE METALIZING PLAN TO THANK FOR MAKING MY WORK PROFITABLE AND EASY. I WORK MY OWN HOURS AT HOME.

BABY SHOE METALIZING WHAT'S THAT JIM?



AS A BABY SHOE METALIZER, I PRESERVE BABY'S FIRST SHOES IN REAL BRONZE, GOLD, SILVER, OR PEARL FOR MOTHERS IN MY NEIGHBORHOOD. THEY'RE HAPPY TO PAY ME WELL BECAUSE I MAKE THEM EVERLASTING KEEPSAKES OF BABY'S FIRST STEPS.

IS THERE ENOUGH WORK TO KEEP YOU BUSY?



PLENTY! MORE THAN 3 MILLION BABIES ARE BORN A YEAR AND METALIZING BABY SHOES IS REAL EASY. EVEN MY WIFE AND SON CAN DO IT IF I'M RUSHED. IT'S EASY TO TURN OUT ENOUGH TO MAKE \$5 OR MORE PER HOUR.

IS IT HARD TO LEARN AND HOW MUCH MONEY DO YOU NEED?



**MAN NO!** KIKTAVI'S INSTRUCTIONS ARE REAL EASY TO UNDERSTAND. BEST OF ALL YOU START WITHOUT OVERHEAD OR BIG INVESTMENT IN STOCK. WHY NOT MAIL THE COUPON RIGHT NOW - GET FULL DETAILS FREE!!!



## NEW BIG PROFIT FIELD NOW OPEN TO YOU

Metalize Baby Shoes and other precious keepsakes with Genuine BRONZE, SILVER, GOLD. And the popular PEARL finishes, too. Even such objects as the leaves of trees, shells, and hundreds of other items become valuable objects of beauty when plated with jewel like metal.

**WANT BIG MONEY?** Want to add to your weekly paychecks? If you want to add to the family income in your spare time, then you owe it to yourself and family to get the FREE FACTS about this exciting, profitable business. WANT TO BE YOUR OWN BOSS? Tired of working for others? Then THIS is what you've been looking for. An opportunity to be independent and build a secure future without risking your present job. Have 2 paychecks instead of one in as short a time as a week.

## MILLIONS OF NEW PROSPECTS YEARLY!

Yes, the market is HUGE and GROWING BIGGER. More than 3 million Babies born in a year. A steady year 'round income-no seasonal slumps. This is ideal for a man and wife who want to work together right at home for extra income or a profitable full time business. Learn quickly in a matter of days and without previous experience of any kind.

KIKTAVI CO., Dept. PM-572, 11029 So. Vermont Ave., Los Angeles 44, Calif.



## AIRMAIL COUPON TODAY

A few cents may bring back many dollars to YOU. Delay may be costly. Mail coupon now for FREE book and full details. NO RISK OR OBLIGATION ON YOUR PART.

## SEND FOR FREE BOOK NOW!

Kiktavi Company, Dept. PM-572  
11029 So. Vermont Ave., Los Angeles 44, Calif.

**Okay!** Send me FREE FACTS on how to make BIG MONEY at Home by metalizing Baby Shoes. Remember, it's FREE and postpaid.

NAME \_\_\_\_\_  
ADDRESS \_\_\_\_\_  
CITY \_\_\_\_\_ ZONE \_\_\_\_\_ STATE \_\_\_\_\_

Whatever the job, you'll do it better with nationally advertised products. Ask for products advertised in POPULAR MECHANICS



# LEARN MEAT CUTTING AT NATIONAL

Pay After Graduation



The steady dependable trade of Meat Cutting taught easily in 8 short weeks. YOU LEARN BY DOING under actual meat market conditions in big modern school at Toledo.

For beginners or men with experience. Get a profitable store of your own. Remember, PEOPLE MUST EAT! Big pay jobs. Free employment help. Thousands of successful graduates.

Buying, cutting, percentage, pricing, advertising, selling, etc. A complete retail meat education. National School established 35 years. Get National training NOW. Pay your tuition in easy weekly payments

after you graduate. Send coupon for FREE 52 page school catalog — TODAY. G.I. approved.

## National School of Meat Cutting, Inc., Dept. 50-N, Toledo 4, Ohio

Send me your FREE school catalog on National Training at Toledo in Meat Cutting, Meat Merchandising and Self Service Meats. No obligation. No salesman will call.

Name \_\_\_\_\_ Age \_\_\_\_\_  
Address \_\_\_\_\_  
City \_\_\_\_\_ State \_\_\_\_\_  
Approved for training Korean Veterans

make it with 60c worth of sand & cement!

**SELL IT FOR \$2000**

every home a prospect for these "LIFETIME"

# CONCRETE INCINERATORS

Make big profits manufacturing rust proof, fire proof, almost indestructible concrete incinerators in your own backyard or garage... full or part time. Sell to home-owners, hardware, department and garden supply stores. Phila. manufacturer doing big volume with Sears, Roebuck; large department stores. Easy to follow instructions and all needed equipment supplied. Exclusive protected franchise—No competition! Territories going fast. Write immediately for full details.



Dept. PM-27, T. C. TOR, 2113 Bellevue St., Phila. 40, Penna.

Gentlemen:

Rush full information about your concrete incinerator protected franchise offer.

Name \_\_\_\_\_

Street No. or R.D. \_\_\_\_\_

City \_\_\_\_\_

Zone \_\_\_\_\_

State \_\_\_\_\_

# SEND FOR Free Record

START SPEAKING  
**SPANISH**  
OR  
**FRENCH**



**ALMOST OVERNIGHT!**



MORE MONEY



NEW CAREER



TRAVEL FUN

HERE'S the easiest way to learn a new language. Listen to FREE 2-sided non-breakable record. Let your eyes follow words in FREE sample lesson. Almost at once you'll be chatting whole sentences in your new language with a perfect accent! Offer may end soon. Rush 10c to help cover cost of special packaging, shipping of free record, lesson. State language you want. We'll also send free information on full Cortina course. No obligation.

**CORTINA ACADEMY**

"Originators of the Phonograph Method"

Dept. 642, 136 W. 52nd St., New York 19, N.Y.

Also:  
GERMAN  
ITALIAN  
RUSSIAN  
JAPANESE  
BRAZILIAN

OUR AD HAS BEEN IN THIS MAGAZINE LONGER THAN ANY OTHER TIRE CO. NEARLY EVERYONE BUYS FROM STANDARD.



23 YEARS AT THIS ADDRESS  
TUBE FREE WITH EVERY PASSENGER TIRE

Our entire stock of very slightly worn EXTRA MILEAGE TOP GRADE Tires, (Written Insurance Guarantee). SEND AD

EVERYBODY 10% off ON EVERY TIRE



**FREE** If you buy 2 or more Passenger 4-ply tires, WE GIVE ONE tire FREE, on each order. Does not include W.W or Truck Tires, or Snow Tires.

Specialists in Truck Tires—Selected for Toughest Jobs—Tops in Value

12 MOS. WRITTEN GUARANTEE WITH EVERY TIRE	12 MOS. WRITTEN GUARANTEE WITH EVERY TIRE	12 MOS. WRITTEN GUARANTEE WITH EVERY TIRE	12 MOS. WRITTEN GUARANTEE WITH EVERY TIRE
600-16 \$5.92	475-15 \$4.82	700-15 (G) \$7.52	700-20 \$9.92
600-16 (G) 5.92	640-15 4.22	750-16 (S) 9.72	750-20 (10) 15.72
650-16 5.72	670-15 5.52	700-17 9.82	750-20 (8) 11.92
650-16 (G) 6.62	710-15 5.52	750-17 10.32	825-20 18.92
750-16 (G) 7.52	760-15 5.82	825-15 12.92	900-20 17.92
550-17 3.72	800-15 5.92	600-20 9.02	1000-20 17.92
650-15 5.52	820-15 5.92	600-20 9.82	1100-20 19.92
700-15 4.92	700-16 (G) 7.32	750-15 10.72	1100-22 18.92

"EXTRA SPECIAL" SOME NEAR NEW all size 4-ply pass. \$7.92  
FREE TIRE with 2 or more of these also.—W.W. \$1.00  
Extra Factory Tested Tube given—GIANT TIRE SALE. EA.

**SNOW TIRES \$9.02** ORDER ANY 4 PLY PASSENGER SIZE  
12 MO. GUAR. BLACK WALL  
Thousands of tires shipped all over the U.S.A. All tires shipped F.O.B. Phila. Send Check or M.O. with this ad. Dept. 2, No C.O.D.  
**STANDARD 834 N. Broad St., Philadelphia 30, Pa.**

## PEE WEE BATTERYLESS "LIFETIME" RADIO

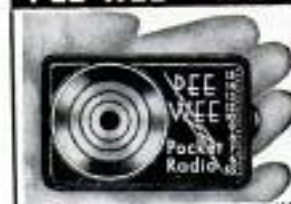

**REALLY WORKS — FOR LIFE!**  
Works WITHOUT TUBES, BATTERIES OR ELECTRICAL PLUG-INS. Will never run down or burn out! World's smallest. SMALLER THAN A PACK OF CIGARETTES! GUARANTEED TO RECEIVE LOCAL RADIO STATIONS ANYTIME—ANYWHERE YOU GO! Sensational new Ferrite Selective Tuner — Permanent diode, Super SPEAKERPHONE, durable black and gold plastic case.

SEND ONLY \$2.00 (with ck, mo) and pay postman \$4.99 COD postage on arrival or send \$6.99 for postpaid delivery. SENT COMPLETE READY TO LISTEN WITH LIFETIME GUARANTEE. Nothing extra to buy — ever. Available only from: MIDWAY COMPANY Dept. WPM-2 KEARNEY, NEBRASKA

## LEARN PLASTICS



**COMPLETE LOW COST SHOP METHOD HOME TRAINING NOW AVAILABLE**

Get in on Big Money opportunities in Plastic molding, casting, forming, carving, etc. Earn as you learn with Interstate's professionally prepared course. All plastic materials furnished.

WRITE FOR FREE BOOKLET

**INTERSTATE TRAINING SERVICE**  
DEPT. C-3, PORTLAND 13, OREGON

## FREE AMAZING NEW BOOK "HOW TO ANSWER ADS"



Never before have you seen anything like this. Tells you in simple language the correct way to answer ads. Gets you quicker replies—better results, and greater satisfaction. Will save you time and money and it's ABSOLUTELY FREE. No obligation whatever. Every reader of advertising should have this booklet. Send a postcard for your copy NOW. F. W. JOHNSON, Popular Mechanics Magazine, Room 600-A, 204 East Ontario Street, Chicago 11, Ill.

## SHEET METAL BRAKES



- Forms angles, locks, pans, etc. Quick eccentric clamp. All steel construction.
- 15"-16 gauge steel.....\$28.00
- 38"-22 gauge steel.....\$37.00
- 48"-24 gauge steel.....\$52.00
- Floor stand.....\$ 8.00
- 15"-24 gauge Folder.....\$16.50
- 36" Pan and Box brake.....\$60.00
- 3/4 x 3 Adjustable Bender.....\$11.50
- 16 gauge 7" Bench Shear 3 adj. gauge \$16.50
- 30"-20 gauge Curve Former.....\$11.50

ORDER DIRECT OR SEND FOR FREE CATALOG  
**VYKE MFG. CO., P-4158 Jason St., Denver 11, Colo.**

## FREE—Amazing Book on RHEUMATISM, ARTHRITIS

If you suffer aches, pains and discomforts of Rheumatism, as manifested in ARTHRITIS, NEURITIS, SCIATICA or LUMBAGO, send today for this FREE Book. It reveals important facts about why drugs and medicine give only temporary relief without removing cause. Explains a proven, specialized system of treatment that may save you years of distress. No obligation. Write for this FREE Book today!  
**BALL CLINIC, DEPT. 756, EXCELSIOR SPRINGS, MO.**

POPULAR MECHANICS



As a Cavitec manufacturer you can supply all the units to build all the walls of the "Cavalier" for



\*National Average

**\$96213\***

Blueprints available \$15.00 per set



Superfine masonry at sensationally low price explains why the local manufacturing of Cavitec has such great potentials as a community enterprise. Local processing of local materials effects vast economies . . . enables low prices to builders yet upward of 100% mark-up on basic costs. Hundreds of choice franchise-protected territories still open. Machine available on lease. "Cavalier", shown above, indicates the kind of price-appeal which helps sell Cavitec for every type of residential, commercial and industrial construction. Write at once for "Opportunity, Unlimited" and tentative reservation of territory.

16" long  
2 1/4" high  
8" and 4" thick  
• Modular dimensions  
Large voids for insulation qualities  
• Range of 14 shades and tones  
• Striated or plain face



W. E. DUNN MFG. CO.  
409 W. 24th Street, Holland, Michigan  
844 Dundas Highway, Cooksville, Ont.

## REAL ESTATE BE AN AGENT

PAYS BIG! SEND FOR FREE, BIG, ILLUSTRATED CATALOG NOW! Graduates report making substantial incomes. Start and run your own business quickly. Men, women of all ages, learn easily. Course covers Sales, Property Management, Appraising, Loans, Mortgages, and related subjects. STUDY AT HOME or in classrooms in leading cities. Diploma awarded. Write TODAY for free book! No obligation. Approved for Korean Veterans

FREE BOOK TELLS NOW

WEAVER SCHOOL OF REAL ESTATE (Est. 1908)  
2024A Grand Kansas City 8, Mo.



### Easy to make your own BOWS—ARROWS—EQUIPMENT

Illustrated Hand-Book 84 pgs. \$1, tells you how! Large Colored Catalog 5c—Send for it!

Ask your dealer for "Stemmler's Archery" (Oldest Mfr. in U.S.A.)

L. E. STEMMLER CO.

Manorville (Box 1) L. I., N. Y.

TV Strong man DAN LURIE



Send for FREE Catalog

### \$10,000 REWARD

If correct use of my new body building course fails to build you a "HE-MAN" BODY The secret is in my revolutionary, exclusive Body Mould system. Yours FREE with famous

DAN LURIE BARBELLS

Scientific! Fastest, surest method known—beats all other training methods. Results guaranteed. Special low prices. 80 lb. set \$ 8.98 • 100 lb. set \$14.98 150 lb. set \$21.98 • 200 lb. set \$27.98 14c per lb. F.O.B. 50% Deposit required

DAN LURIE BARBELL CO.  
52M2 Bristol St., Dept. 7898, B'klyn, 12, N. Y.

NOW NO ONE CAN KEEP A SECRET FROM YOU! 20x-40x-60x TELESCOPE only \$299 postpaid

Amaze your friends... See what they're doing—without being seen!

Special: Order now, get free carrying case.

Money back guarantee. Send cash, check or money order.



I. J. STONE, Dept. T-B-2 • 1616 Oak St. • Santa Monica, Calif.

# Make your interest in AUTO MECHANICS & DIESEL PAY OFF!



OUR FAMOUS SHOP METHOD HOME TRAINING PREPARES YOU FOR BIG TIME PAY AT HOME IN SPARE TIME

## YOU GET AND KEEP ALL THIS EQUIPMENT



Complete set of professional tools and All-Metal Tool Box. Same top-quality equipment used by expert mechanics everywhere. Use them, display them proudly.



"Motor Analyzing Set" contains Standard Engine Vacuum Fuel Pump Tester, Remote Starter Switch, Modern Timing Light, Standard Compression Tester. Plus compact carrying case & instructions.



Top-quality Socket Wrench with Fittings. Real professional tools you'll use during your lifetime career in repairing all types of engines, from foreign cars to big diesel jobs.

Nearly 60 million cars and trucks on our roads! If you could talk to owners of garages, service stations and car dealerships (as we do every day), you'd realize America's DESPERATE NEED FOR TRAINED MECHANICS.

Take your choice—One modern course prepares you for Auto-Mechanic jobs, Airplane Mechanics, Farm Machinery Repair, all Diesel Jobs, Experimental Labs, Government Work, Engine Specialties, etc. A qualified, ALL-AROUND Mechanic always has a good job.

Every phase is Shop-Tested! Streamlined lessons, diagrams, manuals are easy to understand. Earn as you learn. Free Graduate Employment Service.

FREE! VALUABLE BOOK & SAMPLE LESSON JUST SEND COUPON

RESIDENT TRAINING AT LOS ANGELES! If you wish to take Resident Training at Los Angeles, in our big, modern Shops & Labs, check special box in coupon for full information.



APPROVED FOR GI TRAINING NATIONAL SCHOOLS  
Los Angeles 37, California  
Canada: 811 W. Hastings St., Vancouver, B. C.

## NATIONAL SCHOOLS TECHNICAL TRADE TRAINING SINCE 1905 LOS ANGELES 37, CALIFORNIA

NATIONAL SCHOOLS, Dept. DB-27 MAIL NOW TO OFFICE NEAREST YOU

4000 S. FIGUEROA ST. LOS ANGELES 37, CALIF. OR 187 N. LA SALLE ST. CHICAGO 1, ILLINOIS  
Send for FREE Auto-Diesel Opportunity Book and Sample Lesson.

NAME \_\_\_\_\_ AGE \_\_\_\_\_

ADDRESS \_\_\_\_\_

CITY \_\_\_\_\_ ZONE \_\_\_\_\_ STATE \_\_\_\_\_

Check if interested ONLY in Resident School Training at Los Angeles

VETERANS: Give date of discharge \_\_\_\_\_

# NEW MIRACLE MONEY SPRAY

**EARN 400%**  
PROFIT Spraying Anything at Home

PLAIN FINISH WORTH 60¢

SPRAYED FINISH worth \$2.50



## SPRAY ANYTHING for BIG PROFITS!

**Instantly!** you can spray plain finished things such as lamps, figurines, signs, cards, glasses, novelties—ANYTHING, into beautiful rich textured items that sell for expensive prices. You'll be amazed!

**MAGIC NEW MICRO FLUFF INVENTION.** If you've ever felt rich expensive velvet, you'll know how this amazing spray feels to the touch. Now, we have developed an exclusive discovery that lets you hand spray anything with this startling material (in over 24 brilliant and fluorescent colors too). OVER 5,000 BIG PROFIT USES IN EVERY TOWN AND CITY IN AMERICA.

**START IN YOUR OWN HOME.** You don't need big capital, expensive machinery or inventory to start spraying micro-fluff for profit. Any-

one can change cheap items into beautiful expensive merchandise right on any table in his home. That's all you need.

**EARN UP TO \$15.00 PER HOUR AT HOME.** It's easy and fun once you learn the secrets. Already, we are getting letters like Mr. Hoover's stating he's earning \$10,000 a year from a spare time start. Many say "swamped with orders already."

**WE SUPPLY EVERYTHING** you need to start earning Big money with our amazing New Discovery Right Now—TODAY!

**FREE!** BOOKLET, Home-Profit SECRETS, and FREE SAMPLE KIT (16 fabulous colors) ALL FREE!

**RUSH** coupon today if you are interested in a startling new Big Profit home-business and if you are 18 years or older.

### SUPPLY LIMITED—RUSH COUPON TODAY!

COAST INDUSTRIES (Home Business Division) DEPT. B-2  
Los Angeles 61, California

PLEASE RUSH  
FREE BOOKLET, FREE SAMPLE KIT—everything!

Name \_\_\_\_\_ Age \_\_\_\_\_  
Address \_\_\_\_\_  
City \_\_\_\_\_ State \_\_\_\_\_



COAST INDUSTRIES, Dept. B-2  
Los Angeles 61, Calif

# PRESTO MASTER GLAZE

--FOR ALL CARS--



Car Owners! Meet Master Glaze—the sensationally different luster for new and used cars! Not a wax—not an oil polish—not a paint!—nothing that "smears" over the surface.

**AGENTS**  
An unusual opportunity! Quick, flashy demonstrator. Big profits. Good territory. Write today!

MASTER GLAZE is a unique discovery—quick and easy to apply! Gives a hard, glass-like surface. Even gasoline cannot dull it! Lasts six months to a year! Amazing luster—beautiful, sparkling clean and brilliant! Doesn't finger-mark—doesn't smear! A match box full glazes an entire car. Seals the pores, protects! NOTHING LIKE IT!

## FREE SAMPLE

Send name, address on postcard for details and free sample  
MASTER GLAZE, 7720-861 Harwood Ave., Milwaukee 13, Wis.

# Learn CARBURETOR and IGNITION



## Start Training at Home For This Clean, High-Class Type of Position

Get in line for a raise—or for more profits in your own shop. Learn testing and adjusting with latest-type scientific motor tune-up equipment. This enables you to locate the trouble exactly, and fix it fast—handling and getting paid for more jobs per day. There's money in this, and it's clean, high-class work which gets the respect and confidence of your customers.

**Send for FREE SAMPLE LESSON**  
Carburetor and Ignition Specialization offers very superior opportunities for better pay and bigger profits because relatively few mechanics know anything about this time-saving, money-making new test equipment. Now our spare-time home-study method teaches you the principles and shortens your shop training. Ambitious men (age 18-55): Send for full **FACTS AND FREE SAMPLE LESSON** at once. Write today to

**UTILITIES ENGINEERING INSTITUTE**  
2525 Sheffield Ave., Dept. OC-6, Chicago 14

# BE A CLAIM INVESTIGATOR



**INVESTIGATE ACCIDENTS!** Many earning \$750 to \$1000 a month. Thousands of insurance companies, airlines, steamship lines and Government Offices need Claim Investigators. Also big opportunities for your own spare time business. We train you at home. National Placement Service **FREE** of extra charge. Bill King writes: "Your course has paid off for me with large earnings. You can quote me—your Adjuster Training Course is worth many times the cost." Write **TODAY** for **FREE** book.

## UNIVERSAL SCHOOLS

University Park, Dept. PM-2, Box 8202, Dallas 5, Texas

# MAKE UP TO \$20 A DAY WITH

## EASISHARP



Big profits in your spare time sharpening scissors. We show you how to start making money immediately. This is your chance now to have your own business and a steady income. Sharpen a pair of scissors in less than two minutes. A child can operate it. Weighs only 10 lbs. Every home, barber, tailor, dressmaker—everybody uses scissors and all need sharpening two to four times a year. Don't let some one else beat you to this opportunity. Write immediately to

**MONEY MAKING SALES PLAN FREE**

**SERR-EDGE MACHINE CO., 9731 Lorain Ave., Cleveland, Ohio**

# RHEUMATISM

## NEURITIS • SCIATICA • LUMBAGO

Why continue to suffer agonizing pains when usual remedies have failed. Learn how thousands have been successfully treated by an amazing new method which is fully explained in our New **FREE** Book. Don't wait. Write today. No obligation.

**EXCELSIOR INSTITUTE, Dept. C9806, Excelsior Spgs., Mo.**

# Learn PHOTO PORTRAIT RETOUCHING

MAKE TO \$5 AN HOUR SPARE—FULL TIME  
EASY TO LEARN

**MEN! WOMEN! LEARN—EARN AT HOME**

Learn professional secrets of Photo-negative retouching—glamorize Portraits and Bridal Photos the way they do in famous Hollywood Photo Studio. Amazing new, step-by-step, fully illustrated instructions make learning easy. Prepare for big pay job, in Photo Studio, or have your own Retouching Studio at home. Operate by mail—anywhere. No previous experience or art training needed. We send you everything—full instructions—all needed equipment and Proven plan that brings big profit orders right to your home by mail. Examine complete outfit in your home—then decide! **FREE**—full details. Write NOW!



SEND NO MONEY JUST YOUR NAME

**DUVAL SCHOOL, Dept. 52, 100 South Vermont Avenue, Los Angeles 4, Calif.**

**World's Most  
THRILLING  
HOBBY!**



"Very pleased with Schirmer's Course, it contains so much information. The plant on my left had 6 blooms. 2 were cut off before picture was taken. The one on my right also had 6 blooms."  
**JAMES COSTO**  
—Ohio

Fill your Home with **ORCHIDS**  
Every Month of the Year!



**LOUIS and GLADYS SCHIRMER**  
SUCCESSFUL HOME-GROWERS, SAY:  
"We'll Show You How We Raised  
Orchid Plants Worth a Fortune—  
Starting At Home in Spare Time."

**NO GREENHOUSES NEEDED...** Successful family of home growers now reveal their secrets for your pleasure and profit. Learn exciting facts about raising beautiful Orchids at home... how to grow dozens of varieties in every rainbow color... have Orchids in full bloom every month of the year! Many grow without soil, getting food from the air. **NO GREENHOUSE NEEDED.** Start on table or window ledge.

**THRILLING HOBBY—Exciting Home Business.** Imagine the delight of watching gorgeous Orchids burst into bloom right in your own living room! The big lavender corsage Orchids you see in every flower shop—also many others in all sizes and colors. Orchids for your own enjoyment, for gifts or to sell at good profits.

**FINE PROFITS—Any location—Retail—wholesale—Mail Order.** Learn how to market your Orchids for profit, no matter where you live—small town, big city, or on a farm. Millions sold by mail order, year 'round. Tropical Flowerland's "Quick-Profit Plan" helps you start at once, without investment in stock. No overhead.

**SCHIRMERS' complete instructions and blooming-size Orchid plant sent for examination in your own home—NO OBLIGATION TO BUY A THING...**

Schirmer's Course is complete, nearly 300 large size pages filled with show-how drawings and photos—many in full color. Shows how to grow 30 different kinds of Orchids at home. How to market Orchids for extra income spare or full time. Also includes blooming-size Orchid plant. Send no money, just fill out and mail the coupon today—airmail is quicker.

TROPICAL FLOWERLAND, Dept. 312, 100 S. Vermont, Los Angeles 4, Calif.

**HOW TO GROW**

# ORCHIDS

**PROFITABLE  
Home Business**

**NATURE'S MOST  
FABULOUS FLOWER**

**In Your Own  
LIVING ROOM!**

**Home Growers Coast  
to Coast Benefit from  
the Schirmers' Help**



My Orchids are doing fine. I sell many blooms and haven't really started to try yet. I owe my success to the Schirmers.  
**MRS. FRANK HARWOOD**—Oregon

Growing Orchids for profit lets me have my business at home. When I first saw your ad. I had never seen an Orchid.  
**MRS. SEABIE SMITH**—Arkansas



Orchids offer rich reward in leisure. There is financial reward for one interested commercially, as I am. Thanks a million for everything.  
**MR. S. V. SMART**—Colorado

I have standing orders for future flowers and divisions of this year. I shall always be grateful to the Schirmers.  
**MRS. ROBERT E. LEE**—Ohio



**NO GREENHOUSE NEEDED  
YEAR 'ROUND—ANY CLIMATE  
MAINE TO CALIFORNIA**

"Growing Orchids a never ending delight. Most of my plants kept at my office where I relax after strenuous day of court reporting. This plant had 11 blooms for Mother's Day."  
**RUBY B. HUGHES**  
—Oregon



**FUN FOR ALL THE FAMILY.** It's great fun to grow Orchids. And the whole family can help—from teen-agers up. Mr. Schirmer himself is over 60—was nearly 50 when he and Mrs. Schirmer first started to grow Orchids for profit.

**LEARN HOW ORCHIDS MULTIPLY.** Learn how one plant may become many, each as valuable as the first! Flower production and plant stock should both increase steadily—year after year—and so should your profits!

**FREE—REAL  
ORCHID SEEDS AND  
MONEY-MAKING  
PLAN!**

**AIRMAIL THIS COUPON NOW!**

TROPICAL FLOWERLAND, Dept. 312  
100 So. Vermont Ave., Los Angeles 4, Calif.  
Please rush me FREE Orchid seeds and FREE details of your offer of Louis and Gladys Schirmer's instructions which show me how to grow Orchids at home. The instructions will include a real blooming-size Orchid plant and valuable "quick-profit" plan all sent me to examine at home without obligation of any kind.

Name \_\_\_\_\_  
Street \_\_\_\_\_  
Town \_\_\_\_\_ Zone \_\_\_\_\_ State \_\_\_\_\_

This is the book that has started thousands on the road to success as home Orchid growers.





Warner Products Co., Baldwinville, N. Y.

## Car-Window Grille Keeps Pets Inside

Pets riding in automobiles cannot jump out when the rear windows are equipped with chrome-plated grilles. The grille hooks around the window molding and is held firmly by springs. The window can be raised and lowered with the grille in place. The device is also useful in keeping children from putting their arms or heads out of the window.

←Grille covers window to protect pets. Kids, too

## Magnetic Carrier Grips Top of Car

Lightweight objects such as fishing poles or skis are carried atop the car safely with a pair of rubber blocks held firmly in position by magnetism. You simply set the blocks in place and two strong permanent magnets molded into the rubber grip the roof firmly. The magnets can't wear out and will hold securely even on the roughest roads.

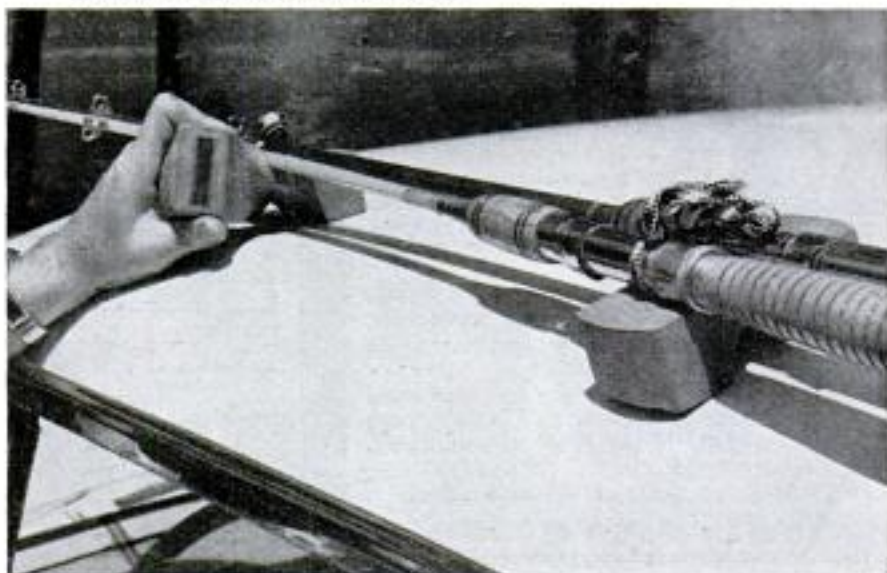

Magnetic Products Corp., 13025 Halldale St., Gardena, Calif.



## Plywood Beds For Station Wagon

Two sheets of plywood can be used to form beds in the rear of a station wagon without loss of storage space. The panels are supported by foot-high furniture legs, leaving room beneath for storing considerable equipment, such as fishing rods, camping gear and guns. They are cut to fit the exact shape of the wagon sides. Each is locked into position by screen-door hooks that slip into bars bolted on the side panels of the car.

←Beds are a foot high, provide storage space beneath

**Do YOU Want to Qualify for  
A BETTER JOB AT BIGGER PAY?**



# CLIMB TO SUCCESS! in Spare Time at Home

• Jobs are calling—calling to those who want more responsible jobs, in bigger pay brackets, with increasing chances for promotion—and who have the ambition to devote some of their spare time to acquiring necessary knowledge and skill. As little as just a few hours a week, in time you can easily spare, can produce surprising results in lifting you up to higher and higher levels of employment, income and security—even eventually to management positions or a business of your own. In the coupon below are listed some of the large number of training opportunities offered by AMERICAN SCHOOL—now in its 60th year. Check the one that interests you most and fill in your name and address. Or if you prefer some other career, write the subject in the margin. Then mail the coupon without delay.

—FULL INFORMATION...NO COST...NO OBLIGATION—

**AMERICAN SCHOOL, Dept. G245, Drexel at 58th, Chicago 37, Ill.**

Without obligation, please send FREE and postpaid, full particulars about the subject checked below.

- |  |   |   |
|--|---|---|
| <input type="checkbox"/> Accounting              | <input type="checkbox"/> Contracting              | <input type="checkbox"/> Mechanical Engineering |
| <input type="checkbox"/> Apprenticeship Courses  | <input type="checkbox"/> Diesel Technician        | <input type="checkbox"/> Mechanical Technology  |
| <input type="checkbox"/> Architecture & Building | <input type="checkbox"/> Drafting—Building Trades | <input type="checkbox"/> Metalworking Courses   |
| <input type="checkbox"/> Automotive Technician   | <input type="checkbox"/> Drafting—Machine Trades  | <input type="checkbox"/> Plumbing—Practical     |
| <input type="checkbox"/> Better Foremanship      | <input type="checkbox"/> Electrical Engineering   | <input type="checkbox"/> Private Secretary      |
| <input type="checkbox"/> Blueprint Reading       | <input type="checkbox"/> Electricity—Practical    | <input type="checkbox"/> Retail Merchandising   |
| <input type="checkbox"/> Bookkeeping             | <input type="checkbox"/> Electronics—Industrial   | <input type="checkbox"/> Salesmanship—Outside   |
| <input type="checkbox"/> Business Management     | <input type="checkbox"/> HIGH SCHOOL COURSES      | <input type="checkbox"/> Sheet Metal Work       |
| <input type="checkbox"/> Civil Engineering       | <input type="checkbox"/> Machinists               | <input type="checkbox"/> Tool Making            |

Name \_\_\_\_\_ Occupation \_\_\_\_\_

Home Address \_\_\_\_\_ Age \_\_\_\_\_

City \_\_\_\_\_ State \_\_\_\_\_

Canadians: Write American School, Dept. G245, 6083 Sherbrooke St. W, Montreal

## SALESMEN WANTED

Prefer men over 50. Earnings \$5000 to \$8000 per year, calling on hardware stores and lumber yards, selling and installing Popular Mechanics show windows. No window trimming experience necessary (we train you) but selling experience essential. Must have automobile. Average territory consists of about 5 counties. Salesmen have exclusive territory. Home every night.

Not a get rich quick scheme but steady dignified work by which a skilled, industrious salesman can earn a good living. This company, in cooperation with Popular Mechanics and the leading manufacturers of tools, equipment and materials, offers retailers traffic-stopping window displays to retail hardware stores and lumber yards at a nominal cost. All equipment furnished. Endorsed by many retailers, jobbers and manufacturers. Much repeat business. Extras offer additional earning opportunity. Desirable but not necessary to have knowledge of hardware and lumber lines. Personal training given.

For details write to Window Displays, Inc., giving all the facts about yourself. If your letter indicates that you might qualify, an appointment will be made for an interview.

**WINDOW DISPLAYS, INC.**

1580 SHERMAN AVENUE

EVANSTON, ILLINOIS

## You can start a \$40<sup>00</sup> a Day Business IN YOUR SPARE TIME



### MAKE BIG CASH PROFITS IN YOUR OWN HOME SHARPENING HOUSEHOLD, GARDEN, SHOP TOOLS

Now you can turn spare time into Big Cash Profits with new Belsaw Sharp-All. Sharpen knives, scissors, shears, snips, ice skates, hedge trimmers, mower blades, grass whips, axes, chisels, screw drivers, scrapers and saws. Your own CASH business with no inventory. No calls to make. No experience needed.

Learn how easily you can start your own spare-time business. Amazing low-cost, easy payment plan. Send postcard for FREE BOOK.

**BELSAW SHARP-ALL CO**  
717 Field Building • Kansas City 11, Missouri



# Know-How Increases Versatility of Shop Jointer

In addition to its regular uses, a jointer, or planer can be used to taper a board, remove an unwanted taper from a board or to plane a surface on a length of warped lumber. Before performing any of these operations, be sure the knives are flush with the top of the front table. To taper a board, measure the difference in width from one end to the other, then lower the rear table that amount. Place the forward corner of the board on the front table and run the board through the jointer, as in Fig. A. To remove a taper in a board, repeat the operation, but run the board over the knives in reverse, as in Fig. B. Another way to remove the taper in a piece of stock is shown in Fig. C. A line is drawn the length of the stock, showing the width desired. The wide end is fed into the knives as the rear table gradually is lowered until the knives cut to the line. The board then is reversed and run over the knives. The cut will, of course, come out even with the cut made in the other end. If a board is bowed,

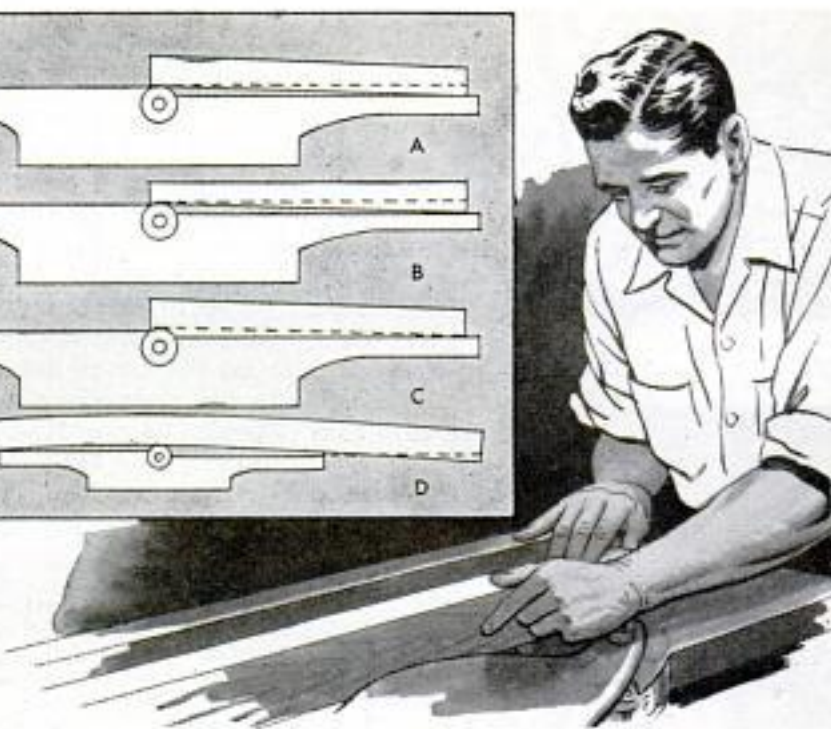
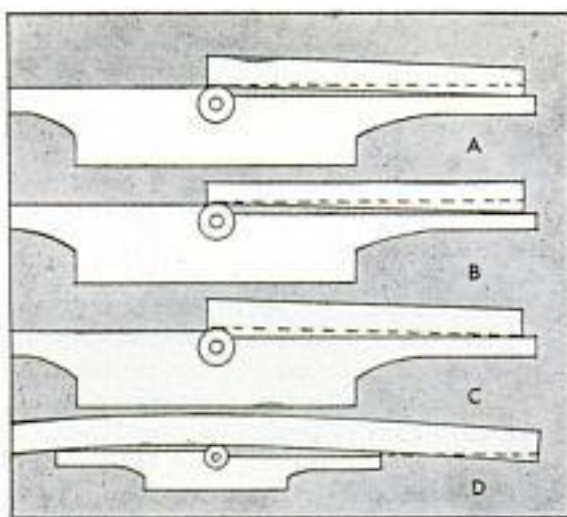

high center over the knives, as in Fig. D, and move it forward over the knives. Then reverse the board, start from center and cut to the other end. Several passes, with the table set lower each time, may be necessary to cut a true surface. When performing the operations described, the jointer guard must be in place to protect the hands as shown in the illustration.

C. H. Sanders, Portland, Ore.

## Sideboards on Lime Spreader Triple Load Capacity

The capacity of a pull-type lime spreader was tripled, with subsequent savings in time, by installing a bottomless box on top



of the hopper. Bridging of the increased amount of lime or fertilizer was prevented by raising the agitator on its shaft. The front and two ends of the box are made of  $\frac{3}{4}$ -in. lumber 12 in. wide, the back being heavy sheet metal bent to the curvature of the hopper.

## Weight Tips Bucket

If it is necessary to dip water from a cistern, well or deep excavation, slip a short length of pipe over the rope to rest against the bucket bail. This will weight the bail sufficiently to tip the bucket when it rests on the surface of the water. File the ends of the pipe smooth to prevent them from fraying the rope.

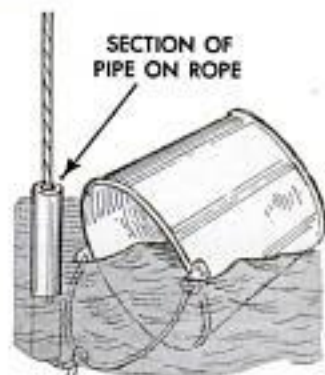

# NEW RUBBER STAMP BUSINESS PAYS BEGINNERS UP TO \$9.20 AN HR.

**START AT HOME  
IN SPARE TIME**  
with Table Top Machine!

The multi-million dollar Rubber Stamp business—once controlled by a few big companies—is now being taken over by small operators—one in each community throughout the United States. Men and Women who have this inexpensive machine can turn out huge quantities of Rubber Stamps with special wording that buyers once were forced to buy from big cities. Material costing only 27c makes a stamp that sells for \$1.80. The machine that does the work is simple and easy to operate and it turns out as many as six Rubber Stamps at a time, each with different wording such as names, addresses, notices, stock numbers, prices and other "copy" needed by offices, factories and individuals. Working full capacity, it can earn as much as \$9.20 an hour for the operator! Now you can get into the big-pay business yourself, with your own home as headquarters. You don't need experience. We supply everything, including complete instructions and eight ways to get business coming in fast. Start making up to \$9.20 an hour from the very beginning. Cash in on the profitable Rubber Stamp business in your community, right away. We'll mail full particulars FREE and no salesman will call. Be first in your locality. Rush coupon today or send your name on postcard to

**RUBBER STAMP DIV., Dept. R-2-B**  
1512 JARVIS AVENUE • CHICAGO 26, ILLINOIS



**RUBBER STAMP DIV.**  
1512 Jarvis Ave., Dept. R-2-B  
Chicago 26, Illinois

**FREE!**

Please rush full particulars about the little machine that can get me started in the profitable Rubber Stamp business at home in spare time. Everything you send me is FREE and no salesman will call.

NAME.....

ADDRESS.....

CITY.....ZONE.....STATE.....

## BE A LANDSCAPE CONTRACTOR

Make \$20 to \$60 a day. Millions of new and old homes, estates, etc., need modern landscaping. Contracting is full time job for those who want to start own business. Start with smaller projects, and work into larger jobs. We show you how. Easy-to-follow Home Study Course. Hundreds of successful graduates. Write for FREE Book.

**NATIONAL LANDSCAPE INSTITUTE**

310 S. Robertson Blvd. Dept. M-27 Los Angeles 48, Calif.

## NEW 18 ft. OFFSHORE CRUISER KIT

17 Models as low as \$42.00 (freight included). Fiberglass boat covering kits, marine supplies, etc.



Top and side curtains available!

**TAFT MARINE WOODCRAFT**

Dept. PM-257 • 636 39th Ave. N.E. • Minneapolis 21, Minn.

## New HOME-IMPORT BUSINESS!

Men - Women. We show you how to import big-profit items at amazing low foreign prices (examples at left). Your home is your office. Get list of 157 Imports FREE! Full or spare time business by Mail Order. Or take volume orders from stores. Import jewelry, clothing, sporting goods, hardware, etc. NO EXPERIENCE OR INVESTMENT IN PRODUCTS NEEDED. Without obligation send today for complete details and list of 157 imports FREE! Air mail reaches us over night. THE MELLINGER CO., 1717 Westwood Boulevard, Dept. G252, Los Angeles 24, California.



Clocks 65¢  
in Germany—  
\$5 value  
in U.S.A.

# Make Money in ART

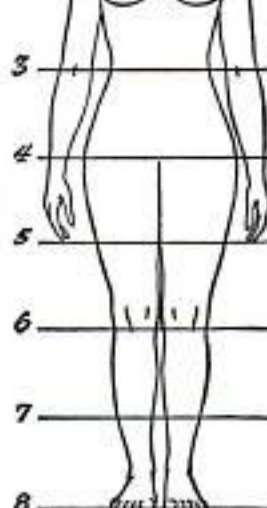

**It's EASIER  
Than You Think!**

DRAWING at left shows how to proportion average human figure, 8 heads tall. General art instruction has been simplified same way in our famous home study course. With it, you can develop artistic ability you never dreamed you had—train for top pay in Illustrating, Cartooning, Design, Fashion Art, Lettering, Portraits, TV. Low cost. Individual supervision.

**SEND FOR FREE BOOK.** Describes our methods. Quotes students. Talent Test also sent free. No obligation. No salesman will call. Mail coupon now. **Washington School of Art, Studio 142, Port Washington, N. Y.**

**WASHINGTON SCHOOL OF ART (Estab. 1914)**

STUDIO 142, PORT WASHINGTON, N. Y.  
Send me —FREE— illustrated book, "Art for Pleasure and Profit," plus free talent test. No obligation. No salesman will call.

Name..... (Please Print)

Address.....

City.....State.....

# Direct Factory... ...Special Offer



## A Tong for "MA"

### KOOL-HAND Tongs

- New positive grip with automatic spring action tension.
- Ideal for lifting hot baby bottles, fruit jars, baked potatoes, sweet corn, wieners or hot dishes.
- Handy, attractive, durable chrome with life-long action . . . easy to clean.



## A Saw for "PA"

### JIFFY-MASTER Hack Saw

- A necessary and handy tool for every home mechanic, plumber or electrician.
- Cuts anything . . . in restricted places where ordinary hack saws will not work.
- Adjustable, complete. High grade blade furnished. Uses any new or broken hack saw blade.

Tong 47c  
Saw 97c

POSTPAID \$1.44 plus sales tax where required.

Kindly send check or money order.  
Money refunded if not completely satisfied.

**DIESEL POWER, Inc.** P.O. BOX 72  
GREENVILLE, PA.

## Go after the BIG MONEY

in  
**ELECTRICAL**  
Repair  
and Maintenance

Keeping industrial and domestic electrical machinery "going"—that's a big-pay job for thousands of men—big today—and ever-growing, in this electrical age! Get into this promising line—grow with it into bigger opportunities and get really worthwhile pay. Let this big, practical, Electrical Maintenance and Repair Library show you how—as it has hundreds of other men.

5 volumes 2112 pages 1801 illustrations

Starts at beginning, and takes you step-by-step through every phase of connecting, altering, testing, repairing all types of equipment. How to install motors, generators, rewind motors; inspect, repair starters; locate trouble, test induction motors, and MUCH MORE! One entire volume crammed with trouble-shooting charts. Simple diagrams make everything crystal-clear. Gives best on-the-job practice of experts. Will help to put you in big-pay class and rate you an EXPERT electrical worker.



**FREE**

**10-DAY TRIAL**

Send no money. Just mail coupon. Easy payments.

McGraw-Hill Book Co., Dept. PM-2  
327 West 41st St., New York 18, N. Y.

Send me for FREE 10-Days' Examination the Electrical Maintenance and Repair Library. If not satisfied I will return books. Otherwise, I will send \$5.00, plus delivery costs, then and \$4.00 a month for 5 months, until total of \$25.00 is paid.

Name \_\_\_\_\_

Home Address \_\_\_\_\_

City & State \_\_\_\_\_

WE PAY DELIVERY cost if you enclose \$5.00 first payment WITH coupon. Same return privilege for full refund.

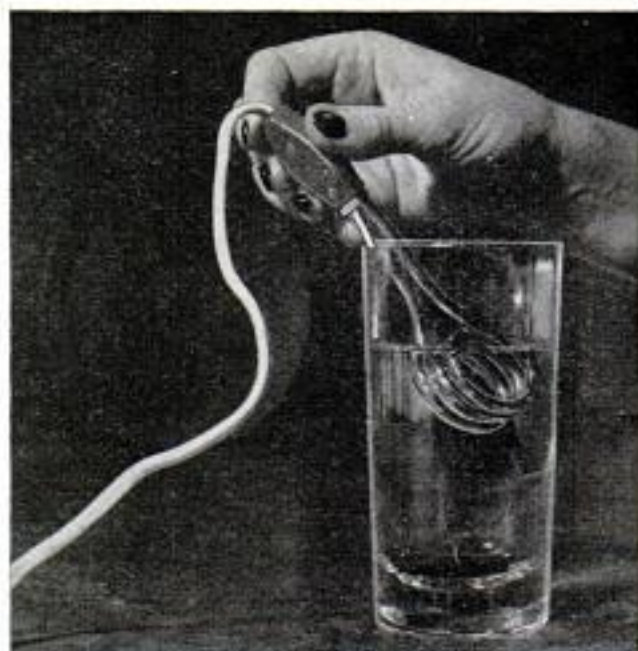

## Portable Heater Warms Drinks in the Cup

When you're on the road, you can heat your coffee, boil eggs or warm the baby's bottle just by dunking a new portable immersion heater in the liquid. The midget heater has a coil that won't discolor from heat, rust or corrosion. The coil is mounted in a small plastic base with clip to suspend it on the edge of a glass, cup or pot. The unit plugs into any a.c. or d.c. 110-volt outlet. It will set a cup of cold water boiling in two minutes. When it has done its job, just slip it into its small zippered case and tuck it back in the luggage.

## Chemical Reduces Slipping Of Locomotive Wheels

Operating independently of trains, a motorized car will spray a new chemical on the rails to reduce the slipping of locomotive wheels. Research has shown that slipping is caused by a film of oil spread by moisture and resisting the weight of locomotives. The chemical breaks through the oil film. It is expected to increase the present tonnage ratings by at least 25 percent.

## Weed Saves Lives

Agave, a weed that kills livestock in southwestern United States, may prove to be a source of smilagenin from which cortisone is made. (Cortisone is used to treat arthritis, inflammatory eye diseases and asthma.) Agave, if used commercially, will be cleared from lands that can be recovered for productive purposes. This plant also may serve as an emergency source of fiber for rope or cord.





# 100 BEST Woodworking Projects

The "Must" for All Home Workshops

Selected by Popular Mechanics Editors

Enjoy the fun of making things. Revel in the pride of the craftsman when neighbors and friends admire your handiwork. Get 100 BEST WOODWORKING PROJECTS, complete with simplified instruction, plans, diagrams and more than 400 how-to-do-it pictures. Make all kinds of furniture — chairs, tables, desks, bed room furniture. Make baby carriages, clock cases, lamps, book shelves, fireplaces, attic ladder, folding screen, kitchen accessories, games, swings, storage bins, garden sets, etc., at little or no cost. Send only \$2.00 with name and address today. Money back if not pleased.



POPULAR MECHANICS PRESS, Dept. 257  
200 E. ONTARIO STREET CHICAGO 11, ILL.

Marine KIT BOATS-DO IT YOURSELF-SAVE 50%



MARCO 14  
\$189.50 Delivered

WRITE FOR FREE FOLDER

or send \$1.00 for complete catalog.  
ACCESSORIES • FIBERGLAS  
**Marine ASSOCIATES**  
BOX 8188W LONG BEACH 11, CALIF.

8' to 14' models, factory to you, no dealers, mahogany decks and framework, all brass fastenings, 14' hull kits as low as \$129.50 including freight charges. CATALOG 35c includes Kits, Hardware, Trailers, Fiberglass.

## MECHANICAL PENCIL CALCULATOR

NEW INVENTION

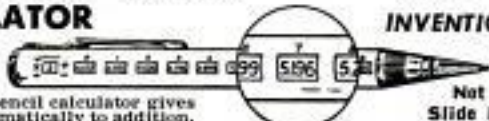

MATH-WIZ pencil calculator gives answers automatically to addition, multiplication and square root problems. (Indirect subtraction and division.) Easy to operate, comes in gold anodized aluminum casing. Useful gift for students, engineers, draftsmen and in all industry. Only \$2.25 postpaid. No C.O.D.  
JACK WEISER, 1233 S. Fairfax Ave., Los Angeles 19, Calif.

Not a Slide Rule

## WANT HIGH PAY and STEADY WORK?

Get into

# DIESEL AND HEAVY EQUIPMENT



Men are now being selected to train for the Diesel and Heavy Equipment industry. High pay and future security are the benefits of a trained and qualified Diesel man. If you are mechanical minded, write to us for free information without obligation as to how you may become a part of this rapidly expanding industry in . . .

- DIESEL MECHANICS
- DIESEL PARTS
- DIESEL OPERATION
- DIESEL SALES

MAIL THIS COUPON TODAY!

We will give you complete details about possibilities for you in the Diesel and Heavy Equipment field, without cost or obligation. Fill in the information below, or write at once to:

**TRACTOR TRAINING SERVICE, INC., Dept. PM-11**

1525 E. 53rd St., Chicago 15, Illinois or  
3334A Bloor St., West, Toronto 18, Canada

Gentlemen:

I would like all the facts about opportunities for me in Diesel.

NAME \_\_\_\_\_ AGE \_\_\_\_\_

ADDRESS \_\_\_\_\_

CITY & STATE \_\_\_\_\_



## Coach Rooms on Zephyr Offer Pullman Privacy

Coach travelers on the Burlington Railroad's new Denver Zephyr are afforded the privacy of a new kind of sleeping accommodation on two Slumbercoach cars. The Slumbercoach rooms, available at a modest charge above the low coach fares, are both single and double. Both provide window seats by day which are made into beds at night with private toilet and wash basin. The new coaches carry 40 passengers, 24 in the single rooms and 16 in the 8 double rooms. For mothers traveling with babies, the cars are provided with cribs which can be conveniently suspended in the rooms. The cars were designed by the Budd Mfg. Co.



Write to **SKIN DIVER**  
to  
**MAGAZINE (Monthly)**  
Box 128-P  
Lynwood, California

6th year of publication. Complete national and worldwide coverage on all spearfishing and underwater diving activities.

**THE FIRST AND ONLY NATIONAL MAGAZINE OF ITS KIND!**

**SEND \$100**  
For  
5 Month trial Subscription

Subscription Rates  
1 yr. \$3.00 Foreign 1 yr. \$4.00



## CONCRETE BLOCK HOME PLANS

### \$2500 RANCH HOME



Build your own 28'x48' Ranch Home, complete for \$2500. No block cutting necessary. Under slab forced air heating. Contains 12'x20' living-dining room, 10'x10' and 11'x12' bedrooms, 12'x12' den with fireplace, 11'x12' kitchen, bath, six closets, utility room, carport or garage. Genuine blueprints scale 1/4"=1', instructions, and material cost list \$2.00 ppd. Money back guarantee. \$1900 DUPLEX, 24'x36'. Each side contains 11'x17' liv. room and kitchenette, 10'x11' bedroom, bath, five closets. Plans \$2.00. \$1150 GARAGE APARTMENT, 22'x24', liv. room, kit., two bedrooms, bath. Double garage below. Plans \$1.00. MEMBER ARKANSAS HOME BUILDERS ASSOC.

BAILEY BUILDERS, 7602 Harmon Drive, Little Rock, Ark.

## MAKE \$5.00 AN HOUR

Many Agents Do—Selling the famous "Magic Hundred" sewing kits. 100 spools of quality thread, 90 colors in hinged plastic box. Retailing at \$1.25, costs 80c.

Send \$1.00 for sample kit, sells on sight. Better yet order 1 dozen. Make \$16.20 profit and get stunning sample case free.

**FREE WITH EVERY 3 DOZEN ORDER**  
**SAMPLE CASE — \$4.95 VALUE**

MAGIC HUNDRED THREAD, PM-2 305 Knowlton St., Bridgeport, Conn.

## RUPTURED?

Something different. Light. Cool. No leg straps. No elastic. No pressure on hips or spine. Inexpensive. Worn by Mechanics, Farmers, Doctors, etc., everywhere. Guaranteed. Write

**HAND-LOCK PRODUCTS** EST. 1893  
DEPT. PM, PRESTON, ONT., CAN.

### Be an industrial designer

Combine your design abilities with technical aptitudes in Industrial Design training at Art Center School in California. Work under practicing professionals for upper level jobs as automotive stylists, product and package designers. Design offices, stores, motels, showrooms, shopping centers. Constant demand for graduates. Recent placements with Ford, G.M., Kaiser Aluminum, G.E., Raymond Loewy and other leading design studios. 700 students. Co-ed. Accred. S.P.A. Degree. Four-year course can be completed in 2 yrs. 8 mos. by year-round training. New terms Feb., June, Sept. Enroll early. Write Mr. Mead for new catalog. 5353 West 3rd St., Los Angeles 5, California.

## ART CENTER SCHOOL

## HOW TO FIX ANY AIR COOLED ENGINE!



Save time and money servicing small engines on power lawn mowers, small tractors, industrial applications, etc. **SMALL ENGINES SERVICE MANUAL** shows how to make expert repairs, tune-up, overhaul or troubleshoot on 200 makes and models. Edited by engineers and professional mechanics. Covers any job on popular 2 or 4-cycle engines. Includes 1, 2 and 4 cylinder models, light weight and heavy duty, 1 to 35 HP. Contains 25,000 procedures, easy-to-follow instructions, time-saving shortcuts. 6,000 specifications. Parts information on 1,700 items. Only manual of its kind. Order NOW at \$3.45 introductory price. Send check or M.O. Money refunded if you're not satisfied. Clip this.

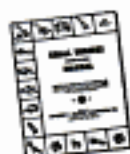

**SMALL ENGINES SERVICE MANUAL** 690 Graphic Arts Bldg.  
Kansas City 5, Mo.



# BIG MONEY in ELECTRIC APPLIANCE REPAIRING. Start YOUR OWN BUSINESS!

### OVER 50,000,000 FAMILIES

Have one or more appliances which need servicing and repairs. Earn \$5.00 to \$6.00 an hour in your spare time!

### LET US SET YOU UP IN BUSINESS

CHRISTY has helped thousands of men in all parts of the world get started in their own full or part time, big money-making businesses. **CHRISTY TRAINING IS COMPLETE TRAINING!** We teach you how to quickly locate electrical troubles, furnish you with the "CHRISTY ELECTRONIC KIT" for easily locating shorts, breaks, opens, etc., How to speedily make needed repairs, etc. CHRISTY shows you how to set up your own business, build needed power tools from spare parts, how to get business, what to charge, etc.

### CHRISTY FINANCES YOU!

CTS Shop Method, Home Training Program can be had on a Pay As You Learn Plan.

SEND FOR FREE BOOK AND Plan today.

### CHRISTY TRADES SCHOOL

4804 N. Kedzie Ave., Dept. D-6303, Chicago 25



**CHRISTY TRADES SCHOOL, Dept. D-6303,**  
4804 N. Kedzie Ave., Chicago 25

Send me your **FREE** book on Electrical Appliance Repairing and instructions for paying later from **EARNINGS WHILE LEARNING.**

Name \_\_\_\_\_ Age \_\_\_\_\_

Address \_\_\_\_\_

City \_\_\_\_\_ Zone \_\_\_\_\_ State \_\_\_\_\_

**1000'S  
OF USES**  
sew for  
fun and profit



# genuine SUEDE LEATHER WHOLESALE! only 39¢ ft.

rich colors

Buckskin Beige	Hunter's Red	
Chocolate Brown	Forest Green	
Powder Blue, Pearl Gray, Baby Pink		
SIZES		
3 full sides approx. 24 ft.	\$9.35	
2 full sides approx. 16 ft.	\$7.75	
1 full side approx. 8 ft.	\$4.75	
1/2 side approx. 4 ft.	\$2.75	
Some 1/2 swatches	.25	
Add 50¢ for shipping & packing		

We have purchased nearly a carload of fine suede leather at a fraction of its real value. Beautiful tanned leather can be offered to you for a limited time at only 39¢ ft. These handsome hides can be cut and sewn like cloth. Genuine leather lasts a lifetime. Loads of uses... duck straps, quivers, coats, jumpers, hunting vests, gloves, shirts, hats, etc. Make table covers, book covers; pillows, sporting goods etc. Cover chairs or use as throw rug. It's simple and fun to decorate. Order now at this unheard-of low price. Save \$ Comes with our easy instructions and patterns: Specify color and size. Satisfaction guaranteed. Send to: **WHOLESALE IMPORT CO.** Box 75-N, San Gabriel, Calif.



Let me show you!

## HOW TO SPEAK AND WRITE LIKE A COLLEGE GRADUATE

I have helped thousands of men and women who have not had college training in English to become effective speakers, writers, and conversationalists. With my new C. I. METHOD, you can stop making mistakes, build up your vocabulary, speed up your reading, develop writing skill, learn the "secrets" of conversation. You don't have to go back to school. Takes only 15 minutes a day at home. Costs little. 32-page booklet mailed FREE upon request. Send me a card or letter TODAY!

**Don Bolander, Career Institute**  
Dept. 1052 25 East Jackson Chicago 4, Illinois  
Please mail me your FREE 32-page booklet on English.

Name \_\_\_\_\_  
Address \_\_\_\_\_  
City \_\_\_\_\_ Zone \_\_\_\_\_ State \_\_\_\_\_

## ELECTRIC MOTOR



A low-cost, dependable motor with many uses. Ideal for displays, pumps, fans, heaters, toys. No radio interference. Every one guaranteed. Write for free catalog.

**PENNSYLVANIA WHOLESALE DISTRIBUTORS**  
104 N. 6th STREET PHILADELPHIA 6, PA.



New 1957  
SPORTABOUT  
CARS and  
GOLF CARS.  
Write for  
literature.

## ESHELMAN TRACTORS

For Better Lawns and Gardens investigate Esheleman Riding Rotary Mowers, Trimmers, Tractors. Advertised in GOOD HOUSEKEEPING. Thousands of Satisfied Users. Write for Free Literature.  
Dept. 24, ESHELMAN, Balto. 2, Md.



Shipping Points: BALTIMORE • CHICAGO • NEW YORK

Encourage This Fellow!  
Give His Natural Talents  
a Grand Lift With This  
Popular Mechanics  
Helpful Book!



## Every Boy Should Have It! The Build-It-Yourself Book for Boys

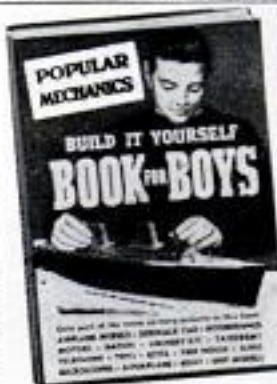

192 Pages  
469 Pictures

It's natural for boys to want to make things—to work with tools—to fashion the kind of things kids want. So give boys the Build-It-Yourself Book for Boys. Encourage a youngster to express himself—make him happy—with the sensational new Popular Mechanics book that shows how to make 56 different things every boy dreams about. It covers science, mechanics, electricity, modeling and other fields. 192 pages of easy-to-follow instructions. 469 how-to-do-it pictures.

**Try It • Your Money Back If You Want It!**  
Build-It-Yourself Book for Boys sent postpaid for \$2.50 or COD, charges extra. Money refunded if you are not pleased after 5 days' use. Mail the coupon for quick service.

Use This Coupon for Quick Book Service

**POPULAR MECHANICS PRESS, Dept. 257**  
200 East Ontario Street, Chicago 11, Illinois

Send "Build-It-Yourself Book for Boys." I understand you will refund full price if I return book in 5 days.

I enclose \$2.50  Send COD

Name \_\_\_\_\_

Address \_\_\_\_\_

City \_\_\_\_\_ Zone \_\_\_\_\_ State \_\_\_\_\_

**POPULAR MECHANICS**

Copyrighted material



## Science and Mechanics Especially for Boys

Boys can make all of these with the help of this fine Popular Mechanics book—Tree House—Sidewalk Auto—Midsize Racer Hydroplane With Engine—Practical Microscope—Fascinating Electrical Dart Game. 51 other things boys want. Airplane Models, Aquaplane, Archery Kit, Bird Houses and Shelter, Boats, Bobsled, Boomer-

56 Toys, Games  
Gadgets, Models, Boats,  
Electrical Devices, Autos—  
That Boys Can Make

angs, Cannon Toy, Electric Motors, Garage Toy, Helicopter Toy, Hunting Knife, Kites, Log Cabins, Marble Game, Printing Press, Radio Sets, Rafts, Railroad Modeling, Scooters, Sprinkler Truck, Squirt Gun, SS United States Model, Surfboard, Tank Toy, Taxi-dermy, Telegraph Set, Telephone, Water Skis, Weather Instruments, Toboggan, Worktable.

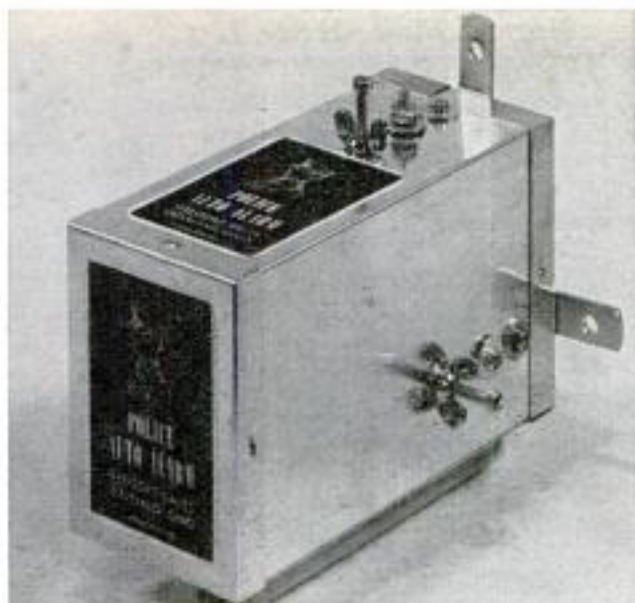

## Auto Alarm Halts Vandals

Few car thieves or vandals have courage to complete their crime while the vehicle's horn shrieks. This noise is initiated by an alarm unit installed on the auto's firewall under the engine hood. Working on 6 or 12-volt circuits, the apparatus can be switched on when the owner leaves and switched off when he returns. The alarm stops automatically 15 seconds after tampering halts. Construction is aluminum.

## S-t-r-e-t-c-h-a-b-l-e Typing Paper

Old-time printers often send newcomers in search of the "type stretcher." Now even a stenographer can stretch type. A new typing paper consists of a flexible sheet laminated to a backing sheet with a pressure-sensitive adhesive. There are horizontal cuts in the flexible paper which match the spacing of standard typewriter lines. The typist types out the copy. Then, in justifying it, she lifts up and stretches the lines to the right-hand margin.



# I WILL TRAIN YOU FOR RADIO- TELEVISION

ON MY EXCLUSIVE  
NO-OBLIGATION  
NO-RISK TRAINING PLAN



Frank L. Sprayberry,  
President

Let me prove to you . . . without cost or obligation . . . that I can prepare you to be a Radio-Television Serviceman in 10 Months or Less

Let the true facts speak for themselves! That's why I want you to have my big new catalog and an actual sample lesson of Sprayberry Training . . . both FREE! Read, then make up your own mind! Train on my exclusive NO OBLIGATION PLAN . . . which means you DO NOT sign any kind of time payment contract. You pay for and accept your training as fast or as slowly as you wish. Prepare now for big paying jobs in Radio-TV or your own business. I will help you earn while you learn . . . in spare hours at home.



## Get Practical Experience with 25 Kits of Radio-TV Parts

Practical experience counts most. In addition to modern lessons, you train with actual parts and equipment. Build the famous Sprayberry Training Television Set, Multi-Range Tester, 2-Band Radio, other Test Equipment—all yours to keep. Get latest training on Color TV, Transistors, Hi-Fi and UHF Conversions . . . included to make your training more valuable.

You owe it to yourself to get all the facts . . . Mail coupon for catalog and sample lesson—FREE

See for yourself . . . in actual pictures and descriptions . . . why Sprayberry Radio-Television Training offers more. Backed by almost 25 years of training experience. Three training plans to suit your exact needs. Rush coupon today for big new catalog and sample lesson. No obligation; no salesman will call.

TWO  
BIG  
FREE  
BOOKS

**SPRAYBERRY ACADEMY OF RADIO**  
Dept. 10-H, 111 N. Canal St., Chicago 6, Ill.



**Mail Coupon Today!**

SPRAYBERRY ACADEMY OF RADIO Mail for FREE  
Dept. 10 H, 111 N. Canal St., Chicago 6, Ill. Facts and  
Sample Lesson

Please rush catalog on your ALL-NEW Radio-Television Training Plans. I understand this does not obligate me and that no salesman will call. Include Sample Lesson FREE.

Name \_\_\_\_\_ Age \_\_\_\_\_  
Address \_\_\_\_\_  
City \_\_\_\_\_ Zone \_\_\_\_\_ State \_\_\_\_\_

# MANUFACTURE THIS BEAUTIFUL CONCRETE OUTDOOR FIREPLACE

Right In Your Own Backyard

\$4.00 Worth of Sand & Cement produces this Attractive Fireplace.

Sells on Sight from \$60. to \$80. Easy to start your own Profitable Business.

The General Fireplace Molds and Process are the most amazing and foolproof ever invented. Simple to operate. Two men can produce five fireplaces a day.



## BIG DEMAND!!

Sell all you produce to Department Stores, Homeowners, Parks, Nurseries and Picnic Groves. Fireplaces sell on sight. No experience necessary. We supply full operating instructions and equipment plus the know-how that spells BIG PROFITS. This is an outstanding opportunity for men of vision and small capital to get into a busy rich paying field. Don't delay, be the only exclusive manufacturer in your own home town. Mail coupon at once for full details as to how you can reserve your territory. Molds sold only on exclusive franchise.

**GENERAL ENGINES CO., Inc., Dept. MF-27**  
ROUTE 130, THOROFARE, N. J.

Mr. Tor of Philadelphia writes: Sold 250 in first 4 months. Selling to Sears Roebuck, John Wanamaker, and Gimbel Bros. in Philadelphia area.

Name .....  
Address .....  
City ..... Zone .....  
State .....

# LEARN TO MOUNT BIRDS



## ANIMALS, FISH, PETS

Be a Taxidermist. Save your hunting TROPHIES. Have a fine home-museum. Hunters, save and MOUNT your beautiful DUCKS, QUAIL, DEER, TAN skins, Great Fun. Spare-time PROFITS. **FREE BOOK** Tells ALL about it. 100 fine wild-game pictures, 68 pages. SEND TODAY, don't delay. Get this WONDERFUL FREE BOOK, MEN AND BOYS. Learn Taxidermy. Double your hunting pleasure. Rush letter or POSTAL today. STATE YOUR AGE. N. W. SCHOOL OF TAXIDERMISTRY, Dept. 2562, Omaha, Neb.

Whatever the job, you'll do it better with nationally advertised products. Ask for products advertised in POPULAR MECHANICS



# AMAZING NEW PERSONAL POCKET RADIO



LISTEN IN PRIVATE WHILE YOU WALK!

SMALLER AND LIGHTER THAN ANY TRANSISTOR "POCKET RADIO!" Wt. only 1/2 lb. Size 1 1/2" x 2 1/4" x 3/4" complete. Black Gold Beakproof plastic case. POSITIVELY NO HOOKUPS OR WIRES NEEDED! BUILT IN 1000 MILE ANTENNA! Soap in flashlight batteries lasts for months. "Glow in the Dark!" Easy to use top controls (while walking, riding, etc.). Has special tiny, soft plastic almost invisible ear-plug—LETS YOU ALONE LISTEN ANYTIME. ANYWHERE without anyone else knowing you are hearing radio music, sports, news, weather, etc. GUARANTEED TO WORK ANYWHERE RADIO CAN BE USED. ONE YEAR SERVICE GUARANTEE.

SEND ONLY \$5.00 (ck. mo) and pay postman \$14.95 plus postage on delivery or send \$19.95 for postpaid delivery. A REAL \$29.95 VALUE! AVAILABLE NOW ONLY FROM US AT HALF PRICE WHILE OUR SUPPLY LASTS. American made! You can always get repairs if ever needed. NOT AN UNWORKABLE INCOMPLETE KIT OF PARTS OR PLAYTHING. A REAL MIDGET PERSONAL POCKET SIZE RADIO. Get yours now—Listen when you want without bothering others. Price will go up soon so rush your order now for YOUR TINY TONE POCKET PERSONAL RADIO. Available only from:

WESTERN RADIO Dept. APR-2 KEARNEY, NEBR.

## Handy Mail Order List

### Little Library of Useful INFORMATION

5 for \$1.00  
12 for \$2.00  
25¢ Each

Here at amazingly low cost is the practical help and information you have always wanted. Articles in previous issues of Popular Mechanics have been classified according to subject and are now available in these handy reprint booklets.

- How to Use Measuring Tools—Micrometers, Calipers, etc.—106.
- Power Driven Saws—74.
- Drill Presses, Grinders, etc.—79.
- Wood, Metal-Turning Lathes—81.
- Filing Machine, Hack Saw, Cutoff Wheel, Shaper—82.
- Lathe Tools You Can Make—101.
- Workbenches—Tool Cabinets—47.
- Spray Painting—84.
- From Pattern to Casting—91.
- Tool and Saw Sharpening—92.
- Sharpening Drills, Wood Bits—90.
- Successful Wood Turning—32.
- How to Read Blueprints—71.
- Metal Turning Lathe Kinks—99.
- Operating a Metal Lathe—100.
- Heat Treating, Hardening—102.
- Working With Glass—103.
- Servicing Electric Motors—75.
- Electromagnets & Solenoids—44.
- Transformer Construction—41.
- The Boy Electrician—43.
- Soldering and Brazing—17.
- Arc and Spot Welders—5.
- Electroplating With Nickel, Chromium, Cadmium, etc.—86.
- Plating Wood, etc.—87.
- Lower Your Fuel Costs—31.
- Curing Leaky Basements—45.
- Fitting Home Game Room—55.
- Indoor & Outdoor Fireplaces—88.
- Backyard Gardening—39.
- Lawn and Garden Novelties—72.
- Trellises, Pergolas, Fences—76.
- Lawn and Garden Furniture—77.
- Playground Equipment—73.
- How to Use Your Drill Press—125.
- Making Serving Trays—53.
- Knots and Ropework—105.
- Sanders—80.
- House-Wiring—89.
- Hanging Wallpaper—38.
- Built-in Fixtures—78.
- Bird Houses—7.
- Magazine Racks—49.
- Clock Cases—50.
- Book Ends—52.
- Small Tables—54.
- Smoking Stands—56.
- Decks—58.
- Book Cases—59.
- Action Toys—56.
- High Flying Kites—67.
- Telescopes—20.
- Metal Craft—28.
- Small Looms—37.
- Working With Plastics—61.
- Simple Home Improvements—104.
- Ridding Home of Insect Pests—107.
- Children's Room Furniture—51.
- Jigsawed Novelties—57.
- Doll House & Doll Furniture—60.
- 25 Shelves You Can Make—64.
- Novelties Turned on Lathe—62.
- Inlay Pictures—Veneering—63.
- Wood, Soap Carving—65.
- Windmills & Weather-vanes—68.
- Lamps from Wood, Metal—69.
- Rustic Furniture—18.
- Wood Finishing—40.
- How to Fix Electrical Appliances—111.
- Painting Your House—117.
- Build Your Own Relays—123.
- Rowboats, Small Dinghy—83.
- Small Sail Boats—84.
- Two Outdoor Runabouts—85.
- Build Own Canoe, Kayak—30.
- Build Class-E Ice Yacht—22.
- Auto Kinks, Shortcuts—10.
- Lawn and Garden Equipment—124.
- Motor-Driven Midget Cars—34.
- Stop Auto Electric Troubles—95.
- Photo Printers and Dryers—25.
- Photo Darkroom Equipment—96.
- Trick and Table Top Photos—97.
- Home Movie Equipment—118.
- Poultry Houses—108.
- Guns and Decoys—109.
- Re-Silvering Mirrors—70.
- Chemical Experiments—93.
- Log Cabins, Tourist Houses—14.
- Using Basic Tools—120.
- Farm and Garden Tractors—8.
- Building Extra Attic Rooms—23.
- Attractive Basement Rooms—24.
- Gem Cutting—42.
- Photo Enlargers—1.
- Photo Kinks—98.
- Cleaning Formulas—11.
- Taxidermy—9.
- Photo Lighting—119.
- Training Dogs—35.
- Small Furnaces—36.

Check Titles Wanted, Clip, Mail with Remittance to  
**POPULAR MECHANICS PRESS, Dept. 257, 200 E. Ontario, Chicago 11**

# PLEASE SEND ME



for the time checked.  
I am enclosing . . .

- 1 year \$3.50
- 2 years \$6.00

name \_\_\_\_\_  
address \_\_\_\_\_  
city \_\_\_\_\_ zone \_\_\_\_\_ state \_\_\_\_\_

Hand this order to your newsdealer or send it to  
**POPULAR MECHANICS**  
200 East Ontario St. Chicago 11, Ill.



### Locomotive Moves Freight By Remote Control

Controlled by a technician in a control tower many yards distant, an "engineerless" electric shunting locomotive switches freight trains in Munich, Germany. Thirteen radio-transmitted orders move this engine at five different speeds. If the radio sound wave stops, the locomotive comes to a halt. Although moving slowly, this engine responds more quickly and effectively than steam and diesel locomotives.

### Wheel Temperatures Rise Fast

When a 300,000-pound airplane lands at 100 or more miles per hour, its wheel temperatures rise to more than 200 degrees Fahrenheit a few seconds after brakes are applied.

# DIESEL MECHANICS IN DEMAND

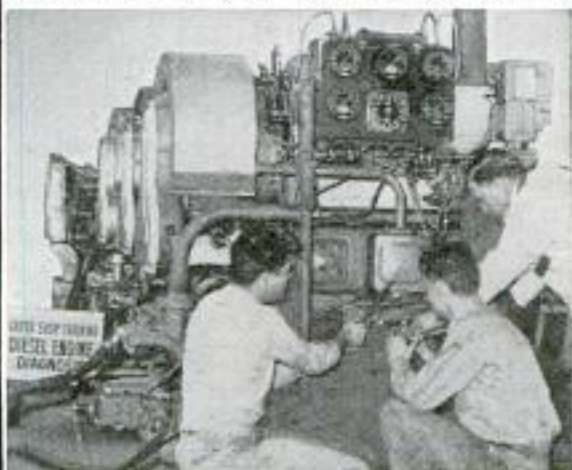

Learn to earn big pay in DIESEL in our large, modern equipped Chicago school and shop. No previous experience or training necessary. We help you find living quarters and part time job while in school. Complete, practical courses taught in the following trades, under the supervision of experienced, expert technicians.

APPROVED FOR CIVILIANS  OR GI'S

## — CHOOSE YOUR TRADE —

CHECK HERE	WEEKS
<input type="checkbox"/> DIESEL MECHANICS	20
<input type="checkbox"/> AUTO MECHANICS	20
<input type="checkbox"/> BODY & FENDER	16 2/3
<input type="checkbox"/> GAS-ARC WELDING	4 - 12
<input type="checkbox"/> REFRIGERATION	13 1/2
<input type="checkbox"/> AIR CONDITIONING	8 1/3
<input type="checkbox"/> MACHINIST TRADE	30
<input type="checkbox"/> ADVANCED MACHINIST (includes tool & die)	32 1/2
<input type="checkbox"/> PIANO TUNING & REPAIR	36

Heavy Construction Equipment Operators Training School  
Road Building, Terracing, Land Clearing, etc. Reservation for starting classes now being accepted.

### CHOOSE YOUR ENGINEERING COURSE

These courses are intended as terminal education for men who wish to enter the Diesel-Automotive and Refrigeration-Air Conditioning fields as technicians. These courses are designed to prepare men for supervisory positions. Students with a high school education, or equivalent, will be accepted.

<input type="checkbox"/> DIESEL AUTOMOTIVE ENGINEERING	2 years
<input type="checkbox"/> REFRIGERATION & AIR COND. ENGINEERING	18 months

### FREE EMPLOYMENT HELP

Start your career with Greer by checking your interest above and mail coupon for complete information at no obligation.

NAME \_\_\_\_\_ AGE \_\_\_\_\_

STREET \_\_\_\_\_

TOWN \_\_\_\_\_ ZONE \_\_\_\_\_ STATE \_\_\_\_\_

Established 1902 — Over 50,000 Graduates.  
55 years of continuous trade school experience  
to guide your training.

**GREER SHOP  
TRAINING**  
Box B, 2236 S. Michigan Ave.  
Chicago 16, Illinois

# PREPARE FOR THE BEST JOBS

**TRAIN at HOME**  
IN YOUR SPARE TIME  
or at  
**ALLIED INSTITUTE**  
in Chicago

- MECH. ENGINEER
- DRAFTSMAN
- TOOL DESIGNER
- TOOL ENGINEER
- TOOL & DIE MAKER
- MASTER MACHINIST

## NO RECESSION FOR ALLIED TRAINED MEN

**MORE JOBS THAN GRADUATES** Shortages of Draftsmen, Designers, Tool Engineers, Machinists, Tool & Die Makers are so widespread that you can pick a highly paid key job and look forward to Achievement and Security.

You can begin your training in Short Courses and continue progressively to a Bachelor Degree in 26 months.

Allied is approved by Industry, Dept. of Education, Office of Public Instruction, State of Illinois, U.S. Veterans Admin., U.S. Dept. of Justice. Accredited: C. S. A.

SEND FOR  
**FREE**  
BOOKS

**ALLIED SCHOOL of MECHANICAL TRADES**  
1338-42 South Michigan Ave. Dept. PM-2 Chicago 5, Illinois

SEND ME WITHOUT OBLIGATION INFO. ON YOUR COURSES:

HOME STUDY  RESIDENT  VETERAN  NON VETERAN

NAME \_\_\_\_\_

ADDRESS \_\_\_\_\_ AGE \_\_\_\_\_

CITY \_\_\_\_\_ COUNTY \_\_\_\_\_ STATE \_\_\_\_\_

## Free! AIRMAIL COLLECTION



Get this spectacular collection of all-different, genuine Airmails from strange, far-away countries in Asia, Africa, Europe, the exotic Orient! World's largest airmail, scarce \$27 stamp, old Zeppelin, many, many others. A truly remarkable collection containing stamps worth up to 40c each at catalog prices! **EXTRA:** new illustrated booklet "Men Against the Sky." **PLUS** Bargain Catalog and other unusual offers. Send 10c for mailing. Mail coupon today!

**JAMESTOWN STAMP CO. Dept. F2 PM JAMESTOWN, N. Y.**

RUSH my Free Airmail Collection and other offers. I enclose 10c for mailing costs.

Name \_\_\_\_\_  
Street \_\_\_\_\_  
City \_\_\_\_\_ State \_\_\_\_\_

## ELECTROPLATING EQUIPMENT

SUPPLIES & INSTRUCTIONS for  
HOME WORKSHOPS  
JEWELRY MFRS.  
BABY SHOE METALIZERS  
INDUSTRIAL PLATERS

Complete Assemblies of  
COPPER, NICKEL, CHROME  
GOLD, SILVER. Chemicals  
& Anodes — small or large  
quantities.

COMPLETE COPPER, NICKEL,  
CHROME PLATING ASSEMBLY  
ONLY \$275.00

RECTIFIERS: 10 to 1000 amps.  
TANKS: Steel, Stainless,  
P.V.C., Rubber-Lined



FREE CATALOG

Complete line of metal and onyx baby shoe mountings.

**HOLLYWOOD BRONZE SUPPLY**

1624A East 1st St., Los Angeles 33, Calif.

## WORKBENCH PARTNERS

POPULAR MECHANICS for helpful "how-to" information and YOUR DEALER for quality products that do the job best. He stocks and displays nationally advertised products — products advertised in POPULAR MECHANICS

PM TAG of  
INTEGRITY

## All About TELEVISION



How to  
Replace Tubes  
Install Antennas  
Make Adjustments



## Cut Down Repair Bills . . . Prevent Trouble

John Derby, well-known TV engineer, tells and shows you how to save money on the servicing and repair of your TV set. He shows you just how you can locate trouble, and in most cases make repairs yourself in the matter of minutes.

## Special Picture Section SHOWS You HOW to Locate Trouble

A special chapter contains actual photos of defective TV pictures. You merely compare the picture on your screen with pictures in the book, find the trouble at once and directions which tell just how to fix it. The very first time you use the TV Repair Manual your savings will exceed the small cost of the book. Order your copy now. Your money back in 7 days if it isn't entirely satisfactory.

POPULAR MECHANICS PRESS, Dept. 257  
200 East Ontario St., Chicago 11, Ill.

Send at once my copy of the TV Repair Manual. Remittance for \$1.00 enclosed. If it isn't entirely satisfactory I may return it in 7 days for a full refund.

NAME \_\_\_\_\_

ADDRESS \_\_\_\_\_

CITY \_\_\_\_\_ ZONE \_\_\_\_\_ STATE \_\_\_\_\_

Send C.O.D. (U.S.A. only). Postage extra.



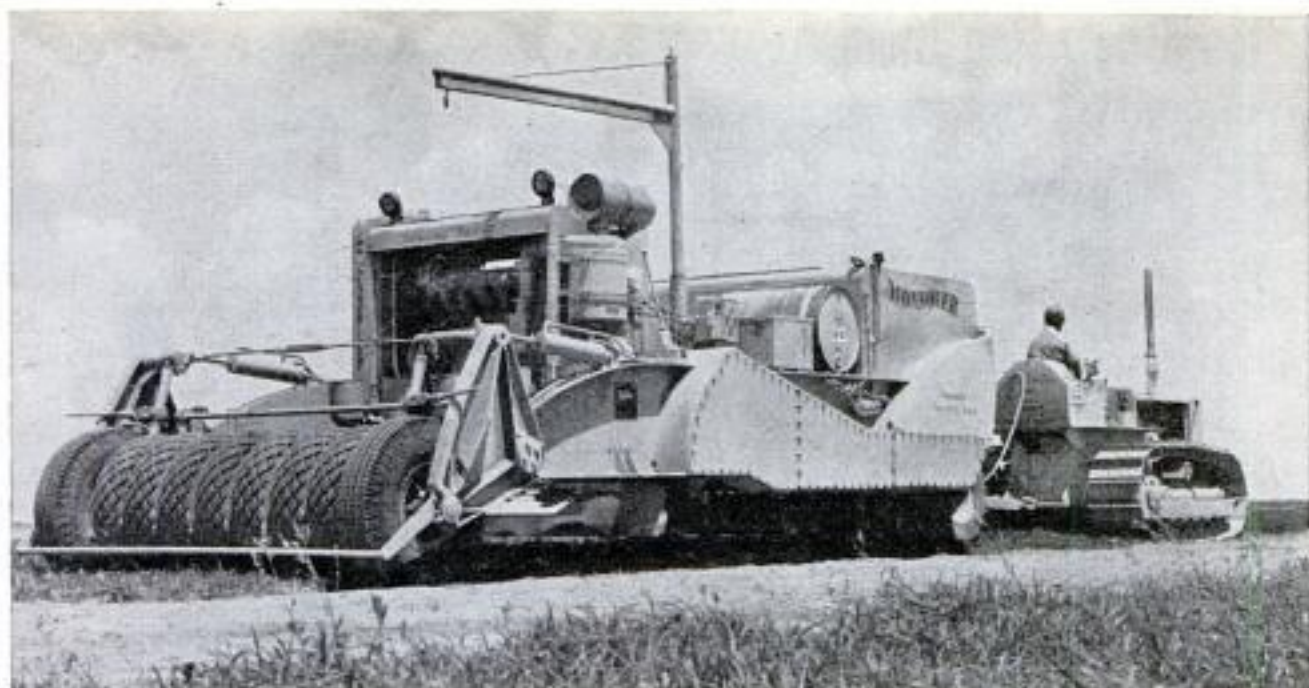

Wonsover, Nortland Portland Corp., 53 Exchange St., Portland, Me.

Preparing a strip of crop land eight feet wide, this all-purpose machine will cover two to five acres hourly

## All-in-One Farm Machine Prepares, Plants Crop Soil Acreage

IN ONE PASS a new farm machine will completely prepare and condition the soil, plant the seed and pack the earth. The 12-ton machine is towed by a tractor. The operator controls the functions of the machine by pushing buttons on a control panel. The machine prepares a strip eight feet wide and will cover from two to five acres per hour. At the front are two bins for lime or fertilizer and two tanks for weed or pest killers or liquid fertilizer. Behind the

bins is a three-shaft hammer mill which pulverizes the soil to a depth of 10 inches. The hammers also crush any vegetation and pulverize small stones. A revolving blade of hard rubber smooths the soil. Any seeder the farmer may have can be installed in the seeding bay, and the machine can be adjusted to plant broadcast or in rows. Seven wheels pack the soil over the seed, and a final sprayer applies pre-emergence spray to kill weeds or insects.

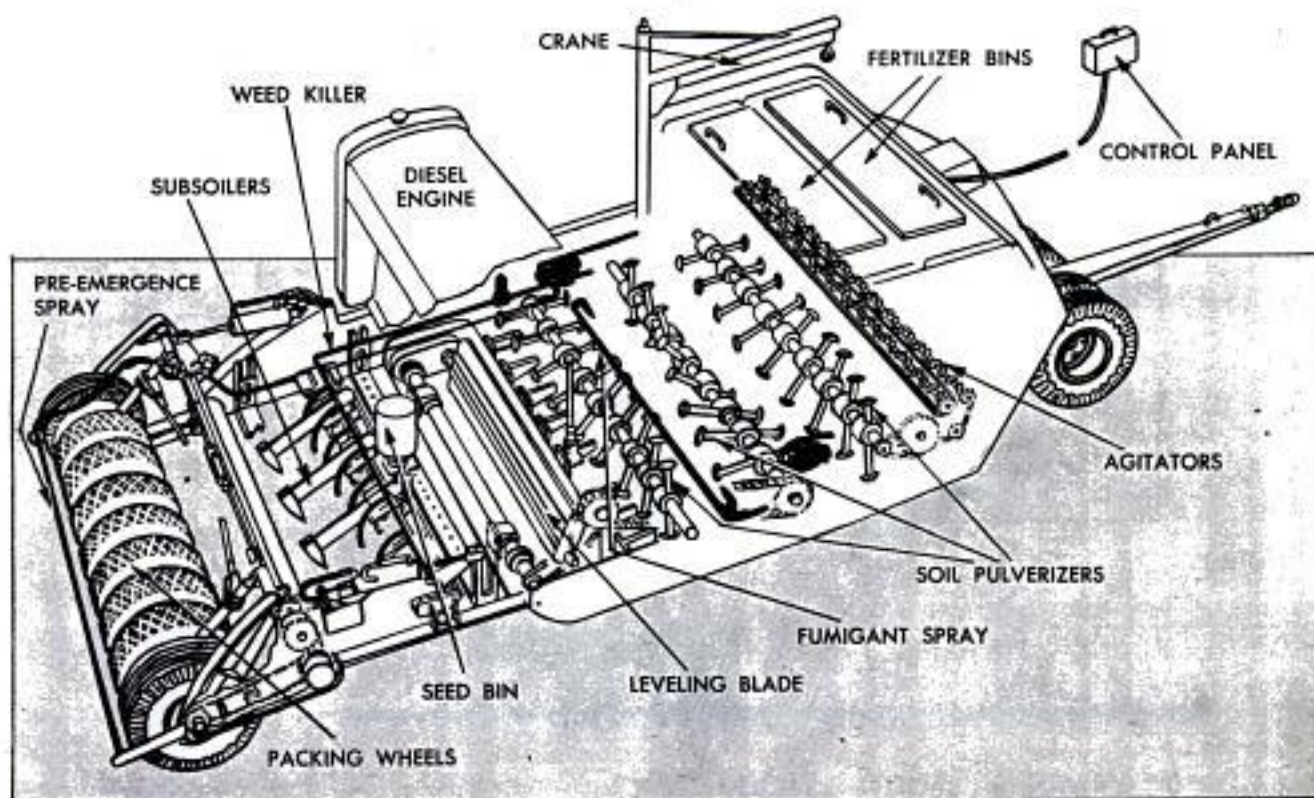

"We'll be using them for years..."



...that's why we pick the Brand that's made a Name for itself!"

EVERYTHING that goes into a new house takes a big bite out of the family budget. And it's all too true that you have to live with mistakes you make in buying . . . whether they be appliances, furniture, food, clothing or whatever. So buy brands that have made a name for themselves. You're bound to be satisfied.

#### FOUR WAYS BRAND NAMES SATISFY YOU MOST

**1. BUY WITH TRUST!**

Spend *confidently* on known quality. Brand Names wear best, work best, taste best, are best.

**2. SHOP WITH EASE!**

Spend *efficiently* on proved value. Brand Names save time "puzzling" over labels, models, prices, etc.

**3. ENJOY MORE CHOICE!**

Spend *shrewdly* among widest selections. Brand Names offer the most in sizes, types, colors, flavors, etc.

**4. GET THE "LATEST"!**

Spend *smartly* on up-to-date products. Brand Names keep improving, modernizing, introducing new things.



MANUFACTURER



DEALER



CUSTOMER

"I made it!"

"I sold it!"

"I bought it!"

Advertisers in this magazine are good names to know. They're proud of their brands 'cause they satisfy so.

BRAND NAMES FOUNDATION, INC. • 37 Fifth Avenue • New York 16, N. Y.

# BE YOUR OWN BOSS

Make Hundreds of \$ Spare or Full Time Work

## NO EXPERIENCE NEEDED

Here is the ideal business with no previous experience or large investment required and no high-priced equipment to buy. A business that will return dollars for the pennies you invest.

## YOU CAN CAST ANYTHING

With *Flexible Mold Making and Ornamental Casting*, an amazing fact-packed book, you learn how you can cast practically any article in concrete, plaster, imitation marble or any other casting material using a marvelous new process. You can make ash trays, novelties, garden and lawn ornaments and hundreds of other highly profitable items that cost you but a few cents and sell for as much as \$5.00 and more. Why you can even make true-to-life full-sized busts of your neighbors and friends.

## NO EXPENSIVE MOLDS TO BUY

Why buy high-priced molds from others? Learn how you can make your own molds quickly, easily and inexpensively with materials that can be used over and over. You get copyrighted formulas, complete instructions and detailed how-to-do-it photographs as well as complete sources of supply for the few inexpensive materials you need. This is the only book printed in America today that contains instructions for making profitable papier-mache casts.

## MONEY BACK GUARANTEE

Start on your road to extra income and independence today. Send only \$1.98 for your copy of *Flexible Mold Making and Ornamental Casting*. Complete satisfaction guaranteed or your money refunded within seven days.

## POPULAR MECHANICS PRESS

Dept. 257, 200 E. Ontario St., Chicago 11, Ill.

You can make simply and cheaply



## Build a Boat for Fun or Profit

Popular Mechanics

# 23 BOATS

You Can Build



## Complete Patterns and Working Drawings

Build the boat you have always wanted. Build it for fun or to sell at a profit. Get Popular Mechanics 23 BOATS YOU CAN BUILD — row boats, canoes, sail boats, power boats and other craft including a 25 ft. cabin cruiser that sleeps four; 11½ ft. car-top row boat; 8 ft. duck boat; 15 ft. sailing knockabout — in all, 23 of the most popular boats. Book includes more than 500 photos, plans, diagrams and working drawings, plus step by step instruction that anyone can follow. Only simple tools needed. Material list of lumber, hardware, fittings, etc. included. Order today, under money-back guarantee. Only \$2.75 postpaid.

Row Boats, Canoes  
Sail Boats, Power  
Boats and Others



POPULAR MECHANICS PRESS, Dept. 257, 200 E. Ontario St., Chicago 11

## Men: Get Into AUTO MECHANICS & DIESEL

Good jobs, high pay, security are yours as a qualified Auto-Diesel mechanic. Train NOW in the big famous Shops at National Schools in Los Angeles. Over 50 years experience, since 1905, in successfully training ambitious men. Here you work on ALL ENGINES. You master fuel injection, motor tune-up, general mechanics, automatic transmissions, all power equipment, in shortest possible time. Most complete, up-to-date equipment offered by any school. Expert, friendly instructors and engineers. Help in finding home near school. Part time job while in training. Mail coupon NOW, TODAY, for all the facts.

### NATIONAL SCHOOLS

National Schools Dept. DXB-27  
4000 So. Figueroa Los Angeles 37, Calif.  
Send Free Auto-Diesel Opportunity Book Today.

Name \_\_\_\_\_ Age \_\_\_\_\_  
Address \_\_\_\_\_  
City \_\_\_\_\_ State \_\_\_\_\_



# The Power of Words

Revealing Insight  
into Your Ability  
to Succeed—Send  
for FREE Booklet



Use words with new power in speaking, writing. Remarkable program makes English a function of your entire personality. You will be astonished at the ability you soon develop to express yourself, and handle varied situations confidently. This new training method is based on an understanding of fundamental psychological factors which so often limit participation in communication activities. You learn to verbalize, say what you want to say clearly, correctly, with assurance.

## FUNCTIONAL TRAINING IN ENGLISH QUICKLY DEVELOPS ABILITY TO COMMUNICATE IDEAS

Functional English gives direction to your personality drives. Here is a fascinating, creative way to develop into a good speaker, interesting conversationalist, effective writer of letters, reports, etc. English becomes a vital expression of your entire personality. You build a dynamic vocabulary, learn to use English meaningfully as well as correctly.

## PSYCHOLOGICAL INSIGHT SHOWS YOU HOW TO USE ENGLISH AS A WORKING TOOL

You practice this activity program at first in your own home. Quickly it becomes part of all your daily business and social experiences. You receive many valuable services—help in preparation of talks, instruction in correct pronunciation, assistance in preparing reports and writing letters, etc.

Now, more than ever, ability to communicate, to express ideas clearly and significantly is essential for progress to higher earnings in business and industry. Write today for "The Power of Words," the amazing FREE booklet about Functional English. Find out about this method which employs psychological insight into personality drives to give you confidence, self-assurance, and power in the use of the English language. Mail coupon today.

## PRINCIPLE INSTRUCTION CENTER

Dept. B-8 2956 Peterson Avenue Chicago 45, Ill.

### MAIL COUPON TODAY FOR FREE BOOKLET

PRINCIPLE INSTRUCTION CENTER, Dept. B-8,  
2956 Peterson Avenue, Chicago 45, Ill.

Please send me your FREE Booklet, "POWER OF WORDS."

Name \_\_\_\_\_ Age \_\_\_\_\_

Address \_\_\_\_\_

City \_\_\_\_\_ Zone \_\_\_\_\_ State \_\_\_\_\_

**AT YOUR  
NEWSSTAND  
NOW!**

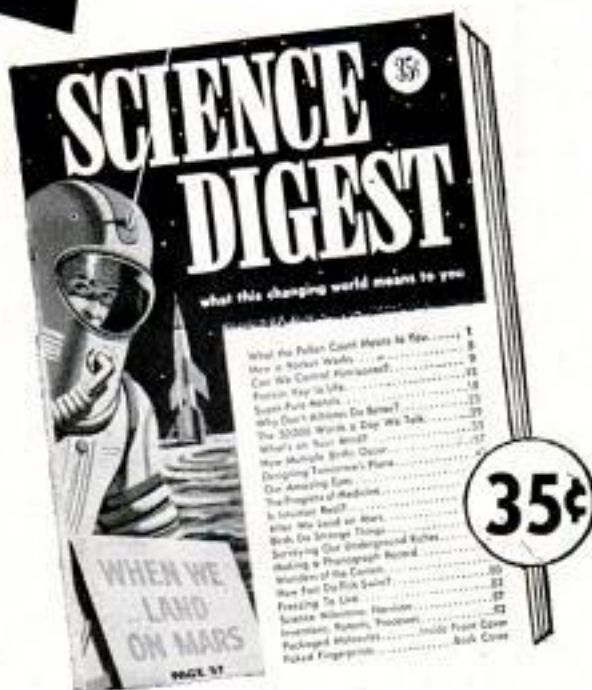

**KEEP UP-TO-DATE ON  
THE WONDERFUL  
WORLD OF SCIENCE  
WITH THIS  
WONDERFUL MAGAZINE**

Pick up a copy of **SCIENCE DIGEST** today . . . and become acquainted with the pocket-sized magazine that tells you "what this Changing World means to you."

Expert editors choose the finest articles on science, medicine, geography, psychology from the magazines and books of the world . . . and serve them up to you in easy-to-understand form.

You'll like this magazine. At your newsstands . . . only 35¢. One year subscription: \$3.50.

**ADDRESS: DEPT. X-21, SCIENCE DIGEST  
200 East Ontario Street • Chicago 11, Illinois**



**Twin-Wall Concrete Block  
Has Built-in Air Space**

Built into a new type of concrete block is a continuous air cavity, producing double-wall construction at low cost. The block is made by casting two separate concrete units which are bound together by steel ties. The design simplifies the installation of wiring and plumbing and has a higher insulating value than ordinary concrete block. The top, bottom and end surfaces of each block are keyed for ease of construction. No mortar is used in laying the blocks, but the joints of the finished wall are pointed to seal out moisture.

**Green Grass the Year 'Round**

Can you keep your lawn green throughout the winter? It's possible with a new grass dye. In effect, you paint your lawn green in the fall and it stays green all winter. After the first killing frost you mix one gallon of a new color concentrate with 11 gallons of water and spray it on the lawn with any spray gun that will produce a fine mist. This quantity is enough to spray a lawn measuring about 40 by 45 feet. After a two-hour drying period the grass is permanently dyed, and the color will not rub off even when wet. It lasts until the following spring when the grass begins to grow and the dyed portion is cut off.

☐ Latest boon to golfers who face water holes is a golf ball that floats.

# FORD Owners SAVE MONEY



Learn How to Make Your Ford Run Better . . . Last Longer . . . and Save Hundreds of Dollars!

Get this book, written especially for you, without one penny of risk and get more out of your car. Mail coupon for **MANUAL FOR FORD OWNERS** today. When the book comes, skip through the pages and see how your investment in one of America's most popular automobiles can be even a better investment than you thought. If you don't agree, send the book back and you'll get your money back.

### A Popular Mechanics Book Written Just for You

Not a re-hash of service manuals. A complete new Popular Mechanics book written for the Ford owner by an outstanding automotive authority with the full cooperation of Ford engineers and service directors. It will save you money on repairs and service; make your Ford last longer; give you safe, economical and trouble-free motoring. And this is true whether you take your Ford to a regular service station or service it at home.

### Prevents Trouble. Cuts Down on Repair Bills

Nothing like this manual anywhere. It covers all phases of operation, service and maintenance. It has entire chapters on the individual parts of your Ford—battery, ignition, starter, generator, regulator, lighting, fuel system, engine, lubrication, gasoline qualities, cooling systems, transmission, differential, rear axle, brakes, wheel alignment, tire care, body maintenance, trouble shooting on the road, etc. It covers your Ford, new and older models, step by step—bumper to bumper—showing you how parts operate; what can go wrong; how repairs and adjustments should be made and how to avoid all types of trouble.

### Money Back if Not Satisfied

Mail the coupon today. Send only \$3.50 or you can pay postman. Money back guarantee protects you.

### Official, Authoritative, Practical Information

Written by C. E. Packer, formerly service school instructor and auto show lecturer for automobile manufacturers, Member Society of Automotive Engineers, Special Services Editor of Automobile Digest, contributor to leading magazines, author of some of the biggest selling books on Automotive subjects.

### Entire Chapters on Fordomatic and Overdrive



304 Pages. Hundreds of How-To-Do-It Illustrations and Diagrams

The entire book follows Popular Mechanics famous easy-to-read and easy-to-understand style. While primarily intended for the Ford owner, to help him get more out of his car at lower cost, it can be worth its weight in gold to the auto mechanic and service station operator who works, not only on Fords, but on all other makes as well, to which the information in the book can be easily applied.

## Order on this Coupon

POPULAR MECHANICS PRESS, Dept. 257  
200 E. Ontario St., Chicago 11, Ill.

Send Manual for Ford Owners at once. If not satisfactory I will return it within 7 days and you will refund full purchase price.

Remittance for \$3.50 enclosed.  Send C.O.D.

Name \_\_\_\_\_

Address \_\_\_\_\_

City \_\_\_\_\_ State \_\_\_\_\_

# How to get a valuable commercial FCC License

Get this Amazing Booklet **FREE**

MONEY MAKING FCC LICENSE INFORMATION

An FCC License Can Be Your Guarantee of Success in Electronics

TELLS HOW . . .

1. . . thousands of brand-new, better paying radio-TV-electronics jobs are now open to FCC License Holders.
2. . . we guarantee to train and coach you until you get your FCC License.
3. . . our effective nation-wide Job-Finding Service helps you get the better paying jobs.



GET ALL 3 FREE!

MAIL COUPON NOW!

Accredited by National Home Study Council

Cleveland Institute of Radio Electronics

Desk PM-1, 4900 Euclid Ave., Cleveland 13, Ohio

Please send Free Booklets prepared to help me get ahead in Electronics. I have had training or experience in Electronics as indicated below:

- |   |   |
|---|---|
| <input type="checkbox"/> Military           | <input type="checkbox"/> Broadcasting       |
| <input type="checkbox"/> Radio-TV Servicing | <input type="checkbox"/> Home Experimenting |
| <input type="checkbox"/> Manufacturing      | <input type="checkbox"/> Telephone Company  |
| <input type="checkbox"/> Amateur Radio      | <input type="checkbox"/> Other _____        |



In what kind of work are you now engaged? \_\_\_\_\_ In what branch of Electronics are you interested? \_\_\_\_\_

Name \_\_\_\_\_ Age \_\_\_\_\_

Address \_\_\_\_\_

City \_\_\_\_\_ Zone \_\_\_\_\_ State \_\_\_\_\_

PM-1 Special Tuition Rates to Members of Armed Forces



MY  
**"BIG  
 IDEA"**  
 MAKES  
**BIGGER  
 PROFITS**  
**FOR  
 YOU!**

**I'VE GOT IT!—A MONEY-MAKING "SHOE SELLING" IDEA SO NEW, SO DIFFERENT—YET SO SIMPLE!**

Even if you've never sold a thing before, now you can walk up to any prospect and get him to buy 2 or 3 pairs of shoes as eagerly as a kid grabbing for candy. You can pick up fat cash commissions and bonuses showing my beautiful line of men's, women's and children's shoes—with patented *Air Cushion* comfort in dress, work and sport styles.

**YOURS ABSOLUTELY FREE!**

It doesn't cost you a penny to give my "BIG IDEA" a try. Write to me *this minute* if you want the security, independence and prestige of a *big steady income*. I'll rush my "BIG IDEA" to you in complete detail, plus my big Selling Outfit **FREE!** Write:

**CHARLES CHESTER SHOE CO.**  
 B573 Chester Bldg., Brockton, Mass.

**NEVER AT THIS LOW PRICE!**

## GENUINE 120-POWER ACHROMATIC TELESCOPE

with Coated Lens and  
 3-POWER FINDER attached

ONLY  
**\$18.95**  
 PREPAID

**EXTRA BONUS GIFTS:**

- 108 page book, "Discover The Stars"
- Magic Star Finder Dial
- 220X & 400X Eyepiece lenses



**BRING THE MOON, PLANETS, STARS, PEOPLE 120 TIMES CLOSER, CLEARER, SHARPER.**

Never before has an ACHROMATIC 120X telescope with range finder and tripod sold for anywhere near this amazing low price! Now you can not only explore the heavens and bring the moon, planets, stars, etc. 120 times closer, but you can also observe all distant objects, people, ships, etc. too, because all pictures are erect, and not upside down as in all astronomical telescopes. The kind of needle-sharp color-free viewing only a genuine achromatic lens can bring you. Ready for immediate use. Its 5 precision lenses bring you viewing at 40X—80X—120X, the tubes extend to 43", made of jet bakelite, finished in camera bellows black (for sharper, clearer images). Trimmed with gleaming brass. The 3 power finder scope mounted on main tube is a feature usually found on more expensive telescopes—brings difficult objects on target before observing with main scope. For extra stability 5 ft. hardwood folding tripod is equipped with heavy cast iron head fitted with Criterion's famous 360 degree all aluminum mount that locks instantly in any position. Obtainable only from Criterion, shipped prepaid. 4-Bonus gifts—108 page book "Discover The Stars," magic star finder dial that aids in locating stars ANYWHERE at ANY TIME of the year, and 220X and 400X eyepiece lenses included free of any cost for experiments. You must be completely satisfied with this super offer or your money back in full. Shipped to you complete, nothing else to buy, at the amazing low price of \$18.95. Without tripod \$14.95.

Send cash, check, or money order today to:  
**Dept. PMA10, Criterion Co., 331 Church St., Hartford, Conn.**

**YOURS  
 FREE!**

**VUER-  
 PROJECTOR  
 & Full Color Slide  
 Kit—Authentic  
 \$4.95 Value!**



### If You're Interested In **BREEDING TROPICAL FISH** For Profit & Pleasure

This handsome, precision-viewing instrument and color slides are yours **FREE**—just for showing your interest in Tropical Fish Breeding! See gorgeous BETTAS, colorful TETRAS, exotic ANGEL FISH, etc., in the vibrant beauty of full color! Convince yourself Tropical Fish Breeding is the profitable, easy-to-start home business for you! Breed them in your living room, spare-room, anywhere. Success is assured because we'll buy every fish you produce! No experience or costly equipment needed. Start spare-time, on a "shoe-string"... build a \$10,000 home business! Investigate!

Write today for **FREE** details on "Profit-Proven" Success Plan & Vuer! (If under 17, ask for plan A.)

**TROPICAL FISH  
 BREEDERS OF AMERICA**  
 Dept. D-2  
 Los Angeles 61, Calif.



## WHOLESALE CATALOG!

30-80% Discounts! Appliances, Musical Instruments, Typewriters, Tools, Watches, Jewelry, Cameras, Housewares, etc.

**CONSOLIDATED DISTRIBUTORS**  
 1300-03 MAIN CLIFTON, NEW JERSEY

## SENSATIONAL TIRE SAVINGS!

FINE QUALITY USED TIRES! NOT RECAPS!  
 GOODYEAR, FIRESTONE, ETC.

**WRITTEN 12 MO. GUARANTEE BOND**

**FREE TUBE**  
 with ea. pass. tire!

600-16	\$5.24	750-1-6(8)	\$10.00
670-15	5.44	750-20	12.05
710-15	5.64	825-20	19.05
760-15	5.84	900-20	18.55
800-15	5.94	1000-20	19.50

**FREE PRICE LIST OF ALL OTHER TIRE SIZES!**

(SHIPMENTS RUSHED! Send chk. or M.O. Prices FOB, Phila.)

**BELMONT, 1001-PM Spring Garden, Phila. 23, Pa.**



POPULAR  
 MECHANICS

## BIG-FAMILY HOUSE

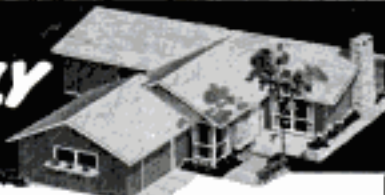

Now—at moderate size—a completely livable modern home for the 3-, 4- and 5-children family. Beautifully planned throughout: eliminates crowding by a unique balance of adult and child living areas in just 1350 sq. ft. Features 4 bedrooms, 2 bathrooms, a feeling of space and convenience missing in many larger conventional houses. Can be built with partial basement—or on full concrete-slab foundation.

### Easy, Inexpensive to Build

All necessary materials are standard and obtainable in any lumberyard. This design saves on materials, materials cost, lot cost and labor—gives you a truly outstanding home for comfortable big-family living.

**Low in  
 Cost...  
 High in  
 Privacy**

A split-living home so well designed each family member can have privacy and space for himself!

**POPULAR MECHANICS PRESS, Dept. 257**

200 E. Ontario Street, Chicago 11, Illinois

Send at once Plans for the Big-Family House.

Complete Set of 7 Blueprints . . . **\$12.50**

Remittance enclosed

Send COD (postage extra)\*

Name \_\_\_\_\_

Address \_\_\_\_\_

City \_\_\_\_\_ Zone \_\_\_\_\_ State \_\_\_\_\_

\* No COD's outside U.S.A.

## Vacuum Sweeper For Airstrips

To free jet airstrips of engine-injuring rubble, a giant vacuum sweeper with a 10-foot nozzle and 500-mile-per-hour suction now is under development. While moving down runways at 25 miles per hour, the 25-ton sweeper sucks up objects as large as three-inch steel cylinders. The van housing the sweeper is 35 feet long, 14 feet high and 8 feet wide. One man drives the machine, which has a control panel in the cab to operate all mechanisms electronically. Generating 2000 times the suction power of a home vacuum cleaner, this machine has a 32-blade, 2-stage, 39-inch-diameter blower to generate this power. Weighing 4650 pounds, the blower is spun at 3400 revolutions per minute.



Wayne Manufacturing Co., 1275 E. Lexington, Pomona, Calif.

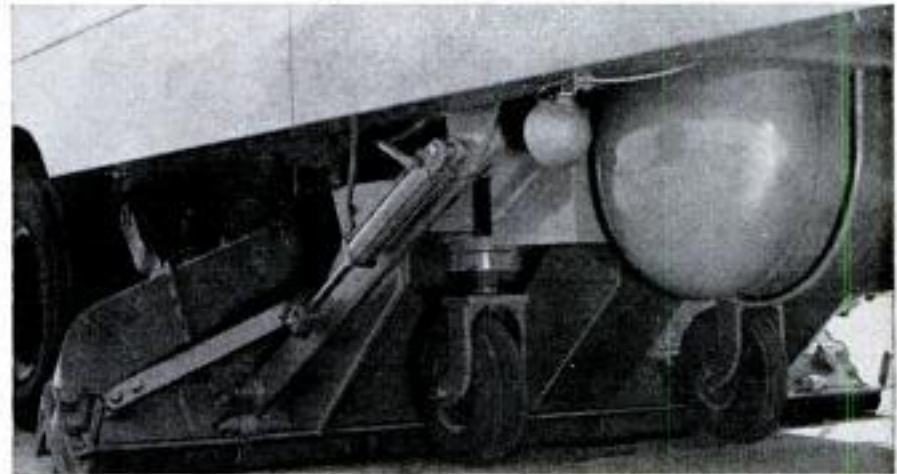

## Massachusetts Church for Four Persons Is Only Five by Eleven Feet



Seating four persons, a church at Hudson, Mass., is 5 feet wide and 11 feet long. Yet, as many as 100 people have gathered outside this chapel for Sunday services conducted by its pastor, the Rev. Louis West, former minister of the South Baptist Church of South Boston.

## Heated Concrete Slabs

Electrically heated concrete slabs give life-sustaining warmth to newborn calves and chickens. Purdue University kept a calf alive for eight weeks by limiting the animal's life to a dry, three by four-foot concrete-block mat containing heating cables. These tests ran from January to May and used four or less kilowatt hours of heat daily. Although no straw or other materials were permitted as bedding, results indicated that sand or rubber mats could have been substituted if kept dry at 75 degrees F.

# Sell "MIRACLE BOWLS" for the EASIEST MONEY you ever made!

WATER ADDED TO  
THIS...



MAKES IT GROW LIKE THIS



Yes, there's BIG money in THIS dollar seller, because prospects buy on first contact... not just one, but several at a time. No matter where you live... small town or big city... this amazing \$1.00 seller gives you an opportunity to earn BIG profits every day... full time or spare time.

The idea is simple. A variety of flower seeds are mixed in specially prepared soil, packed in stylish styron plastic bowls. Add water and within a few days green shoots appear. Soon the "Miracle Bowl" becomes a prolific flower garden that blooms for weeks.

Sell door to door or store to store with profits running up to 125%. Act fast! Send for sample and complete sales kit or trial order. Satisfaction guaranteed.

### MAIL THIS COUPON

- MIRACLE BOWLS, 111 King Bldg., Littleton, Colorado
- Rush one "Miracle Bowl" and complete sales kit @ \$1.00 postpaid
- Send trial order of twelve (12) "Miracle Bowls" @ \$7.20 postpaid.  
(My profit \$4.80)
- Send order of 3 dozen (36) "Miracle Bowls" @ \$18.00 postpaid.  
(My profit \$18.00)

Name \_\_\_\_\_  
Address \_\_\_\_\_  
City \_\_\_\_\_ Zone \_\_\_\_\_ State \_\_\_\_\_

## RUN A CAFE OR DINER

I can show you how to get into this marvelous business. Opportunities plentiful when you know how to proceed. Be independent! Learn every phase of the business from how to get started quickly on small investment to menu planning, food preparations, money-making methods, the 7 ways to finance your first place. 20 fact-filled lessons in course. Study at home. Free trial. Money-back guarantee. Write today for FREE booklet.

SCHOOL OF RESTAURANT ARTS, Box 12-D, Fremont, Ohio

Please send me, without obligation, my copy of "Cafe, Diner Business."

Name \_\_\_\_\_  
Address \_\_\_\_\_

## MAKE STRIPES with new PAINT PEN

**Straight, curved, single or double**  
With any color paint, stripe furniture, bikes, autos, model planes, toys, linoleum, wall-board. Clean, crisp decorative lines. Can't clog or smear. Also use with glue, tempers, textile paint or underglaze... on wood, glass, plastic, ceramics, metals, fabrics and paper.  
Ask your dealer or order direct.

**DEALERS** Master paint striping tool in display carton. Write for discounts.  
**HOBBY** "Professional" results every time. Simple, easy to use.  
**MFRS** Ask about heavy duty industrial striping tools.

**DOUBLE STRIPE MODEL \$3.25**  
**5 COMBINATIONS.**

Single 1/16" stripe model \$1.25

Other single stripe models \$1.75 ea.  
1/64", 1/32", 3/64", 5/64", 3/32" & 1/8"

Complete Kit \$5.00 (all 7 tips)

Extra tips 90c ea.

Extra 1/4" tip..\$1.20

**WENDELL MFG. CO.** 4234 LINCOLN AVE., Dept. 326 CHICAGO 18, ILLINOIS

# LAST CHANCE to get your Famous What to Make Books

Profit—  
Pleasure—  
Projects  
in Each  
Volume



Famous WHAT TO MAKE books are going fast. Don't delay — last chance to buy. Each volume and project different. Complete illustrated building instructions. Projects for home—family—hobbies. Contains ceramics, cabinets, house trailer, novelties, handicrafts, lamps, toys, chairs, metal work, photography, tables, plus thousands of other pleasure projects to make.

Vol. 1— 490 copies	Vol. 7—1660 copies
2—1340 "	8—1885 "
3—1665 "	9—1190 "
4—1280 "	10— 555 "
5—1340 "	11—no copies left
6—1595 "	12— 860 copies

### NEW LOW LOW PRICE

Take advantage of this clearance sale. Sold originally at \$1.75, any volume yours at the new low figure of 98c. Hurry, mail coupon for your volumes today. Any five volumes \$4.00.

**Save — Save — Save**  
**Were \$1.75 Now 98c**

### HURRY—MAIL COUPON TODAY

Popular Mechanics Press, Dept. 257  
200 East Ontario Street  
Chicago 11, Illinois

Gentlemen:

Please send me the following volumes of the famous WHAT TO MAKE series. I have drawn a circle around the volumes I want. Volumes — 1 2 3 4 5 6 7 8 9 10 12. I am enclosing a check or money order at 98c for each volume or any five volumes for only \$4.00.

Name \_\_\_\_\_

Address \_\_\_\_\_

City \_\_\_\_\_ State \_\_\_\_\_



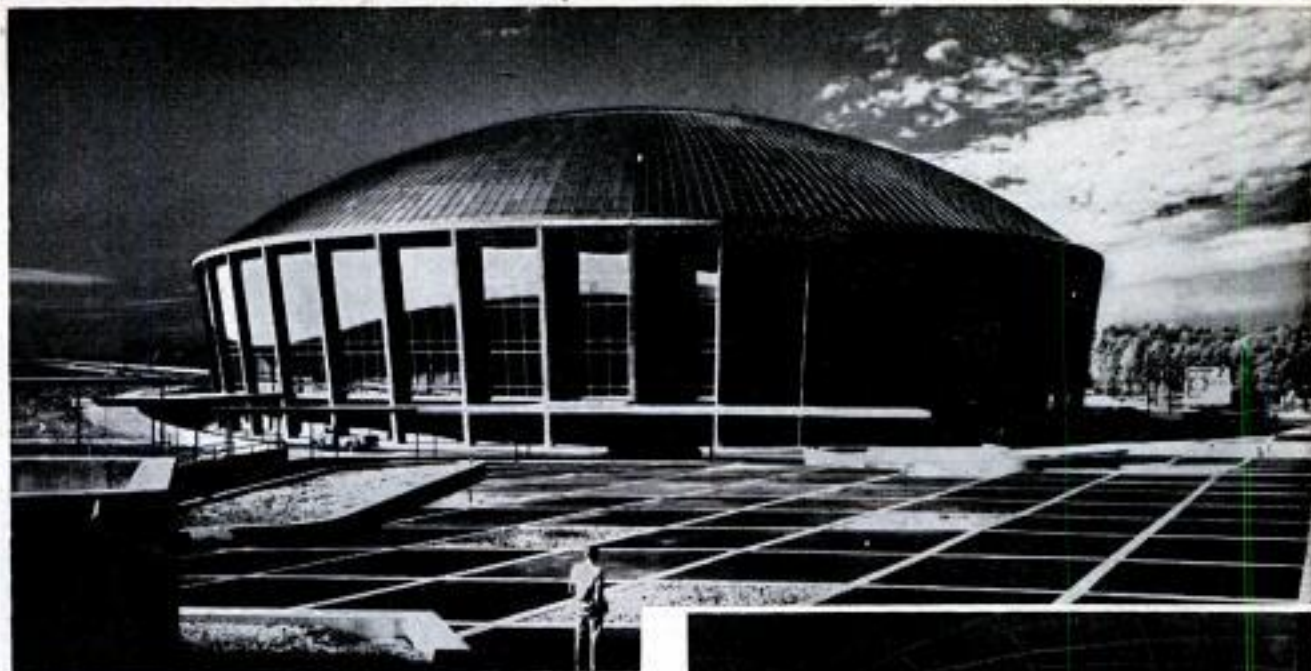

## Two-Acre Dome

Charlotte, N. C., can now boast a dome that dwarfs St. Peter's in Rome (138 feet in diameter) and St. Sophia's in Istanbul (107 feet). The aluminum-sheathed dome of the Charlotte Coliseum measures 332 feet in diameter, covering an area of more than two acres. Forty-eight concrete pillars support the dome at its perimeter, but not a single column obstructs the audience's view of the arena. There are seats for 13,500 people on permanent concrete bleacher tiers around a 99 by 212-foot arena. Vast stairways and ramps are arranged so the entire building can be cleared in four minutes. The dome's welded-steel framing is topped by slabs of concrete and wood shavings. A steel tension ring holds the frame.



## Fiat 600 Beach Wagon Has U-Shaped Seat

Fresh air is what you get plenty of in the Pinin Farina-designed body for Italy's popular Fiat 600. But then, fresh air is what you want at the beach and the new body is called "Spiaggia" which in Italian means

beach. A U-shaped bench wraps around the rear passenger compartment to provide seating for four or five persons. The engine and chassis are the same as in the conventional Fiat 600, an Italian family car.



**Build it Yourself!** Furniture • Furnishings • Work Benches • Children's Toys • Shelves • Boat • Cupola • Weathervane • With

**Popular Mechanics NEW**

# FULL SIZE PATTERNS

## Authentic Designs by Professional Designer

Now save money and turn out professional-looking jobs in your own home. Merely trace any of these patterns on lumber, saw, smooth the edges and assemble—that's all there is to it. Every pattern has been proven for design and correct fit. Each nail, screw, dowel and bolt is clearly located on the pattern. You can't go wrong. Order from the listings below today!

## 24 Money-Saving Patterns...



104. Modern Step Table



101. CRUSETTE. 12 Foot Utility Outboard

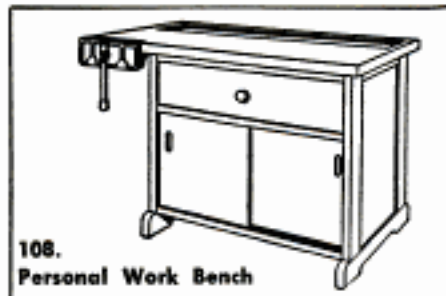

108. Personal Work Bench

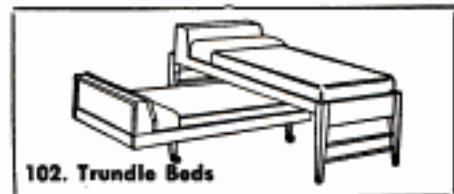

102. Trundle Beds

#101. Utility Outboard. Build this runabout at amazing savings with ordinary hand tools. Length 12 feet, beam 4½ feet. Complete material list and instructions included. Four patterns ..... \$2.00  
 #102. Trundle Beds. Space-saving beds that are safer for young people. 90 x 45½ inches. Top bed 40 inches, lower bed 29 inches high. Three patterns in set..... \$1.50  
 #103. Modern Cocktail Table. Matches 104 (illustrated). 40 x 19 inches, 15½ inches high. Plank top and metal grill inserts in sides. One pattern..... 50 cents  
 #104. Modern Step Table. Companion piece to 103. This handsome table is 28 x 18 inches, upper step 24 inches high. Complete in one pattern..... 50 cents  
 #105. Toys for the Children. "Giraffe Drawing Board" and "Backing Bronco" riding toy. Pattern includes painting suggestions. One pattern..... 50 cents  
 #106. Juvenile Chest Robe. Has hanging storage space, two drawers and shelf, 30 inches wide, 16 inches deep, 39 inches high. Two patterns in set..... \$1.00  
 #107. Cupola and Weathervane. 24 x 24 inches, 34 inches high, plus height of vane, which is made of metal or tempered hardboard. One pattern..... 50 cents  
 #108. Personal Work Bench. This compact, sturdy work bench has sliding doors and a drawer. Top is 44 x 20 inches, 35 inches high. Lots of work space in small area. Two patterns in set..... \$1.00  
 #109. Valances and Trims. Twelve designs for nearly all requirements. Merely trace patterns on the wood, saw and assemble. Finishing suggestions given. One pattern..... 50 cents  
 #110. Decorative Wall Shelves. Two designs. Modern shelf with metal trim is 28 x 16 x 8 inches. Traditional shelf is 29½ x 16 x 8 inches. One pattern..... 50 cents  
 #111. TV Chair. Seat 22 inches deep, 24 inches wide. Overall, 27½ x 32½ inches, 26½ inches high. Sagless springs and foam rubber. Two patterns in set..... \$1.00  
 #112. Modern Tub Chair. Seat 22 inches deep, 24 inches wide. Overall, 28 x 27 x 27 inches. Sagless type springs and foam rubber. Two patterns in set..... \$1.00

#113. Sofa Bed. A sofa by day, a comfortable bed for one at night. 78¾ x 29¾ inches, 33 inches high, with removable bolster. Uses 4½ inch standard foam rubber or other mattress. Two patterns in set..... \$1.00  
 #114. Love Seat. Uses sagless type springs with foam rubber padding. 48 inches between arms, 21 inches deep. Overall, 55½ x 29 inches. Two patterns in set..... \$1.00  
 #115. Corner Table. Use with tables 103 and 104 for handsome grouping, or alone. 29½ x 29½ inches, 18 inches high, plus an 8 inch diagonal step. One pattern..... 50 cents  
 #116. Palette Coffee Table. Using hand saw, you can make this in one evening. 31½ x 41½ inches at widest point. Finishing suggestions and materials list included. 50 cents  
 #117. Traditional Magazine Rack. Graceful design. 8 x 15½ inches, 14 inches high, using ½-inch thick plywood. Sanding and finishing instructions. One pattern..... 50 cents  
 #118. Three Metalcraft Projects. Coach lamp, "jeweled" lamp, hanging planter in brass, copper or bright tin. Smartly styled. No experience needed. Two patterns..... \$1.00  
 #119. Twin-Bed Headboard. Give your twin bed a new look with this attractive headboard.

Modern; simple lines. Angled front panel has sliding door. Standard twin-bed size. One pattern..... 50 cents  
 #120. Modern Night Stand. Step style. Overhanging top for lamp, etc., with space below for books. Roomy drawer at bottom for storage. Base is 14 x 20 inches, Top shelf 9½ x 20 inches. Height: 23¾ inches. Complete instructions. One pattern..... 50 cents  
 #121. Jolly Santa Claus. A Christmas lawn cutout to cheer the passerby. Trace pattern on wood, prime paint, fill in face and clothing details, paint. One pattern..... 50 cents  
 #122. Sleigh and Reindeer. For lawn or roof. Reindeer 26 inches wide, 35 inches high. Sleigh with Santa 40 inches wide, 30 inches high. Use cord for reins. Use reindeer singly or in series. Two patterns..... \$1.00  
 #123. Children's Dinette Set. Chair and table set ideal for the playroom. Table 20 x 28 inches, 21 inches high. Chair seat 12 x 13½ inches, overall height 22 inches. One pattern..... 50 cents  
 #124. Shoeshine Boxes. Two designs, one of square step shape which can double as step stool, the other a half oval design. Ample room in each to hold polishes, cloths, brushes. One pattern..... 50 cents

## Order Blank for Popular Mechanics Patterns

Popular Mechanics Press • 200 E. Ontario St. • Chicago 11

Send postpaid Popular Mechanics Full Size Patterns as indicated below. Remittance for \$\_\_\_\_\_ enclosed. I understand that any pattern which does not please me may be returned within 7 days for full refund. Dept. 1256

Gentlemen: Please send me Full Size Patterns numbers:  
 101 102 103 104 105 106 107 108 109 110 111 112 113 114  
 115 116 117 118 119 120 121 122 123 124  
 (circle numbers desired)

Name \_\_\_\_\_  
 Address \_\_\_\_\_  
 City \_\_\_\_\_ State \_\_\_\_\_



# DRAFTING

Offers You —  
MORE MONEY  
JOB SECURITY  
EXCITING OPPORTUNITIES  
BIG PAY PROMOTIONS  
PROFESSIONAL STATUS

IT'S EASY — AT HOME — IN YOUR SPARE TIME — PAY AS YOU LEARN

 Completed your course and was made Shop Foreman with a 50% increase in salary. W.R.

 After completing your course my salary increased from \$350 to \$820 per month. G.T.W.

 Was promoted ahead of four other men with a pay increase after completing your course. W.K.A.

## MECHANICAL OR AERONAUTICAL

IN JUST A FEW SHORT MONTHS, you too, can be cashing the big pay checks and enjoying an assured future in industry. Never before has there been such a demand for these key men. You can keep your present job while you prepare for a better one. Get into the profession that pays off with success and security. You need no previous experience or training. C.E.I.'s modern, practical courses are prepared especially for Home Study. A Professional Engineer will guide and train you . . . what's more, we help you get a job. Many of our graduates and today's leaders were once in your spot and they used Drafting as their ladder to success. Let a C.E.I. DIPLOMA open the way for you!



**PROFESSIONAL EQUIPMENT Included At No Extra Cost!**  
Professional instruments, large drafting board, complete set of triangles, lettering guide, french curve, Engineer's scale, T-square, etc.

**ADDITIONAL EXTRA TRAINING IN CLEVELAND AT NO EXTRA COST**  
50 HOURS OF SPECIALIZED, POST-GRADUATE TRAINING FOR TWO WEEKS AT OUR RESIDENT SCHOOL.



## MAIL COUPON TODAY

CLEVELAND ENGINEERING INSTITUTE  
DEPT. PM-2G  
6300 Euclid Ave. — Cleveland 3, Ohio  
 Mechanical  Aeronautical

NAME \_\_\_\_\_ AGE \_\_\_\_\_  
ADDRESS \_\_\_\_\_  
CITY \_\_\_\_\_ STATE \_\_\_\_\_

No Obligation — No Salesmen

SEND FOR **FREE** SUCCESS BOOK AND FREE SAMPLE LESSON



**CLEVELAND ENGINEERING INSTITUTE**

RESIDENT and HOME STUDY COURSES

## YES! SEND



directly  
to my door  
every month

I am enclosing  
 \$3.50 for 1 year  
 \$8.00 for 3 years

name \_\_\_\_\_  
address \_\_\_\_\_  
city \_\_\_\_\_ zone \_\_\_\_\_ state \_\_\_\_\_

Hand this order to your newsdealer or send it to  
**POPULAR MECHANICS**  
200 East Ontario St. Chicago 11, Ill.

## TRAINED MEN NEEDED!

**BIG PAY! — GOOD FUTURE!**

- DIESEL  ELECTRONICS  
 AUTO  AUTOMATION

NEVER BEFORE has the opportunity been so good for the properly trained mechanic and technician to step into **BIG PAY POSITIONS** with rapid advancement and future security virtually assured.

**YOUR SUCCESS** depends on the quality of training you receive . . . and the reputation of the school you attend.

**YOUR GUARANTEE** we are giving the best in mechanical and technical training is proved by the fact . . . we have a waiting list of good pay positions for our graduates, with leading companies throughout the United States.

**RESIDENT SHOP TRAINING** is easier and costs less than you may think! We provide you with housing and part-time jobs while in school, plus free nation-wide placement service for graduates.

Check subject above in which you are interested and mail for

FREE BOOKLET  
**BAILEY**  
Technical Schools  
Veteran Approved  
1634 S. Grand, St. Louis 4, Mo.

Name \_\_\_\_\_ Age \_\_\_\_\_  
Street \_\_\_\_\_  
Town \_\_\_\_\_ Zone \_\_\_\_\_ State \_\_\_\_\_

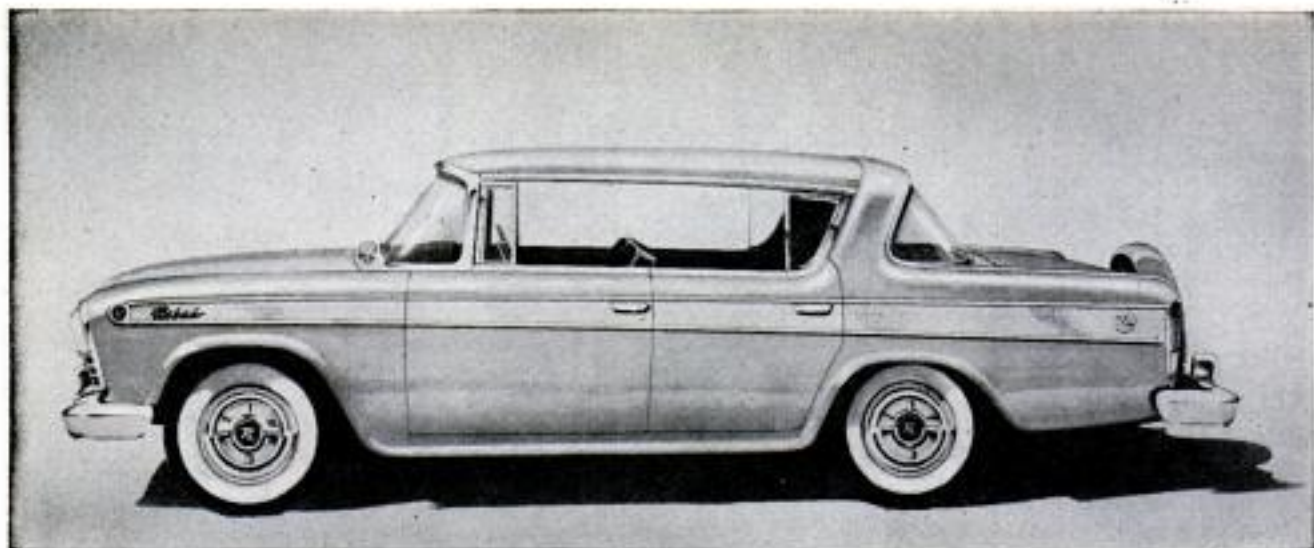

## Rambler Rebel Has Electronic Fuel Injection

RATED AT 288 horsepower, the Rambler Rebel V8 has electronic fuel injection. It will go into production in March and be available for delivery early in May. The extra cost of injection is not yet known, but it's expected to be about \$375.

A small box filled with transistors is the "brains" of the system. Into it are fed six pieces of data: (1) inlet-manifold pressure; (2) deceleration cutoff (to shut off fuel during periods of coasting); (3) starting

enrichment (equivalent to an automatic choke); (4) idle-mixture enrichment; (5) acceleration enrichment and (6) altitude compensation.

This data is combined to "tell" the solenoid-operated injector valves how much fuel to meter into each cylinder. It's the same system used on B-29 bombers. The fuel pump (a low pressure is used) is located at the tank to end all vapor-lock troubles.

**DRAFTING**  
*pays* **BIG MONEY!**

Draftsmen earn more, enjoy pleasanter working conditions. Get into DRAFTING and Blue-Printing, the starting point of all production. Trained Draftsmen are needed everywhere. Machines can never replace the draftsman.

### LEARN AT HOME IN SPARE TIME

Revolutionary new method teaches you quickly the hows and whys of Mechanical, Structural, Machine, Architectural, etc. Drafting. You are sent professional drafting instruments, drafting equipment, portable drafting table, etc., at no extra cost. You learn by making actual drawings.

**BIG MONEY... ADVANCEMENT OPPORTUNITIES** offered trained draftsmen. Drafting is light, pleasant work, paying big salaries. Is a stepping stone to top managerial jobs. The draftsman plans the World of Tomorrow. That is why drafting is such interesting work.

### OWN YOUR OWN DRAFTING FIRM

The investment requirement is small, the earning possibilities great. Many draftsmen eventually branch out into manufacturing the products they created. Learn of the opportunities in Drafting.

## MAIL THIS COUPON TODAY!

CHRISTY TRADES SCHOOL, Dept. DB-3203  
4804 N. Kedzie Ave., Chicago 25

Mail at once your big FREE book on Drafting and Blue-Printing. Tell me how your Home Training and Professional Drafting Instruments, Portable Drafting Table, Drafting Equipment, etc. can be had on a PAY AS YOU LEARN plan.

NAME \_\_\_\_\_ Age \_\_\_\_\_  
ADDRESS \_\_\_\_\_ CITY \_\_\_\_\_ STATE \_\_\_\_\_

## FURNITURE FOR YOUR BEDROOM

YOU'LL BE THE ENVY of your neighbors with this beautiful bedroom suite in honey maple, oak or walnut! Here's a bed with storage space... a three-piece vanity with cosmetic compartment and makeup mirror... a Mr. and Mrs. dresser... twin night stands with drawers!



Send for Complete PLANS Only \$2.00

**YOU MAKE IT YOURSELF!** Only two power tools, a saw and a jointer, are needed to turn out this modern bedroom furniture. No other project of Popular Mechanics Magazine in recent years has captured the fancy of home craftsmen as has this easy-to-build suite. Letters demanding detailed plans poured in after the suite was pictured in Popular Mechanics. And now the plans are ready! They're detailed scaled drawings—a complete set of 4. Send for them today!

POPULAR MECHANICS PRESS, Dept. 257  
200 East Ontario Street, Chicago 11, Illinois

I enclose \_\_\_\_\_ for a complete set of plans for making the modern bedroom suite illustrated above.

Name \_\_\_\_\_  
Address \_\_\_\_\_  
City \_\_\_\_\_ Zone \_\_\_\_\_ State \_\_\_\_\_



Cancer can't strike me,  
I'm hiding.



Cancer?

The American Cancer Society says that too many people die of it, NEEDLESSLY! That's why I have an annual medical checkup however well I feel. I know the seven danger signals. And when I want sound information, I get it from my Unit of the

AMERICAN CANCER SOCIETY



B. S. Degree, Aero., Chem., Civil, Elec., Mech., & Electronic Eng. (inc. Radio & TV). B.S. degree in 36 mo. in Math., Chem., Physics, Prep. courses. Low rate. Earn board. Large industrial center. Students from 48 states, 21 countries. Demand for grads. G.I. app. Enter March, June, Sept., Dec. Catalog. 1627 E. Washington Boulevard Fort Wayne 2, Indiana

ENGINEERING  
DEGREE IN  
27 MONTHS

INDIANA TECHNICAL COLLEGE

New PROFIT-PROVEN\* Home-Business!

"I make \$400<sup>00</sup>  
a week!"



\*Proves MR. J. T. ANDERSON, Inglewood, Calif.  
(Notarized statement on file in our office and open to inspection)

Send your name and address today and we will mail you FREE complete REVEALING DETAILS, SAMPLES, OPPORTUNITY PLAN, "HOW TO" BOOKLET, ETC. Absolutely free to you—no obligation.

FREE!  
SAMPLES &  
BOOKLET



Big Money?—sure it is—because Huge Profits are waiting to be "tapped" with this MIRACLE NEW PRINTING METHOD. Now, you may share the exciting secrets and build a big-paying FULL OR SPARE TIME Screen Printing Business right IN YOUR OWN HOME. Yes, we'll teach you, too, how to turn pennies into dollars in this newest, most sensational printing method ever invented. WHAT IS SCREEN-PRINT? It's an exciting new printing technique—amazingly simple and fascinating. (It may soon revolutionize the entire printing industry) NO EXPENSIVE EQUIPMENT, no printing press, no "cuts," no art ability, no experience is necessary—yet you can print beautiful professional jobs on PAPER, GLASS, LEATHER, CLOTH—ANYTHING! You print in all colors—even new "glowing" FLUORESCENT COLORS. It's amazing—but true! EARN PROFITS IMMEDIATELY—IN YOUR OWN HOME! Start in your garage, basement, kitchen, spare room—anywhere! It's much easier than you think. Then expand as this new printing industry grows. 300% PROFIT on some jobs—earn up to \$12.50 per hr. HELP FILL THE HUGE GROWING DEMAND. No selling because every business in your area needs Screen-Printing. You can save them up to 50% on printing, too. WE SUPPLY EVERYTHING YOU NEED. Never before has such a profitability been offered to anyone wishing to start a full-time or spare-time "business of his own." Don't Hesitate! Write!

Screen-Print Co., Dept. 22  
15127 S. Broadway, L.A. 61, Calif.

FREE!



1. URANIUM TESTER!
2. CHEMICAL PUZZLE!
3. POLAROID ANALYSER KIT!

An amazing URANIUM TESTER, a fascinating CHEMICAL PUZZLE (worth \$2.50 if you can solve it) and a valuable POLAROID ANALYSING KIT, all FREE with our great new catalog of OPPORTUNITIES IN CHEMISTRY! Learn BAKING, How To Make Precious SYNTHETIC GEMS, PRACTICAL CHEMISTRY, HORTICULTURE (Florist), TAXIDERMISTRY, ADHESIVES, MOULDABLE & CASTING COMPOSITIONS, PLASTICS, ELECTROPLATING, COSMETICS, PERFUMES, MINERALOGY, CHEMICAL PRINTING, CRIME LAB., How To Convert WATER into GAS! Complete courses and instructions from \$2.00 and up! Easy payment plan. Send 25c today for CATALOG, details, Uranium Tester, Chemical Puzzle and Analyser KIT! NATIONAL SCHOOL OF CHEMISTRY, P.O. BOX 606-P, Redwood City, Calif.

4 Pc. Set Carbide Tipped MASONRY DRILLS Imported From Holland—Highest Quality!



The king of stone drills. Special carbide tip makes drilling easy by hand or electric power. Keen, hardened cutting edges easily bore clean holes in wall board, cement, brick, marble, stone, slate, plaster, and the hardest granite. Fits all standard chucks. Set contains 3/16", 1/4", 5/16", 3/8" drills in snap closure, compartmented plastic case. You'll get best results for hundreds of drillings! Order several sets at this low price! ONLY \$3.25 ppd.

ALSO AVAILABLE—4 Pc. Masonry Drill Set with 1/4" turned down shanks, 1/4", 5/16", 3/8", 1/2" drills in snap closure, compartmented plastic case. \$4.90 plus 25c pp., hdg.

20 Pc. Set WIRE GAUGE DRILLS NOS. 61-80

ONLY \$2.50 ppd.

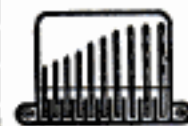

What a buy! This set of drills, sizes no. 61-80, is precision made throughout of finest tool steel! It's tops for precision work in woods, plastic, iron, aluminum, etc. Yet the complete set—20 high quality drills, plus a plastic kit with a marked pocket for each drill—is only \$2.50! Act right now!

RAMMER HAMMER Easy Way To Drive Small Nails!

- no bruised fingers
- no dropped nails

ONLY \$2 ppd.



Insert nail into nozzle, magnet grips nail. Place nozzle against exact spot you want nail driven, push Rammer-Hammer with palm—job is done! For hobbyists, carpenters, framers, shelving, toy making, screens, mouldings, weatherstripping. Made of cadmium plated steel and aluminum. 2 interchangeable sockets fit nails, brads, wood screws up to 1 1/2".

75c ea. For Finest Precision Pliers

- Flat Nose • Combination • Diagonal Cutter
- End Cutting Nippers • Round Nose • One Side Flat—One Side Round • Snipe

Now! Calibrated Level

\$2 ppd.



No Guesswork! No bother with inexact "bubble-type" level! Devil Level is CALIBRATED for hairline accuracy! Needle points to exact degrees, inches anything is off level or plumb. Measures vert., horiz., all angles! Level pictures, shelves, TV antennas, etc. One side measures degrees of level, other pitch or inch rise per ft. Fits in pocket. For hobbyists, handyman, housewives.

For Jewelers, Optical Workers, Hobbyists, Craftsmen of all Kinds! These superb German instruments are of deep-forged, heat-treated high quality tool steel, fabricated to most exacting specifications. All-over ground and polished to smooth hard surfaces. Smooth working joints with just the right tension. Jaws meet perfectly to safely and securely hold even the most delicate objects in the hard-to-reach corners and angles. Each plier 4" long. 75c ea.—all 7 for \$5.00 ppd.

Minimum order \$1.00. Send Check or M.O. C.O.D. plus fee. Money Back Guarantee.

SCOTT-MITCHELL HOUSE, INC.

Dept. M-309, 611 Broadway New York 12, N.Y.

## Plymouth Fury Has 290 Horsepower

COMBINING high performance with family-car roominess, the 1957 Plymouth Fury develops a wheel-spinning 290 horsepower. It is distinguished from other Plymouths by a gold-colored aluminum grille and side paneling. The engine has two four-barrel carburetors and a displacement of 318 cubic inches. Highly tuned for top performance, it uses special domed pistons, high-intensity cams, high-load valve springs and, of course, dual exhausts. A heavy-duty suspension system has been engineered under the Fury for the sharp, firm ride and flat cornering demanded by sports-car drivers.



**FREE!**  
**NEW**  
**ISSUES..**

plus new, rare  
**BONUS OFFER!**



RUSH COUPON TODAY for generous collection just released NEW ISSUE British Empire Stamps. All genuine, all different, very difficult to get. Thanks to agents all over the Empire, valuable, desirable stamps both mint and used — topicals, pictorials, bi-colors, commemoratives, many more. Due to present scarcity, we give only one packet. ALSO FREE! Exclusive — never before offered — "BRITISH EMPIRE BONUS PACKET". Unusual out-of-the-way, seldom-seen Coronations, Jubilees, Royal Visits, Commemoratives, others. No two packets alike. MORE! Other offers for your free inspection plus FREE copy helpful STAMP COLLECTOR'S GUIDE. Supply limited, so we give only one of these collections. If coupon clipped, send name and 10¢ for postage, handling to GARCELON STAMP CO., Dept. PM2N, Calais, Maine.

Stamp Collector's Guide

GARCELON STAMP CO., Dept. PM2N  
Calais, Maine. RUSH New Issues, BONUS PACKET,  
other offers. Enclosed 10¢ for postage, handling. (PLEASE PRINT)

\_\_\_\_\_  
\_\_\_\_\_  
\_\_\_\_\_

... TURN CONCRETE  
**INTO GOLD!**



**MOTOR  
DRIVEN**

R.L.T. of  
New York City re-  
ports: "MY GENERAL  
BLOCK MACHINE  
PAID FOR ITSELF  
IN FIRST 2 WEEKS!"  
Hundreds now in  
use the world over!  
Write for FREE details today!

**MAKE UP TO \$75 A DAY  
IN YOUR OWN BUSINESS**

If you want to have your own business — to start a business on your own — here's your big opportunity! New high speed, low cost General block machine produces up to 1,000 concrete blocks a day. Sell all you make to builders, supply houses, and others for homes, factories, buildings, garages. Cash in on the building boom! You can make profits of 100% to 150% — up to \$75 a day! General block machine equipped with 1/2 h.p. electric motor — or can be supplied with gasoline engine — works anywhere, in little space, indoors or out. Operates from ordinary house light socket. Simple, foolproof 3 step operation — so easy a child can do it. Makes superior 3 core blocks any size from 4" to 12". Also makes chimney, ash, corner and other types. Blocks meet any building code anywhere in the country. Materials — sand, water, cement, available anywhere. Simple illustrated operating instructions and mixing formulas for cement and cinder blocks supplied with each machine. Write for FREE folder with full information.

**EXTRA**

Amazing illustrated book gives floor plans for 6 sensational concrete block bungalows. Tells how to lay blocks, lay out building lines, mix concrete, build steps, porch and concrete floors all at great savings. Written by experts. Can save many times the cost of the machine! Get it now! No strings attached. Send \$1.

BOOK SENT FREE IF YOU BUY MACHINE.  
\$1 REFUNDED IF YOU BUY LATER.

**GENERAL ENGINES CO.**

DEPT. M-27, ROUTE 130, THOROFARE, N. J.

HOW TO  
BUILD  
YOUR OWN  
CONCRETE  
BLOCK  
HOME  
Only \$1 Prepaid

# Bass Fishermen will Say I'm Crazy . . . until they try my method!



**But, after an honest trial, if you're at all like the other men to whom I've told my strange plan, you'll guard it with your last breath.**

Don't jump at conclusions. I'm not a manufacturer of any fancy new lure. I have no reels or lines to sell. I'm a professional man and make a good living in my profession. But my all-absorbing hobby is fishing. And, quite by accident, I've discovered how to go to waters that most fishermen say are fished out and come in with a good catch of the biggest bass that you ever saw. The savage old bass that got so big, because they were "wise" to every ordinary way of fishing.

This METHOD is NOT spinning, trolling, casting, fly fishing, trot line fishing, set line fishing, hand line fishing, live bait fishing, jugging, netting, trapping, or seining. No live bait or prepared bait is used. You can carry all of the equipment you need in one hand.

The whole method can be learned in twenty minutes—twenty minutes of fascinating reading. All the extra equipment you need, you can buy locally at a cost of less than a dollar. Yet with it, you can come in after an hour or two of the greatest excitement of your life, with a stringer full. Not one or two miserable 12 or 14 inch over-sized keepers—but five or six real beauties with real poundage behind them. The kind that don't need a word of explanation of the professional skill of the man who caught them. Absolutely legal, too—in every state.

This amazing method was developed by a little group of professional fishermen. Though they were public guides, they rarely divulged their method to their patrons. They used it only when fishing for their own tables. It is possible that no man on your waters has ever seen it, ever heard of it, or ever used it. And when you have given it the first trial, you will be as closed-mouthed as a man who has suddenly discovered a gold mine. Because with this method you can fish within a hundred feet of the best fishermen in the county

and pull in ferocious big ones while they come home empty handed. No special skill is required. The method is just as deadly in the hands of a novice as in the hands of an old timer. My method will be disclosed only to those men in each area who will give me their word of honor not to give the method to anyone else.

Send me your name. Let me tell you how you can try out this deadly method of bringing in big bass from your local waters. Let me tell you why I let you try out my unusual method for the whole fishing season without risking a penny of your money. Send your name for details of my money-back trial offer. There is no charge for this information, now or at any other time. Just your name is all I need. But I guarantee that the information I send you will make you a complete skeptic—until you decide to try my method! And then, your own catches will fill you with disbelief. Send your name, today. This will be fun.

**ERIC B. FARE, Libertyville 4, Illinois**

**Eric B. Fare, Libertyville 4, Illinois**

Dear Mr. Fare: Send me complete information without any charge and without the slightest obligation. Tell me how I can learn your method of catching big bass from waters many say are "fished out," even when the old timers are reporting "No Luck."

Name.....

Address.....

City.....Zone.....State.....

## SEE YOUR DEALER

Two steps to professional results in your workshop: (1) check **POPULAR MECHANICS** for helpful "how to" suggestions; (2) discuss your project with your dealer. He knows the importance of working with quality products. They're advertised in **POPULAR MECHANICS**



FEBRUARY 1957

## SALE

**16 X 50** REGULARLY \$69.50  
SAVE \$44.51!

High powered, whisper-weight (27 oz.) color corrected, Achromatic binoculars. 7" high! EZ to hold, EZ to focus. Instant finger-tip adjustment. **SALE PRICE FOR THIS SALE ONLY** including case and straps! Made in Japan. **USE 30 DAYS. \$24.99** If not satisfied return for full refund. Add tax. UNITED BINOCULAR CO., 9043 S. Western, ARF-1208, Chicago 20. DEALERS WANTED



## Become A --- BUILDING CONTRACTOR!

MAIL COUPON for FREE BROCHURE

Simplified home study training program. Learn every phase of building, estimating, contracting. Fortunes are made in this line of work every year. Use spare hours—no interference with present work. Diploma awarded. Low tuition rates.

**AMERICAN TECHNICAL SOCIETY**

Dept. PM-257, 850 E. 58th Street, Chicago 37, Ill.  
Please send me your FREE Brochure and full details of your building, estimating and contracting training program.

Name.....

Address.....

City.....State.....



# Get into ... PLASTIC LAMINATING AT HOME!

Sensational New  
**"ONE MAN  
BUSINESS"**

... pays \$10 to \$20 profit  
for each dollar of cost.

Make \$20 to \$30 a day by our  
**MAGIC MAIL PLAN ... get  
orders and cash from your mailman!**



Here's the newest and most fascinating of all home-operated businesses. For the first time, a simplified machine brings the fabulous profits of Plastic Sealing and Plastic Laminating within the reach of the small operator. Can be

operated in a corner of the kitchen, basement, or garage. And any man or woman, regardless of age, education, or experience—can learn this interesting work in a few minutes of reading—can turn out professional jobs after one hour's practice.

## TWO EXCITING FIELDS FOR BIG PROFITS!

No house-to-house canvassing. No face-to-face selling. We not only supply the equipment you need for the work, but also show you exactly how to cash in big daily profits from two big demand fields.

### A FORTUNE IN PLASTIC SEALING

Millions of people want to protect valuable cards, photographs, documents and papers against wear, soil, and damage. By our MAGIC MAIL Plan you get this business through the mails. Open envelopes and take out money and orders. Details of this plan will amaze you. It will be sent free. Just mail coupon.

### ENORMOUS PROFITS IN LAMINATING

A creative, artistic business. Gift shops sell your entire output. Just a few of thousands of giftwares illustrated on this page. Beautiful colors. Endless designs. Exclusive "one of a kind" appeal brings sales at ten to twenty times the cost of materials. Beautiful illustrations and instructions for making these artistic novelties sent free.

**NO MONEY—  
Just Send Name!**



**RUSH COUPON**

Never before has such an opportunity been offered the small, home-operator—an opportunity to gain complete personal independence in a big money business of your own. Don't lose a minute. Get the facts at once. All information, fully illustrated with pictures, is free. Send the coupon—or send your name and address on a postcard. There is no charge now, or at any other time. Send for the information on this exciting opportunity today



### \$5-\$10-and \$20 BILLS COME TO YOU IN THE MAIL

By our MAGIC MAIL Plan you sit at home, send out mail, and get back money and orders. Additional profits in supplying lifetime protection for SNAPSHOTS—IDENTIFICATION CARDS—DISCHARGE PAPERS—DRIVERS' LICENSES—SOCIAL SECURITY CARDS—VOTERS REG. CARDS—MENUS—BIRTH CERTIFICATES—CREDIT CARDS—BIRTH AND WEDDING ANNOUNCEMENTS—PASSES—DOCUMENTS.

Lifetime protection. See how laminating prevents soiling, wear, and moisture damage with flexible, plastic covers.



**WARNER ELECTRIC CO.**  
1512 Jarvis, Dept. L-10-B Chicago 26, Illinois

**WARNER ELECTRIC CO., Dept. L-10-B**  
1512 Jarvis Avenue, Chicago 26, Illinois

Please mail, postage prepaid, complete information with illustrations showing the things I can make and the money possibilities in Plastic Laminating. All this is free. No Salesman is to call. Also, tell me how I get orders and money from my Postman by the MAGIC MAIL Plan.

NAME \_\_\_\_\_  
ADDRESS \_\_\_\_\_  
CITY \_\_\_\_\_ ZONE \_\_\_\_\_ STATE \_\_\_\_\_

### Thousands of Beautiful ART CREATIONS

Made by Laminating as explained in our Free information. Send coupon for list and pictures of COSTUME JEWELRY—JEWELS—CIGARETTE BOXES—CUFF LINKS—NOVELTY BUTTONS—TRAYS—CANDLESTICKS—COASTERS—CLOCK CASES—LAMP BASES—PICTURE FRAMES—BOOK ENDS—CHARMS—ADVERTISING SIGNS—NAME PLATES—BELT BUCKLES—CHECKERS—PAPER KNIVES—CHESSMEN—BOOKMARKS—TIE RACKS—KEEPSAKES OF ALL KINDS.





# CLASSIFIED ADVERTISEMENTS



Advertisements in this section \$1.25 per word, each insertion, minimum 10 words, payable in advance.

To be inserted under proper classification, copy must be in our office the

20th of the second month preceding date of issue

F. W. Johnson, Manager, Classified Advertising

Popular Mechanics Magazine, 200 East Ontario Street, Chicago 11, Illinois

## YOU'LL PROFIT

By reading and answering the classified ads in this section. Hundreds of opportunities for you to make and save money

### AUTOMOBILES, MIDGET CARS

ANTIQUÉ Automobile color slides, 2x2. Illustrated catalog free. Universal, Box 779A, Beverly Hills, Calif.

BOYS' Power-driven auto. Build your own. Plans 25 cents. Sypher Co., Sta. F., Toledo, Ohio.

HUNDREDS Of automobile catalogs—American, antique, foreign; dealer books, glossy photographs, service manuals; free motor magazines, offered with non-profit club. Write today for free information. Auto Maniacs, Stockbridge, Mich.

NEW 1957 Automobiles—Up to 25% off retail prices. Meder, 550-PM Fifth Avenue, New York City 36.

### AUTO SUPPLIES AND EQUIPMENT

CURB Parking. Backing single space behind auto easy. 1" steering wheel attachment. Sample \$1.00. E-Z-Park, Box 148, Falmouth, Mass.

TERRIFIC Information, book, Automotive Diagnosis—Tune Up 536 pp., \$5.95 ppd. Money-back guarantee. Request free folder. Master Technical Press, 1010 W. Crescent, Park Ridge 5, Ill.

FORD 1909-1932 New parts. Biggest catalog 25¢. Huber, 15 Emerson, Clifton, New Jersey.

SAVE Money on Jeep and army truck parts. Large inventory. Catalogs for Jeep or G.M.C. owners. American Auto Parts Co., 1830 Locust, Kansas City, Mo.

AMAZING Bargain offer! The famous General Electric auto engine heater for cars, trucks, tractors, assures incredibly fast, easy starts at sub-zero temperatures. Listed \$8.95—Our extra-special only \$3.95, postpaid, prompt shipment. Dealers, agents wanted. First order brings you sensational 500% profit plan. Hurry, secure your territory! "GE Engine Heater Sales," Milwaukee 7, Wisconsin.

FREE! New catalog. Speed, power, mileage increasing equipment. Discounts! Almqvist Engineering, Milford PM5, Penna.

SAVE On parts, accessories, tools, dress-up items, gadgets! Largest giant 1957 catalog ever. Only 25¢ (refunded first order). Newhouse Automotive Industries, 5803E Beverly, Los Angeles 23, Calif.

RING-Valve job while you drive \$6.00 postpaid. Safe, proven, guaranteed. Literature. Motaloy, Grantham, Penna.

USED Speed and power equipment. O.H.V. engines. Largest supply. Send 25¢ for list. Speedway, 1719 "N," Lincoln, Nebraska.

NEW And used parts at savings. Complete guaranteed parts service for all models cars and trucks—1924 and later. Largest in the West. Army parts specialists. No catalog. Submit your needs for quotations. Fast mail order service. Pioneer Auto and Truck Parts Co., 734 W. 134th Ave., Denver 17, Colorado.

### AUTO TRAILERS

TRAILER Building manual \$1.00. Booklet 30¢. Kameron, Box 1153, Milwaukee 1, Wis.

BUILD Expanding eight foot trailer. Accommodates five. Literature 10¢. Framar Company, Wilmington, Mass.

TRAILER Manual. Over 200 pages, 250 pictures. Tells how to: buy, tow, travel, build, live-in, repair. \$1.98. Trail-er-Club of America, Dept. PM81, Box 1376, Beverly Hills, Calif.

### MOTORCYCLES, BICYCLES, MOTORSCOOTERS AND SUPPLIES

BICYCLE Shock absorbers, \$5.95. Free leaflet. Thomas, Box 1873, Oakland 4, California.

MOTORCYCLE Equipment service, bulletins 20¢. Wichita Cycle Co., 813 Ohio, Wichita Falls, Texas. Our 31st year.

WHIZZER Motors \$20.00; midget race car reasonable; motorscooter \$6.00; Cushman two-speed \$20.00. Send 25¢ (35¢ first class mail) for catalog #30 jammed with sensational bargains in wheels, motors, motorscooters, midget cars, motorbikes, construction plans, etc. Gail, 1313 Jefferson, Toledo, Ohio.

PARTS For Cushman, Doodle-Bug, Salisbury, etc. Send make, model, 25¢ for price list. Motor Scooter Parts Co., Dept. P2, Box 7311, Indianapolis 1, Indiana.

BANKRUPT Motorcycles \$35 up. Bicycles \$12.50 up. Small gasoline motors \$4.00 up. Catalogue bulletin 25¢. Bunico, 146-A, Covington, Virginia.

IMPORTED Motorcycles 1957 models now available. Singles, twins, square four. NSU, Ariel, BMW, Lambretta. Save money! Glenn Walraven Motors, Marion, Ohio. Phone 2-4135.

HARLEY - Davidsons — Used bargains. New, used parts, accessories for all models. Bulletin, catalog 25¢. Knuth's (Factory Dealer), 1753 Muskego, Milwaukee, Wis.

RECONDITIONED Motorcycles and motors, Chromium accessories. Complete stock Indian parts. Expert rebuilding. Fast service. Indian Motorcycle Sales, Kansas City 27, Missouri.

WHIZZER Motor \$10; two cylinder engine \$5; Whizzer Pacemaker \$25; motorscooter \$12, midget car \$30, less motors. Professional midget track racer \$163; Crosley convertible \$100; Cushman motorscooter \$30. (Mail order only.) Send 25¢ (35¢ for first class mailing) for directory-catalogue Number 75, listing these and hundreds of other bargains in new and used midget cars, motorscooters, engines, homebuilders parts, plans, etc. Midget Motors Directory, Athens, Ohio.

### AVIATION

AVIATION Surplus bargain catalogue. One dime. Box 22 PM7, Thomasville, Penna.

PROPELLERS. Plans, supplies by world's oldest and largest manufacturer of special design airboat and snowplane propellers. Latest designs. Prompt delivery. Satisfaction guaranteed. 48 page catalog 25¢. Banks-Maxwell, Box 3301E, Ft. Worth 5, Texas.

FOR Sale: Surplus aircrafts; fuselages; aircraft engines; assemblies; instruments; electronics; radiotelephones. Buy direct from U. S. government surplus depots. List and procedure \$1.00. Brody, Box 8-PMH, Sunnyside 4, New York.

NEW Lightplane circulars, illustrated 30¢. Kameron, Box 1153, Milwaukee 1, Wis.

### BATTERIES, GENERATORS

EDISON Nickel storage batteries. Any voltage, any amperage. Unconditionally guaranteed. Power plants, generators, motors. Literature. Hawley Smith Co., Croton Falls 1, N. Y.

### ELECTRICAL SUPPLIES

LAMPS—Parts catalog showing wiring instructions, 25¢. Gyro Lamps, 5402P Clark, Chicago 40.

TELEPHONE Transmitter, hand set type and ear cap receiver inter-house phones, speakers or any communication purpose. Both only \$1.00. No cod's. Telephones, Dept. D-1, 1760 Lunt, Chicago 26.

ELECTRIC Pencil: Engraves all metals \$2.00. Beyer Mfg., 10511-H Springfield, Chicago 43.

LAMP, Electrical parts, wholesale. Thousands of items for repairing, converting. Catalog 25¢. Brown Lamp, Box 303, Clayton 5, Mo.

### WELDING, SOLDERING, PLATING

NEW And different oxy-acetylene outfit welds, cuts, heats, brazes, with interchangeable tips. No attachments needed. Light, portable. Complete outfit, full instructions, only \$78.50. Special money-saving plan for oxygen and acetylene supply. Write for free literature today: Dept. M, Linde Air Products Company, 30 East 42nd Street, New York 17, N. Y.

WELDERS, 110/220, \$39.50. Morris, 1070 Inner Drive, Schenectady 3, New York.

ELECTROPLATING Equipment, anodes and solutions for all types of plating. Instructions. Assemble your own plater and save. Free catalog. Ramyr, Dept. E-4, 1624 East First Street, Los Angeles 33, California.

ACETYLENE Welding outfits new \$54.50; used \$34.50; arcwelders \$56.50. Eagle Welding, Dept. PM, 5085 Broadway, Chicago 40, Ill.

FREE Electrical repair pamphlet with arc welding manual \$1.00. Marnel, Box 7642, Denver 15, Colorado.

**"BUILD-UR-OWN"** a.c. welder and a.c. power plant with a good used engine and low cost Hobart generator. Welds anywhere and supplies 5kw stand-by power for any emergency. Write Hobartweld, Box M-373, Troy, Ohio.

**WELDER Headquarters**—Free catalog welders, kits, hydraulics. Build 360-ampere welder using aircraft generator—plans 25¢, catalog included. Dunbar Manufacturing, Houston 23, Texas.

#### MACHINERY, TOOLS, SUPPLIES

**INVENTORY Reduction sale.** You can get a set of three of our regular carbide tipped masonry drills 1/4, 3/8, 1/2 for the price of one drill. Send \$3.25. Postpaid anywhere in the United States. Warwick Twist Drill Co., Manila, Arkansas.

**WHOLESALE Tool catalog.** Send \$1.00. Yuhas, 3350 Theodore, Detroit 11, Mich.

**LAWNMOWER Sharpeners,** five newest high speed inventions. Turner-Cline, 430 Yellowstone, Pocatello, Idaho.

**"MACHINE Tool Reconditioning."** Amazing manual for machinists. Simplifies preventive maintenance. Free circular. Machine Tool Publications, 322 Holly, St. Paul 2, Minnesota.

#### SURVEYING INSTRUMENTS

**NEW And guaranteed factory rebuilt transits and levels,** sale or rent, with purchase option. We will repair, trade or buy old instruments. Write for list M-72, Warren-Knight Co. (Manufacturers of Surveying Instruments), 136 N. 12th St., Philadelphia 7, Penna.

#### ENGINES, MOTORS, DYNAMOS

**1/2 HORSEPOWER Electric motors,** a.c. 110, used, good \$5.00 each, f.o.b. Plant Machinery Corp., Richmond & Norris Sts., Philadelphia 25, Penna.

**REWIND Motors yourself.** Complete instructions \$1.00. Lewis Mfg., Howell, Michigan.

**WINDING Data.** 275 motors, single and three phase, \$1.10. Data Company, Box 7831, Kansas City 38, Mo.

**SMALL Electric motors.** Accessories. Literature free. Kitco, Dept. 11, Box 212, Monroe, Wisconsin.

**DIESEL Injector parts wanted.** OM71-110. Bares, 7120 Carnegie, Cleveland 3, Ohio.

**A. C. Generators.** 750 watt \$42.50; 1500 watt \$67.50. Motors, 5 horse \$110; 3 horse \$87.50; 1 horse \$38.50. Butler, 1885 Milwaukee, Chicago.

#### BOATS, OUTBOARD MOTORS

**24—1886 BRAND New Scott-Atwater 18 H.P. electric starting outboards.** Regularly \$482.95, now \$379.00. Others. Last 25¢, Donz, Mt. Ephraim, N. J.

**FREE Catalog!** Boat kits, trailers, fiberglass, marine hardware. Luger Industries, Dept. M2, 3404 Lyndale South, Minneapolis, Minnesota.

**SAVE Money.** New, used outboard motor parts. Send wants. Stamp appreciated. Outboard Motor Mart, 229-M State, Boston 9, Mass.

**SUPER Deluxe catalogue,** with actual 8 by 10 inch photographs, marine conversions, Ford, Jeep engines, kits and accessories. Catalogue \$1.00 refundable. Gershel Engineering, Oceanside, New York.

**300 PLANS, Catalog 50¢.** Patterns, kits. Outboards 2.5 h.p. \$79.95! Marinecraft, Box 161-M, Brighton, Mass.

**NEW!** "How to Make Old Boats New with Fiberglass." 10¢. Castolite Company, Marine Division, Dept. BM-101, Woodstock, Illinois.

**USED Marine engines and outboard motors** now selling at half price, free list. Tell us your needs. Masters Boats, 212 W. Chicago, Chicago, Ill.

**FIBERGLASS.** Top marine grade. Yard or kit. Ontario Fiberglass Co., Box M, Ontario, N. Y.

**BOAT Plans.** Full size patterns. Frame kits. Modern inboards and outboards for amateur builders. Complete new catalog 50¢ or specify requirements. Glen Designs, Box 568, Compton, Calif.

**NEW, Used, rebuilt marine motors.** Marine conversions, fittings. Free catalog. Stokes Marine Supply, Dept. 24, Coldwater, Michigan.

**FIBERGLAS Permanent boat water-proofing.** Special 25% winter discount. Complete kits, \$8.45 up. Guaranteed materials. Easy application. Full instructions. Free literature. Ajax Plastics, Dept. PM, P.O. Box 1323, Fort Worth, Texas.

**MARINE Conversions for Ford and Jeep engines.** Catalog 25¢. Lehman Manufacturing Company, 972D Broad Street, Newark 2, New Jersey.

**FORDS And Jeeps 100% marine engines** with famous Convo-Kits. Deluxe catalogue 25¢ coin. Oscomotors, 3627B Lawrence, Philadelphia 40, Penna.

**FULL Size, cut-to-shape boat patterns,** blueprints, 7 1/2—38 feet. New 86 page illustrated "Build-A-Boat" catalog of naval architect-designed cruisers, runabouts, skiffs, outboard boats, sailing, racing, houseboats, 50¢. "How to Build a Boat" booklet, \$2.50. Cleveland Boat Blueprint Co., Dept. A-66, Box 1651, Cleveland, Ohio.

**MARINE Conversion,** Willys to Cadillac, engines, kits and parts. Catalogue and conversion hints free. Barr Marine, 2706 Castor Avenue, Philadelphia 34, Penna.

**FIBERGLAS Boat coating.** Plexiglas boat windshields—Clear, blue, green tints. Wholesale-retail. Instructive information catalog free! Oem-O'-Lite, 5529 Cahuenga, North Hollywood, California.

**STEEL-Wood, boat plans, cruisers—sail,** 21-42 feet. Free information. Please specify size-type. John B. Clark, N.A., Box 51, Bay Village, Ohio.

#### ATHLETIC EQUIPMENT, BODY BUILDING COURSES

**OUTSTANDING Physical development!** New guaranteed system uses only a rope! Strength, health, gain, reduce. Free details. Roperise, 4834 Art St., Room 200, San Diego 15, California.

**BARBELLS.** Dumbbells. Courses. Free catalogue. Good Barbell Co., Reading, Penna.

**BE Taller!** Coach's "Inch-At-A-Time" system #1, complete. Marty Snyder, Box 185-MC, Union City, New Jersey.

**DISABLE Any bully,** with two fingers. Secrets, Ju-Jitsu, 96 pages, illustrations, \$1.50. Special chapter for women. Seico, Box 38, Cooper Station, New York 3, N. Y.

#### SPORTING GOODS, GUNS, FISHING TACKLE, ARCHERY, TRAPPING

**TENTS, Camping equipment;** tremendous selection. Send 20¢ for 136 page tent, camping equipment catalogue-handbook listing all national camping sites. Morstan, 10-21R 50th Ave., Long Island City 1, New York.

**FREE Below wholesale fishing catalog.** Fishing Tackle Mart, Dept. 52, Box 8737, Chicago 80, Ill.

**GUNSMITHS!** Illustrated gun parts catalog, 50¢. Shelley Braverman, Athens 2, New York.

**FREE Sporting goods catalogs!** Save 70%. Econ-O-Mart, Whippany 2, New Jersey.

**WOOLYWORMS.** Hottest fish lure. Bass, bluegills, trout. Ten, \$1.00. Description free. Parks, Route 8, New Brighton, Penna.

**MOLDS For fisherman's sinkers,** jigs, squids, casting and spinning lures. Free catalog. Sweet's Molds, Tonawanda 1, New York.

**SPORTSMEN'S Knives** ground razor sharp with pocket size revolving whetstone. Literature free. Mohawk Sales Service, 94 First Street, Dalton, Mass.

**FREE 182 Page fishing catalog.** Includes latest "do it yourself" kits. Netcraft Company, Dept. B2, Toledo 13, Ohio.

**LUGERS! Mausers! Colts! P. 38s! Kentuckies! Weatherby's!** Antique-modern guns, successories. Super catalog 50¢. Agramonte's, Yonkers 20, N. Y.

**ARCHERS.** Save! Free five dollar credit certificate and completely new illustrated 1967 catalog. Bows, arrows, raw materials. Offer expires February 28th. Send 10¢ for handling. Pride Archery, Dept. PM2-7, RFD #1, Danbury, Connecticut.

**FREE Fishing scent secrets.** Johnston's, 312 Lake Avenue, Ithaca, New York.

**ARROWS—Unsurpassed for speed, accuracy.** 26 kinds. Accessories, raw materials. Free catalog. Marlin Archery, Ames, Iowa.

**180 PROFUSELY Illustrated pages** antique pistols, swords, daggers, armor, etc. 50¢. Robert Abels, M860 Lexington Ave., New York City 21.

**BUILD Barbecue.** Complete plans. Booklet 25¢. Free catalog. Popular Mechanics Press, 633 N. St. Clair St., Chicago 11.

**BIG Money raising crickets and 12 inch African fishworms.** Free literature. Carter Ranch, Plains, Georgia.

**JAP Rifle altering to 30-06,** \$8.00. Japshells, \$3.75. Catalog 5¢. T. P. Shop, West Branch 11, Mich.

**GUNSMITH—400 Page illustrated course** \$4. Pioneer Press, Harriman, Tennessee.

**FREE Catalog.** Newest items. Bargains. Gadgets. Beads. Spinners. Lure parts. Sinkers molds. Finnyports, MC, Toledo 6, Ohio.

**5000 BARGAINS.** Firearms, binoculars, war relics. Catalog 50¢. Smith Firearms, Runnemed, N. J.

**SAMPLE: 25c Copy of "The Archers' Magazine."** Send 10c. 1290 Walnut Street, Philadelphia 7, Pennsylvania.

#### BINOCULARS, TELESCOPES, MICROSCOPES, MAGNIFIERS

**REFLECTOR Telescope kits** \$5.25 (3") to \$175 (12"). Mirrors, cells, focusing mounts, tripods, eye systems. Anything, everything in telescopes. Free catalog. Also ready to use telescope from \$25. Esco Products, Oakridge, N. J.

**AMAZING Prices** precision binoculars, special slow season winter reductions. Free trial. Folder "Binocular Selecting," catalog free. Prentiss Importers, Mercury Bldg., West Los Angeles 25, Calif.

**ASTRONOMICAL Telescopes—** Make your own. Complete instructions 10¢. Free catalog. Precision Optics, 1001-B East 163d St., New York City 59.

**BINOCULARS, Telescopes, microscopes.** Terrific values \$3.98 up. Request free money-saving catalog. Criterion, Dept. P 51, Hartford, Conn.

**REFLECTING Telescope, 60X,** completely assembled \$29.75. Guaranteed observatory clearness. Free information. Skyscope, 475 Fifth Avenue, New York City 17.

**400X Telescopes** easily made. Kit includes focusing tube, erector, five finished lenses and building instructions—\$3.75. Free booklet on completed telescopes, tripods, mirrors, lens kits, etc. Suffolk Science, Mattituck 3, New York.

**MICROSCOPE Catalog** free. Research Scientific Supplies, 60 Wall St., New York City 5.

**BINOCULARS, Riflescopes, etc.** Exclusive models! Tremendous selection. \$100,000.00 stock! Free 56 page illustrated catalog. United, 9043 S. Western, A-1308, Chicago 20. Dealers wanted.

**DYNASCOPE—Sensational new reflector telescope.** Send for details. Criterion Co., Dept. DP 29, Hartford, Conn.

**FREE Telescope literature.** Something really new. Holm Jamer, Manerville, N. Y.

**BUILD Your own reflector telescope.** Complete kit; mirrors, eyepieces, tripod, all other accessories. Request free illustrated literature. Criterion Manufacturing, Dept. DPM 28, Hartford, Conn.

**WAR Surplus bargains:** Millions of lenses, instruments, telescopes, binoculars, components and complete line of astronomical telescope items. World's greatest optical market place! Send only \$1.00 for beginner's 10-lens kit and big instruction booklet Stock 2-CH. Write for catalog CH, free! Edmund Scientific Co., Barrington, New Jersey.

#### PLANTS, SEEDS, BULBS, NURSERY AND GARDEN SUPPLIES

**WORLD'S Greatest cash crop.** Free information. Write Ginseng Gardens, Asheville, N. C.

**TREES And shrubs—** Raise your own from seed for shade, windbreak, snow fence, ornament, erosion control, etc. For free planting guide, price list, write Woodlot Seed Company, Norway 9, Michigan.

**OPERATE Profitable garden.** Write: Regal Industries, Spring Lake Road, Streator-PP, Illinois.

**CUT Landscaping costs by half.** 100 money saving tricks. Pamphlet \$1.00. Bayer Gardens, Route #1, Neenah, Wis.

## PETS—DOGS, BIRDS, RABBITS, HAMSTERS, ETC.

**ANIMALS**, Birds, reptiles. List 25¢. Menagerie, 3704 So. Pecan, Fort Worth 10, Texas.

**HAMSTERS**—Young Golden pairs, \$2.95, breeders \$3.95. Free booklet. Jer-Pet's Hamstery, 2425 Hoyt, Muskegon Heights 13, Mich.

**ANGORAS**, Chinchillas — World's most profitable rabbits! Particulars free. Grinsteads, Edwardsville, Illinois.

**SKUNKS**, Monkeys, reptiles, pets many kinds. Illustrated catalogue, 23¢. Trails End Co., St. Stephen, S. C.

**MINK** — \$25 Up. Satisfaction guaranteed. Blue Sky Mink Ranch, Henry, Ill.

**HAMSTERS**—Golden: young, \$3.00 pair. Fully developed \$4.00 pair. Adirondack Hamstery, Prospect 10-B, N. Y.

**CHINCHILLAS** Into fabulous furs. Pedigreed. Registered. Reasonably priced. Care directions. Stewart Chinchilla Ranch, Washingtonville, N. Y.

**HUNTERS!** Raccoon Mountain and Short Creek kennels now combined. Large number of coonhounds, foxhounds, rabbit-hounds, beaglehounds, bird-dogs, puppies. Free literature and pictures. Trial Dures Thomas, Owner, Box 464, Boaz, Alabama.

**RAISE** Rabbits successfully by knowing facts. 48 page illustrated book describing 25 breeds. Housing, feeding, breeding, marketing, etc. Plus bulletin, 25 cents. American Rabbit Association, 36 Arba Building, Pittsburgh, Penna.

**STANDARD** Rabbit Journal, Milton 3, Penna. Year \$1.00. Sample dime. Beginners manual 25¢.

**MAKE** Money raising chinchillas, mink, nutria, rabbits, cavies for us. Free catalog. Keeney Brothers, New Freedom 2, Penna.

**FREE** Book. Grow mushrooms. Guaranteed market. Mushrooms, Dept. 171, 2954 Admiral Way, Seattle, Wash.

**BEAUTIFUL** Pure white pedigreed police puppies. Ansonia Kennels, McHenry, N. Dak.

**RAISE** Rabbits on \$500 month plan. Plenty markets. Free details. White's Rabbitry, Mount Pleasant, Michigan.

**RAISE** Nutria: Registered breeding stock, all colors, all ages. Get the "Facts" \$1.00. Lund's Ranch, 9725 Sunland Blvd., Sunland 2, Calif.

**EXTRA** Money raising Angora, New Zealand rabbits. Write Martin's Rabbitry, Morganfield, Ky.

**GRAY** Crickets: Special advertising material (limited offer) free to dealers ordering crickets. Use material for your advertising. Crickets shipped immediately, any quantity. Live delivery guaranteed. Scientifically raised. Write for free literature and price list. Owen Crickets, Farm 2, 2818—25th, Lubbock, Texas.

**HOBBY** For yourself, son. Enjoyment, profit, raising game birds. Pictorial monthly tells how. Breeders Gazette, 1328-M Allen Park, Salt Lake City, Utah.

## FUR BEARING ANIMALS

**RABBIT** Raising booklet-magazine 10¢. Stahl, Hickman Mills 1, Mo.

**AMAZING** Profits converting greens into nutria fur. Nutria carcasses into mink. Voight Farms, Atlanta 2, Texas.

**BRED** Female minks, raccoons, skunks. Baby skunks, raccoons. Catalog, 25¢. Shady Fur Farm, Springfield, Minnesota.

**RAISE** Mink: Free booklet, pen plans, inside secrets, feed, care. Mink are money makers. Investigate today. Lawrence Molegard, Brigham City 12, Utah.

**MINK** Raising information free. Complete. Lake Superior Mink Farm, Superior, EEl, Wisconsin.

**1000 BRED** Mink. Booklet, plans 25¢. Lake Ontario Ranch, Gravel Road, Webster, N. Y.

## FARMS, FARM LANDS, REAL ESTATE

**CANADIAN** Tax sale lands for three dollars an acre and up. Small monthly payments. Farms, timber, hunting and fishing camps, minerals. Limited number of properties. Write at once for free catalogue. Tax Sale Service, Room 165, 120 Bloor St., W., Toronto 5, Canada.

**FLORIDA** Lakefront homesites. Easy monthly payments. Complete literature free. Write Box 1311, Eustis, Florida.

**FLORIDA'S** Finest homesite bargain—80 by 135 feet for \$240—pay \$10 monthly. Near famous Panama City pleasure resort. Wonderful fishing, hunting. Choice 10 and 20 acre winter garden farms. Also beautifully wooded deluxe trailer sites. Booklet free. Wendell Wood, Fountain, Florida.

**FREE** Picture catalog lake properties; low prices. Risberg Real Estate, Box PM-257, Hayward, Wisconsin.

**CALIFORNIA** And Florida consultants. We solve all problems; moving, selecting a town, jobs, real estate, business, retirement. Free questionnaire. Surveys, 36 Wendover, Kenmore, N. Y.

**FABULOUS** Opportunities! Government land, U. S., Alaska. Write Sledge Surveys, Macon, Mississippi.

**OZARKS!** \$8 Acre. Listings, information free. Write: Armstrongs, Shook, Missouri.

**BIG** Strout catalog! Mailed free! Farms, homes, businesses, bargains galore! Accurate, reliable descriptions of over 3000 properties in 36 coast-to-coast states! Livestock, equipment often included, many with low down payments and easy terms! World's largest. Serving you 56 years! Depend on Strout Realty, 7-MP S. Dearborn St., Chicago 3, Ill.

**HOMESITES** \$15 Monthly—California's finest garden section. Morro Bay's scenic shores. Wonderful fishing, boating. Fertile soil, softest water, temperate climate, congenial community. Free literature. Richard Otto, Department M, San Luis Obispo, California.

**FLORIDA**. Nice homesites, \$245 at \$10 monthly. Folder free. Howard Vernor, DeLand, Florida.

## POULTRY, FARM SUPPLIES

**GUINEAS**, Ducks, pheasants, eggs and babies; 50 varieties chicks. Low prices, gorgeous book free. Berry's Farm, Route 12, Clarinda, Iowa.

**RAISE** Turkeys the new way. Information explaining how to make up to \$3,000 in your own backyard. Literature 10¢. Address: National Turkey Institute, Dept. 3, Columbus, Kansas.

**GOSLINGS**; All pedigreed breeds. Free descriptive literature. Ridenour's Ranch, Goulds 45, Florida.

**LARGER** Eggs bring larger profits. Free booklet. Linden's, Knox, Indiana.

**POULTRY** Farmers, broiler growers, turkey raisers read the new American Poultry Journal for latest ideas and greater profits. 12 months, 50¢. Special offer, 4 years \$1.00. American Poultry Journal, 180 North Wash, Chicago.

## PROFITABLE OCCUPATIONS

**EARN** \$100.00 A day installing window air conditioners. Millions are sold each year, shortage of trained men. Simple to install after a few hours training. Complete illustrated instructions \$3.00. Anderson Installation Co., 21740 N. Tuller Ct., Birmingham, Mich.

**THEY** Hand him \$100! Free packet. "Secret Journal." 919 secrets-plans! Work home. Publicco, Oceanside, Calif.

**HOME** Mailorder sources, methods, opportunities. Literature free. Carnahan Bros., 9510-D Acacia, Fontana, Calif.

**MAGAZINE** Subscriptions. Largest commissions, bonus. Qualified Agency, 451PA Kingston, Brooklyn 25, N. Y.

**\$10,800 PROFITS!** Your own mailorder business! No risk! Success plan free! Treasury, 709 Webster, New Rochelle L-36, N. Y.

**MAKE** To sell, insulated metal bird houses. Good profit, fast sales. Complete sample kit \$1.00 postpaid. Specialty Manufacturing, Box 236, Cassopolis, Michigan.

**EASY** Street is right down our alley! You'll be set for life in this highly profitable type of automotive service. We train you in our modern, accredited school to become an expert in this specialized service. Thousands of jobs open. Millions of car owners need this service! Write today for facts, no obligation, strictest confidence. Address Box No. 607, Rock Island, Illinois.

**INVESTIGATE** Accidents—Earn \$750 to \$1,000 month. Thousands of airlines, insurance companies, steamship lines urgently need claim investigators. We train you home spare time. Placement counsel and help. Free book—Now! No obligation. Universal Schools, T-2, Box 8202, Dallas 5, Texas.

**FREE!** "301 Profitable Small Businesses!" Amazing shoestring plans! Work home! Start sparetime! Deumant Surveys, Kenmore 23-R, N. Y.

**MAKE** Malta famous almond cookies. Samples, particulars 20¢, Box 83, Elgin, Ill.

**HANDICAPPED** Folks. Excellent pay. Travel U.S.A. Transportation furnished. Advancement, permanent jobs. Help wanted. Box 4605, Kansas City 9, Mo.

**BUY** Wholesale thousands nationally advertised products at big discount. Free "Wholesale Plan." American Buyers', Hertel Station, Buffalo 16-B1, N. Y.

**WELDING** Pays big money. Learn easily at best equipped school in country. Non-profit school with low cost training. G.I. approved. Write Hobart Trade School, Box M-272, Troy, Ohio.

**REPAIR** Porcelain on appliances. Much needed service! Profitable! Free information! Enamel Repair, 422 Prospect, Buffalo 1, New York.

**FORTUNES** Made raising fishworms, crickets. Free literature. Three Oaks Ranch, Dresden, Tenn.

**FREE!** Natural roses. Expect a surprise! Greens, Grand'mere, Que., Canada.

**EARN** \$300.00 Weekly making "bacon drippers" from wire coat hangers. Plans \$1.00. Information free. Danlan Company, Pound Ridge, N. Y.

**JOB** Guidance. What job are you suited for? Send for free questionnaire. National Guidance Service, Landisville, Penna.

**TYPISTS!** Make money at home! Mailers, 2 Madison, Greencastle, Indiana.

**PROFITS** — With pleasure, preserving flowers indefinitely. Eight proven methods. Artcrafts, 12 St. John Road, St. Andrews, N.B., Canada.

**FOREIGN** Jobs—Latin America, Alaska, Canada, up to \$1500 monthly. Up-to-date 1957 foreign service directory gives complete information; hot list of firms hiring for military and civilian construction, aircraft, oil, exporters-importers, mining, \$1.00. How-when-where to apply. 9th successful year! Global Reports, Box 883-S, Hollywood 28, Calif.

**MAKE** Flexible molds. Cast plaques, figurines. Free sample. Tooker, 1045-M Fairview, Hamilton, Ohio.

**FREE** Book. Grow mushrooms. Guaranteed market. Mushrooms, Dept. 99, 2954 Admiral Way, Seattle, Wash.

**VENDING** Machines—No selling. Operate a route of coin machines and earn amazing profits. 32-page catalog free. Parkway Machine Corporation, Dept. 25, 715 Ensor Street, Baltimore 2, Maryland.

**YOUR** Own wholesale business without investment. Free catalog. Norris, 487-X Broadway, New York City.

**BE** The Popular Mechanics representative in your neighborhood and earn big profits in your spare time. Write Popular Mechanics Magazine, Room 408M, 200 E. Ontario St., Chicago, Ill.

**RAISE** Pheasants on \$100 week plan. Little capital and space can make you independent. Free details. Great Central System, Columbus 1, Kansas.

**MAKE** New greaseless doughnuts in kitchen. Sell stores. Free recipes. Michael Ray, 3603 South 15th Ave., Minneapolis 7, Minnesota.

**AUCTIONEERING**—Home study course. Diploma granted. Auction School, Ft. Smith, Ark.

**FREE** Book "505 Odd, Successful Businesses." Work home. Pacific, Oceanside, Calif.

**FREE** Folio "\$5,000-\$45,000: Unlimited Vacations." No merchandise. Unknown! Work home, sparetime! Haylings, Carlsbad, Calif.

**LEARN** How to supply needed information to clients. It pays well. You are taught in a short time, at small cost. Frank Pix, 2056 Switzer, St. Louis 31, Mo.

**BIG** Money raising fishworms and crickets. Free literature. Carter Wormery, Plains, Georgia.

**\$60 WEEKLY**, Spare time—Easy! Home Venetian blind laundry. Free book. Burt, 2434A, Wichita 13, Kansas.

**BUY** Wholesale! Discounts to 80%! Appliances, cameras, sporting goods, housewares, watches, tools, clothing, etc. Buy-Rite 73-03, Wagaraw, Hawthorne 2, New Jersey.

## BOOKS, PERIODICALS, PICTURES, POSTCARDS

BOOKS Bought and sold. E. R. Burroughs, Brand, Schultz, Haggard. Send wants, Di Stefano, 1833 East 24 St., Brooklyn 29, N. Y.

BRITISH Book bargains. Any subject. Catalog 10¢. Transbooks, Box 22-PM1, Brooklyn 26, N. Y.

SIGHT-Saving testaments. Lincoln House of Good Books, Galesburg, Ill.

BOOKS, Essays, lectures, plans. Experimental information. Free list. Tipp Scientific Co., Tipp City 5, Ohio.

INTENSELY Interesting Alaska magazine! True experiences on "The Last Frontier." Send \$1.00 for six back issues. The Alaska Sportsman, Ketchikan, Alaska.

POCKET Novels or magazines, 8 for \$1.00. Mixed selection. George's, Lombard and Central, Baltimore 2.

NATIONAL Geographic Magazines, 1888-1956. Periodical Service, Box 465-PM, Wilmington, Delaware.

OUT-Of-Print books at lowest prices! You name it—we find it! Fast service. No obligation. International Bookfinders, Box 3003-PM, Beverly Hills, Calif.

"SCIENCE Milestones." Records march of science starting 400 years before Christ, right up to date. Amazing facts revealed. 312 pages packed with startling information that will thrill you. A real history of science. \$5.00. Literature free. Popular Mechanics Press, 200-8M East Ontario St., Chicago 11, Ill.

RARE Magazines, catalog 10¢. Nationwide Exchange, Box 1375-P, San Antonio 6, Texas.

BOOKFINDERS! All subjects. Send wants! Jaher Book Service, 183 Hazelwood Drive, Westbury, N. Y.

BOOKHUNTERS! Scarce, rare, miscellaneous books. Atlantic Book Service, Cedar Street, Charlestown 29, Mass.

JOHN Friend, bookfinder, can get the book you want. Free search service. Box 197PM, Cardiff, Calif.

FREE: Exciting catalog packed with books covering most everything. Think of it—From cover to cover you will find described and illustrated hundreds of books telling how to fix and how to build almost anything. How to remodel your home; do your own decorating, plumbing, electrical work. Simplified books covering concrete work, carpentry, painting, furniture making and refinishing. How to build your own boat, home workshop tools. Best books on photography, welding, hobbies, homecraft. How to make a home freezer. Send for your free copy now. Popular Mechanics Press, 200-8C East Ontario St., Chicago 11, Ill.

## GAMES, TOYS, NOVELTIES

CINNABAR, Exciting rock and mineral game, 56 cards, brilliant colors. \$1.25. Dozens other nature items. Free catalog. Naturegraph, San Martin, California.

## MAGIC TRICKS, PUZZLES, JOKER NOVELTIES

FREE Illustrated magic catalog! Entertainment. Great opportunities. Write. Great Heaney, Oshkosh, Wis.

3100 NOVELTIES, Jokes, tricks, gadgets, funmakers, hobbies. Big catalog 10¢. Johnson-Smith, D-407, Detroit 7.

VENTRILLO, Professional voice-throwing instrument and catalog 25¢. Box 971-PM, Philadelphia 5.

WOODEN Nickels, catalog, trick, 10¢. Magico, Box 1375-P, San Antonio 6, Texas.

DOLLAR Magic set free with catalog 25¢. 4462-PM Germantown, Philadelphia.

WORLD'S Finest professional magic. Joker novelties. Giant illustrated catalog 10¢. Top Hat, Evanston 12, Illinois.

500 TRICKS, Douglas famous 120-page catalog, only 10¢. Fastest service to magicians for 30 years. Send 10¢ today. Douglas Magician, Dept. 1, Dallas, Texas.

SMOKEBOMBS 25¢, 7 For \$1.00. Terrific! 4463-PM Greene, Philadelphia 44.

FREE Trick and professional catalog of 600 tricks, \$1.00. Terry's Magic Studio, 1921-66th Street, Brooklyn 4, New York.

PROFESSIONAL Catalog, 175 pages, 25¢. Williams, 900 Plymouth, Ellwood City, Penna.

SVENGALI Trick deck free with catalog 50¢. 1746-PM Market, Philadelphia 3.

COMPLETELY Illustrated 500 trick magic catalog 25¢. Stowell, Woodstock, New York.

SENSATIONAL Magician's wand 25¢. Vanishes handkerchief! Catalog included. Box 1352-PM, Philadelphia 5.

BE A magician! Large professional catalog of latest tricks, 35¢. Ireland, C-109 North Dearborn, Chicago 2, Illinois.

## COINS, TOKENS, CURRENCY

GIANT U. S. coin catalog 25¢. Acecoin, 314 So. Clark, Chicago 4.

\$100.00 FOR Certain Indianheads; Lincoln pennies \$75.00. Booklet showing prices paid, 25¢. Lincoln Coins, D-229, Glendale, Arizona.

PROTECT And glorify your proof sets. Plastic proof holder \$1.00. Skorupa Co., 7412 Arkyle, Harwood Heights, Ill.

OLD Money wanted. Do you know that coin collectors pay up to \$100.00 for certain U. S. cents? And high premiums for all rare coins? We buy all kinds. Send 4¢ for large coin folder. May mean much profit to you. Numismatic Co., Dept. 20, Fort Worth, Texas.

12 DIFFERENT Indian cents, coin list, \$1.00. Pounds, Box 231B, Northwales, Penna.

FREE! Foreign coin, banknote and coin collectors illustrated catalog to approval service applicants. Send 3¢ postage. Tatham Coinco, Springfield 30, Mass.

THREE Different uncirculated U. S. silver dollars, \$5. Melvin Carmichael, 4041 Delaware, Klamath Falls, Oregon.

WE Pay \$100.00 each for certain Lincoln head pennies. Sort all U.S. coins for us spare or full time. All coins are now in circulation and can be found by anyone. Send \$1.00 for catalog listing our paying prices. \$1.00 refunded on our first purchase we make from you. Viroqua Coin Company, Dept. F-4, Viroqua, Wisconsin.

10 DIFFERENT Large Canadian cents \$1.00. Jorgensen, 146 Park, Buffalo 1, N. Y.

INDIAN Pennies—12 different \$1.00. Rhode, 105 Windsor, Reading, Penna.

60 DIFFERENT Coins \$1.00. 60 different bills \$1.00. Oddehon, Box 482, St. Louis, Mo.

GIANT 80 Page bargain catalogue (only one like it in America) \$1.00. Fine 35 gold \$10.95. Bebee's, 4514 North 30th, Omaha 11, Nebraska.

COINS From Formosa, Vatican, etc., plus foreign banknote, 10¢ with coin approvals. Littleton Coin Co., Littleton 81, New Hampshire.

36 DIFFERENT Foreign coins \$1.00. Robbins, 1007 Cleveland, Montgomery 8, Alabama.

U. S. Coin approvals. Reasonable. Hutchinson, 3463 "I" Street, Philadelphia 34, Pennsylvania.

BARGAIN Lists, Indianhead cent, 10¢. Economy Sales, 156-A Dean, Mansfield, Mass.

GET Profit and pleasure in collecting old coins. Send 10¢ for 56-page illustrated coin catalog. You'll be delighted with it. Send for it now. B. Max Mehl, 370 Mehl Building, Fort Worth, Texas. Largest rare coin establishment in U. S. Established 40 years.

WANTED 1822 \$5.00 Gold, pay \$10,000.00. 1913 liberty head nickel \$4,000.00. 1894-S dime \$2,000.00. 1876-C.C. 20¢ piece \$1,000.00. 1901-S quarter \$40.00-\$400.00. 1922 50¢ \$6.00-\$60.00. 1928 Hawaiian 50¢ \$90.00. 1885 trade dollar \$1,000.00. Uncirculated dollars 1804 to 1839, 1893-S, 1895-P, 1903-O, \$100.00-\$5,000.00. Certain dates, small cents before 1924, \$325.00; halfcents, \$500.00; 2¢ pieces, \$70.00; 3¢ pieces, \$90.00; halfdimes, \$500.00; dimes before 1943, \$300.00; quarters before 1924, \$1,000.00; half dollars before 1905, \$1,000.00. Hundreds of others worth \$10.00-\$1,000.00. Canadian coins, 1921-5¢ silver, \$50.00. 1889 dimes, \$25.00. 1875 quarters, \$50.00. 1921, 50¢ \$200.00. Wanted large cents, gold coins, paper money, etc. Know their true value. Our large illustrated guarantee buying-selling catalogue, send \$1.00. Purchase catalogue, giving complete all-coin information before sending coins; none c.o.d. Catalogue dollar refunded on \$20.00 sale. Thousands of persons have sold us coins. Worthycoin Corporation, Leaders Numismatic Quotations K-212-C, Boston 8, Massachusetts.

FIFTEEN Different Indianhead cents \$1.00. Bargain lists free. Sayers, 1000 East Unaka, Johnson City, Tennessee.

BARGAINS, U.S. coins; 1893 Columbian world's fair half dollar, \$1.00. Ten different Indian pennies, 75¢. Two-cent piece, and 3-cent piece, \$1.00. Gold ¼ eagle, \$9.00. Gold ½ eagle, \$12.50. Beautiful coin bracelet, \$1.00. Many coins available. What do you need? Rare Coin Company, 31 North Clark, Chicago 2.

NAZI Coin, Italian banknote, lists, All-10¢. Approvals. Dwight Musser, Dunbar, West Virginia.

OLD Coins, currency bought, sold. Large list 10¢. Thos. J. Settle, Box 1173, Church Street Station, New York 8, N.Y.

LARGEST Coin magazine, 180 pages, 35¢. Scrapbook, T320-J Milwaukee, Chicago 31.

SAN Francisco mint closed! Made only cents and dimes in 1955. In short supply and great demand. One each, brilliant uncirculated, for 25¢. Free coin lists with order. Bryson Stamp & Coin Company, 612 White, Toledo 5, Ohio.

U. S. Large cent, 2¢ piece and bargain list, only \$1. DeImaco, Box 1123, Wilmington, Del.

MORGAN Dollars, 1878-87-90-91-978 \$2.00 ea. New illustrated catalog 25¢. Shultz, Box 746, Salt Lake 10, Utah.

LINCOLN Cents 1910-S, 1913-S, 1921-S, 1923-S, 1924-S, 1933-D all for \$2. Gasser's, Box 34615, Los Angeles 34, Calif.

## STAMP COLLECTING

GIANT Stamp 200 free! Snakes, leopards, rhinoceros, zebu, koalabear and other fierce jungle beasts. Approvals. Send 10¢ for handling. Free stamp magazine. Lincoln Stamp Co., St. Catherine's 518, Ontario.

TOPS! Free book, "How to Collect Stamps." Send for your copy today! Approvals. Littleton Stamp Co., Littleton 81, N. H.

MACAO, Nepal, Burma, Transvaal, Haiti, free! Satisfying approvals follow. Delval, Box 142, Palmyra, N. J.

ROOSEVELT Triangle, 27 others, 3¢. Approvals. Maryland Stamps, Arlington, Baltimore 15, Maryland.

100 BRITISH Empire 5¢. Sets, packets and singles on approval. Mokwa, 1657 N. Tripp, Chicago 39, Ill.

CANADA, Queens, wildlife, commemoratives 10 var, 10¢, attractive approvals. Rheasme, 6391 11th Ave., Montreal 36, Canada.

100 FOREIGN, 20 U.S. commemoratives, 10¢. Approvals. Weckerling, 3210H Hancock, Austin 3, Texas.

PENNY Approvals regardless catalogue. Kloster, 4164 52nd St., San Diego 5, Calif.

THIRD Dimension stamps. Know them. Information 5¢ stamps. Patron, Apartado 1, Campeche, Camp., Mexico.

GERMAN Error plus 21 mint. Approvals. Box 44, Ravinia, Highland Park, Illinois.

VATICAN Cardinals mint set 10¢ with approvals. H. Thompson, Box 552, Monmouth, Illinois.

TWENTY Different Mexico 5¢, approvals. Stampcraft, Box 935-A, Brownsville, Texas.

FREE 10 Different sports to sincere approval applicants. Edison Stamp Co., Edison Centre Sta., Miami 51, Fla.

FIRST U.N. set. Among world's prettiest. Only 10¢. Approvals. Welles, Box 1246-R, New York City 8.

LIBERIA Beautiful set of four native flowers, priced at 60¢ in standard catalog, only 10¢. Approvals. Goliath Company, Bethlehem Fl, New Hampshire.

PORT-Said, Syria, Lebanon, Egypt, Israel, free! Personalized approvals. Panorama, Box 229, Miami 2, Florida.

84 WORLD Coats-of-arms in color, 10¢. Approvals follow. Monumental, Box 3307, Baltimore 14, Maryland.

U.S. Stamps. Discount priced. Giant catalog 15¢. Raymax, 35-VZ Maiden Lane, New York City 38.

275 STAMPS Only 10¢ with approvals. Wm. Rice, 87 Washington Ave., Kingston 14, N. Y.

75 DIFFERENT U.S., 10¢. Approvals. Edgar, Box 437M, Punxsutawney, Penna.

ZEPPELINS—Complete Germany set free with foreign approvals. Postage appreciated. Variety Stamps, 57-X Circuit, Newton Highlands 61, Mass.

FREE! 107 British Colony stamps. All different, from Britain's farflung colonial empire. Catalog value \$2.50. Free stamp magazine, approvals. Send 10¢ for handling. Act now! Niagara Stamp Co., St. Catherine's 71, Ontario.

FOREIGN Approvals with free gift. Smith, 504 Water St., Warren, Penna.

135 DIFFERENT U. S. commemoratives \$1.00; 50, 25¢. Request approvals. Harold Holub, 18 East 198th St., New York 68, N. Y.

FREE! Giant catalog offering thousands of bargains. Sent with beautiful approvals. Jamestown Stamp Co., Dept. E2PMC, Jamestown, N. Y.

50 DENMARK Free. Approvals. Walter Kotowski, 19265 Eureka, Detroit 34, Mich.

101 DIFFERENT 10¢ Approval applicants. Anderson, 1112 Harrison, San Francisco 3, Calif.

FAR Eastern Republic scarce multicolored imperforate set, plus 30 other interesting stamps. Only 10¢ to approval applicants. Montalto, New Church, Virginia.

FREE Stamps to approval applicants. Rawls, 9098 W. Swan Circle, Brentwood 17, Mo.

50 DIFFERENT Israel \$1.00, approvals. Coral, Box 224, Riverside Station, Miami, Florida.

MONACO Triangles 10¢. Approvals. Karr Ross, 2614 Elmwood, Alexandria, Virginia.

40,000 VARIETIES Available on approvals. 1/4¢ upwards. Keigwin, Box 933B, Daytona, Florida.

FREE! 50 British Colonies. 5¢ handling. Approvals included. Kensington Stamps, Buffalo 15, N. Y.

FREE Packet! Angola, Azores, Mongolia, Nepal, Palestine. Fascinating approvals. Coral, Box 7095, Ludlum, Miami 55, Fla.

SIX Triangles free to approval applicants. Rare, Box 633, Coconut Grove Station, Miami 33, Florida.

500 DIFFERENT With approvals 25¢. Park Stamp and Supply, 101M Rochelle, Rochelle Park, New Jersey.

GIGANTIC Collection free. Includes triangles early United States, animals, commemoratives, British Colonies, high value pictorials, etc. Complete collection plus big illustrated magazine all free. Send 5¢ for postage. Gray Stamp Company, Dept. PM, Toronto, Canada.

WOW! 135 All different Germany 10¢. Zeppelins, semi-postals, airmails, high values. Big bargain lists and approvals included. Jamestown Stamp, Dept. A2PMC, Jamestown, N. Y.

50% OFF Scott catalogue; send for bargain approvals. Catalina Stamps, Box 206-A, Avalon, California.

FREE! Monaco, triangle, Cameroons, Togoland! Approvals. Keating, 2520-F Boulevard, Jersey City, New Jersey.

FANTASTIC Collection: Triangles, bi-colors, weird fish, jungle beasts, British Colonies, dead countries, sports, Siberian surcharges, wild birds, flying horse, many more. Just 5¢; approvals and bargain catalogue. Robert Menifee, 4307 Butlerplace, Oklahoma City 18, Oklahoma.

LUXEMBOURG, 25 Different 5¢. Approvals. Neal, 5950 Tower, Riverside, Calif.

SIBERIA. First stamps issued. 1909 set of four miniature surcharged stamps. Catalogues 52¢; just 5¢; approvals. Robert Menifee, 4307 Butlerplace, Oklahoma City 18, Oklahoma.

FREE! 25 Different Mozambique Company with approvals. Send 10¢ handling. Foxboro, Box 167, Foxboro, Massachusetts.

200 DIFFERENT, Including triangles, pictorials, only 10¢ with approvals. Finney, Box 89, El Monte, Calif.

FREE Stamps with low-priced worldwide approvals. Postage paid. Enclose 10¢. P. Roy, 160 St. Johns Place, Brooklyn, N. Y.

ALBANIAN-Roosevelt set free. Approvals. W-B Stamps, Wilkes-Barre, Penna.

99 DIFFERENT Latin Americans, just 10¢. Approvals included. Fred Pittsley, South Montgomery, Napa, Calif.

PENNY Approvals; bargains for pennies. Free gifts. Penny Stamps, Orange 1, California.

125 DIFFERENT United States—\$1.00, approvals. Utechts, 1143J North Keeler, Chicago 51.

NIUE, Cook, Samoa, Sarawak, many other fascinating issues from far away places. 5¢ with approvals. Stamp Imports, Peterborough, Ontario, Canada.

CROATIA Government in exile, triangles, 12 different picturing beautiful birds and flowers. 5¢; approvals. James Menifee, 4307 Butlerplace, Oklahoma City, Okla.

UNITED Nations, latest meteorologicals. (Complete—mint) 10¢. Approvals. William Deems, Ravenswood, West Virginia.

KENYA—Queen set to 1/-Free with approvals. Lee Hoover, Box 3594, Portland 8, Oregon.

200 DIFF. World wide 25¢, plus surprise packet. Packet list free. Econopackets, Box 168, Riverside 9, Calif.

60 DIFFERENT Canada 50¢. 60 different U. S. commemorative 50¢. George Lawson, Middleburg, New York.

VATICAN, 25 Different mint stamps, 25¢ with approvals. Excellio Stamp Company, Box 469, Red Bank, N. J.

THREE Monaco Pipex, 50 others with approvals. Bennett, Candor 3, N. Y.

1957 U.S., U.N. illustrated catalogue free. Stone, 192 Washington, Boston 8, Mass.

U. S. \$5 Coolidge (S. D.)—25¢, approvals. Gatewood, Box 346, Winston-Salem, N. C.

PRICE List, foreign and U. S. No approvals. Stamps, 5000 Miami, St. Louis 9, Mo.

FRENCH Colonies stamps on approval. Bernou, R. 1, Box 367, Clearwater, Fla.

FREE! 25 Different mint China. Approvals. Wright, 6435 Edloe, Houston 5, Texas.

FREE! Triangles, coronations, sports, animals, Monaco Pipex; given approval applicants. Exotic, Box 482-M, Coral Gables 34, Florida.

TRIESTE Automobiles complete! Catalogues \$1.65; only 30¢ with approvals. Connelly, Box 474, Portsmouth, New Hampshire.

500 DIFFERENT 50¢. Giant, midget triangles. Others. 3¢. Delton Page, Box 201X, East Paterson, New Jersey.

UNITED States. Fine mint airmails. #C7, #C8, #C9, #C10. Only \$1.00. Approvals accompany. Whiton Paine, Westport 11, Connecticut.

FREE! 50 Different British Colonies. Inexpensive approvals follow. Pan-American, Box 24, Coconut Grove, Miami 33, Florida.

CANADA, 1870 To date. 1000 mixed \$1.00. Higher values, commems. 300 mixed \$2.00. Affleck, 163 Alexandra St., Oshawa, Ont., Can.

UNITED States commemorative collection containing 33 different—10¢. Approvals. White, 516-A Avenue L, Brooklyn 30, New York.

TWO \$5.00 U.S. stamps plus 20 different, 10¢ with U.S. approvals. Irwin, Box 1105, Brooklyn 30, N. Y.

SELL Your surplus good grade stamps. Write, describing fully what you have. Vanroy Shirk, Lebanon, Pennsylvania.

FREE! Catalog! About stamps. Illustrated. Free! The Stampmart, Hartford 1, Connecticut.

FREE United States price list. Mark Hanna, 335 Fifth Ave., Pittsburgh 22, Penna.

50 DIFFERENT Argentine 10¢. Approvals. Reuter, 611 W. 40th Pl., Los Angeles 37.

77 DIFFERENT U.S.—25¢. Approvals. Utechts, 1143D North Keeler, Chicago 51.

U. S. Classics. Over 50 yrs. old. 15 selected old-timers. Missing in biggest collections. All 15 at less than 1¢ each. 10¢ with approvals. Jaro, Box 246-T, New York City 8.

50 DIFFERENT United States 5¢ with bargain approvals, lists. Bookman, Box 8245-M, Madeira Beach, Fla.

AMAZING Offer! 200 United States stamps—including commemoratives, airmails, high denominations to \$1.00. Only 10¢ to approval applicants! Illustrated bargain lists free. Mystic Stamp Co., Dept. 80, Camden, New York.

100 STAMPS, 10¢ With approvals. Smith, 508A Brooks, College Station, Texas.

225 STAMPS For only 10¢! This mammoth value includes airmails, pictorials; stamps from strange countries cataloging up to 23¢ each! Also approvals. Mystic Stamp Company, Camden 80, New York.

MINT U.S. plate blocks. Bargain approvals. Kuehl, 3125 East K, Tacoma 4, Washington.

ECONOMICAL 15¢, 16, 2¢. Approvals. 22,000 varieties. Dresel, Box 128-N, West Englewood, New Jersey.

OLD Scarce U.S. seconds on approvals. Slight imperfections, lowest prices. Herfield, Cliftonhill Sta., Newark 8, N. J.

100 OLD United States between 1881 and 1935, \$1.00. Roush Stamps, 51 Chestnut, Mansfield, Ohio.

UNITED States approvals. Select copies, used—mint. Kingsbury, Fairfax, Vermont.

ICELAND 10 Different beautiful stamps for only 10 cents to applicants for our good old fashioned approvals. Old Colony Stamp Co., Dept. A, Milford, Connecticut.

100 DIFFERENT China 10¢. Approvals. Coast, P.O. 2187H, Santa Ana, California.

1-2¢ EACH! Thousands of exciting worldwide stamps. Free examination. Cole, Box 223-A, Buffalo 21, N. Y.

SELL Stamps to our readers. Your ad in this space will be read by thousands of stamp buyers. I'll prove that to you. Write now for Folder "S." F. W. Johnson, Classified Advertising Manager, Popular Mechanics, 200 E. Ontario St., Chicago 11, Ill.

FREE United States illustrated catalog. Bailey, 45 Bromfield, Boston, Mass.

U.S. Flag, \$5.00 stamps, 25 different collection. Only 10¢. Approvals. Willett Stamps, Box 390-A, Mount Kisco, N. Y.

PICTORIAL Packet from Antigua, Barbados, British Guiana, British Honduras, Burma, Curacao, Leewards, Rhodesia, Trinidad, Tobago, and many other hard to get countries. Bi-colors, topicals. Tremendous value. Each stamp a beauty. 10¢ with inexpensive, attractive approvals. Roseland Stamps, Spring Lake 2, Michigan.

100 DIFFERENT China 10¢ with approvals. Plymouth, Box 510-M, Bell, California.

FREE Stamp collection! 100 different stamps from Europe, Africa, Asia, Scandinavia, Balkans, etc. 3¢ to approval applicants. Tatham Stamp Co., Springfield 30, Mass.

STAMP Collecting outfit, includes packet worldwide stamps, package hinges, watermark detector, millimeter gauge. Everything 10¢ with approvals. Lorain Brown, Marion 1, Michigan.

FREE—Mint British Colonies from North Borneo, Caymans, Seychelles, Dominica, Papua, New Guinea, Sarawak, Brunel. Free with approvals. Viking, Great Neck 8, N. Y.

100 DIFFERENT Austria, 10¢. Approvals. Aronson, Box F, Newton Centre 59, Mass.

GIANT Approvals, thousands different, 1¢ and 2¢ each. Wahl's Stamp Exchange, 7008P Farragut, Chicago 31, Ill.

MINT U. S. at face value! All different older commemoratives! Send 25¢ for yours with first selection mint U. S. approvals. Western, Box 1689P, Salinas, California.

100 DIFFERENT U. S. commemoratives \$1.00. Wiggins, Box 73-P, Guild, N. H.

8 CANAL Zone 10¢. Approvals! Merkel Stamps, 45 Cherry, Holyoke, Mass.

SELLING Out. Surprise packet 40¢. Perley Porter, West Medway, Mass.

14,000 DIFFERENT! Fascinating new club plan systematically builds your collection. Only 50¢ weekly. Details free. L. G. Ware, Baldwin 75, New York.

FREE! Korea, Eritrea, Somaliland, Curacao, Mongolia; satisfying approvals. Buckeye, 163 No. Congress, Athens, Ohio.

100 DIFF. Foreign, 50 diff. U.S.A. 10¢ approvals. Kem, 670 W. Florence, Los Angeles 44, Calif.

WONDERFUL Offer. 7 complete mint sets only 10¢ with approvals. Reich (M26), 1633 Lawrence, Chicago 40.

70 DIFFERENT U.S., included 35 commemoratives, 25¢. No approvals. Seldenberg, Appleton, Wisconsin.

U. S. Revenues on approval. El Jay Stamps, Box 286, New York 38, New York.

**SOUVENIR** Sheet Russia 1937 10¢ with approvals. Kingman, 30 Empire, Yonkers 4, N. Y.

**WEIRD** Diamond shape coffee stamps. Lovely flower triangle! First American big commemorative. Greenland, idol dancer, etc. Free with approvals. Capital Stamp Co., Ferrysburg 2, Mich.

**WANT** Lists filled. 100,000 varieties available. References. Downey Stamp Service, Box 70A, Bell, California.

**BRAZILIAN** Packet airmailed direct, \$1.00. Mauricio, Caixa Postal 515, Anapolis, Goias, Brazil.

**FIVE** Different sets French Colonies, 10¢ with approvals. Banner, Box 65, Park Forest, Illinois.

**84 BICOLORED** World flags 10¢, inexpensive approvals. Americana, Box 1560, North Miami, Florida.

**QUEEN** Elizabeth mint sets! Barbados, Caymans, Dominica, Tristan, Gibraltar, Leewards. 21 bicolors—25¢! Approvals. Gannon Stamps, Box 931, Canton 1, Ohio.

**SUPERIOR** Worldwide mission mixture. Amazing variety! Half pound only \$1.50. Baye Nielsen, 4545B Harvard, Montreal 28, Canada.

**FREE** Sample! Interesting, informative, illustrated. National Stamp News, Anderson, South Carolina.

**25 PICTORIALS** 10¢ With approvals. Blaha, 3730 Cleveland, Brookfield, Ill.

**ADEN** To Zanzibar! A special collection of over 200 different stamps from Aden, Barbados, Cyprus, Dahomey, Egypt, Falkland Is., Guadeloupe, Hejaz, Israel, etc., to Zanzibar. Very unusual collection, catalog value easily \$5.00. Some really scarce ones included! Only 25¢ to approval applicants! Write today and receive free—Eisenhower, Grace Kelly and Geo. Washington stamps from Monaco! Lyle Clark, Muskegon 2, Michigan.

**FREE!** Your choice any volume Scott's International, Master Global albums, Scott's 1957 catalogues when you buy our sensational foreign approvals. Write for details with trial selection. Bargain Stamps, Redlands, California.

**25 DIFFERENT** Philippines 10¢. Attractive approvals. Barry, Box 25, Shelbyville, Michigan.

**100 DIFFERENT** Netherlands, 10¢; inexpensive approvals. Mattenson, Box 985, Philadelphia 5, Penna.

**25 DIFFERENT** Egyptian, 5¢. Inexpensive approvals. Somith, Box 83, Brooklyn (Rugby), N. Y.

**ALL** Different—500, 50¢; 1000, \$1.25; 2000, \$3.00; 5000, \$12.00; 100 Canada 35¢. Approvals. K. S. Holmes, London, Canada.

**30 DIFFERENT** Commemoratives 1893 up 10¢. U. S. approvals. K&B, Box 70, Brooklyn 23, N. Y.

**WEDDING**, Pipex, triangles, animals, free! Inexpensive approvals. Rose Stamps, 711 Arundel, Emporia, Kansas.

**EXCITING** "Strange countries" packet. Free with approvals! Saxon, Orange, California.

**TEN** Topical triangles 10¢. Approvals. Gernert, 4235-X Alton, Louisville 7, Ky.

**FAMOUS** Americans, 21 different, 25¢, approvals. Ludwig, 9012 Niles, Affton 23, Mo.

**FREE!** British West Indies packet, with colorful, inexpensive approvals. Townsend, Box 386, Chester, Penna.

**FLOWERS!** Spanish colonies 1956 set complete 15¢ with approvals. Ralph Rice, 15 Longlane, West Hartford 7, Connecticut.

**PAKISTAN**, 25 Different 10¢ with inexpensive approvals. Rogers, Box 485-M, Albany 1, N. Y.

**FREE!** 9 Armenia bi-colored, (50¢ value) with approvals. Diane, Box 70-M, Hartsville, South Carolina.

**25 DIFFERENT** Spanish colonies 10¢; attractive, inexpensive approvals. Village Stamps, Box 111, New York 9, N. Y.

**BEAUTIFUL** Liberia Pipex postage set 10¢. Approvals. Jess T. Green, P.O. Box 698, Mountain View, California.

**12,000 PENNY** Approvals waiting for you. Many from exotic countries, pictorials, airmails, new issues. Tilbury, Box 862, Newark 1, N. J.

**50 DIFFERENT** Switzerland 10¢; colorful, inexpensive approvals. Ekhardt, Box 33, Ekhardt, Indiana.

**DOMINICAN** Bicolored commemorative packet free with interesting approvals. Hilltop, Box 896, Havertown, Penna.

**U. S. mint** specials! 13 different commemorative, 25¢; flags, complete, \$1.00; 4 different souvenir sheets, \$1.00. Free price list. Brooks, 2352P East 23rd Street, Brooklyn 29, New York.

**COMMEMORATIVES**, Triangles, pictorials—25 different free with approvals. Beacon Sales, Maynard, Massachusetts.

**FREE!** Monaco Roosevelt set! Inexpensive approvals. Atomic, Box 295-A, Silver Spring, Maryland.

**QUALITY** Approvals, 500 at 2¢ each. Hadrian, 12 East 31st, New York City 16.

**90,000 STAMPS** Sale: Big lot including beautiful Mona Lisa, Greece, Egypt, Malta, Turkey, \$1. Extra special better stamps \$2. Giant assortment \$5. Literature free. Persil, 436 N. Y. Ave., Brooklyn 25, N. Y.

### ANTIQUES, RELICS, INDIAN GOODS, CURIOS

**ILLINOIS "Gesundheit"** — Disposing of \$300,000.00 collection of 500 historical firearms; revolutionary, civil, Indian war, flintlocks, muskatoons, swords, bayonets, bullet molds, powder flasks, Kentucky rifles, pepperboxes, dueling pistols, 50,000 Indian relics, collectors cartridges, coins, Confederate money. Agates, minerals, fossils, mounted birds, animals, deerheads, gold dollars, bo-wood, violin wood, blower-horns, daguerreotypes, a 400 page catalog would not list everything. Send 35¢ for profusely illustrated catalog. Heike's, Brookville, Wenona, Illinois.

**10 ANCIENT** Arrowheads \$2.00. Grooved tomahawk \$3.00. List free. Lear's, Glenwood, Arkansas.

**SELECTED** War arrowhead \$1.00. List 5¢. H. Talburt, Calico Rock, Ark.

**SCALPING** Knife, spearhead, thunderbird \$4.00. Catalog free. Arrowhead, Glenwood, Arkansas.

### PRECIOUS STONES, MINERALS

**18 COLORFUL** And basic U. S. mineral specimens attractively boxed with descriptive folder \$1.00 prepaid. Included free dinosaur bone pocket piece, Rock Haven Mineral Co., Whitefield 2, N. H.

**TEN** Minerals \$1.50, six fluorescent \$1.00, five crystallized minerals \$1.00, fool's gold 25¢. Hartoon, Winston, N. Mex.

**EARTH** Science, the Rockhounds' national magazine. Subscription \$2.00, sample 25¢. Box 1357, Chicago 90.

**SAPPHIRE**, Topaz, tourmaline, garnet, peridot. Five uncut gem specimens, \$1.00. Ten polished gems, baroque shaped, \$1.00. Free bargain list jewelry, gems. Profitable, easy "do-it-yourself" projects. O'Brien's, 1116M Wilcox, Hollywood 38, Calif.

**CUT** Gems, make jewelry—For profit or fun. 100 page magazine tells how; where to get supplies. Sample 25¢ or request free literature. Lapidary Journal, Del Mar 2, Calif.

**AGATES**, Gems, machines. Free list. Northwest Gems, 2819 North Warner, Tacoma 7, Washington.

**SIX** Assorted polished stones \$2.00. Artcraft, Box 268, St. Cloud, Minnesota.

**MINERALS** Of economic interest. 64 one-inch specimens, labeled, \$6.00 postpaid. Satisfaction guaranteed. Minerals Unlimited, 1724 University, Berkeley 3, California.

**FIND** Uranium, tungsten, mercury, hundreds of other minerals with Mineralight. Free information kit on fun and profit in fluorescent minerals; hobby set. Write Dept. PM8, Ultra-Violet Products, San Gabriel, California.

### HOBBIES AND COLLECTIONS

**125 MILITARY** Campaign ribbons, shoulder patches. Includes purple heart ribbons. Sterling silver officer's wing insignia free with order. \$2.00 postpaid. Victory, 8211 South Alameda Street, Los Angeles, Calif.

**BUTTERFLIES**, Real, colorful specimens from Asia, Africa. For collectors, hobbyists; 20 assorted \$2.00. American Butterfly Co., 3706 Rosedale Road, Baltimore 15, Maryland.

**COLLECTORS** Matchbook covers, 100 different unused, \$1.00. Catalog 25¢. Album \$3.00. Charles Edelman, 1311-C East 84, Cleveland 3, Ohio.

**INVENTING** Can be an interesting and profitable hobby. Write for complete particulars. Institute of American Inventors, Dept. 40-E, 635-F St., N.W., Washington 4, D. C.

**NAZI** Insignia, 12 different \$1.00. Medals, patches, armbands, flags, daggers. Illustrated lists, 10 cents. Medcrafts, Box 532, Victoria, B.C. 2, Canada.

**WANTED** Old cigarette cards. Write Charles Bray, East Bangor, Penna.

**MILITARY** Miniatures, Civil War, Custer's Cavalry, American Revolution and U. S. Marines. Illustrated catalog 35¢. Bussler Miniatures, Dept. 2, 40 Howe St., Quincy 69, Mass.

### CAMERAS, PHOTO SUPPLIES

**PHOTOGRAPHY** For pleasure or profit. Learn at home. Practical basic training. Long established school. Free booklet. American School of Photography, 835 Diversey Parkway, Dept. 3442, Chicago 14.

**BASS** Says: Quality cameras since 1910. When in Chicago visit the camera cross roads of the world, or write us your favorite equipment, new or used. Satisfaction guaranteed. Bass Camera Co., Dept. AG, 179 W. Madison St., Chicago 2, Ill.

**BUY** Wholesale nationally advertised cameras, photo supplies, thousands other products at big discount. Free "Wholesale Plan." American Buyers, Hertel Station, Buffalo 16-E1, N. Y.

**LEARN** Camera repair. Easy, complete, approved home-study course. Free illustrated booklet. National Camera Repair School, Dept. L-2, Englewood, Colo.

**3-D** Stereo camera, flashgun and viewer. English import. Complete outfit only \$12.95. Literature, photo 10¢. Navair, 4234 Adams, San Diego 16, Calif.

### PHOTO FINISHING

**STAROTYPE** Enlargements: Amazingly different. Eight 5x7's or five 8x10's—\$1.00. Hargraves, Box 373, Hollywood 28, California.

**8-HOUR** Service on deluxe jumbo prints. 8-exposure roll developed and 8 jumbo prints 40c, 12 exposure 55c, 16 exposure 70c; 35mm. 20 exposure 75c, 36 exposure \$1.25. Jumbo decklegrade reprints 4c each. Contact prints made if specified. Bay Photo Service, P.O. Box 210, Oakland, California.

**EKTACHROME** Processing — \$1.00. Transparencies printed, 2X 45¢; 3X 65¢. Photocolor Laboratory, P.O. Box 617, Toledo 1, Ohio.

**ENLARGEMENTS**, Heavyweight eight 5x7's or five 8x10's, \$1.00. Jack Koons, Huntington Mills, Luzerne County, Pennsylvania.

**SUPERIOR** Quality. Prompt service. 8 jumbos in album 40¢. 18 contacts 50¢. Jumbo reprints 5¢. Satisfaction guaranteed. Also complete color film finishing service. Write for free circulars and mailers. Fast-X-Photo, Box A, Jersey City, N. J.

**LIFETONE** (Copyright) ultra fine grain prints. Custom developing plus oversize prints on heavy portrait weight paper. Salon quality. 8 exposure 70¢, 12 exposure \$1.00; 35mm—30 exposure \$1.75, 36 exposure \$2.75. Free mailers and circulars. Send to Lifetone Photo, Post Office Box 96, Chicago 17, Illinois.

**8-12 EXPOSURE** Rolls 39 cents jumbo prints. Free 5x7 enlargement with each roll developed. Guaranteed work, one day service. Lincoln Studios, Dept. K, Box 13, Lincoln, Nebraska.

**QUALITY** Kodak finishing. 8 exposure roll 40¢; 12 exposure 60¢; 18 exposure 70¢. Reprints 5¢. Fast service. Guaranteed quality. 40 years continuous operation. Be a satisfied customer. We do color. Send for mailers. Mail Order Photo Service, Box 297, Watertown, Wisconsin.

**COLOR** Developing. Ektachrome, Anscochrome rolls \$1.00. Dycolor, Box 3223A, Washington 9, D.C.

**EKTACHROME**, Anscochrome, Processed \$1.00. Fast Kodachrome, Kodacolor service. National Color Corporation, Box 55P, Northside, Atlanta, Georgia.

**NEW** Kolourchrome color prints. White borders. 2 1/2 x 3 1/4, 2 9/16, 3 1/4 x 3 1/4, 4 1/4, 4 9/16, 5 x 7, 9 9/16. Anscochrome—Ektachrome processing \$1.00. Kolour Labs, Inc., Box 383, Boise, Idaho.

### MOTION PICTURES AND SOUND EQUIPMENT

**16MM.** Sound films. Free lists. Crawford Films, 412 Page St., Fort Worth 10, Texas.

**8-16MM.** Films. Free catalogue, with sample film 10¢. Garden, 690 Howard Avenue, Brooklyn, N. Y.

**FREE!** Blackhawk's big sale catalog new and used 16mm., 8mm. films; 2"x2" color slides; used 16mm. sound projectors. Biggest stock in U.S.A. Blackhawk Films, 1700 Eastin, Davenport, Iowa.

**SAVE 50%!** Guaranteed-fresh color, b.w. movie film! 8mm., 16mm. Free catalog! Eso-R, 47th Holly, Kansas City 12, Missouri.

**16 MM.** Sound films. Bargain prices. Bedner, 5300 So. Talman, Chicago.

**5,000 8-16MM.** Movie films. Free catalogues. International, Greenvale, N. Y.

**TAPE** Recorders, tape. Unusual values. Free catalog. Dressner, 69-02M 174 St., Flushing 65, N. Y.

**MOVIE** Camera film: 8mm. roll \$1.50, 16mm. 100' \$3.00. Free processing. Better Films, 742 New Lots, Brooklyn, N. Y.

**RECORDERS,** Tapes; wholesale. Free catalogue. Carstan, 215 E. 88, New York City 28.

### MUSIC AND MUSICAL INSTRUMENTS

**ACCORDIONS** Wholesale—10 day trial. Free catalog. American Accordion Center, 5329-PM-2 Belmont, Chicago.

**INDEPENDENT** Songwriters agency, wants songpoems, songs. P.O. Box 16A, New York City 19.

**SONGWRITERS:** Recording company wants new songs. Royalty basis. National sales, promotion if selected. Send material. Music Makers, Dept. E-30, Box 2507, Hollywood, Calif.

**POEMS** Songs wanted! Recording, publishing. Bengol, 93 Jefferson, Chelsea 50, Massachusetts.

**ACCORDION** Repair Guide. New edition. Simple, basic, indispensable. Explains making reeds, bellows, basses. Money return guarantee. Send \$3. Fischer, Box 402, Bellingham, Wash.

**ACCORDIONS**—Direct from importer. Save 50% and more! Free trial. Lifetime guarantee. Trades accepted. Free catalog. Write Accordion Manufacturers, Dept. 27R, 2003 Chicago, Chicago 22, Illinois.

**SONG** Request forms made for two dollars. Howard Olenk, Mount Morris, Mich.

**PLAY** Piano the first day! Copyrighted secret. Details free. Miracle Method, Box 5205P, Phoenix, Arizona.

**ACCORDIONS,** Wholesale to everyone. Save up to 60%. All national known brands. Free catalogue. Del Principe, 29 South Cicero, Chicago 44.

**WRITE** Songs. Big money and reputation. Write for information. J. Gordon Pub. Co., 4700 South California Avenue, Chicago.

**SONGPOEMS** And lyrics wanted. Mail to: TinPan Alley, Inc., 1650 Broadway, New York 19, N. Y.

**SONGS** Into dollars. Share \$29 million dollars yearly for new songwriters, song-poets. Songs composed, published, promoted by famous firm. Information appraisal free. Send to Nordyke Publishing, 6000 Sunset, Hollywood 28PM, California.

**POEMS** Wanted for new songs. Send poems. Free examination. Immediate consideration. Songcrafters, 2724 Arcade Station, Nashville, Tenn.

**WANTED** Used guitars and banjos. Write description and price wanted. Eddie Bell, 101 West 46 Street, New York 36, N. Y.

**SONG** Poems wanted. Five Star Music Masters, 630 Beacon Building, Boston.

**POEMS** Wanted for new songs. Send poems. Immediate consideration. Crown Music Company, 49-C West 32 Street, New York City.

### RADIO, TELEVISION AND ELECTRONICS

**KNOW** Your television! Circuit diagram with detailed tube and parts data. Send make and model number, \$1.00. Telpix, P.O. Box 1283, Oakland 4, Calif.

**WHOLESALE:** Phonographs, Radios, Tape recorders. Catalogue 25¢ (refundable). Towers, 155, Philadelphia 5.

**CRYSTAL** Radio experimenters write to Hulet, 305 Hope, Lakewood, N. J.

**FREE!** Giant bargain catalog. 100's items. Transistor radios, kits, portables, audio, electronics, photographic, optics, tools, household. Write Lektron, 131M Everett, Chelsea, Mass.

**GOVERNMENT** Approved two-way radio. 10 mile range. Operator's license unnecessary! \$69.75. Hart, 467 Park, Birmingham, Michigan.

**"ONE Tube DX'er"** handbook 30¢. Laboratories, 328-C Fuller, Redwood City, California.

**GOVERNMENT** Surplus radio gear. Astounding picture list 5¢. Meshna, Malden 48, Mass.

### BUSINESS OPPORTUNITIES

**\$5000.00 YEARLY.** Part time, in one of these businesses: Mail order; real estate; photography; insurance; bookkeeping; collection. Write today. Nationwide, 618 Savannah, Columbus 4, Ohio.

**MAKE** Attractive, durable, building plastic, easily, 800% profit. Exclusive district. Bays Laboratory, Oklahoma City 9.

**FREE** Book. Grow mushrooms. Guaranteed market. Mushrooms, Dept. 172, 2954 Admiral Way, Seattle, Wash.

**PRINTING,** Office supplies wholesale. Save 50%. Royal, Box 368-A, Cleveland 27, Ohio.

**MAKE** Flexible molds. Cast plaques, figurines. Free sample. Tooker, 1045-R Fairview, Hamilton, Ohio.

**WANT** To make big money at home? \$10.00 profit in an hour possible with invisible reweaving. Make tears, holes disappear from clothing, fabrics. Steady year-round demand from cleaners, laundries, homes. Details free. Fabroon, 8334-S Prairie, Chicago 19, Illinois.

**TAPE** Recording! Exceptionally profitable opportunity in your area. Free information. Baron's, Lynden, Washington.

**NATURAL** Molding rubber, extra thick. Free sample. W. Wooley, 1016-A Donald, Peoria, Illinois.

**INTERNATIONAL** Mailorder business. Complete setup service—Not just instructions. Hermes, 152 West 42, New York City 26.

**\$100 WEEKLY** Raising earthworms! Free plan reveals how! Oakhaven-P, Cedar Hill, Texas.

**YOU** Can make money at home in spare time taking magazine renewal subscriptions. No capital or experience necessary. All supplies furnished. Write today! McGregor Magazine Agency, Dept. 500B, Mount Morris, Illinois.

**BIG** Money raising fishworms and crickets. Free literature. Carter Farms, Plains, Georgia.

**INTERESTED** Mail order? Samples leading mail order magazines 10¢. Palm, Box 1221, Baton Rouge, La.

**START** Home business making statuary, plaques, novelties, garden furniture, artificial marble flooring, liquid marble. Make your own flexible molds. Amazing profits. Only \$1.98. Free literature. Popular Mechanics Press, 631 No. St. Clair St., Chicago 11.

**UNUSUAL** Mailorder opportunity. Tested. We supply everything. Girard's, Azusa, Calif.

**\$80 WEEKLY.** Spare time, easy! Home Venetian blind laundry. Free book. Burt, 2434A, Wichita 13, Kansas.

**FREE** List (unusual businesses) for homeworkers. Ballard's, 425 East Catherine, Louisville 3, Ky.

**YOUR** Own mailorder business. Manual 25¢. George McCutcheon, 638 W. Creighton, Fort Wayne, Ind.

**FREE:** "How to make quick, easy money." Gee., La Verne, California.

**WHOLESALE**—Thousands nationally advertised products. Buy, sell. Amazing profits. New, free plan. Associated Wholesalers, 1016-D Starr, Burlington, Iowa.

**WANT** More business? Here's an amazing opportunity to increase your sales. Talk to thousands of interested readers of "Mechanics Popular." Our Spanish Edition covers the Latin American countries like a blanket. They're real mailorder buyers. Classified rate 75¢ per word. Try an ad in our next issue. Classified Advertising Department. Popular Mechanics Magazine, 200 East Ontario Street, Chicago 11, Ill.

**PLATE** Baby shoes, jewelry, gifts, bronze and colored pearl. Free booklet. Platex, 11029 South Vermont, Los Angeles 44.

**VENDING** Machines—No selling. Operate a route of coin machines and earn amazing profits. 32-page catalog free. Parkway Machine Corporation, Dept. 25, 715 Ensor Street, Baltimore 2, Maryland.

**GROW** Orchids at home—Profitable, fascinating. Year 'round. Maine to California. No greenhouse. Gorgeous cactuses, cymbidiums, etc. Successful home grower shows you how. Full details free. Flowerland, 100 So. Vermont, Los Angeles 4.

**HOME** Workshop books. Free catalog. Popular Mechanics Press, 631 N. St. Clair St., Chicago 11.

**LIQUID** Rubber, make flexible molds. Free sample. Chaney, 1130 E. 16th St., Jacksonville 6, Fla.

**MONEY** In saw and lawnmower sharpening sparetime at home. Free book. Virgil Foley Company, Columbia Heights, Minnesota.

**FREE** Folio "\$5,000-\$45,000, Unlimited Vacations." No merchandise, equipment. Unknown! Work home, sparetime! Haylings, Carlsbad, Calif.

**\$250 WEEK** Cleaning venetian blinds. Patented machinery. Free literature. Robinson, 7213B, Indianapolis 1, Indiana.

**FIX** Typewriters. Inexpensive home course teaches factory secrets. Free booklet. Write, Typewriter, Tarentum 1, Penna.

**\$70 WEEKLY**—Home, spare time. Simplified mail bookkeeping. Immediate income—easy! Auditax, 34757A, Los Angeles 34.

**BRUSH** Plating outfits for plating articles in the home and shop. No tanks necessary. Good income spare or full time. Free particulars. Gunmetal Co., Ave. H, Decatur, Illinois.

**50% PROFIT** Baking new greaseless doughnuts in kitchen. Grocers buy daily. Free recipes. M. Ray, 3605 South 15th, Minneapolis 7, Minnesota.

**\$1,000 MONTHLY** Possible in collection agency business. Free details. Write Cole Associates, Syracuse 2, N. Y.

**TO \$100.00** Weekly. Sparetime, home operated mailorder business. Successful beginner's plan. Everything supplied. Lynn, 10420-M National, Los Angeles 34.

**FREE** Book "303 Odd, Successful Businesses." Work home. Expect something odd! Pacific, Oceanside, Calif.

**REBUILD** Batteries; repair dolls; make rubber stamps; "60 Ideas" free. Universal, Box 1076-A, Peoria, Ill.

**PLASTERCRAFT** Molds, liquid rubber, plasters, flocks, candle supplies. Catalog and manual free. Blue Rapids Supply, Blue Rapids, Kansas.

**EARN \$10,000** Yearly raising Angora rabbit wool for us. Information 25¢ coin. American Angora Company, Malta 12, Montana.

**BREED** Rare tropical fish at home. Earn big money! Learn secrets! Help fill huge demand. Amazing opportunity! Free plan. Tropical Fish Breeders, Los Angeles 61, Calif.

**MINK** Raising information free. Complete. Lake Superior Mink Farm. Superior, EEL, Wisconsin.

**COPUBLISH** Mail Sale Advertiser, leading mail order paper. Details, latest copy, dime. Vanroy Shirk, Lebanon, Penna.

**HIGHEST** Commissions all magazines. Free catalogue, supplies, prizes, exclusive extras. Subscription Service Co., Box 2070, Birmingham, Alabama.

"MAILORDER Laws and Regulations." \$1.00. Explains licenses, taxes, legal requirements. Tasker, 105 East Custis, Alexandria, Virginia.

LEARN Real estate by listening to records. Lee Institute, Brookline 46, Mass.

I want to send you proof of the wonderful pulling power of Popular Mechanics classified pages. What's your proposition? Write me today. Include literature if possible. F. W. Johnson, Manager Classified Advertising, Popular Mechanics Magazine, 200 E. Ontario St., Chicago 11, Ill.

IMPORT Your own products in small lots. Also, start profitable mail-order business using International drop shipment method. Capital unnecessary. Free details. Georgia Overseas Trading Company, Dept. W, 715 Persons Bldg., Macon, Ga.

POPCORN And potato chip equipment. Eakins, Box 933 A7, Springfield, Ohio.

123 WAYS To make money. Kent Co., 1060 N.E. 127 St., N. Miami, Fla.

FREE "Franchise Profit Letter" describes nationwide opportunities. Exclusive distributorships, dealerships, agency operations. Write today. National Franchise Reports, 333 North Michigan, Chicago 1.

DO Drain cleaning by electric machine. Highly profitable, non-competitive business. Full details and prices. Electric Sewer Cleaning Co., Allston 34, Mass.

LEARN Sewing machine repairing. To \$125.00 weekly. Sparetime. Supplies. "Add to present business." Write today! Taylor Service, Box 2126, San Bernardino, Calif.

LEARN Photo-negative portrait retouching. Men, women. \$5 hour possible spare or full time at home. Easy, glamorous. Work for photographers by mail order. Full details sent free. Duval, 100 So. Vermont, Los Angeles 4.

EARTHWORM Growers needed! Good paying home business. Profits to \$1,000.00 a month! We teach you how to raise, and where to sell. Start now! Send \$5.00 for special beginner's unit—You get 1,000 big red Egyptian breeding earthworms, plus our terrific 1957 raising, marketing manual, postpaid! National Earthworm Growers' Co-Op, 4163 Pedley Avenue, Norco, Calif.

PROFITABLE Mail order methods, ideas, opportunities. Clearly, authentically revealed in amazing new publications now available. Free details. Write: Wellington Publishing, Box 4157, Austin 51, Texas.

YOUR Own name brand business. No investment; no inventory. Part time or full time. Sell famous brands of appliances, housewares, silverware, radios, vacuum cleaners, lamps, tools, clocks, watches, jewelry, etc., etc., over 1000 items. Join thousands of successful independent dealers. Send for free catalog and dealer price list. H. B. Davis Corp., Dept. 11, 145 W. 15 St., New York City.

SPARE Time vending machine route for ball pens. Bonomo, 54 Jefferson St., Brooklyn 6, N.Y.

BUSINESS Of your own. In the multi-million dollar automotive business. Five products you can make and sell. Complete with formulas, \$10.00 value, only \$1.00. Professional Men's Service Div., Box 4194, Tulsa 9, Okla.

GUARANTEED — Profitable. Sparetime. Home. Mailorder business. \$1.00. AAA, 100 Airport, San Antonio 12, Texas.

\$5,000 YEARLY. Spare time at home. Nothing to buy. No local selling. Dignified. Guaranteed. Home Harvest, Rt. 3, Box 3491-A, Albuquerque, New Mexico.

MAIL Order business. Make money in a "collective mail order business" with repeat income. Orders come direct to you with a big profit on every sale. Only \$1.00. Include this ad for 100 free circulars. Collective Enterprises, P.O.B. 179, Murray Hill Station, New York 18, N.Y.

BUY Wholesale! Discounts to 80%! Appliances, cameras, sporting goods, housewares, watches, tools, clothing, etc. Buy-Rite 73-01, Wagaraw, Hawthorne 2, New Jersey.

BEAUTIFUL Feather pictures. 200% profit! Free details; sample 20¢ stamps. Sylviap, Apartado 9036, Mexico City.

BECOME A game warden, professional hunter! Join forestry, park, fishery services. Good pay! Opportunities open! Free revealing "Select-Job Chart," details, job-getting secrets. Write Home Study Institute 1036-RFY, Los Angeles 19, California.

MAKE Extra money. Cash commissions. Everybody buys easy-to-sell advertising book matches. Union label. All sizes. Cuts for all businesses. Powerhouse selling kit free. Steady repeat business. No experience necessary. Superior Match Co., Dept. MX-257, 7528 S. Greenwood, Chicago 19.

MAKE Money, handpainting novelty trays. No selling. Flocraft, Farrell 15, Penna.

FREE! "301 Profitable Small Businesses!" Amazing shoestring plans! Work home! Start sparetime! Deumant Surveys, Kenmore 23-R, N. Y.

EXPERIENCE Unnecessary. Earn big money bookkeeping. Copyrighted "5 Minute System." Complete instructions \$1.00. Cooke's, Seaside, California.

WHOLESALE Catalogue! Appliances, cameras, watches! Cam Company, 6806PM 20th Ave., Brooklyn 4, N. Y.

WANTED: Home producers, to be subcontractors. Cast plastic products for manufacturers in our clearing house service. Thousands of easily made items required. Cash in at home, without previous experience. Plastic Service Associates, Dept. 2-PM, East Boston 28, Massachusetts.

AMAZING Profits in local mimeographing! Start on shoestring. Merritt Mimeo, Basking Ridge, N. J.

WAXES Floors without wax. New invention. No more floor wax to buy. Sensational seller. Samples sent on trial. Kristee 107, Akron, Ohio.

COLOR Slides sell your product. Duplicates amazingly low priced. Free price list. Hamilton Color, 127 N. 2nd, Hamilton, Ohio.

START A buying service, buy wholesale thousands nationally advertised products. Make big profits selling at sizable discounts. Postcard brings details. American Buyers, Hertel Station, Buffalo 16-C1, New York.

NEW Method for overhauling car motors pays up to \$25 a day. 125% profit. Write, Stephens Enterprises, Hartstown 1, Penna.

MAKE Perfumes, cleaners, polishes, cosmetics. Sell mailorder. International, 6347 Parnell PM-27, Chicago 21, Illinois.

GROW Expensive herbs for us! Big profits home-business of your own. Year around profitability! We supply everything necessary! Send for free rare seeds and revealing plan. National Herb Exchange, Dept. FY, Gardena, Calif.

"HOW To Start a Business" booklet sent free! If you know any trade, go into business for yourself! Learn the 9 easy steps to follow. We've guided 5,000 others to success. Revealing free booklet yours for the asking! Write! National Business Consultants, Office FY, Los Angeles 61, Calif.

IMPORT-Export opportunity, profitable, world-wide, mail-order business from home, without capital; or travel abroad. Established world trader ships instructions for no-risk examination. Experience unnecessary. Free details. Mellinger Q702, Los Angeles 24.

BECOME Tax consultant. Graduates earn \$3,000 every tax season preparing returns evenings. State approved. Union Institute, 68 Hudson, Hoboken, 2T, N. J.

START Your own business on credit. Your own boss. 1598 dealers sold \$5,000 to \$32,000 in 1955. We supply stocks, equipment on credit. 200 home necessities. Sales experience unnecessary. Pleasant profitable business backed by world-wide industry. Write Rawleigh's, Dept. B-U-PPM, Freeport, Ill.

PORTABLE Garbage disposal sells itself! Earn \$2135 monthly. 100% profit. No installation, UL approved. Retail \$89.50. Choice territories. Free demonstrator offer, kit. Write today. New-Home Co., 42, P.O. Box 840, Beverly Hills, Calif.

IMPORT-Export! Mailorder opportunities. Details. Warner, Box 6, Fort Scott, Kansas.

HIGH Profits selling trailer awnings, carports. Canvas Center, Tampa 10, Fla.

DISCOVERY Makes \$1,500 in three weeks! Free packet. "Secret Journal." 919 secrets—plans! Work home. Publicos, Oceanside, Calif.

\$51,000 FROM Two pair chinchillas. Krystal-Blu, 4835 Cecelia, Bell, Calif.

FLORIDA! 500 Job classifieds \$5. Red Kerce, Tallahassee, Fla.

SPECIALIZED Magazines—5,166 publications—current copies. Also 1,148 self-help books. All trades, professions, sports, hobbies, etc. List free. Publications, 34C North Ritter, Indianapolis 19, Indiana.

NEWEST Spare, full-time home business \$5 to \$10 hour possible. Paint with suede—The finish with touch and eye-appeal. Beautifully auto dashboards, signs, radios, toys, figurines, lamps—1001 others. Complete, step-by-step instructions sent for no-risk examination. Free details. Coast FY, Los Angeles 61.

WANTED! Home workers to assemble luggage and cases for ready market. Instructions, materials, tools, everything supplied. Free details. Abarsi, 807-BB Sunset, Los Angeles 12.

BRAND New mail buyers' names \$10 per 1,000 on gummed labels. Sara-Kay Imports, Tallahassee, Florida.

OPERATE Profitable mail order business. Write Walter Service, 4159A East 112th, Cleveland 5, Ohio.

MAKE Money in a business of your own in Latin America. Others have done it, so can you. Write airmail. Thomas, Apartado 2988, San Jose, Costa Rica.

PARLAY \$400 Into 1600 in one year, no selling. Car required. MLC, Box 12, Signal Mtn., Tenn.

CASH From sawdust (seventy methods). Tin-cans (thirty methods). Newspapers (eighteen methods). Instructions 50¢ each. All three \$1.00. Charles Company, 12-DXV, Norwood, Ohio.

PROFITABLE Home mail-order business. Big profits. Details free. Gryder, Box 187, Barberton, Ohio.

MAKE, Sell perfumes, household products. Jordan, 743 South Dorrance, Philadelphia 46, Penna.

LIQUID Marble—Brushed! Sprayed! Mold novelties, tile! Particulars free. Marbleizing Service, Edwardsville, Illinois.

MAKE 30 Products. Sell mailorder. Complete manufacturing details, 35¢. Herman Reynolds, Jefferson, Georgia.

FLORIDA Opportunities! Hundreds of jobs, businesses, farms, groves, homes. Free details; Florida Opportunity Journal, Vero Beach 14F, Florida.

\$20-\$50 WEEKLY With local mimeographing plans. Mozell Mimeo, Bonham, Texas.

LEARN Why the most successful saw shops use Acme saw shop equipment. Free literature. No obligation. Max Mfg. Co., 138 Stockton Ave., San Jose 26, Calif.

GET The facts! Complete mail order course only \$4.98. Satisfaction guaranteed. 24 page catalog of money-making opportunities sent free. Satisfaction guaranteed. Cohen, Dept. PMP, 7731 Yates, Chicago 49, Ill.

BUSINESS Of your own. Manufacture concentrated rug and upholstery cleaner, wonderful wool soap, liquid detergent, oven cleaner. Formulas \$1.00 each, 11 for \$3.00. Burns, 509 Elliscott, Buffalo, N. Y.

STOP Looking! Start earning! Unique profitable business at home. No inventory or experience needed. Spare or full time. General Associated, 119 South Western, Los Angeles 4, California.

SELL Phonograph records. Get in on volume sales. All labels, speeds. Prices, promotions and details \$1.00. Twentieth Century, Box 1884-Grand Central, New York 17, N. Y.

MAKE \$46 Square foot plywood; jig saw necessary. Free information. Woodart, Bridgewater, Mass.

11,000 NEW Prospects daily. Baby record books, shoes, albums. Sell mailorder. Use our literature. Write: No-Co-Ro, Capitola, California.

FLEXIBLE Rubber molds for plaster and Marble figurines. Sample and large illustrated catalog 25¢, refunded on first order. K-C Novelties, Dept. 36, Southampton, Massachusetts.

MONEY-Making opportunity! Complete instructions 10¢. Perinchief, 178 St. James Place, Brooklyn 38, N. Y.



**6 MONEY-Making** postcard mailorder plans, 25¢. Bernard North, 64 Lincoln Road, Brooklyn 25, New York.

**LEARN** Baby shoe bronzing. Formula, instructions, \$1.00. Beachcraft, 115 Springfield, Lawrence, Mass.

**MAIL** Order advertising agency executive reveals sensational no-risk advertising and merchandise methods. Start in office or home; minimum capital; positive profits. Free details: Impact! 3407 Prospect Avenue, Dept. 11-2, Cleveland 15, Ohio.

**BECOME** One of our many successful wholesale dealers, without investment or inventory. Imports from all over the world. Famous brand appliances, radios, watches, jewelry. Excellent profits. Write for free catalog of over 1,000 items and wholesale price list. International Associates, Box 1143-D, Chicago 90.

**FREE** Cadillac, \$10,000 yearly. Cars, accessories wholesale. Strateway, 6228E, Charlotte 7, N. C.

**MAILORDER** Envelope business in your home. No investment. Omaha Envelope Company, 4721-A California, Omaha 3, Nebr.

**START** Mail order discount business at home. Offer gifts, appliances, cookware, housewares, cutlery, dinnerware, silverware, jewelry, watches, etc., at discounts up to 75%. No stock needed. We ship your orders under your label. Catalogs printed with your name can cost you nothing. Postcard brings sample catalog, complete details. Topval Corp., Lindenhurst 218, N. Y.

**RAISE** Nutria—America's newest opportunity. Luxurious fur. Easily and economically raised. Disease free. Guaranteed market with exceptional profits. Visit or write. Cabana Nutria of Illinois, Rushville, Illinois.

**OPERATE** Money making international "drop-ship" business. Western Activities, 1518 Pl Wilton, Los Angeles 19, California.

**PRINT** Without a printing press! Amazing new method! Print colorful signs, banners, cards, posters, glassware; anything at home. Big profits. Money-making opportunity! We supply everything. Beautiful sample, home-business plan free! Write Screen-Print Company, PM-PY, Los Angeles 61, California.

**COLORGLAZED** Concrete pottery made without molds. Patented method. Cemetery products, novelties, tiles. Basement leak-sealing. Money-making projects. Booklet, details free. Men only. National Potteries Company, Grand Rapids, Minnesota.

**OWN** Your business. Water softener dealers wanted. \$3,000 needed for minimum stock. High profit item on nationally advertised line. Training program. Write today. P-M, Dept. D, 600 S. Michigan Ave., Chicago 5.

**MAKE** Money in landscaping—Start your own business, part or full time. Many good paying positions open. Earn while learning. Send for free book. National Landscape Institute, Dept. M-27-C, 310 S. Robertson Blvd., Los Angeles 48, Calif.

### **MONEYMAKING OPPORTUNITIES**

**MEN** And women wanted to start home business in spare time with little table-top rubber stamp machine. Easy to earn up to \$9.80 an hour without previous experience. Full particulars free by mail. Send postcard to Roberts, 1512 Jarvis, Room 7-B, Chicago 26, Ill.

**PROFIT** Raising flowers. \$1.00 tells how! Wells Gardens, Washington, Michigan.

"HOME Business Digest" has money-making opportunities galore. Sample 25¢. Donovan, 79-PM Greenbelt, Levittown, New York.

**WHOLESALE!** Sell yourself, sell neighbors aluminum awnings; beautiful baked enamel finish. Write: Jack, Box 10254, Tampa, Fla.

**MEN — Women!** Start money-making plastic laminating business at home in spare time. Material that costs 11¢ brings back \$2.58. No canvassing or selling but mail orders bring in \$20 a day. Write for full particulars free. Rush name on postcard to Warner, Room 7-B, 1512 Jarvis, Chicago 26, Ill.

**MAKE** Money writing short paragraphs! No tedious study, I tell you what to write, where and how to sell; and supply list of editors buying from beginners. Many small checks add up quickly. Write to sell, right away. Send for free facts. Benson Barrett, Dept. C-27-B, 7464 Clark, Chicago 26.

**START** A buying service, buy wholesale thousands nationally advertised products. Make big profits selling at sizable discounts. Postcard brings details. American Buyers, Hertel Station, Buffalo 16-D1, New York.

**FREE!** "301 Profitable Small Businesses!" Amazing shoeing plans! Work home! Start sparetime! Deumant Surveys, Kenmore 23-R, N. Y.

**START** Big-pay business at home in spare time. No experience needed to operate little table-top machine for bronzing baby shoes. Make \$5.46 profit on every pair. Full particulars free. Send postcard to Mason, 1512 Jarvis, Room 7-B, Chicago 26, Ill.

**WE** Pay \$100.00 each for certain Lincoln head pennies. Sort all U.S. coins for us spare or full time. All coins are now in circulation and can be found by anyone. Send \$1.00 for catalog listing our paying prices. \$1.00 refunded on our first purchase we make from you. Viroqua Coin Company, Dept. P-5, Viroqua, Wisconsin.

**SELL** Nothing—Yet have a reserve! Free packet. "Secret Journal," 919 secrets—plans! Work home. Publica, Oceanside, Calif.

**OWN** Collection agency office. Pays big. Free details. Franklin Credit, Roanoke 4, Virginia.

**PROFITABLE** Opportunities, plans, ideas. Send 25¢. Monix, 3652 Puuku Makai Drive, Honolulu, T. H.

**100% PROFIT** Mailing postcards. Write PCO, 322½ Brady, Davenport, Iowa.

**YOU** Can sell metal bird feeders and insulated bird houses. Good profit, fast sales. Sample feeder \$6.00, sample house \$2.00 postpaid. Specialty Manufacturing, Box 236, Cassopolis, Michigan.

**KILL** Pests for profit! New shortcut methods. Rid homes, farms, resorts, businesses of termites, roaches, rodents, etc. Ideal spare, full time business. Nation-wide need. Huge profits! Free business plan. Contrex, 429 South Western Avenue, Los Angeles 4, Calif.

**UP** To \$4.00 hourly! Make old, unused articles into saleable items. Free circular. P. Warman Publishers, Uniontown, Penna.

**FASCINATING** 12 Tool stainless steel sportsman's knives. 200% profit. Sample \$3.00. Malik Sales, 1617 Scoville, Berwyn, Ill.

**MONEY** Making opportunities. Copper Hill Sales Service, Copper Hill, Va.

**RAISE** Rabbits on \$500 month plan. Plenty markets. Free details. White's Rabbitry, Mount Pleasant, Michigan.

**\$45.00 PROFIT** From one bag of cement. Complete instructions and formula \$1.00. McComb & Son, Hometown, Indiana.

**LEARN** Technical metaphysics and insure your future. Easy, inexpensive correspondence course. Simplest method known. Diploma. Write: Premier College of Technical Metaphysics, 2532 McKenzie St., Vancouver 8, B. C., Canada.

**BIG** Money raising, fishworms and crickets. Free literature. Carter Hatchery, Plains, Georgia.

**EARN** Money evenings copying and duplicating comic cartoons for advertisers. Adservice, Argyle 1, Wisconsin.

**\$60 WEEKLY**, Spare time—easy! Home Venetian blind laundry. Free book. Burt, 2434A, Wichita 13, Kansas.

**SELL** Titania gems. Far more brilliant than diamonds. Catalog 10¢. Diamonite, 2420-M 77th, Oakland 5, California.

**VENDING** Machines—No selling. Operate a route of coin machines and earn amazing profits. 32-page catalog free. Parkway Machine Corporation, Dept. 37, 715 Ensor Street, Baltimore 2, Maryland.

**FREE** Book "505 Odd, Successful Businesses." Work home. Pacific, Oceanside, Calif.

**PRIZE** Contests provide fabulous and confidential home income opportunities! Here's how and where to win your share! Send stamp! National Contest Bulletin, Box 2685-P, Miami 16, Florida.

**START** A profitable subscription business in spare time! We need men and women (young or old) as representatives for all leading national magazines. Liberal commissions on all subscriptions. Supplies free. Send this ad with your name and address to: Agency Bureau, Dept. PM, Hearst Magazines, 250 West 55th St., New York 19, N. Y.

**EARN** \$50.00 Daily making mats, shoes and mud guards from old tires. S and S Patents Inc., 1307 North Clark St., Chicago 10, Ill.

**100% PROFIT.** No investment. Stamp brings details, samples. Miller, Box 584, Brooklyn 1, New York.

**ATTENTION** Typewriter owners. Make handsome profits. Write today. Groves Company, 682, Hastings 8, Nebraska.

**DOLLARS** Every day! Amazing new magic mail plan. Set-up free. Miller, Box 588X, Oshkosh, Wis.

**GENERAL** Contest Bulletin. Lists contests monthly. Sample, 25¢. 1609½ East 5th, Duluth, Minn.

**READ** Progressive Mailtrade, the magazine that tells how to make money by mail. Dime brings sample and special offer. Progressive Mailtrade, Box 357, Sheboygan, Wisconsin.

**RAISE** Money for church, club, school. New plans. Free details. Theron Fox, 1296½ Yosemite, San Jose, Calif.

**FREE** Book. Grow mushrooms. Guaranteed market. Mushrooms, Dept. 173, 2954 Admiral Way, Seattle, Wash.

**IMPORTED** Rosaries. 300% profit. Sample \$1.00. Malik Sales, 1617 Scoville, Berwyn, Ill.

**FREE** Success plan folio. "Secret Journal," 919 secrets! Work home—Successfully! Publica, Oceanside, Calif.

### **FORMULAS, PLANS, ETC.**

**FORMULAS;** All kinds, latest, best. Literature free. Kemixal, Park Ridge, Ill.

**FREE** Information, lists. 10,000 authentic formulas. Brockway, Gage Building, Topeka, Kansas.

**PRODUCT** Analysis, manufacturing formulas, processes developed. Moderate fees. Plastics, Box 1574, Boston 4, Mass.

**PRACTICAL** Formulas. Lists free. Cummings, Chemist, Gordon Ave., Syracuse 4, N. Y.

**LATE**, Modern manufacturing formulas. List free. Moon Chemical, Martville, New York.

**FORMULAS** For latest money-making discoveries. New! Good! Valuable literature free! Miller, Chemist, 1517-D, Tampa, Florida.

**VALUABLE** Information, guaranteed formulas, what's needed? Box 512-P, Brownfield, Texas.

### **PLASTICS**

**LAMINATING** Supplies. Free price list. Solomonson, 46 Cornhill, Boston 8, Mass.

**LEARN** Plastics fabrication for spare time income. Low cost home training now available. Write for free booklet. Interstate Training Service, Dept. D-3, Portland 13, Ore.

**CARDS**, Photos, plastic sealed by machine. Wallet size 50¢, 3 for \$1.00. Box 516, Davenport, Oklahoma.

**PLEXIGLAS**, Fiberglass, polyester, acetate. Instructive wholesale-retail catalog free! Gem-O'-Lite, 5529 Cahuenga, North Hollywood, California.

**BOXES**, Plastic. Free list. Althor, 170 Bay 23 Street, Brooklyn, N. Y.

**CREATE** Colorful tiles, mosaics, jewelry with new Castoglas for yourself, gifts, profit. No tools, heat, experience needed. Manuals 10¢ each. All three only 25¢. Castolite, Dept. BT-101, Woodstock, Ill.

**CASTING** And embedding course. Easy method with liquid plastic, flexible molds. Details free. Plastic Arts, 416 El Camino, San Carlos, California.

**PLEXIGLAS**. Square foot cost. 1/16", \$1.18; 1/8", \$1.32; 3/16", \$1.86; 1/4", \$2.21; 3/8", \$3.23; 1/2", \$4.36. Colors add 10¢. Send 15¢ for postage. Aristocrat Plastics, 23-25 Sussex Avenue, Newark, N. J.

**NEW** Liquid casting plastic, clear, colors. Embed real flowers, coins, photos. New manual shows fine things you can make at home and sell at big profit. Send 25¢. Castolite, Dept. B-101, Woodstock, Illinois.

## CHEMISTRY

80 PAGE Booklets! "Beginners Chemistry," "Chemistry," "Physics," "Relativity," "Light," "Astronomy," "Electricity," "Radio," "Useful Tables," "Scientific Oddities." 10¢ each. Franks, 3121 South Racine, Chicago 8.

CHEMICALS, Supplies catalog, 25¢. Laboratory Sales, Box 161-E, Brighton, Mass.

ILLUSTRATED Catalog: Chemistry, mineralogy, biology 20¢. Tracey Laboratories, Evanston, Illinois.

CHEMICALS And apparatus for industrial, analytical, and private laboratories. Catalog 25¢. Dept. M-50, Biological Supply Co., 1178 Mt. Hope Ave., Rochester 20, N. Y.

## AGENTS WANTED

YOU Can make money at home in spare time taking magazine renewal subscriptions. No capital or experience necessary. All supplies furnished. Write today! McGregor Magazine Agency, Dept. 500A, Mount Morris, Illinois.

RUN Spare-time greeting card and gift shop at home. Show friends samples of our wonderful new 1957 all-occasion greeting cards and gifts. Take their orders and earn up to 100% profit. No experience necessary. Costs nothing to try. Write today for samples on approval. Regal Greetings, Dept. 33, Ferndale, Michigan.

AGENTS — 300% Profit selling genuine gold window letters; stores and offices. Free samples. Metallic Sign Letter Co., 1217-D West Newport, Chicago.

WHOLESALE Comedy cards! Samples, \$1.00. Sebastian, 10934-B Hamlin, North Hollywood, California.

PRINTING, Advertising salesmen—Excellent moneymaking sideline selling decalcomania name plates, small quantities. Automobile initials, sign letters. Free samples. Ralco, XL, Boston 19, Mass.

GOLDMINE Of 600 money makers. Copy free. Specialty Salesman Magazine, Desk 5-B, 307 N. Michigan, Chicago 1.

EXCLUSIVE Line of personal initialed buckles, belts, cap badges, 3,000 emblems, etc. Hook-Fast, Dept. PM, Roanoke, Va.

YOUR Ad in this space will get some good agents for you. Yes, I'll prove it. Write for Folder "A" right now. F. W. Johnson, Classified Advertising Manager, Popular Mechanics Magazine, 300 E. Ontario St., Chicago 11, Ill.

SELL Profitable personalized rugs. For information write Bobby's, Dept. M10, Manitow Springs, Colorado.

YOUR Own business—Used suits \$1.50, overcoats 85¢, mackinaws 35¢, shoes 12½¢, ladies coats 30¢, dresses 15¢. Enormous profits. Catalog free. Nathan Portnoy Associates, 605-AA West 12th Place, Chicago 7.

GOLD Or silver letters, numbers. Windows, doors, trucks. 1" to 6". 500% profits. Free samples. Atlas-T, 544 West 79th, Chicago 20.

CALIFORNIA Sweet smelling beads. Sensational sellers. Particulars free. Mission, 2328-PM W. Pico, Los Angeles 6, California.

SCHOOL Seniors—Be popular with classmates. Have spending money galore. Details free. Craftcards, Box 235-L, Pittsburgh 19, Pennsylvania.

AMAZING 500% Profit offer. See under "Auto Supplies." GE Engine Heater Sales, Milwaukee 7.

EASY Handwork makes fast-selling articles. Sample free. Sunmade Company, Brockton 64, Massachusetts.

AMAZING "Cut flowers" greeting cards sell fast! So real even stems are cut. Keep 85¢ on each \$1.25 everyday assortment. \$85.00 easy! 140 finest card, novelty, stationery money-makers. Gift bonuses. Assortments on approval. Act fast—Get "hot plate" salt-pepper free! Creative, 4401 Cermak, Dept. 517-F, Chicago 23.

VITA-Zest. Health producing vitamins and minerals. Whirlwind seller. Great repeater. Amazing profits. Free details. Vita-Zest Co., 210R East South St., Orlando, Florida.

"SUPER Glo" signs. Earn \$25.00 day. Magic flashlight test. Advance profits. Prospects everywhere. Sample kit and catalog help you sell on sight. Active Display Advertising, 1702 West 19th Street, Chicago 8, Illinois.

FREE! Sunshine's Studio everyday assortment. Special introductory offer to big profits available selling Sunshine exclusive everyday cards, imprinted stationery, gift wraps, deluxe 21 card assortment, etc. Free catalog. Send postcard today for sample kit on approval. Sunshine Art Studios, Inc., Dept. PM3, Springfield 1, Mass.; Pasadena 1, California (East of Rockies address Springfield).

FREE! Beautiful feather pictures. 200% profit! Apartado 9036, Mexico 1, D. F.

SELL Rotary lawnmowers, good profit. Lutz Distributors, P.O. Box 41, Louisville 17, Kentucky.

CLEANS Windows without mess. Strange dry cleaning-cloth. Replaces liquids. Windows gleam. Samples sent on trial. Kristee 61, Akron, Ohio.

MAKE Extra cash—Quickly! Show newest big value \$1, \$1.25, \$1.50 assortments of birthday, get well, Valentine, Easter greeting cards, gift wrappings, stationery, gifts—In spare time. Big profits, bonus. Friends, others buy on sight. Write for samples on approval, free gift offer, details. Hedenkamp, 361 Broadway, Dept. PM-46, New York City.

GREETING Cards—\$50.00 cash from 40 boxes sensational all-purpose assortment. Big money all year from special occasion cards—Mother's, Father's day, birthdays, Eastern Star. Best all-occasion assortments, stationery, gifts. Bargain specials. Color catalog. Samples on approval. Midwest, 1113 Washington, Dept. 707-B, St. Louis 1, Mo.

IF You want to earn money fast, I'll send you free sample stocking of newest stretch DuPont nylons to sell at only \$1 a pair. American Mills, Dept. 604, Indianapolis 7, Ind.

MEN, Women, make money spare time plus new car as bonus for encouragement. Amazing hosiery guaranteed to wear without holes, snags, and runs, or replaced free. For example, lovely 60 gauge nylons guaranteed for as long as 1½ years or replaced free. Write Wilknit, 1772 Wash., Greenfield, Ohio.

SELL World famous \$1.00 Taubman laundry marking pen. Sample free with first dozen order at 50% discount. No c.o.d.'s. Samuel Taubman, 176 Madison Avenue, New York 16, N. Y.

IF You're interested in making money in selling, see the hundreds of exceptional opportunities in Salesmen's Opportunity Magazine. Send name for your copy, absolutely free. Tell us what you're selling now. Opportunity, 848 N. Dearborn, Dept. 46, Chicago 10, Illinois.

\$1,000.00 A Month for making dramatic 3-second demonstration of amazing lightweight Presto fire extinguisher. New chemical used by airforce snuffs out fires instantly. Only \$4.95. Terrific commissions. Millions want it. Free kit. Merlite, 114 E. 32nd, Dept. P-698, New York City 16.

BUY Wholesale thousands nationally advertised products at big discount. Free "Wholesale Plan." American Buyers, Hertz Station, Buffalo 16-A1, N. Y.

MYSTIC — Terrific demonstrator! Big profits. Makes glasses gleam. Samples sent on trial to selected territories. Metro, Dept. A, Box 151, Oak Park, Illinois.

SHINE Cars without polish. New invention. Lightning seller. Cars gleam like mirror. Samples sent on trial. Kristee 62, Akron, Ohio.

EARN To \$4 hour writing orders for appliances, gifts, housewares, etc., at big discounts. Confidential wholesale prices and details free. Bond Specialties, 1537B West Vernon, Phoenix, Arizona.

BIG Profits selling amazing liquid. Mends fabric without sewing. Free sample. Seal-Rite, 355 Imperial, Youngstown 9, Ohio.

60% PROFIT On cosmetics — Famous nationally advertised Hollywood cosmetics pay 60%. Make \$25 day up. Hire others. For free samples, details, write Studio Girl, Glendale, Calif., Dept. 1272G.

FLUORESCENT Letter sign kit. Send 25¢ for samples. Coloray Corporation, 370 Brannan, San Francisco 7.

\$1000 MONTHLY Selling fire extinguishers? Unusual plan builds sales. Laircraft, Box 5008-J, Detroit 35, Michigan.

EXCLUSIVE Distributorships. Top quality low cost English chamois. Babrok, Hudson Falls, N. Y.

## BUY IT WHOLESALE

BUY Wholesale! Nationally advertised appliances, radios, watches, etc. Catalog \$1.00 (refundable). D'Auria, Box 355-PM, Jackson, Michigan.

BAROAINS, Joblots, closeouts. 2000 items. Tremendous savings, clothing, toys, gifts, jewelry, television, etc. 25¢ brings wholesale catalog. \$1.00 merchandise certificate included free. Reliable Jobbing, 311-B North Desplaines, Chicago.

BUY Wholesale! Discounts to 80%! Appliances, cameras, sporting goods, housewares, watches, tools, clothing, etc. Buy-Rite, 73-04 Wagaraw, Hawthorne 2, New Jersey.

BUY Wholesale stock rubber stamps. Write Grant Stamp Co., 63 Grant St., Buffalo 13, N. Y.

WHOLESALE Catalog! Appliances; housewares; jewelry! Postcard! Midwest, 156-M, Pontiac, Illinois.

CATALOGS! General merchandise, clothing, tools; each \$1.00; jewelry 50¢; Gifts, 25¢. Edith's, Deep River, Conn.

BIG Multicolor wholesale catalog! Housewares, appliances, clothing, tools, cameras, luggage, radios, phonographs, recorders, watches, jewelry. Name brands. Huge discounts. Postcard: Selbyco, Decatur 153, Illinois.

TEN Wholesalers who will send you their catalogs free for the asking and one who pays you to distribute wholesale catalogs. For one dollar I will send their names and addresses. C. Hopkins, 8 Christopher Court, Lodi, New Jersey.

## SALESMEN—DISTRIBUTORS

SELL "Grease that won't melt." including moly products in a complete line of heavy duty lubricants. Our leading salesmen now earning over \$12,000 a year. Write immediately to E. J. Baker, Dept. P-7, P.O. Box 676, Dayton, Ohio.

INCREASE Present income \$75-up weekly. Dealers, farmers, agents—demonstrate nationally known Gro-Green liquid fertilizer nutrients. Results guaranteed. Full-part time. Samples free. Campbell Co., Rochelle 209, Illinois.

NEW Jobs open in selling! Send name, address for five free issues of Opportunity Magazine's money-making guide, listing hundreds of companies who'll pay you well, full or part-time. No experience needed. Opportunity, 850 N. Dearborn, Dept. 17, Chicago 10, Ill.

ONE Monument sale weekly earns \$200 or more. Jones Monumental Works, St. Cloud, Minn.

CASH In on Chestlite, successor to flashlight. Profit over 100%. Protected territories still open for this patented money-maker. Write for details right now. Chestlite, 620 W. Anaheim, Long Beach 13, Calif.

WE Are the world's largest manufacturer of portable adding machines. Highest grade. Best service, highest profit. You are sure to win. Lightning Adding Machine Sales Co., 2306-C W. Slauson Ave., Los Angeles 43, Calif.

100% PROFITS Vitamins! Direct and mail sales, homes, offices, stores, and get your own needs wholesale. Details free. Sample \$2. Roberts, 432 Fremont, Springfield, Ohio.

AD Matches! Sell amazing designs—10, 20, 30, 40 and 240-light book matches. Bigger spot cash commissions; every business a prospect. Low prices for high quality. Repeats. Start without experience; men, women; full, part time. Buy nothing! Sales kit furnished. Match Corp., Dept. PM-86, Chicago 32, Illinois.

GET Into big money. Steady profits, stainless tablewares. Mann, Woodcliff Lake, New Jersey.

FRENCH Parfum. Book repair kit. Profits. Martin, Colgate, North Dakota.

**MAKE** Extra money. Cash commissions. Everybody buys easy-to-sell advertising book matches. Union label. All sizes. Cuts for all businesses. Powerhouse selling kit free. Steady repeat business. No experience necessary. Superior Match Co., Dept. M-257, 7528 S. Greenwood, Chicago 19.

**MY** Free outfit puts you in a fine business! Just 2 sales a day brings you up to \$217 extra a month in big money shoe business! Complete line of air cushion shoes for men, women. Just rush postcard for your powerful free selling outfit! Mason Shoe, Dept. C-48, Chippewa Falls, Wisconsin.

**HUGE** Market for new kitchen tool. Combination scoop, measure, funnel. Attractive profits. C. Nicodemus Co., 447 Clinton Hgts., Columbus 2, Ohio.

**WILL** You wear new suits and topcoats without one penny cost and agree to show them to friends? You can make up to \$30 in a day even in spare time, without canvassing. J. C. Field & Son, Inc., Harrison & Throp Sts., Dept. D-1826, Chicago 7, Illinois.

**\$1,000.00** A Month for making dramatic 3-second demonstration of amazing light-weight Presto fire extinguisher. New chemical used by airforce snuffs out fires instantly. Only \$4.95. Terrific commissions. Millions want it. Free kit. Merlite, 114 E. 32nd, Dept. P-888, New York City 18.

**IS** \$150 Weekly worth 2¢ postcard to you? Send name, address, shoe size for sensational "dollar-a-second" demonstration and amazing new footwear on approval. Flexiclogs, Box 27X-B, New Holstein, Wis.

**GET** New shirt outfit free. Make \$90.00 weekly on 5 average orders a day. Famous quality made-to-measure dress and sport shirts at \$3.95 up sell fast to all men. No experience needed. Full or part time. Write: Packard Shirt Co., Dept. 451, Terre Haute, Ind.

**EARN** Big money selling exclusive "Little Giant" spray fire extinguisher. \$1.95 retailer. For home, car, office, store, boat. Also available refillable extinguishers and home alarm systems. Big profit. Special deals. Astoria Manufacturing Company, 42-02 Vernon Blvd., Astoria 1, N. Y.

**MONEY-Making** opportunity! Take big profit orders for world famous patented varieties fruit trees. Also flowering shrubs, roses, vines. Big sales outfit free. Stark Bro's, Desk 30127, Louisiana, Missouri.

**ANYONE** Can sell famous Hoover uniforms for beauty shops, waitresses, nurses, doctors, others. All popular miracle fabrics—Nylon, dacron, orlon. Exclusive styles, top quality. Big cash income now, real future. Equipment free. Hoover, Dept. B-100, New York 11, N. Y.

**250% PROFIT** Selling Power Oil. Details free. Power Oil, Box 1073, Spokane 10, Washington.

**BIG** Moneymaking opportunity. Exclusive line work uniforms, jackets, pants, shirts, coveralls. Advertising embrodered. Every business prospect. Outfit free. Master Co., B-12 Water, Ligonier, Indiana.

**AMAZING** Discovery. Master Glaze, puts brilliant glass like surface on cars. Free sample. Information. Big commissions. Master Glaze, Dept. 868, 7720 Harwood, Milwaukee, Wis.

**NEW** Attractive nite-life switch plate. Manufacturer wants distributor salesmen. Wonderful opportunity. Owlite, Pittsburgh 18, Penna.

**SALESMAN.** Educational. Up to \$1,500 month. Seavy Institute, 429 So. Western Ave., Los Angeles 5, Calif.

## EMPLOYMENT INFORMATION

**COPYRIGHTED** Reports on best paying jobs with travel, adventure, promotions. Construction, aviation, shipping, laborers, clerical, trades, supervisory, factory, unusual opportunities. Many types of work. Skilled and unskilled. Foreign and state-side openings for men and women. Only \$2.00 (\$2.25 airmail), including registration-advisory service. Satisfaction guaranteed. Included absolutely free: Special reports on Alaska, Spanish airbase construction, South American opportunities and husband-wife foreign jobs. Research Services, Suite 207-PM Brown Building, St. Louis 5, Missouri.

**SOUTHERN** California job opportunities. Hundreds of employment ads, housing information airmailed \$1.00 complete. California Enterprises, 610 South Broadway, Suite 623, Los Angeles 14, Calif.

**FOREIGN, Alaskan, U.S.A., jobs!** To \$15,000 monthly! Million Americans employed overseas. Copyrighted reports. Who to contact for highest paying jobs. Laborers, trades, truck drivers, office, engineers, many others. 52 countries—St. Lawrence project, Spain, Latin America, Northern project, Europe. Year registration-advisory service. Application forms. Unconditional money-back guarantee! \$2.00 (airmailed \$2.25). C.O.D.'s accepted. International Reporter, St. Louis 1-PQ, Missouri.

**HIGH** Paying jobs: Foreign, USA. All trades. Travel paid. Information. Application forms. Write Dept. 21H, National, 1020 Broad, Newark, N. J.

## EDUCATIONAL AND INSTRUCTION

**TIMESTUDY**—Your key to positive personal profits. Associated Techniques, P.O. Box 235, Hollidaysburg, Penna.

**BOOKS.** Free 1957 catalog, 100 pages. Text, vocational, educational, instructional subjects. Millions of volumes, new and used. Bargain prices. Books bought. Est. 1902. Long's College Book Co., Dept. PM, Columbus 1, Ohio.

**BLUEPRINT** Reading—Train at home. Learn to read blueprints with confidence in 10 easy lessons. Write today Belton School, 1059-J North Lawndale, Chicago 51.

**DRAFTING,** Design, blueprint reading. Good paying. Easy to learn at home. Minimum age 17. Write Utilities Engineering Institute, Dept. TC-4, 2525 Sheffield, Chicago 14.

**GIRLS.** Women, Practical nurses needed. Learn profitable career at home easily. Many earn while learning. High school not required. Free booklet. Wayne School, 2525 Sheffield, Dept. PG-30, Chicago 14.

**FINISH** High school at home, spare time. No classes. Diploma awarded. Write for free catalog. Wayne School, Catalog HP-72, 2527 Sheffield, Chicago 14.

**WELDING** Training pays at Hobart Welding School, Box M-271, Troy, Ohio. VA contract. Best equipment. Catalog free.

**ORTHODOX** Bible courses. Earn degree. Free bulletin! Bible School, 1050 Broad-ripple Ave., Indianapolis, Ind.

**INVESTIGATORS** Trained, men-women. Learn fascinating, profitable profession, spare time study. Big pay. Important details on how to open your own agency in any state. Free booklet. Investigator, Box 490, Times Square Station, New York 36, N. Y.

**LEARN** Blue print reading. \$10.00 for five months course. Refunded 10 days if not satisfied. American Blue Print Reader, 564 Main Street, East Orange, N. J.

**IMMEDIATE** Continuous monthly earnings operating your own simplified bookkeeping, control analysis service. Amazing details free. Vanderdrift, 35E Franklin Street, East Orange, New Jersey.

**LEARN** While asleep! Details free. Research Association, Box 610-MC, Omaha, Nebraska.

**DRAWING** Simplified. Alphabetical creations. Really fascinating! Book \$2.00. Davis' Letterpictures, 2301 Vine, Kansas City, Mo.

**COMPLETE** Your high school at home in spare time with 60-year-old school. Texts furnished. No classes. Diploma. Information booklet free. American School, Dept. X245, Drexel at 58th, Chicago 37, Illinois.

**MEMORY** Education. Additional mental power. Science of memory. Memorology, volume one free, without obligation. Memorology Studio, 2016-M Sunnyside, Chicago 25, Ill.

**REFRIGERATION,** Air conditioning. Extension course. Free booklet. Mechanics School, 11029-PX South Vermont, Los Angeles 44.

**FREE** Book. Grow mushrooms. Guaranteed market. Mushrooms, Dept. 174, 2954 Admiral Way, Seattle, Wash.

**PIANO** Tuning pays. Learned easily at home. GI approved. 59th year. Free booklet. Niles Bryant School, Dept. P, 3731 Stockton, Sacramento 20, Calif.

**SPEAK,** Sing with power, personality. Home self-training method on records. Amazing details free. Canfield, 2018-A 5th Ave. South, Minneapolis 4, Minn.

**PIANO** Tuning pays. Big money in spare time. Learn at home in 30 days. No musical knowledge necessary. Phonograph, records, tools and instructions furnished. Personal instructions available. Free catalog. Capital Tuning School, 16 Southwest Second, Fort Lauderdale, Fla.

**EXCEPTIONAL** Home study plan. P. Woodworth, Box 4867, Detroit 19, Mich.

**STUDY** For Doctor's degree of psychology, metaphysics and divinity. Correspondence courses only. College of Divine Metaphysics, Dept. P-M, 2811 North Illinois, Indianapolis 8, Indiana.

**LEARN** Mineralogy at home. Diploma course. Fortunes now being made in uranium and other minerals. Free catalog. Mineral Science Institute, Desk 2, 159 East Ontario, Chicago 11.

**HIGH** School diploma at home. Licensed teachers—Approved materials. Southern States Academy, Box 144-MX, Station E, Atlanta, Georgia.

**EARN** While you learn. Auto and diesel mechanics master this top paying trade. Many graduates earn \$100 a week and up. Approved for Korean veterans. For free information write Dept. No. 256, Nashville Auto-Diesel College, Nashville 3, Tenn.

**BE** A real estate broker. Study at home. Write for free book today. GI approved. Weaver School of Real Estate, 2018P Grand, Kansas City, Missouri.

**USED** Correspondence courses and educational books bought, sold, rented. Free catalog. Educational Exchange, Menlo, Georgia.

**BOOKS;** Hundreds of subjects. Big catalog free. Popular Mechanics Press, 200-BO East Ontario St., Chicago 11.

**HELP** Yourself to abundant living. Our courses have aided students to richer fuller lives. Learn secret of contentment, happiness. Earn degrees Ps.D., MsD. Write for free book. College of Universal Truth Correspondence School, 23-C E. Jackson, Chicago.

**USED** Correspondence courses and books sold and rented. Money back guarantee. Catalog free. (Courses bought.) Lee Mountain, Pisgah, Alabama.

**SECRET** Investigation. Experience unnecessary. Investigators particulars free. George Wagner, M125 West 86th, New York 24.

**BOOKKEEPERS!** Increase your earnings! Operate your own simplified "Dollar-A-Week" bookkeeping and tax service. Full or spare time. Details free. No obligation. Ellis, Box 200, Cedar Grove, North Carolina.

**WANT** A diesel job? New opportunities to increase income. Higher pay. More money. We can help you qualify. Tools. Shop method home training. Write today! Diesel, Tractor, Heavy Equipment Division, Interstate Training Service, Dept. B-3, Portland 13, Oregon.

**I** Want to send you proof of the wonderful pulling power of Popular Mechanics classified pages. What's your proposition? Write me today. Include literature if possible. F. W. Johnson, Manager Classified Advertising, Popular Mechanics Magazine, 200 E. Ontario St., Chicago 11, Ill.

**INVESTIGATOR** Training. Phillips Secret Service System, 1917-B North Kenneth, Chicago 39.

**HANDWRITING** Analysis now accepted in college, business, industry. Our men, women who use grapho analysis spare, full time earning more money, getting prestige, success, happiness. Uncrowded, fascinating field for intelligent men, women anxious to get ahead. We need more members. Investigate this growing field where you give a real service to your fellow man. Opportunities unlimited. Free sample lesson and information to all over 21. Write today! Igas, 2307 National Station, Dept. 615, Springfield, Missouri.

**BARGAIN.** Exciting Little Library booklets. 25¢ each. Tool making, painting, welding, home improvement, games, models, plastics, lamp making, glass blowing, boats, photographs. Free catalog. Popular Mechanics Press, 200-LB East Ontario St., Chicago 11.

**GAIN** New knowledge, perspective. Revolutionary easy way learn decimal equivalents common fractions without memorizing. Fun. Practical. Details free. Val Palmer, 1322 12th St., Rockford, Ill.

**ENGINEERING.** Home study. Midwest Engineering School, 10923 Hillcrest, Hickman Mills, Missouri.

**PHYSICAL** Therapy and massage. We train you at home. Earn big profits from your own private practice or work with hospitals and doctors. Free catalogue. National Institute, Desk 4, 159 E. Ontario, Chicago, Ill.

**ENGINEERING** Degrees earned by home study. (Residential courses also available.) Pacific International University (American College of Engineering), Box 27724-B, Hollywood 27, California.

**USED** Radio-TV correspondence courses sold. Money-back guarantee. Free list. Courses bought. Nafziger, 3566-A Diamond Ave., Oakland 2, Calif.

**BOOKKEEPING** Course \$1.00. Details free. Wyss, 104½ Frances, St. Joseph, Missouri.

**TRANSFORM** Yourself via subconscious. Free brochure. Box 847 (H-2), Ocean Park, Calif.

**"HOW To Break and Train Horses"**—A book every farmer and horseman should have. It is free; no obligation. Simply address Beery School of Horsemanship, Dept. 1102-C, Pleasant Hill, Ohio.

**USED** Correspondence courses and books, bought, sold, rented. Money-back guarantee. Free catalog. Bayles, 311 Essex, Hackensack, New Jersey.

**MECHANICALLY** Inclined men needed for careers in jet industry as jet mechanics, overhaul, maintenance, service, with opportunities for bigger pay, better jobs, security. For information on first all-jet home training: United Jet Schools, Dept. PM, International Airport, San Francisco.

**MEMORIZING** Made easy. Booklet \$1.00. Memorale, 1424 Emerson, Salt Lake City, Utah.

**LEARN** To sing at home. Money-back guarantee. Spanish instructions only. Academia "Novo," Apartado 1894-L, Monterrey, Mexico.

**\$10,000 YEARLY.** Learn real estate. Free information. Seavy Institute, 429 So. Western Ave., Los Angeles 5, Calif.

**"SECRETS** Most People Don't Know." Amazing details free. Dr. Sutton, Benton, Kentucky.

**STUDENTS**—The Maxwell Simplified Method of Study will help you get better grades. Simple, efficient, proven. Only one dollar. Study Methods, Box 419, Pacific Grove, California.

#### PLAYS, STORIES, MANUSCRIPTS

**WRITERS!** There is a strong demand in the New York market for all types of material. We offer honest appraisal and placement. Write for terms today! Daniel S. Mead, Literary Agent, 419 Fourth Avenue, New York.

**WANT** Your book published? Learn how we publish, advertise, promote, distribute. Many successes. Free booklet PM. Vantage, 120 West 31, New York City.

**WANTED:** Book manuscripts, all subjects considered. Greenwich Book Pub., Attn. Mr. Zealand, 489 Fifth Ave., New York City.

#### SPECIAL SERVICES

**INFORMATION** On anything. Ferguson Research Specialists, 116-14 141 St., South Ozone Park 35, N.Y.

#### CARTOONING, COMMERCIAL ART, SHOWCARD & SIGN PAINTING, TATTOOING

**YOU** Can entertain with chalk talks. Catalog 10¢. Balda The Cartoonist, Oshkosh, Wis.

**LEARN** Sign painting at home. Free talent test. Ben Kerns, Box 812-PM, Greenville, S.C.

**PAINT** Signs—Master die cut, outline letter patterns. Complete assortment 1½" to 12" high, prepaid \$2.00. Eyerly, 583, Newton, Iowa.

**BASIC** Art training at home. New plan. Free talent test. Students' Art Club, Kennebunkport, Maine.

**CARTOON** Your way to fame. Minimum age seventeen. Write Cartoons-of-the-Month, Roslyn, New York.

**SAVE** On quality printing! Samples, price list by return mail. Print-Rite Service, Box 874, Pottstown, Penna.

**SAVE** On quality printing! Samples, price list by return mail. Print-Rite Service, Box 874, Pottstown, Penna.

**SAVE** On quality printing! Samples, price list by return mail. Print-Rite Service, Box 874, Pottstown, Penna.

**SAVE** On quality printing! Samples, price list by return mail. Print-Rite Service, Box 874, Pottstown, Penna.

**SAVE** On quality printing! Samples, price list by return mail. Print-Rite Service, Box 874, Pottstown, Penna.

**SAVE** On quality printing! Samples, price list by return mail. Print-Rite Service, Box 874, Pottstown, Penna.

**SAVE** On quality printing! Samples, price list by return mail. Print-Rite Service, Box 874, Pottstown, Penna.

**"HOW To Make Money With Simple Cartoons."** A book everyone who likes to draw should have. It is free; no obligation. Simply address Cartoonists' Exchange, Dept. 92, Pleasant Hill, Ohio.

**TATTOO** Supplies—Free catalog. Spaulding & Rogers, Dept. M, Court St., Jacksonville, No. Carolina.

**LEARN** Cartooning. Fame, fortune, independence possible. Complete 25 lesson course \$2.50. Check. Herco, P.O. Box 382, St. Petersburg, Florida.

**TATTOOING** Outfits, licensed course. Brochures 25¢. Zeis, 728 Leslie, Rockford, Illinois.

#### ADVERTISING AGENCIES, LETTER WRITERS, FOR ADVERTISERS

**ADVERTISING,** Result-getting ads prepared, placed newspapers, magazines, radio, anywhere! Lowest rates. Catalogue free. Baker Advertising Agency, 189 W. Madison, Chicago 2.

**MAILING** Lists most any classification \$3.00 1000. Your circulars mailed with ours \$4.00 1000. Write for our literature. Dixie Mailers, King, N. C.

**ADVERTISE:** 24 Words, 100 Canadian newspapers \$5.50. Lists free. Advertising Bureau, 10511-C Springfield, Chicago 43.

**FREE!** 1957 Advertisers Rate and Data Directory. 52 pages! E. H. Brown Advertising Agency, 20 N. Wacker, Chicago 6.

**ADVERTISING** Ratebook leading newspapers, magazines, free. Chicago Advertising Agency, Chicago 4.

**ARTWORK,** Cartoons. Free folder. Knarr, Box 898, Oil City, Penna.

**WANT** More business? Here's an amazing opportunity to increase your sales. Talk to thousands of interested readers of "Mechanica Popular." Our Spanish Edition covers the Latin American countries like a blanket. They're real mailorder buyers. Classified rate 75¢ per word. Try an ad in our next issue. Classified Advertising Department, Popular Mechanics Magazine, 200 East Ontario Street, Chicago 11, Ill.

#### RUBBER STAMPS AND OFFICE SUPPLIES

**THREE** Line pocket stamp or regular with free pad \$1.00. Barber, Marengo, Ohio.

**THREE** Lines and pad dollar. Moderns, 924B Patrick, Jonesboro, Arkansas.

**3 LINES,** \$1.00. Cushioned—Indexed. Satisfaction guaranteed! Campfield, 14 Beaufort Circle, Springfield 4, Mass.

#### TYPEWRITERS, DUPLICATORS, OFFICE DEVICES

**IBM** Electric typewriter \$59.95. Albin, 423 Broome St., New York City 13.

**PORTABLE** Mimeograph! Uses no stencil, no ink. The newest, cleanest, smallest, lightest and cheapest. Weight 15 pounds. DuPont Distributors, P.O. Box 695, Dept. A, New York 1, N. Y.

**RECONDITIONED** Typewriters, duplicating, printing devices. \$25.00 up. Supplies. Appliances. DixieGraph, King, N. C.

#### PRINTING, MULTIGRAPHING, MIMEOGRAPHING, GUMMED LABELS

**MIMEOGRAPHING**—Letters, pricelists, formulas, instructions. Lowest prices. Lem's Letter Shop, 5710 Stanton, Detroit 8.

**CIRCULARS,** Booklets, letterheads, statements, Estimates, anything! Loneim Printers, Paulding, Ohio.

**ADS** Running under this heading sell printing. Ask me for proof. I'll gladly send you amazing facts. Ask for Folder "P" F. W. Johnson, 200 E. Ontario St., Chicago 11, Ill.

**FREE** Catalog business, personal printing. D.M. Press, Sebastopol, California.

**QUALITY** Printing! Free new catalog showing prices, types, cuts. Napco Press, Dept. PM, 2337 Bath Avenue, Brooklyn 14.

**OFFSET** Printing—\$6.50 1000, 8½x11, 16 lb. National Letter, 251 W. 42 St., New York City 38.

**QUALITY** Reasonable business and personal printing. Hundreds or thousands. Hendrickson, 129 N. Prater, Northlake, Illinois.

**SAVE** On quality printing! Samples, price list by return mail. Print-Rite Service, Box 874, Pottstown, Penna.

**SAVE** On quality printing! Samples, price list by return mail. Print-Rite Service, Box 874, Pottstown, Penna.

**SAVE** On quality printing! Samples, price list by return mail. Print-Rite Service, Box 874, Pottstown, Penna.

**SAVE** On quality printing! Samples, price list by return mail. Print-Rite Service, Box 874, Pottstown, Penna.

**BUSINESS** Printing catalog, free. McDonald, 545 North Oakland, Pasadena 4, California.

**TWO-Color** shipping labels. Your copy. Lowest prices. Sample free. Perfection Printing, 6 Public Square, Fredericktown, Ohio.

**500 NAME** And address printed gummed labels, 3 lines \$1.00. No c.o.d.'s. Print clearly. Addison, PM-2, 1840 Addison, Chicago 13.

**FREE** Samples, printing, mimeographing, offset, rubber stamps. Reasonable. Stark Press, Capitola, Calif.

**BUSINESS** Printing. Samples, prices free. Howprint, 723-G Eunice, Webster Groves 19, Missouri.

**125 LETTERHEADS** (8½x11 Watermarked) and 125 6¼ envelopes. Carefully printed, \$3.00. Postpaid. Race Printers, Hudson, New York.

**BEST** Printing. Free catalog. Immediate service. Satisfaction guaranteed. Rich, 24 Burlington, Springfield, Mass.

**PRINTING** Bargains, thousand cards \$3.95. List stamp, catalogue dime. Robinsons, Sebastopol, California.

**QUALITY** Letterpress, offset printing. Economical. Catalog. DeLuxe, 518-PM West 79th, Chicago 20.

**1000 RAISED** Letters business cards \$3.50. Samples. Pioneer, Island Park 6, New York.

**100 BUSINESS** Cards \$1.00. Print Shop, 1418 Broadway, Rockford, Illinois.

**150 8½x11 LETTERHEADS,** 150 6¼ Envelopes, neatly printed your copy, \$3.00. Brookside Press, Wonder Lake, Illinois.

**FREE** Catalog, samples. Dealers wanted. Sutton Printing, Box 852-P, Waycross, Georgia.

#### PRINTING OUTFITS AND SUPPLIES

**PRESSES,** Type cabinets, supplies. List for stamp. Lincoln Press Company, 220-B Hartwell, Fall River, Mass.

**MAKE** Your own self-molding rubber stamps and printing cuts. Flexirubber, Argyle 2, Wisconsin.

**RUBBER** Stamp making presses, hydraulic operated, electrically heated. Sizes 5"x8", 8"x12", 10"x15" starting outfits. All kinds supplies. Custom Manufacturing, 601 N. Jefferson, Springfield, Missouri.

**DO** Your own printing. Save money. Simple rules. We supply everything. Print for others; good profit. Raised printing like engraving too. Have home shop. Details free. Kelsey Presses, V-11, Meriden, Connecticut.

**PRINTING** Presses, type, supplies, lists 3¢. Turnbaugh Service, Mechanicsburg, Penna.

**WHOLESALE** Paper. Complete prices and samples \$1.00. Twentieth Century, Box 1884-Grand Central, New York 17, N. Y.

#### PATENT ATTORNEYS

**INVENTORS**—If you believe you have an invention, you should find out how to protect it. The firm of McMorro, Berman & Davidson with offices in Washington, D. C., is qualified to take the necessary steps for you. Send for copy of our patent booklet "How to Protect Your Invention." We will also send you an "Invention Record" form. No obligation. They are yours for the asking. McMorro, Berman & Davidson, Registered Patent Attorneys, 134-L Victor Building, Washington 1, D. C.

**INVENTORS**—Take these preliminary steps toward patent protection. Sketch and describe your invention. Sign, date and have this disclosure witnessed by two people who understand your invention. Have us make a preliminary search among U.S. patents already granted for similar types of invention. We report on the probable patentability of your invention and recommend your further course of action. Write for our instructive booklet, "Patent Protection for Inventors" and convenient "Evidence of Invention" disclosure form. Victor J. Evans & Co., 331-B Merlin Building, Washington 6, D. C.

**INVENTORS:** Without obligation, write for information explaining the steps you should take to secure a patent. John Randolph, Registered Patent Attorney, 203 Columbian Bldg., Washington 1, D. C.

**CANADA**—Ramsay Company Registered, 273 Bank Street, Ottawa, Canada.

**INVENTION** Record form free and "Patent Information Every Inventor Should Have." Carl Miller, Registered Patent Attorney, Woolworth Building, New York.

C. A. Snow & Co.—M427, Snow Building, Washington 1, D. C. Registered Patent Attorneys. Write for information.

**INVENTORS:** When you are satisfied that you have invented something of value write me, without obligation, for information as to what steps you should take to secure a patent. Write Patrick D. Beavers, Registered Patent Atty., 835 Columbian Bldg., Washington 1, D. C.

**PATENTS.** "Proof of Invention" free. E. E. Vrooman, Registered Patent Attorney, 507 McKim Building, Washington 5, D. C.

"INVENTOR'S Guide" and "Record of Invention" free on request. Frank P. Ledermann, Registered Patent Attorney, 154 Nassau Street, New York City.

**REGISTERED** Patent attorney offers services. Sanders, 8430 Evans, Chicago 37, Illinois.

**INVENTORS:** Learn how to protect your invention. Unless the inventor is familiar with patent matters, he should engage a competent registered patent attorney or agent to represent him. We are registered to practice before the U. S. Patent Office and prepared to serve you in handling your patent matters. "Patent Guide for the Inventor" containing detailed information concerning patent protection and procedure with "Record of Invention" form will be forwarded to you upon request—without obligation. Clarence A. O'Brien & Harvey Jacobson, Registered Patent Attorneys, 71B-A District National Building, Washington, D. C.

"HOME Improvement Guide." New, amazing 192 page volume. Packed with ideas, plans for remodeling, decorating, landscaping, built-in projects. \$2.50 prepaid. Popular Mechanics Press, 200-80 East Ontario St., Chicago 11.

#### FOR INVENTORS

**INVENTORS:** Learn how to protect your invention. Unless the inventor is familiar with patent matters, he should engage a competent registered patent attorney or agent to represent him. We are registered to practice before the U. S. Patent Office and prepared to serve you in handling your patent matters. "Patent Guide for the Inventor" containing detailed information concerning patent protection and procedure with "Record of Invention" form will be forwarded to you upon request—without obligation. Clarence A. O'Brien & Harvey Jacobson, Registered Patent Attorneys, 71A-A District National Building, Washington, D. C.

**WANTED.** New ideas. Well-known manufacturer with established national distribution is looking for new products that can be developed and marketed. If you have an idea, invention or device which is patented, contact us for an offer. If it is unpatented, write for our special agreement form protecting you and us with regard to any disclosure. Write P. O. Box 1138, Providence 1, R. I.

**PROTECTION** For your invention or idea. Send \$1.00 for instructions on how to protect your interests. Don't send your secrets or models. Your dollar entitles you to limited analysis of costs, development, merchandising, etc., after your ideas are secured to your satisfaction. We will patent, copyright, promote, merchandise your ideas on percentage basis if you lack financing. Arizona Patent Research Laboratory, Inc., Box 2468, Phoenix, Arizona.

**FREE** Record of invention form. Keep idea secret until recorded. Patent office search, including copies of closest patents, plus sales suggestions, \$5. We contact hundreds of manufacturers seeking inventions. Inventors Sales and Engineering Service, Box 4973, Washington, D. C.

**INVENTORS!** Have your good, patentable ideas? Write Mr. Metzler, 11 West 42nd Street, New York City.

**INVENTORS—**If you believe you have an invention, you should find out how to protect it. The firm of McMorrow, Berman & Davidson with offices in Washington, D. C., is qualified to take the necessary steps for you. Send for copy of our patent booklet "How to Protect Your Invention." We will also send you an "Invention Record" form. No obligation. They are yours for the asking. McMorrow, Berman & Davidson, Registered Patent Attorneys, 134-K Victor Building, Washington 1, D. C.

**INVENTORS—**Send for free patent information book and inventor's record. Registered Patent Attorney, Associate Examiner. Patent Office 1922-29, Patent Attorney & Advisor, Navy Department 1930-47. Gustave Miller, 145A Warner Building, Washington 4, D. C.

**INVENTORS—**This firm is registered to practice before the United States Patent Office and available to assist you in the preparation and prosecution of your patent application. "Patent Protection for Inventors" booklet containing detailed information and steps to take toward patent protection sent promptly upon request. No obligation. Victor J. Evans & Co., 332-B Merlin Building, Washington 6, D. C.

**PATENT** Searches \$5.00. 48-hour service. Free invention protection forms. Write Raymond L. Smith, Patent Searcher, 629 Sheraton Building, Washington 5, D. C.

**IDEAS** Developed for products and your profit with effective patent protection at low definite cost. Foreign patents: Canadian patents filed \$100.00. Patent development costs now deductible from tax payments. 30 yrs. in business. Joseph O'Brien, Patent-Development Engineer, 132 Nassau St., New York 38, N. Y.

**PATENTS.** How to prepare and file your own patent application. Send \$2.95 for book, Paladin Pubns., Atlantic and Pacific Sts., Baltimore, N. Y.

**PATENT** Searches \$5.00. 48-hour airmail service. Invention protection forms free. Write Patent Engineering Service, 711 14th Street N. W., Washington 5, D. C.

**INVENTORS!** Free book. "Selling Your Invention." Inventors Exchange-D, Hartford 1, Connecticut.

**INVENTORS:** Test the commercial value of your patented or unpatented inventions, quickly and inexpensively. Write for free information. Institute of American Inventors, Dept. 40-B, 635-F St., N.W., Washington 4, D. C.

**PATENT** Searches, including copies of nearest patents, \$5.00. Reports airmailed within 48 hours. More than 100 registered patent attorneys use my service. For free invention protection forms, write Miss Ann Hastings, P.O. Box 178, Washington 4, D. C.

**INVENTION** Record form free and "Patent Information Every Inventor Should Have." Carl Miller, Registered Patent Attorney, Woolworth Building, New York.

**SEARCHES—**Put your patent searches in the hands of a registered patent attorney or agent, as he qualifies to give a worthwhile patentability report. Record of invention form upon request and information on patent protection. Patrick D. Beavers, Registered Patent Attorney, 938 Columbian Bldg., Washington 1, D. C.

**INVENTORS:** Information on patent procedure furnished on request, without obligation. John Randolph, Registered Patent Attorney, 262 Columbian Building, Washington 1, D. C.

"INVENTOR'S Guide" and "Record of Invention" free on request. Frank P. Ledermann, 154 Nassau Street, New York 38, N. Y.

#### INVENTIONS WANTED

**INVENTORS.** Do you want to sell or license your invention on cash or royalty basis? Write Kessler Corporation, 521W, Fremont, Ohio.

**LET** Us sell your patented or unpatented invention. Write Box 142, Pittsburg, Kansas.

**INVENTORS** Having unpatented ideas, patents for sale, manufacturers will finance to \$1,000,000. What have you to offer? Inventors Creative Service, 354 South Spring, Los Angeles 13, Calif.

**INVENTIONS** Wanted. Patented or patent pending. 26 years experience promoting inventions. National Service Bureau, 3120 Meramec, St. Louis 18, Mo.

**INVENTIONS** Wanted. Patented; unpatented. Tremendous manufacturers lists. Global Marketing Service, 2420 77th, Oakland 5, California.

**SUPERIOR** Promotions. Patented; unpatented inventions. Information booklet, free. Superior, 338-344 North Rodeo, Beverly Hills, Calif.

**CASH** Buyers for inventions. Write National Inventors Institute, Box 7097, Cleveland 28, Ohio.

**INVENTORS.** Give us the opportunity to explain our selling plan for your invention, gadget or device, patented or unpatented; free particulars available upon request. Demarest and Demarest, Box 95, Battle Creek, Michigan.

**INVENTORS:** Hundreds of manufacturers have requested our assistance in locating marketable new products. Complete information free. Institute of American Inventors, Dept. 40-D, 635-F St. N.W., Washington 4, D. C.

**INVENTORS.** Don't sell your invention patented or unpatented until you receive our offer. Write Cowgill, Box 298, Marion, Ohio.

**INVENTIONS** Wanted now by my manufacturer-clients. Patented, unpatented. Write Adams, Patent Broker, 80-S Wall Street, Financial District, New York City.

#### MANUFACTURING

**CASTING:** Aluminum and die-cast—letters, numerals, toys, novelties, etc. Small or large quantities. Estimates furnished. Correspondence invited. Goodell Mfg. Co., St. Francis, Kansas.

**PLASTICS** Molding. Low mold costs. Short runs accepted. Molded Industrial, Whitestone 57, N. Y.

**NEW** Paint manufacturing equipment. Finest formulas, and knowhow. Price \$189.00. Box 208, Worthington, Ind.

**MODELS**—Small lot manufacturing. Metals, plastics, etc. Milburn, Burlington, Kentucky.

#### MODELS, MODEL SUPPLIES

**DIAPHRAGM.** Liquid pump plans, \$1.00. Simple, efficient. Bales, So. Second, Dodge City, Kansas.

**GIANT** New 1957 "O" Gauge catalog for sale—Timpale model railroaders. 92 pages 8 1/2 x 11, 2600 items, 180 car kits, 46 locomotives, hard-to-find model building parts. Price \$1.00 (refundable on \$10.00 order). All-Nation Hobby Shop, 178 N. LaSalle, Chicago 1.

**FREE** Catalog, powered gas models, airplanes, boats, racecars. Scientific Model Company, Newark, New Jersey.

**SHIP** Models—Authentic scale. Complete kits with tapered wood masts and spars, carved mahogany hulls, perfectly detailed wood blocks and dead-eyes, cast metal parts, all keyed and numbered. Even mahogany base boards with brass pegs. Simplified instructions cut building time. Send 10¢ for new catalog of 22 ships and 4 guns. Dept. 650, Marine Model Co., Halesite, Long Island, New York.

**POWER** Models. Unusual steam gasoline and traction engines, fittings, metals. Comprehensive catalog \$1.00. Chas. Cole, Ventura, Calif.

**BUILD** Miniature passenger hauling live steam locomotive with file and drillpress. We do machine work, you bolt it together. Catalog 50¢. Little Engines, Lomita, Calif.

**SHIP** and yacht model fittings; blueprints. Send 35¢ for illustrated catalog listing hundreds of items. A. J. Fisher, 1002-1 Etowah Ave., Royal Oak, Mich.

**SHIP** Models. Most complete line in New England. Kits, fittings, plans, books, tools, engines, motors. Illustrated catalog 30¢. James Bliss & Co., Inc., Dept. SM, 342 Atlantic Ave., Boston 10, Mass.

**BALSA** Wood and model aircraft. 40-page catalog 25¢. Sig Co., Montezuma, Iowa.

**SHIP** Model kits and fittings including clippers, trawler, fishermen, frigates, privateer, radio control tug, etc. Send 25¢ for 1957 catalog. Model Shipways, Box 85, Bogota, N. J.

#### HOME CRAFTSMEN

**STYLECRAFT** Sure fire hits. "Pre-traced" leather kits. Handbags, billfolds, filigree belts, over fifty other projects. Patterns on leather. Why trace? Just carve, assemble and lace. Large assortment "precarved" kits also available. Send 25¢ for catalog, free folder. Refunded first order. Apache Leather Company, 2804 E. Washington St., Phoenix, Arizona.

**DO-It-Yourself** booklets 25¢. 24 subjects. Free catalog. Popular Mechanics Press, 631 N. St. Clair St., Chicago 11.

ALL Crafts, supplies. Large free catalog. National Handicraft, 199 William Street, New York City 38.

**WOODWORKING** And cabinetmaking course for beginning and advanced home craftsmen. Only complete low-cost home training program available. Write for free booklet. Interstate Training Service, Dept. G-3, Portland 13, Ore.

I Want to send you proof of the wonderful pulling power of Popular Mechanics classified pages. What's your proposition? Write me today. Include literature if possible. F. W. Johnson, Manager Classified Advertising, Popular Mechanics Magazine, 200 E. Ontario St., Chicago 11, Ill.

129 FULL-Size jigsaw patterns. Artist-drawn. \$1. Craftplans, 1321-A Michigan, Chicago 5.

**LEARN** Art metalcraft and jewelry making. Complete, inexpensive, home training course now available. Special tools and materials furnished. Write for free booklet. Interstate Training Service, Dept. L-3, Portland 13, Oregon.

**LEATHERCRAFT.** Send 10¢ for new 76-page catalog of tools, supplies, kits, including metalcrafts, enameling, ceramics, all other crafts. Complete stock. Reasonable. Since 1910, Sax Bros., Dept. PM1, 1111 N. 3rd, Milwaukee, Wis.

18 FULL-Size patterns. Save money with easy-to-use, professionally designed full-size patterns. Make money selling beautiful, useful furniture. Make modern step and cocktail tables; metal lamps; cupola; 12-foot outboard. All patterns test-built; sold with money-back guarantee. Get your free list of these convenient, economical patterns today. Popular Mechanics Press, 200-HH E. Ontario Street, Chicago 11, Ill.

**LEATHERCRAFT.** Kits, copper, artist's supplies. New catalog. Midas, 7705 State, Huntington Park, California.

**KNOCKDOWN** Cedar chests. Lumber and veneers. Free price list. Giles & Kendall Company, Huntsville, Ala.

FREE. New catalog, 1,668 patterns, designs. Craftplans, 1321-A Michigan Ave., Chicago 5.

FREE "Do-it-yourself" leathercraft catalog. Tandy Leather Company, Box 791-019, Fort Worth, Texas.

OVER 900 Woodworking projects. Books and patterns. Free catalog. Craftsman, 115-C Worth St., New York City 13.

16 NEW Lawn chairs, 22 picnic tables, benches, trellises, etc. All 38 plans with necessary full size patterns, \$1.00. Mastercraft 25M, 7041 Olcott, Chicago 31, Ill.

**MARTIN-House,** 20 rooms, ventilated, easy to clean, keep out sparrows feature. Complete blueprint, \$1.00. List of other original projects included. Hager Design, R.R. 3, Box 33D, Rockford, Illinois.

**BUY** Wholesale nationally advertised power, hand tools, thousands other products at big discounts. Free "Wholesale Plan." American Buyers', Hertel Station, Buffalo 16-F1, N. Y.

101 FULL Size patterns. Smart, new gifts, novelties, lawn figures, shelves, action windmills, alphabets. Plus "Make Money Jig Sawing." Only \$1.00. Mastercraft 25M, 7041 Olcott, Chicago 31, Illinois.

**TABLE** Legs—Beautiful sturdy birch. Turned, tapered, or bent laminated. 15" high, set of 4 only \$3.75 postpaid. Brackets to attach included. Makes hundreds professional designs. Write for free catalog quality furniture kits, legs, tops, plywood. Birchwood Industries, Dept. 3, Fitchburg, Mass.

FREE. Complete illustrated catalog, leathercraft kits, supplies. J. C. Larson Co., 820 S. Tripp, Dept. 6927-L, Chicago 24.

**LEATHERCRAFT.** Copper enameling, mosaic tile, shellcraft, metal tooling, beadcraft, many more crafts. Free big catalog. Kit Kraft, Dept. 222, Studio City 1, Calif.

**KNOCKDOWN** Cedar chests and lumber. Free price list. Bedford Lumber Company, Shelbyville, Tennessee.

**LAMP** Size cypress knee with nipple installed \$3.00. Cy Products, Dept. 2-F, Lafayette, La.

**DRIFTWOOD**—All kinds. Finest for homecrafters. Free details. Beachcomber, Rt. 1, Box 3250, Florence, Oregon.

**FABULOUS** Polyurethane foam. More cushioning in less space than any other material. 1/4", 20¢ sq. ft.; 3/8", 25¢; 1", 65¢; 2", \$1.30. Prepaid any address United States. No c.o.d.'s. Poly-Foamers, Box 296, Cadillac, Mich.

#### DO IT YOURSELF

"READY-Kit" motor vibrator massage unit. Home business, motorizing chairs, tables, cushions for homes, hospitals, reducing salons. Free catalog tells. Mary-Mac Factory, 1012 Powhattan, Dallas 2, Texas.

"NITE-Glo" disc. Car lites reflects disc. Shows object at nite. Use on posts, bumpers, houses, driveways, boats, trailers, trucks, garages, etc. Adhesive back 2 1/2" disc. Sticks to any surface. 15 disc to package complete \$1.00. Active Display Advertising, 1702 West 19th Street, Chicago 8, Illinois.

**PERMAFILM** Seals, photographs, cards. Eight 6x3 sheets, \$1.00. Samples. Press-O-Matic, 111P Branch, Arroyo Grande, California.

18 FULL-Size patterns. Save money with easy-to-use, professionally designed full-size patterns. Make money selling beautiful, useful furniture. Make modern step and cocktail tables; metal lamps; cupola; 12-foot outboard. All patterns test-built; sold with money-back guarantee. Get your free list of these convenient, economical patterns today. Popular Mechanics Press, 200-HH E. Ontario Street, Chicago 11, Illinois.

**CLOCK** Movements—Gorgeous dials, plans, kits. See ad page 325.

**DO-it-yourself** family trampolines. American Trampoline Company, Jefferson, Iowa.

**GRANDFATHER** Clock movements, blueprints, kits. Wholesale catalog 25¢. Mason-Sullivan, Noroton, Conn.

**MAKE** A burner from scrap pipe, fittings. Makes hottest whitest flame, no smoke, cannot explode. Uses drained crank-case oil, crude oil of any kind. Hundreds of uses, fire, a forge fire, a boiler, 1 or a thousand h.p. Protects orchards from freeze, etc. Makes it in hrs. time. Makes its own power. Will fire a boiler from cold start to steam in minutes. Send \$3.00 for pictures, complete instructions, how to make and operate. Universal Engineering Services, 202 West Dunn Avenue, Killeen, Texas.

**BUILD** Your own optical instrument! New book—"Fun With Optics" tells you how! 32 exciting pages. Full diagrammed instructions on how to build telephoto lenses, telescopes, microscopes, slide viewers, artist drawing projectors, binoculars, magnifiers, riflescopes, etc. We can furnish the lenses, prisms and parts you'll need. To get this terrific book send your name and address and only 50¢, full price. Request Stock No. 9050-CY. Edmund Scientific Company, Barrington, New Jersey.

#### WATCHES, OLD GOLD, JEWELRY

**COSTUME** Jewelry supplies. Catalog and samples. 35¢. Largest line in America. Milady-Fair Co., G.P.O. Box 1323, New York City 1.

**HIGHEST** Cash for old gold, broken jewelry, gold teeth, watches, diamonds, silverware, spectacles, platinum, mercury. Free information. Rose Refiners, Heyworth Bldg., Chicago 2.

**WATCH** And clock repairing books. Free catalog. North American, 2320-AB Milwaukee, Chicago 47, Ill.

**WATCHMAKERS**—Jewelers', machinists' tools. Watchmaking course. Catalog 25¢. Bengale, Culver City, California.

**COSTUME** Jewelry. Samples and list \$1.00. Mulheim's, North Industry 10, Ohio.

**WATCHES** Completely repaired \$4.00. Guaranteed. Freeman's Watch Repair, Rosston, Okla.

**COPPER** Enameling supplies, rhinestones, pearls, jewelry settings. Catalog 10¢. J & M Novelties, Dept. CB-3, Griffith, Indiana.

**COPPER** Enameling, jewelry findings, rhinestone supplies. 87 page catalog 25¢. Bergen, 300-PM Southwest 17th Avenue, Miami, Florida.

**PREFERRED** Source for quality settings and stones. Manufacture costume jewelry at home. Extensive catalog 25¢. A. V. Cutt Co., 210-F Fifth Ave., New York 10, N. Y.

#### RAZORS, BLADES, SHARPENING

**TEN** Double edge blades 10¢; hundred 75¢; thousand \$6.00. Enterprises, 605 Wells, St. Paul 1, Minnesota.

#### FOR THE HOME

**FOAM** Rubber furniture cushions. Factory seconds. 50% discount. Free catalog. Perma-Foam, 238C Rhode Island Ave., East Orange, New Jersey.

**BE** Your own plumber. You can. Few inexpensive tools and our instructive book, "Home Plumbing Guide," shows and tells you how. Hundreds of photographs and diagrams. Easy to follow. 160 pages. \$3.50. Catalog free. Popular Mechanics Press, 200PG East Ontario St., Chicago 11, Ill.

**SAVE** 30% On fuel oil bills. Fast action treatment. Saves you up to \$8.50 on 250 gallons. Prevents sludge, soot, corrosion. Free booklet included, "How to Get the Most Heat From Your Boilers." Pint can \$2.00, 2 cans \$3.75 p.p. Active D. A. Co., 1702 W. 19th St., Chicago 8, Ill.

**HOME** Plans. 10 architect designs of 2, 3, and 4 bedroom contemporary ranch homes, carefully selected for livability, economical construction and beautifully illustrated exteriors. Send \$1.00 for information and plan collection to make your choice. Blue prints available. (\$1.00 refunded first blue print order). S. & P. Plan Service, P. O. Box 333, Cincinnati 14, Ohio.

#### OF INTEREST TO WOMEN

**FREE.** Finest tableware made like sterling. Newest patterns. Join: The Gift Club, Dept. M., Box 81, Beecher, Ill.

**EARN** Money at home. Learn invisible reweaving at home. Licensed, approved school. Free details. Eastern School of Reweaving, 73 Main Street, Dept. 827, Hempstead, N. Y.

**EMBROIDER** Stamped linens. Buy direct from manufacturer and save. Send for free catalog. Merrilee, 16 West 19th St., Dept. 342, New York 11, N. Y.

**GOOD** Money in weaving. Weave rugs at home for neighbors on \$89.50 Union loom. Thousands doing it. Booklet free. Caricraft Co., Polk St., Boonville, N. Y.

**FREE** Book. Grow mushrooms. Guaranteed market. Mushrooms, Dept. 176, 2954 Admiral Way, Seattle, Wash.

**WANT** To make big money at home? \$10.00 profit in an hour possible with invisible mending. Make tears, holes, disappear from clothing, fabrics. Steady year-round demand from cleaners, laundries, homes. Details free. Fabricon, 8332-S Prairie, Chicago 19, Illinois.

**SELL** Fine fabrics. Get yours wholesale. Box 863, Norwalk, Conn.

**BOOKS:** Hundreds of subjects. Big catalog free. Popular Mechanics Press, 200-BC East Ontario St., Chicago 11.

**MAKE** New greaseless doughnuts in kitchen. Sell stores. Free recipes. Morgan Ray, 3605 South 15th, Minneapolis 7, Minn.

"8 MISTAKES Parents Make." Every parent should have this new book about child training. It is free; no obligation. Simply address Parents Association, Dept. 672, Pleasant Hill, Ohio.

**RAISE** Money! Making, selling artificial flowers, corsages, novelties. Big illustrated catalog 25¢ (refundable). Profitkrafts, 4513B21 Lorain, Cleveland 2, Ohio.

#### PERSONAL

"HOW Can I find out?" You can! Information confidentially developed. Any matter, person, problem. Worldwide. Officially licensed. Established 1922. William Herman, 170 Broadway, New York City.

**BOOKS:** Hundreds of subjects. Big catalog free. Popular Mechanics Press, 200-BC East Ontario St., Chicago 11.

**HONOLULU,** Hawaii, Box 5238. Personal or business address. Other services.

**HOLLYWOOD!** Your letters remained! Postmarked anywhere within U.S.A. \$1.00! Box 972, Santa Barbara.

**SIMPLE** Television repairs. Marvelous booklet 25¢. Free catalog. Popular Mechanics Press, 633 N. St. Clair St., Chicago 11.

**SASKATCHEWAN** The oil province. Regina newspaper classified airmailed \$1. Stenseth, Box 231, Regina, Sask., Canada.

**YOUR** Key to popularity and success. A revealing booklet, \$1.00. P.O. Box 601, Ironwood, Michigan.

**BILLS!** Bills! Bills! Pay them quickly with cash loan by mail, \$100.00 to \$600.00. Repay in small monthly installments over 20 months. Your payments may run 1/2 less than now; have money left over to spend. Loan order blank mailed free in plain envelope. Advise amount you need. State Finance Co., 323 Securities Bldg., Dept. J-227, Omaha 2, Nebr.

**REMAIL 25¢.** 12 Assorted California scenic postcards \$1.00. Remailed free. Los Angeles Sunday classified \$1.00. Mexico shopping. Write your wants. Wynn's, 1165 E. Ramsey, Banning, Calif.

**DYNAMIC** Booklet reveals difference between synthetic and natural vitamins and minerals. Free. Bonnie, 1605 N. W. 79th St., Miami 47, Florida.

**WONDER** "Master Formula" changes and improves your life and affairs. Write: Teocritic-PM, Box 27683, Hollywood 27, California.

#### REMAILING SERVICE

**LETTERS** Remailed, etc., from Canada 35¢. I affix Canadian air stamp. Ross, 83 Belhaven Rd., Toronto 8, Ont.

**SECRET** Mail receiving, forwarding system. \$3 month. Hedgpech, Box 830, Alhambra 23, California.

**HOLLYWOOD,** Beverly Hills, Los Angeles, Santa Monica remails 25¢. View-cards 5¢ each. Danchak, P.O. Box 1065, Santa Monica, California.

**COLUMBUS** Mail forwarding-receiving address for rent. Details free. William McLaughlin, 800 Stewart, Columbus 6, Ohio.

**TRENTON:** Remails 25¢. Matelena, 3576 E. State Extension, Trenton, N. J.

**BRAZILIAN** Rearmails 50¢. Forwarding service. Mauricio, Caixa Postal 515, Anapolis, Golas, Brazil.

**SAN Fernando, Calif.**—Remails 25¢. Mail received—forwarded \$3.00 month. 5 scenic cards \$1.00, remailed free. Los Angeles Sunday classified \$1.00. Homer, 13247 Sayre Street, San Fernando, California.

**HOLLYWOOD-Long Beach** remail 25¢. Receiving-forwarding address. Lenormans, 722 Magnolia, Long Beach, California.

**BEAUTIFUL** Pictorial view cards New York City. Only 10 for 25¢. Remailed 10¢. B. Grant, 385 East 144 St., Bronx 54, New York City.

**UNITED Nations** stamped and remailed. 30¢. Zwirn, 430 Livingston Ave., New Brunswick, N. J.

#### TREASURE FINDERS

**TREASURE.** Metal, mineral detectors. M-Scope. Used worldwide for treasure hunting. Mineralights, Geiger, scintillation counters. Prices from \$14.75. Fully guaranteed. Use our time payment plan. Free booklets on treasure hunting, uranium prospecting. Free catalog. Fisher Research Lab, Inc., Dept. PM-C1, Palo Alto, Calif.

**URANIUM.** Gold, silver treasure. New power-packed highly sensitive metal detectors. Geiger counters and mineralights. Kits and assembled models from \$12.50. Lightest weight, guaranteed, free literature. Electronic Applications, Dept. M, Box 8, Arlington 10, Virginia.

**FIND** Buried treasure, gold and silver, with Goldak's sensational 3 1/2 lb. "find-it" locator, only \$49.50. Write for free literature on complete line of mineral, metal locators; Geiger and scintillation counters. Goldak, 1541 W. Glenoaks Blvd., Glendale, Calif.

**FREE 16-Page** manual from world's largest mfr. of prospecting equipment. Detron Corp., 5528 Vineland, North Hollywood, Calif.

**FIND** Uranium, valuable metals and minerals, buried treasures! One of the world's oldest and most reliable suppliers offers a complete line of equipment—Geiger counters, assay and test kits, metal detectors, etc. All instruments traded and repaired. Write for free literature on profitable prospecting. The Radiac Co., Inc., 489 Fifth Ave., Dept. PM-2, New York 17, N. Y.

**FOR** Treasure locators, geiger, scintillation counters, mineralights, M-Scope. Fisher Research Laboratory. See advertisement page 281.

**LITHIUM.** The wonder metal. Free booklet describes prospecting information, uses, etc. Nu Age, Box 142, North Battleford, Sask., Canada.

#### FOR SALE—MISCELLANEOUS

**HEARING** Aid batteries, wholesale. Free list. Habs, Box 51, York, Penna.

**BOOKS:** Hundreds of subjects. Big catalog free. Popular Mechanics Press, 200-BC East Ontario St., Chicago 11.

**100 DOUBLE** Edge razor blades. \$1.00. Guaranteed. W & D Sales, Box 11, Dyersville, Iowa.

#### WANTED—MISCELLANEOUS

**CASH** For Indian bird stones; antique northwest coast totem, masks, carvings. Send photos. Robert Stolper, 8852 Cynthia Street, Los Angeles, California.

**BOOKS:** Hundreds of subjects. Big catalog free. Popular Mechanics Press, 200-BC East Ontario St., Chicago 11.

**SCRAP** Mercury (quicksilver) containers supplied — Tantalum, tungsten, silver, platinum. Metallurgical Products Company, Established 1909, 35th & Moore Sts., Philadelphia 45, Penna.

#### MISCELLANEOUS

**70 BIBLE** Lessons, 25¢. Bulletin, Box 87, Cathedral Station, New York City 25.

**DRESSES** 24¢; Shoes 39¢; men's suits \$4.95; trousers \$1.20. Better used clothing. Free catalog. Transworld, 164-S Christopher, Brooklyn 12, N. Y.

**RECEIVE** Mail for one year, 25¢. Dave Hoffman, Clarence, New York.

**VIOLINS** Repaired. Bows repaired. A. E. Rice, Box 1027, Baird, Texas.

**BEAUTIFUL** Portraits done in oils from photographs. Anyone can afford my reasonable prices. Free particulars. Elmer Brunow, 2452A No. 17 St., Milwaukee 6, Wisconsin.

**19 VITAMINS** And minerals in one tablet. Regularly \$4.00. Introductory offer \$2.50. Postpaid. M. T. Steidl, Inc., Fargo, N. Dak.

**MIMEO.** Bond, duplicating papers \$1.00 ream. Samples. Brookman Paper Co., 555 Westchester Ave., New York City 55.

**FREE** Vitamin catalogue—Quality products. Feel better, younger, more vigorous! Buy direct, save! Vitamin-Center, Drawer 2318P, Detroit 31.

**SOLAR-Heated** earth home meetings, May 12th, 1957. Mammoth Cave Home magazine subscription. Free book: "How To Build Your Own Home of Earth." \$2.00. S. R. House, P.O. Box 727, Indianapolis 6, Ind.

**KEYS** Duplicated. All kinds. 40¢ each. Carmack Service, 962 Perry Highway, Pittsburgh 37, Penna.

**INTERESTED** In puzzle contests? Valuable information free. Unique, Box 99, Mt. Vernon, Ill.

**JAPAN:** Buy gifts from Japan. Kimono, artistic handicrafts, novelties, others. Business information \$1.00. Send money orders. Clarence Yamagata, Room 202, Naka 7 Bldg., Marunouchi, Tokyo, Japan.

**\$100 WEEKLY** Raising earthworms! Free plan reveals how! Oakhaven-M. Cedar Hill, Texas.

**HOW** To remodel, basement, attic. Booklet 25¢. Free catalog. Popular Mechanics Press, 633 N. St. Clair St., Chicago 11.

**FREE** Book. Grow mushrooms. Guaranteed market. Mushrooms, Dept. 175, 2954 Admiral Way, Seattle, Wash.

**DO** It yourself. What? Repair TV, build furniture, make barbecue, plumbing repairs, build boats, do house wiring, remodel home, lay tile, modernize kitchen, repair home, and scores of other things you can do yourself. Books covering each subject, only 25¢. Send for descriptive list. It's free. Popular Mechanics Press, 200-LB East Ontario St., Chicago 11, Ill.

**RECEIVE** Magazine samples, mails, catalogues, offers from everywhere. Get listed 25¢. Rorick, Cincinnati 26, Ohio.

**YOUR** Name wanted. We'll send 1000 publishers, mailers, wholesalers your name, on our list one year 25¢. Dixie Mailers, King, N. C.

**HOUSE** Wiring—Electrical repairs. 32-page booklet 25¢. Popular Mechanics Press, 633 N. St. Clair St., Chicago 11.

**CESSPOOLS,** Septic tanks, outhouses, clogged drains, cleaned, deodorized without digging, pumping. Sursolvent reduces contents. Reclaims leachability. Old systems work like new. Free details. Electric Sewer Cleaning, Aliston 34, Mass.

**"HOME** Improvement Guide." New, amazing 192 page volume. Packed with ideas, plans for remodeling, decorating, landscaping, built-in projects. \$2.50 pre-paid. Popular Mechanics Press, 200-HG East Ontario St., Chicago 11.

**BUILD** Small boats. Booklet 25¢. Catalog free. Popular Mechanics Press, 633 N. St. Clair St., Chicago 11.

**BARGAIN.** Exciting Little Library booklets. 25¢ each. Tool making, painting, welding, home improvement, games, models, plastics, lamp making, glass blowing, boats, photographs. Free catalog. Popular Mechanics Press, 200-LB East Ontario St., Chicago 11.

**MEN,** Help safeguard your hat from being snatched up by mistake with identifying hat cards placed inside. Dozen 25¢ coin. Simplex, P.O. Box 193, South Bend, Indiana.

**HOW** To read blueprints. Amazing booklet 25¢. Free catalog. Popular Mechanics Press, 631 N. St. Clair St., Chicago 11.

**REMODEL** Your own home. Save hundreds of dollars. New, amazing book shows you how. Written so you can understand it. Step by step instructions make it easy. Fully illustrated, 400 photographs, hundreds of diagrams, 160 pages. \$2.95. Literature free. Popular Mechanics Press, 200-RH East Ontario St., Chicago 11, Ill.

**BIO** Malls, four months listing, 25¢. Wright Publications, 2270 Hubbard, Memphis 8, Tenn.

**STUPENDOUS** Mental power. Adults. Details 3¢. Delmar Wisdom, 846 Sunnyside, Chicago 40.

**BUY** Wholesale! Discounts to 80%! Appliances, cameras, sporting goods, housewares, watches, tools, clothing, etc. Buy-Rite 73-02, Wagaraw, Hawthorne 2, New Jersey.

I want to send you proof of the wonderful pulling power of Popular Mechanics classified pages. What's your proposition? Write me today. Include literature if possible. F. W. Johnson, Manager Classified Advertising, Popular Mechanics Magazine, 200 E. Ontario St., Chicago 11, Ill.

**RECEIVE** Mails, magazines, samples. Your name in numerous mailing lists 25¢. Greenwood, Box 1116-BY, New York City 8.

**BOYS!** Girls! Make hundreds of different things with Twist-Kraft. Make miniature flowers, figures, animals, furniture, houses and loads of other interesting things with these multi-colored fuzzy wires. To get your complete set send only \$1 to: E. T. Gilbert Mfg. Co., 228-236 South Ave., Rochester 4, New York.

**SHARPEN** And service lawnmowers \$10.00 hour possible. build your own grinder, small cost, 26th year. Wirt's, 2419 Osahn, Burlington, Iowa.

**AUTO** Conditioning record teaches effortless self-improvement! \$2.00. Grauer, 2260 Burnett, Brooklyn 29-B.

**GET** The facts about the fastest growing area in the U. S., the great Pacific Northwest. Information about jobs, business opportunities, real estate, weather, recreation. This could be your big opportunity. Send \$1.00 to: Ronruss, Box 124, Bellingham, Washington.

**WANT** More business? Here's an amazing opportunity to increase your sales. Talk to thousands of interested readers of "Mechanics Popular." Our Spanish Edition covers the Latin American countries like a blanket. They're real mailorder buyers. Classified rate 75¢ per word. Try an ad in our next issue. Classified Advertising Department, Popular Mechanics Magazine, 200 East Ontario Street, Chicago 11, Ill.

**VERY** Important. Cost a dollar, worth a million. Particulars a stamp. Johnson, B552, Memphis 1, Tenn.

**CIGARETTES.** Make 20 for 9¢. Facts free. Moberly, Box 810, Owensboro, Ky.

**FREE** Wood preserving guide. What and where to use for home and yard. Rot Stoppers, 978 Ellicott, Buffalo 9, N. Y.

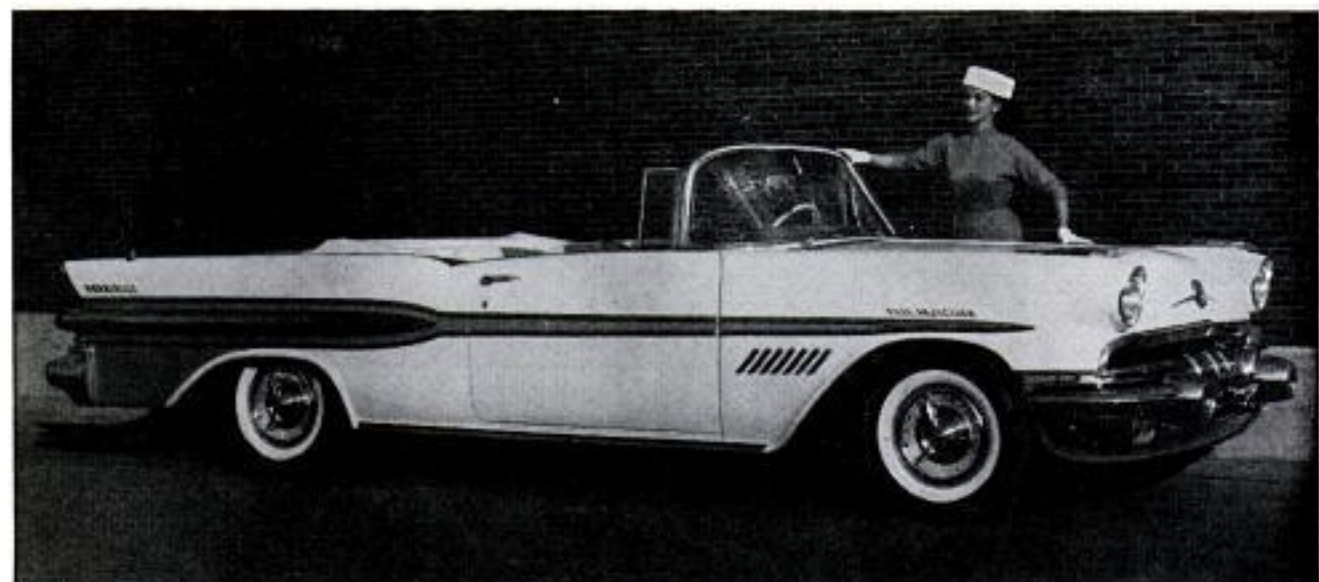

## Pontiac Shows Limited-Edition Models

YOU CAN'T buy one, but the Pontiac Bonneville convertible has a 300-horsepower fuel-injection engine. It's for dealer's use only in a mass field test before public sale begins.

You can buy a Transcontinental wagon with reclining front seat complete with barber-chair-type headrest for long-trip comfort.



# FREE 1957 CATALOG!

Over 15,000 bargains in the fields of Hi-Fi, Radio, Television and Electronics!

Send for Your Copy Today!

### E-Z TERMS!

Only 10% Down  
Top Trade-Ins  
Up to 50% Savings  
on More Than  
800 Guaranteed  
Reconditioned  
Eqpt. Items!



**WORLD RADIO LABORATORIES**  
The World's Largest Distributor of Amateur Radio Eqpt.  
3415 W. Broadway — Council Bluffs, Iowa  
Leo I. Meyerson **PERSONALIZED SERVICE**

### MAIL HANDY COUPON

WORLD RADIO LABORATORIES, INC. PM-2  
3415 W. Broadway — Council Bluffs, Iowa

PLEASE RUSH ME:  Free Catalog  Hi-Fi Booklet  
 Info on Kits  Recond. Eqpt. List

NAME \_\_\_\_\_  
ADDRESS \_\_\_\_\_  
CITY \_\_\_\_\_ STATE \_\_\_\_\_

## Finish HIGH SCHOOL AT HOME

Complete 4 Yrs. in 12 Months

Learn More! Earn More! Enter professional or technical schools. Advance Socially. Live a Happier, Fuller Life. Individual Courses or complete schedule. **WRITE FOR SCHOOL BULLETIN.**

**ACADEMY FOR ADULTS**

30 W. Washington, Dept. PM-27, Chicago, Ill.



### DEVELOP A HE-MAN VOICE!

Write for FREE book "How to Strengthen Your Voice for Greater Success" by Eugene Penchlinger. No obligation. Book will be mailed at once in plain wrapper, postpaid. Just send your name and address. State age.

**PREFECT VOICE INSTITUTE, 210 S. Clinton St., Studio BT-2, Chicago 6, Ill.**



### LOCKSMITHING

Practical Up-to-Date Course — ONLY \$5.95  
53 illustrated self-instruction lessons. Easy to learn. Full price only \$8.95 postpaid—or COD plus postage. Satisfaction guaranteed or full refund! **NELSON HALL CO., 210 S. Clinton St., Dept. BT-2, Chicago 6, Ill.**

## MAN WANTED

### WHY SETTLE FOR LESS THAN \$140,000 IN A YEAR

The days are gone when a "few thousand" a year salary was enough for a man to take care of his family, buy a new car, and "salt some away for the future."

If you are a middle-aged man and want to make good in a new field, we can make you a fine offer to join our top men who are paid up to \$22,000 in a year.

Earnings paid in advance, no investment needed. Write a personal letter to **PRESIDENT, Dept. PM, P.O. Box 711, Fort Worth 1, Texas.** If you live in Canada write **President, Dept. PM, 25 Industrial St., Toronto 17, Ont.**



# SAVE \$ ON U\$ GOV'T \$URPLUS\$

Our publication "Government Surplus Sales" lists hundreds of items for sale by the U. S. Government at tremendous savings, as low as 1c on a \$1.00.

These are samples of the savings that are being made:

LIFE BOAT .....\$12.00	GRINDER .....\$4.69	SHAPER .....\$15.00	DUMP TRUCK.....\$76.77
TRACTOR .....\$75.00	TYPEWRITER ....\$7.51	FREEZER .....\$50.00	SPRAY PAINTER.....\$15.25
	MOTOR .....\$4.00		

Hundreds others listed in our bulletin "Government Surplus Sales" and may be purchased direct from U. S. Government. Hunting, Fishing, Camping, Sporting Equipment, Photographic Equipment and Supplies, Radio and Electronic Equipment, Amphibious Trucks, Jeeps, Boats, Motors, Binoculars, Plumbing, Electrical Equip., Cars, Power Tools, Machinery, Chemicals, Furniture, Office Equipment, Supplies, Scrap, Etc.

How may you receive our bulletin "Government Surplus Sales?" By sending \$1.00 to  
**GOVERNMENT SURPLUS SALES, P. O. Box 169, Department 8-5, East Hartford 8, Conn.**

## How to Build Your Own GARAGE



Save as Much as 50%  
of Usual Construction Costs

Get Popular Mechanics' brand new book **How to Build Your Own Garage** by Wayne Leckey, Assistant Shop Notes Editor, and find out how you can build your own garage at savings of 50% of usual cost. Leckey tells in famous step-by-step instructions and shows in big, clear photos, drawings and diagrams how to perform every building operation from laying the concrete to installing the final trim. There are 25 designs. Brick, frame, and concrete block fully covered. Send \$3.50 for your copy. 7-day money back guarantee.

POPULAR MECHANICS PRESS, 200 E. Ontario, Chicago 11, Ill.

## FREE AMAZING NEW BOOK "HOW TO ANSWER ADS"



Never before have you seen anything like this. Tells you in simple language the correct way to answer ads. Gets you quicker replies—better results, and greater satisfaction. Will save you time and money and it's **ABSOLUTELY FREE**. No obligation whatever. Every reader of advertising should have this booklet. Send a postcard for your copy NOW. F. W. JOHNSON, Popular Mechanics Magazine, Room 600-A, 204 East Ontario Street, Chicago 11, Ill.

**WHOLESALE Electric Guitars - Parts - Factory to You**  
 Solid-body Spanish, amplifiers, pedal harp-chord guitars, double-necks, single-necks, triple necks, solid-body mandolin, pickup mikes, non-electric instruments, etc. 1957 Models wholesale. **FREE CATALOG**. Free home study course with instruments. Parts & plans available to build your own.  
**CARVIN CO., Box 287, PM-2, Covina, Calif.**

## I'll Send You This Handsome SAMPLE CASE—FREE



and Show You How to Make Up to \$30.00 in a Day  
 Mail coupon for this Free Tailoring Sample Case packed with 150 beautiful, big-value suit and overcoat fabrics. Take orders from friends, fellow-workers, others, for fine quality, made-to-measure clothes. Pocket big cash profits in advance. Because wearing our suits and overcoats brings more orders, we make it easy for you to get your own clothes without 1c cost. No experience is needed. **SATISFACTION GUARANTEED. SEND NO MONEY.** Just fill out and mail coupon—today!  
**J. C. FIELD & SON, Harrison & Throop Streets DEPT. D-1716 CHICAGO 7, ILLINOIS**

**J. C. FIELD & SON, Dept. D-1716 Harrison & Throop Sts., Chicago 7, Ill.**  
 Dear Sir: I WANT A MADE-TO-MEASURE SUIT TO WEAR AND SHOW, without paying 1c for it. Rush details and Sample Kit of actual fabrics, **ABSOLUTELY FREE.**

NAME.....AGE.....  
 ADDRESS.....  
 CITY.....STATE.....

## NEW! PLUMB BOB REEL



**PLUMBS, CENTERS, ALIGNS EXACTLY!**  
 You can't miss with Line-Master! No re-set! Unbreakable point drives into wood, mortar, holds fixed distance from vertical surface. Suspends perfectly from overhead line. Non-fouling reel, adjustable line drag, cast alloy case, beaded aperture, 50' nylon line. \$3.25 postpaid. Guaranteed. Send cash, check, M.O. today. No C.O.D.  
**LINE-MASTER, Box 3821-A2, Seattle 24, Wn.**

## NEW! ARBO-GASTER GETS BIG BASS WAY DOWN DEEP



"Others weren't catching 'em, but we got near-limits every day with new Reflector-finish Arbo-gasters," says B. C. Joyner, Memphis, Tenn. (left) and N. Simich, Akron, Ohio. Largest of 11 bass from Horse-shoe Lake, Ark. was 6 lbs. Large lip keeps Arbo-gaster deep! Amazingly snagless, controls perfectly. Sparkling, non-fade Reflector finish or Standard Colors. 5/8 oz. or 1/4 oz.—\$1.35 each.

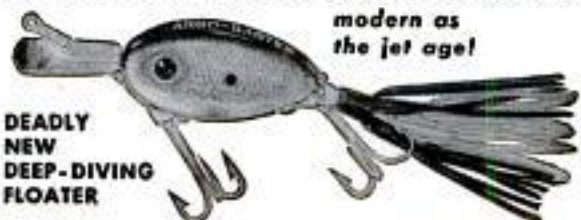

## MAIL FOR BIG FREE CATALOG

**FRED ARBOGAST CO., INC.,**  
 2222 W. North St., Akron 3, Ohio  
 Please send my **FREE** copy of latest Arbogast color catalog of baits—full of pictures of catches.

Name.....  
 Address.....  
 City.....State.....

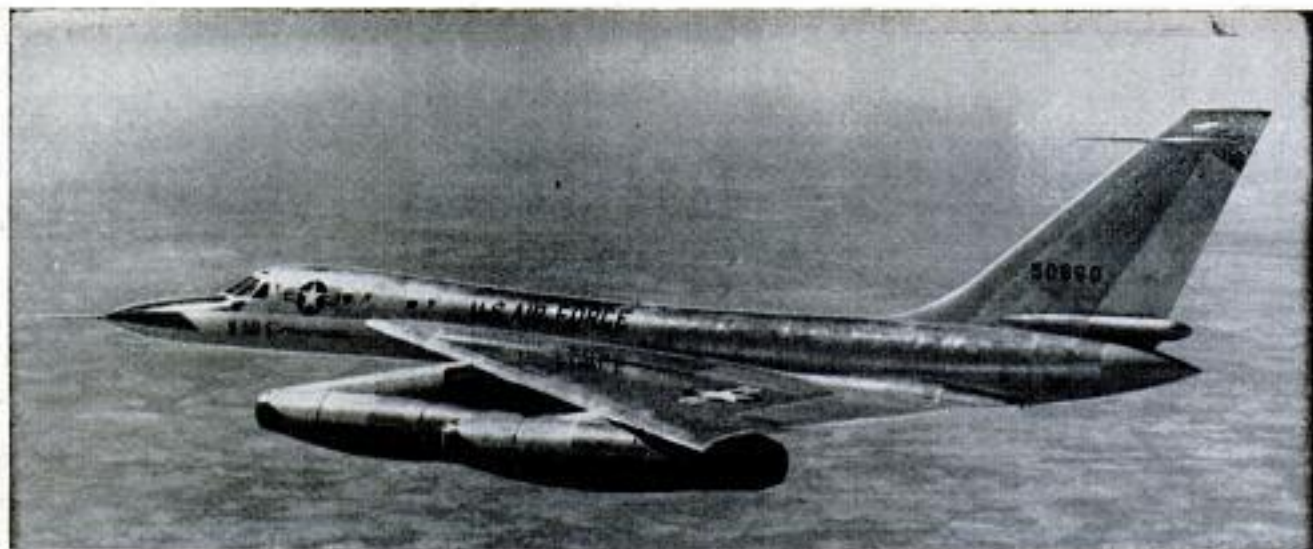

## 50,000 Feet— B-58's "Basement"



AMERICA'S first faster-than-sound bomber, the B-58 Hustler, will operate at altitudes above 50,000 feet. With a crew of three, this aircraft will be powered by four General Electric J-79 turbojet engines with afterburners. The plane is 95 feet long, has a wingspan of 55 feet and a vertical fin standing 30 feet above the ground. Its stilt-like main landing gear includes 16 tires. The B-58 has been undergoing flight tests since Nov. 11, 1956. This delta-wing bomber was designed and built by Fort Worth, Tex., plant personnel of Convair Division of General Dynamics Corporation.



# BUILD YOUR OWN POWER TOOLS-

PLANS  
only  
**1.00**  
EACH  
POSTPAID

With **GIL-BILT PARTS-PLAN KITS**  
**10" TILT/ARBOR SAW**



Sturdy wood, steel, and aluminum construction. NEW DEPARTMENT ball bearings. Capacity and performance of floor saws selling for \$150.00 and up. Plans, all metal parts in kit with 10" comb. blade **\$25.90**, less blade **\$22.95**. F.O.B. St. Louis. Detail PLANS—PATTERNS only \$1.00 postpaid.

## 12-IN. BAND SAW

Ball bearing drive, rigid cast aluminum wheels, rubber tires. Handles stock up to 6 inches thick. Cuts to center of 24" circle, 18 x 18 inch tilt table. Capacity and performance of band saws selling for \$80 and up. Plans and all metal parts in kit with 1/4" blade **\$23.95**. Detail PLANS—PATTERNS only \$1.00 postpaid.



For shipments up to 600 miles, add 5%; over 600 add 10%. Amount in excess of actual postage will be refunded. Also Build-it-yourself 18" Band Saw, 6" Belt Sander, Shaper, 8" Tilt-Table Saw. Simplified plans, build easily with hand tools only. Advertised and sold for 9 years, over 30,000 units in use. Money back Guarantee. **FREE CATALOG.**

**GILLIOM POWER TOOLS** DEPT. 508, LAMBERT FIELD ST. LOUIS 21, MISSOURI

## 2 WAY PORTABLE RADIO SET SENDS - RECEIVES UP TO 10 MILES AS SHOWN

with built-in antenna or hundreds of miles with outside antenna! Works on 80 and 40 meter amateur radio bands—also Aircraft and overseas broadcast bands (3 to 8mc). **PORTABLE SELF-CONTAINED POWERED WITH STANDARD LONG LIFE, LOW COST PORTABLE RADIO BATTERIES. NO AC PLUG-INS NEEDED!** Take it with you everywhere you go—on trips, vacations, camping—Keep in contact with home, friends. Has 5 watt crystal controlled transmitter—Sensitive Regenerative Receiver, Yoke-listen switch. Wt. only 3 lbs. Size, only 6"x4"x4". **TESTED—PROVEN—SIMPLIFIED—PRACTICAL.** Full information given on quick easy to get license. **SEND ONLY \$3.00** (bill, ck, mo) and pay postman \$11.95 C.O.D. postage on arrival or send \$14.95 for postpaid delivery. Complete kit includes all parts, tube, coils, plastic cabinet, easy instructions. (Set of batteries \$2.75; crystal \$1.25). **COMPLETELY WIRED AND TESTED POSTPAID \$19.95.** A regular \$49.95 value—Order now before price goes up. **GUARANTEED - AVAILABLE ONLY FROM:**



**WESTERN RADIO** Dept. BNM-2 KEARNEY, NEBR.

**DO IT YOURSELF BUT DO IT BETTER WITH THE RIGHT MATERIALS!**



### You Need This

How to select and how to use—Lumber, mill-work, plywood and hard-board—Exterior wall and roof materials—Hardwood floors and floor coverings—Wall and ceiling materials—Doors, windows, screens and weather stripping—Glass, the material of tomorrow—Plumbing pipes and fittings—Electrical equipment—Nails, screws, bolts, etc.—Hinges, locks and other hardware—Paints and miscellaneous products.

192 Fact filled pages.  
667 how-to-do-it pictures

Popular Mechanics Press, Dept. 257, 200 E. Ontario St., Chicago 11

## Get Popular Mechanics DO-IT-YOURSELF Materials Guide

The Key to Buying and Using Lumber, Hardware and Other Home Workshop Materials

The right lumber. The right grade. The right fastenings, nails, screws, glue and other hardware. These are all just as important as the right design and the right kind of workmanship. It's true, whether you're fixing up the house, making a fine piece of furniture or knocking out a time-killing gadget. Get Popular Mechanics Materials Guide. Fills a long-felt need of home owners and home workshop fans. Has how-to-do-it information too. Send only \$2.95 for postpaid delivery. Money back if you want it in 5 days.



## \$10-\$50-\$100 MORE IN YOUR PAY ENVELOPE!

Pick and Choose from Hundreds of Positions with

**FAMILY-MAN SALARIES**  
in the Classified Ads daily!

# MATH

YOU CAN LEARN AT HOME QUICKLY—EASILY

The One firm foundation essential for all these

**IN-DEMAND PROFESSIONS**

- FOREMAN**      **ENGINEER**
- INDUSTRIAL DESIGNER**
- DRAFTSMAN**      **ACCOUNTANT**
- WHITE COLLAR WORKER**
- SURVEYOR**      **STATISTICIAN**
- BUSINESS MANAGER**

Give yourself—and your family—the advantages of a higher education! Just a few minutes a day with **MATH FOR THE PRACTICAL MAN** can change your life—and theirs!

IF you never went to college—IF you've forgotten the math you were taught—or—even if you never were good at figures—you can be a whiz at **MATH FOR THE PRACTICAL MAN**.

Just thirty minutes a day—and you learn—Arithmetic, Algebra, Geometry, Trigonometry, Calculus—the background you need for hundreds of positions with **FAMILY-MAN SALARIES**, in the Classified Columns daily! Before you eat your heart out over another Classified Ad Section—send for this Math Course that can change the course of your future!

**FREE for 10 days**  
**SEE FOR YOURSELF!**

**D. VAN NOSTRAND COMPANY, INC.**  
120 Alexander Street, Princeton, N. J.  
Please send me the 5 volumes of **MATH FOR THE PRACTICAL MAN**. I understand that I may return the set within 10 days if not satisfied, at no obligation.

\_\_\_I enclose \$9.85. (Reg. \$14.75) **PM2-57**  
\_\_\_Bill me after 10 days

NAME \_\_\_\_\_  
ADDRESS \_\_\_\_\_  
CITY \_\_\_\_\_ STATE \_\_\_\_\_

# Get these BIG NEW **POPULAR MECHANICS** BOOKS at your newsstand

*WORTH MANY TIMES  
THEIR PRICE... in fun...  
... in money-saving ideas!*

**POPULAR MECHANICS**  
**WHAT TO MAKE**  
AND HOW TO MAKE IT

**POPULAR MECHANICS**  
**1957 CARS FACT BOOK**

**POPULAR MECHANICS**  
**ELECTRONICS MADE EASY**  
A BUILD-IT-YOURSELF BOOK

**POPULAR MECHANICS**  
**GETTING STARTED WITH POWER TOOLS**

**WHAT TO MAKE—1957.** Here, with many diagrams and easy to follow text, are hundreds of home and hobby projects. They're all easy to make, useful and satisfying. A few examples: re-covering a card table; mirror framing; building a floor polisher, a greenhouse, child's playhouse, infra-red lamp barbecue.

**ELECTRONICS MADE EASY.** Now you can build your own Hi-Fi set, a "miracle" transistor radio, and many other electronic devices that add so much enjoyment to modern living. This book tells and shows how. It covers in detail electronic theory and practice and build-it-yourself projects in language even the novice can understand and put to immediate practical application.

**1957 CARS FACT BOOK.** Want to know all about the new cars—price, styles, mechanical performance, innovations? Then this is the book for you. Describes all the domestic and many of the foreign models, with scores of photographs and construction details. If you're planning on buying a new car, or they hold great interest for you, here's a complete, informative, one-source reference that's the finest on the newsstands.

**GETTING STARTED WITH POWER TOOLS.** An ideal guide for the man who has recently purchased power tools or is planning to—as well as the experienced craftsman. By following the simple directions in this book, you can become an expert in handling any home-workshop power tools. Covers tool components, selection, methods of operation with many tips, safety procedures, layout of a home workshop.

## ASK FOR THEM TODAY!

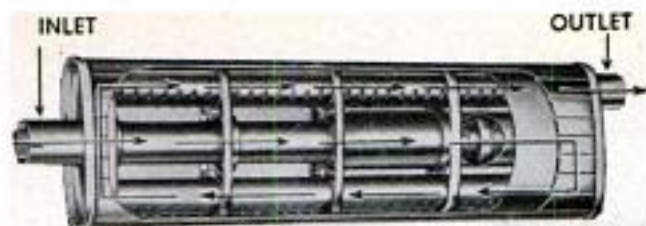

The AP Parts Corp., Toledo 1, Ohio

## Muffler Stays Drier, Lasts Longer

IT'S THE COLD SPOT in a muffler that wears out first because it's there that the condensation settles to rust the metal. A new muffler design which eliminates these cold spots is said to make mufflers last 25 percent longer, according to the manufacturer. By distributing the heat throughout the entire shell, the new design "cooks out" moisture and prevents internal rusting. Another major cause of muffler failure is the extreme temperature differences between the hot and the cold sections. These differences result in metal fatigue which causes rapid breakdown of the shell. The new muffler, called Dri-Flow, uniformly distributes heat by a constant even flow of exhaust gas through the entire interior. This keeps all chambers at a temperature that is high enough to evaporate moisture without creating excessively hot spots. There is said to be no loss in silencing.

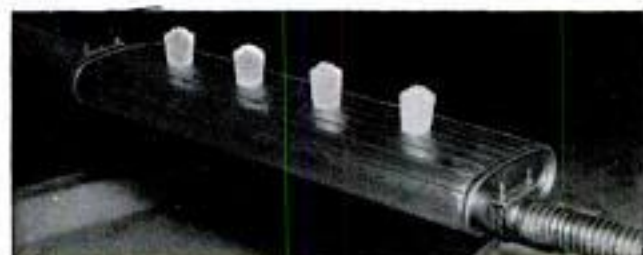

Heat distribution in a muffler is tested by observing how candles melt during a 10-minute engine test run



Above, old design melts candles unevenly. Below, the new muffler has even heat distribution, melts evenly

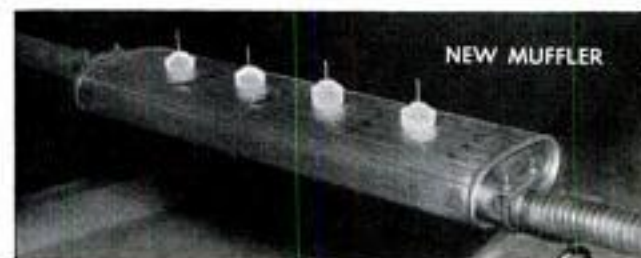

# The NEW Hi-torque HANDEE®

The Newest of all Hand Tools

**A COMPLETE WORKSHOP IN YOUR HAND.**

The perfect power tool for model building, wood carving, costume jewelry making, plastics engraving, gift initialing, etc. Grinds, polishes, cuts, saws, routs, engraves, cleans and burnishes. Packed with speed (25,000 r.p.m.) and power.

Perfectly balanced, cool running, fits the hand for pencil point precision in delicate work. 110 volt or 220 volt (if specified) 25 to 60 cycles AC or DC.

With every type of cutting tool in metal case—\$32.95 Unconditionally Guaranteed

with 6 accessories  
**\$23.95**

SEND ORDER TODAY!

Chicago Wheel & Mfg. Co., 1101 W. Monroe St., Chicago 7 PM-2  
Rush Postpaid the following:

Handee with every type of cutting tool in metal case @ \$32.95

Handee with 6 Accessories @ \$23.95

Check  Money Order Enclosed  Send COD

Send Literature

Name.....

Address.....

City.....Zone.....State.....

## GET THE HABIT OF READING OUR CLASSIFIED ADS.

Wonderful Opportunities Amazing Bargains

**KEEP YOUR... EYE ON BENJAMIN for HIGH H.C. COMP**

"First in POWER and ACCURACY"

**AIR GUNS & CO<sub>2</sub> GAS GUNS—Top Quality at LOWEST PRICES!**

BB BB or 177 or 22

**BENJAMIN SUPER**  
CO<sub>2</sub> Gas Carbine with Reg. Stock as low as **\$14.95**  
Deluxe Model with Custom Stock (Shown) as Low as \$17.95

Benjamin Air Rifles and Benjamin Air Pistols are Recognized All Over the World for Finest Workmanship and Highest Quality at Lowest Prices. Adjustable Power with Amazing Optimum Force. Fully Guaranteed—Safe—Accurate—Economic, Easy to Use anywhere—12 Models for Target and Small Game BB or 177 or 22.

All Models Benjamin CO<sub>2</sub> Carbine Gas Rifles and Benjamin CO<sub>2</sub> Rocket Gas Pistols Use Standard Size CO<sub>2</sub> Cartridges (available everywhere). 2-Stage Hi-LO Jet Power—High for Small Game—Low for Target—Up to 50 Shots from each Cartridge. No Pumping—Safe—Accurate—Economic—Non Toxic—12 Models BB or 177 or 22.

**FREE!** Catalog All Models Benjamin Air Guns & CO<sub>2</sub> Guns & Supplies. Also, Money-Saving Offer on Hunting & Fishing Accessories.

Send Free Gun Catalog and Special Offer!

**MAIL TODAY!**  
BENJAMIN AIR RIFLE CO.,  
896 MARION ST., ST. LOUIS 4, MO., U.S.A.

Name.....

Address.....

City.....State.....



## Mercedes-Benz 300 SL Roadster

Previously available only as a gull-wing-doored coupe, the Mercedes-Benz 300 SL will soon be sold with a convertible-roadster body. Its basic engineering will be the same as that of the famed coupe, which has a six-cylinder fuel-injection engine and a phenomenal road-holding ability. The new model

will be introduced in the spring show at Geneva, Switzerland.

### Rain Gutters Made in Purple Plastic

Don't be surprised during a thunder-shower to see water pouring down purple plastic rain gutters. Made of glass fiber reinforced with polyester plastic material, these gutters are said to last longer than the metal gutters.

Permanent Products Inc., 102 W. Fairfield, St. Paul, Minn.

### Supercooling Unit Reaches -328° F.

Gas liquefaction in a new machine produces temperatures of minus 328 degrees F. at the push of a button. Making five quarts of liquid air hourly, the apparatus measures 37 inches long, 20 inches wide and 34 inches high, excluding swinging spout and concrete mounting base. It works on a 220-volt, three-phase circuit for a 10-horsepower load and weighs 660 pounds. Using helium in the gas-refrigeration cycle, the unit takes air or gas to be liquefied into a chamber surrounding the cylinder at normal atmospheric pressure; the air or gas condenses on the cold surface of the head until enough is present to be run off. This system provides an oil-free, high-purity product.



## DO YOU EARN \$125 PER WEEK? Hundreds of our GRADUATES Do

Auto and Diesel repair shops today are short of trained mechanics. **THINK** why? More cars and trucks on the road than ever before. And the government is now starting its huge road building program—super express, coast to coast highways, making even more diesel jobs to maintain diesel road building machinery. Our graduates have been in demand by the best garages for 37 years.

**WE TRAIN YOU** for these top-paying jobs. Shop training on a splendid variety of both gas and diesel engines, automatic transmissions, engine analyzers, electrical testing machines, injection pumps, calibrating equipment, etc. **G. I. APPROVED.**

### Other courses: BODY & FENDER — WELDING

These are also top-paying trades offering good futures and often lead to your own business.

Students from all states in the union and 24 foreign countries  
**NOT A CORRESPONDENCE COURSE.**



**Earn While You Learn . . . .**  
Day & night courses—we help night students get jobs. Most courses start monthly. Write today for full particulars.

### NASHVILLE AUTO-DIESEL COLLEGE

226 7th Ave., N. Dept. 75 Nashville 3, Tenn.

## Here's the Adhesive with **The Strength of 10 Men**



**Pliobond**

BY **GOOD YEAR**

"BONDS ANYTHING TO ANYTHING"

Available at chain, hardware and hobby stores everywhere.

POPULAR MECHANICS

Pliobond—T. M. The Goodyear Tire & Rubber Company, Akron, Ohio

**NEW Govt. Released**  
Original  
Cost  
**\$444.00**



**HOMELITE "Carryable"**  
**GENERATING PLANT**  
60 CYCLE,  
1500 WATT  
**\$189.00**

Single Phase, 115 Vt., A.C.

Carrying handles for  
easy portability. Fits  
easily in car trunk.

Fully  
Guaranteed

Save Hundreds of \$ \$ \$

**PAYS FOR ITSELF!** Saves time, labor and money. Provides on-the-spot power for CONSTRUCTION, etc. where none is available or expensive to run in. LARGE ENOUGH for Floodlights; Saws; Pumps; and many more labor-saving, heavy-duty machines. Ideal as a stand-by emergency power plant to duplicate house current. Plenty of power for lights, refrigerator, deep freeze, oil burner, radio, etc. Specifications below CAN'T BE MATCHED anywhere at this price!

**GENERATOR** 1500-1700 Watts, 115 Volts, 60 cycle, single phase, A.C. Overload capacity well above its rated output. Excellent automatic voltage regulation plus Field Rheostat for even closer adjustment. Built-in Volt Meter. Oversize brushes.

**ENGINE** Famous Homelite single cylinder engine. Air cooled; two cycle. Easy rope start. Dust and rain-proof ignition system. Built-in automatic governor. Foolproof pressure vapor lubrication system. Adjustable jet-type carburetor.

This Precision power plant has ball and needle bearings throughout and costs only 8c an hour to operate. Satisfaction Guaranteed.  
**SUPPLY LIMITED! IMMEDIATE DELIVERY! ORDER FROM AD**  
FREE Catalog of Compressors, Motors and Welders  
**ROBERTS ELECTRIC CO., Dept. PM-559, 849 W. Grand, Chicago 22, Ill.**

**NEW MAGIC RADIO WALKIE TALKIE!**

**YOUR OWN POCKET SIZE RADIO STATION!**

BROADCASTS TO ANY HOME OR CAR RADIO WITHOUT WIRES OR HOOKUPS! Wt. only 5 oz. Size, 1 1/2 x 2 1/4 x 4 1/2". Built-in telescoping antenna. Powerful Transistor-sensitive microphone, frequency setter, break-in switch! Runs for weeks on self-contained flashlight batteries. Durable plastic case. With this Radio Talkie you CAN TALK TO YOUR FRIENDS UP TO A BLOCK OR MORE AWAY! Talk up to 1 mile or more between two automobiles. INSTANT OPERATION! Just push button to talk! No license needed. Uses inductive field magnetic radiation. Useful and real fun in a million ways! GUARANTEED TO WORK. 1 YEAR SERVICE GUARANTEE.

SEND ONLY \$3.00 (cash, ch. mo) and pay postman \$3.36 COD postage or send \$1.36 for prepaid delivery. COMPLETE READY TO OPERATE with instructions and hundreds of ways and tricks for broadcasts thru any radio you desire. Price may go up soon, so get your NEW POWERFUL RADIO VOX WALKIE TALKIE NOW. Available only from: WESTERN RADIO, Dept. RPM-2, KEARNEY, NEBR.



**YOU CAN BUILD A VIOLIN FOR PLEASURE OR PROFIT**



Now you can build a rich toned mellow violin modeled after a famous "Strad." YOU CAN MAKE A STRADIVARIUS VIOLIN contains 8 full size plans plus complete instructions. You work directly from the plans with no confusing scale of dimensions to translate. Detailed instructions for each step including varnishing and stringing—even shows how to build your own tools. Cloth bound. Order today from

**POPULAR MECHANICS PRESS . . . \$3.50**  
Dept. 257, 200 East Ontario Street, Chicago 11, Illinois

**NOW—THE QUICK-WAY TO SHARPEN ALL CIRCULAR SAWS**

**NEW**

Model  
PG-12  
Complete  
No  
extras to  
buy.  
**\$16.50**  
Postage  
Paid



Model PG-12 sharpens joints, gums, and retreads all cross cut, rip, combination, miter, and planer blades up to 12" in diameter. Two precision index plates give versatile, accurate sharpening. Guarantees precise spacing of teeth. New safety rest prevents tilting and gouging of blade. Save time and money. Special \$3.00 grinding wheel also included for use on your own power table. Fits regular or radial swing tables.

Order today. Send check, cash, or money order. We pay postage. FREE Booklet—"How To Sharpen Saws."

**QUICK-WAY SAW CO.**

136 TOMPKINS ST. CORTLAND, N. Y.

**24 Drilling Combinations with Parker No. 4 Wood Screw COUNTERSINK BIT SET**

**Parker COUNTERSINK BITS for WOOD SCREWS**  
No. 4  
For all electric drill, drill press and hand drills

Drills and Countersinks  
3 depths for flush or recessed screws  
— in 1 operation —  
4 bits for the 8 most popular screw sizes

TO ABOUT STOP  
Press spring and slide the stop to one of the three marks on the bit shaft. Stop hole automatically.

**PARKER MANUFACTURING CO.**  
WORCESTER 1, MASS., U.S.A.

Drills and countersinks to flush, putty or plug depths for 8 most popular screw sizes. Depth-a-dapter adjusts easily on all 4 bits.

At your hardware Dealer's Only  
**\$1.70**  
per set

**PARKER MANUFACTURING CO.**  
WORCESTER 1, MASS., U.S.A.

**Koenig ALL-STEEL CABS for JEEPS**  
FULL AND HALF CABS



- ★ PROTECTION — from weather and burglary.
  - ★ SAFETY — All-steel, welded construction. No rivets. Safety glass used throughout.
  - ★ COMFORT — Full air-spaced head lining and door lining. No vibration.
  - ★ CONVENIENCE — Roll-down windows, full opening.
- Available in full cabs (cover entire body), and half cabs (cover front passenger compartment).

**KING POWER WINCHES**

For all Willys Jeeps, 4WD trucks and station wagons . . . also for Ford, Chevrolet, International and Dodge trucks.

Dependable pull power designed to fit specific pull and hoist needs. King power winches have pull capacities of 8,000 to 19,000 lbs.



Koenig Cabs and King Winches for Willys vehicles are available through Willys Motors, Inc., and Willys-Overland Export Corp. distributors or dealers. Write for descriptive literature.

**Koenig IRON WORKS, Inc.**  
P.O. Box 7728 HOUSTON 7, TEXAS

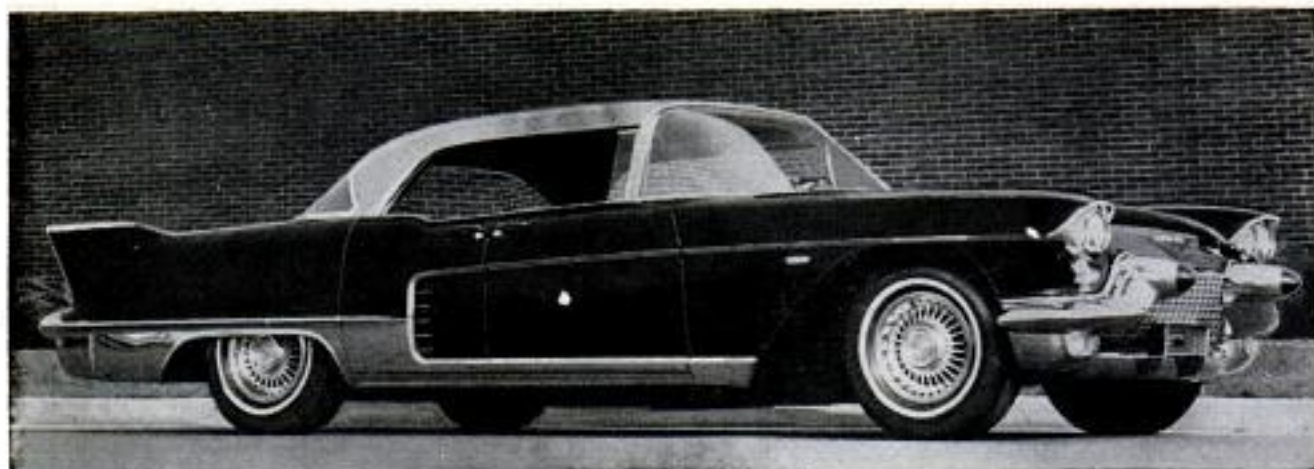

## It's THE Brougham

THERE WAS A TIME when the word "brougham" was generic—it described a type of auto body. Now there is only one Brougham: THE Eldorado Brougham, a \$12,500 (at least) beauty that radiates lushness, luxury and lots of money.

Big news on the Brougham is its air suspension. Each wheel has an individual air spring (however, the rear wheels are not independently suspended, there still being a solid rear axle). Air pressure keeps the car at the same height regardless of load.



## BIG AND BEAUTIFUL

Old Town's NEW 18' LAPSTRAKE



The *Whole Tribe* can put to sea in this big handsome beauty! She's 18' long, 92" wide, holds all the family with ease. Cruises at 25 mph (powered by two 30-HP motors). Like all Old Town Boats, she's rugged . . . and ready for years and years of dependable service.

**FREE CATALOG** describes outboards, canoes, sailboats — craft for every kind of boating fun. Send for your copy TODAY.

## OLD TOWN BOATS

Old Town Canoe Co., 442 Middle St., Old Town, Maine  
PLEASE SEND ME FREE CATALOG

Name \_\_\_\_\_

Address \_\_\_\_\_

City \_\_\_\_\_ State \_\_\_\_\_



### KEY - BAK KEY-REEL

Carry your keys on a KEY-BAK key-reel. Keeps keys handy! Safest. Keeps clothing neat. 24" long stainless-steel chain reaches all locks. Pocket-watch size. Sturdily constructed to last for years. GUARANTEED. For all who use and carry keys. Dealers Wanted!

LUMMIS MFG. CO., Pasadena 8, Calif. | CTL CO., Wausau, Wis. **\$2.95** per.



### \$\$\$ TREASURE \$\$\$

Find lost or hidden treasure with new, improved metal detector. Works around salt water. Has no ground pick-up. Find coins, jewelry, gold and silver . . . Civil War relics. A profitable hobby. Also Scintillation Counters. Free literature.

**GARDINER ELECTRONICS** Dept. 14  
2545 E. Indian School, Phoenix, Arizona



### FORTUNES IN DIVING

*Train at Home in Spare Time*  
Write Today for Amazing Free Booklet

Here is one of the greatest opportunities of our time. Make big money fast in Skin and Lung Diving. Trained divers needed in hundreds of industries and by government. Build a successful business of your own. Hourly rates among highest paid in any field. Training program by E. R. Cross, world famous master diver. Instruction directly under supervision of former Navy frogman. Get the facts now. Write for **FREE BOOKLET TODAY!**

**U. A. S. CORPORATION**  
Dept. PM-2 5637 W. 63rd Place, Chicago 38, Ill.

POPULAR MECHANICS



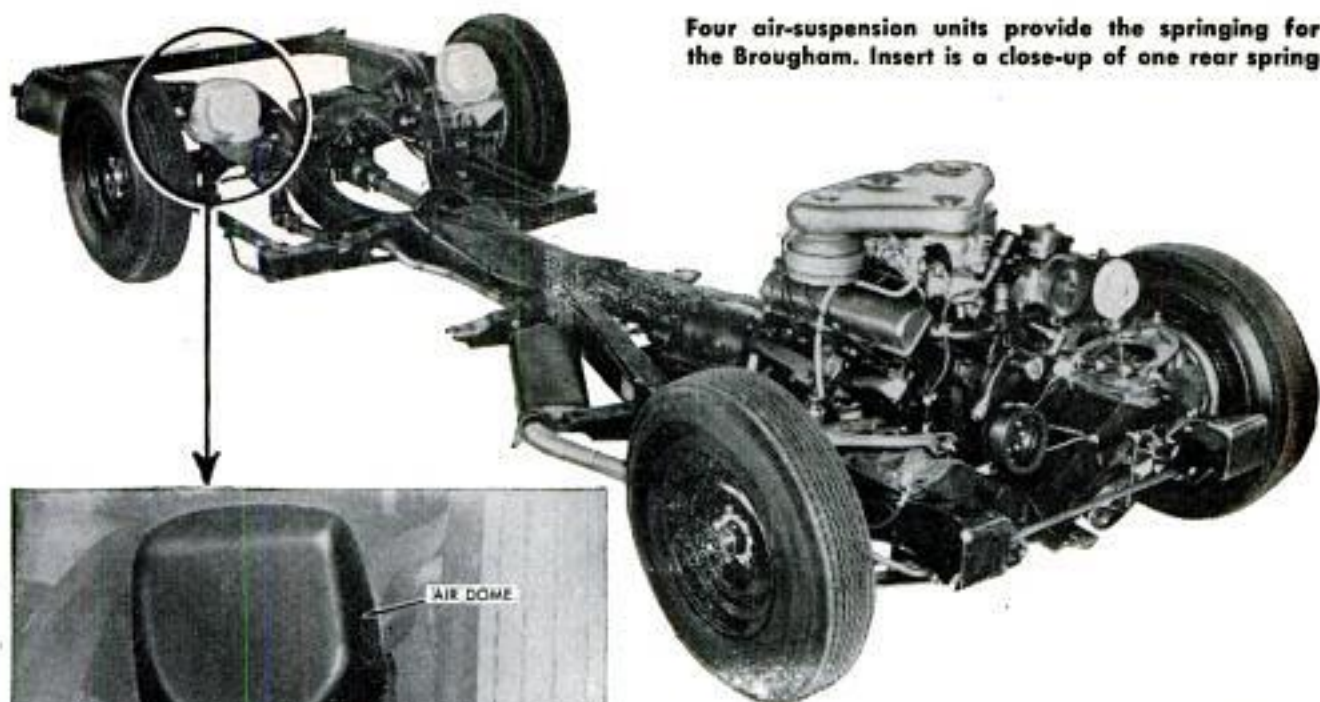

Four air-suspension units provide the springing for the Brougham. Insert is a close-up of one rear spring

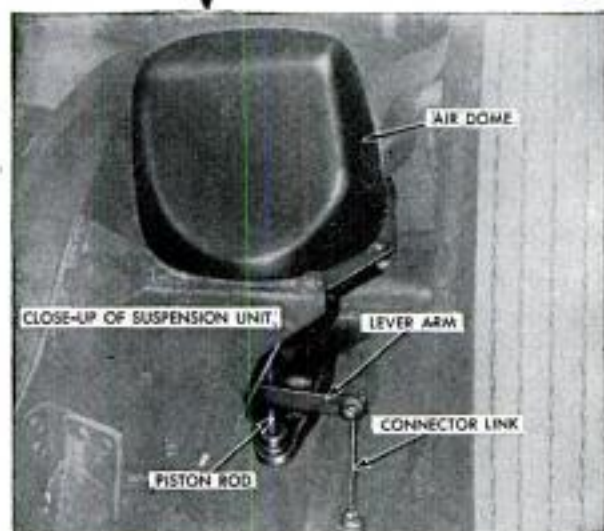

The engine develops 325 horsepower. Plans to include fuel injection were dropped because of production bugs; twin four-barrel carburetors are used instead.

You may have your Brougham carpeted with mouton, a specially processed lamb-skin. The glovebox comes with fitted compact, lipstick, cigarette case, drinking cups and an extra-large vanity mirror.

**BUILD  
IT  
YOURSELF**

### Heathkit BROADCAST BAND RECEIVER KIT

Have you ever experienced the thrill of building your own radio? Invest a few of your dollars—a few hours of your time, and build a truly worthwhile broadcast band receiver. Transformer operation eliminates potential shock hazard characteristic of "economy" AC-DC sets. Operates as radio, phono, amplifier, or tuner. Fine tone quality, excellent sensitivity. Simplified Construction Manual outlines basic theory of radio principles. Actually a radio course in itself. Price includes tubes—speaker—chassis, etc. Every part you need! Order your Heathkit Radio Kit today.



MODEL BR-2  
incl. fed.  
excise tax  
(Less Cabinet)  
**\$1925**  
SHPG. WT. 10 LBS.

#### OTHER "BUILD IT YOURSELF" Heathkits

Oscilloscope  
Vacuum Tube Voltmeter  
Signal Generator  
Amateur Transmitter  
Communications Receiver  
Multimeter  
Handitester  
Hi-Fi Amplifier

Hi-Fi Preamplifier  
Battery Eliminator  
Signal Tracer  
Tube Checker  
(and over 50 others)

WRITE FOR  
Free CATALOG

## HEATH COMPANY

A Subsidiary of Daystrom, Inc.  
BENTON HARBOR 17, MICH.



Fast cutting  
Top quality

**GENSCO**

## SWEDISH WOOD CHISELS

Woodworking projects have that little extra professional touch when Gensco Swedish Wood Chisels are used. They're tops: hand ground, razor sharp blades, Tenite II handles are unbreakable and fire resistant . . . won't pull loose, sizes from 1/4" to 2".

Buy these accurate cutting, easier to use Gensco Wood Chisels at all leading hardware stores today. Available in sets of 4, 6 or 11 chisels in vinyl coated canvas rolls.



**GENSCO**

**GENSCO TOOLS**

A DIVISION OF  
GENERAL STEEL WAREHOUSE CO., INC.  
1832 N. Kostner Ave., Chicago 39, Illinois



## UNIMAT 10 IN 1 COMPLETE WORKSHOP

CRAFTSMEN, MODEL BUILDERS, HOBBYISTS AND INVENTORS all over the world are choosing this unique and extremely versatile electric tool for machining small parts from steel, brass, wood, aluminum and plastics. Highly acclaimed because of its precision results, UNIMAT offers these serious craftsmen many other worthwhile advantages.

**UNIMAT BASIC UNIT (shown) INCLUDES:** 1—a Precision Lathe and all accessories necessary to convert it quickly and easily into a 2—Drill Press; 3—Hand Drill; 4—Polishing and Grinding Machine; 5—Tool Grinding Machine; 6—Milling Machine. With the Basic Unit you also get these 13 accessories free: AC/DC Power Motor, with reduction pulleys (11 speeds—375 R.P.M. to 9200 R.P.M.), self-centering universal three-jaw “Cushman” lathe chuck with reversible jaws (int. 2 1/2" Dia.), 1/4" Drill Chuck, Pivoting Tool Holder, Grindstone Holder, Lathe Dog, Face Plate, 2 centers, Allen Wrenches, Easy-to-follow instruction manual, all packed in sturdy wood veneer carrying case!

**ADDITIONAL ATTACHMENTS** are available for further versatility of your Basic Unit: 7—The Jig Saw; 8—Threading Attachment; 9—Circular Saw; 10—Indexing and Dividing Attachment. All attachments can be ordered individually with the Basic Unit, or at any time. Attachments not shown.

**PORTABLE AND COMPACT**—two more reasons for its great popularity. All operations require little working space and are performed on just one base. There is also high quality built into this unique machine tool. The ball-bearing headstock spindle has a 1/4" O center. It also features a built-in rack, so that the headstock spindle can be adjusted 1" in either direction. This feature gives the drill press its stroke when in the upright position. The tailstock is threaded and will take either lathe or drill chuck. Constructed of high quality hardened and ground steel and a cast iron ribbed lathe bed, UNIMAT adds up to a top notch machine tool that will enable you to create a limitless variety of objects—from just about any kind of stock material.

**UNIMAT BASIC UNIT COSTS ONLY \$99.50** and can be obtained on a budget plan for as little as \$49.50 down, and \$10 a month for 5 months. There's no charge for this service. It is shipped prepaid East of the Mississippi. West thereof, a slight charge is necessary. Additional literature is also available for only 10c to cover mailing costs. Look into this amazing precision tool today. It will prove worth your while. Mail your order today to Dept. PM-27 Dealer Inquiries Invited! **AMERICAN EDELSTAAL (AMSTERDAM) INC.** New York 13, N. Y. 350 Broadway

## RUGGED

**WOLVERINE GLOVES**

...but  
oh so  
comfortable



For complete hand protection, wear rugged Wolverine Pigskins. Triple-tanned for extra wear, yet soft, flexible—soak 'em, they dry out soft, comfortable.

*feel that tanned-in softness*

rockford, michigan



Cheaper PRICED Tires are Cheaper GRADE Tires  
SINCE 1915 "I've shipped a million tires and made a million friends." I ask the chance to treat you right!

I replace FAST any defective tire, frt. excl. We try to ship your favorite brand (Not Recaps)

**GOODYEAR** Goodrich, U.S., Firestone & others, not recaps, worn slightly.

**12 MONTH GUAR.** FREE This pictured Tire Ash Tray given with 2 or more tires

### TAKE 20% DISCOUNT OFF EVERY TIRE ORDERED

600-16 \$5.78	670-15 \$5.68	700-20 \$8.98	600-16 (6) \$5.68
650-16 6.18	710-15 5.88	750-20 9.88	650-16 (6) 7.48
700-16 6.28	760-15 8.88	820-20 16.58	700-16 (6) 7.68
640-15 5.68	800-15 6.18	900-20 18.58	700-15 (6) 7.28
700-15 5.48	820-15 6.18	1000-20 17.28	750-16 7.58
W.W. \$1. Extra	700-17 9.98	1100-20 17.28	750-17 12.98

Take \$1 off for each free car or truck tube you don't want. 750-20 MIL. MUD-GRIP, Guar. 12 MOS. \$17.98 900-16 MIL. MUD-GRIP, Guar. 12 MOS. \$13.99 Send Ck. or M.O. & Ad for just shipment, F.O.B. Phila. I select your tires as if my future depended on it!

**MARVIN BLATT** 6th & Spring Garden Philadelphia, Pa. CO. ADJUSTED \$7.95 WHITE TIRES with NEW Tire service guaranteed any WALLS car \$1. Ext.

**WHOLESALE TOOL CATALOG**

## MAKE EXTRA MONEY

**Start Your Own Business**

Sell tools part time, full time. Save money for your industrial and institutional use. A MILLION DOLLAR INVENTORY AT YOUR FINGERTIPS.

Buy NATIONALLY ADVERTISED hand tools, hardware, fans, motors, power tools, paints, etc., NO INVESTMENT REQUIRED. Buy as you need it. Up to 30% DEALER'S DISCOUNT.

Send \$1 Deposit for mammoth wholesale dealers catalog. \$1 refunded on first purchase or returned if you are not 100% satisfied.

**SILVO HARDWARE CO., Dept. PM-2, 108 Market St., Phila. 6, Pa.**

**NON RUST**

## FAIRGATE'S

**48" STRAIGHT EDGE METAL RULE**  
FAST, ACCURATE RESULTS

- HARD ALUMINUM
- CLEAR LEGIBILITY

36" - \$2.25  
40" - \$4.50  
72" - \$6.50

SEND FOR CIRCULAR

**FAIRGATE RULE CO., COLD SPRING, N.Y. DEPT. P.M.**

## BRONZE FOUNDRY

Schools and Home Workshops

Make your own castings of aluminum, copper, bronze, silver. Foundry sets are available in three sizes including 2400 Deg. F. blast furnaces. Prices \$26.50, \$33.50, and \$48.00 f.o.b. Marysville, Kansas.

**KANSAS CITY SPECIALTIES CO.**

P.O. Box 6022 Dept. P-2 Marysville, Kan.

LOW AS \$99

**ESHELMAN TRACTORS**

Plows-Cultivates-Saws  
Cuts-Dozer-Harrows  
Hauls-Snow-Flows  
Rolls

New 1957 SPORTABOUT CARS and GOLF CARS. Write for literature.

Shipping Points: BALTIMORE - CHICAGO - KENOSHA

Eshelman Tractors, Tillers, Riding Rotary Mowers for Better Lawns and Gardens. Advertisers in GOOD HOUSEKEEPING. Thousands of satisfied users. Write for Free Literature. Dept. 23, ESHELMAN, Balto. 2, Md. \$453.75

## AMAZON JIVARO

### SHRUNKEN HEAD

Amazing replica of fabled native curios with a legend that owners have good luck. A strong stomach helps too because these 4" heads defy detection from just a few feet away, with remarkably true skin and hair. Sensational to hang in the car, den, bar. Have fun with this guy who got pickled once too often.

**\$150** ppd.

**GREENLAND STUDIOS, Dept. PM-3**  
5858 Forbes St. Pittsburgh 17, Pa.

## Self-Raising Tent

Lay out a new camping tent on the ground, remove a couple of pins, and the tent pops up automatically. Two coiled springs push the aluminum frame to its upright position. The tent measures 5 feet wide, 6½ feet long and 6½ feet tall. It has a sewn-in floor, a zipper door and a flap that pulls down for complete enclosure. Side mosquito nets can be installed when the tent is attached to the rear of a station wagon. A similar tent of striped canvas is made for poolside or beach.

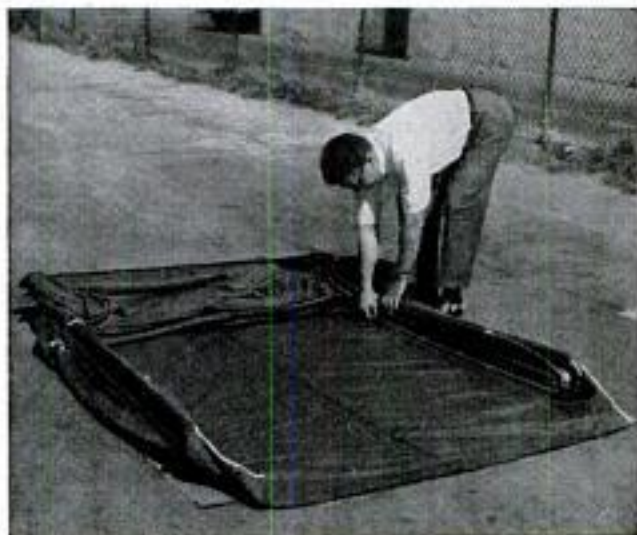

FEBRUARY 1957

# FREE! 1957 ALLIED ELECTRONIC SUPPLY CATALOG



SAVE ON EVERYTHING IN ELECTRONICS

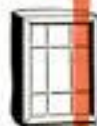

Everything for Experimenters, Builders & Amateurs, Servicemen, Engineers & Hi-Fi Hobbyists



WORLD'S LARGEST STOCKS



Send for ALLIED'S money-saving guide to *everything* in Radio, Hi-Fi and Electronics! Select from the world's largest stocks: High Fidelity systems and components; latest builders' kits (see the famous KNIGHT-KIT line); recorders and phono equipment; TV tubes, antennas, accessories; Amateur station equipment; P.A. Systems; test instruments; industrial electronic supplies—plus *everything* in parts, tubes, transistors, tools and books. Get more for your money—send for your FREE 1957 ALLIED Catalog!

Everything in Electronics from One Reliable Source

OUR 36TH YEAR

Send for FREE CATALOG

## ALLIED RADIO

ALLIED RADIO CORP., Dept. 5-B-7  
100 N. Western Ave., Chicago 80, Ill.

Rush FREE 1957 ALLIED 356-Page Catalog

Name \_\_\_\_\_

Address \_\_\_\_\_

City \_\_\_\_\_ Zone \_\_\_\_\_ State \_\_\_\_\_



TO THE MAN LOOKING FOR A  
**SECURE FUTURE**  
*Learn* **OIL  
BURNER  
SERVICING**

AT HOME IN  
YOUR SPARE TIME

Enjoy real security . . .  
earn top wages . . . get ahead faster.

Learn a trade where Trained Men are always in demand. High starting salary, plus hundreds of opportunities for advancement in the fast-growing Oil Burner industry, which U. S. Government predicts will double in size in next few years. We teach you Installation, Operation, Maintenance and Servicing. Complete course. Remember, Trained Men command best jobs — highest wages. Our Oil Burner graduates are 100% employed.

LEARN AND EARN IN YOUR SPARE TIME

Put your spare time to work. Learn a specialized trade. No previous experience or special education necessary. Act today! Cash in tomorrow! Earn while you learn, doing repair jobs in your own area. Low tuition, only \$5 starts your Tools furnished. Send coupon now! No obligation.

Mass Trades has trained thousands for success since 1938.

RESIDENT SCHOOL — APPROVED FOR VETERANS

WRITE NOW FOR FREE SAMPLE LESSON AND BOOKLET

MASS. TRADES

161 High Street, Boston 10, Mass.

Please send me FREE sample lesson and booklet

NAME . . . . . AGE . . . . .

ADDRESS . . . . .

CITY . . . . . ZONE . . . . . STATE . . . . .

Now! Do 90% of your  
**WOODWORKING**

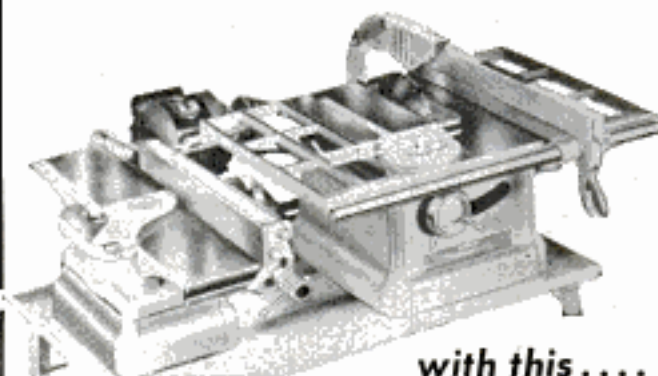

with this . . .

**DURO MASTER  
COMBINATION SAW/JOINTER**

Here's the most versatile, most practical, combination power tool unit ever designed! It's truly the "jack of all trades" for every workshop. Performs all of your woodworking jobs accurately, safely, easily—including dadoing, cross-cutting, ripping, tenoning, bevel cutting, rabbeting, taper cutting, plus many others. Both, 8" saw and 4 1/2" jointer are operated from a single motor and it takes but seconds to switch from unit to unit . . . an exclusive Duro feature. Has many other unusual and exclusive features.

Saw Jointer Only  
**\$136.00**



Write for FREE Power Tool Catalog showing this remarkable unit and the complete Duro line of power tools. Learn about Duro's patented motor mount that permits you to run a complete power tool workshop — with a single motor!

**DURO METAL PRODUCTS CO.**  
2677 NO. KILDARE AVE., CHICAGO 39, ILL.

**WHERE-TO-BUY-IT INDEX**

Source of supply appears after items commercially available

**AUTOMOTIVE**

It's THE Brougham . . . . . 102  
Fold-up spare tire (The Gates Rubber Co., 999 S. Broadway, Denver, Colo.) . . . . . 110  
Clothes rack fits over rear cushion of auto (Eldon Mfg. & Engineering Co., 6546 W. State St., Milwaukee 13, Wis.) . . . . . 136  
Hammock keeps baby comfortable in car (California Ways, 132 N. B St., San Mateo, Calif.) . . . . . 145  
Rear-view-mirror mount is unbreakable . . . . . 145  
German diesel tractor has air-cooling system . . . . . 159

**AVIATION**

Hull-testing tank for seaplanes . . . . . 129  
Barrel-shaped airplane tires permit rough-field landings . . . . . 158  
All-jet transport aircraft . . . . . 284

**BOATS**

Hydrojet boat . . . . . 130  
Back-yard "ark" . . . . . 135  
German wing boat "walks" through water . . . . . 144

**CONSTRUCTION**

Bamboo scaffolds made to go up 15 stories . . . . . 134  
Prefab plaster walls cut building costs . . . . . 141  
Flagstone mold has flexible form (Castle Patio Mold, Dept. 18, 1001 Aviation Dr., Glendale 3, Calif.) . . . . . 144  
Drill of flexible shaft cuts roots from sewer (Miller Sewer Rod Co., 4642 N. Central Ave., Chicago 30) . . . . . 145

**MISCELLANEOUS**

"Through the wall" fireplace heats both rooms (Superior Fireplace Co., 1708 E. 15th St., Los Angeles 21, Calif.) . . . . . 119  
Shadow box snaps snowflakes . . . . . 120  
Blizzards from sprinklers cover slopes with snow . . . . . 127  
Roof rolls back on roller-skate wheels . . . . . 128  
"Lazy Susan" stores 300 slides (G & M Zadiix Products Co., 299 Third Ave., Brooklyn 15, N.Y.) . . . . . 130  
Bicycle built for two . . . . . 130  
Mechanical gold-panner makes "old timer's" methods obsolete (Denver Equipment Co., 1400 17th St., Denver, Colo.) . . . . . 136  
Patrol spotlights smuggling activities . . . . . 148  
Moving belt gathers eggs in tanks of water . . . . . 149  
Pistol-grip camera mount (Royal Photo Distributors, 78 W. 47th St., New York City 36) . . . . . 149  
Stork gets new bill from aluminum sash . . . . . 159  
Douglas fir seed . . . . . 306  
Hydraulic tower for TV . . . . . 306

**Radio-Television, Electronics**

Automatic convertible-top closer . . . . . 262  
Additional indicators aid in checking car performance . . . . . 264

**SCIENCE**

De-inking process recycles old newsprint (Dr. Norman Hackerman, Chemistry Dept., University of Texas, Austin, Tex.) 129  
100 barrels of asphalt yield 108 barrels of products (G. T. Gwin, Humble Oil & Refining Co., Baytown, Tex.) . . . . . 129  
Vaccine for worst cattle disease . . . . . 130  
Extractor finds mosquito eggs . . . . . 131  
Mobile gas-turbine power station . . . . . 131  
Underground fire revives oil well . . . . . 132  
Electronic trail markers guide drivers in the Arctic . . . . . 134  
Portable hydromassage unit gives treatment in user's bathtub (Candido Jacuzzi, Inc., 4160 Bayless Ave., Richmond, Calif.) 134  
Machine monitors radar unit (Miller Associates, P.O. Box 369, Lakeville, Conn.) . . . . . 134  
Portable drilling rig for prospecting requires no water (Houston Tool Co., P.O. Box 251, Santa Susana, Calif.) . . . . . 148  
Frogmen recovered from water by giant "slingshot" . . . . . 158  
Aurora recorder . . . . . 274

**WHAT'S NEW FOR YOUR HOME**

Food canisters . . . . . 146  
Charcoal broiler with electric blower . . . . . 146  
Dish drainer folds lengthwise . . . . . 146  
Spring-action aluminum scouring-pad holder . . . . . 146  
Home chlorinating unit . . . . . 147  
Cooked foods kept hot in thermostatically controlled drawers 147  
Self-contained, automatic humidifier . . . . . 147  
Double-duty cooking appliance . . . . . 147

**Craftsman and Shop Notes Index**

**AUTOMOTIVE**

Sun-powered car . . . . . 233  
Bowl cover "weatherproofs" outside rear-view mirror . . . . . 235  
Portable ignition tester "broadcasts" diagnosis . . . . . 245  
"Stethoscope" aids in diagnosing auto ills . . . . . 252  
Tool bent from coat-hanger wire aids changing car-door lock . . . . . 253  
Pushing or towing cars equipped with automatic transmissions 253

(Continued to page 108)

save \$700 and up..

# "DRAGSTER-500"

Pat. Design

## TURBO-ELECTRIC SUPERCHARGERS



**\$99.50 and you assemble**

6 HRS. FOR ASSEMBLY  
AND INSTALLATION  
1/2" CAPACITY DRILL PRESS  
REQD.

**TYPICAL 0-60 M.P.H.  
PERFORMANCE**

MAKE	Stock	With Dragster
Ford V-8 Fordomatic	12.5	8.1
Lincoln Capri	12.4	7.9
Cadillac -62-	10.0	6.8
Oldsmobile Super-88	10.6	7.0
Chevrolet V-8 Powerglide	12.3	7.3
Buick Century	9.8	6.4
Mercury Mercomatic	11.9	7.5
Chrysler New Yorker	10.8	7.6
Thunderbird	9.5	6.2
Dodge V-8 PowerFlite	14.5	8.7

UNITS NOW IN STOCK FOR ALL EUROPEAN AND AMERICAN MAKES. ALSO AVAILABLE FOR MARINE ENGINES AT THIS SAME LOW FACTORY TO YOU PRICE.

**TRECO PRODUCTS**  
5313 Peachtree Rd.  
Chamblee, Ga.

### COMPLETE

Nothing else to buy

Why pay \$800 for a full race engine? Supercharging is the simplest way to get significant power boosts (40% and up). Operate at will—flip the switch to the off position and enjoy the smoothness and economy that only an unmodified engine offers.

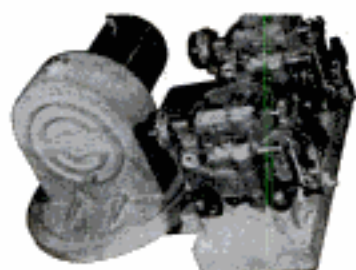

**\$149.50 factory assembled**

2 HRS. TO INSTALL  
GUARANTEED &  
APPROVED

### Engineering Features . . .

- **Low Cost**—The "Dragster 500" is the most inexpensive supercharger available. Supercharging adds more H.P. per dollar than any other means that may be used to increase H.P.—The Dragster simply crams more fuel-air mixture into the cylinders under pressure, resulting in a much higher H.P. output.
- **Variable Output**—The Dragster features a patented electro-pneumatic load balance system, which automatically supplies the engine with additional volume upon demand.
- **Independent Drive**—The Dragster does not burden the engine with excessive loads, but simply uses a small amount of stored energy from your battery, leaving your engine free for rapid accelerations. No pulleys. No belts. No modifications.
- **Self Lubrication**—The complete power train including all bearings and gears operate submerged in an oil bath reservoir. This complete and thorough lubrication insures the unit of a long trouble free life.

**TRECO PRODUCTS CO.**  
5313 PEACHTREE RD., CHAMBLEE, GA.

ENCLOSED FIND \$10.00 DEPOSIT.

Please ship  unassembled  assembled supercharger.  
I will pay balance upon arrival.

Make of car \_\_\_\_\_ Year \_\_\_\_\_

No. of cylinders \_\_\_\_\_ Battery voltage \_\_\_\_\_

NAME \_\_\_\_\_

ADDRESS \_\_\_\_\_

CITY \_\_\_\_\_ ZONE \_\_\_\_\_ STATE \_\_\_\_\_

# YOUR TIME IS IMPORTANT!

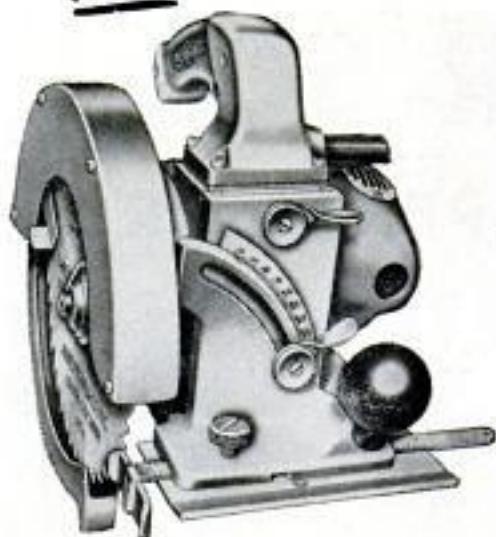

Time is money. And that's the sound dollars and cents reason for owning this modern, powerful, Sioux Electric Saw.

Home projects take shape in a hurry—like the new recreation room, the new garage, the extra bedroom.

Your Sioux Saw hurries things along, and pays for itself in a hurry too!



Look for SIUOX in the yellow pages under "Electric Tools"

Write for Free Catalog



**ALBERTSON & CO., INC. SIOUX CITY, IOWA, U.S.A.**



## CHOOSE YOUR NEW HOME FROM HUNDREDS of *Garlinghouse HOME PLANS* SHOWN IN THESE 5 LATEST PLAN BOOKS

These beautiful books contain hundreds of colored drawings, photos, floor plans and descriptions—making it easy and economical to select your new home. All sizes and styles are shown. Complete working plans, specifications, lumber and mill lists available for each design at **Low Cost**—enabling you to get bids quickly—or to figure doing part or all the work yourself. The moderate price of these plans is your best investment when building since you know in advance what you are getting, thus avoiding misunderstandings. 24 hour service on plans with a money-back guarantee if unused plans are returned in five days.

- **"RANCH & SUBURBAN"**  
125 plans most practical for town and country. Many in color .....50c
- **"CHOICE SELECTED HOMES"**  
82 designs (12 are split-levels) 2 and 3 bedrooms. 32 in color..50c
- **"NEW SMALL HOMES"**  
Over 80 new plans. Sizes 650 to 1175 sq. ft. floor space. 1, 2 and 3 bedrooms. 32 in color.....50c
- **"NEW BRICK HOMES"**  
64 genuine beauties, brick exteriors. Varied styles and sizes. 50c
- **"PLANS FOR NEW HOMES"**  
84 very desirable homes in wide variety of styles and sizes. 32 in full color.....50c

All 5 above books for \$2.00

**ORDER YOUR BOOKS TODAY**

All Books Mailed **POSTPAID**. No C.O.D.'s Please

Our Plan Service used by Builders and Lumber Dealers for over 45 years—America's Pioneer Home Plan Service.

**L. F. GARLINGHOUSE CO., INC., Box PM-27 TOPEKA, KANSAS**

(Continued from page 106)

### FARMS

Hydraulic carriers for farm machinery.....	249
Windmill ladder in haymow aids in stacking bales.....	252
Feed "sled" made from old boiler is towed behind tractor.....	255
Field drag of square timbers more efficient than blade.....	255
Rack on tractor serves as grille guard and pusher.....	255

### HOUSE AND HOME

Quaint old cobbler's bench.....	209
Ways to hang valance boards on trim or wall.....	216
Four steps in planning a stairway.....	220
Metal hasp locks window screen.....	220
Lower shelves of open bookcase are "off limits" to tykes.....	228
Attic ladder in wall cabinet is always handy.....	232
These snack tables stack.....	234
Heavy-duty cellar-door bolt improvised from pipe.....	240
Small trunk is toy chest for children's room.....	240

### HOUSEHOLD HINTS

Solving Home Problems—	
Medicine cabinet is out of children's reach.....	214
Raw potato makes a good scouring pad.....	214
Strip of adhesive tape prevents bathroom door from locking.....	214
Guard for sharp point of meat thermometer.....	214
Luminous tape locates water tumbler on night stand.....	214
Cup hook inside drawer holds spare key.....	214
Adhesive-tape spool stores lengths of fancy ribbon.....	215
Cellulose sponge makes a good clothesbrush.....	215
Roll-type memo pad.....	215
Emergency coat hanger.....	215
Candies will remain straight if dipped in shellac.....	215
Garbage can secured with holder.....	215
Rejuvenating scuffed luggage.....	229
Strip of corrugated board stores cup hooks.....	229
This on-a-door rack holds magazines galore.....	229
Plastic coaster under knob protects drawer front.....	238
Replacing missing fragments in broken china figurine.....	239

### MISCELLANEOUS

All-metal napkin holder of unusual design.....	211
Plastic bottle tops have many uses.....	212
Modified pencil sharpener cuts extra-long points.....	216
Quickly made marking stencil.....	216
Frequently used angles filed in triangle.....	220
Neater method of taping signs to inside of store windows.....	220
Marbles spot railing holes in concrete stoop.....	228
Mutilage container-applier made from India-link bottle.....	228
Fishing-lure fastener altered so it will not pull open.....	232
Slots in lettering guide save ruling lines.....	235
Brass bearings and hubs for model wheels.....	236
Measuring a hillside lot.....	237
Line taped on spinning reel prevented from unwinding.....	238
Loop-the-loop.....	239
On the Market—	
Flowerpot holder.....	259
Jellied semigloss enamel.....	259
Doorstop attaches to door hinge.....	259
Modern furniture pulls.....	259
Prequilted upholstery.....	259

### PHOTOGRAPHY

Picture a name.....	217
Print in your signature.....	221
One negative—How many pictures?.....	250

### TOOLS

Shopping for Tools—	
Universal work support.....	246
Wrench jaws consist of hardened-steel rollers.....	246
Mason's modular rule for spacing masonry units.....	246
Screw-anchor "gun".....	246
Nonslip belt.....	246
Universal tenoning jig.....	246
Protractor attachment for builder's level.....	247
Scaffold bracket has foot lift.....	247
"Hold down" machine vise.....	247
Home-workshop-size machines.....	247
Hand-tool cutouts.....	248
Line template.....	248
Motor mount saves time.....	248
Portable jigsaw.....	248
Barbed-wire reel driven by tricycle-type tractor.....	248

(Continued to page 110)

**NOTICE**—It is the intention of this magazine to provide its readers with information regarding the latest developments in the mechanical arts. Except where otherwise indicated, this magazine has no information as to any unexpired patents in respect of the developments reported herein. In the event that commercial use is to be made of any of the developments reported herein, it is suggested that legal counsel be consulted to avoid liability for patent infringement. It is not the purpose of this magazine to encourage patent infringement but, as indicated, it is the intention of this magazine to report on the latest developments in the mechanical arts.

## REPAIR YOUR OWN HOME HEATING SYSTEM

... save money with

# DEVCON

THE PLASTIC STEEL

80% STEEL - 20% PLASTIC

DEVCON, the mending marvel, handles like modeling clay . . . hardens in 2 hours even under water . . . no shrinkage . . . bonds to iron, brass, aluminum, wood, glass, concrete . . . most any clean surface.

For home, farm, garage or marine use . . . DEVCON fixes leaks, cracks and breaks in radiators, tanks, pipes, boiler jackets . . . just about any type of repair! Easy to use, DEVCON will save you hundreds of dollars.

Home Kit — enough for several projects — \$1.98

Also — 1 lb. package for big jobs — \$3.95

Buy it now at leading hardware, hobby and specialty stores — write for free booklet on home repairs.



## DEVCON CORP

175 Endicott St., Danvers, Mass.

### BUY GREAT NECK HAND TOOLS

... for long-lasting performance



CHROME PLATED ADJUSTABLE TUBULAR HACK SAW

## GREAT NECK SAW MFRS., Inc.

MINEOLA, N. Y. — SEE YOUR LOCAL STORE

### ARE YOUR SCREWS USA-MADE? BUY SOUTHERN AND BE SURE!

**FREE CHART**

WRITE TODAY FOR "TC-4" showing how to select the right screw for the right job, pilot hole sizes, etc., etc.

SOUTHERN SCREW CO.  
Box 1360-PM, Statesville, N. C.

### TOP SPEED BETTER SKIING or FUN

MICHIGAN AQUA-JET propellers win twice as often in the "National Stock Outboard Championship" as all other wheels, custom-built included. Inexpensive stock propellers, requiring no alteration of lower unit, each specifically engineered for motor used (5 HP and larger). Send card for FREE 1957 catalog — the Outboarder's Bible. Shows how to get better performance from specific motor-boat-load combination for racing, skiing, cruising, pleasure — also fine line of boat fittings. Michigan Wheel Co., Dept. P-2, Grand Rapids 3, Mich.



THE GENIE SAYS:

Get NEW CAR PERFORMANCE for less than 50¢ a month



USE THE DUO-MAGIC OF

# DRI-POWR

TO STOP ENGINE STUTTER

LIGHTNING-ACTION Power Concentrate of DRI-POWR (for OIL) Improves Engine Performance of Your Car; Reactivates gum-slowed Hydraulic Valve Lifters and Rings. Super-charged DRI-POWR (for GAS) Stops Traffic Stalls, Carbon Ping, Gas Waste; Frees Sticky Valves; Cleans Carburetors.



PLUS THE CLEANING MAGIC OF

# DEE-GUMM VAPOR ACTION

TO RESTORE GO-POWER!

STICKY ENGINE GUM and Varnish form in your Engine whether your car is Parked or being Driven — ROBBING you of Horsepower. DEE-GUMM makes Gum and Varnish VANISH! Frees Sticky Hydraulic Valve Lifters, Stops Fuel Waste and Costly Repairs — Restores New Car Performance!

SINCE 1935

PROVEN by Scientific Instruments and Thousands of Car Owners

ASK FOR IT at your Service Station, Garage, Car Dealer or Write DRI-POWR Co., P. O. Box 125, Azusa, Calif.



DISTRIBUTORS' OPPORTUNITY

We will consider the application of responsible men who wish to be in business for themselves as exclusive distributors of DRI-POWR PRODUCTS in certain protected territories. Write us today for full details.



Rear Booth DISPLAY of Mobile Units used by Distributors of our 23 DRI-POWR PRODUCTS.

DRI-POWR COMPANY, Azusa, Calif.

# Atlas GIVES YOU GREATER VALUE PER DOLLAR

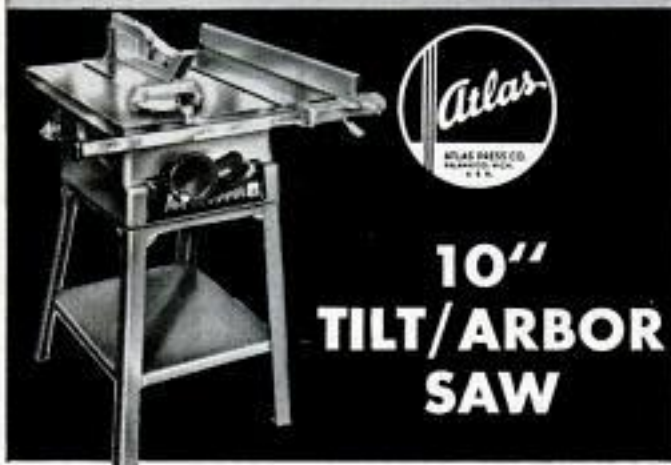

## 10" TILT/ARBOR SAW

With this precision ATLAS 10" circular saw you can do almost every basic wood-working operation . . . faster, more accurately, and with greater safety. You can crosscut, rip, miter, dado, and shape with greater ease, precision, and smoothness. Unexcelled for general carpentry, this great saw also gives you the accuracy you need for fine cabinet work, built-ins, trim, and furniture projects. It's the only saw with rigid triangular arbor support, balanced tilt mechanism, bigger arbor, push-pull depth and angle control, and double-locking lift-off fence with vernier control.



## 24" BALL BEARING JIG SAW

This is the saw you need for those fine decorative curves, beautiful inlays and "inside" cutting in wood, metal or plastics. Superlatively smooth in performance. Has massive 14" x 14" table . . . precisely balanced automotive-type drive mechanism . . . oil bath lubrication . . . exclusive new type universal chucks . . . continuous type air blower. Table tilts 45° to right, 15° to left, swivels 90°. Variable or 4-speed models. Heavy, pyramid design stand. Your shop is not complete without this great new Atlas 24" Jig Saw . . . see it at your Atlas dealer's or —

WRITE FOR ILLUSTRATED LITERATURE

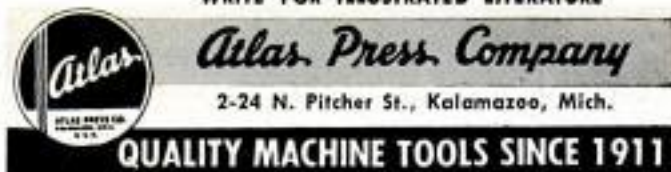

(Continued from page 108)

"Turn" it with a circle cutter.....	250
How would you do it?.....	256
Rubber washers dampen noise of power tools.....	260

### WORKSHOP HINTS

Hasp makes drop-leaf hinge.....	211
Prebored guide block aids in sharp-angle drilling.....	211
Quieting electric-clock motor.....	211
Decorate wood with a torch.....	218
Graphite from pencil lubricates miter-gauge groove on bench saw.....	228
Sawhorse has leg extenders.....	228
Bench-mounted abrasive disk for sanding small surfaces.....	232
Slotted wooden strips can be reinforced with dowels.....	232
Wooden mallet made nonmarring with section of inner tube.....	235
Adhesive-tape spools dispense wire, solder and twine.....	236
Imitation wrought-iron hinges.....	236
Lead shot anchors screw in enlarged hole.....	236
Rope end is disposable acid brush.....	238
Hose spacers eliminate resetting of depth gauge on drill press.....	245
Tubing on C-clamp screw keeps weld spatter off threads.....	245
Wooden vise jaws grip tubing.....	245
Clamp to braze bandsaw blades made from strap hinge.....	252
C-clamp on ladder holds hammer.....	253
Drilled holes kept in perfect alignment by pilot pin.....	253
Make this electric lawn trimmer-edger.....	254
Modified screwdriver blade removes carburetor jets.....	255
Corrugated-cardboard rack holds small power-tool accessories.....	258
Drill bit with notched shank provides leather punch.....	258
Hanger positions hammer ready for use.....	258
Handles permit better grip on steel-post driver.....	258
Threading die holds short screw for grinding and cutting.....	258
Bevel aids filing metal to dimension line.....	260
Drill-press vise improvised from woodworker's hand screw.....	260
Masking tape replaces C-clamps for holding rip fence on jigsaw.....	260



### Fold-Up Spare Tire

Drivers can replace flat tires with a 10-pound spare that requires storage space less than the size of a football. Conventional, inflated tires weigh 2½ times as much and take up five times the space. When a tire blows, the motorist takes it from the rim with a special pulling apparatus, places the unfolded spare on the rim, and inflates it with a bottle of carbon dioxide. The new tire is good for 1000 miles.





# GUIDE



Watch  
WIDE WIDE WORLD  
NBC-TV



Presents  
a BIG  
Difference in  
Headlamps

*Extra 3-Step Electronic Check Builds in Industry's Most Accurate Safety-Aiming!*



**1** Special machine accurately locates center of light beam for every Guide T-3 Headlamp that comes down the line. Once this "center" is found, lamp is locked in place . . .



**2** . . . electronic brain measures height of each "Guide Point" and automatically computes amount of grinding necessary. This information is then stored and passed along . . .

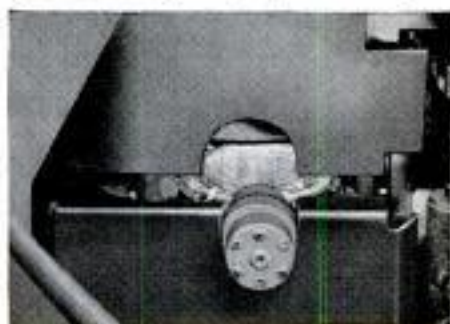

**3** . . . automatic grinder takes "Guide Points" down to proper height with gem-like precision. When grinding is complete, lamps can then be aimed with amazing precision.

**YOU GAIN** because perfect aim is a must these days when new industry-approved advances build greater power and a new, more efficient pattern into most headlamps. However, to get the benefits of this increased power (10% more light on the high beam) and improved pattern (80 feet more "seeing distance" on the right for "low-beam" driving) headlamps *must be perfectly aimed*. This means lamps must be within a fraction of a degree for horizontal aim, and must be held to even closer tolerances in the vertical plane.

That is the whole point and purpose of the gem-ground "Guide Points" on the face of every Guide T-3 Headlamp.

Perfect aim in minutes, in daylight! And, only Guide can guarantee it! They're standard equipment on all General Motors cars and trucks. See your nearby authorized Guide dealer now.

AC SPARK PLUG  THE ELECTRONICS DIVISION OF GENERAL MOTORS

Buy in pairs where you see





You may have to wait for this, but...



Designed by Raymond L. Jordan

## right now you can enjoy that “New Car Feel”

While you're waiting for your “dream car” there's no need to put up with sluggish performance in the car you're now driving. Your Doctor of Motors—your skilled mechanic—knows how to restore the responsive power of your car's engine and to bring back that satisfying “New Car Feel.”

Your Doctor of Motors also knows that there is no better way to restore full-power performance with positive oil control than to install Perfect Circle 2-in-1 Chrome piston rings. Perfect Circles are plated with thick, solid chrome that resists wear, more than doubles the life of cylinders, pistons and rings. See your Doctor of Motors for an engine check-up today! Perfect Circle Corporation, Hagerstown, Ind., The Perfect Circle Co., Don Mills, Ontario.

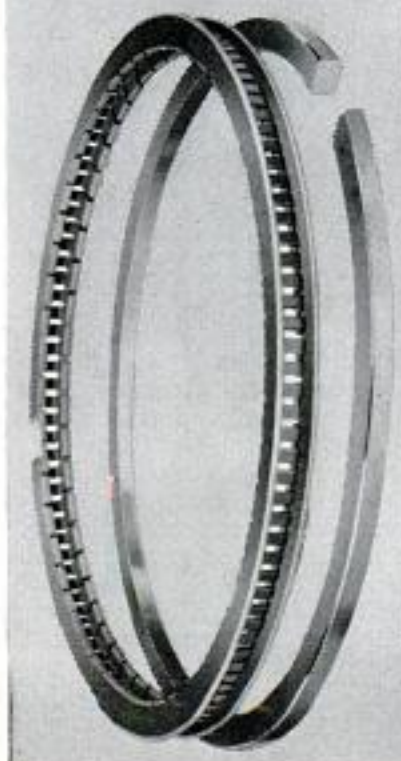

Install

# PERFECT CIRCLE

2-in-1

Chrome Piston Rings



You'll be surprised how quickly and economically your Doctor of Motors can bring back the “New Car Feel” to your car!

**WITH TREES** like anything else, there can be too much of a good thing. Plant an infant, and in a few years your home grounds are threatened by a lusty monster. A pruning knife just seems to stimulate its growth all the more.

That's why dwarf trees have been arousing so much interest in the home landscaper—as well as the orchardist who wants fruit in a hurry from trees easy to spray and pick.

But not till you see the dramatic research results at Arnold Arboretum do you realize how near we're getting to an era of trees measured-to-order.

Here, near Boston, at "America's Greatest Garden," its expert, Dr. Karl Sax, can deftly peel off a half-inch-high ring of apple bark, then "graft" it back on—but up-

# POPULAR FEBRUARY 1957 MECHANICS

WRITTEN SO YOU CAN UNDERSTAND IT  
VOL. 107 NO. 2

side down this time. A rubber band clamps it snug. The wound heals, but the tampered tree now turns its energy to making fruit instead of wood.

Or take a shade tree, say a maple. Invert a two-inch band of bark when the tree has grown two thirds of the way up to an overhead telephone wire. The full story

## THE TRICKS HE PLAYS ON TREES!

By  
**William  
Gilman**



Copyrighted material

EIGHT STEPS FOR GRAFTING



A sharp knife is used to make a vertical cut in Nanking cherry sapling to which will be grafted bud of an elephant-heart plum

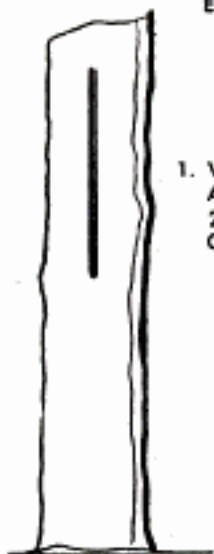

1. VERTICAL CUT ABOUT 2" LONG 2" TO 4" ABOVE GROUND LEVEL

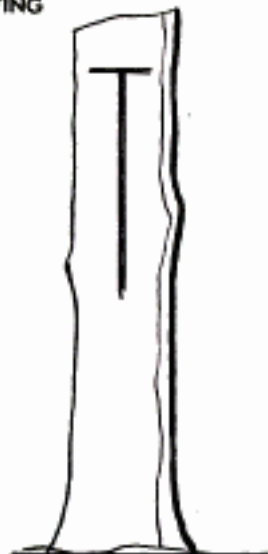

2. HORIZONTAL CUT TO FORM TEE ABOUT 1/2" WIDE



3. T-CUT HAS BEEN GENTLY PRIED OPEN WITH KNIFE



4. SLICE PLUMP BUD FROM "BUD STICK" TAKING SLIVER 1 1/2" OR 2" LONG WITH BUD NEAR CENTER

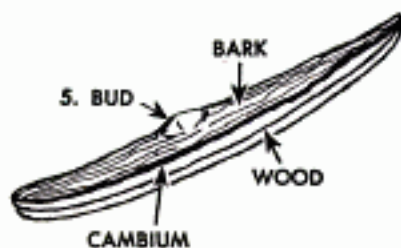

5. BUD  
6. WITH BUD POINTING UP SLIVER IS INSERTED IN T-SHAPED INCISION



The graft was a success. Here the plum bud is opening on the cherry stock. The upper part of cherry sapling has been cut off

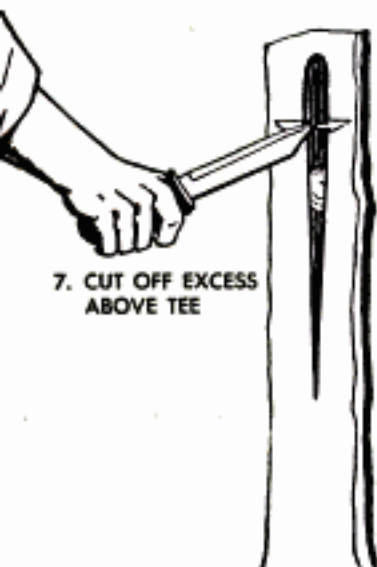

7. CUT OFF EXCESS ABOVE TEE



8. TIE UP GRAFT WITH FLAT RUBBER BAND BUT DON'T COVER BUD





Eleanor Gilman photos

Branches of dwarfed McIntosh apple tree are looped for added dwarf effect. First loop is just atop trunk

isn't in yet, but research indicates the tree can be braked before it engulfs the wire.

Almost any young tree can be dwarfed by this "bark inversion" method, says Doctor Sax, the arboretum's noted botanist-horticulturist and former director. He's done it on trees up to six inches in diameter. For even faster results in slowing down the tree, he can reverse two bands of bark, one above the other.

Just what happens? Its leaves manufac-

ture the tree's food which sap then carries down to the roots for growth of the tree. Inverting the bark slows that sap flow, puts the roots on a restricted diet.

Eventually after several years the sap will regain its normal pace. That's the time for another bark inversion.

Admittedly, this method is for the experienced green thumb. But there are many dwarfing tricks that Sax plays on trees, several of which are not only eye openers

With plastic wrap, Sax shows how you can pot a tree while it is in bloom. His tub is sawed-off wooden keg

Another looping experiment has dwarfed pear top that was grafted to ordinary hawthorn rootstock



Copyrighted material



This rare cherry shrub—not a tree—was created by Dr. Karl Sax by crossing young Asiatic cherry trees

but within the grasp of ordinary hands.

Most curious, perhaps, is looping. Just that single loop called the overhand knot. It's tied in early summer when the tiny tree's little trunk is a limber whip. In a couple years, the enlarged trunk shows a pretzel-like bulge and you have a healthy dwarf.

Sax started this as a quick method for saving space in his testing orchard where experimental varieties have to spend several years. Five years later, his knotted trees are only half the size of normal ones growing nearby.

Using radioactive tracer methods, he's found this dwarfing is again caused by

slowing those nutrient juices which descend from leaves by gravity. In that loop circuit, the sap doesn't want to flow uphill. The effect is like standing the tree on its head.

Like other dwarfing methods, this does more than keep the fruit tree's head down to six feet or so. With more nutrient remaining above in the buds, their increased vigor means fruit earlier and larger. So you have a dwarf apple fruiting in its third year—five years or more ahead of the same variety growing normally.

Sax points out that more conventional midgets—with special rootstocks to do the

(Continued to page 318)

Left, knot was tied in three-year-old apple tree to dwarf it when the tree was only one year old

Center below, Sax looped poplars to study growth effect. Below right, "bark inversion" dwarfs a tree



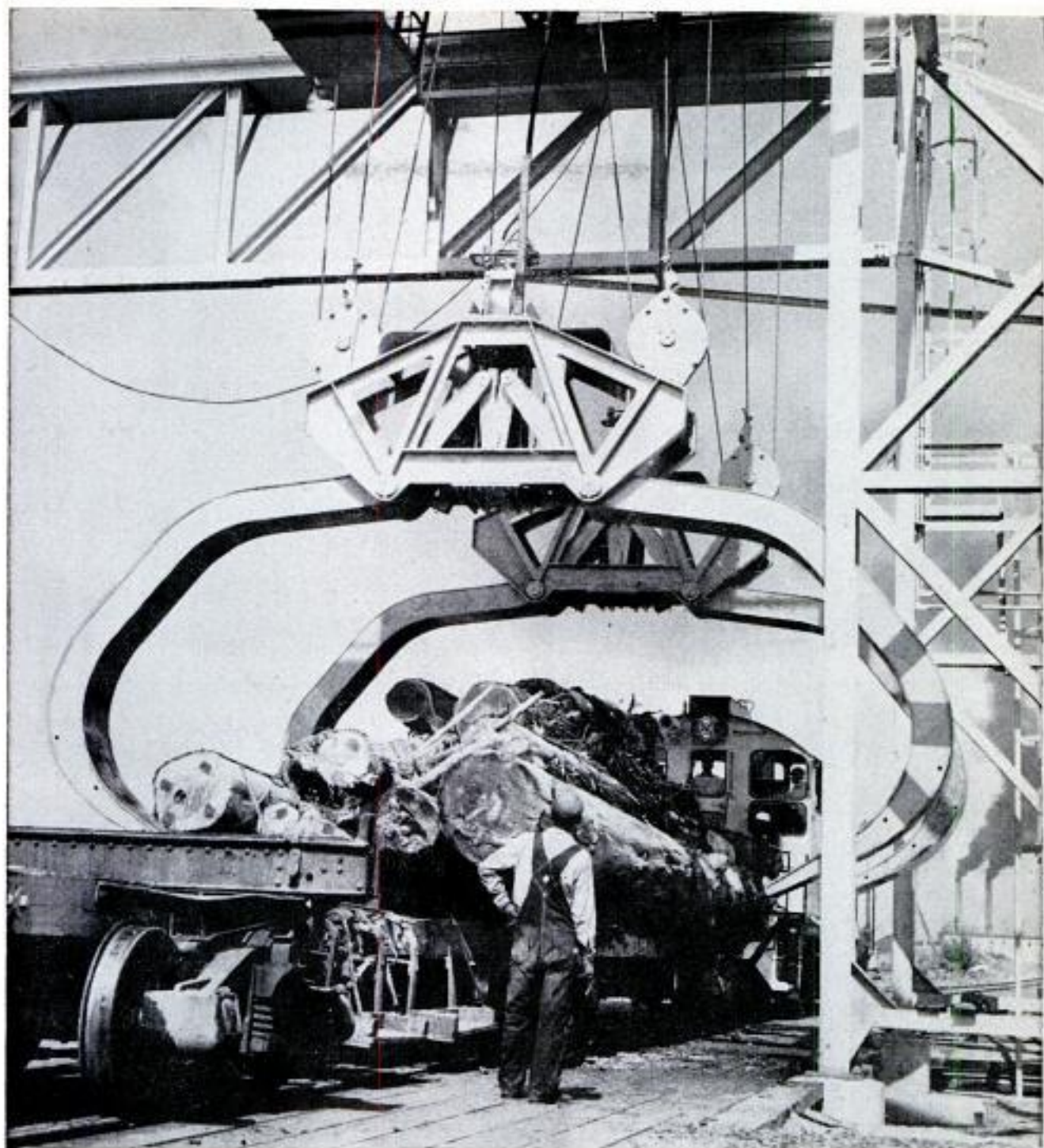

## GIANT TONGS UNLOAD A LUMBER TRAIN

"GRAPPLER" AND "STACKER," operated in the Pacific Northwest, daily transfer tons of huge logs from trucks to storage sites without breakage. At Longview, Wash., the 95-ton, one-man grappler crane unloads 250 railroad cars each day at a 2½-minute cycle. With a clear span of 100 feet, the crane has a 75-ton capacity. Electrical power moves the crane and drives the compressor to activate air grapples that open to a 16-foot width. Main power comes from a torque converter diesel engine. In the 27-ton stacker at Grays Harbor, Wash., one operator at a single control panel "lifts" a truckload of logs as high as a three-story

house. Curved prongs move forward and down to wrap around the load from the top; three prongs go underneath, and other prongs push logs from the carrying forks to the storage pile after the 33-foot boom has been tilted forward for stacking. With a 25-ton capacity the stacker handles 50 logs per bite in a five-minute cycle. The stacker is 33 feet long, 30 feet high and 12 feet wide. A 300-horsepower diesel engine provides a.c. and d.c. power to two generators. Each of the four wheels on the stacker has its d.c. motor. Fork lift, steering gear, prongs and tilt each has its individual a.c. motor.



U.S. Navy photo

Propelled by rockets, an atomic depth charge blasts toward an enemy submarine miles from the launcher

## Flying Depth Charges "Kill" Enemy Subs Miles Away

Crewman readies a rocket depth charge for insertion in the firing unit, which can move in an almost complete circle

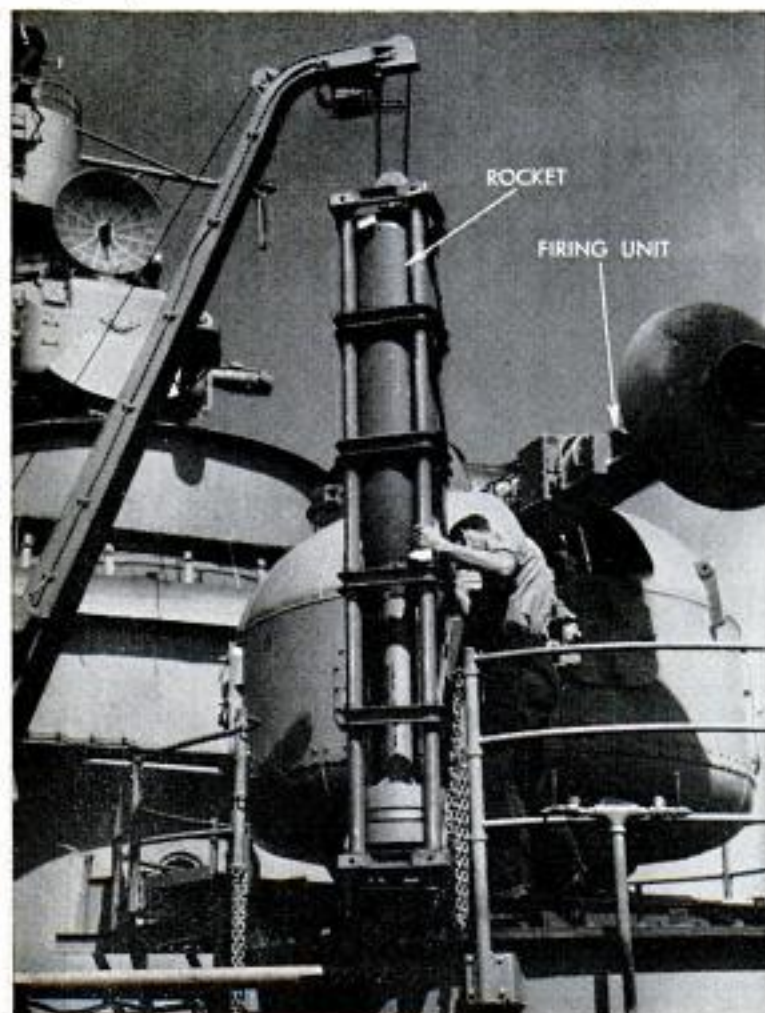

Dropped by aircraft or projected from a surface warship for delayed detonation, atomic depth charges and rocket-borne missiles now can sink enemy submarines miles away from the point of explosion. The atomic missiles can be set to explode at depths considerably greater than practiced with usual antisubmarine charges. Prior to atomic depth bombs, the rocket-borne missile (shown in photos) has held the spotlight in this phase of warfare. Launchers capable of training in an almost complete circle fire more effectively in wider areas and at greater distances from their targets than previously.

### "Electric" Rubber

Silicone rubber that conducts electricity without wires and resists temperatures up to 400 degrees F. can be used to make antifogging heater pads on aircraft cameras. Since this substance can be made into electrically conductive tubing or hose, it may be effective in draining static charges, preventing sparking in hospital operating rooms, or handling of explosive gases or dusts.



## Sweden's Volvo Gets New Style

Best-selling car in Sweden, the Volvo (at right and below) has a reputation for tough, rugged construction and fine workmanship. Now it adds a stylish body to its line. The new body, called the Amazon, has four doors and slab sides. Its four-cylinder 96-cubic-inch engine is famed for reliability. Coil springs are used all around. Older models had only two doors.



## Deep-Diving Record Goes to 600 Feet

Diving to 600 feet in Norwegian waters, a British sailor has broken the previous record of 535 feet set in 1948 by another British sailor. George Wookey, wearing a helmeted diving suit and supplied with an oxygen-helium mixture for breathing, made his record plunge from H.M.S. *Reclaim*, an experimental undersea-research ship. The British Navy has been studying problems of diving to great depths as a safeguard for men trapped in sunken subs.

## "Through the Wall" Fireplace Heats Both Rooms

With a new prefabricated fireplace unit you can view the fire from two different rooms. In the past, one disadvantage of a "through the wall" fireplace was the lack of a back wall to reflect the heat into the

room. The prefabricated fireplace has air inlets from each room. The air is heated beneath the firebox, passes up through channels in the sides of the fireplace and is discharged into both rooms.



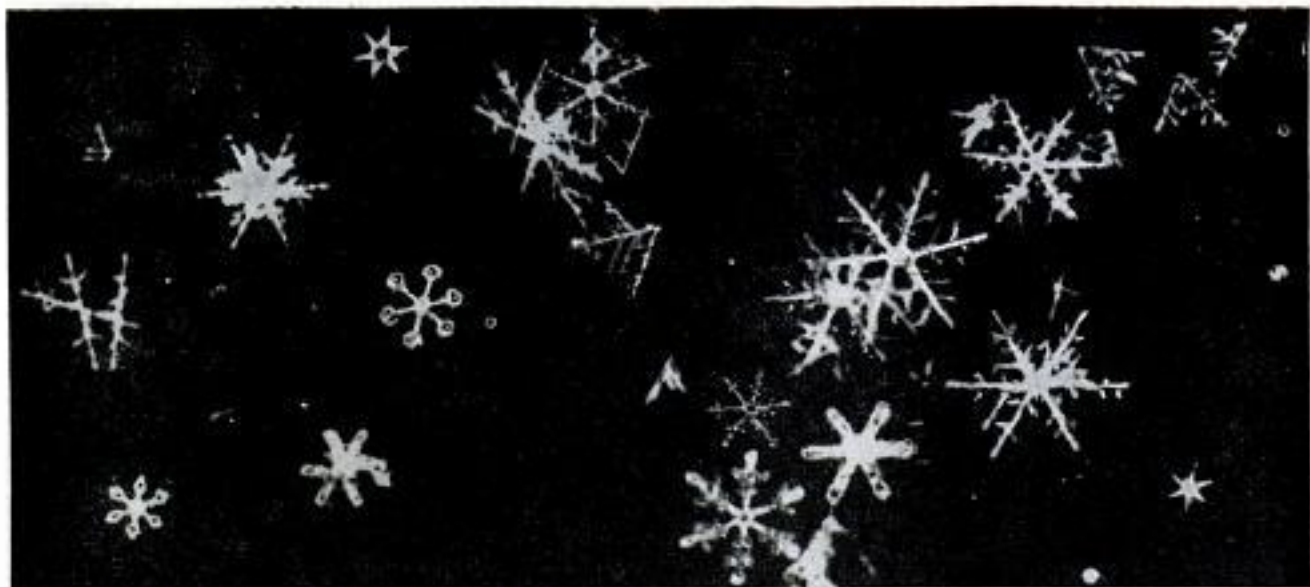

Pictures of snowflakes above were made with Japanese weatherman's shadow box diagrammed below

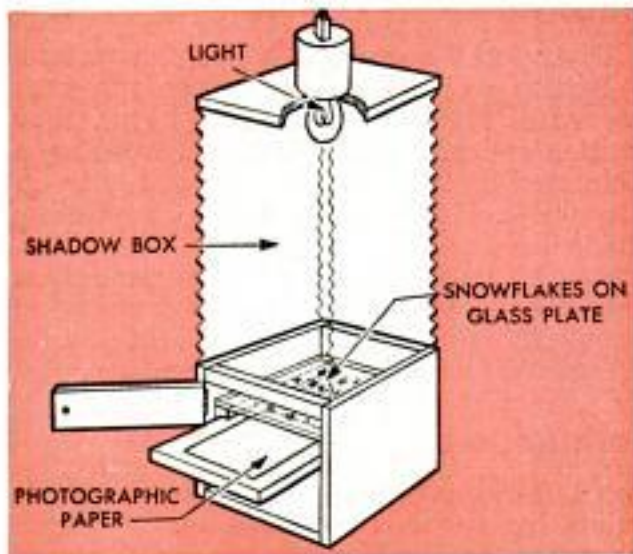

Chilled glass plate is taken outdoors during snow-storm and then replaced atop film holder in the box. Below, close-up photograph of ice crystal in water

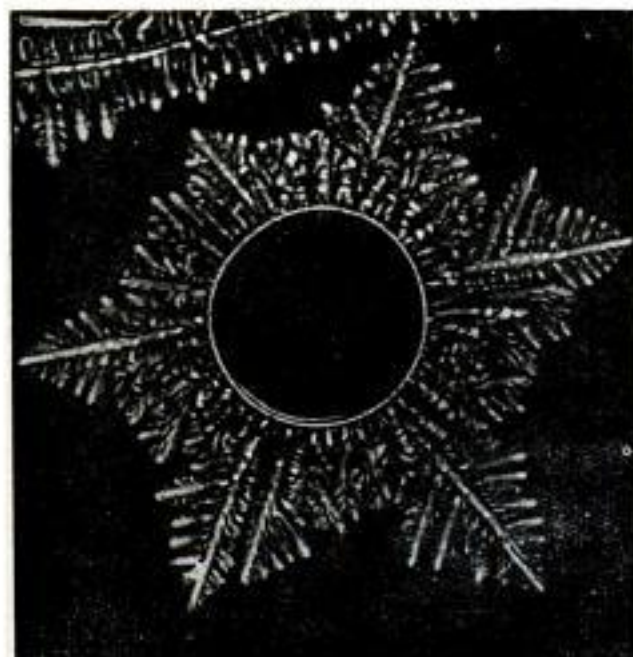

## Shadow Box Snaps Image of Snowflakes

PHOTOGRAPHING SNOWFLAKES in actual size usually is reserved for people with thousand-dollar cameras and infinite patience. Then, the chance of snapping a picture before the lacy filaments dissolve into nothing is slim.

Plagued by these facts, plus a slender budget for his snow-crystal research at Hokkaido University in Japan, meteorologist Keiji Higuchi invented and built his own snow camera. His shadow box is simple to make and easy to operate. All you need is a two-foot-long, light-tight carton measuring three by four inches inside, a single-cell flashlight, a 2¼ by 3¼ cut-film holder with slide and several sheets of clear glass, three by four inches. A small base constructed of plywood scrap contains the film holder on simple slide strips. The surface of each glass sheet is treated with silicone oil to repel water and the entire apparatus is cooled to outside temperature. A glass plate exposed briefly to falling snow is put into the dark box directly on top of the film holder. By removing the slide from the film holder and illuminating the glass plate from above with the flashlight bulb for a few seconds, shadows of the crystals are produced on the photographic paper. The image is created in nearly true scale and outlines the snow crystals in every detail.

Doctor Higuchi's work with his shadow camera was conducted in an igloo half way up Mount Tokachi on Hokkaido Island. He found that different types and sizes of snowflakes fall during one storm. A 1½-inch flake contained as many as 4000 crystals. He uses the box for "shadow-graphing" many transparent objects including soap film and ice crystals in water.



Advertising a bowling-pin spotter, a studio built a king-size alley, used girl "pins" and huge bowling ball

*Live pins topple before a monstrous bowling ball . . . paper cutouts play tennis . . . a cake of soap does a strip tease . . . it's all*

## Backstage Wizardry of the TV Commercials

By Richard F. Dempewolff

**R**INGING TELEPHONES, glaring klieg lights, harried people stumbling across snarls of rubber cable, make a madhouse of a small well-equipped movie studio on New York's west 56th Street. Two live children dangle from the ceiling by wires, clawing idly at the air. Somebody shouts at a pair of dejected donkeys that stand sadly in the middle of the set.

"Take 16," yells a director. Cameras swing toward the melee. People and animals untangle themselves for the sixteenth go at a sequence in which humans are supposed to fly, and animals turn into machines. Eventually, the twentieth or the thirtieth "take" is successful and another TV commercial is completed.

Marty Ransahoff, head man at Filmways, a company that produces 500 TV commercials yearly, winces when he recalls that particular filming. "It looked pretty

Stop motion promotes a deodorant. Cutout figures on the table move past the clock in a 60-second spot

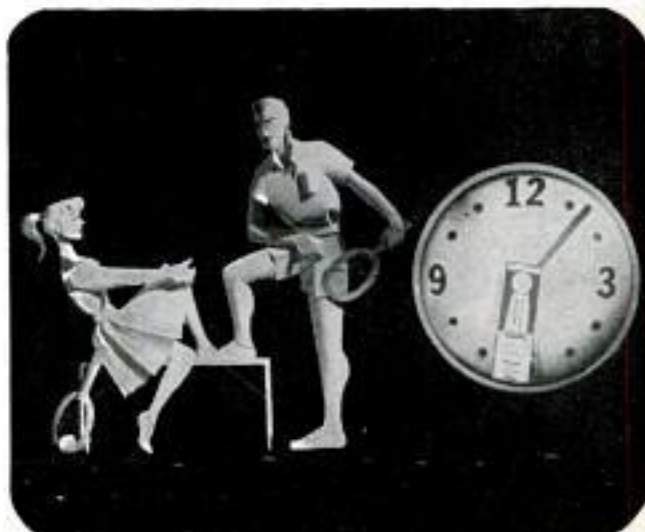

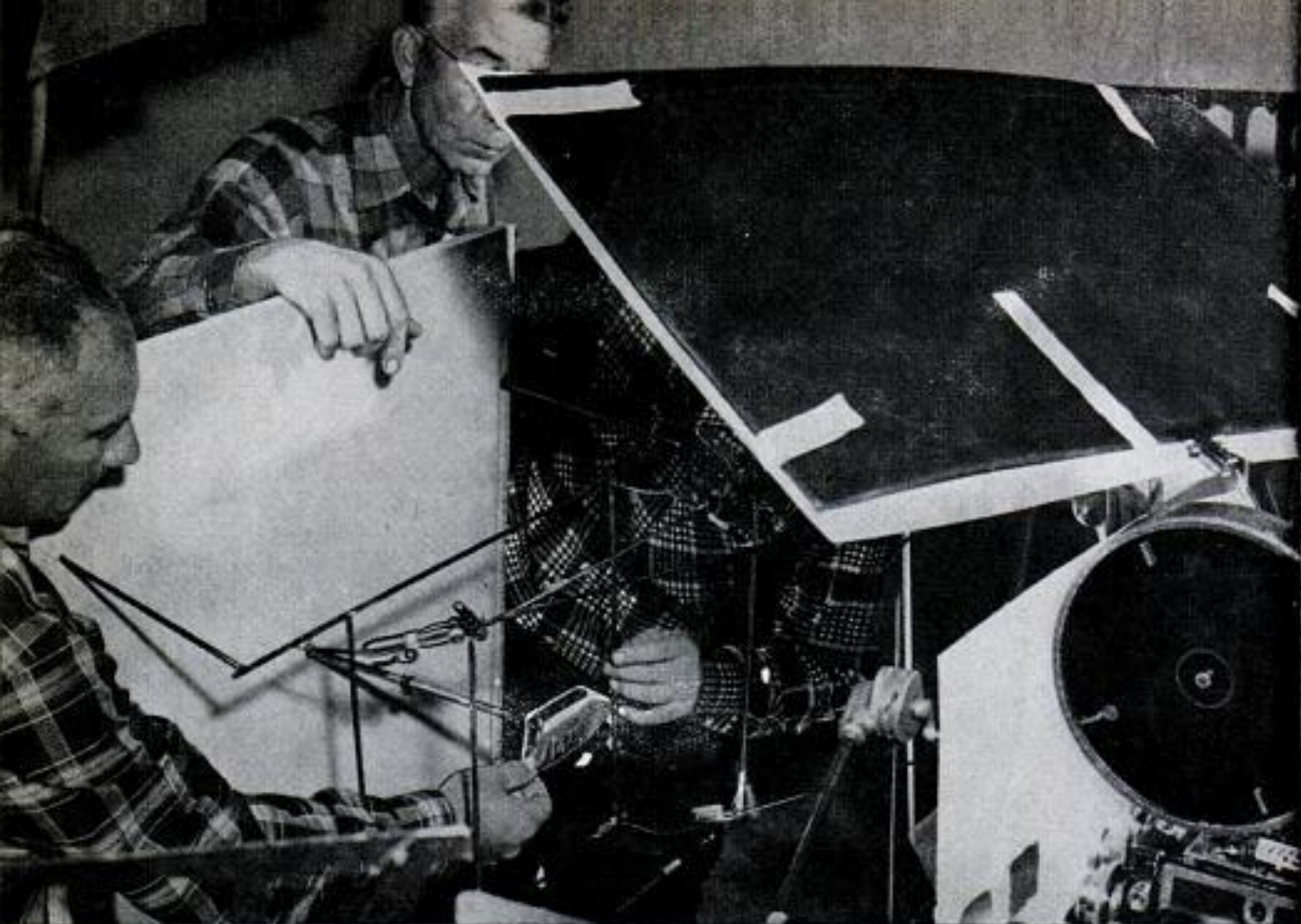

In stop motion this Universal Pictures' rig enables the camera to show a bar of soap unwrapping itself

cute on the story board prepared by the advertising agency," he says. "The scene showed a boy and girl riding across a desert on burros. They meet a chuck wagon and eat some famous breakfast food. Their burros turn into bicycles and they fly off through the sky because of the extra energy they absorbed. Sounded easy.

#### Burros Have Different Ideas

"It wasn't. The burros were completely unmanageable. They wouldn't let the kids

stay aboard, so we had to build a fence along the stage and have a man ride an electric dolly behind it, leading the animals with hidden reins. For days we rigged invisible traveling wires to lift and carry the kids on their bikes. Nothing worked. We finally just hoisted them off the floor and used a sky-and-cloud rear projection to provide a moving background that made them appear to soar through the air."

If you happened to see that commercial, you may remember that it lasted 60 sec-

Sitting in a lounge chair, this "traveler" rides a cart on rails through "four countries" within 30 seconds

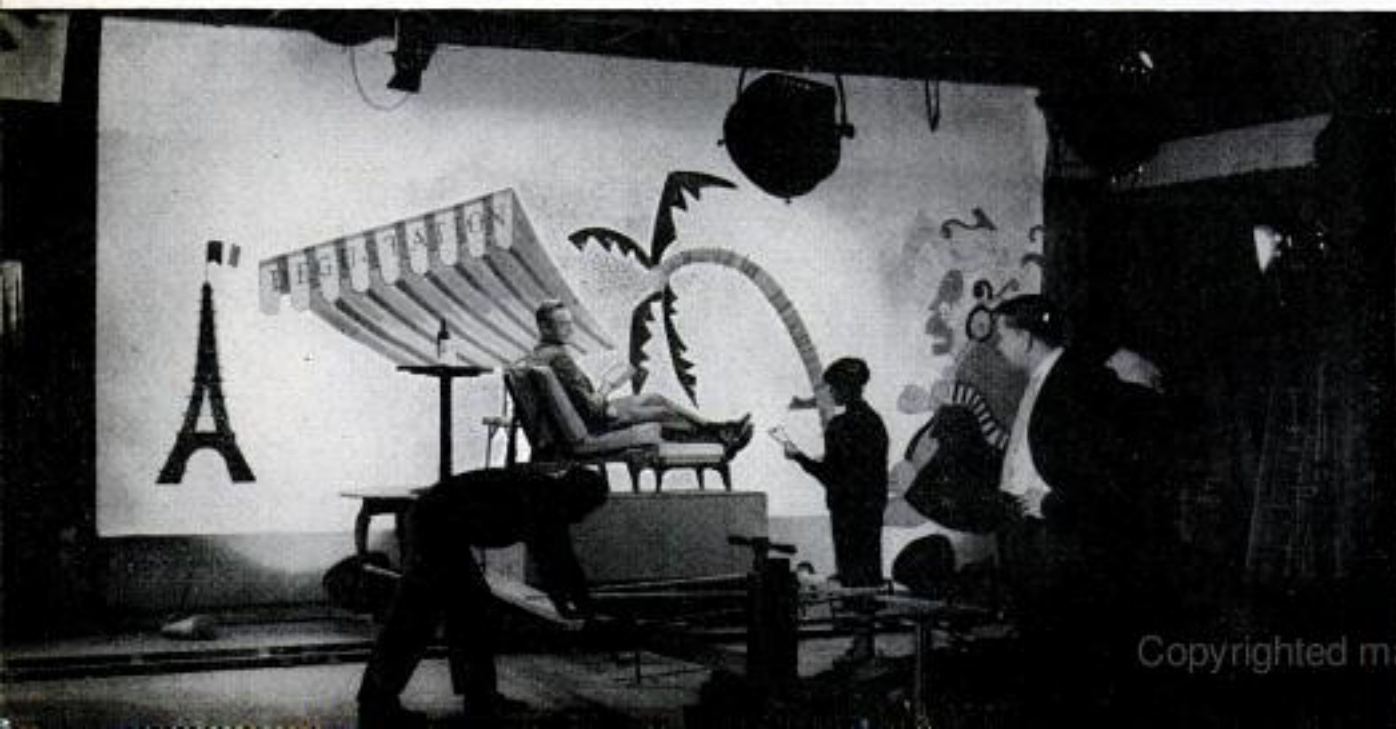



Plugging playshoes, this spot had models on backs under a sheet with legs poked through clouds of dry ice

onds. But it gave Marty and his crew a week of headaches, cost thousands of feet of film, and required one solid day of shooting before it looked right.

#### Commercials Are Big Business

Ransahoff's outfit is only one of a mushrooming crop of studios specializing in production of the snappy commercials that pepper your favorite TV programs, a lucrative new industry that divides an annual \$30,000,000 plum.

Sarra, a New York producer who turns out 300 to 500 spots each year, once had his cameramen working underwater in a tank for nearly a week to shoot a one-minute commercial of a water purifier in action. Over at United Pictures, scenery experts built a complete duplicate of the American Stock Exchange as it was in the 1800s when it operated from street curbs. Another time, the job of shooting a 10-second sequence of eight spanking-new cars riding in a circle was accomplished by renting a

After each exposure in this stop-motion shot, technicians make microscopic changes in puppet poses



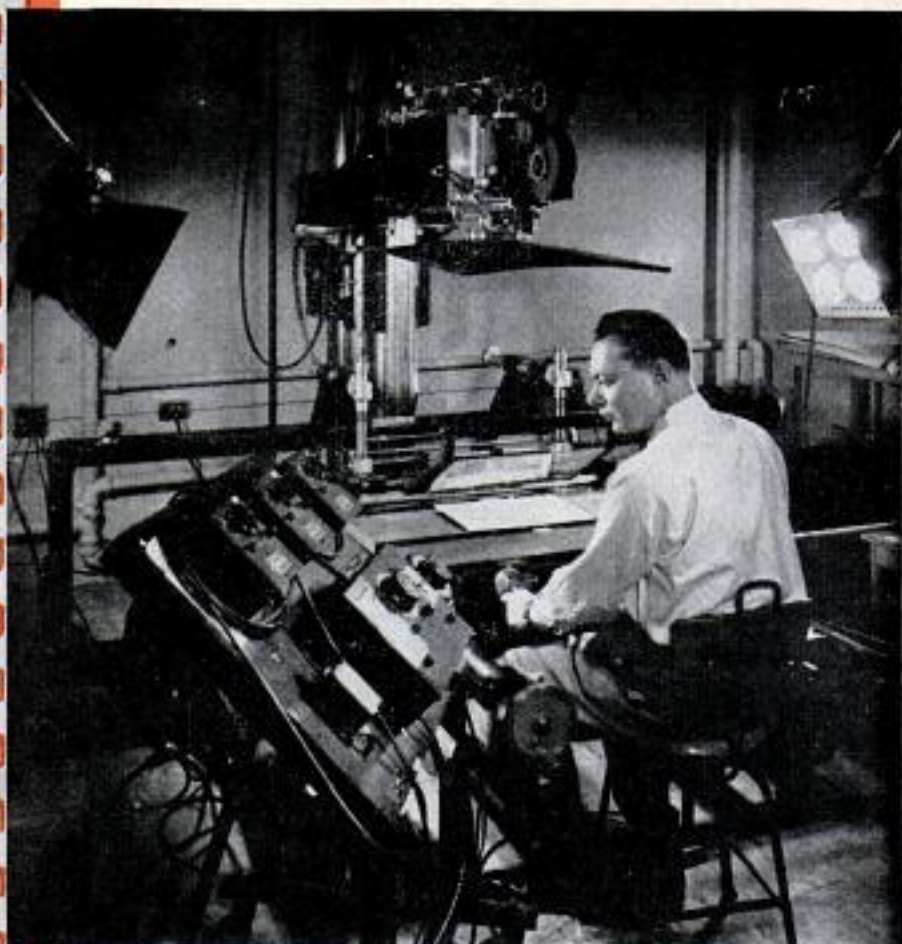

Electronic cameras photograph animated-cartoon commercials by shooting 1440 individual drawings to make up one 60-second spot

10-story derrick and building a special camera platform. This was hoisted 100 feet in the air so cameramen could shoot the entire parade from above.

To accommodate the sponsor of a 60-second extravaganza plugging a cosmetic, Steve Elliot, top kick at Elliot, Unger and Elliot in New York, scoured the town for the miles of pipe and gallons of refrigerant it took to construct a genuine ice-skating pond surrounded by snow-covered woodlands in the studio.

The 23-second problem of displaying a new line of ladies' playshoes (which look better upside-down than right-side-up in pictures) was lavishly solved at Bill Miesegaes' Transfilm studios. A dozen barelegged models were hired to lie on their backs and kick playshoe-clad feet through a 25 by 30-foot cloud of swirling vapor. Dry ice, dipped in pans of hot water spotted around the rim of a huge bin, created clouds that were wafted gently around the kicking legs by fans. A huge plastic sheet was hung over the area about a foot off the floor. Holes, big enough to accommodate thighs, were cut in it for each girl. Lying on their backs under the sheet, the girls stuck their legs through the elastic-rimmed holes, which assured a tight fit so the carbon dioxide couldn't smother them.

Production of a TV commercial begins when the advertising agency sends the studio a "story board," a series of boxed sketches like a comic-book layout—indicating sequences that are to be shot. Along with it goes a script, detailing scenery, props and dialogue. A one-minute spot may run from \$1500 to more than \$15,000. A studio may have to shoot 5000 feet of film

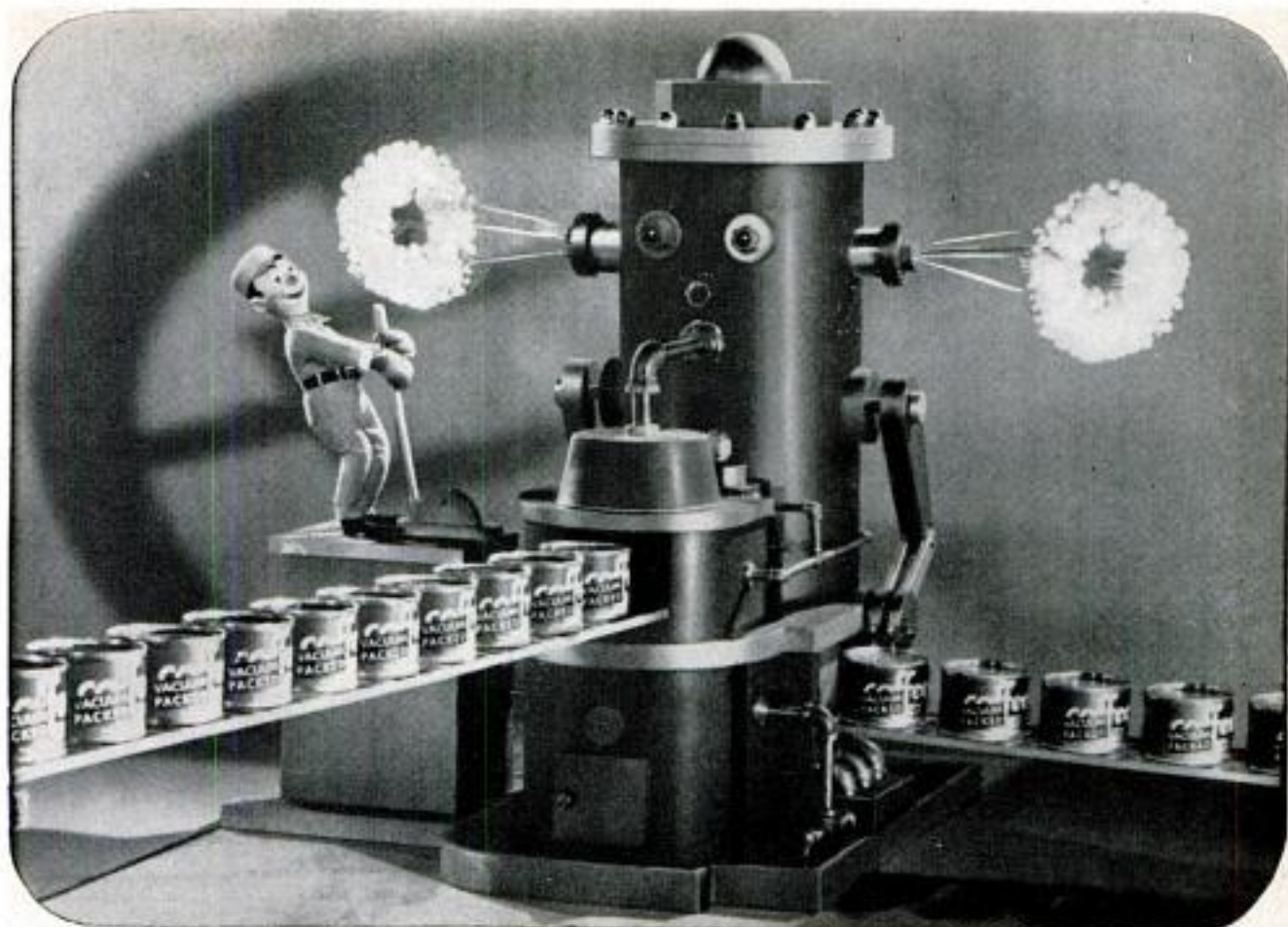

**On TV this stop-motion spot will show cans moving into machine, the man pumping and smoke being emitted**

before a complex "30" (half-minute spot) is ready to be "aired." "I've seen story boards for 60-second spots that Cecil B. deMille couldn't produce in a two-hour movie," claims Morris Behrens, Sarra's right-hand man. One recent commercial filled a special studio with 40 actors, six famous beauty queens, Guy Lombardo and his orchestra and Jinx Falkenberg. It lasted four minutes. So did a complete series of

spot commercials that sent scouts from Science Pictures out to sign up six elephants, a chimpanzee, two tugboats, a pair of diesel locomotives and a five-story pile driver.

"It was for a tire account," explains John Thayer, Science Pictures' vice-president. "The idea was to try to destroy the client's product on TV. The chimp was dressed up, handed an ice pick, and was supposed to

Out of season, these plants are made of paper. They will have real lima beans tied to their stalks

Real spinach plants and soil are installed in the studio-built garden. Most foods on TV are authentic

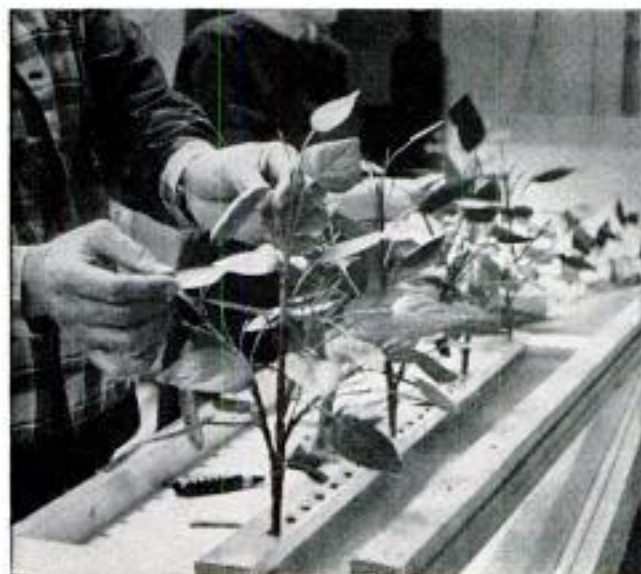



While a model primps with cosmetics at a two-way mirror, camera crews photograph from mirror's other side



Above, refrigerator shelves supported by invisible wires "float" in black. Below, plastic covers camera photographing the washing of fresh spinach

jab away at the tire to prove it was blow-outproof. But the monkey wasn't having any. He screamed, leaped all over the set, jabbed at everything but the tire most of a day, before settling down to business.

"After that, we staged a tug o' war with six circus elephants—three on a side, with the tire in the middle. When the elephants couldn't yank it apart, we tied the tire between two tugboats on the East River. The tire didn't break, but we spent days hunting for heavy Manila mooring line that could stand the strain. Then, we set up the cameras in a freight yard and had diesel engines ram the tire simultaneously from opposite directions. They crimped the steel

(Continued to page 310)

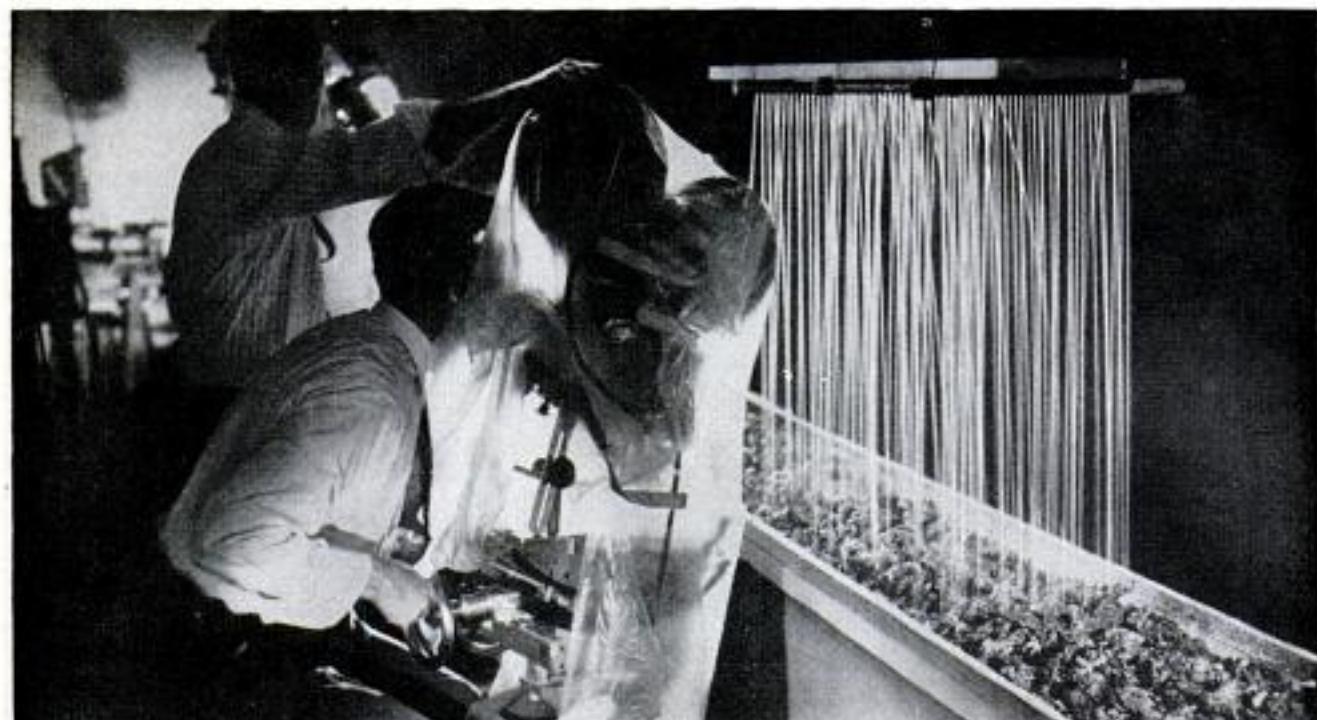



# Blizzards From Sprinklers Cover Slopes With Snow

SKI-RESORT OWNERS across the country, watching their profits melt away in cloudless skies, are resorting to a new technique—making their own snow. To create blizzards they stretch two hose lines up the ski slope, one carrying water and the other compressed air. Under high pressure the water and air mix inside a sprinkler and the mixture is ejected in a fine mist. All nature must do is provide a temperature a few degrees below freezing and presto—snow! The flakes can be coarse or fine depending upon proportion of water to air.

Some resorts have permanent installations buried below the frost line. At others, men drag the sprinklers from place to place to distribute the snow evenly.

Out on Moonridge Mountain, near Big Bear, Calif., there's a six-man crew working to cover a slope the size of four football fields. The snow makers brew their blizzards at night, building a foot-deep base on the first cold night, then adding six or eight inches each ensuing night to keep the slope in good shape following the activities of skiers during the day.

One group of men, calling itself the "pneumonia detail," occasionally throws vegetable dye into the water system, just to amaze the customers. Sure enough, out comes colored snow.

Top right, snow maker points to standard sprinkler used to create the blizzards. Drawing shows how water and compressed air are combined to make snow.

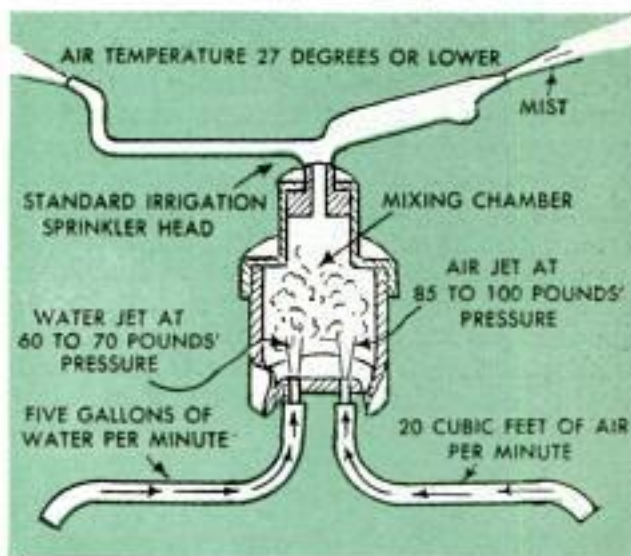



Moving on roller-skate wheels and channel-iron track, this rolling roof is closed from the room below

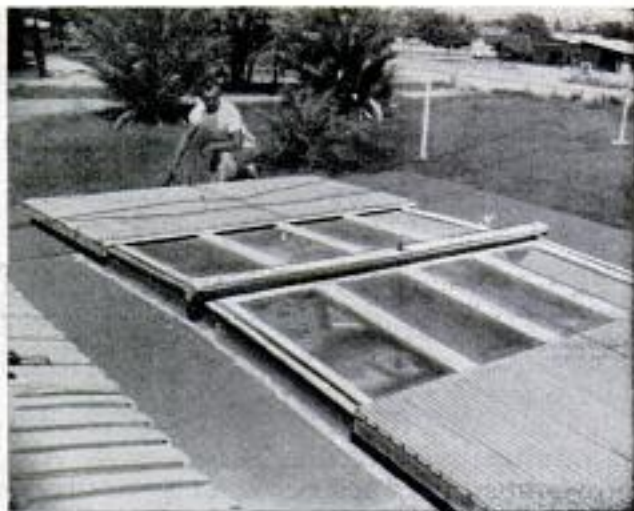

Here sliding roof sections covered with corrugated metal are rolled back to let in the Arizona sunshine

## Roof Rolls Back on Roller-Skate Wheels

SLICING OUT an eight by nine-foot opening in the ceiling of his home's fun room, John Vykruta of Tempe, Ariz., has installed a rolling roof. He and his family now have year-round access to sunshine or starlight in privacy and comfort. Vykruta, a carpenter, first made rustproof screens with white pine borders to go inside the opening. Then, framing the "skylight," he screwed channel-iron track to it. On wood skeletons fitted to the dimensions of the gap, Vykruta fastened corrugated-metal, waterproof roofing material. These sections were laid on the frame over the opening. Removing eight wheels from a pair of roller skates, he put these "ball bearings" on the track under the outer edges of the movable sec-

tions. To make the roof a rolling unit, a system was devised with 50 feet of control cable connected to pulleys at either end of the roof top. The cable led to eight feet of sprocket chain which dropped vertically on the side of the house to a miniature ship's wheel in the fun room. A person moving this wheel slightly can open or close the hatchlike roof. Additional waterproofing is provided by a metal-covered center piece that runs along the ridge of the roof to overlap top edges of the sections when they are closed. Board facing on the sides of these sections gives added strength and unity to the moving roof. This durable setup has survived 80-mile-per-hour winds.

Looking up from inside his home's fun room, John Vykruta inspects the screens on his "movable skylight"

Cable on the rolling roof connects to this chain and leads into the fun room to a ship's wheel





Seaplane hulls can be tested at speeds up to 68 miles per hour in Convair's new hydrodynamics laboratory

To save time and reduce development costs of advanced-type seaplanes, Convair is installing an \$800,000 hydrodynamics laboratory at its San Diego, Calif., plant. The laboratory will consist of two 300-foot towing tanks, joined in the center by a 100-foot-square turning basin. Each towing tank is 12 feet wide and six feet deep, and models of seaplane hulls can be run through them at speeds up to 68 miles per hour. Instruments on the models, as well as high-speed cameras located along the sides of the tank, will record the characteristics of the model being tested. A stainless-steel cable on a drum driven by hydraulic pumps pulls the model through the water, accelerating it to top speed in about 50 feet of run. The first of the 300-foot tanks is already completed.

## Hull-Testing Tank for Seaplanes

Battery of instruments records the characteristics of models

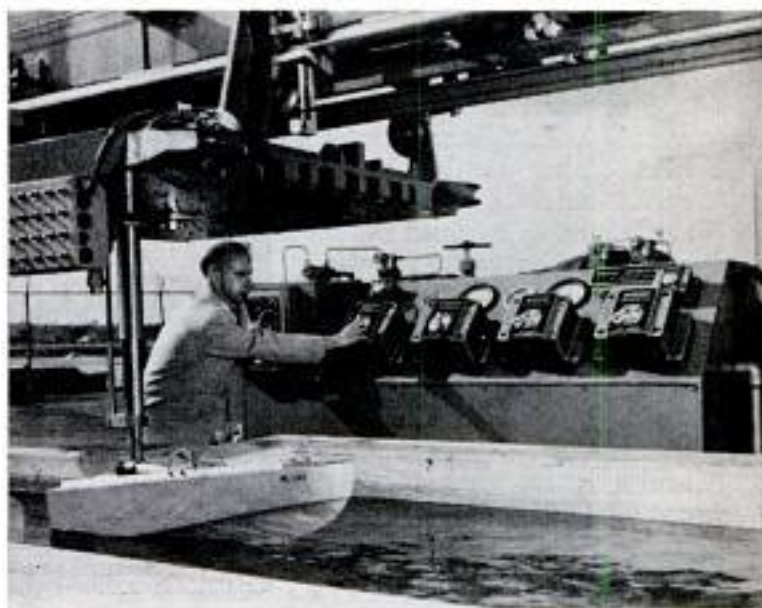

## De-Inking Process Reclaims Old Newsprint

Newsprint can be reclaimed for repeated use by a de-inking process that supersedes older, expensive, complicated methods. The economical, efficient new method yields pulp equal in color, brightness and strength to original pulp. Shredded paper is placed in water with a detergent and salt that loosen and separate the ink from the cellulose fibers. The mixture is heated and charged with an electric current to increase separation before the water is removed and the fibers are washed and bleached.

## 100 Barrels of Asphalt Yield 105 Barrels of Products

Combining asphalt and by-product hydrogen, oil-refinery researchers have developed a hydrogenation technique that produces 105 barrels of products from 100 barrels of asphalt. Previous conversion of asphalt into fuel products has resulted in loss to less valuable materials, such as coke and "drygas." From 100 barrels of asphalt the yield is as much as 20 barrels of gasoline and heating oil, 40 barrels of gas oil suitable as catalytic cracking feed stock, and 45 barrels of material of fuel-oil quality.



## Bicycle Built of Two

Only the wheels of a bicycle are evident in a bicycle act performed by two young Italian acrobats. Their own bodies form the framework of the vehicle. The rear member of the team pedals a unicycle while grasping the ankles of his partner, who steers with her hands. The youngsters planned a debut in Paris.

## Vaccine for Worst Cattle Disease

Rinderpest is considered the world's worst cattle disease, killing millions of head of cattle in Africa and Asia annually. So far the disease has not spread to this country, though American cattle are highly susceptible to it. Now a team of government scientists has developed a vaccine which is considered the most effective ever produced to protect cattle from the disease.

## "Lazy Susan" Stores 300 Slides

Storage for 300 slides made from 35-millimeter film takes only small space using a "Lazy Susan" type of cabinet made of high-impact plastic. Twelve compartments in the cabinet hold 25 slides each, making individual slides easy to locate. The top of the cabinet rotates over the compartments and a lifting bar raises the contents of each compartment for easy removal from the unit.

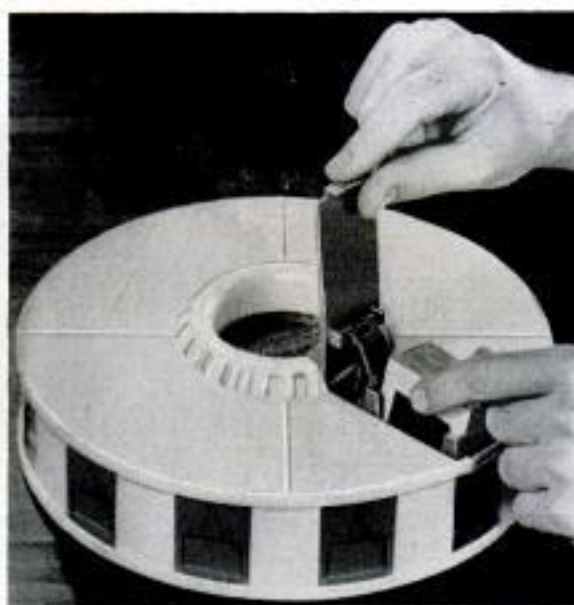

## Hydrojet Boat

At a speed of 20 miles per hour, a hydrojet boat built in New Zealand can turn in its own length. It is steered simply by changing the angle of its jet pipe. A 10-horsepower English Ford automobile engine works a pump that sucks up water and forces it out the jet at the back. The boat, which has traversed some of the most dangerous and remote rapids of New Zealand's fast-flowing, shallow rivers, can float in only four inches of water. It was recently developed by Charles Hamilton.

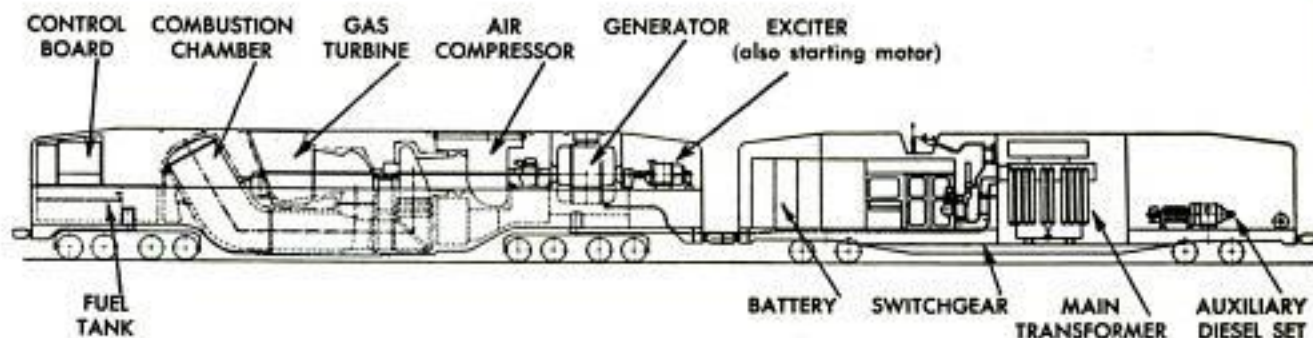
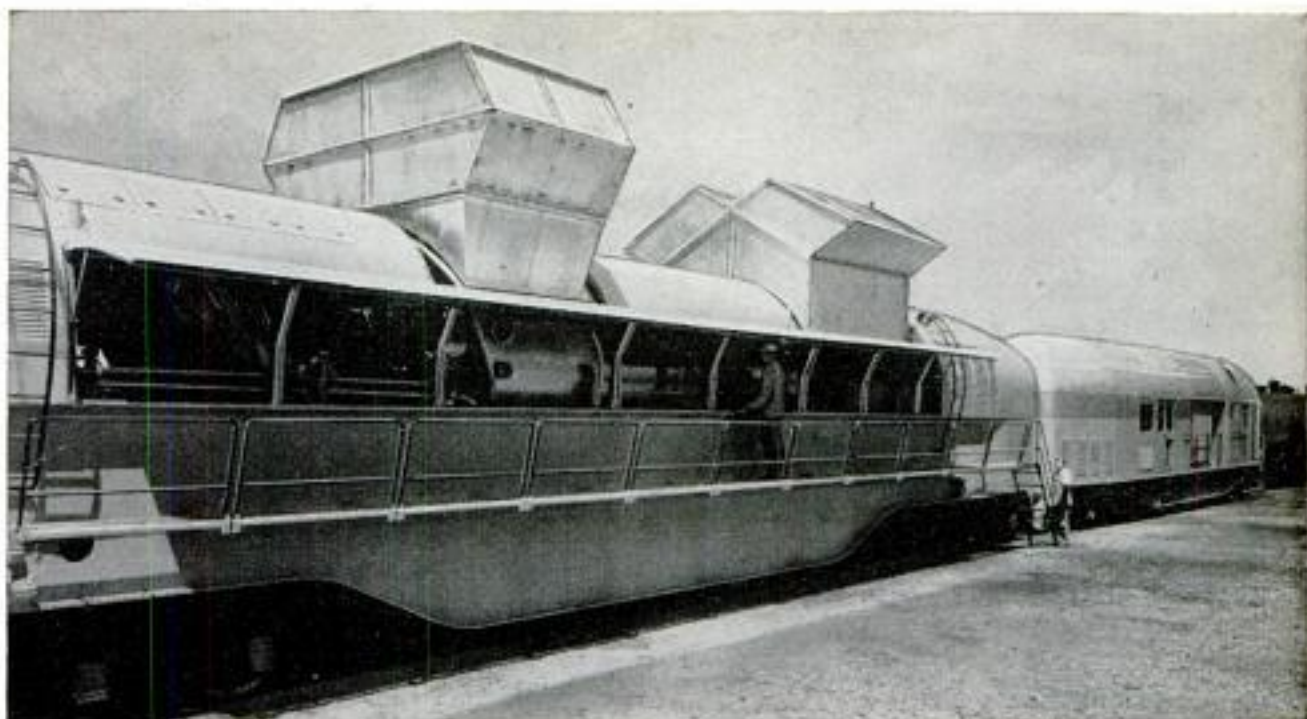

## Mobile Gas-Turbine Power Station

Enough electric power to supply a small town comes from a gas-turbine generating plant housed in two railroad cars. Made in Switzerland for Mexican use, the 6200-kilowatt emergency unit can be set up in a day. Housed in the 75-foot front van is the compact power plant, consisting of a compressor, combustion chamber, turbine and generator. The second 60-foot car holds the

transformer and switchgear, electric-control room, a battery and a small diesel starting engine. At an installation, side panels on the power plant are opened, inspection platforms mounted along the sides, the air-inlet and gas-outlet silencers fitted on the roof, a fuel line run to a tank car behind, and the transformer connected to the town's power system.

## Extractor Finds Mosquito Eggs

Finding a needle in a haystack is simple compared to the job undertaken by Prof. William R. Horsfall and his graduate students at the University of Illinois. They find mosquito eggs in soil samples. Such eggs may lie dormant on dry soil for a year and then hatch upon being submerged in floodwaters. The researchers have devised an extractor for finding the tiny eggs. Soil samples are placed in a fine-mesh drum. A washing process eliminates most of the material, and the residue is washed through three more screens. The final residue then is put in a salt-water solution and the eggs rise to the top.



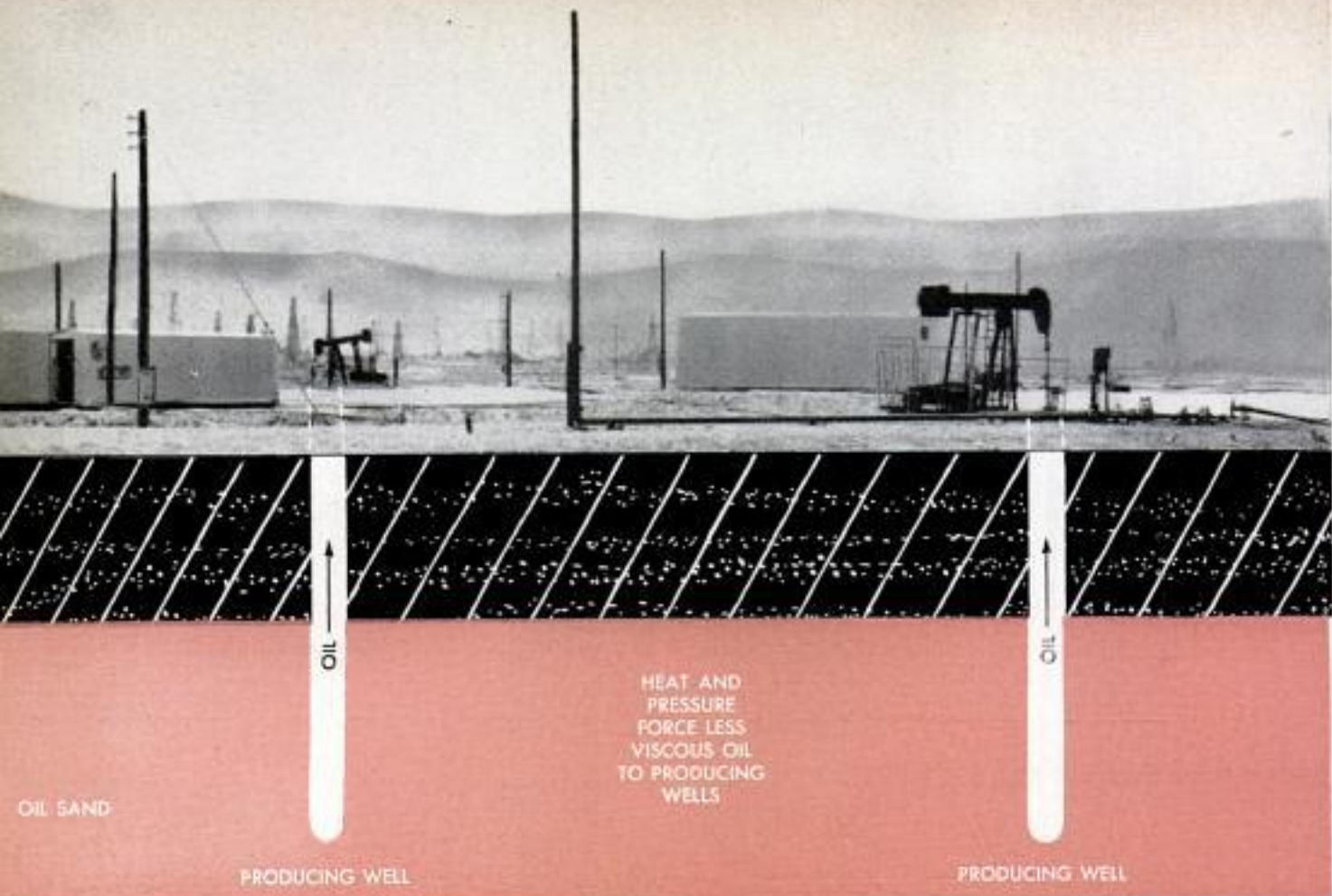

Scientist, below, turns knob of igniter to set off underground fire at oil field, above, near Maricopa, Calif.

# Underground Fire Revives Oil Well

By William T. Rintoul

**P**ETE SIMM AND HIS TEAM of imaginative scientists are literally setting the world on fire. It's all part of a bold experiment to boil more oil out of the earth and has resulted in the creation of an underground inferno in California.

"It may not be as hot as Hades," one of Simm's fellow scientists says wiping his brow in 100-plus heat, "but it's the closest we could come." The temperature 2000 feet below him, where thin oil sands have been set on fire, is over the 1000-degree-F. mark.

## Experiment Near Maricopa

The scene of this operation is the dusty Midway-Sunset oil field near Maricopa—a world removed from the publicized tourist attractions of California. If the thermal recovery experiment proves successful, it could revive fading oil fields



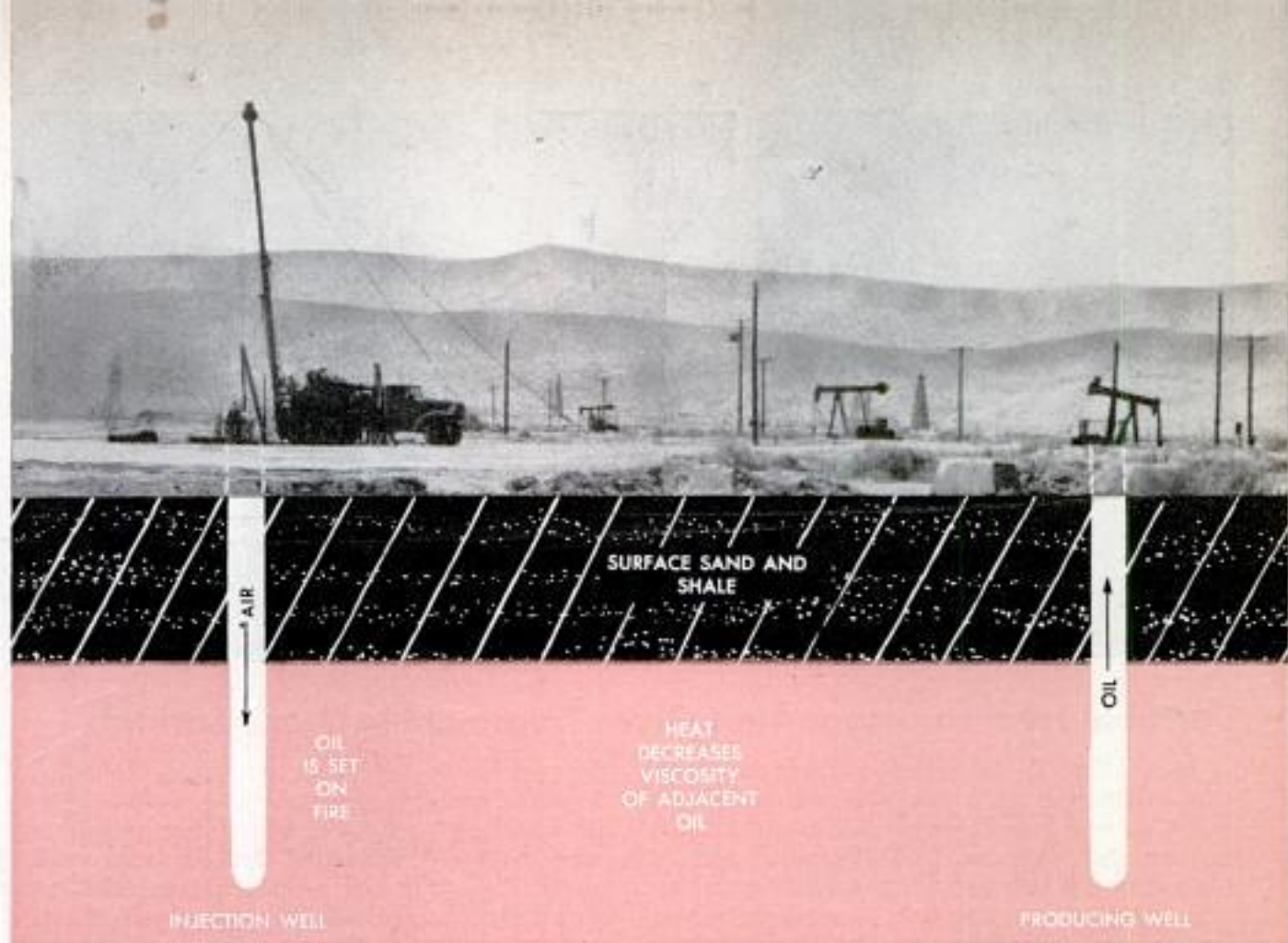

Regulated compressed air is forced into injection well to control fire after it is started with air and gas

and possibly add millions of barrels of needed oil to the nation's reserve.

Oilmen have known for years that they can't recover all the oil in a given pool by present production methods. Sometimes they leave more than 75 percent of the oil in the ground because there simply is no way to get it out. The experiment at Maricopa is an attempt to solve the problem in a new way—by setting depleted oil sands on fire to force more oil from them. It is being conducted by California Research Corporation, subsidiary of the Standard Oil Company of California.

### Special Tool Ignites Oil

At Maricopa, scientists are injecting high-pressure compressed air down an injection well to depleted sands. Oil in the vicinity of the injection well is ignited with a specially designed tool. The resulting heat front is forced outward toward three production wells, located about 200 feet from the injection well in different directions, to boil out previously unrecovered oil.

Here's how the ignition system works: An electrically operated igniter energizes a heating coil at the bottom of the injection well. Three minutes after the knob is turned on the igniter, a "thermistor" at the bottom of the hole tells scientists in the control house that the underground fire is raging. Initially both gas and air are in-

jected into the well to insure combustion of the oil sand.

Simm says there is no danger of the fire flaring out of control. The thermistor sets off an alarm in the control house if the heat begins to get out of hand. By regulating compressed air going to the combustion front, operators can keep the situation under control.

### Compressor Aids Fire

A 600-horsepower air compressor is providing sufficient capacity for the experiment. Special metering, gauging and sampling facilities have been installed to observe the test, production increases of wells, and changes in composition of the hydrocarbon system as combustion proceeds. Scientists are keeping a 24-hour watch at the site. They say the big question is not whether underground combustion will work, but whether or not it will prove to be economically sound. The technique was tested successfully by Cal Research and The California Company, another Standard subsidiary, in the Irvine-Furnace oil field in Kentucky.

The Maricopa experiment is costing about a million dollars and is expected to take a full year to complete the tests. Final results will not be computed by any one individual or group. The scientists plan to use an electronic computer. ★ ★ ★



## Portable Hydromassage Unit Gives Treatment in User's Bathtub

Any bathtub becomes a hydrotherapy tank with use of a portable agitator that bubbles and swirls water to soothe frayed nerves and muscles. The 25-pound unit is placed in the tub and plugged into an electric outlet. A float switch turns it on when water level reaches seven inches. The noz-

zle can be adjusted for gentle or forceful flow or turned to one side to provide overall whirling action. A hose attachment is used to treat sprained ankles and sore spots. The unit can help athletes, victims of arthritis, bursitis, spastic paralysis, rheumatism and polio.

## Machine Monitors Radar Units

Machine-monitoring of radar may replace the human operator subject to "radar hypnosis" induced by staring at the screen. An automatic device sounds an alarm when a distant object is sighted by radar or when the monitoring unit or radar apparatus fails.

## Electronic Trail Markers Guide Drivers in the Arctic

Electronic trail markers forecast future Arctic travel as safe as a midnight raid on the family refrigerator. Developed by Army researchers and tested on 100 miles of Greenland icecap, this safety system consists of two parallel wires and a vehicular-mounted radio-type receiver. Alternating current is fed into wires, buried under snow on each side of the trail, to electrically mark the route. Indicators in the vehicle give the driver his position on the trail and warn him, when his snowmobile goes out of bounds across a current-transmitting trail wire, to return between the wires.



## Bamboo Scaffolds Made To Go Up 15 Stories

Bamboo scaffolds up to 15 stories high are used to construct buildings in Hong Kong. Poles are lashed together with bamboo strips. No nails are used. The structure forms a secure frame from which concrete work, plastering and painting can be undertaken. Bamboo, plentiful in the Far East, is light, strong, cheap and can be reused repeatedly.





## Back-Yard "Ark"

LIKE NOAH, Eugene Kane of McHenry, Ill., set out to build his own boat in his back yard. Unlike Noah, he'll use the boat to cruise the world. Sixteen years ago, while living in Chicago, Kane started building an 18-ton cabin cruiser in the tiny yard behind his apartment building. He worked steadily on it for years until it outgrew the yard, then hired a house mover to move it to the back yard of his new home in McHenry. He figures it will take him about four more years to finish it. He then will retire from his job as auto-shop teacher in a high school, and he and his wife will set off to see the world. The boat will have three state-rooms, two baths, a galley and a sun deck. Two 125-horsepower engines, bought as scrap and overhauled, will give it a top speed of 15 miles per hour. Kane figures the *Galilivant* will be worth \$75,000.

Kane fits window in cabin of 50-foot cruiser as craft rests on blocks in his back yard. Right, boat will be powered by two 125-horsepower engines which he bought as scrap and overhauled. Below, craft outgrew tiny yard behind Kane's apartment building in Chicago

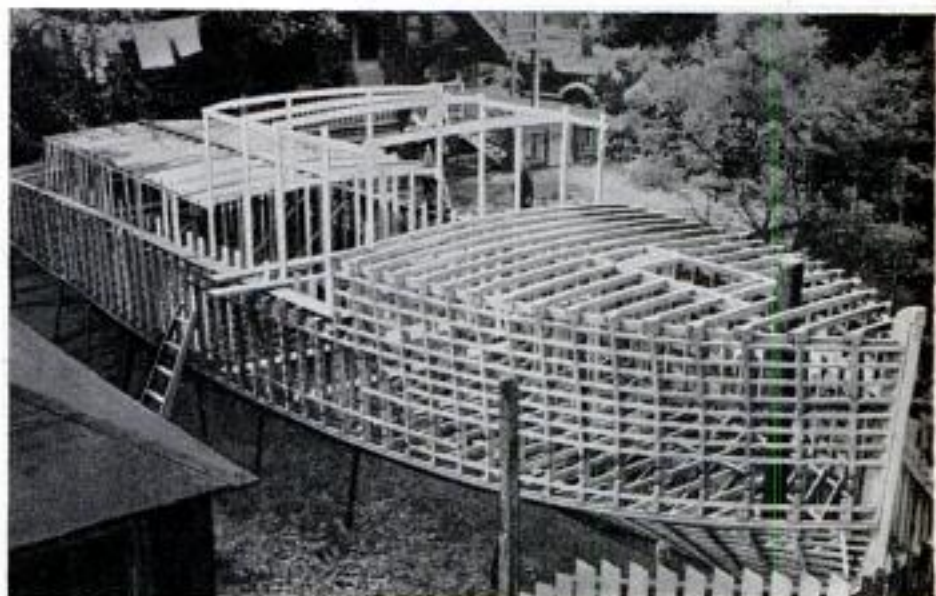
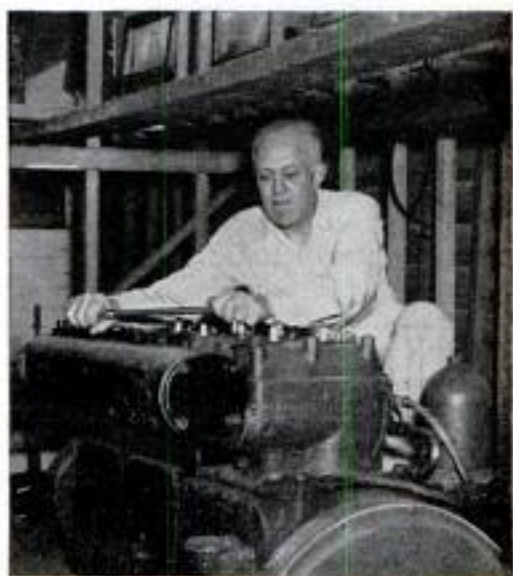



## Mechanical Gold-Panner Makes "Old Timer's" Methods Obsolete

Panning for gold now, you drive a Jeep with a trailer to a location, back the trailer to the river's edge and start the mechanical gold-panning device in the trailer. Then you start shoveling gravel from the river bottom into the machine, which will handle up to 20 cubic yards per day. Motion of the machine duplicates hand-panning. It has a coarse top screen where oversize gravel is washed and discharged, a fine screen and nugget trap and two pans with matting for trapping heavy grains. Later when you've worked the surface gravel, you attach a



dredge probe which can be extended to a maximum length of 15 feet for working deep and inaccessible pockets.



## Clothes Rack Fits Over Rear Cushion of Auto

Fitting over the back cushion of the rear seat, a convenient clothes rack for the car does not interfere with the use of the rear doors. Nor does it block rear vision. It is easily removed when destination is reached. With two of the racks in position, vacationers can carry a dozen or more garments in a non-wrinkling position that saves time in packing a suitcase as well as bills for pressing.

☐ At a peak traffic hour on a summer day, nearly 25,000 people ride aboard 665 commercial airliners in the skies over the United States.



Making first rescue flight from the scene of an accident to a hospital, an RCAF copter lands with patient

## Canada's Copter King

*—He found a new way to land whirlybirds  
on mountain peaks*

**By Carson Kerr**

ONE MORNING LAST MAY, a dozen members of the Vancouver, B.C., Alpine Club were climbing 4890-foot Mount Seymour a few miles north of the city. As they set their sights on a snow-covered peak, one of the mountaineers, Mrs. Olive Bavins, suddenly lost her balance and fell 100 feet down the steep slope. Her husband and other climbers found her almost unconscious, lying 15 feet below the edge of a crevasse. Hurriedly constructing a makeshift stretcher, they raised the injured woman to the ledge. Her back had been broken.

Quickly they telephoned for aid from the Royal Canadian Air Force Rescue Flight unit stationed at Sea Island Airport, Vancouver. While helicopter and crew were en route, Mrs. Bavins was carried several hundred feet up the mountainside to the only level landing space

available, a plot less than 50 square feet in area. Shortly, pilot-officers Don Park and Ray Steen set their twin-rotor Piasecki copter on the "postage stamp" field, took Mrs. Bavins aboard, and whirled her to Shaughnessy Hospital in Vancouver, saving her life. The incident marked the

**Mrs. Olive Bavins, who suffered a broken back in a mountainside fall, credits her complete recovery to a helicopter rescue mission**





Helicopter student pilots learn to laugh at obstacles like Black Tusk Peak, shown here in the background



Training starts with landings on water in an open area of park with pontoon-equipped helicopters



Above, student pilots progress to trickier landing sites, such as this rocky spot in a creek bed. Below, with skis the copter and pilot search out a "postage stamp" field for a practice landing



Above, toward the end of the 12-week course, daredevil copter pilots carry relief cargo to an "air-strip" in rugged terrain. Below is the final test: A pinpoint landing of supplies in a snowbound area



first time in Canada that an injured person had been flown directly from the scene of the accident to a hospital. This new type of RCAF rescue service had been tested experimentally only six weeks earlier. The altitude-landing techniques used in this service were developed by Carl Agar, Canada's "copter king."

Agar's foolproof landing method again succeeded a week after the rescue of Mrs. Bavins. District Forester D. B. Taylor requested RCAF assistance in battling a blaze that had broken out high above Sechart Inlet, where cliffs were too steep for men to scale with a load of any kind. While Taylor's crew climbed up to the fire, pilots Park and Steen ferried fire-fighting equipment to a pinpoint site at the 1400-foot level on the burning mountainside. What could have been a very serious outbreak was soon brought under control. This specialized type of copter landing has made possible many "impossible" projects, including mountain construction of dams, power stations, transmission lines, pipelines, railroads and roads, as well as fishery, mining, mapping and military surveys throughout Canada and the far north. Pilots Park and Steen each hold one of Agar's "diplomas for daredevils," signifying they are graduates of his school of instruction in mountain helicopter flight.

Back in 1948 when anyone who even talked about flying a helicopter at high

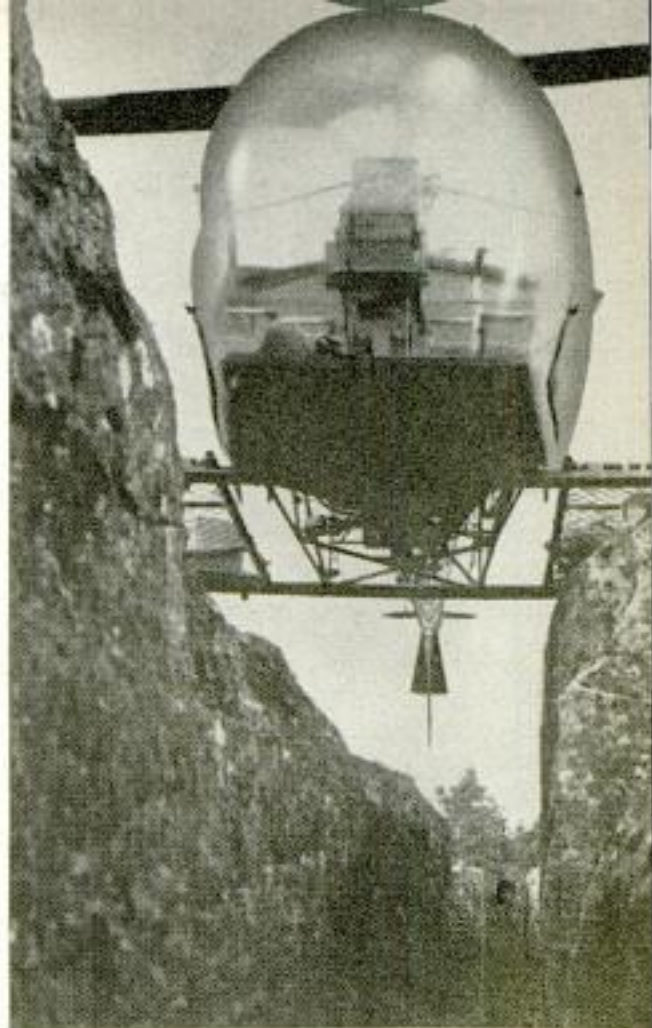

Above, new straddle technique allows copter to land on level ledges of chasms. Below, Carl Agar, Canada's copter king, stands by a whirlybird, an aircraft that he learned to fly 10 years ago. He is now 55

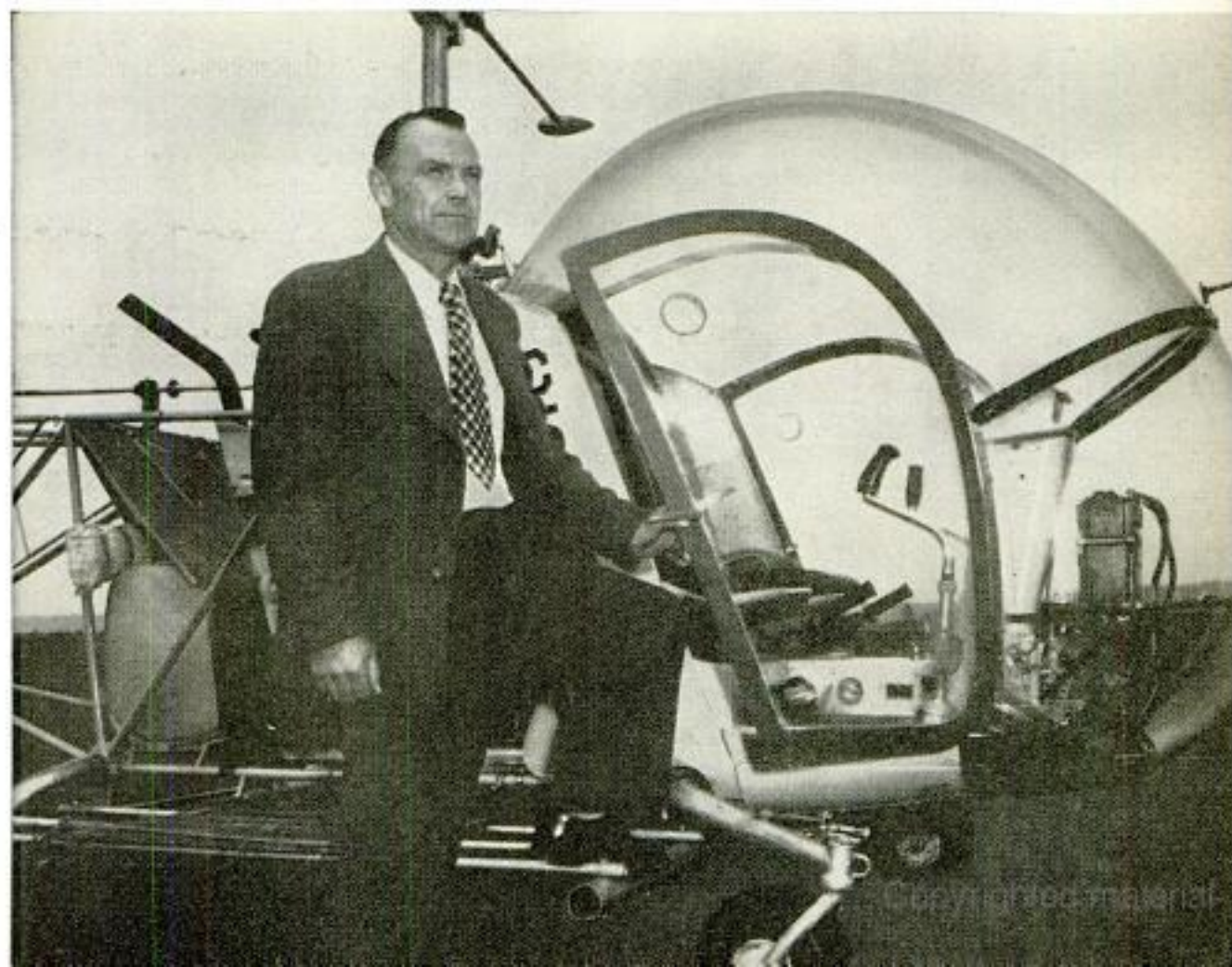



Steadily decreasing speed and altitude in approach, the Agar method permits zero ground-speed landing

"Flare out" landing requires a vertical sloop, putting strain on the engine and making crash possible

altitude was considered harebrained, Agar accepted the challenge of wicked winds, destructive updrafts and downdrafts and precarious perches. The area he chose for his initial test, selected from air photos, was 5300-foot Mount Wahleach. While not the highest peak in the Canadian Rockies, its conical summit made it one of the most treacherous. His landing spot was a little frozen lake, less than 50 yards across at its widest point, cupped in the side of a precipitous 60-degree slope in such a way that the lake was almost concealed from view.

Recalls the dean of daredevils: "A copter landing surface *can* be microscopic but it *must* be flat. Because I had no idea what the texture of the ice would be like, I decided against the surface of the lake. Instead, after careful study, I picked a small lip of rock at its edge. It took seven passes before I set her down—six of which I was

Platforms like this, located at the 3300-foot level, were landing fields for the famous Alcan project



sure would be my last—but this slow process enabled me to hit on a brand-new landing technique."

### Zero Ground Speed

The unexpected discovery led to his arrival over the landing place at zero ground speed and near-zero altitude, without at any time exceeding the power boost required to hover. This was opposed to the old landing method, still used by many copter pilots, involving a violent "flare out" stop that puts a heavy strain on the motors. In making the Mount Wahleach landing, Carl's approach was long, gradual and horizontal, with a steady decrease in speed and altitude all the way in. This made it easy for him to obtain the boost necessary for hovering and lowering his machine the final few feet to the ground.

A conventional flare-out approach would have meant faster, vertical descent, ending with an upward sloop. The motor would have had to counteract downward movement and provide the power boost, making failure a distinct possibility. When a copter motor fails before it has overcome descent speed, the machine frequently is unable to autorotate to the ground; this has been the cause of more helicopter crashes than anything else. The technique pioneered by Agar has been learned since by pilots from Canada, the United States, France, South America and Indonesia.

"In mountain flying, where the thinner air not only makes the motor less efficient but reduces the 'bite' of rotor blades, the Agar approach is an absolute must," points out pilot Park. "We use it at all times, even for landing on an airfield, for the simple reason that we believe it to be the safest and surest method. But altitude landings call for a much more extensive knowledge of air currents."

Carl's pioneering paid off in the form of a continuing contract with the British

(Continued to page 278)



Plaster and sisal fibers at joined corners of the house are trimmed to allow placing of brick veneer

## Prefab Plaster Walls Cut Building Costs

PREFABRICATED walls of plaster that support upper floors and roofs are cutting the cost of homes and office buildings in Australia. The walls—only 2½ inches thick—are reinforced with 6-inch galvanized-iron mesh. Tests show they are strong enough to support many times the load of a normal roof.

Australian architects and builders describe this revolutionary construction method as "the biggest structural change in building techniques in centuries." Government officials are considering the plaster walls for public buildings. Foreign countries are taking notice and one (Burma)

Construction began here seven days ago. Carpenters, tilers and bricklayers work simultaneously



FEBRUARY 1957



With the conventional foundation and floor joists in position, plaster walls are installed by crane

sent a mission of five top experts to study the new building method.

Plaster-wall buildings can be weather-proofed with brick veneer, wood or asbestos siding. Whatever siding is used, the house is considerably less expensive than a conventionally framed home.

With the same labor force it takes to complete a conventional 1300-square-foot, three-bedroom home in 65 working days, an identical structure with prefabricated plaster walls can be built in 15 working days. Almost all of the craftsmen needed on the total job can work at the same time.

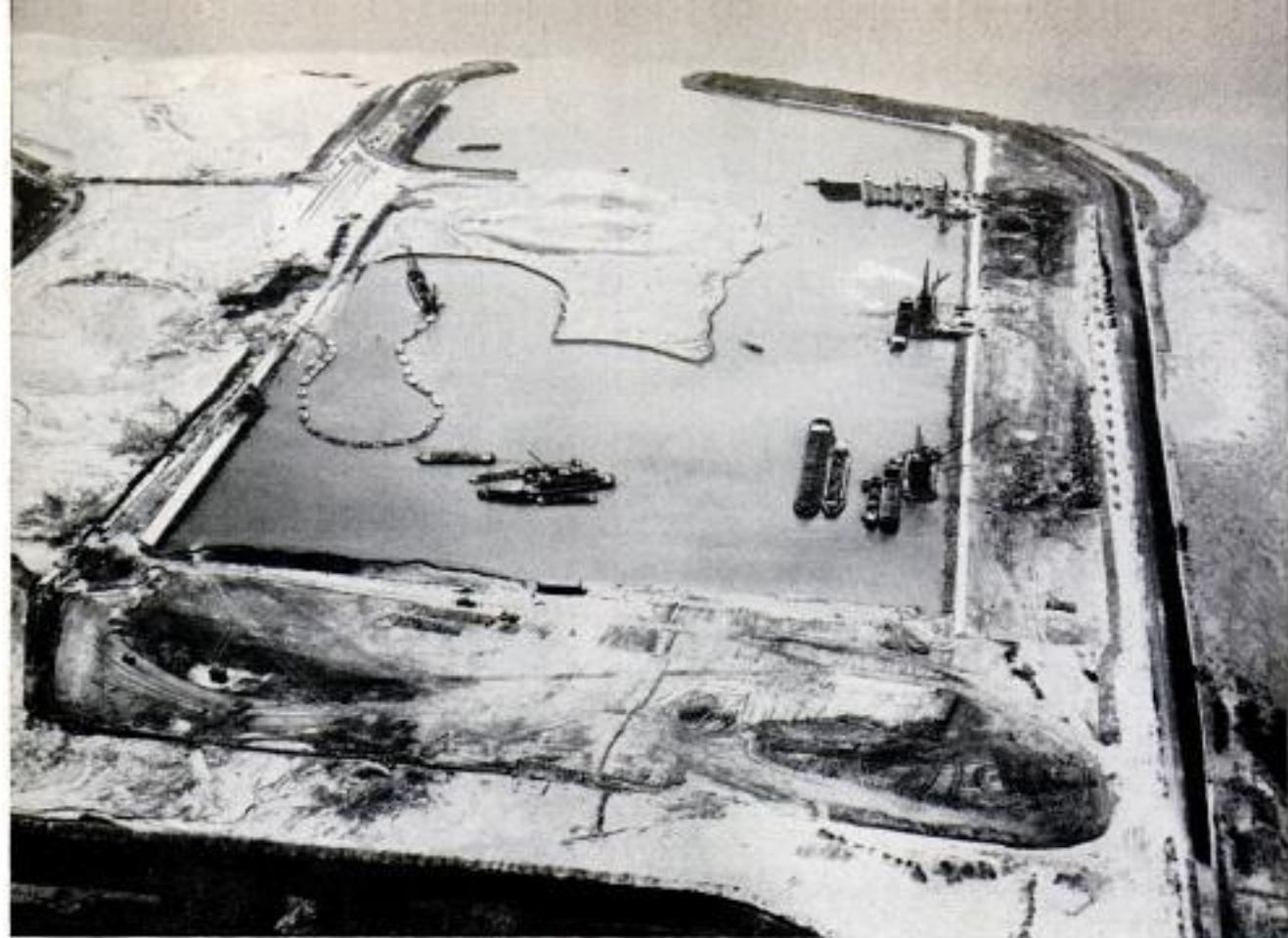

Establishment of a dam here near the new city of Hellevoetsluis will be the first phase of "Deltaplan"

## HOLLAND REMAKES ITS MAP

**H**OLLAND, the most densely crowded land in Europe, is fighting back against the sea with a billion-dollar program that in 25 years will create 781 square miles for new industries, port installations, living and recreational areas. This project, called the "Deltaplan," is to include reclamation of 58.5 square miles from islands fringing the country's southwestern coastline.

### Disastrous Tides

The gigantic scheme is due partly to overflowing spring tides which in 1954 swept tragically through the low country, drowning 1600 persons. These plans are also intended to counteract the effects of a fast-multiplying people in a nation which has coupled a high birth rate with the lowest death rate in the world, according to the World Health Organization. Combined with the need for national safety against nature is the ominous urgency of absorbing an expected one-million-person increase in population by 1980 in towns between Amsterdam and Rotterdam alone. The new venture, it is believed, will help to assimilate this increase.

New land will be devoted to agricultural purposes to feed the compact citizenry. Other tracts will be assigned to industry,

and nine new cities will be laid out to contain 100,000 occupants each. Certain existing waterways will be closed and various new ones created. State engineers will re-route railway lines and build new roads for the enterprise. In effect, Holland is having its chin remodeled.

Companion project to the current agriculturally aimed Zuider Zee works program, the Deltaplan initially calls for damming of specific southwestern waterways. The one exception is to be the Schelde River connecting Antwerp, Belgium, with the North Sea. Work has begun near the new city of Hellevoetsluis, where mattresses of interwoven brush and poles have been lowered to the bottom of the Haringvliet River to protect its banks from erosion. Hundreds more such mattresses will be installed in this dangerous, broad stream during the 12 years required to build the dam. Other new communities to be established are: Brielle, Spukenisse, Hoogvliet, Hoekse Waard, Middelharnis, Tiengemeten and two sister cities sharing the name Denbommel.

Haringvliet River basin, starting point for the endeavor, will be a satellite port for Rotterdam. A new canal will connect this port and its industrial center with the



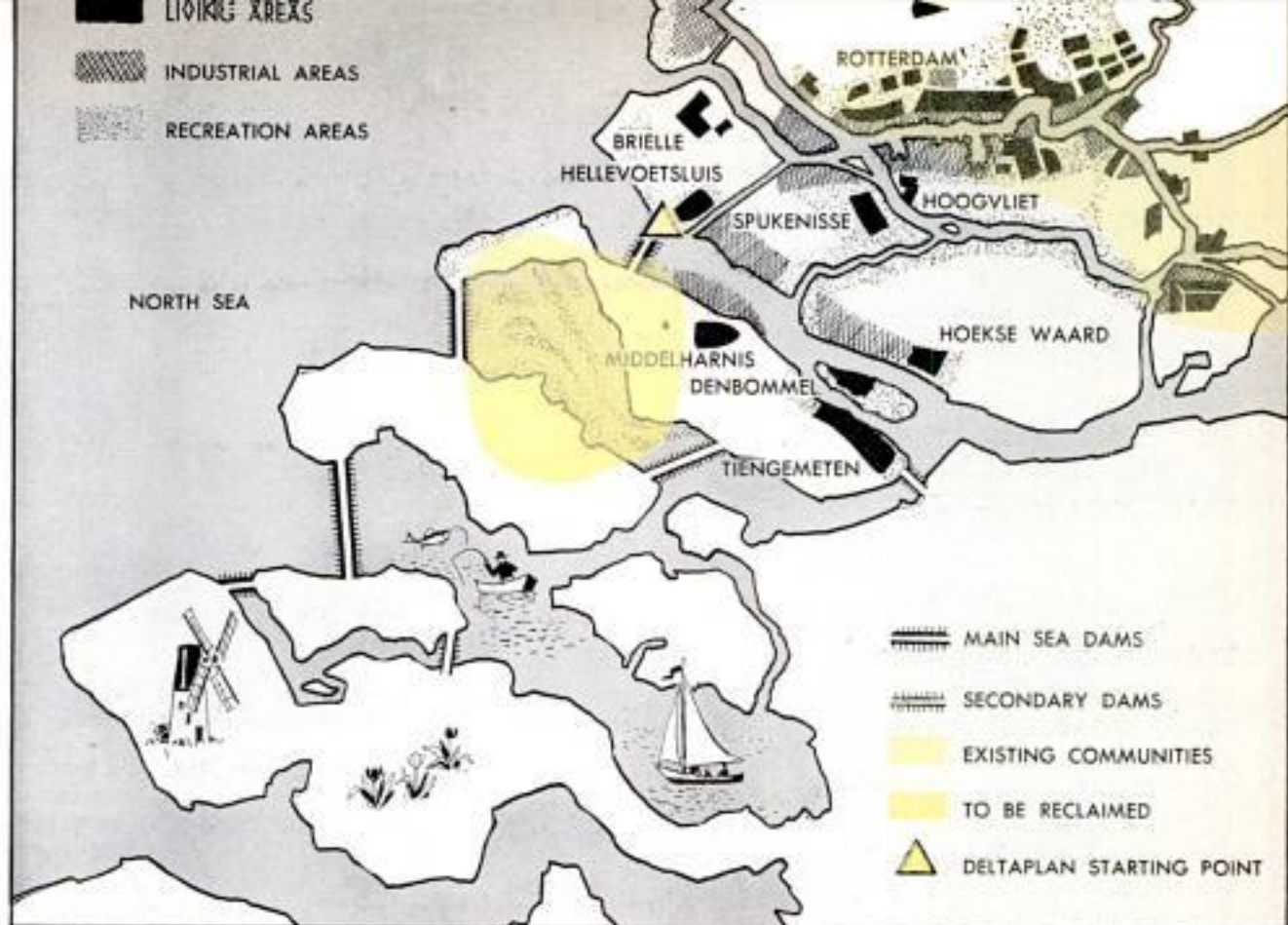

On this map are the existing communities, the area to be reclaimed and sites of Deltaplan's new cities

## WITH ACRES FROM THE SEA

New Waterway, an artificial river bringing ships from the North Sea to Rotterdam and linking Antwerp to Rotterdam by canal.

Three highways and numerous small roads will tie the remainder of Holland to the new terrain. Tunnels will be built below the New Waterway and the Haringvliet to connect Delta territory to the land north of Rotterdam. Among new railroads scheduled for construction is a line shortening the route for international trains to Brussels, Belgium, and Paris.

### Big Vacation Area

A section 42 miles long and 18 miles wide is to be set aside, with the Grevelingen locale as its nucleus. Two million residents are anticipated. Based on the total 500,000 acres of Deltaplan, including 37,500 reclaimed acres, plans are being made to service 600,000 daily visitors and 100,000 vacationers. Lakes will accommodate 10,000 sailboats at the same time, and the entire recreational location will be less than 24 miles from the nine new municipalities. Hotels, camping and sports facilities are to be available, and along one of the rivers will be a wooded park of 6250 acres.

Dutch engineers had considered possibilities for closing various sea branches even

before World War II. But the 13.1-foot variation between ebb and flood tides, causing tremendously destructive currents, made it a certainty that any mattresses, stones or other damming materials would be carried away by rampaging waters. However, technological progress in hydraulic engineering now has made attainable the closing of these sea branches. For the first time in almost 50 years the various rivers and waterways involved in this program can be restrained satisfactorily through use of dams, sluices, and similar water-controlling devices.

Such an achievement has come about, not only by putting to work the most promising ideas gleaned from other countries, but through an active investigative series of experiments undertaken in the Dutch government's own hydraulic laboratories. Here, the wash of waves can be reproduced accurately, as can the action of underwater currents, or other marine conditions.

In reshaping its national map, the Netherlands is providing for the welfare of its people, while taking back from an unrelenting Nature the prize that modern science has made accessible: Land and water on which to thrive in security. ★★★



Riding on its three legs, this boat moves higher in the water as it gains speed. Front wings of the vessel have movable fins to keep the boat from rolling badly

## German Wing Boat "Walks" Through Water

Demonstrated in the Elbe River, near Hamburg, Germany, a new wing boat designed by a German engineer "walks" through the water on three legs. Each of the legs has a small wing near its foot. The lower part of the rear leg is movable and is used to steer the boat, while propellers on the two front wings drive it. The faster the boat travels, the higher it rides, and at full throttle the legs are halfway out of the water. The front wings also have movable fins to help keep the craft from rolling in rough seas.



## Flagstone Mold Has Flexible Form

Preshaped flagstones for walks, patios or paving projects may be made by adding or removing parts from a flexible form on the ground. The user pours concrete into the mold and trowels on desired colors. This flagstone kit has eight pieces.

☐ A flexible drinking straw that contains a chocolate filler to flavor milk has been marketed.

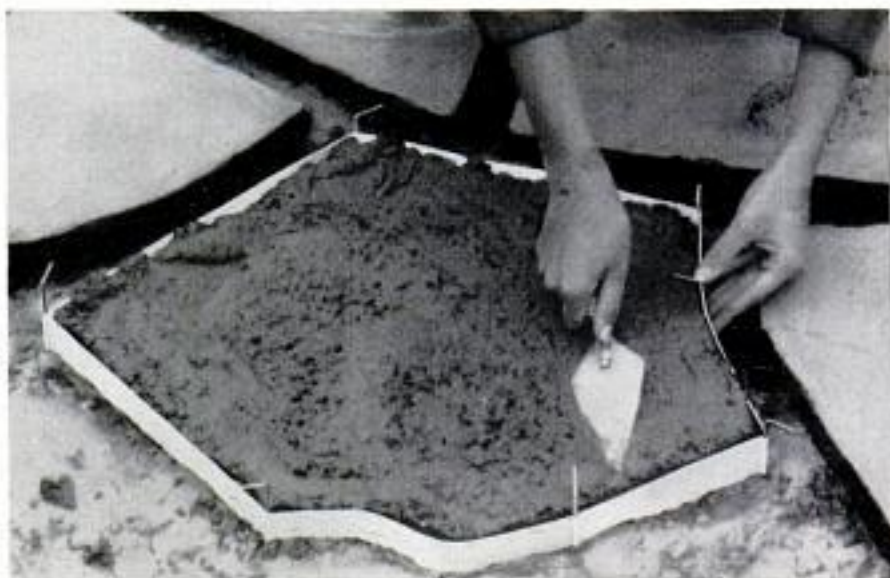



**5. USING A CUP OF CHLORINE BLEACH** weekly, a home chlorinating unit prevents water pollution for families with private wells. This unit can purify 75,000 gallons of water daily, if necessary

Clayton Mark and Co., 1900 Dempster St., Evanston, Ill.



**6. COOKED FOODS CAN BE KEPT HOT** in two thermostatically controlled covered stainless-steel drawers with individual humidity controls. The unit, working on 110-volt current, fits in a cabinet

Toastmaster Products Div., McGraw Electric Co., Elgin, Ill.

**7. SELF-CONTAINED, AUTOMATIC HUMIDIFIER** can be plugged into a heating duct of a warm-air heating system already installed. Warm air, passing through duct, carries evaporating water

Skuttle Manufacturing Co., Milford, Mich.

**8. DOUBLE-DUTY COOKING APPLIANCE** has a frying-pan on one side and a broiler on the other—both operating at the same time, if needed. This electric unit can plug into any household outlet

J. Franklin Industries Inc., 2906 Peterson Ave., Chicago

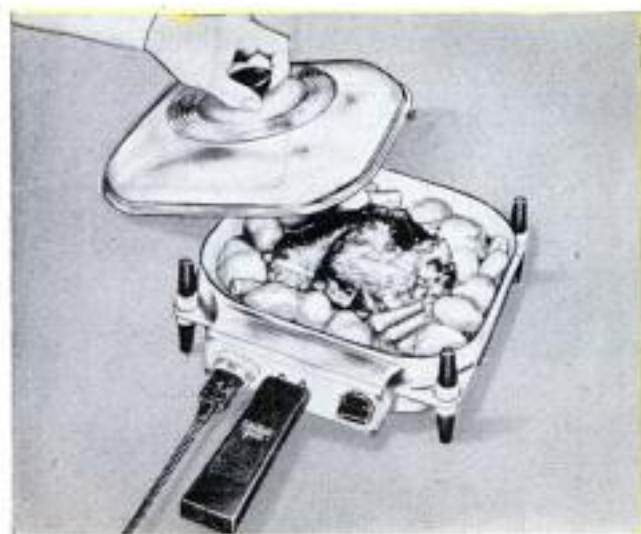

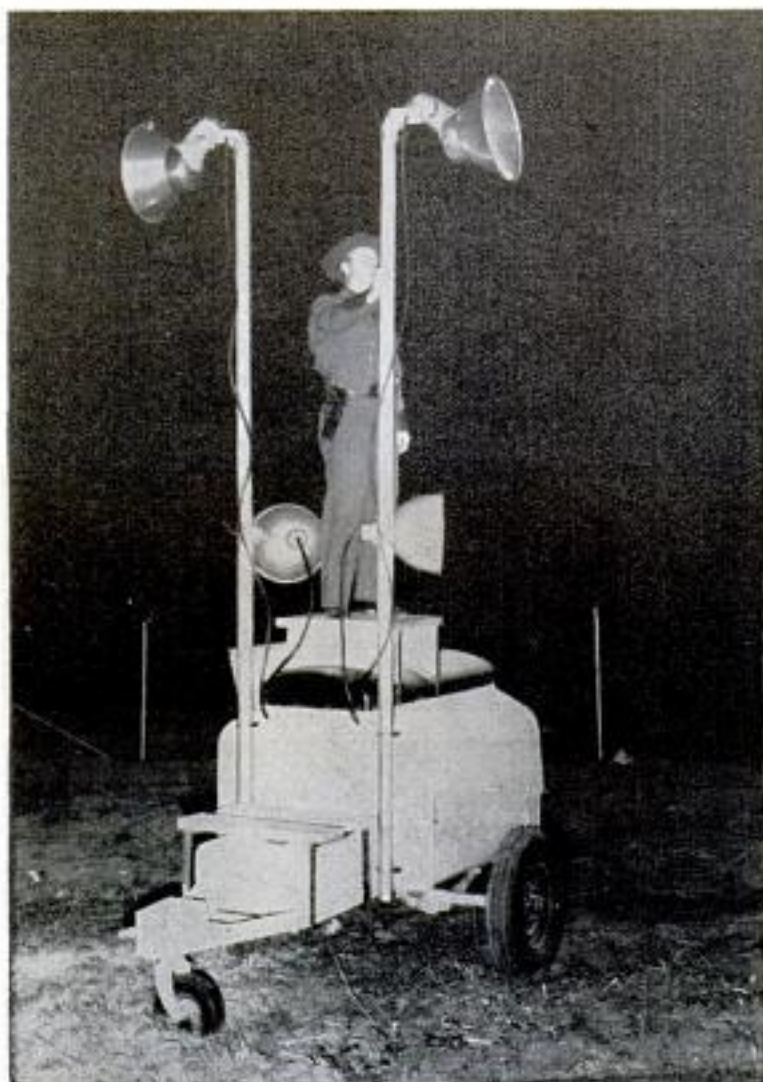

## Patrol Spotlights Smuggling Activities

"Curb-service daylight" stops smugglers from crossing an illuminated 1520-foot gap of river bed between San Ysidro, Calif., and Tijuana, Baja California, Mexico. Source of this lighting is a unit built around a 115-volt, 5000-watt, 60-cycle generator and powered by a four-cylinder, four-cycle, 25-horsepower gasoline engine.

Operated by a two-man U.S. Border Patrol team, the unit's top lights can be extended quickly from six-foot traveling height to 12-foot operating level. Top lights use 1500-watt bulbs. Bottom lights have 500-watt bulbs. Each light is in a reflector.

Patrolmen can put the unit into action within three minutes of arrival at a specific spot. The top aluminum section telescopes into the bottom section. An L-shaped screw handle, threaded through a boss, locks the top section in desired heights and positions. The unit consumes one gallon of gasoline per hour of operation.

**Portable spotlight unit exposes dry river bed between U.S. and Mexico**

## Portable Drilling Rig for Prospecting Requires No Water

Prospectors and miners can explore for ore as deep as 100 feet with a drilling rig that requires no water and deposits its cuttings in glass jars for inspection and assaying. Entirely self-contained, the exploration drill weighs 125 pounds. It can be carried in a car, packed by two men into difficult country and set up in a few minutes. The device uses a vacuum pump to pull air down in the hole and then up through the drill pipe. Movement of the air helps keep the bit cool, prolonging its life, at the same time the cuttings are carried to the surface. The drill may be swiveled to bore at any angle from the surface and has a manual pull-down to control the speed of drilling. It is designed for all types of mining exploration and for shallow oil and water prospecting.

Powered by a nine-horsepower gasoline engine, portable drilling rig cuts a hole 1 $\frac{3}{4}$  inches in diameter



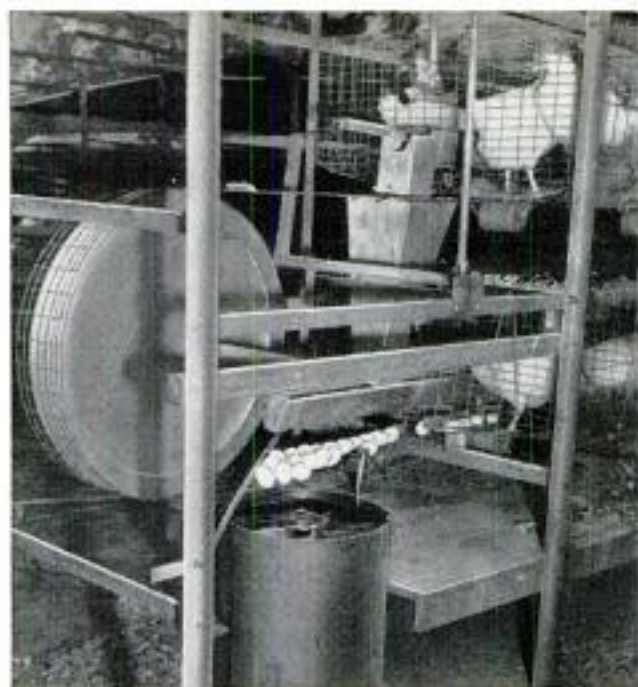

Eggs roll down the sloping cages onto a continuous belt made of wire. The belt moves twice a day, depositing the eggs gently in basket inside water tank

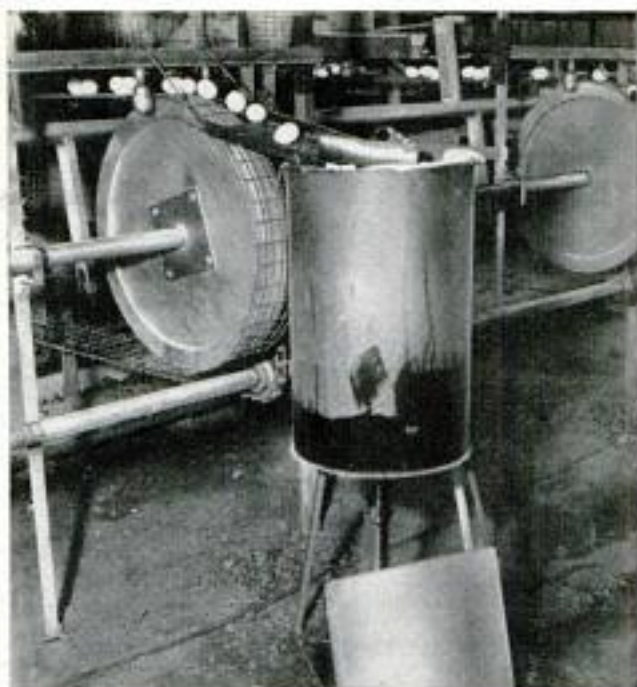

Top side of belt collects the eggs from the upper tier of cages, depositing them at the other end of the line. Below, poultryman lifts out filled basket

## Moving Belt Gathers Eggs In Tanks of Water

Assembly-line methods have even taken over the old-time kid's chore of gathering the eggs. George Carver has installed an automatic egg collector at his San Fernando, Calif., ranch. The chickens live in two tiers of cages. When an egg is laid, it rolls down the sloping floor of the cage and on to a continuous belt made of welded wire. The belt, powered by an electric motor, passes around two wooden wheels, one at each end of the line. At each end of the line the eggs are forced off the belt and fall into a tank of water, which drops them gently into an egg basket in the bottom. A time clock turns on the motor for four minutes twice a day. At the end of each four-minute period the poultryman lifts out the full baskets of eggs.



## Pistol-Grip Camera Mount

Long-focal-length lenses are focused and held steady with the same hand when the camera is mounted on a new pistol grip. The other hand is then free to release the shutter at the moment the action is at its peak. When the trigger is pulled all the way back, the lens is focused on infinity. When the trigger is released, the lens focuses on points closer than infinity. If desired, the infinity setting can be adjusted to a precise point, such as the basket on a basketball court, so you can quickly focus on it at any time simply by squeezing the trigger to its limit.



Jim Simmons stands beside his handcraft: A stylized deer head, owl, wading bird, and a wooden plaque

# WOOD SCULPTURE THAT "JUST HAPPENS"

By Robert M. Hyatt



Before this woodworker has finished a product, he may have sawed, burned, wire-brushed, or rubbed it with a variety of paint colors

**A**N ALLIGATOR peered out of a rough slab of wood that Jim Simmons of Taos, N. Mex., picked up one day five years ago. The 'gator glared at him, a fantastic saurian formed naturally in the grain.

Jim thought he might improve a bit on the critter. He cut, chipped, gouged and planed, then rubbed paint into the grain. When the job was done, Jim had a water dragon like none ever seen in the swamps. He set the monster on the mantel and asked his wife, Mildred, what she thought of it.

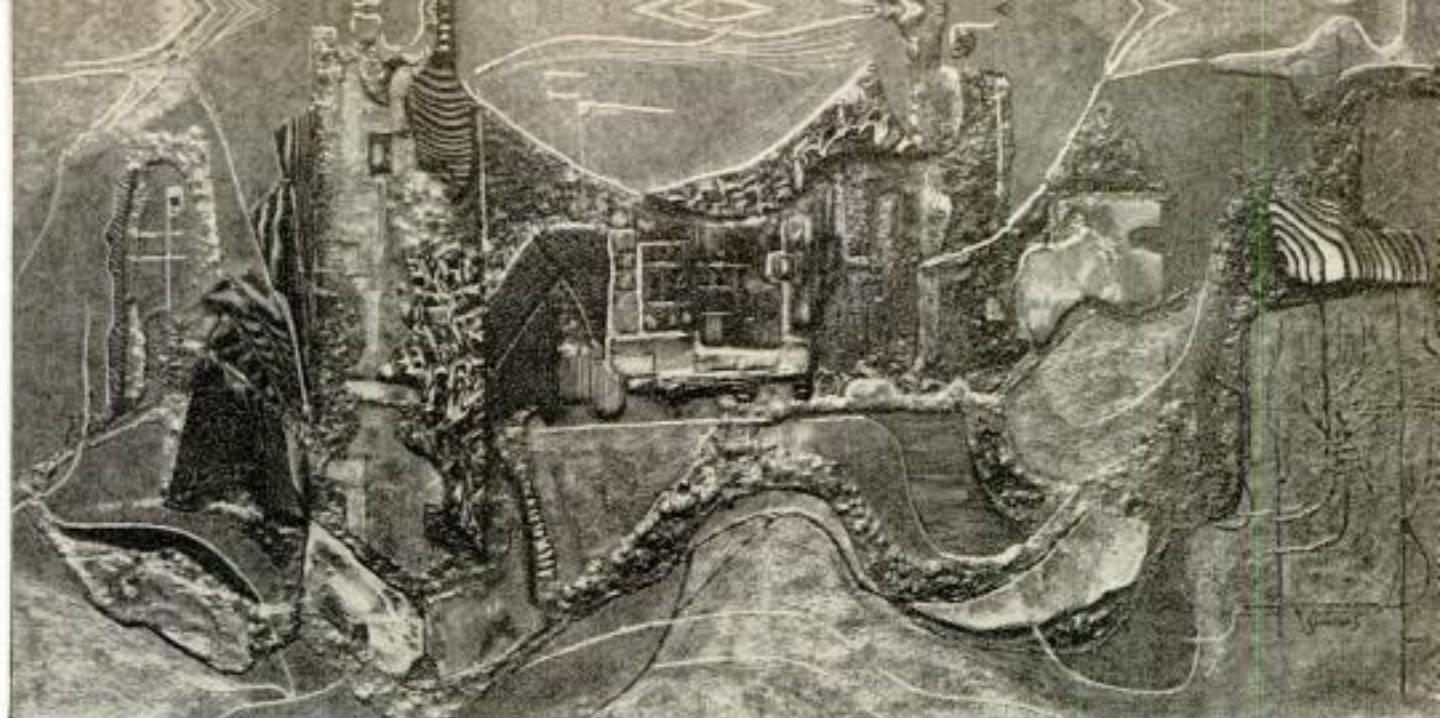

Here is one of the fascinating wooden plaques made by this artisan from a hunk of wood found in the forest

"It's crazy," she told him, "but it's clever. Maybe you can find other animals in wood."

Jim did. He was looking for a way to make money; perhaps this was the making of a new art that would sell. In the next few days he came up with the beginnings of an owl, a gull, a bear and a fish. After he had given them the same treatment as the 'gator, he had a bizarre group of creatures. At a local art store his collection sold readily. Orders came in for more.

"I really got busy then," says Jim. Practice and a rapidly growing market spurred his creative instinct, fostered already by professional training at art school in Indianapolis. He began turning out long-horned "deer" heads, birds on the wing, and long-billed wading birds never seen by Audubon. He made several large flat plaques with improbable but fascinating scenes.

Later he gouged from knotty blocks a

half dozen fruit bowls. These became one of his best-selling items. Since his product was strictly woodsy, he gave it the name of Taos Sylvanesque ware. Today he is unable to keep abreast of demand for it.

The Simmons workshop is a one-man operation. Production is limited to the number of pieces of raw materials that can be found with natural markings which might resemble something after the materials are processed. When Jim starts working on a chunk of wood, he follows no set pattern. Often, he has little idea of just what he is going to make.

"I simply let nature, tools and paint go to bat," he explains. "And sometimes the result startles even me."

With saw, torch, brush and elbow grease, Jim Simmons is making a living from "crazy wood" art . . . a case of improving nature's handiwork. ★ ★ ★

Chipping out an oversize fruit bowl from wood, the "crazy wood" art manufacturer finds lucrative work



Wire-brushing is one of the techniques used to bring out the character of knotty wood pieces



*Machines—some more specialized,  
some more versatile—are setting  
new trends in agriculture.*

## FARM EQUIPMENT ON PARADE



**SPECIALIZED PRIME MOVER** to take over much of the work of the tractor is one of the latest developments. Shown here is the "Uni-Tractor." Implements such as the hay baler mount on the side of machine. The inset shows the same power unit operating an ammonia-fertilizer applicator. Four other implements are available

Minneapolis-Moline Co., Box 1050, Minneapolis 1, Minn.

**GRAIN COMBINE** is as much at home in a wheat field as in corn. The same rasp-bar cylinder that knocks wheat kernels from the hulls also shells corn. The two-row cornpicker with snapping rollers fits on the front and can be replaced in an hour with grain platform

Deere and Co., Moline, Ill.







O. H. Sheldon and Joe Amoral, Hughson, Calif.

**ORCHARD CULTIVATOR**, mounted on the end of a tractor tool bar, digs weeds from around trees. Small wheel serves as bumper. When wheel hits tree, heavy coil spring stretches and lets cultivator swing around the trunk

**CRANE** takes the backache out of many heavy lifting jobs. Mounted on the rear of the tractor, it is powered by the tractor's hydraulic system. Here a heavy drum is lifted by a chain looped over the crane's hook  
Tractor and Implement Div., Ford Motor Co.,  
Birmingham, Mich.



**CONCRETE MIXER** spun by the tractor's power take-off saves time and labor on farm concrete jobs. Hydraulic arms dump the contents of drum, which has a one-bag capacity at a five-to-one mixing ratio. Attachment will mix concrete while tractor is on the way to the pouring site. It also can be used to mix feed and seed

Universal Pulleys Co., Inc.,  
230 N. Mosley, Wichita, Kans.





**PLASTIC CARPET** to cover strawberries speeds ripening of the fruit, guards against mold rot caused by damp weather and keeps the soil beneath soft and moist in dry weather by retarding evaporation. Holes along the edges let water reach the roots. The thin film of plastic is unrolled from a reel mounted on the tractor. Earth is tamped along the sides. Holes then are punched in the film and plants are drawn into the open by hand

Extruders Inc., Hawthorne, Calif.



**MOTOR SCOOTER** now has taken its place on the farm. Truck body for the little scooter is large enough to haul calves and other livestock. Scooter can be used to carry feed, is economical transportation for errands around farm and ranch

Cushman Motor Works,  
900 N. 21st St., Lincoln, Neb.

**CROP DRIER** drives literally tons of water from a bin loaded with small grain or shelled corn. The oil-fueled heater-blower also can be used to dry hay, permits early harvesting before crop deteriorates. Drying unit can be hooked up to the mobile bin as below or to permanent bin

New Holland Machine Co.,  
New Holland, Pa.





**MIDGET BROTHER** for big tractors has a complete line of 22 implements for yard and garden work. Equipped with automotive-type steering and brakes, the midget has a sealed transmission and scaled-down tractor tires. Power comes from either a 2½ or 3½-horsepower engine

Wheel-Horse Products Co., 2643 Dixie Hwy. North, South Bend 17, Ind.

**MOISTURE METERS** help outwit the weather by continually registering the available soil moisture on gauges. One meter has a short rod, the other a long rod. The rods are spiked into the soil where they measure moisture at different depths to indicate when and how much water is needed from irrigation systems in dry farm areas

T. W. Prosser Co., Elvertale, Calif.

**PASTURE RENOVATOR** cuts through sod to deposit fertilizer at one level and grass seed at another. This eliminates the time and labor required for plowing, disking and harrowing, and permits grazing while pasture is being renovated. The soil and sod are undisturbed. Power for driving the feed mechanisms comes from the wheels

International Harvester Co., 180 N. Michigan Ave., Chicago 1

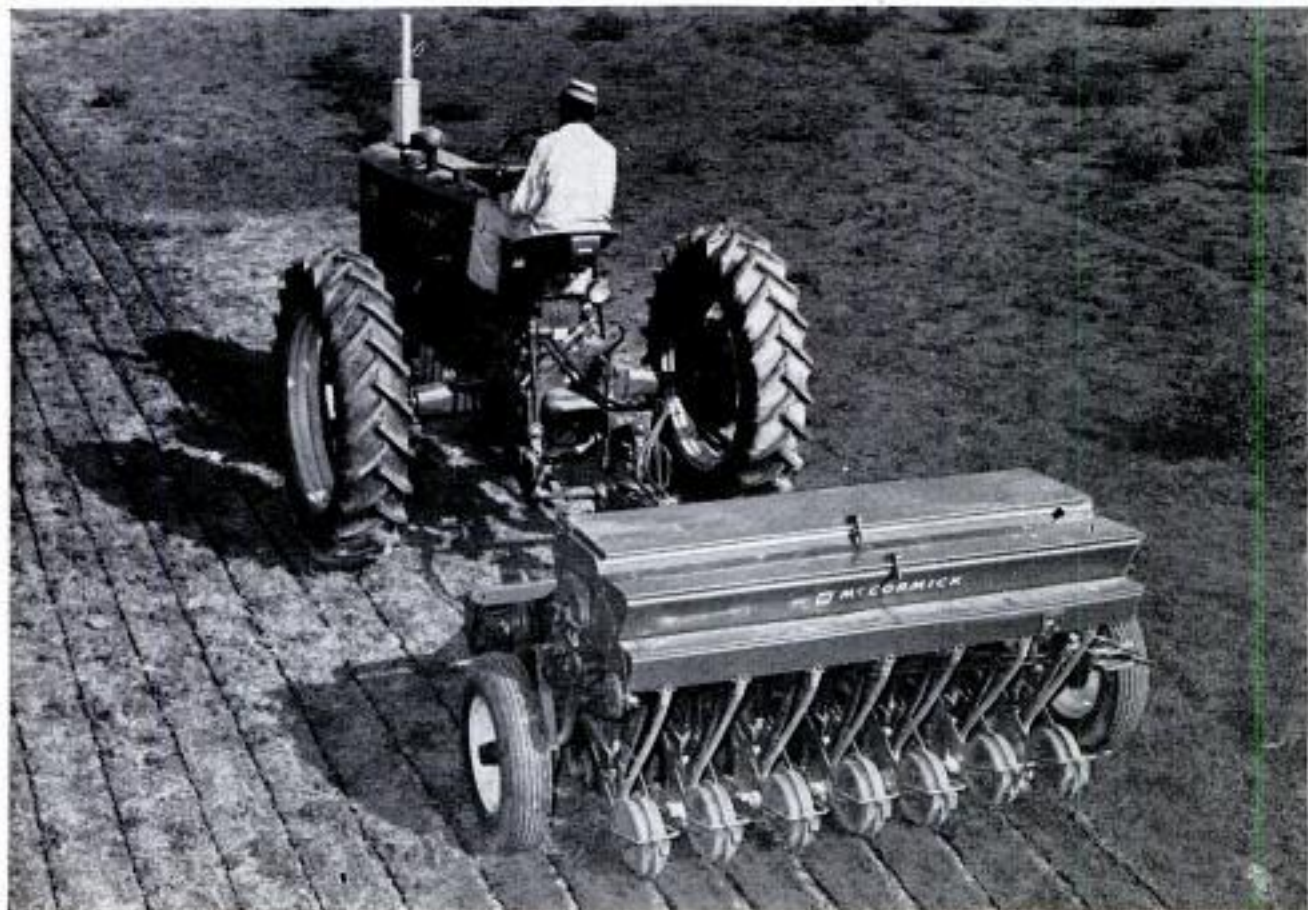
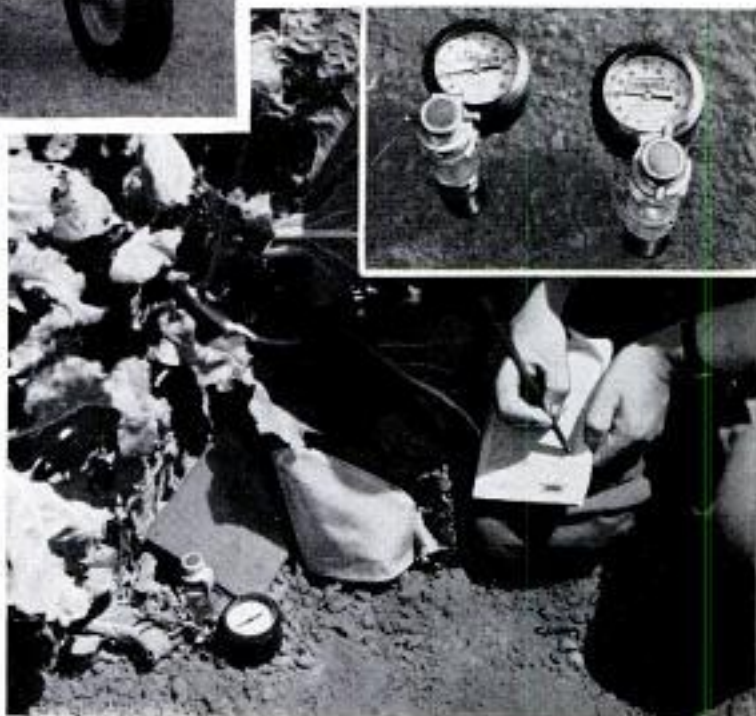

# UP-TO-DATE TRACTOR SPECIFICATIONS

Make and Model	Engine	Max. Drawbar HP (On Gasoline Where More Than One Fuel Is Available)	Rated RPM	Cylinders and Dis- placement	Com- pression Ratio	Speeds Forward	Speeds Reverse	Advised Speeds	No. and Size of Plows	Cultivating Clearance (Inches)	Power Take Off	Hy- draulic Power Unit	Size of Rear Tire
<b>ALLIS-CHALMERS</b>													
B	Own	20.60	1500	4-125	6.25	3	1	2.75, 4.25, 8.5	1-16, 18	21.75	Opt.	Opt.	9 x 24
CA	Own	23.55	1650	4-125	6.75	4	1	2.0, 3.5, 4.5, 11.25	2-14	22.5	Std.	Std.	10 x 24
G	Cont'l	9.59	1800	4-62	5.62	4	1	1.6, 2.25, 3.5, 7.0	1-12	17.3	None	Opt.	6 x 30
WD-45	Own	40.0	1400	4-226	6.45	4	1	2.6, 3.75, 5, 11.25	3-14	29.4	Std.	Std.	12 x 28
WD-45 Diesel	—	—	1625	4-230	—	—	—	—	—	—	—	—	—
<b>J. I. CASE</b>													
311	Own	Not yet tested	1750	4-148	7.1	4 or 12	1 or 3	2.6, 3.8, 5.0, 12.4	3-14	22.0	Opt.	Std.	11 x 28
411	Own	47.21	1450	4-251	6.5	8	2	1.3, 1.9, 2.6, 3.7, 4.7, 6.7, 9.1, 13.2	4-14	24.2	Opt.	Std.	12 x 38
500 Diesel	Own	56.55	1350	6-377	15.0	4	1	2.69, 3.70, 4.91, 10.19	5-14	—	Opt.	Opt.	14 x 30
<b>BLACK HAWK COCKSHUTT</b>													
30	Cont'l	26.74	1800	4-140	6.75	4	1	2.3, 3.5, 5.0, 12.5	1, 2-14	21.8 (A.A.), 24.3 (Tri)	Opt.	Opt.	10 x 24
30	Buda	26.43	1650	4-153	6.2	4-8	1-2	3.1, 4.5, 6.2, 13.5	2, 3-14	23.5 (A.A.), 16.5 (Axle)	Opt.	Opt.	10 x 38
35	Hercules	—	1650	4-198	6.5	6	2	1.6, 2.7, 3.7, 4.6, 6.3, 10.5	3	27.0 (Tri)	Opt.	Opt.	11 x 38
40	Buda	40.06	1650	6-230	6.2	6	2	1.6, 2.7, 3.7, 4.6, 6.3, 10.5	3, 4-14	24.0 (A.A.), 17.0 (Axle)	Opt.	Opt.	12 x 38
Golden Eagle	Perkins	—	1650	4-269.5	17.5	6	2	1.6, 2.7, 3.7, 4.6, 6.3, 10.5	4	24.0 (A.A.), 17.0 (Axle)	Opt.	Opt.	12 x 38
50	Buda	51.51	1650	6-273	6.6	6	2	1.6, 2.7, 3.7, 4.6, 6.3, 10.5	4, 5-14	26.5 (Tri)	Opt.	Opt.	14 x 34
<b>JOHN DEERE</b>													
429	Own	—	1850	2-113	7.0	4	1	1.6, 3.1, 4.2, 12.0	2, 3-14	21.0 (A.A.), 21.0 (Tri)	Std.	Std.	10 x 34
50 Gas	Own	27.49	1250	2-190	6.1	6	1	1.5, 2.5, 3.5, 4.5, 6.0, 10.5	2, 3-14	22.4 (A.A.), 24.1 (Tri)	Std.	Std.	10 x 38
60 Gas	Own	38.94	975	2-321	6.0	6	1	1.5, 2.5, 3.5, 4.5, 6.0, 11.5	3, 4-14	23.1 (A.A.), 25.3 (Tri)	Std.	Std.	11 x 38, 13 x 26, 13 x 30
70 Gas	Own	44.21	975	2-379	6.15	6	1	2.5, 3.5, 4.5, 6.5, 9.0, 13.0	4, 5-14	23.1 (A.A.), 25.3 (Tri)	Std.	Opt.	12 x 36, 14 x 30
70 Diesel	Own	45.66	1125	2-376	16.0	6	1	2.5, 3.5, 4.5, 6.5, 9.0, 13.0	4, 5-14	23.1 (A.A.), 25.3 (Tri)	Std.	Opt.	12 x 36, 14 x 30
80 Diesel	Own	61.76	1125	2-471	18.0	6	1	2.5, 3.5, 4.5, 5.5, 7.0, 12.5	5, 6-14	—	Opt.	Opt.	14 x 34
<b>FERGUSON</b>													
35	Cont'l	31.68	2000	4-134	6.6	6	2	1.33, 1.99, 3.65, 5.30, 7.96, 14.59	2, 3-14	21.0	Std.	Std.	11 x 28, 13 x 24
40	Cont'l	32 approx.	2000	4-134	6.6	6	2	1.33, 1.99, 3.65, 5.30, 7.96, 14.59	2, 3-14	20.25	Std.	Std.	11 x 28, 13 x 24
Hi-40 (4-Wheel)	Cont'l	32 approx.	2000	4-134	6.6	6	2	1.5, 2.25, 4.12, 5.99, 9.00, 16.5	2, 3-14	25.25	Std.	Std.	11 x 38
Hi-40 (Single-Wheel Tricycle)	Cont'l	32 approx.	2000	4-134	6.6	6	2	1.5, 2.25, 4.12, 5.99, 9.00, 16.5	2, 3-14	25.25	Std.	Std.	11 x 38
Hi-40 (Dual-Wheel Tricycle)	Cont'l	32 approx.	2000	4-134	6.6	6	2	1.5, 2.25, 4.12, 5.99, 9.00, 16.5	2, 3-14	25.25	Std.	Std.	11 x 38
<b>FORD</b>													
600 (SU-4-Wheel)	Own	29.37	2000	4-134	6.6	4	1	3.72, 4.79, 6.59, 13.74	2-14	20.35	None	None	10 x 28
630 (SU-4-Wheel)	Own	29.37	2000	4-134	6.6	4	1	3.72, 4.79, 6.59, 13.74	2-14	20.35	None	None	10 x 28
640 (4-Wheel)	Own	29.37	2000	4-134	6.6	4	1	3.81, 4.89, 6.73, 14.00	2-14	21.02	Std.	Std.	11 x 28
650 (4-Wheel)	Own	29.75	2000	4-134	6.6	5	1	2.39, 3.79, 5.04, 6.96, 12.38	2-14	21.02	Std.	Std.	11 x 28
660 (4-Wheel)	Own	29.75	2000	4-134	6.6	5	1	2.39, 3.79, 5.04, 6.96, 12.38	2-14	21.02	Std.	Std.	11 x 28
740 (Tricycle)	Own	29.22	2000	4-134	6.6	4	1	3.54, 4.56, 6.26, 13.06	2-14	21.49	Std.	Std.	11 x 28
820 (SU-4-Wheel)	Own	39.80	2200	4-172	6.75	5	1	2.16, 3.43, 4.56, 6.30, 11.21	3-14	20.21	None	None	10 x 28
850 (4-Wheel)	Own	40.18	2200	4-172	6.75	5	1	2.30, 3.66, 4.87, 6.72, 11.96	3-14	21.36	Std.	Std.	12 x 28
860 (4-Wheel)	Own	40.18	2200	4-172	6.75	5	1	2.30, 3.66, 4.87, 6.72, 11.96	3-14	21.36	Std.	Std.	12 x 28
950 (Tricycle)	Own	40.62	2200	4-172	6.75	5	1	2.30, 3.66, 4.86, 6.71, 11.95	3-14	21.44	Std.	Std.	12 x 28
960 (Tricycle)	Own	40.62	2200	4-172	6.75	5	1	2.30, 3.66, 4.86, 6.71, 11.95	3-14	21.44	Std.	Std.	12 x 28

Make and Model	Engine	Max. Drawbar HP (On Gasoline Where More Than One Fuel Is Available)	Cylinders and Dis- placement	Com- pression Ratio	Speeds Forward	Speeds Reverse	Advised Speeds	No. and Size of Plows	Cultivating Clearance (Inches)	Power Take Off	Hy- draulic Unit	Size of Rear Tire
<b>INTL. HARVESTER</b>												
Cub	Own	9.4	4-60	6.5	3	1	2.4, 3.2, 7.3	1-12	20.5	Opt.	Opt.	8 x 24
Cub Le-Boy	Own	9.4	4-60	6.5	3	1	2.3, 3.1, 6.9	1-12	14.0	Opt.	Opt.	7 x 24
100	Own	18.99	4-123	6.5	4	1	2.3, 3.7, 4.8, 10.0	1-16	22.0	Opt.	Opt.	9 x 24
200	Own	22.27	4-123	6.5	4	1	2.4, 3.9, 5.1, 10.7	2-14	23 (A.A.), 23.5 (Tri)	Opt.	Std.	10 x 35
300	Own	35.87	4-168	6.8	10	2	1.68, 2.50, 2.58, 3.82, 3.48, 4.15, 4.65, 5.60, 10.80, 15.11	3-14	19.0 (A.A.), 25.5 (Tri)	Opt.	Opt.	11 x 38
400	Own	47.34	4-264	6.13	10	2	1.09, 2.20, 2.60, 3.35, 3.26, 4.83, 4.53, 6.71, 11.27, 15.70	4-14	22.5 (A.A.)	Opt.	Opt.	12 x 38
300 Utility	Own	29.48	4-169	6.8	10	2	2.6, 1.8, 4.0, 2.7, 5.4, 3.6, 6.9, 4.6, 16.7, 11.3	3-14	21.0	Opt.	Opt.	10 x 28
W-400	Own	47.38	4-264	6.4	10	2	1.6, 2.4, 2.0, 3.7, 3.1, 4.7, 4.4, 6.5, 10.9, 16.1	4-14	26.0 (Tri)	Opt.	Opt.	14 x 30
600	Own	—	4-350	5.4	5	1	2.4, 3.2, 4.5, 5, 15.8	5-14	—	Opt.	Opt.	14 x 34
<b>MASSEY-HARRIS</b>												
Pacer	Cont'l	17.31	4-91	6.1	3	1	2.88, 3.77, 7.25	2-12	20.5	Opt.	Std.	9 x 24, 10 x 24, 6 x 30
MH50	Cont'l	31 approx.	4-134	6.6	6	2	1.33, 1.99, 3.84, 5.32, 7.96, 14.57	3-14	21.3, 26.9	Std.	Std.	10 x 38, 11 x 38
333	Cont'l	40.50	4-208	6.5	10	2	1.43, 2.16, 2.44, 2.87, 3.68, 3.73, 4.36, 6.36, 7.97, 13.6	3, 4-14	24.5	Opt.	Opt.	11 x 38, 12 x 38, 12 x 38, 13 x 38
444	Cont'l	46.00	4-277	6.25	10	2	1.43, 2.16, 2.44, 2.87, 3.68, 3.73, 4.36, 6.36, 7.97, 13.6	4-14	25.0	Opt.	Opt.	12 x 38, 13 x 38, 13 x 30, 14 x 30
555	Cont'l	60.45	4-382	5.8	4	1	2.96, 4.22, 5.22, 12.07	5-14	—	Opt.	Opt.	15 x 34
<b>MINNEAPOLIS-</b>												
<b>MOLINE</b>												
BF	Hercules	25.11	4-133	6.5	4	1	2.4, 3.7, 5.2, 13.0	2-14	22.0 (A.A.), 26 (Tri)	Opt.	Std.	10 x 28, 10 x 38
BG	Hercules	—	4-133	6.5	4	1	2.3, 3.5, 4.9, 12.5	2-14	20.5 (A.A.)	Opt.	Std.	11 x 24
GB	Own	61.45	4-403	5.74, 10.3	5	1	2.7, 3.8, 4.4, 6.3, 14.7	5-14	14.75	Opt.	Opt.	15 x 34
U, JB Series	Own	40.00	4-283	6.3, 8.5	5	1	2.6, 3.6, 4.2, 6.1, 14.1	4-14	25.0 (Type N) 18.0 (Type S) 20.0 (Type E) 19.8 (Type U) 25.0 (Type U) 25.0 (Type N) 12.2 (Type S)	Opt.	Opt.	12 x 38
Z, ZB Series	Own	33.36	4-206	4.7, 6.2, 7.7	5	1	2.4, 3.6, 4.6, 6.3, 13.1	3-14	—	Opt.	Opt.	11 x 38
445	Own	40.0	4-206	5.8, 10.04	5 or 10	1 or 2	1.46, 2.78, 2.93, 4.26, 3.44, 6.48, 5.28, 10.05, 8.09, 15.4	3-14	25.5 (A.A.), 25.5 (Tri)	Opt.	Opt.	11 x 28
<b>OLIVER</b>												
Super 55-HC	Own	36.75	4-144	7.0	6	2	1.6, 2.4, 3.3, 5, 6, 12.5	2, 3-14	19.75	Opt.	Std.	10 x 28
Super 55-D Diesel	Own	28.97	4-144	15.5	6	2	1.6, 2.5, 3.3, 5, 6, 12.5	2, 3-14	19.75	Opt.	Std.	10 x 28
Super 66-HC-RC	Own	29.69	4-144	7.0	6	2	2.3, 3.6, 5.1, 6, 10.4	2, 3-14	24.1	Opt.	Opt.	9 x 38
Super 66-D-RC Diesel	Own	29.09	4-144	15.5	6	2	2.1, 3.6, 5.1, 6.1, 10.4	2, 3-14	24.8	Opt.	Opt.	9 x 38
Super 77-HC-RC	Own	40.16	6-216	7.0	6	2	2.45, 3.2, 4.3, 5.6, 6.6, 11.5	3, 4-14	24.8	Opt.	Opt.	11 x 38
Super 77-D-RC Diesel	Own	40.04	6-216	15.5	6	2	2.5, 3.2, 4.3, 5.6, 6.6, 11.5	3, 4-14	24.8	Opt.	Opt.	11 x 38
Super 88-HC-RC	Own	49.81	6-285	7.0	6	2	2.5, 3.2, 4.3, 5.6, 6.8, 11.8	4-14	25.6	Opt.	Opt.	12 x 38
Super 88-D-RC Diesel	Own	49.58	6-285	15.5	6	2	2.5, 3.2, 4.3, 5.6, 6.8, 11.8	4-14	25.6	Opt.	Opt.	12 x 38
Super 99-HC	Own	61.00	6-302	6.2	6	2	2.5, 3.2, 4.4, 5.7, 7.2, 12.8	4, 5-14	11.81	Opt.	Opt.	14 x 34
Super 99-D Diesel	Own	60.90	6-302	15.5	6	2	2.5, 3.2, 4.4, 5.7, 7.2, 12.8	4, 5-14	11.81	Opt.	Opt.	14 x 34
Super 99-GM Diesel	General Motors	71.44	3-213	17.0	6	2	2.6, 3.5, 4.7, 6.1, 7.7, 13.7	5, 6-14	11.81	Opt.	Opt.	15 x 34

\*Adjustable Axle †Tricycle



### Barrel-Shaped Airplane Tires Permit Rough-Field Landings

Aimed at making it possible to land a light plane in plowed fields, clearings and other rough areas, a soft, barrel-shaped tire is being tested by Goodyear. Called Terra-Tires, they carry from three to

eight pounds of pressure, are 24 inches wide, and roll softly over rough ground and small obstacles. Such tires are expected to prove useful to flying farmers and ranchers, Army observers and bush pilots.



### Frogmen Recovered From Water By Giant "Slingshot"

Navy frogmen can now be recovered from the water after completion of their missions in three seconds or less by means of a slingshot type of device. As the recovery boat, traveling at 14 knots, passes the frogman he is thrown a large loop attached to a tensioned cord. The force of the swimmer's acceleration, from zero speed in the water to the speed of the boat, stretches the cord. The cord then snaps back, pulling the swimmer out of the water and into a rubber boat.



## Stork Gets New Bill From Aluminum Sash

Ol' Tin Horn, a black European stork at Crandon Park Zoo in Miami, Fla., couldn't eat and almost died of starvation after he broke off the end of his lower bill. But Zoo Director Robert Mattin came to the rescue with a replacement made from an aluminum sash, and attached it with machine screws. The bird can now eat as before, easily picking up small fish.

Starving after he broke his bill, this stork now struts happily around with an aluminum-reinforced beak

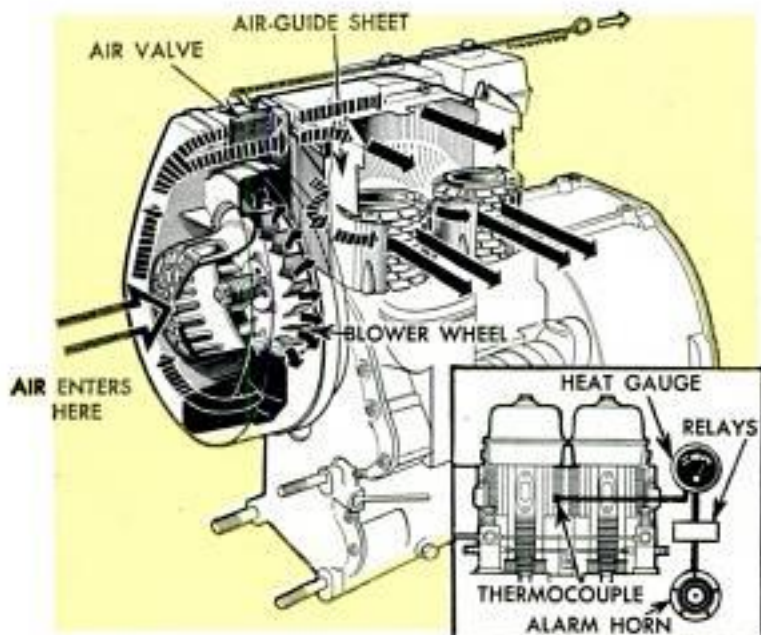

## German Diesel Tractor Has Air-Cooling System

Air cools a diesel tractor engine developed in Germany by the makers of Porsche automobiles. Air is sucked into a housing at the front of the engine by a 24-vane blower and directed around the cylinders to cool them. A thermocouple takes the engine's temperature to control a heat gauge and sound an alarm horn if the engine gets too hot. Two-cylinder and three-cylinder engines are made by this firm. The tractor also has a fluid coupling, or clutch, in front of the conventional transmission that prevents a heavy load from stalling the engine.

A generator for the tractor's lighting system is mounted in front of the engine on the same shaft as the blowers

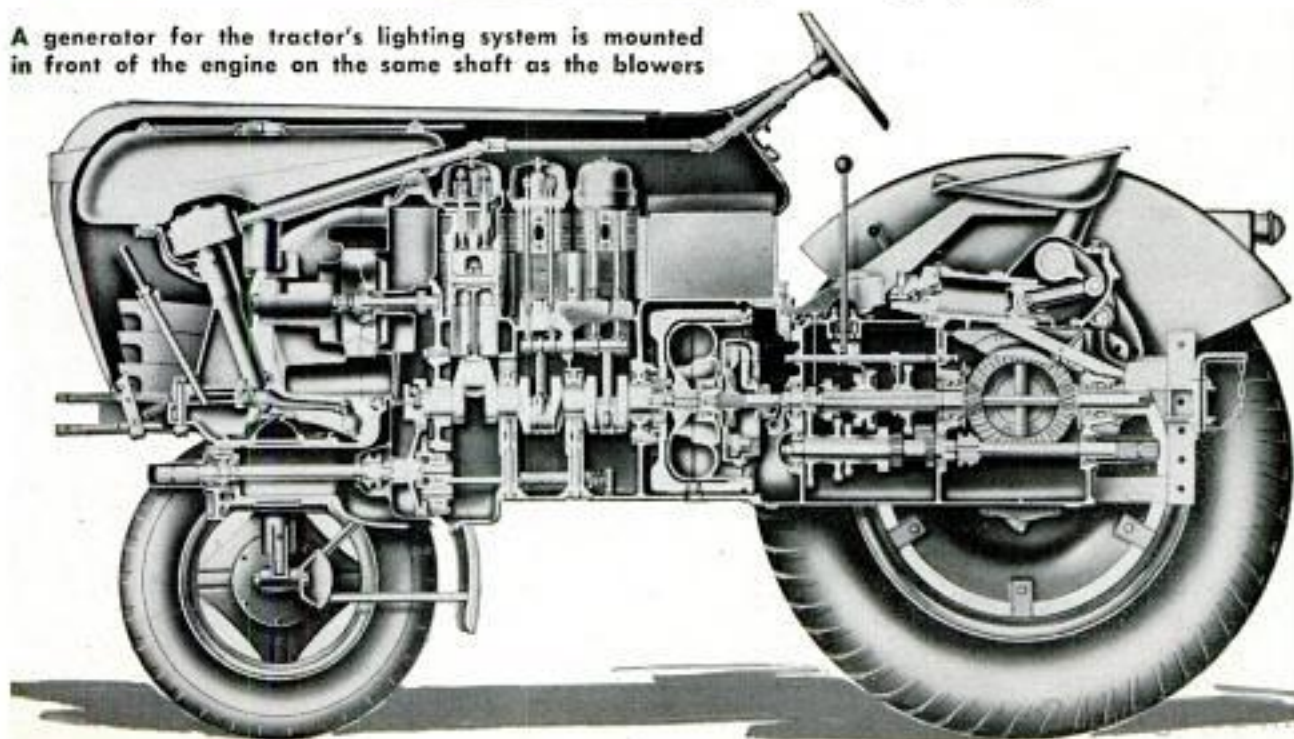

THIS IS YOUR YEARBOOK of automobiles for 1957. On the following pages *Popular Mechanics* presents the story of the automotive industry for this year. The full-color section is devoted to eight memorable days in man's eternal quest for speed. There were many memorable days, and there will be more, but these paintings depict eight days which cannot be omitted from any discussion of the subject. Also included in the section are articles on racing, durability tests, economy cars, carburetors and the first of a two-part article showing you how to build your own personal sportster. In addition, of course, are specifications and photographs of all 1957 models.

## EIGHT MEMORABLE DAYS in the History of Speed

By **ARTHUR R. RAILTON**, *Automotive Editor*

Paintings by Robert Korta, *PM artist*

**M**AN LIKES to go fast.

To some men, speed is a compulsion. Only overwhelming compulsion can explain why men sacrifice time, money and, not infrequently, their lives for speed.

There are rewards, of course. But they don't match the risks. The one guarantee to the successful is the satisfaction of knowing that, temporarily at least, he is the world's fastest driver. For those who fail, there is nothing.

From the day man first put wheels under a platform, he has raced against his fellow men. When that platform became an automobile, he began racing the clock.

This was the start of the Golden Era of Speed—50 years of enormous achievement.

It was only 50 years from December 1898 when Comte de Chasseloup-Laubat set the first record of 39.24 miles per hour, until September 1947 when John Cobb covered the mile at an average speed of 394.20 miles per hour.

A mile a minute, that

frightening speed once dreamed of as the ultimate, turned out instead to be only a starting point. A short four months after the first speed record was set, Camille Jenatton tore along a French road at 65.79 miles per hour. In the crowded, exciting half century that began in 1898, man multiplied the speed he could travel across land about 10 times.

In those 50 years, the wheeled platform changed from a small, top-heavy machine on which the driver sat like a cowboy on a horse to a ground-hugging monster in which the driver fits like a hand in a glove.

But the drivers changed little if any. They were all determined, daring men who wanted more than anything else to go fast—faster than anybody had ever gone before them. The difference between 39 miles per hour in 1898 and 394 miles per hour in 1947 was a difference in machines, not men.

In the eight pages of this full-color section, *Popular Mechanics* pays tribute to

(Continued to page 169)

Reprints of these eight paintings printed on one side only and suitable for framing are available (as long as the supply lasts) for 25 cents in coin to cover costs. Address requests to Bureau of Information, *Popular Mechanics*, 200 East Ontario St., Chicago 11, Ill.



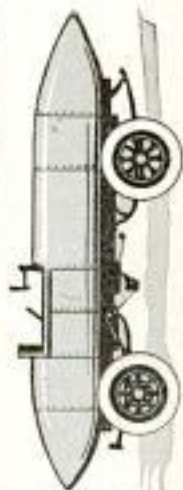

## **JENATZY 1899—60 miles per hour**

The story of automotive speed begins in April 1899 when, on a road at Acheres, France, an electric-powered car driven by Frenchman Camille Jenatzy was the first to go a mile a minute, averaging 65.79 miles per hour for one kilometer.



## ***RIGOLLY 1904—100 miles per hour***

First to hit 100 was another Frenchman, M. Rigolly who, on July 21, 1904, in a four-cylinder, angular-bodied Gobron-Brillie averaged 103.56 miles per hour for one kilometer along a dusty road at Ostend, Belgium.

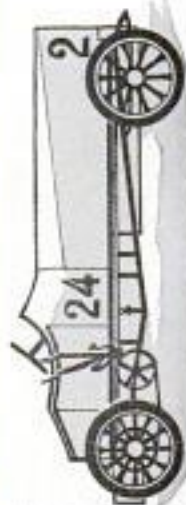



## **MARRIOTT 1906—120 miles per hour**

First to go two miles a minute was American Fred Marriott who, on January 27, 1906, drove the sleek, unbelievably simple Stanley Steamer Rocket at 127.66 miles per hour for one mile along the hard sands at Daytona Beach, Florida.

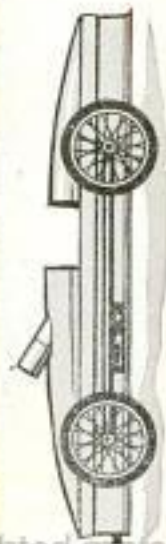



## ***DePAOLO 1925—100 miles per hour at Indianapolis***

First to break 100 for the 500 miles of the famous Indianapolis Race was Pete De Paolo who averaged 101.13 miles per hour in a supercharged Ducsenberg on May 30, 1925, beating out a Miller Junior Eight by less than a minute.

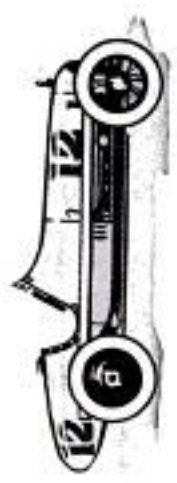

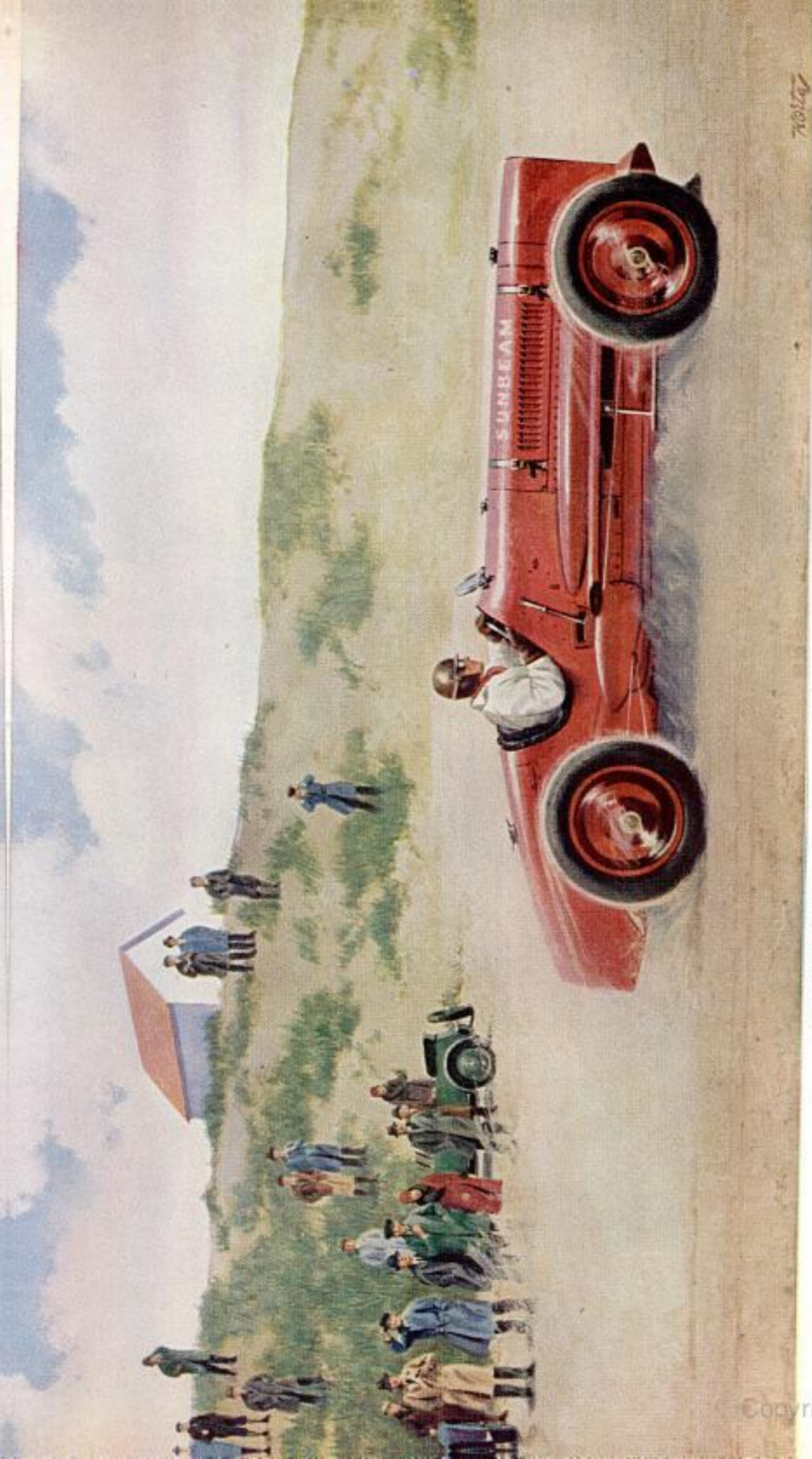

## **SEGRAVE 1926—Last of the Normals**

On Southport sands, England, on March 17, 1926, H.O.D. Segrave hit 152.33 miles per hour in his four-liter Sunbeam V12, the last of the true racing cars to hold the record. After this, aircraft-engined, specialized giants took over.



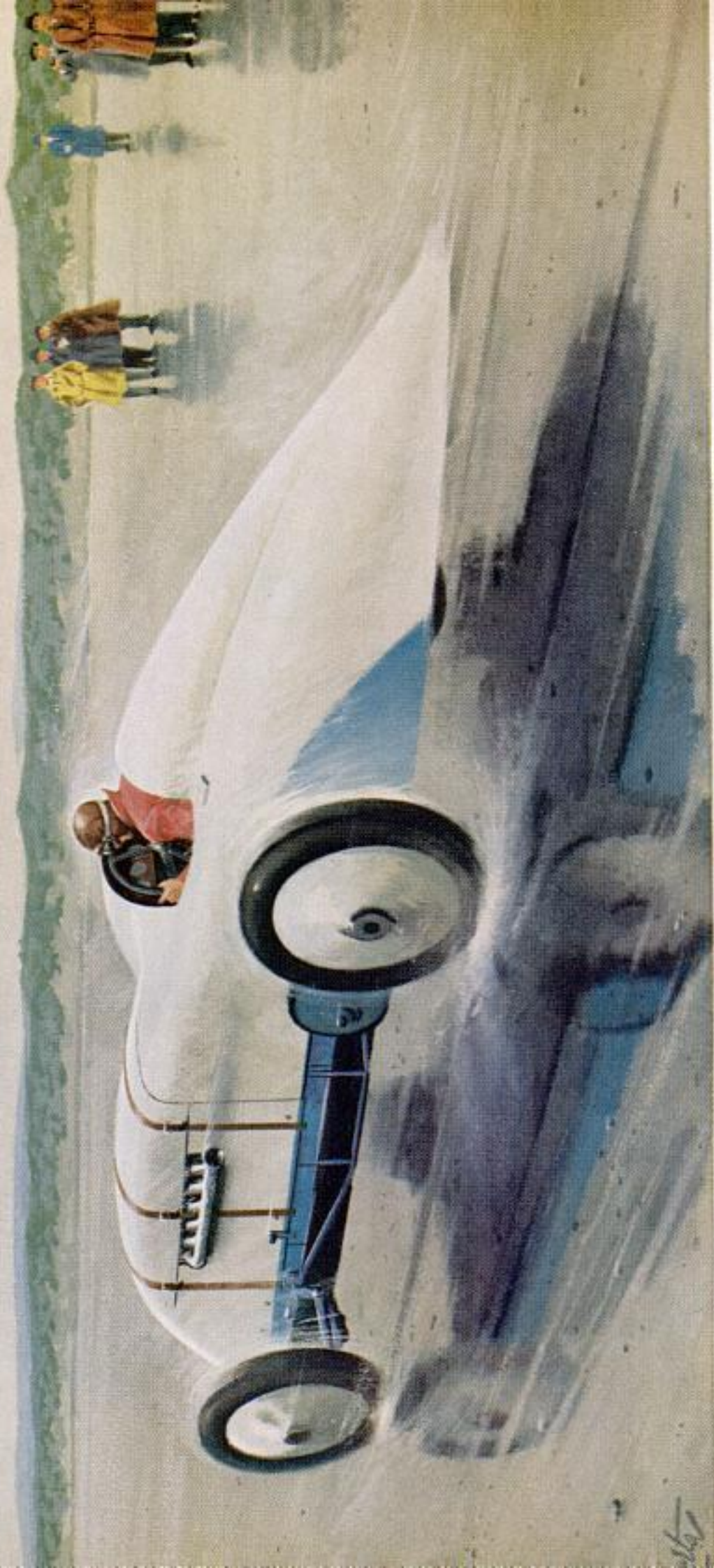

### ***THOMAS 1926—First of the Leviathans***

To begin the reign of the giants, Britisher Parry Thomas drove a record 171.02 miles per hour on a wet beach at Pendine, Wales. His car with its V12 Liberty aircraft engine had a displacement seven times larger than that of Segrave's.



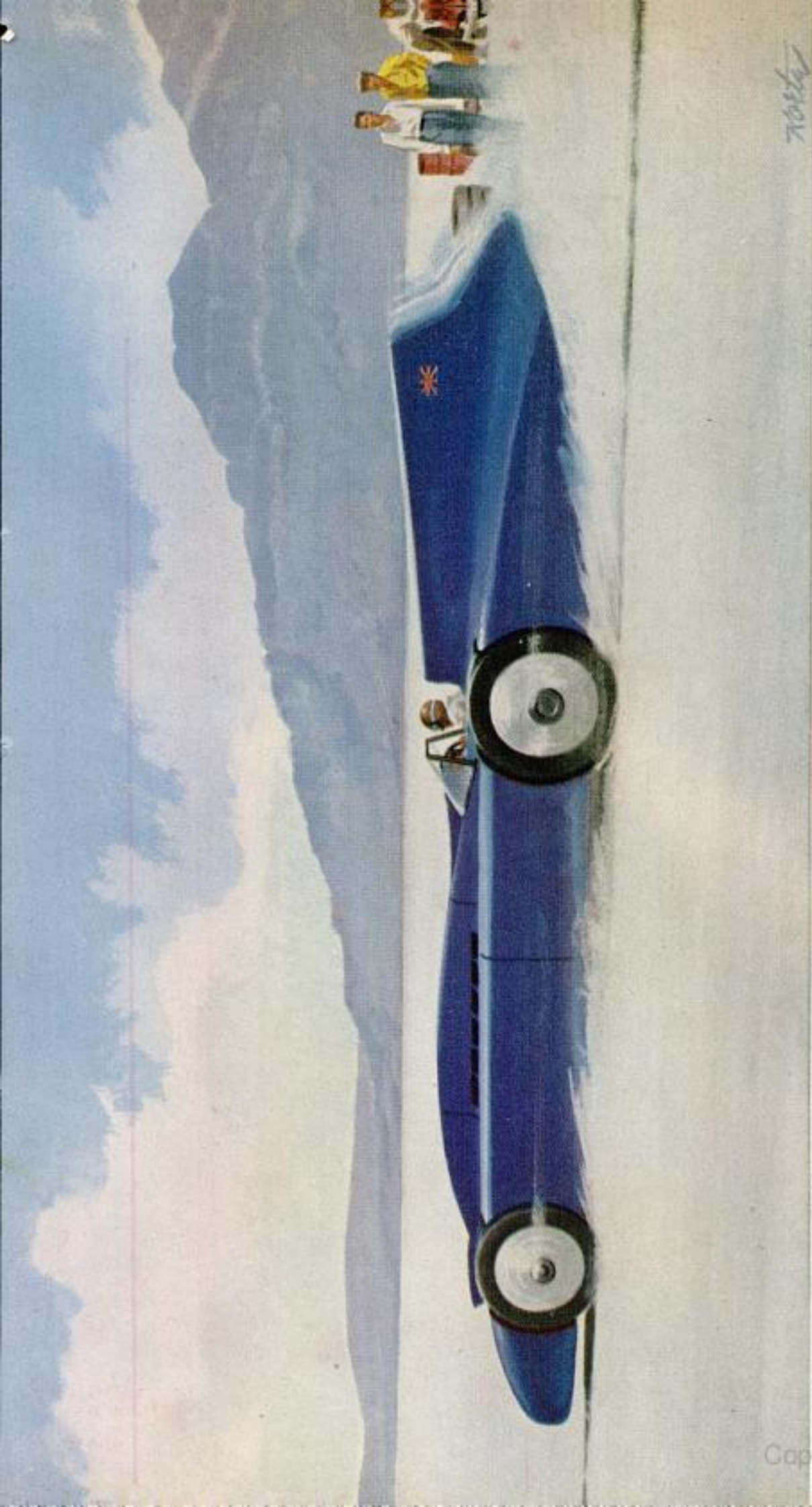

## **CAMPBELL 1935—300 miles per hour**

On the parched whiteness of Bonneville Salt Flats, Utah, Sir Malcolm Campbell became the first to go 300 miles per hour when he drove his 2500-horsepower aircraft-engined Blue Bird at a record 301.129 miles per hour September 3, 1935.



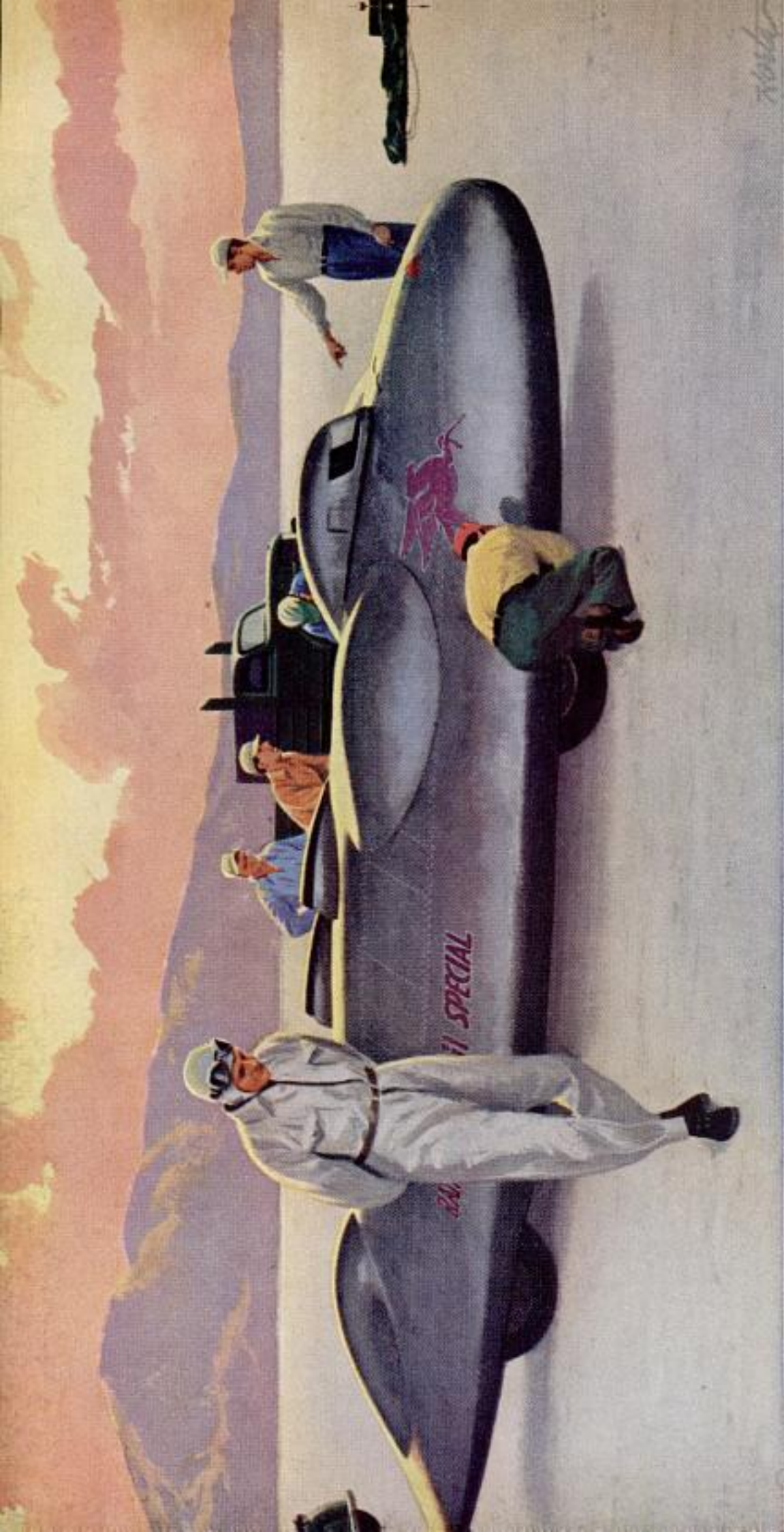

## ***COBB 1947—400 miles per hour***

John Cobb of England paces nervously as his Railton Special is readied for its speed runs at Bonneville, September 16, 1947. One run was timed at 403.14 miles per hour. His two-way average of 394.196 miles per hour is the present record.

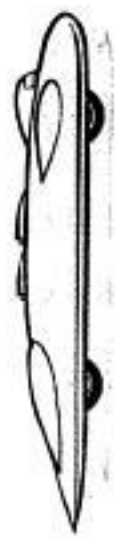



those men who have devoted their efforts to speed. On these pages are pictured eight memorable days in the continuing quest for faster land transportation. Many important events had to be omitted. Those chosen were picked as representative of the half century.

Omitted, too, were the failures—some of which were magnificent. Perhaps the most magnificent of all was the tragic failure of the American, Frank Lockhart, who was killed at Daytona Beach while driving his Black Hawk Stutz more than 200 miles per hour. Lockhart's car had two engines with a combined displacement of only three liters. He was trying to break a record held by cars many times larger. And he would perhaps have succeeded except for the bumpy condition of the beach. His would have been, as one British writer describes it, "a triumph of technical skill over brute force almost without parallel in motoring history."

The story begins on a road outside Paris where in December 1898 two pioneers began competing for the speed crown. Both, realizing the inadequacies of the gasoline engines of the era, put their faith in electricity.

After a series of alternating record-setting runs, Jenatzy came out victorious in April 1899 with a speed of 65.79 miles per hour, becoming the first person to drive a mile a minute (actually he was driving over a kilometer course and probably did

not realize he had hit the magical mile-a-minute figure).

His competitor, Chasseloup-Laubat, will be remembered as being the first speed-record holder with his initial run of 39.24 miles per hour in the electric Jeantaud in December 1898.

Electricity gave way to steam in 1902 when Serpollet in a streamlined steamer averaged 75.06 miles per hour, nearly 10 miles faster than the fastest electric.

It wasn't until August 1902 that the gasoline engine came into the picture. An American, W. K. Vanderbilt (in a European Mars car, however), went to Ablis, France, and raised the steamer's mark to 76.08 miles per hour.

Gasoline remained king for three years through a succession of record-breaking runs that included one by Henry Ford in the Ford 999, a gearless, clutchless monster, that hit 91.37 miles per hour on the ice at Lake St. Clair, Wis. Ford's speed fame was short-lived, however, as two weeks later, Vanderbilt in a Mercedes raised the record to 92.30 miles per hour at Daytona.

Steam made its brief comeback when Fred Marriott in the Stanley Steamer Rocket, a fragile looking ultrastreamlined speedster, averaged 127.66 miles per hour at Daytona to become the first man to go two miles a minute.

In 1914 rules were established requiring that speed runs be made in two directions

(Continued to page 286)

For a complete listing of the World's Land Speed Records turn to page 288

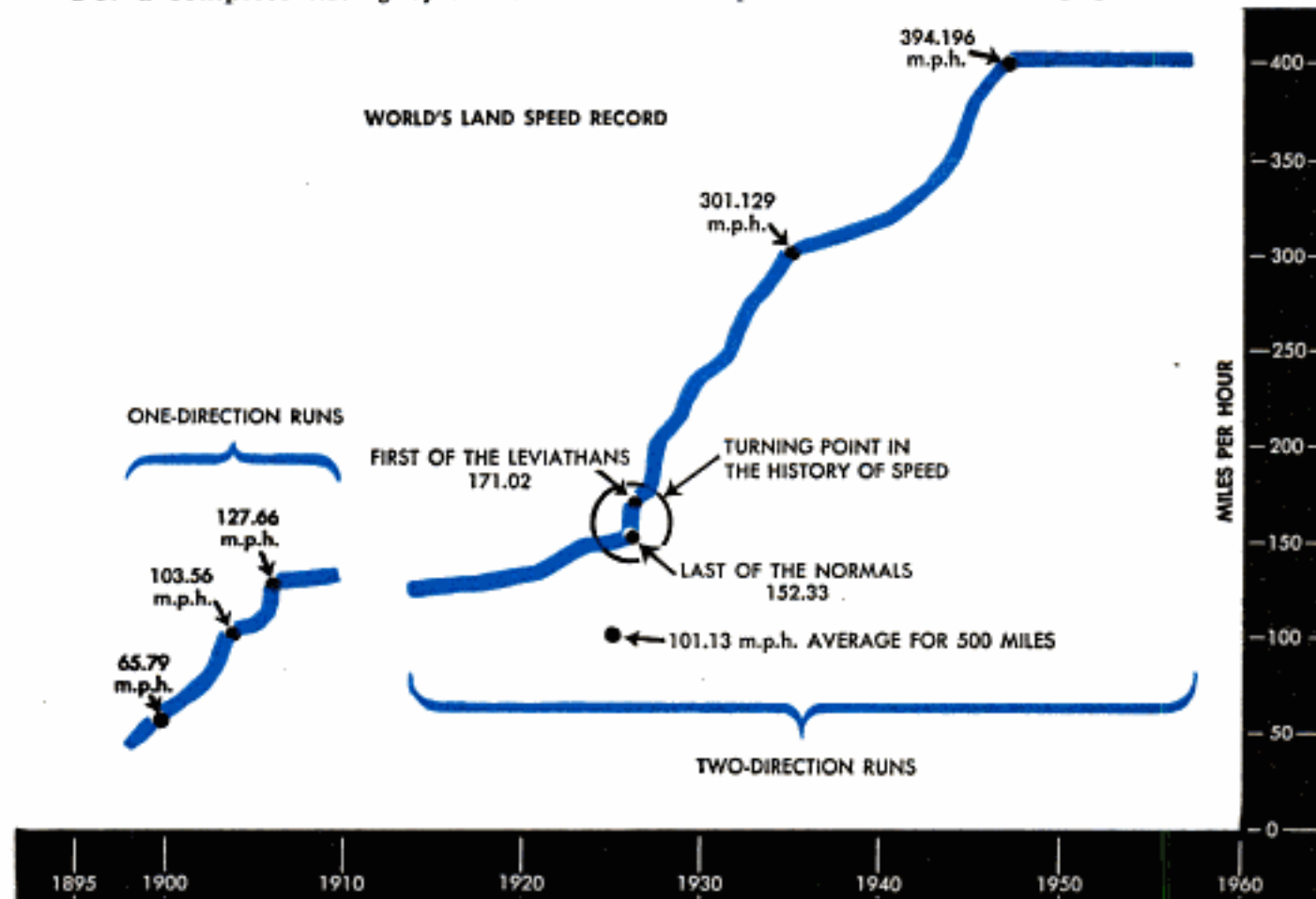

# PARADE OF '57 CARS

IT'S A YEAR of change—dimensional changes, for the most part.

To be sure, there are important engineering changes, but most of them came because the stylists said that the 1957 cars must be lowered drastically.

The decision to make the new cars lower (and the average 1957 car is 2.1 inches lower than last year's model) forced engineers to redesign frames, bodies, shells, suspensions and wheels.

Almost unanimously, the industry adopted the 14-inch wheel. Frames are new and in great variety, ranging from the sturdy X-frame of the Cadillac, to the straight-through Chrysler Corporation frame, to the billowing curves of the Ford frame.

Horsepower is up, but it is less shouted about this year in advertisements. (Safety also seems to be quietly ignored in the ads, this year.) In 1957, average horsepower is 234.6 compared with 209.4 in the

(Continued to page 296)

PRODUCTION OF PASSENGER CARS DURING 1956

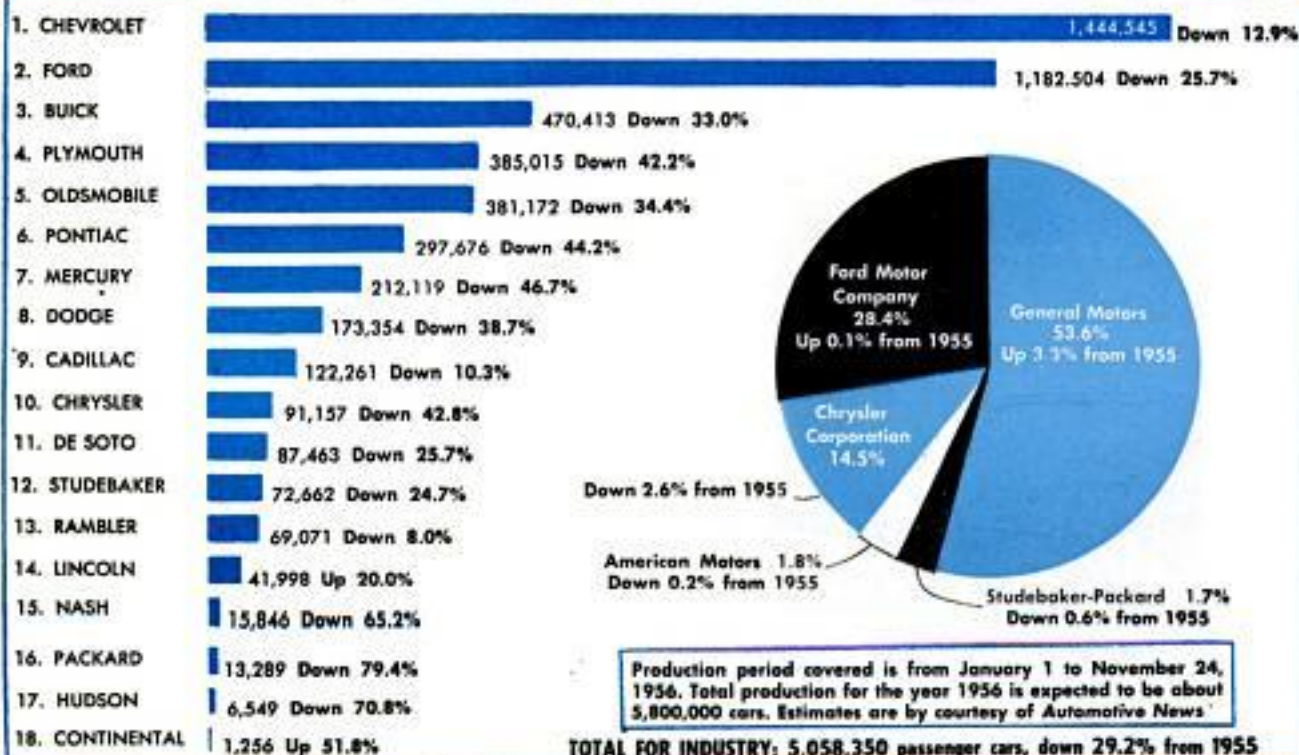



## BUICK

Completely new, Buick retains its identity. Still present are the identifying "holes" in the front fenders, the full fender cutouts for all wheels, the characteristic Buick grille. It's longer, lower and more powerful. It's also more expensive. Prices range from \$2545 to \$3994—up 8 percent.



## CADILLAC

Seen head-on, Cadillac looks much the same, but from the side and rear it takes on a new look. Most apparent is the new shape of the tailfin, Cadillac's trademark for so many years. Taillights are now mounted low, just above the bumper and the tailfin tapers to a featheredge, as did the Eldorado's last year. Prices range from \$4609 to \$7586—up 10 percent from 1956.

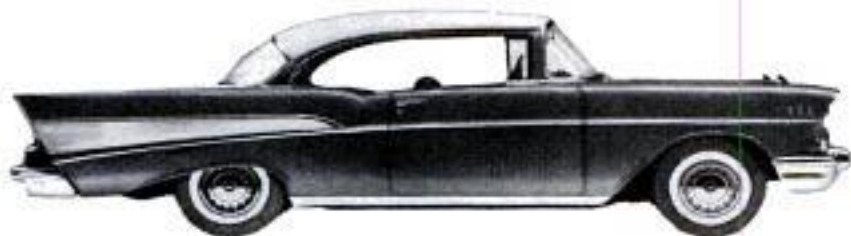

## CHEVROLET

After one of its most successful years, the Chevrolet has made only minor changes. It is the same basic car with all-new front sheet metal and grille, plus entirely new rear-end styling. It now has large tailfins and a massive front grille that looks somewhat like a Buick. It is 2½ inches longer, but at 200 inches is the second shortest in the industry. Prices range from \$1968 to \$2827—up 6.7 percent.





## CHRYSLER

You won't believe it until you measure them, but the new Chryslers are shorter than last year's. The low line and the wedge shape deceive you. Horsepower is 325 on New Yorkers, 295 on Saratogas (a new line this year) and 285 on Windsors. Prices range from \$3030 to \$4574—up 4.5 percent.



## CONTINENTAL

It's still the Mark II and there are no outward changes to identify it as the 1957 model. Under the sheet metal, though, there have been many engineering changes. Most important is a 28-pound reduction in weight as a result of changes in the frame construction. Announced this year was a convertible model built by a custom-body shop in Texas. Price is \$9695—up 1.5 percent.



## DE SOTO

De Soto has added a new series to its line—the Firesweep. This is a clever combination of Dodge and De Soto that adds a lower-price model. Its front grille is different from the rest of the line, sharing Dodge sheet metal. All De Sotos have the flattened-U rear styling that makes them instantly recognizable. Prices range from \$2724 to \$3830—up 6.9 percent from 1956.



## DODGE

Although it increased wheelbase two inches, Dodge added only a fraction of an inch to over-all length. Its tucked-in tailfin styling makes it look about a foot lower (it's 3.8 inches lower). Styling is dramatically different. Displacement is up sharply to 325. Prices range from \$2329 to \$3091—up 5 percent.

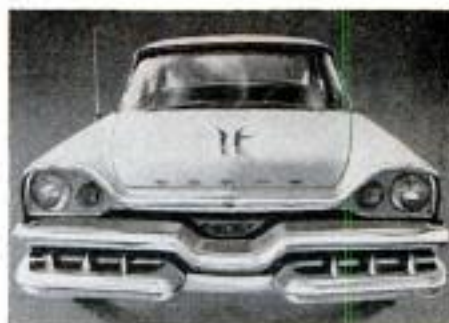

## ELDORADO

Still awaited but due in the showrooms this month is the Eldorado Brougham (not shown here). Less fabulous, but fine nonetheless, are the Eldorado Seville hardtop and Biarritz convertible. Basically Cadillacs, they have sharply different rear-end styling. The \$10,000-plus Brougham will be different under the skin, too. Prices range from \$7218 to something over \$10,000.



## FORD

You have a choice of two sizes of Fords for '57, both being longer than the 1956 models. The big Fairlane is 9.2 inches longer. Promised for delivery this month is a hardtop convertible that converts (see *PM*, Jan. '57, page 115)—the first in the industry. Prices range from \$1953 to \$2746—up 5.1 percent (these do not include the as-yet-unpriced retractable hardtop).





## HUDSON

By changing the curve of the roof panel, Hudson has been able to lower its over-all height almost two inches while retaining the same body. It also adopted the 14-inch wheel. Prices range from \$2750 to \$3030—down 11.2 percent from 1956.



## IMPERIAL

There's no mistaking the Imperial. It's a completely distinctive car in the Chrysler family. The bomb-sight taillights are styled into the trailing edges of the rear fenders, no longer do they stand upright defiantly. Simulated tire cover on trunk lid is optional, as are dual headlights. From \$4661 to \$5646, apparently down from 1956, but it is impossible to be precise because models are not comparable.



## LINCOLN

Lincoln has given its front-end styling a new look by mounting four headlights in vertical pairs. Rear-end styling is drastically changed by sharply canted tailfins. New for 1957 is the four-door hardtop, first such model Lincoln has offered. All have dual exhausts, all develop 300 horsepower. Optional are electric door locks, nonslip differential. Prices range from \$4576 to \$5309, up 11.8 percent.





## MERCURY

Adding the Turnpike Cruiser, Mercury has invaded the upper-medium price field to leave space for the new Edsel below it in '58. The Cruiser has dual headlights, lowerable rear window and other innovations. Prices range from \$2536 to \$3500—up 7.9 percent on comparable models.



## NASH

Styling changes at Nash include an all-new front end with four small headlights. These lights have been moved out of the grille and into the normal location in the ends of the fenders. Taillights are larger, although similar in design to last year's. The roof is lower by two inches. Fourteen-inch wheels are used. From \$2750 to \$3030—down 9.4 percent.



## OLDSMOBILE

You'll have no trouble identifying the 1957 Oldsmobile despite its all-new styling. The typical Oldsmobile look is retained. It is much lower and longer. Innovations include a printed-circuit dashboard, power-assisted heater controls. Also new are four station wagons, two of which have pillarless hardtop styling. Prices range from \$2691 to \$4167—up 11.4 percent from 1956.





## PACKARD

Packard is making a new start with its Packard-Clipper series. The traditional prestige-laden Packard is gone. This new car is a Studebaker with Packard identification. It is powered by the Studebaker V8 with supercharger. Prices not yet available, but probably lower than in 1956.



## PLYMOUTH

Plymouth represents high styling at Chrysler Corporation and on it rests the company's hopes. It has performance, too. Engineering changes include torsion bars in front and a new frame. Rear-spring mountings are changed to reduce windup on starts and stops. Prices range from \$1978 to \$2608 (wagon prices not yet available)—up 5.2 percent from the 1956 series.

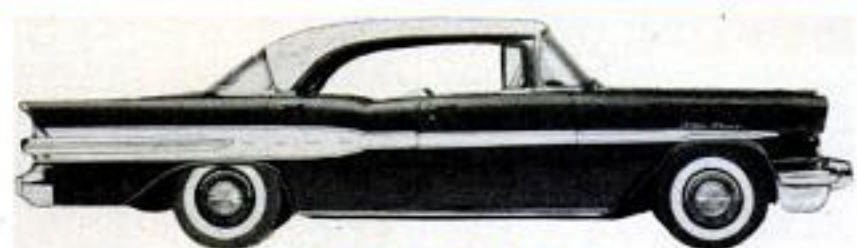

## PONTIAC

Slightly longer than last year's, the new Pontiac features a projectile-type side treatment that seems to add feet to its over-all length. It also, for the first time in years, has no Silver Streaks of chrome to identify it. Displacement is up with a longer stroke. The V8 engine has vented valve stems to keep oil from being sucked by during deceleration. Prices range from \$2428 to \$3446—up 8.3 percent.





## RAMBLER

Rambler offers a V8 engine, for the first time, in addition to its usual Six. The new V8 develops 190 horsepower with only a 250-cubic-inch displacement. Styling changes, after last year's all-new body, are minor. Prices range from \$1925 to \$2657—up 5.3 percent.



## STUDEBAKER

Studebaker increased its width and length for 1957, but its basic styling is unchanged. It has also introduced a four-door station wagon to the line. Offered this year is a special safety mounting for seats to prevent them from being torn loose in an accident. Prices range from \$2001 to \$2666—up 4.7 percent from 1956. For information on the Hawks, turn the page.



## VOLKSWAGEN

For the first time, a foreign car has moved ahead of some domestic cars in sales. That car is the Volkswagen. No changes were made for 1957 except the use of tubeless tires. In fact, Volkswagen styling has not changed since 1947. Prices range from \$1495 to \$2550, also unchanged.



# The Specials—Sports-Type, Personal Cars

A PHENOMENON of the American automobile industry is the special sports-type car. Examples are shown on this page.

Not a sports car (although the Corvette comes close) and not a family car, the sports-type car is often called a personal car, which means, apparently, that it isn't

roomy enough for the wife and children!

Whatever else the sports-type car is, it must be high-powered and fast. It is expensive, also. It is designed to appeal to the man who wants a sports car, but doesn't want to sacrifice the comfort and convenience of the reliable American automobile.



## CHRYSLER 300C

Consistently a winner of championships, the Chrysler 300C has 375 horsepower, the industry's top. It also has brake-cooling air intakes below headlights. In a Chrysler-run test, it went 145.7 m.p.h. Built as a two-door hardtop and convertible, prices are not yet available.



## CORVETTE

For \$480 extra you get fuel injection to give the Corvette 283 horsepower and with only 283 cubic inches! It comes either as a convertible or hardtop (with power windows and top). Price: \$3427.



## GOLDEN HAWK

Supercharged and loaded with power, the Golden Hawk develops 275 horsepower. The supercharger provides peak power in acceleration and cuts out for economy at cruising speed. Tailfins are new this year. Price is \$3182.



## THUNDERBIRD

If you want performance plus, the Bird's optional 312-cubic-inch engine has 285 horsepower. Standard Bird engine develops 212 horsepower. The rear end is longer and the spare is now back inside the trunk. Hard and soft tops are available. Price: \$3367.

# SPECIFICATIONS OF THE 1957 CARS

	Lowest-Price 4-Door Model	Shipping Weight	Wheelbase	Over-All Length	Over-All Width	Over-All Height	Turn-Circle Diameter	Displacement	Max. Hp.	Comp. Ratio	Max. Torque	Bore and Stroke	
<b>VOLKSWAGEN</b> Two-door sedan	\$1495	1600	94.5	160.0	60.5	59.0	36.0	72.7	36	6.0		3.031x2.520	<b>VOLKSWAGEN</b> Two-door sedan
<b>RAMBLER</b> Deluxe Six Custom V8	\$1925 \$2285	2801 3179	108.0 108.0	191.1 191.1	71.3 71.3	58.0 58.4	37.5 37.5	195.0 250.0	125 190	8.25 8.00	175 240	3.125x4.250 3.50 x 3.25	<b>RAMBLER</b> Deluxe Six Custom V8
<b>FORD</b> Custom Six Custom 300 V8 Fairlane 500 V8	\$2004 \$2219 \$2395	3197 3334 3452	116.0 116.0 118.0	201.7 201.7 207.7	77.0 77.0 77.0	57.2 57.2 57.2	40.1 40.1 40.6	223.0 271.0 292.0	144 100 212	8.6 8.6 9.1	212 270 297	3.62 x 3.60 3.62 x 3.30 3.75 x 3.30	<b>FORD</b> Custom Six Custom 300 V8 Fairlane 500 V8
<b>CHEVROLET</b> One-Fifty Six Two-Ten V8 Bel Air V8	\$2020 \$2246 \$2405	3281 3291 3353	115.0 115.0 115.0	200.0 200.0 200.0	73.9 73.9 73.9	59.9 59.9 59.9	41.5 41.5 41.5	235.5 265.0 283.0	140 162 220	8.0 8.0 9.5	210 257 300	3.56 x 3.94 3.75 x 3.00 3.87 x 3.00	<b>CHEVROLET</b> One-Fifty Six Two-Ten V8 Bel Air V8
<b>PLYMOUTH</b> Plaza Six Plaza V8 Belvedere V8	\$2025 \$2125 \$2380	3260 3405 3475	118.0 118.0 118.0	204.0 204.6 204.6	78.2 78.2 78.2	56.5 56.6 56.6	42.4 42.4 42.4	230.0 277.0 301.0	132 197 215	8.0 8.0 8.5	205 270 285	3.25 x 4.63 3.75 x 3.13 3.91 x 3.13	<b>PLYMOUTH</b> Plaza Six Plaza V8 Belvedere V8
<b>STUDEBAKER</b> Champion Six Commander V8 Pres. Classic V8 Silver Hawk Six Silver Hawk V8 Golden Hawk V8	\$2040 \$2173 \$2558 \$2142 \$2263 \$3182	2810 3140 3270 2790 3185 3400	116.5 116.5 120.5 120.5 120.5 120.5	202.4 202.4 206.4 203.0 203.0 203.0	75.8 75.8 75.8 71.3 71.3 71.3	59.5 59.8 59.9 54.7 54.7 55.1	39.5 30.5 41.0 41.0 41.0 41.0	185.6 250.2 280.0 185.6 280.0 280.0	161 180 225 101 78 275	7.8 7.8 8.3 7.8 7.8 7.5	152 260 305 152 300 333	3.00 x 4.375 3.563x3.250 3.563x3.625 3.00 x 4.375 3.563x3.250 3.563x3.625	<b>STUDEBAKER</b> Champion Six Commander V8 Pres. Classic V8 Silver Hawk Six Silver Hawk V8 Golden Hawk V8
<b>DODGE</b> Coronet Six Coronet V8 Custom Royal V8	\$2410 \$2518 \$2826	3470 3620 3690	122.0 122.0 122.0	212.2 212.2 212.2	77.0 77.0 77.0	56.6 56.8 56.8	43.8 43.8 43.8	210.0 325.0 325.0	138 245 260	8.0 8.5 8.5	208 320 335	3.25 x 4.63 3.69 x 3.80 3.69 x 3.80	<b>DODGE</b> Coronet Six Coronet V8 Custom Royal V8
<b>PONTIAC</b> Chieftain V8 Super Chief V8 Star Chief V8	\$2492 \$2620 \$2804	3560 3585 3630	122.0 122.0 124.0	206.8 206.8 213.8	75.0 75.2 75.2	60.0 60.1 60.1	42.5 42.5 43.0	347.0 347.0 347.0	227 244 244	8.5 8.5 8.5	333 338 338	3.94 x 3.56 3.94 x 3.56 3.94 x 3.56	<b>PONTIAC</b> Chieftain V8 Super Chief V8 Star Chief V8
<b>MERCURY</b> Monterey V8 Montclair V8 Turnpike Cruiser	\$2605 \$3148 \$3500	3800 3905 4050	122.0 122.0 122.0	211.1 211.1 211.1	79.1 79.1 79.1	56.6 56.6 56.6	43.3 43.3 43.3	312.0 312.0 368.0	255 255 290	9.75 9.75 9.75	340 340 405	3.80 x 3.44 3.80 x 3.14 4.00 x 3.66	<b>MERCURY</b> Monterey V8 Montclair V8 Turnpike Cruiser
<b>BUICK</b> Special V8 Century V8 Super V8 Roadmaster V8	\$2609 \$3256 \$3623 \$3981	4001 4156 4354 4469	122.0 122.0 127.5 127.5	208.4 208.4 215.3 215.3	74.8 74.8 77.6 77.6	58.4 58.7 59.4 59.3	43.2 43.2 44.5 44.5	364.0 364.0 364.0 364.0	210 300 300 300	8.0 10.0 10.0 10.0	340 400 400 400	4.125x3.40 4.125x3.40 4.125x3.40 4.125x3.40	<b>BUICK</b> Special V8 Century V8 Super V8 Roadmaster V8
<b>DE SOTO</b> Fireweed V8 Firestone V8 Fireflite V8	\$2724 \$2898 \$3427	3675 3955 4025	122.0 126.0 126.0	215.8 218.0 218.0	78.2 78.2 78.2	56.7 57.0 57.0	43.8 45.3 45.3	325.0 341.0 341.0	245 270 295	8.5 9.25 9.25	320 350 375	3.69 x 3.80 3.78 x 3.80 3.78 x 3.80	<b>DE SOTO</b> Fireweed V8 Firestone V8 Fireflite V8
<b>HUDSON</b> Hornet Super V8	\$2750	3589	121.3	209.3	78.0	60.4	42.0	327.0	255	9.0	345	4.00 x 3.25	<b>HUDSON</b> Hornet Super V8
<b>NASH</b> Ambassador V8	\$2750	3507	121.3	209.3	78.0	60.4	42.0	327.0	255	9.0	345	4.00 x 3.25	<b>NASH</b> Ambassador V8
<b>OLDSMOBILE</b> Eighty-Eight V8 Super 88 V8 Ninety-Eight V8	\$2750 \$2988 \$3601	4000 4040 4347	122.0 122.0 126.0	208.2 208.2 216.7	76.4 76.4 76.4	58.2 58.2 58.2	42.0 42.0 43.0	370.7 370.7 370.7	277 277 277	9.5 9.5 9.5	400 400 400	4.0 x 3.687 4.0 x 3.687 4.0 x 3.687	<b>OLDSMOBILE</b> Eighty-Eight V8 Super 88 V8 Ninety-Eight V8
<b>PACKARD</b> Clipper V8	N.A.	3400*	120.5	211.8	76.0	60.1	40.5	280.0	275	7.8	333	3.563x3.025	<b>PACKARD</b> Clipper V8
<b>CHRYSLER</b> Windsor V8 Saratoga V8 New Yorker V8 300C	\$3030 \$3660 \$4108	3905 4165 4315	126.0 126.0 126.0 126.0	210.2 219.2 219.2 219.2	78.8 78.8 78.8 78.8	57.0 57.0 57.2 54.7	45.3 45.3 45.3 45.3	354.0 354.0 392.0 392.0	285 295 325 375	9.25 9.25 9.25 9.25	365 390 430 420	3.94 x 3.63 3.94 x 3.63 4.00 x 3.90 4.00 x 3.90	<b>CHRYSLER</b> Windsor V8 Saratoga V8 New Yorker V8 300C
<b>CADILLAC</b> Series 62 V8 Series 60 V8 Series 75 V8 Eldorado Seville	\$4713 \$5539 \$7348 \$7218	4505 4755	129.5 133.0 149.8 129.5	215.9 224.1 236.2 221.1	80.0 80.0 80.0 80.0	59.1 59.1 61.6 57.0		365.0 365.0 365.0 365.0	300 300 300 325	10.0 10.0 10.0 10.0	400 400 400 400	4.00 x 3.625 4.00 x 3.625 4.00 x 3.625 4.00 x 3.625	<b>CADILLAC</b> Series 62 V8 Series 60 V8 Series 75 V8 Eldorado Seville
<b>LINCOLN</b> Capri V8 Premiere V8	\$4722 \$5222	4660 4660	126.0 126.0	224.6 224.6	80.3 80.3	60.2 60.2	45.5 45.5	368.0 368.0	300 300	10.1 10.1	415 415	4.00 x 3.66 4.00 x 3.66	<b>LINCOLN</b> Capri V8 Premiere V8
<b>IMPERIAL</b> Imperial V8 Crown V8 LeBaron V8	\$4764 \$5325 \$5646	4646 4740 4765	129.0 129.0 129.0	224.0 224.0 224.0	81.2 81.2 81.2	56.7 56.7 56.7	46.4 46.4 46.4	392.0 392.0 392.0	325 325 325	9.25 9.25 9.25	430 430 430	4.00 x 3.90 4.00 x 3.90 4.00 x 3.90	<b>IMPERIAL</b> Imperial V8 Crown V8 LeBaron V8
<b>CONTINENTAL</b> Two-dr. hardtop	\$6695	4797	126.0	218.5	77.5	56.0	45.3	368.0		10.0		4.00 x 3.66	<b>CONTINENTAL</b> Two-dr. hardtop
<b>THUNDERBIRD</b> Two-door hardtop Optional engine	\$3367	3290	102.0	181.4	72.8	51.6	34.0	292.0 312.0	212 245	9.1 9.7	297 332	3.75 x 3.30 3.80 x 3.44	<b>THUNDERBIRD</b> Two-door hardtop Optional engine
<b>CORVETTE</b> Two-door hardtop With fuel injection	\$3437 \$3917	2730	102.0	168.0	70.5	51.1	36.9	283.0 283.0	220 283	9.5 10.5	300 290	3.875x3.00 3.875x3.00	<b>CORVETTE</b> Two-door hardtop With fuel injection

## NOTES

\* Estimated.  
† Overdrive standard.  
‡ With optional engine.  
§ Automatic transmission standard.  
All specifications except Studebaker Hawks, Chrysler 300C, Cadillac Eldorado, Continental, Thunderbird, Corvette and Volkswagen are for four-door models. For those cars that do not offer four-door sedans, specifications are for the equivalent four-door hardtop.

All dimensions are in inches except turn-circle diameters which are in feet.

Prices are the advertised-delivered price and include federal taxes and all charges except freight to your city, optional equipment, state and local taxes.

All horsepower ratings are for standard equipment models only, except as noted. Additional horsepower is available on many cars with various extra-cost options.



# Compare the 1957 Cars

**S**PECIFICATIONS can be confusing when you have nothing to compare. Properly organized, they will save you time and effort.

Here, in order, are various vital statistics on the new cars. Also shown are industry averages. All are for four-door models when they are available.

These lists will be helpful if you have a long-legged mother-in-law who demands plenty of room in the back seat. If garage space is a problem, the answers are here also.

Prices shown include Federal taxes and everything but freight to your city, optional equipment and state or local taxes.

## Displacement

Imperial	392.0
Chrysler New Yorker	392.0
Oldsmobile	370.7
Continental	368.0
Lincoln	368.0
Mercury Turn. Cruiser	368.0
Cadillac	365.0
Buick	364.0
Chrysler Windsor	354.0
Chrysler Saratoga	354.0
Pontiac	347.0
De Soto	341.0
Nash	327.0
Hudson	327.0
De Soto Firesweep	325.0
Dodge	325.0
Mercury	312.0

**Average 306.50**

Plymouth	301.0
Packard	289.0
Studebaker Classic	289.0
Plymouth Plaza V8	277.0
Ford Custom V8	272.0
Chevrolet V8	265.0
Studebaker Commander	259.2
Rambler V8	250.0
Chevrolet 6	235.5
Dodge 6	230.0
Plymouth 6	230.0
Ford 6	223.0
Rambler 6	195.6
Studebaker Champ	185.6

## Horsepower

(Standard equipment only)

Imperial	325
Chrysler New Yorker	325
Cadillac	300
Buick Roadmaster	300
Buick Super	300
Buick Century	300
Lincoln	300
Chrysler Saratoga	295
De Soto Fireflite	295
Mercury Turn. Cruiser	290
Chrysler Windsor	285
Oldsmobile	277
Packard	275
De Soto Firedome	270
Dodge Cust. Royal	260
Hudson	255
Nash	255
Mercury Montclair	255
Mercury Monterey	255
De Soto Firesweep	245
Dodge Royal	245
Pontiac Super Chief	244
Pontiac Star Chief	244

**Average 234.58**

Pontiac Chieftain	227
Plymouth Savoy V8	215
Plymouth Belvedere V8	215
Ford Fairlane 500 V8	212
Buick Special	210
Studebaker Classic	210
Plymouth Plaza V8	197
Rambler V8	190

Ford Custom V8	190
Studebaker Comm. V8	180
Chevrolet V8	162
Ford Custom 6	144
Chevrolet 6	140
Dodge 6	138
Plymouth 6	132
Rambler 6	125
Studebaker Champion	101

## Shipping Weight

Continental	4797
Imperial LeBaron	4765
Cadillac 60	4755
Imperial Crown	4740
Lincoln	4660
Imperial	4646
Cadillac 62	4595
Buick Roadmaster	4469
Buick Super	4354
Oldsmobile 88	4347
Chrysler New Yorker	4315
Chrysler Saratoga	4165
Buick Century	4156
Olds Super 88	4049
De Soto Fireflite	4025
Buick Special	4001
Oldsmobile 88	4000
Chrysler Windsor	3995
De Soto Firedome	3955
Mercury Montclair	3905
Mercury Monterey	3890

**Average 3818.2**

Dodge Custom Royal	3690
De Soto Firesweep	3675
Pontiac Star Chief	3630
Dodge Royal	3620
Nash	3597
Hudson	3589
Pontiac Super Chief	3585
Pontiac Chieftain	3560
Plymouth Belvedere	3475
Dodge 6	3470
Ford Fairlane	3452
Plymouth Savoy	3415
Plymouth Plaza	3405
Packard (estimated)	3400
Ford Custom	3334
Chevrolet 6	3300
Chevrolet V8	3291
Studebaker Classic	3270
Plymouth Plaza 6	3260
Ford Custom 6	3197
Rambler V8	3179
Studebaker Comm. V8	3140
Rambler 6	2891
Studebaker Champ. 6	2810

## Over-all Length

Cadillac	236.2
Lincoln	224.6
Cadillac 60	224.4
Imperial	224.0
Chrysler	219.2
Continental	218.5
De Soto Firedome	218.0
De Soto Fireflite	218.0
Oldsmobile 98	216.7
Cadillac 62	215.9

De Soto Firesweep	215.8
Buick Super	215.3
Buick Roadmaster	215.3
Pontiac Star Chief	213.8
Dodge	212.2

**Average 211.89**

Packard	211.8
Mercury	211.1
Hudson	209.3
Nash	209.3
Buick Special	208.4
Buick Century	208.4
Oldsmobile 88	208.2
Olds Super 88	208.2
Ford Fairlane	207.7
Pontiac Chieftain	206.8
Pontiac Super Chief	206.8
Studebaker Classic	206.4
Plymouth	204.6
Studebaker Comm.	202.4
Studebaker Champ	202.4
Ford Custom	201.7
Chevrolet	200.0
Rambler	191.1

## Pounds Per Horsepower

(Standard equipment only)

Packard (estimated)	12.36
Chrysler New Yorker	13.28
De Soto Fireflite	13.64
Buick Century	13.85
Chrysler Windsor	14.02
Hudson	14.07
Nash	14.11
Chrysler Saratoga	14.12
Dodge Custom Royal	14.19
Imperial	14.30
Oldsmobile 88	14.44
Buick Super	14.51
Olds Super 88	14.62
De Soto Firedome	14.65
Pontiac Super Chief	14.69
Dodge Royal	14.78
Pontiac Star Chief	14.88
Buick Roadmaster	14.90
De Soto Firesweep	15.00
Mercury Monterey	15.25
Mercury Montclair	15.31
Cadillac 62	15.32
Lincoln	15.53
Stude. Pres. Classic	15.57
Pontiac Chieftain	15.68
Oldsmobile 98	15.69
Cadillac 60	15.85
Plymouth Savoy V8	15.88
Plymouth Belvedere V8	16.16
Ford Fairlane V8	16.28

**Average 16.62**

Rambler V8	16.73
Plymouth Plaza V8	17.28
Studebaker Comm.	17.44
Ford Custom V8	17.55
Buick Special	19.05
Chevrolet V8	20.31
Ford Custom 6	22.20
Rambler 6	23.13
Chevrolet 6	23.57
Plymouth Plaza 6	24.71
Dodge 6	25.14
Studebaker Champ. 6	27.82

### Front Hiproom

Cadillac 75	65.5
Buick Super	65.5
Buick Roadmaster	65.3
Cadillac 62	65.2
Cadillac 60	65.0
Nash	65.0
Hudson	65.0
Imperial	63.5
Chrysler	63.0
De Soto	63.0
Dodge	63.0
Plymouth	63.0

Average 62.59

Buick Special	62.5
Buick Century	62.5
Oldsmobile 88	62.5
Olds Super 88	62.5
Oldsmobile 98	62.3
Chevrolet	62.1
Pontiac	61.9
Lincoln	61.7
Mercury	61.3
Ford Custom	60.3
Ford Fairlane	60.0
Rambler	59.8
Continental	59.6
Packard	59.5
Studebaker	59.5

### Rear Hiproom

Cadillac 60	65.0
Cadillac 62	65.0
Buick Super	65.0
Buick Roadmaster	64.8
Hudson	64.5
Nash	64.5
Lincoln	63.8
Imperial	63.2
Pontiac	63.1
Chevrolet	63.0
Mercury	62.9
Chrysler	62.7
De Soto	62.7
Dodge	62.7
Plymouth	62.7
Buick Special	62.2
Buick Century	62.2
Oldsmobile 88	62.2
Olds Super 88	62.2

Average 62.20

Olds 98	62.0
Ford Custom	60.3
Ford Fairlane	60.1
Rambler	60.1
Packard	59.0
Studebaker	59.0
Cadillac 75	57.8
Continental	56.6

### Front Legroom

Imperial	46.2
Plymouth	45.9
Dodge	45.5
Chrysler	45.5
De Soto	45.5
Cadillac 60	45.2
Cadillac 62	45.0
Lincoln	44.8
Chevrolet	44.7
Oldsmobile 88	44.4
Ford Custom	44.3
Olds Super 88	44.2
Oldsmobile 98	44.2
Mercury	44.2

Average 44.11

Packard	44.0
Buick Super	44.0
Buick Roadmaster	43.6
Cadillac 75	43.5
Buick Special	43.4
Pontiac	43.4
Buick Century	43.3
Ford Fairlane	43.2
Rambler	43.0
Nash	42.5
Hudson	42.5
Continental	42.5
Studebaker	42.5

### Rear Legroom

Cadillac 60	45.3
Cadillac 62	45.2
Buick Super	45.0
Buick Roadmaster	45.0
Imperial	45.0
Chrysler	43.0
De Soto	43.0
Dodge	42.5
Lincoln	42.5
Buick Special	42.4
Buick Century	42.3

Average 42.05

Rambler	42.0
Pontiac Chieftain	42.0
Ford Custom	41.8
Pontiac Star Chief	41.8
Pontiac Super Chief	41.8
Oldsmobile 98	41.8
Oldsmobile 88	41.8
Olds Super 88	41.6
Plymouth	41.5
Mercury	41.4
Packard	41.0
Studebaker Classic	41.0
Ford Fairlane	40.7
Nash	40.1
Hudson	40.1
Chevrolet	39.8

Continental	39.1
Studebaker	39.0

### Front Headroom

Cadillac 75	36.6
Studebaker	36.5
Packard	36.5
Hudson	36.4
Nash	36.4
Chevrolet	36.0
Rambler	36.0
Pontiac	35.8
Buick Super	35.8
Lincoln	35.4
Oldsmobile 88	35.3
Plymouth	35.3

Average 35.27

Buick Century	35.2
Continental	35.1
Cadillac 62	35.0
Olds Super 88	34.9
Ford Custom	34.9
Oldsmobile 98	34.8
Chrysler	34.8
De Soto	34.8
Dodge	34.8
Buick Roadmaster	34.6
Imperial	34.5
Mercury	33.9
Ford Fairlane	33.9
Cadillac 60	33.9

### Rear Headroom

Pontiac	35.8
Chevrolet	35.6
Studebaker	35.5
Packard	35.5
Cadillac 75	35.3
Hudson	35.3
Nash	35.3
Rambler	35.0
Buick Super	35.0
Cadillac 62	34.9
Cadillac 60	34.7
Chrysler	34.6
De Soto	34.6
Continental	34.6

Average 34.50

Buick Roadmaster	34.3
Dodge	34.2
Imperial	34.2
Plymouth	34.2
Lincoln	34.1
Oldsmobile 88	33.8
Olds Super 88	33.8
Buick Century	33.8
Ford Custom	33.6
Ford Fairlane	33.6
Mercury	33.5
Oldsmobile 98	33.4
Buick Special	33.3

## ADVERTISED-DELIVERED PRICES

(Lowest-price 4-door models except as noted)

<b>\$1400</b>	Volkswagen 2-dr. ....\$1495	<b>\$2300</b>	Ford Fairlane V8.....\$2349	<b>\$3000</b>	Chrysler Windsor.....\$3030
<b>\$1500</b>	Metropolitan 2-dr.....\$1527		Chevrolet Bel Air V8...\$2362	<b>\$3100</b>	Mercury Montclair.....\$3148
<b>\$1900</b>	Rambler Deluxe 6.....\$1925		Plymouth Belvedere V8..\$2380	<b>\$3200</b>	Buick Century .....\$3296
<b>\$2000</b>	Ford Custom 6.....\$2004	<b>\$2400</b>	Ford Fairlane 500 V8...\$2395	<b>\$3400</b>	De Soto Fireflite.....\$3427
	Chevrolet 150 6.....\$2020		Stude. President V8....\$2407	<b>\$3500</b>	Mercury Turnpike Cruiser..\$3500
	Plymouth Plaza 6.....\$2025		Dodge Coronet 6.....\$2410	<b>\$3600</b>	Buick Super .....\$3623
	Stude. Champion.....\$2049		Pontiac Chieftain V8...\$2492		Chrysler Saratoga.....\$3660
	Rambler Super 6.....\$2065	<b>\$2500</b>			Oldsmobile 98.....\$3691
<b>\$2100</b>	Ford Custom V8.....\$2104		Dodge Coronet V8.....\$2518	<b>\$3900</b>	Buick Roadmaster.....\$3981
	Ford Custom 300 6.....\$2119		Stude. Pres. Classic V8...\$2538	<b>\$4100</b>	Chrysler New Yorker....\$4108
	Chevrolet 150 V8.....\$2120	<b>\$2600</b>		<b>\$4700</b>	Cadillac 62.....\$4713
	Plymouth Plaza V8.....\$2125		Mercury Monterey.....\$2605		Lincoln Capri.....\$4722
	Chevrolet 210 6.....\$2146		Buick Special.....\$2609		Imperial .....\$4764
	Rambler Custom 6.....\$2155		Pontiac Super Chief....\$2629	<b>Over \$5000</b>	Lincoln Premiere.....\$5222
	Plymouth Savoy 6.....\$2164		Dodge Royal.....\$2657		Imperial Crown.....\$5325
	Stude. Champ. Deluxe...\$2171	<b>\$2700</b>			Cadillac 60 Special.....\$5539
	Stude. Comm. V8.....\$2173		De Soto Firesweep.....\$2724		Imperial LeBaron.....\$5646
	Rambler Super V8.....\$2195		Hudson Super.....\$2750		Eldorado Seville 2-dr....\$7218
<b>\$2200</b>	Ford Custom 300 V8....\$2219		Nash Super.....\$2750		Cadillac 75.....\$7248
	Ford Fairlane 6.....\$2249	<b>\$2800</b>	Oldsmobile 88.....\$2756		Cadillac 75 Limousine...\$7586
	Chevrolet Bel Air 6.....\$2262		Pontiac Star Chief.....\$2804		Continental 2-dr.....\$9695
	Plymouth Savoy V8.....\$2264		Dodge Custom Royal....\$2826		
	Plymouth Belvedere....\$2280		De Soto Fire dome.....\$2898		
	Rambler Custom V8....\$2285	<b>\$2900</b>			
	Ford Fairlane 500 6....\$2295		Hudson Custom.....\$2940		
	Stude. Comm. Deluxe V8..\$2295		Nash Custom.....\$2940		
			Olds Super 88.....\$2988		

## WHAT IS A HORSEPOWER?

Officially, the definition of a horsepower is 550 foot pounds of work per second or 33,000 foot pounds of work per minute. That is the amount of work that James Watt decided a healthy horse could perform. But it doesn't mean much to most of us.

To give you an idea of what one horsepower is here is a different example:

If you weigh 165 pounds or so, climb one flight of stairs (about 10 feet of vertical climb) in three seconds and you are developing one horsepower.

Perhaps that doesn't seem like much work. The reason is that your legs are strong and are accustomed to lifting your body around. Try raising a 165-pound box to a 10-foot-high shelf in three seconds and you'll be more impressed.

Or if you want to get added appreciation of how much work a one-horsepower motor can do for hours on end, climb those stairs all day at a rate of one flight every three seconds! After the first few flights you'll have a new understanding of what one horsepower really is!

THREE SECONDS

TWO SECONDS

ONE SECOND

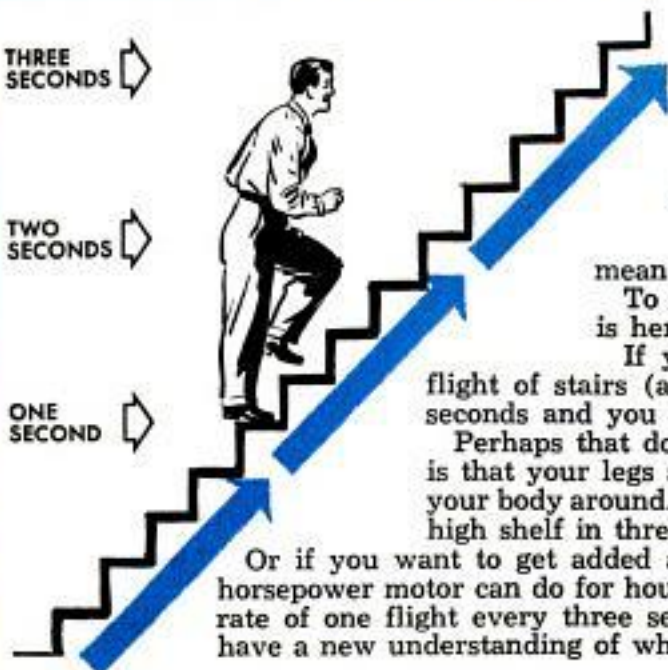

# WHERE DO THE HORSES GO?

By Dale Kelly, SAE

**I**F ALL THE power developed by an automobile were available to accelerate the car, 70 horsepower would, according to simple engineering calculations, take a 4000-pound car from a standstill to 60 miles per hour in 13 seconds.

Yet modern cars capable of such performance have to develop, on a chassis dynamometer, a rear-wheel horsepower of 100 to 110 and they require an advertised engine output of around 200 horsepower. Apparently, considerable power is lost in converting gasoline energy to automobile performance.

This article, based in part on a series of

papers presented before the Society of Automotive Engineers, will show the various ways in which the heat energy of the gasoline reaching the carburetor is lost or wasted before a small fraction of it becomes available at the rear wheels to accelerate the car.

For illustration purposes, we will describe what happens in a car equipped with power steering, air conditioning, an engine with an advertised horsepower of 200, and a weight with two passengers of 4000 pounds. This imaginary car corresponds roughly to a so-called "loaded" car in the low-price field.

An engine advertised at 200 horsepower, running wide open on a test stand, uses about 15 gallons of gasoline per hour. The heat energy of this amount of gasoline would be equal, if completely converted to mechanical energy, to 750 horsepower or six times as much as can be obtained from the same amount of dynamite.

But even in the best of today's engines about half of the heat energy of the fuel is lost in the hot exhaust gases and almost half of what's left is carried to the radiator by the cooling water. Older, low-compression engines waste even more energy in the form of heat.

The remainder is converted to mechanical power and delivered to the tops of the pistons. This power can be measured with a cylinder-pressure indicator and is known as the indicated horsepower.

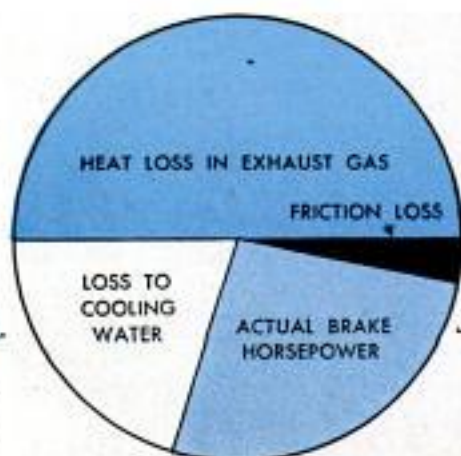
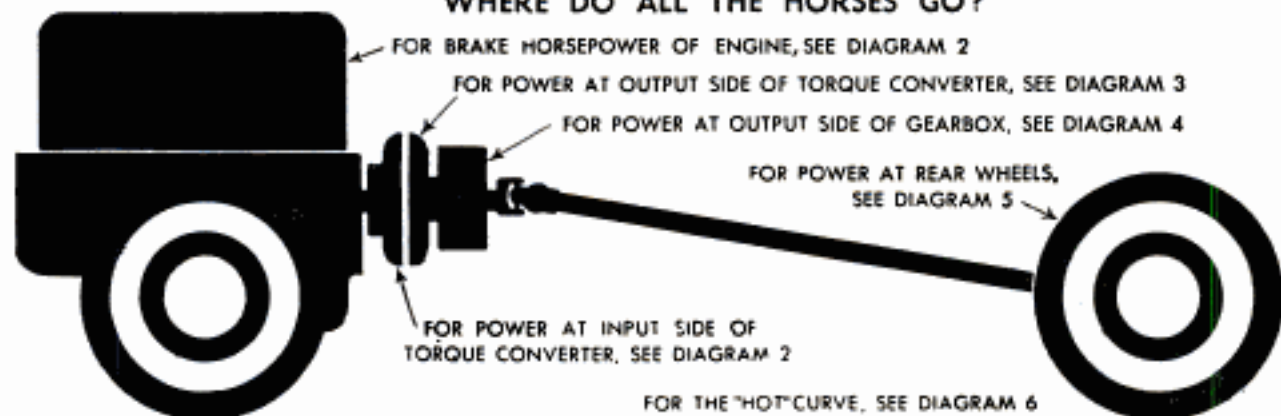

FIGURE 1

Horsepower ratings of cars go up every year. Engines of 300 horsepower are not unusual anymore. 200 horsepower seems to be a bare minimum for a family car these days. What happens to all this power? What is it used for? *PM* asked its engineering authority, Dale Kelly, to explain where all this horsepower goes. Here is his report with explanatory graphs.

### WHERE DO ALL THE HORSES GO?



But this indicated horsepower can do no work without moving pistons and other parts of the engine. That means additional power is lost in piston and bearing friction and in driving the oil and water pumps.

The remainder, about a quarter of the total energy in the fuel, is delivered to the dynamometer or "brake" with which an engine is loaded while on test and is known as the brake horsepower.

The dotted curve shows the indicated horsepower at various engine speeds. The curve just below it is the brake horsepower. The highest point on the brake-horsepower curve is the advertised horsepower.

Advertised horsepower is obtained on an engine not encumbered by a fan, generator, muffler or air cleaner. No heat is applied to the inlet manifold to inflate the air and reduce the weight the engine can draw in, and the ignition is advanced to maximum power setting regardless of whether ordinary gasoline would knock at such a setting.

Finally, the results are based on the relatively favorable atmospheric conditions adopted as standard by the Society of Automotive Engineers. These conditions include: Sea-level pressure, no water vapor to dilute the oxygen supply, and air entering the carburetor at a cool 60 degrees. That's how advertised horsepower is obtained. It is not the horsepower you get when you drive the car.

When the engine is installed in a car, the horsepower at high speed is reduced 7 percent by dual mufflers or 14 percent by a single muffler and another 3 percent by the air cleaner. These losses, however, are much less at medium speeds and negligible at low speeds.

Power is reduced from 1 to 5 percent by the amount of manifold heating usually supplied to give good warmup in cold weather and is reduced another 1 to 6 percent (more at low speed, less at high speed) by ignition timing necessary to prevent knocking on present fuels.

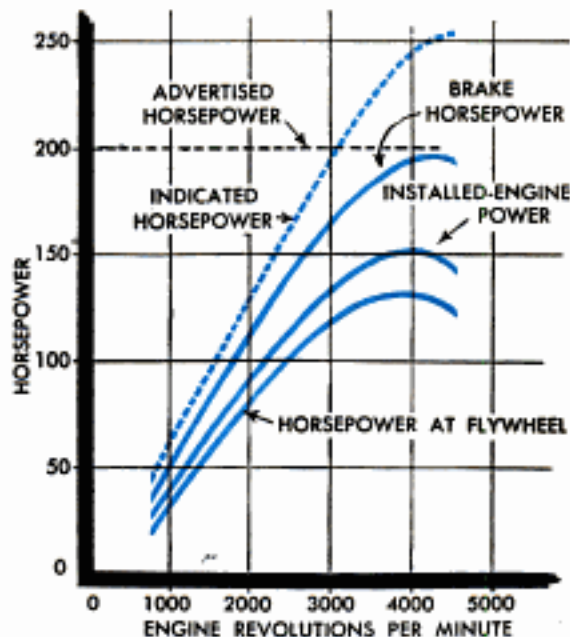

FIGURE 2

Driving in the average Detroit weather (instead of the SAE standard) would reduce the power at all speeds by about 10 percent.

The third curve on the graph (installed-engine power) shows that when all these factors are taken into account, our original 200 horses at 4400 revolutions per minute have shrunk to 153 at 4000 r.p.m. But this is only the beginning!

The generator drag depends on the

battery condition and on the electrical load.

With no load except the ignition, the generator requires about one horsepower when the battery is fully charged and about two horsepower when it is almost dead. This drag is increased about  $\frac{1}{4}$  horsepower by the headlights and  $\frac{1}{10}$  horsepower by a typical car radio.

A typical fan requires just over  $\frac{1}{2}$  horsepower at an engine speed of 2000 r.p.m., but the drag goes up with the third power of the speed. At twice the speed the fan requires eight times ( $2 \times 2 \times 2$ ) the power or  $4\frac{1}{2}$  horsepower.

This is inherently wasteful, because while  $\frac{1}{2}$  horsepower is occasionally needed to cool the engine at 2000 r.p.m., nothing remotely approaching  $4\frac{1}{2}$  horsepower is needed to move enough cooling air at any speed, slow or fast. If the fan were driven only when needed by a thermostatically controlled clutch, it would be idle most of

the time. Mercury now has such a clutch.

Air conditioning and power steering take engine power, too. The hydraulic pump used in power steering takes about 2 horsepower at 4000 r.p.m. when the car is moving straight ahead, more when turning.

A typical air-conditioner compressor takes 9 horsepower at an engine speed of 4000 r.p.m., but it does not run under load all the time unless the weather is extremely hot and the thermostat set for maximum.

The refrigerant condenser used in air conditioning is mounted ahead of the radiator and the size or speed of the engine fan increased. It may take  $7\frac{1}{2}$  horsepower.

From all the above you can see (by looking at the bottom curve in Figure 2) that the engine rated at 200 horsepower actually delivers 135 horsepower to the transmission when installed in a car with power steering and air conditioning and operated in hot weather.

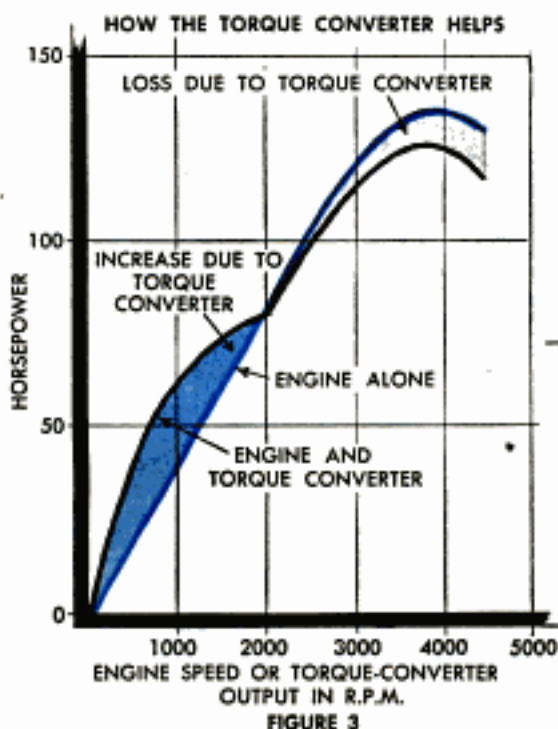

The power developed by any internal-combustion engine is nearly proportional to its speed. In other words, it is poor at low engine speeds.

This fact, illustrated by the curves in Figure 2, is the reason why to get good performance at low car speeds you have to increase engine speed and, therefore, rear-wheel power by a transmission.

In most modern automatic transmissions, power from the engine flows first to a torque converter. At high car speeds, the entire torque converter locks together and turns as a unit, giving virtually no increase in engine revolutions. But at low car speeds the converter permits engine speed and power to increase and the added power is delivered in the form of increased torque at the converter output. This is shown by the blue area on the graph. The solid blue line shows what the power would have been without a converter.

Note that the peak power at high speeds is somewhat cut down by losses in the torque converter (gray area). The lost power is evident as heat in the converter oil. At low speeds, the power is increased by the converter (black line).

Still more power at low car speeds can be obtained if the power output of the torque converter is made to pass through a gearbox with one or more gear ratios that can be engaged as needed.

Most modern transmissions have a planetary gear train with one or two forward speeds, in addition to direct drive and a reverse.

The power-output curve of the gearbox is similar in shape to the solid-black line shown in Figure 3, but it is pushed to the left by an amount which depends upon the gear ratio in use.

You can see that we have developed a more horizontal power curve. This is desirable for good performance under a variety of car speeds.

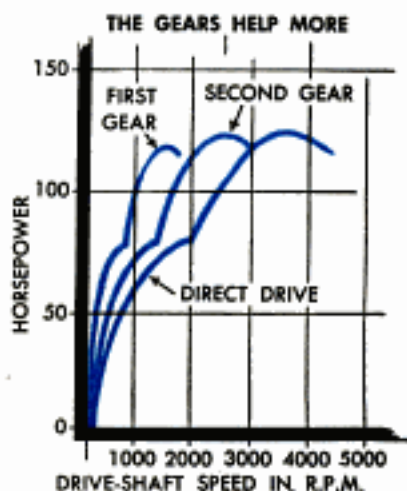



Combining those parts of the curves in Figure 4 that are used in a typical automatic transmission and deducting 5 percent for losses in the rear axle, we get the maximum power available at the rear wheels.

The lower solid-blue curve (marked "total power required to go at this speed") shows how sharply the need for more power increases as speed increases. Most of this sharp increase is due to wind resistance. Tire friction and front-wheel-bearing friction increase more gradually as speed increases.

The point where the two solid-blue lines come together is, of course, the maximum speed you can get from this car.

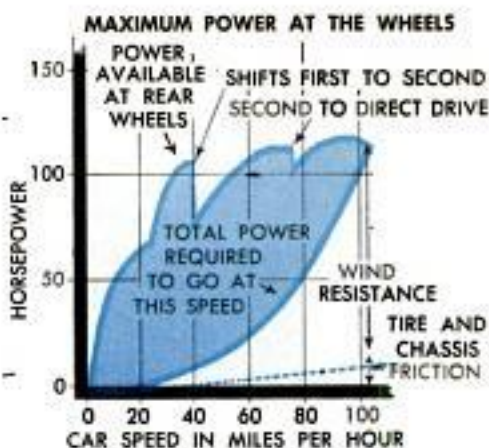

FIGURE 5

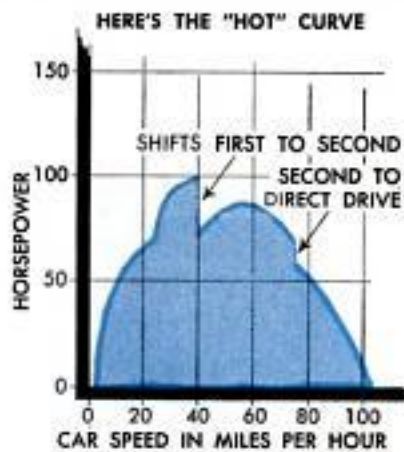

FIGURE 6

The height of this curve is equal to the height of the blue area in Figure 5.

It shows how much reserve power a motorist, cruising on the level, can call on by tramping down to accelerate or climb a hill. This is the horsepower curve that tells you how "hot" the car is. It is the only horsepower curve that does.

The curve drops to zero at a standstill

and at the maximum speed, but the horsepower is fairly constant in the middle-speed range where most driving is done. In the car considered here, reserve power is between 80 and 90 at most speeds from 20 to 70 miles per hour. From the standpoint of road performance, therefore, this car could be better described as an 85-horsepower car than as a 200-horsepower car.

Acceleration at any speed can be figured from the reserve horsepower at that speed. Simply divide the reserve power (per 1000 pounds of car weight) by the acceleration requirement below for any given speed. The result is the acceleration in miles per hour per second.

Speed, m.p.h.	20	30	40	50	60	70	80
Power requirement:	3.0	4.1	5.2	6.4	7.6	8.9	10.1

Thus if you have a reserve power of 100 at 60 miles per hour in a 4000-pound car, you can accelerate at a rate of 5.7 miles per hour per second from that speed.

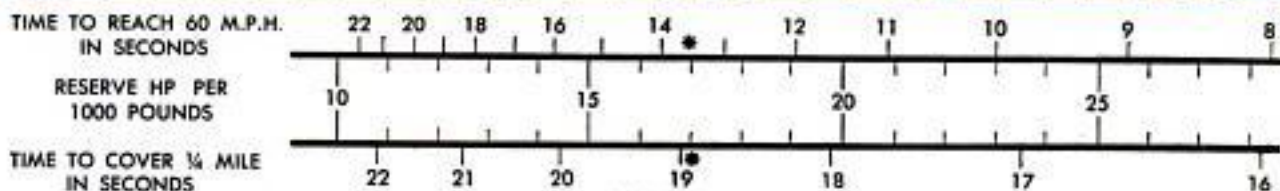

FIGURE 7

The approximate time required to reach 60 miles per hour or to cover a quarter of a mile from a standing start can be determined from the average reserve power.

For example, the car we are considering has an average reserve between 0 and 60 miles per hour of about 70 horsepower or about 17 horsepower per 1000 pounds. It will, therefore, reach 60 in about 13 or 14 seconds and cover a quarter mile in about 19 seconds (see asterisks on scale).

Conversely, if you have measured the time for 0-to-60 or for a quarter mile from a standing start, the chart shown here will give you the average reserve horsepower.

Incidentally, don't let anyone tell you that engine torque, rather than horsepower, is the real tipoff to car performance.

No matter how high the engine torque, the car can't give good all-around performance without a high ratio of reserve horsepower to weight.

Likewise, barring an improper rear-axle ratio or the use of the wrong transmission gear (for example, accelerating a manual-transmission car from 20 miles per hour in high gear) a good power-to-weight ratio will always give good performance, with perhaps some sacrifice in engine durability, no matter how low the torque.



Mystery: Find the road! Spectators come to the rescue of drivers mired in the soupy Australian quagmire



# The World's Toughest Car Test

By Roland Burggraf

Drivers help each other when the going gets too rough. If not, one stuck car will hold up the entire parade





It's midnight, but crowds await the cars in mid-Australian towns. Note the kangaroo guards on front of car

**A**USTRALIANS BELIEVE in legalized torture—at least of cars and drivers in the famed 'round-the-continent Reliability Trials.

Every year Australians put on two torturous car tests apparently designed to prove that anything will break if it is bent often enough!

Each trial covers as many as 8500 miles of snow, mountains, deserts, tropical bogs and rock-covered plains. And the object seems to be to avoid anything as civilized as a road wherever possible.

Prizes worth more than \$75,000 are at stake. One of the trials, the Mobilgas Trial, is open to all stock cars built since 1950. The other, the Ampol Trial, permits stocks of any year.

In the two trials, 210 cars took part last year. Only 55 of them finished. Dozens of drivers ended up in hospitals, some seriously injured trying to maintain the almost impossible average speed of 40 miles per hour required to keep from being penalized. Two drivers were killed when their car plunged over a cliff.

Four teams of drivers nearly died of thirst and starvation when their vehicles broke down in the baked desert country deep inside the big continent. Many others were saved from a similar plight by rescue aircraft.

Of the cars taking part, about half were written off as complete wrecks. The others ended up in dealers' showrooms as proof of their durability.

And proof it is indeed. The course is laid out to be as torturous as possible. Highways and roads are skirted wherever a goat

track can be found. Survey teams take about eight weeks to plot the course (a different course is used each year). Each trial tries to outdo the other in sadistic achievement.

Competitors are expected to cover the 8000 miles in two weeks. On various legs of the route, average speeds are even greater than 40 miles per hour.

In one trial, a maximum rest period of 12 hours for the crews met with bitter protests. Drivers complained that such a schedule made the trial more an endurance test for humans than a reliability test for cars.

There is actually a lot of both in the trials. Both driver and car have to be outstanding to come through successfully.

If the route turns out to be too easy, custom calls for the addition of a surprise section known as the "horror stretch." This section involves new, sadistic trails blazed into the heart of the mountainous timber country, and spiced with a sprinkling of virtually impassable creek beds and treacherous mud bogs. These horror stretches are usually saved for last-minute inclusion should a particularly skilled (and lucky) driver appear to be coming through without too many penalty points.

Thousands of spectators watch the trials across the continent, ranging from well-to-do socialites in Sydney to primitive aboriginals who roam the inland deserts in tribes. Helpful fans follow behind the cars in some areas or wait beside likely spots to help lift them out of bogs and creek beds. Every town provides hot food for weary drivers.



Home is a long way off at a time like this! Each trial has a "horror stretch" through the tropical jungle

When the trial does happen to be routed along a road, the cars are driven wide open to build up precious time advantage so there are extra minutes for engine adjustments and repairs at the next control point. Speeds of 100 miles per hour over gravel roads are not unusual—often with unfortunate results as the cars spin out, ending up in the ditch.

The most common hazard is the kangaroo. These mammals, which grow to a height of 10 feet and often weigh 500 pounds, frequent the center of the con-

tinent in packs numbering hundreds of thousands. When they decide to play tag with the contestants, there's little a driver can do. Their amazingly powerful hind legs carry them upward and forward in leaps of 40 feet or more. They bounce along in front of the cars with complete unconcern and sometimes, as the saying goes, they zig when they should have zagged or vice versa!

Over one 3000-mile stretch two well-known trials drivers drove continuously without sleep to pile up a fine record only to meet disaster when they hit a kangaroo, wrecking their car. Not only did the impact wreck the car, but the 'roo was thrown through the windshield scattering glass and hospitalizing both drivers for cuts and concussions.

One stage of the run that covered 1339 miles had to be covered in 36 hours and included only one two-hour meal break during the whole period. To meet that schedule required an average of almost 40 miles per hour for 36 hours with most of it on poor roads or no roads at all, in the normal meaning of the word.

There are other problems, too. Drivers complain that signposts are sometimes changed (either by unfair competitors

Too much speed, a soft, slick corner and this old-time Airflow Chrysler was out of the race. About 75 percent of the cars fail to make it home





On stretches like this, the cars are driven wide open to pick up valuable minutes for needed rest and repairs

or by local residents who resent the fact that the cars ruin their primitive roads) and as a result, cars wind up in dead-end canyons in the dark of night.

Thus far the trials have been dominated by the light European cars. Competing against dozens of big American and British cars, such light cars as the Renault, the Volkswagen and the Peugeot have taken almost all honors. The one exception was in 1953 when a 1948 Ford V8 won the open event.

This year, Volkswagen almost monopolized the winnings, taking the open and team events in the 7000-mile Ampol Trial and also in the 8500-mile Mobilgas Trial.

Of the American cars, the only recent success was chalked up by a Ford Customline which won the class and team events for the over-2500-cubic-centimeter class. However, it was 162 points behind the 1500-class Volkswagen in the open.

Drivers claim that the short body and almost complete lack of overhang, plus the indestructible air-cooled engine in the rear, make the VW the ideal trial car. Large American cars, though things of engineering beauty and artistic styling, are at a tremendous disadvantage in woods and swamps.

One thing is certain: Any car that finishes either trial can be proud of its stamina. There's no tougher car test in all the world!

★ ★ ★



Above, one De Soto hit a kangaroo and still finished. It was lucky. Often a total wreck is the result of such a collision. Below, crossing a bridge over an icy mountain stream. Part of the trial is along snow-covered roads in the Australian Alps



# DO SMALL CARS

**T**O FIND OUT for its readers how economical the small, foreign car is, *Popular Mechanics* set up a commuting test run from suburban Elgin, Ill., to downtown Chicago.

The one-way distance is about 39 miles. Half of it is on a four-lane highway with speed limits from 45 miles per hour to unlimited. The other half is on traffic-clogged city streets with 25-mile-per-hour limits.

Eight foreign cars were tested, ranging in price from about \$1200 to \$3400. They range in luxury from the austere Lloyd to the deluxe Borgward and Magette. They represent four countries: England, Ger-

many, France and Sweden, plus the British-American Metropolitan.

Three 1957 American cars were used for comparison: Chevrolet, Ford and Plymouth. No attempt was made to select the most economical model. Instead, the most popular model was used, this being the deluxe series with standard V8 engine and automatic transmission. This combination was considered the "normal" car bought and used by the man who drives to work.

Each car was driven morning and night over precisely the same route at the height of rush-hour traffic. The driver was alone in the car. The same driver made all runs.



## CHEVROLET:

Average miles per gallon: 14.02  
Weekly gasoline bill: \$8.35  
Gasoline cost per mile: 2.1 cents

**H**ERE IN THE United States something strange is taking place: Sales of small foreign cars are increasing faster than the sales of domestic cars (but they still are a mere one percent of the total market).

Foreign-car dealers report that orders are coming in faster than they can be filled. Many are months behind in deliveries. And, the dealers say, there has been a sudden switch in buyer interest from the small racy sports cars to nonglamorous, workaday family car.

What has brought this about? Is economy the reason? Is there enough economy of operation in the small car to override its disadvantages? *PM* wanted to find out.

To learn just how much an owner of a small car saves, *PM* tested eight foreign

cars in the manner described at the top of the page. Here, in summary, is what was learned:

- Small cars will save you considerable money if you drive many miles a day. The more you drive, the more you will save. On the commuter's route *PM* used (admittedly a long one) the saving on gasoline amounted to more than \$300 a year when the most economical small car was pitted against the least economical American car. Oil and tire savings are likely to be on the side of the lighter car also.

- Small cars will probably save you money on service because, being simpler, they are less likely to get out of order. And, when they do need servicing, they require less time because they are easier to work



## FORD:

Average miles per gallon: 12.82  
Weekly gasoline bill: \$9.13  
Gasoline cost per mile: 2.3 cents

# MAKE CENTS?

No attempt was made to squeeze maximum economy from any of the cars. They were driven so as to get the "owner" to work and back as quickly as possible.

A count was made of each stop so no car would be handicapped by extreme traffic situations. Standing time (stop lights and jams) was clocked and recorded. These delays averaged out over the trial period and all cars met about the same general conditions. What differences there were do not seem important enough to change the results of the test.

Finally, completely separate from the main test, a single one-way run was made to get the maximum economy. Speed was held to 55 miles per hour. No fast starts were made. In traffic, cars were driven along with the normal flow. No attempt was made to "get there first." The more economical results of this "relaxed" driving are described in the text of the article.



## PLYMOUTH:

Average miles per gallon:	13.81
Weekly gasoline bill:	\$8.48
Gasoline cost per mile:	2.2 cents



on and time is money in the repair shop.

- Small cars will probably save money on depreciation (with some exceptions) because they cost less and therefore drop less in value each year.

But does all this economy offset the disadvantages of the small car? Here are some limitations to be considered:

- Service is often not easy to obtain and, in some cases when obtainable, is not very good. However, this situation is improving as more foreign cars are sold.

- Comfort and roominess are sacrificed in the very small cars (in the larger "small" cars such as the Magnette and Borgward there is ample room for most uses). Passenger comfort suffers most. The driver in all these cars has plenty of room and, because he drives more effortlessly and with more maneuverability, he is likely to be excessively enthusiastic about his small car. But passengers, deprived of the fun of driving, may complain about the cramped quarters and of being tossed about by the quickness of the turns. Most of the small cars will seat only four adults. Some will seat five. Only one, the Borgward, will seat six persons.

- Very small cars are not likely to have the same prestige or social values as a new American car. Nor are they likely to be as frequently admired. They attract attention all right, but as often as not it will be critical. The small car looks fragile in traffic and is usually scorned by owners of bigger American models. It is also likely to be "pushed around" in traffic by big-car bullies.

Now let's discuss each of the 11 cars tested in more detail.

## Chevrolet Bel Air

Most economical of the three American cars tested was the Chevrolet Bel Air V8 with Powerglide automatic transmission.

During the test runs it averaged 14.02 miles per gallon on regular gasoline. It was a new car at the time the test was made and it is possible that it might require premium fuel (at an added cost per gallon but no added mileage) as it carbons up.

Average cost per mile for gasoline was 2.1 cents and, on the test run, its fuel bill was \$8.35 a week.

In the special "light footed" driving test, the Chevrolet averaged 17.15 miles per



**CITROEN 2CV:**

Average miles per gallon: 47.78  
Weekly gasoline bill: \$2.45  
Gasoline cost per mile: 0.6 cent



**LLOYD:**

Average miles per gallon: 35.45  
Weekly gasoline bill: \$3.30  
Gasoline cost per mile: 0.8 cent



**RENAULT DAUPHINE:**

Average miles per gallon: 35.08  
Weekly gasoline bill: \$3.34  
Gasoline cost per mile: 0.8 cent



**VOLKSWAGEN:**

Average miles per gallon: 31.22  
Weekly gasoline bill: \$3.75  
Gasoline cost per mile: 1.0 cent

gallon, the second best of the three American cars.

The 1957 Chevrolet is an extremely well assembled car, has excellent handling characteristics and responds well to the driver who sits high and has excellent visibility. The hood seems short (in fact, the entire car has a feeling of compactness despite its over-all length of 200 inches).

**Plymouth Belvedere**

Second best of the American cars in over-all economy was the Plymouth Belvedere V8 with the new three-speed Torqueflite automatic transmission.

The Plymouth averaged 13.81 miles per gallon during the test. In the special economy run, it took top honors among the American cars by averaging 17.38 miles per gallon.

The Plymouth V8 did not require premium gasoline and, although new at the time of the test, it probably will not ever require this extra-cost fuel because of the low-octane requirement of the engine.

Average cost per mile for gasoline was 2.2 cents, the weekly fuel bill was \$8.48.

The 1957 Plymouth suffered from those initial assembly troubles that plague all manufacturers when a new model is brought out. Interior fits were poor in several places.

Handling is excellent although the low front seat seems to make the driver feel the car is bigger than it is (actually it is slightly shorter than the 1956 Plymouth). Until accustomed to them, the high tailfins in the rear-view mirror may startle the driver into thinking somebody is right behind him. The rear-view-mirror location on the top of the dashboard is not good when there are three in the front seat, but it does eliminate a previous blind spot in the center of the windshield.

**Ford Fairlane 500**

Ford's Fairlane 500 was equipped with the standard V8 engine and Fordomatic transmission. It had about 1000 miles on it at the time of the test.

In the over-all mileage test, Ford averaged 12.82 miles per gallon to place third among the Big Three. Its weekly gasoline bill was \$9.13 and its cost per mile for gasoline was 2.3 cents. In the special economy run, the Ford averaged 16.29 miles per gallon, about one mile per gallon under the other two.

The Ford performed well on regular gasoline, although it is possible that premium fuel would be required when the engine carboned up.

Ford, too, handled very well in the traffic test. It, like the Plymouth, feels bigger than it is and requires some experience



before the driver is confident enough to slip into tight places in traffic.

The car seems to have exceptional acceleration from zero to 30 and caution is essential when feeding gas to the engine. The throttle foot has to be moved carefully or you may climb right up on the rear of the car ahead of you.

Production fits of the interior trim of the Ford were very good considering the fact that it is all new.

### Citroen 2CV

By far the most economical of all the cars tested was the uniquely ugly Citroen 2CV, a French import. It sells for about \$1300 in this country. It averaged an amazing 47.78 miles per gallon over-all and in the special economy run it went 50.78 miles to the gallon. Only regular gasoline was used. Fuel cost per mile was  $\frac{9}{10}$  cent—just over a half cent.

Driving the Citroen is an experience. The shift lever pulls in and out of the dashboard instead of shifting in the normal H-pattern. The two-cylinder air-cooled engine drives the front wheels and on sharp turns at low speed the car grabs as the wheels "dig" into the pavement. The model tested had an automatic clutch which made it impossible to stall the engine. Whenever the car stopped the clutch automatically disengaged. The clutch pedal had to be used for shifting, however. Shifting is easy to learn, and the car can be driven in town using only two speeds, second and third.

Top speed is a mere 45 miles per hour. Jackrabbit starts are impossible (this accounts for the relatively minor increase in economy of the light-footed run over the regular runs). Strong headwinds slow the car down noticeably.

Its front-wheel drive makes it an excellent winter-driving car and it should plow through snow effortlessly. It can be driven across fields and through ditches without damage. In France, the 2CV is the farmer's favorite "beast of burden."

Its ride is softer than anything you've experienced. If anything, it is too soft. On undulating surfaces, it is likely to start bobbing like a boat. Seats are extremely comfortable and can be lifted out quickly for use as lawn furniture.

### Lloyd

Another two-cylinder, air-cooled, front-drive import, the German Lloyd is better looking but not so impressive as the 2CV.

It is basic transportation and not much more. Despite a very small engine it does have excellent top speed, being capable of 60 miles per hour. However, at that speed it is noisy and not at all comfortable.

(Continued to page 300)



**BORGWARD ISABELLA:**

Average miles per gallon: 25.18  
Weekly gasoline bill: \$4.65  
Gasoline cost per mile: 1.2 cents



**VOLVO:**

Average miles per gallon: 24.38  
Weekly gasoline bill: \$4.79  
Gasoline cost per mile: 1.2 cents



**METROPOLITAN:**

Average miles per gallon: 24.02  
Weekly gasoline bill: \$4.87  
Gasoline cost per mile: 1.2 cents



**MG MAGNETTE:**

Average miles per gallon: 21.53  
Weekly gasoline bill: \$5.44  
Gasoline cost per mile: 1.4 cents

## PM Asked the Experts— the Men Who Tow Away the Wrecks

**They Say:**

# Cars Are Getting Safer, But . . .

**SLOW DOWN, MISTER,** slow down! That's the advice of the men who respond to auto-accident calls—the men who run the tow services of the nation.

Cars are getting safer, they say, but the public drives too fast. The best way to make cars safer would be to lower the top speed. These tow men feel that most accidents are caused by driving too fast. "Slow down and live" describes their viewpoint exactly.

Popular Mechanics asked 1000 operators of wrecking services all over the country about the 1956 cars. In 1956, you'll recall, such safety features as seat belts, crash-proof door latches, padded dashboards and visors and recessed steering columns were highly publicized.

These safety-stressed cars have been on the road for a year and we wanted to find out if the safety emphasis paid off.

Here is what these experts told us:

### ✓ Are the safety features in the 1956 cars saving lives?

Yes .....	70.9%
No .....	19.0%
Don't know.....	10.1%

### ✓ Which features are most effective in saving lives?

Seat belts.....	40.9%
Safety door latches.....	22.1%
Padded dashboards.....	19.7%
Deep-dish steering wheel.....	11.8%

There was considerable agreement, as you can see, on the value of seat belts, but in almost every case there was the qualification "if they were worn." Many owners apparently are sitting on their seat belts instead of wearing them. The wrecker servicemen emphasize that belts must be worn all the time, not only when driving fast.

### ✓ What is the value of seat belts?

Excellent, if worn.....	83.4%
Don't recommend them.....	8.6%
Don't know.....	0.8%

### ✓ Which features are least effective in saving lives?

Padded dashboards.....	11.8%
Padded visors.....	10.2%
Deep-dish steering wheels.....	8.0%
Safety door latches.....	7.1%

### ✓ Do safety door latches keep doors closed in accidents?

Yes, they do.....	57.5%
No, they don't.....	24.4%
Sometimes or don't know.....	18.1%

### ✓ Do hardtop roofs offer as much protection as sedan roofs?

No, they don't.....	63.0%
Yes, they do.....	24.4%
About same or don't know.....	12.6%

### ✓ How can present cars be made safer?

Lower the top speed.....	21.3%
Provide less horsepower.....	15.0%
Improve the brakes.....	14.1%
Only by driver education.....	14.1%
Build stronger frames, bodies.....	13.4%
Install roll bars.....	8.0%

**WE WENT** to the Auto Show—the 42nd National Automobile Show in New York, the first national show since 1940.

But unlike most of those who attended, our interest was not in 1957, but in 1958—and after. What comes next?

We asked a lot of questions. We talked to scores of persons from the beautiful models in the Pontiac exhibit (who, by the way, don't like high tailfins) to Harlow H. Curtice, president of General Motors (who doesn't like them either!).

Here are some impressions of interest, things you didn't read in the newspapers:

- There will be no unit body in the General Motors line for 1958 despite lots of rumors to the contrary. Take it from Mr. Curtice, who stated so with finality.

- There will be an all-new Chevrolet and an all-new Pontiac that, for the first time, won't be sisters under the skin. As Ford and Mercury did for 1957, Chevrolet and Pontiac will part company in 1958 with two separate body shells. And they will be even lower than the low cars of today. Look for Chevrolet to offer fuel injection at a much lower price in 1958. That \$480 price tag on the Ramjet system is completely unrealistic. It doesn't cost anything close to that to build. The aim of the high price is to keep too many buyers from ordering it. By next year, the system will be better suited for mass production and servicing and you will see it with a much lower price.

Ed Cole, general manager of Chevrolet, told this reporter that in three years he expects fuel injection to be on 30 percent of the Chevrolets sold. The extra price would be only about \$50, he guessed. (Actually, very few engineers seem ready to argue that there is anything spectacular about fuel injection except that it's the latest, the newest and therefore the best sales pitch they can offer. You can get just about the same performance from three two-barrel carburetors at a lower price.) With fuel injection and some other engine tricks, Chevrolet will probably offer at least 300 horsepower in 1958.

- There is no evidence that the industry is taking up the small-car challenge. Mr. Curtice told this reporter that even if Volkswagen sales jumped to more than 150,000 units a year in this country it wouldn't be enough to warrant GM's entering the market (current VW sales: 60,000 a year). Tooling costs (everything would have to be new—body, engine, running gear) would make the price too high unless sales were 200,000 or so.

But George Romney of American Motors is not of the same opinion. He says he could make money on a much smaller number of units. He may go into the mar-

# Detroit Listening Post



By Art Railton

ket seriously after 1958, but his first aim is to get through 1957 with a profit. Romney didn't say it, but it is known that American Motors is working on a four-passenger version of the Metropolitan. AM seems to have tied its future to the small car. It is probable that the Met and the Rambler will become the basic cars of the company in a few years. Romney did state that the Hudson and Nash would remain distinctive in size from the Rambler in 1958. So there apparently is no plan to drop the big cars.

If plans work out, look for future Hudson-Nash models to have swivel seats, lounge chairs, high-fidelity radio and record players, television and other special comfort features that will set them apart as long-distance high-comfort cars. The Rambler will then become the normal-use family car. The Met will be the grocery-store, down-to-the-station car.

- Edsel, Ford's new car for 1958, will have plenty of interchangeability of parts with both Ford and Mercury.

- Studebaker-Packard unveiled the 1957 Packard for the first time. It is, as stated here months ago, a big Studebaker with Packard trim. It is to be called the Packard Clipper. Eventually, it may be the Studebaker Clipper.

Harold E. Churchill, president of S-P, said that the rest of the industry is just catching up with the advanced styling of the 1953 Studebaker. He's right, but in this business it's just as dangerous to be ahead of the trend as to be behind it.

Kaiser-Frazer had slab sides, low belt lines, low seats, 1958-style steering wheels and many other features of today's cars, but they failed despite them. Styling awards rarely go to cars that sell—it's the prize-winners that seem to go broke.

- Buick will have its new transmission ready for 1958. It is basically the same design as the new Chevrolet transmission although nothing about it is the same in production. This Chevrolet job (known as

(Continued to page 308)



Photo courtesy Autocar Magazine

Start of British Grand Prix at Silverstone. Schell (arrow) failed to finish. Winner was Fangio in a Ferrari

# *I Race in the Big*

**G**RAND PRIX racing is to Europeans what the World Series is to Americans. And if I ever won the championship, I would feel the way Don Larsen must have felt when he pitched the perfect game last fall.

Because I'm a Grand Prix race driver. Racing is as much a part of me as my blood. It's something I couldn't stop doing

even if I wanted to—and I will never want to.

I'm an unusual figure on the race course—an American Grand Prix racer. Most Americans have never heard of it, or if they have, they probably don't know how to pronounce it (incidentally, it's "Grahnd Pree").

Grand Prix racers drive the ultimate in

Harry Schell, who tells his story here, corners the Vanwall Grand Prix racer on the circuit at Silverstone





Photo courtesy Autocar Magazine

Seconds after the start of the Belgian Grand Prix, Schell runs sixth (arrow). He finished in fourth place

# Leagues

By Harry Schell

AMERICA'S ONLY GRAND PRIX DRIVER

Schell, an American who lives in Paris, is the only full-time G.P. driver wearing the blue and white of America. Here he is after a Vanwall victory at Castle Coomb



Schell's big thrill was just ahead at this moment—the start of the French Grand Prix at Reims. The arrow points to Schell's car which failed only two laps later. He then continued the race in a teammate's car and battled it out with the three Ferraris that lead the field here. Fangio, world's champion driver, is in the lead Ferrari, number 14



automobiles. Each car is designed to do everything as perfectly as it can be done.

It must accelerate fast. It must corner fast. It must brake fast. It must do all these things continuously for hundreds of miles, its engine roaring at top speed all the time. It must be the finest piece of machinery man can put together.

In the German Grand Prix circuit at Nurburgring, there is a corner coming up every three seconds! Drivers make gear changes every 15 seconds. It's a 14-mile course with more twists and curves than a basket of pretzels. It climbs to a height of 2000 feet and descends quickly to 600 feet. I've never counted them, but I've been told there are 180 curves in the course.

That may sound like an obstacle course—and it is. But the amazing thing is that the lap record for the 14 miles is an average of 87.74 miles per hour. That record was set by the world's champion and the world's greatest driver, J. M. Fangio of Argentina, in a Ferrari last summer.

Compared with someone like Fangio, the greatest driver of the generation, I am an all-thumbs novice, but I've battled it out with him on occasion. He always wins, though.

My biggest thrill came last July in the Grand Prix of Reims in France. I was number-one driver of the Vanwall team. The Vanwall is a British four-cylinder car built by Tony Vanderwell. It has done very well so far and promises to be a great car in this year's racing.

I started in the second row alongside my Vanwall teammate, Mike Hawthorn. Ahead of us in the front row were three Ferraris, driven by Fangio, Collins (the world's number-three driver) and Castellotti.

My orders from Tony Vanderwell were: "Watch the engine limit of 7100 r.p.m. Please don't break my car. Do the best you can."

To be told to do what you want in a race like this against the world's greatest is a wonderful expression of confidence. It is also a tremendous responsibility.

With the high-pitch bark of the Ferraris leading the way, the race started.

For the first two laps I was



Here's how they were in the great attack at Reims: Fangio, Castellotti, Collins, Schell (arrow) and Moss

fourth, hanging tight to the tails of the three Ferraris. Then, bang, went my big dream!

The rear axle broke. I limped into the pits. The race we had prepared so hard for, had worked night and day to win, was over in two quick laps. Such are the heartbreaks of racing.

Repairs were made and I went back into the race, but far behind the leaders. I

was feeling hopelessly beaten when suddenly my teammate, Mike Hawthorn, roared past making a signal as he went by. I understood instantly.

Mike was giving me another chance. He was asking me if I wanted his car. He was right up there with the leaders. I sped around the course as fast as my car would make it and waited in the pits for Mike to come in.

What a magnificent gesture he was making! He, an Englishman, driving an English car, was offering to turn it over to me, an



Schell drives his blue-and-white Maserati to the lead in the Grand Prix of Argentina. He was later relieved in a state of exhaustion



Road & Track Magazine photo

Lots of smoke and ruined hopes—the end of Schell's Vanwall in the British Grand Prix only three laps before the finish of race



Above, here's what happens to tires on the rugged Monza circuit. Below, beautiful and powerful new Maserati Grand Prix race car

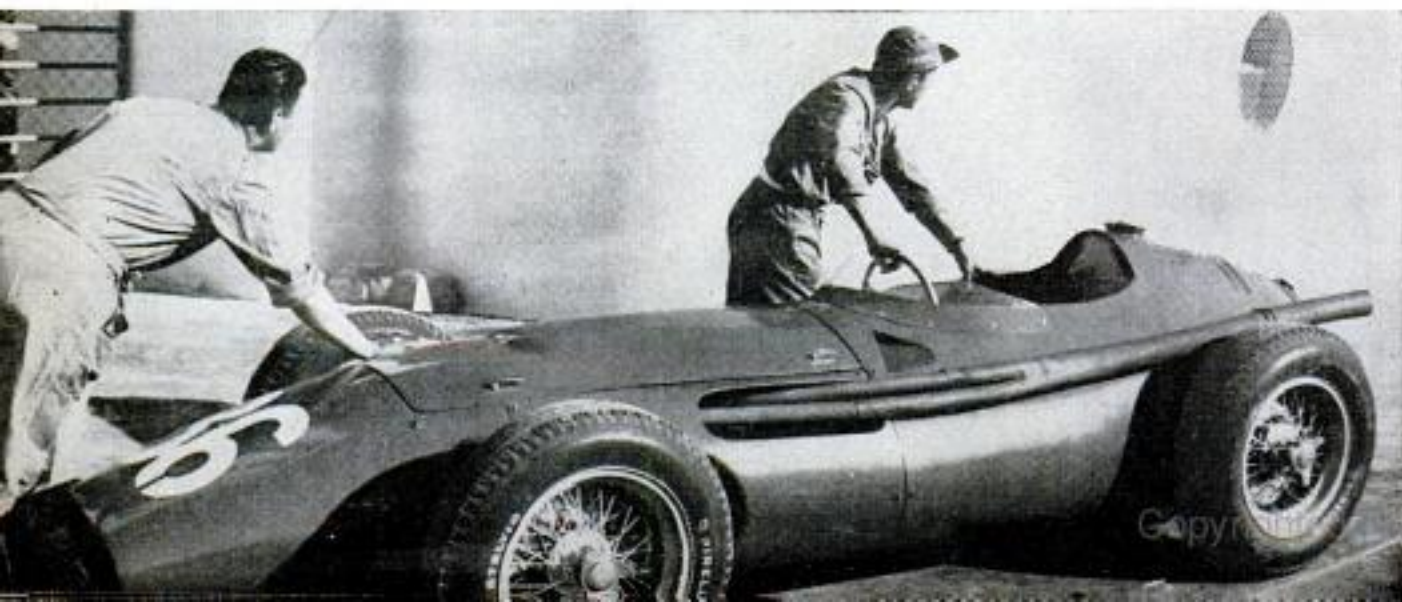

American. I shall always remember this.

Hawthorn roared into the pits. In nine seconds we changed drivers. I jumped in his car and took off after the leaders. I was 52 seconds behind.

The fantastic chase began. The crowds began to sense the excitement. The funny-looking green Vanwall began to move up on the great Ferraris. The three leaders felt comfortably in the lead. I began to gain steadily on them at about five seconds a lap.

I moved into sixth place on the 17th lap, then into fifth on the 20th. On the 21st I was in fourth place, gaining steadily.

By the 23rd lap I was only 24 seconds behind, on the 25th only 12.5 seconds, on the 27th lap 11.2 seconds.

On the 30th lap I was right on the tail of Collins in the third-place Ferrari.

My heart was pounding. I was never going to let go if I could help it. It was my great chance. But Fangio had other ideas!

Suddenly he started off like a bomb, taking the others with him. For three laps they wouldn't let me pass. Fangio was in the lead and Collins and Castellotti were trying to pass each other to keep me from attacking Fangio.

It was too much for me. I couldn't stand it any more. I had to plan my attack. I would pass on the braking at the Thillois curve. By going far into the corner without braking I could, with a bit of luck, get past the first two. Then, still with luck, I

(Continued to page 290)





## Build "THE BUG"

### Your personal sportster for \$400

#### PART I

**H**AVE YOU EVER WANTED a personal sports car completely different from anything else on the street? Here's your chance to build such a car—and you won't have to mortgage the old homestead to pay for it.

This car (which we have affectionately nicknamed "The Bug") was designed specifically for *Popular Mechanics* readers and has been engineered to make construction as simple as possible. Building the ex-

tremely strong tubular "space frame" is no more complicated than putting together a model airplane from a drawing. Compound curves have been almost completely eliminated from the body, yet the car's over-all appearance is low, racy and modern. The prototype car, which was used for all illustrations in this article, was assembled from Crosley components, but the basic construction methods and techniques described can be used to assemble the sportster with components from any car. For that reason no dimensions are given, as they will vary

Right-hand photo shows method of drawing the full-size side elevation on a concrete floor with chalk. Lengths of steel tubing then are placed over drawing and welded together as shown in left-hand photo

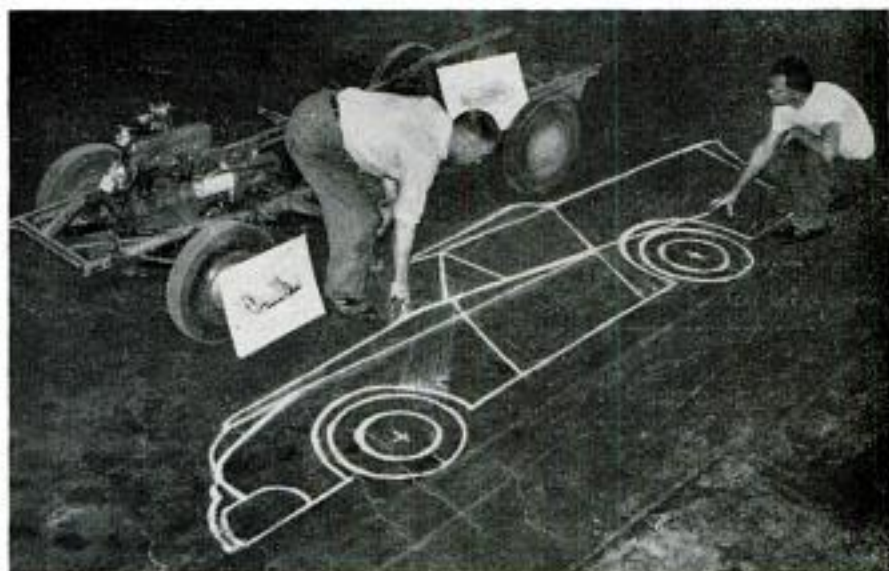

with each car and with each builder. Any second-hand or junked car can be used for components, but it is suggested that it be one with a small six or four-cylinder engine to keep down costs and to produce a lighter-weight finished car.

Start by stripping the car down to its chassis and wheels, saving instruments, door and trunk locks and hinges and any other items that can be reused. Overhaul the engine, transmission and brake system as necessary. Wheelbase of the sportster should be about 100 in. After determining how much the original wheelbase must be

reduced, have the drive shaft shortened that amount at a shop that specializes in this type of work.

Place the stripped chassis on a concrete driveway or garage floor and draw a full-size side elevation of the tubular frame alongside it with chalk, lower right-hand photo, page 201. Keep the lower frame members slightly above the bottom of the differential case, which generally is the lowest part of a car's running gear. Your own styling ideas, leg length and height as well as the location of the engine and other components will determine the design

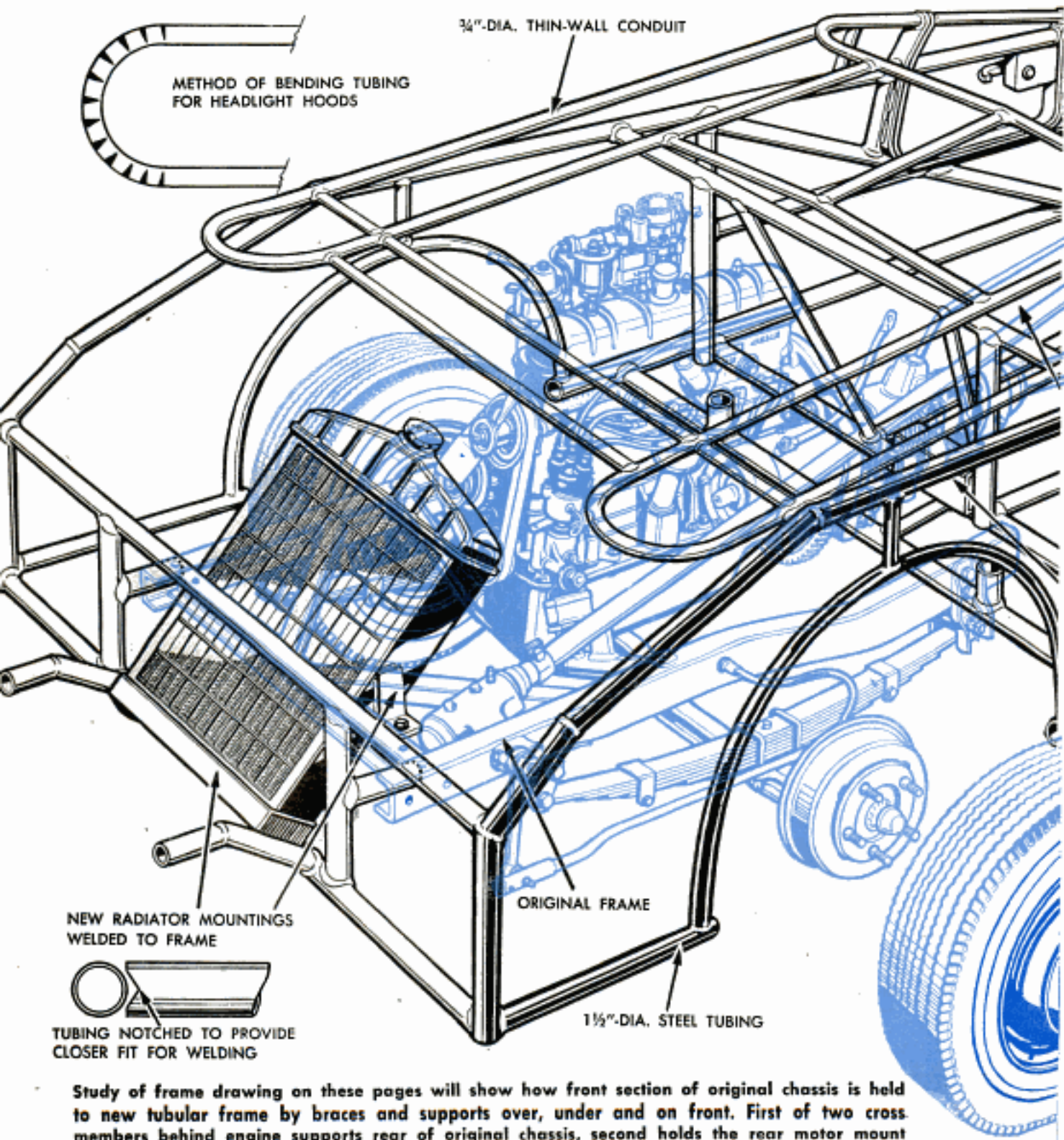

Study of frame drawing on these pages will show how front section of original chassis is held to new tubular frame by braces and supports over, under and on front. First of two cross members behind engine supports rear of original chassis, second holds the rear motor mount

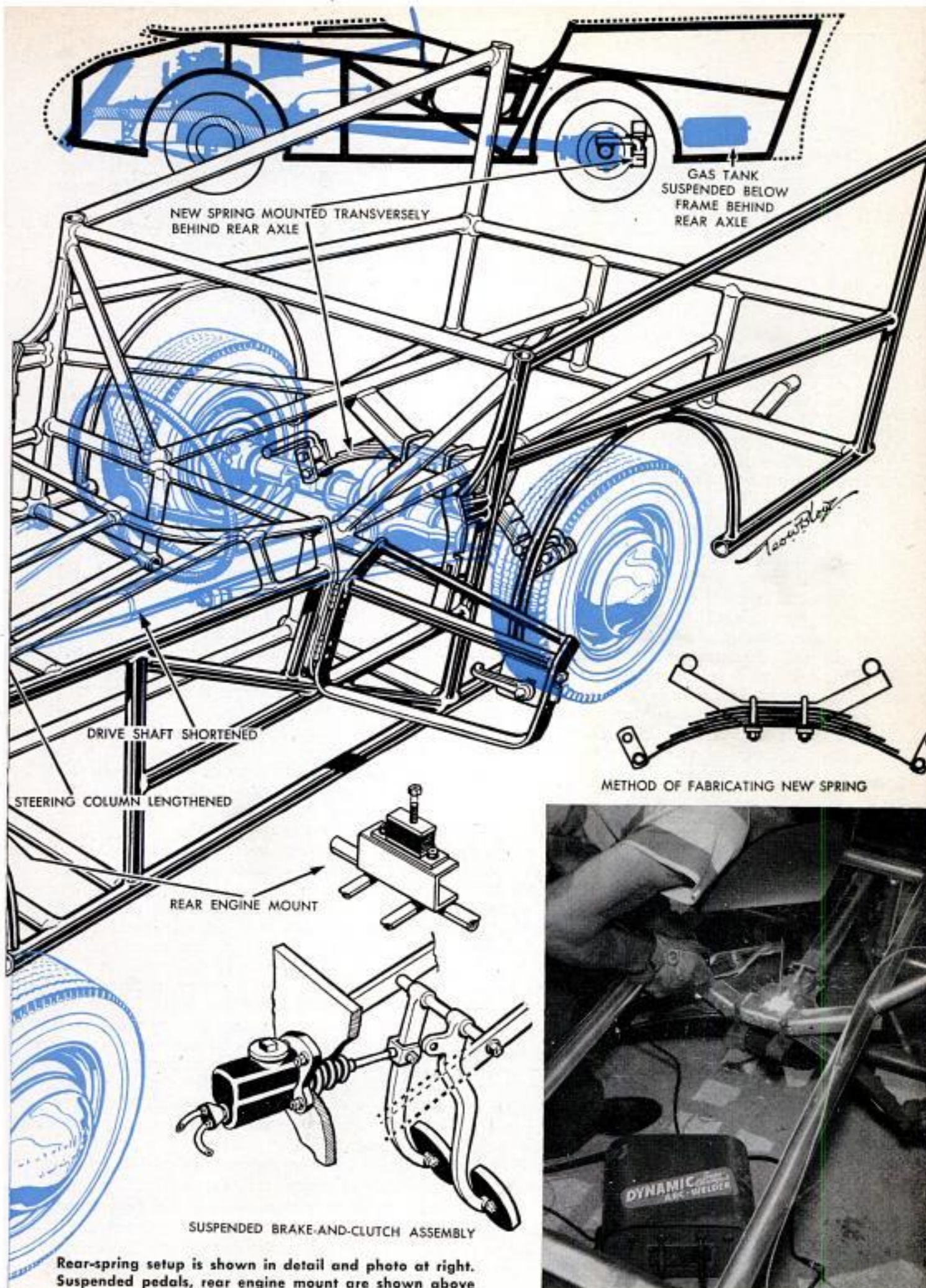

Rear-spring setup is shown in detail and photo at right. Suspended pedals, rear engine mount are shown above

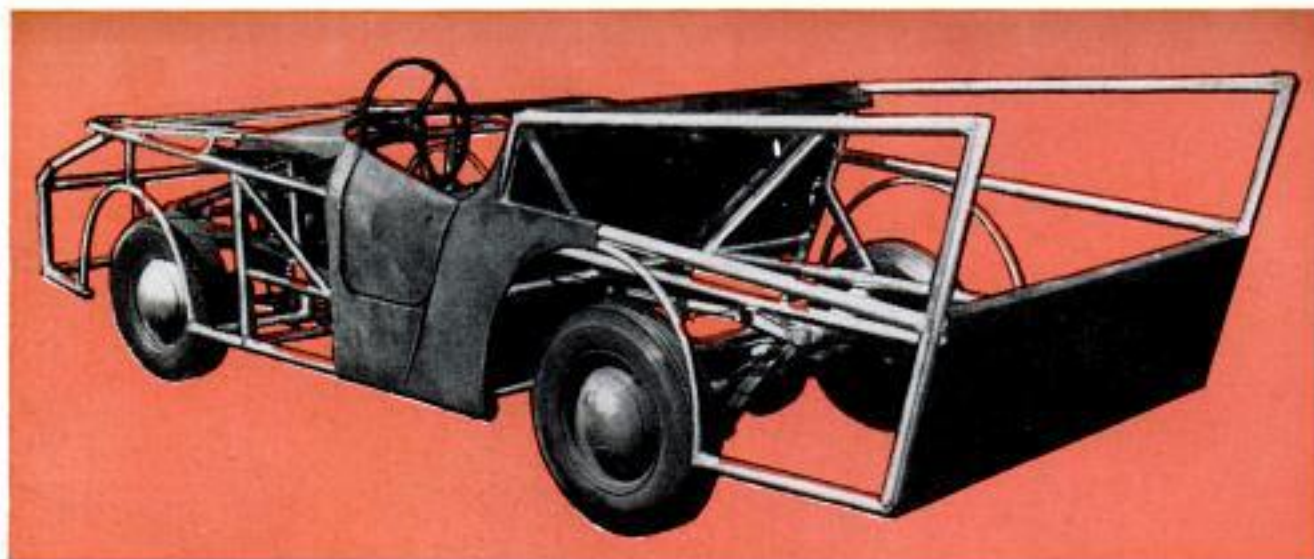

Photo above shows general appearance of partially finished sportster. Body is "wrapped" over frame

of the elevation. The basic plan shown on pages 202 and 203 can be modified in an infinite number of ways. Welded steel tubing, 1½-in. dia., with a wall thickness of .020 in., was used for the prototype in which the Crosley components were installed, and with sufficient cross bracing, this tubing will make a frame strong enough to handle most of the smaller engines. If a larger power plant is used it will be necessary to use tubing of 2-in. dia. or larger, and it should be seamless steel. Chrome-moly tubing is used for cars that are raced in competition, but this type tubing is quite expensive, and since the sportster described in this article is not designed for racing, chrome-moly tubing will not be considered as frame material. The top of the forward portion of the sportster frame, and the wheel openings, are formed from ¾-in. thin-wall conduit. Although the 1½-in. tubing used for the main frame can be used only in straight lines, the thin-wall conduit is shaped readily with a bending tool and presents a chance for individual styling of the hood area of the sportster, as well as any desired shape for the wheel openings.

After the full-size drawing has been made, cut pairs of lengths of 1½-in. tubing required to make the frame sides and weld together each side directly over the drawing, left-hand photo page 201. When both sides have been welded solid and matched to assure they are the same, cut cross pieces to go between them. The cross pieces all are the same length, and should be long enough to keep the inside of the side frame members about 2 in. outside the hub caps of the axle with the wider tread, if there is a difference in treads. Now, place an assembled frame side on each side of the original chassis and block them up to provide correct ground clearance in a vertical

position. Also, block up the original chassis to keep it level. Fit and tack-weld as many cross pieces between the frame sides as is possible over and under the original chassis. The front section of the original frame, including spring hangers and motor mounts, is to be retained, so tack-weld tubular braces and supports between it and the new frame wherever convenient, page 202. Next, move the rear axle forward and reconnect the now-shortened drive shaft. With a cutting torch, cut the old frame just behind the rear hangers of the front springs and remove it. Recheck the alignment of the tubular frame sides, then locate the rest of the cross pieces and other bracing members and weld all joints solidly. Cut a section of channel from the old chassis and shape a spring support for the transverse spring used behind the rear axle. Transverse mounting of the rear spring permits the frame to be positioned lower in relation to the axle, and the spring is clear of the cockpit, which would not be the case if two springs were used and mounted in the more conventional fore-and-aft position. The spring used for the transverse setup should be one from a heavier car. For the Crosley, a Plymouth spring was used. Cut the main leaf to fit the spring supports, allowing for the length required to heat and bend new eyes. Other leaves are fitted on top of the main leaf and are bent with progressively smaller radii or angles so they are compressed under tension when clamped to the spring support. Install 3 or 4 leaves at this point in construction to support the car. When the sportster is completely finished it is necessary to use trial-and-error to determine whether more or less leaves are required to provide correct springing and handling. Location of the tubular shock absorbers—

(Continued to page 276)

# Automatic Chokes



By George R. Willys

**B**ECAUSE THEY HAVE become so dependable, automatic chokes generally are ignored until an automobile engine becomes hard to start. As much as any other part, the automatic choke is responsible for the easy-starting, smooth-running, long-lasting qualities of the modern automobile engine. Valves no longer need regrinding every few thousand miles, and engine wear is minimized when a cold engine is started because adequate lubrication is assured.

Almost all cars now use the type of automatic choke that consists primarily of a heat-sensitive coil spring, or thermostat, that pulls on a lever to close the choke valve. As the spring is warmed by engine

heat, it stretches and releases the choke valve. The latter is offset on the choke shaft, so that its own weight aids in its opening. Fig. 1 is a schematic drawing of this type of choke. Heated, fresh air is introduced into the choke housing through a tube that leads to a "stove" or heating chamber located inside, or against the exhaust manifold. Three types of stoves are shown at the right in Fig. 3. The center type is one that is used on some V8 engines and is a U-shaped length of tubing located inside the exhaust manifold. One end of the tubing is open to the fresh air, the other end discharges into the choke housing, as do all tubes supplying heated air to choke

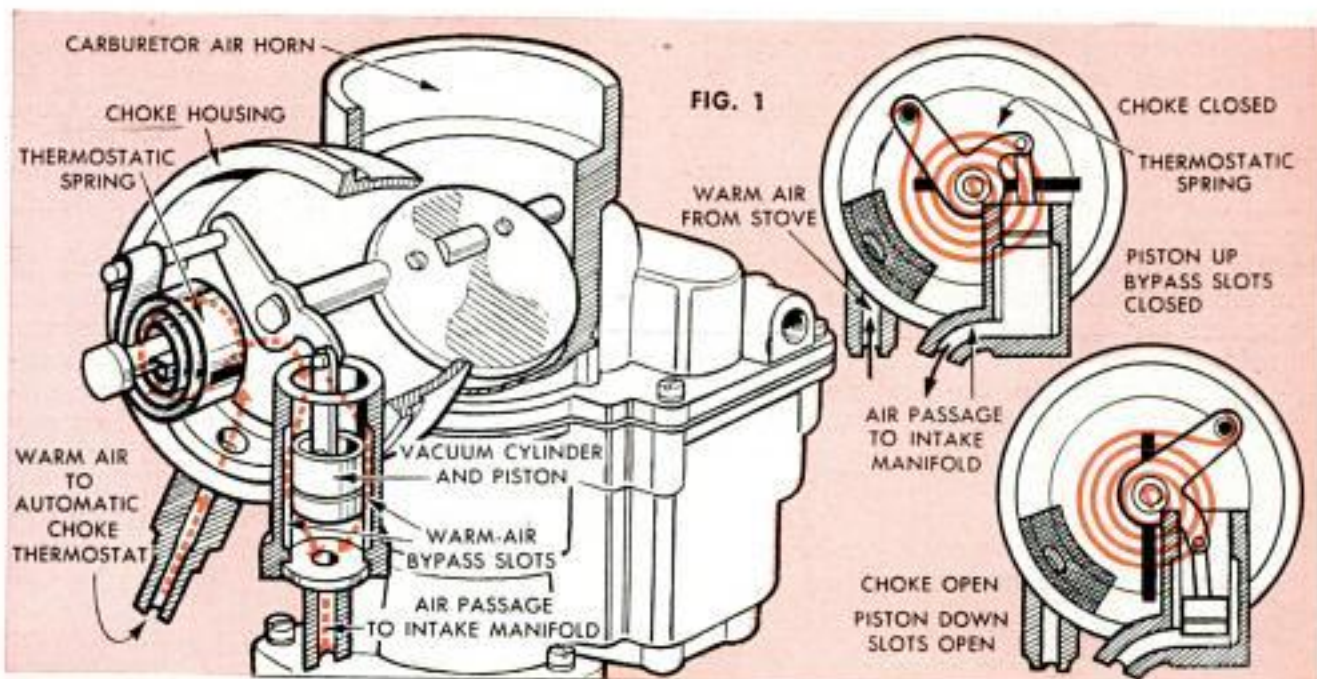

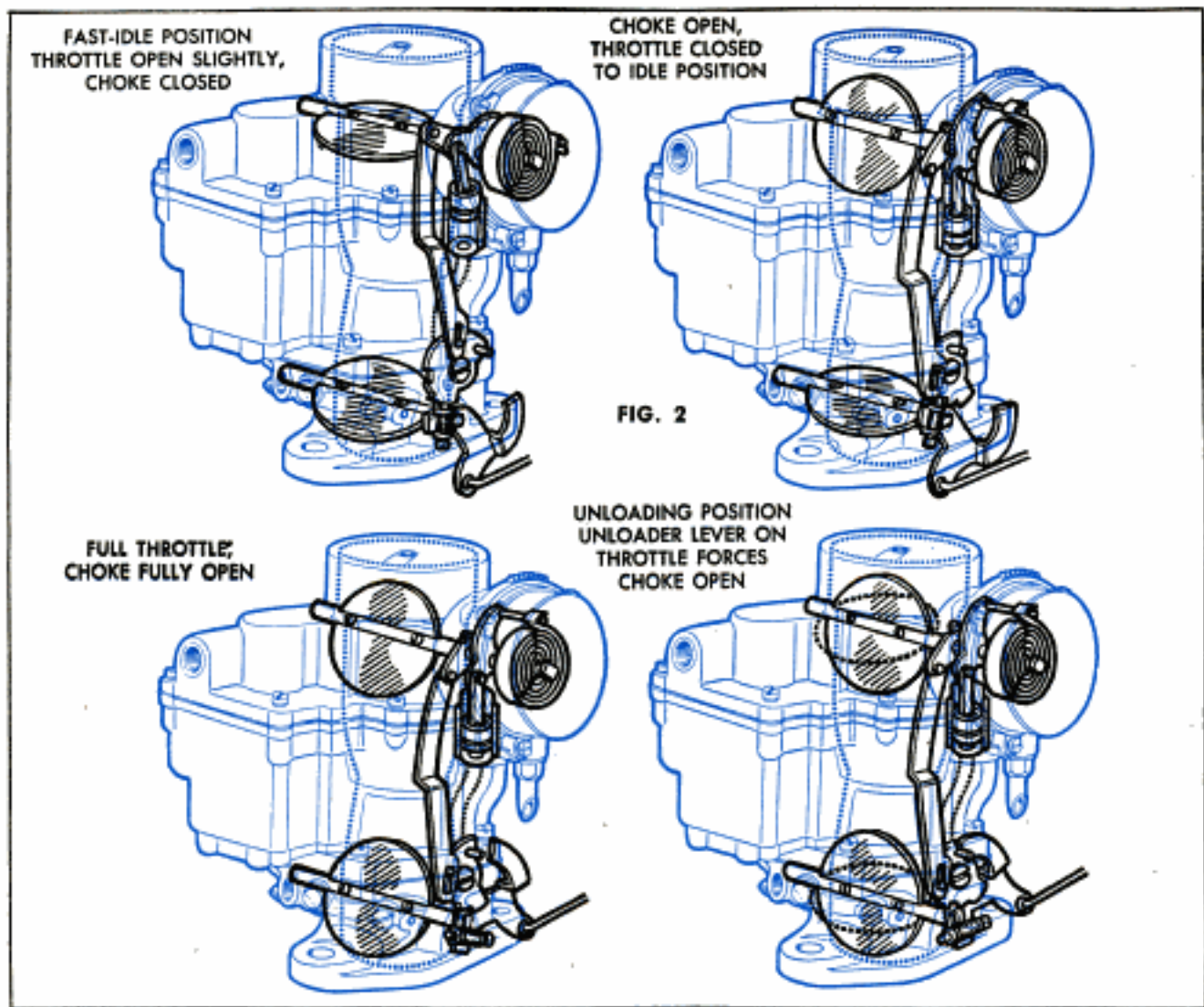

Drawings by George How

housings. To further assist in positive opening of the choke valve, a vacuum piston is linked to the opposite end of the choke lever from the thermostatic spring, Fig. 1. Intake-manifold vacuum pulls the piston downward the moment the engine starts, and thus applies tension on the thermostatic spring. When the piston travels a short distance it uncovers bypass slots in the cylinder through which warm air entering the choke housing is discharged into the intake manifold. This action assures a constant supply of freshly heated air to expand the thermostatic spring. The colored arrows and dotted lines in the carburetor in Fig. 1 show the path of this air. Since the air is discharged into the intake manifold, less air is required through the carburetor throat to provide the correct air-to-gasoline ratio to the engine, and all carburetors with automatic chokes are calibrated to compensate for this extra air. This is one reason why installing a hand choke on a carburetor that originally was equipped with an automatic choke results in poorer performance and mileage.

#### Starting a Car

When a car has been standing overnight

the choke valve will be wide open, and must be closed to "choke" the engine. On most cars it is necessary only to depress the accelerator pedal halfway to release a fast-idle cam and lever, which permits the thermostatic spring to close the choke. The next step is to engage the starter. On cars that combine the starter with the accelerator pedal, it is necessary only to depress the accelerator until the starter engages. Do not depress the accelerator all the way. To do so overrides the choke control and the unloader lever opens the choke valve as shown in the lower right-hand detail in Fig. 2.

When the choke has been actuated by depressing the accelerator, and the starter has started the engine, the fast-idle cam will open the throttle slightly and the carburetor will be fully "choked," upper right-hand detail, Fig. 2. The engine will supply full power so the car can immediately be driven, and the fast-idle cam will hold the throttle at an idle speed that will assure adequate lubrication to the cold engine.

#### Proper Air-to-Fuel Ratio

When vaporized gasoline and air are drawn into a cold engine, much of the fuel

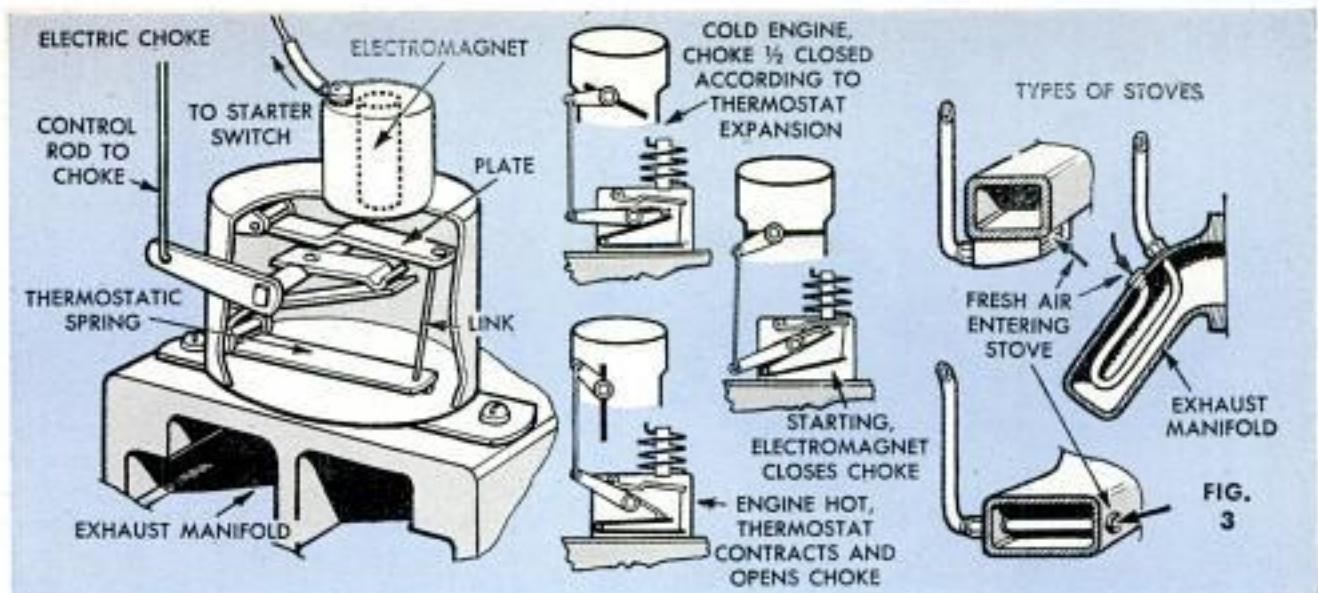

condenses on the cold metal walls of the manifold and cylinders. Therefore, unless an excess of gasoline is pulled into the engine by means of "choking," the fuel mixture remaining in vapor form will be "lean," meaning there is an excess of air. Gasoline burns only when combined with air in the proportion of about 13 or 15 to 1. Thus, when a cold engine is run with the choke open, air that does not combine with gasoline in combustion simply is pulled through the engine and discharged out the exhaust. As the air passes over the red-hot exhaust valves it combines with the glowing steel and burns the valves. Since an automatic choke does not allow a lean mixture to enter the engine, it thus protects the valves against burning.

### Using the "Unloader"

When an engine has been run only a few minutes, then shut off and allowed to stand for a short while, difficulty is experienced in starting the engine because it "floods." This is due to the fact that the choke ther-

mostat cools quickly when warm air is not pulled through the choke housing, and it contracts and closes the choke valve. The engine itself is still warm inside and cannot burn the rich mixture supplied by the closed choke. The "unloader" mechanism is used in this circumstance. Press the accelerator pedal to the floor and hold it down while engaging the starter. This procedure causes the unloader lever to open the choke valve and the throttle valve also is held open. As soon as the excess gasoline has been discharged through the exhaust so the remaining mixture is of the proper fuel-air ratio, the engine will fire and start.

### Types of Mechanisms

Fast-idle cams and unloader levers can be located either on the throttle shaft out in the open as indicated on the down-draft carburetor in Fig. 4, or can be located inside the automatic-choke housing, as shown on the side-draft carburetor in the same figure. In either case the mechanism functions exactly the same. Fig. 2 shows

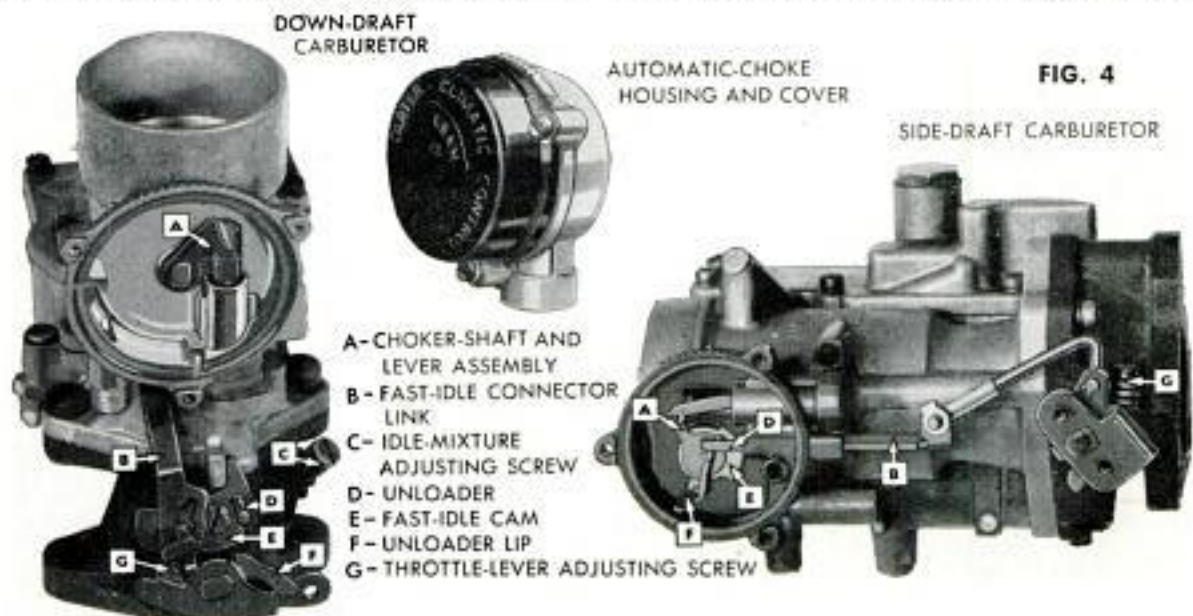

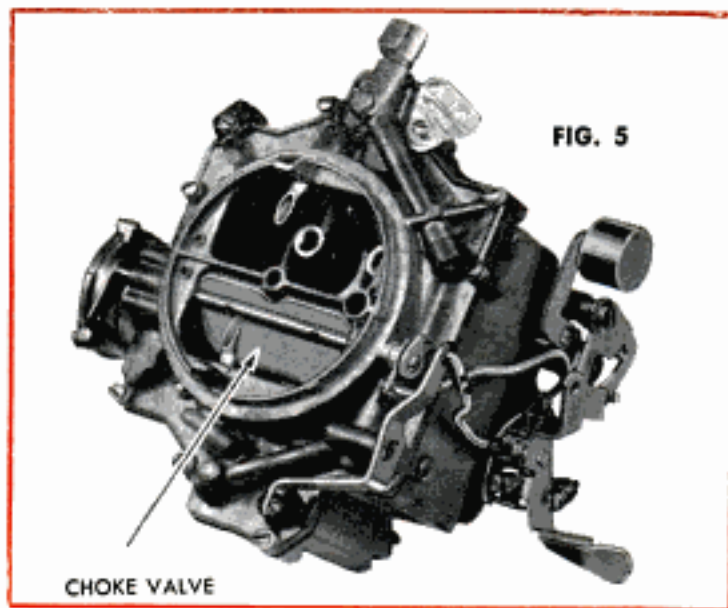

FIG. 5

CHOKE VALVE

ENGINE COLD, CHOKE CLOSED, PRIMARY THROTTLES IN FAST-IDLE POSITION READY TO START, SECONDARY THROTTLES LOCKED IN CLOSED POSITION

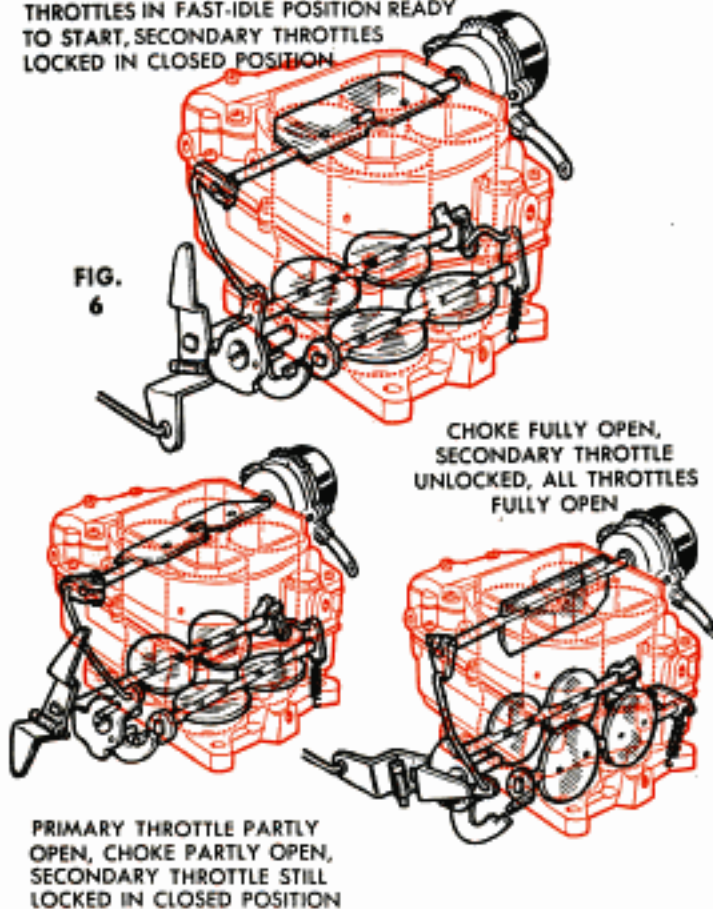

FIG. 6

CHOKE FULLY OPEN, SECONDARY THROTTLE UNLOCKED, ALL THROTTLES FULLY OPEN

PRIMARY THROTTLE PARTLY OPEN, CHOKE PARTLY OPEN, SECONDARY THROTTLE STILL LOCKED IN CLOSED POSITION

a representative carburetor, and indicates the various positions assumed by the choke and throttle valves, fast-idle cam, unloader, vacuum piston and thermostatic spring. All automatic chokes and their mechanisms function in a similar manner.

### Four-Barrel Carburetors

Automatic chokes on four-barrel carburetors function in exactly the same manner as single units, but operate only on the primary barrels, since the auxiliary barrels cannot be opened until the engine reaches operating temperature. On some four-barrel units, as shown in Figs. 5, 6 and 7, the automatic choke is given the additional job of keeping the auxiliary throttles closed until the choke has opened completely.

### Electric Automatic Chokes

Electric chokes, left-hand detail, Fig. 3, still are used on some cars. This type choke is actuated by stepping on the starter. Electric current from the starter switch then flows to an electromagnet in the choke. The magnet attracts a pivoted metal plate that is under tension from a flat, U-shaped thermostatic spring. The shaft on which the plate pivots is linked to the choke valve and thus closes it. The choke mechanism is mounted on the exhaust manifold and, as the thermostatic spring is heated, it collapses slowly, removing tension from the plate. Also, when the starter switch is released, the electromagnet no longer is energized and so the plate lowers with the spring, opening the choke. If, subsequently, the engine is restarted, the plate will be too far away from the magnet to be affected, and the choke will not reclose. ★ ★ ★

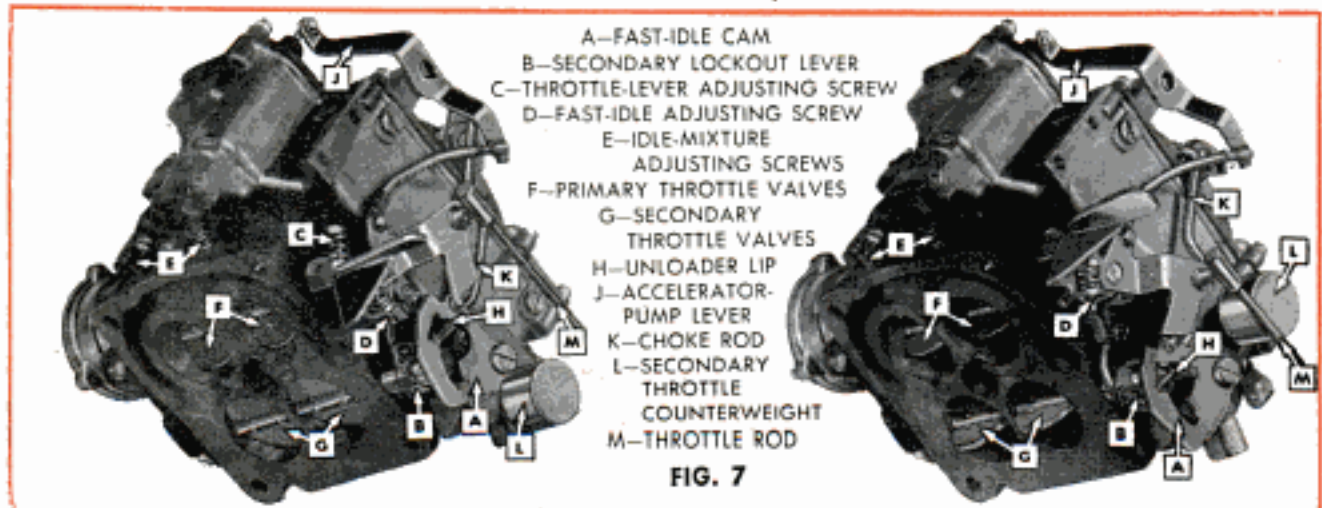

- A—FAST-IDLE CAM
- B—SECONDARY LOCKOUT LEVER
- C—THROTTLE-LEVER ADJUSTING SCREW
- D—FAST-IDLE ADJUSTING SCREW
- E—IDLE-MIXTURE ADJUSTING SCREWS
- F—PRIMARY THROTTLE VALVES
- G—SECONDARY THROTTLE VALVES
- H—UNLOADER LIP
- J—ACCELERATOR-PUMP LEVER
- K—CHOKE ROD
- L—SECONDARY THROTTLE COUNTERWEIGHT
- M—THROTTLE ROD

FIG. 7



## CRAFTSMAN



*An unusual piece for your living room, this charming coffee table in mellow pine takes its authentic design from a*

## QUAINT OLD COBBLER'S BENCH



**By John N. Bergen**

**I**F YOU LIKE the warmth and charm of early pine furniture, you'll be eager to start making this unusual coffee table which is a replica of the old-time cobbler's bench. The traylike nail compartments will hold cigarettes, candy and nuts, while the roomy drawer provides a handy place to keep playing cards, chessmen, extra cigarettes and the like.

Start by making the drawer compartment. This is built around an open drawer frame, measuring  $14\frac{1}{2} \times 16\frac{7}{8}$  in., which has a  $\frac{3}{4} \times 1$ -in. drawer runner added at the center. Front and rear members of the frame are grooved in the edges to take tenons on the ends of the side members. The sides of the compartment measure  $4\frac{1}{2}$  in. wide. These are nailed together at the rear corners and fastened to the edges of the drawer frame with glue and screws driven from the inside. The leg assemblies are made alike, differing only in over-all

Worn effect is simulated by carving away certain edges where wear would normally occur. Be careful not to overdo it

size, and in each case are half-lapped at the upper corners. Screws in counterbored holes, plus glue, are used to fasten the lapped corners and then wooden screw plugs are used to cap the holes. Screw holes also are made in the leg crossrails for attaching them to the top. The top itself is cut from  $1\frac{1}{4}$  or  $1\frac{1}{8}$ -in. material. Chances are you'll have to glue several boards together edgewise to make a  $16\frac{1}{2}$ -in. panel. A  $2\frac{1}{4}$ -in.-wide railing is added

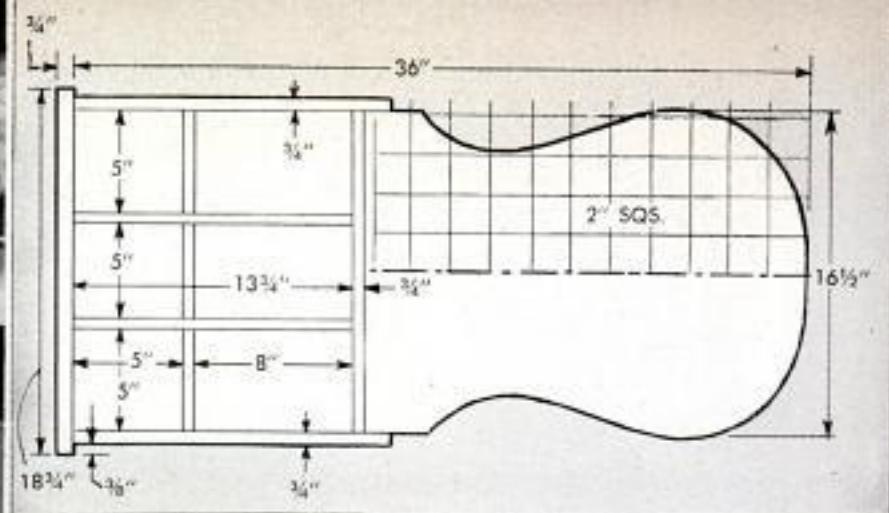
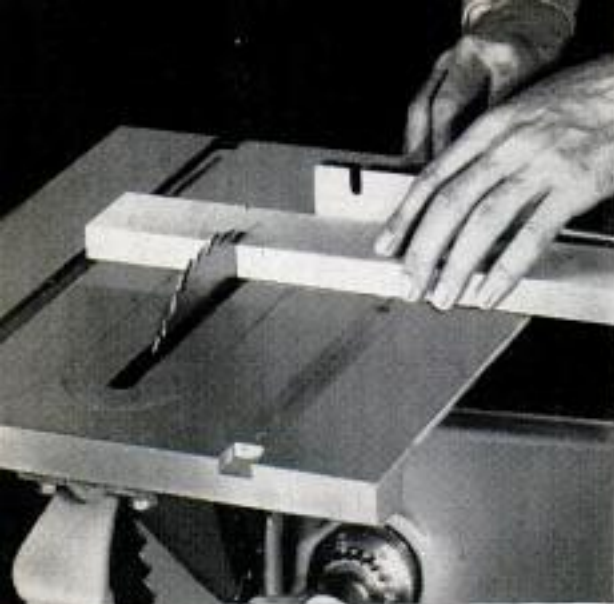

Except for the rounded end of the top, all parts are cut to size with a circular saw

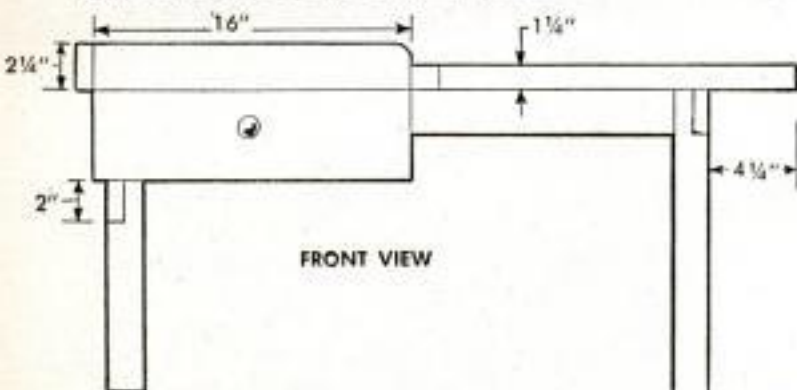

to three sides of the square end of the top after the rounded end is band-sawed to shape. The strips that compartmentize the top measure  $\frac{5}{16}$  x  $\frac{3}{4}$  in. and can be half-lapped where they cross or merely butted. The drawer is made to fit the opening. Note in detail B that the ends of the drawer front protrude to lap the sides of the compartment. Finally, a  $1\frac{1}{4}$  x 2 x  $14\frac{1}{2}$ -in. rail is added to the underside of the top between the drawer compartment and the right-hand set of legs to add rigidity to the latter. Finish with light stain and wax. ★ ★ ★

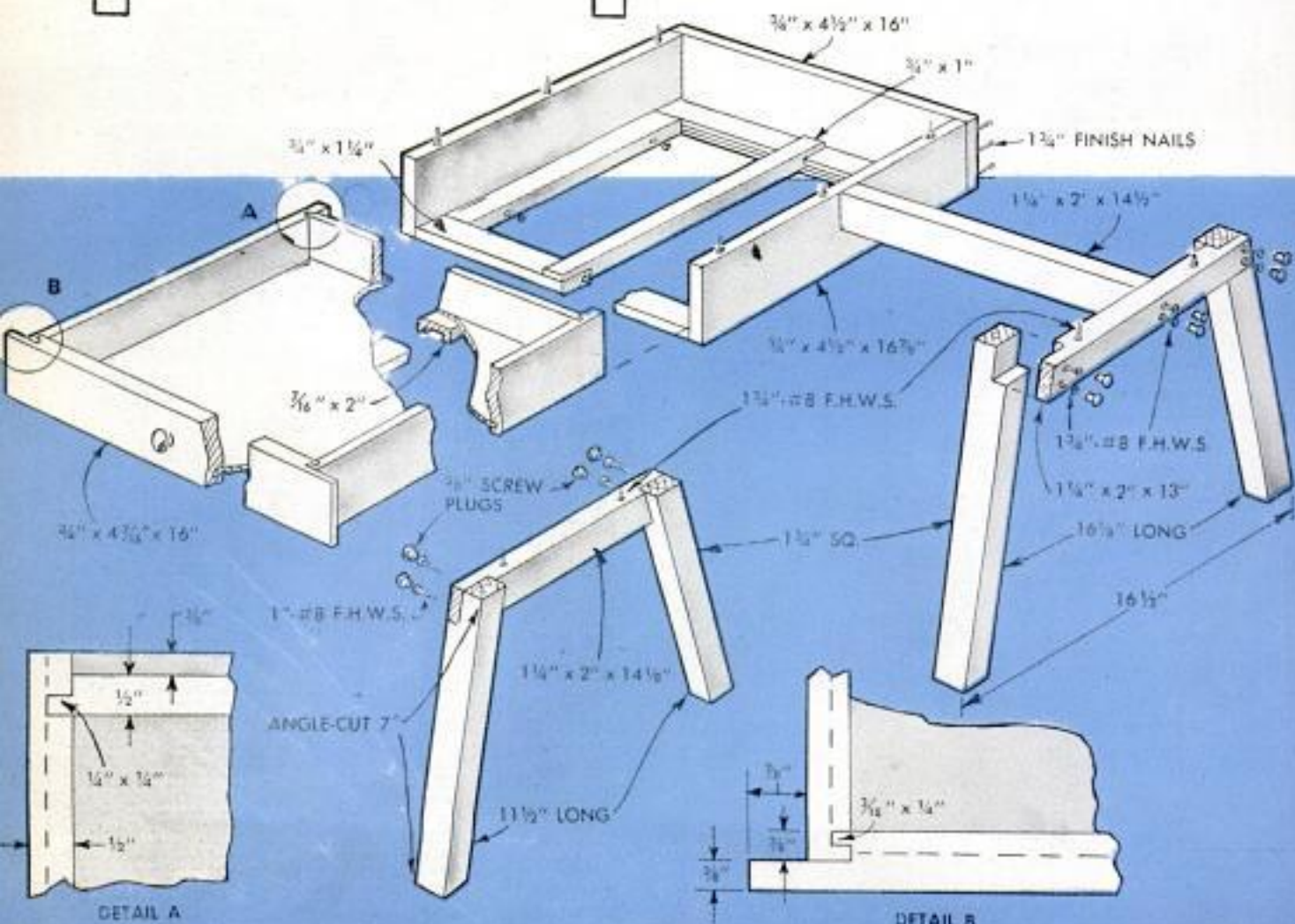

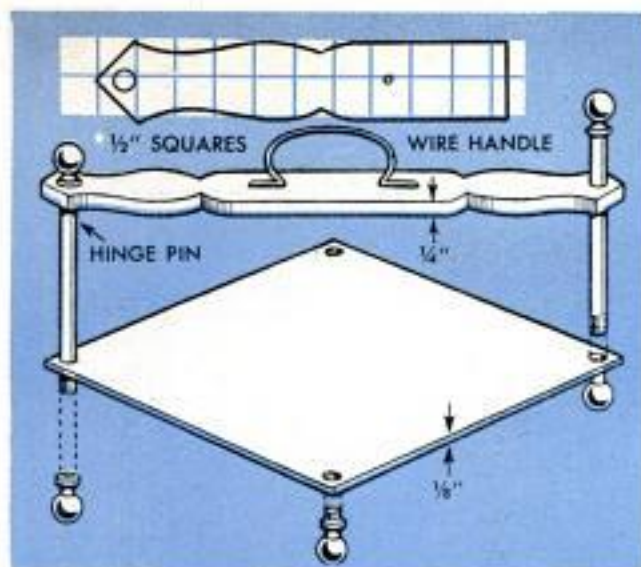

## All-Metal Napkin Holder of Unusual Design

This all-metal holder keeps paper napkins neatly stacked and, because of its weight, is ideal for use outdoors. Steel, brass or bronze materials can be used for any or all parts, and the holder may be finished as desired. The base is a  $\frac{1}{8}$  x 8 x 8-in. plate, the two vertical posts are hinge pins and the crossbar is cut from  $\frac{1}{4}$ -in. stock as indicated in the squared detail. The ball feet are cutoff hinge pins.

The hinge pins are threaded at the ends to screw into tapped holes at opposite corners of the base and project to take ball feet, which are drilled and tapped to screw onto them. The other feet are similarly drilled and tapped for short studs, which screw into tapped holes in the base. The wire handle on the crossbar is peened in holes counterbored on the underside.

Bertram Brownold, Cedarhurst, N. Y.

### Hasp Makes Drop-Leaf Hinge

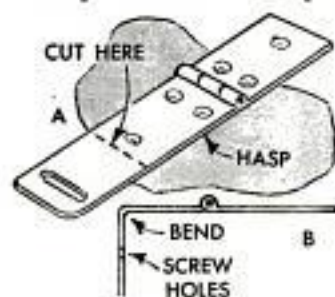

When you need to replace a single hinge on a drop-leaf table there's no reason to buy a pair. Make the single hinge from a long hasp. Just cut the long leaf

of the hasp to the required length and drill and countersink additional holes for screws. Or if a tool-chest hinge is needed bend the leaf 90 deg.

### Prebored Guide Block Aids In Sharp-Angle Drilling

When drilling a hole at a sharp angle to a surface, try drilling a hole at the same angle in a scrap block of wood and clamping it in the vise next to the work to guide the bit as shown in the photo. For more accurate work, drill a second hole through the guide block at a right angle to the first one and joining it at the point of exit, so that the bit can be positioned exactly at the desired point of entry.

### Quieting Electric-Clock Motor

When his electric clock became noisy due to lack of lubrication, one man removed the sealed motor from its frame and placed a few drops of light oil around the clock gear. The motor then was held over a light bulb until it became warm and air escaping from the bearing of the sealed motor bubbled out through the oil. When the bubbling stopped, the motor was removed from the heat and allowed to cool. Atmospheric pressure then forced the oil into the space from which the air had been evacuated by the heat.

Stanley Clark, East Bradenton, Fla.

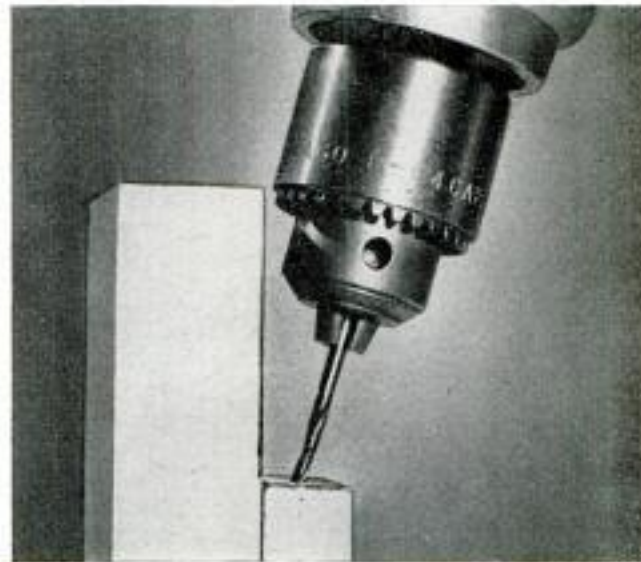

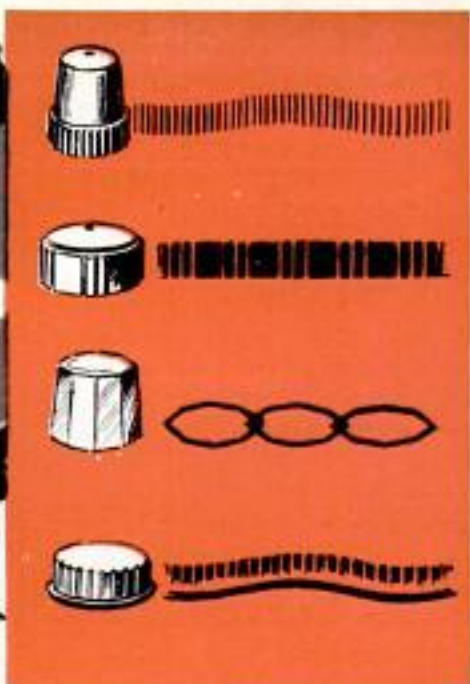

## PLASTIC BOTTLE TOPS HAVE MANY USES

By J. W. Rocke

PLASTIC CAPS, such as are used on toothpaste and shaving-cream tubes, medicine bottles and other containers have not outlived their usefulness when the containers are empty. Made in a wide variety of shapes and sizes, and varying in composi-

tion from hard and brittle to soft and flexible, the caps can be utilized for "special effects" inking rollers, as indicated in the illustration and detail, for electrical insulators and for nonscratching furniture legs. Some caps can be used as replacements for wheels lost from plastic toys, others as tiny cups and plates for doll dishes.



Multiposition switches for model-train control and other low-voltage applications are made by slotting plastic cap, fitting it with shim-stock contact arm. Assembly is mounted on a piece of hardboard with a circle of small screws acting as contacts for individual voltage settings. Rotation of the knob causes shim to bridge circuits



Handle of twisted wire fitted on plastic cap provides handy spoon for measuring powdered glue and other materials. Flat cap is used for the purpose, so it can be placed flat on workbench without problem of having it tip over, as with kitchen spoon. A number of the spoons in various sizes will assure correct quantity measure

Insulated screw-on terminal caps for electrical test equipment that provide both protection against shock and neat appearance, are made by cementing brass nuts in plastic caps. Fill cap with wood putty, then press nut into place. If the terminal post is quite long, it may be necessary to drill all the way through the cap



Soft plastic caps used on some pill containers make ideal nonmarking "feet" for small chests and cabinets. As indicated in the drawing of a radio cabinet, the caps simply are glued to the bottom with rubber or household cement. The top of the cap is cemented to the cabinet and the resilient lower portion that will not mark or scratch

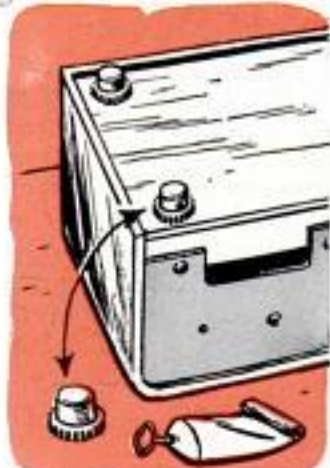

## Bird Feeder Suspended From Tree Has Transparent Trough

This easy-to-make bird-feeding station features a visible feed supply seen through transparent sides of glass or plastic. The roof and floor are cut from  $\frac{1}{4}$ -in. tempered hard-board and the ends from  $\frac{1}{2}$ -in. stock. Form slots for the windows on the inside of the end pieces by nailing on small strips of wood. Cut the windows shorter than the height of the slots to allow for a prop under the lower edge. The amount of opening is determined by the size of the feed placed in the feeder. Nail one half of the roof to the end pieces and hinge the other section to it with a strip of canvas to provide access for filling the feeder. An L-hook locks the hinged section in the closed position. Install a triangular ridge

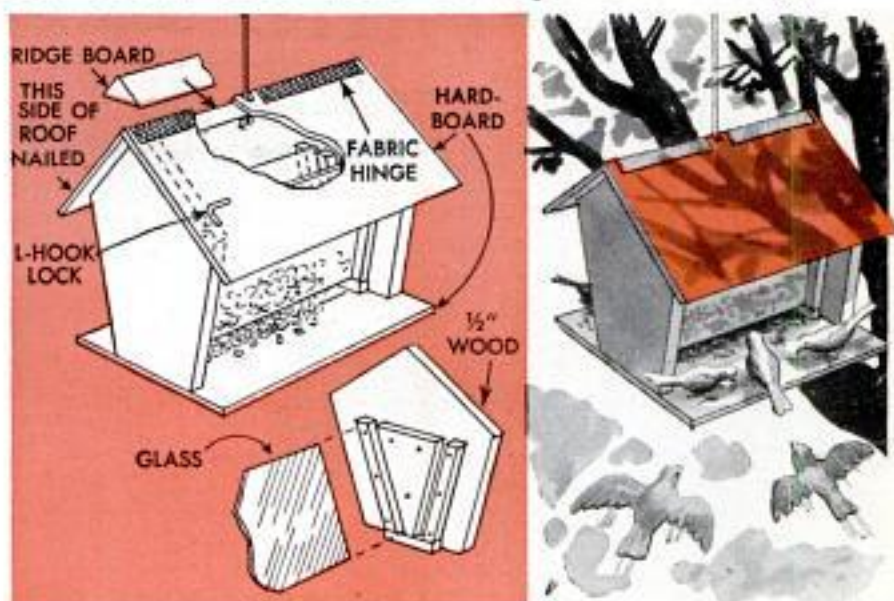

block under the peak of the roof and run a length of wire up through a hole in the center of it, as shown. Suspend the feeder from a tree at a height convenient for refilling and watch the birds have a picnic.

## Laundry Table Rests on Tubs

A flat surface for sorting the laundry is easy to make by cutting a panel of plywood or hardboard to fit over the top of the laundry tubs with a little overlap. Wood cleats screwed to the underside of the panel to fit inside the tubs will keep it in place. If hardboard is used, the screws will have to be driven down from the top side.

## Suede-Shoe Brush Cleans Wood-Bit Screw Point

A suede-shoe brush is just the thing to clear the screw points of wood-boring bits that have become clogged with wood fibers or pitch. The brass bristles of the brush clean the screw points thoroughly without damaging the thread.



## Shutter on Box Camera Altered To Accommodate Fast Film

The only alteration necessary to increase the shutter speed of an inexpensive box camera is to cover about two thirds of the shutter opening with a strip of black masking tape as shown in the photo. This will result in a shutter speed of about  $\frac{1}{100}$  second, permitting use of the new, faster films when it is desirable to stop motion, such as a running play at a football game.

Ken Murray, Colon, Mich.



# SOLVING Home Problems



**MEDICINE CABINET** hung on an open area of the bathroom wall is out of reach of all except grownups. Its location discourages all attempts of young adventurers to reach contents



**HALF OF A RAW POTATO** dipped in fine pumice makes a good scouring pad for kitchen utensils. Contains just the right amount of moisture to hold abrasive

**GUARD FOR SHARP POINT** of a meat thermometer is made by centering a hole in a short length of dowel. Hole is just large enough to take point snugly



**STRIP OF ADHESIVE TAPE** placed over the locking bolt in the bathroom door will effectively prevent small fry from locking themselves in the bathroom

**LUMINOUS TAPE** locates a tumbler of water or any other object placed on a night stand. Cut a small square of tape and attach to tumbler at a point about halfway between the bottom and the rim. Other objects may require longer tape strips placed either vertically or horizontally



**CUP HOOK** screwed to inside surface of any convenient drawer front keeps that spare car, house or garage-door key always at hand when needed. Several keys can be stored in this manner in a single drawer. Cup hooks also can be attached to kitchen-cabinet door





**ADHESIVE-TAPE SPOOL** is just the thing for storing lengths of fancy ribbon. Spools come in different widths for different sizes of tape. The spool selected should be slightly wider than the ribbon to avoid curling or tearing the edges on the spool flanges



**CELLULOSE SPONGE**, also a rubber sponge, makes a good clothesbrush, especially when traveling. It is light, packs in small space and washes clean in a jiffy. Will pick up finest lint dust from rough fabrics

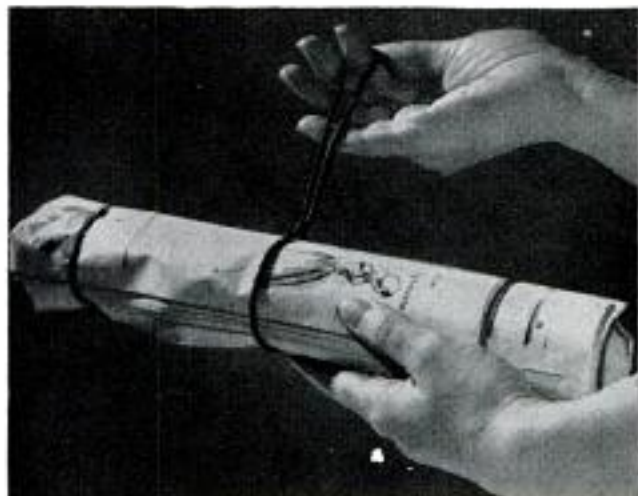

**COAT HANGER** for emergency use is made by rolling a newspaper tightly. Place rubber bands around roll near ends, then loop a cord tightly at the center

**ROLL-TYPE MEMO PAD** can be made in a few minutes from a block of hardwood, two film spools, four angle brackets and screws. Assemble as pictured, then load one spool with a roll of adding-machine paper



**CANDLES** will remain straight in the hottest weather if you dip them full length in shellac which has been thinned with alcohol. Pour thinned shellac in tall container

**GARBAGE CAN** can't be upset by dogs or rolled away by high winds if you secure it with this holder. Bend a length of 1/4-in. steel rod to a U-shape, form loops in the ends and attach with screw eyes and bolts

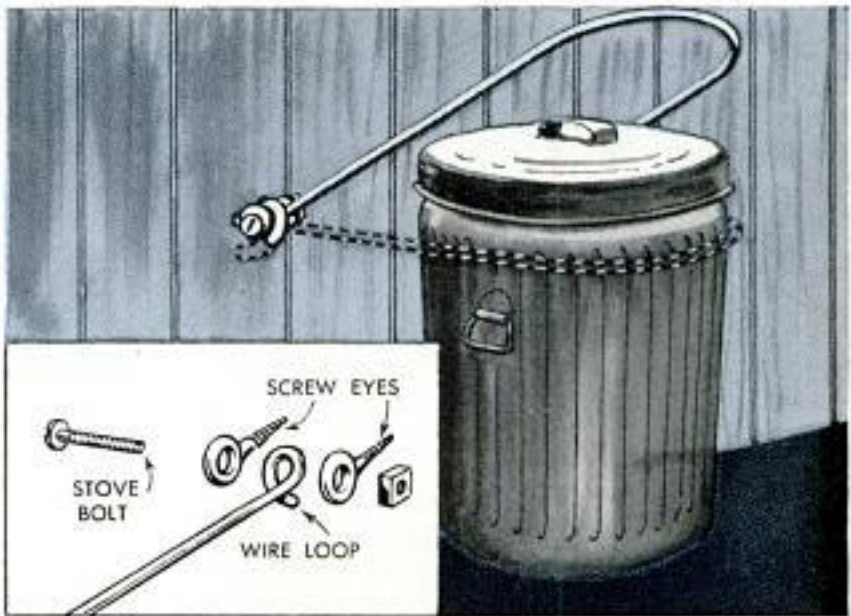

# Ways to Hang Valance Boards on Trim or Wall



These four simple ways to hang window valance boards permit them to be removed and replaced instantly. The two upper details, A and C, show screw eyes driven into the ends of open-top valance boards to slip over a finishing nail in the window trim, or an L-hook in a stud. An alternative method, shown at the lower right, detail D, is the use of a metal angle having a T-slot that hooks over a wood screw. Wherever the weight of a valance is carried by the ends, these should consist of plywood since ordinary wood is likely to split when screws are driven near the edges. The lower detail, B, shows a closed-top valance board drilled to fit over a finishing nail in the window trim, or to engage an L-hook driven into the wall. All of the hanging methods suggested still allow dust covers to be added to the tops of the open valances.

## Quickly Made Marking Stencil

Here is a quick way of making stencils for marking boxes, drawers and other bulky items. Punch out the characters with a series of perforations in a thin sheet of brass shim stock resting on cardboard or soft wood. A scribe or phonograph needle in a holder may be used as a punch, and the resulting burr on the reverse side of the sheet can be removed with a file. To transfer the punched design, apply stencil or stamp-pad ink with a heavy bristle brush. A similar-type mask can be used as

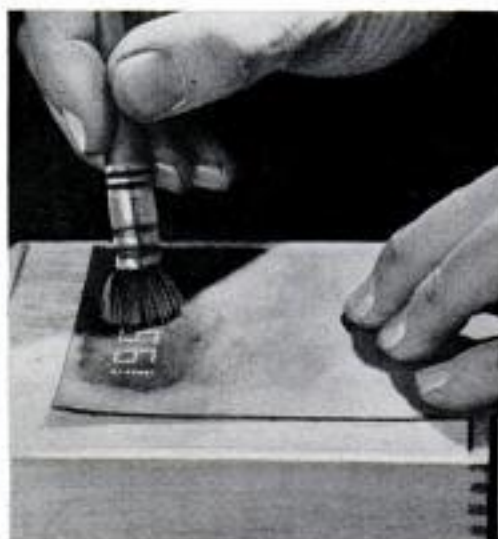

a negative for reproducing designs or characters photographically.

Walter E. Burton, Akron, Ohio.



## Modified Pencil Sharpener Cuts Extra-Long Points

A wall-mounted pencil sharpener can be made to cut a long, sharp point such as is desired by draftsmen and artists, with one slight modification. Simply file a small notch across the metal ridge at one end of the cutter holder as shown in the photo (cutter cylinders have been removed). This permits deeper penetration of the lead between the cylinders while sharpening.

Instead of using a blotter to blot a large blob of ink on writing paper or other surface, touch the hot tip of an extinguished match to the wet ink. Most of the liquid will be evaporated instantly and the balance absorbed by the porous match head.



# PICTURE a NAME

By John Hosack



**V** is for Valerie  
Our little girl  
She is precious to us  
Just like a pearl



**A** is for action  
Running in the park  
Having lots of fun  
'Till almost dark



**L** is for lady  
And also for love  
A sweet little girl  
Soft as a dove

IT IS FUN picturing a child's name in the manner shown on this page. The name is your "shooting script." A short name of three to five letters is the easiest to picture and make into a wall display as indicated in the tinted sketch. If the name is longer, try to shorten it or use a nickname.

First, think up a word to go with each letter of the child's name. For example, using the name BOB, the first letter suggests ball, B is for ball; then, O is for orange; and, B is for bank. Take pictures of Bob with a ball, with an orange and with his bank, and write as many additional lines for the verse under each picture as desired. Keep the picture situations simple, direct and to the point to strengthen the relationship between name and picture, and use prints with similar tonal values. Cement the prints on pieces of mounting board, using rubber cement.



## DECORATE WOOD WITH A TORCH

By *Walter E. Burton*

USING THE TINY, superhot flame from a soldering torch as a "stenciling brush" you can produce any number of attractive decorative designs on wood. To do this type of "pyro stenciling," you use sheet-metal cutouts or any flat object, such as a key, as reverse "stencils," or shields, to produce white outlines on a dark background, the white being the natural color of the wood, of course. In the reverse process, the outline of the object is cut through the metal, or incised, the process producing a silhouette, or silhouettes, on a white

background, the latter in the natural color of the wood.

Basswood is probably the best wood for the purpose as it blackens, or chars, more uniformly. White pine is the best second choice, white-pine plywood being ideal for the key caddy and such items as large wall plaques. The trick in charring the wood to a uniform color is to use a torch tip giving a medium, pointed flame, and to keep the flame moving uniformly over the surface of the wood. Care must be taken not to heat the metal to the point where it chars the wood underneath. Take precaution against fire. Wear a leather glove. ★★★

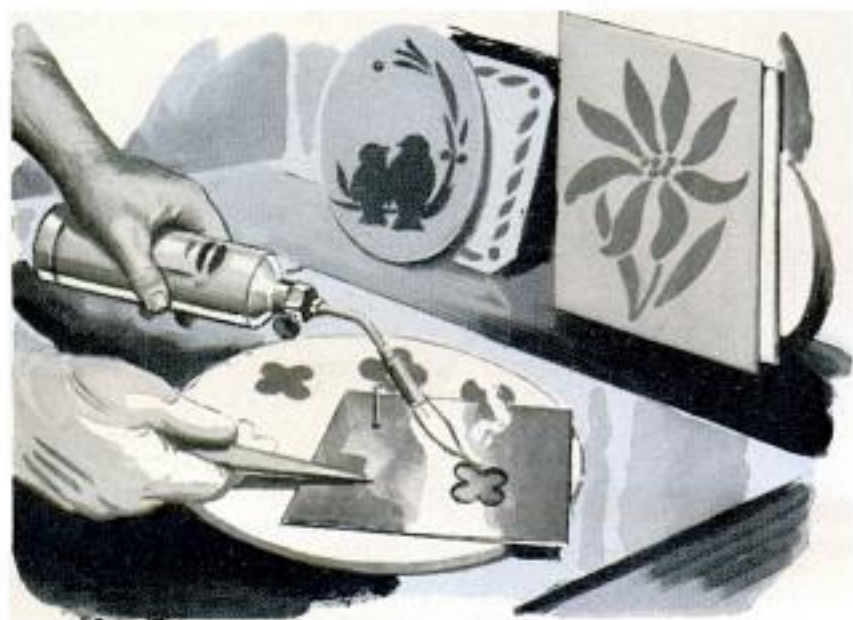

## WALL PLAQUE

You can make most attractive and novel wall plaques by "pyro stenciling" various floral and pattern designs on basswood or pine-faced plywood. In this work the sheet-metal stencil, or template, has the design cut through, or incised. The design is first laid out on the surface of the metal and then cut through with a coping saw, using a fine-toothed blade. Blades used by jewelers are just the thing. Before lighting the torch, cover the bench top with a sheet of asbestos. Clear away wood chips

## JEWEL BOX

Small boxes made from bass-wood are available ready-made. They come unfinished and of a size suitable for storing costume jewelry, cards, cigarettes and other small items. Although originally designed for decorating with self-hardening clay or enamel, these boxes are just the thing for pyro stenciling in a variety of designs, only one of which is pictured, a simple diagonal "tiger" stripe which is burned on the wood in the manner shown, using a small rectangular piece of sheet metal cut with one edge straight. Playing flame along straightedge gives a blackened stripe, one edge straight, one somewhat irregular. Space stripes uniformly



## INITIALS

By using sheet-metal letter cutouts you can stencil initials, letter signs, estate name plates, business signs. The letter cutouts (each one an individual letter except in larger sizes) should be cut from 18-ga., or heavier, sheet metal so that they will lay flat on surface of wood. Due to the relatively small area covered by the metal and the necessity for producing sharp, clean edges, flame-stenciling letters requires somewhat more careful handling of the torch than necessary in other cases

## HOT PAD

Procedure in stenciling hot pads is very similar to that followed in making plaques. One novel method is illustrated, stencil being of the incised type, which is cut to a V-shape and pivoted near the point as shown. By moving stencil you can make repeat designs equally spaced around center point of round pad. In following out this procedure be sure not to overheat the sheet-metal stencil. Permit it to cool at intervals, or dip in cold water. In working white on black, care must be taken when stenciling stems or any narrow parts that flame does not work under metal and char the wood



## Neater Method for Taping Signs To Inside of Store Windows



Instead of pressing strips of removable gummed tape diagonally across the corners of small paper signs to fix them to the inside of windows, try the much neater method illustrated. Holes about  $\frac{1}{2}$  in. in diameter are punched through the sign near the corners, then pieces of tape are stuck to the back of the sign across the holes. The gummed surfaces of the tape exposed through the holes are pressed against the glass. For a touch of color, use colored tape.

## Frequently Used Angles Filed in Triangle

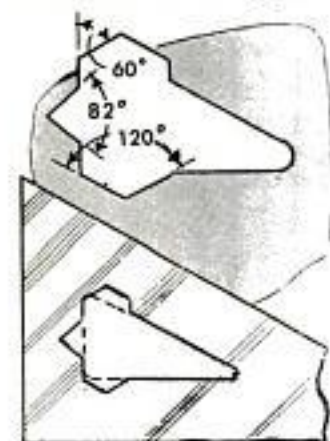

Mechanical draftsmen can save a great deal of time by having a few frequently used angles filed in the center of their triangles. As shown, two adjacent sides of a hexagon, arranged in alignment directly opposite each other, will save the need for turning

the triangle over repeatedly when laying off hexagons of the same or smaller size. Another angle that proves to be highly convenient is the 82-deg. angle of countersinks and flat-headed or oval-headed screws and bolts, which are often used in mechanical drawings.

## Metal Hasp Locks Window Screen

The danger of small children opening a window screen and falling out may be practically eliminated with this simple hasp. It is made by slotting and bending a small strip of tin or aluminum and attaching it to

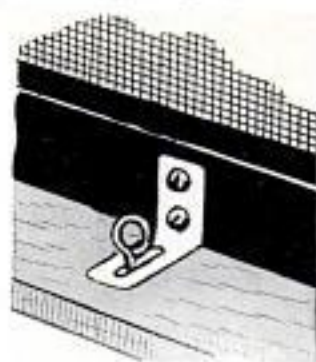

the screen as indicated. A screw eye driven into the window sill engages the slot in the hasp and, when turned at right angles to the slot, locks the hasp.

## Four Steps in Planning a Stairway

When laying out a stairway, there are four things to consider to assure ease in climbing and maximum safety. First, clearance from tread to ceiling should be at least 7 ft. Second, angle of stairs should be from 30 to 36 deg. and never over 50 deg. Third, width of the treads should be between  $10\frac{1}{2}$  and 12 in., and the height of the riser from  $6\frac{3}{4}$  to  $7\frac{1}{2}$  in. Fourth, all risers and treads in a stairway should be equal. To find the number of steps in a proposed stairway divide the vertical distance between floors (given in inches) by 7, the average riser height. Exact riser height is then found by dividing the whole number of the above answer into the vertical dimension. If the decimal in the first answer was over .50 the next higher whole number should be used as the divisor in the second computation.

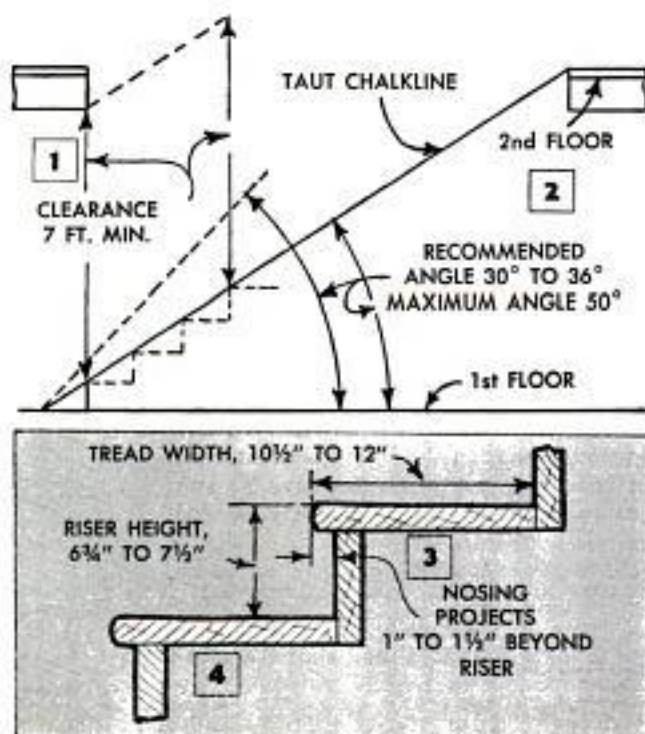

# PRINT IN *Your Signature*

YOUR SIGNATURE printed in photographically not only personalizes the print, it identifies the picture as your own work. The first step is to copy the signature, using a fast-processing film. Then cut an opening near the lower right-hand corner of a large piece of cardboard and mount the signature negative on the underside, centering it in the opening. Of course, the opening in the cardboard must be far enough from the edges so that the signature can be positioned on the print in the easel without any of the sensitized paper being exposed outside the edges of the cardboard. To locate the signature, slide a piece of opaque paper under the negative and turn on the enlarger light. With the image (picture) projected on the cardboard, just move the latter until the signature is located. Ordinarily, the signature should be printed in an area of comparatively light tone, as in the upper right-hand photo. Now, turn off the enlarger, withdraw the opaque paper and print in the signature, using a pocket flashlight as in the photo below. Also, your customers will always know how to order reprints if you stamp each print with an order number and your address as shown by the facsimile.

Eugene A. Hancock, Loveland, Colo.



The signature should be located in a comparatively light area of the print so that it is readily seen

**FOR MORE PRINTS  
Of This Picture - Ask For**

**No. 16875**

*Hancock Studio*  
**Loveland, Colorado**

Above, stamp the back of each print with your address and an identifying number. Below, how the signature is printed in through an opening in the cardboard





## New Look for INTERIOR WALLS

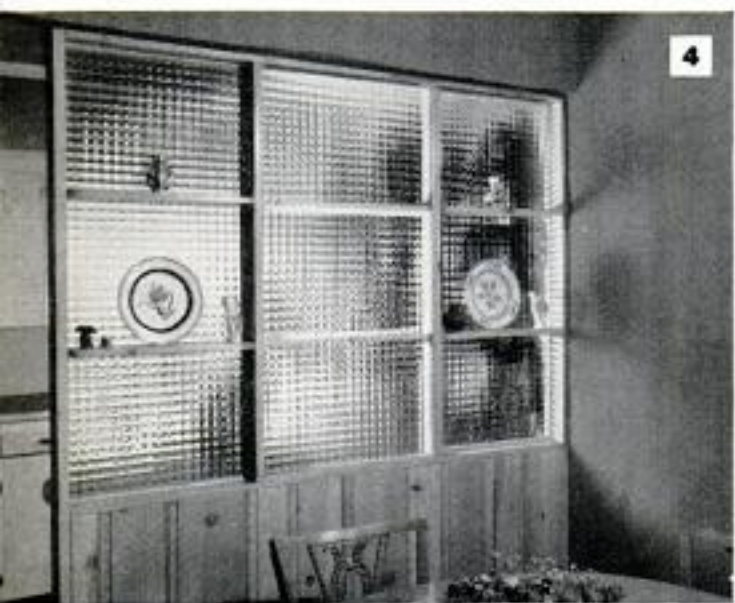

By Enno R. Haan

**B**EFORE STARTING to build a new home or remodel an older one, you will want to investigate some of the exciting possibilities for smart room planning offered by the use of the various materials available for modern dry-wall construction.

### Some Dry-Wall Advantages

Prepared wall coverings do not require a drying-out period which may cause work delays, and the installation cost is negligible if the homeowner does the work himself. Many wall-covering materials come prefinished, which eliminates the need of subsequent painting, while others come primed to facilitate one-coat finishing.

### Variety of Materials

Glass fiber, Figs. 1 and 2, is a comparatively new and colorful material. Lightweight, translucent and shatterproof, it is available in flat or corrugated panels of various sizes. Used for screens and partitions, it gives contrast and variety for accent touches in decorating.

Extreme durability and no need for subsequent decorating are the features of hard, laminated plastics, which can be used on kitchens and bathroom walls as in Fig. 3. Colored structural glass has similar application. This must be pre-cut and drilled by manufacturers to specifications. Trans-



lucent decorative glass, available in many textured surfaces, can be used for partitions as in Fig. 4. Another interesting variation in glass is the use of glass blocks for partitions. These are strikingly modern but strictly non-load-carrying.

Strips of bamboo, Fig. 7, obtainable in 4 to 8-ft. lengths, can be used to produce a cool garden motif or oriental atmosphere. Other wall-covering materials that have been produced in a variety of new forms for greater usefulness and convenience include wood and plywood, hardboards and the less-dense insulating boards, asbestos-cement and gypsum wallboards, plastic, sheet-metal and ceramic tile; also thin, flexible sheet materials, including various kinds of plastics, cork and linoleum.

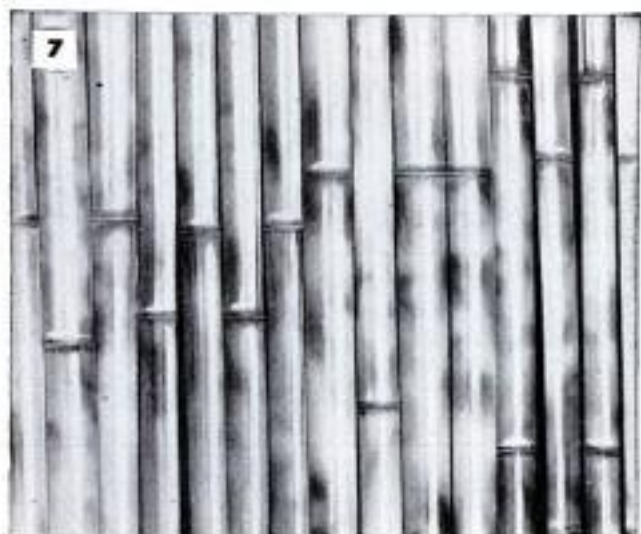
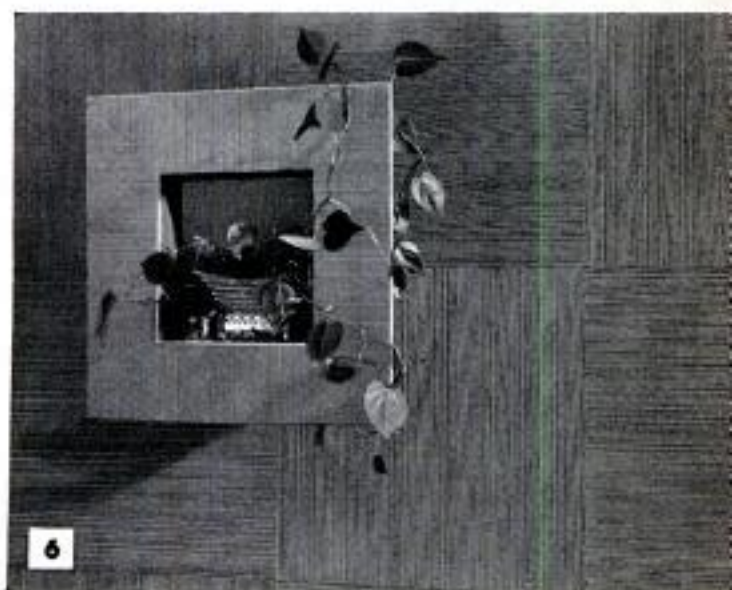



9



10

### Surfaces and Finishes

Striated surfaces have become quite popular. Large expanses can be given the effect of greater height or width if the lines are arranged vertically or horizontally. Fig. 6 shows a checkerboard styling of squares of striated material. An unusual texture in plywood is accentuation of grain as shown in Fig. 8. Recently developed, corrugated and perforated hardboard, Figs. 9 and 10, are valuable for breaking up the monotony of continuous, flat surfaces. One new form of hardboard is both corrugated and perforated for more versatile and smart application.

Acoustical tile, Fig. 15, is of softer consistency than hardboard and is perforated with small holes or narrow slots that absorb sound vibration. Some wall-covering materials are backed by foil, or with a water-resistant coating, to act as a vapor barrier. Foil also serves as reflective insulation. A number of wall-covering materials come prefinished as, for example, the baked-on enamel on some tiles. Other materials may be encased in tough Manila

paper printed to simulate wood grain. Color also can be uniform throughout the material, as in some plastics.

### Forms of Rigid Wall Coverings

Most rigid wall-covering materials come in one or more of the following forms: (1) Tiles or blocks, Figs. 6, 12, 14, 15, 17 and 20, up to 16 x 32 in. in size. (2) Planking, Figs. 5 and 11, which comes in 8 to 16-in. widths and usually has lapped or tongue-and-groove edges. It may be applied either vertically or horizontally. (3) The large 4-ft.-wide panels known as building board, Figs. 13, 16 and 19. This sometimes is scored to simulate planking or tile and, if the material is hard and dense, may have pre-drilled holes for nailing. (4) Panels of other sizes as in Figs. 1, 2 and 3.

### Nailing Bases

Ceilings are covered first, then walls from the top down. Most wall-covering materials are fastened with nails, staples or clips to wall studs and ceiling joists, Figs. 13 and 16, to furring strips, Figs. 11



11



12





13



14

and 14, or directly to the surfaces of walls as in Figs. 5, 12 and 17. Studs and joists generally are spaced 16 in. on centers, but furring strips are spaced from 6 to 12 in., depending on the product and the manufacturer's instructions.

Furring strips usually are nailed at right angles to studs and joists. Hardened, spiral-shank concrete nails often can be used to fasten furring vertically or horizontally to green concrete or to mortar joints of masonry. When concrete or mortar is too hard for such penetration, holes are drilled with a carbide-tipped bit. The holes then are plugged with tight-fitting dowels into which nails are driven, or suitable screw anchors are used instead.

Most types of building board require suitable nailing bases for rigid support at all edges. The sole and top plates of partition framing provide that at the bottom and top of a wall. When building board is arranged horizontally, a nailing base should be installed for the midway joint as in Fig. 16. Spaces between joists at the edges of a ceiling should have nailing bases unless other means of support are provided. An exception to this general rule of providing nailing bases under all edges exists with gypsum wallboard. Here perforated tape, which is used in conjunction with cement to reinforce edges and seal cracks, produces strong joints that need not be nailed at points between studs and joists.

#### Fastening With Nails and Staples

Different kinds of wallboards require different nails in respect to kind and size, as recommended by manufacturers. Nails should penetrate nailing bases no less than  $\frac{3}{4}$  in., sometimes more. Often nailheads are concealed by sinking them slightly below the wallboard surface, and then "spotting" them with a special filler or

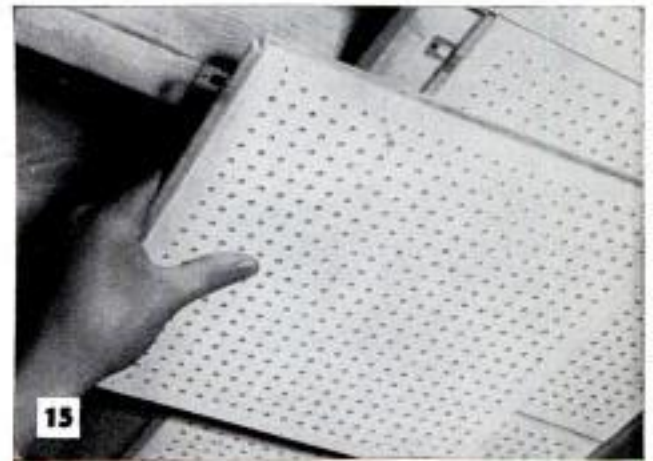

15

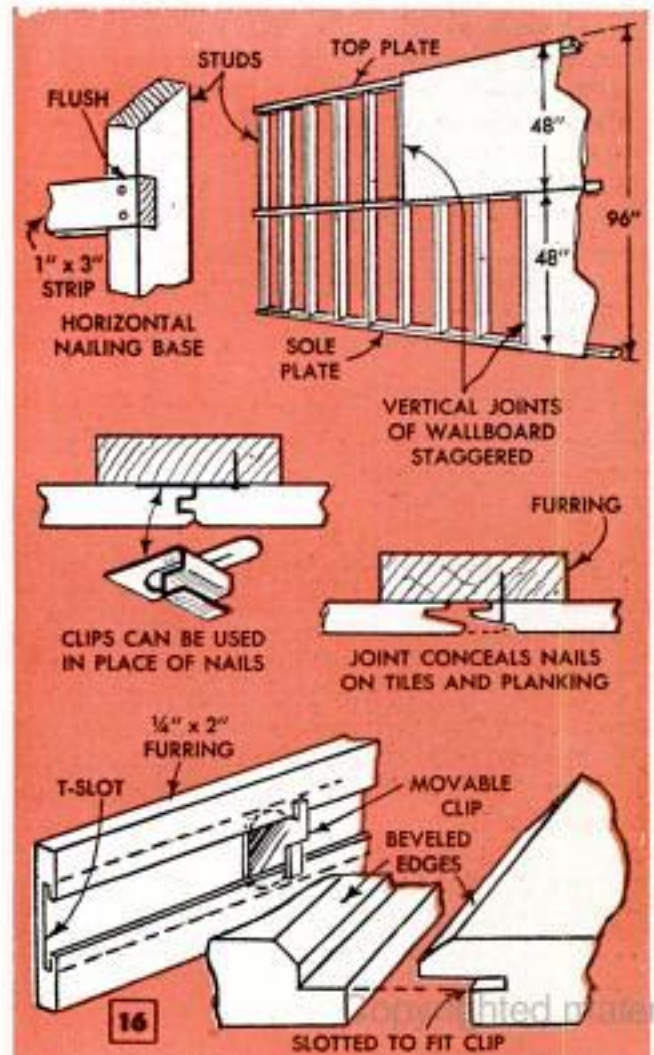

16

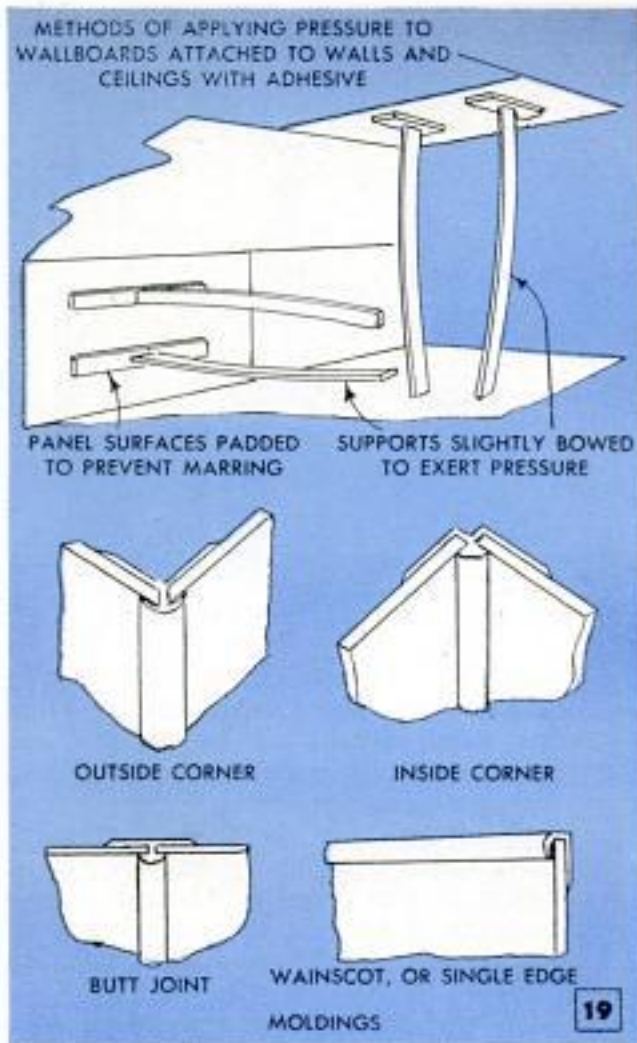
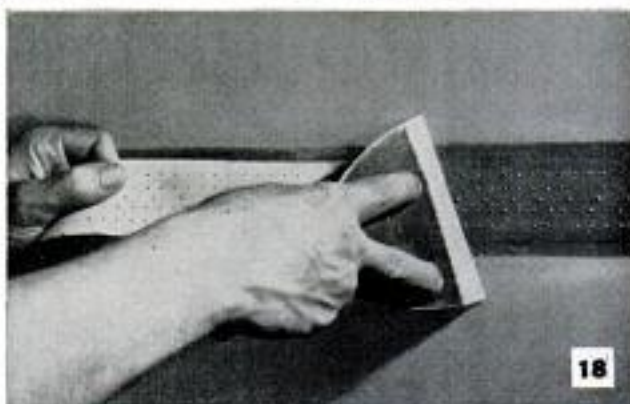

cement. Nails holding tongue-and-groove planking and tiles are driven into the lip edges as in Fig. 16 and concealed by the overlap of the adjoining plank or tiles.

The usual procedure in applying building board is to nail it to intermediate studs, joists or furring strips from the center out, and then nail it at the edges. However, for asbestos-cement board, it is recommended that one edge be nailed first, after which nailing proceeds from this edge across the sheet to keep it flat.

Stapling, Fig. 14, is a fast method of attachment but is confined to the less dense types of wallboards. The staples should be rust-resistant and of suitable size for the thickness of wall covering used.

#### Clips for Tiles and Planking

Metal clips as shown in Figs. 11, 12, 15 and 16 often are preferred to nails for tiles and planking. Clips provide complete support yet permit slight movement of the material when it expands or contracts. Fig. 16 shows a novel clip arrangement for holding  $\frac{1}{4}$ -in. plywood planking to furring strips that have a T-slot to hold clips, which also fit a cut under the tongue edge of the planking, thus eliminating nails and the problem of concealing the heads.

Most wallboards as well as structural glass, plastic and metal tile can be installed with suitable adhesives. When an adhesive is used, the backing must be flat, rigid, in good condition and firmly anchored. Peeling paint or enamel and all traces of wallpaper must be removed, cracks should be filled and damaged spots repaired.

Adhesive can be applied by using a correctly notched spreader to apply daubs or ridges of the adhesive to the wallboard. On large panels the daubs may be from  $\frac{1}{8}$  to  $\frac{1}{4}$  in. thick, about 3 in. in diameter and spaced about 10 or 12 in. apart. On small tiles daubs are deposited near the corners as in Fig. 17. Ridges of adhesive often are deposited on planking, lengthwise, at center and edges, using a special tool. Large panels can be kept in firm contact with a backing such as a plastered wall, until the adhesive has set sufficiently, by using braces and wedges as shown in Fig. 19. Another method is to use a few finishing nails where necessary, sinking them below the surface and covering them later.

#### Edge and Corner Treatments

Examples of the most common types of molding available from various wallboard manufacturers are shown in Fig. 19. The molding may be wood, metal or plastic.

Wallboard having beveled or rounded edges forms V-joints when assembled and these are left uncovered.

Joining edges of recess-edge gypsum board are covered with perforated tape embedded in cement and covered with it as shown in Fig. 18. Three separate applications of cement, well feathered out, are usually required. When dry, the joints are sanded. Inside corners are similarly done with the tape which then is creased lengthwise at its center. Outside corners are provided with a special metal-reinforced tape.

### Tile-Laying Hints

Some important details not to be overlooked when applying wall tile are as follows: Remove all loose, scaly paint and put the wall in good condition. Unless you start at a vertical corner molding, you will need horizontal and vertical guide lines. These you snap with a chalk line after carefully locating their positions so you will not have to cut tile to narrow widths when fitting them at the edges of the wall.

Adhesive and tile should be kept at room temperature for several hours before application. Rigid tile generally is "snapped" on previously applied adhesive, Fig. 20, so it comes about  $\frac{1}{8}$  in. from tile already in place, after which it can be moved by pressing on the tile gently with the tips of the fingers. When installing plastic tile at registers, place a suitable thickness of asbestos paper between the metal and tile.

### Working With Wallboard

When the softer types of wallboard are located where they are vulnerable to impact and consequent damage, a strong, rigid backing of plaster, wood or other equally suitable material should be provided behind them for support.

When building board is applied horizontally, using lengths that extend across the entire wall, and the wall is not higher than 8 ft. 3 in. (gap at the floor to be concealed by baseboard), there will be a minimum amount of joining edges to be concealed. Building board should be installed vertically where walls exceed 8 ft. 3 in. in height. Basic arrangements of building board for best appearance of joints are shown in Fig. 21. Some materials, like gypsum and asbestos-cement wallboard can be fractured along a scored line.

Hardboard is available in regular and in tempered varieties. The latter has about seven times as much strength and ability to withstand abrasion as the former. Because hardboard changes slightly in size with changes in humidity, the moisture content of wall panels should be maximum at the time of installation. This can be

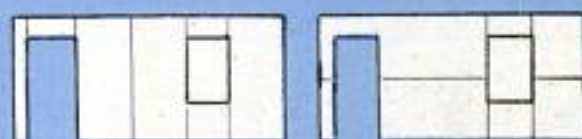

PLACEMENT OF WALLBOARD AROUND WINDOW AND DOOR OPENINGS

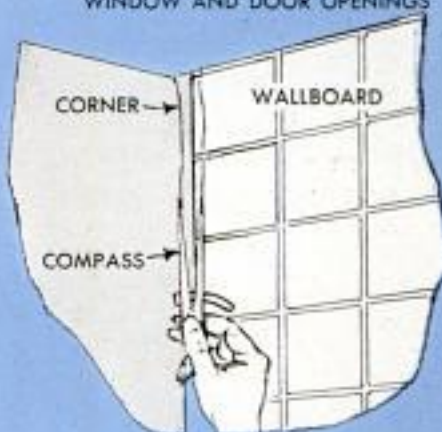

MARKING WALLBOARD TO FIT IRREGULAR CORNER

assured by placing wet cloths or newspapers between pairs of panels arranged with the smooth sides facing outwards for about 12 hours.

Often the corners of rooms are not very straight and then wallboard must be cut to fit it accurately. You can mark the wallboard for cutting by transferring the variations of the corner to it by using a pair of dividers as shown in Fig. 21. ★ ★ ★

Photos in preceding article were used through courtesy of following: Fig. 1, Piton Plastics Corp.; Fig. 2, L.O.F. Glass Fibers Co.; Fig. 3, Formica Co.; Fig. 4, Libby-Owens-Ford Glass Co.; Fig. 5, United States Plywood Corp.; Fig. 6, Chapman Mfg. Co.; Fig. 7, Thomas S. Crandall; Fig. 8, Georgia Pacific Plywood Co.; Figs. 11 and 12, Masonite Corp.; Fig. 13, Colotex Corp.; Fig. 14, National Gypsum Co.; Figs. 15 and 17, Wood Conversion Co.; Fig. 18, United States Gypsum Co.; Fig. 20, Vikon Tile Corp.

## Lower Shelves of Open Bookcase Are "Off Limits" to Tykes



You can make the lower shelves of an open bookcase temporarily inaccessible to roaming tots who take great delight in turning a room upside down. Simply cut a panel of plywood or hardboard to suit the width of the bookcase and attach two friction catches to the inside to hold the panel in place. Two finger holes let an adult remove the panel quickly.

## Mucilage Container-Applicator Made From India-Ink Bottle

India-ink bottles now on the market make ideal container-applicators for mucilage and thin glue, as the bottle stoppers operate in much the same manner as a medicine dropper. After the contents have been used, the bottles are cleaned and filled with glue which can be applied in a line or a single spot simply by squeezing the bulb of the filled stopper.



## Sawhorse Has Leg Extenders

Sawhorses fitted with adjustable leg extenders as shown can be used for many more jobs than ordinary ones. To make the conversion, simply screw two pipe clamps to the inside of each leg and drill three or four holes two inches apart and starting about two inches above the uppermost clamp on each leg. Then, insert a length of steel pipe in each pair of clamps and place a bolt in the hole in each leg that will provide the desired leg height. Use wing nuts to fasten the bolts for easier changing and place rubber crutch or cane tips on the exposed pipe ends to prevent damage to floors.



O. C. Grant, Springfield, Mass.

## Marbles Spot Railing Holes In Concrete Stoop

Using glass bottles to form anchor holes for ornamental-iron railings in a concrete stoop is a common stunt, but usually the bottoms of the bottles are left exposed to show their locations. Where the railing is to be installed at a future date, a less conspicuous way of spotting the bottles is to center a marble on the bottom of each one so it just peeks through the troweled surface. Then when you are ready to break open the holes at a later date, it's an easy matter to spot the marbles and tap them with a hammer to break the glass.—Frank A. Javor, Newark, N. J.



## Graphite From Pencil Lubricates Miter-Gauge Groove on Bench Saw

A bench-saw miter gauge will slide freely in its groove if given an occasional lubrication with the graphite from a carpenter's pencil. Simply run the point up and down the groove until a sufficient amount of graphite is deposited on the bearing surfaces. Oil should not be used, since particles of dust mix with it and cause the gauge to stick. Oil also might get on the work and stain it.

# This On-A-Door Rack Holds Magazines Galore

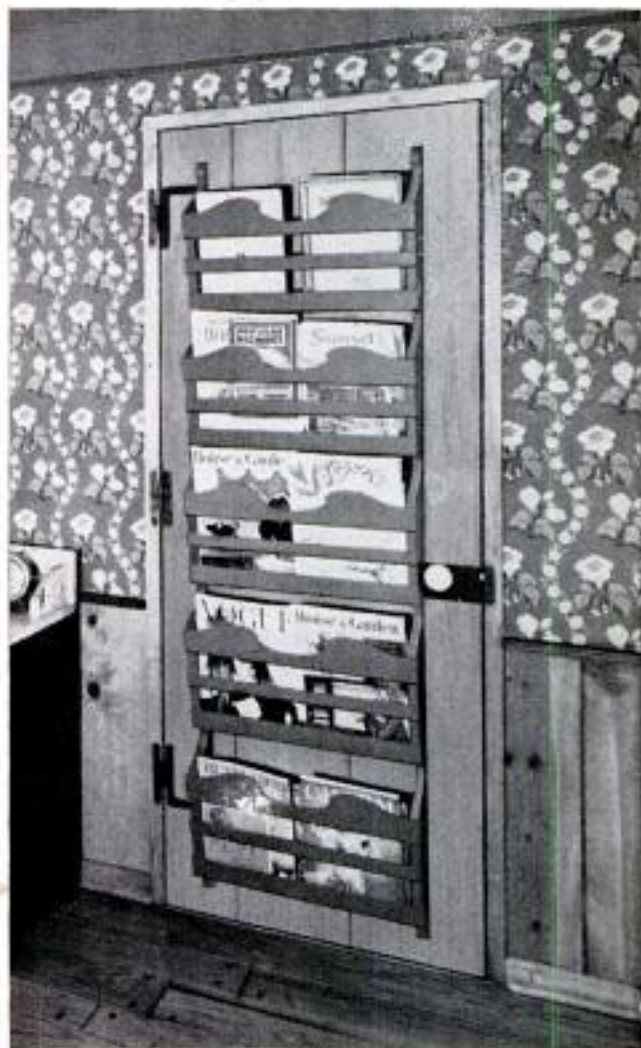
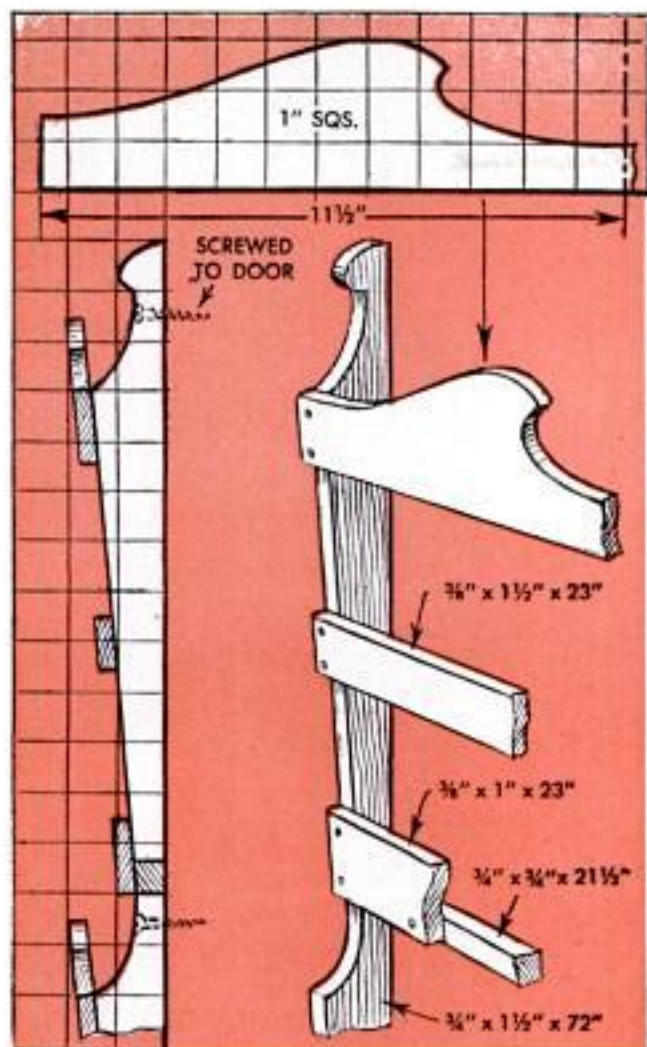

Your magazines are not only always conveniently at hand when kept in this on-a-door rack, but the array of colorful covers will help to add a bright touch of color to a family room. It's a perfect jigsaw project, the scrolled sides being a repeat pattern the height of the door. The sides are screwed to the door first,

then the plain and scrolled cross pieces are nailed to them with small finishing nails. A  $\frac{3}{4}$ -in.-sq. piece forms the bottom of each magazine compartment. The original rack was done in Chinese red to contrast against a natural-finish door. Width of rack, of course, must suit door.—Hi Sibley, Nuevo, Calif.

## Strip of Corrugated Board Stores Cup Hooks

Cup hooks are classified among those small household items so easily lost or misplaced, especially those few left over from the last purchase you made. Of course you put them away, but where? Cup hooks are easy to locate if you take the time to cut a narrow strip from corrugated board and screw the hooks into the edge as pictured. Extra screws can be stored this way too.

## Rejuvenating Scuffed Luggage

If you have a piece of luggage that is badly scuffed and should be discarded, you may be able to improve its appearance for a few more trips by coating it with liquid shoe polish. When dry, coat with thin white shellac which will give the luggage the appearance of a glazed finish.

Doris Fenn, Chicago.

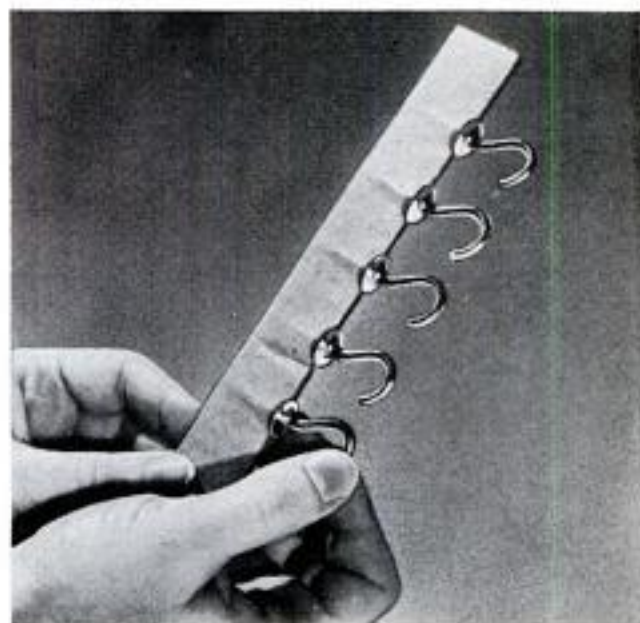



Whether enlargement of entire negative, above, or only main subject, below, treatment is effective

## One Negative

**N**O MATTER how carefully you compose a picture in the view finder of your camera, there will almost without fail be some unwanted material at the top, bottom or sides that should be eliminated—"cropped away"—when making prints. With two L-shaped "rulers" and a print made from the entire negative the best composition can be selected, as shown in the photo on the bottom of this page, and enlarged. Lines drawn with a grease pencil at each corner of the area selected serve as guide lines to aid adjusting and focusing the enlarger. After a print of one combination is made, wipe off the guide lines and try another



Photos and information courtesy  
Eastman Kodak Co.

Below, L-shaped "rulers" cut from cardboard enable photographer to select and "view" best composition more easily before making enlargement of it

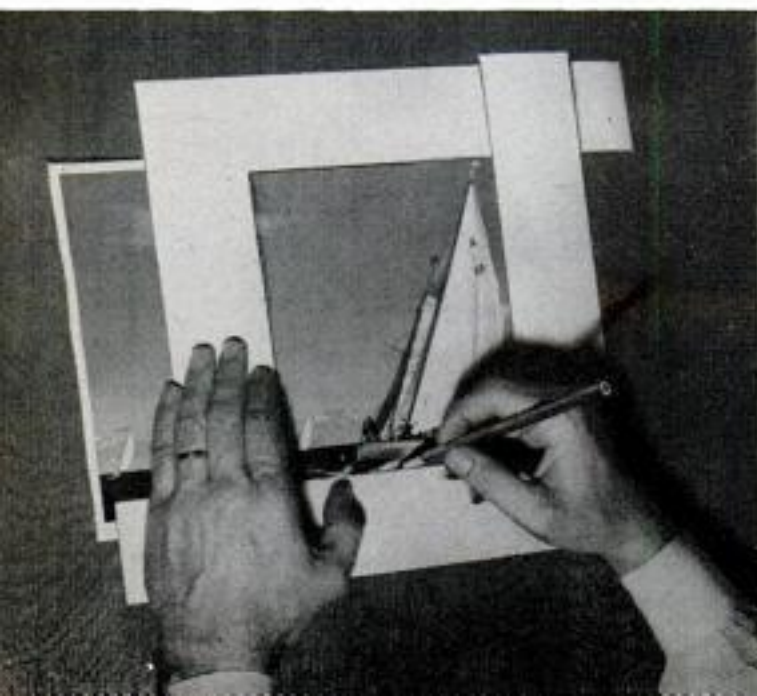



Right, removal of small boat makes number 18 underdog in race. Left, removal of big boat changes picture

## *How Many Pictures?*

combination that will present the subject differently.

Cropping a picture close to the main subject helps to focus attention on it and strengthens vertical lines when only the sides are cropped, lower left. Maximum enlargement and close cropping on all sides reduces the picture to its essentials for a dramatic view, lower right. ★ ★ ★

Below at left, number 18 boat is center of interest while smaller boat creates illusion of distance

Center, with all but larger boat eliminated from picture just one strong center of interest remains

Right, maximum enlargement and picture cropped to essentials produces more dramatic, intimate view



# Attic Ladder in Wall Cabinet Is Always Handy

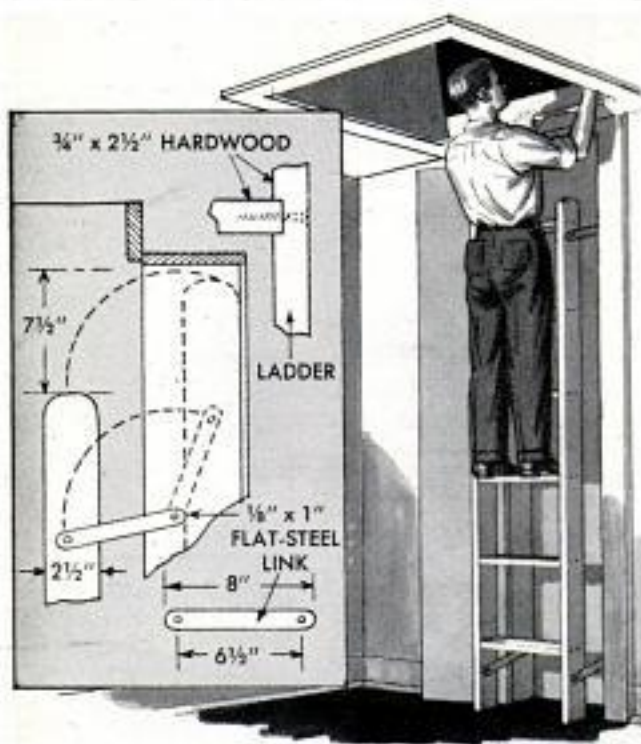

Going after a ladder whenever you want to go up into the attic is no longer necessary when one is permanently installed below the ceiling opening. It can be built into the wall like an ironing board or housed in a shallow floor-to-ceiling cabinet attached to the wall. Attached to pivoting links, the ladder is merely lifted up and out to bring it into ready use. Four flat-iron links, all parallel to each other, pivot the ladder to the cabinet. Bolts and washers are used to attach the links to the ladder; screws and washers to the cabinet. Outside width of the ladder should be about  $\frac{1}{2}$  in. less than the inside width of the cabinet. Note how the ladder rests against the cabinet back with the links resting at an angle slightly beyond the vertical, which prevents the ladder from falling out of the cabinet.

Reduce corrosion stains from nails, hinges, screens and downspouts by painting or varnishing the affected surfaces.

## Slotted Wooden Strips Can Be Reinforced With Dowels

When a piece of wood is slotted lengthwise to serve as an adjustable sliding member of an assembly, and it is subject to weight or pressure, the ends should be reinforced with dowels to prevent them from splitting. Drill holes across the ends and glue the dowels in place. When the glue has dried, cut off the projecting ends of the dowels and sand them flush with the surrounding surface. An alternative for a slotted wood strip is to recess two narrower strips along one edge as shown, applying glue to the joining edges as well as to the dowels. A third method would be to use carriage or stove bolts instead of dowels.

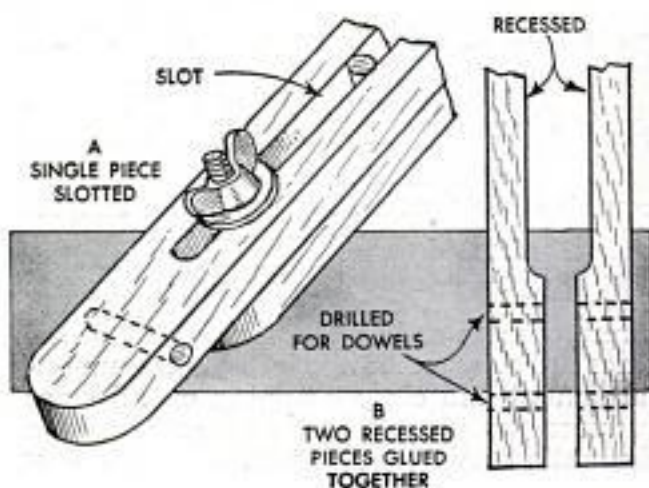

## Fishing-Lure Fastener Altered So It Will Not Pull Open

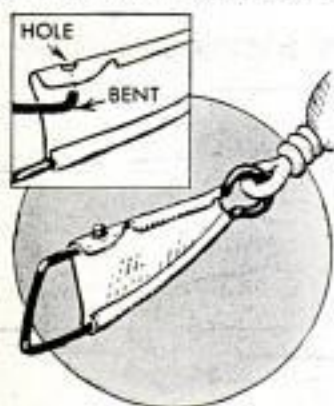

If you have ever lost a hooked fish because the snap fastener holding the lure was pulled open, you will appreciate the value of this simple alteration that will prevent such trouble. Drill a hole in the catch as indicated and bend the end of the wire

hook at right angles so it engages the hole. The fastener then can be subjected to many times the previous pull without opening.

## Bench-Mounted Abrasive Disk For Sanding Small Surfaces

With a sanding disk mounted horizontally on a block of wood clamped to his workbench as shown, one home craftsman was able to sand small pieces of wood, plastic and metal more quickly and accurately than possible with a sanding block. To mount the disk, a hole is drilled in the block of wood to accommodate the mounting shaft.



Walter E. Burton, Akron, Ohio.



Photo courtesy Delco-Remy Div.,  
General Motors Corp.

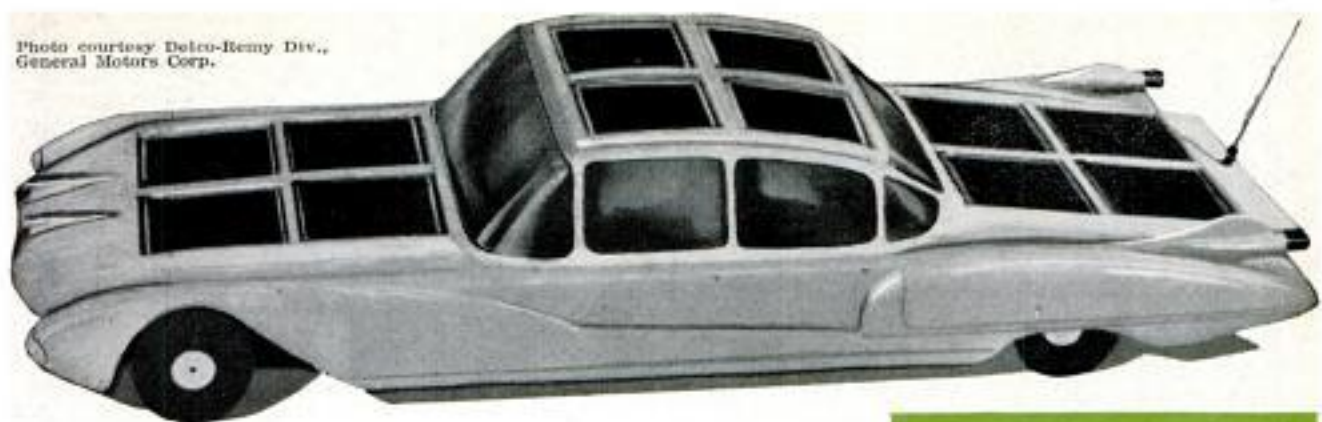

## Sun-Powered Car

SUNLIGHT IS THE FUEL used to power this model car, solar energy being converted directly to electricity through 12 selenium cells hooked in series-parallel and connected to a low-inertia electric motor. The motor operates on 1.5 v., rotating at 2000 r.p.m. The car body is made of balsa wood in five sections, the two center sections being hollowed out to receive the pine chassis, motor and drive mechanism. Power is transmitted from the motor to a drive shaft rotating parallel to it by means of precision gears with a 3 to 1 ratio, the smaller gear being on the motor shaft. The drive shaft delivers its rotation to the rear axle through a ladder-type chain that runs on sprockets on the drive shaft and axle. Wheels for the car are 1½-in.-dia. aluminum with rubber tires. Axle size is ⅛ in. and the wheels can be obtained at most hobby shops. No. 20 stranded, insulated copper wire is used to connect the rectifiers to the motor as shown in the wiring diagram at the right.

By W. K. Mitchell

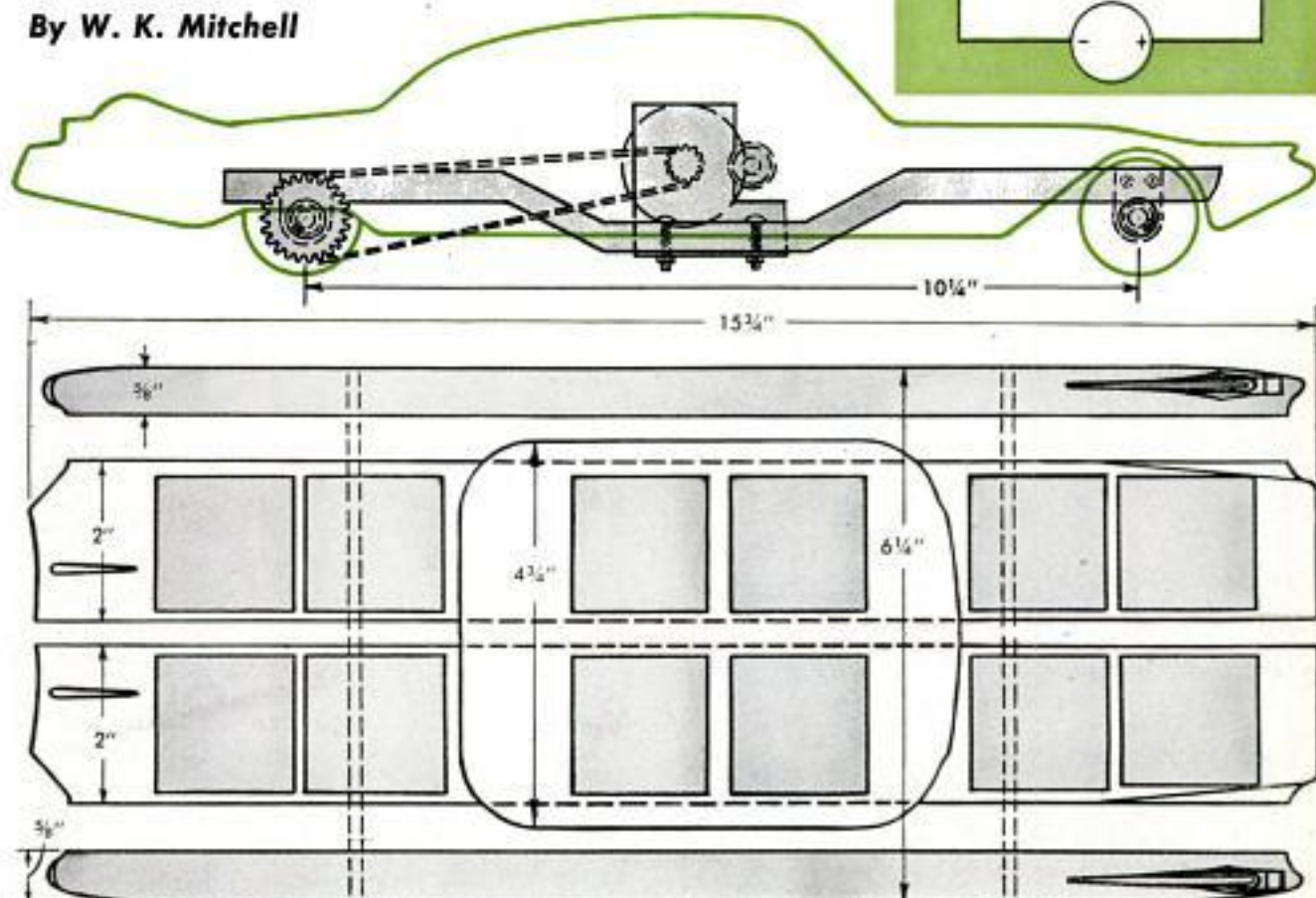
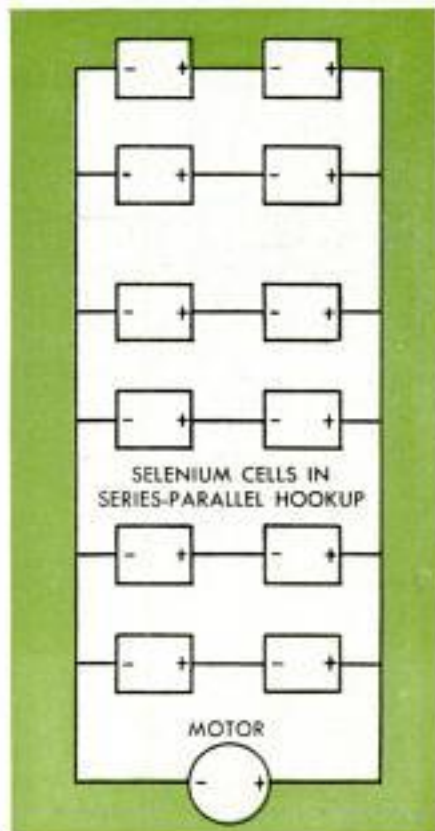

# THESE SNACK TABLES STACK

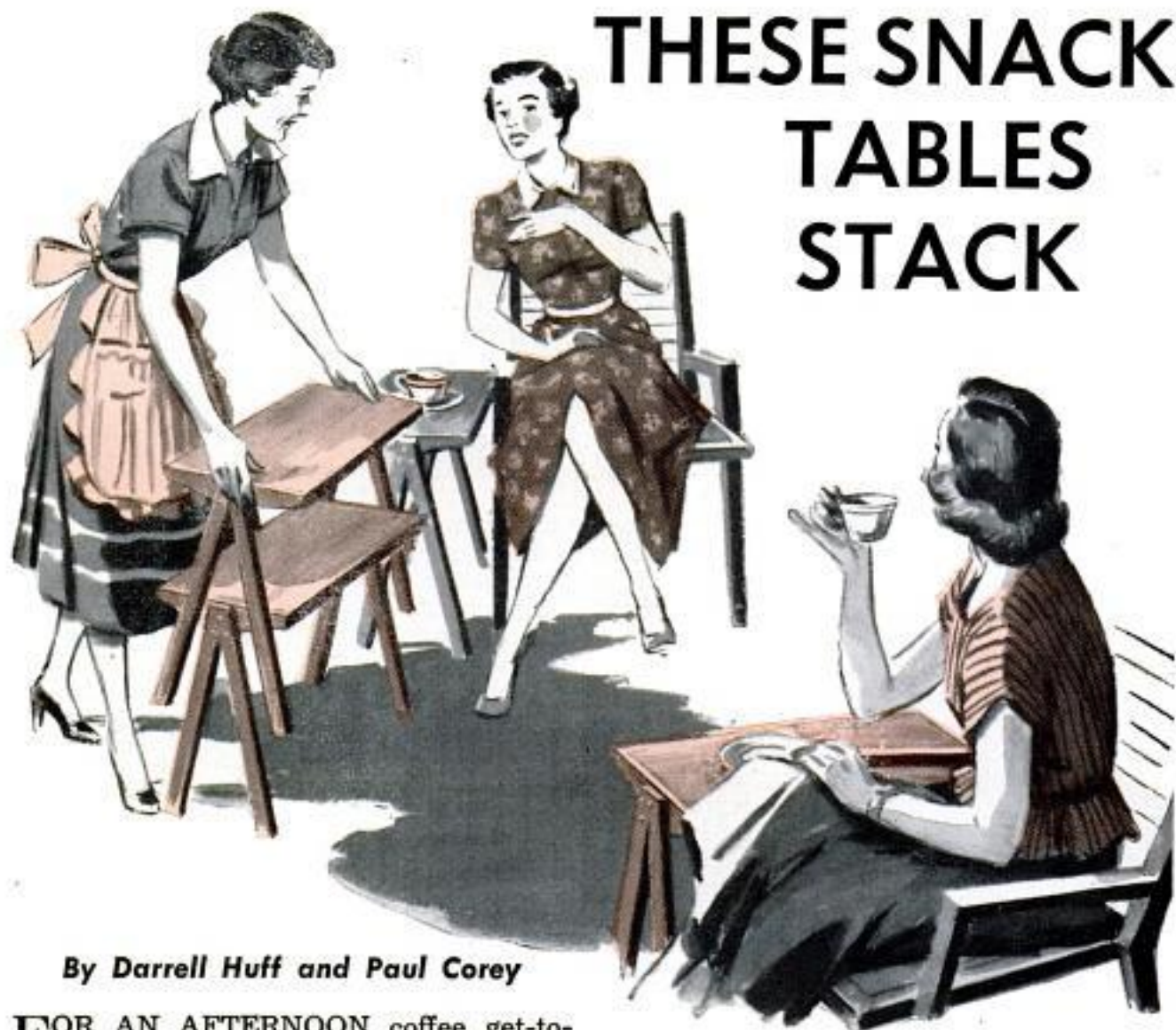

By Darrell Huff and Paul Corey

FOR AN AFTERNOON coffee get-together or a late TV snack, these little individual serving tables are the handiest things, and their V-shaped legs permit them to be stacked four, six or eight high to save space when stowed away in a closet. They also can be put to work as end tables, and two of them stacked make a fine telephone stand with a shelf between for a

directory and a pencil and note pad.

All cuts can be made on a circular saw, and since the tables are alike, any number can be mass-produced quickly by using simple guide blocks and fixtures to assure uniformity. Plywood is best for the tops, although flat solid stock will do. The ends of the tops are housed in rabbets cut in  $1\frac{3}{4}$ -in.-thick end pieces to which the legs are fastened. Make the rabbets with a dado saw and tilt the table, or the saw, as the case may be, about 1 deg. so the legs, when attached, will cant outward a bit to facilitate stacking. The legs are assembled in pairs by grooving the angle-cut ends for  $\frac{1}{4}$ -in. splines. When glued and dried, the points are sanded off and the ends rounded. The rabbeted end pieces are attached to the ends of the tops with glue and wood screws, the latter being driven into the tops from the underside. Each pair of legs is attached to the end pieces with three oval-head wood screws. A simple finish consists of three coats of water-white lacquer. Lacquer sealer for the first coat will do a better job. Light rubbing with fine sandpaper between coats is recommended. ★★★

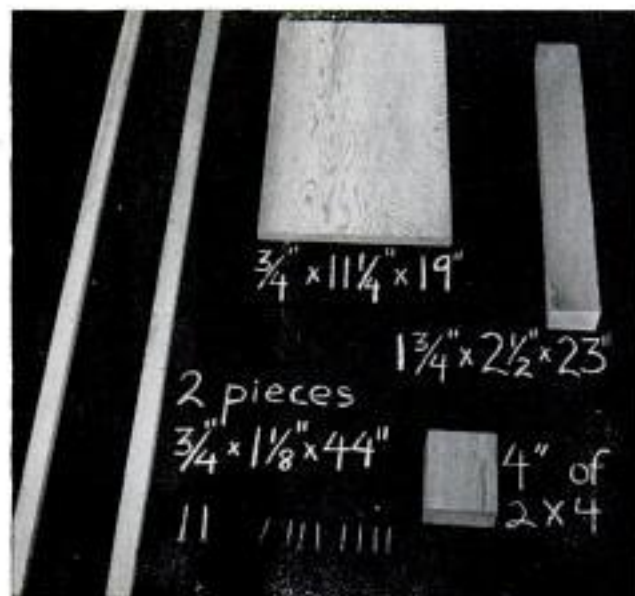

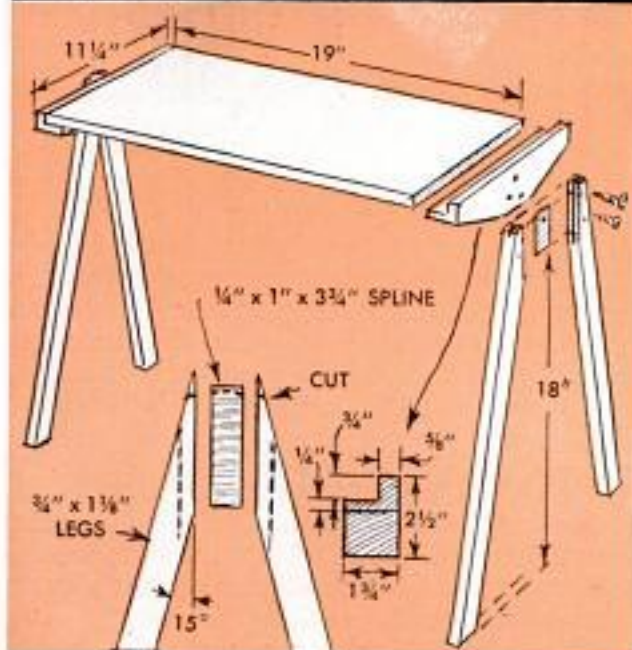

Upper photo, the rabbeted end pieces are fastened to the ends of the tops with glue and screws. Sawing the rabbets at a slight angle cants the end pieces slightly so that legs, too, will slant outward

Below, drive upper screw first, then, when the table top is leveled by measuring from each corner, drive the other two screws. Use a 2-in. screw at the top and No. 8 1 1/4-in. screws below. Glue the legs also



FEBRUARY 1957

## Bowl Cover "Weatherproofs" Outside Rear-View Mirror

If your car is parked outside during the winter, exterior-mounted rear-view mirrors can be kept free of ice and sleet by covering them with plastic bowl covers. Available in sizes to fit any mirror, the covers also can be chosen in a color to match the car. When not

in use, they can be stored under the front seat.—Irwin F. Combs, Oswego, N. Y.

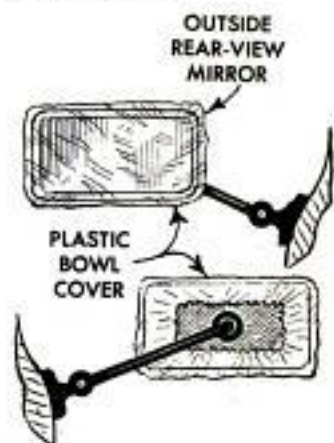

## Slots in Lettering Guide Save Ruling Lines

There's no need to spend extra time ruling groups of parallel height lines when adding lettering to drawings. All you need is the plastic guide shown. By penciling the lettering within the slots, the height is automatically kept uniform. A scratched line above and parallel with each slot is used to space each line with the lower edge of previous lettering. The slots are easily cut in thin plastic or celluloid with a razor blade.

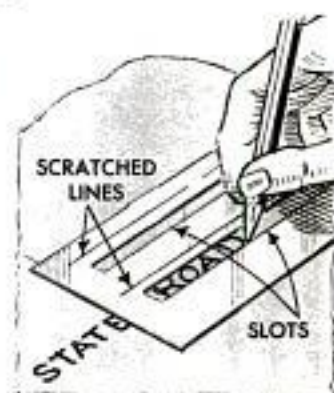

## Wooden Mallet Made Nonmarring With Section of Inner Tube

When it is necessary to strike tight-fitting parts of an assembly without causing surface damage, and a rubber mallet is not available, you can cushion a wooden mallet with a strip of inner tube for this purpose. Simply stretch a wide section of auto inner tube over the head and handle as shown. Tie the rubber to the handle just behind the head so that the handle can be gripped conveniently.

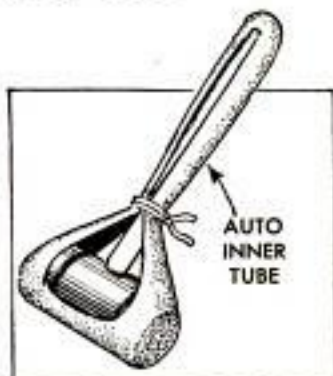

## Adhesive-Tape Spools Dispense Wire, Solder and Twine

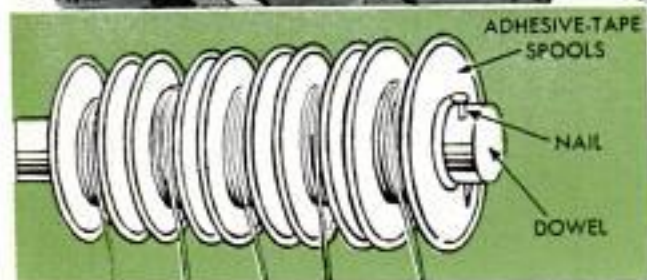
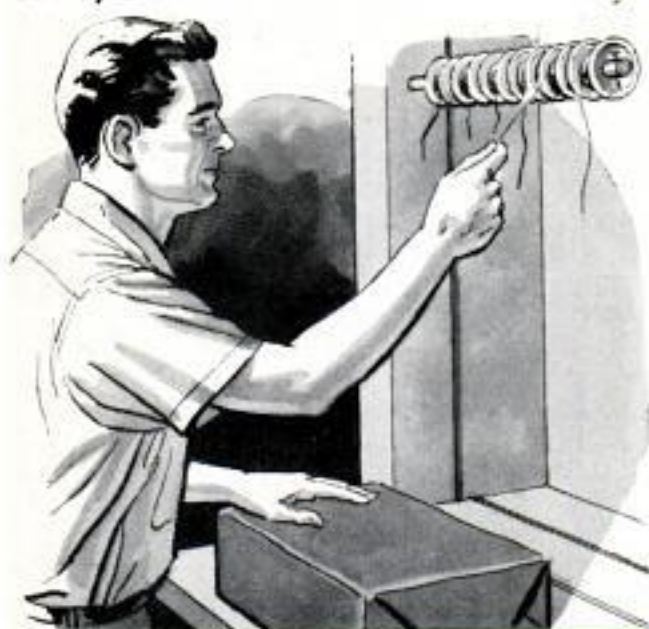

Empty adhesive-tape spools placed on a dowel over the workbench as shown provide handy storage for wire solder and wire or twine of various sizes used in the shop. The dowel, which is glued in a hole drilled through a wall stud, should be strong enough to support several spools of material yet not too large for easy turning of the spools.

Victor H. Lamoy, Upper Jay, N. Y.

## Lead Shot Anchors Screw In Enlarged Hole

One home craftsman has found that a screw can be made to fit tightly in an enlarged hole by forcing a small lead shot in the hole before driving the screw. Turning the screw into the hole not only forces the shot into the wood, but the screw threads also cut into the lead to provide a doubly secure anchorage.

G. E. Hendrickson, Argyle, Wis.

### *Shopping for a Trailer?*

There are two important things to consider to assure safe, trouble-free trailering; overload springs and weight-distributing hitches. In a March feature Clinton Hull points out their importance and tells how to determine the right type best suited to meet individual trailer requirements

## Brass Bearings and Hubs For Model Wheels

Wooden wheels on models can be equipped with brass bearings and hubs by using automobile brake-shoe rivets installed as shown in the detail. First, drill a hole large enough to admit the axle through the center of each rivet and another hole through the center of each wheel so that the rivets used as bearings will fit snugly in the wheel. After removing all burrs from the rivets, coat them on the outside with glue or liquid solder and press them in place. Paper shims should be used between rivetheads when soldering the hubs on axles to maintain sufficient clearance.

Robert Thompson, Clinton, Iowa.

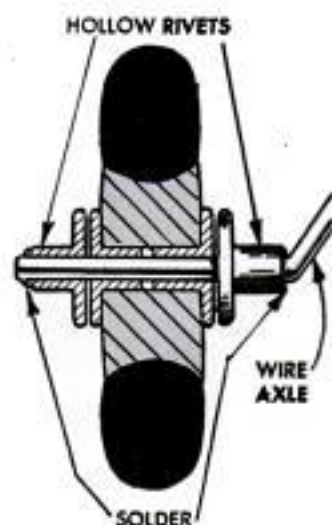

## Imitation Wrought-Iron Hinges

An ordinary butt hinge becomes a wrought-iron L-hinge by the simple addition of three strips of hardwood. Rip the strips to about  $\frac{1}{16}$ -in. thickness, cut to length required and screw in place as pictured, using square-headed screws. Paint the exposed portion of the butt hinge and the strips flat black before installing.

Frank A. Javor, Newark, N. J.

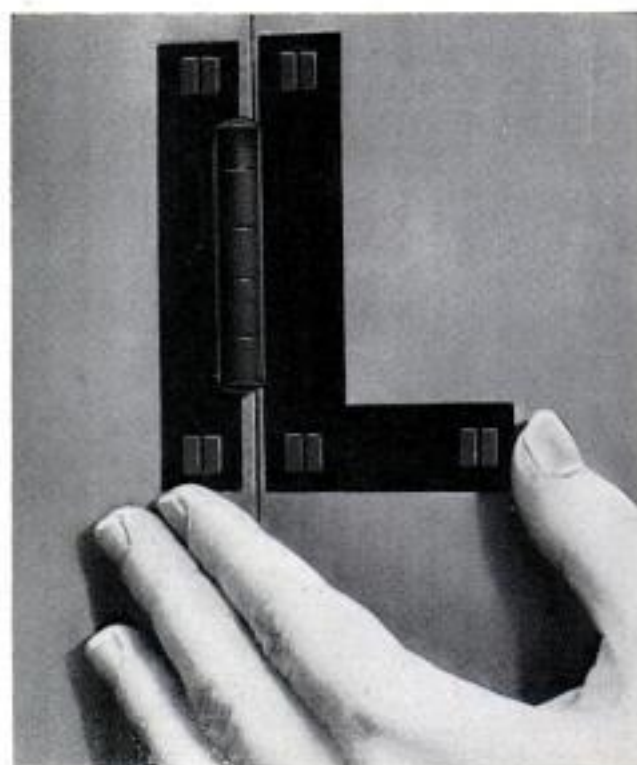

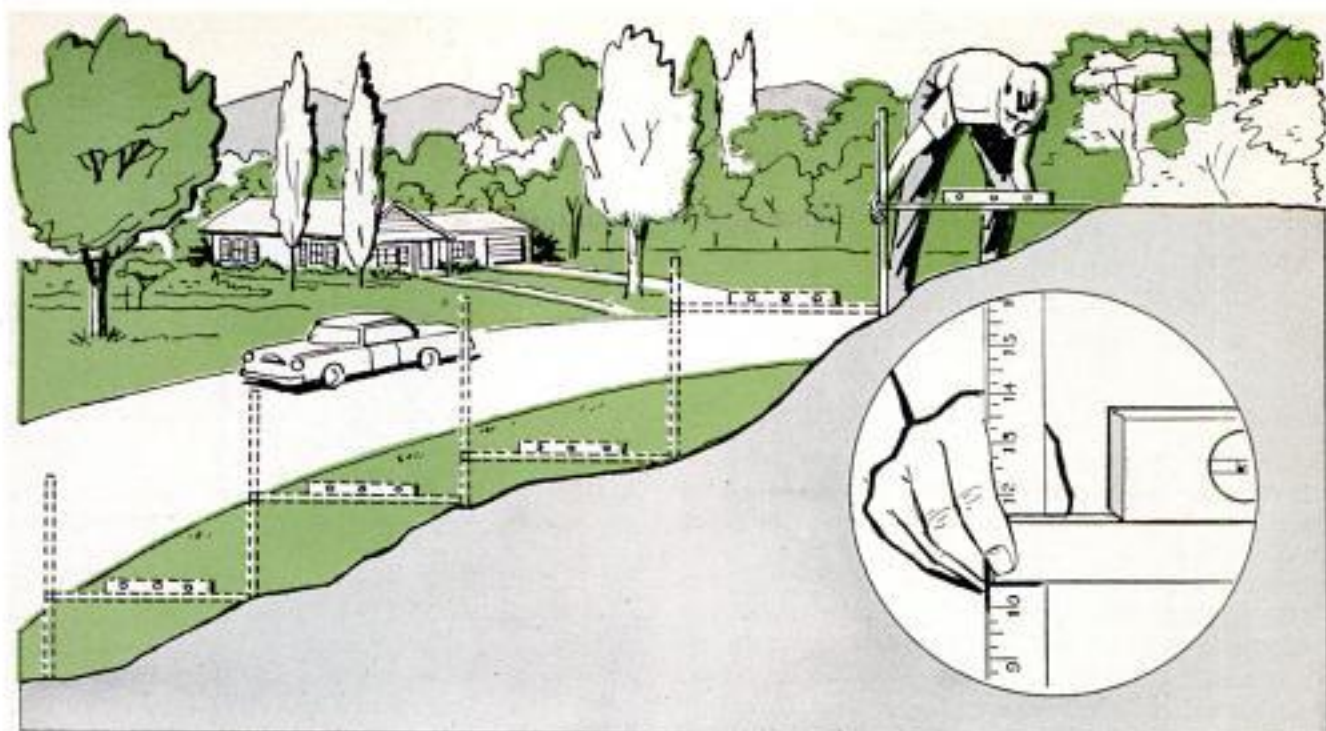

1. Illustration and detail indicate how yardstick, level and length of wood are used to measure slope

## MEASURING A HILLSIDE LOT

By Ralph Wellner

**I**N MANY CASES, building lots that have a beautiful view are on a hillside, which presents added problems to anyone looking for a site on which to have a home built, since the exact degree of the slope must be known by an architect when he designs a home for that location. Also, if the prospective home builder has already chosen a house plan, it will be necessary to determine whether that house can successfully be adapted to the hillside being considered.

It would be impractical, of course, to check the slope of every hillside shown to the buyer, and it would be prohibitively expensive to have a professional surveyor make a topographical plat of each lot, but with the simple method described in this article, it is possible to check the slope of locations that seem particularly desirable. The results are accurate enough that the elevation of a house plan can readily be superimposed on a scale drawing of the slope to determine the feasibility of constructing a particular house on that hillside lot.

Tools required for the measurement of grade slope are: A yardstick, a 2 or 3-ft. length of wood and a level. Unless the slope is extremely steep—one that can hardly be climbed—a 3-ft. length of wood will be accurate enough. The three tools are used as illustrated in Fig. 1. Hold the yardstick as nearly vertical as possible,

hold the 3-ft. stick horizontally from the slope to the yardstick and true it with the level. Read the figure on the yardstick which shows beneath the stick and write it down. Repeat this operation every 3 ft. either up or down the slope, from lot line to sidewalk or reverse, and make a table as shown in Fig. 2. The first column is the horizontal distance, in 3-ft. increments, the second column is the reading on the yardstick at each step. The third column is obtained by adding each new height measurement to the previous total, and thus shows the elevation at any point.

To get a complete picture of the slope, one that can be used to show how a house

2. SAMPLE TABLE

DISTANCE	HEIGHT	TOTAL
0	—	—
3'	16"	1'-4"
6'	11"	2'-3"
9'	7"	2'-10"
12'	19"	4'-5"
15'	27"	6'-8"
18'	23"	8'-7"
21'	25"	10'-8"
24'	25"	12'-9"
27'	29"	15'-2"
30'	20"	16'-10"
33'	10"	17'-8"
36'	5"	18'-1"
39'	2"	18'-3"

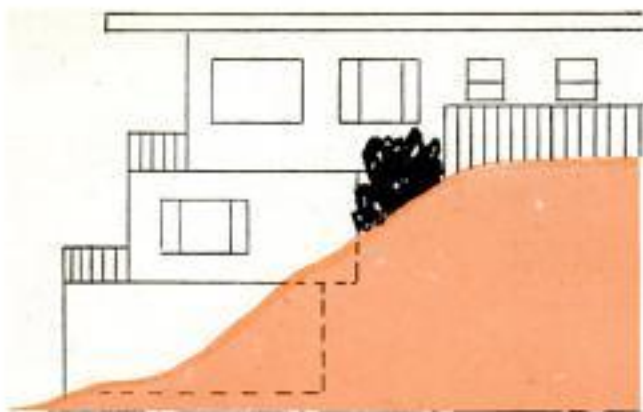

3. When measurements on table are converted to graph form, house-plan elevation can be superimposed

would appear on the lot, as in Fig. 3, use the figures in the table to make a graph like the one in Fig. 4. First, draw a horizontal line on a large sheet of paper, then rule vertical lines every  $\frac{3}{4}$  in. to represent the 3-ft. distances used to measure the slope. The graph will be  $\frac{1}{4}$ -in. scale, which means that if a 2-ft. stick were used, the vertical lines should be spaced  $\frac{1}{2}$  in. apart and measurements taken at 2-ft. intervals. Now, on the graph, measure up the scale a distance equal to the number shown in the

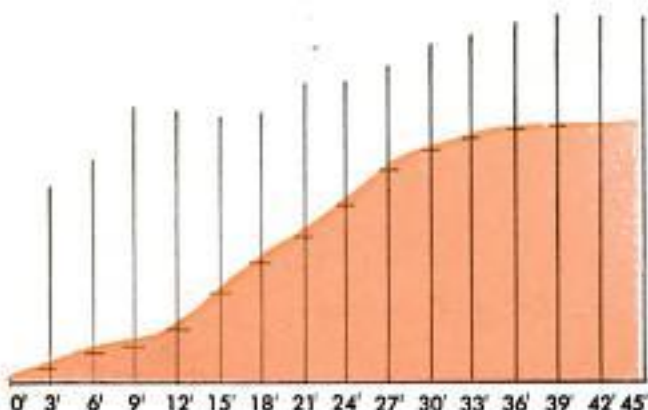

4. Figures from table are converted to graph form by marking scale measurements on vertical lines

total column opposite 3 ft. in the table. Do the same on the 6-ft. mark, and continue through all the vertical lines in the same manner. When all the vertical lines have been marked, carefully draw in a gently curving line to connect all the marks. You now will have a cross section of the hillside, and any house-plan elevation drawn to  $\frac{1}{4}$ -in. scale can be superimposed on this line to accurately determine how it will appear when the house is built on the lot, as in Fig. 3. ★ ★ ★

### Plastic Coaster Under Knob Protects Drawer Front



Plastic coasters or discarded tops from plastic refrigerator dishes protect the finish around drawer or door knobs when fastened under the knobs. To install the plastic remove the knob and drill a hole in the center of a coaster so that the knob screw

will turn through it when reinstalled. With this protection smudges around the knobs can be wiped off as often as you like without damaging the finish of the furniture.

### Rope End Is Disposable Acid Brush

When a brush is needed to apply acid to a soldering job or glue on wooden joints, a disposable one can be made by wrapping a short length of rope with soft wire. Leave about 1 in. of the rope unbound at one end so that the fibers fan out like the bristles on a brush.

□ Double-hung window sash that binds can be made to run free by rubbing floor wax on the sash grooves of the frame.

### Line Taped on Spinning Reel Prevented From Unwinding

Here is a practical way of securing the end of a line on a spinning reel when it is not in use. Simply press a short strip of adhesive tape over the end of the line and against the body of the reel. When the line is needed again, the tape is pulled back far enough to release it and the tape is then replaced for later use.

John Krill, Jr., North Lima, Ohio.



# Loop-the-Loop

## ACTION TOY

By Ralph T. Moore

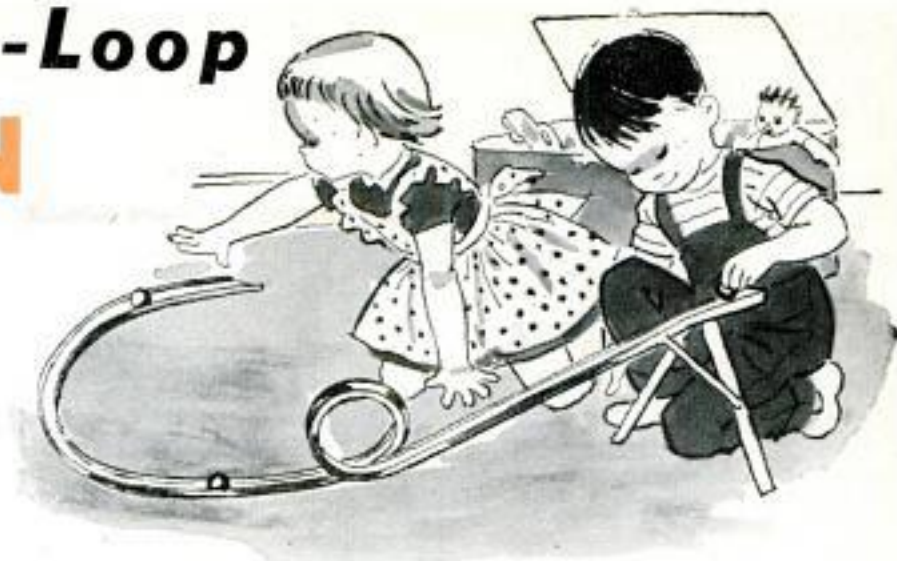

CONSISTING primarily of a length of curved channel down which steel balls are rolled, this toy was designed to include the feature required of any toy made for very young children—simplicity of operation. The channel measures  $\frac{3}{8}$  x  $\frac{3}{4}$  x 48 in. and can be steel, although this metal probably will require heating to permit it to be bent. Light aluminum channel can be bent cold if care is taken not to bend it too rapidly. The flanges of the channel will spread apart when it is bent in a loop, but they can be bent back by placing the channel on its side and reshaping with a wooden mallet. Legs for the channel are bent from a single piece of the same size channel as used for the curved track. It is

notched and bent as indicated. The brace between the channel track and the legs is bent from flat stock  $\frac{1}{16}$  x  $\frac{1}{2}$  x 14 in. to form a U-shape and is fastened to the underside of the channel by  $\frac{1}{8}$ -in. flatheaded screws that are countersunk so the heads are slightly below the inside surface of the channel. Although not shown in the detail, a brace between the legs near their lower ends would prevent them from being forced apart should a child lean on the upper end of the channel. Steel balls,  $\frac{1}{2}$  in. in dia., are used to loop the loop.

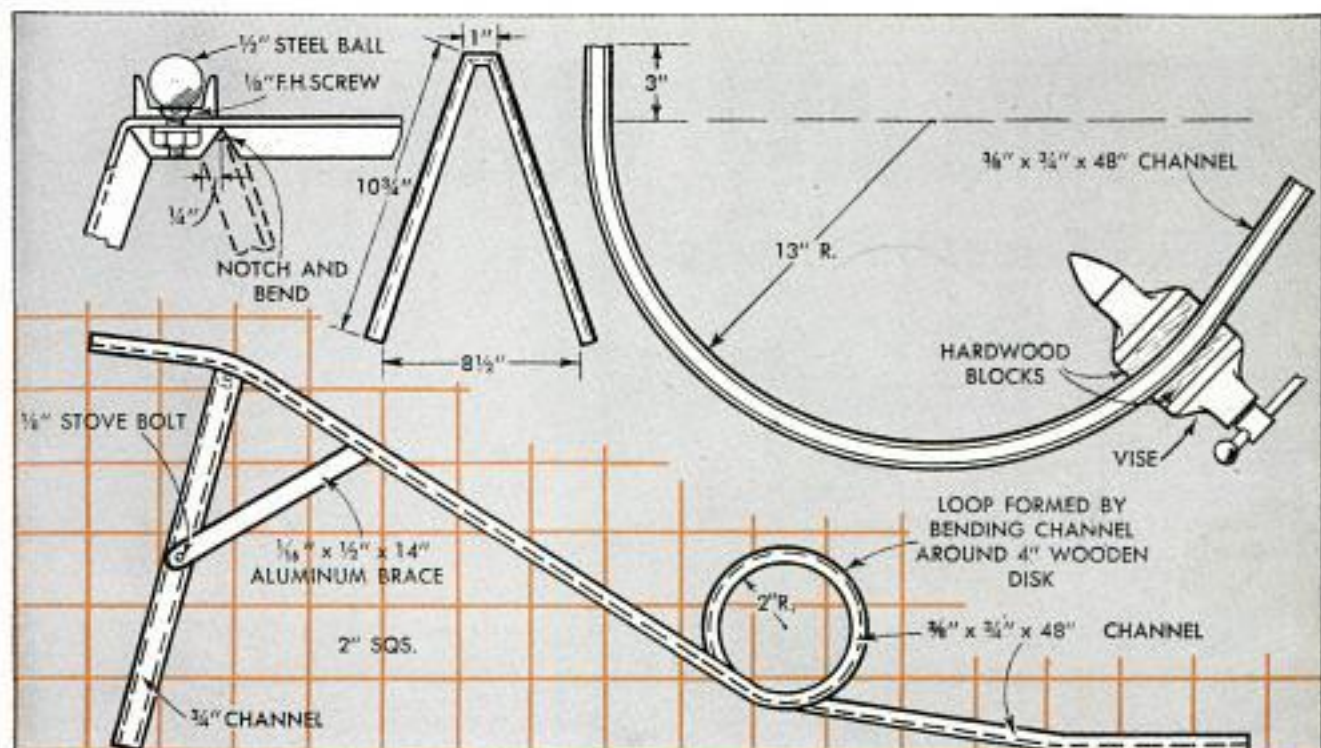

### Replacing Missing Fragments in Broken China Figurine

When assembling the fragments of a shattered china figurine with household cement, there usually are two or three very small pieces missing. In such a situation, fit pieces of light cardboard in the

openings and paint them to match the china. When the paint is dry, apply a china "glaze" by brushing on a thin coating of transparent cement.

Walt White, Indianapolis, Ind.

## Small Trunk Is Toy Chest For Children's Room



An old trunk fitted with casters and decorated in gay colors is a good place to keep toys. The attractive chest shown, with flowers and the child's name painted on the sides, provides a place to store toys and playthings out of the way.

Arthur G. Patterson, Minneapolis, Minn.

Heel marks on linoleum floors can be removed with fine steel wool saturated with soap.

## Heavy-Duty Cellar-Door Bolt Improvised From Pipe

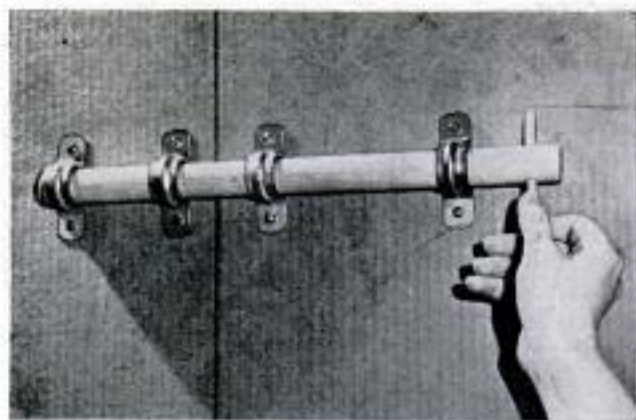

A length of pipe or broom handle fitted to a cellar door with pipe hangers makes a sturdy and inexpensive door bolt. Select pipe or broomstick that will slide easily under strap-type pipe hangers, one pair of which should be spaced close together on the doorframe and the other pair about a foot apart on the door. The latter will support the bolt when it is pulled aside in the open position. The whole assembly should be given a slight downward tilt so that the bolt will remain in the closed position. A small crosspin installed at the high end of the bolt will prevent it from sliding out.

Frank A. Javor, Newark, N. J.

# Build This House Yourself!

## Save 65% Easily!

Two bedrooms, a spacious living room, bath, carport, compact dining room and kitchen all in a space 24 x 46 feet. You can build the Precut House in three stages, using any of numerous floor plans—all of which are designed to provide maximum comfort with minimum cost. Think of it! You can build that house you've always wanted. You can make a livable shell for only \$1800. The second stage will give you a summer home with all conveniences for only \$2800. When you add the third stage, you have a luxury home for year 'round living, in any climate, for only \$3800!



**Livable Shell—\$1800; Summer Home—\$2800; Luxury Home—\$3800; Simplified How-To-Do-It Instructions—Hundreds of Pictures—Working Blueprint Plans!**

You can build the house with the book alone. The plans make it easier. The book gives lists of materials required, all measurements and dimensions, suggestions for financing and tells in words and shows in pictures every detail of construction. Richard Dempewolf, author of the "Precut House" book, built the house in 1650 man hours for \$3731.23—complete!

Features of Expensive Homes are included: built-in furniture, unusual amount of closet space, adaptability to various interior arrangements, and materials designed especially for amateur builders. The book is \$2.50 and a complete set of 10 blueprints \$12.50 (a duplicate set is \$5.00). You can place a C.O.D. order or mail your remittance in full.

Order book and plans from

POPULAR MECHANICS BOOKSHOP

208 E. Ontario St.

Chicago 11, Ill.





## AUTO-POWERED ARC WELDER

By Norman E. Schultz

**S**MALL ENOUGH to be hidden beneath the hood of a passenger car, yet powerful enough to handle electrodes up to  $\frac{3}{16}$ -in. dia., this 200-amp. welder is powered by the engine of the car in which it is installed, and can be taken anywhere that an automobile can be driven.

The main component of the welder is a war-surplus Delco Remy P-1 aircraft generator that is rated at 24 v. and 200 amp. at 2500 to 4000 r.p.m. Since this generator has a counterclockwise rotation, it must be turned end for end and driven from the commutator end when rotated by a car engine. This requires that the floating shaft, which drives the free-turning armature, be removed from the generator and modified. First, cut this shaft about  $1\frac{1}{2}$  in. from the driving spline. Next, center-drill the end of a 7-in. length of  $\frac{3}{4}$ -in. steel shafting to provide a press fit for the cutoff shaft. Force the  $1\frac{1}{2}$ -in. length into the hole in the new shaft and braze or weld it in place. Mill a  $\frac{3}{16} \times \frac{3}{16}$ -in. keyway 4 in. long in the end of the shaft to hold the pulleys and bore a clearance hole for the shaft in the end housing of the generator opposite the original location. The shaft now will project from the end of the generator in which the air scoop is located, Fig. 4.

### Frame and Supports

Fig. 4 gives the dimensions and method of assembling the supporting frame for the

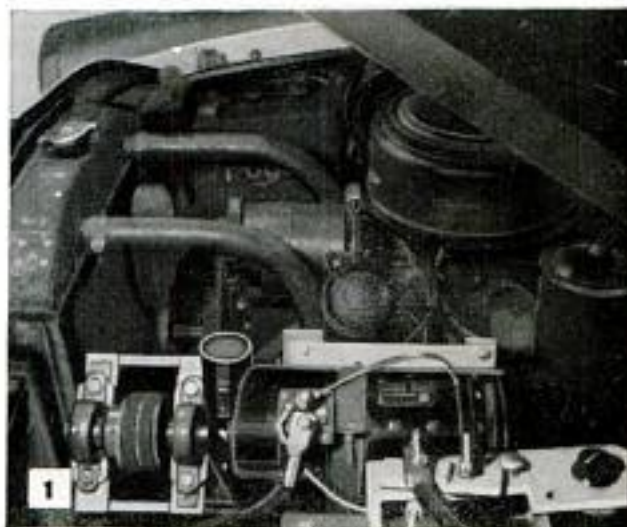

Above, welder connected and ready to run. Below, support frames bolted to head, ready for welder

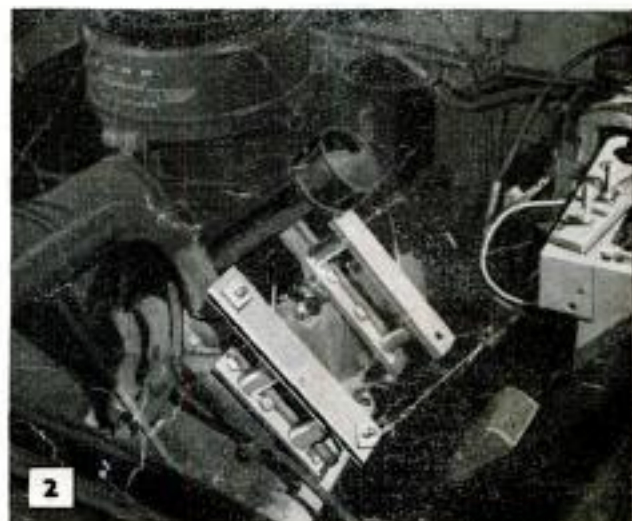

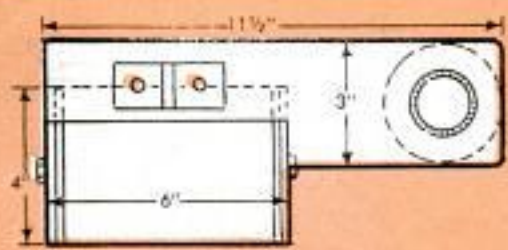

P-1 AIRCRAFT GENERATOR  
200 AMPS.—24 VOLTS AT  
2500 TO 4000 R.P.M.

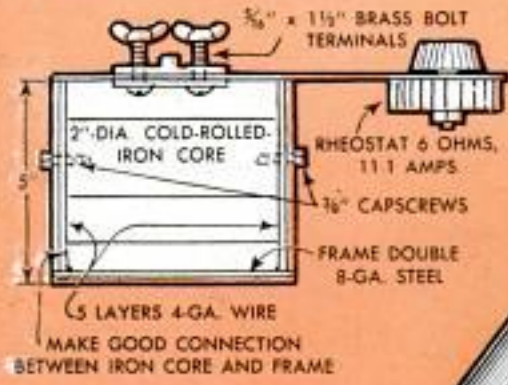

3

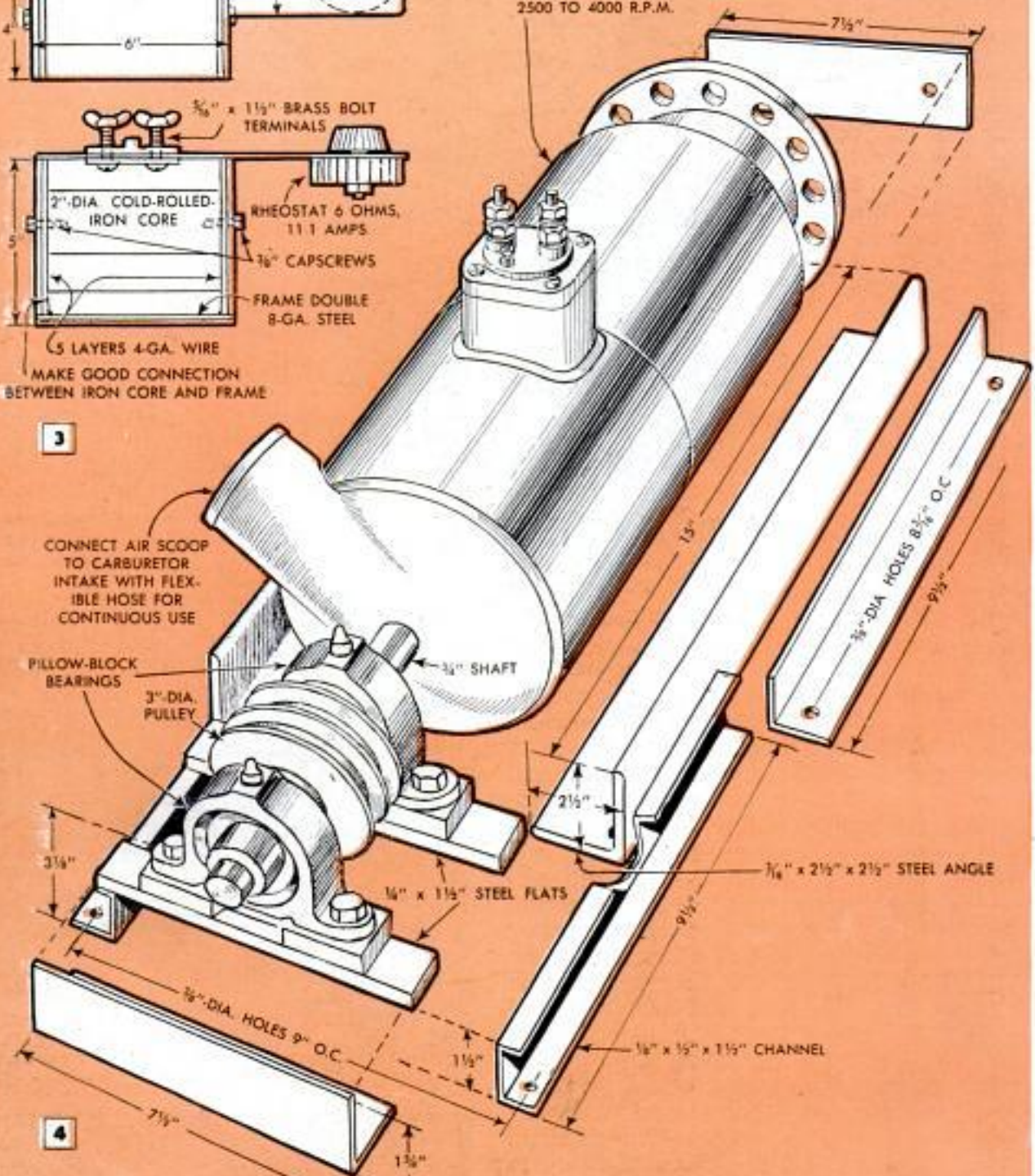

4

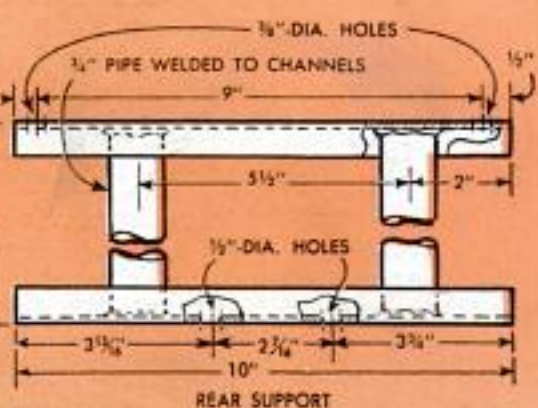
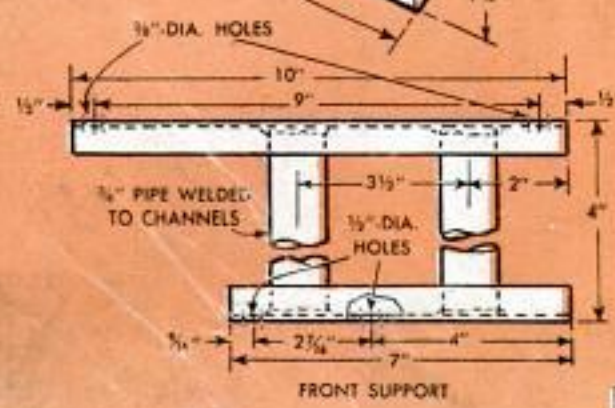

5

generator. One flange of the  $\frac{1}{8} \times 1\frac{1}{2} \times 1\frac{1}{2}$ -in. channel is cut back to  $\frac{1}{2}$  in. as indicated. When assembling the frame, first mount the two self-aligning, pillow-block bearings on the shaft; then adjust the various frame members to keep the shaft aligned properly while they are welded together.

Front and rear supports for the generator frame are shown in Fig. 5. These supports were designed to hold the frame above the spark plugs when they are bolted to the head of a 1953 or 1954 "flathead" V8 engine, Fig. 2. Supports for bolting the generator frame to in-line-type engines and overhead-valve V8 engines will have to be modified or redesigned to suit a particular engine. Steel angles, spaced by lengths of  $\frac{3}{4}$ -in. pipe, were used on the original supports. Holes in the bottom angles are  $\frac{1}{2}$ -in. dia. to fit over the head bolts while holes in the upper angles are  $\frac{3}{8}$ -in. dia., and are matched by holes in the generator-support frame. When considered necessary for more rigid mounting, a center support also can be used.

### Drive Pulleys

A 3-in.-dia. double V-pulley is fitted on the welding-generator shaft. A 6-in.-dia. double V-pulley is welded to the crankshaft pulley of the car engine. Care must be taken in the latter operation to make sure the double pulley is centered on the crankshaft pulley to prevent misalignment. The center of the double pulley is cut out to permit tightening the pulley nut on the crankshaft. Because the engine fan will strike the modified pulleys, it is necessary to reposition it. Remove the blades from the fan hub, insert spacers and rivet the blades to the hub as shown in Fig. 8. On a different type of engine, more or less modi-

fication of the fan may be required. When the fan is moved forward it requires that the radiator be moved forward a similar distance to keep the fan blades clear of it. On the original car, four  $\frac{5}{8}$ -in. hardwood blocks were used as spacers to relocate the radiator. Sheet-metal pans at the top and bottom of the radiator may require cutting or bending to allow the forward movement of the radiator.

### Arc Stabilizer and Rheostat

To assure that the welder produces a steady arc, an arc stabilizer must be wired into the welding circuit. The stabilizer, Figs. 3 and 7, consists of a core of 2-in.-dia. cold-rolled steel approximately  $5\frac{1}{2}$  in. long. First, a layer of insulating cloth is wrapped on the core, then four layers of 4-ga. enamel-coated copper wire are wrapped on the core, each layer being separated by insulating cloth. Finally, the completed core is wrapped with tape and tied to make sure the wire stays wrapped tightly. The beginning and end leads are left about 9 in. long to permit attaching them to the terminals. Make sure the ends of the stabilizer core make good contact with the metal frame which is made of double 8-ga. sheet steel. Short flanges are bent along the edges, then mitered at the corners and welded to provide additional strength as shown in Fig. 7.

The frame for the stabilizer also is used to support the rheostat, terminal connections and throttle for controlling engine speed, Figs. 3 and 7. The rheostat is a heavy-duty type, rated at 6 ohms, 11.1 amp. Fig. 6 is a wiring diagram, showing the connections between the stabilizer, welder and rheostat. Note that all wires in this circuit are 4 ga., except the lines to the

Wiring diagram showing how welding generator, arc stabilizer and rheostat are connected in circuit

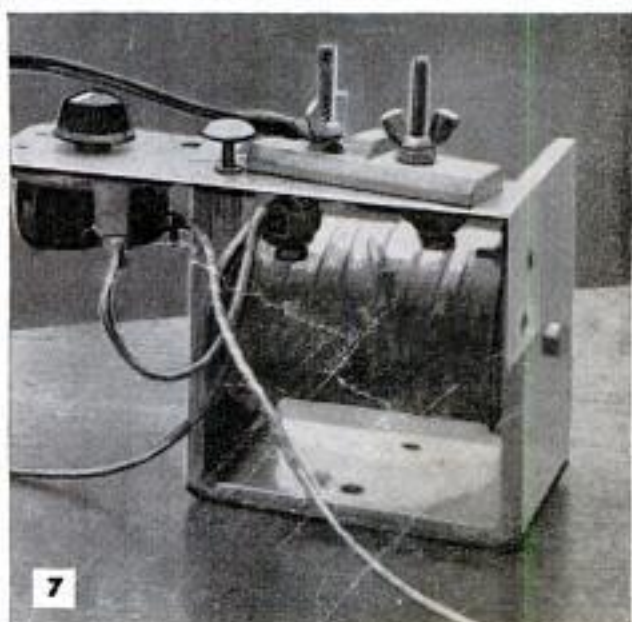
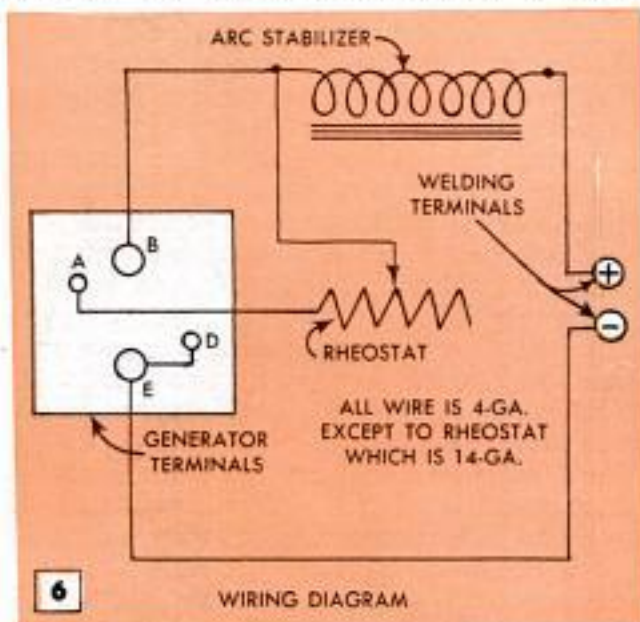

Arc-stabilizer-rheostat assembly. Note how flanges are bent on stabilizer frame for added rigidity

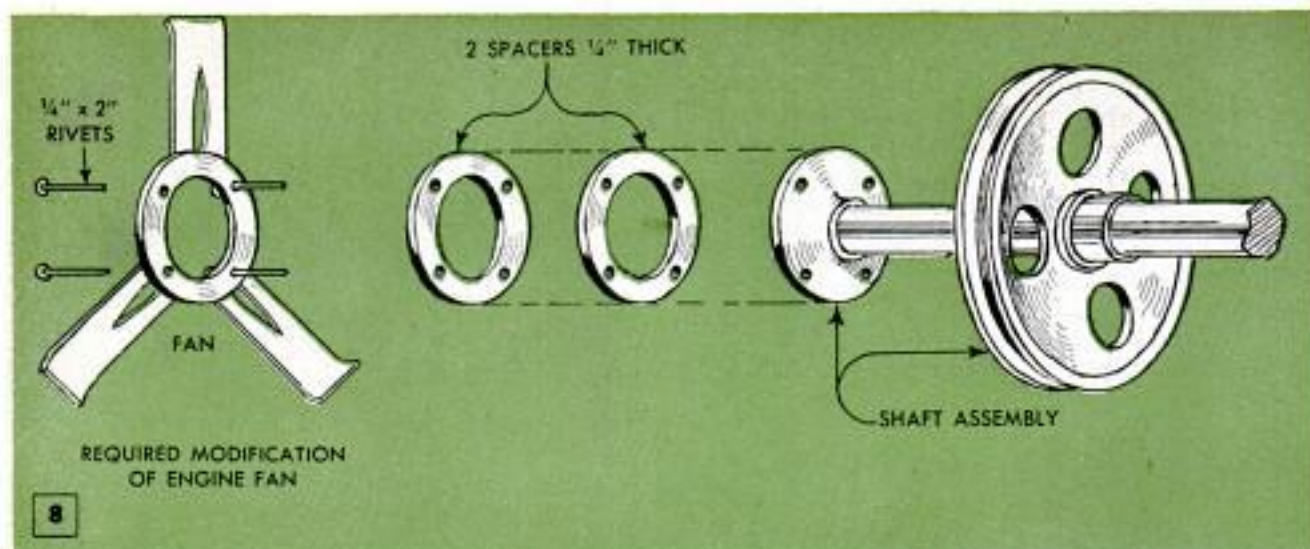

Original engine fan was modified by removing blades from hub, adding spacers, then riveting blades

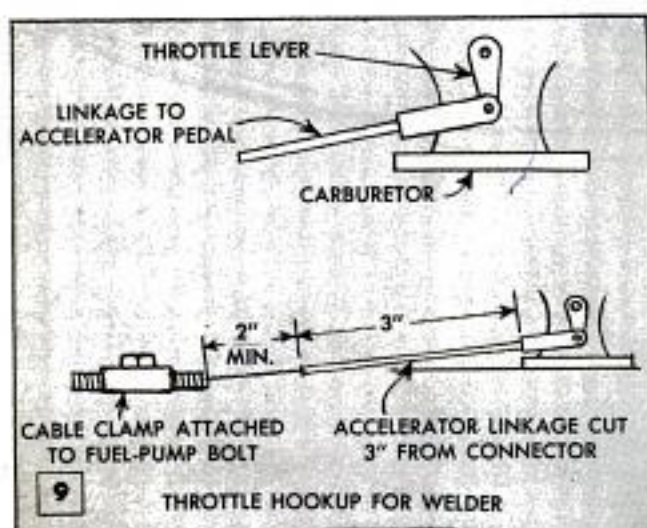

One method of controlling engine speed requires choke cable to which linkage is welded as shown

rheostat which are 14 ga. As shown in Figs. 1 and 2, the stabilizer-rheostat assembly is bolted to the inside of a fender. Large washers on the underside prevent the bolts from pulling through the sheet metal of the fender.

### Throttle Hookup

To control the speed of the car engine and thus the r.p.m. of the welding generator, it is necessary to add an auxiliary throttle control to the carburetor. As shown in Fig. 9, some cars are equipped with throttle linkage that has spring-loaded connectors that easily snap off without tools. An extra piece of the linkage is welded or brazed to the end of a choke cable that leads to the stabilizer frame where it is easy to reach when operating the welder. To change from control by foot throttle inside the car to hand control at the welder requires only unhooking one control and hooking on the other.

On engines with other types of linkage connectors it may be possible to locate the

choke cable so that it can be hooked onto the throttle lever without the necessity of removing the regular foot-control linkage. In some cases, the latter-type linkage is bolted together and requires the use of wrenches for disassembly. The less time required to connect the welder to the engine, the more time used profitably for welding, so it is important that any shortcut in making the hookup be considered.

### Operating the Welder

Two heavy-duty V-belts are used to drive the welder from the crankshaft. Belts for the original installation were 54 in. long. Belts for other type installations are selected by measuring the distance around and between both sets of pulleys. To install the belts on the generator pulleys, the front pillow-block bearing is removed, both belts slipped over the pulleys, then the bearing is reinstalled. To fit the belts on the crankshaft pulleys, tip the forward end of the welder frame down, loop the belts over the crankshaft pulleys, then level the welder. Belt tension is adjusted by fitting thin washers or sheet-metal shims between the forward ends of the welder frame and the support frame.

When the welder is to be run continuously for some time on a big job, connect the air scoop of the welding generator, Fig. 5, to the air horn of the carburetor with flexible tubing. Carburetor vacuum will draw air through the generator housing, thus cooling the generator. An ammeter and voltmeter are not wired into the welder, and since each welder will differ in characteristics due to being custom-built, no precise calibration of the rheostat is suggested. After a few jobs with the welder, the operator will become familiar with the machine and can make his own calibrations, which can be marked on the frame under the rheostat dial. ★ ★ ★

## Portable Ignition Tester "Broadcasts" Diagnosis

When regular ignition-testing equipment is not available, one mechanic uses a portable device small enough to be slipped into his pocket. It consists of a radio earphone, a line switch and the condenser from an automobile distributor wired as shown in the detail and fitted with "alligator" clips. One wire is clipped to the primary lead on the distributor and the other is grounded, while the wires are led to the front seat of the car so the driver can control the switch and listen to the clicks caused by the opening and closing of the breaker points as transmitted through the earphone. As the engine is speeded up, the clicks will merge and become a buzz. If the buzz or clicking skips at the point where the engine misses, it indicates that the ignition is at fault. If the miss does not occur when the tester is on, it is quite likely that the condenser in the distributor is faulty since the condenser in the tester is now doing the job. As a double check on this latter condition, examine the distributor points. If they appear a dark blue, it

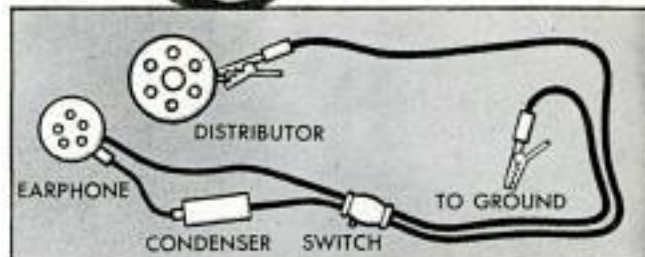

is an indication that the condenser should be replaced as soon as is practicable.

C. G. Launius, Chicago.

## Wooden Vise Jaws Grip Tubing

Thin-walled conduit and tubing can be held in a vise without crushing out of round or burring by using auxiliary soft-wood jaws. For tubing up to 1 in. in diameter cut a 4-in. length from 2 x 4 stock. Drill a hole lengthwise through the block so the hole is the same diameter as outside diameter of the tubing. Saw the block through at the center.

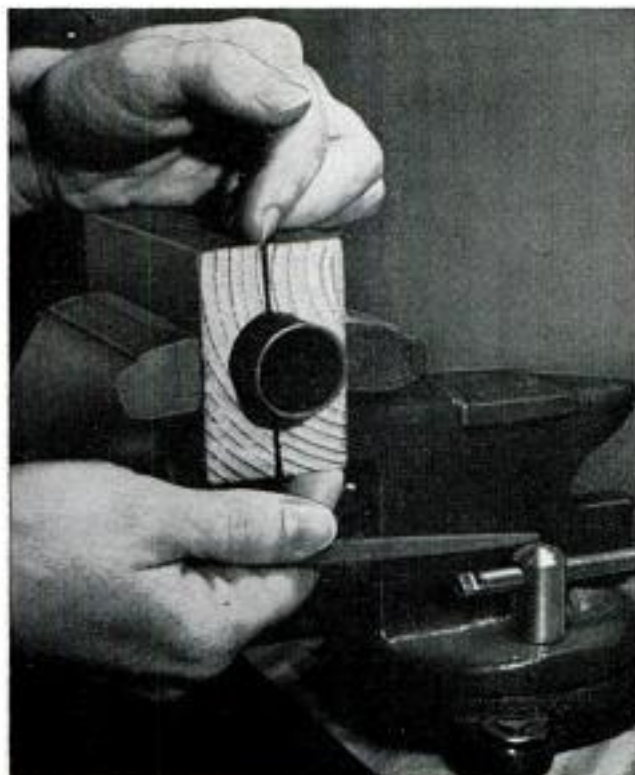

## Hose Spacers Eliminate Resetting Of Depth Gauge on Drill Press

Constant resetting of the depth gauge on a drill press can be avoided by fitting interchangeable pieces of split rubber hose, around the shaft of the gauge as shown. Cut to specific lengths, the hose spacers will stop the drilling at the desired depth yet when removed permit drilling to full depth.

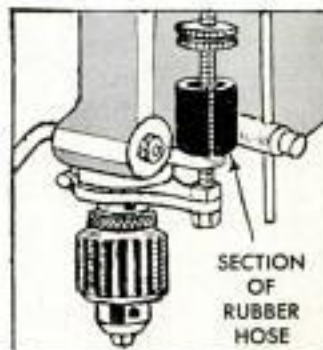

## Tubing on C-Clamp Screw Keeps Weld Spatter Off Threads

To keep weld spatter from collecting on the threads of a C-clamp adjusting screw, weld a slotted piece of tubing to the swiveling pad on the end of the screw. As the clamp is adjusted, the shield travels longitudinally with the pad, thus covering the screw thread.

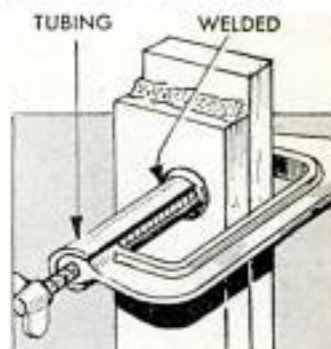

# SHOPPING

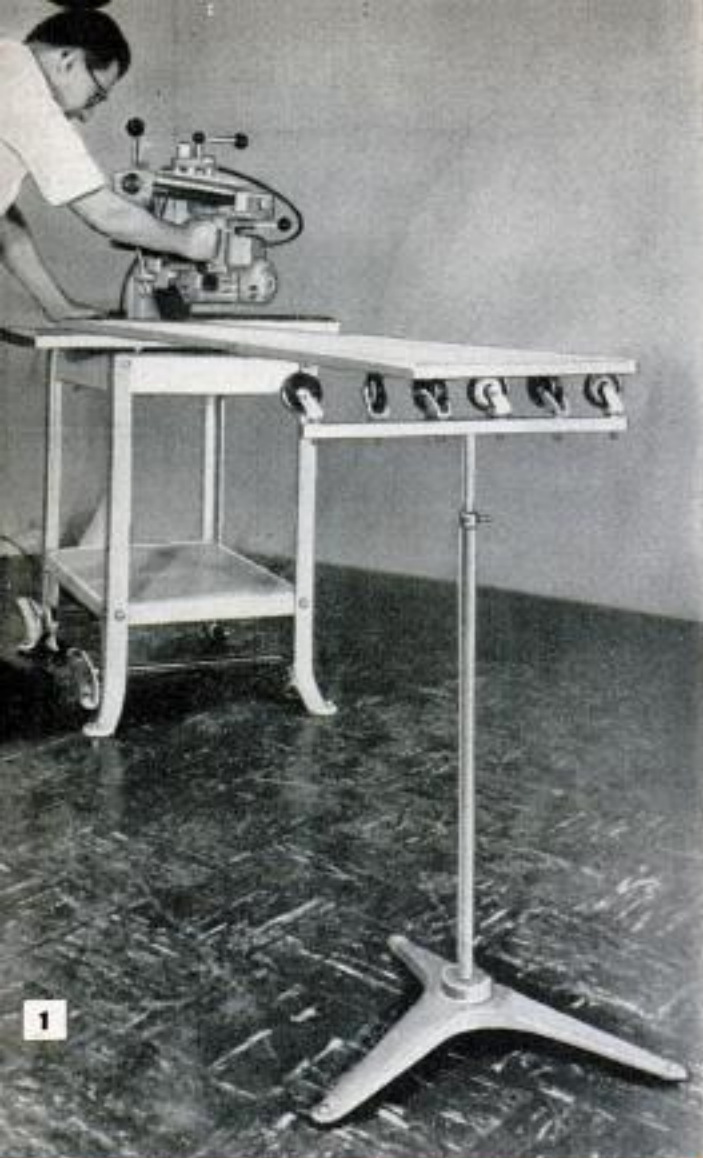

1



2

**1. UNIVERSAL WORK SUPPORT** solves the long-board problem in small shops and light industrial applications. The six-caster head not only supports the work at the desired height, it also permits it to be moved in any direction while cut is being made

Delta Power Tool Div., Rockwell Mfg. Co.,  
452 N. Lexington Ave., Pittsburgh 3, Pa.

**2. JAWS OF THIS WRENCH** consist of hardened-steel rollers that lock with a camming action. Especially designed for tube fittings, nuts of soft brass, aluminum and plastic. Tightens or loosens without damaging corners of hex or square nuts. Has ratchet action

TKP Co., 920 Fisher Bldg., Detroit 2, Mich.

**3. MASON'S MODULAR RULE** for spacing masonry units fills a need among bricklayers and masons working with concrete blocks, tile and glass blocks. Inside of folding rule is marked with 6 different scales in a 16-in. module for various types of work

Lufkin Rule Co., Saginaw, Mich.

**4. SCREW-ANCHOR "GUN"** speeds up the job of installing screw anchors in hollow-wall construction. Drives 6 to 8 anchors per min. in prepared holes. Makes perfect installations without chipping edges of holes or marking the wall. Fits into any small toolkit

Molly Corp., Reading, Pa.

**5. NONSLIP BELT**, described as a herringbone-indexing type, gives the same positive drive as gears with a greater flexibility of speed range and less error due to backlash. Wedging action of the belt teeth centers the belt in the tread of the gears

Kinevox Div., Electromation Co., Burbank, Calif.

**6. UNIVERSAL TENONING JIG** has adjustable guides and clamps which will hold either hard or soft-wood stock in any position for making end cuts on a circular-saw table. Jig slides in miter-gauge slot, holds the stock vertically to make tenons, lap joints, spline cuts

Sears, Roebuck & Co., Chicago 7

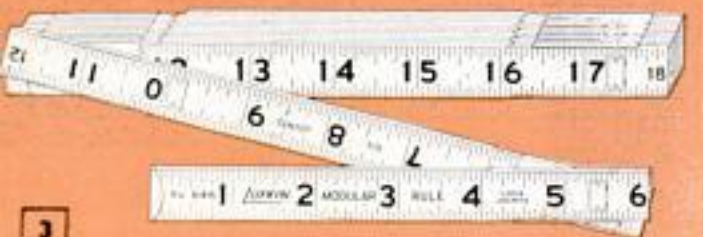

3



4



5

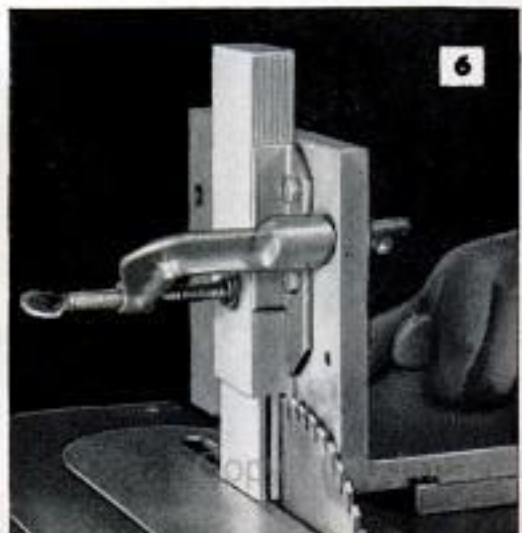

6

# FOR TOOLS



**7. PROTRACTOR ATTACHMENT** for builder's level measures inches-per-foot drop and angles from 0 to 45 deg. Dial rotates past register, or witness, marks on a metal plate. For measuring drop, dial can be pre-set and the level will indicate the correct fall for ditches and runs of tile or pipe. Graduated dial can be locked in any desired position with setscrew

J. H. Scharf Mfg. Co., 6120 Binney St., Omaha, Neb.

**8. SCAFFOLD BRACKET** has simple, safe foot lift to raise the scaffold platform to any desired position. Platform is lowered by means of crank. Can't slip or tilt while being raised or lowered. Brackets move up and down on uprights consisting of two 2 x 4s bolted together and braced to building. Combination guard rail and workbench brackets also available

P. Holtsma Adjustable Scaffold Bracket Co., 261-263 E. 23rd St., Paterson 4, N. J.

**9. "HOLD-DOWN" MACHINE VISE** has new-type hinged jaws that are positioned to exert a downward pressure on work when tightened, this action being shown in accompanying detail. Low height of jaws eliminates use of parallels on all work except that of very thin section. Center line of clamping screw is in line with center of jaw, holding work seated on base

Illinois Metal Products, 420 W. Superior St., Chicago 10

**10. HOME-WORKSHOP SIZE**, these machines come with continuous-duty, built-in motors. Jointer handles stock 4½ in. wide and cuts rabbets to a depth of ¾ in. Both the infeed and outfeed tables are adjustable. Two models of the tilting-arbor saw are available, one having somewhat greater capacity for handling wide stock. Both saws are supplied with ¾-hp. motors

Toolkraft Corp., Plainfield St., Springfield, Mass.

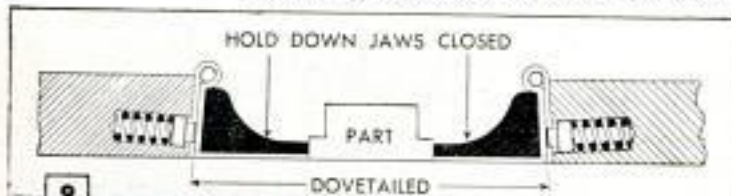
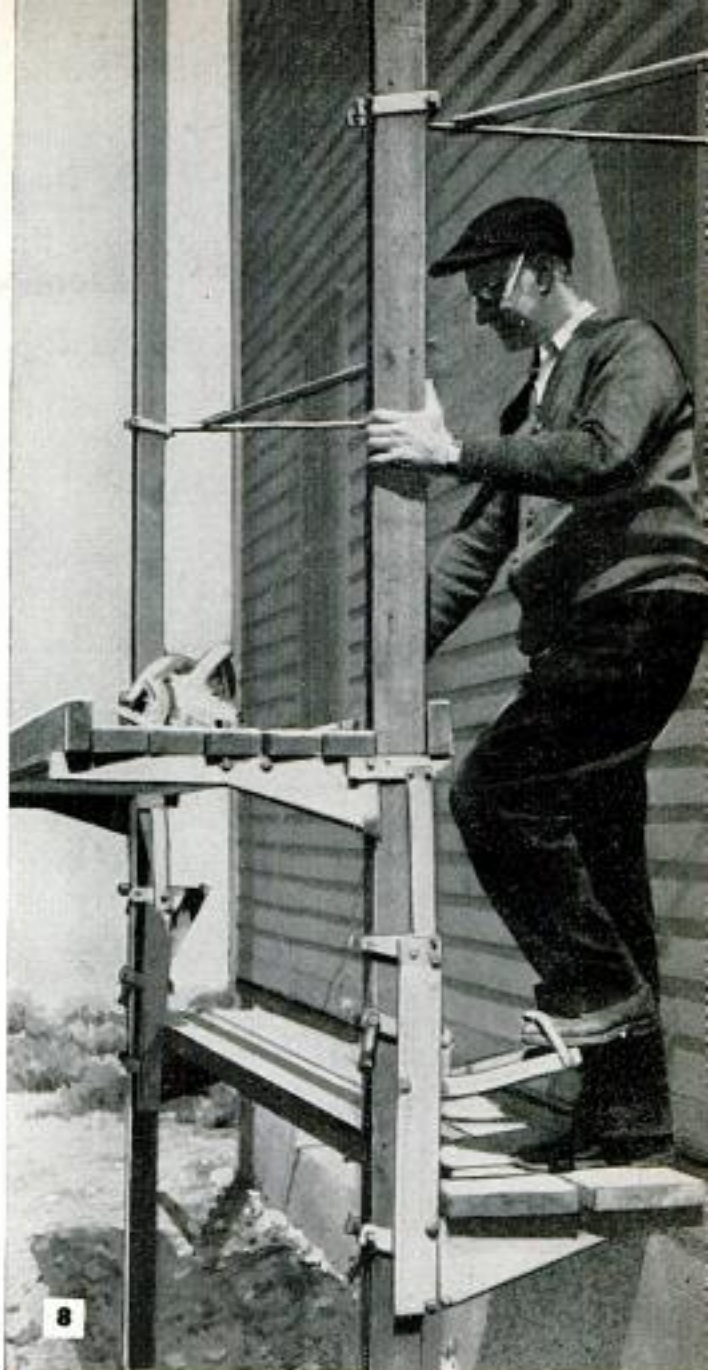

## SHOPPING FOR TOOLS

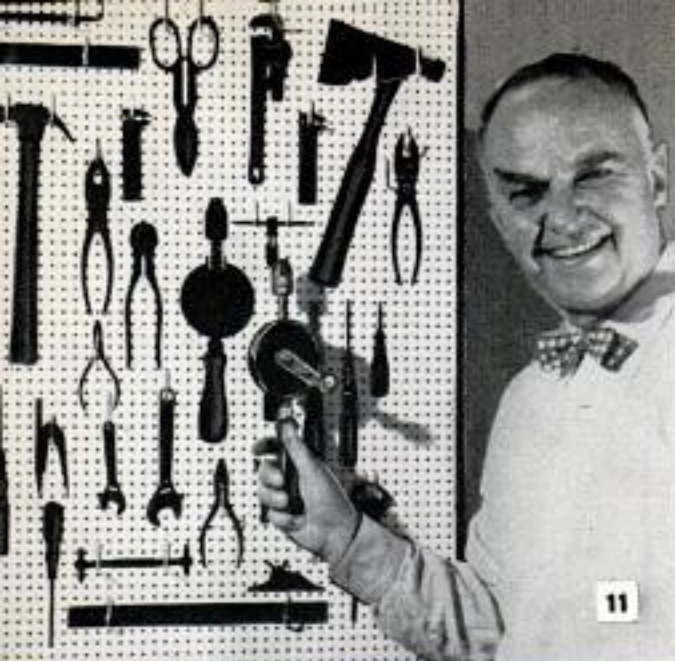

11

**11. HAND-TOOL CUTOUTS** are die-cut to full-size silhouettes of 42 basic hand tools. Coated on one side with a pressure-sensitive adhesive they stick to any dry, smooth surface. Enables you to keep the tool panel well organized, every tool always in its place. Cutouts soon will be available for other types of tools

Tool Shadows, 109 E. 81st St., New York City 28

**12. LINE TEMPLATE** enables artists and draftsmen to draw dot-and-dash lines with fast strokes of ball-point pen or pencil. Dots and dashes are of uniform length and spacing. Produces 6 different lines: short and long dash, long dash and dot, long dash and two dots, short dash and two dots, short dash and dot

Dot-N-Dasher, P.O. Box 668, Crosskill, N. J.

**13. MOTOR MOUNT** saves time when transferring motor from one machine to another. Consists of two parts, one attached to machine, the other to motor base. Motor base slides into part attached to machine. When in position, motor base is pinned to machine base. Additional machine bases are available

Warren Williams Productions, 5247 W. Adams Blvd., Los Angeles 16, Calif.

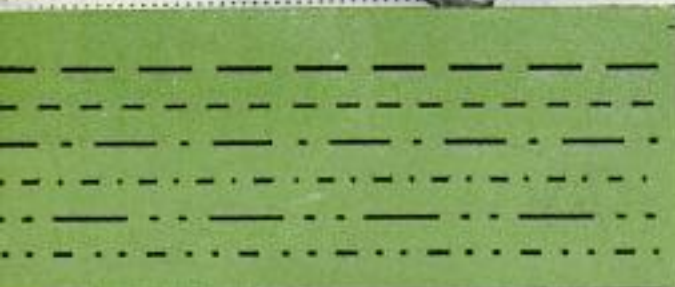

12

**14. PORTABLE JIGSAW** has 1-in. stroke. Cuts 2-in. stock at 90 deg., 1 $\frac{3}{4}$ -in. stock when tilted to 45 deg. Motor housing forms operating handle and an auxiliary knob gives firm, two-handed grip for making short-radius cuts at an angle. Sawdust is removed from line of cut by means of a special built-in blower

Black & Decker Mfg. Co., Towson 4, Md.

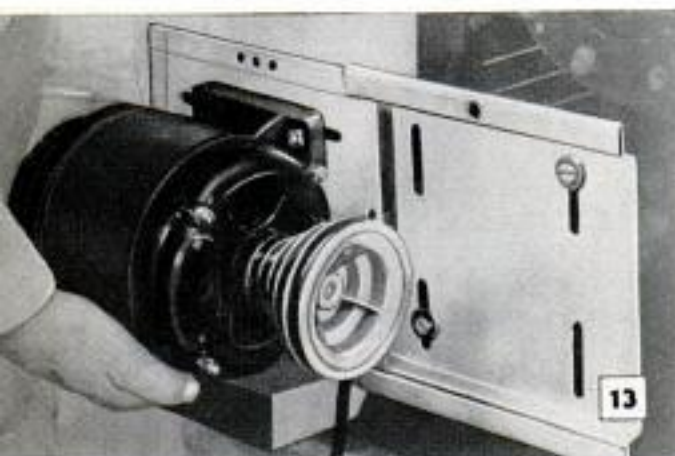

13

**15. BARBED-WIRE REEL** is driven by the front wheels of tricycle-type tractor. Safe. Wire can't injure driver should it break while being reeled in. Wire is unreeled by backing tractor at slow speeds. Wire reel can be removed from driving spindle and another substituted. Reel holds 80 rods of barbed wire

Wire Reel Co., Mendota, Ill.



14



15



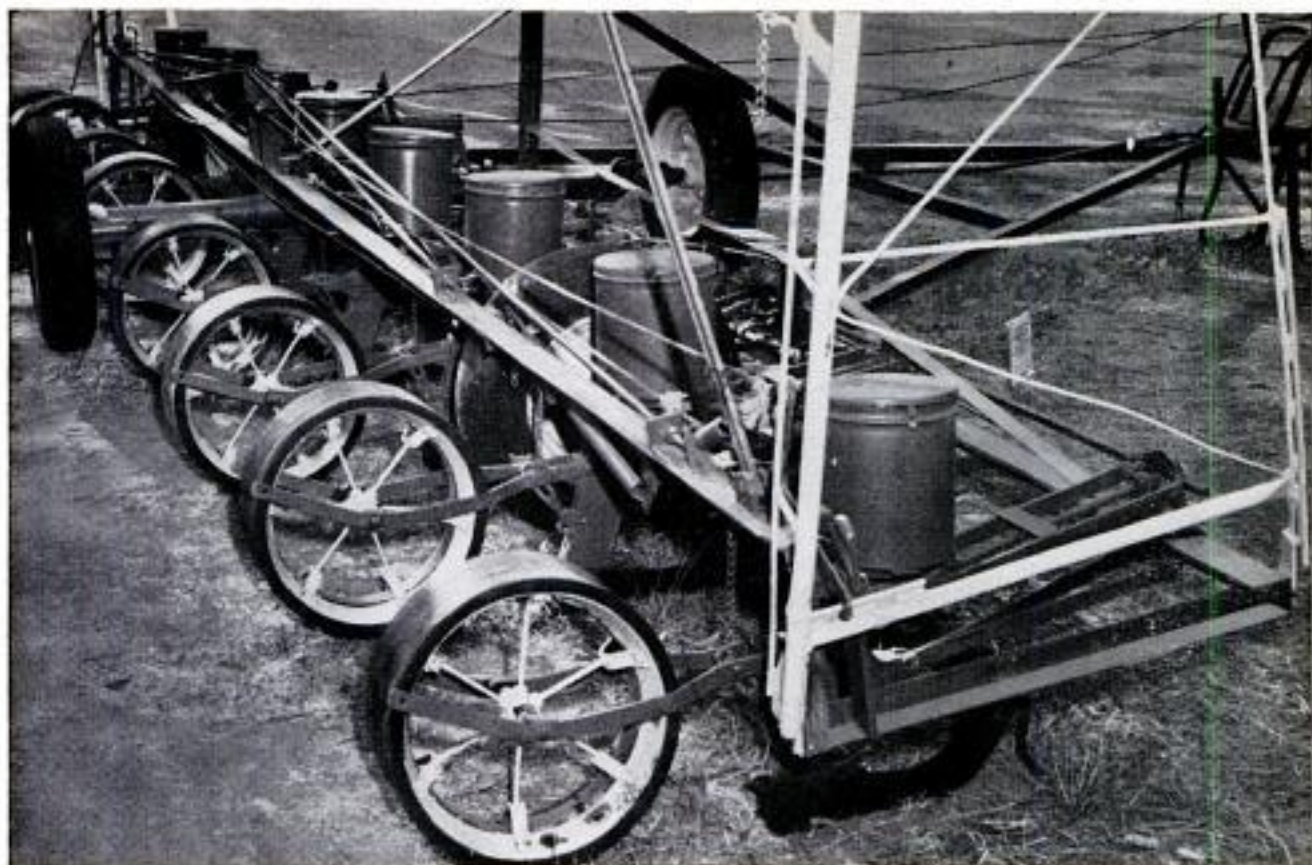

## HYDRAULIC CARRIERS For Farm Machinery

A MULTIPLE-SECTION rotary hoe, corn planter or other unusually wide piece of farm equipment can be towed sideways on a public road or through farm gates, when a rubber-tired carrier like one of the types shown in the photos is attached to the implement and operated from the tractor's hydraulic system. The 8-row corn planter, above, was made from four 2-row planters attached to an angle-iron frame mounted on a car-axle assembly. The assembly is lowered by means of a hydraulic-lift unit installed on it, while the hitch bar that is used when the planter is in operation is folded against its upper framework where it is secured for towing.

The multiple-section rotary hoe shown at the bottom of the page is transported between farmyard and fields by means of a detachable carrier, also operated from the tractor's hydraulic system. Chains are crisscrossed under the sections of the rotary hoe and fastened to hooks on an inside edge of the I-beams forming the side rails of the carrier. The hydraulic unit shown pivots the axle to raise or lower the carrier as desired. Similar hydraulically operated carrier equipment can be devised and built for almost any wide implement used on a farm.

A. M. Wettach, Mt. Pleasant, Iowa.

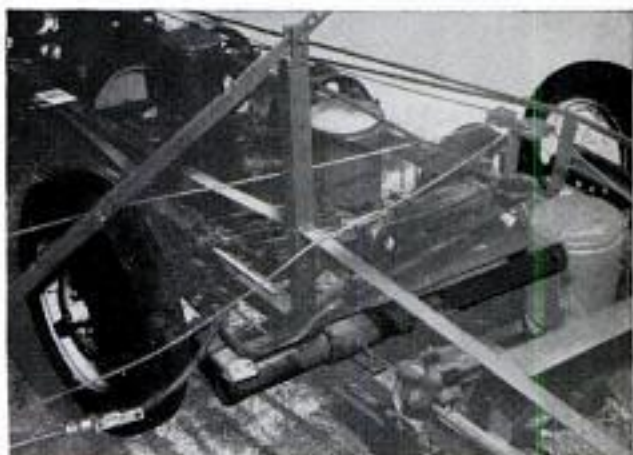

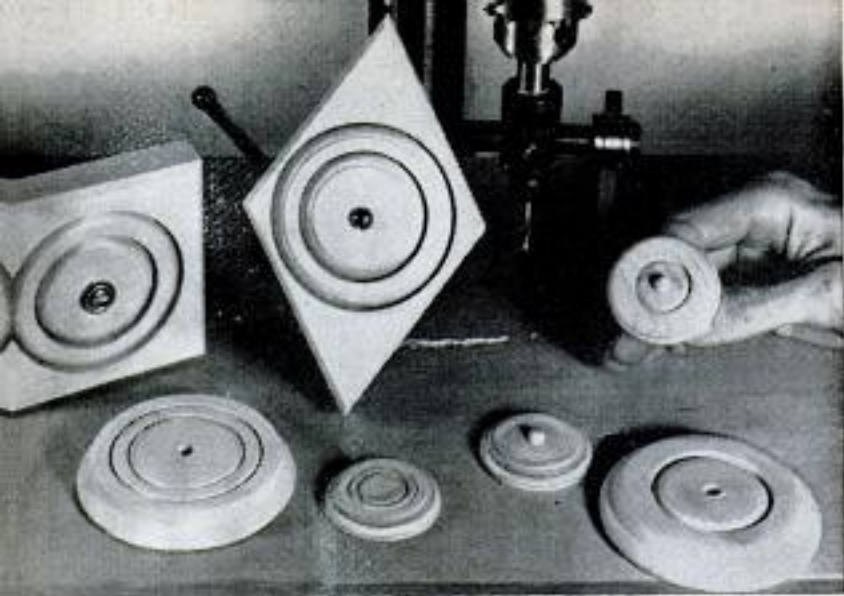

1. Rosettes of many designs can be "turned" by using a circle cutter, as shown above. Pilot hole is plugged with dowel or screw. Dowel is sanded flush, or rounded to finish pattern. Screw plugs hole and also provides means of attaching rosette

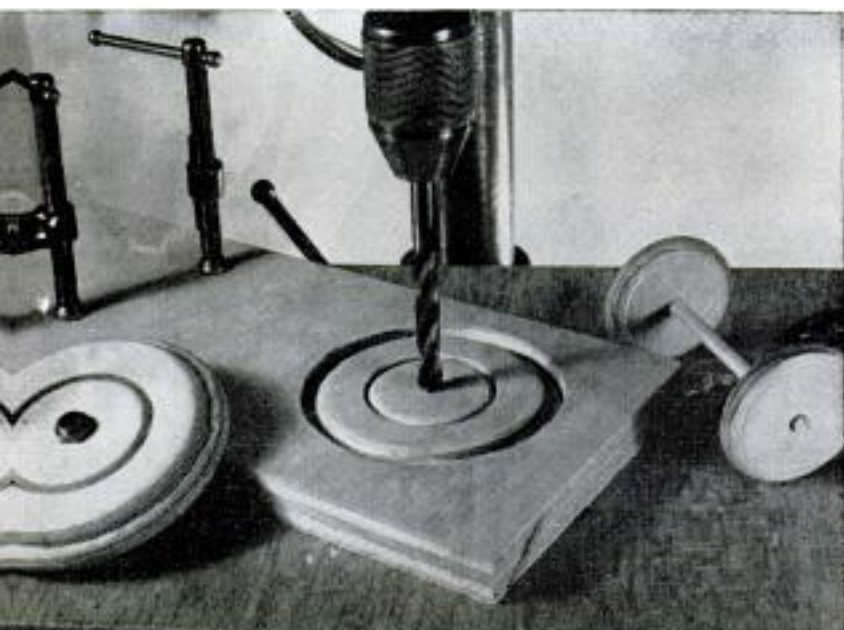

2. Wheels of various sizes, and with designs limited only by imagination, are made with circle cutter. Small wheels are glued to dowel axles, larger wheels are fitted with bushings

3. Tapered hardwood dowel chucked in drill press accommodates pilot holes drilled by circle cutter and permits disks to be sanded while rotating. Moisten dowel to raise grain, add friction



# "TURN" IT *with a* CIRCLE CUTTER

By R. W. Johnson

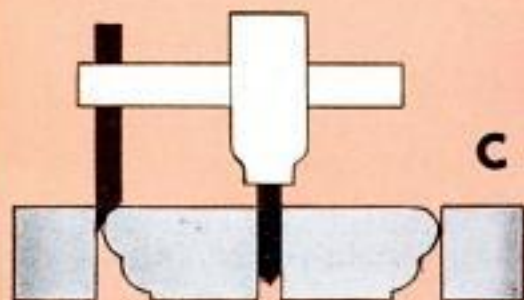
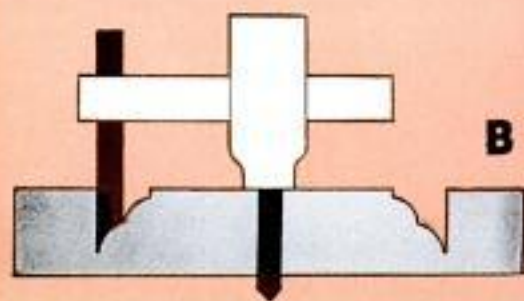
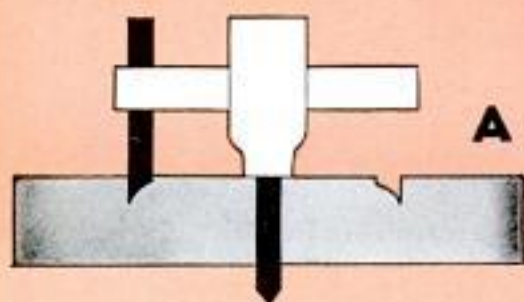

**G**ENERALLY USED by most home craftsmen as an oversized, adjustable wood bit, a circle cutter actually is a versatile tool with many uses, and can do some operations ordinarily done on a lathe. For example, light-duty V-belt pulleys can be made by cutting two wooden disks, then gluing and screwing them together so the bevels formed by the angle of the cutter provide a V-groove on the circumference.

Protect the paint around the handles of kitchen-cabinet doors and drawers by installing backing plates cut from plastic laminate that matches the material used on the counter tops. Thin materials, such as plastic laminates and sheet metal, should be sandwiched between sheets of 1/4-in. plywood when being cut with a circle cutter, both to hold them flat and to prevent them from spinning and cutting fingers.

Rosettes for decorating doors, furniture and window cornices can be made in an almost unlimited number of designs by using the circle cutter, Fig. 1. Pilot holes can be plugged with dowels that are sanded flush or rounded to finish a design. Screws can be inserted to plug the holes and also to provide a means of fastening the rosettes. Details A and B show how a rosette first is cut to shape. Detail C shows how the stock then is inverted and the rosette cut free. This same method is used when forming wheels with a circle cutter.

Wooden wheels of various sizes are simple to make with the hole cutter, Fig. 2. Small wheels are glued to dowel axles, larger ones are redrilled to receive short lengths of pipe or tubing to act as bushings. To accurately redrill pilot holes, clamp a piece of stock to the drill-press table and cut a hole of a size that will hold a wheel snugly. Then, without moving stock or table, replace the circle cutter with a drill bit of the proper size, fit the wheel in the cutout and rebore the hole to size.

Wooden disks cut by the circle cutter can be sanded on the drill press by forcing the pilot hole onto a slightly tapered hardwood dowel chucked in the press, as in Fig. 3.

Wooden rings are made by first cutting a number of holes in the stock of the correct inside diameter. Next, cut a disk of slightly thicker stock and nail it to a piece of plywood. Adjust the circle cutter for the outside diameter of the rings, fit the holes over the disk and cut the rings, Fig. 5.

The handy tape dispenser in Fig. 6 consists of two wooden disks cut to fit inside the rolls. The disks turn on dowels forced into a piece of plywood. Corrugated fasteners soldered to 6d finishing nails provide cutters. When cutting circles in fairly long stock, Fig. 4, it can be hand-held. Shorter pieces must be clamped. ★ ★ ★



4. Above, long pieces of stock can be hand-held when using circle cutter, small pieces are clamped to table for safety. 5. Below, wooden rings are cut by using disk as jig to center holes, cut to inside diameter of rings, under circle cutter. Cutter is readjusted for outside diameter of rings and second cut is made

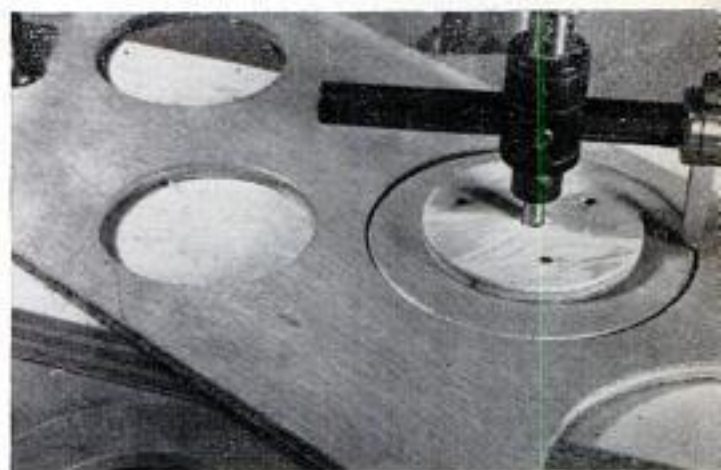

6. Shop tape dispenser consists of two wooden disks that fit inside tape rolls and turn on dowels fitted in board. Corrugated fasteners provide tape cutters, slotted coffee cans protect tape against dust and dirt



# "Stethoscope" Aids in Diagnosing Auto Ills

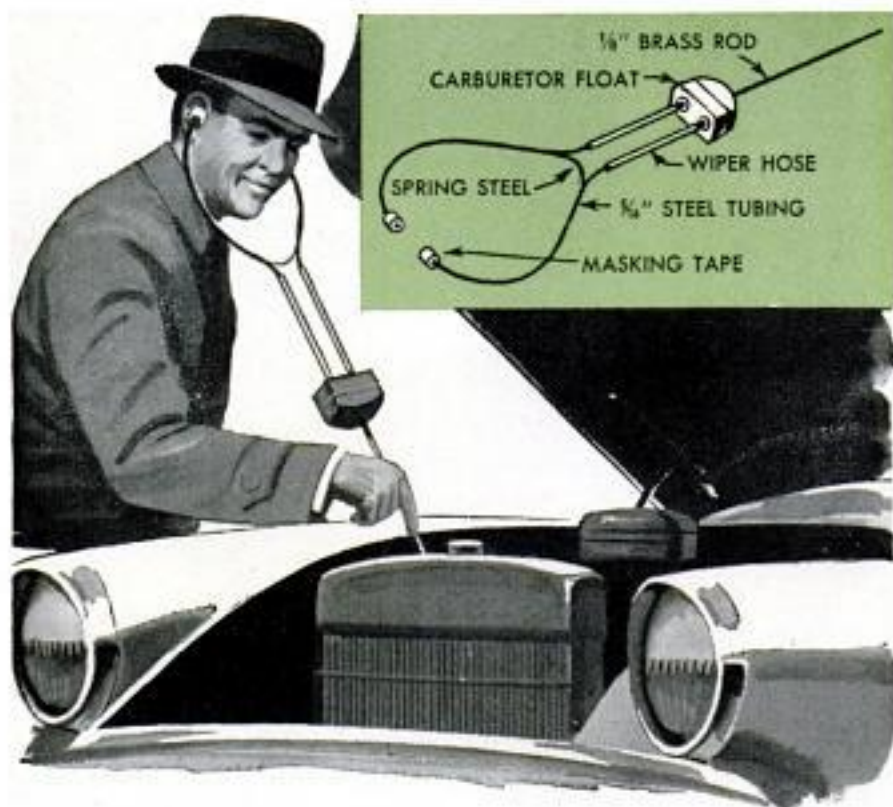

Diagnosing the source of erratic noises in the engine, transmission or even the body of an automobile is much less of a problem when a "stethoscope" is used. Patterned after the familiar instrument carried by every doctor, this automotive stethoscope uses a carburetor float as a sound-amplifying device. The probe, or sound pickup, is a 15-in. length of  $\frac{1}{8}$ -in. brass rod soldered to one side of the float. Two 1-in. lengths of  $\frac{1}{16}$ -in. copper tubing are soldered to the opposite side of the float over two holes drilled in it. The "earphones" of the stethoscope consist of two lengths of  $\frac{5}{16}$ -in. steel tubing bent as indicated and held together with a

length of flat-steel spring, silver soldered. Windshield-wiper hose is used to connect the earpiece tubing to the float.

Stanley Clark, East Bradenton, Fla.

## Windmill Ladder in Haymow Aids in Stacking Bales

Good use is made of the ladder leg of a dismantled windmill on this farm. The ladder is secured to a roof column in the hay barn, where it provides easy access to the baled hay, no matter how high it is piled.—A. M. Wettach, Mt. Pleasant, Iowa.



## Clamp to Braze Bandsaw Blades Made From Strap Hinge

Ends of a bandsaw blade can be held in position for brazing by means of a clamp made by modifying a large strap hinge. The end of one leaf is shortened, and the end of the other leaf is bent at 45 deg. as indicated. When the bent leaf is gripped in a vise the clamp will hold the work in a convenient position. A large hole drilled through both leaves of the hinge exposes the ends of the blade for brazing. Bevel the ends of the blade so they may be lapped.

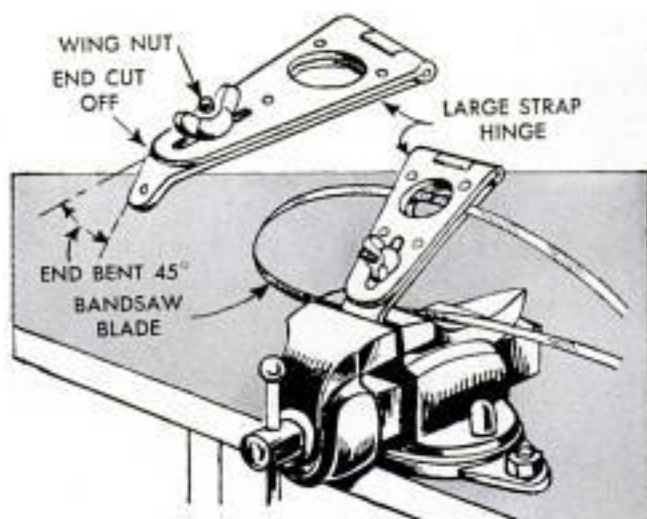

## Drilled Holes Kept in Perfect Alignment by Pilot Pin

When drilling a piece of work in which holes in two legs, or projections, must be in perfect alignment, here is one method of doing it. Clamp the work on the table of a drill press or vertical miller and drill a hole in one projection. Next, clamp a  $\frac{1}{2}$  or  $\frac{5}{8}$ -in. steel plate to the table and drill a hole of the same diameter in it. Into this hole fit a steel pin of equal diameter and slip the work down over this pin as shown in the lower detail. Now, when a hole is drilled in the upper projection it will be in exact alignment with the hole in the lower projection of the work.

Frank La Saracina, New York City.

## C-Clamp on Ladder Holds Hammer

Holding a hammer safely at hand when working on a ladder may be done by attaching a large C-clamp to the ladder. Be sure the clamp is tightened against the ladder rail.



## Tool Bent From Coat-Hanger Wire Aids Changing Car-Door Lock

Changing the cylinder in an auto-door lock is not difficult if the bar extending from the cylinder can be guided through the door mechanism. To accomplish this easily, form a tool by filing a point on one end of a length of coat-hanger wire and bending a loop for a handle on the other end. Push the point of the tool through the door upholstery opposite the lock and lead it through the opening in the door. Fit the end of the lock-cylinder bar over the point of the tool and push the bar through the door opening. The tool will permit moving the bar in any direction to facilitate threading it through the door mechanism.

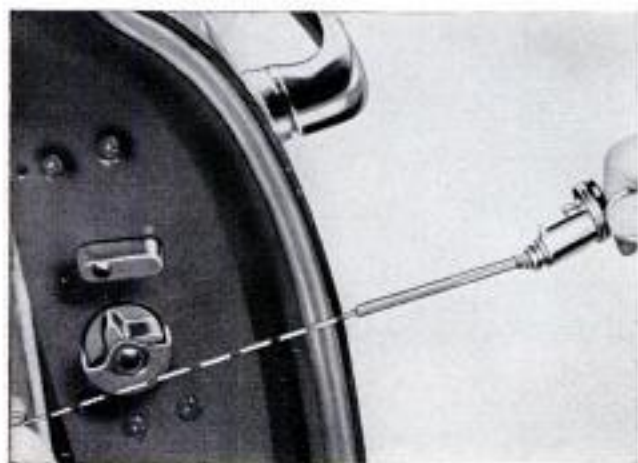

FEBRUARY 1957

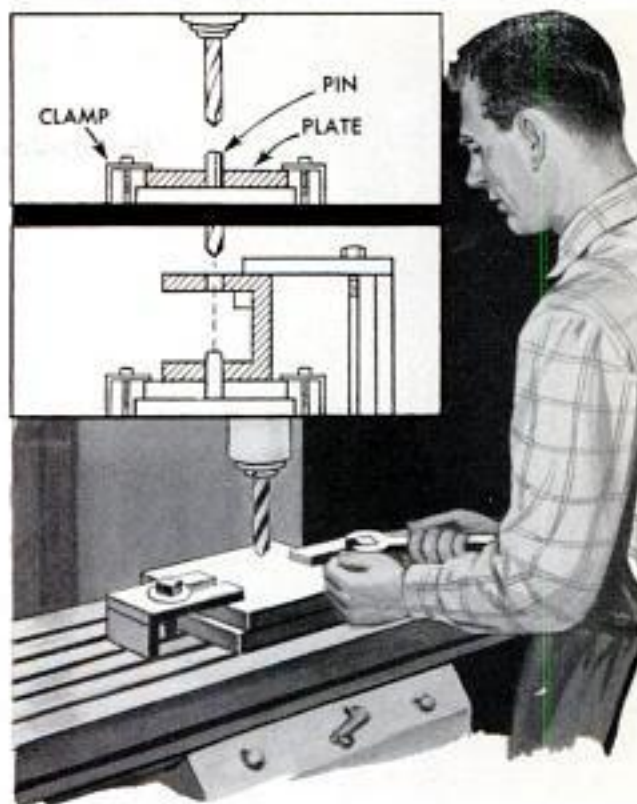

## Pushing or Towing Cars Equipped With Automatic Transmissions

When it is necessary to push or tow a car equipped with automatic transmission, proper procedure for the specific car must be followed. When pushing cars equipped with Fordomatic, Hydra-Matic, or Powerglide, begin with the ignition Off and the shift lever in Neutral, and when the car reaches a speed of 20 m.p.h. turn on the ignition and shift into Drive. Cars with Borg-Warner, Dynaflow, PowerFlite, or Ultramatic Drive should be pushed with the ignition On and the shift in Neutral until a speed of approximately 20 m.p.h. and then shifted into the Drive position. However, before pushing a car with Borg-Warner transmission the automatic choke must be set by depressing the accelerator to the floor once. Fluid Drive, Gyro-Matic, Presto-Matic, Tip-Toe Shift and Vacuumatic-equipped cars should be set in Low gear with the ignition left Off until the car reaches 15 m.p.h., at which time the ignition is turned on. Hy-Drive transmissions are set in the Drive position and the car ignition turned On preparatory to pushing.

Most cars with automatic transmissions can be towed a reasonable distance on the rear wheels at a speed of about 30 m.p.h. if the shift lever is first put in the Neutral position. But, with Hydra-Matic the drive shaft must be dropped or the car towed on the front wheels. If an automatic transmission is inoperative, the car should be towed on front wheels with rear wheels raised.

# Make This Electric LAWN TRIMMER-EDGER

By W. G. Waggoner



HERE IS an electric lawn trimmer-edger that you can make in a few hours out of an old sewing-machine motor or other small motor, a few pieces of wood and metal and a trimmer blade. The only item that need be purchased is the blade. The handle was fabricated from a length of thin-wall conduit in which the wires that supply current to the motor are inserted. A bolt and wing nut, used to attach the handle, allow the unit to be held in two positions—one for trimming around shrubs or next to walls or fences as shown below, and one for edging a lawn around sidewalks or stepping stones as shown in the illustration at left.

The stationary cutter, as detailed in the drawing, forces grass away from the sidewalk and into the blade for a better job of edging. It also serves as a spacer for obtaining a uniform edge around the lawn while preventing the blade from striking the sidewalk or other object around which the lawn is being trimmed. The two-piece guard is made of  $\frac{1}{8}$ -in. flat steel and serves the dual purpose of protecting the operator from flying debris that might be thrown by the whirling blade, and functions as a retainer to prevent the blade assembly from flying off its shaft should the blade come loose.

Handle, secured to machine by bolt and wing nut, used in normal position, above, when edging lawn, reversed when unit is used as trimmer, below. Guard prevents contact between blade and other objects

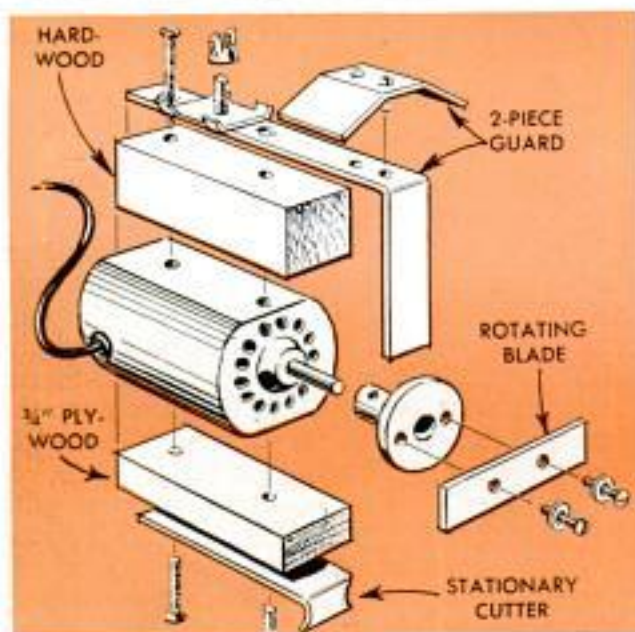

## Rack on Front of Tractor Serves as Grille Guard and Pusher

Small equipment and sacks of feed can be carried on this rack, which pivots on the front of the tractor so that it can be raised up in front of the grille to protect it when pushing wagons and implements. Frame of the rack, which is 18 x 26 in., is welded together from square iron tubing, and has pieces of a leaf spring welded across it to provide cushioning for pushing. Mounting of the rack will vary with different tractors. The rack shown is pivoted to the upturned ends of the tractor frame and rests on a bumper, also added for pushing, when in the lowered position. A bolt fitted through a hole in the rack and into the end of the frame locks the rack in the vertical position.



## Field Drag of Square Timbers More Efficient Than Blade

Square timbers, strapped together to form a field drag, are used by one farmer because the timber drag has less tendency to "plow under" than a conventional blade type. Bottom edges of the drag—formed by the timber corners—are fitted with steel angles to minimize wear.

C. F. Marley, Nokomis, Ill.



## Modified Screwdriver Blade Removes Carburetor Jets

An ordinary screwdriver can be modified for use on carburetors by grinding down the blade so it will fit into the openings in the castings. Keep the edges of the blade parallel, so the tip will extend the full width of the slots in the jets, as shown in the photo. The jets are brass, and a too-narrow screwdriver blade will easily damage them.—Ed Packer, Oak Park, Ill.



## Feed "Sled" Made From Old Boiler Is Towed Behind Tractor

This welded silage and feed trough is built like a sled so that it can be "skidded" behind a tractor to any location around the farm. A discarded hot-water boiler was cut in two lengthwise with a torch and one end was removed from each boiler half. The open ends of the two halves then were welded together to form a trough 10 ft. long and 2½ ft. wide. The framing and skids are 1½-in. pipe, with uprights spaced 2 ft. from each of the ends and 3 ft. apart. Cross bracing between the end up-

rights is cut from steel angles and is welded in place. After assembly the trough was wire-brushed to remove rust, then painted with aluminum paint.



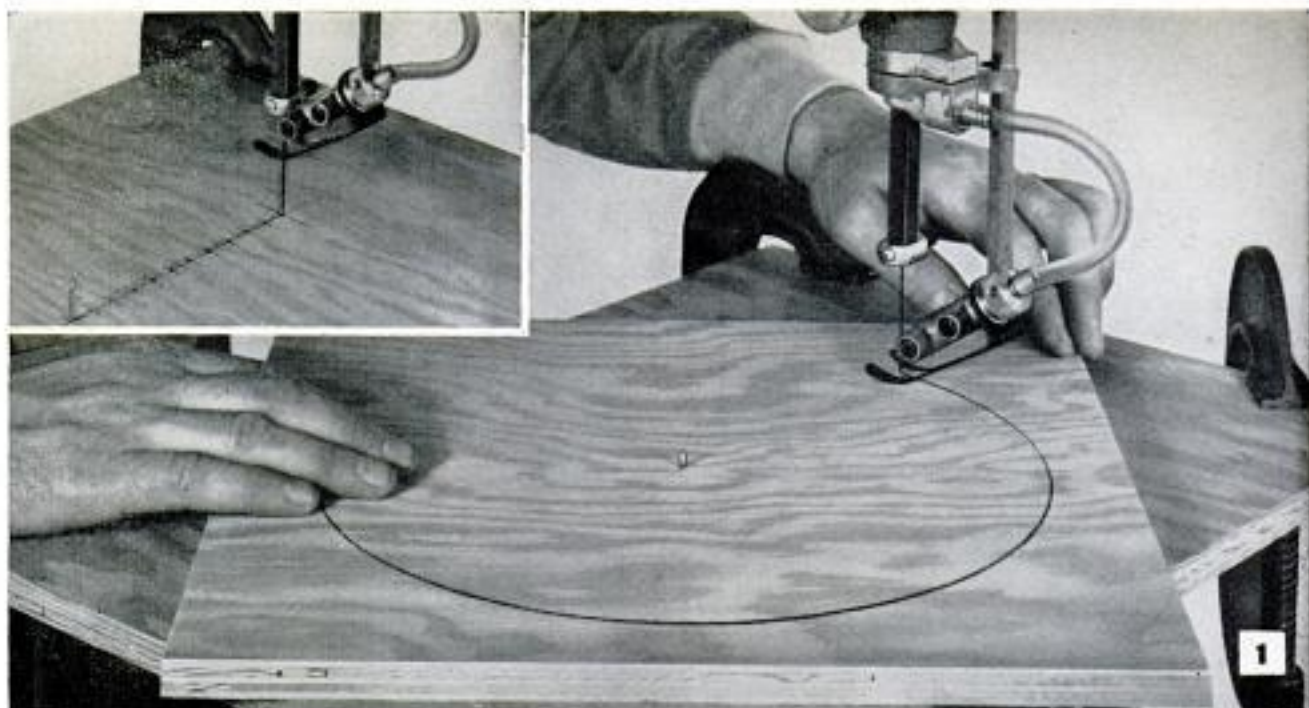

## How Would You Do It?

By Chris Nelson

**1. Q—How can you make a simple, variable-size jig that will assure cutting true circles on a jigsaw?**

A—Drill a series of blade-size holes  $\frac{1}{4}$  or  $\frac{1}{2}$  in. apart in a piece of  $\frac{3}{4}$ -in. plywood. Drive a nail from beneath for a pivot as in inset. Slip blade through hole that gives correct diameter circle and clamp jig to saw table. Rotate work against blade

**2. Q—What should be done with the protective paper covering on sheet plastic when cutting it with a jigsaw?**

A—Leave the protective paper on the plastic until all work is finished. The paper will prevent the plastic from being scratched while being handled, sawed and filed. Woodcutting blades can be used on plastic, but special "skip tooth" blades are better

**3. Q—In what manner can a jigsaw be modified to cut oversize stock and also make internal cuts quickly?**

A—Remove the upper arm of the jigsaw and set it up as a saber saw as shown in the right-hand photograph below. There then will be no limit to the size of stock that can be handled on the saw, and internal cuts can be made without removing the blade

**4. Q—How can bevel-cutting produce three-dimensional, stock-saving lamp bases?**

A—Make a series of bevel cuts, such as drawn on stock in lower right-hand photo. Push pieces toward narrowest part of openings to produce shape as in upper right-hand photo. The important thing to remember when bevel-cutting is that work should always be on same side of blade as in left-hand photo

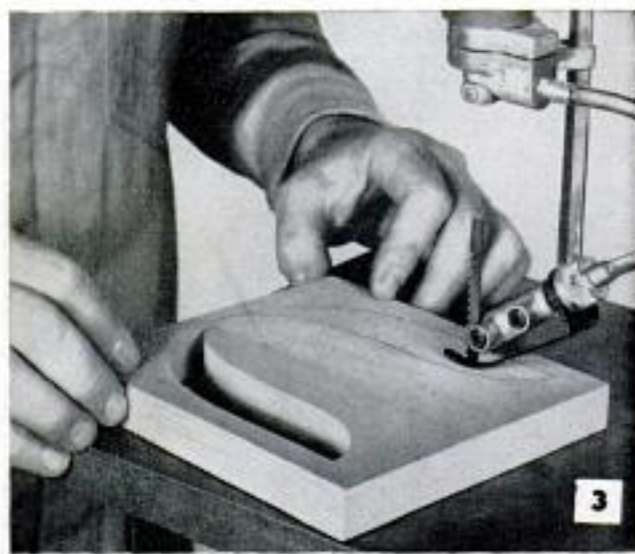



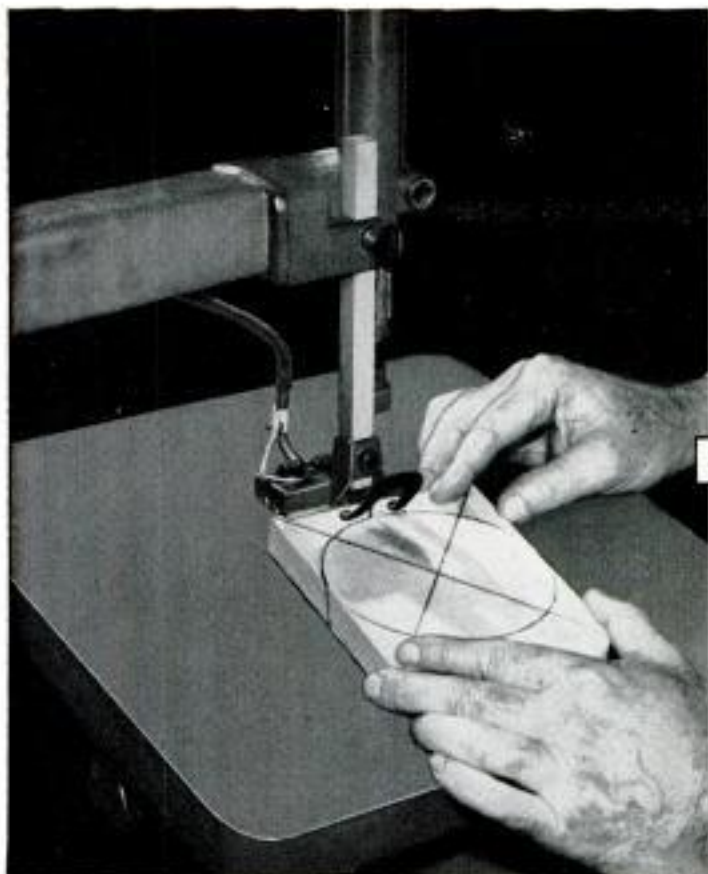

4

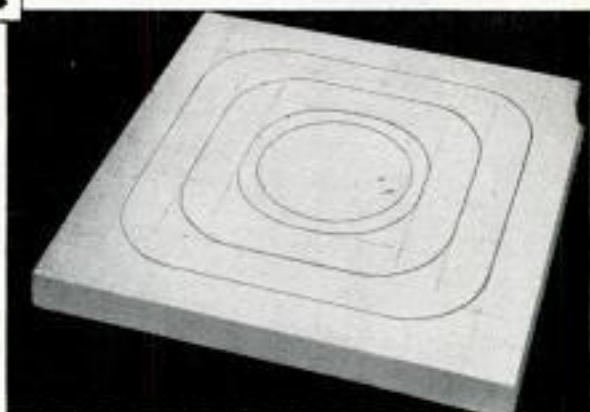

**5. Q—What accessory or attachment is available for a jigsaw to permit using it as a power tool for fast smoothing of the edges of cutouts made on the jigsaw?**

**A—**Machine files, designed to be gripped in the lower jaw of a jigsaw, are made in a variety of shapes. The inset shows how the file is gripped in the chuck; the larger photo shows the file being used to smooth the edges of a light-gauge sheet-metal cutout that has been made on the jigsaw



5



**6. Q—When cutting thin sheet metal or sheet plastics, what modification should be made to the jigsaw table to prevent these lighter-gauge materials from being bent under the blade?**

**A—**Use an auxiliary table to keep thin materials from bending. It can be a sheet of plywood drilled to accommodate the blade, or a special insert of wood, metal or hardboard as shown in inset photo that temporarily replaces the regular table insert



6

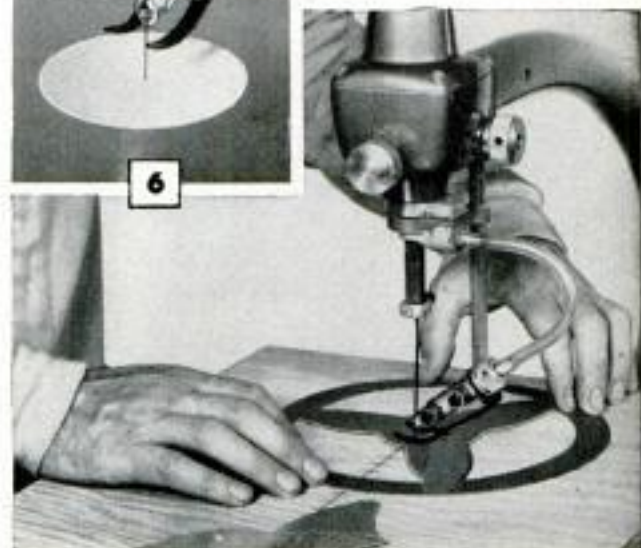

## Handles Permit Better Grip On Steel-Post Driver



Two lengths of iron rod shaped as shown and welded to a steel-post driver make it easier to use. Gripping the handles is less fatiguing than gripping the pipe, especially when driving posts in hard ground.

C. F. Marley, Nokomis, Ill.

## Hanger Positions Hammer Ready for Use

Your hammer is always within handy reach when you store it in this novel hanger. Using the hammer head as a guide, drill and shape a beveled hardwood block to take the head as pictured. Fit of the head in the block should be fairly loose for easy removal. Attach to tool panel with a pair of screws driven from the back.



## Corrugated-Cardboard Rack Holds Small Power-Tool Accessories

A strip of double-faced, corrugated cardboard serves as an ideal holder for small power-tool accessories. The shaft of each accessory is slipped into one of the "pockets" formed by the corrugations with the working end exposed for easy selection. The holder can be attached to a wall or shelf in a convenient location, or placed on a workbench as shown.

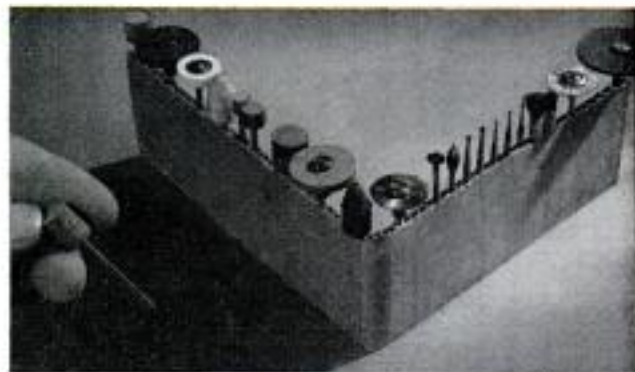

## Threading Die Holds Short Screw For Grinding and Cutting

When grinding or making end cuts in setscrews or short machine screws first place them in a thread-cutting die and they can then be more easily handled. Loosen the adjusting screw on the die after work is in place and the die will close around it. Detail shows die being held in position by magnetic chuck on surface grinder table.



## Drill Bit With Notched Shank Provides Leather Punch

Modifying the shank end of a drill bit by filing or grinding a V-notch in it as indicated will provide a serviceable punch for cutting holes in leather and light-gauge sheet metal. The two lips formed on the bit make a shear cut through the leather.

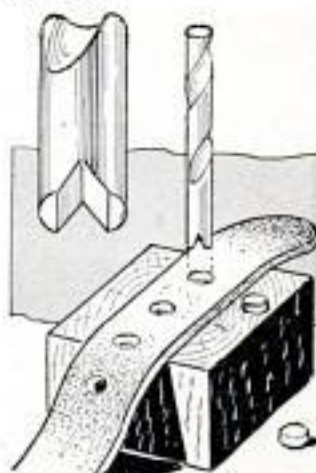

*On the*  
**MARKET**  
*for Do-It-Yourselfers*



1

**1. FLOWERPOT HOLDER** comes in two sizes to take 4 and 6-in. pots. Attaches securely to decorative metalwork, iron porch railings and columns. No screws or bolts required. Weight of pot locks holder

Tennessee Fabricating Co., 1490 Grimes St., Memphis, Tenn.

**2. JELLED SEMIGLOSS ENAMEL** comes in a collapsible tube. Apply to the brush like toothpaste. Spreads easily just like ordinary enamel but without thinning or stirring. Comes in medium and large-size tubes

American-Marietta Co., 101 E. Ontario St., Chicago 11

**3. DOORSTOP**, or bumper, attaches to the door hinge rather than baseboard and is adjustable for regulating distance door can open. To install, remove hinge pin, insert pin in door bumper and then replace

Clifford's, 922 N. Fourth St., Milwaukee 3, Wis.

**4. MODERN FURNITURE PULLS** in bright brass finish are available in various design combinations, several of which are shown in the accompanying sketches. A number of modern furniture designs are available

Paultless Caster Corp., Furniture Hardware Div., Evansville 7, Ind.

**5. PREQUILTED UPHOLSTERY** is a combination cushioning and covering material consisting of a plastic facing heat-sealed to a plastic "foam" cushion having fabric backing. Comes in various patterns, thicknesses

General Tire & Rubber Co., Bolta Products Div., Lawrence, Mass.



2

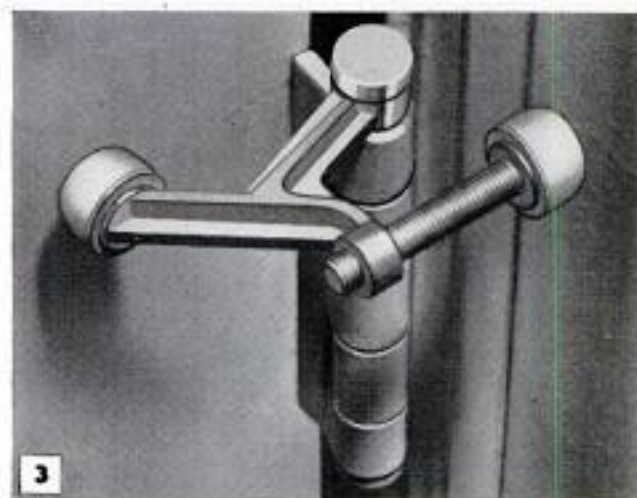

3

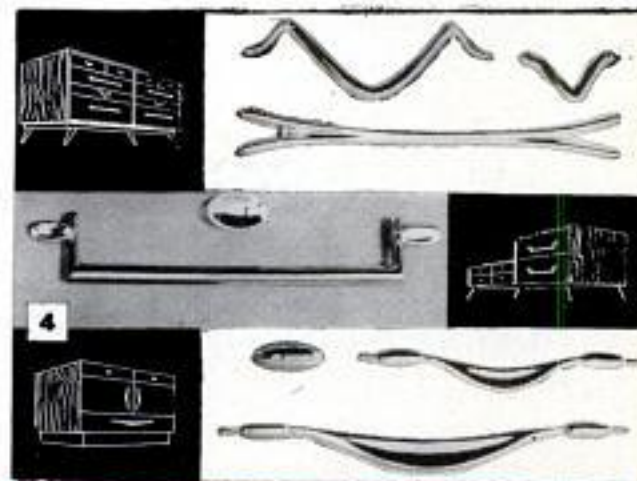

4



5



## Drill-Press Vice Improvised From Woodworker's Hand Screw

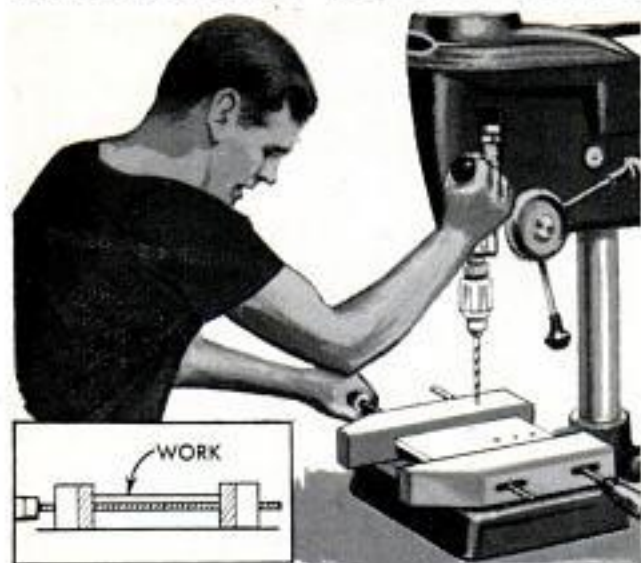

You'll find a woodworker's hand screw highly useful as a drill-press vice for safely holding thin work which is larger than the capacity of a regular drill-press vise. Simply open the jaws wide enough to accept the work and rest it on the threaded spindles of the clamp. Then tighten the jaws. The spindles give good support and hold the work parallel with the table. Another method of clamping work in a hand screw is to fasten cleats to the top of the jaws  $\frac{1}{2}$  in. or so in from the edges. The work is laid on top of the jaws and tightened against the cleats to hold it.

Phonograph-record albums are ideal for storing sandpaper. The pockets permit "filing" the various grades separately.

## Rubber Washers Dampen Noise of Power Tools

Two rubber washers placed on each of the screws that fastens a tool stand to the workbench, so that the base of the stand is sandwiched between them, will effectively cut the amount of noise produced by the tool. Mounting screws should be  $\frac{1}{8}$  in. smaller than the diameter of the holes in the stand base and should be centered and tightened sufficiently to prevent vibrations from being transmitted down through them to the bench. A metal washer under the head of each screw will keep it from wearing through the hole in the top cushioning washer. Use  $\frac{1}{4}$ -in.-thick washers.—J. B. Sullivan, Garden City, N. Y.

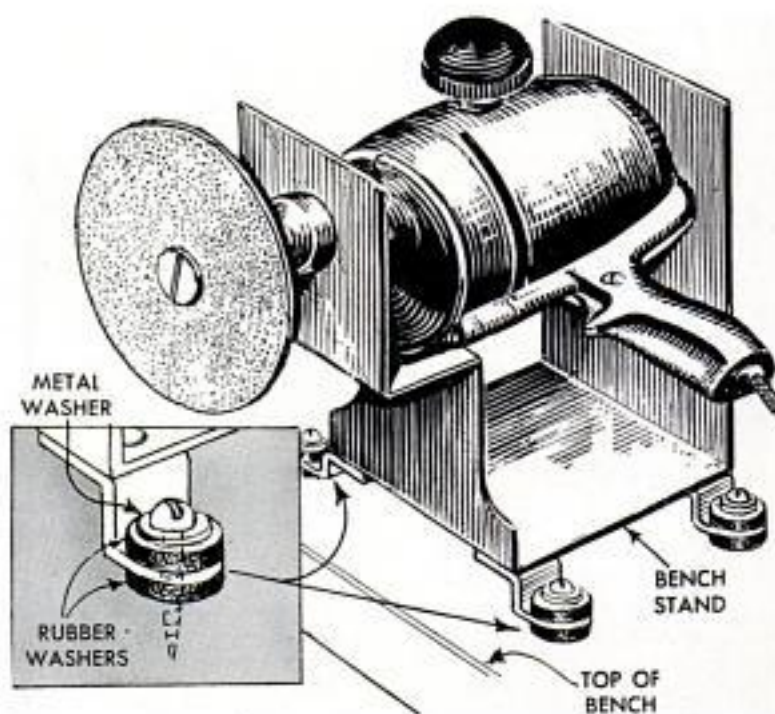

## Bevel Aids Filing Metal To Dimension Line

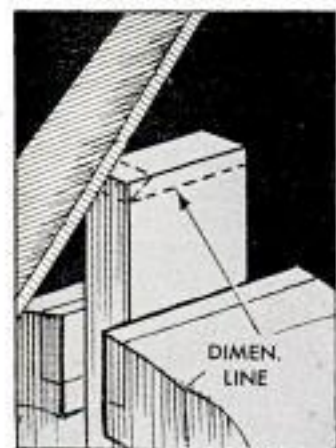

When shortening a piece of metal to a dimension line, first file a bevel on the marked side to the dimension line as shown, and then file the metal squarely down to the base of this bevel for easier filing and more accurate results. If the metal is quite thick, it

will be easier to file bevels on both edges first.—Howard E. Moody, Upper Jay, N. Y.

## Masking Tape Replaces C-Clamps For Holding Rip Fence on Jigsaw

When C-clamps are not available, or are being used on other work, strips of masking tape can be substituted for the clamps to hold a wooden rip fence in place on the table of a jigsaw.

Apply the tape lengthwise of the fence, starting on the top surface of the wood as indicated and running it around and under the edges of the table to assure maximum holding power.

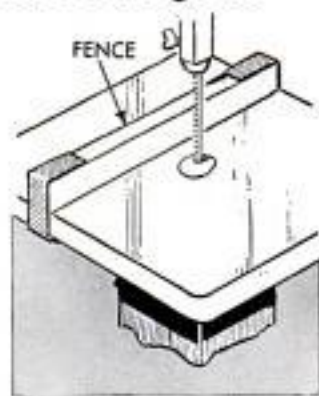

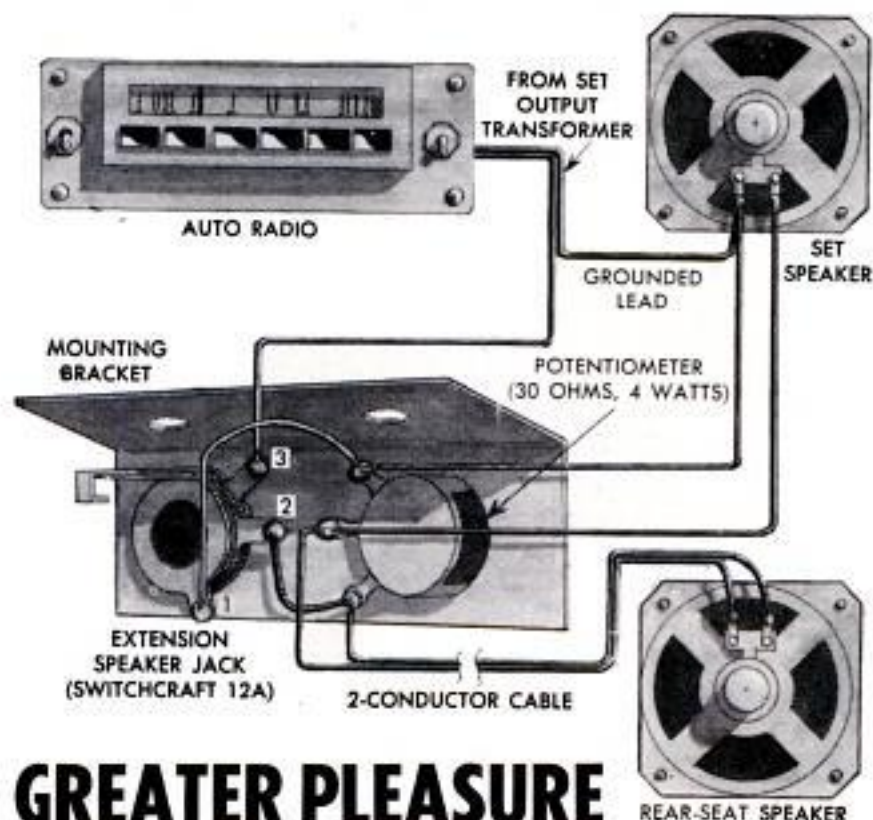

## GREATER PLEASURE FROM CAR RADIOS

THERE IS NO DOUBT that automobile radios contribute greatly to the pleasures of modern driving. Yet, in spite of their wide acceptance, such receivers usually fail to take advantage of all their capabilities. In most cars, for example, the radio is equipped with only a single dash-mounted speaker, which does not provide adequate rear-seat coverage unless the volume is turned up to a level which is uncomfortable to the driver and other front-seat occupants. Furthermore, for high-speed country driving, where the companionship of the radio is most desirable, the high noise level within the car often makes radio listening difficult, if not impossible. And finally, auto-radio listening is often restricted to areas in the immediate vicinity of the car itself by the lack of an extension speaker jack which would permit the use of an externally placed speaker for lawn parties, picnics and other outdoor activities.

By fashioning a simple control panel using only two inexpensive parts, and making some minor wiring changes, these handicaps can be eliminated.

The pictorial diagram, above, shows the simplicity of the necessary wiring, while the resulting performance can be determined from the schematic on page 272. Instead of having a single speaker connected to the output transformer of the set, we now have an additional rear-seat speaker wired in series with the original one. The top lead of the rear-seat unit is connected through the normally closed contacts 2 and 3 of a jack to the output transformer. As long as no plug is inserted in the jack, the signal from the transformer will divide between the two speakers.

A potentiometer is connected to the speakers in such a way that the position of its rotary contact determines the signal distribution to the two speakers. In the center position the signal is equally divided. But as the control is rotated, the volume of one of the speakers is gradually

(Continued to page 272)

# AUTOMATIC CONVERTIBLE- TOP CLOSER

By Byron G. Wels

Photos by Kinner Photo Service



FARMERS are not the only folks concerned with the weather these days. With the approach of the spring and summer seasons, every convertible owner will try to outguess the weatherman each time he parks his car. An overcast sky may cause him to raise the top, only to find, on his return, that the weather has cleared and the temperature in the car closely resembles that of a Turkish bath. A wrong guess in the other direction can have more damaging consequences as seat covers and contents are soaked by a sudden shower.

But, if you own a convertible, you don't have to gamble on the weather. For a small investment of time and money you can install this automatic top-closing circuit which literally "raises the roof" the minute it starts to rain.

## How It Works

The operation of the system is really quite simple, as shown in the diagram below. A homemade rain detector is wired in

series with two switches and a relay coil across the automobile battery. As long as the detector is dry, it represents an open circuit, and no battery current can flow. But, when a few drops of rain strike the detector, this unit automatically shorts out, and the resulting current (if the disabling switch is closed) activates the relay. As a result, the relay contacts will close and short out the "top closing" portion of the "top switch," causing the top to rise.

The limit switch is mounted near the top of the windshield frame, Fig. 2, so that the closing top will activate the leaf-spring actuator of the switch when the top has reached the limit of its travel. This interrupts the current through the relay coil and shuts off the top-closing motor. The disabling switch cuts out the automatic circuit and permits manual operation.

The heart of the entire system is the rain detector which can easily be made from two pieces of fine-mesh copper screening, about 4 in. square, and a piece of blotting

Fig. 1. Diagram of automatic convertible-top-closing circuit. Top switch, at right, is part of car equipment

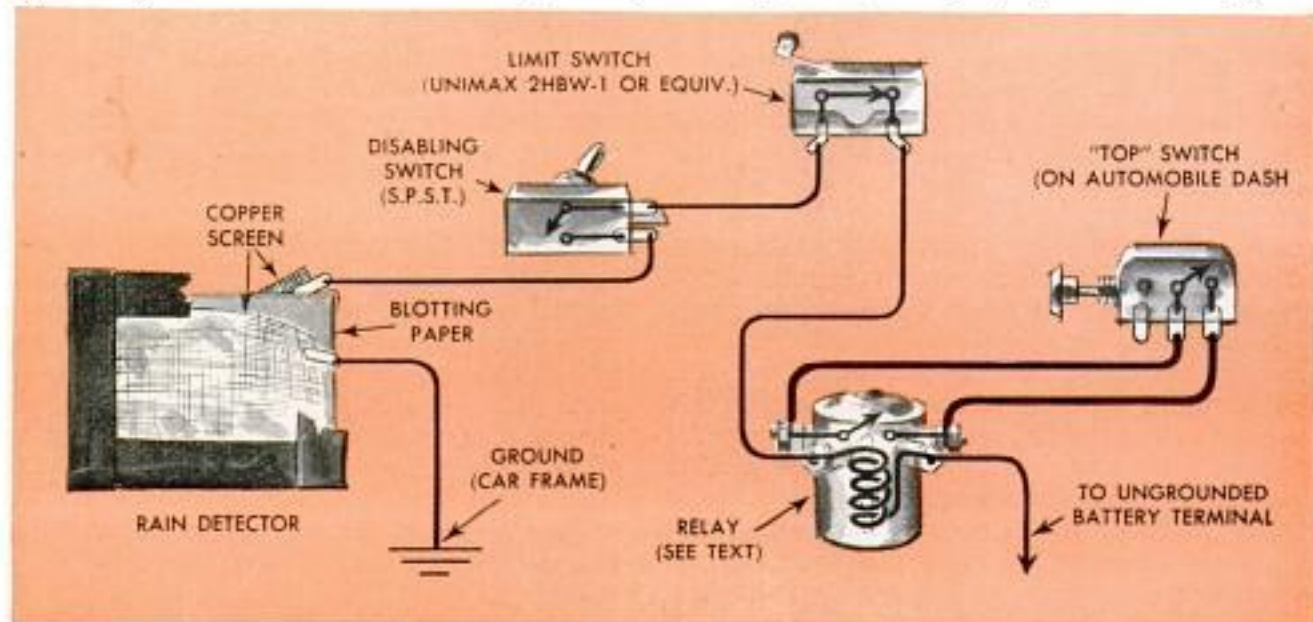

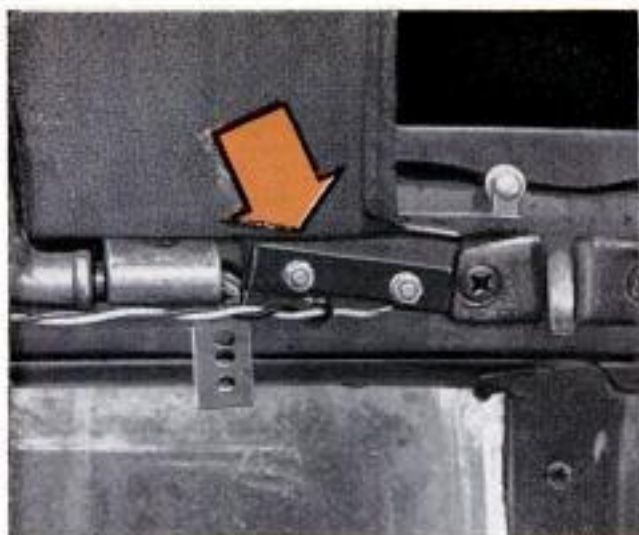

Fig. 2. Limit switch installed near top of windshield shuts off motor when top has reached end of travel

paper (the kind with blotting paper on both sides). Thoroughly soak the blotting paper in a saturated solution of salt water and permit it to dry completely. Now, solder a length of wire to each of the screens and form a "sandwich," as shown in Fig. 1. The blotting paper should extend about  $\frac{1}{4}$  in. beyond the screening on all sides. Cover the edges of the "sandwich" with cloth tape, bringing the wires out through a slit in the tape.

The detector is ultimately fastened to the top portion of the front seat, as illustrated in Fig. 3. Allow the detector to follow the curvature of the seat, as this will assure good contact between screens and blotter.

### Components

The two switches are standard items, listed in all catalogues of major radio-parts distributors. The choice of the proper relay, however, depends upon the voltage of the car battery and upon the original top-closing circuitry. The relay coil must have the same rating as the battery voltage, and its contacts must be able to withstand the current which would normally flow through the dash-mounted switch. In most cases, the dash switch merely activates another relay, so that the current through the switch is relatively small. In this event, any ordinary 6 or 12-v. radio relay will do the job. But, if the circuit is wired so that the entire current drawn by the top-closing motor must flow through the switch, a special relay is needed. The motor current can be in the neighborhood of 90 to 100 amps., and the relay contacts must be rated at that value or more. A Struthers-Dunn relay, type CX1535, is suitable for a 12-v. battery system, while a Leach, type 7220-24, relay will handle the requirements of a 6-v. system. Both are listed in a catalogue distributed by Relay

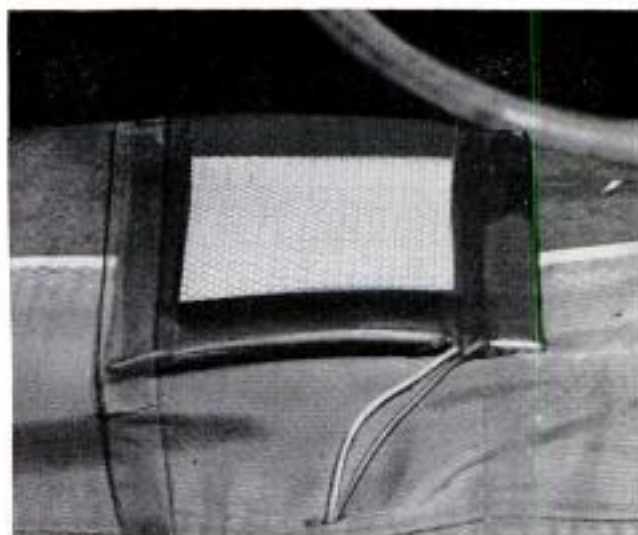

Fig. 3. Rain detector is taped to top of front seat, grounded screen up, to prevent possible short circuit

Sales Inc., Box 186, West Chicago, Ill.

If a heavy-duty relay is needed, the wires from its contacts to the dash-mounted switch must also be heavy enough to handle the required amount of current.

### Installation

The manually operated top-closing switch is usually located just under the dashboard. It is normally a s.p.d.t. switch having three lugs. As shown in Fig. 1, the relay contacts must be connected to the center lug and that particular end lug which, when shorted out, causes the top to rise. To determine which end lug to use, merely open the top halfway and momentarily short the center lug to one of the others, using a short length of heavy-gauge wire. If the top continues to move "up," you have located the correct lug.

The relay may be mounted under the dash near the top-closing switch, and the disabling switch should be fastened to the dash within easy reach of the driver.

Some care must be used in mounting the limit switch to the windshield frame. This switch should be mounted on a rigid bracket and so positioned that, with the top fully closed (but not locked), the spring actuator of the switch is fully depressed by the top. Any slight final adjustment can be made by bending the actuator. The interconnecting wires must be soldered to the normally closed contacts of the switch.

Once the detector has gone through its operation, the disabling switch must be shut off (opened) before the top is lowered by means of the manually operated switch. Failure to observe this precaution may result in damage if the detector is not completely dry before the top is lowered. Once the top is down, this switch can again be closed, and the circuit will be ready for another cycle.

★ ★ ★

# ADDITIONAL INDICATORS AID IN CHECKING CAR PERFORMANCE

By Dale Kelly

TODAY'S AUTOMOBILES are equipped with one of two types of dash indicators to help the driver check the operation of his car: dash gauges or panel lights. Both systems have advantages and disadvantages. The gauges provide an accurate indication of the performance of a particular system, but do not necessarily draw the driver's attention to a possible defect. The panel lights are likely to be noticed much sooner in the event of trouble, but do not give an exact indication of the car's performance.

The illustration below shows how to add panel lights to a car equipped with gauges, and an ammeter to the system which employs only lights. To install the ammeter, locate the heavy cable running from the battery terminal to the starter solenoid. From one end of this cable, a smaller wire ("X" in the illustration below) leads to generator, ignition, lights, etc. Disconnect the small wire from the solenoid. Now, run a pair of wires from a dash-mounted ammeter (50-0-50 amperes) into the engine compartment. Connect one of these to the

previously disconnected wire, and the other to the solenoid terminal from which the wire was removed. Disconnect the grounded battery lead while doing this, to prevent an accidental short circuit.

Installation of the charge and fuse indicator lights needs little explanation. In each case, just add two wires as shown by the dotted lines in the illustration. The charge indicator will light if the generator stops charging while the motor is running and will give warning if the ignition is left "on" when the car is not in use. A lit fuse indicator means that the fuse or circuit breaker to the lights is open. This may be due to an overload in the lighting circuit.

To add the oil-pressure light, you will have to buy a few items of hardware and an oil-pressure switch, as shown in the lower right portion of the drawing. The switch shown is a Chevrolet part No. 1998149, handled by car dealers. Buy the other fittings from builders' supply houses.

The bulbs should be about 3 c.p. and 6 or 12 v., to match the voltage of the car battery. Bayonet-base bulbs and corresponding sockets should be used.

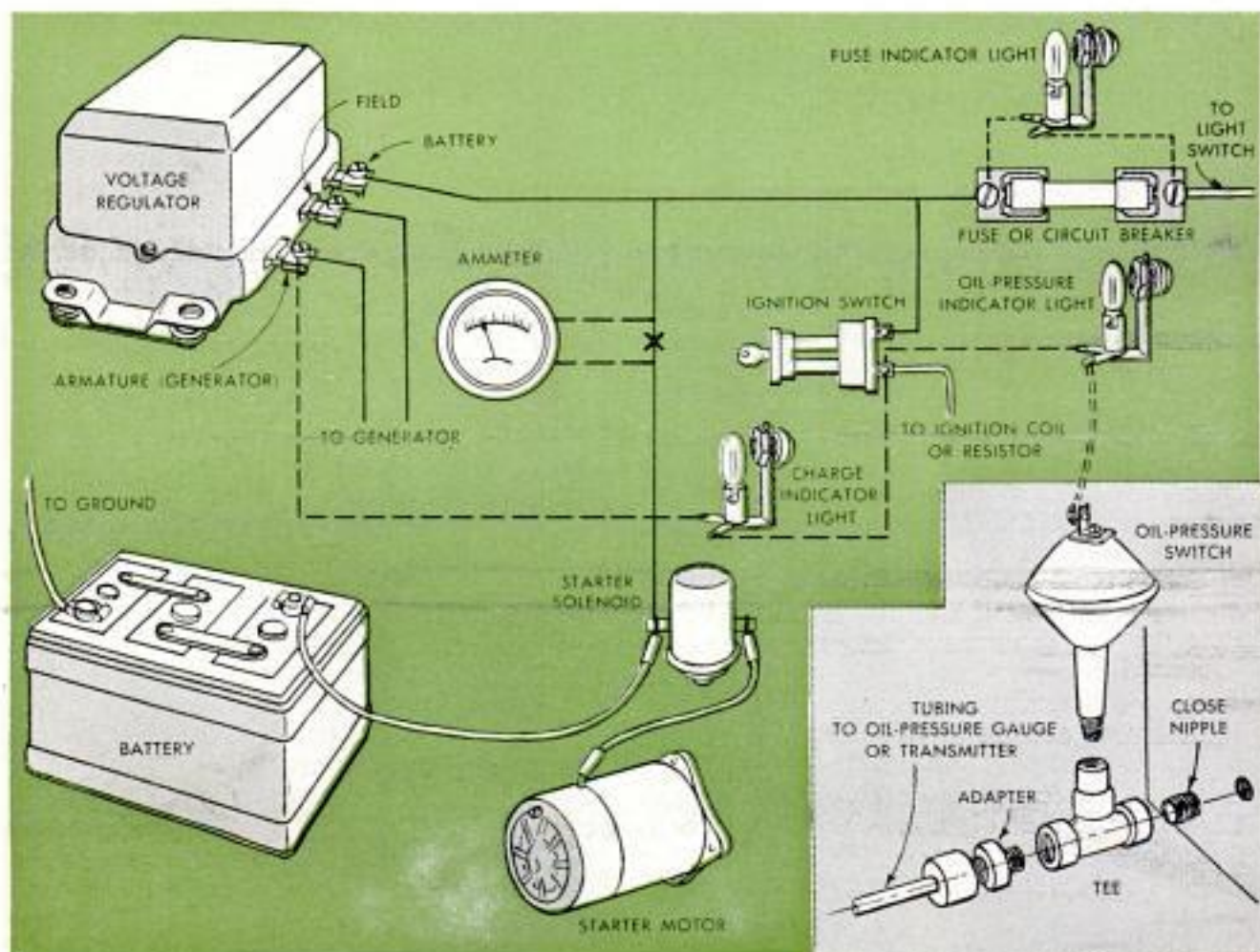



**Name your test!**

**Here's solid proof**

**you can bank  
on new ACs...**

**for full-mileage efficiency!**

AC Spark Plugs are tested under traffic-crawl conditions in Chicago; 104° heat in Phoenix, Arizona; 20° below zero in Fairbanks, Alaska; 14,000 feet up on Pikes Peak; below sea level in Death Valley; and with 100% humidity in the Louisiana bayou country! In all these tests of starting, cruising, climbing and idling ability, ACs come through with flying colors.

Your car rates spark plugs that hold their full efficiency between changes — as recommended by your car's manufacturer. So, take the good advice of your AC retailer and install new AC Hot Tip Spark Plugs, engineered and super-tested for your kind of driving. You'll feel a smooth difference in power and pickup . . . notice fuel savings, too!

Rush-hour traffic  
on Chicago's famed  
Michigan Avenue.

Watch  
WIDE WIDE WORLD  
NBC-TV



**hot tip  
spark plugs**



**NOTE:** For most efficient operation,  
change spark plugs at least every 10,000 miles.

AC SPARK PLUG  THE ELECTRONICS DIVISION OF GENERAL MOTORS

# Everything you need to PROCESS COLOR SLIDES

exposed on Kodak Ektachrome Film

Think of it—in *less than two hours* after you click the last shot on a roll of No. 135 Kodak Ektachrome Film, your full-color transparencies can be completely processed. And as soon as the film is dry, it takes only a few seconds to mount each sparkling frame for *immediate* viewing!

*Everything* you need—equipment, supplies, step-by-step instructions—are included in the new Kodak Ektachrome Processing Outfit, 35mm. Since you work in normal roomlight, you can process color slides anywhere—even on a vacation trip. The chemicals in the outfit will process six 20-exposure rolls of No. 135 Kodak Ektachrome Film

(either Daylight Type or Type F). Complete replacement of these chemicals costs only \$1.80.

Ask your Kodak dealer to show you how easy it is to process Ektachrome transparencies. And don't forget . . . he also has Kodak Photo-Hobby Outfits for developing and printing black-and-white snapshots. These kits also contain *everything* needed—and are so easy to use your whole family will enjoy them. *Kodak Photo-Hobby Outfits*, from \$9.95.

**NO  
DARKROOM  
REQUIRED**

**KODAK EKTACHROME PROCESSING OUTFIT, 35mm \$26.50**

These are the four basic steps in processing—

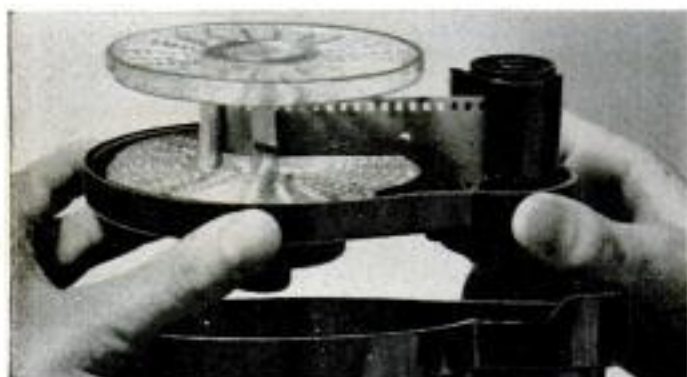

**KODAK DAY-LOAD TANK** simplifies transfer of exposed film from the film magazine to a transparent reel. Reel and magazine fit into separate tank compartments. With light-tight tank cover in place, loading the film onto the tank reel takes place by simply turning a knob. It's all done in normal roomlight!



**ONLY 6 CHEMICALS**, interspersed with plain water baths, are needed to bring out the gorgeous colors in Kodak Ektachrome Film. Each chemical is stored in its own color-coded container. With the empty film cartridge removed, liquids are poured in and out of the developing tank in full roomlight as shown!

**EASTMAN KODAK COMPANY,**



#### OUTFIT INCLUDES

- Kodak Day-Load Tank
- Kodak Ektachrome Processing Kit, Process E-2 (chemicals)
- Thermometer
- Stirring Paddle
- Plastic Film Clips
- 16-oz. Graduate
- 6 pint-size Color-Coded Containers
- 100 Kodak Ready-Mounts
- Two Trimming Guides
- 4 Kodaslide Storage Boxes
- Step-by-Step Instruction Card

## mounting Ektachrome transparencies . . .

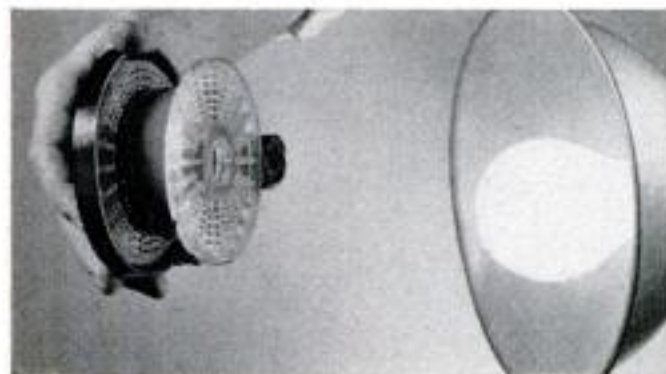

**RE-EXPOSING** the color film (to reverse the images from negative to positive) takes only 60 seconds. No need to touch the film with the fingers because light reaches all portions of it through slots in the tank reel. After re-exposure, film receives final processing baths.



**FULLY DEVELOPED** film is dried in the usual way. Individual frames are cut to size with trimming guides, then inserted in cardboard mounts provided. Edges of each mount are sealed with a warm iron.

**Rochester 4, N. Y.**

*Prices include Federal Tax where applicable and are subject to change without notice.*

**Kodak**  
TRADE MARK

# Which *Finishing* Weldwood Wizard can help you today?



It's a good idea to keep them all handy. You never know what finishing problem may develop in working with wood. As products of the world's largest plywood organization, these "wizards" are designed to give you expert results in many finishing tasks.

For protecting and bringing out the natural beauty of any wood—use **SATINLAC**

Makes the most practical, beautiful and durable natural finish for hard or soft wood! So quick-drying you can apply 3 coats a day. SATINLAC is so easy to maintain!



For blond woody effects without a "painty" look—use **WHITE FIRZITE**



Versatile! A two-fold boon: (1) As an undercoater for soft wood or plywood paint jobs, seals pores to help prevent grain raise and checking. (2) As a finish, produces a blond woody finish with no "painty" look. Great for pickled and wiped effects too!

For making fir plywood look like costlier woods—use **CLEAR FIRZITE**

Magic action for plywood stain jobs! Tame wild grain with a starting coat of Clear Firzite—add colors in oil to achieve the rich look of oak, walnut, mahogany. Clear Firzite also helps prevent grain raise and face checking.



Ask your hardware, paint, or lumber dealer about these Weldwood Finishing Wizards... or mail coupon for FREE leaflets.

**UNITED STATES PLYWOOD CORPORATION**  
Box 525 — New York 46, N. Y. PM2-75

Send me leaflets on:

Satinlac  White Firzite  Clear Firzite

NAME \_\_\_\_\_

ADDRESS \_\_\_\_\_

CITY \_\_\_\_\_ ZONE \_\_\_\_\_ STATE \_\_\_\_\_

## Clinic for Homemakers



As a service to our readers in solving the hundreds of problems pertaining to a home—inside or out—the editors of Popular Mechanics invite you to present your problems to The Clinic Editor for help and advice. Address your questions to The Clinic Editor, Popular Mechanics Magazine, 200 East Ontario Street, Chicago 11, Ill.

### Pool Leaks

Q—I have a large lily pool which has leaked each season since it was built 3 years ago. It is of concrete, about 20 in. deep, with a stone curb and there are cracks in the walls at several points. I have tried a number of methods of filling these cracks, but none has been fully successful. Do you have any suggestions? —Y. L., Ohio.



A—Cracking of the walls probably is due to frost action, although, of course, there could be other causes, such as unstable soil, for example. Whatever the cause, it is more or less apparent from your description that the only permanent remedy is to break up the walls, perhaps the entire pool, and rebuild with reinforced concrete of sufficient cross-sectional area to prevent cracking under ordinary conditions. However, it may be worthwhile to attempt a temporary repair by first cleaning all loose material from the cracks and filling either with a bituminous material or with a new-type concrete "glue" which is available. This is mixed with a special topping material to a puttylike consistency and forced into the cracks. The repair thus made may have to be renewed each year, but the treatment should prevent leaks throughout the season.

### Concrete Piers

Q—I have planned to build an open porch. The floor will be supported on wooden posts. My carpenter says the posts should be supported on concrete piers. I had thought that supporting each of the posts on a fairly large flat stone would be sufficient. Should I follow my carpenter's advice? —B. H., Mo.



A—Yes. Even though the initial cost will be somewhat higher, we gather from your description that the porch is a permanent structure and, if this is so, then the posts should be supported on concrete piers as your carpenter recommends. The piers will require comparatively little additional labor as holes dug with a posthole auger to the

(Continued to page 270)

# Which Weldwood® Wizard can help you today?



What are you making or mending? Do you know about Weldwood's new developments in adhesives? Do you know that you need special glues for special jobs? Do you keep on hand all 4 of these Weldwood Wizards, developed to make your jobs easier, quicker?

## For wood-to-wood joints that never come loose—use **WELDWOOD Plastic Resin GLUE**

Imagine—joints glued with this Wizard are stronger than the wood itself! And they grow even stronger with age! That's why it's America's most popular wood glue. Highly water-resistant, stain- and rot-proof. Easy-to-mix powder. 15c, 35c, 65c and larger sizes.

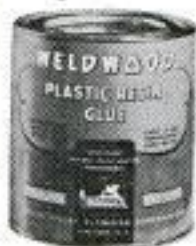

## For weatherproof boat repairs—use **WELDWOOD WATERPROOF RESORCINOL GLUE**

100% Waterproof! A "must" for any wood gluing exposed to climate, boiling or salt water, cold weather, mold, fungus, mild acids, alkalies, etc. Terrific for sporting goods, woodwork in damp basements, lawn furniture. ¼ pints, pints, quarts, gallons.



## For in-a-hurry gluing of wood, paper, cloth, fabric—use **WELDWOOD PRESTO-SET® GLUE**

Ready to use. Sets fast! Glues like magic! Presto-Set is the Weldwood-perfected white glue that bonds wood to wood, wood to cloth, cloth to paper, upholstery fabrics to wood, leather to leather, etc. Clean to work with—no sticky hands. 19c, 29c, 49c tubes; pint and quart jars.



## For putting up plywood panels without nails—use **WELDWOOD CONTACT CEMENT**

Revolutionary! Speedier, easier, new way to install plywood panels. No nails, no holes to fill and finish. Bonds instantly, permanently on contact. No clamps and presses—ideal for applying plastic laminates like Micarta to table tops, kitchen counters, etc. 1001 other uses for home, hobby, garage. 29c, 40c, 70c and larger sizes.



*There's a special Weldwood Wizard for every gluing job. Ask your lumber, paint or hardware dealer... or mail coupon for FREE leaflets.*

### UNITED STATES PLYWOOD CORPORATION

Box 525 - New York 46, N. Y.

PM2-7G

Send me leaflets on:

- Weldwood Plastic Resin Glue
- Weldwood Waterproof Resorcinol Glue
- Weldwood Presto-Set Glue
- Weldwood Contact Cement

NAME \_\_\_\_\_

ADDRESS \_\_\_\_\_

CITY \_\_\_\_\_ ZONE \_\_\_\_\_ STATE \_\_\_\_\_



**MORE POWER  
FOR YOUR CAR!  
SAVE OIL! SAVE GAS!**

## Sealed Power KROMEX RING SETS

Solid chrome plating on top compression ring and on oil ring side rails fights heat, friction and corrosion, gives double ring life. These sets control oil instantly, break in fast, make pistons and cylinders wear longer. Sealed Power KromeX Ring Sets are the finest ring sets ever made.

**ALL CAR MANUFACTURERS  
USE SEALED POWER RINGS**

Sealed Power Piston Rings are approved for use in all car and truck engines made by all automobile manufacturers. Your car deserves the top quality rings so widely used for original equipment. If your engine is worth re-ringing, it's worth using the best rings—those preferred by manufacturers—Sealed Power.

### YOU NEED THIS FREE MANUAL

Write for your free copy of "Care & Feeding of Engines," a 24-page illustrated handbook of engine care which may save you a lot of time and money. When you re-ring, be sure to use SEALED POWER KromeX Ring Sets. Their chrome faces fight heat and friction, and they seat fast, control oil immediately, and give you double ring life. Sealed Power, Dept. G-2, Muskegon, Mich.



# Sealed Power PISTON RINGS

**BEST IN NEW CARS! • BEST IN OLD CARS!**

(Continued from page 268)

required depth and filled with concrete should be sufficient. You do not give the over-all size of the porch so it is not possible for us to suggest the number of piers you would require, or how they should be spaced. Ordinarily, the distance between piers should not exceed 6 ft. but, of course, this is only a general recommendation.

### Concealed Nails

**Q**—Recently I had occasion to remove the warped top from a very old chest of drawers. I found that it had been attached with long nails of the old-fashioned kind which are square. What puzzled me was how the craftsman concealed the heads of the nails so effectively, there being no indication that nails were used. Can you tell me how it was done? — C. T., Conn.

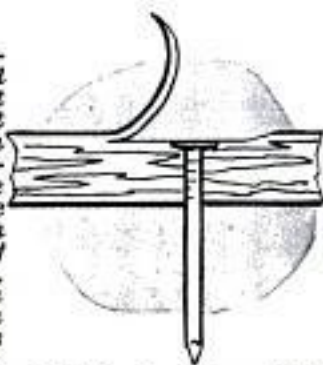

**A**—There is an old method of blind nailing which was frequently used by individual craftsmen. The procedure does conceal the heads of the nails very effectively. In some instances the heads of screws are concealed in the same way. The trick is to lift a chip with a wide-sweep gouge from the top surface of the work without breaking it from the wood. Then the nail or screw is driven in the concavity, the head set flush with the wood, and the lifted chip glued back into place. Use a glue that does not discolor the wood. In carrying out this procedure the greatest care must be taken not to break the chip. The gouge should be ground with a long bevel and the edge honed razor-sharp. If the procedure is carefully carried out and the wood smoothly sanded after the glue has set, it will be difficult, if not impossible, to discover where the nails or screws have been driven. Should you intend to replace the top it may necessary to cut off the original nails flush with the underside of the top, and replace either by nailing or using screws in the manner described. Of course, nails or screws will have to be driven in new locations. There is danger of splitting the wood should you attempt to withdraw the original nails.

### Removing Rust Stains From Concrete

**Q**—There are rust stains on my concrete walk at a point where a downspout emptied into a drain-tile. All gutters and downspouts have recently been replaced and I would like to know how to remove the rust spots. They cover an area about 2 ft. square. I've tried scrubbing with soapy water and a steel-bristle brush. This helped some, but the stains are still noticeable. Is there a solution that will remove the stain completely?—E. L., Ala.

**A**—Although we would be rather doubtful about the success of the venture, it might be worthwhile to try scrubbing the stains with a fairly strong solution of trisodium phosphate. Often this step proves fairly successful. Another method employs sodium citrate, commercial glycerin, water and whiting mixed to a paste which is spread over the discoloration and left until dry. To make the mixture add 1 part sodium citrate to about 6 parts water, then add the glycerin, also about 6 parts. Then mix in enough whiting to form a paste the consistency of thick cream and spread this thickly over the stained area.

### Wood Ashes as Fertilizer

**Q**—I've been told that I should save all wood ashes from my fireplaces (I have two) and use these as fertilizer for shrubs and garden plants. Is it true that wood ashes are good to use as fertilizer? Y. L., Kans.

**A**—Ashes of nearly all woods contain valuable potash and other trace elements which are in themselves plant foods. Of course, the quantity of available plant food will vary somewhat, depending on the kind of wood, or woods, which were burned to form the ash. Ashes also contain certain inert materials which are helpful in loosening soils which tend to puddle when wet and harden when drying out.

# New Saws at Low Prices!

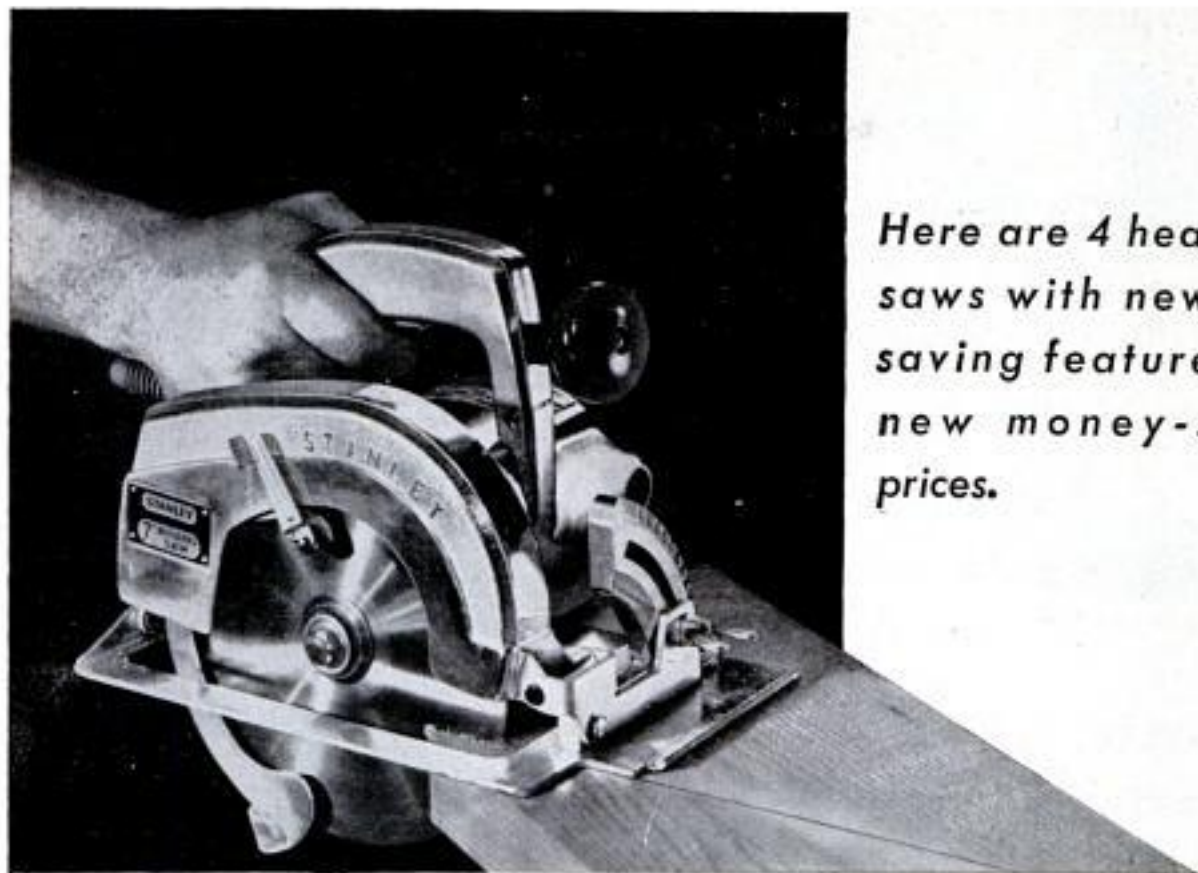

Here are 4 heavy duty saws with new work-saving features...at new money-saving prices.

*Talk about prices! Look at these!*

<b>6" H65</b> cuts 2" at 90°, 1½" at 45° .....	<b>only \$59.95</b>
<b>6½" H68</b> cuts 2-3/16" at 90°, 1½" at 45° .....	<b>only \$64.95</b>
<b>7" H70</b> cuts 2¾" at 90°, 1¾" at 45° .....	<b>only \$69.95</b>
<b>8" H85</b> cuts 2¾" at 90°, 2½" at 45° .....	<b>only \$79.95</b>

*Talk about features! Look at these!*

"Free-Start" Guard — Exclusive Stanley feature illustrated clearly in photo above. The guard never sticks at any angle of cut, there's never a "hang-up" at the start . . . new guard gives maximum blade coverage.

"Motor-Saver" Drive — Exclusive Stanley feature protects saw motor against shock from sudden impact caused by striking foreign objects such as nails, etc. Blade mounts on flange collar . . . no wear on armature shaft, no blade freezing.

Buy power tools with Stanley features at low Stanley prices . . . buy Stanley Electric Tools. Your dealer has them or can get them for you. For free Catalog 400, write Stanley Electric Tools, Division of The Stanley Works, 622 Myrtle Street, New Britain, Conn.

# STANLEY



## Look, Pal...

you're wasting money driving  
with those worn-out piston rings

Oil-pumping is the first sign of worn-out piston rings. And worn-out piston rings mean power drop-off—costly wastage of gas and oil—expensive repairs later on.

The sooner you act, the less it will cost. See your motor specialist the minute oil-pumping warns you there's trouble ahead. When he recommends new piston rings, ask him for Hastings. They're engineered exclusively for replacement service . . . to provide the additional lubrication worn engines need . . . to stop oil-pumping, save gasoline and restore lost performance. Truly the best money you can spend on your car.

HASTINGS MANUFACTURING CO. • HASTINGS, MICH.

# HASTINGS

## PISTON RINGS

**TOUGH** on oil-pumping • **GENTLE** on cylinder walls

Buy these Hastings Products with confidence:  
Piston Rings, Casite, Wear Reducer,  
Oil Filters, Spark Plugs

## Greater Pleasure From Car Radios

(Continued from page 261)

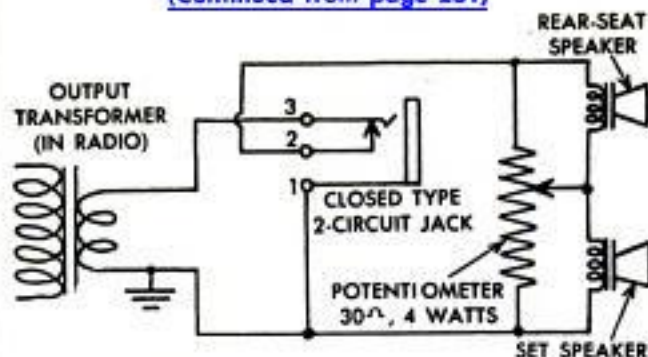

Schematic diagram of necessary wiring changes for increasing the versatility of automobile radios

reduced until, in either extreme position, one of them is completely shut off.

When a phone plug is inserted in the jack on the control panel, contacts 2 and 3 of the jack are opened and both car speakers are deactivated. All of the signal is channeled to an extension speaker or earpiece which may be connected to the plug. A personal hearing-aid-type earpiece can be used to good advantage in bringing the radio sound directly to the ear where it is not masked by the high noise level within the car even at high speeds.

For an extension speaker, any 3.2-ohm unit is suitable. The cable between this speaker and the control panel may be several hundred feet in length without causing serious attenuation.

### Wiring Procedure

The voice coil of the car-radio speaker is normally connected to the set with two wires or a two-conductor cable. One of these wires is usually grounded by being soldered directly to the radio chassis. If the speaker is mounted within the radio, the entire unit will have to be removed from the car before the required wiring changes can be made. In this event, the grounded lead can be located by removing the radio cover and observing which of the speaker wires is soldered to the chassis. Once this is found, the other wire, the ungrounded one, is detached from the speaker voice-coil lug and soldered to lug 3 of the jack. A separate wire is soldered between the now open speaker lug and the center terminal of the potentiometer. Another wire is connected between the grounded speaker lug and the top terminal of the control. This, and all subsequent wiring, is clearly shown in the pictorial diagram.

If the set speaker is mounted separately from the radio, and is easily accessible, neither the radio nor the speaker need be

(Continued to page 274)



# First trade-in offer in **SHOPSMITH** **HISTORY!**



*Yippee!*

**DON'T MISS SHOPSMITH'S BIG  
POWER TOOL ROUND-UP**

**Feb. 15 through March 9**

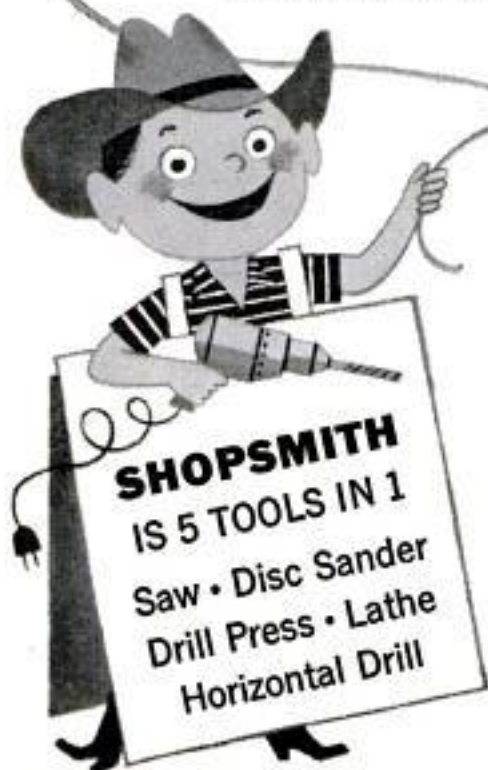

**SHOPSMITH**  
IS 5 TOOLS IN 1  
Saw • Disc Sander  
Drill Press • Lathe  
Horizontal Drill

© T. M. REG.

**B**een hankering to own SHOPSMITH for a long time? Here's your golden opportunity to make that wish for America's finest *complete* home workshop come true . . . at a saving *never* before available in SHOPSMITH history.

Just lasso, drag, or carry an old power tool to your nearest dealer and get a \$45.00 trade-in on the magnificent SHOPSMITH—the undisputed quality leader in its field!

We have made it so easy for you to own Shopsmith that you can't afford to pass up this big trade-in offer. Do it *now* during the big nation-wide power tool round-up.

See it demonstrated at leading hardware and department stores, or at any Montgomery Ward store. For 3 *free* books, write: MAGNA POWER TOOL CORP., Dept. 502-M, Box 2808, at office nearest you: Ft. Wayne, Ind., OR Menlo Park, Calif.



MAGNA POWER TOOL CORPORATION  
*America's Finest Power Tools*

**ONLY SHOPSMITH LETS YOU COMPLETE THE JOB!**

FEBRUARY 1957

Copyrighted material 273

removed from the car. However, it is necessary to determine which is the ungrounded speaker lug. To do this, solder a wire to both the negative and the positive terminals of an ordinary flashlight battery. Connect the other end of one of these wires to an unpainted metallic part of the car frame or dash, and momentarily touch one of the speaker lugs with the other wire. If a click is heard through the speaker, that particular speaker lug is *ungrounded*. The wiring can then proceed as explained in the preceding paragraph.

The rear-seat speaker may be installed under the package shelf behind the rear seat. This involves cutting a speaker opening into the shelf panel. Alternatively, the speaker can be installed in a small cabinet and placed in any desired location. In either case the interconnecting cable can be hidden beneath the floor mats.

#### Materials

The extension-speaker jack and control are mounted on a small bracket which can easily be made from a piece of aluminum. The bracket should be fastened to the dash within easy reach of the driver. Both the extension speaker and rear-seat unit may be of any desired size, but should have 3.2-ohm voice coils. The midget earpiece for personal listening should also be of the low-

impedance type. A suitable 8-ohm unit, as well as all other needed components, are listed in a number of catalogues from radio-parts distributors. A list of some major distributors who issue free catalogues is available from the *Popular Mechanics* Radio and Electronics Department upon receipt of ordinary letter postage. ★ ★ ★

#### Aurora Recorder

Northern lights too faint for detection by human eyes will be recorded automatically during the International Geophysical Year starting July 1, 1957. An automatic aurora recorder will produce tabulated data directly. The sky's light is caught on a mirror that automatically tilts to different positions from horizon to horizon every five minutes. A second mirror reflects the light beam through a light chopper, lens and aperture to a photomultiplier. This device records readings directly on a strip chart for immediate viewing and as numbers on punched tape for later study or automatic analysis. Power consumption is 280 watts.

☞ Since 1776 the United States has produced nearly 3,000,000,000,000 board feet of lumber, enough to build 300,000,000 five-room frame houses or a boardwalk six feet wide all the way to the sun.

WATCH THAT BALL...  
OR I'LL TAKE YOU PAL!

IT'S WORTH THE LOSS  
IF I WIN THAT GAL!

SMELLS GRAND!  
PACKS RIGHT!  
SMOKES SWEET!  
CAN'T BITE!

YOU'RE A  
PIPE SMOKING MAN?  
THEN YOU'RE  
FOR ME!

IT'S  
SIR WALTER  
RALEIGH—  
NATURALLY!

SIR WALTER RALEIGH'S BLEND  
OF CHOICE KENTUCKY BURLEYS  
IS EXTRA-AGED TO GUARD  
AGAINST TONGUE BITE.

**FREE!**

24-PAGE BOOKLET ON  
PIPE CARE. JUST WRITE  
TO: SIR WALTER RALEIGH  
DEPT. 125-B  
LOUISVILLE, KY.



**BE YOUR OWN BOSS  
WORK AT HOME  
IN SPARE  
OR FULL TIME**

**THERE'S BIG  
MONEY IN THIS  
FINE BUSINESS**

**SHARPENING  
LAWN MOWERS...**

**ONLY THE NEW MODEL "B"  
UNIVERSAL GRINDER  
ALLOWS YOU TO GRIND  
POWER AND HAND MOWERS  
BETTER, FASTER, AND EASIER  
... AND GIVES YOU  
ALL THESE ADVANTAGES**

- SMALL INVESTMENT
- EASE OF OPERATION
- NO REMOVAL OF ENGINE,  
BED-KNIFE, HANDLE, OR ROLLER
- EASE OF MOWER ADJUSTMENT
- LESS TIME PER MOWER
- MORE SATISFIED CUSTOMERS

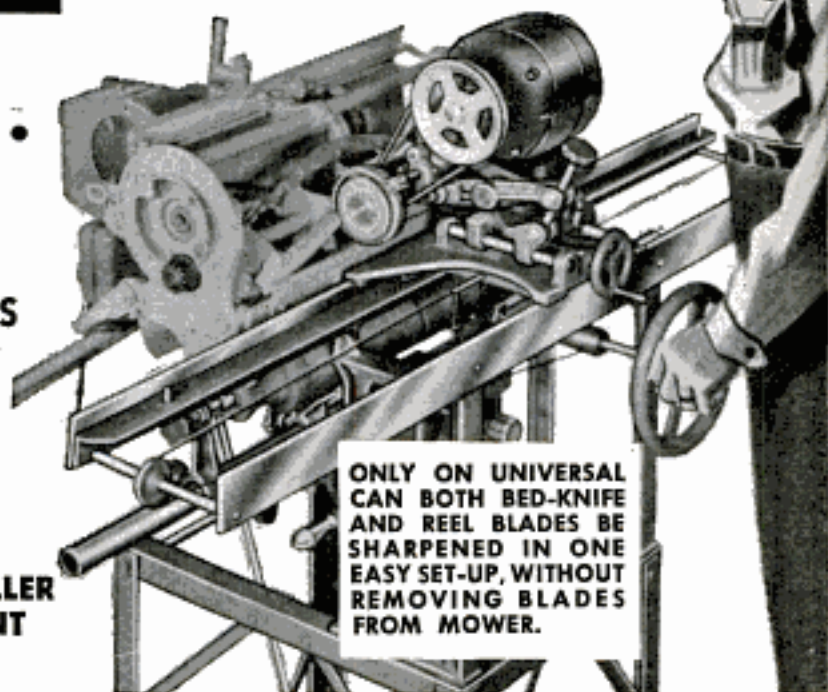

**ONLY ON UNIVERSAL  
CAN BOTH BED-KNIFE  
AND REEL BLADES BE  
SHARPENED IN ONE  
EASY SET-UP, WITHOUT  
REMOVING BLADES  
FROM MOWER.**

**Read What These  
Universal Owners Say:**

J.S. of Michigan writes:  
*"I figure my profits  
(last season) at over  
\$1,000.00."*

Mr. C. H. R. of Ohio,  
says, *"This season, I  
have taken in \$3,688.20."*

Another Universal own-  
er from Pennsylvania  
tells us: *"I spent only  
40c for a newspaper ad  
and have done nearly  
\$500.00 worth of busi-  
ness."*

Mr. B. of California  
writes: *"The lawn mow-  
er grinding business,  
with my Universal  
Grinder, has been a  
gold mine these last two  
years."*

G. E. of Arkansas says:  
*"I have had my Univer-  
sal Grinder two months  
and made a net profit of  
\$227.00 in spare time."*

● Thousands of men have started this profit-  
able business of their own with a small invest-  
ment. The Universal is low in price and high  
in value. You can start in your garage or base-  
ment; and, by following our simple instructions,  
the Universal Lawn Mower Grinder will put  
you on the road to profit.

The Universal Lawn Mower Grinder is a  
simplified design built to sharpen power and  
hand mowers with a minimum of effort. Any-  
one having a little mechanical ability can do  
a good job, without previous experience. The  
Universal is the only lawn mower sharpener in  
the world that enables you to grind both bed-  
knife and reel blades in one set-up, without  
removing them from the mower. No extra at-  
tachments or equipment necessary to do a  
complete job. Just follow a few simple in-  
structions and you can turn out a perfect job  
on your very first mower.

If you are now working, you can start this  
fine business and still keep your present job.  
It takes only 20 to 30 minutes to grind a  
mower and, by using just a few evenings a  
week, you can earn a substantial spare-time  
income to develop a full-time business of your  
own and buy all those extra things for yourself  
and family that help make this a better world  
to live in.

There are probably 50,000,000 hand and power  
lawn mowers in America that should be  
sharpened every year. A good number of these  
are in your very community. Commercial  
mowers at golf courses, cemeteries, hospitals,

parks, schools, etc. bring even larger fees; and,  
with the speed, ease, and accuracy of opera-  
tion the Universal provides, you can build a  
business that will provide a lifetime future. It's  
a business that no one is too young to earn a  
good living in; and, likewise, one that you  
never grow too old to operate at a good profit.  
(Some of our most successful users are re-  
tired). You can shape your own future, make  
your business as modest or as large as you  
wish. You are your own boss, to come, go, and  
do as you like.

As long as grass continues to grow, mowers  
will have to be sharpened in order to cut it.  
Having a Universal Lawn Mower Grinder will  
enable you to get your share of this profitable  
business.

You can operate your business from home—no  
trudging to the job; fighting crowds; no more  
dissatisfaction with job or boss in this good  
business. It's easy, profitable work; so easy a  
boy can do it. It's pleasant, convenient, and,  
best of all . . . it's highly profitable. Others  
are enjoying the happy, carefree life of being  
their own boss—why not you? Whether you  
want the security and independence of a full-  
time business of your own, or the extra living  
comforts spare time profits can bring, you  
owe it to yourself and family to send the  
coupon today. Now don't put it off. Investi-  
gate our proved success plan now. We furnish  
complete instructions, everything you need to  
start and develop a good profitable business.  
Just fill in and mail the coupon now.

**ROGERS  
MANUFACTURING CO.  
LINDSEY,  
OHIO**

**ROGERS MANUFACTURING CO.**  
Dept. M-27, Lindsey, Ohio  
Gentlemen: Please rush me details about the  
profit possibilities of the Universal Lawn Mower  
Grinder.  
NAME \_\_\_\_\_  
STREET \_\_\_\_\_  
CITY \_\_\_\_\_ STATE \_\_\_\_\_



## "Pedigreed" Parts FOR YOUR

# CARTER



## CARBURETOR

Today's CARTER Carburetor is a precision instrument. Each part is designed to exacting tolerances to give you the performance you need for modern fuels and high-compression engines.

No wonder, then, that it's so important to insist that *only genuine CARTER Repair Parts* should be used whenever your carburetor needs overhauling. Ask your service man to overhaul your carburetor using a genuine CARTER Repair Parts Kit... look under **CARBURETOR** in the classified section of your phone book for Carter parts and service.

**CARTER CARBURETOR**  
DIVISION OF **OCF** INDUSTRIES  
INCORPORATED  
ST. LOUIS 7, MISSOURI

## Build "THE BUG"

(Continued from page 204)

not shown—also must be figured on a trial-and-error basis. In most cases, the front shock absorbers can be used as is.

Rear-axle spring hangers are lengths of  $\frac{3}{4}$  or 1-in. steel round bent to an L-shape and welded to the top of the rear-axle housing. Short lengths of pipe are welded to the ends of the hangers to accommodate the spring-shackle bolts and bushings. Regular shackles are used, but must be cut to fit a particular setup, detail page 203. Gas welding was used in assembly of the frame, but a small arc welder proved invaluable for heavier work, photo page 203, and was used extensively for assembling the body. The concentrated heat of the arc has less tendency to buckle sheet steel.

Unless it is necessary, do not reposition the steering-gear box, as this will affect steering geometry. Instead, lengthen or shorten the steering column. Because the floor of the car is so low, it is necessary to suspend the brake and clutch pedals from beneath the cowl. The original pedals and cross-shaft probably can be used, but the rods between the pedal arms and pedal pads should be shortened or eliminated to provide more legroom, detail page 203. Two master cylinders of the type that bolt to the fire wall are mounted ahead of the pedals and connected by threaded rods and clevises. The brake cylinder is used in the normal manner, but the clutch cylinder is used to actuate the original master cylinder which is modified to be a "slave" cylinder for operating the clutch throwout arm. The reservoir is cut off the cylinder and both vent holes are welded shut. Hone out the cylinder and rebuild it with a new kit, but leave out the compensation valve. Bolt the cylinder to the frame so it lines up with the clutch throwout arm and couple the cylinder and arm with a threaded rod and clevis to provide adjustment for clutch wear. Steel tubing and brake hose are used to connect slave and master cylinders.

Location of the radiator is indicated on page 202, but this unit can be mounted in any position as long as the filler pipe is above the engine cylinder head to assure water to the top of the head. The gasoline tank is shown behind the rear axle, which keeps it low and clear of the cockpit. Depending on personal choice, the filler tube for the tank can be extended through the side or rear of the body of the sportster. For safety the end of the filler tube must be outside the body. Do not end the tube inside the trunk where gasoline fumes could collect and present a hazard.

(Continued next month)



# ALADDIN READI-CUT HOUSES ARE ENGINEERED TO SAVE YOU THOUSANDS OF DOLLARS!



**BUILD IT YOURSELF!**—Aladdin designed and manufactured the first Readi-Cut Home over 50 years ago. Tens of thousands of people have discovered how easy it is to build an Aladdin. Our customers have saved thousands of dollars by doing part or all of the work themselves. **NOT PRE-FABRICATED**—The lumber is cut to fit by precision machines, ready to be nailed in place. Each piece is marked and shown on our erection drawings. **QUALITY**—All materials...lumber, doors, windows, flooring, paint, hardware...everything furnished are highest quality. Not only do you save—your finished Aladdin Home will be a joy to behold—beautifully designed and solidly constructed to meet the highest building standards. **CATALOG**—Send for Aladdin's handsome new catalog now and you will understand how Aladdin can save you up to 30 or 40% on your new home. Mail the Coupon today.



**120 Modern READI-CUT PLANS**  
 5 to 8 Rooms from \$3,000  
 WE PAY THE FREIGHT  
 RANCH • TWO-STORY  
 COLONIAL • CAPE COD

**SEND 25¢ FOR 72 PAGE CATALOG IN COLOR**



MAIL COUPON TO:  
**The ALADDIN CO., Bay City, Mich.**

M-18

Name \_\_\_\_\_

Street \_\_\_\_\_

City \_\_\_\_\_ State \_\_\_\_\_

NEW

# Starrett

'Satin Chrome'

STEEL  
RULES



(Pioneered by Starrett)

'Satin Chrome Finish', the no-glare, hard wearing, multi-plate finish, pioneered by Starrett, is now available on most Starrett steel rules in 6 to 72-inch lengths with fractional or decimal graduations. Satin Chrome blades also available for combination squares, sets and bevel protractors. You can read these rules faster, easier in any light, without eyestrain or errors. Satin Chrome Finish also resists moisture, acids, perspiration, rust and stains.

### DECIMAL GRADUATED RULES

In addition to these new Satin Chrome finish rules, Starrett offers a full line of standard steel rules and shrink rules decimal graduated in quick-reading 10ths and 50ths in accordance with approved industry standards. The complete line features full-flexible, semi-flexible, spring tempered and heavy spring tempered types. Also, decimal graduated blades for Starrett combination squares and bevel protractors.

### BIG NEW CATALOG — FREE

Describes and illustrates over 3000 Starrett Tools. Write for it. Address Dept. AP.



THE L. S. STARRETT CO., ATHOL, MASS., U. S. A.

Since 1880 — World's Greatest Toolmakers



# Starrett

MECHANICS' HAND MEASURING TOOLS AND PRECISION INSTRUMENTS  
DIAL INDICATORS • STEEL TAPES • PRECISION GROUND FLAT STOCK  
BACKSAWS • HOLE SAWS • BAND SAWS • BAND KNIVES

## Canada's Copter King

(Continued from page 140)

Columbia Government Topographical Division. Operations of his company, Okanagan Helicopters, have enabled the division to accomplish as much in one year as it previously did in five. His next move was into the prospecting field, and he is credited with the success of much of the recent new development of Canada's natural resources. Searching for uranium, oil or other well-hidden deposits, he and his staff use aerial photography and such instruments as the scintillometer and the magnetometer. In the proving of likely locations, as much as 30 tons of construction and drilling equipment have been carried by copter to a single site, individual components weighing up to 1000 pounds. Both Bell and Sikorsky helicopters are used, the latter carrying the heavier loads, and it is expected that use of the Sikorsky 58 will mean even greater weights can be airlifted.

For the construction of a water-storage dam at Palisades Lake in the Rockies, all materials and supplies—including concrete mixers—were moved in by these airborne "pack horses." In the initial survey of this virtually inaccessible area, Agar found the approach to the only possible landing place blocked by a tree 100 feet high. It was impossible for lumberjacks to fell it, because it was rooted on such a steep slope. Nor was it feasible for a whirlybird to get close enough to lower men to do the job. Carl solved this problem by flying "bush expert" Herk Skuce to the tree and hovering while Herk blasted the top away with a 30-30-caliber rifle.

Okanagan Helicopters' reputation spread with the construction of the Aluminum Company of Canada's Kemano-Kitimat power project in the Cascade Mountains of northern British Columbia. Agar and his associates first surveyed the dam sites and transmission-line routes, then carried out an exacting triangulation survey for construction of a 10-mile tunnel. Donkey engines, pumps, rock drills, prefabricated houses, kitchen ranges and refrigerators were among the heavier types of supplies dropped from Sikorskys, without the copters even coming in contact with the ground. In the more inaccessible areas the smaller Bells were used, after carpenters and lumber had been lowered and landing platforms erected. The copters weren't used as a cure-all but as a trail-blazing and emergency method of transportation for men and materials. In six years, starting in 1949, this project alone required over 47,000

(Continued to page 280)

# "You can outwit Winter Weather . . . Save Gas that other drivers waste!"



says *Mauri Rose* . . . top professional driver, three-time Indianapolis 500-mile winner.

Skill can cut your transportation bill. Sensible driving and skilled Rochester service are an unbeatable economy combination! Your Rochester Carburetor specialist is ready to help you outwit winter weather right now . . . cleaning fuel filters, making sure unloader and fast-idle adjustments are set for good cold starting . . . putting all his training to work for you. See him right away—protect the performance and economy that are engineered into your Rochester Carburetor!

Standard equipment on Cadillac, Buick, Oldsmobile, Pontiac and Chevrolet.



"Proper warm-up saves gas! To start, depress accelerator halfway, then let your engine idle at least 30 seconds before moving. Stay under 30 mph until engine temperature starts to rise!"

"In snow or on icy roads, hurrying away from a stop doesn't pay . . . it just spins your wheels and wastes fuel. By easing into motion you prevent sideslips and burn less gas in the bargain."



**R** **OCHESTER**  
**CARBURETORS**



ROCHESTER PRODUCTS DIVISION OF GENERAL MOTORS, ROCHESTER, N.Y.

FEBRUARY 1957

Copyrighted material 279

*At Last!*

**A "TOOTHLESS" PLIER  
THAT GRIPS  
WITHOUT GOUGING**



**CHANNELLOCK**

**No. 415 Smoothjaw PLIER**

Just  
The Thing  
For Chrome  
Fixtures and  
Fittings



One of the handiest tools you'll ever use . . . the new "toothless", smooth-jaw plier that grips without gouging. Just the ticket for gripping chrome-plated fittings, plastic, wood and other smooth surfaces. Especially handy on chrome sink-fixtures and other hard-to-handle jobs. Jaws quickly adjustable to full 2" opening. Get yourself a Channellock No. 415 Smoothjaw Plier. You'll find it's "the right tool" on scores of jobs in home and shop.

**Ask Your Hardware Man For A  
CHANNELLOCK Smoothjaw PLIER**

**MADE ONLY BY**

**CHAMPION DEARMENT TOOL CO.  
MEADVILLE, PENNSYLVANIA**

helicopter landings, and more than two million pounds of freight were ferried in with the "flying egg beaters."

Engineers estimated that copters cut at least two years from the time it took to complete the Alcan project. Mother Nature was given a hand when helicopters were used to speed the spring thaw at Tahtsa Lake, 3000 feet above sea level. After a 12-mile strip of its frozen surface had been sprayed with lampblack, the resulting absorption of the sun's rays made the 30 feet of snow disappear at the rate of one foot per day. Icebreaking barges were then operated in the cleared swath, and a route for transportation of 500 construction men and tons of heavy equipment established ahead of schedule.

Okanagan's copters contributed importantly to construction of the 700-mile Trans-Mountain oil pipeline, stretching across the Rockies from Edmonton to Vancouver, and now patrol this pipeline three times a month. The company maintains patrols of the Alcan transmission lines and last winter was instrumental in restoring facilities through locating damage done by a snowslide and transporting men and materials to effect repairs. Last year Okanagan crews took part in Operation Franklin, a geological survey of islands in the Arctic Ocean less than 300 miles from the Magnetic Pole, ferrying teams of dogs as far as 160 miles from base camps. Agar's helicopter know-how also has been used in Canada as the "eyes" of tractor trains crossing the snowbound wilds, for timber-cruising, forest reseeding and the dropping of poisoned bait used in rodent-eradication campaigns.

From a two-man, one-machine outfit with a gross revenue of \$6152 in 1947, Okanagan Helicopters has an estimated 1956 gross in excess of \$1,500,000. The only copter company licensed to operate from Vancouver Airport, it now boasts a fleet of 26 Bells, 6 Sikorsky 55s and 4 Sikorsky 58s, valued at more than \$2,000,000. The firm's 105 employees (90 percent of them stockholders) represent 1145 years of aviation experience and over 40,000 hours of flying time. Subsidiaries stretch across Canada and operations have been especially effective in Newfoundland. There, a helicopter "hospital ship," carrying doctor, nurse, X-ray and other equipment, services remote sections of the 900-mile coastline.

Accident-wise, Agar had his first close call nine years ago, with only 50 hours of helicopter flying time in his logbook. Attempting to spray a hilly orchard in the Okanagan Valley, he made too sharp a turn, lost revolutions and crash-landed astride

(Continued to page 282)



ARKANSAS TRAVELER PRESENTS

THE NEW

# Forward Sweep DESIGN



An entirely new concept in boat design! No seams below the water line.\* New strength, beauty, performance. Exciting colors. Fifteen models for '57.

Send for free folder.

\*In 15 ft. models only.

## Arkansas TRAVELER

ARKANSAS TRAVELER BOATS: 2006 E. 14th St., Little Rock, Ark.

COUNTRY  
SQUIRE  
TRACTOR

with  
ROTARY,  
REEL TYPE  
or SICKLE  
MOWER



## CUT GRASS THE EASY WAY

ALSO plows, harrows, cultivators, plants, rakes hay, sprays, bulldozers, plows snow, saws cord-wood. Write for FREE CATALOG

COUNTRY SQUIRE  
TRACTOR CO.

P.O. Box 107, K-2A  
Muskego, Wisconsin



## EXPLORE FOR TREASURE!

Find gold, silver, coins, jewelry, battle relics! Treasure-Metal-Mineral Detectors. M-SCOPE. Used worldwide for Treasure Hunting. Mineralights. Geiger. Scintillation Counters. Prices from \$14.75. Fully GUARANTEED. Time Payment Plan. FREE Treasure and Uranium booklets. New outfitting catalog. FISHER RESEARCH LAB., INC., Dept. PM-1, Palo Alto, Calif.

# READY CUT HOMES

**\$2150 AND UP DIRECT FROM MILL**

YOU SAVE the items which help make today's building cost expensive: high labor cost, contractor's profit and overhead, insurance, architect's fees. Cut-to-Fit eliminates usual lumber and material waste, also costly mistakes. Anyone can assemble. Simple, easy-to-follow plans furnished and each part numbered. Complete with all lumber, roofing, nails, glass, hardware, paint, doors, windows. Freight paid. Low-cost building plans sold separately if desired. 57 Homes and Floor Plans.



5 EASY PAY PLANS  
COLOR CATALOG

Send  
25c



INTERNATIONAL MILL & TIMBER CO.  
Dept. PM27 Bay City, Mich.

if you have to glue it . . .

# LET ELMER DO IT!



Repair or build  
quickly with strong  
**ELMER'S®  
GLUE-ALL**

Use Elmer's modern plastic glue for any porous material such as wood, paper, cloth or pottery. It's easy to apply, fast drying and won't stain. Takes the goo out of gluing. Perfect for the home workshop.



Get a completely waterproof bond with  
**ELMER'S® WATERPROOF GLUE**

It's the glue that boating experts use. Apply on any joint subject to water, weather, acids or alkalis. Super bond is stronger than wood itself!



Bond plastic laminates or plywood wall panels with  
**ELMER'S® CONTACT CEMENT**

No clamps, nails or presses needed to do professional job quickly. Highly resistant to heat and water. Available in regular or non-flammable type to meet every need.



Check **ELMER'S Glue Chart**  
for the right glue for the job.

IF IT'S **Borden's**  
IT'S GOT TO BE GOOD



The Borden Company, Chemical Division

# CUT PERFECT GROOVES WITH *Warren* WASHERS ON YOUR SAW BLADE!

You Just DIAL  
the Cut Wanted

over 250,000  
sets in use!

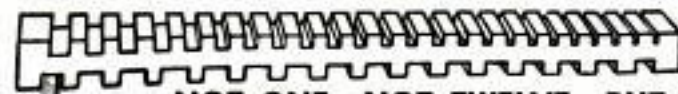

NOT ONE—NOT TWELVE—BUT  
40 DIFFERENT CUTS!

Warren Washers—engineered to cut clean, accurate, parallel grooves with your present power saw. 40 micromatic adjustments—just dial the desired width. Actually strengthens blade, eliminates vibration—leave on saw for straight cuts. No burning or chewing. Over 250,000 satisfied users in 48 States and many foreign lands. Be sure to get genuine Warren Washers . . . they're guaranteed!

**FREE!** Send for free descriptive booklet. Arbor sizes  $\frac{1}{2}$ ",  $\frac{3}{8}$ ",  $\frac{3}{4}$ ", 1". See your dealer or write direct.

ONLY  
**\$4.95**  
SET

**WARREN WASHERS CO.**  
Dept. 22, Box 98, North End Station, Detroit, Mich.

## New "PULL-GEAR" SPEED-REDUCING PULLEY



Provides Correct Speed and  
Power to Drill Up to  $1\frac{3}{8}$ "  
with  $\frac{1}{2}$  H.P. Motor

Amazing new internally geared speed reducer doubles drill press capacity. Greater power, greater efficiency, greater productivity.

Provides the correct speed and power for larger drilling, reaming, tapping and boring on light presses. Easily installed in five minutes. Adaptable to all type machines. Spindle speed range approx. 45 to 3000 RPM. Made in 3 motor shaft sizes:  $\frac{1}{2}$ "— $\frac{5}{8}$ "— $\frac{3}{4}$ ". Write for literature.

WRITE  
FOR  
LITERATURE

**THE PULL-GEAR CO.**  
25427 Mound Road  
Center Line, Mich.

some 6500-volt power lines. The aircraft shorted the top wires, and they crackled like pistol shots as sparks showered his plastic cabin bubble. When the upper wires finally melted, the copter dropped to those below for another round of hair-raising high voltage. When the whirlybird eventually dropped to the valley floor, the perspiring pilot breathed a prayer of thanks for having worn rubber-soled shoes and being seated on a rubber cushion.

His most embarrassing moment came when Agar flew a prominent government official to a tiny knob on the side of a mountain peak. As soon as they had landed, he told his passenger to hop out. When the door was opened, they discovered that one wheel was resting only on air. If either man had shifted his weight to that side, the copter probably would have toppled over, with nothing to stop it from bouncing 2000 feet below. And had he hopped, the official would have been Okanagan's first fatality.

"It took only a couple of minutes to put her down on all fours," Carl remembers. "Nowadays, a lot of flying is done by instruments, but our pilots still fly by the seat of their pants. If you're going to lose even a foot of altitude, you have to feel it. It's usually too late to act when you see trouble; you have to sense it in advance. It may be perfectly peaceful on one mountain peak, but you get slapped by a 60-mile gale on the next. You can't make mistakes."

Although men under 28 years old are preferred as student pilots of fixed-wing aircraft, the opposite applies to helicopters. Qualifications for acceptance at his school are a minimum of 1500 hours of flying ordinary planes and a genuine fondness for helicopter flight. Preference is given mature pilots, particularly those who are married and have children, since statistics show that added age and responsibility are important safety factors. Agar is 55 years old. The school is located at Penticton in Canada's Okanagan Valley. Fledgling daredevils take a 12-week course, 50 lectures and 30 hours in the air. The organization was established in 1951. In 1954 the first American pilots, 22 officers of the Army Transport Helicopter Battalion, were trained by Okanagan.

### Only Mountain Copter School

"Since this is the only school specializing in mountain operation," Capt. Lloyd Watland of Ft. Riley, Kans., comments, "it's the only place pilots can come for instruction. The few of us who receive this valuable training each year spread quite a bit of the know-how throughout our branch of the services."

(Continued to page 284)

# PEELS PAINT OFF furniture

# boats floors woodwork

Makes ANY refinishing job easier

FAST - CLEAN

Non-Inflammable - Needs No Neutralizing



## KLEAN-STRIP

PAINT REMOVER

The Klean-Strip Co., Inc.  
2340 S. Lauderdale, Memphis 6, Tenn.

**NOW You Can DRILL, SAW, REAM, CUT  
... ALL WITH ONE BIT!**

Beaver's new improved Hi-Speed side cutting drill bit can be used on any electric drill, drill press, lathe, etc. Made from the finest American hi-speed steel. 3 1/4" long, 2" side cutting section, 1/4" diameter. Designed to cut steel, wood, plastic, aluminum, etc. MONEY back guaranteed. Specify types desired. All Purpose, Wood and Heavy Metal. BUY From Your Dealer or send check or money order today. Dealer inquiries invited.

BEAVER DRILL & TOOL CO., 30318 McGee Trafficway, Kansas City, Mo.



**FIND HIDDEN RICHES!**

NOW—find buried treasure, gold, silver, and metal objects, with sensational 3 1/2-lb. locator—GOLDAK'S "FIND-IT" ... only \$49.50 complete with earphones, batteries, instructions.

Manufacturers of metal detection devices since 1933.

Write for FREE literature full line metal, mineral locators, geiger and scintillation counters.

GOLDAK CO. 1542-2 W. Glenoaks Blvd., Glendale, Calif.



**FINISH CONCRETE OR MASONRY WALLS  
WITH WALLBOARD OR WOOD PANELS—**

**Do It Yourself  
this easy,  
low-cost way!**

Just attach Gemco Anchor Nails (16" apart) to walls with waterproof Tuff-Bond Adhesive. These will hold furring strips securely in place. Then nail wallboard or wood panels to furring strips ... and the job is done. It's that simple! All you need is the Gemco Anchor Nail Kit ... at better dealers everywhere. If your dealer cannot supply you, write ...

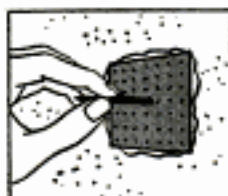

Goodloe E. Moore, Incorporated, Danville 2, Ill.

FEBRUARY 1957

**FUN-WORK YARD TRACTOR**

**WHEEL-HORSE** RIDE-AWAY



SENSATIONAL  
LOW PRICE

Turn work into FUN! Do a dozen back-breaking jobs in a jiffy. Yard-size tractor with 5 forward speeds and 1 reverse. 3 1/2 hp (or 2 1/2 hp) engine. Heavy channel steel chassis. Mow 5-foot swath at 5 mph. Plow snow, cultivate, haul compost, pull any of 22 attaching tools for yard and garden. Write for details, and name of dealer.

**WHEEL-HORSE PRODUCTS**

2644-C Dixieway North

South Bend, Indiana

**YOU  
can build  
this lean-to  
storage shed**



and dozens of other worthwhile things for your home—at one-third normal cost!

You never know your capabilities until you try. For thousands of people, Easi-Bld® Patterns and Homasote Insulating-Building Boards have opened up a whole new world of fun, satisfaction and proud possession.

Take this lean-to storage shed. Get Pattern #89 (50¢) from your lumber dealer. Enclosed is the complete list of materials required—which he supplies. Now—step by step—you are guided by 3-dimensional views and full-size patterns for angle-cuts. (No blueprints.) It's fun! Before you know it, you have the perfect storage place for bicycles, lawnmower, garden tools, summer furniture.

All you need is the know-how—and you get it with Easi-Bld Patterns and the Homasote Handbook. Whether it's a valance-bookcase, a swing-up garage door, a guest house, or any other project—when you work this way your only cost is the cost of the materials—about one-third what you would otherwise pay. Look for the Easi-Bld emblem on your dealer's counter. And mail the coupon today for your free copy of the Homasote Handbook.

\*T. M. Reg. Easi-Bld Pattern Company



HOMASOTE COMPANY, Department B-5, Trenton 3, N. J.  
Send me the 68-page Homasote Handbook.

Name .....

Address .....

City ..... Zone ..... State .....

**Breeze to work for only  
pennies  
a week**



**with never a worry  
about traffic or parking  
on a  
HARLEY-DAVIDSON  
HUMMER**

Here's a healthy, happy way to save money, beat traffic, avoid the inconvenience of using public transportation. Get yourself a new 100-mile-a-gallon Hummer. Zip quickly, safely past crawling lanes of cars to bypass traffic jams . . . enjoy being able to park practically anywhere.

If you're looking for transportation like this—to get to work or to free your car for the family—see your dealer. He'll teach you to ride in minutes and show you how easy it is to own a Hummer.



*. . . after minimum  
down payment. That  
includes fire, theft  
and collision insur-  
ance; local taxes;  
freight and carry-  
ing charges.*

**HARLEY-DAVIDSON MOTOR COMPANY**  
Dept. P, Milwaukee 1, Wisconsin

Okanagan grads think nothing of setting a machine down on a tiny target, such as a cast-off cigarette carton, a few feet from the brink of a 1000-foot chasm and at an elevation of 8000 feet. Understandably, Agar, their instructor, has received high Canadian awards. During World War II, he taught conventional flying so well that he won the Air Force Cross. In 1950 he was awarded the McKee Trophy, presented annually in recognition of the Canadian making the greatest contribution to aviation.

In the immediate post-World War II period, Carl sold the farm he'd had for 20 years, moved his wife Anne and their two children to the coast, and went into partnership with another RCAF vet, Alf Stringer, in operation of an airplane service for fruit growers. In 1946, after selling shares to orchard owners, they switched to a helicopter, which Carl learned to fly. The "flying windmills" had proven effective and economical in flat California orchards but were a flop in British Columbia because of the hilly terrain. Carl's conquering of Mount Wahleach was all that saved the partners from financial disaster.

Not one to be complacent, Agar also has demonstrated how a copter can be set down safely with only fresh air beneath its fuselage. Although he first tried it simply for the sake of finding out whether it could be done, he and the graduates of his school now are proficient at landing astride narrow mountain chasms. This method has proven useful for landings in areas where there are no level spots of sufficient size, but where a machine can be landed safely straddle-style. If a "flying palm tree" can land on a spot, Agar can pilot it there. That's why they call him Canada's copter king. ★★★

### All-Jet Transport Aircraft

Pure jet air transports, the first to come from United States factories, are scheduled for initial operations in 1959. These aircraft are part of a \$500,000,000 order by foreign and domestic airlines for new transport planes to be delivered by 1960, according to a survey by Esso Export Corporation. However, reciprocating engines will carry the heavier load of air passengers and freight indefinitely, the survey indicated. A grand total of 1485 aircraft of all makes and models is included in this order. The U.S. will produce 948; the British, 484; the French, 22; and the Dutch, 31. Long-range, piston-powered units total 454; medium-range, piston-powered, 157; medium-range turboprops, 401; long-range turboprops, 189, and long-range pure jets, 284.

No Rotary Tiller like the  
**NEW Ariens**  
**MULTIMATIC**

Handle swings horizontally 180° for 2-direction operation with front or rear-mounted Insta-Hitch attachments! Another Ariens "first"!



Ball and cam differential for positive traction.

For amazing versatility, performance, easy handling see the Ariens Multi-Matic! Powered by Kohler 3.6 h.p. engine. Fingertip operating controls. 16" tillage. Insta-Hitch attachments.

See your dealer or write:

**ARIENS COMPANY**  
161 CALUMET ST. • BRILLION, WIS.

**Guaranteed original equipment  
Replacement Auto Parts . . . at  
Western Auto**

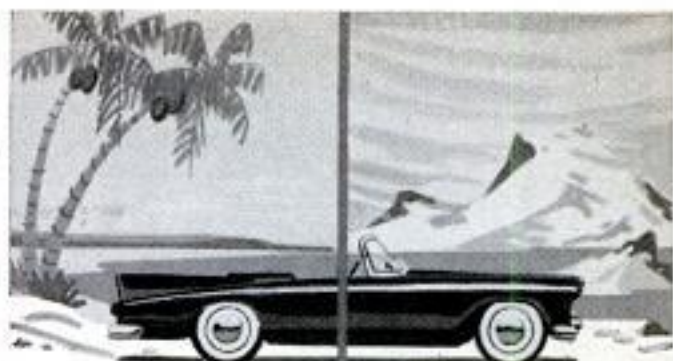

**TROPIC HEAT OR ARCTIC COLD  
YOU'LL START AND YOU'LL GO!**

When a fuel pump has been tested under strict government supervision and found to work perfectly at 114 degrees above zero and at 76 degrees below zero, we think it has proved itself the best on the market. That's what the Bendix\* Electric Fuel Pump did. Positively eliminates vapor lock. No other pump even close to its price class could match it. Better get one for your car. (Send for free illustrated folder.)

\*REG. U.S. PAT. OFF.



**Bendix**  
**ELECTRIC FUEL PUMP**

BENDIX AVIATION CORP. • (Eclipse Machine Div.), Elmira, N. Y.



**YOU can do those BIG  
PAY JOBS** with this  
easy to use **hobart welder**

**EARN BIG PROFITS!**

**CASH IN-**  
on the big demand for emergency repair work

**LOW INVESTMENT**  
... low cost operation

Send for Lessons Book . . . 200 pages self-teaching . . . only \$1.00

**Mail Coupon**

and receive welder's vest pocket guide **free**

**INVESTIGATE** these money-makers TODAY!

200 amp. light weight, low cost "BANTAM CHAMP" is specially designed to let you do production and repair work in your own shop.



200 amp. TRANSFORMER AC welder for operating on single phase 220 volt power. Ideal for shops that would like to do production and repair work.



200 amp. AC Power-AC Welder Combination. Four cylinder air cooled engine. Furnishes current for welding—power for running tools, lights, etc. Mounts easily on truck or trailer.



In or out of the shop this Husky Boy arc welder can earn big profits for you and will quickly pay for itself out of increased earnings. Welds anywhere. Light weight and easy to use without special training. Cash in on the big demand for arc welding. Get into the bigger paying jobs now—write Hobart Brothers Co., Box M-27, Troy, Ohio, Ph. FE 2-1223.

**HOBART TRADE SCHOOL** . . . learn arc welding quickly by actual on-the-job experience. Complete or partial courses. G.I. approved. Non profit.

**HOBART BROTHERS CO., Box M-27, Troy, Ohio**

Without obligation, send complete details on:

200 amp. "HUSKY BOY"  200 amp. "BANTAM CHAMP"  200 amp. AC TRANSFORMER  AC POWER-AC WELDER COMB.

NAME \_\_\_\_\_

ADDRESS \_\_\_\_\_

CITY \_\_\_\_\_ STATE \_\_\_\_\_

Send Free Welder's Vest Pocket Guide.

# Soldering is Easy



with  
INSTANT STARTING

# Lenk

LIQUEFIED LP PETROLEUM  
**Torch**

only **\$2.95**

THE ONLY THROW-AWAY FUEL-CONTAINER WITH SELF-SEALING SAFETY VALVE.

Here's what you can do:

- regular soldering, sweat fittings,
- silver soldering, refinish furniture,
- remove paint and putty.

Available at Hardware Counters Everywhere

Write for FREE  
Soldering Instructions

THE **Lenk** MFG. CO.  
BOSTON 15, MASS.

## Eight Memorable Days in The History of Speed

(Continued from page 169)

with the average of the two being the official speed.

By 1926 the speed record stood at 150.87 miles per hour, a record set by Malcolm Campbell in a Sunbeam. He had broken his own record to do it, a record of 146.16 miles per hour, both set at Pendine sands in Wales. Thus Campbell became the first man to average 150 miles per hour.

Sunbeam came through again when H. O. D. Segrave, in the smallest gasoline car ever to hold the record, set a new mark of 152.33 miles per hour at Southport, England. The engine represented a triumph of design, it being a V12 engine of only 244-cubic-inch displacement—smaller than any eight-cylinder engine built in an American production car today. The Segrave car was no special car—it was a practical racing vehicle, the last of the normal cars to hold the record. From here on, the emphasis was on specialized cars with aircraft engines, cars designed to go extremely fast in a straight line for a short distance.

The first of this parade of monsters was the Liberty-aircraft-engine Higham Special driven by J. G. P. Thomas. It boosted the speed mark to 169.20 and started the record zooming upward after years of gradual increases (see chart on page 169 for a visual record of this turning point).

Despite the fact that the Liberty engine wasn't running right, Thomas easily smashed all existing speed records. The lesson was clear—to those interested—the way to set records was to get a tremendous engine and put it on wheels. Aircraft engines became the typical choice.

The following day Thomas ran through the mile again and raised the record to 171.4 miles per hour despite an extremely wet beach.

The Liberty engine had a 27,059-cubic-centimeter displacement (1650 cubic inches), almost seven times more than the Sunbeam whose record it broke.

From here on, the record climbed sharply. By 1927, the speed merchants discovered that the hard sand at Daytona was best for their runs. Segrave brought a twin-engined 1000-horsepower Sunbeam to the Florida beach and boosted the mark to 203.79 miles per hour, becoming the first to break the double-century barrier.

In the following year, 1928, three drivers made the pilgrimage to Daytona: Lockhart's previously mentioned and ill-fated Stutz; Keech's three-engined Triplex special, a tremendous car of great power and

(Continued to page 288)

# LUFKIN

## MICROMETERS

### With NEW CAM LOCK

LOCK EASIER  
FASTER

MORE SECURELY

Now, you can lock faster, more securely with just a flick of the thumb. This new cam-action lock positively secures the thimble from movement until the reading is made or transferred. An exclusive new feature, available only on Lufkin Big Barrel Micrometers.

BUY **LUFKIN** TAPES • RULES • PRECISION TOOLS  
AT YOUR HARDWARE OR TOOL STORE

BETTER MEASURE WITH **LUFKIN**

THE LUFKIN RULE CO., SAGINAW, MICHIGAN



396

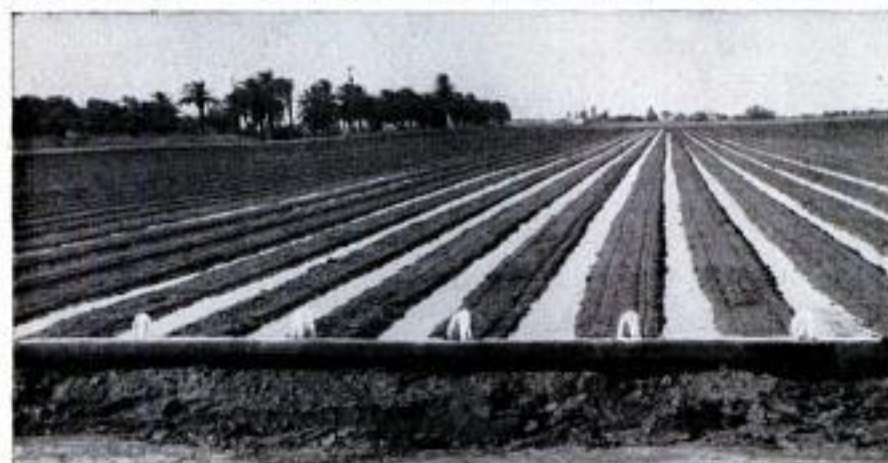

## Irrigation Hose

Farmers can now irrigate their crops with a king-size hose somewhat like the soaker hose used on lawns. Flat when empty, it rounds into shape when in use. Water spurts out through holes spaced every 40 inches along its length to supply conventional irrigation rows or to soak a particular area. Flow is controlled by stoppers which plug individual holes or by regulators which direct the water to either side. The hose, which is easily rolled up and moved, and which is made in diameters ranging from 2 to 18 inches, takes the place of a supply ditch. It can be left permanently in place, for it is made of rotproof polyethylene.

## new catalog

for the handyman

### GET THIS 100 PAGE CATALOG TODAY

Bigger than ever—expanded sections with information and illustrations on new supplies, new projects and unusual products that make interesting items easier to make. Big sections on plans, hardwood, plywood, veneers, furniture trim, cabinet hardware, lamp parts, finishing material, many others.

Enclose 25c to cover cost of postage and handling which will be refunded with your first order.

Minnesota Woodworkers Supply Co., Dept M-2  
1713 Olson Highway, Minneapolis 5, Minnesota



## KING MIDGET

Drive it for .75c per week. Rider Agents wanted—earn your own car free. Also KING MIDGET JUNIOR chassis, finely engineered, ready to run and priced at a fraction of any similar car. **GET THE FACTS.** Send 25c for 32 page picture book giving special prices and agents proposition on both cars. Or send \$1 (refunded first order) for this plus actual assembly book and service manual.

MIDGET MOTORS CORPORATION, ATHENS 1, OHIO



FEBRUARY 1957

IT'S HERE!

Darra-James

## Moter Tools



...Power Packed Beauties  
with BUILT-IN-MOTORS

CONVENIENT: Darra-James Moter Tools take the guesswork out of choosing the proper motor. They come complete with Timing Belt, Pulley and G. E. Motor with Cord, Plug and Switch. Nothing to buy! TIME-**SAVING**: Nothing to set up! No time lost! Simple to Operate: Just plug in, flip the switch and operate. MOVABLE: Each Moter Tool is compact—can be carried quickly and easily from one place to another. SUGGEST: Entire tool is constructed of heavy-duty cast-iron to assure many years of trouble-free service. CHOICE OF COLORS: Available in Slate Grey or Woodland Green. ECONOMICAL: Cost less than similar tools and motors purchased separately. GUARANTEE: All Darra-James Power Tools are guaranteed against defects for a full five years.



6" Tilting Arbor Saw (Model 825)  
A quality saw at a minimum price.



6" Tilting Arbor Saw (Model 815)  
An economy saw that performs all operations of high-priced models.

All Darra-James Power Tools  
can now be purchased for  
only 10% down  
on convenient Credit Plan



Write today for free  
folder on Moter Tools and  
free folder of complete  
line of Darra-James  
Standard Power-Tools.

4 1/2" Jointer (Model 845) Featuring  
Parallel Motion to maintain constant  
distance between table and  
blades at all depths of cut.

## TOOLKRAFT CORPORATION

400 PLAINFIELD ST., SPRINGFIELD, MASS.



little engineering; and Campbell's Napier-engined Special.

Campbell set the new record at 206.96 miles per hour. A few months later Ray Keech, an American, in the crude Triplex-White Special, raised it to 207.55.

The following year, March 1929, Segrave returned to Daytona in a Napier-aircraft-engine car, the Golden Arrow, and boosted the record sharply to 231.36 miles per hour, an achievement which won him a knighthood when he returned to England.

Malcolm Campbell then began a series of record-breaking runs which gave him a monopoly on the mark until 1937. In 1931, 1932, 1933 and 1935, Campbell set new records. Finally at Bonneville he became the first to hit 300 miles per hour with an average of 301.13.

This marked the ninth time that Campbell, (by this time he was Sir Malcolm) had held the speed record—an achievement unmatched by anyone else.

Discovery of the Salt Flats at Bonneville gave impetus to the drive for speed. In 1937 G. E. T. Eyston drove his Thunderbolt at 312.00 miles per hour to wrest the crown from Sir Malcolm.

The Thunderbolt was the ultimate in the trend toward bigness. It was a seven-ton leviathan that rolled on eight wheels and was powered by two Rolls-Royce aircraft

engines developing a total of 6000 horsepower with 73,000 cubic centimeters or 4453 cubic inches of displacement.

The following year, Eyston raised his record to 345.5 miles per hour. A month later, September 1938, the Railton Special driven by J. R. Cobb took the crown from the Thunderbolt with a speed of 350.2 miles per hour.

The Railton was different from the cars that preceded it. Its designer, Reid A. Railton (now living in California and no relation of the author), developed a completely original car for Cobb. The body was kept as small and as light as possible. There were two aircraft engines, each driving two wheels of the four-wheel drive.

Later the same month Eyston came back to break Cobb's mark and raise the record to 357.50 miles per hour. The following August, Cobb regained the crown with an average of 369.70 miles per hour.

There the record stood until after World War II when Cobb returned to Bonneville in his same Railton Special and, for the first time in history, drove a vehicle over land at a speed of more than 400 miles per hour. On his south-to-north run, he averaged 403.14 miles per hour. His north-to-south run was 385.65 miles per hour, for a two-way average of 394.20 miles per hour, the present world's record. ★ ★ ★

## WORLD'S LAND-SPEED RECORDS

### One Direction Only

Date	Driver	Car	Place	M. P. H.
Dec. 1898	Chasseloup-Laubat	Jeantaud	France	39.24
Jan. 1899	Jenatzy	Jeantaud	France	41.42
Jan. 1899	Chasseloup-Laubat	Jeantaud	France	43.69
Jan. 1899	Jenatzy	Jeantaud	France	49.92
Mar. 1899	Chasseloup-Laubat	Jeantaud	France	57.80
Apr. 1899	Jenatzy	Jeantaud	France	65.79
Apr. 1902	Serpollet	Serpollet	France	75.06
Aug. 1902	Vanderbilt	Mors	France	78.08
Nov. 1902	Fournier	Mors	France	78.60
Nov. 1902	Augier	Mors	France	77.13
July 1903	Rigolly	Gobron-Brillie	Belgium	83.47
Nov. 1903	Duray	Gobron-Brillie	France	84.73
Jan. 1904	Ford	Ford 999	Wisconsin	91.37
Jan. 1904	Vanderbilt	Mercedes	Daytona	92.30
Mar. 1904	Rigolly	Gobron-Brillie	France	94.78
May 1904	de Caters	Mercedes	Belgium	97.25
July 1904	Rigolly	Gobron-Brillie	Belgium	103.55
Nov. 1904	Baras	Darracq	Belgium	104.52
Jan. 1905	Macdonald	Napier	Daytona	104.65
Dec. 1905	Hemery	Darracq	France	109.65
Jan. 1906	Marrriott	Stanley	Daytona	127.66
Mar. 1910	Oldfield	Benz	Daytona	131.72

### Two Directions

June 1914	Hornsted	Benz	England	124.10
May 1922	Guinness	Sunbeam	England	133.75
July 1924	Thomas	Delage	France	143.31
July 1924	Eldridge	Fiat	France	146.01
Sept. 1924	Campbell	Sunbeam	Wales	146.16
Mar. 1926	Campbell	Sunbeam	Wales	150.87
Mar. 1926	Segrave	Sunbeam	England	152.33
Apr. 1926	Thomas	Thomas Special	Wales	169.30
Apr. 1926	Thomas	Thomas Special	Wales	171.02
Feb. 1927	Campbell	Napier-Campbell	Wales	174.88
Mar. 1927	Segrave	Sunbeam	Daytona	203.79
Feb. 1928	Campbell	Napier-Campbell	Daytona	206.96
Apr. 1928	Keech	Triplex-White	Daytona	207.55
Mar. 1929	Segrave	Irving-Napier	Daytona	231.44
Feb. 1931	Campbell	Napier-Campbell	Daytona	246.09
Feb. 1932	Campbell	Napier-Campbell	Daytona	253.97
Feb. 1933	Campbell	Campbell Special	Daytona	272.46
Mar. 1935	Campbell	Campbell Special	Daytona	276.82
Sept. 1935	Campbell	Campbell Special	Bonneville	301.13
Nov. 1937	Eyston	Thunderbolt	Bonneville	312.00
Aug. 1938	Eyston	Thunderbolt	Bonneville	345.50
Sept. 1938	Cobb	Railton	Bonneville	350.20
Sept. 1938	Eyston	Thunderbolt	Bonneville	357.50
Aug. 1939	Cobb	Railton	Bonneville	369.70
Sept. 1947	Cobb	Railton	Bonneville	394.20



## GOT A LOCK PROBLEM?

To make locks work easier and last longer, add a few drops of LOCK-EASE to any lock mechanism. LOCK-EASE—a graphited fluid flushes out dirt—leaves a long-wearing protective film to seal out rain, snow, salt, ice and dust that cause locks to stick, rust and wear out. LOCK-EASE prevents keys from sticking...locks from freezing. Use LOCK-EASE on car locks, garage locks, padlocks and all door locks in and out of the home. For best results, "LOCK-EASE" locks regularly! 4-oz. "Drop or Stream" can only 49c, everywhere.



### LOCK-EASE®

Graphited  
LOCK  
FLUID

American Grease Stick Co.  
Muskegon, Michigan



## DO EVERY FASTENING JOB 10 TIMES FASTER!

Amazing one-hand operation, 10 times faster than hammer & nails. Can't jam.



At your local hardware dealer or lumber yard

### ARROW

DO-IT-YOURSELF  
TACKER, No. T-50

for ceiling tile, insulation, wire fence & every home job

Arrow Fastener Co., Inc., 1 Junius St., Brooklyn, N. Y.

## RIDING MOWER

Deluxe SPRINGFIELD model. 3½ h.p. engine. 24" cut. 4 forward speeds and reverse. 4 wheel stability. Brakes, recoil starter, and side grass exhaust. Cart, roller, spiker, snow blade and other attachments.



WRITE FOR FREE LITERATURE.

Quick Mfg., Inc., 3257 E. Main, Springfield, Ohio

## MECHANIC'S FAVORITE!

Here's the number one choice—



It's the Huot Model 100 DeLuxe Chest—custom designed for mechanics who want the finest protection plus maximum accessibility for fine tools. Eleven drawers—seven of them cork-lined for protection. Three heavy-duty drawers for large tools—1 extra deep drawer for power tools. Single latch locks entire cabinet. Two-tone oil-resistant finish. Free bulletin describes 12 tool chests.

HUOT MFG. CO.

555 No. Wheeler Street, St. Paul 4, Minnesota



Pat'd

# WARN HUBS ON YOUR Jeep®

## Save gears, tires, gas



Use economical free-wheeling 2-wheel drive or tractive 4 w.d. as you shift with **LOCK-O-MATICS**

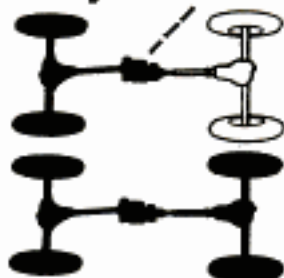

—they automatically disengage the front wheels from the front drive in 2-wheel drive

—and automatically re-engage the front wheels for 4-wheel drive, forward, reverse

With Warn Hubs on your 4-wheel drive, it is *two vehicles in one*, because you can use it as a standard 2-wheel drive, or 4-wheel drive.

Warn Hubs "idle" the front drive in 2-wheel drive—stop front end drag, give your vehicle free-wheeling pep, speed, power in high; make it handle easier, run quieter. And they increase front drive life in *proportion to your mileage in 2-wheel drive!* You get better "mileage" on tires, engine and gas, too.

4-wheel drive operates as usual, when you need it—automatically, as you shift, with Warn Lock-O-matics, through manual controls with Warn Locking Hubs. Over 100,000 Warn Hubs are now in use around the world—*proof* of their many advantages. To get maximum use of *your* 4-wheel drive, have your local 4 w.d. dealer install Warn Hubs now. Models for all 4 w.ds. to 1½ tons. Free literature on request.

## WARN MFG. CO.

Riverton Box 6064-A2  
Seattle 88, Wash.

## I Race in the Big Leagues

(Continued from page 200)

could take Fangio on the outside. Flat out on the straight I would be a bit better on acceleration than the Ferrari and I hoped to use this to pull ahead.

Roaring along the straight at 180 miles per hour, Collins wouldn't let me by. At 400 yards from the corner I was still hitting 180. I kept my foot down until 300 yards. Then I jumped on the brakes. Everything was fine. I passed Collins and Castellotti, then suddenly my brakes locked. For an instant I lost control. I decided to go straight ahead. I couldn't make the corner.

Just as suddenly, at the last instant, the brakes unlocked and the green Vanwall turned. In an instant I was alongside Fangio, passing on the outside.

But Fangio wouldn't let go. For one mile I stayed alongside the greatest driver of them all, fighting it out. First I was ahead by a nose, then he was. It was Grand Prix racing at its most exciting.

Then up came the curve and there was nothing for me to do. He kept his foot down and I had to let him pull ahead. I decided to tag on his tail and attack again on the last two laps.

But every time I tried to make a move, Collins would pull alongside and I was boxed. Then the Vanwall began to backfire. I knew it was the end. The bracket of the fuel-injection pump had broken. My dream was ended.

I pulled into the pits. The crowd was yelling "Schell—Vanwall." It was fantastic. They were cheering me more than him who had won. I learned that in the chase Fangio had set a new lap record of 127.29 miles per hour.

My dream collapsed, but I was not sorry for myself as much as for Tony Vanderwell and his mechanics. I had had the most exciting moment of my career.

If racing was like that all the time it would be unbearable. But there are long, tedious hours when misfortune and despair take over. No race is long when you have a chance to win. Every race is endless when you are hopelessly behind.

I was brought up in the smell of castor oil. My father and mother were involved in racing before the war. My father was killed at the wheel of his sports car. Racing seems to be in my blood.

As I plunge along the straight at Reims at 180 miles per hour or when I round a corner of Monza in a nice drift, I feel on top of the world. Racing is my life. I am a hopeless addict.

I began racing seriously when I was

(Continued to page 292)

**MEASURES UP!**  
ONLY **\$2.39**  
(10 FT.)  
the *Evans*  
**KING-SIZE**  
**TAPE**  
IT STANDS UP STRAIGHT  
6-8-10-12 FOOT LENGTHS



Long upright measuring jobs are easy with Evans King Size. Blade is a full 3/4" wide... 33% wider than ordinary tapes. Stands straight up or lays down flat—won't bend or buckle. Easier to read, too. Free belt clip. Tenite utility case. Sliding end hook—for 100% accurate inside-outside measuring.

**Exclusive! NO FIGURING!**

Work in feet & inches? Read here ▶   
Work in inches? Read here ▶ 

ALSO... get *Evans* Regular White-Tapes

- 6 Ft. only 98¢ 50 Ft. only \$4.98
- FREE Tenite utility case • All Evans quality features • 6-8-10-12-50-100 foot lengths

Ask your hardware dealer—Today!

**Evans RULE CO.**

Elizabeth, N. J. Montreal, Que.

**NEW 1957 EDITION JUST OUT!**



Get This Giant Catalog Of

**WOOD**  
& WOODWORKING  
MATERIALS

TOOLS—PLANS—SUPPLIES

World's Largest Selection of Finest Domestic and Imported Woods... Mouldings, Hardware Tools—ALL AT LOW MONEY SAVING PRICES!

Your complete wood buying guide and project book. Craftsman is your best, most complete source of finest kiln-dried domestic and rare imported woods, beautiful wood inlays, colorful bandings, matched plywoods, embossed mouldings, carved ornaments, newest woodworking tools, "hard to find" cabinet hardware and fittings... more than 1,500 items! Packed with newest scroll saw patterns, project ideas and money making plans. Enclose 25¢ (refunded with first order) to help pay mailing, handling cost. Write

Craftsman Wood Service Co., Dept. A-2  
2729 S. Mary Street, Chicago 8, Ill.

**132 PAGES**

Many in full color

packed with rare, fancy & imported woods... veneers, plywoods, patterns, tools, ornaments, hardware... everything for the woodworker.

**MAIL COUPON NOW!**

**CRAFTSMAN WOOD SERVICE CO., Dept. A-2**  
2729 S. Mary Street, Chicago 8, Ill.

Enclosed find 25¢. Rush WOODWORKERS' CATALOG.

NAME \_\_\_\_\_  
ADDRESS \_\_\_\_\_  
CITY \_\_\_\_\_ ZONE \_\_\_\_\_ STATE \_\_\_\_\_

**Rare opportunity for a  
"LIVE-WIRE" MOTORCYCLIST**  
Move ahead at high speed as  
a Harley-Davidson Dealer

"Greatest ever." That's one of the milder compliments motorcyclists the country over pay the great 1957 Harley-Davidson line. Their enthusiasm is your big opportunity to enjoy good profits this year and for years to come . . . the added rewards of being in a business that deals with dynamic, energetic young people. If you're the right man—there's a big future for you as a Harley-Davidson Dealer. You'll be selling the world's finest motorcycles . . . be backed by a strong national advertising program . . . get plenty of local sales and promotion helps . . . the kind of full cooperation that practically assures success. Why not write now and tell us about yourself, your sales experience, how much you can afford to invest? For prompt reply, address Dept. P, HARLEY-DAVIDSON MOTOR CO., MILWAUKEE 1, WISCONSIN.

**BOAT KITS 28 MODELS—8 to 19 ft.  
\$39 up—FREE FREIGHT**

SAVE 2/3! Easy-to-build MAHOGANY FRAMES—DECKS



19' CRUISER KIT \$499.50!

SEND 10¢ for  
KIT CATALOG!  
Includes Hardware  
—Trailers—Fiberglass

**BOAT PLANS—Patterns—Frame Kits**

**Craig Craft**  
Tonawanda, N. Y.

Build over 50 modern boats from large scale plans, available with FULL-SIZE patterns, new PRE-FAB frame kits! All types: prams to cruisers, 6 to 25 ft. Best buy for Amateurs! SEND 10¢ for CATALOG.

**JEEP OWNERS**

RE-POWER NOW with your choice of three famous V-8 engines

**FORD** • **CHEVROLET** • **MERCURY**  
CONVERSION KITS now available to fit ALL 2 and 4 Whi-Drive Willys Jeeps. . . Priced \$43.25 to \$64.75 . . . If you want fast action tell us which V-8 engine you wish to use . . . give us the year . . . 2 or 4 Whi-Drive . . . body style of your vehicle. Send min. \$15.00 dep. and we will ship correct kit, bal. C.O.D. Send full amount for prepaid shipment. Wire, phone or write for FREE details.

**HOOSIER MACHINE PRODUCTS CO.**

312 S.E. 6th St. Phone 676 Pendleton, Oregon, U.S.A.

**KEEP YOUR  
WORKSHOP TOOLS  
SAFE AND ORDERLY**



This 7-drawer machinist's chest has a place for every tool. Extra durable heavy gauge steel. Felt lined drawers protect delicate edges . . . operate easily. Size: 8½" x 13½" x 20¼". \$27.95 at leading hardware stores. Slightly higher west. Other home workshop models from \$1.25 up.

**WATERLOO VALVE SPRING COMPRESSOR CO.**  
Waterloo, Iowa

**"CRESTOGRIP"  
UTILITY  
PLIER**

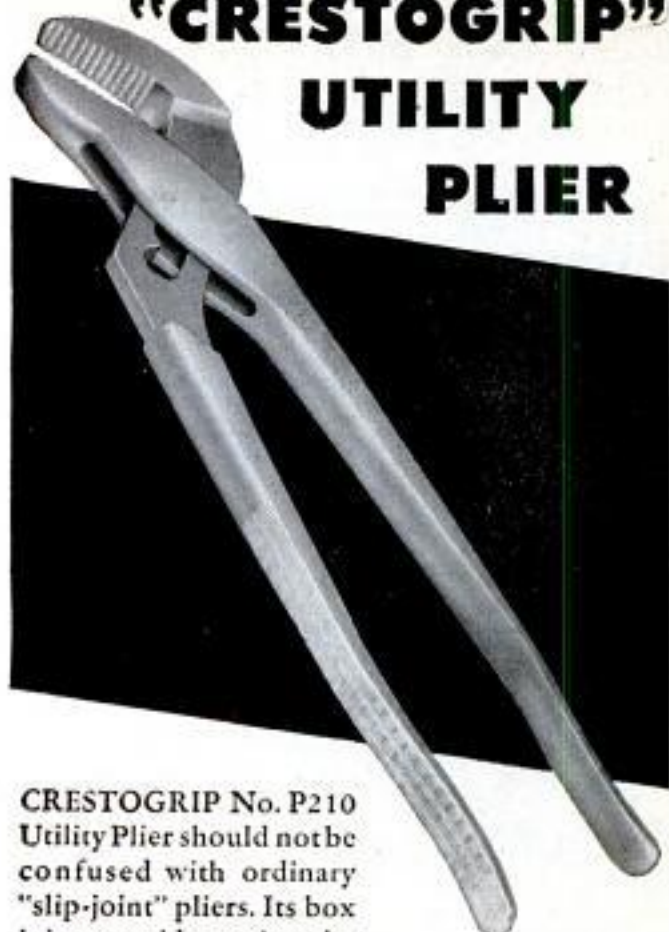

CRESTOGRIP No. P210 Utility Plier should not be confused with ordinary "slip-joint" pliers. Its box joint provides twice the strength of the conventional lap joint and eliminates sideways twist and strain. Grips flat, square, hex or round objects with powerful leverage. Adjusts to four positions up to 1½" capacity. It has no rivet projections and measures only ½" at its thickest point. Finished in rust-resistant zinc plate.

**ARTISAN'S  
TIE  
CLASP**



• For the craftsman or hobbyist who is proud of his skill, a handsome gold-plated clasp designed by a leading jewelry manufacturer. A \$2.00 value... yours for 50¢, post paid. Write Crescent Tool Co., Jamestown, N. Y., Dept. M.

**CRESCENT TOOLS**  
*Give Wings to Work*



*Sign of the Artisan  
Symbol of Excellence*

Crescent is our trade-mark, registered in the United States and abroad, for wrenches and other tools. Sold by leading distributors and retailers everywhere and made only by

**CRESCENT TOOL COMPANY, JAMESTOWN, N. Y.**

# have fun with electronics

## BUILD YOUR OWN knight-kit

**IT'S EASY—  
AND YOU SAVE!**

**KNIGHT-KITS** are famous for their clear "step-and-check" instructions. You'll marvel at how easy they are to assemble. You'll be thrilled with their performance—proud of your work. You can't miss—and you save money!



### Transistor Radio Kit

Experiment with the marvel of transistors! Printed circuit mounting board simplifies assembly—just make a few solder connections. Delivers fine broadcast reception. Fits in palm of your hand; powered by penlight cell that lasts for months. Complete with all parts, transistor, penlight cell. Shpg. wt., 2 lbs.

**83 Y 765. Transistor Radio Kit... \$4.35**  
**83 Y 266. Headset & Antenna Kit... \$3.15**



### Famous 2-Band "Space-Spanner"

Thrilling new bandswitching receiver. Selects exciting short wave on 6 to 18 mc (foreign, amateur, aircraft, police, marine); and full regular broadcast. Sensitive regenerative circuit; 4" PM speaker; beam-power output. Easy to build. All parts supplied (less cabinet). 4½ lbs.

**83 Y 243. "Space-Spanner" Kit... \$15.95**  
**83 Y 247. Cabinet for above... \$2.90**



### Transistorized Electronic 10-in-1 Lab Kit

Sensational—work with transistors! Assemble the basic parts, then complete project after exciting project (10 of them in all) just by plugging leads into proper jacks on printed-circuit board—no wiring changes needed. Make the following: AM radio, amplifier, wireless broadcaster, code practice oscillator, electronic timer, switch, flasher, or any of 3 other electronic relays. Includes all parts, 2 transistors, battery, headphones and instructions for each project. Shpg. wt., 3 lbs.

**83 Y 299. Electronic Lab Kit... \$15.45**



### 2-Way Intercom Kit

It's easy and inexpensive to build your own 2-station intercom! Use it in home or office. Makes ideal "baby sitter". Extra high gain—delivers full output from only a whisper. Complete with 50 ft. cable (up to 200 ft. may be added), antique-white cases, tubes and all parts. For AC-DC. 7 lbs.

**83 Y 295. 2-Way Intercom Kit... \$14.75**

**Dozens of other  
knight-kits  
available**

**GET THE BIG  
356-  
PAGE**

**FREE**

## ALLIED CATALOG

See our complete selection of **KNIGHT-KITS**—plus the world's largest stocks of Hi-Fi systems and equipment, recorders, Amateur equipment, test instruments, TV components, parts, tubes and tools. **FREE**—send for it!



**World's Largest  
Electronic  
Supply House**

**Our 36th Year**

**ALLIED RADIO CORP., Dept. 5-88-7  
100 N. Western Ave., Chicago 80, Ill.**

Send **FREE** 356-Page **ALLIED** Catalog

Send the following **KNIGHT-KITS**: \_\_\_\_\_

\_\_\_\_\_ \$ \_\_\_\_\_ encl. Prices Net F.O.B. Chicago

Name \_\_\_\_\_

Address \_\_\_\_\_

City \_\_\_\_\_ Zone \_\_\_\_\_ State \_\_\_\_\_

released from the Army after the war. I settled in France. The only car I could afford was an old Maserati—a tired car and very difficult to drive. It eventually ended up at Indianapolis where the engine blew up on me, littering the track with bits of steel. I don't know why I brought this junk to Indianapolis against all my friends' advice. I suppose it was because I wanted to race in my own country.

In 1947 I bought a single-seater Cisitalia, but I was no winner with that. Then in 1949, I bought a sports Talbot which brought me my first victories—two in one day in Saar. But I was still a long way from the big leagues. I was still a second-stringer in the minors.

I moved along to a season of racing in a modified Maserati with Enrico Plate's team. But the cars were old and tired and we blew up in race after race.

Finally I got my first contract with a factory team (known as a "works" team). It was Gordini. Gordini is a small, not-very-wealthy builder and often runs out of money. We were not usually in the running, but I was moving up and I was grateful.

Soon I decided the fragile little blue Gordini was not going to win for me so I went independent again, buying a second-hand Maserati which had been driven previously by Fangio. Needless to say, Fangio had driven the guts out of the car. It was old and worn. Time and time again I pulled into the pits sitting in a pool of oil. The same old story of a tired, worn-out car.

Finally, the miracle happened. Maserati turned up short a driver for the Spanish Grand Prix in Barcelona. They sold me one of their cars. It was a proper "works" car, much faster than my Maserati. The race was the final leg of the championship and everybody was there: Mercedes-Benz, Ferrari and all the other great names.

In practice, I made the third fastest time and was put in the front line of starters for the first time in my life in a championship event. I was next to Ascari, Fangio and Hawthorn.

Nobody believed my time except the Maserati owner and his mechanic. Everybody felt that the timekeeper had made a mistake. This novice American couldn't be up there, they were sure.

The team manager who had sold me the car asked me to make Ascari and Fangio break, no matter how many r.p.m.s I had to do. I was to be the pace setter. What a responsibility. I had to break the masters!

As soon as the flag dropped I shot into the lead for four laps. Ascari was on my

(Continued to page 294)

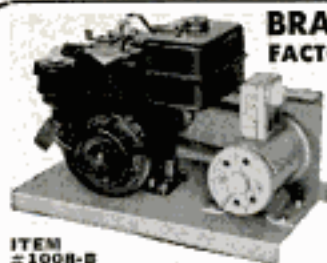

**BRAND NEW 1957!**  
**FACTORY-TO-YOU-VALUE**  
**PORTABLE**  
**ELECTRIC**  
**LIGHT**  
**PLANTS**

ITEM #1008-B

Dimensions:  
 Length 20 1/2"  
 Width 12"  
 Height 16"

**POWER TO OPERATE:**  
 • Water pump, Radio, Lights, Air-conditioner • Refrigerator, Deep Freezer, Incubator • Electric Saw, Electric Drills, Pipe Bender

**Compact—Fits in the Trunk of Your Car**

**FULL 1000 WATTS** continuous duty. 115 Volts, A.C. 60 cycles, 9 amps. Powered by husky Briggs-Stratton engine with recoil starter. Engine and generator operate at 3600 R.P.M. for maximum efficiency at minimum weight. Both units are mounted on steel base, with heavy sheet metal belt guard. Generator is self-regulating, and is equipped with outlet box containing fuse and 2 A. C. convenience receptacles. Cost only 5¢ an hour to operate. Shipping wt. 100 lbs. (Regular price \$225). You save \$65.50. Now only, F.O.B. Chicago..... **159.50**

**700 WATT-GENERATOR SET**—same as above, slightly smaller—with Briggs-Stratton Engine—Model 705—F.O.B. Chicago..... **129.50**

**ITEM #2008—2000 WATTS** 115 V. A.C. generator set, powered by Briggs-Stratton engine. Mounted on portable steel carrying base for easy handling.—Just right for small cottage and cabins needing inexpensive 2000 Watts of electricity. Ship. Wt. 190 lbs. F.O.B. Chicago..... **295.00**

**Brand New! 5-TON BLACKHAWK**  
**HYDRAULIC LIFT KIT**  
 Now Only **38.95** Complete

**THE COMPLETE KIT**

For—• Dumping farm wagons  
 • Adjusting depth of plows  
 • Hydraulic press • Hydraulic jack • Snow plows.

**KIT CONSISTS OF:**

- 1—Brand new Blackhawk Model P-151—Hydraulic hand pump with built-in oil tank and release valve. Rated from 1200 P.S.I. — to 8400 P.S.I. 20" handle. Dim. 8"x6"x6". Item #82..... **22.50**
- 1—6 Ft. length double wire braid rubber covered hydraulic hose—tested to 20,000 lbs. Item #2784..... **3.95**
- 1—Hydraulic cylinder, 3" bore, 6" stroke. Husky 3/4" solid steel shaft. Will lift 10,000 lbs. using pump pressure. Clevis mountings that take 3/4" diameter pins. May be used for double action service. Item #419 **\$12.50**
- 2-Qts. non-foaming hydraulic fluid..... **1.00**
- All necessary hydraulic fittings.
- Total ship. wt.—40 lbs.

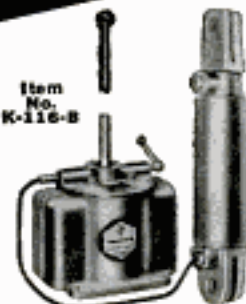

Item No. K-116-B

**COMPLETE KIT PRICE..... 38.95**  
**ALL OF ABOVE INCLUDED F.O.B. Chicago**

**GROBAN FOUR-WAY OPEN CENTER HYDRAULIC CONTROL VALVE**

**ITEM #126**—Four-way open center control valve, with built-in adjustable relief valve factory set at 1000 P.S.I. Spring loaded neutral position. For use with one double acting cylinder. In neutral position cylinder is locked and pump un-loaded. Can be used as single unit or mounted in series. Has 3/4" pipe thread inlet and outlet. 1/2" pipe thread cylinder ports. Finger grip handle. Ship. wt. 10 1/2 lbs. **AN OUTSTANDING BUY!** F.O.B. Chicago..... **23.50**



**SELECTED TOP VALUE SPECIALS!**  
 SURPLUS ITEMS AT FRACTION OF ORIGINAL GOV'T. COST.  
**AT GROBAN'S**

**1/4" METAL STAMPING SET**  
**STAMP YOUR NAME ON WOOD OR METAL!**



ITEM #390

Full alphabet A to Z, "&" and period. Precision hand trimmed deep cut, hardened **STEEL STAMPS**—in fitted Wooden Box—made to rigid U.S. Navy specifications by Young Bros.—Comparable to sets selling for \$27.00. Shipping Wt. 5 lbs. F.O.B. Chicago..... **5.95**

**U.S. NAVY ALL BRONZE CENTRIFUGAL PUMP**



ITEM #384

These all bronze Centrifugal Pumps are ideal for use as marine bilge pumps, circulating pumps, fire protection or irrigation, car-washing, dewatering, basement sump pumping, lawn sprinkling. Will pump water, oil, brine, gasoline, DDT and sulphur compounds. Equipped with 6" adjustable 'V' pulley, 2" dia. inlet and outlet, 180 GPM capacity. Inlet and outlet take hose with 2 1/4" inside diameter. Dimensions: 11" x 8" x 11".

Total head-feet	Speed	H.P.	GPM
25	3800 RPM	3	180
15	3000 RPM	1 1/4	90
20	2400 RPM	1 1/2	75

Back plate may be rotated for most convenient inlet position. Gov't acquisition cost \$98.00. Shipping weight 31 lbs. F.O.B. Chicago..... **29.50**

**HOBART 2 H.P. 12-24 VOLT ELECTRIC MOTOR**

**ITEM #315**—Rated 24 volts D.C. 90 amps. 4000 R.P.M. Has 1/2" spline shaft on both ends of motor, ball bearing construction, as specified for use with electric wheelchair design Popular Mechanics March issue, 1953. Convertible for use on 6 to 12 volts. Shipping Wt. 21 lbs. Dimensions: 11" x 5" x 6 1/2". F.O.B. Chicago..... **13.00**



**MULTI-PURPOSE HYDRAULIC PUMP OR MOTOR**

**ITEM #255** Silent, high efficiency, Helical Gear Type Ball Bearing. Hydraulic Pump or Motor. Rated 8 Gal. Per Min. At 1500 R.P.M.—Delivers 1000 P. S. I. Using 6 H.P.—Reversible Rotation—3/4" Pipe Thread Inlet and Outlet Ports—1/4" Drain Port—3/4" shaft with keyway and flat for either direct or pulley drive. Dimensions—5 1/2" high, 7 1/4" long, 5 1/8" wide. Shipping weight 18 lbs. F.O.B. Chicago..... **52.50**



**ORDER DIRECT FROM AD SATISFACTION GUARANTEED**  
 Send Payment Or Purchase Order Today  
 For Phone Orders Call WEBSTER 9-3793

**NEW 1957 CATALOG FREE**

**60 PAGES**—Chockfull of unsurpassed War Surplus and newly manufactured Equipment Bargains for farm, home, factory, workshop. Write letter today.

**G.E. SEALED BEAM SPOTLIGHTS**  
**THROWS A BEAM TO 1000 FT.**

**ITEM #418** General Electric "Mazda" 5 1/2" Sealed Beam. Uses conventional 110 Volt current A.C.—D.C. Fine for lighting up drive-ways, signs, parking lots, displays, garages. Built for use as Flashing Signal for U.S. Navy—to stand heavy surge loads. Shipping Wt. 2 lbs. U.S. Gov't. Cost \$12.68 ea. New Each..... **2.50** Postpaid  
**Lots of 3 — 6.00 Postpaid**



**GROBAN SUPPLY CO. Dept. PM-2**  
**1139 S. WABASH AVE., CHICAGO 5, ILL.**



**Loosens Rusted Bolts nuts, screws, "frozen" parts!**  
**LIQUID WRENCH**

The super-penetrating rust solvent that quickly loosens rust and corrosion.  
**AT HARDWARE STORES, GARAGES SERVICE STATIONS, EVERYWHERE**  
**RADIATOR SPECIALTY CO.**  
 Charlotte, N. C.



**GENUINE ALNICO MAGNETS**

**AMAZING, PERMANENT, NON-ELECTRIC, HIGHLY PRACTICAL.** Conduct interesting experiments. Hundreds of uses. Retrieve valuable steel items such as guns, tackle from fresh or salt water; tools from tanks & drains. **GUARANTEED.** Try any magnet one week. Money back if you are not well-pleased.  
 No. M-710 (Wt. 53 oz.) Has pull of 225 lbs. on steel block... **\$16.50**  
 No. M-625 (Wt. 70 oz.) Has pull of 125 lbs. on steel block... **\$9.50**  
 No. M-575 (Wt. 18 oz.) Has pull of 75 lbs. on steel block... **\$6.50**  
 No. M-500 (Wt. 13 oz.) Has pull of 50 lbs. on steel block... **\$4.50**  
 No. M-300 Kit of Flat Bars 5 Pairs (10 Magnets)..... **\$3.00**  
 No. M-250 Kit of Round Rods 5 Pairs (10 Magnets)..... **\$2.50**  
 No. M-47 Hot Pad Magnets, 10 for \$1.00..... **50¢** for \$4.87  
 No. M-35 Hobbyist assortment of 8 small magnets..... **\$1.50**  
 Send N.O. or check. We pay postage. Sorry no C.O.D.'s.  
**MIAMI MAGNET COMPANY, 3240 N.W. 27th Ave., Miami 42, Fla.**

new

Fir Plywood

# 8 BOAT PLANS

only 25¢ each



See your lumber dealer or use coupon below.

Large, easy-to-follow plans contain illustrated step-by-step instructions and complete bill of materials.



No. 30. 7' 9" Pram Dinghy



No. 35. 11' 3" Outboard



No. 40. 13' 4" Outboard



No. 45. 13' 9" Punt



No. 50. 15' Outboard



No. 55. 15' 11" Runabout



No. 60. 18' Day Cruiser



No. 65. 20' Cabin Cruiser

**\*Use Only Exterior Fir Plywood For All Marine Construction**

(EXT-DFPA® Means 100% Waterproof Glue!)

EXT-DFPA®

EXT-DFPA®

Douglas Fir Plywood Association, Dept. 9, Tacoma, 2, Wash.

Please send plans checked below. I enclose 25c for each. (Good in U.S.A. only)

No. 30  No. 35  No. 40  No. 45  No. 50  No. 55  No. 60  No. 65

Name \_\_\_\_\_

Address \_\_\_\_\_

City \_\_\_\_\_ Zone \_\_\_\_\_ State \_\_\_\_\_

tail and passed me on the fifth lap. For three more laps we stayed together. It was a real thrill, a battle with Ascari.

What I had been dreaming of for years was happening. I fought as hard as I could. Then Ascari's car blew up. I was in the lead with 12 seconds on Hawthorn and Trintignant and 25 seconds on Fangio.

The Maserati pit gave the blue flag every lap—faster, faster, faster.

But Hawthorn and Trintignant were too much for me. For an hour we jockeyed back and forth. First they were ahead, then I was. Finally, I slid off the road and broke a rear axle. That ended it.

But despite great disappointment, I couldn't have been happier. It had been my first real clash with the greats. There I was, an independent, ahead of all the team cars. And the car that was ahead was painted blue and white—the colors of the United States. It was a proud moment for an American overseas.

In Grand Prix racing I have been in many countries. I am still a long way from a success, measured against such greats as Fangio. But I am in this game for life and I hope some day to bring the championship to America.

There is one thing I can assure you. It's no game for relaxing. The night before a race, you don't sleep much. You think about this corner, about how you are going to take that curve; how you are going to pass another driver or if you are going to slide off the road. And if you do, how you are going to get out.

I believe every driver, even the greatest, is nervous at the starting line. I walk around the cars for the five minutes before the start, kidding with the drivers so I won't think about the race. Two minutes before the start I jump into my car and don't look at anything except my watch and the flag.

Then comes the 30-second signal. At 20 seconds, I put on my goggles. At 10 seconds I put the car in first gear. Then comes the short but endlessly long count: 5—4—3—2—1—GO!

It's fantastic. Instantly I relax and the thrill of the sport begins. Suddenly I am alert, unafraid. It is an amazing experience, this transformation of a tense, jittery driver into an utterly relaxed person in the second it takes the flag to drop. Anyway, that's how I feel when I'm at the wheel and I'm sure others feel the same.

From then on it's a battle of men and machines. The battle for the Grand Prix—top honors in the big league of racing. Top honors in a sport that, like a drug, makes you an addict and won't let go until either you or it wins out. ★ ★ ★

# NEW! MODEL 400 SIMPLEX Lawnmower Sharpener

Small investment  
returns

**Big Profits!**

## Many Exclusive Features . . .

The NEW SIMPLEX is the fastest, most accurate straight-line lawnmower grinder ever built . . . gives you all these advantages:

- Grinds all mowers—reel type, rotary, hand or power, any size.
- No dis-assembly needed, gas and oil remain in engine, support bar rotates.
- Grinding head feeds both horizontally and vertically, turns 90° for bed knives.
- Fast, positive adjustments, 4-point support on steel base with leveling screws.
- Rugged, long life construction and many other features.

## THE FATE·ROOT·HEATH COMPANY

Dept. PM-2 • Plymouth, Ohio



Get the facts on the new Simplex 400 before you buy any sharpener.

**Send for free brochure today!**

## Find HIDDEN TREASURES

GOLD, SILVER, PRECIOUS METALS with the Famous Model 27 Metal Detector. Lightweight, ultra-sensitive, low cost. None finer. Also GEIGER COUNTERS for uranium and the VIOLITE for tungsten. INFORMATION FREE

THE *Detectron* CORP.  
5528 Vineland Ave., No. Hollywood, Calif.



## Handy Black & Decker 1/4" Drill



with geared chuck  
only \$29.95

All-around drill for wood, metal, plastics. 44% more power. Smoother operation. Accessories available to drill, saw, sand, drive screws, polish, buff . . . 1001 home jobs. B&D quality assured. See your dealer for a demonstration today.



**Black & Decker**

World's Largest Maker of Portable Electric Tools

## SAVE MONEY ON YOUR COMPRESSED AIR

buy this complete  
SMITH 45-P air compressor



Right for spray painters, plumbers, contractors, monument shops, tire changing trucks, maintenance shops, quarries, utilities, many other users. Delivers 45 plus cu. ft. per minute; pressure up to 150 P.S.I. Powered by Wisconsin 4-cyl. air-cooled engine; uses less than 1 gal. gasoline an hour! Most compact, biggest-value compressor for its capacity anywhere! Other models to 230 cfm.



GORDON SMITH & COMPANY, Inc.

411 College Street, Bowling Green, Ky.

FEBRUARY 1957



Distinctively designed for a smooth, soaring ride and flashing beauty. Powered by Cushman Husky 4-cycle engine. Up to 50 miles per hour, 100 miles per gallon. Ruggedly built. Ride it anywhere, everywhere for just 3/4 cent per mile.

- Sold and serviced nationally; replacement parts available immediately
- Ask your Cushman dealer for FREE demonstration
- Dealer inquiries invited.

**Write for new FREE booklet today  
CUSHMAN MOTOR WORKS, INC.**  
906 No. 21st, Lincoln, Nebraska

## Parade of '57 Cars

(Continued from page 170)

previous year. Performance should be better because pounds per horsepower dropped from 18.4 in 1956 to 16.6 in 1957.

How was horsepower increased? In the classic manner: more displacement. There's no substitute for inches, as the saying goes.

Average displacement for 1957 is 306.5 cubic inches, up sharply from the 290.2 figure of 1956.

Over-all lengths jumped also although only 1.1 inches. But when you consider the increase in over-all length in the 15 years from 1941 to 1955 was only 2.7 inches, a one-year jump of 1.1 inches looks big.

Actually three cars (Chrysler, De Soto and Plymouth) are shorter this year, although the Plymouth is shorter by a mere 0.4 inch, hardly enough to be noticed. Ten cars are longer in 1957. Eight of the 1957 cars are wider and four are narrower.

What is happening is that the big cars are getting shorter and the small cars are getting longer. In 1953, for example, the longest car was 237 inches over-all, the shortest car was 181 inches, a spread of 56 inches. This year, the longest car is 227 inches over-all (a decrease of 10 inches) and the shortest car is 191 inches long (an increase of 10 inches) to make a spread of

only 36 inches. If the trend continues, the obvious result will be that all cars, regardless of price, will be the same size.

Inside there are changes, too. Most noticeable when you first get into a 1957 car is the decreased height of the seats. This was done in order to provide headroom in the lower bodies. Yet front-seat headroom, on the average, decreased from 35.9 inches last year to 35.27 inches this year. Rear-seat headroom dropped from 34.8 inches to 34.5 inches.

Front-seat legroom increased sharply from 42.05 inches in 1956 to 44.8 inches this year. But the story is different in the back seat where legroom dropped from 44.8 inches in 1956 to 42.05 inches in 1957.

Prices went up in 1957 much more than over-all length. The buyer of a 1957 car will have to pay 7.17 percent more than he would have paid for a comparable model in 1956.

Only two of the cars have lowered prices on comparable models. They are Hudson (down 11.2 percent) and Nash (down 9.4 percent). Biggest increases were in Oldsmobile prices which jumped 11.4 percent and Lincoln prices which jumped 11.78 percent.

The over-all percentage increase would be greater if it included such new models

(Continued to page 298)

## House a hobby handsomely in space-saving built-ins!

This useful group of Western Pine shelves and cabinets houses Hi-Fi equipment, records and books.

Clean-cutting, smooth-surfaced and economical Western Pine woods are a joy to use in any workshop project. They are carefully selected and well seasoned, take all finishes without grain raising. See them at your local lumber dealer.

### FREE! New booklet of bright ideas!

"FRIENDLY HOME IDEAS"—85 photographs, many in color, feature traditional and contemporary ideas for building, decorating and remodeling using cheerful Western Pines. Also new modern finishes. Write for your FREE copy to WESTERN PINE ASSOCIATION, Dept. 901-N, Yeon Building, Portland 4, Oregon.



## The Western Pines

Idaho White Pine

Ponderosa Pine

Sugar Pine

and these woods from the Western Pine mills

WHITE FIR • INCENSE CEDAR

RED CEDAR • DOUGLAS FIR

ENGELMANN SPRUCE

LOGPOLE PINE • LARCH

are manufactured to high standards of seasoning, grading, measurement



TODAY'S WESTERN PINE TREE FARMING GUARANTEES LUMBER TOMORROW



# THOR SPEEDSAWS

*Super-power at popular prices*

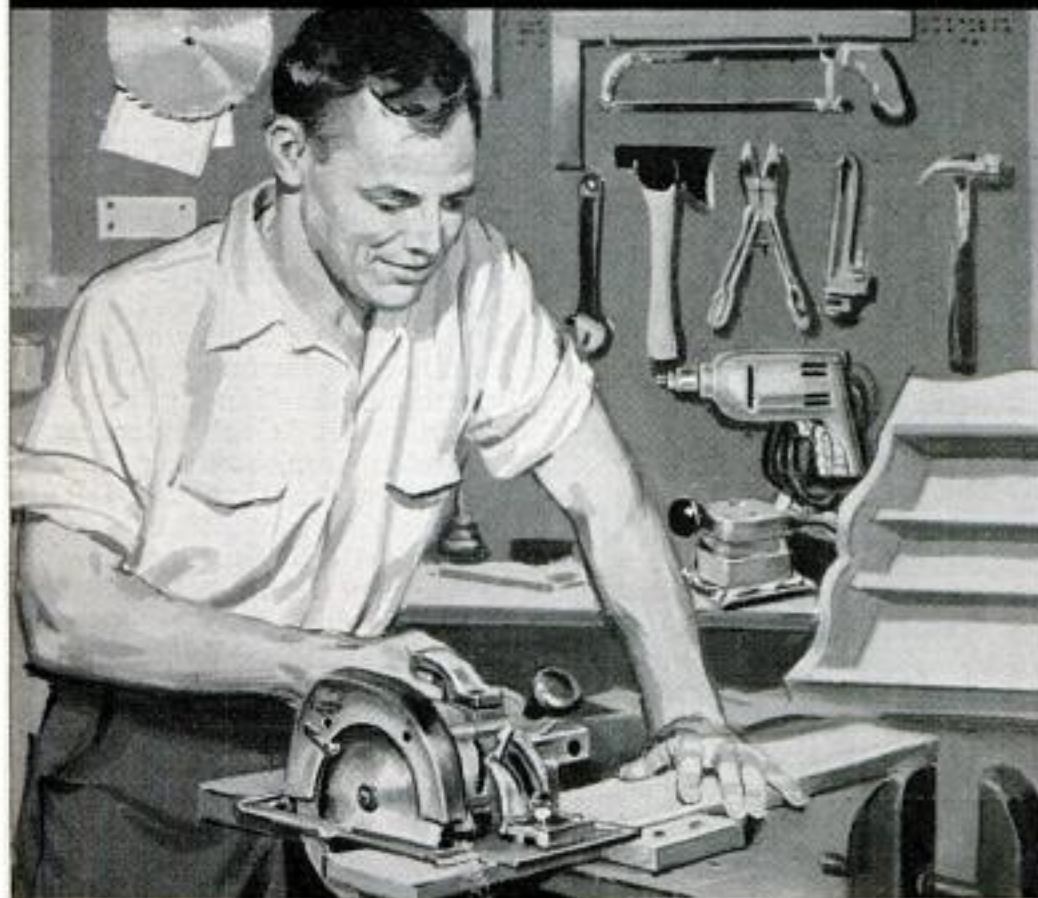

MODEL 450  
6½" SPEEDSAW  
ONLY  
**\$49<sup>95</sup>**

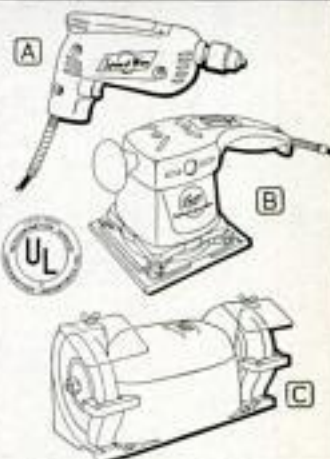

- A Thor SpeedDrill**
- B Thor SpeedSander**
- C Thor SpeedGrinder**

Be sure to see the complete line of Thor SpeedSanders, SpeedGrinders, SpeedDrills, and SpeedSaws at your hardware dealer's.

Model 450 6½" SpeedSaw is at home in the carpenter shop or the home workshop. Cuts 2 x 4's at 45°. Highest quality ball and anti-friction bearings throughout. Easy adjustments for depth and angle cuts. Powered by Thor's stallproof motor.

When you check the electric saw market, you'll find just how much more value Thor packs into its SpeedSaws. Even more amazing are SpeedSaw prices—just about half what you would expect to pay for tools of this quality.

Thor's new model 450 & 475 SpeedSaws are rugged tools, perfect for the contrac-

tor, woodworking plants and for the man with the home workshop who really wants the best.

Both saws are powered by stallproof Thor-built motors—plenty of zip for the toughest cuts. Other Thor SpeedSaws from \$29.95 up. Speedway Mfg. Co., a division of Thor Power Tool Co., Aurora, Illinois.



**THOR POWER TOOL COMPANY**

*Branches in all principal cities*

World's largest exclusive manufacturer of portable air and electric tools

MODEL 475  
7¼" SPEEDSAW  
JUST  
**\$64<sup>95</sup>**



Model 475 is priced at about half what you would expect to pay for a saw with these features: 1.75 h.p. All ball-bearing construction for heavy duty service. Weight just 14 lbs. Cuts 2 x 4's at 45°.



as the hardtop station wagons of Buick, Oldsmobile and Mercury, the new Ford Fairlane 500 line (which was not built last year) and the new Mercury Turnpike Cruiser line as well as other higher-price new models such as the Rambler V8. These were omitted from the average because no comparable models were built in 1956.

The most important engineering development for the year is the adoption of torsion bars for front-end springing by the entire Chrysler family of cars. This marks the first major change in front-suspension design in many years, with the single exception of the Packard torsion-bar suspension system introduced two years ago.

Other engineering innovations were relatively minor factors in the over-all car market. Chevrolet announced it had fuel injection for its entire line, but few, if any, 1957 Chevrolets have been built with it at this writing months after introduction date. Most of the limited number of fuel-injection engines (and Chevrolet is not releasing production figures) are expected to go into competition models of the Corvette. It is extremely unlikely that fuel-injection engines will appear in Chevrolet dealers' showrooms in quantity during 1957.

Cadillac also is announcing its air-oil-suspension system on the super-deluxe Brougham, but that \$10,000 car can hardly be considered an important factor in the total car market.

Business for the whole car industry was down during 1956 but, experts say, it will increase in the 1957 model year. General Motors increased its share of the total market in 1956 by 3.3 percent, thanks principally to the amazing sales record of Chevrolet and Cadillac during the year. GM made in 1956, 53.6 percent of the cars built in the nation. Ford Motor Company increased its percentage slightly, by 0.1 percent. Chrysler Corporation's share dropped 2.6 percent. American Motors (down 0.2 percent) and Studebaker-Packard (down 0.6 percent) also declined. (All these figures are as of November 24, 1956.)

Packard, the fine car of yesteryear, died quietly during the model year 1956. Whether it will be reincarnated in 1958 is still uncertain, but the 1957 model is simply a deluxe Studebaker with trim changes. It is being built in South Bend on Studebaker assembly lines.

It is impossible to conclude this summary of the 1957 automobile picture without a mention, at least, of the Volkswagen. For the first time, PM includes a foreign car in its parade of new cars. And with reason. The Volkswagen during 1956 actually outsold at least seven domestic cars in this country. ★ ★ ★

## Discriminating motorists

**insist on years-ahead Quaker State  
for trouble-free driving**

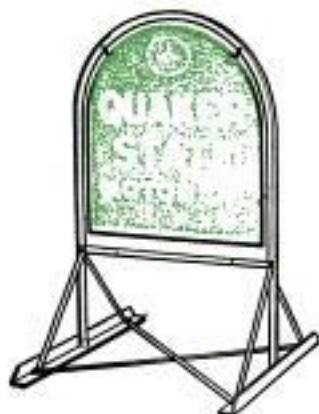

Super-refined from Pure Pennsylvania Grade Crude Oil, world's finest. Famous for performance, protection, economy! Try it!

**QUAKER STATE OIL REFINING CORP., OIL CITY, PA.**  
Member Pennsylvania Grade Crude Oil Association

# GRAVELY

New **EASE** for Country Living!

Now! 30 Tools



POWER CULTIVATE YOUR GARDEN



MOW GRASS OR WEEDS MULCH LEAVES



MOW LAWN AREAS



MOW TALL GRASS, WEEDS, CROPS



BLOW SNOW AWAY



MOVE SNOW, DIRT



HAUL HALF-TON LOADS



WRITE TODAY

## GRAVELY gets the Job done Better, Faster!

Even plowing a perfect seedbed in one operation is *easy* with a Gravelly! Because the Gravelly has the *extra* power you need for the tough jobs.

With 30 attachments, you do every lawn and garden job with a performance-proved attachment that does the job *better, faster, easier!* Gravelly attachments put the power to work where it counts,—at the attachment,—by direct drive from the engine!

### More For Your Money!

You get more power, more performance, more for your money when you buy Gravelly. The cut-away view of the tractor on the right shows you the clean, compact design which is the reason for the remarkable performance of the Gravelly Tractor.

### New Rotary Cultivator

Now, power-cultivate your garden with the new Gravelly Rotary Cultivator—one of seven NEW attachments for the Gravelly. Never before have you been offered such versatility, such power for your jobs!

- ALL-GEAR DRIVE
- POWER REVERSE
- Power Attachments Securely Mounted by Only 4 Bolts



SINCE 1922

Send coupon today for "Power vs. Drudgery", the big booklet that shows how Gravelly equipment solves your upkeep and gardening problems . . . faster, easier, better! (EASY PAYMENT PLAN)

**GRAVELLY TRACTORS, INC.**  
BOX 263, DUNBAR, W. VA.

Please send me "Power vs. Drudgery" Booklet and dealer's name.

NAME \_\_\_\_\_

ADDRESS \_\_\_\_\_

CITY \_\_\_\_\_ STATE \_\_\_\_\_

**FIELD-TESTED SINCE 1922**

## Next best thing to Power Steering!



# BALL BEARING

## IDLER ARM KIT



Adjusts out  
steering play  
with a twist  
of a nut!

### **POSITIVE STEERING CONTROL** Idler

Arm "floats" between ball bearings. No slack, no bind! Not a gadget. Makes steering easier, safer, quieter. Even improves cars with power steering!

**SAVES MONEY** Maintains alignment. Prolongs life of tires and front-end parts!

**EASY TO INSTALL** Any garage that can re-set toe-in (easy with Moog Toe-in Gauge) can install in a matter of minutes!

Ask your favorite automotive supplier to demonstrate the Moog Ball-Bearing Idler Arm. Kit K-251 fits 4 out of 5 cars.

**MOOG INDUSTRIES, INC.**  
St. Louis 14, Mo.

Manufacturers of the most complete line of "under-the-car" parts.

## Do Small Cars Make Cents?

(Continued from page 193)

The Lloyd averaged 35.45 miles per gallon during the test for a weekly gasoline bill of \$3.30 and a fuel cost per mile of less than one cent,  $\frac{9}{10}$  cent to be exact. In the special economy test it averaged 41.59 miles per gallon.

Extremely small, the Lloyd is easily maneuvered in traffic, but it rides hard and is not designed for comfort. It is, perhaps, just a little too elemental for American drivers.

### Renault Dauphine

Newest of the French Renaults is the Dauphine. It is an excellent car to drive either on the highway or in traffic. It has four doors, (it and the Magnette being the only imports tested with four doors) and is easy to get in and out of. Visibility is excellent all around and, although the water-cooled four-cylinder engine is in the rear, you'd never guess it from its styling.

Gasoline economy is excellent. Over-all it averaged 35.08 miles per gallon, only slightly lower than the Lloyd. This gave a weekly fuel bill of \$3.34 and a cost per mile for gasoline of  $\frac{9}{10}$  cent.

In the special economy trial, the Dauphine averaged 40.73 miles per gallon.

Some of the outstanding characteristics of the Dauphine are its amazingly quiet four-cylinder engine that is scarcely audible while idling, its excellent and quick-acting hot-water heater, its large rear window for good rear visibility.

Altogether it is a fine car and it will maintain a fast highway speed apparently without effort.

### Volkswagen

Best-selling foreign car in this country, the Volkswagen is powered by a four-cylinder, rear engine that is air cooled and somewhat noisy. It is an extremely nimble car and is one that tempts you to drive at its limit at all times.

The VW consistently made better time in the test than any other car (including the American models). It is most pleasant to drive, being a happy combination of sedan comfort and sports-car handling. It can be driven all day at 65 miles per hour. Its four-speed transmission, when properly used, enables you to scoot through traffic.

Over-all gasoline mileage was 31.22 miles per gallon for a weekly gasoline bill of \$3.75 and a cost per mile of gasoline of 1.0 cent.

In the special economy run, the Volkswagen mileage jumped to 41.16 miles per

(Continued to page 302)

ROCKWELL-BUILT

# DELTA 14" utility drill press



## ... industrial quality at low home workshop price!

No other drill press in its class offers you so much for so little—so much power, ruggedness, and precision, so many outstanding features, so many industrial quality extras!

**UNMATCHED VERSATILITY**—Six interchangeable spindles make it easy to adapt for routing, shaping, mortising, grinding, reaming—and countless other jobs.

**EASY, ACCURATE OPERATION**—Swing-type belt guard for fast, easy speed changes—work table with clamping ledges

and T-slots facilitates work—easy adjustment around quill to compensate for wear—plus all the Delta Quality features that mean accurate, trouble-free operation.

**PRODUCTION-LINE RUGGEDNESS**—This is the same 14" drill press being used in thousands of industrial plants! It's yours now at a new *low* price—and for just a few dollars down on the easy Delta Budget Plan.

See this great new Delta 14" Utility Drill Press—compare, and you'll see why it's your biggest drill press value. Your Delta Dealer is listed under "TOOLS" in the Yellow Pages.

Send coupon for catalog—today!



another product by  
**ROCKWELL**



DELTA POWER TOOL DIVISION,  
ROCKWELL MANUFACTURING CO.  
502B N. LEXINGTON AVE., PITTSBURGH 8, PA.

- Please send complete information on new Delta 14" Utility Drill Press.
- Please send names of my nearest Delta Dealers.

Name \_\_\_\_\_

Address \_\_\_\_\_

City \_\_\_\_\_ County \_\_\_\_\_ State \_\_\_\_\_

# Nicholson Saw Quiz

How many of these saws do you know?

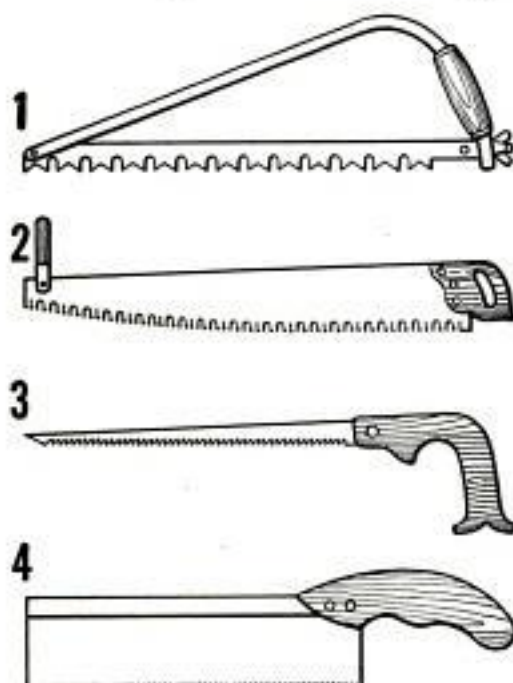

Answers: 1. Pruning Saw. 2. One-Man Cross-cut Saw. 3. Keyhole Saw. 4. Dovetail Saw.

EVERY craftsman knows that there's a saw for every cutting job. And there's a Nicholson or Black Diamond file that's been designed for keeping teeth keen on every saw made—files for hand saws, crosscuts, chain saws, circular blades. You name the saw, we've got the file to keep it in topnotch cutting condition.

A dull saw is an inefficient—and often a dangerous—tool. Keep *all* of your saws sharp... with Nicholson or Black Diamond files.

**FREE: "File Philosophy."** Big new edition on types, use and care of files. Write for your copy soon.



**NICHOLSON FILE COMPANY**

Providence, R.I.

(In Canada: Nicholson File Company of Canada Ltd., Port Hope, Ontario)



**NICHOLSON FILES**  
A FILE FOR EVERY PURPOSE

gallon, an indication of how hard it was driven in the main test. This was the biggest jump (almost 10 miles per gallon) of any car in the test.

Rear visibility on the VW is extremely limited by a very small rear window. An outside mirror is essential for driving in traffic. Heater operation has been improved considerably in the past two years and the current model seems quite adequate in this.

Handling is very good as is the ride over rough roads. It has independent suspension all around. Workmanship is excellent and the body is sturdy. Doors open and close nicely.

## Borgward Isabella

The Borgward, by the standards of the "small" cars that precede it in this story, is big. It is also well-built and carries a much higher price tag (over \$3000). Interior appointments are excellent and the ride is superior. Comfort is unexcelled.

It averaged 25.18 miles to the gallon during the test for a weekly gasoline bill of \$4.65 and a gasoline cost per mile of 1.2 cents. In the special economy run, the gasoline mileage increased slightly to 28.96 miles per gallon.

Extremely fast, it has a top speed of about 100 miles per hour. The four-cylinder engine drives through a four-speed transmission. The shift lever is mounted on the steering column and on the test car it was somewhat "rubbery" in operation but this was later corrected by linkage adjustments.

## Volvo

The only Swedish car in the test, the Volvo is large enough to look like an American car of 10 years ago. It is very fast and has handling qualities unmatched by any car in the test regardless of price. The Volvo can be wheeled around corners like a sports car and yet it rides quietly and comfortably. Its heating system is excellent.

During the over-all test it averaged 24.38 miles per gallon for a weekly bill of \$4.79 and a cost per mile for gasoline of 1.2 cents. In the special economy run it averaged 28.96 miles per gallon.

Workmanship, inside and out, in the Volvo is exceptional. Its four-cylinder engine is conventional in design, built for long life and ease of maintenance.

## Metropolitan

A combination of American and British design, the Metropolitan is sold by American Motors dealers in the United States. Therefore, it has more widespread service facilities than other foreign cars. It is built

(Continued to page 304)



Design, styling, accessories, new for '57. Molded Plywoods, Ply-Lap, aluminum, cedar strip. On display at Chicago and other boat shows. FREE Catalog. **WAGEMAKER COMPANY**  
Dept. 27-57, Grand Rapids, Michigan



**CUT RADIO CHASSIS HOLES IN 1-1/2 MINUTES OR LESS**  
Quickly make accurate round, square, key, or "D" openings . . . in metal, bakelite or hard rubber . . . with GREENLEE Radio Chassis Punches. Simply turn with a wrench. Many sizes. Write for details. Greenlee Tool Co., 2102 Columbia Avenue, Rockford, Illinois.



**PAGE FOR TILLING PLOWING MOWING**  
**FULL LINE** 2 to 6 HP with complete gear drive and reverse.  
**Free Catalog** **LOW PRICES** **EASY TERMS** **Over 30 Years Experience**  
**FULLY GUARANTEED!** Over 60 attachments available!  
**PAGE 1904-F 5. 81st STREET MILWAUKEE, WIS.**



**"FIRE UP"**  
YOUR ENGINE AT ALL SPEEDS WITH AUTO-LITE RESISTOR SPARK PLUGS WITH **POWER TIP**  
LOOK FOR THE PROTRUDING TIP!

**stock your shop**



**SCREWS • BOLTS • NUTS**

Look for this in your hardware store—the newest, cleverest, most convenient method for buying your screws and bolts, and for keeping them handy for quick use! Sparkling clear-plastic boxes, brilliantly labeled, are packed with generous quantities of top-quality screws. NOT an assortment. Each box contains one size only. Available in 40 most-wanted sizes and types. Start to "STOCK your SHOP" now!

**59c PER BOX**

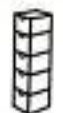

**5-BOX DrawnBack** USED IN MANY WAYS

**ELCO TOOL & SCREW CORP., Rockford, Ill.**

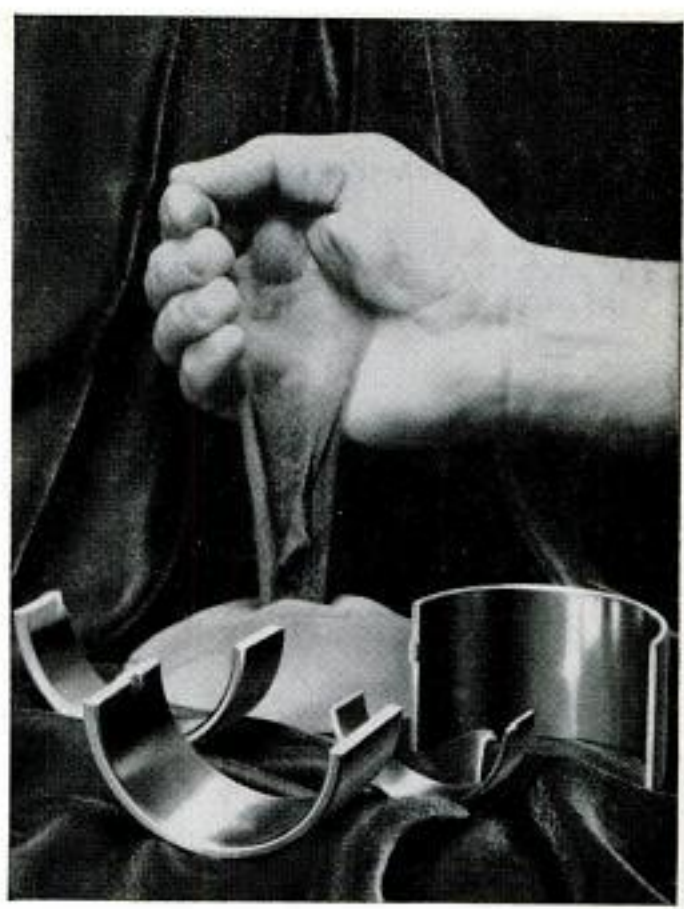

*Through research metal powder makes better engine bearings*

Searching for a superior long-mileage bearing for heavy-duty operation, Federal-Mogul research found the "magic key" in powder metallurgy. Copper and lead were alloyed in powder so fine it quickly sifts through the mesh of a screen that will hold water. Yet each dust-like particle is a pure, balanced alloy. Heat and pressure compact, bond the powder to steel strip. A new process . . . a new bearing . . . a new mileage horizon! Today we produce millions of them for original equipment and service replacement.

**FEDERAL-MOGUL SERVICE**  
*Division of*  
**Federal-Mogul-Bower Bearings, Inc.**

**Mechanics Know . . .**  
that the black and red Federal-Mogul box identifies the service bearing line as modern as today's engines.

**RESEARCH • DESIGN**  
**METALLURGY • PRECISION**  
**MANUFACTURING • SERVICE**



# REPLACE YOUR

## OLD WOOD CELLAR DOOR



## WITH A MODERN ALL-STEEL BILCO DOOR

# DO IT YOURSELF

IN JUST 3 TO 4 HOURS

Think of it! Only a few hours of pleasant work to replace your unsightly, troublesome wood hatchway with a lifetime, weathertight BILCO . . . the door installed on tens of thousands of new homes.

**PAYS FOR ITSELF!** Cost so little, yet never needs repair or replacement. Operates at a touch. Smooth, trim appearance adds amazing new beauty to your home.

Rush coupon TODAY for free folder and "Do It Yourself" pamphlet showing step by step replacement of wood hatchway.

# Bilco®

AMERICA'S FINEST  
BASEMENT DOOR

THE BILCO CO.  
DEPT. 943C  
NEW HAVEN, CONN.

Gentlemen: Please send me "Do It Yourself Pamphlet" along with other literature showing sizes.

Name \_\_\_\_\_

Street \_\_\_\_\_

City \_\_\_\_\_ State \_\_\_\_\_

by the Austin company in England and has an Austin engine and can be serviced by Austin dealers.

In the over-all economy test it averaged 24.02 miles per gallon for a weekly bill of \$4.87 and a cost per mile of 1.2 cents. In the special economy run, it averaged 32.58 miles per gallon.

The Metropolitan is extremely small inside and out. It is a two seater only and does not have the comfortable ride of most other cars in this test. It has excellent acceleration and, having only three speeds, can be driven around town without frequent shifting of gears, unlike many of the other foreign cars. It is a fine car for "scooting" in traffic.

On the highway it is fast and rides comfortably. On rough roads and over railroad crossings its hard riding becomes apparent.

### Magnette

With typical British luxury built in, the MG Magnette is a full-size economy car. It rides better than any car in the test (being just a shade better than the Borgward) and has the convenience of four doors. It is very roomy for four persons and can seat five without crowding.

Its average over-all was 21.53 miles per gallon. Weekly gasoline bill was \$5.44 and the cost per mile for fuel is 1.4 cents. No special economy run was made with the Magnette. It is a very durable, richly finished car both inside and out and gives the appearance of quality.

### Conclusion

The results of the test will have to speak for themselves. You will have to decide if the gasoline saving is enough to make the small car enticing to you.

You must remember that, while the American cars use more gasoline, they perform some of the work for you. The automatic transmission shifts itself and, in traffic, that is desirable to some. However, in the three 1957 American cars tested, the driver's left foot was kept busy most of the time operating the foot brake because of the tendency to over-accelerate due to the big engines. There is some question as to whether the amount of driver effort saved by the automatic shift is important because of the added work of braking.

Wheel turning is easier and faster on the small cars and you will be less tired from maneuvering. But you can get a similar help in the American cars by ordering power steering. However, you will still have to do more wheel turning in all except the Plymouth.

There are other nonfinancial advantages

(Continued to page 306)



*now, in power tools, too,*  
**if it's Remington, it's right!**



powerful enough  
to drill  
through steel...

light enough  
for a woman to  
wax fine furniture!

*the famous 149B Power Drill has 5  
great features that make it right for you!*

only  
**\$28.50\***

- Precision geared chuck for greater accuracy!
- Heat treated gears for longer life!
- Balanced armatures for smoother running!
- Anti-heating fan for cooler operation and longer wear!
- Die cast aluminum alloy housing for light weight...longer life!

**MODEL 149B.** 1/4-inch drill; AC-DC 25 to 60 cycle; 115 volts; 2500 rpm. free speed; 1500 rpm. load speed; 3lbs.; U.L. approved.

Here's the answer to the tough ones—the jobs that defy ordinary drills! Yes, now you can have power tools by Remington, the newest name in power tools...the greatest name in sporting firearms and ammunition for 141 years.

Model 149B has the power of drills costing twice as much! And it's built for superior performance on the most rugged jobs—as are *all* of Remington's famous Mall power tools.

With its attachments, this drill can be used as a saw, planer, sander, polisher, paint mixer, hedge trimmer, screw driver, and in many other ways. Saves hours of work.

There's a power tool by Mall Tool Company, Division of Remington Arms Company, Inc., for every need. For further information just fill out the convenient coupon.

**Remington** Mall

**MALL TOOL COMPANY**  
 Division of Remington Arms Company, Inc.  
 25000 South Western Avenue - Park Forest, Illinois



Electric Saws for every carpentry job.



Belt and Orbital type sanders.

\*Prices and specifications subject to change without notice.

• **MALL TOOL COMPANY, Division of Remington Arms Company, Inc. Dept. B6**  
 • 25000 S. Western Avenue, Park Forest, Illinois

• Please send free catalog on Portable Electric Tools.

• NAME \_\_\_\_\_  
 • STREET \_\_\_\_\_  
 • CITY \_\_\_\_\_ ZONE \_\_\_\_\_ STATE \_\_\_\_\_

*Kean Kutt says...*



**SHARK  
BRAND**

SWEDISH CHISELS  
MAKE HARD JOBS  
EASY because of

**SWEDISH CHARCOAL STEEL**

The steel used in Shark Brand Chisels contains fewer impurities than steel made with coal or coke and when it is properly annealed and tempered becomes tough but not brittle and therefore they hold their edge much, much longer.



... but there's more to why Shark Brand Chisels outlast and out perform ordinary chisels. Ask for them at your hardware dealer... write for new free booklet Dept. PM



**Sandvik STEEL, INC.**

Saw & Tool Division  
1702 NEVINS RD. FAIR LAWN, N. J.

IN CANADA: P.O. DRAWER 1330, STATION "O," MONTREAL 9

**\$500** in 4 months  
spare time

**Is what I made with the  
FOLEY LAWN MOWER SHARPENER**

... and I can sharpen all power mowers. No one can go wrong with the Foley machine."—V. J. Patterson wrote us. Get in this profitable business where you take in CASH right from the start. 99c of every dollar you take in is YOUR profit! The Foley Lawn Mower Sharpener handles all makes of hand and power mowers—up to 3 or 4 per hour. Hand mowers run \$1.50 to \$3.00—power mowers \$5.00 to \$8.00.

"In my home town of 5,000 I paid for the Foley 4 or 5 times over the first season. I also put a \$1033 oil furnace in my new house."—B. Mathews.

"We sharpened nearly 1000 mowers our first season and gained a reputation for the best work."—J. W. Kemper

**FREE PLAN** shows how to start—no experience needed. Foley prices are low—easy payments available. Get set now for big profits this Spring and Summer. Send coupon today—no salesman will call.

Send coupon for **FREE BOOK**  
"HOW TO SHARPEN POWER MOWERS"



**FOLEY MFG. CO., 207-7 Foley Bldg., Minneapolis 18, Minn.**  
Send **FREE BOOK** "How to Sharpen Power Mowers," and **FREE PLAN** on lawn mower business.

Name \_\_\_\_\_  
Address \_\_\_\_\_

to the small car. One is the fact that it does not fill up the garage and, probably for the first time in years, you will have room for the kids' bikes, the lawn mower and the car at the same time. It is also easier to park, to wash and to polish.

Thousands are finding the small car ideal as a second car. Many admit that very soon, the second car becomes the first car because of its ease of handling.

There it is: The case for the small car. If you're looking for a car to commute, look over the small-car field. You may find that you like one of them. ★★★



**Hydraulic Tower for TV**

In five minutes' time a hydraulic tower can be raised 75 feet in the air, to assist in remote television pickups. The tower unit, designed by the Illinois Bell Telephone Company, is the first of its kind. Another truck which accompanies the tower vehicle acts as a control center during the telecasts.

**Douglas Fir Seed**

West Germany, which devotes as high a percentage of its tillable land to forests as the United States, is buying all Douglas fir seed available. These seeds will be raised in West German state forests for the lumber industry. Annually, West Germany imports 25,000 pounds of fir seed at \$12 per pound.

# SEND COUPON TODAY!

United States Plywood Corporation  
Box 61, New York 46, N. Y.

PM 2-57

Please send me a copy of your 96-page book "Projects You Can Build With Old Craftsman Pine Plywood." I enclose 25¢.

NAME.....

ADDRESS.....

CITY.....STATE.....

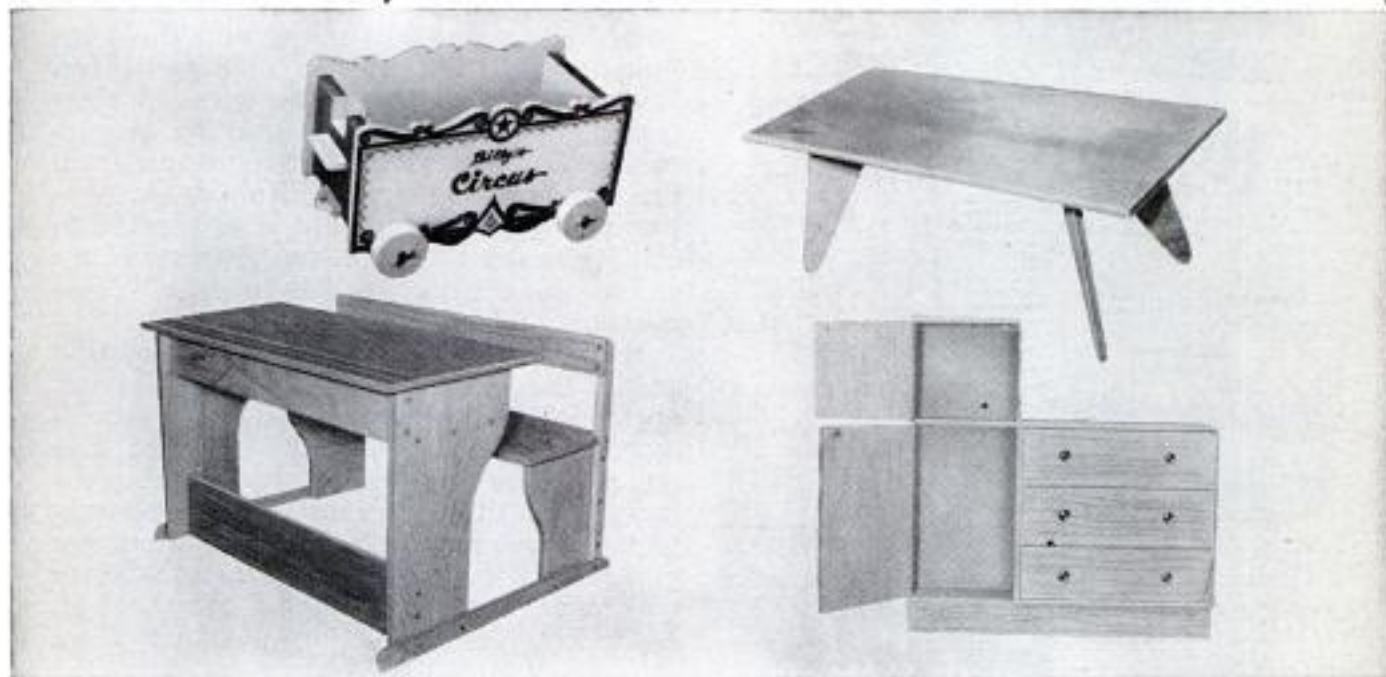

Upper left: 14" long circus wagon; upper right: 40" long rectangular coffee table; lower left: play-school bench; lower right: 53" high wardrobe-chest of drawers.

## New book shows how to build projects like these with OLD CRAFTSMAN PINE PLYWOOD

Furniture . . . cabinets . . . built-ins. You name it—and you can build it better with Weldwood Old Craftsman Pine Plywood. For Old Craftsman is the easiest working, easiest painting plywood ever. That's because it combines all the advantages of pine lumber with all of the advantages of rugged plywood construction.

And if you're anxious to start working with Old Craftsman, here's your golden

opportunity: a brand-new 96-page book of pine plywood projects. This book shows you 17 projects you can build to save you money, save you space, or just give you a lot of fun.

The book gives tips on working with pine plywood, and has plenty of pictures and easy-to-follow directions. Best of all, this 50¢ value costs you only 25¢. Send for your copy today!



# Weldwood®

## Old Craftsman PINE PLYWOOD

A product of United States Plywood Corporation  
Weldwood—The Best Known Name in Plywood



LOOK FOR THIS LABEL

# FREE!

## 228-page CATALOG—with 16 pages of last minute NEW items!



### FIRST 1957 ACCESSORIES

Parts and Accessories for all makes and models of cars from 1920 thru 1957!

### Saves UP TO 50%

on all parts for your car, truck, hot rod, custom car or station wagon—all models.

Get your FREE copy now . . . everything you need for your car, truck, custom styled car or hot rod. Save up to 50% buying-by-mail from Whitney! Thousands of hard-to-find items for cars from 1920 to 1957. See newest Hollywood accessories not offered in stores; high speed and power parts, custom styling equipment . . . all at lowest prices! Guaranteed satisfaction or money back. Our 20th year. Mail coupon.

#### RUSH COUPON

Please send 25¢ to help pay catalog mailing and handling costs. We will credit 25¢ on your first order for \$5.00 or more. Mail coupon NOW!



JUST A FEW OF OVER 75,000 ITEMS

J. C. WHITNEY & CO., 1917 P-2 Archer Ave., Chicago 16, Illinois

### Mail This Coupon Today!

J. C. WHITNEY & CO., 1917 P-2 Archer Avenue, Chicago 16, Illinois

Rush giant 1957 catalog of auto parts and accessories at sale prices. I enclose 25¢ to cover part of mailing and handling cost, which will be credited to me on my first \$5.00-or-more order.

Name \_\_\_\_\_

Address \_\_\_\_\_

City \_\_\_\_\_ State \_\_\_\_\_

## Detroit Listening Post

(Continued from page 195)

Turboglide) was slow getting into production. In the month of December Chevrolet built only 1200 of them while building about 42,000 cars every week! Production in January is 6000 units—a long way from enough to fill the orders.

Buick will also offer fuel injection as an option in 1958, we hear.

● Electronics will move into the auto industry in a big way in 1958 and after. Rambler started the move with its electronic-metering fuel injection (it is surprising how many "firsts" have come from the smaller companies). Nobody is prepared to price it now, but it's expected to sell for under \$300. Not too far distant are electronic controls for automatic transmissions and, maybe, ignition.

● In some ways, the most interesting part of the Auto Show was a symposium of automobile stylists sponsored by the American Society of Industrial Designers. The stylists came from every automobile company and they presented the industry viewpoint. It was the question-and-answer period that was interesting. The audience was made up of professional designers in all fields. What were their questions? Here are some:

"Do sales managers ever know anything but what has gone by? Why should they be permitted to influence design?"

"Is there any chance of a car being designed as a 'safety' car?"

"Why has the Rambler grown larger?"

"Why do cars look so much alike?"

"Is there any chance of a trend toward less horsepower?"

"Why all the chrome?"

These were typical questions. The answers defended the industry's attitudes. These stylists were right when they stated that Detroit builds the type of car that the public wants. Mr. Churchill of Studebaker-Packard stated about the same thing when he said that in 1957 Studebaker has a car that is styled within the trend of the industry. What he means is that it's in style with what the public wants.

Annual style changes, the industry men said, actually save the customer money by creating demands which make big production runs possible, reducing unit costs.

But, cautioned the GM stylist, you can't go too far with changes. You must not make the owner of your last year's car too unhappy or he'll lose his feeling of attachment with your company and he won't come back. He doesn't want to feel that you are deliberately "obsoleting" the car he has invested his money in. ★ ★ ★

**GIGANTIC  
SAVE-TO-70%**

# MAIL SALE

**WAR SURPLUS  
EXCESS INVENTORY  
BANKRUPT STOCK**

## ARMY POWER PLANTS

Amazing buys surplus Army and factory-to-plant and generators. Save to 60%.

- 1000-w, 115-v, 60-c \$179.50 Ppd.
- 2000-w, 115-v, 60-c \$269.95 Ppd.
- 3000-w, 115-v, 60-c \$299.50 Ppd.
- 5000-w, 115-v, 60-c \$497.50 Ppd.

Many other plants, generators. Get catalog.

## HYDRAULICS—PUMPS—AIR COMPRESSORS

Bargains in surplus finest quality hydraulic pumps, cylinders, valves. Also irrigation pumps, plastic pipe-fittings and air compressors, air tanks, regulators, gauges, paint spray, etc.

- Farm hyd. cylinder \$14.95. 1500-lb. gauge, \$3.40. Blackhawk hyd. system \$24.95. Control valve \$12.95. Air Compressor \$19.95. Air Tank \$8.79. Gauge 160-lb. \$1.89. Air Regulator \$3.29. Air Filter \$2.99. Many other air items.
- Irrigation Pump 3 1/2" \$44.37. Plastic Pipe 1/2" \$2. 3/4" \$2. 1" \$2. Rotary Gas Pump \$22.96. All of the above prepaid.

## DIAL EXTENSION TELEPHONE

Modern handset dial telephones. Use for extension to main phone on private systems.

- You can receive or originate calls. Has no bell. Use where main line ringing can be heard. List \$29.60.

SALE ..... \$8.61 Ppd.



## PREVIOUS SPECIALS

- Prtbl blower-htr 100,000 btu ..... FOB \$92.75
- Surveyors Level, tripod, rod ..... Ppd \$48.80
- Multi-Speed AC Motor 110-v... Ppd \$9.42
- Automatic Step-by-step Switch... Ppd \$13.71
- Hand Winch, 1000 lb. capacity Ppd \$8.95
- Invald Chair, 6 or 12 v motor FOB \$14.99
- Window Display Motor 20 rpm 110v Ppd \$2.71
- Burglar-Fire Alarm System... Ppd \$13.95
- Electric Alarm Bell AC-DC... Ppd 73c
- Pneumatic Tree Trimmer 10'... FOB \$8.59
- 545 1/2" Electric Drill 110v... Ppd \$30.95
- Farm-Industry Gas Hand Pump FOB \$9.71
- Finest Plastic Water Pipe 1 1/2" Ppd 8c
- Weed Sprayer, 5-row complete... Ppd \$97.65

## GEAR REDUCTION MOTOR BARGAINS

(a) INDUSTRIAL MOTOR.  
54 to 1 ratio. Output 10 to 200 rpm. Hi-torque. Run on 6 or 12 volts DC or 110-AC thru rheostat. Many uses. Cost \$35. \$4.97 Ppd.



(b) GOLF AND SMALL CAR MOTOR. Powerful, runs on 6, 12 or 24 volt battery. Speed 100 to 300 rpm. Wt. 34 lbs. Cost \$250. .... \$19.46 F.O.B.

## SPECIAL OF THE MONTH!

### G.E. Portable Power Generator

115-v, 3000-w DC

- Buy of the year! Genuine G.E. ball bearing DC unit. Operates electric AC-DC type portable tools — saws, chain saws, drills, sanders, etc.
- Also operates 115-v lights (will handle 30 100-w bulbs), electric heaters, etc. 11"x11"x20". Wt. 160 lbs.
- Complete ready to use. Driving shaft 1 1/2" 3". Speed 2400 RPM. New condition. Govt. Cost \$199. SALE..... \$49.71 FOB



## STAINLESS STEEL TANKS

Brand new 12x24" 400-lb. pressure capy. Wt. 17 lbs. Last chance to get these marvelous Air Corp units. No more available. Complete with air-filling valve.

Use for air compressors, spray systems (fill partially with liquid), air horns, 100s uses, home-industry. 1/2" pipe thread openings. Commercial cost would be over \$40. Also complete parts for air compressor systems at low prices (See new winter catalog.) Govt. Cost over \$30. SALE, \$16.95 FOB.



ORDER FROM AD or write for big new WINTER CATALOG 1000s items at tremendous savings. We pay frt. except where FOB.

**BURDEN SALES COMPANY**  
804 "D" St. LINCOLN, NEBRASKA



## MUFFLER TROUBLE?

Repair muffler and exhaust leaks with finger and thumb in ten minutes. No tools — no mixing. Withstands heat and vibration. Stops carbon monoxide gas poisoning. \$1.69 can. Canada, \$1.79.

### HOLT'S Gum Muffler Seal

At Auto Accessory and Parts Replacement Stores, or write us for Full Details.

TREGLOWN CO., INC., Fanwood 116, N. J.

IN CANADA: Treglown, Ltd., 1366 Greene Ave., Montreal 6

## ONE-BAG MIXER THAT TRANSPORTS



Universal Transmix® transports, mixes and dumps cement, silage, dirt, etc. P. T. O. driven — no gears or chains. Can be installed or removed in 15 minutes. Fits Ford, Ferguson, AC-WD, IHC Super C, H&M, Case VAC, J.D.-40, Oliver 55, and other 2- and 3-plow tractors. Unconditionally guaranteed. See your dealer or write, giving tractor model, to

UNIVERSAL PULLEYS COMPANY  
385 NORTH MOSLEY • WICHITA, KANSAS

## make your own Gems 32.50 P.O.D.

The Gem Maker comes complete with all necessary equipment, including a super-charged diamond blade for sawing, and all wheels for grinding, shaping and polishing; also complete instructions. The complete equipment as shown, less motor and belt, for only \$32.50. L.o.b. Burlington, Wisconsin. Write today for information and literature.

**B & I MANUFACTURING CO.**  
Dept. P, Burlington, Wis.

## SENSATIONAL NEW HIGH SPEED DRILL MASTER

NOW turns the ordinary shop drill into HIGH SPEED DRILL. PRESS at a big saving. When DRILLMASTER is used on a 5,000 rpm drill press its top speed will be 20,000 rpm. Does the work of expensive high speed drill presses on brass, aluminum, plastic and cast iron where high speed drilling is necessary. Available for work of any size runs. Fits any 1/2" chuck, holding drills from 5/32 to #80. Shafts are heat treated and ground. Ball bearings and oil impregnated bearings and gear train are housed in cast aluminum. Precision made throughout. \$62.50 Fob. MAIL ORDER TODAY only. \$62.50 Fob. Qd. Wt. ON C.O.D. ORDERS WE REQUIRE A 10% DEPOSIT. 2% DIRZIUS MACHINE SHOP "K", 1423-25 So. 52nd Ave., Cicero 50, Ill.

## Jiffy SAWHORSE BRACKETS

NO NAILS NO SCREWS NO BOLTS

Now a sawhorse in a jiffy! Just use Jiffy Brackets and 2x4s. Sold by hdw. and bldg. supply stores everywhere, or order direct. \$1.95 A pair.

GRAND HAVEN STAMPED PRODUCTS CO.  
Grand Haven, Mich.



## Short Cuts with WILHOLD WHITE GLUE



with Orthoal

Glue joints. Glue glass in place. One 1 1/2" brad holds mitre while glue dries

**MAKE PICTURE FRAMES without dowels or splines**

You'll like it better. Simplifies woodworking. Sets quick, dries clear,

holds permanently. Illustrated, one of many Wilhold shortcuts. FREE BOOKLET.

Paint, Hardware, Lumber, Variety Stores. Or write WILHOLD PRODUCTS Los Angeles 31, Calif.; Chicago 44, Ill.

## DRILL STAND & SHARPENER

Fits all portable drills; converts drill to bench grinder. Sharpens round shank drills from 3/32" to 1 1/2" diameter. Grinds 4 different drill point angles. Recessed guides eliminate use of protractor or fussy set-up work. Stand, \$6.95. Sharpener, \$2.95. Complete set includes stand, sharpener, wheelguard, clamp for drill, grinding wheel, arbor... \$8.95 PPD.

## SAW SHARPENING IS EASY

Super Filer No. 11 joints and sharpens hand and circular saws 6" to 10" with all teeth correct in height, depth, pitch, bevel. When file hits steel roller, teeth are finished. Saw runs true with no side pull. Includes 8" file. \$9.95 PPD.

"TRU-CIRCLE" saw set automatically sets teeth at 10° or more. \$2.95 PPD.

**SUPER SAW FILER No. 6**  
Automatically controls depth, angle, pitch for all saws. Precision made and calibrated. Use in any vise or clamp. Includes \$6.50 PPD.

**SEND FOR FREE CATALOG** A. D. MCBURNEY, 5908 Hollywood Blvd., Hollywood 28, Cal., Dept. A-27

GRINDS • CARVES • ENGRAVES  
DRILLS • ROUTS • SHARPENS

## DREMEL *Electric* MOTO-TOOL

The handiest tool you can own for household jobs, your workshop, or hobby projects. Handles like a pencil. It saves time—makes all jobs easier—gives the finished product a professional look.

The Dremel Moto-Tool has an excellent record as a precision tool in industry. Fastest, most powerful tool of its kind—27,000 rpm. Buy a Moto-Tool—it will pay for itself in no time. See your dealer today.



MODEL No. 2 (Wgt. 1.3 oz.).....\$17.85

MODEL No. 1.....\$12.85

Moto-Tool Kit No. 2

Includes Model No. 2 Moto-Tool, 23 accessories (high-speed-steel cutters, grinders, polishers, etc.) in a steel case.....\$25.95

Kit No. 1.....\$21.50

**SEE YOUR DEALER.** If he cannot supply you, order direct from factory on a 6-day trial, money back guarantee. Send full amount and we pay postage or send \$2.00, and pay postman balance plus C.O.D. charges and fee.

**DREMEL MFG. CO., Dept. 117B, Racine, Wisconsin**

## new LOCKMATIC plier

locks its grip automatically. No adjusting needed. Easy trigger release. 7 1/4" size. Introductory special \$1.75 ppd.

Sarvie Tool Co., Alexandria, Minn.



*Six or V-8*  
*the going is great!*  
**'57 FORD**

## ROTO-HOE

**FAST,  
SMOOTH-HANDLING,  
EASY**

**Makes Gardening FUN!**



ROTO-HOE doesn't jump around, doesn't have to be jiggled, joggled, and bounced along. It's smooth, easy, pulls itself along. You'll enjoy growing fresh vegetables and beautiful flowers—without backaches, weeding problems—ROTO-HOE tills, cultivates between the rows, helps you have a better garden, more time to relax. Complete 2 h.p. ROTO-HOE only \$129.50. 22" Self-Propelling ROTO-CUTTER and many other low-cost attachments use same power unit, change so quickly. Write for FREE color folder, nearby dealer's name.

**ROTO-HOE & SPRAYER CO., Dept. P-19, Newbury, Ohio**

## Backstage Wizardry of the TV Commercials

(Continued from page 126)

rim, but the tire stayed whole. Finally, we took a sequence of a pile driver whomping down on the wheel, with the same result. The demonstrations were so spectacular on TV that, even if the tire had come apart, the film could have been great commercials for whatever broke it."

### Complete City in Studio

Most studios making TV commercials have discovered that it's usually cheaper to build a complete city in the studio, where power and facilities are available, than to shoot on location. Transfilm, to get a few seconds showing the inside of a refrigerator, built a refrigerator interior without any walls; shelves were suspended by invisible wire and shot against a black background. Prop rooms of TV-commercial studios are warehouses for model villages, sections of houses, complete rooms, mountain streams, whole woodlands of artificial trees and ferns, and enough food to stock a supermarket. Walk into Steve Elliot's prop room, and he may throw a man-size boulder at you. Don't duck. Catch it and heave it back. It's hollow rubber and weighs four ounces.

To achieve realism, TV-commercial producers have to be inventors, entrepreneurs, good businessmen and sometimes magicians. Typical was the time Steve Elliot got

(Continued to page 312)

Animation is achieved via Oxberry stand, compound and camera with motorized zoom, handwheel control

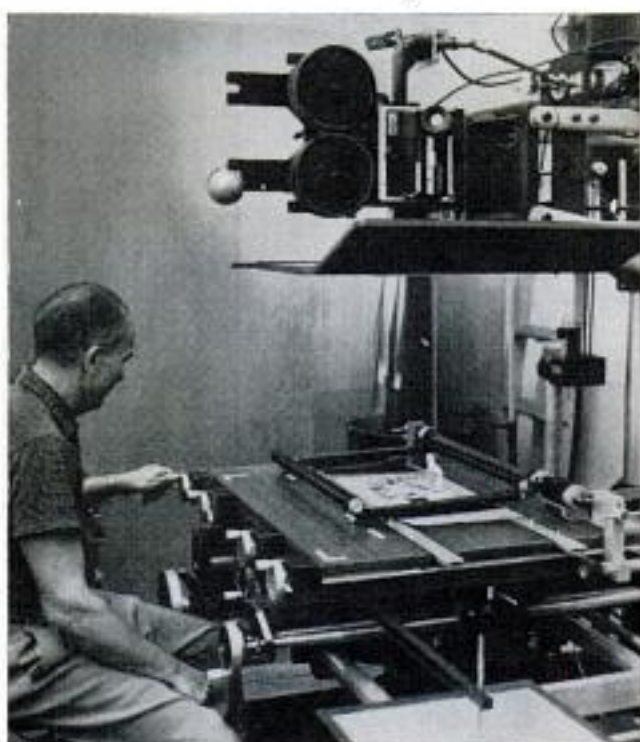



**AH-H-H-H!** Never before such a perfect blending of beauty, strength, and performance in a boat! Arkansas Traveler's new **FORWARD SWEEP** brings you a "Years-ahead" concept in boat design. You *must* see it! Write.

ARKANSAS TRAVELER BOATS, 2006 E. 14th, Little Rock, Ark.

*Arkansas* **TRAVELER** ALUMINUM BOATS

## HOW TO BUILD Your Own GARAGE

Save Up to 50% of Usual Cost!

Get Popular Mechanics' brand new book **How to Build Your Own Garage** by Wayne Leckey, Assistant Shop Notes Editor, and find out how you can build your own garage at savings of 50% of usual cost. Leckey tells in clear step-by-step instructions and shows in big, clear photos, drawings and diagrams how to perform every building operation from laying the concrete to installing the final trim. There are 25 designs. Brick, frame, and concrete block fully covered. Send \$3.50 for your copy. 7-day money back guarantee.

POPULAR MECHANICS PRESS, 200 E. Ontario, Chicago 11, Ill.

## FREE CATALOG

Over 300 books on Fishing, Hunting, Home Repairs and Improvements, Bricklaying, Welding, Home Workshop, Power Tools, Hobbies, Crafts, Home Building, Trades, Making Money at Home, Furniture Making, Woodworking, Carving, Photography, Art, Drawing, Mechanics, Engineering, Refrigeration, Plumbing, Radio-TV, Electricity, Automobiles, Farming, Livestock, Gardening, Decorating, Painting, many, many more. Send for yours today.

POPULAR MECHANICS PRESS, 200 E. Ontario St., Chicago 11

### SEE YOUR DEALER

Two steps to professional results in your workshop: (1) check POPULAR MECHANICS for helpful "how to" suggestions; (2) discuss your project with you dealer. He knows the importance of working with quality products. They're advertised in POPULAR MECHANICS.



FEBRUARY 1957



*It's easy  
to have  
MODERN  
KITCHEN  
VENTILATION*

There's nothing like a Trade-Wind Ventilating Hood to make any housewife happy... and comfortable while she cooks. Keeps the kitchen as well as the entire house, free of greasy fumes and odors.

Powerful Trade-Wind blower units install in a cabinet over the range, or in the ceiling. Many styles to choose from. And a Trade-Wind is fun to install in new or existing homes... or your electrician can do it for you.

Mail the coupon for full color brochure.

**YOU GET more WITH TRADE-WIND**

Trade-Wind Motorfans, Inc. Dept. PM  
7757 Paramount Blvd., Rivera, Calif.

Please send full color brochure on Trade-Wind equipment.

Name \_\_\_\_\_

Address \_\_\_\_\_

AGAIN CONSTANTINE BRINGS YOU  
AMERICA'S NEWEST AND FINEST

**WOOD**  
TOOL, MATERIAL  
AND CRAFTSMAN  
SUPPLY MANUAL



### 145th ANNIVERSARY EDITION

This new catalog is the biggest and best woodworking and hobby-book America's leading supplier to craftsmen has ever published. Everything for the woodworker at lowest prices. Plans, projects, patterns, How-To-Do-It Articles, sections on newest power and hand tools, finishing materials, inlay borders and panels. Over 83 inlay designs; wood identification panel shows 60 different woods in natural color. Woodworking's finest book, invaluable to homeowners and craftsmen. Send for your copy today!

126 pages — Full Color. Complete selection of Rare and Fancy Imported and Domestic woods, veneers, inlays, carvings, mouldings, hard-to-get items, hardware, upholstery supplies, and Do-It-Yourself Information.

**ALBERT CONSTANTINE & SON, Inc.**  
2058H EASTCHESTER ROAD NEW YORK 61, NEW YORK

### MAIL COUPON TODAY

**ALBERT CONSTANTINE & SON, INC.**  
2058H Eastchester Rd., New York 61, N. Y.

Please send copy of 1957 Master Manual. Enclosed is 50¢ (refunded on first order) to cover postage and handling.

Name \_\_\_\_\_

Address \_\_\_\_\_

City \_\_\_\_\_

Zone \_\_\_\_\_ State \_\_\_\_\_

# FREE PLAN

Tells How to Start  
Your Own Business

## FILING SAWS



Saws come  
from 20 and  
30 miles

Files Thousands of Saws  
in Spare Time

"I rented a two-car garage and have all the work I can do. Some days I start 6:30 in the morning. I get work 20 and 30 miles from my place of business."  
—Charles H. Smith

"I have done 4 or 5 thousand saws in my spare time in the 4½ years since I got the outfit, and they are all coming back with repeat orders."  
—Len Crego.

### FOLEY FILED SAWS BRING NEW CUSTOMERS

Here is a steady repeat CASH business that pays up to \$3 to \$5 an hour, and you can start in your own basement or garage in your spare time. Every saw you sharpen with the machine accuracy of the Foley Saw Filer is an ad that brings more customers. S. M. Hollingshead wrote to us: "I am doing very well with my Foley Filer, and I am glad I invested in your machinery. It is very satisfactory and works very well in the small community in which I live."

You can file all hand saws, also hand and crosscut circular saws on the Foley Saw Filer. The adjustments are simple—there is no eyestrain—and you can start right away to turn out perfect cutting saws. "The first saw I sharpened with my Foley Saw Filer came out 100%. I think it is a marvel of perfection."—writes Clarence E. Parsons.

"**MONEY MAKING FACTS**" explains how you can get business from hardware stores, home owners, farmers, carpenters, schools, mills, factories, etc. Just think—with a modest investment, no overhead, no stock of goods to carry, you can start right in on a cash business that will help pay the rent, buy groceries, or a new car. Get the facts—send coupon today for this practical, money making plan. No salesman will call.



Send for **FREE BOOK**

FOLEY MFG. CO., 216-7 Foley Bldg.,  
Minneapolis 18, Minn.

Send me free book "**MONEY MAKING FACTS**"

Name \_\_\_\_\_

Address \_\_\_\_\_

a story board for a soap account. The script called for a flying fountain of cherubs all spouting water from their mouths. They made Celastic cherubs without trouble, and rigged wires to make them fly. "The trick," explains Steve, "was to get water up in the air without visible pipes, and have it spout from the little angels without flooding the studio." The dilemma was solved by a studio genius who remembered the old magician's trick of the magic spigot. Thin glass tubes were run from floor tanks up to cherubic mouths. Water pumped up inside the tubes flowed over the top and down the outside, in a perfect imitation of free-flowing streams. They emptied into the same tanks they sprang from, in a continuous-flow operation.

### Can't Fool Public

The struggle for realism can reach fantastic proportions—especially in food commercials. "The public doesn't like being fooled," explains one producer. "Most sponsors and agencies now insist on real live food."

This policy gave a six-aspirin headache to Transfilm last winter when a frozen-food account wanted a 60-second commercial showing fresh crops being picked and processed—from garden to freezer. "We built a whole truck garden and processing plant in the studio," recalls Phil Frankel, Transfilm production man. "Trucks dumped tons of soil on the floor, at the same moment studio hands were dismantling a bathroom where a pretty model had been taking a sudsy soak for a bath-salts commercial the day before. Nearby greenhouses supplied bean, spinach and strawberry plants. Fresh fruit was tied to proper bushes and trees. Within a few hours a flowering farm grew under hot light, and pickers moved in for the cameras. The only tough part of the processing procedure was the washing. We piled the picked vegetables in a bin, put a plastic shower curtain around the camera and caught the high-pressure spray in a flume that drained off to a sink 100 feet away. The cameras shot through a gap in the curtain and we hardly got soaked at all."

### Tricks Achieve Realism

In spite of the insistence on realism, producers still must resort to some tricks, especially since natural food doesn't always look as appetizing on TV as it really is. Whipped cream after an hour under the hot klieg lights looks awful; shaving cream looks delicious, and that's what many producers use on their cakes. Real coffee looks pallid; plain water and aniline dye

(Continued to page 314)



## AMMUNITION



Reload a whole carton for the cost of a few rounds of factory ammunition. Shotgun shells, rifle and pistol cartridges can be reloaded safely and easily with an inexpensive set of famous IDEAL Reloading Tools. 164 page IDEAL Reloaders Handbook ... \$1.00, postpaid. Free folder on request.

**THE LYMAN GUN SIGHT CORP.**  
MIDDLEFIELD, CONN.

**SMALL! POWERFUL!**

**ECONOMY TRACTOR**

Unequaled value! Low price! America's finest tractor. Ruggedly built. Easy to operate. 700 lbs. Borg-Warner clutch, trans, and diff 140 to 1 reduction. 40% more drawbar pull than ordinary tractors 8-1/4 H.P. engine. 20 quick change implements. HOOD, FENDERS.

Thousands In Use Write for complete details.

Engineering Products Co.  
915-K-2 Niagara Ct.  
Waukesha, Wisconsin

**Exclusive Double-Bearing HEAVY-DUTY PUMPS**

IRRIGATE • DRAIN • CIRCULATE • SPRAY  
Up to 7,500 GPH. 3,000 GPH from 25" well. Use 1/4 to 1 HP motor, 1 1/4" inlet; 1" outlet. Stainless shaft. TYPE X—2 oilless bronze bearings. **\$10.95**  
Won't rust.

TYPE XB—Ball bearing model. **\$12.95**  
Postpaid if cash with order. Rush your order today

**MONEY BACK GUARANTEE**  
Centrifugal and Gear Pumps in All Sizes  
**LABAWCO PUMPS, Belle Mead 2, N. J.**

**ELECTRIC WELDER** AC or DC 110 Volts

The "Little Marvel" all-metal welder. 5-year written guarantee. Welds 1/4" metal or money back. Repairs tanks, tools, fenders, machine parts, etc. Complete with everything—rods, unit, eye shield, directions. \$46.95 plus 50c postage. Flame torch necessary for soldering, cutting, brazing \$3.95 complete with carbons, brass rods, flux. \$2.00 Deposit on C.O.D. 75 ampere 1/4 inch Transformer Welder \$21.95 F.O.B.

**ESSAY MFG. CO., Dept. 51, Quincy 89, Mass.**

**\$695** Complete

## HOME PAINTING TIP No. 8



### PAINTING FURNITURE?

Stretchy "SCOTCH" Masking Tape hugs curves, keeps edges neat. Strips cleanly;

paint will not bleed through. Get 39¢, 69¢, 98¢, \$1.69 sizes in handy cutter-edge carton wherever paint is sold. Made by Minnesota Mining & Mfg. Co., St. Paul 6, Minn.

# KLEINS



## AID TO YOUR CRAFTSMANSHIP

These three pliers—a Klein Side Cutting Plier, Long Nose Plier and Oblique Cutting Plier—belong in every workman's kit.

They put the exclamation point after your good workmanship! For a century Klein has stood for the finest in pliers and Kleins are still the standard of comparison by which other pliers are judged.

There is a type and size of Klein Plier for every job—all famous for Klein quality "since 1857."



Your hardware store has Kleins in stock or can get them for you quickly. Look for this new display board. It shows the most popular items in the Klein line.



**Mathias KLEIN & Sons**  
Established 1857 Chicago, Ill., U.S.A.

7200 McCORMICK ROAD • CHICAGO 45, ILLINOIS

# It's Tops...



Sizes  
for any  
pipe cutting  
need



for quick clean cuts . . .

## RIDGID Heavy-Duty Pipe Cutter

Powerfully built—guaranteed not to warp or break, always tracks perfectly . . . Famous RIDGID thin-blade or heavy-duty cutter wheels of tool steel roll easily, cleanly through any pipe. Special wheels for stainless steel, cast iron. Every cutter factory-tested. For your work or home, it's most for your money—buy it at your Hardware Store!

Genuine  
**RIDGID**  
The World's Most  
Popular Pipe Wrench



# RIDGID

Work-Saver Pipe Tools

The Ridge Tool Company, Elyria, Ohio, U. S. A.

are what you usually see on the TV screen. Since steam won't photograph decently, there's usually a cigarette smoking up neatly behind the cup. Steam from a boiling pot won't show up; but that's easily remedied by dropping dry ice in the pot. Cake is always an "appetizing" mocha color; icing is usually green, because green comes out much whiter (real white or pale blue glazes, and black shimmers, so dark green is used instead). Most fresh vegetables get a coating of oil to make them sparkle and look delicious. And the beautiful fresh steaks you see are probably coated with petroleum jelly, because without it even the best one would look dull on the screen. But the food is fresh!

### Snowflakes Individually Selected

Detailwise, for a simple soapflake spot, Science Pictures' staff once spent 34 days picking out individual flakes the right shape and size, coating each one with fluorescent paint and dropping it into water while cameras ground away under black light to show how nicely the flakes dissolved. The final sequence, showing the perfect flake dissolving perfectly, lasted less than 10 seconds.

It takes about 90 feet of film for a 60-second commercial, but a producer may shoot anywhere from 2000 to 8000 feet on retakes before everyone is happy.

In soap commercials, showing ladies luxuriating in bathtubs, the property man periodically spruces up the suds around milady with a compressed-air hose or bicycle pump to make the soap look extra sudsy and hide the strapless bathing suit the model is wearing.

### Shoot Picture in Reverse

"Lots of times, we shoot things going backwards, then reverse the film," explains Transfilm's Phil Franke. "If you want to drive a car up to within an inch of a wall and stop dead, it's easier on the car's grille and the wall to start at the wall, back away and reverse the pictures. Also, if we want to make something look like it's hanging in the air, we can set it on the ground and shoot it upside down. Saves time and money."

Technicians at Science Pictures were told to figure a way to show a new tire tread "squeezed" to a panic stop on pavement. After weeks of false starts, they finally wound up with a huge piece of specially made plate glass 2½ inches thick and suspended on a steel framework. The camera looked up under the glass. The car was on top; its rear end was jacked off the glass while wheels were set spinning. As

(Continued to page 316)

## Automatic Saw Set...

### MAKE EXTRA PROFITS!

Set 400 teeth per minute on hand or band saws, 4 to 16 point, with the BeMaCo Automatic Saw Set. Fast, accurate, true hammer-anvil action sets teeth uniformly, eliminates tooth breakage. Used profitably by saw shops and manufacturers everywhere. Every machine positively guaranteed! Write for details—today!

Saw  
Machine  
Division  
26-C

**BEAVER MFG. CO.**  
800 ISIS AVENUE • INGLEWOOD, CALIF.

## GARDEN TILLERS at LOWEST COST



3 models light weight deep tilling  
EASY gardening with 1 power tool.  
EASY to assemble Model 5K only \$59.00 less engine.  
EASY to operate 8" and 12" models—powerful engines.  
EASY to order by mail—immediate delivery.

Also riding tractors, 2-wheel garden tractors, riding and power mowers. FREE CATALOG. Buy direct from:

**RED-E TRACTOR CO.**  
RICHFIELD 9, WISC.

## BUILD YOUR OWN AUTOMATIC AIR COMPRESSOR

#K-55 Complete Automatic Air Compressor Unit: Knocked Down, 3 CFM Air Compressor 1/2 HP AC Motor 12x24 Stainless Steel Tank on Wheels: Pressure Switch, Air Regulator, Gauge, Check Valve, Safety Valve, Hose & Tire Chuck, UNIT COMPLETE (\$150 Value) ONLY \$97.00. Same as above 1 HP Unit 9 CFM Twin Cylinder Compressor Tank on Wheels, All Accessories, You Assemble #SK-100, ONLY \$169.50.

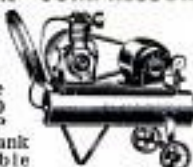

Order from THIS AD. GUARANTEED. FOB Chicago  
C. MARSHALL SALES, 3546 Fullerton Ave., Dept. P-2, CHICAGO 47

## ONE-MAN SAWMILL LOW \$50.00 AS... 50 DOWN



Take BELSAW Portable Sawmill right to the trees—turn out valuable lumber for home and farm—sell to local yards—make up to \$50 a day custom sawing for neighbors. BELSAW lasts a lifetime. No crew needed. Power with tractor or auto engine. Beginners get excellent results. Send today for FREE BOOK.

**BELSAW MACHINERY CO.**  
3457 Field Bldg., Kansas City 11, Missouri

## YOUR DEALER CAN HELP YOU

He makes it his business to know the right equipment and materials for you. They're advertised in POPULAR MECHANICS

**PM TAG of INTEGRITY**



## WELD IT YOURSELF IN A JIFFY!

Weld, Cut, Braze, Solder; Iron, Steel, Brass, Bronze, Aluminum and other metals safely and easily. Make your wrought iron furniture, porch railings, fences, knick-knacks and other metal specialties. With this fine equipment anyone can do professional-like work with little practice. Tool and equipment breakdowns are annoying and costly. Don't let them bother you. The Dynamic will pay for itself quickly in both time and money and is designed to operate from any properly wired 110 volt AC line.

Order your Dynamic Industrial type transformer Arc Welder for Workshop or Industrial use today. Order from this ad.

Literature on larger equipment available on request.

**DYNAMIC WELDER COMPANY, 1808 S. Federal Street, Dept. D2-B, Chicago 16, Illinois**

## You Can't Beat this POWER TOOL VALUE!

### "ARCO JIG-SAW"

WITH EXCLUSIVE  
CIRCLE-CUTTER  
& RIP GAGE!

ONLY  
**\$10.95**  
with Blade



FITS  
ANY  
1/4" DRILL

### CUTS ANY SHAPE • SAWS ANY MATERIAL

"Arco Jig-Saw" with adjustable Circle-Cutter & Rip Gage cuts perfect circles up to 20" diam., rips accurately to 10" wide. Cuts intricate patterns—however large—in wood, metals, plastics—even cuts 2x4's! Has same capacity as \$55 jig-saws! "Air-Jet" blows away sawdust. Converts to Table Saw with "ARCO STAND" Sturdy Casting & Clamp... \$2.95 & Extra Blades for wood, plastics, metals... \$1.95 At Your Dealer or order direct on 10-DAY MONEY BACK GUARANTEE. Send check, M.O. (ppd.) C.O.D. + post.

## ARROW METAL PRODUCTS CO.

Dept. PM-2 140 WEST BROADWAY, NEW YORK 13, N. Y.

## U-MAK-IT BOAT KITS



SAVE 1/2 THE COST

Now added to the famous U-Mak-It Boat Kit line—Easy to assemble

LAPSTRAKE SKIFF KITS

Greatest line of kits in our 29 years of boat kit pioneering.

30 models — prams, row-boats, runabouts, cabin cruisers and the new lapstrake skiffs.

### SEND FOR ILLUSTR. CATALOG

showing all models 8' to 23', prices, construc. details, access., hardware, trailers, motors, all you need to build your own! SEND 35c (coin) for postage & handling

**U-MAK-IT products** 703P Whitier St., Bronx 59, N.Y.





**USE**

## PHILIPPINE MAHOGANY

*for paneling,  
furniture and  
built-ins*

Write for New 16-page  
"Do-it-yourself" booklet,  
with ideas and detailed  
instructions.

*Available in Solid Lumber or Plywood*

### PHILIPPINE MAHOGANY ASSOCIATION, INC.

Dept. PM, 1017 Fair Oaks Avenue  
South Pasadena, California

PHILIPPINE LUMBER PRODUCERS' ASSOCIATION, INC., Manila



**MORE POWER  
IN YOUR GRIP**  
with **P & C**  
**PLIERS!**

You've got real gripping power with P&C Pliers... rugged, highest quality alloy steel, deeply milled sharp teeth, hardened steel bolt, perfect jaw alignment. Chrome plated, easy-grip handles let you work faster, easier with less effort. Buy P&C.

BUY YOUR TOOLS from the  
P&C Merchandisers, in over  
12,000 stores coast to coast.  
Send 10c for tool catalog.

P&C . . . the best tools  
money can buy



**P & C**®

**TOOL COMPANY**

Box 5926, PORTLAND 22, ORE.  
SCHILLER PARK, ILL.

the camera ground, the jacks dropped the car; tires squeeged and, after a few thousand feet of film were shot on retakes, the sequence was ready.

Animation, made famous by Walt Disney, is a simple, tedious business of making up and photographing some 1440 separate drawings for a one-minute spot. The job may take eight to ten months and cost up to \$12,000. Larger studios use electronically operated cameras that shoot the drawings a frame at a time as finished sketches are fed into them.

### Stop Motion for Puppets

Stop motion, even more expensive, may involve the use of little puppetlike dolls. After each single frame is shot, technicians make microscopic changes in positions of puppet arms, legs and faces. When the 1440 frames (for a 60-second spot) are run off, the minute consecutive changes turn the puppets into walking, talking, gesturing dolls that carry the sponsor's message across the country. Stop motion may show a milk bottle lifting itself up and pouring its contents into a glass seemingly without benefit of human hands. One gadget, used by Universal Pictures to make a bar of soap unwrap itself, is a vast jungle of jointed steel rods that take up half the area of a good-sized studio.

Technical problems aren't all that beset the "spot" producers. Once a certain story board called for a Swiss cheese. All the studio could find was solid American cheese, so they decided to drill holes in it. The suggestion sparked a minor jurisdictional dispute over whether it was a job for carpenters or prop men. Where else could this happen but in the turbulent world of TV commercials? ★ ★ ★

### Tin Cans Cool Wind Tunnel

Eight million tin cans have been poured into the air-storage section of a new wind tunnel to act as a radiator to keep air temperature nearly constant during tests. At North American Aviation, Inc., Los Angeles, Calif., the cans now fill eight steel spheres, each 36 feet in diameter, where 200,000 cubic feet of compressed air is stored. Without these cans air temperature would drop about 200 degrees F. during tests, seriously affecting results; the cans reduce this temperature dip to a workable 30 degrees. In this single tunnel, research is to be conducted in subsonic, transsonic and speeds up to 2500 miles per hour.

☐ Smelting a ton of aluminum requires enough electrical energy to supply needs of an average American home for 10 years.

most amazing blade you ever saw!

# Tyler SPYRAL BLADE

SAWS METAL, WOOD, PLASTIC, ETC.  
up or down, right or left, even in circles!

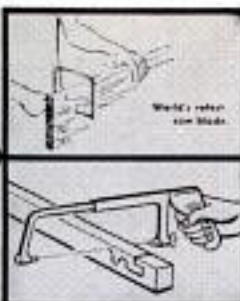

Does what no other Blade can Do. Fits Standard Coping Saw or Hacksaw Frames. NO special adapters needed! World's safest saw blade.

You'll find hundreds of uses for Tyler Spyral Blades. There's nothing like them! The first important improvement in blades since the invention of the saw. Fun to use... cuts so fast and easy; no chipping or tearing—leaves clean smooth edge.

Ask for TYLER SPYRAL BLADES at  
HARDWARE, LUMBER, AUTO & VARIETY STORES  
Everywhere

TYLER MANUFACTURING CO. 1005 W. Arbor Vitae Ave., Inglewood, Calif.

## I CAN SAVE YOU 94%!

REAL  
LOW  
PRICES

Send for NEW 1957 Illustrated BOOK of BIG WAR SURPLUS BARGAINS for mechanics, farmers, gadgeteers.



### AIRCRAFT STARTERS

Makes excellent winch for lifting, wagon unloaders, pulling stumps, stretching fence or moving heavy objects—1001 uses at home, farm or factory. Operates on 6 to 32 volts or manually. Built-in reduction gear (140 to 1) and clutch. High torque, low speed. Mfg. by Bendix at many times this price.

P.O. Box York (wght. 42 lbs.)  
only \$14.89

**WAR SURPLUS  
BARGAIN FREE!**



Make your own conversion

K. ORT, Dept. P2M, York, Pa.

## Print Your Own



Cards, Stationery, Advertising, Circulars, labels, photo and movie titles, church work, tags, etc. Save money. Sold direct from factory only. Raised printing like engraving, too.

### Own a Printing Business

Print for Others, Good Profit. Have home shop. Junior press \$15; Senior \$29 up. We supply everything. Easy rules. Pays for self in short time. Write for free catalog of outfits and all details.

KELSEY PRESSES, C-37 Meriden, Conn.

## Wholesale! TOOLS! GUNS! CAMERAS!

AGENTS — BUY TOOLS, PHOTO EQUIP., SPORTING GOODS, JEWELRY AND THOUSANDS OTHER NATIONALLY ADVERTISED PRODUCTS AT BIG DISCOUNTS. BIG PROFITS SELLING TO OTHERS.

Get up to  
**40% off**

POSTCARD BRINGS FREE COPY "THE WHOLESALE PLAN"

AMERICAN BUYERS SERVICE

HERTEL STATION, DEPT. 15, BUFFALO 16, NEW YORK

ANYONE can be an EXPERT with

# deft

## WOOD FINISH

Deft SEALS, PRIMES, FINISHES. Dries in 30 min. No thinning, nothing else to use. BAR TOP, semi-gloss interior finish.

Free Booklet

Be GOOD to your WOOD, DEFT-finish it.  
DESMONDS, 1826 W. 54, LOS ANGELES 62, CALIF.



DREMEL  
MOTO-  
JIG SAW

## Family Fun Starts Here!

Woodworking is a happy family hobby, with a Dremel Moto-Jig Saw. You don't need special skills. A card table can be your workbench.

The Dremel is not a toy—it's a professional-quality tool. It cuts wood 1 3/4" thick. It has a super-safe blade guard—a tilting table—and a Rotary Motor, not a reciprocating vibrator. It operates on a new rocker-action principle—actually outperforms more expensive jig saws!

These features have made the Dremel No. 1 choice in home workshop, Cub Scouting, elementary schools, 4-H, etc. Be sure the jig saw you buy not only looks like a Dremel—be sure it is a genuine Dremel!

Write for FREE folder describing 8 new pattern packets of fun-to-make jig saw projects and new power tool catalog.

- Model 15  
15" throat ..... \$29.95
- Model 8  
8" throat ..... \$23.50

SEE YOUR DEALER: If he cannot supply you, order direct from factory on 5-DAY TRIAL, MONEY BACK GUARANTEE. We ship postpaid.

DREMEL MFG. CO., Dept. 117-B, Racine, Wis.



**NEW!**  
**SHAW**  
RM 24 MOWER  
WITH AMAZING  
MAGIC  
DRIVE

Three Speeds  
forward  
neutral & reverse

Wide range of speeds, complete gear selection gives you outstanding mowing control for any terrain, any type mowing. Low cost!  
3 sizes, cut 24, 32 and 36".

See your Shaw dealer or write for free literature.

Dealer inquiries invited.  
**SHAW**  
DU-ALL  
**Manufacturing Company**  
4502 East Front Street, Galesburg, Kansas  
668-72 N. 4th Street, Columbus, Ohio

**MAKE YOUR OWN  
BOLTS, BRACES,  
HANGERS!**



now available  
**GALVANIZED!**

**REDI-BOLT®  
THREADED STEEL RODS**

Save repair and construction time. Just cut to length; heat and bend; add std. nuts. Seven sizes: 1/4", 5/16", 3/8", 7/16", 1/2", 5/8", and 3/4". Handy lengths of 24" and 36". Available in galvanized or blue rust-resistant finish.

Sold in Leading Hardware Stores

**REDI-BOLT, Inc.**

5330 Indianapolis Blvd., East Chicago, Indiana

Buy nationally advertised products. Ask with confidence for the brands advertised in POPULAR MECHANICS



**POWER GALORE FROM TINY  
BATTERY-OPERATED MOTORS**



No. 1049 Gear Train with Hi-Drive Motor delivers high power at approx. 6 RPM on 3 volts—higher speeds on higher voltages. No. 2000 gives many speeds from 30 to 400 RPM. For hobby uses, research and small industrial devices. This list of quality motors and power kits may help solve a gift or technical problem for you.

- No. 8-100 Hi-Drive Motor, 3-6V. . . . . \$2.50
- No. 9-100 Same for 6-12V. . . . . \$3.00
- No. 3-100 Tiny Atom Motor, 1 1/2-3V. . . . . \$2.00
- For higher voltages. . . . . \$2.50
- No. 3113M Tiny Atom motor assembly kit with many acc. . . . . \$3.50
- No. 1300M Small accessories kit. \$1.00
- No. 3700 Large accessories kit. \$3.00
- No. 4000 Deluxe accessories kit with motor. . . . . \$5.00
- No. 700 Super-Power kit with motor, speed reducer, all accessories. . . . . \$10.00
- No. 88 Kit of 8 pulleys—2 belts \$2.00
- \*No. 3000 Vari-speed gear unit. \$4.00
- \*No. 1049 Gear train with Hi-Drive motor No. 8-100. . . . . \$5.95
- Same with No. 9-100 Motor. . . . . \$6.45
- \* Item illustrated. Ask for FREE Cat.

All Wilson's motors have Permanent Alnico Magnets.

Remit with order and we pay postage in U.S.A. No C.O.D. Add 3% Sales Tax for delivery in Ohio. Write Dept. PM.



For quick delivery see your local dealer — or order direct

**WILSON'S OF CLEVELAND**

425 Lakeside Ave., N.W. • Cleveland 13, Ohio

**The Tricks He Plays on Trees!**

(Continued from page 116)

dwarfing—have been grown by European gardeners for hundreds of years. They are now easily available from nurseries in this country. The work his staff has done at Arnold has aimed at new ways for dwarfing apples and pears, and better results with the rootstocks for dwarfing peaches and plums. Whatever the method, he sees little excuse any more for burdening the countryside home with large fruit trees. He figures it this way:

"On a garden plot large enough to grow four standard trees, it's possible to grow 16 dwarfs. Instead of two standard varieties of apple, one pear and one peach, it's possible to grow four varieties of apple, four peach, four pear and four plum—with some space left for raspberries and grapes."

**Tips for Gardeners**

And he has tips for the do-it-yourself gardener. Knotting the tree's trunk is usually done ahead of budding a desired fruit variety onto young rootstock. But even the tree a few years old can be restrained, without any grafting know-how, simply by

(Continued to page 320)

Here Doctor Sax uses a piece of cotoneaster to join rootstock and bud that were not "compatible"



**WAR SURPLUS** AND OTHER **SAVING** **SAVE UP TO 90%**

**BUILD YOUR OWN ARC WELDER, LIGHT PLANT OR BATTERY CHARGER**

**Complete Kit \$39.95**

Kit consists of: 1 Famous Navy NEA-5 Generator, New! Combination AC-DC Type, AC voltage—115 V, DC voltage—24 V, 200-300 Amps, 2 complete generators in 1 . . . 2 separate fields & 2 separate armatures on same shaft yet no larger than regulator generator. Ideal for home, farm & shop lighting plants by hooking wires to AC side which will give 1200 watts. DC side can be used for charging batteries, welding & operating war surplus low voltage hobby motors & equipment. Also in kit: 1 Voltage Regulator DC, 1 Voltage Regulator AC, 1 Reverse Current Relay, 1 Ammeter and Shunt, 1 Voltmeter, 0 to 30 Volts, 1 Rheostat, 1 Electrode Holder, 1 Giant Toggle Switch, Welder's Shield, Wiring diagram for hookup as welder, Wt. under 100 lbs. Approx. GOVT. COST \$600. Kit, \$39.95. Navy NEA-5 Generator (only) — same as above . . . if purchased separately—\$27.50.

**R1 GENERATOR KIT** Jack & Heints or GE. Rated 300 Amps, 24-32 Volts. With same items as above incl. 300 Amp Ammeter. Approx. GOVT. COST for kit \$600. Complete kit only \$39.95. Wt. 60 lbs.

**BENDIX PUMP & MOTOR**

Can be used for pumping fuel, oil or wherever hydraulic pressure is required. Pump has 1" connections, built-in relief valve, adjustable up to 1500 lbs. Max. capacity 6 GPM. 1 1/2 H.P., 24 volt motor, 4000 RPM. Can be used on 12 to 36 volts. Approx. GOVT. COST \$350. NEW — \$10.95.

**AIRCRAFT PORTABLE SEALED-BEAM SPOTLIGHT**

Trigger-type. Can be used for boats, trucks or wherever a powerful light is required. Operates on 12 or 24 Volt. Any sealed-beam light can be inserted. 10' hard rubber cord. Standard 2-prong plug. Mfd. by Grimes. Approx. GOVT. COST \$35. NEW, \$4.50 incl. 24 v. bulb.

**BENDIX AIRCRAFT COMPASS**

For boats, trucks, cars. By Pioneer Instrument Co., div. Bendix. Mark VIII. Graduated in increments of 1°; 360°. Major graduations every 5°. Magnetic. Can be lighted with 6, 12 or 24 volt standard bulb. Flush panel mounting. Approx. GOVT. COST \$250. Perfect . . . \$10.95 pos.

**"HELIOS" ORIGINAL TOOLMAKERS VERNIER CALIPERS**

ULTRAPRECISION — Imported. Used by machinists at Lockheed, Douglas, Bendix, GM, RCA, GE. Model 51/2E. Genuine Helios. Hardened lapped precision surfaces. 1/1000" and 1/128" graduations. Handy slide roll and thumb lock. Quick, accurate depth. A \$35 value. De Luxe finish. ALL NEW. Just \$6.95. Leather carrying case, \$1 extra.

**MICROMETERS**

Chrome plated, precision engineered, carefully tested to give long life. All new 0-1" cap. \$2.25 ea., 1-2" cap. \$3.50.



**140-1 REDUCTION GEAR!** Make your own winches, hoists, wagon unloaders, stump pullers or fence stretcher. Sturdy Aircraft quality. Built-in (removable) 24 V. AC, motor & clutch. High torque, Low speed. 100's of uses. Wgt. 42 lbs. Approx. GOVT. COST \$300. Like New only \$12.00

**HEAVY-DUTY RHEOSTAT** Designed for heavy-duty use with Air Force heated suits. Ideal for regulating voltage on electric welders, model trains, lights, generators; controls soldering irons, etc. Rated 5.75 ohms, 100 watts with double windings and dual female 25 amp, 125 volt receptacles. Size: 7" H x 3 1/4" W x 1 3/4" D. Shpg. Wt. 2 1/2 lbs. Approx. GOVT. COST \$25. Brand new, only \$1.95.



**LONG-FLUTE, HIGH SPEED DRILLS** 15 assorted sizes, up to 1/2". Like NEW. Approx. GOVT. COST \$25. Only \$2.50.

**HIGH SPEED HAND TAPS** 10 assorted, precision-ground thread. National Mfr. Like NEW. Up to 1/2". Approx. GOVT. COST \$25. Only \$2.50.

**PRECISION GROUND SQUARES** Production engineer's squares. Accuracy guaranteed. Mfd. by Wright & Moore, Sheffield, Eng. Square blades, hardened & tempered. Brand NEW. Fraction of original cost. 2" — \$2.75, 3" — \$3.00, 4" — \$3.25, 6" — \$3.75, 9" — \$7.00, 12" — \$6.75.

**DOUBLE-ACTION HYDRAULIC CYLINDERS** Oil or air operated. Ideal for shop, production machinery, hydraulic boat steering and 100's of other uses. Steel barrel, new, aircraft quality, precision-built. Extremely rugged, can stand tremendous pressures. Able to do job usually requiring cylinder 5 times its size.

**ROD END BEARING:** 7/8" length of stroke, 3/8" shaft, 1 1/8" bore, 13" overall. Approx. GOVT. COST \$75. NEW, \$3.95 ea., 2 for \$7.  
**DOUBLE SPRING LOADED!** Zerk lubricated end mounting. 7/8" length of stroke, 9/16" shaft, 1 3/8" bore, overall length 15". Spring is removable. Approx. GOVT. COST \$75. NEW, \$3.95 ea., 2 for \$7.

**AMES DIAL INDICATOR** Mounted on adjustable frame. Graduated in 1/1000". Will give readings on bolt stretch and all round & revolving materials. Shockless. Approx. GOVT. COST \$125. New—\$10.95 pos.

**HOMELITE PORTABLE POWER PLANT** Buy power for pennies. Ideal for welding, battery charging, emergency lights for cabins, camps, trailers, aircraft or wherever power needed. Easy rope pull starting. Fully equipped, ready to start. 2000 W, 32 V., 5 HP. Complete, nothing else to buy. Like new, tested. Shock mounted. De Luxe type. Net wt. 115 lbs., gross wt. cased 200 lbs. Approx. GOVT. COST \$700. While they last—\$59.95.

**NEW! BIG CATALOG** Largest ever . . . just out . . . new low prices. Send 25c for your copy today. Prices F.O.B. Culver City unless otherwise stated. Check, cash or money order. 50% deposit for C.O.D.

**AIRBORNE SALES CO., INC. DEPT. PM257**  
8501 Stellar Drive, Culver City, Calif.

**Change your oil and filter NOW!**

**ONLY A MOLDED PLYWOOD BOAT KIT assures you that professional look!**

Build this runabout in 75% less time with this kit by America's largest molded plywood hull maker. Strong as steel . . . weight for weight . . . assured precision fit . . . simple tools are all you need. Pre-cut all mahogany parts mean factory-built appearance inside and out. Cruiser semi-kits having one-piece hulls also available.

See your dealer or write for information



**U. S. MOLDED SHAPES, INC.**  
651 Market St. S.W. • Grand Rapids 2, Michigan

**TOP QUALITY**



Built of the finest materials, Gerstner Chests are acknowledged top quality everywhere. Free catalog to machinists and toolmakers.  
**GERSTNER TOOL CHESTS**  
457 Columbia St., Dayton 7, Ohio

**SAVE MONEY on LUMBER with the LOW-COST BELSAW PLANER**

**Convert Rough and Random Size Lumber Into Cabinet Finished Stock**

Now anyone can make perfect cabinet finished stock from low-cost rough lumber . . . any size up to 12 1/4 inches wide and 6 inches thick. Turn out high grade finished material at a fraction of the cost you pay lumber yards. Big 42-inch-long bed makes it easy to plane heavy, wide and long pieces . . . BELSAW self-feeds at 14 to 34 feet per minute.

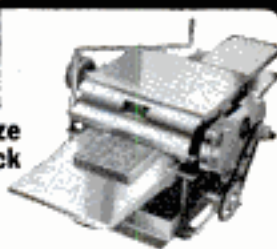

**USE THIS ONE LOW-COST MACHINE for Planing, Jointing, Sawing, Milling, Tongue and Groove.**

You can easily make flooring, siding and many other popular patterns with your Belsaw. Your Belsaw quickly pays for itself with savings on raw materials and profits on finished stock . . . a highly profitable machine for custom work. Compare Belsaw with any 12-inch planer on the market . . . Belsaw gives you more essential features—yet costs you \$50 to \$125 less than others.

Send Today for Free Literature on the Belsaw Multi-Duty Planer.  
**BELSAW MACHINERY CO 2057 Field Bldg. Kansas City 11, Mo.**

# LUBRIPLATE LUBRICANTS



## Make Cars Run Better... Last Longer!

LUBRIPLATE H.D.S. MOTOR OIL is made especially for today's high speed, high compression engines, both gasoline and diesel. Fully detergent, requiring no additional additives.

LUBRIPLATE AUTO-LUBE "A" is the perfect all-purpose automotive grease type lubricant. Use it for every grease application.

Your car deserves the best. . . .  
Use **LUBRIPLATE**—You'll see the difference immediately!

At Better Service Stations and Car Dealers

### OTHER LUBRIPLATE PRODUCTS

**LUBRIPLATE  
2-C MOTOR OIL**  
for outboards

**LUBRIPLATE  
OUTBOARD GREASES**  
for underwater gears

**LUBRIPLATE  
IN HANDY TUBES**  
for sports and  
household uses

**LUBRIPLATE  
INDUSTRIAL LUBRICANTS**  
for every application

LUBRIPLATE DIVISION, Fiske Brothers Refining Co.  
Newark 5, N. J., Toledo 5, Ohio.

# POWERFUL!

Man, here's  
light! 1/4-mile beam —  
15,000 beam candle  
power. Compact, easy to  
carry, built to last! Uses two 6-volt  
batteries. See your dealer.

DELTA ELECTRIC CO., Marion, Ind.

**\$7.25**

less battery.



**Delta POWER-KING** ELECTRIC LANTERN

looping upper branches, or tying them together with string or rubber bands so that they form arches or bridges.

A version of this has been practiced in the Balkans for centuries. It's the simplest way to discourage upright growth by checking sap flow. Or you can try older ways — tying the branches to walls or fences, espalier fashion; or pulling a pear's upright branches out horizontally with strings anchored in the ground.

If you learn the simplest kind of grafting, called budding, there's more leeway for fun and profit. For example, you can then manufacture your own peaches and plums — trees that fruit quickly and are the right size for a lawn or for handy tubs.

### Nanking Cherry Provides Roots

Sax has discovered the Nanking cherry to be ideal rootstock. It's a common ornamental from China, hardy, inexpensive, a low shrub producing small sour cherries. Plant their seeds and they sprout like mad, giving you loads of seedlings for rootstock.

Bud scions from desired peach or plum varieties "catch on" to this rootstock easily and start fruiting the second year. At eight years, Sax picks 100 full-size peaches off a tree only six feet high, although for extra-special specimens he recommends thinning fruits to hang six inches apart.

Here are Sax's eight basic steps for simple grafting: 1. Make a vertical cut into the

(Continued to page 322)

Setting out a row of dwarf trees five feet apart





**SEALS HEAT IN... SEALS COLD OUT**



**Bridgeport INNER-SEAL**  
WEATHER STRIPPING

*Like Shiver*

Guaranteed by Good Housekeeping

Get a warmer, more comfortable home AND save up to 20% on fuel costs with INNER-SEAL weather stripping on your doors, windows, storm windows!

INNER-SEAL is waterproof, tough, flexible; easy to install; lasts for years. Spring steel wire molded in neoprene-coated sponge rubber assures tight seal. Has Good Housekeeping guarantee.

Buy it in exact-length "do-it-yourself" paks or in bulk at hardware, variety stores, building suppliers. Get free weather stripping booklet "Why Shiver" from dealer or write Dept. PM.

**BRIDGEPORT FABRICS, INC.**

200 HOLLAND AVE., BRIDGEPORT 9, CONN.



**G E A R S**

**In Stock - Immediate Delivery**

Gears, speed reducers, sprockets, thrust bearings, flexible couplings, pulleys, etc. A complete line is carried in our Chicago stock. Can also quote on special gears of any kind. Send in your blueprints and inquiries.

Send for Complete Catalog No. 10

**CHICAGO GEAR WORKS**  
440-50 N. Oakley Blvd., CHICAGO 12, ILL.

**MONEY for MEN ALL DATA FREE**

THE PLASTEX Industry needs manufacturers on small scale and for big production of Lamp and Clock Stands, Art Goods and Novelties in Plastex and Marble imitation. Experience unnecessary. 1/2¢ material makes regular 10¢ store sellers. Rubber moulds furnished for speed production. Small investment brings good returns. We are now placing big Chain Store Orders with manufacturers. Ambitious men have chance for real prosperity. Our Free booklet will interest and benefit you.

**PLASTEX INDUSTRIES, Dept. A**  
3400 Third Ave. New York 50, N. Y.

- ★ COMMERCIAL
- ★ FARM AND HOME
- ★ HOSPITAL



**LOW COST Katolight**  
**ELECTRIC PLANTS**

PROVIDE PORTABLE OR STANDBY POWER ANYWHERE... ANYTIME!

Permit uninterrupted operation of electrical equipment despite power failure. Extra high overload capacity. Durably built for long dependable service.

A FULL LINE FROM 350 WATTS TO 75 KW-UP.

Write for FOLDER today!

**KATOLIGHT CORPORATION** Box 891-22, Mankato, Minn.

You can tell a **DISSTON** by the **SMOOTH EDGE** you get!

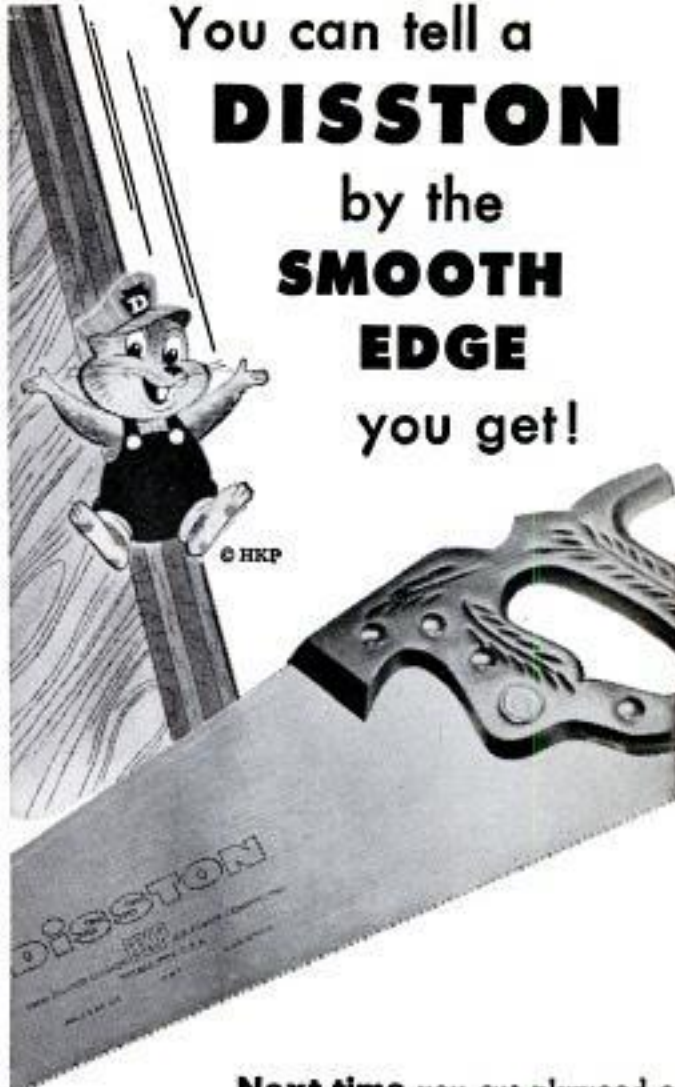

© HKP

Next time you cut plywood or other well-seasoned woods, use a 10-, 11- or 12-point Disston Hand Saw. Note how easily it cuts . . . what a beautifully smooth finished edge it leaves! That's because these fine-toothed saws are specifically designed for finishing work. Made of fine tool steel, with perfectly tempered and double taper ground blade, Disston Saws give years and years of service, too.

At better hardware dealers... everywhere!



Choose a 5 1/2-point Disston Hand Saw for cutting with the grain.

Choose a 7-, 8- or 9-point Disston Hand Saw for cutting across the grain.

**FREE ILLUSTRATED BOOKLET!** 64-page Disston Saw, Tool & File Manual. Tells how to choose and use tools; how to care for them. Helpful hints on wood and metal working, and selection of materials. For your free copy write today to: **Henry Disston Division, H. K. Porter Company, Inc., Philadelphia 35, Pa.**

**DISSTON · HKP**



**FOR THE TOUGH PULL... 'Tugit'**

This handy lever-operated 'Tugit' Hoist lifts or shifts tons easily, safely. Imagine — only 40 lbs. of pull on the handle to lift 2,000 lbs. A powerful, automatic brake holds the load where you want it. The handle can't kick back and hit you. A flick of the fingertip lever and 'Tugit' is ready for controlled lowering action. Entire mechanism is fully enclosed — never needs oiling. Portable 'Tugit' operates smoothly in close quarters and at all angles. Ideal for 1000's of lifting or pulling jobs on farms, in repair shops, boat-yards and construction. Get a 'Tugit' for your tool box, truck or car trunk. 1 and 2-ton sizes. Small size weighs only 16½ lbs. Priced from \$63.50 up. See your Shaw-Box Distributor or write for Bulletin 388.

- Spots trailers
- Pulls cars out of mud, snow
- Lifts machinery
- Unearths stumps, boulders
- Erects fences
- Lays pipe
- Lifts boats, motors
- Stretches cables, belts

57B-2  
  
**MANNING, MAXWELL & MOORE, INC.**  
 SHAW-BOX CRANE & HOIST DIVISION  
 354 W. BROADWAY MUSKEGON, MICHIGAN

**Warm, Dry Floors**  
 With **ZONOLITE**<sup>®</sup>  
**INSULATING CONCRETE**



**Blocks Condensation, Prevents Heat Loss!**  
 Building or remodeling a house, garage or farm structure? Here's a way to be sure of warm, dry floors all year 'round! One inch of Zonolite concrete insulates as well as 12 to 16 inches of ordinary concrete! **LIGHTWEIGHT...easy to mix. You can do it yourself!** A good investment in any building for comfort, fuel savings; for increased profits from farm stock. See your building supply dealer for FREE estimate on how much Zonolite Concrete Aggregate you'll need for your job.

Zonolite Company, Dept. PM-27  
 135 S. LaSalle St., Chicago 3, Ill.  
 Please rush free "How-to-do-it" manual. No obligation.

Name.....  
 Address.....  
 City.....Zone.....State.....



bark of sapling selected for graft. This cut should be two inches long and from two to four inches above ground. 2. Make a half-inch horizontal cut at the top of the vertical cut, forming a T. 3. Pry open the T-cut with a knife. 4. Slice a fat "bud stick" 1½ to 2 inches long with the bud in the center. 5. Make sure grafting sliver contains bud, bark, cambium and wood. 6. Insert bud stick in T-cut with bud pointed up. 7. Cut off excess part of sliver above tee. 8. Tie up graft with rubber band.

Through another, more conventional method known as "double working," Sax also originates dwarfs in special cases where rootstock and the desired variety's bud don't join together well. This incompatibility is solved by using a third specimen as "middleman."

For example, there's the old saying: "Plant pears—plant for your heirs." Sax, however, gets fast-fruiting dwarfs. His trick here is to bud ordinary cotoneaster on hawthorn rootstock, then bud pear on the cotoneaster part. At five years, such a tree is less than five feet high and laden with fruit.

All such dwarfs are planted in soil the ordinary way. But they needn't be. How about potting dwarfs so that you can move them where you want them, when you want them?

For more than 1000 years, the Japanese have skillfully used "Bonsai" pot-binding methods for turning normal trees into beautiful midgets. But this is an intricate and patient art involving root pruning, frequent transplantings, pinching buds here and training branches there.

By contrast, potting the modern dwarf is easy. The container can be anything from a gaily painted old washtub to a pot of long-lived redwood which you can buy in knockdown form and assemble quickly. Sax's own favorites come from a brewery. He gets wooden kegs, which are being replaced by aluminum ones, and saws them in half.

He's also grateful for polyethylene plastic. It saves lots of watering work. When it's wrapped around the balled and burlapped roots of a tree or shrub being transplanted, hardly any water can evaporate from the soil.

You can set the dwarf out in soil of the garden or lawn, with that plastic wrap staying on to limit root growth. Or into a pot, and it will need watering only once or twice a month. This factor alone is enough to excite any amateur botanist.

Another plastic blessing that Sax points out: You can safely transplant any time—even when the tree is in full bloom. ★ ★ ★

Schupack's Amazing Tool Bargains! Save up to 100%!

**75 Mounted Wheels & Miniature Cutters.** Regular \$11.00 value **\$4.50** Post-paid  
 For cutting and grinding on mild wood, metal or plastic. Includes 25 mtd. wheels and points on 3/32" shanks; 24 miniature cutters on 3/32" shanks; 25 short shank min. cutters. Will fit all electric drills and hand grinders.

**2 DRUM SANDERS**  
 With 12 Bands in Assorted Grits. 1 1/2" dia. x 1" long on 1/4" arbor with 12 bands ..... **\$1.50** Post-paid  
 One drum, 1" dia. x 1" long on 1/4" arbor with 6 extra sleeves ..... **\$1.00** Post-paid

**8 Carbon Steel Wood Bits for Brace.** Assorted sizes, 3/32" to 5/8", for drilling on wood or metal. **\$1.75** P.P.

**15 Assorted Drills.** From 1/16" to 1/2" high speed steel and carbon. Only **\$3.95** P.P.

**30 Assorted Drills.** High speed steel & carbon. Up to 1/2" dia. **\$2.75** P.P.

**12 Assorted Drills.** High speed and carbon steel from 1/8" to 1/2" **\$3.60** P.P.

**10 Larger Assorted Taps** from 5/8" to 2 1/2". \$50.00 value. Shipped by Ex. Express only. P.O.B. Chicago. **\$19.50**

**32 H.S. steel drills.** Threaded shanks from 3/32" to 1/2". Reg. \$9.50 value only. **\$2.00** P.P.

**12 MOUNTED WHEELS** and points on bank. **\$2.85** P.P.  
 For grinding on plastic wood, soft & hard metals. Regular Value \$5.40.

**18 Mounted points** on 3/32" shank **\$2.50**; 12 mtd. wheels on 1/4" shank **\$3.60**

**18 Rotary Cutters** P.P. **\$5.85**  
 Assorted sizes cutter on 1/4" or 3/32" shank. Will fit all hand grinders. Ideal for cutting wood, metal, or plastic. Brand new.

**ADAPTER CHUCK**  
 With 2 interchangeable collets, opening from 3/32" to 1/2". on 1/4" mandrel. Price each only **\$1.50** P.P. Adapter Chuck. From 60 to 80 on 3/32 in. Mandrel **\$1.00**

**10 ASSORTED TAPS.** Precision ground thread. All popular sizes up to 1 1/4". Brand new. **\$2.50**

**7 H.S. and carbon drills** from 6" to 12" in length. Assorted sizes up to 1/4" diam. for drilling in hard to reach places. A reg. \$1.95 P.P. \$1.00 val. for only **\$1.95** P.P.

**12 Larger Drills.** From 1/4" to 1-1/8". High speed steel and carbon **\$7.50** P.P.

**5 Woodworkers Drills.** From 1/4" to 3/4" on 1/4" shanks. **\$2.95** P.P.

No C.O.D.'s. Catalog 10c

SCHUPACK SUPPLY CO. 7311 COTTAGE GROVE AVE. DEPT PM-13 CHICAGO 16, ILL.

**GO Unerringly WITH HULL AUTO COMPASS**

Only a Hull Auto Compass can give you, behind the wheel, the unerring sense of direction of a homing pigeon. Know the right way at every turn, anywhere. No more guesswork, mistakes!

At your dealer's or write for literature. **MOST COMPASS DRIVERS \$4.95 and USE HULL \$6.50**

HULL MFG. CO. P.O. Box 246-D-2, Warren, Ohio



**New Long Lasting Combination Blade Roc-Edge 6" SAW \$1.49**  
 Fits any power saw. At all Hardware Stores

**DIGS 2" TRENCHES to 18" DEEP**

New Model B DITCH WITCH digs 2-in. trenches to 18-in. deep. Perfect for lawn sprinkler systems, utility service lines. Digs straight, curved and cornered trenches in all soils, even rocky and frozen. Low Cost! Write for new Bulletin. **THE CHARLES MACHINE WORKS 620 B Street Perry, Oklahoma**



Protect your home against power interruptions with an...

**ONAN Emergency ELECTRIC PLANT**

Provides dependable stand-by electricity for heating system, pumps, freezer, lights, appliances. Keeps home safe, livable. Automatic start and stop. Find out how little it costs!

**A SIZE FOR EVERY NEED**  
 500 to 75,000 watts. Compact, quiet-running. Gasoline-powered. Priced from \$255.00

**D. W. ONAN & SONS, INC.**  
 3241 University Ave. S. E. • Minneapolis 14, Minnesota

**HERE'S YOUR COMPLETE POWER TOOL WORKSHOP**

**FOR ONLY \$7995**

**FACTORY TO YOU**

**8" SAW**

- TRY SUPERSHOP FREE
  - WE PAY FREIGHT
  - YOU BE THE JUDGE
  - EASY PAY PLAN
- Why does Power Tools Inc. make such an unusual offer? Our business is manufacturing and selling power tools direct to people like yourself. We have had experience with hundreds of thousands of people regarding their home workshop requirements. Supershop meets these requirements. This has been proven.

The combination of direct selling, advanced design and efficient manufacturing enables us to give the greatest power tool value in America today. That is why we have the courage to make you this offer.

This free trial is truly free. The machine is prepaid to your door and if it does not satisfy you, you return it at our expense. If you keep Supershop you pay the low factory-to-you cash price — or easy payments to fit your budget.

Write for free information. Mail the handy coupon — or send a postcard. We'll mail you colorful brochures on Supershop — and full details on the FREE TRIAL HOME OFFER. Absolutely no obligation.

POWER TOOLS INC. 192 YATES AVE. BELOIT, WISCONSIN

**POWER TOOLS INC. • BELOIT, WIS.**

Send me your FREE brochures on Supershop and complete information about the Free Home Trial Plan. I am under no obligation.

NAME \_\_\_\_\_

ADDRESS \_\_\_\_\_

CITY \_\_\_\_\_ STATE \_\_\_\_\_



**More cutting power** ✓  
for 1/4" electric drills

**Irwin Speedbor "88"**  
most revolutionary bit in years

Irwin's Exclusive Hollow Ground Point and spade-type cutters bore faster, deeper, cleaner with less power. Try the Speedbor "88" in your small 1/4" electric drill or drill press and see. Get smooth, effortless cutting action in hard or soft woods, plaster, plywood, plastics — even hardrock maple! Forged in one piece from solid bar of high carbon steel, hardened full length to stay sharp. And remember . . . the hollow ground point is exclusive with Irwin's Speedbor "88". Buy individual sizes or sets from your independent hardware dealer.

No. 886-R plastic roll set of 6, sizes 3/8" to 1", only \$4.50

only  
**75¢**  
each  
any size,  
1/4" to 1"



**IRWIN** • the original solid center auger bit  
Wilmington, Ohio • screw drivers • screw driver bits

**WELD** **BRAZE**  
**SOLDER** **CUT**



Acclaimed by thousands of Homeowners, Mechanics and Hobbyists as the welder of 1001 uses. Easily operated from properly wired 110 volt AC or DC line. The ideal gift with a life-long use. . . . Order today on 10 day money back guarantee.

**FOUR-WAY WELDER CO., Dept. F2-B**  
1810 S. Federal St. • Chicago 16, Ill.

**WELDER**  
Complete with  
Twin Carbon Arc  
Torch and ac-  
cessories . . . to  
handle all metal-  
craft work.



**Brick Carrier Saves Time  
And Effort for Workers**

Steel pallets, each holding 56 bricks, are saving time and effort for masons' helpers. Wheeled to the bricklayer on a regular two-wheeled truck, the pallet can be slipped off the truck with the bricks and left on the scaffold while the helper goes back to the pile for another load in another pallet. Eyes in each pallet provide a means for hoisting the load.



**JEEP & 4-WHEEL DRIVE OWNERS**

**FRONT DRIVE WITH  
FREE-LOCK HUBS**

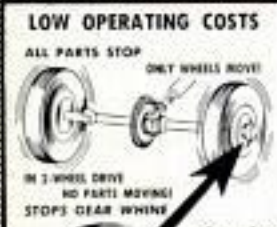

**FRONT DRIVE—NO  
FREE-LOCK HUBS**

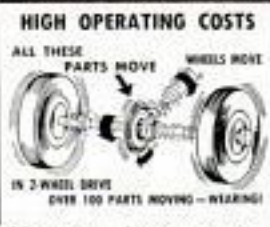

Stop front drive wear  
Reduce engine wear  
Save gasoline

Increase power  
Tires last longer  
Easier steering

**UNCONDITIONALLY GUARANTEED!**  
Benefit now from this money-returning investment.

©FLC Ask dealer to order yours now. Write for **FREE FOLDER**  
**FREE-LOCK CORPORATION**  
6301 NORTH FEDERAL BLVD., DENVER 11, COLORADO

**SAVE UP TO 85% ON GOV'T SURPLUS & FACTORY CLOSEOUT**

**AIR FORCE 2000 WATT POWER GENERATOR**



IDEAL FOR USE ON FARM, IN CAMP, CABIN, HIRE AS A RELIABLE STAND-BY POWER SOURCE!  
Delivers 20 V, DC at 70 amps. Rated capacity is 2000 Watts. Driven by a single cylinder, air-cooled 2-cycle gasoline engine. Turns at 3600 R.P.M. Comes complete with built-in voltage regulator and voltmeter. Available in rope or push-button start. by battery. SAVE - Order NOW!

Size: 21" x 18-1/2" x 18-1/2"

**ONLY 89.95**

**SPECIAL AIR PRESSURE TANKS**



G-1 Type, Stainless Steel, Shatterproof and rustless. Built to withstand up to 400 PSI with high safety factor. Has 1/4" pipe ports. Ideal for use in Air Storage for painting, spraying, etc. Can also be used for water storage, as a buoy, etc. Size: 12 1/2" diam. x 24" length. . . .

NEW and UNUSED **16.95** USED **11.95**

**SURPLUS GEARS**

**85 to 1 GEAR RATIO**  
For use where tremendous power at a low take-off speed is desired. Drives thru a train of 6 gears rotating on self-lubricating, hi-speed roller bearings. Take-off shafts are 1/4" and 3/8" NEW in excellent condition. **5.95 USED 8.95**



**AIR CORPS 2500 LB. LIFT WINCH HOIST**



Now **29.50**  
Ideal for use in garage, shops, boat yards, on trucks, etc. Has bronze worm gear drive with 24 to 1 ratio and 3-speed crank. Comes with 18 ft of 3/16" high tensile steel cable and crank. Capacity 2500 lbs. WINCH HOIST—Some on above but has a free-spool, pull-out clutch. HOIST MOUNT FRAME - **4.50**

**SAVE ON STEEL CABLE**

1/8" ALLOY STEEL CABLE - 7 x 19 Strand. . . . per foot - **9/16**  
3/16" STAINLESS STEEL CABLE Aircraft Quality - Rust and Corrosion Proof. Finest you can buy!  
7 x 19 Strand . . . . . per ft. - **23c**  
We also carry a complete line of fine quality ALLOY STEEL cable from 1/16" to 9/32" and STAINLESS Steel from 1/16" to 5/16". Write for prices.

**SAVE ON HYDRAULIC PARTS & SUPPLIES**



No. 3 - DOUBLE ACTION - Has a 1" bore and adjustable stroke 2-1/2" to 4" with internal sleeve steps. 1/2" dia. shaft. Will lift or push up to 1100 lbs. in weight. **5.95**  
FREE CATALOG  
Showing our entire line Genuine Gov't Surplus Hyd., Cyls., & Supplies.

**LARGEST FIRM OF ITS TYPE IN THE WORLD**

**NEW 3400 RPM - 1/2 HP POWER SAW**



**RIPS - CROSSCUTS CUTS A FINISHED 2x4 LIKE A KNIFE THROUGH BUTTER**  
COMPARES TO SAWS SELLING UP TO \$49.50 **19.98** Complete with 5-1/2" Blade

A rugged, professional type, adjustable saw. Will cut any angle from 0 to 45°. Has an adjustable 0 to 6" rip fence. Safety-trigger switch on handle. Full 1/2 HP Universal AC-DC, 110-120 Volt, 60 cycle motor. Weighs only 6 1/2 lbs. Thousands already sold. Your satisfaction guaranteed.

**NEW EXTRA SAW BLADES - Available in Rip, Crosscut or Combination. Please Specify **2.25 EA.****

**NEW DRILL DRIVEN BAND SAW**



17.95 VAL.  
Easily operated by any 1/4" (or larger) drill and can be adapted to any other similar drill. Saws straight lines or curves. Makes corners, cabinets, toys, etc. Full 10" throat, cuts to the center of 20" board. Has a tilt table, oilite bearings, adjustable high impact, phenolic pulleys, 3/16" saw steel blade, die-cast aluminum housing.

**12.88**

1/4" ELECTRIC DRILL with JACOBS CHUCK - One of the greatest drill values ever offered. Ideal for operating bandsaw above, drilling, etc. **12.95**

**SAVE 50% PHILIPPINE MAHOAGANY LUAN PLYWOOD**

For Paneling Dens, Offices, etc. Use in Cabinets, Furniture, etc. Rotary cut. Both sides sanded. Bonded with finest resin adhesive. Face side unjointed. Shipped at lowest rates.

3MM (1/8") x 3FT. x 6 FT. **1.79** PER SHEET  
\$5.00 VALUE  
MINIMUM ORDER 8 SHEETS  
FREE SAMPLE ON REQUEST  
1/4" x 4 FT. x 8 FT. **9.50 VAL. 4.49 PER SHEET**  
MIN. ORDER 4 SHEETS

**SAVE 50% ON TRANSLUCENT FIBERGLAS PANELS**

Ideal for the home or office and in new construction. Finest quality in many widths and lengths. A variety of colors to suit every taste. Send for a FREE SAMPLE and booklet. Worth 85c per sq. ft. **ONLY 49c SQ. FT.**

**NEW 60 to 600 POWER - 2 EYEPiece SPECIAL MICROSCOPE**

HAS 60 - 120 - 200 - 300 - 400 & 600 POWER MAGNIFICATION WITH ILLUMINATED SUB-STAGE MIRROR and TRIPLE TURRET  
Now you can change magnification with a simple slide of the dual eyepiece turret. No loss of focus - No readjusting. Your choice of 6X or 20X eyepiece with any of the objective lenses - instantly! Spends your work and efficiency!  
INCLUDES THESE ADDED FEATURES:  
Has triple revolving turret with 10X, 20X and 30X precision ground and polished lenses. Dual eyepiece turret and New Patented Sub-Stage with built-in, battery operated light - needs no external light - a large sub-stage mirror with variable iris, all-metal body that inclines through 90°. Comes in fitted hardwood case with glass slides included. **16.95**



**Palley's** TERMS: Send Check, Cash or Money Order. 30% Deposit with C.O.D. Price F.O.B. Los Angeles, Calif. Warehouse, 2243 EAST VERNON AVE., DEPT. PM-2 \*LOS ANGELES 58, CALIF.

**BUILD FINE GRANDFATHER CLOCK NOW**

The simple sensible **SPEEDE** Redi-Kut way as thousands have - FOR YOURSELF OR SELL AT A GOOD PROFIT. **SAVE HALF. SHOP TESTED PLANS "SPIRIT OF THE CENTURY"** Narrow waist 83" tall or stately straight side "SPIRIT OF AMERICA." **EASY-TO-FOLLOW** photopack PLANS & LIFE SIZE PATTERNS tell all - plus **MOVEMENT BROCHURE** \$40 up also heavy brass weight Westminster, tube chime, movements, gorgeous bronze-silver **MOVING MOON** dial, 3 1/4" solid-mahogany case kits. Send \$1.00 today - Both plans \$1.50 RUSH.

Kuempel Chime Clock Works, 29 Kuempel Bldg., Minneapolis 16, Minn.

**SHAW PLOW, CULTIVATE, MOW, RAKE BULLDOZE, SNOWPLOW SAW WOOD**

**TRACTORS**

Just steer it with power turn. Several walking & riding models up to 14 H.P. Low price! Write for **FREE literature**. **SHAW Manufacturing Co.** 4502 Front St., Galesburg, Kansas 668-G2 N. 4th St., Columbus, Ohio



**\$5000 PER DAY AND MORE**



**SERRATING AND SHARPENING TABLE KNIVES**

**SAW-KEEN PORTABLE, ELECTRIC, EASY-TO-OPERATE**

Be your own boss, work anywhere, full or part time. Every restaurant, hotel, drive-in, etc., repeat customers. Serrated (saw-edged) table and steak knives in great demand. \$98.50 investment returns first week. Guaranteed. Write today for proven daily profit plan. **CUTTER-CRAFT** 58-U SOUTH RAYMOND PASADENA 1, CALIF.

# MODERN

## IMPROVED LAWN MOWER SHARPENER AND BED KNIFE GRINDER



\$275.00  
FOB  
PASADENA,  
CALIF.

Grinds any reel type mower. Hollow grinds or flat grinds bed knives. New micro feed grinding head. Sharpens hand and power mowers. No disassembly of wheels, Roller, handle or gasoline engine. No draining of gasoline or oil. Precision sharpens more mowers per hour. Costs less. Compare before you buy. If it isn't a MODERN it can't be MODERN.

WRITE FOR FREE BOOKLET 10A

The Modern Lapping Machine is designed to fit the needs of any large user of mowers and the lawn mower shops. Laps any reel type mower. 1/2 H.P. motor, \$67.95 fob, Pasadena, Calif.



MODERN MFG. CO., 160 N. FAIR OAKS, PASADENA, CALIFORNIA

### DO IT YOURSELF

It's Easy With ...

Soldering's really a "cinch" ... when you use time-tested, reliable KESTER ... available everywhere.

FREE! "Soldering Simplified" ... 16-page how-to-solder booklet. At your dealer or write direct.

**KESTER SOLDER COMPANY**

4251 Wrightwood Avenue Chicago 39, Illinois



## 64" FLEXIBLE SHAFT

WOVEN WIRE CORE

USE AS  
ELECTRIC  
DRILL

\$5.95

REAL BARGAIN — cannot be duplicated for \$15.00. Coupling fits 1/2" or 3/4" motor shaft (state which); other end fits standard chuck. Durable, heavy. Use it for grinding, polishing, buffing, drilling, etc. Heavier const. Chuck for same only \$1.25. Send check or money order and we will ship P.P. prepaid or C.O.D. Plus Postage. Money refunded if not satisfied.



**L. C. DOWNEY CO. — Dept. M**  
8004 TRAYMORE AVE., PHILA. 18, PA.

## PAINT ROLLER and Tray Set, Only \$1.98

FREE—\$1.12 Dynel Cover with Every Set



Finest 7" roller, phenolic core, sewed long-nap dynel. Applies all types paint, varnish. Roller-Tray-Cover cost \$5.50 most stores. Buy direct. ONLY \$1.98 post-paid. Satisfaction Guaranteed. VESPER ROLLER CO., Vesper, Wisc.

# Red Devil



### PUTTY KNIVES WALL SCRAPERS SPACHTLING KNIVES

Top-quality professionally-styled at prices to suit your pocket-book. High carbon, tempered steel blades — imported hardwood or tenite handles.

FREE

How to Fix Broken Windows. Illustrated instructions on cutting and replacing window panes.



**Red Devil Tools. Dept. 141**  
2400 Vauxhall Road, Union, N. J., U. S. A.

Please send FREE copy of "HOW TO FIX BROKEN WINDOWS."

NAME \_\_\_\_\_  
ADDRESS \_\_\_\_\_  
CITY \_\_\_\_\_ ZONE \_\_\_\_\_ STATE \_\_\_\_\_

1661

## Metal Turning Lathe for Model Makers



SEND FOR FREE FOLDER describing the new Lathe for Model Makers. 15 1/4" bed with 4 1/2" swing; 7" between centers. Guaranteed. **\$35.00** Only ...

f.o.b. Lansing.

Rosemoor Manufacturing Co.,  
2501 Bernice Rd., Lansing, Ill.

## THE ORIGINAL PACKAGED BOAT KITS

Made ONLY by *Custom-Craft*

Top Performance,  
Design, Styling!  
Over 70 Models  
8 to 21 ft

World's largest line! Over 200 Boats; Kits, Formed-Hulls, Semi & Custom-finished! All types: Prows - Cruisers! Easy to build! Flying-stern, Tredronic bottom, Bulkhead construction!

Send 35¢ for KIT CATALOG

52 pages! Includes Victory Series, hardware, paint accessories, Fiberglass! Send \$1.00 for Catalog Plus "Boating Handbook". DEALERS-AGENTS INQUIRE

## BOAT PLANS & PATTERNS Frame-Pac Kits

World's largest selection; over 200 plans, full-size patterns, frame-pac kits! Designed strictly for amateurs! All types: prows, kayaks, racers, runabouts, catamarans, houseboats, cruisers - Inboard-outboard 6-40' wood-plywood-steel! Send 35¢ for PLAN CATALOG Catalog PLUS "Boatbuilding Handbook" \$1.00

DEPT. P-38

CUSTOM-CRAFT - BUFFALO 7, N. Y.

## PORTABLE LIGHT PLANTS

**HI-LINE 6000 WATT PLANT**  
(Item 162) Push Button Start 115-230 v. 60 cyc. A.C. A brute of a power plant with a rugged 14.6 hp. Wisconsin engine. Plenty of electricity for ranges, water heaters, freezers, pumps, machinery, etc. Affords both 110 and 220 volts. Ideal where heavy current is needed. Wt. 590 lbs. Easily worth \$995. With crank start. **\$585.50**  
Factory price...  
Same plant, but with self-starter, **\$645.00**

## BATTERY CHARGING GENERATOR

**Push Button Start**  
A husky, 750 watt plant designed for charging 6 or 12 volt batteries in just minutes. When mounted with two 6 volt batteries, it provides a terrific cold weather motor starting unit, also perfect as a 12 volt light plant on boats! Charges all batteries anywhere—no hi-line current needed. Ideal for service stations, contractors, fleets, boats and farms. With ammeter and cutout. (Item 821) Wt. 120 lbs. Reg. **\$295.** Comes complete **\$119.50**



## HEATING & VENTILATING FAN

(Item 10) Easily installed in furnace pipes. Forces even heat to all rooms. Over range removes kitchen smoke and odors. Powerful, continuous duty motor, 110-120 v. AC. Mount in wall or ceiling to ventilate any area. Quiet, super-efficient fan moves huge volume of air. (400 to 600 CFM).  
8" Pipe, wt. 5 lb. .... **\$6.85**  
9" Pipe, wt. 6 lb. .... **\$7.85**  
10" Pipe, wt. 7 lb. .... **\$8.85**  
12" Pipe, wt. 8 lb. .... **\$9.85**



**HEAVY DUTY FAN.** Semi-enclosed motor, suitable for spray booths, restaurant exhausts, poultry houses, etc. 10" Fan, wt. 8 lbs. (Item 106)..... **\$11.95**  
12" Fan, wt. 10 lbs. (Item 106)..... **\$12.95**  
**HIGH SPEED BARN FAN** similar to above, but larger, high speed motor moves huge volume of air.  
12" Fan (Item 106)..... **\$14.95**  
14" Fan (Item 106)..... **\$17.95**

## EXTENSION CORD

Heavy duty and very flexible. Neoprene 14-2 cable, 20 year quality. Wt. 13 lbs. (Item 185) 100 ft. Complete with rubber plug and outlet. A terrific buy at only **\$8.95**  
No. 10-2 Power Cable. Heavy duty, very flexible, 20 ft. with male and female fittings. Wt. 4 lbs. (Item 818h)..... **\$5.15**  
20 ft. without fittings (818a)..... **\$4.15**  
50 ft. (Item 592) with fittings..... **\$13.45**  
100 ft. (Item 135) with fittings..... **\$25.95**  
No. 12-2 Power Cable. Very flexible rubber covered, special outside shield for grounding power tools, etc. 50 ft. (Item 193) Wt. 8 lbs. **\$6.95.** 100 ft. (Item 200)..... **\$12.95**  
No. 8-2 Conductor Power Cable. 30 ft. heavy duty, very flexible rubber covered with male & female plug (Item 817)..... **\$12.95**



## GIANT METAL SHEARS

**"PEXTO"**  
Nine inch cutting blade made of special high carbon alloy steel, perfectly aligned and ground. Easily cuts steel plate up to 1/2 gauge or 1/4" thick. Overall length 40". Wt. 23 lbs. (Item 156) Regular **\$49.50.** While they last. **\$14.95**

## JET STEAM MASTER

Now, a super efficient portable steam generator that produces live steam at 100 lbs. pressure in 60 seconds from a cold start! Produces large volume of high pressure steam on 2 pints of fuel oil. Instantly cleans sticks, grease, dirt, rust, old paint, etc. off implements and road machinery. Pays for itself in a few weeks. Sterilizes soil. Sterilizes as it cleans. All equipment, etc. Fully automatic—oil fired with new, built-in lifetime bronze water circulating pump. Draws water from faucet or bucket. Simple and safe—anyone can use it; built-in safety valve. Complete with 12 ft. of hi-pressure steam hose and new triple efficiency steam gun that automatically mixes in soap solution if desired. Wt. 250 lbs. (Item 463). **\$349.50**  
Special factory price.....



**BUY** at dealer prices **direct from MASTER MECHANIC'S factory**

**700 WATT PLANT**  
(Item 24) **PUSH BUTTON START**  
115 v. 60 cyc. AC Powered by a rugged 2.2 HP. easy starting Briggs engine. No wiring necessary; just plug in and operate. Plenty of current for any oil burner, freezer, brooder, emergency lights, etc. which require up to 700 watts. Ideal for television and radios. Complete with voltmeter and built-in winding to charge 6 v. auto batteries. (Item 24) Wt. 75 lbs. Easily fits in car trunk. Be prepared if storm knocks out power lines. **\$143.50**  
Regular \$275.00 value.....  
1200 Watt Plant (Item 45) same as Item 24 but larger generator and engine with 50% greater output..... **\$199.50**  
**GIANT 2500 WATT BELT DRIVE PLANT** 110-120 v. 60 cyc. AC, absolutely the best made. Skid mounted-Portable. Powered by an easy starting Briggs or Wisconsin 6 HP engine—complete with all accessories; engine easily disconnected for other uses. Big outlet box, voltmeter, (Item 31) Wt. 210 lbs. Reg. price \$885. Special at..... **\$299.50**  
Same plant with electric self starter (Item 31a)..... **\$359.50**  
Generator only and control box..... **\$169.50**

**"RIGID" PIPE STRAP WRENCH**  
This new, unusual strap wrench grips pipes, nuts, and large fittings. Vise tight without scratching. Ends all marring and slipping on polished or chrome pipes and fittings. Takes all the sweat out of cleaning sink traps, handling nuts, large unions, fittings, etc. Where ordinary wrenches are not big enough. The harder you pull, the tighter it grips. Big 12" handle and 1 1/2"x24" heavy web strap—will last a lifetime! Wt. 3 lbs. (Item 383) Reg. \$3.95. Our special..... **\$1.95**  
Super 1 1/2" model—larger for more leverage and bigger fittings. (Item 383A)..... **\$2.95**

**Variable Speed Selector**  
Heavy duty, made by B. F. GOODRICH for industrial use. Provides instant speed changes for any drive. For machine tools, dryers, painting, conveyors, production lines, hoists—any operation requiring variable speed. Employs reliable "trouble free" planetary system. No hydraulic power losses. Infinite range, smooth operation, easy installation. It sizes: 1/2-1 hp., 36 lbs.; 1-2 hp., Wt. 55 lbs.; 2-3 hp., Wt. 105 lbs.; Reg. list \$228, \$252 and \$352. Our prices **\$79.50, \$89.50 and \$114.50**

**MASTER AIR COMPRESSOR**  
**COMPARE!** This is the only compressor built with a NO RUST stainless steel tank. Safe up to 500 lbs. (Item 209) High pressure type 14 c.f.m.) Large volume of air for heavy duty service. For paint spraying, inflating truck & auto tires, stressing, sand blasting, etc. Piston type 2" bore compressor with built-in air filter. Master built with high strength alloys and precision bearings. Tank, 12"x24", 2100 cu. in. cap. Equipped with automatic switch that starts and stops motor to maintain desired pressure (up to 150 lbs.) and check valve, safety valve, gauge, shut-off valve, 20 ft. air hose and tire chuck. Beautifully balanced on ball bearing wheels and rubber tires. Don't take chances with used or surplus equipment. Our compressors are factory new and are guaranteed **SAFE.** Low factory prices. 1 1/2 HP Model (cap. 85 lbs.)..... **\$109.50**  
Reg. \$175. (Item 209).....  
2 1/2 HP heavy duty model, Reg.-Inst. motor & unloader switch (Item 209a)..... **\$129.50**



**MASTER DC ARC WELDERS**  
Now! a portable rugged, industrial type welder with terrific performance, yet at a price hundreds of dollars less than you'd expect. Senior model made for years of trouble-free, continuous service. High capacity DC welding unit enables you to tackle any job with confidence—easily welds anything up to 3" plate using from 1/16" to 1/2" rods. Built-in stabilizer and cooling system makes arc easy to strike and hold. Dual control rheostat provides low heat soldering, heating and welding from 30 to 300 amps. Complete with instructions, guarantee and triple V-belt or flat pulley. Easy to hook up and easy to operate. **WELDER ONLY - DUAL CONTROL MODEL.** Same as above, but drive with your tractor, jeep or gas engine of 14 HP or more. (Item..... **\$119.50**  
160 lbs. Wt. 150 lbs. \$425 value.....  
**WELDER ONLY - INDUSTRIAL MODEL** same as above but with ceramic rotary type rheostat providing 74 different heat settings for all types of welding (Item 38b)..... **\$139.50**  
\$500.00 value.....  
**COMPLETE POWER MASTER** (Illustrated above) powered by a 14.6 hp., air cooled Wisconsin engine. Wt. 480 lbs. (Item 280) Compares with welder costing \$1200. **\$449.50**  
Factory Special.....  
**WELDING KIT** Two 10 ft. leads, welding helmet, electrode holder, ground clamp. Sold only with welder at..... **\$10.50**

## LESS THAN WHOLESALE

**1500 WATT PLANT**  
115v. 60 cyc. AC Push Button Start. Powered by a 3 1/2 HP. Clinton engine. Combines big output with easy portability. Provides emergency power for operating any oil burner, sump pump, freezer, television, lights, communications systems, etc. which require up to 1500 watts. (Item 22) Wt. 110 lbs. Reg. \$475 value. Factory price... **\$239.50**



**1750 Watt Plant** Powered by 4.5 Briggs engine. Electric starting & battery charging built-in! Factory price... **\$279.50**

**MASTER-LITE 2500 Watt Plant** 110/120 v. 60 cyc. AC. A powerful plant, ruggedly constructed and yet designed for easy portability. Can be started by rope or built-in 12 v. electric push button starter. Built-in winding to charge battery. Powered by a big 6.30 HP Briggs engine—complete with all accessories. Includes control box, voltmeter, and handy plug-in power receptacle. An ideal plant for permanent or stand-by service. Wt. 225 lbs. Reg. price \$645.00 (Item 21) Factory Price..... **\$329.50**



**DUAL VOLTAGE 110/220** — \$30 additional. We make every type and size of light plants—Write, giving us your requirements!

## Double Acting Hydraulic Cylinder

A powerful cylinder mfr'd. by Massey Harris which develops both a pushing and a pulling action. Will push 8,100 lbs., with a 1000 PSI pump pressure. Cylinder is 3 1/2" O.D. with 3 1/2" stroke—standard heavy duty clevises on both ends. Has standard 1 1/2" pipe thread opening. Good for lifting buckets or blades, raising or lowering implements, hydraulic presses, etc. Can also be used as an air cylinder. (Item 802) Wt. 17 lbs. Reg. \$68 value. Special..... **\$14.95**

**OTHER DOUBLE ACTING CYLINDERS**  
8" stroke — 3" bore..... **\$34.00**  
10" stroke — 3" bore..... **34.80**  
16" stroke — 3" bore..... **43.00**  
24" stroke — 3" bore..... **47.50**  
**HYDRAULIC CONTROL VALVE**—4 way open center valve with built-in adjustable relief; easily mounted. Finger tip control. Wt. 116 lbs. (Item 822)..... **\$21.50**

## 9 TON HYDRAULIC PRESS

A tremendously powerful hydraulic press, capable of exerting 18,000 lbs. pressure. Pays for itself many times over—straightening bent connecting rods, knur pins, crank shafts, axles, link pins and bars—or pushing out frozen bearings and bushings. Developed pressure under precise control and visible at all times on accurate gauge. Complete with both large and small anvils and tips to straighten any kind of curve or bend. (Item 464) Wt. 110 lb. Actual list price \$365. Our special close-out price..... **\$69.50**  
**SCREW TYPE PRESS** Nine ton capacity. See Jan. Pop. Mech's, ad for details—or write. Complete, Wt. 150 lbs. (Item 797)..... **\$49.50**

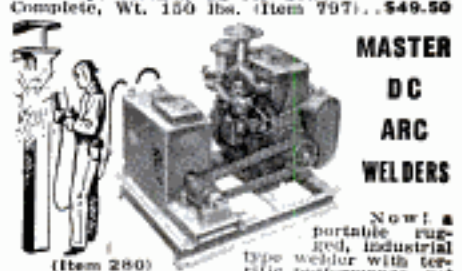

**MASTER DC ARC WELDERS**  
Now! a portable rugged, industrial type welder with terrific performance, yet at a price hundreds of dollars less than you'd expect. Senior model made for years of trouble-free, continuous service. High capacity DC welding unit enables you to tackle any job with confidence—easily welds anything up to 3" plate using from 1/16" to 1/2" rods. Built-in stabilizer and cooling system makes arc easy to strike and hold. Dual control rheostat provides low heat soldering, heating and welding from 30 to 300 amps. Complete with instructions, guarantee and triple V-belt or flat pulley. Easy to hook up and easy to operate. **WELDER ONLY - DUAL CONTROL MODEL.** Same as above, but drive with your tractor, jeep or gas engine of 14 HP or more. (Item..... **\$119.50**  
160 lbs. Wt. 150 lbs. \$425 value.....  
**WELDER ONLY - INDUSTRIAL MODEL** same as above but with ceramic rotary type rheostat providing 74 different heat settings for all types of welding (Item 38b)..... **\$139.50**  
\$500.00 value.....  
**COMPLETE POWER MASTER** (Illustrated above) powered by a 14.6 hp., air cooled Wisconsin engine. Wt. 480 lbs. (Item 280) Compares with welder costing \$1200. **\$449.50**  
Factory Special.....  
**WELDING KIT** Two 10 ft. leads, welding helmet, electrode holder, ground clamp. Sold only with welder at..... **\$10.50**

Send check or M.O. Prices f.o.b. Factory. 10 day Money back guarantee. SEND 10c for... **MASTER MECHANIC MFG. CO., DEPT. 95-P Burlington, Wis.** **BIG 1957 Catalog**

# MORE ACCURACY • VERSATILITY • DEPENDABILITY FOR YOUR MONEY

**SOUTH BEND** gives you quality that counts — quality that pays off in better and faster metal working by means of more accuracy, versatility and dependability.

Compare the South Bend 7" Shaper and Pedestal Grinder with any others on this basis. You'll find that their quality actually gives you more value on a dollar-for-dollar basis. The best way to prove this is in your own plant. Let our distributor show you how both of these efficient machine tools can best be used in your production, toolroom or maintenance work. Time payment terms available.

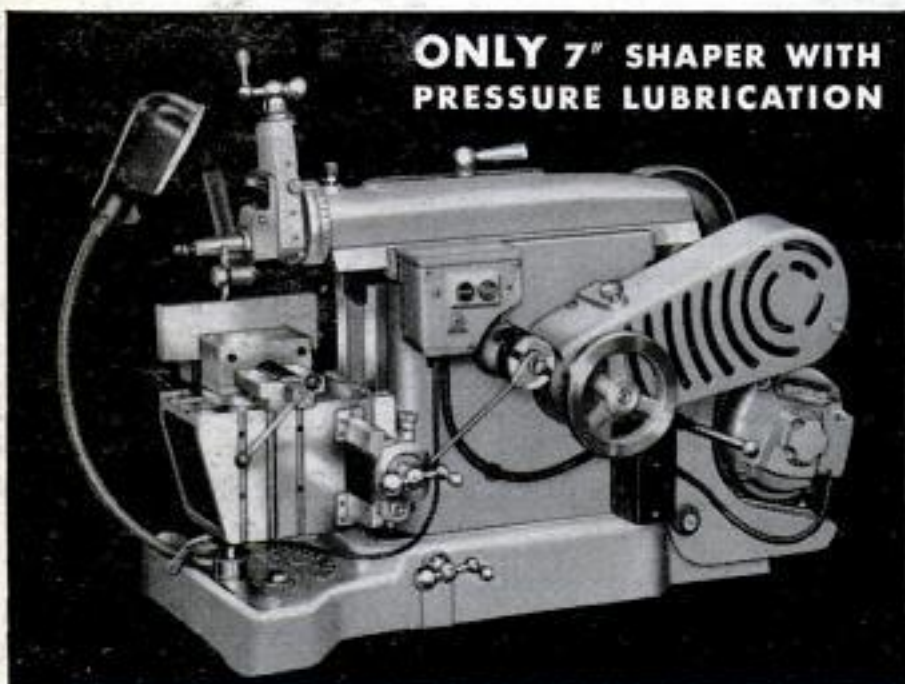

**ONLY 7" SHAPER WITH  
PRESSURE LUBRICATION**

7" Precision Bench Shaper—\$573

(Prices f.o.b. factory, less motors)

10" Pedestal Grinder—\$270



PLEASE SEND INFORMATION CHECKED:

<input type="checkbox"/> 9" and 10" BENCH LATHES	<input type="checkbox"/> 10" to 16-24" FLOOR LATHES	<input type="checkbox"/> DRILL PRESSES	<input type="checkbox"/> 1/2" & 1" Collet TURRET LATHES	<input type="checkbox"/> TOOL GRINDERS	<input type="checkbox"/> 7" BENCH SHAPERS	<input type="checkbox"/> MILLING MACHINES
--	---	--	---	--	---	---

Name \_\_\_\_\_ Street \_\_\_\_\_  
City \_\_\_\_\_ State \_\_\_\_\_

Building Better Tools Since 1906 • SOUTH BEND LATHE • South Bend 22, Indiana



Now available...direct to you from the Publisher

BRAND NEW EDITION OF THE WORLD FAMOUS

# ENCYCLOPAEDIA BRITANNICA

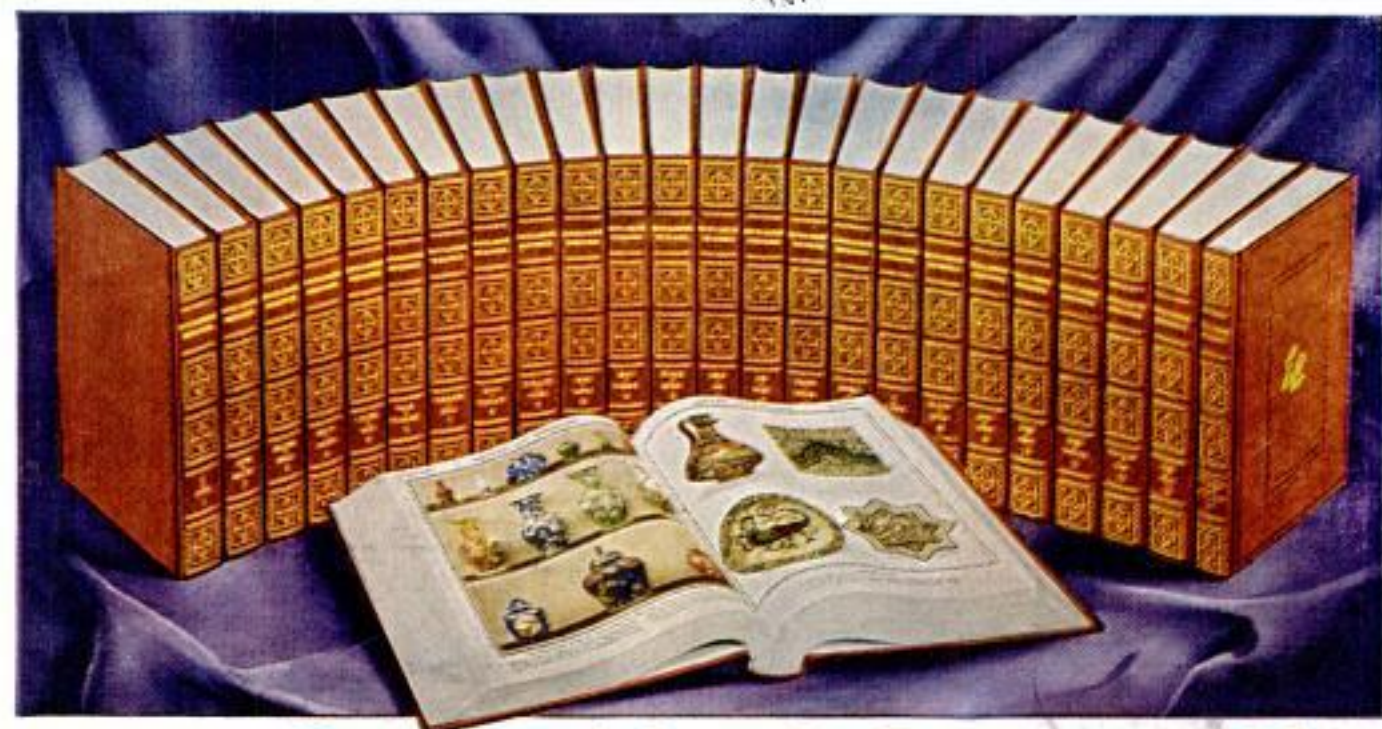

## On Easy...Book a Month Payment Plan

All 24 Volumes Delivered Immediately—You Pay Later on Easy-to-Own Purchase Plan

Yes, the latest edition of Britannica—the greatest treasure of knowledge ever published—is now being offered on a remarkable plan that puts this world-renowned reference library within reach of *every* family. All 24 volumes will be placed in your home...NOW...you pay for it as you enjoy it...*as easy as buying a book a month!*

### Thousands of Subjects of Practical Value to Your Whole Family



every kind of hobby... plus a treasure house of knowledge on *all* subjects. Useable information that can save you many dollars.

### New Edition Profusely Illustrated

The new Britannica almost "televises" the information to you by means of 23,225 pictures, plus charts, maps and drawings. But it does not merely show "attractive" pictures—it is the work of 5,258 of the world's best minds. The final authority on factual knowledge; a constant inspiration that will enrich the lives of yourself and your family.

Mail Coupon NOW for FREE BOOKLET!



Self-confidence—and the confidence of others—are two rewards you can expect from Britannica's world of facts. For instance, did you know...

- Britannica provides instant and authentic information on every conceivable subject or thought.



- Britannica will enable parents to work more closely with their children at home... helping them build a more solid foundation in today's highly competitive society.

- It will build self-confidence... by helping all members of your family to understand... and talk intelligently on every subject that enters into the lives of successful men and women.

### Preview Booklet Offered FREE!

Simply fill in and mail the coupon today, and we will send you... *without cost or obligation*... a copy of our beautiful new booklet which contains an exciting preview of the latest edition of Encyclopaedia Britannica. Send no money—not even for postage. It's yours, *absolutely free!*

Just as soon as we receive your coupon, we will send your illustrated free booklet, so that you can read and enjoy it at your leisure, in the privacy of your home. There is no obligation, of course. However, since this offer is necessarily limited, please mail the coupon *today* before it slips your mind.

ENCYCLOPAEDIA BRITANNICA, Dept. 45-F

425 N. Michigan Avenue, Chicago 11, Ill.

Please send me, free and without obligation, your colorful Preview Booklet which pictures and describes the latest edition of ENCYCLOPAEDIA BRITANNICA in exciting full detail. Also include complete information on how I may obtain this magnificent set, direct from the publisher, on the Book a Month Payment Plan.

Name \_\_\_\_\_  
(Please Print)

Address \_\_\_\_\_

City \_\_\_\_\_ Zone \_\_\_\_\_ State \_\_\_\_\_

In Canada, write E. B. Ltd., Terminal Bldg., Toronto, Ontario

# HAVE A REAL CIGARETTE \_

## have a Camel

R. J. Reynolds Tobacco Co., Winston-Salem, N. C.



"I want a real cigarette — one with plenty of good flavor. That's why I smoke Camels, and have for 10 years. It's all cigarette — all the way."

*Jim Ferguson*  
HELICOPTER PILOT

Discover the difference between "just smoking" and Camels!

**Taste** the difference! You'll find that Camels are rich, full-flavored, and deeply satisfying — pack after pack. They never let you down.

**Feel** the difference! The exclusive Camel blend of quality tobaccos is unequalled for *smooth* smoking. Camels are easy to get along with.

**Enjoy** the difference! More people smoke Camels, year after year, than any other brand of any kind. Try Camels — they've really got it!

America's real smoke is **Camel** — the largest-selling cigarette today!

Copyrighted material