

HOW TO PLAN THAT VACATION CABIN

# POPULAR MECHANICS

JAN. 1957  
35¢





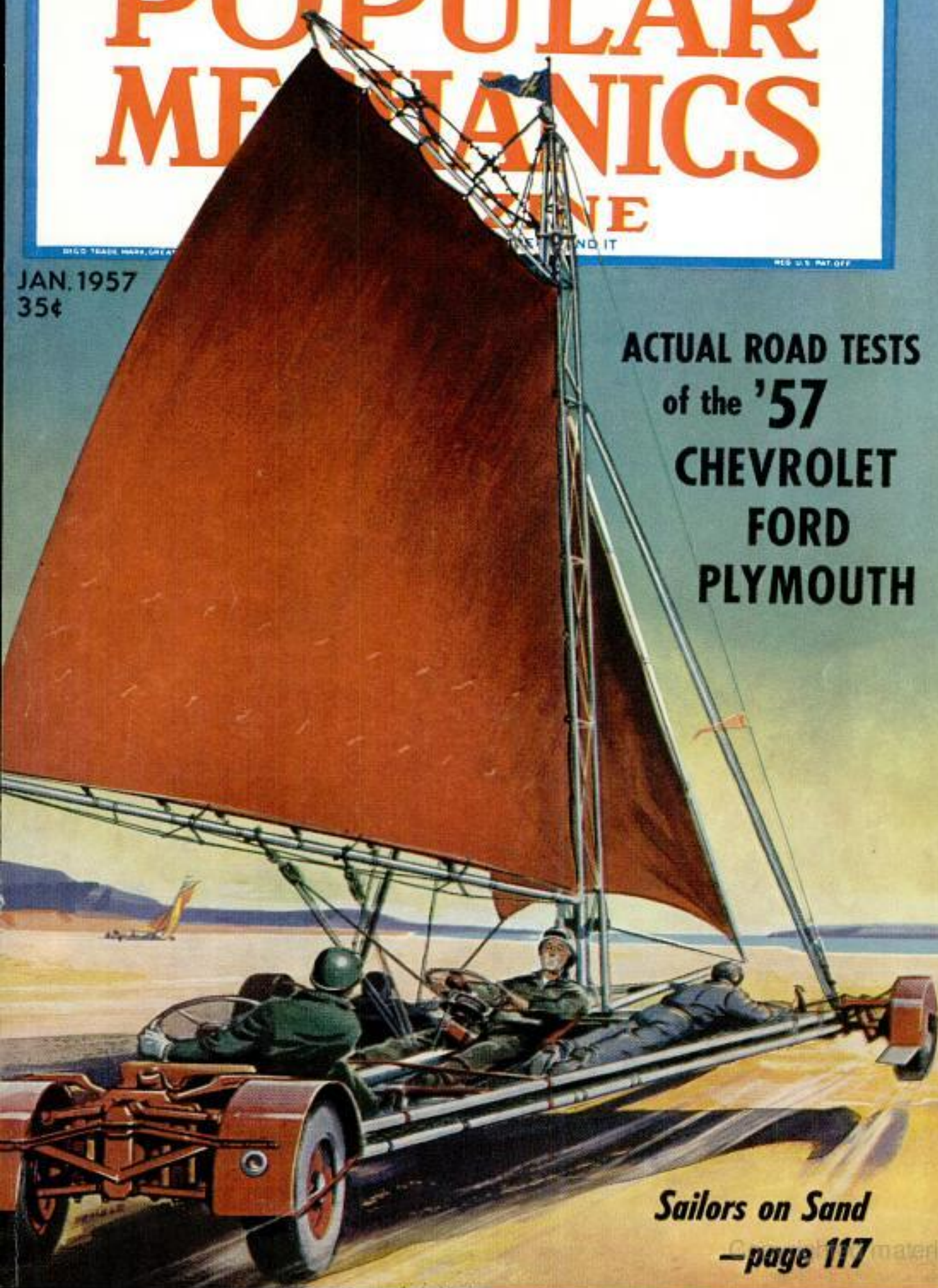

ACTUAL ROAD TESTS  
of the '57  
CHEVROLET  
FORD  
PLYMOUTH

*Sailors on Sand*  
—page 117



# Champion spark plugs power 130 out of 134 stock car winners !

## BOX SCORE OF 1956\* NASCAR WINNERS

		Short track	Convertible	Grand National	Total
Ford		10	26	13	49
Chevrolet		18	10	3	31
Dodge		1	10	10	21
Chrysler		0	0	19	19
Mercury		2	0	5	7
Oldsmobile		1	0	1	2
Buick		0	1	0	1

\*through Oct. 14

**Tremendous record compiled by seven different makes of cars proves Champions are best for your car, too! If you've gone about 10,000 miles without a spark plug change, they can boost your road horsepower by 24%!**

What could be more dramatic proof of Champions' amazing performance? Out of 134 winning stock cars in 1956 NASCAR† races, 130 were powered by Champion Spark Plugs!

This kind of performance shows that Champions are best for *your* car, too. In fact, independent engineers have proved that if you've gone about 10,000 miles without a spark plug change, new Champions can give your car an *immedi-*

*ate* gain in road horsepower—a gain that averaged 24% in tests with all major makes of cars!

If you haven't had your spark plugs checked recently, chances are you're losing power! For spark plugs should be checked every 5,000 miles—and changed every 10,000 miles—to assure maximum performance. Replace *your* old plugs with new Champions—and get more road horsepower *instantly!*

†National Association of Stock Car Auto Racing, Inc.



**Cars that win stock car races** are no different from the cars you drive. But the men who race them know how to get every last ounce of horsepower. That's why the overwhelming majority of winners—better than 96%—are equipped with Champion Spark Plugs.



# AT LAST, AN AIR FILTER THAT REALLY PROTECTS YOUR ENGINE!

New FRAM  
**FILTRONIC**  
CARBURETOR  
AIR FILTER  
obsoletes all  
other air  
filter types



Here's  
the **SECRET**

Exclusive FRAM patented, built-in gasket  
absolutely prevents by-passing.

**TIME WAS** when your new-car manual warned: *Service your air filter every 1,000 miles.* It had to be! If you let it slide, engine wear jumped alarmingly as a result of abrasive dust and dirt passed by the already loaded filter. Cleaning efficiency dropped sharply and it was costly to keep your filter serviced.

**THE AMAZING NEW FRAM "FILTRONIC" CARBURETOR AIR FILTER** ends all that! Here's the air filter that performs mile after mile with a bare minimum of attention. It *keeps* its high efficiency—99. + % through all its life! No abrasive dirt or dust can by-pass it. Engine wear is cut up to 90%! And, it's a cinch to service! Takes but a minute or two to remove the specially-developed dry-type cartridge, clean it and re-install.

**WHY IS THIS NEW FRAM "FILTRONIC" AIR FILTER** so efficient? Because the exclusive FRAM-patented built-in gasket absolutely prevents by-passing and is a FRAM feature not found in any other filter! Dirt and dust *absolutely* cannot by-pass to damage vital engine parts. Your engine breathes clean air only; you save your engine's power; you lengthen your engine's life!

**Revolutionary New  
FRAM "FILTRONIC"  
AIR FILTER Now  
Standard Equipment  
on these Great Engines!**

Continental • Ford  
Lincoln • Mercury  
Studebaker • Thunderbird  
Turnpike Cruiser  
American La France  
Autocar • Clark • Cummins  
Diamond T • Divco  
General Supply  
Harley Davidson • Lycoming  
Reo • Sheppard



Send for  
**FREE BOOKLET!**

16 pages of **FACTS** and  
illustrations show how to  
keep new-car performance  
for thousands of extra  
miles! Send coupon today!

FRAM CORPORATION  
Providence 16, R. I.  
Fram Canada Ltd., Stratford, Ont.

This One



K6D3-76F-9GA8

Street.....

City.....Zone....State.....



Better  
Results...

WHEN YOU USE THE  
**PACEMAKER GRAPHIC®**  
**SYSTEM OF PHOTOGRAPHY**

The Pacemaker Graphic 45 provides the advanced amateur with a complete system of photography that has been proved best by press and professional photographers the world over. Three types of focusing, three types of viewfinding, three types of flash synchronization and three types of shutter release give you a wide choice of techniques to solve any picture-taking problem. Fitted with Graflok Back, you can use any of the film receptacles shown below for sheet, roll or even Polaroid's professional "picture-in-a-minute" film! Your Graflex dealer (listed in the yellow pages of your phone book) will gladly give you a demonstration. Pacemaker Graphic 45 with Graflok Back, Graphic Rangefinder, 135mm. Optar f/4.7 lens and Graflex fully synchronized shutter as little as—\$18.90 a month!



**GRAFMATIC® FILM HOLDER**  
Actually a sheet film magazine. Holds 6 sheets. Changing is lightning fast, smooth and fool-proof. Little thicker than a 2-sheet holder.



**GRAFLEX® ROLL HOLDER**  
Adapts Graphic for use of low cost, daylight loading roll film. Gives you the utmost in film economy.



**GRAPHIC®  
POLAROID  
BACK**

This special back permits use of the new professional Polaroid film for "picture-in-a-minute" photography.



**RITEWAY® FILM HOLDERS**  
The ultimate in film receptacles. Accurate film positioning always. Unconditional two year guarantee.

For further information see your dealer or write Dept. PM-17, Graflex, Inc., Rochester 8, N. Y. Prices include federal tax where applicable and are subject to change without notice. Prices slightly higher in Canada.

**GRAFLEX®**  
A SUBSIDIARY OF 



**Building Blocks for Fence  
Lock Without Mortar**

Fences or attractive garden walls can be made with a building block which requires no mortar. The block was developed by a student, Paul G. Priestley, at the Institute of Design, Illinois Institute of Technology. The block appears as a flat rectangle from the front and forms an H when viewed from a side. After the first row of blocks is laid, subsequent rows fit into grooves of the blocks below. The blocks can be laid in many designs and the inventor sees possibilities in them for room dividers that can be moved with ease.

**Satellites Would Extend  
Range of Television**

Manmade space-satellites, traveling 4000 miles high at four locations over the earth's equator, will serve as relay stations in a worldwide-TV system, a General Electric rocket expert has predicted. TV signals could be transmitted to the nearest satellite from a ground site on the equator. Relayed from satellite to satellite, these signals could be retransmitted to a selected TV-receiving station on earth. Need for high-altitude satellites is caused by the high radio frequency of TV signals, which are limited in range due to straight-line transmission over the earth's curved surface. At a 4000-mile altitude the effect of the earth's curvature on TV transmission and reception would be lessened.

# Popular Mechanics Magazine

Registered in U. S. Patent Office and Canada

H. H. WINDSOR, Founder

H. H. WINDSOR, JR., Editor and Publisher



## Next Month

DR. KARL SAX, the guiding genius of an arboretum famed as "America's Greatest Garden," can change an ordinary tree into a dwarf. He tells how you can do the same in a feature next month in which he reveals "The Tricks He Plays on Trees"

### POPULAR MECHANICS INTERNATIONAL EDITIONS

Mecanique Populaire (French)  
 Mecánica Popular (Spanish)  
 Populaer Mekanik (Danish)  
 Populär Mekanik (Swedish)  
 Populare Mechanik (German)

Sources of further information not listed in the index, starting on page 90, about articles in this issue, frequently are shown in the Where-to-Find-It List prepared for each issue. A copy may be obtained by readers, without charge, from Bureau of Information, Popular Mechanics, 200 East Ontario Street, Chicago 11, Ill.

Published monthly by Popular Mechanics Company, 200 E. Ontario St., Chicago 11, Ill. H. H. Windsor, Jr., president; Wm. Harrison Petridge, exec. vice-pres.; Franklin S. Forsberg, operations vice-pres.; D. F. Windsor, vice-president and secretary-treasurer; H. H. Windsor III, vice-president; W. T. Windsor, vice-president; Joseph R. Busell, Jr., advertising manager; Alan M. Deyoe, circulation manager. Single copy in the United States and Canada, 35 cents; subscription rates in the United States and possessions, Canada and countries of the Pan-American Postal Union, 1 year \$3.50; 2 years, \$6.00; 3 years, \$8.00. To all other countries add \$1.00 a year over United States prices for overseas postage. If you plan to move, notify us at least 30 days in advance so you will not miss an issue. Give both your old and new addresses. Entered as Second Class Matter, September 15, 1903, at the Post Office at Chicago, Illinois, under Act of March 3, 1879. Entered as Second Class Matter at Post Office Dept., Canada. Registered as Second Class Matter at the Post Office at Mexico, D. F., Mexico, June 20, 1950. Copyright 1956 by Popular Mechanics Company. Copyright under International Copyright Union. Copyright in France. All rights reserved under Pan-American Copyright Union. Printed in the United States of America.

Volume 107 JANUARY 1957 Number 1

Address all communications to: 200 E. Ontario St., Chicago 11, Ill.

Managing Editor.....Roderick M. Grant  
 Assistant Managing Editor.....Wayne Whittaker  
 Shop Notes and Crafts Editor.....James R. Ward  
 Radio-Television, Electronics Editor.....Lothar Stern  
 Associate Editor.....Clifford B. Hicks  
 Associate Editor, Automotive.....Arthur R. Railton  
 Associate Editor, Shop Notes and Crafts.....Wayne C. Leckey  
 Associate Editor, Shop Notes.....W. Clyde Lamney  
 Assistant Editor, Crafts.....Jay W. Hedden  
 Assistant Editor, Makeup.....John C. Dalen  
 Art Director.....Frank Beatty  
 Assistant Editors—Robert E. Dorsett, Emily M. Rice, Earl F. Wobeck  
 Eastern Editor.....Richard F. Dempewolf  
 Empire State Bldg., Room 2906, New York City 1  
 Western Editor.....Thomas E. Stimson, Jr.  
 Suite 1010, 3460 Wilshire Blvd., Los Angeles 5, Calif.  
 London Manager.....Douglas W. Wedderspoon  
 Eagle House, Jermyn St., London S. W. 1, England  
 Director, Bureau of Information.....Allan Carpenter  
 200 E. Ontario St., Chicago 11

### Advertising Offices

Chicago: 200 E. Ontario St., Whitehall 4-0100; New York: Empire State Bldg., 350 Fifth Ave., Longacre 5-7580; Detroit: General Motors Bldg., TRinity 5-8711; Cleveland: Hanna Bldg., 1422 Euclid Ave., PRospect 1-0456; Los Angeles: 3460 Wilshire, DUNKirk 2-8458; San Francisco: Russ Bldg., 235 Montgomery St., YUKon 2-0823.

## In This Issue . . .

How to Plan That Vacation Cabin . . . . .	97
PM Road Tests the "Big Three"	
The 1957 Chevrolet . . . . .	106
The 1957 Ford . . . . .	108
The 1957 Plymouth . . . . .	110
Detroit Listening Post . . . . .	116
They Sail on Sand . . . . .	117
Keeping Up With the Atom . . . . .	123
Where an Angler's Thrill Becomes a Masterpiece . . . . .	129
Big Mack, World's Longest Suspension Bridge . . . . .	138
Do It Yourself With Kits . . . . .	144
Scale Models Avert Engineer's Headaches . . . . .	148
City With a Sinking Feeling . . . . .	152
Goal No. 3 — Disease-Free Crops . . . . .	165
What's New for Your Home . . . . .	170
Radio, TV and Electronics . . . . .	177

## For the Craftsman . . .

Desk-Chair Combination . . . . .	181
Staved Boxes . . . . .	190
Solving Home Problems . . . . .	198
Modeling the Lachlan Macleay — Part II . . . . .	201
Brakes for Today's Traffic . . . . .	214
How Would You Do It? . . . . .	230
Shopping for Tools . . . . .	234
On the Market for Do-It-Yourselfers . . . . .	236
Clinic for Homemakers . . . . .	240

See pages 90, 92 and 94

for other items and manufacturers of available products

# EASY CASTS

QUICK AS A FLASH



... with  
**PUSH-BUTTON  
Magic!**

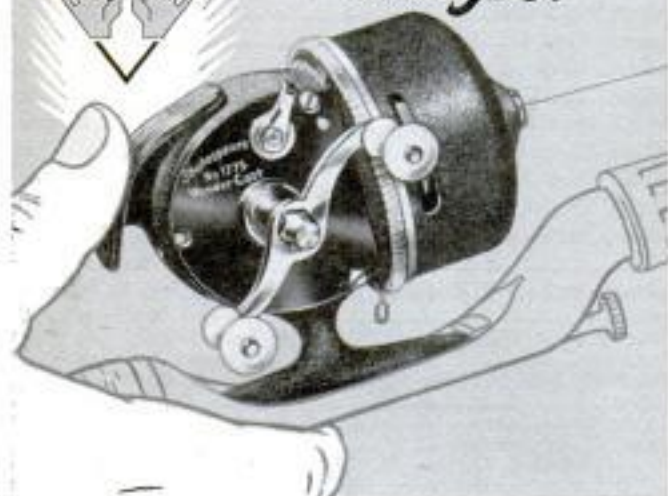

## Shakespeare PUSH-BUTTON WONDERCAST

Just a push of the button ... a s-w-i-s-h of the rod ... presto! You're push-button fishing! All the good attributes of bait casting plus the benefits of fixed-spool spinning are combined for backlash-free, "magic" casts of live bait, light or heavy lures. Ask your dealer about its advanced design, trouble-free performance, and rugged construction. Sparkling duo-tone black finish, non-reverse crank; outer cone turns for quick drag changes. Easy to handle bait casting crank. All outstanding features to help everyone catch more fish—*have more fun!* No. 1775 (filled with 125 yds. 6 lb. monofilament) ..... \$19.95

**"FISHIN' FUN"  
FOR EVERYONE**



**5 BRAND NEW FISHING BOOKLETS  
AND CALENDAR FREE!**

Latest in fishing tips and tricks by the experts. Covers spinning, bait casting, push-button, fly and saltwater fishing.



**SHAKESPEARE COMPANY**  
Dept. PM-1, Kalamazoo, Michigan  
Please send me your 5 brand new fishing booklets and calendar, free!

NAME \_\_\_\_\_

ADDRESS \_\_\_\_\_

CITY \_\_\_\_\_ ZONE \_\_\_\_\_ STATE \_\_\_\_\_



## Portable Trap

O. F. Mossberg & Sons, Inc., New Haven 5, Conn.



Coveys of clay birds, hurled up to 60 yards from a 1½-pound aluminum hand trap, bring actual field conditions close to the practicing hunter. Swung like a baseball bat, the nonmechanical trap has no moving parts and releases from one to three spinning targets at a time. The unit is 37 inches long, has a removable handle which locks inside the trap frame for carrying or storage, and is operated right or left-handed. A retaining spring along the rubber-lined track holds clay targets in place prior to throwing. Speed and angle of release can be varied.



Ithaca Gun Co., Inc., Ithaca, N. Y.

## Glowing Gun Sight

Picking up light rays to glow a bright red-orange against the target, a plastic-pellet gun sight increases accuracy and speeds sighting in weather involving poor lighting conditions. The pellet is mounted in steel.

Chemical "stop drop" sprays that prevent fruit from falling off trees are cutting pre-harvest losses of apples and pears from 20 percent to less than 6 percent.

POPULAR MECHANICS

Copyrighted material

New versatile

# Screwdriver Kit only \$36<sup>95</sup>

It's a 1/4" drill...a screw setter...a power screwdriver!



Porter-Cable's amazing new Screwdriver Kit gives you *three* of the world's handiest tools—at a real bargain price, if you act now.

The matchless Porter-Cable drill has all the speed and power you will ever need for any kind of drilling up to 1/4" in steel and 1/2" in hard wood.

The unique screw setter attachment drills precision pilot holes for the threaded portion of the screw, and a larger hole for the shank, countersinks for the screw head and counterbores for putty and wood plugs—all in one easy operation.

And simply by inserting the screwdriver attachment into the chuck, this Porter-Cable drill becomes a power screwdriver. It performs all your screwdriving needs easier, faster than ever.

This amazing screwdriver kit helps you get professional results in furniture-making, home improvements, fine cabinet work and shop work of every kind. Save \$5.00 if you buy *now*.

**Porter-Cable**

*Quality Electric Tools*

## SPECIAL INTRODUCTORY OFFER!

Model 161 Screwdriver Kit, complete with adjustable Screw Setter (for No. 8 screws) and Screw Driver attachments with slotted screw bit and Phillips bit, and Carrying Case constructed of strong, welded steel.

\$41.95 value... **\$36<sup>95</sup>**  
now only

Offer expires Jan. 31, 1957



SEE YOUR DEALER—OR MAIL COUPON TODAY!

- PORTER-CABLE MACHINE CO.
- 7141 N. Salina St., Syracuse 8, N. Y.
- Please send me complete information on Model 161 Screwdriver Kit and name of my nearest dealer.

Name \_\_\_\_\_

Address \_\_\_\_\_

City \_\_\_\_\_ Zone \_\_\_\_\_ State \_\_\_\_\_

In Canada: write Porter-Cable, Ltd., Box 5019, Ont., Canadian prices slightly higher.

# Do Your Work Easily with PROTO's New, Improved Flat Wrenches

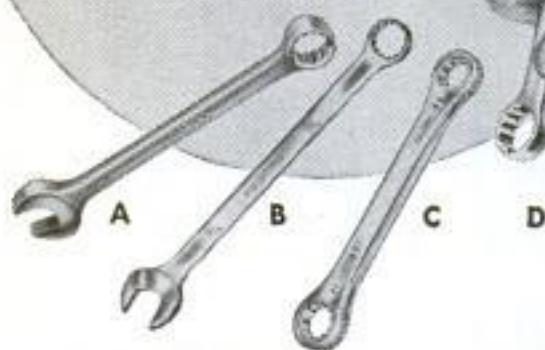

## CHECK THESE FEATURES!

**Balance . . . Proportion . . . Design •  
PROTOLLOY Steels • Good Obstruction  
Clearance • Tough, Non-Slip Finish •  
Plainly Marked Openings.**

PROTO Flat Wrenches are truly "professional quality" tools, made of specially forged alloy steel, carefully heat treated. Designs are based on scientific study to make them as slim as possible for convenience in tight places, yet reinforced properly where it counts to eliminate breakage. See your nearby PROTO dealer today. Send 10¢ for catalog of entire line to

### PROTO TOOLS

2217 Santa Fe Ave., Los Angeles 54, Calif.  
Eastern Factory, Jamestown, N.Y. • Canadian Factory, London, Ont.

**A. NEW!** Whitworth Combination Box & Open End Wrenches. Four sizes commonly used on foreign automobiles and motorcycles. Whitworth openings,  $\frac{3}{16}$ " to  $\frac{3}{8}$ ". Lengths,  $5\frac{1}{4}$ " to  $8\frac{1}{4}$ ". Satin chrome plated.

**B. NEW!** Long 6-Point Box & Open End Wrenches. Provide greater gripping area for heavier torque loads.  $\frac{3}{16}$ " to  $\frac{3}{8}$ " openings.  $5\frac{3}{4}$ " to  $9\frac{1}{8}$ " lengths. Satin chrome plated.

**C. NEW!** Ratcheting 12-point Box Wrench. For oil filter work on new cars.  $\frac{5}{8}$ " x  $\frac{3}{4}$ " openings.  $8\frac{1}{8}$ " long. PROTO line now includes 6 tools in this series.

**D. NEW!** Double Head 12-Point 15° Box Wrench. Meets Mil. Spec. Designed for use on elastic stop nuts. Openings,  $\frac{3}{16}$ " x  $\frac{17}{32}$ ". Length,  $5\frac{1}{4}$ ". Satin chrome plated.



AS688

## ACROSS THE DESK



Like to compare the performance of Chevrolet, Ford and Plymouth as reported by experts? Turn to page 106 for analyses of the Big Three by Dale Kelly, engineer, and Floyd Clymer, who has taken all three '57 models into the country for test runs.

### To the Editor:

The annual house section of your magazine (PM, Oct. 1956) is a wonderful idea and I would like to add my opinion on "What is wrong with today's houses."

First, I think there is not enough thought given to eating areas. That is the only time you can get the family together, but not sitting in front of a wall in a little dark corner or on a stool. The eating area, rather than the sink, should be in front of windows to inspire chumminess, friendliness and relaxation. A dining area in the living room is only used on state occasions; therefore, the kitchen is very important.

Second, the garage should always be next to the kitchen; parcels and groceries should not be carried through bedrooms or living room.

Our interest is running high at the moment because we wish to dispose of our spacious 12-room house for a five-room house. We have an adorable location with all the land we wish; the living room shall have to be at the rear of the house because the view is of the most beautiful sunsets in New England.

I may as well tell you what we want in a house: Living room about 400 square feet, two bedrooms about 180 square feet and kitchen about 180 square feet (no stool and no breakfast nook). Many cabinets and many closets and a screened porch, not a breezeway. Full basement. You see this is not to be pretentious but just perfect for a retiring couple. Many of our friends are also looking for this type home.

Hoping my ideas may be of some value. We find *Popular Mechanics* the most interesting literature that comes into our home.

Mrs. Fred Kingdon,  
56 Pakachoag St.,  
Auburn, Mass.



We were in error in stating that the nail-on bricks described on page 140, November 1956, are  $2\frac{1}{2}$  inches thick. The face of the brick is  $2\frac{1}{2}$  by  $11\frac{1}{2}$ , but its thickness is only one inch, making the brick only one fourth the weight of ordinary brick.

(Continued to page 8)

POPULAR MECHANICS





To the man who wants to enjoy  
**an ACCOUNTANT'S CAREER**



**IF** you're that man, here's something that will interest you.

Not a magic formula — not a get-rich-quick scheme — but something more substantial, more practical.

Of course, you need something more than just the desire to be an accountant. You've got to pay the price — be willing to study earnestly, thoroughly.

Still, wouldn't it be worth your while to sacrifice some of your leisure in favor of interesting home study — over a comparatively brief period? Always provided that the rewards were good — a salary of \$4,000 to \$10,000 and up?

An accountant's duties are interesting, varied and of real worth to his employers. He has *standing!*

Do you feel that such things aren't for you? Well, don't be too sure. Very possibly they *can* be!

Why not, like so many before you, investigate LaSalle's modern Problem Method of training for an Accounting position?

Just suppose you were permitted to work in an accounting firm under the personal supervision of an expert accountant. Suppose, with his aid, you studied accounting principles and solved problems day by day — easy ones at first — then more difficult ones. If you could do this — and could turn to him for advice as the problems became complex — soon you'd master them all.

That's the training you follow in principle under the LaSalle Problem Method.

You cover accounting from Basic Accounting right through Accounting Systems and Income Tax Procedure. As you go along, you absorb the principles of General Accounting, Auditing and Basic Cost Accounting. Then you may choose Commercial Accounting, Industrial Accounting or Public Accounting and prepare for the C. P. A. examinations.

Your progress is as speedy as you care to make it — depending on your own eagerness to learn and the time you spend in study.

Will recognition come? The only answer, as you know, is that success *does* come to the man who is really *trained*. It's possible your employers will notice your improvement in a very few weeks or months. Indeed, many LaSalle graduates have paid for their training — with increased earnings — before they have completed it! For accountants, who are trained in organization and management, are the executives of the future.

**Send Today For Free Book**

**"Accountancy, The Profession That Pays"**

For your own good get all the facts about this completely new and modern accounting training. Write for Free book "Accountancy, The Profession That Pays," which will prove that Accounting offers brilliant futures to those who aren't afraid of serious home study, and will show the wide range of opportunities that exist today. No cost or obligation. If you want a position of higher income, greater prestige and professional standing . . . MAIL THE COUPON NOW!

Over 4,200 Certified  
 Public Accountants among  
 LaSalle alumni

Member, National Home Study Council



**LASALLE EXTENSION UNIVERSITY**  
 A CORRESPONDENCE INSTITUTION

417 S. Dearborn St. Dept. 164 H Chicago 5, Ill.

I want to be an accountant. Send me without obligation, Free book, "Accountancy, The Profession That Pays."

Name.....Age.....

Address.....

City, Zone & State.....



# Do You Like art?

## DRAW FOR MONEY!

**Our Simple Method Proves You Can Learn to Draw at Home in Spare Time**

**YES**, now you can learn Commercial Art, Designing, Illustrating, Cartooning etc.—*right at home in spare time!* If you like to draw, YOU, with the proper training may be able to trade your dull job for a glamorous career.

There's a big demand today for story and advertising illustrations, cartoons, signs, TV settings, fashion sketches, etc. Competent artists are today worth \$100, \$200, \$300 per week and more. Our famous "Show-How" home-study method can give you the training you need to make good—quickly, easily, enjoyably, in your spare time.



### Thrills of an Art Career

Think what this will mean! You can be your own boss—as a freelance artist or head of your own art studio. Work at home, on your spare time. Meet interesting people—fellow artists, advertising and publishing executives. Best of all, get paid for enjoying the thrill of self-expression . . . of seeing your work admired by the public!

### Get Individual Guidance

Our famous school trains you step-by-step, right at home in your spare time, with clear A-B-C explanations and how-to-do-it pictures. Each of your lessons is personally reviewed by a gifted art instructor who writes and sketches suggestions and hints right on your own lesson sheet. Reasonable tuition fees. Earn while you learn. **TWO Complete Art Outfits** included at no extra cost.

### They Traded Dull Jobs For Glamorous Careers



L. E. SIKES, Jr., Lake Wales, Fla.

"I now own my own business. Without the training I received from the WSA I'd still be a clerk." — MRS. TAVI TEICHMAN, Northfield, N. J.



## FREE ART TALENT TEST AND VALUABLE BOOK



Mail coupon for our Art Talent Test. When you complete it, return it for criticism by expert art instructors. It's fun and it's free. And it may open the door to a fascinating career. Coupon also brings you our illustrated 32-page **FREE BOOK**, "Art for Pleasure and Profit." No obligation. No salesman will call. Don't delay. Mail coupon at once to: **WASHINGTON SCHOOL OF ART, Studio 141, Port Washington, N. Y.** (Established 1914)

### WASHINGTON SCHOOL OF ART Studio 141, Port Washington, N. Y.

Please send me—without obligation—FREE Art Talent Test and FREE illustrated 32-page book, "Art for Pleasure and Profit." No salesman is to call on me.

Name \_\_\_\_\_ Age \_\_\_\_\_  
(PLEASE PRINT PLAINLY)

Address \_\_\_\_\_

City \_\_\_\_\_ Zone \_\_\_\_\_ State \_\_\_\_\_

### To the Editor:

Enclosed is a snapshot of a three-wheel car I built. The body is from a cracked-up airplane (cut the tail and front seat off), Model-T steering wheel, one-wheel trailer



wheels and tires, motorcycle sprocket and chain, scooter brake and Briggs & Stratton motor. Top speed, 22 miles per hour.

Gail D. Wilson,  
5100 Colonial Dr.,  
Minneapolis, Minn.

### To the Editor:

As a vocational teacher I have always found *Popular Mechanics Magazine* an abundant source of teaching materials. Its pages are packed full of ideas which with a little enthusiasm and sweat often can prove profitable. In the present emphasis on vocational education and the development of home industries sponsored by our



government, your magazine has proved one of the best means toward that end. It's no wonder, therefore, that it has been very popular with students anywhere and everywhere here.

Enclosed picture shows you what some of my vocational students produced from ideas found in *Popular Mechanics* (August 1953, Craftsman Section). Some have sold

(Continued to page 10)

*if you're in your twenties or early thirties, here's a solid-gold opportunity to make*

# BIG MONEY BY 35



We're willing to wager that, given the proper guidance and training, you can at least double your present income within the next few years.

We'll put up three interesting and valuable books to help prove this point.

One is the gold-mine of helpful career tips, "How to Succeed."

Another is a handbook outlining opportunities in your particular field of interest (see list in coupon below).

The third is a sample lesson in Basic Mathe-

matics which demonstrates how easily yet how thoroughly I.C.S. helps you master a subject.

These books will be especially useful to you if you are between 20 and 35—provided you want to enjoy the rewards of success before you reach middle age. Actually, the famous I.C.S. method of "Success Conditioning" knows no age limit. It's never too late to learn.

Hurry up your future! Mark and mail the coupon today.

**For Real Job Security—Get an I. C. S. Diploma! I. C. S., Scranton 9, Penna. Member, National Home Study Council**

## INTERNATIONAL CORRESPONDENCE SCHOOLS

**65<sup>TH</sup>  
YEAR**

**BOX 04953A, SCRANTON 9, PENNA.**

Without cost or obligation, send me "HOW TO SUCCEED" and the opportunity booklet about the field BEFORE which I have marked X (plus sample lesson):

- ARCHITECTURE and BUILDING CONSTRUCTION
- Air Conditioning—Refrig.
- Architecture
- Architectural Interiors
- Building Contractor
- Building Estimator
- Building Maintenance
- Carpentry and Mill Work
- Heating
- Painting Contractor
- Plumbing
- Reading Arch. Blueprints
- ART**
- Cartooning
- Commercial Art
- Fashion Illustrating
- Magazine Illustrating
- Show Card and Sign Lettering
- Sketching and Painting
- AUTOMOTIVE**
- Auto Body Rebuilding
- Auto Elec. Technician
- Auto-Engine Tune Up
- Automobile Mechanic

- AVIATION
- Aeronautical Engineering Jr.
- Aircraft & Engine Mechanic
- BUSINESS**
- Advertising
- Bookkeeping and Accounting
- Business Administration
- Business Correspondence
- Public Accounting
- Creative Salesmanship
- Federal Tax
- Letter-writing Improvement
- Office Management
- Professional Secretary
- Retail Business Management
- Sales Management
- Stenographic-Secretarial
- Traffic Management
- CHEMISTRY**
- Analytical Chemistry
- Chemical Engineering
- Chem. Lab. Technician
- General Chemistry
- Natural Gas Prod. & Trans.
- Petroleum Engineering
- Plastics
- Pulp and Paper Making

- CIVIL, STRUCTURAL ENGINEERING**
- Civil Engineering
- Construction Engineering
- Highway Engineering
- Reading Struct. Blueprints
- Sanitary Engineering
- Structural Engineering
- Surveying and Mapping
- DRAFTING**
- Aircraft Drafting
- Architectural Drafting
- Electrical Drafting
- Mechanical Drafting
- Mine Surveying and Mapping
- Plumbing Drawing and Estimating
- Structural Drafting
- ELECTRICAL**
- Electrical Engineering
- Electrical Maintenance
- Electrician  Contracting
- Lineman
- HIGH SCHOOL**
- Commercial  Good English
- High School Subjects
- Mathematics

- LEADERSHIP**
- Foremanship
- Industrial Supervision
- Leadership and Organization
- Personnel-Labor Relations
- MECHANICAL AND SHOP**
- Gas—Electric Welding
- Heat Treatment  Metallurgy
- Industrial Engineering
- Industrial Instrumentation
- Industrial Supervision
- Internal Combustion Engines
- Machine Design-Drafting
- Machine Shop Inspection
- Machine Shop Practice
- Mechanical Engineering
- Quality Control
- Reading Shop Blueprints
- Refrigeration
- Sheet Metal Worker
- Tool Design  Toolmaking
- RADIO, TELEVISION**
- Industrial Electronics
- Practical Radio TV Eng'ng
- Radio and TV Servicing
- Radio Operating

- Television Technician
- RAILROAD**
- Air Brake Equipment
- Car Inspector
- Diesel Engineer & Fireman
- Section Foreman
- STEAM AND DIESEL POWER**
- Combustion Engineering
- Diesel—Elec.  Diesel Eng's
- Electric Light and Power
- Stationary Fireman
- Stationary Steam Engineering
- TEXTILE**
- Carding and Spinning
- Cotton, Rayon, Woolen Mfg.
- Finishing and Dyeing
- Loom Fix'g  Textile Des'ing
- Textile Eng'g  Throwing
- Warping and Weaving
- MISCELLANEOUS**
- Domestic Refrigeration
- Marine Engineering
- Ocean Navigation
- Professional Engineering
- Short Story Writing
- Telephony

Name \_\_\_\_\_ Age \_\_\_\_\_ Home Address \_\_\_\_\_  
 City \_\_\_\_\_ Zone \_\_\_\_\_ State \_\_\_\_\_ Working Hours \_\_\_\_\_ A.M. to P.M. \_\_\_\_\_  
 Occupation \_\_\_\_\_

Canadian residents send coupon to International Correspondence Schools, Canadian, Ltd., Montreal, Canada. . . . Special tuition rates to members of the U. S. Armed Forces.

(Continued from page 8)

their products for 20 pesos (\$10, U.S.) Most brought their luggage home as presents to their parents. You bet admiring eyes popped!

R. B. Castro,  
Vocational Dept.,  
West Visayan Academy,  
Box 502, Iloilo City,  
Philippines

☆☆☆

Several readers have called our attention to similarities between the airplane built by Bob Nesmith of Houston, Tex. ("The Plane for the Do-It-Yourselfer," October 1956) and the airplane designed by Steve Wittman of the Wittman Flying Service, Oshkosh, Wis.

Mr. Wittman, designer of a light plane called "The Tail Wind," writes us that he sold a set of plans to Mr. Nesmith and adds: "At present there are 64 Tail Winds being built in the United States, one in Sweden and Belgium. The plans are copyrighted and the landing gear is patented."

Mr. Nesmith writes us that he did not build his Cougar from Mr. Wittman's plans; that he does "have a set of his [Wittman's] plans along with over 100 sets of plans of other airplanes," and lists a number of

differences in materials, controls and dimensions between his Cougar and the Tail Wind.

Since there are differences in opinion involving both copyrights and patent rights *Popular Mechanics* regrets that it cannot refer readers interested in these airplane plans to the owners of the plans at this time.

#### To the Editor:

I read your magazine whenever I can get one, which is not very often, and I find it one of the most interesting of its kind. I wonder if you can put me in touch with some fellows who would be interested in exchanging general mechanical information? I would prefer a hobbyist, as I am one myself.

Alfred Sing,  
114 Duke St.,  
Kingston,  
Georgetown, British Guiana

☆☆☆

☞ Goldfish are fed regularly while the family is away on a vacation of several weeks by means of an electric feeder with a slowly revolving spoon that scoops up a measured amount of food and tosses it into the water every 24 hours.

## New greaseless way to keep your hair neat all day

Doak Walker took a shower.. .. then he used Vitalis



**TACKLES DRIED-OUT HAIR...** New Vitalis keeps hair in place and prevents dryness with V-7, the *greaseless* grooming discovery. You never have an over-slick, plastered-down look. Try it. You'll like it.



Vitalis scores high with this all-time football great.

### New VITALIS® Hair Tonic with V-7®

ANOTHER FINE PRODUCT  
OF BRISTOL-MYERS

## You Practice **SERVICING** with Kits I Send You

Nothing takes the place of PRACTICAL EXPERIENCE. That's why NRI training is based on LEARNING BY DOING. You use parts I send to build many circuits common to Radio and Television. With my Servicing Course you build the modern Radio shown at left. You build a Multitester and use it to help make \$10, \$15 a week fixing sets in spare time while training. All equipment is yours to keep. Coupon below will bring book of important facts. It shows other equipment you build.



## You Practice **BROADCASTING** with Kits I Send You

As part of my Communications Course I send you parts to build low-power Broadcasting Transmitter at left. Use it to get practical experience. You put this station "on the air" . . . perform procedures demanded of broadcasting station operators. An FCC Commercial Operator's License can be your ticket to a bright future. My Communications Course trains you to get your license. Mail coupon. Book shows other equipment you build for practical experience.

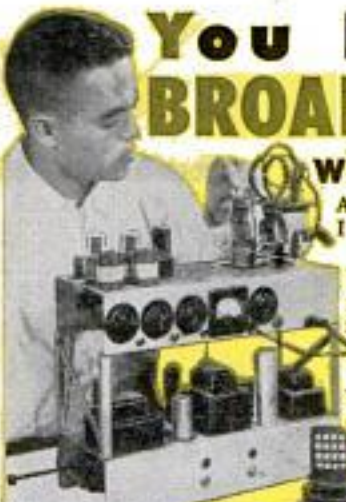

# I Will Train You at Home in Spare Time to be a **RADIO-TELEVISION** Technician



### TELEVISION

**Making Jobs, Prosperity**  
25 million homes have Television sets now. Thousands more sold every week. Trained men needed to make, install, service TV sets. About 200 television stations on the air. Hundreds more being built. Good job opportunities here for qualified technicians, operators, etc.



### America's Fast Growing Industry Offers You Good Pay, Success

Training PLUS opportunity is the PERFECT COMBINATION for job security, advancement. When times are good, the trained man makes the BETTER PAY, gets PROMOTED. When jobs are scarce, the trained man enjoys GREATER SECURITY. NRI training can help assure you and your family more of the better things of life. Radio is bigger than ever with over 3,000 broadcasting stations and more than 115 MILLION sets in use, and Television is moving ahead fast.

## N.R.I. Training Leads to Good Jobs Like These

### I TRAINED THESE MEN

"I have progressed very rapidly. My present position is Studio Supervisor with KEDD Television, Wichita."—Elmer Frowaldt, 9026 Stadium, Wichita, Kans.

"Fix sets part time in my shop. Made about \$600 first three months of the year. Could have more but this is about all I can handle."—Frank Beer, Lorain, Ohio.

"I've come a long way in Radio and Television since graduating. Have my own business on Main Street."—Joe Travers, Asbury Park, New Jersey.

"I didn't know a thing about Radio. Now have a good job as Studio Engineer at KMMJ."—Bill Delzell, Central City, Nebraska.

**BROADCASTING:** Chief Technician, Chief Operator, Power Monitor, Recording Operator, Remote Control Operator. **SERVICING:** Home and Auto Radios, Television Receivers, FM Radios, P.A. Systems. **IN RADIO PLANTS:** Design Assistant, Technician, Tester, Serviceman, Service Manager. **SHIP AND HARBOR RADIO:** Chief Operator, Radio-Telephone Operator. **GOVERNMENT RADIO:** Operator in Army, Navy, Marine Corps, Forestry Service Dispatcher, Airways Radio Operator. **AVIATION RADIO:** Transmitter Technician, Receiver Technician, Airport Transmitter Operator. **TELEVISION:** Pick-up Operator, Television Technician, Remote Control Operator.



### Start Soon to Make \$10, \$15 a Week Extra Fixing Sets

My training is practical, complete; is backed by 40 years of success training men at home. My well-illustrated lessons give you basic principles you need and my skillfully developed kits of parts "bring to life" things you learn from the lessons. I start sending you special booklets the day you enroll, that show you how to fix sets. Multitester you build with my parts helps you discover and correct set troubles, helps you make money fixing neighbors' sets in spare time while training. Many make \$10, \$15 a week extra this way.

### Mail Coupon — Find Out What Radio-Television Offer You

Aet now to get more of the good things of life. I send actual lesson to prove NRI home training is practical, thorough. My 64-page book "How to be a Success in Radio-Television" shows what my graduates are doing and earning. It gives important facts about your opportunities in Radio-Television. Take NRI training for as little as \$5 a month. Many graduates make more than the total cost of my training in two weeks. Mail coupon now to: J. E. SMITH, President, Dept. 7AA, National Radio Institute, Washington 9, D. C. Our 40th year.

**AVAILABLE to all qualified VETERANS UNDER G.I. BILLS**

### Good for Both—FREE

MR. J. E. SMITH, President, Dept. 7AA National Radio Institute, Washington 9, D. C. Mail me Sample Lesson and 64-page Book, FREE. (No salesman will call. Please write plainly.)

Name.....Age.....  
Address.....  
City.....Zone.....State.....  
**VETS** write in date of discharge.....



### Mail Today-Tested Way to Better Pay

# 99¢ YOUR CHOICE ANY ARTICLE

ANY 4 for only \$2.99

ANY ITEM on this page for ONLY 99¢! Values up to \$4.00! Save even more. CHOOSE ANY 4 ITEMS for ONLY \$2.99! All brand-new merchandise. These incredible money-

saving DISCOUNTS are given to win 25,000 new friends! Act fast. Quantities limited! Rush coupon now! THORESEN'S, Dept. 6-A, 352 4th Ave., N.Y. 10, N.Y.



**Hi-Speed HOME & CAR WASHER**

Reg. \$1.98 **99c**

Scrubs, suds, rinses in one operation. Wash in HALF the time! No splashing! No back or arm strain! New improved model has 2 heads, built-in hydraulic sudser. Get complete kit: 3-section handle (extends to 3 feet); 2 heads; automatic sudser; detergent pellets. Thousands sold at \$2.98 & \$1.98—now 99c! NO. 44

**THE SPORTSMAN HUNTING KNIFE**

\$2.98 Value **99c**

Unusual strength, perfect balance, field tested by veteran hunters! Crafted from high carbon steel. Protective metal guards. Will give many years of rugged, dependable service. 8 1/2" long. Use it to hunt small game, to skin wild animals, to cut underbrush, hemp, etc. Use it at home to carve roasts, etc. Handsome snap-button sheath included. Makes ideal gift souvenir! NO. 122.....99c



Formerly \$1.98

**3-Color Police FLASHLIGHT!**

Changes colors like magic—RED, WHITE or GREEN! Powerful beam visible miles away. Spotlite and floodlite combined. For home, farm, office, factory. Lifesaver in highway emergencies. Thousands in use by police. Sold for \$1.98 to \$2.98—now 99c! NO. 75



**Plastic Storm Windows 4 for 99c**

**MONTE CARLO Stainless Steel Steak Knives**

Reg. \$2.00 **3 for 99c**



**99c**

\$1.98 VALUE

**Fisherman's Cork Stainless Steel Knife**

Truly a boon for every outdoor man! Light, genuine cork handle keeps knife afloat—even in 6 inches of water! Stainless steel double-edge blade can't rust, corrode or tarnish. One side extra sharp for slicing, cutting, chopping. Other side serrated for scraping and skinning your catch. Snap-button, leather sheath. \$1.98 value, now only 99c! NO. 125



**TRANS-KLEER**—amazing flexible product seals out wintry blasts! Transparent as glass. Won't chip, peel or rattle. Weighs ounces, yet has 3,000 lbs. tensile strength per cubic inch! Resists snow, sleet, rain, humidity up to 33 degrees below freezing! Easy to apply—no nails, no screws, no tools! Cut and fit any window. Press on scotch tape border. That's all! At winter's end fold away for next season. Two million sold at 49¢ per window. Our price 99¢ for 4 windows; \$1.99 for 10 windows! NO. 74

Greatest cutlery bargain we have ever offered. The very same steak knives advertised in *House Beautiful* for \$2.00 each—now price slashed to 3 for 99c! Incredible bargain possible only because of our tremendous buying power plus magic of the American dollar abroad! These exquisite Monte Carlo steak knives are made of the finest Korium stainless steel by old world craftsmen in Solingen, West Germany—Europe's famed cutlery center! Blades will never

rust or corrode. Hollow ground like a barber's razor, with serrated edges for finer, faster cutting! Never need polishing or sharpening! Slice thru thick steaks and roasts fast and easy! Handles finished in beautiful design of autumn leaves in rich colors of Gold, embossed on background of pastel Ivory Styrene. All first-quality, 100,000 already sold! NO. 89.....3 for 99c FREE: Handsome fitted case on order of 12 or more!

**STAINLESS STEEL CAMPERS KIT**

Full-Size Knife, Fork, Spoon Interlock! Can't Shake Loose!

Everything in place in a minimum of space! Slide fork over lugs of spoon, then slide knife over fork—all 3 are now locked! No more lost or misplaced utensils in the field. Made of stainless steel—won't rust, corrode or tarnish! Ideal for all outdoor men. Keep extra set in car. Leather carry case included. NO. 126.....now **99c**



**MONEY-BACK GUARANTEE!**

**THORESEN'S, Dept. 6-A**  
352 Fourth Avenue, New York 10, N. Y.

RUSH the items listed below at 99c each (4 for only \$2.99) for home trial. **MONEY-BACK GUARANTEE:** If I am not completely satisfied, I will return merchandise in 10 days for full and prompt refund.

Payment enclosed. Send prepaid  Send C.O.D. plus fees

NO.	QUANTITY	ARTICLE	PRICE

NAME \_\_\_\_\_

ADDRESS \_\_\_\_\_

CITY \_\_\_\_\_ ZONE \_\_\_\_\_ STATE \_\_\_\_\_

CANADIANS: Address 45 St. James St., West, Montreal 1, P.Q.

**Famous! Powerful!**

**Black Eagle German Binoculars**

Reg. \$3.98 **99c**

LIMIT: One per family.



Thousands of sportsmen gladly paid \$3.98 for these famed Black Eagle binoculars. Now, for a limited time only, you get them at a fantastic 70% DISCOUNT—only 99c! You SAVE \$3.00! Remember, these are Germany's renowned long-range binoculars with features often found in expensive binoculars! The Black Eagle brings in distant people, objects, birds, animals, planes, ships, buildings, etc. sharp and clear. No distortion! Hi-fidelity viewing up to 25 MILES AWAY! Synchronized center focusing. Sturdy—yet light, only 8 oz. No. 78.....now 99c

Limit: one per family.

# INVENTORS

Learn how to protect your invention. The U. S. Patent Laws provide that any new and useful art, machine, article of manufacture, or composition of matter, or any new and useful improvement thereof, may be patented if the act of invention is involved. Therefore, every inventor with a valuable invention should take advantage of the Patent Laws and proceed for patent protection in order to safeguard his rights.

A patent gives the inventor the exclusive right to prevent others from making, using, or selling the invention claimed in the patent for a period of seventeen years.

The Patent Laws were enacted for the benefit of the inventor to give him protection for the features of his invention which are patentable. These features must be properly and concisely set forth and claimed in a formal application for patent, in order to comply with the requirements of the Patent Laws. For that reason, unless the inventor is familiar with patent matters, he should engage a competent registered patent attorney or agent to represent him. We are registered to practice before the U. S. Patent Office and are prepared to serve you in the handling of your patent matters.

A specially prepared booklet entitled "Patent Guide for the Inventor", containing detailed information with respect to patent protection and procedure, together with a "Record of Invention" form will be promptly forwarded to you without obligation upon request.

---

## CLARENCE A. O'BRIEN & HARVEY JACOBSON

*Registered Patent Attorneys*

71-A DISTRICT NATIONAL BUILDING  
WASHINGTON 5, D. C.

## WHAT SECRET POWER DID THIS MAN POSSESS?

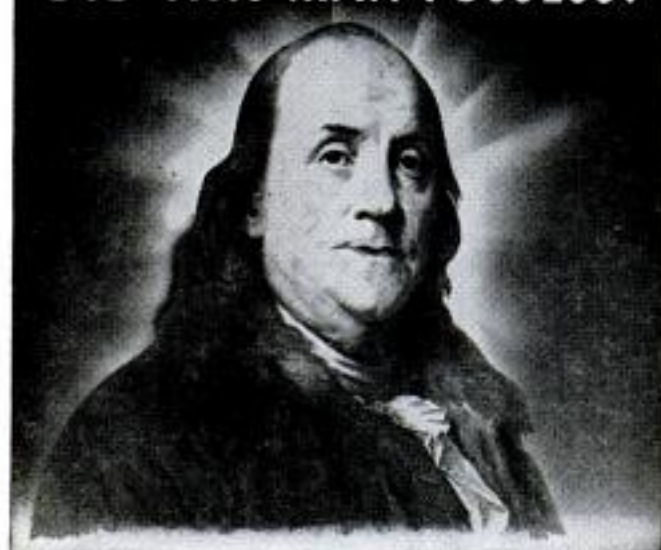

**BENJAMIN FRANKLIN**  
(A Rosicrucian)

**WHY** was this man great? How does anyone—man or woman—achieve greatness? Is it not by mastery of the powers within ourselves? Know the mysterious world within you! Attune yourself to the wisdom of the ages! Grasp the inner power of your mind! Learn the secrets of a full and peaceful life!

Benjamin Franklin—like many other learned and great men and women—was a Rosicrucian. The Rosicrucians (NOT a religious organization) first came to America in 1694. Today, headquarters of the Rosicrucians send over seven million pieces of mail annually to all parts of the world. Write for YOUR FREE COPY of "The Mastery of Life"—TODAY. No obligation. No salesmen. A non-profit organization. Address: Scribe X.O.Z.

**THIS BOOK FREE!**



## The ROSICRUCIANS

SAN JOSE • (AMORC) • CALIFORNIA

—SEND THIS COUPON—

Scribe X.O.Z.  
The ROSICRUCIANS (AMORC)  
San Jose, California

Please send me the free book, *The Mastery of Life*, which explains how I may learn to use my faculties and powers of mind.

Name \_\_\_\_\_

Address \_\_\_\_\_

City \_\_\_\_\_

## BECOME AN EXPERT IN TRAFFIC and TRANSPORTATION

TODAY qualified men in this field earn \$4,000 to \$10,000 and up. Thousands are needed. We train you in spare time at home for executive positions in Traffic Management.

LaSalle's complete Traffic and Transportation program gives you a thorough knowledge of this field. Program covers Transportation Agencies—How to Ship by Rail, Express, Water, MOTOR TRUCK, Air, Freight Forwarder and Mail Carriers.

Investigate the splendid opportunities available. Low cost-easy terms. Placement counsel and help. Write today for FREE 48-page book "Traffic and Transportation—the Fast Growing Profession."

**LASALLE EXTENSION UNIVERSITY**  
*A Correspondence Institution*

417 S. Dearborn St., Dept. 164T, Chicago 5, Illinois

## FOR BIG MEN ONLY!



**SIZES 10 to 16**      **WIDTHS AAA to EEE**

We specialize in LARGE SIZES ONLY—sizes 10 to 16; widths AAA to EEE. Dress, sport, casual and work shoes, golf shoes; insulated boots; sock; slippers; rubbers; overshoes; shoe trees. Also... sport shirts in your exact, extra-long sleeve length. Enjoy perfect fit in your hard-to-find size at amazingly low cost. Satisfaction Guaranteed. Sold by mail only. Write for FREE Style Book TODAY!

KING-SIZE, INC., 117 Brockton, Mass.

The finest of Gifts...

## ENCYCLOPAEDIA BRITANNICA



**SEND FOR THIS FREE!**

Make money. Know how to break and train horses. Write today for this book FREE, together with special offer of a course in Animal Breeding. If you are interested in Gaiting and Riding the saddle horse, check here ( ) Do it today—now.

BEERY SCHOOL OF HORSEMANSHIP  
Dept. 1101 Pleasant Hill, Ohio



## LEFAX TECHNICAL DATA BOOKS

POCKET SIZE • LOOSE LEAF

Printed on loose leaf, 6 hole, 63g"x33g" bond paper, each book contains about 140 pages of technical data, condensed, accurate, essential, for engineer, technical worker, teacher, student, business man **\$1.25** each

Architecture	Surveying Tables	Machine Design	Radio
Home Heating	Highway Eng'g.	Machinist's Data	Television & FM
Electrician's Data	General Math	Mech. of Materials	Electricity, AC
Builder's Data	Math Tables	Pwr. Trans. Mach.	Electricity, DC
Lumber Data	Physics	Thermo. Tbls. &	AC Motors
Air Conditioning	Trig-Log Tables	Charts	Conversion Tbl.
Building Constr.	Gen'l Chemistry	Phys. & Thermo-	Steel Forms
Reinf. Concrete	Chemical Tables	dynamic Data	Welding Data
Piping Data	Analytic Chem.	Metals	Transformers
Surveying	Mech'l Drawing	Hydraulics	Relays & Meters

Write for FREE catalogs (2000 listings). See how helpful LEFAX can be to you. Send \$1.25 book, or \$6 for any five books to

LEFAX PUBLISHERS, Dept. PM-17, PHILADELPHIA 7, PA.



Train in Big  
**COYNE**  
Shops

# GREAT OPPORTUNITY FIELDS!

**TELEVISION OR ELECTRICITY**  
RADIO-COLOR TV ELECTRONICS



Instructor helping students check the wiring and trace the circuits of television receivers.

Instructor explaining operation and testing of a large Motor Generator.

This big fire-proof building is occupied entirely by Coyne.

## YOUNG MEN AND OLDER MEN— PREPARE FOR A CAREER WITH A FUTURE!

Conditions are changing. Many "one operation" jobs will not last. Don't be satisfied with a "no future" job. Whether 17 or up to 45 years of age, train the Coyne way for a better job and a real future in Electricity-Electronics or Television-Radio, fields that offer a world of opportunities.

### TELEVISION-RADIO- COLOR TV

Here at COYNE you're trained for Testing, Trouble-Shooting and Servicing on AM and FM Radio Units, Auto Radio, Television, etc. Thousands of Coyne trained men in good jobs or own well paying TV-Radio businesses of their own.

### ELECTRICITY ELECTRONICS

Big opportunities everywhere—city, town and country, in Power Plant Work, Motors, Industrial Electronics, Armature Winding, Home and Factory Wiring, Appliances, Refrigeration, Maintenance, Illumination, etc.

## WE TRAIN YOU IN CHICAGO

Our famous Practical-Technical method gives you practical experience on a massive outlay of equipment plus necessary technical training right here in the great Coyne shops.

*Training in Refrigeration and Electric Appliances can be included.*

**Training offered  
to VETERANS and  
NON-VETS alike**

### START NOW—PAY LATER

Enroll now, pay most of tuition later. Part time employment help for students. Lifetime employment service to Graduates.

B. W. COOKE, President

**COYNE**  
ELECTRICAL SCHOOL

FOUNDED 1899

A TECHNICAL TRADE INSTITUTE OPERATED NOT FOR PROFIT

500 S. PAULINA STREET, CHICAGO, Dept. 17-72H

ELECTRICITY ★ RADIO ★ TELEVISION ★ REFRIGERATION ★ ELECTRONICS

## OLDEST AND BEST EQUIPPED SCHOOL OF ITS KIND IN THE U.S.

### Mail Coupon for Big FREE Book!

Whether you prefer Television-Radio or Electricity-Electronics, mail coupon TODAY and we'll mail you a Big, fully Illustrated Book "Guide to Careers in Electricity-Electronics and Television-Radio" which describes all the training we offer. No salesman will call.



B. W. Cooke, President  
COYNE ELECTRICAL SCHOOL, Dept. 17-72H  
500 S. Paulina St., Chicago 12, Ill.

Send me your Big Free book. I am interested in field checked below. This does not obligate me.

- TELEVISION-RADIO  
 ELECTRICITY-ELECTRONICS

Name \_\_\_\_\_

Address \_\_\_\_\_

City \_\_\_\_\_ State \_\_\_\_\_

# Make Money Fixing Electric Appliances



**Actual Lesson FREE** Fast Growing Field Offers Good Pay, Security Interesting Work



Over 40 Years Experience Backs Up NRI Training



**Find Out What Appliance Repair Offers You**

## Learn at Home in Spare Time

Earn more money. Enjoy doing important, interesting work. Learn Electrical Appliance Servicing. This is a field of increasing opportunity. Today there is an average of more than ten appliances in every wired home. More than eighty million additional appliances, valued at about 8 billion dollars sold in one year. Find out more about this great, growing field. Find out how NRI can train you, at home and in spare time to be an Appliance Service Technician. See how you can start soon to make extra money servicing appliances.

## Add to Your Income Soon After Enrollment Opportunities Increasing for Service Technicians

NRI Training is practical, thorough. You get easy-to-understand lessons, and NRI supplies parts to build professional type Multi-Use Tester. Use it to get practical experience. Soon, you can add to your income by servicing appliances. Build a profitable "sideline" for your spare time—qualify for a good job—develop a business and be your own boss. As an Appliance Service Technician, your opportunities are broad—your services wanted, gladly paid for, highly regarded in your community.

Appliances are necessary to comfortable, convenient living. Owners pay well to keep them in repair. The field is amazingly big. In addition to major appliances such as electric ranges, air conditioners, refrigerators, there are over 40,000,000 electric irons, 5,000,000 electric blankets, 15,000,000 coffee makers, plus more millions of vacuum cleaners, fans, toasters, mixers, etc.

## Learn and Earn with Tester Diploma when You Finish



Locate appliance troubles easily with Tester you build. For only \$2.50 with enrollment and \$5 per month get training including Tester. Mail coupon for Sample Lesson and Book—your first step toward more interesting work, bigger earnings. Address NRI, Dept. AA7, Washington 9, D. C.

## Mail Coupon FOR LESSON AND BOOK FREE

**National Radio Institute**  
Dept. AA7, Washington 9, D. C.

Please send me Electric Appliance Servicing Lesson and Book FREE. (I understand no salesman will call.)

Name \_\_\_\_\_ Age \_\_\_\_\_

Address \_\_\_\_\_

City \_\_\_\_\_ Zone \_\_\_\_\_ State \_\_\_\_\_

APPROVED MEMBER, NATIONAL HOME STUDY COUNCIL

# INVENTORS

If you believe that you have an invention, you should find out how to protect it. The first step is to have a search made of the prior pertinent U. S. patents. If a report on this search indicates that the invention appears patentable you can apply for a patent, and the specifications and claims should be prepared.

The firm of McMorrow, Berman & Davidson, with offices in Washington, D. C., is qualified to take the necessary steps for you. We can make a preliminary search on your invention, advise you whether we think it can be patented, and prepare your application for patent.

Unless you are fully familiar with the U. S. Patent Laws, we recommend that you engage the services of a Registered Patent Attorney to protect your interests. The patent laws are *your* laws. A patent gives you the right to prevent others from making, using or selling the invention claimed in your patent for a period of 17 years.

Use these patent laws for your protection. Investigate whether your invention can be patented. If you have what you believe to be an invention, we suggest that you have this firm make a search for you.

*Send for a copy of our Patent Booklet entitled "How To Protect Your Invention," containing information about patent protection and patent procedure. Along with this we will also send you an "Invention Record" form, for your use in writing down and sketching details of your invention. We will mail them promptly. No obligation. They are yours for the asking.*

**McMORROW, BERMAN & DAVIDSON**

*Registered Patent Attorneys*

**PATENTS • COPYRIGHTS • PATENTS**

**1357 VICTOR BUILDING, WASHINGTON 1, D. C.**

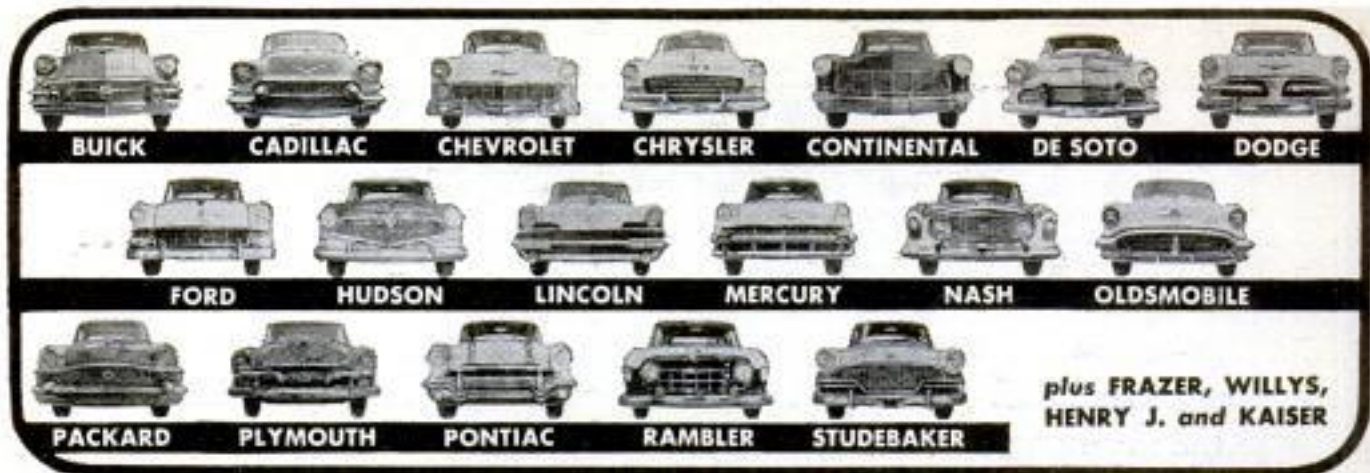

# Tune Up, Pep Up, Fix Up ANY CAR!

**NOW! Even beginners can handle practically ANY job on ANY make, model or part!**



**Keep 'em running like clockwork!**

There's a secret to fixing cars . . . and this world famous Chilton "ALL CARS" Manual is it! With it, you can handle practically any job faster, easier and better than you may have dreamed.

From engines to transmissions . . . from power steering to overdrives . . . from carburetors to ignitions . . . it tells you just what you need to know . . . shows almost every operation step by step in almost 3000 big, clear pictures. Using your Chilton Manual is like having the 19 Chilton experts who prepared it standing beside you. Just follow their simple instructions and it is next to impossible to go wrong . . . even on the toughest jobs!

## PRACTICE 10 DAYS . . . FREE

No guess work! No lost time! Just look up the make, model and part you want to fix. Trouble-shooting charts help you locate what's wrong. Then every step of making needed repairs or adjustments is explained in a way you're sure to understand. Puzzling details are made crystal clear.

You'll find this giant Manual in almost every car shop . . . because it saves loads of time even for the experts. You'll find it in schools, in Army-Navy training . . . and wherever beginners are fixing CARS BECAUSE IT MAKES EVERY JOB SO EASY TO DO.

From beginning to end, the Chilton

"ALL CARS" Manual is a complete practical working guide by Chilton's Motor Age and Automotive Industries magazine experts. It shows how to handle jobs with standard tools under ordinary conditions.

You learn work-saving shortcuts. You learn what mistakes to avoid. In many cases, Chilton even takes into account the wear of parts on old cars and gives you "wear adjusted" specifications for best possible car performance. Covers every model of above 22 leading makes from 1940 through 1956—over 650 models in all.

Contains over 800 pages; 53 Trouble-shooting Charts; 397 Quick Check Data Tables; almost 3000 specially-taken pictures; and thousands of specifications.

Chilton Shows  
You How in this  
**GIANT NEW**  
**4 3/4 lb. EDITION**  
of the world's most  
famous car repair manual

BY THE WORLD'S  
LARGEST AUTOMOTIVE  
PUBLISHERS



## EXTRA BONUS! 214 CAR REPAIR TIPS FREE

For a limited time only, we will include FREE the famous 64-page Chilton SHOP KINKS book with your purchase of the above Chilton "ALL CARS" Service Manual. Tips include easy ways to locate shorts; correct vibration, sticking wiper motors; remove broken studs or frozen bearings; eliminate drive shaft noises; bond brakes without "high" spots—and over 200 more! Any one of them can save you many hours of hard work!

CHILTON BOOKS ARE SOLD BY LEADING BOOK STORES.

### MAIL COUPON! See for yourself how easy it is!

THE CHILTON COMPANY, Dept. PM-17X, 5605 Chestnut Street, Philadelphia 39, Pa.

Send me the big new CHILTON "ALL CARS" REPAIR MANUAL (price only \$6.95) for 10-day FREE EXAMINATION. Include the SHOP KINKS book at no extra cost. If I like the "ALL CARS" Manual, I will promptly remit \$1.95 (plus 45c postage and handling); then send \$2.50 each month for two months in full payment. Otherwise I will return both books postpaid in 10 days and owe you nothing.

Name.....

Address.....

City, Zone, State.....

**SAVE!**  
Send \$6.95 with order and Chilton pays postage-handling. Some 10-day return privilege with money refunded.

(Outside U.S.A.—Price \$8.95 cash with order. 10-day return privilege.)



**JACK DEMPSEY**  
Former World's Heavy-weight Boxing Champion  
Long-time friend and supporter of DeVry Tech.

**Jack Dempsey says:**

**"Find Out TODAY How  
YOU MAY TRAIN  
AT HOME**

**For Great Opportunities in  
TELEVISION  
RADIO · ELECTRONICS**

See, too, How DeVry Tech Helps A Man  
Get Started in this Field



**Nick Barton, Illinois,**  
a DTI grad, now has his own business and tells us he is "literally snowed with work."



**George D. Crouch, California,**  
was a retail store clerk. He took the DeVry Program, and today is in business for himself.

**Get the Facts**

**FREE** from

**DEVRY TECH**

**Fill Out This Chart and Mail  
with Coupon . . .  
No Obligation!**



It costs you nothing to find out, and it may mean the turning point in your life. Let DeVry Tech tell you if you have the basic qualifications. Send in the personal rating chart today. Get the free leaflet, "89 Ways to Earn Money in Television-Radio-Electronics."

**Free Sample Lesson**



Let us give you without cost a Sample Lesson. See for yourself how easy it is to follow. DeVry Tech's down-to-earth instructions, practical training experiments, the test equipment you build and KEEP, the exclusive home training films . . . make learning simple and fast. Subject matter is broken down small enough and clearly enough for you to absorb it.

**Get These Added Benefits**

Whether you train at home or in our large, well-equipped, million-dollar Chicago Laboratories, you are not tied to a long-term contract . . . You have the privilege of canceling the program at any time.

**ARE YOU DRAFT AGE?** Mention it when you mail the coupon. We have valuable information for you.  
Accredited Member of National Home Study Council



**DEVRY TECHNICAL INSTITUTE**

CHICAGO 41, ILLINOIS

FORMERLY

DEFOREST'S TRAINING, INC.

"One of America's Foremost Electronics Training Centers"

**PERSONAL RATING CHART**

- 1. AGE**—If you are between the ages of 17 and 55, place the numeral 5 in the square at right. If above or below those ages, mark yourself 3.
  - 2. EDUCATION**—If you have graduated from high school, mark 5 in the square at right. If you finished 8th grade, mark 3.
  - 3. DEPENDENTS**—If you are free to come to Chicago, rate yourself 5. If you prefer to study at home and hold your present job, put down the number 3.
  - 4. ABILITY**—If you've had any experience in handling a soldering iron or doing simple home wiring, rate yourself 5. If you feel you can follow simple "How-to-do-it" instructions, mark down 3.
  - 5. AMBITION**—Are you interested in training for a real future in a promising field? Mark down 5. Or do you simply want to prepare for a better job with more money? Put down 3.
- If you are subject to military service, please mark "X" here.

**MAIL CHART AND COUPON NOW!**

DEVRY TECHNICAL INSTITUTE  
4141 Belmont Ave., Chicago 41, Ill., Dept. PM-1-N

I would like late facts about the many opportunities in Television-Radio-Electronics, including the 3 free publications, and how DeVry Tech may prepare me for my start in this billion-dollar field.

Name \_\_\_\_\_ Age \_\_\_\_\_  
Please Print  
Street \_\_\_\_\_ Apt. \_\_\_\_\_  
City \_\_\_\_\_ Zone \_\_\_\_\_ State \_\_\_\_\_

1049A  
DeVry's Canadian Training Center is at  
580 Roselawn Avenue, Toronto 12, Ontario

# Inventors

If you consider your invention valuable, take these necessary preliminary steps promptly to protect it by applying for a United States patent.

Sketch and describe your invention. (For convenience in starting action on your invention, use "Evidence of Invention" form offered below.)

Sign, date and have this invention disclosure witnessed by two people capable of understanding your invention.

Have us make a preliminary search among U. S. patents already granted for similar types of invention.

We then prepare a report for you on the probable patentability of your invention and recommend your further course of action.

This firm is registered to practice before the U. S. Patent Office. We are available to assist you in the preparation and prosecution of your application for patent.

We shall be glad to send you promptly and without obligation, an instructive booklet—"Patent Protection for Inventors"—and our convenient "Evidence of Invention" form.

**VICTOR J. EVANS & Co.** *Merlin M. Evans*  
REGISTERED PATENT ATTORNEY  
330-A MERLIN BUILDING, WASHINGTON 6, D. C.



## college graduates get ahead faster!

You see it in your own city. They have higher incomes . . . advance more rapidly. Grasp your chance for a better life. Industrial growth . . . automation . . . technical advances create career opportunities for engineers, accountants, management experts. Share rewards awaiting college-trained men. Important firms visit campus regularly to employ Tri-State College graduates. Start any quarter in this world-famed college. Approved for veterans.

### Bach. of Science degree in 27 months

In Mechanical, Civil, Electrical, Chemical, Aeronautical, Radio (TV-Electronics) Engineering. In 36 months a B.S. in Business Administration (General Business, Accounting, Motor Transport Management majors). Superior students may accelerate. 35-week course in Drafting. Intensive program: technical fundamentals stressed; comprehensive courses with more professional class hours. Small classes: personalized instruction. Enrollment limited to 1550. Preparatory courses. Beautiful campus. Well-equipped, new and modernized buildings and laboratories. Enter March, June, Sept., Jan. Earnest, capable students (whose time and budget require accelerated courses and modest costs) are invited to write **Joan McCarthy, Director of Admissions**, for catalog and book "Your Career in Engineering and Commerce."



## TRI-STATE COLLEGE

417 College Avenue • • • Angola, Indiana

## TELEPHONES



### Desk Stand Style

Slightly used but in excellent condition

Many Valuable Uses  
Inter-House Phones House to Barn, etc.  
Loud Speakers Microphones  
Educational Purposes, Toys, etc.

Come complete, ready to use with wiring diagrams included. **\$2.75 Postpaid** in U.S.A.  
Two complete for only **\$5.00**  
**TELEPHONE LAMP KIT** — with illustrated instructions for making Desk Telephone Lamp including all parts (harp, nipples, push switch, cord, plug, etc.) . . . \$6.50 Ppd. (Shade is not included).

**MICROPHONE**, Dept. X-4602, 1760 W. Lunt Ave., Chicago 26, Ill.

## MAKE TREMENDOUS PROFITS

Have fun! Earn Big Money! Cast plaster figurines, bookends, plaques, novelties at home in your spare time with X.L. rubber mould! **NO EXPERIENCE NEEDED!** Models and rubber for 3 molds, only \$1.50 ppd. Send 25c (refunded with order) for 40 page catalog now!  
**PLASTIC ARTS STUDIO** 3403 SO. MADISON, DEPT. PM2  
MUNCIE, INDIANA

## STAMP COLLECTORS!

319 DIFFERENT STAMPS 25c

This big imported collection includes: Giant glider aviation set showing real and toy gliders, Israel airport and ancient coin set. Fish and insect life from far-off Ima, Sahara, Guinea, Red Cross Flag, Nurse and Blood Transfusion, curious child artwork plus hundreds of fascinating issues from all parts of the world. Altogether 319 all different stamps cataloging \$7.25—for only 25c to introduce our bargain approvals. **NO U.S. Valuable IMPERF. ERROR and 48-Page Stamp Dictionary** included free as long as they last.  
**STAMPEX CO.**, Box 47-BM, White Plains, New York



### HOW TO TURN Concrete INTO Gold

\$2.00

### A MUST FOR EVERYONE CONCERNED!

This MANUAL Tells You How To Make Handsome Profits From Concrete Items YOU CAN MAKE

All you need is a mold or two and a little determination. This Manual contains large, clear pictures, gives prices and description of more than 200 different molds you can buy direct from the manufacturer. AND... priceless trade secrets that make production a snap. Take the first step Today!!!

SEND ONLY \$1.00 FOR YOUR COPY (Shipped to you by First Class Mail)

**CONCRETE MACHINERY COMPANY, INC.**  
Dept PM Hickory, N. C.

# "I Got My Start in Music This 'TEACH-YOURSELF' Way"

...says famous orchestra leader

## LAWRENCE WELK

Television Star of  
"The Lawrence Welk Show"

[MONDAY AND SATURDAY EVENINGS-ABC-TV]



I got my start in music with a U.S. School Course. Now easy it is to learn to read notes and play music this "teach yourself" way! In fact, this school did so much for me that I enrolled my two daughters.

*Lawrence Welk*

**You, Too, Can Play Your Favorite Instrument  
—Even If You Don't Know a Single Note of Music  
Now! Start Right Out Playing Real Pieces by NOTE.**

**W**HY are you cheating yourself of the thrills of playing music? You think it's "too hard" to teach yourself? You can't afford private lessons? The nearest teacher is too far away? It would take "too long" to learn?

people, build your self-confidence. The pleasures of *appreciating* music more.

Regardless of what YOU want out of music, here's the easy way to get it! In just a few weeks, you can be playing **REAL MUSIC** on your favorite instrument. Not by any "trick" method. But actually reading and playing real sheet music—so confidently your friends will be amazed!

### Enjoy All These Advantages

No boring scales and exercises. Lessons consist of delightful songs, hymns, waltzes, etc., with simple how-to-play-it directions and large clear pictures. Learn in the privacy of your own home, in spare time. None of the inconvenience and personality problems of having a private teacher—and costs only about a TENTH as much. Everything is so clear—so easy to understand—even youngsters "catch on" right away. Whole family can learn for price of one. Mail coupon now.

900,000 STUDENTS  
59 Successful Years



**FROM FARM TO FAME.** Above are Lawrence Welk and his famous "Champagne Music" orchestra of TV fame. When Welk was a farm lad, a U. S. School of Music Course taught him to read and play music in his spare time.

### And Here's What Other Students Say

#### High School Boy Learns Very Quickly

"Couldn't play a note. Now play at parties. All my friends were surprised and asked me how I learned so quickly."

—Bobby Smith, Grove Hill, Ala.

#### "How Happy I Am"

"How happy I am. I play for parties, entertainments. Never once thought I would be able to play the piano. Thanks a million!"

—Cora Franklin Duke, Bumpass, Va.

#### "Friends Were Amazed"

"Didn't know a note on piano. In a short time I could play simple hymns. Friends were amazed. Now entertain at parties, play at church."

—Samuel Moses, Mt. Vernon, Tenn.

Over 900,000 people have found a simple answer to these difficulties. One of them was a farm boy named Lawrence Welk. Early in life he showed a love of music, and by 13 had learned to play his father's old "squeeze box" by ear. After years of farm labor, came the day when he was rewarded with a modern accordion. He enrolled in the home study Course of the U. S. School of Music and was soon playing real music by note. Thus he started on the road that led to the present triumph of Lawrence Welk and his "Champagne Music" on ABC-TV.

### What Music Can Do for YOU

You may simply want to learn to play for the sheer joy of it. The fun of entertaining your friends—of being invited to play at parties, where you meet interesting



### Mail Coupon for FREE BOOK

Let us SHOW you why our way to learn music is so EASY—and so much fun! See why our method has been so successful for 59 years. Mail the coupon for our valuable 36-page **FREE BOOK**. No obligation. No salesman will call on you. It can mean so much to you for the rest of your entire life—if you will mail the coupon TODAY! **U. S. SCHOOL OF MUSIC, Studio A301, Port Washington, N. Y.** Reduced prices on instruments to our students.

### U. S. SCHOOL OF MUSIC Studio A301, Port Washington, N. Y.

I am interested in learning to play, particularly the instrument checked below. Please send me your free illustrated booklet, "How to Learn Music at Home." NO SALESMAN IS TO CALL UPON ME.

- |  |  |   |
|--|--|---|
| <input type="checkbox"/> Piano           | <input type="checkbox"/> Pipe, Hammond, Reed Organ | <input type="checkbox"/> Piccolo                  |
| <input type="checkbox"/> Guitar          | <input type="checkbox"/> Tenor Banjo               | <input type="checkbox"/> Modern Elementary        |
| <input type="checkbox"/> Steel Guitar    | <input type="checkbox"/> Ukulele                   | <input type="checkbox"/> Harmony                  |
| <input type="checkbox"/> Violin          | <input type="checkbox"/> Clarinet                  | <input type="checkbox"/> Mandolin                 |
| <input type="checkbox"/> Piano Accordion | <input type="checkbox"/> Trombone                  | <input type="checkbox"/> Practical Finger Control |
| <input type="checkbox"/> Saxophone       | <input type="checkbox"/> Flute                     |   |
| <input type="checkbox"/> Trumpet, Cornet |  |   |

Do you have the Instrument? \_\_\_\_\_

Mr. \_\_\_\_\_  
Mrs. \_\_\_\_\_  
Miss \_\_\_\_\_  
(Please Print Carefully)

Address \_\_\_\_\_

City \_\_\_\_\_ State \_\_\_\_\_

CHECK HERE for Booklet A if you are under 18 years.

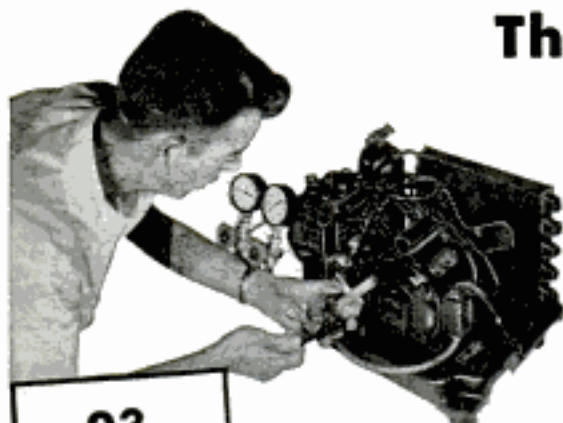

## This CTI Student Is Training at Home in Spare Time for a Big-Pay Job . . .

As a CTI student, you build a complete, heavy-duty, commercial-type refrigeration high-side. You get all parts and tools without extra cost. You do 10 complete troubleshooting and service jobs. You build (and keep) an air conditioner, freezer, refrigerator or milk cooler. Only CTI sends 23 big kits—brings Shop Method training right into you home!

**23**  
BIG KITS  
to build  
AIR CONDITIONER  
REFRIGERATOR  
FREEZER or  
MILK COOLER

## Be a Success — Be Secure in AIR CONDITIONING AND REFRIGERATION

### Letters from Students Show Value of Training



"When I came home from the army, there was no work. Thanks to CTI training, I am now employed full time at good wages. I got 3 raises and a bonus. Have my own home."—*Daniel Stevens, Springfield, O.*

"Without the practical and theoretical training I received through CTI, I never could have started a business of my own. I have a small shop. Am financially independent."—*K. Sellman, Guthrie Center, Ia.*

"Am very glad I learned through CTI. I am now an able refrigeration technician. Am earning good wages, find my work interesting. I recommend CTI to any ambitious man."—*A. W. Heindrich, Kewanee, Ill.*



"I find the lessons very interesting and easy. Since my fifth lesson I have been working on refrigerators. I rebuild old ones and sell at a nice profit. Am planning a full time shop."—*W. O. Ward, Mich.*

"Your course proved to be very valuable to me. As a result of your training, my partner and I run our own repair shop. He is also a CTI graduate. We also employ a former CTI student as our outside repair technician."—*J. J. Giertuga, Chicago.*

"My training thru CTI has changed my life. It has changed it from working for bare necessities to my owning a business."—*J. J. Kish, E. Chicago, Ind.*

Do you really want to be a success? Then get into air conditioning and refrigeration! This old, established industry offers security. Because it's growing bigger every day, thousands of new jobs must be filled. Many pay up to \$125 a week and more. Most set the stage for you to open a shop. Find out how you can train at home in spare time. Just fill out and mail coupon for two new books that give the facts. Both are free.



R. C. Anderson  
President

### Over 150,000,000 Units Need Service and Repair

This is why the air conditioning and refrigeration industry needs trained technicians so badly: Over 150 million units are in use today. Each year, some 3 million refrigerators, 1 million freezers, and 2 million air conditioners are produced. Yet, experts say the surface has hardly been scratched. It takes tens of thousands of trained men to keep commercial and home units in working order.

### AUTO AIR CONDITIONERS

It is estimated that this year, over 300,000 new cars will have air conditioners. Tens of thousands of older models also are in the market. Already the auto industry is seeking trained men for this exacting work. Be one!



### Earn Cash as You Train

CTI training is so practical that soon after starting, many students do repair work in spare time for profit. It's not unusual for students to have a going business by the time they graduate. Assembling CTI kits, doing real repair jobs, you learn fast. No need to waste years in low-pay apprenticeship.

### Training You Can Trust

CTI home training was developed in our own resident shops—thoroughly tested in the field. CTI was the only civilian school to train men in refrigeration for the U.S. Army during WWII. That CTI is way-ahead in home instruction is proved by the practical training kits that we provide. You can't get better or more complete training.

### COMMERCIAL TRADES INSTITUTE

1400 Greenleaf Ave. Dept. R-328  
Chicago 26, Illinois

Mail me your book *Success in Air Conditioning and Refrigeration*, and *Sample Lesson*. Both FREE.

Name \_\_\_\_\_ Age \_\_\_\_\_

Address \_\_\_\_\_

City \_\_\_\_\_ Zone \_\_\_\_\_ State \_\_\_\_\_



### MAIL COUPON FOR 2 FREE BOOKS

You can have the full story on your opportunities by filling out and mailing coupon. CTI will send you two new books, just off the press. Act today.

• CTI graduates often open shops. You can start a business with a small investment. Start small, grow big!



Get the Facts First—then Decide





2900 photos and diagrams, plus crystal-clear directions, make every operation easy as A-B-C.

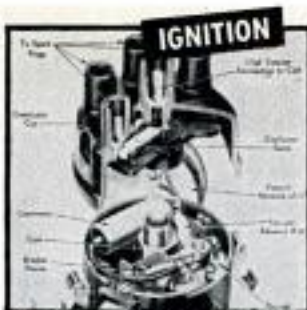

Diagrams, tables and text take the "mystery" out of all ignition systems.

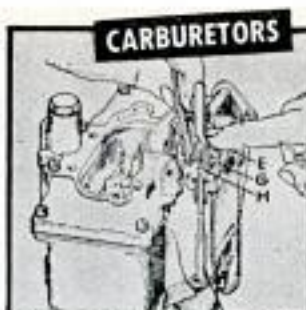

You get illustrated adjustment procedures for all types of carburetors.



ALL AUTOMATIC TRANSMISSIONS are fully covered in special big section. (NOTE: All pictures shown here are greatly reduced in size. Actually, this giant book is almost a foot high!)

# Here's the EASY Step-by-Step Way to FIX ANY PART OF ANY CAR



Fuel pumps can cause trouble. Pictures show exactly how to take them apart, fix them.

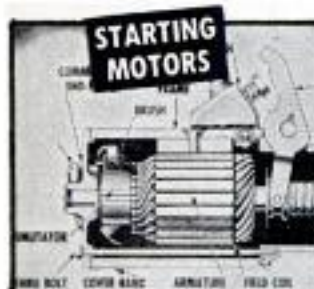

No guesswork. Clear pictures show how to fix starting motor, generator, brakes, etc.

**Just 2 of the Many Letters of Praise**  
Does Every Job. "My MOTOR Manual is a wonderful help. It has put me in a position to do every job."—S. L. Sharpless, Los Angeles, Calif.  
Amazed Self and Friends. "I amazed myself and my friends, too. Now do jobs that stumped me before."—Michael Bulicky, Newark, N. J.

Now—Whether You're a Beginner or Expert Mechanic—You Can "Lick" Any Auto Repair Job On Any Car Built from 1946 Through 1956!

**in a jiffy!**

Now you can tackle any repair job, and do it quickly, easily, right—the first time! MOTOR'S BRAND-NEW AUTO REPAIR MANUAL shows you how—with crystal-clear pictures and step-by-step directions you can easily follow.

No guesswork. This giant guide tells you where to start; what tools to use. Leads you easily and quickly through the entire operation. Covers everything from a simple carburetor adjustment to a complete overhaul.

## Everything You Need to Know

**BIG, NEW REVISED Edition has MORE REPAIR INFORMATION THAN EVER! OVER 1,000 giant pages, 2,900 "This-Is-How" pictures—** clear drawings, diagrams, cutaway photos—**make every step EASY.** 391 "Quick Check" charts—23,436 essential repair specifications. 225,000 service and repair facts. Instructions and pictures so complete, so clear—you CAN'T go wrong!

Even a green beginner can do a good job. And top mechanics will be amazed at the time-saving procedures.

## The "Meat" of Over 160 Official Shop Manuals

The editors have put together the "Know-How" from over 160 Official Shop Manuals; "boiled it down" into one handy indexed book.

Includes ALL Automatic Transmissions. Covers new Carburetors, Engines, Fuel Pumps, 12-Volt Ignition System, Starting Motors, Generators, Distributors, Voltage Regulators, Axles, Brakes, Power Steering, etc. PLUS new Trouble-Shooter

section that enables you to spot any car trouble in a jiffy.

Factory Specifications and Adjustment Tables. Tune-up Charts, Tables of Measurements and Clearances. Overhauling, Replacement Facts—AND MUCH MORE.

Used by Armed Forces, hundreds of thousands of auto service men! Now try it on this GUARANTEE:

**Try Book for a Week FREE SEND NO MONEY**

Pay nothing to postman. Test book in your own garage or shop. It's GUARANTEED to pay for itself in 7 days. If it doesn't just return the book, and owe nothing. Rush coupon for your free-trial copy of this great money-saving Manual. MOTOR Book Dept., Desk 11, 250 West 55th St., New York 19, N. Y.

USED BY  
U.S. ARMY  
NAVY  
MARINES



**SEND NO MONEY! TRY BOOK FREE! FOR A WEEK FREE!**

**Same FREE 7-Day Offer on MOTOR'S Brand-New TRUCK REPAIR MANUAL**  
Covers EVERY job on EVERY gasoline-powered truck made from 1946 thru 1956—including GM and Cummins Diesels. Over 2,000 clear illustrations. Over 2,000 check facts. Check box for coupon for free trial.

**COVERS 737 MODELS— ALL THESE MAKES**

Buick	Ford	Nash
Cadillac	Frazer	Oldsmobile
Chevrolet	Henry J	Packard
Chrysler	Hudson	Plymouth
Clipper	Imperial	Pontiac
Continental	Jeep	Rambler
Crosley	Kaiser	Studebaker
De Soto	Lincoln	Thunderbird
Dodge	Mercury	Willys

**2,000,000 COPIES SOLD!**

## MAIL COUPON NOW FOR 7-DAY FREE TRIAL

MOTOR Book Dept., Desk 11, 250 West 55th Street, New York 19, N. Y.

Rush to me at once! (Check box opposite book you want.)

MOTOR'S New AUTO REPAIR MANUAL. If okay, I'll remit just \$2.00 in seven days, then \$2.00 monthly for two months and a final payment of \$5c (plus 35c delivery charge) one month after that. Otherwise, I'll return the book postpaid in seven days. (Foreign price: Remit \$9.00 cash with order.)

MOTOR'S New TRUCK REPAIR MANUAL. (Described at left.) If okay I will remit \$2.00 in seven days, and \$2.00 monthly for three months, plus 35c delivery charge with final payment. Otherwise I will return book promptly. (Foreign price: Remit \$10.00 cash with order.)

Print Name.....Age.....

Print Address.....

City & Zone No.....State.....

SAVE 35c delivery charge by enclosing WITH COUPON check or money order for full payment of \$6.95 for Auto Repair Manual (or \$8.00 for Truck Manual). Same 7-day return-for-refund privilege applies.



You can make money in

# WATCH REPAIRING

Learn at home the low cost Sweazey Way

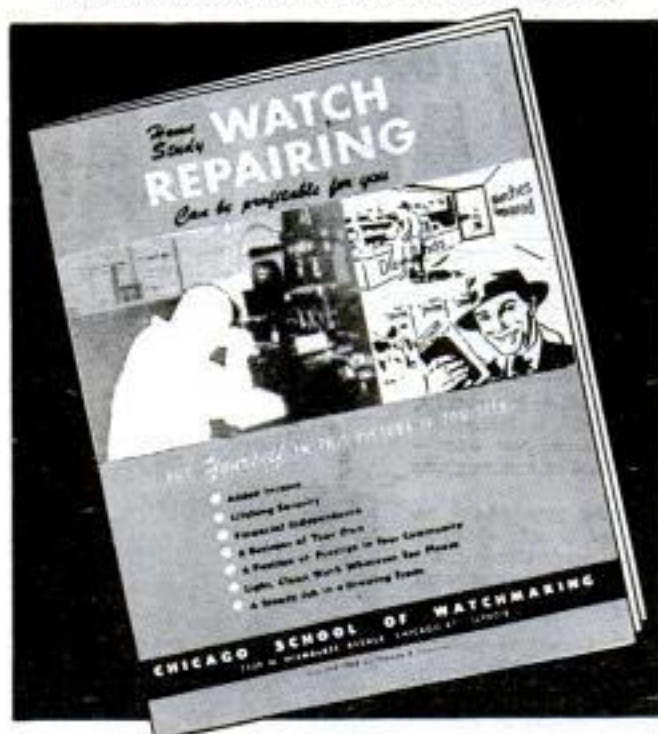

## Free book and sample lesson

Opportunities now for trained watch repairmen are the best in years. Part time watchmakers reported earnings up to \$6 an hour on survey.

The easy-to-follow Sweazey home study System shows you step by step how to repair Swiss and American watches from start to finish. Starts you making repairs right away. Covers all phases. Uses original methods developed in training professional watchmakers since 1908. No previous experience needed. Age is no barrier.

**SPECIAL WATCHMAKER'S TOOLS** and materials are offered with course at no extra charge to students starting now.

**TERMS AS LOW AS \$5 A MONTH** for this modern, professionally prepared training. Get facts now. See how the Sweazey System makes watch repairing interesting, practical and certain . . . prepares you for success in a good job or business of your own. Send for **FREE OPPORTUNITY BOOK** and **SAMPLE LESSON**. No cost or obligation. Write today!

**CHICAGO SCHOOL OF WATCHMAKING**  
2330 N. Milwaukee Ave., Dept. 117, Chicago 47, Illinois  
Member, National Home Study Council

### MAIL COUPON TODAY! No obligation

**CHICAGO SCHOOL OF WATCHMAKING**  
2330 N. Milwaukee Ave., Dept. 117, Chicago 47, Illinois

Please rush Free Booklet and Sample Lesson and tell me how I can learn watch repairing at home.

Name \_\_\_\_\_ Age \_\_\_\_\_

Address \_\_\_\_\_

City \_\_\_\_\_ Zone \_\_\_\_\_ State \_\_\_\_\_



## ... TURN CONCRETE INTO GOLD!

### MAKE UP TO \$75 A DAY IN YOUR OWN BUSINESS

If you want to have your own business - to start a business on your own - here's your big opportunity! New high speed, low cost General block machine produces up to 1,000 concrete blocks a day. Sell all you make to builders, supply houses, and others for homes, factories, buildings, garages. Cash in on the building boom! You can make profits of 100% to 150% - up to \$75 a day! General block machine equipped with 1/2 h.p. electric motor - or can be supplied with gasoline engine - works anywhere, in tight space, indoors or out. Operates from ordinary house light socket. Simple, foolproof 3 step operation - so easy a child can do it. Makes superior 3 core blocks any size from 4" to 12". Also makes chimney, sash, corner and other types. Blocks meet any building code anywhere in the country. Materials - sand, water, cement, available anywhere. Simple illustrated operating instructions and mixing formulas for cement and cinder blocks supplied with each machine. Write for **FREE** folder with full information.

**MOTOR DRIVEN**

R.L.T. of New York City reports: "MY GENERAL BLOCK MACHINE PAID FOR ITSELF IN FIRST 2 WEEKS!" Hundreds now in use the world over! Write for **FREE** details today!

**EXTRA**

Amazing illustrated book gives floor plans for 6 sensational concrete block bungalows. Tells how to lay blocks, lay out building lines, mix concrete, build steps, porch and concrete floors all at great savings. Written by experts. Can save many times the cost of the machine! Get it now! No strings attached. Send \$1.-

BOOK SENT FREE IF YOU BUY MACHINE.  
\$1 REFUNDED IF YOU BUY LATER.

## GENERAL ENGINES CO.

DEPT. M-17, ROUTE 130, THOROFARE, N. J.

**HOW TO BUILD YOUR OWN CONCRETE BLOCK HOME**  
Only \$1 Prepaid

## FREE - U.S. STAMPS

U. S. 1943 Bi-Colored Flag of Occupied Nations (as illustrated) Airmails, Commemoratives, Regular Issues, included in this collection of 25 selected, all different, genuine U. S. stamps. **PLUS VALUABLE U. S. \$5.00 STAMP.** Everything for 10c to cover mailing expenses. Approvals included. Act at once.

WILLETT CO., P.O. Box 390, Dept. 707, Mount Kisco, N. Y.



# BANKRUPT

**STOCKS & SURPLUS BARGAINS • FREE CATALOG.**  
**PRACTICAL ENGINEERING COMPANY**  
707 North Sheridan Road Tulsa, Oklahoma

## Sell NEW INVENTIONS

**SEEKING NEW PRODUCTS? . . .** Get my outfit of Newest Household Needs. See my 47 money-making specialties. Latest conveniences for your home and car. Newest Inventions! All Fast Sellers! **Make Big Money. Take orders from friends.** Be first to write. Hurry - just a postcard will do. **SEND NO MONEY. Just your name.**  
**KRISTEE PRODUCTS, Dept. 695, Akron 8, Ohio**

## 60 POWER TELESCOPE \$3.98

**VARIABLE EYEPIECE 20X-40X-60X - BRASS BOUND NEW!** Three telescopes in one, 3 different magnifications. 20 power for ultra-bright images with 40 and 60 power for extra long range. Guaranteed to bring distant objects, people, sports events, ships, moon, stars, etc. 60 times as close.

Most powerful for anywhere near the moon. ey. 5 sections. Closes to 1 ft. long. Contains 4 ground and polished lenses. Also used as a powerful compound microscope. Directions included. Mass production enables us to offer this instrument at amazing price of \$3.98 complete. Money back guarantee. We pay postage. Get yours now. **CRITERION CO., 331 Church St., Hartford, Conn., Dept. PMB 42**



POPULAR MECHANICS

Get into

# TELEVISION RADIO-ELECTRONICS



LEARN ALL 8 PHASES  
BY SHOP METHOD

1. Television . . . including Color TV
2. Radio . . . AM, FM
3. Industrial Electronics
4. Communications

OF THE INDUSTRY  
HOME TRAINING

5. Sound Recording & Hi-Fidelity
6. Automation
7. FCC License Preparation
8. Radar & Micro Waves

Let National Schools of Los Angeles, a Practical Resident Technical School for over 50 years, train you at home by Shop-Method for unlimited opportunities in All phases of TV, Electronics, Radio.

You get 19 big kits  
of equipment!

GOOD JOBS . . . MORE MONEY  
SECURITY . . . ALL CAN BE YOURS

YOU are needed in the great modern Television-Electronics industry. Trained technicians are in growing demand, at excellent pay, in sales and service, manufacturing, broadcasting, telecasting, communications, research, and many other important branches of the field. National Schools Master Shop-Method Training, with newly added lessons and equipment prepares you in your spare time right in your own home for these fascinating opportunities. OUR OUTSTANDING METHOD IS PROVED BY THE SUCCESS OF GRADUATES ALL OVER THE WORLD!

#### YOUR TRAINING IS ALL INCLUSIVE

We prepare you for a long list of job opportunities. Thousands of TV and Radio receivers are being sold every day—more than ever before. And, now, Color TV is here. Applications of Electronics in industry—AUTOMATION—are growing in tremendous strides. The whole field is alive—opening up new, important jobs rapidly. National Schools complete training program qualifies you in all phases of the industry.

#### YOU EARN WHILE YOU LEARN

Many students pay for their entire training—and more—with spare time earning. We'll show you how you can, too! Early in your course you receive material that shows you how to earn extra money servicing TV and Radio receivers, appliances, etc., for friends and acquaintances.

#### YOU GET EVERYTHING YOU NEED

Clear, profusely illustrated lessons, shop-tested manuals, modern circuit diagrams, practical job projects—all the valuable equipment shown above—many other materials and services—consultation privilege with our qualified staff, and Graduate Employment Service. EVERYTHING YOU NEED for outstanding success in Electronics.

INDUSTRY NEEDS YOU. NATIONAL SCHOOLS  
WILL TRAIN YOU. SEND FOR FACTS TODAY  
NO OBLIGATION.

YOU LEARN BY SHOP METHOD . . . you do servicing, circuit analysis, and do over 100 down-to-earth experiments. You build a Superhet Receiver and a modern TV Receiver, from the ground up, including a new, big screen picture tube. You also receive a professional, factory-made MULTI-TESTER. All of this standard equipment is yours to keep . . . at just one low tuition.

#### RESIDENT TRAINING AT LOS ANGELES

If you wish to take your training in our Resident School at Los Angeles, the world's TV capital, start NOW in our big, modern Shops, Labs and Radio-TV Studios. Here you work with latest Electronic equipment—professionally installed—finest, most complete facilities offered by any school. Expert, friendly instructors. Personal attention. Graduate Employment Service. Help in finding home near school . . . and part time job while you learn. Check box in coupon for full information.

Approved for  
GI Training



### NATIONAL SCHOOLS

LOS ANGELES 37, CALIF.

In Canada: 811 W. Hastings St., Vancouver, B. C.

FREE!  
VALUABLE BOOK  
& SAMPLE LESSON  
—Just Send  
Coupon!



### NATIONAL SCHOOLS

TECHNICAL TRADE TRAINING SINCE 1903  
LOS ANGELES 37, CALIFORNIA

GET FAST SERVICE—MAIL NOW TO OFFICE NEAREST YOU!

NATIONAL SCHOOLS, DEPT. RB-17  
4000 S. FIGUEROA ST. OR 187 N. LA SALLE ST.  
LOS ANGELES 37, CALIF. CHICAGO 1, ILL.  
Rush free TV-Radio "Opportunity" Book and sample  
lesson. No salesman will call.

NAME \_\_\_\_\_ AGE \_\_\_\_\_

ADDRESS \_\_\_\_\_

CITY \_\_\_\_\_ ZONE \_\_\_\_\_ STATE \_\_\_\_\_

Check if interested ONLY in Resident School training at Los Angeles.  
VETERANS: Give date of Discharge \_\_\_\_\_

*Yours for only* **10¢**

2-SIDED, NON-BREAKABLE

**RECORD**

**START SPEAKING  
SPANISH  
OR  
FRENCH  
QUICKLY, EASILY!**

JUST MAIL the coupon for this sample record and lesson (enclosing only 10¢ to help cover postage and handling).

Listen as native instructor speaks to you on record. Let your eyes follow words in sample lesson, at same time. Quickly you'll be "chatting" easily in your new language—with a perfect accent!

Now's the time to learn a new language. It gives you such an advantage in business, social life and when traveling. And here's the easiest way to learn—by listening! You gain a perfect accent—because that's all you hear! Also there is no drudgery learning grammar "the hard way"—you pick it up in CONVERSATION.

**MAIL COUPON NOW**

There are no "strings" to this offer. But it may end soon. Hurry! Rush coupon with only 10¢ for your record and lesson. We'll also send FREE book about full Cortina course, which includes text books and recordings. No obligation.

**CORTINA ACADEMY**  
*Established 1882*

Dept. 641, 136 W. 52nd St., New York 19

**MAIL NOW FOR Sample Record**

CORTINA ACADEMY, Dept. 641, 136 W. 52nd Street, New York 19, N. Y.

Please mail me a Sample Record and Lesson in (check)

- Spanish  French  German  Russian  
 Italian  Japanese  Brazilian

and complete information about full Cortina Course. Enclosed is 10¢ (coin or stamps) to help cover the cost of special packaging, shipping. I understand this does not obligate me in any way.

Name .....

Address .....

City..... Zone.... State.....



More Money

New Career

Travel Fun

Cultural Enjoyment

Also:  
RUSSIAN  
GERMAN  
ITALIAN  
JAPANESE  
BRAZILIAN-  
PORTUGUESE

**MIRACLE TOMATO  
Yields 2 BUSHELS  
To a Vine**



Now—You can grow the world's most amazing Tomato right in your own garden and get from 2 to 3 bushels of delicious, ripe tomatoes from every vine.

**BURGESS CLIMBING  
TRIP-L-CROP**

TOMATO grows 16 to 20 feet high. Huge, meaty, solid fruit, wonderful flavor. Some weigh as much as 2 pounds each. Unsurpassed for canning and slicing. Blight free—drought and disease-resistant. Grows in any garden Outyields all other varieties.

**TRIAL PACKET 10c**  
Postpaid. Order Today  
**3 Packets for 25c**

Write for FREE complete Catalog listing many unusual Seeds, Plants and Bulbs.

**BURGESS SEED & PLANT CO.**  
117 B. Galesburg, Mich.



**GIANT BALLOONS**

The best! Surplus US Govt. (new overage) Neoprene weather target balloons. **FOR FUN**—Great in backyard, at parties, picnics, fairs. Young & old enjoy 'em! **FOR ADVERTISING**—Attract big crowds to business openings, civic events, trade shows, exhibitions. Paint 'em with a sales message and they'll pay off for you! **FOR PROMS**—Makes any high school or college prom more festive. Real cool! Approx. inflated sizes.

3 ft. dia., 49c—5 ft. dia., 99c

Postage paid on prepaid orders. Cal. res. add sales tax.

**VOLUME SALES CO., War Assets Division**  
3930 Sunset Blvd., Dept. PM-157, Los Angeles 29, Calif.

**CABINET MAKING**



**LOW COST HOME TRAINING COURSE FOR BEGINNERS & ADVANCED CRAFTSMEN**  
Make money. Learn skills and secrets of fine woodworking and tool use. Professionally prepared shop method training tells and shows how. Covers everything. Easy to master.

Write for Free Booklet

**INTERSTATE TRAINING SERVICE**  
DEPT. F3, PORTLAND 13, OREGON

**Subscribe to...Trailer Topics Magazine**

6-Month Trial Subscription \$1



Discover how you can enjoy every modern convenience in your own home for just pennies a day. Read the true-life stories of those who live in mobilehomes and love it.

Only \$3.00 for 2 years.

**TRAILER TOPICS MAGAZINE**  
Suite 1573 28 East Jackson Blvd. Chicago 4, Illinois

POPULAR MECHANICS

# FREE

## A NEW HOME INDUSTRY



GEARS



FISHING LURES



JEWELRY GEMS

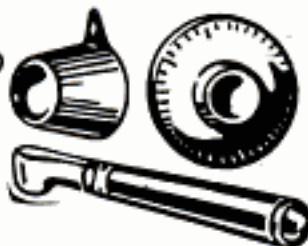

HANDLES  
KNIVES - DIALS



STATUES  
FIGURINES

Let us show you how extremely easy and **PROFITABLE** it is to make beautiful and useful things out of **LIQUID PLASTIC, LIQUID MARBLE, LIQUID IVORY, LIQUID GLASS, LIQUID EBONY, LIQUID PORCELAIN, LIQUID GEMSTONE, CERAMICS, ETC.** . . . . as easy as pouring water out of a glass! Make tools, dies, gadgets, novelties, jewelry, gifts, artware, ceramics . . . . . a million useful things! Valuable products that sell themselves on sight because of their exciting beauty and practical utility.

For years we have been teaching and guiding ambitious people in how to acquire profitable and fascinating occupations, starting at home or in your own shop (with only a few dollars investment), how to make more money than ever before! We now offer **YOU** the same unlimited opportunities!

### **MANUFACTURE WITHOUT TOOLS OR MACHINERY!**

No previous experience or special ability is needed in order to manufacture with **PLASTICAST Liquid Plastics**. Our special book the "**WONDERS OF LIQUID PLASTICS**" reveals all. Our Liquid Plastics serve so many diverse and useful functions, and can so easily be converted into beautiful and attractive products that thousands of our customers are now actively engaged in a wide variety of pride giving and profitable businesses established with the aid of our products and instructions!

**FREE** Catalog 19 is devoted exclusively (108 pages) to the art of manufacturing **EVERYTHING** without tools or machinery! Send for it today! We will include valuable book **THE WONDERS OF LIQUID PLASTICS** absolutely **FREE**. Catalog No. 19 - 25c.

**PLASTICAST CO., Dept. PC-1102**  
6612 N. Clark St. Chicago 26, Ill.

### **WE BUY THOUSANDS OF PLASTICAST ITEMS ANNUALLY**

Let us start you in business! We always need **GEMCRAFT** stones, made from **PLASTICASTINGS**, for our regular customers. We guarantee to buy your output too, when made from **PLASTICAST MATERIALS**.

### **MATERIALS and INSTRUCTIONS**

We can supply you with everything you need. **MATERIALS** in single or gross lots. As much or as little as you want. **INSTRUCTIONS** included with all shipments. In addition, we carry a complete library of beginners and advanced technical books on the manufacture and sale of plastics, from which you can select.

Send only 25c for big, giant-sized catalog of Casting Materials, Molds and Accessories and we will include **FREE** our remarkable book "The Wonders of Liquid Plastics."

**PLASTICAST CO., Dept. PC-1102**  
6612 N. Clark St., Chicago 26, Ill.

I am enclosing 25c for **PLASTICAST** Catalog No. 19 and include **FREE** of extra cost the book "**THE WONDERS OF LIQUID PLASTICS.**"

Name \_\_\_\_\_ Age \_\_\_\_\_

Address \_\_\_\_\_

City \_\_\_\_\_ Zone \_\_\_\_\_ State \_\_\_\_\_



# 20 YEARS OLD!

He's already an

# ELECTRONICS ENGINEERING DESIGNER

Out of high school just 2 years ago, this young man has already started a fascinating, highly rewarding career in electronics engineering. No matter whether you are now 18 years old—or 28—a 26-month Embry-Riddle education will prepare you for a quick start in this lucrative professional field.

Electronics Engineering Design course concentrates on essential technical studies and practical projects. With the aid of top flight Embry-Riddle instructors you'll master many absorbing fundamentals... Microwaves and Radar, Servomechanisms, Industrial Electronics and Television, to mention a few of the subjects.

The demand for trained engineers is greater than the supply—and will be for years! So take the first step now—mail this coupon. And remember, study and play in Miami's perfect year-round climate is stimulating and exciting.

FOUNDED 1926



Training Authorized under G.I. Bills

**Embry-Riddle International**  
SCHOOL OF AVIATION  
MAIL THIS COUPON TODAY

DEAN OF ADMISSIONS, Dept. 99  
Embry-Riddle School of Aviation, Miami 30, Florida  
Without obligation, please send FREE and postpaid full particulars.

- ELECTRONICS ENGINEERING DESIGN
- AERONAUTICAL ENGINEERING DESIGN

Name..... Age.....

Address.....

City..... State.....

I am a (check one)  Veteran  Non-Veteran

**INSURED TIRE SERVICE**  
**POPULAR BRANDS**  
**FREE** INSURANCE POLICY given with each used tire sold. We guarantee the amount of service you pay for.  
NOWHERE CAN SUCH QUALITY BE FOUND AT SUCH LOW PRICE!

**SPECIAL!** Deduct 10% on orders for two or more used tires

**YOU CAN'T LOSE!!**

**GOODYEAR SUBURBANITE TYPE SNOW TIRES**  
New Tire Guarantee—Factory Rebuilt  
BEST WINTER TRACTION OF ALL!

670x15	\$9.95	710x15	650x16	650x15	\$10.90
600x16		760x15	800-820x15		

**Super Quality — Rugged Performance — 6 Months Insured Service**

600x16	\$3.68	670x15	\$3.95	700x16	\$4.45	760x16	\$4.75
650x16	3.85	670x16	4.08	710x15	4.35	820x15	4.65
650x16	4.25	700x15	3.95	760x15	4.45	850x17	4.65

**Supreme Quality — Nothing Finer — 12 Months Insured Service**

600x16	\$5.25	475x19	\$5.48	700x15	\$10.45	700x20	\$12.50
600x16	6.75	640x19	4.95	750x16	15.95	750x20	15.50
650x16	5.75	670x15	5.35	700x17	11.95	750x20	17.50
650x16	7.25	710x15	5.45	750x17	15.45	820x20	21.50
700x16	6.35	760x15	5.95	750x15	10.95	800x20	19.95
750x16	6.45	800x15	6.35	30x5	11.25	1000x20	20.45
850x16	4.95	820x15	6.35	600x20	10.95	1100x20	21.25
850x17	4.75	850x15	5.35	650x20	11.75	1000x22	21.95
650x15	5.25	670x16	5.15	32x6	11.95	1100x22	22.75
700x15	5.35	700x16	10.25	32x6	12.75	1100x24	25.95

Whitewalls \$1.00 extra.

**MIDLAND TIRE SALES**  
Speedy shipments on Mail Orders. F.O.B. Chicago. Insurance policy sent with each order. Deduct 10% on orders for 2 or more used tires. Send CHECK or MONEY ORDER.—No COD's.  
3701 S. Normal, Dept. PM-54, Chicago 9, Ill.



Let me show you

## HOW TO SPEAK AND WRITE LIKE A COLLEGE GRADUATE

I have helped thousands of men and women who have not had college training in English to become effective speakers, writers, and conversationalists. With my new C. I. METHOD, you can stop making mistakes, build up your vocabulary, speed up your reading, develop writing skill, learn the "secrets" of conversation. You don't have to go back to school. Takes only 15 minutes a day at home. Costs little. 32-page booklet mailed FREE upon request. Send me a card or letter TODAY!

Dept. 1051 Don Bolander, Career Institute 25 East Jackson Chicago 4, Illinois

**RADIO** Engineering. All phases radio & electronics theory & practice; television; FM; broadcasting; servicing; aviation; marine & police radio. Prepare for good pay; 21-month course. Graduates in demand by major companies. Enter Jan., April, July, Sept. Regular campus life. Write for catalog.  
VALPARAISO TECHNICAL INSTITUTE, Dept. D, Valparaiso, Ind.

**GROW HERBS FOR US!**  
AT HOME— IN YOUR SPARE TIME  
Help fill our huge demand—used in expensive medicines. Easy to grow indoors or out—multiply rapidly. Year around Profitability! You grow 'em—we buy 'em! We supply everything you need. Free rare seeds and revealing plan is yours free for the asking. Be one of the first to profit—rush name and address to: NATIONAL HERB EXCHANGE, Dept. A-1 Gardena, Calif.

FREE SEEDS Write!

**Get Yourself FIXED FOR LIFE in the Big Pay Shoe Business!**

I'LL PUT UP THE MONEY TO GIVE YOU A FLYING START!

I GIVE PRODUCERS THEIR OWN SHOES AS A BONUS!

It's no trick at all to make big money—FULL OR SPARE TIME—with America's most comfortable shoes! Amazing new "Spring-Step" cushion invention proves it by actual demonstration. Only ORTHO-VENT has it! There is no other shoe in the world like it. Repeat orders are sure, steady. One try and a customer is sold for life. Profits are BIG. Orders are sure and easy with the most amazing 2-minute demonstration in the history of the shoe business. No experience needed. No investment to make. Everything, including actual cut-a-ways, furnished free! Be the big-pay ORTHO-VENT man in your territory. Write TODAY! E. C. Brand, Sales Manager.

**ORTHO-VENT SHOE COMPANY**  
1171 College Ave. SALEM, VIRGINIA

**PRICES SLASHED ON FINE IMPORTED**

# ACCORDIONS

**BUY NOW-BUY DIRECT**

**SAVE  $\frac{1}{2}$  OR MORE**



**5 DAYS  
FREE TRIAL**

**BONUS GIFTS FREE!**

Home Study Course  
Deluxe Music Stand  
Year's Supply of Music  
Lifetime Guarantee

Name in Chrome Letters  
Bellows Protector  
Fine Quality Carrying Case  
Music Portfolio

### PHILHARMONIC Cathedral

A magnificent accordion for the professional accordionist and those who demand the peak of quality.

**FREE COLOR  
CATALOG  
RUSH COUPON**

**Small Down Payment—Easy Terms**

**Buy Direct from America's  
Largest Exclusive Dealer of  
Fine Imported Accordions**

You'll never buy for less! Rush coupon for exciting FREE Color Catalog of latest model brand new Imported Italian Accordions. You'll save one half — or more — by ordering NOW! Get FREE 5-DAY PLAYING TRIAL with positive money back guarantee. If you decide to keep it, pay only pennies a day on amazing easy terms. We are America's largest exclusive direct accordion dealer. We buy for less—and pass our savings on to you. Each accordion bears the famous brand name of an outstanding manufacturer—each is hand selected for quality and superior tone. Each accordion carries our LIFETIME WARRANTY!

**NEWEST 1957 MODELS NOW HERE**

More than 30 brand new models to choose from. Accordions for beginners up to magnificent professional instruments. Personal help in selection if desired. Trade-ins accepted. Get in on the fun and popularity only an accordion can give you. Rush coupon at once for big new FREE Color Catalog and new low wholesale price list. No obligation. Write today.

**ACCORDION MANUFACTURERS  
and WHOLESALERS OUTLET**  
Dept. R-17, 2003 W. Chicago Avenue,  
Chicago 22, Illinois

Send FREE Color Catalog of newest model accordions; also latest wholesale price list.

Name \_\_\_\_\_

Address \_\_\_\_\_

City \_\_\_\_\_ State \_\_\_\_\_

**ACCORDION MANUFACTURERS AND  
WHOLESALERS OUTLET**

2003 W. Chicago Avenue, Dept. R-17, Chicago 22, Illinois

**SAM HANKS**, famous race driver-mechanic says,  
 "I'd like a  
**NATIONAL SCHOOLS** trained mechanic on  
 my crew... any employer would!"

Sam Hanks holds American Closed Course record (182.5 M.P.H.); also many state and national racing titles. At Indianapolis he was 2nd last year, 3rd in '52 and '53.

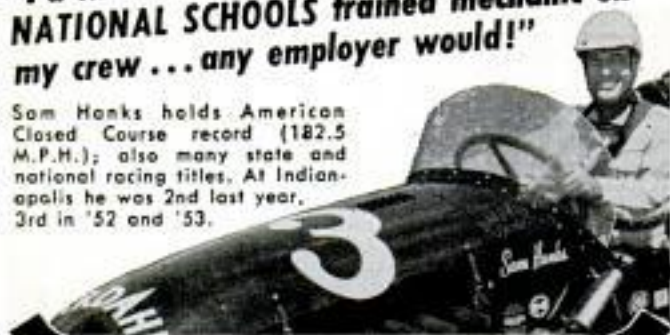

**MASTER ALL ENGINES  
 AT HOME IN YOUR SPARE TIME  
 NATIONAL SCHOOLS  
 AUTO MECHANICS & DIESEL  
 COURSE**  
 INCLUDING FUEL INJECTION

**YOU GET AND KEEP ALL THIS EQUIPMENT**



Complete set of professional tools and All-Metal Tool Box. Same top-quality equipment used by expert mechanics everywhere. Use them, display them proudly.



"Motor Analyzing Set" contains Standard Engine Vacuum Fuel Pump Tester, Remote Starter Switch, Modern Timing Light, Standard Compression Tester. Plus compact carrying case & instructions.



Top-quality Socket Wrench with fittings. Real professional tools you'll use during your lifetime career in repairing all types of engines, from foreign cars to big diesel jobs.

"I've worked alongside National Schools-trained mechanics," reports Sam Hanks. "They're tops, because they get all-around training, and they know how to repair fast and right the first time. No wonder National Schools graduates command top pay."

Earn as you learn men! We'll show you how. Streamlined lessons, diagrams, manuals, latest equipment, practical methods prepare you for hundreds of jobs in scores of industries. Free Placement Assistance.

Approved for GI Training.



Resident Training at Los Angeles  
 If you wish to take your Auto-Diesel training in our famous Resident School at Los Angeles, check special box in coupon for full information.

**NATIONAL SCHOOLS**  
 Los Angeles 37, California  
 CANADA: 811 W. Hastings St., Vancouver, B. C.

**NATIONAL SCHOOLS**  
 TECHNICAL TRADE TRAINING SINCE 1905  
 LOS ANGELES 37, CALIFORNIA

**NATIONAL SCHOOLS, Dept DB-17  
 MAIL NOW TO OFFICE NEAREST YOU**

4000 S. FIGUEROA ST. OR 187 N. LA SALLE ST.  
 LOS ANGELES 37, CALIF. CHICAGO 1, ILL.  
 Send for FREE Auto-Diesel Opportunity Book and Sample Lesson.

NAME \_\_\_\_\_ AGE \_\_\_\_\_

ADDRESS \_\_\_\_\_

CITY \_\_\_\_\_ ZONE \_\_\_\_\_ STATE \_\_\_\_\_

Check if interested ONLY in Resident School Training at Los Angeles  
 VETERANS: Give date of discharge \_\_\_\_\_

## Shrinks Hemorrhoids New Way Without Surgery

Science Finds Healing Substance That  
 Relieves Pain—Shrinks Hemorrhoids

For the first time science has found a new healing substance with the astonishing ability to shrink hemorrhoids and to relieve pain—without surgery.

In case after case, while gently relieving pain, actual reduction (shrinkage) took place.

Most amazing of all—results were so thorough that sufferers made astonishing statements like "Piles have ceased to be a problem!"

The secret is a new healing substance (Bio-Dyne\*)—discovery of a world-famous research institute.

This substance is now available in suppository or ointment form under the name Preparation H.\* Ask for it at all drug counters—money back guarantee. \*Reg. U. S. Pat. Off.

**SAVE GAS, GEARS,  
 TIRES ON YOUR  
 4-WHEEL DRIVE!**



**Stop Front End Drag in 2 W. D.**

Get maximum use of your vehicle with these famous hubs! They "take out" the front end in 2-wheel drive, give your vehicle "pick-up" economy, pep, speed, power, handling ease; stop front end gear whine, shimmy. 4-wheel drive as usual, when you need it—automatically, as you shift, with Warn Lock-o-matics, manually with Locking hubs. Models for all makes 4 w.d.s. to 1½ tons at truck dealers everywhere, or write:

WARN MFG. CO., Riverton Box 6064-A1, Seattle 88, Wn.



**WARN  
 HUBS**

## JEEP OWNERS

RE-POWER NOW with your choice of three famous V-8 engines

**FORD • CHEVROLET • MERCURY**

CONVERSION KITS now available to fit ALL 2 and 4 Whl-Drive Willys Jeeps. Priced \$43.25 to \$64.75... if you want fast action tell us which V-8 engine you wish to use... give us the year... 2 or 4 Whl-Drive... body style of your vehicle. Send min. \$15.00 dep. and we will ship correct kit, bal. C.O.D. Send full amount for prepaid shipment. Wire, phone or write for FREE details.

**HOOSIER MACHINE PRODUCTS CO.**

312 S.E. 6th St. Phone 676 Pendleton, Oregon, U.S.A.

## FREE GERMAN STEEL HUNTING KNIFE



**4-INCH BLADE**

We give you handiest hunting and fishing knife you've ever had! Has 4-INCH LONG highly tempered steel blade—VERY SHARP! Attractive handle. We send knife FREE to acquaint you with our below-wholesale bargains. Please send 25c for handling. NO LIMIT—but send 25c handling for each knife. Order TODAY! HUNTING KNIFE, Dept. K-135, Box 881, St. Louis, Mo.

2011 Offers... 88 Pages

YOUR **FREE!**  
 COPY

1106 pictures illustrate 2011 offers!—in our new 88 page 1957 catalog. FREE TO YOU from America's largest direct-to-you seed and nursery house. Over 60 years in business. Mail card today!

HENRY FIELD Seed & Nursery Co.  
 7104 Oak St., Shenandoah, Iowa



POPULAR MECHANICS

Copyrighted material



# New Rubber Stamp Business Pays Beginners <sup>UP</sup> <sub>TO</sub> \$9.20 an hr.

**Start at home in spare  
time with this little  
table top machine**

The multi-million dollar Rubber Stamp Business—once controlled by a few big companies—is now being taken over by small home operators—one in each community throughout the U.S. Men and women who have this inexpensive machine can turn out huge quantities of Rubber Stamps with special wording that buyers once were forced to order from big cities. Material costing only 27¢ makes a stamp that sells for \$1.80. The machine that does the work is simple and easy to operate and it turns out as many as six Rubber Stamps at a time each with different wording such as names, addresses, notices, stock numbers, prices and other "copy" needed by offices, factories and individuals. Working full capacity, it can earn as much as \$9.20 an hour for the operator! Now you can get into the big-pay business yourself, with your own home as headquarters. You don't need any experience. We supply everything, including complete instructions and eight ways to get business coming in fast. Start making up to \$9.20 an hour from the very beginning. Cash in on the profitable Rubber Stamp Business in your community right away.

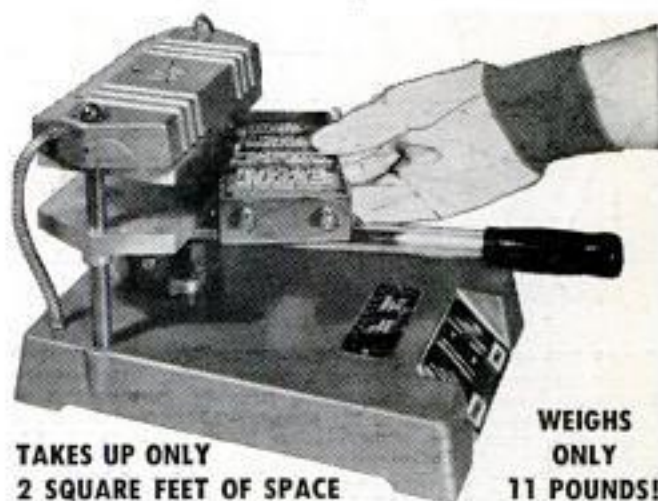

**TAKES UP ONLY  
2 SQUARE FEET OF SPACE**

**WEIGHS  
ONLY  
11 POUNDS!**

Read the complete and fascinating Rubber Stamp story in a big 110-page Book recently published by the Warner Electric Company. The book is profusely illustrated with more than 100 pictures and photographs. *And you can read it for a full two weeks without risking a penny of your own money.*

**Here's what the new  
WARNER PLAN Tells You  
about Making Money  
with RUBBER STAMPS**

### CHAPTERS

1. HOW TO have fun now and at the same time provide for a secure and prosperous future.
2. HOW TO check the advantages of operating a Rubber Stamp Business in your own community.
3. HOW TO acquire a general knowledge of the business based on a brief history of the Rubber Stamp.
4. HOW TO visualize the scope of the Rubber Stamp market.
5. HOW TO make a Rubber Stamp (general outline).
6. HOW TO assess the value of Warner Equipment.
7. HOW TO get acquainted with the "Tools of your Trade."
8. HOW TO make a Rubber Stamp (Specific procedure).
9. HOW TO mount a vulcanized Rubber Stamp.
10. HOW TO make "Special" Rubber Stamps.
11. HOW TO cut plastic Matrix Board for the chase.
12. HOW TO get the right price for the Rubber Stamps you make.
13. HOW TO price your complete Rubber Stamp Line.
14. HOW TO figure costs so you will be sure of a substantial profit on all the work you turn out.
15. HOW TO set up your workshop.
16. HOW TO get the most out of Warner's "Eight Tested Sources for Getting Business."
17. HOW TO operate at peak efficiency when YOU ARE YOUR OWN BOSS.
18. HOW TO get started on a cash outlay so small that you can get back your entire investment inside of two weeks.

## NEW WARNER SUCCESS PLAN

**Tells How to Build — Step by Step — to  
big profits and Personal Independence**  
**READ THIS PLAN FOR 2 WEEKS  
ENTIRELY AT MY RISK.**



110 Pages  
More Than 100  
Pictures

Now Ready to Mail  
Tell Me Where To  
Send Your Copy

**USE COUPON**

In this amazing Plan you will find exact and detailed instructions for starting a Home Business in spare time—without giving up your present job and without risking the loss of a single pay check. The Warner Plan shows you—with pictures, photographs and drawings—just how to make Rubber Stamps just as good as those turned out by the big companies. It shows how to get orders without canvassing or house-to-house selling. It shows you how to expand, how to get others to work for you and how to be SURE of at least twice the money you made on your present job for a life of personal independence.

But don't make any decision now. Read the Plan first—entirely at my risk. Then—after you have made a careful investigation—after you have talked things over with your family—only then do you decide what you want to do.

The thing to do now is to get full details which I will send you FREE. No salesman will call to urge you to buy anything. Mail coupon today—or just send me a postcard—and I will see that complete information goes out to you by return mail—postage paid.

**RUBBER STAMP DIVISION**

1512 Jarvis Ave., Dept. R-2-A, Chicago 26, Illinois

**RUBBER STAMP DIVISION  
1512 Jarvis Avenue, Dept. R-2-A  
Chicago 26, Illinois**

**SEND NO  
MONEY**

Please rush full particulars about the little machine that can get me started in the profitable Rubber Stamp Business at home in spare time. Everything you send me is FREE. No salesman will call.

Name \_\_\_\_\_

Address \_\_\_\_\_

City \_\_\_\_\_ Zone \_\_\_\_\_ State \_\_\_\_\_

# DRAFTSMEN



**CASH BIG  
PAY CHECKS!**

**Train Now for  
more success,  
greater security**

**LEARN AT HOME IN SPARE TIME  
(or at college in Chicago)**

Check the want ads in any newspaper—SEE the big-pay opportunities open to you as a draftsman. What's more, you can learn this well-paid, prestige profession at home — quickly, easily! No special talent needed. Get complete, step-by-step Chicago Tech lessons in the mail, spend a few pleasant hours studying each week. In a short time you'll be a well-trained draftsman, ready to take your pick of many good jobs. Act now!



**Free Information—Mail Coupon Today!**

Get FREE TRIAL LESSON plus information about C.T.C. practical training. Learn what successful Chicago Tech graduates say about high pay and opportunities in drafting. No charge, or obligation.

## CHICAGO TECHNICAL COLLEGE

A-215 Tech Bldg., 2000 So. Michigan Ave.  
Chicago 16, Illinois

Mail me FREE lesson with facts about big opportunities in DRAFTING.

Name \_\_\_\_\_ Age \_\_\_\_\_

Address \_\_\_\_\_

City \_\_\_\_\_ Zone \_\_\_\_\_ State \_\_\_\_\_

## EVERYTHING YOU NEED TO ENJOY STAMP COLLECTING for 25¢



### LARGE ALBUM & STAMP COLLECTION, Hinges & Midget Encyclopedia

- 1) LARGE ILLUSTRATED ALBUM. Spaces for thousands of stamps from all over the world. Hinges too. A happy home for your stamps for years.
- 2) VALUABLE COLLECTION OF STAMPS. MONACO—Grace Kelly Wedding Stamp-of-the-Year. Korea, many more. 107 all different.
- 3) MIDGET ENCYCLOPEDIA — STAMP DICTIONARY — STAMP IDENTIFIER.

Total value \$1.25 — only 25¢ to introduce our bargain approvals. Money back guarantee.  
SEND 25¢ TODAY. ASK FOR LOT F0-25

ZENITH CO. 81 WILLOUGHBY ST. B'KLYN 1, N. Y.

## MAKE *Extra* MONEY!

**A DELIGHTFUL CAREER—SPARE  
OR FULL TIME—WITH FAMOUS...**

### HOOVER Uniforms

A permanent big-income business for you — spare or full time! Experience not necessary. Take orders for famous HOOVER line of smart, colorful uniforms for waitresses, beauticians, nurses, doctors, etc.—including Nylon, Dacron, Orlon. HOOVER UNIFORMS are known everywhere for smart, dressmaker styling plus top quality and value. Complete Style Presentation, actual sample fabrics, full instructions for starting—all supplied FREE. Write TODAY.

**HOOVER UNIFORMS**  
Dept. AG-39 • New York 11, N. Y.



## Money in SHELLCRAFT

Trained Commercial Shellcrafters

earn big money. Elderly lady reports

\$7,000.00 a year. Ohio couple boasts

\$1,800.00 in ten weeks while wife

holds secretarial job. GET PROOF

there is money in this fascinating

trade. Write today for FREE SHELLS

and information on Training Plan.

**NATIONAL SHELLCRAFT SCHOOL**

5652 34th St. N.

St. Petersburg, Fla.



## LEARN TO BECOME A GAME WARDEN

or GOVT. HUNTER. Join FORESTRY, FISHERY, or WILDLIFE Services. Excellent opportunities! Good pay \$2500 to \$10,800 a year! Pleasant Work, Prestige, Real Security, Healthful Working Conditions, and Retirement Income can all be yours. Help fill the demand in your area. Make your love of the outdoors become your business. Learn at home in spare time—it's Easy! Fun! Fascinating!

**FREE!** (if over 17 years old.) Complete, illustrated booklet that gives you complete facts, SUPPLY LIMITED—send your name and address now—TODAY!

HOME STUDY EDUCATORS, Dept. H-1  
1038 S. La Brea Los Angeles 19, Calif.

## MANUFACTURE

Concrete Barbecues, Incinerators, Windows and Flower Boxes, 100 per day, with a single steel form in your back yard. Some make \$1,000.00 per month. Combination Form, 24" sq., 8" deep, \$26.00 express prepaid. New techniques build fireproof house and 30 other fast selling items. Make molds for 50¢. Guaranteed illustrated instructions with combination rock simulating tool. \$1.00.

**VYKE MFG. CO.,** 8-4158 Jason St., Denver 11, Colorado

## ARTHRITIS—RHEUMATISM VITAL FACTS EXPLAINED

### FREE DESCRIPTIVE BOOK

How crippling deformities may be avoided. This amazing FREE BOOK explains why ordinary methods give only temporary relief—if that. Describes a drugless method of treatment successfully applied in thousands of cases. Write for this 36-page FREE BOOK today. No obligation.  
**BALL CLINIC, DEPT. 756, EXCELSIOR SPRINGS, MO.**

## Learn PHOTOGRAPHY at Home

Splendid opportunities. Prepare in spare time. Practical basic training. Long-established school. Send for free book, "Opportunities in Photography." No obligation.  
**American School of Photography, 835 Diversey Parkway, Dept. 1251, Chicago 14, Ill.**

**RCA** offers you the  
 finest training  
 at home in  
**Radio-TV**  
 electronics,  
**TV servicing,**  
**Color TV**

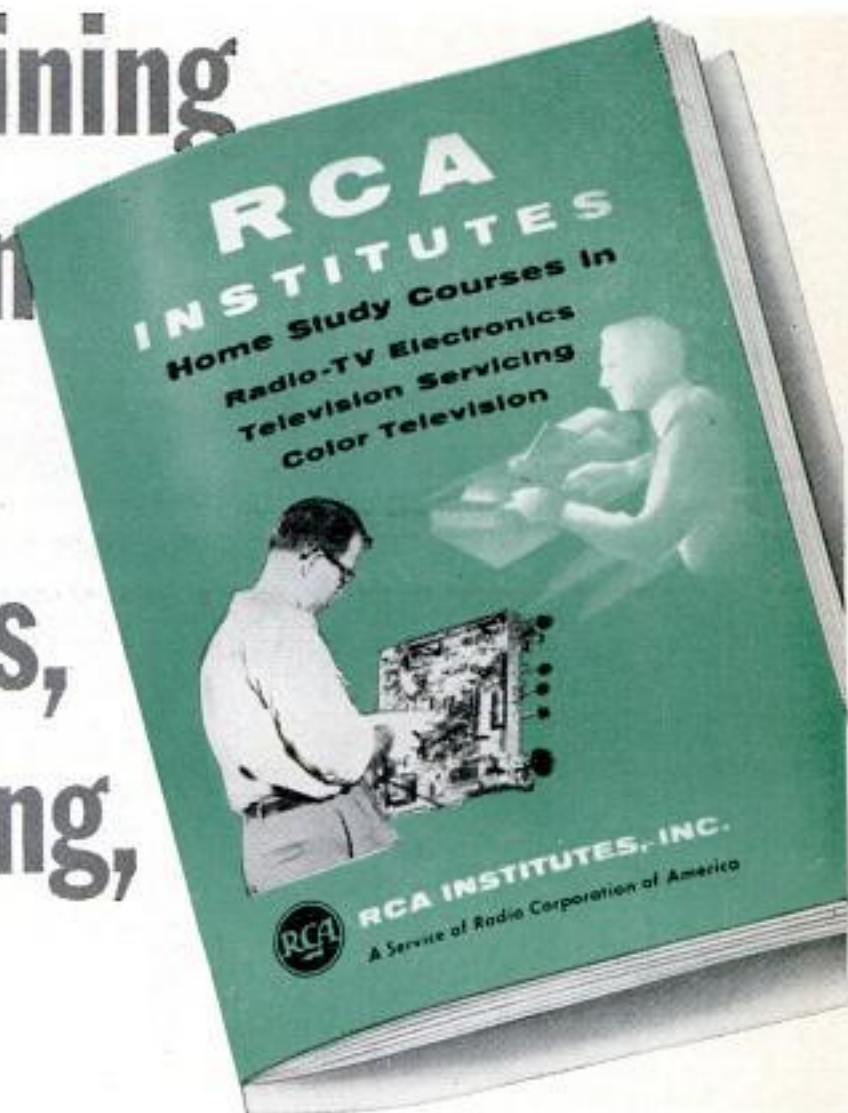

**SEND FOR THIS FREE  
 BOOK NOW!**

The instruction you receive and equipment you get (and keep) will start you on your way. Pay-as-you-learn. You pay for only one study group at a time. This 52 page book contains complete information on Home Study Courses for the beginner and the advanced student.



**RCA INSTITUTES, INC.**  
 A SERVICE OF RADIO CORPORATION OF AMERICA  
 350 WEST FOURTH STREET, NEW YORK 14, N.Y.

RCA Institutes, Inc., Home Study PM-17,  
 350 West Fourth Street New York 14, N. Y.  
 Without obligation, send me FREE CATALOG  
 on Home Study Courses in Radio, Television  
 and Color TV. No salesman will call.

Name.....  
 Please Print  
 Address.....  
 City..... Zone..... State.....

VETERANS  
 KOREAN G. I.  
 P. L. 550  
 CHECK HERE  
 ( )



**YOU**  
can  
acquire

## LAW NIGHTS AT HOME! LL. B. DEGREE

LaSalle's famous Law Library—used as reference in many Law libraries and Law offices—has enabled thousands to master Law surprisingly fast, in spare hours at home, for business and professional advancement.

These 14 remarkable volumes, compiled by leading professors and lawyers, cover the whole basic field of Law in condensed, orderly, simplified manner.

You advance rapidly with this great library, plus special lectures furnished. We guide you step-by-step with personalized Problem Method of instruction . . . you learn by doing—handling legal problems—not by memorizing rules.

Send for two FREE booklets, "Law Training for Leadership," and "Evidence," answering questions about Law and its value to you, and telling how LaSalle Law graduates are winning rapid advancement in business and public life. Mail coupon below. No obligation.

### LA SALLE EXTENSION UNIVERSITY A Correspondence Institution

417 S. Dearborn St. Dept. 164L Chicago 5, Ill.

Send me your two FREE booklets described above, without obligation.

Name.....Age.....

Street.....

City, Zone & State.....

### WHOLESALE Electric Guitars - Parts - Factory to You

Solid-body Spanish, amplifiers, pedal harp-chord guitars, double-necks, single-necks, triple necks, solid-body mandolin, pickup mikes, non-electric instruments, etc. 1957 Models Wholesale. FREE CATALOG. Free home study course with instruments. Parts & plans available to build your own.

CARVIN CO., Box 287, PM-1, Covina, Calif.

## SAVE HUNDREDS OF DOLLARS with HOME-A-MINUTE "KIT"

This is not something to fool around with.



### A Hard Hitting System of Saving Big Money

Design and build your New Home, Attic Flat, Extra Bedrooms or Remodeling—IN MINUTES—with dozens of fiber partitions, Doors, Windows, Kitchen Cabinets, made to 1/4 inch scale same as blueprint. THEN, BE-

LIEVE IT OR NOT, YOU, THE LAYMAN, who knows nothing about building, can estimate your own costs—IN MINUTES—after you adjust charts to local prices.

Don't build anything until you get this "KIT" if you want to save money. Handbook tells you how. This information should not pass you by. Complete "KIT" \$3.95 ppd., if COD plus postage and \$1 deposit required. Handbook without "KIT" \$1.95 or free literature. Money back guarantee. Return in 10 days.

**SPECIAL NOTICE!**—As a builder, controlling over 3 million dollars worth of home construction, we will ATTEMPT, but not promise, to obtain a special discount to you for your building materials on your new project, thru your favorite, local, Lumber Dealer. Details with "KIT."

R. D. HALL & CO. 2825 N. 69th St. MILWAUKEE 10, WIS.

# SHORTHAND IN 6 WEEKS

Write 120 words per minute  
Age no obstacle—LOWEST COST

Famous SPEEDWRITING shorthand. No symbols; no machines; uses ABC's. Easiest to learn and use. Fast preparation for a better position. Nationally used in leading offices and Civil Service. 120 words per minute—50% FASTER than Civil Service requirements. Over 350,000 taught by mail or through classroom instruction. The very low cost will surprise you. Typing available. 34th Year. Schools in over 400 cities in U.S., Canada, Cuba, and Hawaii.

Write For Free Booklet To: School of

DID YOU SEE  
READER'S DIGEST  
ARTICLE ON

## Speedwriting

Dept. 1501-7, 55 W. 42 St., N.Y. 36 (R)

## PEE WEE BATTERYLESS "LIFETIME" RADIO



**REALLY WORKS — FOR LIFE!**  
Works WITHOUT TUBES, BATTERIES OR ELECTRICAL PLUG-INS. Will never run down or burn out! World's smallest, SMALLER THAN A PACK OF CIGARETTES! GUARANTEED TO RECEIVE LOCAL RADIO STATIONS ANYTIME—ANYWHERE YOU GO! Sensational new Ferrite Selective Tuner — Perma-Crystal diode, Super SPEAKERPHONE, durable black and gold plastic case.

SEND ONLY \$2.00 (bill ck. mo) and pay postman \$4.99 COD delivery. SENT COMPLETE READY TO LISTEN WITH LIFETIME GUARANTEE. Nothing extra to buy — ever. Available only from: MIDWAY COMPANY Dept. WPM-1 KEARNEY, NEBRASKA

## 250 POWER . . . .



Complete Telescope Lens Kit only \$3.49 postpaid

Conquer Space, Explore the Universe, Planets, Moon Craters, New Stars, etc. Complete Lens Kit consists of 80 inch focal length ground and polished objective lens, eyepiece lenses for 50 POWER, 100 POWER, 150 POWER, 200 POWER, 250 POWER, and all necessary lens fittings. Easy to make from simple step by step instructions. (Tripod and mount not included.) Money back guarantee.

BUSSE SALES CO., Hartford, Conn., Dept. PM 53

## DON'T RISK YOUR LIFE

Learn to Drive Better

Send immediately for NEW book "How to Improve Your Driving and Avoid Accidents." Place \$1.00 and your name and address in an envelope, mail to:

NEIL HAINES

PO Box 89

Sturgeon Bay, Wisconsin

## BE A LANDSCAPE CONTRACTOR

Make \$20 to \$60 a day. Millions of new and old homes, estates, etc., need modern landscaping. Contracting is full time job for those who want to start own business. Start with smaller projects, and work into larger jobs. We show you how. Easy-to-follow Home Study Course. Hundreds of successful graduates. Write for FREE Book.

NATIONAL LANDSCAPE INSTITUTE

310 S. Robertson Blvd. Dept. M-17 Los Angeles 48, Calif.

## RUPTURED? Write for New Relief FACTS FREE!

### ENJOY NEW FREEDOM

of action, peace of mind and comfort at work or play. Proven, patented MILLER holds your rupture back Day & Night—will bring you lasting relief! Has helped thousands of others!

For FREE facts in plain wrapper—

Send Name and Address to  
FRED B. MILLER, DEPT. 1-A

Manufacturer, HAGERSTOWN, MARYLAND



ENTIRELY DIFFERENT

**TRAIN FOR GOOD PAY IN A FIELD THAT ISN'T CROWDED!**



# NOW! you can LEARN ELECTRIC MOTOR REPAIR

... A good-paying, modern profession



## OPPORTUNITIES EVERYWHERE!

Don't drift into a rut! Don't train for something that everybody and his brother are studying! Consider the facts. . . . The average small home has at least 11 electric motors! Big homes have many more—in phonographs, recorders, oil burners, refrigerators, washers, fans, clocks, mixers, cleaners, air conditioners, etc., etc. Millions more in office, industrial, mining, and transit equipment. Be the well-paid expert who can keep them working!

... for only \$6<sup>95</sup>

FOR THE COMPLETE TRAINING . . . .

**COVERS EVERY MOTOR TYPE IN COMMON USE**

Every day, more and more electric motors and motor control systems are being used BOTH in industry and in home appliances. The expert who can install and keep them working properly is a valuable man in this Electrical Age. The pay is surprisingly good. The field is tremendous—and growing rapidly. Trained men find opportunities everywhere for full or part time work. **ELECTRIC MOTOR REPAIR**, the big 560-page training course book teaches you the work step by step—quickly and easily—at home in spare time. There is no other book like it. Ideal for beginners or for actual bench use in busy shops. Over 100,000 copies already in use in leading vocational schools, shops, and for home study.

## FREE STUDY GUIDE

A unique Study Guide booklet of 500 practical motor study questions—priced and sold separately at 25c—is yours FREE with your request to examine **ELECTRIC MOTOR REPAIR** book. Makes learning easier—speeds up the work! See coupon.



## SHOWS YOU HOW . . . Every Step of the Way!

Based on what you can learn quickly at home from **ELECTRIC MOTOR REPAIR** you can train for prompt profitable installation, servicing, repairing and complete rewinding of practically any motor in use today.

You learn fast! You learn right! Every subject is clearly explained by text AND ALSO by more than 900 illustrations and diagrams. You not only read what to do—you SEE how it is done. Quick reference guides tell you how to handle specific jobs. When a certain motor comes in for repairs, just look it up. **ELECTRIC MOTOR REPAIR** tells you what to do—and exactly how to do it.

**ELECTRIC MOTOR REPAIR** is designed for use right at the service bench. Unique Duo-Spiral Binding divides the book into

two sections so that both text and related diagrams can be viewed together. An instructor standing by your side could hardly do better! **ELECTRIC MOTOR REPAIR** covers the entire field—from alternating- and direct-current motors and generators, etc. to mechanical and electrical and electronic control systems. Right down the line, it explains trouble diagnosing, repair, rewinding and maintenance in a way you can easily understand.

## LEARN FAST . . . no lessons to wait for! EARN WHILE YOU LEARN

Practice by repairing motors for friends, neighbors or nearby business houses. Earn while you learn this profitable, fast-growing business!

If sold as a course and sent to you in lesson form, you'd regard **ELECTRIC MOTOR REPAIR** as a bargain at 10 times the price! Instead, you get it all at once—for only \$6.95. You learn fast . . . and right. Here are just a few of the motor types that are fully covered:

- Split-Phase Motors
- Capacitor Motors
- Repulsion-type Motors
- Polyphase Motors
- Alternating-Current Motor Controls
- Direct-Current Armature Winding
- Direct-Current Motors
- Direct-Current Motor Controls
- Universal, Shaded-pole, and Fan Motors
- D-C-Generators, Synchronous Motors and Generators
- Electronic Motor Controls . . .



**Send No Money! PRACTICE 10 DAYS FREE!**

Dept. PM-17, RINEHART & COMPANY, Inc.,  
232 Madison Ave., New York 16, N. Y.

Send me the 560-page **ELECTRIC MOTOR REPAIR** home-training book:

- \$6.95 enclosed in full payment; or
- Send C.O.D. for \$6.95 plus postal charges; or
- Send on 10-DAY FREE EXAMINATION and I will then remit \$6.95 plus small postage and handling charge, or return book postpaid in 10 days.

On cash and C.O.D. orders, book may be returned in 10 days if unsatisfactory and your \$6.95 will be refunded.

Name \_\_\_\_\_

Address \_\_\_\_\_

City, Zone, State \_\_\_\_\_  
(Outside U.S.A. \$7.45 cash only—same return privilege)



Train AT HOME for a GOOD JOB in  
**AUTO MECHANICS**

A better job with more pay will mean better living for you. It can mean a fine home, a new car, nice vacations, and good educations for the kids. If you would like to earn up to \$125 a week and more—and be able to afford better living, *train yourself* in Auto Mechanics. You can do it with CTI showing you how—and you can learn at home in spare time!

**GOOD JOBS ARE WAITING EVERYWHERE** because there are over 60 million cars and trucks on the road—7 million new ones each year. One-third are in the heavy-repair classification. Skilled mechanics are needed to keep these cars operating. You can be one of them—make big money, enjoy lifetime security—even open a shop!

**EARN AS YOU LEARN** just as many CTI students do. They make up to \$15 a week and more in spare time. Some start their own shops by graduation time. CTI Shop-Method Home training, based on resident school practice, makes every step easy.

**DIESEL MECHANICS OR BODY-FENDER TRAINING** is also yours at no extra cost. A wonderful chance to give yourself a well-rounded education. Only CTI gives you this extra choice! Get the facts: Mail coupon.



**YOU PRACTICE WITH THIS TUNE-UP KIT**

Kit includes a Compression Tester, a Vacuum Gauge and Fuel Pump Tester, an Ignition Timing Light, and a portable steel case. These professional instruments help you locate engine troubles, let you get useful practice. You keep this kit!

**MECHANIC'S TOOLS TOO**

You'll use these tools to get real experience. They'll increase your interest, stamp you as a "pro." You'll earn spare time cash with them. No extra cost for tools—you keep them.



**MAIL COUPON TODAY!**

**MAIL TODAY FOR 2 FREE BOOKS**

COMMERCIAL TRADES INSTITUTE  
 1400 Greenleaf Ave., Chicago 26  
 Dept. A-439

Send your new Auto Mechanics book and Sample Lesson, BOTH FREE.

Name \_\_\_\_\_ Age \_\_\_\_\_

Address \_\_\_\_\_

City \_\_\_\_\_ Zone \_\_\_\_\_ State \_\_\_\_\_



**INVENTORS**

PROTECT YOUR INVENTION BY A U. S. PATENT. SEND FOR FREE "INVENTION RECORD" FORM AND "PATENT INFORMATION EVERY INVENTOR SHOULD HAVE."

**CARL MILLER**

REGISTERED PATENT ATTORNEY

WOOLWORTH BLDG., 36th FLOOR, 17A  
 NEW YORK CITY

**INVENTORS**

Whether an invention is patentable can be substantially determined by a search of the U. S. Patent records. Without obligation, write for information explaining the steps you should take to secure a patent.

**JOHN N. RANDOLPH**

Registered Patent Attorney

201 Columbian Building, Washington 1, D. C.

**INVENTORS**

Send for PATENT INFORMATION Book and INVENTOR'S RECORD without obligation

**GUSTAVE MILLER**

17-PM WARNER BUILDING  
 WASHINGTON 4, D.C.

REGISTERED PATENT ATTORNEY

ASSOCIATE EXAMINER  
 U.S. PAT. OFF. 1922-1929

Patent Attorney & Advisor  
 U. S. NAVY DEPT. 1930-1947  
**PATENT LAWYER**

**HELPFUL BOOKS**

Send post card asking for FREE catalog  
 Popular Mechanics Press, 200 E. Ontario, Dept. 601, Chicago 11

**INVENTIONS WANTED**

If you want to market, or sell, your invention for cash or royalties, write for our Free Booklet, send no drawings. We also welcome hearing from firms, or private capital, wishing to review inventions in any field. We will be glad to send notice of our clients' inventions.

**GLOBAL MARKETING SERVICE**

2420 77th Ave. Dept. PD Oakland 5, Calif.

**INVENTORS**

U. S. Patents protect your inventions. Our free book of "Instructions on Patent Procedure for Inventors," also "Certificate of Invention" form sent without obligation.

**C. A. SNOW & CO.**

REGISTERED PATENT ATTORNEYS

428 SNOW BUILDING WASHINGTON 1, D. C.

**INVENTORS**

I shall be pleased to furnish you, upon request, with full information relative to patent procedure—without any obligation on your part.

**PATRICK D. BEAVERS**

Registered Patent Attorney

934 Columbian Building Washington 1, D. C.

● We will show you how to earn **\$8,750 PROFIT first year** on just 2 jobs a day. We furnish all equipment and supplies . . . personally train you in your town to run:



# Your OWN

## Nationally-Advertised

# Business

### YOU BECOME AN EXPERT IN THE CLEANING & PROTECTING OF RUGS & UPHOLSTERY

Even if you are now employed you may start enjoying the prestige and financial independence of your OWN business. We are ready to expand our world-wide organization and offer an unusual lifetime opportunity to reliable and diligent men. You will be trained in your town by a Duraclean dealer, who will reveal the Duraclean System and plans for building business. He will help you get quickly established. Just 2 average jobs a day earns \$8,750 NET profit first year. Employ others and MULTIPLY profits. Business grows from recommendations and repeat orders. Under our guidance you become an expert in the care of rugs and upholstery, a profession for which there is now great demand. Easy to learn. We furnish everything required. No shop needed.

Even if now employed you can start from home!

### WE PROVIDE 25 SERVICES TO HELP YOU BUILD BUSINESS

These are full-time dealerships, but you can start part-time from home. All work is done with portable equipment in homes, offices, hotels, institutions and to revive used car upholstery for auto dealers. Furniture stores, cleaning shops, etc., turn over work to you. We work with you 12 months of the year and provide 25 regular services to help you build business: National Advertising in McCall's, House & Garden, a dozen others. Products Insurance. Complete Advertising Kit including cuts, mats, folders, radio & TV musical recording. Publicity Program gets free local newspaper stories. Monthly Magazine. Sales Book. National & Regional Conventions. Prizes. Pocket Demonstrators. Many others.

### 3 WAYS TO MAKE MONEY

A Duraclean Dealership qualifies you to offer three different services. Thus on some jobs you actually make TRIPLE profits.

1. **Duraclean** (shown above): Not a safer or more effective process for cleaning and reviving rugs, carpets and upholstery. Recommended by leading stores and fabric manufacturers. Unique Duraclean method cleans by ABSORPTION. Eliminates machine scrubbing, soaking, shrinkage, avoids harsh soaps. Aerated foam manufactured by portable electric Foamovator removes dirt, grease, unsightly spots. Fabrics revive, color tones restored. So fast-drying customers use furnishings within few hours!

2. **Durashield**: A brand new soil retarding treatment that KEEPS furnishings clean MONTHS longer. Applied after cleaning by electric Spraymaster, this invisible film (called "colloidal silica" by chemists) protects each fiber from dirt. So new a development you may be first in town to offer this type service. Easily and quickly applied.

3. **Duraproof** (right): Protects against damage by moths and carpet beetles. Besides rugs, carpets and upholstery, customers want furs, clothing, pianos, blankets and closets Duraproofed. U.S. Government says "Moths are present in practically every household." Only such treatment backed by an International 6-year Warranty!



### Easy Terms

A moderate payment establishes your own business—pay balance from sales. We furnish electric machines, complete sales and advertising material and enough supplies to return your TOTAL investment.

### Send for FREE Booklet

Our first letter and illustrated booklet explain the urgently needed services, waiting market, your large profit, easy terms and PROTECTED territory. Send coupon for free facts today.



### What Dealers Say

L. B. Hayes: First month I grossed \$770.17. Duraclean proved so popular, I'm now full-time.

R. N. Ritter: Seldom go under \$200 per week by myself.

L. Johnson: Every customer leads to 2 or 3 more.

W. Abbott: In past 7 months I've taken in over \$12,000.

M. Lassanske: Original investment returned in 2 months.

W. Lookiebill: We've had 20 years of pleasant dealings. I'm 65 but setting sights for 20 more years.

More dealer comments in our literature. Send coupon today.

**Duraclean Co.** 7-161 Duraclean Bldg., DEERFIELD, ILLINOIS

### "OWN a Business" Coupon

DURACLEAN CO., 7-161 Duraclean Bldg., Deerfield, Ill.

Please rush free booklet and letter giving full details of how I may OWN a growing, lifetime business and start while still employed.

Name \_\_\_\_\_

Address \_\_\_\_\_

City \_\_\_\_\_ State \_\_\_\_\_

# I WILL TRAIN YOU FOR RADIO-TELEVISION

ON MY EXCLUSIVE  
NO-OBLIGATION  
NO-RISK TRAINING PLAN



Frank L. Sprayberry, President

Let me prove to you . . . without cost or obligation . . . that I can prepare you to be a Radio-Television Serviceman in 10 Months or Less

Let the true facts speak for themselves! That's why I want you to have my big new catalog and an actual sample lesson of Sprayberry Training . . . both FREE! Read, then make up your own mind! Train on my exclusive NO OBLIGATION PLAN . . . which means you DO NOT sign any kind of time payment contract. You pay for and accept your training as fast or as slowly as you wish. Prepare now for big paying jobs in Radio-TV or your own business. I will help you earn while you learn . . . in spare hours at home.



## Get Practical Experience with 25 Kits of Radio-TV Parts

Practical experience counts most. In addition to modern lessons, you train with actual parts and equipment. Build the famous Sprayberry Training Television Set, Multi-Range Tester, 2-Band Radio, other Test Equipment—all yours to keep. Get latest training

on Color TV, Transistors, Hi-Fi and UHF Conversions . . . included to make your training more valuable.

You owe it to yourself to get all the facts . . . Mail coupon for catalog and sample lesson—FREE

See for yourself . . . in actual pictures and descriptions . . . why Sprayberry Radio-Television Training offers more. Backed by almost 25 years of training experience. Three training plans to suit your exact needs. Rush coupon today for big new catalog and sample lesson. No obligation; no salesman will call.

**SPRAYBERRY ACADEMY OF RADIO**  
Dept. 10-G, 111 N. Canal St., Chicago 6, Ill.

TWO  
BIG  
FREE  
BOOKS

Mail Coupon Today!



SPRAYBERRY ACADEMY OF RADIO Mail for FREE  
Dept. 10-G, 111 N. Canal St., Chicago 6, Ill. Facts and Sample Lesson

Please rush catalog on your All-NEW Radio-Television Training Plans. I understand this does not obligate me and that no salesman will call. Include Sample Lesson FREE.

Name \_\_\_\_\_ Age \_\_\_\_\_  
Address \_\_\_\_\_  
City \_\_\_\_\_ Zone \_\_\_\_\_ State \_\_\_\_\_

## "How to Go into Business for YOURSELF"

If you know a trade or occupation—why not go into business for yourself? Why not make the profits others are now making?

IT'S EASY TO START A NEW BUSINESS. It's easier than you think—once you learn the 9 easy steps of building a new business of your own. National Business Consultants has shown over 5000 others how to be successful—let us show YOU too. We guide you every step of the way with sound, proved simple business practices. **EXPAND YOUR OWN BUSINESS.** Learn our tested, profit-making methods for business success. If you already own a business, let N.B.C. guide you too. You'll be amazed. **SEND FOR FREE BOOKLET TODAY!** "How to Start a Business" is jam-packed with revealing information. In easy-to-understand language it explains how to start and make any kind of business profitable. Free for the asking! Sent to you in confidential plain envelope. *Just write:*  
**NATIONAL BUSINESS CONSULTANTS, Office P-1, Los Angeles 61, Calif.**



**BOTH FREE!**  
Rush Name on Postcard Today!



## ASSEMBLE A BIG 100 POWER 3" REFLECTING TELESCOPE

See Stars Close Up!  
with this complete 87 piece "Do-It-Yourself" Kit. See the moon, stars close up, or view terrestrially. Kit includes: 3" f/10 aluminum and overcoated. Spherical Mirror—40X Eyepiece and 100X Barlow Lens—Crossline Finder, sturdy 40" Tripod—fork type Equatorial Mount. Complete instructions furnished. Order by Stock No. Send check or M.O. Money back guarantee. Shipping. **\$29.50 f.o.b.** weight 10 lbs. Stock No. 83,025-II. Barrington, N. J.  
Ask for FREE catalog M

**EDMUND SCIENTIFIC CO., Barrington, N. J., U.S.A.**

## WHEELS WHEELS WHEELS

7" Disc Wheel 3/4" Tire 3/4" sleeve	45c ea.
8" Disc Wheel 1 1/4" Tire 1 1/2" sleeve	70c ea.
7" Disc Wheel 1" Tire 1 1/2" ball bearing	80c ea.
8" Disc Wheel 1 1/4" Tire 1 1/2" ball bearing	1.00 ea.
6" Disc Wheel 1.50 semi-pneum. Tire 1 1/2" B.B.	1.35 ea.
8" Disc Wheel 2" semi-pneum. T. 1 1/2" B.B.	1.50 ea.
10" Disc Wheel 1.75 semi-pneum. T. 1 1/2" B.B.	1.50 ea.
10" Disc Wheel 2.75 semi-pneum. Tire 1 1/2" B.B.	2.50 ea.
12" Disc Wheel 1.75 semi-pneum. T. 1 1/2" B.B.	2.85 ea.

Above wheel prices includes hub caps, excepting 10 x 2.75. Postage extra. C.O.D.'s accepted. Axles extra. Sizes, 5/16", 3/8", 1/2" dia. Cut to size per inch long. End holes drilled.

**UNITED WHEEL STAMPING CO.**  
11918 S. MARSHFIELD AVE., PM-1, CHICAGO 43, ILLINOIS



## MECHANICAL DENTISTRY

A profession offering unlimited opportunities. Most modern and complete course embracing every branch from Plate to Porcelain Work, which prepares you to work for Dentists or start your own business. Individual instruction—practical training in day or night school. No books—no classes. Catalog upon request.

**MCCARRIE SCHOOL OF MECHANICAL DENTISTRY**  
207 N. Broad Street Dept. 61 Philadelphia 7, Penna.



## LEARN WHILE ASLEEP!

PHENOMENAL RESULTS! 52 rushes fact-filled instruction book. "Sleep-Learning—Its Theory, Application & Technique. Guaranteed. RESEARCH ASSOCIATION, P.O. BOX 610-AA, Omaha, Nebr.

## GET RESULTS! RUPTURE RELIEF GUARANTEED!



RESULTS—OR YOUR MONEY BACK  
Write now for free booklet and pictures of rupture care. You can be helped . . . work steady, with low cost, easy-to-wear Web Truss. Thousands satisfied.

**WEB TRUSS CO. Dept. M-1, Hagerstown, Maryland**

## CARBURETOR SAVES GAS VACUATING OVERRICH MIXTURES



Car owners who are getting poor gas mileage, and wasting money due to overrich mixtures, will be pleased to learn how to save gas. Easily installed Vacu-matic invention is Automatic and operates on the supercharge principle. For cars, trucks, tractors.

**SALESMEN WANTED! Big Profits!**  
FOR FREE PARTICULARS, HOW YOU CAN GET ONE ON YOUR OWN CAR FOR INTRODUCING, just send your name and address on a post card to—  
**VACU-MATIC CARBURETOR, Dept. 866, Wauwatosa, Wis.**



# Up to 9 Miles More Per Gallon! Up to 20 More Horsepower!

All From One Simple Change in Your Car!

YES! In the next two minutes I'm going to show you how you can get up to 20 MORE HORSEPOWER from your car . . . how you can save enough gas in a single year to

drive up to A FULL THOUSAND MILES . . . how you can eliminate most of the ignition knocks and pings that are driving you crazy now . . . how you can get battery-saving, sure-fire starting even in below-freezing weather—and do it without buying one single complicated gadget—without paying a mechanic a penny! How? SIMPLY BY CHANGING THE COLOR OF YOUR SPARK PLUGS!

By ED MITCHELL

Let me say this at the start. What I'm offering you on this page is a very simple investment. I want you to try the most fantastic spark plug in the world, entirely at my risk! A spark plug that costs only a few pennies more than the old-fashioned model that's on your car today. A spark plug that lasts up to 10 times as long as that old-fashioned model . . . that gives you the full blazing horsepower that that old plug is robbing you of today . . . and that actually saves you enough gas to drive half way across America, every single year that you use it!

Does this sound impossible? It's been proven a thousand times this year! Here is a small sample of that proof.

## This is Why Your Car Wastes Gas, Loses Power

Some day, if you ever have a spare moment, lift one of the spark plugs out of your car. Look at the bottom of that plug. In 10 seconds, you'll learn more about gas waste than any book could teach you in a year.

If that plug has been in your car a thousand miles or more, then what you'll see on the bottom of that plug is FILTH! The Firing Point of that plug—the most important single point in your car—will be choked to death with BLACK, FILTHY CARBON! Carbon that robs your car of as much as 20 vital horsepower every time your engine fires!

Now, wipe that filth away. And look at the Firing Point itself. This is the POWER POINT of your car . . . the pin-head of electricity that turns raw gas into 200 horsepower of driving energy! And what is the condi-

tion of that Point? CORRODED . . . PITTED . . . SCARRED . . . AND WORN! Hardly able to deliver half the spark it should! Wasting gas . . . wasting money, every time you put your foot down on the pedal!

Yes! You pay \$2000 . . . \$3000 . . . \$4000 for your car. And a single 58c part robs you of the real power and enjoyment of that car.

## At Last A Plug So Smart That It "Thinks"

Now look at the new plug—the jet-finish "POWER-FLASH" plug that I send you—for only a few pennies more than you're paying today!

Here is a plug that has not only ONE firing point—but hundreds of firing points! That fires so fast, so effectively, an alien that is actually ELIMINATES THAT DEADLY CARBON BURNS IT UP . . . THROWS IT AWAY . . . KEEPS ITSELF SPARKLING CLEAN, ON EVERY SINGLE STROKE! The full, blazing horsepower that was there when your car was brand-new, is still there 30,000 miles later.

But that's just the beginning! This plug actually gives you the different firing power you need for every driving condition—smooth, dependable power for city stop-and-go driving . . . effortless horsepower for the parkway . . . blazing reserve power for super speeds! No more missing, sputtering, knocking when you want to pull ahead of other cars at high speeds! No more greasy take-offs at the lights! FULL POWER 24 HOURS A DAY . . . or we send you a new set FREE!

And that's still just the beginning! Best of all—this is the toughest, strongest, longest-lasting plug ever made! YOU COULD ACTUALLY POUND IT AGAINST A CONCRETE WALL WITH A HAMMER, WITHOUT EVEN DENTING IT—AND THIS AMAZING PLUG WOULD STILL FIRE CLEAN AND HOT FOR 30,000 MILES! Yes! These fantastic plugs give you such terrific, consistent, long-lasting service that



## See The Amazing Difference Yourself!



- This new "Power-Flash" Jet-Compression Power Plug (on the left) is guaranteed to be the most powerful longest lasting Spark Plug ever made! Here's why:
1. Only "Power-Flash" gives you an unlimited number of firing points—plus a guaranteed minimum of 2000 more spark actions than ordinary plugs! Highest compression, longest engine life, more mileage, more hot spots!
  2. Only "Power-Flash" gives you automatic heat and gap control! Absolutely thinks for itself! Gives you instant, wider spark for smoother performance, instant starting, faster pick-up even in freezing weather!
  3. Only "Power-Flash" gives you automatic self-cleaning action! Actively forces dirt to clean itself. Keeps the crown, center, longer life, more lasting "plug" or power loss!
  4. Only "Power-Flash" gives you longest insulation! Made! Lifetime guaranteed—diamond-like hardness! Gets rid of deadly heat up to 20 times faster than ordinary insulators!

This set starting guarantee: Satisfaction guaranteed for the full price of \$1.00. Refund . . . or a new set FREE! Act TODAY!

we can afford to make one of the most amazing guarantees you ever heard!

## Try It at My Risk, Today!

What have you got to lose? These amazing jet-finish "POWER-FLASH" plugs cost only \$1.45 each—or \$8.70 for a complete set for six-cylinder cars, and \$11.95 for a complete set for

eight-cylinder cars. They cost only a few pennies more than ordinary old-fashioned plugs—and they can save you up to \$100 this year!

Here is my guarantee to you. Put these plugs in your car yourself. No mechanic needed. Nothing to adjust. From the very first moment that you get back in that car and drive, you must notice amazing new power and pick-up—or I'll send you a new set free!

You must notice raw gas savings . . . you must eliminate most ignition knocks and pings . . . you must get instant carbon-free, cold weather starting . . . and

## FREE BONUS!

Sensational, Nationally Advertised, Car Book Saves You Up To \$250 On Repairs This Year Alone!

Over a quarter-of-a-million drivers have paid up to \$2.00 for the same exact book—called "Double"—but now IT'S YOURS FREE!

The legendary Car Book that made history by advertising millions of economy-minded car-owners how they could save up to \$250 a year in costly gas and repair bills. The sensational book that tipped the lid off all the professional tips and tricks known by the nation's trouble-shooters and auto-mechanics! Here, are all the eye-opening, money-saving secrets that save you better after dollar in costly car upkeep and repairs.

Here are simple tips that show you how to add amazing mileage to your car—without touching a tool—without even lifting the hood of your car! Here's a fantastic 30-second trick that gives you up to 2-3 extra miles per gallon! Another secret shows you how to switch one single wire and save up to 50 gallons of gas in your water driving . . . how you can add up to 10,000 more miles to your tires—how to get your "dead" battery started in just one minute—without a pump or a key!

Yes, professional tips that can save you hundreds of dollars a year! And it's all yours—FREE! How would you like to get power to move away from other cars at the lights . . . to drive up to 5,000 miles—without changing your oil! Other important tips show you how to remove rust from your chassis . . . make dents and scratches disappear for good . . . to stop steering wheel "play" . . . how to adjust your own brakes and save \$5 . . . to repair your chipped windshield and save \$25 . . . to fix a leaky radiator and save \$20!

Yes, all this and more is yours—absolutely FREE—our BONUS GIFT to you with your purchase of the amazing new "POWER-FLASH" PLUGS which are absolutely guaranteed for two years or 30,000 miles of the most fabulous spark plug service you've ever enjoyed! And if you want this special FREE BONUS—the sensational book "How To Double The Performance of Your Car"—you must order your "POWER-FLASH" PLUGS today! Our supply of this free, Pearl Edition of the Car-Book is limited! So act NOW!

you must get this thrilling, new-car performance year-in, and year-out! FOR TWO FULL YEARS, OR 30,000 MILES—or I'll send you a new set—FREE! You have nothing to lose! BUT THE SUPPLY OF THESE PLUGS IS STRICTLY LIMITED. THE NICKEL ALLOY WHICH MAKES UP THEIR ELECTRODES IS HELD IN SHORT SUPPLY BY THE UNITED STATES GOVERNMENT. THIS WILL BE ABSOLUTELY THE LAST TIME WE CAN MAKE THIS OFFER! ACT TODAY!

© Entire Contents Copyrighted by Eugene Stevens, Inc., 1936

## Mail No Risk Coupon Today!

EUGENE STEVENS, INC.  
312 WEST 21 ST., DEPT. SP-52  
NEW YORK 11, N. Y.

IMPORTANT!  
Please fill in the entire coupon. PLEASE PRINT!

Gentlemen: Yes, I want to try your amazing "POWER-FLASH" Jet-Finish Spark Plugs entirely at your risk! I will pay postage only amount charged below plus low C.O.D. charges.

\$7.75 for a matched set of six "POWER-FLASH" Spark Plugs.  \$11.95 for a matched set of eight "POWER-FLASH" Spark Plugs.

I understand that these "POWER-FLASH" Plugs must give me more power, tremendous new performance, amazing gas savings . . . must actually do everything you say for a period of 1 FULL YEAR or 30,000 MILES, or I may simply return them for a NEW SET FREE!

Also send me your Extra Gift Premium, the Free nationally advertised car-book, "How To Double The Performance of Your Car." This book is mine to keep as a Free Gift even if I return the plugs.

NAME OF CAR \_\_\_\_\_ YEAR \_\_\_\_\_

MODEL \_\_\_\_\_ NO. OF CYLINDERS \_\_\_\_\_

NAME \_\_\_\_\_

ADDRESS \_\_\_\_\_

CITY \_\_\_\_\_ ZONE \_\_\_\_\_ STATE \_\_\_\_\_

CHECK HERE AND SAVE MONEY! Enclose check or money order and we will pay all postage and handling charges. You save as much as \$6.00!

## HERE'S PROOF!

Users Report Fantastic New Mileage—  
Breathtaking New Power!

"Your Power Plugs are well on the way to getting for themselves the far better mileage about \$2.00 a month on my gasoline bill. As far as I can save, I am getting 9 miles more per gallon of gas than I used to get."

"Although I did have a new set of spark plugs in my car before replacing them with your Power Plugs, the old plugs made my engine sputter and start a lot better, smoother and starts a lot better, too."

E. O., Detroit, Mich.

"I bought your plugs for my '34 Ford some time ago . . . so far as I can tell I am getting at least 8 miles per gallon better mileage. Also my Ford has far better pickup and horsepower. I have driven about 12,000 miles since purchasing the plugs and they are in as good condition as ever."

C. C., Avila, Indiana

"I replaced the expensive-type spark plugs in my Lincoln Continental with yours. With the old style plugs, I was getting approximately 15 miles in the gallon. During the first thousand miles of operation with Power Plugs, my mileage increased to 22 miles per gallon. This was an increase of 7 miles per gallon. In addition to the increased mileage, it was happy to notice much better filling and absolutely no stalling. Mile which I formerly had to second gear now presents no problem in climbing with high gear. My heavy Continental used to lug away from signals; now it dashes away."

D. C. W., President Exporting Co.

A JONES MECHANIC SAYS:

"I own my living relying automobile. I have installed all kinds of spark plugs over the past 15 years. You boys really have something. I have never met a plug before that does as true and hot and on our test equipment, every installation has shown a big increase in horsepower, as much as 25% in some cases. For the boys who want more power and better pickup, you have the answer."

J. C., Memphis, Arkansas

"Your plugs have been in my car now for three or four months, and I must say it's running better than it ever did before, and I am getting a lot better mileage out of it. At least as much as the D.C. you claim."

"I'd say your plugs are well worth the price you ask, especially as I do not expect to have to buy a new set so long as I have my power—\$1.00 money."

R. M. D., Chicago, Ill.  
30,000 MILES WITHOUT A SINGLE ADJUSTMENT

"I have just disposed of the car in which your spark plugs were installed. The mileage facts may be of interest to you."

"Speedometer reading, mileage at installation—37,200—mileage at this date 41,250. No replacement or adjustments since installation and plugs giving perfect service."

G. K. H., Indianapolis, Indiana

## AMAZING MONEY-BACK GUARANTEE!

Clip this guarantee section out of this page. It authorizes you to try these amazing POWER-FLASH Spark Plugs entirely at our risk! First—test them for one full month for surging power, thrilling new driving performance, breathtaking gas savings! During that very first month alone:

1) These plugs MUST give you up to 9 miles MORE per gallon—INSTANTLY—or every cent of your money back!

2) These plugs MUST give you up to 20 MORE horsepower—INSTANTLY—or every cent of your money back!

And 3)—as an extra added assurance—These plugs must continue to give you this power, performance and gas savings—FOR TWO FULL YEARS—or we will send you a brand-new set, ABSOLUTELY FREE!

You have nothing to lose! This is probably the most amazing guarantee in car history! No strings! No questions asked! Act TODAY!

DEALERS: DISTRIBUTORS: CASH IN ON HUGE, FULL PAGE NEWSPAPER AND MAGAZINE CAMPAIGN: WRITE FOR FREE DETAILS!

# WHAT ALL AUTO MECHANICS WANT TO KNOW

1664 PAGES



This Big Practical Book gives full information with working diagrams covering principles, construction, ignition, service & repair of modern cars, trucks and buses. Diesel Engines, Hydrumatic & Fluid Drives Fully Explained. A complete Guide of 1664 Pages, over 1500 Illustrations showing inside views of working parts & instructions for service jobs.

**IT PAYS TO KNOW**  
**\$4 COMPLETE • PAY \$1 A MO.**  
 TO GET THIS ASSISTANCE FOR YOURSELF SIMPLY FILL IN AND MAIL COUPON TODAY.

Every Mechanic can Step Up his Skill with AUDELS GUIDES. Containing Practical Inside Information in a Handy Form. Covers facts and figures of your Trade. All illustrated and explained. Books sent to you for 7 DAYS FREE EXAMINATION. Send No Money Nothing to Pay Postman. Check Books Wanted — Mail Today.

## MAIL ORDER

AUDEL, Publishers, 49 W. 23 St., New York 10, N.Y.



Please send me for FREE EXAMINATION books marked (x) below, if I decide to keep them I agree to mail \$1 in 7 days on each book or set ordered and further mail \$1 monthly on each book or set until I have paid price, otherwise I will return them.

- HOME APPLIANCE SERVICE GUIDE, 800 Pages \$4
- AUTOMOBILE MECHANICS GUIDE, 1664 Pages. 4
- TRUCK & TRACTOR GUIDE, 1299 Pages . . . 4
- DIESEL ENGINE MANUAL, 575 Pages . . . 2
- MACHINISTS HANDY BOOK, 1650 Pages . . . 4
- WELDERS GUIDE, 600 Pages . . . . . 1
- BLUE PRINT READING, 440 Pages . . . . . 2
- MATHEMATICS & CALCULATIONS, 700 Pages. 2
- SHEET METAL PATTERN LAYOUTS, 1100 Pages 4
- SHEET METAL WORKERS HANDY BOOK, 388 Pgs. 1
- MECHANICAL DRAWING GUIDE, 160 Pages . . 1
- MECHANICAL DRAWING & DESIGN, 480 Pages . 2
- TELEVISION SERVICE MANUAL, 434 Pages . . 2
- RADIOMANS GUIDE, 1080 Pages . . . . . 4
- ELECTRONIC DEVICES, 216 Pages . . . . . 2
- ELECTRIC MOTOR GUIDE, 1000 Pages . . . . 4
- WIRING DIAGRAMS (Light & Power), 272 Pgs. 1
- ELECTRICIANS EXAMINATIONS, 250 Pages . . 1
- ELECTRIC POWER CALCULATIONS, 425 Pages. 2
- HANDY BOOK OF ELECTRICITY, 1440 Pages. . 4
- ELECTRIC DICTIONARY, 9000 Terms . . . . . 2
- ELECTRIC LIBRARY, 7000 Pages (12 Book Set) 18
- REFRIGERATION & Air Conditioning, 1280 Pgs. 4
- MILLWRIGHTS & MECHANICS GUIDE, 1200 Pgs. 4
- POWER PLANT ENGINEERS GUIDE, 1500 Pages 4
- ENGINEERS & FIREMANS EXAMS, 525 Pages . 1
- PUMPS, Hydraulics & Air Compressors, 1658 Pgs. 4
- OPERATING ENGINEERS LIBRARY (3 Books) . 9
- CARPENTERS & BUILDERS GUIDES (4 Book Set) 6
- PLUMBERS & Steamfitters Guides (4 Book Set) 6
- MASONS AND BUILDERS GUIDES (4 Book Set) 6
- PAINTERS & DECORATORS MANUAL, 450 Pgs. 2
- HOUSE HEATING GUIDE, 1000 Pages . . . . . 4
- OIL BURNER GUIDE, 384 Pages . . . . . 1

**Check NOW!**

You Can Look Over Any Guide In Your Own Home

Start the Easy Payments If Satisfied

**MAIL THIS TODAY**



Name \_\_\_\_\_  
 Address \_\_\_\_\_  
 Occupation \_\_\_\_\_  
 Employed by \_\_\_\_\_ P-1

**It's NEW! It's DIFFERENT!**

## 40, 80 & 120 POWER TELESCOPE WITH TRIPOD

**\$1295**

Observe stars, moon, planets. See distant ships, people, etc. appear feet away! Crystal-clear image sharpness at all powers. All images erect. Telescope, with five precision lenses and 40" long black leatherette covered tube mounted on 5 ft. hardwood tripod, cast aluminum head. Vertical and horizontal movements machined aluminum, tension controls on each. 3X finder scope attached locates target fast. Telescope completely assembled with tripod PLUS 3 FREE GIFTS only \$12.95 postpd. Satisfaction guaranteed.

**SUFFOLK SCIENCE SERVICE**  
 Dept. PM-1 Mattituck, N. Y.

**GET THESE GIFTS FREE!**

1. 120 pg. book "Discover the Stars"
2. Star Finder Dial
3. 200 & 400X eyepiece lenses

# PLAY GUITAR IN 7 DAYS OR GET MONEY BACK



**SURPRISE FRIENDS, RELATIVES, HAVE POPULARITY AND FUN GALORE!**

In popular music; a \$2.00 Guitarist Book of Knowledge—TOTAL VALUE \$5.75—ALL THREE for only \$2.98. SEND NO MONEY: Just name and address, pay postman \$2.98 plus C.O.D. postage. (Or send \$3.00 with order and I pay postage.) Same Guarantee. (Sorry, no C.O.D. to A.P.O., F.P.O. or outside U. S. A. Canada and Foreign \$3.00 with order.) Rush your order now

ED SALE • STUDIO 801-A • BRADLEY BEACH, N. J.

# MAKE MONEY WRITING

*.. short paragraphs!*

You don't have to be a trained author to make money writing. Hundreds now making money every day on short paragraphs. I tell you what to write, where and how to sell; and supply big list of editors who buy from beginners. Lots of small checks in a hurry bring cash that adds up quickly. No tedious study. Write to sell, right away. Send for free facts. **BENSON BARRETT, Dept. 27-A, 7464 N. Clark St., Chicago 26, Ill.**

# FREE! 107 BRITISH COLONY STAMPS

All different from Britain's farflung colonial empire. Catalog value \$2.50. FREE STAMP MAGAZINE. Approvals Send 10c for handling. Act now!

**NIAGARA STAMP COMPANY**  
 St. Catharines 77, Ont., Canada



# STUDY TO BE A DOCTOR of Psychology or Metaphysics

Obtain a Ph.D., M.A., or Ph.D. Be a Teacher, Lecturer or Accredited Practitioner. Teach others how to achieve Health, Happiness and Contentment. Chartered by State. Correspondence Courses only. Write for FREE book telling how.

**THE NEOTARIAN FELLOWSHIP**  
 Desk B. Pickwick Building Kansas City 6, Missouri

# REAL ESTATE BE A BROKER

**PAYS BIG! SEND FOR FREE, BIG, ILLUSTRATED CATALOG NOW!** Graduates report making substantial incomes. Start and run your own business quickly. Men, women of all ages, learn easily. Course covers Sales, Property Management, Appraising, Loans, Mortgages, and related subjects. **STUDY AT HOME** or in classrooms in leading cities. Diploma awarded. Write TODAY for free book! No obligation. Approved for World War II and Korean Veterans

**WEAVER SCHOOL OF REAL ESTATE (Est. 1936)**  
 2020R Grand Avenue Kansas City, Mo.



# RUPTURED

**BE FREE FROM TRUSS SLAVERY**

Now there is a new modern Non-Surgical treatment designed to permanently correct rupture. These Non-Surgical treatments are so certain, that a Lifetime Certificate of Assurance is given. Write today for our New FREE Book that gives facts that may save you painful and expensive surgery, and tells how non-surgically you may again work, live, play and love and enjoy life in the manner you desire. There is no obligation. **Excelsior Hernia Clinic, Dept. 8305, Excelsior Spgs., Mo.**

# How to CRACK the education barrier



Is there an "education barrier" between you and promotion? Are young college graduates being brought in to fill positions above you?

You can break down that barrier . . . gain real security, responsibility, prestige . . . *surprise fellow employees and win their respect.* You can match yourself against the smartest of the college boys and come out a WINNER. Here's how!

## AN HOUR A DAY THE I. C. S. WAY!

If you can spare an hour a day, if you have the determination to make good, if you're willing to invest pennies now for dollars later on—then I.C.S. can help you. You can be a man or woman, young or old, skilled or unskilled. So long as you

can understand simple language and illustrated training manuals, you need have no doubts. The I.C.S. hour-a-day plan is SUCCESS-PROVED. You learn while you earn—anywhere, any time. And the cost?—*less than a quarter a day!*

### Just pick the subject you want!

Only I. C. S. offers you such a wide range of subjects to choose from. Drafting. Engineering. Television. Aeronautics. Business. High School. 256 courses in all. *I. C. S. is the oldest, largest home-study school. It is also the best known in business and industry.*

### Free catalog plus free books!

When you mail the coupon below, you get a complete catalog on the subject you check with information about employment opportunities, training requirements, etc. And you get "How to Succeed"—36 pages of valuable tips on winning recognition, pay raises, success. Also, a free sample lesson in basic mathematics.

For Real Job Security—Get an I. C. S. Diploma! I. C. S., Scranton 9, Penna. Member, National Home Study Council

## INTERNATIONAL CORRESPONDENCE SCHOOLS

65<sup>TH</sup> YEAR

BOX 62953A, SCRANTON 9, PENNA.

Without cost or obligation, send me "HOW TO SUCCEED" and the opportunity booklet about the field BEFORE which I have marked X (plus sample lesson):

- |  |   |  |   |  |
|--|---|--|---|--|
| <p><b>ARCHITECTURE and BUILDING CONSTRUCTION</b></p> <ul style="list-style-type: none"> <li><input type="checkbox"/> Air Conditioning—Refrig.</li> <li><input type="checkbox"/> Architecture</li> <li><input type="checkbox"/> Architectural Interiors</li> <li><input type="checkbox"/> Building Contractor</li> <li><input type="checkbox"/> Building Estimator</li> <li><input type="checkbox"/> Building Maintenance</li> <li><input type="checkbox"/> Carpentry and Mill Work</li> <li><input type="checkbox"/> Heating</li> <li><input type="checkbox"/> Painting Contractor</li> <li><input type="checkbox"/> Plumbing</li> <li><input type="checkbox"/> Reading Arch. Blueprints</li> </ul> <p><b>ART</b></p> <ul style="list-style-type: none"> <li><input type="checkbox"/> Cartooning</li> <li><input type="checkbox"/> Commercial Art</li> <li><input type="checkbox"/> Fashion Illustrating</li> <li><input type="checkbox"/> Magazine Illustrating</li> <li><input type="checkbox"/> Show Card and Sign Lettering</li> <li><input type="checkbox"/> Sketching and Painting</li> </ul> <p><b>AUTOMOTIVE</b></p> <ul style="list-style-type: none"> <li><input type="checkbox"/> Auto Body Rebuilding</li> <li><input type="checkbox"/> Auto Elec. Technician</li> <li><input type="checkbox"/> Auto-Engine Tune Up</li> <li><input type="checkbox"/> Automobile Mechanic</li> </ul> | <p><b>AVIATION</b></p> <ul style="list-style-type: none"> <li><input type="checkbox"/> Aeronautical Engineering Jr.</li> <li><input type="checkbox"/> Aircraft &amp; Engine Mechanic</li> </ul> <p><b>BUSINESS</b></p> <ul style="list-style-type: none"> <li><input type="checkbox"/> Advertising</li> <li><input type="checkbox"/> Bookkeeping and Accounting</li> <li><input type="checkbox"/> Business Administration</li> <li><input type="checkbox"/> Business Correspondence</li> <li><input type="checkbox"/> Public Accounting</li> <li><input type="checkbox"/> Creative Salesmanship</li> <li><input type="checkbox"/> Federal Tax</li> <li><input type="checkbox"/> Letter-writing Improvement</li> <li><input type="checkbox"/> Office Management</li> <li><input type="checkbox"/> Professional Secretary</li> <li><input type="checkbox"/> Retail Business Management</li> <li><input type="checkbox"/> Sales Management</li> <li><input type="checkbox"/> Stenographic-Secretarial</li> <li><input type="checkbox"/> Traffic Management</li> </ul> <p><b>CHEMISTRY</b></p> <ul style="list-style-type: none"> <li><input type="checkbox"/> Analytical Chemistry</li> <li><input type="checkbox"/> Chemical Engineering</li> <li><input type="checkbox"/> Chem. Lab. Technician</li> <li><input type="checkbox"/> General Chemistry</li> <li><input type="checkbox"/> Natural Gas Prod. &amp; Trans.</li> <li><input type="checkbox"/> Petroleum Engineering</li> <li><input type="checkbox"/> Plastics</li> <li><input type="checkbox"/> Pulp and Paper Making</li> </ul> | <p><b>CIVIL, STRUCTURAL ENGINEERING</b></p> <ul style="list-style-type: none"> <li><input type="checkbox"/> Civil Engineering</li> <li><input type="checkbox"/> Construction Engineering</li> <li><input type="checkbox"/> Highway Engineering</li> <li><input type="checkbox"/> Reading Struct. Blueprints</li> <li><input type="checkbox"/> Sanitary Engineering</li> <li><input type="checkbox"/> Structural Engineering</li> <li><input type="checkbox"/> Surveying and Mapping</li> </ul> <p><b>DRAFTING</b></p> <ul style="list-style-type: none"> <li><input type="checkbox"/> Aircraft Drafting</li> <li><input type="checkbox"/> Architectural Drafting</li> <li><input type="checkbox"/> Electrical Drafting</li> <li><input type="checkbox"/> Mechanical Drafting</li> <li><input type="checkbox"/> Mine Surveying and Mapping</li> <li><input type="checkbox"/> Plumbing Drawing and Estimating</li> <li><input type="checkbox"/> Structural Drafting</li> </ul> <p><b>ELECTRICAL</b></p> <ul style="list-style-type: none"> <li><input type="checkbox"/> Electrical Engineering</li> <li><input type="checkbox"/> Electrical Maintenance</li> <li><input type="checkbox"/> Electrician <input type="checkbox"/> Contracting</li> <li><input type="checkbox"/> Lineman</li> </ul> <p><b>HIGH SCHOOL</b></p> <ul style="list-style-type: none"> <li><input type="checkbox"/> Commercial <input type="checkbox"/> Good English</li> <li><input type="checkbox"/> High School Subjects</li> <li><input type="checkbox"/> Mathematics</li> </ul> | <p>(Partial list of 256 courses)</p> <p><b>LEADERSHIP</b></p> <ul style="list-style-type: none"> <li><input type="checkbox"/> Foremanship</li> <li><input type="checkbox"/> Industrial Supervision</li> <li><input type="checkbox"/> Leadership and Organization</li> <li><input type="checkbox"/> Personnel-Labor Relations</li> </ul> <p><b>MECHANICAL AND SHOP</b></p> <ul style="list-style-type: none"> <li><input type="checkbox"/> Gas—Electric Welding</li> <li><input type="checkbox"/> Heat Treatment <input type="checkbox"/> Metallurgy</li> <li><input type="checkbox"/> Industrial Engineering</li> <li><input type="checkbox"/> Industrial Instrumentation</li> <li><input type="checkbox"/> Industrial Supervision</li> <li><input type="checkbox"/> Internal Combustion Engines</li> <li><input type="checkbox"/> Machine Design-Drafting</li> <li><input type="checkbox"/> Machine Shop Inspection</li> <li><input type="checkbox"/> Machine Shop Practice</li> <li><input type="checkbox"/> Mechanical Engineering</li> <li><input type="checkbox"/> Quality Control</li> <li><input type="checkbox"/> Reading Shop Blueprints</li> <li><input type="checkbox"/> Refrigeration</li> <li><input type="checkbox"/> Sheet Metal Worker</li> <li><input type="checkbox"/> Tool Design <input type="checkbox"/> Toolmaking</li> </ul> <p><b>RADIO, TELEVISION</b></p> <ul style="list-style-type: none"> <li><input type="checkbox"/> Industrial Electronics</li> <li><input type="checkbox"/> Practical Radio TV Eng'ing</li> <li><input type="checkbox"/> Radio and TV Servicing</li> <li><input type="checkbox"/> Radio Operating</li> </ul> | <ul style="list-style-type: none"> <li><input type="checkbox"/> Television Technician</li> </ul> <p><b>RAILROAD</b></p> <ul style="list-style-type: none"> <li><input type="checkbox"/> Air Brake Equipment</li> <li><input type="checkbox"/> Car Inspector</li> <li><input type="checkbox"/> Diesel Engineer &amp; Fireman</li> <li><input type="checkbox"/> Section Foreman</li> </ul> <p><b>STEAM AND DIESEL POWER</b></p> <ul style="list-style-type: none"> <li><input type="checkbox"/> Combustion Engineering</li> <li><input type="checkbox"/> Diesel—Elec. <input type="checkbox"/> Diesel Eng's</li> <li><input type="checkbox"/> Electric Light and Power</li> <li><input type="checkbox"/> Stationary Fireman</li> <li><input type="checkbox"/> Stationary Steam Engineering</li> </ul> <p><b>TEXTILE</b></p> <ul style="list-style-type: none"> <li><input type="checkbox"/> Carding and Spinning</li> <li><input type="checkbox"/> Cotton, Rayon, Woolen Mfg.</li> <li><input type="checkbox"/> Finishing and Dyeing</li> <li><input type="checkbox"/> Loom Fix'g <input type="checkbox"/> Textile Des'ing</li> <li><input type="checkbox"/> Textile Eng'g <input type="checkbox"/> Throwing</li> <li><input type="checkbox"/> Warping and Weaving</li> </ul> <p><b>MISCELLANEOUS</b></p> <ul style="list-style-type: none"> <li><input type="checkbox"/> Domestic Refrigeration</li> <li><input type="checkbox"/> Marine Engineering</li> <li><input type="checkbox"/> Ocean Navigation</li> <li><input type="checkbox"/> Professional Engineering</li> <li><input type="checkbox"/> Short Story Writing</li> <li><input type="checkbox"/> Telephony</li> </ul> |
|--|---|--|---|--|

Name \_\_\_\_\_ Age \_\_\_\_\_ Home Address \_\_\_\_\_

City \_\_\_\_\_ Zone \_\_\_\_\_ State \_\_\_\_\_ Working Hours \_\_\_\_\_ A.M. to P.M. \_\_\_\_\_

Occupation \_\_\_\_\_

Canadian residents send coupon to International Correspondence Schools, Canadian, Ltd., Montreal, Canada. . . . Special tuition rates to members of the U. S. Armed Forces.

# The Amazing Potentialities of Memory

**I** LITTLE thought when I arrived at my friend Borg's house that I was about to see something truly extraordinary, and to increase my mental powers tenfold.

He had asked me to come to Stockholm to lecture to the Swedes about Lister and other British scientists. On the evening of my arrival, after the champagne, our conversation turned naturally to the problems of public speaking and to the great labour imposed on us lecturers by the need to be word perfect in our lectures.

Borg then told me that his power of memory would probably amaze me — and I had known him, while we were studying law together in Paris to have the most deplorable memory!

So he went to the end of the dining room and asked me to write down a hundred three-figure numbers, calling each one out in a clear voice. When I had filled the edge of an old newspaper with figures, Borg repeated them to me in the order in which I had written them down and then in reverse order, that is beginning with the last number. He also allowed me to ask him the relative position of different numbers: for example, which was the 24th, the 72nd, and the 38th, and I noticed that he replied to all my questions at once and without effort, as if the figures which I had written on the paper had been also written in his brain.

I was dumbfounded by such a feat and sought in vain for the trick which enabled him to achieve it. My friend then said: "The thing you have just seen and which seems so remarkable is, in fact, quite simple; everybody has a memory good enough to do the same, but few indeed can use this wonderful faculty."

He then revealed to me how I could achieve a similar feat of memory, and I at once mastered the secret — without mistakes and without effort — as you too will master it tomorrow.

But I did not stop at these amusing experiments. I applied the principles I had learned in my daily work. I could now remember, with unbelievable facility, the lectures I heard and those which I gave myself, the names of people I met—even if it was only once—as well as their addresses, and a thousand other details which were most useful to me. Finally, I discovered after a while that not only had my memory improved, but that I had also acquired greater powers of concentration; a surer judgment—which is by no means surprising since the keenness of our intellect is primarily dependent on the number and variety of the things we remember.

If you would like to share this experience and to possess those mental powers which are still our best chance of success in life, ask D. P. Borg to send you his interesting booklet *The Eternal Laws of Success*—he will send it free to anyone who wants to improve his memory. Here is the address:

**D. P. BORG, c/o Aubanel Publishers  
14 Lower Baggot St. Dublin, Ireland**

Write now—while copies of this booklet are still available.  
L. CONWAY

**YOURS FREE!**

**VUER-PROJECTOR & Full Color Slide Kit—Authentic \$4.95 Value!**

**If You're Interested In BREEDING TROPICAL FISH For Profit & Pleasure**

This handsome, precision-viewing instrument and color slides are yours FREE—just for showing your interest in Tropical Fish Breeding! See gorgeous BUTTAS, colorful TETRAS, exotic ANGEL FISH, etc., in the vibrant beauty of full color! Convince yourself Tropical Fish Breeding is the profitable, easy-to-start home business for you! Breed them in your living room, spare-room, anywhere. Success is assured because we'll buy every fish you produce! No experience or costly equipment needed. Start spare-time, on a "shoe-string"... build a \$10,000 home business! Investigate!

Write today for FREE details on "Profit-Proven" Success Plan & Vuor! (If under 17, ask for plan A.)

**TROPICAL FISH BREEDERS OF AMERICA**  
Dept. D-1  
Los Angeles 61, Calif.



**Free! VALUABLE U. S. A! PLUS COMPLETE U. S. CATALOG**

**Sensational Get-Acquainted Offer!** Get this scarce genuine postage stamp, as illustrated, picturing first U.S.A. (issued in 1847!) PLUS big collection of 30 all-different United States: 19th century, valuable \$5 stamp, etc. PLUS collection beautiful Commemoratives including '93 Columbian, Boy Scouts, Wild West, many others. EXTRA: other exciting offers; 64-page Collector's Guide; Big Bargain Catalog of U.S. Stamps. Send 10c to help cover mailing costs. **ACT NOW!** HARRIS, 3402 TRANSIT BLDG., BOSTON 17, MASS.



**NOW NO ONE CAN KEEP A SECRET FROM YOU!** only **\$269** postpaid

**20x-40x-60x TELESCOPE**

Amaze your friends... See what they're doing—without being seen!

Special: Order now, get Free carrying case

3-range all metal telescope magnifies up to 60 power. Watch ball games, look at the moon, stars, animals, distant buildings... up close. Rotating eyepiece, bright chrome-like tube, made for long use. Good on hikes, camping trips, can use either 20x, 40x, or 60x power instantly. Opens to 3-times its length. No assembling, ready-to-use, no special instructions required. Money back guarantee. Send cash, check or money order to:

**L. J. STONE, Dept. TB-1, 1816 Oak St. • Santa Monica, Calif.**



**ENGINEERING DEGREE IN 27 MONTHS**

**INDIANA TECHNICAL COLLEGE**

B. S. Degree, Aero., Chem., Civil, Elec., Mech., & Electronic Eng. (inc. Radio & TV). B.S. degree in 36 mo. in Math., Chem., Physics. Prep. courses. Low rate. Earn board. Large industrial center. Students from 48 states, 21 countries. Demand for grads. G.I. appr. Enter March, June, Sept., Dec. Catalog.

1617 E. Washington Boulevard  
Fort Wayne 2, Indiana

**WAR SURPLUS BARGAINS**

**\$500,000.00 INVENTORY for QUICK LIQUIDATION**

Surplus items—hundreds of them for home, shop, factory, farm and outdoor use. New items, used items, reconditioned items—all at tremendous savings—all priced for quick sale.

Page After Page of Values

This big catalog shows page after page of amazing money saving values. Write for your copy today. Send 10c to cover postage, mailing, etc. Write today! **SEND TODAY FOR YOUR COPY**

**10c**

**STARK'S** 212 W. Madison St.  
Dept. PM-571  
CHICAGO 6, ILL.



# HERE'S A READY-MADE FUTURE FOR YOU

MILLIONS OF HOMES IN U.S.  
HAVE 6-12 SMALL APPLIANCES  
& MILLIONS MORE SOLD EVERY  
YEAR. MILLIONS  
NEED REPAIR NOW  
WITH THE NEED  
INCREASING  
DAILY!

## Start Your Own Business IN

# ELECTRICAL APPLIANCE REPAIRING

### EARN WHILE YOU LEARN

"Only had your course a few short weeks and have already made \$800.00."

J.D.S., St. Louis, Mo.

"I work day times at the shipyard and after 4:00 P.M. I operate from my cellar and garage. I average \$10.00 to \$15.00 clear every day."

W. H., Brookline, Mass.

"Make \$15.00 Saturdays and more. Am only able to operate in my spare time. It is just what a mechanically minded man needs." G.O.P., Thomasville, Ga.

## 3 EASY STEPS

We send you the "CHRISTY" Electronic Kit. A multi-purpose trouble tracer. Indicates current consumption, shorts, breaks, etc.

We teach you Electrical Appliance Repairing with cross indexed Illustrated Manuals. The Easy-to-Remember-Way.

We show you How to Get Business and Keep Business Coming to you.

### IN YOUR OWN KITCHEN, BASEMENT OR GARAGE

Learn at home in your spare time this fascinating, big paying profession.

If you are mechanically inclined, can hold and use tools, we can give you the training and time saving kits that will enable you to . . . Command More Money At Work . . . A Better Paying Job Elsewhere . . . Or A Business Of Your Own! New Shop Method Home Training teaches you both the technical and practical side of Electricity by having you work with your hands Building, Testing, Repairing. All instruction manuals are written in easy-to-understand language, chock full of hundreds of detailed photos and drawings. We show you how to quickly locate the trouble, how to fix it and what to charge. ALSO, how to do House Wiring, Welding, Nickel Plating, Sharpen Lawn Mowers, Skates, etc. and how to build power tools you need from spare parts.

### \$5.00 TO \$6.00 AN HOUR

Often charged for making ordinary repairs. We show you how to repair refrigerators, vacuum cleaners, washing machines, motors, irons, etc.

CHRISTY TRADES SCHOOL, Dept. D-6203  
4804 N. KEDZIE AVE. CHICAGO 25

## SEND FOR FREE BOOK!

CHRISTY TRADES SCHOOL, Dept. D-6203  
4804 N. Kedzie Ave., Chicago 25, Ill.

Please send me FREE Illustrated Book on Electrical Appliance Repairing and Special form for Paying Later from Earnings.

NAME \_\_\_\_\_ AGE \_\_\_\_\_

ADDRESS \_\_\_\_\_

CITY \_\_\_\_\_ ZONE \_\_\_\_\_ STATE \_\_\_\_\_



WE GIVE  
YOU THIS  
ELECTRONIC  
KIT TROUBLE  
FINDER



## You Can Be A CLAIM INVESTIGATOR

We'll Train YOU for a LIFE OF EXCITEMENT • BIG PAY • SECURITY in the fast growing billion-dollar Claim Adjustment Field.



### INVESTIGATE



AUTO ACCIDENTS



WINDSTORM LOSSES



BURGLARIES

### EVERY COMMUNITY NEEDS ADJUSTERS

Every second of every day accidents and losses happen—and trained claim adjusters are needed to investigate and to distribute billions of dollars.

Yes, thousands of insurance companies, airlines, railroad companies, steamship lines, and Government Offices must continually use Claim Investigators and Adjusters. Trained Claim Agents are always in demand. Many earn over \$750 a month.

Here is your opportunity. At home in spare time you can learn this fascinating work—easily, quickly.

In taking our Adjuster Training Course you are given the necessary knowledge either to enter your own business or to work with one of the large companies.

Mail This Coupon NOW for FREE Book

UNIVERSAL SCHOOLS, Dept. PM-1  
University Park, Box 8202, Dallas 5, Texas

Please rush me your free book on Claim Investigation. This does not obligate me and no salesman will call.

Name \_\_\_\_\_ Age \_\_\_\_\_

Address \_\_\_\_\_

City \_\_\_\_\_ Zone \_\_\_\_\_ State \_\_\_\_\_

NEVER AT THIS LOW PRICE!

## GENUINE 120-POWER ACHROMATIC TELESCOPE

with Coated Lens and  
3-POWER FINDER attached

ONLY  
**\$18.95**  
PREPAID

### EXTRA BONUS GIFTS:

- 108 page book, "Discover The Stars"
- Magic Star Finder Dial
- 220X & 400X Eyepiece lenses

BRING THE MOON, PLANETS, STARS, PEOPLE 120 TIMES CLOSER, CLEARER, SHARPER.

Never before has an ACHROMATIC 120X telescope with range finder and tripod sold for anywhere near this amazing low price! Now you can not only explore the heavens and bring the moon, planets, stars, etc. 120 times closer, but you can also observe all distant objects, people, ships, etc. too, because all pictures are erect, and not upside down as in all astronomical telescopes. The kind of needle-sharp color-free viewing only a genuine achromatic lens can bring you. Ready for immediate use. Its 5 precision lenses bring you viewing at 40X—80X—120X. The tubes extend to 43", made of jet bakelite, finished in camera bellows black (for sharper, clearer images). Trimmed with gleaming brass. The 3 power finder scope mounted on main tube is a feature usually found on more expensive telescopes—brings difficult objects on target before observing with main scope. For extra stability 5 ft. hardwood folding tripod is equipped with heavy cast iron head fitted with Criterion's famous 360 degree all aluminum mount that locks instantly in any position. Obtainable only from Criterion, shipped prepaid. 4-Bonus gifts—108 page book "Discover The Stars," magic star finder dial that aids in locating stars ANYWHERE at ANY TIME of the year, and 220X and 400X eyepiece lenses included free of any cost for experiments. You must be completely satisfied with this super offer or your money back in full. Shipped to you complete, nothing else to buy, at the amazing low price of \$18.95. Without tripod \$14.95.

Send cash, check, or money order today to:  
Dept. PMA9, Criterion Co., 331 Church St., Hartford, Conn.

## FREE-A BUSINESS OF YOUR OWN

• Start Spare Time • No Training Period  
• No Investment • No Stock to Buy  
**SUBSTANTIAL MONEY-MAKING OPPORTUNITY**

Your Total Cost  
—a 3-cent stamp

All we ask of you is that you like to sell. If you can make a fair living selling anything else, we will show you how to make tremendous profits as a MASTER Work Garment Salesman, and furnish everything you need, free.

MASTER Work Garment salesmen are making thousands of dollars in hundreds of communities all over America. Men who—a year ago—didn't know what a work garment was, are now buying homes and cars with the profits from a MASTER Dealer franchise. Your sales are volume sales, repeat sales, steady-income-to-you sales. Every business in the country is a prospect for uniforms and work clothes with name-and-advertising embroidery. Stores can't compete. MASTER brings you the world's finest, most complete quality lines in new styles and fabrics. We supply everything you need—samples, sales material and guidance. You can start right away in your spare time. Keep present job until you are sure your new business is all we say. Write us today for full details.

**GEO. MASTER GARMENT CO.**  
759 WATER STREET, LIGONIER, INDIANA



## LEARN TYPEWRITER REPAIR!

You don't have to type to repair

Learn TYPEWRITER REPAIR and build your own future. Earnings up to \$5 an hour. Inexpensive home study course teaches factory methods by simplified, practical, learn-by-doing system. Operate full or spare time right from your own home. Free booklet tells all about it.

R-915 Cerbet St.  
TYPEWRITER REPAIR TRAINING • Tarentum 11, Pa.

HOW TO START YOUR OWN TYPEWRITER REPAIR BUSINESS

FREE BOOKLET!

## TRIANGLE PROBLEMS?

Solve with new, unique "Trigsie" trigonometer—set two slides, read answers direct. No formulas, no figuring. Precision made plastic—accurate for practical purposes. Only \$4.85, postpaid if check enclosed. C.O.D.'s accepted. Satisfaction or money back without question. Free literature.

VANORA PRODUCTS, Dept. P-1, Box 8485, Kansas City 14, Mo.

## It's Easy to PLAY the GUITAR

Learn at Home with My Studio Method on Records

Play the Very First Day

NOW—learn by the method that made top-billed musicians of my pupils. Lessons on records with text, music and a fine steel stringed, professional guitar.

FREE MUSIC OPPORTUNITY BOOK

No obligation! Write today!

SID MARGOLIS STUDIOS (formerly with CBS, NBC, name bands, etc.)  
c/o THUNDERBIRD, Dept. FA701,  
Valley Stream, N. Y.

## DO IT YOURSELF!

Make Money! Save Money!

Easy to do professional-looking lettering job on signs, trucks, boats, windows—any surface, anywhere! Complete kit contains 2 full alphabets and numbers—4 in. and 1½ in. die-cut master letter patterns—simple instructions, with illustrations for any lettering job, and camel hair lettering brush. Save Money lettering your own signs—make money in your own sign business!

Complete Kit, postpaid, only **\$5.95**  
Order today! Send cash, check or money order (No C.O.D.)

The FARRELL COMPANY, Dept. B-1  
734 N. Long Ave. Chicago 44, Ill.

SIGN LETTERING KIT



**TURN RIGHT**

# Get on the Road to a Better Job-Brighter Future with **RIGHT** Training

**IN SPARE TIME, AT HOME**

**—then You Can Really GO!**

**AMERICAN SCHOOL, Dept. G145, Drexel at 58th, Chicago 37, Ill.**

Without obligation, please send **FREE** and postpaid, full particulars about the home study course checked below.

- |  |   |   |
|--|---|---|
| <input type="checkbox"/> Accounting              | <input type="checkbox"/> Contracting                | <input type="checkbox"/> Mechanical Engineering |
| <input type="checkbox"/> Apprenticeship Courses  | <input type="checkbox"/> Diesel Technician          | <input type="checkbox"/> Mechanical Technology  |
| <input type="checkbox"/> Architecture & Building | <input type="checkbox"/> Drafting—Building Trades   | <input type="checkbox"/> Metalworking Courses   |
| <input type="checkbox"/> Automotive Technician   | <input type="checkbox"/> Drafting—Machine Trades    | <input type="checkbox"/> Plumbing—Practical     |
| <input type="checkbox"/> Better Foremanship      | <input type="checkbox"/> Electrical Engineering     | <input type="checkbox"/> Private Secretary      |
| <input type="checkbox"/> Blueprint Reading       | <input type="checkbox"/> Electricity—Practical      | <input type="checkbox"/> Retail Merchandising   |
| <input type="checkbox"/> Bookkeeping             | <input type="checkbox"/> Electronics—Industrial     | <input type="checkbox"/> Salesmanship—Outside   |
| <input type="checkbox"/> Business Management     | <input type="checkbox"/> <b>HIGH SCHOOL COURSES</b> | <input type="checkbox"/> Sheet Metal Work       |
| <input type="checkbox"/> Civil Engineering       | <input type="checkbox"/> Machinists                 | <input type="checkbox"/> Tool Making            |

NAME \_\_\_\_\_ OCCUPATION \_\_\_\_\_

HOME ADDRESS \_\_\_\_\_ AGE \_\_\_\_\_

CITY \_\_\_\_\_ STATE \_\_\_\_\_

**START NOW by checking, filling in and mailing this coupon.  
You'll get full information — No cost, No obligation!**

• Today, make the **BIG** decision of your life. Choose the career you want and take the first easy step toward your goal. Learn how you can get the training that can put you in the bigger pay class and give you security in the years ahead. Find out how, in spare time at home, you can qualify for work you prefer, and higher pay. Or if you are already in the work you like, find out how you can win quicker promotion and a larger income.

### **Backed by 60 Years of Training Know-How**

Since 1897 American School has helped many thousands of ambitious people toward success by providing specialized training for

commercial and technical advancement. Its study program for you has been prepared by experts in the subject you select and the school will give you guidance every step of the way. In time you might otherwise waste and at a cost you can afford you can prepare at home and really **GO** on the *right* road.

### **Don't Delay YOUR Start**

Give serious thought to the list of training courses listed above. Pick the opportunity that interests you, check it and add your name and address. (Check more than one if you are undecided which appeals most.) Then clip and mail the coupon. Full information will be supplied without cost or obligation.

**PRACTICAL, EFFECTIVE HOME STUDY TRAINING SINCE 1897**

**AMERICAN SCHOOL, Dept. G145, Drexel at 58th, Chicago 37, Ill.**

Canadian Residents: Write to American School, Dept. G145, 6083 Sherbrooke St. West, Montreal

**THE SOONER YOU START, THE SOONER YOUR GOAL CAN BE REACHED**

# ENGINEERING



Photo of Heald Electrical Laboratory  
Enroll Now for New Term

Heald College Ranks **FIRST**  
West of the Mississippi  
in "Who's Who" in America

Send for **FREE** Information

## Heald Engineering College

Van Ness at Post, Dept. PM-1  
San Francisco, California

Thousands of  
Engineers Needed  
for Hard Pressed  
Industry

### BACHELOR OF SCIENCE DEGREE, 27 MONTHS

- Degree Courses:**
- Electronic Engineering
  - Electrical Engineering
  - Highway Engineering
  - Mechanical Engineering
  - Structural Engineering
  - Civil Engineering
  - Architecture
- Diploma Courses:**
- TELEVISION  Celertv
  - Tool & Die Design
  - Architectural Drafting
  - Mechanical Drafting
  - Structural Drafting
  - Surveying
  - Estimating
  - Master Electrician
- Approved for Veterans

NAME \_\_\_\_\_  
STREET \_\_\_\_\_  
CITY \_\_\_\_\_  
STATE \_\_\_\_\_

**Makes**  
**\$216.00 A MONTH**  
**IN SPARE TIME!**



M. M. REARICK SAYS: "I AVERAGE UP TO \$216.00 A MONTH OPERATING MY BELSAW SHARP-ALL AFTER WORK AND ON SATURDAYS" YOU can start your own spare-time business in your own home. With the new Belsaw Sharp-All you can sharpen all knives, scissors, shears, snips, ice skates, mower blades, hedge trimmers, grass whips, axes, chisels, screw drivers, scrapers and saws... just about any household, garden and shop tool. Your own CASH business with no inventory. No calls to make. No experience needed.

Learn how easily you can start your own spare-time business. Amazing low cost, easy-payment plan. Send postcard for **FREE BOOK**.



**BELSAW SHARP-ALL CO**  
717 Field Building • Kansas City 11, Missouri

## STEP UP PERFORMANCE OF YOUR OUTBOARD



Send card for **OUTBOARDER'S BIBLE** — our 1957 catalog. It's **FREE**. Contains much valuable information on how to get **MORE SPEED**, or more **THRUST** for **WATER SKIING** from motors of 7½ to 60 HP; better performance and load carrying capacity from any motor old or new. Easily understood recommendations enable you to choose a propeller virtually custom-built for your motor-boat-load combination — inexpensive, more rugged and damage-proof than the original. Write, **NOW**, Michigan Wheel Co., Dept. P-1, Grand Rapids 3, Mich.

## STUDY INDUSTRIAL DESIGN

You can train at Art Center School in California with practicing professionals for upper-level jobs in **INDUSTRIAL DESIGN**. Recent graduates have been added to the staff at General Motors, Chrysler, Raymond Loewy, Henry Dreyfuss, etc. Majors in transportation, general product design, structures, community development, packaging, display, 4-year degree courses. Learn to combine imaginative design with technical proficiency, coordinate utility and beauty, stimulating environment. Field trips. Advantages of mild Southern California climate and nearby holiday spots. Accredited. Coed. Placement service. Established 26 years. New terms February, June, September. Catalog.

**ART CENTER SCHOOL**, Edward M. Adams, Director  
5353 WEST THIRD STREET, LOS ANGELES 5, CALIFORNIA



### DEVELOP A HE-MAN VOICE!

Write for **FREE** book "How to Strengthen Your Voice for Greater Success" by Eugene Feuchtinger. No obligation. Book will be mailed at once in plain wrapper, postpaid. Just send your name and address. State age. **PREFECT VOICE INSTITUTE**, 210 S. Clinton St., Studio AT-2, Chicago 6, Ill.

## LEARN PLASTICS



### COMPLETE LOW COST SHOP METHOD HOME TRAINING NOW AVAILABLE

Get in on Big Money opportunities in Plastic molding, casting, forming, carving, etc. Earn as you learn with Interstate's professionally prepared course. All plastic materials furnished.

**WRITE FOR FREE BOOKLET** **INTERSTATE TRAINING SERVICE**  
DEPT. C-3, PORTLAND 13, OREGON

## YES! SEND



directly  
to my door  
every month

- I am enclosing
- \$3.50 for 1 year
  - \$8.00 for 3 years

name \_\_\_\_\_

address \_\_\_\_\_

city \_\_\_\_\_ zone \_\_\_\_\_ state \_\_\_\_\_

Hand this order to your newsdealer or send it to  
**POPULAR MECHANICS**  
200 East Ontario St. Chicago 11, Ill.



**NOW**

**MAKE MONEY! SAVE MONEY!**

# Electro **PLATE AUTO CHROME**

A REMARKABLE NEW INVENTION  
**PLATES AS YOU BRUSH!**

with  
**PERMANENT  
PLATING**

**FACTORY-NEW BRILLIANCE  
FOR CAR CHROME!**

Here at last is the car-owner's answer to all chrome problems . . . a dramatic new invention called **SPEEDPLATER**. It actually plates **NEW METAL** as you brush. And the plating you apply becomes an **INDESTRUCTIBLE** part of the bumper, grille or trim itself. How your car will shine! You'll be mighty proud when you remove ugly rust spots and replat metal to a **NEW SPARKLE** . . . when you bring new, gleaming beauty to worn, dull, even blistered chrome areas of your car. This fast, sensational method of brush-plating gives **FACTORY-NEW BRILLIANCE** that bonds itself onto your car. It forms a hard, sparkling surface defying all elements!

**BUMPERS—GRILLWORK—ALL CAR TRIM  
RESTORED TO NEW BRILLIANCE!**

Here is how easily you **REPLATE** your car . . . You simply attach **SPEEDPLATER'S** clamps to your car's battery, then dip **SPEEDPLATE Brush** into the miracle solution and start plating anywhere around your car. This safe, mild current **WORKS FAST**—yet uses less battery juice than the tiniest light on your car.

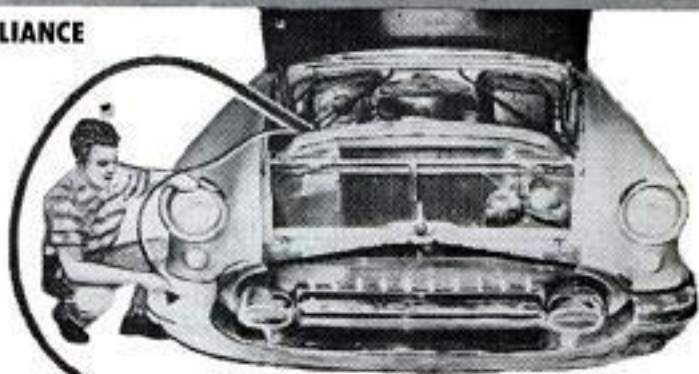

*Quickly Builds up a  
Thick, New Plating  
With Each  
Application*



**Make Big Money Plating Other Cars!**

Now you can add to your income during spare-time hours . . . because 8 out of 10 cars on the road today **NEED REPLATING**. You can charge from \$5.00 for touching-up to \$50.00 for replating an entire car. It's easy and there's good money in it for you. When your neighbors see the brilliant plating on your car, they'll surely want you to do the job for them! Replate other things for profit too—faucets, home appliances, tableware, cutlery, doctors' and dentists' instruments.

**AMAZING NEW SPEEDPLATER** has already plated thousands of cars with Extraordinary Results! Here are just a few of the many unsolicited comments received from thrilled users: ". . . The outfit arrived O.K. and I must say it does everything you say it does and more . . . Thanks very much for sending me something that is really worth many times the price you charge . . ." Rev. M.D. Awtry, Naples, Fla. . .

"To say I am pleased is putting it very mild. I have got more work than two of us can do . . . we had to start Booking Jobs Ahead like the family Doctor . . ." Frank Sumner, Kokomo, Ind.

**READ  
WHAT  
USERS  
SAY!**

**SPEEDPLATER ALSO PLATES  
GOLD, SILVER, RHODIUM with  
MIRACLE PLATING SOLUTIONS**

Your sensational **SPEEDPLATER Brush** will also plate Silver, Gold, Rhodium. Just attach **SPEEDPLATER'S** clamps to your car's battery for fast, excellent results. Restore, **REPLATE** these precious metals with Empire's Miracle Plating Solutions—

Gold Plating Solution . . . . . \$ 5.00  
Silver Plating Solution . . . . . 3.00  
Rhodium Plating Solution . . . . . 10.00

Full, simple instructions included with every Gold, Silver and Rhodium Plating Kit. Make good, extra money replating silverware, jewelry, car insignias, etc. Follow-up that big demand for metal plating!

**CASH REFUND IF NOT COMPLETELY SATISFIED**

**MAIL COUPON NOW—YOU RISK NOTHING**

If you want to put a new permanent gleam on **YOUR CAR'S** Bumpers, Grille, Ornament, Trim, you can do it right away and not risk a dime. If you are not satisfied with great results, it doesn't cost you a penny! Just mail coupon with only \$1 deposit—then pay postman \$18.95 plus postage when your kit arrives. If you send \$19.95 we pay all postage charges. Either way you must be **COMPLETELY SATISFIED** or you may return all in 10 days for **FULL CASH REFUND** of purchase price. **ACT NOW! HERE'S WHAT YOU GET: SPEEDPLATER Brush** with Stainless Steel Permanent Anode; Wires and Clamps for battery hook-up; Copper Plating Solution for shiny base plate; Special **BRITEPLATE** Solution for gleaming top plating; Special Buff and Buffing Compound; Special Metal Polish; Full simple instructions.

**EMPIRE MERCHANDISING CO., Dept. P-17  
4 North 3rd Ave., Mt. Vernon, N. Y.**

Please rush my Electro-SPEEDPLATING Outfit.

I enclose \$1 deposit—Send C.O.D. plus postage.

I enclose \$19.95—Rush it postpaid.

I understand that I must be **COMPLETELY SATISFIED** or I may return entire outfit in 10 days for **FULL CASH REFUND**.

Name \_\_\_\_\_

Address \_\_\_\_\_

City \_\_\_\_\_ State \_\_\_\_\_

Same Money-Back Guarantee applies to Miracle Plating Solutions for **GOLD—\$5; SILVER—\$3; RHODIUM—\$10.**

**"TOOK IN \$217  
FIRST 10 DAYS"**

Some make more, some less

We help you to start Your Own All-Year Business

**Make Big Money!** With our easily operated, highly efficient wall washer, Chas. Stelle took in \$217 gross in first ten days. E. L. Goss took in more than \$10,000 in one year. E. C. Taber wrote, "I made \$400 gross in two weeks." And no wonder—this machine washes walls 6 times faster and better than by hand. **Your Money-making Opportunity.** Enjoy independence—freedom from bosses, layoffs. Customers everywhere—homes, offices, schools, etc. Expenses low, profits high. No shop necessary; operate from home. Can start spare time until your full time is available.



Lose no time. Get all facts without obligation

**FREE BOOK! MAIL COUPON TODAY!**

- VON SCHRADER MFG. CO.
- 110 "W" Pl., Racine, Wisconsin
- Send at once (no obligation) your **FREE** booklet containing information about your
- **WALL WASHING MACHINE** and how I can start my own permanent, profitable business.
- Name \_\_\_\_\_
- Address \_\_\_\_\_
- City \_\_\_\_\_ Zone \_\_\_\_\_ State \_\_\_\_\_

**I'll Send You This Handsome  
SAMPLE CASE—FREE!**



**Make up to \$30.00 in a Day!**

**Your Own Tailored Suits Without 1¢ Cost**

If you want to make more money, spare time or full time, rush the coupon below today for this big, valuable tailoring Sample Case packed with 150 beautiful, big-value suit and overcoat samples. Just show the samples and just-minute styles to friends, fellow-workers, others. Take their orders for fine made-to-measure clothes—and pocket **BIG CASH PROFITS** in advance. No experience, no tailoring knowledge needed—and no money needed, ever. **WE SUPPLY EVERYTHING FREE**.. sample case, sample suitings, equipment, complete instructions. Start making money first day!

**Use Spare Evenings... Weekends... Make Money... Get Suits!**

It's easy to make money taking orders in just spare time—lunch-time, evenings, weekends. When men see the fine fit, quality and value of our suits—**THEY ORDER!** So we make it easy for you to get your own personal suits and overcoats without paying even one penny. Don't wait! Rush coupon with your name, address, and age for **FREE** Sample Case.

**W. Z. GIBSON, INC., Dept. C-516  
500 South Throop Street, Chicago 7, Illinois**

**W. Z. GIBSON, INC., Dept. C-516  
500 S. Throop St., Chicago 7, Ill.**  
Please rush **ABSOLUTELY FREE** the valuable Sample Case with suit fabrics and style display. Include instructions, money-making plans and details for getting my own suits without paying one cent.

Name \_\_\_\_\_ Age \_\_\_\_\_  
Address \_\_\_\_\_  
City \_\_\_\_\_ State \_\_\_\_\_

50 Years of Combined family experience in High Quality tires.

**23 YEARS AT THIS ADDRESS**

**TUBE FREE WITH EVERY PASSENGER TIRE**



Our entire stock of very slightly worn **EXTRA MILEAGE TOP GRADE** Tires, (Written Insurance Guarantee). **SEND AD**



**EVERYBODY 10% off ON EVERY TIRE**  
**MAY DEDUCT**

**FREE** If you buy 2 or more Passenger 4-ply tires, WE GIVE ONE tire FREE, on each order. Does not include W.W. or Truck Tires, or Snow Tires.

Specialists in Truck Tires—Selected for Toughest Jobs—Tops in Value

12 MOS. WRITTEN GUARANTEE WITH EVERY TIRE	
600-16	\$5.52 475-19 \$4.82 700-15(8) \$7.52 700-20 \$9.92
600-16(6)	5.92 640-15 4.22 750-16(8) 9.72 750-20(10) 15.72
650-16	5.72 670-15 5.52 700-17 9.82 750-20(8) 11.92
650-16(6)	6.62 710-15 5.32 750-17 10.32 825-20 18.92
750-16(6)	7.52 760-15 5.82 825-15 12.92 900-20 17.92
550-17	3.72 800-15 5.92 800-20 9.02 1000-20 17.92
650-15	5.52 820-15 5.92 850-20 9.82 1100-20 19.92
700-15	4.92 700-16 R. 7.72 750-16 10.72 1100-22 18.92

**"EXTRA SPECIAL" SOME NEAR NEW all size 4-ply pass. FREE TIRE with 2 or more of these also.—W.W. \$1.00**  
Extra Factory Tested Tube given—**GIANT TIRE SALE. EA.**

**SNOW TIRES \$9.02** ORDER ANY 4 PLY PASSENGER SIZE  
EA. 12 MO. GUAR. BLACK WALL

Thousands of tires shipped all over the U.S.A. All tires shipped F.O.B. Phila. Send Check or M.O. with this ad. Dept. 2. No C.O.D.

**STANDARD 834 N. Broad St., Philadelphia 30, Pa.**

**LAW FREE BOOK** THE LAW TRAINED MAN

Write today for a **FREE** copy of illustrated law book, "THE LAW-TRAINED MAN," which shows how to earn the professional Bachelor of Laws (LL.B.) degree through home study of the famous Blackstone Law Course. All necessary books and lessons provided. Moderate cost; convenient monthly terms. Write for **FREE** law training book today.

**Blackstone School of Law, 225 N. Michigan Ave.**

Founded 1890 Dept. 51 Chicago 1, Ill.

**What Every Mason Wants**



We have important Masonic books and lodge supplies for Blue Lodge, Chapter, Commandery, Scottish Rite, and Shrine.

**OUR RITUALS ARE USED THE WORLD OVER**  
Send for free catalog of books and rituals for Masons, Odd Fellows, Knights of Pythias, Knights of Columbus, etc.

**EZRA A. COOK PUBLICATIONS, INC. P.O. Box 796, 25A, Chicago 90, Ill.**

**MONEY in DONUTS**

Make new greaseless donuts. Start in kitchen. No smoke. Sell stores. **HALF PROFIT.** Cash daily. Free recipes. No obligation. Write! **MARTIN RAY CO., 3605 SO. 15th AVENUE, MINNEAPOLIS 7, MINN.**

**MINK \$25.00 EACH**

BRED FEMALES FOR SPRING DELIVERY  
BOOK "DOMESTIC MINK" \$1.00  
**HARRY SAXTON'S MINK RANCH, Bemus Point, N. Y.**

**BUY IT WHOLESALE!**

**GET UP TO 40% OFF**  
Agents—Start Buying Service at Home. Get big-name merchandise for clients up to 40% off. Sales easy as you can give sizeable discounts, still make fat commissions. Postcard brings **FREE COPY "The Wholesale Plan."**

**American Buyers Service**

**HERTEL STATION, DEPT. R, BUFFALO 16, N. Y.**

**AMAZON JIVARO**

**SHRUNKEN HEAD**

Amazing replica of fabled native curios with a legend that owners have good luck. A strong stomach helps too because these 4" heads defy detection from just a few feet away, with remarkably true skin and hair. Sensational to hang in the car, den, bar. Have fun with this guy who got pickled once too often. **\$150 ppd.**

**GREENLAND STUDIOS, Dept. PM-2  
5858 Forbes St. Pittsburgh 17, Pa.**



# Just Pick the Kind of Body YOU Want

*Charles Atlas*  
"World's Most Perfectly Developed Man."



**TROPHY GIVEN AWAY**  
Win this handsome Trophy, over 1½ ft. high!

**RIGHT IN THE COUPON BELOW!**  
...and I'll PROVE How EASILY You Can Have It...

## Almost Overnight

WHAT kind of body do YOU want? One with the kind of power-packed shoulders that make girls go "Ga-Ga" on the beach? Or sledge-hammer biceps that will make the toughest bully respect you! Or strong-as-steel stomach muscles; a slim waist? Just tell me WHERE you want it—and I'll add SOLID INCHES of muscle, FAST! I don't care how old or how young you are—or what your present physical condition may be. Just check the "dream build" you've always wanted—right in the coupon below. Then just give me 15 minutes a day of your spare time—in the privacy of your own room—and I'll give you exactly what you ask for: RESULTS you can see, feel, and measure with a tape!

### WHAT'S MY SECRET?

"DYNAMIC TENSION"—that's my secret! It's the NATURAL method that I myself developed to change my body from the miserable skinny-chested weakling I was at 17 to my present "World's Most Perfectly Developed" body. Thousands have become marvelous physical specimens my way. I want YOU to be next!

No gadgets, no contraptions. You simply use the DORMANT muscle-power in your own God-given body. Before you know it, you're a NEW MAN—full of red-blooded get-up-and-go—healthy and handsome!

**FREE** My Valuable Illustrated 32-Page Book. NOT \$1.00 — NOT 10c — but FREE!

Send for my famous book showing how "Dynamic Tension" makes you a new man. 32 pages packed with photographs and valuable advice. See what my method has done for thousands, what it can do for YOU.

This book is a real prize. Just glancing through it may mean the turning point in your whole life! Rush coupon to me personally: CHARLES ATLAS, Dept. 8A, 115 East 23rd St., New York 10, N. Y.



Charles Atlas thrilled millions of TV viewers with his handsome build and dynamic personality when he recently appeared as a guest on two TV shows, "Masquerade Party," and "I've Got A Secret."

### JUST LOOK AT THE RESULTS I GET!



"When I started your Course I weighed only 141. Now weigh 170."  
—T. K., N. Y.



"Have put 3½" on chest (normal). 2½" expanded."  
—P. S., N. Y.



### Why Be Half a Man?

... when it's so easy to become a real HE-MAN my natural way. Most fellows spend all of their lives feeling only HALF ALIVE. But you don't have to put up with that. Give yourself honest answers to these important questions. ARE YOU:

- Skinny and Run Down?
- Overweight and Short of Breath?
- Always Tired?
- Nervous?
- Shy and Lacking in Confidence?
- Slow at Sports?
- Do You Want to Gain or Lose Weight?
- Are you ashamed of your HALF-MAN build?

I tell you what you can do about these HALF-ALIVE symptoms in my valuable FREE Book. Pick the kind of body you want—right in the coupon below. Mail it to me personally and I'll rush you my free Book at once!

### Here's The Kind of Men I Build:

Meet Hector Romero, a recent winner of one of my Atlas Trophies for the most improvement in just 3 months.

CHARLES ATLAS, Dept. 8A,  
115 East 23rd St., New York 10, N. Y.

Dear Charles Atlas: Here's the kind of Body I Want:

(Check as many as you like)

- More Weight—Solid in The Right Places
- Broader Chest and Shoulders
- More Powerful Arms and Grip
- Slimmer Waist and Hips
- More Powerful Leg Muscles
- Better Sleep, More Energy

Send me absolutely FREE a copy of your famous book showing how "Dynamic Tension" can make me a new man—32 pages, crammed with photographs, answers to vital health questions, and valuable advice. I understand this book is mine to keep and sending for it does not obligate me in any way.

Name \_\_\_\_\_ Age \_\_\_\_\_  
(Please Print Plainly)

Address \_\_\_\_\_

City \_\_\_\_\_ State \_\_\_\_\_

If under 14 years of age check here for Booklet A.

# Learn to MOUNT Birds and Animals



**To All Men & Boys!**

Here is **FUN** and **PROFIT!**

## Send Coupon for Free Book

Tells all about **Taxidermy**, and how you can learn at home to mount life-like **Birds, Animals, Game-Heads, Fish**. Save your valuable trophies. Decorate your home and den. Learn genuine **Chrome Tanning** for harness and nice leather buckskins and fine furs. Mount **Common** specimens, squirrels, rabbits, owls, even **Frogs**. Also marvelous craft-work groups, both useful, humorous. Wild game not necessary. Marvellous hobby. Fascinating.

**BIG PROFITS** Turn your spare time to cash. Have a sideline profitable business. Mount game trophies for sportmen; sell your own mounts; save money and **Make Money** with expert tanning. Learn by mail from old reliable school with 400,000 graduates. **Investigate Now**. Send coupon or letter or post card **Right Now** for this marvelous **FREE BOOK**. There is no cost or obligation. Please state your **AGE**.

## FREE BOOK

Northwestern School of Taxidermy,  
2501 Elwood Bldg., Omaha, Neb.

Gentlemen—Please send me your **FREE** 48-page booklet explaining **Taxidermy**. (Please print plainly, and state **age**. Use postal card if more convenient.)

Name \_\_\_\_\_

Age \_\_\_\_\_

Address \_\_\_\_\_



# MATHEMATICS

**ADVANCED**

INDUSTRY TODAY DEMANDS. MORE THAN EVER, THE MAN WITH A GOOD MATHEMATICAL FOUNDATION.

In any branch of engineering, too, mathematics (up to and including calculus) is essential if you want to get ahead in this modern age of technical development. Our reasonably priced home study courses can train you by easy stages to advanced standards—even from an elementary beginning. Examination successes have been won by our students throughout the world. Write today for our handbook listing mathematics and over ninety other courses in all branches of engineering.

Civil	Radio	A.M.I.Mech.E.
Structural	Electronics	A.M.Brit.I.R.E.
Mechanical	Aeronautical	A.F.R.Ae.S.
Electrical	A.M.I.C.E.	B.Sc. (Pure Science)

## 105 PAGE HANDBOOK FREE

Canadian Institute of Science and Technology Limited  
637 Century Bldg., 412, 5th St. N.W. Washington, D.C.  
Please forward free of cost or obligation your handbook, "ENGINEERING OPPORTUNITIES".

Name.....

Address.....

..... Course

Interested in..... Age

Canadian Address: Canadian Institute of Science  
Garden Building, 263 Adelaide St. W., Toronto, Ont.



**FISHERMEN**  
SEND FOR  
**FREE**  
CATALOGUE  
**TODAY!**

FULLY ILLUSTRATED  
FULLY DESCRIPTIVE  
ALL PRICES LISTED

**Make Your Own SINKERS!  
JIGS! SQUIDS! CASTING  
AND SPINNING LURES!**

It's fun, it's easy with Sweet's  
**ALUMINUM MOLDS**

Molds for fresh and salt water  
fishermen. Handled and hinged  
for easy, fast operation. Over 100  
types, 500 sizes. Write for free  
catalogue.

AS LOW AS  
**\$2.95**  
PER MOLD



**SWEET'S MOLDS**  
Tonawanda 16, N. Y.

## OWN CALIFORNIA LAND

STATE GOV'T. LANDS. 500,000 Acres as low as \$2. per acre min. offer 40 to 640 Acre. Ranch and Farm Tracts. Southern and Northern California Locations.

**NO HOMESTEADING! NO IMPROVEMENTS! NO SALES TO ATTEND!** you select, apply and **BUY DIRECT** through the mail. Lists & maps now available. **WRITE RESEARCH DIV.**

**RANCH DEVELOPMENT CORP.** 760 FOOTHILL BLVD. REALTO, CALIFORNIA  
LARGEST LAND CORPORATION OF ITS KIND IN THE WORLD

## Secrets of VENTRILOQUISM Now Revealed!



Easy to learn in 60 to 90 days with our Home Study Course. **RESULTS GUARANTEED.** Make Money! Be Popular! Have Fun! Big Opportunity! Radio, Television, Stage Appearances! For **FREE** information regarding price and terms **WRITE:** You must state your age. Dummy Catalog 25c.  
**FRED MAHER SCHOOL OF VENTRILOQUISM**  
Box 38, Studio PM-1 Kensington Station  
Detroit 24, Michigan

## SEND ME



every month so I am sure to see each new issue. Here's

- \$3.50 for 1 year  
 \$8.00 for 3 years

name \_\_\_\_\_

address \_\_\_\_\_

city \_\_\_\_\_

zone \_\_\_\_\_

state \_\_\_\_\_

Hand this order to your newsdealer or send it to

**POPULAR MECHANICS**  
200 East Ontario St. Chicago 11, Ill.

ON LAND·IN THE AIR *and* ON THE SEA..

# BIG MONEY

*awaits*  
**TRAINED  
 TECHNICIANS**  
*in*  
**TELEVISION·RADIO·  
 ELECTRONICS·RADAR**



## EARN *As You Learn*

Christy Shop-Method Home Training makes you a more valuable and desirable technician, assures you of more money, faster progress and greater success. This practical step-by-step training makes everything interesting and easy, makes learning fun.

You don't have to leave home or quit your job to learn this simple, easy way. A few hours of your spare time each week soon prepares you for earning while learning and later for a big-pay job or profitable business of your own in this fabulous, fast-growing new industry.

3 new books contain complete information. Describe the course and many opportunities in this fantastic new field. Send for your 3 free books today!

### The Only Complete Course!

C.T.S. training covers every phase of this fascinating new subject. You get this comprehensive training starting with your first lesson. You learn Radar, Sonar, Television, Radio and Electronics in C.T.S.'s Complete course. This broader knowledge and greater understanding means more jobs and higher pay for you. Why be satisfied with less? You learn faster and better with Christy Shop-Method Home Training. It gives you all the training you need in a clear, simple, easy-to-understand way.

Big pay, interesting work, immediate success, await those thoroughly trained in all branches of electronics. And the C.T.S. Master Shop-Method Home Training Course is the only complete course in Radar, Sonar, Television, Radio and Electronics.

### MAIL COUPON TODAY!

CHRISTY TRADES SCHOOL, INC.  
 Dept. T-1003, 4804 N. Kedzie Ave., Chicago 25, Ill.

Gentlemen:

Please send me, without cost or obligation, two FREE Lessons and the new 24-page illustrated book telling all about the C.T.S. Master Shop-Method Home Training Course in Radar, Sonar, Television, Radio and Electronics, and the many opportunities this new field offers.

Name \_\_\_\_\_ Age \_\_\_\_\_

Address \_\_\_\_\_

City \_\_\_\_\_ State \_\_\_\_\_



### 19 TRAINING INSTRUMENTS INCLUDED

In a few months you learn what used to take years of hard work to master, reach your goal sooner and are better prepared to make maximum progress. Send for complete information today!

CHRISTY TRADES SCHOOL, INC.  
 Dept. T-1003  
 4804 N. Kedzie, Chicago 25, Ill.

FOR YOUR  
**TECHNICAL EDUCATION**  
 COME TO THE  
**COLLEGE OF TECHNOLOGY**  
 UNIVERSITY OF HOUSTON  
 (Located in Houston, Texas)

Select from one of these fields NOW.

- Air Conditioning & Refrigeration Technology
- Air Cond., Ref., and Sta. Engr. Technology
- Diesel Technology
- Diesel Electric Technology
- Drafting Technology
- Electrical Technology
- Electronic Technology

Prepare for your Future NOW . . .

- Latest methods and equipment • Excellent faculty
- Accredited curricula • Extensive free counseling and guidance service • Full college activities • Beautiful 275 acre campus • Co-educational • Opportunity for part-time job while you learn • Graduate placement • University T.V. and Radio stations • G.I. approved—V.A. on campus
- Open to high school graduates or equivalent. Opportunity for graduates of the above technical programs to continue education and earn a Bachelor of Applied Science degree—
- Sept., Feb., and June semesters. • FREE brochure.

Mark X before the program of your choice.

Tear out ad and send in with name and address.

**COLLEGE OF TECHNOLOGY, University of Houston**  
 DEPT. 117, 3801 Cullen Blvd., Houston, Texas

**FREE!**  
**NEW**  
**ISSUES..**

plus new, rare  
 BONUS OFFER!



RUSH COUPON TODAY for generous collection just released NEW ISSUE British Empire Stamps. All genuine, all different, very difficult to get. Thanks to agents all over the Empire, valuable, desirable stamps both mint and used — topicals, pictorials, bi-colors, commemoratives, many more. Due to present scarcity, we give only one packet. ALSO FREE! Exclusive — never before offered — "BRITISH EMPIRE BONUS PACKET". Unusual out-of-the-way, seldom-seen Coronations, Jubilees, Royal Visits, Commemoratives, others. No two packets alike. MORE! Other offers for your free inspection plus FREE copy helpful STAMP COLLECTOR'S GUIDE. Supply limited, so we give only one of these collections. If coupon clipped, send name and 10¢ for postage, handling to GARCELON STAMP CO., Dept. PM1N, Calais, Maine.

**GARCELON STAMP CO., Dept. PM1N**  
 Calais, Maine. RUSH New Issues, BONUS PACKET,  
 other offers. Enclosed 10¢ for postage, handling. (PLEASE PRINT)

Stamp Collector's Guide

\_\_\_\_\_  
 \_\_\_\_\_  
 \_\_\_\_\_

Write to **SKIN DIVER**  
 MAGAZINE (Monthly)  
 Box 128-P  
 Lynwood, California

6th year of publication. Complete national and world-wide coverage on all spearfishing and underwater diving activities.

**SEND \$100**  
 For 5 Month trial Subscription

Subscription Rates  
 1 yr. \$3.00 Foreign 1 yr. \$4.00

**THE FIRST AND ONLY NATIONAL MAGAZINE OF ITS KIND!**

**REAL ESTATE**  
**BE AN AGENT**

PAYS BIG! SEND FOR FREE, BIG, ILLUSTRATED CATALOG NOW! Graduates report making substantial incomes. Start and run your own business quickly. Men, women of all ages, learn easily. Course covers Sales, Property Management, Appraising, Loans, Mortgages, and related subjects. STUDY AT HOME or in classrooms in leading cities. Diploma awarded. Write TODAY for free book! No obligation. Approved for Korean Veterans.

**WEAVER SCHOOL OF REAL ESTATE (Est. 1936)**  
 2024A Grand Kansas City 8, Mo.

**FREE BOOK TELLS NOW**

**LEARN TO BE AN EXECUTIVE!**

Trained men are needed now for big-paying management positions in business and industry. The Thomas Method of Individual Instruction trains you at home under expert supervision. Business men approved. 15 thorough courses in business admin., industrial, retail, office management, advtg., personnel, salesmanship, human relations, etc. Write for FREE BOOK, "Management Opportunities," and complete details. No obligation.

**THOMAS SCHOOLS, Dept. A1, 1428-11th Ave., Seattle 22, Wash.**

Grow authentic, LIVE dwarf trees!  
 Fascinating hobby! Profitable business!

**GROW MINIATURE TREES**  
 SEND FOR FREE SEED & INFORMATION!

**MINIATURE NURSERY CLUB**  
 Dept. J-1, P.O. Box 8794,  
 Los Angeles 8, Calif.

**GET THE HABIT OF READING**  
 OUR CLASSIFIED ADS.

Wonderful Opportunities Amazing Bargains

**500 TRICKS** **MAGIC TRICKS**  
 IT'S FUN TO DO MAGIC

Be popular! Amaze—mystify—entertain! For 30 years Douglas has satisfied customers all over the world. Now, you can enjoy this fascinating hobby. Only 10¢ brings our Catalog 500 Tricks, containing brand new tricks for pocket, parlor, stage. Join in the fun—send 10¢ today!

**Douglas Magicland, Dept. A, Dallas, Texas**

**WORLD'S LOWEST PRICED**  
**ADDING MACHINE**

Counts up to 999,999,999  
 IDEAL FOR BUSINESS AND PERSONAL USE—GUARANTEED ACCURATE.  
 Not a toy. Operates with only a finger flick. Adds, subtracts, multiplies, divides. Counts up to one billion. Pays for itself over and over. Ideal Gift—for Business, Income Tax and School use.  
**MONEY BACK GUARANTEE.** Send name and address. Pay postman only \$2.95 plus postage. Beautiful rich-looking Leatherette Case included at no extra cost. Money back in 10 days if not delighted. AGENTS WANTED.

**Calculator Machine Company**  
 P.O. Box 126, Dept. F-57, Huntingdon Valley, Penna.

Vest Pocket Size  
**FREE TRIAL \$2.95**  
 only  
**TOTAL COST SEND NO MONEY**



# Train at Home or in the Big Allied Shops AIR CONDITIONING HEATING & REFRIGERATION

ALLIED offers YOU the finest training for one of the greatest industries of our time. You can be sure of the quality of ALLIED training—resident training on a wide variety of equipment—and Home Study training that has behind it a great resident school.



## BIG KITS

### ALLIED TRAINING PREPARED WITH COOPERATION OF INDUSTRY

Only a school with the established reputation of ALLIED could have been given the cooperation by leading industries in the Air Conditioning, Heating and Refrigeration fields which has made this training so outstanding.

You Are Supplied Shop-Work Kits if You Prefer to Train at Home Right in your own home you do practical air conditioning and refrigeration work made possible by ALLIED training. You build an Air Conditioner, Freezer, or other units of your choice.

#### Send Today for Free Sample Lesson and Book

Air Conditioning and Refrigeration are changing the living habits of millions of people. Plan to get into this great industry now—it's your chance to go up to higher and still higher earnings or build a successful business of your own. Get the facts about ALLIED training and how you can be helped. Mail the coupon for free book and sample lesson—no obligation.

### ALLIED SCHOOL OF MECHANICAL TRADES

ALLIED INSTITUTE OF TECHNOLOGY

1338-42 South Michigan Ave., Dept. PM-1A, Chicago 5, Ill.

Gentlemen: Mail me FREE BOOKS explaining ALLIED'S training program in AIR CONDITIONING, HEATING, and REFRIGERATION.

I am interested in resident training  home study

Name \_\_\_\_\_ Age \_\_\_\_\_

Address \_\_\_\_\_

City \_\_\_\_\_ State \_\_\_\_\_

## "HOW I DOUBLED MY INCOME In Less Than A Year, As A CUSTOM UPHOLSTERER"



Alvin Lederkramer, Former Low Salaried  
Auto Mechanic — Now Earning Big Pay

"When I enrolled for UTS training I was an auto mechanic earning a meager salary. While learning I earned good spare-time money. After graduation, I got a job in upholstery with better pay than ever before. Now, less than one year later, I've doubled my income. Soon, I'll get into my own business. The future looks bright, thanks to UTS."

WHAT DO YOU WANT? Your Own Profitable Business—A Steady Job — Substantial Sparetime Earnings — A More Secure Future? They're all waiting for YOU in the Big-Opportunity Field of Custom Furniture Upholstery.

The big nationwide housing boom has created a great demand for trained upholsterers. Prepare for this well-paid trade — easily, quickly. You can earn as you learn to make good money all year 'round at home, in your own shop, or in a well-paid job. The practical N. Y. State-approved UTS Course teaches you professional custom furniture upholstery, reupholstery, slip-covers, furniture finishing, window cornice, cushion, and drapery making. Course includes—FREE—ALL tools, complete frames and materials.

FREE ILLUSTRATED BOOK — FREE SAMPLE LESSON!

Our FREE book, "YOUR NEW WAY TO A SUCCESSFUL CAREER" with FREE Sample Lesson shows you how. WRITE TODAY! Training in N.Y. School also available. Upholstery Trades School, Dept. FA-305, 721 B'way, N. Y. 3

MAIL COUPON TODAY

## APPROVED FOR VETERANS

UPHOLSTERY TRADES SCHOOL, Dept. FA-305  
721 Broadway, New York 3, N. Y.

Please send me FREE book with FREE Sample Lesson. No obligation—no salesman will call.

Home Study  In N.Y. School Training

Name \_\_\_\_\_ (Please print plainly)

Address \_\_\_\_\_

City \_\_\_\_\_ Zone \_\_\_\_\_ State \_\_\_\_\_

Check if Korean Veteran

MATERIALS FREE WITH COURSE YOU MAKE

SLIPPER CHAIR

CLUB CHAIR

OTTOMAN PLUS SLIP COVERS

Yours to keep or sell

## Learn PHOTO PORTRAIT RETOUCHING

MAKE TO \$5 AN HOUR

SPARE—FULL TIME

EASY TO LEARN

WOMEN! LEARN—EARN AT HOME

Learn professional secrets of Photo-negative retouching—glamorize Portraits and Bridal Photos the way they do in famous Hollywood Photo Studio. Amazing new, step-by-step, fully illustrated instructions make learning easy. Prepare for big pay job, in Photo Studio, or have your own Retouching Studio at home. Operate by mail—anywhere. No previous experience or art training needed. We send you everything—full instructions—all needed equipment and Proven plan that brings big profit orders right to your home by mail. Examine complete outfit in your home—then decide! FREE—full details. Write NOW!



SEND NO MONEY JUST YOUR NAME

DUVAL SCHOOL, Dept. 51, 100 South Vermont Avenue, Los Angeles 4, Calif.

## \$6,000-\$10,000 YEARLY OPERATING AUTO RADIATOR SERVICE SHOP



World's largest radiator shop equipment mfr. will assist responsible individuals in setting up radiator shops. Opportunity to own secure profitable business. First year averages \$6,000 to \$10,000. Garage or service station can operate as dept. Over 1,000 INLAND shops now operating. As little as \$295 down for equipment starts you. INLAND will finance balance and furnish training. Write to

INLAND MFG. CO., Dept. PM-1, 1108 Jackson St., Omaha 2, Nebr.

TV Strong man DAN LURIE



## \$10,000 REWARD

If correct use of my new body building course fails to build you a "HE-MAN" BODY The secret is in my revolutionary, exclusive Body Mould system. Yours FREE with famous

### DAN LURIE BARBELLS

Scientific! Fastest, surest method known —beats all other training methods. Results guaranteed. Special low prices. 80 lb. set \$ 8.98 • 100 lb. set \$14.98 150 lb. set \$21.98 • 200 lb. set \$27.98 14c per Lb. F.O.B. 50% Deposit required

DAN LURIE BARBELL CO.

52M1 Bristol St., Dept. 759A, B'klyn, 12, N. Y.

Write Like This

MIRACULOUS IMPROVEMENT in your Penmanship in six hours practice with Grooved Letters. No failures. Inexpensive. No charges unless you're satisfied after 6 hours practice.

WRITE OZMENT BOX 665 34-P, ST. LOUIS, MISSOURI

Complete OUTLINE FREE!

FORCES You to Save \$100.00 a Year Automatically

Get Perpetual Date & Amount Bank. 25c a day keeps Date up to date. Also totals amount saved. Makes you save daily, or calendar date won't change. Save for vacations, car, payments, etc. Use year after year. Reg. \$3.50. Now only \$1.99 each; 3 for \$5.75 ppd. Mail cash, check or m.o. to:

LEECRAFT DEPT. PM, 300 ALBANY AVE. BROOKLYN 13, N. Y.

Finish HIGH SCHOOL AT HOME

Complete 4 Yrs. in 12 Months

Learn More! Earn More! Enter professional or technical schools. Advance Socially. Live a Happier, Fuller Life. Individual Courses or complete schedule. WRITE FOR SCHOOL BULLETIN.

ACADEMY FOR ADULTS  
30 W. Washington, Dept. PM-17, Chicago, Ill.

NOW! ENJOY HIGH INCOME AS A RADIO AND TELEVISION ANNOUNCER

It's true! Many announcers today are earning salaries running into the five and six figure bracket. Our training will equip you to do the same. Make up your mind to qualify for the many positions open to trained radio and television announcers now. Rush a postcard or letter today for free literature.

FEDERAL EXTENSION SERVICE 145 PRYOR AVENUE, DEPT. 11 TONAWANDA, N. Y.



# Make up to \$18<sup>00</sup> PER HOUR!



with this NEW

## PLASTIC SANDWICH MACHINE!

Amazing earnings are possible with this remarkable PLASTIC SANDWICH MACHINE.

Make PLASTIC SANDWICHES that cost you less than 10c each, take only 2 to 3 minutes of your time, yet sell for 50c to \$1.00 each! That's 600% to 1200% PROFIT!

"Plastic Sandwiches" are thin sheets of plastic fused (laminated) around social security cards, photographs, driver's licenses, letters, membership cards, etc. Anything you want to save permanently.

We want to introduce our Plastic Sandwich Machines from coast to coast as quickly as possible. We supply the finest quality, quicker, surer working plastic sheets at rock bottom prices.

Send today for FREE sample and illustrated literature about Plastic Sandwich Machines from \$39.50 up.

### PLASTICAST CO.

6612 N. Clark St., Dept. LM-901  
Chicago 26.

**FREE  
SAMPLE  
SENT**

PLASTICAST CO., Dept. LM-901  
6612 N. Clark St., Chicago 26

Please send me FREE sample and illustrated literature. No obligation.

Name \_\_\_\_\_ Age \_\_\_\_\_

Address \_\_\_\_\_

City \_\_\_\_\_ Zone \_\_\_\_\_ State \_\_\_\_\_

### Exclusive Double-Bearing HEAVY-DUTY PUMPS

IRRIGATE • DRAIN • CIRCULATE • SPRAY  
Up to 7,500 GPH. 3,000 GPH from 25' well. Use 1/4 to 1 HP motor. 1 1/4" inlet; 1" outlet. Stainless shaft. TYPE X—2 oilless bronze bearings. \$10.95

Won't rust. . . . . \$12.95  
TYPE XB—Ball bearing model. . . . . \$12.95  
Postpaid if rush with order. Rush your order today

**MONEY BACK GUARANTEE**  
Centrifugal and Gear Pumps in All Sizes  
LABAWCO PUMPS, Belle Mead 2, N. J.



## "Building Beautifiers" Can Earn High Incomes

Colorcrete, a cementitious plastic, gives lifetime beauty and protection to drab, dirty masonry — concrete, stucco, etc. — on all kinds of buildings. Tough, tenacious, enduring. Easily cleaned. Helps to daylight dark interiors. Choice of gleaming white or 30 colors. Applied under pneumatic pressure to form an inseparable bond.



More Colorcretors are needed to supply the ever-increasing demand. Low investment appeals to men of limited capital. Work is easy, fascinating, highly profitable. Broad opportunity to develop a lifetime business. No special ability or experience needed because we supply full instructions and sales operation. Colorcrete machine is simple to operate, easy to move around. Write today for Opportunity Book.

Colorcrete Industries, Inc. **COLORCRETE** CS  
570 Ottawa Av., Holland, Mich.  
IN CANADA: DUNN MASONRY MACHINERY LIMITED  
1020 Dundas Highway, Cooksville, Ont.

## Want to pass a CIVIL SERVICE TEST?

# START AS HIGH AS \$4,080.00 A YEAR!

Prepare NOW for 1957 Examinations

### MEN—WOMEN

Postoffice Clerks-Carriers  
Railway Postal Clerks  
Stenographers  
Accountants  
Immigrant  
Inspectors  
Typists  
Meat  
Inspectors  
Many Other  
Early Jobs

### FRANKLIN INSTITUTE

(Not Government Connected)  
Dept. C-93  
Rochester 4, N. Y.

Sirs: Rush to me, FREE of charge, list of many U. S. Civil Service big pay jobs. Send FREE 36-page illustrated booklet describing salaries, vacations, benefits, work, etc. Tell me how to prepare for one of these tests.

MAIL  
COUPON  
TODAY  
SURE

COUPON  
Name \_\_\_\_\_  
Street \_\_\_\_\_  
City \_\_\_\_\_ Age? \_\_\_\_\_

# NOW — Get this NEW expert SELF-TRAINING ENJOY BIG PAY AS MACHINIST

(\$2.30, \$2.50 AN HOUR AND MORE)



## New Revised Edition on Free 10-Day Trial

For big-pay job as machinist get this sure-fire working knowledge NOW. American industry demands thousands more machinists for today's booming production lines. Opportunities in every town for men who are handy with tools, like to work with machines, and able to figure. Get expert "know-how" from latest 322-page reference book and home-study reading course, "THE COMPLETE BOOK OF MACHINE SHOP PRACTICE."

Tells you, step-by-step, how each tool is used and how to do machine-shop work efficiently. Over 874 DRAWINGS and PHOTOS show clear details every tool, every operation. Easy-to-read text explains each machining problem in clear, simple language. Examine FREE for 10 days—you take no risk. Just mail coupon.

## Every Basic Machine Shop Operation Explained

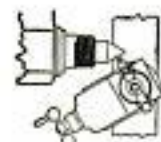

You get full information on how to operate lathe, shaper, planer, miller, drill press, tool grinders. How to use accessories such as chucks, adapters, boring bars, threading gauge, twist drills, calipers, lubricants, coolants, etc. How to work from drawings and specifications. How to use gage blocks, sine bar, center gages, verniers, micrometers, etc.

You get expert guidance on details of turning work between centers; machining to a shoulder; outside machining such as taper turning; inside machining such as drilling, reaming, tapered reaming, boring, tapping, etc. Also explains threads and thread cutting, how to calculate change gears, knurling, spinning, how to process and finish metals, full section on milling, shaping, planing, etc.

No previous knowledge of shop techniques required. This remarkable volume takes you step-by-step from elementary beginnings to shop practices through every detail you need to know to work each type of machine and perform each machining operation properly.

Examine book 10 days free. Send no money. Just mail coupon to get the new COMPLETE BOOK OF MACHINE SHOP PRACTICE for FREE ten-day trial.

## MAIL THIS COUPON NOW

PRENTICE-HALL, INC., Dept. 5688-A1  
Englewood Cliffs, New Jersey

Send me for 10 DAYS' FREE TRIAL, a copy of THE COMPLETE BOOK OF MACHINE SHOP PRACTICE. I will return it in ten days and pay nothing—or will keep it and send only \$1.95 down (plus postage) and \$2.50 monthly for two months.

Name \_\_\_\_\_

Address \_\_\_\_\_

City \_\_\_\_\_ Zone \_\_\_\_\_ State \_\_\_\_\_

SAVE! send \$6.95 WITH THIS COUPON and we will pay postage and packing. Same return privilege: money-back guarantee.

## MAKE STRIPES with new PAINT PEN

**Straight, curved, single or double** With any color paint, stripe furniture, bikes, autos, model planes, toys, linoleum, wall-board. Clean, crisp decorative lines. Can't clog or smear. Also use with glue, tempera, textile paint or underglaze... on wood, glass plastic, ceramics, metals, fabrics and paper. Ask your dealer or order direct.

**DEALERS**  
Master paint  
striping tool  
in display  
carton. Write  
for discounts.

**HOBBY**  
"Professional"  
results every  
time. Simple,  
easy to use.

**MFRS**  
Ask about  
heavy duty  
industrial  
striping  
tools.

**DOUBLE STRIPE MODEL** \$3.25  
**5 COMBINATIONS.**

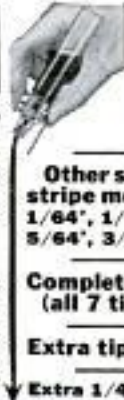

Single  
1/16"  
stripe  
model  
**\$1.25**

Other single \$1.75  
stripe models  
1/64", 1/32", 3/64",  
5/64", 3/32" & 1/8"

Complete Kit \$5.00  
(all 7 tips)

Extra tips 90c ea.  
Extra 1/4" tip...\$1.20

**WENDELL MFG. CO.** 4234 LINCOLN AVE., Dept. 325  
CHICAGO 18, ILLINOIS

## HARD ALUMINUM



## STRAIGHT EDGE-RULES

TRUE NO RUST STRAIGHT EDGES WITH LEGIBLE, VISIBLE, TRUE GRADUATIONS. PREVENTS EYESTRAIN, GIVES YOU NEATNESS AND NECESSITY IN YOUR WORK.

24" — \$1.10 ea.
36" — 2.25 ea.
48" — 3.50 ea.
60" — 4.50 ea.
72" — 6.50 ea.

WRITE FOR CATALOG

**THE FAIRGATE RULE COMPANY**  
DEPT. PM, COLD SPRING ON-HUDSON, N. Y.

## BE A CAMERA CRAFTSMAN...

Send for FREE BOOK!

Many are needed in this big paying field and new service methods at home. In your spare time! Instruction, tools, special equipment & everything you need is included in this approved course. Write for big FREE illustrated booklet that tells you HOW!

**national camera repair school - DEPT. V-1**  
ENGLEWOOD COLORADO

## SCIENTIFIC CRIME DETECTION



### IT'S EASY TO LEARN

Let us teach you in your own home. Learn Finger Printing, Firearms Identification, Police Photography, Criminal Investigation Methods thoroughly, quickly, at small cost. Over 800 Bureaus of Identification in the U. S. employ I. A. S. students or graduates. Write today, stating age.

**INSTITUTE OF APPLIED SCIENCE, 1920 Sunnyside Ave., Dept. 1351**  
(A Correspondence School Since 1916) Chicago 40, Ill.

## MONEY in WORMS

Big money made raising fishworms and crickets. Billions used yearly—unlimited market—sell by mail—We teach you how to raise and where to sell. Learn about our new, tremendous 6 to 12 inch African Redworms—in demand everywhere. Free Literature. **CARTER WORM RANCH, PLAINS, GEORGIA**

## KEY - BAK KEY-REEL

Carry your keys on a KEY-BAK key-reel. Keeps keys handy! Safe! Keeps clothing neat. 24" long stainless-steel chain reaches all locks. Pocket-watch size. Sturdily constructed to last for years. GUARANTEED. For all who use and carry keys. Dealers Wanted!

**WEAR IT ON YOUR BELT! IT REELS BACK YOUR KEYS!**

**LUMMIS MFG. CO.** Pasadena 8, Calif. **CTL CO.** Wausau, Wis. **\$2.95** Per.

Enjoy the Fascinating Story of the Horseless Carriage in

## Popular Mechanics AUTO ALBUM

The most intriguing book about the automobile ever printed. It's thrilling, fascinating and informative. From the very first gasoline-propelled buggy to the cars of today and the atomic auto of the future. The first cars — the men who made them — the scrambled start and the development of the fabulous auto industry—the story of auto racing—the growth of the Nation's highways, 166 thrilling action pictures—old-time cars—racing cars—early auto advertising—automotive oddities. Roll call of names of more than 2000 autos made in the U.S. included. Ideal gift book. Cloth bound, only \$3.00 by mail. Money back if not pleased.

**POPULAR MECHANICS PRESS, Dept. PM-157**  
200 East Ontario Street Chicago 11, Illinois

**World's Most  
THRILLING  
HOBBY!**



"Very pleased with Schirmer's Course, it contains so much information. The plant on my left had 6 blooms. 2 were cut off before picture was taken. The one on my right also had 6 blooms."

**JAMES COSTO**  
—Ohio

**HOW TO GROW**

**PROFITABLE  
Home Business**

# ORCHIDS

**NATURE'S MOST  
FABULOUS FLOWER  
In Your Own  
LIVING ROOM!**

**NO GREENHOUSE NEEDED  
YEAR 'ROUND - ANY CLIMATE  
MAINE TO CALIFORNIA**

Fill your Home with **ORCHIDS**  
Every Month of the Year!



**LOUIS and GLADYS SCHIRMER**  
SUCCESSFUL HOME-GROWERS, SAY:  
"We'll Show You How We Raised  
Orchid Plants Worth a Fortune—  
Starting At Home in Spare Time."

**NO GREENHOUSES NEEDED...** Successful family of home growers now reveal their secrets for your pleasure and profit. Learn exciting facts about raising beautiful Orchids at home... how to grow dozens of varieties in every rainbow color... have Orchids in full bloom every month of the year! Many grow without soil, getting food from the air. **NO GREENHOUSE NEEDED.** Start on table or window ledge.

**THRILLING HOBBY—Exciting Home Business.** Imagine the delight of watching gorgeous Orchids burst into bloom right in your own living room! The big lavender corsage Orchids you see in every flower shop—also many others in all sizes and colors. Orchids for your own enjoyment, for gifts or to sell at good profits.

**FINE PROFITS—Any location—Retail—wholesale—Mail Order.** Learn how to market your Orchids for profit, no matter where you live—small town, big city, or on a farm. Millions sold by mail order, year 'round. Tropical Flowerland's "Quick-Profit Plan" helps you start at once, without investment in stock. No overhead.

**SCHIRMERS' complete  
instructions and blooming-size  
Orchid plant sent for examination in your  
own home—NO OBLIGATION TO  
BUY A THING...**

Schirmer's Course is complete, nearly 300 large size pages filled with show-how drawings and photos—many in full color. Shows how to grow 30 different kinds of Orchids at home. How to market Orchids for extra income spare or full time. Also includes blooming-size Orchid plant. Send no money, just fill out and mail the coupon today—airmail is quicker.

TROPICAL FLOWERLAND, Dept. 311, 100 S. Vermont, Los Angeles 4, Calif.

**Home Growers Coast  
to Coast Benefit from  
the Schirmers' Help**



My Orchids are doing fine. I sell many blooms and haven't really started to try yet. I owe my success to the Schirmers.  
**MRS. FRANK HARWOOD—Oregon**

Growing Orchids for profit lets me have my business at home. When I first saw your ad, I had never seen an Orchid.  
**MRS. SCARLE SMITH—Arkansas**



Orchids offer rich reward in beauty. There is financial reward for one interested commercially, as I am. Thanks a million for everything.  
**MR. S. V. SMART—Colorado**



I have standing orders for future flowers and divisions of this plant. I shall always be grateful to the Schirmers.  
**MRS. ROBERT E. LEE—Ohio**



"Growing Orchids a never ending delight. Most of my plants kept at my office where I relax after strenuous day of court reporting. This plant had 11 blooms for Mother's Day."

**RUBY B. HUGHES**  
—Oregon



**FUN FOR ALL THE FAMILY.** It's great fun to grow Orchids. And the whole family can help—from teen-agers up. Mr. Schirmer himself is over 60—was nearly 50 when he and Mrs. Schirmer first started to grow Orchids for profit.

**LEARN HOW ORCHIDS MULTIPLY.** Learn how one plant may become many, each as valuable as the first! Flower production and plant stock should both increase steadily—year after year—and so should your profits!

**FREE—REAL  
ORCHID SEEDS AND  
MONEY-MAKING  
PLAN!**

**AIRMAIL THIS COUPON NOW!**

TROPICAL FLOWERLAND, Dept. 311  
100 So. Vermont Ave., Los Angeles 4, Calif.  
Please rush me FREE Orchid seeds and FREE details of your offer of Louis and Gladys Schirmer's instructions which show me how to grow Orchids at home. The instructions will include a real blooming-size Orchid plant and valuable "quick-profit" plan all sent me to examine at home without obligation of any kind.

Name \_\_\_\_\_  
Street \_\_\_\_\_  
Town \_\_\_\_\_ Zone \_\_\_\_\_ State \_\_\_\_\_

This is the book that has started thousands on the road to success as home orchid growers.



not everyone does as well, but E. O. Lockin, who started a business of his own, reports...

for 12 months I've averaged  
**\$800 PER MONTH INCOME**—  
 most of it clear profit for me!

Many men have discovered how to be independent, to be free of bosses and layoffs. L. A. Eagles grossed more than \$200 his first week. Others report gross up to \$12,000 per year. How much you make depends largely on you. You need no special skill, no large investment.

**No shop necessary.** Our ELECTRIC RUG WASHER cleans rugs, carpets right on floor... helps to show their natural color, beauty. So efficient and safe, used by largest hotels and railroads.

You take no risk. Machines fully guaranteed. Write for full information including how to make big profits in YOUR OWN business.



**MAIL COUPON TODAY FOR FREE BOOK**

**VON SCHRADER MFG. CO., 110 "R" PL, Racine, Wis.**

Without obligation, send your **FREE** booklet containing information about your **ELECTRIC RUG WASHER** and how I can start my own permanent, profitable business.

Name \_\_\_\_\_  
 Address \_\_\_\_\_  
 City \_\_\_\_\_ Zone \_\_\_\_\_ State \_\_\_\_\_

**NOW** The Short Cut to Learning  
 You've Been Waiting for



Learn Anything  
**FASTER...more easily**  
 with the amazing  
**DORMIPHONE**

The Scientific Discovery That Works for You... Awake or Asleep

Now, at last, science shows you how to learn "by ear." With the Dormiphonic device, you start learning when awake... continue while asleep... save time, effort, learn more, faster. So simple a child can operate it — so easy and practical it is used by educators, psychologists, people of all ages and occupations all over the world.

**Break Down Barriers to Learning**

Find out HOW Dormiphonic works FOR YOU—how it can help you learn more in less time, without intensive self-application.

Write for **FREE** Book, "A New Dimension in Learning," or call for **FREE DEMONSTRATION**—Get the Scientific Evidence Today.

- Keep ahead in your work
- Memorize more quickly
- Make school subjects easier
- Help break bad habits
- Help induce sleep
- Learn a language
- Correct your speech

**MODERNOPHONE, INC.** Circle 7-0830

236-017 RADIO CITY, NEW YORK 20, N. Y.

Gentlemen: Please send me your **FREE** Booklet. I am interested in learning more about the **DORMIPHONE** and what it can do for me. No obligation—no salesman will call.

If under 18, check here for Special Booklet A

NAME \_\_\_\_\_

ADDRESS \_\_\_\_\_

CITY \_\_\_\_\_ ZONE \_\_\_\_\_ STATE \_\_\_\_\_

My main interest in Dormiphonics is for:

- Learning a Language  Speech Improvement  
 Memorization  Sleep Inducement  
 Habit Correction  School or College Work



**DON'T SWAP SAFETY FOR "DISCOUNTS"**

Cheaper PRICED Tires are Cheaper GRADE Tires

**FREE** This pictured Tire Ash Tray given with 2 or more tires

We try to ship your favorite brand (not recaps)

**GOODYEAR**

Goodrich, U. S. General, Firestone & others, worn slightly.

If you don't want the Free Tube take \$1 off each tire!

**12 MONTH GUARANTEE** I replace **FAST** any defective tire, **frt. excl.**

600-16	\$5.28	670-15	\$5.18	700-20	\$7.98	600-16(10)	\$4.68
640-15	5.18	710-15	5.38	750-20	8.88	650-16(10)	5.48
650-16	5.68	760-15	5.38	825-20	13.58	700-16(10)	6.08
700-16	5.78	800-15	5.68	900-20	14.58	700-15(10)	6.88
700-15	4.98	820-15	5.68	1000-20	16.28	750-16	6.58
W.W. S1 Extra		700-17	8.98	1100-20	16.28	750-17	11.98

**SUBURBANITE SNOW** & others. Mud-Grip. Retreaded & Slightly used. 12 Mo. Guarantee **\$6.06** any car

Military Mud Grip Guarantee 12 Months 800-16 \$13.39 750-20 17.39

Send Ck. or M.O. & Ad for fast shipment. F.O.B. Phila. I select your tires as if my future depended on it!

**MARVIN BLATT 6th & Spring Garden Philadelphia, Pa.** CO. ADJUSTED **\$7.95** WHITE Tires with NEW Tire service guaranteed any car \$1. Ext.

**make your own Gems 32.50 F.O.B.**

The Gem Maker comes complete with all necessary equipment, including a super-charged diamond blade for sawing, and all wheels for grinding, shaping and polishing; also complete instructions. The complete equipment as shown, less motor and belt, for only \$32.50. f.o.b., Burlington, Wisconsin. Write today for information and literature.

**B & I MANUFACTURING CO.**  
 Dept. P, Burlington, Wis.

**LEARN LOCKSMITHING**

Learn this fascinating, profitable trade from experts in your spare time at home! Age or physical handicap no disadvantage. Year around, steady income. Full or part time. Practical, illustrated lessons. You can make money even while learning! All materials and special tools supplied without extra charge.

**INSTITUTE OF LOCKSMITHING, Dept. P-86**  
 15 PARK AVENUE RUTHERFORD, N. J.  
 Lic. by N. J. State Board of Education  
 Approved for Veterans

send for **FREE BOOKLET**

**HELPFUL BOOKS**

Send post card asking for **FREE** catalog

Popular Mechanics Press, 200 E. Ontario, Dept. 601, Chicago 11

**Now! TEST YOUR OWN TV — RADIO TUBES!**

**EVEN THE PICTURE TUBE**

Checks fuses, appliances, etc. Easy, safe to use. Insert tube in socket. Pilot light instantly indicates if tube needs replacement. Rugged metal case (not plastic). AC or DC. One service call saved pays for tester. Only \$3.95 post. or C.O.D. plus charges. Deluxe Model \$4.95. Instructions. 3-yr. guarantee.

**GEIGER ENGINEERING CORP., Dept. G-1109, 6349 N. Western Ave., Chicago, Ill.**

**How to Build Your Own GARAGE**

Save as Much as 50% of Usual Construction Costs

Get Popular Mechanics' brand new book **How to Build Your Own Garage** by Wayne Leckey, Assistant Shop Notes Editor, and find out how you can build your own garage at savings of 50% of usual cost. Leckey tells in famous step-by-step instructions and shows in big, clear photos, drawings and diagrams how to perform every building operation from laying the concrete to installing the final trim. There are 25 designs. Brick, frame, and concrete block fully covered. Send \$3.50 for your copy. 7-day money back guarantee.

POPULAR MECHANICS PRESS, 200 E. Ontario, Chicago 11, Ill.

# BEST JOBS ARE FILLED BY ALLIED TRAINED MEN

Yes, you can train now for the best paying jobs, and become one of the Builders of Industry! Due to the great present day industrial expansion programs throughout our country, Industry has been clamoring for Allied-trained men to fill important jobs. Shortages of Draftsmen, Designers, Tool Engineers, Machinists, Tool and Die Makers are so wide spread that you can pick one of these highly paid key jobs and then look forward to a life of security and success. Get started now—take advantage of these opportunities to earn good money—to build for your security and success.

*Foundation of Industry is Built by the:*

**DRAFTSMAN  
MASTER MACHINIST  
TOOL-DIE MAKER  
TOOL-DIE DESIGNER  
TOOL ENGINEER  
MACHINE DESIGNER  
MECH. ENGINEER**

Allied is the outstanding school of its kind—the foremost school in its field. Allied is approved by Industry, Department of Registration and Education, Department of Public Instruction, State of Illinois, Department of Justice for Foreign Students, and the Veterans Administration. Accredited by Central Schools Association.

**Train at Home in Your Spare Time  
or at The Allied Institute in Chicago**



Free employment service and housing assistance all through your training period and after your graduation. Our industrial contacts cover the U.S.A.

**SEND FOR FREE BOOKS**

**ALLIED SCHOOL  
of Mechanical Trades  
1338-42 South Michigan Ave  
Chicago 5, Illinois**

Allied's training program permits you to study right at home in your spare time or at the Allied Institute's fully equipped shops and laboratories. You can begin your training in short courses and continue progressively to a Bachelor Degree in 26 months.

## ALLIED SCHOOL of MECHANICAL TRADES

*Allied Institute of Technology*  
1235-42 South Michigan Ave., Dept. PM-2, Chicago 5, Illinois

Gentlemen:

Mail me FREE BOOKS explaining ALLIED'S courses of instruction, and FREE SAMPLE lessons.

I am interested in resident training  home study

VETS write in date of discharge \_\_\_\_\_

Name \_\_\_\_\_ Age \_\_\_\_\_

Address \_\_\_\_\_

City \_\_\_\_\_ County \_\_\_\_\_ State \_\_\_\_\_

These 1000's of  
**NEW facts**  
**NEW ideas**  
**NEW figures**  
**NEW methods**

Step up your  
**MACHINE SHOP I.Q.**  
your key to  
stepped-up pay

**NEW**



New machines, methods, and materials—great metalworking advances—face every man in the field with urgent need for plenty of new know-how. That's why R. Le Grand, American Machinist magazine editor, took a long-famous handbook, completely revised it, brought it up to the minute as

**The NEW AMERICAN MACHINIST'S HANDBOOK**  
1579 pages • 774 illustrations • 45 sections covering

Covers feeds and speeds, tools, jigs, fixtures, materials, standards, tolerances, methods—thousands of details. Gives you quick, plain, dependable answers. See how it meets your needs. Just mail coupon.

**TRY IT FREE**  
10 DAYS Over 4 months to pay

**MACHINING • FORMING • ASSEMBLY • MATERIALS • FINISHING • INSPECTION • FASTENING • DRAFTING • TOOL ENGINEERING • STANDARDS • POWER TRANSMISSION • MATHEMATICS**

**McGRAW-HILL BOOK CO.** (Offer Good in U.S.A. Only)  
Dept. PM-1, 327 W. 41 St., N. Y. C. 36

Send me Le Grand's New American Machinist's Handbook for 10 days' FREE examination. In 10 days I will send \$3.00 plus few cents for delivery, then \$2.00 monthly until \$11.00 is paid, or return book postpaid.

(Print) Name \_\_\_\_\_  
Address \_\_\_\_\_  
City \_\_\_\_\_ Zone \_\_\_\_\_ State \_\_\_\_\_  
Employed by \_\_\_\_\_ PM-1

**AMAZING STAMP OFFER!**

**Free**

TO GET NAMES FOR OUR MAILING LIST

- 1 WORLD MAP**—authentic 3 ft. sq. Mercator projection map, used by air and sea navigators—yours FREE!
- 2 STAMP FINDER**—identifies stamps around the world—no matter how strange their script letters—yours FREE!
- 3 ENCYCLOPEDIA OF STAMP-ISSUING COUNTRIES**—Tells area, location, population, parent country, etc.—yours FREE!



**Also FREE: 30 MUCH-WANTED FOREIGN STAMPS**

NOW you can identify even the strangest stamps—at a glance—with this GIANT world map and stamp guide. Opens up to 3 SQUARE FEET to make a big handsome wall map you'll be proud to display in your room. THE PHILATELIC WORLD MAP & GUIDE is well-known among stamp fans all over the country. Complete and up-to-date. Locates the tiniest, most remote stamp-issuing countries in the world. While our supply lasts—we'll send it to you FREE. But that's not all! You also get—FREE—30 colorful foreign stamps—from exciting, far-off places like San Marino, Djibouti, etc. Included is Chinese anti-Communist stamp with face value of \$10,000 in Nationalist money! Also interesting stamp offers for your inspection. No obligation. But hurry. Offer may be withdrawn at any time. Send your name and address, with 10c to cover postage and handling, to **LITTLETON STAMP CO., Dept. PM-1, Littleton, New Hampshire.**

**Make Big Money At Home**

**BEFORE**  
**AFTER**

**INVISIBLE REWEAVING**

**PAYS UP TO \$10.00 IN AN HOUR!**  
Here's your chance for spare-time earnings at home! Be the INVISIBLE REWEAVER in your own community. Make cuts, burns, moth holes, tears in dresses, suits, all fabrics DISAPPEAR! Do it at home—in spare time. Demand from tailors, cleaners, dept. stores, laundries, individuals. Profits up to \$10 for 1 hour's work reported! Write for details.  
**FABRICON CO., 8342 S. Prairie Ave., Dept. 321. Chicago 19, Ill.**

**ELECTROPLATE IT YOURSELF!**

NOW using NEW plating kit, it's easy to electroplate any object with the same LUSTER and DURABILITY as done by the most expensive equip. Complete kit and instructions on plating metal and non-metal objects, with Nickel, Chrome, Copper, Gold, etc. ONLY \$5.95. SEND NO MONEY—everything sent C.O.D. plus postage. OR send \$5.95 now and receive it postpaid. Money back in 7 days if not satisfied.

**EASY INSTRUCTIONS**

**M. Z. SALES CO., Dept. G-11, 113 W. 42nd St., New York 36, N. Y.**

**FREE CRAFTPLANS CATALOG!**

1,668 Plans, Patterns; all kinds of things to make for Fun, Profit. CRAFTPLANS actual full-size patterns, enable you to make beautiful, useful projects EASIER, FASTER. Rush postcard with name and address, for FREE CATALOG.

**CRAFTPLANS 1321 S. Michigan Ave. Dept. A-271, Chicago 5**

**PLEASE SEND ME**



for the time checked.  
I am enclosing . . .

1 year \$3.50  
 2 years \$6.00

name \_\_\_\_\_  
address \_\_\_\_\_  
city \_\_\_\_\_ zone \_\_\_\_\_ state \_\_\_\_\_

Hand this order to your newsdealer or send it to  
**POPULAR MECHANICS**  
200 East Ontario St. Chicago 11, Ill.



The Catalog Featured on Cover of "Mad" Comics!

# Catalog of 3,100 Novelties, Gadgets, Jokes & Tricks

Send 10c for amazing catalog of novelties, joke articles, funmakers, tricks, gadgets, live animals, scientific supplies, hobbies, plants & boats, unusual seeds, time-savers, cameras, optical goods, projectors, movies, lucky jewelry, religious goods, disguises, masks, musical instruments, stamps, coins, puzzles, fortune tellers, radios, auto & bike accessories, telescopes, magnifiers, compasses, banks, smokers items, artist supplies, printing sets, engines, motors, abackers, knives, billfolds, guns, rifles, sports, books, games, plants, pennants, emblems, etc. Send name, address and 10c to:

**JOHNSON SMITH & CO.**  
Dept. 533 Detroit 7, Mich.

Here's 10c. Rush me New Catalog!

Johnson Smith & Co., Dept. 533, Detroit 7, Mich.

Name \_\_\_\_\_

Address \_\_\_\_\_

**New**  
**1957 Issue**



## 100X Area Projector

— Enlarges Pictures, Printing, & Objects! — Full Color!

**NEW!** Electric Magna-Vue Optical Instrument projects & enlarges clippings, pictures, sketches, objects in full natural color, correctly & readable. Project on wall, screen or table. **MAGNIFIES 200 AREAS.** Enlarges any material up to 3 1/2x4-in. to 32x40 in. For home, school, class, business, shop use. Also make signs, sketches easy from any copy. Enamelled steel, 10 1/2-in. high. Quality 3" focusing lens. Operates on standard 110 volt current. Money back guarantee. **Price Postpaid \$4.98**

JOHNSON SMITH CO., Dept. 533, Detroit 7, Mich.

## New! TINY POCKET SIZE RADIO

**\$2.98** Listen at work, play, in bed. Fits shirt pocket. No tubes. No batteries. No electric plug-ins. No expense. Plays day & night forever. New self-powered diode rectifier replaces tubes. No building. Use short aerial for local stations. Complete broadcast band. Red plastic case only 3 x 3 1/4 x 1 1/2 inches. Lifetime guarantee. **Radio (without phone) \$2.98.** Hearing Aid Phone (plugs in ear, flesh-colored, almost invisible) **\$1.98.** Regular phone **\$1.25.**

JOHNSON SMITH & COMPANY Dept. 533 Detroit 7, Mich.



## 256X AREA MAGNIFYING Telescope \$2.98

Magnifies 256 times area. 5-lens optical system, brass fittings, comfortable rubber moulded eyepiece, imitation black leather finish. 1 1/2-in. closed; 1 3/4-in. open; 1 1/4-in. diameter. **ONLY \$2.98**

## 12-Foot BULL WHIP

**HARD HITTING! LOUD CRACKING!** Experts knock ashes off cigarettes. Yank people off feet. Used by trainers, ranchmen. Loud cracker like shot-gun blast. 4-ply hand plaited all leather. With loop handle.

6-ft. \$1.98. 8-ft. \$2.69. 10-ft. \$3.29. 12-ft. \$5.45.

## POWERFUL ELECTRIC GENERATOR

Generates Up to 75 Volts. Use to generate electricity, to ring bells, light up lights, as a medical battery, deliver terrific electric shock as joke, many electrical experiments, classroom uses, etc. Cost over \$20 new. Used but excellent operating condition. Hand crank or gear wheel drive. Made by leading electrical companies. Each has 3 or 4 five-inch 1-lb. magnets (alone worth more than total cost), generating armature, wire leads, gear crank, ready for use. Originally used in crank phones. Complete unit weighs over 5 lbs. **Postpaid \$3.95.**

JOHNSON SMITH COMPANY, Dept. 533, Detroit 7, Mich.

## SELL JUST ONE KEEP/SAFE A DAY - EARN \$8,000 A YEAR!

95% of homes, farms, small businesses are prospects for KEEP/SAFE — the quality-built personal safe that undersells all others. Only safe sold direct. \$26 to \$40 profit per sale. Exclusive territory, chance to be district agent. Get details, giving address including county.

JOHN D. BRUSH & CO., INC., 575 West Ave., Rochester 11, N.Y.

## LEARN METALCRAFT and JEWELRY MAKING

Low Cost Home Training Now Available. Make money. Learn profitable skills and arts of decorative metal and jewelry crafts. Course is complete. Professionally prepared. Easy to master. Special tools and materials furnished.

Write for Free Booklet **INTERSTATE TRAINING SERVICE**  
DEPT. K-3 PORTLAND 13, OREGON

## BUILD, FLY HELICOPTER!

Simple plans and kits now ready for famous Bensen helicopter glider on wheels or floats, also self-propelled Gyro-Copter. Send \$1 for Three-View drawing and specs of Glider, \$2 for Copter data.

Send \$1 or \$2 TODAY!

**BENSEN AIRCRAFT CORP.**, Dept. PM-17  
P. O. Box 2725, Raleigh, N. C.

Name \_\_\_\_\_ Street \_\_\_\_\_  
City \_\_\_\_\_ State \_\_\_\_\_

## RUN A CAFE OR DINER

I can show you how to get into this marvelous business. Opportunities plentiful when you know how to proceed. Be independent! Learn every phase of the business from how to get started quickly on small investment to menu planning, food preparations, money-making methods, the 7 ways to finance your first place. 20 fact-filled lessons in course. Study at home. Free trial. Money-back guarantee. Write today for FREE booklet.

**SCHOOL OF RESTAURANT ARTS**, Box 11-D, Fremont, Ohio

Please send me, without obligation, my copy of "Cafe, Diner Business."  
Name \_\_\_\_\_  
Address \_\_\_\_\_

## Top Pay Jobs in TV-ELECTRONICS-RADIO

High pay, opportunity, prestige, security ... all yours, as a qualified Electronics Technician! Get your training NOW in the big, recognized shops, Labs, and TV-Radio Studios at National Schools in Los Angeles, foremost since 1905. Here you work with latest Electronics equipment — professionally installed — finest, most complete facilities offered by any school. Expert, friendly instructors. Personal attention. Graduate Employment Service. Help in finding home near school. Part time job while you learn. Mail coupon NOW, TODAY ... for full information.

**NATIONAL SCHOOLS**  
National Schools Dept. RXB-17  
4000 So. Figueroa Los Angeles 37, Calif.  
Send Free Electronics Opportunity Book Today

Name \_\_\_\_\_ Age \_\_\_\_\_  
Address \_\_\_\_\_  
City \_\_\_\_\_ State \_\_\_\_\_

## TRAIN AT HOME FOR BIG PAY IN HOME BUILDING AND CONSTRUCTION

Make big money in a better job or a business of your own! Each year over \$20 billions are spent on home remodeling alone.



**BE A CONTRACTOR**  
Five out of every 10 homes need repairs or modernizing. HBTI trains you at home in every phase of contracting. You learn complete home building and construction. Earn good money as a builder by sub-contracting all the work!

### EARN SPARE TIME CASH

Build dormers, porches, stairways, attics. Earn up to \$4 an hour, plus commission on materials. Seven out of every 10 home owners want work done—there's lots of opportunity in your own community. Mail coupon for two valuable free books.



### MAIL TODAY - 2 FREE BOOKS

**HOME BUILDERS TRAINING INSTITUTE, Dept. HB-130**  
1400 Greenleaf Ave., Chicago 26, Ill.

Send Success Book and Sample Lesson. Both FREE.

Name \_\_\_\_\_ Age \_\_\_\_\_

Address \_\_\_\_\_

City \_\_\_\_\_ Zone \_\_\_\_\_ State \_\_\_\_\_

### NEW MAGIC RADIO WALKIE TALKIE!

**YOUR OWN POCKET SIZE RADIO STATION!**

BROADCASTS TO ANY HOME OR CAR RADIO WITHOUT WIRES OR HOOKUPS! Wt. only 5 oz. Size, 1 1/2 x 2 1/2 x 4 1/2". Built-in telescoping antenna. Powerful Transistor-sensitive microphones, frequency setter, break-in switch! Runs for weeks on self-contained flashlight batteries. Durable plastic case. With this Radio Talkie you CAN TALK TO YOUR FRIENDS UP TO A BLOCK OR MORE AWAY! Talk up to 1 mile or more between two automobiles. INSTANT OPERATION! Just push button to talk! No license needed. Uses inductive field magnetic radiation. Useful and real fun in a million ways! GUARANTEED TO WORK. 1 YEAR SERVICE GUARANTEE.

SEND ONLY \$2.00. (cash, ck, mo) and pay postman \$0.50 COB postage or send \$1.38 for prepaid delivery. COMPLETE READY TO OPERATE with instructions and hundreds of ways and tricks for broadcasts thru any radio you desire. Price may go up soon, so get your NEW POWERFUL RADIO WALKIE TALKIE NOW. Available only from WESTERN RADIO, Dept. RPM-1, KEARNEY, NEBR.



## DEER HUNTERS! ENFIELD RIFLE SALE

We have made a special low cost purchase of surplus British Lee Enfield Army rifles. They are one of the world's most accurate rifles and ideal without any further expense for deer, bear and any North American or African big game. Adjustable sights. 10 shot, bolt action, barrel 25", wt. approx. 8 1/2 lbs. These guns have British ordnance and proofhouse marks. Thousands used by U.S. hunters. All bores are guaranteed in good condition. .303 softnose ammunition is made by Rem., Win., Western and Peters, always available everywhere. We remove cosmoline and re-oil lightly before shipping. Sling included. Bayonet, \$1.95 additional. We have softnose ammo, 20 rds. for \$2.95; military target ammo, 100 rds., \$7.50.

JUST  
**\$19.95**



**TO ORDER:** Send check, cash or money order. 1/2 deposit for C.O.D. Shipped express collect, Pasadena, Calif. Calif. resid. add 4% state tax. 10-day unconditional money back guarantee.

**THE ELLNER COMPANY**  
1206-B S. Maple Avenue, Los Angeles 15, Calif.

### YOU BUILD 'EM — WE SELL 'EM EARN UP TO \$50.00 A DAY AT HOME

Participate in our national sales and sub-contract plan—spare time—full time. You assemble special luggage and cases for photographers, musicians, salesmen, and all types of portables. We supply complete instructions—materials—tools—everything. No previous experience necessary. Free details. Abarsi Cascraft, Dept. AA, 807 W. Sunset Blvd., Los Angeles 12, Calif.

Also  
Eshelman  
TRACTORS,  
RIDING  
ROTARY  
MOWERS.  
ROTARY  
TILLERS  
at amazing  
savings.  
Write for Free  
Literature.

### ESHELMAN ADULT SPORT CAR



**COSTS ONLY 1/4th Usual Prices**

**TO BUY . . . . TO DRIVE**

Solve parking problems with this new extra small car. Ideal for City Delivery, Or runabout use. Completely equipped. Powerful. Guar. 1 yr. Only \$8 in. long. Write for Literature. Dept. 12, ESHELMAN, Balto. 2, Md.

### FREE BERRY'S NEW POULTRY BOOK



Gorgeously illustrated, describing DAY-OLD and 4-WEEK CHICKS, 50 varieties, sexed or unsexed, AMERICA'S FINEST; also Ducks, Geese, Guineas. ORIGINAL BERRY'S FARM, for over 50 years. Beautiful book and LOW PRICE LIST FREE, stamps appreciated.

BERRY'S POULTRY FARM, Box 29, Clarinda, Iowa

## RHEUMATISM

NEURITIS • SCIATICA • LUMBAGO

Why continue to suffer agonizing pains when usual remedies have failed. Learn how thousands have been successfully treated by an amazing new method which is fully explained in our New FREE Book. Don't wait. Write today. No obligation.

EXCELSIOR INSTITUTE, Dept. C9806, Excelsior Spgs., Mo.

## SAVE \$ ON U\$ GOV'T \$URPLUS\$

Our publication "Government Surplus Sales" lists hundreds of items for sale by the U. S. Government at tremendous savings, as low as 1c on a \$1.00.

These are samples of the savings that are being made:

LIFE BOAT . . . . \$12.00	GRINDER . . . . \$4.69	SHAPER . . . . \$15.00	DUMP TRUCK . . . . \$76.77
TRACTOR . . . . \$75.00	TYPEWRITER . . . . \$7.51	FREEZER . . . . \$50.00	SPRAY PAINTER . . . . \$15.25
	MOTOR . . . . \$4.00		

Hundreds others listed in our bulletin "Government Surplus Sales" and may be purchased direct from U. S. Government, Hunting, Fishing, Camping, Sporting Equipment, Photographic Equipment and Supplies, Radio and Electronic Equipment, Amphibious Trucks, Jeeps, Boats, Motors, Binoculars, Plumbing, Electrical Equip., Cars, Power Tools, Machinery, Chemicals, Furniture, Office Equipment, Supplies, Scrap, Etc.

How may you receive our bulletin "Government Surplus Sales?" By sending \$1.00 to

**GOVERNMENT SURPLUS SALES, P. O. Box 169, Department 8-5, East Hartford 8, Conn.**



# "HOME SWEET HOME" vs. FACTORY BLUES

**I'm beat Jim!**

RUSHING FOR THE BUS - FIGHTING CROWDS - BOSS IS UPSET - NOISY MACHINERY CLANGING ALL DAY - I'VE REALLY HAD IT. BUT YOU LOOK FRESH AS ALL GET-OUT, AFTER WORKING AT HOME ALL DAY, TOO. HOW DO YOU DO IT? WHAT'S THE SECRET?

AFTER THE FACTORY CLOSER, BOB MEETS HIS FRIEND JIM...



LATER AT JIM'S HOME...

I HAVE THE KIKTAVI BABY SHOE METALIZING PLAN TO THANK FOR MAKING MY WORK PROFITABLE AND EASY. I WORK MY OWN HOURS AT HOME.

BABY SHOE METALIZING WHAT'S THAT JIM?



AS A BABY SHOE METALIZER, I PRESERVE BABY'S FIRST SHOES IN REAL BRONZE, GOLD, SILVER, OR PEARL FOR MOTHERS IN MY NEIGHBORHOOD. THEY'RE HAPPY TO PAY ME WELL BECAUSE I MAKE THEM EVERLASTING KEEPSAKES OF BABY'S FIRST STEPS.

IS THERE ENOUGH WORK TO KEEP YOU BUSY?



PLENTY! MORE THAN 3 MILLION BABIES ARE BORN A YEAR AND METALIZING BABY SHOES IS REAL EASY. EVEN MY WIFE AND SON CAN DO IT IF I'M RUSHED. IT'S EASY TO TURN OUT ENOUGH TO MAKE \$5 OR MORE PER HOUR.

IS IT HARD TO LEARN AND HOW MUCH MONEY DO YOU NEED?



**MAN NO!** KIKTAVI'S INSTRUCTIONS ARE REAL EASY TO UNDERSTAND. BEST OF ALL YOU START WITHOUT OVERHEAD OR BIG INVESTMENT IN STOCK. WHY NOT MAIL THE COUPON RIGHT NOW - GET FULL DETAILS FREE!!!



## NEW BIG PROFIT FIELD NOW OPEN TO YOU

Metalize Baby Shoes and other precious keepsakes with Genuine BRONZE, SILVER, GOLD. And the popular PEARL finishes, too. Even such objects as the leaves of trees, shells, and hundreds of other items become valuable objects of beauty when plated with jewel-like metal.

**WANT BIG MONEY?** Want to add to your weekly paychecks? If you want to add to the family income in your spare time, then you owe it to yourself and family to get the FREE FACTS about this exciting, profitable business. WANT TO BE YOUR OWN BOSS? Tired of working for others? Then THIS is what you've been looking for. An opportunity to be independent and build a secure future without risking your present job. Have 2 paychecks instead of one in as short a time as a week.

## MILLIONS OF NEW PROSPECTS YEARLY!

Yes, the market is HUGE and GROWING BIGGER. More than 3 million Babies born in a year. A steady year 'round income-no seasonal slumps. This is ideal for a man and wife who want to work together right at home for extra income or a profitable full time business. Learn quickly in a matter of days and without previous experience of any kind.

KIKTAVI CO. Dept. PM-571, 11029 So. Vermont Ave., Los Angeles 44, Calif.



## AIRMAIL COUPON TODAY

A few cents may bring back many dollars to YOU. Delay may be costly. Mail coupon now for FREE book and full details. NO RISK OF OBLIGATION ON YOUR PART.

## SEND FOR FREE BOOK NOW!

Kiktavi Company, Dept. 338-571  
11029 So. Vermont Ave., Los Angeles 44, Calif.

Okay! Send me FREE FACTS on how to make BIG MONEY at Home by metalizing Baby Shoes. Remember, it's FREE and postpaid.

NAME \_\_\_\_\_  
ADDRESS \_\_\_\_\_  
CITY \_\_\_\_\_ ZONE \_\_\_\_\_ STATE \_\_\_\_\_

## FIX OUTBOARD MOTORS

## POWERMOWERS, AND ALL SMALL 2 & 4-CYCLE GASOLINE ENGINES

Repair your own equipment or MAKE EXTRA MONEY in this growing field. Fully illustrated, easy-to-understand, Home Study Course. Write for FREE information.

**LINCOLN TECHNICAL INSTITUTE**  
SUITE 1-E, 472 MARKET STREET, NEWARK 5, N. J.

you can be  
**TALLER**  
too, in

THE ORIGINAL AND GENUINE  
**ELEVATORS**  
HEIGHT-INCREASING SHOES  
"YOUR PERSONAL PEDISTAL"

FREE BOOKLET  
WRITE

"ELEVATORS" do so many wonderful things for you. You slip on a pair and grow almost 2 inches taller at once. It's amazing . . . because they look and feel just like any other fine quality shoes you've ever worn. 31 styles for street, sport, dress



STONE-TARLOW CO., INC., DEPT. PM157, BROCKTON 68, MASS.

## ENGINEERING DEGREE IN 27 MONTHS

### B. S. DEGREE IN

Aeronautical, Chemical, Civil, Electrical, Mechanical and Electronic Engineering (inc. Radio and TV)  
Big Demand for Graduates

Hundreds of young men are earning B. S. ENGINEERING DEGREES annually in this recognized institution - year around classes optional. Also B.S. in 36 mo. in Mathematics, Chemistry, Physics. New terms start quarterly. Many students earn a major part of their college expenses in this large industrial center. Low tuition. Competent instruction.

Thorough, intense practical program. Modern, well-equipped laboratories including new physics laboratory and modern wind tunnel. Individualized instruction emphasized. Government approved for G.I.'s. Engineering Science preparatory courses. Students from 48 states and 21 foreign countries. Enter March, June, September and December. Send coupon for free catalog and full information. Enroll now.

## INDIANA TECHNICAL COLLEGE

517 E. Washington Boulevard, Fort Wayne 2, Indiana

Please send me free information on 27 MO. B.S. DEGREES in:

Aeronautical  Chemical  Civil  Electrical

on 36 MONTH B.S. DEGREES in:

Mathematics  Chemistry  Physics

Name \_\_\_\_\_

Address \_\_\_\_\_

YOUR NEIGHBORHOOD NEEDS AN ELECTRICAL APPLIANCE



# TROUBLE SHOOTER

Men needed to repair and service all kinds of Electrical Appliances—AUTOMATIC WASHERS - DRYERS - IRONS - VACUUMS - TOASTERS - REFRIGERATORS - FANS - HOME FREEZERS - AIR CONDITIONERS—home and industrial motors, etc.—also home and industrial wiring.

**Big, Year-'Round Profits!**  
HELP US FILL HUGE DEMAND

MODERN BIG PROFIT ONE-MAN BUSINESS TOURS AT HOME—SPARE OR FULL TIME.

No previous experience needed. New, visual "Shop-Practice" method quickly shows you how. Hundreds of plain-as-day "How to" photos and drawings make it easy. A corner of garage, porch, attic, or basement in all the space needed. No costly losses—no big overhead. We show you how to make business come to you.

**BIG MONEY, SECURE FUTURE—INDEPENDENCE.**

P. V. in N. Y. says, "I made \$500 in 3 months while studying." T. E. H. in W. Va. says, "Made \$11 a day while learning."

**EVERYTHING FURNISHED—Including BIG TOOL KIT** Instructions are complete and include a Tool Kit and Appliance Tester. Everything furnished to help you build your own big-profit business at home. Our new 30-day income plan shows you how to start making money almost at once. Send no money—just your name and address on coupon below. I will rush you FREE complete success plan with full details. Do it NOW—BE FIRST!

**PACIFIC TRAINING SCHOOL, Dept. P-571**

11029 So. Vermont Ave., Los Angeles 44, Calif.

**PACIFIC TRAINING SCHOOL, Dept. P-571**

11029 So. Vermont Ave., Los Angeles 44, Calif.

Gentlemen: Rush me postpaid your FREE plan for success in the Appliance Repair Business and the Free Book Entitled "The Appliance Repair Business and You" and remember I am under no obligation.

Name \_\_\_\_\_

Address \_\_\_\_\_

City \_\_\_\_\_ Zone \_\_\_\_\_ State \_\_\_\_\_

## NEW BENJAMIN SUPER CO<sub>2</sub> GAS CARBINE—\$15.95\*

HI-LO (2 Stages) Jet Power  
Cal. .177 or .22

RIFLED  
Shoots  
Pellets  
& Darts



Illustrated—Deluxe  
Model Benjamin Super 03  
Carbine Gas Rifle with Carbine Stock—\$18.95

IDEAL FOR TARGET AND SMALL  
GAME SAFE—ECONOMICAL—ACCURATE

CONVENIENT—PRACTICAL—NON TOXIC. EASY TO

OPERATE—NO PUMPING—NO FLINCHING.

Get 40 SHOTS from each 10¢ STANDARD

SIZE CO<sub>2</sub> (Soda) CARTRIDGE. Up to 3" Penetration. Ask your Dealer for Demonstration.

\*Size as Model Pictured above except with Regular Stock.

BENJAMIN AIR RIFLE CO. 896 MARION ST., ST. LOUIS 4, MO., U.S.A.

## TALK - LISTEN - AROUND THE WORLD!



### 2 WAY RADIO SET

SENDS AND RECEIVES THOUSANDS OF MILES on Amateur 80 and 40 meter bands—also, Aircraft and overseas broadcasts (3 to 8 mi). PORTABLE SELF-CONTAINED BATTERY POWERED! NO AC PLUG-INS. NO DANGEROUS HI-VOLTAGES. Low cost battery lasts for MONTHS. Crystal controlled transmitter—Power input up to 5 watts—ENOUGH TO TALK 1 MILE OR 1000. REGENERATIVE RECEIVER pulls in weakest stations. Front Panel Send-receive switch—PROVEN—SIMPLIFIED—PRACTICAL—SAFE for radio beginners. Easy to get license. Full information included.

SEND ONLY \$5.00 (bill, check, m.o.) and pay postman \$0.95 C.O.D. postage on arrival or send \$14.95 and we will send postpaid. Complete kit includes all parts, tube, coils, cabinet, full instructions, less batteries and crystal—or COMPLETELY WIRED AND TESTED FOR \$19.95! Compare! A real \$49.95 value. Available only from

WESTERN RADIO DEPT. BNM-1 KEARNEY, NEBRASKA

# Now You Can Upholster Any Piece of Furniture!

## Upholster—Restyle Any Piece of Furniture Yourself

John Bergen, custom furniture designer, tells and shows you how to transform old out-of-date furniture into brand new smart-looking comfortable furniture in his new book **ALL ABOUT UPHOLSTERING**.

### No Experience Needed

Bergen tells you every step to follow in amazingly clear easy-to-understand step-by-step instructions and then shows you how in hundreds of big, clear drawings and photos. You read and see how to strip the old frame. Install new webbing and springs, apply burlap, install stuffing and padding, fit the muslin cover and the final fabric and install trim.

### Use New Materials—Methods

Now you can have furniture upholstered with foam rubber, saless springs and other new materials that add so much to comfort and durability and are so costly when included in new furniture.

### Save 50% of Usual Cost

Don't pay a small fortune for new furniture when you can make your old furniture better than new! Why pay high prices to have someone else upholster and restyle your old furniture when you can do it yourself for cost of materials alone? It's easy and it's fun.

### Special Chapter on Slipcovers

Learn how to make custom-made slipcovers with professional look and fit. Find out how you can realize tremendous savings by investing a few spare-time hours and the cost of a few yards of fabrics.

### 7-Day Money Back Guarantee

Send for your copy of **ALL ABOUT UPHOLSTERING** today. Read and use it for 7 days. If it isn't entirely satisfactory return it for a full refund.

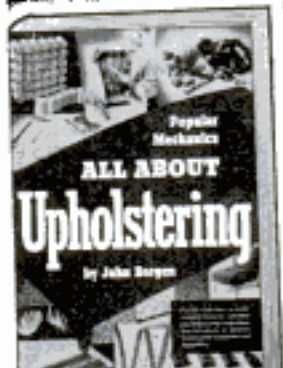

## USE THIS HANDY ORDER COUPON

POPULAR MECHANICS PRESS, Dept. 157  
200 E. Ontario St., Chicago 11, Illinois

Gentlemen:

Please send my copy of **ALL ABOUT UPHOLSTERING**. Enclosed is my remittance of \$3.50. If I am not completely satisfied with the book I will return it for a full refund after 7 days.

Name \_\_\_\_\_

Address \_\_\_\_\_

City \_\_\_\_\_ Zone \_\_\_\_\_ State \_\_\_\_\_

# DISTRIBUTORS WANTED . . .

**NATIONAL MANUFACTURER OF NEW  
INFRA-RED SANDWICH MACHINE  
HAS OPENINGS IN ONE OF THE MOST  
FABULOUS NEW BUSINESSES OF THE DAY!**

If you have a sales force of at least several men—or can hire and train a force quickly then we invite you to write us at once. We manufacture a new kind of Infra-Red Sandwich Machine which makes it possible for taverns, clubs, service stations, drug stores, bowling alleys, etc., to cash in on the sales of hot toasted sandwiches without the expense of kitchens, food preparation, etc. You sell to Route Operators who will install machines and service them regularly full or spare time. Profit opportunity is fabulous. Already paying "jack-pot" profits in other territories. We want a man capable of taking over the territory as Distributor. Sample investment of only \$59.50 means we want the right man—not his money. Write fully about yourself and your background for complete details and possible personal interview.

**FLOYD NEWKIRK • W & K MFG. CO.**  
Dept. 571, 2319 Hampton Avenue, St. Louis 10, Missouri



## Become an **Electrical Engineer at MSOE** in Milwaukee

**Electronics Communications  
Electrical Power  
Industrial Electronics**

Join the Engineering team! Over 50% of the nation's industrial leaders began their careers with engineering training. Jobs are waiting for well-trained men.

Milwaukee School of Engineering's educational program of technical institute and collegiate engineering courses offers you step-by-step advancement. Save a valuable year through MSOE's optional year-round study system. Prepare yourself for the opportunities ahead in one of these MSOE courses:

**Engineering**  
(Bachelor of Science degree in Electrical Engineering)

**Engineering Technician**  
(Associate in Applied Science degree)  
MSOE also offers courses in mechanical engineering and technology.

MSOE's complete, modern facilities include specialized technical laboratories and equipment, visual aid theater, and amateur radio station. Courses approved for veteran training. 50,000 former students. Excellent placement record for graduates.

**4 TERM OPENINGS YEARLY**  
OCTOBER, JANUARY, APRIL, JULY

Clip and Mail Today!



## MILWAUKEE School of Engineering

Dept. PM-157, 1025 N. Milwaukee St.  
Milwaukee 1, Wisconsin

I am interested in: (Please print)  
 Electrical Engineering course  
 Engineering Technician course  
 Mechanical Engineering

Name.....Age.....

Address.....

City and State.....

If veteran, date of discharge.....

JANUARY 1957

65

Copyrighted material

### TASOPE PHOTO-ENGRAVING PLANTS



Material Cost  
Of This Cut 3c  
Selling Price  
\$1.00 And Up

Establish your own profitable PHOTO-ENGRAVING business. Make cuts for newspapers, printers, and advertisers. Make etched name plates, plaques etc. Instructions furnished, no experience necessary. Sold direct from factory since 1931. First five hundred cuts sold locally or by mail will pay for plant and pay you well for your time. Write for FREE catalog.

TASOPE, DEPT. PM-1, AURORA, MO.



#### HEATING ELEMENT

1320 W. insulated and mounted 110 V. 10"x9 1/2"—make your own heater for Bath or Poultry House.

\$10 Value \$1.50 PPD.



#### 2 SHAPER CUTTERS

\$1.50 PPD.

For planing and shaping, 1" face; 1/8" radius; 1/8" arbor. Total Value \$5.00. Ideal for lathes, etc.

### PENNA. WHOLESALE DISTRIBUTORS

104 N. 6th ST., PHILA., PA.

### SENSATIONAL TIRE SAVINGS!

FINE QUALITY USED TIRES! NOT RECAPS!  
GOODYEAR, FIRESTONE, ETC.

WRITTEN 12 MO. GUARANTEE BOND

FREE TUBE  
with ea. pass. tire!

600-16	\$5.24	750-1-618	\$10.60
670-15	5.44	750-20	12.05
710-15	5.64	825-20	19.05
780-15	5.84	900-20	18.55
800-15	5.94	1000-20	19.50

FREE PRICE LIST OF ALL "OTHER TIRE SIZES!"  
(SHIPMENTS RUSHED! Send chk. or M.O. Prices FOB, Phila.)

BELMONT, 1001-PM Spring Garden, Phila. 23, Pa.



### FREE AMAZING NEW BOOK "HOW TO ANSWER ADS"

how to  
answer  
ads

Never before have you seen anything like this. Tells you in simple language the correct way to answer ads. Gets you quicker replies—better results, and greater satisfaction. Will save you time and money and it's ABSOLUTELY FREE. No obligation whatever. Every reader of advertising should have this booklet. Send a postcard for your copy NOW. F. W. Johnson, Popular Mechanics Magazine, Room 600-A, 204 East Ontario Street, Chicago 11, Illinois.

# YOU, TOO, CAN BE A WIZARD at FIGURES

**MAIL COUPON for New Book that Makes Mathematics EASY READ 5 DAYS FREE!**

Had trouble with MATHEMATICS, like so many other people? You probably were taught incorrectly. Try this new step-by-step method, with easy-to-understand examples right in your own home in spare time. Makes learning MATH a snap. It's all due to proper presentation, and you'll now find it not only easier, but actually fascinating. To get ahead on any job, you need to know your mathematics. It's a social asset, too. Why not try this method and see?

**SEND NO MONEY.** Just mail the coupon, and we'll send you "Practical Mathematics" for 5 days FREE EXAMINATION. Pay nothing now. Pay nothing to postman. Just mail coupon.

**AMERICAN TECHNICAL SOCIETY, Dept. AE-1**  
848 E. 58th St., Chicago 37, Ill.

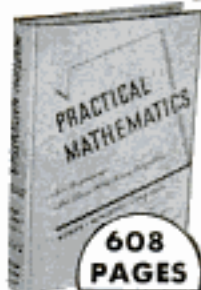

Only **\$3.95**  
**COMPLETE**

**Contents include:** Basic arithmetic simplified. How to solve problems with fractions quickly. Short cuts to figuring weights and measures. Methods for figuring areas and volume. How to use Logarithms and figure square root.

**AMERICAN TECHNICAL SOCIETY, Dept. AE-1**  
848 E. 58th St., Chicago 37, Ill. **JUST MAIL THIS**

Please send me "Practical Mathematics" for 5 days FREE EXAMINATION. If I decide to keep the Book, I will send you \$3.95 within 5 days, plus shipping costs. Otherwise I will return it and owe you nothing.

NAME.....  
ADDRESS.....  
CITY..... ZONE..... STATE.....

If you prefer to enclose \$3.95 with coupon, check here, and we pay all shipping costs. Money refunded if not delighted.

## MANUFACTURE THIS BEAUTIFUL CONCRETE OUTDOOR FIREPLACE

Right In Your Own Backyard

**\$4.00 Worth of Sand & Cement produces this Attractive Fireplace.**

**Sells on Sight from \$60. to \$80. Easy to start your own profitable Business.**

The General Fireplace Molds and Process are the most amazing and foolproof ever invented. Simple to operate. Two men can produce five fireplaces a day.



### BIG DEMAND!!

Sell all you produce to Department Stores, Homeowners, Parks, Nurseries and Picnic Groves. Fireplaces sell on sight. No experience necessary. We supply full operating instructions and equipment plus the know-how that spells BIG PROFITS. This is an outstanding opportunity for men of vision and small capital to get into a busy rich paying field. Don't delay, be the only exclusive manufacturer in your own home town. Mail coupon at once for full details as to how you can reserve your territory. Molds sold only on exclusive franchise.

**GENERAL ENGINES CO., Inc., Dept. MF-17**  
ROUTE 130, THOROFARE, N. J.

Mr. Tor of Philadelphia writes: Sold 250 in first 4 months. Selling to Sears Roebuck, John Wanamaker, and Gimbel Bros. in Philadelphia area.

Name.....  
Address.....  
City..... Zone.....  
State.....

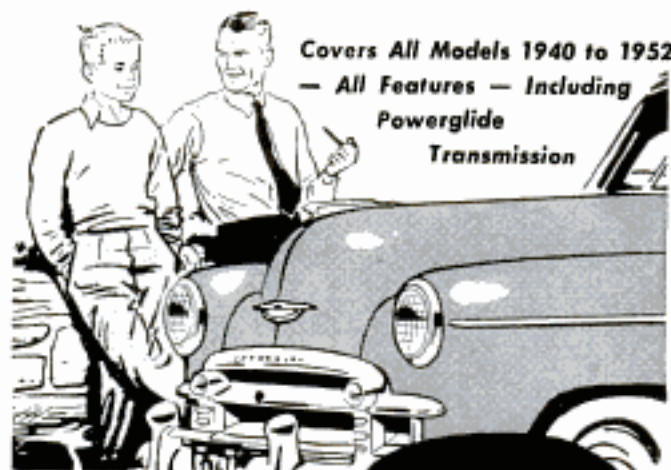

Covers All Models 1940 to 1952  
— All Features — Including  
Powerglide  
Transmission

## Get Popular Mechanics Owner's Manual

If you drive a Chevrolet—any model—1940 to 1952—get this owner's manual today. It will save you money on repairs and service; give you safe, economical and trouble-free motoring and protect your investment in your Chevrolet by keeping it constantly at top value. Can easily be worth hundreds of dollars to you in a single year.

Learn All About Chevrolet's Powerglide Automatic Transmission

Know Your Chevrolet Valve-in-Head Engine and How It Operates

Understand Chevrolet's Center Point Steering and Unitized Knee-Action.

Protect Your Investment. Know Your Chevrolet.



**Chevrolet Owners**  
Spend Less to Own and Drive Your Car

### Official, Authoritative Bumper to Bumper Information

Prepared by a noted automotive authority and Popular Mechanics editors with the full cooperation of Chevrolet engineers and service specialists. Covers all phases of Chevrolet operation, service and maintenance. 304 pages of practical information and hundreds of photos, diagrams, charts, and sectional views, make every part, every operation, easy to understand. Complete index enables you to put your finger on the information you want instantly.

### Prevents Costly Repairs

Explains everything about your car: what can go wrong; how proper adjustment and servicing should be done; how to prevent major troubles and costly repairs later on. Even if you don't service your car at home the manual will save you important money on every day operation.

### Mail Coupon Today

Mail coupon now. Send only \$3.50 for prepaid delivery or you can pay postman, plus charges. See money back guarantee in coupon.

**POPULAR MECHANICS PRESS, Dept. 157**  
200 East Ontario St., Chicago

Send Manual for Chevrolet Owners at once. If not satisfactory I will return it within 5 days and you will refund full purchase price.

Remittance for \$3.50 enclosed.  Send C.O.D.

Name.....

Address.....

City..... State.....

# "SEA CRAFT"



Build this luxurious cabin cruiser yourself and save money. What a beauty it is! A 25-foot boat readily adaptable as a sport fisher, express cruiser, or utility boat. Cruises effortlessly at 15 knots with a marine engine or converted auto motor. Its spacious cabin sleeps four and has a galley complete with fresh-water tank, sink, and cook stove. Has open cockpit large enough for fishing, lounging, etc. During war the Coast Guard used "Sea Craft" for ship-to-shore travel. Order today your complete set of seven large-size blueprints scaled 1 inch to the foot. These, plus a 40-page two-color illustrated booklet giving step-by-step instructions, only \$10.00.

**POPULAR MECHANICS PRESS**

200 EAST ONTARIO ST., Dept. 1156, CHICAGO 11, ILL.

## Free! SOUTH of the BORDER



Start TODAY to enjoy an exciting new hobby! Rush Coupon for big, valuable collection of genuine, all-different postage stamps from the exciting land of the mysterious Amazon . . . scarce airmails, gorgeous commemoratives, giant-sized stamps picturing wild horses, covered wagons, action-packed fights, native war heroes; PLUS sensational train stamp, beautiful "Christ of the Andes"; many others. EXTRA! Bargain Catalog, "Collector's Manual" plus other exciting offers for your inspection. Enclose 10¢ for mailing expenses. . . ACT NOW!

JAMESTOWN STAMP CO. Dept. N1PM JAMESTOWN, N. Y.



RUSH my Free Airmail Collection and other offers. I enclose 10¢ for mailing costs.

Name.....

Street.....

City.....State.....

# DIESEL MECHANICS IN DEMAND

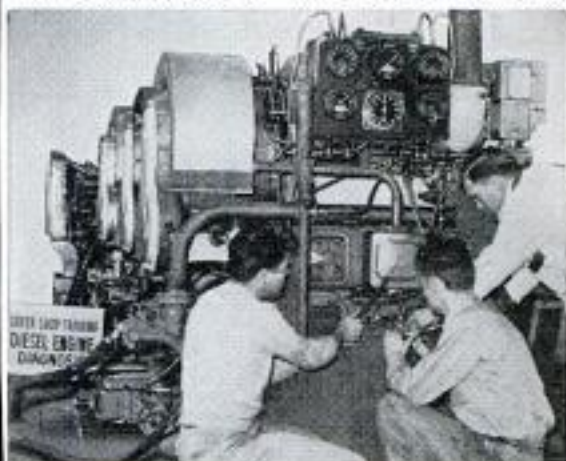

Learn to earn big pay in DIESEL in our large, modern equipped Chicago school and shop. No previous experience or training necessary. We help you find living quarters and part time job while in school. Complete, practical courses taught in the following trades, under the supervision of experienced, expert technicians.

APPROVED FOR CIVILIANS  OR GI'S

## — CHOOSE YOUR TRADE —

CHECK HERE	WEEKS
<input type="checkbox"/> DIESEL MECHANICS	20
<input type="checkbox"/> AUTO MECHANICS	20
<input type="checkbox"/> BODY & FENDER	16 2/3
<input type="checkbox"/> GAS-ARC WELDING	4 - 12
<input type="checkbox"/> REFRIGERATION	13 1/2
<input type="checkbox"/> AIR CONDITIONING	8 1/3
<input type="checkbox"/> MACHINIST TRADE	30
<input type="checkbox"/> ADVANCED MACHINIST (includes tool & die)	32 1/2
<input type="checkbox"/> PIANO TUNING & REPAIR	36

Heavy Construction Equipment Operators Training School Road Building, Terracing, Land Clearing, etc. Reservation for starting classes now being accepted.

## CHOOSE YOUR ENGINEERING COURSE

These courses are intended as terminal education for men who wish to enter the Diesel-Automotive and Refrigeration-Air Conditioning fields as technicians. These courses are designed to prepare men for supervisory positions. Students with a high school education, or equivalent, will be accepted.

<input type="checkbox"/> DIESEL AUTOMOTIVE ENGINEERING.....	2 years
<input type="checkbox"/> REFRIGERATION & AIR COND. ENGINEERING.....	18 months

## FREE EMPLOYMENT HELP

Start your career with Greer by checking your interest above and mail coupon for complete information at no obligation.

NAME.....AGE.....

STREET.....

TOWN.....ZONE.....STATE.....

Established 1902 — Over 50,000 Graduates.  
55 years of continuous trade school experience to guide your training.

**GREER SHOP TRAINING**  
Box A, 2236 S. Michigan Ave.  
Chicago 16, Illinois

# IMPORT PAYS BIG!

B. L. MELLINGER  
Exporter-Importer

**NEW WORLD TRADE BOOM OFFERS BIG PROFIT OPPORTUNITY** to ambitious Men and Women everywhere. I'll show you how you may import Thousands of desirable products at low foreign prices for buyers in your locality at high U.S. Prices—how you can operate a world-wide mail-order Import-Export business from home whether you live in a big city, or small town.

*B. L. Mellinger*

## HERE'S PROOF!

As startling first-hand proof I will send you an actual import from overseas, **AT MY COST**—something to see and use. Just mail me 25¢ in coin and I will rush you this Imported Melson Automatic cigarette lighter—made to retail in the U.S. at \$2. This magnificent Import will convince you of the tremendous profits being made in World Trade.

**START AT ONCE WITHOUT CAPITAL** or previous experience. Fantastic profits are possible. My training also includes shipment to you of many sample imports from 'round the world.

**GRASP THIS OPPORTUNITY TODAY!** Send for your Melson Automatic cigarette lighter now and I will include full details that show you how to learn my Big Profit secrets of Import-Export—complete instructions that will put you on the road to a Profitable business of your own. Opportunity to travel abroad for profit and pleasure. I'll also show you how you can save many dollars on your own purchases of Clothes, Tools, Gems, Antiques, Watches, Cameras, China, Silks, Toys, etc. You can have the complete details FREE without ordering the lighter if you wish, but I would like to send you the Melson lighter as an actual demonstration of Import Values. Either way, mail coupon Now. Airmail reaches me overnight.

The Mellinger Co., Dept. G251, 1717 Westwood, Los Angeles, 24, Calif.

HERE'S MORE PROOF!

"We operate a profitable World Trade Business from our home... Thanks to MELLINGER."

Don and Muriel  
Bowman, Calif.

MAIL  
COUPON NOW!

The Mellinger Co., Dept. G251  
1717 Westwood, Los Angeles 24, Calif.

Mr. Mellinger:  Show me the big profits to be made through World Trade. I enclose 25¢ in coin. Send me one Melson Cigarette Lighter and your plan that shows me how to learn the secrets of World Trade. (No lighter without a coupon. Only one to a person.)  
 Just send your FREE World Trade Plan.

Name \_\_\_\_\_ Age \_\_\_\_\_  
Street \_\_\_\_\_  
Town \_\_\_\_\_ Zone \_\_\_\_\_ State \_\_\_\_\_

# Even if You CAN'T DRAW

Anyone Can Draw With This Amazing New Invention—Instantly The "Magic Art Reproducer"

## A STRAIGHT LINE

# DRAW

## the FIRST DAY!

### NO LESSONS! NO TALENT!

### Also Excellent for Every Other Type of Drawing!



\$1.98

Complete for only

• Human Figures • Outdoor Scenes, landscapes, buildings • Still life, vases, bowls of fruit, lamps, furniture, all objects • Copy photos, other pictures, portraits, etc. • Copy blueprints, designs, decorations, etc., for woodwork, machine, for needlework, crocheting, knitting • Copy all cartoons.

Yes, anyone from 5 to 80 can draw or sketch or paint anything now—the very first time you use the "Magic Art Reproducer" like a professional artist—no matter how "hopeless" you think you are! Anything you want to draw is automatically seen on any sheet of paper instantly! Then easily and quickly follow the lines of the "picture image" with your pencil... and you have an accurate original drawing that anyone would think an artist had done! Also makes drawing larger or smaller as you wish. Anyone can use it on any desk, table, board, etc.—indoors or outdoors! No other lessons or practice or talent needed!

Have fun! Be popular! Everyone will ask you to draw them. You'll be in demand! After a short time, you may find you can draw well without the "Magic Art Reproducer" because you have developed a "knack" and feeling artists have—which may lead to a good paying art career.

FREE with order



A.B.C. Guidance of Figure Drawing  
This valuable illustrated guide contains simple guidance on drawing human figures. Includes techniques, shading, proportions, etc., to use with your "Magic Art Reproducer" for added touches to your drawings.

SEND NO MONEY!

Free 10-Day Trial!

Just send name and address. Pay postman on delivery \$1.98 plus postage. Or send only \$1.98 with order and we pay postage. 10 Day Trial must satisfy or money will be refunded.

NORTON PRODUCTS, Dept. 115, 296 Broadway, N. Y. C.

## YOU CAN BUILD A VIOLIN FOR PLEASURE OR PROFIT

Now you can build a rich toned mellow violin modeled after a famous "Strad." YOU CAN MAKE A STRADIVARIUS VIOLIN contains 8 full scale plans plus complete instructions. You work directly from the plans with no confusing scale of dimensions to translate. Detailed instructions for each step including varnishing and stringing—even shows how to build your own tools. Cloth bound. Order today from

POPULAR MECHANICS PRESS \$3.50  
Dept. 1256, 200 East Ontario Street, Chicago 11, Illinois

## SURPLUS SALE

\$39.50 NEW TOOL POST GRINDERS  
REGULAR PRICE \$125.00

Less Grinding Wheel TAKES WHEELS UP TO 1 1/2"x4" EXTRA QUILL INTERNAL OR \$19.50

MONEY BACK GUARANTEE  
EDWARD J. NOLAN, PULASKI, NEW YORK

## DRAFTING is the way to Big Income OPPORTUNITIES!

Learn at home in your spare time. Become a professional Draftsman. Enjoy good pay, respected position in an ever growing field. CHRISTY TRAINING is easy and clear. You learn by making actual drawings, planning production, see things develop. You learn the interesting, easy-to-remember way by doing.

### PAY AS YOU LEARN PLAN

CTS will send you 50 illustrated drafting manuals, set of professional drafting instruments, equipment and supplies plus a portable drafting table... everything you need! Send name for FREE BOOK and PAY LATER FORM. CHRISTY TRADES SCHOOL, 4804 N. Kedzie, Dept. DB-3103, Chicago 25.



# "Never Needs Water" New **WATERLESS** BATTERY MADE WITH SILICON

U. S. PAT. A. P.  
408439

## INSTALL IT... FORGET IT!

Here at last is the battery science has been trying to perfect for more than 100 years! Think of it—now you can install in your car the most powerful battery ever built, then forget it completely for at least five long years!

## BELL TELEPHONE LED THE WAY!

Bell Telephone's invention of the famed Silicon Solar Battery led to the discovery of the **SILICON WATERLESS BATTERY**. The activated silicon incorporated in this revolutionary new battery has the same properties as that used in the Bell Telephone battery which possesses almost limitless power!

## 50,000 STARTS A YEAR FOR 10 LONG YEARS!

What other battery stores such tremendous reserve power that it can deliver the equivalent of more than 120 starts a day for 10 years or more? The **SILICON WATERLESS BATTERY** did it in the toughest battery test ever devised by any laboratory—made a total of half a million starts!

## NEVER USES WATER... NEVER OVERHEATS... NEVER FREEZES... NEVER NEEDS ATTENTION

Every **SILICON WATERLESS BATTERY** is permanently sealed at the factory. Patented breather valves replace the customary battery caps and are never removed. You never add water, you never even bother to check—you install it and forget it! Cells cannot be damaged by carelessness.

Exhaustive tests under conditions ranging from the mid-summer heat of

## READ WHAT USERS SAY!

"I used the battery you shipped me in starting 5 cars in 40° below zero weather and the battery did not lose any power!"

E. F. F., Rexford, Montana

"On January 23rd, the official temperature at 8 A.M. was 32 degrees below zero. There were about 20 cars in the parking lot and my car was the only car whose battery turned the motor over fast enough to start a car."

D. J. W., East Hartford, Conn.

"I have given the **SILICON WATERLESS BATTERY** some very rigid tests in severely cold weather. Last night it was 22 degrees below zero. My car stood outside and had instant starting power after 10 hours in that cold."

H. H. A., Winnipeg, Manitoba, Canada



1234 N. La Brea Avenue, Los Angeles 38, Calif.

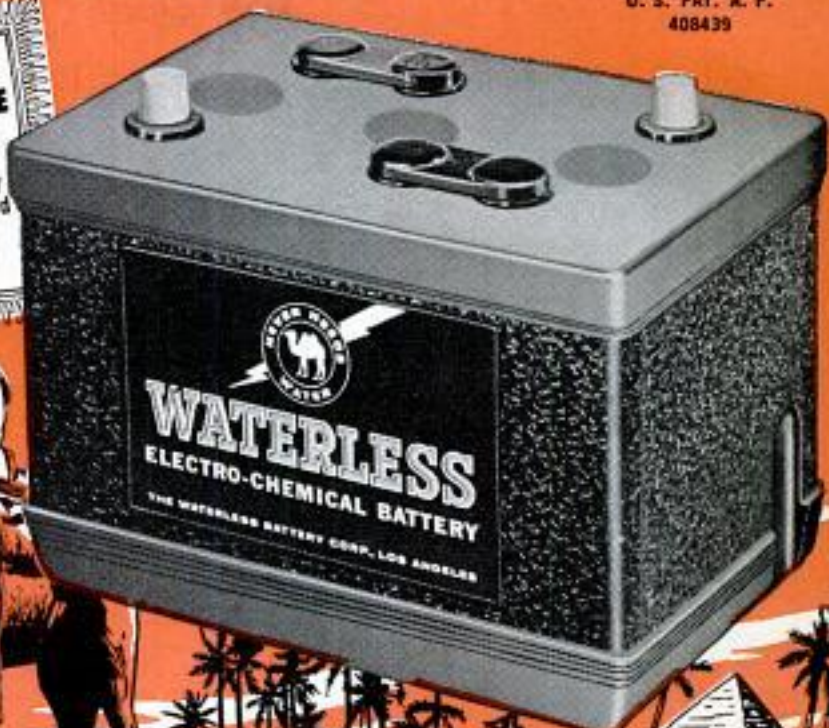

## Certified!

- The **SILICON WATERLESS BATTERY** delivers quick starting power for 10-ton truck engines at 70° below zero—far more than your car needs.
- The **SILICON WATERLESS BATTERY** makes your car lights burn brighter by Westinghouse light meter test.
- Tachometer R. P. M. tests prove that the **SILICON WATERLESS BATTERY** turns your engine-over faster.
- The **SILICON WATERLESS BATTERY** is powerful enough to start your car engine 50,000 times a year for at least 10 years!
- In competitive laboratory tests, the **SILICON WATERLESS BATTERY** produced 400% more power than one of the nation's top-selling, nationally-advertised batteries!
- The above statements of fact are certified to be true in every respect.

AS LOW AS  
**\$19.95**

## OPPORTUNITY FOR DISTRIBUTORS

We are now appointing distributors and dealers in exclusive territories protected by written franchise. Many choice areas available. No charge for franchise. Write, wire or phone today.

**WATERLESS BATTERY CORPORATION, Dept. PM-17**  
1234 N. La Brea Ave., Los Angeles 38, California

Please rush me a **SILICON WATERLESS BATTERY**, factory paying all shipping charges to my door.

- Cash, check or money order enclosed.  
 \$10 deposit enclosed. I will pay balance C.O.D.

Name \_\_\_\_\_

Address \_\_\_\_\_

City \_\_\_\_\_ Zone \_\_\_\_\_ State \_\_\_\_\_

6-volt Standard (2 yr. guarantee) @ ..... \$19.95  
(available only in 6-volt)

6-volt Premium (5 yr. guarantee) @ ..... \$34.95

12-volt Premium (5 yr. guarantee) @ ..... \$34.95

Make of car \_\_\_\_\_ Year & Model \_\_\_\_\_

I'll Set You Up In a  
**MONEY-MAKING  
 BUSINESS** You Can  
 Run From Home!



**EVERYTHING  
 FURNISHED  
 FREE!**

• • •  
**TOP MEN MAKE  
 \$5 - \$10  
 AN HOUR!**  
 • • •  
**YOU NEVER  
 INVEST  
 ONE CENT!**

**I'll Show You How to Make  
 BIG MONEY The First Hour!**

Get into a high-paying business without spending a cent! I'll rush you, absolutely FREE, a powerful Starting Business Outfit. It contains EVERYTHING you need to make exciting cash profits from the first hour!

As the Mason Shoe Counselor in your town, you can start taking easy orders the minute your Outfit arrives. You need no experience. I'll show you how to add as much as \$217 EXTRA income a month for just 2 orders a day... how to take orders from friends, relatives, neighbors, folks where you work.

EVERYONE wants comfortable shoes. Mason Air-Cushion shoes are backed by Good Housekeeping Seal, have been accepted for advertising by the American Medical Association. Some topnotch men have taken up to 20 orders their first day, earning up to \$10 an hour!

**MASON SHOES ARE NOT SOLD IN STORES!** Folks must buy from you and keep buying from you! You feature 160 dress, sport, work shoe styles for men, women... with such EXTRA features as Air Cushion Innersoles, Steel Shanks, work soles of Neoprene, Cork, Cushion Neoprene Crepe, Safety Shoes.

You'll run the best "shoe store" business in town, because you actually "carry" a greater selection than a store. You draw on our stock of over 200,000 pairs in sizes 2½ to 15, widths AAAA to EEEE. No need to substitute... folks get the style, size, width they order. No wonder you can expect fast profits!

**Rush Coupon for Your FREE Outfit!**

Start now! We will rush absolutely FREE EVERYTHING you need to start making Big Money from the very first hour! Send your coupon TODAY!

**MASON SHOE MFG. CO., Dept. 581**  
 CHIPPEWA FALLS, WISCONSIN

Send for **FREE** Outfit!

Mr. Ned Mason, Dept. 581

Mason Shoe Mfg. Co., Chippewa Falls, Wis.

Please set me up in a MONEY-MAKING BUSINESS I can run from home. Rush FREE and postpaid my Starting Business Outfit with EVERYTHING I need to start making extra cash from the first hour!

Name.....

Address.....

Town..... State.....

**MANNLICHER  
 CARCANO  
 CARBINE** **\$19<sup>95</sup>**  
**6-SHOT  
 BOLT  
 ACTION** **HUNTERS!**

Here is the hard-hitting, extremely accurate and powerful Carcano carbine, elite small arm of the pro-war Italian Army, all milled parts. Built with famous Mannlicher action. Bore guaranteed good. Weight: 6½ pounds. Excellent saddle weapon. Compact, fast handling, deadly on all big game. FREE: 18 rds. 6.5 MM ammo, in clips with each gun. Additional mt. ammo: \$7.50 per 100 rds. Barrel: 18½ TO ORDER. Send check, cash or money order. ¼ DEPOSIT FOR C.O.D. Shipped F.O.B. RR Exp. Pasadena, Calif. California resid. add 4% state tax.

**GOLDEN STATE ARMS CORPORATION**  
 347 Artery Building, 1185 East Colorado Street, Pasadena 1, California

**MEN WANTED** Earn \$100 Per Week and up

**AUTO DIESEL MECHANICS**

Master a trade with a future--learn Auto-Diesel mechanics in our shops. You learn with tools on real equipment. Earn while you learn. Many of our graduates earn \$100 per week and up. No previous experience necessary. Day and night courses. Approved for veterans. Write for free bulletin.

**NASHVILLE AUTO-DIESEL COLLEGE**  
 226 7th Ave., N., Dept. 73 Nashville 3, Tenn.

**Learn ACCOUNTING** Business Administration

Bookkeeping, secretarial and allied subjects at home in your spare time or attend nationally approved resident school. Write for FREE Success Book giving complete details on courses, plans, rates and employment opportunities. G.I. approved. Write Dept. A.

**Hills BUSINESS UNIVERSITY AND EXTENSION SCHOOL**  
 629 W. MAIN ST. OKLAHOMA CITY 2, OKLAHOMA

**SALESMEN WANTED**

Earnings \$5000 to \$8000 per year, calling on hardware stores and lumber yards, selling and installing Popular Mechanics show windows. No window trimming experience necessary (we train you) but selling experience essential. Must have automobile. Average territory consists of about 5 counties. Salesmen have exclusive territory. Home every night.

Not a get rich quick scheme but steady dignified work by which a skilled, industrious salesman can earn a good living. This company, in cooperation with Popular Mechanics and the leading manufacturers of tools, equipment and materials, offers retailers traffic-stopping window displays to retail hardware stores and lumber yards at a nominal cost. All equipment furnished. Endorsed by many retailers, jobbers and manufacturers. Much repeat business. Extras offer additional earning opportunity. Desirable but not necessary to have knowledge of hardware and lumber lines. Personal training given.

For details write, giving all the facts about yourself. If your letter indicates that you might qualify, an appointment will be made for an interview.

**WINDOW DISPLAYS, INC.**  
 1609 SHERMAN AVENUE EVANSTON, ILLINOIS



**WORLD'S  
BEST  
WANT-AD  
MEDIUM**

# CLASSIFIED ADVERTISEMENTS



Advertisements in this section \$1.25 per word, each insertion, minimum 10 words, payable in advance.

To be inserted under proper classification, copy must be in our office the

20th of the second month preceding date of issue

F. W. Johnson, Manager, Classified Advertising

Popular Mechanics Magazine, 200 East Ontario Street, Chicago 11, Illinois

## YOU'LL PROFIT

By reading and answering the classified ads in this section. Hundreds of opportunities for you to make and save money

### AUTOMOBILES, MIDGET CARS

**BOYS' Power-driven auto.** Build your own. Plans 25 cents. Sypher Co., Sta. F., Toledo, Ohio.

**HANDBOOKS.** Repair manuals, motor-books. Catalog 10¢. Gray, Hurstpierpoint, Sussex, England.

**NON-Profit organization offers automobile literature, old, modern, foreign; dealer books, service manuals, glossy photographs; free motor magazines.** Write for free information. Auto Maniacs, Stockbridge, Mich.

**NEW 1957 Automobiles—Up to 25% off retail prices.** Meder, 550-PM Fifth Avenue, New York City 38.

### AUTO SUPPLIES AND EQUIPMENT

**SAVE Money on jeep and army truck parts.** Large inventory. Catalogs for jeep or GMC. American Auto Parts Co., 1830-PM Locust, Kansas City, Mo.

**AMAZING Bargain offer!** The famous General Electric auto engine heater for cars, trucks, tractors, assures incredibly fast, easy starts at sub-zero temperatures. Listed \$8.95—Our extra-special only \$3.95, postpaid, prompt shipment. Dealers, agents wanted. First order brings you sensational 500% profit plan. Hurry, secure your territory! "GE Engine Heater Sales," Milwaukee 7, Wisconsin.

**FREE! New catalog.** Speed, power, mileage increasing equipment. Discounts! Almuist Engineering, Milford PM5, Penna.

**SAVE On parts, accessories, tools, dress-up items, gadgets!** Largest giant 1957 catalog ever. Only 25¢ (refunded first order). Newhouse Automotive Industries, 8803E Beverly, Los Angeles 22, Calif.

**CRANKSHAFT Grinder, hand operated.** Makes bearings fit without taking engine apart, \$3.75. Literature. L. D. McGee, 719 Cascade St., Wenatchee, Wash.

**PATRON Saint of travelers.** Large, heavy sterling silver Saint Christopher's medal for automobiles. Clips to car's sun visor. Satisfied or money back. \$3.95. Merry Crane Imports, Box 2507, Cincinnati 37, Ohio.

**FORD T and A parts?** Try best source old car parts anywhere. Wisneski, Milwaukee 7, Wis.

**TIRES At tremendous savings.** Tractor, grader, truck, aircraft, army surplus, and passenger. Send for free catalogue. Duddy's, 152 N. Beacon St., Boston 35, Massachusetts.

**MOTORIST Save gasoline** vacuumating overrich mixtures. For free particulars, how to install on your car for introducing write, Vacuumatic, Dept. 863, Wauwatosa, Wis. Salesmen wanted.

**NEW 1908-1934 Ford parts.** Catalog 25¢. Huber, 15 Emerson, Clifton, New Jersey.

**RING-Valve job while you drive \$8.00 postpaid.** Safe, proven, guaranteed. Literature. Motaloy, Grantham, Penna.

**USED Speed and power equipment.** O.H.V. engines. Largest supply. Send 25¢ for list. Speedway, 1719 "N," Lincoln, Nebraska.

**LATEST Custom accessories.** Items not in stores. New low prices. Continental tire kits, push-button doors, trunks, etc. New illustrated catalog, biggest ever, 25¢. Eastern Auto, 3319-A South Grand, Los Angeles 7, California.

**NEW And used parts at savings.** Complete guaranteed parts service for all models cars and trucks—1924 and later. Largest in the West. Army parts specialists. No catalog. Submit your needs for quotations. Fast mail order service. Pioneer Auto and Truck Parts Co., 734 W. 13th Ave., Denver 17, Colorado.

### AUTO TRAILERS

**TRAILER Building manual \$1.00.** Booklet 30¢. Kamcraft, Box 1153, Milwaukee 1, Wis.

**BUILD Expanding eight foot trailer.** Accommodates five. Literature 10¢. Fra-Mar Company, Wilmington, Mass.

### MOTORCYCLES, BICYCLES, MOTORSCOOTERS AND SUPPLIES

**RECONDITIONED Motorcycles and motors.** Chromium accessories. Complete stock Indian parts. Expert rebuilding. Fast service. Indian Motorcycle Sales, Kansas City 27, Missouri.

**WHIZZER Motor \$10;** two cylinder engine \$5; Whizzer Pacemaker \$25; motor-scooter \$12, midget car \$30, less motors. Professional midget track racer \$165; Crosley convertible \$100; Cushman motor-scooter \$30. (Mail order only.) Send 25¢ (35¢ for first class mailing) for directory-catalogue Number 75, listing these and hundreds of other bargains in new and used midget cars, motorscooters, engines, homebuilders parts, plans, etc. Midget Motors Directory, Athens, Ohio.

**PARTS For Cushman, Doodle-Bug, Salisbury, etc.** Send make, model, 25¢ for price list. Motor Scooter Parts Co., Dept. P1, Box 7211, Indianapolis 1, Indiana.

**BANKRUPT Motorcycle bargains.** Catalog bulletin 25¢. Bunico, 146, Covington, Va.

**HARLEY - Davidsons — Used bargains.** New, used parts, accessories for all models. Bulletin, catalog 25¢. Knuth's (Factory Dealer), 1753 Muskego, Milwaukee, Wis.

**MOTORCYCLE Parts—New, used.** Al Rodi, 1404 DeKalb, Atlanta 7, Georgia.

### AVIATION

**PARACHUTES Used once, \$3.00.** Small chutes \$1.00 postpaid. Airplane photographs, beautiful large 14x17 color reproductions. Decorate dens, etc. with war planes in action. Six assorted. Send \$1.00. Jarvis, Box 126-J, Bostonia, California.

**PRICED Aviation surplus catalog.** 25¢. Aero Parts, 8102 Lockheed, Houston, Tex.

**BUY Surplus aircraft; fuselages; accessories; engines; instruments; electronics—** Direct from U. S. government depots. List and procedure \$1.00. Brody, Box 8-PME, Sunnyside 4, New York.

**SMALL Tube bending, precision work.** Mordus, 245 Dodd, East Orange, New Jersey.

**BUILD Flying Flea jeep conversion wagon, trailers, etc.** Large manual \$1.00. Kamcraft, Box 1153, Milwaukee 1, Wis.

**AVIATION Surplus bargain catalogue.** One dime. Box 22 PM7, Thomasville, Penna.

**PROPELLERS.** Plans, supplies by world's oldest and largest manufacturer of special design airboat and snowplane propellers. Latest designs. Prompt delivery. Satisfaction guaranteed. 48 page catalog 25¢. Banks-Maxwell, Box 3301E, Ft. Worth 5, Texas.

**YOUR Ad in this space will get some good agents for you.** Yes, I'll prove it. Write for Folder "A" right now. F. W. Johnson, Classified Advertising Manager, Popular Mechanics Magazine, 200 E. Ontario St., Chicago 11, Ill.

### ELECTRICAL SUPPLIES

**ELECTRIC Pencil; Engraves all metals \$2.00.** Beyer Mfg., 10511-H Springfield, Chicago 43.

**LAMP.** Electrical parts, wholesale. Thousands of items for repairing, converting. Catalog 25¢. Brown Lamp, Box 305, Clayton 5, Mo.

**TELEPHONE Transmitter.** Hand set type. Suitable for inter-house phones, speakers or any communication purpose. Delivered two for \$1.00. No c.o.d.'s. Telephones, Dept. C-1095, 1760 Lunt, Chicago 26.

**LAMPS—Parts catalog showing wiring instructions.** 25¢. Gyro Lamps, 5402P Clark, Chicago 40.

### WELDING, SOLDERING, PLATING

**A.C. Welders, 4 sizes.** Lowest prices. Free literature. Holgerson's Serv., Canton, Kan.

**WELDERS, 110/220, \$39.50.** Morris, 1070 Inner Drive, Schenectady 3, New York.

**ELECTROPLATING Equipment, anodes and solutions for all types of plating.** Instructions. Assemble your own plater and save. Free catalog. Ramyr, Dept. E-4, 1624 East First Street, Los Angeles 33, California.

**ACETYLENE Welding outfits new \$54.50; used \$34.50; arcwelders \$56.50.** Eagle Welding, Dept. PM, 5085 Broadway, Chicago 40, Ill.

**BUILD 200-Ampere welder using aircraft generator.** Plans 25¢ including big catalog welder-kits, generators, hydraulics. Dunbar Mfg., 6600 Sylvan, Houston 23, Texas.

"BUILD-UR-OWN" a.c. welder and a.c. power plant with a good used engine and low cost Hobart generator. Welds anywhere and supplies 5kw stand-by power for any emergency. Write Hobartweld, Box M-173, Troy, Ohio.

#### MACHINERY, TOOLS, SUPPLIES

FOR Sale: Cincinnati planer, 9 foot bed, cross and vertical feed, motor attached, perfect, \$1000.00. Also LeBlond tool lathe and South Bend production lathe, both perfect, cheap. Fred Spicknall, La Belle, Missouri.

SPECIAL! 4-In-1 screwdriver tool, \$1.00. Laircraft Company, Box 3008-C, Detroit 35, Michigan.

LAWNMOWER Sharpeners, five latest high speed inventions. Dealers wanted. Turner-Cline, 430 Yellowstone, Pocatello, Idaho.

#### ENGINES, MOTORS, DYNAMOS

DIESEL Injector parts wanted, GM71-110. Bares, 7120 Carnegie, Cleveland 3, Ohio.

A. C. Generators, 750 watt \$42.50; 1500 watt \$67.50. Motors, 5 horse \$110; 3 horse \$87.50; 1 horse \$38.50. Butler, 1885 Milwaukee, Chicago.

1/2 HORSEPOWER Electric motors, a.c. 110, used, good \$5.00 each, f.o.b. Plant Machinery Corp., Richmond & Norris Sts., Philadelphia 25, Penna.

REWIND Motors yourself. Complete instructions \$1.00. Lewis Mfg., Howell, Michigan.

WINDING Data, 275 motors, single and three phase, \$1.10. Data Company, Box 7631, Kansas City 28, Mo.

#### BOATS, OUTBOARD MOTORS

BOAT Plans. Full size patterns. Frame kits. Modern inboards and outboards for amateur builders. Complete new catalog 50¢ or specify requirements. Glen Designs, Box 568, Compton, Calif.

NEW, Used, rebuilt marine motors. Marine conversions, fittings. Free catalog. Stokes Marine Supply, Dept. 24, Coldwater, Michigan.

FIBERGLAS Permanent boat waterproofing. Special 25% winter discount. Complete kits, \$9.45 up. Guaranteed materials. Easy application. Full instructions. Free literature. Ajax Plastics, Dept. PM, P.O. Box 1323, Fort Worth, Texas.

MARINE Conversions for Ford and Jeep engines. Catalog 25c. Lehman Manufacturing Company, 972D Broad Street, Newark 2, New Jersey.

FORDS And Jeeps 100% marine engines with famous Convo-Kits. Deluxe catalogue 25c coin. Oscomotors, 3627B Lawrence, Philadelphia 40, Penna.

APPROVED Underwriter modern marine conversions. Ford and Jeep. Gershel, Oceanside, N. Y.

FULL Size, cut-to-shape boat patterns, blueprints, 7 1/2-38 feet. New 86 page illustrated "Build-A-Boat" catalog of naval architect-designed cruisers, runabouts, skiffs, outboard boats, sailing, racing, houseboats, 50¢. "How to Build a Boat" booklet, \$2.50. Cleveland Boat Blueprint Co., Dept. A-65, Box 1651, Cleveland, Ohio.

PLANS, Patterns, kits. Catalog, 50¢. Outboards, 2.5 h.p. \$79.95! Marinecraft, Box 161-M, Brighton, Mass.

FREE Catalog! Boat kits, trailers, fiberglass, marine hardware. Luger Industries, Dept. M1, 3404 Lyndale South, Minneapolis, Minnesota.

MARINE Conversion, Willys to Cadillac, engines, kits and parts. Catalogue and conversion hints free. Barr Marine, 2705 Castor Avenue, Philadelphia 34, Penna.

FIBERGLAS Boat coating. Plexiglas boat windshields—Clear, blue, green tints. Wholesale-retail. Instructional information catalog free! Gem-O'-Lite, 5529 Cahuenga, North Hollywood, California.

JOHNSON Outboard specialists. Used parts for all models at substantial savings. Prompt quotations. Specify model serial. Crandall-Hicks, 910 Commonwealth, Boston, Mass.

STEEL-Wood, boat plans, cruisers—sail, 21-42 feet. Free information. Please specify size-type. John B. Clark, N.A., Box 51, Bay Village, Ohio.

#### ATHLETIC EQUIPMENT, BODY BUILDING COURSES

BE Taller! Coach's "Inch-At-A-Time" system \$1, complete. Marty Snyder, Box 195-MA, Union City, New Jersey.

OUTSTANDING Physical development! New guaranteed system uses only a rope! Strength, health, gain, reduce. Free details. Roperice, 4834 Art St., Room 205, San Diego 15, California.

DISABLE Any bully, with two fingers. Secrets, Ju-Jitsu, 96 pages, illustrations, \$1.50. Seico, Box 38, Cooper Station, New York 3, N. Y.

BARBELLS, Dumbbells. Courses. Free catalogue. Good Barbell Co., Reading, Penna.

#### SPORTING GOODS, GUNS, FISHING TACKLE, ARCHERY, TRAPPING

180 PROFUSELY Illustrated pages antique pistols, swords, daggers, armor, etc. 50¢. Robert Abels, M860 Lexington Ave., New York City 21.

HOW To catch fish, scent secrets. 10¢. Johnston's, 312 Lake Avenue, Ithaca, New York.

BUILD Barbecue. Complete plans. Booklet 25¢. Free catalog. Popular Mechanics Press, 633 N. St. Clair St., Chicago 11.

BIG Money raising crickets and 12 inch African fishworms. Free literature. Carter Ranch, Plains, Georgia.

JAP Rifle altering to 30-06, \$6.00. Jap-shells, \$3.75. Catalog 5¢. T. P. Shop, West Branch 11, Mich.

SAVE! Free five dollar credit certificate and completely new illustrated 1957 catalog. Bows, arrows, raw materials. Offer now extended to February 28, 1957. Send 10¢ for handling. Pride Archery, RFD #1, Danbury, Connecticut.

FREE—Below wholesale fishing catalog, insulated clothing, etc. Fishing Tackle Mart, Dept. 51, Box 6737, Chicago, Ill.

GUNSMITH—400 Page illustrated course \$4. Pioneer Press, Harriman, Tennessee.

FREE Catalog. Newest items. Bargains. Gadgets. Beads. Spinners. Lure parts. Sinker molds. Finnyports, MC, Toledo 6, Ohio.

DIVING Equipment for skin divers and professional divers. Send 25¢ for catalog and decompression chart. Disco, 212 N. Broadway, Milwaukee 2, Wisconsin.

5000 BARGAINS. Firearms, binoculars, war relics. Catalog 50¢. Smith Firearms, Runnede, N. J.

SAMPLE: 25c Copy of "The Archers' Magazine." Send 10c. 1200 Walnut Street, Philadelphia 7, Pennsylvania.

CAMP Blankets, grey, \$3.99. 62x82, 3 1/4 lbs. Litchfield Wool Blanket Company, Litchfield, Minnesota.

ARRO-Ping vest pocket archery set with 6 safety rubber tips, 6 metal tips, 1 whistle tip, \$2.00 pp. Arro-Ping, Box 779 HC, Colorado Springs, Colorado.

AUTHENTIC Primitive weapon reproductions! Spears, cross-bows, edged weapons, etc. Colorful. Deadly. Decorative. Catalog 10¢. Primitive Weapons, Pevely MA, Missouri.

#### BINOCULARS, TELESCOPES, MICROSCOPES, MAGNIFIERS

BUILD Your own reflector telescope. Complete kit: mirrors, eyepieces, tripod, all other accessories. Request free illustrated literature. Criterion Manufacturing, Dept. DPM 25, Hartford, Conn.

REFLECTOR Telescope kits \$6.25 (3") to \$175 (12"). Mirrors, cells, focusing mounts, tripods, eye systems. Anything, everything in telescopes. Free catalog. Also ready to use telescope from \$25. Esco Products, Oakridge, N. J.

COMBINATION 100X Astronomical telescope and telescopic camera easily made. Lenses and instructions \$3.00. Instructions alone 25¢. Holm Jamer, Manorville, N. Y.

BINOCULARS, Telescopes, microscopes. Terrific values \$3.98 up. Request free money-saving catalog. Criterion, Dept. P 50, Hartford, Conn.

REFLECTING Telescope, 60X, completely assembled \$29.75. Guaranteed observatory clearness. Free information. Skyscope, 475 Fifth Avenue, New York City 17.

400X Telescopes easily made. Kit includes focusing tube, erector, five finished lenses and building instructions—\$3.75. Free booklet on completed telescopes, tripods, mirrors, lens kits, etc. Suffolk Science, Mattituck 3, New York.

MICROSCOPE Catalog free. Research Scientific Supplies, 60 Wall St., New York City 5.

DYNASCOPE—Sensational new reflector telescope. Send for details. Criterion Co., Dept. DP 28, Hartford, Conn.

WAR Surplus bargains: Millions of lenses, instruments, telescopes, binoculars, components and complete line of astronomical telescope items. World's greatest optical market place! Send only \$1.00 for beginner's 10-lens kit and big instruction booklet stock 3-CH. Write for catalog CH, free! Edmund Scientific Corp., Barrington, New Jersey.

AMAZING Prices precision binoculars, special slow season winter reductions. Free trial. Folder "Binocular Selecting" catalog free. Prentiss Importers, Mercury Bldg., West Los Angeles 25, Calif.

ASTRONOMICAL Telescopes—Make your own. Complete instructions 10¢. Free catalog. Precision Optics, 1001-B East 163d St., New York City 59.

#### PLANTS, SEEDS, BULBS, NURSERY AND GARDEN SUPPLIES

EVERGREENS, Azaleas, rhododendrons in baby sizes. Ornamental shrubs, trees, hollies. Send for free spring catalog. Green Ridge Nursery, Madison 10, Ohio.

WINTER Wonder; grow flowers, vegetables, only water and chemical. \$2.00 instructions; chemical free. Lawler Laboratories, 1629 Allston Way, Berkeley 3, Calif.

WORLD'S Greatest cash crop. Free information. Write Ginseng Gardens, Asheville, N. C.

TREES And shrubs—Raise your own from seed for shade, windbreak, snow fence, ornament, erosion control, etc. For free planting guide, price list, write Woodlot Seed Company, Norway 9, Michigan.

#### PETS—DOGS, BIRDS, RABBITS, HAMSTERS, ETC.

HUNTERS! Raccoon Mountain and Short Creek kennels now combined. Large number of coonhounds, foxhounds, rabbit-hounds, beaglehounds, bird-dogs, puppies. Free literature and pictures. Trial. Dures Thomas, Owner, Box 464, Boaz, Alabama.

HAMSTERS, Pair \$2.95. Free booklet. Jer-Fre's Hamstery, 2425 Hoyt, Muskegon Heights 13, Mich.

RAISE Rabbits successfully by knowing facts. 48 page illustrated book describing 25 breeds. Housing, feeding, breeding, marketing, etc. Plus bulletin. 25 cents. American Rabbit Association, 38 Arba Building, Pittsburgh, Penna.

STANDARD Rabbit Journal, Milton 3, Penna. Year \$1.00. Sample dime. Beginners manual 25¢.

MAKE Money raising chinchillas, mink, nutria, rabbits, cavies for us. Free catalog. Keeney Brothers, New Freedom 2, Penna.

HAMSTERS—Golden: young, \$8.00 pair. Fully developed \$4.00 pair. Adirondack Hamstery, Prospect 10-A, N. Y.

PETS, All kinds, Catalog \$1. Carroll Blakey, Floral 1, Ala.

AMERICAN Rabbit Journal, Warrenton 3, Missouri. Tells how, \$1 year.

FREE Book. Grow mushrooms. Guaranteed market. Mushrooms, Dept. 171, 2954 Admiral Way, Seattle, Wash.

AMERICAN Pigeon Journal, Warrenton 3, Missouri. Raise pigeons successfully, \$2.00 year.

BEAUTIFUL Pure white pedigreed police puppies. Ansonia Kennels, McHenry, N. Dak.

RAISE Rabbits on \$500 month plan. Plenty markets. Free details. White's Rabbitry, Mount Pleasant, Michigan.

RAISE Nutria: Registered breeding stock, all colors, all ages. Get the "Facts" \$1.00. Lund's Ranch, 9725 Sunland Blvd., Sunland 2, Calif.

EXTRA Money raising Angora, New Zealand rabbits. Write Martin's Rabbitry, Morganfield, Ky.

## FUR BEARING ANIMALS

**BRED** Female minks, raccoons, skunks. Baby skunks, raccoons. Catalog. 25¢. Shady Fur Farm, Springfield, Minnesota.

**RAISE Mink:** Free booklet, pen plans, inside secrets, feed, care. Mink are money makers. Investigate today. Lawrence Mould, Brigham City 12, Utah.

**MINK** Raising information free. Complete. Lake Superior Mink Farm, Superior, EEL, Wisconsin.

1000 **BRED Mink.** Booklet, plans 25¢. Lake Ontario Ranch, Gravel Road, Webster, N. Y.

**FINE** Furs, scarfs, capes, coats, robes and rug head mounts from your own skins. Stylish and useful. Fox, mink, muskrat, raccoon, beaver, horse, cow, beautifully tanned with hair on. Fashioned and styled to your order. Get full value from your skins! 49 years experience. Satisfaction guaranteed. Ship your skins now. Upon receipt, we will acknowledge and send our recommendations, styles, etc. Cowrie Tanning Co., 351 Market Street, Des Moines, Iowa.

**RAISE Nutria—Vegetarian;** raise mink, carnivorous. Individually or combined, potential terrific. Voight Farms, Atlanta 2, Texas.

**REGISTERED** Pedigreed chinchillas. Georgia Word, 209 West 36th, Savannah, Georgia.

## FARMS, FARM LANDS, REAL ESTATE

**BIG** Strout catalog! Mailed free! Farms, homes, businesses, bargains galore! Accurate, reliable descriptions of over 3000 properties in 36 coast-to-coast states! Livestock, equipment often included, many with low down payments and easy terms! World's largest. Serving you 58 years! Depend on Strout Realty, 7-MF S. Dearborn St., Chicago 3, Ill.

**HOMESITES** \$15 Monthly—California's finest garden section. Morro Bay's scenic shores. Wonderful fishing, boating. Fertile soil, softest water, temperate climate, congenial community. Free literature. Richard Otto, Department M, San Luis Obispo, California.

**FLORIDA.** Nice homesites, \$245 at \$10 monthly. Folder free. Howard Vernor, Deland, Florida.

**FALCON** Lake resort site at Zapata, Texas. No money down and \$7.50 per month buys beautiful lot adjoining city. Full price only \$149.50. Utilities, including city water. Ideal for vacation, retirement or trailer site living. Write for free photos. M. Matlock, Pipe Creek, Texas.

**OZARKS!** \$8 Acre. Listings, information free. Write: Armstrongs, Shook, Missouri.

**TEXAS** Resort sites near Mammoth Lake. Excellent hunting and fishing. Ideal climate year round. City water and electricity to each lot. Ideal for permanent living. Total cost \$149.50. No down payment. \$7.50 monthly. Write for photos, maps, etc. Kate Falcon, Matlock, Pipe Creek, Texas.

**FLORIDA** Bargain homes. Low taxes. Cummins Realty Agency, Box 848, Eustis, Florida.

**MAKE** Money in Texas. Get yourself a fine tract now near Houston for only \$245. \$15 cash and \$15 monthly. Fastest growing city and second largest seaport in U. S. Huge \$100 million steel plant. World's greatest oil producing, refining, chemical, manufacturing and shipping center. Many are making phenomenal profits here and you can too. These beautiful tracts located in Houston's desirable southside suburbs with all-weather streets, electricity, schools, bus service, etc. Insured title. Write today for maps, pictures, full information free. Bailey Wood, Box 6804, Houston 5, Texas.

**OWNER** Listed properties. Avoid commission. Details. Home Bargains, Ozark, Missouri.

**FABULOUS** Opportunities! Government land, U. S., Alaska. Write Sledge Surveys, Macon, Mississippi.

## POULTRY, FARM SUPPLIES

**POULTRY** Farmers, broiler growers, turkey raisers read the new American Poultry Journal for latest ideas and greater profits. 12 months, 50¢. Special offer, 4 years \$1.00. American Poultry Journal, 180 North Wabash, Chicago.

## PROFITABLE OCCUPATIONS

**BUY** Wholesale thousands nationally advertised products at big discount. Free "Wholesale Plan." American Buyers', Hertel Station, Buffalo 16-B, N. Y.

**WELDING** Pays big money. Learn easily at best equipped school in country. Non-profit school with low cost training. G.I. approved. Write Hobart Trade School, Box M-172, Troy, Ohio.

**\$10,000 PROFITS!** Your own mailorder business! No risk! Success plan free! Treasury, 709 Webster, New Rochelle L-35, N. Y.

**PROFITS**—With pleasure, preserving flowers indefinitely. Eight proven methods. Artcrafts, 12 St. John Road, St. Andrews, N.B., Canada.

**FOREIGN** Jobs—Latin America, Alaska, Canada, up to \$1500 monthly. Up-to-date 1957 foreign service directory gives complete information; hot list of firms hiring for military and civilian construction, aircraft, oil, exporters-importers, mining, \$1.00. How-when-where to apply. 9th successful year! Global Reports, Box 883-S, Hollywood 28, Calif.

**MAKE** Flexible molds. Cast plaques, figurines. Free sample. Tooker, 1045-M Fairview, Hamilton, Ohio.

**FREE** Book. Grow mushrooms. Guaranteed market. Mushrooms, Dept. 99, 2954 Admiral Way, Seattle, Wash.

**VENDING** Machines—No selling. Operate a route of coin machines and earn amazing profits. 32-page catalog free. Parkway Machine Corporation, Dept. 25, 715 Ensor Street, Baltimore 2, Maryland.

**YOUR** Own wholesale business without investment. Free catalog. Norris, 487-X Broadway, New York City.

**BE** The Popular Mechanics representative in your neighborhood and earn big profits in your spare time. Write Popular Mechanics Magazine, Room 408M, 200 E. Ontario St., Chicago, Ill.

**RAISE** Pheasants on \$100 week plan. Little capital and space can make you independent. Free details. Great Central System, Columbus 1, Kansas.

**MAKE** New greaseless doughnuts in kitchen. Sell stores. Free recipes. Michael Ray, 3805 South 15th Ave., Minneapolis 7, Minnesota.

**AUCTIONEERING**—Home study course. Diploma granted. Auction School, Ft. Smith, Ark.

**FREE** Book "505 Odd, Successful Businesses." Work home. Pacific, Oceanside, Calif.

**JOB** Guidance. What jobs are you suited for? Approved methods. Request free questionnaire. National Guidance Service, Landisville, Penna.

**FREE** Folio "\$5,000-\$45,000; Unlimited Vacations." No merchandise. Unknown! Work home, sparetime! Haylings, Carlsbad, Calif.

**LEARN** How to supply needed information to clients. It pays well. You are taught in a short time, at small cost. Frank Fix, 2056 Switzer, St. Louis 21, Mo.

**BIG** Money raising fishworms and crickets. Free literature. Carter Wormery, Plains, Georgia.

**MUSHROOMS** Now bring bigger, quicker cash. Spawna plus newest manureless growing, marketing methods. \$1.00. Free literature. Luxur, 641 South 19th, Newark 3, N. J.

**\$60 WEEKLY,** Spare time—Easy! Home venetian blind laundry. Free book. Burtit, 2434A, Wichita 13, Kansas.

**FREE** Success plan folio. "Secret Journal." 919 secrets! Work home—Successfully! Publico, Oceanside, Calif.

**MICHIGAN'S** Booming. Thousands of jobs. List of employers \$1.00. Tisch-Craft, Laingsburg, Michigan.

**HOME** Mailorder literature free. Carnahan Bros., 9810 Acacia, Fontana, Calif.

**AUTOMOTIVE** Books. Free catalog. Popular Mechanics Press, 631 N. St. Clair St., Chicago 11.

**BE** In business for yourself. For \$15 postpaid, will ship you 200 pairs assorted earrings. Values to \$75. Send check-money order. Prestige Button, 245-7 Ave., New York City.

**SIX** Hours monthly plus \$450 capital makes 100% yearly. No selling. Charms, Box 12, Signal Mtn., Tenn.

**HOW** You can make genuine gold or silver plated custom made jewelry—For yourself, sell for profit, give as gifts, 48 page catalog shows hundreds of kits. Earrings, pins, necklaces, cuff links, tie clips, rings, etc. Kits contain everything. It's fun, easy, no experience needed. Send only 25¢ for this unusual catalog, plus free how to sell booklet. Mail today! Don-Bar Co., Dept. M-11, 3511 W. Armitage, Chicago 47, Ill.

**BUY** Wholesale! Discounts to 80%! Appliances, cameras, sporting goods, housewares, watches, tools, clothing, etc. Buy-Rite 73-03, Wagaraw, Hawthorne 2, New Jersey.

**DOLLARS** Daily! No canvassing. Method \$1. Mailmarts, Cincinnati 38-C, Ohio.

## BOOKS, PERIODICALS, PICTURES, POSTCARDS

**BOOKS**—All subjects, located promptly; including genealogies, Americana, Orientalia. Paramount Book Service, 39 Hope-dale, Allston 34, Boston, Mass.

**GOLD**—Authentic old pictures and history of "World's Greatest Gold Camp"—Cripple Creek, Colorado. Send 75¢ to Palace Drug, Cripple Creek, Colorado.

**BRITISH** Book bargains—All subjects. Catalog 10¢. Transbooks, Box 22-PMH, Brooklyn 26, N. Y.

**DO** It yourself. Do it expertly. Books \$2.00 each. Write for free price list. Sanders & Co., 1762 Euclid, Lincoln, Nebr.

**SPECIAL** Catalog, send 10¢. Critic Books, 10020 Hawthorne, Inglewood 2, Calif.

**BOOKS,** Essays and lectures! Unusual, odd information you cannot get elsewhere. Many, only one copy each. New list free. Now ready. Rush name. J. Houston Maupin, 201 North Hyatt St., Tipp City 5, Ohio.

**NATIONAL** Geographic Magazines, 1888-1956, Periodical Service, Box 465-PM, Wilmington, Delaware.

**OUT-Of-Print** books at lowest prices! You name it—we find it! Past service. No obligation. International Bookfinders, Box 3003-PM, Beverly Hills, Calif.

**"SCIENCE** Milestones." Records march of science starting 400 years before Christ, right up to date. Amazing facts revealed. 312 pages packed with startling information that will thrill you. A real history of science. \$5.00. Literature free. Popular Mechanics Press, 200-SM East Ontario St., Chicago 11, Ill.

**RARE** Magazines, catalog 10¢. Nationwide Exchange, Box 1375-P, San Antonio 6, Texas.

**BOOKFINDERS!** All subjects. Send wants! Jaher Book Service, 183 Hazelwood Drive, Westbury, N. Y.

**BOOKHUNTERS!** Scarce, rare, miscellaneous books. Atlantic Book Service, Cedar Street, Charlestown 29, Mass.

**JOHN** Friend, bookfinder, can get the book you want. Free search service. Box 197PM, Cardiff, Calif.

**FREE:** Exciting catalog packed with books covering most everything. Think of it—From cover to cover you will find described and illustrated hundreds of books telling how to fix and how to build almost anything. How to remodel your home; do your own decorating, plumbing, electrical work. Simplified books covering concrete work, carpentry, painting, furniture making and refinishing. How to build your own boat, home workshop tools. Best books on photography, welding, hobbies, homecraft. How to make a home freezer. Send for your free copy now. Popular Mechanics Press, 200-SO East Ontario St., Chicago 11, Ill.

## MAGIC TRICKS, PUZZLES, JOKER NOVELTIES

**COMPLETELY** Illustrated 500 trick magic catalog 25¢. Stowell, Woodstock, New York.

**LEARN** Ventriloquism, easiest method. Details free. Smith, 2125 No. Bigelow, Peoria, Ill.

**SENSATIONAL** Magician's wand 25¢. Vanishes handkerchief! Catalog included. Box 1352-PM, Philadelphia 5.

**BE** A magician! Large professional catalog of latest tricks. 35¢. Ireland, C-109 North Dearborn, Chicago 2, Illinois.

3100 NOVELTIES. Jokes, tricks, gadgets, funmakers, hobbies. Big catalog 10¢. Johnson-Smith, D-407, Detroit 7.

VENTRILLO, Professional voice-throwing instrument and catalog 25¢. Box 971-PM, Philadelphia 5.

WOODEN Nickels, catalog, trick, 10¢. Magico, Box 1375-P, San Antonio 6, Texas.

DOLLAR Magic set free with catalog 25¢. 4462-PM Germantown, Philadelphia.

WORLD'S Finest professional magic. Joker novelties. Giant illustrated catalog 10¢. Top Hat, Evanston 12, Illinois.

500 TRICKS, Douglas famous 120-page catalog, only 10¢. Fastest service to magicians for 30 years. Send 10¢ today. Douglas Magicland, Dept. 1, Dallas, Texas.

SMOKEBOMBS 25¢. 7 For \$1.00. Terrible! 4463-PM Greene, Philadelphia 44.

FREE Trick and professional catalog of 600 tricks, \$1.00. Terry's Magic Studio, 1921-46th Street, Brooklyn 4, New York.

PROFESSIONAL Catalog, 175 pages, 25¢. Williams, 900 Plymouth, Ellwood City, Penna.

SVENGALI Trick deck free with catalog 50¢. 1746-PM Market, Philadelphia 3.

### COINS, TOKENS, CURRENCY

8 SCARCE Canadian cents, 1922-1927, fine, \$3.50. Jorgensen, 146 Park, Buffalo 1, N. Y.

FIFTEEN Different Indianhead cents \$1.00. Bargain lists free. Sayers, 1000 East Unaka, Johnson City, Tennessee.

BARGAINS, U.S. coins: 1893 Columbian world's fair half dollar, \$1.00. Ten different Indian pennies, 75¢. Two-cent piece, and 3-cent piece, \$1.00. Gold 1/2 eagle, \$9.00. Gold 1/4 eagle, \$12.50. Beautiful coin bracelet, \$1.00. Many coins available. What do you need? Rare Coin Company, 31 North Clark, Chicago 2.

50,000 COINS, Medals, bills, Lists free. Collectors magazine 25¢. Nagy, 8-P South 18th, Philadelphia 3, Penna.

NAZI Coin, Italian banknote, lists, All-10¢. Approvals. Dwight Musser, Dunbar, West Virginia.

CZECHOSLOVAKIA, India, Finland, Vatican City, Austria—All 10¢. Jolie, Roslyn Heights, N. Y.

OLD Coins, currency bought, sold. Large list 10¢. Thos. J. Settle, Box 1173, Church Street Station, New York 8, N. Y.

LARGEST Coin magazine, 180 pages, 35¢. Scrapbook, 7320-J Milwaukee, Chicago 31.

SAN Francisco mint closed! Made only cents and dimes in 1955. In short supply and great demand. One each, brilliant uncirculated, for 25¢. Free coin lists with order. Bryson Stamp & Coin Company, 612 White, Toledo 5, Ohio.

U. S. Large cent, 2¢ piece and bargain list, only \$1. Delmao, Box 1123, Wilmington, Del.

MORGAN Dollars, 1878-87-90-91-978 \$2.00 ea. New illustrated catalog 25¢. Shultz, Box 746, Salt Lake 10, Utah.

LINCOLN Cents 1910-S, 1913-S, 1921-S, 1923-S, 1924-S, 1933-D all for \$2. Gasser's, Box 34615, Los Angeles 34, Calif.

WANTED 1822 \$5.00 Gold, pay \$10,000.00. 1913 liberty head nickel \$4,000.00. 1894-S dime \$2,000.00. 1876-C.C. 20¢ piece \$1,000.00. 1901-S quarter \$40.00-\$400.00. 1922 50¢ \$8.00-\$60.00. 1928 Hawaiian 50¢ \$90.00. 1885 trade dollar \$1,000.00. Uncirculated dollars 1804 to 1839, 1893-S, 1895-P, 1903-O, \$100.00-\$5,000.00. Certain dates, small cents before 1924, \$325.00; halfcents, \$500.00; 2¢ pieces, \$70.00; 3¢ pieces, \$90.00; halfdimes, \$500.00; dimes before 1943, \$300.00; quarters before 1924, \$1,000.00; half dollars before 1905, \$1,000.00. Hundreds of others worth \$10.00-\$1,000.00. Canadian coins, 1921-5¢ silver, \$50.00. 1889 dimes, \$25.00. 1875 quarters, \$50.00. 1921, 50¢ \$200.00. Wanted large cents, gold coins, paper money, etc. Know their true value. Our large illustrated guarantee buying-selling catalogue, send \$1.00. Purchase catalogue, giving complete all-coin information before sending coins; none c.o.d. Catalogue dollar refunded on \$20.00 sale. Thousands of persons have sold us coins. Worthwhile Corporation, 125-ers Numismatic Quotations K-293-C, Boston 8, Massachusetts.

COINS From Formosa, Vatican, etc., plus foreign banknote, 10¢ with coin approvals. Littleton Coin Co., Littleton 51, New Hampshire.

36 DIFFERENT Foreign coins \$1.00. Robbins, 1007 Cleveland, Montgomery 8, Alabama.

U. S. Coin approvals. Reasonable. Hutchinson, 3463 "I" Street, Philadelphia 34, Pennsylvania.

60 ASSORTED Coins \$1.00. 100 assorted bills \$1.00. Oddehon, Box 482, St. Louis, Mo.

COINS—20 Countries \$1.00. 96-country album \$2.50. World, Box 401, Davenport, Iowa.

18 DIFFERENT Foreign countries, \$1.00. All coins brand new. Kay Coin, Box 407, Bloomfield, N. J.

OLD Money wanted. Will pay fifty dollars for nickel of 1913 with liberty head (no buffalo). We pay cash premiums for all rare coins. Send 4¢ for large coin folder. May mean much profit to you. Numismatic Co., Dept. 20, Fort Worth, Texas.

BARGAIN Lists, Indianhead cent, 10¢. Economy Sales, 156-A Dean, Mansfield, Mass.

GET Profit and pleasure in collecting old coins. Send 10¢ for 56-page illustrated coin catalog. You'll be delighted with it. Send for it now. B. Max Mehl, 370 Mehl Building, Port Worth, Texas. Largest rare coin establishment in U. S. Established 40 years.

UNCIRCULATED 1958P-1955P halves 99¢ each, 1955D quarters 49¢. Pollard, 1214 N. New Jersey, Indianapolis 2, Ind.

### STAMP COLLECTING

77 DIFFERENT U.S.—25¢. Approvals. Utchts, 1143D North Kedler, Chicago 51.

100 STAMPS, 10¢ With approvals. Smith, 508A Brooks, College Station, Texas.

225 STAMPS For only 10¢! This mammoth value includes airmails, pictorials; stamps from strange countries cataloging up to 25¢ each! Also approvals. Mystic Stamp Company, Camden 80, New York.

1500 STAMPS \$1.00 On and off paper. Good variety. World wide. Many pictorials. No approvals follow. Satisfaction guaranteed. Whalen, 1435 First Ave., Oakland 6, Calif.

MINT U.S. plate blocks, Bargain approvals. Kuehl, 3125 East K, Tacoma 4, Washington.

FREE! 55 British Colonies. 5¢ handling. Approvals included. Kensington Stamps, Buffalo 15, N. Y.

ECONOMICAL 1/2¢, 1¢, 2¢. Approvals, 22,000 varieties. Dresel, Box 128-N, West Englewood, New Jersey.

50 DIFFERENT Juvenile stamps \$1. Ernst Schmid, Hauptpostfach 255, Zürich, Switzerland.

UNITED States commemorative collection containing 33 different—10¢. Approvals. White, 516-A Avenue L, Brooklyn 39, New York.

TWO \$5.00 U.S. stamps plus 20 different, 10¢ with U.S. approvals. Irwin, Box 1105, Brooklyn 30, N. Y.

SELL Your surplus good grade stamps. Write, describing fully what you have. Vanroy Shirk, Lebanon, Pennsylvania.

FREE! Catalog! About stamps. Illustrated. Free! The Stampmart, Hartford 1, Connecticut.

FREE United States price list. Mark Hanna, 335 Fifth Ave., Pittsburgh 22, Penna.

50 DIFFERENT Argentine 10¢. Approvals. Reuter, 611 W. 40th Pl., Los Angeles 37.

U. S. Classics. Over 50 yrs. old. 15 selected old-timers. Missing in biggest collections. All 15 at less than 1¢ each. 10¢ with approvals. Jaro, Box 246-T, New York City 8.

50 DIFFERENT United States 5¢ with bargain approvals, lists. Bookman, Box 8245-M, Madeira Beach, Fla.

AMAZING Offer! 200 United States stamps—including commemoratives, airmails, high denominations to \$1.00. Only 10¢ to approval applicants! Illustrated bargain lists free. Mystic Stamp Co., Dept. 80, Camden, New York.

OLD Scarce U.S. seconds on approvals. Slight imperfections, lowest prices. Hernefeld, Clintonhill Sta., Newark 8, N. J.

100 OLD United States between 1861 and 1935, \$1.00. Roush Stamps, 51 Chestnut, Mansfield, Ohio.

UNITED States approvals. Select copies, used—mint. Kingsbury, Fairfax, Vermont.

ICELAND 10 Different beautiful stamps for only 10 cents to applicants for our good old fashioned approvals. Old Colony Stamp Co., Dept. A, Milford, Connecticut.

100 DIFFERENT China 10¢. Approvals. Coast, P.O. 2187H, Santa Ana, California.

1-2¢ EACH! Thousands of exciting worldwide stamps. Free examination. Cole, Box 223-A, Buffalo 21, N. Y.

SELL Stamps to our readers. Your ad in this space will be read by thousands of stamp buyers. I'll prove that to you. Write now for Folder "S." F. W. Johnson, Classified Advertising Manager, Popular Mechanics, 200 E. Ontario St., Chicago 11, Ill.

300 DIFF. World wide 25¢, plus surprise packet. Packet list free. Econopackets, Box 168, Riverside 9, Calif.

FREE United States illustrated catalog. Bailey, 45 Bromfield, Boston, Mass.

AMERICAN Commemoratives; Colonial pictorials; Asian topicals; with surprising approvals. Bristol, Canton Center, Conn.

U.S. Flag, \$5.00 stamps, 25 different collection. Only 10¢. Approvals. Willett Stamps, Box 390-A, Mount Kisco, N. Y.

300 DIFFERENT Given free with approvals. Particulars. Windsor Stamps, 8834 Cornell Ave., Chicago 17.

PICTORIAL Packet from Antigua, Barbados, British Guiana, British Honduras, Burma, Caracas, Leewards, Rhodesia, Trinidad, Tobago, and many other hard to get countries. Bi-colors, topicals. Tremendous value. Each stamp a beauty. 10¢ with inexpensive, attractive approvals. Roseland Stamps, Spring Lake 2, Michigan.

505 DIFFERENT Stamps 25¢. Cape of Good Hope triangle commemorative; Darkest Africa jungle flower set; multicolored Portuguese West Africa map stamp. Amazing collection 505 stamps, catalogues over \$15.00, to approval applicants 25¢. Jayne, Box 44-V, Brooklyn 23, N. Y.

FREE! Giant catalog offering thousands of bargains. Sent with beautiful approvals. Jamestown Stamp Co., Dept. EIPMC, Jamestown, N. Y.

100 DIFFERENT China 10¢ with approvals. Plymouth, Box 510-M, Bell, California.

U. S. stamps! Bargain catalog! Sullivan's, 127-F East 4th, St. Paul 1, Minn.

FREE Stamp collection! 100 different stamps from Europe, Africa, Asia, Scandinavia, Balkans, etc. 3¢ to approval applicants. Tatham Stamp Co., Springfield 30, Mass.

FREE Sample stamp newspaper, information on collecting, special lists. Approvals. Littleton Stamp Co., Littleton A1, New Hampshire.

CANADA — Newfoundland collection including early issues, commemoratives, pictorials and high values. Plus set of fascinating triangle stamps. Plus set of unused British Colonies. Plus large stamp book. All four offers free. Send 10¢ to cover postage. Empire Stamp Corp., Dept. PM, Toronto, Canada.

WORLD'S Best postage directory of worldwide leading 122 wholesale stamp houses. \$2.00. Worldwide all different approval type stamps wholesale to everyone \$1.20, \$3.00 and \$5.00 per packet. Far East 50 different large beautiful pictorials \$1.00. Transworld, WHM235, Flood, B. C., Canada.

STAMP Collecting outfit, includes packet worldwide stamps, package hinges, watermark detector, millimeter gauge. Everything 10¢ with approvals. Lorain Brown, Marion 1, Michigan.

FREE—Mint British Colonies from North Borneo, Caymans, Seychelles, Dominica, Papua, New Guinea, Sarawak, Brunel. Free with approvals. Viking, Great Neck 8, N. Y.

GRAB Bags, \$1.00 each. Satisfaction guaranteed. Simon, 125 Dewbourne, Toronto 10, Canada.

COLORFUL Set, dogs, triangles, free with approvals. Philatelic Roundup, Pennington 1, New Jersey.

100 DIFFERENT Austria, 10¢. Approvals. Aronson, Box P, Newton Centre 59, Mass.

DEALERS Wholesale list. Postage 3¢. Frank, 5031 Queensberry, Baltimore 15, Maryland.

U. S. mint comm. #07-1085-1¢ and postage. H. Wilhelm, 16566 Mendota, Detroit, Mich.

GIANT Approvals, thousands different, 1¢ and 2¢ each. Wahl's Stamp Exchange, 7008P Farragut, Chicago 31, Ill.

500 WORLD Mixture 25¢. Better approvals. Whitney, 5800 Division South, Grand Rapids 8, Michigan.

10 DIFFERENT Sports free with attractive approvals. Edison, Box 246, Edison Center, Miami 51, Florida.

MINT U. S. at face value! All different older commemoratives! Send 23¢ for yours with first selection mint U. S. approvals. Western, Box 1689P, Salinas, California.

100 FINEST World stamps \$2.00! Hostrop, Largobellavista 3, Livorno, Italy.

FRENCH North Africa, 20 different includes bicolored, pictorials. Only fifteen cents with approvals. Vulcan, Box 9053, Birmingham 9, Alabama.

PROFITABLE Stamp dealing quickly learned. Tournoux, 6462 83 Place, West Forest Hills, New York.

UNITED States and foreign approvals. Used. Smith, 504 Water St., Warren, Penna.

100 DIFFERENT U. S. commemoratives \$1.00. Wiggins, Box 72-P, Guild, N. H.

SEVEN Mint sets — 10¢. Approvals. Security, Box 113, So. Orange, N. J.

SPAIN 100 Different 10¢ to approval applicants. Morell, 203 Penimore St., Brooklyn 25, N. Y.

TEN Sets Czechoslovakia 20¢. Approvals. Vail, Box 334, Hicksville, New York.

10 CRAZY Shaped stamps, 3¢ to approval applicants. Knopp, Box 1381, Bristol, Conn.

8 CANAL Zone 10¢. Approvals! Merkel Stamps, 45 Cherry, Holyoke, Mass.

MONACO Nudes mint 10¢. Approvals. Barricks, 1734 Seward, Detroit 6, Mich.

SELLING Out. Surprise packet 40¢. Perley Porter, West Medway, Mass.

FREE, 5 Israel different with our personalized approvals. George Barwick, 1941 Danbury, Detroit, Michigan.

14,000 DIFFERENT! Fascinating new club plan systematically builds your collection. Only 50¢ weekly. Details free. L. G. Ware, Baldwin 75, New York.

FREE! Korea, Eritrea, Somaliland, Curacao, Mongolia; satisfying approvals. Buckeye, 163 No. Congress, Athens, Ohio.

100 DIFF. Foreign, 50 diff. U.S.A. 10¢ approvals. Kem, 670 W. Florence, Los Angeles 44, Calif.

FIRST Day cover approvals! Valuable airmail cover free with first selection. Myers, Coopersburg, Penna.

GIANT U. S. coin catalog 25¢. Acecoin, 314 So. Clark, Chicago 4.

WOW! 135 All different Germany 10¢. Zeppelins, semi-postals, airmails, high values. Big bargain lists and approvals included. Jamestown Stamp, Dept. A1PMC, Jamestown, N. Y.

WONDERFUL Offer. 7 complete mint sets only 10¢ with approvals. Reich (M26), 1033 Lawrence, Chicago 40.

70 DIFFERENT U.S., included 35 commemoratives, 25¢. No approvals. Seidenberg, Appleton, Wisconsin.

U. S. Revenues on approval. El Jay Stamps, Box 286, New York 38, New York.

SOUVENIR Sheet Russia 1937 10¢ with approvals. Kingman, 30 Empire, Yonkers 4, N. Y.

WEIRD Diamond shape coffee stamps. Lovely flower triangle! First American big commemorative. Greenland, idol dancer, etc. Free with approvals. Capital Stamp Co., Ferrysburg 2, Mich.

WANT Lists filled, 100,000 varieties available. References. Downey Stamp Service, Box 70A, Bell, California.

BRAZILIAN Packet airmailed direct, \$1.00. Mauricio, Caixa Postal 515, Anapolis, Golas, Brazil.

FRENCH Colonies packet, bicolored, free with approvals. Spangenberg, Box 334, Bristol, Penna.

FIVE Different sets French Colonies, 10¢ with approvals. Banner, Box 65, Park Forest, Illinois.

84 BICOLORED World flags 10¢, inexpensive approvals. Americana, Box 1560, North Miami, Florida.

BAHAWALPUR, UPU, eight values complete, free with approvals. Taconic Stamps, Box 137, Anram, New York.

LIBERIA Bicolored birds, three triangles, free with approvals. Jayvee, Box 83, Newark, N.J.

QUEEN Elizabeth mint sets! Barbados, Caymans, Dominica, Tristan, Gibraltar, Leewards, 21 bicolored—25¢! Approvals. Gannon Stamps, Box 931, Canton 1, Ohio.

50 DIFFERENT U.S. 10¢. Approvals accompany. Standard, 10840 Woodview, Parma Hts. 30, Ohio.

SUPERIOR Worldwide mission mixture, Amazing variety! Half pound only \$1.50. Baye Nielsen, 4545B Harvard, Montreal 28, Canada.

50 DIFFERENT U.S. commemoratives 25¢; 135, \$1. Request approvals. Harold Hofub, 18 East 198th St., New York 68, N.Y.

FREE Sample! Interesting, informative, illustrated. National Stamp News, Anderson, South Carolina.

25 PICTORIALS 10¢ With approvals. Blaha, 3730 Cleveland, Brookfield, Ill.

ADEN To Zanzibar! A special collection of over 200 different stamps from Aden, Barbados, Cyprus, Dahomey, Egypt, Falkland Is., Guadeloupe, Hejaz, Israel, etc., to Zanzibar. Very unusual collection, catalog value easily \$5.00. Some really scarce ones included! Only 25¢ to approval applicants! Write today and receive free—Eisenhower, Grace Kelly and Geo. Washington stamps from Monaco! Lyle Clark, Muskegon 2, Michigan.

FREE! Your choice any volume Scott's International, Master Global albums, Scott's 1957 catalogues when you buy our sensational foreign approvals. Write for details with trial selection. Bargain Stamps, Redlands, California.

FREE Price list over 1000 packets! 500 different stamps 75¢, 1000—\$1.50. No approvals included. Banthos, Box 122PM, New York 4, N. Y.

25 DIFFERENT Philippines 10¢. Attractive approvals. Barry, Box 25, Shelbyville, Michigan.

100 DIFFERENT Netherlands, 10¢; inexpensive approvals. Mattenson, Box 983, Philadelphia 5, Penna.

ISRAEL, 15 Different, 10¢; approvals follow. Chippewa, Box 321, Doylestown, Ohio.

FIVE Triangles free to approval applicants. Rare, Box 633, Coconut Grove Station, Miami 33, Florida.

50 SPAIN, Free to approval applicants. Dixie, Box 1992, Meridian, Mississippi.

25 DIFFERENT Egyptian, 5¢. Inexpensive approvals. Semith, Box 83, Brooklyn (Rugby), N. Y.

ALL Different — 500, 50¢; 1000, \$1.25; 2000, \$3.00; 5000, \$12.00; 100 Canada 35¢. Approvals. K. S. Holmes, London, Canada.

RUSSIA, 25 Exciting gems 5¢ with approvals. Belmont Stamps, Washington 15, D. C.

100 BRITISH Colonies, 10¢, inexpensive approvals. Pan-American, Box 24, Coconut Grove, Miami 33, Florida.

30 DIFFERENT Commemoratives 1893 up 10¢. U. S. approvals. K&B, Box 70, Brooklyn 23, N. Y.

FREE! Albania Roosevelt bicolored set; inexpensive approvals. Longvue, Box 1301, Lexington, Kentucky.

WEDDING, Pipex, triangles, animals, free! Inexpensive approvals. Rose Stamps, 711 Arundel, Emporia, Kansas.

25 DIFFERENT, 25 Countries, free! Attractive approvals. Weaver, 4410 S.E. Bybee, Portland 6, Oregon.

EXCITING "Strange countries" packet. Free with approvals! Saxon, Orange, California.

TEN Topical triangles 10¢. Approvals. Gernert, 4235-X Alton, Louisville 7, Ky.

FAMOUS Americans, 21 different, 25¢, approvals. Ludwig, 9012 Niles, Afton 23, Mo.

FREE Two nice sets with approvals. Benezra, 3530 Paulding Ave., New York 69, New York.

FREE! British West Indies packet, with colorful, inexpensive approvals. Townsend, Box 386, Chester, Penna.

FLOWERS! Spanish colonies, 1956 set complete 15¢ with approvals. Ralph Rice, 15 Longlane, West Hartford 7, Connecticut.

PAKISTAN, 25 Different 10¢ with inexpensive approvals. Rogers, Box 455-M, Albany 1, N. Y.

500 WORLDWIDE Mixture. Big variety, 25¢. Monjar, Fairmount, Cincinnati 14, Ohio.

FREE! 9 Armenia bi-colored, (50¢ value) with approvals. Diane, Box 70-M, Hartsville, South Carolina.

FREE! 25 Different Mozambique Company, with superior approvals. Send 10¢ handling charges. Foxboro Stamp Company, Box 167, Foxboro, Massachusetts.

25 DIFFERENT Spanish colonies 10¢; attractive, inexpensive approvals. Village Stamps, Box 111, New York 9, N. Y.

HUNGARY 1956 Olympic games bicolored "diamond" commemoratives — Free! Approvals. William Deems, Ravenswood, West Virginia.

BEAUTIFUL Liberia Pipex postage set 10¢. Approvals. Jess T. Green, P.O. Box 698, Mountain View, California.

MONKEYS On stamps. Free set to approval applicants. Collier, Chamblee, Ga.

TRIANGLES, 13 Different 10¢ with approvals. Nickerson, 310 Idaho, LaHabra, California.

STAMPS Of the winds. Grecian airmail sets. 25¢ with request for approval selection. South Shore Stamp Company, 90 Oak Street, Lynbrook, New York.

50 DIFFERENT Philippines 35¢ to buyers of our foreign approvals. Tru-Value, P.O. Box 2098, Santa Ana, Calif.

100 FOREIGN, 20 U.S. commemoratives, 10¢. Approvals. Weckerling, 3210P Hancock, Austin 3, Texas.

20 PICTORIAL Sets high value \$1.00, request approvals. E. Thomas, 7031 S. Talman, Chicago 29, Illinois.

101 DIFF. Plus first Greenland stamp, 5¢ with approvals. Finney, Box 89, El Monte, Calif.

100 DIFFERENT U.S.—50¢ approvals. Utchits, 1143 North Keeler, Chicago 51.

FIRST U. N. set. Among world's prettiest. Only 10¢. Approvals. Welles, Box 1246-R, New York City 8.

12,000 PENNY Approvals waiting for you. Many from exotic countries, pictorials, airmails, new issues. Tilbury, Box 862, Newark 1, N. J.

50 DIFFERENT Switzerland 10¢; colorful, inexpensive approvals. Elkhart, Box 33, Elkhart, Indiana.

DOMINICAN Bicolored commemorative packet free with interesting approvals. Hilltop, Box 696, Havertown, Penna.

16 "FIRST Issues" from 16 countries! Extraordinary collection, (all Scott's #1.) including United Nations, Singapore, Vietnam, etc. Rare value, only 25¢, with approvals. Variety Stamps, 57-F Circuit, Newton Highlands 81, Mass.

U. S. commemoratives, 100 mixed 25¢. Ray Worth, 321 So. Cicero, Chicago 44.

MOZAMBIQUE Company set free. Approvals. Weitz, Box 63P, Orange, N. J.

DEALERS Wholesale list free. Airmail. Smith Company, Halfwaytree, Jamaica, B.W.I.

U. S. mint specials! 13 different commemoratives, 25¢; flags, complete, \$1.00; 4 different souvenir sheets, \$1.00. Free price list. Brooks, 3352P East 33rd Street, Brooklyn 29, New York.

SWITZERLAND Prize package, 100 different—trains, bridges, castles, commemoratives, bi-colors, pictorials. Unusual cancellations too! Only 25¢ with approvals. Edmund Molzan, 730 Pomona, El Cerrito 8, California.

MYSTERY Lots—Guaranteed over \$5.00 catalogue value, only \$2.00. Approvals accompany if requested. Allen Stamp Co., 11302 Garden Drive, Anaheim, Calif.

200 FOREIGN, 200 U.S., \$1.00. Hast, 3297 Marshall, St. Louis 21, Mo.

**SOUTH America!** British colonies! Liquidating thousands at 2¢ each regardless of catalog. Request trial selection today! Moffat's, 740 A Milton, Rock Hill, South Carolina.

**FAMOUS Men, jungle scenes, zoo, United States commemoratives, 100 others.** Ten cents with request for thrifty approvals. Casner Stamps, 247-A Riverside, El Paso, Texas.

**FREE!** Bargain worldwide packet list. No approvals. Lakewood Postal, 2226 Lincoln, Lakewood 7, Ohio.

**INDIVIDUAL Stamp album absolutely free.** Tasker, 105 East Custis, Alexandria, Virginia.

**EGYPT'S Suez Canal commemorative 10¢, approvals.** Gatewood, Box 346, Winston-Salem, N. C.

**COMMEMORATIVES, Triangles, pictorials—25 different free with approvals.** Beacon Sales, Maynard, Massachusetts.

**FREE!** Monaco, Togoland, Cameroons! Approvals. Keating, 2320-P Boulevard, Jersey City, N. J.

**100 UNITED States commemoratives 75¢.** Request approvals. Jemink, Tampa 1, Fla.

**FINLAND—Lakenland, 111 diff. 50¢, 1000 good mixture \$2.00, 1 kg. \$5.00, 1000 world mixtures \$2.00.** Epairio, Mantta, Finland.

**FREE!** 750 Mixed world. Send quarter for postage. Weird giant mixture! Isco, Dept. APM, 4405 Basswood, Bellaire, Tex.

**SURPRISE Set (mint) and fifty different free with approvals that satisfy.** Stamp Imports, Peterborough, Ontario, Canada.

**WORLDWIDE Stamp exchange.** Details free. I.S.L., Box 24, Sheungwan, Hong Kong.

**FREE** Introductory packet to approval applicants. Anderson, 1112 Harrison, San Francisco 3, Calif.

**TRIANGLES, French Colonials, 50 others 10¢ with approvals.** Bennett, Candor 3, N. Y.

**1957 U.S. Illustrated catalogue free.** Stone's, 192 Washington, Boston 8, Mass.

**300 DIFFERENT World-wide 25¢, plus exotic Cambodi dancers set.** Approvals. Mark Stamps, 4628 N. Hollywood Avenue, Milwaukee 11, Wisconsin.

**\$2.00 CATALOGUE Only 10¢.** Coral Stamps, Box 224, Riverside Station, Miami, Florida.

**EVERYTHING Goes.** Tremendous accumulation. Collections, lots, albums, miscellaneous. Closing out cheap. Lists free. Alateo, Maynard, Mass.

**TRIESTE.** Automobile set, 15¢. Catalog value \$1.65. Approvals. Wilson, 380 Sackett, Brooklyn 31, New York.

**100 DIFFERENT Latin American 25¢ to buyers of our foreign approvals.** Golden-State, P.O. Box 325M, El Toro, Calif.

**ARMENIA.** Old set free. With approvals. W-B Stamp Co., Wilkes-Barre, Penna.

**FREE!** Monaco Roosevelt set! Inexpensive approvals. Atomic, Box 295-A, Silver Spring, Maryland.

**GERMANY** Below wholesale. Request price list. Kaperi, P.O.B. 35175, Los Angeles, Calif.

**QUALITY Approvals, 500 at 2¢ each.** Hadrian, 12 East 31st, New York City 16.

**LIBERIA Birds complete, 25¢ to approval applicants.** BKJ, Astor Station, Boston 23, Mass.

**ITALY—100 Different 10¢ with approvals.** DeRespinis, G.P.O. Box 771A, New York 1, N. Y.

**90,000 STAMPS Sale!** Big lot including beautiful Mona Lisa, Greece, Egypt, Malta, Turkey, \$1. Extra special better stamps \$2. Giant assortment \$5. Literature free. Persil, 436 N. Y. Ave., Brooklyn 25, N. Y.

**FREE!** U.S. price list (1957) to all our approval customers. Write for a selection today. New-Way Stamp Co., Lawrence, Massachusetts.

#### **ANTIQUES, RELICS, INDIAN GOODS, CURIOS**

**10 ANCIENT Arrowheads \$2.00.** Grooved tomahawk \$3.00. List free. Lear's, Glenwood, Arkansas.

**SELECTED War arrowhead \$1.00.** List 5¢. H. Talburt, Calico Rock, Ark.

**ILLINOIS "Gesundheit" — Disposing of \$300,000.00 collection of 500 historical firearms; revolutionary, civil, Indian war, flintlocks, muskatoons, swords, bayonets, bullet molds, powder flasks, Kentucky rifles, pepperboxes, dueling pistols, 50,000 Indian relics, collectors cartridges, coins, Confederate money, Agates, minerals, fossils, mounted birds, animals, deerheads, gold dollars, bo-wood, violin wood, blorbons, daguerrotypes, a 400 page catalog would not list everything. Send 35¢ for profusely illustrated catalog. Heike's, Dadeville, Wenona, Illinois.**

**SCALPING Knife, spearhead, thunderbird \$4.00.** Catalog free. Arrowhead, Glenwood, Arkansas.

**4 PERFECT Arrowheads \$1.00.** Smith, 841 N. Tacoma, Indianapolis, Indiana.

#### **PRECIOUS STONES, MINERALS**

**EARTH Science, the Rockhounds' national magazine.** Subscription \$2.00, sample 25¢. Box 1357, Chicago 90.

**OPALS, Sapphires airmailed direct from Australia.** Collection 12 rough Australian gems \$5 and \$10. Send cheque or international money-order. Free catalogue. Australian Gem Trading Co., 49 Elizabeth Street, Melbourne, Australia.

**CUT Gems, make jewelry—For profit or fun.** 100 page magazine tells how: where to get supplies. Sample 25¢ or request free literature. Lapidary Journal, Del Mar 2, Calif.

**AGATES, Gems, machines.** Free list. Northwest Gems, 2819 North Warner, Tacoma 7, Washington.

**SAPPHIRE, Topaz, tourmaline, garnet, peridot.** Five uncut gem specimens, \$1.00. Ten polished gems, baroque shaped, \$1.00. Free bargain list jewelry, gems. Profitable, easy "do-it-yourself" projects. O'Brien's, 1116M Wilcox, Hollywood 38, Calif.

#### **HOBBIES AND COLLECTIONS**

**COLLECTORS Matchbook covers, 100 different unused, \$1.00.** Catalog 25¢. Album \$3.00. Charles Edelman, 1311-C East 84, Cleveland 3, Ohio.

**MILITARY Miniatures.** Civil War. Custer's Cavalry, American Revolution and U. S. Marines. Illustrated catalog 25¢. Bussler Miniatures, Dept. Z, 40 Howe St., Quincy 69, Mass.

**INVENTING Can be an interesting and profitable hobby.** Write for complete particulars. Institute of American Inventors, Dept. 40-E, 635-F St., N.W., Washington 4, D. C.

**NAZI Insignia, 12 different \$1.00.** Medals, patches, armbands, flags, daggers. Illustrated lists, 10 cents. Medcrafts, Box 532, Victoria, B.C. 2, Canada.

**DISPLAY Cases!** Details for stamp. Poster, 852 Lake Rushville, New York.

#### **CAMERAS, PHOTO SUPPLIES**

**FREE! Free! Free! Bargain book.** Big savings—Still, movie camera, equipment and supplies. Photographic headquarters since 1899. Central Camera Company, Dept. 1-11, 230 S. Wabash Ave., Chicago 4, Illinois.

**3-D Stereo camera, flashgun and viewer.** English import. Complete outfit only \$12.95. Literature, photo 25¢. Navair, 4224 Adams, San Diego 16, Calif.

**PHOTOGRAPHY For pleasure or profit.** Learn at home. Practical basic training. Long established school. Free booklet. American School of Photography, 835 Diversey Parkway, Dept. 3442, Chicago 14.

**BUY Wholesale nationally advertised cameras, photo supplies, thousands other products at big discount.** Free "Wholesale Plan." American Buyers, Hertel Station, Buffalo 16-E, N. Y.

**ARGUS C-3 outfit \$49.50.** Discounts to 60%. Photo equipment, appliances. Free catalog. Mellers Mart, Box 135-MP, Peabham, New York.

**BASS Says: Quality cameras since 1910.** When in Chicago visit the camera cross roads of the world, or write us for your favorite equipment, new or used. Satisfaction guaranteed. Bass Camera Co., Dept. AG, 179 W. Madison St., Chicago 2, Ill.

**20 TO 75% Discount everything photographic, gift-ware.** Free catalogue. Dart, 3812E Atlantic Avenue, Brooklyn 24, New York.

#### **PHOTO FINISHING**

**5x7's—10¢ EACH.** Send negatives. Huffman, 309 Water, Whitesboro, Texas.

**FROM Rolls or negatives, Jumbos 4¢ each.** Contacts 3¢. 30 jumbos \$1.00. Highest quality. Sharp, fadeproof guaranteed prints. Quantity orders special rates. Square Deal Photos, Hutchinson, Kansas.

**STAROTYPE Enlargements; Amazingly different.** Eight 5x7's or five 8x10's—\$1.00. Hargraves, Box 373, Hollywood 28, California.

**8-HOUR Service on deluxe jumbo prints.** 8-exposure roll developed and 8 jumbo prints 40¢, 12 exposure 55¢, 16 exposure 70¢; 35mm. 20 exposure 75¢, 36 exposure \$1.25. Jumbo deckledge reprints 4¢ each. Contact prints made if specified. Bay Photo Service, P.O. Box 210, Oakland, California.

**QUALITY Kodak finishing, 8 exposure roll 35¢; 12 exposure 50¢; 16 exposure 60¢.** Reprints 4¢. Fast service. Guaranteed quality. 40 years continuous operation. Be a satisfied customer. We do color. Send for mailers. Mail Order Photo Service, Box 297, Watertown, Wisconsin.

**EKTACHROME Processing — \$1.00.** Transparencies printed, 2X 45¢; 3X 65¢. Photocolor Laboratory, P.O. Box 617, Toledo 1, Ohio.

**ENLARGEMENTS, Heavyweight eight 5x7's or five 8x10's, \$1.00.** Jack Koons, Huntington Mills, Luzerne County, Pennsylvania.

**SUPERIOR Quality.** Prompt service, 8 jumbos in album 40¢, 16 contacts 50¢. Jumbo reprints 5¢. Satisfaction guaranteed. Also complete color film finishing service. Write for free circulars and mailers. Fast-X-Photo, Box A, Jersey City, N. J.

**ONE-Day quality photo finishing service at no extra cost.** Prints, reprints, enlargements in giant and negative sizes. Mailed coast to coast. 8 exposure roll developed for 42¢ complete. Send for free mailing kit. Royal Snapshot, P.O. Box 543, Milwaukee 1, Wisconsin.

**EKTACHROME—Anscochrome processed.** Mounted \$1.00. National Color Corporation, Box 55, Northside, Atlanta 5, Georgia.

**LIFETONE (Copyright) ultra fine grain prints.** Custom developing plus oversize prints on heavy portrait weight paper. Salon quality. 8 exposure 70¢, 12 exposure \$1.00; 35mm—20 exposure \$1.75, 36 exposure \$2.75. Free mailers and circulars. Send to Lifetone Photo, Post Office Box 96, Chicago 17, Illinois.

**8-12 EXPOSURE Rolls 39 cents jumbo prints.** Free 5x7 enlargement with each roll developed. Guaranteed work, one day service. Lincoln Studios, Dept. K, Box 13, Lincoln, Nebraska.

#### **MOTION PICTURES AND SOUND EQUIPMENT**

**5,000 8-16MM. Movie films.** Free catalogues. International, Greenvale, N. Y.

**TAPE Recorders, tape.** Unusual values. Free catalog. Dressner, 69-02M 174 St., Flushing 65, N. Y.

**MOVIE Camera film; 8mm. roll \$1.50, 16mm. 100' \$3.00.** Free processing. Better Films, 742 New Lots, Brooklyn, N. Y.

**RECORDERS, Tapes; wholesale.** Free catalogue. Carstan, 215 E. 88, New York City 28.

**FREE Catalog.** Save dollars. Fresh 8mm., 16mm. b&w and color film. Home processing equipment. Superior Bulk Film Company, 448 No. Wells, Chicago 10.

**FREE! Blackhawk's big sale catalog new and used 16mm., 8mm. films; 3"x3" color slides; used 16mm. sound projectors.** Biggest stock in U.S.A. Blackhawk Films, 1700 Eastin, Davenport, Iowa.

**SAVE 50%! Guaranteed-fresh color, b&w. movie film! 8mm., 16mm.** Free catalog! Eso-R, 47th Holly, Kansas City 12, Missouri.

**16 MM. Sound films.** Bargain prices. Bedner, 5300 So. Talman, Chicago.

**SPECIAL For Lent "Entire Life of Christ." 8mm. silent, 16mm. narrated with sacred music.** Hemenway Film, 424 Little Bldg., Boston 16, Mass.

**16 MM. Sound movies.** Rented, sold. Hutton Rental Service, Bellows Falls, Vt.

## MUSIC AND MUSICAL INSTRUMENTS

**SONG** Request forms made for two dollars. Howard Olenik, Mount Morris, Mich.

**POEMS**, Songs wanted! Recording, promotion. Bengol, 93 Jefferson, Chelsea 50, Massachusetts.

**PLAY** Piano the first day! Copyrighted secret. Details free. Miracle Method, Box 5203P, Phoenix, Arizona.

**ACCORDIONS**, Wholesale to everyone. Save up to 60%. All national known brands. Free catalogue. Del Principe, 29 South Cicero, Chicago 44.

**WRITE** Songs. Big money and reputation. Write for information. J. Gordon Pub. Co., 4700 South California Avenue, Chicago.

**SONGPOEMS** And lyrics wanted. Mail to: TinPan Alley, Inc., 1650 Broadway, New York 19, N. Y.

**SWISS** Musical movements, \$1.90. Helax, 218 West 72nd Street, New York 23.

**DISCOUNTS**, Instruments, accessories, national brands. Tempo Music, 37 Cutler, New London, Connecticut.

**SONGS** Into dollars. Share \$29 million dollars yearly for new songwriters, song-poets. Songs composed, published, promoted by famous firm. Information, appraisal free. Send to Nordyke Publishing, 6000 Sunset, Hollywood 28PM, California.

**FREE** Records of your song. Your words, my melody. Free information. Johnny Mack's Melody Mart, 1094 West 39th Street, Dept. A, Los Angeles 37.

**POEMS** Wanted for new songs. Send poems. Free examination. Immediate consideration. Songcrafters, 2724 Arcade Station, Nashville, Tenn.

**WANTED** Used guitars and banjos. Write description and price wanted. Eddie Bell, 101 West 46 Street, New York 36, N. Y.

**ACCORDIONS**—Direct from importer. Save 50% and more! Free trial. Lifetime guarantee. Trades accepted. Free catalog. Write Accordion Manufacturers, Dept. 17R, 2063 Chicago, Chicago 22, Illinois.

**SONG** Poems wanted. Five Star Music Masters, 630 Beacon Building, Boston.

**ACCORDIONS** Wholesale—10 day trial. Free catalog. American Accordion Center, 5329-PM-1 Belmont, Chicago.

**SONGWRITERS**: Recording company wants new songs. Royalty basis. National sales, promotion if selected. Send material. Music Makers, Dept. E-29, Box 2507, Hollywood, Calif.

**POEMS** Wanted for new songs. Send poems. Immediate consideration. Crown Music Company, 49-C West 32 Street, New York City.

**SONGWRITER'S** Magazine 25¢. Songsmith, Dept. 2P, 511 Thurston, Rochester, N. Y.

**SACRED** Music composed to religious words. Reginald Belcher, Box 334, Morristown, New Jersey.

**ELECTRIC** Guitars, amplifiers, wholesale. Free catalog. Carvin PMM, Covina, California.

## RADIO, TELEVISION AND ELECTRONICS

**CRYSTAL** Radio kit \$1.00, preassembled \$1.25, phone \$1.75; catalogue. Clearco Crystal Company, 2966 North 4th, Milwaukee 12, Wisconsin.

**TWO-Way** radio. Portable. 10 mile range. Operator's license unnecessary. \$69.75, prepaid. Hart, 467 Park, Birmingham, Michigan.

**CRYSTAL** Radio experimenters, write Hulet, 305 Hope, Lakewood, New Jersey.

**WALKIE-Talkie**. Build wireless two-way portable radiophone for less than \$10.00. Plans 50¢. Springfield Enterprises, Box 54-B1, Springfield Gardens 13, New York.

**KNOW** Your television! Circuit diagram with detailed tube and parts data. Send make and model number, \$1.00. Telpix, P.O. Box 1283, Oakland 4, Calif.

**EXPERIMENTERS**: Make hi-fidelity, self-powered loudspeaker radio. Plays forever. Operating expense zero. Rush \$1.00 for fully diagrammed instructions. Satisfaction guaranteed. Act now! Janecck Development Company, Dept. BA, 373 East 155th St., New York 55, N. Y.

**WHOLESALE**: Phonographs. Radios. Tape recorders. Catalogue 25¢ (refundable). Towers, 155, Philadelphia 5.

**FREE!** Newark's new 1957 catalog. A postcard will bring you 306 pages full of the latest releases and largest selections of the world's finest radio, TV, amateur, electronics and high fidelity equipment. Write today to: Newark Electric Company, 223 W. Madison St., Dept. PM-1, Chicago 6, Ill.

**ELECTRIC** Guitars, amplifiers, wholesale. Free catalog. Carvin PMR, Covina, California.

**POCKET-Vac** cleaner \$5.95. TV tube booster \$3. World-Export, Box 929, Indio, California.

**ENJOY** 3-Color television now! Screens for every black-white set. Complete details free. Zingo Products, Johnstown, New York.

## BUSINESS OPPORTUNITIES

**PORTABLE** Garbage disposal sells itself! Earn \$2135 monthly. 100% profit. No installation, UL approved. Retail \$89.50. Choice territories. Free demonstrator offer, kit. Write today. New-Home Co., 41, P.O. Box 840, Beverly Hills, Calif.

**MAKE** Money growing miniature trees on your window sill. Free seed and plan. National Nursery, Dept. M-JY, Inglewood 4, Calif.

**BUY** Wholesale! Resell at big profits. Brand name merchandise—Appliances, cookware, housewares, watches, jewelry, dry goods, clothing, sporting goods, toys, gifts, etc. Free 1957 color catalog with confidential cost sheet. Merit Home Products, Dept. PM-1, 107 Manhattan Ave., Brooklyn 6, New York.

**TREMENDOUS** Profit in your own home mail-order fish bait business. Terrific potential. Buchholz, Realtor's, Edgerton, Wisconsin.

**MADE** \$10,000.00 Typing at home. Guaranteed profit. Amazing information 10¢. Lenore Felgen, Box 1125-PM, Oak Park, Ill.

**STRANGE** Dry window cleaner. Sells like wild. Replaces messy rags, liquids. Simply glide over glass. Samples sent on trial. Kristee 106, Akron, Ohio.

**GROW** Expensive herbs for us! Big profits home-business of your own. Year around profitability! We supply everything necessary! Send for free rare seeds and revealing plan. National Herb Exchange, Dept. JY, Gardena, Calif.

**A Big-paying** business for a man in his 50's. One of our men makes \$11,000 in a year. Other top men in their 50's earn up to \$5,000 to \$8,000 right from the start. We pay earnings in advance. Require no investment. Write confidential letter to President, Dept. PM, Box 676, Dayton 1, Ohio.

**MAKE** Extra money. Cash commissions. Everybody buys easy-to-sell advertising book matches. Union label. All sizes—Cuts for all businesses. Powerhouse selling kit free. Steady repeat business. No experience necessary. Superior Match Co., Dept. MX-157, 7328 S. Greenwood, Chicago 19.

**\$5000.00 YEARLY**, Part time, in one of these businesses: Mail order; real estate; photography; insurance; bookkeeping; collection. Write today. Nationwide, 618 Savannah, Columbus 4, Ohio.

**START** A buying service, buy wholesale thousands nationally advertised products. Make big profits selling at sizable discounts. Postcard brings details. American Buyers, Hertel Station, Buffalo 16-C, New York.

**IMPORT-Export** opportunity, profitable, world-wide, mail-order business from home, without capital; or travel abroad. Established world trader ships instructions for no-risk examination. Experience unnecessary. Free details. Mellinger G701, Los Angeles 24.

**MAKE** Attractive, durable, building plastic, easily. 800% profit. Exclusive district. Bays Laboratory, Oklahoma City 9.

**FREE** Book. Grow mushrooms. Guaranteed market. Mushrooms, Dept. 172, 2954 Admiral Way, Seattle, Wash.

**PRINTING**, Office supplies wholesale. Save 50%. Royal, Box 388-A, Cleveland 27, Ohio.

**BECOME** Tax consultant. Graduates earn \$3,000 every tax season preparing returns evenings. State approved. Union Institute, 68 Hudson, Hoboken, 28, N. J.

**YOU** For president of collection agency. We have helped hundreds get their names on office doors. Franklin Credit, Roanoke 7, Virginia.

**MAKE** Flexible molds. Cast plaques, figurines. Free sample. Tooker, 1045-R Fairview, Hamilton, Ohio.

**MAIL** Order advertising agency executive reveals sensational no-risk advertising and merchandise methods. Start in office or home; minimum capital; positive profits. Free details: Impact! 2108 Payne, Dept. 11-1, Cleveland 14, Ohio.

**WANT** To make big money at home? \$10.00 profit in an hour possible with invisible reweaving. Make tears, holes disappear from clothing, fabrics. Steady year-round demand from cleaners, laundries, homes. Details free. Fabricon, 8334-S Prairie, Chicago 19, Illinois.

**"HOW To Start a Business"** booklet sent free! If you know any trade, go into business for yourself! Learn the 9 easy steps to follow. We've guided 5,000 others to success. Revealing free booklet yours for the asking! Write! National Business Consultants, Office JY, Los Angeles 61, Calif.

**MAKE** Perfumes, cleaners, polishes, cosmetics, home. Sell mailorder. International, 6347 Parnell PM-17, Chicago 21, Illinois.

**DEALERS** Wanted. Exclusive franchise to people who qualify on terrific new product. \$10,000 cash required plus good background. Excellent opportunity to net \$50,000 a year and up. Immediate response necessary. Write P. O. Box 1076, Jacksonville, Florida.

**WANTED!** Home workers to assemble luggage and cases for ready market. Instructions, materials, tools, everything supplied. Free details. Abarst, 807-BA Sunset, Los Angeles 12.

**SHAVING** Revolution. No electricity, soap, blades required. Amazing. 2323 Bon Air, Montreal, Canada.

**BECOME** A game warden, professional hunter! Join forestry, park, fishery services. Good pay! Opportunities open! Free revealing "Select-Job Chart," details, job-getting secrets. Write Home Study Institute 1038-RJY, Los Angeles 19, California.

**TAPE** Recording! Exceptionally profitable opportunity in your area. Free information. Baron's, Lynden, Washington.

**NATURAL** Molding rubber, extra thick. Free sample. W. Wooley, 1016-A Donald, Peoria, Illinois.

**INTERNATIONAL** Mailorder business. Complete setup service—Not just instructions. Hermes, 152 West 42, New York City 26.

**\$100 WEEKLY** Raising earthworms! Free plan reveals how! Oakhaven-P, Cedar Hill, Texas.

**PROFITABLE**—Shear sharpening. Proven facts. Write. W. Zell, Summitville, Indiana.

**YOU** Can make money at home in spare time taking magazine renewal subscriptions. No capital or experience necessary. All supplies furnished. Write today! McGregor Magazine Agency, Dept. 500B, Mount Morris, Illinois.

**BIG** Money raising fishworms and crickets. Free literature. Carter Farms, Plains, Georgia.

**INTERESTED** Mail order? Samples leading mail order magazines 10¢. Palm, Box 1221, Baton Rouge, La.

**CASH** Income—Collecting local information. No selling. Free facts. Dorset, 2217 So. Walnut, Muncie, Ind.

**CASH** From sawdust, seventy methods. Tin-cans, thirty methods. Newspapers, eighteen methods. Instructions 50¢ each. All three \$1.00. Charles Company, 12-DXV, Norwood, Ohio.

**START** Home business making statuary, plaques, novelties, garden furniture, artificial marble flooring, liquid marble. Make your own flexible molds. Amazing profits. Only \$1.98. Free literature. Popular Mechanics Press, 631 No. St. Clair St., Chicago 11.

**UNUSUAL** Mailorder opportunity. Tested. We supply everything. Girard's, Azusa, Calif.

**MAKE** \$46 From square foot plywood; jig saw necessary. Free information. Woodarts, X-7, Bridgewater, Mass.

**\$60 WEEKLY.** Spare time, easy! Home Venetian blind laundry. Free book. Burt, 2434A, Wichita 13, Kansas.

**FREE List** (unusual businesses) for homeworkers. Ballard's, 425 East Catherine, Louisville 3, Ky.

**YOUR Own mailorder business.** Manual 25¢. George McCutcheon, 638 W. Creighton, Fort Wayne, Ind.

**FREE:** "How to make quick, easy money." Gec., La Verne, California.

**WHOLESALE**—Thousands nationally advertised products. Buy, sell. Amazing profits. New, free plan. Associated Wholesalers, 1016-D Starr, Burlington, Iowa.

**WANT More business?** Here's an amazing opportunity to increase your sales. Talk to thousands of interested readers of "Mechanics Popular." Our Spanish Edition covers the Latin American countries like a blanket. They're real mailorder buyers. Classified rate 75¢ per word. Try an ad in our next issue. Classified Advertising Department, Popular Mechanics Magazine, 200 East Ontario Street, Chicago 11, Ill.

**PLATE** Baby shoes, jewelry, gifts, bronze and colored pearl. Free booklet. Platex, 11029 South Vermont, Los Angeles 44.

**VENDING Machines**—No selling. Operate a route of coin machines and earn amazing profits. 32-page catalog free. Parkway Machine Corporation, Dept. 26, 715 Ensor Street, Baltimore 2, Maryland.

**HOW To make up to \$100.00 a week in spare time**—by mail. Tested, money-making plan. Free details. Personal Press, 1412-PM Great Northern Bldg., Chicago 4, Illinois.

**GROW Orchids at home**—Profitable, fascinating. Year 'round, Maine to California. No greenhouse. Gorgeous cactleys, cymbidiums, etc. Successful home grower shows you how. Full details free. Flowerland, 100 So. Vermont, Los Angeles 4.

**HOME Workshop books.** Free catalog. Popular Mechanics Press, 631 N. St. Clair St., Chicago 11.

**COLORGLAZED Concrete pottery** made without molds. Patented method. Cemetery products, novelties, tiles. Basement leak-sealing. Money-making projects. Booklet, details free. Men only. National Potteries Company, Grand Rapids, Minnesota.

**11,000 NEW Prospects daily.** Baby record books, shoes, albums. Sell mailorder. Everything furnished. Free literature. No-Co-Ro, Capitola, California.

**LIQUID Rubber,** make flexible molds. Free sample. Chaney, 1130 E. 18th St., Jacksonville 6, Fla.

**MONEY In saw and lawnmower sharpening** sparetime at home. Free book. Virgil Foley Company, Columbia Heights, Minnesota.

**FREE Folio** "85,000-\$45,000, Unlimited Vacations." No merchandise, equipment. Unknown! Work home, sparetime! Haylings, Carlsbad, Calif.

**\$250 WEEK** Cleaning venetian blinds. Patented machinery. Free literature. Robinson, 7213B, Indianapolis 1, Indiana.

**FIX Typewriters.** Inexpensive home course teaches factory secrets. Free booklet. Write, Typewriter, Tarentum 1, Penna.

**\$70 WEEKLY**—Home, spare time. Simplified mail bookkeeping. Immediate income—easy! Auditax, 34757A, Los Angeles 34.

**BRUSH Plating outfits** for plating articles in the home and shop. No tanks necessary. Good income spare or full time. Free particulars. Gunmetal Co., Ave. H, Decatur, Illinois.

**50% PROFIT** Baking new greaseless doughnuts in kitchen. Grocers buy daily. Free recipes. M. Ray, 3605 South 15th, Minneapolis 7, Minnesota.

**\$1,000 MONTHLY** Possible in collection agency business. Free details. Write Cole Associates, Syracuse 2, N. Y.

**TO \$100.00 Weekly.** Sparetime, home operated mailorder business. Successful beginner's plan. Everything supplied. Lynn, 10420-M National, Los Angeles 34.

**FREE Book** "305 Odd, Successful Businesses." Work home. Expect something odd! Pacific, Oceanside, Calif.

**REBUILD Batteries;** repair dolls; make rubber stamps; "60 Ideas" free. Universal, Box 1076-A, Peoria, Ill.

**PLASTERCRAFT** Molds, liquid rubber, plasters, stocks, candle supplies. Catalog and manual free. Blue Rapids Supply, Blue Rapids, Kansas.

**EARN \$10,000** Yearly raising Angora rabbit wool for us. Information 25¢ coin. American Angora Company, Malta 12, Montana.

**BREED** Rare tropical fish at home. Earn big money! Learn secrets! Help fill huge demand. Amazing opportunity! Free plan. Tropical Fish Breeders, Los Angeles 61, Calif.

**MINK** Raising information free. Complete. Lake Superior Mink Farm, Superior, EEL, Wisconsin.

**COPUBLISH** Mail Sale Advertiser, leading mail order paper. Details, latest copy, dime. Vanroy Shirk, Lebanon, Penna.

**HIGHEST Commissions** all magazines. Free catalogue, supplies, prizes, exclusive extras. Subscription Service Co., Box 2070, Birmingham, Alabama.

**MAKE,** Sell perfumes, household products. Jordan, 743 South Dorrance, Philadelphia 46, Penna.

**"MAILORDER** Laws and Regulations," \$1.00. Explains licenses, taxes, legal requirements. Tasker, 105 East Custis, Alexandria, Virginia.

**LEARN** Real estate by listening to records. Lee Institute, Brookline 46, Mass.

**I Want to send you proof** of the wonderful pulling power of Popular Mechanics classified pages. What's your proposition? Write me today. Include literature if possible. F. W. Johnson, Manager Classified Advertising, Popular Mechanics Magazine, 200 E. Ontario St., Chicago 11, Ill.

**FREE Success plan** folio. "Secret Journal," 919 secrets! Work home—Successfully! Publico, Oceanside, Calif.

**IMPORT** Your own products in small lots. Also, start profitable mail-order business using international drop shipment method. Capital unnecessary. Free details. Georgia Overseas Trading Company, Dept. W, 715 Persons Bldg., Macon, Ga.

**SPECIALIZED Magazines.** Current copies, 5,186 publications. Also 1148 self-help books. All trades, professions, sports, hobbies, etc. Free list. Publications, 34C North Ritter, Indianapolis 19, Indiana.

**INCREASE** Your income. Free literature. Bercher, Box 500, Shreveport, La.

**WANTED:** Home producers, to be subcontractors. Cast plastic products for manufacturers in our clearing house service. Thousands of easily made items required. Cash in at home, without previous experience. Plastic Service Associates, Dept. 1-PM, East Boston 28, Massachusetts.

**MAKE Money** in landscaping. Start your own business, part or full time. Many good paying positions open. Earn while learning. Send for free book. National Landscape Institute, Dept. M-17-C, 310 S. Robertson Blvd., Los Angeles 48, Calif.

**POPCORN** And potato chip equipment. Eakins, Box 933 A7, Springfield, Ohio.

**123 WAYS** To make money. Kent Co., 1060 N.E. 127 St., N. Miami, Fla.

**START** Your own business on credit. Your own boss. 1598 dealers sold \$5,000 to \$32,000 in 1955. We supply stocks, equipment on credit. 200 home necessities. Sales experience unnecessary. Pleasant profitable business backed by world-wide industry. Write Rawleigh's, Dept. A-U-PPM, Freeport, Ill.

**FREE "Franchise Profit Letter"** describes nationwide opportunities. Exclusive distributorships, dealerships, agency operations. Write today. National Franchise Reports, 333 North Michigan, Chicago 1.

**OPERATE** Profitable mail order business! Splendid opportunity. For details write: Thomas Bond, 1637H West Vernon, Phoenix, Arizona.

**5 BIG** Moneymaking offers free! Local or mailorder! Calif Agency, 170 So. 17th, San Jose 12, Calif.

**DO Drain** cleaning by electric machine. Highly profitable, non-competitive business. Full details and prices. Electric Sewer Cleaning Co., Allston 34, Mass.

**LEARN** Sewing machine repairing. To \$125.00 weekly. Sparetime. Supplies. "Add to present business." Write today! Taylor Service, Box 2128, San Bernardino, Calif.

**OPERATE** Your own sparetime business distributing reflective tape product. 195% commissions possible. No investment. Write Nite-Site, Manitou Beach, Hilton, N. Y.

**OPERATE** Restaurant or diner. Free booklet reveals plan. Write Restaurant Arts, 11-BU, Fremont, Ohio.

**LEARN** Photo-negative portrait retouching. Men, women. \$5 hour possible spare or full time at home. Easy, glamorous. Work for photographers by mail order. Full details sent free. Duval, 100 So. Vermont, Los Angeles 4.

**EARTHWORM** Growers needed! Good paying home business. Profits to \$1,000.00 a month! We teach you how to raise, and where to sell. Start now! Send \$5.00 for special beginner's unit—You get 1,000 big red Egyptian breeder earthworms, plus our terrific 1957 raising, marketing manual, postpaid! National Earthworm Growers' Co-Op, 4163 Pedley Avenue, Norco, Calif.

**PROFITABLE** Mail order methods, ideas, opportunities. Clearly, authentically revealed in amazing new publications now available. Free details. Write: Wellington Publishing, Box 4157, Austin 51, Texas.

**VENDING Machines**—Every description. New or used. Lowest prices. Start a route or sell outright. Mack Postal, 2952 Milwaukee, Chicago 18.

**YOUR Own name brand business.** No investment; no inventory. Part time or full time. Sell famous brands of appliances, housewares, silverware, radios, vacuum cleaners, lamps, tools, clocks, watches, jewelry, etc., etc., over 1000 items. Join thousands of successful independent dealers. Send for free catalog and dealer price list. H. B. Davis Corp., Dept. 11, 145 W. 15 St., New York City.

**BUSINESS** Of your own. In the multi-million dollar automotive business. Five products you can make and sell. Complete with formulas, \$10.00 value, only \$1.00. Professional Men's Service Div., Box 4194, Tulsa 9, Okla.

**SPARE** Time vending machine route for ball pens. Bonomo, 54 Jefferson St., Brooklyn 6, N. Y.

**WOULD** You spin Angora wool at home? Fascinating, profitable. Angora House, PM, Springfield, Ill.

**BUSINESS** And real estate ads mailed \$2. Greenway, 3549 W. 135, Hawthorne, California.

**FREE Lists.** 640,000 items wholesale. P. Cottage Industries, Omaha 12, Nebr.

**GUARANTEED**—Profitable. Sparetime. Home. Mailorder business. \$1.00. AAA, 100 Airport, San Antonio 12, Texas.

**3 BIG** Opportunity-laden issues. 25¢. Profitable selling, 2007 Wyoming, Washington 9, D.C.

**MAKE** Money. Work home. Enjoy life. Opportunities galore. Free details. H. & L. Products, 756 So. Normandie, 308 Pop., Los Angeles 5, Calif.

**BIG** Package of mailorder magazines, \$2.00. Sample magazine, 25¢. Pickett, Mt. Airy, Md.

**\$5,000 YEARLY.** Spare time at home. Nothing to buy. No local selling. Dignified. Guaranteed. Home Harvest, Rt. 3, Box 3491-A, Albuquerque, New Mexico.

**MAIL** Order business. Make money in a "collective mail order business" with repeat income. Orders come direct to you with a big profit on every sale. Only \$1.00. Include this ad for 100 free circulars. Collective Enterprises, P.O.B. 179, Murray Hill Station, New York 16, N.Y.

**BUY Wholesale!** Discounts to 80%! Appliances, cameras, sporting goods, housewares, watches, tools, clothing, etc. Buy-Rite 73-01, Wagaraw, Hawthorne 2, New Jersey.

**BRICKLAYERS** Literature, opportunities, layoff plans, retirement. Information 25¢. Pretlo Services, Box 114, Durham, N.C.

**OPERATE** Money-making mail order business. Write Adams, Box 5415, Chicago 80, Illinois.

**HOW** And where to sell mailing lists. New instructions gives low-down about this fascinating home business venture. Further details. Write now. Megargel, 32 Fairway, Ludlow, Mass.

**PROMOTE** Capital for your new product, proposition. Write, Knott, 109 St. Stephen, Boston 15.



**BEAUTIFUL** Feather pictures. 200% profit! Free details; sample 20¢ stamps. Sylviap, Apartado 9036, Mexico City.

**TYPE** For pay. 25-ways. Instructions 50¢, refundable. Empire, 1513-PM1, New York City 80.

**NEWEST** Spare, full-time home business \$5 to \$10 hour possible. Paint with suede—The finish with touch and eye-appeal. Beautiful auto dashboards, signs, radios, toys, figurines, lamps—1001 others. Complete, step-by-step instructions sent for no-risk examination. Free details. Coast JY, Los Angeles 61.

**START** Mail order discount business at home. Offer gifts, appliances, cookware, housewares, cutlery, dinnerware, silverware, jewelry, watches, etc., at discounts up to 75%. No stock needed. We ship your orders under your label. Catalogs printed with your name can cost you nothing. Postcard brings sample catalog, complete details. Topval Corp., Lindenhurst 118, N.Y.

**MAILORDER**—Make it pay. I did, so can you. Being in close touch with the Patent Office, Washington D.C., I can give you from five to twelve novelties, gadgets, etc., relatively new to mailorder, including name and address of manufacturer or supplier who will drop-ship on your label. Some are good. Write for this month's articles. McClain's, Box 471, Detroit 4, Mich.

"I Earn \$400.00 a week." I've learned an amazing new method of printing colorful signs, banners, cards, posters, glassware—anything. No printing press or other expensive equipment is necessary! Big money-making opportunity for anyone. Write for my secret and revealing home-business plan, you'll be amazed! Mr. Anderson, Screen Print Company, Dept. JY, Los Angeles 61, California.

#### MONEYMAKING OPPORTUNITIES

**LEARN** Technical metaphysics and insure your future. Easy, inexpensive correspondence course. Simplest method known. Diploma. Write: Premier College of Technical Metaphysics, 2532 McKenzie St., Vancouver 8, B.C., Canada.

**BIG** Money raising, fishworms and crickets. Free literature. Carter Hatchery, Plains, Georgia.

**EARN** Money evenings copying and duplicating comic cartoons for advertisers. Adservice, Argyle 1, Wisconsin.

**\$60 WEEKLY**, Spare time—easy! Home Venetian blind laundry. Free book. Burt, 2434A, Wichita 13, Kansas.

**SELL** Titania gems. Far more brilliant than diamonds. Catalog 10¢. Diamondite, 2420-M 77th, Oakland 5, California.

**BUY** Wholesale! Save 66%!! Appliances, furniture, jewelry, toys, sporting goods, tools. Free details. National Buyers Service, Box 3338EB, San Francisco.

**MIMEOGRAPHING** Services pay sensational local profits. Exciting secret plans exposed! Rush name. Mozelle Mimeo Shop, Bonham, Texas.

**VENDING** Machines—No selling. Operate a route of coin machines and earn amazing profits. 32-page catalog free. Parkway Machine Corporation, Dept. 27, 715 Ensor Street, Baltimore 2, Maryland.

**PLEASANT** Profits—Let us show you how to start your own complete scissors and tool sharpening business. Free details. Serr-Edge Inc., 9729 Lorain, Cleveland 2, Ohio.

**FREE** Book "505 Odd, Successful Businesses." Work home. Pacific, Oceanside, Calif.

**PRIZE** Contests provide fabulous and confidential home income opportunities! Here's how and where to win your share! Send stamp! National Contest Bulletin, Box 2635-P, Miami 16, Florida.

**START** A profitable subscription business in spare time! We need men and women (young or old) as representatives for all leading national magazines. Liberal commissions on all subscriptions. Supplies free. Send this ad with your name and address to: Agency Bureau, Dept. PM, Hearst Magazines, 250 West 55th St., New York 19, N. Y.

**EARN** \$50.00 Daily making mats, shoes and mud guards from old tires. S and S Patents Inc., 1307 North Clark St., Chicago 10, Ill.

**100% PROFIT**. No investment. Stamp brings details, samples. Miller, Box 584, Brooklyn 1, New York.

**CONTESTANTS!** Contests, helps. Write. Contests, 166 Catherine St., Red Bank, N. J.

**ATTENTION** Typewriter owners. Make handsome profits. Write today. Groves Company, 682, Hastings 8, Nebraska.

"**MONEY** Getter's Bulletin," sample 25¢. Donovan, 791 Greenbelt, Levittown, N. Y.

**FREE** Folio "\$5,000-\$45,000, Unlimited Vacations." No merchandise. Unknown! Work home, sparetime! Haylings, Carlsbad, Calif.

**DOLLARS** Every day! Amazing new magic mail plan. Set-up free. Miller, Box 588X, Oshkosh, Wis.

**GENERAL** Contest Bulletin. Lists contests monthly. Sample, 25¢. 1609 1/2 East 5th, Duluth, Minn.

**READ** Progressive Mailtrade, the magazine that tells how to make money by mail. Dime brings sample and special offer. Progressive Mailtrade, Box 357, Sheboygan, Wisconsin.

**RAISE** Money for church, club, school. New plans. Free details. Theron Fox, 1296 1/2 Yosemite, San Jose, Calif.

**MEN** And women wanted to start home business in spare time with little table-top rubber stamp machine. Easy to earn up to \$9.80 an hour without previous experience. Full particulars free by mail. Send postcard to Roberts, 1512 Jarvis, Room 7-A, Chicago 26, Ill.

**NEW** Sandwich! Outsell barbecue or hamburger. Make it yourself from ingredients obtainable in your own town. No special equipment needed, no franchise. Copyrighted manual containing recipe sent postpaid \$5.00. Haskell D. Boyer, P.O. Box 1486, Fort Worth 1, Texas.

**MAKE** \$5,000 Yearly sparetime raising mink, chinchillas, nutria, etc. Free booklet reveals proved plans. Write Purs, 588 Mt. Pleasant Road, Toronto 1, Canada.

**FREE** Book. Grow mushrooms. Guaranteed market. Mushrooms, Dept. 173, 2954 Admiral Way, Seattle, Wash.

**IMPORTED** Rosaries. 300% profit. Sample \$1.00. Malik Sales, 1617 Scoville, Berwyn, Ill.

**START** Big-pay business at home in spare time. No experience needed to operate little table-top machine for bronzing baby shoes. Make \$5.46 profit on every pair. Full particulars free. Send postcard to Mason, 1512 Jarvis, Room 7-A, Chicago 26, Ill.

**FREE** Success plan folio. "Secret Journal!" 919 secrets! Work home—Successfully! Publico, OceanSide, Calif.

"**HOW** To Win Prize Contests." Free information. National, 9128-P E.W. 26th, Portland 19, Oregon.

**AMAZING** Successes through franchises! Become exclusive franchise holder your territory. Information rushed. National Franchise Reports, 333 North Michigan, Chicago 1.

**MAKE** Money writing short paragraphs! No tedious study, I tell you what to write, where and how to sell; and supply list of editors buying from beginners. Many small checks add up quickly. Write to sell, right away. Send for free facts. Benson Barrett, Dept. C-27-A, 7464 Clark, Chicago 28.

**TREMENDOUS** Opportunities. Buy government surplus now direct from Uncle Sam. Buy and sell—Jeeps; trucks; tractors; farm machinery; boats; airplanes; hunting, fishing, sporting equipment; shop equipment; electronics; cameras; building, plumbing equipment. Direct from U. S. govt. depots. List and procedure \$1.00. Brody, Box 8-PMG, Sunnyside 4, N. Y.

**FASCINATING** 12 Tool stainless steel sportsman's knives. 200% profit. Sample \$3.00. Malik Sales, 1617 Scoville, Berwyn, Ill.

**MEN**—Women! Start money-making plastic laminating business at home in spare time. Material that costs 11¢ brings back \$2.58. No canvassing or selling but mail orders bring in \$20 a day. Write for full particulars free. Rush name on postcard to Warner, Room 7-A, 1512 Jarvis, Chicago 26, Ill.

**START** A buying service, buy wholesale thousands nationally advertised products. Make big profits selling at sizable discounts. Postcard brings details. American Buyers, Hertel Station, Buffalo 16-D, New York.

**MONEY** Making opportunities. Copper Hill Sales Service, Copper Hill, Va.

**NEW** Low cost duplicator. Prints like high priced machines. Guaranteed. Postcard size only \$1 postpaid. Duplicator, 4313 6th Ave., Tacoma 6, Washington.

**RAISE** Rabbits on \$500 month plan. Plenty markets. Free details. White's Rabbitry, Mount Pleasant, Michigan.

**\$45.00 PROFIT** From one bag of cement. Complete instructions and formula \$1.00. McComb & Son, Hometown, Indiana.

#### EXPORT — IMPORT

**FREE**, Free, free! Foreign import's catalogue. Hershey Mail Mart, Box 543, Hermosa Beach, Calif.

**DIRECTLY** Imported cigarette lighters 37¢, your door. \$2 seller. Drop-shipped 50¢. Two different models \$1. U.S.S. Importers, 565 North Coles, Maple Shade, New Jersey.

#### FORMULAS, PLANS, ETC.

**MAKE** 30 Products. Complete manufacturing details, 25¢. Herman Reynolds, Jefferson, Georgia.

**PRODUCT** Analysis, manufacturing formulas, processes developed. Moderate fees. Plastics, Box 1574, Boston 4, Mass.

**PRACTICAL** Formulas. Lists free. Cummings, Chemist, Gordon Ave., Syracuse 4, N. Y.

**LATE**, Modern manufacturing formulas. List free. Moon Chemical, Martville, New York.

**FORMULAS** For latest money-making discoveries. New! Good! Valuable literature free! Miller, Chemist, 1517-D, Tampa, Florida.

**FREE** Formula catalog. Anything analyzed \$35.00. Western Chemical, Salem, Oregon.

**FORMULAS**; All kinds, latest, best. Literature free. Kemixal, Park Ridge, Ill.

**FREE** Information, lists, 10,000 authentic formulas. Brockway, Gage Building, Topeka, Kansas.

#### PLASTICS

**NEW** Liquid casting plastic, clear, colors. Embed real flowers, insects, photos, coins. Saw, drill, carve. Send 25¢ for handbook, "How to Cast with Liquid Plastic," and proved success plan showing how to make money at home. Castolite, Dept. A-101, Woodstock, Ill.

**LAMINATING** Supplies. Free price list. Solomon, 46 Cornhill, Boston 8, Mass.

**LEARN** Plastics fabrication for spare time income. Low cost home training now available. Write for free booklet. Interstate Training Service, Dept. D-3, Portland 13, Ore.

**PLASTIC**, Sheet, rod, tubing. Catalog 10¢. Coleman Sales, 5926 Cornell, Dearborn, Michigan.

**PLEXIGLAS**, Lucite. Square foot cost: 1/16", \$1.18; 1/8", \$1.52; 3/16", \$1.86; 1/4", \$2.21; 3/8", \$3.23; 1/2", \$4.36. Colors add 10%. Send 15¢ for postage. Aristocrat Plastics, 23-25 Sussex Avenue, Newark, N. J.

**CARDS**, Photos, plastic sealed by machine. Wallet size 50¢, 3 for \$1.00. Box 516, Davenport, Oklahoma.

**PLEXIGLAS**, Fiberglass, polyester, acetate. Instructive wholesale-retail catalog free! Gem-O-Lite, 5529 Cahuenga, North Hollywood, California.

**BOXES**, Plastic. Free list. Althor, 170 Bay 23 Street, Brooklyn, N.Y.

#### CHEMISTRY

**ILLUSTRATED** Catalog: Chemistry, mineralogy, biology 20¢. Tracey Laboratories, Evanston, Illinois.

**CHEMICALS** And apparatus for industrial, analytical, and private laboratories. Catalog 25¢. Dept. M-50, Biological Supply Co., 1178 Mt. Hope Ave., Rochester 20, N. Y.

**ANALYZE** Like professionals do. Kit \$3.00. Steiner, Suite 940, 127 N. Dearborn St., Chicago 2, Ill.

**FREE!** 5 Unusual dazzling experiments. Send 3¢ stamp. Chem-Tron, 114 East 28th St., New York 16, New York.

**60 PAGE Booklets!** "Beginners Chemistry," "Chemistry," "Physics," "Relativity," "Light," "Astronomy," "Electricity," "Radio," "Useful Tables," "Scientific Oddities." 10¢ each. Franks, 3121 South Racine, Chicago 8.

**BEGINNER'S Modern chemistry.** All ages. Plus sample uranium ore. \$1.00. Future Chemists of America, Oakdale, Penna.

**CHEMICALS, Supplies catalog, 25¢.** Laboratory Sales, Box 161-E, Brighton, Mass.

**AMAZING New book of science.** Experiments, formulas and catalogue of laboratory supplies. Only 25¢. National Scientific Co., Dept. PM-1, 500 W. Road, Lombard, Illinois.

#### AGENTS WANTED

**\$1,000.00 A Month** for making dramatic 3-second demonstration of amazing lightweight Presto fire extinguisher. New chemical used by airforce snuffs out fire instantly. Only \$4.95. Terrific commissions. Millions want it. Free kit. Merlite, 114 E. 32nd, Dept. P-66R, New York City 16.

**MEN-Women agents:** Sensational new money-makers — Beautifully hand-painted, plastic personalized photo enlargements, compacts, rings, bracelets, lockets, etc. Simply take orders, pocket 40% commission. We deliver and collect. Sales outfit free. Novelco, 3343 North Avenue, Chicago 47.

**DISTRIBUTORSHIPS Open.** Low cost unbeatable English chamoms. Chamtana Tannery, Hudson Falls, N. Y.

**60% PROFIT** On cosmetics — Famous nationally advertised Hollywood cosmetics pay 60%! Make \$25-day up! Hire others. For free samples, details, write Studio Girl, Glendale, Calif., Dept. 1271-G.

**YOU Can make money at home** in spare time taking magazine renewal subscriptions. No capital or experience necessary. All supplies furnished. Write today! McGregor Magazine Agency, Dept. 560A, Mount Morris, Illinois.

**IF You want to earn money fast,** I'll send you free sample stocking of newest stretch DuPont Nylons to sell at only \$1 a pair. American Mills, Dept. 603, Indianapolis 7, Ind.

**RUN Spare-time greeting card and gift shop at home.** Show friends samples of our wonderful new 1957 all-occasion greeting cards and gifts. Take their orders and earn up to 100% profit. No experience necessary. Costs nothing to try. Write today for samples on approval. Regal Greetings, Dept. 33, Ferndale, Michigan.

**"FOG-Stop" windshield cloth.** Instantly removes blurry mist, frost, sleet, snow. Stops windshield fogging. Samples sent on trial. Kristee 59, Akron, Ohio.

**MAKE Extra cash—Quickly!** Show newest big value \$1, \$1.25, \$1.50 assortments of birthday, get well, Valentine, Easter greeting cards, gift wrappings, stationery, gifts in spare time. Big profits, bonus. Friends, others buy on sight. Write for samples on approval, free gift offer, details. Hedenkamp, 361 Broadway, Dept. PM-45, New York City.

**AGENTS — 300% Profit** selling genuine gold window letters; stores and offices. Free samples. Metallic Sign Letter Co., 1217-D West Newport, Chicago.

**SELL New automatic floor waxer.** Trigger on handle. Retail \$2.95. Your profit 125%. Write Smith, Inc., Greenfield 15, Mass.

**BUY Wholesale** thousands nationally advertised products at big discount. Free "Wholesale Plan." American Buyers, Hertz Station, Buffalo 16-A, N. Y.

**BEAUTIFUL Feather pictures.** 200% profit! Free sample. Apartado 9036, Mexico 1, D. F.

**SEEKING New products?** Get my outfit 47 money-making specialties. Latest conveniences for home, car. Send no money. Just your name. Kristee 60, Akron, Ohio.

**WHOLESALE Comedy cards!** Samples, \$1.00. Sebastian, 10934-B Hamlin, North Hollywood, California.

**IF You're interested in making money** in selling, see the hundreds of exceptional opportunities in Salesmen's Opportunity Magazine. Send name for your copy, absolutely free. Tell us what you're selling now. Opportunity, 848 N. Dearborn, Dept. 39, Chicago 10, Illinois.

**PRINTING, Advertising salesmen—**Excellent moneymaking sideline selling decalcomania name plates, small quantities. Automobile initials, sign letters. Free samples. Ralco, XL, Boston 19, Mass.

**GOLDMINE Of 600 money makers.** Copy free. Specialty Salesman Magazine, Desk 5-B, 307 N. Michigan, Chicago 1.

**EXCLUSIVE Line of personal initialed** buckles, belts, cap badges, 3,000 emblems, etc. Hook-Fast, Dept. PM, Roanoke, Va.

**YOUR Ad in this space will get** some good agents for you. Yes, I'll prove it. Write for Folder "A" right now. F. W. Johnson, Classified Advertising Manager, Popular Mechanics Magazine, 200 E. Ontario St., Chicago 11, Ill.

**SELL Profitable personalized rugs.** For information write Bobby's, Dept. M10, Manitou Springs, Colorado.

**BUY Wholesale! 100,000 name brand** products! Save 66%!! Big profits selling others spare time! Free details! National Buyers Service, Box 3338EE, San Francisco.

**YOUR Own business—Used suits \$1.50,** overcoats 65c, mackinaws 35c, shoes 12 1/2c, ladies coats 30c, dresses 15c. Enormous profits. Catalog free. Nathan Portnoy Associates, 805-AA West 12th Place, Chicago 7.

**GOLD Or silver letters, numbers.** Windows, doors, trucks, 1" to 6". 500% profits. Free samples. Atlas-T, 544 West 79th, Chicago 20.

**CALIFORNIA Sweet smelling beads.** Sensational sellers. Particulars free. Mission, 2328-PM W. Pico, Los Angeles 6, California.

**SCHOOL Seniors—Be popular with** classmates. Have spending money galore. Details free. Craftcards, Box 235-L, Pittsburgh 19, Pennsylvania.

**"BOY Electrician."** Build motors, etc. Booklet 25¢. Popular Mechanics Press, 631 N. St. Clair St., Chicago 11.

**AMAZING 500% Profit offer.** See under "Auto Supplies." GE Engine Heater Sales, Milwaukee 7.

**FLUORESCENT Letter sign kit.** Write for details. Coloray Corporation, 370 Brannan, San Francisco 7.

**DAY-Glo signs.** Free sample. Cook, 51 Martin Avenue, Saratoga Springs, New York.

**SELL Unique imports.** Large profits. No investment. Write Bond Specialties, 1637A West Vernon, Phoenix, Arizona.

**EASY Handwork makes fast-selling** articles. Sample free. Sunmade Company, Brockton 64, Massachusetts.

**COUNTRY Salesmen.** Automatic fire extinguisher. Huge profits. Out-O-Matic Co., 1737 E. 31st, Dept. 27, Denver, Colo.

**GREETING Cards—\$50.00 cash** from 40 boxes sensational all-purpose assortment. Big money all year from special occasion cards—Mother's, Father's Day, birthdays, Eastern Star. Best all-occasion assortments, stationery, gifts. Bargain specials. Color catalog. Samples on approval. Midwest, 1113 Washington, Dept. 707-A, St. Louis 1, Mo.

**AMAZING "Cut flowers" greeting cards** sell fast! So real even stems are cut. Keep 85¢ on each \$1.25 everyday assortment. \$85.00 easy! 140 finest card, novelty, stationery money-makers. Gift bonuses. Assortments on approval. Act fast—Get "hot plate" salt-pepper free! Creative, 4401 Cermak, Dept. 517-F, Chicago 23.

**EASIEST Extra money year round** from greeting cards, personal stationery, unusual gifts. Everything that's new, fastest selling, most profitable for you. No experience needed. Samples on approval. \$1.25 gift for prompt action. Cardinal, 1410 State, Cincinnati 14.

**BIG Money-making opportunity.** Exclusive line work uniforms. Jackets, pants, shirts, coveralls. Advertising embroidered. Every business prospect. Outfit free. Master Co., 425 Water, Ligonier, Ind.

**VITA-Zest.** Health producing vitamins and minerals. Whirlwind seller. Great repeater. Amazing profits. Free details. Vita-Zest Co., 210R East South St., Orlando, Florida.

**SENSATIONAL Seller.** Push button needle threader. A gold mine. \$1.00. Sample refundable. J. Veitri, 1463 Newkirk St., Philadelphia 21, Penna.

**AGENTS 90% Profit** selling name brand merchandise. Koser, 1400 East 2 St., Brooklyn, N.Y.

#### BUY IT WHOLESALE

**WHOLESALE Catalog!** Appliances, cameras, watches. Distributors, Box 106A, Hudson, New York.

**FREE Gift catalog.** Wholesale catalogs, name brands. Edith's, Deep River, Conn.

**WHOLESALE Catalog!** Appliances; housewares; jewelry! Postcard! Midwest, 156-M, Pontiac, Illinois.

**BUY Wholesale!** Nationally advertised appliances, radios, watches, etc. Catalog \$1.00 (refundable). D'Auria, Box 355-PM, Jackson, Michigan.

**"MAGIC For everybody."** 25¢. Free catalog. Popular Mechanics Press, 631 N. St. Clair St., Chicago 11.

**BARGAINS, Joblots, closeouts.** 2000 items. Tremendous savings, clothing, toys, gifts, jewelry, television, etc. 25¢ brings wholesale catalog. \$1.00 merchandise certificate included free. Reliable Jobbing, 311-B North Desplaines, Chicago.

**SEND \$3.00.** New catalog with \$3.00 saving certificate. Appliances, etc. Time payments. Ivan Wagner, 1015 Larkin, San Francisco.

**VITAMINS—Buy direct.** Save 40%. State formula now using for free sample. Vitamin Specialties Co., Philadelphia 40, Penna.

**BIG Multicolor wholesale catalog!** Housewares, appliances, clothing, tools, cameras, luggage, radios, phonographs, recorders, watches, jewelry. Name brands. Huge discounts. Postcard: Selbyco, Decatur 152, Illinois.

**ELECTRIC Guitars, amplifiers,** wholesale. Free catalog. Carvin PMW, Covina, Calif.

**BUY Wholesale! Discounts to 80%!** Appliances, cameras, sporting goods, housewares, watches, tools, clothing, etc. Buy-Rite, 73-04 Wagaraw, Hawthorne 2, New Jersey.

#### SALESMEN—DISTRIBUTORS

**STOCK Signs—Attractive, fast selling,** various colored backgrounds, large profits. Fifteen samples one dollar. Details free. F. I. Adams, 158 Roberta Road, Ormond Beach, Fla.

**SALESMEN Add extra profits** to your income. Sell trading stamps and stamp saver books, printed with merchant's name, to your present retail store accounts, supermarkets, gas stations, etc. Boosts business up to 40%. Worthmore, Dept. D, 1625 South Michigan Avenue, Chicago 16, Illinois.

**WILL You wear new suits and top-**coats without one penny cost and agree to show them to friends? You can make up to \$30.00 in a day even in spare time, without canvassing. Stone-Field, 532 South Throop Street, Dept. C-926, Chicago 7, Illinois.

**MONEY-Making opportunity!** Take big profit orders for world famous patented varieties fruit trees. Also flowering shrubs, roses, vines. Big sales outfit free. Stark Bro's, Desk 30117, Louisiana, Missouri.

**AD Matches! Sell amazing designs—10,** 20, 30, 40 and 240-light book matches. Bigger spot cash commissions; every business a prospect. Low prices for high quality. Repeats. Start without experience; men, women; full, part time. Buy nothing! Sales kit furnished. Match Corp., Dept. PM-85, Chicago 32, Illinois.

**CALENDARS, Advertising novelties,** matches. All styles, including religious, varnished, 12 sheet, girls. Hundreds of advertising novelties, book matches, etc. Fleming Calendar Co., Sales Division, 6539 Cottage Grove, Chicago 37, Ill.

\$1,000.00 A Month for making dramatic 3-second demonstration of amazing light-weight Presto fire extinguisher. New chemical used by airforce snuffs out fire instantly. Only \$4.95. Terrific commissions. Millions want it. Free kit. Merlite, 114 E. 32nd, Dept. P-66R, New York 16.

ANYONE Can sell famous Hoover uniforms for beauty shops, waitresses, nurses, doctors, others. All popular miracle fabrics—Nylon, dacron, orlon. Exclusive styles, top quality. Big cash income now, real future. Equipment free. Hoover, Dept. A-160, New York 11, N.Y.

BOOK Repair kit. Schools. High profit. Martine, Colgate, N. Dak.

MAKE Extra money. Cash commissions. Everybody buys easy-to-sell advertising book matches. Union label. All sizes—Cuts for all businesses. Powerhouse selling kit free. Steady repeat business. No experience necessary. Superior Match Co., Dept. M-157, 7528 S. Greenwood, Chicago 19.

SELL "Grease that won't melt," including moly products in a complete line of heavy duty lubricants. Our leading salesmen now earning over \$12,000 in a year. Write immediately to E. J. Baker, Dept. P-7, P.O. Box 676, Dayton, Ohio.

INCREASE Present income \$75-up weekly. Dealers, farmers, agents—demonstrate nationally known Gro-Green liquid fertilizer nutrients. Results guaranteed. Full-part time. Samples free. Campbell Co., Rochelle 209, Illinois.

NEW Jobs open in selling! Send name, address for five free issues of Opportunity Magazine's money-making guide, listing hundreds of companies who'll pay you well, full or part-time. No experience needed. Opportunity, 850 N. Dearborn, Dept. 17, Chicago 10, Ill.

ONE Monument sale weekly earns \$200 or more. Jones Monumental Works, St. Cloud, Minn.

CASH In on Chestlite, successor to flashlight. Profit over 100%. Protected territories still open for this patented money-maker. Write for details right now. Chestlite, 620 W. Anaheim, Long Beach 13, Calif.

GET New shirt outfit free. Make \$90.00 weekly on 5 average orders a day. Famous quality made-to-measure dress and sport shirts at \$3.95 up sell fast to all men. No experience needed. Full or part time. Write: Packard Shirt Co., Dept. 450, Terre Haute, Ind.

WE Are the world's largest manufacturer of portable adding machines. Highest grade. Best service, highest profit. You are sure to win. Lightning Adding Machine Sales Co., 2306-C W. Slauson Ave., Los Angeles 43, Calif.

100% PROFITS Vitamins! Direct and mail sales, homes, offices, stores, and get your own needs wholesale. Details free. Sample \$2. Roberts, 432 Fremont, Springfield, Ohio.

BUILD Sales by recruiting productive distributors selling direct or to retail outlets. Secure most concentrated circulation through classified columns of Salesman's Opportunity. Write for facts. Gilbert, Salesman's Opportunity, Room 1700, 850 N. Dearborn, Chicago 10.

## EMPLOYMENT INFORMATION

JOB Information. High pay. South America, the Islands, U.S.A., foreign countries. All trades. Clerical, labor, engineers, drivers, others. Women also. Companies pay overseas fare if hired. Write Section 92P, National Employment Information, 1020 Broad, Newark, N. J.

HIGHEST Pay available in greater Chicago classified listings airmailed \$1. Jobs, 5345 South Halsted, Chicago 8, Illinois.

COPYRIGHTED Reports on best paying jobs with travel, adventure, promotions. Construction, aviation, shipping, laborers, clerical, trades, supervisory, factory, unusual opportunities. Many types of work. Skilled and unskilled. Foreign and state-side openings for men and women. Only \$2.00 (\$2.25 airmail), including registration-advisory service. Satisfaction guaranteed. Included absolutely free! Special reports on Alaska, Spanish airbase construction, South American opportunities and husband-wife foreign jobs. Research Services, Suite 207-PML Brown Building, St. Louis 5, Missouri.

SUNSHINE City—Classified list business opportunities, help wanted, apartments, houses. All \$1.00 check. Herco Industries, P.O. Box 382, St. Petersburg, Florida.

FOREIGN, Alaskan, U.S.A., jobs! To \$15,000 monthly! Million Americans employed overseas. Copyrighted reports. Who to contact for highest paying jobs. Laborers, trades, truck drivers, office, engineers, many others. 52 countries—St. Lawrence project, Spain, Latin America, Northern project, Europe. Year registration-advisory service. Application forms. Unconditional money-back guarantee! \$2.00 (airmailed \$2.25). C.O.D.'s accepted. International Reporter, St. Louis 1-PO, Missouri.

## EDUCATIONAL AND INSTRUCTION

MEMORY Education. Additional mental power. Science of memory. Memorology, volume one free, without obligation. Memorology Studio, 2016-M Sunnyside, Chicago 25, Ill.

BLUEPRINT Reading—Train at home. Learn to read blueprints with confidence in 10 easy lessons. Write today Belton School, 1059-G North Lawndale, Chicago 51.

LEARN By ear with Dormiphone. While you sleep, amazing new scientific invention works for you. Revolutionary Dormiphonic tools give you a shortcut to learning languages, correct speech; memorizing facts, figures; ideal for self-improvement, relaxation, habit training. Saves time, effort. So simple children benefit. Used by educators, psychologists. Write today for fascinating free book. No obligation. Modernophone, Inc., 320-017 Mezz., Radio City, New York 20.

WHY Struggle with multiplication when this simple device will do the job quickly and accurately? Invaluable for merchants, produce dealers, farmers, students, and anyone who is required to do great deal of multiplying. Multiplies any number from 1 through 100 by any number from 1 through 100 by the very simple process of adding two numbers. Send for free descriptive literature, or send only \$2.00 for a postpaid calculator. If not satisfied, money will be refunded if calculator returned within ten days. Storbakken, Box 26, Viroqua, Wis.

LEARN Another language at home with Linguaphone, the world's standard conversational method on fine, life-like recordings. You learn to speak French, Spanish, German, Japanese, Modern Greek—any of 34 modern languages easily, quickly, naturally. It's like living in another country. Complete language courses available for free trial. Send for free book and details of free trial. No obligation. Linguaphone Institute, T-83-017 Radio City, New York 20.

CAKE Decorating made easy. Teach yourself this fascinating art at home. New step by step method, amazingly simple. Particulars free. Cake Decorating Institute, Box 648, Wantagh, New York.

TRAINING For dignified profession. Real estate and others. Home study, time payment. Diploma. Seavy Realty Institute, 429 So. Western, Los Angeles, Calif.

SKILLED Linotype operators make high wages. Learn operating and machine maintenance. Instructive 32 page catalog free. Stagner Linotype School, 232 West Ontario, Chicago 10.

COMPLETE Your high school at home in spare time with 60-year-old school. Texts furnished. No classes. Diploma. Information booklet free. American School, Dept. X143, Drexel at 58th, Chicago 37, Illinois.

REFRIGERATION, Air conditioning. Extension course. Free booklet. Mechanics School, 11029-PX South Vermont, Los Angeles 44.

FREE Book. Grow mushrooms. Guaranteed market. Mushrooms, Dept. 174, 2954 Admiral Way, Seattle, Wash.

WELDING Training pays at Hobart Welding School, Box M-171, Troy, Ohio. VA contract. Best equipment. Catalog free.

MATHEMATICS. All levels. Correspondence. UCSM, 2406 W. Garfield, Milwaukee, Wisconsin.

LEARN While asleep! Details free. Research Association, Box 610-MC, Omaha, Nebraska.

PIANO Tuning pays. Learned easily at home. GI approved. 59th year. Free booklet. Niles Bryant School, Dept. P, 3731 Stockton, Sacramento 20, Calif.

SPEAK. Sing with power, personality. Home self-training method on records. Amazing details free. Canfield, 2018-A 5th Ave. South, Minneapolis 4, Minn.

PIANO Tuning pays. Big money in spare time. Learn at home in 30 days. No musical knowledge necessary. Phonograph, records, tools and instructions furnished. Personal instructions available. Free catalog. Capital Tuning School, 16 Southwest Second, Fort Lauderdale, Fla.

STUDY For Doctor's degree of psychology, metaphysics and divinity. Correspondence courses only. College of Divine Metaphysics, Dept. P-M, 2811 North Illinois, Indianapolis 8, Indiana.

LEARN Mineralogy at home. Diploma course. Fortunes now being made in uranium and other minerals. Free catalog. Mineral Science Institute, Desk 2, 159 East Ontario, Chicago 11.

HIGH School diploma at home. Licensed teachers—Approved materials. Southern States Academy, Box 144-MX, Station E, Atlanta, Georgia.

EARN While you learn. Auto and diesel mechanics master this top paying trade. Many graduates earn \$100 a week and up. Approved for Korean veterans. For free information write Dept. No. 256, Nashville Auto-Diesel College, Nashville 3, Tenn.

BE A real estate broker. Study at home. Write for free book today. GI approved. Weaver School of Real Estate, 2018P Grand, Kansas City, Missouri.

USED Correspondence courses and educational books bought, sold, rented. Free catalog. Educational Exchange, Menlo, Georgia.

BOOKS; Hundreds of subjects. Big catalog free. Popular Mechanics Press, 200-BC East Ontario St., Chicago 11.

HELP Yourself to abundant living. Our courses have added students to richer fuller lives. Learn secret of contentment, happiness. Earn degrees Ph.D., M.S.D. Write for free book. College of Universal Truth Correspondence School, 23-C E. Jackson, Chicago.

USED Correspondence courses and books sold and rented. Money back guarantee. Catalog free. (Courses bought.) Lee Mountain, Pisgah, Alabama.

SECRET Investigation. Experience unnecessary. Investigators particulars free. George Wagner, M123 West 86th, New York 24.

BOOKKEEPERS! Increase your earnings! Operate your own simplified "Dollar-A-Week" bookkeeping and tax service. Full or spare time. Details free. No obligation. Ellis, Box 300, Cedar Grove, North Carolina.

WANT A diesel job? New opportunities to increase income. Higher pay. More money. We can help you qualify. Tools. Shop method home training. Write today! Diesel, Tractor, Heavy Equipment Division, Interstate Training Service, Dept. B-3, Portland 13, Oregon.

I want to send you proof of the wonderful pulling power of Popular Mechanics classified pages. What's your proposition? Write me today. Include literature if possible. F. W. Johnson, Manager Classified Advertising, Popular Mechanics Magazine, 200 E. Ontario St., Chicago 11, Ill.

INVESTIGATOR Training. Phillips Secret Service System, 1917-B North Keneth, Chicago 39.

HELP Yourself! Solve personal problems by self-mastery. Free information. The Leavitt Science, Clinton, Illinois.

HANDWRITING Analysis now accepted in college, business, industry. Our men, women who use grapho analysis spare, full time earning more money, getting prestige, success, happiness. Uncrowded, fascinating field for intelligent men, women anxious to get ahead. We need more members. Investigate this growing field where you give a real service to your fellow man. Opportunities unlimited. Free sample lesson and information to all over 21. Write today! Igas, 2307 National Station, Dep't. 615, Springfield, Missouri.

BARGAIN. Exciting Little Library booklets. 25¢ each. Tool making, painting, welding, home improvement, games, models, plastics, lamp making, glass blowing, boats, photographs. Free catalog. Popular Mechanics Press, 200-LB East Ontario St., Chicago 11.

**ENGINEERING** Degrees earned by home study. (Residential courses also available.) Pacific International University (formerly American College of Engineering), Box 27124-B, Hollywood 27, California.

**GAIN** New knowledge, perspective. Revolutionary easy way learn decimal equivalents common fractions without memorizing. Fun. Practical. Details free. Val Palmer, 1322 12th St., Rockford, Ill.

**EXCEPTIONAL** Home study plan. F. M. Woodworth, Box 4867, Detroit 19, Mich.

**ENGINEERING**, Home study. Midwest Engineering School, 10923 Hillcrest, Hickman Mills, Missouri.

**PHYSICAL** Therapy and massage. We train you at home. Earn big profits from your own private practice or work with hospitals and doctors. Free catalogue. National Institute, Desk 4, 159 E. Ontario, Chicago, Ill.

**EARN** College degree. Remain employed. Golden States University, 5625-P Melrose Ave., Los Angeles 38, California.

**FINISH** High school at home, spare time. No classes. Diploma awarded. Write for free catalog. Wayne School, Catalog HF-71, 2527 Sheffield, Chicago 14.

**LEARN** Advertising—America's highest paid profession. Botts Advertising, 1211 Laura MP, Wichita, Kans.

**CALCULATOR** And instructions, \$2.50. Japanese Abacus. Satisfaction guaranteed. Money, 45 East 28, New York City.

**DIPLOMAS**, Physical therapy, massage. Drugless Therapy, Box 177A, Fruitland, Idaho.

**U. S. Civil Service** tests! Training until appointed. Men-women, 18-55. Start high as \$340.00 month. Experience often unnecessary. Get free 36-page book showing jobs, salaries, requirements, sample tests, benefits. Write today: Franklin Institute, Dept. C-24, Rochester, N. Y.

**LEARN** Camera repair. Easy, complete, approved home-study course. Free illustrated booklet. National Camera Repair School, Dept. L-1, Englewood, Colo.

**LEARN** Motor repairing at home. Easily mastered. Free details. Lincoln School, Box 52, Hempstead, N. Y.

**DRAFTING**, Design, blueprint reading. Good paying. Easily to learn at home. Minimum age 17. Write Utilities Engineering Institute, Dept. TC-3, 2525 Sheffield, Chicago 14.

**REAL** Estate. Be a broker. Large earnings. Easy to learn. Details. Box 256, Cumberland, Indiana.

**DEGREE** Correspondence courses, divinity, psychology, science, philosophy. Auras, Central Valley, New York.

**TRANSFORM** Yourself via subconscious. Free brochure. Box 847 (H-1), Ocean Park, Calif.

#### PLAYS, STORIES, MANUSCRIPTS

**WANT** Your book published? Learn how we publish, advertise, promote, distribute. Many successes. Free booklet PM. Vantage, 120 West 31, New York City.

**WANTED:** Book manuscripts, all subjects considered. Greenwich Book Pub., Attn. Mr. Zealand, 489 Fifth Ave., New York City.

**ALL** The world loves an author! You too can win friends and royalty checks! If you write, we appraise/sell. Write/phone. Daniel S. Mead, Literary Agent, 419 Fourth Ave., New York City 16. Telephone: Ore. 9-1150.

#### SPECIAL SERVICES

**INFORMATION** On anything. Ferguson Research Specialists, 116-14 141 St., South Ozone Park 36, N. Y.

#### CARTOONING, COMMERCIAL ART, SHOWCARD & SIGN PAINTING, TATTOOING

**LEARN** Sign painting at home. Particulars free. Bolger, 148 Concord, River Edge, New Jersey.

**YOU** Can entertain with chalk talks. Catalog 10¢. Balda The Cartoonist, Oshkosh, Wis.

**LEARN** Sign painting at home. Free talent test. Ben Kerns, Box 812-PM, Greenville, S. C.

**DRAW** Your way to fame. Free information. Cartoons-of-the-Month, Roslyn, New York.

**ART** Self employment 23 plans \$1. Satisfaction guaranteed. Barebo, O'Fallon, Missouri.

**"HOW To Make Money With Simple Cartoons."** A book everyone who likes to draw should have. It is free; no obligation. Simply address Cartoonists' Exchange, Dept. 91, Pleasant Hill, Ohio.

**PAINT** Signs—Master die cut, outline letter patterns. Complete assortment 1 1/2" to 12" high, prepaid \$2.00. Eyerly, 583, Newton, Iowa.

**BASIC** Art training at home. New plan. Free talent test. Students' Art Club, Kennebunkport, Maine.

#### ADVERTISING AGENCIES, LETTER WRITERS, FOR ADVERTISERS

**FREE!** 1957 Advertisers Rate and Data Directory. 52 pages! E. H. Brown Advertising Agency, 20 N. Wacker, Chicago 6.

**ADVERTISING** Ratebook leading newspapers, magazines, free. Chicago Advertising Agency, Chicago 4.

**ADVERTISING**, Result-getting ads prepared, placed newspapers, magazines, radio, anywhere! Lowest rates. Catalogue free. Baker Advertising Agency, 189 W. Madison, Chicago 2.

**MAILING** Lists most any classification \$5.00 1000. Your circulars mailed with ours \$4.00 1000. Write for our literature. Dixie Mailers, King, N. C.

**ADVERTISE:** 24 Words, 100 Canadian newspapers \$5.50. Lists free. Advertising Bureau, 10511-C Springfield, Chicago 43.

**WANT** More business? Here's an amazing opportunity to increase your sales. Talk to thousands of interested readers of "Mechanica Popular." Our Spanish Edition covers the Latin American countries like a blanket. They're real mailorder buyers. Classified rate 75¢ per word. Try an ad in our next issue. Classified Advertising Department, Popular Mechanics Magazine, 200 East Ontario Street, Chicago 11, Ill.

#### RUBBER STAMPS AND OFFICE SUPPLIES

**3 LINES**, \$1.00. Cushioned—Indexed. Satisfaction guaranteed! Campfield, 14 Beaufort Circle, Springfield 4, Mass.

**PRINTING**, Stamps, supplies wholesale, 25,000 items. Literature free. Brost Press, Rapid City, South Dakota.

**THREE** Line pocket stamp or regular with free pad \$1.00. Barber, Marengo, Ohio.

**THREE** Lines, pocket case, pad \$1.00. Colford, 1610 Rucker, Everett, Wash.

**FREE** Style list stock stamps. Criterion, Box 2326, Denver 25, Colo.

#### TYPEWRITERS, DUPLICATORS, OFFICE DEVICES

**PORTABLE** Mimeograph! Uses no stencil, no ink. The newest, cleanest, smallest, lightest and cheapest. Weight 15 pounds. DuPont Distributors, P.O. Box 695, Dept. A, New York 1, N. Y.

**RECONDITIONED** Typewriters, duplicating, printing devices, \$25.00 up. Supplies, Appliances, DixieGraph, King, N. C.

**NEW** Portable typewriters, latest models. Underwood, Royal, Remington, Smith Corona, only. Reduced prices. State wants. Rex Sales Co., Box 2602, San Diego 12, California.

**IBM** Electric typewriter \$59.95. Albin, 423 Broome St., New York City 13.

#### PRINTING, MULTIGRAPHING, MIMEOGRAPHING, GUMMED LABELS

**1000** RAISED Letters business cards \$2.50. Samples. Pioneer, Island Park 4, N. Y.

**SPECIALIZING**. Letterheads, envelopes. Samples free. Ink-Daubers, 933 Longfellow, Jackson, Mich.

**MIMEOGRAPHING**—Letters, pricelists, formulas, instructions. Lowest prices. Lem's Letter Shop, 5710 Stanton, Detroit 8.

**500** NAME And address printed gummed labels, 3 lines \$1.00. No c.o.d.'s. Print clearly. Addison, PM-1, 1840 Addison, Chicago 13.

**CIRCULARS**, Booklets, letterheads, statements, Estimates, anything! Lonelm Printers, Paulding, Ohio.

**ADS** Running under this heading sell printing. Ask me for proof, I'll gladly send you amazing facts. Ask for Folder "P." F. W. Johnson, 200 E. Ontario St., Chicago 11, Ill.

**BUSINESS** Printing. Reasonable. Catalog free. Howprint, 723-G Eunice, Webster Groves 19, Missouri.

**100** BUSINESS Cards \$1.00. Printers, 1418 Broadway, Rockford, Illinois.

**FREE** Catalog business, personal printing. D.M. Press, Sebastopol, California.

**QUALITY** Printing! Free new catalog showing prices, types, cuts. Napco Press, Dept. PM, 2337 Bath Avenue, Brooklyn 14.

**FREE** Catalog. Distinctive printing. Reasonable prices. Vosacek Printing, 4444A Ute, San Diego 17, Calif.

**GUMMED** Labels in rolls. Name and address. 3 lines, 1/2 x 1 1/4, 500 \$1.00. Guaranteed. Prompt delivery. Alexander, Box 474, Pomona, California.

**OFFSET** Printing — \$6.50 1000, 8 1/2 x 11, 16 lb. National Letter, 251 W. 42 St., New York City 36.

**100** LETTERHEADS, 8 1/2 x 11 Watermarked, and 100 6 3/4 envelopes, carefully printed, \$2.00 postpaid. Race Printers, Hudson, New York.

**GOOD** Printing, low prices. Samples. Westway Press, 4047E Westway, Toledo 12, Ohio.

**50** SHEETS, 50 Envelopes, distinctive stationery neatly printed, your name and address, \$3.00. Dornbush, Wonder Lake, Illinois.

**DISTINCTIVE** Circulars, stationery. Free list, samples. Prospect Press, Wayzata, Minnesota.

**INVESTIGATE** Our printing, before you buy. Hibberlin, 3060 Berkshire, Birmingham, Michigan.

**100** LETTERHEADS 5 1/2 x 8 1/2, 100 Envelopes three lines, both printed same \$2.00, add 25¢ postage. Sheldon, 115 Ninth, Philipsburg, Penna.

**FREE** Catalog, samples. Dealers wanted. Sutton Printing, Box 853-P, Waycross, Georgia.

**ECONOMICAL** Printing of books, catalogs, publications. Catalog free. Adams Printery, 30 West Washington, Chicago 2, Illinois.

**QUALITY** Reasonable business and personal printing. Hundreds or thousands. Hendrickson, 129 N. Prater, Northlake, Illinois.

**BEAUTIFUL** Wedding announcements, business cards. Bargains. Decco, Box 3315M, St. Louis 3.

**FREE** Catalogue, business, personal printing. Suburban Press, 3013 North Victoria, St. Paul 13, Minnesota.

#### PRINTING OUTFITS AND SUPPLIES

**RUBBER** Stamp making presses, hydraulic operated, electrically heated. Sizes 5"x8", 8"x12", 10"x15" starting outfits. All kinds supplies. Custom Manufacturing, 601 N. Jefferson, Springfield, Missouri.

**PRESSES**, Type cabinets, supplies. List for stamp. Lincoln Press Company, 220-A Hartwell, Fall River, Mass.

**DO** Your own printing. Save money. Simple rules. We supply everything. Print for others; good profit. Raised printing like engraving too. Have home shop. Details free. Kelsey Presses, V-11, Meriden, Connecticut.

**PRINTING** Presses, type, supplies, lists 3¢. Turnbaugh Service, Mechanicsburg, Penna.

**MAKE** Your own self-molding rubber stamps and printing cuts. Flexirubber, Argyle 1, Wisconsin.

#### PATENT ATTORNEYS

**INVENTORS:** Without obligation, write for information explaining the steps you should take to secure a patent. John Randolph, Registered Patent Attorney, 203 Columbian Bldg., Washington 1, D. C.

**INVENTION** Record form free and "Patent Information Every Inventor Should Have." Carl Miller, Registered Patent Attorney, Woolworth Building, New York.

C. A. Snow & Co.—M477, Snow Building, Washington 1, D. C. Registered Patent Attorneys. Write for information.

**INVENTORS**—Take these preliminary steps toward patent protection. Sketch and describe your invention. Sign, date and have this disclosure witnessed by two people who understand your invention. Have us make a preliminary search among U.S. patents already granted for similar types of invention. We report on the probable patentability of your invention and recommend your further course of action. Write for our instructive booklet, "Patent Protection for Inventors" and convenient "Evidence of Invention" disclosure form. Victor J. Evans & Co., 331-A Meriin Building, Washington 6, D. C.

**INVENTORS**: When you are satisfied that you have invented something of value write me, without obligation, for information as to what steps you should take to secure a patent. Write Patrick D. Beavers, Registered Patent Atty., 935 Columbian Bldg., Washington 1, D. C.

**PATENTS**. "Proof of Invention" free. E. E. Vrooman, Registered Patent Attorney, 507 McKim Building, Washington 5, D. C.

"INVENTOR'S Guide" and "Record of Invention" free on request. Frank P. Ledermann, Registered Patent Attorney, 154 Nassau Street, New York City.

**PATENTS**—Irving L. McCathran, 315 McLachlen Bldg., Washington 1, D. C. Registered Patent Attorney.

**REGISTERED** Patent attorney offers services. Sanders, 6430 Evans, Chicago 37, Illinois.

**INVENTORS**: Learn how to protect your invention. Unless the inventor is familiar with patent matters, he should engage a competent registered patent attorney or agent to represent him. We are registered to practice before the U. S. Patent Office and prepared to serve you in handling your patent matters. "Patent Guide for the Inventor" containing detailed information concerning patent protection and procedure with "Record of Invention" form will be forwarded to you upon request—without obligation. Clarence A. O'Brien & Harvey Jacobson, Registered Patent Attorneys, 71B-A District National Building, Washington, D. C.

"HOME Improvement Guide." New, amazing 192 page volume. Packed with ideas, plans for remodeling, decorating, landscaping, built-in projects. \$2.50 pre-paid. Popular Mechanics Press, 200-HQ East Ontario St., Chicago 11.

**INVENTORS**—If you believe you have an invention, you should find out how to protect it. The firm of McMorrow, Berman & Davidson with offices in Washington, D. C., is qualified to take the necessary steps for you. Send for copy of our patent booklet "How to Protect Your Invention." We will also send you an "Invention Record" form. No obligation. They are yours for the asking. McMorrow, Berman & Davidson, Registered Patent Attorneys, 134-G Victor Building, Washington 1, D. C.

#### FOR INVENTORS

**INVENTORS**—If you believe you have an invention, you should find out how to protect it. The firm of McMorrow, Berman & Davidson with offices in Washington, D. C., is qualified to take the necessary steps for you. Send for copy of our patent booklet "How to Protect Your Invention." We will also send you an "Invention Record" form. No obligation. They are yours for the asking. McMorrow, Berman & Davidson, Registered Patent Attorneys, 134-H Victor Building, Washington 1, D. C.

**INVENTORS**: Learn how to protect your invention. Unless the inventor is familiar with patent matters, he should engage a competent registered patent attorney or agent to represent him. We are registered to practice before the U. S. Patent Office and prepared to serve you in handling your patent matters. "Patent Guide for the Inventor" containing detailed information concerning patent protection and procedure with "Record of Invention" form will be forwarded to you upon request—without obligation. Clarence A. O'Brien & Harvey Jacobson, Registered Patent Attorneys, 71A-A District National Building, Washington, D. C.

**ELECTRONIC**, Research service, mfg. P.O. Box 412, Riv. Sta., Miami 35, Fla.

**INVENTORS**: Test the commercial value of your patented or unpatented inventions, quickly and inexpensively. Write for free information. Institute of American Inventors, Dept. 40-B, 635-F St., N.W., Washington 4, D. C.

**PATENT** Searches, including copies of nearest patents, \$6.00. Reports airmailed within 48 hours. More than 100 registered patent attorneys use my service. For free invention protection forms, write Miss Ann Hastings, P.O. Box 176, Washington 4, D. C.

**HANDBOOK**: How to Make the Million Your Idea May Be Worth. Information every inventor should know by a firm who knows. \$1.00 postpaid. Money back guarantee. Cosom Industries, 6012 Wayzata Boulevard, Minneapolis 16, Minnesota.

**INVENTION** Record form free and "Patent Information Every Inventor Should Have." Carl Miller, Registered Patent Attorney, Woolworth Building, New York.

**SEARCHES**—Put your patent searches in the hands of a registered patent attorney or agent, as he qualifies to give a worthwhile patentability report. Record of invention form upon request and information on patent protection. Patrick D. Beavers, Registered Patent Attorney, 936 Columbian Bldg., Washington 1, D. C.

**INVENTORS**: Information on patent procedure furnished on request, without obligation. John Randolph, Registered Patent Attorney, 202 Columbian Building, Washington 1, D. C.

"INVENTOR'S Guide" and "Record of Invention" free on request. Frank P. Ledermann, 154 Nassau Street, New York 38, N. Y.

**PATENT** Searches \$5.00. 48-hour service. Free invention protection forms. Write Raymond L. Smith, Patent Searcher, 620 Sheraton Building, Washington 5, D. C.

**IDEAS** Developed for products and your profit with effective patent protection at low definite cost. Foreign patents: Canadian patents filed \$100.00. Patent development costs now deductible from tax payments. 30 yrs. in business. Joseph O'Brien, Patent-Development Engineer, 132 Nassau St., New York 38, N. Y.

**PATENTS**. How to prepare and file your own patent application. Send \$2.95 for book. Paladin Pubns., Atlantic and Pacific Sts., Bellmore, N. Y.

**INVENTORS**—This firm is registered to practice before the United States Patent Office and available to assist you in the preparation and prosecution of your patent application. "Patent Protection for Inventors" booklet containing detailed information and steps to take toward patent protection sent promptly upon request. No obligation. Victor J. Evans & Co., 332-A Meriin Building, Washington 6, D. C.

**PATENT** Searches \$5.00. 48-hour airmail service. Invention protection forms free. Write Patent Engineering Service, 711 14th Street N. W., Washington 5, D. C.

**INVENTORS**—Send for free patent information book and inventor's record. Registered Patent Attorney, Associate Examiner, Patent Office 1922-29, Patent Attorney & Advisor, Navy Department 1930-47. Gustave Miller, 136A Warner Building, Washington 4, D. C.

**INVENTORS!** Free book, "Selling Your Invention." Inventors Exchange-D, Hartford 1, Connecticut.

**INVENTORS!** Have you good patentable ideas? Write Mr. Metzler, 11 West 42nd Street, New York, N. Y.

#### INVENTIONS WANTED

**INVENTORS** Having unpatented ideas, patents for sale, manufacturers will finance to \$1,000,000. What have you to offer? Inventors Creative Service, 354 South Spring, Los Angeles 13, Calif.

**INVENTIONS** Promoted—A-1 service for years. Adam Fisher Co., 5418 (P) Idaho, St. Louis, Mo.

**INVENTIONS** Wanted. Patented or patent pending. 26 years experience promoting inventions. National Service Bureau, 3120 Meramec, St. Louis 18, Mo.

**INVENTIONS** Wanted. Patented; unpatented. Tremendous manufacturers lists. Global Marketing Service, 2420 77th, Oakland 5, California.

**INVENTORS**. Give us the opportunity to explain our selling plan for your invention, gadget or device, patented or unpatented; free particulars available upon request. Demarest and Demarest, Box 95, Battle Creek, Michigan.

**INVENTORS**: Hundreds of manufacturers have requested our assistance in locating marketable new products. Complete information free. Institute of American Inventors, Dept. 40-D, 635-F St. N.W., Washington 4, D. C.

**CASH** Buyers for inventions. Write National Inventors Institute, Box 7007, Cleveland 28, Ohio.

**INVENTORS**. Don't sell your invention patented or unpatented until you receive our offer. Write Congill, Box 298, Marion, Ohio.

**INVENTIONS** Wanted now by my manufacturer-clients. Patented, unpatented. Write Adams, Patent Broker, 80-8 Wall Street, Financial District, New York City.

**INVENTIONS** Needed immediately for manufacturers. For additional information write Kessler Corporation, 311W, Fremont, Ohio.

**SUPERIOR** Promotions. Patented; unpatented inventions. Information booklet, free. Superior, 338-344 North Rodeo, Beverly Hills, Calif.

**INVENTORS**. Models produced. Weede M<sup>r</sup> 'hine Company, R.D., Rockland, Maine.

**FREE** Publicity possible for your invention. For additional information, write: Salter-Lee Associates, Inc., Dept. S, 15 West 44 Street, New York 36, New York.

#### MANUFACTURING

**MODELS**—Small lot manufacturing. Metals, plastics, etc. Milburn, Burlington, Kentucky.

**NEW** Automatic paint manufacturing equipment, reasonably priced. Finest Federal formulas means highest quality production at lower prices. Your products really sell. Not just a hobby but a real lifetime security. Three hours labor, \$100.00 profit. We actually show you every detail. Box 205, Worthington, Ind.

#### MODELS. MODEL SUPPLIES

**WORKING** Steam engines, boilers, tractors, fittings. Catalog \$1.00. Tiny Power, Corvallis, Oregon.

**POWER** Models. Unusual steam gasoline and traction engines, fittings, metals. Comprehensive catalog \$1.00. Chas. Cole, Ventura, Calif.

**BUILD** Miniature passenger hauling live steam locomotive with file and drillpress. We do machine work, you bolt it together. Catalog 50¢. Little Engines, Lomita, Calif.

**SHIP** And yacht model fittings; blueprints. Send 35¢ for illustrated catalog listing hundreds of items. A. J. Fisher, 1002-1 Etowah Ave., Royal Oak, Mich.

**SHIP** Models. Most complete line in New England. Kits, fittings, plans, books, tools, engines, motors. Illustrated catalog 30¢. James Bliss & Co., Inc., Dept. SM, 342 Atlantic Ave., Boston 10, Mass.

**BALSA** Wood and model aircraft. 40-page catalog 25¢. Sig Co., Montezuma, Iowa.

**SHIP** Model kits and fittings including clippers, trawler, fishermen, frigates, privateer, radio control tug, etc. Send 25¢ for 1937 catalog. Model Shipways, Box 85, Bogota, N. J.

**FB4** Jet engine. Literature, service manual, dime. Stanmore, Cherry Valley, N. Y.

**GIANT** New 1957 "O" Gauge catalog for scale—Tinplate model railroads. 92 pages 8½x11, 2600 items, 180 car kits 46 locomotives, hard-to-find model building parts. Price \$1.00 (refundable on \$10.00 order). All-Nation Hobby Shop, 178 N. LaSalle, Chicago 1.

#### HOME CRAFTSMEN

129 **FULL**-Size jigsaw patterns. Artist-drawn. \$1. Craftplans, 1321-A Michigan, Chicago 5.

**JIGSAW** Patterns for boys! Large variety, gifts, novelties, usefuls, pinups, lawn ornaments. \$1.00. Pauls Plans, 4633 North 18th, Milwaukee 9, Wisconsin.

**LEATHERCRAFT.** Copper, silversmith complete do it yourself kits. Handbags, belts, billfolds many others. Leathers, tools. Catalogue 25¢ refunded with first order. Art Handicrafts, PM, 194 William St., New York 38, N. Y.

101 FULL Size patterns. Smart, new, gifts, novelties, lawn figures, shelves, action windmills, alphabets. Plus "Make Money Jig Sawing." Only \$1.00. Mastercraft 15M, 7041 Olcott, Chicago 31, Illinois.

BUY Wholesale nationally advertised power, hand tools, thousands other products at big discounts. Free "Wholesale Plan." American Buyers', Hertel Station, Buffalo 16-P, N. Y.

**LEATHERCRAFT.** Copper enameling, mosaic tile, shellcraft, metal tooling, beadcraft, many more crafts. Free big catalog. Kit Kraft, Dept. 221, Studio City 1, Calif.

**TABLES**—All kinds. Made in minutes with our folding leg sets. Brightly plated steel tubing. Plastic ball tips prevent floor damage. Free literature. Naward Co., 1274 Levick St., Philadelphia 11, Penna.

16 NEW lawn chairs, 22 picnic tables, benches, trellises, etc. All 38 plans with necessary full size patterns. \$1.00. Mastercraft 13M, 7041 Olcott, Chicago 31, Ill.

**JIGSAW** Patterns 1¢, 5¢ each. Full size. Barbo, O'Fallon, Mo.

**METALCRAFT.** Big illustrated catalog free. Aluminum, copper, and enameling supplies. J. C. Larson Co., 820 S. Tripp, Dept. 6227-M, Chicago 24.

**STYLECRAFT** Sure fire hits. "Pre-traced" leather kits. Handbags, billfolds, filigree belts, over fifty other projects. Patterns on leather. Why trace? Just carve, assemble and lace. Large assortment "precarved" kits also available. Send 25¢ for catalog, free folder. Refund-able first order. Apache Leather Company, 2804 E. Washington St., Phoenix, Arizona.

**DO-It-Yourself** booklets 25¢. 24 subjects. Free catalog. Popular Mechanics Press, 631 N. St. Clair St., Chicago 11.

**KNOCKDOWN** Cedar chests and lumber. Free price list. Bedford Lumber Company, Shelbyville, Tennessee.

**ALL** Crafts, supplies. Large free catalog. National Handicraft, 199 William Street, New York City 38.

**WOODWORKING** And cabinetmaking course for beginning and advanced home craftsmen. Only complete low-cost home training program available. Write for free booklet. Interstate Training Service, Dept. G-3, Portland 13, Ore.

I Want to send you proof of the wonderful pulling power of Popular Mechanics classified pages. What's your proposition? Write me today. Include literature if possible. F. W. Johnson, Manager Classified Advertising, Popular Mechanics Magazine, 200 E. Ontario St., Chicago 11, Ill.

**LEARN** Art metalcraft and jewelry making. Complete, inexpensive, home training course now available. Special tools and materials furnished. Write for free booklet. Interstate Training Service, Dept. L-3, Portland 13, Oregon.

**LEATHERCRAFT.** Send 10¢ for new 76-page catalog of tools, supplies, kits, including metalcrafts, enameling, ceramics, all other crafts. Complete stock. Reasonable. Since 1910. Sax Bros., Dept. PM1, 1111 N. 3rd, Milwaukee, Wis.

18 FULL-Size patterns. Save money with easy-to-use, professionally designed full-size patterns. Make money selling beautiful, useful furniture. Make modern step and cocktail tables; metal lamps; cupola; 12-foot outboard. All patterns test-built; sold with money-back guarantee. Get your free list of these convenient, economical patterns today. Popular Mechanics Press, 200-HH E. Ontario Street, Chicago 11, Ill.

**LEATHERCRAFT.** Kits, copper, artist's supplies. New catalog. Midas, 7705 State, Huntington Park, California.

**EPOXY** Adhesive. Bonds everything. \$1.50. Agents wanted. Avan, 2323 Wolf-ram, Chicago 18.

**FREE.** Complete illustrated catalog, leathercraft kits, supplies. J. C. Larson Co., 820 S. Tripp, Dept. 6827-L, Chicago 24.

89 FULL Size jig saw patterns of beautiful shelves, ornaments, toys, novelties. Plus "How, Where to Sell." Only \$1.00. Mastercraft 14M, 7041 Olcott, Chicago 31, Illinois.

**KNOCKDOWN** Cedar chests, Lumber and veneers. Free price list. Giles & Kendall Company, Huntsville, Ala.

**FREE.** New catalog, 1,668 patterns, designs. Craftplans, 1521-A Michigan Ave., Chicago 5.

**MONEYMAKING** Projects for woodcraft shops. Northland Products, Route 1282-M, Rockland, Maine.

**PATTERNS** Flying ducks, man sawing wood, Dutch maid churning butter, and 30 lawn ornaments, only \$1.00. Lincoln Studio, Columbia, Conn.

**LEARN** Profitable copper enameling at home. Lesson #1, full details, bonus, \$1 refundable. Supply catalogue 25¢. Bergen Arts & Crafts, 200 Southwest 17th Avenue, Miami, Florida.

**LAMP** Size cypress knee with nipple installed \$2.00. Cy Products, Dept. 2-D, Lafayette, La.

**FREE** "Do-it-yourself" leathercraft catalog. Tandy Leather Company, Box 791-019, Fort Worth, Texas.

**OVER** 900 Woodworking projects. Books and patterns. Free catalog. Craftsman, 115-C Worth St., New York City 13.

### DO IT YOURSELF

**ELECTRIC** Wiring guide. Indoor, outdoor installations. Circuits, insulation, weatherproofing, remote control—Everything. Complete instructions, diagrams. Only \$1.00. Craftsman Publishing, 115-E5 Worth Street, New York City 13.

**BARBECUE** Pit—Sandstone finish, pre-fabricated. Patio stones, beautiful colors. Forms inexpensive. Pictures and data 50¢. Pop Bradford, 324 Carolina Dr., El Paso, Texas.

**"READY-Kit"** motor vibrator massage unit. Home business, motorizing chairs, tables, cushions for homes, hospitals, reducing salons. Free catalog tells. Mary-Mac Factory, 1012 Powhattan, Dallas 2, Texas.

**BUILD** Your own power tools with pipe fittings at low cost. Complete blue prints and instructions for \$1.00. Drill Press, band saw, grinder, shaper, jig saw, lathe. Earl Rhodes, Box 804, Meade, Kansas.

**CLOCK** Movements—Gorgeous dials, plans, kits. See ad page 271.

18 FULL-Size patterns. Save money with easy-to-use, professionally designed full-size patterns. Make money selling beautiful, useful furniture. Make modern step and cocktail tables; metal lamps; cupola; 12-foot outboard. All patterns test-built; sold with money-back guarantee. Get your free list of these convenient, economical patterns today. Popular Mechanics Press, 200-HH E. Ontario Street, Chicago 11, Illinois.

**GRANDFATHER** Clock movements, dials, kits. Wholesale catalog 25¢. Mason-Sullivan, Noroton, Conn.

### WATCHES, OLD GOLD, JEWELRY

10 WATCHES \$18.00. Minor repairs. Catalog 20¢. Berkwit, 1150 Castle Hill, New York City 62.

**WATCHMAKERS'**—Jewelers' supplies, instructions. Catalog 20¢. Bengale Company, Culver City, California.

**COSTUME** Jewelry supplies. Catalog and samples. 35¢. Largest line in America. Milady-Pair Co., G.P.O. Box 1328, New York City 1.

**COPPER** Enameling supplies, rhinestones, pearls, jewelry settings. Catalog 10¢. J & M Novelties, Dept. CA-3, Griffith, Indiana.

**HIGHEST** Cash for old gold, broken jewelry, gold teeth, watches, diamonds, silverware, spectacles, platinum, mercury. Free information. Rose Refiners, Heyworth Bldg., Chicago 2.

**WATCHMAKERS'** Tools, materials, supplies, watches. Catalog. Gales, Box 1000, Chicago 90, Illinois.

**WATCH** And clock repairing books. Free catalog. North American, 2320-AA Milwaukee, Chicago 47, Ill.

### RAZORS, BLADES, SHARPENING

**BEAUTIFUL** Zingo ladies' electric shaver. \$6 postpaid. Guaranteed. Zingo Products, Johnstown, New York.

### FOR THE HOME

**HOME** Plans. 10 architect designs of 2, 3, and 4 bedroom contemporary ranch homes, carefully selected for livability, economical construction and beautifully illustrated exteriors. Send \$1.00 for information and plan collection to make your choice. Blue prints available. (\$1.00 refunded first blue print order). S. & P. Plan Service, P. O. Box 333, Cincinnati 14, Ohio.

**FOAM** Rubber furniture cushions. Factory seconds. 50% discount. Free catalog. Perma-Foam, 236C Rhode Island Ave., East Orange, New Jersey.

**BE** Your own plumber. You can. Few inexpensive tools and our instructive book, "Home Plumbing Guide," shows and tells you how. Hundreds of photographs and diagrams. Easy to follow. 160 pages. \$3.50. Catalog free. Popular Mechanics Press, 200PG East Ontario St., Chicago 11, Ill.

### OF INTEREST TO WOMEN

**EMBROIDER** Stamped linens. Buy direct from manufacturer and save. Send for free catalog. Merrilee, 16 West 19th St., Dept. 299, New York 11, N. Y.

**GOOD** Money in weaving. Weave rugs at home for neighbors on \$69.50 Union loom. Thousands doing it. Booklet free. Caricraft Co., Polk St., Boonville, N. Y.

**"8 MISTAKES** Parents Make." Every parent should have this new book about child training. It is free; no obligation. Simply address Parents Association, Dept. 671, Pleasant Hill, Ohio.

**RAISE** Money! Making, selling artificial flowers, corsages, novelties. Big illustrated catalog 25¢ (refundable). Profitkrafts, 4513A21 Lorain, Cleveland 2, Ohio.

**FREE** Book. Grow mushrooms. Guaranteed market. Mushrooms, Dept. 176, 2954 Admiral Way, Seattle, Wash.

**WANT** To make big money at home? \$10.00 profit in an hour possible with invisible mending. Make tears, holes, disappear from clothing, fabrics. Steady year-round demand from cleaners, laundries, homes. Details free. Fabricon, 8332-S Prairie, Chicago 19, Illinois.

**SELL** Fine fabrics. Get yours wholesale. Box 863, Norwalk, Conn.

**BOOKS;** Hundreds of subjects. Big catalog free. Popular Mechanics Press, 200-BC East Ontario St., Chicago 11.

**MAKE** New greaseless doughnuts in kitchen. Sell stores. Free recipes. Morgan Ray, 3605 South 15th, Minneapolis 7, Minn.

**RAINCOAT** Salesladies wanted. Rubberized silk direct from Japanese importer. Inquire Rainwear Ltd., Box 392, Lexington, Kentucky.

### PERSONAL

**FLORIDA** Jobs, opportunities, property rentals, sales, hundreds of offers now. Tampa-St. Petersburg area, complete listing \$1.00. Florida Research, Box 215, Clearwater, Florida.

**BILLS!** Bills! Bills! Pay them quickly with cash loan by mail, \$100.00 to \$600.00. Repay in small monthly installments over 30 months. Your payments may run 1/2 less than now; have money left over to spend. Loan order blank mailed free in plain envelope. Advise amount you need. State Finance Co., 323 Securities Bldg., Dept. H-227, Omaha 2, Nebr.

**BUY** Vitamins direct. Amazing savings. Catalog free. Matoska, White Bear, Minn.

**HEAR** Better with your hearing aid. Free booklet. Wallace Cheek, 10 Curtis Square, Gloucester, Mass.

**VITAMINS**—Save 40%. Buy direct. State formula now using for sample. Vitamin Specialty Co., Philadelphia 40, Penna.

**SIMPLE** Television repairs. Marvelous booklet 25¢. Free catalog. Popular Mechanics Press, 633 N. St. Clair St., Chicago 11.

"HOW Can I find out?" You can! Information confidentially developed. Any matter, person, problem. Worldwide. Officially licensed. Established 1922. William Herman, 170 Broadway, New York City.

**BOOKS:** Hundreds of subjects. Big catalog free. Popular Mechanics Press, 200-BC East Ontario St., Chicago 11.

**HONOLULU,** Hawaii, Box 5236. Personal or business address. Other services.

**SPENDING** Too much money? Here's the answer to your problem! New, simplified "Money Manager" expense record book. Easy, fascinating to use. Shows where your money goes, how to control it. Sold only by mail! Only \$2 complete, postpaid, with amazing, informative 184-page booklet tells you how to plan financial security. Covers budgeting, investing, savings, insurance, buying. Order from "Better Things," Box 1084-A, Little Rock, Ark.

**NEW YORK** City remaining 25¢. Help wanted \$1.00. Information. Service. Purity, Box 15, Arverne, N. Y.

**HOLLYWOOD!** Your letters remailed! Postmarked anywhere within U.S.A. \$1.00! Box 972, Santa Barbara.

#### REMAILING SERVICE

**BARRANQUILLA,** Colombia. South America—Letter remailed 25¢. T. P. Dann, 75-175, Carrera 60, Barranquilla, Colombia.

**COLUMBUS** Mail forwarding-receiving address for rent. Details free. William McLaughlin, 800 Stewart, Columbus 6, Ohio.

**REMAINS** From the Stampede city 25¢. Classifieds \$1.00. S. Sheldrake, Box 722, Calgary, Alberta, Canada.

**ITALY!** Receive-forward air remails \$1.00. Hostrop, Largo Bellavista 3, Livorno, Italy.

**TRENTON:** Remails 25¢. Matelena 3376 E. State Extension, Trenton, N. J.

**BRAZILIAN** Reairmails 50¢. Forwarding service. Mauricio, Caixa Postal 813, Anapolis, Golas, Brazil.

**HOLLYWOOD—Long Beach** remail 25¢. Receiving-forwarding address. Shopping. Lenormand, 722 Magnolia, Long Beach, California.

**CHICAGO** Remails 25¢, mailing addresses 83 month. Mailings, 8245 South Halsted, Chicago 9, Illinois.

**LETTERS** Rемаiled, etc., from Canada 35¢. I affix Canadian air stamp. Ross, 83 Belhaven Rd., Toronto 8, Ont.

**COLUMBUS, Ohio.** Remails 25¢, etc. John Volan, 1437 N. High St., Columbus 1, Ohio.

**SECRET** Mail receiving, forwarding system. \$3 month. Hedgpeth, Box 830, Alhambra 23, California.

**FREE** Details. Mail received-forwarded. Todd, 6092 Pedley Road, Dept. PM, Riverside, Calif.

**HOLLYWOOD,** Beverly Hills, Los Angeles, Santa Monica remails 25¢. Viewcards 5¢ each. Danchak, P.O. Box 1065, Santa Monica, California.

#### TREASURE FINDERS

**GOLD, Silver, metal detectors.** Geiger counters for uranium. Violites. Sensational new fully guaranteed models. None finer. Information free. Detectron Corp., 5528 Vineland Ave., North Hollywood, Calif.

**TREASURE, Metal, mineral detectors.** M-Scope. Used worldwide for treasure hunting. Mineralsights. Geiger, scintillation counters. Prices from \$14.75. Fully guaranteed. Use our time payment plan. Free booklets on treasure hunting, uranium prospecting. Free catalog. Fisher Research Lab, Inc., Dept. PM-C1, Palo Alto, Calif.

**URANIUM, Gold, silver treasure.** New power-packed highly sensitive metal detectors. Geiger counters and mineralights. Kits and assembled models from \$12.50. Lightest weight, guaranteed, free literature. Electronic Applications, Dept. M, Box 8, Arlington 10, Virginia.

**FIND** Buried treasure, gold and silver, with Goldak's sensational 3½ lb. "find-it" locator, only \$49.50. Write for free literature on complete line of mineral, metal locators; Geiger and scintillation counters. Goldak, 1541 W. Glenoaks Blvd., Glendale, Calif.

**FIND** Uranium, valuable metals and minerals, buried treasures! One of the world's oldest and most reliable suppliers offers a complete line of equipment—Geiger counters, assay and test kits, metal detectors, etc. All instruments traded and repaired. Write for free literature on profitable prospecting. The Radiac Co., Inc., 489 Fifth Ave., Dept. PM1, New York 17, N. Y.

#### FOR SALE—MISCELLANEOUS

**HIGH** Vacuum pumps, neon signs and tube makers. Half price—Megovacs-Duo-seal, induction heaters, glass working machinery. Windsor Co., Glen Ellyn, Ill. Phone 9.

**BOOKS:** Hundreds of subjects. Big catalog free. Popular Mechanics Press, 200-BC East Ontario St., Chicago 11.

**UNCLAIMED.** Cleaned, pressed men's shirts. 6 for \$2.99. Fairview, 4480 Park Ave., New York 57, N. Y.

**MIRROR** One side; transparent from other side. See and photograph people unawares. 8"x10", \$2. 16"x20", \$5. One-Way Mirror, Dept. PM-2, Box 625, Mt. Vernon, N. Y.

**DO IT** yourself. What? Repair TV, build furniture, make barbecue, plumbing repairs, build boats, do house wiring, remodel home, lay tile, modernize kitchen, repair home, and scores of other things you can do yourself. Books covering each subject, only 25¢. Send for descriptive list. It's free. Popular Mechanics Press, 200-LB East Ontario St., Chicago 11, Ill.

#### WANTED—MISCELLANEOUS

**SCRAP** Mercury (quicksilver) containers supplied — Tantalum, tungsten, silver, platinum. Metallurgical Products Company, Established 1909, 35th & Moore Sts., Philadelphia 45, Penna.

**QUICKSILVER,** Sterling, silver solders, precious metals. Wholesale Terminal, Norwood, Massachusetts.

**CASH** For Indian bird stones: antique northwest coast totem, masks, carvings. Send photos. Robert Stolper, 8852 Cynthia Street, Los Angeles, California.

**BOOKS:** Hundreds of subjects. Big catalog free. Popular Mechanics Press, 200-BC East Ontario St., Chicago 11.

#### MISCELLANEOUS

**FREE** Book. Grow mushrooms. Guaranteed market. Mushrooms, Dept. 175, 2954 Admiral Way, Seattle, Wash.

**HAIRCUT** As you like it. Booklet 25¢. Mastrolia, 32-22CM 89th, Jackson Heights 69, New York.

**JAPAN:** Buy gifts from Japan. Kimono, artistic handicrafts, novelties, others. Business information \$1.00. Send money orders. Clarence Yamagata, Room 302, Naka 7 Bldg., Marunouchi, Tokyo, Japan.

**\$100 WEEKLY** Raising earthworms! Free plan reveals how! Oakhaven-M. Cedar Hill, Texas.

**HOW** To remodel, basement, attic. Booklet 25¢. Free catalog. Popular Mechanics Press, 633 N. St. Clair St., Chicago 11.

**LEATHER** Jackets renovated, expertly. Free circular 8. Berlew Mfg. Co., Freeport, New York.

**DO IT** yourself. What? Repair TV, build furniture, make barbecue, plumbing repairs, build boats, do house wiring, remodel home, lay tile, modernize kitchen, repair home, and scores of other things you can do yourself. Books covering each subject, only 25¢. Send for descriptive list. It's free. Popular Mechanics Press, 200-LB East Ontario St., Chicago 11, Ill.

**RECEIVE** Magazine samples, mails, catalogues, offers from everywhere. Get listed 25¢. Rorick, Cincinnati 28, Ohio.

**YOUR** Name wanted. We'll send 1000 publishers, mailers, wholesalers your name on our list one year 25¢. Dixie Mailers, King, N. C.

**WANT** More business? Here's an amazing opportunity to increase your sales. Talk to thousands of interested readers of "Mechanics Popular." Our Spanish Edition covers the Latin American countries like a blanket. They're real mailorder buyers. Classified rate 75¢ per word. Try an ad in our next issue. Classified Advertising Department, Popular Mechanics Magazine, 200 East Ontario Street, Chicago 11, Ill.

**CESSPOOLS,** Septic tanks, outhouses, clogged drains, cleaned, deodorized without digging, pumping. Bursolvent reduces contents. Reclaims leachability. Old systems work like new. Free details. Electric Sewer Cleaning, Allston 34, Mass.

**HOUSE** Wiring—Electrical repairs. 32-page booklet 25¢. Popular Mechanics Press, 633 N. St. Clair St., Chicago 11.

**"HOME** Improvement Guide." New, amazing 192 page volume. Packed with ideas, plans for remodeling, decorating, landscaping, built-in projects. \$2.50 pre-paid. Popular Mechanics Press, 200-HG East Ontario St., Chicago 11.

**BUILD** Small boats. Booklet 25¢. Catalog free. Popular Mechanics Press, 633 N. St. Clair St., Chicago 11.

**BARGAIN.** Exciting Little Library booklets. 25¢ each. Tool making, painting, welding, home improvement, games, models, plastics, lamp making, glass blowing, boats, photographs. Free catalog. Popular Mechanics Press, 200-LB East Ontario St., Chicago 11.

**MEN,** Help safeguard your hat from being snatched up by mistake with identifying hat cards placed inside. Dozen 25¢ coin. Simplex, P.O. Box 193, South Bend, Indiana.

**PROFESSIONAL** Painting unbelievably easy with our special brush. Only \$1.00 postpaid. Kang Brush Co., 7323 State Road, Philadelphia 35, Penna.

**HOW** To read blueprints. Amazing booklet 25¢. Free catalog. Popular Mechanics Press, 631 N. St. Clair St., Chicago 11.

**SAMPLES,** Magazines, catalogs, opportunities. Year, 25¢. Star Directory, Leming, Texas.

**FREE** Vitamin catalogue—Quality capsules. Feel more vigorous, younger, better! Buy direct, save! Vitamin-Center, Drawer 2318P, Detroit 31.

**REMODEL** Your own home. Save hundreds of dollars. New, amazing book shows you how. Written so you can understand it. Step by step instructions make it easy. Fully illustrated, 400 photographs, hundreds of diagrams, 160 pages. \$2.95. Literature free. Popular Mechanics Press, 200-RH East Ontario St., Chicago 11, Ill.

**SMOKED** Whitefish 5 lb. ctn. \$4.15. postpaid. Smoked Ciscoes 5 lb. ctn. \$3.75. Write for complete catalog price list. Sivertson Bros. Fisheries, 366 Lake Ave. South, Duluth, Minn.

**BIG** Mails, four months listing, 25¢. Wright Publications, 2270 Hubbard, Memphis 8, Tenn.

**STUPENDOUS** Mental power. Adults. Details 3¢. Delmar Wisdom, 846 Sunnyside, Chicago 40.

**SELL!** Buy! Trade! Anything. Write: Trading Post Magazine, 525 Dewey, Jackson 40, Michigan.

**SUPER** Memory overnight! Success guaranteed! Bijou, Box 1727-M4, Hollywood 48, Calif.

**ELECTRIC** Guitars, amplifiers, wholesale. Free catalog. Carvin PMS, Covina, Calif.

**FOAM** Rubber. All sizes and thicknesses. Send your measurements for free estimate. Foam Pair, 2819 Atlantic Avenue, Brooklyn, New York.

**BUY** Wholesale! Discounts to 30%! Appliances, cameras, sporting goods, housewares, watches, tools, clothing, etc. Buy-Rite 73-02, Wagaraw, Hawthorne 2, New Jersey.

**SIMPLY** Draw a tree. Send with 25¢ for character analysis. Jacques Darche, Sherbrooke 2, Que., Canada.

I want to send you proof of the wonderful pulling power of Popular Mechanics classified pages. What's your proposition? Write me today. Include literature if possible. F. W. Johnson, Manager Classified Advertising, Popular Mechanics Magazine, 200 E. Ontario St., Chicago 11, Ill.

**WE** Ordain and license worthy Fundamentalists Christians in underdenominational ministry. Data with official magazine 10¢. Stamps accepted. Dr. McCaw, 18750 Tilson Avenue, Cupertino, California.



**MEN! TRAIN NOW FOR  
A BIG PAY FUTURE IN  
DIESEL  
& SCIENTIFIC MOTOR TUNE-UP**

- Diesel Construction
- Diesel Engine Repairman
- Diesel Operator
- Industrial Maintenance
- Auto Engine Rebuilding
- Bus & Truck Maintenance

**Be a Trained Diesel Man**

Go places with DIESEL! Farms, factories and power plants, trains, ships, trucks, buses all use DIESEL POWER... all need DIESEL-trained men! You can start your DIESEL training at home, in spare time, with tested, proved U E I training. Course includes practical work on Diesel engines under skilled instructors. You learn the operation, maintenance, servicing of all types of Diesel engines, PLUS Scientific Motor Tune-up.

**ACT NOW!** If you have mechanical ability, you'll like Diesel! High School diploma not necessary. Write now for FREE book, "EARNING POWER IN DIESEL." Act Today!



**MAIL NOW FOR FREE BOOK!**

UTILITIES ENGINEERING INSTITUTE, Dept. DC-84  
2521 Sheffield Ave., Chicago 14, Ill. (Founded 1927)  
O. K.! Rush, without obligation, FREE Book on DIESEL.

NAME \_\_\_\_\_  
ADDRESS \_\_\_\_\_  
CITY \_\_\_\_\_ ZONE \_\_\_\_\_ STATE \_\_\_\_\_  
 Check here for information if under 17.

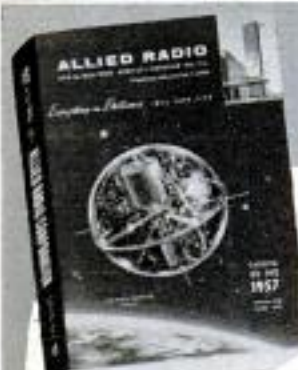

**Save on  
hi-fi**

**SEND FOR THE 1957  
ALLIED CATALOG**

**free** Features the world's largest selection of systems and components. Shows you how to choose a custom Hi-Fi music system for your home at no more than the cost of an ordinary phonograph. Tells you what to look for and how to save money. Offers dozens of complete systems and hundreds of individual units, including the famous money-saving Hi-Fi Knight-Kits. For everything in Hi-Fi and Electronics, get the FREE 1957 Allied Catalog.

**ALLIED RADIO**  
*America's Hi-Fi Center*

ALLIED RADIO CORP., Dept. A-17  
100 N. Western Ave., Chicago 80, Ill.  
 Send FREE 1957 ALLIED Catalog.

Name \_\_\_\_\_  
Address \_\_\_\_\_  
City \_\_\_\_\_ Zone \_\_\_\_\_ State \_\_\_\_\_



**Fence of Baseball Bats**

Baseball fan deluxe, Ralph Crowe of Phoenix, Ariz., has built a picket fence from 126 used bats. The fence is in his home's front yard. For three years the Crowes have collected such relics from diamond wars featuring the New York Giants, Phoenix Stars and American Legion squads.

**Safety Alarm Bell Rings  
When Truck Backs Up**

Most accidents caused by trucks backing up can be prevented if the truck is equipped with an automatic safety alarm which rings a bell whenever the truck reverses. The device is entirely mechanical and works by gravity, consisting of an assembly having a six-inch metal bell, and four hammers which ring it, attached directly to the rear wheels of dual-wheeled vehicles. As the truck backs up, gravity causes each hammer in turn to strike the bell, making four soundings for each turn of the wheel, and warning anyone standing in back of the truck.

E. D. Ballard Co., 275 Eighth St., San Francisco 3, Calif.





# LEARN MEAT CUTTING AT NATIONAL

Pay After Graduation



The steady dependable trade of Meat Cutting taught easily in 8 short weeks. YOU LEARN BY DOING under actual meat market conditions in big modern school at Toledo.

For beginners or men with experience. Get a profitable store of your own. Remember, PEOPLE MUST EAT! Big pay jobs. Free employment help. Thousands of successful graduates.

Buying, cutting, percentage, pricing, advertising, selling, etc. A complete retail meat education. National School established 35 years. Get National training NOW. Pay your tuition in easy weekly payments

after you graduate. Send coupon for FREE 52 page school catalog — TODAY. G.I. approved.

National School of Meat Cutting, Inc., Dept. 50-M, Toledo 4, Ohio

Send me your FREE school catalog on National Training at Toledo in Meat Cutting, Meat Merchandising and Self Service Meats. No obligation. No salesman will call.

Name \_\_\_\_\_ Age \_\_\_\_\_

Address \_\_\_\_\_

City \_\_\_\_\_ State \_\_\_\_\_

Approved for training Korean Veterans

**"Remember Me"**  
**JOIN THE MARCH OF DIMES**  
 IN JANUARY

**High School at Home**

**MANY FINISH IN 2 YEARS**

No classes. No time wasted going to and from school. Progress as fast as your time and abilities permit. Standard H. S. texts supplied. Thousands enroll each year in this 60-year-old school. Send for FREE descriptive booklet.

AMERICAN SCHOOL, Dept. H145  
 Drexel at 58th St., Chicago 37, Ill.

Without obligation, please send FREE descriptive booklet.

Name \_\_\_\_\_

Address \_\_\_\_\_

Complete Canadian Courses available. Write American School, Dept. H145, 6083 Sherbrooke St. W., Montreal

**SPARE-TIME MONEYMAKING OPPORTUNITIES**  
**READ OUR CLASSIFIED ADS**  
 HUNDREDS OF BARGAINS      AMAZING OFFERS

Sensational **GEAR** value 25 for

**BRASS GEARS-SHAFTS-BUSHINGS-BEARINGS**

Repairmen - Experimentors - Instrument Makers - Hobbyists - etc. Bag of 25 assorted gears (bevel, spur, worm, spiral, ring, helical, angle, etc.)

Send name, address, and \$1.

**LYNN SURPLUS** 476 Broad Street  
 Newark 2, N. J.

"N. J.'s Largest Government Surplus Outlet"

**25 for** POST PAID

## Get into... PLASTIC LAMINATING AT HOME!



**THIS MAN...**  
 ... is taking out of the machine a Plastic Sealing Job — ordered by mail — only 11c in material cost brings back \$2.53 in cash by mail. Capacity of machine: \$25.00 profit per hour of operation.

Get **ORDERS** and **CASH** from your mailman—do work in **SPARE TIME** at home — or expand into **FULL TIME** business. Send coupon for Free facts about the newest and most fascinating of all home operated businesses. For the first time a simplified machine brings the fabulous profits of **Plastic Sealing and Plastic Laminating** within the reach of the small operator. Anyone can learn to operate the machine with a few minutes practice—then with our **Magic Mail Plan** can get mail orders pouring in daily with cash in every envelope. **No canvassing—no selling.** We even

**Make \$20 to \$30 a Day by..**  
**MAGIC MAIL PLAN!**

supply the circulars you mail to bring back cash and orders. Don't waste a minute. Rush your name. We'll send you **FREE** and postpaid, pictures, prices, details, and all the facts you need to start. Mail coupon or send name on postcard. No charge. Warner Electric Co., 1512 Jarvis Av., Dept. L-10-A, Chicago 26, Ill.

**Make Thousands of Beautiful Art Creations**  
**COSTUME JEWELRY • CIGARETTE BOXES**  
**TRAYS • CANDLESTICKS • COASTERS**  
**LAMP BASES • BOOK ENDS...ALL IN**  
**SPARKLING COLORED PLASTIC**



WARNER ELECTRIC CO., 1512 Jarvis Av.

Dept. L-10-A, Chicago 26, Ill.

At no cost to me, please rush complete details postage prepaid. I am under no obligation.

Name \_\_\_\_\_

Address \_\_\_\_\_

City \_\_\_\_\_ Zone \_\_\_\_\_ State \_\_\_\_\_

# Build This Beautiful Corner Table

Full-Size Pattern  
Now Available



To make this attractive table, you merely trace the design on wood, saw, smooth the edges and assemble. It's so easy it takes all the guesswork out of furniture building. Designed as a companion piece for the step and cocktail tables detailed in Full-Size Patterns Nos. 103 and 104, this table can be used alone or with any grouping of contemporary furniture.

## Other Patterns In This Series

There are 14 other full-size patterns in stock. These include a 12-foot boat, a work bench and toys for the children. For details, send coupon.

## Guaranteed to Please

Designed by John Bergen, noted furniture designer, this table will be a handsome addition to your home. If, however, you are not thoroughly pleased with the pattern, you may return it within 7 days for a full refund. The price is only 50c.

Order on this Handy Coupon

POPULAR MECHANICS PRESS, 200 E. Ontario St., Chicago 11

Please send postpaid the Full-Size Corner Table Pattern. If not satisfied, I will return it within 7 days for a full refund of the purchase price.

- Send the Corner Table Pattern (I enclose 50c)  
 Send information on other full-size patterns

Name \_\_\_\_\_

Address \_\_\_\_\_

City \_\_\_\_\_ State \_\_\_\_\_



T. G. Milner and Sons, Pine Bluff, Ark.

## Floating Fish Stringer

Fancy stories by fishermen, about the one that got away after he was already on the stringer, won't be valid after anglers begin using a floating fish stringer. Consisting of a small aluminum drum, the stringer has nine hooks, each of which is large enough to hold several fish. It is attached to the boat by a chain and floats alongside. One big feature of the stringer is that it will not tangle in underwater brush or the motor as it is towed.

## Cigarette Lighter Carries Its Own Ash Tray

Stranded without an ash tray, you just slide out and use the bottom of a new West German cigarette lighter. Weighing less than four ounces and equipped with a cigarette rest, the lighter has its fuel chamber isolated from the ash tray.

Coloma Merchandise Exchange, Coloma, Mich.

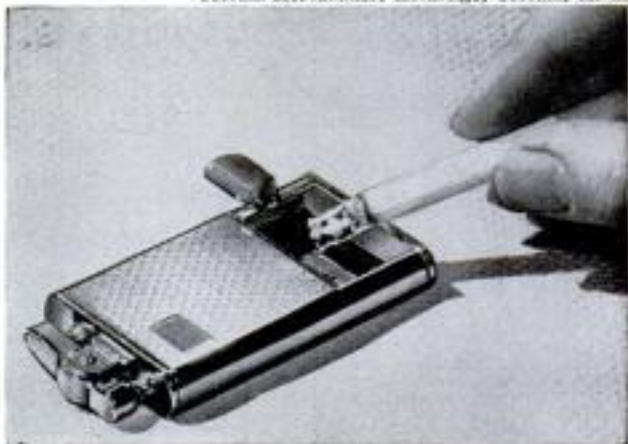

## GET LATEST OFFICIAL AIRCRAFT PHOTOS

NOW, FIRST TIME ANYWHERE exclusive official, sharp photos of advanced Supersonic Rockets, Jets, Historical planes. All makes, hundreds from which to choose.

### SPECIAL OFFER

with your name and address. Send 35c... get Four 3 1/2 x 5 photos, world's fastest jets. Illustrated catalog, with order. Money back Guarantee. Mail today.



DEPT. PE BOX 75084  
LOS ANGELES 5, CALIFORNIA

AVIATION PHOTO EXCHANGE

## HELPFUL BOOKS

Send post card asking for FREE catalog

Popular Mechanics Press, 200 E. Ontario, Dept. 601, Chicago 11

## AMAZING NEW PERSONAL POCKET RADIO

LISTEN IN PRIVATE WHILE YOU WALK!

SMALLER AND LIGHTER THAN ANY TRANSISTOR "POCKET RADIO!" Wt. only 1/2 lb. Size 1" x 2 1/4" x 1 1/4" complete. Black Gold breakproof plastic case. POSITIVELY NO HOOKUPS OR WIRES NEEDED! BUILT IN 1000 MILE ANTENNA! Soap in flashlight batteries lasts for months. "Glow in the Dark!" Easy to use top controls (while walking, riding, etc.). Has special 100% soft plastic almost invisible ear-plug—LETS YOU ALONE LISTEN ANYTIME. ANYWHERE without anyone else knowing you are hearing radio music, sports, news, weather, etc. GUARANTEED TO WORK ANYWHERE RADIO CAN BE USED. ONE YEAR SERVICE GUARANTEE.

SEND ONLY \$5.00 (ck. mo) and pay postman \$14.95 plus postage on delivery or send \$18.95 for postpaid delivery. A REAL

\$20.00 VALUE! AVAILABLE NOW ONLY FROM US AT HALF PRICE WHILE OUR SUPPLY LASTS. American made! You can always get repairs if ever needed. NOT AN UNWORKABLE INCOMPLETE KIT OF PARTS OR PLAYTHING. A REAL MIDGET PERSONAL POCKET SIZE RADIO. Get yours now—Listen when you want without bothering others. Price will go up soon so rush your order now for YOUR TINY TONE POCKET PERSONAL RADIO. Available only from:

WESTERN RADIO Dept. APN-1 KEARNEY, NEBR.

# Make SURE, SAFE INSULATED ELECTRICAL CONNECTIONS

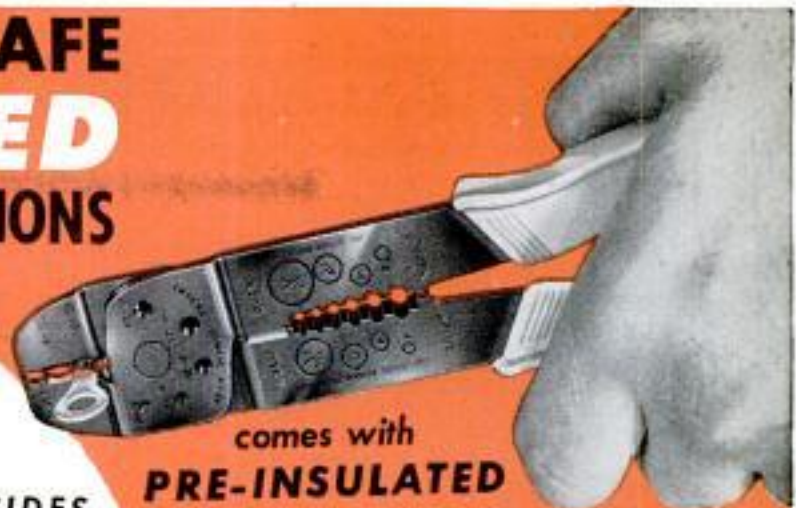

## The New SUPER ~~CLAMP~~ Hand Tool

The ONE Tool for ALL Wire Sizes used in Home Wiring, Appliances, Automobiles.

### DOES ALL THESE THINGS BESIDES

**CRIMPS** Solderless Terminals and Connectors without solder or tape for safe connections.

**CUTS** Wire, making clean, sharp cut through insulation and Conductor.

**STRIPS** Wire sizes #22-#10. Gauges assure proper length for sure, safe crimp.

**SHEARS** Bolts and screws without damaging threads — no filing or hack sawing.

comes with  
**PRE-INSULATED**



**FREE with Each TOOL**

### ORDER DIRECT—USE COUPON

Only  
**\$3.95**  
Post Paid

Satisfaction guaranteed or money back. Send check or money order for \$3.95.

M. Russell Berger, Incorporated  
National Distributor Consumers and Dealers  
Manufactured by:

**AMP INCORPORATED**  
401 North Broad Street, Phila. 8, Penna.

M. Russell Berger, Incorporated  
401 North Broad Street, Phila. 8, Penna.  
Dept. JA, Room 995

Send me post paid the new super Champ Hand Tool. I am enclosing \$3.95. (Penna. residents add 15c sales tax.)

check  money order

NAME .....

ADDRESS .....

CITY.....ZONE.....STATE.....



## Every Boy Should Have This Build-It-Yourself Book for Boys!

It's natural for boys to want to make things—to fuss with tools—to fashion the kind of things "kids"

want. So give boys the Build-It-Yourself Book for Boys. Encourage a youngster to express himself through the sensational new Popular Mechanics book that shows how to make 56 different things every boy dreams about. It covers science, mechanics, electricity, modeling and other fields. 192 pages of easy-to-follow instruction and 469 how-to-do-it pictures.

### 56 Toys, Games, Gadgets, Models, Boats, Electrical Devices, Cars and Other Things Boys Can Make at Home

How to make—Airplane Models, Aquaplane, Archery Kit, Bird Houses and Shelter, Boats, Bobsleds, Boomerangs, Cannon Toy, Electric game, Electric Motors, Garage Toy, Helicopter Toy, Hunting Knife, Hydroplane Model, Kites, Log Cabins, Marble Game, Microscope, Printing Press, Radio Sets, Rafts, Railroad Modeling, Shooter, Scooter, Sidewalk Cars, Sprinkler

Truck, Squirt Gun, SS United States Model, Surfboard, Tank Toy, Taxidermy, Telegraph Set, Telephone, Tree House, Water Skis, Weather Instruments, Toboggan, Worktable.

Build-It-Yourself for Boys sent postpaid for \$2.50 or COD, charges additional. Money refunded if you are not pleased after 5 days' use. Mail order to address below.

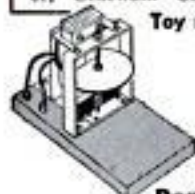

Toy motor



Boomerangs



"Ju-be"—the punt.

**POPULAR MECHANICS PRESS**  
Dept. 157, 200 E. Ontario St., Chicago 11

## TRAINED MEN NEEDED!

### BIG PAY!—GOOD FUTURE!

- DIESEL  ELECTRONICS  
 AUTO  AUTOMATION

NEVER BEFORE has the opportunity been so good for the properly trained mechanic and technician to step into BIG PAY POSITIONS with rapid advancement and future security virtually assured.

YOUR SUCCESS depends on the quality of training you receive... and the reputation of the school you attend.

YOUR GUARANTEE we are giving the best in mechanical and technical training is proved by the fact... we have a waiting list of good pay positions for our graduates, with leading companies throughout the United States.

RESIDENT SHOP TRAINING is easier and costs less than you may think! We provide you with housing and part-time jobs while in school, plus free nation-wide placement service for graduates.

Check subject above in which you are interested and mail for

FREE BOOKLET

Your Future  
IN  
ELECTRONICS  
AND  
AUTOMATION

**BAILEY**  
Technical Schools

Veteran Approved

1634 S. Grand, St. Louis 4, Mo.

Your Future  
in...  
DIESEL and  
AUTO  
MECHANICS

Name \_\_\_\_\_ Age \_\_\_\_\_

Street \_\_\_\_\_

Town \_\_\_\_\_ Zone \_\_\_\_\_ State \_\_\_\_\_

See where to find it here

**For the first time ever: ONE TESTER PROVIDES ALL THE SERVICES LISTED BELOW!**

Superior's New Model

**76**



**IT'S A CONDENSER BRIDGE** with a range of .00001 Microfarad to 1000 Microfarads (Measures power factor and leakage too.)

**IT'S A RESISTANCE BRIDGE** with a range of 100 ohms to 5 megohms

**IT'S A SIGNAL TRACER** which will enable you to trace the signal from antenna to speaker of all receivers and to finally pinpoint the exact cause of trouble whether it be a part or circuit defect.

**IT'S A TV ANTENNA TESTER** The TV Antenna Tester section is used first to determine if a "break" exists in the TV antenna and if a break does exist the specific point (in feet from set) where it is.

**✓ CAPACITY BRIDGE SECTION**  
4 Ranges: .00001 Microfarad to .005 Microfarad; .001 Microfarad to .5 Microfarad; 1 Microfarad to 50 Microfarads; 20 Microfarads to 1000 Microfarads. Will locate shorts, and leakages up to 20 megohms. Will measure the power factor of all condensers.

**✓ RESISTANCE BRIDGE SECTION**  
2 Ranges: 100 ohms to 50,000 ohms; 10,000 ohms to 5 megohms.

**✓ SIGNAL TRACER SECTION**  
With the use of the R.F. and A.F. Probes included with the Model 76, you can make stage gain measurements, locate signal loss in R.F. and Audio stages, localize faulty stages, locate distortion and hum, etc. Provision has been made for use of phones and meter if desired.

**✓ TV ANTENNA TESTER SECTION**  
Loss of sync., snow and instability are only a few of the faults which may be due to a break in the antenna, so why not check the TV antenna first? The Model 76 will enable you to locate a break in any TV antenna and if a break does exist, the Model 76 will measure the location of the break in feet from the set terminals.

Model 76 comes complete with all accessories including R.F. and A.F. Probes; Test Leads and operating instructions. Nothing else to buy.

**26<sup>95</sup>**

**SHIPPED ON APPROVAL**

**NO MONEY WITH ORDER - NO C.O.D.**

Try the above instrument for 10 days before you buy. If completely satisfied then send down payment and pay balance as indicated on coupon. **No Interest or Finance Charges Added!** If not completely satisfied, return unit to us, no explanation necessary.

**MOSS ELECTRONIC DIST. CO., INC.**  
Dept. D-318 3849 Tenth Ave., New York 34, N. Y.

Please send Model 76 for free examination. If it meets with my approval I will remit \$5.05 within 10 days and then pay \$5.00 monthly for 4 months. If not satisfactory, I may return for cancellation of account.

Name.....

Address.....

City.....Zone.....State.....

All prices net, F.O.B., N.Y.C.

**WHERE-TO-BUY-IT INDEX**

Source of supply appears after items commercially available

**AUTOMOTIVE**

Truck gets power from overhead wires (Kenworth Motor Truck Co., 8801 E. Marginal Way, Seattle, Wash.).....101  
 Three-way dumper.....102  
 Vibrator helps locate rattles on auto (Breeze Corporation, Inc., 700 Liberty Ave., Union, N.J.).....112  
 Mercury's lushest: Turnpike Cruiser.....114  
 It's here—a hardtop that converts.....115  
 Radar unit selects speed violators only (Admiral Corp., 1191 Merchandise Mart, Chicago 54).....124  
 Pressure-controlled top-cylinder oiler meters engine lubricant (Van-Hecker, Inc., 22 E. Jackson Blvd., Chicago 45).....135  
 Tiny Mercedes zips 22 miles per hour.....136  
 Protective slip covers keep wagons clean (Wagonliner Co., 2406 E. Court St., Flint 3, Mich.).....142  
 Gasoline engines power small-fry tractors.....164  
 Straps clamped to car permit motorists to carry extra clothes (Engineered Enterprises, Dept. H-36, 56 Werner Ave., Daly City, Calif.).....164  
 Automobile desk folds for storing (Taylor Products Co., 316 Washington St., Brookline 46, Mass.).....169  
 Exhaust system traps lead.....243

**AVIATION**

Channel-wing plane (Custer Channel Wing Corp., Hagerstown, Md.).....103  
 Synthetic rubber resists heat.....103  
 U. S. tests B-58 Hustler—America's first supersonic plane.....104  
 Aerial fire engine.....125  
 First helicopter carrier airlifts teams of Marines.....137  
 Vacuum cleaner sweeps airport.....156  
 Whirlybird's newest job: flying TV station for the Navy.....176

**BOATS**

Trailer trucks travel on ocean-going ships (McLean Industries, Inc., Mobile, Ala.).....142  
 Outboard-motor generator powers boat accessories (Evinrude Motors, Milwaukee 16, Wis.).....157  
 Inboard-outboard boat.....161  
 Two-blade metal rudder steers as well as propels small boat.....258

**CONSTRUCTION**

Portable electric concrete mixer has five-bag capacity (Master Vibrator Co., 1752 Stanley Ave., Dayton 1, Ohio).....102  
 Italians restore 1500-year-old bridge stone by stone.....151  
 Tool stamps design in concrete (Burbank-Wasserman Co., 566 Commercial St., San Francisco 11, Calif.).....156  
 Hemisphere house.....258

**MISCELLANEOUS**

Electric clock keeps going when power fails (H. K. Nickell, National Duplex Clock Sales Co., 189 W. Madison St., Chicago 2).....103  
 Submarine escape.....104  
 "Inexpensive" homemade crop sprayer covers 500 acres daily.....113  
 Photographic typesetter (Mergenthaler Linotype Co., 29 Ryerson St., Brooklyn 5, N. Y.).....113  
 Weed-spraying railroad engine has five-car killing fluid supply.....113  
 Germ killers are discovered in soft coal.....124  
 Boxcars unloaded by rocking action.....136  
 Harvard restores 49-foot skeleton of biggest marine reptile.....143  
 Do It Yourself With Kits—  
 Outboard motor.....144  
 Aluminum carport.....144  
 Coffee-table kit.....145  
 Authentic post lantern.....145  
 Astronomical telescope.....145  
 Viewer enlarges image five times (The Franklin Institute, Philadelphia 2, Pa.).....156  
 Magic whistle stop shuts off radio.....169  
 Plow clears palmetto from Florida farmland.....173  
 Water jet scales fish.....173  
 TV watches study hall and relays criticism (General Precision Laboratory, Inc., Pleasantville, N. Y.).....176  
 Automatic checkout counter (Union Bag-Camp Paper Corp., 233 Broadway, New York City 7).....243  
 Glass-eye monitor checks fire alarm (Standard Alarm & Signal Co., Berkeley Heights, N.J.).....243  
 One-piece dial telephone (North Electric Co., Galion, Ohio).....243  
 Baby-food rack uses gravity to dispense stock (H. J. Heinz Co., 1062 Congress St., Pittsburgh, Pa.).....246  
 German coal ceramics make nonsmoking ornaments.....246  
 Goose decoy is inflatable (Rex Mfg. Co., P. O. Box 8, Morrill, Neb.).....248  
 "Diving board" mouse trap (Snider Mfg. Co., Hubbard, Iowa).....256  
 Pocket receiver for doctor.....256  
 Hogs eat feathers.....268

**PHOTOGRAPHY**

Automatic enlarging timer eliminates need for test strips (Fotomatic Corp., 2603 Kessler Blvd., North Dr., Indianapolis 22, Ind.).....169  
 Films now dispensed through vending machine (Alco Film Distributors, 360 N.W. 71st St., Miami 50, Fla.).....248

(Continued to page 92)

**DO IT YOURSELF BUT DO IT BETTER  
WITH THE RIGHT MATERIALS!**



**Get  
Popular  
Mechanics  
DO-IT-YOURSELF  
Materials  
Guide**

**The Key to Buying and Using  
Lumber, Hardware and Other  
Home Workshop Materials**

The right lumber. The right grade. The right fastenings, nails, screws, glue and other hardware. These are all just as important as the right design and the right kind of workmanship. It's true, whether you're fixing up the house, making a fine piece of furniture or knocking out a time-killing gadget. Get Popular Mechanics Materials Guide. Fills a long-felt need of home owners and home workshop fans. Has how-to-do-it information too. Send only \$2.95 for postpaid delivery. Money back if you want it in 5 days.

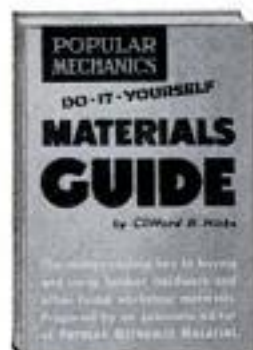

**You Need This**

How to select and how to use—Lumber, millwork, plywood and hardboard—Exterior wall and roof materials—Hardwood floors and floor coverings—Wall and ceiling materials—Doors, windows, screens and weather stripping—Glass, the material of tomorrow—Plumbing pipes and fittings—Electrical equipment—Nails, screws, bolts, etc.—Hinges, locks and other hardware—Paints and miscellaneous products.  
192 Fact filled pages.  
667 how-to-do-it pictures

Popular Mechanics Press, Dept. 157, 200 E. Ontario St., Chicago 11



**POPULAR MECHANICS  
BIG-FAMILY  
HOUSE**

Now—at moderate size—a completely livable modern home for the 3-, 4- and 5-children family. Beautifully planned throughout; eliminates crowding by a unique balance of adult and child living areas in just 1350 sq. ft. Features 4 bedrooms, 2 bathrooms, a feeling of space and convenience missing in many larger conventional houses. Can be built with partial basement—or on full concrete-slab foundation.

**Low in  
Cost...  
High in  
Privacy**

A split-living home so well designed each family member can have privacy and space for himself!

**Easy, Inexpensive to Build**  
All necessary materials are standard and obtainable in any lumberyard. This design saves on materials, materials cost, lot cost and labor—gives you a truly outstanding home for comfortable big-family living.

**POPULAR MECHANICS PRESS, Dept. 157  
200 E. Ontario Street, Chicago 11, Illinois**

Send at once Plans for the Big-Family House.  
Complete Set of 7 Blueprints . . . \$12.50  
 Remittance enclosed  Send COD (postage extra)\*  
Name \_\_\_\_\_  
Address \_\_\_\_\_  
City \_\_\_\_\_ Zone \_\_\_\_\_ State \_\_\_\_\_  
\* No COD's outside U.S.A.

**Earn Better Money**



**Learn Scientific Engine Tune-up and Service!** In just four weeks you can become a tune-up expert, using the most modern test and tune-up equipment • Good jobs open all the time in this growing field, paying real money for men who have learned how to handle the up-to-date electronic testing methods which 1957 high-efficiency auto engines call for • You don't need to have finished school to learn how to handle every aspect of auto testing • Automotive electricity, learn everything you need to know about how the electric system of a car works • How to find troubles, how to adjust to manufacturers' specifications • Carburetors, how to check their working, how to fix them quickly, accurately • You work on modern, late model engines, step-by-step, learning where breakdowns happen and what to do about them • Not a correspondence course, a fully-equipped school to teach auto engine testing and tune-up • Classes start first Monday in each month at SUN Electric headquarters on Chicago's beautiful northwest side • Full cost \$35.00 a week for four weeks including use of tools and textbooks • 1st week: Modern Tune-up Methods • 2nd week: Automotive Electricity • 3rd week: Test Equipment Operation • 4th week: Service Merchandising • Classes limited to 12 men each so you get what amounts to individual instruction • SUN'S cafeteria is open to you for tasty low-cost meals • Living quarters can be arranged for you if you wish, at an attractive price • G.I. Bill approved • Take this quick way to better income now!

**Mail in Coupon  
for complete  
information,  
brochure free**

-----  
Sun Electric Corp., Dept. P-1  
8323 N. Avondale, Chicago 31, Ill.  
Please send free brochure.  
Name \_\_\_\_\_  
Address \_\_\_\_\_  
City \_\_\_\_\_ Zone \_\_\_\_\_ State \_\_\_\_\_  
-----

1541

**BRIGGS & STRATTON Gas Engine Driven  
1000-Watt, A.C., GENERATING PLANT**



**115-VOLT, 60-CYCLE  
A.C., SINGLE PHASE**  
Handles Electric Saws, Pumps,  
Floodlights, Pipe threaders,  
Benders, Drills . . . lights,  
refrigerator, oil burner,  
radio, deep freeze, etc.

**BRAND NEW SURPLUS**  
Regularly \$279.00  
**SAVE MANY \$ \$ \$**  
See Sale Price Below

**FULLY GUARANTEED!**  
**PAYS FOR ITSELF** Saves time, labor and money. Provides on-the-spot power for construction, etc. where none is available or expensive to run in. **DUPLICATES STANDARD HOUSE CURRENT.** Generator and engine mounted on strong steel base with sturdy belt guard. Operates at 3600 R.P.M. for top efficiency. **PORTABLE!** Weighs only 75 lbs. Easily fits in smallest car trunk. Equipped with standard double outlet receptacle with overload fuse protection. **ECONOMICAL—**runs 3 hours on 1/2 gal. gas. Complete as pictured, ready to operate. 21" long, 12" wide, 16" high.  
**GENERATOR** 1000 Watt continuous duty. 115 Volt, 60 cycle, single phase. A.C. Automatic voltage regulation. Ball bearing!  
**ENGINE** Famous easy starting Briggs & Stratton 4-cycle air cooled, with automatic recoil rope starter. Adjustable automatic governor. Adjustable jet carburetor. Dust and rain proof ignition.  
**1000 Watt Continuous duty with 2 1/2 HP Briggs & Stratton engine w/recoil rope starter** **STOCK # 418B \$159.50 fob**

**Stock #356B** 750 Watt Continuous duty with 2 1/4 HP Briggs & Stratton engine w/recoil rope starter **\$129.50 fob**

**WARRANTY—Covered by Briggs & Stratton World Wide Warranty Service**  
**GENERATOR ALONE** 750-WATT.....\$59.50 fob  
1000-WATT.....\$79.50 fob  
2000-WATT.....\$133 fob  
**SUPPLY LIMITED! ORDER DIRECT FROM THIS AD!**  
**FREE CATALOG OF OTHER SURPLUS**  
**ROBERTS ELECTRIC CO., 849 W. GRAND, DEPT. PM-542, CHICAGO 22, ILL.**

# FREE! 1957 ALLIED ELECTRONIC SUPPLY CATALOG

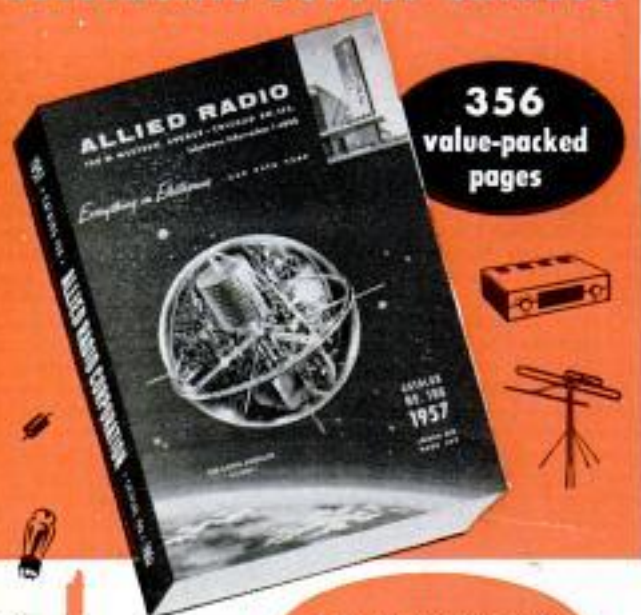

356  
value-packed  
pages

SAVE ON EVERYTHING  
IN ELECTRONICS

Everything for  
Experimenters, Builders & Amateurs,  
Servicemen, Engineers & Hi-Fi Hobbyists

Send for ALLIED's money-saving guide to *everything* in Radio, Hi-Fi and Electronics! Select from the world's largest stocks: High Fidelity systems and components; latest builders' kits (see the famous KNIGHT-KIT line); recorders and phono equipment; TV tubes, antennas, accessories; Amateur station equipment; P.A. Systems; test instruments; industrial electronic supplies—plus *everything* in parts, tubes, transistors, tools and books. Get more for your money—send for your FREE 1957 ALLIED Catalog!

Everything in Electronics from  
One Reliable Source  
OUR 36TH YEAR

Send for  
FREE  
CATALOG

## ALLIED RADIO

ALLIED RADIO CORP., Dept. 5-A-7  
100 N. Western Ave., Chicago 80, Ill.

Rush FREE 1957 ALLIED 356-Page Catalog

Name \_\_\_\_\_

Address \_\_\_\_\_

City \_\_\_\_\_ Zone \_\_\_\_\_ State \_\_\_\_\_

(Continued from page 90)

### SCIENCE

Crayons detect war gases.....	112
Ocean-going raft.....	112
Automatic anesthetizer becomes surgical tool.....	135
Electronic device identifies metals (Brush Electronics Co., 3405 Perkins Ave., Cleveland 14, Ohio).....	135
Silicone rubber guards airborne electronics.....	135
Electronic skin thermometer records patient's temperature.....	136
Synthetic passenger-car tires derived from oil-refinery gases (Esso Research & Engineering Co., 15 W. 51st St., New York City 19).....	142
Polyester resins made with citric acid for structural purposes.....	143
Infrared rays thaw frozen coal train (Perfection Industries, Div. of Hupp Corp., 4609 Platt Ave., Cleveland 4, Ohio).....	164
Purify radioactive water in 30 minutes.....	238
Inflated safety shoes aid search for mines.....	266

### WHAT'S NEW FOR YOUR HOME

Baby high chair.....	170
Foam-rubber pad scours and polishes.....	170
Convertible sofa.....	170
Automatic toaster-oven.....	171
Burglarproof lock.....	171
Centralized vacuum cleaning.....	171

### Radio-Television, Electronics

New Products of Interest—

FM-AM Hi-Fi auto radio (American Elite, Inc., 7 Park Ave., New York City 16).....	177
Combination radio, tape recorder and PA system (Wilcox-Gay Corp., 79 Washington, Brooklyn, N.Y.).....	177
Voice-controlled intercom (Talk-a-Phone Co., 1512 Pulaski Rd., Chicago).....	177
Swivel base indoor TV antenna (Channel Master Corp., Ellenville, N.Y.).....	177

### Craftsman and Shop Notes Index

#### AUTOMOTIVE

Brakes for today's traffic.....	214
Carbon removed from pistons with modified ring section.....	222
Checking carburetor float level.....	228
Oil-can dispenser saves time and space in service station.....	228

#### FARM

"Self closing" turn button.....	205
Inverted funnel holds plumb bob when aligning fence posts.....	217
Track-mounted grain cart saves feeding time.....	224
Pivoting pinch bar removes electric-fence insulators.....	226
Light low-coat brush hook.....	227
Adjustable metal stock chute.....	228
Permanent stock-pond filter.....	232

#### HOUSE AND HOME

Midget spice cabinet.....	184
Incinerator built from oil drum has removable grate.....	188
Buzzing heard when playing piano caused by vibrating object.....	189
Dry ice aids tile removal.....	196
Storage space utilized over dropped ceiling.....	197
Quick refinish for furniture.....	200
Lath holds linoleum edge while cement sets.....	208
Wooden fruit bowl supported on wire-coat-hanger legs.....	208
A third member for your automatic laundry.....	209
Caster cups on hairpin legs prevent damage to floors.....	210
Kitchen cabinet for condiments and towels.....	216
Metal washer on ball-lift rod improves flush-tank action.....	217
Wire-mesh debris catchers for basement-window wells.....	217

#### HOUSEHOLD HINTS

Floating short-stemmed flowers.....	188
Bowl cover keeps plates clean.....	193
Handle of discarded toothbrush is ideal tab for house keys.....	196
Solving Home Problems—	
Window shelf in kitchen.....	198
Gum eraser cleans piano keys.....	198
Plastic baskets make ideal containers.....	198
Length of tape around measuring cup assures accuracy.....	198
Curtain rod above radiator for hanging clothes.....	198
Stubborn sash lifted easily.....	199
Cleaning pastry board.....	199
Silence door hinges that squeak.....	199
Prevent small-fry tamperers from turning on water.....	199
Keeping roll of wall paper under control.....	199
Remove stubborn finger ring.....	199
Flashlight rack holds spare cells.....	200
Replacement pad for floor mop cut from cellulose sponge.....	210

(Continued to page 94)

# FREE!



1. URANIUM TESTER!
2. CHEMICAL PUZZLE!
3. POLAROID ANALYSER KIT!

An amazing URANIUM TESTER, a fascinating CHEMICAL PUZZLE (worth \$2.50 if you can solve it) and a valuable POLAROID ANALYSING KIT, all FREE with our great new catalog of OPPORTUNITIES IN CHEMISTRY! Learn BAKING, How To Make Precious SYNTHETIC GEMS, PRACTICAL CHEMISTRY, HORTICULTURE (Florist), TAXIDERM, ADHESIVES, MOLDABLE & CASTING COMPOSITIONS, PLASTICS, ELECTROPLATING, COSMETICS, PERFUMES, MINERALOGY, CHEMICAL PRINTING, CRIME LAB., How To Convert WATER into GAS! Complete courses and instructions from \$2.00 and up! Easy payment plan. Send 25c today for CATALOG, details, Uranium Tester, Chemical Puzzle and Analyser Kit! NATIONAL SCHOOL OF CHEMISTRY, P.O. BOX 606-P, Redwood City, Calif.

## CONCRETE BLOCK HOME PLANS

### \$2500 RANCH HOME



Build your own 25'x48' Ranch Home from our easy to follow plans. No block cutting necessary. Efficient, under slab, forced air heating—furnace and prefab duct system available. Contains 12'x20' living-dining room, 10'x10' and 11'x12' bedrooms, 12'x12' den with fireplace, 11'x12' kitchen, bath, six closets, utility room, carport or garage. Genuine blueprints scale 1/4"=1', instructions, and material cost list \$2.00 ppd. Money back guarantee. \$1900 DUPLICATION, 24'x36'. Each side contains 11'x17' liv. room-kitchenette, 10'x11' bedroom, bath, five clo. Plans \$2.00. \$1150 GARAGE APARTMENT, 22'x24' liv. room, kit., two bedrooms, bath. Double garage below. Plans \$1.00.

MEMBER ARKANSAS HOME BUILDERS ASSOC.

BAILEY BUILDERS 7604 Harmon Drive Little Rock, Ark.

## 100 BEST Woodworking Projects



SELECTED FOR YOU BY POPULAR MECHANICS EDITORS. Enjoy the fun—the pride—of making things. Get 100 BEST WOODWORKING PROJECTS, complete with simplified instruction, plans, diagrams and more than 400 how-to-do-it pictures. Make all kinds of furniture, baby carriages, clocks, lamps, book shelves, fireplaces and other useful articles at little or no cost. Send only \$2.00 with name and address. Money back if not pleased.

POPULAR MECHANICS PRESS, Dept. 157, 200 E. Ontario St., Chicago 11

## FIND HIDDEN RICHES!

NOW—find buried treasure, gold, silver, and metal objects, with sensational 3 1/2-lb. locator—GOLDAK'S "FIND-IT" . . . only \$49.50 complete with earphones, batteries, instructions.



Manufacturers of metal detection devices since 1933.

Write for FREE literature full line metal, mineral locator; geiger and scintillation counters.

GOLDAK CO. 1542-1W. Glenoaks Blvd., Glendale, Calif.

## Men: Get Into AUTO MECHANICS & DIESEL



Good jobs, high pay, security are yours as a qualified Auto-Diesel mechanic. Train NOW in the big famous Shops at National Schools in Los Angeles. Over 50 years experience, since 1905, in successfully training ambitious men. Here you work on ALL ENGINES. You master fuel injection, motor tune-up, general mechanics, automatic transmissions, all power equipment, in shortest possible time. Most complete, up-to-date equipment offered by any school. Expert, friendly instructors and engineers. Help in finding home near school. Part time job while in training. Mail coupon NOW, TODAY, for all the facts.

### NATIONAL SCHOOLS

National Schools Dept. DXB-17  
4000 So. Figueroa Los Angeles 37, Calif.  
Send Free Auto-Diesel Opportunity Book Today.

Name \_\_\_\_\_ Age \_\_\_\_\_  
Address \_\_\_\_\_  
City \_\_\_\_\_ State \_\_\_\_\_



# Is your wagon draggin'?

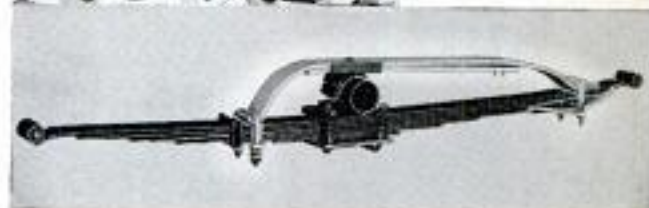

## Eliminate "rear end sag" with new, low-cost

# MOOG PH OVERLOAD HELPER SPRINGS

### for passenger cars and station wagons

Do you scrape your car's tailpipe on steep driveways? *Moog PH Overloads restore correct height to sagging rear springs!*

Do you load down your car with sporting gear, salesman's samples, the kids, etc.? *Moog PH Overloads add 1200 lbs. extra capacity!*

Does your car's rear end sway at high speeds and on turns? *Moog PH Overloads avoid dangerous concentration of weight at one point and stabilize the ride, improve cornering whether car is loaded or not!*

**Low-cost installation takes only 15-20 minutes using a single wrench!** See your favorite automotive supplier for Moog PH Overload Helper Springs.

Moog Industries, Inc.,  
St. Louis 14, Mo.

Spring Specialists  
Since 1919



Manufacturers of the most complete line of "under-the-car" parts

## MISCELLANEOUS

Desk-chair	181
Alphabet-noodle monograms	183
Neat storage for lamp bulbs	186
Safe combination hidden	186
"Roll up" storage for brushes made from bamboo place mat	188
How to mount a wall map	189
Concrete-filled tires anchor volley-ball-net uprights	196
Hand liquid dispensers made from lighter-fluid cans	196
Grommets from pencil erasers	197
L-hooks permit quick removal of martin-house sides	200
Vegetable puppets	206
How to start a siphon	208
Match lengthens pen refill	209
Vanity table doubles as desk	210
Plastic dropcloth speeds masking auto for painting	212
Redecorating with light	213
Guide lines made on linoleum with china-marking pencil	218
Overflow from drain tile inlet passes through floodgate	220
Double-duty mailbox standard also supports sign	222
Squeeze-type plastic bottle doubles as grease gun	222
Milk-can cart "climbs" stairs	224
Spring-leaf "lines" on back of hoe speed mixing of concrete	232
Shop chair swivels to any working position	233
On the Market—	
Self-adhesive floor felt	236
Sliding drawers	236
Driveway topping	236
Expansion anchors	236

## PHOTOGRAPHY

Direct-bounce flash lighting	187
"Sync" motor drives photo timer	194
Multiple-reel holders speed film developing	208
Strong hypo substitutes for rapid fixing solution	216

## TOOLS

Tool for clinching nails	218
Modelmaker's gear puller	221
Threading small rods accurately	221
Accessory cabinets for power tools	223
Internal keyway cut in bushing	223
Shopping for Tools—	
Handy household tool combines sharpener and glass cutter	234
Hacksaw frame	234
Reamers with replaceable and interchangeable heads	234
Aluminum ladder folds for storage	234
Stationary table converts saw	234
Table-top machine shop	235
Self-centering drills	235
Drill-press vise	235
Pencil-size torch uses gas cartridge	235

## WORKSHOP HINTS

Folding basket-weave screen from Venetian-blind slats	183
Marrowed chromium coatings easily renewed	183
Two nuts and washer used to tighten studs	184
Soldering ceramics	185
Hose stored on semicircular bracket nailed to wall studs	186
Cuts on friction-tape roll release threads from edge	187
Plug helps remove pipe nipple from steam radiator	187
Sandpaper gripped securely in two-piece sanding block	187
Preventing paint accumulation in heel of brush	188
Crossbars on stepladders support scaffold plank	193
Masking tape used as handle when fitting cabinet door	196
Work shield for driving screws	197
Wooden shelf brackets cut without wasted stock	200
Leather loop on wire brush reduces hand strain	205
Legs of sawhorse are adjustable to various heights	205
Bit prevented from slipping into previously drilled hole	210
Butt joint fitted accurately by using doubled sandpaper	212
Center point for compass provided by thumbtack	212
Rack for sanding belts	212
Cotter key driven into stake is quick-release line holder	217
Paper clamp "pinchproofs" saw	217
Flattened end of paper clip provides midjet screwdriver	218
Chucking thin blanks for face machining	219
Heavy-duty extension cord kept on handy reel	222
Tubing on microscope protects worker's glasses	224
Squaring bottom of blind hole	224
Indexing head for gear cutting	225
Chip tray for drill press	227
Flumb bob made from chuck shell	227
Hacksaw is emergency wood rasp	228
Shop geometry	229
How would you do it?	230
Pronged wedges lock handles in ax and hammer heads	232
Scored lines on saw table assure accurate miter-gauge setting	232
Pipe wrench and flat-jaw vise hold pipe for threading	233

**NOTICE**—It is the intention of this magazine to provide its readers with information regarding the latest developments in the mechanical arts. Except where otherwise indicated, this magazine has no information as to any unexpired patents in respect of the developments reported herein. In the event that commercial use is to be made of any of the developments reported herein, it is suggested that legal counsel be consulted to avoid liability for patent infringement. It is not the purpose of this magazine to encourage patent infringement but, as indicated, it is the intention of this magazine to report on the latest developments in the mechanical arts.

# 23 BOATS YOU CAN BUILD



## You Can Build These Boats Without Experience With Few Tools, and Little Time to Spare!

And the best part is that after you have completed your boat, you will know it is seaworthy as well as eye-worthy. This book, a few tools, and some time each day in your garage or basement, is all you'll need to complete the boat of your dreams. Nothing is left to the imagination. Everything is planned for you before you turn back the cover of the book. All you do is follow simple step-by-step instructions and show how photos and drawings.

### Building and Service Hints Provided

You'll learn how to build your boat right the first time. Success in building a boat depends on two things. Knowing beforehand exactly what type boat you want to build and then getting started correctly on the construction. With this book it's simple. Material lists are supplied where essential, listing lumber required, hardware, sailcloth, fittings, etc. Also included are hundreds of hints for building your boat right, the best boat for beginners, and tips on servicing boats after they are built.

### Special Chapter on Boats for Sportsmen

If you are a sportsman, hunter, fisherman, trapper, or just plan to use your boat for pleasure, this chapter contains ideal craft for your use. Perhaps you have a canoe in mind, or a rowboat that can be carried on your auto. Maybe you have always wanted a duckboat but have been reluctant to purchase one because of the expense. All these boats plus a 3-second

tion rowboat, and 12-foot plywood outboard, are available in this one chapter alone. All are easy to construct, and beautiful to own. Step-by-step instructions, photographs and illustrations, plus important material lists carry you right through from the forming of the keel to the last coat of paint and varnish.

### Half a Million Persons Build Their Own

There are more than half a million persons in the United States who regularly build boats for pleasure or for profit. They form a cross section of American life. And theirs is a double reward—the fun of building the boat, and the thrill of using it when it is finished.

### Partial Listing of Boats

Think of being able to build and own the following boats: "Su-Lu" the PT-type Plywood Dinghy, 11-ft. Skiff, "Sport" a V-Bottom Inboard, "Tramp" a 15-ft. Sailing Knockabout, "Sea Craft" a 25-ft. Cabin Cruiser, "Zephyr" a 14-ft Sailing Dinghy, "Arrowhead" a 21-ft. Sloop, a bicycle Boat, Motor-driven Paddle Board, "Skimmer" a Sturdy Plywood Kayak, "Skip" a Pram-Type Dinghy, "Tiny" a 6-ft. Training Ship, and many more, from large to small and at a fraction of the purchase cost!

### 7-Day Money Back Guarantee

Send for your copy of 23 BOATS YOU CAN BUILD today. Read and use it for 7 days. If it isn't entirely satisfactory return it for a full refund.

*Use This Handy Order Coupon*

### POPULAR MECHANICS PRESS

200 E. Ontario St., Chicago 11, Illinois

Gentlemen:

Please send my copy of 23 BOATS YOU CAN BUILD. Enclosed is my remittance of \$2.75. If I am not completely satisfied with the book I will return it for a full refund after 7 days.

Name \_\_\_\_\_

Address \_\_\_\_\_

City \_\_\_\_\_ Zone \_\_\_\_\_ State \_\_\_\_\_





## HOME PLAN BOOKS

### CHOOSE YOUR NEW HOME FROM HUNDREDS of *Garlinghouse HOME PLANS* SHOWN IN THESE 5 LATEST PLAN BOOKS

These beautiful books contain hundreds of colored drawings, photos, floor plans and descriptions—making it easy and economical to select your new home. All sizes and styles are shown. Complete working plans, specifications, lumber and mill lists available for each design at **Low Cost**—enabling you to get bids quickly—or to figure doing part or all the work yourself. The moderate price of these plans is your best investment when building since you know in advance what you are getting, thus avoiding misunderstandings. 24 hour service on plans with a money-back guarantee if unused plans are returned in five days.

- **"RANCH & SUBURBAN"**  
125 plans most practical for town and country. Many in color .....50c
- **"CHOICE SELECTED HOMES"**  
82 designs (12 are split-levels) 2 and 3 bedrooms. 32 in color...50c
- **"NEW SMALL HOMES"**  
Over 80 new plans. Sizes 650 to 1175 sq. ft. floor space. 1, 2 and 3 bedrooms. 32 in color....50c
- **"NEW BRICK HOMES"**  
64 genuine beauties, brick exteriors. Varied styles and sizes. 50c
- **"PLANS FOR NEW HOMES"**  
84 very desirable homes in wide variety of styles and sizes. 32 in full color.....50c

All 5 above books for \$2.00

**ORDER YOUR BOOKS TODAY**

All Books Mailed **POSTPAID**. No C.O.D.'s Please  
Our Plan Service used by Builders and Lumber Dealers for over 45 years—America's Pioneer Home Plan Service.

**L. F. GARLINGHOUSE CO., INC.,** Box PM-17 **TOPEKA, KANSAS**



**NEW!** **RECLAIMO**  
ELECTRICALLY HEATED  
Oil RE-REFINING Filter  
A Wm. Schwabz Product  
CAR - TRUCK - TRACTOR OWNERS  
GET WISE to the most efficient filter ever developed!  
Folder with full details FREE.  
RECLAIMO MFG. CO. 6251 Touhy Ave., Dept. M-17, Chicago 30, Ill.

**"GETTING THE MOST OUT OF YOUR RADIAL SAW"**  
NEW DELTA hard cover book gives easy-to-follow instructions, over 300 illustrations on ripping, drilling, routing, etc. Only \$1.00. Also get FREE folder on complete Delta Library; Delta Power Tool Div., Rockwell Mfg. Co., 502A N. Lexington Ave., Pgh. 8, Pa.

**Also Eshelman 2 Passenger SPORT & GOLF Cars**  
Costs small fraction of most other cars.  
4 times more gas mileage  
Write for FREE Literature

**ESHELMAN TRACTORS** LOW AS \$99  
Plows • Cultivators • Saws • Dozers • Harrows  
• Snow-Plows • Rolls • Mowers • Mows • Tillage  
Eshelman Tractors, Fillers, Riding Rotary Mowers for Better Lawns and Gardens.  
Advertised in 6000 HOUSEKEEPING. Thousands of Satisfied Users.  
Dept. 4, ESHELMAN, Balto. 2, Md. **Model S605**

Shipping Point: BALTIMORE - CHICAGO - BIRD

**I CAN SAVE YOU 94%!**  
REAL LOW PRICES  
Send for NEW 1957 Illustrated BOOK of BIG WAR SURPLUS BARGAINS for mechanics, farmers, gadgeteers.

**AIRCRAFT STARTERS**  
Make excellent winch for lifting, wagon unloaders, pulling stumps, stretching fences or moving heavy objects—100 uses at home, farm or factory. Operates on 6 to 32 volts or manually. Built-in reduction gear (140 to 1) and clutch. High torque, low speed. Mfg. by Bendix at many times this price.  
F.O.B. York (wght. 42 lbs.)  
**only \$14.89**



**WAR SURPLUS BARGAIN FREE!**

Make your own conversion  
**K. ORT, Dept. P1M, York, Pa.**

## Feature for Feature *Atlas* is your best buy!

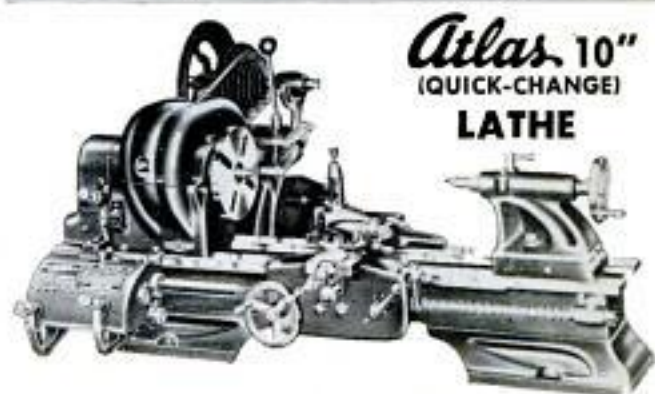

**Atlas 10"**  
(QUICK-CHANGE)  
**LATHE**

For development work, home repairs, a hobby or commercial shop—no other lathe in the low-cost field compares with this Atlas 10" lathe. Timken tapered roller bearings, precision-ground bed, 16 spindle speeds, instant selection of 54 threads or feeds, complete V-belt drive and power cross and longitudinal feeds are but a few of the many features that make it the most accurate and efficient lathe in its class. Send for the latest catalog today!

## *Atlas 7"* SHAPER

Atlas is the most practical 7" shaper . . . and the greatest value. It handles the complete range of shaping operations—quickly, easily and accurately. It is the only 7" shaper that is Timken bearing equipped . . . the only 7" shaper with roller bearings on countershaft spindle, cast iron bull gear with 1" face, and outside stroke adjustment. Exceptionally heavy and ruggedly built. Has ground ways, 4 speeds, 5 reversible automatic power cross feeds. Send for latest catalog.

**TIMKEN BEARING EQUIPPED**



WRITE FOR ILLUSTRATED LITERATURE



**Atlas Press Company**  
1-24 N. Pitcher St., Kalamazoo, Mich.  
**QUALITY MACHINE TOOLS SINCE 1911**

"We'll be using them for years..."



...that's why we pick the Brand that's made a Name for itself!"

EVERYTHING that goes into a new house takes a big bite out of the family budget. And it's all too true that you have to live with mistakes you make in buying . . . whether they be appliances, furniture, food, clothing or whatever. So buy brands that have made a name for themselves. You're bound to be satisfied.

#### FOUR WAYS BRAND NAMES SATISFY YOU MOST

**1. BUY WITH TRUST!**

Spend *confidently* on known quality. Brand Names wear best, work best, taste best, are best.

**2. SHOP WITH EASE!**

Spend *efficiently* on proved value. Brand Names save time "puzzling" over labels, models, prices, etc.

**3. ENJOY MORE CHOICE!**

Spend *shrewdly* among widest selections. Brand Names offer the most in sizes, types, colors, flavors, etc.

**4. GET THE "LATEST"!**

Spend *smartly* on up-to-date products. Brand Names keep improving, modernizing, introducing new things.



MANUFACTURER



DEALER



CUSTOMER

"I made it!"

"I sold it!"

"I bought it!"

Advertisers in this magazine are good names to know. They're proud of their brands 'cause they satisfy so.

**BRAND NAMES FOUNDATION, INC.** • 37 Fifth Avenue • New York 16, N. Y.

# POPULAR JANUARY 1957 MECHANICS

WRITTEN SO YOU CAN UNDERSTAND IT  
VOL. 107 NO. 1

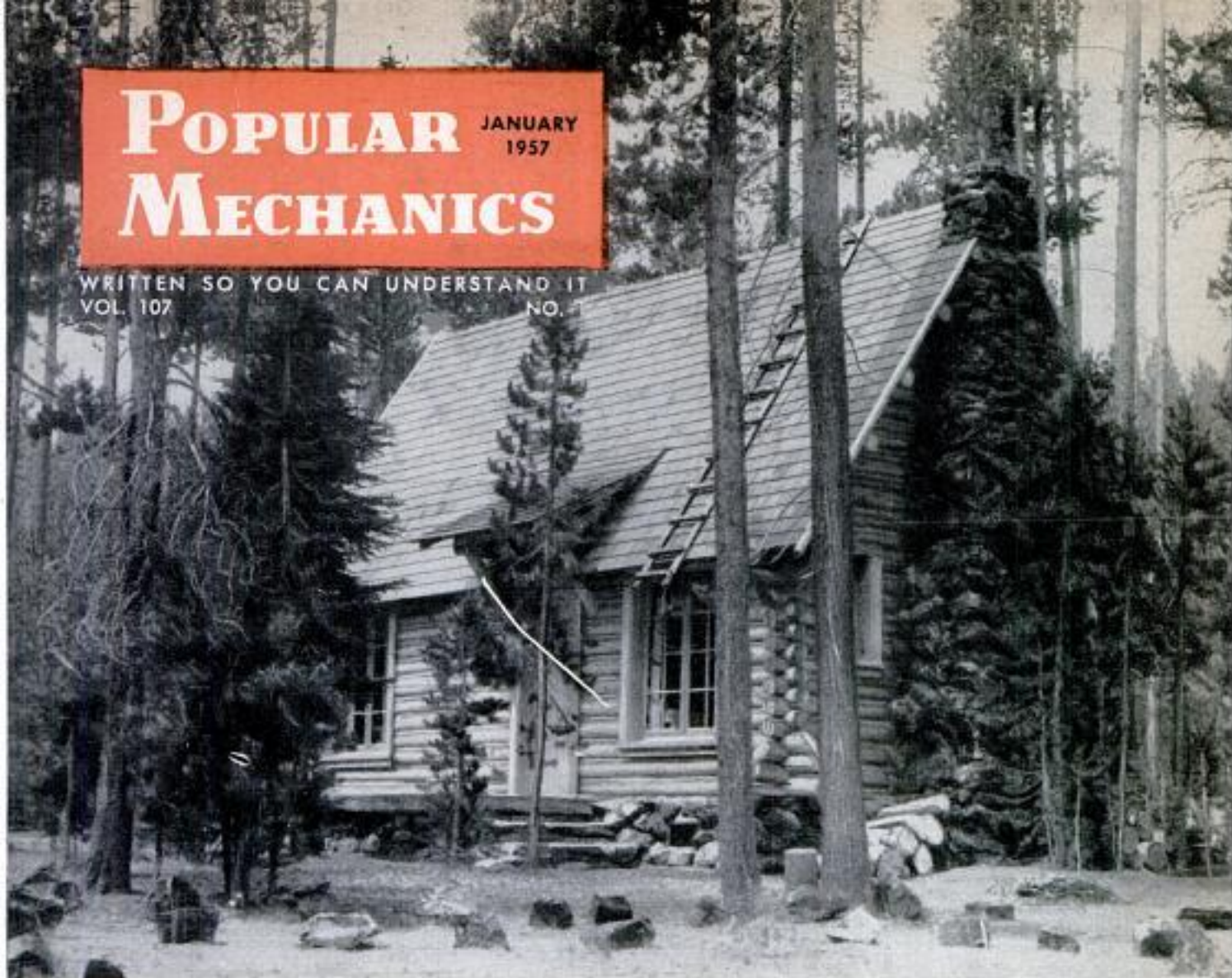

U.S. Forest Service photo

This attractive vacation cabin in Oregon is one of 16,000 that have been built on national-forest land



## How to Plan That Vacation Cabin

By Marion H. Kemp

**W**HETHER YOUR FAMILY'S preference for a vacation spot is a mountain cabin lulled by the whisper of tall pines, a beach house open to the tang of salt air and roar of surf, or just a quiet week-end retreat without anything dramatic in the way of scenery, it should be an investment in carefree living with a minimum of expense, upkeep and responsibility.

Looking for a suitable site can be almost as enjoyable as the final result, when your "getting away from it all" haven has become a reality. Searching jaunts are fun—planning where to look, exploring out-of-the-way places. Lively family discussions over the merits and disadvantages of a proposed location can be fun, too, and

can be worthwhile in a monetary sense.

But don't let the beauty of a view, or the contrast of nature-in-the-rough to your city dwelling, sway judgment and consideration. Before investing in a vacation site—investigate!

There are many things to consider that are never a problem in urban areas. Americans take for granted the protection of community guardians. Ascertain if, in case of an emergency, there are fire-fighting facilities, police and a hospital within a reasonable distance. As a matter of course we accept the electricity, heating, shopping, transportation and communication conveniences of a modern civilization. Ask yourself which of these conveniences



PM's precast house can be built as a roughly finished simple cottage or year-round home. Floor plan is below

your family can do without in a cabin in the back country.

What about electricity for lighting and refrigeration? Can you do without it or can it be brought in, and at what cost? Are the terrain and soil such that drainage and sewage disposal will not be a headache? Must you keep in touch with your office while away? If so, will you be able to do so from your chosen location?

An adequate, pure and convenient water supply is of the utmost importance. The cartoons of a harried vacationette hauling

buckets up a hill may be humorous to the modern housewife in her home, but put her in the same situation under the guise of roughing it and the little woman will soon take a dim view of her family's vacations! If a well must be drilled, or water piped any distance, estimate before you buy—the cost of drilling and water pipes can scuttle any budget.

A matter for serious consideration is the road into your property. Is it accessible at all times of year, and under any weather condition? Will it become a deeply rutted,



Here is the most popular floor plan of this house which was introduced by *Popular Mechanics* in 1955. None of interior partitions is load-bearing so they can be shifted for a variety of plans. Unique window panel at rear of house provides for "switchable" windows to suit owner's desires. Features of the home are a big living room, fireplace, many built-ins, lots of storage space and a roomy porch. Foundation is concrete slab, exterior siding is weatherproof composition board

muddy trail during heavy rains? Will the babbling brooks you so admire flood and make travel impossible? What about snow in winter? If on the desert or by the ocean, will you be constantly digging out of drifting sand? The most beautiful hillside view in the world loses much of its charm if all supplies must be lugged up or down a dangerous, precipitous path. Before any final decision on a secluded vacation spot, especially if you plan to build and must have materials and supplies hauled in, determine the expense and work necessary to keep your road passable in all kinds of weather.

For week-end convenience, as well as longer stays, the distance from home should not be so great that the trip becomes a chore. Locate your vacation spot within reasonable reach and you will use and enjoy it more often.

If hunting and fishing are family hobbies, their possibilities should be thoroughly investigated. All counties do not permit every type of hunting. If it is your dream to stock a pond or stream on your property for fishing purposes, cooperation and expert advice are yours for the asking from state fish-and-game officials. There are many excellent pamphlets obtainable through state and federal departments. Take advantage of their know-how before such a project is started, unless you are an expert yourself.

A clear title, which is more or less taken for granted these days in the purchase of urban property, is not always the case when you are dealing with an undeveloped locality. Title and possible legal entanglements, especially if you are contemplating buying a property up for sale for back taxes, should be carefully investigated. By all means check local ordinances. They may prevent your particular purpose for acquiring a vacation site, such as installing an outdoor shooting range or indulging in speedboating on a nearby river.

You might also want to consider one of our national forests as a site for your summer home. Did you know that 16,000 homes have already been built on national-forest land? Suitable areas are selected by experienced forest officers and are surveyed into lots of about one acre each. In each case the forest environment is preserved and each site is isolated from its neighbors. If you want such a site get in touch with the supervisor of the particular national forest in which you are interested. He issues "special-use permits" for \$20 to \$50 a year, depending on location, facilities, size and other factors. Although the builder never gets title to the land, renewal of the permit from year to year at a modest



Photos by Dan Bauer

Unhappy owner of this cabin on a California river found out it was below flood-level stage of stream



Cabin owner with lack of foresight finds road to his summer home is impassable during the rainy season

Heavy rains and melting snow caused the hillside to slide down and almost engulf poorly located cabin





Courtesy Masonite Corp.

Summer cottage designed for do-it-yourself builders is made of hardboard panels prefabricated in workshop

Plan # AE-203

Floor plan for cottage above provides four rooms in 20 by 20-foot structure. Porch or carport is optional



fee is assured if reasonable rules are observed. Design and construction of the buildings must be approved by the forest officer in charge. Such homes, of course, are not to be used for commercial purposes but must be occupied as private residences. The homes may not be sold without approval of the forest supervisor.

Naturally you have your own ideas for a vacation home suitable to the particular terrain and climate of its location. Whatever you do—whether it is remodeling and repairing, building yourself, using a contractor, local labor or a combination of any of these methods—have your place

built to a definite plan. Know what you can afford, and adhere to the principle that anything jerry-built or haphazardly done will, in the long run, prove more expensive to maintain and repair. Consider carefully the pleasure and convenience of built-ins. Install more than what you consider adequate-storage facilities. One insect and rodent-proof cupboard is worth all the shelves that can be built. Doors and windows should be stoutly constructed and as prowler-protected as possible. Strong, well-fitting shutters are a small initial expense that can pay long-term dividends in protection against weather and pilfering.

There is nothing more delightful than the open hearth, the crackling logs, the rugged beauty of a rustic fireplace. Know that it is as safe as it is soul-satisfying. You don't want your dreams and carefree vacations to go up in smoke. The mortality rate of cabins, due to inadequate fire protection, is very high.

Since a vacation cottage should be equally enjoyed by all members of a family, their individual needs and wishes merit consideration. Please allow me, as an eyebrow-singed, smoke-eating camp cook to become very forceful about a little matter too often disregarded. Very few women enjoy, much less are able to prepare a satisfactory, well-balanced meal over a smoky campfire or a fractious wood stove. Why should they, when the soot-blackened pots, the unregulated heat, the extra time and work are unnecessary? A Coleman camp stove, or the efficiency of a modern butane or kerosene range is within the

(Continued to page 268)

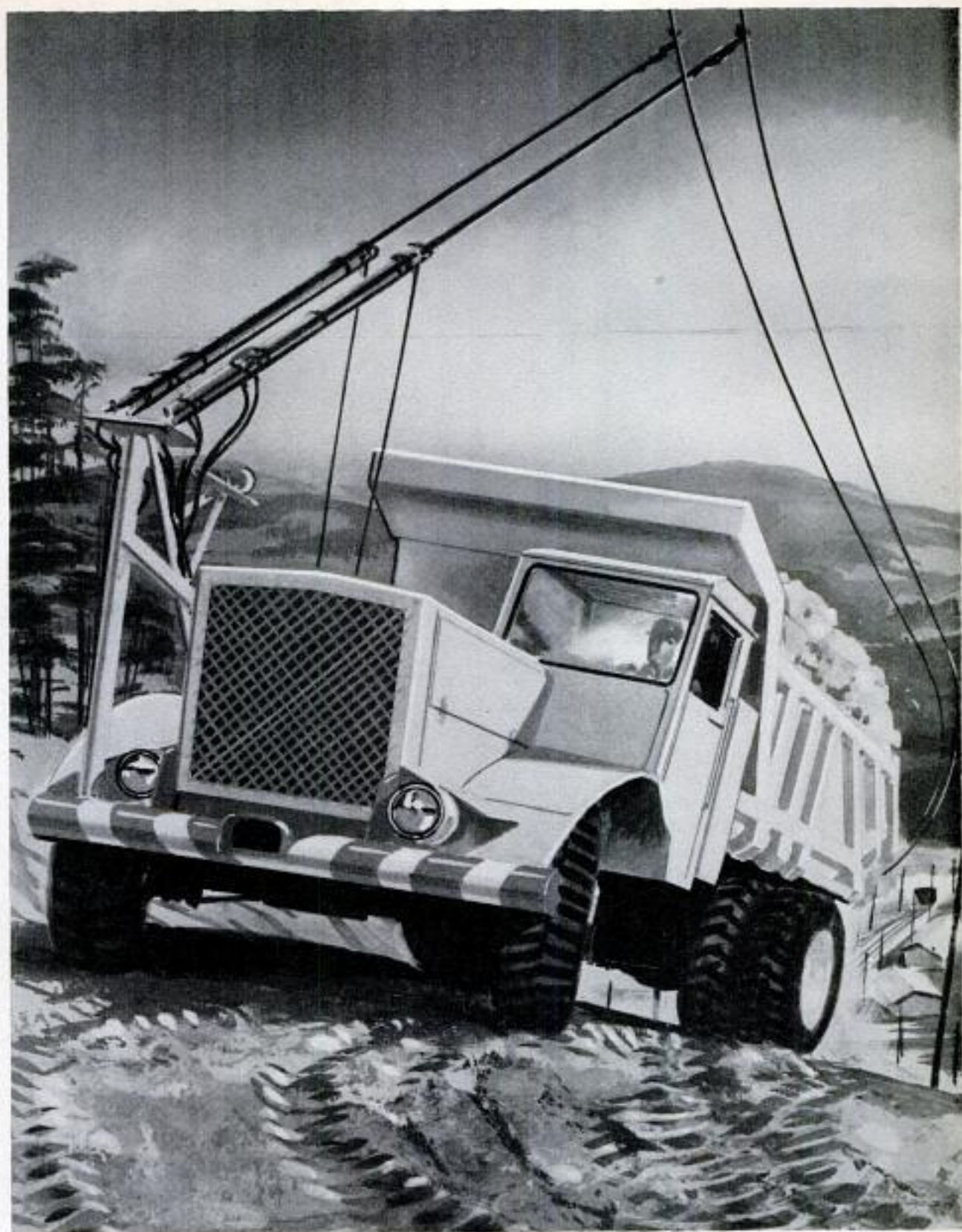

## Truck Gets Power From Overhead Wires

ELECTRIC TRACTION MOTORS power a dump truck that gets current from overhead wires through a trolley. Four of the trucks will be used at Crestmore, Calif., to move limestone rock from an underground mine to a crusher on the surface. Two thou-

sand feet of the mile-long haul are underground and on a 10-percent grade. Down at the loading zone, the trolleys are disconnected and cable reels plugged in to give the trucks more mobility. The truck solves problems of safety and ventilation.



### Three-Way Dumper

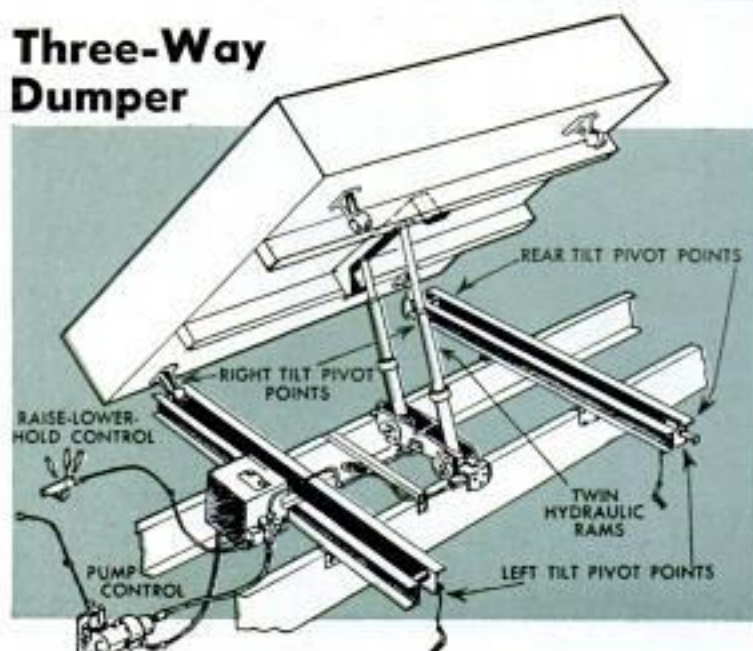

Capable of dumping in any of three directions, a British truck simplifies unloading in tight places. Two hydraulic rams are used to raise the body. Both sides are hinged and can be lowered in the same manner as the tailgate. The body comes in various sizes, with the largest having over-all length of 17 feet. The truck can be driven with the body in any intermediate position, making it ideal for spreading gravel along the shoulder of a roadway, either to right or left.

### Portable Electric Concrete Mixer Has Five-Bag Capacity



Featuring one-man portability, an electric mixer for concrete, plaster and terrazzo can be used on the job site. It can be assembled in less than a minute by inserting an electric mixing unit in a tub. The tub has a capacity of five bags of premixed aggregate and the entire unit can be transported easily in a car trunk, station wagon or small truck. The mixer operates from any 115-volt outlet. If desired, extra tubs can be used to mix different colors.

### Copter De-Ices Wires

Flying above a power line, a helicopter trailing a bamboo pole has knocked ice off the wires with the dragging action of the pole and the downdraft of its rotors.



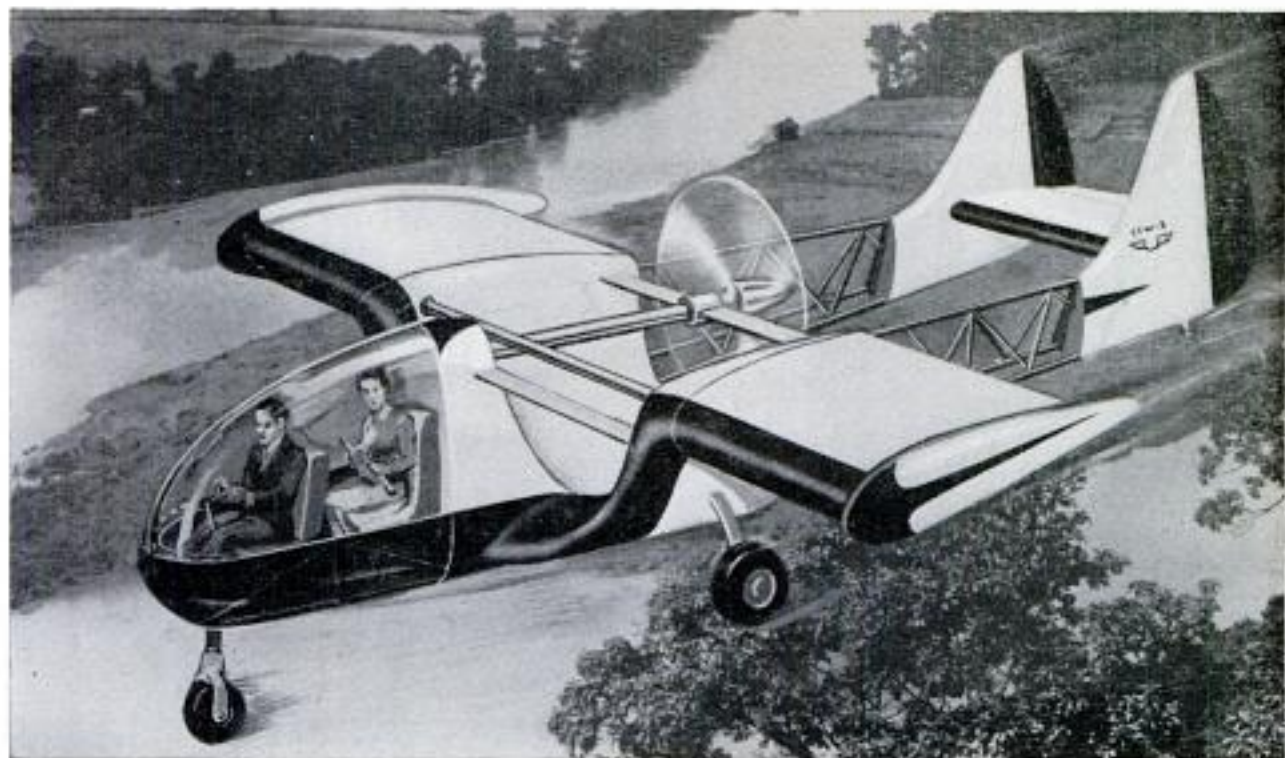

## Channel-Wing Plane

Blending of auto and aircraft are merely a step away, if tests succeed on a plane with a single-channel wing that has outboard panels working like ailerons. By mid-1957 experiments will have pin-pointed whether this prototype can take off and land at five miles per hour inside its own length of 18 feet. One trial involves the clearing of a 50-foot obstacle within 300 feet of a standing start and at a climb rate of 4000 feet per minute. Carrying two passengers and powered by a 240-horsepower engine, the craft is expected to fly 200 miles per hour at a range of 1200 miles. The plane operates on a principle developed by Willard R. Custer (See *PM*, May 1947): Lift

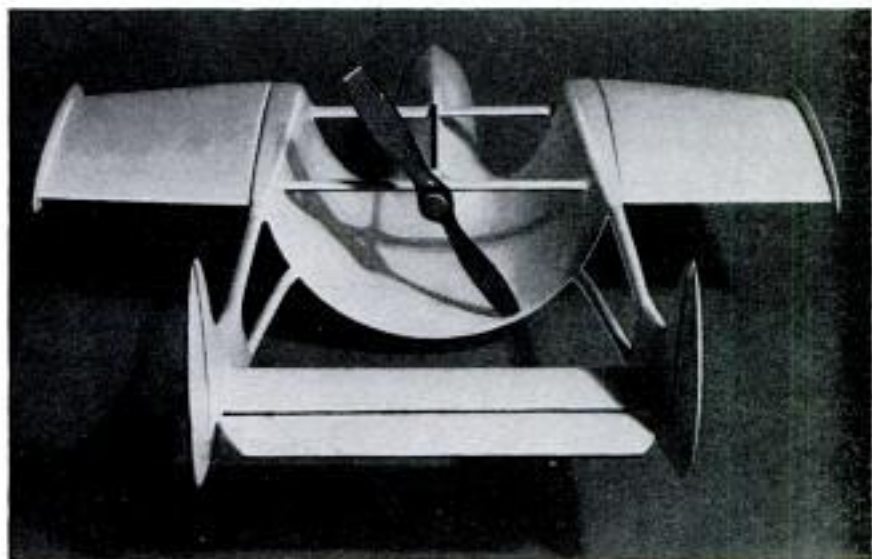

and thrust are produced by drawing air at tremendous speeds through the channel wing. Pending test outcome, designers plan a craft that will land on a road, folding its wings to a width of less than eight feet and disengaging the propeller shaft to become an automobile, all without halting.

## Synthetic Rubber Resists Heat

Synthetic rubber has a new candidate for honors in resisting heat of supersonic jets, frigid temperatures of the upper air and attack of fuels, lubricants and hydraulic fluids. Strong and elastic after long exposure to air heated to 400 degrees F., the material is flexible to 98 degrees below zero. This rubber resists aromatic and paraffinic-type fuels and certain hydraulic fluids used in current aircraft.

JANUARY 1957

## Electric Clock Keeps Going When Power Fails

You can now buy an electric clock that keeps going when power fails. Whenever electricity is shut off, a spring built into the clock automatically takes over and accurate time is kept until the electric motor is back in operation. The spring will operate the clock for 30 hours without rewinding. A red flag on the face of the clock shows when rewinding is necessary.

103

# SUBMARINE ESCAPE

**C**REW MEN of the undersea fleets using a new escape system can leave sunken submarines at the rate of one man every five seconds. In the past it has taken five minutes for each man. Recent lifesaving techniques are replacing permanent, bulky escape locks built into sub hulls. The long-used "breathing bags" for repurifying air during an escapee's rise to the surface will soon be obsolete.

British and American sub services are rapidly installing escape methods and gear involving three radical revisions of old-time procedures. First, a twill tunnel stored in the ceiling of the sub's pressure hull under the escape hatch is unfolded to provide access to crewmen seeking outside waters. Also, individual air-and-gas mixtures are available to those waiting to use the escape tunnel. Storage cylinders, piping and valves make breathing possible. Finally, on the principle that pressure inside a man's lungs at certain depths is greater than the pressure of surrounding water, present escapees are instructed not to hold their breath during ascent but to let water pressure force air from their lungs. Air will rush from a man's mouth (his nose being clipped shut) in such a way that water cannot enter to suffocate him.

If a sub sinks in 200 feet of water, the crewmen will move into escape compartments, one at either end of the stricken vessel. While dressing in cold-resistant rubber immersion suits, they assemble the twill tunnel and slowly flood the compartment, leaving a large bubble of air at the ceiling. When the compartment is sufficiently flooded to equalize inside and outside water pressures, the escape-hatch cover is opened to admit water over the escape hatch above the compartment. One by one, crewmen crawl into the bottom of the tunnel, up through the escape hatch, and into cold, dark water around the hull's exterior.

Meanwhile, individuals lined up for entry into the tunnel "tap" air-and-gas reserves by working valves in head-level piping. Each man inflates the rubber collar of his suit to help his ascent which is made at the rate of four feet per second. Faster ascent would produce agonizing "bends." He allows lessening water pressure to expel air from his lungs, as he moves upward. Surfacing, he inflates the entire suit and floats until rescuers see a red electric light on his collar.

Britain has lost 140 men and two subs during the last six years. ★ ★ ★



## *U. S. Tests B-58 Hustler— America's First Supersonic Bomber*

Capable of flying more than 1000 miles per hour, the new Convair B-58 Hustler is the first U.S.-made supersonic bomber. It is powered by four turbojet engines slung under the wing in separate nacelles and has a delta-wing span of 55 feet, a length of 95 feet and a swept-back vertical stabilizer 30 feet high. Elevons in the wing's trailing edges combine functions of conventional ailerons and elevators. A pilot, navigator-

bombardier, and defensive-systems operator will crew the aircraft at altitudes above 50,000 feet. This bomber is said to be the first production plane to use brazed stainless-steel sandwich panel as primary structure. Included in the B-58's 16 major near-automatic subsystems is equipment for launching guided missiles from points outside the reach of the enemy. It will be in squadron service in two or three years.

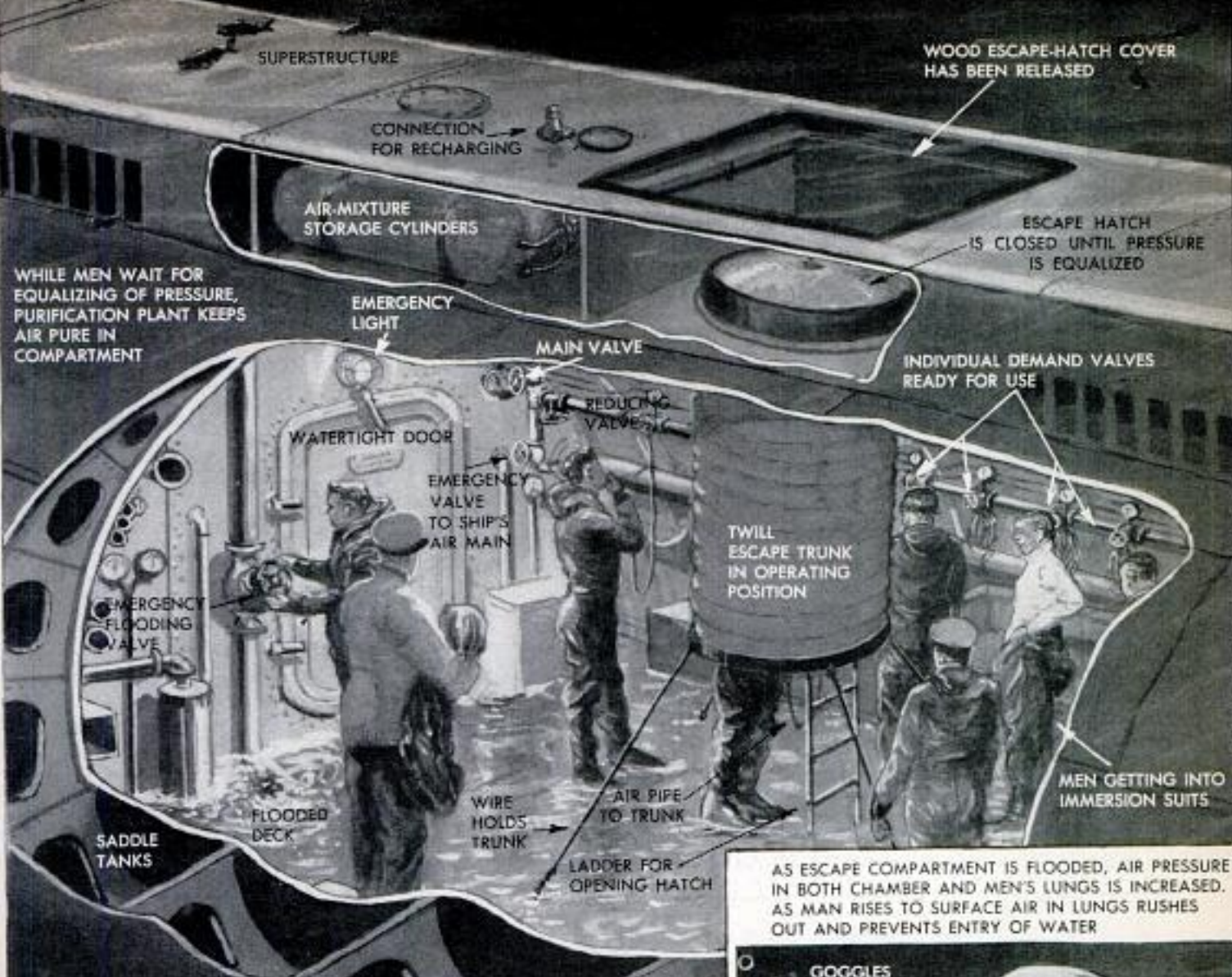

AS ESCAPE COMPARTMENT IS FLOODED, AIR PRESSURE IN BOTH CHAMBER AND MEN'S LUNGS IS INCREASED. AS MAN RISES TO SURFACE AIR IN LUNGS RUSHES OUT AND PREVENTS ENTRY OF WATER



# An Engineer Analyzes 1957 Chevrolet V8

By Dale Kelly, SAE

**MODEL TESTED:** Two-Ten four-door sedan with 283-cubic-inch V8 engine, four-barrel carburetor, dual exhausts and Powerglide transmission.

Rear-axle ratio: 3.36 to 1. Wheelbase: 115 inches. Tires: 7.50 by 14. Weight: 3474 pounds with gas

tank half full (54 percent on the front wheels, 46 percent on rear).

Barometer: 29.06 inches, temperature 81 degrees F., payload 400 pounds for acceleration tests, 200 pounds for economy tests.

## ACCELERATION TIME FROM STANDING START IN SECONDS



	0 to 20	0 to 40	0 to 60	0 to 80	¼ mile
Ignition timed for regular gasoline	2.5	5.6	11.5	19.2	18.5
Ignition timed for premium gasoline	2.5	5.4	11.3	19.1	18.4

Ignition timed for super-fuel (90 to 105 octane)

No improvement

The watch was started the instant the accelerator was floored. The engine was not run up against the brakes. All tests in Drive range.

## FUEL ECONOMY IN MILES PER GALLON



	Steady 30 m.p.h.	Steady 50 m.p.h.	Steady 70 m.p.h.	Traffic Route
Ignition timed for regular gasoline	21.8	18.9	15.5	10.2
Ignition timed for premium gasoline	22.0	19.6	16.0	10.2

In the traffic test the car makes 10 full stops per mile and is driven fast enough to average 15 miles per hour.

**ESTIMATED AVERAGE ANNUAL GASOLINE BILL: \$166 for 10,000 miles.**

## SPEEDOMETER ERROR (MILES PER HOUR)



Speedometer speed	20	30	40	50	60	70	80
True speed	20	29	39	50	60	70	80

## ODOMETER ERROR

Distance registered for covering an actual 100 miles: 99 miles. Odometer error: 1 percent low.

## DRIVER'S VISION



Distance at which part of road in front of car could be seen (A in sketch).....17 feet  
 Distance at which full width of road could be seen (B in sketch).....20 feet

## GROUND CLEARANCE (unloaded car)



Radius of sharpest dip that could be crossed without "hanging up" (solid line).....22 feet  
 Radius of sharpest hump that could be crossed without "hanging up" (dotted line).....17 feet  
 Deepest rut that could be driven in.....7 inches  
 Curb clearance for door opening.....12 inches

## MISCELLANEOUS

### STEERING

Steering-wheel turns from straight ahead to steer outer front wheel in a 100-foot circle: 0.9 turn.

Diameter of smallest circle inside which the wheels could turn (curb-to-curb): 42 feet.

Diameter of smallest walled circle inside which entire car could turn (wall-to-wall): 44 feet.

Steering-wheel turns, lock-to-lock: 4.6 turns.

Steering-wheel diameter: 18 inches.

### TRUNK CAPACITY

Number of standard cartons (1 cubic-foot each) that could be packed into trunk: 9 cartons.

### CENTER OF GRAVITY

Height of center of gravity of unloaded car: 23 inches.

**WATER RESISTANCE:** Good.

### MEASURED DIMENSIONS

Length: 200.5 in. Width: 74.0 in. Height: 62.25 in.

Dale Kelly, Registered Professional Engineer



## CLYMER DRIVES 1957 CHEVROLET V8

By Floyd Clymer

**T**HE TEST was from Los Angeles via Lake Arrowhead, the Rim of the World Highway and the edge of the Mojave Desert to Bakersfield, returning via San Luis Obispo and Santa Barbara. Total distance was 635 miles, including several miles of off-road desert and mountain driving.

The car was the Bel Air four-door sedan powered by the extra-cost 283-cubic-inch V8 engine and power pack, including a four-barrel carburetor.

The power-pack V8 has a 9.5-to-1 compression ratio. The standard Chevrolet V8 has a 265-cubic-inch displacement and an 8.0-to-1 compression ratio.

We had hoped to test a Chevrolet with the new fuel injection and Turboglide automatic transmission, but neither of these was available in production models at the time of the test.

The 115-inch wheelbase car has all the fine characteristics of the 1956 Chevrolet insofar as roadability, maneuverability and handling are concerned. There is some front-end bounce when driving fast over dips as the front end has rather soft springing. There also is some roll on the corners.

The extra-long rear springs are widely spaced for better rear-end stability. The new 14-inch tires require but 22 pounds of air pressure and give a softer ride than previous tires.

There is a feeling of safety in the way the car handles at high speed. Ball joints are used in the front-end suspension.

Top speed is 112 miles per hour by the speedometer, which checked out fast on this particular car although only 2 percent at the high end—not nearly as much error as other makes tested.

I found some fade when braking constantly in descending sharp grades near San Bernardino and over the Rim of the World Highway. There was some tire squeal on corners and some brake-lining squeaks at times.

A slight drag of three pounds on the power steering unit gives an artificial "feel" of the road.

The Powerglide transmission is very dependable and will take an awful beating—as will the car itself. With normal throttle opening, upshift is smooth. If the throttle is held on the floor, final upshift takes place at 55 miles per hour, which is too early. It is a little on the rough side as well. Downshift can be used below 55 miles per hour. It would be better if you could downshift at speeds up to 70. Between 45 and 50, the powerful engine unleashes a terrific surge to make the downshift a little rough when the throttle is floored.

(Continued to page 270)

On these six pages, PM presents two expert reports on the 1957 Chevrolet, Ford and Plymouth. Our two experts, Kelly and Clymer, tested actual assembly-line cars, not engineering test models. The tests were made on public highways, not on company proving grounds. PM Owners Reports on these three cars will appear in early issues.

# An Engineer Analyzes the 1957 Ford V8

By Dale Kelly, SAE

**MODEL TESTED:** Fairlane 500 V8 four-door sedan with a two-barrel carburetor, the 292-cubic-inch engine and Fordomatic transmission. (Additional tests were run, as noted below, on Car No. 2 which had a four-barrel carburetor and the 312-cubic-inch V8 engine.)

Rear-axle ratio: 3.10 to 1. Wheelbase: 118 inches. Tires: 8.00 by 14. Weight: 3731 pounds with gas tank half full (56.5 percent on the front wheels, 43.5 percent on the rear wheels).

Barometer 29.2 inches, temperature 86 degrees F., payload 400 pounds for acceleration tests, 200 pounds for economy tests.

## ACCELERATION TIME FROM STANDING START IN SECONDS



	0 to 20	0 to 40	0 to 60	0 to 80	1/4 mile
Ignition timed for regular gasoline	3.0	7.2	14.2	28.0	20.1
Car No. 2		6.2	11.9		
Ignition timed for premium gasoline	3.0	6.9	13.8	27.0	19.8

Ignition timed for super-fuel (90 to 105 octane)

No improvement

The watch was started the instant the accelerator was floored. The engine was not run up against the brakes. All tests in Drive range.

## FUEL ECONOMY IN MILES PER GALLON



	Steady 30 m.p.h.	Steady 50 m.p.h.	Steady 70 m.p.h.	Traffic Route
Ignition timed for regular gasoline	18.3	17.3	14.9	10.2
Ignition timed for premium gasoline	18.4	17.3	14.1	10.2

In the traffic test the car makes 10 full stops per mile and is driven fast enough to average 15 miles per hour.

**ESTIMATED AVERAGE ANNUAL GASOLINE BILL: \$185 for 10,000 miles.**

## SPEEDOMETER ERROR (MILES PER HOUR)



Speedometer speed	20	30	40	50	60	70	80
True speed	22	32	44	56	67	77	86
True speed car No. 2		26	35	43	52	60.5	

## ODOMETER ERROR

Distance registered for covering an actual 100 miles: 84 miles. Odometer error: 16 percent low (These errors in speedometer and odometer performance were obviously not typical of all Fords and must have been due to an assembly-line blunder in selection of the wrong speedometer drive gear. Car No. 2 is probably more typical of Ford.)

## DRIVER'S VISION



Distance at which part of road in front of car could be seen (A in sketch).....16 feet  
Distance at which full width of road could be seen (B in sketch).....22 feet

## GROUND CLEARANCE (unloaded car)



Radius of sharpest dip that could be crossed without "hanging up" (solid line).....24 feet  
Radius of sharpest hump that could be crossed without "hanging up" (dotted line).....17 feet  
Deepest rut that could be driven in.....7 inches  
Curb clearance for door opening.....12 inches

## MISCELLANEOUS

### STEERING

Steering-wheel turns from straight ahead to steer outer front wheel in a 100-foot circle: 0.9 turns.

Diameter of smallest circle inside which the wheels could turn (curb-to-curb): 41.5 feet.

Diameter of smallest walled circle inside which entire car could turn (wall-to-wall): 44 feet.

Steering-wheel turns, lock-to-lock: 4.4 turns. (This differs from manufacturer's claims but is an actual measurement.)

Steering-wheel diameter: 17.5 inches.

### TRUNK CAPACITY

Number of standard cartons (1 cubic-foot each) that could be packed into trunk: 14 cartons.

### CENTER OF GRAVITY

Height of center of gravity of unloaded car: 23.3 inches.

**WATER RESISTANCE:** Fair. (In high-pressure car wash some water leaked in around right-front ventilator pane.)

### MEASURED DIMENSIONS

Length: 208.0 in. Width: 77.5 in. Height: 58.25 in.

Dale Kelly, Registered Professional Engineer



## CLYMER DRIVES THE 1957 FORD V8

By Floyd Clymer

**T**HE 1957 FORD tested was the 118-inch wheelbase Fairlane. The route was from Washington, D. C., over winding roads and hills near Gettysburg and through Harrisburg, Pa. Then I drove to New York City on turnpikes, returning through Delaware and Maryland. Total mileage was 605 miles.

Later in California, I topped off the Ford tests with a Fairlane 500 four-door sedan with power pack V8, driving it on some high-speed tests for an additional 356 miles.

I found the bodies of both cars to be tight and dustfree and the Western car covered many miles on the dusty Mojave Desert.

Driving against strong side winds in Pennsylvania, I found the car extremely stable. In a heavy rain, there were no water leaks. The body is well insulated and has a minimum of wind noise and rumble.

There is little body roll. Due to the lowness of the car, there is a feeling of safety when cornering and driving at speed on rough roads. Weighing about 400 pounds more than the 1956 Ford, this car has the feel of the larger car that it is.

The 14-inch wheels, with a 22-pound air pressure, cushion the bumps and yet have less tire squeal than previously.

Both Fords I tested gave very good performance. The Fairlane 500 had terrific acceleration. On long stretches out West, the speedometer needle would hit 120 miles per hour. Like most speedometers, this one was fast—the amount was about eight

percent, average for a production model.

The engine is extremely smooth with very little vibration. The car did not overheat, even in the desert.

Fordomatic shift is smooth, except that with fully depressed throttle the final upshift at 65 is a little rough. Downshift can be made at speeds below 62 miles per hour.

Rigidity is noticeable. No squeaks or rattles developed. Doors open and close very easily. Push-down knobs lock front as well as rear doors from inside.

Suspension is improved and the ball-joint front suspension is retained. Even though over-all height is only 57.2 inches (3.2 inches lower than last year), road clearance is reduced only a half inch.

Ford power steering is good, although there is considerable pressure or drag apparent when turning the wheel. It is intended to give a "feel" of the road. Five and one-half turns are required from lock to lock. This is too many for a power-steering car. Faster steering would be desirable.

Ford has increased gas-tank capacity to 20 gallons—I am happy to see that.

Vision is improved. There is some front-fender vibration on rough roads, especially at high speeds.

The new inside-operating hood lock is desirable and it may help reduce theft of underhood parts. The hood is now hinged from the front and opens from the rear. This is a safety feature as there is no longer

(Continued to page 272)

# An Engineer Analyzes 1957 Plymouth V8

By Dale Kelly, SAE

**MODEL TESTED:** Belvedere four-door sedan with 301-cubic-inch V8, two-barrel carburetor and TorqueFlite transmission.

Rear-axle ratio: 3.36 to 1. Wheelbase: 118 inches. Tires: 7.50 by 14. Weight: 3820 pounds with gas

tank half full (54 percent on the front wheels, 46 percent on the rear wheels).

Barometer: 28.89 inches, temperature 82 degrees F., payload 400 pounds for acceleration tests, 200 pounds for fuel economy.



## ACCELERATION TIME FROM STANDING START IN SECONDS

	0 to 20	0 to 40	0 to 60	0 to 80	1/4 mile
Ignition timed for regular gasoline	2.5	6.8	14.5	27.1	19.9
Ignition timed for premium gasoline	No improvement possible with either premium or super-fuel				

The watch was started the instant the accelerator was floored. The engine was not run up against the brakes. All tests in Drive range.



## FUEL ECONOMY IN MILES PER GALLON

	Steady 30 m.p.h.	Steady 50 m.p.h.	Steady 70 m.p.h.	Traffic Route
Ignition timed for regular gasoline	18.9	15.8	12.8	11.1
<i>In the traffic test the car makes 10 full stops per mile and is driven fast enough to average 15 miles per hour.</i>				

**ESTIMATED AVERAGE ANNUAL GASOLINE BILL: \$182 for 10,000 miles.**

(Based on the use of regular gasoline entirely as there is no advantage in using premium fuel in this engine.)



## SPEEDOMETER ERROR (MILES PER HOUR)

Speedometer speed	20	30	40	50	60	70	80
True speed	19	29	38	46	55	64	72

## ODOMETER ERROR

Distance registered for covering an actual 100 miles: 104 miles.  
Odometer error: 4 percent high.



## DRIVER'S VISION

Distance at which part of road in front of car could be seen (A in sketch).....19 feet  
Distance at which full width of road could be seen (B in sketch).....24 feet



## GROUND CLEARANCE (unloaded car)

Radius of sharpest dip that could be crossed without "hanging up" (solid line).....27.5 feet  
Radius of sharpest hump that could be crossed without "hanging up" (dotted line).....20 feet  
Deepest rut that could be driven in.....6.5 inches  
Curb clearance for door opening.....13 inches

## MISCELLANEOUS

### STEERING

Steering-wheel turns from straight ahead to steer outer front wheel in a 100-foot circle: 0.65 turn.

Diameter of smallest circle inside which the wheels could turn (curb-to-curb): 41 feet.

Diameter of smallest walled circle inside which entire car could turn (wall-to-wall): 45 feet.

Steering-wheel turns, lock-to-lock: 3.4 turns.

Steering-wheel diameter: 17 inches.

### TRUNK CAPACITY

Number of standard cartons (1 cubic-foot each) that could be packed into trunk: 18 cartons.

### CENTER OF GRAVITY

Height of center of gravity of unloaded car: 22.6 inches.

**WATER RESISTANCE:** Good.

### MEASURED DIMENSIONS

Length: 204.0 in. Width: 76.5 in. Height: 58.38 in.

Dale Kelly, Registered Professional Engineer





## CLYMER DRIVES 1957 PLYMOUTH V8

By Floyd Clymer

**T**HE TEST totaled 2760 miles from Detroit to Los Angeles, including some off-highway runs. The car was a Belvedere four-door sedan with power pack. The 301-cubic-inch Fury V8 engine is fast and powerful. It is also quiet and vibrationfree. The more miles I drove the 1957 Plymouth the more convinced I became that it was one of the finest cars I have driven.

Weighing 3900 pounds, the test car had a 118-inch wheelbase, three inches longer than 1956. It has the roadability and handling characteristics of a large, heavy car which, actually, it is. However, it is a fraction of an inch shorter over-all than last year. It is 3.6 inches wider.

I rate roadability and handling of the Plymouth as its outstanding features. Chassis and suspension are new. Conventional front coil springs have been replaced with 44.6-inch-long torsion bars. Springing results from the twisting of these one-inch rods. This system is, of course, not new, having been used in some European cars for years.

The Plymouth is only 56.6 inches high, several inches lower than previously. The floor has a slight stepdown design, further contributing to its low center of weight. Ball-joint front suspension is used. The new front end greatly reduces roll on corners, a roll which was above average on previous Plymouths. Front-end dip as brakes are applied has been minimized. The hood is rather flat and wide as are the front fenders. There is slight vibration of

front-fender ends on rough roads, however it is less than in previous Plymouths.

The rear suspension is redesigned to allow for the lower frame. Due to the off-center mounting of the rear axle on the springs, there is less windup when power or brakes are applied. The axle is attached to the spring about one third of the way back from the front shackle, allowing a stiffer action between the axle and the front spring hangers.

The lower center of gravity makes the car a safer car under all driving conditions. Fourteen-inch wheels contribute to the lowered position. Ground clearance has been reduced about a half inch. There is less tire squeal on corners this year.

TorqueFlite transmission, new in the Belvedere this year, has five push buttons and is a three-speed unit. It provides increased acceleration, economy and better downhill braking. In models other than the Belvedere, the two-speed PowerFlite (with four buttons) is used.

You can downshift below 62 miles per hour by flooring the throttle.

The car does have extreme high speed. The speedometer needle would hit 115 on long stretches (it was fast by six percent on this particular car). It hit 100 with what seemed to be little effort. Handling at this speed was outstanding. I covered 1004 miles in one day from Kansas City to Albuquerque, N. Mex., and 841 miles the next day from Albuquerque to Los

(Continued to page 274)



## Ocean-Going Raft

Drifting on a bamboo raft named Tahiti Nui, a French scientist and four countrymen plan a round-trip voyage between Papeete, Tahiti, and South America. The raft is built like ancient Polynesian craft:

No nails or bolts, sails woven of leaves, and with centerboards rather than rudders. Electronic gear aboard will be used to record weather and oceanic data. The group has scheduled a landing in Chile by late January, with a similar waterborne return to Tahiti from Peru. Leader of the party is Eric de Bisschop.



## Vibrator Helps Locate Rattles on Auto

Hooked to the bumper of a car, a vibrating device enables the mechanic to hear and locate body rattles without taking the car out on a road test. A control box permits him to vary the frequency of the vibration as he walks around the car listening for rattles. The device, working on an electro-mechanical principle, weighs 34 pounds, plugs into 110-volt outlet.

## Crayons Detect War Gases

Marks with chemical crayons on paper, wood, stone or painted surfaces help detect war gases. The Army Chemical Corps has developed the crayons which turn red, green or blue in the presence of such gases as phosgene, hydrogen cyanide, lewisite and cyanogen chloride. Peacetime applications of these crayons include use in fumigating, chemical manufacturing, air pollution and smog control.

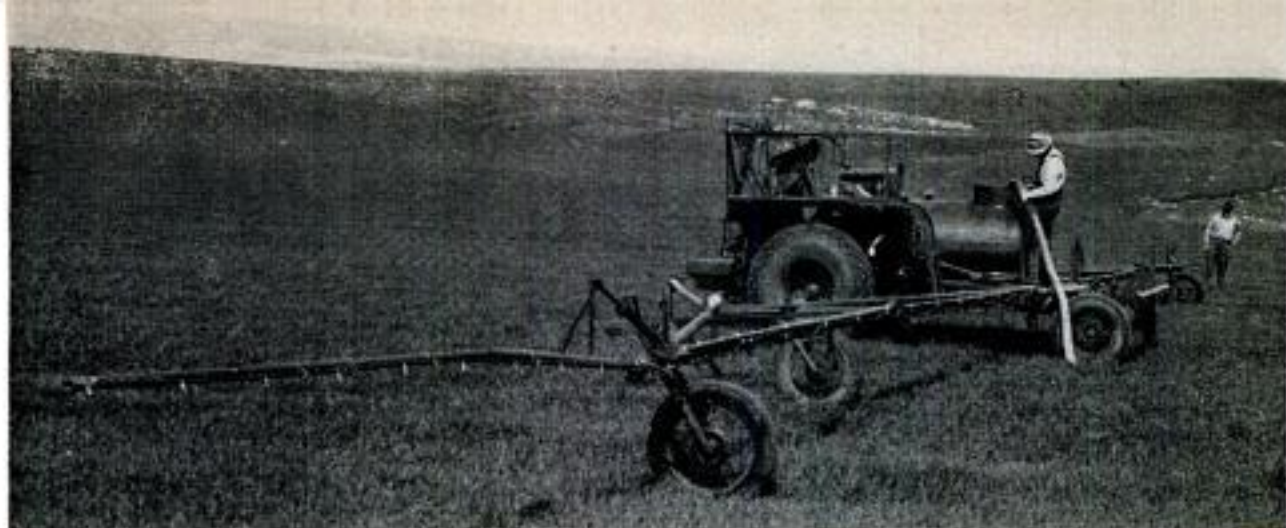

## "Inexpensive" Homemade Crop Sprayer Covers 500 Acres Daily

Five hundred acres a day are covered by a 130-foot-wide crop sprayer powered by a stripped-down, self-propelled grain binder that mounts a spray tank. Pipes and supporting frame ride on four motorcycle wheels. The builders, Paff brothers of Gar-

field, Wash., claim lower costs when compared with aerial spraying, and greater benefits, because of more direct application. A motorcycle is driven along the edge of the previously sprayed strip to guide the driver of the sprayer.

## Photographic Typesetter

Over 10,000 type styles and sizes can be set on an easily operated desk-top machine for setting display type and headlines photographically. Setting type for 6 to 90-point size, the machine uses negative templates to provide upper and lower-case letters. All work, including the developing of the photographic copy, can be carried out in a lighted room. Type can be set in a straight line, curved to fit a layout or staggered, as desired.

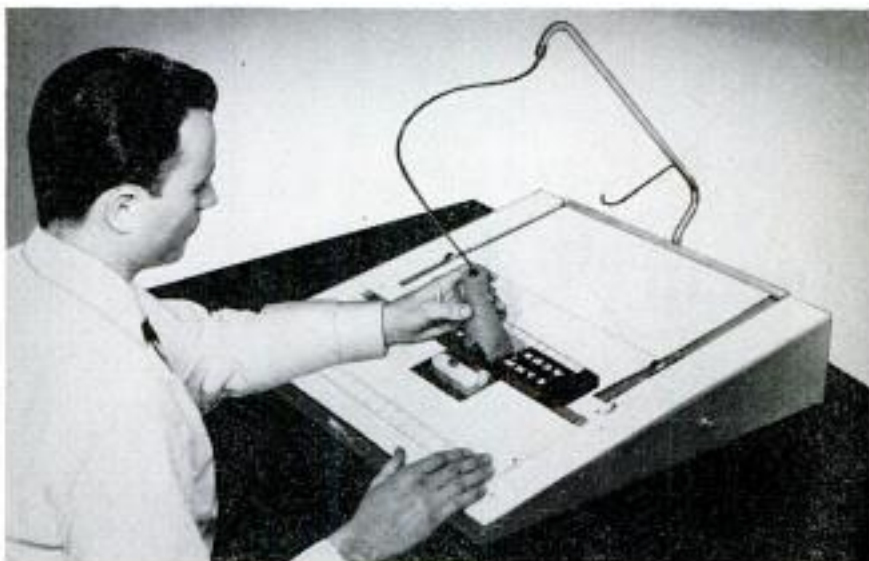

Setting type for 6 to 90-point size, this photographic-typesetting machine uses negative templates to provide upper and lower-case lettering

## Weed-Spraying Railroad Engine Has Five-Car Killing Fluid Supply



Weeds between the tracks of the German Federal Railway are killed by a spraying engine that pulls five tank cars behind it. The cars, filled with weed-killing fluid, supply the sprayer through a large hose that runs the length of the train. Ten of these trains have been ordered.

Even after two years of scrubbing and washing, a new paint with a special additive will kill germs that contact it.



Arrows point to the air-intake pods atop compound-wrap windshield. Dual headlights are optional on Cruiser

## Mercury's Lushest: Turnpike Cruiser

MERCURY SAVED ITS ACE for the final round: It introduced the Turnpike Cruiser at the New York Auto Show. Other Mercurys came out a month earlier.

The Cruiser has several new ideas that are exclusive. It also has, of course, such

Mercury innovations as the air-isolated rear-spring hangers (see *PM*, Nov. 1956).

Exclusive on the Turnpike Cruiser is a ventilation system that takes fresh air in at roof level through louvered pods at each end of the windshield and exhausts it through a rear window that lowers into the trunk.

Rear window is in three sections. Center portion lowers into the trunk



Four headlights are available on the Cruiser as an option. The new compound-curve windshield wraps upward as well as sideways. The V8 engine has 368-cubic-inch displacement and develops 290 horsepower (this same engine is available on other Mercurys at extra cost). With a four-barrel carburetor and a 9.75 to 1 compression ratio, this big engine gives the Turnpike Cruiser a performance of 0 to 60 miles per hour in 10.5 seconds (based on manufacturer's claims, not on *PM* test) for a fully equipped car with four persons aboard.

# It's Here—A Hardtop That Converts

IF YOU LIKE TO DRIVE with the top down, but don't like flapping canvas, the Ford retractable hardtop is your car.

It's a genuine two-door steel hardtop. At the touch of a button, the top folds itself slightly and disappears into the trunk, making the car an open convertible.

To make the top disappear, Ford had to add three inches to the trunk (the car is 210.7 inches long, a fraction of an inch shorter than the 1957 Mercury).

The forward portion of the roof is hinged to fold under as it goes down. The trunk lid pivots from the rear, opening at the front end. Luggage space is restricted and difficult to get at.

Removing the spare tire (recessed in a floor well) is virtually impossible unless you climb inside the trunk. But for those who like their cars sporty such handicaps are minor indeed. Ford begins delivery this month. Price is unknown at this writing.

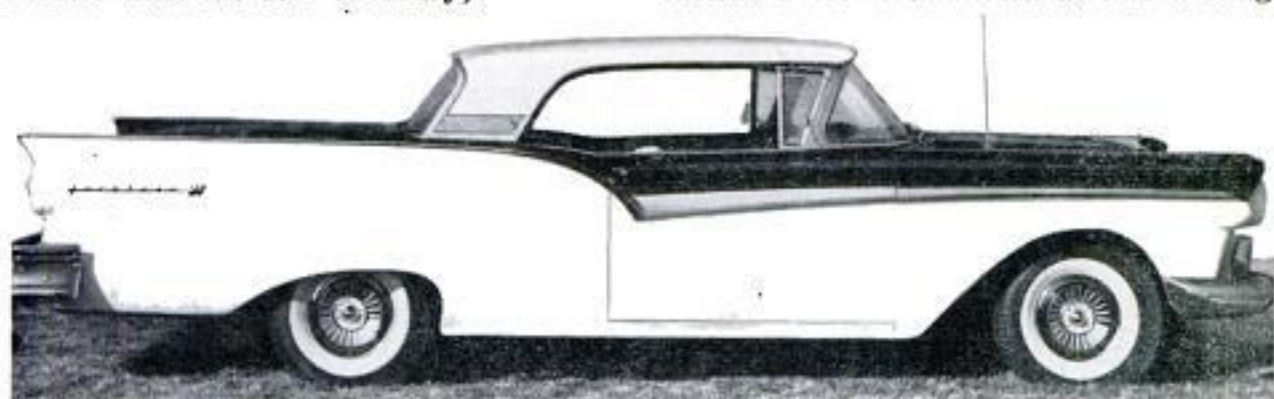

Longer than any other Ford, the retractable hardtop has a distinctive look with its squared-off top. The trunk has been extended three inches. The roof had to be made flatter and shallower in order for it to fit inside the trunk



Above, as the top lowers, its forward edge folds under to shorten its overall length. The whole operation is automatic once the button is pushed. It takes 40 seconds for the cycle and it can't be started until the engine is stopped and transmission in neutral. If you just want to load the trunk, you stop the cycle when the trunk lid has opened, but before the top has moved



# Detroit Listening Post



By Art Railton

**CHEVROLET CAUGHT** the industry (and those who write about the industry) by surprise when it announced it was offering fuel injection for 1957 models.

No wonder. It turns out that the secret was well kept because there had been no production of the fuel-injection system prior to announcement. The only units they had were engineering prototypes, so naturally nobody knew about them!

Now, they say, production is under way and you will be able to get fuel injection in your Chevrolet for an extra \$450.

At that price it won't eliminate carburetors, but it is hoped that as production builds up the price will drop. All the first units are going into Corvettes anyway, so don't expect to find one under the hood of your neighbor's new Chevy.

This fuel-injection business is mixed-up, to say it politely. Cadillac's Eldorado Brougham (the \$10,000 plus car that will go on sale sometime in February) was all set to have it, then it was dropped, then it was uncertain as it is at this writing.

## Must Be Bug-Free

Why the uncertainty? Simply that Cadillac wants to be sure the system is bug-free. Four test cars have been wearing themselves out covering every part of the country to make sure. After all, when you buy the most expensive car in the country, you don't want it to break down some evening on your way to the club. The fact that it has the latest fuel injection won't help your morale at the moment!

By the time you read this you'll know if the bugs are out. This column's guess is that it won't have fuel injection—Cadillac will play it safe.

Don't expect to see many of the Broughams on the road. Not that the country can't afford them. It's Cadillac that can't afford to put too many out. There's no doubt that even with a \$10,000-plus price tag, Cadillac loses money on every one it delivers. The loss is chalked up to advertising.

Guesses are that between 1500 and 1700 Broughams will be built per year. That's about six a day. Its only competition (Continental) built six cars in one recent week against over 50 for the same week last year. Continental insists the drop is not due to a drop in demand, but that Lincoln needs its line to build hardtops.

## It's the Edsel

They finally admitted it. The new E-car at Ford is named the Edsel, honoring the late Edsel Ford, son of the founder and father of Henry II, Benson and William Clay. The name was picked from 18,000 submitted.

Ford won't say it officially, but the Edsel is apparently going to fit pricewise between Ford and Mercury, not between Mercury and Lincoln as so long rumored by just about everybody. Covering the lower-medium field with the Edsel would explain why Mercury moved up this year with its Turnpike Cruiser and, at the same time, dropped its Medalist price leader introduced only last year.

But Mercury's in step with the trend. Everything's moving up, including prices. For 1957 cars, you will pay 7.17 percent more than you did for 1956 cars. On a \$3000 car, that amounts to over \$200.

You get more for your money, though. The average 1957 car is 1.1 inches longer and 0.7 inch wider than the average 1956 car. It's 2.1 inches lower—whether that's a plus or a minus is hard to say.

From 1941 to 1955, average car length increased only 2.7 inches. Now in one year, the figure increases 1.1 inches—that's a big stretch for one model year.

Of course, average lengths are misleading. After all, there always have been big cars. But at one time there were small cars also. Now we still have the big car (although strangely enough they are getting smaller—in 1933 the smallest Cadillac weighed 5000 pounds, in 1957 the smallest Cadillac weighs 4595 pounds), but the small car seems to have gone.

The Plymouth four-door sedan in 1933 weighed 2645 pounds. The lowest-price four-door Plymouth V8 this year weighs 3405 pounds.

Yet cars don't get much roomier. Compared with the 1956 Plymouth, the 1957 Plymouth interior is larger in only 5 of 11 dimensions, it is smaller in 6 of 11. The 1957 Ford interior is smaller than the 1956 interior in 5 dimensions, larger in 3 dimensions and unchanged in 3 more. And if you want to be really confused, the "big" Ford Fairlane is smaller inside than the "small" Ford Custom. Yet outside it is six inches longer! If you want more room, buy the small Ford. Confused?

*Gale winds are welcome to these yachtsmen as they seek to top the 100-mile-per-hour mark in strange craft that are part sailboat and part automobile, with aerodynamics thrown in.*

# THEY SAIL ON SAND

By Robert E. Dorsett

**G**ALE-FORCE WINDS SMASHED at the sand yacht, as four crash-helmeted men pushed it along a barren English beach. Suddenly, a gust of air hit the vehicle with a mighty fist. The quartet flung themselves aboard. Just nine seconds later, craft and crew were flashing over the shore line at 60 miles per hour. For *Coronation Year, Mark II*, sailboat on wheels, was about to carry its team to a new world's record in the Flying Mile at Lytham St. Annes, England. And despite fog, cold and wet, a stormy breeze was blasting the 1500-pound monster toward the fastest speed ever achieved by a sand yacht.

Four hundred yards distant a marker fluttered—the starting point. Timers stood, stop watches ready. Only mast top and pennant showed, as the craft sliced past the line to disappear into raw haze. Stop watches clicked. Officially, the run was under way.

Aft on the *Mark II* the tillerman wrestled a cumbersome steering wheel. Amidships the winchman doggedly held the mainsail taut. And on either side of him next to whirling wheels lay a man handling jibsail lines.

Visibility at best had been 200 yards. Now considerably worse, fog prevented forward crew members from seeing the tillerman 15 feet to their rear. Isolated, he guided the *Mark II* blindly through misleading mists toward the half-mile marker. Abruptly sighting the nearby flag, he slewed the ship in a three-second whiplash turn within its length and steered instinctively along the return-trip tack. Seconds more of jolting, sand-spitting speed, and the *Mark II* slashed across the finish line at 70 miles per hour. Official time average for

*Coronation Year, Mark II*, here moves at 62 miles per hour, with Richard Millett Denning, owner and steersman, at the helm

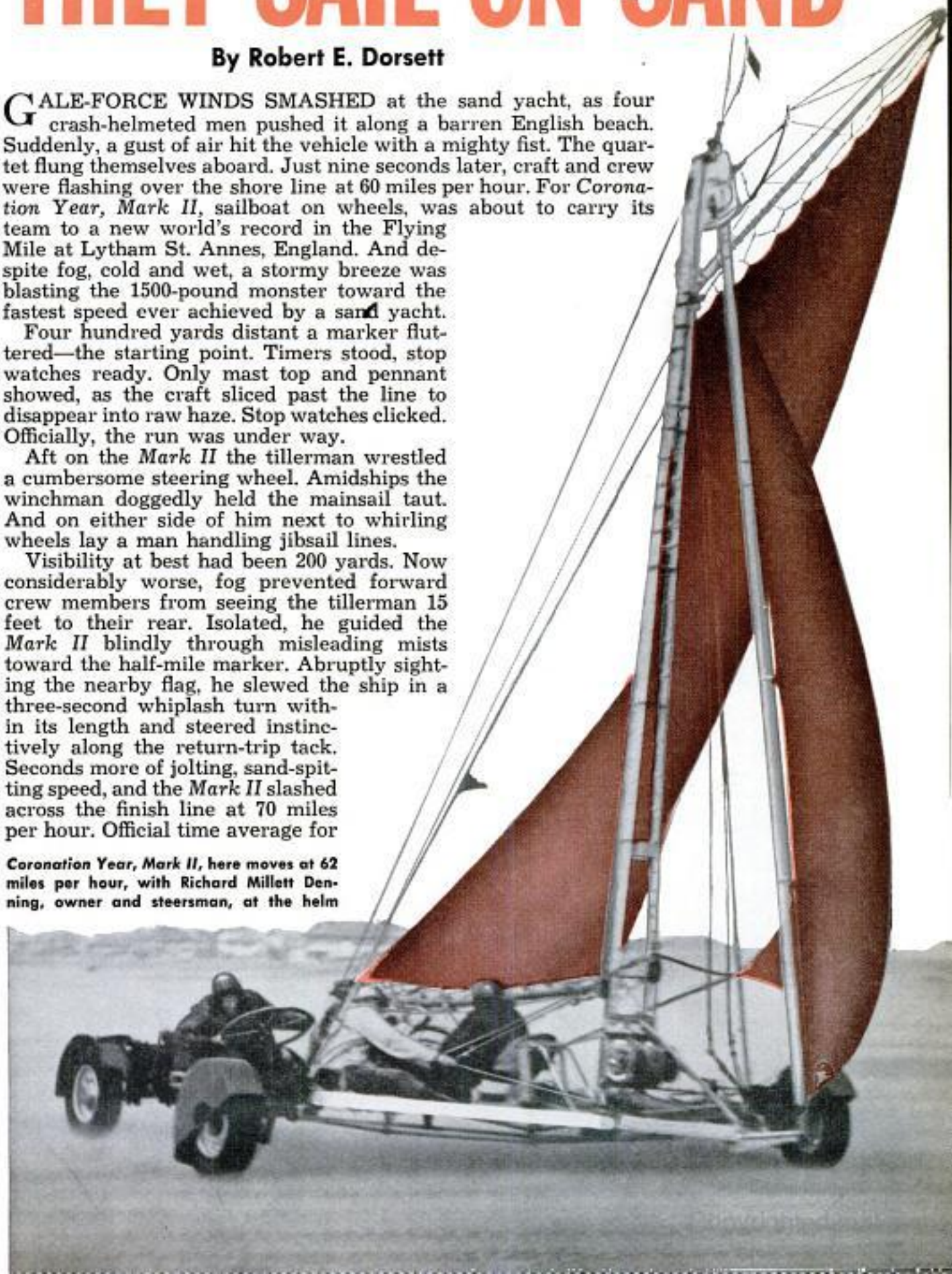

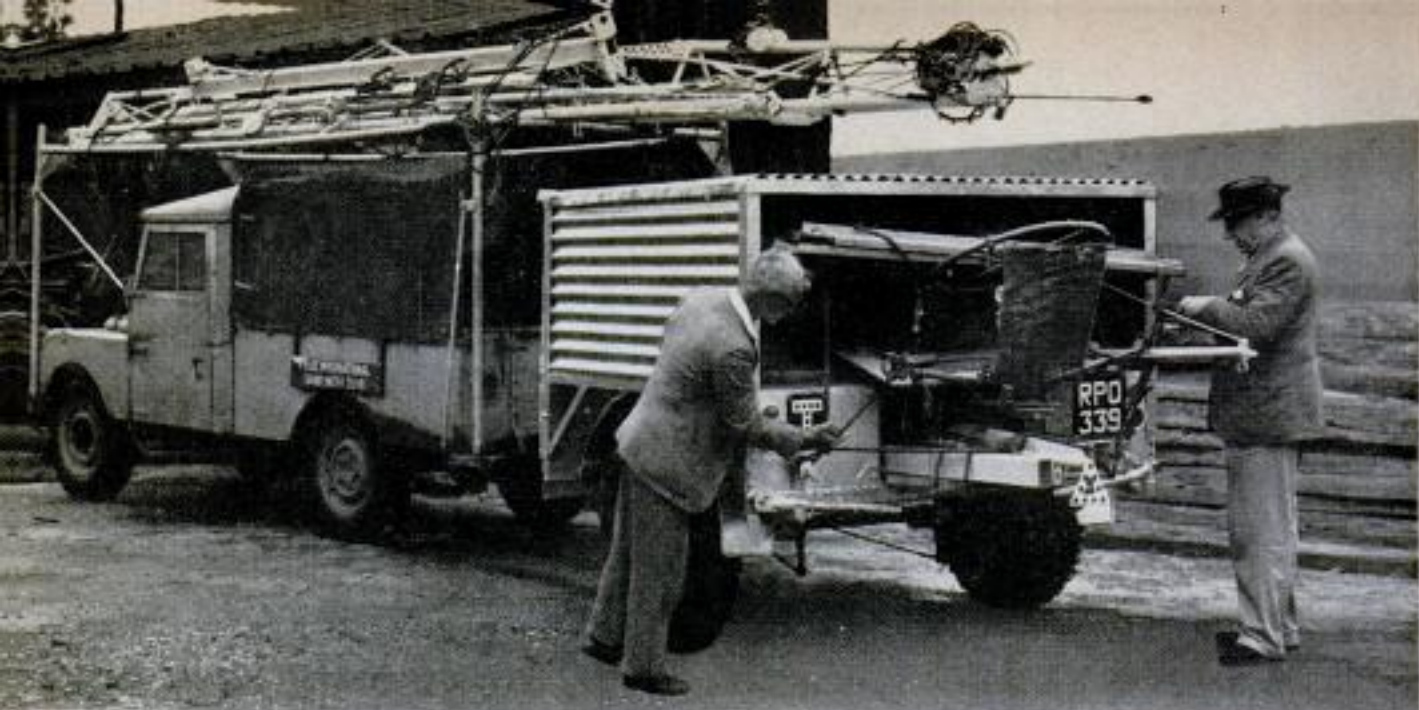

Parts of the *Mark II* are packed atop a small truck and inside a trailer for transportation to another race

the mile: 57.7 miles per hour—a new world's record.

Later that day the American yacht *Flying Slipper*, netting 46.2 miles per hour average on the same course, was unable to better the *Mark II*'s time. None of the 18 other competitors of the day did as well. Thus, Richard Millett Denning, owner and pilot of the *Mark II*, and his crew became leading contenders for the sand-yachtsman's goal—a speed of 100 miles per hour.

*Mark II* is the culmination of the biggest

and best in sand yachting—and the most expensive. Costing \$6000 (average homemade yachts are worth \$200), the *Mark II* has been two years in design and three years in construction. Able to withstand full-gale winds without crumpling, the big land boat looks like a large equilateral triangle made of aluminum alloy, with steel tubing as ribs extending from a "strong-back" brace along the craft's center axis. Four wheels are used in straight-line travel; in turning, the yacht utilizes only three

Aboard the *Mark II* are the tillerman, left foreground, the mainsail winchman and jibmen on each side





wheels: The two back wheels pivot as one on a horizontal sleeve independent of steering.

The yacht's 26-foot length includes a bowsprit at the front of a 16-foot-wide frame. *Mark II*'s main and jib sails are supported by a 20-foot high-tensile steel mast. Leading edge of the jib is kept straight by a Duralumin stay pole to the bowsprit from the top of this mast. Main and jib sail have a total area of 372 square feet. The jibsail, overlapping the mainsail, is worked on an endless-rope system. The mainsail is handled by a sun-and-planetary internal-gearred winch.

Hydraulic brakes are fitted on the yacht's rear wheels which are independently suspended and have pneumatic tires. For transportation purposes, the *Mark II* breaks into compact subassemblies which can be packed into a trailer.

Normal crew for cruising is four, but three are used for point-to-point racing, and two men team up for usual Flying Mile conditions.

#### Sand-Yachting History

Historically, sand yachting originated sometime between 1895 and the turn of the century. Make-shift iron wheels, old wood parts and bedsheet sails were successfully combined to produce 15 to 20-mile-per-hour speeds. Primitive land yachts sped along Southport, England, shores. Equally antique models were operated by Francois Dumont and eight brothers on Belgian beaches. Louis Bleriot, the first aviator to fly across the English Channel, lured the Belgians to France for sand-yacht races by offering a flight in his aircraft as a prize. Now the sport also is enjoyed at Daytona Beach, Fla., on California's dry lakes, and on sandy wastes in New Zealand, Australia, Holland and Africa. Sand-yachting season extends from late fall to early spring, when beaches are relatively bare. Wearing apparel for this sport is catch-as-catch-can; one enthusiast even participates barefooted.

Sand yachts are divided into two categories: the ships copied after nautical craft stressing fore-and-aft rigging and cockpit; and those designed as land craft or "motor" types (though they do not have motors), with one large



Above, with a crew of four aboard, the *Mark II* dwarfs one of the homemade sand yachts built by a young enthusiast. Below, perched high on the mast, one of the crew helps hoist the large mainsail of the *Mark II*. The boom rest, right, will be removed





Above, located at the forward end of the yacht, this winch wheel and cable keep the mainsail taut



Above, R. M. Denning is at the steering wheel of the *Mark II*, which was five years in design and building

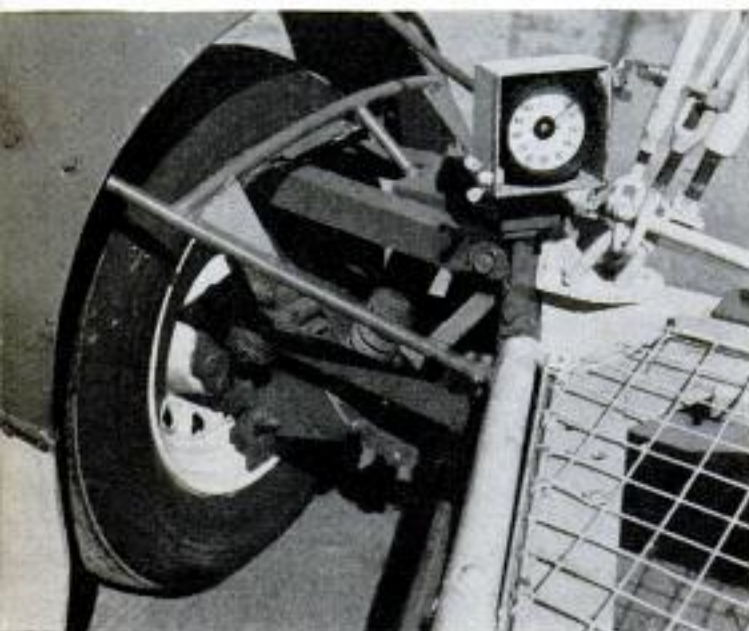

Left, this closeup of front-wheel hydraulic dampers and coil springing on the *Mark II* shows how the big yacht is able to ride out jarring record runs

Below, where races for the larger craft extend to 20 miles, smaller makeshift land boats usually are limited to one-half-mile heats for younger yachtsmen

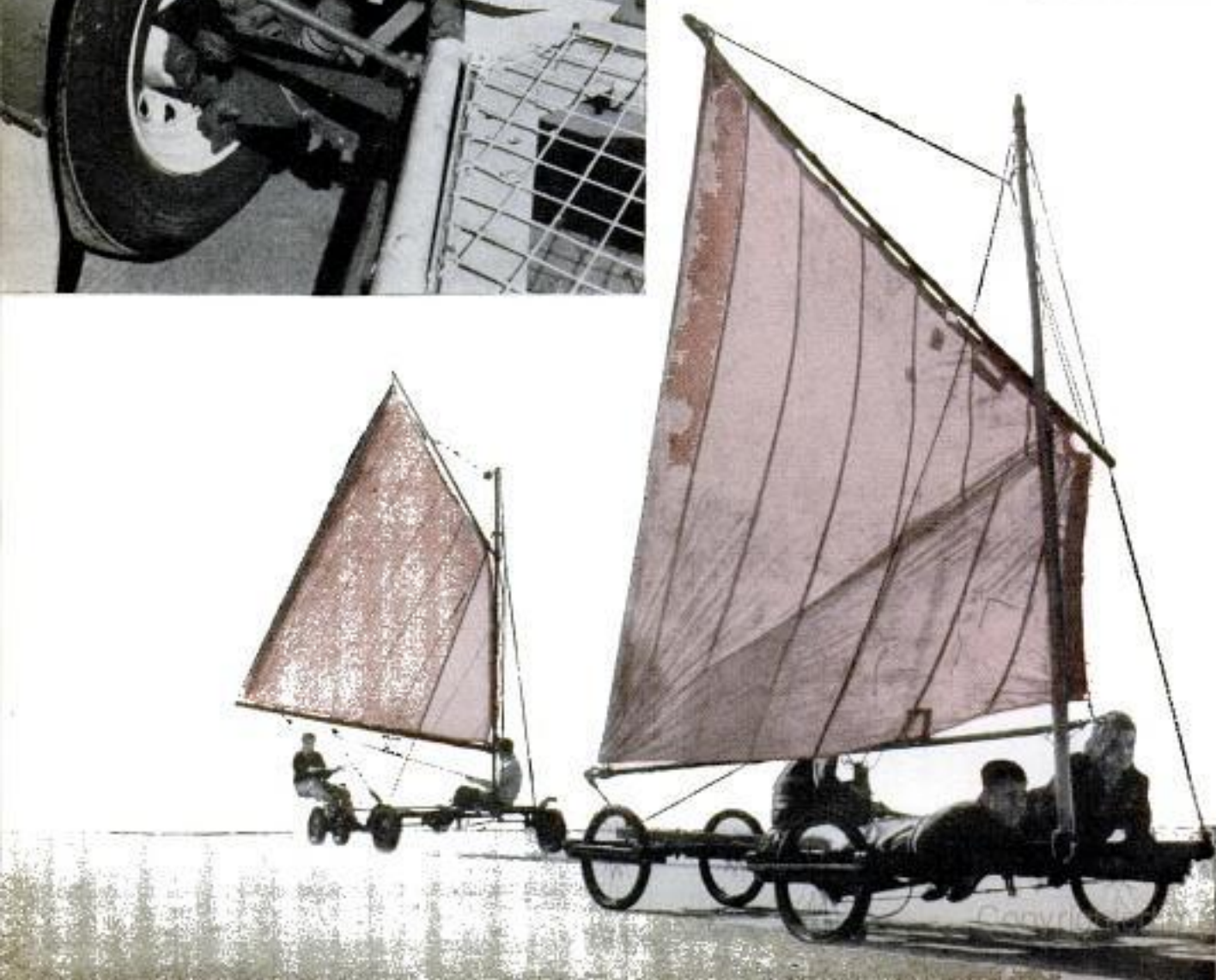



On a windy day at the beach, sand yachtsmen ready their sand craft for a race. Note structural variations

mainsail and an open chassis. The latter type is most popular. The most maneuverable ones have a triangular chassis, in contrast to rectangular, four-wheel models. Sea-type sand yachts usually run on unsprung wheels, while motor types use springing for at least the front wheels.

Structurally, masts are the chief problem, especially since guy-wiring sometimes is a hindrance. High-tensile aluminum tubing provides structural strength. Mechanically, steering is the paramount difficulty, and steering wheels and tiller bars are subjects of heated arguments.

#### Sand, Ice, Water Yachts

Although similar in shape to their first cousins on ice and water, these specialized land boats are strangely different. For example, rigidity is all-important to the sand yacht. Frame, mast and other assemblies must withstand hammer blows not often delivered to ice and water boats. Mild gusts will maintain movement for these latter craft, but for the average 400-pound sand yacht (measuring 12 feet wide by 15 feet long with a mast 24 feet high) an initial blast of 15 miles per hour is needed. And the sail must use every ounce of wind it can beg, borrow or steal to keep up the yacht's momentum. Not only this, but the sand boat must make hairpin, lightning-like reverses at 30 to 50 miles per hour to begin another tack; and having made the turn,

Below, holding the rear wheel assembly, two young men are aided by a boy in pulling their triangular craft to the beach



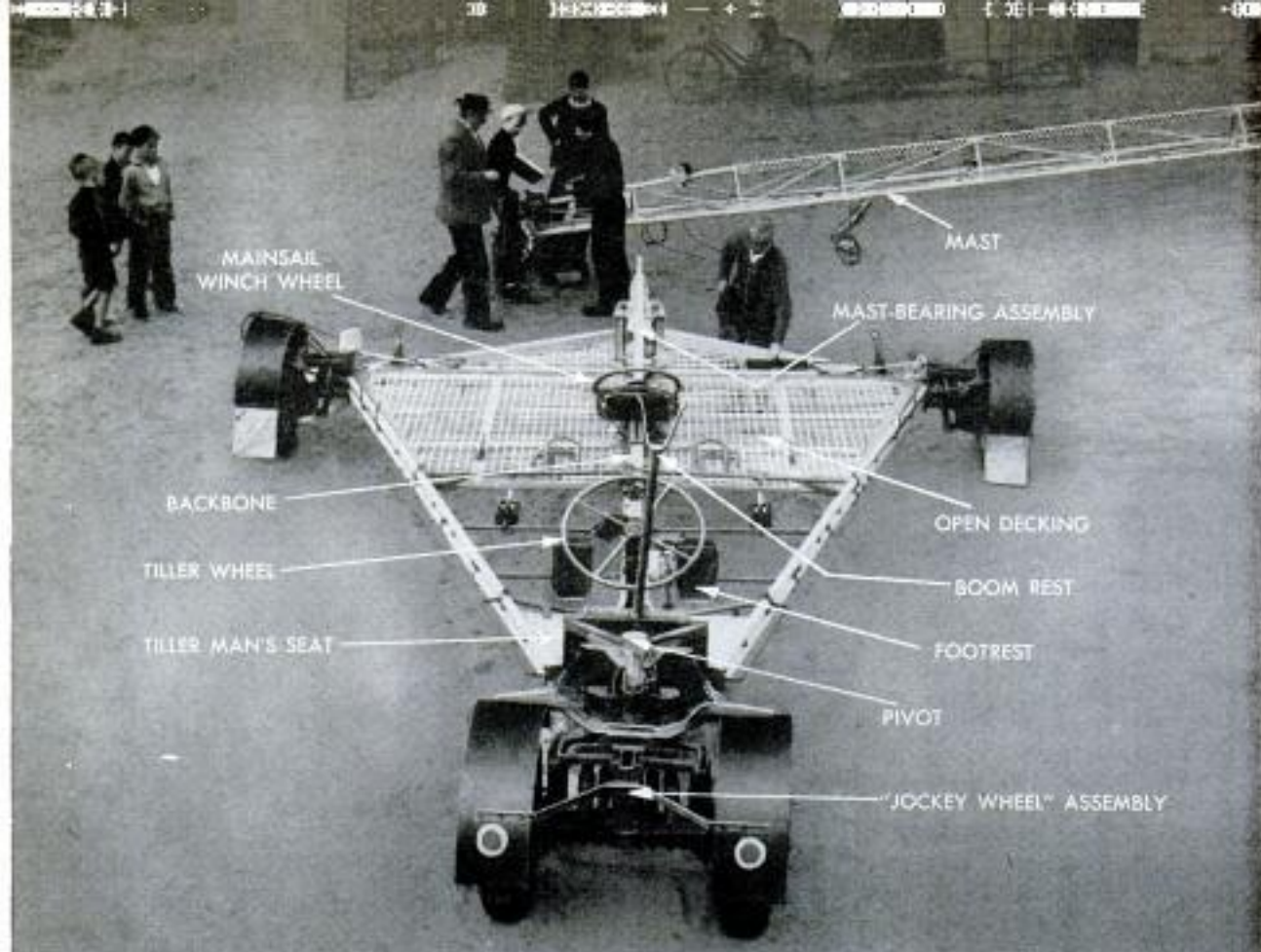

After seating the aluminum mast in the mast-bearing assembly, these men will install the sail boom rig

the craft's momentum must be regained by another smashing blow from the wind. Any lack of rigidity under these conditions results in loss of speed and maneuverability. Yet, ice and water boats can bend easily and sail reasonably fast without 100 percent economy of wind.

A wind-driven water boat tends to heel over in healthy breezes—a luxury permitted by its stabilizing keel or centerboard. The sand yacht must rely on wide base and axle support for uprightness in a wind. In addition, flat surfaces on a sand yacht are deadly because they tend to resist the wind. Therefore, a good sand yacht has a specialized chassis and mast with extra-light sails. This "open" type structure allows minimum weight and wind resistance and steals little wind from the sails.

Even sailing techniques produce variations in these three cousins. Ice and water

craft are subject to currents, drift and side-slipping, while the sand yacht moves in unerring straight lines. In tacking, the land boat gains ground in frequent jogging jumps along a path determined in most cases by the shape of the beach. Ice and water yachts usually have larger areas in which to maneuver.

By the way, don't get the impression that sand yachting is restricted to adults. The Fylde International Sand Yacht Club at Lytham St. Annes, with more than 100 members and 15 competing yachts, holds periodic races of 16 to 20 miles' distance for its voting-age members. But with these longer races, there are half-mile heats for youngsters 14 years and under who have built homemade yachts. In each category the spirit and fun are equal, based on the philosophy that today's sand yachtsmen are tomorrow's *Mark II* teams. ★ ★ ★

Tacking in a sand-yacht race is restricted by the shape of the beach. Offshore winds are ideal for best racing

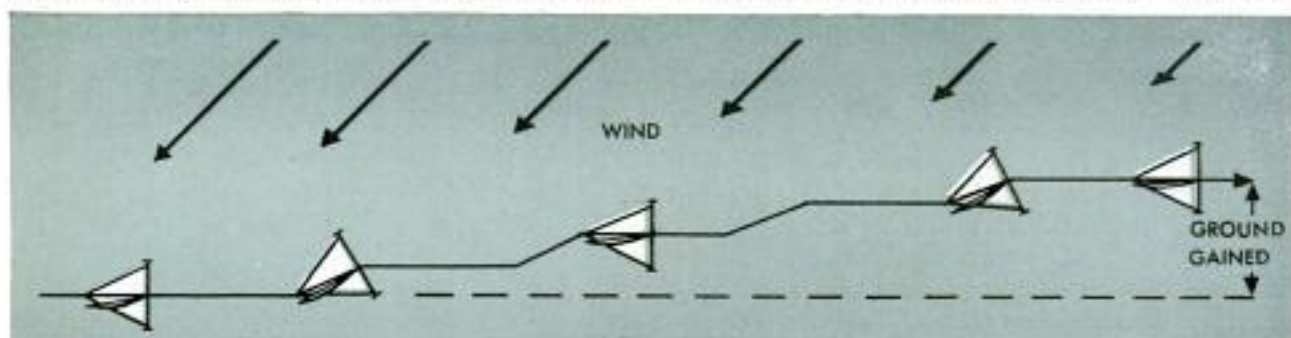



# KEEPING UP WITH THE ATOM



**H**IGH-ENERGY atomic particles soon will produce plastics so tough they can be used as the structural members of buildings, predicts an oil company scientist.

Dr. Harold Gershinowitz, president of Shell Development Company, recently stated that "high-energy bombardment will do for plastics what forging did for iron and vulcanizing did for rubber." Already, ordinary liquid plastics can be changed into unique new solids with extremely high resistance to heat, chemical change and shock.

For basic research in this field, the company has a brand-new 3,000,000-volt electron accelerator, most powerful radiation source in industry. It accelerates atomic particles to nearly the speed of light and then fires them into the material being processed.

The photo at right shows the continuous-belt "escalator" which carries electrons to the top of the accelerator. The electrons are stored there until the required voltage is built up, then fired down through a vacuum tube at the target. Such high-energy particles produce strange effects. They can vulcanize rubber, change the color of many standard chemicals and give oils and greases properties they've never had.

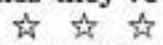

One of the interesting paradoxes in the search for new materials for nuclear reactors was pointed out by AEC Commissioner Willard F. Libby recently. A group of metallurgists is searching for a completely noncorrosible fuel element, a metal that will not dissolve in the highly cor-

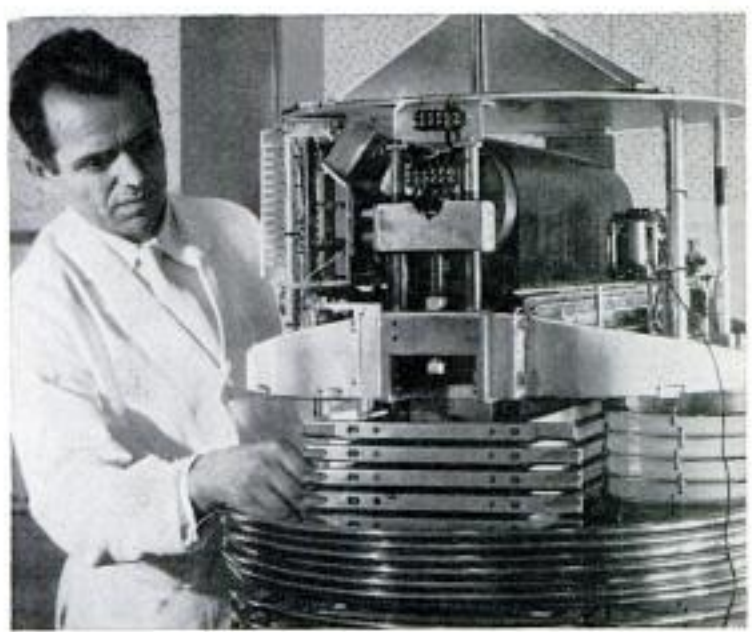

rosive reactor. At the same time, a group of chemists is asked to find ways to dissolve this noncorrosible metal so a spent fuel element can be processed for radioactivity at moderate cost!



Recently a Naval scientist challenged some basic physical concepts. For many years physicists have thought that minus 459.6 degrees F. is absolute zero, and that the speed of light is the fastest theoretical speed possible. These concepts aren't necessarily true, says L. Carroll.

He theorizes that if atoms could be made extremely cold instead of hot, a "new type of superatomic energy" could be released. In his concept, as the atom got colder and colder its electrons would gravitate toward the nucleus faster and faster, at last plunging into the nucleus, disintegrating it and releasing its entire energy.

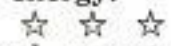

Mechanical monsters of the atomic age will be entombed in the desolate tunnel shown in the photo at left.

Recently this tunnel was built at the Hanford plant, reaching 500 feet out beneath the desert. A giant piece of apparatus too "hot" to be repaired now will be loaded aboard a railway flatcar and rolled into the tunnel. There both the car and its contaminated cargo will be entombed forever behind massive water-filled concrete doors.

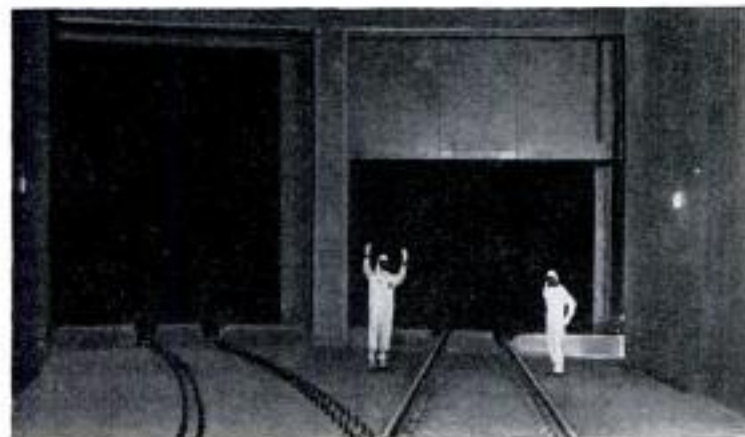



## Radar Unit Selects Speed Violators Only

Cars traveling within the speed limit are ignored by a new radar unit, while those exceeding the limit are instantly spotted. The radar meter, built by Admiral, can be preset for the prevailing speed limit. It then registers only the cars that break the law. An optional attachment will take a

picture of the license number of the violator's car along with the speed reading. Floodlights can be synchronized to operate automatically with the meter at night. Another optional attachment is a tape recorder which permits a traffic officer to record a car's speed and license number.

## Germ Killers Are Discovered in Soft Coal

Coal produces organisms that slow down or kill infectious diseases. In soft coal, Martin Rogoff of the Bureau of Mines has found 35 bacterial cultures, three molds and four actinomycetes, related to wonder-drug-producing soil bacteria. Study of

lignites, peat moss, and soft coal indicates that germ-killing potency of organisms increase with successive stages of coal formation. Hard coal, as yet untested for these properties, may prove to make possible even more potent wonder drugs.



## *Aerial Fire Engine*

HELICOPTERS soon will serve as aerial fire-and-rescue engines at military and civilian air bases in this country. After landing a three-man fire-fighting team and extinguishing gear at the crash scene the pilot maneuvers the "whirly-bird" to help control the blaze by beating on flames with powerful rotor downwash. Afterwards, these airborne ambulances fly the injured to distant hospitals. Effectiveness of helicopters for such rescue work has been tested by simulated emergencies. A number of dummy pilots have been "saved" from burning planes in less than 45 seconds after arrival of copter and crew at the site. Similar Marine HOK-1 models could assist fire-and-rescue projects in areas inaccessible to ground-operated fire engines and rescue trucks. With a gas-turbine power plant installed, and equipped with a Lycoming XT-53 free-shaft turbine engine, this helicopter is said to be the first U. S. aircraft of its kind airborne with a turbine developed to helicopter turbine specifications. Usable cabin volume has been doubled by mounting the turbine above the fuselage between the twin tail booms. The Kaman Aircraft Corporation of Bloomfield, Conn., builds these helicopters.

Above, flying to the scene of the crash, the helicopter hovers and quickly sets the fire-fighting equipment on the ground



Above, as the helicopter overhead uses powerful rotor downwash to beat on the flames, two firemen operate dry-chemical extinguishers and open a path for the third fireman to rescue the dummy pilot. Below, third fireman carries the dummy from plane





Now it's the frame and not the picture that gets the attention of Leo Thompson in his Miami, Fla., plant

*A Coast Guard veteran wanted a better way to frame his own paintings. Now he has a new career making*

## Aluminum Picture Frames

*By Edward G. Dickson and Max Hunn*

**L**EO G. THOMPSON is in business in Miami, Fla., today because he was a frustrated artist during his years in the U. S. Coast Guard. This frustration was caused by the cheap wooden picture frames in which he had to display his oil paintings. The frames warped, would come apart at the corners and frequently had to be refinished.

Thompson says he used to dream about sturdy metal frames to hold his pictures and finally decided to do something about it. As a machinist's mate, metalsmith and a chief in the aviation branch of the Coast Guard, he had the shop facilities for experimentation in his spare time. By the time he retired in 1953, he had worked out the details for his colored-aluminum pic-

Cross sections show some of the designs available in Thompson's picture moldings made in many colors





ture frames and was ready to become a manufacturer. He has a patent pending on the frames.

Now, in his small plant, he is turning out picture and mirror frames in eight different styles of aluminum, color-anodized in a variety of hues—gold, silver, red, blue, green and others—in demand by department stores and interior decorators.

With the increasing popularity of colors in home decorating, Thompson's frames are put to a variety of uses. Some buy the frames to harmonize with or accentuate the color of the pictures to be framed; others incorporate the colors of the frames into decorating schemes; some take a large frame and make it a central decorating item in a room, harmonizing other colors with it. A display man in one department store used one of the mirror frames in a window display as a table top. This led to so many inquiries for tables of this type that Thompson had to start manufacturing them. First, he had to design legs which could be attached to the mirror frames.

The aluminum which Thompson uses is extruded from dies he designed for the frames. All extrusions are of the same thickness. Each of the four basic designs is "reversible," so he actually has eight designs. He cuts the extrusions on an electric bench saw in his shop, checks the miter cuts for accuracy, ships the pieces in special boxes to Indianapolis for the anodizing process. This step comes after the cutting because he wants the color to be worked into the corner joints as well as the rest of the frame. When they return from the color processing, the pieces are ready to be assembled.

This step, too, is a simple one, but the key to Thompson's invention. The corners of the frames are locked tightly together by corner brackets. Bolts set in the brackets are self-locked into corresponding holes in other plates. Each corner is held securely by two plates set in grooves in the molding.

The former coastguardsman and artist devised another feature to enhance his in-

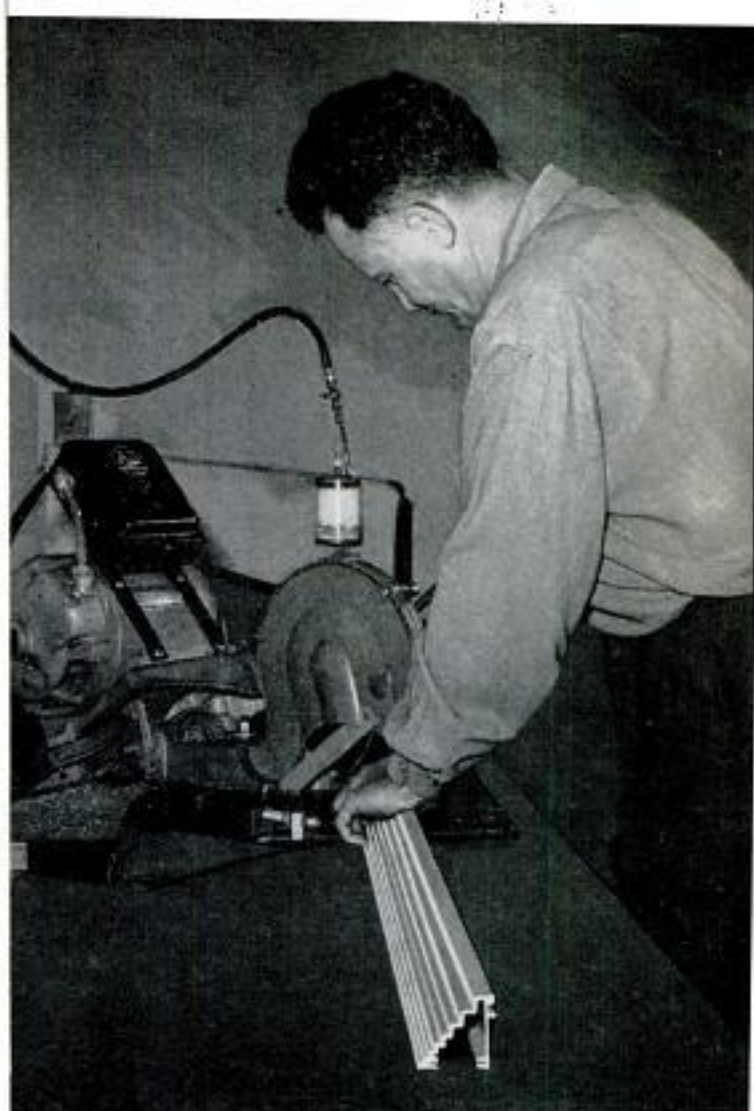

Thompson uses power cutoff saw to miter corners of aluminum molding before frames get color treatment

vention—a steel spring clip which holds the picture or mirror in place and does away with brads or nails. Frames are made in sizes ranging from 9 by 12 inches to 36 by 60 inches.

Thompson's roughest obstacles in the growth of his venture have come not from the technical end but from the business side. Many years in service had divorced him from methods in the commercial world and he discovered he had a lot to learn. His thriving company, Alumin Art, is evidence that he learned quickly.

In the Coast Guard, Thompson had time to practice his hobby of painting. Now—in retirement—he is so busy he rarely has time to pick up a brush. ★ ★ ★

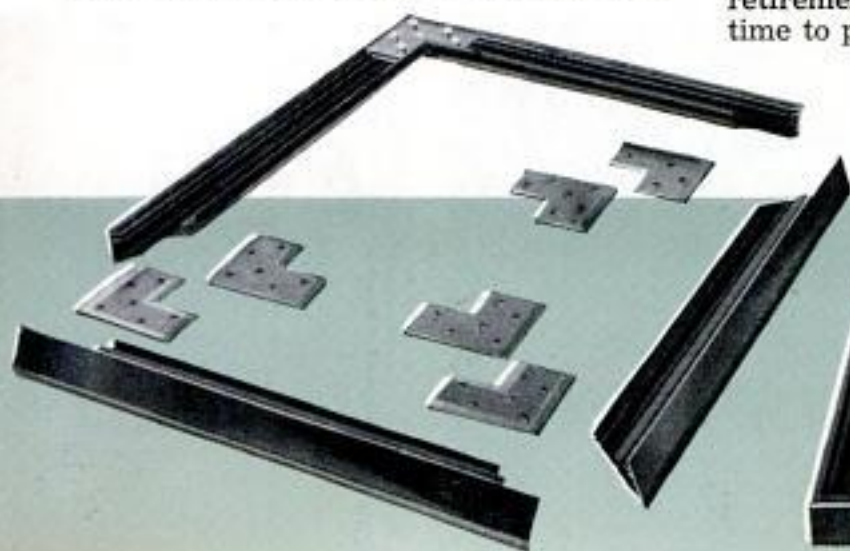

Left, one corner bracket is ready for fastening. Below, completely assembled metal frame is shown from front view

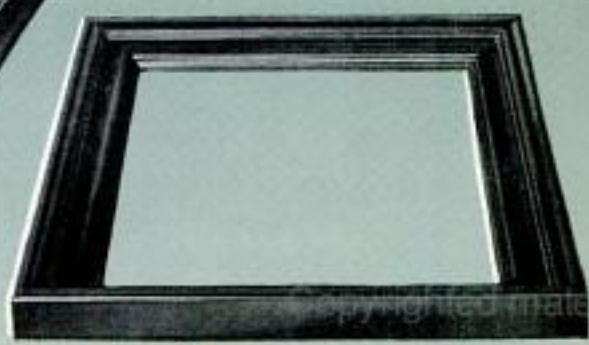

**NEXT MONTH:**

**PM's  
FAMED  
ANNUAL  
AUTO ISSUE**

**Another great magazine with more than 50 pages about automobiles. Your yearbook of 1957 cars**

**Here are some of the features:**

- Full details on '57 cars
- 8-page full-color album "The History of Speed"
- World's toughest car test
- America's only Grand Prix driver tells his story
- How to build a personal sportster
- Do "economy" cars make cents?

**GET YOUR COPY OF THE FEBRUARY ISSUE on the newsstands January 29**

**Buick  
Cadillac  
Chevrolet  
Chrysler  
Continental  
De Soto  
Dodge  
Ford  
Hudson  
Imperial  
Lincoln  
Mercury  
Metropolitan  
Nash  
Oldsmobile  
Packard  
Plymouth  
Pontiac  
Rambler  
Studebaker  
Volkswagen  
Chrysler 300C  
Corvette  
Thunderbird  
Studebaker Hawk**

Copyrighted material



Reese's favorite is this fighting sailfish mounted against a painting. Even the sail bones are the originals

## Where an Angler's Thrill Becomes a Masterpiece

By George X. Sand

OPEN THE DOOR of a typical pink-stucco building in Ft. Lauderdale, Fla., and you step into another world—a Jules Verne submarine world. Muted light shimmers from aquamarine walls. Rainbow-hued marine denizens surround you. Overhead the shadowy hulk of a sleek

eight-foot hammerhead shark curves sinuously. A barracuda lunges with open mouth, razor teeth glinting. The brilliance of a big red snapper stands in sharp contrast to the sea-green background. So do the mottled colors of an ugly spined scorpion fish, a dazzling triggerfish, a



Painting is done with an airbrush, followed by touch-up by hand. Right, varying shades make red snapper difficult to paint

monstrous blowfish. The wet tentacles of a young octopus almost seem to move. On all sides sailfish leap, and flying fish skim across the walls, wings extended. Each creature has been trapped forever in a lifelike attitude by a master craftsman.

There are about 3500 species of fish that swim in Florida waters, and Joseph T. Reese—a specialist who is himself an ardent fisherman—has cured and mounted most of them at one time or another. From the biggest (a 1320-pound, 14-foot Peruvian marlin) to the smallest (a half-inch butterfly fish that required work under magnification with tweezers

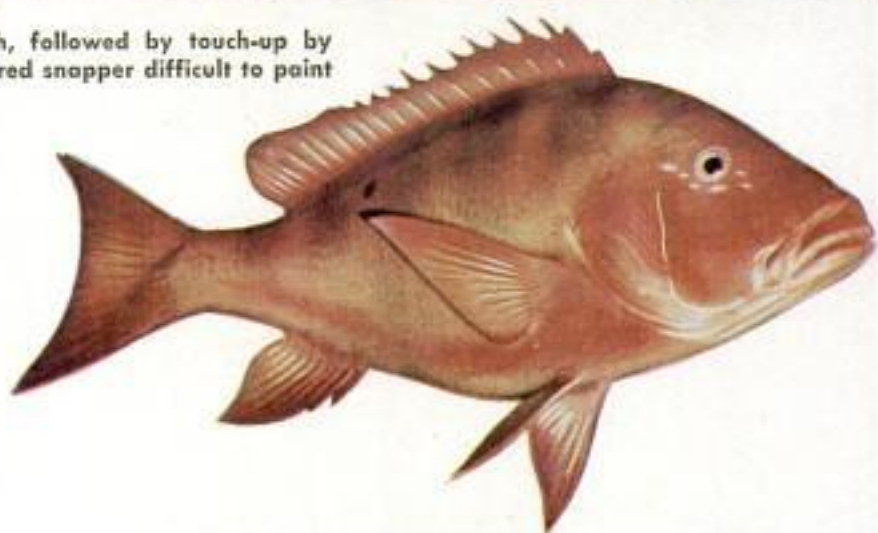

and scalpel) every specimen undergoes the same painstaking process.

"The uninformed fellow," says Reese, "thinks of a fish taxidermist as a man who works in a place that smells like a fish market, a man who cleans the innards



Rainbow hues of the triggerfish call for the touch of a real artist. Some fish change color as they change their activities from cruising to fighting

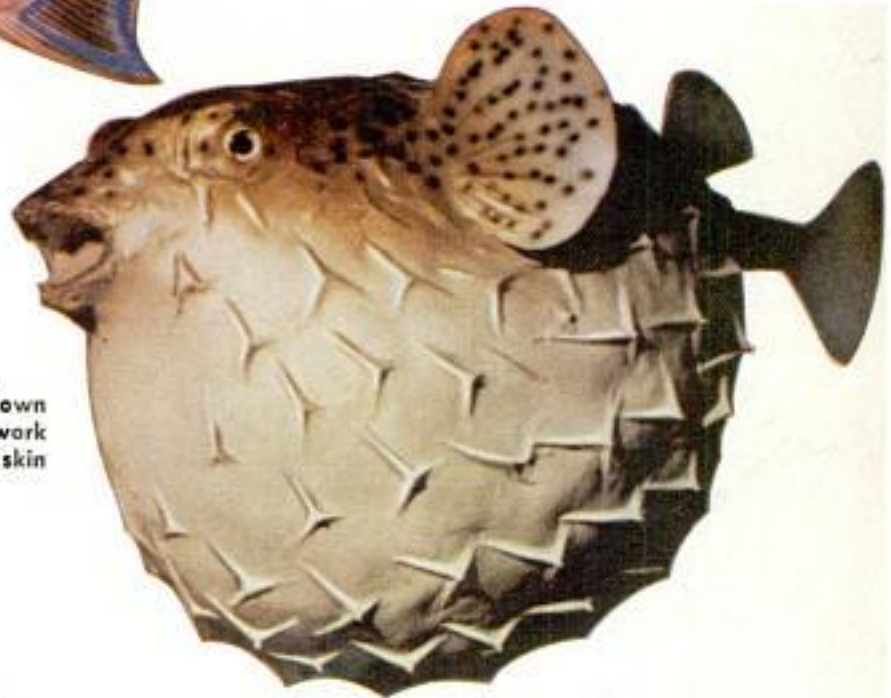

Reese mounted this blowfish in full-blown condition. Balloonlike stomach has a network of bones that had to be cured with the skin



This ugly character, a scorpion fish, has such intricate spots it required days of painting with a hand brush

from a trophy and stuffs the remains with fistfuls of straw. Nothing could be further from the truth."

In the shops behind Joe Reese's display room you can watch him and his crew of 25 experts processing 1300 to 1400 trophy fish at any given time. Through schools of game fish, big and small, mounted on work palettes that hang from the rafters, the men move from job to job. In spite of the volume of fish moving through the shop, the only smell is a faint suggestion of formaldehyde and lacquer. White-coated specialists work with surgical tools, plaster molds, vernier scales and modern tanning equipment. No fish is ever "stuffed" with

anything. There are 70 operations that go into the production of a single mounted sailfish. Curing takes two months; making the finished mount requires another month. Send him your prize catch in March and you'll probably hang it on the wall about July.

#### Childhood Interest

Reese's interest in preserving wildlife for posterity began in Oklahoma when he was nine. "I wanted to keep the owls, hawks, herons and snakes that I caught or shot," he recalls, "but the folks didn't like what my specimens did to the atmosphere." From the family encyclopedia he learned to remove skins, cure them in a mixture of alum and arsenic, and stuff them with excelsior, using a wire skeleton for rigidity. "I saved a lot of trophies that way," he recalls. "But I wasn't satisfied."



Baby octopus was skinned from the underside so incisions would not show. In this case Reese used rubber mold instead of plaster so he could save delicate suction cups

Rare butterfly fish has intricate ribs in its sails. This fish can soar out of water, occasionally climbs trees to breathe fresh air



Back to the books he went to study the clay-and-plaster techniques (in which skins are stretched over sculptures) used by such masters as Carl Akeley, whose realistic jungle cats and other beasts stalk the dioramas of the American Museum of Natural History. Under taxidermist Guy Rush, Joe served as apprentice in museum work. In college, where courses in comparative anatomy, biology and chemistry made him familiar with dissecting tools and techniques, he turned out his first professional mounts. He put in a stretch of time at an art school, studying sculpture and color.

So far it was all land animals. Then Joe took a fishing vacation in Florida. "I was appalled by the crudeness of mounts turned out by most marine taxidermists," he says. "They worked from stock models of paper, burlap and glue in different sizes, cast from stock molds. The skin of the fish was stretched over these prefabricated stuffings. The result no more resembled the original fish than a rat resembles a mouse."

### Museum Specimens

That was 20 years ago. Today his work hangs on the walls of a marine museum he created for Cornell University, and you'll find his specimens in Waikiki Aquarium at the University of Hawaii. From all over the world men with salt in their hair ship their prize catches to Ft. Lauderdale.

Reese's method is known as "hollow

sculpture mounting," and it involves making a plaster mold of every specimen the moment it arrives.

First the fish (which must arrive in perfect condition) is carefully tagged and measured. "The finished mount," says Joe, "should come within  $\frac{1}{32}$  inch of the original fish or it's a poor job."

Once sized and tagged, the specimen is posed on wooden blocks in a lifelike attitude (curved as though swimming or contorted in a splendid leap). Plaster is poured over it to form a split mold. Then the mold is removed and put aside for weeks while the skin is prepared in an operation requiring skill and ingenuity. "It takes two years to train a good skinner," says Reese.

Through a small slit in the side of the fish that will be fastened against the mounting, every vestige of flesh and nearly all bone are removed with surgical in-



First step in mounting a dolphin is to measure it precisely, then lay it out in a lifelike position

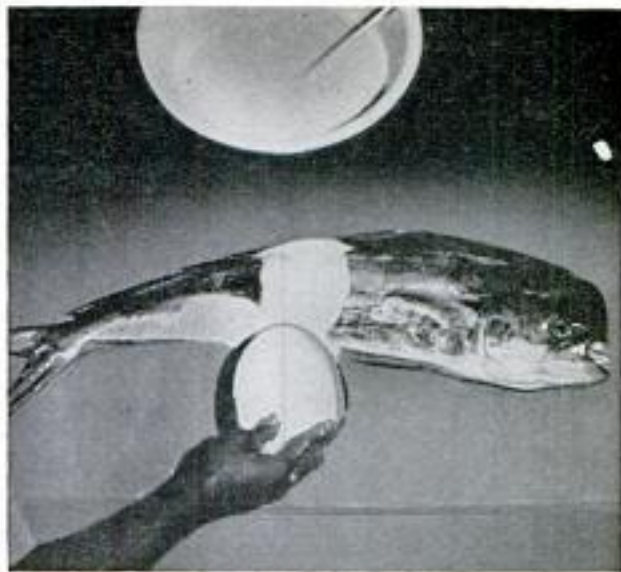

After the fish is blocked up in the proper curved pose, plaster is poured over it to form a direct cast



Cast then is split lengthwise and the fish removed. The cast is stored, as it won't be needed for weeks

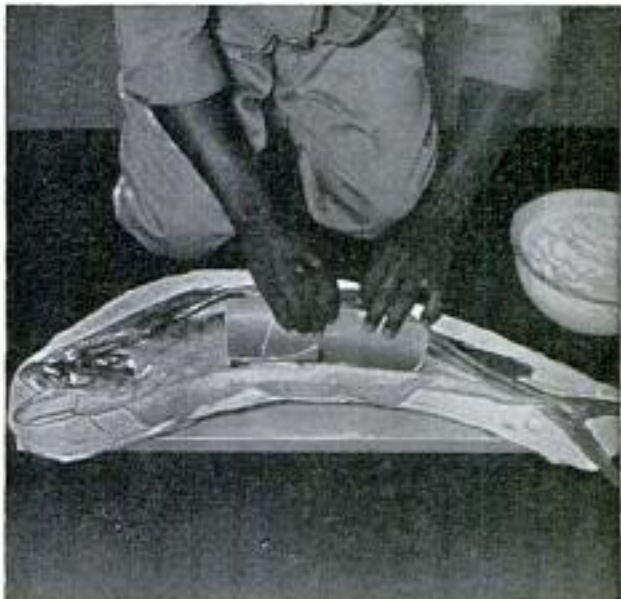

After hide is tanned, it goes back into mold. Asbestos paper mixed with paste is pressed against inside of skin. Below, opposite side is filled through slit in mold. After drying, dolphin is ready for paint

struments. In some cases, such as the kingfish and bonito, this means handling a skin so thin you can read a newspaper through it. "Sometimes," explains the taxidermist, "a skin as delicate as cigarette paper must support a heavy tail structure, and we have to strengthen it by spraying it with gelatin before it's removed."

Oddly, a shark's hide, which you'd think would be tough as leather, comes apart like paper under a knife. "We toughen it with formaldehyde," says Reese, "the way we do for rays and octopuses. It stiffens the skin and the specimen."

#### Mounting a Baby Sailfish

According to the taxidermist, few creatures can't be skinned if you know how. "Not long ago," he reveals, "a captain named Seeman saw a three-weeks-old

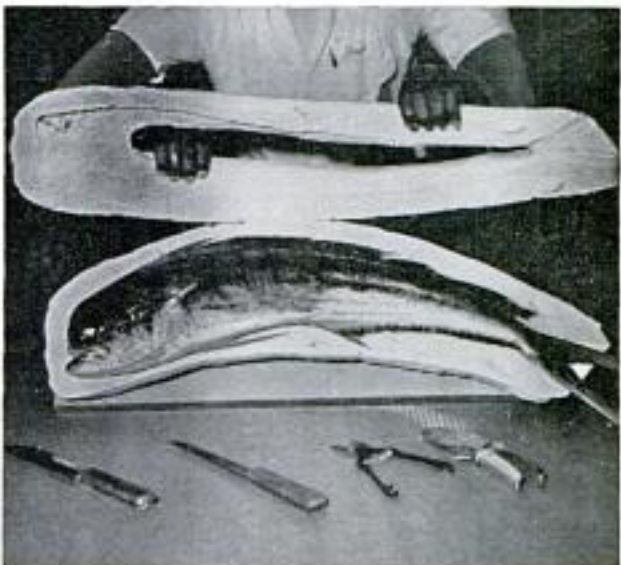



Here's one of the biggest molds ever built. The skin of a record 631-pound blue marlin is replaced in its plaster cast



Skinner has touch of a surgeon. Some skins are so thin you can read print through them



Sail of a sailfish sometimes is torn beyond repair. Here a prefabricated sail made of hardboard is mounted on a fish. Below, in spray-painting process fish is first painted white, then its own authentic colors are reproduced over base coat



baby sailfish, 7½ inches long, drifting past his boat. He dipped up the little fellow in his hat and sent it to me as a present. At first, mounting it seemed impossible because of its size, and its ridiculous, out-of-proportion sail of delicate membrane." By using glue over the skin to keep it from shredding, however, Joe skinned the oddity and mounted it in a majestic leaping pose. Today, the miniature fish sits in a plastic case on his desk, leaping from a miniature ocean in a diorama.

Fish skins go through a series of chemical baths to remove natural oils and organic matter and to preserve them for a lifetime. After weeks of curing, the hide is fitted back in the original mold. Through a slot in the back, expert craftsmen model paste-soaked asbestos paper against the inner lining of the skin, pressing it firmly against the inside walls of the mold. Thus a firm core is built up inside the fish.

After removing chalky plaster residue, checking against original measurements and pointing up any tears or flaws, a worker moves the trophy to the paint room. Reese's crew is broken down so that each man performs a specific part of the job, but the painting is usually reserved for himself and one other expert. Perhaps it brings out the artist in him. The delicate shadings that make a mounted fish look real or phony are something he knows almost by instinct.

(Continued to page 244)



## Electronic Device Identifies Metals

Identification of unknown metals can now be done without laboratory analysis with an electronic device based on the principle of the thermocouple effect. This effect is an electromotive force produced when two dissimilar metals are joined. To use the new instrument, the operator places an electrode in contact with the metal to be tested. The voltage generated by this contact is amplified and transmitted to a meter, where the reading is compared with readings obtained from samples whose metallurgical characteristics are known.

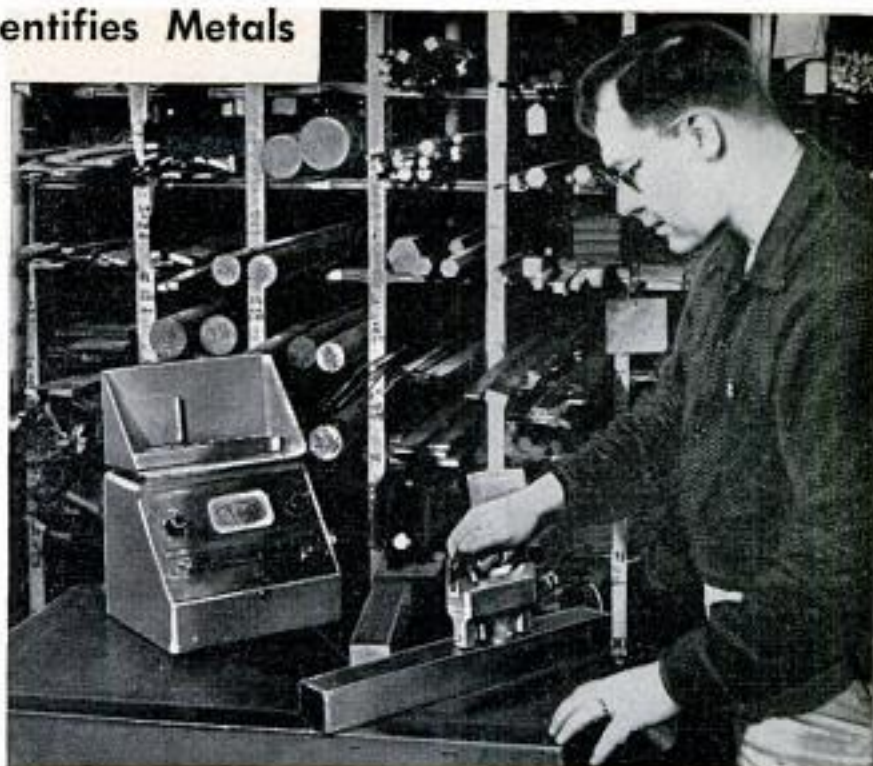

## Automatic Anesthetizer Becomes Surgical Tool

Machine-dispensed artificial respiration and automatically administered anesthetics are surgical stand-bys today. Control of rate and depth of a patient's breathing is monitored by a device which mechanically changes the pressure of the oxygen-nitrous oxide mixture given. The changes depend on the breath's concentration of carbon dioxide. Doctors will use this machine with polio victims and others unable to breath spontaneously.

## Silicone Rubber Guards Airborne Electronics

Silicone rubber is the latest link in the chain of electrical insulating materials developed for high-speed jet aircraft and guided-missile flight. Designed for airborne electronic equipment, the new substance can survive minus 85 degrees F. to plus 500 degrees F. Lab tests show this compound to be effective insulation for power transformers in service for 500 hours at internal temperatures as high as 482 degrees F.

## Pressure-Controlled Top-Cylinder Oiler Meters Engine Lubricant

Fed into the top of the cylinder by the pressure of air flowing into the carburetor, lubricant is metered into the engine as it is needed regardless of vacuum variations. Most top-cylinder oilers depend upon engine vacuum to meter lubricant and this creates problems when the car is running uphill with less vacuum and downhill with more vacuum. In the new oiler, engine speed and throttle-valve opening control the oil flow. The impact of the air rushing through the carburetor is transmitted to the oil in the reservoir, forcing the oil in metered amounts back into the air stream. Additional protection during cold-start

periods is built into the device in the form of a thermostatic control which opens the valve wider when the oil is at a low temperature and closes the valve as the engine compartment warms.

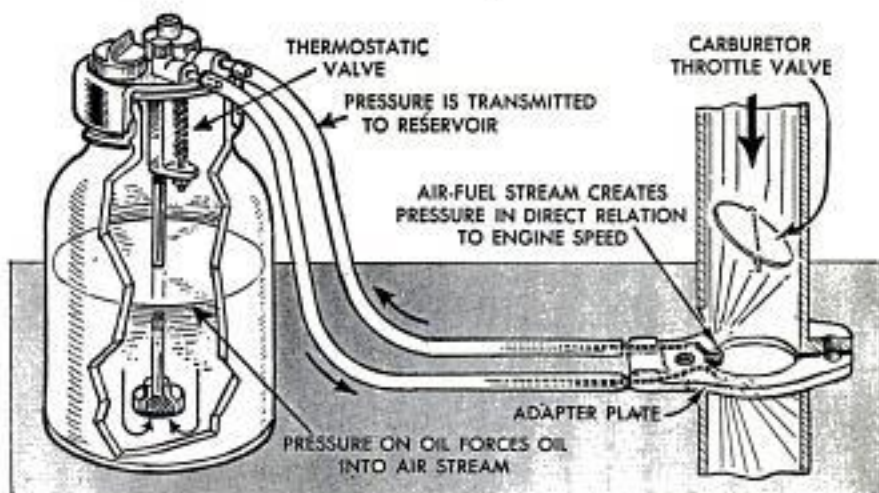

## Electronic Skin Thermometer Records Patient's Temperature



Touched to a patient's skin, an electronic skin thermometer takes the body temperature immediately and can also be used to make a permanent record of it. All the work is done by a tiny heat-sensitive element, called a thermister, and a precision electric meter which measures the temperature accurately to two tenths of a degree. Aside from saving time, the electronic thermometer will simplify temperature taking in children and persons too ill to hold a mercury thermometer in their mouths.

## Tiny Mercedes Zips 22 Miles Per Hour

Not much over a foot high is a midget Mercedes Benz Grand Prix racer built by Josef Janschuetz of Baden-Baden, Germany. Top speed is 22 miles per hour. The one-horsepower water-cooled motor hits 7000 revolutions per minute. The car has a magneto ignition, four speeds, is fueled with gasoline and has a steel-tube chassis with individual spring suspension.



Janschuetz rides a trailer as he operates the controls in the cockpit. His feet rest on metal supports on each side of the car.



## Boxcars Unloaded By Rocking Action

Boxcars are emptied of grain by the gentle rocking action of an unloading platform. The car rests on standard rails. One rail is higher than the other to give the car an eight-degree side tilt. The entire platform on which the car rests is gently rocked endwise by a 25-horsepower motor, raising and lowering each end of the car a distance of three inches. Grain in the car is shifted slowly to the middle and spills out the open side door into a hopper.



## First Helicopter Carrier Airlifts Teams of Marines

Marines are whirling aloft in helicopters from the deck of the USS *Thetis Bay*, the first carrier designed for helicopters. A rebuilt baby flattop, the ship can carry 1000 Marines and more than 20 helicopters for putting them ashore. Each 'copter carries a team of four men to the landing area, then returns for another team. Depending upon what is learned with the *Thetis Bay*, new helicopter carriers may have a cloverleaf of four or more round landing platforms instead of an ordinary flight deck.



Top, flight of four helicopters departs for shore. Above, helicopter can land, load and take off in 14 seconds. Below, 20-knot *Thetis Bay* is 517 feet long

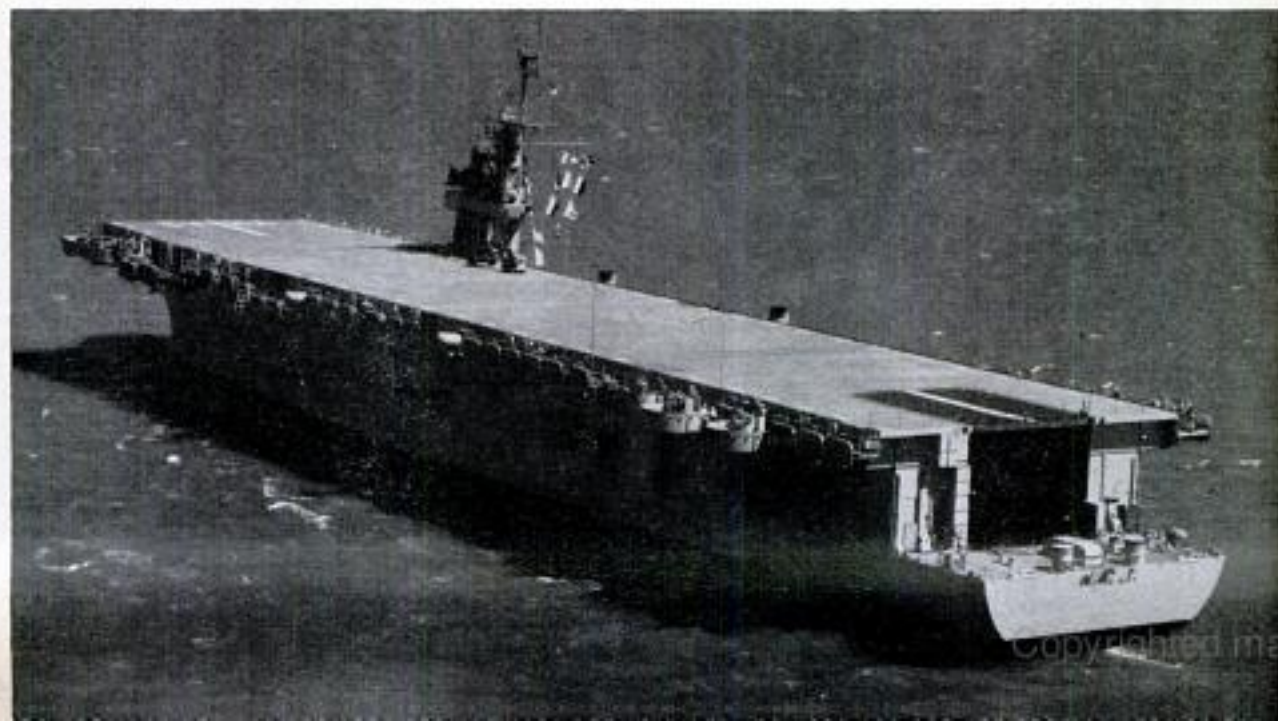
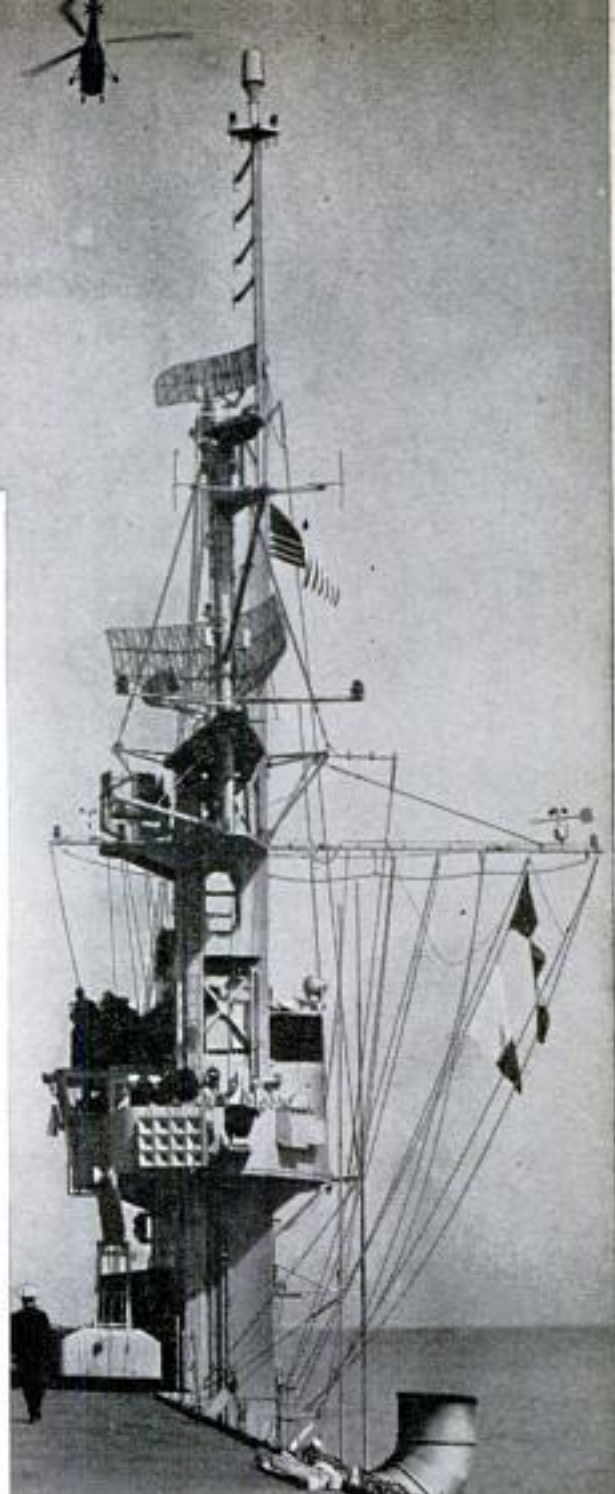



Up on the catwalk, bridgemen pull the dead wire down into cable after spinning wheel passes them

## **BIG MACK, THE WORLD'S**

**By Leonard F. Hilts**

*PM* Photos by Joe Fletcher

**S**TANDING LIKE legendary giants wading in a stream, two huge but graceful towers of red steel loom up in the middle of the Straits of Mackinac, the narrow neck of water which separates Lake Michigan and Lake Huron. Right at home in this land which was once the preserve of Paul Bunyan, these giants are at present unemployed, but by November 1957 they'll be hard at work carrying the cables of the world's largest suspension bridge on their broad shoulders.

A dream for the past 50 years, this bridge will link the mainland of Michigan with the state's Upper Peninsula and will replace the five busy ferry boats which now move traffic across this strip of water. But, as any vacationist knows who has driven that way, the boats simply can't do the job. Carrying over 100 cars each, the ferries make the trip in 53 minutes—and they pause only long enough at each dock to unload and reload. Yet during the busy summer season waiting cars line up, and

Artist's conception of completed bridge. Total length of the bridge, including approaches, will be five miles



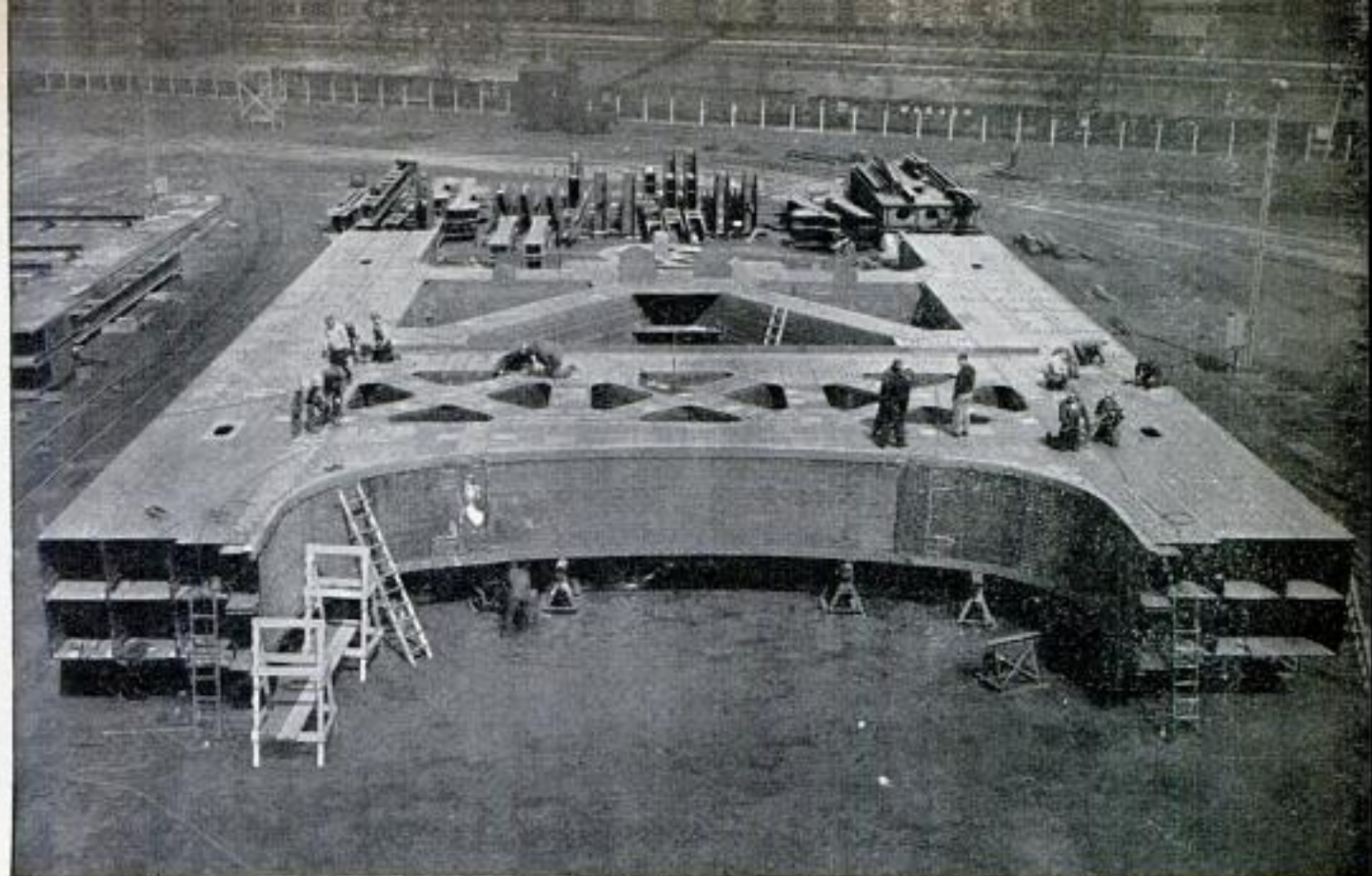

Sections of the two towers were fabricated on land, floated out to bridge site and hoisted into position

## LONGEST SUSPENSION BRIDGE

delays of four to ten hours are common. And on the big holiday week ends, the line of cars stretching from the ferry docks may reach 20 miles in length.

Big Mack, as the bridge is nicknamed, will accommodate 600 cars per hour, with the trip across the straits taking 10 minutes. The total length of the bridge, from the beginning of its approach in Mackinaw City on the mainland, to its junction with Route 2 just outside St. Ignace on the peninsula, will be just over five miles.

The Oakland Bay Bridge is longer. The distance between towers on the Golden Gate Bridge is greater by 400 feet. Big Mack's biggest claim to fame is that it is the longest suspension bridge, from cable anchorage to cable anchorage, in the

The bridge towers are 552 feet high and support the giant cables from which the suspension span is hung

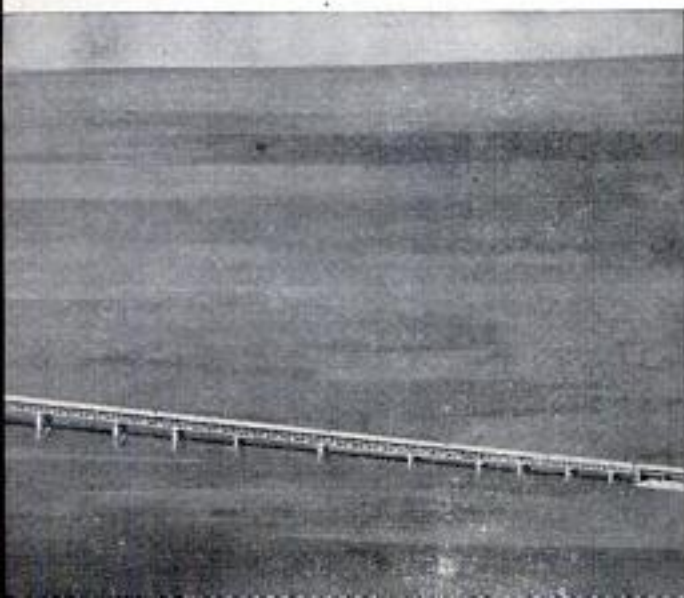
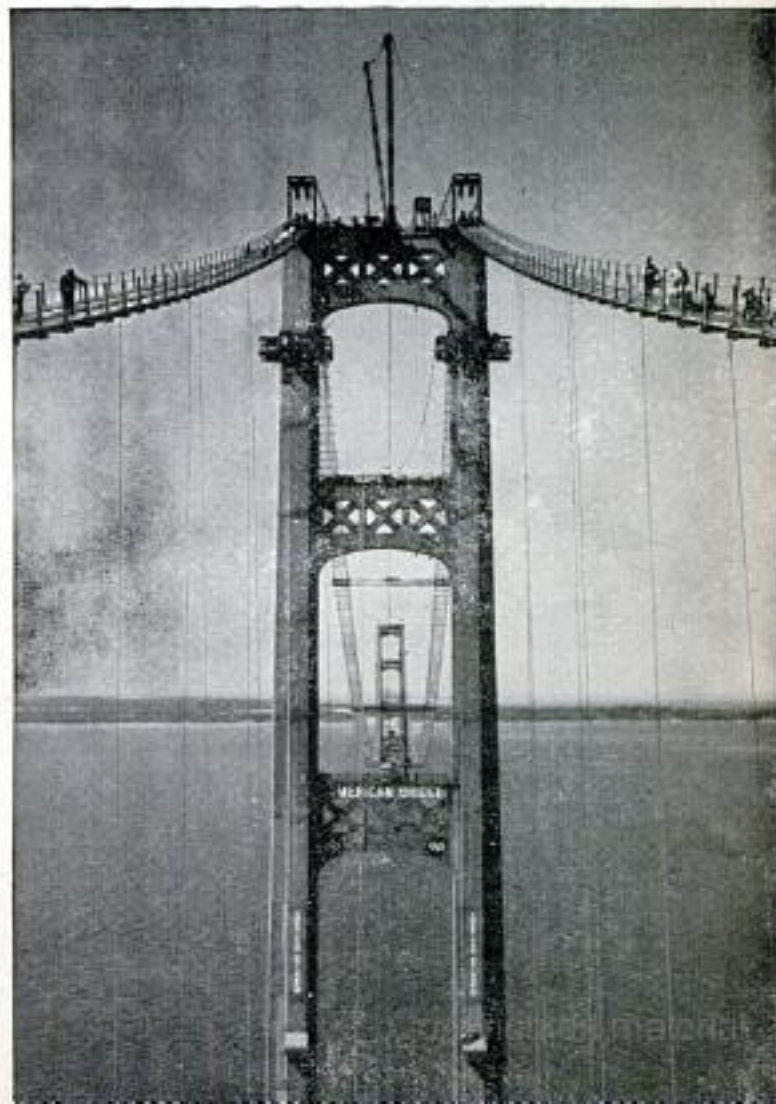

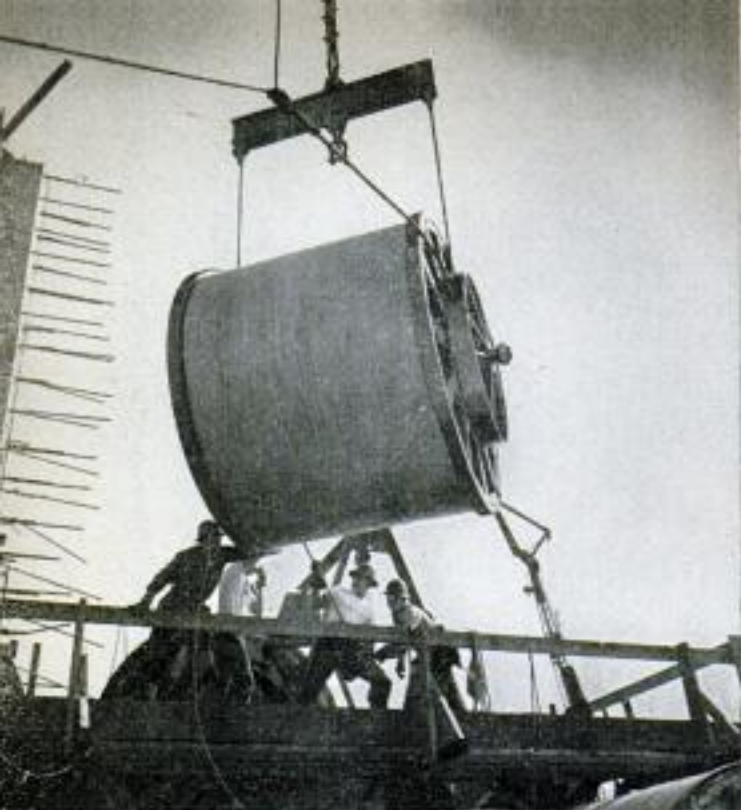

Reel of wire is swung into position on rack high on anchorage pier. This wire is spun to form a cable

After being placed on strand shoe, wire is looped around spinning wheel, which is started on new trip

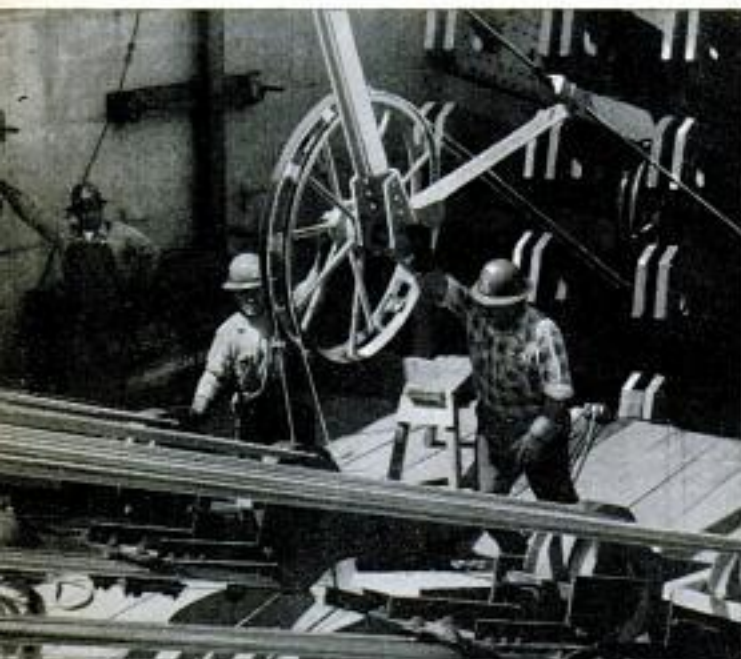

world. More roadway—7400 feet of it—will hang from its cables than from any other bridge.

The tremendous concrete piers which support the bridge go down 206 feet under the two towers to bedrock to hold up the nearly 7000 tons of steel in each tower. The approaches are long spans made of steel members which rest on piers. The towers, 552 feet high and tall as the Washington Monument, have the task of holding up the big cables from which the suspension span will be hung. And the suspension span contains the roadway itself—four lanes

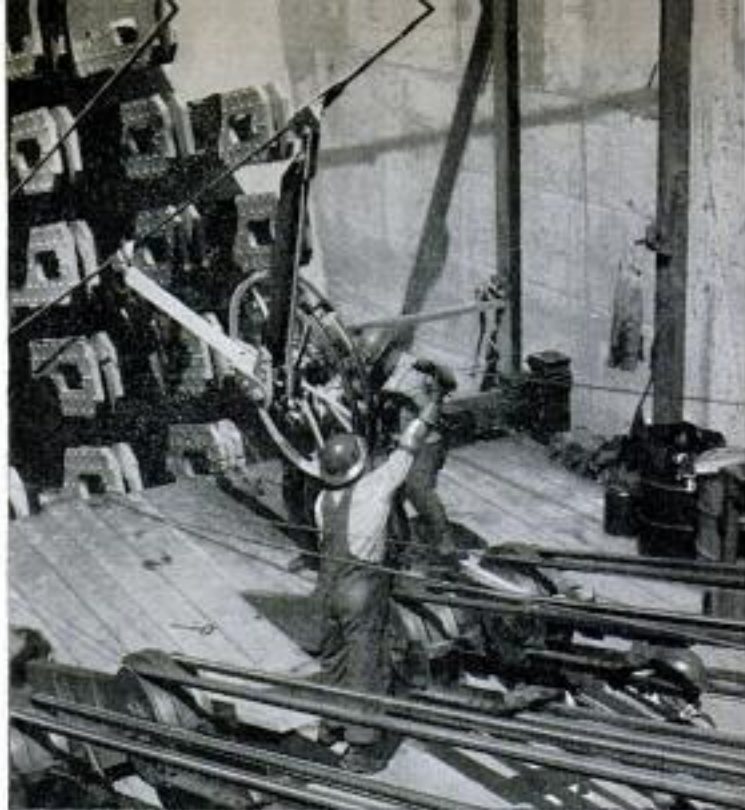

As wheel arrives in pit, wire is removed, reversed and put on strand shoe. It is then part of cable

As wheel travels along, wire is payed out. Bottom wire is dead and is pulled down to be part of cable



and 48 feet wide. If the motorist who drives across this engineering marvel will take time to look up, he will see the giant cables which make such a structure possible. Two of them, each  $24\frac{1}{2}$  inches in diameter, rise out of anchorages at each end of the suspension span, cross the tops of the towers, and sag down between them in graceful arcs. Every 39 feet along the cable a steel-cable band is clamped, around which is looped a  $2\frac{1}{4}$ -inch wire rope. These wire ropes are actually the suspenders which hold up the roadway. Coming down from the cable, they are attached to the stiffen-

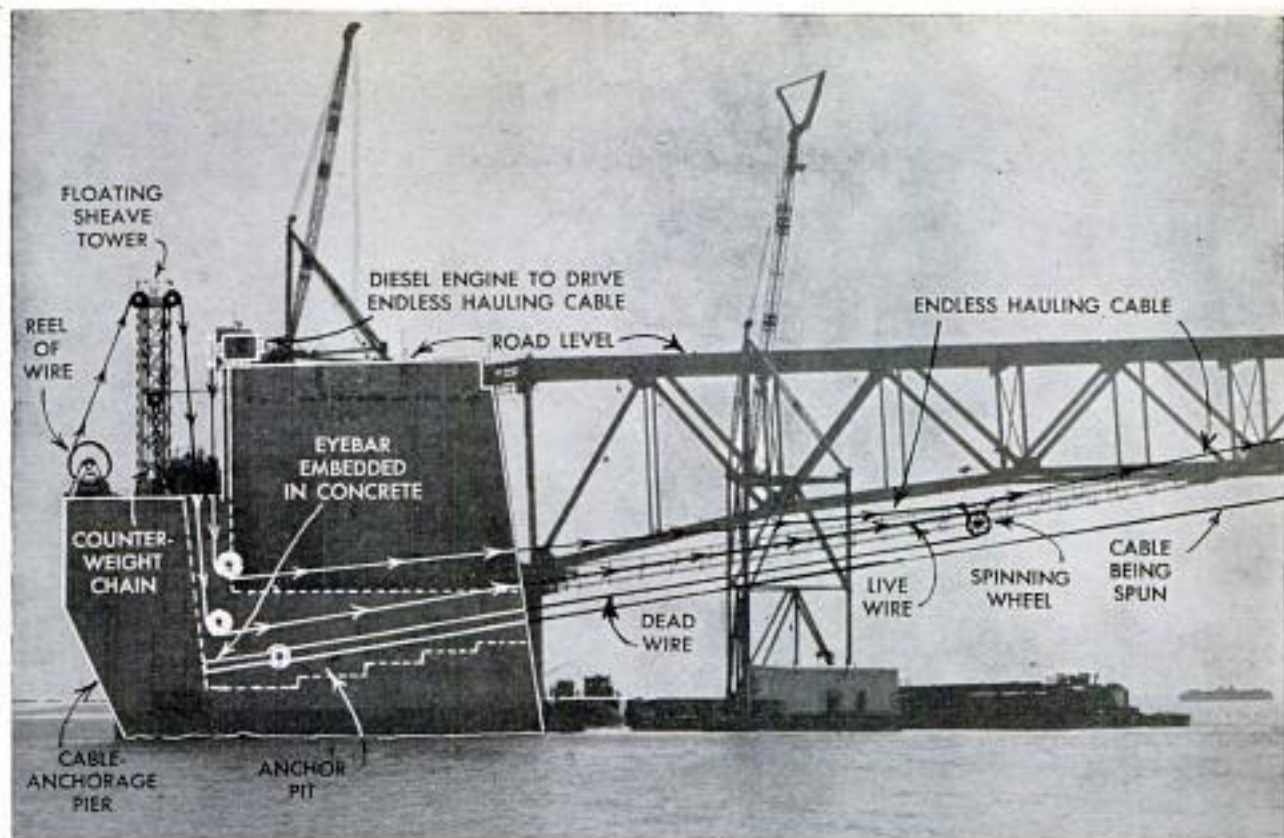

**Simplified diagram superimposed on photo of cable anchorage shows basic principle of cable spinning. Wire feeds from reel through floating sheaves tower and on to spinning wheel which carries it across bridge**

ing trusses of the suspension span and bear its weight.

Before 1854, suspension bridges were hung from giant chains and were sharply limited as to size. But in that year, John Roebling announced that he intended to build a new type of suspension bridge across Niagara Falls. The bridge, he said, would be hung from cables. The cables would be too big to drag or hoist into position, and therefore he would make or "spin" them right on the structure of the bridge.

Many of the ideas he incorporated in the bridge—and especially the trick of spinning the cables on the structure—were so novel that engineers scoffed and predicted the bridge would collapse in the first good wind that came along.

It didn't. In fact, it proved to be the forefather of a long line of big suspension bridges, including the Brooklyn Bridge, built in 1883. Improvements have been made in Roebling's method of spinning the cables, but the principle remains basically the same.

The phrase "cable spinning" commonly used by engineers is a misnomer, for the wire is not twisted or spun as the cable is made, but is strung in place a strand at a time and bound into the final product.

The cables on Big Mack are of high-tensile galvanized wire about the diameter of a pencil. Each of the cables consists of

12,580 wires, divided into 37 strands of 340 wires each. Forty-one thousand miles of wire, spliced to make two continuous wires for each cable, are used, and the cables plus their fittings weigh a staggering total of 25,000,000 pounds.

Each cable-anchorage pier is a manmade island of 170,000 tons of concrete and steel, 115 feet wide and 135 feet long. These piers must resist the tremendous pull of the cables and the weight they support, and transmit this reaction to the bedrock on which the pier is founded. Each cable has its own anchorage pit in each pier.

(Continued to page 260)

**Approach spans were also prefabricated and floated into position. Here span is carried by barges**





## Protective Slip Covers Keep Wagons Clean

They were bound to come—slip covers for station wagons. Originally a utility vehicle designed to take rough treatment, the wagon has become a handsome, comfortable automobile just as vulnerable to abuse as any car. To protect upholstery and trim of the station wagon a plastic-coated liner is available that snaps into place from the front seat to the top of the tailgate, covering the sides at the same time. No drilling is required to install the liner, its snap fasteners being held in place by the body screws on the floor and side panels.

## Synthetic Passenger-Car Tires Derived From Oil-Refinery Gases

Passenger cars soon may have synthetic-rubber tires made of butyl, derived from oil-refinery gases. Present auto tires consist of synthetic rubber known as "GR-S" plus lesser amounts of natural rubber. Lab and road-tested all-butyl tires show immunity to atmospheric or chemical attacks, smoother riding comfort and low noise

level. Recent safety checks demonstrate that butyl-tired cars traveling 60 miles per hour on wet pavement stop in 30 percent less distance than vehicles having GR-S and natural-rubber tires. On dry roads butyl tires halt cars in 20 percent less distance. Also, the new tires do not "squeal" when rounding corners.



## Trailer Trucks Travel On Ocean-Going Ships

Piggyback transport of truck-trailer bodies has spread from the railroad industry to shipping. Three specially adapted tankers now offer a weekly service from the New York area to Houston, Tex. Freight is picked up by truck within a 200-mile radius of New York and delivered within a 200-mile radius of Houston. At Port Newark, N. J., a huge crane lifts each trailer body from its chassis and swings it onto the ship where it is clamped to the deck. One vessel can carry 58 of the 33-foot aluminum trailer bodies with 2,320,000 pounds of freight. At Houston, vans are refastened to tractor-trailer chassis and delivered by highway to the consignees. The ship can also carry a top deck load in sealed containers.

British scientists are endeavoring to make invisible the vapor trails formed by jet planes at high altitudes by converting the hot exhaust gases into cool, noncondensing gas streams.



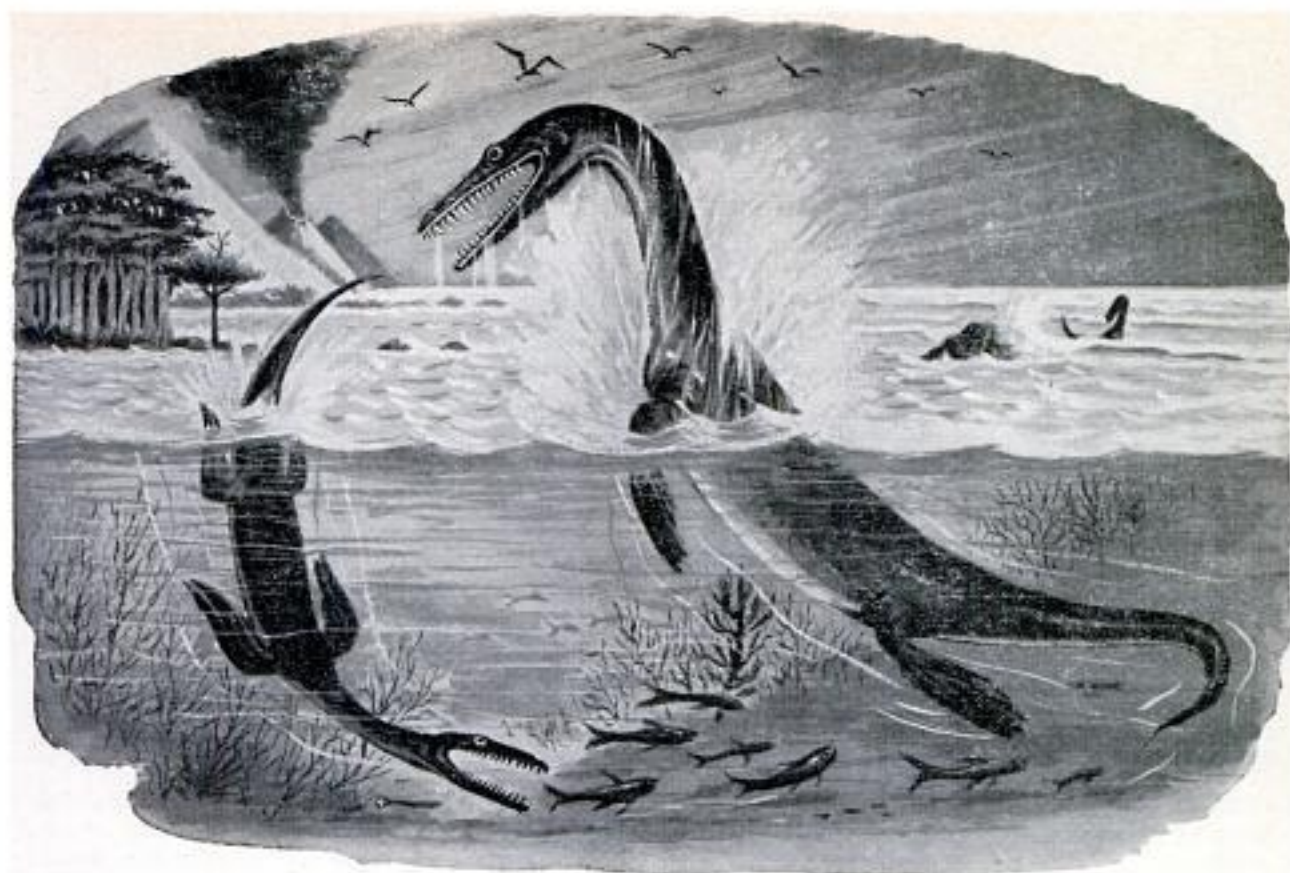

## Harvard Restores 49-Foot Skeleton of Biggest Marine Reptile

Kronosaurus, believed to be the biggest marine reptile that ever lived, is being restored for public display at Harvard's Museum of Comparative Zoology. The 49-foot-long creature lived 120 million years ago, long before dinosaurs, and preyed upon other great reptiles and large fish. It propelled itself with four massive flippers, each 6 feet long, that jutted from a body 6 feet thick and 20 feet in length. The

head was 9 feet long, the neck 10, the tail 10. The Harvard specimen is the only complete skeleton ever found. It was discovered in Australia encased in hard dolomite rock. The dolomite is being separated from the mineralized bone by chipping and with acetic acid. The few missing bones and bone parts from the ancient reptile are being filled in with glue, asbestos fiber and plaster of paris.



Named "Kronosaurus," the larger monster above lived 120 million years ago and ate reptiles and fish



## Polyester Resins Made With Citric Acid for Structural Purposes

Citric acid seems destined to replace the soybean and peanut, when it comes to versatility. Essential in products ranging from foods to hair rinses and rejuvenating

oil wells, this acid helps prepare certain polyester synthetic resins. The latter have seen structural use in automobile bodies, radomes and for boat hulls.



**OUTBOARD MOTOR** in kit form has now been added to the do-it-yourself field. Kit comes complete with all parts and only a screwdriver and adjustable wrench are needed for assembly. The motor is an air-cooled type developing 2½ horsepower and will give

about 2½ hours of cruising per filling of fuel. It is ideal for small boats and for trolling. A book of simplified instructions is included in each kit and all parts are guaranteed. By assembling his own motor, the do-it-yourselfer can save 25 percent of the cost

Continental Mfg. Corp., Washington Blvd. at Motor Ave., Culver City, Calif.

# DO IT YOURSELF

## *With Kits*



**ALUMINUM CARPORT** comes as a kit you can assemble yourself. Two sizes are available, for one or two cars, and both can be erected quickly without special tools. The legs are adjustable to any required height up to eight feet six inches, and may be bolted into cement or mounted on casters for portability. The port can also be used as a cover for a boat moorage, a breezeway or as an attractive outdoor living room if screened sides are attached to the frame

H. C. Mun Co., 162 7th St., Oakland, Calif.

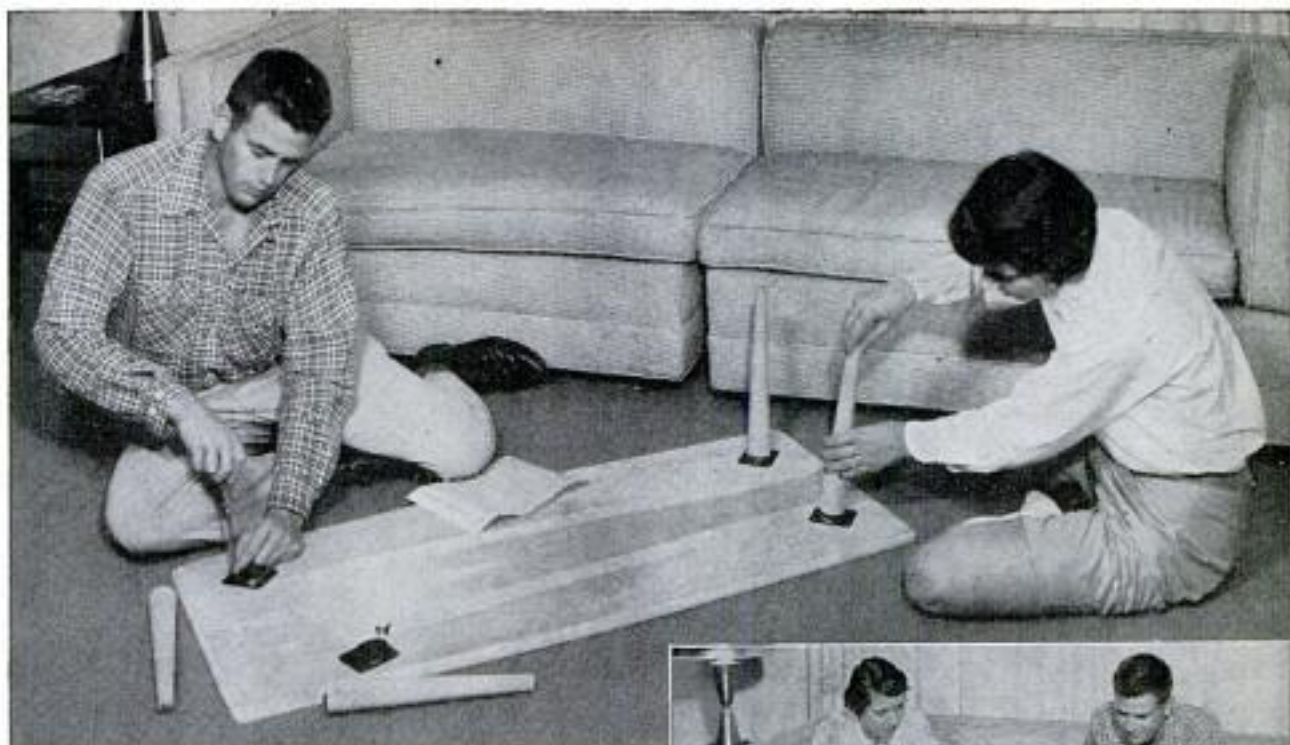

**COFFEE-TABLE KIT** is one of a series of do-it-yourself furniture kits. Each kit contains maple legs, and a premachined table top. Called Peg-Legs, the legs are available in many sizes for those who want to design their own furniture. They are equipped with a unique metal-to-metal fastener which assures solid construction. The complete kits are available in a wide variety of table-top patterns and leg sizes

Perry Furniture Co., Grand Rapids, Mich.



**AUTHENTIC POST LANTERN**, an elegant reminder of the gaslight era, now comes as a kit which can be put together in an hour. The lantern is made of copper and everything is included in the kit, even the glass

The St. George's, Dept. A, East Hartford, Conn.



**ASTRONOMICAL TELESCOPE** of the reflecting type, with a 3-inch mirror and 100-power lens, comes as a kit with all necessary parts, including a 40-inch tripod, in one package. Manufacturer says a nine-year-old child can assemble the telescope. The finished scope can also be used terrestrially

Edmund Scientific Corp.,  
Barrington 195, N.J.



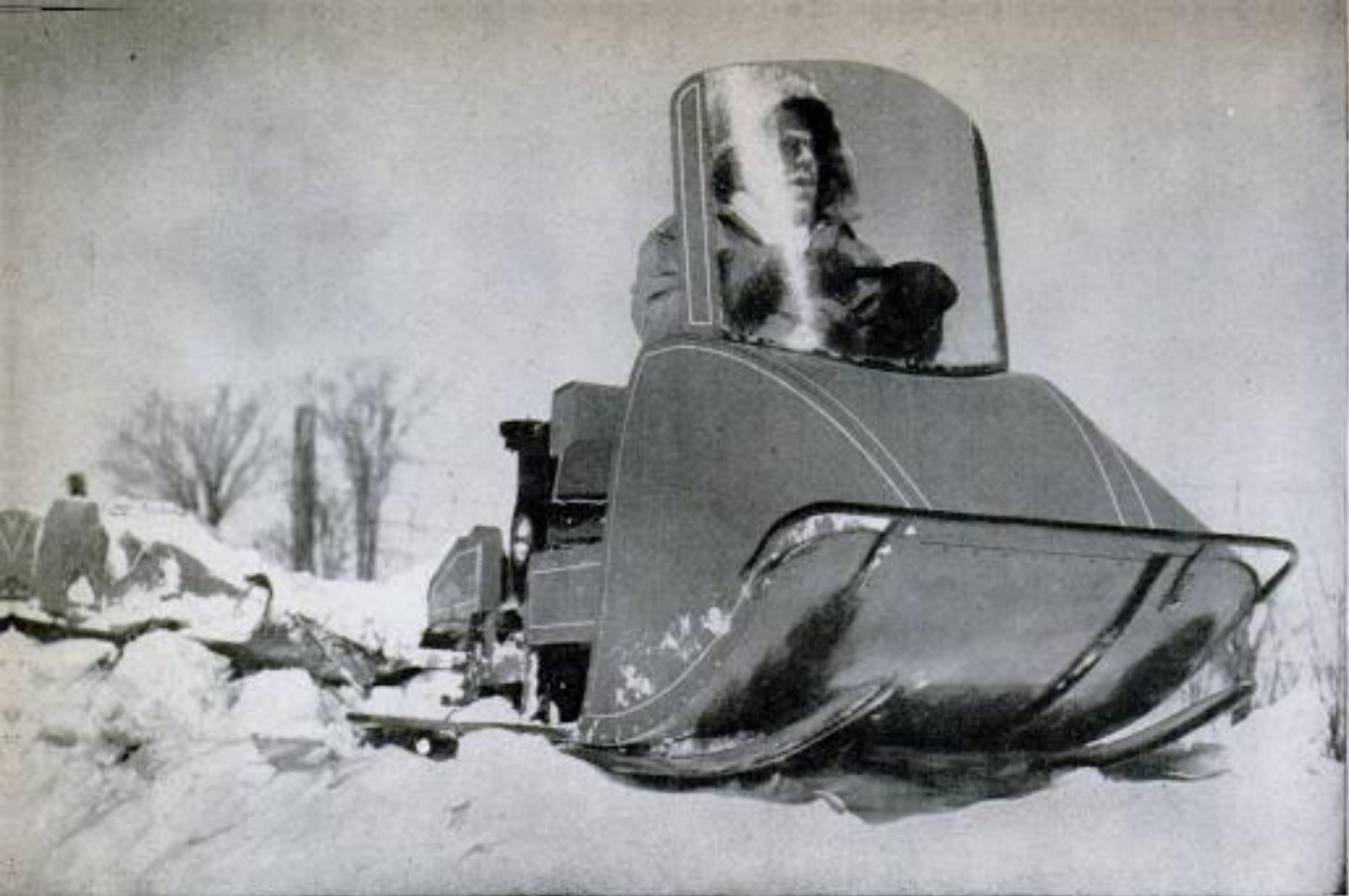

Motorized toboggans have steering runners that steer like car wheels. The windshield here is an accessory

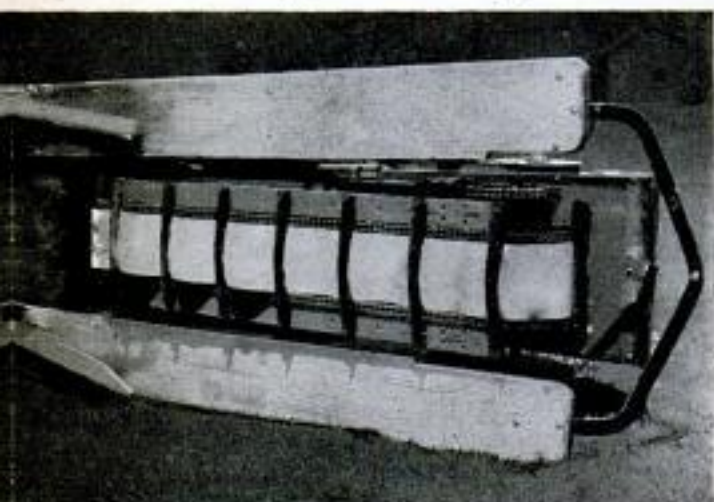

Underside of the motor sled reveals the endless belt which drives this vehicle

# MOTOR SLED

By Neil Duncan

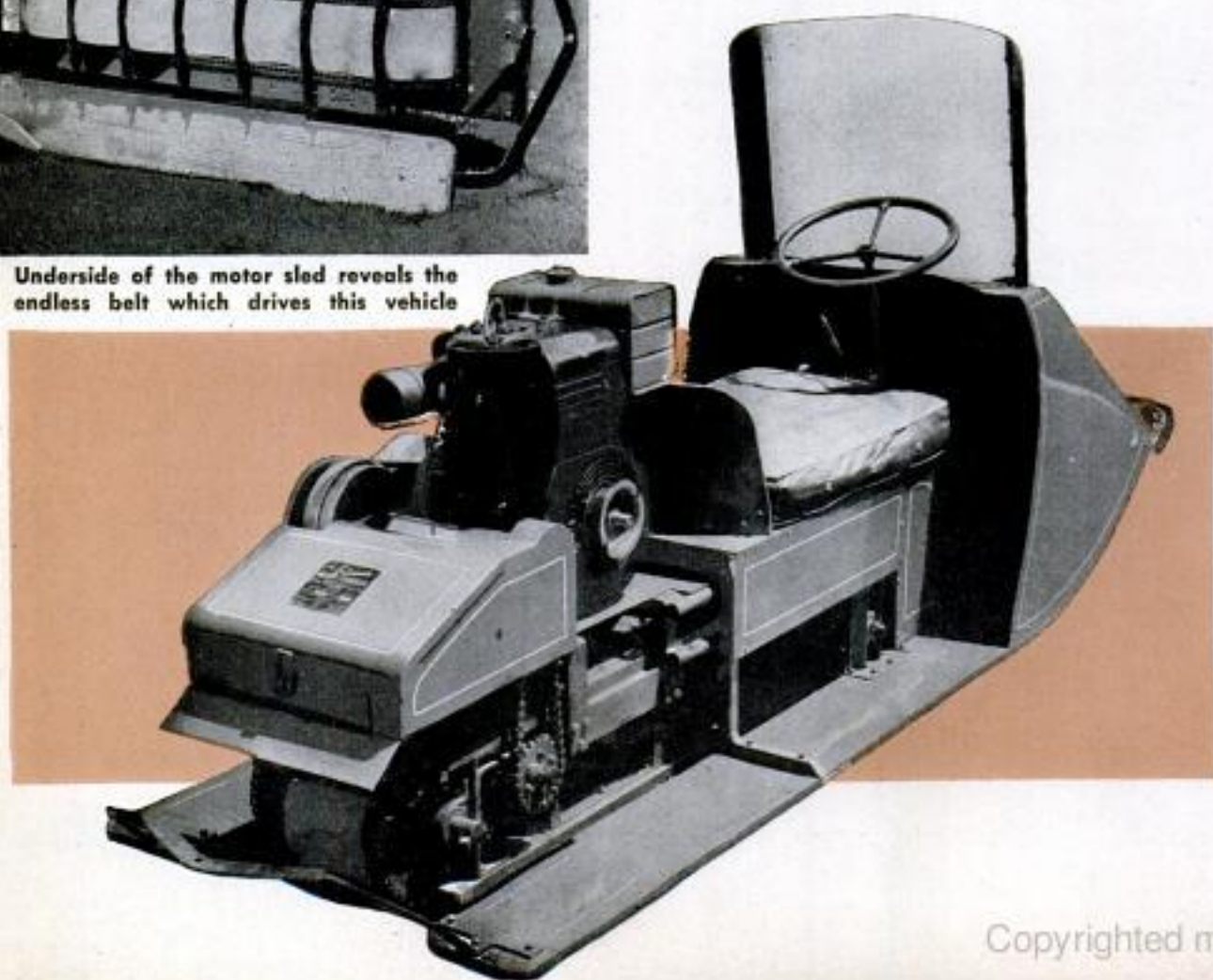

Copyrighted material



Pulling a load of 800 pounds with an eight-horsepower engine adds up to 10 to 15 miles per hour on the trail

## DOES A DOG TEAM'S WORK

CANADA'S arctic-winter wilderness today finds the noisy yammer of gasoline engines replacing the bark of Husky dog teams, and a miniature tractor—the motorized toboggan—is gaining favor. Big oil and mineral-exploration teams long have depended on large tractor trains to haul heavy equipment over ice and muskeg. But for small parties, such as surveying crews, dog teams have been the only means of transport. Experimental comparison has decided the issue.

Powered toboggans are almost 8 feet long, 33 inches wide and 3 feet high, including laminated-wood runners, steered like car wheels. Using an endless-belt system, a single-cylinder, eight-horsepower motor drives the 425-pound toboggan 5 to 25 miles per hour.

Snarling dog teams, food, sleighs and

drivers size up unfavorably with machines and gasoline, which are easier to maneuver, lighter, and less costly to operate or transfer. Also, dogs need handlers, while one mechanic can service many items of machinery with little difficulty.

A maximum load of 16 men (2500 pounds) has been carried by motorized toboggan. However, a mechanized unit and two nine-foot tow toboggans normally carry 600 to 800 pounds. This toboggan train moves faster than a dog team could travel with half the load. Yet, survey parties still insist on dog teams for breaking trail and emergencies. ★ ★ ★

Hooking up motor of toboggan to a circular saw, these men can make short work of cutting wood for cooking or heating. Dogs can't compete here



# Scale Models Avert Engineers' Headaches

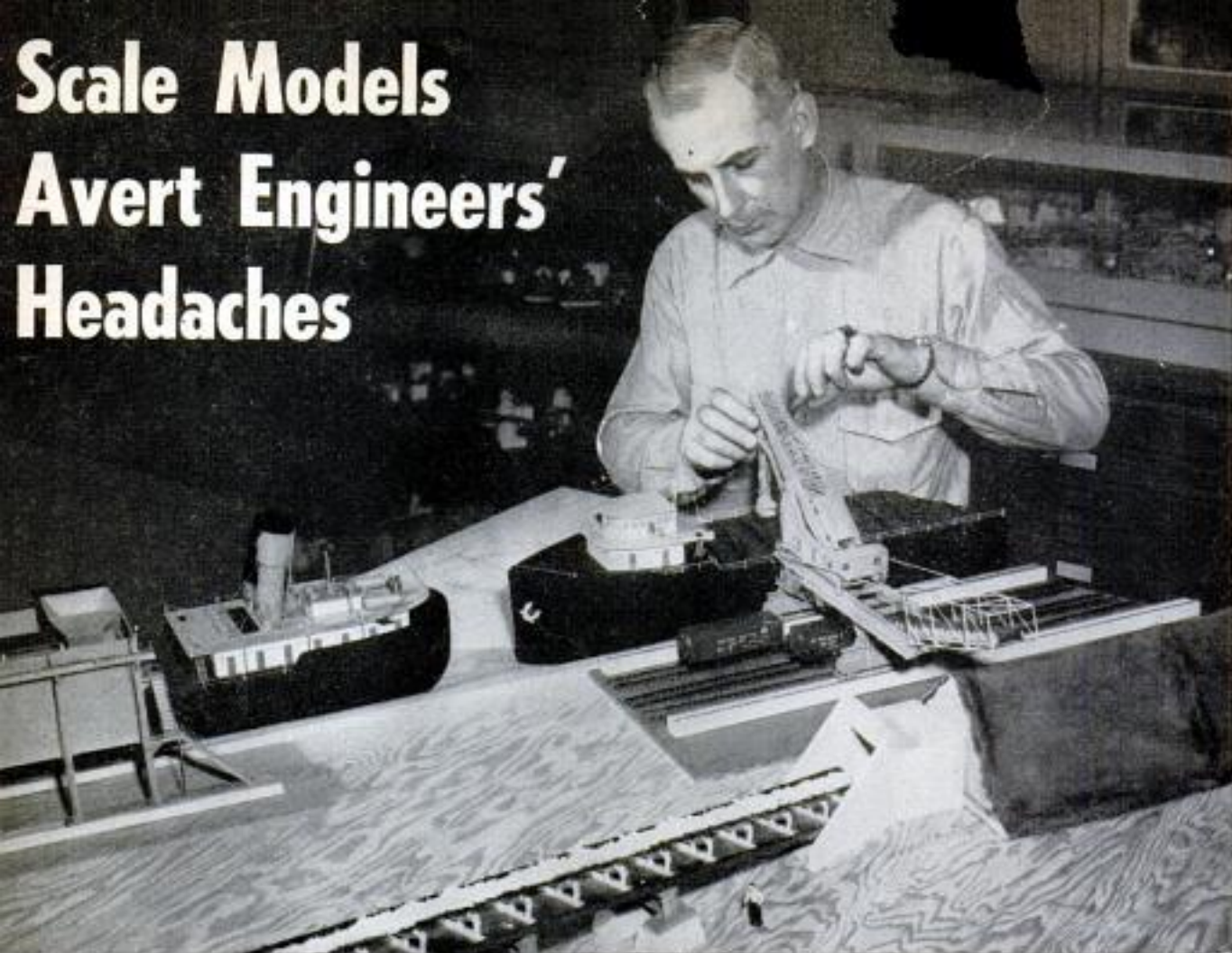

Tisen adjusts a scale model of an ore unloader, part of an 18-foot working model of trans-Ohio conveyor belt

By **Walter E. Burton**

**I**N A SORT of factory within a factory, W. C. Tisen constructs, on a reduced scale such as one fourth inch to one foot, branch plants, factory installations and machines—often before they are built full-size. His workroom, buried deep in the main plant of the Goodyear Tire and Rubber Company at Akron, Ohio, contains a carefully kept collection of scale models of Goodyear factories located in various parts of the world.

The models Bill Tisen builds earn their keep by enabling engineers and officials to work out arrangements of buildings, locations of machines and other details before a proposed branch factory is started or a projected change in existing equipment is tried.

Many a home shop boasts more extensive power equipment than Tisen uses. A wood-turning lathe with a three-jaw universal chuck, a drill press and a 10-inch circular saw equipped with molding cutter are the main items. Compressed air is available for spray-painting. Tisen assigns a lot of importance to hand tools, particularly the special ones he makes from old files and other pieces of tool steel.

The model builder believes that his methods can be adopted by almost any amateur

craftsman who wants to make miniature copies of railway equipment, parts of ships, military equipment such as big guns, aircraft of all sorts, buildings or almost anything else.

Briefly, here is how Tisen creates a model of a piece of machinery: He first prepares pencil drawings, usually on a scale of one fourth inch to the foot, and exact as to shape. Using them as a guide, he makes parts from transparent plastic, then cements the parts together to form the complete machine. If only one model is required, he paints and uses the plastic model itself. If duplicates are wanted, he places it in a wooden box and pours around it a self-curing rubber molding compound; and from the resulting mold he makes as many plaster castings as are needed. These plaster machines require almost no touching-up. He gives them a spray-lacquer finish, using plenty of air in order to produce a satiny surface that will photograph readily.

Tisen constructs miniature buildings largely of patternmaker's pine. For an older type of building, he may make the windows by drawing them or having them printed on cardboard, which he then glues to the building exterior. For modern one-story



Set up as an exhibit, model of the Riverlake Belt Conveyor Line gets a final check before going on tour

factory buildings, strips of graph paper make excellent representations of windows. Lacquer undercoater sprayed on the buildings produces a realistic finish, using a red color for brick walls, and a gray color for painted steel.

The model builder prefers asbestos fiber, mixed with water to form a paste, for reproducing earth and rocks. It is easily painted with show-card water colors. For trees he uses natural sponge or foamed latex rubber. The rubber is easily trimmed to shape with scissors and joined with rubber cement, and it takes show-card paint readily. For fastening plastic and plaster models, trees and other items permanently in position he employs model-airplane or similar cement. When there is a possibility that the item will be shifted at a later time, he uses rubber cement.

Goodyear technical men use one of Tisen's models to visualize and discuss proposed improvements to be made at one of Goodyear's branch factories

When seeking the countless little odds and ends that a model may require, Tisen often visits local ten-cent stores—especially their jewelry counters. One time he needed some tiny disks to use on a model, and found that sequins filled the bill perfectly. At home he keeps a sizable "junk box" collection of bits and pieces. And when ten-cent stores and junk boxes fail to yield the little wheel or rod or button desired, he proceeds to make it. For example, he



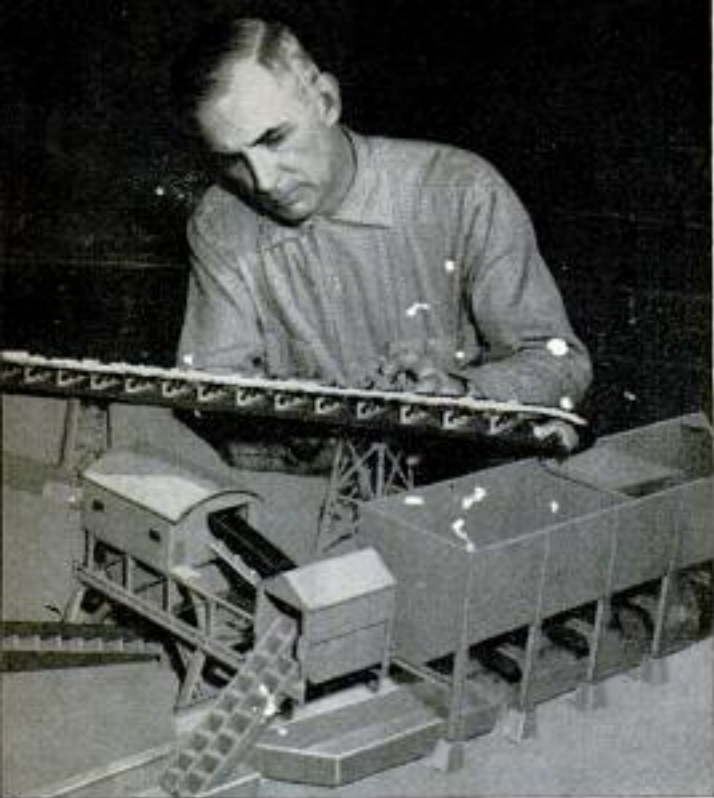

Model of trans-Ohio conveyor system was set up to show how proposed system would look and operate

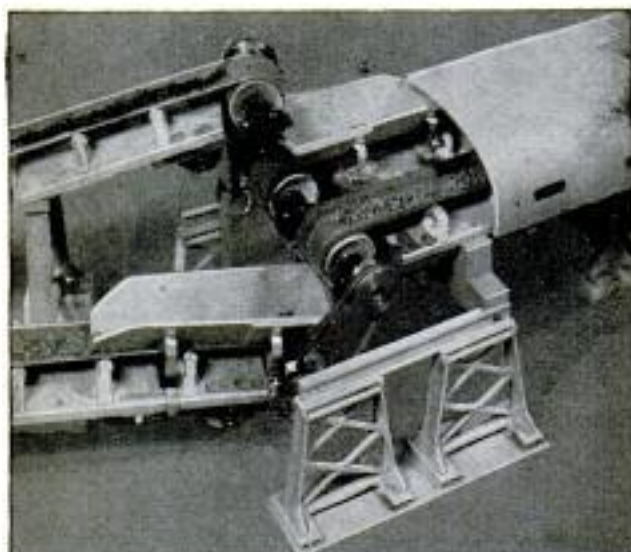

produces miniature models of steel I-beams by cutting grooves in rectangular strips of transparent plastic with a circular-saw molding-cutter attachment. Painted gray or red, they look remarkably like the real thing. Sometimes he casts metal parts in rubber molds, using an alloy that melts at a temperature low enough to prevent damage to the rubber. The casting can be filed, drilled, or otherwise worked, and painted or lacquered any color.

#### Most Difficult Project

The project that gave Tisen the hardest time was a working model of the proposed Riverlake Belt Conveyor Line. Plans have been made for building, across the state of Ohio, a rubber-belt conveyor system for hauling iron ore and coal. Tisen had no blueprints; in fact, many of the details were in a rather hazy stage. He made the model, which had to be portable for trailer travel, in three sections totaling 18 feet in length. Unlike the real thing, the \$25,000 model conveyor had to have facilities for returning the "iron ore" and "coal" to the starting point automatically and continuously. So the model builder created an elaborate "underground" network of machinery, virtually a second complete conveyor system.

Modelmaking such as Tisen does at Goodyear saves money and time and prevents a lot of headaches. Someone has calculated that, in a single project involving a branch plant, enough was saved by means of a model to pay the model-maker's salary and his model-shop expenses for a number of years. ★ ★ ★

Tisen builds intricate detail into models, left. This is part of a transfer point between strands of belt

When duplicates of a model must be made, below, Tisen makes mold of original, then plaster castings

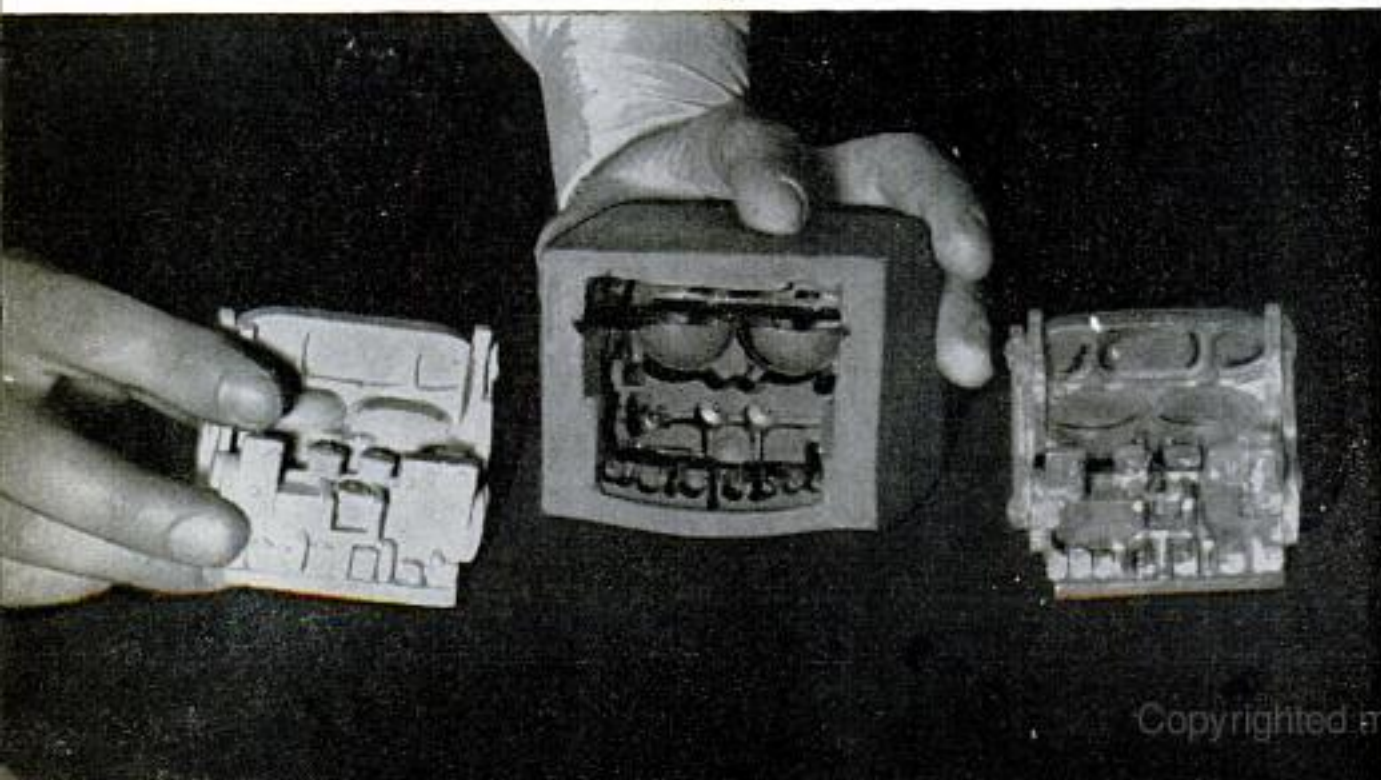





Aerial view of the blasted Ponte Della Pietra, showing temporary steel bridge for use during restoration

## Italians Restore Old Bridge Stone by Stone

When the German occupation forces pulled out of Verona, Italy, in World War II, they blew up the Ponte Della Pietra behind them. Now the townspeople have decided to restore the 1500-year-old bridge to its original condition. All stones from the original bridge have been dredged from

Architects made faithful models of each stone salvaged from river, assembled them on small bridge

the river bottom, and architects, using enlarged photographs, are carefully locating the position of each stone in the structure. Eventually each stone will be placed in its original position. The bridge, with each stone accurately reproduced, was first made in miniature to guide the builders.

Using enlarged photograph of bridge taken before the war, architects try to identify position of each stone





Dirt road at left is raised above high-tide mark. The steam electrical generating plant has sunk 22 feet

## CITY WITH A **SINKING** FEELING **SINKING**

*We're talking about Long Beach, Calif., whose harbor land has sunk 22 feet in recent years. Some folks who used to see the ocean from their office windows now look up at it.*

**By Claude M. Kreider**

**W**HEN 2000 ACRES of valuable harbor land sink below high-tide level and Pacific waves threaten to flood the area, it's time to consult the experts. And when this slowly subsiding, oval-shaped bowl contains \$500,000,000 worth of docks, warehouses, industrial plants, a Navy shipyard and 2500 producing oil wells, the problem becomes even more complex. Today, such a difficulty faces officials of Long Beach, Calif., Naval authorities and private owners of industrial installations in the vicinity.

Signs of sinking were first noticed at the site of a large steam electrical generating plant. The heavy structure obviously was settling into the sandy soil. But geologists and engineers sought a more fundamental solution, since receding land ex-

tended far beyond the plant in a gradual, shallow slope in every direction. Scientists finally credited the strange depression to reduction of gas pressure in underlying earth structure due to extensive withdrawals of oil and gas from local fields.

The problem is not new. A report in 1940 by engineers to the Navy Bureau of Yards and Docks predicted total future settling of seven feet. This announcement was succeeded by later statements jumping the figure to nine feet. By 1948 estimates placed maximum sinking at 16 to 18 feet, and in 1951 competent authorities agreed that subsidence might total 22 feet—the point of today's lowest ebb. Recent long-range appraisals made for the Long Beach Harbor Department fix final settling at 30

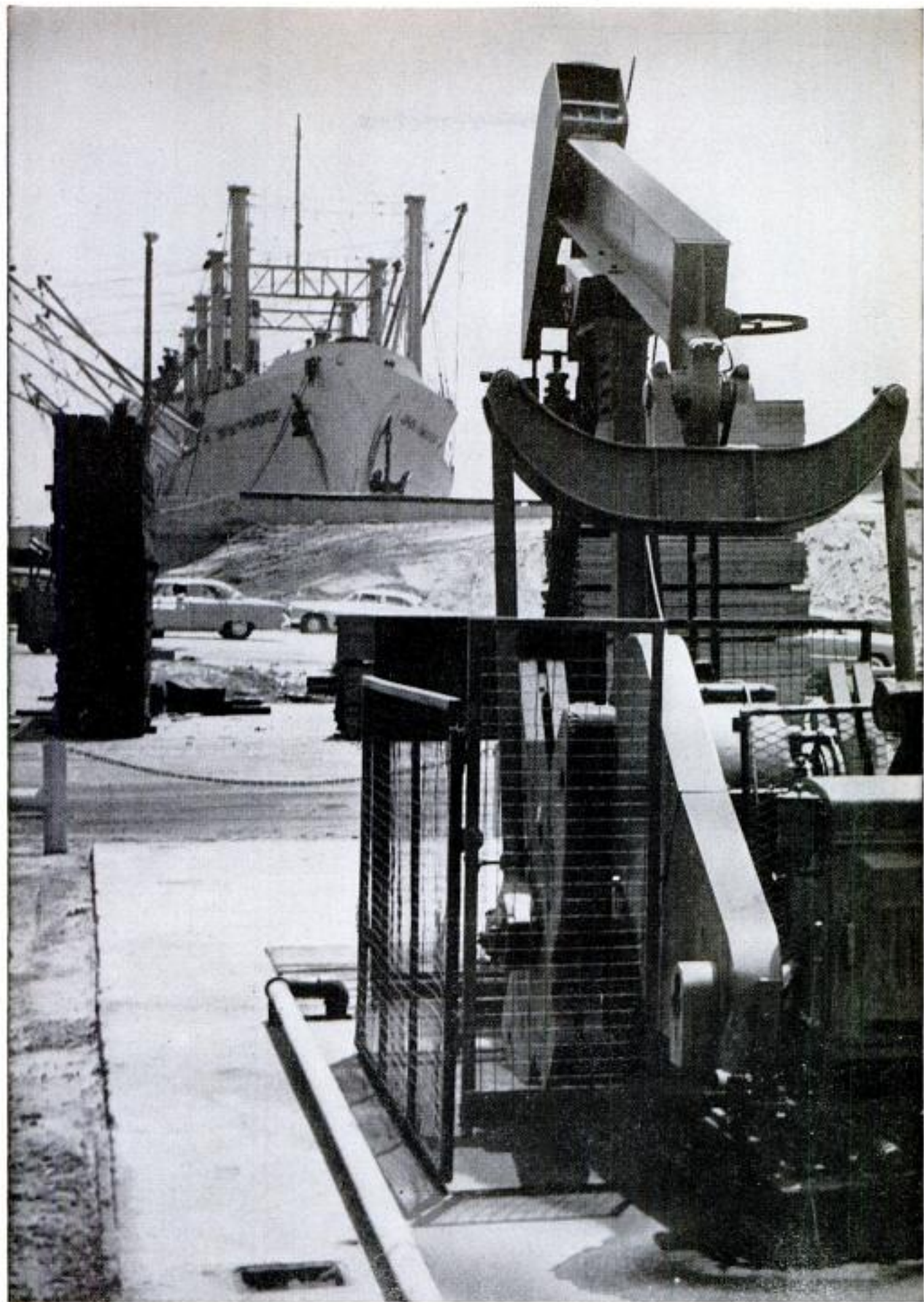

The oil-well pumping unit in the foreground is at a much lower elevation than the ship floating in the ocean in the background. A concrete seawall has been installed around the ship channel at Long Beach



Long Beach Harbor Department Headquarters, once overlooking ship channels, now sits below a 20-foot dike

feet, with computations indicating the sinking will end around 1972.

Paradoxically, withdrawals of gas and oil from these fields are still continuing side by side with remedial measures. Oil and gas removal has become a calculated risk, based on realization that it is more profitable to rehabilitate the subsided area at a known cost than to hamper various lucrative projects now in full-time operation. For example, in 1955 annual production of this entire oil field was 39,000,000 barrels of crude oil and 34,200,000 thousand feet of natural gas, the whole of which was valued at \$100,000,000.

Also, in Long Beach Harbor there are

30 miles of ship channels, wharves and docks, which handled 8,415,000 tons of shipping in 1955. Through this largest of the West Coast cotton-shipping ports passed 452,000 bales of cotton last year. Potential long-range expansion of port facilities and oil production will add 8 to 12 miles of waterfront to the receding area. Rather than retreat from such a financially optimistic future, Long Beach workers have elected to stay and fight. The outcome will affect the economy of southern California and distant areas served.

In counterattacking, Long Beach Harbor Department, assisted by private ownership and Naval authorities, has definite

Well head, center rear, will be at ground level when earth-fill operations upgrading the area are finished



plans to meet the situation's needs. These remedies, however, do not include one all-encompassing solution, as obstacles are many and varied. For instance, seen as an inadequate answer is one simple fill, which would require 50,000,000 cubic yards of material to raise the area back to normal level. And this would compensate only for the sinking to the two-foot contour line of the bowl, in addition to curtailing industrial activities during the project.

Then, too, diking of the entire area is seen as impracticable due to a strange horizontal movement accompanying subsidence. This movement has been measured at  $4\frac{1}{2}$  inches per 100 feet. Indicating the effect of such sliding, repair and realignment of many oil wells with broken or crushed casings have been necessary. A barge bridge crossing the main harbor entrance channel has required raising of its fixed portions to overcome this side-slipping action. Differential settling of towers of a huge vertical-lift bridge has necessitated expensive readjustments, with more foreseen. Harbor sheds, built with contraction joints for normal conditions, have been set "out of plumb." One 120 by 832-foot steel-and-concrete structure was shortened by  $12\frac{3}{4}$  inches on one side, resulting in the cutting out of a strip the full width through the building to permit "replumbing" and rejoining of the structure's halves. Other such properties will have to be raised, additionally entailing elevation of railroad and highway approaches to a grade still practicable for traffic. Coupled with destructive horizontal movement is prohibitive size needed for a dike, if a large-scale plan using this device were adopted.



Discharge tube, pumped to keep rain and floodwaters from area, runs through one of the protecting dikes

Enclosure of 15 square miles with a broad dike 30 feet high and impervious to seepage would be necessary, and tremendous locks and gates would have to front harbor entrances.

Even drainage problems now cannot be faced in this area in the usual way. Flow of storm drains has been reversed, complicating this common remedy for handling surface-water floods. Where once these mains carried water to the sea, salt water now flows back to inundate streets and buildings. Sewers have been crushed at their joints. A 48-inch line, leading to a treatment plant, now carries ground water

(Continued to page 250)

Water in foreground covers the floor of a wharf that was once many feet above high tide at Long Beach

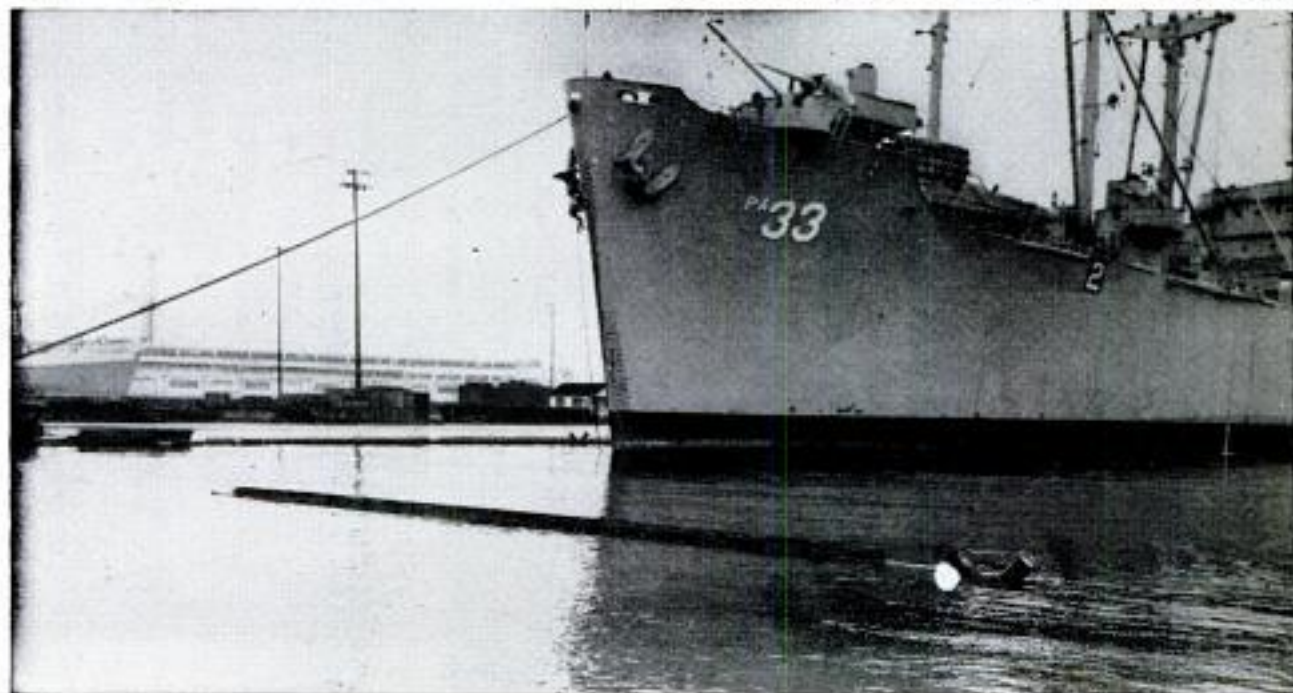



## Viewer Enlarges Image Five Times

People with poor vision can read easily with a viewer that projects a three or five-times-enlarged image of text on a foot-wide screen. The unit is illuminated by a 40-watt bulb, is small, light and rugged enough to be portable. The counter-balanced top housing is pushed down to rest on the book or magazine page, and is easily raised to allow for turning of pages. No focusing adjustments are necessary.

## Vacuum Cleaner Sweeps Airport

Landing strips at Baltimore's Friendship International Airport are swept with a 30,000-pound vacuum cleaner that has the power of 1200 living-room units. It can clean 2,000,000 square feet of runway an hour. The unit picks up loose bolts, nuts, gravel and other litter harmful to jet engines.

This 30,000-pound vacuum cleaner has power of 1200 living-room vacuum units

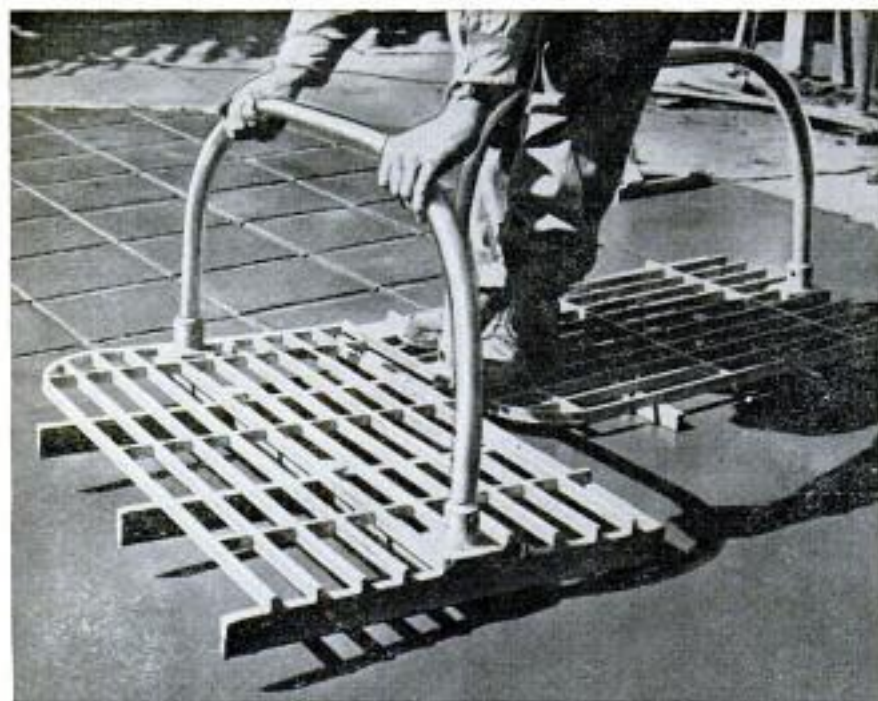
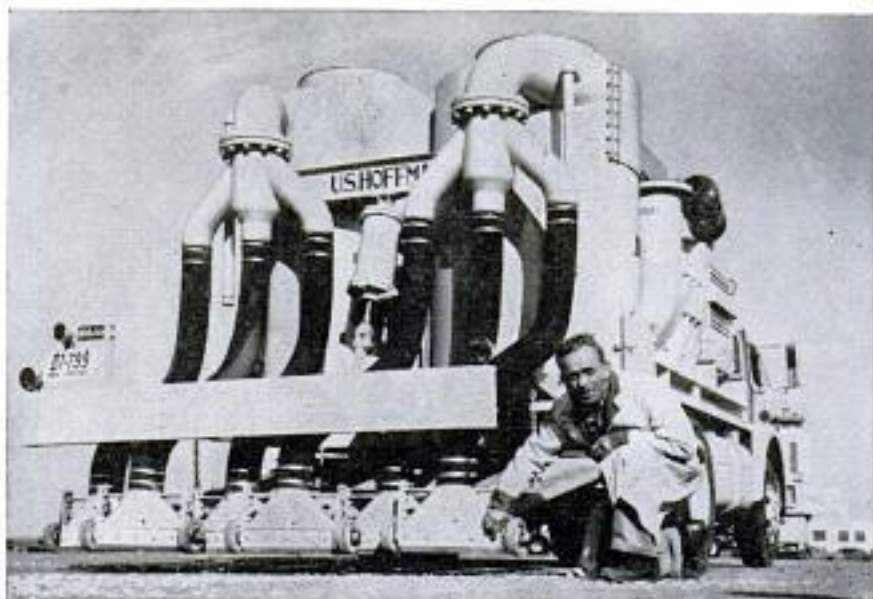

## Tool Stamps Design In Concrete

Poured concrete slabs can be given the appearance of hand-laid brick and tile with a new tool that stamps a pattern into the surface. The concrete surface first is topped with color. After the surface is troweled to the desired texture, the tool with its projecting metal flanges is used to impress the surface with the pattern. After the concrete is cured, the joints are filled with mortar. The method, says the manufacturer, is less expensive than brick or tile.



## Outboard-Motor Generator Powers Boat Accessories

AN AUTOMOBILE-TYPE GENERATOR is one of the features of Evinrude's '57 outboard-motor line. Also, some of the new motors have higher horsepower, a slip-clutch propeller for underwater obstacles, a reduced-compression system for easier starting and an improved air silencer. The new generator, optional equipment, is a d.c. system for two of the company's 35-horsepower motors. It provides power for a boat's electrical accessories, such as lights, phone, pumps and radio. The generator is rated 12 volts with continuous output of 10 amperes. The system is equipped with a current and voltage regulator to prevent overcharging of the battery. Powerwise, the firm's 15-horsepower models have jumped three horsepower, while the 30-horsepower motors are up to 35 horsepower. The new slip-clutch propeller disengages on contact with a subsurface obstruction and engages shortly after passing the rock or log.

Heavy-duty generator, reduced-compression system and slip-clutch propeller are at right. Below is boat electric circuit

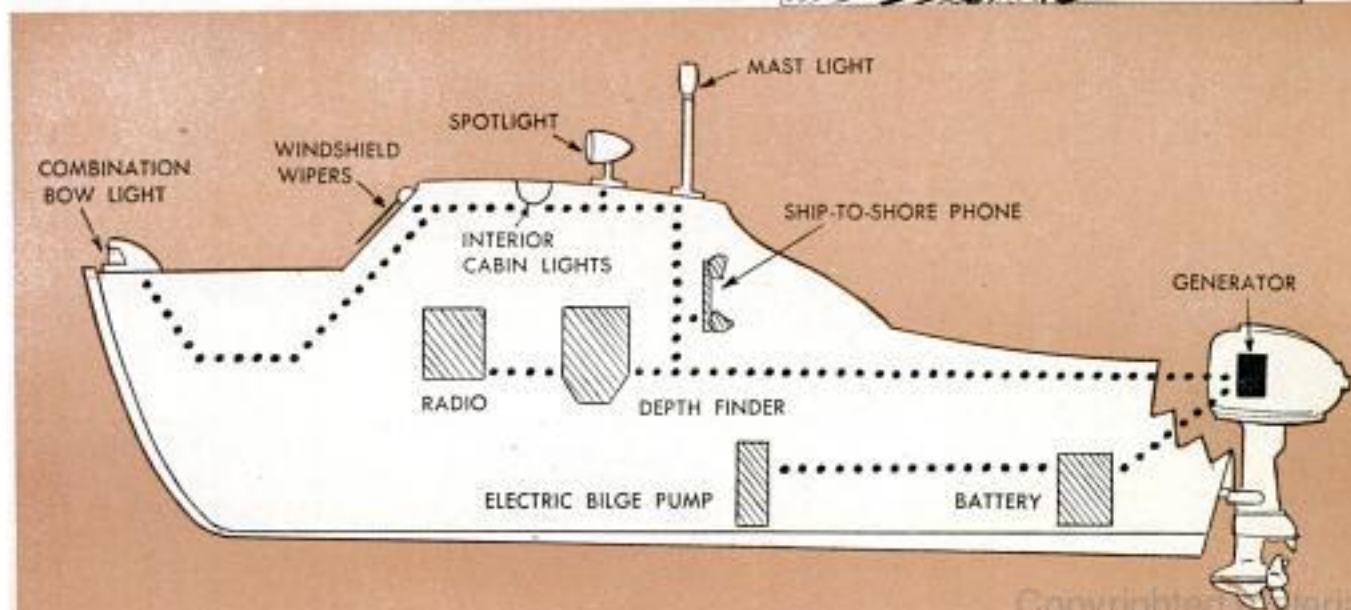
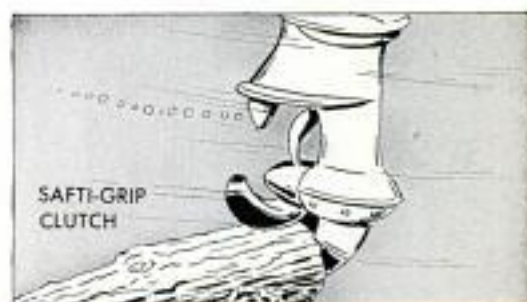
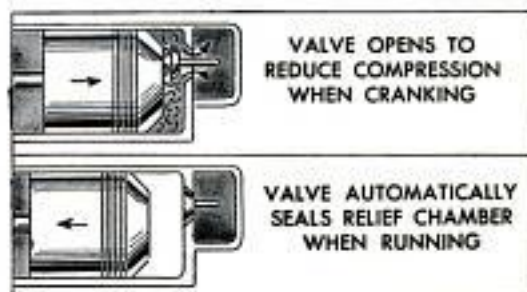
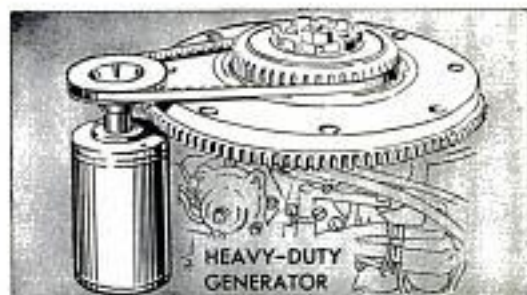



By Harry F. Unger

# Family Airport

Left, "Alabam" and his boys change the wind sock at Airhaven once each year. Below, an ambulance service uses the airport as an emergency terminal

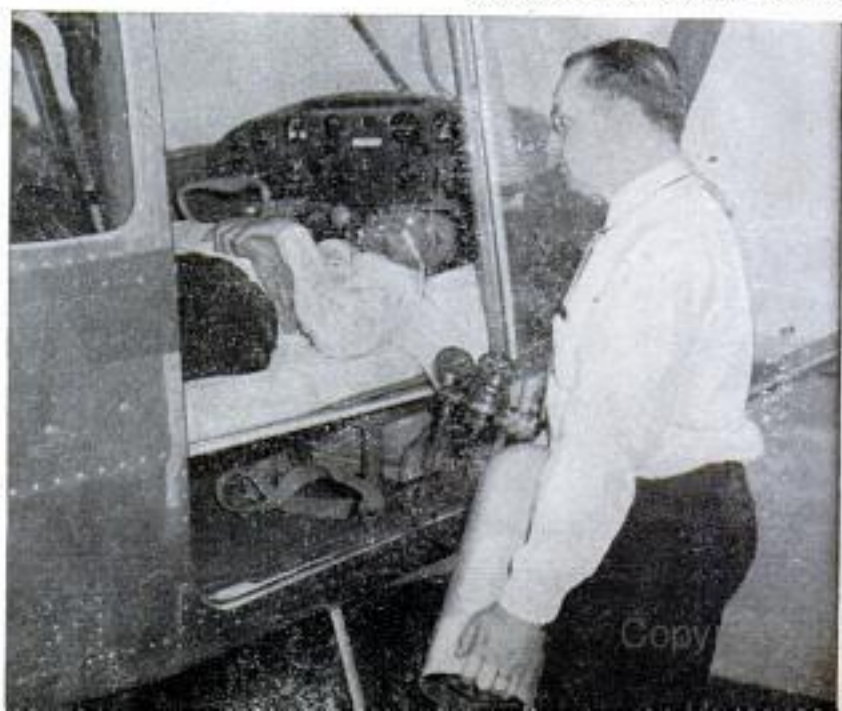





This is a bird's-eye view of Airhaven Airport, with its 3200-foot-long strip and 130 acres of facilities

**S**TRETCHING OUT before a mobile home near Glendale, Ariz., is a 3200-foot-long "welcome mat" named Airhaven Airport. This strip forms the nucleus for a one-family business operated by five human dynamos—the Powers quintet.

Each member of this clan has specialized duties. Garrett "Alabam" Powers, the father, inspects and rebuilds small aircraft. Elizabeth, his wife, replaces fabric on several plane wings weekly and reupholsters cockpits. Melvin, 14, and Carl, 10, refuel, wash customers' ships, and clean up the airport in out-of-school hours. And a 65-year-old grandfather, R. C. Powers, rides herd on the bookkeeping.

From the status of stockholder and head of the firm's maintenance shop since 1946,

Alabam took over responsibility for the failing field after the organization had burst its post-World War II financial corset. Today, from 75 to 100 planes use this successful airport's facilities on week ends, and about 50 to 75 aircraft are based permanently on the strip. Flying groups, such as the Crowl Dusters; Luke Aero Club, composed of nonflying Air Force personnel; Westside Flying Club, and the Grimshaw Air Ambulance operate from Airhaven. Incidentally, numerous air searches for missing persons and escaped convicts have originated from this field, with Alabam assisting the flying deputy sheriffs of Maricopa County on a neighborly no-charge basis.

For the average plane owner no radio

Rolling the small planes around the airport is one of the tasks in which three of the Powers' clan "turn to"





Mrs. Powers checks the upholstery, while Alabam looks over a faulty engine in the airport's repair pit



"Mrs. Alabam" and son put fresh fabric on a plane wing. This and upholstery are her specialties

Below, the Powerses pack for a picnic flight. Right, below, Alabam hand signals to an incoming plane



equipment is required to land at Airhaven. Although the intercom is in service from 8 a.m. to 10 p.m. daily, many are the times Alabam is routed from sleep to direct a transient pilot and his plane to the next airport on a flight plan. Alabam also has installed an underground refueling island of his own design and gradually is oiling the runways and ramp for dust control.

A World War II CAA inspector of B-24s and B-29s, Alabam has loved aircraft since his first contact with barnstorming pilots in 1927 at Waycross, Ga. In fact, the family now owns a Piper Tri-Pacer Model 150, a Cessna Air Master, C-165 and a Piper P-11 trainer. The Powerses occasionally use the ships in joining a breakfast flying club.

But the quintet is engrossed chiefly in running noisy Airhaven, which is their front yard. For the Powerses, the roaring planes on the strip make a lulling sound. Alabam says: "When that noise stops, something's wrong." And he's right. ★★



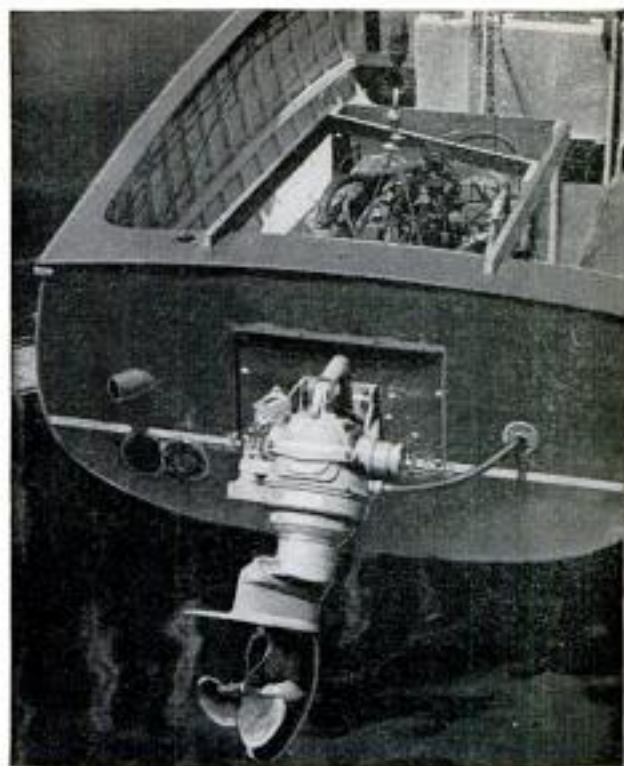
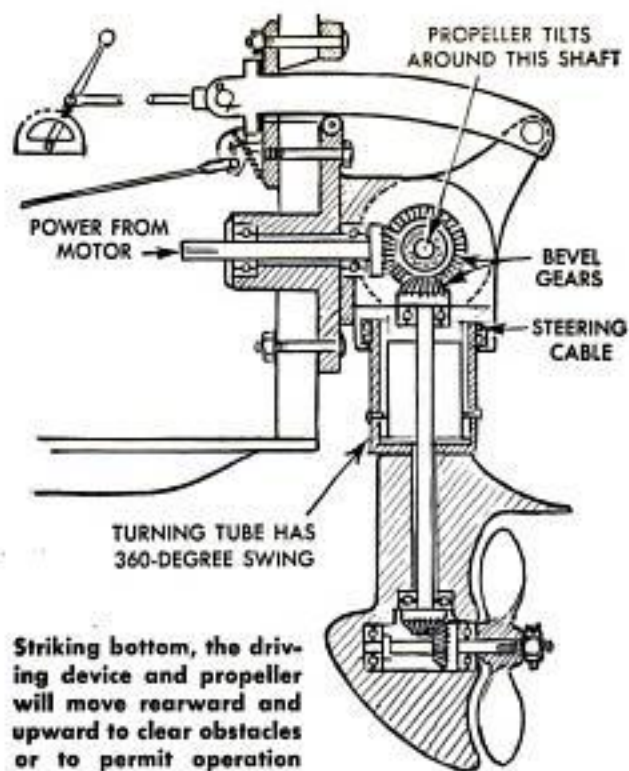

## INBOARD-OUTBOARD BOAT

BY AN INGENUOUS propulsion system, Robert W. Hills of Miami, Fla., has made his inboard-powered boat as maneuverable as a smaller craft fitted with an outboard motor. Hills worked two years to combine advantages of inboard and outboard motors. His 19-foot boat has a 75-horsepower

inboard. The drive shaft goes through the boat's transom to bevel gears which transmit power to the propeller. Gears permit the propeller to be turned to face in any direction and to be moved upward in an arc from vertical to horizontal, allowing use in water as shallow as the boat's draft.

Builder of this inboard-outboard combination is able to whip the craft around safely within its own length





Driven off the road into a pile of sand at 40 miles per hour, the test car shows no signs of loss of control

## CENTER-LINE STEERING—Better Than POWER?

**T**HERE'S A 1951 Cadillac in Benton Harbor, Mich., that has been driven off the road more times than anyone cares to recall. It's a test car for a steering system that some experts say is better than power steering—and it has no power assist at all.

It's called center-line steering and what it does you'll probably refuse to believe. That 1951 test car can do things that would put other cars into a ditch and the drivers into a hospital—and it does it without a moment's loss of control or, for that matter, without any sensation of danger.

You can aim the center-line-equipped car off the road into a deep and soft shoulder, take your hands off the steering wheel and just sit there! What happens? Nothing! The car plows right through the soft dirt.

At 40 miles per hour you can aim the car so one front wheel will hit a big pile of sand. Take your hands off the wheel. Again, nothing happens. The car plows ahead without a twist or a jerk.

What's behind all this magic? Simply an application of the laws of leverage.

The conventional front end has its wheels mounted on spindles that extend outward six inches or so from the pivot on which the weight of the car rests. Every time one front wheel hits a bump, a soft pile of sand or snow, or drops off into the shoulder, the thrust rearward is multiplied by the leverage of the spindle. The force jerks the steering wheel around, twists the other front wheel and may cause a complete loss of control.

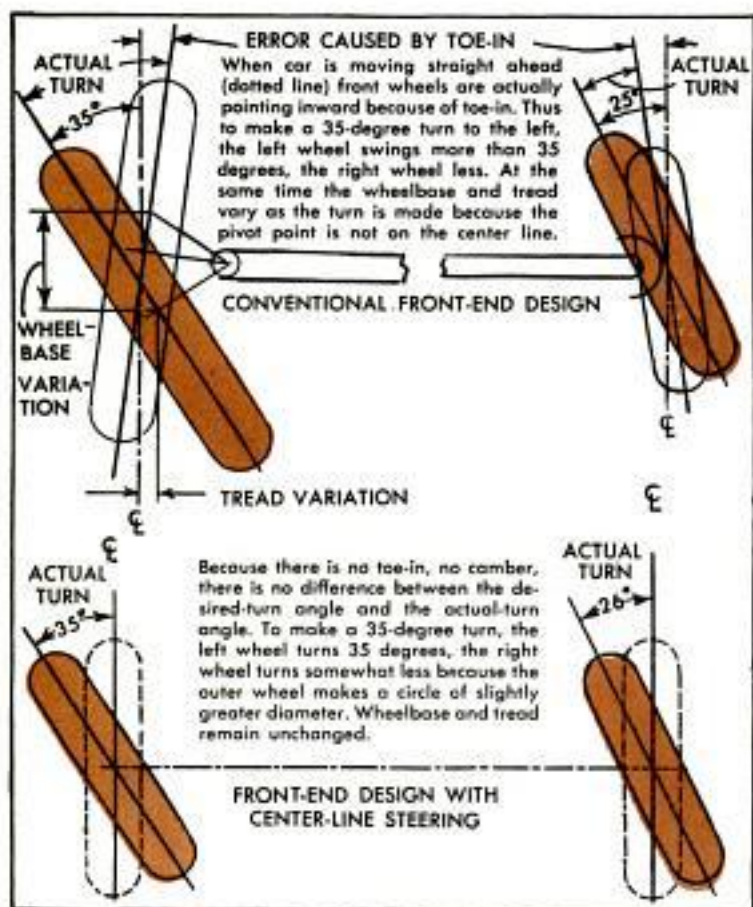

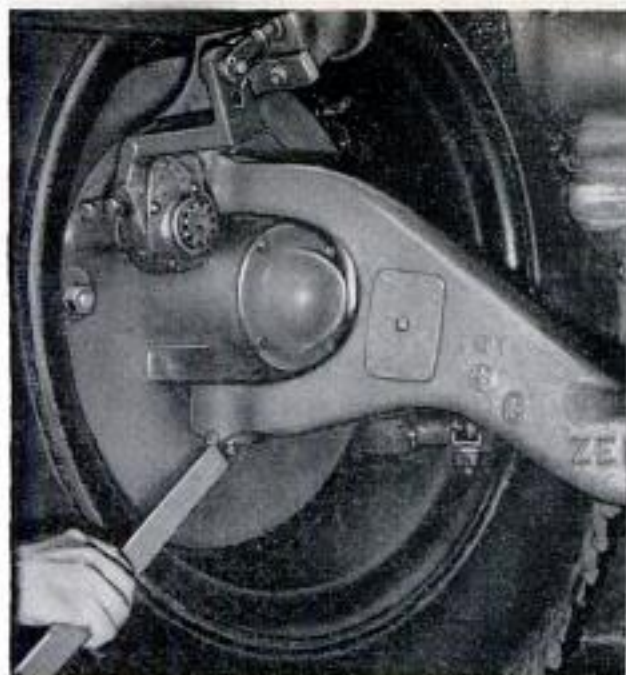

**CENTER-LINE steering on truck.** Stick shows where load is carried. Bearings are on center line of wheel

With center-line steering that's eliminated. There is no leverage effect. Forces pushing against the front wheel are thrust directly along the center line of the wheel and there is no twisting to turn the wheels and cause loss of control. That's why you can take your hands off the steering wheel while a front tire is blown out from under you without so much as a moment's fright.

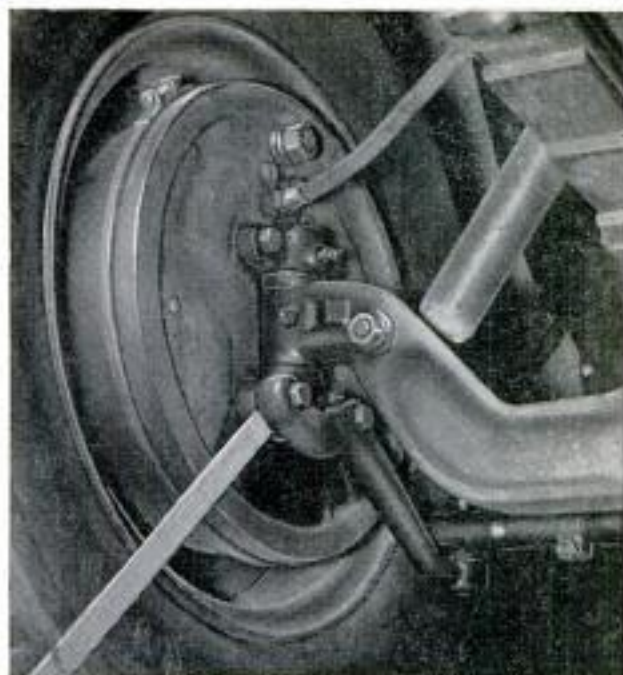

**CONVENTIONAL design.** Stick points to kingpin. It carries the load far inboard of wheel center line

The car goes straight ahead bumping along on a flat tire.

What other advantages are there? Well, steering is effortless just as long as the car is moving. When it's absolutely stationary, steering is no easier than that of any car without power steering. But just edge the car ahead, even the slightest bit, and

(Continued to page 248)

CENTER LINE OF THE WHEEL

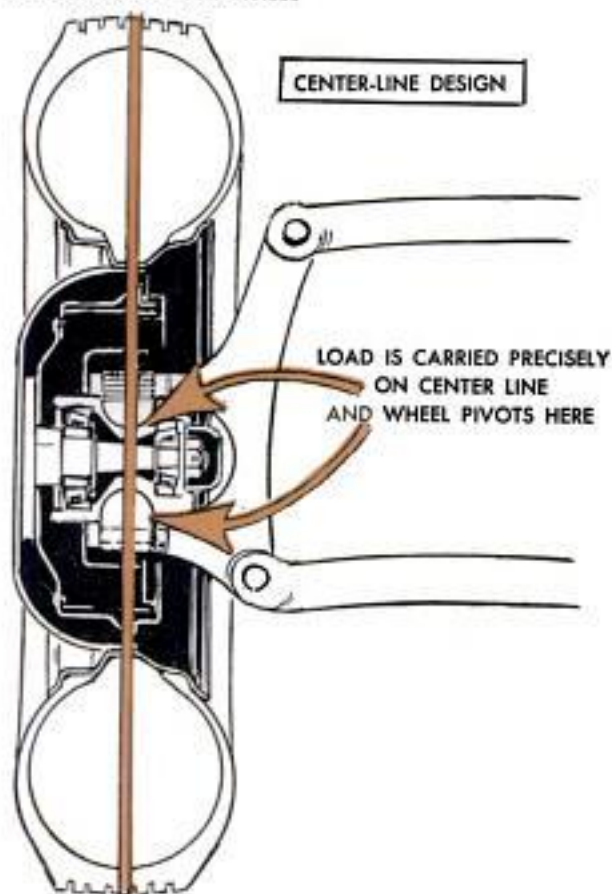

CENTER LINE OF THE WHEEL

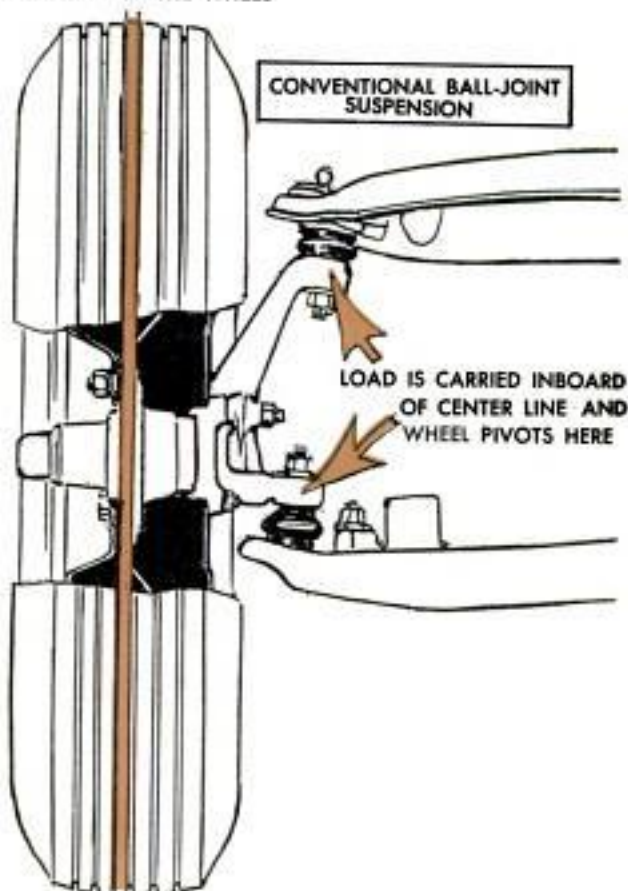

## Gasoline Engines Power Small-Fry Tractors

Left, crawler-type tractor and below, wheel-type for miniature farmer

Two miniature tractors are the pride of an Iowa farm boy. Marvin Green, a Boyden, Iowa, farmer, built the two tractors for his seven-year-old son. Both are powered by air-cooled gasoline engines. One is a row-crop wheel tractor with a 1929 Ford transmission and differential and a 1923 Chevrolet steering gear. It even has a hand clutch in keeping with its full-size counterpart. The other is a crawler type, with tracks made of plates welded to heavy roller chain. Model-T clutches steer the tractor.



## Straps Clamped to Car Permit Motorists to Carry Extra Clothes

You can carry extra clothes on your next automobile trip with hooked straps that are clamped in the top of the rear door and fastened to rain gutter. Each strap holds up to five garment hangers. When not in use, the folded straps are kept in the glove compartment.

ⓂJupiter once had 20 times its present mass, members of the American Astronomical Society have speculated, but lost the excess through gradual evaporation.

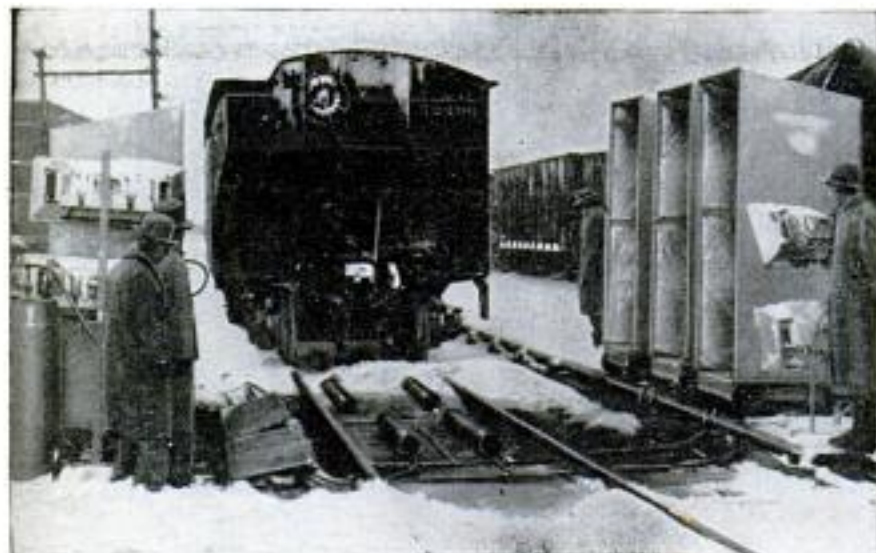

## Infrared Rays Thaw Frozen Coal Train

Coal frozen in rail cars is thawed for unloading by gas-fired infrared heaters on each side of the tracks. The method halves usual thawing time. If tests are successful, similar units may be installed in 400-foot-long corridors along the tracks to thaw cars as they move toward unloading points. The process may supplant methods using oil burners and torches.



Hybrid varieties of corn resist disease, are multiplying the farmer's yield

*Plant diseases cost each person in the United States \$20 per year. In this article, the last of a series on the farmer's greatest enemies, science sets its sights on*



Doctor Stakman, one of authors, studies wheat in test plot. Specially bred varieties resist rust

## GOAL No. 3

# DISEASE-FREE CROPS

**By Dr. E. C. Stakman,**  
*Professor Emeritus of Plant Pathology and former Head of the Department,  
University of Minnesota;*  
and

**Dr. Carl J. Eide,**  
*Professor of Plant Pathology, University of Minnesota*

**N**OT LONG AGO a truck gardener in Minnesota discovered that his land had become infested with a particularly destructive fungus. The fungus causes a disease known as club root in cabbage, cauliflower, turnips and similar crops. Today the fungus still is in the truck-gardener's soil and will stay there indefinitely,

for no one knows a practical way of eliminating it. The man's land is worth more than \$1500 an acre, yet he faces the necessity of growing a less profitable crop than those he formerly raised. To him, the fungus invasion is a tragedy.

The Minnesotan is just one of thousands of farmers whose profits are being ravaged

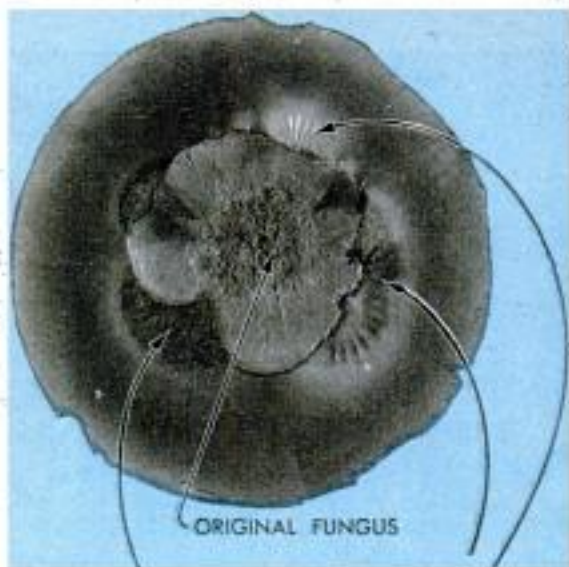

**MUTANT TYPES THAT MAY PRODUCE DIFFERENT EFFECTS ON CORN**

*University of Minnesota photo*

Ordinary corn-smut fungus naturally produces several mutant types with different effects than parent type

Late blight fungus killed potatoes in foreground; plot in background was sprayed with modern fungicide



Experiment shows yield of potatoes from rows of equal length, sprayed with different fungicides. The old standby, Bordeaux mixture, had little effect. Note big yield with Manzate, one of the newer fungicides

*Ministry of Agriculture of Colombia photos*



by plant diseases. But farmers are not the only losers. Plant diseases cost the United States at least \$3,000,000,000 a year. You, the consumer, pay this high bill at the rate of almost \$20 for every person in your family. Obviously we need better disease-control methods.

The farmer has only one interest in plant-disease control. It enables him to produce greater yields of higher-quality crops at lower cost. If a control method does not pay, he does not use it.

### Important Advances

Progress in the field of plant-disease control is not spectacular. Yet important advances in plant pathology, the science of plant diseases, are being made constantly.

Compare the problem with that of human or veterinary medicine. At present, diseased plants can't be cured like most sick animals and humans can be cured. Therefore we must prevent the diseases. Of course, if blighted leaves or rotted limbs of trees are removed, the rest of the plant



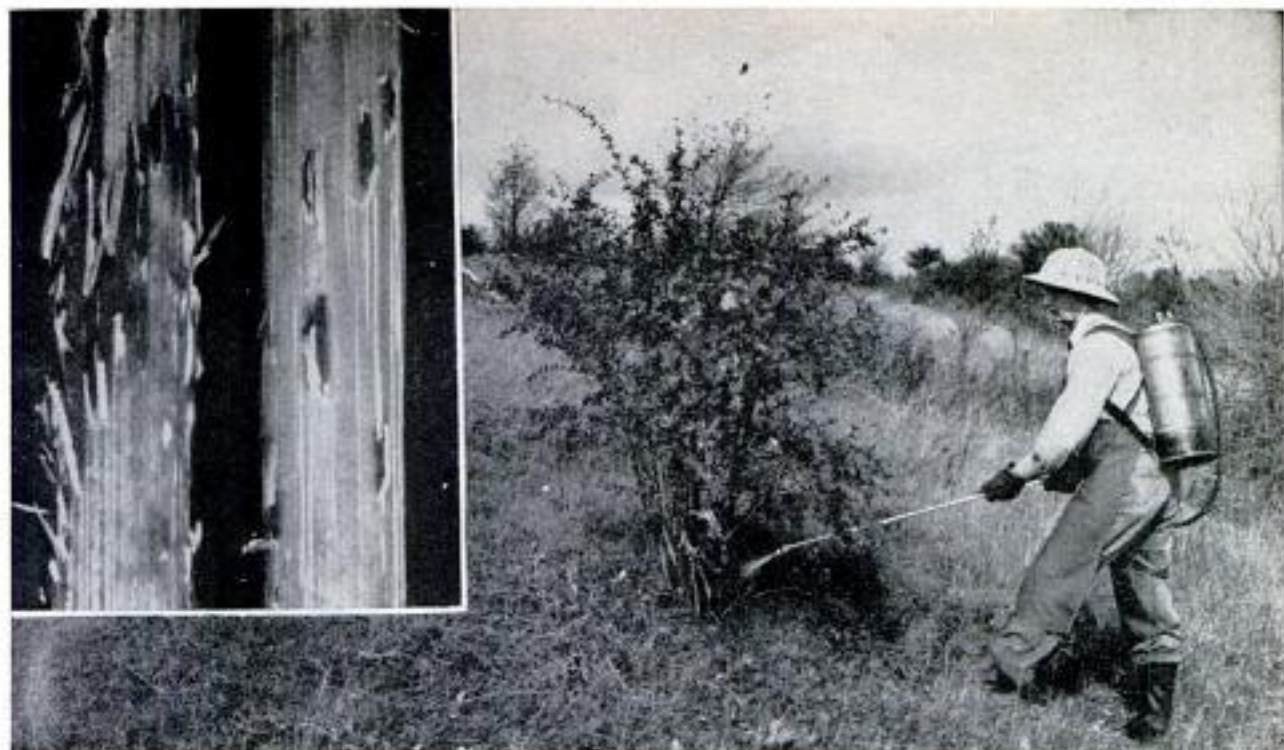

U. S. Department of Agriculture photo

**Inset, wheat ruined by stem rust. This can be prevented by spraying nearby rust-spreading barberry bushes**

may survive without apparent harm. The lost parts may be replaced by new growth, but the part of the plant that is infected does not recover in the sense that a person recovers from measles.

And there's another difference. Only rarely is an individual plant valuable enough to receive care as an individual patient. A farmer would have 300,000 corn-plant patients on 20 acres of corn if he gave each one individual care. Therefore we must try to prevent disease in entire fields or even more extensive areas. This means it is largely a matter of "plant public health," and in many cases must be managed by public servants rather than individual farmers.

The problem is fantastically complex. There are hundreds of kinds of crops, and each may be attacked by many diseases in its life from the seed bed to the seed bin. Malnutrition—a deficiency of nitrogen, phosphorus, potassium, boron or other mineral elements—causes some diseases. Bad weather can touch off others. Most diseases, however, are caused by microscopic organisms—parasitic fungi, bacteria, nematodes (microscopic worms) or viruses. They live on or in the tissues of the plant and are called plant pathogens. Plant pathology tries to enable man to eat plant products before the pathogens eat them or spoil them.

#### **Diverse Weapons**

There is such a wide variety of plant diseases that we must have diverse weapons to fight them off. The successful farmer or

florist knows what diseases are likely to attack his crops and takes steps to prevent them. Here is a list of his possible steps in the order they might be employed during the season:

**Barley seedlings at left were grown from disinfected seed. Those at right were untreated, probably will die**

University of Minnesota photo

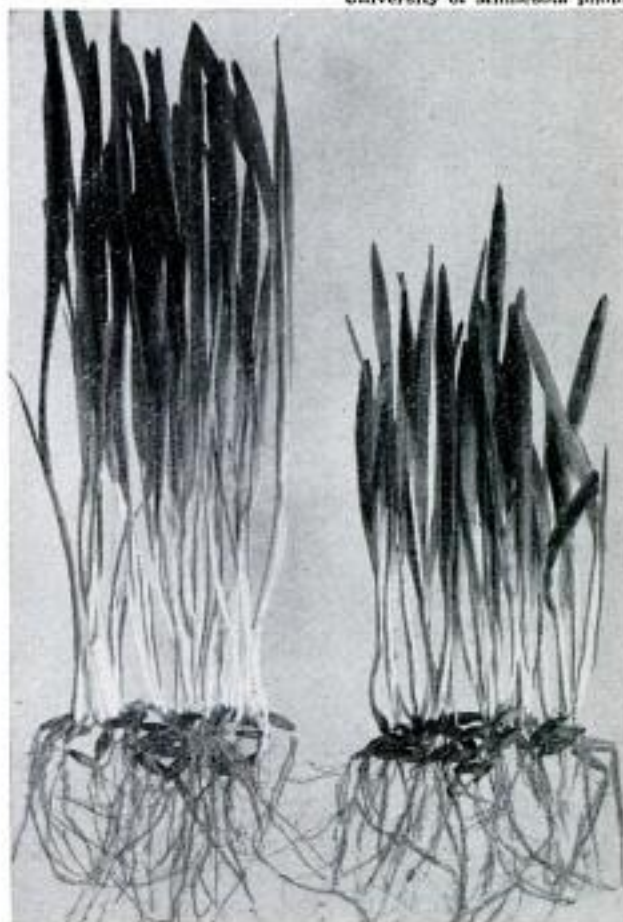

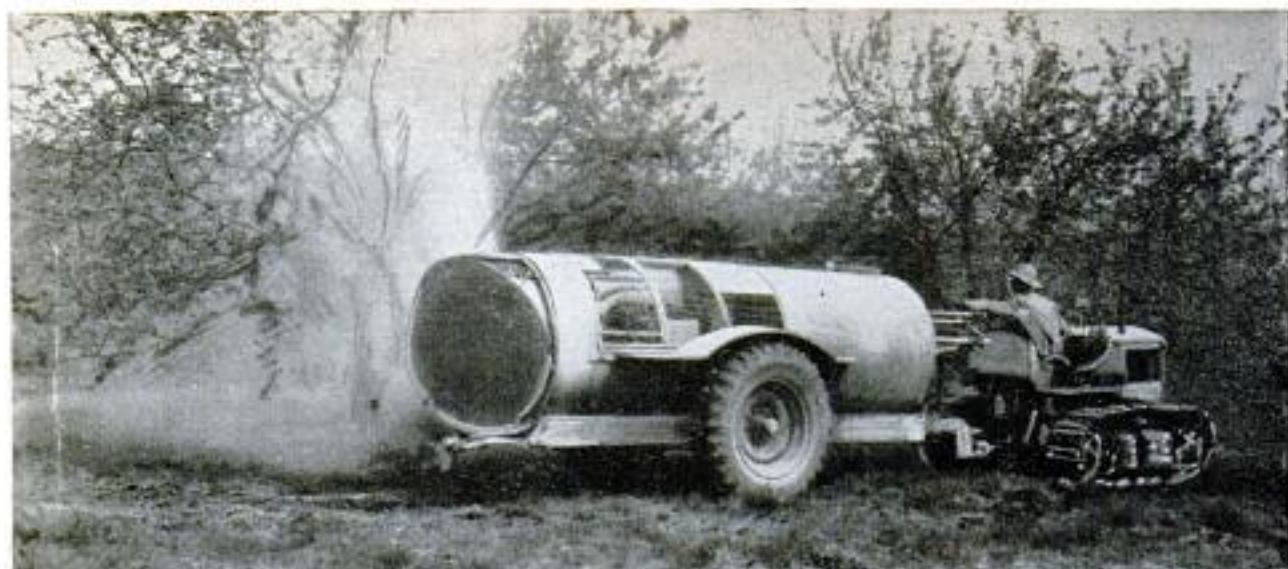

University of Minnesota photo

Huge modern sprayers can blanket entire orchards with fungicides, assuring higher yields from healthy trees

1. He selects crops suited to soil and climate, fertilizes the soil properly and uses the right methods of cultivation.

2. He avoids land infested with disease organisms, or rotates crops so the organisms will die out, or kills them with steam or chemicals.

3. He selects disease-resistant varieties if possible.

4. He uses seed or other planting stock that is free from pathogens.

5. He disinfects the seed or planting stock with chemicals or heat if diseases can be prevented in that way.

6. He sprays or dusts growing plants with fungicides if it is possible and profitable to do so.

Other measures, such as quarantining or destroying diseased plants on a large scale, cannot be done by the individual and therefore must be done by government agencies. The important point to remember is that there is no panacea for plant diseases.

#### No "Miracle Drugs"

To most of us, the phrase "plant-disease control" conjures up a picture of a farmer spraying his crop with some kind of disinfectant or medicine, the plant equivalent of a bottle of pills or shot of penicillin. Although millions of dollars are spent each year on such "medicines," called fungicides, they will control only a small

(Continued to page 252)

Flax production would be impossible without resistant types, as shown in differing yields of these test plots

University of Minnesota photo



## Magic Whistle Stop Shuts Off Radio

Simply by squeezing a "magic" whistle, you can turn a new German radio on or off from across the room. A specially tuned relay system responds to the frequency of the whistle. It makes it unnecessary to walk across the room to quiet the radio when you want to talk on the telephone.

## DC-3 Still Popular

Most commonly used plane by United States' domestic airlines is still the pre-war DC-3, with 302 of them flying out of a total of 1118 airliners in operation.



## Automobile Desk Folds for Storing

Resting on the dashboard and seat cushion, an automobile desk provides a firm, smooth writing surface for salesmen, route men or anyone who must take notes in a car. The writing surface is a firm sheet of steel and has a spring clip on it that keeps papers in position. The desk can be closed to a length of 26 inches for storing when not in use.

☐ An Arizona inventor has been granted a patent on a mixture of cotton-gin waste and molasses in pellet form for livestock feed.

## Automatic Enlarging Timer Eliminates Need for Test Strips

Projection prints are exposed correctly every time without test strips by a fully automatic photoelectric enlarging timer. The photosensitive head measures the light as it falls on the enlarging paper and shuts the enlarger off when properly exposed. It can be used with any enlarger. All you do is place the negative in the enlarger, set a paper-selector dial to the proper sensitivity and aim the photosensitive head at the projected image. Then with the paper in the easel, turn on the enlarger and the timing control does the rest, turning off the enlarger when exposure is complete. The device is designed for use by professional photographers.





## WHAT'S NEW FOR Home

**BABY HIGH CHAIR** fastens to and folds under the kitchen table. Four screws secure a bracket, which holds the chair at the correct distance from the table edge. Folded, the chair is 4 inches deep, 13 inches wide, and extends 22 inches under the table top. A child cannot stand in this chair, which has an anodized-aluminum frame of etched aluminum finish or varied colors. A special table converts for adult use

Plymouth Mfg. Co., 5825 Tingle Ave., S.  
Minneapolis 10, Minn.

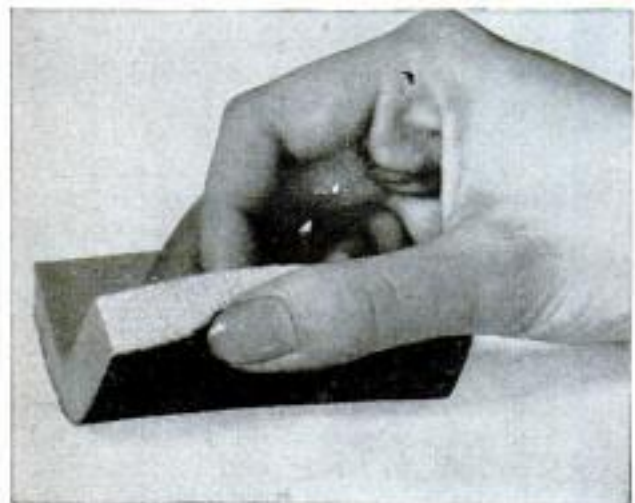

**FOAM-RUBBER PAD** coated with abrasive particles will scour and polish without scratching. Flexible and compressible, this pad rinses clean prior to squeezing and drying. There is no danger, as in metal pads, of slivers harming the skin. Measuring three by three inches, the pad is one half inch thick. After use in the kitchen, the pad becomes less abrasive and can be used to clean bathtubs, sinks and enamelware

Rubber Scrubber Corp., P.O. Box 122, Watertown, N. Y.

**CONVERTIBLE SOFA** automatically becomes a bed nine seconds after you have set the controls and turned a key in a lock on the sofa. The mechanism operating these controls is inside the upholstery. Power comes from a one-third-horsepower electric motor. To prevent accidents a fuse in the mechanism blows when more than 15 pounds' pressure has been exerted against the sofa while it is converting into a bed

Castro Convertibles, Nassau Terminal Bld.,  
New Hyde Park, N. Y.



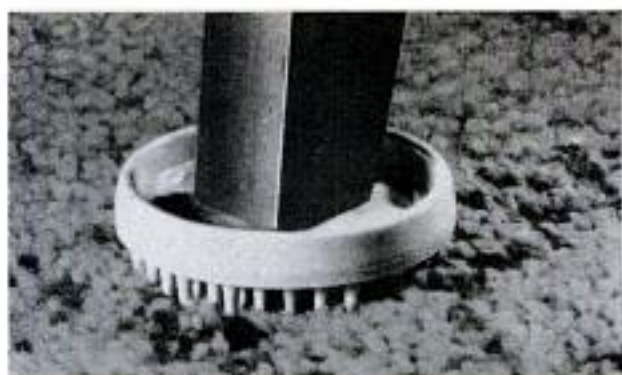

**FURNITURE SUPPORTS** will not mar or dent your carpet. Many molded legs give multiple support, permitting the pile of the carpet to remain vertical under the heaviest of loads. Made of plastic, these supports keep furniture from shifting and are available in blonde, clear or walnut-mahogany-type finishes

Childlore Co., 331 Southwest Blvd., Kansas City, Mo.

**AUTOMATIC TOASTER-OVEN** features a vertical toasting section and an oven drawer. A selector dial indicates toaster or oven. Another dial sets the degree of brownness in the toasting section or oven. A chrome-plated steel shell covers the unit, which has heat-resistant plastic handles, feet and controls

General Electric Co., 1285 Boston Ave., Bridgeport, Conn.

**BURGLARPROOF LOCK** has no keyhole on the outside of the door for prowlers to "pick." No knob turns or moves without a specially fitted key. This lock fits any door and is of all-metal construction. Using one-way slotted screws, the lock can be installed without removing the present lock. Lock resists forced entry

Loxem Mfg. Co., 481 Main St., New Rochelle, N. Y.

**CENTRALIZED VACUUM CLEANING** operates from a motor, suction fan and dust collector installed in the basement, garage or utility room. Steel pipes in the walls run from the basement unit to various rooms in the house, emerging at floor or wall outlets. A 25-foot, lightweight tube plugs into outlets for cleaning

Central Vacuum Corp., 3667 W. Sixth St., Los Angeles 5, Calif.



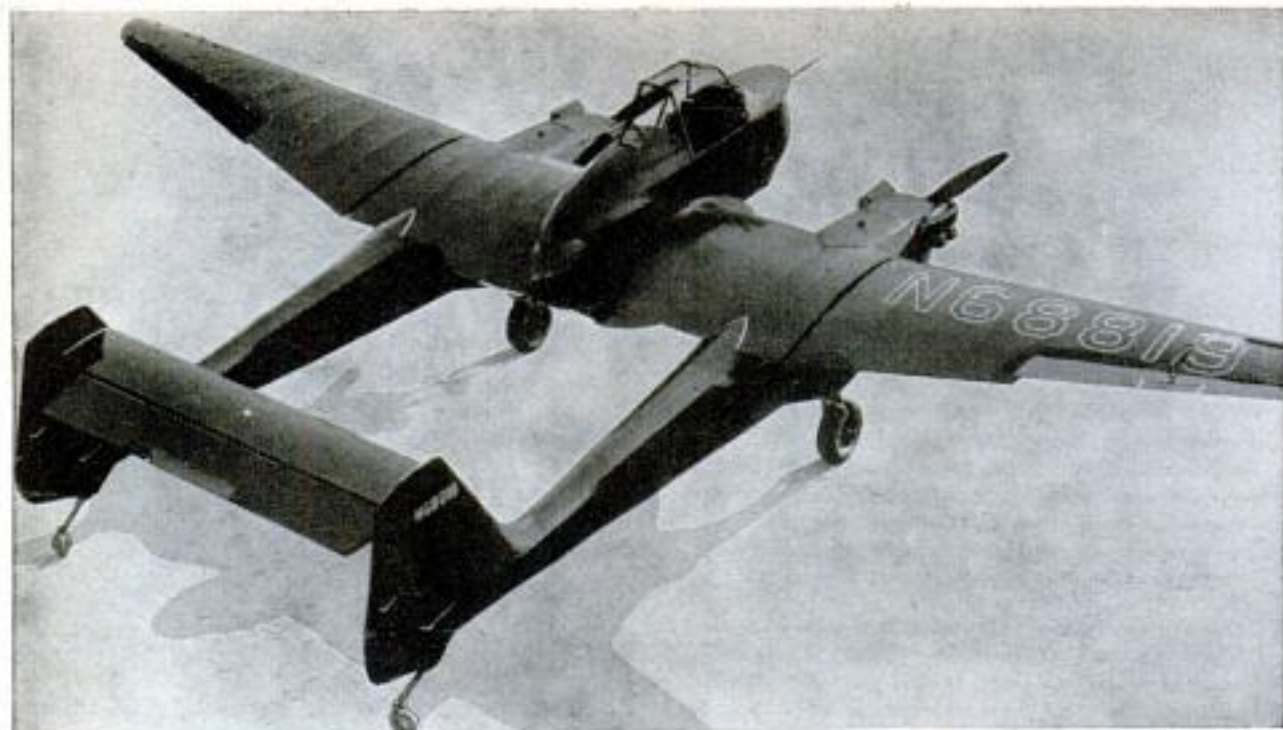

## POD PLANE

POD-CARRYING PLANES that can land, detach their cargo, hook on another pod and take off in a fraction of the time conventional aircraft transfer their cargo are the proposal of E. W. "Speed" Gardenhire.

The prototype "AirUtility" has already been built by the North Sacramento, Calif., pilot, mechanic and aeronautical engineer. He would like to produce a fleet of these versatile planes which could carry passengers, freight, military supplies and a variety of special loads in specialized pods fastened between the wheels, beneath the cockpit. Loading and unloading would be reduced to the simple operation of attaching or detaching a convenient prepacked unit. There would be no waste time for the power plant.

Speed, his wife and daughter, have adopted the twin-tailed bimotor as a family project. AirUtility first flew in 1949. Modified, it is now undergoing certification tests. Three freight lines and agricultural dust sprayers are interested in the plane.

PASSENGER POD



AMBULANCE POD

CARGO POD



CARGO LASHED



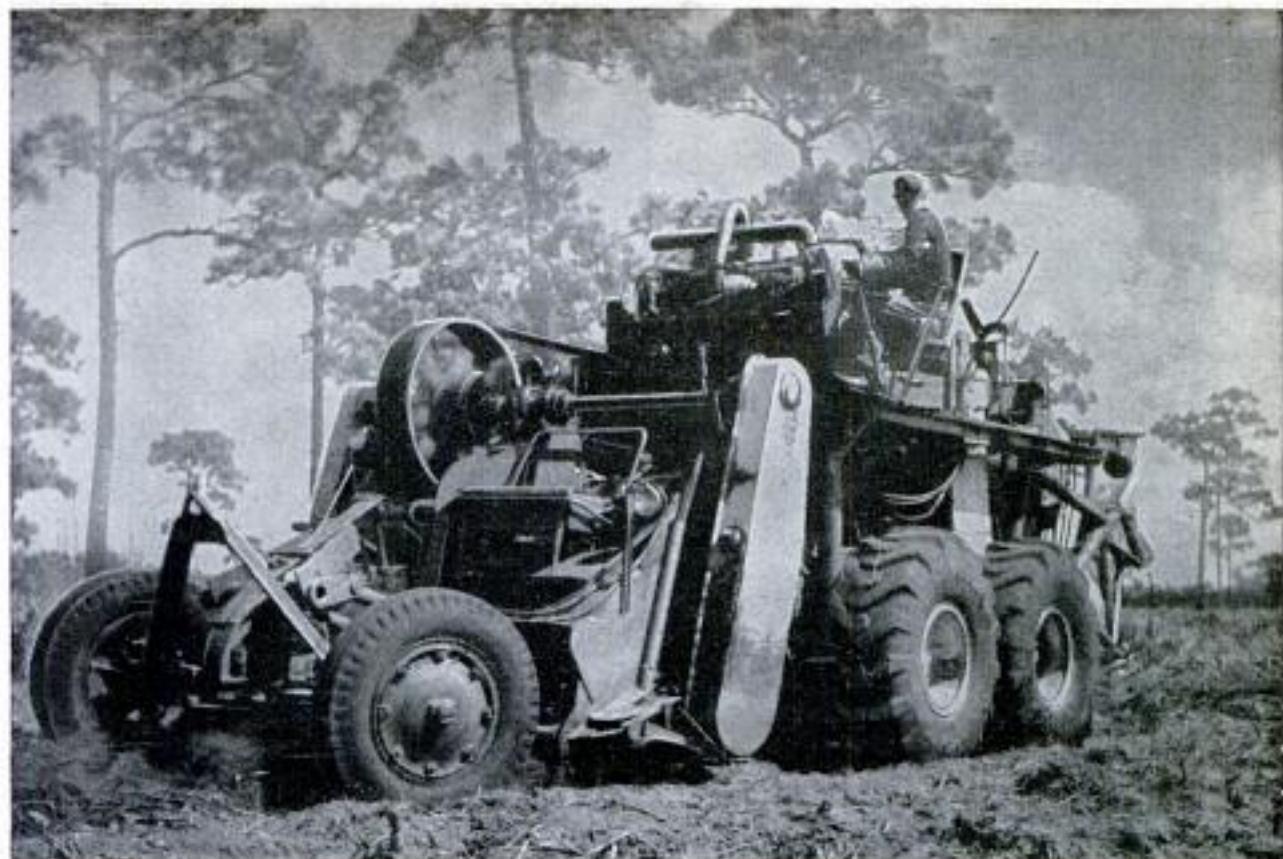

Rotary plow beneath the huge machine digs up palmetto roots and other brush to clear Florida farmland

## Plow Clears Palmetto From Florida Farmland

Clearing farmland in Florida consists largely of rooting out palmetto, a low growth with fan-shaped leaves. A huge new machine not only clears the palmetto but stacks it for burning. A rotary plow digs up the palmetto and other roots. The brush is deposited on a conveyor and carried to a big basket on the rear of the machine. When the basket is full, the brush is dumped in a pile. The machine will clear up to 20 acres in 24 hours.

Roots are deposited in a big basket at rear of the machine. Later the basket is dumped. Pile of roots can then be burned



## Water Jet Scales Fish

Fitted to an ordinary garden hose, a special nozzle produces a powerful jet of water which lifts the scales from fish. Bass, bluegills, crappies and most game fish can be scaled with the water jet. The fish is held by the tail in a clamp, and is flopped over when the scales have been cleaned from one side.



Model showed engineer that small triangular segments at opposite balance points held up structure



When triangular segments were removed simultaneously with jerk on a string, model fell straight and true

Holes were drilled in the wall at predetermined balance points and dynamite charges packed inside

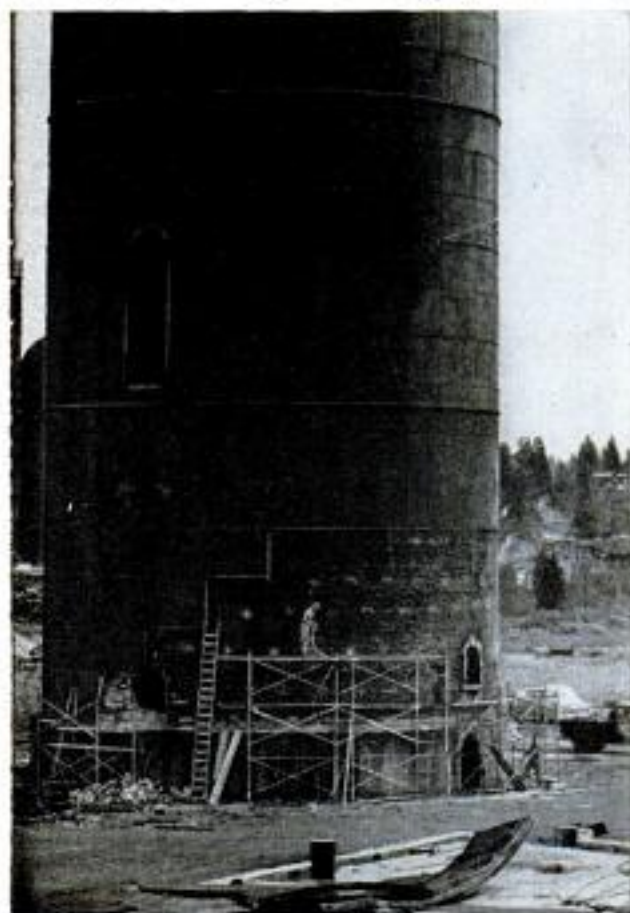

Engineer marked out the predicted line of fall as determined by the model, then touched off dynamite

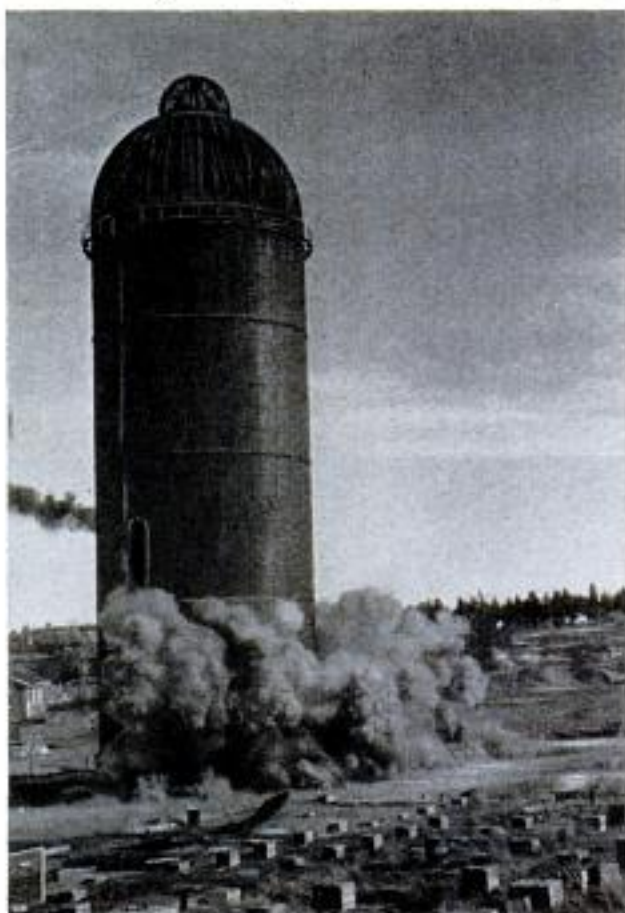



**I**N THE LUMBERING TOWN of Bend, Ore., a huge structure recently was felled with all the accuracy of an old-time lumberjack felling a big tree.

The structure was a sawmill scrap burner 160 feet high and 50 feet in diameter, built from 90 tons of steel and 835 tons of masonry. When a lumber company decided to abandon the structure, the contract for razing it was given to young civil engineer, H. A. Pyzdrowski.

Pyzdrowski believed there was an easier and better way to do the job than to take the huge structure apart piece by piece. He suggested that dynamite be used to fell the old scrap burner. It was considered a risky step to take because the only time dynamite had been used to raze a somewhat similar building, the structure had fallen in a different direction than anticipated with disastrous results to surrounding buildings.

To convince the owners that the operation would be successful, Pyzdrowski built a scale model of the burner. Next he made a cut in the model similar to the cut a

woodsman makes in felling a large tree. He made the cut in segments so he could determine precisely which segments controlled the fall. With the aid of the model, he discovered that small sections at the balance points on opposite sides were the elements which accurately determined direction of fall. Rather than risk failure due to a miscalculation at these points, he had them drilled out with an air drill.

When the time came to fell the burner, the overlay of  $\frac{3}{16}$ -inch steel plate was removed from a section of the wall in an approximation of a woodsman's cut. In the three-foot-thick brick wall, 156 sticks of dynamite were placed with the greatest load at the bottom. The dynamite was fused so the bottom charges would explode first, leaving room for the rubble from the higher sections.

Prior to dropping the burner, Pyzdrowski calculated the line of fall. He drove a flag into the ground to mark this line from the base of the burner. When the structure came crashing down like a giant tree, the top was in direct line with the flag. ★ ★ ★

Ancient scrap burner weighing 835 tons came thundering down, much as a tree falls in the direction controlled by woodsman's ax. When dust cleared, demolished burner was lying exactly along predicted line





Milwaukee Journal photos

The TV above, monitored from the principal's office, keeps students at right on job

### TV Watches Study Hall And Relays Criticism

TV is fighting spitball throwers and pigtail yankers. At New London (Wis.) High School, the glassy eye of a TV camera peers at pupils in the study hall. There are no teachers in the hall. Instead, secretaries in the principal's and superintendent's offices watch a monitor screen in between regular duties. A public-address system picks up sounds in the study hall and relays admonitions



to students. Paul Loofboro, superintendent, estimates the TV monitor saves the school one half a teacher's annual salary.

### Whirlybird's Newest Job: Flying TV Station for the Navy

Helicopters now may become self-contained flying television stations, as the result of tests made by the Navy's Bureau of Ships. A television system developed by Philco for the Navy to control amphibious

landings has proved so successful in transmitting clear pictures to a receiving location 50 miles from the plane, that the Navy is considering further use of it. Tests were made at altitudes of 500 to 2500 feet.





## New Products of Interest



Performance, convenience and styling are featured in this new type of indoor TV antenna which is said to filter out electrical interference and reduce picture "ghosts" to a minimum. A control knob permits the antenna to be tuned to the same channel as the set itself, in order to provide proper matching for optimum performance. Swivel base mounting allows antenna rotation without marring furniture

High-fidelity-radio reception is available for automobiles with this imported FM-AM receiver. Designed to fit most cars, the radio operates from 6 or 12-volt batteries. Features include 4-gang permeability tuner, 11 tuned circuits, coaxial speaker, rear-speaker plug and tone controls. Audio response is said to be essentially flat from 40 to 16,000 c.p.s. FM sensitivity: 3 microvolts for 20-db quieting



This new tape recorder starts automatically, at predetermined times, to record radio programs or microphone pickups. Model has a built-in eight-tube receiver and Telechron clock with automatic time-switching facilities. Seven speakers, including a 12-in. public-address type, provide panoramic sound reproduction. Other features are: Two recording speeds, 8-watt amplifier, dual-level indicator, and tone controls. Unit can be used as a public-address system to cover an area containing several thousand persons. Ideal for schools, clubs or industrial applications



Automatic voice control eliminates the use of a manual press-to-talk switch, yet permits private and selective communication in this newly designed intercom system. The voice automatically activates talk-listen switch even when conversing with conventional touch-controlled units. Also contains auto-

matic traffic control which tells user by means of multicolored lights whether a line is clear, busy or being called. Shown below is 10-station master and accompanying substation. Arrows point to two control buttons. One permits setup for private listening; the other clears line at end of conversation



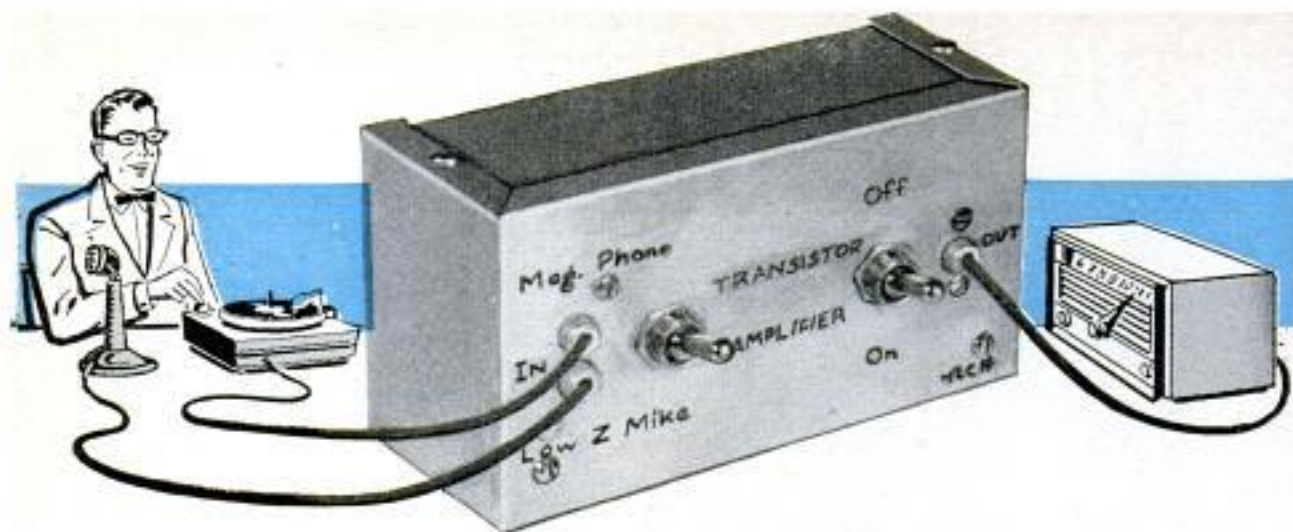

## DUAL INPUT TRANSISTORIZED PREAMPLIFIER

By Dr. Richard C. Hitchcock

**M**ANY A GOOD audio amplifier or radio of earlier vintage was designed for use in conjunction with a record player employing a crystal phono cartridge. Such cartridges have a high signal output, but provide far more distortion than can be tolerated in a high-fidelity sound system. But, while the amplifier itself may be capable of much better performance, it can not be used with the more modern magnetic cartridges without additional amplification and equalization to compensate for the characteristics of these units.

If you plan to improve your phono system by changing to a record player using a magnetic cartridge, you can still retain your present amplifier by adding this simple but effective transistorized preamplifier. This addition will also permit you to use the amplifier as a public-address

system in conjunction with a suitable microphone.

### Why Transistors?

In high-gain, low-level amplifiers transistors have a number of important advantages over vacuum tubes. The extremely low power requirements of these units makes battery operation practical. The six inexpensive pen-light cells used in this unit, for example, have an estimated life of six months when used at a rate of about three hours per day. The operating costs, therefore, are negligible, and the hum problem often associated with vacuum-tube circuits is entirely eliminated. Microphonics, those "ringing" sounds caused by vibration of vacuum-tube elements, are nonexistent, and the completed preamplifier is practically noise-free in operation.

Fig. 1. Schematic wiring diagram of transistor preamplifier for magnetic phono cartridges and microphones

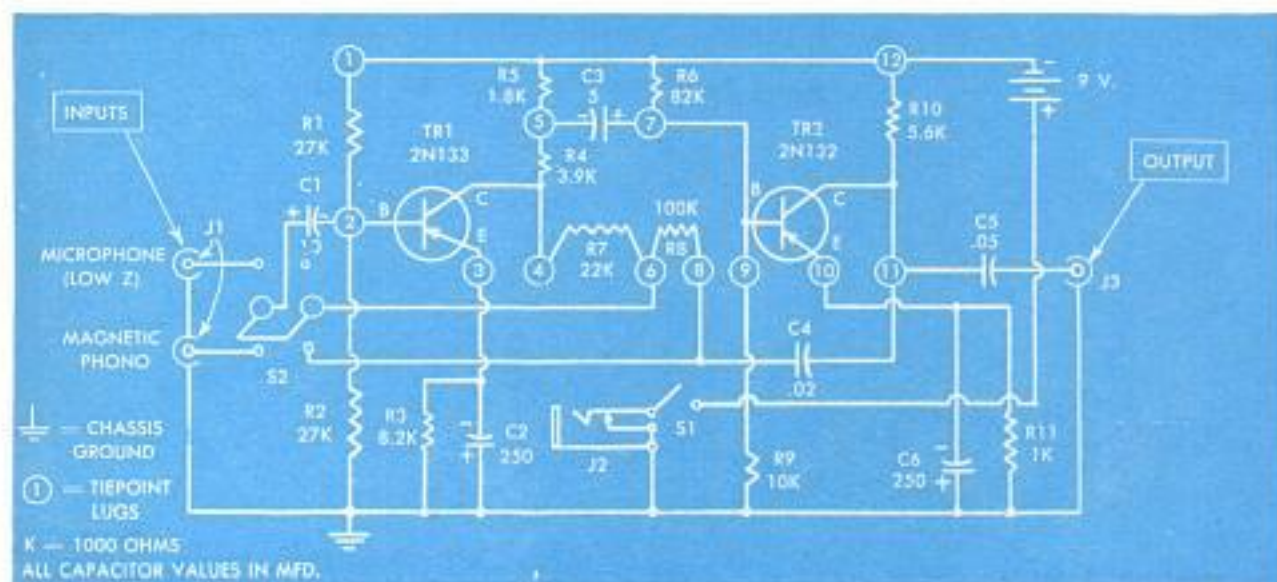

## The Circuit

The schematic diagram of the transistor preamplifier is illustrated in Fig. 1. The circuit consists of two transistors, one of which, the 2N133, is a special, low-noise unit. Resistance-capacitance coupling is used between the two stages. With the switch, S2, in the Mike position there is a small amount of negative feedback, through C4, R8 and R7, from the collector of the output to the collector of the input stage. This feedback is approximately the same at all frequencies so that the amplifier response is essentially flat over the entire audio-frequency range.

### LIST OF MATERIALS

**RESISTORS:** (All resistors  $\frac{1}{2}$  w. 10 percent. K=1000 ohms) R1, R2=27K; R3=8.2K; R4=3.9K; R5=1.8K; R6=82K; R7=22K; R8=100K; R9=10K; R10=5.6K; R11=1K.

**CAPACITORS:** C1=10-mfd. 50-v. electrolytic; C2=250-mfd. 6-v. electrolytic; C3=5-mfd. 50-v. electrolytic; C4=.02-mfd. 200-v. paper; C6=250-mfd. 6-v. electrolytic; C5=.05-mfd. 200-v. paper.

**MISCELLANEOUS:** TR1=Raytheon 2N133; TR2=Raytheon 2N132; S1=s.p.s.t. toggle switch; S2=d.p.d.t. toggle switch; J1=dual phone input jack; J2=closed-circuit jack, Mallory A-2A; J3=single phone jack.

**HARDWARE:** Aluminum case,  $5\frac{1}{4} \times 3 \times 2\frac{3}{8}$ ; ICA 29341; 12-point terminal strip; battery holders for 3 type Z pen-light cells, Lafayette MS-171 or equiv. (2 read.); type Z pen-light cells (6 read.); hookup wire; rosin-core solder.

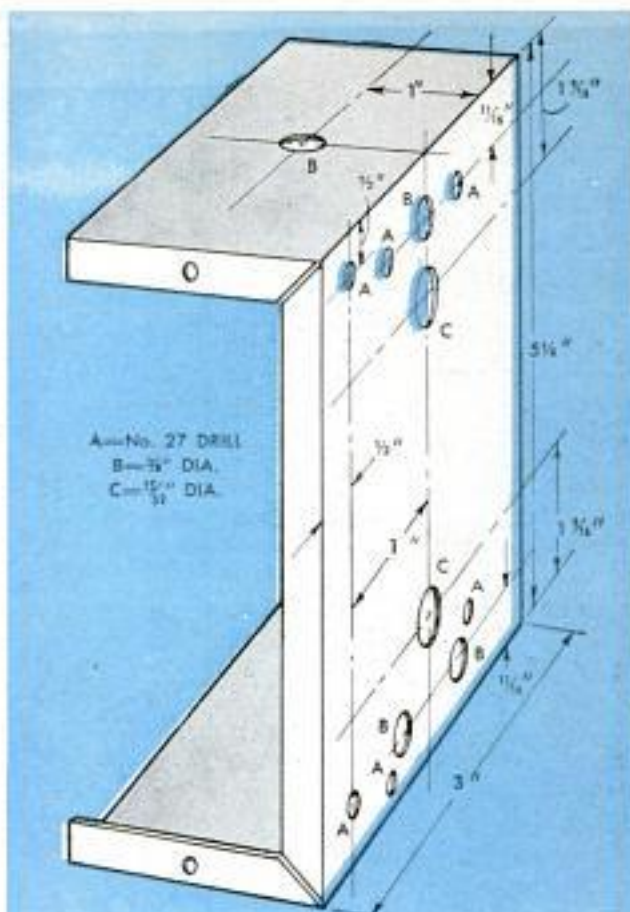

Fig. 2. Chassis layout for preamplifier

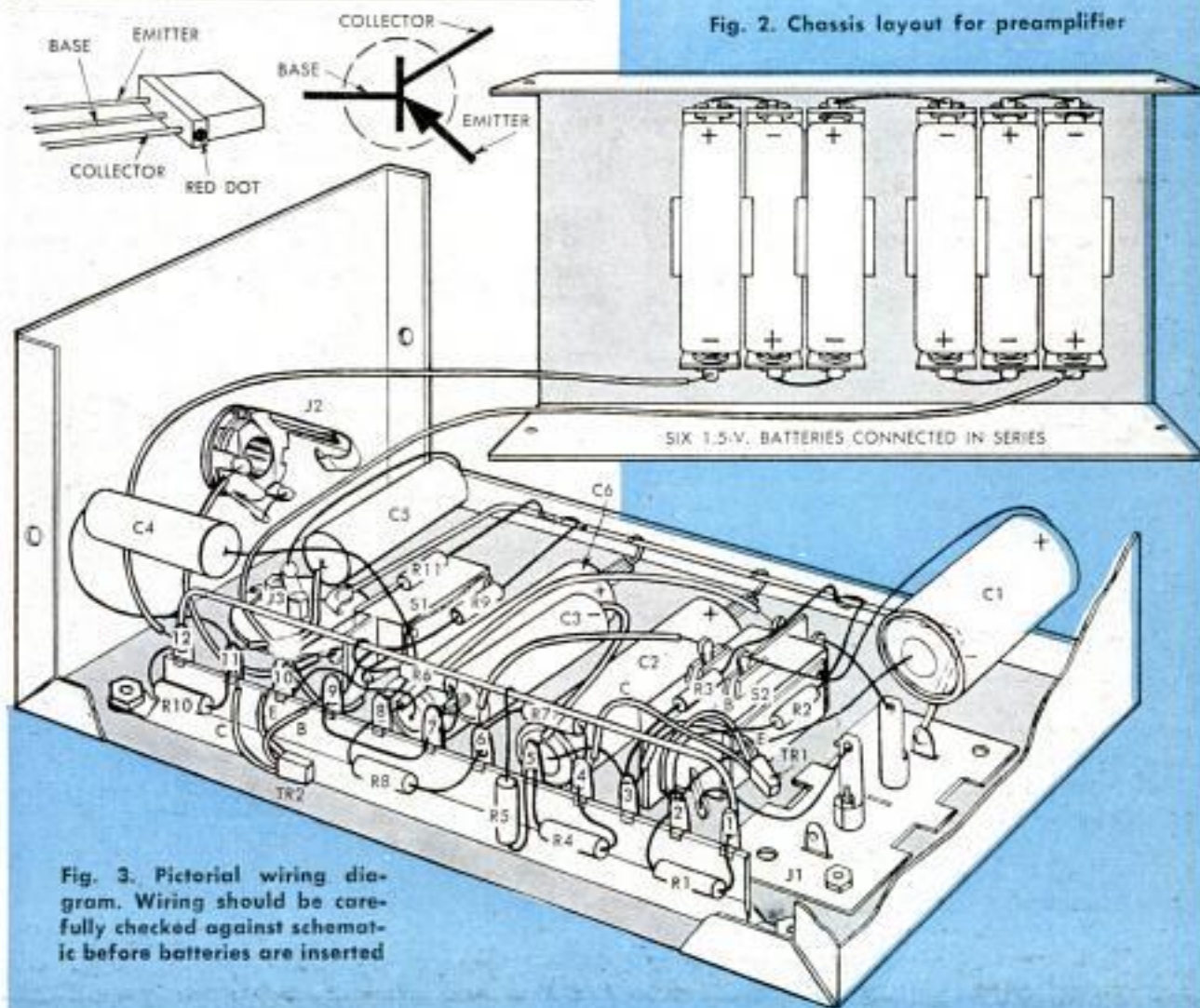

Fig. 3. Pictorial wiring diagram. Wiring should be carefully checked against schematic before batteries are inserted

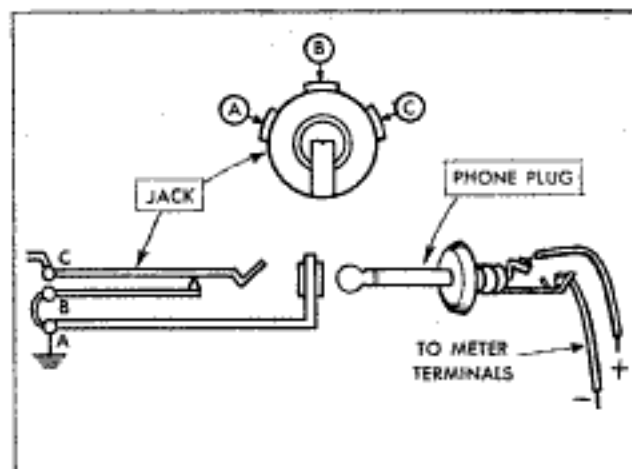

Fig. 4. Test jack terminal identification. Polarity must be observed when connecting meter leads to plug

When S2 is set to the Mag Phono position, R8 is shorted out and only the smaller resistor R7 remains in series with C4 to limit the feedback current. At high audio frequencies, the reactance of C4 is negligible, and the amplification is considerably reduced by the relatively large amount of negative feedback. As the signal decreases in frequency, the reactance of C4 increases. As a result, the feedback current becomes smaller and the amplification goes up. This rise of amplification at low frequencies compensates for the characteristics of magnetic cartridges. The other resistors and capacitors in the circuit are used primarily to apply the proper operating currents to the transistor elements and to provide bias, stabilization and coupling.

The test jack, J2, is so connected that all battery current flows through its normally closed contacts. A milliammeter plugged into this jack can be used to check for the proper operation of the preamplifier and to determine the condition of the batteries after prolonged use.

The preamplifier has no tone or volume controls since these are usually present in the main amplifier. Their use here would represent an unnecessary and often confusing duplication of functions.

### Construction

All parts used in this project are available from most radio-parts distributors and construction is not difficult. The parts are mounted in a standard aluminum case which is first drilled and punched as shown in Fig. 2. Then, the switches, jacks and the 12-point terminal strip are mounted in accordance with the pictorial diagram of Fig. 3. Connect a U-shaped length of No. 16 tinned copper wire between tie points 1 and 12 so that the horizontal portion of the wire is about  $1\frac{1}{8}$  in. above the base. A similar bus wire, raised about  $\frac{1}{4}$  in. above the base, connects the ground lugs of the

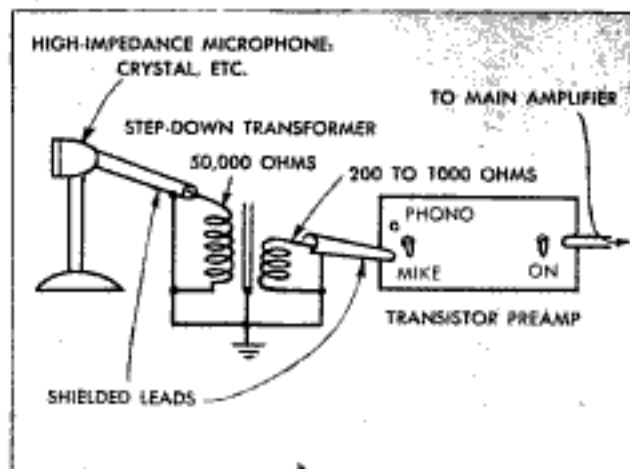

Fig. 5. Method of connecting high-impedance microphone to preamplifier through step-down transformer

input and output jacks and serves as a common ground for other connections.

The various capacitors, resistors and wires can now be soldered in place, as illustrated. Be sure, however, to leave a small opening in those terminal-strip lugs to which the transistor leads will be connected later. Polarity (plus and minus) of electrolytic capacitors must be observed as these units are wired into the chassis. Finally, the transistors are soldered into place after their leads have been covered with "spaghetti."

The two greatest enemies of transistors are heat and reversed voltage polarity on the transistor elements. These units, therefore, should be installed with special care. Before soldering, make sure that the transistor elements are connected to the correct tie points, and then apply the soldering iron to the junction for only a very short instant, just long enough to make a good connection. (Rosin-core solder with a low melting point should be used for a quick connection without excessive heat.)

Fig. 3 shows the proper method of mounting and wiring the battery clips in the back cover of the case. Be sure to mount these so that there will be no interference between them and the components mounted in the main chassis when the two pieces are fastened together. Use flexible stranded wire between battery clips and chassis.

### Testing

The wiring should be carefully checked against both pictorial and schematic diagrams before the batteries are inserted in the clips. It is a good idea to check the voltage of each cell before insertion. Each should measure about 1.5 volts. Again, polarity must be carefully observed as the cells are clipped in.

A d.c. milliammeter with a full-scale deflection of 5 or 10 ma. can be used to

(Continued to page 264)

X162

X162  
TME

WTM 58

POPULAR  
MECHANICS

## CRAFTSMAN



Those Christmas coloring books will go well with this

## Desk-Chair

By Harold Jackson

WITH ONE SIMPLE MOTION, this novel youth-size chair can be converted into a neat little desk that is just right for play or school homework. When used as a chair, the back locks firmly in place. By sitting astraddle the chair backwards and pushing the back up and outward, the chair is changed into a desk. A small metal clip locks the desk top securely in place. Releasing this clip permits the desk top to be returned to its original position as a chair back. A small drawer that opens at one side is handy for pencils, crayons and paper.

### Any Wood Will Do

The drawings show how the parts are made and fitted together. Dowels, screws and glue are used in assembling the parts. Hardwood is best for this project but any clear, straight-grained wood can be used. All screwheads are deeply sunk and the holes plugged wherever they show.

A spring clip on the underside holds the desk top in place. It is placed so that it locks over the upper dowel rung at the



top of the legs. The recess at this point is to allow space for the clip to operate freely. The clip is released by pressing upward on it if you want to change from desk to chair.

### Drawer Under the Seat

Standard drawer construction is used in making the drawer. It is mounted on guide strips fastened to the inside face of the seat rails and the drawer sides are grooved to fit the guides. Glue and nails are used in assembling the drawer, and a small knob is attached to the front.

Each back leg is cut from a piece 4 x 25 in. Follow the side-view drawing in laying them out. Where possible it is best to band-saw or jigsaw them as a pair to assure identical shape and also sand and bore the holes for the dowel rungs while the two

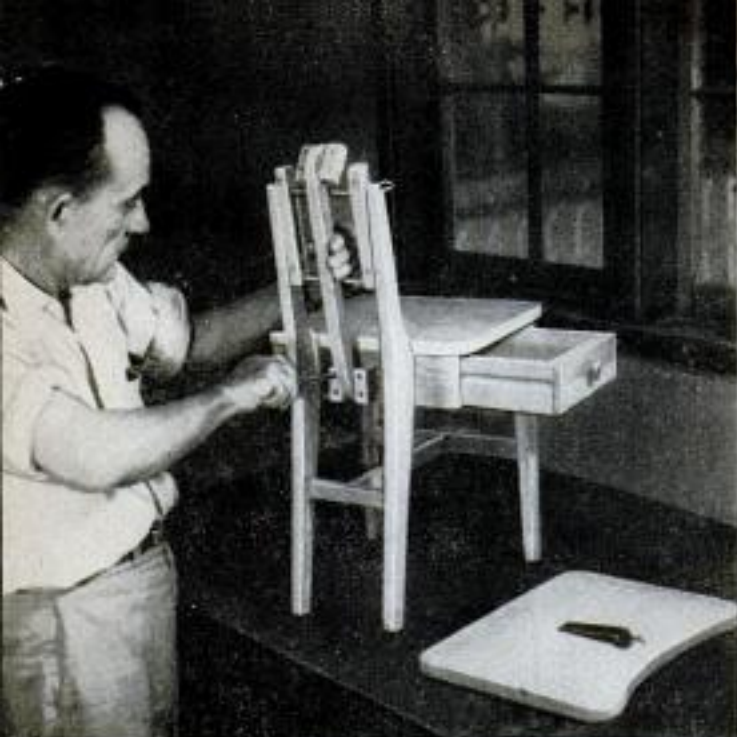

Pivot blocks for the lower end of the desk-top brace are attached securely with screws to side of chair seat rail. Brace must work freely to fold properly

The combination desk-top-and-chair-back is attached with screws to slotted cleats that ride on dowel rungs. Notice how notched ends of cleats hook over lower rung to lock desk top in chair-back position

back-leg pieces are still tacked together.

Dowel pins and screws are used in assembling the chair frame. Glue is applied to all joints at the time of final assembly. Three rails are all that are used in the chair, one side being left open for the drawer. Screws for attaching the seat board are placed in counterbored holes in the rails. Corners of both the seat board and back board are rounded as shown. The arm should be made of  $\frac{3}{4}$ -in. plywood for strength and to prevent splitting at the ends.

The desk action of the chair back is easy to see in the side view. The holes for the countersunk screws are plugged with plugs made of  $\frac{3}{8}$ -in. dowel. These are glued and sanded down smooth. Holes and moving parts may have to be filed or sanded a little to make the parts work freely. The completed project can be finished with wood stain and varnished or painted. ★★★

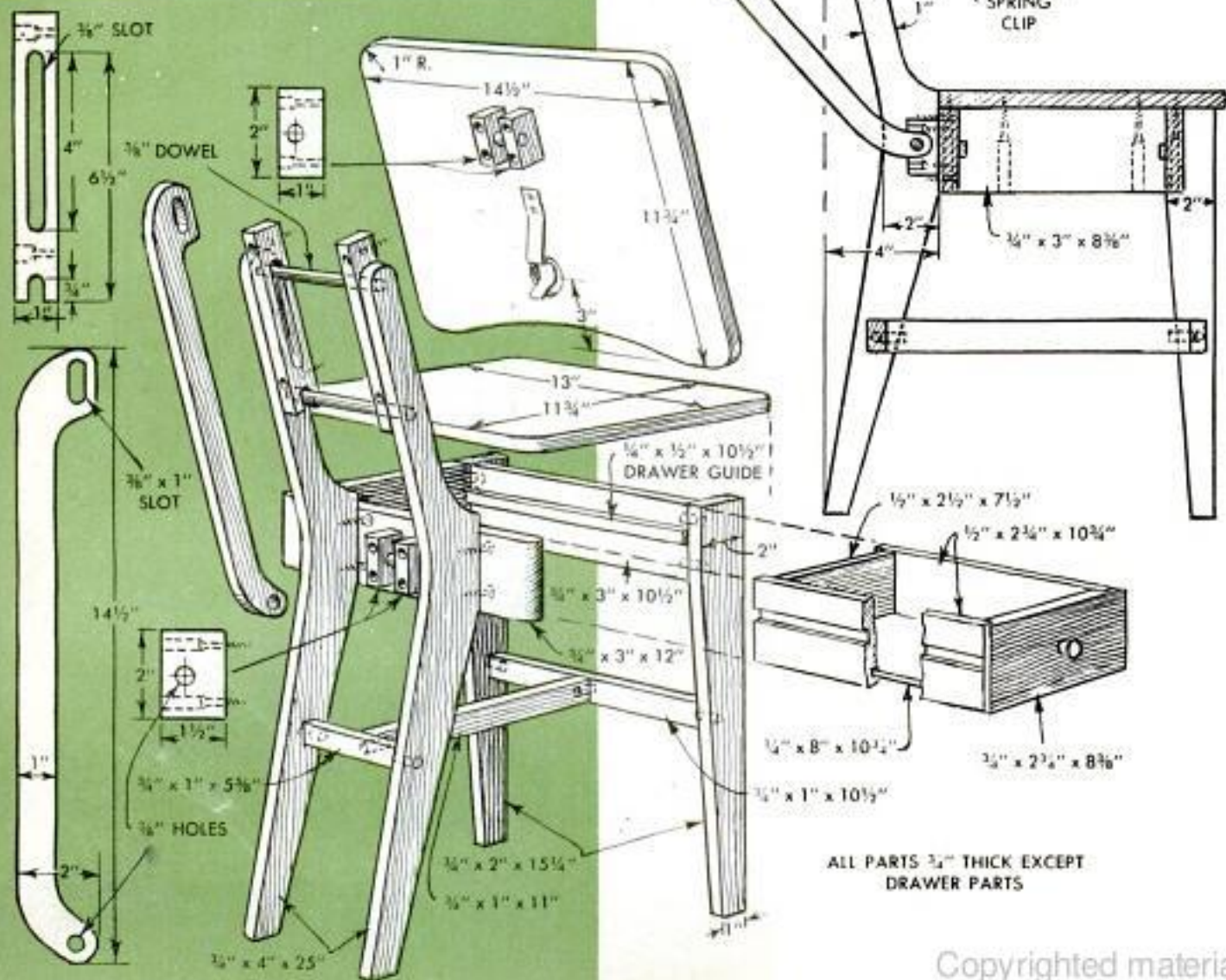



## Folding Basket-Weave Screen From Venetian-Blind Slats

Slats from discarded Venetian blinds can be used to make an attractive folding screen as shown in the illustration. The screen can be made with two or more sections depending upon the number of slats available. Width of the sections is determined by the length of the slats which are cut down to exclude the cord holes. The frames are assembled first using either 1 or 2-in. stock. Strong corners are produced by grooving the mitered frame for  $\frac{1}{4}$ -in. splines of plywood, which are glued in place. After the glue dries cut the splines off flush with the edges of the framing. Side members of the frames are grooved on the inside edges to take the ends of the slats. Diameter of the vertical rods around which the slats are bent

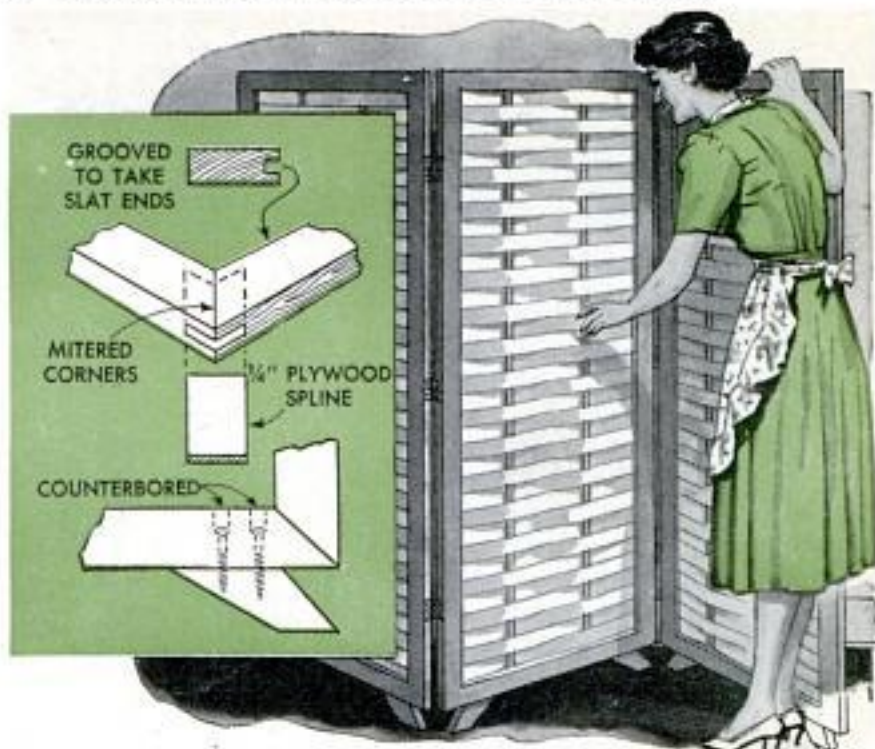

should be approximately half the thickness of the framing. Small tapered feet are fastened to the bottom of each section.

## Marred Chromium Coatings Easily Renewed

Chromium-plated fittings such as headlight rings, hood ornaments and miscellaneous trim are coated with a thin layer of clear plastic lacquer. With age, this coating sometimes discolors, chips off or checks, leaving the once bright and smooth finish dull and irregular.

In order to remove this coating, manufacturers of chrome protectives recommend the use of strong solvents such as acetone, lacquer thinner or abrasives. Unfortunately, these agents are laborious, time consuming and require some skill in their application.

A better way to do the job is to immerse the fitting in very hot, but not boiling water. After the metal has heated thoroughly, the old coating will loosen so that it can be peeled off in strips. If an occasional speck is stubborn, it can be removed with a soap-saturated steel-wool pad.

Once the old coating is completely removed, simply dry and buff the part with a clean, soft cloth. After that, a new coat can be sprayed or brushed on.

Charles Younger, River Edge, N. J.

☞ A cake may be cut into three layers by wrapping a heavy thread around it, crossing the thread ends and pulling on them.

## Alphabet-Noodle Monograms

If you want a personalized jewelry box, letter opener, or other item, here is an easy way of applying your monogram. Take the required letters from a package of alphabet noodles and glue them on the handle or other flat surface. After the glue has dried, cover the letters with one or two coats of clear shellac.

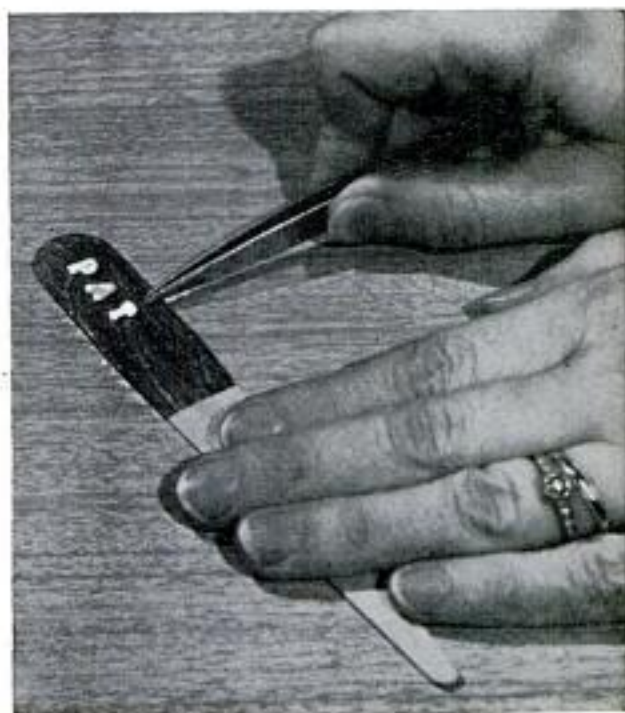

W.T.M. 58



# Midget Spice Cabinet

This little one-drawer spice cabinet, made entirely with hand tools and assembled with brads and glue, is a good place to keep frequently used seasoning within easy reach. All members are  $\frac{3}{8}$ -in. birch, and were sanded with a fine grade of sandpaper before assembly and finished in natural grain. The knob on the drawer is simply a  $\frac{3}{8}$ -in. dowel tapered slightly and rounded on the end.

The drawer of the cabinet should be made slightly smaller than the dimensions given for proper clearance. A hole can be drilled in the back of the cabinet for hanging on a wall as shown in the photo, or it may be screwed to one end of a kitchen cabinet near the range.

Hi Sibley, Nuevo, Calif.

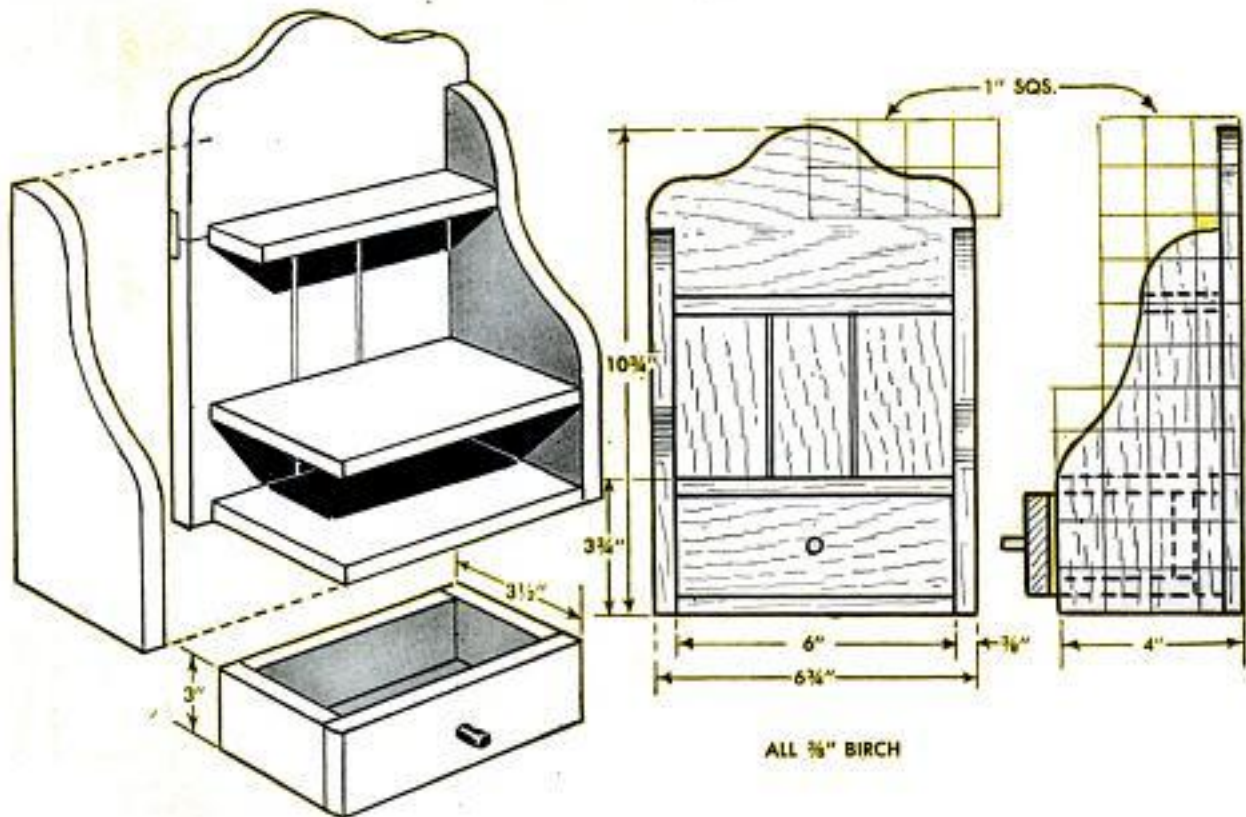

## Two Nuts and Washer Used To Tighten Studs

If you use a single nut when tightening a stud bolt you will undoubtedly run into trouble when the nut is backed off. The bolt is usually loosened also, and you're right back where you started. To successfully tighten a stud, use two nuts and a washer in between. Turn the bottom nut on with the flat side up. Tighten the stud by using the wrench on the top nut. You can loosen the nuts without disturbing the

stud by first turning down the bottom nut. This will release pressure on the upper one and allow them both to be removed easily.

Victor H. Lamoy, Upper Jay, N. Y.

☛ Texture paints are best for hiding plaster cracks or dry-wall seams, and are also good for covering patched or rough plaster as they are thicker in consistency and can be easily stippled to conceal defects.

WTM 58  
+  
SN 58



EARRING



LAPEL PINS



# SOLDERING CERAMICS

By Byron G. Wels

**S**OLDERING METAL to ceramics is a new technique that promises to eliminate completely the many problems resulting from the present method of attaching clips, pins and earpieces to ceramic jewelry with cement. Where jewelers' cement is difficult to control and often runs over the article, ruining its appearance, solder will run only where the heat is applied. Although clamps must be used to hold a metal fastener to a ceramic article while the cement sets, often marring the glaze, the weight of the soldering iron is sufficient to hold the fastener while it is soldered, and the metal cools in a matter of moments to provide a positive bond.

When making a piece of ceramic jewelry onto which a metal fastener is to be soldered, proceed in the usual manner. Pre-fire the article, then when cooled apply the glaze to the front but not the back of the article. Fire it to set the glaze, then allow

After the ceramic has been pre-fired, then glazed and fired again, paint silver on the unglazed back



it to cool and paint the unglazed back with a silver solution (DuPont Silver No. 4756). Be sure to shake the bottle of solution vigorously so that it is thoroughly mixed. Apply two coats of the silver, allowing the first to dry completely before applying the

Fire the silver-painted ceramic for 30 min. at 500 deg. C., then cool and buff shiny with steel wool

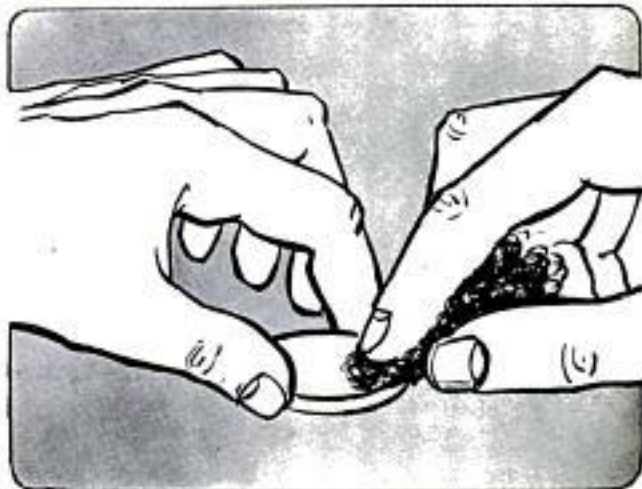
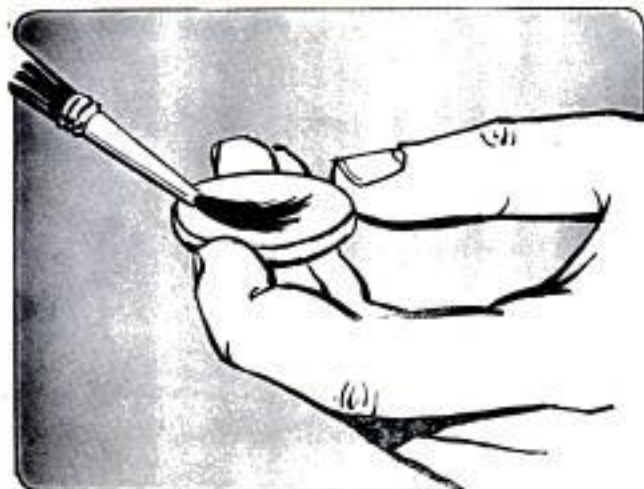



Tin both the silvered portion of the ceramic and the metal attachment with solder, using rosin flux

second. When dry, fire the ceramic in the kiln at a temperature of 500 deg. C. (1250 deg. F.) for 30 min. Remove the article from the kiln when it has cooled to room temperature. The silver now is mixed with the structure of the ceramic base and actually is fired into it.

Now buff the silver carefully with steel wool until it shines. Use rosin-type paste flux and tin the silver with solder. Do the

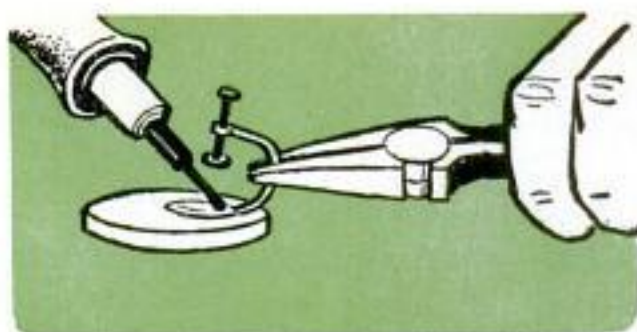

Hold the attachment on the ceramic with pliers, apply the iron and "sweat solder" them together

same with the metal fastener that is to be attached to the ceramic. With a pair of pointed-nose pliers, hold the fastener in place on the back of the ceramic item and "sweat solder" it in position. As soon as the solder has cooled enough to set, the job is done. When the assembly has cooled, wipe over the soldered joint with a piece of absorbent cotton dipped in alcohol to remove the excess flux. ★ ★ ★

## Hose Stored on Semicircular Bracket Nailed to Wall Studs

Two short lengths of 2 x 2 or 2 x 4 nailed to wall studs in a garage provide a handy wall bracket for storing a garden hose. A piece of sheet metal curved and nailed to the two members as shown supports the hose properly in its natural coil. A broom clip attached to one of the pieces will hold either end of the hose while it is being wound around the supports.—Sam Fenn, Chicago.

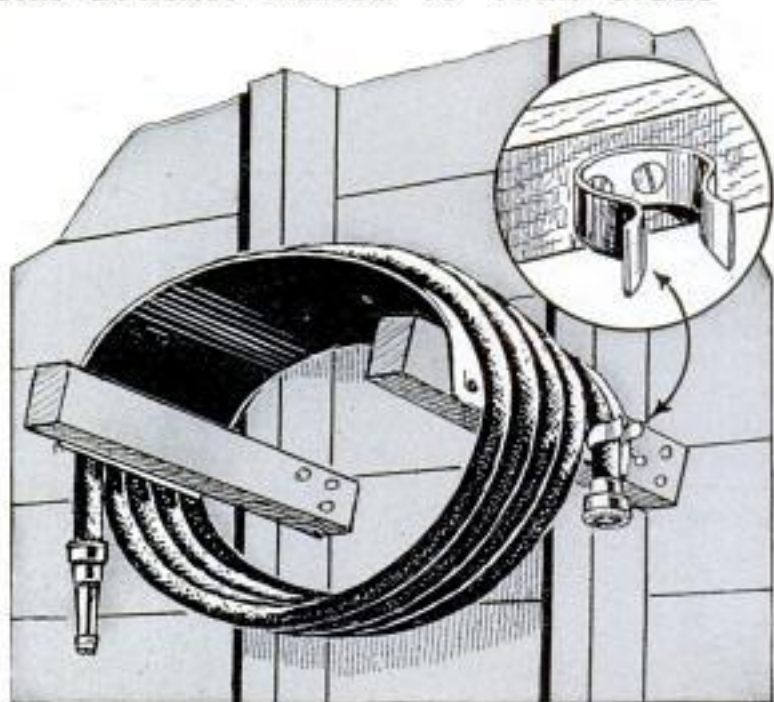

## Safe Combination Hidden

An extra copy of the combination to the office safe may be hidden behind the label of a file drawer for emergency use. Location of the combination should be changed at regular intervals to the fronts of other file drawers.

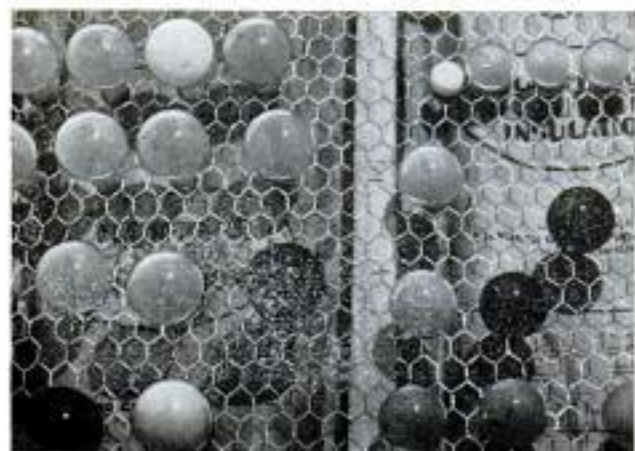

## Neat Storage for Lamp Bulbs

Running out of lamp bulbs of a particular size will no longer be a problem when they are stored in a piece of chicken-wire fencing nailed to the studs of a garage or basement entryway. The bases of standard light bulbs fit snugly in the openings of 1-in.-mesh wire.

Earl V. Wilhelm, Chillicothe, Ohio.

Ⓢ Carpeting tacked on the bottom step of the basement stairs will identify it as the last step even when it cannot be seen over an object being carried.

## Sandpaper Gripp'd Securely in Two-Piece Sanding Block

Made to take 4½ x 5-in. sheets of sandpaper, this sanding block is comfortable to use and permits rapid changing of the sandpaper. The sheets are wrapped around the lower block and sandwiched between it and the upper one. The top block is cut from 2-in. stock and fits between edge strips screwed to the lower block. A piece of felt is glued to the underside of the lower block to cushion the sandpaper. A flat-headed bolt running up through both blocks barely projects above the top one to allow for washer and knurled nut which hold the two blocks together.

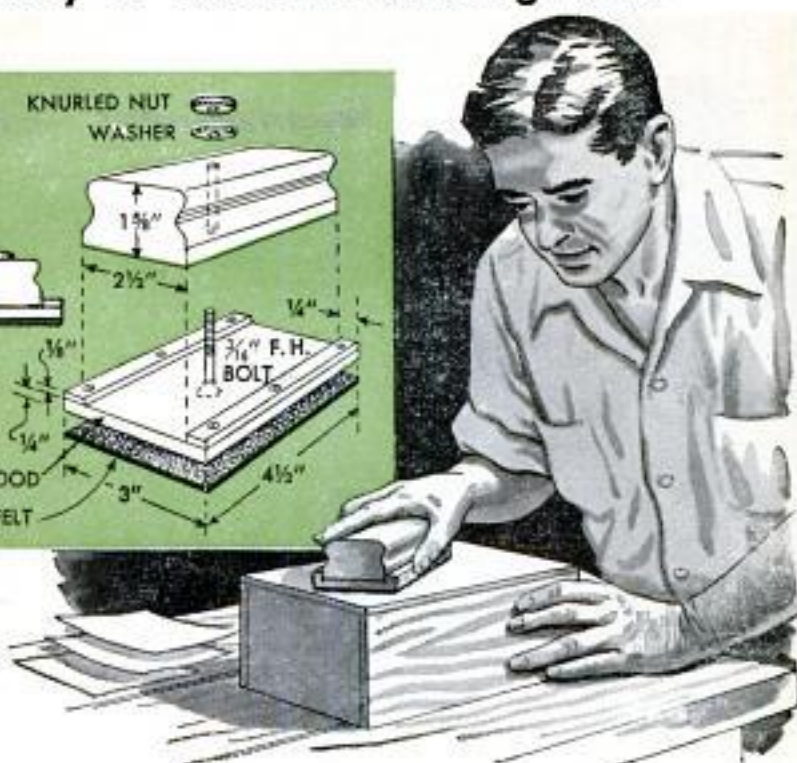
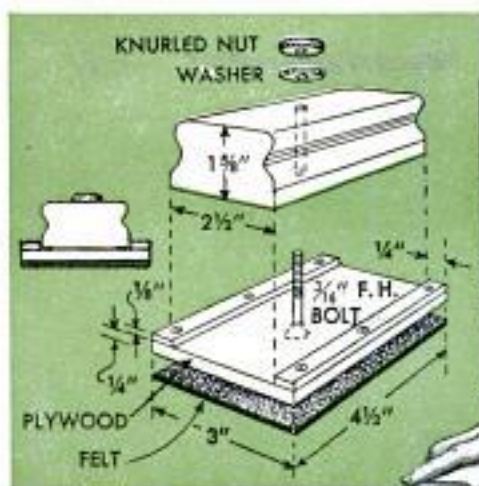

## Cuts on Friction-Tape Roll Release Threads From Edge



When friction tape is pulled from a roll there often are two or three threads that stick to the edge and which must be removed after unwrapping several turns. To avoid

this, make four shallow knife cuts in each side of the roll as indicated. The cuts separate the threads into short lengths that readily pull off the roll with the tape.

Robert V. Thompson, Clinton, Iowa.

## Plug Helps Remove Pipe Nipple From Steam Radiator



When removing a corroded nipple from a steam radiator, drive a wooden plug into it before applying the wrench. If the plug is trimmed to fit snugly, there will be little danger of crushing the nipple. Also, the

plug may be hammered lightly to aid in loosening the nipple before a wrench pressure is applied.

## Direct-Bounce Flash Lighting

By adding an angled reflector under the flash unit on your camera you can have the benefit of simultaneous direct and bounce lighting. Cut from aluminum sheet insulation or light-grade reflective metal, the reflector is shaped around the lamp base and taped or soldered to the back of the regular reflector. Light which normally is cast down at the floor and lost is diverted upward by the additional reflector and the combined lighting helps to soften shadow effects.



## "Roll Up" Storage for Brushes Made From Bamboo Place Mat



Lightweight and easy to carry, a bamboo place mat provides an ideal method of carrying artists' paintbrushes. Two strips of narrow elastic stitched across the mat provide loops to hold the brushes and prevent them from rubbing against each other. When spread flat, the mat displays the brushes ready for quick selection. When rolled, for easier carrying, the mat prevents damage to the bristles, and air can pass through the slats to dry cleaned brushes.

Mrs. Michael Fey, New York City.

## Preventing Paint Accumulation In Heel of Brush

It is much simpler to prevent paint from accumulating in the bristles at the heel of a brush than it is to remove the paint after it has hardened. A simple preventive measure is occasionally to squirt solvent from an oil can directly into the bristles next to the ferrule while the brush is being used.

Ken Murray, Colon, Mich.



## Floating Short-Stemmed Flowers

To float a bouquet of short-stemmed flowers in a shallow bowl and hold them in neat arrangement use a disk of paraffin, such as is removed from a glass of jelly. Cut a hole in the disk and insert the stems in the hole. The paraffin will float sufficiently to support the flowers. Paraffin disks of various sizes may be molded by pouring the melted wax into a pan or saucer.



## Incinerator Built From Oil Drum Has Removable Grate



For an incinerator that is inexpensive and easy to build, use an oil drum. Make several slits or holes in the top of the drum, cut the top free and drop it on V-shaped tabs cut from the sides of the barrel. An opening is cut in the bottom and the barrel is placed on blocks as shown. This prevents excessive corrosion and provides for easy removal of ashes. The holes in the grate and the four openings left by the tabs provide ample draft. A piece of hardware cloth fastened to a wire frame will serve as a spark shield.—

S. S. Miner, Niles, Mich.

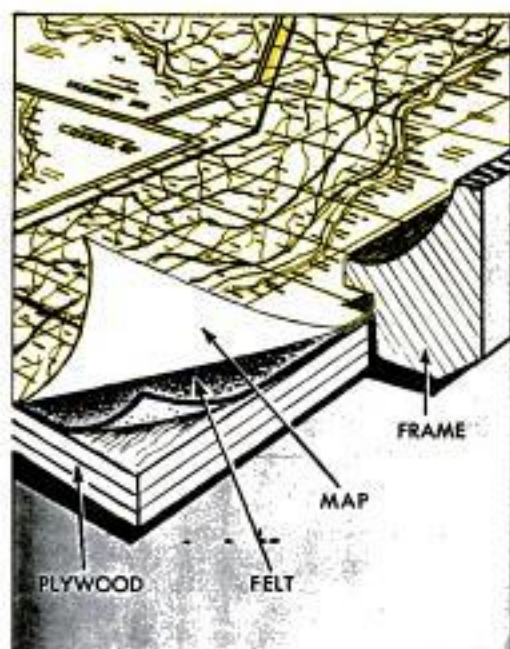

## HOW TO MOUNT A WALL MAP

A road map of your own state or a map of the United States or the world mounted on a sheet of plywood and hung in a convenient spot is a handy reference for planning week-end trips and vacations or following current events. Also, it is a colorful wall decoration for the living room or den. When mounting a map, be sure to cut the plywood large enough to accommodate a frame around the border. Lining felt, such as is used under linoleum-floor coverings, is glued to the plywood with linoleum paste to prevent the map from becoming wrinkled or cracked when there are extreme changes in humidity. Next, the map is pasted on the felt and any air pockets that appear are rolled out with a rolling pin. Any style trim can be used for a frame and finished as desired.—Hal Roth, Berkeley, Calif.



Below, frame is attached to mounted map with finishing nails. Heads of the nails are set below the surface and holes filled



## Buzzing Heard When Playing Piano Caused by Vibrating Object

When a buzzing sound is heard while a piano is being played it often can be traced to an object somewhere in the room which tends to vibrate at a given frequency. To locate the offending object, first find the note which seems to cause the buzzing and then have someone strike the key while you try to locate the origin of the noise. It may be a lamp, vase or the glass in a picture frame. In one particular instance the

vibrating object was found to be a loose pane of glass in a leaded window hidden behind a heavy drapery. If the origin of the sound cannot be located, call a piano tuner.

C. S. Onderdonk, Jr., Margate City, N. J.

Regular eyeglasses can be modified to protect eyes against snow blindness by fitting two strips of tape across each lens to provide a horizontal slot about  $\frac{1}{4}$  in. wide.

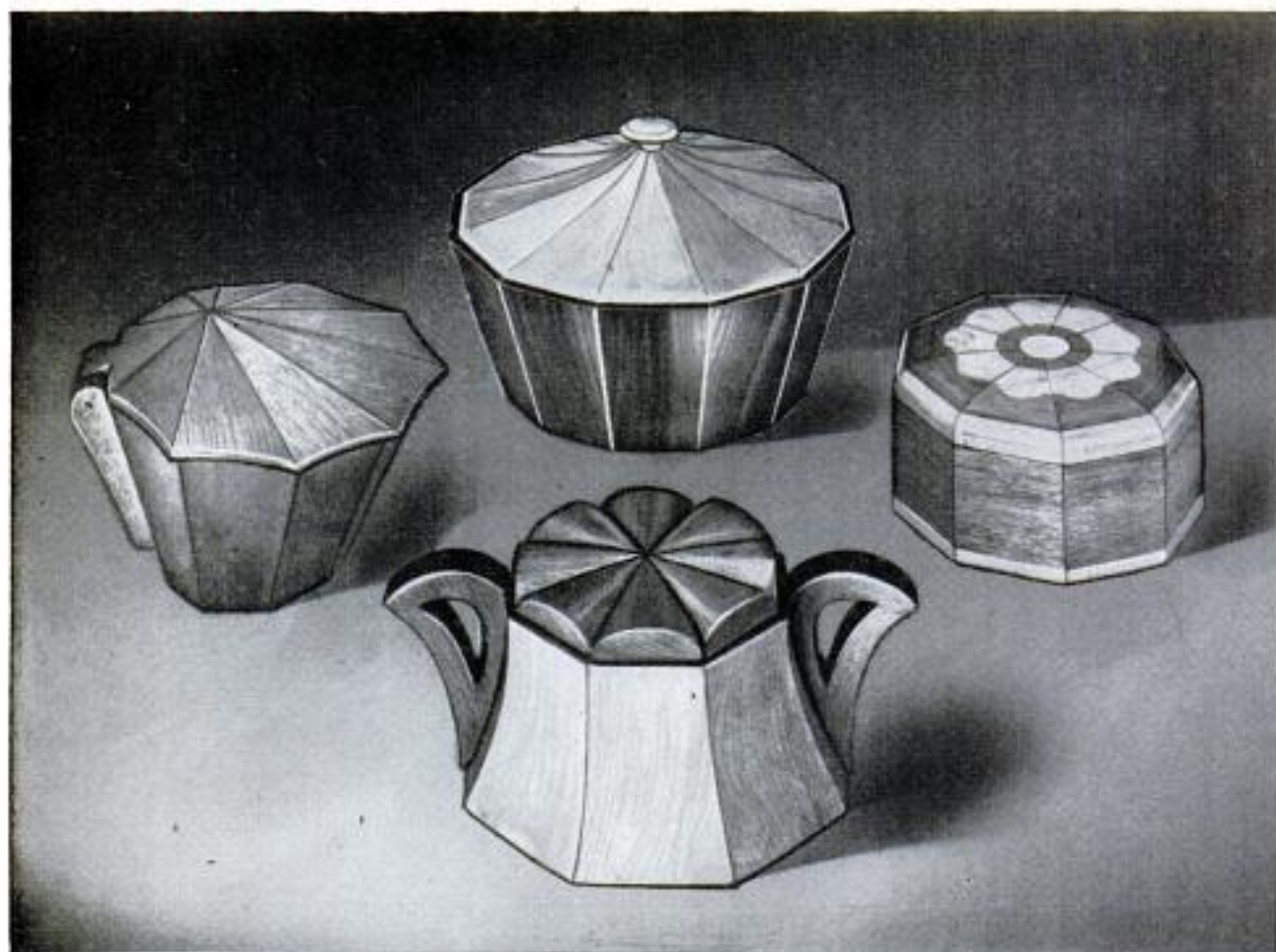

# STAVED

By Edwin M. Love

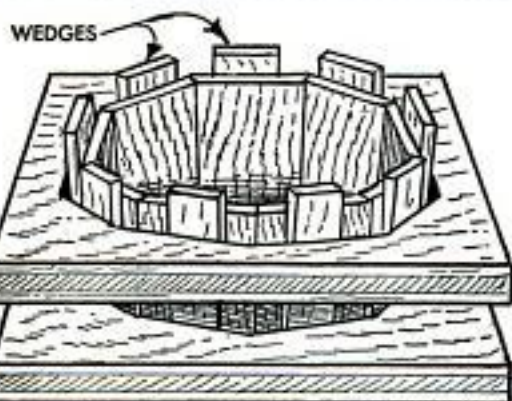

1 CLAMPING INLAID BOX

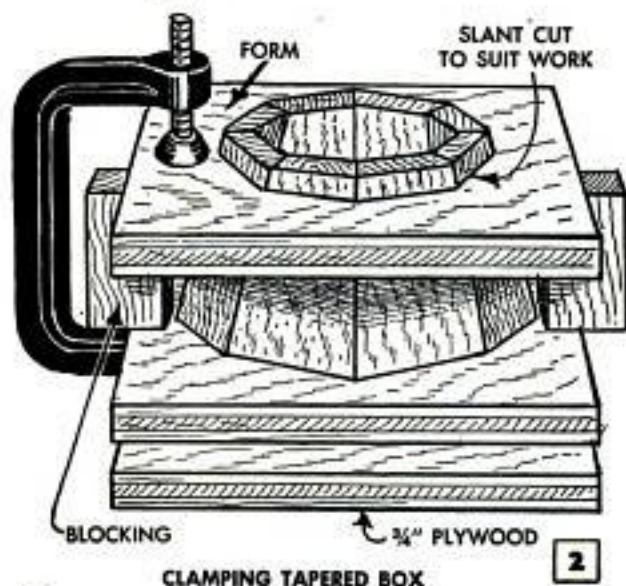

2 CLAMPING TAPERED BOX

**STAVED SIDES** and lids give ornamental boxes an individuality that can be attained by no other construction. The four boxes shown above are typical of staved work, with similar methods used in all. To cut the sides of tapered boxes, swivel the miter gauge and tilt the blade the degrees indicated in the drawings. Clamp the pieces dry to check the joints and, if splines are used, run the grooves afterward. A band clamp is excellent for the box with vertical sides, but if not available, use form clamps made by sawing openings in  $\frac{3}{4}$ -in. plywood. Slip them over the assembled staves and drive in wedges as shown in Fig. 1.

Two sizes of forms are forced down over tapered boxes and clamped to the base board as shown in Fig. 2. The inlays of the 12-sided box, Fig. 3, are  $\frac{1}{16}$ -in. strips of maple inserted in the joints. Apply glue freely to joining surfaces and press lightly together, going around the box in rotation. By the time the clamps are arranged, the glue has soaked in enough and become tacky. Pressure forces out the excess,



**TWELVE-SIDED BOX**

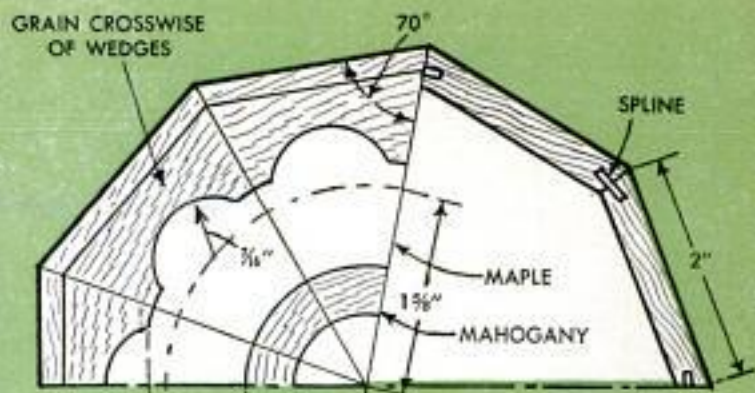
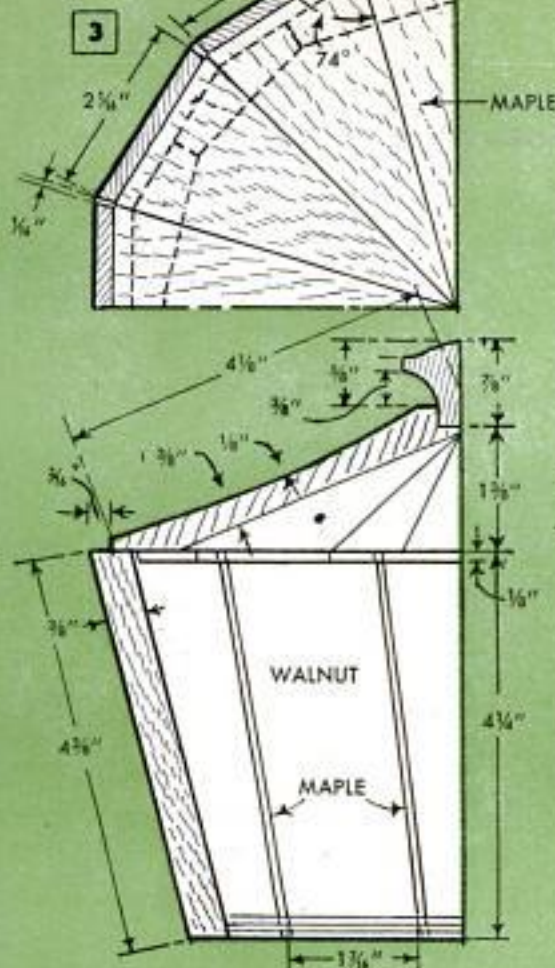

**INLAID BOX**

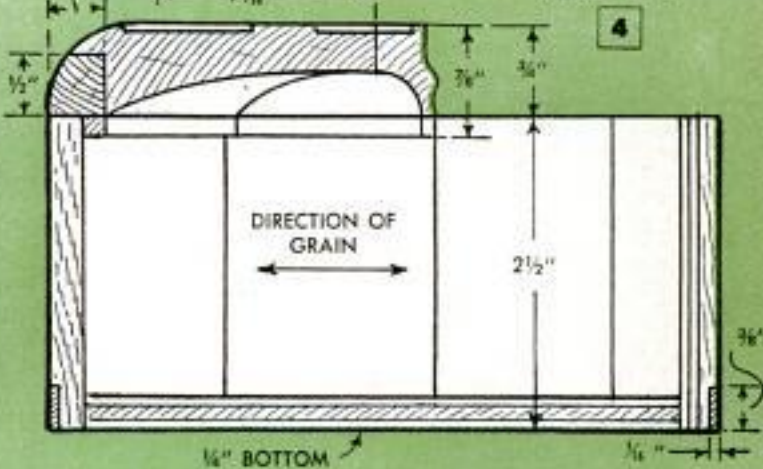

# BOXES

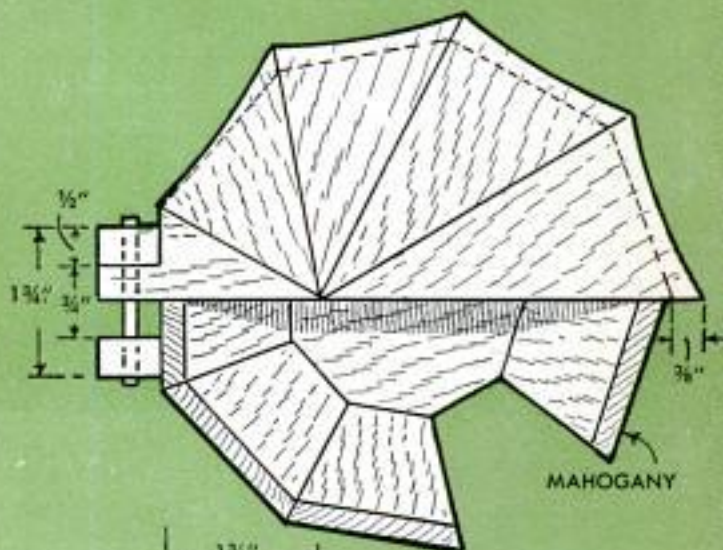
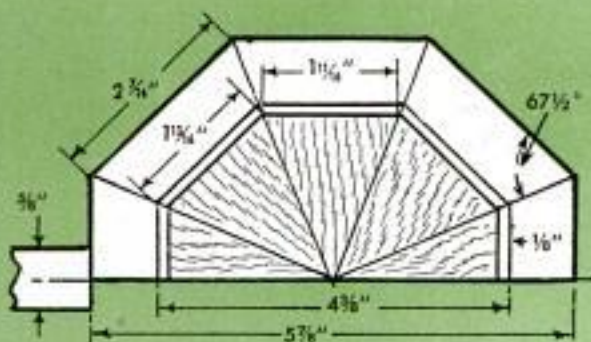

**6 TILTED BOX**

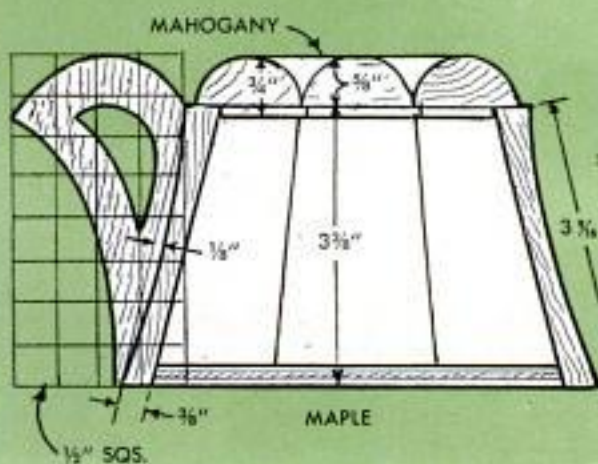
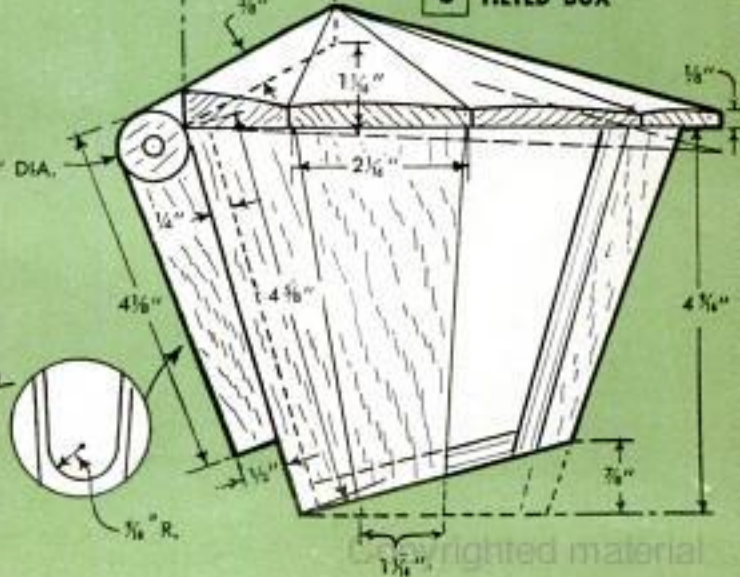

**5 BOX WITH HANDLES**



7 Sanding disk chucked in drill press is used to sand uneven ends of staves. Lock quill for final sanding

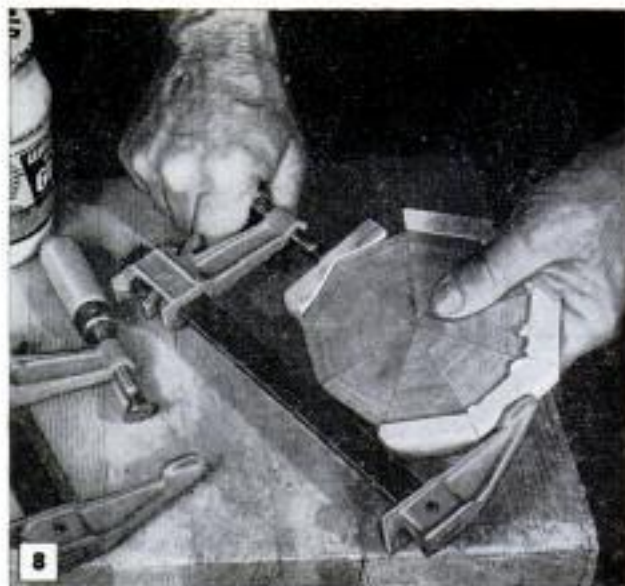

8 Saddle blocks of scrap wood seat the clamp jaws when gluing inlay blocks to the edges of pyramidal lid

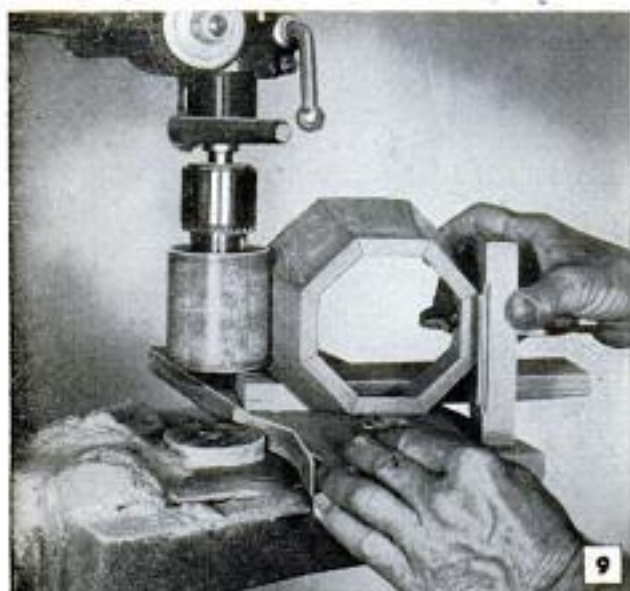

9 Above, special fixture holds box for scalloping faces of staves. Note disk attached to drill-press table against which fixture rides. Below, pyramidal lid is assembled over full-size pattern drawn on board

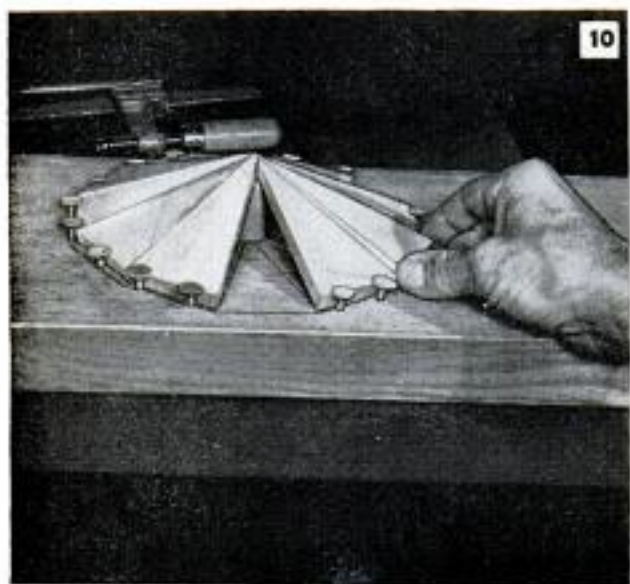

10 When dishing sections of pyramidal lid, each stave must be held on a level axis to assure uniformity



fingers. Fit the remaining wedges, glue and clamp. Smooth both sides of the lid on a sander, rabbet for the edge blocks and glue on the edge blocks, using a notched block to shield the corners and seat the clamp jaw as in Fig. 8. Assemble the lid for the handled box, Fig. 5, in the same way after roughing out the tops with a sanding disk.

Cut the wedges for a pyramidal lid with the saw blade tilted according to the drawing, Fig. 3. To assemble, lay out the plan on a board, nail in a center post made of  $\frac{3}{4}$ -in. dowel chamfered at the top, and locate every other wedge as in Fig. 10. Glue the tips and hold the bases with large-headed nails. Glue in the remaining wedges, allowing the points to rise slightly above the first. Apply pressure with a hollowed block laid on top and held with a clamp. A similar method works for the off-center lid of the tilted box, Fig. 6. A base block traced from the top of the finished box allows projection of the lid overhang. Glue the wide ends of the wedges to the base. As the edge angles of the wedges are variable, they can be determined by holding the first wedges in position, marking the edges by comparison with the layout.

Side and lid staves are hollowed by use of simple jigs in combination with a sanding drum. Center a plywood disk of the same diameter beneath the drum, holding it with a bolt through the drill-press table, Fig. 11. If necessary, face the disk with a strip or two of cardboard to get correct sanding depth, see Fig. 9. When a sanded side comes around to the upright it must be shimmed out to make up for material sanded away. For this reason it is best to rough out the box and then go over it again with a finishing cut.

A lid is clamped against the upright of the jig with the wedge to be sanded in a horizontal position, Fig. 11. After sanding, any slight offset of the corners with the joints is corrected by hand with a scraper and sandpaper. Jigsaw the three inlays for the inlay box, Fig. 4, with edges slightly undercut, and file smooth. Trace around them on the lid, chisel the mortises close to the lines and take an impression by clamping the inlays in place. Remove, and trim the mortises accordingly.

Lids that are not rabbeted have ledges built up with small pieces glued in place. Try the lids in place, rotating them to find the best fit, and glue a small boss inside the box, notching the ledge to clear it. This will position the lid correctly each time.

One leaf of the hinged lid, Fig. 6, is solid with its wedge. Make the other leaf and glue it to the longest box stave. To scallop the edges, hold the lid firmly against the box and dress the edges on a drum. ★ ★ ★



### Crossbars on Stepladders Support Scaffold Plank

A pipe crossbar on each ladder will assure steadier and safer footing when a pair of stepladders is used to support a scaffold plank for painting and other similar jobs. The crossbars eliminate the chance of breaking a ladder step, and at the same time strengthen the ladders. Each crossbar is a length of pipe with floor flanges on each end that are screwed to the inside surfaces of the ladder rails as shown. If several working heights are normally used, more than one crossbar may be installed on each ladder.

### Bowl Cover Keeps Plates Clean

Plastic bowl covers slipped over seldom used, stacked plates will keep them dust-free for immediate use when company drops in. No longer do you have to rinse off plates to avoid embarrassment. It's a fine idea for everyday use as well if plates must be kept on open shelves.

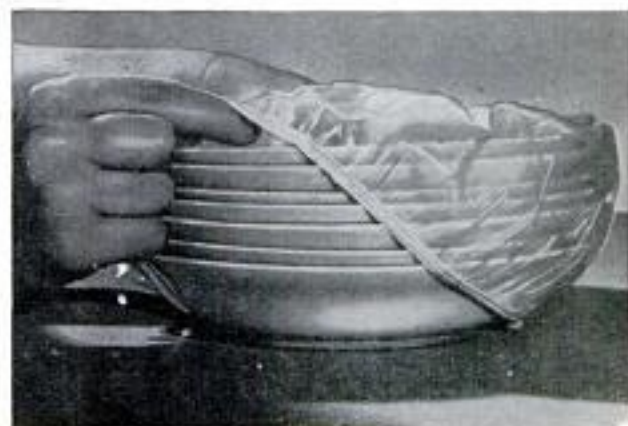



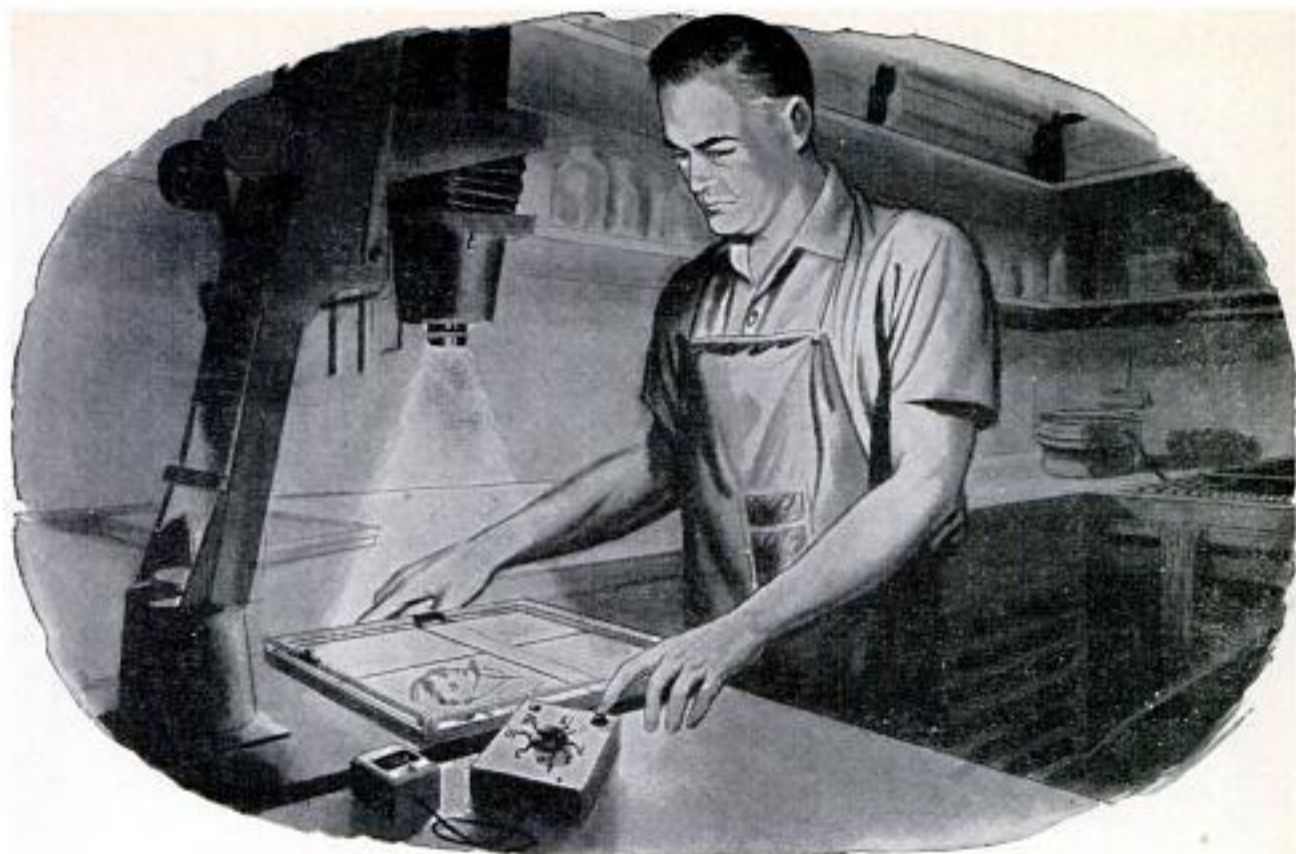

When installing the contact-spring assembly, Fig. 5, mount it on the chassis so that the longer contact spring does not extend beyond the center of the cam pin. After wiring the timer as shown in Fig. 2, it is ready to calibrate.

#### Calibrating the Timer

To calibrate the timer, plug an electric clock into the timed outlet of the timer and note the interval involved at the various positions you select by turning the knob. Mark and number these positions on the chassis as shown in Fig. 1. Cam con-

tacts are open when the pointer is at zero. When the cam is rotated (for selection of a time interval) the contacts close, preparing the circuit for operation. Depressing the push button activates the relay which then "locks" through its own contacts and the cam-spring contacts. When the motor returns the cam to normal position and reopens the cam springs, the time interval ends and the unit is ready to start a new cycle. After calibrating the timer, recheck all the wiring, making sure that there are no bare wires in contact with the chassis.

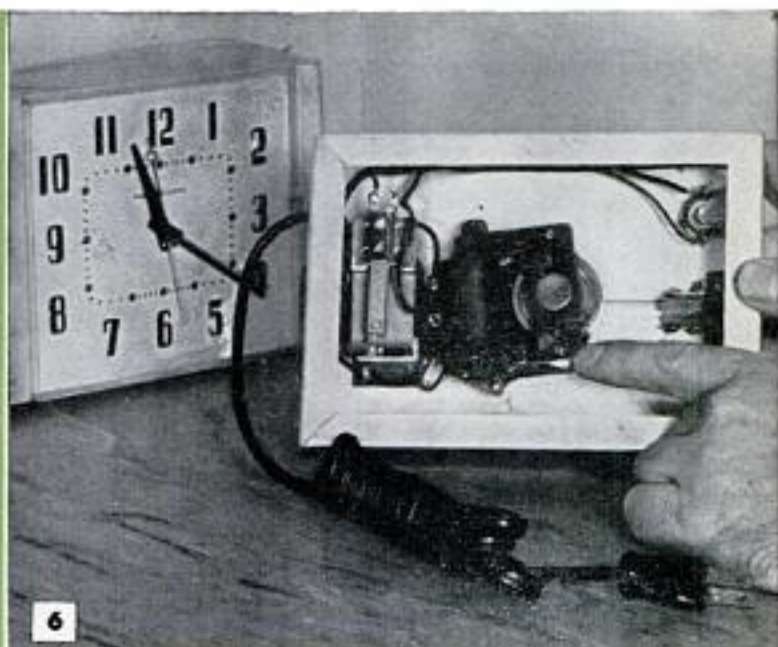
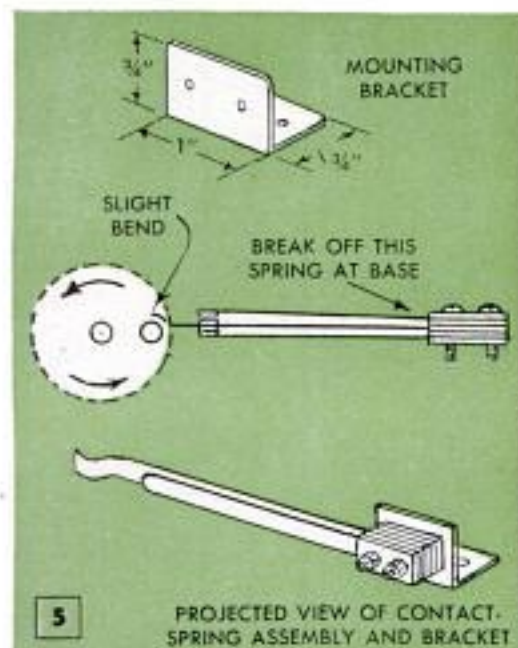

## Concrete-Filled Tires Anchor Volley-Ball-Net Uprights



Pipe uprights for a volley-ball or badminton net that are anchored in concrete-filled tires as shown are easy to move to a new location to prevent damage to the lawn by constant playing in one area. When casting an anchor of this type, center the post in the tire and hold it vertical with three guy wires staked 120 deg. apart. Leave the wires in place until the concrete hardens. Holes for fastening the net should be drilled in the pipes before anchoring them in the concrete-filled tires.

Mrs. Dale Pease, Ft. Wayne, Ind.

## Masking Tape Used as Handle When Fitting Cabinet Door

A strip of masking tape attached to a cabinet door that is being flush mounted serves as a convenient handle for opening the door as often as necessary until the hardware is installed properly. One end of the tape is stuck to the inside face of the door and brought around to the front where it can be grasped to pull the door open. Having to pry the door open with a knife is apt to mar the wood.

G. E. Hendrickson, Argyle, Wis.

## Dry Ice Aids Tile Removal

When plastic tile must be removed to gain access to pipes or wiring, try wrapping a flat piece of dry ice that is large enough to cover one tile in a cloth and hold it against the tile to be removed. In a few seconds contraction of the plastic will cause the tile to pop off the wall without breaking. This method of removing small areas of tile usually will work in all cases except newly installed tile.

Stuart Knepp, Columbus, Ohio.

## Handle of Discarded Toothbrush Is Ideal Tab for House Keys

The handle of a discarded toothbrush can be made into a tab for house keys. An additional hole is drilled so that it can be hung on a nail and the color distinguishes various keys.



## Hand Liquid Dispensers Made From Lighter-Fluid Cans



Lighter-fluid cans with plastic self-sealing spouts can be used as handy dispensers for small quantities of liquids. Filled with water, one of the cans becomes a leakproof car-window washer. Enlarging the hole in the spout will permit the can to be used for dispensing thick liquids. If a cap is slightly damaged when pried off a can, drop a little plastic cement inside its sealing ring before replacing it. —Richard S. Downie, Falls Church, Va.



### Storage Space Utilized Over Dropped Ceiling

Wasted space over a ceiling dropped during remodeling was converted by one homeowner into a much needed storage enclosure for suitcases and little-used boxes of material as shown in the illustration above. Working from inside the closet, which was added when the ceiling was dropped, the false joists were covered with hardboard, and sliding doors, also hardboard, were installed at the point of entry.

Presence of a closet is essential for access to the dead space. When a ceiling is lowered in a room that has a closet, it is only necessary to remove the part of the wall separating the dead space from the inside of the closet before installing hardboard flooring and sliding doors. The interior of the enclosure is painted white to assure adequate illumination.

Courtesy Masonite Corp.

### Work Shield for Driving Screws

Nicks and gouges in a finished surface, caused by a screwdriver slipping off a screwhead, can be prevented by using a hardboard shield. Drill a hole slightly larger than the screwhead in a scrap of hardboard and drop the shield over the screw being turned.

### Grommets From Pencil Erasers

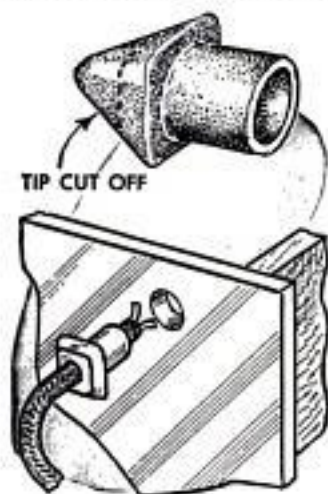

Rubber grommets can be made from slip-on pencil erasers. Simply cut off the point as shown and extend the hole on through the eraser. Stiff bare wire wound on the opposite end when grommets have been installed will hold them in place under any normal conditions.

One finger cut from an old glove and pinned to the inside of a purse serves as a convenient holder for an inhaler tube.

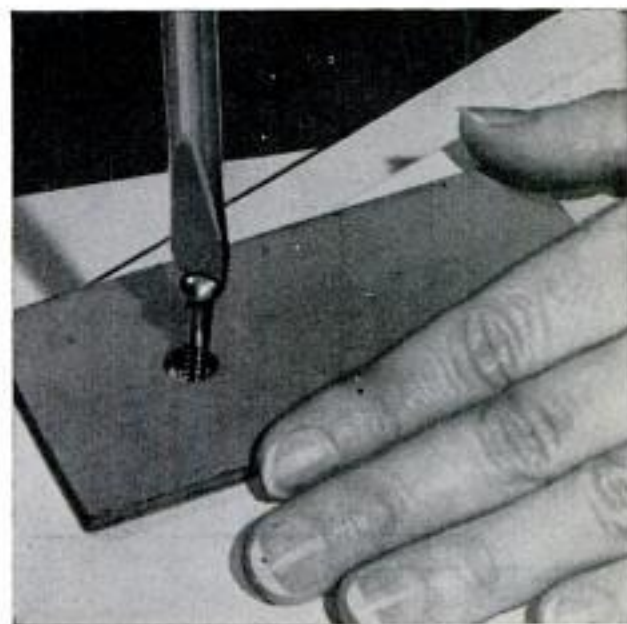

# SOLVING Home Problems

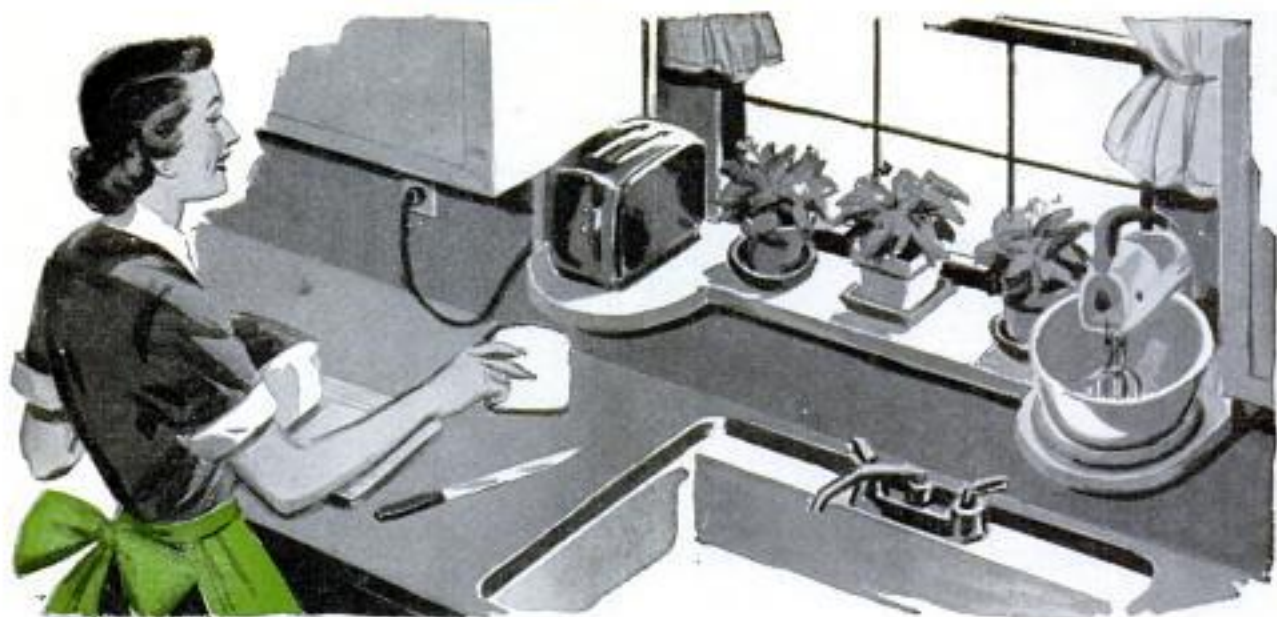

**THIS WINDOW SHELF** solves three kitchen problems—provides parking space for toaster, food mixer and potted plants. Cut shelf from  $\frac{3}{4}$ -in. plywood and surface with colorful Marlite and contact adhesive



**EVER THINK OF USING** a gum eraser to clean piano keys? It does the trick neatly, takes off finger marks and other surface stains without danger of dulling or otherwise damaging the surface of the keys

**IF THAT RECIPE** turned out badly, it may be that you misread the amount of some ingredient on the measuring-cup scale. Next time stick a length of tape around the cup at the required level and you'll be sure



198



**SAVE TWO PLASTIC BASKETS** in which small fruits and berries are sold and you can make an ideal container for a ball of twine or wool yarn. Lace edges of baskets together to form a hinge. Tie with cord

**THOROUGHLY WET MITTENS,** stockings and other child's garments can result from a snowball fight or building a snow man. Dry quickly on a curtain rod supported on L-hooks driven into wall above radiator

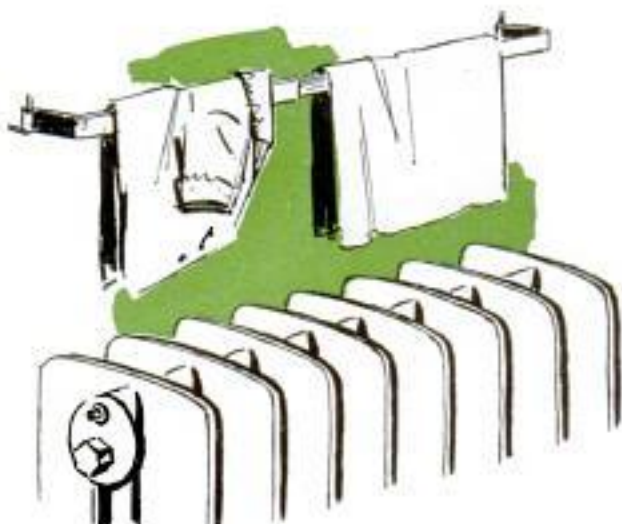

POPULAR MECHANICS

Copyrighted material





**A STUBBORN SASH** will yield to this lifter. Tap the block lightly to loosen one side, then shift slanting upright. Repeat procedure on opposite corner of sash



**IF THE JOB OF CLEANING** a pastry board is something you don't like to think about, try using a plastic windshield scraper. It turns the trick in half the time and with less exertion than is required by other methods. Scraper won't scuff board or raise grain



**SMALL-FRY TAMPERERS** can't turn on the water if you lock the sill cock in the manner pictured. The padlock and an S-hook (or a flat chain link) are all you need

**KEEP THAT ROLL** of wallpaper, below left, under control at all times by placing it in a short section of steel Venetian-blind slat tacked to the bench top

**CELLULOSE TAPE** pressed onto your finger, below right, will aid in removing a stubborn finger ring. In some instances two pieces of tape may be required

**THAT ANNOYING SQUEAK** in interior door hinges can be silenced for a long time simply by lifting pin and rubbing its surface with a soft lead pencil

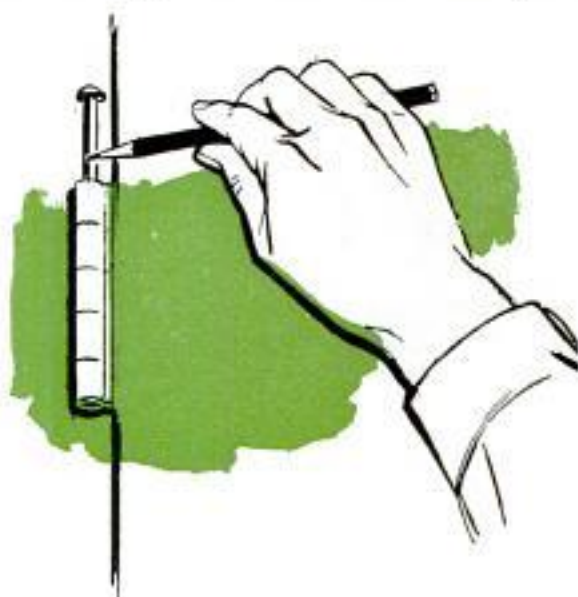

## Wooden Shelf Brackets Cut Without Wasted Stock

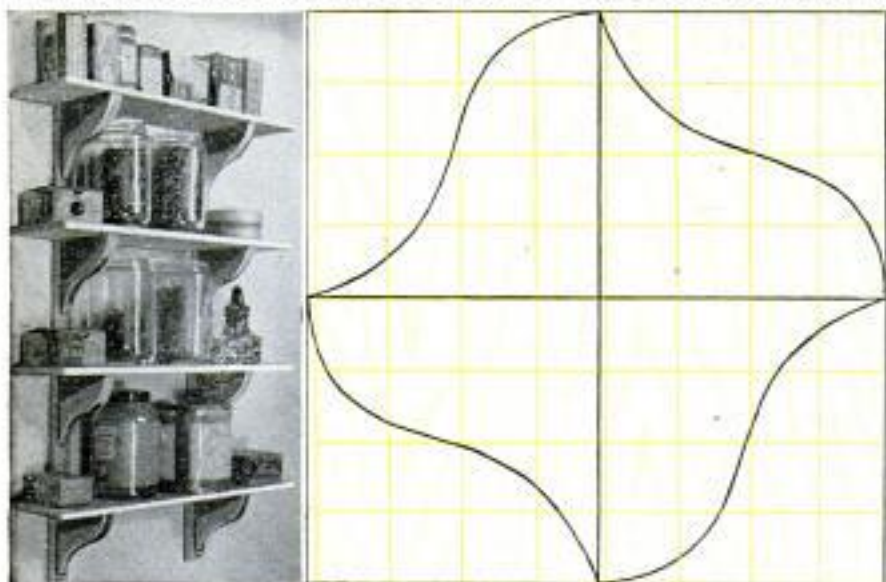

Any even number of wooden shelf brackets can be cut with absolutely no wasted stock if the pattern shown in the squared diagram at left is used. Both height and width of the brackets are the same, since a square piece of stock must be used. When solid stock is used, direction of grain must be watched. Plywood, either  $\frac{3}{8}$  or  $\frac{1}{2}$  in., is best, since the grain problem is eliminated. Bertram Brownold, Cedarhurst, N. Y.

## L-Hooks Permit Quick Removal Of Martin-House Sides

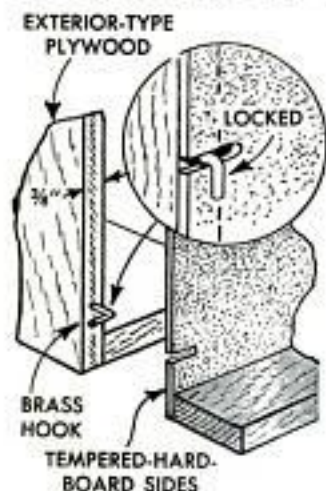

You will find that all the nests of a colony martin house can be made quickly accessible for cleaning if the sides are attached with L-hooks, one near each corner. Short saw cuts in the sides line up with the hooks, which are driven into the ends of the house. When the heads of the L-hooks are parallel to the cuts, a side comes off easily, but is locked in place when the heads of the hooks are turned at right angles.

When the heads of the L-hooks are parallel to the cuts, a side comes off easily, but is locked in place when the heads of the hooks are turned at right angles.

## Quick Refinish for Furniture

Checked and scratched varnish finishes can be smoothed quickly and easily by applying what is known to professional refinishers as an amalgamate. Commercial amalgamates are available, but ordinary alcohol can be used. First clean the surfaces thoroughly with turpentine and allow to dry. Then apply the amalgamate, or the alcohol, wiping it on with a piece of cheesecloth. When the surface is dry rub lightly with a wool pad dusted with fine pumice. After rubbing, wash the surface with clean, soft water to remove all traces of pumice and finish with a coat of flat or semiflat varnish. Finally, rub down with fine steel wool to obtain a smooth finish. Dust carefully with a soft cloth, then apply wax.

To give longer life to perforated folio sheets, reinforce the holes by using staples at opposite sides of each hole.

## Flashlight Rack Holds Spare Cells

Your household flashlight will always be within easy reach, and a spare bulb and dry cells will be with it, when this rack is attached to the wall at a handy location. Use  $\frac{3}{8}$ -in. stock and lay out the back and brackets on  $\frac{1}{2}$ -in. squares. Bracket spacing and length of shelf and dowel are determined by the flashlight. Ends of the  $\frac{3}{4}$ -in. dowel are reduced to  $\frac{3}{8}$  in.—John M. Avery, Dexter, N. Y.

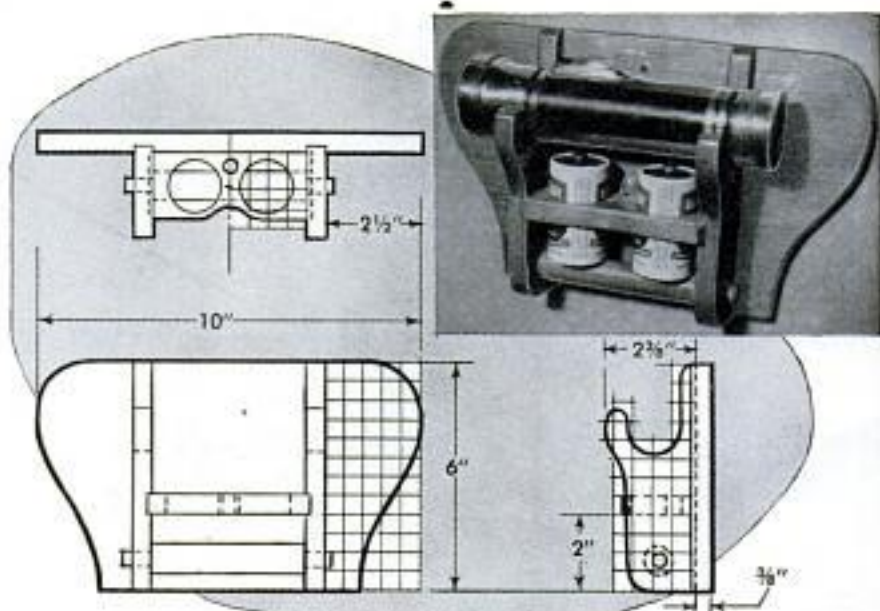

WTM 58

# MODELING THE LACHLAN MACLEAY

By Louis Martin Reitz

## PART II—Superstructure

WITH THE HULL completed to the point described last month, you are ready to add the superstructure to your 18-in. model of the towboat *Lachlan Macleay*. First of all, take the time to make a stand to support the hull and protect the props and rudders at the stern. This can be a temporary stand at this time or the finished one, and may consist of two cradle-like pieces, as shown in Fig. 11, or two spool-shaped brass turnings. In either case, they are screwed to the flat portion of the hull and to a baseboard of walnut, molded around the edge and given a rich hand-rubbed finish. If later you wish to make a protective display case for your model, a groove can be run around the baseboard edges to receive a glass or plastic case.

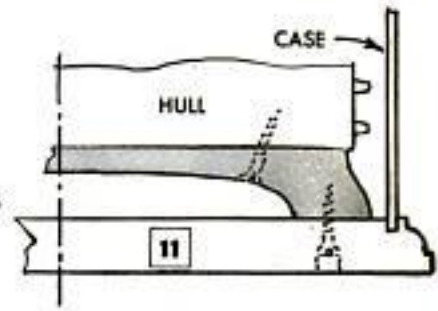
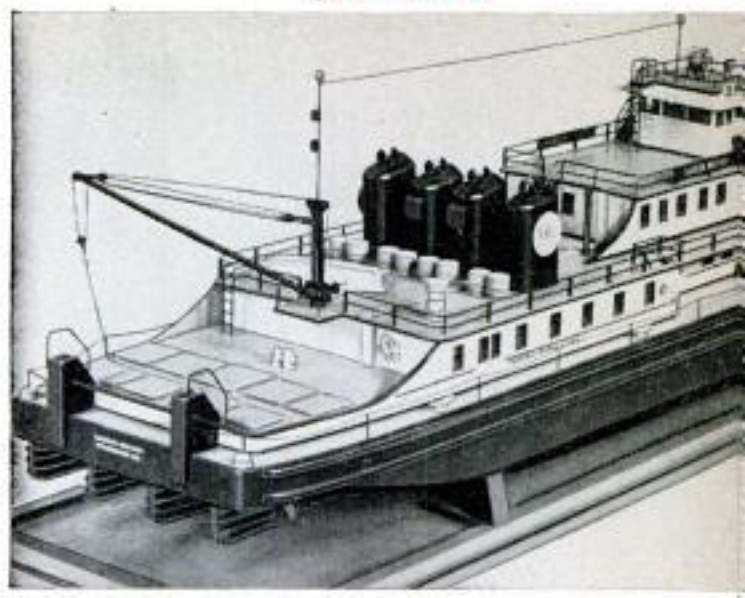

Front and rear patterns of deckhouses given below are half size. Profile view, also half size, is given on the following page. This means all sizes must be doubled

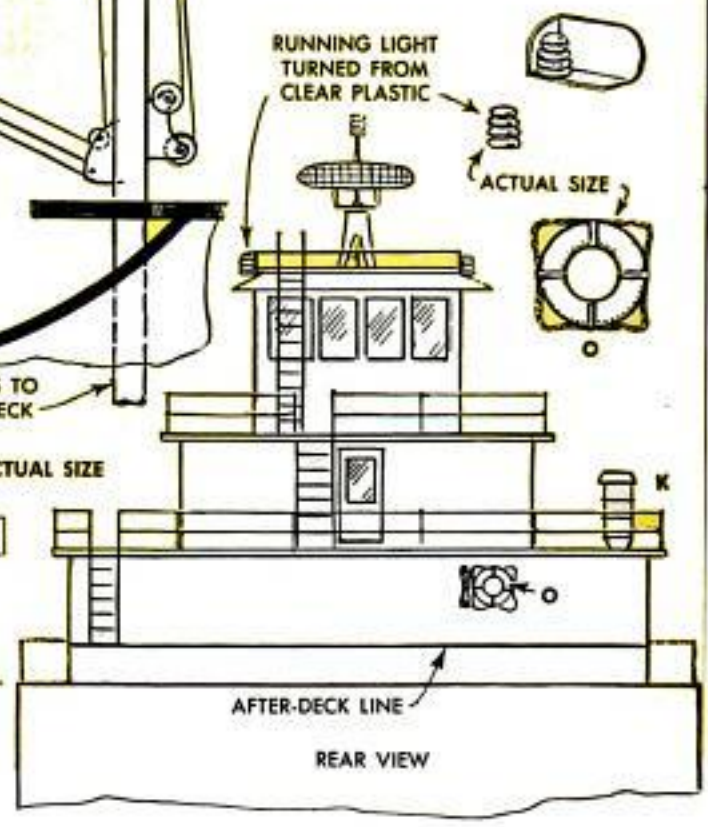
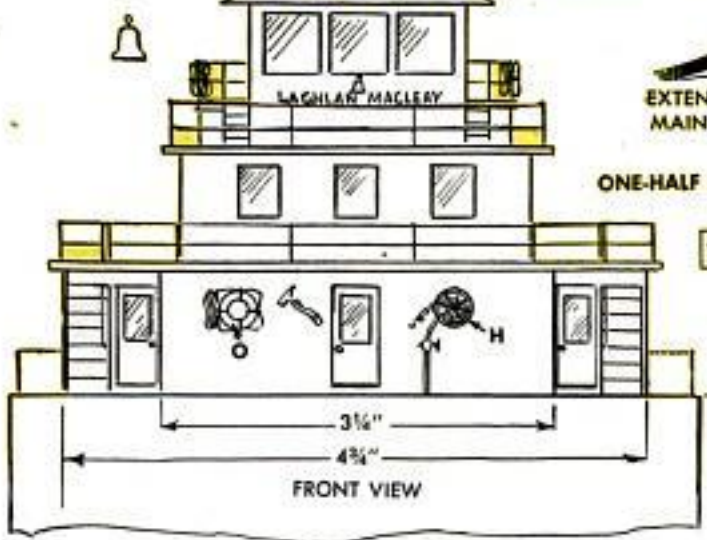
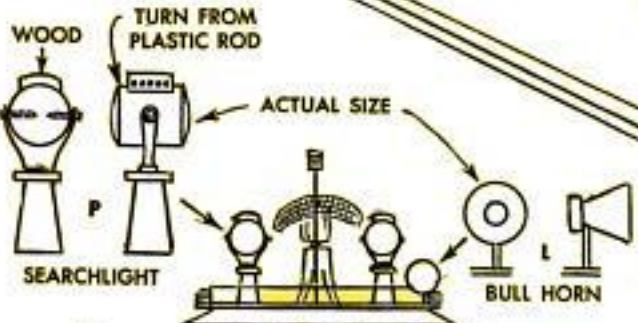
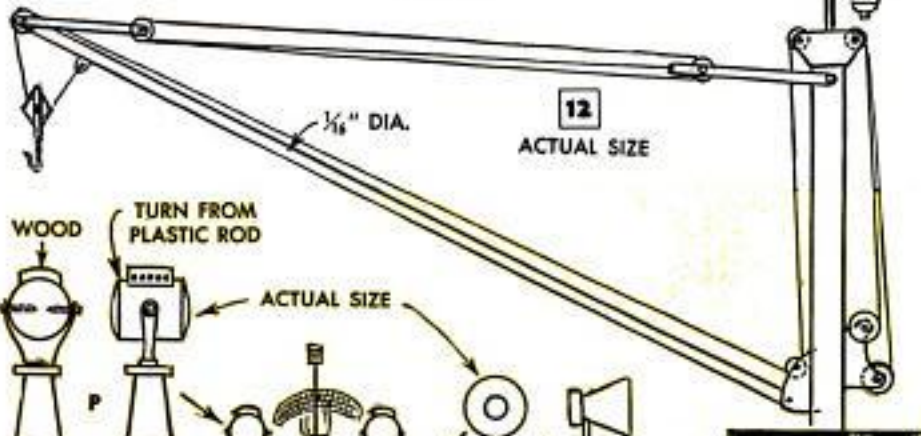



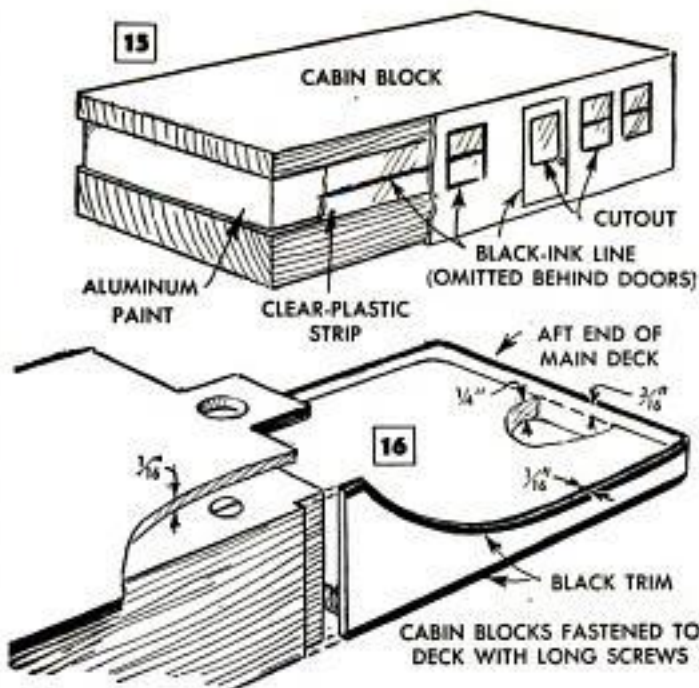

### The Deckhouses

On a model of this size, it is best to make the deckhouses of solid blocks. Figs. 13 and 14 show these houses one half actual size, which means you will have to double their sizes in laying them out on your wood. For the most part, the houses are merely rectangular blocks of wood. Perhaps the neatest way of simulating the various doors and windows on the houses is to cut shallow recesses in the edges completely around the blocks to receive a strip of clear plastic as detailed in Fig. 15. The recesses are first painted aluminum and then a black ink line is ruled in the center of the recesses to represent the sash. The ink lines are stopped where they cross door openings. After the plastic strips are pressed in place, the windows and doors of each particular deckhouse are laid out on a strip of thin cardboard and the window openings are cut out neatly with a razor blade. Cut out just the "glass" portion, and then outline window frames with black drawing ink. The doors can be treated the same way or glued on separately.

A baseboard is inked  $\frac{3}{32}$  in. wide all around each deckhouse. Actually, all this should be done after the cardboard is glued to the houses and painted jonquil yellow. Notice in Fig. 16 how the curved aprons aft of the deckhouses fit flush in shallow rabbets at the corners. The deckhouses are fastened to the hull with long wood screws, which are later covered by the decks. It will help a lot in attaching the railings if the decks are of metal, as the railing stanchions can then be spot-soldered to them.

### Making the Railing

Fig. 17 details a simple jig for forming the deck railing. It consists of a hardwood block grooved across the face. These grooves position  $\frac{1}{2}$ -in. brads which are

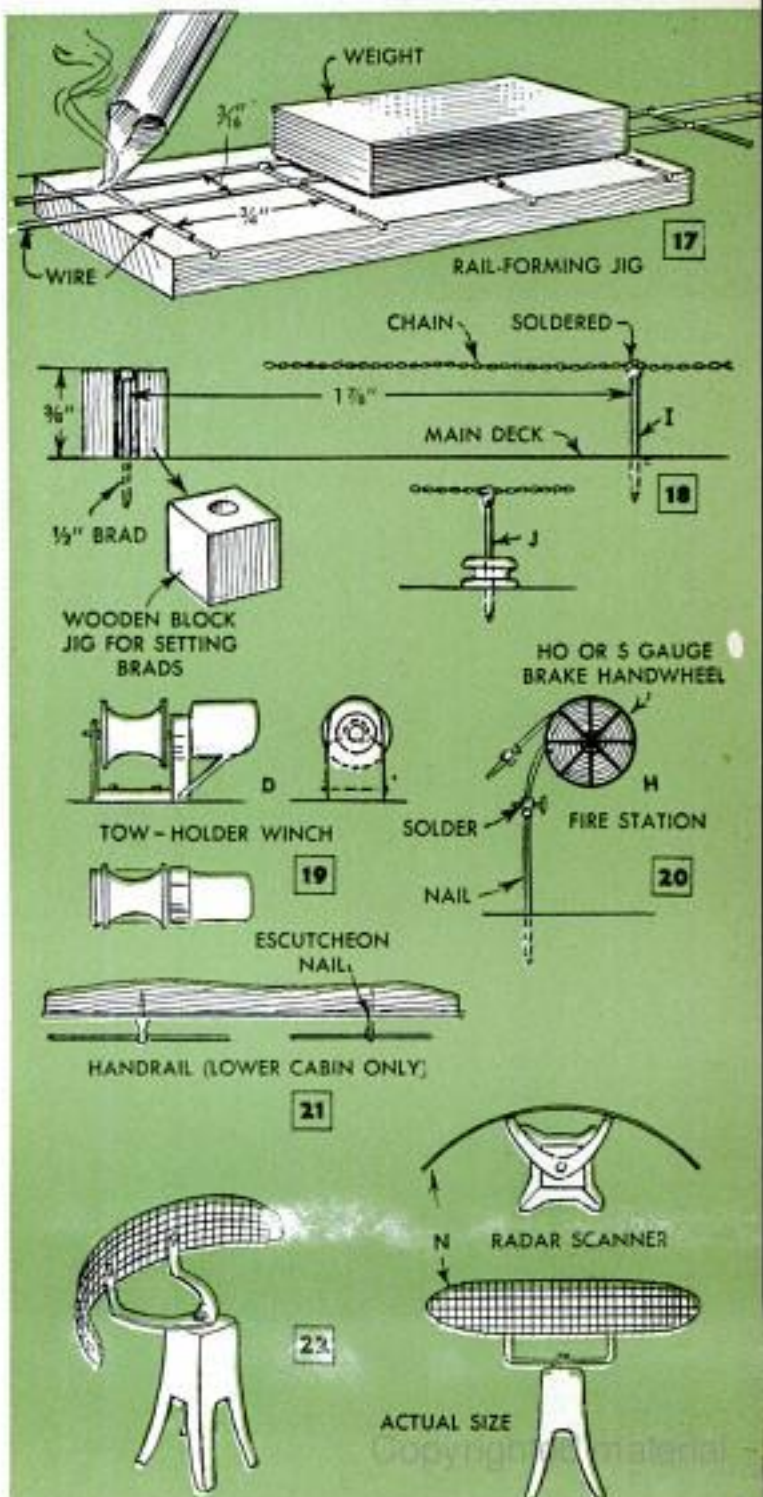
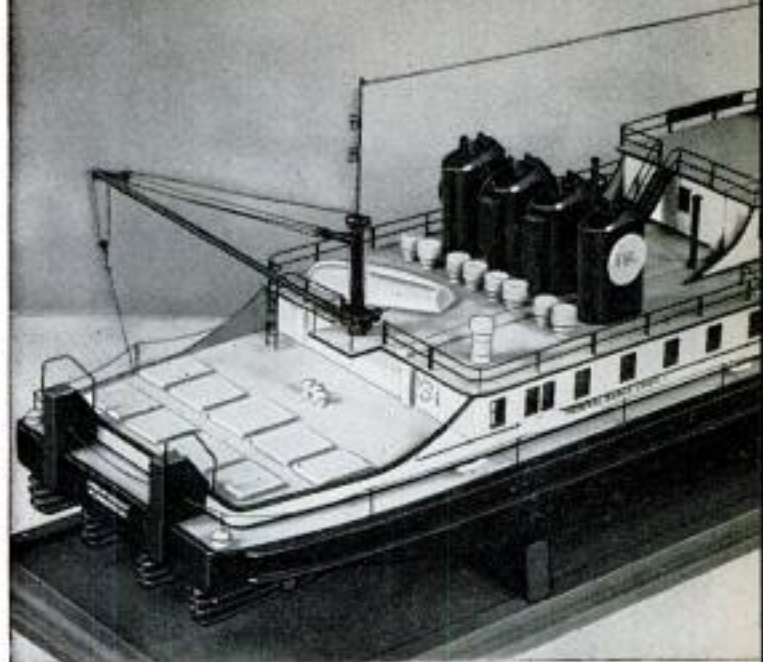



placed in them to provide stanchions for the two-strand wire railing which is spot-soldered to the brads  $\frac{3}{16}$  in. apart. A weight holds the wires in place as they are soldered. Use a tiny soldering iron for this and avoid over-soldering. It is best to add the railings to decks before fastening them to the deckhouses. Before the railing is applied to the second deck, sometimes called the boiler deck, the two openings should be cut for stairways. These are located on both port and starboard. See deck view, Fig. 14. Add the handrails on the lower cabin, Fig. 21; also the vent and filler pipes for the fuel-oil bunkers and the fire-hose assemblies, Fig. 20. The latter fittings can be simulated with fishline dipped in cement, coiled and then painted gold. There are three of these fire stations, one on the forward bulkhead and one on each side aft. In mounting the railings, leave enough stock to join onto the stairs, or ladders, on the upper deck and the ladder aft on the second deck. The ladders can be purchased ready-made. You will need five of them, two being placed on the main deck, one leading from the second deck to the upper deck and one on each side to the pilothouse. One ladder can be cut in half to make the two on each side of the bridge, Fig. 23.

#### Adding Rest of Fittings

Most of the fittings required can be purchased, although you may have to make some from bits of wood and plastic. All fittings are keyed with the deck plan, Fig. 14, to show where they all go on the model. Fig. 18 shows how to set the stanchions for the chain railing that skirts the main deck. These are  $\frac{1}{2}$ -in. brads spaced  $1\frac{1}{8}$  in. apart and driven to project  $\frac{3}{8}$  in. above the deck. A small block of wood with a hole through it and slipped over the brads when driving

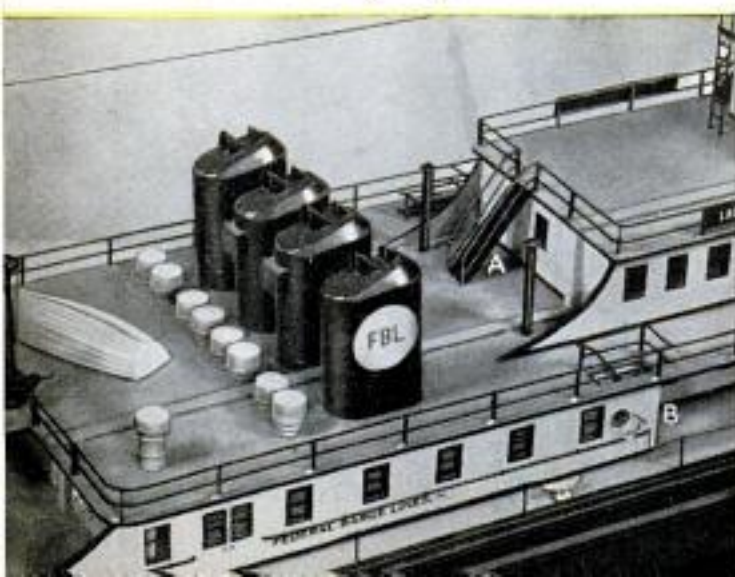
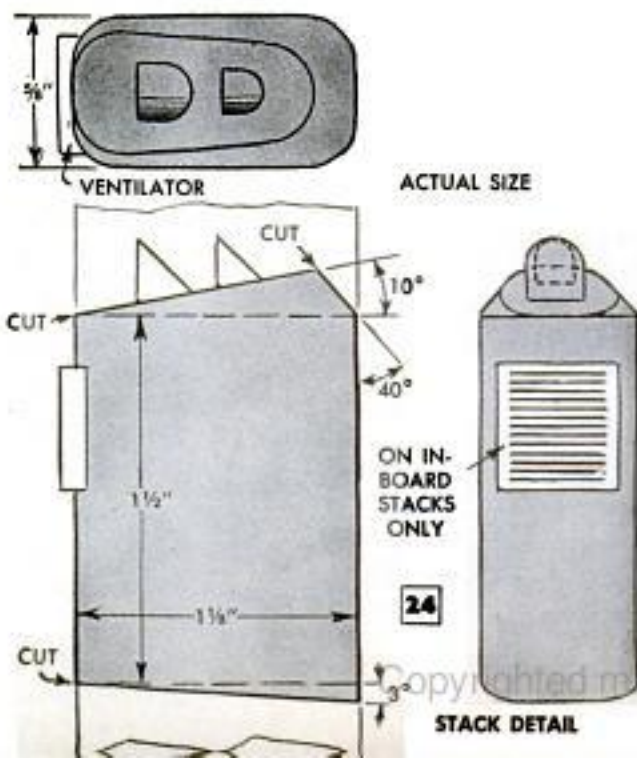
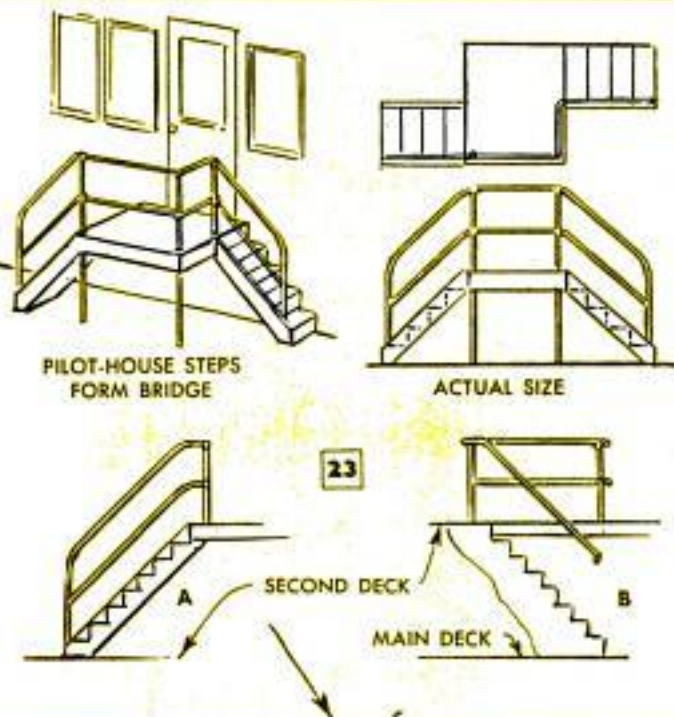

them will assure all being the same height. Oxidized model chain having 32 links to the inch is soldered to the head of each brad. As you will see, the chain railing begins at the forward knees and continues aft to corner stanchions which are mounted on buttons, or roller chocks. From here the chain goes through holes in the aft knees.

The stacks, which actually are shrouds for the exhaust pipes and mufflers, are detailed in Fig. 24. Four are required, all being the same size and shape and differing only in the placement of the fan ventilators. The outboard stacks have the vents mounted on the outer faces, under the FBL lettering, while the vents on the inboard stacks are placed on the aft sides. The detail shows the stacks actual size ready for tracing. The two small vents on top of each stack are short pieces of dowel. The circular letter boards are cut from light cardboard, painted yellow and lettered in red.

Details of the crane are given in Fig. 12. Most of it is made of dowels, the pulleys being formed from plastic rod and the sheaves and rest from thin sheet brass. Running lights atop the crane mast and the pilothouse mast, as well as the lights on each side of the pilothouse, are fashioned from bits of plastic. The topmost lights are white, while the two lower lights on the crane mast are red. The port light on the pilothouse is red and starboard one is green. Fine black thread is used for the antenna and glass beads for the insulators. Figs. 19 and 22 detail the remaining fittings, the towholder winches and the radar scanner. You'll notice in the photos that there are nine hatch covers on the aft deck. These are represented by small squares of cardboard. A tiny lifeboat is placed upside down on the second deck aft of the stacks. All fittings, including the railings, are painted black and the decks are medium gray. ★ ★ ★

### Leather Loop on Wire Brush Reduces Hand Strain



brush so it extends at one side for insertion of the thumb. The loop should fit your thumb snugly, but not so tightly that it is uncomfortable.

Hand strain suffered in gripping a wire brush to hold it safely, especially when working on a ladder, may be reduced by tacking a loop of leather or rubber to the top of the

### Legs of Sawhorse Are Adjustable To Various Heights



Support scaffold planks on uneven surfaces with sawhorses having adjustable legs. The legs utilize two sections of pipe with the lower piece sliding inside the other. Equidistant holes are drilled in a line along the lower section of pipe. A bolt slipped through a hole at the bottom of the outside pipe and into any one of the holes permits adjusting the leg to the desired height.

Hugh Lineback, Stillwater, Okla.

### "Self Closing" Turn Button

Wooden turn buttons used to hold doors, gates and shutters sometimes accidentally rotate to an open position due to vibration or other causes. To prevent this, locate the pivot of the turn button off center as indicated. Its own weight then will cause the turn button to assume a horizontal position when it is free to turn.



WTM 58.

# Vegetable Puppets



Let the youngsters paint puppet faces with water color, assuring easy cleaning of hands and clothes



Above, fruit, vegetables and egg provide a variety of shapes for different character's heads. Below, first step in preparing vegetable for making puppet head is to cut finger hole with coring tool



WHEN IT COMES to rainy-day entertainment, nothing pleases youngsters more than watching the intriguing antics of puppets, except actually working the puppets themselves. What's more, materials for making the whimsical creatures are as close as the vegetable bin and sewing basket. As shown on these pages, almost any vegetable of moderate size, many fruits and even empty, whole eggshells can be used for puppet heads.

The first step in making the head is to cut a finger hole in the fruit or vegetable with a paring knife or coring tool, Fig. 3. Next, paint on the features of the faces with tempera or water colors. The children can help in this operation, Fig. 1, and water paints are more easily washed from clothes and hands than oil-base types. Hair for the figures can be absorbent cotton or yarn cemented in place. Hair also can simply be painted on, with a bandanna providing an added touch, Fig. 2. Dresses for the puppets are simple to cut out and sew, Fig. 7. Sew them inside out, then turn right-side out to assure smooth seams. Include

Next step in making puppet head after cutting finger hole is to paint on face with tempera or water colors





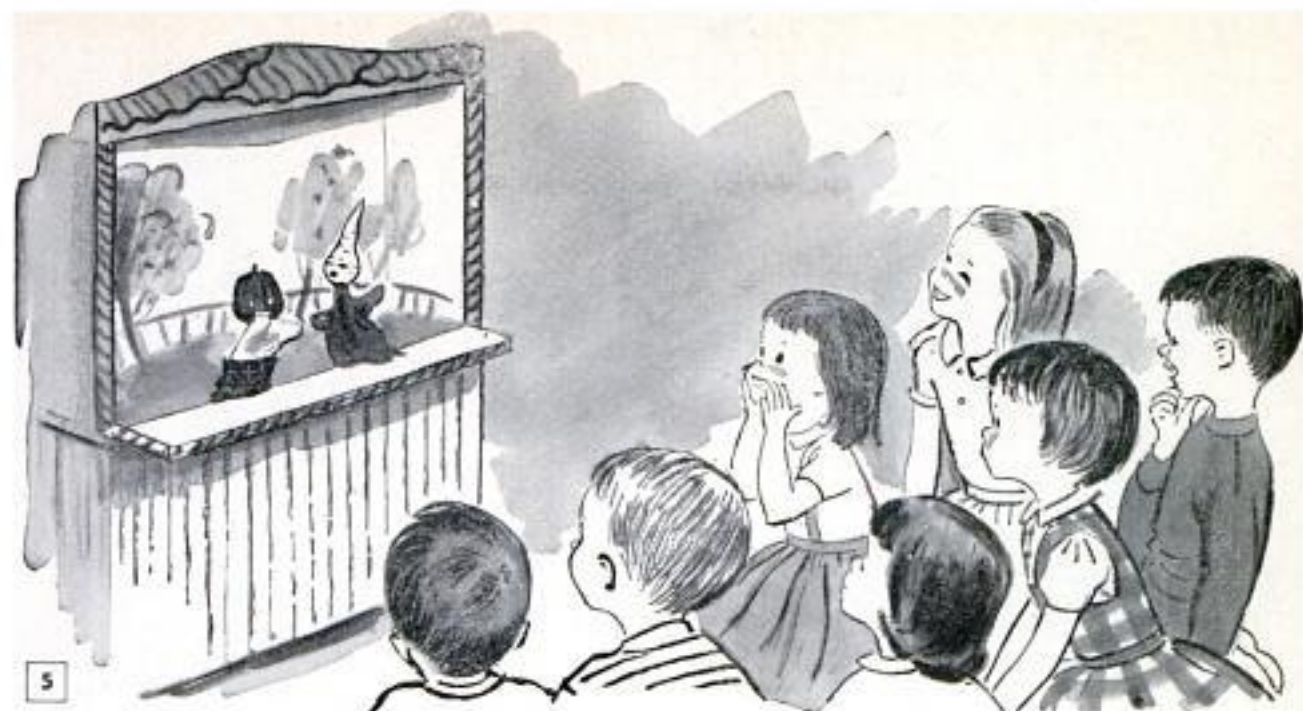

three "arms," the center one being used to cover the finger that is inserted in the head of the puppet, as in Fig. 8. Measure hand span of the child who will work the puppet to determine the correct dress size. Hands or fingers can be painted or embroidered on the ends of the arms, or hands from discarded dolls may be attached. Odds and ends of ribbons, feathers and costume jewelry can be used as dress accessories.

A stage for a puppet show can be a large cardboard box cut to form the stage and painted as desired, Fig. 6, or can be a more elaborate structure of hardboard or plywood, Fig. 5. Lights and curtains that open and close will add an authentic touch. With lights above the stage and a translucent backdrop, the puppeteers can sit or stand behind the backdrop while working the puppets without being visible to the audience.

★ ★ ★

Puppet dress is sewn with inside out, then turned right-side out, so finished dress has smooth seams

Above, "Carrot Top" and "Green-Pepper Head" entertain the youngsters with their antics on stage



Above, puppet stage can be large cardboard box cut to shape and painted to provide backdrop. Below, center "arm" of puppet's dress actually covers index finger that is inserted in hole cut in head



## Wooden Fruit Bowl Supported on Wire-Coat-Hanger Legs

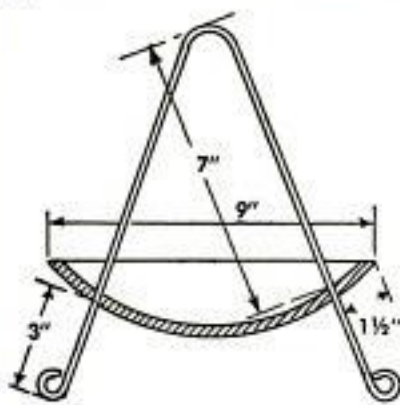

SPACE HOLES BY LAYING  
5 1/4" SQUARE PAPER ON  
BOWL BOTTOM AND MARK-  
ING CORNERS

With the addition of "wrought iron" legs formed from two wire coat hangers, a 9-in. wooden bowl can be made into a modern fruit tray. Both pieces of coat-hanger wire are cut to a length of 23 in., and bent to the shape of a hairpin. Location of the four angular holes drilled through the bowl is determined by centering a 5 1/4-in. square of paper on the bottom of the bowl and marking the wood at each corner. Proper angle for the holes

is estimated when drilling; then the "hairpins" are pushed through. Eyelets are formed at the bottom of each leg and the top arcs joined together with soft copper wire to form a handle. Friction should hold the bowl in place, but as a precaution, cellulose cement should be forced into the holes around the wires.

Walter E. Burton, Akron, Ohio.

## Lath Holds Linoleum Edge While Cement Sets

To assure a good bond along the edges of newly laid linoleum, one homeowner tacked a border of wooden lath around it as shown. The lath strips, coated with grease on the underside to prevent cement from adhering to them, are removed after the cement has set. Small box nails are used to fasten the strips to avoid noticeable holes in the floor around the linoleum and ease removal of the lath.

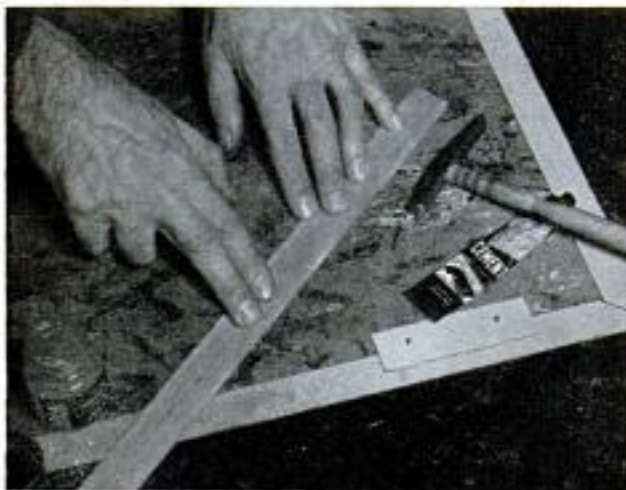

## How to Start a Siphon

Starting a siphon hose is relatively easy if it is done as follows: Insert the hose in the liquid to within an inch or so of the upper end. Then place a finger tightly over the upper end, draw the hose rapidly up (but not completely out of the liquid) and down below the level of the liquid, removing your finger during the downward motion. This rapid motion will cause the liquid to push the remaining air ahead of it as it flows out.

W. Shupenia, Smoky Lake, Alta.

## Multiple-Reel Holders Speed Film Developing

Aluminum molding strips or 1/8-in. aluminum wire bent into the shapes shown provide holders upon which as many as nine reels of film (three reels per holder) can be developed simultaneously in one tank. Aluminum holders must be removed when reels are placed in hypo solution to prevent its contamination.

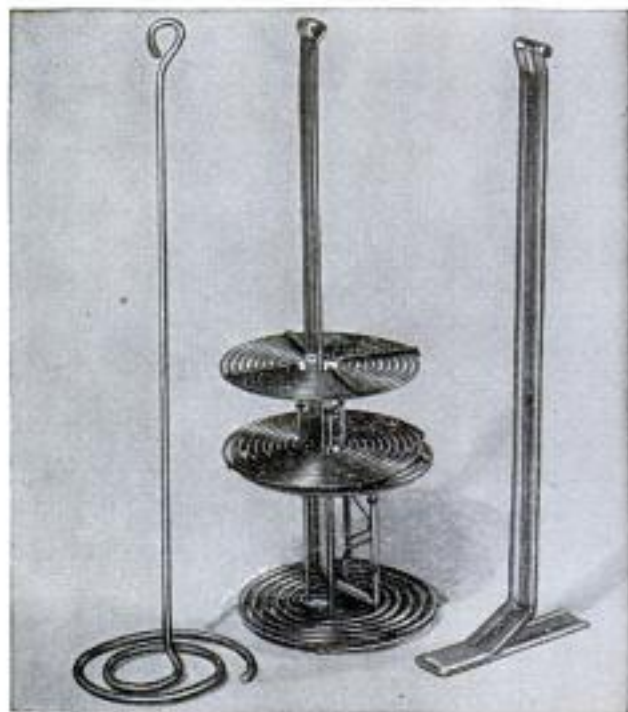

POPULAR MECHANICS

## A Third Member for Your Automatic Laundry

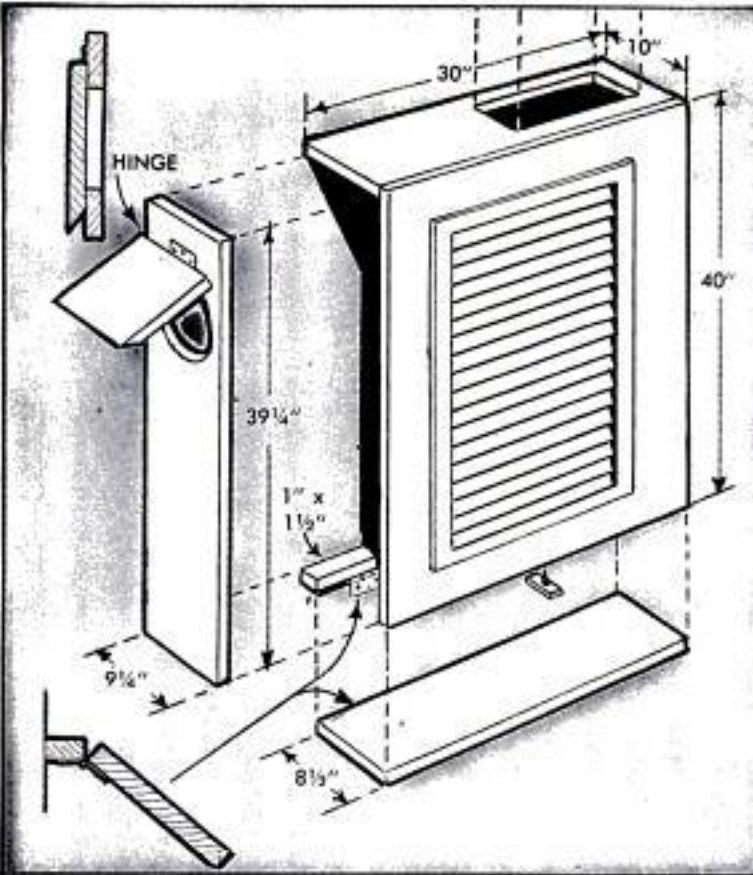

By M. C. Anderson

Even with an automatic clothes washer and drier, collecting and sorting soiled clothing must be done by hand. You can bring "automation" closer to the home laundry by building and installing this storage hamper which permits the clothes to be dropped directly to the tops of the washer and drier for convenient sorting. If the laundry room is in the basement, extend a chute from the hamper up between the floor joists so that clothing can be dropped into it without the need for entering the basement. In a two-story house with the laundry on the first floor, or basement, a similar arrangement can be made. When the laundry equipment is in a utility room of a one-story ranch-type home, build the hamper with a door near the top of one side. Soiled clothing left on the washer or drier by the children can easily be dropped into the hamper by taller members of the family.

Dimensions of the hamper can be changed to suit the size of the family wash, but the hamper should not project more than 10 in. from the wall to avoid interfering with the opening of the lids on some types of washers, and to allow circulation of air around both units to aid in carrying away excess heat. To simplify construction, the louvered panel in the



front of the hamper can be replaced by a sheet of attractive perforated hardboard. The 1 x 1 1/2-in. strip on the bottom of the hamper is screwed securely to the wall and the bottom is hinged to it. A simple wooden turn button is used to keep the bottom shut. Be sure that any nails or screws that project into the hamper are cut off and filed flush, and that all wood surfaces are smooth, so clothing will not be snagged or torn. A coat of waterproof varnish will aid in keeping the inside of the hamper smooth and dry.

### Match Lengthens Pen Refill

When the correct-length refill for a ball-point pen cannot be had, a shorter one may be used by extending its length with a matchstick. Remove the head and shape one end of the stick to fit tightly in the top of the refill. Then cut the stick to the proper length and place the assembly in the pen.—Harry Radzinsky, New York City.



### Caster Cups on Hairpin Legs Prevent Damage to Floors

Hardwood caster cups permanently attached to hairpin legs of modern furniture with brass cup hooks or screweyes prevent damage to floors. Press the eye around the leg but leave it loose enough to slide and turn in all directions, so it can adjust to uneven floors.

William C. Eymann, Palo Alto, Calif.

### Replacement Pad for Floor Mop Cut From Cellulose Sponge

Cut to fit and fastened with waterproof cement, a cellulose sponge may be used as a replacement pad for a sponge-type floor mop. A saving of about two thirds the cost of a regular replacement pad is realized and, since synthetic sponges are commonly used around the home, one may be at hand.

Kate L. Onderdonk, Margate City, N. J.

### Bit Prevented From Slipping Into Previously Drilled Hole



To drill a series of holes close together without the bit slipping back into a previously drilled hole, clamp the work in a vise as shown. Holes already drilled are concealed between the jaws of the vise which can be used as a guide. —Arthur Shults, South Bend, Ind.

# VANITY TABLE Doubles As Desk

By Ralph Treves

USED EITHER as a vanity or as a practical desk for the home or business office, this unit has the proportion and design detail that belong with modern furnishings. You purchase the pedestals ready-made and then make the top and frame for the two center drawers in your own shop. Fig. 1 pictures the unit in use as a vanity, the over-all dimensions having been worked out so that the unit fits neatly into the wall recess. When used as an office desk the over-all width can be reduced somewhat if desired.

The top is  $\frac{3}{4}$ -in. hardwood-faced plywood surfaced with wood-grained plastic applied with contact adhesive. The plastic sheet should be of a color and grain to match the wood in the pedestals. Apply the plastic facing to both sides of the plywood and finish edges with wood-grained "tape" made especially for the purpose. After making the top the next step is to remove the tops from the pedestals (so that the new top will be at the correct height), Fig. 2. Then make the drawer frame and the drawer, or drawers, as required, following the general construction detailed on the opposite page. The detail shows the simplest type of drawer construction but, of course, you can use conventional construction if you have the necessary equipment at hand. Screw the drawer frame to the underside of the top, Fig. 3, then screw the pedestals to the top and also to the edges of the added drawer frame as in Fig. 4. Then finish the wood to match the room furnishings. ★ ★ ★

After "veneering" plywood top with a plastic wood-grained facing, drawer frame is screwed in place

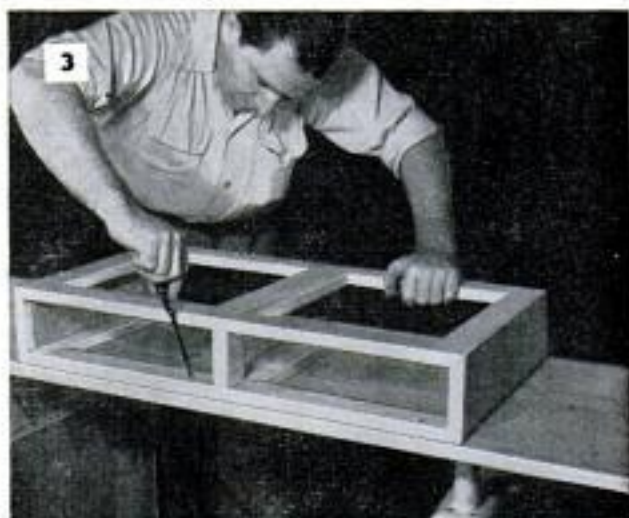



1

Here the vanity-desk unit is sized to fit neatly in a wall recess. When used as a desk the top can be made in the same general proportions, or made somewhat shorter and the center frame designed for one drawer

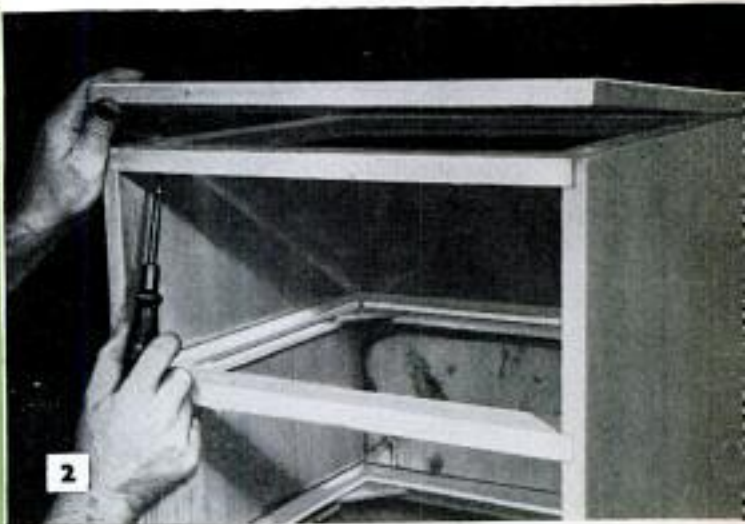
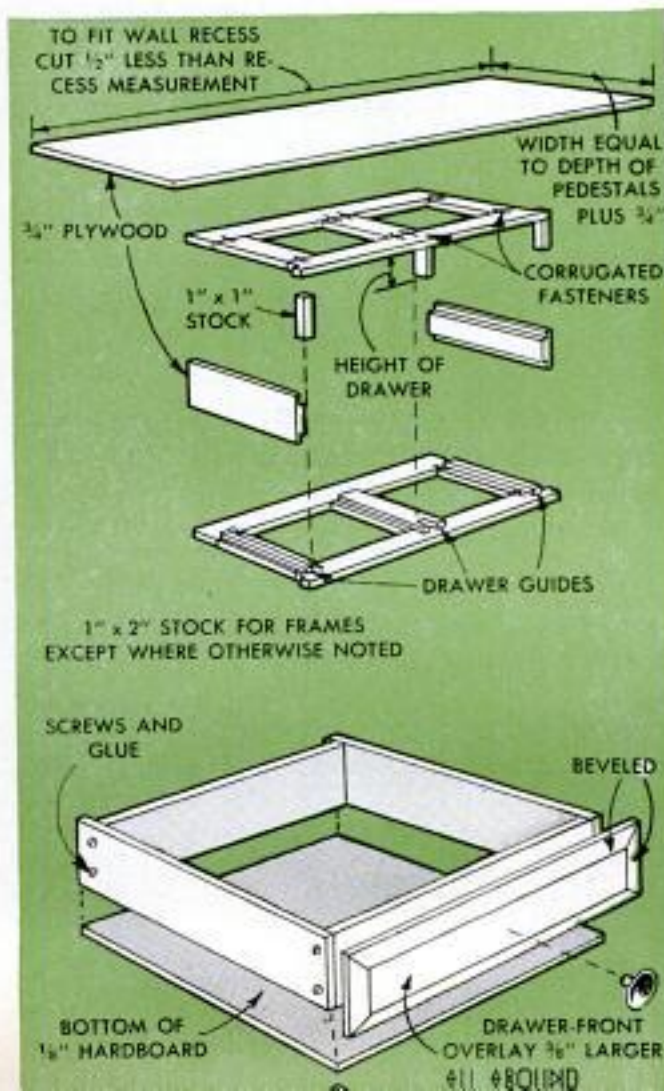

2

Above, standard tops with which pedestals are supplied are removed to give new top proper height. Below, pedestals are screwed to frame



4

DRAWER FRAMING IS ATTACHED  
TO SIDE OF PEDESTAL WITH  
FLATHEADED SCREWS

## Plastic Dropcloth Speeds Masking Auto for Painting

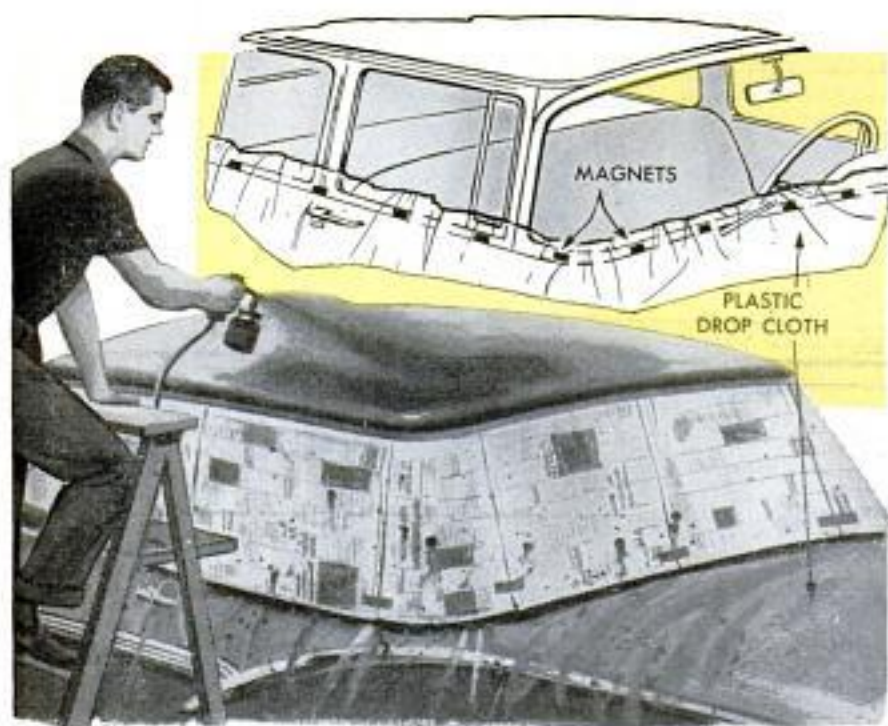

You can save both time and masking tape when repainting a car, especially two-toning, by covering the bottom color with a plastic dropcloth held in position by small magnets as shown. The windows are covered with strips of newspapers taped to the drip molding. With this method, a car can be completely masked in a few minutes. Apply the bottom color first, and allow it to become dry before masking for the second color. — Stanley Clark, East Bradenton, Fla.

☞ To provide luster and added toughness to exterior oil paint, add a little spar varnish.

## Butt Joint Fitted Accurately By Using Doubled Sandpaper

To assure a tight-fitting butt joint between two wooden panels, simultaneously sand the edges to be joined. Double a piece of sandpaper so the abrasive is on the outside, then slide it back and forth between the panels that have been clamped together so there is just enough clearance for the sandpaper. Place the panels on blocks so the sandpaper does not catch on the workbench top.



## Make Your Own Sports Car

by utilizing parts from any junked or used car. If you have ever wanted to build a car of your own, completely original in design and styling, don't miss the article in the February issue which shows in detail how to build a modern, low-slung sports car with a competition-type frame

## Rack for Sanding Belts

To keep sanding belts close at hand and in order, provide a rack for them as shown. Wooden clothespins set in holes drilled in a board and the latter mounted on the shop wall near the sander make a convenient rack. The belts are squeezed together and inserted in the clothespins.



## Center Point for Compass Provided by Thumbtack

When using a compass on soft materials such as cork, rubber, or cloth, place a thumbtack at the center point and mark it with a center punch. The compass point will have a true center and the circle drawn by the compass will be accurate.

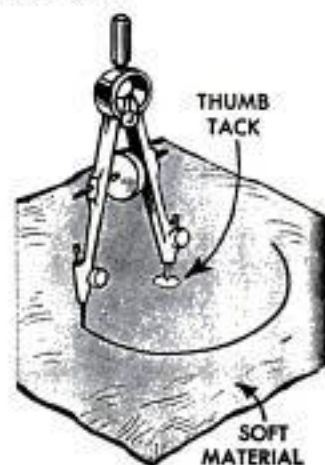

# REDECORATING WITH LIGHT

REPLACING an old-fashioned ceiling light fixture with a smart, modern unit is an extremely effective way of improving the appearance of a room, and requires very little time, effort and expense when compared to the increased beauty and better lighting it adds to the room. The first step in removing the old fixture—after unscrewing the fuse that supplies current to this particular circuit to eliminate any chance of getting shocked—is to take off the small locking collar that holds the canopy which covers the fixture mounting and wires. In some cases the collar can simply be unscrewed, in others it may be held with a setscrew that must be removed. Generally both collar and setscrew are brass, so care must be used not to break off the screw. With the collar removed, pull down the canopy to expose the wires. Cut the two wires coming from the fixture at a point an inch or two below the taped splices. This is to aid in identifying the wires when installing the new fixtures, and to avoid disturbing other wires in the ceiling junction box that may lead to wall receptacles and switches. Remove the old fixture which may be fastened in one of two ways, either by a single locknut on the mounting stud, or by screws and nuts to a strap. If a strap was used for the old fixture, check to see if the new fixture can be attached to it. If not, discard it and replace it with a new one. The strap is held on the mounting stud by a locknut. Now, attach the new fixture to the strap with screws and nuts. Next, take one of the ceiling wires and remove the tape and unwind the splice. If the wires have been

Drop the canopy on the old fixture, then pull down the wires and cut them at a point below the splices

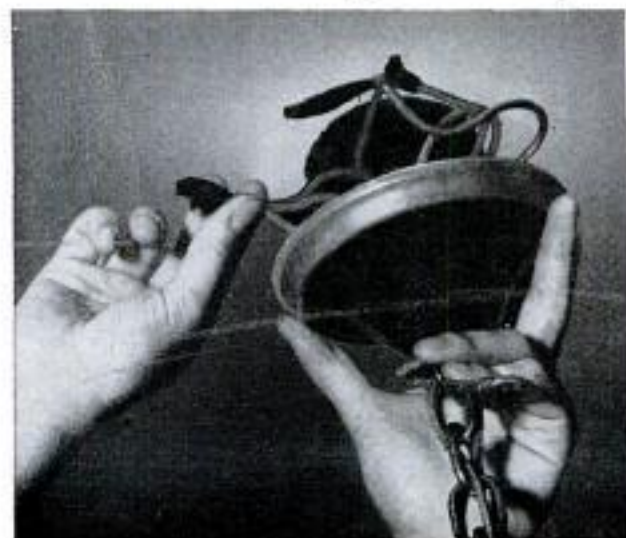

JANUARY 1957



Better quality of lighting and greater beauty are double advantages provided by modern light fixture

soldered, cut the splice and file off the solder. Twist this wire onto a wire of the same color on the new fixture. A black or colored wire is the "hot" wire, and a white wire is the neutral or ground wire. Twist the wires together so the twisted portion is at right angles to the wires, making an "underwriters" splice. Do not make an "in-line" splice for the sake of neatness. After splicing both wires, wrap them with electrician's tape and tuck them up around the fixture mounting. Slip on the new canopy and hold it in place with the locking collar.

Courtesy American Home Lighting Institute.

Canopy on new fixture is held in place by locking collar. This is turned against it as shown below



213

Copyrighted material

SN 51

# BRAKES FOR TODAY'S

By Ed Packer

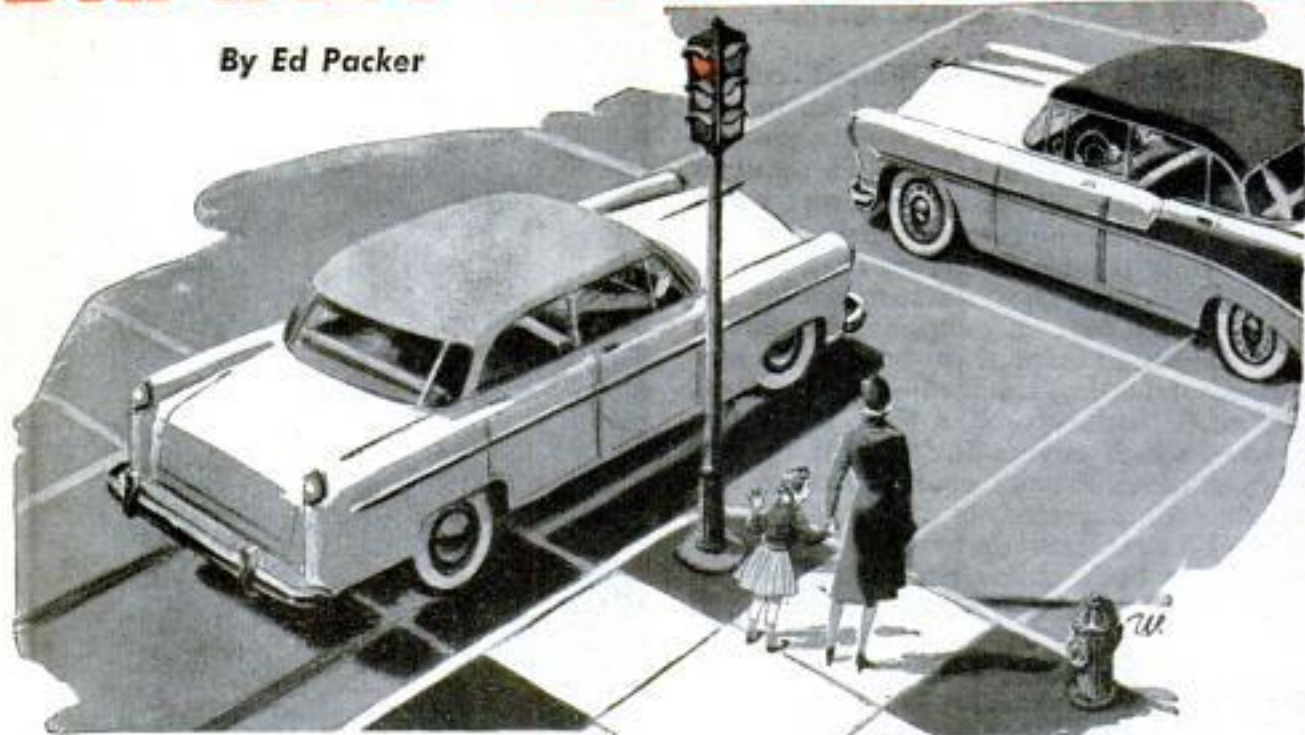

After wheels are removed, boots on wheel cylinders are pulled back and cylinders checked for leakage. Below, new brake lining is buffed to a true radius



**GOOD BRAKES** can save your life, and the best way to make sure the braking system of your car is always in top condition is, first, to recognize the symptoms that indicate trouble. Second, have the trouble corrected immediately. Third, use only material recommended by the manufacturer of your car, or materials of comparable quality and dependability.

## Symptoms and Causes

One symptom of brake trouble that often is ignored is a "spongy" pedal. Generally it is caused by air in the hydraulic lines, and simply "bleeding" the brakes will eliminate it. However, air does not enter the system normally and a spongy pedal indicates that somewhere in the system there is a leak that is allowing fluid to escape and be replaced by air. It could be a leaking connection, wheel cylinder or master cylinder or a break in either the tubing or a flexible hose. All components should be checked to find the leak, and it should be repaired immediately. If, when you hold the brake pedal down firmly, it slowly moves down under the pressure, the master cylinder should be overhauled or replaced. The compensation valve in the cylinder is leaking and sooner or later will fail completely. Any time that the brake pedal goes lower than about 3 in. from the floor—power brakes being excepted since they have an extremely short travel—the brakes should be adjusted, and one front wheel pulled to check the condition of the lining. Should a car pull to



# TRAFFIC

either right or left when the brakes are applied, it generally indicates that grease or brake fluid is running onto the lining and causing the brake to "seize." Pull the wheel that is giving the trouble and check the grease seal. If it is all right, and brake fluid is leaking from the cylinder, it should be repaired or replaced. Brake fluid usually can be washed from the linings with alcohol, after which the lining should be sanded lightly to remove the glaze. Grease cannot be removed from lining and requires that the lining be replaced. Never replace lining on a single wheel without replacing the lining on the opposite wheel, to assure equal braking characteristics of each wheel.

## Complete Brake Relining

If you check your brakes and find they need relining, here's what a mechanic will do. He first removes all wheels and checks for leaking wheel cylinders, Fig. 1. They must be repaired or replaced. Scored drums will require turning on a drum lathe, unless gauging, Fig. 3, shows that they have already been turned oversize to the maximum limits, which means they must be replaced. Out-of-round drums will be trued. After new lining has been installed, it may be necessary to buff it to a true radius if the shoes are distorted, Fig. 2. After reassembly of the brakes on the backing plates, the drums are reinstalled, Fig. 5—front-wheel bearings are repacked with grease first—and the brakes are adjusted, Fig. 4. ★ ★ ★



Above, drums are checked for true radius and to see if they have been turned oversize beyond limits



With drums reinstalled, brakes are bled and adjusted so there is no drag, good pedal. Below, front-wheel bearings are repacked before drums are reinstalled. In latter operation, care is taken not to use an excess of grease which may run onto brake drums



167A 58

# Kitchen Cabinet for Condiments and Towels

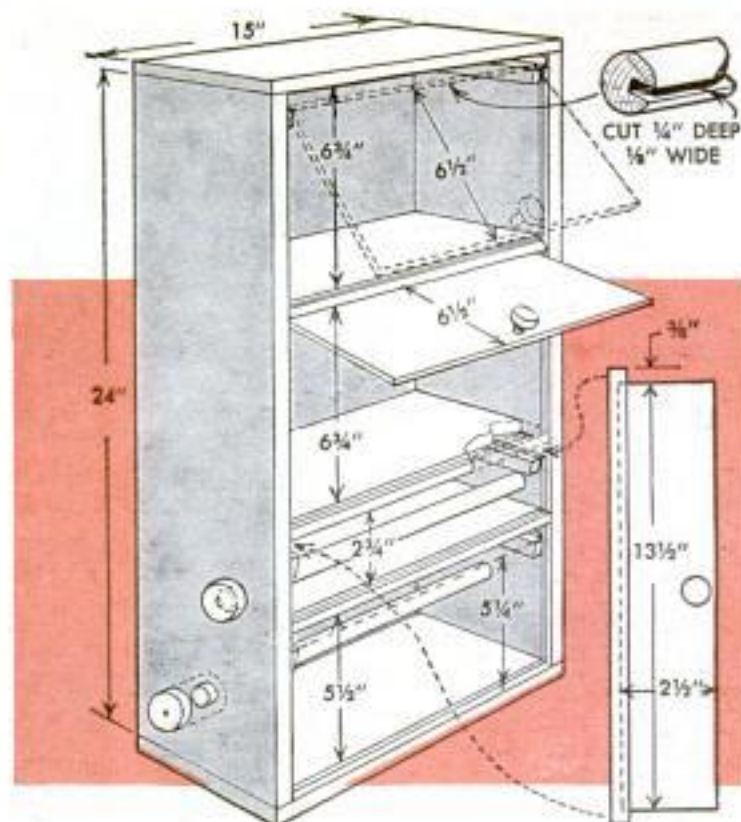

A useful cabinet to have in your kitchen is this combination wall-mounted unit. It has plenty of room for condiments on the two top shelves and ample space for a roll of waxed paper and a roll of paper towels mounted on dowels in the bottom section. Sliding doors provide easy access, keep dust out and give the cabinet a smart appearance. The sides are 3/4-in. plywood while the top, bottom and back members are cut from 1/2-in. material.

The doors of the cabinet are made of 1/8-in. wood or hardboard, each glued into a 1/2-in. dowel that is grooved as shown in the detail. The dowel extends 1/2 in. beyond the sides of the door so that it will slide in 1/2-in. grooves cut in the sides of the cabinet. Cleats, nailed at the bottom edge of the grooves, support the doors when they are open. The 1/4-in. plywood shelves are glued and nailed into position directly above the slots. Facing strips nailed over the front edges of the cabinet provide stops for the sliding dowels, while 1/4-in. wooden strips tacked to the top of each shelf 1/8 in. from the front edge serve as doorstops when the doors are closed.

T. K. Hastings, Los Angeles, Calif.

## Strong Hypo Substitutes for Rapid Fixing Solution

With the new single powder acid fix on the market it is possible for photographers to mix a double-strength hypo and get the same effect as a rapid fixing solution, and at less cost. The hypo mixture has none of the caustic properties of the ammonium-chloride rapid fix and has none of the corrosive effect of the latter. By using this double-strength hypo, films will clear equally as fast as when treated with a rapid

fix, and the hypo will actually last three to four times longer than a mixture of normal strength. When used on prints, the bleaching characteristics of a rapid fix are not present and the time allowance for immersion of the prints is not a controlling factor. A mixing ratio of acid fix, two parts to water, one part, is suitable for most general requirements.

Robert C. Florian, Cicero, Ill.

## Wire-Mesh Debris Catchers for Basement-Window Wells

To facilitate the removal of leaves and other debris from air wells around basement windows place a  $\frac{1}{4}$  or  $\frac{1}{2}$ -in. mesh screen, cut to size, in the bottom of the well. It can be held flat by first welding a rim of  $\frac{1}{4}$ -in. rod around the edge of the screen. Upright handles, also of  $\frac{1}{4}$ -in. metal rods, are bent to shape and welded to the rim on opposite sides.

A. L. Kaser, Niles, Mich.

## Metal Washer on Ball-Lift Rod Improves Flush-Tank Action

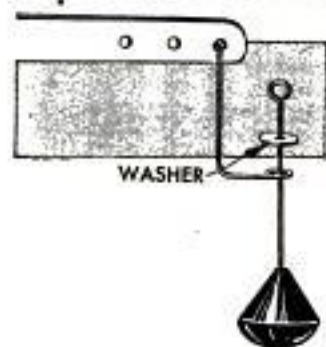

A small metal washer slipped over the lift rod on a flush-tank ball will keep the rod from catching on the lift wire, a common problem which prevents the ball from seating. Unscrew the lift rod from the

ball, remove it from the lift-wire loop, slip the washer over the rod and replace the rod so the washer is between the loops of the lift rod and wire as shown.

Bob Hewitt, Colorado Springs, Colo.

## Paper Clamp "Pinchproofs" Saw

It is easy to prevent a saw from binding when the severed pieces twist against each other, by slipping a sturdy paper clamp over the cut as shown. The clamp keeps the pieces in line, allowing the saw to ride smoothly through the entire cut.

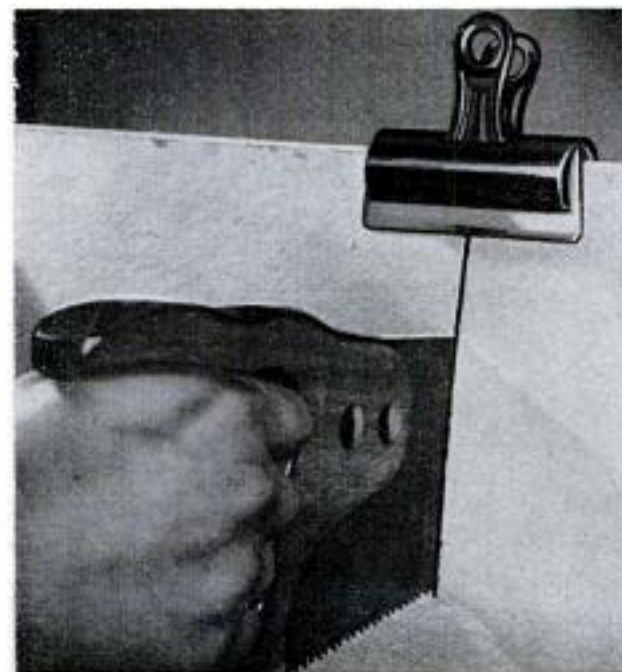

## Inverted Funnel Holds Plumb Bob When Aligning Fence Posts

The difficulty of suspending a plumb bob to swing freely when attempting perpendicular alignment of a newly set fence post can be overcome by attaching the plumb line to the edge of a funnel set in an inverted position on top of the post. For a better job, the earth should be tamped loosely around the post before beginning the aligning operation.

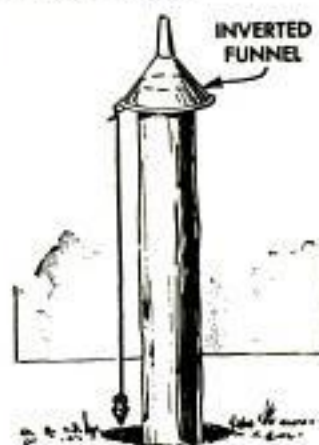

## Cotter Key Driven Into Stake Is Quick-Release Line Holder

To simplify the job of tightening and releasing a mason's line on an anchor stake, drive a large cotter key into the end of the stake and insert the line through the eye of the key. The stretched line is held tightly by being pulled down between the legs of the key as indicated. Pulling the line upward from any point along it into the eye of the cotter key will release it.

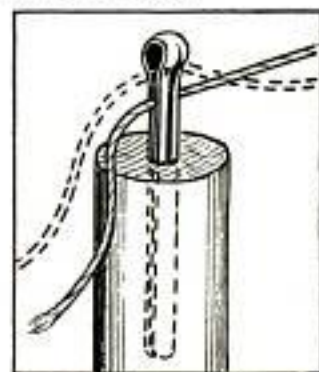

## Guide Lines Made on Linoleum With China-Marking Pencil



When marking linoleum for cutting, use a china-marking pencil, the type which often is used to write on frozen-food packages. The soft lead makes a clearly visible line on the hard-surfaced floor covering and is removed easily with a damp cloth.

## Flattened End of Paper Clip Provides Midget Screwdriver

If a small screwdriver is needed to tighten a compass or other instrument, make an emergency one by flattening the end of a paper clip. A file will quickly square the flattened end of the wire to fit the tiny screw slots.



## Tool for Clinching Nails

A doorknob with its square shaft is used as a nail-clinching tool by a crating and furniture-moving contractor. The tool is used to bend the nails as indicated, after which they may be driven into the wood.

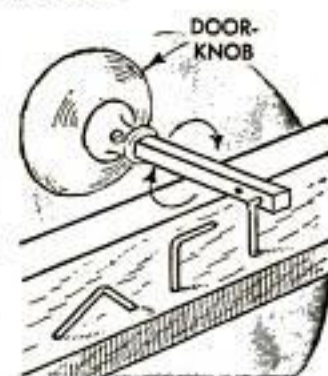

# Do-It-Yourself MATERIALS GUIDE

## for the Homeowner and Handyman

### Cross Indexed for Easy Use

If you've ever walked into a hardware store without knowing exactly what you need (and walked out without being sure of what you'd bought), you'll want a copy of this new guide that lists *all* the specifications for *all* Do-It-Yourself materials. With this book, you'll know exactly what to look for, and how to save money when you buy.

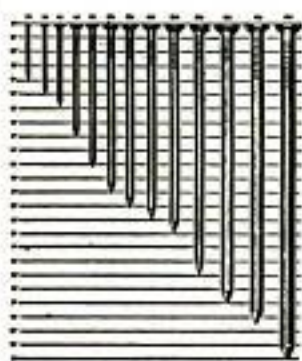

Need to know how long a 50d (penny) nail is? In the Do-It-Yourself Materials Guide, charts like the one at the left (4½ times larger in the book) will show you it's 5½ inches.

The chart at the right, of common wood-screw sizes and gauges, is typical of the dozens of illustrations (all much larger) in the book. Now you'll know how to choose and where to use building and hobby materials.



### A Key to Buying and Using:

Adhesives	Fuses	Plumbing
Bolts	Glass	Plywood
Bricks	Hinges	Roofing
Conduit	Locks	Siding
Doors	Millwork	Tile
Glass fiber	Paint	Wiring

... Plus 31 other basic products.  
For only \$2.95 you can get this 160-page guide that will *save you time and money every time you buy supplies*. So send your order today to:

**POPULAR MECHANICS PRESS, 200 East Ontario Street, Chicago 11, Illinois**

THE **POPULAR MECHANICS** SHOP NOTES

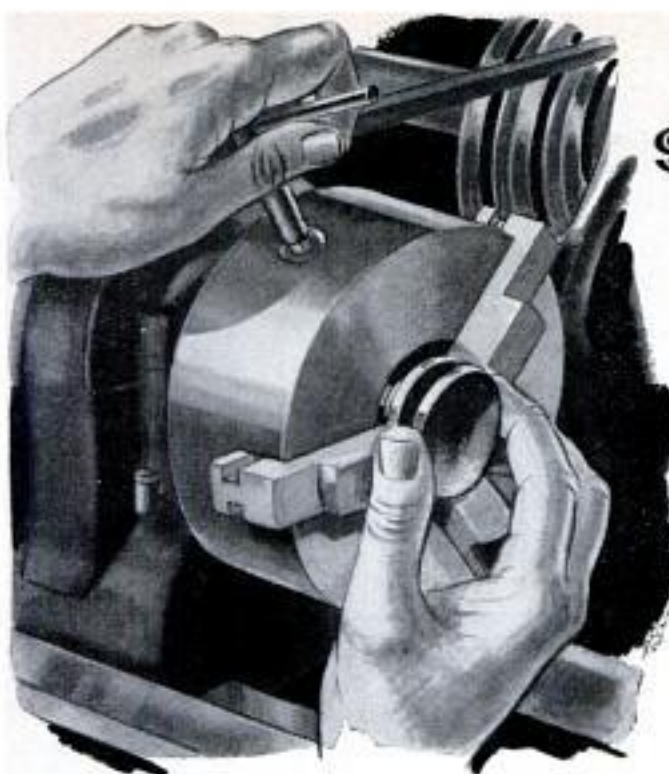

# CHUCKING THIN BLANKS For Face Machining

By C. W. Woodson

WHEN STEP-CHUCK equipment is not available, or when the amount of work to be done does not warrant the cost of such equipment, facing of thin metal blanks (disks) may be done accurately with any one of several simple lathe setups. For repetitive work, the stop

shown in details A, B and C below is perhaps the best. It positions the work accurately to any desired projection beyond the chuck jaws. The latter automatically position the work concentrically when tightened. The stop consists of the spindle A, the taper sleeve and a machined pad

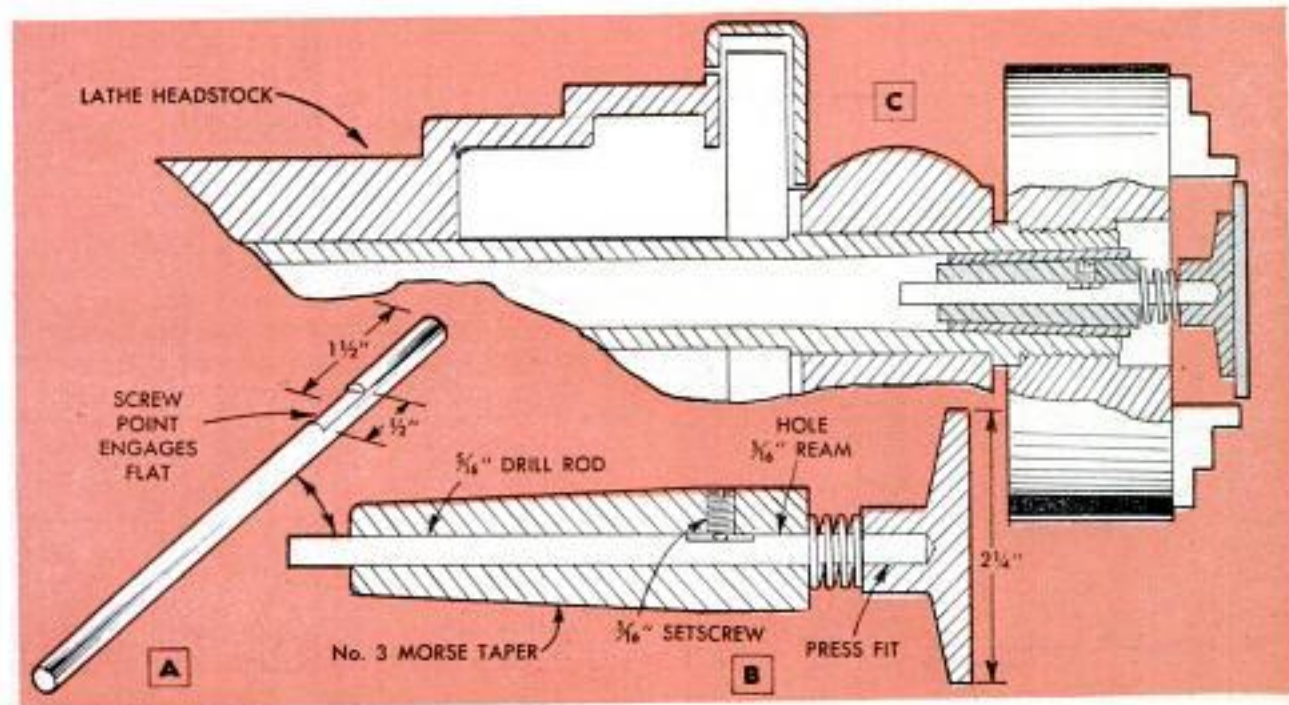

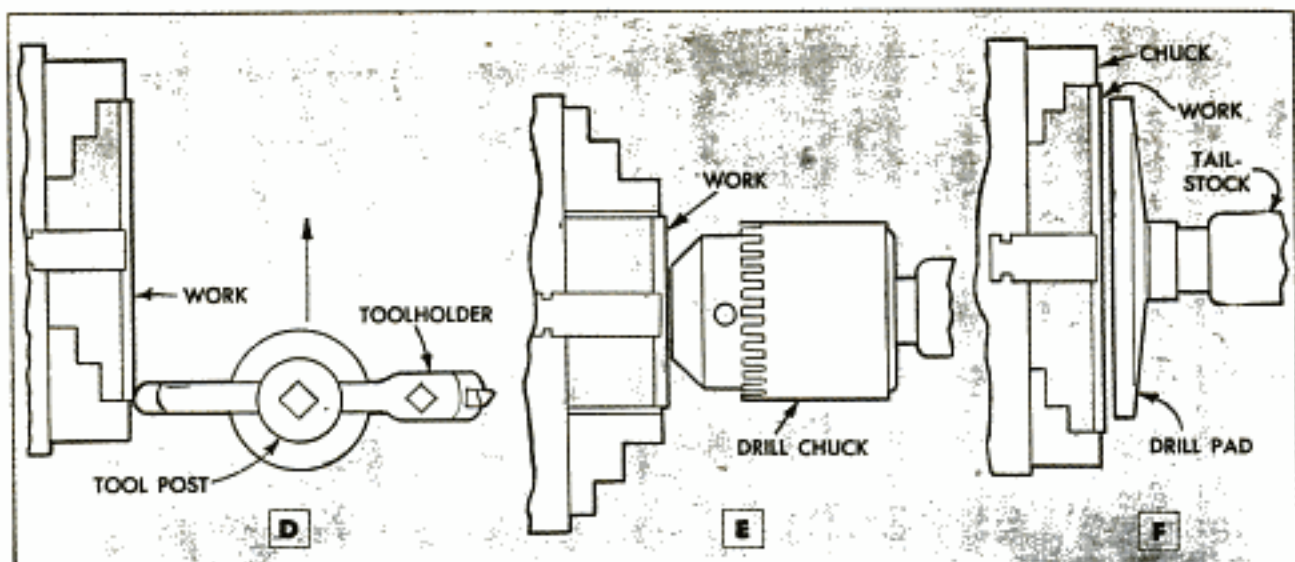

assembled with a spring loading as in detail B. Note that a setscrew engages a flat filed on the spindle and limits the travel of the pad in two directions. The setup is shown in detail C. In use, the work is placed against the pad, pressed into the desired position and the chuck jaws tightened. Although the sleeve is given as No. 3 Morse taper and the diameter of the pad as  $2\frac{1}{4}$  in., these parts can be made in various sizes to suit both the lathe size and the nature of the work.

Another method, especially useful where speed is not important, employs a lathe drill pad to position the work as in detail F. As detailed, the pad is mounted in the tailstock, which is brought up close to the chuck. Then the work is centered, using any one of the several methods of centering in a 4-jaw chuck. When using the 3-jaw chuck this step is, of course, eliminated. Next, the blank is held against the pad and the tailstock sleeve is run up to bring the blank into position in the chuck jaws.

Care must be taken to hold the blank tightly against the pad as the jaws are tightened.

Details D and E outline two other methods of chucking a thin metal blank. In the first, detail D, the toolholder is swung parallel with the lathe axis and positioned in relation to the work as indicated. The blank is chucked with the chuck jaws drawn to just sufficient tension to hold it in position, the end, or heel, of the toolholder touching the face of the blank lightly. Then run the tool in the direction of the arrow, using the carriage cross-feed screw. Turn the chuck by hand 90 deg. and repeat. This procedure will bring the blank into position for a facing cut. The other method employs the geared drill chuck as in detail E. The chuck is placed in the tailstock sleeve and the jaws fully retracted. Then the blank is held squarely against the end of the chuck body as indicated while the jaws of the lathe chuck are tightened. Small-diameter blanks can be centered accurately in this way. ★ ★ ★

## Overflow From Drain Tile Inlet Passes Through Floodgate



Under normal conditions water flows into this field-tile inlet and is discharged at a point 800 ft. away. Trash is kept out by a welded-steel grate. When there is an abnormally heavy flow of water the concrete spillway leads water into the field on the other side of the fence where it spreads out over a grassed waterway. Any heavy flow of water will open the floodgate which is suspended on a pipe frame. The inlet tile is 7 in. below ground level, and the retaining walls on each side of the spillway are 10 in. high.

☞ When polishing brass, use the same cloth for both buffing and applying the polish. The residue left on the cloth after the liquid evaporates acts as a fine abrasive.

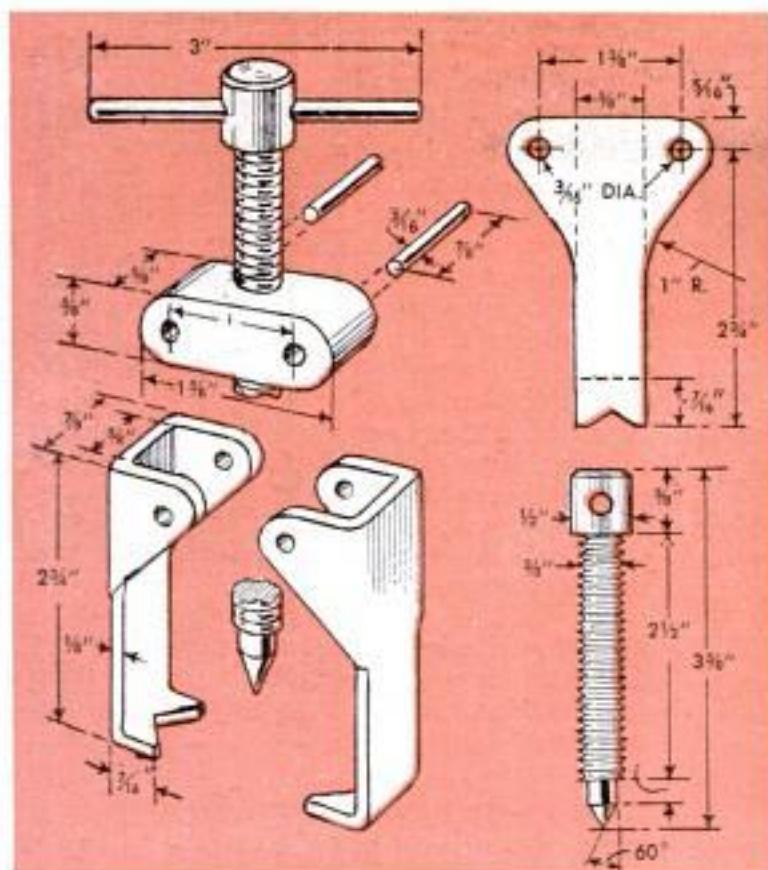

## Modelmaker's Gear Puller

Designed for model work, the capacity of this gear puller ranges from very small pinions to gears or wheels slightly over 2 in. in diameter, and it will exert sufficient pressure to remove the most stubborn pulley, collar or other shape that has been driven onto a shaft. Sheet steel  $\frac{1}{8}$  in. thick is used for the two arms. Rough-cut them to shape with a hacksaw, then finish to correct size by hand filing. The upper ends of the arms are bent in a vise around a  $\frac{5}{8}$ -in.-sq. steel bar. The lower end of each arm is bent at a right angle to form a hook and a V-notch is filed in it to provide clearance around a shaft when pulling small-diameter gears. Steel bar stock  $\frac{5}{8}$  in. sq. is

used to make the crossbar which has both ends ground to a radius, then is drilled for the two  $\frac{3}{16}$ -in. hinge pins. Cross-drill and tap the bar to receive the  $\frac{3}{8}$ -in. portion of the hand screw. The screw is made from a piece of  $\frac{1}{2}$ -in.-dia. round stock shouldered to  $\frac{3}{8}$  in. for all but  $\frac{5}{8}$  in. of its length. After the thread is cut on the screw with a die, the lower end is reduced to  $\frac{1}{4}$ -in. dia. by cutting away the threads. The end then is turned to a 60-deg. point as indicated. Cross-drill a  $\frac{3}{16}$ -in. hole through the upper end of the screw to accommodate the handle which is a 3-in. length of drill rod. Peen over the ends of the hinge pins to prevent them from working loose.

### Threading Small Rods Accurately

Accurately threading the ends of small-diameter rods is difficult with an ordinary die holder, but when the die is mounted in a three-jaw chuck of a lathe and the rod aligned in a tailstock drill chuck, threads can be cut accurately by merely feeding the work to the die. Turn the three-jaw chuck slowly back and forth by hand, advancing the die slightly with each forward turn. A light, steady pressure should be kept on the tailstock handwheel to slowly advance the work to the die. Use oil or cutting compound to lubricate the die.

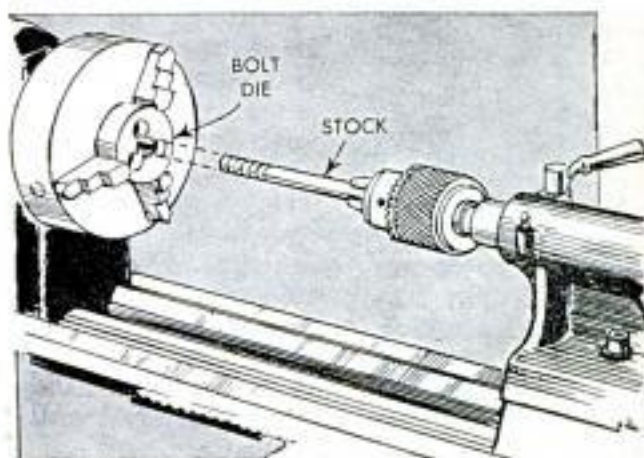

## Heavy-Duty Extension Cord Kept on Handy Reel



When electrically powered tools and equipment are used at some distance from farm buildings, this reel provides any length of heavy-duty extension cord needed. Two plywood disks nailed to the ends of a length of 2 x 2 form the drum, and a long bolt passed through a hole drilled lengthwise in the 2 x 2 provides an axle. A socket is wired to one end of the cord and the other end is wired to a receptacle fastened to the reel. A second cord connects the receptacle to the power source.

## Squeeze-Type Plastic Bottle Doubles As Grease Gun



ically in measured quantities. Nozzle of the bottle fits tightly into the lube holes in housings which are normally plugged.

☐ A nail dipped in hot water or melted paraffin can be driven into a plastered wall without crumbling the plaster.

## Double-Duty Mailbox Standard Also Supports Sign

Hanging a sign advertising his business on an arm above the mailbox support is the method used by one farmer to avoid having several standards along the highway.



Pipe and fittings are used to assemble the support. The pipe on which the mailbox rests is screwed into a pipe tee that has been reamed out to turn freely on the standard. A steel pin fitted through the standard supports the tee.

☐ Weak cells in a three-cell flashlight can be used to produce sufficient light if a bulb from a two-cell unit is substituted for the three-cell bulb.

## Carbon Removed From Pistons With Modified Ring Section

Costfree and effective, a section of piston ring is a handy tool for removing carbon from the ring lands of a piston. Its one drawback is that the sharp edges of the ring tend to widen the lands. To avoid this, grind off the sharp edges of the ring to within a point about  $\frac{1}{16}$  in. from the end. For more comfortable operation, fit the ring section in a file handle as indicated. When removing carbon with this improvised tool be careful not to score the grooves.—Ed Packer, Oak Park, Ill.





SN 58

# Accessory Cabinets For Power Tools

A SMALL CABINET built into or attached to the stand or bench that supports a stationary power tool is a convenient place to store the accessory items and special wrenches used with the machine. Also, machined surfaces of accessories are protected from dust and rust and the appearance of the stand is improved.

The shallow cabinet on the table saw, shown in the two photos below, has ample room for a dado head and inset, extra blades, etc., and is an example of a cabinet that is attached to a stand where the motor occupies the lower part of it. Accessories are hung on dowels, clips and small blocks on the inside and outside of the cabinet.

When the lower part of a stand is not occupied by a motor, it can be enclosed to form a cabinet as shown in the photo on right. A sliding tray holds small items, such as router bits, mortising drills, circle cutters, etc., while larger accessories, such as the drill-press vise, hold-downs, etc., are stored at the bottom. Similar cabinets can be constructed for lathe benches, shaper stands and other power tools. Doors and latches for built-in cabinets are bolted directly to the frame of the stand or bench. The wooden members of a cabinet can be varnished or painted to match the stand.

W. F. Gephart, Dallas, Tex.

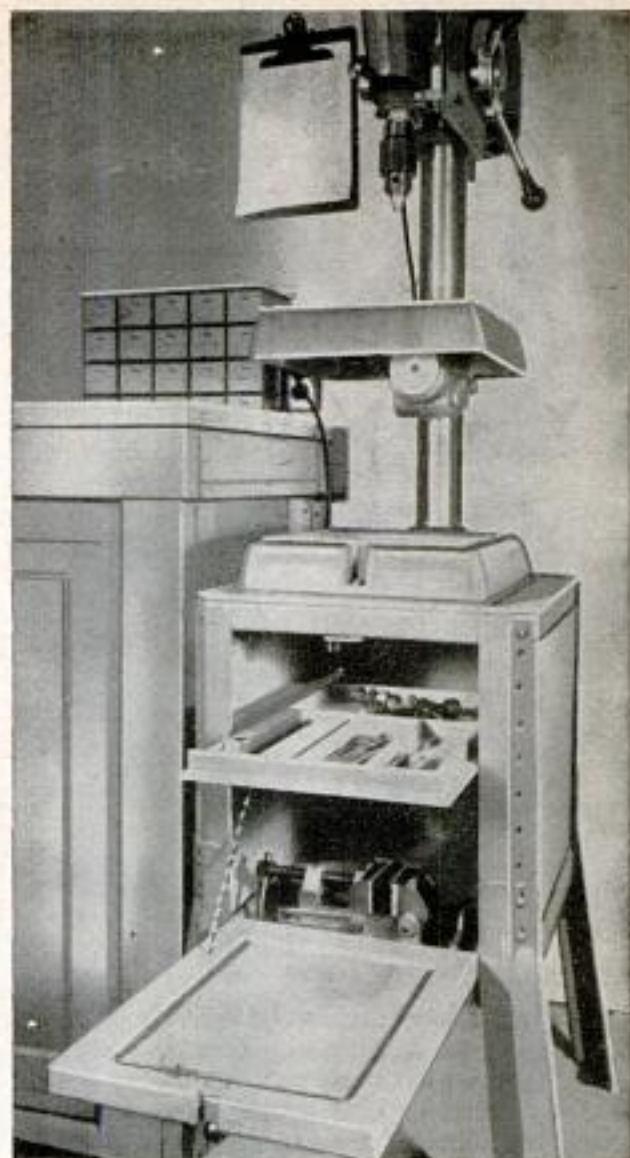

Shallow cabinet attached to table saw, photos below, provides handy storage for blades and accessories

Stands containing no motor or machinery are suitable for built-in type of cabinet as shown above

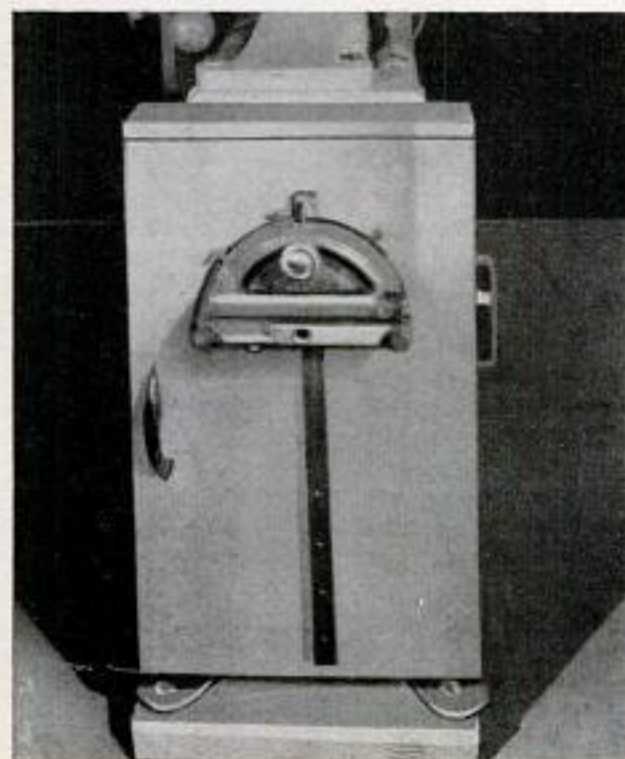

## Tubing on Microscope Protects Worker's Glasses



Eyeglasses of workers who use microscopes need not become scratched from frequent contact with the eyepiece of the instrument. A simple way to avoid this trouble is to stretch a short section of rubber tubing over the eyepiece so it extends above it slightly. If rubber tubing of the correct size is not available, a single wrapping of  $\frac{1}{2}$ -in.-wide adhesive tape provides a good substitute.

## Milk-Can Cart "Climbs" Stairs

Take the lifting and carrying out of handling milk cans with this cart that even rolls up or down stairs. The wheels are 8 in. in diameter, the axle  $\frac{1}{2}$  x 24 in., and the handle a  $5\frac{1}{2}$ -ft. length of pipe shaped as shown. The handle is welded to the axle and braced with two steel rods. Wheels are retained with cotter pins so they can roll free. A hook welded to the handle at the right height permits support of the can by one of its handles. A metal loop, also welded to the handle, provides a handgrip by which the cart is guided up or down steps.

## Track-Mounted Grain Cart Saves Feeding Time

For quick and effortless feeding of grain to cattle, one Midwestern farmer uses this small cart which runs on rails above a row of feed bunks. The grain flows from an overhead bin in the granary into a spout that can be lowered into the cart. One end of the cart is hinged so that the grain can be poured in each bunk as the cart is moved along.—A. M. Wettach, Mt. Pleasant, Iowa.

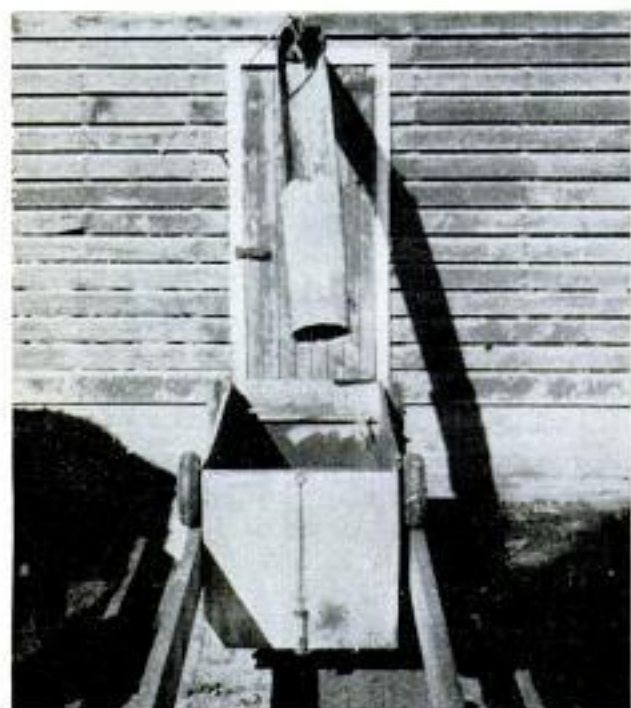

## Squaring Bottom of Blind Hole

When it is necessary to square the bottom of a blind hole, as in making a pivot bearing, use an end mill of the same diameter as the drill. Run the drill to required depth, and then square the bottom of the hole with the end mill.

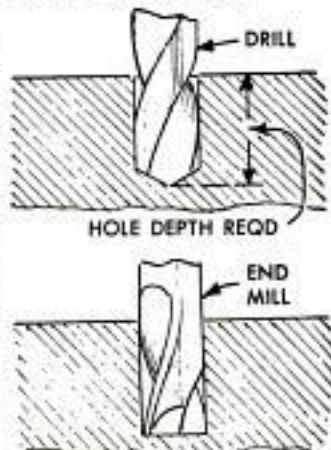

SN 58

# INDEXING HEAD For Gear Cutting

By R. D. Shriner



**U**SING A CHANGE GEAR from your lathe for indexing the cuts accurately, you can cut almost any required number of teeth on gear blanks up to approximately 4 in. in diameter with this simple indexing head. It is designed to be used in a lathe milling attachment and, of course, the maximum diameter of the blank that can be machined will depend on the swing of the lathe over the bed. Rough castings for the main body of the indexing head and also the indexing bracket are available complete with all necessary steel parts. Machining is done by the purchaser to suit his own requirements. Nearly all necessary machining can be done on the lathe on which the unit is to be used.

Detail drawings on the following page show how the parts are machined and assembled. Only general over-all dimensions are given, as the shouldered ends of the shaft and the bushings must be dimensioned to fit the lathe change gears and the gear blanks. Also, the indexing rod, or plunger, must be machined to fit the change gear which is used as an indexing disk. The photo at the right shows the lathe setup for machining the side of the body casting with a fly cutter held in the lathe chuck. Both sides and the bosses for the shaft lock screws can be machined with this setup. The ends of the casting are

machined by mounting the casting on the compound. Line boring is done with the casting mounted on the compound and using a boring bar mounted between centers. Bores can be finished by grinding or reaming to  $\frac{5}{8}$  in.

The index bracket, or arm, is bolted or

Body casting is trued on both sides, and tops of locking-screw bosses are faced with setup pictured

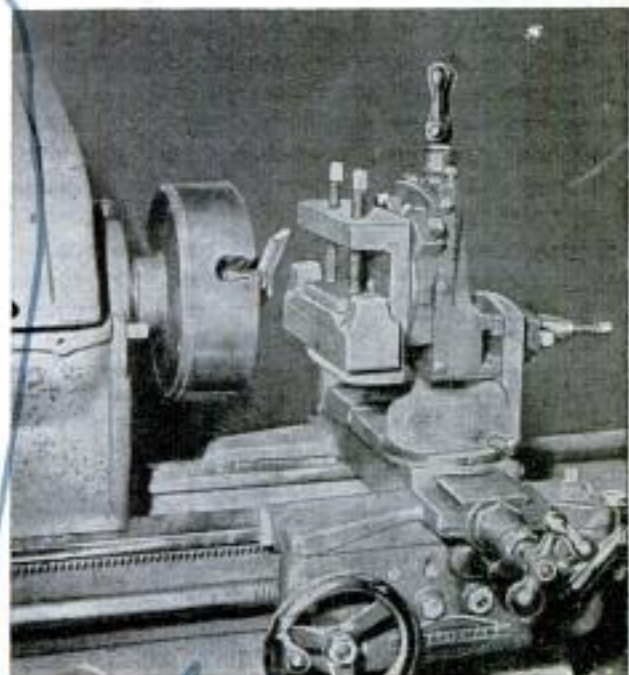

see front

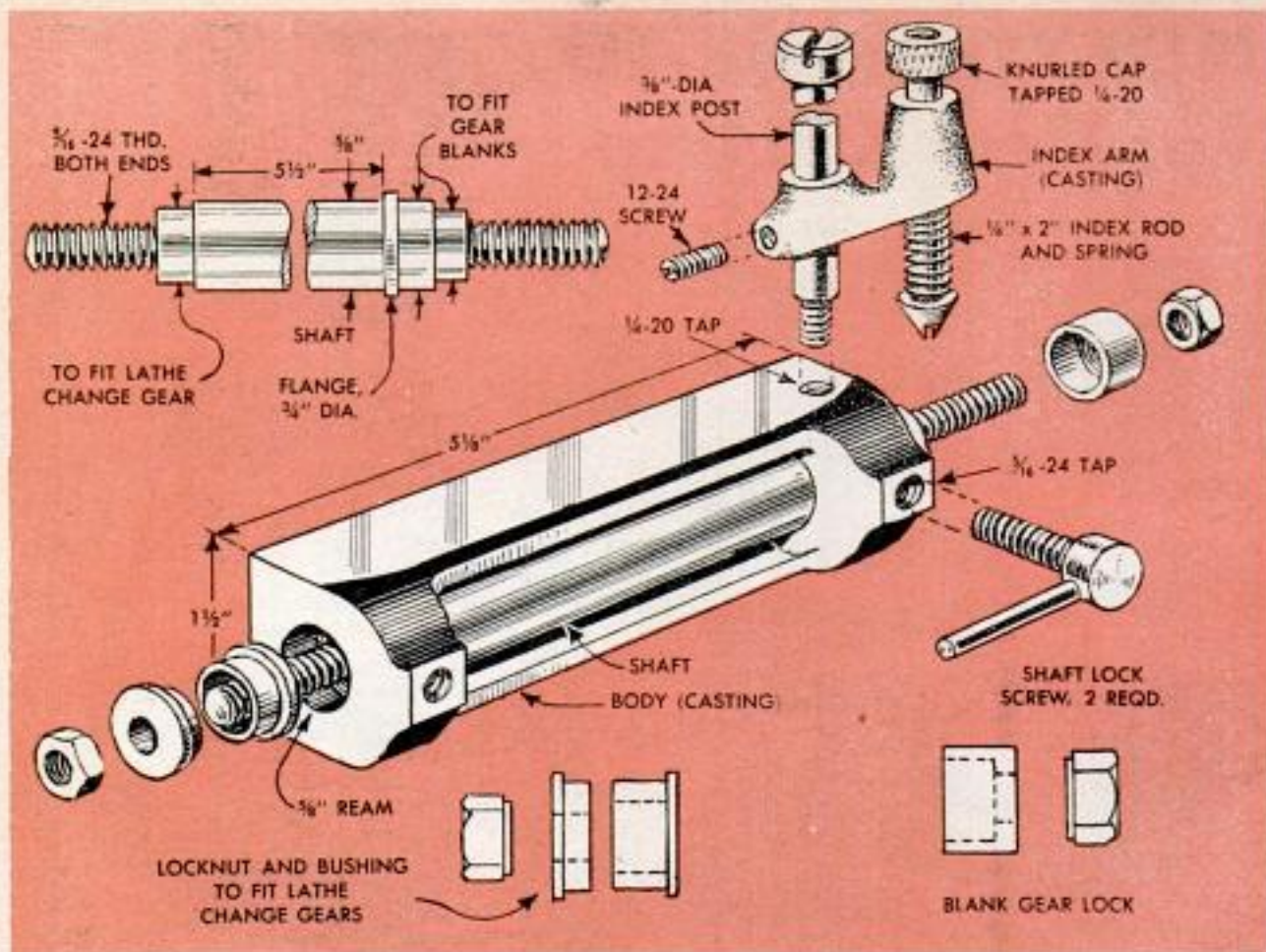

Only general over-all dimensions can be given as certain parts must be machined to suit requirements

clamped to the faceplate and the top ends of the bosses are machined flat before spotting and drilling the holes. Spacing of the holes must be determined from the shoulders run on the shaft. Machine the index post to body diameter, shoulder and thread one end and slot the head as indicated. Machine the index rod, or plunger, turn one end to a taper and slot to fit the indexing-gear tooth. Thread the other end and turn, knurl, drill and tap the cap. Finally, drill and tap the horizontal boss on the casting for a 12-24 headless setscrew. Locking screws are made by turning the hex head of a capscrew round, drilling a 1/8-in. hole transversely and driving a length of 1/8-in. rod into the hole to form a handle.

Dimensions are not given for the bushings which carry the indexing change gear or the gear blank. These must be turned

and bored to suit the work. Note that the length of the shaft from the left-hand shoulder cut to the inner edge of the flange is given as 5 1/2 in. This dimension is arbitrary and depends on whether or not the change gear used as an indexing disk has a flush or extended hub. If the hub is flush, it may be necessary to machine the shaft to 5 1/2 in. and use a 3/8-in. collar between the end of the body casting and the inner surface of the hub in order to gain sufficient clearance for the gear teeth and also to align them with the indexing rod.

Teeth in the gear blanks are cut with a round bar and fly cutter, the assembly being held in a drill chuck attached to the live spindle of the lathe as in the upper illustration on the preceding page. The cutter must be carefully ground to give the gear teeth the correct size and shape. ★★

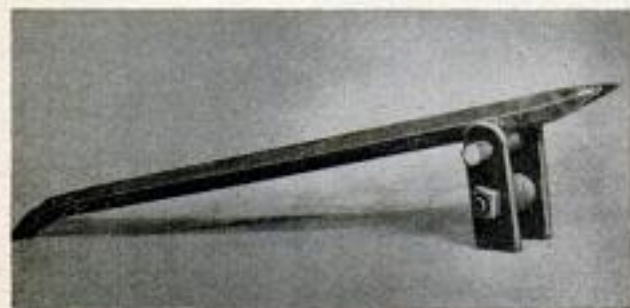

### Pivoting Pinch Bar Removes Electric-Fence Insulators

This small pinch bar fitted with a welded pivot and bracket was designed to remove electric-fence insulators without cracking the porcelain. The short end is indented like a claw and sharpened to slip under the head of the insulator nail.

A. M. Wettach, Mt. Pleasant, Iowa.

## CHIP TRAY for Drill Press

This chip tray was made from a discarded refrigerator shelf and a photographer's ferrotype tin and is supported beneath the drill-press table in the position pictured, using two S-shaped brackets and a U-shaped hanger bent from a piece of heavy wire. The edges of the ferrotype tin are bent up to form sides and ends about  $\frac{1}{2}$  in. high. The welded-wire refrigerator shelf is cut down to suitable size and the front brackets are made by flattening and drilling the ends of lengths of thin-wall conduit. The top ends of the brackets are attached with thumbscrews, the latter turned into holes drilled and tapped in the drill-press table.

Refrigerator shelf is attached to drill-press table with S-shaped brackets made from thin-wall tubing

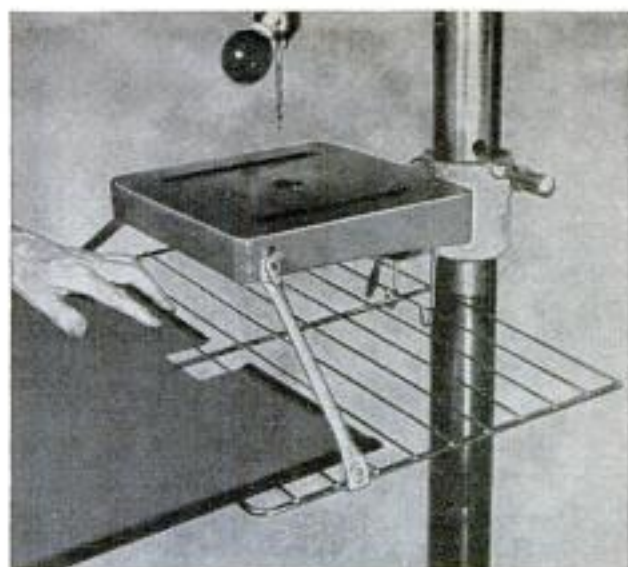
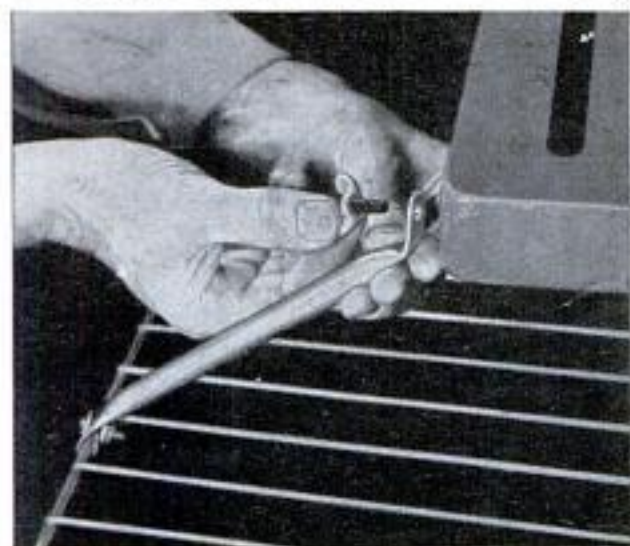

Above, ferrotype tin slides into position on shelf. Below, ferrotype tin catches, retains oil and chips

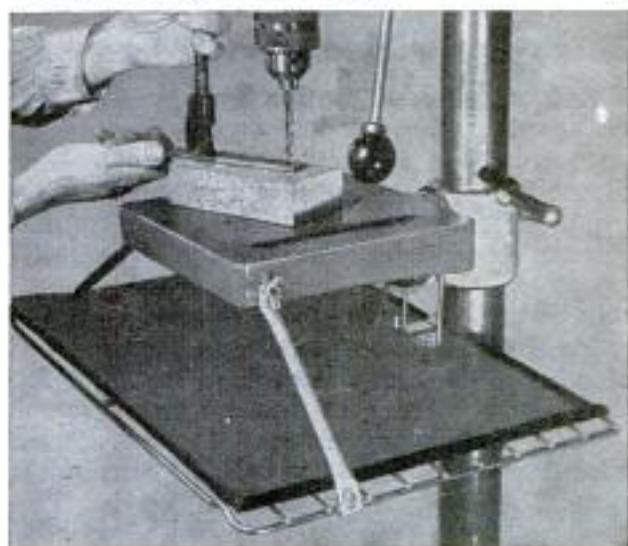

## Plumb Bob Made From Chuck Shell

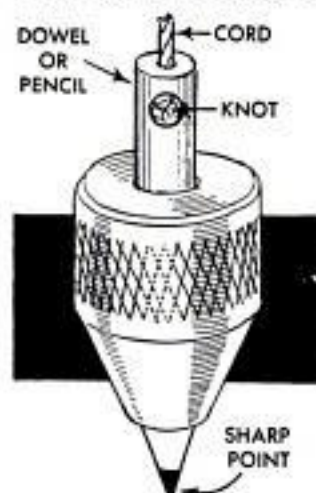

A practical plumb bob is easily made from a small drill-chuck shell by using an ordinary lead pencil as the pointer. Drill a small hole transversely through the pencil about  $\frac{3}{4}$  in. from the end. Remove the lead above the hole, insert the cord and tie a knot in the end. Then sharpen the pencil to a point, insert in the top end of the chuck shell. When the threads have engaged the pencil, turn latter until the point projects from the lower end of the chuck. A small dowel also can be made to serve the same purpose as the pencil.—Frank Shore, New York City.

## Light Low-Cost Brush Hook

This brush hook was built along box-framing principles to cut down on weight and cost. Upright teeth and square-shaped crossbeams are hollow, being constructed from  $\frac{3}{4}$ -in. steel plate welded together at the corners. Strength and serviceability are proving comparable to conventional units constructed of solid steel.

Roscoe LeGresley, Kooskia, Idaho.

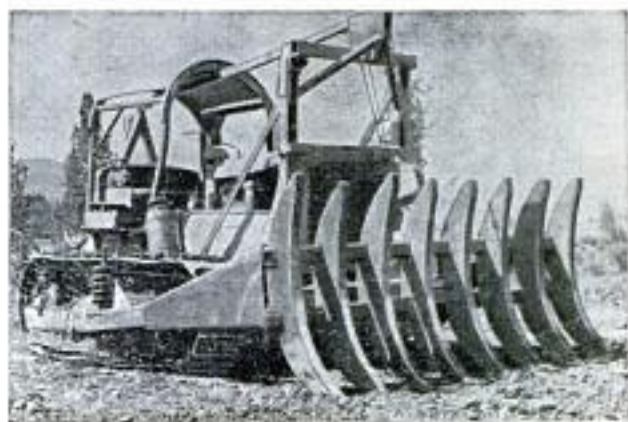

## Oil-Can Dispenser Saves Time and Space in Service Station



Located adjacent to the grease rack where it occupies a minimum of space, yet is handy, this vertical rack holds a generous supply of 1-qt. cans of motor oil. Partitions are spaced so the cans slide easily, and a triangular-shaped block on each side of the front edge at the bottom of each partition prevents the cans from rolling out. Sheets of hardboard are used to cover the front of the rack.

George R. Harrison, Valparaiso, Ind.

ⓘ Before filling holes and cracks with putty it is best to seal the wood with a coat of paint. This will prevent the oil in the putty from being absorbed into the wood, causing the putty to dry and fall out.

## Checking Carburetor Float Level

Although lowering the float level in the carburetor of an older engine sometimes will improve performance, a number of factors first should be checked before making any adjustments. A leaking float, which has become partly filled with gasoline, will produce the same effect as a too-high setting of the float. The filled float loses some of its buoyancy and requires a higher level of gasoline to raise it so that it will close the needle valve and shut off the gasoline supply from the pump. To determine whether or not a float is leaking, remove it from the carburetor and shake it. The sloshing sound of liquid inside it will be apparent. A second condition that will produce the symptoms of a high float level is a leaking needle and seat in the gasoline-supply line. Carburetor repairmen check these for tightness by removing the needle-and-seat assembly from the carburetor and sucking through it. If the assembly leaks under vacuum, it should be replaced. Reassemble the carburetor and install a shut-off valve between the carburetor and the gasoline-supply line from the fuel pump. Start the engine and run it until it is at normal operating temperature, then allow it to idle and shut off the valve. If the engine gradually speeds up as the gasoline in the float bowl is used, the float should be set lower. Bend the float arm only about  $\frac{1}{16}$  in. at a time, then retest the setting by using the valve as before. When the engine no longer speeds up, the setting will be fairly accurate. As a rule of the thumb, when no gauge or specifications are available, invert the carburetor fuel-bowl cover and align the float so it is approximately parallel with the cover.

Ed Packer, Oak Park, Ill.

## Adjustable Metal Stock Chute

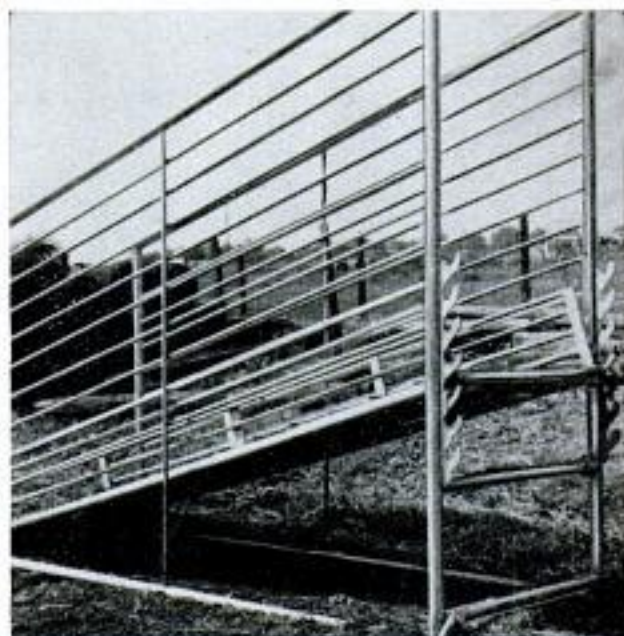

One Midwestern university has equipped its dairy farms with stock chutes similar to the one pictured above. Constructed primarily of metal rods and pipes, chute ramp adjusts to the height of any truck bed

## Hacksaw Is Emergency Wood Rasp

When no wood rasp is available, and the amount of stock to be removed is only about  $\frac{1}{16}$  in., a hacksaw can be used for the job. Hold both the saw frame and blade flat against the wood and saw back and forth. The offset teeth of the blade will provide an easily controlled rasping effect.

Frank Shore, New York City.

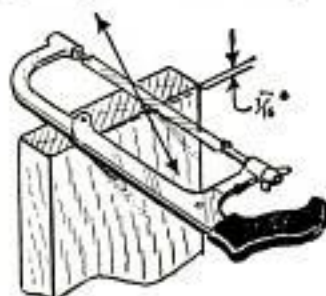

# SHOP GEOMETRY

MAKING A WORKING DRAWING to scale usually is the first step when planning a shop project from scratch. In this preliminary step you may find it necessary to divide circles accurately into five or more equal segments, or perhaps bisect a line or an angle. It's simple, quickly done, when you know how. The details below show how to solve several common shop-layout problems, using a pencil compass and making the layouts on drawing paper, or directly on the stock, when it is possible to make a layout full-size. When working to scale, keep the pencil point very sharp to minimize as far as possible any error due to the thickness of the line.

Ernest R. Ranucci, Fanwood, N. J.



SN 58

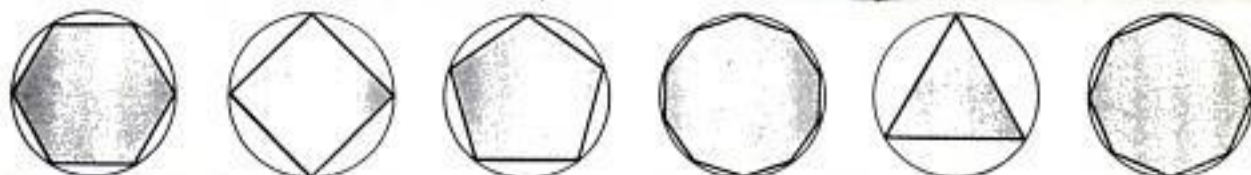

## TO BISECT A LINE

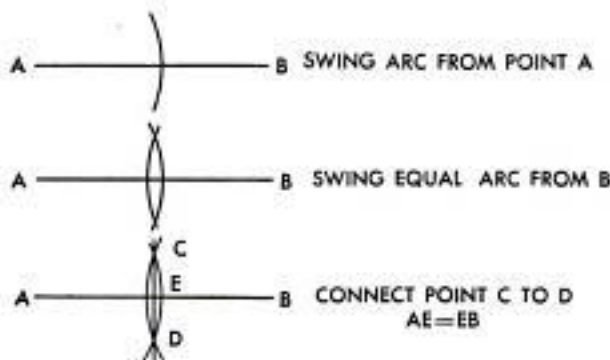

## TO DIVIDE CIRCLE INTO 4 EQUAL PARTS

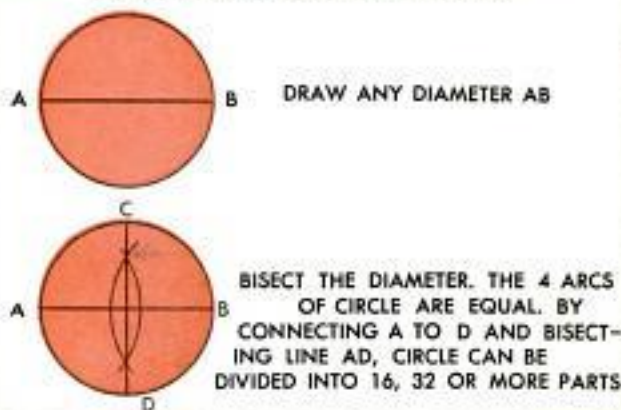

## TO DIVIDE CIRCLE INTO 6 EQUAL PARTS

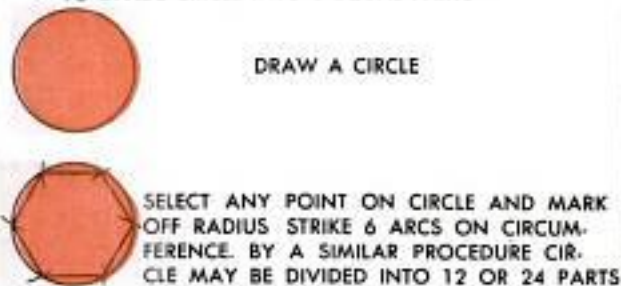

## TO DIVIDE CIRCLE INTO 5 EQUAL PARTS

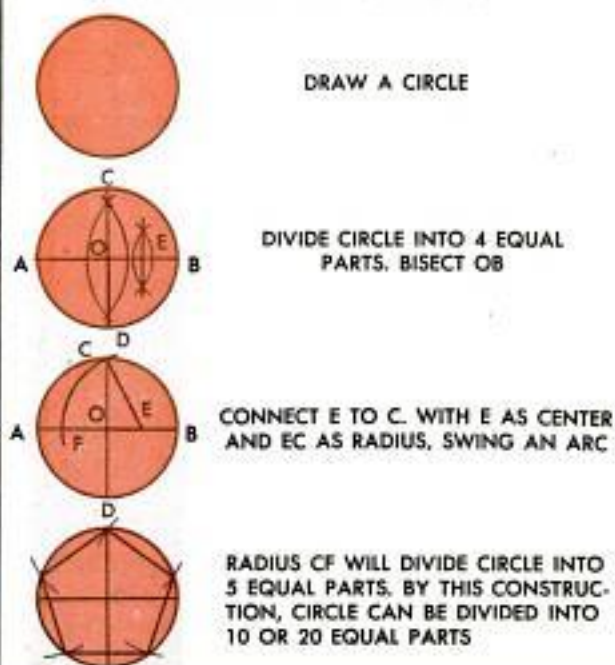

## TO BISECT AN ANGLE

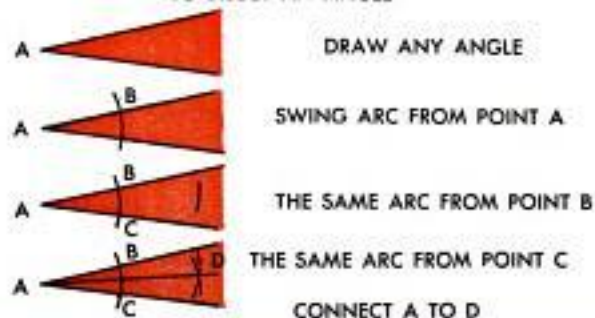

# HOW WOULD YOU DO IT?

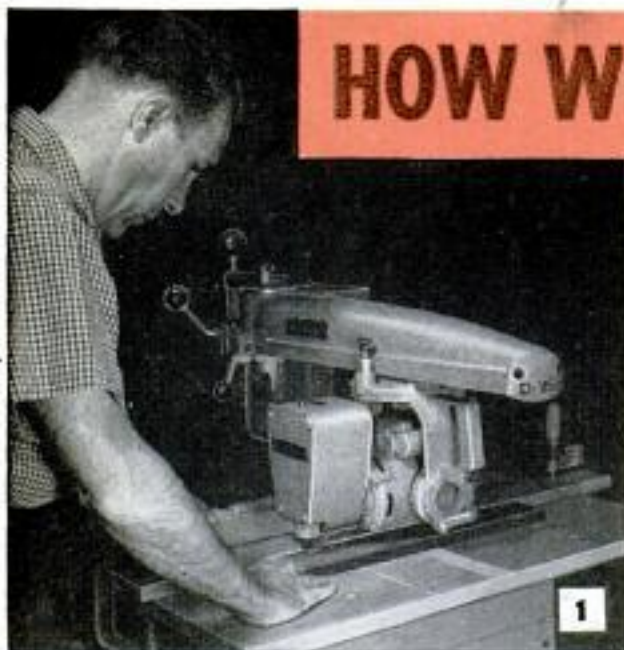

By Chris Nelson

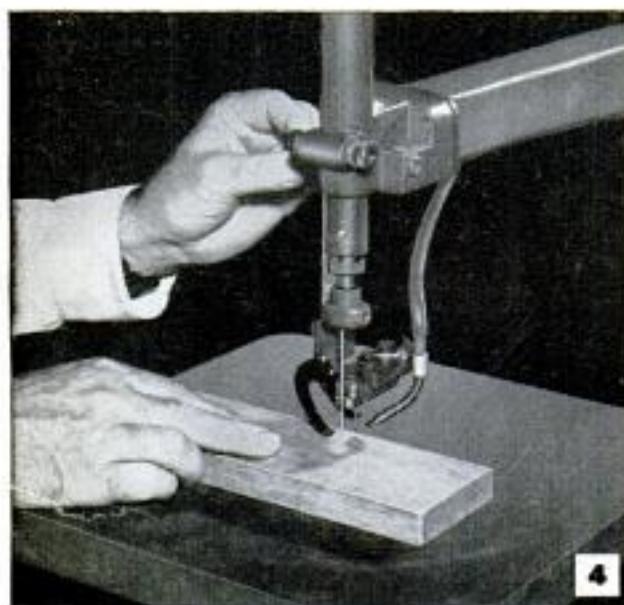

**1. Q—What piece of auxiliary equipment can be rigged up in a minute for making straight-line cuts on a jigsaw?**

**A—**A fence will speed up and improve your straight cutting. You can make one from a straight board and a pair of C-clamps. It works well on any jigsaw or with a saber attachment for a radial-arm saw

**2. Q—How should one stand and place the hands for easy, comfortable jigsawing?**

**A—**Stand in front of the table. Use the left hand to guide the work and keep the blade on the cutting line and the right hand to feed the stock

**3. Q—What should be done to avoid blade breakage when changing from cutting thin stock to heavy lumber that is as much as 2 in. thick?**

**A—**Use a heavy blade, usually a coarse one. For stock from  $\frac{1}{2}$  to 2 in. thick, a good choice is a  $\frac{3}{4}$ -in. blade having about seven teeth to the inch

**4. Q—How should the spring hold-down be adjusted for easy and accurate jigsawing?**

**A—**Let the hold-down drop onto the surface of the stock. Then press down lightly and fasten it. Pressure must be sufficient to keep the stock from bouncing up and down, but light enough to permit moving the material easily and without being marred by the hold-down

**5. Q—What's the quickest, neatest way to cut uniform round-end slots within a board?**

**A—**First drill holes of the desired diameter at each end of each slot. Then simply cut away the material between the holes as shown top left, opposite page





**6. Q—How can a drum sander be used to sand curved work on a jigsaw?**

A—The sander is chucked in the lower blade jaw and to raise the work above the lower edge of the sander an auxiliary table is clamped to the jigsaw table. This can be merely a flat board clamped close to the drum or a hole can be provided to slip over the drum

**7. Q—How are internal cutouts made on a jigsaw?**

A—First drill a blade-insertion hole in waste area for each cutout. Loosen the blade from the upper chuck, slip it through the hole and then retighten the upper chuck. It's often satisfactory and much faster to use the jigsaw as a saber saw for this kind of work

**8. Q—How is a jigsaw used for cutting dowels to length for pegs, handles, glue joints and so on?**

A—It's difficult to cut off dowels quickly and neatly on a circular saw, but a jigsaw does it nicely. Use a fence as a stop and a backup block to guide the dowel squarely as it is pushed

**9. Q—What fixed rule about circular-saw work can be violated when cutting off duplicate pieces with a jigsaw?**

A—Use a fence as a stop so all pieces will be the same length. Never do this on a circular saw. As picture shows, use a square push block behind work

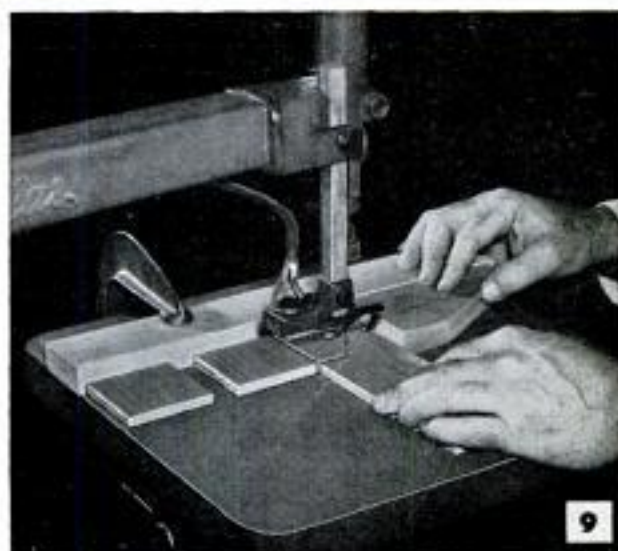
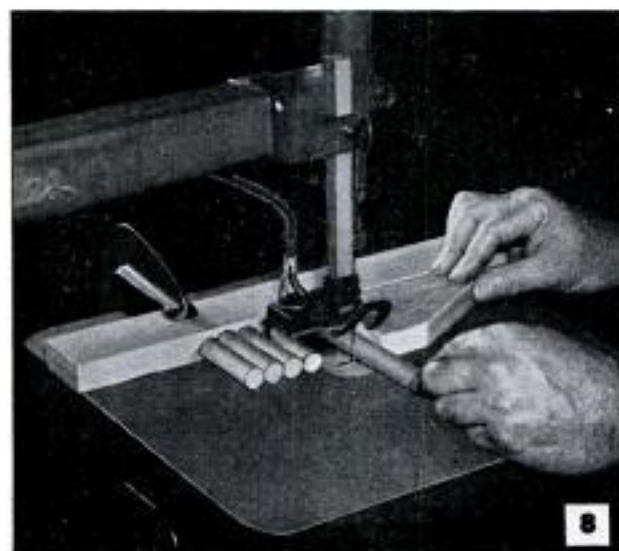
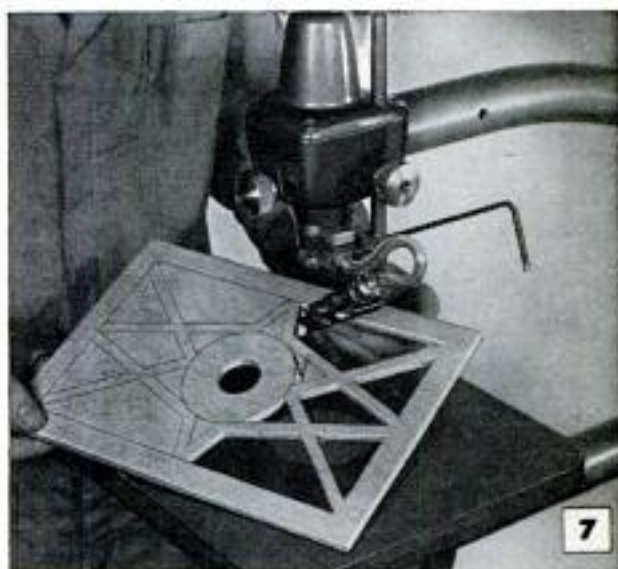
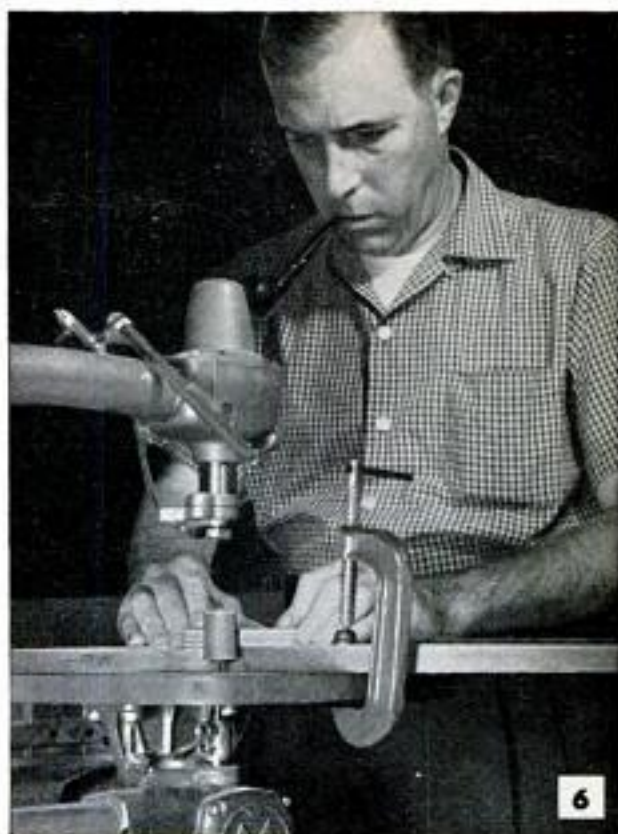

## Spring-Leaf "Tines" on Back of Hoe Speed Mixing of Concrete



To speed the hand mixing of dry ingredients for mortar and concrete, one contractor welded 6-in. lengths of automobile spring to the backs of the hoes used for the job. The ends of the spring sections are ground to a radius. Lumps in the ingredients are easily broken by the spring "tines" and material which settles in the corners of the mortar box is easily dislodged and mixed thoroughly into the bulk of the concrete or mortar.

Bob Poulson, Los Angeles, Calif.

## Scored Lines on Saw Table Assure Accurate Miter-Gauge Setting

Scribing precise angular lines on a new saw table will assure future accuracy in setting the miter gauge, since the pointer on the gauge can be accidentally bent so that its accuracy cannot be depended upon.



To scribe the lines, set the gauge at the exact angle and run a sharp steel awl along the faceplate, marking for both right and left hand cuts. For future work, set the miter gauge flush with the line.

## Pronged Wedges Lock Handles In Ax and Hammer Heads

Hammer and ax heads are held firmly on their handles when steel wedges like this one are used. Each wedge consists of a piece of flat steel with a hole drilled in its center. Two hacksaw cuts into the hole form the two prongs, which are filed to a wedge shape. When driven into a wooden handle, the prongs spread, locking the wedge in place.

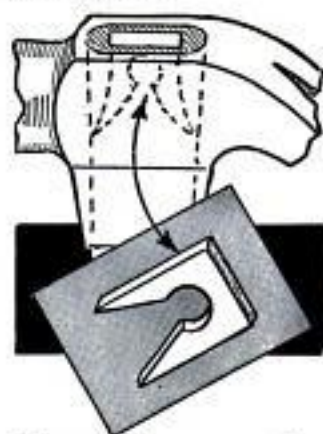

Stanley Clark, East Bradenton, Fla.

Paint accidentally dropped on the enameled surfaces of heavy appliances such as refrigerators can be removed with a cloth dipped in turpentine. Wash off the resulting film with hot soapy water, but do not rub.

## Permanent Stock-Pond Filter

Farmers can equip their stock ponds with permanent filters by encasing gravel-filled oil drums in brick or stone as shown. Even after the drums have rusted away, the filter continues to operate. Erect a concrete base a few inches larger than the diameter of the drum with the outer edge serving as a foundation for the masonry. Remove both ends from an empty oil drum and perforate the side with numerous holes about  $\frac{1}{4}$  in. in diameter. Place it on the foundation and fill with a mixture of sand and gravel. Then wall up around it with bricks or small rocks, leaving the vertical joints free of mortar to permit seepage. The barrel serves as a form, and after it rusts away, the installation still remains intact and in effective operation.

Louis M. Reitz, Bourbon, Mo.

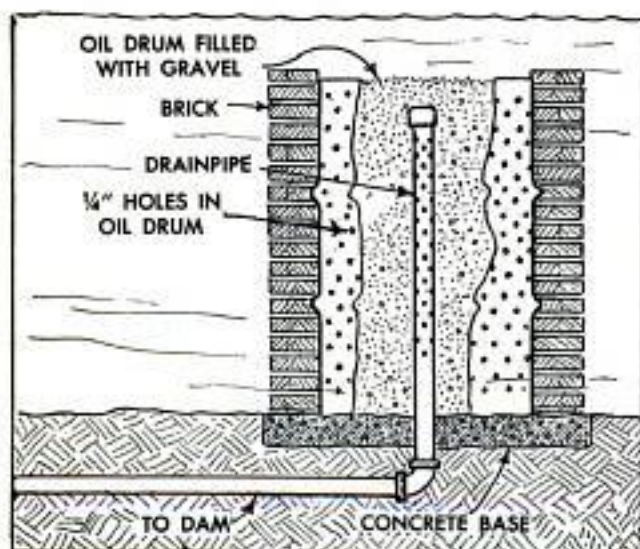

# Shop Chair Swivels to Any Working Position

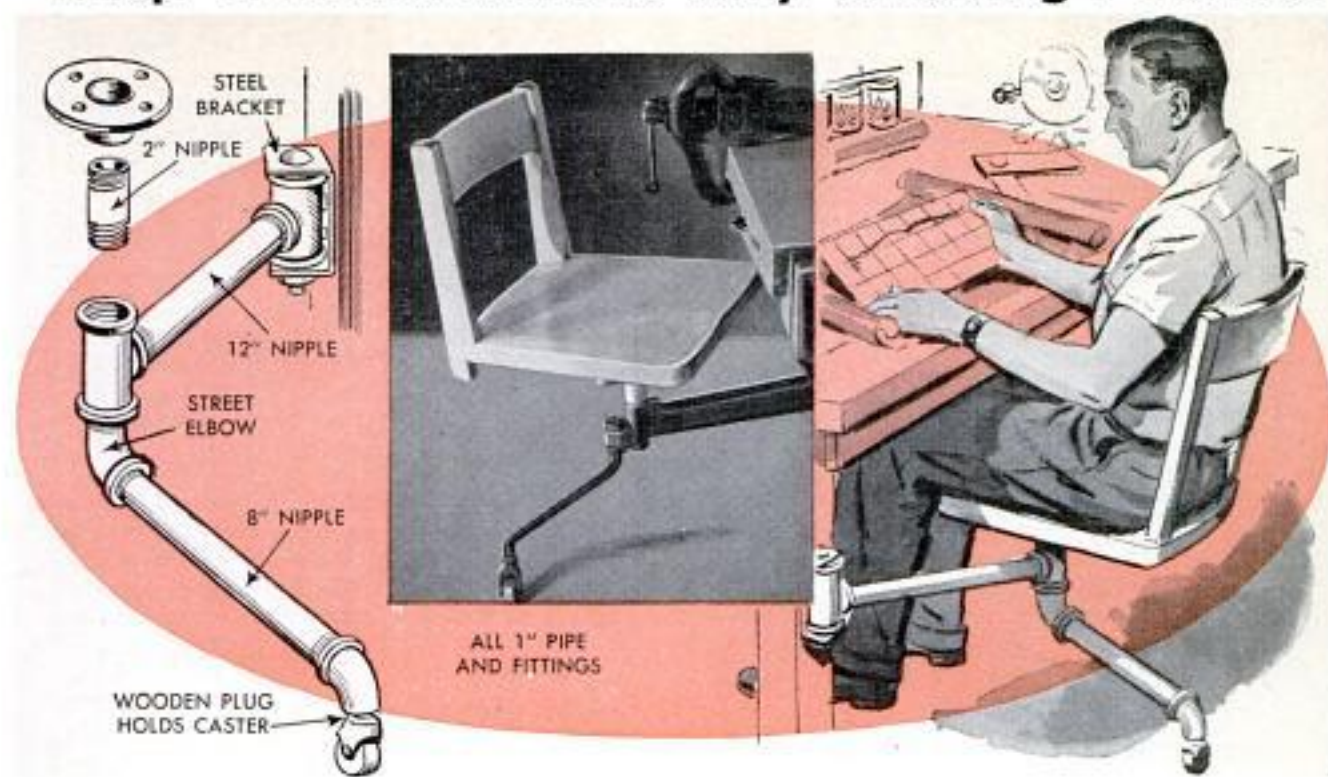

The original chair pictured was made by using a swiveling frame salvaged from a discarded typist's chair of the type having a pivot bracket that bolted to a corner of the desk. Although such swiveling fixtures are not now readily available, the same type of bracket, or frame, can be assembled from pipe nipples and fittings in the manner detailed. When finished you have a comfortable shop chair that swivels around the end of the bench. Make the pivot bracket from a short length of heavy steel channel. Drill and countersink holes in the

body of the channel for heavy screws. Drill the webs for a  $\frac{1}{16}$ -in. pivot bolt and screw to the bench leg. Next center-drill two pipe plugs (plugs must fit the pipe tee) to take the  $\frac{1}{16}$ -in. pivot bolt and turn these into the tee to serve as bearings. This assembly forms the swiveling head. From this point on the assembly is clearly shown in the detail. After assembly, the pipe tees are welded to the connecting 12-in. nipple. The chair seat and back can be made from hardwood in the simple design pictured.

D. C. Marshall, Manhattan, Kans.

## Pipe Wrench and Flat-Jaw Vise Hold Pipe for Threading

For small plumbing jobs where pipe has to be threaded without the aid of a pipe vise, holding the length of pipe with a pipe wrench and flat-jaw vise will prove satisfactory. Clamp the wrench firmly to the pipe and place the pipe in the vise. The wrench should rest against the top of the bench, so the cutting pressure of the die results in a tighter grip by the wrench, preventing the pipe from turning.

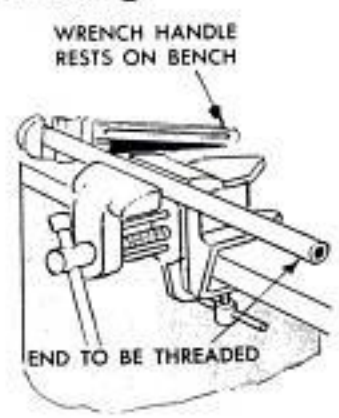

Howard E. Moody, Upper Jay, N. Y.

## Internal Keyway Cut in Bushing

A keyway may be cut on the inside of a bushing or pulley, mounted on a lathe, by means of a cutting tool attached to a boring bar as shown. The bar is moved back and forth by the carriage handwheel, and is adjusted by the cross-feed to take a thin shaving on each forward stroke.

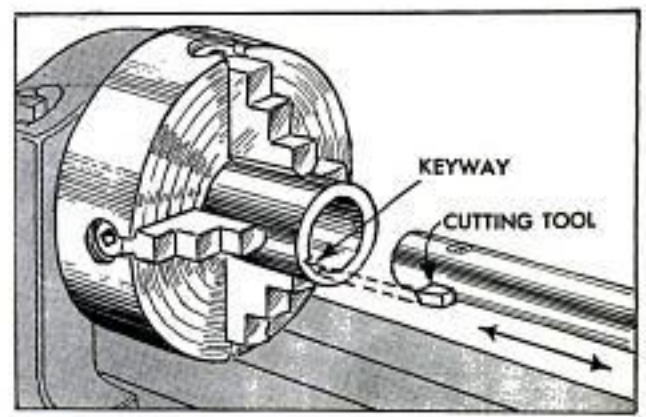

# SHOPPING FOR TOOLS

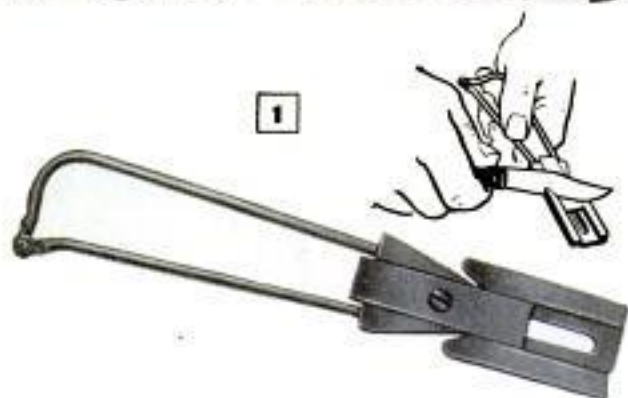
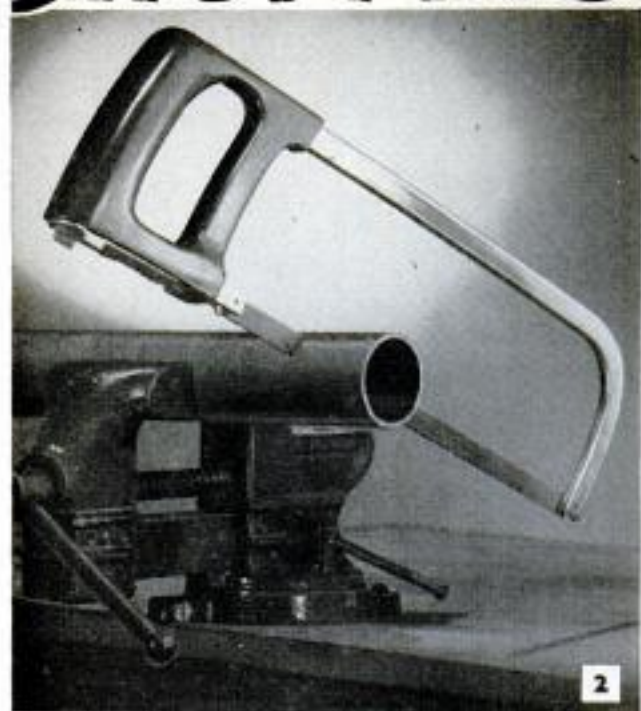

**1. HANDY HOUSEHOLD TOOL** combines a sharpener and useful glass cutter in one unit. Nearly all types of common edge tools can be sharpened with a few strokes by placing the blades, edge down, against the guides and drawing across the hardened cutter

Cash Co., Box 333, Beverly Hills, Calif.

**2. HACKSAW FRAME** adjusts to take 10 or 12-in. blades which are held at the proper tension by a cam-action locking device, the operating lever being located below the handle. Frame is of single-member construction, permitting work in close quarters

Clemson Bros., Inc., Middletown, N. Y.

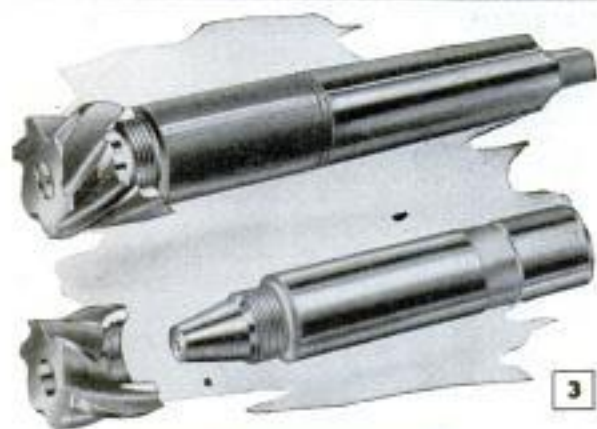

**3. REAMERS** with replaceable and interchangeable heads cut replacement costs in both small and large shops. Heads are automatically aligned when screwed onto the tapered shank. Straight and tapered shanks are furnished for heads  $\frac{1}{2}$  to  $2\frac{3}{4}$  in. in dia.

Tomkins-Johnson Co., Jackson, Mich.

**4. ALUMINUM LADDER** folds for storage in small space, making it especially suited to needs of homeowners. Angle brace locks in position when ladder is opened. Finger-tip pressure releases brace, permits ladder to fold. Available in 6 to 14-ft. lengths

Dalton Mfg. Co., 20 S. Central Ave., St. Louis 8, Mo.

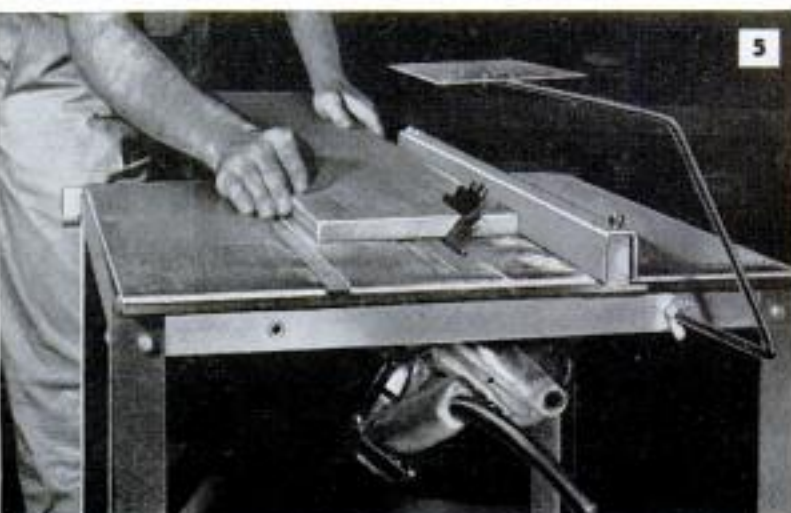
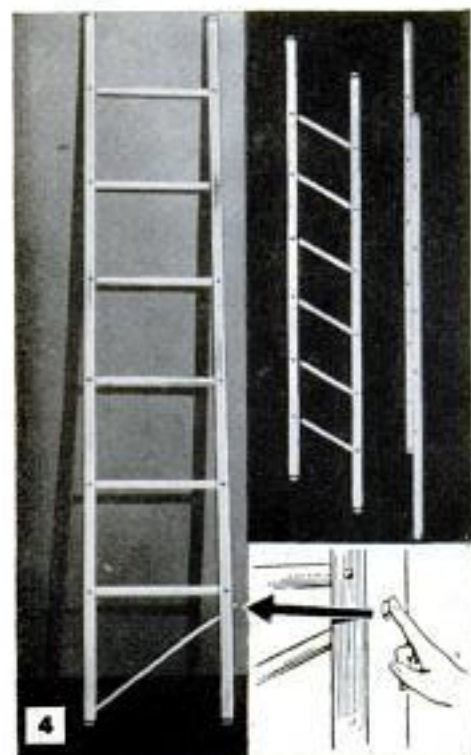

**5. STATIONARY TABLE** converts portable electric saws into a tilting-arbor bench saw for making bevel cuts up to 45 deg. Equipment regularly furnished includes adjustable miter gauge, ripping fence and adjustable guard. Table top is aluminum. Legs are of steel

Black & Decker Mfg. Co., Towson, Md.



**6. TABLE-TOP MACHINE SHOP** for jewelers, instrument builders and modelmakers consists of a basic unit and accessories that make it possible to perform 10 machining operations on metals, plastics and wood, with accuracy to .0004 on metals. Attachments are available for metal sawing, threading, indexing and milling. Set up as a lathe, machine swings work up to 2 3/4-in. dia. Distance between centers is 7 in.

American Edelstaal (Amsterdam) Inc.,  
350 Broadway, New York City 13

**8. DRILL-PRESS VISE** has protractor for setup and indexing work, also quick-acting jaws that slide into position and lock by turning a single screw. Jaws can be swiveled to grip work of irregular shape. Protractor aids in layout and development of hole patterns, angular milling cuts and in routing relief work in wood. Work can be locked in vise and then shifted and positioned without swinging drill-press head

The K-Vise Co., Inc., 115 Farrand Ave.,  
LaPorte, Ind.

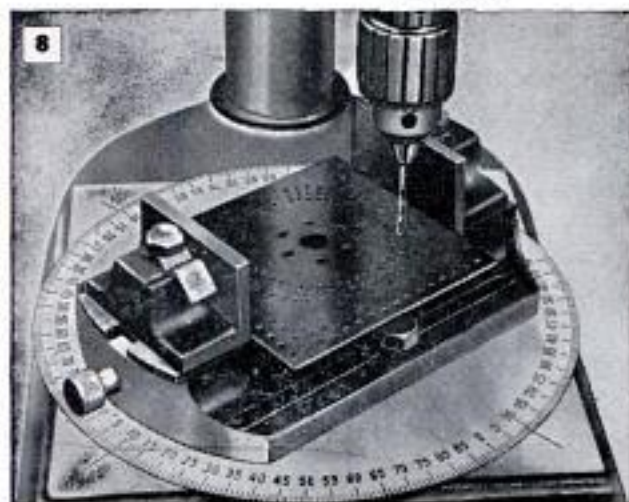

**7. SELF-CENTERING DRILLS** are especially designed and heat treated for applications requiring a shorter, stiffer drill bit which will withstand severe stress without breakage. Drills are self-centering due to specially ground split point (see enlarged view). This feature adapts the drill bits to sheet-metal drilling, and also contributes to more accurate work when bits are used in portable electric drills for drilling wood or metal. Available in the fractional sizes from 3/64 to 17/64 in., in all letter sizes and in wire-gauge sizes from 1 to 30

Chicago-Latrobe, 411 W. Ontario St., Chicago 10



7



**9. PENCIL-SIZE TORCH** uses gas cartridge similar to the type used in charging cigarette lighters. Each cartridge supplies fuel for approximately 30 min. of operation at full heat. Specially designed tip gives 3500-deg. pinpoint flame for soldering or brazing in hard-to-reach places. Flame is controlled or shut off entirely by turning cartridge

Kibbe Mfg. Co., Inc., Bloomfield, N. J.



9



## On the MARKET

for Do-It-Yourselfers

**SELF-ADHESIVE FLOOR FELT** makes do-it-yourself floor tiling nearly as easy as painting the walls. Felt is coated with a pressure-sensitive adhesive on both sides. You simply unroll it on the floor. Then strip off the protective backing from a small area and begin laying the tile, continuing to strip off the backing as you go

Spring Packing Corp., 332 S. Michigan, Chicago

**SLIDING DRAWERS** molded from phenolic plastic greatly simplify the construction of projects involving the making and fitting of conventional drawers. Molded drawers come with special lips and guides as in sectional detail at the left, and are easily fitted into any cabinet frame. The drawers will not warp, shrink, swell

The Richardson Co., Melrose Park, Ill.



**DRIVEWAY TOPPING**, lower left, not only is an attractive repair for old driveways of asphalt or concrete, it also acts as a sealer. Dries hard in 2 to 3 hr., ready for use. Won't soften from exposure to extreme heat or crack due to severe cold. Covers 50 to 60 sq. ft. per gal., depending on condition of surface over which it is applied

Sylvania Chemical Co., 8444 Broadway, Cleveland

**EXPANSION ANCHORS**, below, fasten shelf brackets, signs, conduit and downspouts to masonry quickly and securely. Just drill a 1/4-in. hole in the masonry, insert expansion sleeve, or rivet, and drive home the pin. Anchor consists of two parts assembled in a friction fit so that neither of the parts can be lost in handling

Southco Div., South Chester Corp., Lester, Pa.



# New! MAGNA offers America's finest tilt arbor saw!



## MAGNA 9-in. Saw with "The Helping Hand"

The Magna 9-in. Saw is the only tilt arbor saw with "The Helping Hand"—a built-in extension which makes the largest (34" x 24") effective table on the market—gives you bigger rip and cross-cut capacity than even 10-in. saws! Check these important features: Epicyclic Speed-gear Control gives you full 45° tilt with only 10 turns of knob (40 to 60 turns on other saws!) • Single-knob Control—push for blade height, pull for tilt • Self-aligning Fence locks both front and back with single

knob • Externally adjustable Tilt Stops, easy to reach • Colored Safety Zone Table Insert cannot catch work piece • Exclusive pressure-cast tub front bolted rigidly to table, coordinates all controls • 3 Auto-stops on Miter Gauge • Inter-change Arbor for quick change of blades • Constant belt tension at any degree of tilt • Easily converted to largest capacity saw-jointer (operates at any height of blade) with Magna 4-in. Jointer and the inexpensive Magna Saw-Jointer Adaptor Kit!

Own the MAGNA 9-in. SAW (less motor and stand) for only \$99.95



MAGNA POWER TOOL CORPORATION  
America's Finest Power Tools

® T. M. REG.

### MAGNA POWER TOOL CORPORATION

Dept. 803-M at factory nearest you:  
Box 2808, Fort Wayne, Indiana, or Menlo Park, Calif.

Please send me a free 16-page catalog describing the Magna 9-in. Saw and the complete Magna Line.

NAME \_\_\_\_\_

ADDRESS \_\_\_\_\_

CITY \_\_\_\_\_ ZONE \_\_\_\_\_ STATE \_\_\_\_\_



## Two-Blade Metal Rudder Steers as Well as Propels Small Boat



Two finlike metal blades operated by moving rounded handle bars serve both as oars and rudder for a small boat. The combination is the development of an Italian inventor and is hinged to the stern of the boat. The boat can be turned without losing speed or can be made to turn 360 degrees without forward motion.

## Purify Radioactive Water In 30 Minutes

Drinking water, contaminated by radioactive fallout in atomic war, can be made safe in 30 minutes by a process basically the same as that used in home water softeners. Chief chemicals involved are ion-exchange resins, which remove industrial wastes from water. These resins can clear small or medium-sized public water supplies, if not too heavily contaminated, after atomic attack or improper disposal of waste from nuclear reactors, atomic research sites or hospitals.

Use 'em together



No. 10  
only \$1.89

the **STAR** Hack Saw Blade  
& the **STAR** "Lever-Lock" Frame ...

Get Better Metal Cutting Results  
Change Blades Faster

**Exclusive!**

One-piece solid Heat-Treated Back

**Exclusive!**

"Lever-Lock"...change Blades Instantly.

**Exclusive!**

Tenite handle molded around steel back for greatest strength...perfect balance!

AT ALL LEADING HARDWARE STORES

**It's Yours!**

...Info-packed booklet on metal cutting.  
Send 10¢ in coin.

Clemson Bros., Inc., Middletown, N. Y., U. S. A.

**BUILD  
IT  
YOURSELF**

## Heathkit BROADCAST BAND RECEIVER KIT



MODEL BR-2

incl. fed.  
excise tax  
(Less Cabinet)

\$1925

SHPG. WT. 10 LBS.

Have you ever experienced the thrill of building your own radio? Invest a few of your dollars—a few hours of your time, and build a truly worthwhile broadcast band receiver. Transformer operation eliminates potential shock hazard characteristic of "economy" AC-DC sets. Operates as radio, phono, amplifier, or tuner. Fine tone quality, excellent sensitivity. Simplified Construction Manual outlines basic theory of radio principles. Actually a radio course in itself. Price includes tubes—speaker—chassis, etc. Every part you need! Order your Heathkit Radio Kit today.

### OTHER "BUILD IT YOURSELF" Heathkits

Oscilloscope  
Vacuum Tube Voltmeter  
Signal Generator  
Amateur Transmitter  
Communications Receiver  
Multimeter  
Handitester  
Hi-Fi Amplifier

Hi-Fi Preamplifier  
Battery Eliminator  
Signal Tracer  
Tube Checker  
(and over 50 others)

WRITE FOR  
Free CATALOG

**HEATH COMPANY**

A Subsidiary of Daystrom, Inc.  
BENTON HARBOR 17, MICH.





# "I got a swell deal from my Army Recruiter"



## "He showed me how to choose my technical course before enlistment"

"After looking into the other services, I picked Army because it really offers you the best deal—a chance to choose just the job training you want *before* you enlist. I was sure surprised at how many courses there were to choose from—over 100! I picked Construction Drafting, and the course is even better than I'd expected. It's giving me the practical experience I need to become an expert in my field. What's more, I've got a chance to take even more courses later on. Believe me, only the Army guarantees you this sort of training. Why don't you find out about this program from your Army Recruiter? My recruiter was a real nice guy and sure helped me get what I wanted."

*Henry W. Luetkemeyer Jr*

Pvt. Henry W. Luetkemeyer, Jr.  
Euclid, Ohio  
Graduate, Euclid High School



M/Sgt. Alfred De Baun  
Army Recruiter  
Cleveland, Ohio

### YOUR ARMY RECRUITER OFFERS YOU THIS SAME SPECIAL DEAL

The Army Recruiter in your town can give you the same deal Henry's got. There are over 100 courses to choose from—photography, medicine, finance, communications, engineering—practically everything. And, the course you *pick* is the course you *get*! You receive a written guarantee that a place

in class is reserved for you after high school graduation. And not until then do you actually enlist. If you're a senior, you can prepare yourself for a rewarding future right *now*! Just see your Army Recruiter and reserve the course of your choice—at no obligation!

**Get choice, not chance, from your Army Recruiter**



# Care and Feeding of Engines



BY  
S. P. CORP

## AIRLEAKS CAUSE LOSS OF COOLANT

Air drawn into the cooling system may raise the level in the radiator causing loss of coolant through the overflow pipe. To check for air leaks on the suction side of the pump:

1. With water level in radiator at line stamped on its rear block, open radiator cap pressure valve and attach hose to lower end of overflow pipe.
2. Run engine in neutral. When gauge reaches constant operating temperature put free end of rubber hose into bottle, or catchpot.
3. A continuous flow of air bubbles out of the end of the hose is an indication that air is being sucked into the system through waterproof seal, lower radiator hose or cylinder head gasket.

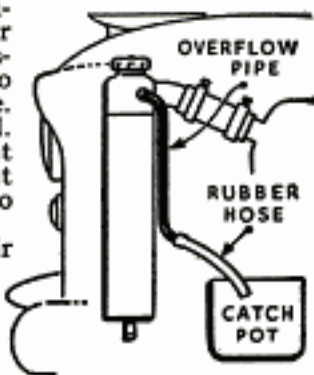

"CATCHPOT" INSTALLATION

## FORGOTTEN AIR-CLEANERS

Engine bearings, pistons, rings and cylinder walls wear rapidly when dirty air enters the engine. Even when the carburetor air-cleaner is kept clean the air-cleaner at the oil filler tube may be neglected, resulting in high oil-consumption.

If your car has power brakes, there is a third air-cleaner which must be serviced twice a year. Air is taken into the engine through the intake manifold when power brakes are released. If this air is dirty, it may be the cause of excessive engine wear. To prevent this, remove the air-cleaner hair filter, wash in a cleaning solvent, dry and re-install.

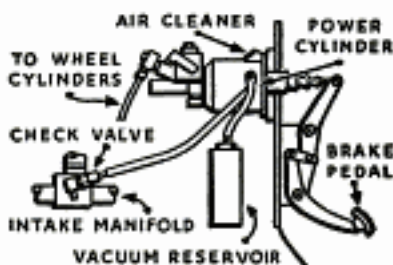

VACUUM BOOSTER BRAKE SYSTEM

## YOU NEED THIS FREE MANUAL

Write for your free copy of "Care & Feeding of Engines," a 24-page illustrated handbook of engine care which may save you a lot of time and money. When you re-ring, be sure to use SEALED POWER KromeX Ring Sets. Their chrome faces fight heat and friction, and they seat fast, control oil immediately, and give you double ring life. Sealed Power, Dept. G-1, Muskegon, Mich.



# Sealed Power

## PISTON RINGS

# Clinic for Homemakers



As a service to our readers in solving the hundreds of problems pertaining to a home—inside or out—the editors of *Popular Mechanics* invite you to present your problems to The Clinic Editor for help and advice. Address your questions to The Clinic Editor, *Popular Mechanics Magazine*, 200 East Ontario Street, Chicago 11, Ill.



## Basket-Weave Fence

Q—I want to build a basket-weave fence but don't know how to determine the size of posts and boards to use. The fence will be about 5 ft. high and about 60 ft. in length. Should the boards be spaced or should they be placed edge to edge? What length boards should I use? Should the posts be set in concrete?

I. S., Fla.

Q—Ordinarily, for a fence of this height and length you would use 1 x 4 or 1 x 6-in. boards and posts about 4 in. in diameter. Redwood is an excellent choice, both for posts and boards, or slats, with western red cedar and cypress being about equally good as second choice. Some basket-weave fences now are being built using mill slabs, or bark cuttings, as the slats. This makes an attractive fence when the wood is finished with a creosote stain, or other outdoor stains such as are used on shingles. You did not say how you intend to finish the material. Ordinarily, 1-in. stock (3/4 in. actual thickness) is used for slats, the latter being about 12 ft. long. In this case the posts should be set about 6 ft. apart. However, if a tighter weave is desirable, then it's best to use 3/8 or 1/2-in. stock for slats, the length of each slat ranging from 6 to 10 ft. For permanence, the posts should be set in concrete.

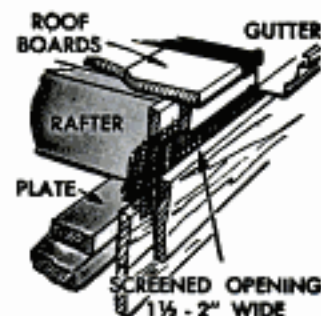

## Venting Flat Roof

Q—I'm planning to build a home with a flat roof having no overhang. The roof will slope only slightly in two directions, with gravel and asphalt on top and an insulating board attached to the underside of the joists, or rafters. How can I vent the space between the rafters?

F. S., Ariz.

A—You can plan the structure in such a way as to provide a continuous screened opening, or spaced openings just below the gutter. Perhaps the continuous screened opening would be the simplest as the opening can be provided by using two narrow frieze boards, one nailed above the other to the ends of the rafters, with a space of about 1 1/2 in. between. In this we are assuming that the house is of frame construction similar to that shown in the sketch, which is not complete in all

(Continued to page 242)



### Automatic Checkout Counter

Automatic checkout counters will eliminate waiting time and jangled nerves for supermarket shoppers. Three-section speed-up units will be available this year. In operation, a conveyor belt brings packages within reach of a cashier who places them in a movable bin and presses a button. The groceries are fed into one of three bag sizes, tilted for pickup by the customer.

### Exhaust System Traps Lead

Lead particles, added to gasoline to increase antiknock qualities, are not a significant factor in city smog, says an engineer of the Ethyl Corporation, manufacturers of the lead additive. These particles are trapped by the car's exhaust system during partial-throttle operation, as in city driving. During subsequent high-speed driving, the lead is expelled on the open road, cleaning the system so it is able to trap more particles once city driving is resumed. Tests show, say the chemists, that only about 25 percent of the lead in the gasoline is exhausted in city-type driving. At full-throttle acceleration, the exhausted lead runs up as high as 1990 percent of the amount in the gasoline actually being consumed by the engine.

**grips like a pipe wrench**

**a cinch  
to handle**



**CHAN NEL LOCK**

**No. 420**

Terrific gripping power on any shape  $\frac{1}{8}$ " to  $1\frac{3}{4}$ " size. Long and streamlined . . . easy to use in hard-to-get-at places! Some of the reasons why Channellock is the favorite plier of craftsmen everywhere. And Channellock will be your favorite, too . . . for the same reasons. No other plier does so many jobs so well. Ask your hardware man for a Channellock No. 420.

**BE SURE IT'S A GENUINE CHANNELLOCK**



**CHAMPION DEPARTMENT TOOL Co. MEADVILLE, PA.**

# Soldering is Easy

with  
INSTANT STARTING



# Lenk

LIQUEFIED **LP** PETROLEUM  
**Torch**



only **\$2.95**

THE ONLY THROW-AWAY FUEL-CONTAINER WITH SELF-SEALING SAFETY VALVE.

Here's what you can do:

- regular soldering, sweat fittings,
- silver soldering, refinish furniture,
- remove paint and putty.

Available at Hardware Counters Everywhere

Write for FREE Soldering Instructions

THE **Lenk** MFG. CO.  
BOSTON 15, MASS.

Get out and  
**GO-GO-GO**  
on your  
**Cushman**  
**EAGLE**

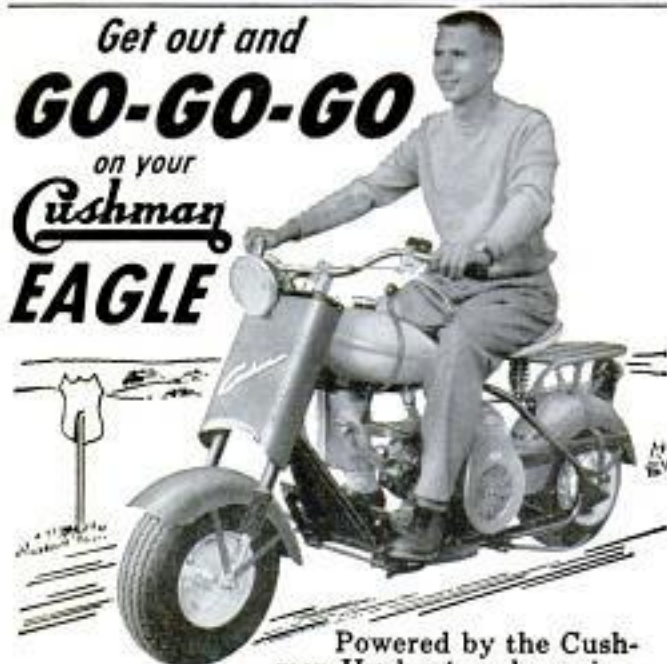

Powered by the Cushman Husky 4-cycle engine.

Up to 50 miles per hour, 100 miles per gallon. Distinctively designed and ruggedly built for flashing beauty and a smooth, soaring ride. Go anywhere, everywhere for just 3/4 cent per mile.

- Sold and serviced nationally; replacement parts available immediately
- See your Cushman dealer for FREE demonstration ride or write for illustrated booklet
- Dealer inquiries invited

Write for new **FREE** booklet today  
**CUSHMAN MOTOR WORKS, INC.**

905 No. 21st, Lincoln, Nebraska

(Continued from page 240)

details. It is intended only to suggest the procedure which might be carried out. Use 14-mesh galvanized-steel screen or bronze screen and be sure it is drawn to a uniform tension before tacking in place. Galvanized screening can be painted for additional protection after it is tacked in place.

### Yard Fill

**Q**—My home is at the lower side of a slight slope and my neighbor's yards are graded somewhat higher than mine. During heavy rains my yard is flooded and some water seeps into my basement through the concrete-block wall. I had thought of having a concrete curb, or dam, built along the lot line. Would this help?  
C. E., Kans.



**A**—Perhaps, but a curb, or dam, as you describe it, may not be permissible under your local building code. You do not give the length of the lot, but in any case the construction of such a dam, or curb, would be quite expensive, as you would have to carry the concrete below the normal frost line for your locality. This procedure would require trenching to the necessary depth and the construction of a suitable form above grade. We think you will find it more satisfactory in the long run, also perhaps less expensive, to consider filling and grading your lot to prevent floodwaters from reaching the foundation walls.

### Concealing Metal Posts

**Q**—The center beam in my basement is supported on round metal posts, or columns. I want to divide the basement into rooms and one wall is at the center directly under the center beam. I had thought of replacing the metal posts with wooden ones. Would this be practical?—C. S., N.J.

**A**—Why not consider boxing in the posts? Judging from your description, this would be the recommended procedure. Replacing the metal posts supporting the center beam would be a rather extensive undertaking, as the structure would have to be supported on jacks while the change was being made. Then, of course, there is the additional problem of adequate concrete piers. By boxing in the existing supporting posts you would avoid the extra labor involved, and by selecting the wood used in the square columns you would finish with an attractive job. A nailing base at the lower ends of the metal supporting posts is easily made by using two short lengths of 2 x 4 stock, each piece cut to the same length as the inside measurement of the proposed wooden column. Make a semi-circular cut in from the edge of each piece, the depth of the cut equal to half the diameter of the metal post. Then drill holes in each piece for bolts and clamp the two members to the column.

### Chimney Cover Prevents Leaks

**Q**—My fireplace chimney has a very large flue, about 8 x 16 in. During prolonged rainstorms water apparently comes down the chimney and seeps through to the plaster above the fireplace mantel. The plaster will have to be patched over a considerable area. But what can I do to prevent water entering the chimney flue?—I. N., Okla.

**A**—Probably the best procedure is to cast a concrete cover in a wooden or sheet-metal form, the outside dimensions being the same as the outside measurements of the chimney and the thickness about 3 in. The concrete cover should be reinforced with welded wire fabric. Cut the latter about 1 1/2 in. smaller each way than the inside measurements of the form. Pour about half the concrete, level it and place the fabric. Then finish the pouring. The cover thus made should be supported on bricks laid in mortar at the four corners of the chimney. These corners should be laid up two to three bricks high and the cover placed on top. Mortar the top faces of the brick columns before placing the cover.

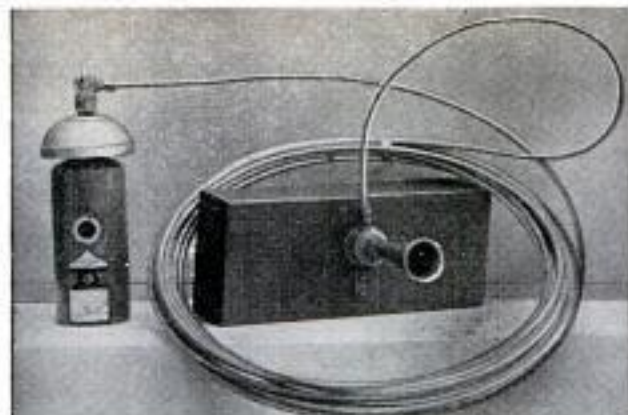

### Glass-Eye Monitor Checks Fire Alarm

Glancing into a nonmechanical, glass-eye monitor, a homeowner can verify that the fire detection system in his house is in good working order. The monitor is part of an automatic, nonelectric, self-contained fire-alarm network that depends on heat-expanded gas to set off a warning horn. The system can be installed by the average person. Containers, placed in the basement, attic and at the head of the stairs on the second floor, are interconnected by aluminum tubing. When heat from a fire raises the temperature of gas in a container, the gas expands and forces a lead plug, located behind the warning horn, out of its seat. Gas flows through the horn and sounds it for 18 minutes at a noise range of one half to three quarters of a mile.

### One-Piece Dial Telephone

Telephone numbers are dialed in the underside of a new one-piece dial-transmitting-receiving unit. When this device is lifted, a switch in its base begins line-connecting operations. Reseating the unit will disconnect the line.

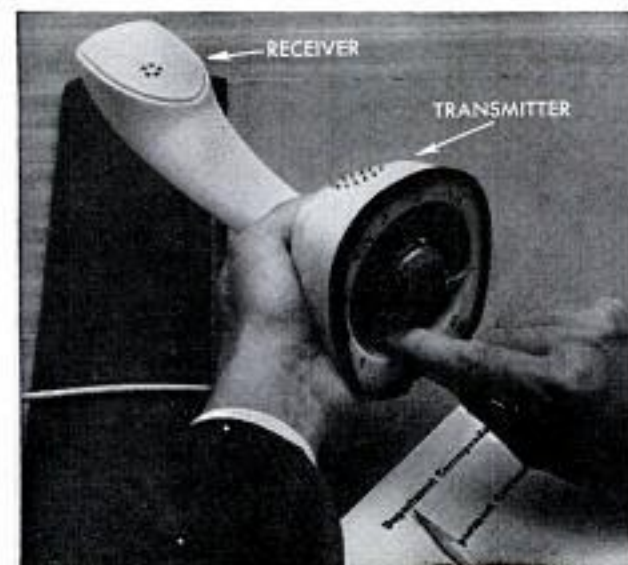

## Balanced Design

FOR BETTER, FASTER, PRECISION MEASURING

No. 230FL and T230FI  
with Direct Feel plus  
Friction Thimble



No. 230RL and T230RL  
with Direct Feel plus  
Ratchet Stop



EVERY DETAIL  
PRECISELY  
RIGHT

## Starrett<sup>®</sup> MICROMETER CALIPERS

Only Starrett with over 75 years of precision know-how offers you micrometer calipers with 12 big features all in perfect balance for easy handling, faster measuring, easy reading and lifetime accuracy.

Balanced design with correct thimble diameter; no-glare Satin Chrome Finish; Hi-Micro lapped mirror finish on anvil and spindle faces; one-piece spindle with extra hard threads ground from the solid and stabilized; rigid one-piece frame with deep throat and taper for narrow slots and tight places; quick reading figures; convenient decimal equivalents; quick, easy adjustment; lock nut and ratchet stop or friction thimble.

Ask your distributor or tool store to show you these finest micrometers ever to carry the Starrett name.

### BIG NEW CATALOG — FREE

Describes and illustrates over 3000 Starrett Tools. Write for it. Address Dept. AP



THE L. S. STARRETT CO., ATHOL, MASS., U. S. A.  
Since 1880 — World's Greatest Toolmakers



# Starrett

MECHANICS' HAND MEASURING TOOLS AND PRECISION INSTRUMENTS  
DIAL INDICATORS • STEEL TAPES • PRECISION GROUND FLAT STOCK  
HACKSAWS • HOLE SAWS • BAND SAWS • BAND KNIVES

## Where an Angler's Thrill Becomes a Masterpiece

(Continued from page 134)

Working from thousands of notes made by personal observation, and from color photographs by the hundreds, the master goes to work with airbrush. "A lot depends on the pose," he explains. "Many fish change color for different activities. The deep bronze of a cruising dolphin flares into vivid blue and gold when he strikes at a morsel or fights a line. Pull him aboard and before you get home he'll be a leaden gray. The sail's famous royal-blue, black-spotted dorsal fin is actually dull brown when he's coasting along."

Reese starts by spraying a specimen white. Then successive layers of darker colors are superimposed until all the actual hues are achieved in the right places. On small specimens he may work with a tiny hand brush, accurately shading hundreds of minute scales.

After a week of drying, finished mounts are given a final coat of lacquer and shipped to their destinations at a rate of nearly 500 a month.

### Hardboard "Sails"

Save for the eyes, every exterior bit of a fish is usually the fish's original equipment. An exception is the majestic dorsal fin on a sailfish. The delicate membrane webbed between strawlike ribs is often tattered beyond repair during the battle to land him. Even if it weren't, the tissue would dry and crumble after a few years, and shipping it would be hazardous. So in Reese's shop you can watch men cutting and gluing paper ribs to hardboard "sails" which are substituted for the real sails.

The trouble with hardboard sails is that they limit the sinuous action you can put into the lithe body of a sailfish, and Reese doesn't like to be limited when he's striving for accuracy. So when he got a beautiful seven-footer one day, he put his ingenuity to work.

"I wanted it to be the most accurate mount ever made," he says. "I'd watched those beauties break out of the water too many times to kid myself into thinking that a simple arch was all they threw. They are a mass of fighting curves that I'd never seen reproduced."

Studying photographs and relying on memory, he worked three months on elaborate molds and preparations. Using the original bone ribs, split down the middle, he stretched a sheet of  $\frac{1}{32}$ -inch aluminum between them, curving it to conform to the fish's sinuous spine. The result is a

museum piece of perfect marine mounting.

The baby octopus that hangs in his reception room is a tribute to his ingenuity. To hide any trace of the incisions he skinned it from the underside, and saved the suction cups by using a rubber mold instead of a plaster mold. He reinforced the delicate tentacle tips and coated the entire creature with clear liquid plastic to give it a wet, slippery look. "On occasion, I've reconstructed damaged skins with glass cloth and polystyrene," he admits. "Actually, an entire fish could be made up of these materials and no one could tell it from the real thing if it were carefully executed."

### Young Taxidermists

Although he no longer mounts land creatures, Reese occasionally is jolted from bed by a ringing doorbell to identify or "stuff" a bird or animal some youngster has shot. One boy showed up at three a.m. with a dead rattlesnake and wanted to know how to tan the skin and whether the meat was good eating. "I've put together a set of basic do-it-yourself skinning and tanning instructions that I give those boys," he says. "If the kid comes back with a good skin, I criticize the job he's done, provide him with a set of eyes and start him off mounting his specimen. The country needs good taxidermists, and maybe some of those boys will help fill the vacancies."

Though he refuses to create freak mounts, the taxidermist on one occasion agreed under pressure to make up a composite fish from separate species for a famous sportsman who obviously wanted to perpetrate a deception. Annoyed, Reese carried out the assignment in such a way no one could be deceived by it. The marine "whatsis" stood 18 inches high, with dolphin's head flawlessly hitched to a tarpon's body and ending in a barracuda's tail. Besides giving it a buxom torso, he painted its lips carmine, put a come-hither look in the eyes and draped them with dreamy inch-long lashes!

Once a couple drove up to the studio in an ancient car. In the rear lay an eight-foot sailfish, brought in for mounting with the mistaken belief the charge would be but \$10 or \$15. (For an average sailfish, about six feet in length, the cost is \$100.)

"They were so disappointed they almost had tears in their eyes," the taxidermist recalls. "When they asked if they couldn't pay for their fish at the rate of 50 cents a week, I hadn't the heart to refuse them."

"Most of the fish brought to me for mounting are far from record breakers," he continues. "They are preserved purely for the sake of recalling some particular thrill to a happy sportsman." ★ ★ ★

# CUT PERFECT GROOVES WITH *Warren* WASHERS ON YOUR SAW BLADE!

You Just **DIAL** the Cut Wanted

over **250,000** sets in use!

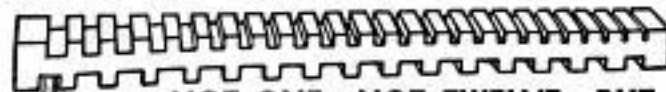

**NOT ONE—NOT TWELVE—BUT 40 DIFFERENT CUTS!**

Warren Washers—engineered to cut clean, accurate, parallel grooves with your present power saw. 40 micromatic adjustments—just dial the desired width. Actually strengthens blade, eliminates vibration—leave on saw for straight cuts. No burning or chewing. Over 250,000 satisfied users in 48 States and many foreign lands. Be sure to get genuine Warren Washers... they're guaranteed!

**FREE!** Send for free descriptive booklet. Arbor sizes  $\frac{1}{2}$ ",  $\frac{3}{8}$ ",  $\frac{3}{4}$ ", 1". See your dealer or write direct.

**WARREN WASHERS CO.**

Dept. 21, Box 98, North End Station, Detroit, Mich.

**ONLY \$4.95 SET**

## H **HARGRAVE** The Complete Line of Tested **TOOLS**

**INDUSTRIAL QUALITY TOOLS FOR EVERY WORKSHOP**



**WRITE FOR FREE CATALOG**

Showing a complete line of Clamps for all purposes, openings from  $\frac{3}{8}$ " to 12" and depths from  $\frac{1}{2}$ " to 16", also Chisels, Punches, Masonry Drills for hand and power hammers, Carbide Rotary Drills, Gasket Cutters, File Cleaners, etc.

**See Your Local Hardware Dealer**

**THE CINCINNATI TOOL CO.**

1942 WAVERLY AVE.

CINCINNATI 12, OHIO

# earn big money arc welding

A Real Profit Maker

Investigate these **LOW COST arc welders**



AC WELDER-AC POWER



"BUILD YOUR OWN"



"BIG BROTHER"



TRANSFORMERS

**WELD ANYWHERE**—IT'S EASY WITH THIS NEW LOW COST "HUSKY BOY." Here's your chance to get into the fast growing welding business. Let the welder pay for itself out of extra profits.

**EARN EXTRA MONEY**—BIG DEMAND FOR WELDING ON EMERGENCY REPAIR WORK. Do welding on the spot—saves expensive replacement parts, costly tear down and assembly. Welding is important to you if you want to get into bigger paying work.

**ALL TYPES—ALL SIZES.** Don't be satisfied until you've checked the new Hobart Welders that are ready to go to work for you on a moment's notice. HOBART BROTHERS COMPANY, BOX M-17, TROY, OHIO, PHONE FE-21223—"one of the world's largest builders of arc welding equipment."



**Modern Welding Lessons Book**  
200 pages. Fully illustrated. Learn arc welding in your spare time... only \$1.00.

**Hobart**

- HOBART BROTHERS CO., BOX M-17, TROY, OHIO
- Without obligation send me details on:
  - 200 amp. "Husky Boy"     300 amp. "Build Your Own"
  - AC Power-AC Welder Comb.     250 amp. "Big Brother"
  - 180 to 500 amp. Transformers.

**free** packet guide for welders

Name \_\_\_\_\_  
Address \_\_\_\_\_  
City \_\_\_\_\_ State \_\_\_\_\_



## German Coal Ceramics Make Nonsoiling Ornaments

Handsome ornaments, such as wall plaques, clock faces and paperweights, are made of a ceramic material that is nothing more than clean pit coal molded under high pressure and baked. The finished product

is black in color, solid and nonsoiling. Its dark surface takes on a rich beauty when artistically lighted. A firm in Germany is using the coal ceramics to make many articles, both decorative and useful.

## Baby-Food Rack Uses Gravity to Dispense Stock

Gravity and inclined planes are the basis of a new plastic dispensing rack for baby foods. Canned stock is fed into the top of the rack and moves by gravity down angled planes to the front of the display unit for

selection by a customer. This apparatus saves time and space, provides continuous rotation of fresh canned stock, and eliminates breakage for the retailer. Uniformity of arrangement benefits the consumer.

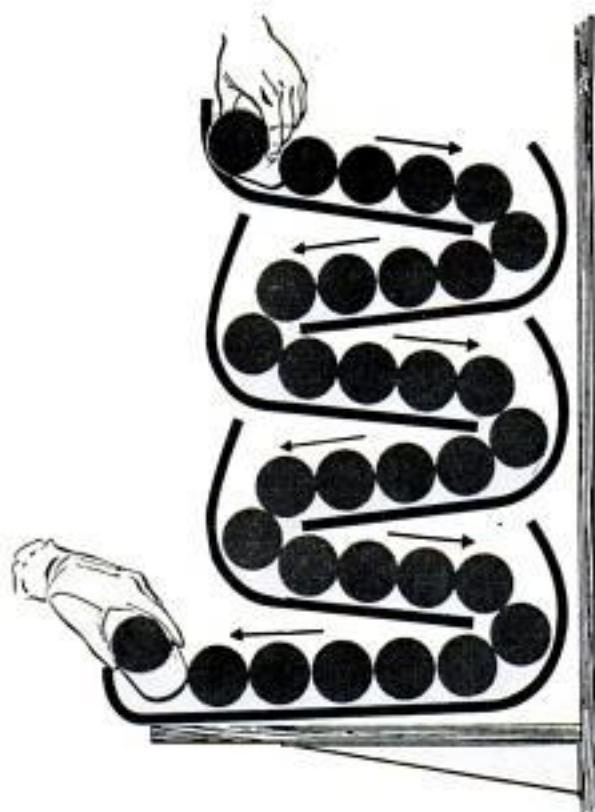



## SAVE MONEY on LUMBER

with the LOW-COST  
**BELSAW PLANER**

### Convert Rough and Random Size Lumber Into Cabinet Finished Stock

Now anyone can make perfect cabinet finished stock from low-cost rough lumber...any size up to 12 1/4 inches wide and 6 inches thick. Turn out high grade finished material at a fraction of the cost you pay lumber yards. Big 42-inch-long bed makes it easy to plane heavy, wide and long pieces... BELSAW self-feeds at 14 to 34 feet per minute.

### USE THIS ONE LOW-COST MACHINE for Planing, Jointing, Sawing, Milling, Tongue and Groove.

You can easily make flooring, siding and many other popular patterns with your Belsaw. Your Belsaw quickly pays for itself with savings on raw materials and profits on finished stock... a highly profitable machine for custom work. Compare Belsaw with any 12-inch planer on the market... Belsaw gives you more essential features—yet costs you \$50 to \$125 less than others.

### Send Today for Free Literature on the Belsaw Multi-Duty Planer.

**BELSAW MACHINERY CO** 2057 Field Bldg. Kansas City 11, Mo.



## it's NEW! it's ALL IN ONE LEVEL · SQUARE · TAPE

IT'S A LEVEL!  
Built-in, accurate unbreakable Level.



IT'S A TAPE!  
10 ft., replaceable WYTEFACE® Tape.

IT'S A SQUARE!  
Accurate Square. Easy to use.

Only \$1.98

at your hardware store



**KEUFFEL & ESSER CO.**  
Hoboken, N. J.

SMALL! POWERFUL!

## ECONOMY TRACTOR



Unequaled value! Low price!  
America's finest tractor. Ruggedly built. Easy to operate. 790 lbs. Borg-Warner clutch, trans. and diff 180 to 1 reduction. 40% more drawbar pull than ordinary tractors 8-1/4 H. P. engine. 20 quick change implements. HOOD, FENDERS.

Thousands In Use Write for complete details.  
Engineering Products Co.  
915-K-1 Niagara Ct.  
Waukesha, Wisconsin

Six or V-8  
the going is great!  
**'57 FORD**

## Find HIDDEN TREASURES

GOLD, SILVER, PRECIOUS METALS with the Famous Model 27 Metal Detector. Lightweight, ultra-sensitive, low cost. None finer. Also GEIGER COUNTERS for uranium and the VIOLITE for tungsten. INFORMATION FREE

THE *Detectron* CORP.  
5528 Vineland Ave., No. Hollywood, Calif.



Protect your home against power interruptions with an...

## ONAN Emergency ELECTRIC PLANT

Provides dependable stand-by electricity for heating system, pumps, freezer, lights, appliances. Keeps home safe, livable. Automatic start and stop. Find out how little it costs!

Write for Folder!

**D. W. ONAN & SONS, INC.**  
3654 University Ave. S. E. • Minneapolis 14, Minnesota

A SIZE FOR EVERY NEED  
500 to 75,000 watts.  
Compact, quiet-running.  
Gasoline-powered  
Priced from \$255.00

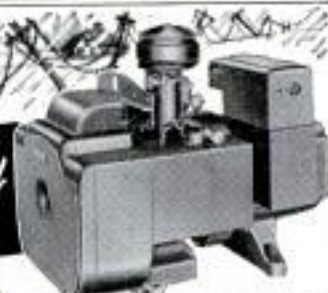

## SHE'S ROOMY AND RUGGED the Old Town Oceanboat

TAKE the whole family for a spin in your fast, big (16-foot) outboard boat! Well-braced for the heaviest motors, planes beautifully. Safe and seaworthy. Bow flares to keep your passengers dry. Planking's painted gleaming white. Built for years of service.

FREE CATALOG illustrates boats for sport, for the family, and all kinds of canoes, outboard boats, rowboats and dinghies.

## OLD TOWN BOATS

OLD TOWN CANOE COMPANY  
441 Middle Street, Old Town, Maine  
PLEASE SEND ME FREE CATALOG

Name \_\_\_\_\_  
Address \_\_\_\_\_  
City \_\_\_\_\_ State \_\_\_\_\_



## Films Now Dispensed Through Vending Machine

Coin-operated dispensers provide black-and-white roll film to customers in sizes 120, 620 and 127 when two quarters are deposited in the slot. In addition to mechanically selling film, the machine also provides envelopes into which the exposed film can be placed. Dropped into a slot in the device, the film is picked up daily, developed and printed, and then mailed to the owner. Order blanks are provided for other photographic necessities, such as movie film and flash bulbs which also will be mailed or delivered.

## Goose Decoy Is Inflatable

Geese, failing to fall prey to hunters with a new, inflatable, extra-thick rubber decoy, just don't know enough to surrender. Sixteen different styles of 22 by 10-inch decoys with detachable feet and legs are available. Hand-painted and hand-molded, these false geese are made rigid by blowing or pumping air through a valve in the decoy's tail.



## Center-Line Steering—Better Than Power?

(Continued from page 163)

the wheels turn as easily as with power steering. All that is required is that the wheels are moving and steering effort is reduced drastically.

And there is also a drastic reduction in tire wear. Conventional front-end geometry has to have toe-in and camber. Center-line steering has neither—no toe-in, no camber. Therefore the tire is running straight down the road without scuffing.

With conventional steering (power-assisted or not) the tire is scuffed sideways about 50 feet for every mile of driving. Side scuffing is important in tire wear.

The 1951 Cadillac test car already has 65,000 test miles on its front tires. The tread has been inspected by tire-company officials who estimate the tires still have enough rubber to go a total of from 80,000 to 100,000 miles. And remember that those 65,000 miles were under test conditions for the most part.

Actually power steering can cover up a great many faults in a conventional spindle-steering system. Center-line steering eliminates many of these faults, but its designers do not claim it will make power steering unnecessary. They say it will more likely augment power steering. They visualize a future combination of the two.

Power steering is fine for parking and maneuvering at very low speeds. It is unnecessary (and, some say, undesirable) on the highway. These engineers visualize a low-cost, on-off power-steering unit that will operate only when the car is standing still or moving very slowly. On the highway, center-line steering will provide the safety advantages of power steering without its disadvantages and costs.

Developers of the center-line system, Transportation Engineering Components, Inc., of Benton Harbor, already are making these units for trucks. On trucks, where a front-wheel blowout can mean disaster, the stability of center-line steering is a sure-fire hit. And steering is easy. Big trucks steer as easily as passenger cars through city streets—all that is necessary is that the vehicle be moving. There is no jerking of the steering wheel when the truck goes over bumps.

The developers see a big future for the design in passenger cars and have been demonstrating the design to manufacturers. It is still uncertain, but if the acceptance by the truckers is any indication, you may be getting center-line steering in your new car within a few years. ★ ★ ★

# SMALL INVESTMENT PUTS YOU IN GOOD PAYING BUSINESS OF YOUR OWN

**ROGERS MANUFACTURING CO.**  
Dept. M-17, Lindsey, Ohio

Gentlemen: Please rush complete details about  
the big-profit possibilities of the Universal  
Lawn Mower Grinder. **FREE**

Name \_\_\_\_\_

Address \_\_\_\_\_

State \_\_\_\_\_

City \_\_\_\_\_

## SHARPENING LAWN MOWERS IN SPARE OR FULL TIME . . . AT GOOD PROFIT.

Thousands are successfully earning good money with the Universal plan of a spare or full time business in their garage or basement. Previous experience not necessary. Age no handicap. C.H.R. of Ohio made \$3,688.20 working part time, in one season. The new Universal is the only grinder in the world that enables you to grind both the bed knife and reel blades . . . **IN A SINGLE SET-UP**

. . . without removing them from the mower. Just put the mower in the grinder, follow a few simple instructions and you can do an expert job sharpening hand or power mowers without removing engine, handle, or roller. **SEND COUPON** today for success plan of this low investment big pay business of your own.

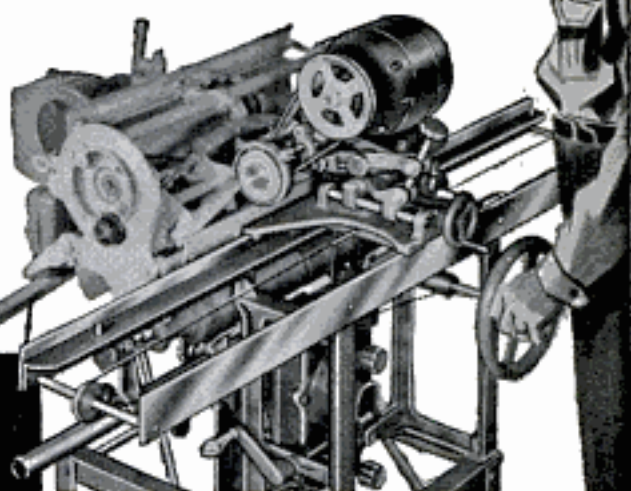

**ROGERS MANUFACTURING CO.**  
**LINDSEY, OHIO**

## FOR STUCK LOCKS

Best year-round protection against lock failure from sticking - rust - freezing. The modern method endorsed by lock experts—at service stations, hardware, auto supply, variety stores and super markets, everywhere. 4-oz. Drop or Stream can only 49c.



**LOCK-EASE®**

Graphited  
LOCK FLUID



AMERICAN GREASE STICK CO. MUSKEGON, MICHIGAN

## SOLVE YOUR STORAGE PROBLEM

With TURNBUCKLES Perforated Board fixtures you can easily end space-wasting clutter and keep everything neatly in place until needed.

TURNBUCKLES do-it-yourself fixtures come in a wide variety of shapes and sizes . . . fit easily into any wall-hung perforated board . . . and hold everything from clothing and kitchen utensils to hand tools and garden equipment.

**TURNBUCKLES, INC.**  
BOX 333, MICHIGAN CITY, IND.

Send for your free copy of space saving suggestions for home, farm and workshop.

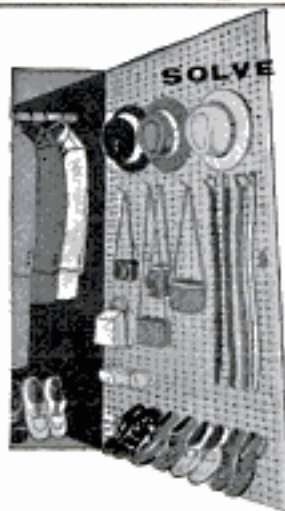

63

**PEELS PAINT OFF**  furniture



boats



floors



woodwork

Makes ANY refinishing job easier

FAST - CLEAN

Non-Inflammable - Needs No Neutralizing



**KLEAN-STRIP**  
PAINT REMOVER

The Klean-Strip Co., Inc.  
2340 S. Lauderdale, Memphis 6, Tenn.

249

JANUARY 1957

# Beautiful Liberty Homes

## Only \$2376 to \$7950



The 3 bedroom Woodlawn

### 43 house designs

Cape Cod bungalows. Long, low ranch homes with 2, 3, 4 bedrooms. Brick, siding or shake exteriors. Large living-dining areas, "dream kitchens". All designs and floor plans included in catalog. Build with basement or utility room. Individualize in many ways.

**Build it yourself . . .  
or direct its construction!**

Save thousands of dollars either way. The unique Liberty Home Building Plan outlines every step for you. Blueprints, working plans are simple, easy to follow. Lumber is pre-cut to exact size . . . each piece numbered. Do all the work yourself, or hire carpenters.



### 4 PAYMENT PLANS

Liberty Homes are acceptable for FHA or VA financing. Full details are outlined in catalog.

Materials Shipped Complete  
Freight Prepaid

Send 25c for colorful 52-page catalog

43 Liberty Homes with detailed floor plans

### LIBERTY HOMES

Lewis Manufacturing Co. • 1278 Lafayette Ave. • Bay City, Michigan  
Please send me your Liberty Homes Catalog for which I enclose 25c.

NAME \_\_\_\_\_

STREET or RFD \_\_\_\_\_

CITY \_\_\_\_\_

STATE \_\_\_\_\_

SAVE 1/2 - 2/3 THE PRICE OF FACTORY-BUILT BOATS

**BOAT  
KIT  
CATALOG  
Free!**

Write:

Runabouts, cruisers, convertibles, fishing; 43 models, 8 through 18 ft. Freight paid, \$39.25 up. Assembled and finished by experienced owners. Luger boats equal factory-built in speed, handling, style, beauty; yet save you 1/2 to 2/3. Owners say: "Fastest boat on river." . . . "Pleasure to assemble." . . . "Everyone admires my Luger." Thousands in use. Send for big, free boat kit catalog; also lists fiberglass, hardware, accessories, trailers, paint. Write for catalog today.



**LUGER INDUSTRIES, INC.** DEPT. B-1 3404 Lyndale S. Minneapolis 8, Minn.

## City With a Sinking Feeling

(Continued from page 155)

to the plant which has been converted into a pumping station to dispose of this water.

Combining and adding to possible solutions, Harbor Manager E. J. Amar and Chief Engineer Robert Shoemaker plus consultants have developed interlocking correctional measures. These include: Earth-filled dikes spotted strategically; consolidated earth levees with cores of impermeable muds and clays in locations used exclusively for oil production; elevation of low spots to positions above high tide and ground-water drainage; the raising of large, valuable structures to higher elevations, and bulkheads of steel and concrete to hold back the ocean at inside ends of ship channels.

Remedial work to date by all parties has cost more than \$50,000,000 with the Long Beach Harbor Department spending an estimated \$24,500,000. Another \$53,000,000 and possibly more money is believed mandatory for completion of future counteractive projects. Fortunately, tremendous oil and gas production on city-owned land administered by the Harbor Department provides funds for these activities. From 1000 wells pours a stream of oil and natural gas totaling \$24,000,000 annually. These wells are located on "made" land, consisting of sand and silt pumped from the harbor floor during the dredging of shipping channels.

Ironically, there are two compensations that please engineers battling the weird land recession. Since the floor beneath shipping channels is sinking also, dredging to deepen these channels is no longer necessary, and all efforts can be directed to correction of the complex problems ashore. The second compensation is that subsidence actually causes the oil field to yield more gas and oil than it would otherwise. In pressing down on the field, the sinking soil forces older wells to produce longer than expected. This "milking dry" process usually is accomplished by water-flooding or gas-repressuring techniques.

Long Beach has chosen to challenge its destiny, and by so doing to enrich itself from the earth shrinking beneath the city's foundations. Perhaps, 1972 will be the year of decision. ★ ★ ★

☐ Certified pilots in the United States have now reached the total of 298,076, which includes, among others, 132,525 private, 72,957 commercial and 11,774 airline-transport pilots; 3000 of these also hold helicopter licenses and 100 more fly helicopters only.

# TENSE NERVOUS HEADACHES

call for

## STRONGER Yet SAFER

# ANACIN

Won't Upset The Stomach

Anacin® not only gives stronger, faster relief from pain of headache, but is also safer. Won't upset the stomach and has no bad effects. You see, Anacin is like a doctor's prescription. That is, Anacin contains not just one but a combination of medically proven, active ingredients. Scientific research has proved no single drug can give such strong yet such safe relief as Anacin. Buy Anacin Tablets today!



## "FIRE UP"

YOUR ENGINE AT ALL SPEEDS WITH  
AUTO-LITE RESISTOR SPARK PLUGS WITH

## POWER TIP

LOOK FOR THE PROTRUDING TIP!



### Easy to make your own BOWS—ARROWS—EQUIPMENT

Illustrated Hand-Book 84 pgs. \$1, tells you how! Large Colored Catalog 5c—Send for it!

Ask your dealer for "Stemmler's Archery" (Oldest Mfr. in U.S.A.)

**L. E. STEMMLER CO.**

Manorville (Box 1) L. I., N. Y.

### DIGS 2" TRENCHES to 18" DEEP

New Model B DITCH WITCH digs 2-in. trenches to 18-in. deep. Perfect for lawn sprinkler systems, utility service lines. Digs straight, curved and cornered trenches in all soils, even rocky and frozen. Low Cost! Write for new Bulletin. THE CHARLES MACHINE WORKS 620 B Street Perry, Oklahoma



**\$5000**  
**PER DAY**  
**AND MORE**

**SERRATING AND SHARPENING TABLE KNIVES**

**SAW-KEEN** PORTABLE, ELECTRIC, EASY - TO - OPERATE

Be your own boss, work anywhere, full or part time. Every restaurant, hotel, drive-in, etc., repeat customers. Serrated (saw-edged) table and steak knives in great demand. \$98.50 investment returns first week. Guaranteed. Write today for proven daily profit plan.

**CUTTER-CRAFT** 58-Y SOUTH RAYMOND PASADENA 1, CALIF.

## have fun with electronics

### BUILD YOUR OWN knight-kit

IT'S EASY—  
AND YOU SAVE!

KNIGHT-KITS are famous for their clear "step-and-check" instructions. You'll marvel at how easy they are to assemble. You'll be thrilled with their performance—proud of your work. You can't miss—and you save money!



#### Transistor Radio Kit

Experiment with the marvel of transistors! Printed circuit mounting board simplifies assembly—just make a few solder connections. Delivers fine broadcast reception. Fits in palm of your hand; powered by penlight cell that lasts for months. Complete with all parts, transistor, penlight cell. Shpg. wt., 2 lbs.

83 Y 765. Transistor Radio Kit... **\$4.35**  
83 Y 266. Headset & Antenna Kit... **\$3.15**



#### Famous 2-Band "Space-Scanner"

Thrilling new bandswitching receiver. Selects exciting short wave on 6 to 18 mc (foreign, amateur, aircraft, police, marine); and full regular broadcast. Sensitive regenerative circuit; 4" PM speaker; beam-power output. Easy to build. All parts supplied (less cabinet). 4½ lbs.

83 Y 243. "Space-Scanner" Kit... **\$15.95**  
83 Y 247. Cabinet for above... **\$2.90**



#### Transistorized Electronic 10-in-1 Lab Kit

Sensational—work with transistors! Assemble the basic parts, then complete project after exciting project (10 of them in all) just by plugging leads into proper jacks on printed-circuit board—no wiring changes needed. Make the following: AM radio, amplifier, wireless broadcaster, code practice oscillator, electronic timer, switch, flasher, or any of 3 other electronic relays. Includes all parts, 2 transistors, battery, headphones and instructions for each project. Shpg. wt., 3 lbs.

83 Y 299. Electronic Lab Kit... **\$15.45**



#### 2-Way Intercom Kit

It's easy and inexpensive to build your own 2-station intercom! Use it in home or office. Makes ideal "baby sitter". Extra high gain—delivers full output from only a whisper. Complete with 50 ft. cable (up to 200 ft. may be added), antique-white cases, tubes and all parts. For AC-DC, 7 lbs.

83 Y 295. 2-Way Intercom Kit... **\$14.75**

Dozens of other  
knight-kits  
available

GET THE BIG **FREE**  
356-  
PAGE 1957

### ALLIED CATALOG

See our complete selection of KNIGHT-KITS—plus the world's largest stocks of Hi-Fi systems and equipment, recorders, Amateur equipment, test instruments, TV components, parts, tubes and tools. FREE—send for it!



### ALLIED RADIO

ALLIED RADIO CORP., Dept. 5-AA-7  
100 N. Western Ave., Chicago 80, Ill.

□ Send FREE 356-Page ALLIED Catalog

Send the following KNIGHT-KITS: \_\_\_\_\_

\_\_\_\_\_ \$\_\_\_\_\_ encl. Prices Net F.O.B. Chicago

Name \_\_\_\_\_

Address \_\_\_\_\_

City \_\_\_\_\_ Zone \_\_\_\_\_ State \_\_\_\_\_

World's Largest  
Electronic  
Supply House  
Our 36th Year

## Goal No. 3—Disease-Free Crops

(Continued from page 168)



New spray gun for home use holds fungicide in plastic bag. Such sprays help prevent plant diseases

percentage of plant diseases. So far there are no "miracle drugs" in this field.

Plant-disease control, though, has emerged from its patent-medicine stage. In the past 25 years hundreds of chemicals have been tested and a few dozen improved fungicides and seed disinfectants are now on the market.

On small-grain seed, organic mercury compounds are effective against many diseases, are not likely to harm the seed and are easy to apply. Several other organic compounds such as thiram, captan and dichlone are widely used on corn, vegetable and flower seeds. Some of these compounds, along with such well-known antibiotics as streptomycin, can be used safely on cut-potato seed pieces, protecting them against decay organisms.

Of the new foliage sprays and dusts, the group known as dithiocarbamates probably is the most successful. These include such unfamiliar names as ferbam, zineb and maneb. The old stand-bys, of course, were Bordeaux mixture and sulphur. The new ones are a little more effective against a greater number of disease fungi; they stick

to the plant better and injure it less; they are a little easier to use, but generally no cheaper.

These foliage sprays and dusts are poisons that kill disease fungi before they can penetrate the plants. All susceptible surfaces of the plant must be covered, so their application requires good spraying and dusting machinery. Airplanes sometimes do the job on larger acreages. Repeated applications must be made, both to cover new growth and to replace the fungicide washed off by rain.

Spraying or dusting with fungicides is a tedious and expensive job, but so far we have no better answer to the problem. Fungicides effectively control such diseases as apple scab, potato late blight and the mildews and blights of other plants. We've usually considered them too expensive for use in controlling the rusts of cereals, but recent improvements in machinery have touched off new experiments to learn whether such applications might now be profitable.

### Chemicals That Penetrate Plants

Plant pathologists have always hoped that someday they would find chemicals which would actually penetrate the plant, diffuse to all parts of it and protect it from disease. Such chemicals could be applied to the soil and taken up through the roots, applied to the seed or sprayed on the leaves and absorbed through them. They would protect the plant against infection or even cure it of disease.

We've edged closer to this goal in the past five years. We've borrowed medicines from the family doctor. Certain antibiotics, notably streptomycin, will penetrate the plant, move through it and protect it against infection. Some synthetic chemicals move through the plant in the same way and show promise of controlling virus diseases as well as those caused by fungi and bacteria. If such toxic chemicals prove practical, they may revolutionize plant-disease control. At that time plant pathologists will have a truly spectacular announcement to make to the world.

Meanwhile, streptomycin is preventing some bacterial diseases that have never been controlled with chemical sprays. Apple fire blight, bacterial blight of beans and other diseases have been prevented with low-concentration sprays of streptomycin, applied several times during the season.

Streptomycin and another antibiotic, actidione, also will control certain fungus diseases. Actidione wipes out powdery mildew and rust on apple leaves.

(Continued to page 254)



**"Remember Me"**  
**JOIN THE**  
**MARCH OF DIMES**  
 IN JANUARY



### SPRINGFIELD TILLER

One unit plows, discs, weeds. Rotating tine discs are guaranteed for life. Removable individually without wrenches to till wide or narrow rows. 3 h.p. engine. Finger-tip control. Furrowing tool, cultivator, aerator, roller and other attachments.

WRITE FOR FREE LITERATURE. Quick Mfg., Inc.  
 3257 E. Main St., Springfield, Ohio



### BRONZE FOUNDRY

Schools and Home Workshops

Make your own castings of aluminum, copper, bronze, silver. Foundry sets are available in three sizes including 2400 Deg. F. blast Furnaces. \$26.50; \$33.50; and \$46.00 f.o.b. Marysville, Kans. Free Circular.

KANSAS CITY SPECIALTIES CO. P. O. Box 6022, Dept. P-1  
 MARYSVILLE, KANS.

### ONE-MAN SAWMILL LOW \$50.00 DOWN AS...



Take BELSAW Portable Sawmill right to the trees—burn out valuable lumber for home and farm—sell to local yards—make up to \$50 a day custom sawing for neighbors. BELSAW lasts a lifetime. No crew needed. Power with tractor or auto engine. Beginners get excellent results. Send today for FREE BOOK.

BELSAW MACHINERY CO  
 3457 Field Bldg., Kansas City 11, Missouri

### SENSATIONAL NEW HIGH SPEED DRILL MASTER

NOW turns the ordinary shop drill into HIGH SPEED DRILL PRESS at a big saving. When DRILLMASTER is used on a 5,000 rpm drill press its top speed will be 20,000 rpm. Does the work of expensive high speed drill presses on brass, aluminum, plastics and cast iron where high speed drilling is necessary. Available for work of any size runs. Fits any 1/2" chuck, holding drills from 5/32 to #80. Shafts are heat treated and ground. Ball bearings and oil impregnated bearings and gear train are housed in cast aluminum. Precision made throughout. \$62.50 Fob. MAIL ORDER TODAY only. ON C.O.D. ORDERS WE REQUIRE A 10% DEPOSIT. 22" DIRZIUS MACHINE SHOP "J", 1423-25 So. 52nd Ave., Cicero 50, Ill.

### BIRCH TABLE LEGS—TOPS PLYWOOD—FURNITURE KITS

Build attractive, modern furniture pieces with highest grade selected birch table legs. Choice of turned, tapered or bent laminated. Smoothly sanded with brackets, ready to attach and finish, 15" high. Set of 4, only \$3.75 pcd. Also Aluminum Folding Legs, 30" high, \$9.95 set of 4. Order now. Write for FREE CATALOG of quality furniture kits, legs, tops, plywood.

BIRCHWOOD INDUSTRIES  
 DEPT. 13 FITCHBURG, MASS.

### MONEY for MEN ALL DATA FREE

THE PLASTEX Industry needs manufacturers on small scale and for big production of Lamp and Clock Stands, Art Goods and Novelties in Plastex and Marble imitation. Experience unnecessary. 1/2" material makes regular 10¢ store sellers. Rubber molds furnished for speed production. Small investment brings good returns. We are now placing big Chain Store Orders with manufacturers. Ambitious men have chance for real prosperity. Our Free booklet will interest and benefit you.

PLASTEX INDUSTRIES, Dept. A  
 3400 Third Ave. New York 56, N. Y.

### Now! Cover plywood edges with real wood



### New Flexible Weldwood Wood-Trim

Avoid unsightly edges in building any plywood project—tables, desks, cabinets, etc. Give them a "pro" finish with Weldwood Wood-Trim. So flexible you can beautify any edge—straight, curved, angled. In handy rolls, Wood-Trim is a cinch to apply. No clamps, nails, hot iron, etc. Just use Weldwood Contact Cement or Presto-Set® Glue.

#### Countless Decorating Uses!

Trim lamp shades with Wood-Trim! Decorate picture frames! Smarten coffee tables, clocks, waste baskets, etc. 8 ft. rolls 1" wide, 89¢ ea. Oak, African Mahogany, Walnut, Birch, Fir, Korina®.

For perfect wood finishing jobs, use FIRZITE® and SATINLAC®



Another Weldwood Wizard

At hardware, paint, lumber dealers. Write for free leaflet to Dept. PM1-7WT.

UNITED STATES PLYWOOD CORP., Box 525, New York 46

### RIDE THE WAVES in the NEW '57 models



with WOLVERINE

Molded plywoods, aluminums, Ply-Laps. Redesignated and improved for wide acceptance by boating public. See them at New York and other major boat shows. FREE Catalog on request.

WAGEMAKER COMPANY  
 Dept. 27-57 Grand Rapids, Michigan

Actually, antibiotics probably control a great deal of disease without any help from man. Many microbes in the soil fight each other. The bacterium that causes ring rot of potatoes is a good example of a pathogen that is quickly killed by other microbes in the soil.

Can we find organisms which will fight plant pathogens, and add them to the soil artificially? This usually is ineffective because the nature of the soil determines which organisms will survive in this microscopic world. A fungus that kills a second one in the laboratory may itself be destroyed by a third one in the soil.

Our well-known medical antibiotics came from the soil originally, and sometimes through cultivation we can help the natural antibiotics in the earth. For example, in some areas, green rye plowed into the soil stimulates the growth of bacteria that fight off the pathogen causing potato scab.

Florists long have known that steam or chemicals will wipe out plant pathogens in the soil. Such methods have been used only in greenhouses, seed beds or on high-value crops because they are so expensive. Usually the soil must be sealed so the chemicals will not escape too fast.

Improved machinery for applying the chemicals, and plastic films for covering the soil have cut the cost of using these chemicals. The most important of the chemicals are chloropicrin and methyl bromide, but two new materials with tongue-twisting names, dichloropropene and dichloropropane, have been found especially effective against nematodes. Furthermore, they can be applied with field machinery and require no soil cover. They are a great advance in soil treatment, controlling nematodes of tobacco, pineapple, cotton and vegetables. Still other chemicals, such as (hold your breath) pentachloronitrobenzene, can be applied as solids and hold promise of controlling cabbage club root and potato scab.

### Disease-Resistant Plants

We should not discount the possibility of curing plants or making them immune to disease by chemical treatment. However, striking progress is also being made in the use of disease-resistant varieties of plants.

Many such varieties are available today: Peas, watermelons and flax resistant to soil-borne wilts; wheat and oats resistant to certain rusts and smuts; potatoes immune from certain viruses. Indeed, were it not for such resistant varieties, some crops such as flax could not be grown at all economically. It often is less work for

the farmer to raise disease-resistant varieties than disease-susceptible ones. Many farmers using such varieties are unaware that they are resistant, or even of the disease they are resisting!

But even these special varieties are not the complete answer. Change is the law of life. Fungi and bacteria are living plants, mostly microscopic in size, but living nonetheless, and even the viruses behave in many ways like living things. They keep changing. While man breeds new varieties of wheat, oats, corn, rice and potatoes, nature breeds virulent new races of plant pathogens. Varieties may be resistant for a number of years, then succumb to new races of fungi which nature spawns. It is the age-old battle of man against nature.

### Two-Front Attack

Plant pathologists are attacking this problem on two fronts. First, they are learning much more about present and possible future races of parasites, so they can predict what they will be up against. Second, they are finding out more about *what* protects some varieties against disease. Through such basic, painstaking research, man is gaining on nature.

Farmers, for the most part, would be amazed to know how much more disease resistance is "built into" our principal crops than there was 25 years ago, and more is being added continually. Listen to the roll call. Flax wilt and flax rust have been kept under reasonably good control. The damage from smuts of corn and some small grains has been greatly reduced. Because of semiresistant varieties, seed treatments are now effective in controlling the stinking smut of wheat that destroyed or befouled huge quantities of that grain in the Pacific Northwest a few decades ago. In some areas, blight-susceptible potatoes must be sprayed at least eight times, but new varieties have enough built-in resistance to require only four sprayings—a considerable saving to the farmer. Improved varieties of bread wheat in the spring-wheat region of the United States and Canada will yield half a crop in a bad rust year, while susceptible varieties yield almost nothing.

But most encouraging of all is the fact that the intelligent farmer now realizes the complexity of plant-disease problems and what he can do to help solve them. He continues to hope that miracle drugs or completely disease-resistant varieties will relieve him of his plant-disease worries, but he is realistic enough to learn what he now has to do to control diseases. Not only is he supporting research, but he is applying the results more intelligently. ★ ★ ★



# KING MIDGET

Drive it for 75c per week. Rider Agents wanted—earn your own car free. Also KING MIDGET JUNIOR chassis, finely engineered, ready to run and priced at a fraction of any similar car. GET THE FACTS. Send 25c for 32 page picture book giving special prices and agents proposition on both cars. Or send \$1 (refunded first order) for this plus actual assembly book and service manual.

MIDGET MOTORS CORPORATION, ATHENS 1, OHIO



Works in seconds!

**Loosens Rusted Bolts**  
nuts, screws, "frozen" parts!

## LIQUID WRENCH

The super-penetrating rust solvent that quickly loosens rust and corrosion.

AT HARDWARE STORES, GARAGES  
SERVICE STATIONS, EVERYWHERE

**RADIATOR SPECIALTY CO.**  
Charlotte, N. C.

3 oz. CAN  
**30c**

**Drive with Confidence**

**DINSMORE Auto Compasses**

Shows you the right way—the short cuts. Saves time, money. Write for new compass history folder, "Pants—Knives—Compasses," and name of nearest dealer.

**DINSMORE INSTRUMENT CO., 1802-21 Kelso St., Flint 1, Mich.**

ONLY COMPASS APPROVED BY AUTO MAKERS

**NEW 18 ft. OFFSHORE CRUISER KIT**

17 Models as low as \$42.00 (freight included). Fiberglass boat covering kits, marine supplies, etc.

**TAFT MARINE WOODCRAFT**  
Dept. PM-157 • 626 29th Ave. N. E. • Minneapolis 21, Minn.

BEST PRICES ON CONVERTIBLE TOPS

ONLY \$399  
Freight included. FREE FOLDERS

**NOW—THE QUICK-WAY TO SHARPEN ALL CIRCULAR SAWS**

**NEW**

Model PG-12 sharpens, joints, gums, and retooths all cross cut, rip, combination, miter, and planer blades up to 12" in diameter. Two precision index plates give versatile, accurate sharpening. Guarantees precise spacing of teeth. New safety rest prevents tilting and gouging of blade. Save time and money. Special \$3.00 grinding wheel also included for use on your own power table. Fits regular or radial swing tables.

Model PG-12 Complete No extras to buy. **\$16.50** Postage Paid

Order today. Send check, cash, or money order. We pay postage. **FREE** Booklet—"How To Sharpen Saws."

**QUICK-WAY SAW CO.**  
136 TOMPKINS ST. CORTLAND, N. Y.

# GRAVELY

## New EASE in Country Living!

**NOW! 30 TOOLS**

Even plowing is easy — perfect seedbed in one operation with Rotary Plow! . . . only one of 30 sturdy, year-round tools . . . Powerful 5-HP Gravely Tractor does every lawn, garden and field job easier, better! All-gear Drive, Power Reverse. Push-button Starter optional.

Write today for FREE 24-page "Power vs Drudgery" Booklet.

**EASY PAY PLAN**

**GRAVELY TRACTORS, INC.**  
BOX 163 DUNBAR, W. VA.  
**FIELD-TESTED SINCE 1922**

**B&D Jig Saw . . . Versatile, Powerful, Balanced!**

Does work of jig saw, sabre saw, keyhole saw, plus most band saw operations. See your B&D Dealer—today!

**\$54.50** includes 5 cutting blades

**Black & Decker** World's largest maker of portable electric tools

# INSULATE NOW

for as **\$67.60** low as

cost for average attic

**Do it Yourself in One Afternoon!**

# ZONOLITE®

**VERMICULITE INSULATION**

Easiest of all insulations to install . . . save as much as \$100 installation costs. Cuts fuel bills up to 40%. Fireproof, rotproof, permanent.

**LIFETIME GUARANTEE!**  
Zonolite is guaranteed to last the lifetime of the building in which it is installed. No further maintenance is ever required.

Write for **FREE** **How to Insulate** **BOOKLET**

Zonolite Company, Dept. PM-17  
135 So. LaSalle St., Chicago 3, Ill.

Please rush your **FREE** Booklet, MI-47 with details on How to Insulate.

Name.....  
Address.....  
City..... Zone..... State.....

**AT LUMBER OR BUILDING MATERIAL DEALERS**

**IT'S HERE!**

**Darra-James**

**Moter Tools**



**...Power Packed Beauties  
with BUILT-IN-MOTORS**

**CONVENIENT:** Darra-James Moter tools take the guesswork out of choosing the proper motor. They come complete with Timing Belt, Pulley and G. E. Motor with Cord, Plug and Switch. Nothing to buy! **TIME-SAVING:** Nothing to set up! No time lost! **Simple to Operate:** Just plug in. Flip the switch and operate. **MOVABLE:** Each Moter tool is compact—can be carried quickly and easily from one place to another. **RUGGED:** Entire tool is constructed of heavy-duty cast-iron to assure many years of trouble-free service. **CHOICE OF COLORS:** Available in Slate Grey or Woodland Green. **ECONOMICAL:** Cost less than similar tools and motors purchased separately. **GUARANTEE:** All Darra-James Power Tools are guaranteed against defects for a full five years.



**8" Tilting Arbor Saw (Model 825)**  
A quality saw at a minimum price.



**8" Tilting Arbor Saw (Model 815)**  
An economy saw that performs all operations of high-priced models.



**4 1/2" Joleter (Model 845)** Featuring Parallel Motion to maintain constant distance between table and blades at all depths of cut.

All Darra-James Power Tools can now be purchased for only 10% down on convenient Credit Plan

**\$8495**

Write today for free folder on Moter tools and free folder of complete line of Darra-James Standard Power-Tools.

**TOOLKRAFT CORPORATION**

400 PLAINFIELD ST., SPRINGFIELD, MASS.



**NEW 1957 EDITION JUST OUT!**



Get This Giant Catalog Of

**WOOD  
& WOODWORKING  
MATERIALS**

**TOOLS—PLANS—SUPPLIES**

**World's Largest Selection of Finest Domestic and Imported Woods ... Mouldings, Hardware Tools—ALL AT LOW MONEY SAVING PRICES!**

Your complete wood buying guide and project book. Craftsman is your best, most complete source of finest kiln-dried domestic and rare imported woods, beautiful wood inlays, colorful bandings, matched plywoods, embossed mouldings, carved ornaments, newest woodworking tools, "hard to find" cabinet hardware and fittings ... more than 1,500 items! Packed with newest scroll saw patterns, project ideas and money making plans. Enclose 25c (refunded with first order) to help pay mailing, handling cost. Write

Craftsman Wood Service Co., Dept. A-1  
2729 S. Mary Street, Chicago 8, Ill.

**132 PAGES**

Many in full color

packed with rare, fancy & imported woods ... veneers, plywoods, patterns, tools, ornaments, hardware ... everything for the woodworker.

**MAIL COUPON NOW!**

**CRAFTSMAN WOOD SERVICE CO., Dept. A-1**  
2729 S. Mary Street, Chicago 8, Ill.

Enclosed find 25c. Rush WOODWORKERS' CATALOG.

NAME \_\_\_\_\_  
ADDRESS \_\_\_\_\_  
CITY \_\_\_\_\_ ZONE \_\_\_\_\_ STATE \_\_\_\_\_



**Pocket Receiver for Doctor**

Summoned by the buzz of a five-ounce receiver in his breast pocket, a doctor in London's St. Thomas Hospital is notified that he is needed elsewhere. Each receiver has its own wavelength and is operated from the hospital's switchboard.

**"Diving Board" Mouse Trap**

Lured up a ramp toward bait fixed at the opposite side of a tank, a mouse walks on a "diving board" which drops him into the tank's water-filled bottom. The drowned mouse can be destroyed without having to touch him. This plastic mousetrap has no springs and automatically resets itself as the diving board returns to position before the intact bait.

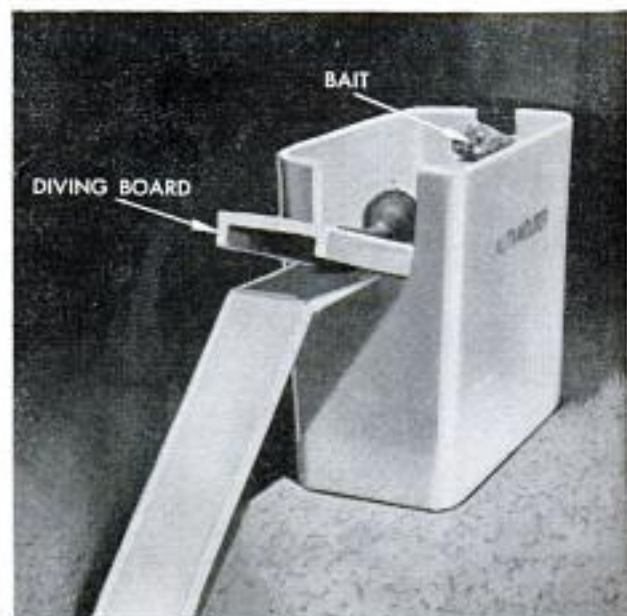

POPULAR MECHANICS PRESS, Dept. PM157

200 E. Ontario Street, Chicago 11, Illinois

Gentlemen: Please send copies of book nos.:

1 2 3 4 5 6 7 8 9 10 11 12 13 14

15 16 17 18 19 20 21 22 23 24 25 26

(circle numbers desired)

Remittance enclosed

Send C.O.D. (\$2.00 or more) I enclose \$\_\_\_\_\_

Name \_\_\_\_\_

Address \_\_\_\_\_

City \_\_\_\_\_ Zone \_\_\_\_\_ State \_\_\_\_\_

**FILL-IN and  
MAIL THIS  
← COUPON!**

## SAVE MONEY *with these* NEW DO-IT-YOURSELF BOOKS



**1. HOW TO PAINT INSIDE AND OUT:** Step-by-step instructions. Easy to follow illus.

**2. HOW TO LAY LINOLEUM AND TILE:** How to get the best from your labors. Diagrams.

**3. HOW TO REMODEL YOUR BASEMENT AND ATTIC:** Planning ideas, hints, instructions. Illus.

**4. HOW TO TAKE CARE OF YOUR LAWN:** Detailed guide to a perfect lawn and healthy shrubs.

**5. HOUSE WIRING AND ELECTRICAL REPAIRS:** Ideas and instructions for the homemaker. Diagrams.

**6. SMALL BOATS YOU CAN BUILD:** Plywood dinghy, 15-ft. sailing knockabout, 8-ft. duckboat, etc.

**7. PLUMBING REPAIRS MADE SIMPLE:** Fix faucet noises, water hammer, clogged pipes yourself.

**8. FENCES, GATES, TRELLISES AND WALKS:** Variety of fences, etc., with instructions, diagrams.

**9. BUILT-IN FURNITURE FOR YOUR HOME:** Wall cabinet, wardrobe, linen closet, crib, etc.

**10. BUILD YOUR OWN BARBECUE:** Stone and brick fireplaces, grills, barbecue pits, etc.

**11. LAWN AND GARDEN PROJECTS:** Picnic furniture, folding chairs, garden pool, etc.

**12. THREE LOW-COST HOMES YOU CAN BUILD YOURSELF:** Build your own home—save half the cost.

**13. 125 SIMPLE HOME REPAIRS:** Stop faucet leaks, replace sash cords, cut glass, etc.

**14. SIMPLE TELEVISION REPAIRS:** Only a screwdriver, pliers and soldering iron necessary.

**15. MODERNIZE YOUR KITCHEN:** Planning for convenience and economy. Ideas, diagrams.

**16. 30 ONE-EVENING PROJECTS:** Decorative, easy-to-make chairs, lamps, tables, shelves, etc., for the home.

**17. HOW TO WINTERIZE YOUR HOME:** Prepare for bad weather. Make storm windows, repair roofs, etc.

**18. HOW TO SET UP YOUR HOME WORKSHOP:** Detailed layout plans for basement conversion. Diagrams.

**19. LANDSCAPING YOUR HOME AT LOW COST:** How to plan and plant beautiful home surroundings.

**20. CONCRETE CONSTRUCTION AROUND THE HOME:** How to make steps, walks, driveways, fireplaces, etc.

**21. REFINISHING FURNITURE, FLOORS AND WOODWORK:** What you need and how to do the job properly.

**22. HOW TO USE POWER TOOLS IN YOUR HOME WORKSHOP:** Basic and advanced operations, ideas, tips.

**23. HOW TO CURE YOUR LEAKY BASEMENT:** Causes of, and how to stop, dampness and water seepage.

**24. MONEY-SAVING HOUSEHOLD FORMULAS:** Safe, efficient polishes, cosmetics, etc., you can make.

**25. UPHOLSTERING AT HOME:** Using foam rubber, upholster chairs, benches, etc., at a big saving.

**26. HOW TO GET THE MOST OUT OF YOUR CIRCULAR SAW:** How to build and use this tool for best results.

**ONLY  
25¢ EACH**

**PLEASE NOTE**  
Minimum Order Five (5) Books

**5 for  
\$1.00**

# Hemisphere House



Nicknamed "bubble dwellers," a Swedish architect and his family are living experimentally in a home that looks like half of an iron sphere. Large rectangular win-

dows and globes clustered on the roof provide lighting. The foundation of the building is concrete and has terraces and steps leading to a nearby lake.

## MODERN

### IMPROVED LAWN MOWER SHARPENER AND BED KNIFE GRINDER



\$275.00  
FOB  
PASADENA,  
CALIF.

Grinds any reel type mower. Hollow grinds or flat grinds bed knives. New micro feed grinding head. Sharpens hand and power mowers. No disassembly of wheels, roller, handle or gasoline engine. No draining of gasoline or oil. Precision sharpens more mowers per hour. Costs less. Compare before you buy. If it isn't a MODERN it can't be MODERN.

WRITE FOR FREE BOOKLET 10A

The Modern Lapping Machine is designed to fit the needs of any user of lawnmowers and the lawn mower shops. Laps any reel type mower. 1/2 H.P. motor, \$67.95 fob, Pasadena, Calif.



MODERN MFG. CO., 160 N. FAIR OAKS, PASADENA, CALIFORNIA

## CUT-TO-FIT HOMES CUT BUILDING COSTS

ORDER NOW

SAVE UP TO 1/3

CHOICE  
OF  
57  
DESIGNS



Build your own home and save the builders' profit—plus savings in lumber and labor with Sterling Ready-Cut-Homes. Anyone can assemble with simple, easy to follow plans furnished. Every house complete with all lumber, roofing, nails, glass, hardware, paint, doors and windows marked ready to erect. Freight paid. Complete building plans ready for filing at low cost. Sold separately if desired. Write today!

PRICED FROM \$2150 up  
Five Easy Payment Plans

Send 25c for NEW COLOR CATALOG

INTERNATIONAL MILL AND TIMBER CO.  
DEPT. PM-17, BAY CITY, MICHIGAN



**5-BOX DrawRacks**  
**STACK WITHOUT SLIPPING**  
**OR FASTEN TO WALL**  
 The newest, cleverest, most convenient method of keeping your screws and bolts handy for quick use!

## stock your Shop

SCREWS • BOLTS • NUTS



**59¢**  
 PER BOX

Look in your hardware store for the revolving display rack that contains all 40 of the most-wanted types and sizes of screws, bolts, and nuts. You get generous quantities in clear plastic boxes, brilliantly labeled for fast, accurate selection. Start to "Stock your Shop" today!

ELCO TOOL & SCREW CORP., Rockford, Ill.



## KATO A.C. GENERATORS

**A WIDE VARIETY FOR ANY ELECTRICAL APPLICATION!**

Adaptable to all well-known makes of engines. 350 Watts through 500 KVA and larger. To 600V. Odd frequencies from 15 to 1000 cycles. Also, Rotary Converters, High Frequency Changers, Motor Generator Sets.

**KATO Engineering Company**  
 1402 First Ave., Mankato, Minn.

FREE FOLDER



## G E A R S

**In Stock - Immediate Delivery**  
 Gears, speed reducers, sprockets, thrust bearings, flexible couplings, pulleys, etc. A complete line is carried in our Chicago stock. Can also quote on special gears of any kind. Send in your blueprints and inquiries.

**Send for Complete Catalog No. 10**  
**CHICAGO GEAR WORKS**  
 440-50 N. Oakley Blvd., CHICAGO 12, ILL.



## GENUINE ALNICO MAGNETS

**AMAZING, PERMANENT, NON-ELECTRIC, HIGHLY PRACTICAL.**  
 Conduct interesting experiments. Hundreds of uses. Retrieve valuable steel items such as guns, tackle from fresh or salt water; tools from tanks & drains. **GUARANTEED.** Try any magnet one week. Money back if you are not well-pleased.

No. M-710 (Wt. 53 oz.) Has pull of 225 lbs. on steel block... \$16.50  
 No. M-625 (Wt. 70 oz.) Has pull of 125 lbs. on steel block... 50.50  
 No. M-575 (Wt. 18 oz.) Has pull of 75 lbs. on steel block... 56.50  
 No. M-500 (Wt. 13 oz.) Has pull of 50 lbs. on steel block... 54.50  
 No. M-300 Kit of Flat Bars & Pairs (10 Magnets)... 52.00  
 No. M-250 Kit of Round Rods & Pairs (10 Magnets)... 52.50  
 No. M-47 Hot Pad Magnets, 10 for \$1.00... 50 for \$4.87  
 No. M-35 Hobbyist assortment of 8 small magnets... \$1.50

Send N.O. or check. We pay postage. Sorry no C.O.D.'s.  
**MIAMI MAGNET COMPANY, 3240 N.W. 27th Ave., Miami 42, Fla.**



**The Modern PLASTIC**  
**for lasting Home Repairs**

**PERMANENTLY** mends cracks or holes in wood, tile, stone or plaster. Sticks and stays put—Does not chip, shrink or fall out. Easy to use. Economical. Mold it, chisel it, polish or paint it. The big 4-lb. can is obtainable from your lumber, paint or hardware dealer at \$1.25; or will be shipped direct postpaid (in U. S.) for \$1.50. Complete satisfaction guaranteed or your money refunded.

**DONALD DURHAM CO.**  
 Box 804-T Des Moines, Iowa



**...DO YOU KNOW ABOUT HAND SAWS?**

## QUALITY STEEL...

Good saw steel should be hard enough to hold its cutting edge and yet malleable enough to be flexible. Only saw manufacturers who operate their own mines and steel mills can give you the uniform controlled steel consistency necessary in every saw blade. Sandvik Swedish Charcoal Steel Hand Saws feature this high quality hand saw steel. This is only one of Sandvik's many exclusive advantages. Before you buy any hand saw, ask your dealer to show you a Sandvik.



Write today for the new 16 page booklet... "Things You Should Know About Hand Saws". It's free - Dept. PM



**Sandvik STEEL, INC.**

Saw & Tool Division

1702 NEVINS ROAD, FAIR LAWN, N. J.  
 IN CANADA: P.O. Drawer 1330, Station "O", Montreal 9

**Guaranteed Auto Parts**  
**at Western Auto**



Your **WISEST** investment in a **ROTARY TILLER** is an

**Ariens**



•with the **WIDEST** choice of models to meet every tilling need

Light, medium or heavy duty rotary tillers for every tilling job; attachments for all-year use. Unequaled power, performance! For free literature, see your dealer, or write:

**ARIENS 161 Calumet St. • Brillion, Wis.**

# Build this beautiful Liberty Home yourself or direct its construction



The 3 bedroom Woodlawn

## Save thousands of dollars ...either way!

The unique Liberty Home Building Plan outlines every step for you. Blueprints, working plans are simple, easy to follow. Lumber is pre-cut to exact size... each piece numbered. Do all the work yourself or hire carpenters. Plans may be individualized in many ways.

### 43 designs...\$2376 to \$7950

Cape Cod bungalows. Ranch homes with 2, 3, 4 bedrooms. Brick siding or shake exteriors. Large living-dining areas, "dream kitchens".

#### 4 ATTRACTIVE PAYMENT PLANS

Liberty Homes acceptable for FHA or VA financing. Details in catalog.

MATERIALS SHIPPED COMPLETE  
FREIGHT PREPAID

Send 25c for colorful 52-page catalog.  
43 Liberty Homes with detailed floor plans.



#### LIBERTY HOMES

Lewis Manufacturing Co. • 1271 Lafayette Ave. • Bay City, Michigan  
Please send me your Liberty Homes Catalog for which I enclose 25c.

NAME \_\_\_\_\_

STREET or RFD \_\_\_\_\_

CITY \_\_\_\_\_ STATE \_\_\_\_\_

**THE ORIGINAL PACKAGED BOAT KITS** Made ONLY by *Custom-Craft*

World's largest line! Over 200 Boats: Kits, Formed-Hulls, Semi & Custom-Finished! All types: Prams -Cruisers! Easy to build! Flying stern, Trednic bottom, Bulkhead construction!

Top Performance, Design, Styling! Over 70 Models 8 to 21 ft

**Send 35¢ for KIT CATALOG**

52 pages: Includes Victory Series, hardware, paint accessories, Fiberglass! Send \$1.00 for Catalog Plus "Boating Handbook". DEALERS-AGENTS INQUIRE

**BOAT PLANS & PATTERNS Frame-Pac Kits** World's largest selection: over 200 plans, full-size patterns, frame-pac kits! Designed strictly for amateurs! All types: prams, kayaks, racers, runabouts, catamarans, houseboats, cruisers. Inboard-outboard 6-40' wood-plywood-steel!

**Send 35¢ for PLAN CATALOG** Catalog PLUS "Boatbuilding Handbook" \$1.00

DEPT. PM CUSTOM-CRAFT - BUFFALO 7, N.Y.

## Big Mack, the World's Longest Suspension Bridge

(Continued from page 141)

The spinning of these big cables is a fascinating operation to watch, and begins as soon as the anchorages and towers are ready. The cable-spinning crew, highly trained engineers and bridgemen of the American Bridge Division of United States Steel Corp., finished the cables on the Walt Whitman Bridge, crossing the Delaware River at Philadelphia, just in time to begin spinning the cables on Big Mack.

Their first job was to swing the two long footbridges from anchorage to anchorage, across the tops of the towers in the same arcs that the cable was to travel. A walk along this footbridge is perfectly safe, but it is not a stroll for the weak of heart. The floor of the footbridge is made of chain-link fencing, so that any time the stroller glances down, he can see the blue water of the straits between his feet and it's a long way down. As he approaches either tower, he is well over 40 stories up.

After the footbridges were strung, master wires were stretched across—one for each cable—and then carefully surveyed. Once adjusted to the proper sag, these wires served as patterns to which succeeding wires were spun.

The basic spinning rig consists of a wheel, four feet in diameter, which is pulled back and forth across the bridge on a tramway by an endless hauling rope. This rig is held over the footbridge by sheaves on pipe frames supported by the tramway cables, which are located on top of the towers and periodically along the footbridge.

To begin the spinning, a reel of bridge wire weighing 32,000 pounds is hoisted in a rack on the anchorage, and wire from it is fed through a floating-sheave tower. The purpose of this tower is to maintain a constant tension on the wire as it is fed into the cable, which it does by means of a heavy chain hung from its floating wheel. After leaving this tower, the wire is routed to the cable-anchorage pit.

The first wire is anchored—it will later be spliced to the last wire so that one half of each strand will be one continuous wire—and then it is looped over the grooved rim of the spinning wheel. Then the wheel moves out of the anchorage pit and starts the long climb to the top of the first tower. As it moves, it pulls wire from the reel which pays out around the wheel and into its place in the cable.

The wire paying out of the reel is called the live wire, because it is moving; once

(Continued to page 262)

POPULAR MECHANICS



# HERE'S A MONEYMAKER FOR YOU!

## make up to \$3 or \$5 an hour with the FOLEY SAW FILER

Ask yourself these three questions: 1. Do I really want to get ahead *faster*? 2. How can I do it? 3. Am I willing to use my spare time? If you answer "Yes" to questions 1 and 3—then we have a positive answer for you on No. 2. Men make up to \$3 or \$5 an hour sharpening hand, band and circular saws with Foley Saw Filers. No experience needed, to turn out sharp, smooth-cutting saws with this automatic machine. Start in spare time—no canvassing.

### HERE'S THE WAY TO START

Read "Money Making Facts"—shows you how others have added hundreds or thousands of dollars to their incomes in this steady, repeat, CASH business. Start your own business in your basement or garage, no overhead, small investment. Send for "Money Making Facts"—mail coupon now. No salesman will call.

### HERE'S PROOF

"When Mr. Patrick got his Foley Saw Filer in March 1946 he made a good and wonderful investment. He has done so well that we bought a house and paid for it; bought a new car, built an addition to our house. Nicest of all, it's all paid for." Mrs. Leslie Patrick.

"I made \$765 last year filing saws, and it sure comes in handy. I do this work in my spare time." —James B. Williams

"Last year's profit amounted to \$3,000. Not so bad for a one-man outfit." —Charles C. Hough.

"I have done 4 or 5 thousand saws in my spare time in the 4½ years since I got the outfit, and they are all coming back with repeat orders." —Len Crego.



FOLEY MFG. CO., 116-7 Foley Bldg., Minneapolis 18, Minn.

Send me free book "MONEY MAKING FACTS"

NAME \_\_\_\_\_

ADDRESS \_\_\_\_\_

### 24-Page Illustrated DO-IT-YOURSELF PROJECTS BOOK

Describes attic finishing, built-in cabinets, add-a-room, recreation room, kitchen remodeling, summer cottage and farm projects. Helpful information on how to get started, planning, cost estimating, materials purchasing, proper procedures, nail charts, moulding designs, etc. Send 25c and also receive 52-PAGE POWER TOOL CATALOG.

BOICE-CRANE CO., 943 Central — Toledo 6, Ohio



### NEW, IMPROVED CALCULATOR FOR WOODWORKERS only 25c

Instantly gives information on lumber, nails, concrete mixes, painting materials, etc. Convenient, simple to read. Just set dial for nail specifications, to convert linear to board feet, find bit sizes for screws, compare characteristics of woods. 6" diameter heavily varnished cardboard. Send 25c, no stamps, please to Greenlee Tool Co., 2101 Columbia Avenue, Rockford, Illinois.



# why...

YOU SHOULD EQUIP YOUR TRAILER WITH

## BULL DOG

- AXLE ASSEMBLIES
- JACKS • COUPLERS

Straight or drop axles in single or tandem—capacity up to 10,000 lbs.—any width. Also Torq-Less Axles for all types of trailers.

**JACKS**—Bull Dog Jacks make hitching and parking a one-man job.

**COUPLERS**—Bull Dog Couplers hitch or unhitch to trailer in a moment.

Write today for FREE Descriptive folder 13A.

HAMMER BLOW TOOL COMPANY

WAUSAU, WISCONSIN



## "BUBBLE OFF" OLD PAINT



You will be amazed how ZIP-STRIP magically "bubbles off" old paint in minutes, leaves surfaces clean and ready to refinish immediately. It's new, different, fast, safe. Removes 8 to 10 coats with one application. No sanding. No harm to hands. Cannot explode or burn. Simply flow it on, let it bubble, wipe away. Be sure you get genuine ZIP-STRIP in the yellow-and-black can. At better paint, hardware and variety stores everywhere.



Send today for New Refinishing Booklet and ZIP-STRIP sample!

Enclose 25¢ to cover handling and mailing of helpful 12-page refinishing guidebook and sample of ZIP-STRIP.

STAR BRONZE COMPANY ALLIANCE, OHIO

JANUARY 1957

261

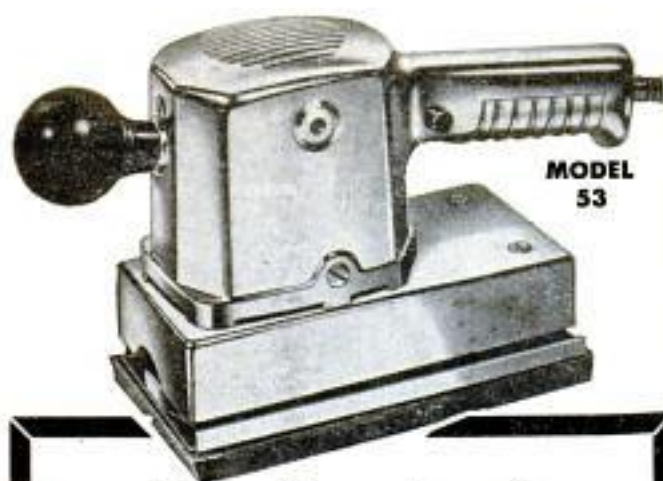

## The Secret of Scratch-free Sanding!

Ask any expert—the secret of a perfect finish is to sand with the wood grain! The old-time craftsman did when he sanded by hand. And so do you, when you use a Dremel Straight-Line Action Sander—except that a powerful motor does all the work.

With Dremel Straight-Line Action, you leave no cross-grain scratches or orbital swirl marks to mar the finish of your project. Three models to choose from.

Get a Dremel from your local power tool dealer. If he can't supply you, order direct from factory on 5-DAY TRIAL, money back guarantee. We ship postpaid. Write for free power tool catalog.

### DREMEL Straight Line Action POWER SANDERS

Model B.....	\$14.85
Model 2000.....	\$19.95
Model 2000 Deluxe kit.....	\$24.50
Model 53.....	\$34.85



**DREMEL MFG. CO.**  
DEPT. 117A RACINE, WIS.

### ARKANSAS TRAVELER PRESENTS THE NEW *Forward Sweep* DESIGN



An entirely new concept in boat design! No seams below the water line.\* New strength, beauty, performance. Exciting colors. Fifteen models for '57.

Send for free folder.

\*In 15 ft. models only.

*Arkansas*  
**TRAVELER**

ARKANSAS TRAVELER BOATS, 2006 E. 14th St., Little Rock, Ark.

the wire circles the wheel, it no longer moves, and becomes the dead wire. As the wheel passes stations along the footbridge, bridgemen reach up and pull the dead wire temporarily down into hooks in the floor of the footbridge.

When the wheel reaches the other anchorage after an 18-minute trip, it is stopped. The crew pulls the loop of wire from the wheel, and places the loop over its permanent anchor—called a strand shoe. The wires are removed from their temporary positions along the footbridge and tensioned to their correct locations in the strand. Then the live wire is picked up once more and looped around the wheel again. This leaves the dead wire anchored to the strand shoe and the live wire free to pay out.

In this manner, the spinning continues until all the strands are finished. One half of each strand is actually spun from one continuous length of wire, looped around the strand shoes on each side—much in the same manner as a housewife wraps her knitting yarn around her husband's extended hands before balling it. When the wire from one reel is exhausted, the wire from the next reel is spliced in.

In actual operation, the spinning wheel carries two loops of wire at a time, and two wheels operate simultaneously, one leaving each anchorage at the same moment and passing in the middle of the bridge. Thus it is possible to spin four strands at the same time, if the wheels are alternated every other trip.

When all of the wires for a strand have been spun, the strand is bound with narrow metal bands. When all of the strands have been completed, a compacter is placed on the cable which compresses it into its final circular shape.

After the suspension span is completed and is hanging from the big cable, it is wrapped over its entire length with galvanized wire as a protective measure.

Big Mack was begun in 1953, and will cost \$99,800,000. Traffic surveys indicate that enough cars will use the bridge to pay for it by 1975. Dr. D. B. Steinman, the bridge's designer, planned it so that high winds would have little effect on it. Aerodynamically, the suspension span serves virtually as an airplane wing when the wind blows across it. To prevent lift from developing at such times, the outer traffic lanes on the roadway will be concrete topped with a bituminous material, while inner lanes will be open iron grillwork.

The cable spinning was completed before the end of the 1956 construction season and the bridge is scheduled to be opened for service next November. ★ ★ ★



### MASTER & SLAVE HYDRAULIC REMOTE CONTROL SET



**ITEM #415**—Designed for remote operation of controls on engines, boats, special machinery, etc. Eliminates complicated mechanical linkages, cables, pulleys, etc. The master unit connects to the slave unit with a single 1/4" tube.

When master control lever is moved, slave lever follows exactly. Light, compact, aluminum alloy construction.

Dim. of both unit: 5 1/2" W, 9" H, 1 3/4" D. (exclusive of handle) Ship. Wt. 8 lbs. **27.50** per pair F.O.B. Chicago. (Note — tubing not supplied)

### BRAND NEW 1 H.P. 12 Volt Electric Motor

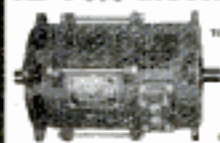

• For electric wheel chairs (Pop. Mech. design—Mar.-1953)  
• For electric golf carts  
• For self-propelled scooters, children's mid-coast cars

**ITEM #308**  
Rated 1 H.P., 100 amps., 6000 R.P.M., 12 volts, D.C.—This double shaft motor of ball-bearing construction may be run on 6 volts for lower horsepower requirements—Standard 1/2" shafts, flange mounting. Dimensions: 2 1/2" x 4 1/2" x 2 1/2", wt. 19 lbs. A real **12.50** F.O.B. Chicago value at.....

### 2 H.P. ELECTRIC MOTOR

24 Volts, 90 Amps, 4000 RPM. Spline shaft both ends. Style similar to above. Mfgd. by Hobart or Diehl. **ITEM #510** **13.00** F.O.B. Chicago.....

### SAVE \$30.30 ON THIS PESCO HYDRAULIC CONTROL VALVE



**ITEM #371V**  
FOR SAFE POSITIVE CONTROL OF HYDRAULIC CYLINDERS AND MOTORS

—SPLIT-T IN RELIEF VALVE—factory set at 1200 P.S.I. • FOUR-WAY VALVE—to operate one double acting cylinder • OPEN CENTER—with valve in neutral, cylinder is locked in position and pump is unloaded. • SPRING RETURN TO NEUTRAL • FULLY BALANCED PLUNGER • EASILY STACKED INTO 2, 3, or 4 valve combinations for multiple cylinder operation. • 8 gal. per min. capacity, at 1500 P.S.I.—3/4" pipe ports • CONNECT PUSH RODS TO HANDLE FOR REMOTE CONTROL • EASY MOUNTING • LIST PRICE—\$46.80. • YOU SAVE \$30.30. DIMENSIONS—9"x4 1/2"x2 1/2"—Ship. Wt.—8 lbs. **16.50** F.O.B. Chicago.....

## SELECTED TOP VALUE SPECIALS!

SURPLUS ITEMS AT FRACTION OF ORIGINAL GOV'T. COST  
AT GROBAN'S

### BELT DRIVEN A. C. GENERATORS



**ITEM #1010**  
10" long x 8" high x 6" wide. Shipping wt. 27 lbs. F.O.B. Chicago. **79.50**

Model 700—750 Watts A.C. **59.50**  
Model 2000—2000 Watt A.C. Generator.. **133.00**

### BRAND NEW HEAVY DUTY TWO UNIT VICKERS HYDRAULIC PUMP

• For Hydraulic Presses • For Lift Trucks • For Tractors • For Road Machinery  
The Vickers model V-2129-FLH is actually two hydraulic pumps on a common shaft. The large hydraulic pump is rated at 21 G.P.M., 1000 lbs. P.S.I. at 1200 R.P.M., for conventional hydraulic system and the small pump is rated at 3 G.P.M. and 1000 lbs. P.S.I. for power steering or for a second hydraulic system. Rotation counterclockwise. Use them individually or collectively.



Dimensions: 13 3/4" Long X 9" in diameter with 1" shaft. 1 1/2" inlet port and 1 1/4" outlet port on large pump. 1" inlet port and 3/4" outlet port on the small pump. Shipping Wt. 66 lbs. Worth \$212.50. Now priced below the value of the smallest pump! **69.50** F.O.B. Chicago.....

### TO START YOUR ENGINE THIS WINTER —USE THIS BRAND NEW PORTABLE HEATER

**ITEM #422**  
Ideal for preheating engines, warming farm equipment and rooms, drying plaster, burning weeds, melting ice and snow, burning off paint. Burns any gasoline, gives intense blow-torch type heat. STEWART WARNER Model 796A—rated 40,000 B.T.U. Complete with 4' flexible heat duct, 5 pint gas tank, carrying handle, blower fan, fuel filter, Tillotson carburetor and full instructions. U. S. Air Force paid \$81.75. Shipping Wt. 25 lbs. **22.50** Now only F.O.B. Chicago.....

ORDER DIRECT FROM AD FREE! — NEW CATALOG 1957 EDITION, 60 PAGES, chock-full of unsurpassed War Surplus and newly manufactured Equipment Bargains for farm, home, factory, workshop. Write letter today.

To place phone orders call WEBSTER 9-3793

**GROBAN SUPPLY CO.** Dept. PM-1  
1139 S. WABASH AVE., CHICAGO 5, ILL.

### A. C. ELECTRIC GENERATOR



**ITEM #G-75-D**  
7 1/2 K.W. (7500 WATTS) single phase, 110/220 volt output. 3 wire system. 2 bearing construction. 5 groove 5" V belt pulley included. Self-excited. Foot mounted. Drive generator from tractor or stand by engine. Ample power for 6 room house. Dimensions: 34" x 11 1/2". Shipping Wt. 420 lbs. **295.00** F.O.B. Chicago.....

Complete control box for these generators includes A.C. rheostat, automatic voltage regulator, field rheostat, and voltmeter, already wired and ready to connect to generator. List price \$167.00. Our Price **56.45**

### G.E. SEALED BEAM 300 WATTS 110 VOLTS SPOTLIGHTS

THROWS A BEAM TO 1000 FT.  
**Item #418**  
General Electric Mazda 5 1/2" Sealed Beam  
Uses conventional 110 Volt current A.C., D.C.—Fine for lighting up driveways, signs, parking lots, displays, garages. Built for use as Flashing Signal for U. S. Navy—to stand heavy surge loads. Shipping Wt. 2 lbs. U. S. Gov't. Cost \$12.68 ea.



Now Each **2.50** Postpaid  
Lots of 3—6.00, Postpaid

### HIGGINS BRONZE CENTRIFUGAL PUMP

PUMPS ALMOST ANYTHING  
Fine for: • Irrigation • Sump Pumping • Sewer Drainage  
75 gallons per minute **ITEM #414**  
@ 2400 R. P. M. Higgins Type PNB, Model R, marine bilge pump. Open Impeller design for handling muddy water. Delivers 75 gallons per minute, 30 foot head with 3/4 H.P. motor. Pump body and impeller are made of solid bronze, with alloy steel 1 1/2" diameter shaft, 1 3/4" long. Rotation of the pump is clockwise. Inlet has 1 1/2" pipe thread. Plain 1 1/2" outlet for hose connection. Dimensions 12" x 7" x 8". Shipping weight 23 lbs. F.O.B. Chicago. **23.50**



## Print Your Own

Cards, stationery, circulars, etc. Save money. Print for Others, Good Profit; easy rules sent. Raised Printing like engraving, too. Junior press \$15; Senior \$29 up. Sold direct from factory only. We furnish everything. Write for free details. KELSEY PRESSES, Y-37 Meriden, Connecticut

**Marine KIT BOATS—DO IT YOURSELF—SAVE 50%**  
8' to 14' models, factory to you, no dealers, mahogany decks and framework, all brass fastenings, 14' hull kits as low as \$129.50 including freight charges. CATALOG 35c includes Kits, Hardware, Trailers, Fiberglass.  
**MARCO 14**  
\$189.50 Delivered  
WRITE FOR FREE FOLDER  
Marine ASSOCIATES  
BOX 1388 W. LONG BEACH 11, CALIF.

**AUTOMATIC RETOOTHING**  
MAKES NEW PROFITS  
Cuts new teeth in 50 seconds — any size to 16 points. Old teeth fall off as chips. Easy to operate. A perfect job.  
**BURR MFG. CO.**  
8933-D VENICE BLVD. LOS ANGELES 24, CALIFORNIA

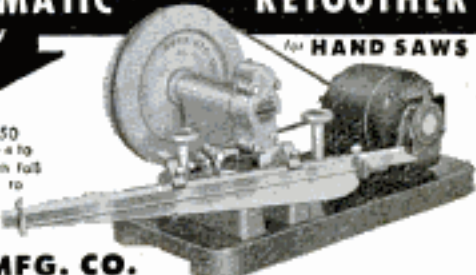

## The mower that DRIVES like a CAR!

**NEW!**  
**SHAW**  
**RM 24 MOWER**  
**WITH AMAZING**  
**MAGIC**  
**DRIVE**



Three Speeds  
forward  
neutral & reverse

Wide range of speeds, and reverse lets you handle any terrain, any type mowing easily, fast. 1½ to 6 M.P.H. at normal engine speed. Throttles down to 65 ft. per min. or up to 550 ft. per min. In neutral, you need not use foot pedal to stop machine. Mows average lawns in high. Then for heavy cutting a flick of finger shifts to lower gear without stopping. Simple durable construction, patents applied for. Low cost!

**Riding Tractors**—2½ to 14 H.P. Pull 8, 10, 12, 14" plows. ¾ to 7 M.P.H.  
**Walking Tractors** 2½ to 5 H.P.

**Tractors**—low as \$99.00  
**Riding Mowers**—low as \$199.00

See your Shaw dealer or write for free literature and name of nearest dealer. Dealer inquiries invited!

**SHAW**  
DU-ALL

**Manufacturing Company**

4510 Front Street, Galesburg, Kansas  
668-G N. 4th Street, Columbus, Ohio

**CUT THE BOLT YOU NEED**  
**TO ANY LENGTH**

**HEAT AND BEND**  
**TO ANY SHAPE**

24" and  
36" lengths

**7 SIZES**

¼" ⅜" ½" ⅝" ¾"  
1" 1½" 2"

**REDI-BOLT**  
**THREADED STEEL RODS**

Ask Your Hardware Dealer or Write

REDI-BOLT, Inc., 5330 Indianapolis Blvd., East Chicago, Ind.

## Dual Input Transistorized Preamplifier

(Continued from page 180)

determine if the preamplifier is operating properly. A phone plug is connected to the meter leads as shown in Fig. 4 and is plugged into the test jack, J2. When the switch of the preamplifier is turned on, there will be an instantaneous current flow of about 5 ma. through the meter. After a few seconds, as the electrolytic capacitors become charged, the current will taper off to about 1.5 ma. and remain at that value. After the test, the meter may be removed from the circuit.

The meter can also be used to check the condition of the batteries after prolonged use. If the normal operating current should drop to less than 1 ma. the batteries are getting old (and possibly noisy) and should be replaced.

### Operation

For proper performance, the load impedance for the amplifier should be high (250,000 ohms or more). This condition is satisfied by most audio amplifiers and radios designed for phono operation. It is merely necessary, therefore, to connect a shielded lead between the output jack of the preamplifier and the phono input jack of the main amplifier or radio.

Shielded cable should also be used between the magnetic phono cartridge and microphone and their corresponding preamplifier input jacks. These cables, if left unshielded, could pick up hum which is not inherently present in the preamplifier.

Shielded cable consists of an insulated center conductor, surrounded with a copper-shield braid. To attach a phono plug to the end of such a cable (phono plugs are needed to match the input jacks of the preamplifier and also the phono jacks of most amplifiers and radios), unravel the shield braid to about one inch from the end of the cable. Strip the insulation from the center conductor for a distance of about ½ in. and insert this conductor in the center hole of a phono plug. Solder this conductor to the plug at the point where it protrudes through the front tip, and cut off any excess length. Then, solder the previously unraveled shield braid to the shell of the plug. Secure solder connections must be made if hum or intermittent operation is to be avoided.

Preassembled cables with almost any type of plug that might be required are commercially available.

The mike input of the preamplifier is

(Continued to page 266)

POPULAR MECHANICS

Copyrighted material

**GIGANTIC MAIL SALE** WAR SURPLUS EXCESS INVENTORY BANKRUPT STOCK

**FARM & INDUSTRY GASOLINE PUMP**  
 • Finest gas pump. 10 g.p.m. Pump from barrels or tanks.  
 • Simply screw 3/4" iron pipe into threaded port and stick in hbl. Connect hose to outlet. Handle works back and forth very easy. Size 6 1/2"x7 1/2"x17". Wt. 13 lb. List \$25.  
**SALE.....\$9.71 FOB**  
 5' Oil Proof Output Hose and Fittings \$3.45

**ARMY POWER PLANTS**  
 • Amazing buys surplus Army and factory-to-you plants and generators. Save to 60%.  
 • 1000-w, 115-v, 60-c \$179.50 Ppd. • 2000-w, 115-v, 60-c \$269.95 Ppd. • 3000-w, 115-v, 60-c \$299.50 FOB. • 5000-w, 115-v, 60-c \$497.50 FOB.  
 Many other plants, generators. Get catalog.

**HYDRAULICS—PUMPS—AIR COMPRESSORS**  
 • Bargains in surplus finest quality hydraulic pumps, cylinders, valves. Also irrigation pumps, plastic pipe-fittings and air compressors, air tanks, regulators, gauges, paint spray, etc.  
 • Farm hyd. cylinder \$14.95. 1500-lb. gauge. \$3.49. Blackhawk hyd. system \$24.95. Control valve \$12.95. Air Compressor \$19.95. Air Tank \$8.79. Gauge 160-lb. \$1.89. Air Regulator \$3.29. Air Filter \$2.99. Many other air items.  
 • Irrigation Pump 2 1/2" \$44.37. Plastic Pipe 1/2" 8c, 3/4" 12c, 1" 20c. Rotary Gas Pump \$22.96. All of the above prepaid.

**GEAR REDUCTION MOTOR BARGAINS**

(a) **INDUSTRIAL MOTOR.**  
 54 to 1 ratio. Output 10 to 200 rpm. Hi-torque. Run on 6 or 12 volts DC or 110-AC thru rheostat. Many uses. Cost \$35.  
**\$4.97 Ppd.**



(b) **GOLF AND SMALL CAR MOTOR.** Powerful, runs on 6, 12 or 24 volt battery. Speed 100 to 300 rpm. Wt. 34 lbs. Cost \$250.....**\$19.46 F.O.B.**

(c) **ELECTRIC WINCH.** Runs on any 6 or 12 volt battery. Capacity 1000 to 2000 lbs. Holds 40 ft. cable. Use on trucks, cranes, farms, etc. Cost \$280. **\$46.71 F.O.B.**



**SPECIALS FROM PREVIOUS ADS**

- Portable Blwr-Htr 100,000 BTU, FOB \$92.75
- Invalids Chair 6-12v motor, FOB, \$14.99
- Surveying Level, tripod and rod Ppd \$46.50

**SPECIAL OF THE MONTH!**

**SPECTACULAR ADVERTISING LIGHT**

- Intensely bright red flashing fresnel optic-lens long-range light. Runs on any 110-v source.
- Marvelous double-lens system plus color filter. Creates intense red (or white by removing filter) flashing concentrated hi-visibility beam. Can be seen for several miles. 500-watt.
- Use at entrance driveways, facing down the hi-way. Wonderful spectacular advertising (a real traffic stopper.) Garages, filling stations, cafes, businesses of all types. Complete with automatic electronic flasher. Height 30". Wt. 82 lbs. Limited quantity at fraction Gov't cost. **\$37.41 F.O.B.** Only.....



**SPECIALS FROM PREVIOUS ADS**

- Multi-Speed AC Motor 110v Ppd.....\$9.42
- Govt. Wind Dir.-Velocity Indctr Ppd \$14.95
- Auto Phone Step-by-Step Switch Ppd \$13.71
- GE Amplifier-Rectifier, Exper FOB \$5.95
- Govt. Reelvg Airway Beacon Lt FOB \$159.50
- Worm Gear Winch 2000 lb. FOB.....\$29.90

**ORDER FROM AD or write for big new WINTER CATALOG** 1000s items at tremendous savings. We pay frt. except where FOB.

**BURDEN SALES COMPANY**  
 803 190" ST. LINCOLN, NEBRASKA

**FREE AMAZING NEW BOOK "HOW TO ANSWER ADS"**

Never before have you seen anything like this. Tells you in simple language the correct way to answer ads. Gets you quicker replies—better results, and greater satisfaction. Will save you time and money and it's **ABSOLUTELY FREE**. No obligation whatever. Every reader of advertising should have this booklet. Send a postcard for your copy NOW. F. W. JOHNSON, Popular Mechanics Magazine, Room 600-A, 204 East Ontario Street, Chicago 11, Ill.



**A NEW YEAR GERSTNER TOOL CHESTS**  
 457 COLUMBIA ST., DAYTON 7, OHIO



**ELECTRIC WELDER** AC or DC 110 Volts

The "Little Marvel" all-metal welder, 5-year written guarantee. Welds 1/8" metal or money back. Repairs tanks, tools, fenders, machine parts, etc. Complete with everything—rods, unit, eye shield, directions. \$6.95 plus 50c postage. Flame torch accessory for soldering, cutting, brazing \$3.95 complete with carbons, brass rods, flux. \$2.00 Deposit on C.O.D. 7.5 ampere 1/4 inch Transformer Welder \$21.95 F.O.B.

**ESSAY MFG. CO., Dept. 51, Quincy 69, Mass.**

**\$6.95** Complete



**BUILD YOUR OWN POWER TOOLS—With GIL-BILT PARTS-PLAN KITS**

**10" TILT/ARBOR SAW**  
 Sturdy wood, steel, and aluminum construction. NEW DEPARTURE ball bearings. Capacity and performance of floor saws selling for \$150.00 and up. Plans, all metal parts in kit with 10" comb. blade \$25.90, less blade \$22.95. F.O.B. St. Louis. Detail PLANS—PATTERNS only \$1.00 postpaid.

**12-IN. BAND SAW**  
 Ball bearing drive, rigid cast aluminum wheels, rubber tires. Handles stock up to 6 inches thick. Cuts to center of 24" circle. 18 x 18 inch tilt table. Capacity and performance of band saws selling for \$80 and up. Plans and all metal parts in kit with 1/2" blade \$23.95. Detail PLANS—PATTERNS only \$1.00 postpaid.

For shipments up to 500 miles, add 3%; over 500 add 10%. Amount in excess of actual postage will be refunded.

Also build-yourself 18" Band Saw, 6" Belt Sander, Shaper, 8" Tilt-Table Saw. Simplified plans, build easily with hand tools only. Advertised and sold for 9 years, over 30,000 units in use. Money back Guarantee. **FREE CATALOG.**

**GILLIOM POWER TOOLS** DEPT. 80A, LAMBERT FIELD ST. LOUIS 21, MISSOURI



**Wholesale! TOOLS! GUNS! CAMERAS!**

AGENTS — BUY TOOLS, PHOTO EQUIP., SPORTING GOODS, JEWELRY AND THOUSANDS OTHER NATIONALLY ADVERTISED PRODUCTS AT BIG DISCOUNTS. BIG PROFITS SELLING TO OTHERS. **POSTCARD BRINGS FREE COPY "THE WHOLESALE PLAN"**

**AMERICAN BUYERS SERVICE**  
 HERTEL STATION, DEPT. 15, BUFFALO 16, NEW YORK

**Get up to 40% off**

**Jet King BUTANE BLOW TORCH**

POCKET-SIZE **ONLY \$1.95 WITH CHARGER**

Every do-it-yourself and hobby fan needs this Kidde JET KING butane Blow Torch. Just the tool you've been looking for to do dozens of jobs in home or hobby...TV, appliance, lamp, radio or plumbing repairs...precision soldering, brazing or metal craft. Useful, too, for starting charcoal fires. A tiny, clean, safe charger does the job.

Each charger gives 30 minutes of intense 3500° pinpoint flame; turns on and off. Extra chargers, 39¢ per box of 2. Money back guarantee. At leading hardware and hobby stores...or send check or money order, we pay postage.

**SOLDERS! BRAZES! FIXES LEAKS!**



**Kidde KIDDE MANUFACTURING CO., INC.**  
 Dept. PM-17  
 42 Farrand Street, Bloomfield, N. J.

Please send me \_\_\_\_\_ JET KING BLOW TORCHES plus \_\_\_\_\_ boxes extra chargers (limit 2 boxes per torch). My check , money order  for \$\_\_\_\_\_ is enclosed.

Name \_\_\_\_\_  
 Street \_\_\_\_\_  
 City \_\_\_\_\_ State \_\_\_\_\_

## You Can't Beat this POWER TOOL VALUE!



YOU CAN DO MORE WITH

### "ARCO-SAW"

- CUTS ANY GROOVE!
- WHIZZES THRU 2 x 4's!

FITS  
ANY  
1/4"  
DRILL



**RIPS • CROSSCUTS • CUTS ANGLES**

Not even a \$100 Portable Saw has a dado cutter! Exclusive "Dado-Arbor" (see sketch above) swivels sawblade to cut grooves up to 1/2" wide x 1" deep in **ONE CUT!** Easily removed to use the saw for ripping, crosscutting or for depth & angle cuts with graduated **Depth-Bevel-Rip Gages.** Right angle steel gear drive & safety-yoke permit **ONE HAND** operation. Incl. 5" blade. **\$12.95**

**BLADES 5" Rip, Crosscut, or Combination. . . . \$1.75**  
At Your Dealer or order direct on our **UNCONDITIONAL 10-DAY MONEY BACK GUARANTEE.** Send check, M.O. (ppd.) C.O.D. plus post.

**ARROW METAL PRODUCTS CO.**

Dept. PM-1 140 WEST BROADWAY, NEW YORK 13, N. Y.

designed for a low-impedance (dynamic) type microphone. When used with high-impedance (crystal or ceramic) phones, a step-down microphone transformer is required. Proper connection of such a unit is shown in Fig. 5.

The magnetic phono input is low impedance to match the output of magnetic (variable reluctance) phono cartridges, such as G-E, Pickering, etc. A crystal cartridge should never be connected to either of the preamplifier input jacks since the high output voltage of such units will overdrive the preamplifier and cause severe distortion.

The preamplifier will deliver a maximum undistorted output voltage of about one volt to the main amplifier. This is usually sufficient to obtain maximum undistorted power output from the latter. The volume and tone quality can be regulated with the controls of the main amplifier. ★ ★ ★

## Inflated Safety Shoes Aid Search for Mines

British sappers working in fields which have been sown with antipersonnel mines will be wearing weird safety shoes. The shoes, looking something like a novel type of snowshoe, are inflated and attached to the regulation shoe. Presumably the shoe distributes the weight of the sapper widely enough to avoid setting off mines under the surface, though precise information is not available. The shoes are still on the secret list in England, though they were displayed at a recent exhibition of war techniques.



### HAVE A BIGGER—MORE EFFICIENT HOME WORKSHOP

Popular Mechanics **PLANNING YOUR HOME WORKSHOP** shows you how to make use of every inch of space in your workshop; detailed floor plans, wiring layouts and power tool hookups plus actual photographs of famous home workshops you can use as models. Save money by building your own shop furniture. Special Where-to-Buy-It Guide. 450 Illustrations. Cloth Bound. Working Diagrams. Order your copy today from **\$2.50**

POPULAR MECHANICS PRESS  
200 E. Ontario Street Chicago 11

## U-MAK-IT BOAT KITS



SAVE 1/2 THE COST

Now added to  
the famous  
**U-Mak-It Boat  
Kit line—Easy  
to assemble**

**LAPSTRAKE SKIFF KITS**

Greatest line of  
kits in our 29 years  
of boat kit pioneering.

30 models — prams, row-  
boats, runabouts, cabin cruis-  
ers and the new lapstrake skiffs.

**SEND FOR ILLUSTR. CATALOG**

showing all models 8' to 23', prices, con-  
struc. details, access., hardware, trailers,  
motors, all you need to build your own!

SEND 35c (coin) for postage & handling

**U-MAK-IT products** 703P Whittier St., Bronx 59, N.Y.



# MAKE UP TO \$25 DAY

## sharpening Discs with New Machine

Now you can quickly sharpen farm discs in a farmer's own yard or shop. New portable Foley Disc Sharpener jacks up harrow, rotates discs as it grinds them—takes only 1 or 2 minutes per blade. Saves farmers time and trouble—no dismantling or hauling to town—and you can make up to \$25 a day. Foley equipment easily carried in car trunk.

**FREE PLAN** — shows how to start in spare time CASH business. No experience needed — no salesman will call on you. Write today.

Dept. 1, C. H. FOLEY CO.  
COLUMBIA HEIGHTS, MINN.



## FLEXIBLE ALUMINUM TUBING

### IRIDITED FOR LONG LIFE

Outlasts regular galvanized tubing, and costs only a few cents more. Iridite process gives a gold-like finish that resists salt and exhaust corrosion. Excellent exhaust tubing for cars and trucks. Has hundreds of other uses. Comes in all 1/16" sizes from 1/2" to 3" ID. OD is 1/8" larger than ID. Send cash plus 50c handling charges for:

1/2" to 15/16" ID—25c per foot; 1" to 1-7/16" ID—40c per foot; 1-1/2" to 1-11/16" ID—50c per foot; 2" to 2-7/16" ID—65c per foot; 2-1/2" to 3" ID—80c per foot.

**ALUMINUM FLEX**  
387 E. QUAKER ST.  
ORCHARD PARK, N.Y.

AVAILABLE WITHOUT IRIDITE COATING — 6c PER FOOT

**PAGE** FOR  
TILLING  
PLOWING  
MOWING

**FULL LINE**  
2 to 6 HP  
with complete  
gear drive  
and reverse.

Free Catalog  
**LOW PRICES**  
EASY TERMS  
Over 30 Years  
Experience

**FULLY  
GUARANTEED!**  
Over 60  
attachments  
available!

**PAGE** 1904-J 5, 81st STREET  
MILWAUKEE, WIS.

New Long Lasting Combination Blade

# Roc-Edge 6" SAW \$1.49

BLADE 7-1199  
8-1499

Fits any power saw. At all Hardware Stores

**"OVERLOADED?"**

## NEW OVERLOAD SPRINGS

DON'T RISK CAR DAMAGE. Patented "Key" Overload Springs support vehicle the way auto makers recommend. Can't damage or bend frame. Fits all leaf spring cars, and station wagons. Doubles load capacity, only \$26.50. Guaranteed. State make, model and year. Extra heavy duty slightly higher. Free folder. Dealers wanted.

**ATTACHED OR REMOVED IN SECONDS WITHOUT TOOLS**

DUO-CONTROL SPRING CO., E. Lansing 1, Mich.

Build Your Own Walks, Driveway, Outdoor Fireplace, Steps, Etc.

## What to Make With CONCRETE

The terrific high costs of even little concrete jobs are mostly for labor. Get Popular Mechanics **WHAT TO MAKE WITH CONCRETE** and save all the labor costs while making your home or farm ship-shape. You can lay foundations, sidewalks and driveways; build steps, outdoor fireplaces, sandboxes, tennis courts, garden and swimming pools and other installations at very little cost. Book shows all — tells all — how to make the right mixture, plan, apply and gives 50 professional short cuts. Hundreds of pictures. Only \$2.00 postpaid. Order today. Money back if not pleased.

**POPULAR MECHANICS PRESS**  
Dept. 157, 200 E. Ontario  
Chicago 11, Ill.

## WAR SURPLUS AND OTHER BARGAINS SAVE UP TO 90%

**AUXILIARY POWER PLANT**  
Mfd. by Lawrence  
Model C-2, Navy type 1. Engine comes complete with spark plugs, generator self starter, voltage regulator, reverse current relay, silencer case, dual scintilla magnets, Stromberg carburetor. Use as portable welder. Develops 300 amps & more. Capacity up to 7 1/2 KW. Engine 14.5 HP. Up to 7500 Wasts. Terrific as standby power supply, in boats, to power small cars, as a complete lighting system. Operates all DC equipment. Like NEW, all engines checked & run before shipment. Wt. cased 360 lbs.; wt. net 139 lbs. Approx. GOVT. COST \$4500. Now only \$187.75.

**BENDIX PUMP & MOTOR**  
Can be used for pumping fuel, oil or where-ever hydraulic pressure is required. Pump has 1" connections, built-in relief valve, adjustable up to 1500 lbs. Max. capacity 6 GPM. 1 1/2 H.P., 24 volt motor, 4000 RPM. Can be used on 12 to 36 volts. Approx. GOVT. COST \$350. NEW — \$10.95.

**SPECIAL HYDRAULIC MAKE-UP KIT**  
KIT No. 25—1 ea. Bendix Hydraulic Pump & Motor, 2 ea. Hydraulic Cylinders—7/8" stroke, 1 1/4" bore, 3/4" shaft, 13" overall. 1 ea. 4-way valve, 1 ea. hydraulic pressure gauge, 2000 lb. pressure dial, 1 ea. purifier oil filter. Approx. GOVT. COST \$500. Shng. Wt. 38 lbs. New—\$30.50.  
KIT No. 35—Same as above with 4 cylinders. Approx. GOVT. COST \$625. Shng. Wt. 45 lbs. New—\$39.50.

**PRECISION GROUND SQUARES**  
Production engineer's squares. Accuracy guaranteed. Mfd. by Wright & Moore, Sheffield, Eng. Square blades, hardened & tempered. Brand NEW. Fraction of original cost. 2"—\$2.75, 3"—\$3.00, 4"—\$3.25, 6"—\$3.75, 8"—\$7.00, 12"—\$8.75.

**ARC WELDER KIT \$27.95** — build your own  
Complete make-up package consisting of 1 Aircraft DC Generator, Electric Auto-Lite 160-240 Amps, 24 Volt, RPM from 2600 up, 1 Rheostat, 1 Giant Toggle Switch, 1 Ammeter, 1 Shunt, 0 to 240 Amps, 1 Voltmeter, 0 to 30 Volts, 1 Electrode Holder, 1 Welder's Shield, 1 Voltage Regulator. Wiring diagram for hookup as welder. Wt. under 100 lbs. Approx. GOVT. COST \$475. Like new, perfect . . . \$27.95.  
DC Generator (only) — same as above . . . if purchased separately: \$12.50.

**R1 GENERATOR KIT** Jack & Heintz or GE. Rated 300 Amps. 24-32 Volts. With same items as above incl. 300 Amp Ammeter. Approx. GOVT. COST for kit \$600. Complete kit only \$39.95. Wt. 60 lbs.

**MICROMETERS** Chrome plated, precision engineered, carefully tested to give long life. All new 0-1" cap. \$2.25 ea., 1-2" cap. \$3.50.

**NEW IMPROVED MAUSER-TYPE VERNIER CALIPERS**  
Quirk, handy, accurate. 6" Vernier Calipers. Glass hardened, lapped measuring surfaces. Fine engraved scales—1/1000" and 1/10mm for inside, outside & depth measurements. Friction thumb release. Larger capacity. 2 gth adjustments. Reg. \$25. Now only \$7.95. Leather case \$1 extra.

**AMES DIAL INDICATOR** Mounted on adjustable frame. Graduated in 1/1000". Will give readings on bolt stretch and all round & revolving materials. Shockless. Approx. GOVT. COST \$125. New—\$10.95 ppa.

**HEAVY-DUTY RHEOSTAT** Designed for heavy-duty use with Air Force heated suits. Ideal for regulating voltage on electric welders, model trains, lights, generators; controls soldering irons, etc. Rated 5.75 ohms, 100 watts with double windings and dual female 25 amp, 125 volt receptacles. Size: 7" H x 3 1/4" W x 1 3/4" D. Shpg. Wt. 2 1/2 lbs. Approx. GOVT. COST \$25. Brand new, only \$1.95.

**LONG-FLUTE, HIGH SPEED DRILLS**  
15 assorted sizes. Up to 1/2". Like NEW. Approx. GOVT. COST \$25. Only \$2.50.

**HIGH SPEED HAND TAPS**  
10 assorted, precision-ground thread, National Mfr. Like NEW. Up to 1/2". Approx. GOVT. COST \$25. Only \$2.50.

**PIONEER MAGNETIC COMPASS**  
For boats, trucks, cars. By Pioneer Instrument Co., Div. of Bendix. No. 1N29-2A. Contains screw-type heeling compensator, removable drawer-type compensator, screw-type horizontal compensator and spider-type compensator. All devices for elimination of errors caused by effects of magnetism. Has constant deviation corrector and course setter. Rotable dial engraved with compass card graduations. Complete with book of instructions, light and mounting screws and shock mounts. Shpg. Wt. 10 lbs. Approx. GOVT cost \$400. NEW. \$13.95

**NEW! BIG CATALOG** Largest ever . . . just out . . . new low prices. Send 25c for your copy today. Prices F.O.B. Culver City unless otherwise stated. Check, cash or money order. 50% deposit for C.O.D.

## AIRBORNE SALES CO., INC. DEPT. PM157

8501 Stellar Drive, Culver City, Calif.

JANUARY 1957

267

Copyrighted material

# LITTLE GIANT

## RAZOR BLADE PLANES

3-WAY CURVE  
PLANE



98¢

FLAT  
PLANE



98¢

JUST USE A DOUBLE-EDGE RAZOR BLADE



This Side for Long Curves  
and Flat Surfaces

FOR JOBS  
OTHER  
PLANES  
CAN'T DO

This Side  
For Short  
Curves and  
Shaving

Adjust  
Here



ADJUSTS  
INSTANTLY  
FOR  
DESIRED  
DEPTH  
OF CUT

The blade moves back and  
forth to adjust the depth of  
cut for the side being used.

PRECISION TOOLS  
SATISFACTION GUARANTEED

SEE THEM AT YOUR HARDWARE DEALER

If "Little Giant" Planes are not yet available in your area, you may order by mail. Include 25¢ additional for postage and handling.

DEALERS, WRITE FOR INFORMATION

WILSON BROS. Dept. PM

BOX 917 COM'L. STA.

SPRINGFIELD, MISSOURI

WELD

BRAZE

SOLDER

CUT



WELDER

Complete with  
Twin Carbon Arc  
Torch and ac-  
cessories... to  
handle all metal-  
craft work.

Acclaimed by thousands of Homeowners, Mechanics and Hobbyists as the welder of 1901 uses. Easily operated from properly wired 110 volt AC or DC line. The ideal gift with a life-long use... Order today on 10 day money back guarantee.

FOUR-WAY WELDER CO., Dept. F2-A  
1810 S. Federal St. • Chicago 16, Ill.

FIX home & car APPLIANCES YOURSELF

NEW! EICO® REDI-TESTER  
KIT \$12.95 Factory-wired \$15.95

Multi-range ac/dc voltmeter, ammeter, ohmmeter, wattmeter, leakage checker. Locates defects in appliances, air-conditioning, furnace control, TV, radio, car batteries, generators, etc. Easy step-by-step instruction book. Send Check or M.O., specify Kit or Wired. Or write for neighborhood distributor's name & FREE catalog P36-1 describing EICO's 30 professional kits & instruments.

Electronic Instrument Co., Inc., 81 Withers St., Bklyn 11, N. Y.

BOAT KITS 28 MODELS - 8 to 19 ft.  
\$39 up - FREE FREIGHT

SAVE 2/3!

Easy-to-build MAHOGANY FRAMES-DECKS

19' CRUISER KIT \$499.50!

SEND 10¢ for

KIT CATALOG!

Includes Hardware

-Trailers-Fiberglass



BOAT PLANS - Patterns - Frame Kits

Build over 50 modern boats from large scale plans, available with FULL-SIZE patterns, new PRE-FAB frame kits! All types; from cruisers, 6 to 25 ft. Best buy for Amateurs! SEND 10¢ for CATALOG.

Craig Craft  
Tonawanda, N. Y.

## How to Plan That Vacation Cabin

(Continued from page 100)

means of anyone. Returning to the subject of fire hazards, a dependable well-operating cookstove is an important safety factor in an isolated place.

A vacation house, whether it is a floored Army-surplus tent, a log cabin or a luxurious chalet can be a heaven-on-earth place. Fortunate indeed is the family who can spend peaceful, pleasant hours in an atmosphere far different from their workaday world. Small Davy Crocketts discover the "wild frontier." Dad comes into his own as an expert on the ways of a man with a fish. The starry firmament and beautiful simplicity of nature are rediscovered. Birds and their calls are known. The tissue of life is woven from memories—plan the site of yours carefully! ★ ★ ★

### CHECK LIST OF THINGS TO CONSIDER IN PLANNING A VACATION CABIN

- 1—Is the distance too great from your home for quick week-end trips?
- 2—If a site is decided upon, can you get clear title? Is the zoning, if any, compatible to your plans—what restrictions must you abide by?
- 3—Is the road leading into the cabin site passable at all times and under all conditions? How much will it cost for maintenance?
- 4—Are the facilities such that all members of the family can equally enjoy vacation pursuits?
- 5—Will local regulations of the proposed area prevent specific family hobbies such as a shooting range or motorboating?
- 6—Is the water supply pure, adequate, inexpensive to install?
- 7—Can the conveniences of electricity, plumbing and telephone be installed at a price you can afford—either now or in the future?
- 8—How close is a fire station, the police, a hospital?
- 9—Do your plans call for adequate built-ins?
- 10—Are you incorporating as many prowler-proof and weatherproof precautions into your vacation cabin as possible?
- 11—Do you have an over-all, methodical plan of construction?

### Hogs Eat Feathers

Hogs are eating feathers in a research project at the University of Tennessee. Feather meal, much cheaper than soybean-oil meal, is a rich source of crude protein. The feathers are steamed or mixed with lime and cooked to make them digestible. The feather-fed hogs are eating less to gain the same amount of weight and apparently are thriving.

Need an extra \$1,000, \$2,000, or more? Make it with an  
**IDEAL LAWNMOWER SHARPENER**



There are thousands of lawnmowers in your locality; Average \$1,000 profit per 250 mowers with customer satisfaction and repeat business assured. Provide this essential service with an Ideal Lawnmower Sharpener, the only machine that grinds the reel to "fit" the bed knife. Compare by any standard. The Ideal, backed by 53 years of experience, costs no more. Write today for complete, free catalog.

**THE FATE-ROOT-HEATH COMPANY**  
Dept. PM-1 Plymouth, Ohio

**HOME-SHOP SCREW DEPT.**

**NEW for HOME-CRAFTERS!**

**OVER 1400 PLATED PIECES** in each of 2 Popular Screw Depts. Priced to save you up to 50% of cost of screws bought in dribbles.

At Your Favorite Hardware & Lumber Supply Store  
A product of **SOUTHERN SCREW CO.**, Statesville, North Carolina

**Metal Turning Lathe for Model Makers**



SEND FOR FREE FOLDER describing the new Lathe for Model Makers. 15 1/4" bed with 4 1/2" swing; 7" between centers. Guaranteed. Only..... **\$35.00**  
f.o.b. Lansing.

Rosemoor Manufacturing Co., 2501 Bernice Rd., Lansing, Ill.

ALSO Adult Eshelman 2 Pass. SPORT & GOLF CARS Fraction of cost of most other cars.

**ESHELMAN CAR SNOW PLOW**  
CLEARS ROADS & DRIVEWAYS



Bolts on to car or truck bumpers easily. Clears snow 12" deep and 72" wide. Lightweight and sturdy. Order now, or write for free catalog.

Dept. 16, **ESHELMAN**, 109 Light St., Baltimore 2, Md.  
SHIPPING POINTS: Baltimore, Chicago, Reno

**MANUFACTURERS SACRIFICE!**

OVERPRODUCTION for Xmas trade causes **NATIONALLY KNOWN** manufacturers of power tools to SACRIFICE at a tremendous loss! These terrific savings passed on to you... buy with confidence. Every power tool has a full **FACTORY GUARANTEE** with authorized service stations in all parts of U.S.A. and Canada... names of tools withheld by request of manufacturers.

**1/2 H.P. 3400 RPM POWER SAW**  
RIPS and CROSSCUTS a 2 x 4 with Extraordinary Ease  
SAVE \$15.00 COMPLETE with  
Regularly \$35.00 **\$19.88** 5 1/2" Combination  
NOW! Sale Price Blade  
Model A—Rugged professional type adjustable saw. Will cut any angle from 0 to 45°. Has adjustable 0 to 6" rip fence. Safety trigger with switch on handle. Full 1/2 HP universal AC-DC 110-120 volt 60 cycle motor. Weighs only 6 1/2 lbs. Extra saw blade available in rip, crosscut or combination... \$2.25 each

**Model B—Super Duty—All Ball-Bearing 4800 RPM POWER SAW**  
Cuts a Full 2 1/4" at 90° and Will Cut a 2 x 4 at 45°  
SAVE \$25.00 COMPLETE with 6 1/4" Carbide  
Regularly \$60.00 **\$34.88** Plated Blade to Supply Saw  
NOW! Sale Price with Extra Performance  
Tremendously rugged ball bearing saw, ideal for continuous rough use. Full 1 HP universal 115 volt AC-DC 60 cycle motor. Power, long service and ease of handling are derived from streamlined design which incorporates a precision dynamically balanced fan-cooled high speed motor—equipped with adjustable riving guide from 1/4" to 8" graduation. Net weight 11 1/2 lbs. Extra combination blades available at \$2.25 each.

**HEAVY DUTY 1/2" Thrust Ball-Bearing ELECTRIC DRILL**  
SAVE \$14.00 Equipped With  
Regularly \$29.95 **\$15.88** Jacobs Geared  
NOW! Sale Price Chuck and Key  
For heavy duty industrial use. Built for years of rough, tough use. Powerful motor gives 1 1/2" capacity in wood and 1/2" capacity in steel. 2000 RPM universal wound AC-DC motor. Voltage features adjustable 115v. AC-DC 2 amperes. Weigh 3 1/2 lbs. 9 in. overall. Lightweight aluminum housing takes effort out of long drilling jobs and perfectly designed pistol grip assures steady one hand operation.

**26 piece RUGGED DUTY 3/8" Thrust Ball Bearing ELECTRIC DRILL with ACCESSORIES**  
SAVE \$14.00 Equipped with  
Regularly \$39.95 **\$25.88** 3/8" Jacobs Geared  
NOW! Sale Price Chuck and Key  
Here's a splendid kit featuring a powerful 3/8" 2 amp., 1500 RPM, 115 volt AC-DC drill. Kit includes sturdy metal box, 6 ass'd. power bits, grinding wheel, 12 sanding discs, polishing buffer, vertical stand, paint mixer. This versatile kit easily handles many jobs in shops, home and industry.

**ROUGH DUTY 1/2" Thrust Ball-Bearing ELECTRIC DRILL**  
SAVE \$16.00 Equipped With  
Regularly \$44.95 **\$28.88** 1 1/2" Jacobs Geared  
Now! Sale Price Chuck and Key  
Powerful 1/2" drill features a 450 RPM 4.5 amp. universal AC-DC 115 volt 60 cycle motor. Aluminum die casting combines strength and light weight durability. Weigh 9 lbs. The low weight to power ratio provides comfortable handling without fatigue. Instant release lock type trigger switch. Precision 3 saw chuck. 7 foot rubber covered 3 wire cord with adapter and plugs.

SEND CHECK OR MONEY ORDER. 1/2 deposit with C.O.D.'s—P.O. Accepted from D&B rated firm. ALL PRICES F.O.B. SAN FRANCISCO

**SAVE 40% to 50% KAPLAN'S**  
Dept. K-2, 1499 MARKET ST., SAN FRANCISCO 3, CALIF.



**SIMPLIFY PREVENTIVE MAINTENANCE WITH MACHINE TOOL RECONDITIONING & THE ART OF HAND SCRAPING (2nd printing)**

SEND FOR FREE FOLDER DESCRIBING ILLUSTRATED BOOK  
MACHINE TOOL PUBLICATIONS, 382 Holly Ave., St. Paul 2, Minn.

**New Protection Against Winter Freeze-ups!**  
**KEEP FROST, SNOW, ICE AWAY FROM!**

- Water Pipes • eaves • gardens
- sidewalks • gutters
- downspouts • driveways

**Easy Heat CABLE KIT**

MELT SNOW ELECTRICALLY from driveways, sidewalks, gutters, eaves. No more BACK BREAKING SNOW SHOVELING! Melt snow electrically as it falls! Or place cables on surface of snow, ice already on ground, see it melt away in minutes! For permanent protection, place cables underneath NEW sidewalks, driveways! Other uses: keeps engine warm in garage. Floor heating in kennels, soil heating in gardens, hot beds, cold frames. Prevents trailer plumbing, water in animal troughs from freezing. You get extra heavy vinyl covered heater wire, UL approved lead wire, plug, instructions.



3 ft. ....	\$1.45	24 ft. ....	\$4.85
6 ft. ....	\$2.15	30 ft. ....	\$5.60
12 ft. ....	\$3.25	40 ft. ....	\$6.85
18 ft. ....	\$3.95	60 ft. ....	\$8.95

**Easy Heat HEAT TAPE**  
Protects WATER PIPES Against Freezeups!

Keeps water pipes above, below ground warm, safe from freezing! Pipes stay warm all over. Heat's distributed evenly along entire length of tape. Twin insulated heat cables run entire length of tape, end in lead wire, plug. Wrap tape around pipe, cover with heavy-duty outer covering, fasten with gummed vinyl tape. Plug in on cold days. Unplug on warmer days! Also protects house trailer plumbing, water pumps, etc. You get: heat tape with twin attached cables, insulating wrap, vinyl tape, instructions.

Easy Heat Fiberglas Insulating Kit **98c** ppd.

3 ft. ....	\$2.25	18 ft. ....	\$4.95
6 ft. ....	\$2.95	24 ft. ....	\$5.75
12 ft. ....	\$3.95		all prices ppd.

Also Available—Easy Heat Thermostat. Saves you money! Attach directly to surface protected by Easy Heat Cable or Tape. It turns heat on when temp. approaches freezing, turns heat off when temp. rises. **\$5.95** ppd.

keeps water pipes above, below ground warm, safe from freezing! Pipes stay warm all over. Heat's distributed evenly along entire length of tape. Twin insulated heat cables run entire length of tape, end in lead wire, plug. Wrap tape around pipe, cover with heavy-duty outer covering, fasten with gummed vinyl tape. Plug in on cold days. Unplug on warmer days! Also protects house trailer plumbing, water pumps, etc. You get: heat tape with twin attached cables, insulating wrap, vinyl tape, instructions.

**AMAZING BLOCK & TACKLE**

PORTABLE—weighs 13 ozs. fits in pocket!  
One Hand Operation  
POWERFUL—lifts up to 1000 pounds!



For HUNTERS • HANDY MEN • FARMERS • TRUCKDRIVERS • YACHTSMEN • MOTORISTS. The great strength, small size, complete portability of the Midget Babe Block & Tackle gives it many uses. In car, home, deer, boats, etc. For lifting heavy articles anywhere! Best grade aluminum. Steel axles. Lubricated for life! Two lifting slings, top and bottom. Heavy welded steel rings. Slings can be doubled for extra strength. With 60 ft. nylon cord, 1-1 ratio, 1000 lb. test. Carrying bag, instructions, locking lions. 1 yr. guarantee. **\$8.95** ppd.  
Also Available—Tiny Babe: Lifts up to 2000 lbs.! With 100 ft. nylon cord, 7-1 ratio, 2000 lb. test, 16 oz. wt. Twice as powerful **\$12.95** ppd. vs \$8.95 model, only.

Send Check or M.O. C.O.D. fee extra **MONEY BACK GUARANTEE**  
**SCOTT-MITCHELL house, INC.** Dept. M-289, 611 Broadway New York 12, N. Y.



## 'Tugit' PULLS 'EM OUT- FAST!

- Uproots trees, posts
- Hauls cars out of mud, snow
- Moves boulders
- Stretches cable
- Erects fences
- Lays pipe
- Lifts boats, motors

There's no end to the tough jobs this handy tool makes easy for you. The smallest 'Tugit' weighs only 16½ lbs. Even a boy can safely lift a ton by tugging on the 12" handle. A mere flick of the finger control lever instantly shifts to lowering action. Operation is simple and a cinch at any angle, even in close quarters. When accurate placing is a "must", 'Tugit' moves the load as little as  $\frac{1}{8}$ " at a time. 'Tugit' has long been a favorite with repair and construction workers. It is built like the finest hoist — lasts for years and years. It is safe — the handle can't kick back. Save time, trouble and expense. Get a portable 'Tugit' for your tool box, truck or car trunk. 1-ton size costs only \$63.50. See your nearby Shaw-Box Distributor or write for Bulletin 388.



578-1

**MANNING, MAXWELL & MOORE, INC.**  
 SHAW-BOX CRANE & HOIST DIVISION  
 354 W. BROADWAY MUSKEGON, MICHIGAN



Get a warmer, more comfortable home AND save up to 20% on fuel costs with INNER-SEAL weather stripping on your doors, windows, storm windows!

INNER-SEAL is waterproof, tough, flexible; easy to install; lasts for years. Spring steel wire molded in neoprene-coated sponge rubber assures tight seal. Has Good Housekeeping guarantee.

Buy it in exact-length "do-it-yourself" paks or in bulk at hardware, variety stores, building suppliers. Get free weather stripping booklet "Why Shiver" from dealer or write Dept. PM.

**BRIDGEPORT FABRICS, INC.**  
 200 HOLLAND AVE., BRIDGEPORT 9, CONN.

## Clymer Drives the 1957 Chevrolet V8

(Continued from page 107)

The rear-axle ratio is 3.36 to 1, but the engine has ample power to handle this rather high choice. Economy is average for such a fast and powerful engine. Premium gas should be used, in my judgment. The gasoline tank holds 16 gallons, which is not enough.

The bumpers offer good protection, front, rear and around the sides. The front bumper and grille are a unit made up of eight sections to make it more economical to repair in event of damage. There is a 16-inch open space between the radiator and the grille. Wheel openings extend high into the fenders, fine for checking air pressure and changing tires.

All-around visibility is good. Instruments are grouped conveniently. Instrument visibility is excellent except that the full-circle horn ring annoys me as it is directly in the line of view of the speedometer dial. Warning gauges are used for oil and generator. I prefer needles.

The two-spoke steering wheel is very flexible, probably a good feature in the event of an accident. The hub is recessed.

The ignition key, as in other GM cars, can be removed with the engine still running. This feature can be a disadvantage.

The new ventilating system brings the fresh air into the body from intake scoops directly above the headlights. The scoops are hidden by the fender tips. Ducts carry the air into the passenger compartment.

The throttle and brake pedals are well located in height, being about the same level in the off position. The parking brake requires more pull than most and the handle is too far away from the driver.

There is adequate space in the glove compartment, well located in the center of the dash. For improved sound distribution, the radio speaker is now aimed upward at the windshield from the center of the instrument panel.

The body is solid and no dust leaked in, nor did any water enter under a high-pressure hose test. It is well insulated and has a minimum of wind noise or body rumble.

Chevrolet has, in my opinion, the best operating door handles, inside and out, in the business. Three and a half turns of the cranks lower or raise the windows, a satisfactory ratio.

The interior is well finished. Seats are comfortably padded. Armrests on the front doors are long and conveniently placed. There is excellent headroom, this being one of the few 1957 cars in which the tall driver can wear a hat. ★★★



## SAW SHARPENING IS EASY

Super Filer No. 11 joints and sharpens hand and circular saws 6" to 10" with all teeth correct in height, depth, pitch, bevel. When file hits hardened steel roller, teeth are finished. Saw runs true with no side pull. Includes 8" file. **\$9.95 PPD.**



"TRU-CIRCLE" saw set automatically sets teeth at 10° or more. **\$2.95 PPD.**



### DOWEL CENTERS

Centers inscribe exact location for opposite holes. Pairs for 1/4", 3/8", 1/2" holes. **\$1.00 PPD.**



### SUPER SAW FILER No. 6

Automatically controls depth, angle, pitch for all saws. Precision made and calibrated. Use in any vise or clamp. Includes 8" file. **\$6.50 PPD.**



MONEY BACK GUARANTEE—CATALOG FREE

A. D. MCBURNEY, 5908 Hollywood Blvd., Hollywood 28, Cal., Dept. A-17

## MUFFLER TROUBLE?

Repair muffler and exhaust leaks with finger and thumb in ten minutes. No tools — no mixing. Withstands heat and vibration. Stops carbon monoxide gas poisoning. **\$1.69 can. Canada, \$1.79.**

### HOLT'S GumGum MUFFLER SEAL

At Auto Accessory and Parts Replacement Stores, or write us for Full Details.

TREGLOWN CO., INC., Fanwood 113, N. J.

IN CANADA: Treglown, Ltd., 1366 Greene Ave., Montreal 6

## WHEN SENSES DULL YOU NEED HULL

### AUTO COMPASS

One of the common causes of lost directions is reduced alertness as miles roll by. Wrong turns are almost inevitable — unless you drive by Hull, the world's most widely used auto compass. At your dealer's or write for literature.

Beaconlite '6.50

Streamline '4.95

HULL MFG. CO. P. O. Box 246-D1, Warren, Ohio



## BUILD FINE GRANDFATHER CLOCK NOW

The simple sensible Red-i-Kut way as thousands have — SAVE HALF. SHOP TESTED PLANS "SPIRIT OF THE CENTURY" Narrow waist 8 1/2" tall or stately straight side "SPIRIT OF AMERICA." EASY-TO-FOLLOW photographs PLANS tell all—plus BROCHURE of heavy brass weight Westminster, tube chime, movements, gorgeous bronze-silver dial, 3 1/2" solid mahogany case kits. Send \$1.00 today—Both plans \$1.50 NOW. Kuempel Chime Clock Works, 28 Kuempel Bldg., Minneapolis 16, Minn.



## DRAINS cellars, cisterns, wash tubs; IRRIGATES - CIRCULATES - SPRAYS \$7.95

Type P Pump has 1,001 uses. Up to 3000 GPH; 450 GPH 80" high or 1800 GPH from 25" well. Use 1/8 to 3/4 HP motor. Coupling included free. 1" inlet; 3/4" outlet. Stainless shaft. Won't rust or clog! Postpaid if cash with order. Rush your order today.

MONEY BACK GUARANTEE  
Centrifugal and Gear Pumps in All Sizes  
LABAWCO PUMPS, Belle Meade 7, N. J.



## "DO IT YOURSELF" IT'S EASY WITH KESTER SOLDER

Soldering's really a "cinch"... when you use time-tested, reliable KESTER... available everywhere.

FREE! "Soldering Simplified"... 16-page how-to-solder booklet. At your dealer or write direct.

KESTER SOLDER COMPANY

4251 Wrightwood Avenue Chicago 39, Illinois



## HERE'S YOUR COMPLETE POWER TOOL WORKSHOP

FOR ONLY

**\$7995**

FACTORY TO YOU

8" SAW



- TRY SUPERSHOP FREE
- WE PAY FREIGHT
- YOU BE THE JUDGE
- EASY PAY PLAN

Why does Power Tools Inc. make such an unusual offer? Our business is manufacturing and selling power tools direct to people like yourself. We have had experience with hundreds of thousands of people regarding their home workshop requirements. Supershop meets these requirements. This has been proven.

The combination of direct selling, advanced design and efficient manufacturing enables us to give the greatest power tool value in America today. That is why we have the courage to make you this offer.

This free trial is truly free. The machine is prepaid to your door and if it does not satisfy you, you return it at our expense. If you keep Supershop you pay the low factory-to-you cash price — or easy payments to fit your budget.

Write for free information. Mail the handy coupon — or send a postcard. We'll mail you colorful brochures on Supershop — and full details on the FREE TRIAL HOME OFFER. Absolutely no obligation.

POWER TOOLS INC. 191 YATES AVE. BELOIT, WISCONSIN

POWER TOOLS INC • BELOIT, WIS.

Send me your FREE brochures on Supershop and complete information about the Free Home Trial Plan. I am under no obligation.

NAME \_\_\_\_\_

ADDRESS \_\_\_\_\_

CITY \_\_\_\_\_ STATE \_\_\_\_\_



1/2" DRILL PRESS



8" SANDER



30" LATHE



8" GRINDER

## Clymer Drives the 1957 Ford V8

(Continued from page 109)

any danger of it flying open, even if not properly latched.

The interior is nicely finished. Instruments are well located. The three-spoke steering wheel has a recessed hub for safety. Speedometer visibility is excellent as there is no upper horn ring to get in the way. There is little glare from the sun by day or from reflections by night. The rear-view mirror is well positioned near the windshield top, but it is too small.

The driving position is comfortable and the car reminds me somewhat of the Thunderbird. To the left of the driver is the left-hand-operated ignition switch which I don't like as I am right-handed. The shift lever is easy to operate and has a parking-lock position.

Window cranks operate easily and only 2½ turns are required for raising or lowering the windows.

The floor hump over the transmission seems more pronounced this year. At the center it is eight inches above the floor.

Warning signals are used instead of the oil and generator needle gauges I prefer. The ventilating and heating system is easily controlled and outside air now enters through an intake just below the windshield. There is a roomy glove compartment. The brake and throttle levers are well located except it is necessary to raise the foot three inches from the accelerator to the brake—this is too much.

There is a large trunk and the lid is self-locking. Bumpers, front and rear, are massive and practical. There are no sharp extensions either front or rear, which is good. I am glad to see Ford has eliminated the sooty, exhaust-pipe extensions that came through the rear bumper on previous models.

The gas-filler cap is behind the license plate as before—an excellent feature. ★★★

## Modern Planes Are Complex

Increased complexity during the past decade is shown by the modern fighter aircraft, which now require 23,000 feet of electric wiring compared to 1500 feet of wiring in the average World War II fighter, according to Lt. Gen. Thomas S. Power, Commander of the U.S. Air Research and Development Command. F-51 Mustangs of World War II needed 2000 engineering man-hours for development. F-86 Sabre Jets of the Korean War required 70,000 man-hours, and today's most recent fighter, the F-100, needed 170,000 man-hours of engineering skill, General Power said.



## UNIMAT 10 IN 1 COMPLETE WORKSHOP

CRAFTSMEN, MODEL BUILDERS, HOBBYISTS AND INVENTORS all over the world are choosing this unique and extremely versatile electric tool for machining small parts from steel, brass, wood, aluminum and plastics. Highly acclaimed because of its precision results, UNIMAT offers these serious craftsmen many other worthwhile advantages.

**UNIMAT BASIC UNIT (shown) INCLUDES:** 1—a Precision Lathe and all accessories necessary to convert it quickly and easily into a 2—Drill Press; 3—Hand Drill; 4—Polishing and Grinding Machine; 5—Tool Grinding Machine; 6—Milling Machine. With the Basic Unit you also get these 13 accessories Free: AC/DC Power Motor, with reduction pulleys (11 speeds—175 R.P.M. to 9200 R.P.M.), self-centering universal three-jaw "Cushman" lathe chuck with reversible jaws (abt 2½" Dia.), ¼" Drill Chuck, Pivoting Tool Holder, Grindstone Holder, Lathe Dog, Face Plate, 2 centers, Allen Wrench, Easy-to-follow instruction manual, all packed in sturdy wood veneer carrying case!

**ADDITIONAL ATTACHMENTS** are available for further versatility of your Basic Unit: 7—The Jig Saw; 8—Threading Attachment; 9—Circular Saw; 10—Indexing and Dividing Attachment. All attachments can be ordered individually with the Basic Unit, or at any time! (Attachments not shown.)

**PORTABLE AND COMPACT**—two more reasons for its great popularity. All operations require little working space and are performed on just one base. There is also high quality built into this unique machine tool. The ball-bearing headstock spindle has a ¼" O center. It also features a built-in rack, so that the headstock spindle can be adjusted 1" in either direction. This feature gives the drill press its stroke when in the upright position. The tailstock is threaded and will take either lathe or drill chuck. Constructed of high quality hardened and ground steel and a cast iron ribbed lathe bed, UNIMAT adds up to a top notch machine tool that will enable you to create a limitless variety of objects—from just about any kind of stock material.

**UNIMAT BASIC UNIT COSTS ONLY \$99.50** and can be obtained on a budget plan for as little as \$49.50 down, and \$10 a month for 5 months. There's no charge for this service. It is shipped prepaid East of the Mississippi. West thereof, a slight charge is necessary. Additional literature is also available for only 10¢ to cover mailing costs. Look into this amazing precision tool today. It will prove worth your while.

Mail your order today to Dept. PM-17 Dealer Inquiries Invited!  
**AMERICAN EDELSTAAL (AMSTERDAM) INC.**  
350 Broadway New York 13, N. Y.

## BUILD YOUR OWN AUTOMATIC AIR COMPRESSOR

±K-55 Complete Automatic Air Compressor Unit: Knocked Down, 3 CFM Air Compressor ½ HP AC Motor 12x24 Stainless Steel Tank on Wheels: Pressure Switch, Air Regulator, Gauge, Check Valve, Safety Valve, Hose & Tire Chuck, UNIT COMPLETE (\$150 Value) ONLY \$97.00. Same as above 1 HP Unit 9 CFM Twin Cylinder Compressor Tank on Wheels, All Accessories, You Assemble ±SK-100. ONLY \$169.50. Order from THIS AD. GUARANTEED. FOB Chicago.

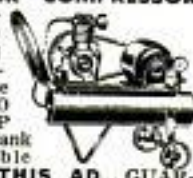

C. MARSHALL SALES, 3546 Fullerton Ave., Dept. P-1, CHICAGO 47

## STANLEY "SURFORM"

An all new surface forming tool

Try Stanley SURFORM at your hardware dealer's now. For free tool catalog write, Stanley Tools, Division of The Stanley Works, 621 Elm Street, New Britain, Connecticut.

Plane type \$3.69

File type \$2.69



## STANLEY

The Tool Box of the World

## Short Cuts



15/16" #18 brads hold while glue dries.

with **WILHOLD WHITE GLUE** with Orthonol

**MAKE DRAWER ENDS without dowels or dovetails** You'll like it better. Simplifies woodworking. Sets quick, dries clear,

holds permanently. Illustrated, one of many Wilhold shortcuts. **FREE BOOKLET.** Paint, Hardware, Lumber, Variety Stores. Or write **WILHOLD PRODUCTS** Los Angeles 31, Calif.; Chicago 44, Ill.

## AMAZING NEW IMPORT TERRESTRIAL & ASTRONOMIC TELESCOPE

83 POWER—40 POWER  
or 23 POWER  
PLUS A

VARIABLE 25 and 60 POWER  
TERRESTRIAL TELESCOPE

Look what you get at this Low Price PLUS a Money Back Guarantee & a 30 Day FREE Trial! You can't lose unless you miss this!

- 1—Astronomical LENSES—Three of 23X, 40X and 83X magnification. Achromatic & precision ground.
- 2—Variable Power LENS of 25 & 60X for straight through viewing. Fully corrected for Terrestrial sighting.
- 3—BODY—Steel for a lifetime of use.
- 4—LENGTH—19-1/2" 22-1/2" extended.
- 5—Objective LENS—Coated large 50mm
- 6—Top Quality SUN FILTER
- 7—One Diagonal PRISM
- 8—4 Power x 10mm Searching Scope with cross hair reticle.
- 9—ADJUSTMENTS—Both free-swinging and universal with lock for positioning.
- 10—Hardwood TRIPOD—T=0 section type, 30" folded, 4-1/2 ft. extended.
- 11—Fitted Hardwood CASE for all parts.

FREE BOOK ON STARS—Tells you all about the stars and the constellations—Where to find them at different times—How to identify them and many other intriguing facts on astronomy.

EXTRA 100X EYEPIECE 750 125X EYEPIECE 995

83 and 40 POWER ASTRONOMICAL SCOPE

Very similar to scope above but has 83X & 40X eyepieces with a 40MM objective lens. Also has a variable eyepiece of 25-30X. Steel tube body is 26" long. Included with scope is sunglass, a pair of prisms (1 erecting), a hardwood tripod and a fitted case. **Only 3995**

25 POWER x 30 MM TELESCOPE & TRIPOD

Nowhere but at PALLEY'S can you find a buy like this! Here's a scope, complete with a sturdy metal tripod, that you can have a lot of fun with. Use it to spot hits on the target, for star-gazing, interesting views of the beach, etc. Made of aluminum and chrome plated brass. Field: 62 ft. at 1000 yds. 1-3/16" dia. lens. **NEW 895 2500 VAL.**

AMAZING NEW DESIGN  
60 to 600 POWER—2 EYEPIECE

SPECIAL MICROSCOPE

HAS 60-120-200-300-400 & 600  
POWER MAGNIFICATION WITH ILLUMINATED  
SUB-STAGE MIRROR and TRIPLE TURRET

Now you can change magnification with a simple shift of the dual eyepiece turret. No loss of focus—No re-adjustments—Your choice of 4X or 20X eyepiece with any of the objective lenses instantly!

INCLUDES THESE ADDED FEATURES:

Has triple revolving turret with 10X, 20X, & 30X precision ground and polished lenses—Dual eyepiece turret with 4X and 20X lenses—New Patented Sub-Stage with a built-in, battery operated light, no external light source needed—A large sub-stage mirror with revolving variable iris—All-metal precision made body, inclines through 90°—Special fitted hardwood case and glass slides.

NEWLY  
DEVELOPED  
IMPORT



SPECIAL \$1695

SAVE  
50%

PHILIPPINE MAHOGANY  
LUAN PLYWOOD  
AT LESS THAN WHOLESALE

For Paneling Dens, Offices, etc. Use in Cabinets, Furniture, etc. Rotary cut. Both sides sanded.

Banded with finest resin adhesive. Face side unjointed. Shipped at lowest rates.

3MM (1/8") x 3FT. x 6 FT. \$500 VALUE PER SHEET	FREE SAMPLE ON REQUEST	1/4" x 4 FT. x 8 FT. 950 VAL. MIN. ORDER 4 SHEETS	449 PER SHEET
---	------------------------	---	---------------

SAVE 50% ON TRANSLUCENT FIBERGLAS PANELS  
Finest quality. Available in many widths and lengths. Excellent color selection. Ideal for home, office, etc. FREE sample and booklet. **49¢ PER SHEET 85¢ VAL.**

SAVE 85% ON HYDRAULIC SURPLUS

One of the largest stocks of Gov't Surplus and Specially Made Hydraulic Cylinders in the country. Also ALL Hydraulic accessories & supplies.

SAVE UP TO 50% ON PALLEY BARGAINS

AMAZING CRYSTAL RADIO

Here is A COMPLETE SELF POWERED RADIO RECEIVER that picks up STANDARD BROADCAST STATIONS without using batteries or electricity! Just plug in the headset, antenna and ground wires and tune in your favorite program. You'll be amazed at the STRONG, CLEAR SIGNAL. Nothing to assemble—nothing to buy. Has a 100KC tuning range. Comes complete with the receiver, sufficient antenna and ground wires PLUS A HEADSET with two 2000 ohm ear-phones. Ideal for that personal or private radio.



ONLY 395

Special 12 Pc. SPORTSMAN'S KNIFE



Complete with Genuine Leather Holster!

NEW LOW PRICE—Some high quality. Over 20,000 sold last year—because of this large volume we are able to greatly reduce our price to you—SAVE!

IDEAL GIFT FOR FATHER, SON or FRIEND  
ELIMINATE 12 ITEMS FROM YOUR PACK

Here is the Perfect Combination Knife-Tool for every Outdoor Sportsman, Hunter, Camper, Fisherman, Boy Scout, Ranger, Rancher, etc. Think of it! 11, Fine quality Steel Tools, precision made to fold easily into the heavy brass covered body. In one neat, compact unit you have (1) a regular knife, (2) a fork, (3) a spoon, (4) a draw-knife, (5) a bone-saw and fish-scaler, (6) scissors, (7) a can and bottle opener, (8) a cork-screw, (9) a awl punch, (10) a screwdriver and (11) a metal file. All this PLUS a genuine leather, belt holster.



SPECIAL PARATROOP

FOLDING MACHETE AND LEATHER HOLSTER

Blade is finest, blue, nickel alloy steel with honed edge. Handle is heavy bakelite with diamond point knurl to assure positive grip. Blade folds into handle and special steel guard like a giant pocket knife. A safety lock holds the open blade rigidly in place. A rowlock strong in handle slips over the wrist to prevent the loss of knife. Ideal for chopping, cutting, etc. Overall 17", blade 11".

289 WITHOUT HOLSTER 1500 VALUE

GENUINE HEAVY DUTY LEATHER HOLSTER—For knife above. Has belt loop and long ratchite frong for leg strap. One-piece, extra heavy leather, double stitched throughout. Comes with a special whetstone. . . . . ONLY—150



FIGHTING KNIFE

NAVY KNIFE 298 LEATHER HOLSTER 100

Dagger design with laminated leather handle. Blade is 6-1/2" long, hollow-ground on the cutting edge and double-edged for 3-1/2" at the point. Ideal skinning or hunting knife. Comes with a genuine leather belt holster. Overall length 11". Order while we can supply.



ARMY SURPLUS

NEW MACHETE ONLY 198

Has 22" Vanadium Steel blade with a 5" curved hardwood handle. Grand new stock. Comes with rugged belt sheath. Ideal for chopping, cutting, clearing, etc.

PORTABLE, FOLDING ARMY SHOVEL—With a 20 inch hardwood handle. Blade will fold to form a pick. 198

3400 RPM—1/2 HP POWER SAW



RIPS - CROSSCUTS

CUTS A FINISHED 2x4 LIKE A KNIFE THROUGH BUTTER

COMPARES TO SAWS SELLING UP TO \$49.50 1998 Complete with 5-1/2" Blade

A rugged, professional type, adjustable saw. Will cut any angle from 0 to 45°. Has an adjustable (8 to 6") rip fence. Safety-trigger switch on handle. Full 1/2 HP Universal AC-DC, 110-120 Volt, 60 cycle motor. Weighs only 6 1/2 lbs. Thousands already sold. Your satisfaction guaranteed.

EXTRA SAW BLADES—Available in Rip, Crosscut or Combination. Please Specify 235EA.

NEW POWER SAW BENCH TABLE

This sturdy, precision made bench-saw table converts our famous power saw (above) to a handy bench-saw. Permits angle and bevel cuts, rip, crosscut & comes with rip fence and mitre guide. 14" x 16" table, 6" high.



NEW ONLY 995

NEW DRILL DRIVEN BAND SAW

Easily driven by any 1/4" electric drill or other similar power source. Has full 10" throat, cuts to center of a 20" board. Table tilts for angle or bevels. Drive pulleys are high impact phenolic and run on siltite bearings. 3/16" saw-steel blade. Die-cast housing and many other fine features. Ideal for "do-it-yourselfers". 1288

Order from This Ad. Pay by M.O. or check, P.O.'s accepted from D&B Term. If deposit with C.O.D.'s All Prices FOB Los Angeles

Palley's

2263 E. VERNON AVE. DEPT. PM-1  
Los Angeles 58, California

## JEEP & 4-WHEEL DRIVE OWNERS

FRONT DRIVE WITH  
**FREE-LOCK HUBS**

FRONT DRIVE - NO  
**FREE-LOCK HUBS**

**LOW OPERATING COSTS**

**HIGH OPERATING COSTS**

ALL PARTS STOP

ALL THESE PARTS MOVE



STOP

WHEEL MOVE



Stop front drive wear  
Reduce engine wear  
Save gasoline

Increase power  
Tires last longer  
Easier steering

**UNCONDITIONALLY GUARANTEED!**

Benefit now from this money-returning investment.

Ask dealer to order yours now. Write for **FREE FOLDER**

**FREE-LOCK CORPORATION**  
6301 NORTH FEDERAL BLVD., DENVER 11, COLORADO

## Clymer Drives the 1957 Plymouth V8

(Continued from page 111)

Angeles. I can truly say that these long drives were made with less fatigue than I have noticed over such distances on test runs with any car, regardless of price.

Instruments are well located and there is no upper horn ring to obstruct visibility. Needle indicators are used for fuel and temperature, warning lights for oil and generator (a standard arrangement in the industry these days, it seems). There is some reflection at night in the upper portion of the windshield, not so much from the dash itself as from the steering column. The cowl of the test car was padded as were the sun visors. The wide rear-view mirror is mounted atop the dash. I like this location, although there was considerable vibration which blurred the rear view.

New this year are circular, swiveling defroster outlets on top of the dash that permit the driver to aim the hot air to any part of the windshield. Gone, at last, is Plymouth's pushup outside air scoop. It is replaced by a flat opening across the cowl.

There is an average-size glove compartment. Its door drops down to open and is likely to hit the legs of the passenger unless care is used. Headroom is reduced this year, more so in the rear than in the front.

The test car had power brakes and the wide foot pedal is well located in relation to the throttle. Plymouth has always had first-rate brakes and I found them to be better than ever this year. There was little tendency to fade, regardless of frequent use in hilly country.

Driving position is comfortable and the wheel position is similar to that of a sports car. Interiors are better than previously and seats are well padded, although the back padding is not thick.

I am sold on the full-time power steering. However, there is a tendency to oversteer until you become accustomed to it.

Front-window vents are smaller than before, but I see no disadvantage here. Doors have a solid feel. Handles are the pull-out design, heavy and strong, but the kind you'd expect on a truck rather than a passenger car. They could be improved as could the key lock. The large trunk requires a key to lock the lid, a feature I do not like.

Rear tailfins are high. Plymouth says these give greater stability. I don't know whether they do or not, but the car is a fascinating one to drive with a feeling of safety and control at any speed.

Economy was satisfactory at normal speeds, but very poor at high speeds. ★★★

**WHOLESALE TOOL CATALOG**

**MAKE EXTRA MONEY**

**Start Your Own Business**

Sell tools part time, full time. Save money for your industrial and institutional use. A MILLION DOLLAR INVENTORY AT YOUR FINGERTIPS.

Buy NATIONALLY ADVERTISED hand tools, hardware, fans, motors, power tools, paints, etc., NO INVESTMENT REQUIRED. Buy as you need it. Up to 50% DEALER DISCOUNT.

Send \$1 deposit for mammoth wholesale dealers catalog. \$1 refunded on first purchase or returned if you are not 100% satisfied.

**SILVO HARDWARE CO., Dept. PM-1, 108 Market St., Phila. 6, Pa.**

**Made \$2,600**

**LAST SEASON**

**with FOLEY LAWN MOWER SHARPENER**

### 99c Profit On Each Dollar!

It costs less than 1c per mower for electricity and material. The Foley sharpens all blades and cutter bar together just like lawn mower manufacturers do it. Start in spare time in basement or garage. The Foley handles up to 3 or 4 mowers per hour—prices run \$1.50 to \$3.00 for hand mowers—\$5.00 to \$8.00 for power mowers.

**FREE — VALUABLE ILLUSTRATED BOOK** shows how to sharpen all leading makes of power mowers. Foley prices are low—easy payment plan lets you pay for machine with profits. **FREE PLAN** tells how to start. Send coupon today—no salesman will call.

"Last year we sharpened and repaired about 1000 lawn mowers for a net profit of \$2,600," says E. G. "Years ago, . . . I bought a Foley Lawn Mower Sharpener," writes W.T.J., "the best investment I ever made. I have made a good living for my wife and myself and have put money in the bank besides."



SEND FOR FREE

BOOK

**FOLEY MFG. CO., 107-7 Foley Bldg., Minneapolis 18, Minn.**  
Send **FREE BOOK** and **FREE PLAN** on Foley Lawn Mower Sharpening business.

Name \_\_\_\_\_

Address \_\_\_\_\_

## PORTABLE LIGHT PLANTS

**MASTER-LITE 2500 Watt Plant**  
110/120 v. 60 cyc. AC. A power-  
ful plant, ruggedly constructed  
and yet designed for easy port-  
ability. Can be started by rope  
or built-in 12 v. elec-  
tric push button start-  
er. Built-in winding  
to charge battery.  
Powered by a big 5.10  
HP Briggs engine—  
complete with all  
accessories, incl. a  
control box, voltmeter,  
and handy plug-in power receptacle. An ideal  
plant for permanent or stand-by service. Wt. 205  
lb. Reg. price \$645.00  
(Item 21) Factory Price ..... **\$329.50**  
**DUAL VOLTAGE 110/220** for Item 21—  
\$30 additional.



(Item 21)

## BATTERY CHARGING GENERATOR

### Push Button Start

A husky, 750 watt plant de-  
signed for charging 6 or  
12 volt batteries in just min-  
utes! When mounted with  
two 6 volt batteries it pro-  
vides a terrific cold weather  
motor starting unit, also perfect  
as a 12 volt light plant on  
boat! Charges all bat-  
teries anywhere—no hi-line  
current needed. Ideal for  
service stations, contractors,  
fleets, boats and farms. Comes complete  
with ammeter and cutout. (Item 821) Wt.  
120 lbs. Regularly \$295.  
Our special, only ..... **\$119.50**



Comes complete

with ammeter and cutout. (Item 821) Wt.

120 lbs. Regularly \$295.

Our special, only ..... \$119.50

## 52 pc. SOCKET SET



Highest quality, guaranteed non-  
breakable sockets made by Husky.  
Beautifully matched chrome thin  
wall alloy absolutely the best.  
Contains a complete set of 38 sockets  
etc. in 1/2" drive, 3/4" drive and 1 1/4"  
drive, plus all necessary exten-  
sions, handles, speeders, reversible  
ratchets, etc.; all uncond. guaran-  
teed against breakage. A beautiful  
set of tools that will handle any  
job in a big doughnut steel box.  
Wt. 17 lbs. (Item 205) List  
price \$62.90.  
Factory Special ..... **\$27.95**

## EXTENSION CORD

Heavy duty  
and very  
flexible.  
Neoprene  
14-2 cable.  
20 year  
quality. So  
tough you  
can drive  
a truck  
over it. Wt. 12 lbs. (Item 185)  
100 ft. Complete with rubber  
plug and outlet. **\$8.95**  
A terrific buy at only .....

No. 10-2 Power Cable. Heavy  
duty, very flexible 20 ft. with  
male and female fittings. Wt. 4  
lbs. (Item 818b) ..... **\$5.15**

20 ft. (Item 592) with fittings ..... **\$4.25**

100 ft. (Item 135) with fittings ..... **\$25.95**

No. 12-2 Power Cable. Very flexible rubber  
covered, special outside shield for grounding  
power tools, etc. 50 ft. (Item 109) Wt. 8 lbs.  
**\$6.95**. 100 ft. (Item 200) ..... **\$12.95**

No. 8-2 Conductor Power Cable. 50 ft. heavy  
duty, very flexible rubber covered with male  
& female plug (Item 817) ..... **\$12.95**

## JET STEAM MASTER

Now, a super effi-  
cient portable steam  
generator that pro-  
duces live steam at  
100 lbs. pressure in  
a cold start! Produces  
large volume of high  
pressure steam on 2  
pints of fuel oil. In-  
stantly cleans sticky  
grease, dirt, rust,  
old paint, etc. off  
implements and road  
machinery. Pays for  
itself in a few weeks.  
Sterilizes soil. Steri-  
lizes as it cleans—  
milk equipment, etc.  
Fully automatic—oil  
lifetime bronze water circulating pump. Draws  
water from faucet or bucket. Simple and safe  
—anyone can use it! Built-in safety valve.  
Complete with 12 ft. of hi-pressure steam  
hose and new triple efficiency steam gun that  
automatically mixes in soap solution if de-  
sired. Wt. 250 lbs. Item 463.  
Special factory price ..... **\$349.50**



Send check or M.O. Prices f.o.b. Factory. 10 day Money back guarantee. SEND 10c for .....

**MASTER MECHANIC MFG. CO.,** DEPT. 75-P

**SAVE middleman profits**  
**BUY DIRECT from**  
**MASTER MECHANIC factory**

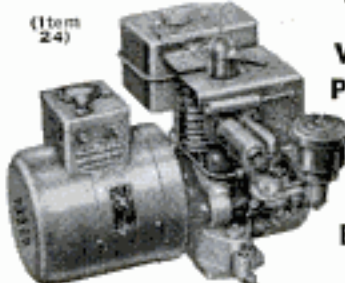

(Item 24)

## 700 WATT PLANT

115 v. 60 cyc. AC Powered by a rugged 2.2 HP,  
easy starting Briggs engine. No wiring ne-  
cessary; just plug in and operate. Plenty of  
current for any oil burner, freezer, brooder,  
emergency lights, etc. which require up to 700  
watts. Ideal for television and radios. Com-  
plete with voltmeter and built-in winding to  
charge 6 v. auto batteries. (Item 24) Wt. 75  
lbs. Easily fits in car trunk. Be prepared if  
storm knocks out power lines. **\$143.50**  
Regular \$275.00 value .....  
**1200 Watt Plant** (Item 45) same as Item  
24 but larger generator and engine **\$199.50**  
with 50% greater output .....

## PUSH BUTTON START

## MASTER MECHANIC'S DC ARC WELDERS

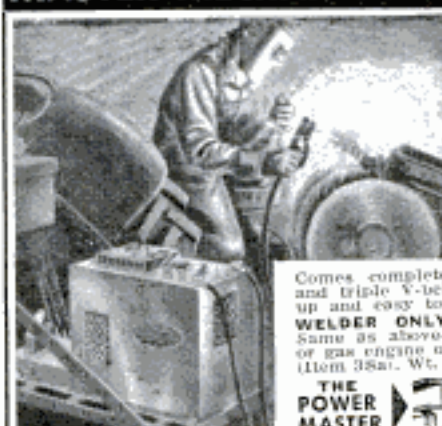

Built in our own factory,  
these big, industrial capacity,  
portable welders provide ter-  
rific performance, yet are sold  
direct-to-you at bedrock fac-  
tory prices—hundreds of dol-  
lars less than you'd expect!  
Senior model (shown in illus-  
tration, left) has high ca-  
pacity DC welding unit—easily  
welds any thing up to 2"  
plate using 1/4" to 3/4"  
rods. Built in stabilizer and  
cooling system makes are easy  
to strike and hold. Dual con-  
trol rheostat provides low  
heat soldering, brazing, and  
welding from 10 to 300 amps.  
with instructions, guarantee  
up and easy to operate.

**WELDER ONLY — DUAL CONTROL MODEL.**  
Same as above—drive with your tractor, jeep  
or gas engine of 14 HP or more. (Item 38a) Wt. 110 lbs. **\$450** value **\$119.50**

## THE POWER MASTER

(Item 38a)

**WELDER ONLY — INDUSTRIAL MODEL**  
same as above but with ceramic rotary  
type rheostat providing 74 different heat  
settings for all types of welding  
(Item 38b) \$500.00 value. **\$139.50**  
**COMPLETE POWER MASTER.** (Illustrated  
at right) powered by a 14.6 hp., air cooled  
Wisconsin engine. Wt. 480 lbs. (Item 280)  
Compares with welder costing  
\$1200. Factory Special ..... **\$449.50**  
**WELDING KIT.** Two 10 ft. leads, welding  
helmet, electrode holder, ground  
clamp. Sold only with welder at, **\$10.50**

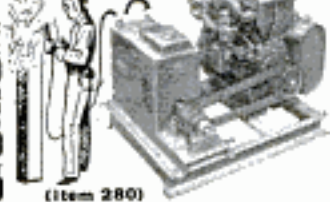

(Item 280)

## GIANT METAL SHEARS



"PEXTO"  
Nine inch cutting blade made of special  
high carbon alloy steel, perfectly aligned  
and ground. Easily cuts steel plate up to 12  
gauge or 1/2" thick. Overall length 40". Wt.  
23 lbs. (Item 156) Regular **\$14.95**  
\$49.50, while they last .....

## Rugged, ball bearing WINCH

Sturdy ball bearing  
winch—super tough  
aluminum alloy con-  
struction. Powered  
by an easy starting  
2 1/2 HP Briggs gas  
engine thru gear  
reduction drive — it  
exerts up to 3000  
lbs. of terrific force  
for hoisting mate-  
rials or pulling.  
Combination gear and pulley reduction re-  
sults in tremendous multiplication of engine  
power. Eater pulley clutch arrangement and  
built-in drum brake (with ratchet hand lever)  
enables operator to ease loads down gently  
and lock at any point desired. Drum handles  
400 ft. of 3/4" cable or 800 ft. of 1/2" cable.  
Ideal for contractors, farm implement trail-  
ers and unlimited other uses!  
(Item 795) Wt. 125 lbs. Only ..... **\$149.50**  
**HAND WINCH**—Same winch with large crank  
handle for extra leverage and 2  
speed drive. (Item 794) Wt. 60 lbs. **\$59.50**



(Item 795)

## LESS THAN WHOLESALE

### GIANT 2500 WATT PLANT

110-120 v. 60 cyc. AC. Absolutely the  
best made — ex-  
clusive dynam-  
ically balanced  
armature; heavy  
windings develop  
up to 5000 watt  
overload for mo-  
tor starting. Skid  
mounted — port-  
able. Powered by  
an easy starting Briggs or Wisconsin 6 HP  
engine—complete with all accessories; engine  
easily disconnected for other uses. Big outlet  
box, voltmeter, no wiring necessary. Ample  
current for all purposes. Factory Warranty.  
(Item 31) Wt. 210 lbs. Reg. price \$585. Special at ..... **\$299.50**  
Same plant with electric  
self starter (Item 31a) ..... **\$359.50**  
Generator only and control box ..... **\$169.50**



### POWER-FLO 3500 WATT

115-230 v. 60 cyc. AC. A  
rugged power plant for heavy  
duty use. Duplex  
power distribution  
provides both 115  
v. and 230 v. out-  
put at the same time  
if desired. Powered  
by a big 8 HP Wis-  
consin engine with  
triple V belt drive.  
Has built-in over-  
load protection. A  
dependable plant for  
either standby or regular service.  
Equipped with electric self  
starter. (Can also be started by  
rope) and plug in outlet box.  
(Item 198) Wt. 310 lbs. **\$439.50**  
Factory price .....  
**GENERATOR ONLY** belt driv-  
en ..... **\$239.50**



(Item 198)

## HEATING & VENTILATING FAN

(Item 10) Easily  
installed in fur-  
nace pipes. Forces  
even heat to all  
rooms. Over range  
removes kitchen  
smoke and odors.  
Powerful contin-  
uous duty motor,  
110-120 v. AC.  
Mount in wall or  
ceiling to venti-  
late any area. Quiet, super ef-  
ficient fan moves huge volume  
of air. (400 to 600 c.f.m.)

8" Pipe, wt. 5 lbs. .... **\$6.85**  
9" Pipe, wt. 6 lbs. .... **\$7.85**  
10" Pipe, wt. 7 lbs. .... **\$8.85**  
12" Pipe, wt. 8 lbs. .... **\$9.85**

**HEAVY DUTY FAN.** Semi-en-  
closed motor, suitable for spray  
booths, restaurant exhausts,  
poultry houses, etc. 10" Fan.  
Wt. 8 lbs. (Item 10E) **\$11.95**.  
12" Fan, Wt. 10 lbs. (Item  
10D) **\$12.95**

**HIGH SPEED BARN FAN** similar  
to above, but larger, high speed  
motor moves huge volume of air.  
12" Fan (Item 10F) ..... **\$14.95**  
14" Fan (Item 10G) ..... **\$17.95**

late any area. Quiet, super ef-  
ficient fan moves huge volume  
of air. (400 to 600 c.f.m.)

8" Pipe, wt. 5 lbs. .... **\$6.85**

9" Pipe, wt. 6 lbs. .... **\$7.85**

10" Pipe, wt. 7 lbs. .... **\$8.85**

12" Pipe, wt. 8 lbs. .... **\$9.85**

## Double Acting Hydraulic Cylinder



A powerful cylinder mfr'd. by Massey Harris  
which develops both a pushing and a pulling  
action. Will push 8,100 lbs. with a 1000 P.S.I.  
pump pressure. Cylinder is 3 3/4" O.D. with  
6 1/2" stroke—standard heavy duty clevises on  
both ends. Has standard 1/2" pipe thread open-  
ings. Can be used for tilting buckets or  
blades, raising or lowering implements, hy-  
draulic presses, etc. Can also be used as an  
air cylinder. (Item 802) Wt. 17  
lbs. Reg. \$68 value. Special ..... **\$14.95**

**HYDRAULIC HOSE COUPLERS** Connect or dis-  
connect hydraulic lines without loss of oil.  
1/2" pipe threads. (Item 819) per set. **\$4.95**

## SCREW-TYPE PRESS

A tremendously powerful press  
capable of exerting nine tons  
of pressure. Pays for itself  
straightening bent parts, or  
pushing out bearings and bush-  
ings. Ideal for manufacturing  
and assembly operations. Be-  
cause of precast control Mas-  
sey 1 1/2" screws permits pre-  
cise control over vertical  
travel. Extra heavy ribbed  
yoke has a throat 2 1/2" high;  
depth capacity for working to  
the center of an 11" ob-  
ject. Includes 8" x 15 1/2"  
vise-type table and two  
pushing arbors. Wt. 150 lbs.  
(Item 797). Reg. **\$149.50**. Special. **\$49.50**



**HYDRAULIC PRESS.** Nine ton  
capacity. See Dec. Pop. Mech's  
ad for details—or write. Com-  
plete Wt. 110 lbs. (Item 404) ..... **\$69.50**

Send check or M.O. Prices f.o.b. Factory. 10 day Money back guarantee. SEND 10c for .....

**MASTER MECHANIC MFG. CO.,** DEPT. 75-P **Burlington, Wis.** **BIG 1957 Catalog**



THE  
**BASIC**  
SHOP TOOL

9" x 3' Model C Bench Lathe \$276.00 f.o.b. factory. Time payment terms available.

## 9" SOUTH BEND LATHE

This South Bend 9" Precision Lathe is the basic tool for your shop. It enables you to perform accurately the same full range of operations done on South Bend Lathes in industry. Also, operations ordinarily performed on other machine tools are made possible through the use of efficient attachments. You get more for your money in a South Bend 9" Lathe.

Write for catalog — see local distributor — look under "Machine Tools" in your classified telephone directory.

**NEW 14" DRILL PRESS**—a ruggedly built tool unsurpassed for accuracy and dependability.

*Write for catalog.*



**SOUTH BEND LATHE WORKS**

*Building Better Tools Since 1906*

455 EAST MADISON STREET, SOUTH BEND 22, INDIANA

A Few of the Many  
Operations You Can Perform



TURNING



BORING



THREADING



FACING



MILLING



GRINDING

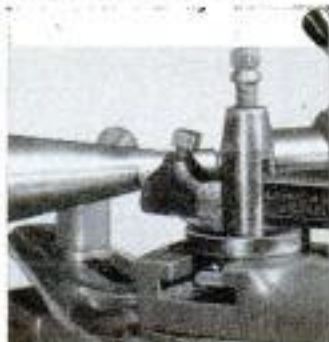

TAPER TURNING

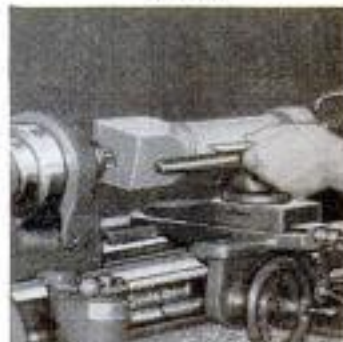

WOOD TURNING

# Even Men with No Experience are Making as High as \$1,000 A Month

A message to all men who are looking for a way to make more money faster, with one of America's greatest inventions wanted by millions

Folks Are Amazed when you Tell Them This New Kind of Protection Costs Only

**\$4.95**



**Here's Your Opportunity to Get into the BIG MONEY CLASS FAST with Sensational PRESTO FIRE EXTINGUISHER. Over 2,000,000 sold for Homes, Offices, Autos, Service Stations, Stores, Farms, Boats!**

Wouldn't you like to be making as much as \$1,000 in a month? Of course not everybody makes such profits starting out, but look at these profit reports: A Florida salesman earned \$600 in 1 month. An Ohio man earned \$2100 in 2 months. A New

York salesman earned \$1500 in one month. A New Hampshire man added the Presto as a sideline and picked up an extra \$1800 in 20 months. Men everywhere, even in off hours, are rolling up amazing profits. How about you?

## WHAT'S THE SECRET?

PRESTO contains an amazing new chemical—"Chlorobromomethane" or "C.B." The Germans developed "C.B." as a secret defense against fire during the war. After the war, a famous American firm, The Dow Chemical Company, acquired the formula from the U. S. Government and began manufacturing it here. Then we (Merlite Industries) designed a handy, yet amazingly effective, fire extinguisher to contain and release this new wonder-chemical. In comparing the effectiveness of "C.B." in fighting fires, The Dow Chemical Company's report states, "It has been proved that 'C.B.' is about 1.5 to 6 times as effective as other common extinguishing agents on an equal weight basis." This means that Presto can be made light and handy so even a woman or child can use. No pumping, no heavy tank. Just twist the knob, and flames disappear!

## WHY LARGE PROFITS ARE EASY

Everyone is terrified by FIRE! Every year fires kill more than 11,000 persons, destroys over SEVEN BILLION DOLLARS of property. Millions of people have been waiting for this sure, simple, inexpensive safeguard. Most people who see the dramatic, five-second demonstration want one or more, at the low price of \$4.95. You make as much as \$2.70 on every one. Get started in this rich new field now. Don't put it off. Every day you hesitate may cost you \$10, \$15, or even \$50 you could otherwise be making. Get the facts FREE. Simply mail postcard in this ad—no stamp needed. But do it now!

## Only Presto Has ALL These Features

-  Ends Fire as Fast as 2 Seconds
-  Chemical Contents 1.5 to 6 times More Effective than Others
-  Weighs Less Than 1 Lb.
-  Easily Held in One Hand—Even by a Child
-  Needs No Inspection or Re-Charging—Does Not Corrode or Deteriorate
-  Costs Only \$4.95—Yet Outperforms Bulky Extinguishers Costing Several Times as Much
-  Automatic Pressure—No Pumping
-  Guaranteed for 20 Years—Certificate is Packed With Every Presto

## Big Money Like This Even in Spare Time



**Charles Kama Reports \$1,000 in One Month**  
"I think I've succeeded pretty well. I'm making more than \$1,000 a month, and I haven't touched bottom yet."  
Charles Kama, Texas



**William F. Wydallis Reports \$15.20 an Hour**  
"For every hour I devoted to the Presto, I find I have earned an average of \$15.20 an hour."  
William F. Wydallis, Ohio



**Walter Gable Reports \$75 to \$80 a Week**  
"My selling time has averaged less than a day or two a week. These part time sales have brought me as much as \$75 to \$80 a week."  
Walter Gable, Md.

**FREE** Full Details of this Truly Amazing Money-Making Opportunity  
**JUST MAIL CARD BELOW**

**IMPORTANT!** Be sure to print your name and address in space on card below. Then simply cut out this card along dotted lines and drop in the mail box. No stamp necessary. We'll rush all facts to you at once, free and without obligation.

**PRINT YOUR NAME and ADDRESS HERE**

**BE SURE TO PRINT YOUR NAME AND ADDRESS ON SPACES BELOW**

FROM  
NAME \_\_\_\_\_  
ADDRESS \_\_\_\_\_  
CITY \_\_\_\_\_ STATE \_\_\_\_\_

**BUSINESS REPLY CARD**  
NO POSTAGE STAMP NECESSARY IF MAILED IN THE UNITED STATES

3c — POSTAGE WILL BE PAID BY —

**MERLITE INDUSTRIES, INC.**

**114 EAST 32ND STREET**

**NEW YORK 16, N. Y.**

**Dept. X-15R**

FIRST CLASS  
PERMIT  
NO. 52914  
NEW YORK, N.Y.

**MERLITE INDUSTRIES, INC. DEPT. X-15R**  
114 E. 32nd ST. NEW YORK, N. Y.

Copyrighted material

# "How to Think Ahead of Your Car and Save Gas Dollars!"

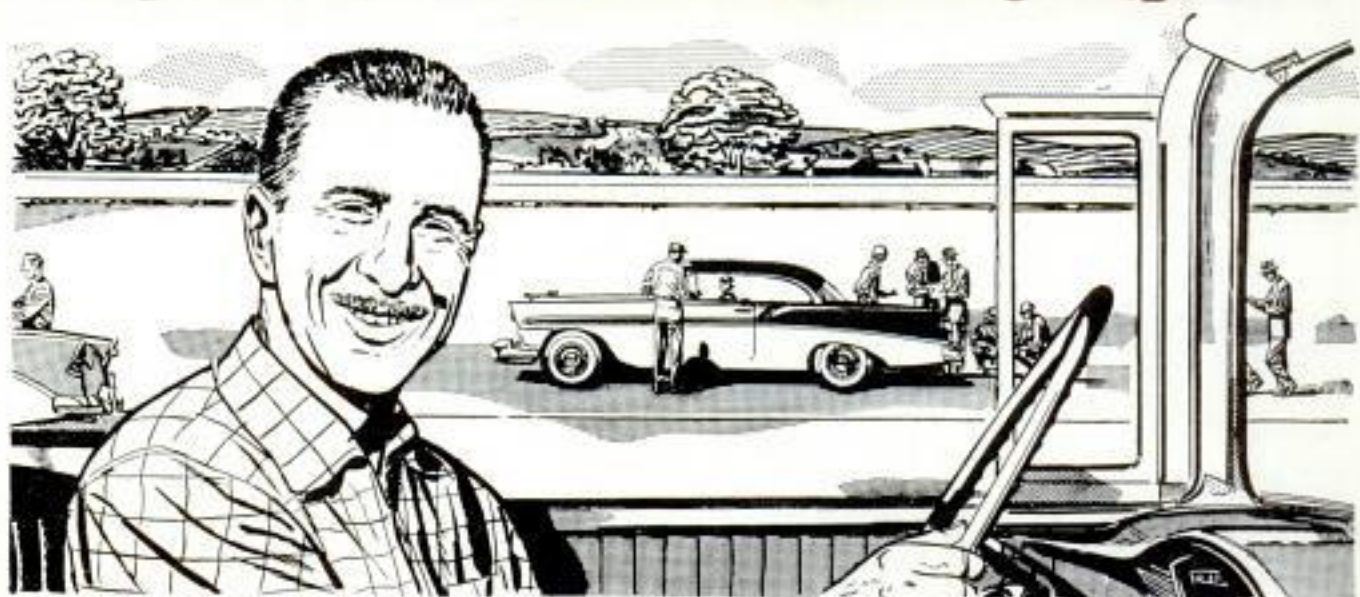

"Professional drivers think ahead of their cars... avoid needless stops and starts... save fuel that many drivers waste..."

*Mauri Rose*

One of America's top professional drivers for over 25 years, three-time Indianapolis 500-mile winner.



"Most drivers waste gas at stop lights. The smart driver goes at a steady pace, slowing down well back of a red light... avoiding the stop if possible."



"A professional driver always keeps well back of the car ahead. This way, he avoids gas-consuming 'panic' stops... possible rear-end collisions."



"A pro never speeds over a hill or into any 'blind' situation. It's dangerous... and even if you can stop in time, it's a stop and start that consumes extra gas."

You can think ahead of your car in more ways than one. Make sure you're getting all the performance you paid for... see your Rochester Carburetor specialist. He'll give your car the kind of care that only a factory-trained mechanic can. And he knows that Rochester Carburetors are precision-built for top performance on today's high-compression engines... they're rugged and reliable! They'll help you save on gas by delivering just the right mixture, at just the right time, to squeeze extra mileage out of every gallon.

Standard equipment on Cadillac, Buick, Oldsmobile, Pontiac and Chevrolet

**R** ROCHESTER  
CARBURETORS

ROCHESTER PRODUCTS DIVISION  
GENERAL MOTORS CORP., ROCHESTER, N. Y.



"A stop every good driver considers necessary is at his factory-trained mechanic's for regular checks on the carburetor and vital engine parts whose condition affects performance and economy."