

# POPULAR MECHANICS

## MAGAZINE

WRITTEN SO YOU CAN UNDERSTAND IT

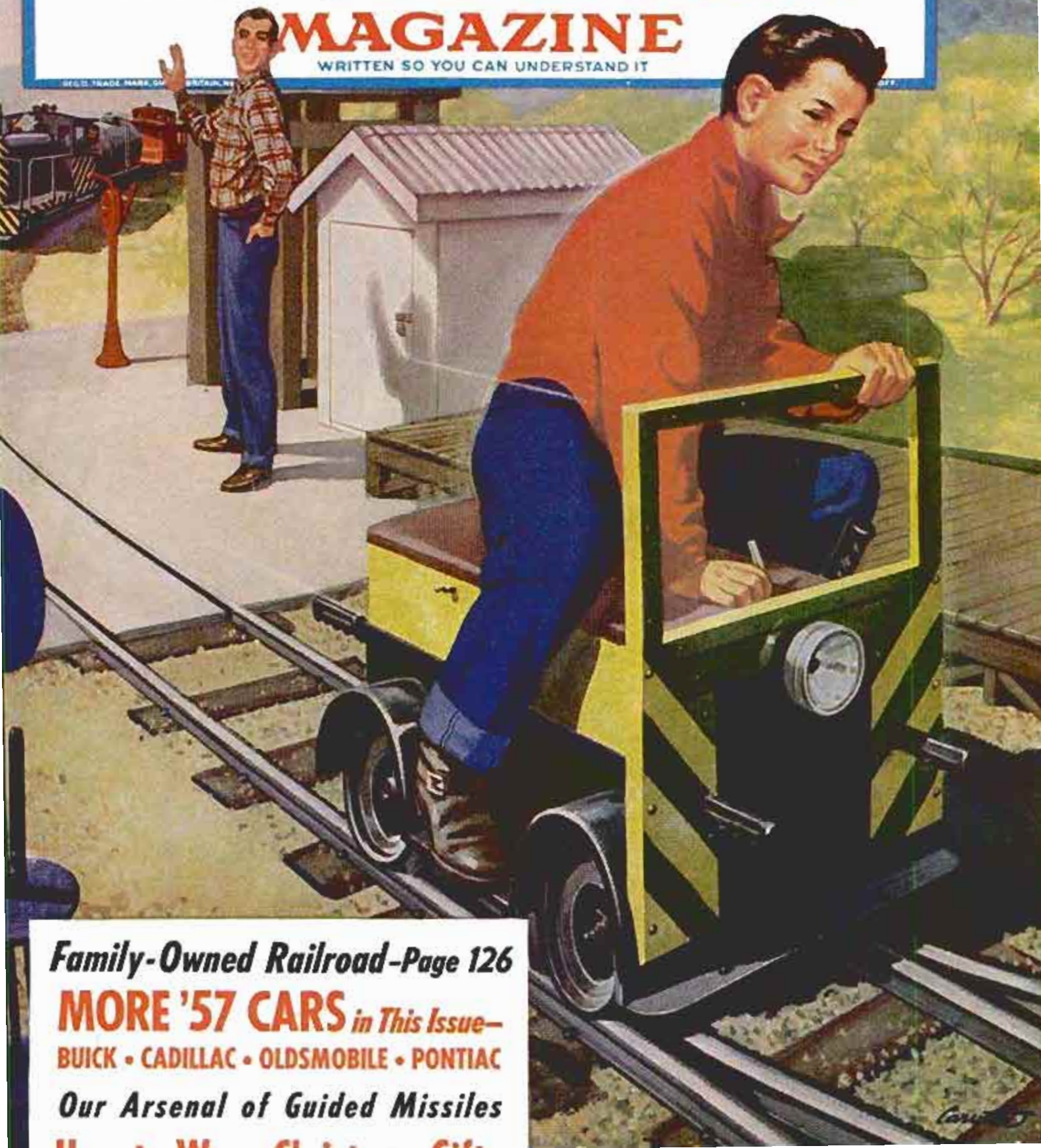

**Family-Owned Railroad—Page 126**

**MORE '57 CARS** in This Issue—

**BUICK • CADILLAC • OLDSMOBILE • PONTIAC**

**Our Arsenal of Guided Missiles**

**How to Make a...**



# BOYS WHO HAVE OUTGROWN "TOYS"...

have thrills and learn skills with these exciting Gilbert Sets!

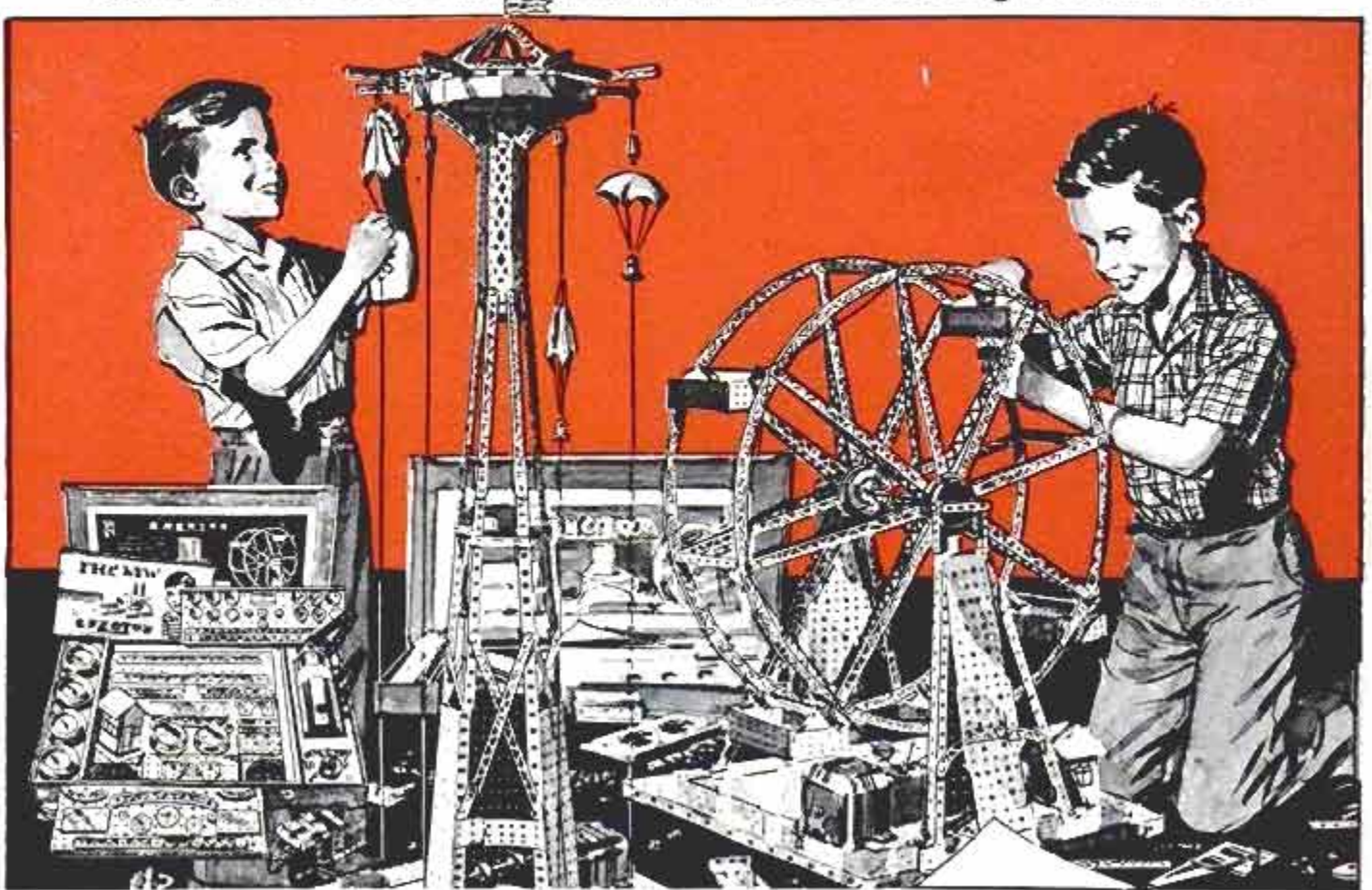

## Hatch real shrimp eggs with Gilbert MICROSCOPE SETS

See minute life in action and study vegetable and mineral structures just like scientists do. Many Gilbert Microscope Sets include real shrimp eggs—you can hatch them and watch 'em grow. This No. 22 Set has 4-turret, 750-power microscope and complete lab equipment. **\$21.50.\*** Others from \$5.50.\*



## Perform thrilling experiments with Gilbert CHEMISTRY SETS

New Gilbert Chemistry Sets are the most complete ever made. Perform chemical tests, original experiments, glass blowing, chemical magic. This No. 15 Set contains six steel shelves full of chemicals. Two test-tube racks, balance, alcohol lamp, many other features. **\$15.95.\*** Others from \$2.95.\*  
\*Slightly higher Denver and West

## Enjoy action, excitement with famous Gilbert ERECTOR SETS

Build hundreds of thrilling action models that really work. Erector gives you many features offered by no other construction toy. Design your own models, or follow the "How to Make 'Em" book that comes with your set. This No. 8½ Erector Set includes 16 lbs. of girders, gears, pinions, wheels and other parts, plus electric motor, lights and magnet, all in big steel chest. **\$27.50.\*** Others from \$2.50.\*

**SEND FOR FREE GILBERT CATALOG TODAY!**

The A. C. Gilbert Co., Dept. 116  
Erector Square, New Haven 6, Conn.

Please send me full-color catalog on Gilbert Erector, Chemistry, Microscope, Tool Chest, Magic and Puzzle Sets.

Name \_\_\_\_\_

Address \_\_\_\_\_

City \_\_\_\_\_ Zone \_\_\_\_\_ State \_\_\_\_\_





**X-RAY ON CHEVROLET**



**This is the '57  
that gets whistles from engineers!**

*Fuel injection on expensive foreign cars is an achievement—but in Chevrolet's class it's close to an industrial miracle! That's one of the big things that have engineers excited about the '57 Chevrolet. But look at some other precedent-breakers:*

**Five advanced engines,** from the "Blue-Flame 140" Six through four V8's—and, with Ramjet fuel injection,\* the top engine in the line produces an astounding 283 h.p. from 283 cubic inches! . . . one horsepower for each cubic inch! That's terrific efficiency!

**Two automatic drives.** One of the world's best-tested automatics, Powerglide.\* And a brand-new torque converter, Turbo-glide,\* with Triple-Turbine take-off. There's even a new position on the quadrant—Hill Retarder—that adds the braking power of the converter to that of the engine on hills.

**Smaller 14-inch wheels.** And Chevrolet uses softer tires with only 22-pound air pressure for a better ride. And there's better traction, too, that enhances Chevy's superior weight distribution.

**Integrated bumper-grille styling.** Smooth and clean, with no separate bumper hung on as an afterthought, it delights the eye. And there's no clutter of small pieces and fastenings to get loose and rattle. Chevy's tail assembly also follows the same modern trend for that tailored-in-steel appearance.

*\*Optional at extra cost.*

*From the '57 Chevrolet's bold prow to the tip of its flight-flared rear fenders everything bears the stamp of advanced engineering . . . engineering that must be seen and sampled by anyone interested in tomorrow's automotive design. . . . Chevrolet Division of General Motors, Detroit 2, Michigan.*

**CHEVROLET**



# New versatile Screwdriver Kit only \$36<sup>95</sup>

It's a 1/4" drill...a screw setter...a power screwdriver!



Porter-Cable's amazing new Screwdriver Kit gives you *three* of the world's handiest tools—at a real bargain price, if you act now.

The matchless Porter-Cable drill has all the speed and power you will ever need for any kind of drilling up to 1/4" in steel and 1/2" in hard wood.

The unique screw setter attachment drills precision pilot holes for the threaded portion of the screw, and a larger hole for the shank, countersinks for the screw head and counterbores for putty and wood plugs—all in one easy operation.

And simply by inserting the screwdriver attachment into the chuck, this Porter-Cable drill becomes a power screwdriver. It performs all your screwdriving needs easier, faster than ever.

This amazing screwdriver kit helps you get professional results in furniture-making, home improvements, fine cabinet work and shop work of every kind. Save \$5.00 if you buy *now*.

## SPECIAL INTRODUCTORY OFFER!

Model 161 Screwdriver Kit, complete with adjustable Screw Setter (for No. 8 screws) and Screw Driver attachments with slotted screw bit and Phillips bit, and Carrying Case constructed of strong, welded steel.

\$41.95 value... **\$36<sup>95</sup>**  
now only  
Offer expires Jan. 31, 1957



SEE YOUR DEALER—OR MAIL COUPON TODAY!

- PORTER-CABLE MACHINE CO.
- 614B N. Salina St., Syracuse 8, N. Y.
- Please send me complete information on Model 161 Screwdriver Kit and name of my nearest dealer.

Name \_\_\_\_\_

Address \_\_\_\_\_

City \_\_\_\_\_ Zone \_\_\_\_\_ State \_\_\_\_\_

**Porter-Cable**

*Quality Electric Tools*

In Canada: write Porter-Cable, Ltd., Box 5019, Ont., Canadian prices slightly higher.



# Popular Mechanics Magazine

Registered in U. S. Patent Office and Canada

H. H. WINDSOR, Founder

H. H. WINDSOR, JR., Editor and Publisher



## Next Month

NOW IS THE TIME to plan that vacation cabin you've always talked about. During the winter months, draw up a plan for action, come spring. A feature next month gives tips on selecting a site and illustrates various types of cabins. Some 16,000 summer homes have been built in our national forests. You too can have a beautiful one-acre site for your own use at low cost. For your family's sake, don't miss this feature

### POPULAR MECHANICS INTERNATIONAL EDITIONS

*Mecanique Populaire* (French)  
*Mecánica Popular* (Spanish)  
*Populaer Mekanik* (Danish)  
*Popular Mekanik* (Swedish)  
*Populare Mechanik* (German)

Sources of further information not listed in the index, starting on page 74, about articles in this issue, frequently are shown in the Where-to-Find-It List prepared for each issue. A copy may be obtained by readers, without charge, from Bureau of Information, Popular Mechanics, 200 East Ontario Street, Chicago 11, Ill.

Published monthly by Popular Mechanics Company, 200 E. Ontario St., Chicago 11, Ill. H. H. Windsor, Jr., president; Wm. Harrison Felridge, exec. vice-pres.; Franklin S. Forsberg, operations vice-pres.; D. F. Windsor, vice-president and secretary-treasurer; H. H. Windsor III, vice-president; W. T. Windsor, vice-president; Joseph R. Buell, Jr., advertising manager; Alan M. Deyoe, circulation manager. Single copy in the United States and Canada, 35 cents; subscription rates in the United States and possessions, Canada, Philippines and countries of the Pan-American Postal Union, 1 year \$3.50; 2 years, \$6.00; 3 years, \$8.00. To all other countries add \$1.00 a year over United States prices for overseas postage. If you plan to move, notify us at least 30 days in advance so you will not miss an issue. Give both your old and new addresses. Entered as Second Class Matter, September 15, 1903, at the Post Office at Chicago, Illinois, under Act of March 3, 1879. Entered as Second Class Matter at Post Office Dept., Canada. Registered as Second Class Matter at the Post Office at Mexico, D. F., Mexico, June 20, 1950.

Copyright 1956 by Popular Mechanics Company. Copyright under International Copyright Union. Copyright in France. All rights reserved under Pan-American Copyright Union. Printed in the United States of America.

**IMPORTANT NOTICE**—It is the intention of this magazine to provide its readers with information regarding the latest developments in the mechanical arts. We take no responsibility as to whether the disclosures contained in our articles are covered by patents and advise readers to investigate this subject before making, using, or selling any of the products, machines, or processes described in order to avoid possible liability for patent infringements.

Volume 106 DECEMBER 1956 Number 6

Address all communications to: 200 E. Ontario St., Chicago 11, Ill.

Managing Editor.....Roderick M. Grant  
 Assistant Managing Editor.....Wayne Whittaker  
 Shop Notes and Crafts Editor.....James R. Ward  
 Radio-Television, Electronics Editor.....Lothar Stern  
 Associate Editor.....Clifford B. Hicks  
 Associate Editor, Automotive.....Arthur R. Railton  
 Associate Editor, Shop Notes and Crafts.....Wayne C. Leckey  
 Associate Editor, Shop Notes.....W. Clyde Lammy  
 Assistant Editor, Crafts.....Jay W. Hedden  
 Assistant Editor, Makeup.....John C. Dolan  
 Automotive Correspondent.....Leo Donovan  
 Art Director.....Frank Beatty  
 Assistant Editors—Robert E. Dorsett, Emily M. Rice, Earl F. Wobeck  
 Eastern Editor.....Richard F. Dempewolff  
 Empire State Bldg., Room 2906, New York City 1  
 Western Editor.....Thomas E. Stimson, Jr.  
 Suite 1010, 3460 Wilshire Blvd., Los Angeles 5, Calif.  
 London Manager.....Douglas W. Wedderspoon  
 Eagle House, Jermyn St., London S. W. 1, England  
 Director, Bureau of Information.....Allan Carpenter  
 200 E. Ontario St., Chicago 11

### Advertising Offices

Chicago: 200 E. Ontario St., Whitehall 4-0100; New York: Empire State Bldg., 350 Fifth Ave., LOngacre 5-7580; Detroit: General Motors Bldg., Trinity 5-8711; Cleveland: Hanna Bldg., 1422 Euclid Ave., PRospect 1-0456; Los Angeles: 3460 Wilshire, DUnkirk 2-8458; San Francisco: Russ Bldg., 235 Montgomery St., YUkon 2-0823.

## In This Issue...

They Keep the Tower Clocks Running	81
Our Missile Arsenal	88
Detroit Listening Post	94
Gas Turbines Pep up Old Liberty Ship	96
More 1957 Cars Debut	102
Keeping Up With the Atom	107
White Land of Mystery	109
There's a Nice Future in Mink	118
Family Owned Narrow-Gauge Railroad	126
The World's Tiniest Town With TV	132
What's New for Your Home	142
Goal No. 2 — Winning the War Against Insects	149
Radio, TV and Electronics	157

## For the Craftsman...

Gift Wrapping	161
Build This Model of the Lachlan Macleay—Part I	170
Solving Home Problems	178
Protect Your Christmas Lighting	192
Decorate With Hardwood Plywood — Part III	197
Christmas Shopping for Tools	208
Is Your Wiring Adequate?—Part II	213
How Would You Do It?	218
Clinic for Homemakers	224

See pages 74, 76 and 78

for other items and manufacturers of available products



# A Christmas Gift you'll both enjoy ...together!

Here's a gift kit built around the Stanley Router that makes working together easy and fun. It includes the big  $\frac{1}{2}$  hp router that does 90% of all woodworking jobs, 5 most useful bits, a straight and circular guide, an instruction manual and 4 free Easi-Bild patterns of things to make. Ask at your hardware store for Stanley Router Gift Kit —

only  
**\$67<sup>95</sup>**  
complete

Another fine gift for the man of the house is this new Stanley  $6\frac{1}{2}$ " heavy duty builders saw. It is powered by a completely ball bearing, Stanley-made motor. The exclusive "Motor-Saver" Drive protects this power against the shock of sudden impact should blade strike a nail or other foreign object. H68 makes all cuts necessary to build a standard home.

only **\$64<sup>95</sup>**

Specify Stanley at your hardware store. Your dealer has these fine tools or can get them for you. For free catalog No. 400, write Stanley Electric Tools, Division of The Stanley Works, 62D Myrtle Street, New Britain, Connecticut.

Cutting a 2 x 4 at 45°

# STANLEY



**"My Army Recruiter  
gave me the opportunity  
I wanted"**

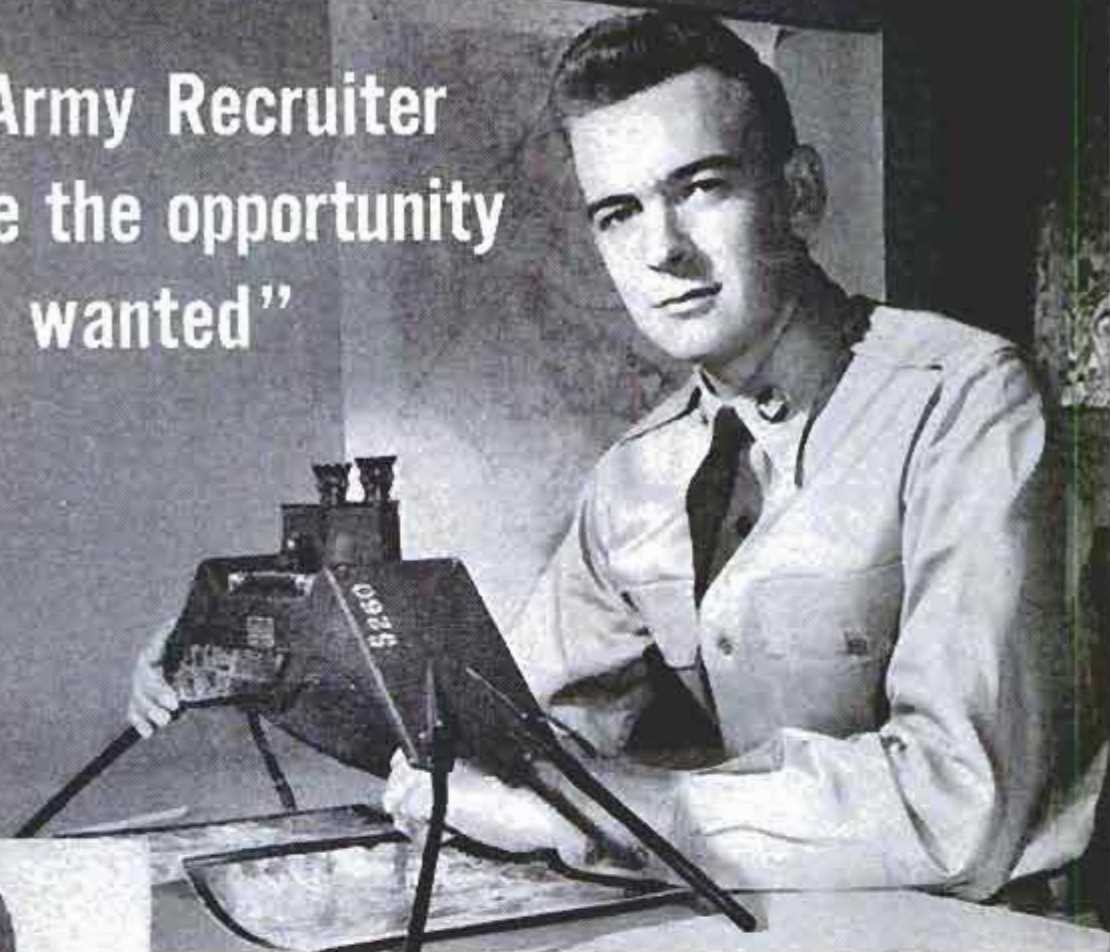

**SFC. Joel R. Ledford**  
Army Recruiter  
Marion, North Carolina

**...*"he showed me how to choose my  
job training before enlistment"***

"I really shopped around before deciding how to serve, and only the Army would guarantee that I'd get the training I wanted. My Army Recruiter was a real friendly guy and showed me how the Army lets you pick your own technical course. And you don't have to enlist until you get a written guarantee that your course is there for you. Now I'm becoming an expert in cartography and will be able to step into a specialist's job. Whatever you're interested in, you can bet the Army has a course in it. You just can't beat the deal the Army offers you. Your recruiter can fix it up for *you*, too. He's a mighty good man to get to know."

*Pvt. William H. Poteat Jr.*

Pvt. William Poteat, Jr.  
Marion, North Carolina  
Graduate, Glenwood High School

**YOUR ARMY RECRUITER WILL HELP YOU  
GET THIS SAME TRAINING PROGRAM**

You can get the same deal Bill got by visiting *your* local Army Recruiter. He'll tell you about the 100 courses to choose from—electronics, engineering, medicine, finance, mechanics—just about everything. When you select your course, your recruiter will get you a written guarantee

that a place in class is waiting for you. And not until after high school graduation do you actually enlist. So get in on this program right now and prepare for a great future. Just see your Army Recruiter and reserve the course of your choice—at no obligation!

**Get choice, not chance, from your Army Recruiter**





FOR YOUR  
**TECHNICAL EDUCATION**  
COME TO THE  
**COLLEGE OF TECHNOLOGY**  
**UNIVERSITY OF HOUSTON**

(Located in Houston, Texas)

*Select* from these fields

- Air Conditioning and Refrigeration Technology
- Air Conditioning, Refrigeration and Stationary Engineering Technology
- Diesel Technology
- Diesel Electric Technology
- Drafting Technology
- Electrical Technology
- Electronic Technology

**PREPARE FOR YOUR FUTURE NOW . . .**

With the very latest methods and equipment, at modern College of Technology, University of Houston. Open to high school graduates or equivalent. Accredited curricula.

Beautiful campus—275 wooded acres in Houston, Texas. All residence halls air conditioned. University T.V. and radio stations. Full college activities, intercollegiate sports, social life. Co-educational. Extensive personal guidance and counseling for all students. Continuing job placement assistance while attending school and at graduation. Earn part of tuition and expenses with part-time job while you learn. G.I. approved—V.A. office on campus.

Opportunity for graduates of the above programs to continue education and earn a Bachelor of Applied Science degree. Sept., Feb., and June semesters. Mail coupon now for FREE brochure. No obligation. Do it today.



**COLLEGE OF TECHNOLOGY, University of Houston**  
DEPT. 106, 3801 Cullen Blvd., Houston, Texas

Without cost or obligation, please send me brochure and full particulars. I am interested in subject marked X above.

Name \_\_\_\_\_ Age \_\_\_\_\_

Address \_\_\_\_\_

City \_\_\_\_\_ State \_\_\_\_\_

**ACROSS THE  
DESK**



**To the Editor:**

In order to deal with the multifarious and difficult problems which continuously arise in the criminal and juvenile courts, a judge naturally persists in probing for causes of delinquency and in devising new methods for meeting this challenge to our society.

It has occurred to me that in a large number of these homes where delinquency exists, there is often a lack of sufficient public schooling and also a lack of good reading matter for parent and child.

In order that I may have at hand in the court a copy of your publication, *Popular Mechanics*, perhaps other periodicals too, if any, which will act as a specimen for me to give to a defendant or family and would contain the information as to your address and cost of subscription, I wonder if you would be good enough to mail me, say, half a dozen copies of some of your back issues. If and when they are exhausted, I will write for more.

In light of the fact that as judge I have the power to send juveniles and adults to institutions for long or short periods at considerable cost either to the individual or to the country, it would appear that there should be some method in the way of supervision here in cases where we consider it proper to allow the offender to return home on probation, and have some supervision by the court over the family life, leisure time and activities and some constructive reading that will outline some useful types of leisure-time activities for the youth involved, and help to reorient his thinking and attitudes about life.

With best regards, and many thanks for any help you may be able to give in this matter, I am

Chauncey M. Depuy,  
President Judge,  
39th Judicial Dist. of Pennsylvania,  
Chambersburg, Pa.

*Popular Mechanics is proud to have a part in Judge Depuy's program and applauds his effort to find a remedy for delinquency—adult and juvenile—in constructive reading that presents useful kinds of leisure-time activities.*

**To the Editor:**

Why do we never see any articles or comments, editorially or news-wise, about

(Continued to page 8)



# 5 reasons why ACCOUNTING

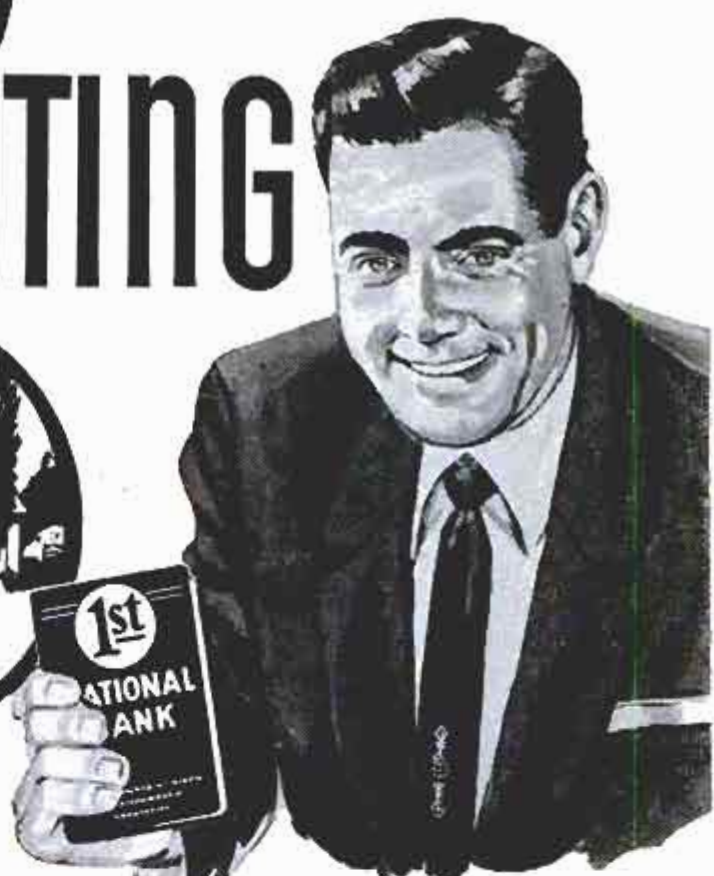

**offers you MORE MONEY... and SUCCESS!**

**REASON #1.** If you were an expert accountant right now, chances are you would find yourself among the highest-paid of all professional men and women. Even back in "depression years," accountants earned more than many men in other major professions.

**REASON #2.** The demand for accountants is great—everywhere. All businesses must have trained accountants to cope with ever-growing requirements. It's a profession offering wide opportunity—always—to the man who knows.

**REASON #3.** You can fit into any business, anywhere in the country—because accounting principles are universal. Think what this means in terms of security and independence!

**REASON #4.** Accounting is open to all. Any man or woman of good intelligence, who enjoys figure work and is willing to follow LaSalle's systematic "problem method" plan, can rapidly qualify for a highly profitable, enjoyable lifetime career... and he doesn't have to finish his training before beginning to "cash in."

**REASON #5.** Without losing a day from your present work, you can prepare in spare hours at home, at low cost, under LaSalle's step-by-step "Problem Method" of "learning by doing." This famous plan accounts for LaSalle's remarkable record of having trained one out of every 13 of all Certified Public Accountants in the U. S. . . . and of having put many thousands of others into high-paying careers.

Send today for Free Sample Lesson and "Accountancy, the Profession That Pays." Learn about the several great fields of opportunity . . . and LaSalle's time-tested plan for helping men and women to rapid advancement, higher income, greater prestige and professional standing. The coupon below will bring this information to you—without cost or obligation.

**MAIL THE COUPON—NOW**  
Member, National Home Study Council

→ **GET FREE SAMPLE LESSON** ←



**LASALLE**  
417 S. Dearborn St.,  
CHICAGO 5, ILL.  
DECEMBER 1956

**LaSalle Extension University**  
— A Correspondence Institution —  
Dept. 1264H, 417 S. Dearborn St., Chicago 5, Ill.

Please ?      This One      in  
Account      the Pro      cy,  
the Pro  
Name . . .      ..  
Address      ..  
City, Zone, State . . . . .

GYG1-SH5-UDTZ



(Continued from page 5)

the lack of reasonable quality in so many of the new cars? What is so taboo about the fact that some of the makers of high-production cars actually do so little to prevent the shoddy workmanship and sloppy assembly that are so well known?

How many readers of *Popular Mechanics* have had the experience of owning a late-model car slapped together by the "quick and dirty" method? How many times have we observed the numerous examples of

poor and skimpy paint jobs, the badly misaligned exterior body parts and shiny trim, and the quick-rusting chrome?

How many readers have had the aggravating experience of repeated expense and loss of valuable time in having many factory-built defects repaired, mainly because certain car makers did not and still do not build more quality into their cars?

Right now is the time for car owners to notify the car makers with repeated reminders that they have responsibility to all of us; that in return for the ever-increasing cost of cars we want at least better workmanship.

R. Blagden,  
Box 42, R.R. No. 3,  
East Hampton, Conn.

☆☆☆

The three-man shovel (left) has never become the standard of comparison in the United States. However, in far-off Korea they are quite common. This is a product of an over-abundance of manpower and a lack of machinery.

(Continued to page 10)



## New greaseless way to keep your hair neat all day



Prevents dry, unruly  
"chimpanzee hair"

New Vitalis keeps hair in place and prevents dryness with V-7, the *greaseless* grooming discovery.

You never have an overslick, plastered-down look. Try it. You'll like it.



# New VITALIS® Hair Tonic with V-7®

ANOTHER FINE PRODUCT  
OF BRISTOL-MYERS

POPULAR MECHANICS





When the other kids ask...

# WHAT DOES YOUR DAD DO?

How does your boy answer them?

Sure... you're his hero. You *know* that. But sometimes it can get kinda tough if the other kids don't seem to understand about the "old man."

It's not that you *like* to be chained to the same old job. Maybe you just *had* to leave school too soon. Maybe the war inter-

fered. Anyway, here you are, stuck because you just don't have enough formal training.

**Well, Mister, You Can Still Make the Grade!**

It isn't easy. You've got to have grit and determination and the will to succeed. As long as you have

these, I.C.S. can put you on the road to real prestige, advancement and security. Your family can really be proud of you!

## Spare-time I.C.S. Study Pays Off!

I.C.S. gives you practical, dollars-and-sense training — the kind that pays off. You choose from 256 courses. You get personalized, sympathetic guidance. You advance as rapidly as your time and ability permit. Does it work? Thomas Dyke was a coal miner with no high school education. He studied with I.C.S., worked his way up to licensed engineer. Today, his income is above the average for college trained engineers. *And this kind of training can work for you!*

**THREE FREE BOOKS—  
SEND TODAY!**

**BOOK No. 1 — "How to Succeed."**  
A gold mine of helpful job tips.

**BOOK No. 2 —** An outline of job opportunities in the field that interests you most.

**BOOK No. 3 —** A sample I.C.S. (math) lesson text that shows you the I.C.S. clear, step-by-step teaching method. Send the coupon today—no obligation!

For Real Job Security—Get an I. C. S. Diploma! I. C. S., Scranton 9, Penna. Member, National Home Study Council

## INTERNATIONAL CORRESPONDENCE SCHOOLS

65<sup>TH</sup>  
YEAR

BOX 58626M, SCRANTON 9, PENNA.

Without cost or obligation, send me "HOW TO SUCCEED" and the opportunity booklet about the field BEFORE which I have marked X (plus sample lesson):

- |                                                                                                                                                                                                                                                                                                                                                                                                                                                                                                                                                                                                                                                                                                                                                                                                                                                                                                                                                                                                                                                                                                                                                                                                                                                                                                                                                                                                  |                                                                                                                                                                                                                                                                                                                                                                                                                                                                                                                                                                                                                                                                                                                                                                                                                                                                                                                                                                                                                                                                                                                                                                                                                                                                                                                                                                                                                                                                                                                                                                                           |                                                                                                                                                                                                                                                                                                                                                                                                                                                                                                                                                                                                                                                                                                                                                                                                                                                                                                                                                                                                                                                                                                                                                                                                                                                                                                                                                                                                                                                                                                                                                          |                                                                                                                                                                                                                                                                                                                                                                                                                                                                                                                                                                                                                                                                                                                                                                                                                                                                                                                                                                                                                                                                                                                                                                                                                                                                                                                                                                                                                                                                                                                                                                                                                         |                                                                                                                                                                                                                                                                                                                                                                                                                                                                                                                                                                                                                                                                                                                                                                                                                                                                                                                                                                                                                                                                                                                                                                                                                                                                                                                                                                                                                                                                                                                                                                                                                                     |
|--------------------------------------------------------------------------------------------------------------------------------------------------------------------------------------------------------------------------------------------------------------------------------------------------------------------------------------------------------------------------------------------------------------------------------------------------------------------------------------------------------------------------------------------------------------------------------------------------------------------------------------------------------------------------------------------------------------------------------------------------------------------------------------------------------------------------------------------------------------------------------------------------------------------------------------------------------------------------------------------------------------------------------------------------------------------------------------------------------------------------------------------------------------------------------------------------------------------------------------------------------------------------------------------------------------------------------------------------------------------------------------------------|-------------------------------------------------------------------------------------------------------------------------------------------------------------------------------------------------------------------------------------------------------------------------------------------------------------------------------------------------------------------------------------------------------------------------------------------------------------------------------------------------------------------------------------------------------------------------------------------------------------------------------------------------------------------------------------------------------------------------------------------------------------------------------------------------------------------------------------------------------------------------------------------------------------------------------------------------------------------------------------------------------------------------------------------------------------------------------------------------------------------------------------------------------------------------------------------------------------------------------------------------------------------------------------------------------------------------------------------------------------------------------------------------------------------------------------------------------------------------------------------------------------------------------------------------------------------------------------------|----------------------------------------------------------------------------------------------------------------------------------------------------------------------------------------------------------------------------------------------------------------------------------------------------------------------------------------------------------------------------------------------------------------------------------------------------------------------------------------------------------------------------------------------------------------------------------------------------------------------------------------------------------------------------------------------------------------------------------------------------------------------------------------------------------------------------------------------------------------------------------------------------------------------------------------------------------------------------------------------------------------------------------------------------------------------------------------------------------------------------------------------------------------------------------------------------------------------------------------------------------------------------------------------------------------------------------------------------------------------------------------------------------------------------------------------------------------------------------------------------------------------------------------------------------|-------------------------------------------------------------------------------------------------------------------------------------------------------------------------------------------------------------------------------------------------------------------------------------------------------------------------------------------------------------------------------------------------------------------------------------------------------------------------------------------------------------------------------------------------------------------------------------------------------------------------------------------------------------------------------------------------------------------------------------------------------------------------------------------------------------------------------------------------------------------------------------------------------------------------------------------------------------------------------------------------------------------------------------------------------------------------------------------------------------------------------------------------------------------------------------------------------------------------------------------------------------------------------------------------------------------------------------------------------------------------------------------------------------------------------------------------------------------------------------------------------------------------------------------------------------------------------------------------------------------------|-------------------------------------------------------------------------------------------------------------------------------------------------------------------------------------------------------------------------------------------------------------------------------------------------------------------------------------------------------------------------------------------------------------------------------------------------------------------------------------------------------------------------------------------------------------------------------------------------------------------------------------------------------------------------------------------------------------------------------------------------------------------------------------------------------------------------------------------------------------------------------------------------------------------------------------------------------------------------------------------------------------------------------------------------------------------------------------------------------------------------------------------------------------------------------------------------------------------------------------------------------------------------------------------------------------------------------------------------------------------------------------------------------------------------------------------------------------------------------------------------------------------------------------------------------------------------------------------------------------------------------------|
| <p><b>ARCHITECTURE and BUILDING CONSTRUCTION</b></p> <ul style="list-style-type: none"> <li><input type="checkbox"/> Air Conditioning—Refrig.</li> <li><input type="checkbox"/> Architecture</li> <li><input type="checkbox"/> Architectural Interiors</li> <li><input type="checkbox"/> Building Contractor</li> <li><input type="checkbox"/> Building Estimator</li> <li><input type="checkbox"/> Building Maintenance</li> <li><input type="checkbox"/> Carpentry and Mill Work</li> <li><input type="checkbox"/> Heating</li> <li><input type="checkbox"/> Painting Contractor</li> <li><input type="checkbox"/> Plumbing</li> <li><input type="checkbox"/> Reading Arch. Blueprints</li> </ul> <p><b>ART</b></p> <ul style="list-style-type: none"> <li><input type="checkbox"/> Cartooning</li> <li><input type="checkbox"/> Commercial Art</li> <li><input type="checkbox"/> Fashion Illustrating</li> <li><input type="checkbox"/> Magazine Illustrating</li> <li><input type="checkbox"/> Show Card and Sign Lettering</li> <li><input type="checkbox"/> Sketching and Painting</li> </ul> <p><b>AUTOMOTIVE</b></p> <ul style="list-style-type: none"> <li><input type="checkbox"/> Auto Body Rebuilding</li> <li><input type="checkbox"/> Auto Elec. Technician</li> <li><input type="checkbox"/> Auto-Engine Tune Up</li> <li><input type="checkbox"/> Automobile Mechanic</li> </ul> | <p><b>AVIATION</b></p> <ul style="list-style-type: none"> <li><input type="checkbox"/> Aeronautical Engineering Jr.</li> <li><input type="checkbox"/> Aircraft &amp; Engine Mechanic</li> </ul> <p><b>BUSINESS</b></p> <ul style="list-style-type: none"> <li><input type="checkbox"/> Advertising</li> <li><input type="checkbox"/> Bookkeeping and Accounting</li> <li><input type="checkbox"/> Business Administration</li> <li><input type="checkbox"/> Business Correspondence</li> <li><input type="checkbox"/> Public Accounting</li> <li><input type="checkbox"/> Creative Salesmanship</li> <li><input type="checkbox"/> Federal Tax</li> <li><input type="checkbox"/> Letter-writing Improvement</li> <li><input type="checkbox"/> Office Management</li> <li><input type="checkbox"/> Professional Secretary</li> <li><input type="checkbox"/> Retail Business Management</li> <li><input type="checkbox"/> Sales Management</li> <li><input type="checkbox"/> Stenographic-Secretarial</li> <li><input type="checkbox"/> Traffic Management</li> </ul> <p><b>CHEMISTRY</b></p> <ul style="list-style-type: none"> <li><input type="checkbox"/> Analytical Chemistry</li> <li><input type="checkbox"/> Chemical Engineering</li> <li><input type="checkbox"/> Chem. Lab. Technician</li> <li><input type="checkbox"/> General Chemistry</li> <li><input type="checkbox"/> Natural Gas Prod. &amp; Trans.</li> <li><input type="checkbox"/> Petroleum Engineering</li> <li><input type="checkbox"/> Plastics</li> <li><input type="checkbox"/> Pulp and Paper Making</li> </ul> | <p><b>CIVIL, STRUCTURAL ENGINEERING</b></p> <ul style="list-style-type: none"> <li><input type="checkbox"/> Civil Engineering</li> <li><input type="checkbox"/> Construction Engineering</li> <li><input type="checkbox"/> Highway Engineering</li> <li><input type="checkbox"/> Reading Struct. Blueprints</li> <li><input type="checkbox"/> Sanitary Engineering</li> <li><input type="checkbox"/> Structural Engineering</li> <li><input type="checkbox"/> Surveying and Mapping</li> </ul> <p><b>DRAFTING</b></p> <ul style="list-style-type: none"> <li><input type="checkbox"/> Aircraft Drafting</li> <li><input type="checkbox"/> Architectural Drafting</li> <li><input type="checkbox"/> Electrical Drafting</li> <li><input type="checkbox"/> Mechanical Drafting</li> <li><input type="checkbox"/> Mine Surveying and Mapping</li> <li><input type="checkbox"/> Plumbing Drawing and Estimating</li> <li><input type="checkbox"/> Structural Drafting</li> </ul> <p><b>ELECTRICAL</b></p> <ul style="list-style-type: none"> <li><input type="checkbox"/> Electrical Engineering</li> <li><input type="checkbox"/> Electrical Maintenance</li> <li><input type="checkbox"/> Electrician <input type="checkbox"/> Contracting</li> <li><input type="checkbox"/> Lineman</li> </ul> <p><b>HIGH SCHOOL</b></p> <ul style="list-style-type: none"> <li><input type="checkbox"/> Commercial <input type="checkbox"/> Good English</li> <li><input type="checkbox"/> High School Subjects</li> <li><input type="checkbox"/> Mathematics</li> </ul> | <p><b>LEADERSHIP</b></p> <ul style="list-style-type: none"> <li><input type="checkbox"/> Foremanship</li> <li><input type="checkbox"/> Industrial Supervision</li> <li><input type="checkbox"/> Leadership and Organization</li> <li><input type="checkbox"/> Personnel-Labor Relations</li> </ul> <p><b>MECHANICAL AND SHOP</b></p> <ul style="list-style-type: none"> <li><input type="checkbox"/> Gas—Electric Welding</li> <li><input type="checkbox"/> Heat Treatment <input type="checkbox"/> Metallurgy</li> <li><input type="checkbox"/> Industrial Engineering</li> <li><input type="checkbox"/> Industrial Instrumentation</li> <li><input type="checkbox"/> Industrial Supervision</li> <li><input type="checkbox"/> Internal Combustion Engines</li> <li><input type="checkbox"/> Machine Design-Drafting</li> <li><input type="checkbox"/> Machine Shop Inspection</li> <li><input type="checkbox"/> Machine Shop Practice</li> <li><input type="checkbox"/> Mechanical Engineering</li> <li><input type="checkbox"/> Quality Control</li> <li><input type="checkbox"/> Reading Shop Blueprints</li> <li><input type="checkbox"/> Refrigeration</li> <li><input type="checkbox"/> Sheet Metal Worker</li> <li><input type="checkbox"/> Tool Design <input type="checkbox"/> Toolmaking</li> </ul> <p><b>RADIO, TELEVISION</b></p> <ul style="list-style-type: none"> <li><input type="checkbox"/> Industrial Electronics</li> <li><input type="checkbox"/> Practical Radio TV Eng'ng</li> <li><input type="checkbox"/> Radio and TV Servicing</li> <li><input type="checkbox"/> Radio Operating</li> </ul> | <p><input type="checkbox"/> Television Technician</p> <p><b>RAILROAD</b></p> <ul style="list-style-type: none"> <li><input type="checkbox"/> Air Brake Equipment</li> <li><input type="checkbox"/> Car Inspector</li> <li><input type="checkbox"/> Diesel Engineer &amp; Fireman</li> <li><input type="checkbox"/> Section Foreman</li> </ul> <p><b>STEAM AND DIESEL POWER</b></p> <ul style="list-style-type: none"> <li><input type="checkbox"/> Combustion Engineering</li> <li><input type="checkbox"/> Diesel—Elec. <input type="checkbox"/> Diesel Eng's</li> <li><input type="checkbox"/> Electric Light and Power</li> <li><input type="checkbox"/> Stationary Fireman</li> <li><input type="checkbox"/> Stationary Steam Engineering</li> </ul> <p><b>TEXTILE</b></p> <ul style="list-style-type: none"> <li><input type="checkbox"/> Carding and Spinning</li> <li><input type="checkbox"/> Cotton, Rayon, Woolen Mfg.</li> <li><input type="checkbox"/> Finishing and Dyeing</li> <li><input type="checkbox"/> Loom Fix'g <input type="checkbox"/> Textile Des'ing</li> <li><input type="checkbox"/> Textile Eng'g <input type="checkbox"/> Throwing</li> <li><input type="checkbox"/> Warping and Weaving</li> </ul> <p><b>MISCELLANEOUS</b></p> <ul style="list-style-type: none"> <li><input type="checkbox"/> Domestic Refrigeration</li> <li><input type="checkbox"/> Marine Engineering</li> <li><input type="checkbox"/> Ocean Navigation</li> <li><input type="checkbox"/> Professional Engineering</li> <li><input type="checkbox"/> Short Story Writing</li> <li><input type="checkbox"/> Telephony</li> </ul> |
|--------------------------------------------------------------------------------------------------------------------------------------------------------------------------------------------------------------------------------------------------------------------------------------------------------------------------------------------------------------------------------------------------------------------------------------------------------------------------------------------------------------------------------------------------------------------------------------------------------------------------------------------------------------------------------------------------------------------------------------------------------------------------------------------------------------------------------------------------------------------------------------------------------------------------------------------------------------------------------------------------------------------------------------------------------------------------------------------------------------------------------------------------------------------------------------------------------------------------------------------------------------------------------------------------------------------------------------------------------------------------------------------------|-------------------------------------------------------------------------------------------------------------------------------------------------------------------------------------------------------------------------------------------------------------------------------------------------------------------------------------------------------------------------------------------------------------------------------------------------------------------------------------------------------------------------------------------------------------------------------------------------------------------------------------------------------------------------------------------------------------------------------------------------------------------------------------------------------------------------------------------------------------------------------------------------------------------------------------------------------------------------------------------------------------------------------------------------------------------------------------------------------------------------------------------------------------------------------------------------------------------------------------------------------------------------------------------------------------------------------------------------------------------------------------------------------------------------------------------------------------------------------------------------------------------------------------------------------------------------------------------|----------------------------------------------------------------------------------------------------------------------------------------------------------------------------------------------------------------------------------------------------------------------------------------------------------------------------------------------------------------------------------------------------------------------------------------------------------------------------------------------------------------------------------------------------------------------------------------------------------------------------------------------------------------------------------------------------------------------------------------------------------------------------------------------------------------------------------------------------------------------------------------------------------------------------------------------------------------------------------------------------------------------------------------------------------------------------------------------------------------------------------------------------------------------------------------------------------------------------------------------------------------------------------------------------------------------------------------------------------------------------------------------------------------------------------------------------------------------------------------------------------------------------------------------------------|-------------------------------------------------------------------------------------------------------------------------------------------------------------------------------------------------------------------------------------------------------------------------------------------------------------------------------------------------------------------------------------------------------------------------------------------------------------------------------------------------------------------------------------------------------------------------------------------------------------------------------------------------------------------------------------------------------------------------------------------------------------------------------------------------------------------------------------------------------------------------------------------------------------------------------------------------------------------------------------------------------------------------------------------------------------------------------------------------------------------------------------------------------------------------------------------------------------------------------------------------------------------------------------------------------------------------------------------------------------------------------------------------------------------------------------------------------------------------------------------------------------------------------------------------------------------------------------------------------------------------|-------------------------------------------------------------------------------------------------------------------------------------------------------------------------------------------------------------------------------------------------------------------------------------------------------------------------------------------------------------------------------------------------------------------------------------------------------------------------------------------------------------------------------------------------------------------------------------------------------------------------------------------------------------------------------------------------------------------------------------------------------------------------------------------------------------------------------------------------------------------------------------------------------------------------------------------------------------------------------------------------------------------------------------------------------------------------------------------------------------------------------------------------------------------------------------------------------------------------------------------------------------------------------------------------------------------------------------------------------------------------------------------------------------------------------------------------------------------------------------------------------------------------------------------------------------------------------------------------------------------------------------|

Name \_\_\_\_\_ Age \_\_\_\_\_ Home Address \_\_\_\_\_

City \_\_\_\_\_ Zone \_\_\_\_\_ State \_\_\_\_\_ Working Hours \_\_\_\_\_ A.M. to P.M. \_\_\_\_\_

Occupation \_\_\_\_\_

Canadian residents send coupon to International Correspondence Schools, Canadian, Ltd., Montreal, Canada. . . . Special tuition rates to members of the U. S. Armed Forces.



# CLEAN YOUR CARBURETOR

Feel the difference!



For quick Winter starts clean your carburetor with GUMOUT. Eliminates stalling, bucking, loss of power.

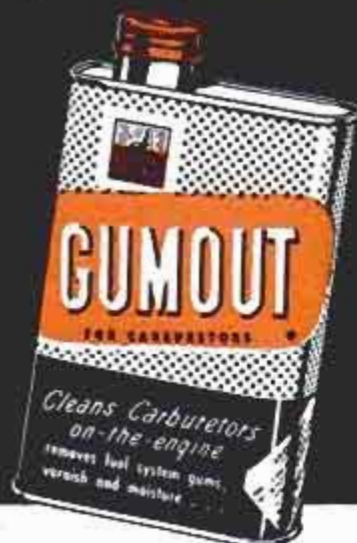

- Whatever the season—don't let a dirty, gummed up carburetor rob your car of power . . . when it's so easy and inexpensive to keep it clean with GUMOUT.
- GUMOUT cleans carburetors fast—without fuss.
- Nothing to take apart. Anyone can use it.
- Have your serviceman run it through your carburetor . . . or just add it to your gas tank at regular intervals.
- Available at service stations, auto supply stores everywhere.



SEND FOR **FREE**

46-page

"CARBURETOR HANDBOOK"

GUMOUT DIVISION  
Pennsylvania Refining Company  
2671 Lisbon Road  
Cleveland 4, Ohio

(Continued from page 8)

## Filipino Motor Bike

From a reader in the Philippines, Timoteo Llevares of Maasin, Leyte, comes this photograph of the motorized bicycle which



he improvised, using a Travis motor of three-quarter horsepower and a V-belt transmission. Llevares is in the plumbing trade. He reports better mileage and speed on the motor bike as it appears here than with the power applied to the front wheel.

## "School Bus" for One

Robert Smith of Woodland, Ill., has his own private "school bus"—a miniature homemade racing car. He drives it daily to and from school at Watseka, Ill. The car is powered by a Briggs and Stratton air-cooled engine, mounted over the rear axle. It has pneumatic tires, springs, a standard steering system, brakes and gearshift.







### YOU BUILD Broadcasting Transmitter

As part of N.R.I. Communications Course you build this low power Transmitter; use it to learn methods required of commercial broadcasting operators, train for FCC license.

### YOU BUILD Signal Generator

N.R.I. sends kits of parts to build this Signal Generator. You get practical experience, conduct tests to compensate Radio frequency amplifiers, practice aligning a typical I.F. video amplifier in TV circuit.



### YOU BUILD Vacuum Tube Voltmeter

Use it to get practical experience, earn extra cash fixing neighbors' sets in spare time. With N.R.I. training you work on circuits common to both Radio and TV. Equipment you build "brings to life" things you learn in N.R.I.'s easy-to-understand lessons. 64-page Catalog FREE, shows all equipment you get.



### YOU BUILD AC-DC Superhet Receiver

N.R.I. servicing training supplies all the parts, everything is yours to keep. Nothing takes the place of practical experience. You get actual servicing experience by practicing with this modern receiver; you learn-by-doing.



# Learn RADIO TELEVISION

by Practicing at Home

## WHAT GRADUATES DO AND SAY

"I am Chief Engineer of Station KOCU in Mandan, N. D. I also have my own spare time business servicing high frequency two-way communications systems."—R. BARNETT, Bismark, N. D.



"We have an appliance store with our Radio and TV servicing, and get TV repairs. During my Army service, NRI training helped get me a top rated job."—W. M. WEIDNER, Fairfax, S. D.



"I am doing very well in spare time TV and Radio. Sometimes have three TV jobs waiting and also fix car Radios for garages. I paid for instruments out of earning."—G. F. SEAMAN, New York, New York.



## NEED FOR TECHNICIANS INCREASING Fast Growing Field Offers Good Pay, Bright Future

Today's OPPORTUNITY field is Radio-Television. Over 125 million home Radios plus 30 million sets in cars and 40,000,000 Television sets means big money for trained Radio-TV Technicians. More than 4,000 Radio and TV Broadcasting stations offer interesting and important positions for technicians, operators, Color television, portable TV sets, Hi-Fi, other developments assure future growth. It's the trained man who gets ahead. The fellow who uses his spare time to develop knowledge and skill gets the better job, drives a better car, lives in a better home, is respected for what he knows and can do. So plan now to get into Radio-TV.

Keep your job while training with N.R.I. You learn at home in your spare time. N.R.I. is the oldest and largest home study Radio-TV School. Our methods have proved successful for more than 40 years. Soon after enrolling, many N.R.I. students start to earn \$10, \$15 a week extra in spare time fixing sets. Many open their own full-time Radio-TV shops after getting N.R.I. Diploma. Find out more. Mail Coupon. Cost is low, terms easy; includes all equipment. Address: National Radio Institute, Dept. 6NA, Washington 9, D. C.

Send for  
**LESSON**  
and **CATALOG**  
**FREE**

**VETERANS**  
Available under  
G.I. Bills



## MAIL COUPON NOW

**NATIONAL RADIO INSTITUTE**  
Dept. 6NA, Washington 9, D. C.

Mail me Sample Lesson and 64-Page Catalog, FREE. (No Salesman will call. Please write plainly.)

Name.....Age.....

Address.....

City.....Zone.....State.....

ACCREDITED MEMBER, NATIONAL HOME STUDY COUNCIL



## WHAT SECRET POWER DID THIS MAN POSSESS?



**BENJAMIN FRANKLIN**  
(A Rosicrucian)

**WHY** was this man great? How does anyone—man or woman—achieve greatness? Is it not by mastery of the powers within ourselves? Know the mysterious world within you! Attune yourself to the wisdom of the ages! Grasp the inner power of your mind! Learn the secrets of a full and peaceful life!

Benjamin Franklin—like many other learned and great men and women—was a Rosicrucian. The Rosicrucians (NOT a religious organization) first came to America in 1694. Today, headquarters of the Rosicrucians send over seven million pieces of mail annually to all parts of the world. Write for **YOUR FREE COPY** of "The Mastery of Life"—**TODAY**. No obligation. No salesmen. A non-profit organization. Address: Scribe W.Z.Z.

**THIS BOOK FREE!**



## The ROSICRUCIANS

SAN JOSE • (AMORC) • CALIFORNIA

—SEND THIS COUPON—

Scribe W.Z.Z.  
The ROSICRUCIANS (AMORC)  
San Jose, California  
Please send me the free book, *The Mastery of Life*, which explains how I may learn to use my faculties and powers of mind.

Name \_\_\_\_\_  
Address \_\_\_\_\_  
City \_\_\_\_\_



**instead of a job  
... train for a Career**



Industrial growth . . . automation . . . technical advances create career opportunities for engineers, accountants, management experts. Share rewards awaiting college-trained men. Important firms visit campus regularly to employ Tri-State College graduates. Start any quarter in this world-famed college. *Approved for veterans.*

**Bach. of Science degree in 27 months**

In Mechanical, Civil, Electrical, Chemical, Aeronautical, Radio (TV-Electronics) Engineering. In 36 Months a B.S. in Business Administration (General Business, Accounting, Motor Transport Management majors). Capable students may accelerate, 36-weeks course in Drafting. *Intensive program: technical fundamentals stressed: comprehensive courses with more professional class hours. Small classes: personalized instruction. For earnest, mature students whose time and budget require accelerated courses and modest costs. Preparatory courses. Beautiful campus in friendly college town. Well-equipped, new and modernized buildings and laboratories. Enter Jan., March, June, Sept. Write Jean McCarthy, Director of Admissions, for "Your Career in Engineering and Commerce."*



**TRI-STATE COLLEGE**

4126 College Avenue • • • Angola, Indiana

**"We're looking for people  
who like to draw..."**



says Norman Rockwell, one of America's 12 Most Famous Artists. If you like to draw, you may have talent to become a successful artist, spare or full time. Find out with our remarkable 12-page Free Art Talent Test. Thousands paid \$1 to take it. Get it FREE. No obligation. Send your name, address, age to: Famous Artists Schools, Dept. 6-N, Westport, Conn.

**WELDING may aid your SUCCESS**

Are and Acetylene; welding metallurgy; Helarc, etc. This is home, spare-time training for men who appreciate the importance of welding and want to advance in the art, get promotion, enlarge own shop, etc. Send for FREE BOOK, Utilities Engineering, 2523 Sheffield, Dept. WC-15, Chicago 14

**LEARN LOCKSMITHING**

Learn this fascinating, profitable trade from experts in your spare time at home! Age or physical handicap no disadvantage. Year around, steady income. Full or part time. Practical, illustrated lessons. You can make money even while learning! All materials and special tools supplied without extra charge. **INSTITUTE OF LOCKSMITHING, Dept. P-85** 15 PARK AVENUE RUTHERFORD, N. J. Lic. by N. J. State Board of Education *Approved for Veterans*

send for **FREE BOOKLET**



**FREE! LAFAYETTE CATALOG**

- WORLD'S LARGEST HI-FI CENTER
- MORE VALUE—MORE ITEMS
- EVERYTHING IN ELECTRONICS



NAME \_\_\_\_\_  
ADDRESS \_\_\_\_\_  
CITY \_\_\_\_\_ ZONE \_\_\_\_\_  
STATE \_\_\_\_\_

**Lafayette Radio** 165-08 Liberty Ave. JAMAICA 33; N. Y. **DEPT KJ** CUT OUT AND MAIL TODAY!





# INVENTORS

**L**earn how to protect your invention. The U. S. Patent Laws provide that any new and useful art, machine, article of manufacture, or composition of matter, or any new and useful improvement thereof, may be patented if the act of invention is involved. Therefore, every inventor with a valuable invention should take advantage of the Patent Laws and proceed for patent protection in order to safeguard his rights.

A patent gives the inventor the exclusive right to prevent others from making, using, or selling the invention claimed in the patent for a period of seventeen years.

The Patent Laws were enacted for the benefit of the inventor to give him protection for the features of his invention which are patentable. These features must be properly and concisely set forth and claimed in a formal application for patent, in order to comply with the requirements of the Patent Laws. For that reason, unless the inventor is familiar with patent matters, he should engage a competent registered patent attorney or agent to represent him. We are registered to practice before the U. S. Patent Office and are prepared to serve you in the handling of your patent matters.

A specially prepared booklet entitled "Patent Guide for the Inventor", containing detailed information with respect to patent protection and procedure, together with a "Record of Invention" form will be promptly forwarded to you without obligation upon request.

**CLARENCE A. O'BRIEN & HARVEY JACOBSON**

*Registered Patent Attorneys*

**61-M DISTRICT NATIONAL BUILDING**

**WASHINGTON 5, D. C.**



**SAM HANKS**, famous race driver-mechanic says,  
 "I'd like a **NATIONAL SCHOOLS**  
 trained mechanic on my crew  
 ... any employer would!"

Sam Hanks holds American Closed Course record (182.5 M.P.H.); also many state and national racing titles. At Indianapolis he was 2nd last year, 3rd in '52 and '53.



**MASTER ALL ENGINES**  
**AT HOME IN YOUR SPARE TIME**  
**NATIONAL SCHOOLS**  
**AUTO MECHANICS & DIESEL**  
**COURSE**  
 INCLUDING FUEL INJECTION

**YOU GET AND KEEP ALL THIS EQUIPMENT**



Complete set of professional Tools and All-Metal Tool Box. Same top-quality equipment used by expert mechanics everywhere. Use them, display them proudly.



"Motor Analyzing Set" contains Standard Engine Vacuum Fuel Pump Tester, Remote Starter Switch, Modern Timing Light, Standard Compression Tester. Plus compact carrying case & instructions.



Top-quality Socket Wrench with Fittings. Real professional tools you'll use during your lifetime career in repairing, all types of engines, from foreign cars to big diesel jobs.

"I've worked alongside National Schools-trained mechanics," reports Sam Hanks. "They're tops, because they get all-around training, and they know how to repair fast and right the first time. No wonder National Schools graduates command top pay."

Earn as you learn men! We'll show you how. Streamlined lessons, diagrams, manuals, latest equipment, practical methods prepare you for hundreds of jobs in scores of industries. Free Placement Assistance. Send coupon now.

**FREE! VALUABLE BOOK & SAMPLE LESSON**  
 JUST SEND COUPON



Approved for GI Training  
**NATIONAL SCHOOLS**

Los Angeles 37, California  
 CANADA: 811 W. Hastings St., Vancouver, B. C.

**NATIONAL SCHOOLS**

TECHNICAL TRADE TRAINING SINCE 1905  
 LOS ANGELES 37, CALIFORNIA

**NATIONAL SCHOOLS, Dept DB-126**  
**MAIL NOW TO OFFICE NEAREST YOU**

4000 S. FIGUEROA ST. OR 187 N. LA SALLE ST.  
 LOS ANGELES 37, CALIF. CHICAGO 1, ILL.  
 Send for FREE Auto-Diesel Opportunity Book and Sample Lesson.

NAME \_\_\_\_\_ AGE \_\_\_\_\_

ADDRESS \_\_\_\_\_

CITY \_\_\_\_\_ ZONE \_\_\_\_\_ STATE \_\_\_\_\_

Check if interested ONLY in Resident Training at Los Angeles.  
 VETERANS: Give date of Discharge \_\_\_\_\_

**INSURED TIRE SERVICE**  
**POPULAR BRANDS**

**FREE** INSURANCE POLICY given with each used tire sold. We guarantee the amount of service you pay for.

**YOU CAN'T LOSE!!**

**GOODYEAR SUBURBANITE TYPE SNOW TIRES**  
 New Tire Guarantee—Factory Rebuilt  
**BEST WINTER TRACTION OF ALL!**

670x15	\$9.95	710x15	650x16	650x15	\$10.90
600x16		760x15	800-820x15		

Super Quality — Regged Performance — 6 Months Insured Service

600x16	\$3.65	670x15	\$3.95	700x16	\$4.45	760x16	\$4.75
650x15	3.85	670x16	4.05	710x15	4.35	820x15	4.95
650x16	4.25	700x15	3.95	760x15	4.45	850x17	4.65

Supreme Quality — Nothing Finer — 12 Months Insured Service

600x16	\$5.25	475x19	\$8.45	700x15(6)	\$10.45	700x20	\$12.50
600x16(6)	6.75	640x15	4.95	780x16(8)	15.95	750x20(8)	15.50
650x16	5.75	670x15	5.35	700x17	11.95	750x20(10)	17.50
650x16(6)	7.25	710x15	5.45	750x17	16.45	825x20	21.50
700x16	8.35	760x15	5.95	750x15	10.95	900x20	19.95
750x16(6)	8.45	800x15	6.35	30x8	11.25	1000x20	20.45
550x18	4.95	820x15	6.35	600x20	10.05	1100x20	21.25
550x17	4.75	550x15	5.35	650x20	11.75	1000x22	21.95
650x15	5.25	670x16	5.15	32x8(6)	11.95	1100x22	22.75
700x15	5.35	700x16(6)	10.25	32x6(10)	12.75	1100x24	25.95

Whitewalls \$1.00 extra.

Speedy shipments on Mail Orders. F.O.B. Chicago. Insurance policy sent with each order. Deduct 10% on orders for 2 or more used tires. Send CHECK or MONEY ORDER.—No COD's.

**MIDLAND TIRE SALES**  
 3701 S. Normal, Dept. PM-53, Chicago 9, Ill.

**THE Big Favorite**  
 SANFORIZED  
**WORK CLOTHES**

**Home Craftsmen And Do-It-Yourself Fans—**  
 Make neat, longwearing Big Favorite work and leisure clothes your "uniform" for workshop and do-it-yourself jobs. Many fashionable, practical styles.

25,000 DEALERS, COAST TO COAST

Guaranteed by Good Housekeeping

**THE FAVORITE GARMENT CO.** Lynchburg, Va. Jackson, Miss.

**WORLD'S LOWEST PRICED ADDING MACHINE**  
 Vest Pocket Size  
**FREE TRIAL \$2.95**

COUNTS UP TO 999,999,999  
**IDEAL FOR BUSINESS AND PERSONAL USE—GUARANTEED ACCURATE.**  
 Not a toy. Operates with only a finger flick. Adds, subtracts, multiplies, divides. Counts up to one billion. Pays for itself over and over. Ideal Gift—for Business, Income Tax and School use. **MONEY BACK GUARANTEE.** Send name and address. Pay postman only \$2.95 plus postage. Beautiful rich-looking Leatherette Case included at no extra cost. Money back in 10 days if not delighted. AGENTS WANTED.

**CALCULATOR MACHINE COMPANY**  
 P.O. Box 126, Dept. D-56, Huntingdon Valley, Penna.

**Shrinks Hemorrhoids**  
**New Way Without Surgery**

**Science Finds Healing Substance That Relieves Pain—Shrinks Hemorrhoids**

For the first time science has found a new healing substance with the astonishing ability to shrink hemorrhoids and to relieve pain—without surgery.

In case after case, while gently relieving pain, actual reduction (shrinkage) took place.

Most amazing of all—results were so thorough that sufferers made astonishing statements like "Piles have ceased to be a problem!"

The secret is a new healing substance (Bio-Dyne\*)—discovery of a world-famous research institute.

This substance is now available in suppository or ointment form under the name *Preparation H*. Ask for it at all drug counters—money back guarantee. \*Reg. U. S. Pat. Off.



LEARN

# ELECTRICITY AND Industrial Electronics

ON REAL EQUIPMENT  
IN THE GREAT SHOPS

# OF COYNE

LARGEST, OLDEST AND BEST EQUIPPED  
SCHOOL OF ITS KIND IN U.S.

This five story Chicago building is occupied entirely by Coyne. Five big floors of Classrooms and Massive Equipment. Thousands of successful men have trained at Coyne during past 58 years. There is no substitute for Coyne's wealth of experience.

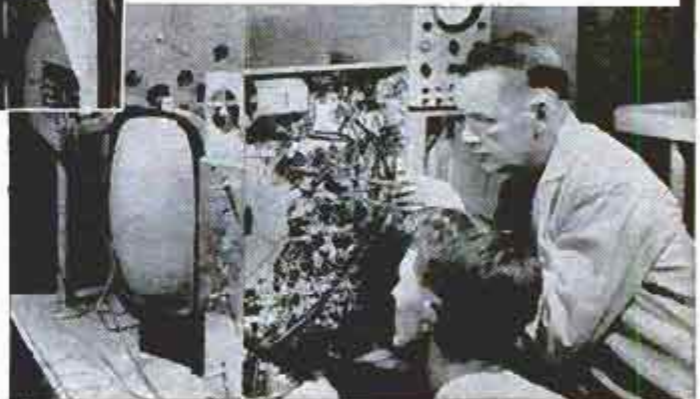
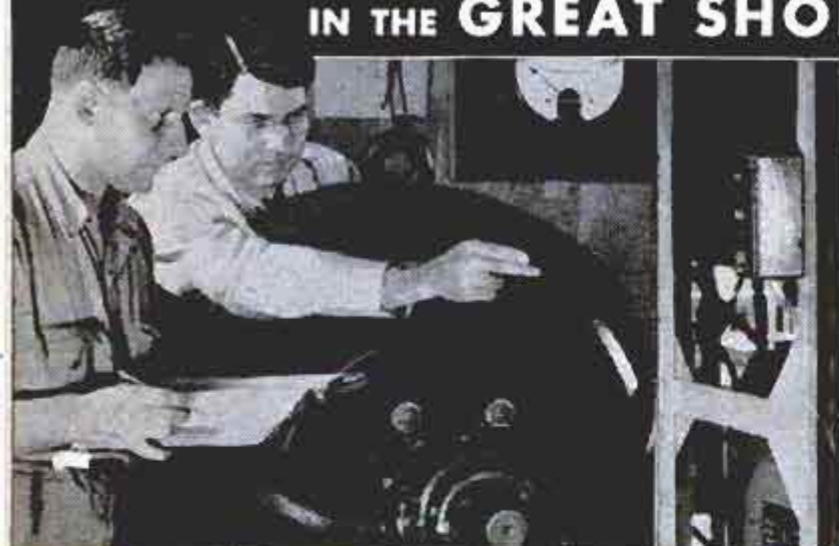

## TELEVISION—RADIO—COLOR TV

Great opportunity for a good job or your own business in one of America's fastest growing industries! New stations by the hundreds . . . new sets by the millions . . . and now Color TV . . . all means greater opportunities in Sales and Service. Separate courses in Radio-Television or in combination with Electricity-Electronics available. Coupon brings details.

### Mail coupon for big free book!

48 Page Illustrated Book, "Guide to Careers" gives you all the facts, answers your questions. Whether you prefer Electricity-Electronics or Television-Radio this book describes all training offered.

All information will come by return mail. No obligation and no salesman will call, so send coupon now!



Coyne Electrical School, Dept. 96-72H  
500 S. Paulina St., Chicago 12, Ill.

Send **BIG FREE BOOK** and details of all training you offer. However, I am especially interested in

Electricity-Electronics       Television-Radio

Name \_\_\_\_\_

Address \_\_\_\_\_

City \_\_\_\_\_ State \_\_\_\_\_

(I understand no Salesman will call.)

## Young men and Older men prepare for OPPORTUNITIES IN ELECTRICITY-ELECTRONICS

Whether 17 or up to 45 years of age, don't be satisfied with a "no future job." Train the Coyne way for a better job in *Electricity-Electronics*—a field that offers a world of opportunities now and in the years ahead. In industry—in the home—Electricity and Electronics are playing a vastly greater role than ever before. New developments and fabulous growth are creating increasing job opportunities.

**AUTOMATION ELECTRONICS**—one of the more recent applications of Industrial Electronics to manufacturing processes—promises to create additional demands for trained Electrical-Electronics men such as we have never seen.

**YOU TRAIN IN CHICAGO**—Learn the easier practical way in shops of Coyne in Chicago. Shop work plus technical training. No advanced education or previous experience needed. Lifetime Employment Service to Coyne Graduates.

**START NOW—PAY LATER**  
New liberalized credit terms and Finance Plans. Part-time employment service to students. Help in making housing arrangements.

**VETERANS OR NON-VETERANS**  
Coyne training is offered to Veterans and Non-Veterans alike. We'll send Bulletin giving full information. Send coupon for details.

Training in Refrigeration and Electric Appliances can be included.



1. You are told the how and why of each job.

2. You're shown how to do it by trained instructors.

3. You do the jobs yourself on finest equipment.

B. W. COOKE JR., President

# COYNE

FOUNDED 1899  
ELECTRICAL SCHOOL

A Technical Trade Institute Operated Not For Profit  
500 S. Paulina Street, Chicago, Dept. 96-72H  
ELECTRICITY • RADIO • TELEVISION • REFRIGERATION • ELECTRONICS





**Want better pay,  
steady work and  
a way to make  
extra money?**

# Learn at Home IN YOUR SPARE TIME to Fix Electrical Appliances

To build a better future, get into a field where there's much important work and the security that comes from knowing a good trade. Servicing electrical appliances offers that OPPORTUNITY. Every wired home has an average of 8 electrical appliances. Up to 10 million new appliances are sold every year and owners pay well to keep them in repair. That's making a fast-growing need for trained men.

## Start Soon to Earn \$3, \$4, \$5 an Hour Extra in Your Spare Time

Start soon to fix electric toasters, clocks, fans, vacuum cleaners and other appliances for neighbors and friends. Work in your basement, garage or spare room. Pick up \$3 to \$5 an Hour extra that way. It's easy to increase your earning power—to pay for this training many times over with your spare time earnings.

## Learn and Earn with Multi-Use Tester Built with Parts We Send

This course includes the parts to build a portable, sturdy Appliance Tester that helps you locate electrical defects quickly and easily. You use it to learn and do actual electrical appliance repair jobs. If you want better pay learn this good

trade. No need to give up your present job. You can train at home in your spare time for only \$2.50 down and \$5.00 a month. A small price to pay for increased earnings, a more secure future. Paste coupon below on a 2c postal or mail in envelope for free book and sample lesson. Address National Radio Institute, Dept. AN6, Washington 9, D. C.

**2c TO MAIL THIS  
COUPON MAY START  
YOU TO SUCCESS  
LESSON AND BOOK  
FREE**



**NATIONAL RADIO INSTITUTE  
Dept. AN6, Washington 9, D.C.**

Please send me Electric Appliance Training lesson and book free. (No salesman will call.)

Name \_\_\_\_\_ Age \_\_\_\_\_

Address \_\_\_\_\_

City \_\_\_\_\_ Zone \_\_\_\_\_ State \_\_\_\_\_

APPROVED MEMBER NATIONAL HOME STUDY COUNCIL



# INVENTORS

If you believe that you have an invention, you should find out how to protect it. The first step is to have a search made of the prior pertinent U. S. patents. If a report on this search indicates that the invention appears patentable you can apply for a patent, and the specifications and claims should be prepared.

The firm of McMorrow, Berman & Davidson, with offices in Washington, D. C., is qualified to take the necessary steps for you. We can make a preliminary search on your invention, advise you whether we think it can be patented, and prepare your application for

patent.

Unless you are fully familiar with the U. S. Patent Laws, we recommend that you engage the services of a Registered Patent Attorney to protect your interests. The patent laws are *your* laws. A patent gives you the right to prevent others from making, using or selling the invention claimed in your patent for a period of 17 years.

Use these patent laws for your protection. Investigate whether your invention can be patented. If you have what you believe to be an invention, we suggest that you have this firm make a search for you.

*Send for a copy of our Patent Booklet entitled "How To Protect Your Invention," containing information about patent protection and patent procedure. Along with this we will also send you an "Invention Record" form, for your use in writing down and sketching details of your invention. We will mail them promptly. No obligation. They are yours for the asking.*

## McMORROW, BERMAN & DAVIDSON

*Registered Patent Attorneys*

**PATENTS • COPYRIGHTS • PATENTS**

**1356 VICTOR BUILDING, WASHINGTON 1, D. C.**



# LET CAR EXPERTS GUIDE YOUR HANDS THROUGH ANY AUTO REPAIR



**QUICKLY--  
EASILY--RIGHT!**

**FREE  
7-DAY  
TRIAL**



**Covers 737 Models  
—1946 thru 1956**

- |             |             |
|-------------|-------------|
| Buick       | Imperial    |
| Cadillac    | Jeep        |
| Chevrolet   | Kaiser      |
| Chrysler    | Lincoln     |
| Clipper     | Mercury     |
| Continental | Nash        |
| Crosley     | Oldsmobile  |
| De Soto     | Packard     |
| Dodge       | Plymouth    |
| Ford        | Pontiac     |
| Frazer      | Rambler     |
| Henry J     | Studebaker  |
| Hudson      | Thunderbird |
|             | Willlys     |

**Same FREE Offer  
On MOTOR'S New Truck  
Repair Manual**

Covers EVERY job on EVERY popular make gasoline and Diesel truck made from 1946 thru 1956. For FREE 7-Day Trial, check the proper box in coupon.



SUPPOSE you had an automobile factory engineer standing right beside you . . . guiding your hands through every step of even the toughest car repair jobs! Think how you'd "whiz through" every job! No wonder, then, 2,000,000 MOTOR'S Auto Manuals have been sold. No wonder so many thousands of beginners and expert mechanics alike are already using MOTOR'S brand-new AUTO REPAIR MANUAL. It shows you, in step-by-step words and pictures, factory-approved repair procedures for fixing ANY part of ANY car, 1946 through 1956!

No guesswork! MOTOR'S Manual "starts from scratch" — leads you through entire job with easy step-by-step directions, clear "how-to" pictures. Tells WHERE to start, what TOOLS to use, how to remove, repair and replace parts. You CAN'T go wrong.

**1000 Big ILLUSTRATED Pages**  
NEW, REVISED, ENLARGED Edition contains the "meat" from over 100 OFFICIAL shop manuals—simplified for YOU in Over 1,000 big pages, 23,426 essential repair specifications on 737 chassis models. More than 2,000 "this-is-how" pictures, 225,000 service and repair facts. Leads beginners every step of the way. Time-saving, factory repair procedures for experts. Used by U. S. Army and Navy.

**Try Book FREE 7 Days**  
SEND NO MONEY! Pay postman nothing. Make Manual PROVE to you what it's got. Unless you agree this is the greatest time and work saver you've ever seen—return book in 7 days and pay nothing. Mail coupon today for MOTOR Book Dept., Desk 1M, 250 W. 55th St., New York 19, N. Y.

**MAIL COUPON NOW FOR 7-DAY FREE TRIAL**

**MOTOR BOOK DEPT.**

Desk 1M, 250 W. 55th St., New York 19, N. Y.

Rush to me at once (check box opposite book you want):

MOTOR'S New AUTO REPAIR MANUAL. If O.K., I will remit \$2 in 7 days, \$2 monthly for 2 months and a final payment of \$6 (plus 35¢ delivery charges) one month after that. Otherwise I will return the book postpaid in 7 days. (Foreign price, remit \$9 in cash with order.)

MOTOR'S New TRUCK REPAIR MANUAL. If O.K., I will remit \$2 in 7 days, and \$2 monthly for 3 months, plus 35¢ delivery charges with final payment. Otherwise I will return book postpaid in 7 days. (Foreign price, remit \$10 cash with order.)

Print Name..... Age.....

Address.....

City..... State.....

Check box and save 35¢ delivery charge by enclosing WITH coupon entire payment of \$6.95 for Auto Repair Manual (or \$8 for Truck Repair Manual.) Same return-refund privilege.



## CONTRACTORS NEED MEN!

trained to operate Bulldozers, Draglines, Back Hoes, Scrapers and Motor Graders and pay high wages to skilled operators! YOU can make big pay in the construction industry if you learn these skills NOW!

Contractors WANT our graduates.  
Write TODAY for FREE School Catalog to  
**NATIONAL SCHOOL OF HEAVY EQUIPMENT OPERATION**  
P. O. Box 8243, Dept. D-11  
Charlotte, N. C.

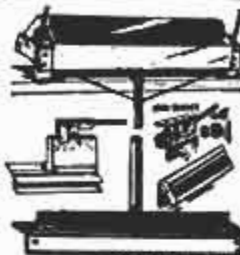

## SHEET METAL BRAKES

Forms angles, locks, pans, etc. Quick electric clamp. All steel construction.

15"—16 gauge steel.....	\$23.50
36"—22 gauge steel.....	35.50
48"—24 gauge steel.....	52.00
49"—16 gauge Bender.....	42.00
12"—12 gauge Bender.....	16.00
18 ga. Electric Bench Shear.....	48.00
1/4 x 3 Adjustable Bender.....	11.50
16 ga. 7" Bench Shear, 3 adj. ga.....	16.50
30"—20 gauge Curve Former.....	9.50

ORDER DIRECT OR SEND FOR FREE CATALOG  
**VYKE MFG. CO., P-4158 Jason St., Denver 11, Colo.**



## ASSEMBLE A BIG 100 POWER 3" REFLECTING TELESCOPE

... with this complete 87 piece "Do-It-Yourself" Kit. See the moon, stars close up, or view terrestrially. Kit includes: 3" f/10 aluminum and over-coated. Spherical Mirror—60X Eyepiece and 100X Barlow Lens—Crossline Finder, sturdy 40" Tripod—fork type Equatorial Mount. Complete instructions furnished. Order by Stock No. Send check or M.O. Money back guarantee. Shipping Weight 10 lbs. Stock No. 85,025-H. \$29.50 f.o.b. Ask for FREE catalog M Barrington, N. J.

**EDMUND SCIENTIFIC CORP., Barrington, N. J., U.S.A.**

## CABINET MAKING



**LOW COST HOME TRAINING COURSE FOR BEGINNERS & ADVANCED CRAFTSMEN**  
Make money. Learn skills and secrets of fine woodworking and tool use. Professionally prepared shop method training tells and shows how. Covers everything. Easy to master.

Write for Free Booklet  
**INTERSTATE TRAINING SERVICE**  
DEPT. F3, PORTLAND 13, OREGON

## REAL ESTATE

**BE A BROKER**  
PAYS BIG! SEND FOR FREE, BIG, ILLUSTRATED CATALOG NOW! Graduates report making substantial incomes. Start and run your own business quickly. Men, women of all ages, learn easily. Course covers Sales, Property Management, Appraising, Loans, Mortgages, and related subjects. STUDY AT HOME or in classrooms in leading cities. Diploma awarded. Write TODAY for free book! No obligation.

Approved for World War II and Korean Veterans  
**WEAVER SCHOOL OF REAL ESTATE (Est. 1936)**  
2020R Grand Avenue  
Kansas City, Mo.

## RUPTURED? Write for New Relief FACTS FREE!

### ENJOY NEW FREEDOM

of action, peace of mind and comfort at work or play. Proven, patented MILLER holds your rupture back Day & Night—will bring you lasting relief! Has helped thousands of others! For FREE facts in plain wrapper—

Send Name and Address to  
**FRED B. MILLER, DEPT. 1-P**  
Manufacturer, HAGERSTOWN, MARYLAND





# NOW in YOUR OWN HOME!



**ELECTRO-LAB**

## LEARN AUTOMATION ELECTRONICS TELEVISION

RADIO • ELECTRONICS  
*FASTER and EASIER with the aid of*  
**DTI EXCLUSIVE  
TRAINING FEATURES**

### EXCLUSIVE! Only DTI Provides Visual Aid Motion Pictures AT HOME

One of the most helpful . . . most modern aids to learning, is motion pictures AT HOME. They are an important part of your DeVry home training. Through the magic of films, you see electricity in action, you see electrons on the march . . . the hidden actions "inside" of a circuit . . . and other important principles of electricity and electronics. DeVry loans you a special movie projector and a series of highly instructive movie films that enable you to see these principles quickly . . . easily . . . and in a much shorter time than by reading alone.



### EXCLUSIVE! The Unique ELECTRO-LAB<sup>®</sup> (above) Provides Needed Practical Experience

To make real progress, you need practical experience. That's the reason you get and KEEP the recently-developed DeVry Electro-Lab. Using its transparent base, you see each circuit top and bottom; you follow special diagrams—quickly attached and detached. You use quick-operating spring clip connectors that cut time-consuming soldering to a minimum. You build circuits faster . . . learn more thoroughly. Altogether you get 16 shipments of fine quality parts. You perform over 300 practical projects, including the building of the versatile 5-inch Oscilloscope and the sensitive, multi-range Vacuum Tube Voltmeter both shown at right. No need to buy this valuable test equipment elsewhere. You build it . . . use it . . . KEEP it, as part of your training. <sup>®</sup>Trademark

### GET PRACTICAL TRAINING IN CHICAGO

If you desire, you can get all of your preparation in our large, well-equipped Chicago training center . . . under expert supervision of experienced instructors. Ask for details!



Member of  
National Home  
Study Council

One of America's Foremost Electronics Training Centers

**DEVRY TECHNICAL INSTITUTE**  
CHICAGO 41, ILLINOIS  
FORMERLY  
**DEFORREST'S TRAINING, INC.**

### OPPORTUNITIES ARE GROWING

The vast Electronics field is growing fast! It is calling for skilled technicians to step into good jobs paying real money. These are interesting positions—in plants . . . TV studios . . . laboratories . . . offices . . . radio stations . . . plus equally wonderful opportunities for starting a profitable full time or part time sales and service business of your own.

Electronics offers a real future! With over 400 TV stations on the air, with more than 30 million TV sets in use, with so many opportunities opening up in Radio Broadcasting, Communications, Instrumentation, Military Electronics and the newer field of Automation Electronics, the need for skilled personnel is increasing.

But to make progress in this fast-moving field you need real KNOW-HOW—the kind you get from an industrial training program—the kind you get from DEVRY TECHNICAL INSTITUTE.

Yes, you get the benefit of a program geared to the needs of industry, and backed by our 25 years of experience in helping men prepare for good jobs or their own business.

#### EMPLOYMENT SERVICE

DTI's efficient Employment Service is ready to help you make your start in the field when you complete the training. Over the past 25 years, we have built up hundreds of contacts with employers of Electronic specialists. You even get valuable advice on starting and operating your own business!

#### MILITARY SERVICE

If you are subject to military service, we have important information for you.

### MAIL COUPON FOR DETAILS!

**89 WAYS TO EARN MONEY IN TELEVISION RADIO ELECTRONICS**

**DEVRY TECHNICAL INSTITUTE**  
4141 Belmont Ave., Chicago 41, Ill. Dept. PM-12-M

Please give me a copy of "89 Ways to Earn Money in Television-Radio-Electronics," together with facts about the opportunity fields I have checked below.

- TELEVISION     COMMUNICATIONS     RADIO  
 NUCLEAR INSTRUMENTATION     AUTOMATION ELECTRONICS

Name \_\_\_\_\_ Age \_\_\_\_\_  
Street \_\_\_\_\_ Apt. \_\_\_\_\_  
City \_\_\_\_\_ Zone \_\_\_\_\_ State \_\_\_\_\_  
1021A DTI's training is available in Canada.



**Yours** FOR  
**JUST \$1.00**

This \$4.95 Regular  
Size Presto  
Fire Extinguisher  
for Letting Us  
Prove How You Can  
**MAKE UP TO**  
**\$1,000 A MONTH**



Charles Kama had NO sales experience until he took up PRESTO, Science's New "Midget Miracle" Fire Extinguisher. He did so well he was featured as "Salesman of the Month" on the front cover of a national sales magazine. He said: "I'm making more than \$1,000.00 a month—and haven't touched bottom yet."

Why do we make this amazing offer? Because we're certain that once you actually use a PRESTO to put out a demonstration fire—you'll realize why it "sells on sight!" An Ohio man made \$75.56 THE VERY FIRST DAY! A Florida salesman earned \$600.00 in 1 month. A New Hampshire man added PRESTO as a sideline and picked up an extra \$1,800 in 20 months.

Most people who see the PRESTO in action want one or more—ESPECIALLY WHEN THE PRICE IS ONLY \$4.95 EACH! Lightweight PRESTO does the job of bulky extinguishers that cost 4 times as much and are 8 times as heavy. The secret is a startling chemical, 1.5 to 6 times as effective as ordinary extinguisher chemicals on an equal weight basis. Makes possible an extinguisher so light, so handy—even a child can use it. Just a twist of the knob and flames disappear. "Sells on sight" to owners of cars, homes, stores, offices, factories, and to stores for re-sale. Guaranteed for 20 years! OVER TWO MILLION ALREADY SOLD!

### Mail Coupon with \$1 for Your PRESTO

Mail coupon with \$1 TODAY—and we'll send you a Regular \$4.95 PRESTO at no additional cost. If not amazed, return PRESTO and we'll refund your \$1.00. Or keep it at big saving when you order 6 or more. You can't lose—you risk nothing. We'll also send you FREE a complete Sales Kit to help you get started. Mail coupon now to MERLITE INDUSTRIES (Presto Div.), 114 E. 32nd St., Dept. X-15P, New York 16, N. Y.

**MERLITE INDUSTRIES (Presto Div.) Dept. X-15P**  
114 E. 32nd ST., NEW YORK 16, N. Y.

I enclose \$1.00 for which please send me regular-size \$4.95 PRESTO as a demonstrator. I agree to demonstrate it to myself and friends. This sample becomes mine to keep at no additional cost when I send you order for 6 or more Prestos. If I decide NOT to sell, I will return the PRESTO to you and you will refund my \$1.00.

Also send me absolutely FREE Complete Sales Kit containing everything I need to get started making good money introducing the PRESTO in my locality.

Name \_\_\_\_\_

Address \_\_\_\_\_

City \_\_\_\_\_ Zone \_\_\_\_\_ State \_\_\_\_\_

IN CANADA: Mopa Co. Ltd., 371 Doved St., Montreal 1, P. Q.

30 Years of Combined family experience in High Quality tires.  
23 YEARS AT THIS ADDRESS  
TUBE FREE WITH EVERY PASSENGER TIRE  
LOW OVERHEAD—LARGE VOLUME SALES & SMALL PROFITS  
BRING YOU THESE "LOWEST PRICES."



**TIRE INSURANCE REPLACEMENT  
GUARANTEE SENT**

Our entire stock of very slightly worn  
EXTRA MILEAGE TOP GRADE Tires.  
(Written Insurance Guaranteed). SEND AD

EVERYBODY 10% off ON EVERY TIRE



**FREE** if you buy 2 or more Passenger 4-ply tires, WE GIVE ONE tire FREE, on each order. Does not include W.W. or Truck Tires, or Snow Tires.

Specialists in Truck Tires—Selected for Toughest Jobs—Tops in Value  
12 MOS. WRITTEN GUARANTEE WITH EVERY TIRE

600-16	\$5.52	475-19	\$4.82	700-15(6)	\$7.52	700-20	\$9.92
600-16(6)	5.92	640-15	4.22	750-16(8)	8.72	750-20(10)	15.72
650-16	5.72	670-15	5.52	700-17	8.82	750-20(8)	11.92
650-16(6)	6.62	710-15	5.52	750-17	10.32	825-20	18.92
700-16	8.02	760-15	5.82	825-15	12.92	900-20	17.92
750-16(6)	7.52	800-15	5.92	650-20	9.02	1000-20	17.92
350-18	4.52	820-15	5.92	650-20	9.82	1100-20	19.92
550-17	3.72	870-16	5.32	32x6(8)	12.02	1100-22	18.92
650-15	5.52	780-16	7.02	32x6(10)	13.92	1000-22	20.02
700-15	4.92	700-16(6)	7.32	750-15	10.72	1100-24	23.02

"EXTRA SPECIAL" SOME NEAR NEW all size 4-ply pass. FREE TIRE with 2 or more of these also.—W.W. \$1.00 Extra Factory Tested Tube given—GIANT TIRE SALE. EA.

**SNOW TIRES \$9.02** ORDER ANY 4 PLY PASSENGER SIZE 12 MO. GUAR. BLACK WALL  
Thousands of tires shipped all over the U.S.A. All tires shipped F.O.B. Phila. Send Check or M.O. with this ad. Dept. 2, No C.O.D.  
**STANDARD 834 N. Broad St., Philadelphia 30, Pa.**

## TELEPHONES



**Desk Stand Style**  
Slightly used but in excellent condition  
Many Valuable Uses  
Inter-House Phones House to Barn, etc.  
Loud Speakers Microphones  
Educational Purposes, Toys, etc.  
Come complete, ready to use with wiring diagrams included. **\$2.75** Postpaid in U.S.A.  
Two complete for only \$5.00  
**TELEPHONE LAMP KIT**—with illustrated instructions for making Desk Telephone Lamp including all parts (harp, nipples, push switch, cord, plug, etc.) \$6.50 Fpd. (Shade is not included).

**MICROPHONE, Dept. X-4502, 1760 W. Lunt Ave., Chicago 26, Ill.**

## BIG MONEY in your own DRY CLEANING BUSINESS

MEN! WOMEN! Let us show you how to open up your own Dry Cleaning shop. Learn AT HOME, in spare time. You'll be amazed to learn that you can go into this fast-growing business with next to no cash at all. Experience unnecessary. Easy-to-understand lessons. Convenient time-payments. Write for FREE details. Imperial School of Dry Cleaning, Dept. rm-12 1700 Touhy, Chicago 26, Ill.

## RHEUMATISM

**NEURITIS • SCIATICA • LUMBAGO**  
Why continue to suffer agonizing pains when usual remedies have failed. Learn how thousands have been successfully treated by an amazing new method which is fully explained in our New FREE Book. Don't wait. Write today. No obligation.  
**EXCELSIOR INSTITUTE, Dept. C9806, Excelsior Spgs., Mo.**

## See the Greatest Show on Earth with this GIANT ASTRONOMICAL TELESCOPE

**\$15.00**  
FULL PRICE



Delivered ready for use. Has 45X, 75X and 100 power individually mounted eyepieces with brass focusing tube plus sun projector lens for observing sun spots and solar storms. Steel telescope tube 50 in. long. Rigid 6 ft. tripod adjustable to any height. Steel forked mounting with closely machined aluminum tripod head assembly assures extra fine adjustment. This professional type instrument provides full power with clear vision at all times. See the moons of Jupiter, our own moon, planets, milky way, double stars, star clusters, etc. All for only \$15.00 FOB Mattituck. Sent express. COD orders require \$5.00 deposit. Satisfaction guaranteed. 200X and 400X eyepieces available at \$2.00 ea.

**SUFFOLK SCIENCE SERVICE**  
Dept. TD-12 MATTITUCK, N. Y.



LOOKING FOR JOB SECURITY AND SUCCESS?

# LET MY STUDENTS AND GRADUATES TELL YOU

## ABOUT MY TRAINING —

### NEW! NEW! NEW! COLOR TELEVISION TECHNICIAN COURSE

Learn the latest. Be prepared for your share of those profits. RTTA's Color TV Servicing Course brings you the most complete, up-to-the-minute data and procedures for the servicing and maintenance of all Color TV receivers and equipment. The 14 lesson course guides you through the development and transmission of the composite color TV signal, and includes troubleshooting and servicing methods. The same step-by-step, easy-to-follow approach used so successfully in our other courses.

### HAS OWN BUSINESS



I have a shop at home and have been working on radio and TV after working hours of my regular job. I average \$50 a week for this part time work. RTTA training helped me in making extra money and giving me experience in the electronic field. 6/30/54

Richard Hennis, Little Rock, Ark.

### SERVICE MANAGER



I manage two radio and television shops, one here and one in Pompano Beach. RTTA training increased my knowledge of TV circuits and showed me new, quicker methods of repairing. Lessons as presented are very concise and clear. 6/23/54

William Phillips, Fort Lauderdale, Fla.

### REPAIRED, EVERY SET



RTTA training helped me to understand TV more thoroughly. I have repaired every set that I was called on to repair. 6/22/54

Andrew Busi, Jr., Iselin, Pa.

L. C. Lane, B.S., M.A.  
President, Radio-Television Training Association. Executive Director, Pierce School of Radio & Television.



## — ABOUT MY EQUIPMENT

YOU GET ALL THIS EQUIPMENT



"... a money making little gem."

I have completed kit #6 and was amazed at how it works. I showed it to a friend of mine and he asked me to set it up for one of the picnics his social club was having. That sure is a money making little gem. 6/17/54

John Fernandez, Fresno, Calif.

"We get excellent pictures..."

I would like to compliment you on an excellent and complete course. We get excellent pictures on my TV set from WSYE (Syracuse, N.Y.), approximately 110 air miles away. The set is working good and I have had to replace only three tubes since I assembled it two years ago. 7/18/54

Larry H. Stafford, Kingston, Ont., Canada

"... very good reception..."

I have really enjoyed the course and have come a long way in TV servicing. I am getting very good reception on my TV station considering that the nearest VHF station is 120 miles. 7/23/54

J. W. Hanlon, Jr., Henderson, Texas

## YOU, TOO, CAN GET A BETTER-PAYING JOB IN THE EVER-EXPANDING RADIO-TELEVISION-ELECTRONICS FIELD

Why limit yourself and your earnings because of your lack of training. Learn AT HOME in your SPARE TIME to be an electronic technician, television repairman, or studio technician. You don't need any experience whatsoever. Many students earn good money in their spare time while learning.

After you finish my Radio-FM Television Course or FM-Television Course you can have, if you want it, two weeks of laboratory training at my associate resident school in New York City—AT NO EXTRA COST.

If you have had previous radio and television experience you can take my practical TV Studio Technician Course to qualify for a good-paying job in a TV studio.

Write to me today and let me show you how you can begin now to put yourself on the road to a better future.

## VETERANS!

My school fully approved to train veterans under new Korean G.I. Bill. Don't lose your school benefits by waiting too long. Write discharge date on coupon.

YOU GET THESE FREE

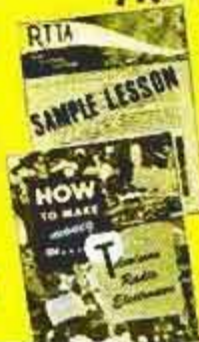

## MAIL THIS COUPON TODAY!

Mr. Leonard C. Lane, President  
RADIO-TELEVISION TRAINING ASSOCIATION  
Dept. PM-12C, 52 E. 19th St., New York 3, N.Y.

Dear Mr. Lane: Send me your NEW FREE BOOK, FREE SAMPLE LESSON, and FREE aids that will show me how I can make TOP MONEY IN TELEVISION. I understand I am under no obligation.

(PLEASE PRINT PLAINLY)

Name \_\_\_\_\_ Age \_\_\_\_\_

Address \_\_\_\_\_

City \_\_\_\_\_ Zone \_\_\_\_\_ State \_\_\_\_\_

- Color TV Course
- Radio-FM-TV Technician Course
- FM-TV Technician Course
- TV Studio Technician Course

### VETERANS!

Write discharge date

## Radio-Television Training Association

52 EAST 19th STREET • NEW YORK 3, N. Y.

Licensed by the State of New York • Approved for Veteran Training

DECEMBER 1956





Have Fun  
and Gain  
Popularity!

YOU can own and play  
a famous make Italian  
**ACCORDION**  
Buy Direct—Save 50%

No Risk Plan . . .

**5 DAYS FREE TRIAL**

There's a whole new world of pleasure, satisfaction and popularity waiting for you the day you start playing your accordion. It's easy to learn and it costs so little to own and play a fine Italian Accordion under our famous No Risk Plan. Play simple tunes with few minutes practice. You select the accordion you want from dozens of smart new models . . . and we'll send it to you on FIVE DAYS FREE TRIAL. We are direct factory importers and distributors . . . and because of our huge volume and great buying advantages, actually **SAVE YOU UP TO 50% AND MORE OFF REGULAR PRICES.** You may have long terms with a low down payment. Trade-ins accepted. Complete Home Study Course included FREE with every instrument. Lifetime guarantee!



**Low Down Payment—Easy Terms**

It pays to deal direct with an accordion specialist! Our buyers travel regularly to Italy where the finest accordions in the world are made. We select only the most outstanding instruments and, each accordion is tested and carefully retuned in our own shops before shipment to you. We invite you to Mail Coupon below for big new color catalog of accordions and facts about this exciting instrument . . . plus lowest wholesale prices . . . ALL FREE. No obligation. Write today.

**ACCORDION MANUFACTURERS AND WHOLESALERS OUTLET**  
DEPT. R126, 2003 W. CHICAGO AVE., CHICAGO 22, ILL.

Mail Coupon Today!

Accordion Manufacturers and Wholesalers  
Outlet, Dept. R126, 2003 W. Chicago Ave.,  
Chicago 22, Ill.

Please rush Color Catalog of newest Italian  
Accordions and low wholesale prices.

Name \_\_\_\_\_  
Address \_\_\_\_\_  
City \_\_\_\_\_ Zone \_\_\_\_\_ State \_\_\_\_\_

**FREE!**  
**BIG COLOR**  
**CATALOG**  
and new  
Low Wholesale  
Prices

You Can Be a Local  
Manufacturer of  
**CAVITEX**

**SUPERFINE  
MASONRY**

Local production explains why Cavitex can offer so much in quality for so little money, yet is so generous in profit potentials. It's a case of streamlined manufacturing—processing local materials for local building—cutting out the high costs of freight and distribution.

Cavitex creates new standards of beauty—in size, proportion and color. "Puts emphasis on the horizontal." Cored-out design for lighter weight and greater insulation values. Available in 8-inch and 4-inch.

Hundreds of territories are available to men looking for a local manufacturing enterprise. Franchise privileges. Responsible operators can obtain basic equipment on attractive rental terms. The Cavitex industry is sponsored by a million-dollar company backed up by fifty years of experience and reputation. Write or wire at once for "Opportunity, Unlimited" and tentative reservation of territory.



**W. E. DUNN MFG. CO.**  
409 W. 24 St., Holland, Mich.  
In Canada  
Dunn Masonry Machinery, Ltd.  
844 Dundas Highway  
Cooksville, Ont.

X-6

Money  
in **SHELLCRAFT**

Trained Commercial Shellcrafters  
earn big money. Elderly lady re-  
ports \$7,000.00 a year.

Ohio couple boasts  
\$1,800.00 in ten  
weeks while wife  
holds secretarial  
job. **GET PROOF**  
there is money in  
this fascinating  
trade. Write today for **FREE SHELLS**  
and information on Training Plan.



**NATIONAL SHELLCRAFT SCHOOL**  
5634 34th St. N. St. Petersburg, Fla.

*Secrets of* **VENTRILOQUISM**  
*Now Revealed!*



Easy to learn in 60 to 90 days with our  
Home Study Course. **RESULTS GUARANTEED.**  
Make Money! Be Popular! Have Fun! Big Op-  
portunity! Radio, Television, Stage Appear-  
ances! For **FREE** information regarding price  
and terms **WRITE.** You must state your age.  
Dummy Catalog 25c.  
**FRED MAHER SCHOOL OF VENTRILOQUISM**  
Box 36, Studio PM-12 Kensington Station  
Detroit 24, Michigan

**Want A Government Job?**



**MEN — WOMEN, 18-55.** Thou-  
sands of positions open. Prepare  
**NOW** for next examinations.  
Write immediately for free 36-  
page book, with list of  
many positions and par-  
ticulars telling how to  
prepare. Grade school  
education often sufficient.  
Veterans get preference.

**FRANKLIN INSTITUTE**

(Not Government Controlled)

Dept. B-93, Rochester 4, N. Y.



# Get "The Most" in Pay and Job Security— LEARN AIR CONDITIONING & REFRIGERATION

MAKE HOME YOUR TRAINING SHOP



BUILD A REFRIGERATOR,  
AIR CONDITIONER,  
FREEZER or  
MILK COOLER

## You Practice with 23 Kits

You learn fast because CTI sends you 23 kits. Illustration shows heavy-duty ¼ h.p. refrigeration high-side which you will build—and keep. Only CTI sends these kits.

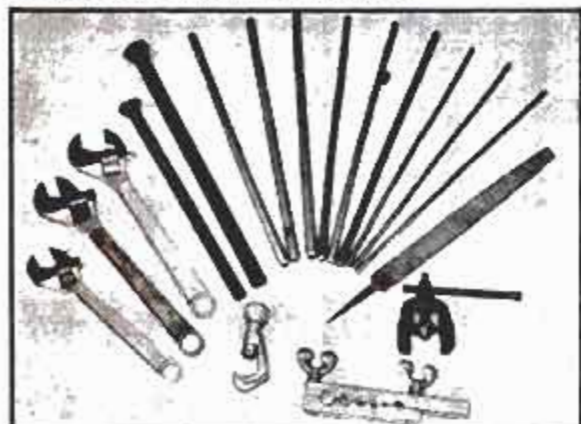

## You Get Professional Tools

Here are tools included in just one kit. You get other tools, tubing, much equipment. Tools develop your interest and skill, speed up training.



## You Learn in Easy Stages

Another kit, which includes motor, fan, pulley, service tools. Kits are sent on a planned schedule to help you learn in easy stages. There's no other training like this!

**A GOOD JOB, MORE MONEY, BRIGHT FUTURE**—all three can be yours in the Air Conditioning & Refrigeration field! *Thousands of mechanics are needed to repair and service the 150 million units in use—and the six million air conditioners, freezers and refrigerators that are produced each year. You can earn up to \$125 a week—and more—if you are trained. For information on how to get this training, just fill out and mail coupon below. No obligation!*



R. C. Anderson  
President CTI

## A New, Easy Way to Learn in Months

CTI training is quick and effective because it is *practical*. You learn by doing. During the course of your training, you receive 23 big kits, including tools. You practice with these kits, get valuable experience. For instance, you do 10 complete service and trouble-shooting jobs with CTI kits. You assemble a heavy-duty, commercial type, ¼ h.p. high side (illustrated at left). You build an air conditioner, refrigerator, freezer or milk cooler—and you keep and use this valuable unit! Only CTI sends you these fine tools and kits—helps you get real *on-the-job* training! And all this fine equipment is yours at *no extra cost!* With CTI training you can *start out* as a mechanic and avoid years of work as a lower-paid apprentice.

## Earn Good Income as You Train, too

CTI training is so practical that students often work in spare time repairing air conditioners and refrigerators. *They add to their income this way.* Some get jobs with local dealers; others work on their own. Many students go in business on graduation. A number get full-time jobs while they're students.

## A Wonderful Opportunity to Be the Boss

If you want to own a business, Refrigeration offers you opportunity for success. Since most jobs are service calls, you can build up a list of potential customers. Very little capital is needed to start.



## Mail Coupon For Two FREE Books

Mail coupon below for two books which give you complete information. One is entitled *Success in Air Conditioning and Refrigeration*. The other is a *Lesson Sample*. Both FREE.

**DO NOT DELAY—MAIL THIS TODAY**

Mr. R. C. Anderson, President Dept. R-317  
COMMERCIAL TRADES INSTITUTE  
1400 Greenleaf Ave., Chicago 26, Ill.

Mail me SUCCESS BOOK and LESSON SAMPLE. No cost or obligation.

Name \_\_\_\_\_ Age \_\_\_\_\_

Address \_\_\_\_\_

City \_\_\_\_\_ Zone \_\_\_\_\_ State \_\_\_\_\_

Member National Home Study Council







BUICK CADILLAC CHEVROLET CHRYSLER



CONTINENTAL DESOTO DODGE FORD

# FIX CARS

## EASIER...TWICE AS FAST!



Chilton's world-famous **ALL CARS Repair Manual** makes every step clear as A-B-C...

Giant new, 4 3/4 lb. edition. **COVERS PRACTICALLY EVERY CAR REPAIR JOB from bumper to bumper...**

**ON EVERY MODEL** of the leading 23 U. S. makes from 1940 through 1956.

Shows how to locate troubles easily.

Then fix them *f-a-s-t*... with standard tools under ordinary conditions.



HUDSON



LINCOLN



MERCURY

### THE BOOK THE EXPERTS USE!

Handle repair jobs faster, easier and better than you may have dreamed possible—even if you have never fixed a car before! You'll find this 850-page Chilton Manual in almost every car repair shop—in Army-Navy Training—in schools... because it makes things so amazingly clear. Ideal for beginners. Saves time for experts. Published each year for 26 years by Chilton, world's largest automotive publishers. Over 3,000,000 copies sold! Almost 3,000 clear, how-to-do-it pictures; 396 Quick Check Tables; 53 Troubleshooting Charts, etc. Price only \$6.95. Practice 10 days at our risk! You be the judge!

See for yourself how easy it is!



NASH



OLDSMOBILE



PACKARD



PLYMOUTH



PONTIAC



RAMBLER



STUDEBAKER

plus FRAZER, WILLYS, HENRY J. and KAISER

## PRACTICE 10 DAYS FREE!

THE CHILTON COMPANY, Dept. PM-126  
5605 Chestnut St., Philadelphia 39, Pa.

Send me the giant new CHILTON "ALL CARS" REPAIR MANUAL (Price \$6.95) for 10-day FREE EXAMINATION. If I like Manual, I will then promptly remit \$1.95 (plus 45c postage and handling); then send \$2.50 each month for two months. Otherwise, I will return manual postpaid in 10 days and owe you nothing. (SAVE! Send \$6.95 with order and we pay postage-handling charge. Same return privilege.)

Name.....

Address.....

City, Zone, State.....

(Outside U.S.A.—Price \$8.95 cash with order.)

Chilton Books are sold by leading book stores.

## CONVERT YOUR CAR INTO A BED



Save on Over-Night Trips — Rest in Solid Comfort —

### QUICK, EASY CONVERSION

Works on 2 and 4-door sedans, club coupes, convertibles. **GUARANTEED** to work when installed by instructions. **PAYS FOR ITSELF** in three nights lodging. IDEAL for hunters, fishermen and travelers. Complete conversion kit and instructions... **\$14.95**

State make, model, whether 2 or 4-door.

SEND CASH, CHECK OR MONEY ORDER TO:

**CAR BED CO., 600 Magnolia Ave., Panama City, Fla.**

## 60 POWER TELESCOPE \$3.98

VARIABLE EYEPIECE 20x-40x-60x—BRASS BOUND

**NEW!** Three telescopes in one, 3 different magnifications. 20 power for ultra-bright images with 40 and 60 power for extra long range. Guaranteed to bring distant objects, people, sports events, ships, moon, stars, etc. 60 times as close. Most powerful for anywhere near the money. 5 sections. Closes to 1 ft. long. Contains 4 ground and polished lenses. Also used as a powerful compound microscope. Directions included. Mass production enables us to offer this instrument at amazing price of \$3.98 complete. Money back guarantee. We pay postage. Get yours now.



**CRITERION CO.**  
DEPT. PMB 41

331 CHURCH ST.  
HARTFORD 3, CONN.



### KIDS! "BIG" RACKET

Make your Bike sound and feel like a real Motorcycle. Adjustable amplifier for normal or loud noise. Simply attached with screwdriver, only **\$1.50**

**BIG RACKET MFG. CO.**

Box 2121 Colorado Springs 2, Colo.



## LEARN WHILE ASLEEP!

**PHENOMENAL RESULTS!** \$2 rushes fact-filled instruction book. "Sleep-Learning—Its Theory, Application & Technique. Guaranteed. RESEARCH ASSOCIATION, P.O. BOX 610-AA, Omaha, Nebr.

## YOU BUILD 'EM — WE SELL 'EM EARN UP TO \$50.00 A DAY AT HOME

Participate in our national sales and sub-contract plan—spare time—full time. You assemble special luggage and cases for photographers, musicians, salesmen, and all types of portables. We supply complete instructions—materials—tools—everything. No previous experience necessary. Free details. Abarsi Cascraft, Dept. AO, 807 W. Sunset Blvd., Los Angeles 12, Calif.

## LAW FREE BOOK THE LAW TRAINED MAN

Write today for a FREE copy of illustrated law book, "THE LAW-TRAINED MAN," which shows how to earn the professional Bachelor of Laws (LL.B.) degree through home study of the famous Blackstone Law Course. All necessary books and lessons provided. Moderate cost; convenient monthly terms. Write for FREE law training book today.

**Blackstone School of Law, 225 N. Michigan Ave.**

Founded 1890 Dept. 59 Chicago 1, Ill.

## Learn PHOTOGRAPHY at Home

Splendid opportunities. Prepare in spare time. Practical basic training. Long-established school. Send for free book, "Opportunities in Photography." No obligation. American School of Photography, 835 Diversy Parkway, Dept. 1358, Chicago 14, Ill.



# NATIONAL SCHOOLS

*proudly presents*

**FOR MEN WHO WANT TO EARN MORE MONEY**

## TELERAMA • ALL 8 BRANCHES OF TELEVISION • ELECTRONICS • RADIO

IN ONE DYNAMIC, MODERN SHOP METHOD, HOME TRAINING COURSE

\*Registration applied for

Another great advance in **HOME STUDY TRAINING**. Let National Schools, of Los Angeles, a practical Technical Resident Trade School for over 50 years, train you at home by Shop-Method, for today's unlimited opportunities in **ALL 8 BRANCHES** of the Television, Electronics, Radio Industry.

Check all you receive in *One Master Course* at One Low Tuition

1. Television — Including Color TV
2. Radio — FM and AM
3. Industrial Electronics
4. Sound Recording and Hi-Fidelity
5. Preparation for FCC License
6. Automation
7. Radar and Sonar
8. Communications

ALL OF THIS MODERN, NEWEST, PRACTICAL EQUIPMENT IS YOURS TO KEEP!

- Parts to Build a modern TV set, including large screen Picture Tube.
- Parts to build a powerful Superhet Receiver, standard broadcast and short wave.
- Parts to conduct many experiments and build Continuity Checker, RF Oscillator, TV Circuits, Audio Oscillator, TRF Receiver, Signal Generator.
- Professional Multitester
- These are a **MUST** for all technicians.

**YOU DO MANY PRACTICAL JOBS.** You do servicing, circuit analysis and many other down-to-earth experiments. You build a modern TV set from the ground up... with equipment kits we give you, including a new large screen picture tube and professional Multitester, at no additional charge.

**EARN AS YOU LEARN!** Many of our students earn their entire tuition and more in Spare Time jobs we show them how to do while learning. **YOU GET GRADUATE ADVISORY SERVICE, TOO.**

**ALL YOURS TO KEEP**

**L. J. ROSENKRANZ**  
President of NATIONAL SCHOOLS



This Master-Shop-Method course is completely up-to-date. Here in Los Angeles, the TV and Electronics center of the world, we are able to keep in constant touch with the industries' latest developments. As a student, you will quickly master all phases at home... in your spare time. Your earning power will grow with every lesson. Just as thousands of National Schools graduates do every day, you can handle servicing, manufacturing, repairing, hundreds of other jobs, or make good money in your own business. **SECURE YOUR FUTURE—NOW. SEND COUPON BELOW.**



IN THESE MODERN TV STUDIOS, SHOPS AND LABORATORIES, your Shop Method Home Study Course was developed by experienced instructors and engineers. What an advantage that is to you at home — each lesson is tested, proved, easy to understand. You can master the most up-to-date projects, such as color TV set repair, printed circuits — even prepare for F.C.C. License and industrial electronics without taking a special course. **TAKE YOUR FIRST STEP NOW TO A TOP-PAY JOB IN TV, ELECTRONICS, RADIO. SEND COUPON BELOW TODAY.**

APPROVED FOR VETERANS AND NON-VETERANS



## NATIONAL SCHOOLS

4000 S. FIGUEROA ST., LOS ANGELES 37, CALIF.  
187 N. LA SALLE ST., CHICAGO 1, ILL.

IN CANADA: 811 W. Hastings St., Vancouver, B. C.

### NATIONAL SCHOOLS

TECHNICAL TRADE TRAINING SINCE 1905  
Los Angeles, California

**GET FAST SERVICE—MAIL NOW TO OFFICE NEAREST YOU!**

NATIONAL SCHOOLS, DEPT. RR-120  
4000 S. FIGUEROA ST. OR 187 N. LA SALLE ST.  
LOS ANGELES 37, CALIF. OR CHICAGO 1, ILL.  
Rush free TV-Radio "Opportunity" Book and sample lesson. No salesman will call.

NAME \_\_\_\_\_ BIRTHDAY \_\_\_\_\_ 19\_\_

ADDRESS \_\_\_\_\_

CITY \_\_\_\_\_ ZONE \_\_\_\_\_ STATE \_\_\_\_\_

Check if interested ONLY in Resident Training at Los Angeles.  
VETERANS: Give Date of Discharge \_\_\_\_\_

**FREE!**

Fully illustrated "CAREER" BOOK in TV, Radio, Electronics. AND actual Sample Lesson—yours at no cost, no obligation **SEND COUPON NOW—TODAY!**





# DRAFTSMEN



**CASH BIG  
PAY CHECKS!**

Train Now for  
more success,  
greater security

**LEARN AT HOME IN SPARE TIME  
(or at college in Chicago)**

Check the want ads in any newspaper—SEE the big-pay opportunities open to you as a draftsman. What's more, you can learn this well-paid, prestige profession at home—quickly, easily! No special talent needed. Get complete, step-by-step Chicago Tech lessons in the mail, spend a few pleasant hours studying each week. In a short time you'll be a well-trained draftsman, ready to take your pick of many good jobs. Act now!



**Free Information—Mail Coupon Today!**

Get FREE TRIAL LESSON plus information about C.T.C. practical training. Learn what successful Chicago Tech graduates say about high pay and opportunities in drafting. No charge, or obligation.

## CHICAGO TECHNICAL COLLEGE

5-254 Tech Bldg., 2000 So. Michigan Ave.  
Chicago 16, Illinois

Mail me FREE lesson with facts about big opportunities  
in DRAFTING.

Name \_\_\_\_\_ Age \_\_\_\_\_  
Address \_\_\_\_\_  
City \_\_\_\_\_ Zone \_\_\_\_\_ State \_\_\_\_\_

*Write Like This* **Complete OUTLINE FREE!**

MIRACULOUS IMPROVEMENT in your Penmanship in six hours practice with Grooved Letters. No failures. Inexpensive. No charges unless you're satisfied after 6 hours practice.

WRITE OZMENT BOX 665  
34-P. ST. LOUIS, MISSOURI

## New! TINY POCKET SIZE RADIO

**\$2.98** Listen at work, play, in bed. Fits shirt pocket. No tubes. No batteries. No electric plug-ins. No expense. Plays day & night forever. New self-powered diode rectifier replaces tubes. No building. Use short aerial for local stations. Complete broadcast band. Red plastic case only 3 x 3 1/4 x 1 inches. Lifetime guarantee. Radio (without phone) \$2.98. Hearing Aid Phone (plugs in ear, flesh-colored, almost invisible) \$1.98. Regular phone \$1.25.

JOHNSON SMITH & COMPANY Dept. 398 Detroit 7, Mich.

## Catalog of 3100 Novelties 10c

Send 10c for amazing catalog of novelties, live animals, scientific supplies, hobbies, funmakers, planes & boats, looms, magic tricks, joke articles, unusual seeds, gads, get timesavers, cameras, optical goods, projectors, movies, lucky jewelry, religious novelties, disguises, musical instruments, stamps, coins, puzzles, fortune tellers, radios, auto & bike accessories, telescopes, magnifiers, compasses, banks, smokers' gadgets, artists' supplies, printing sets, eye glasses, motors, shockers, knives, billfolds, guns, rifles, sports, books, games, plants, etc. Send 10c (3 for 25c—get for friends!).

JOHNSON SMITH & CO. Dept. 398 Detroit 7, Michigan



## DON'T SELL YOURSELF SHORT!

Why let the fact that you're short handicap you? Simply step into "ELEVATORS" amazing height-increasing shoes... you're almost 2 INCHES TALLER instantly. Only you know how you gained the added stature, but everyone notices the difference! Step UP in the world in "ELEVATORS"



THE ORIGINAL AND GENUINE  
**ELEVATORS**  
HEIGHT-INCREASING SHOES  
"YOUR PERSONAL PIEDestal"  
A TRADE MARK OF STONE-TARLOW CO., INC.

For FREE

Booklet and dealer's name write to:

STONE-TARLOW CO., INC., DEPT. PM12, BROCKTON 68, MASS.



## GIANT BALLOONS

The best! Surplus US Govt. (new over-age) Neoprene weather target balloons. FOR FUN—Great in backyard, at parties, picnics, fairs. Young & old enjoy 'em! FOR ADVERTISING—Attract big crowds to business openings, civic events, trade shows, exhibitions. Paint 'em with a sales message and they'll pay off for you! FOR PROMS—Makes any high school or college prom more festive. Real cool! Approx. inflated sizes.

3 ft. dia., 49c—5 ft. dia., 99c

Postage paid on prepaid orders. Cal. res. add sales tax.

**VOLUME SALES CO., War Assets Division**  
3930 Sunset Blvd., Dept. PM1256, Los Angeles 29, Calif.

## LEARN PLASTICS



**COMPLETE LOW COST SHOP METHOD HOME TRAINING NOW AVAILABLE**

Get in on Big Money opportunities in Plastic molding, casting, forming, carving, etc. Earn as you learn with Interstate's professionally prepared course. All plastic materials furnished.

WRITE FOR FREE BOOKLET

**INTERSTATE TRAINING SERVICE**  
DEPT. C-3, PORTLAND 13, OREGON



## MINIATURE ARTIFICIAL TREES

All types and sizes... foliage, fruit and winter trees. Suitable for model railroads, souvenirs, displays, etc. Do it yourself for profit or hobby. Complete kit contains all necessary material, tools and \$2.50 paid instructions. Satisfaction guaranteed. Only \$2.50 post-P. BOECK, 2830 Zulette Avenue, New York 61, N. Y.

Say You Saw It in Popular Mechanics

## JEEP OWNERS

RE-POWER NOW with your choice of three famous V-8 engines  
**FORD • CHEVROLET • MERCURY**  
CONVERSION KITS now available to fit ALL 2 and 4 Whl-Drive Willys Jeeps. . . . Priced \$43.25 to \$64.75 . . . If you want fast action tell us which V-8 engine you wish to use . . . give us the year . . . 2 or 4 Whl-Drive . . . body style of your vehicle. Send min. \$15.00 dep. and we will ship correct kit, bal. C.O.D. Send full amount for prepaid shipment. Wire, phone or write for FREE details.

**HOOSIER MACHINE PRODUCTS CO.**  
312 S.E. 6th St. Phone 676 Pendleton, Oregon, U.S.A.

**SAVE GAS, GEARS,  
TIRES ON YOUR  
4-WHEEL DRIVE!**



**Stop Front End Drag in 2 W. D.**

Get maximum use of your vehicle with these famous hubs! They "take out" the front end in 2-wheel drive, give your vehicle "pick-up" economy, pep, speed, power, handling ease; stop front end gear whine, shimmy. 4-wheel drive as usual, when you need it—automatically, as you shift, with Warn Lock-o-matics, manually with Locking hubs. Models for all makes 4 w.d.s. to 1 1/2 tons at truck dealers everywhere, or write:

**WARN MFG. CO., Riverton Box 6044-A12, Seattle 88, Wn.**



**WARN  
HUBS**



# We'll train & establish you in Your Own Business

## ... even if now employed

We are enlarging this 26-year-old world-wide chain of Duraclean dealerships. Many excellent locations are still available in the U.S.A., Canada, and other countries. If you are reliable and diligent, this is an opportunity to increase your income . . . and have the freedom, financial independence, and prestige of YOUR OWN business.

in spare time and have a profitable, lifetime business when your present job ends. A Duraclean dealer will train and assist you. He'll reveal his successful, proven methods and sales plans. He'll work with you.

Alert dealers can average \$5 hourly gross profit on service they render plus \$3 on EACH service-man at National Price Guide charges. This business is easy to learn . . . quickly established.

These are full time dealerships . . . but you can start

World-wide Service

**FREE Booklet** tells how!

## You Become an Expert in cleaning and protecting Rugs and Upholstery

**DURACLEAN** cleans by absorption. It eliminates scrubbing . . . soaking . . . shrinkage. Aerated foam, created by electric Foamovator, restores natural lubrication in rugs and upholstery. Dirt, grease and many unsightly spots vanish. Fabrics and floor coverings are cleaned with a new consideration for their life and beauty.

This modern process avoids strong soaps and machine scrubbing, eliminating unnecessary wear and breaking of fibers. Fabric life is increased. **DURACLEANING** is done in the home. Customers like this convenience. Fabrics dry in a few hours. Rug pile again stands erect and even. Brilliant colors revive. Furnishings become clean, fresh and enlivened.

**DURAPROOF** is another year 'round service rendered in the home, office or institution — without removing furnishings. It protects upholstery, rugs, furs, clothing and auto interiors against damage by moths and carpet beetles.

U. S. Government says "Moths are present in practically every household . . . No section of country seems free from such infestations." **DURAPROOF** kills moths and carpet beetles . . . it makes materials non-eatable to both. **DURAPROOF** is backed by an International 6-Year Warranty.



Fabrics dry in a few hours. Rug pile again stands erect and even. Brilliant colors revive. Furnishings become clean, fresh and enlivened.

## Easy to Learn • No Overhead Expense

### Permanent, Growing Market

Service is rendered in homes, offices, hotels, theaters, institutions and to revive used-car upholstery for auto dealers. There is need for these services in almost every building. Duraclean dealers operate from their home, an office or shop, as they prefer. It's easy to learn . . . we quickly train you. Rendering service yourself, at first, prepares you to train and supervise service men.

### Repeat and Voluntary Orders

Demonstrations win new customers. **DURACLEAN** Dealers find **REPEAT** and **VOLUNTARY** orders a major source of income. Customers, enthused with results, tell friends and neighbors. Furniture and department stores and others turn over rug and upholstery cleaning and mothproofing to **DURACLEAN** Dealers. We show you 27 ways to get new customers.

### We Help YOU Grow

Our **MUTUAL COOPERATION** program gives you many unique and continuous advantages: National Advertising in Life, McCalls, House & Garden, Canadian Homes & Gardens and a dozen others. Copyright and trademark protection. Certificate approves equipment and materials. Products Insurance. Six-year Warranty. Pocket Demonstrators. Sales Book. Advertising Folders & Cards. Tested Ads. Ad Cuts & Mats. Store Display Cards. Radio & TV Musical Commercials. Home Show Booth Display. Publicity Program gets FREE local newspaper stories. Prizes. Laboratory research and development. Monthly magazine. Resale Service. Annual Conventions. Behind all this is a 26 YEAR OLD headquarters interested in YOUR personal success. If you want to become the owner of a **DURACLEAN** Service business, you should inquire now, TODAY, while territory is still available.

### What Dealers Say

W. Lookiebill: We've had 20 years of pleasant dealings. I'm 65 but am getting my sights for 20 more years.  
Gerald Merriman: \$700 cleaning . . . only 13 working days.  
P. D. Freidinger: 70% of our business is repeat.  
A. Ullman: Every demonstration has been a sale.  
Ellsworth: Your advertising certainly has paid dividends.  
M. Lassanske: Original investment returned in two months. Not sorry I started 'on a shoe string'.  
R. Kimbrough: Finished First White House of Confederacy and am to Duraclean the Governor's Mansion.  
Margaret Turner: Took in \$106 in 15 or 18 hours.  
L. Johnson: Each customer leads to 3 or 4 more.

### EASY TERMS

A moderate payment establishes your own business—pay balance from sales. We furnish electric machines, folders, store cards, introduction slips, sales book, demonstrators and enough material to return your **TOTAL** investment.

### FIRST PROCESS IN THE FIELD TO WIN THIS IMPORTANT HONOR!

As a Duraclean dealer, your services are backed by this famous seal of quality . . . proof that Duraclean has passed rigorous tests. No competitor in your town can boast this seal. Duraclean has also been tested and certified by the American Research & Testing Laboratories. No wonder it's so easy to get business!



### FREE Booklet

Our first letter and illustrated booklet will explain everything — the two modern, urgently needed services, waiting market, how business grows, your large profit, easy terms and **PROTECTED** territory. Clip and mail coupon today! Get all the facts . . . no obligation.

**Duraclean Co.** 6-16D Duraclean Bldg., DEERFIELD, ILLINOIS

### "OWN a Business" Coupon

**DURACLEAN CO., 6-16D Duraclean Bldg., Deerfield, Illinois**  
Without obligation to me, send booklet and letter giving full details. Tell me how I may OWN a growing business of my own built upon satisfied customers.

Name \_\_\_\_\_  
Address \_\_\_\_\_  
City \_\_\_\_\_ State \_\_\_\_\_







**MAKE \$18<sup>00</sup>  
AN HOUR**

**WITH THE NEW**

**PLASTIC SANDWICH MACHINE**

Make **PLASTIC SANDWICHES** that cost you only 8c each, take only 2-3 minutes of your time, yet sell for 50c to \$1.00 each!

"Plastic Sandwiches" are thin sheets of plastic fused (laminated) around social security cards, photographs, driver's licenses, membership cards, etc. Anything you want to permanently save.

Send today for **FREE** sample and illustrated literature for our complete line of sandwich machines from \$39.50 up.

**PLASTICAST CO.** 6612 N. CLARK ST. DEPT. LM-801, CHICAGO 26



**ENCYCLOPAEDIA BRITANNICA**

*For Christmas  
and a Lifetime*



Brand New Edition Now Available  
Direct From The Publisher—On Easy

**Book a Month Payment Plan**

Yes, the latest edition of Britannica—the greatest treasure of knowledge ever published—is now being offered on a remarkable plan that puts this world-renowned reference library within reach of every family. All 24 volumes will be placed in your home NOW...you pay for it as you enjoy it...as easy as buying a book a month.

**New Edition is Profusely Illustrated**

The new Britannica almost "televises" the information to you by means of 23,225 pictures, plus charts, maps and drawings. But it does not merely show "attractive" pictures—it is the work of 5,258 of the world's best minds. The largest and most complete reference set published in America, it will enrich the lives of those who own it for long years to come.



**Preview Booklet Offered FREE!**

Simply fill in and mail the coupon today, and we will send you...without cost or obligation...a copy of our beautiful, new booklet which contains an exciting preview of the latest edition of Encyclopaedia Britannica. Send no money—not even for postage. It's yours, absolutely free!

Just as soon as we receive your coupon, we will send your illustrated free booklet, so that you can read and enjoy it at your leisure, in the privacy of your home. There is no obligation, of course. However, since this offer is necessarily limited, please mail the coupon today before it slips your mind.

**Mail Coupon NOW for**

**FREE  
Booklet!**

ENCYCLOPAEDIA BRITANNICA, DEPT. 34-F  
425 N. Michigan Avenue, Chicago 11, Ill.

Please send me the FREE Preview Booklet and information on how I may obtain the ENCYCLOPAEDIA BRITANNICA, direct from the publisher, on the Book a Month Payment Plan.

NAME \_\_\_\_\_

ADDRESS \_\_\_\_\_

CITY \_\_\_\_\_ STATE \_\_\_\_\_

IN CANADA, WRITE E. B. LTD., TERMINAL BLDG., TORONTO, ONTARIO



**hunting slingshot**

- accurate—powerful—silent
- kills small game, pests
- hits like a rifle

**\$150**

postpaid  
(no cod's)



**I. J. STONE** Dept. B 12, 1616 Oak St. • Santa Monica, Calif.

**SURE FIRE RONSON  
TYPE GIFT LIGHTER**

Most popular cigarette lighter, improved for service by precision factory, under expired Ronson patent. Now sold at less than one-third former price: imported. Money refunded in five days with return of lighter. Send \$2.00 now to

**IDEAL PRODUCTS CO., 132 Nassau St., New York 38, N. Y. Est. 20 yrs.**



**FULL SIZE MODEL KITS!**



**\$5.95**

The original kit. Just out! Now 9 authentic models for den or game room. Wood with machine work done for you. Process for gun metal finish. Order direct or send 15c for interesting, revised catalog.

For NEW illustrated catalog of 9 models...Send 15c to:

**O'BRIEN GUNCRAFT (D) P.O. BOX 657 MADISON, WIS.**



**SEND FOR THIS FREE!**

Make money. Know how to break and train horses. Write today for this book FREE, together with special offer of a course in Animal Breeding. If you are interested in Galting and Ridding the saddle horse, check here ( ) Do it today—now.

**BEERY SCHOOL OF HORSEMANSHIP**  
Dept. 11012 Pleasant Hill, Ohio

**Say You Saw It in Popular Mechanics**

**FREE—Amazing Book on  
RHEUMATISM, ARTHRITIS**

If you suffer aches, pains and discomforts of Rheumatism, as manifested in ARTHRITIS, NEURITIS, SCIATICA or LUMBAGO, send today for this FREE Book. It reveals important facts about why drugs and medicine give only temporary relief without removing cause. Explains a proven, specialized system of treatment that may save you years of distress. No obligation. Write for this FREE Book today!

**BALL CLINIC, DEPT. 756, EXCELSIOR SPRINGS, MO.**



# Inventors

Take these necessary preliminary steps promptly to protect your invention by applying for a United States patent—

Sketch and describe your invention. Sign, date and have this disclosure witnessed by two people who understand your invention. Have us make a preliminary search among U. S. patents already granted for similar types of invention. We then report to you on the probable patentability of your invention and recommend your further course of action.

Write for our instructive booklet, "Patent Protection for Inventors" and our convenient "Evidence of Invention" disclosure form. No obligation.

VICTOR J.  
**EVANS & Co.** *Merlin M. Evans*  
REGISTERED PATENT ATTORNEY

230-P MERLIN BUILDING, WASHINGTON 6, D. C.

## STORM WINDOWS

Regular 49½c

NOW ONLY **19½c**

10.8 Sq. Ft. Size

No Tools • No Screws  
No Nails • No Hooks



### Protect your family all winter for pennies!

Bargain of the year! Now—famous **TRANS-KLEER** Plastic Storm Windows yours for only 19½ cents each! Clear, lightweight, flexible! Won't shatter, chip or turn yellow. Tensile strength of 2,000 lbs. per cubic inch! Insulates against wintry blasts in sub-zero weather. Use year after year—just fold away like cloth. Made by one of world's greatest manufacturers of window-clear plastics. Install in minutes with "Magic" Adheso border—no nails, no screws, no tools! Generous Kit—108 sq. ft.—enough for 10 standard windows, plus Adheso Border—all for 1.98. Supply limited Order **NOW**. Send check, cash or m.o. for prompt free delivery. (COD's plus postage).

**THORESEN'S, Dept. 6-N-74**

352 Fourth Avenue New York 10, N. Y.

(Canadian Address: 45 St. James St., West, Montreal 1, P.Q.)



## MAKE STRIPES with new PAINT PEN

Single 1/16" stripe \$1.25 model

Other single stripe models 1/64", 1/32", 3/64", 5/64", 3/32" & 1/8"

Complete Kit \$5.00 (all 7 tips)

Extra tips 90c ea.

Extra 1/4" tip..\$1.20

**Straight, curved, single or double**  
With any color paint, stripe furniture, bikes, autos, model planes, toys, linoleum, wallboard. Clean, crisp decorative lines. Can't clog or smear. Also use with glue, tempera, textile paint or underglaze...on wood, glass, plastic, ceramics, metals, fabrics and paper. Ask your dealer or order direct.

**DEALERS**

Master paint striping tool in display carton. Write for discounts.

**DOUBLE STRIPE MODEL**

**HOBBY**

"Professional" results every time. Simple, easy to use. Order now.

**MFRS**

Ask about heavy duty industrial striping tools.

**5 COMBINATIONS \$3.25**

**WENDELL MFG. CO.**

4234 LINCOLN AVE., Dept. 324  
CHICAGO 18, ILLINOIS

**ENGINEERING DEGREE IN 27 MONTHS**

**INDIANA TECHNICAL COLLEGE**

B. S. Degree, Aero., Chem., Civil, Elec., Mech., & Electronic Eng. (inc. Radio & TV). B.S. degree in 36 mo. in Math., Chem., Physics. Prep. courses. Low rate. Earn board. Large industrial center. Students from 48 states, 21 countries. Demand for grads. G.I. appr. Enter Dec., March, June, Sept. Catalog.

1612 E. Washington Boulevard  
Fort Wayne 2, Indiana



Now!

## TEST YOUR OWN TV - RADIO TUBES!

**EVEN THE PICTURE TUBE**

Checks fuses, appliances, etc. Easy, safe to use. Insert tube in socket. Pilot light instantly indicates if tube needs replacement. Rugged metal case (not plastic). AC or DC. One service call saved pays for tester. Only \$3.95 ppd. or C.O.D. plus charges. Deluxe Model \$4.95. Instructions. 5-yr. guarantee. **GEIGER ENGINEERING CORP., Dept. G-1101, 6349 N. Western Ave., Chicago, Ill.**

**\$2.95 OR 2 FOR \$5.00!**



**TESTED AND GUARANTEED**

Write for free list on all types of telephones.

Shipments F.O.B.

**TELEPHONE ENGINEERING CO., Dept. B126, Simpson, Pa.**

## DON'T RISK YOUR LIFE

**Learn to Drive Better**

Send immediately for NEW book "How to Improve Your Driving and Avoid Accidents." Place \$1.00 and your name and address in an envelope, mail to:

**NEIL HAINES**

PO Box 89

Sturgeon Bay, Wisconsin



**ELECTRIFY YOUR SEWING MACHINE!**

Buy direct and save! Kit comes fully wired, installed in a 55¢. Fits all machines. **ALL-NEW PARTS!** Guarantee

• AC-DC Motor & bracket • Multi-speed foot control • Cord set & block • 115 v 60 c • Full instructions • Steel pulley & belt

**BONUS:** 10 day free trial. Reg. \$2.95 Sewille given FREE with kit. Reg. \$7.95 pinking shears only \$1 with order. Send no money. Kit sent C.O.D. Or send money order and we'll pay postage. State whether wheel on your machine turns towards or away from you. Shipping wt. 6 lbs.

**SENIOR SEWING MACHINE CO., Box 142, Dept. P5E11, Bklyn 6, N. Y.**

## RUPTURED

**BE FREE FROM TRUSS SLAVERY**

Why put up with wearing a gripping chafing unsanitary truss when there is a new modern **NON-SURGICAL** treatment that is designed to permanently correct rupture. Write today for our New **FREE** Book that gives facts that may save you painful and expensive surgery, and tells how non-surgically you may again work, live, play and love and enjoy life in the manner you desire. There is no obligation.

Excelsior Hernia Clinic, Dept. 8305, Excelsior Springs, Mo.



# Make SURE, SAFE INSULATED ELECTRICAL CONNECTIONS

The New

## SUPER ~~CLAMP~~ Hand Tool

The ONE Tool for ALL Wire Sizes used in Home Wiring, Appliances, Automobiles.

### DOES ALL THESE THINGS BESIDES

**CRIMPS** Solderless Terminals and Connectors without solder or tape for safe connections.

**CUTS** Wire, making clean, sharp cut through Insulation and Conductor.

**STRIPS** Wire sizes #22-#10. Gauges assure proper length for sure, safe crimp.

**SHEARS** Bolts and screws without damaging threads — no filing or hack sawing.

### ORDER DIRECT — USE COUPON

Satisfaction guaranteed or money back. Send check or money order for \$3.95. (Ohio residents add 12c sales tax.)

T. W. Berger, Inc.  
National Distributor Consumers and Dealers  
**AIRCRAFT-MARINE PRODUCTS, Inc.**  
210 DE Mariemont Center Bldg., Cincinnati 27, Ohio

Only  
**\$3.95**  
Post Paid



comes with  
**PRE-INSULATED**



**FREE with Each TOOL**

T. W. Berger, Inc.  
National Distributor Champ Tool  
210 DE Mariemont Center Bldg., Cincinnati 27, Ohio  
Send me post paid the new super Champ Hand Tool. I am enclosing \$3.95. (Ohio residents add 12c sales tax.)  
 check  money order

NAME \_\_\_\_\_  
ADDRESS \_\_\_\_\_  
CITY \_\_\_\_\_ ZONE \_\_\_\_\_ STATE \_\_\_\_\_

### PORTABLE CAR COVER Heavy Vinyl Plastic

Protect Against RAIN • SUN • DUST

Long-lasting plastic, folds compactly, off and on in a jiffy, sturdy elastic binding gives extra security. State make, model and year



Send \$6.95 plus 35¢ postage or sent C.O.D. Extra Heavy Plastic Gauge \$8.95 + 45¢ postage.  
BEA SALES, Dept. 8-6, 125 E. 46th St., New York 17

### SALE

12 X 50 REGULARLY \$67.50  
SAVE \$40.55!

High powered, whisper-weight (27 oz.) color corrected, Achromatic binoculars. 7" high! EZ to hold, EZ to focus. CENTER FOCUS for instant finger-tip adjustment. SALE PRICE FOR THIS SALE ONLY (including case and straps! Made in Japan. USE 30 DAYS, If \$26.95 not satisfied return for refund. UNITED BINOCULAR CO., 9043 S. Western, ARF-1108, Chicago 20. DEALERS WANTED



Add Fed. tax

# LEARN MEAT CUTTING AT NATIONAL

Pay After Graduation



The steady dependable trade of Meat Cutting taught easily in 8 short weeks. YOU LEARN BY DOING under actual meat market conditions in big modern school at Toledo.

For beginners or men with experience. Get a profitable store of your own. Remember, PEOPLE MUST EAT! Big pay jobs. Free employment help. Thousands of successful graduates.

Buying, cutting, percentage, pricing, advertising, selling, etc. A complete retail meat education. National School established 33 years. Get National training NOW. Pay your tuition in easy weekly payments

after you graduate. Send coupon for FREE 52 page school catalog — TODAY. G.I. approved.

National School of Meat Cutting, Inc., Dept. 50-L, Toledo 4, Ohio

Send me your FREE school catalog on National Training at Toledo in Meat Cutting, Meat Merchandising and Self Service Meats. No obligation. No salesman will call.

Name \_\_\_\_\_ Age \_\_\_\_\_

Address \_\_\_\_\_

City \_\_\_\_\_ State \_\_\_\_\_

Approved for training Korean Veterans



# Check the Kind of Body You Want

...and I'll Prove How EASILY You Can Have It!

Charles Atlas



Just tell me, in coupon below, the kind of body you want—and I'll give it to you SO FAST your friends will be amazed! "Dynamic Tension," my easy, 15-minutes-a-day method, will make your chest and shoulders bulge... arms and legs surge with power... your whole body feel "alive!"

**FREE BOOK** 32 pages on how "Dynamic Tension" changed me from a 97-pound weakling into "World's Most Perfectly Developed Man"—and how I'll prove it can change YOU too. Mail coupon NOW!

CHARLES ATLAS, Dept. 812, 115 East 23rd St., New York 10, N. Y.

Dear Charles Atlas: Here's the Kind of Body I want:  
(Check as many as you like)

- |                                                                |                                                    |
|----------------------------------------------------------------|----------------------------------------------------|
| <input type="checkbox"/> More Weight—Solid—in The Right Places | <input type="checkbox"/> Powerful Arms, Legs, Grip |
| <input type="checkbox"/> Broader Chest, Shoulders              | <input type="checkbox"/> Slimmer Waist, Hips       |
|                                                                | <input type="checkbox"/> Better Sleep. More Energy |

Send me absolutely FREE a copy of your famous book showing how "Dynamic Tension" can make me a new man—32 pages, crammed with photographs, answers to vital questions, and valuable advice. No obligation.

NAME \_\_\_\_\_ AGE \_\_\_\_\_  
(please print or write plainly)  
ADDRESS \_\_\_\_\_  
CITY \_\_\_\_\_ STATE \_\_\_\_\_

## ...TURN CONCRETE INTO GOLD!



**MAKE UP TO \$75 A DAY IN YOUR OWN BUSINESS**

If you want to have your own business — to start a business on your own — here's your big opportunity! New high speed, low cost General block machine produces up to 1,000 concrete blocks a day. Sell all you make to builders, supply houses, and others for homes, factories, buildings, garages. Cash in on the building boom! You can make profits of 100% to 130% — up to \$75. a day! General block machine equipped with 1/2 h.p. electric motor — or can be supplied with gasoline engine — works anywhere, in little space, indoors or out. Operates from ordinary house light socket. Simple, foolproof 3 step operation — so easy a child can do it. Makes superior 3 core blocks any size from 4" to 12". Also makes chimney, tank, corner and other types. Blocks meet any building code anywhere in the country. Materials — sand, water, cement, available anywhere. Simple illustrated operating instructions and mixing formulae for cement and cinder blocks supplied with each machine. Write for FREE folder with full information.

**MOTOR DRIVEN**

R. L. T. of New York City reports: "MY GENERAL BLOCK MACHINE PAID FOR ITSELF IN FIRST 2 WEEKS!"  
Hundreds now in use the world over!  
Write for FREE details today!

**EXTRA**

Amazing illustrated book gives floor plans for 6 sensational concrete block bungalows. Tells how to lay blocks, lay out building lines, mix concrete, build steps, porch and concrete floors all at great savings. Written by experts. Can save many times the cost of the machine! Get it now! No strings attached. Send \$1.

BOOK SENT FREE IF YOU BUY MACHINE.  
\$1 REFUNDED IF YOU BUY LATER.

**GENERAL ENGINES CO.**  
DEPT. M-126, ROUTE 130, THOROFARE, N. J.



Great Gift...  
Great Knife



by **CAMILLUS**

- HANDY
- HANDSOME
- HAND-HONED!

PONY JACK  
Style #21

For Christmas—a man-sized selection of America's most popular pocket knives. Precision made for best performance, beauty and durability. Camillus knives make really "sharp" gifts.

**GUARANTEED QUALITY**

**CAMILLUS**  
CUTLERY COMPANY  
Comillus, New York

### TASOPE PHOTO-ENGRAVING PLANTS



Establish your own profitable PHOTO-ENGRAVING business. Make cuts for newspapers, printers, and advertisers. Make etched name plates, plaques etc. Instructions furnished, no experience necessary. Sold direct from factory since 1931. First five hundred cuts sold locally or by mail will pay for plant and pay you well for your time. Write for FREE catalog.

TASOPE, DEPT. PM-12, AURORA, MO.

### High School Course at Home

Many Finish in 2 Years

Go as rapidly as your time and abilities permit. Course equivalent to resident school work — prepares for college entrance exams. Standard H. S. texts supplied. Diploma. Credit for H. S. subjects already completed. Single subjects if desired. High school education is very important for advancement in business and industry and socially. Don't be handicapped all your life. Be a High School graduate. Start your training now. Free Bulletin on request. No obligation.

American School, Dept. H945, Drexel at 58th, Chicago 37

### WHOLESALE Electric Guitars - Parts - Factory to You



Solid-body Spanish, amplifiers, double-necks, single-necks, triple-necks, 4-necks, solid-body mandolin, pickup mikes, non-electric instruments, etc. 1957 Models wholesale. FREE CATALOG. Free home study course with instruments. Parts & plans available to build your own.

CARVIN CO., Box 287, PM-12, Covina, Calif.



### Easy to make your own BOWS—ARROWS—EQUIPMENT

Illustrated Hand-Book 84 pgs. \$1, tells you how! Large Colored Catalog 5c—Send for it!

Ask your dealer for "Stemmler's Archery" (Oldest Mfr. in U.S.A.)

**L. E. STEMMLER CO.**  
Manorville (Box 1) L. I., N. Y.

### MASTER MIND!



**Learn Short-Cut Mathematics**  
Juggle figures, do baffling number tricks. Make people gasp at your marvelous lightning-quick mind. Multiply 4 figures by 4 figures without using old-fashioned multiplication! Big cloth-bound volume: fully illustrated course for self-instruction.

**Sharpen up Your Brain Power**  
Includes worked-out problems, answers, etc. Sensational bargain, only \$3.95 postpaid or COD plus postage. Satisfaction guaranteed or refund. Order this amazing "Short-Cut Mathematics" today!

**NELSON-HALL CO.,** 210 S. Clinton St. Dept. 4MU-2 Chicago 6, Ill. **\$3.95 Complete**



**RCA** offers you the  
 finest training  
 at home in  
 Radio-TV  
 electronics,  
 TV servicing,  
 Color TV

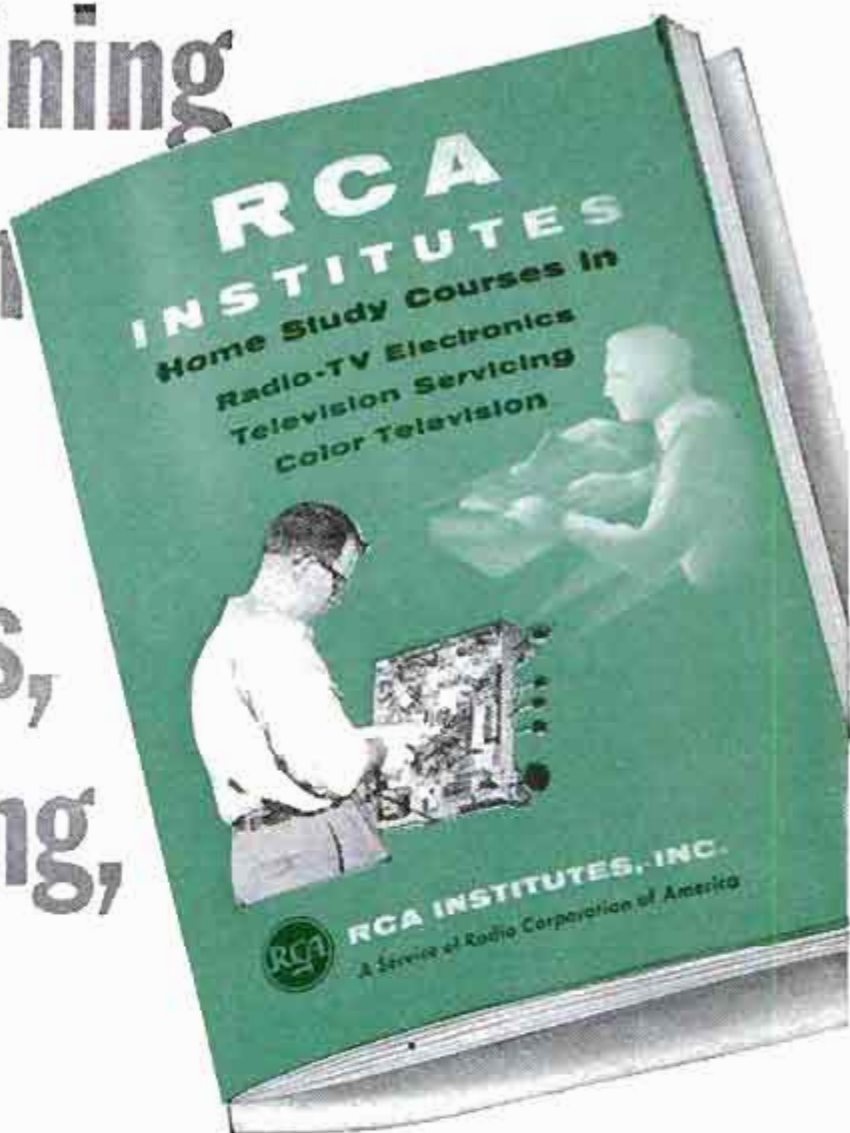

**SEND FOR THIS FREE  
 BOOK NOW!**

The instruction you receive and equipment you get (and keep) will start you on your way. Pay-as-you-learn. You pay for only one study group at a time. This 52 page book contains complete information on Home Study Courses for the beginner and the advanced student.



**RCA INSTITUTES, INC.**  
 A SERVICE OF RADIO CORPORATION OF AMERICA  
 350 WEST FOURTH STREET, NEW YORK 14, N.Y.

RCA Institutes, Inc., Home Study PM126,  
 350 West Fourth Street New York 14, N. Y.  
 Without obligation, send me FREE CATALOG  
 on Home Study Courses in Radio, Television  
 and Color TV. No salesman will call.

Name ..... Please Print .....  
 Address .....  
 City ..... Zone ..... State .....

VETERANS  
 KOREAN G. I.  
 P. L. 550  
 CHECK HERE  
 ( )





YOU  
can  
acquire

## LAW NIGHTS AT HOME! LL. B. DEGREE

LaSalle's famous Law Library—used as reference in many Law libraries and Law offices—has enabled thousands to master Law surprisingly fast, in spare hours at home, for business and professional advancement.

These 14 remarkable volumes, compiled by leading professors and lawyers, cover the whole basic field of Law in condensed, orderly, simplified manner.

You advance rapidly with this great library, plus special lectures furnished. We guide you step-by-step with personalized Problem Method of instruction . . . you learn by doing—handling legal problems—not by memorizing rules.

Send for two FREE booklets, "Law Training for Leadership," and "Evidence," answering questions about Law and its value to you, and telling how LaSalle Law graduates are winning rapid advancement in business and public life. Mail coupon below. No obligation.

### LA SALLE EXTENSION UNIVERSITY A Correspondence Institution

417 S. Dearborn St. Dept. 1264L Chicago 5, Ill.

Send me your two FREE booklets described above, without obligation.

Name.....Age.....

Street.....

City, Zone & State.....

## MAKE TREMENDOUS PROFITS

Have Fun! Earn Big Money! Cast plaster figurines, bookends, plaques, novelties at home in your spare time with X.L. rubber molds! NO EXPERIENCE NEEDED! Molds and rubber for 3 molds, only \$1.50 ppd. Send 25c (refunded with order) for 40 page catalog now!

PLASTIC ARTS STUDIO 3403 SO. MADISON, DEPT. PM2  
MUNCIE, INDIANA

## SAVE HUNDREDS OF DOLLARS with HOME-A-MINUTE "KIT"

This is not something to fool around with.



### A Hard Hitting System of Saving Big Money

Design and build your New Home, Attic Flat, Extra Bedrooms or Remodeling—IN MINUTES—with dozens of fiber partitions, Doors, Windows, Kitchen Cabinets, made to 1/4 inch scale same as blueprint. FIBER, BE-

LIEVE IT OR NOT, YOU, THE LAYMAN, who knows nothing about building, can estimate your own costs—IN MINUTES—after you adjust charts to local prices.

Don't build anything until you get this "KIT" if you want to save money. Handbook tells you how. This information should not pass you by. Complete "KIT" \$3.95 ppd., if COD plus postage and \$1 deposit required. Handbook without "KIT" \$1.95 or free literature. Money back guarantee. Return in 10 days.

**SPECIAL NOTICE!**—As a builder, controlling over 3 million dollars worth of home construction, we will ATTEMPT, but not promise, to obtain a special discount to you for your building materials on your new project, thru your favorite, local, Lumber Dealer. Details with "KIT."

R. C. HALL & CO. 2825 N. 69th St.  
MILWAUKEE 10, WIS.

# ELECTROPLATE IT YOURSELF!

**TOOLS**  
**CHROME WORN**  
**BABY SHOES**

NOW using NEW plating kit. It's easy to electroplate any object with the same LUSTER and DURABILITY as done by the most expensive equip. Complete kit and instructions on plating metal and non-metal objects, with Nickel, Chrome, Copper, Gold, etc. ONLY \$5.95. SEND NO MONEY—everything sent C.O.D. plus postage. OR send \$5.95 now and receive it postpaid. Money back in 7 days if not satisfied.

M. Z. SALES CO., Dept. G-10, 113 W. 42nd St., New York 36, N. Y.

## MECHANICAL PENCIL CALCULATOR

NEW INVENTION

Not a Slide Rule

MATH-WIZ pencil calculator gives answers automatically to addition, multiplication and square root problems. (Indirect subtraction and division.) Easy to operate, comes in gold anodized aluminum casing. Useful gift for students, engineers, draftsmen and in all industry. Only \$2.25 postpaid. No C.O.D. JACK WEISER, 1233 S. Fairfax Ave., Los Angeles 19, Calif.

## FREE! BOAT KIT CATALOG

14' Model Pictured

### 42 TOP PERFORMING MODELS, 8' thru 18'

...from \$39.25 incl. frt.

Runabouts, Cruisers, Convertibles, Fishing, etc. for every purpose with modern styling, advanced design. No experience necessary, amateurs can easily assemble. Save 1/2 to 3/4 "factory-built" prices!

FIBERGLAS, TRAILERS, ACCESSORIES

LUGER INDUSTRIES, INC. DEPT. B-12 3404 Lyndale S.  
Minneapolis 8, Minn.

## RUPTURED?

Something different. Light. Cool. No leg straps. No elastic. No pressure on hips or spine. Inexpensive. Worn by Mechanics, Farmers, Doctors, etc., everywhere. Guaranteed. Write

HAND-LOCK PRODUCTS EST. 1893  
DEPT. PM, PRESTON, ONT., CAN.

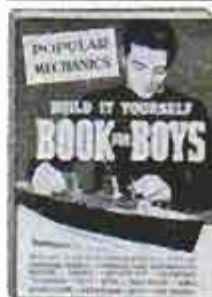

## Every Boy Should Have This Build-It-Yourself Book for Boys!

It's natural for boys to want to make things—to fuss with tools—to fashion the kind of things "kids" want. So give boys the Build-It-Yourself Book for Boys. Encourage a youngster to express himself through the sensational new Popular Mechanics book that shows how to make 56 different things every boy dreams about. It covers science, mechanics, electricity, modeling and other fields. 192 pages of easy-to-follow instruction and 469 how-to-do-it pictures.

### 56 Toys, Games, Gadgets, Models, Boats, Electrical Devices, Cars and Other Things Boys Can Make at Home

How to make—Airplane Models, Truck, Squirt Gun, SS United States Model, Surfboard, Tank Houses and Shelter, Boats, Bob-sleds, Boomerangs, Cannon Toy, Electric game, Electric Motors, Garage Toy, Helicopter Toy, Hunting Knife, Hydroplane Model, Kites, Log Cabins, Marble Game, Microscope, Printing Press, Radio Sets, Rafts, Railroad Modeling, Shooter, Scooter, Sidewalk Cars, Sprinkler

Build-It-Yourself for Boys sent postpaid for \$2.50 or COD, charges additional. Money refunded if you are not pleased after 5 days' use. Mail order to address below.

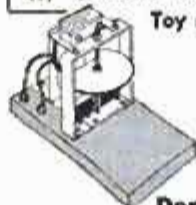

Toy motors



Boomerangs



"Ju-be"—the punt

POPULAR MECHANICS PRESS  
Dept. 1256, 200 E. Ontario St., Chicago 11



HOW TO GROW

# ORCHIDS AT HOME

Most enjoyable hobby I know. People drive 100 miles to see this plant... 10 flowers, 8 1/2 inches across!  
Thomas Hurst-Utah

Learn how you may have real ORCHID FLOWERS blooming in YOUR OWN HOME within a few weeks. Successful home grower now reveals his secrets. Shows you how to grow gorgeous CATTLEYS, CYMBIDIUMS, EPIDENDRUMS, etc. in your living room. No previous experience needed. World's most fascinating hobby—PROFITABLE HOME BUSINESS. Big profit orders come from friends, neighbors, florists, etc. FREE—real ORCHID SEEDS and full details, including PLAN FOR STARTING YOUR OWN BUSINESS—SEND NO MONEY. Write today.



YEAR ROUND ANY CLIMATE NO Green House

FREE! REAL ORCHID SEEDS & \$\$\$ PLAN

TROPICAL FLOWERLAND, Dept. 31M  
4622 Wilshire Blvd., Los Angeles 5, Calif.

How to Learn ORCHID SECRETS \$1 SEEDS

## WHEELS WHEELS WHEELS

7" Disc Wheel 3/4" Tire 3/4" sleeve	45c ea.
8" Disc Wheel 1 1/4" Tire 1/2" sleeve	70c ea.
7" Disc Wheel 1" Tire 1/2" ball bearing	80c ea.
8" Disc Wheel 1 1/4" Tire 1/2" ball bearing	\$1.00 ea.
6" Disc Wheel 1.50 semi-pneum. Tire 1/2" B.B.	\$1.35 ea.
8" Disc Wheel 2" semi-pneum. T. 1/2" B.B.	\$1.50 ea.
10" Disc Wheel 1.75 semi-pneum. T. 1/2" B.B.	\$1.50 ea.
12" Disc Wheel 1.75 semi-pneum. T. 1/2" B.B.	\$3.50 ea.
12" Disc Wheel 1.75 semi-pneum. T. 1/2" B.B.	\$1.85 ea.

Above wheel prices include hub cap. Plus Postage. C.O.D.'s accepted.  
AXLES—Sizes 5/16 in., 3/8 in., 1/2 in.—Cut to size—End holes drilled.

UNITED WHEEL STAMPING CO.

11915 S. MARSHFIELD AVE., PM-12, CHICAGO 43, ILLINOIS

## GET LOADS OF MAIL!

Get Offers, Catalogs, magazines, folders Galore!



Want your mail box stuffed with interesting, attractive offers, catalogs, samples, magazines, etc.? NO OBLIGATION FOR YOU TO BUY ANYTHING! We'll list your name and address with 1000 firms for mail for just \$1.00. Rush \$1.00 & name and address TODAY!  
TOWER PRESS, INC., P.O. Box 591, Lynn 200, Mass.

## MINK \$25.00 EACH

BRED FEMALES FOR SPRING DELIVERY

BOOK "DOMESTIC MINK" \$1.00

HARRY SAXTON'S MINK RANCH, Bemus Point, N. Y.

## "YOU ARE UNDER ARREST!"

Help Bring Crooks to Justice Through Scientific CRIME DETECTION!

We have taught thousands this exciting, profitable, pleasant profession. Let us teach you in your own home. Learn Finger Printing, Firearms Identification, Police Photography, Secret Service Methods thoroughly, quickly, at small cost. Over 800 of all American Bureaus of Identification employ I. A. S. students or graduates. Write stating age, for "Blue Book of Crime."

(A Correspondence School Since 1916)

INSTITUTE OF APPLIED SCIENCE, 1920 Sunnyside Ave., Dept. 1359, Chicago 40, Ill.

# WAR SURPLUS BARGAINS

**\$500,000.00 INVENTORY for QUICK LIQUIDATION**

Surplus items—hundreds of them for home, shop, factory, farm and outdoor use. New items, used items, reconditioned items—all at tremendous savings—all priced for quick sale.

Page After Page of Values

This big catalog shows page after page of amazing money saving values. Write for your copy today. Send 10c to cover postage, mailing, etc. Write today! SEND TODAY FOR YOUR COPY

# 10c

**STARK'S**

212 W. Madison St.  
Dept. PM-5612  
CHICAGO 6, ILL.

# Still dreaming about a good job and more pay?



WAKE UP TO YOUR OPPORTUNITIES IN

# Auto Mechanics

PRACTICAL NEW WAY TO TRAIN AT HOME

Don't rely on *luck* to make your dreams come true! Be practical and depend on *training*. As a skilled man, you can earn up to \$125 a week and more—enjoy security—and even open a shop. Your best bet is to become an auto mechanic. *That's the big opportunity field today.* Over 60 million cars and trucks are on the road, and all require maintenance. At least one-third are in the heavy-repair class. There's so much work that 50,000 mechanics are needed! It's easy to learn this trade at home. Find out *how* by mailing coupon below.



**EARN MONEY IN SPARE TIME** as you train. Many students repair cars for neighbors; others get jobs in local garages; some open shops by the time they graduate. You can learn-and-earn because CTI offers practical Shop-System training.

**DIESEL MECHANICS OR BODY-FENDER REBUILDING** is included at no extra cost. Only CTI offers this extra choice. Get this fully-rounded mechanic's training. Send coupon for two free books.



**YOU PRACTICE WITH THIS TUNE-UP KIT**

Kit includes a Compression Tester, a Vacuum Gauge and Fuel Pump Tester, an Ignition Timing Light, and a portable steel case. These professional instruments help you locate engine troubles, let you get useful practice. You keep this kit!

**MECHANIC'S TOOLS TOO**

You'll use these tools to get real experience. They'll increase your interest, stamp you as a "pro." You'll earn spare time cash with them. No extra cost for tools—you keep them.



**MAIL COUPON TODAY!**

## MAIL TODAY FOR 2 FREE BOOKS

COMMERCIAL TRADES INSTITUTE

1400 Greenleaf Ave., Chicago 26

Dept. A-413

Send your new Auto Mechanics book and Sample Lesson. BOTH FREE.

Name \_\_\_\_\_ Age \_\_\_\_\_

Address \_\_\_\_\_

City \_\_\_\_\_ Zone \_\_\_\_\_ State \_\_\_\_\_





# WHAT ALL AUTO MECHANICS WANT TO KNOW

1664 PAGES



This Big Practical Book gives full information with working diagrams covering principles, construction, ignition, service & repair of modern cars, trucks and buses. Diesel Engines, Hydrumatic & Fluid Drives Fully Explained. A complete Guide of 1664 Pages, over 1500 Illustrations showing inside views of working parts & instructions for service jobs.

**IT PAYS TO KNOW \$4 COMPLETE • PAY \$1 A MO. TO GET THIS ASSISTANCE FOR YOURSELF SIMPLY FILL IN AND MAIL COUPON TODAY.**

Every Mechanic can Step Up his Skill with AUDELS GUIDES. Containing Practical Inside Information in a Handy Form. Covers facts and figures of your Trade. All illustrated and explained. Books sent to you for 7 DAYS FREE EXAMINATION. Send No Money Nothing to Pay Postman. Check Books Wanted — Mail Today.

## MAIL ORDER

AUDEL, Publishers, 49 W. 23 St., New York 10, N.Y.



Please send me for FREE EXAMINATION books marked (x) below. If I decide to keep them I agree to mail \$1 in 7 Days on each book or set ordered and further mail \$1 monthly on each book or set until I have paid price, otherwise I will return them.

**Check NOW!**

You Can Look Over Any Guide In Your Own Home — Start the Easy Payments If Satisfied

**MAIL THIS TODAY**

- HOME APPLIANCE SERVICE GUIDE, 800 Pages \$4
- AUTOMOBILE MECHANICS GUIDE, 1664 Pages. 4
- TRUCK & TRACTOR GUIDE, 1299 Pages . . . 4
- DIESEL ENGINE MANUAL, 575 Pages . . . 2
- MACHINISTS HANDY BOOK, 1650 Pages . . . 4
- WELDERS GUIDE, 600 Pages . . . 1
- BLUE PRINT READING, 440 Pages . . . 2
- MATHEMATICS & CALCULATIONS, 700 Pages. 2
- SHEET METAL PATTERN LAYOUTS, 1100 Pages 4
- SHEET METAL WORKERS HANDY BOOK, 388 Pgs. 1
- MECHANICAL DRAWING GUIDE, 160 Pages . . . 1
- MECHANICAL DRAWING & DESIGN, 480 Pages 2
- TELEVISION SERVICE MANUAL, 434 Pages. . 2
- RADIOMANS GUIDE, 1080 Pages . . . 4
- ELECTRONIC DEVICES, 216 Pages . . . 2
- ELECTRIC MOTOR GUIDE, 1000 Pages . . . 4
- WIRING DIAGRAMS (Light & Power), 272 Pgs. 1
- ELECTRICIANS EXAMINATIONS, 250 Pages. . 1
- ELECTRIC POWER CALCULATIONS, 425 Pages. 2
- HANDY BOOK OF ELECTRICITY, 1440 Pages. . 4
- ELECTRIC DICTIONARY, 9000 Terms . . . 2
- ELECTRIC LIBRARY, 7000 Pages (12 Book Set) 18
- REFRIGERATION & Air Conditioning, 1280 Pgs. 4
- MILLWRIGHTS & MECHANICS GUIDE, 1200 Pgs. 4
- POWER PLANT ENGINEERS GUIDE, 1500 Pages 4
- ENGINEERS & FIREMANS EXAMS, 525 Pages . 1
- PUMPS, Hydraulics & Air Compressors, 1658 Pgs. 4
- OPERATING ENGINEERS LIBRARY (3 Books) . 9
- CARPENTERS & BUILDERS GUIDES (4 Book Set) 6
- PLUMBERS & Steamfitters Guides (4 Book Set) 6
- MASONS AND BUILDERS GUIDES (4 Book Set) 6
- PAINTERS & DECORATORS MANUAL, 450 Pgs. 2
- HOUSE HEATING GUIDE, 1000 Pages . . . 4
- OIL BURNER GUIDE, 384 Pages . . . 1

Name \_\_\_\_\_  
 Address \_\_\_\_\_  
 Occupation \_\_\_\_\_  
 Employed by \_\_\_\_\_ P-12

### TALK - LISTEN - AROUND THE WORLD!

**RADIO AMATEUR TRANSMITTER-RECEIVER!**

SENDS AND RECEIVES THOUSANDS OF MILES on Amateur 80 and 40 meter bands —also, Aircraft and foreign bands (3 to 8 mc). PORTABLE SELF-CONTAINED BATTERY POWERED! NO AC PLUG-INS. NO DANGEROUS HI-VOLTAGES. Low cost battery lasts for MONTHS. Crystal controlled transmitter—Power input up to 5 watts—ENOUGH TO TALK 1 MILE OR 1000. REGENERATIVE RECEIVER pulls in weakest stations. Front Panel Send-recvie switch—No troublesome relays or complicated hookups. Uses any standard antenna. Size only 6"x4"x4". Wt. 3 lbs. TESTED—PROVEN—SIMPLIFIED—PRACTICAL—SAFE for radio beginners (NOVICES). Easy to get license. Full information included.

SEND ONLY \$5.00 (bill, check, mo) and pay postman \$9.95 C.O.D. postage on arrival or send \$14.95 and we will send postpaid. Complete kit includes all parts, tube, coils, full instruction, less batteries and crystal—or COMPLETELY WIRED AND TESTED FOR \$19.95! Steel cabinet \$2.00 extra. Rush order today—NOW!

WESTERN RADIO DEPT. BNM-12 KEARNEY, NEBRASKA

# INVENTORS

PROTECT YOUR INVENTION BY A U. S. PATENT. SEND FOR FREE "INVENTION RECORD" FORM AND "PATENT INFORMATION" EVERY INVENTOR SHOULD HAVE."

**CARL MILLER**  
 REGISTERED PATENT ATTORNEY  
 WOOLWORTH BLDG., 36th FLOOR, 126A  
 NEW YORK CITY

# INVENTORS

U. S. Patents protect your inventions. Our free book of "Instructions on Patent Procedure for Inventors," also "Certificate of Invention" form sent without obligation.

**C. A. SNOW & CO.**  
 REGISTERED PATENT ATTORNEYS  
 428 SNOW BUILDING WASHINGTON 1, D. C.

# INVENTORS

Whether an invention is patentable can be substantially determined by a search of the U. S. Patent records. Without obligation, write for information explaining the steps you should take to secure a patent.

**JOHN N. RANDOLPH**  
 Registered Patent Attorney  
 201 Columbian Building, Washington 1, D. C.

# INVENTORS

Send for PATENT INFORMATION REGISTERED PATENT ATTORNEY  
 Book and INVENTOR'S RECORD ASSOCIATE EXAMINER  
 without obligation U.S. PAT. OFF. 1922-1929

**GUSTAVE MILLER** Patent Attorney & Advisor  
 U. S. NAVY DEPT. 1930-1947  
 126-PM WARNER BUILDING PATENT LAWYER  
 WASHINGTON 4, D.C.

**SPARE-TIME MONEYMAKING OPPORTUNITIES**  
 READ OUR CLASSIFIED ADS  
 HUNDREDS OF BARGAINS AMAZING OFFERS

# INVENTIONS For Sale

Our clients have excellent inventions in many fields to be manufactured and marketed on a cash, royalty or license basis. Full description of clients' inventions will be sent if you state your field of interest. INVENTORS: WE ALSO WANT INVENTIONS OF EVERY TYPE. Write for details.

**GLOBAL MARKETING SERVICE**  
 2420 77th Avenue Dept. M5 Oakland 5, Calif.

# INVENTORS

I shall be pleased to furnish you, upon request, with full information relative to patent procedure—without any obligation on your part.

**PATRICK D. BEAVERS**  
 Registered Patent Attorney  
 934 Columbian Building Washington 1, D. C.



## NEW 128 PAGE CATALOG!



### PRECISION INSTRUMENT PARTS & COMPONENTS

Gears, Shafts, Couplings, Speed-Reducers, Differentials, etc.  
Over 250 items, 4,000 listings, complete with drawings and full specifications of integrated instrument-quality parts made to exacting tolerance standards and finishes. Ideal for...

Engineers — Experimenters  
Model Makers — Shops — Schools

### PIC design corp.

Div. of BENRUS WATCH CO., INC.  
477 Atlantic Ave. East Rockaway, N. Y.

SEND FOR YOUR COPY TODAY —

Enclose 50c to cover handling and postage

## Learn ACCOUNTING Business Administration

Bookkeeping, secretarial and allied subjects at home in your spare time or attend nationally approved resident school. Write for FREE Success Book giving complete details on courses, plans, rates and employment opportunities. G.I. approved. Write Dept. A.



### Hills BUSINESS UNIVERSITY AND EXTENSION SCHOOL

629 W. MAIN ST. OKLAHOMA CITY 2, OKLAHOMA

## LEARN METALCRAFT and JEWELRY MAKING

Low Cost Home Training Now Available

Make money. Learn profitable skills and arts of decorative metal and jewelry crafts. Course is complete. Professionally prepared. Easy to master. Special tools and materials furnished.



Write for Free Booklet **INTERSTATE TRAINING SERVICE**  
DEPT. K-3 PORTLAND 13, OREGON

SAY YOU SAW IT IN POPULAR MECHANICS

## RADIO

Engineering. All phases radio & electronics theory & practice; television; FM; broadcasting; servicing; aviation, marine & police radio. Prepare for good pay; 18-month course. Graduates in demand by major companies. Enter Jan., March, June, Sept. Regular campus life. Write for catalog. **VALPARAISO TECHNICAL INSTITUTE, Dept. D, Valparaiso, Ind.**

EARN WHILE YOU LEARN

## UPHOLSTERY BE YOUR OWN BOSS



Practical, low-cost, LEARN-BY-DOING UTS Course, complete with tools, materials, frames, trains you quickly AT HOME in spare time. Start making money in Upholstery almost at once! Big FREE illustrated book and FREE sample lesson show you how—give full facts about business, job opportunities for men and women. Write TODAY! Also Resident Training. VET Approved. **UPHOLSTERY TRADES SCHOOL**  
Dept. EX-309 721 Broadway, New York 3, N.Y.

Enjoy the Fascinating Story of the Horseless Carriage in



Popular Mechanics

## AUTO ALBUM

166 Illustrations

The most intriguing book about the automobile ever printed. It's thrilling, fascinating and informative. From the very first gasoline-propelled buggy to the cars of today and the atomic auto of the future. The first cars — the men who made them — the scrambled start and the development of the fabulous auto industry—the story of auto racing—the growth of the Nation's highways. 166 thrilling action pictures—old-time cars—racing cars—early auto advertising—automotive oddities. Roll call of names of more than 2000 autos made in the U.S. included. Ideal gift book. Cloth bound, only \$3.00 by mail. Money back if not pleased.

**POPULAR MECHANICS PRESS, Dept. PM-1256**  
200 East Ontario Street Chicago 11, Illinois



# MEN! Make up to \$1,000.00 IN A MONTH!

## without "SELLING"

Sensational Demand for Low-Priced Fire Alarm  
PLUS Sure-Fire "No-Selling" Plan Offers  
Ambitious Men Huge Profit Opportunities



### AMAZING NEW INVENTION

Even beginners who never sold anything in their lives are cleaning up unbelievable profits with the first practical, effective, low priced Fire Alarm ever invented... needed, wanted in homes, factories, offices, stores, on farms, for boats, everywhere. Professional salesmen are making biggest profits in years! Later in this ad I'll tell you about the plan that's producing orders for 1 to 12 Fire Alarms per sale from 8 out of 10 prospects... without selling. Here are the facts about the Fire Alarm. It hangs on the wall like a picture—no wiring, no installation. It's always on guard... it "smells" a fire before danger point.



When temperature rises, Fire Alarm goes off automatically, howls loud warning that can be heard 1/5th mile, wakes up soundest sleeper, gives precious time to put out fire, call fire department, or escape. And it sells for only \$4.95 with profit up to \$2.70 on each one.

### Nearest Thing to AUTOMATION SELLING

#### Make This LIGHTED-MATCH DEMONSTRATION

Sensitive! Lighted match triggers Alarm in 3 seconds!

With our field-tested plan customers sell themselves. No cold canvassing. No hard selling. It's the nearest thing to "Automation Selling." Imagine a sales plan even a child can use successfully because the sales tools we give you (and which you leave with your prospects) do all your selling even while you sleep! No room here to give you all the details, but if you want big money fast, rush the coupon now.

## FREE SALES KIT!

Send no money. Just rush coupon below for all the exciting money-making facts, complete Illustrated Sales Kit, everything you need to make money your first day. Learn how selling only 20 Fire Alarms a day pays you \$1,080.00 profit in a month. No competition anywhere. Get in on the ground floor now. Rush this coupon.

MADE \$26.52 IN 3 HOURS



"Received first shipment about noon. Worked about 3 hours and made \$26.52 profit. It's a terrific seller." Stanley

**MERLITE INDUSTRIES, Inc. (Alarm Division)**  
114 E. 32nd St. Dept. S-15P New York 16, N. Y.

Alvin Wesley, Sales Manager,  
Merlite Industries, Inc., (Alarm Division),  
114 E. 32nd St., Dept. S-15P, New York 16, N. Y.

Rush FREE SALES KIT and full details about your "No-Selling" plan which gives me opportunity to make up to \$1,000.00 in a month without cold canvassing and hard selling—automatically. I am not obligated.

Name \_\_\_\_\_  
Address \_\_\_\_\_  
City \_\_\_\_\_ Zone \_\_\_\_\_ State \_\_\_\_\_  
In Canada: Mopa Co., Ltd., 371 Dowd St., Montreal 1, P.Q.



**"TOOK IN \$217  
FIRST 10 DAYS"**

*Some make more, some less...*

**We help you to start Your  
Own All-Year Business**

**Make Big Money!** With our easily operated, highly efficient wall washer, Charles Stelle took in \$217 gross in first ten days. E. L. Goss took in more than \$10,000 in one year. E. C. Taber wrote, "I made \$400 gross in two weeks." And no wonder... this machine washes walls 6 times faster and better than by hand.



**Your Money-making Opportunity.** We want more men to go into this profitable business for themselves and enjoy independence—freedom from bosses, layoffs. Customers everywhere—homes, offices, schools, churches, hotels, etc. How much you earn depends largely on you. What you take in is mostly profit. No need to rent shop or office; operate business from home. Can start spare time until your full time is available.

**Lose no time. Get all facts without obligation**

**FREE BOOK! MAIL COUPON TODAY!**

• **VON SCHRADER MFG. CO.**  
• W10 "W" PL., Racine, Wisconsin

Send at once (no obligation) your **FREE** booklet containing information about your **WALL WASHING MACHINE** and how I can start my own permanent, profitable business.

Name \_\_\_\_\_  
Address \_\_\_\_\_  
City \_\_\_\_\_ Zone \_\_\_\_\_ State \_\_\_\_\_

**SAY YOU SAW IT IN  
POPULAR MECHANICS**

**BIG MONEY AWAITS MEN  
TRAINED IN**

**TELEVISION — RADIO —  
ELECTRONICS — RADAR**

Only CTS offers **COMPLETE TRAINING** in all phases of Electronics. Why be satisfied with less? You learn by working with actual equipment. Comprehensive Training Program allows you to **EARN AS YOU LEARN.**

**19 TRAINING KITS INCLUDED!**

You receive a Multi-Tester, Oscillator, Signal Tracer, Oscilloscope, Signal Generator, Electronic Timer, Regenerative Radio, 24" TV set (optional) and other valuable testing equipment. **FREE BOOK** and **TWO FREE LESSONS** sent on request. No obligation.



Send for 3  
**FREE  
BOOKS!**

**CHRISTY TRADES SCHOOL, 4804 N. Kedzie, Dept. T-903, Chicago 25**

**GIANT 6 FT. BALLOONS  
59c**



Wow! Genuine Neoprene government surplus (never used) ... giant 6 ft. across, 21 ft. around... at a fraction of original cost. Durable. Can paint on advertising message, inflate and fly. Visible for miles. Great for attracting crowds to fairs, openings, school proms, gas stations. Fun for young and old in backyards or picnics, at the beach, etc. use as water markers & buoys. Order today —only 59c each.  
Special: 2 for \$1.00; 5 for \$2.00; 13 for \$5.00. No C.O.D.

**BALLOONS, P.O. Box 27104, Hollywood 27, Calif.**

**IT'S EASY...  
MAKE MONEY IN PHOTOGRAPHY**

If you are over 17—good pay and fascinating work await you in photography! Start making money quickly in sparetime—step into your own studio or exciting career job. **LEARN-BY-DOING** method trains you at home! Write TODAY for **FREE** catalog. Also Resident Training. Co-ed. 47th Year. Approved for Veterans.

**NEW YORK INSTITUTE OF PHOTOGRAPHY**  
Dept. 49, 10 West 33 Street, New York 1, New York  
**47th YEAR**

**GROW MINIATURE TREES  
FREE! SEEDS & PLAN**



New fascinating HOBBY! \$\$\$ OPPORTUNITY! Real LIVING "Ming" Trees—Beautiful elm, orange, oak, cypress—any kind! Full grown but miniature. Take orders from Interior Decorators, Offices, Hotels, etc. **FREE** Seeds (8 kinds)—Illust. Plan, write: **NATIONAL NURSERY GARDENS, Dept. M12 8463 So. Van Ness, Inglewood 4, California**



**DEVELOP A HE-MAN VOICE!**

Write for **FREE** book "How to Strengthen Your Voice for Greater Success" by Eugene Feuchtinger. No obligation. Book will be mailed at once in plain wrapper, postpaid. Just send your name and address. State age. **PURE VOICE INSTITUTE, 210 S. Clinton St., Studio MU-2, Chicago 6, Ill.**

**FREE AMAZING NEW BOOK  
"HOW TO ANSWER ADS"**



Never before have you seen anything like this. Tells you in simple language the correct way to answer ads. Gets you quicker replies—better results, and greater satisfaction. Will save you time and money and it's **ABSOLUTELY FREE**. No obligation whatever. Every reader of advertising should have this booklet. Send a postcard for your copy NOW. **F. W. JOHNSON, Popular Mechanics Magazine, Room 600-A, 204 East Ontario Street, Chicago 11, Ill.**

**Finish HIGH SCHOOL AT HOME**

**Complete 4 Yrs. in 12 Months**

Learn More! Earn More! Enter professional or technical schools. Advance Socially. Live a Happier, Fuller Life. Individual Courses or complete schedule. **WRITE FOR SCHOOL BULLETIN.**

**ACADEMY FOR ADULTS**

30 W. Washington, Dept. PM-126, Chicago, Ill.

**BUY IT WHOLESALE!**

**GET UP TO 40% OFF**

Agents—Start Buying Service at Home. Get big-name merchandise for clients up to 40% off. Sales easy as you can give sizeable discounts, still make fat commissions. Postcard brings **FREE COPY "The Wholesale Plan."**

**FREE! "THE WHOLESALE PLAN"**

**American Buyers Service**

**HERTEL STATION, DEPT. R, BUFFALO 16, N. Y.**



# "How to Go into Business for YOURSELF"

If you know a trade or occupation—why not go into business for yourself? Why not make the profits others are now making?

IT'S EASY TO START A NEW BUSINESS. It's easier than you think—once you learn the 9 easy steps of building a new business of your own. National Business Consultants has shown over 5000 others how to be successful—let us show YOU too. We guide you every step of the way with sound, proved simple business practices. **EXPAND YOUR OWN BUSINESS.** Learn our tested, profit-making methods for business success. If you already own a business, let N.B.C. guide you too. You'll be amazed. **SEND FOR FREE BOOKLET TODAY!** "How to Start a Business" is jam-packed with revealing information. In easy-to-understand language it explains how to start and make any kind of business profitable. Free for the asking! Sent to you in confidential plain envelope. *Just write:* NATIONAL BUSINESS CONSULTANTS, Office P-12. Los Angeles 61, Calif.



**BOTH FREE!**

Rush Name on Postcard Today!

NOW NO ONE CAN KEEP A SECRET FROM YOU! only \$2.69  
20x-40x-60x TELESCOPE postpaid

Amaze your friends... See what they're doing—without being seen!

Special: Order now, get Free carrying case



3-range all metal telescope magnifies up to 60 power. Watch ball games, look at the moon, stars, animals, distant buildings... up close. Rotating eyepiece, bright chrome-like tube, made for long use. Good on hikes, camping, trips, can use either 20x, 40x, or 60x power instantly! Opens to 3-times its length. No assembling, ready-to-use, no special instructions required. Money back guarantee. Send cash, check or money order to:

I. J. STONE, Dept. TB12, 1616 Oak St. • Santa Monica, Calif.

## SHORTHAND IN

Famous SPEEDWRITING shorthand. 120 words per minute. No symbols; no machines; uses ABC's. Easiest to learn, write and transcribe. Low cost. 350,000 graduates. For business and Civil Service. Typing available. 34th Year. Schools in over 400 cities. Write for FREE booklet to:

**6 WEEKS**

**Speedwriting**

Dept. 1512-6  
55 W. 42 St., N.Y. 36, N.Y.

## STUDY TO BE A DOCTOR of Psychology or Metaphysics

Obtain a Ps.D., Ms.D., or Ph.D. Be a Teacher, Lecturer or Accredited Practitioner. Teach others how to achieve Health, Happiness and Contentment. Chartered by State. Correspondence Courses only. Write for FREE book telling how.

THE NEOTARIAN FELLOWSHIP

Desk 8, Pickwick Building Kansas City 6, Missouri

## MIDGET CAMERA \$2.98

Amazing! Smaller than a pack of cigarettes and yet takes real sharp pictures. Not a toy. Complete with case. Send cash, check or money order to RUBIN'S, 1056 Mac Avenue, Bronx 59, N. Y. C.

WRITE • DRAW • LABEL • MARK ANY SURFACE INSTANT-DRY • WATERPROOF 9 COLORS

The Easy Way To WRITE • DRAW • LABEL • MARK

A shopful of marking devices and inks in one unit!

No Dipping • No Filling • No Loose Ink To Spill

Always Ready To Write!

FREE TIPS ON USE.

STATE OCCUPATION.

**SPEEDRY**

PRODUCTS, INC.

PM-2 RICHMOND HILL 18, N. Y. Pk.

69¢ Refills  
EA. 25¢



## NEW BENJAMIN SUPER CO<sub>2</sub> GAS CARBINE—\$15.95\*

HI-LO (2 Stage) Jet Power Cal. .177 or .22

RIFLED Sheets Pellets & Bullets



Illustrated—Deluxe Model Benjamin Super CO<sub>2</sub> Carbine Gas Rifle with Eastern Stock—\$18.95

IDEAL FOR TARGET AND SMALL GAME. SAFE—ECONOMICAL—ACCURATE

CONVENIENT—PRACTICAL—NON TOXIC. EASY TO OPERATE—NO PUMPING—NO FLINCHING.

Get 40 SHOTS from each 10¢ STANDARD SIZE CO<sub>2</sub> (Soda) CARTRIDGE. Up to ¼" Penetration. Ask your Dealer for Demonstration.

FREE Folder

New Benjamin .177 or .22 CO<sub>2</sub> ROCKET Gas Pistol with HI-LO JET POWER.....\$15.00

BENJAMIN AIR RIFLE CO. 896 MARION ST., ST. LOUIS 4, MO., U. S. A.

## Superior's New Model 70 UTILITY TESTER® FOR REPAIRING ALL ELECTRICAL APPLIANCES MOTORS • AUTOMOBILES • TV TUBES

AS AN ELECTRICAL TROUBLE SHOOTER THE MODEL 70:

- Measures A.C. and D.C. Voltages, A.C. and D.C. Current, Resistances, Leakage, etc.
- Will measure current consumption while the appliance under test is in operation
- Incorporates a sensitive direct-reading resistance range which will measure all resistances commonly used in electrical appliances, motors, etc.
- Leakage detecting circuit will indicate continuity from zero ohms to 5 megohms (5,000,000 ohms)
- Will test Toasters, Irons, Broilers, Heating Pads, Clocks, Fans, Vacuum Cleaners, Refrigerators, Lamps, Fluorescents, Fans, Switches, Thermostats, etc.
- Will test all TV tubes for open filaments, inter-element shorts, burned out tubes, etc. (Will not test TV tubes for quality. An emission type tester such as the Model TC-55 described below is required to test tubes for quality).



AS AN AUTOMOTIVE TESTER THE MODEL 70:

- Tests both 6 Volt and 12 Volt Storage Batteries
- Generators
- Starters
- Distributors
- Ignition Coils
- Regulators
- Relays
- Circuit Breakers
- Cigarette Lighters
- Stop Lights
- Condensers
- Directional Signal Systems
- All Lamps and Bulbs
- Fuses
- Heating Systems
- Horns
- Also will locate poor grounds, breaks in wiring, poor connections, etc.

Handsome round-cornered molded bakelite case, 3½" x 5½" x 2¼". Complete with all test leads. Also included is a 64 page book giving detailed instructions, for testing all electrical appliances, automotive equipment, TV tubes, etc. Only

**15<sup>85</sup>**

Superior's New Streamlined Model TC-55

## TUBE TESTER

QUICKLY AND EFFICIENTLY TESTS RADIO AND TV TUBES INCLUDING: SEVEN PIN MINIATURES; EIGHT PIN SUBMINIATURES, OCTALS AND LOCTALS; NINE PIN NOVALS



YOU CAN'T INSERT A TUBE IN THE WRONG SOCKET. It is impossible to insert the tube in the wrong socket when using the new Model TC-55. Separate sockets are used, one for each type of tube base. If the tube fits in the socket it can be tested. "FREE-POINT" ELEMENT SWITCHING SYSTEM. The Model TC-55 incorporates a newly designed element selector switch system which reduces the possibility of obsolescence to an absolute minimum. Any pin may be used as a filament pin and the voltage applied between that pin and any other pin, or even the

"top-cap." CHECK FOR SHORTS AND LEAKAGES BETWEEN ALL ELEMENTS. The Model TC-55 provides a super sensitive method of checking for shorts and leakages up to 5 Megohms between any and all of the terminals. ELEMENTAL SWITCHES ARE NUMBERED IN STRICT ACCORDANCE WITH R.M.A. SPECIFICATION. One of the most important improvements, we believe, is the fact that the 4 position fast-action snap switches are all numbered in exact accordance with the standard R.M.A. numbering system. Thus, if the element terminating in pin No. 7 of a tube is under test, button No. 7 is used for that test.

The Model TC-55 comes complete with operating instructions and charts. Use it on the bench—use it for field calls. A streamlined carrying case, included at no extra charge, accommodates the tester and back of instructions.

**26<sup>95</sup>**

## SHIPPED ON APPROVAL NO MONEY WITH ORDER—NO C.O.D.

Try either of the above instruments for 10 days before you buy. If completely satisfied then send down payment and pay balance as indicated on coupon. No interest or finance charges added! If not completely satisfied, return unit to us, no explanation necessary.

MOSS ELECTRONIC DIST. CO., INC. Dept. D-305, 3849 Tenth Ave., New York 34, N. Y.

Please run the unit(s) checked. If satisfactory, I will remit down payment within 10 days, and the balance at the monthly rate indicated below. If not satisfactory, I may return merchandise for cancellation of account.

Model 70..... Total Price \$15.85 —\$3.85 within 10 days. Balance \$4.00 monthly for 3 months.

Model TC-55..... Total Price \$26.95—\$6.95 within 10 days. Balance \$5.00 monthly for 4 months.

Name.....

Address.....

City..... Zone..... State.....

All prices net, F.O.B., N.Y.C.



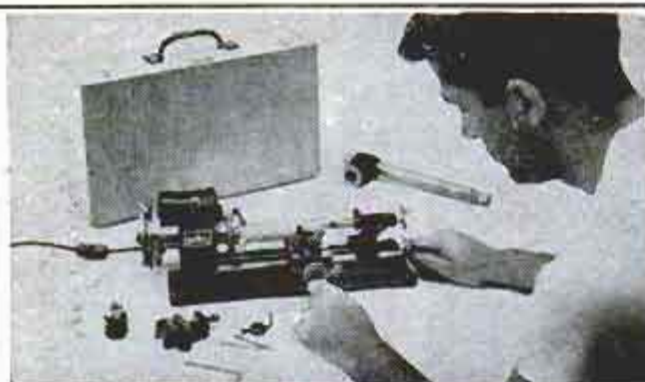

## UNIMAT 10 IN 1 COMPLETE WORKSHOP

CRAFTSMEN, MODEL BUILDERS, HOBBYISTS AND INVENTORS all over the world are choosing this unique and extremely versatile electric tool for machining small parts from steel, brass, wood, aluminum and plastics. Highly acclaimed because of its precision results, UNIMAT offers these serious craftsmen many other worthwhile advantages.

**UNIMAT BASIC UNIT (shown) INCLUDES:** 1—a Precision Lathe and all accessories necessary to convert it quickly and easily into a 2—Drill Press; 3—Hand Drill; 4—Polishing and Grinding Machine; 5—Tool Grinding Machine; 6—Milling Machine. With the Basic Unit you also get these 13 accessories Free: AC/DC Power Motor, with reduction pulleys (11 speeds—375 R.P.M. to 9200 R.P.M.); self-centering universal three-jaw "Cushman" lathe chuck with reversible jaws (abt 2 1/2" Dia.); 1/4" Drill Chuck, Pivoting Tool Holder, Grindstone Holder, Lathe Dog, Face Plate, 2 centers, Allen Wrench. Easy-to-follow instruction manual, all packed in sturdy wood veneer carrying case!

**ADDITIONAL ATTACHMENTS** are available for further versatility of your Basic Unit: 7—The Jig Saw; 8—Threading Attachment; 9—Circular Saw; 10—Indexing and Dividing Attachment. All attachments can be ordered individually with the Basic Unit, or at any time! (Attachments not shown.)

**PORTABLE AND COMPACT**—two more reasons for its great popularity. All operations require little working space and are performed on just one base. There is also high quality built into this unique machine tool. The ball-bearing headstock spindle has a 1/4" O center. It also features a built-in rack, so that the headstock spindle can be adjusted 1" in either direction. This feature gives the drill press its stroke when in the upright position. The tailstock is threaded and will take either lathe or drill chuck. Constructed of high quality hardened and ground steel and a cast iron ribbed lathe bed, UNIMAT adds up to a top notch machine tool that will enable you to create a limitless variety of objects—from just about any kind of stock material.

**UNIMAT BASIC UNIT COSTS ONLY \$99.50** and can be obtained on a budget plan for as little as \$49.50 down, and \$10 a month for 5 months. There's no charge for this service. It is shipped prepaid East of the Mississippi. West thereof, a slight charge is necessary. Additional literature is also available for only 10¢ to cover mailing costs. Look into this amazing precision tool today. It will prove worth your while. Mail your order today to Dept. PM-126 Dealer Inquiries Invited! AMERICAN EDELSTAAL (AMSTERDAM) INC. 350 Broadway New York 13, N. Y.

## GET THE HABIT OF READING OUR CLASSIFIED ADS.

Wonderful Opportunities Amazing Bargains



## BIG PROFIT making Concrete Drain Tile

Millions of dollars' worth of drain tile are used every year for farm drainage, building construction, reclamation projects, highways, and other purposes. And the big swing is to concrete tile because it's better and costs less. Sales potentials are BIG.

Concrete drain tile is locally manufactured of local materials, for direct selling to local users or contractors. Unequal costs—freight, distribution, breakage—are eliminated. While worth more than clay tile, concrete tile can sell for less and still earn a handsome profit.

Tile made on the Champion Machine are strong and uniform. Truly round. All sizes up to 12" diameter. Easy to make because the Champion is simple to operate.

### Get The Champion Facts

Write for the Champion book. Tells about concrete drain tile as an outstanding manufacturing opportunity. Describes the machine and outlines liberal payment terms.

W. E. DUNN MFG. CO.  
522 W. 24th Street, Holland, Mich.



IN CANADA: DUNN MASONRY MACHINERY LIMITED  
970 Dundas Highway, Cooksville, Ont.

**FREE CATALOG & SAMPLE LESSON**

## Profitable Future Now Open to You in WATCH REPAIRING

**Train at Home in Spare Time for High Pay or Profitable Business Opportunities**

Remarkable Sweazey Plan shows you how to repair Swiss or American Watches. No previous experience necessary. Job Guide program starts you making repairs right away. Survey shows part time watchmakers reported hourly rates up to \$6.00 per hour. Includes training to help you get started in business. Get facts today. Send for colorful FREE BOOKLET and FREE SAMPLE LESSON. Here is professional training from famous, long established institution. Founded 1908. Write today — no obligation.

**CHICAGO SCHOOL OF WATCHMAKING**  
2330 N. Milwaukee, Dept. 1126, Chicago 47, Illinois

**FREE CATALOG & SAMPLE LESSON**

## PEE WEE BATTERYLESS "LIFETIME" RADIO

**REALLY WORKS — FOR LIFE!**  
Works WITHOUT TUBES, BATTERIES OR ELECTRICAL PLUGS. Will never run down or burn out! World's smallest. SMALLER THAN A PACK OF CIGARETTES! GUARANTEED TO RECEIVE LOCAL RADIO STATIONS ANYTIME—ANYWHERE YOU GO! Sensational new Ferrite Selective Tuner — Form-Crystal diode, Super SPEAKERPHONE, durable black and gold plastic case.

**SEND ONLY \$2.00** (will ck. mo) and pay postman \$4.99 COD postage on arrival or send \$6.99 for postpaid delivery. SENT COMPLETE READY TO LISTEN WITH LIFETIME GUARANTEE. Nothing extra to buy — ever. Available only from: MIDWAY COMPANY Dept. WPM-12 KEARNEY, NEBRASKA

**250 POWER . . . .**

**Complete Telescope Lens Kit only \$3.49 postpaid**

Conquer Space, Explore the Universe, Planets, Moon Craters, New Stars, etc. Complete Lens Kit consists of 80 inch focal length ground and polished objective lens, eyepiece lenses for 50 POWER, 100 POWER, 150 POWER, 200 POWER, 250 POWER, and all necessary lens fittings. Easy to make from simple step by step instructions. Tripod and mount not included. Money back guarantee.

**BUSSE SALES CO., Hartford 1, Conn., Dept. PM 52**

## REAL ESTATE BE A SALESMAN

**PAYS BIG! SEND FOR FREE, BIG, ILLUSTRATED CATALOG NOW!** Graduates report making substantial incomes. Start and run your own business quickly. Men, women of all ages, learn easily. Course covers Sales, Property Management, Appraising, Loans, Mortgages, and related subjects. **STUDY AT HOME** or in classrooms in leading cities. Diploma awarded. Write TODAY for free book! No obligation. Approved for Korean Veterans

**WEAVER SCHOOL OF REAL ESTATE (Est. 1936)**  
2024B Grand Kansas City 8, Mo.

**FREE BOOK TELLS HOW**

## SPARE-TIME MONEymaking OPPORTUNITIES

READ OUR CLASSIFIED ADS  
HUNDREDS OF BARGAINS AMAZING OFFERS

**YOURS FREE!**

**VUER-PROJECTOR & Full Color Slide Kit—Authentic \$4.95 Value!**

**If You're Interested In BREEDING TROPICAL FISH For Profit & Pleasure**

This handsome, precision-viewing instrument and color slides are yours FREE—just for showing your interest in Tropical Fish Breeding! See gorgeous BETTAS, colorful TETRAS, exotic ANGEL FISH, etc., in the vibrant beauty of full color! Convince yourself Tropical Fish Breeding is the profitable, easy-to-start home business for you! Breed them in your living room, spare-room, anywhere. Success is assured because we'll buy every fish you produce! No experience or costly equipment needed. Start spare-time, on a "shoe-string" . . . build a \$10,000 home business! Investigate!

Write today for FREE details on "Profit-Proven" Success Plan & Vuor! (If under 17, ask for plan A.)

**TROPICAL FISH BREEDERS OF AMERICA**  
Dept. D-12 Los Angeles 61, Calif.



# PICK YOUR OWN SUCCESS STORY FROM THIS PAGE

These are the true stories of people who seemed trapped in routine, low-pay shaky jobs. Handicapped by lack of proper training, they couldn't get the things they wanted out of life—more money, a job they liked, security and happiness.

They are a small sample of the thousands of men and women—young and old—who turn to I. C. S. for help. Their will-to-learn plus I. C. S. training have changed the course of their lives.

Are you discouraged with your job and pay and feel you can't improve yourself because of lack of specialized education? Well, these men and women were in the same boat. With I. C. S. training, one of these success stories could be about you.

I. C. S. is the oldest and largest correspondence school. 256 courses. Business, industrial, engineering, academic, high school. One for you. Direct, job-related. Bedrock facts and theory plus practical application. Complete lesson and answer service. No skimping. Diploma to graduates.

For Real Job Security—Get an I. C. S. Diploma! I. C. S., Scranton 9, Penna. Member, National Home Study Council



**Wins \$3000 contest**—"After my I. C. S. courses I secured a new position," says Mr. Cecil Rhodes. "My income has more than doubled and I recently won a \$3000 sales contest."



**From clerk to Assistant Estimator, thanks to I.C.S.** "Any way you look at it," writes Mrs. Edna James, "the time and money one spends for I. C. S. Courses will be repaid a thousandfold."



**"As a college graduate, I found I.C.S. very valuable."** Robert Lee took the I. C. S. Course in Advertising, is now Promotion Manager for a large corporation. "I. C. S. got me started on the way up," he says.



**From \$152 to \$395 a month**—"I.C.S. made my engineering work more interesting," Frank Bachtik tells us. "I was a Jr. Draftsman making \$152 a month. My present income is \$395.25 a month."

**3 FREE BOOKS**—a 36-page pocket-size guide to advancement, a gold mine of tips on "How to Succeed." Also a big catalog outlining opportunities in your field of interest and a sample I.C.S. lesson (Math.).

## INTERNATIONAL CORRESPONDENCE SCHOOLS

65<sup>TH</sup> YEAR

BOX 92626M, SCRANTON 9, PENNA.

(Partial list of 256 courses)

- Without cost or obligation, send me "HOW TO SUCCEED" and the opportunity booklet about the field BEFORE which I have marked X (plus sample lesson):
- |                                                                                                                                                                                                                                                                                                                                                                                                                                                                                                                                                                                                                                                                                                                                                                                                                                                                                                                                                                                                                                                                                                                                                                                                                                                                                                                                                                                                  |                                                                                                                                                                                                                                                                                                                                                                                                                                                                                                                                                                                                                                                                                                                                                                                                                                                                                                                                                                                                                                                                                                                                                                                                                                                                                                                                                                                                                                                                                                                                                                                           |                                                                                                                                                                                                                                                                                                                                                                                                                                                                                                                                                                                                                                                                                                                                                                                                                                                                                                                                                                                                                                                                                                                                                                                                                                                                                                                                                                                                                                                                                                                                                          |                                                                                                                                                                                                                                                                                                                                                                                                                                                                                                                                                                                                                                                                                                                                                                                                                                                                                                                                                                                                                                                                                                                                                                                                                                                                                                                                                                                                                                                                                                                                                                                                                                                                   |                                                                                                                                                                                                                                                                                                                                                                                                                                                                                                                                                                                                                                                                                                                                                                                                                                                                                                                                                                                                                                                                                                                                                                                                                                                                                                                                                                                                                                                                                                                                                                                                                                   |
|--------------------------------------------------------------------------------------------------------------------------------------------------------------------------------------------------------------------------------------------------------------------------------------------------------------------------------------------------------------------------------------------------------------------------------------------------------------------------------------------------------------------------------------------------------------------------------------------------------------------------------------------------------------------------------------------------------------------------------------------------------------------------------------------------------------------------------------------------------------------------------------------------------------------------------------------------------------------------------------------------------------------------------------------------------------------------------------------------------------------------------------------------------------------------------------------------------------------------------------------------------------------------------------------------------------------------------------------------------------------------------------------------|-------------------------------------------------------------------------------------------------------------------------------------------------------------------------------------------------------------------------------------------------------------------------------------------------------------------------------------------------------------------------------------------------------------------------------------------------------------------------------------------------------------------------------------------------------------------------------------------------------------------------------------------------------------------------------------------------------------------------------------------------------------------------------------------------------------------------------------------------------------------------------------------------------------------------------------------------------------------------------------------------------------------------------------------------------------------------------------------------------------------------------------------------------------------------------------------------------------------------------------------------------------------------------------------------------------------------------------------------------------------------------------------------------------------------------------------------------------------------------------------------------------------------------------------------------------------------------------------|----------------------------------------------------------------------------------------------------------------------------------------------------------------------------------------------------------------------------------------------------------------------------------------------------------------------------------------------------------------------------------------------------------------------------------------------------------------------------------------------------------------------------------------------------------------------------------------------------------------------------------------------------------------------------------------------------------------------------------------------------------------------------------------------------------------------------------------------------------------------------------------------------------------------------------------------------------------------------------------------------------------------------------------------------------------------------------------------------------------------------------------------------------------------------------------------------------------------------------------------------------------------------------------------------------------------------------------------------------------------------------------------------------------------------------------------------------------------------------------------------------------------------------------------------------|-------------------------------------------------------------------------------------------------------------------------------------------------------------------------------------------------------------------------------------------------------------------------------------------------------------------------------------------------------------------------------------------------------------------------------------------------------------------------------------------------------------------------------------------------------------------------------------------------------------------------------------------------------------------------------------------------------------------------------------------------------------------------------------------------------------------------------------------------------------------------------------------------------------------------------------------------------------------------------------------------------------------------------------------------------------------------------------------------------------------------------------------------------------------------------------------------------------------------------------------------------------------------------------------------------------------------------------------------------------------------------------------------------------------------------------------------------------------------------------------------------------------------------------------------------------------------------------------------------------------------------------------------------------------|-----------------------------------------------------------------------------------------------------------------------------------------------------------------------------------------------------------------------------------------------------------------------------------------------------------------------------------------------------------------------------------------------------------------------------------------------------------------------------------------------------------------------------------------------------------------------------------------------------------------------------------------------------------------------------------------------------------------------------------------------------------------------------------------------------------------------------------------------------------------------------------------------------------------------------------------------------------------------------------------------------------------------------------------------------------------------------------------------------------------------------------------------------------------------------------------------------------------------------------------------------------------------------------------------------------------------------------------------------------------------------------------------------------------------------------------------------------------------------------------------------------------------------------------------------------------------------------------------------------------------------------|
| <p><b>ARCHITECTURE and BUILDING CONSTRUCTION</b></p> <ul style="list-style-type: none"> <li><input type="checkbox"/> Air Conditioning—Refrig.</li> <li><input type="checkbox"/> Architecture</li> <li><input type="checkbox"/> Architectural Interiors</li> <li><input type="checkbox"/> Building Contractor</li> <li><input type="checkbox"/> Building Estimator</li> <li><input type="checkbox"/> Building Maintenance</li> <li><input type="checkbox"/> Carpentry and Mill Work</li> <li><input type="checkbox"/> Heating</li> <li><input type="checkbox"/> Painting Contractor</li> <li><input type="checkbox"/> Plumbing</li> <li><input type="checkbox"/> Reading Arch. Blueprints</li> </ul> <p><b>ART</b></p> <ul style="list-style-type: none"> <li><input type="checkbox"/> Cartooning</li> <li><input type="checkbox"/> Commercial Art</li> <li><input type="checkbox"/> Fashion Illustrating</li> <li><input type="checkbox"/> Magazine Illustrating</li> <li><input type="checkbox"/> Show Card and Sign Lettering</li> <li><input type="checkbox"/> Sketching and Painting</li> </ul> <p><b>AUTOMOTIVE</b></p> <ul style="list-style-type: none"> <li><input type="checkbox"/> Auto Body Rebuilding</li> <li><input type="checkbox"/> Auto Elec. Technician</li> <li><input type="checkbox"/> Auto-Engine Tune Up</li> <li><input type="checkbox"/> Automobile Mechanic</li> </ul> | <p><b>AVIATION</b></p> <ul style="list-style-type: none"> <li><input type="checkbox"/> Aeronautical Engineering Jr.</li> <li><input type="checkbox"/> Aircraft &amp; Engine Mechanic</li> </ul> <p><b>BUSINESS</b></p> <ul style="list-style-type: none"> <li><input type="checkbox"/> Advertising</li> <li><input type="checkbox"/> Bookkeeping and Accounting</li> <li><input type="checkbox"/> Business Administration</li> <li><input type="checkbox"/> Business Correspondence</li> <li><input type="checkbox"/> Public Accounting</li> <li><input type="checkbox"/> Creative Salesmanship</li> <li><input type="checkbox"/> Federal Tax</li> <li><input type="checkbox"/> Letter-writing Improvement</li> <li><input type="checkbox"/> Office Management</li> <li><input type="checkbox"/> Professional Secretary</li> <li><input type="checkbox"/> Retail Business Management</li> <li><input type="checkbox"/> Sales Management</li> <li><input type="checkbox"/> Stenographic-Secretarial</li> <li><input type="checkbox"/> Traffic Management</li> </ul> <p><b>CHEMISTRY</b></p> <ul style="list-style-type: none"> <li><input type="checkbox"/> Analytical Chemistry</li> <li><input type="checkbox"/> Chemical Engineering</li> <li><input type="checkbox"/> Chem. Lab. Technician</li> <li><input type="checkbox"/> General Chemistry</li> <li><input type="checkbox"/> Natural Gas Prod. &amp; Trans.</li> <li><input type="checkbox"/> Petroleum Engineering</li> <li><input type="checkbox"/> Plastics</li> <li><input type="checkbox"/> Pulp and Paper Making</li> </ul> | <p><b>CIVIL, STRUCTURAL ENGINEERING</b></p> <ul style="list-style-type: none"> <li><input type="checkbox"/> Civil Engineering</li> <li><input type="checkbox"/> Construction Engineering</li> <li><input type="checkbox"/> Highway Engineering</li> <li><input type="checkbox"/> Reading Struct. Blueprints</li> <li><input type="checkbox"/> Sanitary Engineering</li> <li><input type="checkbox"/> Structural Engineering</li> <li><input type="checkbox"/> Surveying and Mapping</li> </ul> <p><b>DRAFTING</b></p> <ul style="list-style-type: none"> <li><input type="checkbox"/> Aircraft Drafting</li> <li><input type="checkbox"/> Architectural Drafting</li> <li><input type="checkbox"/> Electrical Drafting</li> <li><input type="checkbox"/> Mechanical Drafting</li> <li><input type="checkbox"/> Mine Surveying and Mapping</li> <li><input type="checkbox"/> Plumbing Drawing and Estimating</li> <li><input type="checkbox"/> Structural Drafting</li> </ul> <p><b>ELECTRICAL</b></p> <ul style="list-style-type: none"> <li><input type="checkbox"/> Electrical Engineering</li> <li><input type="checkbox"/> Electrical Maintenance</li> <li><input type="checkbox"/> Electrician <input type="checkbox"/> Contracting</li> <li><input type="checkbox"/> Lineman</li> </ul> <p><b>HIGH SCHOOL</b></p> <ul style="list-style-type: none"> <li><input type="checkbox"/> Commercial <input type="checkbox"/> Good English</li> <li><input type="checkbox"/> High School Subjects</li> <li><input type="checkbox"/> Mathematics</li> </ul> | <p><b>LEADERSHIP</b></p> <ul style="list-style-type: none"> <li><input type="checkbox"/> Foremanship</li> <li><input type="checkbox"/> Industrial Supervision</li> <li><input type="checkbox"/> Leadership and Organization</li> <li><input type="checkbox"/> Personnel-Labor Relations</li> </ul> <p><b>MECHANICAL AND SHOP</b></p> <ul style="list-style-type: none"> <li><input type="checkbox"/> Gas-Electric Welding</li> <li><input type="checkbox"/> Heat Treatment <input type="checkbox"/> Metallurgy</li> <li><input type="checkbox"/> Industrial Engineering</li> <li><input type="checkbox"/> Industrial Instrumentation</li> <li><input type="checkbox"/> Industrial Supervision</li> <li><input type="checkbox"/> Internal Combustion Engines</li> <li><input type="checkbox"/> Machine Design-Drafting</li> <li><input type="checkbox"/> Machine Shop Inspection</li> <li><input type="checkbox"/> Machine Shop Practice</li> <li><input type="checkbox"/> Mechanical Engineering</li> <li><input type="checkbox"/> Quality Control</li> <li><input type="checkbox"/> Reading Shop Blueprints</li> <li><input type="checkbox"/> Refrigeration</li> <li><input type="checkbox"/> Sheet Metal Worker</li> <li><input type="checkbox"/> Tool Design <input type="checkbox"/> Toolmaking</li> <li><input type="checkbox"/> Lineman</li> </ul> <p><b>RADIO, TELEVISION</b></p> <ul style="list-style-type: none"> <li><input type="checkbox"/> Industrial Electronics</li> <li><input type="checkbox"/> Practical Radio TV Eng'ng</li> <li><input type="checkbox"/> Radio and TV Servicing</li> <li><input type="checkbox"/> Radio Operating</li> </ul> | <p><input type="checkbox"/> Television Technician</p> <p><b>RAILROAD</b></p> <ul style="list-style-type: none"> <li><input type="checkbox"/> Air Brake Equipment</li> <li><input type="checkbox"/> Car Inspector</li> <li><input type="checkbox"/> Diesel Engineer &amp; Fireman</li> <li><input type="checkbox"/> Section Foreman</li> </ul> <p><b>STEAM AND DIESEL POWER</b></p> <ul style="list-style-type: none"> <li><input type="checkbox"/> Combustion Engineering</li> <li><input type="checkbox"/> Diesel-Elec. <input type="checkbox"/> Diesel Eng's</li> <li><input type="checkbox"/> Electric Light and Power</li> <li><input type="checkbox"/> Stationary Fireman</li> <li><input type="checkbox"/> Stationary Steam Engineering</li> </ul> <p><b>TEXTILE</b></p> <ul style="list-style-type: none"> <li><input type="checkbox"/> Carding and Spinning</li> <li><input type="checkbox"/> Cotton, Rayon, Woolen Mfg.</li> <li><input type="checkbox"/> Finishing and Dyeing</li> <li><input type="checkbox"/> Loom Fix'g <input type="checkbox"/> Textile Des'g</li> <li><input type="checkbox"/> Textile Eng'g <input type="checkbox"/> Throwing</li> <li><input type="checkbox"/> Warping and Weaving</li> </ul> <p><b>MISCELLANEOUS</b></p> <ul style="list-style-type: none"> <li><input type="checkbox"/> Domestic Refrigeration</li> <li><input type="checkbox"/> Marine Engineering</li> <li><input type="checkbox"/> Ocean Navigation</li> <li><input type="checkbox"/> Professional Engineering</li> <li><input type="checkbox"/> Short Story Writing</li> <li><input type="checkbox"/> Telephony</li> </ul> |
|--------------------------------------------------------------------------------------------------------------------------------------------------------------------------------------------------------------------------------------------------------------------------------------------------------------------------------------------------------------------------------------------------------------------------------------------------------------------------------------------------------------------------------------------------------------------------------------------------------------------------------------------------------------------------------------------------------------------------------------------------------------------------------------------------------------------------------------------------------------------------------------------------------------------------------------------------------------------------------------------------------------------------------------------------------------------------------------------------------------------------------------------------------------------------------------------------------------------------------------------------------------------------------------------------------------------------------------------------------------------------------------------------|-------------------------------------------------------------------------------------------------------------------------------------------------------------------------------------------------------------------------------------------------------------------------------------------------------------------------------------------------------------------------------------------------------------------------------------------------------------------------------------------------------------------------------------------------------------------------------------------------------------------------------------------------------------------------------------------------------------------------------------------------------------------------------------------------------------------------------------------------------------------------------------------------------------------------------------------------------------------------------------------------------------------------------------------------------------------------------------------------------------------------------------------------------------------------------------------------------------------------------------------------------------------------------------------------------------------------------------------------------------------------------------------------------------------------------------------------------------------------------------------------------------------------------------------------------------------------------------------|----------------------------------------------------------------------------------------------------------------------------------------------------------------------------------------------------------------------------------------------------------------------------------------------------------------------------------------------------------------------------------------------------------------------------------------------------------------------------------------------------------------------------------------------------------------------------------------------------------------------------------------------------------------------------------------------------------------------------------------------------------------------------------------------------------------------------------------------------------------------------------------------------------------------------------------------------------------------------------------------------------------------------------------------------------------------------------------------------------------------------------------------------------------------------------------------------------------------------------------------------------------------------------------------------------------------------------------------------------------------------------------------------------------------------------------------------------------------------------------------------------------------------------------------------------|-------------------------------------------------------------------------------------------------------------------------------------------------------------------------------------------------------------------------------------------------------------------------------------------------------------------------------------------------------------------------------------------------------------------------------------------------------------------------------------------------------------------------------------------------------------------------------------------------------------------------------------------------------------------------------------------------------------------------------------------------------------------------------------------------------------------------------------------------------------------------------------------------------------------------------------------------------------------------------------------------------------------------------------------------------------------------------------------------------------------------------------------------------------------------------------------------------------------------------------------------------------------------------------------------------------------------------------------------------------------------------------------------------------------------------------------------------------------------------------------------------------------------------------------------------------------------------------------------------------------------------------------------------------------|-----------------------------------------------------------------------------------------------------------------------------------------------------------------------------------------------------------------------------------------------------------------------------------------------------------------------------------------------------------------------------------------------------------------------------------------------------------------------------------------------------------------------------------------------------------------------------------------------------------------------------------------------------------------------------------------------------------------------------------------------------------------------------------------------------------------------------------------------------------------------------------------------------------------------------------------------------------------------------------------------------------------------------------------------------------------------------------------------------------------------------------------------------------------------------------------------------------------------------------------------------------------------------------------------------------------------------------------------------------------------------------------------------------------------------------------------------------------------------------------------------------------------------------------------------------------------------------------------------------------------------------|

Name \_\_\_\_\_ Age \_\_\_\_\_ Home Address \_\_\_\_\_

City \_\_\_\_\_ Zone \_\_\_\_\_ State \_\_\_\_\_ Working Hours \_\_\_\_\_ A.M. to P.M. \_\_\_\_\_

Occupation \_\_\_\_\_

Canadian residents send coupon to International Correspondence Schools, Canadian, Ltd., Montreal, Canada. . . . Special tuition rates to members of the U. S. Armed Forces.



# Make \$500 an Hour CASH PROFIT THE DAY YOU START!



## START YOUR OWN BUSINESS AT HOME... SHARPEN HOUSEHOLD, GARDEN AND SHOP TOOLS IN SPARE TIME

Now you can turn spare time into Big Cash Profits with new Belsaw Sharp-All. Sharpen knives, scissors, shears, snips, ice skates, mower blades, hedge trimmers, grass whips, axes, chisels, screw drivers, scrapers and saws... just about any household, garden and shop tool. Your own CASH business with no inventory. No calls to make. No experience needed.

Learn how easily you can start your own spare time business. Amazing low cost easy-payment plan. Send postcard for FREE BOOK.

**BELSAW SHARP-ALL CO**

717 Field Bldg. Kansas City 11, Missouri



## I'll Send You This Handsome SAMPLE CASE—FREE!



Make up to  
\$30<sup>00</sup> in a Day!

### Your Own Tailored Suits Without 1¢ Cost

If you want to make more money, spare time or full time, rush the coupon below today for this big, valuable tailoring Sample Case packed with 150 beautiful, big-value suit and overcoat samples. Just show the samples and last-minute styles to friends, fellow-workers, others. Take their orders for fine made-to-measure clothes—and pocket BIG CASH PROFITS in advance. No experience, no tailoring knowledge needed—and no money needed, ever. WE SUPPLY EVERYTHING FREE... sample case, sample suitings, equipment, complete instructions. Start making money first day!

**Use Spare Evenings... Weekends... Make Money... Get Suits!**

It's easy to make money taking orders in just spare time—lunch-time, evenings, weekends. When men see the fine fit, quality and value of our suits—THEY ORDER! So we make it easy for you to get your own personal suits and overcoats without paying even one penny. Don't wait! Rush coupon with your name, address, and age for FREE Sample Case.

### PIONEER TAILORING COMPANY

Dept. B-1116, Congress & Throop Sts., Chicago 7, Ill.

**PIONEER TAILORING CO., Dept. B-1116  
Congress & Throop Sts., Chicago 7, Ill.**

Please rush ABSOLUTELY FREE the valuable Sample Case with suit fabrics and style display. Include instructions, money-making plans and details for getting my own suits without paying one cent.

Name.....Age.....

Address.....

City.....State.....

## FREE! Fabulous Collection from SOUTH of the BORDER



Start TODAY to enjoy an exciting new hobby! Rush Coupon for big, valuable collection of genuine, all-different postage stamps from the exciting land of the mysterious Amazon... scarce airmails, gorgeous commemoratives, giant-sized stamps picturing wild horses, covered wagons, action-packed fights, native war heroes; PLUS sensational train stamp, beautiful "Christ of the Andes"; many others. EXTRA! Bargain Catalog, "Collector's Manual" plus other exciting offers for your inspection. Enclose 10¢ for mailing expenses... ACT NOW! JAMESTOWN STAMP CO. DEPT. N12PM, JAMESTOWN, N. Y.



## OIL BURNER SERVICING

SPARE TIME LEARNING MEANS  
EARNING BIG MONEY

WRITE FOR  
FREE  
LESSON

MASS. TRADE 161-A HIGH ST.  
BOSTON 10, MASS.



## LOCKSMITHING

Practical Up-to-Date Course — ONLY \$5.95  
53 illustrated self-instruction lessons. Easy to learn. Full price only \$5.95 postpaid—or COD plus postage. Satisfaction guaranteed or full refund! NELSON HALL CO., 210 S. Clinton St., Dept. MU-2, Chicago 6, Ill.

## MONEY in WORMS

Big money made raising fishworms and crickets. Billions used yearly—unlimited market—sell by mail—We teach you how to raise and where to sell. Learn about our new, tremendous 6 to 12 inch African Redworm—in demand everywhere. Free Literature. CARTER WORM RANCH, PLAINS, GEORGIA

PLEASE  
SEND ME

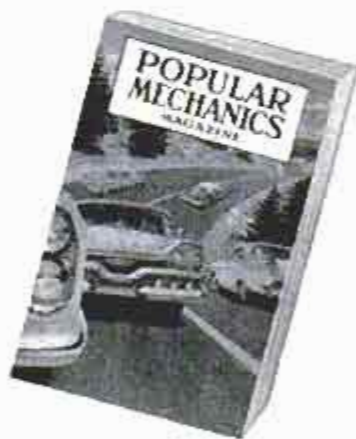

for the  
time checked.

I am enclosing...

1 year \$3.50

2 years \$6.00

name

address

city

zone

state

Hand this order to your newsdealer or send it to  
**POPULAR MECHANICS**  
200 East Ontario St. Chicago 11, Ill.

POPULAR MECHANICS



New PROFIT-PROVEN\* Home-Business!

# "I make \$400<sup>00</sup> a week!"



\*Proves MR. J. T. ANDERSON, Inglewood, Calif.  
(Notorized statement on file in our office and open to inspection)

Big Money?—sure it is—because Huge Profits are waiting to be "tapped" with this **MIRACLE NEW PRINTING METHOD**. Now, you may share the exciting secrets and build a big-paying **FULL OR SPARE TIME** Screen Printing Business right in **YOUR OWN HOME**. Yes, we'll teach you, too, how to turn pennies into dollars in this newest, most sensational printing method ever invented. **WHAT IS SCREEN-PRINT?** It's an exciting new printing technique—amazingly simple and fascinating. (It may soon revolutionize the entire printing industry) **NO EXPENSIVE EQUIPMENT**, no printing press, no "cuts," no art ability, no experience is necessary—yet you can print beautiful professional jobs on **PAPER, GLASS, LEATHER, CLOTH—ANYTHING!** You print in all colors—even new "glowing" **FLUORESCENT**

SCREEN PRINT CO., P.O. Box 61007 So. S. Sta. Dept. 212  
15127 S. Broadway, Los Angeles 61, Calif.  
Gentlemen: Please mail me Free Revealing Details, samples, Opportunity Plan, etc.—All this is sent absolutely Free and sent to me by return mail. I am under no obligation now or ever.

NAME \_\_\_\_\_  
ADDRESS \_\_\_\_\_  
CITY \_\_\_\_\_ ZONE \_\_\_\_\_ STATE \_\_\_\_\_



**free!**  
Complete REVEALING DETAILS, Authentic SAMPLES, Proven Big-Money OPPORTUNITY PLAN, "HOW-TO" BOOKLET. Learn the secrets. Rush this coupon TODAY!

READ WHAT OTHERS ARE SAYING—Investigate! "Would not take \$1000.00 for secret...just what I have been searching the world over for." C.S., Nev.; "Making 75% of living expenses already in spare time." E.L., Ontario; "Made \$80 first week—terrific opportunity"—W.S., Iowa.

Mail Coupon and Learn Secrets Too!

**COLORS.** It's amazing—but true! **EARN PROFITS IMMEDIATELY—IN YOUR OWN HOME!** Start in your garage, basement, kitchen, spare room—anywhere! It's much easier than you think. Then expand as this new printing industry grows. **300% PROFIT** on some jobs—earn up to \$12.50 per hr. **HELP FILL THE HUGE GROWING DEMAND.** No selling because every business in your area needs Screen-Printing. You can save them up to 50% on printing, too. **WE SUPPLY EVERYTHING YOU NEED.** Never before has such a profitability been offered to anyone wishing to start a full-time or spare-time "business of his own." Don't Hesitate! All the **CONFIDENTIAL FACTS** are yours if you **MAIL COUPON TODAY**—before it's too late.



Print colorful ADVERTISING DISPLAYS, SIGNS, BANNERS, POSTERS, LABELS, WALLPAPER, NOVELTIES, INSTRUMENTS, ETC. ET

Do you work all day with **COLD FEET?**

**NOW,** at last, a new, modern, low priced electric foot warmer that will keep you healthy, happy and comfortable



Help prevent colds with... **ELECTRO MAT**

Check stand cashiers, secretaries, assembly line workers, housewives, office workers, theatre cashiers, machine operators, telephone operators, and many others throughout the country are now singing the praises of the Electro Mat. There is no further need to work all day with cold feet. Many colds, causing absenteeism and irritability, can be directly traced to cold feet. **Safe and Economical**

Size 14" x 21" light-weight portable

Consumes less power than a 75 watt light bulb. Mail your check or money order today for **ONLY**

**PETERSON RUBBER MAT CO.**  
5508 N. Halifax Arcadia, California

Please send me... Electro Mats at \$7.95 each  
**IMPORTANT SAYING:**  
If 6 or more ordered, price is only \$6.95 each.  
 C.O.D. Enclose \$1.00 deposit with order.  
 Prepaid

Name \_\_\_\_\_  
Address \_\_\_\_\_  
City \_\_\_\_\_ State \_\_\_\_\_  
PLEASE PRINT CLEARLY

**\$7.95**  
Delivered

**PREPARE FOR BETTER JOB, BIGGER PAY IN SPARE TIME AT HOME**

Today, choose the job you want—and prepare for it in time you might otherwise waste. Or if you are already in the work you like best, start training now for quicker promotion and increased pay. During more than 50 years **AMERICAN SCHOOL** has helped ambitious people to reach higher goals. Check subject that interests you and mail coupon for full information.

**AMERICAN SCHOOL, Dept. G945, Drexel at 58th, Chicago 37, Ill.**  
Without obligation, please send FREE and postpaid, full particulars about the subject checked below.

- |                                                  |                                                 |                                                 |
|--------------------------------------------------|-------------------------------------------------|-------------------------------------------------|
| <input type="checkbox"/> Accounting              | <input type="checkbox"/> Contracting            | <input type="checkbox"/> Mechanical Engineering |
| <input type="checkbox"/> Apprenticeship Courses  | <input type="checkbox"/> Diesel Technician      | <input type="checkbox"/> Mechanical Technology  |
| <input type="checkbox"/> Architecture & Building | <input type="checkbox"/> Drafting—Building      | <input type="checkbox"/> Metalworking Courses   |
| <input type="checkbox"/> Automotive Technician   | <input type="checkbox"/> Drafting—Machine       | <input type="checkbox"/> Plumbing—Practical     |
| <input type="checkbox"/> Better Foremanship      | <input type="checkbox"/> Electrical Engineering | <input type="checkbox"/> Private Secretary      |
| <input type="checkbox"/> Blueprint Reading       | <input type="checkbox"/> Electricity—Practical  | <input type="checkbox"/> Retail Merchandising   |
| <input type="checkbox"/> Bookkeeping             | <input type="checkbox"/> Electronics—Industrial | <input type="checkbox"/> Salesmanship—Outside   |
| <input type="checkbox"/> Business Management     | <input type="checkbox"/> HIGH SCHOOL COURSES    | <input type="checkbox"/> Sheet Metal Work       |
| <input type="checkbox"/> Civil Engineering       | <input type="checkbox"/> Machinists             | <input type="checkbox"/> Tool Making            |

NAME \_\_\_\_\_  
HOME Address \_\_\_\_\_  
CITY \_\_\_\_\_ STATE \_\_\_\_\_  
OCCUPATION \_\_\_\_\_  
AGE \_\_\_\_\_

Conditions: Write American School, Dept. G945, 6083 Sherbrooke St. W., Montreal

**MAIL COUPON NOW**





# 105 POWER SUPER TELESCOPE



Everything for the Astronomer, Hobbyist, Student, & Scout in this complete astronomical super value telescope combination. Comes ready for immediate use, consists of brilliant 33x-65x-105x telescope, 5 foot hardwood Tripod, carrying case for scope, Star Explorer map, 108 page book "Discover the Stars." 3 foot telescope (closes to 16 inches) is brass bound, has 4 precision lenses that will bring distant objects, people, moon, stars, ships, etc., 105 times closer, 11,025 area magnification. All images erect. Sturdily built tripod is equipped with universal mount that has 300 degree horizontal range & 180 degree vertical range. Locks in any position with one simple adjustment. The Star Explorer map enables you to find any star automatically. This marvelous all purpose instrument is proclaimed by Scientists as a most unusual development. Everyone that has used it is amazed at its performance and value. It will fascinate the entire family. Shipped to you complete, nothing else to buy, at the amazing low price of . . . . .

**\$11.95**  
POST PAID

Satisfaction guaranteed or money refunded. We pay all delivery charges. Send check or money order to DEPT. PMS17

CRITERION CO. 331 CHURCH ST., HARTFORD I, CONN.

don't say glue . . . say "Yoo-Hoo"

# UHU<sup>®</sup>

GLUES EVERYTHING BETTER!

At variety, hardware, magazine & newspaper stores

## BIG PAY JOBS for men who qualify in DIESEL



**TRAIN NOW FOR A DIESEL FUTURE.** Steady, high-pay jobs await men qualified in Diesel, Tractor, and Heavy Equipment. Are you qualified for job and advancement opportunities in this fast-growing field? You can qualify!

**COMPLETE DIESEL COURSE NOW AVAILABLE.** If you are ambitious and want to get ahead in this big money field, you'll want to know about the complete Diesel home training course now offered by Interstate Training Service. Covers all phases of operation, repair, service. Easy to master in spare time. No interference with present job. Up-to-the-minute. Regularly revised to cover new developments. We invite comparison of material offered. Advisory placement service for our students.

**YOU OWE IT TO YOURSELF** to investigate Interstate Training Service Diesel Training. Thousands agree it has helped them to better jobs...better pay. It can do the same for you!

WRITE FOR FREE INFORMATION TODAY

INTERSTATE TRAINING SERVICE, Portland 13, Ore.  
Please see that I receive FREE 24-page book, "Getting Ahead in Diesel." (A-3)

NAME \_\_\_\_\_ AGE \_\_\_\_\_  
ADDRESS \_\_\_\_\_  
CITY \_\_\_\_\_ ZONE \_\_\_\_\_ STATE \_\_\_\_\_

## THE ORIGINAL PACKAGED BOAT KITS

Made ONLY by *Custom-Craft*



Top Performance, Design, Styling! Over 70 Models 8 to 21 ft

World's largest line! Over 200 Boats: Kits, Formed-Hulls, Semi & Custom-finished! All types: Prams -Cruisers! Easy to build! Flying stern, Tredonic bottom, Bulkhead construction!

Send 25¢ for KIT CATALOG  
\$2 pages! Includes Victory Series, hardware, paint accessories, Fiberglass! Send \$1.00 for Catalog Plus "Boating Handbook". DEALERS-AGENTS INQUIRE

## BOAT PLANS & PATTERNS Frame-Pac Kits

World's largest selection: over 200 plans, full-size patterns, frame-pac kits! Designed strictly for amateurs! All types: prams, kayaks, racers, runabouts, catamarans, houseboats, cruisers - Inboard-outboard 6-40' wood-plywood-steel!

Send 25¢ for PLAN CATALOG  
Catalog PLUS "Boatbuilding Handbook" \$1.00  
DEPT. PM CUSTOM-CRAFT - BUFFALO 7, N.Y.

## Have a Motorized Shop at Low Cost Make Your Own POWER TOOLS

Popular Mechanics Book Shows How to Make 60 Machines from Scrap and Discarded Materials

Get SIXTY POWER TOOLS AND HOW TO BUILD THEM, the sensational new Popular Mechanics book. Build your own lathe, drill press, sander, circular and band saw and other power tools at a cost of only a few dollars each. Use old auto parts, pipe and wood and odds and ends that cost little or nothing. Every detail of construction is given in plain language you can understand and follow. Hundreds of pictures and plans show every step to follow in making the power tools you want. Clip this ad and mail with name, address and only \$2.50, or we will send C.O.D. (U.S.A.). You'll be amazed with the fine, practical tools you can make and how little they cost. Your money back if you return the book in 7 days. Order today.



Over 250 Pictures

POPULAR MECHANICS PRESS, Dept. 1256, 200 E. Ontario St., Chicago 11

## SALESMEN WANTED

Earnings \$5000 to \$8000 per year, calling on hardware stores and lumber yards, selling and installing Popular Mechanics show windows. No window trimming experience necessary (we train you) but selling experience essential. Must have automobile. Average territory consists of about 5 counties. Salesmen have exclusive territory. Home every night.

Not a get rich quick scheme but steady dignified work by which a skilled, industrious salesman can earn a good living. This company, in cooperation with Popular Mechanics and the leading manufacturers of tools, equipment and materials, offers retailers traffic-stopping window displays to retail hardware stores and lumber yards at a nominal cost. All equipment furnished. Endorsed by many retailers, jobbers and manufacturers. Much repeat business. Extras offer additional earning opportunity. Desirable but not necessary to have knowledge of hardware and lumber lines. Personal training given.

For details write, giving all the facts about yourself. If your letter indicates that you might qualify, an appointment will be made for an interview.

## WINDOW DISPLAYS, INC.

1580 SHERMAN AVENUE EVANSTON, ILLINOIS



# Draw Me

You may win a \$375.00 Scholarship  
in Professional Art

Winner gets a complete art course—free training for a profitable career in commercial art, illustrating or cartooning. You are coached, individually, by professional artists on the staff of world's largest home study art school. Many top artists today have studied with this school. As winner you also get a drawing outfit and valuable art textbooks. Try for this free art course!



### DRAW THIS GIRL'S HEAD

5 inches high. Use pencil. Drawings for January 1957 contest must be received by

January 31. None returned. Winner notified. Amateurs only. Our students not eligible.

### Art Instruction, Inc., STUDIO 12136

500 South 4th Street • Minneapolis 15, Minnesota

Please enter my drawing in your "Draw Me" contest. (PLEASE PRINT)

Name \_\_\_\_\_ AGE \_\_\_\_\_ Phone \_\_\_\_\_

Address \_\_\_\_\_ City \_\_\_\_\_ Zone \_\_\_\_\_

County \_\_\_\_\_ State \_\_\_\_\_ Occupation \_\_\_\_\_

## Big Profits Importing WITHOUT INVESTMENT\*

Importer shows you how to start your own big-paying business full or part time from home or small office space, \*without investment in merchandise, no matter where you live. No previous experience required. Complete, simplified method shows you how to locate exciting low-cost imports to sell in U. S. for big profits. How to import for cash-in-advance mail orders or for stores; by direct shipment from abroad. How "word of mouth" sales to and through friends make big money. Send today for FREE book showing how men and women from coast to coast are making big profits from small import shipments. Air Mail reaches us over night. Mellinger Co., Dept. F25C, 1717 Westwood Blvd., Los Angeles 24, Calif.



## MECHANICAL DENTISTRY

To make Crowns, Plates, Bridgework, etc., for Dentists. Easy practical way to learn mechanical dentistry at home in spare time. FULL EQUIPMENT OF TOOLS AND MATERIALS INCLUDED WITH COURSE. Low tuition. Easy terms. Write for FREE BOOK about this money making profession that is not affected by machine age.

McCARRICK SCHOOL OF MECHANICAL DENTISTRY  
207 N. Broad St., Dept. 60, Philadelphia 7, Pa.

Say You Saw It in Popular Mechanics

## MAKE UP TO \$20 A DAY WITH



## EASISHARP

Big profits in your spare time sharpening scissors. We show you how to start making money immediately. This is your chance now to have your own business and a steady income. Sharpen a pair of scissors in less than two minutes. A child can operate it. Weighs only 10 lbs. Every home, barber, tailor, dressmaker—everybody uses scissors and all need sharpening two to four times a year. Don't let some one else beat you to this opportunity. Write immediately to

SERR-EDGE MACHINE CO., 9731 Lorain Ave., Cleveland, Ohio

# ENGINEERING



Photo of Heald Electrical Laboratory  
Enroll Now for New Term

Heald College Ranks **FIRST**  
West of the Mississippi  
in "Who's Who" in America

Send for FREE Information  
**Heald Engineering College**  
Van Ness at Post, Dept. PE-1  
San Francisco, California

NAME \_\_\_\_\_  
STREET \_\_\_\_\_  
CITY \_\_\_\_\_  
STATE \_\_\_\_\_

Thousands of  
Engineers Needed  
for Hard Pressed  
Industry  
**BACHELOR OF  
SCIENCE DEGREE,  
27 MONTHS**

### Degree Courses:

- Electronic Engineering
- Electrical Engineering
- Highway Engineering
- Mechanical Engineering
- Structural Engineering
- Civil Engineering
- Architecture

### Diploma Courses:

- TELEVISION  Color TV
- Tool & Die Design
- Architectural Drafting
- Mechanical Drafting
- Structural Drafting
- Surveying
- Estimating
- Master Electrician

Approved for Veterans



"Just Like my Mommy...

I'M ALWAYS SATISFIED MOST  
WITH a BRAND THAT'S  
MADE a NAME FOR ITSELF!"



#### FOUR WAYS BRAND NAMES SATISFY YOU MOST

**1. BUY WITH TRUST!**

Spend *confidently* on known quality. Brand Names wear best, work best, taste best, are best.

**3. ENJOY MORE CHOICE!**

Spend *shrewdly* among widest selections. Brand Names offer the most in sizes, types, colors, flavors, etc.

**2. SHOP WITH EASE!**

Spend *efficiently* on proved value. Brand Names save time "puzzling" over labels, models, prices, etc.

**4. GET THE "LATEST"!**

Spend *smartly* on up-to-date products. Brand Names keep improving, modernizing, introducing new things.

"I made it!" "I sold it!" "I bought it!"



MANUFACTURER



DEALER



CUSTOMER

*Advertisers in this magazine  
are good names to know.  
They're proud of their brands  
'cause they satisfy so.*

**BRAND NAMES FOUNDATION, INC.** 437 FIFTH AVE. • NEW YORK 16, N. Y.



# LAST CHANCE

to get your Famous

## What to Make Books

**Profit—  
Pleasure—  
Projects  
in Each  
Volume**



Famous **WHAT TO MAKE** books are going fast. Don't delay — last chance to buy. Each volume and project different. Complete illustrated building instructions. Projects for home—family—hobbies. Contains ceramics, cabinets, house trailer, novelties, handicrafts, lamps, toys, chairs, metal work, photography, tables, plus thousands of other pleasure projects to make.

Vol. 1— 490 copies	Vol. 7—1660 copies
2—1340 "	8—1885 "
3—1665 "	9—1190 "
4—1280 "	10— 555 "
5—1340 "	11—no copies left
6—1595 "	12— 860 copies

### NEW LOW LOW PRICE

Take advantage of this clearance sale. Sold originally at \$1.75, any volume yours at the new low figure of 98c. Hurry, mail coupon for your volumes today. Any five volumes \$4.00.

**Save — Save — Save**  
**Were \$1.75 Now 98c**

**HURRY—MAIL COUPON TODAY**

Popular Mechanics Press, Dept. 1256  
200 East Ontario Street  
Chicago 11, Illinois

Gentlemen:

Please send me the following volumes of the famous **WHAT TO MAKE** series. I have drawn a circle around the volumes I want. Volumes — 1 2 3 4 5 6 7 8 9 10 12. I am enclosing a check or money order at 98c for each volume or any five volumes for only \$4.00.

Name \_\_\_\_\_

Address \_\_\_\_\_

City \_\_\_\_\_ State \_\_\_\_\_

## Tells How You Can Learn to



### Learn At Home

Men, Boys, Hunters, Fishermen, mount and save your lovely wild-game trophies. Be a Taxidermist. Mount Birds, Animals, Heads, Fish, Tan skins. YOU learn easily, quickly in spare time. Have a grand home-museum. The finest and the greatest hobby known, for sportsmen. Fun, real profits.

## FREE BOOK

Yes, **FREE**. Beautiful strange, valuable **Book**, telling all about Taxidermy. Contains over 100 beautiful game-pictures. And it's yours **FREE**, if you rush your request. You can mount all kinds of wild-game, and common specimens too. We can positively **TEACH YOU**. So **GRASP** this opportunity. **RUSH** letter or postal for this amazing **FREE BOOK**. Don't delay. **State your AGE**. **N. W. SCHOOL OF TAXIDERMY, 2512 Elwood Bldg., Omaha 2, Neb.**



1. URANIUM TESTER!
2. CHEMICAL PUZZLE!
3. POLAROID ANALYSER KIT!

An amazing **URANIUM TESTER**, a fascinating **CHEMICAL PUZZLE** (worth \$2.50 if you can solve it) and a valuable **POLAROID ANALYSING KIT**, all **FREE** with our great new catalog of **OPPORTUNITIES IN CHEMISTRY!** Learn **BAKING**. How To Make Precious **SYNTHETIC GEMS**, **PRACTICAL CHEMISTRY**, **HORTICULTURE** (Florist), **TAXIDERMY**, **ADHESIVES**, **MOULDABLE & CASTING COMPOSITIONS**, **PLASTICS**, **ELECTROPLATING**, **COSMETICS**, **PERFUMES**, **MINERALOGY**, **CHEMICAL PRINTING**, **CRIME LAB.**, How To Convert **WATER** into **GAS!** Complete courses and instructions from **\$2.00** and up! Easy payment plan. Send 25c today for **CATALOG**, details, **Uranium Tester**, **Chemical Puzzle** and **Analysing Kit!** **NATIONAL SCHOOL OF CHEMISTRY, P.O. BOX 606-P, Redwood City, Calif.**

## FREE! "HOW TO START YOUR OWN MAIL ORDER BUSINESS"

Earn from \$10,000 to \$20,000 spare time. We'll put you in business and furnish you with everything needed. Exclusive new catalogs every three months —Free advertising—No stock to buy. We ship for you. No experience required. Write today. **MAIL ORDER ASSOCIATES, Paramus 40, N. J.**

**NEW!** **RECLAIMO**  
ELECTRICALLY HEATED  
Oil RE-REFINING Filter  
A Wm. Schwilby Product

**CAR — TRUCK — TRACTOR OWNERS**  
to the most efficient filter ever developed!  
**GET WISE**  
Folder with full details **FREE**.

**RECLAIMO MFG. CO. 6251 Touhy Ave., Dept. M-126, Chicago 30, Ill.**

## Become A --- BUILDING CONTRACTOR!

**MAIL COUPON for FREE BROCHURE**

Simplified home study training program. Learn every phase of building, estimating, contracting. Fortunes are made in this line of work every year. Use spare hours—no interference with present work. Diploma awarded. Low tuition rates

**AMERICAN TECHNICAL SOCIETY**  
Dept. PM-126, 850 E. 58th Street, Chicago 37, Ill.  
Please send me your **FREE Brochure** and full details of your building, estimating and contracting training program.

Name \_\_\_\_\_

Address \_\_\_\_\_

City \_\_\_\_\_ State \_\_\_\_\_



# MAIL ORDER SPECIAL



GASOLINE

**\$9<sup>50</sup>**

## CAMP STOVE

ORIGINAL COST \$80

Ideally suited for drying plaster or paint in new construction

BRAND NEW U. S. ARMY FIELD RANGE Burner Unit, approx. 50,000 B.T.U. complete w/2 extra generators, unit as pictured. Cook on it, use as cabin heater. Shipping wt. approx. 55 lbs. Size: 21 1/2" lg., 19" w., 9 1/2" h.

SPECIAL NEW ARMY MACHETTES ..... \$1.95

FOLDING FOX-HOLE SHOVELS ..... \$1.00

FOX-HOLE PICK-MATTOCK ..... \$1.00

All prices FOB Memphis—order now. Supply limited

**J. P. DAVIDSON CO.**

104 N. Front

Memphis, Tenn.

## FREE AMAZING NEW BOOK "HOW TO ANSWER ADS"



Never before have you seen anything like this. Tells you in simple language the correct way to answer ads. Gets you quicker replies—better results, and greater satisfaction. Will save you time and money and it's ABSOLUTELY FREE. No obligation whatever. Every reader of advertising should have this booklet. Send a postcard for your copy NOW. F. W. Johnson, Popular Mechanics Magazine, Room 600-A, 204 East Ontario Street, Chicago 11, Illinois.

## ENGINEERING DEGREE IN 27 MONTHS

### B. S. DEGREE IN

**Aeronautical, Chemical, Civil, Electrical, Mechanical and Electronic Engineering (inc. Radio and TV)**  
Big Demand for Graduates

Hundreds of young men are earning B. S. ENGINEERING DEGREES annually in this recognized institution—year around classes optional. Also B.S. in 36 mo. in Mathematics, Chemistry, Physics. New terms start quarterly. Many students earn a major part of their college expenses in this large industrial center. Low tuition. Competent instruction.

Thorough, intense practical program. Modern, well-equipped laboratories including new physics laboratory and modern wind tunnel. Individualized instruction emphasized. Government approved for G.I.'s Engineering Science preparatory courses.

Students from 48 states and 21 foreign countries. Enter December, March, June and September. Send coupon for free catalog and full information. Enroll now.

## INDIANA TECHNICAL COLLEGE

5126 E. Washington Boulevard, Fort Wayne 2, Indiana

Please send me free information on 27 MO. B.S. DEGREES in:

Aeronautical  Chemical  Civil  Electrical   
Mechanical  Electronics

on 36 MONTH B.S. DEGREES in:  
Mathematics  Chemistry  Physics

Name \_\_\_\_\_

Address \_\_\_\_\_



## Rocket Engines Assist Take-Off Of Big British Bomber

Vickers Valiant bombers are being equipped with de Havilland Super Sprite rocket engines to assist in take-offs under heavy-load conditions. The Super Sprites are mounted under the wings of the Valiant, inboard of the landing gear. After the take-off, under normal operating conditions, the Super Sprites are jettisoned at an altitude of 700 to 1000 feet. They float to the ground by parachute, where they are picked up for reuse. Fuel for the rocket engines is a liquid consisting of hydrogen peroxide, kerosene and nitrogen.

☞ If you like decimal points, you'll be interested in knowing that a new bathyphotometer, developed at Harvard University, measures light as faint as .000000000001 percent of full sunlight at ocean depths of 2000 feet.



# Get info.. PLASTIC LAMINATING AT HOME!



Get **ORDERS** and **CASH** from your mailman—do work in **SPARE TIME** at home—or expand into **FULL TIME** business. Send coupon for Free facts about the newest and most fascinating of all home operated businesses. For the first time a simplified machine brings the fabulous profits of **Plastic Sealing** and **Plastic Laminating** within the reach of the small operator. Anyone can learn to operate the machine with a few minutes practice—then with our **Magic Mail Plan** can get mail orders pouring in daily with cash in every envelope. **No canvassing—no selling.** We even

**Make \$20 to \$30 a Day by..**  
**MAGIC MAIL PLAN!**

supply the circulars you mail to bring back cash and orders. Don't waste a minute. Rush your name. We'll send you **FREE** and postpaid, pictures, prices, details, and all the facts you need to start. Mail coupon or send name on postcard. No charge. **Warner Electric Co., 1512 Jarvis Av., Dept. L-1012, Chicago 26, Ill.**

## Make Thousands of Beautiful Art Creations

**COSTUME JEWELRY • CIGARETTE BOXES  
TRAYS • CANDLESTICKS • COASTERS  
LAMP BASES • BOOK ENDS...ALL IN  
SPARKLING COLORED PLASTIC**



**THIS MAN ..**  
...is taking out of the machine a Plastic Sealing Job—ordered by mail—only 11c in material cost brings back \$2.58 in cash by mail. Capacity of machine: **\$25.00 profit per hour of operation.**

**WARNER ELECTRIC CO., 1512 Jarvis Av. Dept. L-1012, Chicago 26, Ill.**  
At no cost to me, please rush complete details postage prepaid. I am under no obligation.

Name \_\_\_\_\_  
Address \_\_\_\_\_  
City \_\_\_\_\_ Zone \_\_\_\_\_ State \_\_\_\_\_



## YOU CAN BUILD A VIOLIN FOR PLEASURE OR PROFIT

Now you can build a rich toned mellow violin modeled after a famous "Strad." YOU CAN MAKE A STRADIVARIUS VIOLIN contains 8 full scale plans plus complete instructions. You work directly from the plans with no confusing scale of dimensions to translate. Detailed instructions for each step including varnishing and stringing—even shows how to build your own tools. Cloth bound. Order today from

**POPULAR MECHANICS PRESS . . . \$3.50**  
Dept. 1256, 200 East Ontario Street, Chicago 11, Illinois

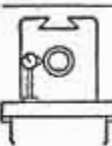

## SIMPLIFY PREVENTIVE MAINTENANCE WITH MACHINE TOOL RECONDITIONING & THE ART OF HAND SCRAPING (2nd printing)

SEND FOR FREE FOLDER DESCRIBING ILLUSTRATED BOOK  
**MACHINE TOOL PUBLICATIONS, 362 Kelly Ave., St. Paul 2, Minn.**

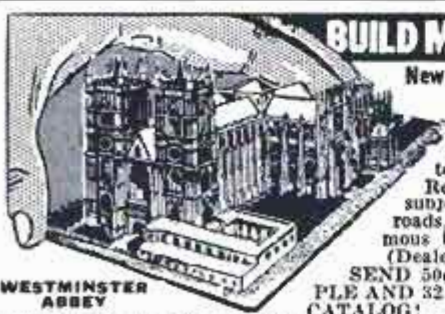

## BUILD MICROMODELS

**New Hobby From England!**  
... hours of satisfying fun and relaxation. Beautifully printed on cards ready to cut and assemble. Realistic miniature. 100 subjects of planes, railroads, ships as well as famous buildings. (Dealer Inquiries Invited)

SEND 50¢ FOR ACTUAL SAMPLE AND 32 PAGE ILLUSTRATED CATALOG!  
**WESTMINSTER ABBEY  
THAYER & STORM, 3909C 50th W., Minneapolis 24, Minn.**

Say You Saw It in Popular Mechanics

## Need an extra \$1,000, \$2,000, or more? Make it with an IDEAL LAWNMOWER SHARPENER

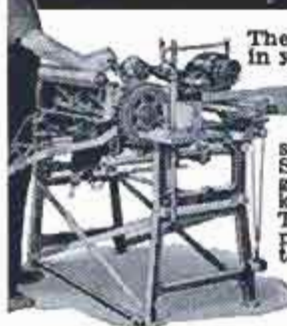

There are thousands of lawnmowers in your locality; Average \$1,000 profit per 250 mowers with customer satisfaction and repeat business assured. Provide this essential service with an Ideal® Lawnmower Sharpener, the only machine that grinds the reel to "fit" the bed knife. Compare by any standard. The Ideal, backed by 53 years of experience, costs no more. Write today for complete, free catalog.

**THE FATE-ROOT-HEATH COMPANY**  
Dept. PM-12 Plymouth, Ohio



## \$6,000-\$10,000 YEARLY OPERATING AUTO RADIATOR SERVICE SHOP

World's largest radiator shop equipment mfr. will assist responsible individuals in setting up radiator shops. Opportunity to own secure profitable business. First year averages \$6,000 to \$10,000. Garage or service station can operate as dept. Over 1,000 INLAND shops now operating. As little as \$295 down for equipment starts you. INLAND will finance balance and furnish training. Write to

**INLAND MFG. CO., Dept. PM-12, 1108 Jackson St., Omaha 2, Nebr.**

## Train at Home or in the Big Allied Shops AIR CONDITIONING HEATING & REFRIGERATION

**ALLIED** offers YOU the finest training for one of the greatest industries of our time. You can be sure of the quality of **ALLIED** training—resident training on a wide variety of equipment—and Home Study training that has behind it a great resident school.



## BIG KITS

### ALLIED TRAINING PREPARED WITH COOPERATION OF INDUSTRY

Only a school with the established reputation of **ALLIED** could have been given the cooperation by leading industries in the Air Conditioning, Heating and Refrigeration fields which has made this training so outstanding.

You Are Supplied Shop-Work Kits if You Prefer to Train at Home Right in your own home you do practical air conditioning and refrigeration work made possible by **ALLIED** training. You build an Air Conditioner, Freezer, or other units of your choice.

Send Today for Free Sample Lesson and Book  
Air Conditioning and Refrigeration are changing the living habits of millions of people. Piar to get into this great industry now—it's your chance to go up to higher and still higher earnings or build a successful business of your own. Get the facts about **ALLIED** training and how you can be helped. Mail the coupon for free book and sample lesson—no obligation.

### ALLIED SCHOOL OF MECHANICAL TRADES ALLIED INSTITUTE OF TECHNOLOGY

1338-42 South Michigan Ave., Dept. PM-12A, Chicago 5, Ill.  
Gentlemen:  
Mail me **FREE BOOKS** explaining **ALLIED'S** training program in **AIR CONDITIONING, HEATING, and REFRIGERATION.**  
 I am interested in resident training  home study  
Name \_\_\_\_\_ Age \_\_\_\_\_  
Address \_\_\_\_\_  
City \_\_\_\_\_ State \_\_\_\_\_



**BUILD  
IT  
YOURSELF**



MODEL BR-2  
incl. fed.  
**\$1925** excise tax  
(Less Cabinet)  
SHPG. WT. 10 LBS.

## Heathkit BROADCAST BAND RECEIVER KIT

Have you ever experienced the thrill of building your own radio? Invest a few of your dollars—a few hours of your time, and build a truly worthwhile broadcast band receiver. Transformer operation eliminates potential shock hazard characteristic of "economy" AC-DC sets. Operates as radio, phono, amplifier, or tuner. Fine tone quality, excellent sensitivity. Simplified Construction Manual outlines basic theory of radio principles. Actually a radio course in itself. Price includes tubes—speaker—chassis, etc. Every part you need! Order your Heathkit Radio Kit today.

### OTHER "BUILD IT YOURSELF" Heathkits

- |                         |                      |
|-------------------------|----------------------|
| Oscilloscope            | Hi-Fi Preamp         |
| Vacuum Tube Voltmeter   | Battery Eliminator   |
| Signal Generator        | Signal Tracer        |
| Amateur Transmitter     | Tube Checker         |
| Communications Receiver | (and over 50 others) |
| Multimeter              |                      |
| Handitester             |                      |
| Hi-Fi Amplifier         |                      |

WRITE FOR  
**Free CATALOG**



**HEATH COMPANY**  
A Subsidiary of Daystrom, Inc.  
BENTON HARBOR 17, MICH.

## GOTTA COMMON CAR COMPLAINT?

- Hard starting
- Engine dies
- Rough idle
- Jerky acceleration
- Low gas mileage



**FUEL  
PRESSURE  
REGULATOR**

**\$6<sup>95</sup>**

## You need a MILESMASTER®

**Milesmaster cures engine troubles**  
It regulates fuel pressure. Keeps raw gas from flooding engine and washing lubrication off cylinders and pistons. Reduces so-called vapor lock. Prevents crankcase dilution which forms harmful gums. Eliminates ignition fouling. Saves wear and tear on carburetor float and needle.

**New motoring thrills**  
If you want a new thrill from smooth, step and go, economical engine operation, have your dealer install a Milesmaster. Save its cost in first few thousand miles.

### What MILESMASTER does for your car

- Saves gas
- Reduces wear
- Prevents dilution
- Provides smooth idle
- Eliminates flooding, percolation, vapor lock
- Filters the fuel
- Traps steel and rust particles

**Money Back Guarantee**  
Have your dealer install MILESMASTER ON your car. If, in two weeks, it is not completely satisfied, your money will be refunded in full.  
**MILESMASTER, INC.**

**MILESMASTER, INC.**  
Factory and Sales: Box 40, Exeland, Wis., U.S.A.  
Executive Office: Suite 703  
6 N. Michigan Ave., Chicago 2, Ill.



## Load-Bearing Window Unit Serves as Wall Panel

No additional support structure is required for a load-bearing prefabricated window unit. It can be used like a wall panel and extended for the entire length of a building. The four-foot modular unit has four panels that accommodate glass or wood. A house can be enclosed completely in one day with these units, according to the manufacturer.

## Germicidal Lamp for Ductwork

Before germs can enter a room, a new type of ultraviolet germicidal lamp kills them in the ductwork of heating, ventilating or air-conditioning systems. This lamp consists of a lamp holder for a standard germicidal lamp tube and a stainless-steel case for the ballast and starter. One screw fastens the entire unit to the duct-system wall.

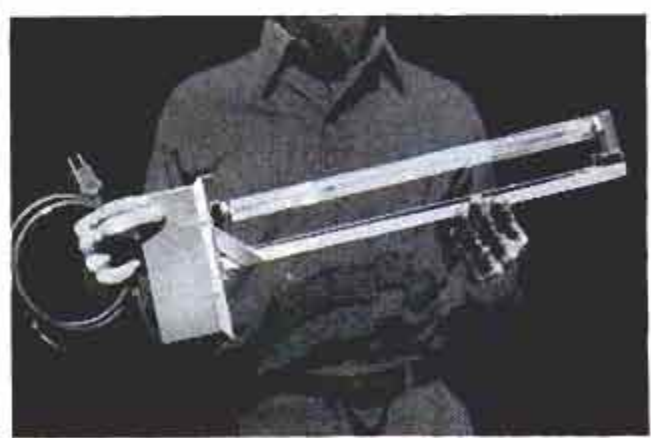





## DON'T SWAP SAFETY FOR "DISCOUNTS"

I replace FAST any defective tire, frt. excl.  
Cheaper PRICED Tires are Cheaper GRADE Tires

**12 MONTH GUAR.** FREE This pictured Tire Ash Tray given with 2 or more tires

We try to ship your favorite brand (Not Recaps)

**GOOD YEAR** Goodrich, U. S., General, Firestone & others, worn slightly.

600-16	\$5.78	670-15	\$5.88	700-20	\$8.98	600-16(6)	\$5.68
650-16	6.18	710-15	5.88	750-20	9.88	650-16(6)	6.48
700-16	6.28	760-15	5.88	825-20	16.58	700-16(6)	7.08
640-15	5.68	800-15	6.18	900-20	15.58	700-15(6)	7.88
700-15	5.48	820-15	6.18	1000-20	17.28	750-16	7.58
W.W. S1. Extra		700-17	9.98	1100-20	17.28	750-17	12.98



**SUBURBANITE SNOW** & others, Mud-Grip, Retreaded & Slightly used. 12 Mo. Guarantee **\$6.22** any car

If you do not want the free tube — **TAKE \$1 OFF** each tire ordered!

750-20 MIL. MUD-GRIP. Guar. 12 MOS. \$17.98

Send Ck. or M.O. & Ad for fast shipment. F.O.B. Phila. I select your tires as if my future depended on it!

**MARVIN BLATT** 6th & Spring Garden Philadelphia, Pa. CO. ADJUSTED TIRES with NEW Tire service guaranteed **\$7.95** any car **WHITE WALLS \$1. Ext.**

## NEW MAGIC RADIO WALKIE TALKIE!

**YOUR OWN POCKET SIZE RADIO STATION!**  
BROADCASTS TO ANY HOME OR CAR RADIO WITHOUT WIRES OR HOOKUPS! Wt. only 5 oz. Size 1 1/2 x 2 1/2 x 4 1/2". Built-in telescoping antenna. Powerful Translator-sensitive microphone. Frequency setter, break-in switch! Runs for weeks on self-contained flashlight batteries. Durable plastic case. With this Radio Talkie you CAN TALK TO YOUR FRIENDS UP TO A BLOCK OR MORE AWAY! Talk up to 1 mile or more between two automobiles. INSTANT OPERATION! Just push button to talk! No license needed. Uses inductive field magnetic radiation. Useful and real fun in a million ways! GUARANTEED TO WORK. 1 YEAR SERVICE GUARANTEE.

SEND ONLY \$2.00. (cash, ck. mo) and pay postman \$2.98 COD postage or send \$11.98 for prepaid delivery. COMPLETE READY TO OPERATE with instructions and hundreds of ways and tricks for broadcasts thru any radio you desire. Price may go up soon, so get your NEW POWERFUL RADIO WALKIE TALKIE NOW. Available only from: WESTERN RADIO, Dept. RPM-12, KEARNEY, NEBR.



## 100 BEST Woodworking Projects

SELECTED FOR YOU BY POPULAR MECHANICS EDITORS  
Enjoy the fun — the pride — of making things. Get 100 BEST WOODWORKING PROJECTS, complete with simplified instruction, plans, diagrams and more than 400 how-to-do-it pictures. Make all kinds of furniture, baby carriages, clocks, lamps, book shelves, fireplaces and other useful articles at little or no cost. Send only \$2.00 with name and address. Money back if not pleased.

POPULAR MECHANICS PRESS, Dept. 1256, 200 E. Ontario St., Chicago 11

# Join MARCH OF DIMES

"Remember Me"

DECEMBER 1956

## EARN MORE THAN EVER BEFORE

# IN HOME BUILDING AND CONSTRUCTION

You can earn up to \$4 per hour on the job — or make big profits in your own building business. Skilled men are needed everywhere—over 300,000 new jobs open yearly. Five out of 10 homes need some re-



pairs. More than \$20 billion will be spent for remodeling this year. Get set now for a better job or big profits and success in your own business!

## TRAIN AT HOME IN SPARE TIME

Learn building construction at home in just a few months. The new, HETI Job-Applied Method is practical, makes every step easy, teaches every phase of building. Add extra dollars to your weekly income as you train. Build dormers, stairs, garages, etc. For full details on both opportunity and training, mail coupon.

## MAIL TODAY • 2 FREE BOOKS

**HOME BUILDERS TRAINING INSTITUTE, Dept. HB-126**  
1400 Greenleaf Ave., Chicago 26, Ill.

Send free Home Building Success Book and Sample Lesson. No cost or obligation on my part.

Name \_\_\_\_\_ Age \_\_\_\_\_  
Address \_\_\_\_\_  
City \_\_\_\_\_ Zone \_\_\_\_\_ State \_\_\_\_\_

## MAKE STRIPES with new PAINT PEN

**Straight, curved, single or double**  
With any color paint, stripe furniture, bikes, autos, model planes, toys, linoleum, wall-board. Clean, crisp decorative lines. Can't clog or smear. Also use with glue, tempera, textile paint or underglaze... on wood, glass, plastic, ceramics, metals, fabrics and paper. Ask your dealer or order direct.



Single 1/16" stripe model **\$1.25**

**DEALERS** Master paint striping tool in display carton. Write for discounts. Order now.  
**HOBBY** "Professional" results every time. Simple, easy to use.  
**MFRS** Ask about heavy duty industrial striping tools.

Other single stripe models 1/64", 1/32", 3/64", 5/64", 3/32" & 1/8" **\$1.75** ea.

**DOUBLE STRIPE MODEL \$3.25**  
5 COMBINATIONS...

Complete Kit **\$5.00** (all 7 tips)  
Extra tips 90c ea.  
Extra 1/4" tip...\$1.20

**WENDELL MFG. CO.** 4234 LINCOLN AVE., Dept. 324 CHICAGO 18, ILLINOIS

## LEARN APPLIANCE REPAIR IN SPARE TIME AT HOME



**START YOUR OWN BUSINESS**  
50,000,000 POTENTIAL CUSTOMERS

New shop-method, home-training system gives you electrical know-how that used to take years to learn. Learn by building valuable testing kits, repairing your own and neighbors' appliances. Appliance repairmen often charge on the basis of \$5.00-\$6.00 an hour!

**FREE ILLUSTRATED BOOK**  
Shows you how you learn every phase of electrical appliance repair. How to make money while you learn. Write today for your FREE copy.

**CHRISTY TRADES SCHOOL**  
DEPT. D-6103, 4804 N. KEDZIE AVE., CHICAGO 25



# DIESEL MECHANICS IN DEMAND



Learn to earn big pay in DIESEL in our large, modern equipped Chicago school and shop. No previous experience or training necessary. We help you find living quarters and part time job while in school. Complete, practical courses taught in the following trades, under the supervision of experienced, expert technicians.

APPROVED FOR CIVILIANS  OR GI'S

## — CHOOSE YOUR TRADE —

CHECK HERE	WEEKS
<input type="checkbox"/> DIESEL MECHANICS	20
<input type="checkbox"/> AUTO MECHANICS	20
<input type="checkbox"/> BODY & FENDER	16 $\frac{2}{3}$
<input type="checkbox"/> GAS-ARC WELDING	4 - 12
<input type="checkbox"/> REFRIGERATION	13 $\frac{1}{2}$
<input type="checkbox"/> AIR CONDITIONING	8 $\frac{1}{3}$
<input type="checkbox"/> MACHINIST TRADE	30
<input type="checkbox"/> ADVANCED MACHINIST (includes tool & die)	32 $\frac{1}{2}$
<input type="checkbox"/> PIANO TUNING & REPAIR	36

## CHOOSE YOUR ENGINEERING COURSE

These courses are intended as terminal education for men who wish to enter the Diesel-Automotive and Refrigeration-Air Conditioning fields as technicians. These courses are designed to prepare men for supervisory positions. Students with a high school education, or equivalent, will be accepted.

<input type="checkbox"/> DIESEL AUTOMOTIVE ENGINEERING	2 years
<input type="checkbox"/> REFRIGERATION & AIR COND. ENGINEERING	18 months

### FREE EMPLOYMENT HELP

Start your career with Greer by checking your interest above and mail coupon for complete information at no obligation.

NAME \_\_\_\_\_ AGE \_\_\_\_\_  
STREET \_\_\_\_\_  
TOWN \_\_\_\_\_ ZONE \_\_\_\_\_ STATE \_\_\_\_\_

Established 1902 — Over 50,000 Graduates.  
54 years of continuous trade school experience to guide your training.

**GREER SHOP TRAINING**  
Box L, 2236 S. Michigan Ave.  
Chicago 16, Illinois

## Build a MOLDED PLYWOOD RUNABOUT With This Complete Kit...



by America's largest maker of molded plywood hulls

Save 75% construction time. Molded plywood hull has strength of steel of same weight... assured precision fit... no complex forms to erect... no framing... no planking. Pre-cut all mahogany parts mean factory built appearance inside and out.



Cruiser semi-kits also available.

See your dealer or write for information to

**U. S. MOLDED SHAPES, INC.**

651 Market St. S.W.

Grand Rapids 2, Michigan

BE A **CAMERA CRAFTSMAN...**

Send for **FREE** book!

national camera repair school - DEPT. V-12

INGLEWOOD COLORADO

**BOAT KITS**

12 Models as low as \$42.00 (freight included). Fiberglass boat covering kits, marine supplies, etc. Free folders.

**TAFT MARINE WOODCRAFT**  
DEPT. PM-12 636-39th Ave. N.E., Minneapolis 21, Minn.

**HELPFUL BOOKS**

Send post card asking for **FREE** catalog

Popular Mechanics Press, 200 E. Ontario, Dept. 601, Chicago 11

**BECOME AN EXPERT IN TRAFFIC and TRANSPORTATION**

Traffic men earn \$4,000 to \$10,000 and up. Thousands of firms need experts on rates, tariffs, regulations. We train you thoroughly in spare time at home for executive traffic jobs. Personal training under traffic authorities. Write for free book "Traffic and Transportation".

**LASALLE Extension University, 417 So. Dearborn St.**  
A Correspondence Institution Dept. 12647, Chicago 5, Ill.

**\$10,000 REWARD**

If correct use of my new body building course fails to build you a "HE-MAN" BODY The secret is in my revolutionary, exclusive Body Mould system. Yours FREE with famous

**DAN LURIE BARBELLS**

Scientific Fastest, surest method known — beats all other training methods. Results guaranteed. Special low prices.

50 lb. set \$ 8.48 • 100 lb. set \$13.98  
150 lb. set \$20.48 • 200 lb. set \$25.98  
13c per lb. F.O.B. 50% Deposit required

**DAN LURIE BARBELLS CO.**  
52M12 Bristol St., Dept. 659M, B'klyn, 12, N. Y.

**STOPS FOGGY WINDSHIELDS**

**NEW Chemical Mitt**

Amazing Discovery! Autoists wild over new FOG-STOP Windshield Cleaner. Simply glide over windshield chemically-treated Mitt — at once glass sparkles crystal clear. Blurry mist, frost, sleet, snow disappear like magic. Stops fogging. Sells like wild!

**SAMPLES FOR AGENTS**

Sample offer sent immediately to all who send name at once. Hurry. Postcard will do. **SEND NO MONEY** — just your name.

**KRISTEE CO., Dept. 694, AKRON 8, OHIO**



**WORLD'S  
BEST  
WANT-AD  
MEDIUM**

# CLASSIFIED ADVERTISEMENTS



Advertisements in this section \$1.25 per word, each insertion, minimum 10 words, payable in advance.

To be inserted under proper classification, copy must be in our office the

20th of the second month preceding date of issue

F. W. Johnson, Manager, Classified Advertising

Popular Mechanics Magazine, 200 East Ontario Street, Chicago 11, Illinois

## YOU'LL PROFIT

By reading and answering the classified ads in this section. Hundreds of opportunities for you to make and save money

### AUTOMOBILES, MIDGET CARS

**AUTOMOBILE** Type front axles, and rear driving units for small cars. Omsco, 313 Harrison, Peoria, Ill.

**CROSLY** Parts and accessories. Van's Sales & Service, Midlothian, Illinois.

**SPORT Car.** Runs on walk, lawn, street. Boys 6-16. \$99.50. Free literature. Micro-Midget, 940 North 23rd St., Omaha 2, Nebraska.

**1956 SUPERIGNITIONER!** Starting, pep, mileage, \$4.50. \$52 Barbells \$39.50. EG, Elmsford, N. Y.

**HUNDREDS** Of automobile catalogs, American, antique, foreign. Dealer books, glossy photographs, shop manuals. Free motor magazines, offered with non-profit club. Write immediately for free information. Auto Maniacs, Stockbridge, Mich.

**NEW 1957 Automobiles—Up to 25% off retail prices.** Meder, 550-PM Fifth Avenue, New York City 36.

### AUTO SUPPLIES AND EQUIPMENT

**NEW 1909-1934 Ford parts.** Free catalog. Huber, 15 Emerson, Clifton, New Jersey.

**SPEED** And power equipment. Hundreds of name brand items, 45 page fully illustrated catalog 50¢. Refunded on first purchase. Midwest Auto Specialties, Dept. K., 13907 Miles Avenue, Cleveland 5, Ohio.

**WEAK** Coil springs? Raised like new; also as strong. Do it yourself easily with kit. \$5.50. Guaranteed. Sales possibilities. Mullins Co., 964 McClure, Whitehaven, Tennessee.

**HIGH** Speed racing ignition points. Sample set \$1.00. Hove Engineering, 529 South 7th, Minneapolis 15, Minn.

**CAR** Burning oil? Millions rave about Vermiculite compression seal. Equivalent of costly ring job. Effective. Absolutely guaranteed. Free details. Rush \$2.00. Morning Star Sales, Clifton 3, N.J.

**SEND \$10.00** And brake shoes. Bonded. Immediately returned. North, 1601 Clybourne, Chicago, Ill.

**JEEP** Tops, American-foreign convertible tops. Free catalogue. Mor-Nan, Box 123, Boston 14, Mass.

**FREE** Information. Garage door operator made with your motor. Best Tools, Inc., Box 92, Berwyn, Illinois.

**SAVE** Money on Jeep and army truck parts. Large inventory. Catalogs for Jeep or GMC. American Auto Parts Co., 1830-PM Locust, Kansas City, Mo.

**AMAZING** Bargain offer! The famous General Electric auto engine heater for cars, trucks, tractors, assures incredibly fast, easy starts at sub-zero temperatures. Listed \$8.95—Our extra-special only \$3.95, postpaid, prompt shipment. Dealers, agents wanted. First order brings you sensational 500% profit plan. Hurry, secure your territory! "GE Engine Heater Sales," Milwaukee 7, Wisconsin.

**AUTO** Accessory and parts catalog, 1956 edition—all new! 180 pages. Save up to 50%. Over 75,000 items, including Hollywood accessories, hi-speed equipment, rebuilt engines, all parts and accessories for all cars and trucks! Hard-to-get parts! Send 25¢ (refundable). J. C. Whitney, 1919-PM Archer, Chicago 16, Ill.

**FREE!** New catalog. Speed, power, mileage increasing equipment. Discounts! Almquist Engineering, Milford PM5, Penna.

**GAS** Mileage: Three simple ways to improve your cars' fuel economy, \$1.00. Mileage, P.O. Box 781, Minneapolis, Minn.

**NEW** And used parts at savings. Complete guaranteed parts service for all models cars and trucks—1924 and later. Largest in the West. Army parts specialists. No catalog. Submit your needs for quotations. Fast mail order service. Pioneer Auto and Truck Parts Co., 734 W. 13th Ave., Denver, Colorado.

**SAVE** On parts, accessories, tools, dress-up items, gadgets! Largest giant 1957 catalog ever. Only 25¢ (refunded first order). Newhouse Automotive Industries, 5803E Beverly, Los Angeles 22, Calif.

**CRANKSHAFT** Grinder, hand operated. Makes bearings fit without taking engine apart, \$3.75. Literature, L. D. McGee, 719 Cascade St., Wenatchee, Wash.

**SCIENTIFIC** Oil test kit, designed and engineered by research laboratory. Qualitatively tests crankcase oil viscosity, dilution, detergent loss and sludge accumulation in five minutes. Simple detailed instructions. Forget mileage, change oil only when needed. Pays for itself in six months. Ten day money back trial. \$4.95 postpaid U.S.A. Californians add 4% tax. Remaco, Box 6056B, San Diego 6, California. Free brochure.

**BLITZ** Ice, snow from windshield with new copper Whisko. Fits key chain. Send 25¢. Whisko, Box 1126, Grand Central Station, New York City.

**JEEP** Owners—V8 power. Read Jeep owners ad, page 26.

**CAR** Burning oil, gas? Losing pep? Try Compression-Seal. Harmless. Results guaranteed. \$1.95 postpaid. Information free. Brook, 268 West 34 Street, New York City 1.

### AUTO TRAILERS

**TRAILER** Building manual \$1.00. Booklet 30¢. Kamcraft, Box 1153, Milwaukee 1, Wis.

### MOTORCYCLES, BICYCLES, MOTORSCOOTERS AND SUPPLIES

**PARTS** For Cushman, Doodle-Bug, Salsbury, etc. Send make, model, 25¢ for price list. Motor Scooter Parts Co., Dept. P10, Box 7211, Indianapolis 1, Indiana.

**HARLEY-Davidson's** — Used bargains, shipped prepaid. New, used parts, accessories for current and obsolete models Bulletin, catalog 25¢. Knuth's (factory dealer), 2491 Fond du Lac, Milwaukee, Wis.

**SMITH** Motorwheel midget car \$45; three wheeled motorscooter \$25; Doodle-bug \$20; 3 h.p. engine \$4. Cushman \$12.50. Powell motorcycle less engine \$20. (Mail-order only). Send 25¢ (35¢ for first class mailing) for directory-catalogue Number 74, just out, listing these and hundreds of other bargains in new and used midget cars, motorscooters, homebuilders parts, plans, etc. Midget Motors Directory, Athens, Ohio.

**RECONDITIONED** Motorcycles and motors. Chromium accessories. Complete stock Indian parts. Expert rebuilding. Fast service. Indian Motorcycle Sales, Kansas City 21, Missouri.

**PARTS, Pistons, new, used.** Harley, Indian, Henderson, list 10¢. Ballak, 811 N. 9th St. St. Louis 1, Missouri.

**MOTORCYCLE** Equipment service, bulletins 20¢. Wichita Cycle Co., 813 Ohio, Wichita Falls, Texas. Our 31st year.

### AVIATION

**PROPELLERS,** Plans, supplies by world's oldest and largest manufacturer of special design airboat and snowplane propellers. Latest designs. Prompt delivery. Satisfaction guaranteed. 48 page catalog 25¢. Banks-Maxwell, Box 3301E, Ft. Worth 5, Texas.

**AVIATION** Surplus bargain catalogue. One dime. Box 22PM, Thomasville, Penna.

**BUY** Surplus aircraft; fuselages; accessories; engines; instruments; electronics—Direct from U. S. government depots. List and procedure \$1.00. Brody, Box 8-PM, Sunnyside 4, New York.

**HELICOPTERS—1** And 3 man. Aviation marvels. Construct own. Plans, \$4.00. \$6.00 respectively. General Aviation, Box 384, Windsor, Ontario, Canada.

### BATTERIES, GENERATORS

**EDISON** Nickel storage batteries. Any voltage, any amperage. Unconditionally guaranteed. Power plants, generators, motors. Literature. Hawley Smith Co., Croton Falls 1, N. Y.

### ELECTRICAL SUPPLIES

**LAMPS—Parts** catalog showing wiring instructions. 25¢. Gyro Lamps, 5402P Clark, Chicago 40.

**TELEPHONE** Transmitter. Hand set type. Suitable for inter-house phones, speakers or any communication purpose. Delivered two for \$1.00. No c.o.d.'s. Telephones, Dept. C-925, 1760 Lunt, Chicago 26.

**ELECTRIC** Pencil: Engraves all metals \$2.00. Beyer Mfg., 10511-H Springfield, Chicago 43.

**LAMP,** Electrical parts, wholesale. Thousands of items for repairing, converting. Catalog 25¢. Brown Lamp, Box 305, Clayton 5, Mo.



## WELDING, SOLDERING, PLATING

NEW, Timesaving oxy-acetylene outfit welds, cuts, heats, brazes. Just change tips. Light, compact, portable. Thrifty to operate, ruggedly built. Complete outfit and instructions, only \$76.50. Special economy plan for supplying gas cylinders. Write for free literature: Dept. M, Linde Air Products Company, 30 East 42nd Street, New York 17, N.Y.

"BUILD-UR-OWN" a.c. welder and a.c. power plant with a good used engine and low cost Hobart generator. Welds anywhere and supplies 5kw stand-by power for any emergency. Write Hobartweld, Box M-1263, Troy, Ohio.

A.C. Welders. 4 sizes. Lowest prices. Free literature. Holgerson's Serv., Canton, Kan.

WELDERS, 110/220, \$39.50. Morris, 1070 Inner Drive, Schenectady 3, New York.

ELECTROPLATING Equipment, anodes and solutions for all types of plating. Instructions. Assemble your own plater and save. Free catalog. Ramyr, Dept. E-4, 1624 East First Street, Los Angeles 33, California.

ACETYLENE Welding outfits new \$54.50; used \$34.50; arcwelders \$56.50. Eagle Welding, Dept. PM, 5085 Broadway, Chicago 40, Ill.

LEARN Welding, arc or torch manuals \$1.00 each. Marnel, Box 7642, Denver 15, Colorado.

## MACHINERY, TOOLS, SUPPLIES

"MACHINE Tool Reconditioning" — Amazing manual for machinists. Simplifies preventive maintenance. Free circular. Machine Tool Publications, 382 Holly, St. Paul 2, Minnesota.

LAWNMOWER Sharpeners New, \$59.75 to \$259.50 until Jan. 1. Turner-Cline, 430 Yellowstone, Pocatello, Idaho.

## ENGINES, MOTORS, DYNAMOS

A. C. Generators. 750 watt \$42.50; 1500 watt \$67.50. Motors, 5 horse \$110; 3 horse \$87.50; 1 horse \$38.50. Butler, 1885 Milwaukee, Chicago.

1/2 HORSEPOWER Electric motors, a.c. 110, used, good \$5.00 each, f.o.b. Plant Machinery Corp., Richmond & Norris Sts., Philadelphia 25, Penna.

REWIND Motors yourself. Complete instructions \$1.00. Lewis Mig., Howell, Michigan.

WINDING Data. 275 motors, single and three phase. \$1.10 Data Company, Box 7631, Kansas City 28, Mo.

INJECTOR Used parts wanted. GM71-110. Bares, 7120 Carnegie, Cleveland 3, Ohio.

## BOATS, OUTBOARD MOTORS

"SPEED-Glas" your boat! Increase speed, strength, protection. 14' kit, \$38.50; bottom only, \$23.25. Try our large repair kit—Only \$4.95. Speed-Glas, Box 423A, Hondo, Texas.

BOAT Plans. Full size patterns. Frame kits. Modern inboards and outboards for amateur builders. Complete new catalog 50¢ or specify requirements. Glen Designs, Box 568, Compton, Calif.

PLASTIC Letters and numbers. All sizes and colors. 3 inch 30¢. Plastics, Box 6161, Lakewood, Calif.

BEGINNERS Boat Manual. All the answers. 24 articles. Pictures. Special chapter on how to buy a used boat. Price \$1.00. Hayes, Box 128, Bridgeport, Conn.

NEW, Used, rebuilt marine motors. Marine conversions, fittings. Free catalog. Stokes Marine Supply, Dept. 24, Coldwater, Michigan.

FIBERGLASS Boat coverings wholesale prices. Free literature, samples. Seifert's, Box 31M, DePere, Wisconsin.

FIBERGLAS Permanent boat waterproofing. Special 25% winter discount. Complete kits, \$9.45 up. Guaranteed materials. Easy application. Full instructions. Free literature. Ajax Plastics, Dept. PM, P.O. Box 1323, Fort Worth, Texas.

MARINE Conversions for Ford and Jeep engines. Catalog 25¢. Lehman Manufacturing Company, 972D Broad Street, Newark 2, New Jersey.

FORDS And Jeeps 100% marine engines with famous Convo-Kits. Deluxe catalogue 25¢ coin. Oscomotors, 3627B Lawrence, Philadelphia 40, Penna.

FULL Size, cut-to-shape boat patterns, blueprints, 7 1/2-38 feet. New 1956 illustrated 85 page "Build-A-Boat" catalog of naval architect-designed cruisers, runabouts, sloops, skiffs, outboard boats, sailing, racing, houseboats, 50¢. 1956 "How-to Build a Boat" booklet, \$2.50. Cleveland Boat Blueprint Co., Dept. A-68, Box 1651, Cleveland 4, Ohio.

FREE Catalog! Boat kits, trailers, fiberglass, marine hardware. Luger Industries, Dept. M11, 3404 Lyndale South, Minneapolis, Minnesota.

SAVE Money. New, used outboard motor parts. Send wants. Stamp appreciated. Outboard Motor Mart, 229-M State, Boston 9, Mass.

APPROVED Underwriter modern marine conversions. Ford and Jeep. Gershel, Oceanside, N.Y.

100 PLANS, Patterns, kits. Catalogs: Powerboat 50¢, sailboat 25¢. Marinecraft, Box 161-M, Brighton, Mass.

A-1 Marine engines bought and sold. Manifolds, clutches, diesels. Helwege, 741 S. Ocean, Freeport, N.Y.

## ATHLETIC EQUIPMENT, BODY BUILDING COURSES

OUTSTANDING Physical development! New guaranteed system uses only a rope! Strength, health, gain, reduce. Free details. Roperise, 4834 Art St., Room 206, San Diego 15, California.

DISABLE Any bully, with two fingers. Secrets. Ju-Jitsu, 98 pages, illustrations. \$1.50. Seico, Box 38, Cooper Station, New York 3, N.Y.

BARBELLS, Dumbbells. Courses. Free catalogue. Good Barbell Co., Reading, Penna.

FEET, Leg muscles hurt? We can help you! Famous Perrins method rebuilds and renews tired muscles. Activates and normalizes circulation. Intensifies nervous forces. No electricity. No internal medication. No massage. No special or expensive equipment. No continuing treatment. Increase your efficiency and complete health. Results are lasting. Write for free information. No obligation. Ornin Company, 1017 13th Street, Des Moines, Iowa.

## SPORTING GOODS, GUNS, FISHING TACKLE, ARCHERY, TRAPPING

DIVING Equipment for skin divers and professional divers. Send 25¢ for catalog and decompression chart. Desco, 212 N. Broadway, Milwaukee 2, Wisconsin.

5000 BARGAINS, Firearms, binoculars, war relics. Catalog 50¢. Smith Firearms, Rummene, N.J.

SAMPLE: 25¢ Copy of "The Archers' Magazine." Send 10¢. 1200 Walnut Street, Philadelphia 7, Pennsylvania.

MOLDS For fisherman's sinkers, jigs, squids, casting and spinning lures. Free catalog. Sweet's Molds, Tonawanda 1, New York.

CAMPING Equipment, tents. Direct from manufacturer. World's largest selection. Send 15¢ for 120-page 1956 tent and camping equipment catalogue-handbook. Morsan Tents, 10-21R, 50th Ave., Long Island City 1, New York.

180 PROFUSELY Illustrated pages antique pistols, swords, daggers, armor, etc. 50¢. Robert Abels, M860 Lexington Ave., New York City 21.

HOW To catch fish, scent secrets. 10¢. Johnston's, 312 Lake Avenue, Ithaca, New York.

CAMPERS, Scouts. Send \$5.95 new all in one camping knife kit. Guaranteed. Stainless steel. Compact utensils. Camper, P.O. 53PM, Glendora, California.

"STRIKE" Liquid lure. Best invention since the fish hook. Amazing! Guaranteed. \$1.25 bottle. Modern, 500 Lafayette Building, Syracuse, New York.

BUILD Barbecue. Complete plans. Booklet 25¢. Free catalog. Popular Mechanics Press, 633 N. St. Clair St., Chicago 11.

20 BEAUTIFUL Flatface plastic spinning lures. Complete kit \$3.00. Retail value \$20.40. Quaker City Mfg. Co., 3514-24 N. Lawrence St., Philadelphia 40, Pa.

FREE Fishing catalog—132 pages. Over 3000 hard to find fishing specialties. Netcraft Company, Dept. PM12, Toledo 13, Ohio.

TRAPPING Pays. Free—How harvest valuable furs. Profitable numbers. Woodsman, Sharon, Massachusetts.

AUTHENTIC Primitive weapon reproductions! Spears, cross-bows, edged weapons, etc. Colorful. Deadly. Decorative. Catalog 10¢. Primitive Weapons, Pevely, Missouri.

BIG Money raising crickets and 12 inch African fishworms. Free literature. Carter Ranch, Plains, Georgia.

JAP Rifle altering to 30-06, \$6.00. Jap-shells, \$3.75. Catalog 5¢. T. P. Shop, West Branch 11, Mich.

ARCHERS Save! Free five dollar credit certificate and completely new illustrated 1957 catalog. Bows, arrows, raw materials. Offer expires January 31, 1957. Send 10¢ for handling. Pride Archery, RFD #1, Danbury, Connecticut.

ED'S Own super cold blue restores, protects, revalues guns, \$1.50. 1,000,000 gun-accessories catalog. 50¢. Ed Agramonte, Yonkers 2G, N.Y.

## BINOCULARS, TELESCOPES, MICROSCOPES, MAGNIFIERS

SALE! United binoculars. Ideal Christmas gifts. \$3.95 to \$250.00. Free 56 page binocular-telescope catalog. United, 9043 S. Western, A-908, Chicago 20, Dealers wanted.

400X Telescopes easily made. Kit includes focusing tube, erector, five finished lenses and building instructions—\$3.75. Free booklet on completed telescopes, tripods, mirrors, lens kits, etc. Suffolk Science, Mattituck 3, New York.

REFLECTING Telescope, 60X, completely assembled \$29.75. Guaranteed observatory clearness. Free information. Skyscope, 475 Fifth Avenue, New York City 17.

AMAZING Prices, precision binoculars and gunscopes. Free trial. Folder, "Binocular Selecting," catalog free. Prentiss Importers, Mercury Bldg., West Los Angeles 25, Calif.

REFLECTING Telescope mirrors and kits. Universal Precision Co., Box 187, Sunbury, Penna.

REFLECTOR Telescope kits \$6.25 (3") to \$175 (12"). Mirrors, cells, focusing mounts, tripods, eye systems. Anything, everything in telescopes. Free catalog. Also ready to use telescopes from \$25. Esco Products, Oakridge, New Jersey. Showroom, 166 Church Street, New York City.

MICROSCOPE Catalog free. Research Scientific Supplies, 60 Wall St., New York City 5.

BUILD Your own reflector telescope. Complete kit: mirrors, eyepieces, tripod, all other accessories. Request free illustrated literature. Criterion Manufacturing, Dept. KPM 24, Hartford, Conn.

ASTRONOMICAL Telescopes. Make your own. Price list and complete instructions 10¢. Precision Optical, 1001-B East 163d St., New York City 59.

POWERFUL Combination astronomical telescope and telescopic camera easily made. Free literature. Instructions 25¢. Holm Jamer, Manorville, N.Y.

60 PAGE Booklets! "Astronomy," "Sun," "Moon," "Comets," "Planets," "Light," "Relativity," "Useful Tables," "Physics," "Scientific Oddities." 10¢ each. Franks, 3121 South Racine, Chicago 8.

MICROSCOPES, Telescopes, binoculars, surveying, everything optical, photographic. Importers prices. 25¢ catalog. Magnification Instrument Co., 2 East 45 St., New York City.

IMPORTED 7X35, 7X50 Binoculars \$35.00—Cased. Outdoor Outfitters, Seneca Falls, N.Y.

DYNASCOPE—Sensational new reflector telescope. Send for details. Criterion Co., Dept. DP 27, Hartford, Conn.

JOE'S Binoculars, 3562 Third, Detroit 1, Michigan. Lowest prices, all sizes, binoculars, microscopes, telescopes catalog.

BINOCULARS, Telescopes, microscopes. Terrific values \$3.98 up. Request free money-saving catalog. Criterion, Dept. P 49, Hartford, Conn.



**WAR Surplus bargains:** Millions of lenses, instruments, telescopes, binoculars, components and complete line of astronomical telescope items. World's greatest optical market place! Send only \$1.00 for beginner's 10-lens kit and big instruction booklet stock 2-CH. Write for catalog CH, free! Edmund Scientific Corp., Barrington, New Jersey.

### PLANTS, SEEDS, BULBS, NURSERY AND GARDEN SUPPLIES

**TREES** And shrubs—Raise your own from seed for shade, windbreak, snow fence, ornament, erosion control, etc. For free planting guide, price list, write Woodlot Seed Company, Norway 9, Michigan.

**WORLD'S** Greatest cash crop. Free information. Write Ginseng Gardens, Asheville, N. C.

### PETS—DOGS, BIRDS, RABBITS, HAMSTERS, ETC.

**PARROTS,** Mynah birds, talking, \$150.00. Small parrots \$50. Pet monkeys \$100.00. Trained chimpanzees \$1000.00. Rare parakeets, canaries \$10.00. Guaranteed. Florida Pet Farms, Florida 1, Ala.

**1000 BRED** Mink. Booklet, plans 25¢. Lake Ontario Ranch, Gravel Road, Webster, N. Y.

**HUNTERS!** Raccoon Mountain and Short Creek kennels now combined. Large number of coonhounds, foxhounds, rabbit-hounds, beaglehounds, bird-dogs, puppies. Free literature and pictures. Trial. Dures Thomas, Owner, Box 464, Boaz, Alabama.

**HAMSTERS,** Pair \$2.95. Free booklet. Jer-Fre's Hamstery, 2425 Hoyt, Muskegon Heights 13, Mich.

**MINK** Raising information free. Complete. Lake Superior Mink Farm, Superior, Wis.

**RAISE** Rabbits successfully by knowing facts. 48 page illustrated book describing 25 breeds. Housing, feeding, breeding, marketing, etc. Plus bulletin. 25 cents. American Rabbit Association, 36 Arba Building, Pittsburgh, Penna.

**STANDARD** Rabbit Journal, Milton 3, Penna. Year \$1.00. Sample dime. Beginners manual 25¢.

**RAISE** Mink: Free booklet, pen plans, inside secrets, feed, care. Mink are money makers. Investigate today. Lawrence Molder, Brigham City 12, Utah.

**MAKE** Money raising chinchillas, mink, nutria, rabbits, cavies for us. Free catalog. Keeney Brothers, New Freedom 2, Penna.

**SPORTSMEN:** World's largest kennel offers 500 Pointers, Setters, Straight Cooners, Combination Hounds, Rabbit and Squirrel Dogs, Beagles, Fox and Wolf Hounds. Trial. Prices reasonable. Catalogue free. Smokey Mountain Kennels, Cleveland, Tennessee.

**HAMSTERS,** Golden: young, \$3.00 pair. Fully developed \$4.00 pair. Adirondack Hamstery, Prospect 160, New York.

**RAISE** Rabbits on \$500 month plan. Plenty markets. Free details. White's Rabbitry, Dept. 120, Mount Pleasant, Michigan.

**TROPICAL** Fish breeders succeed with Peckskill liver formula. Trial jar 25¢. Peckskill Pet Supply, Peckskill, N. Y.

**BEAUTIFUL** Pure white pedigreed police puppies. Ansonia Kennels, Mose, N. Dak.

**GROW** Mushrooms. Cellar, shed. Spare, full time, year round. We pay \$3.50 lb. We paid John Betts \$7,977.76, he started as amateur. Free book. Mushrooms, Dept. 171, 2954 Admiral Way, Seattle, Wash.

**ST. Bernard** puppies. Loving, lasting gifts. Siegend, Wauke, Iowa. Phone 7502.

### FARMS, FARM LANDS, REAL ESTATE

**CALIFORNIA** State government 40 to 640 acre tracts \$5 acre minimum. 25¢ brings information on available locations, maps of 500,000 acres. Pacific Lands, 7419-F Beverly, Los Angeles 36, California.

**FREE** Information. Government land. U.S., Alaska. Sledge Surveys, Macon, Mississippi.

**OZARKS!** \$8 Acre. Listings, information free. Write: Armstrongs, Shook, Missouri.

**FLORIDA** Lakefront homesites. Easy monthly payments. Complete literature free. Write Box 1311, Eustis, Florida.

**BIG** Strout catalog! Mailed free! Farms, homes, businesses, bargains galore! Accurate, reliable descriptions of over 3000 properties in 36 coast-to-coast states! Livestock, equipment often included, many with low down payments and easy terms! World's largest. Serving you 56 years! Depend on Strout Realty, 7-MP S. Dearborn St., Chicago 3, Ill.

**HOMESITES** \$15 Monthly—California's finest garden section, Morro Bay's scenic shores. Wonderful fishing, boating. Fertile soil, softest water, temperate climate, congenial community. Free literature. Richard Otto, Department M, San Luis Obispo, California.

**FLORIDA.** Nice homesites, \$245 at \$10 monthly. Folder free. Howard Vernor, DeLand, Florida.

### POULTRY, FARM SUPPLIES

**POULTRY** Farmers, broiler growers, turkey raisers read the new American Poultry Journal for latest ideas and greater profits. 12 months, 50¢. Special offer, 4 years \$1.00. American Poultry Journal, 180 North Wabash, Chicago.

### PROFITABLE OCCUPATIONS

**VENDING** Machines—No selling. Operate a route of coin machines and earn amazing profits. 32-page catalog free. Parkway Machine Corporation, Dept. 25, 715 Ensor Street, Baltimore 2, Maryland.

**RAISE** Rabbits on \$500 month plan. Plenty markets. Free details. White's Rabbitry, Dept. 121, Mount Pleasant, Michigan.

**YOUR** Own wholesale business without investment. Free catalog. Norris, 487-X Broadway, New York City.

**BE** The Popular Mechanics representative in your neighborhood and earn big profits in your spare time. Write Popular Mechanics Magazine, Room 408M, 200 E. Ontario St., Chicago, Ill.

**BUY** Wholesale! Discounts to 80%! Appliances, cameras, sporting goods, tools, watches, housewares, etc. Free catalogs. Buy-Rite, Box 258-C, Hawthorne, New Jersey.

**FOREIGN** Jobs—Latin America, Alaska, Canada, up to \$1500 monthly. Up-to-date 1956 foreign service directory gives complete information; hot list of firms hiring for military and civilian construction, aircraft, oil, exporters-importers, mining, \$1.00. How-when-where to apply. 9th successful year! Global Reports, Box 883-S, Hollywood 28, Calif.

**RAISE** Pheasants on \$100 week plan. Little capital and space can make you independent. Free details. Great Central System, Columbus 1, Kansas.

**MAKE** New greaseless doughnuts in kitchen. Sell stores. Free recipes. Michael Ray, 3605 South 15th Ave., Minneapolis 7, Minnesota.

**AUCTIONEERING**—Home study course. Diploma granted. Auction School, Ft. Smith, Ark.

**FREE** Book "505 Odd, Successful Businesses." Work home. Pacific, Oceanside, Calif.

**MAKE** Flexible molds. Cast plaques, figurines. Free sample. Tooker, 830-M Chestnut, Hamilton, Ohio.

**JOB** Guidance. What jobs are you suited for? Approved methods. Request free questionnaire. National Guidance Service, Landisville, Penna.

**REPAIR** Porcelain on appliances. Much needed service! Profitable! Free information! Enamel Repair, 422 Prospect, Buffalo 1, New York.

**FREE** Folio "\$5,000-\$45,000: Unlimited Vacations." No merchandise. Unknown! Work home, sparetime! Haylings, Carlsbad, Calif.

**MAKE** Money writing short paragraphs! No tedious study. I tell you what to write, where and how to sell; and supply list of editors buying from beginners. Many small checks add up quickly. Write to sell, right away. Send for free facts. Benson Barrett, Dept. CP-27-Z, 7464 Clark, Chicago 26.

**BUY** Wholesale thousands nationally advertised products at big discount. Free "Wholesale Plan." American Buyers', Hertel Station, Buffalo 16-B1, N.Y.

**LEARN** How to supply needed information to clients. It pays well. You are taught in a short time, at small cost. Frank Fix, 2056 Switzer, St. Louis 21, Mo.

**WELDING** Pays big money. Learn easily at best equipped school in country. Non-profit school with low cost training. O.I. approved. Write Hobart Trade School, Box M-1262, Troy, Ohio.

**BE** A notary public. Guaranteed instructions and advertising signs \$3. Write: Stevens, Box 188, Ft. Gibson, Okla.

**HOME** Mailorder sources, methods, opportunities. Literature free. Carnahan Bros., 9610-D Acacia, Fontana, Calif.

**FOREIGN,** Alaskan, U.S.A., jobs! To \$15,000 monthly! Million Americans employed overseas. Copyrighted reports. Who to contact for highest paying jobs. Laborers, trades, truck drivers, office, engineers, many others. 52 countries—St. Lawrence project, Spain, Latin America, Northern project, Europe. Year registration-advisory service. Application forms. Unconditional money-back guarantee! \$2.00 (airmailed \$2.25). C.O.D.'s accepted. International Reporter, St. Louis 1-PM, Missouri.

**919 SECRETS!** Free plan "Secret Journal Hidden Dollars." Work home, weekends! Publico, Oceanside, Calif.

**BIG** Money raising fishworms and crickets. Free literature. Carter Wormery, Plains, Georgia.

**MAGAZINE** Subscriptions—Largest commissions, bonus. Qualified Agency, 451MA Kingston, Brooklyn 25, N. Y.

**GROW** Mushrooms. Cellar, shed. Spare, full time, year around. We pay \$3.50 lb. We paid John Betts \$7,977.76, he started as amateur. Free book. Mushrooms, Dept. 99, 2954 Admiral Way, Seattle, Wash.

**INVESTIGATE** Accidents—Earn \$750 to \$1,000 month. Thousands of airlines, insurance companies, steamship lines urgently need claim investigators. We train you home spare time. Placement counsel and help. Free book—Now! No obligation. Universal Schools, T-12, Box 8202, Dallas 5, Texas.

**MUSHROOMS** Now bring bigger, quicker cash. Spawn plus newest manureless growing, marketing methods. \$1.00. Free literature. Luxur, 641 South 19th, Newark 3, N. J.

**\$60 WEEKLY,** Spare time—Easy! Home Venetian blind laundry. Free book. Burt, 2434A, Wichita 13, Kansas.

### BOOKS, PERIODICALS, PICTURES, POSTCARDS

**NATIONAL** Geographic Magazines, 1888-1956. Periodical Service, Box 465-PM, Wilmington, Delaware.

**OUT-Of-Print** books at lowest prices! You name it—we find it! Fast service. No obligation. International Bookfinders, Box 3003-PM, Beverly Hills, Calif.

**"SCIENCE** Milestones." Records march of science starting 400 years before Christ, right up to date. Amazing facts revealed. 312 pages packed with startling information that will thrill you. A real history of science. \$5.00. Literature free. Popular Mechanics Press, 200-SM East Ontario St., Chicago 11, Ill.

**RARE** Magazines, catalog 10¢. Nationwide Exchange, Box 1375-P, San Antonio 6, Texas.

**BOOKFINDERS!** All subjects. Send wants! Jaher Book Service, 183 Hazelwood Drive, Westbury, N. Y.

**SPARETIME** Repeat profits taking subscriptions all magazines. Good commissions. Exceptional special offers. Cassell Agency, Boynton Beach, Florida.

**BOOKHUNTERS!** Scarce, rare, miscellaneous books. Atlantic Book Service, Cedar Street, Charlestown 29, Mass.

**JOHN** Friend, bookfinder, can get the book you want. Free search service. Box 197PM, Cardiff, Calif.

**FREE:** Exciting catalog packed with books covering most everything. Think of it—From cover to cover you will find described and illustrated hundreds of books telling how to fix and how to build almost anything. How to remodel your home; do your own decorating, plumbing, electrical work. Simplified books covering concrete work, carpentry, painting, furniture making and refinishing. How to build your own boat, home workshop tools. Best books on photography, welding, hobbies, homecraft. How to make a home freezer. Send for your free copy now. Popular Mechanics Press, 200-BC East Ontario St., Chicago 11, Ill.



BRITISH Magazines: "Motor," "Auto-car," "Motorcycling," "Motor Cycle." Sample bundle \$1.00. British Cycle Subscriptions, Box 4595, Govans P.O., Baltimore 12, Md.

BOOKS, Used clothbound. Popular fiction. 45¢-\$1.00; non-fiction 40¢ up. Also will find books for you. Postal brings catalog, information. Wilke's, 3328 St. Roch, New Orleans 22, La.

BRITISH Book bargains—All subjects. Catalog 10¢. Transbooks, Box 22PMG, Brooklyn 26, N.Y.

HORSE Books—Breaking, training, care. Special bit. Carson, 1304 W. Kiowa, Colorado Springs, Colorado.

BOOKS, Essays and lectures! Unusual, odd information you cannot get elsewhere. Many, only one copy each. New list free. Now ready. Rush name. J. Houston Maupin, 201 North Hyatt St., Tipp City 5, Ohio.

BOOK Catalog, 1000 interesting titles. Send 10¢. Books Publishing Co., Amityville 3, N. Y.

### GAMES, TOYS, NOVELTIES

ELECTRIC Trains, models, toys, games, books. Terrific discounts. Catalog 10¢. Utopia Sales, Box 33 M, Utopia Station, Flushing, N. Y.

### MAGIC TRICKS, PUZZLES, JOKER NOVELTIES

LEARN Ventriloquism, easiest method. Details free. Smith, 2125 No. Bigelow, Peoria, Ill.

NOW! Secrets to 3 amazing self-working card tricks, \$1.00. Regiment, Box 23, New York 36, N.Y.

SENSATIONAL Magician's wand 25¢. Vanishes handkerchief! Catalog included. Box 1352-PM, Philadelphia 5.

LUCKY Lady matching coin, heads and tails 25¢. Pollard, 1214 N. New Jersey, Indianapolis 2, Ind.

"102 MAGIC Tricks" plus big illustrated catalog 50¢. Stowell, Woodstock, New York.

LIGHTED Candle from pocket trick (including 100 refills) \$1.00. Lonergan, 672 North Dearborn, Chicago 10, Illinois.

BE A magician! Large professional catalog of latest tricks. 35¢. Ireland, C-109 North Dearborn, Chicago 2, Illinois.

3100 NOVELTIES, Jokes, tricks, gadgets, funmakers, hobbies. Big catalog 10¢. Johnson-Smith, D-407, Detroit 7.

VENTRILLO, Professional voice-throwing instrument and catalog 25¢. Box 971-PM, Philadelphia 5.

WOODEN Nickels, catalog, trick, 10¢. Magico, Box 1375-P, San Antonio 6, Texas.

DOLLAR Magic set free with catalog 25¢. 4462-PM Germantown, Philadelphia.

WORLD'S Finest professional magic, Joker novelties. Giant illustrated catalog 10¢. Top Hat, Evanston 12, Illinois.

500 TRICKS, Douglas famous 120-page catalog, only 10¢. Fastest service to magicians for 30 years. Send 10¢ today. Douglas Magician, Dept. 1, Dallas, Texas.

SMOKEBOMBS 25¢. 7 For \$1.00. Terrific! 4463-PM Greene, Philadelphia 44.

FREE Trick and professional catalog of 600 tricks, \$1.00. Terry's Magic Studio, 1921-66th Street, Brooklyn 4, New York.

PROFESSIONAL Catalog, 175 pages, 25¢. Williams, 900 Plymouth, Ellwood City, Penna.

SVENGALI Trick deck free with catalog 50¢. 1746-PM Market, Philadelphia 3.

### COINS, TOKENS, CURRENCY

101 DIFFERENT Foreign bills, \$1.00 postpaid. Dwight Musser, Dunbar, W. Va.

OLD Coins, currency bought, sold. Large list 10¢. Thos. J. Settle, Box 1173, Church Street Station, New York 8, N.Y.

LARGEST Coin magazine, 180 pages, 35¢. Scrapbook, 7320-J Milwaukee, Chicago 31.

6-IN-1 Special: Magnifying glass; check list; 25 coin envelopes; giant 60 page bargain catalog; ten different Indian pennies; Mexican ten-peso; All six, \$1.00 postpaid. Ben's Coin Shop, 31 North Clark, Chicago 2, Illinois.

FREE! Foreign coin, banknote and coin collectors illustrated catalog to approval service applicants. Send 3¢ postage. Tatnam Coinco, Springfield 30, Mass.

SAN Francisco mint closed! Made only cents and dimes in 1955. In short supply and great demand. One each, brilliant uncirculated, for 25¢. Free coin lists with order. Bryson Stamp & Coin Company, 612 White, Toledo 5, Ohio.

BARGAIN Lists, Indianhead cent, 10¢. Economy Sales, 157 Dean, Mansfield, Mass.

U. S. Large cent, 2¢ piece and bargain list, only \$1. Delmaco, Box 1123, Wilmington, Del.

MORGAN Dollars, 1878-87-90-91-975 \$2.00 ea. New illustrated catalog 25¢. Shultz, Box 746, Salt Lake 10, Utah.

GET Profit and pleasure in collecting old coins. Send 10¢ for 56-page illustrated coin catalog. You'll be delighted with it. Send for it now. B. Max Mehl, 370 Mehl Building, Fort Worth, Texas. Largest rare coin establishment in U.S. Established 56 years.

LINCOLN Cents 1910-S, 1913-S, 1921-S, 1923-S, 1924-S, 1933-D all for \$2. Gasser's, Box 34615, Los Angeles 34, Calif.

\$20.00 PAID For only two Lincolns. Send 25¢ for complete details and other big cash premiums paid for Lincoln pennies. Ferguson, P. O. Box 15, Fort Lee, New Jersey.

OLD Money wanted. Will pay \$100.00 for 1894 dime, S. mint. \$50.00 for 1913 Liberty head nickel (not buffalo). Big premiums paid for all rare coins. Send 4¢ for large coin folder. May mean much profit to you. Numismatic Co., Dept. 20, Fort Worth, Texas.

COINS From Formosa, Vatican, etc., plus foreign banknote, 10¢ with coin approvals. Littleton Coin Co., Littleton 51, New Hampshire.

36 DIFFERENT Foreign coins \$1.00. Robbins, 1007 Cleveland, Montgomery 8, Alabama.

\$4,000.00 FOR 1913 Liberty head nickel. Uncirculated dollars 1804 to 1839, 1893-S, 1895-P, 1903-O pay \$100.00-\$5,000.00. Certain dates—Small cents before 1915, \$325.00; Dimes before 1917, \$2,000.00; Quarters before 1924, \$1,000.00; Half dollars before 1905, \$1,000.00; 2¢ pieces, \$70.00; 3¢ pieces, \$90.00; Half-dimes, \$500.00. Hundreds of others worth \$10.00-\$1,000.00. Canadian coins: 1921 5¢ Silver, \$50.00. 1889 Dimes, \$25.00. 1875 Quarters, \$50.00. 1921 50¢, \$200.00. Wanted—20¢ pieces, gold coins, paper money, etc. Our large illustrated guarantee buying-selling catalogue, giving complete allcoin information—Send \$1.00. Purchase catalogue before sending coins. Worthycoin Corporation, Leaders numismatic quotations. K-240-C, Boston 8, Massachusetts.

HUNDRED Large Canadian cents \$8.50. Jorgensen, 146 Park, Buffalo 1, N.Y.

WANTED, Hundreds of coins. Highest prices paid. Big buying catalogue, send 50¢. Days, West Baldwin, Maine.

ILLUSTRATED Price list of coins, catalogues, supplies, 25¢. Canada Coin Exchange, 53 Front E, Toronto, Canada.

UNCIRCULATED 1955D Quarters 75¢, 1955P halves \$1.50. Jack Turner, Prescott, Arizona.

COMMEMORATIVE Half dollar uncirculated \$1.00. Bargain lists free. Sayers, 1000 East Unaka, Johnson City, Tennessee.

RARE 12 Sided genuine coin, \$1.00. World, G.P.O. 603, Brooklyn 1, N. Y.

U. S. Coin approvals. Reasonable. Hutchinson, 3463 "I" Street, Philadelphia 34, Pennsylvania.

OLD Collector has many coins to sell. Am paying \$3.40 per hundred Indian pennies. More for certain dates. List 10¢. Tony Hay, Guyandotte, Huntington, W. Va.

\$1000.00 CONFEDERATE Bill, 1861 Montgomery reprint, with bargain lists 15¢. Pollard, 1214 N. New Jersey, Indianapolis 2, Ind.

60 ASSORTED Coins \$1.00. 100 assorted bills \$1.00. Oddehon, Box 482, St. Louis, Mo.

ONLY 10¢ For 5 countries' coins. Jolie, 126Z, Roslyn Heights, N. Y.

50,000 COINS, Medals, bills. Catalogue free. Collectors magazine 10¢. Nagy, 8-P South 18th Street, Philadelphia 3, Penna.

CHRISTMAS Specials—\$20 gold \$39.85; large \$1 bill, new \$4.95; complete sets bright uncirculated—Jefferson nickels \$19.85; Roosevelt dimes \$15.75; Franklin \$12.50; Vatican Holy Year \$1.50; Irish animals \$2.65; General Douglas MacArthur \$3.75. Giant bargain coin catalogue 50¢. Fast service. Bebee's, 4514 North 30th, Omaha 11, Nebraska.

RARE Russian Czarist money. Twelve different denominations, \$1.50. Eight different, \$1.00. Thusta Company, Armonk, New York.

REQUEST "Coin Collector's" greatest monthly magazine. Sample 10¢. Lawrence, Anamosa, Iowa.

### STAMP COLLECTING

160 DIFFERENT United States commemoratives \$1.00. Approval applicants only. Marcel E. Goyette, 199 James Street, Norwalk, Conn.

COLLECTION Monaco stamps featuring wedding of Princess Grace Kelly; also Presidents Eisenhower, Lincoln, Washington, Roosevelt and others. Only 10¢ to introduce approvals. Littleton Stamp Co., Littleton 51, New Hampshire.

FANTASTIC Fish triangle! Queer double stamp, gorgeous Olympic giant triangle, multi-colored dictators flag stamp, etc. Everything only 10¢ with approvals. Rose-land Stamps, Spring Lake 2, Mich.

MONACO. Ships; cataloguing 24¢. 5¢ to adult approval applicants. Randy's Stamps, 1700 10th Avenue South, Escanaba 3, Mich.

GIGANTIC Collection free. Includes triangles, early United States, animals, commemoratives, British Colonies, high value pictorials, etc. Complete collection plus big illustrated magazine all free. Send 5¢ for postage. Gray Stamp Company, Dept. PM, Toronto, Canada.

FREE! Giant catalog offering thousands of bargains. Sent with beautiful approvals. Jamestown Stamp Co., Dept. E12PMC, Jamestown, N.Y.

AFRICA. Triangles, old U.S. and over 100 different others. Everything 10¢ with approvals. Adams Stamps, 4209 Hubby, Waco, Texas.

77 DIFFERENT U.S.—25¢. Approvals. Utechs, 1143D North Keeler, Chicago 51.

U.S. Stamps at discount prices. Giant illustrated catalogue. Only 10¢. Raymax, 37-VZ Maiden Lane, New York City 38.

100 STAMPS, 10¢ With approvals. Smith, 508A Brooks, College Station, Texas.

50 DIFFERENT 5¢. Approvals. Greenwood, 1293 Springfield Ave., Irvington, New Jersey.

25 IRON Curtain, 10¢. Approvals. Bryce, 1106 Morris, Point Pleasant, N.J.

500 WORLD Wide, \$1.00. Dushay, Round Hill Road, Meriden, Conn.

SUPER Bank mixture. Only 10¢ to approval applicants. Felton, Laauwe Ave., Paterson 2, N.J.

225 STAMPS For only 10¢! This mammoth value includes airmails, pictorials; stamps from strange countries cataloguing up to 25¢ each! Also approvals. Mystic Stamp Company, Camden 80, New York.

100 YEAR Old United States classics, all Roosevelt and all other United States and foreign stamps are yours on approval. Send for trial selection with 10¢ for 50 diff. United States. Globus, New York 10, N. Y., Dept. 213.

WILL Send you 20,000 collection, 1/2¢ to 3¢. Many free. Cut Rate, Blue Springs 8, Missouri.

1500 STAMPS \$1.00 On and off paper. Good variety. World wide. Many pictorials. No approvals follow. Satisfaction guaranteed. Whalen, 1435 First Ave., Oakland 6, Calif.

MINT U.S. plate blocks. Bargain approvals. Kuehl, 3125 East K, Tacoma 4, Washington.

U.S. Price list free. Peter Wetterquist, 1635-13th Ave., Rockford, Illinois.

FREE! 55 British Colonies. 5¢ handling. Approvals included. Kensington Stamps, Buffalo 15, N. Y.

ECONOMICAL 1/2¢, 1¢, 2¢. Approvals. 22,000 varieties. Dresel, Box 128-N, West Englewood, New Jersey.

50 DIFFERENT Juvenile stamps \$1. Ernst Schmid, Hauptpostfach 255, Zürich, Switzerland.



FREE! Monaco "triangle." Pakistan! Madagascar! Togoland! Approvals. Keating, 2520-P Boulevard, Jersey City, N.J.

PACKET Of quality stamps 5¢ with approvals. Superb, P. O. Box 7375, Philadelphia 4, Penna.

TRAINS, Ships on stamps. Send 25¢ for fascinating collection. Request approvals. Ed Roper, Coatesville, Penna.

UNITED States commemorative collection containing 33 different—10¢. Approvals. White, 516-A Avenue L, Brooklyn 30, New York.

TRAVEL Through 50 countries! A virtual world cruise! 50 stamps, each from a different country. Abyssinia to Zanzibar. Bargain unsurpassed! To new approval applicants, 5¢. Avalon Stamp Co., Dept. M, Springfield, Mass.

TWO \$5.00 U.S. stamps plus 20 different, 10¢ with U.S. approvals. Irwin, Box 1105, Brooklyn 10, N.Y.

SELL Your surplus good grade stamps. Write, describing fully what you have. Vanroy Shirk, Lebanon, Pennsylvania.

FREE! Catalog! About stamps. Illustrated. Free! The Stampmart, Hartford 1, Connecticut.

FREE United States price list. Mark Hanna, 335 Fifth Ave., Pittsburgh 22, Penna.

50 DIFFERENT Argentine 10¢. Approvals. Reuter, 611 W. 40th Pl., Los Angeles 37.

OLD Scarce U.S. seconds on approvals. Slight imperfections, lowest prices. Hernefield, Clintonhill Sta., Newark 8, N.J.

U.S. Classics. Over 50 yrs. old. 15 selected old-timers. Missing in biggest collections. All 15 at less than 1¢ each. 10¢ with approvals. Jaro, Box 246-T, New York City 8.

50 DIFFERENT United States 5¢ with bargain approvals, lists. Bookman, Box 8245-M, Madeira Beach, Fla.

AMAZING Offer! 200 United States stamps—including commemoratives, airmails, high denominations to \$1.00. Only 10¢ to approval applicants! Illustrated bargain lists free. Mystic Stamp Co., Dept. 80, Camden, New York.

WORLD'S Largest stamp (7½ x 14 inches). A real curiosity! Retailers for 50¢, only 3¢ to approval applicants. Tatham Stamp Co., Springfield 30, Mass.

100 OLD United States between 1861 and 1935, \$1.00. Roush Stamps, 51 Chestnut, Mansfield, Ohio.

MINT Commemoratives at face! Send 25¢ for surprise packet of all different, mint U.S. commemoratives. Mint U.S. approvals too. Western, Box 1689P, Salinas, California.

UNITED States approvals. Select copies, used—mint. Kingsbury, Fairfax, Vermont.

IOELAND 10 Different beautiful stamps for only 10 cents to applicants for our good old fashioned approvals. Old Colony Stamp Co., Dept. A, Milford, Connecticut.

100 DIFFERENT China 10¢. Approvals. Coast, P.O. 2187H, Santa Ana, California.

1-2¢ EACH! Thousands of exciting worldwide stamps. Free examination. Cole, Box 233-A, Buffalo 21, N.Y.

SELL Stamps to our readers. Your ad in this space will be read by thousands of stamp buyers. I'll prove that to you. Write now for Folder "S." F. W. Johnson, Classified Advertising Manager, Popular Mechanics, 200 E. Ontario St., Chicago 11, Ill.

300 DIFF. World wide 25¢, plus surprise packet. Packet list free. Econopackets, Box 168, Riverside 9, Calif.

14,000 DIFFERENT — Yours on our streamlined systematic club plan for only 50¢ weekly. Big shipment every two weeks. Details free. L. G. Ware, Baldwin 75, New York.

FREE United States illustrated catalog. Bailey, 45 Bromfield, Boston, Mass.

AMERICAN Commemoratives; Colonial pictorials; Asian topicals; with surprising approvals. Bristol, Canton Center, Conn.

U.S. Flag. \$5.00 stamps. 25 different collection. Only 10¢. Approvals. Willett Stamps, Box 390-A, Mount Kisco, N.Y.

300 DIFFERENT Given free with approvals. Particulars. Windsor Stamps, 8834 Cornell Ave., Chicago 17.

INTRODUCING Our better United States approvals, we offer 15 most wanted United States stamps, including Columbian, Pan-Pacific, bi-centennials. Army Navy, famous Americans, airmails, other commemoratives; everything 10¢. Ocean Stamps, Box 64-PM, Brooklyn 29, N.Y.

WONDERFUL Offer. 7 complete mint sets only 10¢ with approvals. Reich (M26), 1633 Lawrence, Chicago 40.

70 DIFFERENT U.S., included 35 commemoratives, 25¢. No approvals. Seidenberg, Appleton, Wisconsin.

U. S. Revenues on approval. El Jay Stamps, Box 286, New York 36, New York.

SOUVENIR Sheet Russia 1937 10¢ with approvals. Kingman, 30 Empire, Yonkers 4, N.Y.

WEIRD Diamond shape coffee stamps. Lovely flower triangle! First American big commemorative. Greenland, idol dancer, etc. Free with approvals. Capital Stamp Co., Ferrysburg 2, Mich.

ROOSEVELT. Flower triangles, 26 others, 3¢. Approvals. Marylandco, Arlington, Baltimore 15, Maryland.

WANT Lists filled. 100,000 varieties available. References. Downey Stamp Service, Box 70A, Bell, California.

ARMENIA. Beautiful bicolored, 50¢ value, free with approvals. Diane, Box 70, Hartsville, S.C.

BRAZILIAN Packet airmailed direct, \$1.00. Mauricio, Caixa Postal 515, Anapolis, Golas, Brazil.

FIVE Beautiful Newfoundland free with approvals. Sunshine, Box 1486, St. Petersburg, Florida.

FRENCH Colonies packet, bicolored, free with approvals. Spangenberg, Box 334, Bristol, Penna.

FIVE Different sets French Colonies, 10¢ with approvals. Banner, Box 65, Park Forest, Illinois.

100 DIFFERENT Latin America 25¢. Approvals. Herrmann, Box 1022, Winter Park, Florida.

84 BICOLORED World flags 10¢, inexpensive approvals. Americana, Box 1560, North Miami, Florida.

BAHAWALPUR, UPU, eight values complete, free with approvals. Taconic Stamps, Box 137, Ancram, New York.

LIBERIA Bicolored birds, three triangles, free with approvals. Jayvee, Box 83, Newark, N.J.

QUEEN Elizabeth mint sets! Barbados, Caymans, Dominica, Tristan, Gibraltar, Leewards. 21 bicolored—25¢! Approvals. Gannon Stamps, Box 931, Canton 1, Ohio.

50 DIFFERENT U.S. 10¢. Approvals socompany. Standard, 10840 Woodview, Parma Hts. 30, Ohio.

40,000 VARIETIES Available on approvals. ¼¢ upwards. Keigwin, Box 933B, Daytona, Florida.

SUPERIOR Worldwide mission mixture. Amazing variety! Half pound only \$1.50. Baye Nielsen, 4545B Harvard, Montreal 28, Canada.

125 DIFFERENT Large U.S. commemoratives, \$1.00. Shirabe, 986 Robello, Honolulu 17, Hawaii.

50 DIFFERENT U.S. commemoratives 25¢; 135, \$1. Request approvals. Harold Holub, 18 East 198th St., New York 68, N.Y.

SAVE Money with Park plans. Guaranteed surprise, details, approvals. 25¢. Park, 101 Rochelle, Rochelle Park, N.J.

FREE. 375 Mixed world for dime postage. Approvals. Boisseau, Box 97, Comeau Bay, Que., Canada.

MISSION Mixtures: All U.S.A. One pound 75¢, 5 pounds \$2.50. All foreign: ¼ pound \$1.00, ½ pound \$1.75. No approvals. Free catalog. Postage always extra. Utechs, 1143D North Keeler, Chicago 51.

WOW! 135 All different Germany 10¢. Zeppelins, semi-postals, airmails, high values. Big bargain lists and approvals included. Jamestown Stamp, Dept. A12PMC, Jamestown, N.Y.

100 DIFFERENT Turkey 35¢. Approvals. Santo, 590 Ft. Wash. Ave., New York City 33.

100 DIFFERENT Austria 10¢ or 100 different Switzerland 25¢. Approvals. Aronson, Box F, Newton Centre 59, Mass.

25 DIFF. Australia 10 cents with approvals. Scheerer, Box 301, Pottsville, Pennsylvania.

FREE Sample! Interesting, informative, illustrated. National Stamp News, Anderson, South Carolina.

100 DIFFERENT World 10¢. Free set. Bellel, Mapledale, Hazel Park, Mich.

NEW Zealand packet health stamps, 10¢ with approvals. Philatelic Roundup, Box 155, Pennington, New Jersey.

WEDDING, Pipex, triangles, animals, free with approvals. Choice, Box 366, Miami Beach 39, Florida.

QUALITY Foreign approvals reasonably priced, singles out of full sets. Jungersen Jr., Box 28, Summit, N.J.

OLYMPIC Sport sets. 14 stamps. 10¢ with approvals. Norton, Box 926, San Antonio 6, Texas.

FREE! 25 Different Mozambique company, with superior approvals. Send 10¢ handling charges. Foxboro, Box 167, Foxboro, Massachusetts.

25 PICTORIALS 10¢ With approvals. Blaha, 3730 Cleveland, Brookfield, Ill.

500 FINE Mixed U.S. 15¢. Wright, 201M Mealey, Hagerstown, Maryland.

AUSTRALIA. 50 assorted. Some 75 yrs. \$1.00. Loma Stamps, Box 1007H, G.P.O., Melbourne, Australia.

FIFTY Different British colonials. Plus dozen Confederates (facsimiles) dime! Approvals. Gene's, 1707 N. Congress, Austin, Texas.

ADEN To Zanzibar! A special collection of over 200 different stamps from Aden, Barbados, Cyprus, Dahomey, Egypt, Falkland Is., Guadeloupe, Hejaz, Israel, etc., to Zanzibar. Very unusual collection, catalog value easily \$5.00. Some really scarce ones included! Only 25¢ to approval applicants! Write today and receive free—Eisenhower, Grace Kelly and Geo. Washington stamps from Monaco! Lyle Clark, Muskegon 2, Michigan.

U.S. mint flag set, #909-21, \$1.00. Free price list. Brooks, 2352P East 23rd Street, Brooklyn 29, New York.

FREE! Seven short sets! Approvals. Gernert, 4235-C Alton, Louisville 7, Ky.

FREE! Your choice any volume Scott's International, Master Global albums, Scott's 1957 catalogues when you buy our sensational foreign approvals. Write for details with trial selection. Bargain Stamps, Redlands, California.

FREE Price list over 1000 packets! 500 different stamps 75¢. 1000—\$1.50. No approvals included. Banthos, Box 122PM, New York 4, N.Y.

25 DIFFERENT Philippines 10¢. Attractive approvals. Barry, Box 25, Shelbyville, Michigan.

100 DIFFERENT Netherlands, 10¢; inexpensive approvals. Mattenson, Box 985, Philadelphia 5, Penna.

ISRAEL, 15 Different, 10¢; approvals follow. Chippewa, Box 321, Doylestown, Ohio.

UNITED Nations — New mint set 10¢. Approvals. Reynolds, Rt. 1, Box 220, DeLand, Fla.

25 DIFFERENT Somali 10¢. Inexpensive approvals. Exotic, Box 482-P, Coral Gables 34, Florida.

FIVE Triangles free to approval applicants. Rare, Box 633, Coconut Grove Station, Miami 33, Florida.

25 DIFFERENT Pakistan, 10¢. Inexpensive, attractive approvals follow. Rogers, Box 485, Albany 1, N.Y.

50 SPAIN, Free to approval applicants. Dixie, Box 1992, Meridian, Mississippi.

25 DIFFERENT Egyptian, 5¢. Inexpensive approvals. Smith, Box 83, Brooklyn (Rugby), N.Y.

LUXEMBOURG. 25 Different 5¢. Approvals. Neal, 5950 Tower, Riverside, Calif.

FREE With approval. Spanish Zaragoza religious set. William, Diamond, Penna.

BEAUTIFUL Pictorials, topicals, commemoratives, airmails. Introductory selection 40% discount. Ralph Rice, 15 Longlane, West Hartford 7, Conn.

SPACEOPHOBIA? Fill spaces from our 1¢-2¢ books of 1000. BKJ, Astor Sta., Boston 23, Mass.

100 DIFFERENT U.S. commemoratives \$1.00. Wiggins, Box 72-P, Guild, N.H.

10 CANADIAN Plate blocks \$1.00. George Atkinson, 1215 Greene Avenue, Montreal 6, Canada.



1000 WORLD Wide stamp selection — \$1.00 postpaid. Dimond, 3152 Cuthbert, Oakland 2, Calif.

ALL Different — 500, 50¢; 1000, \$1.25; 2000, \$3.00; 5000, \$12.00; 100 Canada 35¢. Approvals. K. S. Holmes, London, Canada.

FREE! \$7.00 Scott's international album. Details with approvals. Hal Buck, Box 107-P, Stockton, California.

RUSSIA, 25 Exciting gems 5¢ with approvals. Belmont Stamps, Washington 15, D. C.

100 BRITISH Colonies, 10¢. Inexpensive approvals. Pan-American, Box 24, Coconut Grove, Miami 33, Florida.

MINT Canadian Pakistan face value lists 30¢. King, 330 Alexander, Kamloops, B. C., Canada.

WORLD-Wide 1,000 all different \$1.50. Arnold Croll, Manitowoc, Wisconsin.

EIGHT Famous places plus 50 others 10¢ with approvals. Bennett, Candor 3, N. Y.

105 DIFFERENT Stamps from strange countries, pictorials, etc. 5¢. Approvals. E. Gericke, Box 756, Milwaukee 1, Wis.

SELL Used postage stamps by mail! Complete plan \$1.00. 500% profit. Satisfaction guaranteed. Clement Moore, Box 456P, New Egypt, N. J.

QUALITY Approvals, 500 at 2¢ each. Hadrian, 12 East 31st Street, New York City 16.

FREE! 1000 Hinges given applicants for approvals. Buckey, 208 Ludlow Bldg., Dayton 2, Ohio.

50 FRENCH Colonies, 25¢. Approvals. Roy Farr, 455 King William, Hamilton, Canada.

350 DIFFERENT World, 25¢. Pictorials, triangles. Approvals. Edgar, Box 437M, Punxsutawney, Penna.

SPORT Stamps! 12 different, 10¢. Exciting approvals. Donell, Dept. PMD, Box 45-485, Los Angeles 45.

GREAT Britain, Fifty different 10¢. Approvals included. Douglas, Hawkesbury, Ontario, Canada.

PENNY Approvals. Big books, Bargains galore. Royal Stamp Company, Tamaqua, Penna.

30 DIFFERENT Commemoratives 1893 up 10¢. U. S. approvals. K&B, Box 70, Brooklyn 23, N. Y.

ILLUSTRATED 1957 U. S. catalog free. Stone's, 192 Washington, Boston 8, Mass.

VATICAN — 25 Different mint stamps, 25¢ with approvals. Excello Stamp Company, Box 489, Red Bank, New Jersey.

FREE! Spectacular train wreck stamps! Approvals. H & H Stamp Center, Box 76, Brooklyn 26, N. Y.

FREE! 25 Different, 25 countries. Bargain approvals. Flamingo, Box 366, Miami 3, Florida.

U. S. \$5 Coolidge — 35¢ (approvals). Gatewood, Box 346, Winston-Salem, N. C.

SUEZ Canal — 26 different, beautiful Egypt stamps only 10¢ with approvals. Excello, Box 489, Red Bank, New Jersey.

DEVELOP Stamp business. Profitable. Write airmail. Smith Company, Halfwaytree, Jamaica, B.W.I.

FREE! Kelly wedding set, plus 100 worldwide. Approvals. 5¢ handling. Fried, Box 475, North Hollywood 11, Calif.

SIBERIA, First stamps issued, 1909, surcharged set of 4 miniature stamps, cataloging 52¢; just 5¢ with approvals. James Menifee, 4307 Butler Place, Oklahoma City 18, Oklahoma.

FREE! Albania Roosevelt bicolored set; inexpensive approvals. Longvue, Box 1301, Lexington, Kentucky.

30 U.S. Commemoratives 10¢. Approvals. Free packet. Stamporama, Box M1074, North Decatur, Georgia.

BEAUTIFUL Parisian model plus fifty all different free with modern approvals. Stamp Imports, Peterborough, Ontario, Canada.

EXCHANGE Used stamps of all countries for mint U. S. and Canada all quantities. Rene Bien Aime, Rue Duncombe, Port au Prince, Haiti.

"OMNIBUS" Collection: Paratroopers jumping, elephants, madonna, scouts, kissing kids—Plus other exciting complete sets, only 10¢. Unusual approvals. Winthrop Stamps, Groton 9, Conn.

ZEPPELIN Stamps, rarest of the popular topicals. Complete Germany set free, with foreign approvals. (6¢ postage, please.) Variety Stamps, 57-Z Circuit, Newton Highlands 61, Mass.

EXOTIC Africa. Mysterious jungle scenes. Animals, flowers, large pictorials. 100 others. 5¢ with approvals. Finney, Box 89, El Monte, Calif.

JUMBO Approvals, United States, Canada, British Colonies. Enclose 25¢. Peterson, Box 31, St. Paul 2, Minn.

FREE! Persian pictorial packet. Bargain approvals. Phil-Cob, Box 542, Chatham, Massachusetts.

MONACO Roosevelt set free with attractive, inexpensive approvals. Atomic, Box 295, Silver Spring, Maryland.

### ANTIQUES, RELICS, INDIAN GOODS, CURIOS

SCALPING Knife, 3 arrowheads, drill, scraper, list, \$2.00. Spearhead \$1.00. Stan's, 1138 Whittier, Columbus 6, Ohio.

PISTOLS, Swords, daggers, Indian relics, Catalogue free. Collectors magazine 25¢. 10 arrowheads \$1.00. Indmart, 8-P South 18th, Philadelphia 3, Penna.

5 ANCIENT Aztec clay idol heads \$5.00. Mast, 1619 Greenwood, Wilmette, Illinois.

ILLINOIS "Gesundheit" — Disposing of \$300,000.00 collection of 500 historical firearms; revolutionary, civil, Indian war, flintlocks, muskets, swords, bayonets, bullet molds, powder flasks, Kentucky rifles, pepperboxes, dueling pistols, 50,000 Indian relics, collectors cartridges, coins, Confederate money, Agates, minerals, fossils, mounted birds, animals, deerheads, gold dollars, bo-wood, violin wood, blo-horns, daugerrototypes, a 400 page catalog would not list everything. Send 35¢ for profusely illustrated catalog. Heike's, Armory, Wenona, Illinois.

10 ANCIENT Arrowheads \$2.00. Grooved tomahawk \$3.00. List free. Lear's, Glenwood, Arkansas.

SELECTED War arrowhead \$1.00. List 5¢. H. Talburt, Calico Rock, Ark.

SCALPING Knife, spearhead, thunderbird \$4.00. Catalog free. Arrowhead, Glenwood, Arkansas.

### PRECIOUS STONES, MINERALS

HEAVY Minerals. Six vials \$2.00 post paid. Cox Heavy Minerals, 306 North Meridian, Tallahassee, Fla.

TEN New Mexico minerals \$1.50, six fluorescents \$1.00, fool's gold 25¢. Free literature. Hartoon, Winston, New Mexico.

EARTH Science, the Rockhounds' national magazine. Subscription \$2.00, sample 25¢. Box 1357, Chicago 90.

CHRISTMAS Jewelry gifts. Make them yourself. Easy. Profitable. Free bargain list—gems, supplies, projects. Ten polished gems, baroque shaped, \$1.00. Five uncut gems, including sapphire, \$1.00. O'Brien's, 1116M Wilcox, Hollywood 38, California.

GENUINE Peridots or amethyst from Arizona. Tumble polished, 10 for \$1.00. Luther Martin, Box 191, Parker, Arizona.

GENUINE Pieces Devonshire era fossils — \$1.00. Buriello, Maryland, New York.

OPALS, Sapphires airmailed direct from Australia. Collection 12 rough Australian gems \$5 and \$10. Send cheque or international money-order. Free catalogue. Australian Gem Trading Co., 49 Elizabeth Street, Melbourne, Australia.

CUT Gems, make jewelry—For profit or fun, 100 page magazine tells how; where to get supplies. Sample 25¢ or request free literature. Lapidary Journal, Del Mar 2, Calif.

FIND Uranium, tungsten, mercury, hundreds of other minerals with Mineralight. Free information kit on fun and profit in fluorescent minerals; hobby set. Write Dept. PM8, Ultra-Violet Products, San Gabriel, California.

### HOBBIES AND COLLECTIONS

AMAZING Device grows large, water-soluble crystals. Complete with chemical \$3.95. Crystocraft Company, College Station, Texas.

WANTED Old cigarette cards. Write Charles Bray, East Bangor, Penna.

HOBBIES — Models and crafts catalog 10¢. Daters, 831 Divisadero Street, San Francisco 17, California.

FREE — "Learn & Earn" leathercraft catalog. Tandy Craft Center, 35 E. 14th, Dept. E, New York, N. Y.

COLLECTORS Matchbook covers. 100 different unused, \$1.00. Catalog 25¢. Album \$3.00. Charles Edeiman, 1311-C East 84, Cleveland 3, Ohio.

MILITARY Miniatures. Civil War, Custer's Cavalry, American Revolution and U. S. Marines. Illustrated catalog 25¢. Bussler Miniatures, Dept. Z, 40 Howe St., Quincy 69, Mass.

INVENTING Can be an interesting and profitable hobby. Write for complete particulars. Institute of American Inventors, Dept. 40-E, 635-F St., N.W., Washington 4, D. C.

NAZI Insignia, 12 different \$1.00. Medals, patches, armbands, flags, daggers. Illustrated lists, 10 cents. Medcrafts, Box 532, Victoria, B.C. 2, Canada.

100 MILITARY Official shoulder patch insignia, free album, \$5.00. All different. Wolf Appleton, Inc., 566-D Broadway, New York City 12.

### CAMERAS, PHOTO SUPPLIES

BASS Says: Quality cameras since 1910. When in Chicago visit the camera cross roads of the world, or write us for your favorite equipment, new or used. Satisfaction guaranteed. Bass Camera Co., Dept. AG, 179 W. Madison St., Chicago 2, Ill.

20 TO 75% Discount everything photographic, gift-ware. Free catalogue. Dart, 3812E Atlantic Avenue, Brooklyn 24, New York.

CAMERAS, Lenses, enlargers, projectors and accessories. Take up to 15 months to pay. Highest trade-ins and low, low discount prices. Fastest credit service anywhere within U. S. on orders from \$50 to \$5,000! Write for free catalog. Grand Central Camera, Dept. B, 1 East 43rd St., New York 17, N. Y.

BUY Wholesale nationally advertised cameras, photo supplies, thousands other products at big discount. Free "Wholesale Plan." American Buyers, Hertel Station, Buffalo 16-E1, N. Y.

PHOTOGRAPHY For pleasure or profit. Learn at home. Practical basic training. Long established school. Free booklet. American School of Photography, 835 Diversey Parkway, Dept. 3441, Chicago 14.

FREE! Free! Free! Bargain book big savings—Still, movie camera, equipment and supplies. Photographic headquarters since 1899. Central Camera Company, 12-1, 230 S. Wabash Ave., Chicago 4, Ill.

ARGUS Automatic projector \$44.99. Discounts to 60%. Photo equipment, appliances. Free catalog. Mailers Mart, Box 135-MP, Pelham, New York.

IDEAL Xmas gift for every movie enthusiast. Compact, folding, lightweight Movie 4 Lite in metal case. Only \$10.95 prepaid, bulbs extra \$1.35 each. Send check, cash or \$2.00 deposit on c.o.d. Lloyd-Ross Sales, Ltd., 205 East 6th St., Cincinnati, Ohio.

BRAND New Argus C-3 outfit \$49.99 (list \$69.50). Revere (2.5 telephoto 8 mm. \$16.95. Regular \$57.75. Catalog free. Diamond Company, 50 East 42nd St., New York City.

### PHOTO FINISHING

GIVE Personalized photo Christmas cards. New, wide selection to choose from. Get complete information and samples. Write Lincoln Studios, Dept. K, Box 13, Lincoln, Nebraska.

STAROTYPE Enlargements: Amazingly different. Eight 5x7's or five 8x10's — \$1.00. Hargrave, Box 373, Hollywood 28, California.

8-HOUR Service on deluxe jumbo prints. 8-exposure roll developed and 8 jumbo prints 40c, 12 exposure 55c, 16 exposure 70c; 35mm. 20 exposure 75c, 36 exposure \$1.25. Jumbo deckledge reprints 4c each. Contact prints made if specified. Bay Photo Service, P.O. Box 210, Oakland, California.



TEN 5x7—\$1.00. Send negative. Huffman, 309 Water, Whitesboro, Texas.

PHOTOS Copied. 20 wallet-size deluxe prints \$1.00. Original picture returned. Send any size photo or negative. Federal Wallet-Size Photo Co., Dept. PM-6, P.O. Box 2448, Kansas City 6, Mo. (No c.o.d.'s please).

QUALITY Kodak finishing. 8 exposure roll 35¢; 12 exposure 50¢; 16 exposure 60¢. Reprints 4¢. Past service. Guaranteed quality. 40 years continuous operation. Be a satisfied customer. We do color. Send for mailers. Mail Order Photo Service, Box 297, Watertown, Wisconsin.

ENLARGEMENTS! Eight 5x7's or five 8x10's, \$1.00. Wilart Enlargers, Box 967, Little Rock, Ark.

TWO Beautiful enlargements from each picture on roll. 8 exposures 55¢. 12 exposures 75¢. Cut Rate Photos, Dept. B-4, Janesville, Wis.

EKTACHROME Processing — \$1.00. Transparencies printed, 2X 45¢; 3X 65¢. Photocolor Laboratory, P.O. Box 617, Toledo 1, Ohio.

ENLARGEMENTS. Heavyweight eight 5x7's or five 8x10's, \$1.00. Jack Koons, Huntington Mills, Luzerne County, Pennsylvania.

SUPERIOR Quality. Prompt service. 8 jumbos in album 40¢. 16 contacts 50¢. Jumbo reprints 5¢. Satisfaction guaranteed. Also complete color film finishing service. Write for free circulars and mailers. Fast-X-Photo, Box A, Jersey City, N. J.

TWO Beautiful prints from each picture on roll. 8 exposure 40¢; 12 exposure 50¢. Thirty-five years of satisfied customers. Quick service. Lens Photos, Dept. J-4, Janesville, Wis.

#### MOTION PICTURES AND SOUND EQUIPMENT

WILD Life films. Buy direct from studio at tremendous savings. Kodachrome, b&w 8 and 16mm and 2x2 slides. Free illustrated brochure. Wild Life Films, 5614-A Cahuenga Boulevard, North Hollywood, California.

16MM Feature film sale. Rentals \$3.95. Sound Films, Box 262, Chicopee, Mass.

FREE! Blackhawk's big sale catalog new and used 16mm., 8mm. films; 2"x2" color slides; used 16mm. sound projectors. Biggest stock in U.S.A. Blackhawk Films, 1700 Eastin, Davenport, Iowa.

MOVIES; Movies; movies: 8 and 16 mm. B & W and color. Free gift and list sent in well sealed envelope. G & M Films, Box 4161, Glendale, California.

SAVE 50%! Guaranteed-fresh color, b.&w. movie film! 8mm., 16mm. Free catalog! Exo-R, 47th Holly, Kansas City 12, Missouri.

TAPE Recorders, slide projectors, wholesale! Unsurpassed values! Don's, Box 5116, Orlando, Florida.

16MM. Sound-used projectors and films. Rental, sale, exchange, bargain prices. Free lists. Also 8 mm. Specify film size. National Cinema, 71 Dey Street, New York City.

8-16MM. Films. Free catalogue (with sample film 10¢). Garden, 690 Howard Avenue, Brooklyn, N. Y.

5,000 8-16MM. Movie films. Free catalogues. International, Greenvale, N. Y.

TAPE Recorders, tape. Unusual values. Free catalog. Dressner, 69-02M 174 St., Flushing 65, N. Y.

MOVIE Camera film: 8mm. roll \$1.50, 16mm. 100' \$3.00. Free processing. Better Films, 742 New Lots, Brooklyn, N. Y.

RECORDERS. Tapes; wholesale. Free catalogue. Carstan, 215 E. 88, New York City 28.

HI-Fidelity magnetic tape. 7" 1200 foot roll, 3 for \$4.95; 7" 1800 foot roll, 3 for \$5.95. Add 50¢ postage. Money-back guarantee. Florman & Babb, 68 W. 45th, New York City.

FREE Catalog. Save dollars. Fresh 8mm., 16mm. b&w and color film. Home processing equipment. Superior Bulk Film Company, 448 No. Wells, Chicago 10.

8MM. Kodachrome rentals 19¢. Catalog dime. Cooper's Mart, Eaton, Ohio.

#### MUSIC AND MUSICAL INSTRUMENTS

ACCORDIONS Wholesale—10 day trial. Free catalog. American Accordion Center, 5329-PM12 Belmont, Chicago.

SWISS Musical movements (best) \$2.50. Spielman, 131 West 42nd, New York City 36.

SONGWRITERS! Protect your ideas! Hold all poems, songs! Write for safe, correct procedure. Song Service, Dept. F, 333 W. 56th, New York City 19.

ACCORDIONS — Direct from importer. Save 50% and more! Free trial. Lifetime guarantee. Trades accepted. Free catalog. Write Accordion Manufacturers, Dept. 126R, 2003 Chicago, Chicago 22, Illinois.

SONG Request forms made for two dollars. Howard Olenik, Mount Morris, Mich.

LP Records, 50¢ each. Jensen, Box 225, Oakville, Ontario, Canada.

POEMS, Songs wanted! Recording, promotion. Bengol, 93 Jefferson, Chelsea 50, Massachusetts.

POEMS Wanted for new songs. Send poems. Immediate consideration. Crown Music Company, 49C West 32 Street, New York City.

PLAY Piano the first day! Copyrighted secret. Details free. Miracle Method, Box 5203P, Phoenix, Arizona.

SONGWRITERS. Free booklet successful songwriting. Gateway Songs, Box 2470, Hollywood 28, Calif.

ACCORDIONS. Wholesale to everyone. Save up to 60%. All national known brands. Free catalogue. Del Principe, 29 South Cicero, Chicago 44.

WRITE Songs. Big money and reputation. Write for information. J. Gordon Pub. Co., 4700 South California Avenue, Chicago.

SONGPOEMS And lyrics wanted. Mail to: TinPan Alley, Inc., 1650 Broadway, New York 19, N. Y.

SWISS Musical movements, \$1.90. Helax, 218 West 72nd Street, New York 23.

DISCOUNTS. Instruments, accessories, national brands. Tempo Music, 37 Cutler, New London, Connecticut.

SONGS Into dollars. Share \$29 million dollars yearly for new songwriters, song-poets. Songs composed, published, promoted by famous firm. Information, appraisal free. Send to Nordyke Publishing, 6000 Sunset, Hollywood 28PM, California.

FREE Records of your song. Your words, my melody. Free information. Johnny Mack's Melody Mart, 1094 West 39th Street, Dept. A, Los Angeles 37.

SWISS—Musical movements \$1.75 p.p. Lutz, 705 Plaza, P.M., Ontario, Calif.

POEMS Wanted for new songs. Send poems. Free examination. Immediate consideration. Songcrafters, 2724 Arcade Station, Nashville, Tenn.

WANTED Used guitars and banjos. Write description and price wanted. Eddie Bell, 101 West 46 Street, New York 36, N. Y.

SACRED Music composed to religious words. Reginald Belcher, Box 354, Morristown, New Jersey.

#### RADIO, TELEVISION AND ELECTRONICS

BEGINNERS! World reception. Simple construction. Trowbridge, 312 West 75th, Chicago 21.

WALKIE-Talkie plans. 50¢. Fabco Electronics, 7400 Jackson Park, Birmingham, Michigan.

RADIO Experimenters, interesting information. Write: Hulet, 305 Hope, Lakewood, N. J.

EXPERIMENTERS: Make hi-fidelity, self-powered radio receiver. Runs phones or loudspeaker. Low initial cost. Operating expense zero. Plays forever. Rush 50¢ for fully diagrammed descriptive literature. Double your money back if not satisfied. Act now! Jancek, Dept. Y, 373 East 155th St., New York 55, N. Y.

WHOLESALE: Phonographs. Radios. Tape recorders. Catalogue 25¢ (refundable). Towers, 155, Philadelphia 5.

ARMY Throat microphone, new, 50¢. Surmer, Box 118, Jersey City 4, N. J.

CRYSTAL Radio kit \$1.00, preassembled \$1.25, phone \$1.75; catalogue. Clearco Crystal Company, 2966 North 4th, Milwaukee 12, Wisconsin.

TRANSISTORIZED F-M radio kit \$9.95. Ekeradio, 646 North Fair Oaks, Pasadena, California.

WALKIE-Talkie. Build wireless two-way portable radiophone for less than \$10.00. Plans 50¢. Springfield Enterprises, Box 54-B12, Springfield Gardens 13, New York.

ANNOUNCERS Are needed. Order now. "Radio and TV Announcing Made Easy." Only \$4.95 c.o.d. Write, Permain Publications, Box 3173, Odessa, Texas.

24 PAGE Handbook "Crystal Set Construction" including experimenter's catalog 30¢. Laboratories, 328-C Fuller, Redwood City, California.

GOVERNMENT Surplus radio gear. Astounding picture list 5¢. Meshna, Malden 48, Mass.

#### BUSINESS OPPORTUNITIES

BECOME A game warden, professional hunter! Join forestry, park, fishery services. Good pay! Opportunities open! Free revealing "Select-Job Chart," details, job-getting secrets. Write Home Study Institute 1038-RJY, Los Angeles 19, California.

IMPORTED Watch compact. Unlimited market. Most beautiful gift ever. Lowest price. Free literature. All Clear, Merrick Rd., Rockville Centre-N, N.Y.

TAPE Recording! Exceptionally profitable opportunity in your area. Free information. Baron's, Lynden, Washington.

PORTABLE Garbage disposal sells itself! Earn \$2135 monthly. 100% profit. No installation, UL approved. Retail \$89.50. Choice territories. Free demonstrator offer, kit. Write today. New-Home Co., 4C, P.O. Box 840, Beverly Hills, Calif.

SPECIALIZED Magazines—5,166 different, 1,137 self-help books—All businesses, trades, professions, sports, hobbies, etc. Free list. Publications, 34C North Ritter, Indianapolis 19, Indiana.

OWN Collection agency office. Pays big. Free details. Franklin Credit, Roanoke 7, Virginia.

MAIL Order business. Make money in a "collective mail order business" with repeat income. Orders come direct to you with a big profit on every sale. Only \$1.00. Include this ad for 100 free circulars. Collective Enterprises, P.O.B. 179, Murray Hill Station, New York 16, N.Y.

MAKE Extra money. Cash commissions. Everybody buys easy-to-sell advertising book matches. Union label. All sizes—Cuts for all businesses. Powerhouse selling kit free. Steady repeat business. No experience necessary. Superior Match Co., Dept. MX-1256, 7528 S. Greenwood, Chicago 19.

BECOME Tax consultant. Graduates earn \$3,000 every tax season preparing returns evenings. State approved. Union Institute, 68 Hudson, Hoboken, 2R, N.J.

OPERATE Profitable mail order business. Write Walter Service, 4159A East 112th, Cleveland 5, Ohio.

BUY Direct from importer chrome plated 4-way flashlights. Red, green, yellow, white beams. Postpaid sample \$1.00. Quantity discounts. H. Allenby Co., 1261 Broadway, New York City.

FINEST Mallorder manual in the field! Contains thousands of supply sources, plans, and tips. Guaranteed satisfaction. Only \$2.00 postpaid. W. Adams, Box 5415, Chicago 80, Illinois.

\$50-\$75 WEEKLY. Spare time. Repairing electric motors. Details free. Lincoln School, Box 52, Hempstead, N.Y.

BUY Wholesale! Resell at big profits. Brand name merchandise—Appliances, cookware, housewares, watches, jewelry, dry goods, clothing, sporting goods, toys, gifts, etc. Free 1957 color catalog with confidential cost sheet. Merit Home Products, Dept. PM-12, 107 Manhattan Ave., Brooklyn 6, New York.

MAKE Money growing miniature trees on your window sill. Free seed and plan. National Nursery, Dept. M-DR, Inglewood 4, Calif.

OPERATE Restaurant or diner. Free booklet reveals plan. Write Restaurant Arts, BU-112, Fremont, Ohio.



**GROW** Expensive herbs for us! Big profits home-business of your own. Year around profitability! We supply everything necessary! Send for free rare seeds and revealing plan. National Herb Exchange, Dept. DR, Gardena, Calif.

**"HOW To Start a Business"** booklet sent free! If you know any trade, go into business for yourself! Learn the 9 easy steps to follow. We've guided 5,000 others to success. Revealing free booklet yours for the asking! Write! National Business Consultants, Office DR, Los Angeles 81, Calif.

**START A** buying service, buy wholesale thousands nationally advertised products. Make big profits selling at sizable discounts. Postcard brings details. American Buyers, Hertel Station, Buffalo 16-C1, New York.

**MAILORDER Opportunity!** \$100 weekly possible spare time, details. Maday, Box 4623-B, Detroit 34, Michigan.

**NATURAL** Molding rubber, extra thick. Free sample. W. Wooley, 1016-A Donald, Peoria, Illinois.

**INTERNATIONAL** Mailorder business. Complete setup service—Not just instructions. Hermes, 152 West 42, New York City 36.

**IMPORT** Your own products in small lots. Start profitable mail order business using international drop shipment method. Capital unnecessary. Free details. Georgia Overseas Trading Company, Dept. W, 715 Persons Bldg., Macon, Ga.

**\$100 WEEKLY** Raising earthworms! Free plan reveals how! Oakhaven-P, Cedar Hill, Texas.

**PROFITABLE** World-wide importing business without capital! Complete instructions: \$2.00. World Importers, P-112, 939 Vanderhoeven, San Antonio 9, Texas.

**START** Employment agency, pays well. Information \$1.00. Moore, Box 151, Poestenkill, N.Y.

**WANTED:** Home producers, to be subcontractors. Cast plastic products for manufacturers in our clearing house service. Thousands of easily made items required. Cash in at home, without previous experience. Plastic Service Associates, Dept. 12-PM, East Boston 28, Massachusetts.

**MAKE** Perfumes, cleaners, polishes, cosmetics, home. Sell mailorder. International, 6347 Parnell PM126, Chicago 21, Ill.

**SHAVING** Revolution. No electricity, soap, blades required. Perfect, 2325 Bon Air, Montreal, Canada.

**MAIL** Order advertising agency executive reveals sensational no-risk advertising and merchandise methods. Start in office or home; minimum capital; positive profits. Free details: Impact! 2108 Payne, Dept. 11-12, Cleveland 14, Ohio.

**FREE!** Complete mailorder business. Terrific profits! No investment! VitaMins, 2908PM Beverly, Los Angeles 57.

**NEED** Money? No easier way to make it than by sharpening saws or lawnmowers—Spare time or full time. Free literature including shop layouts yours for the asking. Max Mfg. Co., 138 Stockton Ave., San Jose 26, Calif.

**919 SECRETS!** Free complete plan "Secret Journal Hidden Dollars." Work home successfully, weekends! Publico, Oceanside, Calif.

**BE** Your own boss. Write: Bailey, Box 604, Inglewood, California.

**RAISE** Nutria—America's newest opportunity. Luxurious fur. Easily and economically raised. Disease free. Guaranteed market with exceptional profits. Visit or write. Cabana Nutria of Illinois, Rushville, Illinois.

**RAISE** European mutation nutria. Vegetarian, odorless, valuable fur. Terrific potential. Voight Mink Farms, Atlanta 2, Texas.

**FRANCHISES** Make profits! Become exclusive distributor, dealer, agency operator. Request information. National Franchise Reports, PM-528, 333 North Michigan, Chicago 1.

**LIQUID** Marble—Brushed! Sprayed! Mold novelties, tile! Particulars free. Marbleizing Service, Edwardsville, Illinois.

**PROFITABLE**—Shear sharpening. Proven facts. Write. W. Zell, Summitville, Indiana.

**YOU** Can make money at home in spare time taking magazine renewal subscriptions. No capital or experience necessary. All supplies furnished. Write today! McGregor Magazine Agency, Dept. 500B, Mount Morris, Illinois.

**GROW** Mushrooms. Cellar, shed. Spare, full time, year round. We pay \$3.50 lb. We paid John Betts \$7,977.78, he started as amateur. Free book. Mushrooms, Dept. 172, 2954 Admiral Way, Seattle, Wash.

**FLEXIBLE** Rubber molds for plaster and Marbleite figurines. Sample and large illustrated catalog 25¢, refunded on first order. K-C Novelties, Dept. 36, Southampton, Massachusetts.

**BIG** Money raising fishworms and crickets. Free literature. Carter Farms, Plains, Georgia.

**INTERESTED** Mail order? Samples leading mail order magazines 10¢. Palm, Box 1221, Baton Rouge, La.

**CASH** Income—Collecting local information. No selling. Free facts. Dorait, 2217 So. Walnut, Muncie, Ind.

**ONE** Sale by mail or local, then automatic repeats—Needed items! Pickett, Mt. Airy, Maryland.

**\$10.00 PER** Hour net profit in monument cleaning business. Free details. X-Per Monument Cleaning Company, 466 Potomac, P.M.-2, Buffalo 13, New York.

**CASH** From sawdust, seventy methods. Tin-cans, thirty methods. Newspapers, eighteen methods. Instructions 50¢ each. All three \$1.00. Charles Company, 12-DXV, Norwood, Ohio.

**START** Home business making statuary, plaques, novelties, garden furniture, artificial marble flooring, liquid marble. Make your own flexible molds. Amazing profits. Only \$1.98. Free literature. Popular Mechanics Press, 631 No. St. Clair St., Chicago 11.

**UNUSUAL** Mailorder opportunity. Tested. We supply everything. Girard's, Azusa, Calif.

**YOU** Can own business. Over 100 proven plans. Send \$2 to J. Whitmarsh, 462 Central, Lake Orion, Mich.

**MAKE** \$46 From square foot plywood; jigaw necessary. Free information. Woodarts, X-7, Bridgewater, Mass.

**OPERATE** Profitable mail-order business. Wonderful opportunity. Write for details. G. W. Walker, Box 34, Stuyvesant Sta., Brooklyn 33, N. Y.

**\$60 WEEKLY**, Spare time, easy! Home Venetian blind laundry. Free book. Burt, 2434A, Wichita 13, Kansas.

**MONEY** Making plans. Details free. Weldon Erney, 1256PM, Emmaus, Penna.

**RECEIVE** Hundreds of offers, samples, catalogs, gifts, magazines, booklets. Send 25¢. Glenn H. McElhannon, Greenwich, Connecticut.

**FREE** List (unusual businesses) for homeworkers. Ballard's, 425 East Catherine, Louisville 3, Ky.

**YOUR** Own mailorder business. Manual 25¢. George McCutcheon, 638 W. Creighton, Fort Wayne, Ind.

**FREE:** "How to make quick, easy money." Gee, La Verne, California.

**LAMINATE** Pictures, important cards, articles. Pays wonderful profits. No experience. No investment. Free details. Howard Laminating Service, 551 S. Sumter St., Sumter, So. Car.

**WHOLESALE**—Thousands nationally advertised products. Buy, sell. Amazing profits. New, free plan. Associated Wholesalers, 1016-D Starr, Burlington, Iowa.

**HAVE** Profitable home mailorder business selling quilt pieces, remnants—Full, spare time! Over 20,000,000 "repeat" prospects! Rush name for details of this amazing moneymaking business! Coleman, Box 821-A, Newark 1, N. J.

**\$450 SAFE** Investment, 6 hours monthly, 100% yearly dividend. No selling. Charms, Box 12, Signal Mtn., Tenn.

**FREE** Cadillac, \$10,000 yearly. Cars, appliances wholesale. Strateway, 6228F, Charlotte 7, N. C.

**IMPORTS** From all over the world. Will establish you as dealer. Free catalog. International Associates, Box 1143-C, Chicago 90.

**START** Home mailorder business with few dollars. Mailorder courses, homework plans, selfhelp, do-it-yourself books that tell you how. Specify needs. 25¢ brings details. W. Zimmerman, 28 Schuele Avenue, Buffalo 15, New York.

**WANTED!** Home workers to assemble luggage and cases for ready market. Instructions, materials, tools, everything supplied. Free details. Abarsi, 807-BO Sunset, Los Angeles 12.

**AMAZING** New wholesale business. Tremendous profits. Free folio. McCann, 1612 Johnson, Amarillo, Texas.

**WANT** More business? Here's an amazing opportunity to increase your sales. Talk to thousands of interested readers of "Mechanica Popular." Our Spanish Edition covers the Latin American countries like a blanket. They're real mailorder buyers. Classified rate 75¢ per word. Try an ad in our next issue. Classified Advertising Department, Popular Mechanics Magazine, 200 East Ontario Street, Chicago 11, Ill.

**PLATE** Baby shoes, jewelry, gifts, bronze and colored pearl. Free booklet. Platex, 11029 South Vermont, Los Angeles 44.

**VENDING** Machines—No selling. Operate a route of coin machines and earn amazing profits. 32-page catalog free. Parkway Machine Corporation, Dept. 26, 715 Ensor Street, Baltimore 2, Maryland.

**LEARN** Sewing machine repairing easy. Neighborhood sparetime gold mine. Supplies! Free brochure. Taylor Service, Box 2126, San Bernardino, Calif.

**RAISE** Rabbits on \$500 month plan. Plenty markets. Free details. White's Rabbitry, Dept. 122, Mount Pleasant, Michigan.

**HOW** To make up to \$100.00 a week in spare time—by mail. Tested, money-making plan. Free details. Personal Press, 1413-PM Great Northern Bldg., Chicago 4, Illinois.

**FREE** Literature describing moneymaking mailorder plans. National Service, Richland, Georgia.

**GROW** Orchids at home—Profitable, fascinating. Year 'round, Maine to California. No greenhouse. Gorgeous cattleyas, cymbidiums, etc. Successful home grower shows you how. Full details free. Flowerland, 100 So. Vermont, Los Angeles 4.

**BUY** Wholesale! Discounts to 80%! Appliances, cameras, sporting goods, tools, watches, housewares, etc. Free catalogs. Buy-Rite, Box 258A, Hawthorne, New Jersey.

**COLORGLAZED** Concrete pottery made without molds. Patented method. Cemetery products, novelties, tiles. Basement leak-sealing. Money-making projects. Booklet, details free. Men only. National Potteries Company, Grand Rapids, Minnesota.

**IMPORT-Export** opportunity, profitable, world-wide, mail-order business from home, without capital; or travel abroad. Established world trader ships instructions for no-risk examination. Experience unnecessary. Free details. Mellinger F701, Los Angeles 24.

**MAKE** Flexible molds. Cast plaques, figurines, free sample. Tooker, 630-R Chestnut, Hamilton, Ohio.

**11,000 NEW** Prospects daily. Baby record books, shoes, albums. Sell mailorder. Everything furnished. Free literature. No-Co-Ro, Capitola, California.

**LIQUID** Rubber, make flexible molds. Free sample. Chaney, 1130 E. 16th St., Jacksonville 6, Fla.

**WHOLESALE** Catalogue! Appliances, cameras, watches! Cam Company, 6806PM 20th Ave., Brooklyn 4, N. Y.

**MONEY** In saw and lawnmower sharpening sparetime at home. Free book. Virgil Foley Company, Columbia Heights, Minnesota.

**POPOORN** And potato chip equipment. Eakins, Box 933-A6, Springfield, Ohio.

**FREE** Folio "45,000-445,000, Unlimited Vacations." No merchandise, equipment. Unknown! Work home, sparetime! Haylings, Carlsbad, Calif.

**\$250 WEEK** Cleaning venetian blinds. Patented machinery. Free literature. Robinson, 7213B, Indianapolis 1, Indiana.

**FIX** Typewriters. Inexpensive home course teaches factory secrets. Free booklet. Write. Typewriter, Tarentum 1, Penna.



**\$70 WEEKLY**—Home, spare time. Simplified mail bookkeeping. Immediate income—easy! Auditax, 34757A, Los Angeles 34.

**WANT** To make big money at home? \$5 profit in an hour possible with invisible reweaving. Make tears, holes disappear from clothing, fabrics. Steady year-round demand from cleaners, laundries, homes. Details free. Fabricon, 8334 Prairie, Chicago 19, Illinois.

**BRUSH** Plating outfits for plating articles in the home and shop. No tanks necessary. Good income spare or full time. Free particulars. Gunmetal Co., Ave. H, Decatur, Illinois.

**50% PROFIT** Baking new greaseless doughnuts in kitchen. Grocers buy daily. Free recipes. M. Ray, 3605 South 15th, Minneapolis 7, Minnesota.

**\$1,000 MONTHLY** Possible in collection agency business. Free details. Write Cole Associates, Syracuse 2, N. Y.

**TO \$100.00 Weekly**. Sparetime, home operated mailorder business. Successful beginner's plan. Everything supplied. Lynn, 10420-M National, Los Angeles 34.

**FREE** Book "505 Odd, Successful Businesses." Work home. Expect something odd! Pacific, Oceanside, Calif.

**WHOLESALE** Buyers! New 1956 "blue book" gives names of over 3000 jobbers, manufacturers who supply anything. Free details. Associated Wholesalers, 1016-D Starr, Burlington, Iowa.

**REBUILD** Batteries; repair dolls; make rubber stamps; "60 Ideas" free. Universal, Box 1076-A, Peoria, Ill.

**PLASTERCRAFT** Molds, liquid rubber, plasters, floccs, candle supplies. Catalog and manual free. Blue Rapids Supply, Blue Rapids, Kansas.

**EARN \$10,000** Yearly raising Angora rabbit wool for us. Information 25¢ coin. American Angora Company, Malta 12, Montana.

**BREED** Rare tropical fish at home. Earn big money! Learn secrets! Help fill huge demand. Amazing opportunity! Free plan. Tropical Fish Breeders, Los Angeles 61, Calif.

**MINK** Raising information free. Complete. Lake Superior Mink Farm, Superior, E.E.I., Wisconsin.

**NEWEST** Spare, full-time home business. \$5 to \$10 hour possible. Paint with suede—The finish with touch and eye-appeal. Beautify auto dashboards, signs, radios, toys, figurines, lamps—1001 others. Complete, step-by-step instructions sent for no-risk examination. Free details. Coast, Los Angeles 61.

**COPUBLISH** Mail Sale Advertiser, leading mail order paper. Details, latest copy, dime. Vanroy Shirk, Lebanon, Penna.

**MANUFACTURE**—Polishes, cleaners, cosmetics, anything. Literature free. Kemtzer, Park Ridge, Ill.

**EARTHWORMS**: Easy backyard business. Tremendous demand. 600% profit. Instruction book 50¢. 1000 young breeders \$4.50 postpaid. Starr Earthworm Farms, Orland, Calif. America's most publicized grower.

**IMPORT-Export**! Mailorder opportunities. Details. Warner, Box 6, Fort Scott, Kansas.

**SPLENDID** Mail order opportunity. Write Thomas Bond, 1637Q West Vernon, Phoenix, Arizona.

**HIGHEST** Commissions all magazines. Free catalogue, supplies, prizes, exclusive extras. Subscription Service Co., Box 2070, Birmingham, Alabama.

**MAKE**, Sell perfumes, household products. Jordan, 743 South Dorrance, Philadelphia 46, Penna.

**"MAILORDER** Laws and Regulations." \$1.00. Explains licenses, taxes, legal requirements. Tasker, 105 East Custis, Alexandria, Virginia.

**COPUBLISH** Mail Sale Advertiser, leading mail order paper. Details, latest copy, dime. Mail Order Field, P.O. Box 11, New York 60, N. Y.

**LEARN** Real estate by listening to records. Lee Institute, Brookline 46, Mass.

**I'LL** Set you up in your own business free! The "free" means without investing in merchandise or advertising. Free details. Mail Order Field, Box 11, New York 60, N. Y.

**MAIL** Catalogues featuring real merchandise. Charles, Box 32-P, New York 63, N. Y.

**MAIL** Order Manufacturing Guide. Complete details 30 products anyone can manufacture, wholesale. Ideal mail order sellers. 25¢. Albert Daufeldt, Atalissa, Iowa.

**I** Want to send you proof of the wonderful pulling power of Popular Mechanics classified pages. What's your proposition? Write me today. Include literature if possible. F. W. Johnson, Manager Classified Advertising, Popular Mechanics Magazine, 200 E. Ontario St., Chicago 11, Ill.

### MONEYMAKING OPPORTUNITIES

**MEN-Women!** Start money-making plastic laminating business at home in spare time. Material that costs 11¢ brings back \$2.58. No canvassing or selling but mail orders bring in \$20 a day. Write for full particulars free. Rush name on postcard to Warner, Room 712, 1512 Jarvis, Chicago 26, Illinois.

**MAKE** Money writing short paragraphs! No tedious study. I tell you what to write, where and how to sell; and supply list of editors buying from beginners. Many small checks add up quickly. Write to sell, right away. Send for free facts. Benson Barrett, Dept. C-27-Z, 7464 Clark, Chicago 26.

**START** A buying service, buy wholesale thousands nationally advertised products. Make big profits selling at sizable discounts. Postcard brings details. American Buyers, Hertel Station, Buffalo 16-D1, New York.

**WORLD-Wide!** Mail-order business at home. Complete instructions \$2.00. World Importers, P-212, 939 Vanderhoeven, San Antonio 9, Texas.

**LEARN** Technical metaphysics and insure your future. Easy, inexpensive correspondence course. Simplest method known. Diploma. Write: Premier College of Technical Metaphysics, 2532 McKenzie St., Vancouver 8, B.C., Canada.

**START** Big-pay business at home in spare time. No experience needed to operate little table-top machine for bronzing baby shoes. Make \$5.46 profit on every pair. Full particulars free. Send postcard to Mason, 1512 Jarvis, Room 712, Chicago 26, Ill.

**919 SECRETS!** Free complete plan "Secret Journal Hidden Dollars." Work home successfully, weekends! Publico, Oceanside, Calif.

**FRAUDS** To watch out for. Thousands taken daily. 25¢. Barnes, Box 332, Glens Falls, N. Y.

**BIG** Money raising, fishworms and crickets. Free literature. Carter Hatchery, Plains, Georgia.

**GROW** Mushrooms. Cellar, shed. Spare, full time, year round. We pay \$3.50 lb. We paid John Betts \$7,977.76, he started as amateur. Free book. Mushrooms, Dept. 173, 2954 Admiral Way, Seattle, Wash.

**EARN** Money evenings copying and duplicating comic cartoons for advertisers. Adservice, Argyle 1, Wisconsin.

**TAKE** Money-worry out of your future. \$1.00 investment brings you full details on unique, money-making plan. Easy, practical, highly profitable. Send to M. Llorrac, Box 226, Fremont, Mich.

**PRINTING**, Office supplies wholesale. Save 50%. Royal, Box 368-A, Cleveland 27, Ohio.

**\$60 WEEKLY**, Spare time—easy! Home Venetian blind laundry. Free book. Burt, 2434A, Wichita 13, Kansas.

**MAKE** Money, mailing sample business cards. Vosacek Printing, 4444PI Ute, San Diego 17, Calif.

**OLD** Bicycles made into exercisers, merry-go-rounds. Rehabilitation equipment, toy cars, boat drives, wheel chairs, lawn carts, etc. Plans and instructions for each \$1.00, six for \$3.00, 12 for \$5.00. R & R Industries, 396 Wildwood Avenue, Akron, Ohio.

**INCOME** Tax instructions amazingly simplified. No lessons. \$5-\$10 per hour spare time. Particulars free. Reynard, Box 1265-A, Peoria, Ill.

**EXECUTIVES** Tell who gets hired and why. Details free. National Publications, Box 3731, Washington 7, D. C.

**MAIL** Postcards. Receive dollar orders. Keep dollar. Details free. Gryder, Box 187, Barberton, Ohio.

**MEN** And women wanted to start home business in spare time with little table-top rubber stamp machine. Easy to earn up to \$9.80 an hour without previous experience. Full particulars free by mail. Send postcard to Roberts, 1512 Jarvis, Room 712, Chicago 26, Ill.

**SELL** Titania gems. Far more brilliant than diamonds. Catalog 10¢. Diamonite, 2420-M 77th, Oakland 5, California.

**BUY** Wholesale! Save 66%! Appliances, furniture, jewelry, toys, sporting goods, tools. Free details. National Buyers Service, Box 3338EB, San Francisco.

**RAISE** Rabbits on \$500 month plan. Plenty markets. Free details. White's Rabbitry, Dept. 123, Mount Pleasant, Michigan.

**MIMEOGRAPHING** Services pay sensational local profits. Exciting secret plans exposed! Rush name. Mozelle Mimeo Shop, Bonham, Texas.

**VENDING** Machines—No selling. Operate a route of coin machines and earn amazing profits. 32-page catalog free. Parkway Machine Corporation, Dept. 27, 715 Ensor Street, Baltimore 2, Maryland.

**PLEASANT** Profits—Let us show you how to start your own complete scissors and tool sharpening business. Free details. Serr-Edge Inc., 9729 Lorain, Cleveland 2, Ohio.

**FREE** Book "505 Odd, Successful Businesses." Work home. Pacific, Oceanside, Calif.

**PRIZE** Contests provide fabulous and confidential home income opportunities! Here's how and where to win your share! Send stamp! National Contest Bulletin, Box 2685-P, Miami 16, Florida.

**START** A profitable subscription business in spare time! We need men and women (young or old) as representatives for all leading national magazines. Liberal commissions on all subscriptions. Supplies free. Send this ad with your name and address to: Agency Bureau, Dept. FM, Hearst Magazines, 250 West 55th St., New York 19, N. Y.

**EARN \$50.00** Daily making mats, shoes and mud guards from old tires. S and S Patents Inc., 1307 North Clark St., Chicago 10, Ill.

**100% PROFIT**. No investment. Stamp brings details, samples. Miller, Box 584, Brooklyn 1, New York.

**DOLLARS** Every day! Amazing new magic mail plan. Set-up free. Miller, Box 588X, Oshkosh, Wis.

**GENERAL** Contest Bulletin. Lists contests monthly. Sample, 25¢. 1609½ East 5th, Duluth, Minn.

**READ** Progressive Mailtrade, the magazine that tells how to make money by mail. Dime brings sample and special offer. Progressive Mailtrade, Box 357, Sheboygan, Wisconsin.

**RAISE** Money for church, club, school. New plans. Free details. Theron Fox, 1296½ Yosemite, San Jose, Calif.

**SELL** First quality nylon hosiery and lingerie. Continental Wholesale Company, Box 1047, Reidsville, North Carolina.

**CONTESTANTS!** Contests, helps. Write. Contests, 166 Catherine St., Red Bank, N. J.

**ATTENTION** Typewriter owners. Make handsome profits. Write today. Groves Company, 662, Hastings 8, Nebraska.

**JOIN**. Book repair club. Make money. Martin, Colgate, N. Dak.

**"MONEY** Getter's Bulletin," sample 25¢. Donovan, 791 Greenbelt, Levittown, N. Y.

**INCOME** Tax instructions amazingly simplified. No lessons. \$5-\$10 per hour spare time. Particulars free. Reynard, Box 1265-A, Peoria, Ill.

**FREE** Folio "\$5,000-\$45,000, Unlimited Vacations." No merchandise. Unknown! Work home, sparetime! Haylings, Carlsbad, Calif.

### EXPORT — IMPORT

**INTERNATIONAL** Import index lists new exclusive imports. Free list. International, Box 636, Newark 1, N. J.

**\$5.00** GENUINE Imported German pipes 8½". Highly decorated. \$2.00 post-paid. World Importers, P-312, 939 Vanderhoeven, San Antonio 9, Texas.



## FORMULAS, PLANS, ETC.

**FORMULAS** For latest money-making discoveries. New! Good! Valuable literature free! Miller, Chemist, 1517-D, Tampa, Florida.

**10,000 AUTHENTIC Formulas.** Information, lists free. Brockway, 716 Gage, Topeka, Kansas.

**FORMULAS;** All kinds, latest, best. Literature free. Kemixal, Park Ridge, Ill.

**FREE Formula catalog.** Anything analyzed \$35.00. Western Chemical, Salem, Oregon.

**PRODUCT Analysis,** manufacturing formulas, processes developed. Moderate fees. Plastics, Box 1574, Boston 4, Mass.

**PRACTICAL Formulas.** Lists free. Cummings, Chemist, Gordon Ave., Syracuse 4, N. Y.

**LATE, Modern manufacturing formulas.** List free. Moon Chemical, Martville, New York.

## PLASTICS

**NEW Liquid casting plastic,** clear, colors. Embed real flowers, insects, photos, coins. Saw, drill, carve. Send 25¢ for handbook, "How to Cast with Liquid Plastic," and proved success plan showing how to make money at home. Castolite, Dept. P-101, Woodstock, Ill.

**LAMINATING Supplies.** Free price list. Solomson, 46 Cornhill, Boston 8, Mass.

**PLEXIGLAS, Lucite.** Square foot cost. 1/16", \$1.15; 1/8", \$1.20; 3/16", \$1.58; 1/4", \$2.21; 3/8", \$3.23; 1/2", \$4.36. Colors add 10%. Send 15¢ for postage. Aristocrat Plastics, 23-25 Sussex Avenue, Newark, N. J.

**PLEXIGLAS Cut-offs.** Special 5 lb. \$1.50 plus postage. Catalog 10¢. Coleman Sales, 5926 Cornell, Dearborn, Mich.

**LEARN Plastics fabrication** for spare time income. Low cost home training now available. Write for free booklet. Interstate Training Service, Dept. D-3, Portland 13, Ore.

## CHEMISTRY

**SPECTROSCOPE** For quick analysis \$3.00. Kutting, 26278 Arastradero, Los Altos, Calif.

**CHEMICALS, Glassware.** Catalog 25¢. Laboratory Sales, Box 161-E, Brighton, Mass.

**BEGINNER'S Modern chemistry** plus sample uranium ore. \$1.00. Future Chemists of America, Oakdale, Pennsylvania.

**ILLUSTRATED Catalog:** Chemistry, mineralogy, biology 20¢. Tracey Laboratories, Evanston, Illinois.

**CHEMICALS And apparatus** for industrial, analytical, and private laboratories. Catalog 25¢. Dept. M-50, Biological Supply Co., 1176 Mt. Hope Ave., Rochester 20, N. Y.

**ANALYZE Like professionals do.** Kit \$5.00. Steiner, Suite 940, 127 N. Dearborn St., Chicago 2, Ill.

## AGENTS WANTED

**PRINTING, Advertising salesmen—**Excellent moneymaking sideline selling decalcomania name plates, small quantities. Automobile initials, sign letters. Free samples. Ralco, XL Boston 19, Mass.

**GOLDMINE Of 600 money makers.** Copy free. Specialty Salesman Magazine, Desk 5-B, 307 N. Michigan, Chicago 1.

**AGENTS—300% Profit** selling genuine gold window letters; stores and offices. Free samples. Metallic Sign Letter Co., 431-D North Clark, Chicago.

**YOUR Ad in this space** will get some good agents for you. Yes, I'll prove it. Write for Folder "A" right now. F. W. Johnson, Classified Advertising Manager, Popular Mechanics Magazine, 200 E. Ontario St., Chicago 11, Ill.

**BIG Profits** selling ties (\$2.00 value) \$6.50 dozen. Free catalog. Empire Cravats, 611-PM Broadway, New York 12.

**EXCLUSIVE Line** of personal initialed buckles, belts, cap badges, 3,000 emblems, etc. Hook-Fast, Dept. PM, Roanoke, Va.

**FOG-Stop windshield cloth.** Instantly removes blurry mist, frost, sleet, snow. Stops windshield fogging. Samples sent on trial. Kristee Co., Dept. 55, Akron 8, Ohio.

**SELL Profitable personalized rugs.** For information write Bobby's, Dept. M10, Manitou Springs, Colorado.

**BUY Wholesale!** 100,000 name brand products! Save 66%!! Big profits selling others spare time! Free details! National Buyers Service, Box 3338EE, San Francisco.

**FREE!** Beautiful feather pictures 200% profit! Apartado 9036, Mexico 1, D. F.

**YOUR Own business—Used suits** \$1.50, overcoats 65¢, mackinaws 35¢, shoes 12½¢, ladies coats 30¢, dresses 15¢. Enormous profits. Catalog free. Nathan Portnoy Associates, 605-AA West 12th Place, Chicago 7.

**GOLD Or silver letters, numbers.** Windows, doors, trucks, 1" to 6", 500% profits. Free samples. Atlas-T, 544 West 79th, Chicago 20.

**CALIFORNIA Sweet smelling beads.** Sensational sellers. Particulars free. Mission, 2328-PM W. Pico, Los Angeles 5, California.

**SCHOOL Seniors—Be popular** with classmates. Have spending money galore. Details free. Craftcards, Box 235-L, Pittsburgh 19, Pennsylvania.

**YOUR Ad in this space** will get some good agents for you. Yes, I'll prove it. Write for Folder "A" right now. F. W. Johnson, Classified Advertising Manager, Popular Mechanics Magazine, 200 E. Ontario St., Chicago 11, Ill.

**AMAZING 500% Profit offer.** See under "Auto Supplies." GE Engine Heater Sales, Milwaukee 7.

**BIG Money-making opportunity.** Exclusive line work uniforms, jackets, pants, shirts, coveralls. Advertising embroidered. Every business prospect. Outfit free. Master Co., 424 Water, Ligonier, Ind.

**\$1,000.00 A Month** for making dramatic 3-second demonstration of amazing lightweight Presto fire extinguisher. New chemical used by Airforce snuffs out fires instantly. Only \$4.95. Terrific commissions. Millions want it. Free kit. Merlite, 114 E. 32nd, Dept. P-64P, New York 18.

**FLUORESCENT Letter sign kit.** Write for details. Coloray Corporation, 370 Brannan, San Francisco 7.

**BUY Wholesale** thousands nationally advertised products at big discount. Free "Wholesale Plan." American Buyers, Hertz Station, Buffalo 16-A1, N. Y.

**STRANGE Dry window cleaner.** Sells like wild. Replaces messy rags, liquids. Simply glide over glass. Samples sent on trial. Kristee Co., Dept. 58, Akron 8, Ohio.

**REAL Diamond rings.** Sell direct. Make big middleman's profit. No investment. Experience unnecessary. Free catalog, details. Gleamlight, 109B No. Columbus, Mount Vernon, N. Y.

**START Your own business** on credit. Your own boss. 1598 dealers sold \$5,000 to \$32,000 in 1955. We supply stocks, equipment on credit. 200 home necessities. Sales experience unnecessary. Pleasant profitable business backed by world-wide industry. Write Rawleigh's, Dept. L-U-PPM, Freeport, Ill.

**DAY-Glo signs.** Free sample. Cook, 51 Martin Avenue, Saratoga Springs, New York.

**AGENTS Wanted** to sell encyclopedias, dictionaries, atlas. Big profit. Write Darwin Gilmore, Braymer, Mo.

**NEW Invention.** \$4.95 fire alarm, paying up to \$1,100 a month. No wiring. Unlimited market. Dramatic demonstration. Free kit. Merlite (Alarm Div.), 114 E. 32nd St., Dept. P-63P, New York 18, N. Y.

**FAST Selling money makers!** Metallic ironing board cover; purse-shopping bag; many others including \$1 retailers. Quality Products, Dept. A, Box 748, Passaic, N. J.

**BIG Money in valentines!** Easy to earn with 5 different valentine packs. Best sellers for every occasion all year—Mother's, Father's Day, Easter, birthday, all-occasion assortments, gifts, stationery. Over 100% profit on bargain specials. Samples on approval. Midwest, 1113 Washington, Dept. 706-X, St. Louis 1, Mo.

**SELL Unique imports.** Large profits. No investment. Write Bond Specialties, 1637A West Vernon, Phoenix, Arizona.

**FRANCHISES Open.** Steady income. Top quality low cost chamois. Chamtana, Hudson Falls, N. Y.

**EASY Handwork** makes fast-selling articles. Sample free. Sunmade Company, Brockton 64, Massachusetts.

**\$100.00 WEEKLY** Operating home mail-order business. Everything furnished. Grand National, 2131 Railroad Ave., Loleta, Calif.

## BUY IT WHOLESALE

**BUY Wholesale.** 30 to 80% discounts. Brand name nationally advertised merchandise. Giant catalog 98¢. Clark Sales, Dept. 2, 6315 Whitewood, Detroit 10, Mich.

**WHOLESALE.** 17-Jewel watches. Folder sent free. Wm. Lipscomb, 118 Haviland, Greenville, S. C.

**WHOLESALE—Ball point pens,** solid perfumes. Traxler, Box 118, Rockford, Ill.

**WHOLESALE Catalog!** Appliances, cameras, watches. Distributors, Box 106A, Hudson, New York.

**FREE Wholesale catalog.** Name brand appliances, furniture, cameras, watches, luggage, tools, toys, sporting goods. Make Christmas savings-profits! Housewares, 924-P West 79th Street, Chicago 20.

**BUY Wholesale!** Discounts to 80%! Appliances, cameras, sporting goods, tools, watches, housewares, etc. Free catalogs. Buy-Rite, Box 258 D, Hawthorne, New Jersey.

**FREE Gift catalog.** Wholesale catalogs, name brands. Edith's, Deep River, Conn.

**FREE Wholesale catalog!** Appliances, watches, gifts, etc. Myers Company, 1745 High, Topeka 2, Kansas.

**LOOK, 20 To 80% discounts.** Free circular. Radaker, 510-C Park Ave., Anderson, Ind.

**WHOLESALE Catalog!** Huge discounts! Name brand appliances, housewares, etc. Morning Star, 1562 Rosalie, Clifton, N. J.

**BUY Your family needs wholesale.** Five catalogs yearly one dollar. Refundable on first order. J. Whitmarsh, 462 Central Ave., Lake Orion, Mich.

**WHOLESALE Catalog!** Appliances; housewares; jewelry! Postcard! Midwest, 156-M, Pontiac, Illinois.

**BUY Wholesale!** Nationally advertised appliances, radios, watches, etc. Catalog \$1.00 (refundable). D'Auria, Box 355-PM, Jackson, Michigan.

**BARGAINS, Joblots, closeouts.** 2000 items. Tremendous savings, clothing, toys, gifts, jewelry, television, etc. 25¢ brings wholesale catalog. \$1.00 merchandise certificate included free. Reliable Jobbing, 311-B North Desplaines, Chicago.

## SALESMEN—DISTRIBUTORS

**AD Matches!** Sell amazing designs—10, 20, 30, 40 and 240-light book matches. Bigger spot cash commissions; every business a prospect. Low prices for high quality. Repeats. Start without experience; men, women; full, part time. Buy nothing! Sales kit furnished. Match Corp., Dept. PM-84, Chicago 32, Illinois.

**MONEY-Making opportunity!** Take big profit orders for world famous patented varieties fruit trees. Also flowering shrubs, roses, vines. Big sales outfit free. Stark Bro's, Desk 30167, Louisiana, Missouri.

**\$1,000.00 A Month** for making dramatic 3-second demonstration of amazing lightweight Presto fire extinguisher. New chemical used by Airforce snuffs out fires instantly. Only \$4.95. Terrific commissions. Millions want it. Free kit. Merlite, 114 E. 32nd, Dept. P-64P, New York City 18.

**WILL You wear new suits** and topcoats without one penny cost and agree to show them to friends? You can make up to \$30.00 in a day even in spare time, without canvassing. Pioneer Tailoring Co., Congress and Throop Sts., Dept. C-1226, Chicago 7, Illinois.

**LONG Needed invention.** \$60 will earn you \$10,000. National company. Exclusive territory. Contact filling stations. Details free. Dept. 202-W, Cyclo Mfg. Co., 3816 Dahlia, Denver, Colo.



**GOOD** Income, sell Vita-Vim high potency all natural food supplement. Retail \$3.75 months supply, salesman sample and full information \$2.00. Information free. Vita-Vim Company, P.O. Box 7793, Dallas, Texas.

**NEW** Invention, \$4.95 fire alarm, paying up to \$1,100 a month. No wiring. Unlimited market. Dramatic demonstration. Free kit. Merlite (Alarm Div.), 114 E. 32nd St., Dept. P-63P, New York 16, N.Y.

**MAKE** Extra money. Cash commissions. Everybody buys easy-to-sell advertising book matches. Union label. All sizes—Cuts for all businesses. Powerhouse selling kit free. Steady repeat business. No experience necessary. Superior Match Co., Dept. M-1256, 7528 S. Greenwood, Chicago 19.

**NEW** Jobs open in selling! Send name, address for five free issues of Opportunity Magazine's money-making guide, listing hundreds of companies who'll pay you well, full or part-time. No experience needed. Opportunity, 850 N. Dearborn, Dept. 17, Chicago 10, Ill.

**FREE** Facts about the art of sales resistance. To survive—Know the tricks. Write Countersalesmanship, Dept. D1, 120 Boylston St., Boston 16, Massachusetts.

**STOCK** Signs—Attractive, fast selling, various colored backgrounds, large profits. Fifteen samples one dollar. Details free. F. I. Adams, 158 Roberta Road, Ormond Beach, Fla.

**BUILD** Sales by recruiting productive distributors selling direct or to retail outlets. Secure most concentrated circulation through classified columns of Salesman's Opportunity. Write for facts. Gilbert, Salesman's Opportunity, Room 1700, 850 N. Dearborn, Chicago 10.

**WHOLESALE**—Get the big merchandise—Furniture, appliances, T.V.'s, clothing, tools, auto accessories; most anything. Save half. Literature free. Associated Wholesalers, 1016-DY Starr, Burlington, Iowa.

**ONE** Monument sale weekly earns \$200 or more. Jones Monumental Works, St. Cloud, Minn.

**FREE** Catalog ladies' handtooled handbags. Garza, Apartado 82, Tampico, Mexico.

**BIG** Money daily: Two minute demonstration makes easy sale. Demonstrate and sell Campbell's Gro-Green with Dietene fertilizer and nitrogen solutions. Only company manufacturing all formulas for all fertilizer needs. Est. 1928. Free sample and demonstrating kit free. Full or part time. Campbell Company, Rochelle 228, Illinois.

**FISH** Lure, easy sales, free details. Zerek, 210 East Fayette, Syracuse, N.Y.

**NEW** 1958 Calendar samples ready. Write for our liberal proposition. Cussions, May & Co., 715 Bowe St., Richmond 20, Va.

**POWER** Oil eliminates motor overhaul, valve and lifter trouble. Reduces oil consumption. Maintains oil pressure. Ideal for chain saws, outboard motors, airplanes, trucks, tractors. 100% petroleum. Products insurance. Money back guarantee. Territories open. Big profits. Sample \$2.00. Details. Power Oil, Box 1073, Spokane 10, Washington.

**BIG** Profits. Steady work. New, delicious, appealing. Latest candy confection for sales to homes, factories, groups. Big volume year round. \$2.75 large tin. Send \$1.00 for tin and salesman kit complete details, and territory. Supervisors needed. Kinzie Wells Co., Mdse. Mart, Box 3441, Chicago, Ill.

#### EMPLOYMENT INFORMATION

**ALASKAN** Jobs! Gigantic construction projects. Names, addresses companies hiring. Thousands skilled, unskilled needed. High wages. Salary information, Alaskan map, sample application included. Home-steading, mining, fishing, lumbering, aviation, railroad job information. \$2.00 complete. Alaskan Opportunities (PM) Box 362, Kenmore, Wash.

**JOB** Information. High pay. South America, the Islands, U.S.A., foreign countries. All trades. Clerical, labor, engineers, drivers, others. Women also. Companies pay overseas fare if hired. Write Section 92F, National Employment Information, 1020 Broad, Newark, N. J.

**HIGHEST** Pay available in greater Chicago classified listings airmailed \$1. Jobs, 5345 South Halsted, Chicago 9, Illinois.

**\$3000.00 YEARLY.** America's newest profession. Breeding cows artificially. Technicians needed in 48 states. Free education. Information \$1.00. Insemination, Box 683, Proctor, Minn.

**COPYRIGHTED** Reports on best paying jobs with travel, adventure, promotions. Construction, aviation, shipping, laborers, clerical, trades, supervisory, factory, unusual opportunities. Many types of work. Skilled and unskilled. Foreign and state-side openings for men and women. Only \$2.00 (\$2.25 airmail), including registration-advisory service. Satisfaction guaranteed. Included absolutely free: Special reports on Alaska, Spanish airbase construction, South American opportunities and husband-wife foreign jobs. Research Services, Suite 207-PMK, Brown Building, St. Louis 5, Missouri.

**VENEZUELA**—Jobs plentiful. High salaries. For select list send one dollar to: Alfred B. Ruiz, Apartado del Este 4856, Caracas.

**JOBS** Paying to \$350 weekly now available on overseas and American projects. Men and women. All trades. Transportation paid. Free information. Write Transworld, Dept. M12, 200 West 34th St., New York, N. Y.

#### EDUCATIONAL AND INSTRUCTION

**DRAW** Pictures by "touch" system. It really works. \$2. Ken Stover, 7752 California Avenue, Riverside, California.

**SPEAK** Sing with power, personality. Home self-training method on records. Amazing details free. Canfield, 2018-A 5th Ave. South, Minneapolis 4, Minn.

**PIANO** Tuning pays. Big money in spare time. Learn at home in 30 days. No musical knowledge necessary. Phonograph, records, tools and instructions furnished. Personal instructions available. Free catalog. Capital Tuning School, 16 Southwest Second, Fort Lauderdale, Fla.

**STUDY** For Doctor's degree of psychology, metaphysics and divinity. Correspondence courses only. College of Divine Metaphysics, Dept. P-M, 2811 North Illinois, Indianapolis 8, Indiana.

**LEARN** Mineralogy at home. Diploma course. Fortunes now being made in uranium and other minerals. Free catalog. Mineral Science Institute, Desk 2, 159 East Ontario, Chicago 11.

**HIGH** School diploma at home. Licensed teachers—Approved materials. Southern States Academy, Box 144-MX, Station E, Atlanta Georgia.

**BE** A real estate broker. Study at home. Write for free book today. GI approved. Weaver School of Real Estate, 2018P Grand, Kansas City, Missouri.

**EARN** While you learn. Auto and diesel mechanics master this top paying trade. Many graduates earn \$100 a week and up. Approved for Korean veterans. For free information write Dept. No. 256, Nashville Auto-Diesel College, Nashville 3, Tenn.

**USED** Correspondence courses and educational books bought, sold, rented. Free catalog. Educational Exchange, Menlo, Georgia.

**BOOKS:** Hundreds of subjects. Big catalog free. Popular Mechanics Press, 200-BC East Ontario St., Chicago 11.

**HELP** Yourself to abundant living. Our courses have aided students to richer fuller lives. Learn secret of contentment, happiness. Earn degrees Ps.D., MsD. Write for free book. College of Universal Truth Correspondence School, 23-C E. Jackson, Chicago.

**USED** Correspondence courses and books sold and rented. Money back guarantee. Catalog free. (Courses bought.) Lee Mountain, Pisgah, Alabama.

**MIDLAND** Linotype School. Charles City, Iowa. Civilian and veteran courses. Free placement. Established 1909.

**PIANO** Tuning pays. Learned easily at home. GI approved. 59th year. Free booklet, Niles Bryant School, Dept. P, 3731 Stockton, Sacramento 20, Calif.

**SECRET** Investigation. Experience unnecessary. Investigators particulars free. George Wagner, M125 West 86th, New York 24.

**BOOKKEEPERS!** Increase your earnings! Operate your own simplified "Dollar-A-Week" bookkeeping and tax service. Full or spare time. Details free. No obligation. Ellis, Box 200, Cedar Grove, North Carolina.

**WANT** A diesel job? New opportunities to increase income. Higher pay. More money. We can help you qualify. Tools. Shop method home training. Write today! Diesel, Tractor, Heavy Equipment Division, Interstate Training Service, Dept. B-3, Portland 13, Oregon.

**I** Want to send you proof of the wonderful pulling power of Popular Mechanics classified pages. What's your proposition? Write me today. Include literature if possible. F. W. Johnson, Manager Classified Advertising, Popular Mechanics Magazine, 200 E. Ontario St., Chicago 11, Ill.

**INVESTIGATOR** Training. Phillips Secret Service System, 1917-B North Keneth, Chicago 39.

**HELP** Yourself! Solve personal problems by self-mastery. Free information. The Leavitt Science, Clinton, Illinois.

**HANDWRITING** Analysis now accepted in college, business, industry. Our men, women who use grapho analysis spare, full time earning more money, getting prestige, success, happiness. Uncrowded, fascinating field for intelligent men, women anxious to get ahead. We need more members. Investigate this growing field where you give a real service to your fellow man. Opportunities unlimited. Free sample lesson and information to all over 21. Write today! Igas, 2307 National Station, Dep't. 615, Springfield, Missouri.

**BARGAIN.** Exciting Little Library booklets 25¢ each. Tool making, painting, welding, home improvement, games, models, plastics, lamp making, glass blowing, boats, photographs. Free catalog. Popular Mechanics Press, 200-LE East Ontario St., Chicago 11.

**WANTED:** More new writers for TV-radio, magazines, business publications, motion pictures. Learn at home for extra income or exciting full time career. Many students earn while learning. Professional instruction. Send today for free lesson and book. Palmer Institute of Authorship, Desk TM-126, 1680 N. Sycamore, Hollywood 28, California.

**COMPLETE** Your high school at home in spare time with 59-year-old school. Texts furnished. No classes. Diploma. Information booklet free. American School, Dept. X945, Drexel at 58th, Chicago 37, Illinois.

**FINISH** High school at home, spare time. No classes. Diploma awarded. Write for free catalog. Wayne School, Catalog HP-70, 2527 Sheffield, Chicago 14.

**TIMESTUDY**—Your key to positive personal profits. Associated Techniques, P.O. Box 235, Hollidaysburg, Penna.

**IT'S** Fun learning a language by Linguaphone world's standard conversational method. At home, quickly, easily learn to speak French, Spanish, German, Japanese, Modern Greek—34 languages available. Complete recorded courses on free trial. Send for free book and details. No obligation. Try, don't buy! Linguaphone Institute, T-87-126 Rockefeller Plaza, New York City 20.

**ENGINEERING** Degrees earned by home study. (Residential courses also available.) Pacific International University (formerly American College of Engineering), Box 37724-B, Hollywood 27, California.

**WELDING** Training pays at Hobart Welding School, Box M-1261, Troy, Ohio, VA contract. Best equipment. Catalog free.

**GAIN** New knowledge, perspective. Revolutionary easy way learn decimal equivalents common fractions without memorizing. Fun. Practical. Details free. Val Palmer, 1322 12th St., Rockford, Ill.

**BLUEPRINT** Reading—Train at home. Learn to read blueprints with confidence in 10 easy lessons. Write today Belton School, 1059-E North Lawndale, Chicago 51.

**U.S.** Civil service tests! Training until appointed. Men-women, 18-55. Start high as \$340.00 month. Experience often unnecessary. Get free 36-page book showing jobs, salaries, requirements, sample tests, benefits. Write today: Franklin Institute, Dept. B-24, Rochester, N.Y.

**EDUCATE** Your memory. Science of memory simplified. Volume one of Memory free. Memorology Studio, 2016-M Sunnyside, Chicago 25, Ill.

**EXCEPTIONAL** Home study plan. F. M. Woodworth, Box 4867, Detroit 19, Mich.



**LEARN** Camera repair. Easy, complete, approved home-study course. Free illustrated booklet. National Camera Repair School, Dept. L-12, Englewood, Colo.

**GROW** Mushrooms. Cellar, shed. Spare, full time, year round. We pay \$3.50 lb. We paid John Betts \$7,977.76, he started as amateur. Free book. Mushrooms, Dept. 174, 2954 Admiral Way, Seattle, Wash.

**ENGINEERING**, Home study. Midwest Engineering School, 10923 Hillcrest, Hickman Mills, Missouri.

**PHYSICAL** Therapy and massage. We train you at home. Earn big profits from your own private practice or work with hospitals and doctors. Free catalogue. National Institute, Desk 4, 159 E. Ontario, Chicago, Ill.

**TRANSFORM** Yourself via subconscious. Free brochure. Box 847 (H-12), Ocean Park, Calif.

**USED** Correspondence courses and books, bought, sold, rented. Money-back guarantee. Free catalog. Bayles, 211 Essex, Hackensack, New Jersey.

#### PLAYS, STORIES, MANUSCRIPTS

**WANT** Your book published? Learn how we publish, advertise, promote, distribute. Many successes. Free booklet P.M. Vantage, 120 West 31, New York City.

**WANTED:** Book manuscripts, all subjects considered. Greenwich Book Pub., Attn. Mr. Zealand, 489 Fifth Ave., New York City.

**ALL** The world loves an author! You too can win friends and royalty checks! If you write, we appraise/sell. Write/phone. Daniel S. Mead, Literary Agent, 419 Fourth Ave., New York City 16. Telephone: Ore. 9-1150.

#### SPECIAL SERVICES

**DRAFTING**, Designing and engineering service. 6821 So. Campbell, Chicago 29, Ill.

**INFORMATION** On anything. Ferguson Research Specialists, 118-14 141 St., South Ozone Park 36, N. Y.

#### CARTOONING, COMMERCIAL ART, SHOWCARD & SIGN PAINTING, TATTOOING

**"HOW To Make Money With Simple Cartoons."** A book everyone who likes to draw should have. It is free; no obligation. Simply address Cartoonists' Exchange, Dept. 912, Pleasant Hill, Ohio.

**LEARN** Sign painting at home. Particulars free. Bolger, 148 Concord, River Edge, New Jersey.

**YOU** Can entertain with chalk talks. Catalog 10¢. Balda The Cartoonist, Oshkosh, Wis.

**LEARN** Sign painting at home. Free talent test. Ben Kerns, Box 812-PM, Greenville, S.C.

**BASIC** Art training at home. Write for free talent test. Students' Art Club, Kennebunkport, Maine.

**DRAW** Your way to fame. Free information. Cartoons-of-the-Month, Roslyn, New York.

**ART** Self employment 23 plans \$1. Satisfaction guaranteed. Barebo, O'Fallon, Missouri.

**TATTOO** Supplies—Free catalog. Spaulding & Rogers, Dept. M, Court St., Jacksonville, No. Carolina.

#### ADVERTISING AGENCIES, LETTER WRITERS, FOR ADVERTISERS

**ADVERTISING**, Result-getting ads prepared, placed newspapers, magazines, radio, anywhere! Lowest rates. Catalogue free. Baker Advertising Agency, 189 W. Madison, Chicago 2.

**MAILING** Lists most any classification \$5.00 1000. Your circulars mailed with ours \$4.00 1000. Write for our literature. Dixie Mailers, King, N. C.

**ADVERTISE:** 24 Words, 100 Canadian newspapers \$5.50. Lists free. Advertising Bureau, 10511-C Springfield, Chicago 43.

**ADVERTISING** Ratebook leading newspapers, magazines, free. Chicago Advertising Agency, Chicago 4.

**NEED** Products? Salesmen? Markets? Details free! Sayer Associates, 1129-C3 Vermont, Washington 5, D. C.

**WANT** More business? Here's an amazing opportunity to increase your sales. Talk to thousands of interested readers of "Mechanics Popular." Our Spanish Edition covers the Latin American countries like a blanket. They're real mailorder buyers. Classified rate 75¢ per word. Try an ad in our next issue. Classified Advertising Department, Popular Mechanics Magazine, 200 East Ontario Street, Chicago 11, Ill.

#### RUBBER STAMPS AND OFFICE SUPPLIES

**FREE** Style list stock stamps. Criterion, Box 2326, Denver 25, Colo.

**CHRISTMAS** Special. Regular three lines with free stamp pad or three line plastic pocket stamp \$1.00 postpaid. Barber, Marengo, Ohio.

**3 LINES**—Plus stock stamp \$1.00 postpaid. Request catalog. Esco 126 Print, 1240 Lockland, Dayton 4, Ohio.

#### TYPEWRITERS, DUPLICATORS, OFFICE DEVICES

**RECONDITIONED** Typewriters. Like new, all makes, from \$25.00. Details free. Typewriters, 5139-PM North Clark, Chicago 40.

**PORTABLE** Mimeograph! Uses no stencil, no ink. The newest, cleanest, smallest, lightest and cheapest. Weight 15 pounds. DuPont Distributors, P.O. Box 695, Dept. A, New York 1, N. Y.

**RECONDITIONED** Typewriters, duplicating, printing devices. \$25.00 up. Supplies, Appliances, DixieGraph, King, N. C.

#### PRINTING, MULTIGRAPHING, MIMEOGRAPHING, GUMMED LABELS

**CIRCULARS**, Booklets, letterheads, statements, Estimates, anything! Loneim Printers, Paulding, Ohio.

**MIMEOGRAPHING**—Letters, pricelists, formulas, instructions. Lowest prices. Lem's Letter Shop, 5710 Stanton, Detroit 8.

**ADS** Running under this heading sell printing. Ask me for proof, I'll gladly send you amazing facts. Ask for Folder "P." F. W. Johnson, 200 E. Ontario St., Chicago 11, Ill.

**BUSINESS** Printing. Reasonable. Catalog free. Howprint, 723-G Eunice, Webster Groves 19, Missouri.

**RICH**, Distinctive, quality printing. Reasonable prices. Hamel-Printer, Suite 1103, 210 Fifth Avenue, New York 10, N. Y.

**1,000 RAISED** Letters business cards \$3.50. Samples. Pioneer, 195-L Quebec, Island Park, N. Y.

**GOOD** Printing, low prices. Samples. Bosserman 4047E Westway, Toledo 12, Ohio.

**100 BUSINESS** Cards \$1.00. Printers, 1418 Broadway, Rockford, Illinois.

**FREE** Catalog business, personal printing. D.M. Press, Sebastopol, California.

**QUALITY** Printing! Free new catalog showing prices, types, cuts. Napco Press, Dept. PM, 2337 Bath Avenue, Brooklyn 14.

**PERSONAL**, Business, offset. Free estimates. Farlie, Box 2501, San Antonio 6, Tex.

**100 5 1/2 x 8 1/2** LETTERHEADS, Envelopes, cards \$1.00 each p.p. Smith-Printer, 170-05 Baisley Boulevard, Jamaica 34, New York.

**FREE** Catalog. Distinctive printing. Reasonable prices. Vosacek Printing, 4444A Ute, San Diego 17, Calif.

**GUMMED** Labels in rolls. Name and address, 3 lines, 1/2 x 1 3/4, 500 \$1.00. Guaranteed. Prompt delivery. Alexander, Box 474, Pomona, California.

**OFFSET** Printing — \$6.50 1000, 8 1/2 x 11, 16 lb. National Letter, 251 W. 42 St., New York City 36.

**FREE** Catalog, samples. Dealers wanted. Sutton Printing, Box 83-P, Waycross, Georgia.

**100 SHEETS** 5 1/2 x 8 1/2, 100 Envelopes 6 3/4, your copy, \$2.00. Dornbush, Wonder Lake, Illinois.

**STATIONERY** Cabinets (100 letterheads, 100 envelopes) \$2.95. Floyd Miller, Box 143, Dover, N. J.

#### PRINTING OUTFITS AND SUPPLIES

**PRINTING** Presses, type, supplies, lists 3¢. Turnbaugh Service, Mechanicsburg, Penna.

**MAKE** Your own self-molding rubber stamps and printing cuts. Plexirubber, Argyle 1, Wisconsin.

**ZINC** Line, halftone cuts, \$1.25 six square inches. Gallagher's, Box 115, Hazleton, Penna.

**DO** Your own printing. Save money. Simple rules. We supply everything. Print for others; good profit. Raised printing like engraving too. Have home shop. Details free. Kelsey Presses, V-11, Meriden, Connecticut.

**PRESSES**, Type cabinets, supplies. List for stamp. Lincoln Press Company, 220-L Hartwell, Fall River, Mass.

**RUBBER** Stamp making presses, hydraulic operated, electrically heated. 3 sizes 5"x8" 8"x12", 10"x15". Complete starting outfits. All kinds supplies. Custom Manufacturing, 601 N. Jefferson, Springfield, Missouri.

#### PATENT ATTORNEYS

**INVENTORS**—If you believe you have an invention, you should find out how to protect it. The firm of McMorrow, Berman & Davidson with offices in Washington, D. C., is qualified to take the necessary steps for you. Send for copy of our patent booklet "How to Protect Your Invention." We will also send you an "Invention Record" form. No obligation. They are yours for the asking. McMorrow, Berman & Davidson, Registered Patent Attorneys, 134-F Victor Building, Washington 1, D. C.

**INVENTORS**—Take these preliminary steps toward patent protection. Sketch and describe your invention. Sign, date and have this disclosure witnessed by two people who understand your invention. Have us make a preliminary search among U.S. patents already granted for similar types of invention. We report on the probable patentability of your invention and recommend your further course of action. Write for our instructive booklet, "Patent Protection for Inventors" and convenient "Evidence of Invention" disclosure form. Victor J. Evans & Co., 231-F Merlin Building, Washington 6, D. C.

**INVENTORS:** Learn how to protect your invention. Unless the inventor is familiar with patent matters, he should engage a competent registered patent attorney or agent to represent him. We are registered to practice before the U.S. patent office and prepared to serve you in handling your patent matters. "Patent Guide for the Inventor" containing detailed information concerning patent protection and procedure with "Record of Invention" form will be forwarded to you upon request—without obligation. Clarence A. O'Brien & Harvey Jacobson, Registered Patent Attorneys, 61B-K District National Building, Washington, D.C.

**INVENTION** Record form free and "Patent Information Every Inventor Should Have." Carl Miller, Registered Patent Attorney, Woolworth Building, New York.

**C. A. Snow & Co.**—M427, Snow Building, Washington 1, D. C. Registered Patent Attorneys. Write for information.

**INVENTORS:** Without obligation, write for information explaining the steps you should take to secure a patent. John Randolph, Registered Patent Attorney, 203 Columbian Bldg., Washington 1, D. C.

**INVENTORS:** When you are satisfied that you have invented something of value write me, without obligation, for information as to what steps you should take to secure a patent. Write Patrick D. Beavers, Registered Patent Atty., 936 Columbian Bldg., Washington 1, D. C.

**PATENTS.** "Proof of Invention" free. E. E. Vrooman, Registered Patent Attorney, 507 McKim Building, Washington 5, D. C.



"INVENTOR'S Guide" and "Record of Invention" free on request. Frank P. Ledermann, Registered Patent Attorney, 164 Nassau Street, New York City.

PATENTS—Irving L. McCathran, 315 McLachlen Bldg., Washington 1, D. C. Registered Patent Attorney.

REGISTERED Patent attorney offers services. Sanders, 6430 Evans, Chicago 37, Illinois.

"HOME Improvement Guide." New, amazing 192 page volume. Packed with ideas, plans for remodeling, decorating, landscaping, built-in projects. \$2.50 pre-paid. Popular Mechanics Press, 200-HO East Ontario St., Chicago 11.

### INVENTIONS WANTED

INVENTIONS Wanted. Patented or patent pending. 25 years experience promoting inventions. National Service Bureau, 3120 Meramec, St. Louis 18, Mo.

INVENTIONS Wanted. Patented; unpatented. Tremendous manufacturers lists. Global Marketing Service, 2420 77th, Oakland 5, California.

INVENTORS. Give us the opportunity to explain our selling plan for your invention, gadget or device, patented or unpatented; free particulars available upon request. Demarest and Demarest, Box 95, Battle Creek, Michigan.

INVENTIONS Promoted. A-1 service for years. Adam Fisher Co., 5418 Idaho, St. Louis, Mo.

INVENTORS: Hundreds of manufacturers have requested our assistance in locating marketable new products. Complete information free. Institute of American Inventors, Dept. 40-D, 635-P St. N.W., Washington 4, D. C.

CASH Buyers for inventions. Write National Inventors Institute, Box 7007, Cleveland 28, Ohio.

INVENTIONS Promoted. Guaranteed plan. Write for free booklet "Your Invention." Kessler Corporation, 5121W, Fremont, Ohio.

INVENTORS. Don't sell your invention patented or unpatented until you receive our offer. Write Cowgill, Box 298, Marion, Ohio.

SUPERIOR Promotions. Patented; unpatented inventions. Informative booklet, free. Superior, 338-344 North Rodeo, Beverly Hills, Calif.

INVENTIONS Wanted: Free Thomas Edison's formulas for success. American Congress Inventors, Dept. 3021MC 4CPA, Box 1481, Milwaukee 1, Wis.

INVENTIONS Wanted now by my manufacturer-clients. Patented, unpatented. Write Adams, Patent Broker, 80-S Wall Street, Financial District, New York City.

### FOR INVENTORS

INVENTORS: Learn how to protect your invention. Unless the inventor is familiar with patent matters, he should engage a competent registered patent attorney or agent to represent him. We are registered to practice before the U.S. patent office and prepared to serve you in handling your patent matters. "Patent Guide for the Inventor" containing detailed information concerning patent protection and procedure with "Record of Invention" form will be forwarded to you upon request—without obligation. Clarence A. O'Brien & Harvey Jacobson, Registered Patent Attorneys, 61A-K District National Building, Washington, D.C.

INVENTORS: Test the commercial value of your patented or unpatented inventions, quickly and inexpensively. Write for free information. Institute of American Inventors, Dept. 40-B, 635-P St., N.W., Washington 4, D. C.

PATENT Searches \$4.00. Accurate, reliable airmail reports. Free protection forms. Write us first! Patent Service Institute, Albee Building, Washington 5, D. C.

PATENT Searches, including copies of nearest patents, \$6.00. Reports airmailed within 48 hours. More than 100 registered patent attorneys use my service. For free invention protection forms, write Miss Ann Hastings, P.O. Box 176, Washington 4, D. C.

INVENTORS. Models produced, tested and developed. Advice as to patentability. Weede Machine Company, West Meadow Rd., Rockland, Maine.

HANDBOOK: How to Make the Million Your Idea May Be Worth. Information every inventor should know by a firm who knows. \$1.00 postpaid. Money back guarantee. Cosom Industries, 6012 Wayzata Boulevard, Minneapolis 16, Minnesota.

INVENTION Record form free and "Patent Information Every Inventor Should Have." Carl Miller, Registered Patent Attorney, Woolworth Building, New York.

SEARCHES—Put your patent searches in the hands of a registered patent attorney or agent, as he qualifies to give a worthwhile patentability report. Record of invention form upon request and information on patent protection. Patrick D. Beavers, Registered Patent Attorney, 936 Columbian Bldg., Washington 1, D. C.

INVENTORS: Information on patent procedure furnished on request, without obligation. John Randolph, Registered Patent Attorney, 202 Columbian Building, Washington 1, D. C.

"INVENTOR'S Guide" and "Record of Invention" free on request. Frank P. Ledermann, 154 Nassau Street, New York 38, N. Y.

PATENT Searches \$5.00. 48-hour service. Free invention protection forms. Write Raymond L. Smith, Patent Searcher, 620 Sheraton Building, Washington 5, D. C.

INVENTORS—Send for free patent information book and inventor's record. Registered Patent Attorney, Associate Examiner, Patent Office 1922-29, Patent Attorney & Advisor, Navy Department 1930-47. Gustave Miller, 126A Warner Building, Washington 4, D. C.

BOOK Of 3,600 inventions in over 200 classifications. Royalty-free licenses available. Ideas unlimited for inventors. Source \$1.00. How, Box 725, St. Louis, Mo.

MANUFACTURERS Names; any line; 15—\$2.00. Russell Tupper, Sandwich, Mass.

SELL Your invention now! Free details how. Winsor, Box 171, Albuquerque, New Mexico.

PATENT Searches \$5.00. 48-hour airmail service. Invention protection forms free. Write Patent Engineering Service, 711 14th Street N. W., Washington 5, D. C.

IDEAS Protected without patents or copyrights. Technical Service, 282 Woodcliffe Station, North Bergen, N. J.

IDEAS Developed for products and your profit with effective patent protection at low definite cost. Foreign patents: Canadian patents filed \$100.00. Patent development costs now deductible from tax payments. 30 yrs. in business. Joseph O'Brien, Patent-Development Engineer, 132 Nassau St., New York 38, N. Y.

INVENTORS—This firm is registered to practice before the United States Patent Office and available to assist you in the preparation and prosecution of your patent application. "Patent Protection for Inventors" booklet containing detailed information and steps to take toward patent protection sent promptly upon request. No obligation. Victor J. Evans & Co., 232-P Merin Building, Washington 5, D. C.

INVENTORS—If you believe you have an invention, you should find out how to protect it. The firm of McMorrow, Berman & Davidson with offices in Washington, D.C., is qualified to take the necessary steps for you. Send for copy of our patent booklet "How to Protect Your Invention." We will also send you an "Invention Record" form. No obligation. They are yours for the asking. McMorrow, Berman & Davidson, Registered Patent Attorneys, 134-E Victor Building, Washington 1, D. C.

PATENTS. How to prepare and file your own patent application. Send \$2.95 for book. Paladin Pubns., Atlantic and Pacific Sts., Bellmore, N. Y.

### PATENTS FOR SALE

INVENTIONS For sale. Queries from manufacturers solicited. Kessler, Patent Broker, Fremont, Ohio.

MAGNETIC Toy. Educational and fun. Easy to make. J. Borsos, 8683 Louise, Allen Park, Mich.

### MANUFACTURING

MODELS—Small lot manufacturing. Metals, plastics, etc. Milburn, Burlington, Kentucky.

### MODELS, MODEL SUPPLIES

CATALOGS: 84 Page, Ships, fittings 50¢; trains 50¢; collectors soldiers 25¢; with refundable coupon. Radio control 15¢; vehicles, guns 20¢; general hobby 15¢; leathercraft 10¢. Poik's, 314M Fifth Ave., New York City 1.

SHIP Model kits and fittings including clippers, trawler, fishermen, frigates, privateer, radio control tug, etc. Send 25¢ for 1957 catalog. Model Shipways, Box 85, Bogota, N. J.

FB4 Jet engine. Literature, service manual, dime. Stanmore, Cherry Valley, N. Y.

GIANT New 1957 "O" Gauge catalog for scale—Tinplate model railroaders, 92 pages 8½x11, 2600 items, 180 car kits, 46 locomotives, hard-to-find model building parts. Price \$1.00 (refundable on \$10.00 order). All-Nation Hobby Shop, 178 N. LaSalle, Chicago 1.

WILD Animals, imported life like scale models. Over 100 different. Illustrated catalog 25¢. Walters Hobby Shop, 207M French, Utica 4, N. Y.

ELECTRIC Trains. See advertisement Utopia Sales, under classification Games, Toys, Novelties.

WANTED—Miniature operating steam, turbine or diesel power plant for display purposes. Stationary or marine type with boiler, engine, generator, pump, etc. Prefer scale working model. What have you? Reuther Eng. & Mch. Co., 126 South 14th St., Newark 7, N. J.

MINIATURE Artificial trees. Complete kits available. See advertisement page 26.

RAILROADERS! Fabulous Fifth Annual Reference Guide to every imaginable electric train extra for Flyer, Lionel or Marx. 25¢. Catalogs: HO—35¢, 256 pages. All hobbies \$1.00 (refundable). Hobby House, 800-P Huron Road, Cleveland 15, Ohio.

POWER Models. Unusual steam gasoline and traction engines, fittings, metals. Comprehensive catalog \$1.00. Chas. Cole, Ventura, Calif.

BUILD Miniature passenger hauling live steam locomotive with file and drillpress. We do machine work, you bolt it together. Catalog 50¢. Little Engines, Lomita, Calif.

SHIP And yacht model fittings; blueprints. Send 35¢ for illustrated catalog listing hundreds of items. A. J. Fisher, 1002-1 Etowah Ave., Royal Oak, Mich.

SHIP Models. Most complete line in New England. Kits, fittings, plans, books, tools, engines, motors. Illustrated catalog 30¢. James Bliss & Co., Inc., Dept. SM, 342 Atlantic Ave., Boston 10, Mass.

BALSA Wood and model aircraft. 40-page catalog 25¢. Sig Co., Montezuma, Iowa.

LIONEL, American Flyer trains sold, repaired. Big discounts. Bulletin free. Catalog 25¢. Mack Bros., 2043-P Chicago Ave., Chicago 22.

### HOME CRAFTSMEN

JIGSAW Patterns for boys! Large variety, gifts, novelties, useful, pinups, lawn ornaments. \$1.00. Pauls Plans, 4633 North 18th, Milwaukee 9, Wisconsin.

STYLECRAFT Sure fire hits. "Pre-traced" leather kits. Handbags, billfolds, filigree belts, over fifty other projects. Patterns on leather. Why trace? Just carve, assemble and lace. Large assortment "precarved" kits also available. Send 25¢ for catalog, free folder. Refundable first order. Apache Leather Company, 2804 E. Washington St., Phoenix, Arizona.

DO-It-Yourself booklets 25¢. 24 subjects. Free catalog. Popular Mechanics Press, 631 N. St. Clair St., Chicago 11.

KNOCKDOWN Cedar chests and lumber. Free price list. Bedford Lumber Company, Shelbyville, Tennessee.

ALL Crafts, supplies. Large free catalog. National Handicraft, 199 William Street, New York City 38.



FREE Catalog. 1566 patterns and designs. Craftplans, 1321-A South Michigan, Chicago 5.

**WOODWORKING** And cabinetmaking course for beginning and advanced home craftsmen. Only complete low-cost home training program available. Write for free booklet. Interstate Training Service, Dept. G-3, Portland 13, Ore.

I Want to send you proof of the wonderful pulling power of Popular Mechanics classified pages. What's your proposition? Write me today. Include literature if possible. F. W. Johnson, Manager Classified Advertising, Popular Mechanics Magazine, 200 E. Ontario St., Chicago 11, Ill.

129 NEW Full-size jigsaw patterns. Artist-drawn. \$1. Craftplans, 1321-A South Michigan, Chicago 5.

**LEARN** Art metalcraft and jewelry making. Complete, inexpensive, home training course now available. Special tools and materials furnished. Write for free booklet. Interstate Training Service, Dept. L-3, Portland 13, Oregon.

**LEATHERCRAFT.** Send 10¢ for new 76-page catalog of tools, supplies, kits, including metalcrafts, enameling, ceramics, all other crafts. Complete stock. Reasonable. Since 1910. Sax Bros., Dept. PM1, 1111 N. 3rd, Milwaukee, Wis.

18 FULL-Size patterns. Save money with easy-to-use, professionally designed full-size patterns. Make money selling beautiful, useful furniture. Make modern step and cocktail tables; metal lamps; cupola; 12-foot outboard. All patterns test-built; sold with money-back guarantee. Get your free list of these convenient, economical patterns today. Popular Mechanics Press, 200-HH E. Ontario Street, Chicago 11, Ill.

**ARIZONA Bargain:** Five beautiful polished reconstituted turquoise gemstones and findings-gemstone price list all for only 25 cents. Melcrafts, Box 27, Cactus 2, Arizona.

**LEATHERCRAFT.** Copper enameling, mosaic tile, shellcraft, metal tooling, beadcraft, many more crafts. Free big catalog. Kit Kraft, Dept. 2312, Studio City 1, Calif.

FREE. Complete illustrated catalog, leathercraft kits, supplies. J. C. Larson Co., 820 S. Tripp, Dept. 6727-L, Chicago 24.

101 FULL Size patterns. Smart, new, gifts, novelties, lawn figures, shelves, action windmills, alphabets. Plus "Make Money Jig Sawing." Only \$1.00. Mastercraft 125M, 7041 Olcott, Chicago 31, Ill.

119 JIG Saw patterns. Full size, just trace on wood and saw. Clever original designs. \$1.00 postpaid. Burgess Vibrocrafter, Dept. C-26, Grayslake, Illinois.

100 JIGSAW Patterns \$1. Lawn, novelties. Full size. Colors indicated. Hal Barebo, O'Fallon, Mo.

**BUY** Wholesale nationally advertised power, hand tools, thousands other products at big discounts. Free "Wholesale Plan." American Buyers', Hertel Station, Buffalo 16-F1, N.Y.

89 FULL Size Jig saw patterns of beautiful shelves, ornaments, toys, novelties. Plus "How, Where to Sell." Only \$1.00. Mastercraft 124M, 7041 Olcott, Chicago 31, Illinois.

**LEATHERCRAFT.** Kits, copper, artist's supplies. New catalog. Midas, 7705 State, Huntington Park, California.

**MAKE** Expensive enameled copper jewelry, ash trays at fraction of retail price. Easy instructions, supplies, beginners' kits in 77 page catalogue, 25¢. Bergen, 301 S.W. 17th Avenue, Miami, Florida.

**LAMP** Size cypress knee with nipple installed \$2.00. Cy Products, Dept. 2-B, Lafayette, La.

**EPOXY** Adhesive. Bonds everything. \$1.50. Agents wanted. Avan, 2323 Wolf-ram, Chicago 18.

**TABLE** Legs—Beautiful sturdy birch—Turned, tapered, or bent laminated. 15" high, set of 4 only \$3.75 postpaid. Brackets to attach included. Makes hundreds professional designs. Write for free catalog quality furniture kits, legs, tops, plywood. Birchwood Industries, Dept. 2, Fitchburg, Mass.

## DO IT YOURSELF

**LOCK** Tool and kit \$5.00 with booklet to guide you for changing combinations and servicing locks. Write for free literature. Lock Servicing Tool, 3350 N. Orkney St., Philadelphia 40, Penna.

**SIGNS:** Beautiful moulded plastic. Sample letter 35¢. Colors, P.O. Box 108, Spencer, Indiana.

**GRANDFATHER** Clock movements, dials, kits. Wholesale catalog 25¢. Mason-Sullivan, Noroton, Conn.

**MINIATURE** Chippendale spinning wheel picture plans, easy to follow with simple instructions, 7½" high. Sent postpaid anywhere in the U.S., \$2.00, send check or moneyorder to Craftshop, 1353 Olive Way 1, Seattle 23, Washington.

**ROTARY** Mower units, bases, wheels, etc. Free literature. H & T Manufacturing Co., Spirit Lake, Iowa.

**BUILD** Your own power tools, ventilating fans, etc. Complete supply catalog. The Hawthorne Co., Otsego, Mich.

**DON'T** Hibernate this winter! Bud in the spring in a building career. "Around the clock" estimating and blueprint reading system. Accurate, easy and fast. A good field for women. Only \$6.98 c.o.d. Building Construction College, P.O. Box 48434, Hollywood 48, Calif.

**MAKE** Your cabinet. 20 metal drawers, 8" long x 1½" high x 4½" wide. With index handles. 20 metal dividers. 24 gauge metal. \$8.95 postpaid. Johnson Metal Products, Chalmers, Indiana.

**CLOCK** Movements—Gorgeous dials, plans, kits. See ad page 271.

18 FULL-Size patterns. Save money with easy-to-use, professionally designed full-size patterns. Make money selling beautiful, useful furniture. Make modern step and cocktail tables; metal lamps; cupola; 12-foot outboard. All patterns test-built; sold with money-back guarantee. Get your free list of these convenient, economical patterns today. Popular Mechanics Press, 200-HH E. Ontario Street, Chicago 11, Illinois.

## WATCHES. OLD GOLD. JEWELRY

**BEAUTIFUL** Gift, seven gem bracelet, specify, myrrickite, agate, snowflake, tiger-eye, assorted stones, gold or silver. \$3.00 p.p. Monterey jade lucky piece. 50¢ earrings to match, \$1.50. Baroque gem wholesale price list available. Santa Cruz Mountain Gems, P.O. Box 924, Los Gatos, Calif.

**COPPER** Enameling supplies, rhinestones, pearls, jewelry settings. Catalog 10¢. J & M Novelties, Dept. CP-3, Griffith, Indiana.

**WHOLESALE** Name brand watch catalog free. Watches, 1562 Rosalie, Clifton, New Jersey.

10 WATCHES \$18.00. Minor repairs. Catalog 20¢. Berkwit, 1150 Castle Hill, New York City 62.

**WATCHMAKERS'**—Jewelers' supplies, instructions. Catalog 20¢. Bengale Company, Culver City, California.

**COSTUME** Jewelry supplies. Catalog and samples. 35¢. Largest line in America. Milady-Fair Co., G.P.O. Box 1328, New York City 1.

**WATCHES**—Promptly, completely, expertly reconditioned, \$4. Satisfaction guaranteed. Freeman's Jewelry, Rosston, Okla.

**MEN'S** Or ladies', \$79.95. 6 piece golden, Swiss jewel wrist watch set. Guaranteed 2 years. \$18.00 down. \$3.00 month. Frank Jones Sales Co., Rt. 2, Big Sandy, Texas.

**EASY,** Fun, profitable to make rhinestone jewelry. 1957 supply catalogue #3A 25¢. Bergen, 301A S.W. 17th Avenue, Miami, Florida.

**JEWELER'S** Precision tools and supplies for every hobbyist. Illustrated handbook free. Howard Supply, 36-14 11 St., Long Island City 8, New York.

**HELBROS** Watches, jewelry 70% discount. Catalog 25¢. Dorinda, Huntington Station 7, N. Y.

**WATCH** And clock repairing books. Free information. North American, Dept. 16M, 2320 N. Milwaukee, Chicago 47, Illinois.

## RAZORS, BLADES, SHARPENING

120 FINEST Quality, double edge blades \$1.50 postpaid. Guaranteed. Free samples. Kalnals, 1934 N. Hoyne, Chicago 47, Ill.

**ELECTRIC** Razors, all brands, big discounts. Terry Burke, 256 Howard, Brockton 14, Mass.

## FOR THE HOME

**FOAM** Rubber furniture cushions. Factory seconds. 50% discount. Free catalog. Perma-Foam, 2360 Rhode Island Ave., East Orange, New Jersey.

**BE** Your own plumber. You can. Few inexpensive tools and our instructive book, "Home Plumbing Guide," shows and tells you how. Hundreds of photographs and diagrams. Easy to follow. 160 pages. \$3.50. Catalog free. Popular Mechanics Press, 200PG East Ontario St., Chicago 11, Ill.

## OF INTEREST TO WOMEN

"8 MISTAKES Parents Make." Every parent should have this new book about child training. It is free; no obligation. Simply address Parents Association, Dept. 6712, Pleasant Hill, Ohio.

**SELL** Fine fabrics. Get yours wholesale. Box 863, Norwalk, Conn.

**BOOKS:** Hundreds of subjects. Big catalog free. Popular Mechanics Press, 200-BO East Ontario St., Chicago 11.

**MAKE** New greaseless doughnuts in kitchen. Sell stores. Free recipes. Morgan Ray, 3605 South 15th, Minneapolis 7, Minn.

**GROW** Mushrooms. Cellar, shed. Spare, full time, year round. We pay \$3.50 lb. We paid John Betts \$7,977.76, he started as amateur. Free book. Mushrooms, Dept. 176, 2954 Admiral Way, Seattle, Wash.

**RAISE** Money! Making, selling artificial flowers, corsages, novelties. Big illustrated catalog 25¢ (refundable). Profitkrafts, 4512M21 Lorain, Cleveland 2, Ohio.

**FOODMASTER** Saladmaker, cutting, grating, shredding, slicing. Makes tossed salad three minutes. Sturdily constructed, oilite bronze bearing. Last lifetime \$19.95. Write details. H. Johnson, 6017¼ Sunset Blvd., Hollywood, Calif.

**WANT** To make big money at home? \$5 profit in an hour possible with invisible reweaving. Make tears, holes disappear from clothing, fabrics. Steady year-round demand from cleaners, laundries, homes. Details free. Fabricon, 8322 Prairie, Chicago 19, Illinois.

## WANTED—MISCELLANEOUS

\$3 CASH For your old electric shaver regardless of condition. National Dist. Co., 1751 W. Flagler, Miami, Fla.

CASH For Indian bird stones; antique northwest coast totems, mask, carvings. Send photos. Robert Stolper, 8852 Cynthia Street, Los Angeles, California.

**SCRAP** Mercury (quicksilver) containers supplied—Tantalum, tungsten, silver, platinum. Metallurgical Products Company, Established 1909, 35th & Moore Sts., Philadelphia 45, Penna.

**BOOKS:** Hundreds of subjects. Big catalog free. Popular Mechanics Press, 200-BO East Ontario St., Chicago 11.

## PERSONAL

**MONEY** To loan. Entirely by mail. \$100 loan repayable \$6.75 per month. \$300 loan repayable \$19.95 a month. Loans made to \$600. Learn how the air mail way. State amount you need. Write Money-To-Loan, Dept. 658-X, 2014 Dakota Ave., South Sioux City, Nebraska.

**SIMPLE** Television repairs. Marvelous booklet 25¢. Free catalog. Popular Mechanics Press, 633 N. St. Clair St., Chicago 11.

**NEW** Electric shavers. Latest models, Remington 60 deluxe retails \$29.50, your cost \$19.95. Auto-Home 60 deluxe retails \$31.50, cost \$21.50. Choice 6 or 12 volt. Remington Lady Duchess, pink or blue, retails \$21.50, cost \$15.95. Schick 25, retails \$29.50, cost \$19.95. Lady Schick retails \$14.95, cost \$11.95. Norelco retails \$24.95 cost \$15.95. Cash orders prepaid, \$5.00 deposit on c.o.d. orders, charges collect. Rex Sales Co., Box 2802, San Diego, California.



FLORIDA Jobs, opportunities, property rentals, sales, hundreds of offers now. Tampa-St. Petersburg area, complete listing \$1.00. Florida Research, Box 215, Clearwater, Florida.

CHARLES Lewis please contact sister Opal, c/o Main P.O., Box 453, Cincinnati, Ohio.

CHILEAN Exciting license-plates 85¢, colorful chamantos \$8.00. Barceló, Casilla 1352, Santiago, Chile.

VITAMINS—Why overpay? Save 50% over drug store prices! Free catalogue lists all brands, advertised and private. Free samples if you mention product now using. Vitamins, Box 4435, Philadelphia 40, Penna.

HOLLYWOOD! Your letters remailed! Postmarked anywhere within U.S.A. \$1.00! Box 972, Santa Barbara.

"HOW Can I find out?" You can! Information confidentially developed. Any matter, person, problem. Worldwide. Officially licensed. Established 1922, William Herman, 170 Broadway, New York City.

BOOKS: Hundreds of subjects. Big catalogue free. Popular Mechanics Press, 200-BC East Ontario St., Chicago 11.

### REMAILING SERVICE

ALOHA! Six Honolulu postcards—\$1.00. Retailed free. Receiving-forwarding \$2.00 month. Surprise your friends now! Today! Write: Fobel, 3132-DE George Street, Honolulu.

BRAZILIAN Reairmails 50¢. Forwarding service. Mauricio, Caixa Postal 515, Anapolis, Goiás, Brazil.

HOLLYWOOD—Long Beach remail 25¢. Receiving-forwarding address. Shopping. Lenormand, 722 Magnolia, Long Beach, California.

CHICAGO Remails 25¢, mailing addresses \$3 month. Mailings, 5345 South Halsted, Chicago 9, Illinois.

PUERTO Rico. Remails from tropical splendor island, 25¢. 8 color view cards \$1.00, remailed free. U. S. postal rates. Better use air-mail. Ponce Distributors, Rambla 59, Ponce, Puerto Rico.

INDIAN Named. Nanuet, N. Y. Letters, cards remailed 25¢. Box 485, Nanuet, N. Y.

LETTERS Retailed, etc., from Canada 35¢. I affix Canadian air stamp. Ross, 83 Belhaven Rd., Toronto 8, Ont.

WASHINGTON, D. C., remailing 25¢. Six viewcards Washington \$1.00 remailed free. Joanco, Box 3006, Arlington 2, Va.

MONTREAL 34, Que., Canada. Remails 35¢. R. Cote, 1567 E. Laurier.

ORIENT And Pacific Islands. Letters reairmailed \$1.00 each. Capt. H. F. Williams, 442P Merritt Ave., Oakland 10, Calif.

LETTER Remailing, receiving-forwarding address for rent. McLaughlin, 800 Stewart, Columbus 6, Ohio.

COLUMBUS, Ohio. Remails 25¢, etc. John Volan, 1437 N. High St., Columbus 1, Ohio.

SECRET Mail receiving, forwarding system. \$3 month. Hedgpath, Box 830, Alhambra 23, California.

REMAIL 25¢. View card 10¢. Souvenir folder 50¢. Souvenir \$1.00. Nicholas, 402 West Elmore, Dallas 24, Texas.

LETTERS Stamped remailed air, \$1. Jack Wilson, 12 Western Highway, Parramatta, Sydney, Australia.

HISTORIC New Orleans letters remailed 25¢. Postcards 6 for \$1.00. C. O. Tucker, 617 St. Ann St., New Orleans 16, La.

### TREASURE FINDERS

\$389 SCINTILLATOR \$189. \$495 Scintillator \$229. Box 943, Billings, Montana.

FREE. 16-Page manual from world's largest mfr. of prospecting equipment. Detectron Corp., 5528 Vineland, North Hollywood, Calif.

GEIGER Counters, pocket-sized powerful walking-stick type, \$34.95. Polished-copper gold pans, 14½" diameter, \$4.95. Ideal Christmas gifts. Postage prepaid. The Geiger Center, 1201 Broadway, Denver, Colo.

FOR Treasure locators, geiger, scintillation counters, mineralights, M-Scope. Fisher Research Laboratory. See advertisement page 287.

URANIUM Gold, silver treasure. New power-packed highly sensitive metal detectors, Geiger counters and mineralights. Kits and assembled models from \$12.50. Lightest weight, guaranteed, free literature. Electronic Applications, Dept. M, Box 8, Arlington 10, Virginia.

FIND Buried treasure, gold and silver, with Goldak's sensational 3½ lb. "find-it" locator, only \$49.50. Write for free literature on complete line of mineral, metal locators; Geiger and scintillation counters. Goldak, 1541 W. Glenoaks Blvd., Glendale, Calif.

### FOR SALE—MISCELLANEOUS

HEARING Aid batteries, wholesale. Free list. Habs, Box 51, York, Penna.

BOOKS: Hundreds of subjects. Big catalogue free. Popular Mechanics Press, 200-BC East Ontario St., Chicago 11.

100 DOUBLE Edge razor blades, \$1.00. Moneyback guarantee. Dor-Len Sales, Box 21, Galesburg 1, Illinois.

CALIFORNIA Manufactured items. Tremendous market. Send \$1.00 for samples. W & R Sales Co., 2403 Shattuck Ave., Berkeley 4, Calif.

MIRROR One side; transparent from other side. See and photograph people unawares. 8"x10", \$2. 16"x20", \$5. One-Way Mirror, Dept. PM-1, Box 625, Mt. Vernon, N. Y.

DO It yourself. What? Repair TV, build furniture, make barbecue, plumbing repairs, build boats, do house wiring, remodel home, lay tile, modernize kitchen, repair home, and scores of other things you can do yourself. Books covering each subject, only 25¢. Send for descriptive list. It's free. Popular Mechanics Press, 200-LB East Ontario St., Chicago 11, Ill.

### CHRISTMAS SUGGESTIONS

SAVE Dollars. Write us now for discount Christmas price of almost any item. Products, Box 402-M, Benton, Arkansas.

CHRISTMAS Gift special. Pen/pencil set, value \$8.95, now \$3.95. Curtis Bush, Phenix City, Alabama.

### MISCELLANEOUS

MEN—Protect your watch. Leather watch bands with protective-detachable covers. For all standard size watches. \$3.95 postpaid. Custom Watchbands, Box 365, 109 Riverview Ave., Selma, Alabama.

JAPAN: Buy gifts from Japan. Kimono, artistic handicrafts, novelties, others. Business information \$1.00. Send money orders. Clarence Yamagata, Room 202, Naka 7 Bldg., Marunouchi, Tokyo, Japan.

\$100 WEEKLY Raising earthworms! Free plan reveals how! Oakhaven-M. Cedar Hill, Texas.

100 6½"x9½" BROWN Envelopes, unprinted, \$2.25. M. Fortney, R3, Dillsburg, Penna.

HOW To remodel, basement, attic. Booklet 25¢. Free catalog. Popular Mechanics Press, 633 N. St. Clair St., Chicago 11.

LAZY Susan bookcase lamps. Profitable. Beautiful Christmas gift. Details. Key Supply, 5764B N. Lacey, Chicago 30, Ill.

"HOME Improvement Guide." New, amazing 192 page volume. Packed with ideas, plans for remodeling, decorating, landscaping, built-in projects. \$2.50 prepaid. Popular Mechanics Press, 200-HG East Ontario St., Chicago 11.

CIGARETTES—Make 20 for 9¢. Facts free. Moberly, Box 810, Owensboro, Kentucky.

DO It yourself. What? Repair TV, build furniture, make barbecue, plumbing repairs, build boats, do house wiring, remodel home, lay tile, modernize kitchen, repair home, and scores of other things you can do yourself. Books covering each subject, only 25¢. Send for descriptive list. It's free. Popular Mechanics Press, 200-LB East Ontario St., Chicago 11, Ill.

LEATHER Jackets renovated, expertly. Free circular 8. Berlew Mfg. Co., Freeport, New York.

FEEL More vigorous, younger—Better! Get potent vitamin formulas! Buy direct, save! Free catalogue. Vitamin-Center, Drawer 2318P, Detroit 31.

WANT More business? Here's an amazing opportunity to increase your sales. Talk to thousands of interested readers of "Mechanics Popular." Our Spanish Edition covers the Latin American countries like a blanket. They're real mailorder buyers. Classified rate 75¢ per word. Try an ad in our next issue. Classified Advertising Department, Popular Mechanics Magazine, 200 East Ontario Street, Chicago 11, Ill.

RECEIVE Magazine samples, mails, catalogues, offers from everywhere. Get listed 25¢. Rorick, Cincinnati 26, Ohio.

YOUR Name wanted. We'll send 1000 publishers, mailers, wholesalers your name, on our list one year 25¢. Dixie Mailers, King, N. C.

CESSPOOLS, Septic tanks, outhouses, clogged drains, cleaned, deodorized without digging, pumping. Sursolvent reduces contents. Reclaims leachability. Old systems work like new. Free details. Electric Sewer Cleaning, Alston 34, Mass.

HOUSE Wiring—Electrical repairs. 32-page booklet 25¢. Popular Mechanics Press, 633 N. St. Clair St., Chicago 11.

70 BIBLE Lessons, 25¢. Bulletin, Box 87, Cathedral Station, New York City 25.

BUY Wholesale! Discounts to 80%! Appliances, cameras, sporting goods, tools, watches, housewares, etc. Free catalogs. Buy-Rite, Box 258-B, Hawthorne, New Jersey.

BARGAIN. Exciting Little Library booklets. 25¢ each. Tool making, painting, welding, home improvement, games, models, plastics, lamp making, glass blowing, boats, photographs. Free catalog. Popular Mechanics Press, 200-LB East Ontario St., Chicago 11.

VESTPOCKET Radio. 1957 model, pulls stations like magic, loud and clear. Anyone can make it with inexpensive parts available anywhere using our complete assembly information, diagrams, parts list. Send \$1.00 to Merritt Engineering Company, 874 23rd Street, Oakland 12, Calif.

HOW To read blueprints. Amazing booklet 25¢. Free catalog. Popular Mechanics Press, 633 N. St. Clair St., Chicago 11.

YOU Can't sleep? Learn in 624 words how to use the most effective technique yet devised. No drugs, no medicines; psychology only. You will not be disappointed. Send dollar bill, name, complete address (printed) to Warrick, P.O. Box 1855, University Center Station, Cleveland 6, Ohio.

"HOW to Win Prize Contests." Free information. National, 9128-P S.W. 26th, Portland 19, Oregon.

POLISHING Cloths, guaranteed by Good Housekeeping. For auto, furniture, anti-fog for glass, \$1.00. 3 for \$2.75. G. Stationery, 1409 Neck Rd., Brooklyn, N. Y.

OLD Wall and desk telephones working order. Oak cabinets, hand crank for ringing. \$5.00 each. Magnetos with cranks \$2.00 each f.o.b. Telephone Co., Turtle Lake, Wisconsin.

STUPENDOUS Mental power. Adults. Details—3¢. Regent, 846 Sunnyside, Chicago 40.

REMODEL Your own home. Save hundreds of dollars. New, amazing book shows you how. Written so you can understand it. Step by step instructions make it easy. Fully illustrated, 400 photographs, hundreds of diagrams, 160 pages. \$2.95. Literature free. Popular Mechanics Press, 200-RH East Ontario St., Chicago 11, Ill.

ELECTROLUNCH—Electric lunch bucket. Electric Lunch Kit Distributors, P.O. Box 53, Waukegan, Illinois.

GROW Mushrooms. Cellar, shed. Spare, full time, year round. We pay \$3.50 lb. We paid John Betts \$7,977.76, he started as amateur. Free book. Mushrooms, Dept. 175, 2954 Admiral Way, Seattle, Wash.

I want to send you proof of the wonderful pulling power of Popular Mechanics classified pages. What's your proposition? Write me today. Include literature if possible. F. W. Johnson, Manager Classified Advertising, Popular Mechanics Magazine, 200 E. Ontario St., Chicago 11, Ill.



# TRAINED MEN NEEDED!

## BIG PAY!—GOOD FUTURE!

- DIESEL                       ELECTRONICS  
 AUTO                          AUTOMATION

NEVER BEFORE has the opportunity been so good for the properly trained mechanic and technician to step into BIG PAY POSITIONS with rapid advancement and future security virtually assured.

YOUR SUCCESS depends on the quality of training you receive... and the reputation of the school you attend.

YOUR GUARANTEE we are giving the best in mechanical and technical training is proved by the fact... we have a waiting list of good pay positions for our graduates, with leading companies throughout the United States.

RESIDENT SHOP TRAINING is easier and costs less than you may think! We provide you with housing and part-time jobs while in school, plus free nation-wide placement service for graduates.

Check subject above in which you are interested and mail for

FREE BOOKLET

Your Future  
IN  
ELECTRONICS  
AND  
AUTOMATION

**BAILEY**  
Technical Schools

Veteran Approved

1634 S. Grand, St. Louis 4, Mo.

Your Future  
IN  
DIESEL and  
AUTO  
MECHANICS

Name \_\_\_\_\_ Age \_\_\_\_\_  
Street \_\_\_\_\_  
Town \_\_\_\_\_ Zone \_\_\_\_\_ State \_\_\_\_\_

## Multi-Million Dollar Business Now Being Split Up Among Home Operators in Small Communities

### Inexpensive Table Top Machine Pays Profits UP TO \$9.20 AN HOUR

The multi-million dollar Rubber Stamp Business is now being taken over by small home operators throughout the U.S. Men and Women who operate this inexpensive machine can turn out large numbers of Rubber Stamps with special wording of all kinds. Material costing only 27c makes a stamp that sells for \$1.80. The machine is easy for anyone to operate. It molds as many as six Rubber Stamps at a time, each with different wording such as names, addresses, notices, stock numbers, prices and other 'copy' needed by offices, factories and individuals. At full capacity, it can earn as much as \$9.20 an hour for the operator! You don't need experience to get into this big profit business at home. We supply everything, including complete instructions and eight ways to get orders for stamps coming in fast. Start making up to \$9.20 in one hour right away. We'll mail full particulars FREE and no salesman will call. Be first in your locality. Rush coupon. RUBBER STAMP DIV., 1512 Jarvis Ave., Dept. R-212, Chicago 26, Ill.



RUBBER STAMP DIV., Dept. R-212 **FREE!**  
1512 Jarvis Ave., Chicago 26, Ill.

Please mail all facts showing how I can get started in the profitable Rubber Stamp business at home in spare time. Everything you mail me is FREE and no salesman will call.

NAME \_\_\_\_\_

ADDRESS \_\_\_\_\_

CITY \_\_\_\_\_ Zone \_\_\_\_\_ STATE \_\_\_\_\_

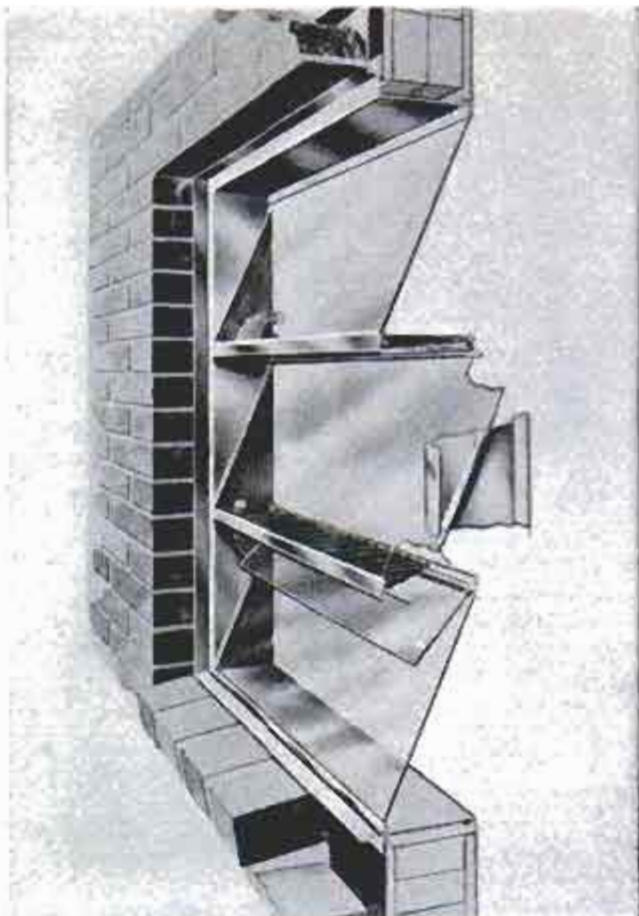

### Window With Z-Profile Has Rainproof Vents

Even when its ventilator panes are dropped in open position, a window with a Z-like profile is rainproof and burglar-proof. This window, which at first glance resembles a louvered window, has fixed slanted panes. Movable ventilator panes form the top and bottom of the zee and close against a horizontal screened section. Other advantages include an absence of drafts, no danger of children falling out, and an unobstructed view.

### Air-to-Ground Loudspeaker Guides Paratroopers

Three to five-minute messages are now broadcast by an airborne loudspeaker system to ground areas where paratroopers are landing. When the center unit of a three-parachute, three-section missile containing the system reaches 4000-foot altitude, the sound reproducer in the loudspeaker begins to operate. The missile housing the system weighs 850 pounds and is 118 inches long by 18 inches in diameter. The loudspeaker apparatus includes a lightweight magnetic-tape playback unit, a 500-watt battery-powered audio amplifier and horn assembly, a pressure-initiated control system and the three-stage parachute arrangement.



# SAVE \$ ON U\$ GOV'T \$URPLUS\$

Our publication "Government Surplus Sales" lists hundreds of items for sale by the U. S. Government at tremendous savings, as low as 1c on a \$1.00.

These are samples of the savings that are being made:

LIFE BOAT ....\$12.00	GRINDER .....\$4.69	SHAPER .....\$15.00	DUMP TRUCK.....\$76.77
TRACTOR .....\$75.00	TYPEWRITER ....\$7.51	FREEZER .....\$50.00	SPRAY PAINTER.....\$15.25
	MOTOR .....\$4.00		

Hundreds others listed in our bulletin "Government Surplus Sales" and may be purchased direct from U. S. Government. Hunting, Fishing, Camping, Sporting Equipment, Photographic Equipment and Supplies, Radio and Electronic Equipment, Amphibious Trucks, Jeeps, Boats, Motors, Binoculars, Plumbing, Electrical Equip., Cars, Power Tools, Machinery, Chemicals, Furniture, Office Equipment, Supplies, Scrap, Etc.

How may you receive our bulletin "Government Surplus Sales?" By sending \$1.00 to  
**GOVERNMENT SURPLUS SALES, P. O. Box 169, Department 8-5, East Hartford 8, Conn.**

Also Eshelman  
 2 Passenger  
**SPORT & GOLF CARS**  
 Costs small fraction of most other cars.  
 4 times more gas mileage  
 Write for FREE Literature and Rider Agent Plan.

**ESHELMAN TRACTORS** LOW AS \$99



Plows • Cultivates • Saws  
 Dozer • Harrows  
 • Snow-Plow • Rolls  
 • Mows • Mows • Tills  
 Eshelman Tractors,  
 Tillers, Riding Rotary  
 Mowers for Belter  
 Lawns and Gardens.  
 Advertised in GOOD  
 HOUSEKEEPING, Thousands  
 of Satisfied Users.  
 Dept. R-512, ESHELMAN, Balto. 2, Md. \$605

Shipping Points: BALTIMORE - CHICAGO - DENVER

**HEAVY OILPH-BALL BEARINGS PUMPS MILLIONS OF GALS.**

**695 CELLAR & SUMP DRAIN** 7500 G.P.H. Pump, Stand, Legs, Coupling, Hardware. **\$14.45**

IRRIGATE, SPRAY, DRAIN OR FILL ANYTHING—ANYWHERE! Will not Rust—Clog—or Leak. Patented Seal. Pumps 2800 gph, 420 gph at 75' high or 1600 gph from 25' well. Six blade impeller. Threaded for pipe, 3/4" inlet, 1/2" outlet. Use 1/2 to 3/4 hp motor . . . 7500 gph 9.95  
 Heavier 2800 gph 8.95 Heavier 11.95  
 Check, MO or COD—Lifetime Trade Guarantee  
 FREE Literature—Comparison Charts

**U. A. T. ENG. & MFG. CO. NICKSVILLE 273, NEW YORK**

## BE YOUR OWN BOSS

Make Hundreds of \$ Spare or Full Time Work

**NO EXPERIENCE NEEDED**  
 Here is the ideal business with no previous experience or large investment required and no high-priced equipment to buy. A business that will return dollars for the pennies you invest.

**YOU CAN CAST ANYTHING**  
 With *Flexible Mold Making and Ornamental Casting*, an amazing fact-packed book, you learn how you can cast practically any article in concrete, plaster, imitation marble or any other casting material using a marvelous new process. You can make ash trays, novelties, garden and lawn ornaments and hundreds of other highly profitable items that cost you but a few cents and sell for as much as \$5.00 and more. Why you can even make true-to-life full-sized busts of your neighbors and friends.

**NO EXPENSIVE MOLDS TO BUY**  
 Why buy high-priced molds from others? Learn how you can make your own molds quickly, easily and inexpensively with materials that can be used over and over. You get copyrighted formulas, complete instructions and detailed how-to-do-it photographs as well as complete sources of supply for the few inexpensive materials you need. This is the only book printed in America today that contains instructions for making profitable papier-mache casts.

**MONEY BACK GUARANTEE**  
 Start on your road to extra income and independence today. Send only \$1.98 for your copy of *Flexible Mold Making and Ornamental Casting*. Complete satisfaction guaranteed or your money refunded within seven days.

**POPULAR MECHANICS PRESS**  
 Dept. 1256, 200 E. Ontario St., Chicago 11, Ill.

You can make simply and cheaply



BUSTS  
 GARDEN URNS  
 NOVELTIES  
 TILE  
 STATUARY

**FREE!** SEND FOR MY NEW PLAN FOR A BUSINESS OF YOUR OWN!



**METALIZE BABY SHOES**

Add to your present income or have a full-time business. Fill huge demand for most precious keepsakes. Start at once—no big investment. Complete instructions include all processing methods. It's fun and very profitable. Start now — SEND NO MONEY — just name and address.

**KINTAVI CO., Dept. PM5612, 11029 So. Vermont, Los Angeles 44, Calif.**

\*Instructions Include Complete Kit of Supplies & Beautiful BRONZED BABY SHOE

## SAY YOU SAW IT IN POPULAR MECHANICS



# PLAY RIGHT AWAY ANY INSTRUMENT

—even if you don't know a single note now!

**NOW** it's EASY to learn ANY instrument. No boring exercises. Even if you don't know a single note now, we'll have you playing delightful pieces RIGHT AWAY—right from your FIRST lesson! And properly BY NOTE. Simple as A-B-C. Make amazing progress. No special "talent" needed. Learn at home in spare time, without a teacher. Only a few cents per lesson. Soon you can play any piece you wish. 900,000 students. (Now in our 58th successful year.)

**FREE 36-PAGE ILLUSTRATED BOOK**  
 —just send this ad, with your name and address filled in below to: U. S. School of Music, Studio 3012, Port Washington, N. Y. (No obligation, no salesman will call.)

Name \_\_\_\_\_  
 Address \_\_\_\_\_





## Miniature of Waikiki Beach Area Shows Plans for Future

Students in Cornell University's College of Architecture have finished a model of Hawaii's Waikiki Beach as it might look in the future. Aimed at preserving Hawaii's original charm while accommodating many more tourists, the model shows new park and beach areas, new hotels located to im-

prove the view and highways with cloverleaf turns to solve the traffic problems that plague the area. The remodeling project was undertaken as a class project when the instructor, Prof. Frederick W. Edmondson, learned that Hawaii in the next 10 years plans an increase of tourists from 100,000 to 280,000 a year, but found concern about congestion and deterioration in Waikiki Beach, Hawaii's major tourist asset. The model will be shipped to Hawaii for study.



## Robot Answers Phone

Job information via recorded telephone message is offered to Los Angeles applicants dialing a number listed in newspaper help-wanted ads. Requirements, and date-time-place for a personal interview are available on a day-and-night basis with this labor-saving technique.

## PREPARE FOR THE BEST JOBS

IN INDUSTRY

**TRAIN at HOME**  
IN YOUR SPARE TIME  
or at  
**ALLIED INSTITUTE**  
in Chicago

- MECH. ENGINEER
- DRAFTSMAN
- TOOL DESIGNER
- TOOL ENGINEER
- TOOL & DIE MAKER
- MASTER MACHINIST

### NO RECESSION FOR ALLIED TRAINED MEN

**MORE JOBS THAN GRADUATES** Shortages of Draftsmen, Designers, Tool Engineers, Machinists, Tool & Die Makers are so widespread that you can pick a highly paid key job and look forward to Achievement and Security.

You can begin your training in Short Courses and continue progressively to a Bachelor Degree in 26 months.

Allied is approved by Industry, Dept. of Education, Office of Public Instruction, State of Illinois, U. S. Veterans Admin., U. S. Dept. of Justice. Accredited: C. S. A.

SEND FOR  
**FREE**  
BOOKS

**ALLIED SCHOOL of MECHANICAL TRADES**  
1338-42 South Michigan Ave. Dept. PM-12 Chicago 5, Illinois

SEND ME WITHOUT OBLIGATION INFO. ON YOUR COURSES:

HOME STUDY  RESIDENT  VETERAN  NON VETERAN

NAME \_\_\_\_\_

ADDRESS \_\_\_\_\_ AGE \_\_\_\_\_

CITY \_\_\_\_\_ COUNTY \_\_\_\_\_ STATE \_\_\_\_\_

**FREE** Catalog  
on Pumps, Fans,  
Motors and Tools.

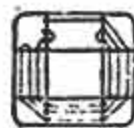

**HEATING ELEMENT**  
1320 W. - 110 V. 10"  
x 9 1/2" - make your  
own heater for Bath  
or Poultry House.  
\$10 Value **\$1.50**

**PENNA.** WHOLESALE DISTRIBUTORS  
104 N. 6th ST. PHILA. PA.

## LEARN DIESEL AT HOME

Train to specialize! Run and repair these remarkable precision machines. Opportunities world-wide. Learn tricks of trade at home; finish quickly in our big Chicago training shops. Send name now for FREE BOOK.



**UTILITIES ENGINEERING INSTITUTE, Est. 1927**  
2521 SHEFFIELD AVE., DEPT. DC-63, CHICAGO 14, ILLINOIS



## Christmas LAWN CUTOUTS

Give a cheerful greeting to passersby! These jolly cutouts are easy to make, fun to display, children love them! Just cut to pattern 1/4-in. exterior plywood or hardboard, prime, draw in features and clothing detail from pattern, paint in gay colors. That's all there is to it!

**Order These FULL-SIZE PATTERNS!**

Plan #121. Jolly Santa. Always a favorite. **50c**  
Plan #122. Sleigh & Reindeer (for lawn or roof). **\$1.00**

## POPULAR MECHANICS PRESS

Dept. 1256, 200 East Ontario Street, Chicago 11, Illinois  
RUSH  Plan #121  Plan #122. I enclose.

Name \_\_\_\_\_

Address \_\_\_\_\_

City \_\_\_\_\_ Zone \_\_\_\_\_ State \_\_\_\_\_





An Introduction to Wonderful Worlds for Young Americans!

One pound Uranium Equal to 2,600,000 pounds of coal

# the Boy Scientist



A Space Platform May Look Something Like This

## New Popular Mechanics Book Packed With Thrilling Facts and Fascinating Information

Get this thrilling Popular Mechanics book for every boy you know. In it, your own boy scientist can pore over the world-shaking discoveries in astronomy, physics, chemistry, sound, electricity, atomic theory and relativity. In the same thrilling pages, he can meet the greats of the world of science such as Galileo, Newton, Franklin, Faraday, Einstein and many others. With its help, he can participate in monumental discoveries by performing the many experiments which are suggested in the book and explained in word and picture.

## The Spark That Opens Up a New World

Written by John Lewellen, noted writer of a dozen books on science and natural history, Preface by Dr. Wilbur Beauchamp, Professor of Education, University of Chicago, who says "the Boy Scientist may well be the spark that starts some boy on the way to becoming a scientist and the Nation's need for scientists is very great."

## Finest Gift for Boys Use "Money Back" Coupon

Is there a boy in your family? Then get him the Boy Scientist. It could be one of the most important books he ever reads. Want to send the supreme gift to some boy you know? Then give him the Boy Scientist too. There is no finer gift for any occasion. Sent postpaid to any address for only \$3.95. Order on Money Back coupon now. If not immensely pleased with the book return in 5 days and the entire purchase price will be refunded.



## Meet These Greats . . . Know Their Achievements

- Galileo . . . the first modern scientist
- Newton . . . the law of gravity and famous three laws of motion
- Boyle . . . and how gases behave
- Archimedes } . . . and
- Pascal } liquids
- Bernoulli } . . . and light
- Huygens } . . . and electricity
- Benjamin Franklin } . . . and electricity
- Bequerel . . . radioactive fog
- Einstein . . . theory of relativity
- Rumford . . . heat
- Mersenne . . . the laws of sound
- Tomorrow . . . will bring new discoveries



Prepared in the famous Popular Mechanics easy-to-read and easy-to-understand style. Adults too, will find this a fascinating book.

Library Cloth Binding  
6 3/4 x 10 in.  
264 Pages  
277 Illustrations

## Use This "On Approval" Coupon

POPULAR MECHANICS PRESS

Dept. 1256, 200 E. Ontario Street, Chicago 11

Send at once \_\_\_\_\_ copies The Boy Scientist, \$3.95 each. I understand I may return books in 5 days and you will refund full purchase price.

- Remittance for \$\_\_\_\_\_ enclosed. Send postpaid.
- Send COD. I will pay postman.

Name \_\_\_\_\_

Address \_\_\_\_\_

City \_\_\_\_\_ Zone \_\_\_\_\_ State \_\_\_\_\_

# NEW MIRACLE MONEY SPRAY

PLAIN FINISH WORTH 60¢

SPRAYED FINISH worth \$2.50

EARN 400% PROFIT Spraying Anything at Home

## SPRAY ANYTHING for BIG PROFITS!

Instantly! you can spray plain finished things such as lamps, figurines, signs, cards, glasses, novelties—ANYTHING, into beautiful rich textured items that sell for expensive prices. You'll be amazed!

**MAGIC NEW MICRO FLUFF INVENTION.** If you've ever felt rich expensive velvet, you'll know how this amazing spray feels to the touch. Now, we have developed an exclusive discovery that lets you hand-spray anything with this startling material (in over 24 brilliant and fluorescent colors too). OVER 5,000 BIG PROFIT USES IN EVERY TOWN AND CITY IN AMERICA.

**START IN YOUR OWN HOME.** You don't need big capital, expensive machinery or inventory to start spraying micro-fluff for profit. Any-

one can change cheap items into beautiful expensive merchandise right on any table in his home. That's all you need.

**EARN UP TO \$15.00 PER HOUR AT HOME.** It's easy and fun once you learn the secrets. Already, we are getting letters like Mr. Hoover's stating he's earning \$10,000 a year from a spare time start. Many say "swamped with orders already."

**WE SUPPLY EVERYTHING** you need to start earning Big money with our amazing New Discovery Right Now—TODAY!

**FREE! BOOKLET, Home-Profit SECRETS, and FREE SAMPLE KIT (16 fabulous colors) ALL FREE!**



COAST INDUSTRIES, Dept. B-12 Los Angeles 61, Calif

**RUSH** coupon today if you are interested in a startling new Big Profit home-business and if you are 18 years or older.

## SUPPLY LIMITED—RUSH COUPON TODAY!

COAST INDUSTRIES (Home-business Division) DEPT. B-12 Los Angeles 61, California

PLEASE RUSH FREE BOOKLET, FREE SAMPLE KIT—everything!

Name \_\_\_\_\_ Age \_\_\_\_\_

Address \_\_\_\_\_

City \_\_\_\_\_ State \_\_\_\_\_

## "ONE EVENING PROJECTS"

NEW DELTA hard cover book features more than 90 different projects, each designed to be built in just one evening—only \$1.00. Also get FREE folder on entire Delta Library: Delta Power Tool Div., Rockwell Mfg. Co., 502M N. Lexington Ave., Pittsburgh 8, Pa.

## SAY YOU SAW IT IN POPULAR MECHANICS

2 1/2 in. Heavy Duty WIRE WHEEL

Fits Any Elec. Drill. 1/4 in. chuck. Removable Arbor.



## IRREPLACEABLE ITEM!

Act Now! For HI-SPEED BUFFING and GRINDING Inner Tubes, Wood, Metal, Rubber. Money Back Guarantee!

\$2.69 VALUE NOW \$1.33 EACH POSTPAID  
3 for \$3.90 POSTPAID  
6 for \$7.60 anywhere in the U.S.A.  
12 for \$15.00

10,000 Mile Guaranteed SPARK PLUGS ea. 29¢

Reg. 89¢ Value SAVE NOW!



Box of 6 . . . \$2.20  
Box of 8 . . . \$2.90

You Can't Buy Better Service for All Cars—Remanufactured, Laboratory Tested—Meets Gov't standards. Sent POSTPAID.

KAPLAN'S 1499 MARKET STREET San Francisco 3, California

AC, Auto Life Champion

MAIL ORDERS Send Check or P.O. Money Order—State Make and No. of Cylinders We Pay Postage





Alaskan fire department's pumper is driven to hole in ice and suction hose is dropped through oil to water

Finding a water supply with which to combat fires when temperatures drop to 20 and 30 degrees below zero is the problem of fire fighters in Alaska. One fire chief solved it by cutting a hole through the 36-inch ice on a lake near his town and inserting a 55-gallon oil drum. Both ends were removed from the drum which was filled with diesel oil. Floating on the water, the oil keeps the water below from freezing. When water is needed for fire fighting, a pumper is brought near the ice hydrant and a suction hose is dropped down through the oil into the water.

## Water From Frozen Lake Fights Fires

Oil drum buried in 36-inch ice is filled with oil to prevent freezing



## Paint Repels Engine Heat

Heat-resistant paint developed by the Army Engineers has proven itself on diesel-engine-exhaust systems. Laboratory tests show the paint to be in perfect condition after 1200 hours of exposure to temperatures above 1400 degrees. In field use, the paint looked no different after 18 months of high temperatures. The paint is brushed or sprayed on. It air-dries in an hour or can be cured by the heat of the engine.

## Hot Water Sprouts Cotton

Cotton seeds are being given hot-water baths to make them sprout. Pima S-1 cotton seeds, a high-yield variety, have a hard covering which causes slow and irregular germination. Studies at the University of California at Los Angeles show that a one-minute immersion of the seeds in water at 185 degrees F. will make most of the seeds germinate within a period of two or three days.



**DO IT YOURSELF BUT DO IT BETTER  
WITH THE RIGHT MATERIALS!**

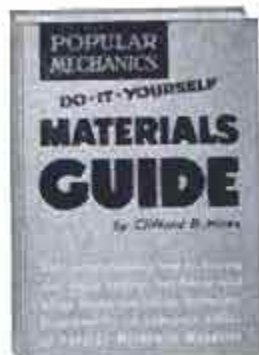

**Get  
Popular  
Mechanics  
DO-IT-YOURSELF  
Materials  
Guide**

**The Key to Buying and Using  
Lumber, Hardware and Other  
Home Workshop Materials**

The right lumber. The right grade. The right fastenings, nails, screws, glue and other hardware. These are all just as important as the right design and the right kind of workmanship. It's true, whether you're fixing up the house, making a fine piece of furniture or knocking out a time-killing gadget. Get Popular Mechanics Materials Guide. Fills a long-felt need of home owners and home workshop fans. Has how-to-do-it information too. Send only \$2.95 for postpaid delivery. Money back if you want it in 5 days.

**You Need This**

How to select and how to use—Lumber, millwork, plywood and hardboard—Exterior wall and roof materials—Hardwood floors and floor coverings—Wall and ceiling materials—Doors, windows, screens and weather stripping—Glass, the material of tomorrow—Plumbing pipes and fittings—Electrical equipment—Nails, screws, bolts, etc.—Hinges, locks and other hardware—Paints and miscellaneous products.

192 Fact filled pages.  
667 how-to-do-it pictures

Popular Mechanics Press, Dept. 1256, 200 E. Ontario St., Chicago 11



Now—at moderate size—a completely livable modern home for the 3-, 4- and 5-children family. Beautifully planned throughout: eliminates crowding by a unique balance of adult and child living areas in just 1350 sq. ft. Features 4 bedrooms, 2 bathrooms, a feeling of space and convenience missing in many larger conventional houses. Can be built with partial basement—or on full concrete-slab foundation.

**Easy, Inexpensive to Build**

All necessary materials are standard and obtainable in any lumberyard. This design saves on materials, materials cost, lot cost and labor—gives you a truly outstanding home for comfortable big-family living.

**Low in  
Cost...  
High in  
Privacy**

A split-living home so well designed each family member can have privacy and space for himself!

**POPULAR MECHANICS PRESS, Dept. 1256  
200 E. Ontario Street, Chicago 11, Illinois**

Send at once Plans for the Big-Family House.

Complete Set of 7 Blueprints . . . \$12.50

Remittance enclosed  Send COD (postage extra)\*

Name \_\_\_\_\_

Address \_\_\_\_\_

City \_\_\_\_\_ Zone \_\_\_\_\_ State \_\_\_\_\_

\* No COD's outside U.S.A.

**PRACTICAL GIFT FOR THE  
MAN AROUND THE HOUSE**

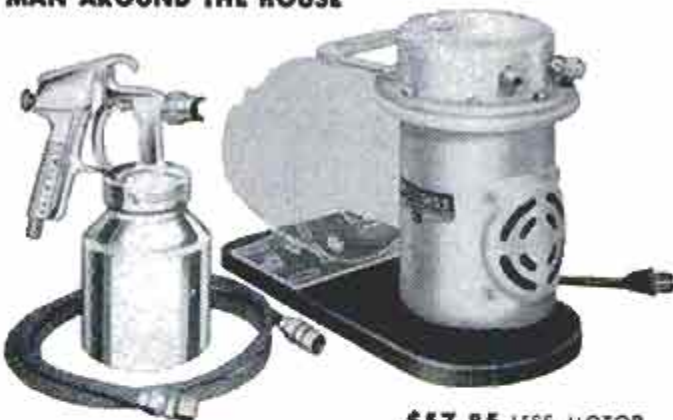

**\$57.85 LESS MOTOR  
(\$59.60 WEST COAST)**

**DEVILBISS "TUFFY"  
HOME SPRAY OUTFIT**

**TAKES THE PAIN OUT OF PAINTING**

Lets you spray-paint indoors or out. Beautiful, full-covering coats on even the toughest jobs—shutters, grill work, ornamental mouldings!

Refinish toys and furniture. Spray-wax floors and cars. Moth-proof garments. Blast dust from furs, grills, rugs, and other hard-to-clean objects. Inflate tires and beach toys.

Save time and effort on hundreds of shop and household jobs. See the "Tuffy" now . . . at your favorite paint store, or hardware . . . or at leading automotive jobbers. Check your yellow pages.

**BUILT TO PROFESSIONAL STANDARDS**

- Outfit includes gun, 1 qt. cup, 12 ft. hose, 1/4 hp compressor, electric motor (optional)
- Rugged, simple in construction
- No exposed belts, pulleys, flywheels
- Delivers clean, oil-free air—pressure adjustable
- Ball-type main bearings—shielded, permanently lubricated

This powerful "Tuffy" Outfit atomizes even heavy-body paints; sprays with a full wide pattern. Operates hour after hour under load without fatigue, and provides maximum pressure with minimum pulsation and vibration.

**THE DEVILBISS COMPANY**

Toledo 1, Ohio

Santa Clara, Calif.

Barrie, Ontario

London, England



Branch Offices in Principal Cities



# Mammoth 1957 Wholesale Tool Catalog

**\$1.00**  
puts You In  
Business

The opportunity now awaits you to own and operate your own business on a part time or full time basis in the lucrative field of **HARDWARE, HAND TOOLS, FANS, POWER TOOLS, MOTORS, PAINTS, etc.,** or **BUY TOOLS FOR YOUR INDUSTRIAL OR INSTITUTIONAL USES.**

## TOOL CATALOG



YOUR NAME



Buy Nationally Advertised Tools for Resale or Industrial or Institutional Use  
**NO INVESTMENT REQUIRED. BUY AS YOU NEED IT. A MILLION DOLLAR INVENTORY AT YOUR FINGER TIPS.**

Discount  
UP TO **50%**

\$1.00 refund on first purchase or refund if you are not 100% satisfied.



Every one needs tools. Meet the demands of the growing "Do-it Yourself" markets. Sell direct from the jumbo buying guide—your cost is known only to you.

ENCLOSE \$1.00 FOR DEALER'S 1957 MAMMOTH TOOL CATALOG.

**JUST FILL OUT  
COUPON**

**SILVO HARDWARE COMPANY**  
Dept. PM-12, 108 Market St., Philadelphia 6, Pa.  
I am enclosing \$1.00. Rush me your dealer's Mammoth Catalog Today. If I am not completely satisfied with your plan, I understand that I can return the Dealer's Catalog for refund, and if I decide to order, my \$1.00 will be deductible from my first order.

NAME .....

ADDRESS .....

CITY ..... ZONE ..... STATE .....

## WHERE-TO-BUY-IT INDEX

Source of supply appears after items commercially available

### AUTOMOTIVE

- Both tire beads broken at once..... 85
- Italian designers plan 125-m.p.h. bus of tomorrow..... 115
- Cantilevered "rear balcony" carries 500 pounds of luggage..... 117
- Renault's experimental gas-turbine car has speed of 200 m.p.h. .... 131
- Engine of test truck slides out for servicing (Schipper Associates, 99 W. Bethane, Detroit 2, Mich.)..... 148

### AVIATION

- Rocket engines assist take-off of big British bomber..... 48
- Air-to-ground loudspeaker guides paratroopers (Frank Judd, Illinois Institute of Technology, Chicago 16)..... 68
- Test chamber simulates flights at 150,000 feet (Air Research and Development Command, USAF, Box 1396, Baltimore, Md.) ..... 75
- Air Force freighter sets new load record of 27,000 pounds... 114
- Tiny TV camera relays pictures of plane's moving parts... 114
- Hot-water rockets to assist take-offs..... 115
- Umbrella-type radar antenna mounted on Super Constellation ..... 122
- Telescoping tunnels help load cargo planes faster..... 125
- Heat wirts airplane model during "thermal barrier" tests... 130
- Quick-change kits convert helicopter for different uses (Bell Aircraft Corp., P.O. Box 482, Fort Worth, Tex.)..... 144
- Convair rocket sets record..... 145
- Barrel-shaped airplane tires permit rough-field landings... 146
- Airport plane movements..... 155
- Fast-take-off rocket ..... 266

### BOATING, FISHING AND HUNTING

- Automatic fish trap uses river power to net salmon..... 87
- Dutch houseboat sports a built-in garage..... 100
- Hand-held foghorn for boat skippers operates on gas cylinder (Falcon Alarm Co., Inc., Summit, N. J.)..... 116
- Plastic poured into molds forms fishing lures (Clinton Sales, Inc., Cleveland, Ohio)..... 123
- Mile-a-minute "sports car on water" has 80 horsepower (Kiekhaefer Corp., 560 S. Hickory, Fond du Lac, Wis.)..... 125
- Fishing lure (Kingfish Lures, 20405 Martin Road, St. Clair Shores, Mich.) ..... 130
- Duck decoy takes beating and springs back to shape (McBell Enterprises, Inc., Racine, Wis.)..... 131
- Duck call for hunters requires no blowing (Scotch Game Call Co., 13721 Brush St., Detroit 3, Mich.)..... 131
- Giant Drake ..... 136

### CONSTRUCTION

- Load-bearing window unit serves as wall panel (Fabricators, Inc., South Norwalk, Conn.)..... 50
- Window with Z-profile has rainproof vents (The Apache Co., Inc., 410 E. Magnolia Ave., Fort Worth, Tex.)..... 68
- Roofer's hoist saves time..... 85
- Prefab church built for \$28,000 (United States Steel Homes, Inc., Harrisburg, Pa.)..... 86
- Humpback bridge has built-in dip..... 95
- Dutch lowland roads rest on wood shavings..... 99
- Mechanical lifters raise wall sections into position (Marvin W. Coleman, 4140 Syracuse, Dearborn, Mich.)..... 108
- 43-Story skyscraper on floating foundation..... 117
- Concrete vibrator contains motor (Master Vibrator Co., 165 Stanley Ave., Dayton 1, Ohio)..... 141
- One-piece steel roof covers auditorium..... 153

### HOUSE AND HOME

- Do-it-yourself carport (Childers Mfg. Co., P.O. Box 7447, Houston, Tex.) ..... 106
- What's New for Your Home—
- Two-in-one oven..... 142
- Snap fasteners will stay closed..... 142
- No-stoop dustpan..... 142
- Unused space under beds put to work..... 142
- Ring-type clothespins adjusted for tension..... 143
- Washer-drier equipment fits narrow space..... 143
- Fast peeler cuts thin strip..... 143
- Furniture kit needs only screwdriver and hammer..... 143
- Santa Claus express encircles home during holidays..... 156

### MISCELLANEOUS

- Germicidal lamp for ductwork (Everett Engineering Co., 1073 S. Second St., Abilene, Tex.)..... 50
- Miniature of Waikiki Beach area shows plans for future..... 70
- Robot answers phone..... 70
- Water from frozen lake fights fires..... 72
- Hot water sprouts cotton..... 72
- Paint repels engine heat..... 72
- Coin-size hearing aid is self-contained (Maico Co., Minneapolis, Minn.) ..... 79
- Marines erect large, air-conditioned, glass-fiber "igloo"..... 85
- Brow lamp focuses light on worker's hands (Leonard Lesley, Morton's Dept. F92, 312 7th St., N.W., Washington 4, D.C.)..... 86

(Continued to page 76)



## Test Chamber Simulates Flights at 150,000 Feet

Latest test chamber developed by the Air Research and Development Command can simulate flights at altitudes in excess of 150,000 feet, and will be used to study

the effect of high-altitude flying on pilots, their protective equipment and instruments. Large windows make it possible for observers to see into the chamber during tests, and air conditioning maintains a constant temperature within the chamber during its operation. Automatic controls maintain atmospheric conditions at the selected altitude. The new test chamber is the first in which explosive decompression tests can be run. These tests simulate the blowing off of a canopy at high altitudes.



Ⓞ A survey of 20,478 wild-cat oil holes that had been drilled in 17 states from 1945 to 1949 shows that only 1 in 11.9 discovered oil or gas, 1 in 14.9 found oil and 1 in 42 discovered as much as 1,000,000 barrels of recoverable oil reserves.

## All About TELEVISION



**How to  
Replace Tubes  
Install Antennas  
Make Adjustments**



### Cut Down Repair Bills ... Prevent Trouble

John Derby, well-known TV engineer, tells and shows you how to save money on the servicing and repair of your TV set. He shows you just how you can locate trouble, and in most cases make repairs yourself in the matter of minutes.

### Special Picture Section SHOWS You HOW to Locate Trouble

A special chapter contains actual photos of defective TV pictures. You merely compare the picture on your screen with pictures in the book, find the trouble at once and directions which tell just how to fix it. The very first time you use the TV Repair Manual your savings will exceed the small cost of the book. Order your copy now. Your money back in 7 days if it isn't entirely satisfactory.

**POPULAR MECHANICS PRESS, Dept. 1256  
200 E. Ontario St., Chicago 11, Ill.**

Send at once my copy of the TV Repair Manual. Remittance for \$3.00 enclosed. If it isn't entirely satisfactory I may return it in 7 days for a full refund.

NAME \_\_\_\_\_

ADDRESS \_\_\_\_\_

CITY \_\_\_\_\_ ZONE \_\_\_\_\_ STATE \_\_\_\_\_

Send C.O.D. (U.S.A. only). Postage extra.



**DO YOU EARN  
\$125 PER WEEK?  
Hundreds of our  
GRADUATES Do**

Auto and Diesel repair shops today are short of trained mechanics. THINK why? More cars and trucks on the road than ever before. And the government is now starting its huge road building program—super express, coast to coast highways, making even more diesel jobs to maintain diesel road building machinery. Our graduates have been in demand by the best garages for 37 years.

**WE TRAIN YOU** for these top-paying jobs. Shop training on a splendid variety of both gas and diesel engines, automatic transmissions, engine analyzers, electrical testing machines, injection pumps, calibrating equipment, etc. G. I. APPROVED.

#### Other courses:

#### **BODY & FENDER — WELDING**

These are also top-paying trades offering good futures and often lead to your own business.

Students from all states in the union and 24 foreign countries ... NOT A CORRESPONDENCE COURSE.



**Earn While You Learn** . . . . .  
Day & night courses—we help night students get jobs. Most courses start monthly. Write today for full particulars.

#### **NASHVILLE AUTO-DIESEL COLLEGE**

226 7th Ave., N.

Dept. 75

Nashville 3, Tenn.



# 1957 ALLIED ELECTRONIC SUPPLY CATALOG

# free!

356  
value-packed  
PAGES

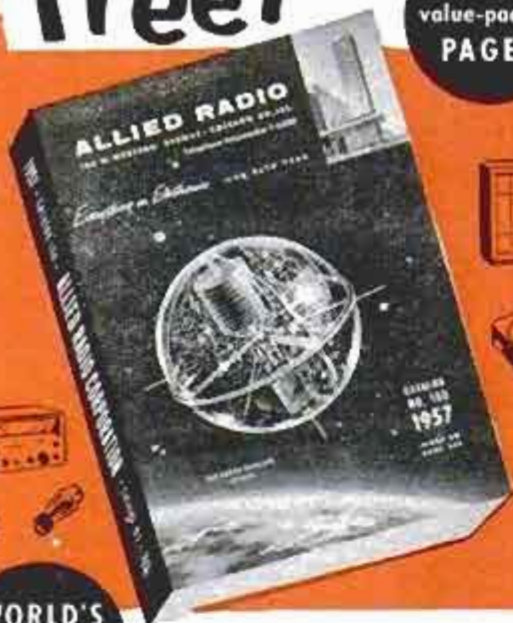

WORLD'S  
LARGEST  
STOCKS

SAVE ON EVERYTHING  
IN ELECTRONICS

Everything for Experimenters, Builders,  
Amateurs, Servicemen, Engineers  
and Hi-Fi Hobbyists

Save on *everything* in Electronics:  
Hi-Fi systems and components;  
latest builders' kits (see the famous  
KNIGHT-KIT line); recorders and phono  
equipment; TV tubes, antennas, accessories;  
Amateur station equipment; P.A. systems;  
test instruments; industrial electronic  
supplies—plus *everything* in parts, tubes,  
transistors, tools and books. Get more for  
your money—send today for your FREE  
1957 ALLIED Catalog!

Everything in Electronics  
From One Reliable Source

Send  
for FREE  
Catalog

ALLIED RADIO

ALLIED RADIO CORP., Dept. 5-M-6  
100 N. Western Ave., Chicago 80, Ill.

Rush FREE 1957 ALLIED 356-Page Catalog

Name \_\_\_\_\_

Address \_\_\_\_\_

City \_\_\_\_\_ Zone \_\_\_\_\_ State \_\_\_\_\_

(Continued from page 74)

Flexible case	87
Electronic eye helps blind switchboard operators	99
Truck bodies travel piggyback	100
Flexible padlock of steel cable (Chris Dist. Co., P.O. Box 1357, Modesto, Calif.)	106
Large scoreboard posts kibitzers on progress of bridge match	108
Snorkel simulator tests sub detectors	115
Camera uses telescope as telephoto lens (Bausch and Lomb Optical Co., 635 Paul St., Rochester, N. Y.)	116
Applause heats the "Met"	117
Backward truck becomes versatile farm derrick	123
Double-barreled camera shoots distant deer	124
Spiked frame atop tower bars fish-dropping gulls	124
Triple-deck train bunks	130
Infrared eye fights back at bullets	137
Colored lights teach piano (Janssen Piano Co., 237 E. 23rd St., New York City 10)	140
Concrete blocks made in minute (Minit-Mould, Box 21, Tonawanda, N. Y.)	140
Multiple piano	140
Container on hoist becomes truck (Borg-Warner International Corp., Ingersoll Kalamazoo Div., 1810 N. Pitcher St., Kalamazoo, Mich.)	141
Truck refrigerator is self-powered	141
Frogmen recovered from water by giant "slingshot" (All American Engineering Co., Box U.S.S. 2658, Du Pont Airport, Wilmington, Del.)	148
One-man loading with truck crane	148
Tractor opens gate in electric fence	154
Helmet for GIs contains two-way radio	154
Inflatable rubberized tent serves for storage or shelter	155
Toy warfare goes modern with electronic cannon (Ny-Lint Tool and Mfg. Co., Rockford, Ill.)	155
Toy fire engine really pumps water (Tonka Toys, Inc., Mound, Minn.)	156
Christmas-tree bagger	256
Find 40-million-year-old eggs	258
"Stained-glass window" (Leisure Ind., Dept. B20, 96-09 Metropolitan Ave., Forest Hills 75, N. Y.)	260
Glass triangles reduce noise (L.O.P. Glass Fibers Co., Toledo, Ohio)	260
Aluminum expansion poles (Grover Photo Products, 341 Arden Ave., Glendale 3, Calif.)	262
Electronics lick heat barrier	262
Pure silicon for hot missiles	268
Heater softens plastic	268

## Radio-Television, Electronics

New Products: Portable handset telephone amplifier (Fisher Research Laboratory, Inc., 1961 University Ave., Palo Alto, Calif.); remote control television tuner (Alliance Mfg. Co., Inc., 100 Lake Park Blvd., Alliance, Ohio); electrostatic speakers (Pickering & Co., Inc., 309 Woods Ave., Ocean-side, L. I., N. Y.); record Dis-Charger (Mercury Scientific Products Corp., 1725 W. 7th St., Los Angeles 17, Calif.); hi-fi record file (Norpine Corp., Chambersburg, Pa.)	157
Magic mike wireless broadcaster	158

## SCIENCE

X ray pictures entire mouth	106
Ice not necessary for rain	116
X-ray trees to find decay	122
Roaming railway car may preserve food by irradiating it	129
Surveyor's radar measures 50 miles at a crack	129
Plaster helmets insure accuracy in treating cancer	135
Water purifier (Olin Mathieson Chemical Corp., 460 Park Ave., New York City 22)	154
Samples of air brought from space	240
Loudspeakers to give tornado warning	252

## Craftsman and Shop Notes Index

### CHRISTMAS DECORATIONS

Three-dimensional star ornaments made from aluminum or tin foil	167
Glass Christmas-tree ornaments shatteredproofed with shellac	184
Conical Christmas ornaments	188
Gifts hung on Christmas tree with drapery hooks	188
Christmas-tree rotator	188
Paper-backed aluminum foil is metallic gift wrapping	191
Foli streamers for decoration	196
Paper-clip ornament hangers	201
Aluminum-foil decorations applied on gift packages	201

### FARM

Horseshoes on tractor chains improve traction on ice	212
Pump house warmed by heat lamp ends worry over frozen pipes	212
Barn-door stanchion gate	220

### HOUSE AND HOME

Wall-type magazine rack held at eye level	167
Handy snack tray for serving television viewers	168
Ornamental shadow box	175
Two-tone candle holder	185

(Continued to page 78)



**CHROME VANADIUM 60 Pc. Set WIRE GAUGE  
29 Pc. DRILL SET CHROME VANADIUM DRILLS**



Specialty made for speed drilling in sturdy plastic tool roll. Finest alloy steel drills hardened and precision ground to the sharpest, longest lasting cutting edge obtainable; will easily and cleanly bite through hardwoods, plastics, aluminum, iron and the toughest steels. Unconditionally guaranteed for thousands of drillings. Full jobber length. Sizes by 64ths from 1/16" to 1/2". NOW . . . . \$6.49 ppd.



Top quality high test Chrome Vanadium Drills designed for speed drilling through toughest steels, woods, plastic, iron and aluminum. Precision ground, long-lasting cutting edges. Guaranteed to give years of satisfaction. A full 60 pc. set, Nos. 1 through 60. A \$14.95 value—NOW ONLY . . . . . \$5.40 PLUS 35c PP. & HDLG.

Same set above available with Hult Metal Index container. Only . . . . \$6.65 PLUS 35c PP. & HDLG.

Send Check or M.O. C.O.D. fee extra. MONEY BACK GUARANTEE

SCOTT-MITCHELL HOUSE, INC. DEPT. M-274, 611 BROADWAY NEW YORK 12, N. Y.

**WHEN SENSES DULL YOU NEED HULL**

**AUTO COMPASS**

One of the common causes of lost directions is reduced alertness as miles roll by. Wrong turns are almost inevitable—unless you drive by Hull, the world's most widely used auto compass. At your dealer's or write for literature.

*BaconLite* '6.50

*Streamline* '4.95

HULL MFG. CO. P. O. Box 246-D12, Warren, Ohio



**x-acto**

KNIVES • TOOLS  
HANDICRAFT KITS



NO. 77  
VIZI-DOME  
WOODCARVING  
SET \$3.60

X-ACTO, INC.  
48-41 Van Dam St.  
Long Island City, N. Y.

Send 20¢ for 28-page Catalog

**SEND ME**



every month so I am sure to see each new issue. Here's

- \$3.50 for 1 year
- \$8.00 for 3 years

name \_\_\_\_\_

address \_\_\_\_\_

city \_\_\_\_\_ zone \_\_\_\_\_ state \_\_\_\_\_

Hand this order to your newsdealer or send it to

**POPULAR MECHANICS**  
200 East Ontario St. Chicago 11, Ill.

**Any man will enjoy new**

**AIROGRATE  
YELLO-BOLE**

**1. Smokes sweeter!**  
Imported briar bowl lined with real honey. Starts caking the instant you light up. Hence, no break-in.

**2. Smokes drier and healthier!** Metal grate condenses moisture, tars, nicotine. No wet heel.

**3. Smokes cooler!** Air-vented chamber draws in fresh air. Aluminum fins and shank throw off heat, cool the smoke.

Famous honey-lining! **\$250**

Extra interchangeable bowls—\$1.25 each

"Icepak" Set—Airopak Yello-Bole Pipe plus two extra bowls, \$5.00

FREE BOOKLET! "How to enjoy a pipe." Write Yello-Bole, Dept. 24, New York 22

BY THE MAKERS OF KAYWOODIE PIPES

**NOW—THE QUICK-WAY TO SHARPEN ALL CIRCULAR SAWS**

**NEW**

Model PG-12 sharpens joints, gums, and retoothes all cross cut, rip, combination, miter, and planer blades up to 12" in diameter. Two precision index plates give versatile, accurate sharpening. Guarantees precise spacing of teeth. New safety rest prevents tilting and gouging of blade. Save time and money. Special \$3.00 grinding wheel also included for use on your own power table. Fits regular or radial swing tables.

Model PG-12 Complete No extras to buy. **\$16.50** Postage Paid

Order today. Send check, cash, or money order. We pay postage. FREE Booklet—"How To Sharpen Saws."

**QUICK-WAY SAW CO.**

136 TOMPKINS ST. CORTLAND, N. Y.



# Forney Family

of REPAIR UNITS  
WELD - BRAZE - SOLDER - CUT - BORE HOLES - HARDFACE  
Also  
Thaw Frozen Water Pipes has Plug-ins for electrical appliances



MODEL  
F-75  
\$59.50  
COMPLETE WITH  
ACCESSORIES



Hand  
Portable  
POWER  
PACKED  
for use on  
115 Volt Line

NEW!  
BATTERY  
CHARGER  
\$49.50

3 Charges—Slow, Medium  
and Fast for both 6 volt  
and 12 volt Batteries.  
Heavy Duty for use with  
most Forney Repair Units

Automatic  
overload  
protection

FAMOUS FORNEY

MODEL "C"

180 Amp Unit meeting REA,  
REMC, and NEMA requirements  
A complete Repair Shop in itself.

MODEL C-B

250 Amp Unit—Everything nec-  
essary in power and range —  
30 heat stages. Uses rods 1/16" - 3/16"



ALSO INDUSTRIAL UNITS

Model I  
350 Amp

Model A  
300 Amp

Model B  
250 Amp



WELDER - CHARGER  
COMBINATION

NEW!  
D-130

operates on  
115 or 120  
volts



IN ADDITION A complete  
line of welding supplies and  
accessories.

WRITE FORNEY ARC WELDERS  
FORT COLLINS, COLORADO

SALES OFFICES throughout U. S. A and Canada  
with openings for full - time qualified men for  
sales positions.

FORNEY - AVIATION DIVISION  
Proudly presents the new  
FORNEY AIRCOUPE  
All metal — 90 HP. — Spin-proof  
Modern two-tone coloring  
ASK ABOUT IT!



(Continued from page 76)  
HOUSEHOLD HINTS

Wire cutter pulls licks.....	176
Fabric-covered frame dresses piano back.....	177
Solving Home Problems—	
Wax-paper strip prevents Thermos-bottle cork from loosening.....	178
Halves of wooden clothespin hold dustpan.....	178
Sponge-rubber ball pressed over garment-hanger hook.....	178
Cake tin is made into Lazy Susan.....	178
Paper doily makes novel cake decorator.....	178
Paper cup molds nontip party candles.....	178
Squeaking closet-door hinges lubricated with soap.....	179
Lemon juice and salt bleach breadboard.....	179
Drawer dividers of unusual construction.....	179
Metal legs fitted with crutch-tip "silencers".....	179
Prevent leather tongues of hiking shoes from slipping.....	179
Cake tin filled with hot water keeps food warm.....	179
Bubble lamp on switch plate.....	180
Ordinary house bricks become decorative book ends.....	180
Tumbler serves as "spotting block" when removing stain from cloth.....	180
Knife frees sticking piano keys.....	184
Prick punch tightens loose screening in aluminum frame.....	184
Ready-made napkin rings.....	190
Proper humidity protects both health and home.....	190
Washers level furniture to prevent wobbling.....	191
Measuring spoons and cups aid in preparing medicines.....	201
Removing tight-fitting cork.....	202
Modern "silver fox" finish for hardwood furniture.....	204
Adjustable eyebolts eliminate sagging clothesline.....	204

MISCELLANEOUS

Wall-mounted aquarium made from TV lens.....	167
Car-trunk lock altered to permit removal of key when lock is open.....	169
Twin easel provides ample work space for two young artists.....	169
Power-line insulators become novel candleholders.....	176
Clothespins replace thumbtacks on "bulletin board".....	180
Aluminum reflector for portrait photography.....	190
Clothespin floats boat key.....	190
Marble game quickly improvised for evening's fun.....	191
Electronics probing tweezers are excellent print tongs.....	196
Hardware cloth permits wheel traction on ice.....	196
Better blueprint reproduction: with colored carbon paper.....	196
Small hektograph duplicator.....	196
Checkbook used as photo album.....	201
Aluminum-foil drapery "linings" keep trailer interiors cooler.....	202
Rubber band holds toothpick on bottle neck when pouring.....	204
Rubber tip holds cane on edge of table.....	204
Heat restores ink flow.....	207

TOOLS

Lazy Susan keeps small tools handy.....	168
Christmas Shopping for Tools—	
Boy-size tool chest.....	208
Portable electric drill.....	208
Portable electric handsaw.....	208
Tilting-arbor saw.....	208
Portable router.....	208
New bench-type circular saw.....	209
Radial saw.....	209
Jigsaw.....	209
Tool tote.....	209
Jigsaw has built-in motor.....	210
Oscillating sander.....	210
Vibrator-type motor drives jigsaw.....	210
Floor-type circular saw.....	210
Microscope.....	210
Metal-turning lathe.....	211
3-wheel bandsaw.....	211
Cold-glue injector.....	211
Portable electric saw and drill kit.....	211
Combination power shop.....	211
Expanding lathe mandrel is quick acting.....	212

WORKSHOP HINTS

Light bulb kept tight.....	168
Determine area of odd shape by weighing hardboard cutout.....	168
Shield protects wooden surface from glancing hammer blow.....	169
Broken chair rung repaired with dowel and coil spring.....	176
Application from shoe-polish can prevents rust on tools.....	176
Easy way of locating screws when silencing squeaky floors.....	177
Handle for razor-blade scraper.....	184
Removing an asphalt tile.....	191
Keep wooden pegs around shop for miscellaneous uses.....	201
Dowel inserted in hose provides toy wheels.....	202
Improvised surveying level requires only pail of water.....	207
Steel wool grips tubing in vise.....	212
Cross-drilling registering holes in round stock.....	217
Magnetic tray separates parts.....	217
Safety switch for home workshop.....	217
Surface grinder work kept cool in soluble oil and water bath.....	217
Notched eraser polishes rods.....	220
Roller chain clamped in vise holds pipe for threading.....	220
Rubber tip on speed indicator provides better shaft contact.....	220



REPAIR YOUR OWN  
HOME HEATING SYSTEM

... save  
money  
with

**DEVCON**

THE PLASTIC STEEL  
80% STEEL — 20% PLASTIC

DEVCON, the mending marvel, handles like modeling clay . . . hardens in 2 hours even under water . . . no shrinkage . . . bonds to iron, brass, aluminum, wood, glass, concrete . . . most any clean surface.

For home, farm, garage or marine use . . . DEVCON fixes leaks, cracks and breaks in radiators, tanks, pipes, boiler jackets . . . just about any type of repair! Easy to use, DEVCON will save you hundreds of dollars.

Home Kit — enough for several projects — \$1.98

Also — 1 lb. package for big jobs — \$3.95

Buy it now at leading hardware, hobby and specialty stores — write for free booklet on home repairs.



**DEVCON CORP**

175 Endicott St., Danvers, Mass.

**WRITE FOR FREE CATALOG**

of Thor SpeedTools, the finest power tools ever built for home use.

**THOR POWER TOOL CO., AURORA, ILL.**



### Coin-Size Hearing Aid Is Self-Contained

You can carry a new thumbnail-size hearing aid like a coin in your pocket and flick it into your ear for a hearing boost in crowds, meetings and theaters. The cordless instrument is designed to correct up to 60 percent of all hearing losses. An aspirin-size battery that fits into the back of the unit powers a circuit that includes match-head-size transistors and condensers as small as tapioca bubbles. Assembled with precision tools under a magnifying glass, it is believed by its manufacturer to be the smallest hearing aid in the world.



## Straight or Curved... PAINT EDGES ARE CLEAN with Behr-cat<sup>®</sup> BRAND Masking Tape

Get an expert paint job with this flexible tape. Follows straight or curved lines, flat or uneven surfaces. It's thin — prevents paint build-up at edges. It's strong — strips off cleanly.

The Behr-cat dispenser box delivers tape fast. The built-in cutter tears tape evenly at the right length. You work quickly, neatly.

Pick the right tape for the job. Look for the Behr-cat display rack at your paint or hardware dealer's. There's a variety of masking tape sizes that are also tops for wrapping, bundling, fastening, reinforcing and repairing.



C-8

Plant and Main Office, Troy, N. Y.



**BEHR-MANNING Co.**

a division of  
NORTON COMPANY

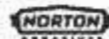

BEHR-MANNING PRODUCTS: Coated Abrasives • Sharpening Stones • Behr-cat Tapes  
NORTON PRODUCTS: Abrasives • Grinding Wheels • Grinding Machines • Refractories





Carl Kiekhaefer gets more power from his Chrysler-built cars with 5-rib Champion spark plugs. He's shown here with two of his big racing winners and part of his remarkable trophy collection

## Big winner in stock car racing uses Champion spark plugs!

And Champions can give your car more power, too! If you've gone 10,000 miles without a spark plug change, they can increase your road horsepower by 24%!

Whether you drive for prizes or pleasure, Champion spark plugs can give you *more road horsepower!*

Carl Kiekhaefer and his drivers—one of the winningest teams in stock car racing history—know this well. That's why they use Champions in all their record-smashing Chrysler-built cars. (What's more, Mr. Kiekhaefer uses Champions in every single one of his famous Mercury Outboard Motors.)

*And here's an important tip for you!* Tests show that if you've gone about 10,000 miles without a spark plug change, new Champions can give you an immediate gain in road horsepower. All major makes of cars were tested—and the average gain was 24%!

Replace your old plugs with Champions today—and you'll feel the difference *at once!*

**CHAMPION**

LOOK FOR THE 5 RIBS



**New Powerfire electrode** stands up better. Photo shows how ordinary electrode (left) burns away. Champion's Powerfire electrode (right), after identical use, is still good for many miles of powerful, full-firing performance.





For over a century the Howard Clock people in New York have been fulfilling their unique mission in life:

# POPULAR DECEMBER 1956 MECHANICS

WRITTEN SO YOU CAN UNDERSTAND IT  
VOL. 106 NO. 6

## They Keep the Tower Clocks Running

**T**HERE'S ONE GROUP of expert mechanics who still go to work exactly as their predecessors did hundreds of years ago. They are the clock tenders who lug their heavy toolkits up countless stone, steel and wooden steps every week all over the United States. The only modern innovation is that in very severe weather they also carry electric heaters. There are neither elevators nor steam radiators in the towers where the great clocks tick away the hours.

What with radio time signals and most

Port in tower-clock dial (arrow) makes repairing, painting or oiling easier. Below, a counterweight is drawn into the steeple. The gear cluster at right turns shafts to three faces

By  
Creighton Peet

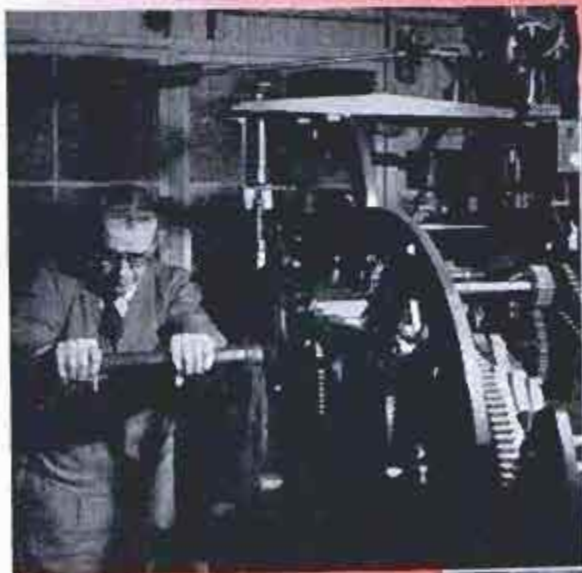





Rudolph Lamm, head of Howard Clock Sales and Service Company, checks clock-mechanism timing

people having wrist watches, tower clocks aren't as common today as they were 112 years ago when the Howard Clock Sales and Service Company opened up in New York. But striking tower clocks in churches, courthouses and college buildings are still an essential part of the daily life of many small communities.

#### 47,000 Clocks Serviced

A clock may run along, striking punctually for a dozen years, but as soon as it goes dead, an urgent call is sent out and a man flies to fix it. In all, the Howard Company services some 47,000 indoor and outdoor clocks in the United States. Chief among its tower clocks are those in New York's City Hall, Trinity Church and Central Park Arsenal, Chicago's Wrigley Tower, St. Augustine Cathedral, the University of Kansas, the Firestone Tire and Rubber Building in Los Angeles and the old State House in Annapolis, Md.

To keep these tower clocks running, the Howard Company has on hand a vast stock of spare parts, which it boasts is sufficiently varied to repair any clock it ever made; of these clocks, company records show that several dating back to the 1880s are still in service. Two floors and a basement in lower Manhattan are lined by shelves loaded with gears, axles, motors, faces, hands, bells, striking hammers, relays, mercury switches and other pieces of equipment. Assorted pendulums are stacked in a bin like cordwood, and the moment obsolete, odd-sized gears are called for, replacements are ordered from a factory.

Up to about 30 years ago, when most



Behind a glass clock dial a repairman oils gears of rod that makes clock's hands turn at different rates

tower clocks and chimes were electrified, all power came from heavy counterweights, some traveling in chutes in the tower to the building's basement; the Howard repair crew was made up of mighty muscle men. Some of the counterweights operating the striking hammers on big bells weighed two or three tons; even with extensive gearing, the weekly chore of lifting these weights on high was no joke. One notable clock mechanism still operated by a 1200-pound counterweight, which travels up and down in a slender stone spire, is that in New York's old Trinity Church. All bell-striking mechanisms were electrified years ago, but it was felt that although an electric power failure might stop the clock, nothing could halt the descent of the counterweight. Accordingly, once weekly for the past 25 years Walter Humphreys has spent half an hour turning a big iron handle to pull up the weight and keep Trinity's three sets of clock hands moving.

#### Birds No Longer Trouble

Clock-tower repairmen seldom have the trouble with pigeons and starlings that they used to. Most tower clocks are now enclosed in small dustproof and pigeon-proof rooms, and ornamental openings in the towers are covered with chicken wire on the inside. But swarms of bees, wasps and hornets must occasionally be smoked out, and repairmen have reported corners filled with dark, undulating blankets of bats. Howard Company workers still remember their biggest and last pigeon war, which took place one night in 1929. Six men mounted the Trinity Tower equipped





New clock assembly is laid out. The pine hour and minute hands are balanced by the short, white, iron rods

with crates into which they popped some 250 birds and their nests. The men then went up Broadway a few blocks to St. Paul's, where they bagged another 150 birds, which were given to pigeon fanciers. In the next few days all openings in both church towers were covered with wire netting.

Snow and ice piling up on hands of clocks seldom cause trouble, but when this happens, repairmen simply throw out of gear one shaft leading to the hands on that face of the tower. In times past, hands cut from thin iron or sheet tin have caused trouble, for they bend or flap just enough in a high wind to lock and stop all movement. In restoring the clock on the Williamsburg, Va., Capitol Building, the Howard people first tried replacing the original metal hands with new ones, but finally installed today's standard, light Georgia-pine hands covered with oil and smalt, a silicate compound which sheds rain and snow. Rudolph Lamm, president of Howard, was much impressed with the works of this clock, first installed in Virginia in 1742. He discovered that each

Bronze figures which swing at bell in New York Herald Square clock get an oiling. Hammers which actually strike the bell are in the rear







Above, campus-clock mechanisms are polished. Below, weekly for 25 years Walter Humphreys has climbed three flights to wind Trinity Church clock

shaft and its gears were made of a single piece of steel, apparently filed out by hand. At today's labor rates, such a clockwork would be worth more than if it were made of solid gold.

As might be anticipated, tower-clock repairmen have their biggest scramble making the change-over to and from daylight-saving time. All other work is forgotten on those days, when everybody in the New York shop starts climbing towers at 8 a.m. Saturday and finishes by 2 a.m. Sunday. The last clock changed is always that of City Hall. Scattered clocks around the country are changed either by janitors or local watchmakers.

Since 1842, when Edward Howard first devised his basic clock and bell-striking mechanisms, practically no changes have been made in this firm's tower clocks, except electrification. The electric motors moving the hands of fairly large clocks are exceedingly small. This is possible because tower-clock hands are balanced with short iron rods which act as counterweights so they will turn very easily. Also, the pine hands used nowadays are surprisingly light. Another factor is that the power from a tiny motor is enormous when magnified by the gearing in a clock mechanism. A  $\frac{1}{2000}$ -horsepower motor geared down 60 to 1 is adequate to operate the hands of a clock with a single face eight feet in diameter. To operate four sets of such hands on all sides of a tower, a  $\frac{1}{150}$ -horsepower motor is sufficient. For four dials 40 feet in diameter, a  $\frac{1}{12}$ -horsepower motor is needed.

Motors operating bell-striking mechanisms also are only  $\frac{1}{12}$ -horsepower; but where the gear ratio to operate four sets of hands is 4-to-1, it is 30-to-1 to lift the bell hammers, some of which weigh up to 300 pounds. Cams worked through reduction gears allow the hammer to fall against a bell as often as needed to strike the hour. Cams for chimes are mounted on a single shaft, one for each bell. In function the cam lifts the hammer until it pushes against a flat spring, building up pressure. Falling from the point of the cam, the hammer strikes the bell which remains stationary. However, another spring below the hammer keeps it from remaining in contact with the bell, so the bell vibrates properly.

Most great tower clocks built in recent years have ports or doors in their faces large enough for a man to reach out and adjust, paint or replace the hands. Years ago, repairmen recall, there were stone towers with no openings except a small one for the shaft holding the hands. It was necessary to sling a bosun's chair over the top of the tower to make any outside repairs on such a clock. The Howard Company services only one such clock today. It is located in Brooklyn. ★ ★ ★

Electric power raises New York City Hall bell hammer. Lower spring keeps hammer away after striking







It takes U. S. Fleet Marines only 45 minutes to erect this "igloo," which can be heated or cooled, as needed

## Marines Erect Large, Air-Conditioned, Glass-Fiber "Igloo"

It takes only 45 minutes for six marines to erect a glass-fiber "igloo" now undergoing tests by certain ground units of the Fleet Marine Force. The structure weighs

2800 pounds, is 20 feet wide and can be built in lengths of 20 to 60 feet. The unit is equipped with its own heating and air-conditioning units.

## Roofer's Hoist Saves Time

Roofers can now drive up to a house and start applying hot roofing material within minutes by employing a hoist designed and built by F. M. Gibbs of Los Gatos, Calif. The entire bed of the truck is lifted to the working level by a series of pulleys, eliminating the need to pull hot tar up to the roof in buckets. Extensions are available so that the hoist can be used on two-story buildings.



## Both Tire Beads Broken at Once

You can remove a tire without taking the wheel from the car with a wheeled unit that breaks both beads on a tire at once. The two arms gripping the tire develop about 2500 pounds of pressure on each side of the tire. Easy to use, the bead breaker operates from an air line. It handles all sizes and types of passenger tires, including tubeless tires and tires on safety rims. Unit is mounted on a neoprene-wheeled dolly.



## Prefab Church Seats 180

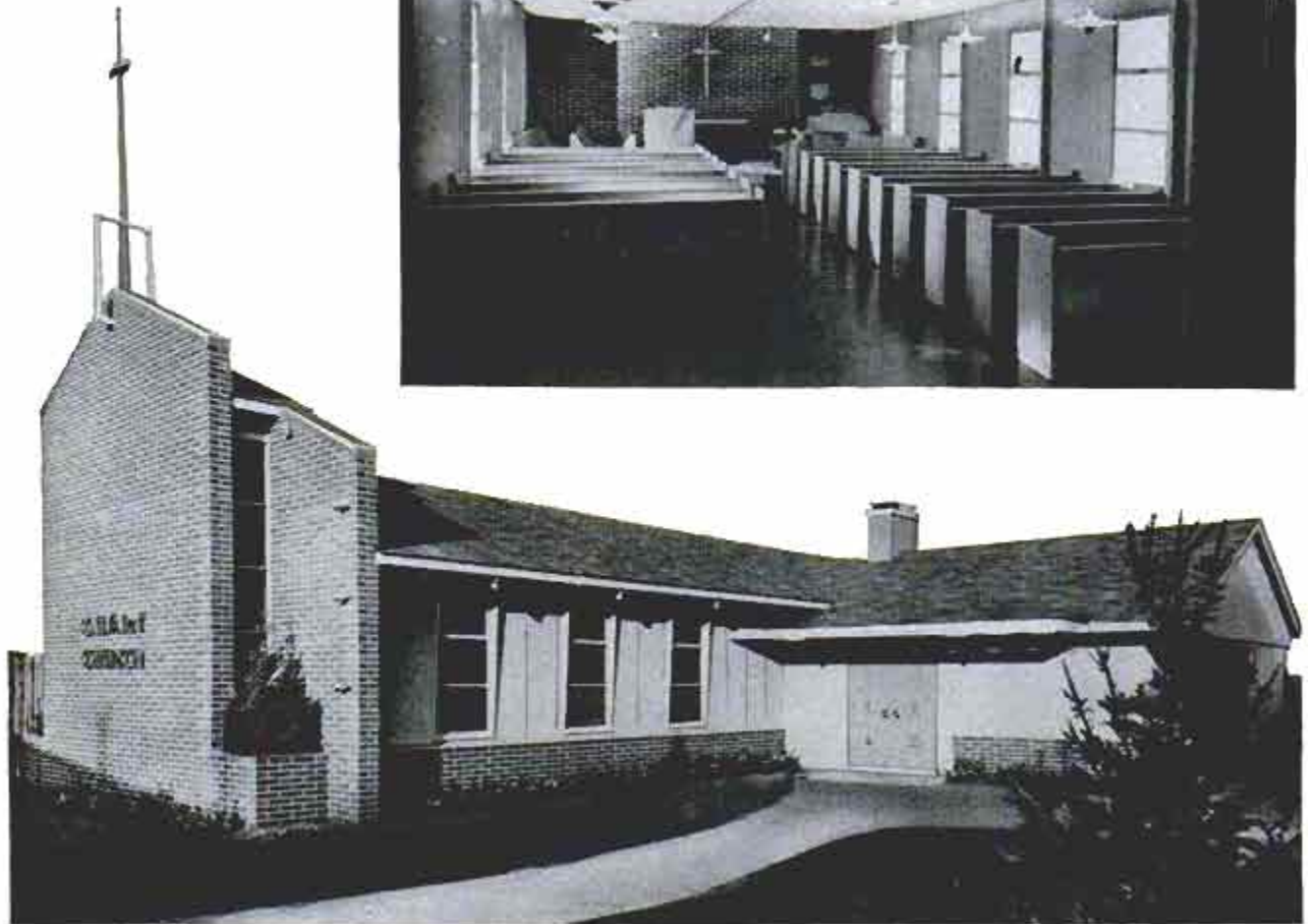

Put together with a variety of floor plans and elevations, a prefabricated church that accommodates 180 persons is available at moderate cost. The church package supplied by the manufacturer includes the pews, an organ, altar, pulpit and other fittings. This costs \$35,000 but does not include

foundation and masonry work, plumbing, heating, electrical wiring and fixtures. A room at the rear of the church is separated from the church proper by an accordion steel sliding door. Many optional items are offered such as full kitchen equipment, bathroom fixtures and spire.

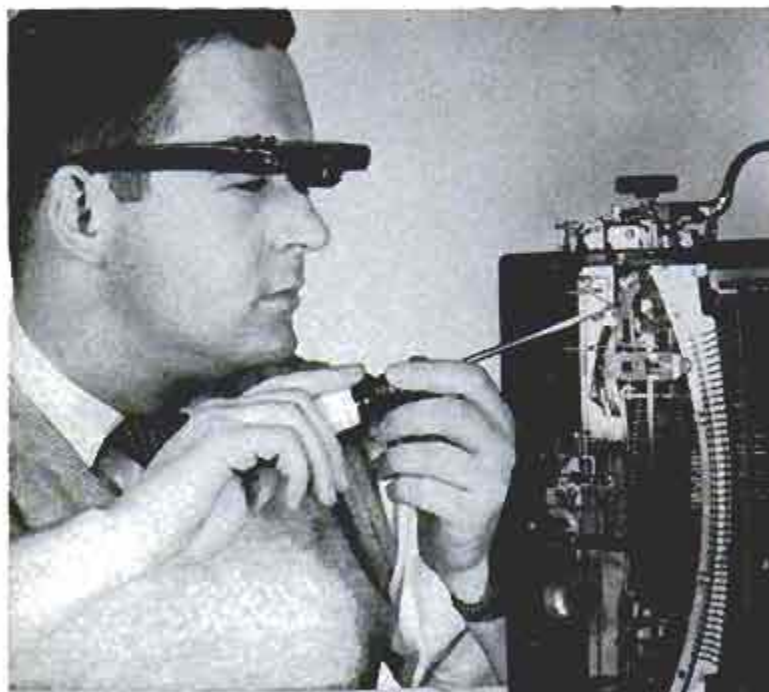

### Brow Lamp Focuses Light On Worker's Hands

Light is directed where you're looking by a flashlight unit that clamps to your brow like spectacles. Because it frees both hands, it is especially useful to mechanics, night nurses, repairmen and campers. The beam can be angled by pushing the bulb up or down with the fingers. A surprising amount of light is furnished by the unit, which has a standard bulb and miniature batteries.

☛ Average diameter of 300 comets analyzed by Dr. N. T. Bobrovnikoff of Ohio State University was 66,000 miles, more than eight times the diameter of the earth.



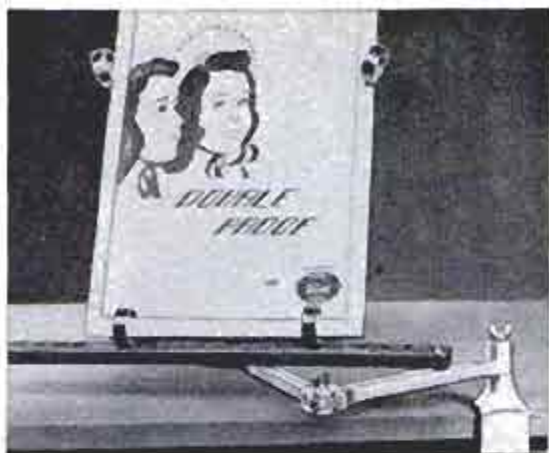

## Flexible Easel

Bedridden artists and stenographers alike can use an easel mounted on a jointed, swing-out arm. Strong spring clips at the bottom and sides hold canvas, magazines, newspapers, letters or copy to be rendered into drawings. The base of the arm is firmly clamped to the nearest piece of furniture. The unit is not yet being manufactured. It was recently put to good use by a young amputee in



Fitzsimons General Hospital, Denver, Colo. Because of his artificial hands, he could not paint unless an assistant held the painting. The new easel, which gripped the canvas, enabled him to paint unaided.

## Automatic Fish Trap Uses River Power to Net Salmon

River power is used for catching salmon on the Fraser River in British Columbia. The current of the stream operates a device resembling a paddle wheel that consists of two basket nets plus a pair of auxiliary paddles. The contrivance may be moored in any part of the stream. Fish that are swimming up the river and that are trapped in one of the nets are automatically dropped into a trough as the net

rotates overhead. From the trough the fish slide into an underwater "live fish" tank. The captured fish are later tagged with plastic markers and are returned to the river. The trap was built by the Canadian Department of Fisheries as an improvement on a crude fishing wheel used by Indians in the Yukon. It permits tagging operations with fewer man-hours of work and with less damage to the fish.

Live salmon are tagged with plastic markers by Canadian conservationists after being caught in this trap

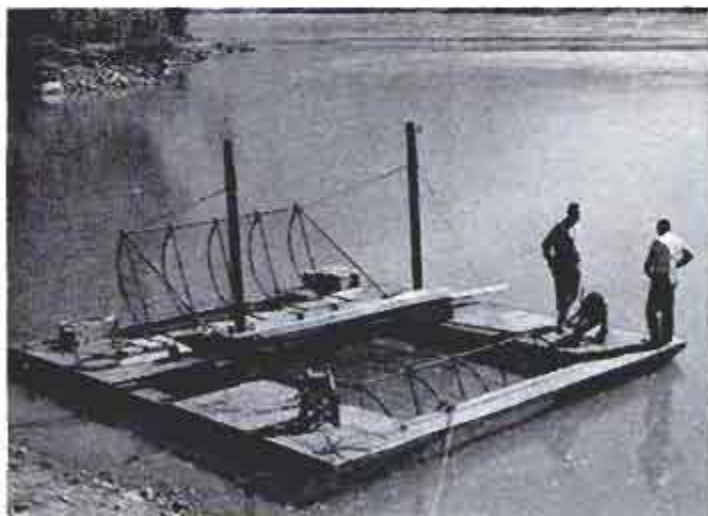



# OUR MISSILE ARSENAL

**F**OR AT LEAST seven centuries man has been firing rockets into the sky. The Chinese fired rockets as weapons as far back as 1232.

But only in the past few years have rockets played a part in defense. Today we have rockets and guided missiles of fantastic complexity. The chart below shows those in our arsenal or under development.

Missiles are guided to their targets in

three ways: By firing them on a particular trajectory, like an artillery shell; by altering their course through radar and radio signals from land, ship or plane; and by building electronic "brains" into the missiles themselves, enabling them to find and track their targets.

Biggest goal of all is the ICBM—the intercontinental ballistic missile, the "ultimate weapon." ★ ★ ★

NAME	DEVELOPED BY OR FOR	LENGTH	WEIGHT (POUNDS)	RANGE (MILES)	REMARKS
<b>SURFACE-TO-SURFACE TYPES</b>					
Redstone I	Army	69'	—	300+	Currently our largest missile; Can carry nuclear warhead
Redstone II	Army	—	—	1500+	Under development; intermediate-range ballistic missile
Honest John	Army	27'	5950	20	Unguided artillery rocket now in service; can carry nuclear warhead
Thor	Air Force	—	—	1500	Under development; intermediate-range ballistic missile
Corporal	Army	40'	12,000	125-200	In service; speeds up to 5000 m.p.h.; can carry nuclear warhead
Matador	Air Force	39'5"	12,000	620	In service; guided pilotless jet aircraft; speeds up to 650 m.p.h.; can carry nuclear warhead
Navaho	Air Force	—	—	5000	Under development; 1000-2000-m.p.h. pilotless bomber
Snark	Air Force	74'	35,000	2000	In production; currently has longest range; 500-600-m.p.h. pilotless bomber; steers by celestial navigation
Regulus	Navy	32'8"	14,300	500	In production and in service; pilotless bomber; for ship-to-ship use; also aboard subs
Atlas	Air Force	100'?	225,000+?	5000+?	Under development; intercontinental ballistic missile; the "ultimate weapon"
Titan	Air Force	—	—	5000+?	Under development; intercontinental ballistic missile; the "ultimate weapon"
<b>SURFACE-TO-AIR TYPES</b>					
Talos	Navy	—	—	—	—
Bomarc	Air Force	66'	8500	—	Supersonic ramjet; long range
Terrier	Navy	14'8"	3350	15	In service; ship-to-air; beam guidance
Tartar	Navy	—	—	—	Ship-to-air; smaller than Terrier
Nike	Army	25'	1000	20	In service here and overseas; beam guidance
Hawk	—	—	—	—	Recently put into production
<b>AIR-TO-SURFACE TYPES</b>					
Petrel	Navy	24'	1500	—	Operational antisubmarine missile; can be launched from helicopter
Rascal	Air Force	20'	—	100	Remote guidance from standby plane
Dove	Air Force	—	—	—	In production; for naval targets; electronic guidance
Bullpup	Air Force	11'?	—	—	Under development; electronic guidance
<b>AIR-TO-AIR TYPES</b>					
Ding-Dong	Air Force	—	—	—	Under development; can carry nuclear warhead
Falcon	Air Force	6'	112	6	In production; armament for fighters
Sparrow	Navy-Air Force	12'	300	6	In service; rides radar beam
Sidewinder	Navy	8'	—	—	In production; infrared homing system; greater range and speed than Sparrow



## REDSTONE

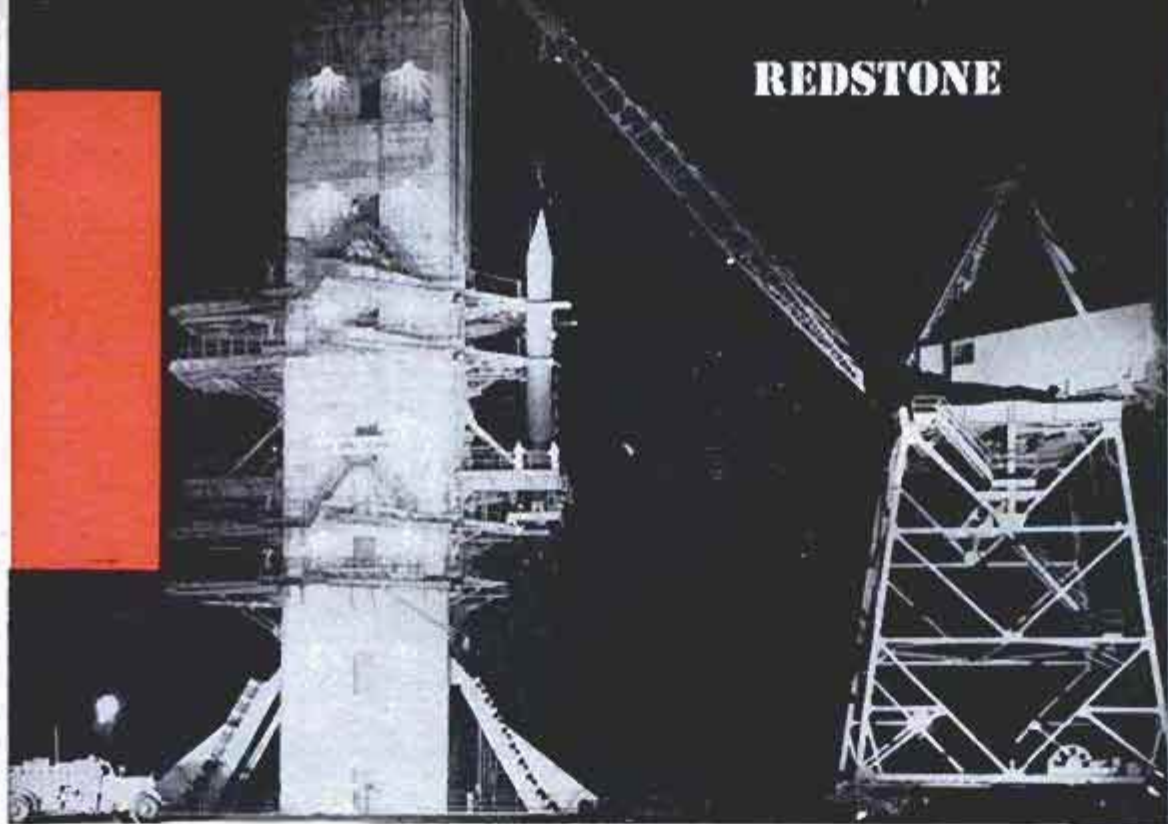

U.S. Army photos

Redstone is largest current rocket. Recent tests were aimed at firing triple-motored Redstone 3000 miles. Above, Redstone is hoisted to test stand. Right, it thunders into the air



## SURFACE-TO-SURFACE MISSILES

Here's "first family" of big missiles. Honest John is a medium to long-range artillery rocket. Corporal can carry a nuclear warhead. Nike is high-speed antiaircraft missile

## HONEST JOHN, NIKE AND CORPORAL

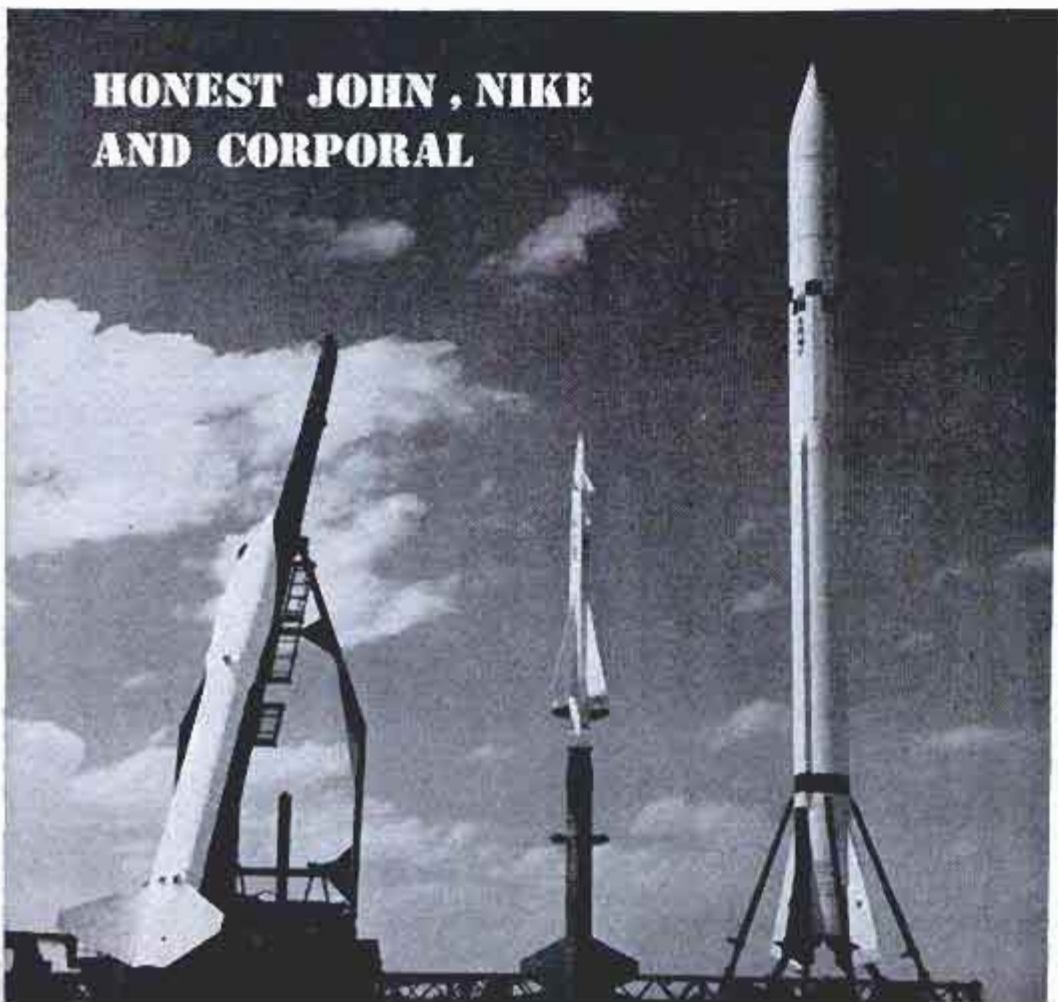



## HONEST JOHN



U.S. Army photo

Honest John roars from a launcher during a training session for troops in Germany. Its primary use is as a long-range artillery piece, blasting enemy concentrations or supplies with either conventional or atomic explosives. It was one of the first big combat-ready rockets

## SURFACE-TO-SURFACE MISSILES



Regulus blasts off the deck in the first released photo showing the launching of this missile from a submarine. This is the Navy's first operational offensive missile. Primarily intended for ship-to-ship use, it has also been fired from carriers, cruisers and guided-missile ships

## REGULUS





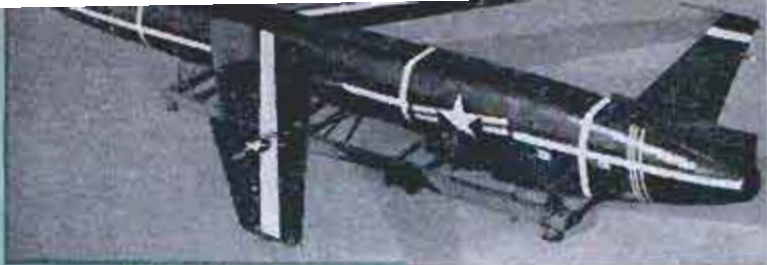

Northrop Aircraft photos

Snark carries rocket boosters to help it roar aloft. An air-breathing missile, it is basically a pilotless jet aircraft with a limited altitude and speed. However, it is our first real intercontinental missile, with a range of about 2000 miles. Biggest disadvantage is that, because of its relatively low speed, it is possible to knock it down with anti-aircraft fire. Snark has a built-in guidance system which enables it to alter its course and "find" its target



## SNARK

New version of the Matador is shown in these photos. It is longer and carries a larger nose section than the first Matadors built. New type is under test and will be given an entirely new airborne guidance system for tactical missions. In effect another guided, unmanned bomber, Matador has a ceiling of about 45,000 feet and a range of more than 600 miles

U.S. Air Force photos



## MATADOR







U.S. Army photo

Nike is the Army's answer to attacking aircraft. Photo shows launching site of a Nike battalion with eight missiles ready for firing. They are supersonic long-range guided missiles designed to locate, track and destroy aircraft by means of electronic brain

## SURFACE-TO-AIR MISSILES



Talos is the Navy's supersonic antiaircraft missile. Relative merits of this missile and the Nike have been a subject of debate. Department of Defense has announced that both missiles will be used in air defense of this country

U.S. Navy photo

**TALOS**



## AIR-TO-SURFACE MISSILES



Petrel is carried by Navy planes primarily for use against enemy ships at sea. It can be launched from patrol aircraft well beyond a ship's antiaircraft defense. Guided by an electronic brain, it "thinks" its way to target

**PETREL**

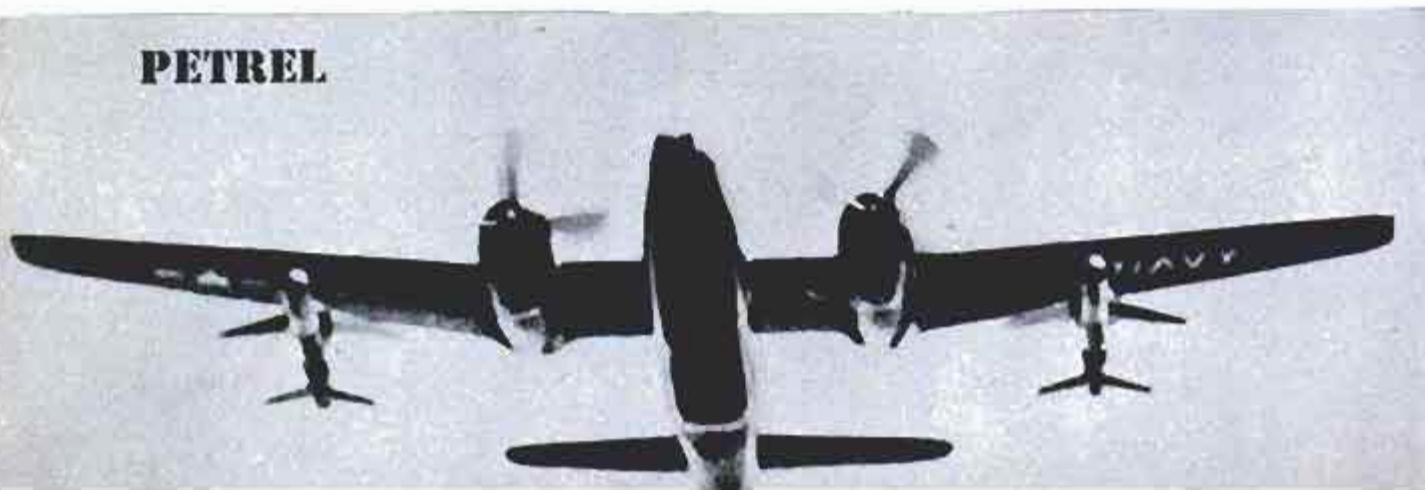





**SPARROW**

Sperry photo

Sparrow is a relatively small (eight-foot) rocket with a range of approximately six miles. The plane carries guidance gear for controlling the Sparrow in flight



## AIR-TO-AIR MISSILES

Sidewinder is the latest missile in the Navy's hands. It can kill supersonic planes at altitudes up to 50,000 feet. Its greatest advantages are simplicity and low cost

Air Force's Falcon is smallest guided missile in production. Falcon is fired automatically by radar, tracks a maneuvering target with its own guidance system

U.S. Air Force photo

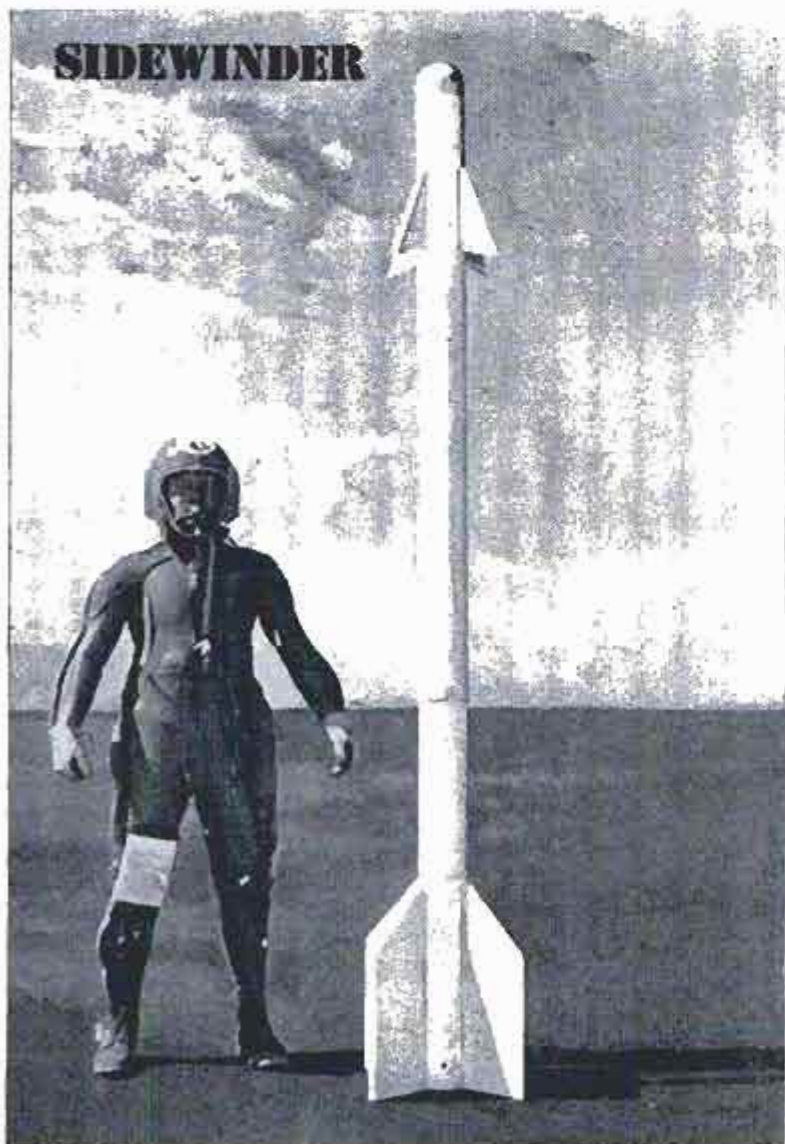



# Detroit Listening Post



By Leo Donovan

**Y**'OU'VE SEEN 'EM, now what do you think? You're the boss from here on in and this column, for one, would like to know what your verdict is.

There are still more to come, but the volume cars are all out and dealers are ready for you to sign on the dotted line.

Still to come is the Mercury Turnpike Cruiser which will be out this month. Lushest of the Mercury line, it features some clever new twists and gimmicks. This division is seriously aiming at Buick's business.

Chrysler is holding back its new 300C until later. This car will be easily distinguishable from other Chryslers. No longer will it share a front grille with Imperial. A fresh and distinctive grille (with a lot of the Chrysler Ghia in it) will set it apart.

Built on a Windsor shell to keep it light, the 300 will have a front end you'll notice and power plant that will give a fabulous power-weight ratio. No, it isn't 400 horsepower, but it's within a stone's throw!

## Packard Still to Come

The only full-line car that hasn't debuted by now is Packard. It's expected in January. As reported here a couple of months back, it has to be a Studebaker with Packard trim. This is a sad day for a great tradition. Another car has gone—let's hope it's only temporarily. How long can this go on, this gradual diminution of makes? That worries the industry—and auto writers, too. After all, what will we write about if all cars are made by the same company?

Optimists at Packard say they will have a new, big and distinctive model ready for the 1958 season. Let's hope they're right—but that's months and millions of dollars in the future in this business.

That about cleans up Year 1957 except for the Eldorado Brougham which some magazines have been saying will be out "shortly" ever since late last summer. Nothing definite yet, except that, as stated here before, it is expected in February.

**Continental doesn't seem to be smiling**

richly any more. It's difficult to know what is going to happen to the idea of a "timeless" car in this price class. Right now the Continental plant is being used to build Lincoln hardtops. Continental explains that this is being done only because Lincoln needs the cars in a hurry. But there's no denying that Continental doesn't need Mark IIs in a hurry—if that's true now, what will happen when the Brougham comes out?

Continental has announced a convertible, but it's a custom job and is not being built in the factory at all. Whether it will be added to the Continental line as a production item is questionable right now.

The Congressional inquiry into safety a few months back caused some fears here in Detroit that cars might soon be taxed according to horsepower. Apparently, the word is out that such fears are ungrounded. Horsepower and displacement are up, up, up. And some strange things have happened. For example, the Oldsmobile 88, a car that competes in the low-medium field, has a displacement of 371 cubic inches, six more than Cadillac, seven more than Buick and 46 inches more than its competitor Dodge!

## Mixed-Up Business

This is, as has been said before, a crazy, mixed-up business. An industry publication reports that a 1957 Ford sold in a used-car wholesale auction five days before it was officially introduced to the public! To be sure, it sold for well over the suggested retail price. Not so lucky were 27 Fords (1957 models) sold at wholesale the week after introduction. These went for prices ranging from \$400 to \$600 below the suggested delivered prices.

These obviously had to come from franchised Ford dealers. Other 1957 Fords showed up in used-car lots simultaneously with the unveiling of the cars in the new-car showrooms. And magazines are told to keep such information secret because it would make dealers mad if anything leaked early!

Oh, well, there are bigger things to worry about. For instance, Dr. Emil Seletz of the University of California school of medicine recently told the International College of Surgeons that we average human beings are not physically equipped to drive a modern, high-powered car.

Something about our inadequate corticospinal reflex responses—if that means anything to you. At the time the doctor spoke, the 1957 cars were not out so he must have been talking about the obsolete 1956 models. If he's right, it's obvious that none of us is equipped to handle the super-powered wonders of 1957!





An optical roller-coaster ride is experienced by autoists on this Richmond-San Rafael humpback bridge

## ***Humpback Bridge Has Built-In Dip***

MOTORISTS, driving the new four-mile toll bridge between Richmond and San Rafael, Calif., brace themselves for a roller-coaster ride. However, the jolting drop never comes, despite an obvious optical dip in this second-longest over-water span bridge in the world. Surpassed only by the San Francisco-Oakland Bay giant several miles to the south, this \$68,000,000 colossus has a built-in structural dent. Engineers constructed a scientific humpback in the bridge's center for two reasons: To save the cost of additional steel girders needed for support, and to make this land-linking steppingstone as earthquakeproof as possible. A three-percent maximum grade is barely noticeable to autoists guiding vehicles along the bridge's two decks, each carrying six lanes of one-way traffic.

Expected the first year of operation are 4,000,000 drivers who will save 2,000,000 hours of travel time by using this route instead of ferryboat transportation replaced by the bridge. Appearancewise, this man-built monster is impressive in a 65,000-gallon paint job. Towers rise 325 feet above waters

of San Francisco Bay, while pilings plunge 222 feet beneath the same surface. Two cantilever spans over the main bay channels provide 185 feet of clearance for ships.

This built-in dip has saved on construction costs and has strengthened the structure against possible earthquake damage





# Gas Turbines Pep Up Old Liberty Ship

By Richard F. Dempewolff

Artist's conception of the General Electric gas turbine installed aboard the old Liberty ship, John Sergeant

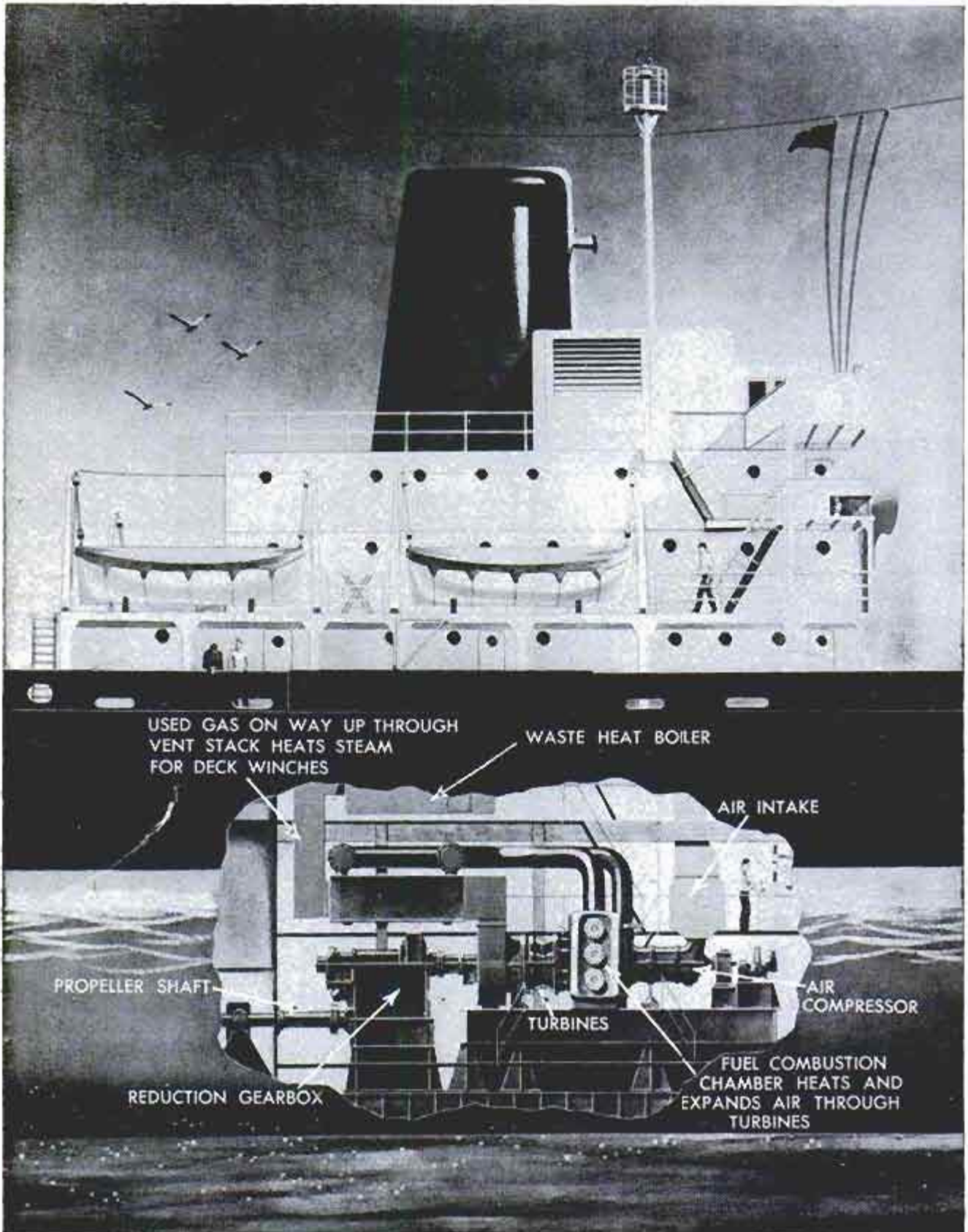



SHIP CAPTAINS heading in toward the Virginia capes recently, saw what should have been a lumbering old 10-knot Liberty ship acting more like a pleasure cruiser than a wartime relic. Slicing swells at a brisk 18 knots, the long, lean freighter whipped through tight circles and figure eights. Periodically, white geysers suddenly sprayed its fantail, and foam boiled under the stern as it slammed into reverse from "full ahead," rumbling to a dead stop in less than four times its length—and in less time than it took bug-eyed observers in distant pilot houses to focus glasses on what was happening.

The *John Sergeant* is a far cry from 1400 sister Liberties huddled in mothball clusters from Olympia, Washington, to New York City (see *Popular Mechanics*, September 1956). As it rode out of Newport News Shipbuilding and Drydock Company's yards this fall, the ship sported a 107-foot rakish bow in place of its former 82-foot pug nose, stretching its lines 25 feet beyond the old 427-foot Liberties. Deep in the hull, the secret responsible for its unusual speed whined softly above the dull roar of burners, while men with noise meters grinned at readings well below those that an ordinary engine room would put out. A new prefabricated power package makes the *John Sergeant* the world's first large merchant ship propelled entirely by gas turbine. That's why the ship's name bears the unique prefix GTS (gas-turbine ship) instead of the usual SS.

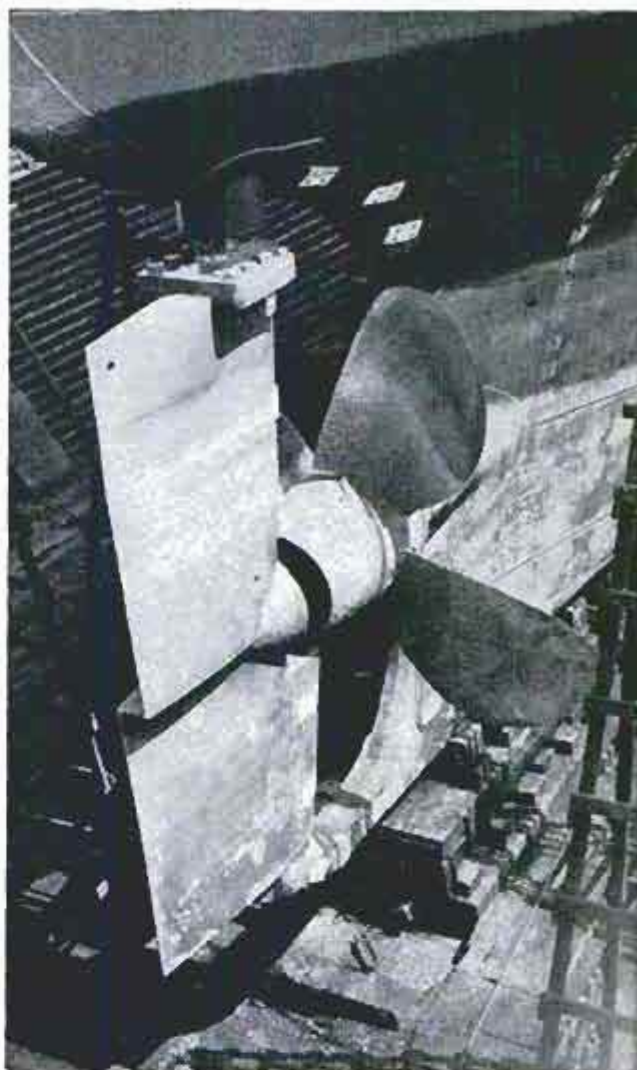

Above, 17-foot variable-pitch propeller, installed with turbines, enables ship to stop dead in two minutes and 40 seconds. Below, first cruise of ship





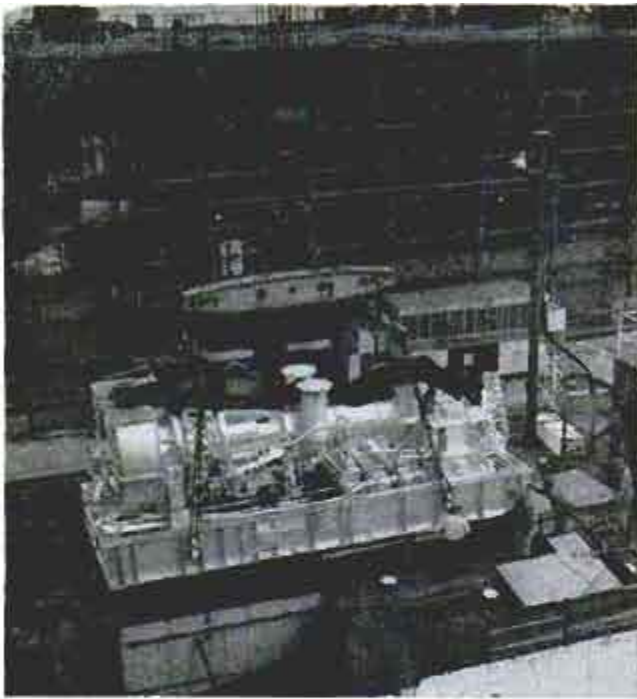

New gas turbine for *John Sergeant* develops over 6000 horsepower, is one third the size of old engine

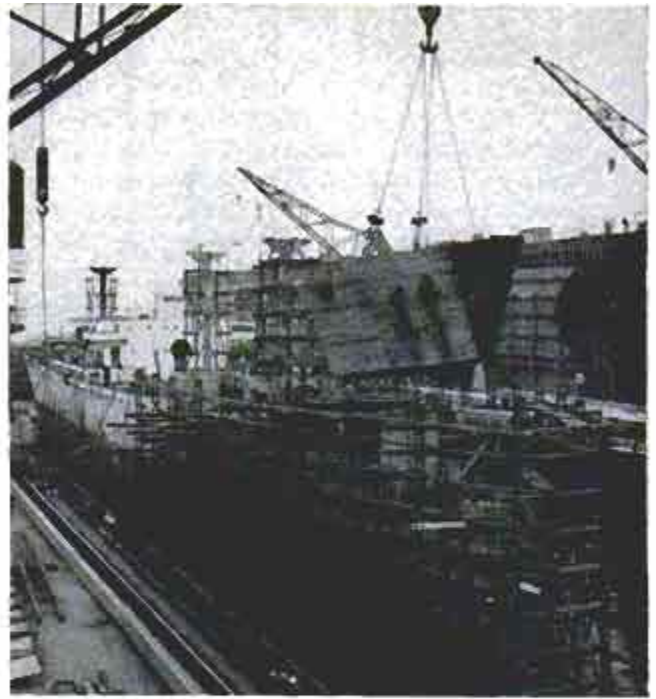

To help increase speed, a sleek new clipper bow, 107 feet long, replaced the old 82-foot snub-nosed bow

Operating on much the same principle as a turboprop aircraft engine, the 6000-horsepower plant sucks in outside air, compresses it, heats it and expands it through turbines that are forced to spin. In turn, they revolve the shaft with smooth, quiet vibrationless power—humming like a giant blower instead of a roaring engine. John J. McMullen, chief of construction and repairs for the U.S. Maritime Service, who spearheaded the *John Sergeant's* rebirth, calls it "the greatest advance in marine prime movers since the diesel."

At the end of the ship's shaft there's another innovation—a 17-foot reversible-pitch propeller with mammoth blades that swivel hydraulically. Up in the pilot house

Model of the ship's engine room shows the modern compact arrangement of controls and instruments

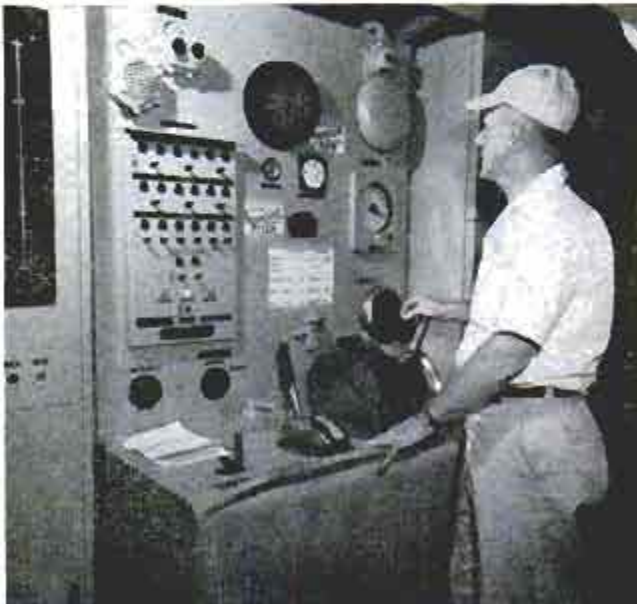

during the recent trials, Capt. E. D. Edwards flipped the single lever control to "crash astern," while the *John Sergeant* was surging forward at full speed. Behind him, underwater, giant blades swung from "full ahead" to "full astern" position in a record 15 seconds, instead of the full one minute required to brake and reverse the shaft of a conventional ship. In two minutes and 40 seconds the *John Sergeant* was "dead in the water." An ordinary ship this size would have taken seven minutes to do the same thing, according to McMullen.

McMullen says, "The unit on this ship has a design horsepower of 6000, but we've been getting 7500. On the North Atlantic, it will be much more because cold air is already partly compressed. You can figure an extra 40 horsepower for every degree drop in outside temperature. On a production basis, the unit will cost about \$50 per horsepower less than steam equipment.

Actually, the *John Sergeant* is only one of four experimental Liberty ships now undergoing conversion as part of a \$12,000,000 program. Reason for the program is to investigate new, economical means of propulsion that can take our mothballed merchant ships out of the "slow barge" category in case they're ever needed again. "Ships incapable of 15 knots should not be considered adequate for logistic support in modern war," the Maritime Commission pointed out recently. When the *John Sergeant* has completed a year of service under the U.S. Lines insignia, McMullen hopes she will prove the answer to atom-age modernization of old 10-knot Liberty-class ships.

★ ★ ★





## Dutch Lowland Roads Rest on Wood Shavings

Dutch engineers have solved the problem of building roads in rural Holland, where the low, flat land is just barely above sea level, by the use of baled wood shavings. A few feet below the land's surface, road builders find muck and mud, and bales of the shavings are placed in

tight formation in this mud. Then earth is shoveled over the bales, packed down and allowed to settle. Later, additional earth is rolled on and finally the macadam surface is added. Virtually the entire shavings output of the Dutch factories is being baled for road-building needs.

## Electronic Eye Helps Blind Switchboard Operators

Weighing less than an ounce, an electronic eye has been developed by the Bell Telephone Laboratories as an aid to blind operators of private-telephone switchboards. A tiny light-sensitive phototransistor fits on the tip of an index finger. When the operator hears the signal of an incoming call she searches along lines of lamps on the board. When she hears a signal from the phototransistor through her headset, she plugs into the jack associated with that lamp, completing the connection.

☛ Argentina is spending about \$62,000,000 for highways in 1956.







## Truck Bodies Travel Piggyback

Special 75-foot railroad flatcars, each carrying three truck bodies, are the newest addition to piggyback transportation of trucks by the railroads. Each of the bodies, called "Mobilvans," is designed to ride on a highway-truck chassis. Instead of shipping an entire trailer by rail, the loaded Mobilvan bodies are lifted by fork truck

from the chassis to the flatcar and locked securely in place. The expense of hauling the dead weight of the chassis and wheels and of tying up expensive trailers is eliminated. The system is being used cooperatively by the Pennsylvania Railroad, The Rail-Trailer Company and the Spector Freight System of Chicago.

## Dutch Houseboat Sports a Built-In Garage

Houseboats are common in Amsterdam, The Netherlands, but houseboats with their own built-in garages are uncommon anywhere. This one, 75 feet long and 18 feet

wide, is a seven-room house with central heating and a shower in addition to the garage. A family of four occupies the house, which is tied to the riverbank.





# AN ENGINEER LOOKS AT THE NEW CARS

By Dale Kelly, SAE

With most of the 1957 cars now in the dealers' showrooms, we asked Dale Kelly, PM's automotive engineer, to give you his thoughts on certain of the year's innovations. At this writing, Kelly is beginning full-scale tests of the 1957 Ford, Chevrolet and Plymouth. He tests only standard production models of these cars. *Popular Mechanics* does not believe its readers are interested in unscientific "quickie" tests of hand-built engineering prototypes. These are not at all the same cars that you will buy. They are free from the defects of mass production. However, because we realize you are interested in an informed opinion, we are bringing you this preliminary account of some of the new engineering features based on information provided by the car companies. Actual test reports of production cars will appear in early issues.

**T**HE 1957 CHEVROLET offers, as optional equipment, the first fuel-injection system used on an American production car.

The system differs from that used on the Mercedes-Benz (and elsewhere) in that gasoline is not injected into the cylinder, but into the inlet manifold just ahead of each inlet valve and, secondly, injection is a steady stream rather than separate pulsations.

Fuel injection avoids a number of weaknesses inherent in carburetors. In the best carburetor there is some variation in the amount of liquid gasoline getting into the different branches of the manifold. If every cylinder is to receive enough gasoline for full power, the carburetor must be so adjusted that some receive more than this, the excess therefore being wasted.

One remedy is to heat the manifold enough to vaporize nearly all the gasoline. Vapor mixes better with the air and distributes more uniformly among the cylinders. Unfortunately, this expands the air also and reduces the weight of air the engine can draw in. Consequently, power is reduced.

Another remedy is to use a manifold small enough to keep the air moving fairly fast even when the engine is running slowly and at light load. But this also reduces power. In some cases it has been necessary to use multiple carburetors, up to one per cylinder.

In fuel injection, the amounts of gasoline reaching the various cylinders are virtually identical, even though the inlet manifold is cold and large in cross-section. Economy and power both benefit.

The Chevrolet version of fuel injection cuts the gasoline flow completely off when the car is coasting against engine drag, so that fewer unpleasant odors and less dead-

ly carbon monoxide are discharged from the exhaust.

## Smaller Wheels

Fatter tires with less air pressure on smaller wheels (14 instead of 15 inches in diameter), are being used to soften the ride and to give an appearance of lowness. The center of the 8.00 x 14 tire is only an eighth-inch closer to the ground than that of the 6.70 x 15 tire it replaces.

It is widely felt that the biggest brakes that can be put on the 15-inch wheels are unduly prone to overheat and fade under repeated severe usage. With the smaller 14-inch wheels carrying the new heavier cars, this situation will hardly get better. It may get worse, unless there is a radical change in the type of brake used.

## Supercharged Hawk

Studebaker uses a supercharger in the 1957 Golden Hawk to get 275 horsepower out of the 289-cubic-inch Studebaker V8 engine. This is the same power rating the Hawk had last year. But last year it used the 352-cubic-inch Packard V8. The supercharger enables Studebaker to get equivalent power with 63 fewer inches.

This supercharger is essentially a centrifugal blower or compressor, driven by belts from the front of the engine, that gives a five-pound-per-square-inch boost to the air entering the carburetor, delivering it at 20 pounds per square inch instead of the normal atmospheric pressure of 15.

Used with a small engine, a supercharger makes it possible to combine exceptional economy with adequate performance.

## Chrysler's Front Suspension

The Chrysler family of cars uses ball-joint suspension in front (this is neither

(Continued to page 258)



**BUICK**



Just over an inch longer, the Super four-door hardtop looks about a foot longer because of its lower lines



Characteristically Buick is the front-grille design. The hood line has been lowered drastically in 1957

## General Motors Offers

LAST SPRING when rumors of great engineering changes were running through the industry, President Harlow E. Curtice of General Motors said "no revolution is coming."

He insisted that there's no place in the business for revolutionary changes. Cars evolve and improve gradually, he said.

Well, General Motors' cars are out for you to see and you'll probably agree that Mr. Curtice was right.

Despite its all-new body and frame, Buick is still recognizable as a Buick. Despite Cadillac's new X-frame, its entirely new sheet metal, it's still definitely a Cadillac—you don't have to read the label. The same is true of Oldsmobile and Pontiac (the last-named is not all new this year, being a major facelift).

But the cars are different, drastically different in certain spots. Some models are more than three inches lower. Many are

New is the Century Caballero, a wagon with no pillars between doors. Grooved roof is for decoration only





**CADILLAC**

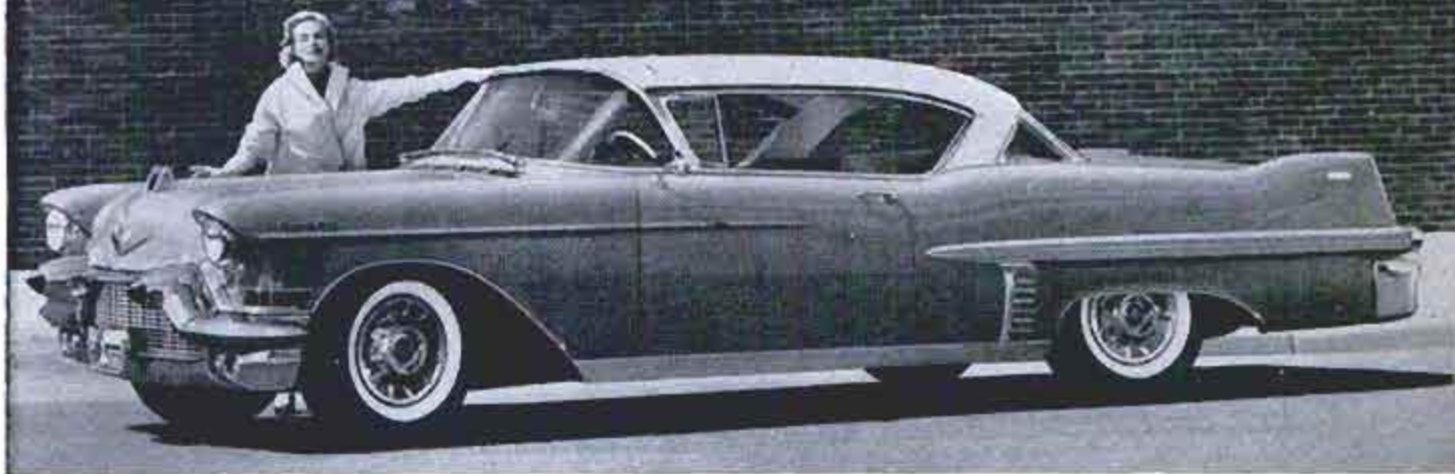

Low, long and luxurious are words to describe the Coupe de Ville. It is two inches lower than the 1956 version

## Three All-New Cars

longer, but not much. Interior dimensions, engineers say, are unchanged or, in some cases, improved.

But the most obvious difference is the lowness. Stand beside one of the new models and you'll find yourself looking down on the roof. And you stoop lower when you enter. But once in, you get a more stable ride because of the lower center of gravity.

Cadillac's X-frame has no side rails. Instead, the body is secured to outrigger mounting brackets. This permits lowering the car and increases torsional rigidity, says Cadillac. Other new frames (Buick and Oldsmobile) are more conventional.

All GM cars now have ball-joint front suspension as, in fact, has the whole industry). All but Pontiac and Chevrolet have sharply raked corner posts on the windshields that bring the lower edge of the glass much farther back. Cadillac and Buick retain the 15-inch wheels, the others



Those dark spots in the center of the bumper guards are molded rubber inserts to reduce parking damage

Tailfins on the Eldorado Biarritz are inboard. There is no continuous bumper. It consists of three sections





# OLDSMOBILE



Super 88 four-door sedan, like all Oldsmobiles, rolls on 14-in. wheels. Note the enlarged windshield



Traditionally, Oldsmobile has had bold, uncluttered front grilles and the 1957 version is no exception

at GM have changed to 14-inch wheels.

Let's be specific, taking the cars in alphabetical order.

## Buick

The enlarged V8 engine develops 300 horsepower in all models but the 250-horsepower Special. Displacement is up sharply to 364 cubic inches. Compression is 10 to 1 (9.5 to 1 on the Special).

Dynaflo transmission is unchanged from last year. ("Pregame tips" of a new transmission were right; Buick changed its mind at the last minute.)

Buick continues full cutouts on all wheels and all models. The hood line is lower, as is the trunk lid. Roadmasters are distinguished by two strips of chrome extending up over the trunk lid along the roof to the windshield. Buick continues its

More than two inches lower and four inches longer this year is the Starfire 98 Holiday four-door hardtop





**PONTIAC**



Pontiac's Star Chief four-door hardtop is lower and has a rocket-shaped two-toning along its full length

torque-tube drive with coil springs on all wheels. Optional on all models is a safety speed reminder that buzzes when a certain speed is reached (if the buzzing annoys you, you can shut it off or raise the speed setting by a knob on the dashboard).

New at Buick is a four-door wagon called the Caballero, featuring hardtop, pillarless construction and a grooved roof.

### Cadillac

You'll get 300 horsepower at Cadillac also, or if you wish you can have 325 in your Eldorado as an optional extra. Compression in all engines is 10 to 1, displacement is 365 cubic inches (one inch more than Buick).

Except for limousine models, all four-door Cadillacs have hardtop, pillarless

(Continued to page 254)



Notice something missing? You're right. The Silver Streaks are gone. The protruding hood ornament, toe

Already long and low, the Star Chief convertible becomes more so when the continental tire mount is added







## X Ray Pictures Entire Mouth

Eliminating the many small X-ray pictures which must be taken to show the entire mouth of a dental patient, a panoramic X-ray machine has been developed by the National Bureau of Standards in cooperation with the U. S. Air Force. The new machine rapidly takes a single panoramic X ray of the entire dental arch. The film is exposed by a narrow X-ray beam passing through the patient's head from the source box on one side to the film box on the other.

## Do-It-Yourself Carport

Homeowners who need low-cost weather protection for the family car can look to a do-it-yourself carport kit which requires only four hours for assembly. All necessary materials are included in one package and only ordinary tools are needed to complete the assembly. Displaying trim, modern lines, the carport should harmonize with most popular home designs.

Assembled in four hours by homeowner, this carport has trim appearance



## Flexible Padlock Of Steel Cable

At first glance a new padlock looks like a steel measuring tape. Actually the lock consists of a small metal case containing a steel cable that forms a shackle. The tip of the cable is pulled out, looped through or around one or more objects and reinserted in the case. When the key is removed the cable is locked securely. When it is fully extended, the cable is 36 inches long.



# KEEPING UP WITH THE ATOM

**T**HAT BUGABOO of the atomic age, the disposal of radioactive wastes, is under continual study. With a new "eye" engineers can "view" what happens to such wastes that are buried in the soil. The "eye"—actually a sodium-iodide crystal—is used in studies of the disposal grounds at the huge Hanford atomic plant.

The crystal is inside the windowless aluminum cylinder shown in the engineer's hands at right. Engineers lower the cylinder into test wells drilled in the ground. The crystal determines which isotopes are contributing radioactivity. This information is transmitted to a strip-chart recorder on the trailer. The test wells are sampled at regular intervals to determine what is happening to the radioactive wastes beneath the surface.



Ever wonder what the heart of a nuclear reactor looks like?

In the photo below you are looking down into the core of a small reactor. The fuel elements are the rectangular tubes, which contain a form of uranium. They

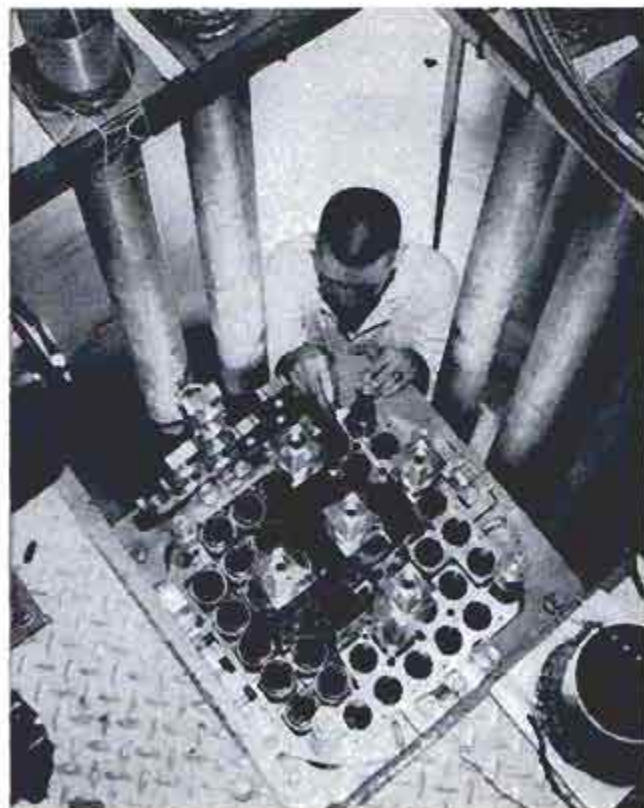

DECEMBER 1956

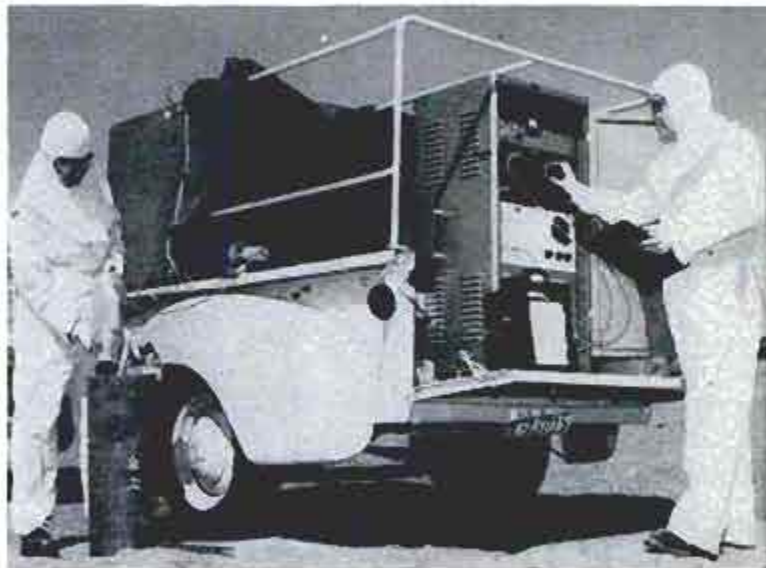

slip into individual sockets in the core.

This reactor is a research project which is helping in the design of the Army Package Power Reactor. You'll hear more about the APPR in coming months. It is a reactor designed to provide electric power at remote military bases, and therefore may be applicable to other remote installations as well. All the parts will be transportable even by air. Personnel will be protected by a combination of iron and water shielding.

This reactor may well pave the way for other small reactors which could produce electric power anywhere on the globe.



And speaking of electric power from the atom, the United States is spending at a rate of \$60,000,000 a year on research into power reactors. A spokesman for the AEC predicts that nuclear energy will be producing electricity about as cheaply as conventional fuels by 1966. He believes that some 25 million kilowatt-hours will be produced in nuclear power plants by 1970.



Can heart attacks be predicted? Possibly, if a new research program using tagged atoms is successful.

Cholesterol, a form of fat, is widely believed to be one of the major causes of heart attacks. Now radioactive hydrogen and carbon are being used in research to tag the buildup of cholesterol. If the research is successful, physicians may be able to trace cholesterol buildup, and warn patients well in advance that they are subject to heart attacks.

107





Workmen crank entire wall section of residence into position. Safety dog prevents falling if cable breaks

## Mechanical Lifters Raise Wall Sections Into Position

Carpenters can easily raise finished walls into position with crank-operated jacks employing a cable and a winch. The hinged base of a jack is temporarily nailed to the floor. The cable anchor, nailed to the top

of the wall, mounts two rollers which follow upward along a track on the jack pole. A spring-actuated safety dog on the cable anchor prevents the wall from falling should the cable break.

## Large Scoreboard Posts Kibitzers on Progress of Bridge Match

British bridge enthusiasts flocked to a London department store recently to watch a contract-bridge match between American and English teams. Since it was impossible for so large a crowd to look over the shoulders of the players, a giant scoreboard was set up to show the cards held by each player, the bidding and the

play. The players sat in a glass-enclosed room, and assistants recorded each play on the scoreboard as soon as it was made. At the end of each hand, a bridge expert interpreted the play for the spectators. The window of the playing room was covered with a layer of fine cheesecloth so that the cards would not be reflected in it.

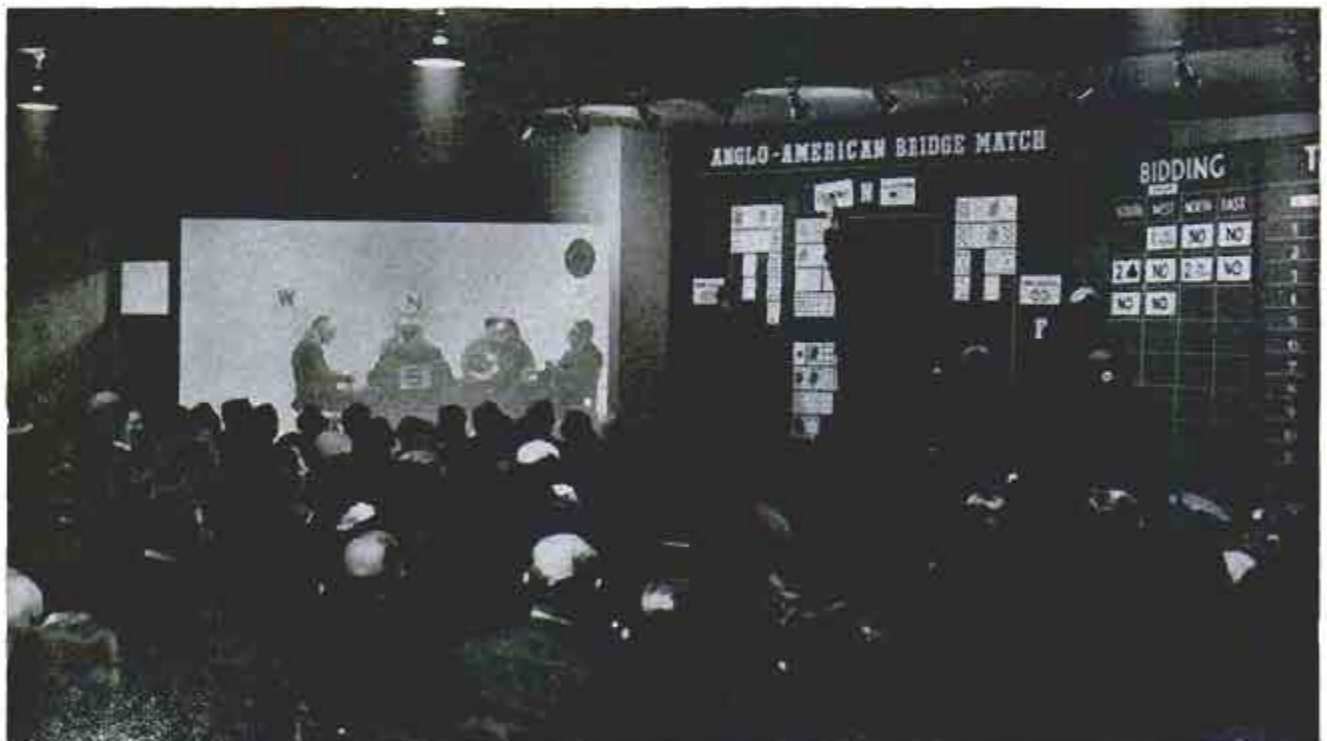



# White Land of Mystery

*At last our scientists are making a mass attack on the weird phenomena of Antarctica, breeding ground of the world's weather, home of the aurora and cosmic rays and mile-deep ice blankets*

**By Richard F. Dempewolff**

**E**ARTH'S FIFTH-LARGEST continent spreads a white-pinnacled land mass more than a thousand miles in every direction from the South Pole. Yet, until now, scientists have known more about the topography of the visible surface of the moon than of this sleeping giant caught in the grip of an ice age. Locked in its frozen

spaces are a hoard of mysteries that have puzzled scientists ever since they were first observed by the few explorers bold enough to venture there.

Right now, 75 geophysicists from the United States are joining scientists from 11 other nations in a historic assault on the white continent's secrets. They comprise

Folded antenna for a new back-pack radio springs into a straight wand when one end is thrown outward







Inside an insulated hut, a Signal Corps team sets up equipment to test radio transmission through the deep blanket of ice. Lightweight hut can be towed into place by a Weasel, below, or parachuted already assembled from a flying boxcar. The huts have precut openings for heater stacks and ventilation



Navy technician, below, protected by tent that can be erected in five minutes, sets up instrument to check earth's magnetic field



the south polar team for the International Geophysical Year—worldwide scientific investigation of the earth and its star, the sun, scheduled for 1957-58 (*Popular Mechanics*, December 1955). From 39 observing stations—some of them deep in the continent—these men will pry into such things as Antarctica's unique weather-breeding phenomena. They'll scrutinize the moving ice blanket that reaches a depth of more than a mile on the continent's 10,000-foot polar plateau. Modern sonic and electronic eyes will probe to find what's under it. Antarctica's auroral, cosmic and ionospheric phenomena will be studied during the bitter polar night from plastic viewing domes. Observations will be compared with simultaneous effects all over the world.

On Operation Deepfreeze I, some 30 private, government and military scientists laid the groundwork for the big push. Dressed in bulky thermo clothes and fur-ruffed hoods, they moved inland to locate base sites and make preliminary observations.

Special building beneath surface of the snow is used for the study of the aurora and air glow. Men climb a shaft to the observation room where they watch through three viewing domes, one of them equipped with an all-sky camera. The fourth dome is used for a telescope and for special instruments which are used in tracking meteors



For years, meteorologists have suspected Antarctica of being the world's most potent weather breeder. Great air masses fan out from the pole, sweeping constantly across the ice with gale and hurricane force. Whisking thick veils of drift off the barrier cliffs, they roar northward over four oceans.

One of the lustiest of these gales is a roaring mass of air that pours northward continually from the Adelie Coast. Its howling gusts have been estimated up to 200 miles per hour. Deepfreeze pilots exploring the area south of Adelie Land have discovered a vast trough some 300 miles wide. Formed by a range of 14,000-foot mountains along the Ross Sea and a great dome of continental ice reaching 13,000 feet to the west, the trough slopes upward from the coast, perhaps as far as the pole. Dr. Paul A. Siple, senior scientist for the expedition, believes this enormous funnel may be the answer to the big wind. During the six-month winter night, he says, temperatures on the high polar plateau may skid to minus 120 degrees. That cold, heavy air cascades down the chute, some spilling through mountain passes onto the Ross Shelf, but most of it barreling to the coast and spreading across the sea in a roaring polar gale.

A frigid air mass of such dimensions is bound to affect weather, wherever it blows.

"We have found evidence of polar Antarctic air everywhere up to 40 degrees latitude," Dr. Morton J. Rubin, IGY meteorologist, told me. "We think we've spotted occasional bursts at the equator."

Weather created in these zones eventually may affect the northern hemisphere. So, what happens in Antarctica today may have its effect in New York and Chicago months from now.

Using Antarctic weather for long-range forecasting is a prospect most weathermen have dreamed about. But who would man observation posts in a land no one can live in except for limited periods? Now, for the first time, some 40 weather stations scattered across the bleak continent will report to Weather Central at Little America, and surface weather maps based on actual observations will give meteorologists their first picture of south-polar weather being born. Doctor Rubin explains that besides the regular bases, satellite stations will be planted miles out on the barrier by several nations. The Australians will have a number of remotes that will automatically radio surface reports for a broader picture.

An interesting experiment is the use of "grasshopper" robot stations to provide continuous weather reports along the route that must be flown by planes ferrying supplies to our own South Pole base this fall. The little automatic weather stations have

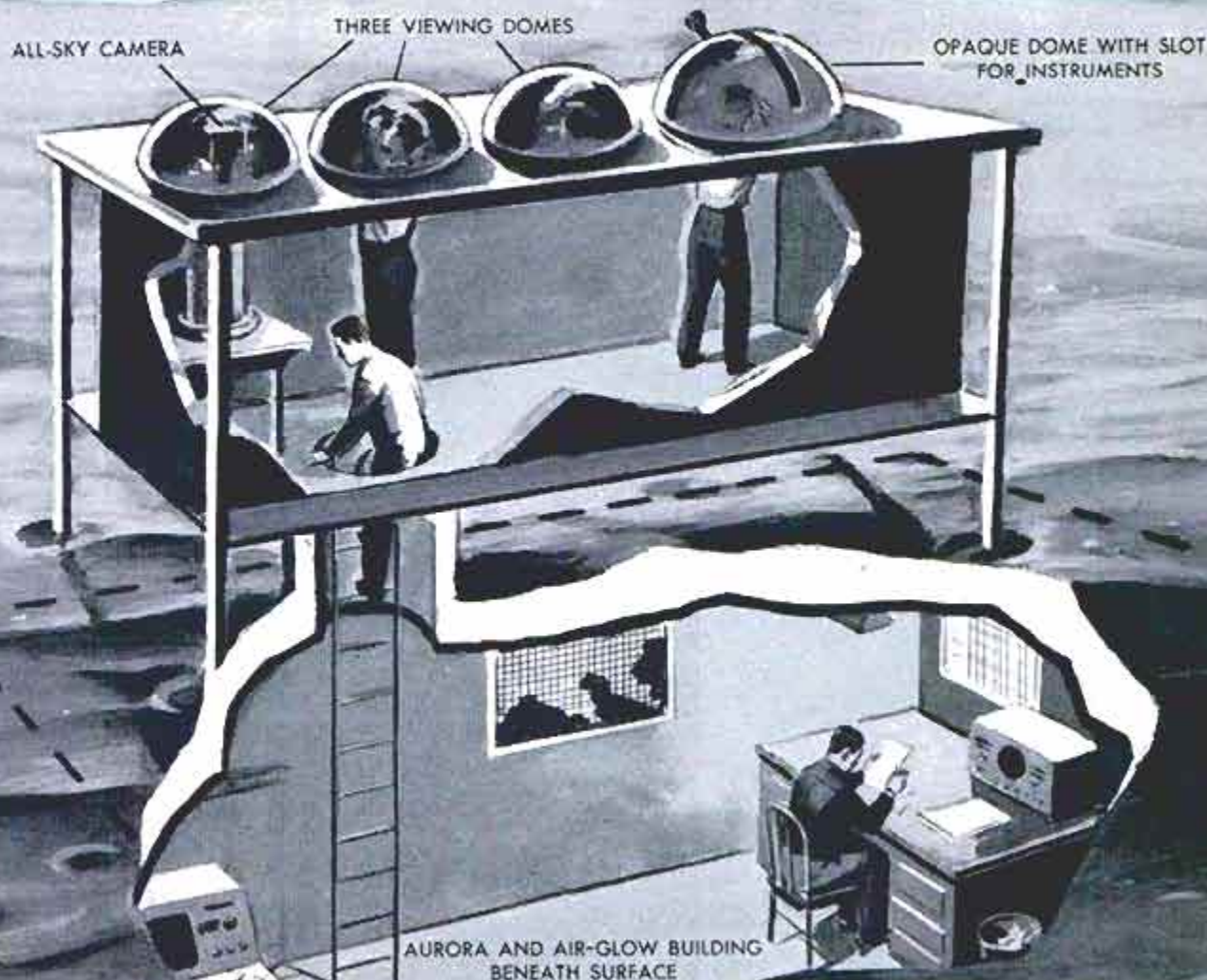



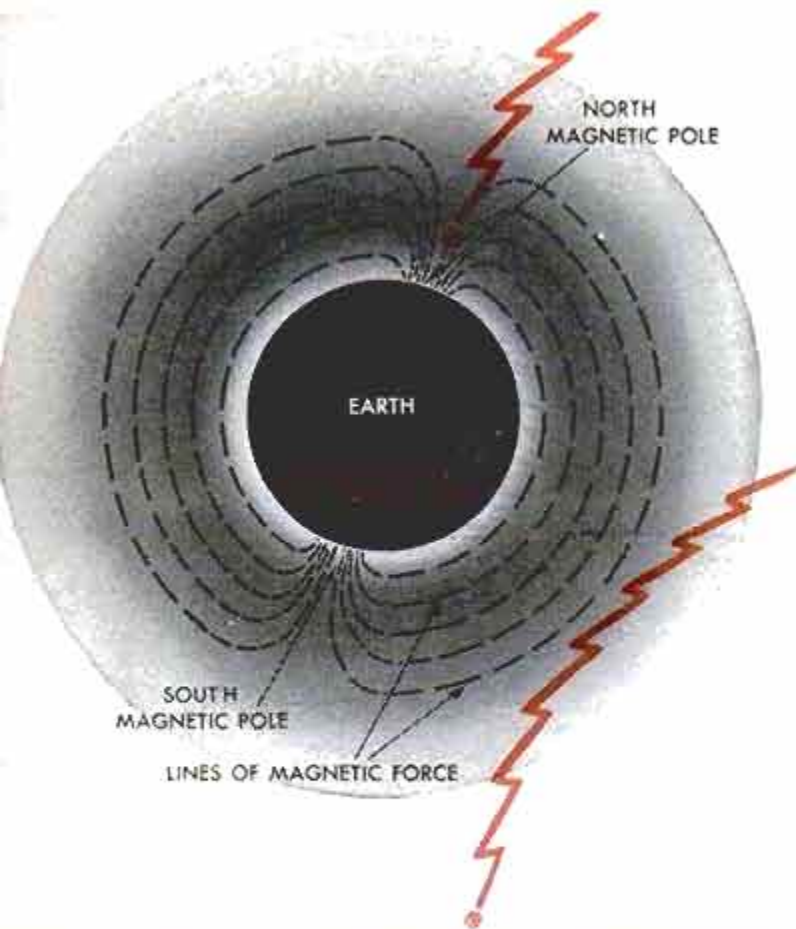

Drawing shows how the earth's magnetic field tends to deflect charged particles except at the poles

a tuning device that can be set to transmit wind force and direction, temperature and pressure every six hours. The tiny box on a stick is parachuted from a plane. When it hits the ground, spidery legs spring out from the central shaft and it sets itself up-right on the ground.

Even more exciting to meteorologists than surface weather maps will be the first charts of south-polar air, drawn from network reports. "In winter," Doctor Rubin points out, "the tropopause disappears or becomes diffuse." This means that the stratosphere, which rides some seven miles high over the United States, may often be found at sea level in Antarctica. Mountains and polar plateaus poke two miles up into it. For this reason south-polar flying is risky. Hazards of high-altitude flight face the pilot on the ground. Full supercharge, jet assist and miles of run are needed just to take off in the thin air.

To probe through the earthbound stratosphere and into weather-making strata above, all bases will send aloft self-tracking rawinsonde equipment. At little America, these balloons, carrying a radar target, will be released through a hatch from a building under the snow. Soaring to heights up to 100,000 feet, they will be tracked through various wind layers by a dish antenna housed in a black plastic dome on a tower above the surface. From similar hatches will go other balloons, with radiosondes dangling beneath them to radio back to earth soundings of temperature, air pressure and humidity.

Actually, Antarctica is a weatherman's museum of curiosities. Across the polar plateau's snow desert, barometric pressures read lower—by one inch of mercury—than any place in the world. This is due, says Rubin, to shuddering temperatures that average 20 to 40 degrees lower than the Arctic.

Out on the white "desert," these pioneers will study the weird snowstorms that start from clouds only waist high. They'll probe atmospheric conditions that cause spectacular displays of light in the sky. Several times in McMurdo Sound we watched white halos—sometimes as many as three—form around the sun. Superimposed on one of these was a tremendous white cross of light. Such displays, as well as dazzling arches of color across the polar sky opposite the sun, and great shimmering columns of white light called "sun dogs" that bracket the sun, are caused by refraction of the sun's rays in high-hanging frozen mists made up of millions of ice spicules.

(Continued to page 244)



Scientist collects sample of snow in paper bag. Snow is melted, and radioactive tritium then tells how long ago the snow fell. Below, movie camera records cosmic-ray penetration of atmosphere near the pole







Thermometers and scales are used to check the temperature and density of snow prior to building airstrip

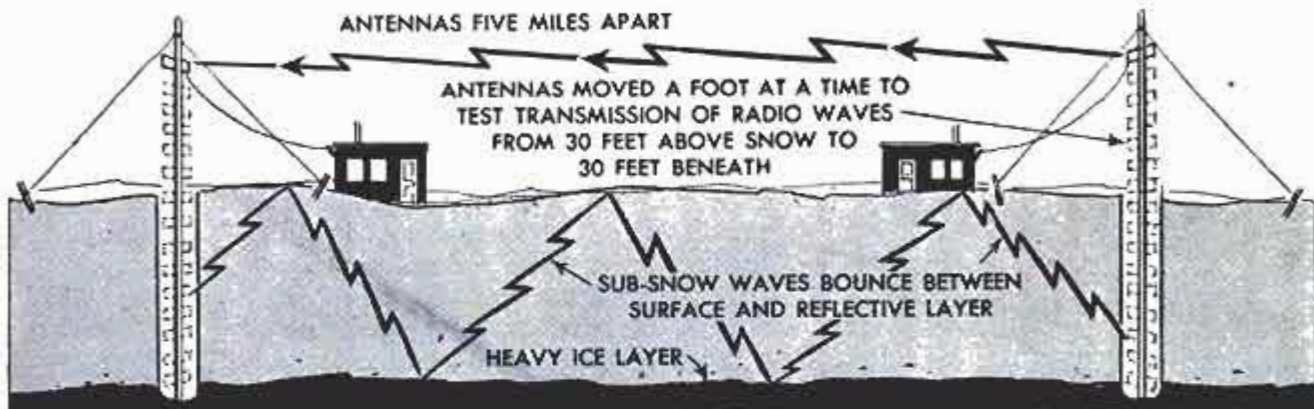
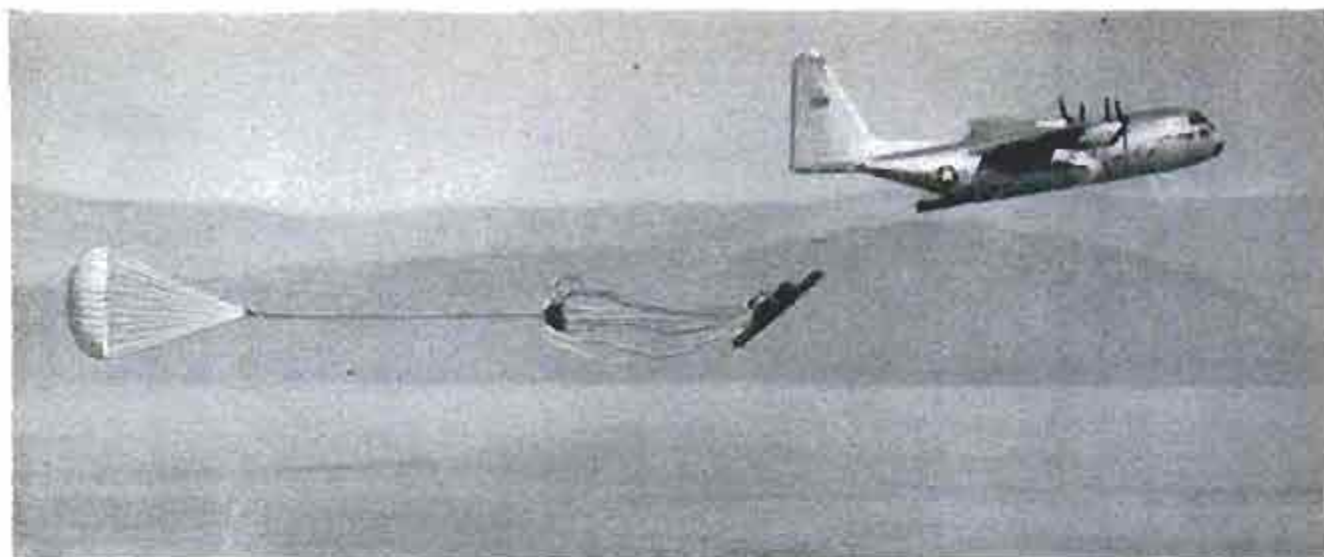

Diagram shows how radio waves can be transmitted through snow by bouncing them between surface and heavy ice layer. Below, captive penguins are force-fed in preparation for trip to States in refrigerated comfort







## Air Force Freighter Sets New Load Record of 27,000 Pounds

Flying at an altitude of 2000 feet, an Air Force Hercules C-130, a prop-jet troop-and-cargo carrier, has dropped the heaviest single load ever launched from an airplane. The load consisted of 27,000 pounds

of iron on a platform, which was lowered to the ground by six 100-foot cargo parachutes. The big drop was made on test flights of the C-130, which is soon to go on active service with the Air Force.

## Tiny TV Camera Relays Pictures of Plane's Moving Parts



Aircraft engineers can study any part of a plane in flight with the aid of a 1½-pound television camera the size of a flashlight. The rugged, heat-resistant unit, attached by cable to a TV set inside the plane, can be mounted outside to relay pictures of fluttering tufts attached to the tail that reveal the air-flow pattern. It can be fitted inside a landing-gear housing to relay a continuous picture of the gear being raised and lowered against the force of the slip stream. During lab tests, it can give a close-up scrutiny of jet engines running on the test block or be placed inside the wing during stress studies under simulated conditions. It may even be used as an inspection tool between flights to peer into inaccessible corners. The camera was developed by Lockheed Aircraft.

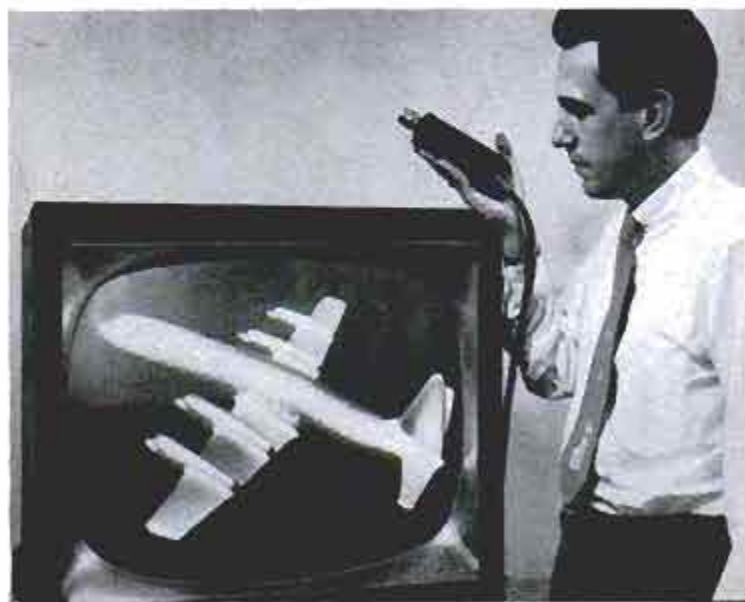





## Italian Designers Plan 125-M.P.H. Bus of Tomorrow

Extreme lightness and a 125-mile-per-hour speed are claimed for an ultramodern bus designed by the Viberti Company of Italy. The bus will eventually be powered by a gas-turbine engine, but a test model is being made with a conventional piston engine. To achieve lightness, the vehicle is

built of plastics without any metal framing. Independent suspension is featured on all four wheels. The tail is like that of an airplane. The interior is air conditioned and has facilities for serving food and watching television. The driver's seat is exactly in the center for good visibility.

## Snorkel Simulator Tests Sub Detectors

Mounted on a torpedo-shaped hull at the U. S. Naval Air Station, Patuxent River, Md., a captured German snorkel is being used to test new antisubmarine-warfare detection devices. Called the snorkel simulator, it is guided around Chesapeake Bay by remote control or by a man sitting in a seat rigged on the side of the tube. Planes from the test center are then dispatched to search out the simulator.

## Hot-Water Rockets To Assist Take-Offs

Hot-water rockets, which produce thrust by emitting steam from high-pressure nozzles, are being considered as replacements for liquid and solid-fuel rockets now used in jet-assisted take-offs of aircraft. German scientists say hot-water rockets would use one fiftieth the fuel of other types and be operated for only 12 cents per ton per second. They suggest the plane be mounted on a wagon which would be accelerated by hot-water rockets up to a velocity where ramjets could take over.

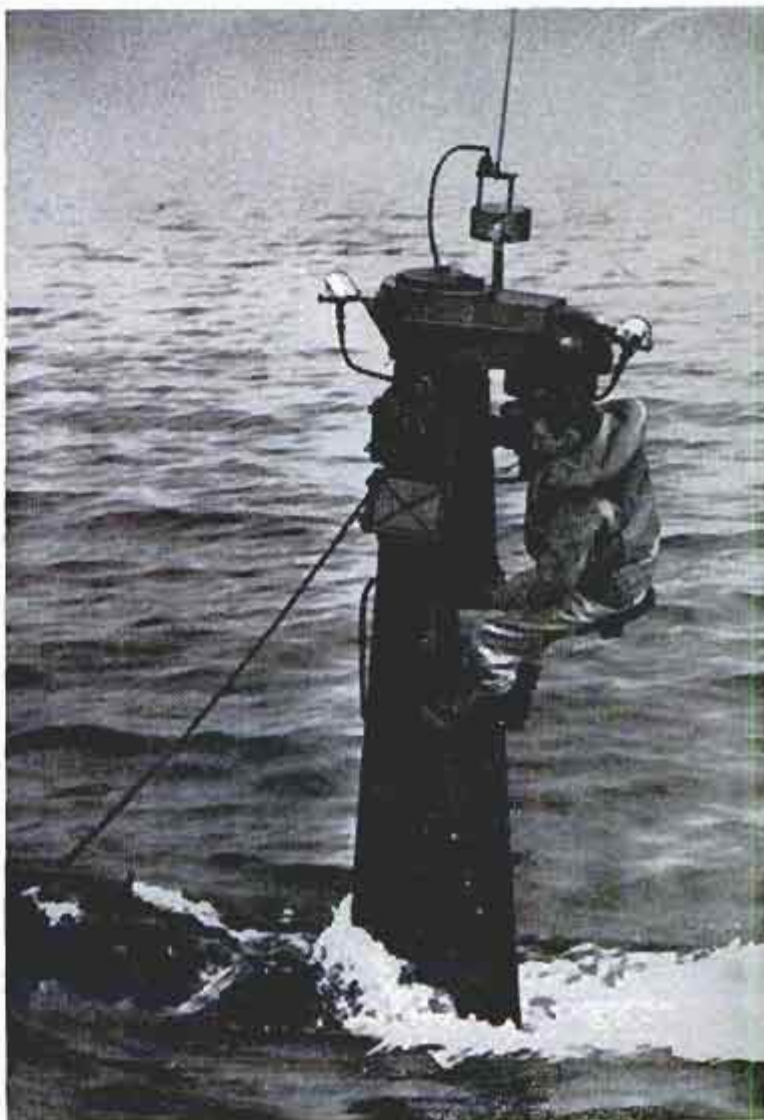





Above, church photographed across lake with normal lens. Below, same church shot through telescope

## Camera Uses Telescope as Telephoto Lens

A powerful telescopic lens for use with a 35-millimeter reflex camera can now be assembled using a telescope plus two adapters and a light-tight sleeve. One adapter supports the camera and the other fits the telescope to any standard tripod. This sleeve connects the eyepiece and the lens of the camera. When used with a 20-power eyepiece, the telescope is equivalent to a 1000-millimeter telescopic lens. With a 30-power eyepiece, it is equal to a 1500-millimeter lens. Total cost is less than \$150.



## Hand-Held Foghorn for Boat Skippers Operates on Gas Cylinder



Fog becomes less dangerous for boat operators if they have a new self-powered foghorn aboard their craft. The horn is powered by Freon gas stored in a cylinder. Touching a switch releases the gas into the six-inch horn, which can be heard more than a mile over open water. The cylinder holds enough gas to deliver 450 two-second blasts. It can be recharged at nominal cost.

## Ice Not Necessary for Rain

Two University of Chicago meteorologists have a new theory of how clouds make rain. It is that rain from summertime clouds most often results from giant chemical particles in the air, rather than from ice particles as had been thought. The particles are usually sulphates over land, salt particles over the ocean. The particles pick up moisture until they become so heavy they fall as raindrops. No ice crystals are involved, since many clouds release rain at above-freezing temperatures.





Stoiadin folds up four rear panels against the front half when he wishes to carry only half a load snugly

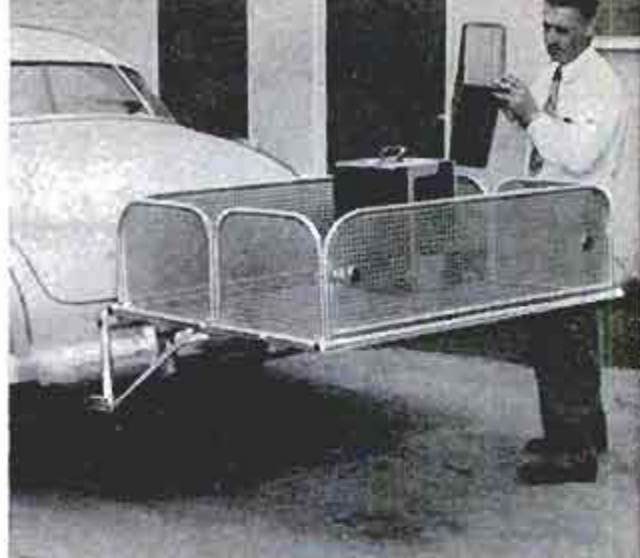

With all of its welded-steel panels extended, the bumper carrier provides plenty of room for suitcases

## Cantilevered "Rear Balcony" Carries 500 Pounds of Luggage

Louis Stoiadin, Los Angeles real-estate salesman, can carry an extra 500 pounds of luggage when he takes a trip—thanks to a rear-bumper carrier he built for his car. The cantilevered structure is supported by fittings which extend under the car to at-

tach to the car frame and rear bumper. The unit is made of steel tubing welded together. Folding side panels are made of perforated sheet steel. The carrier is hinged so that it can be folded into a more compact unit for carrying smaller loads.

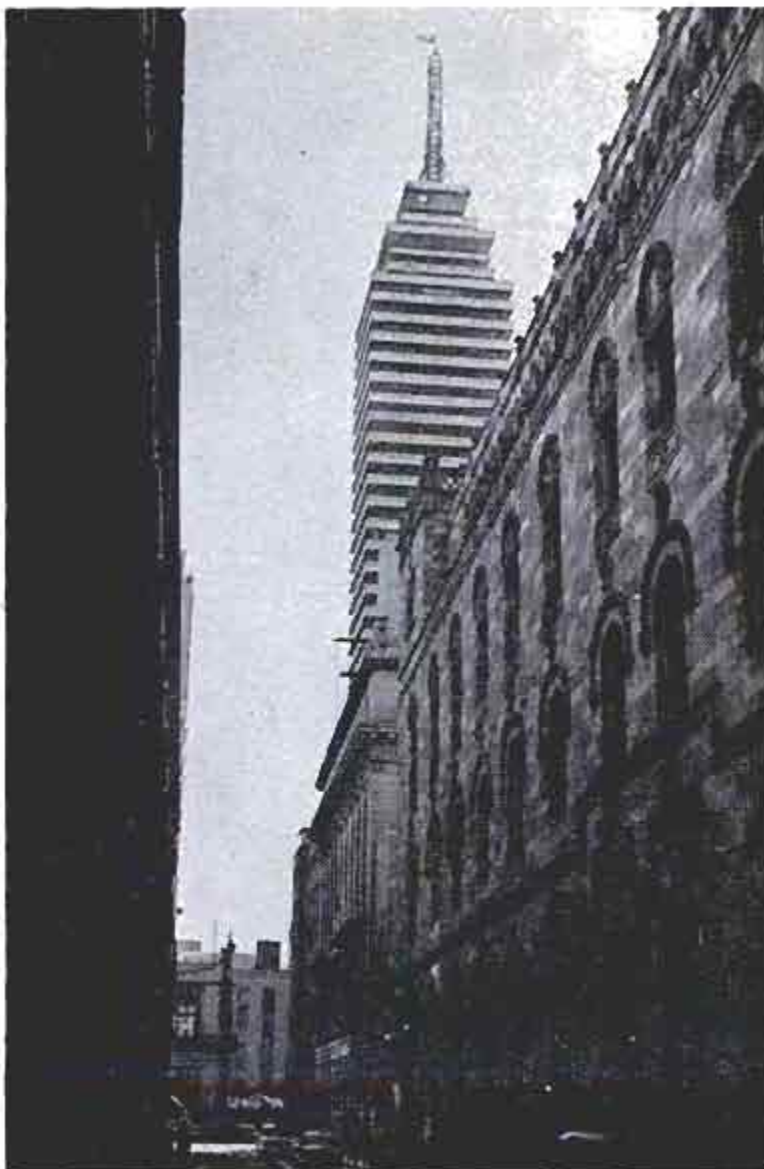

## 43-Story Skyscraper On Floating Foundation

Forty-three-story skyscrapers are not unusual anymore, except in Mexico City where a porous, spongy subsoil is causing the capital of Mexico to sink slowly into the ground. The Palace of Fine Arts, for example, has settled until one third of it is now below street level. In spite of this hazard, engineers are now completing a 43-story skyscraper, which they say will not sink. It has been designed to rest on a floating foundation which partly supports the dead weight of the structure. A hole 45 feet deep and 1190 square yards in area was dug and lined with watertight walls and floor. Like a huge concrete ship, this foundation floats in the subsoil.

## Applause Heats the "Met"

Applause saves fuel at the Metropolitan Opera House. When applauding, the average patron generates one sixth to one third more body heat than at other times, lessening the demand on the heating plant. A full house of 3500 persons generates about a million B.T.U.s—enough to heat 20 six-room homes on a winter day.





Omar Crabb, mink-ranch owner, discusses a pair of 3-week-old Sapphire kits with Francis Shoulak, manager

# There's a Nice Future in Mink



Coats made from rare types of ranch mink have sold for as much as \$30,000. A full coat averages 65 to 75 skins, depending on styling

This is one of the best males on the ranch and the only one Shoulak will handle without gloves. He has been made somewhat of a pet

By Omar Crabb  
as told to  
Jack B. Kemmerer

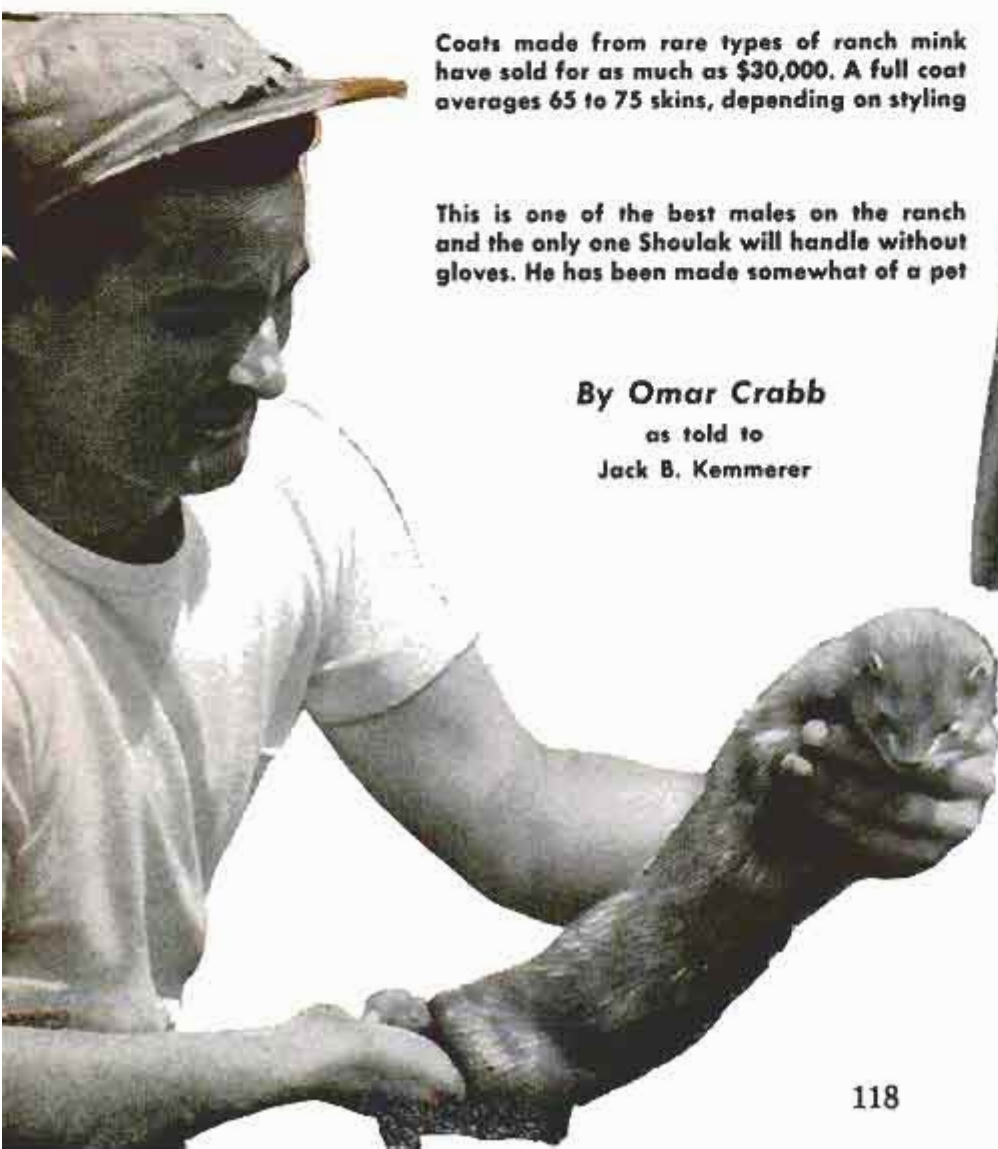





The kits in this litter are fine-quality mink and will be sold to other ranchers as live breeder stock

**R**AISING MINK as a spare-time activity or hobby is not a get-rich-quick business, even though many persons, who know nothing of fur-bearing animals, seem to think they can make a fortune overnight breeding mink. It is one hobby that doesn't require a large sum of money to start. With a small investment, a little study of mink and some pleasant work, you can have a hobby of breeding-mink almost anywhere.

About 12 years ago, in Rouleau, Saskatchewan, Can., I was in the insurance business and had a mink rancher as a client. Becoming acquainted with the animals, I liked them and decided to fool around with a pair in my spare time.

After about two years I felt that here was a hobby that presented a good future if handled properly. Starting with \$800, I bought 19 females and 5 males for \$25 each; the rest of the money went for pens and equipment. You don't need this much, however. You can get two excellent females and one male for about \$400, and the three pens required for the mink can be built cheaply. Of course, if you have the money a bigger investment will realize good returns much faster.

While mink ranching doesn't require a college degree, it does require special knowledge, like any business venture. The

beginner must know what the fur trade considers an ideal mink pelt and why such a pelt is superior.

#### Cold Weather Not Necessary

Contrary to popular belief, extreme cold weather and favorable locations are not necessary to produce high-quality pelts. Mink ranches in California produce top-quality skins, and ranches in back yards of city homes raise a hundred or more mink each year.

Quality ranch mink is superior to wild mink because the pelts have a more even texture, light leather and more beautiful uniform color. With trapping of wild mink decreasing yearly, they must be raised commercially if our ladies are to continue to wear mink.

The first few years I sold a few pelts and live kits, but didn't take any profits. Instead I built the ranch by improving the breed and increasing the number of mink.

Today, the ranch is 125 feet by 750 feet with a six-foot guard fence around the entire place to keep the mink in when they escape from their pens. It consists of four sections—each a separate unit. We have 1000 pens in covered sheds for housing during breeding and whelping time. The second section is 1000 outdoor pens, with cottage roofs, used during pelting time and



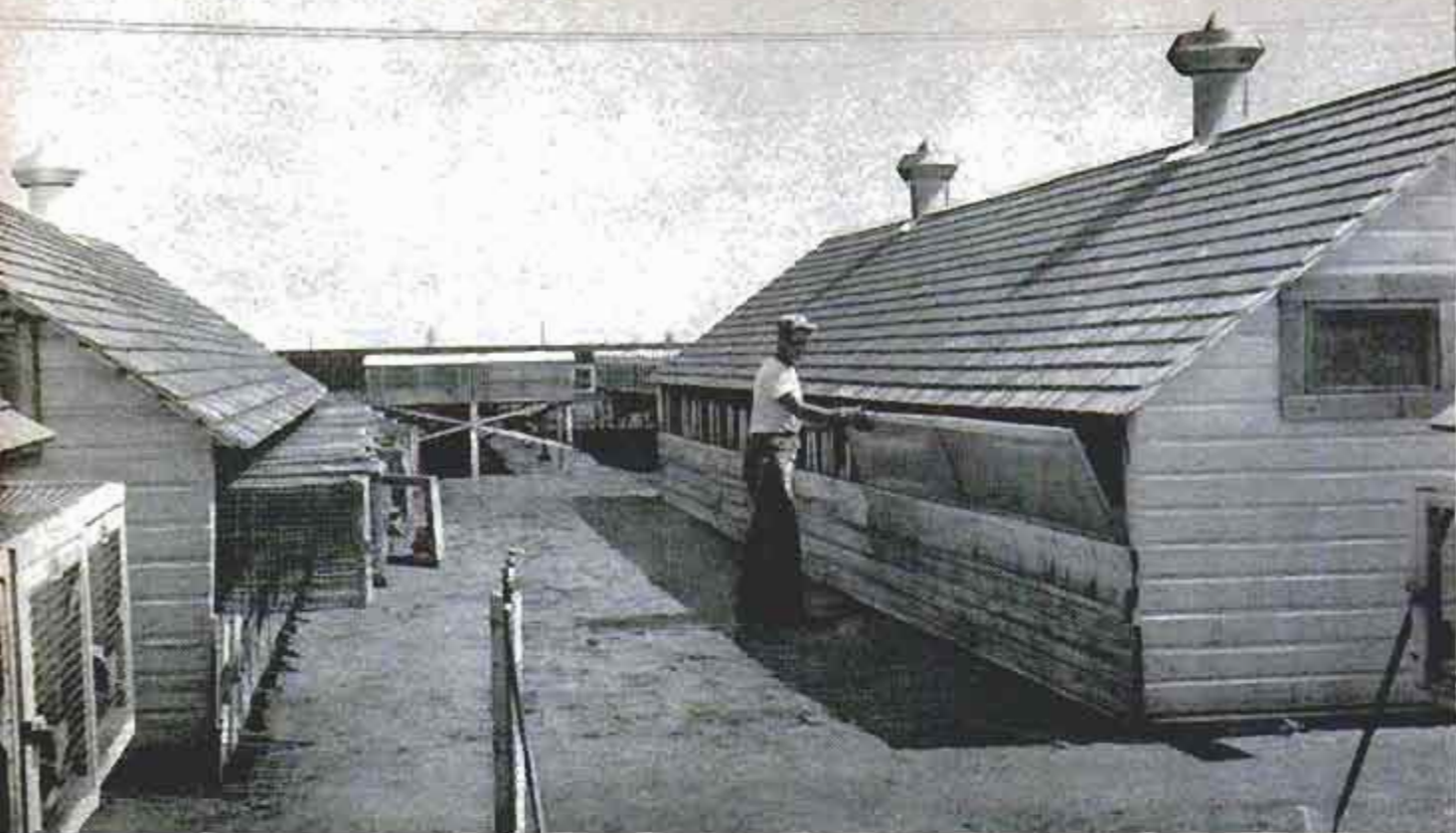

Pens for summer use are built outside of sheds. To keep out severe Canadian winter, sideboards are put on

summer months. The third is our completely modern feed house, and the fourth a 100-ton cold-storage plant.

#### Feeding Equipment

A well-planned, properly equipped feed room is very important on a large ranch such as mine, one of the largest on the Canadian plains. Equally important is the cold-storage plant. A beginner, however, doesn't need all this equipment. Some sort of refrigeration and a meat grinder are sufficient.

Two sets of records are clipped to each pen and are carefully kept up. A third set is kept in a safe



We feed horsemeat, lungs, tripe, liver and some fish. This is ground and mixed with cereals such as bran, brewer's dried yeast, bone meal and milk powder. Heavy fat, tallow or suet should never be fed as the animals can't digest it. However, when a mink is on her own she is apt to eat almost anything. One day a female escaped from her pen with two kits. I knew she couldn't get past the guard fence, so I wasn't worried. Two weeks passed and while we would see her around the ranch, we could never catch her. One day I saw her dart into a hole near the feed house. Digging up the hole we found her and the two kits comfortably set up in a nest with two dead rats, one bird and a chicken for food. I don't know where she got the chicken as none of ours was missing.

Several companies make a prepared cereal, but I never feed it alone and don't recommend feeding any cereal in excess of 15 percent of the total ration.

#### Wheat-Germ Oil Used

In January we add wheat-germ oil to all rations and this continues until the kits are born. Cod-liver oil is used if any of the mink seem to be in poor condition. The ration differs from time to time, with the greater meat content being fed from weaning time until September.

We have a power slicer, grinder and a food mixer that will mix 900 pounds. In summer we feed 700 pounds per day and in the fall it goes up to about 1800 pounds. It costs five cents per day to feed a mink.





Female which had escaped from pen was shown one of her kits. She grabbed it by neck, and was recaptured

March is the mating month and our busiest time. It is important that the mink be in good condition; not too fat, active and not too lean.

Mating time is the period when the stock is improved through inbreeding, cross-breeding and addition of new blood. In order to know the results, records must be kept. We keep records, in triplicate, of every mink.

The indoor pens are made with heavy wire on all four sides and a detachable nest box on the rear. They are so constructed that any mink can be locked in either the pen or nest box. A slide in the nest box serves this purpose. Each pen is numbered, with the same number on the nest box. A set of records of that mink is attached to the roof of the shed above the pen, the duplicate to the nest box, and the third set in the ranch safe.

#### Litter Averages Four Kits

For mating, the male is herded into his nest box and taken to the female and as the nest-box number corresponds with the pen, we always know where each male belongs. Mink have one litter a year, and a male serves many females in one season. I have had males father 103 living kits in one season.

Mink carry their young from 44 to 75 days and usually all kits will be born by June. Our average this year was four kits to the litter, though I have a female that raised 10 kits in her second season. These kits are pelted in November or will repro-

duce the following year if kept as breeders.

When whelping, females are temperamental and special precautions must be taken. No unusual noises, no visitors and I don't even count the kits until they are two weeks old.

(Continued to page 238)

The kit which ranch manager Shoulak is holding in his right hand is a Sapphire, the other is a Kobuk

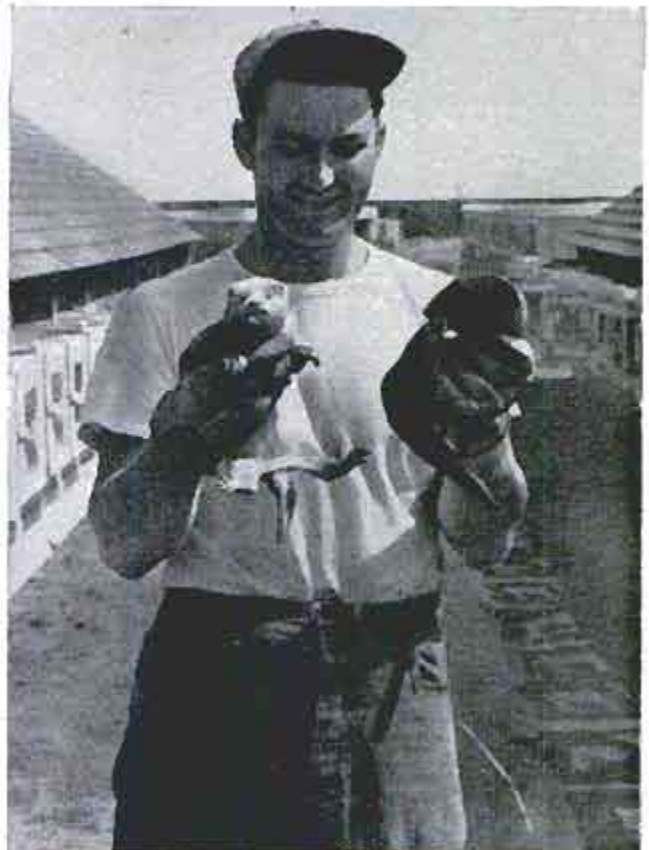





Long-range radar searches for coastal protection require far-reaching antennas. This may be the answer



### Umbrella-Type Radar Antenna Mounted on Super Constellation

Ready to undergo tests, a new radar antenna to be mounted on large aircraft resembles an umbrella or a flying saucer.

The radome is mounted on a U. S. Navy WV-2 Super Constellation, like those now in operation on coastal defense.



### X-Ray Trees to Find Decay

Scientists are now cruising the Iowa woodlands "looking inside" trees to study the extent of decay. Until now such work has been done by dissecting individual tree trunks. But this year tree doctors are looking into tree hearts with a new lightweight X-ray unit developed at Iowa State College. The 13-pound outfit is strapped to the trunk of the tree and shows decayed areas, water-filled cavities and squirrel nests that may be hidden deep in the trunk. Secret of the little X-ray unit is a small lead cylinder with a pellet of irradiated thulium in its center.



## Plastic Poured Into Molds Forms Fishing Lures

Lifelike, brilliantly colored fishing lures are made at home in minutes with a plastic molding kit. The 21 different patterns available include worms, frogs, crayfish, a minnow and several insects. Each kit has one aluminum mold for one to three different specimens. Liquid plastic is dropped into the mold and drawn with a stylus into the smaller parts to make delicate wings, antennae, or legs. Then the mold is heated one to three minutes and quenched in cool water. After removal from the mold, the lures are ready for use. Different colors can be mixed.

Right, liquid plastic is poured into the aluminum mold and distributed with a stylus to form the legs, feelers and other fine parts. Below, next step is to heat the mold. Below right, lifelike lures are ready for use. Mixing plastics gives various colors



## Backward Truck Becomes Versatile Farm Derrick

Ingenuity and an old truck produced one of the most useful pieces of machinery on the farm of Merle Harlow in Whitman County, Wash. Harlow shortened the truck, then reversed the gears and steering. To the odd result he added a standard hydraulic loader. Now the machine loads or lifts almost anything.

Truck appears to back into position because the gears are reversed





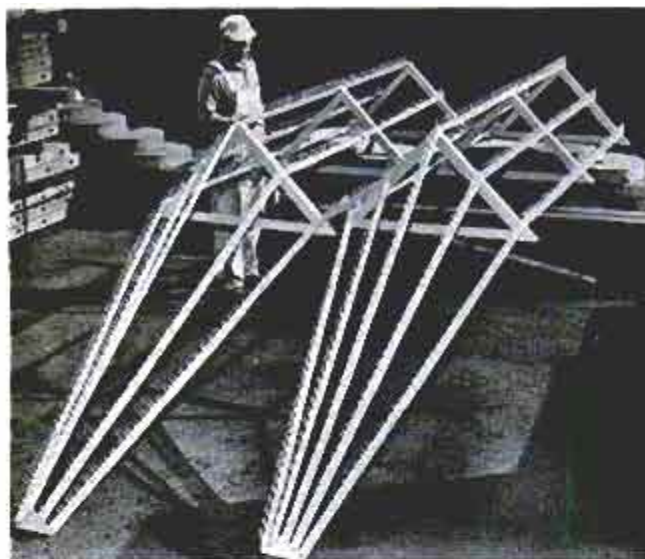

Worker paints spikes after they have been spot-welded to angle irons. Tower in Puget Sound, right, was favorite roost of gulls before frame was mounted

## Spiked Frame Atop Tower Bars Fish-Dropping Gulls

Power-company engineers at Tacoma, Wash., have solved the knotty problem of keeping sea gulls off the top sections of transmission towers in and near the bays of Puget Sound. The gulls like to eat their lunch atop a tower, dropping clams, shells, fish and algae on the frame below. Salt water from the food rusts away the steel fabric of the tower. The birds, as scavengers, rid the bay shores of dead fish and other refuse. They are protected by federal law. The engineers' solution was a spiked frame set over the top cage section of the tower. U-shaped, 2½-inch wire staples were spot-welded to one-inch angle irons fitted together, ten inches apart, in five rows. The \$130 cost of the spiked frame compares with the \$1000 cost of replacing a rusted frame cage section.

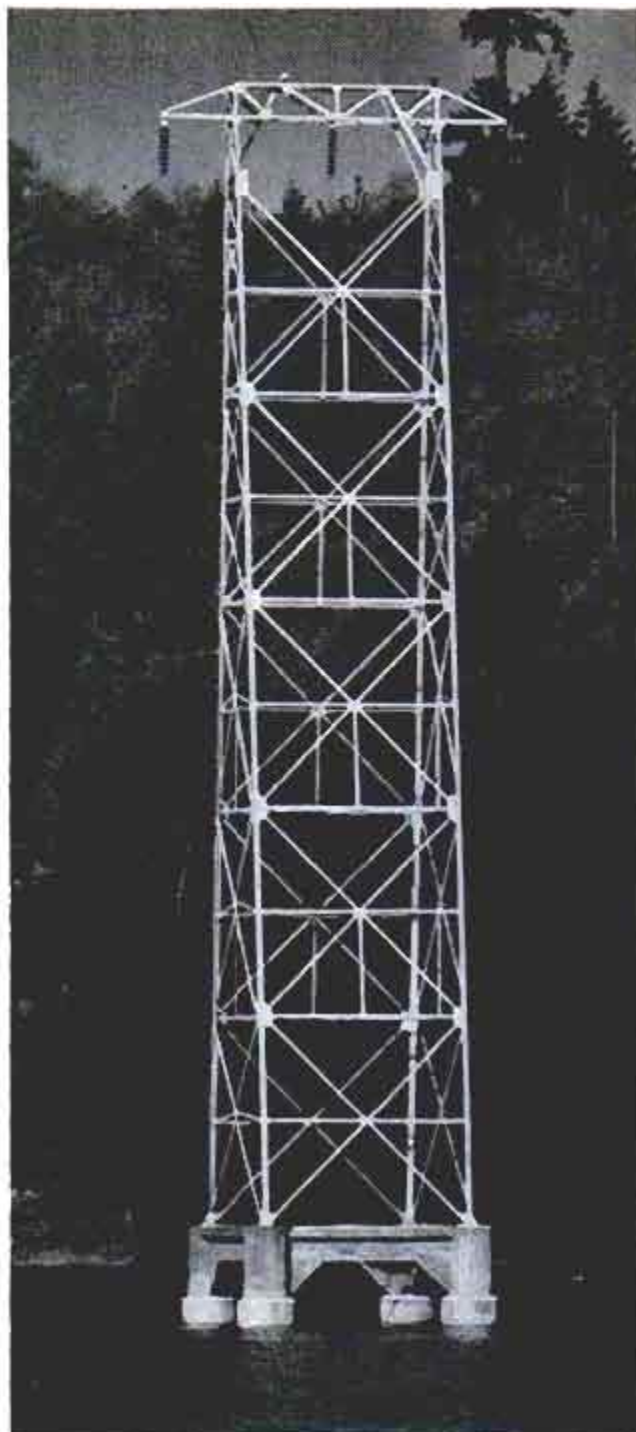

## Double-Barreled Camera Shoots Distant Deer

Two cardboard shipping tubes form the twin telescoping "barrels" of a long-distance camera built by taxidermist Dorf Jones of Olympia, Wash. Jones uses the long focal-length camera to get close-up shots of fleeting deer. The camera lens, with a bulb-and-cable shutter release attached, is mounted on the front end of the assembly. Above it is a lens that throws an image on the ground glass viewer mounted above the film holder at the rear. Jones steadies the camera with a shoulder rest and peers into a hood to watch the ground glass as he slides the front assembly ahead or back to obtain a sharp image. Camera parts came from an old German camera.

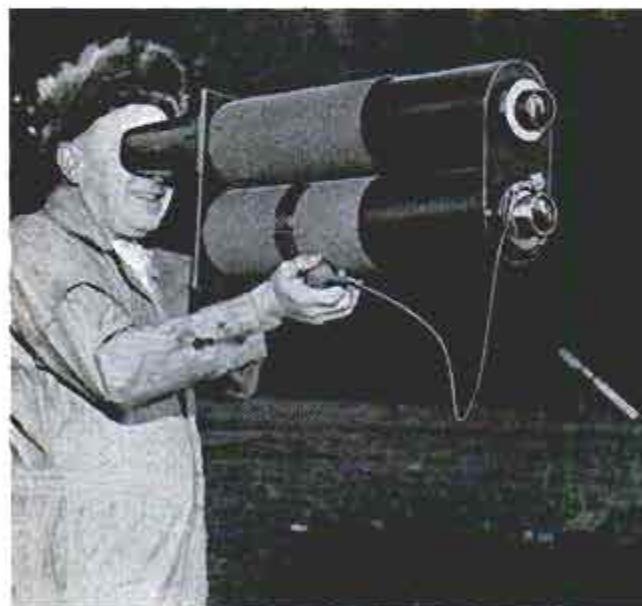





Lockheed Air Terminal, Inc., Burbank, Calif.

Cargo can be loaded and unloaded rapidly in any kind of weather through tunnel, called the "Aerobridge"

## Telescoping Tunnels Help Load Cargo Planes Faster

First tests indicate that a new aid in the loading and unloading of air freighters will save about an hour in turn-around

time for each plane served. A covered tunnel with rollers built into the floor is extended from the side of the freight terminal

when a plane pulls up into position. Totalling 84 feet in length when extended, the covered tunnel makes it possible to handle freight easily in all weather. Packages weighing up to 10,000 pounds slide down the rollers easily. A DC-4 carrying 18,000 pounds of cargo was unloaded in 18 minutes, and then reloaded in 35 minutes.



Cargo rollers speed up loading and unloading, increase plane utilization

## Mile-a-Minute "Sports Car on Water" Has 80 Horsepower

Sporting two Mercury Mark 55H motors, rated at better than 40 horsepower each, a boat that is a kind of sports car of the outboard-boating field has been tearing

around Wisconsin lakes at better than 60 miles per hour. Built by the Kiekhaefer Corp. as a showpiece, the boat has proven popular enough for limited production.





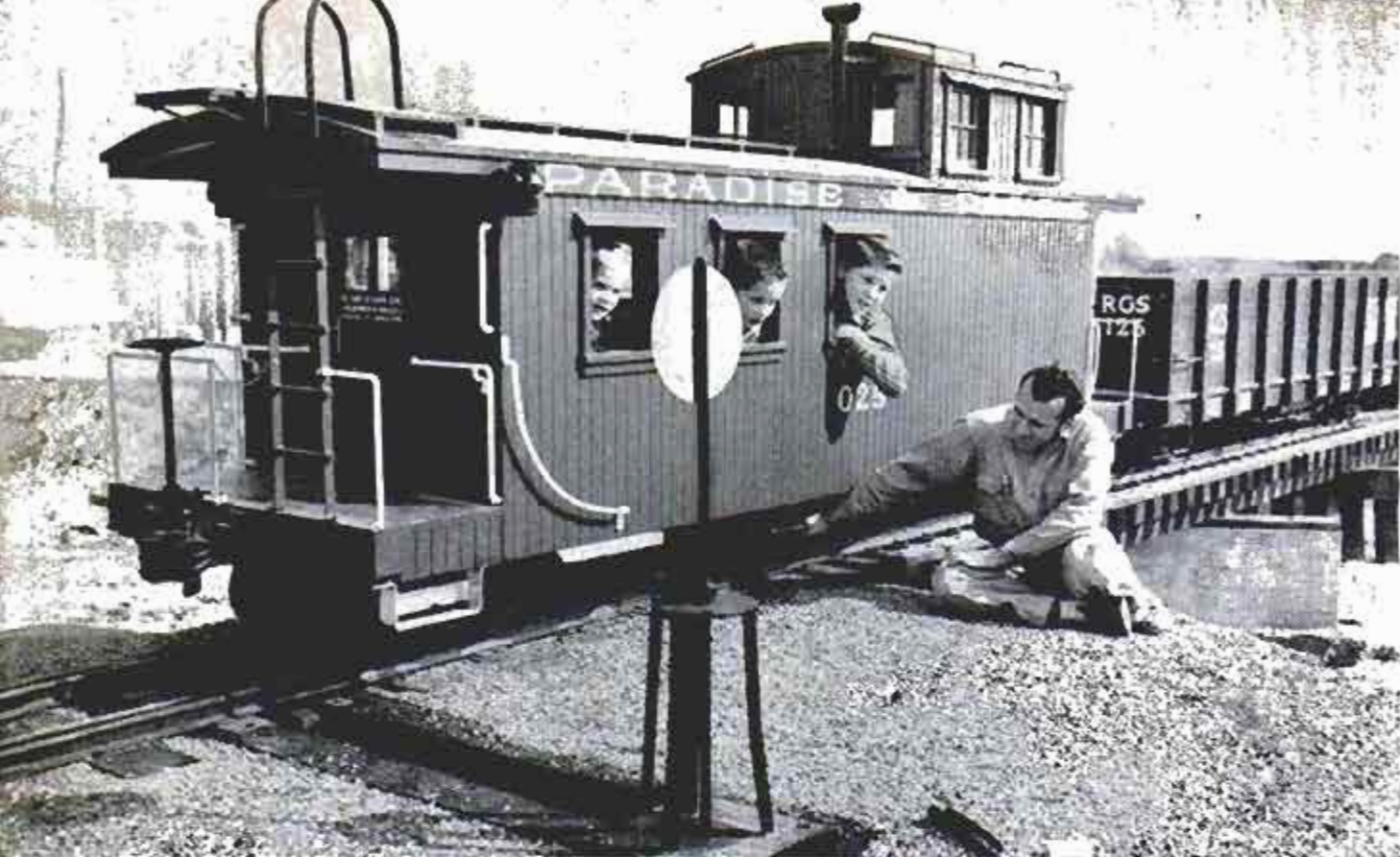

The three sons of Guy Stillman, owner of the railroad, look from caboose as Charles Schlosser fastens bolt

*Out on the Arizona desert you may catch a glimpse of an undersized diesel locomotive hauling a train around a loop. It's Guy Stillman's*

## **FAMILY-OWNED NARROW-**

This is a diagram of the 1¼-mile run over which the diminutive Paradise and Pacific Railroad operates

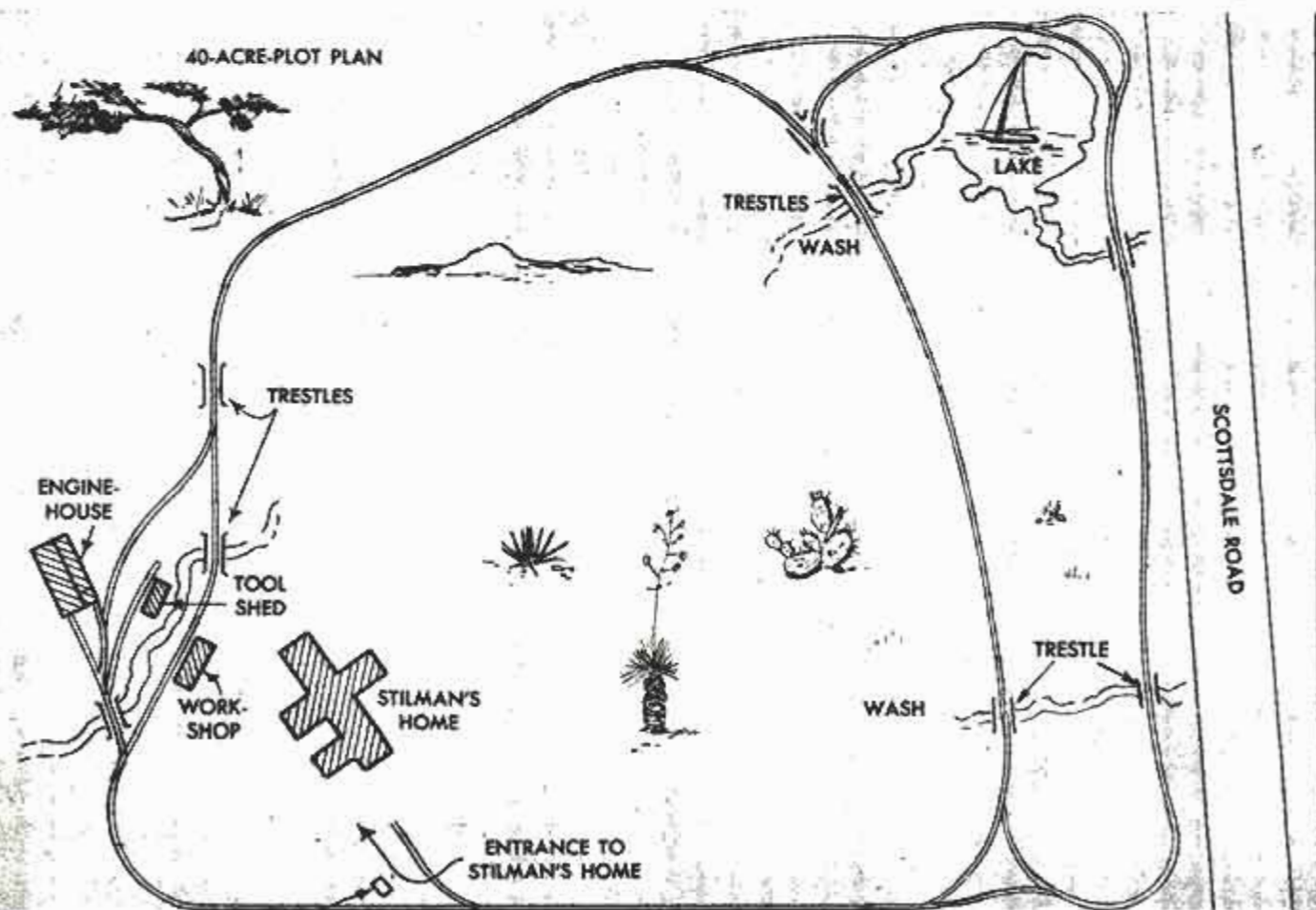



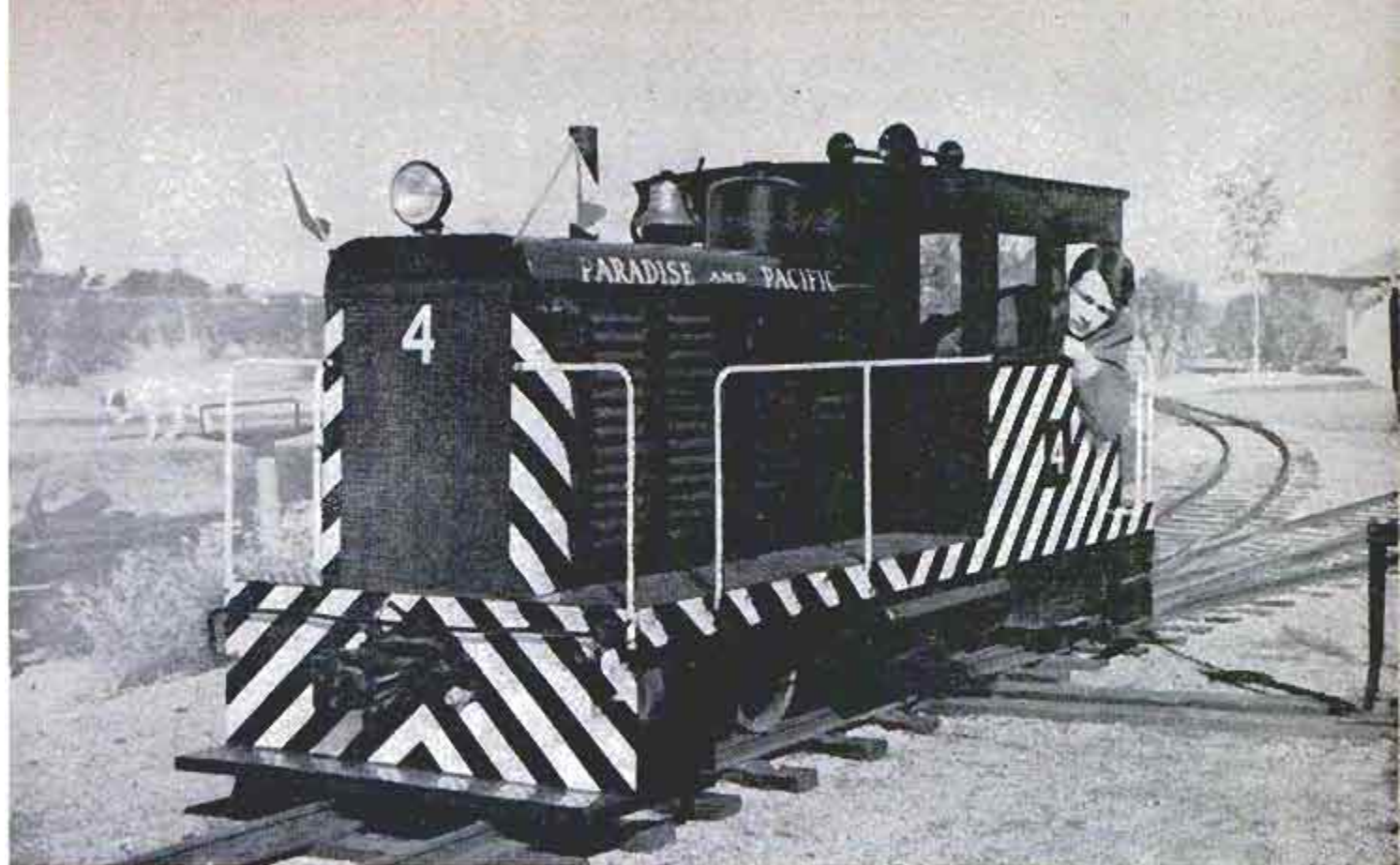

Model of a 44-ton industrial switcher, this locomotive weighs 3200 pounds and is the line's workhorse

## GAUGE RAILROAD

By  
Henry F. Unger

**T**OURISTS NEAR SCOTTSDALE, Ariz., have been known to slam their brakes to the floor at what appears to be a mirage in miniature on the Guy Stillman estate. The reason for all the excitement is the passenger-carrying Paradise and Pacific Railroad rumbling along at 25 miles per hour on its 1¼-mile track.

The miniature locomotive, and all the rest of the equipment on this narrow-gauge railroad, is scaled at five inches to the foot—almost half the real size. Stillman, originator, owner, president and engineer of the Paradise line, has a gay time piloting his locomotive, tank car, two freight cars and caboose. So do his children and their friends.

In this built-to-scale train, Stillman has duplicated a tank car of the Colorado and Southern Railroad, two gondola

Charles Stillman bends over to take a curve on his tiny "contact" machine, while traveling the line







Although seating only two persons here, each of these model gondolas can actually hold 10 persons easily



Doodlebug work train, operated by a neighbor, hauls equipment for workmen on the far end of the track



Above, tank car is backed into its home base by the locomotive. All rolling stock is kept in this shed

Below, Guy Stillman, owner of the Paradise and Pacific Railroad, applies muscle to spikes on the line



cars of the Rio Grande Southern and the Denver and Rio Grande Western railroads, and a bright red caboose of the Denver and Rio Grande Railroad. Workhorse of the lot is a locomotive modeled after a General Electric 44-ton industrial switcher. Weighing 3200 pounds, this locomotive operates with a 20-horsepower Crosley gasoline engine.

Four years ago Stillman teamed up with Charles Schlosser, a draftsman, to create the back-yard line. Resulting cars now measure 12 feet in length and 40 inches in width, with the caboose twice as long. The locomotive, 8 feet long and 40 inches wide, is outfitted—as is the caboose—with automatic air brakes. These safety features have been installed for Stillman's boys: Charles, 10; Chris, 8, and Brook, 5.

Desert flash floods have made maintenance of the track difficult, but recruited workers build up the train's road bed with quantities of nearby decomposed granite and clay. The track now rises 22 feet from a low section on the estate to a guarded entrance at the Stillman home.

Three model mine cars, patterned on actual vehicles in use at copper mines, serve to haul dirt (one yard per car) from a spot next to the track. An automatic belt device does the loading. The tank car also "earns its way" in periodic moistening of the road bed, which has 5000 ties laid one foot apart.

Supplementing his miniature-railway equipment, Stillman has a small "contact" machine for errand-running on the line. This runabout can go 30 miles per hour on the track's 1½-percent grade. A "doodlebug" train hauls equipment for workers.

Neither a toy nor mirage to Stillman and Schlosser, their railroad is scale-model management of real-life railroading. ★ ★ ★



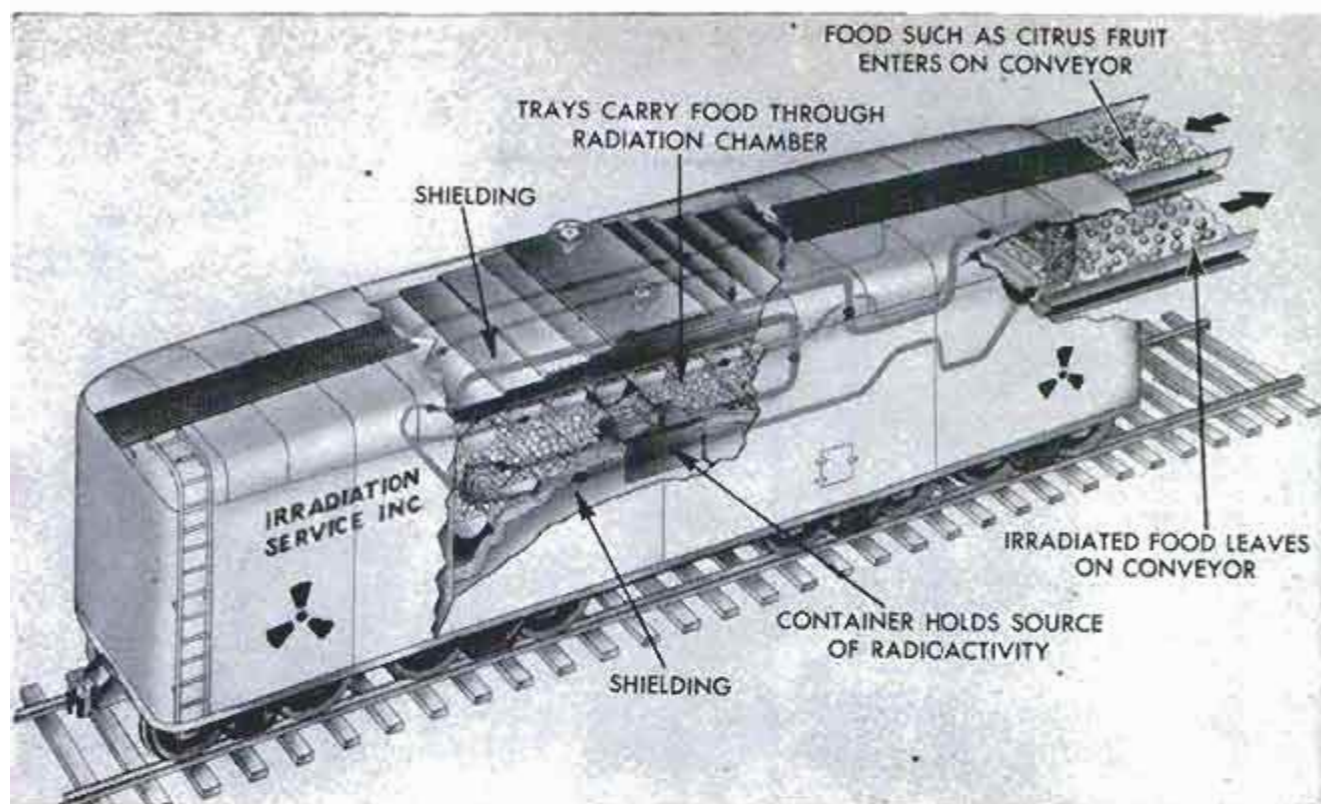

## Roaming Railway Car May Preserve Food by Irradiating It

Food may soon be preserved by exposing it to gamma rays inside a mobile irradiation chamber. L. E. Brownell and his associates at the University of Michigan have made a detailed study for such a chamber to be built inside a railway car. Such a facility could irradiate potatoes on Long Island to inhibit their sprouting, process citrus fruit in the Southwest, then move on to the Midwest to sterilize insects in grain and cereal products. The source of the radiation could

be spent fuel elements from a nuclear reactor. Conveyor belts would dump the food into trays which would move past fuel elements four times before loading the food on another conveyor for reloading outside. Because of the shielding, the car would weigh 173 tons and would ride on four four-wheel trucks. It would cost an estimated \$93,400 to build. One such car could handle one half to 11 tons of food per hour, depending upon the dosage required.

## Surveyor's Radar Tapeline Measures 50 Miles at a Crack

U. S. Army photo

Radar now is giving Army surveyors seven-league boots. With new radar equipment, they can measure off 50 miles in a single leap instead of 20 or 30 small hops. Two Jeep-mounted units with portable masts are set up at distant points and play catch with a radar signal, bouncing it back and forth thousands of times a second. Computers count the catches and measure the distance according to the time the signal takes to make 10,000 round trips. The radar tapeline is accurate within a few feet over a distance of 50 miles.

☐ Pan American World Airways has announced plans to be the first airline to operate turbojet aircraft in Latin America when its DC-8 jetliners are ready in four years.





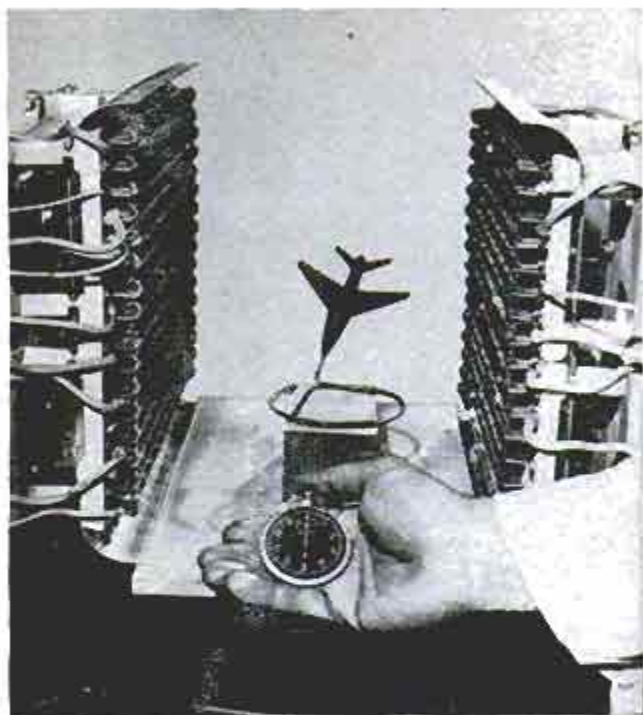

Airplane model made of standard aluminum aircraft skin is placed in thermal laboratory test furnace

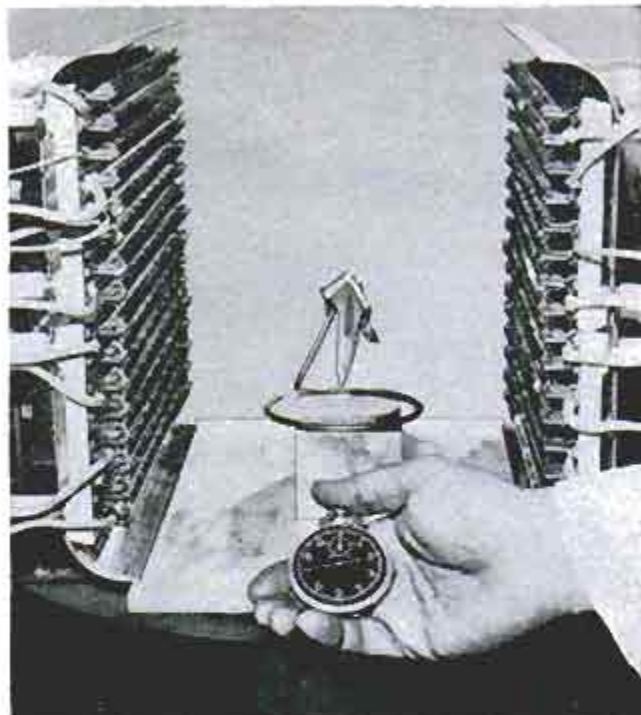

Seven and a half seconds later it has wilted. Aluminum loses 10 percent of strength at 250 degrees

## Heat Wilts Airplane Model During "Thermal Barrier" Tests

After only  $7\frac{1}{2}$  seconds of intense heat, an airplane model made of standard aircraft "skin" wilts like a dishrag in tests conducted by Northrop Aircraft. The experiments are part of the search for heat-resistant metals necessary for high-speed

planes. Ninety percent of the strength of the model is lost at the friction heat generated at 2000 miles per hour. The model is flanked by infrared quartz lamps that can generate heat up to 2000 degrees as science makes an onslaught on the heat barrier.

## Triple-Deck Train Bunks

Three-deck bunks that save space and cost less than standard berths are being introduced on the German Federal Railways. During the day, the bunks fold down into comfortable seats. Twelve

tourist-class cars equipped with the space-saving bunks are now in use between German cities.



## Fishing Lure

Bait is carried in a new double-threat fishing lure. Bacon rind, flavored cotton or worms are inserted through its "eye." The lure has a spiraling action which imitates the action of an injured fish, and is said to attract large fish.







## Renault's Experimental Gas-Turbine Car Has Speed of 200 M.P.H.

Strictly in the experimental stage, the Renault "Flashing Star" has a gas-turbine engine of 260 horsepower. Built like a racing car, the vehicle is extremely light-

weight and has a top speed of more than 200 miles per hour. The turbine develops its peak horsepower at 28,000 revolutions per minute.

## Duck Decoy Takes Beating And Springs Back to Shape

You can't damage a vinyl-plastic duck decoy even by running over it with your automobile. The plastic springs back into shape despite the roughest treatment. Even when peppered with shotgun pellets from a distance of only 30 feet, the decoy will not sink. The plastic seals itself to keep water from penetrating. Each decoy weighs about a pound and is weighted to keep it floating upright.

## Duck Call for Hunters Requires No Blowing

Operated by a Neoprene bellows which the hunter shakes, this duck call requires no blowing, yet according to the manufacturer, produces authentic duck noises. The bellows is attached to a hardwood sounding throat. Shaking the bellows results in short, feeding noises. The loud initial call is made by pulling the bellows out and releasing it.



DECEMBER 1956







Doc Cruickshank stands beside his modern 1000-watt transmitter. He holds original two-watt PM transmitter

Maybe you never heard of Wingham, Ontario. Because a man once read in *Popular Mechanics* how to build a radio transmitter, Wingham today is

# The World's Tiniest

By George Cadogan

WINGHAM, Ont., Can., with a population of 2700, boasts that it is the smallest community in the world with its own TV station. Every citizen of this Canadian town will vouch for this statement.

Unusual ingredients are combined in the formula for this success story: One snow-storm, an issue of *Popular Mechanics*, a man named W. T. "Doc" Cruickshank and 30 years of work.

The initial effort began on a blustery,

snow-filled day in February 1926 when radio was not yet out of diapers, especially in rural areas of Canada up near the shores of Lake Huron and Georgian Bay.

As Doc sat in his shop, he was the only radio retailer and service man in a radius of 50 miles of Wingham. The nearest transmitting station was 100 miles away at Toronto. Detroit—150 miles distant—had a station that came on the air at 4 p.m.

On this particular day it seemed too

CKNX control room overlooks the main studio. In 30 years' time this station has risen to \$750,000 value





stormy to go out selling. All repair jobs were up-to-date, so Doc idly examined a copy of *Popular Mechanics*.

When he came to an article explaining how to make a simple transmitter, he decided to give it a try. Digging through boxes of repair parts, he soon came up with a supply of coil and other component parts. In an hour he had made the tiny transmitter. The unit was completed with addition of a telephone piece for the microphone and storage batteries for power.

Tinkering with the set a day or two later, Doc had a telephone call from a citizen to whom he had sold a receiving set. Yes, Doc was on the air! During the first few weeks, call letters of Canada's newest radio station were JOKE. In the spring the owner learned he would need a license and was assigned call letters 10BP. With power from two to ten watts, 10BP was on the air daily at noon for an hour. Thursday night a special program of music and news was broadcast from Wingham, and this often included reports of hockey games completed moments before.

Six days and nights weekly Doc worked at his shop or out selling. On Saturday night he would tuck his five-pound transmitter under his arm and carry it home for the

# Town With TV

Sunday-morning broadcast of religious music from the piano in the living room of his house.

The Wingham transmitter, with not more than 10 watts of power, was picked up as far away as Detroit. Power gradually was increased to 100 watts. Also, 10BP joined DX Programs which had headquarters at Newark, N. J., and was on the air daily from 4 to 5 a.m., when air lanes were comparatively free. Postcard schedules notified transmitters and listeners as to which stations transmitted on particular dates.

**This 650-foot transmitting tower receives microwave signals from the TV-station studio 20 miles away in Wingham, Ontario, during winter**







A TV camera is being focused on an act by the CKNX Barn Dance Gang—a favorite live entertainment show

With wattage of only 100, Doc's station was heard in Canada, the United States and Central America. He also had listeners in England, South Africa and Europe, and received a letter noting reception of 10BP messages in Taranaki, New Zealand.

One dark day in 1935 the government advised Doc that he and other Canadian "hams" would have to vacate the air lanes for commercial stations. However, in April 1935, Doc was granted a federal license to operate a commercial station at 1200 kilocycles with call letters CKNX.

Beginning with advertising announcements at 50 cents each, CKNX revenue the first month was \$65.50. Over \$2 a day!

Wingham adopted the slogan naming itself "The Radio Town of Canada," as Doc raised CKNX by 1941 to a full-time staff of 13 persons. Gross revenue that year was \$27,000. Savings of \$2200 by Doc served as a down payment on a transmitter to increase power to 1000 watts. RCA Victor went along with this rural entrepreneur and installed a \$30,000 transmitter.

CKNX, now "The Voice of Western Ontario," had its silver anniversary in 1951. Gross revenue was \$200,000 annually; there was a full-time staff of 35; and Doc had completed payments on the station. For Wingham, TV was just over the horizon.

In Canada the government-owned Canadian Broadcasting Corporation had complete control of TV development. CBC selected Toronto, Montreal and other major cities for its own exclusive TV stations. There were to be no private networks competing with the government network.

The Canadian government did provide for TV channels to be available in every area of the country. Channel 8 was assigned to the Owen Sound area to the north of

Wingham, even though private TV in such a sparsely populated area was considered economic suicide.

Then, the National Broadcasting Corporation of the United States applied for Channel 8 for a station to be built at Buffalo. An international agreement between Canada and the United States provides that TV stations on the same channel must be 171 miles apart. If Buffalo got Channel 8, Wingham and this rural area of Ontario could never have TV.

Doc entrained for Ottawa, where he presented modest plans for a small-scale TV station costing \$125,000. He asked for TV Channel 8. The commissioners heard him out and promised to reserve Channel 8 but asked Mr. CKNX to work out plans for a more powerful video station.

Shortly, Doc was shocked to learn that a suitable station at Wingham would require investment of \$500,000 and needed \$250,000 revenue annually to meet expenses. Doc's employees loyally said they'd go out on a limb with him. He queried Ottawa, which replied, "Go ahead."

One of the major items in the \$500,000 problem involved \$223,000 for transmission equipment. RCA Victor agreed to help. Next, the supplier assisted financially on the 650-foot tower, costing \$100,000. Building of a new high school vacated premises now used by the station.

Normally, it takes a year between planning and performance of a new TV station. CKNX did the job in three months with a staff of 65.

Doc estimated first-year losses would be \$30,000. After five months of operation CKNX-TV was almost even, with sufficient revenue anticipated to meet first-year operating expenses. ★ ★ ★



# Plaster Helmets Insure Accuracy In Treating Cancer

CERTAIN TYPES of cancer can be disintegrated right in the body, without surgery. This is done by focusing radiation through the body to the point of the tumor once a day for several weeks. The major problem in this type of treatment is to control the beam of ionizing rays so precisely that it will saturate the malignant tumor but not damage the surrounding healthy tissues.

To provide the accurate aim and necessary protection, a plaster-bandage helmet has been perfected at the Veterans Administration Hospital in the Bronx, N. Y. The helmet is made on the patient's head, then split and taken off and fitted with clamps so that it can be put together again easily. Then, using the helmet, radiologists plan the actual paths the rays must take, using thin stainless-steel rods. They make sure the rods cross at the point where the cancer is located, and that none of the rays will strike an unusually sensitive area.

Finally, the helmet is put back on the patient, and the radiation is applied so that the rays travel along the paths established by the steel rods. After treatment, the helmet is stored for future use.

Upper right, steel rods inserted through the plaster helmet to determine paths of rays. Right, chart used by radiologists in conjunction with helmet to chart course of rays. Below, treatment in progress

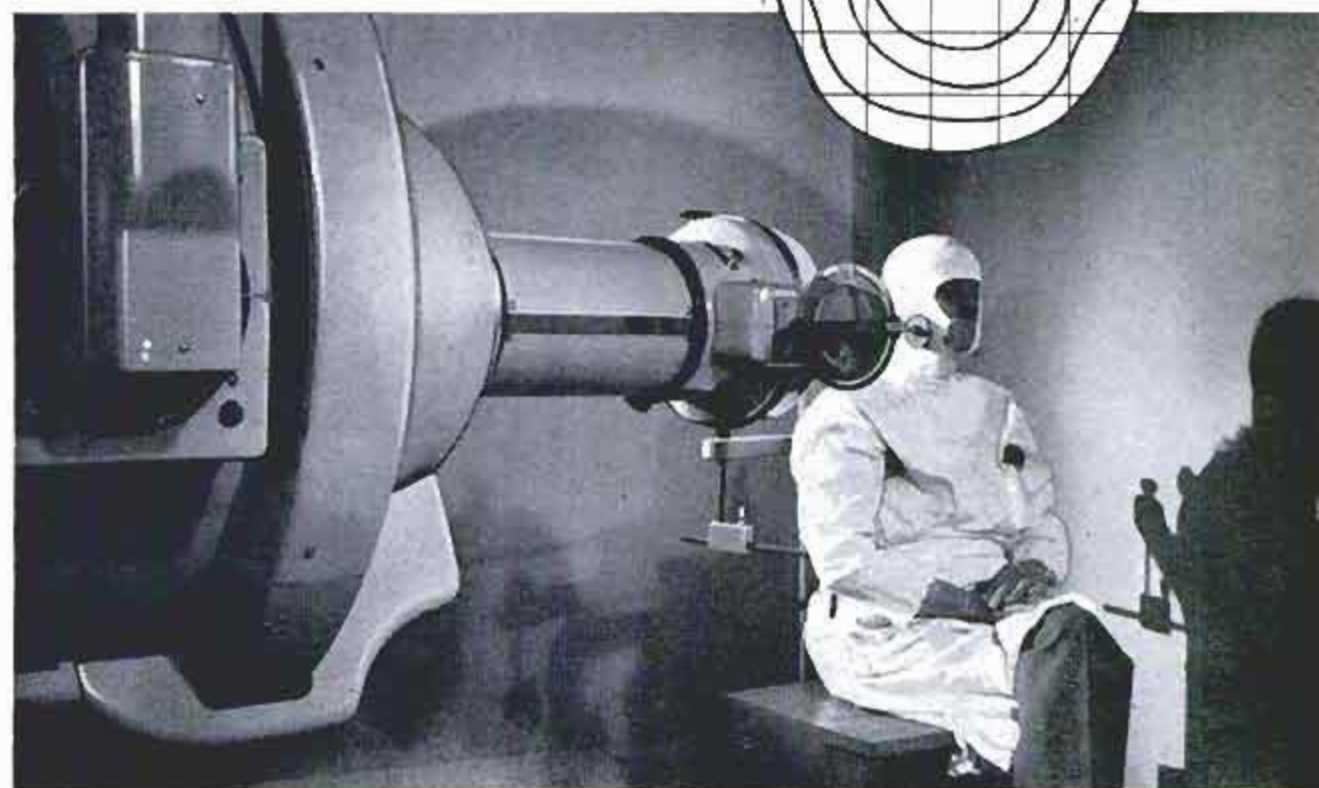
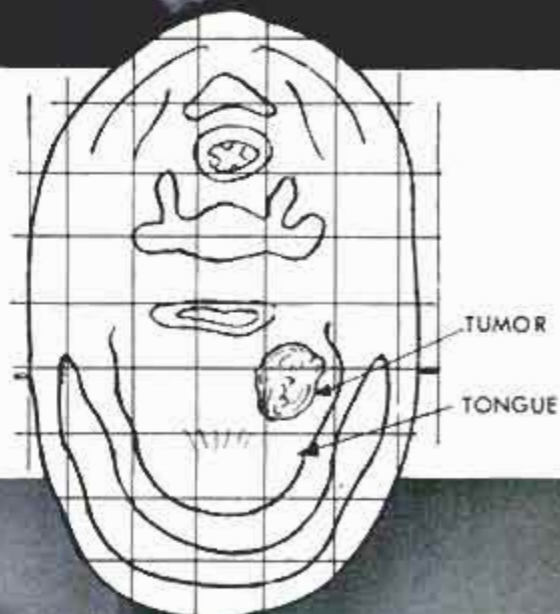
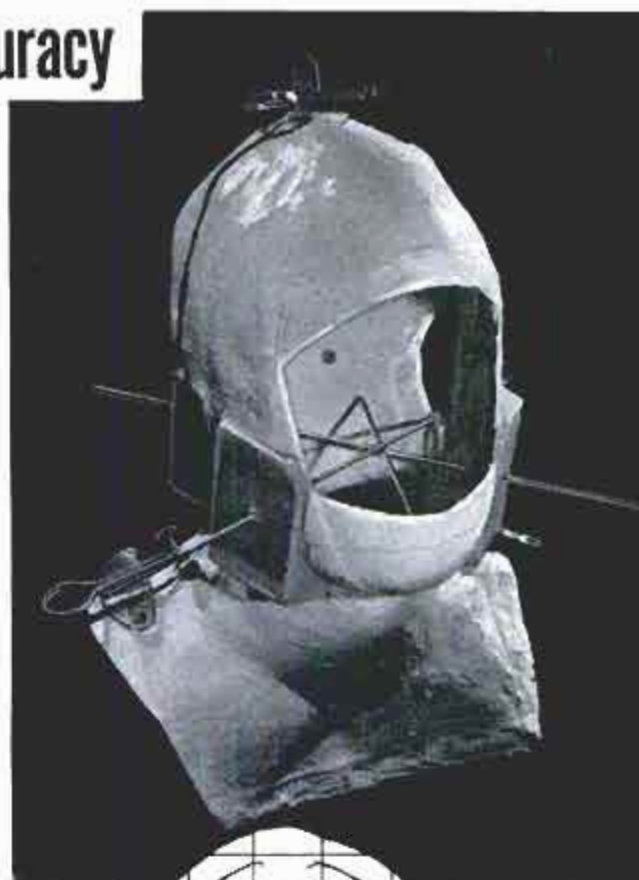





## GIANT DRAKE

Both sets of front wheels steer. When afloat, steering is done with the two propellers which swing in any direction astern

WITH EIGHT WHEELS, all of them powered, the Army's latest amphibious vehicle, the Drake, can outride the heaviest surf. The truck, measuring 42 feet long, has air suspension and all-aluminum frame and hull. Axles and wheels retract into the hull to decrease resistance while the vehicle is in the water. Two six-cylinder engines power the truck, both having fluid-torque transmissions. A central tire-pressure system enables the driver to inflate or deflate the tires while the vehicle is moving. Load capacity of the Drake is in excess of eight tons and, in ship-to-shore work, it can haul items as large as an eight-ton truck. The tire-pressure system will keep the tires inflated despite loss of air due to bullet holes.



If you want proof of the Drake's seaworthiness, here it is. Despite this tumbling through the surf, it remained afloat. Below, the three generations of the Duck family. From left to right: The first 2½-ton Duck, the 4-ton Superduck, the Drake





# Electronic Eye Fights Back At Bullets

ONE OF THE fighter pilot's major bugaboos is fire caused by enemy bullets exploding the fuel tanks. The mental image of a man's plane disintegrating around him in a hot ball of fire, or plunging earthward beneath a squirming column of black smoke, isn't conducive to peace of mind.

Now, electronic "eyes" that can "see" a 2000-mile-per-hour tracer bullet, and hit back at it before the projectile travels 11 inches into an aircraft's fuel tank, may soon protect jet fighters from such explosions.

Recently, at the Army's Aberdeen Proving Grounds, Air Force research men have been machine-gunning fueled planes on the ground, trying to explode them—without much success. Reason: A new unit developed by Republic Aviation. Here's how it works: An electronic eye, installed on the inside wall of the wing tank, detects infrared rays at the very start of the explosion or fire. Instantly, it triggers a gunpowder charge that shatters plastic capsules containing an extinguishing agent inside the tank. Rapidly expanding mist blankets the fire area at a speed of 300 feet per second.

"An explosion in an aircraft fuel tank," explain Republic engineers, "is at its worst within  $\frac{7}{100}$  second. This system nips it within  $\frac{1}{1000}$  second."

The system also guards against false alarms. In case of a slow fire, it "counts" flickers to make sure the light is from an actual fire. But if the fire is intense, it doesn't wait to count.

Cutaway model of F-84 airplane wing is used in these four pictures which show how fire-explosion suppressor works. At top, bullet enters leading edge of wing at right, starting a fire, and proceeds into vapor-filled fuel tank at left to start an explosion. A fire suppressor smothers the blaze at right while capsule shattered by detector explodes mist in fuel tank. Mist blankets the impending explosion, leaving the wing undamaged

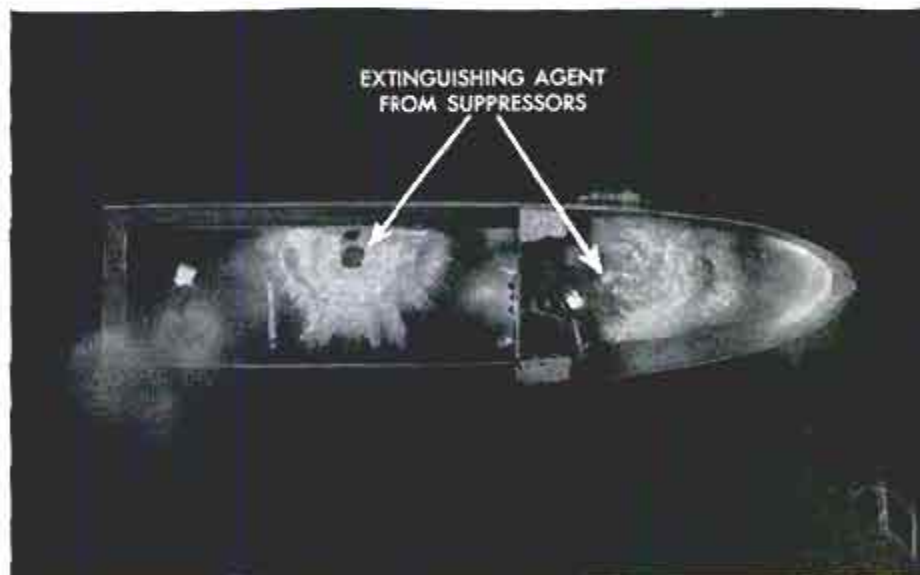
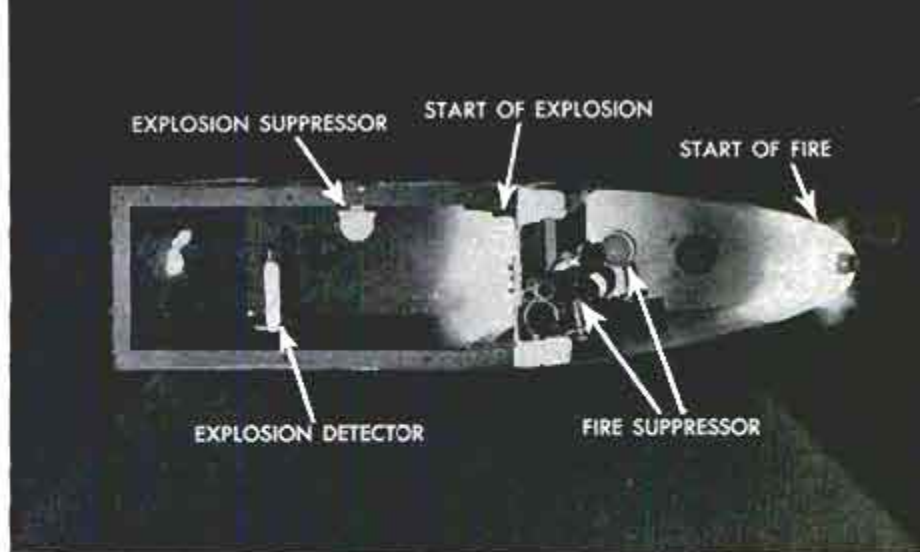



## They told him it couldn't be done — so he built it himself: **A HARDTOP CONVERTIBLE**

**A**FTER FOUR YEARS of trial and error, Raymond P. Meyette, a Fort Lauderdale, Fla., automobile mechanic has done what one company said was impossible: He has designed and built a true hardtop convertible.

"In the past, most of those who tried it either had to end up using a two-part top or sliding the top rearward on channels," Meyette explains. "In either case, this involved hinges or rattles and leaks."

The Meyette solution provides for the quiet and effortless raising first of the trunk deck, then of the one-piece hardtop that is stored upside down beneath the deck. The lid is electrically operated; the top hydraulically. Both are controlled from the dash and may be raised or lowered



By George X. Sand



while the vehicle is actually in motion.

The car Meyette rebuilt started out as a 1952 Nash Ambassador sedan. The top, cut from the rear section of a Kaiser sedan top, pivots from points high up on the quarter panels.

When lowered into the storage compartment, which occupies the rear-seat area of the body, the top is upside down. Before it is lowered, however, the lid of the storage compartment lifts up and then closes as the top disappears.

The pivoting feature does away with the need for moving the top backward on rails. The trouble with such a design, says Meyette, is that the largest part of the top ends up where there is the least room. By pivoting the top, the big portion of the top is stored behind the seat where the body height is greatest.

While he used the top from a Kaiser, it

had to be re-formed to match the car's windshield and back panel. Actually, the entire body is handmade; the only original parts left are the wheel housing and floor.

Because he used many standard parts (many of which he bought at junk-yard prices), the inventor says he has less than \$100 invested in the whole car. "Of course," he hastens to add, "this doesn't take into consideration 4000 hours of my time."

Tinkering with cars is no new hobby for Meyette. He started back on the farm in Vermont at the age of 12. He owned a 1922 Star that had no doors. Getting in and out was simple except for the shin-scraping location of the shift lever and emergency brake. Meyette solved the problem by designing and building a workable steering-column shift and dash-mounted emergency brake, not too much different from those in use today. ★ ★ ★



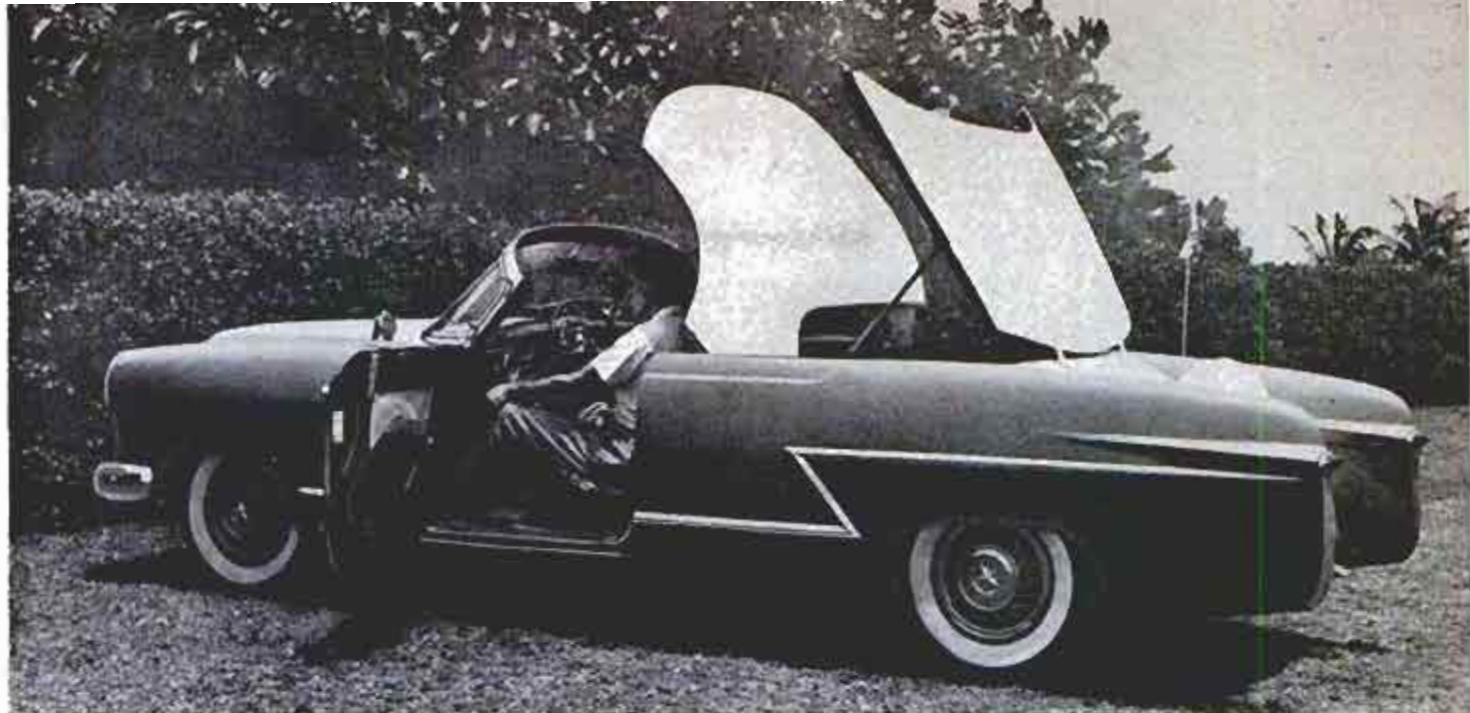

During the raising operation, the top looks like this. First the deck lid opens, then the top comes up

At bottom of page is a diagram of how the top works. Right, a closeup of the mechanism. The screw drive elevates the deck lid and the hydraulic ram lifts the top itself. Left, very little remains of the 1952 Nash styling

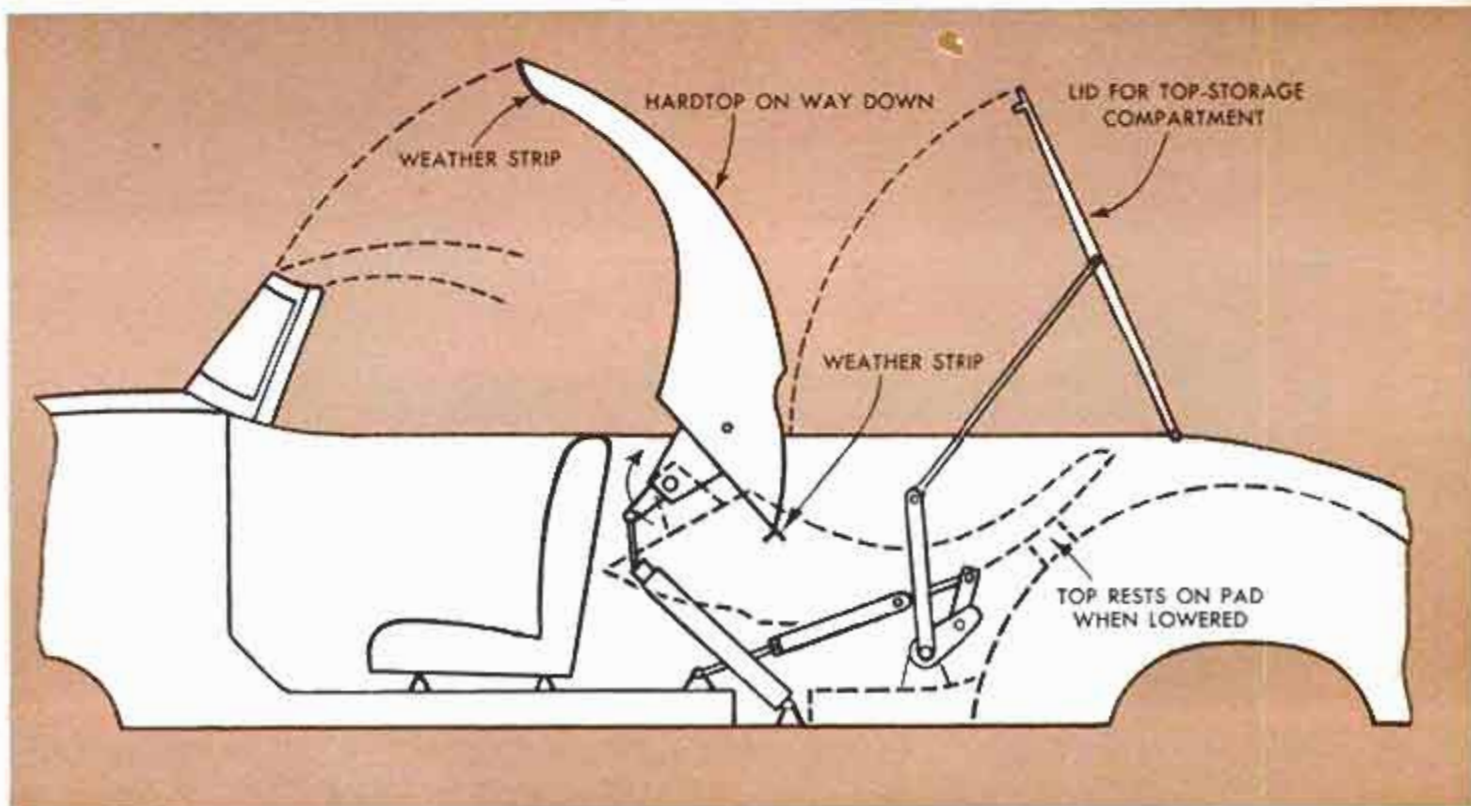
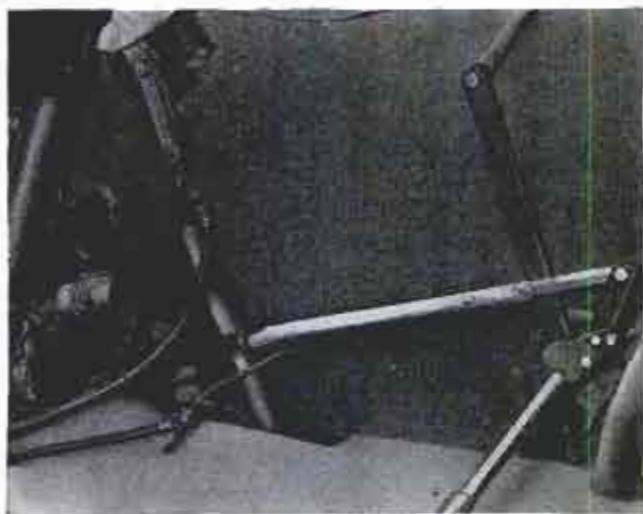
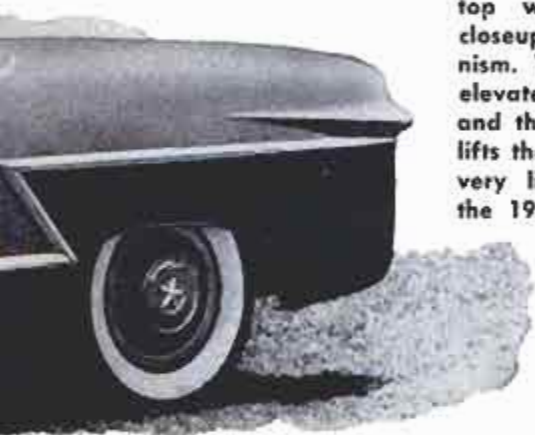





## Colored Lights Teach Piano

It's easy for a beginner to learn the basic chords on a new piano. Directly behind the keyboard are small lights in various colors. Colored dots in the music book indicate which chord should be played. The player strikes the keys which are marked by that color. A plastic indicator, placed above the keys, identifies the right-hand notes necessary to carry the basic tune.

Chords to be played by the left hand are indicated by tiny colored lights

## Concrete Blocks Made in Minute

Colorful concrete garden blocks for a garden walk, terrace or fireplace can be turned out at the rate of one a minute with a special mold and at less than the cost of a postage stamp. The mold makes blocks in different shapes, sizes and colors, with the basic size being 2 by 6 by 8 inches. Supplied with the mold, in kit form, are forming blocks, trowel, coloring pigment samples and an idea folder.

*Letters returned apparently out of business.*

Kit for making concrete blocks has mold, blocks, trowel, pigment samples

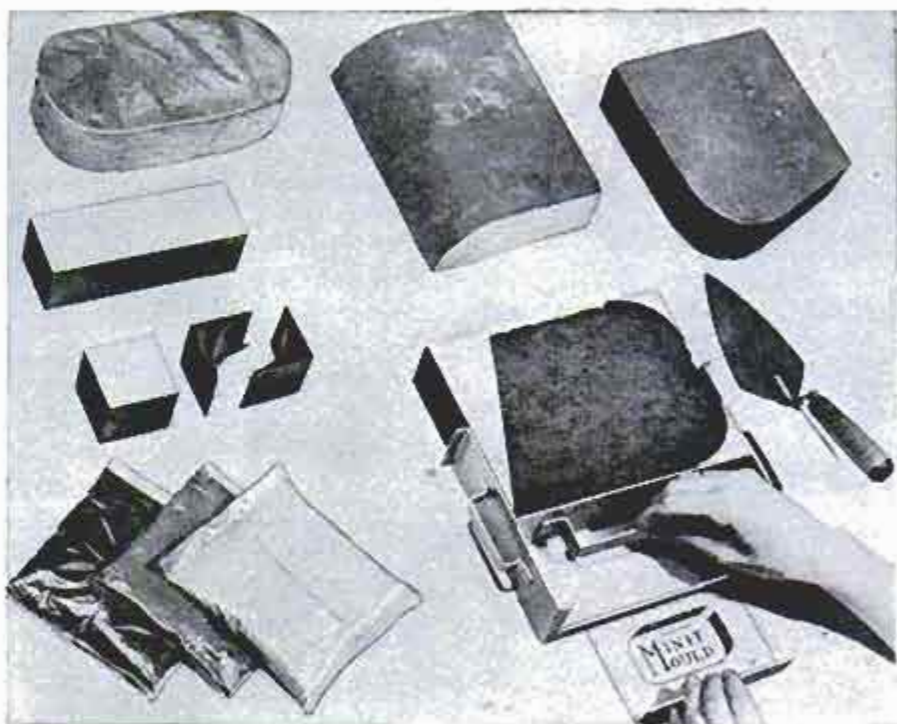

## Multiple Piano

One man can play three pianos at once, each in a different octave, thanks to an Italian invention. Two pianos are connected electrically to the one at which the player sits. As he depresses the keys on his piano, electrical contacts are closed and corresponding keys on the "slave" pianos are depressed by electrical magnets. The pedals work the same way.



## Concrete Vibrator Contains Motor

One man can handle a 25-pound concrete vibrator that contains its motor in the vibrating head. The unit's 25-foot electric extension cord is plugged into the nearest 115-volt outlet. The conventional vibrator, used in industrial construction to take out the bubbles in newly laid concrete, is powered through a flexible shaft by an outside engine manned by an extra workman. The motor of the unit is protected from overheating with a safety thermostat.



## Container on Hoist Becomes Truck Body

Almost any type of material can be handled through a new truck-loading system. The loading mechanism can be mounted on any truck of suitable capacity and consists of a pair of hydraulic hoisting arms that can lift up to nine tons. The arms are used to hoist a special container onto the truck, which then becomes the truck body. Various containers handle solids, powders, liquids and gases.



## Truck Refrigerator Is Self-Powered

Meat delivery trucks of one packing company are refrigerated while on the road by means of a V-belt run from the refrigeration unit to one of the rear wheels. Providing the proper speed for the refrigeration unit at normal driving speeds, this self-powered unit provides adequate refrigeration during the day. At night and during loading at the plant, the unit is plugged into a power source to operate.

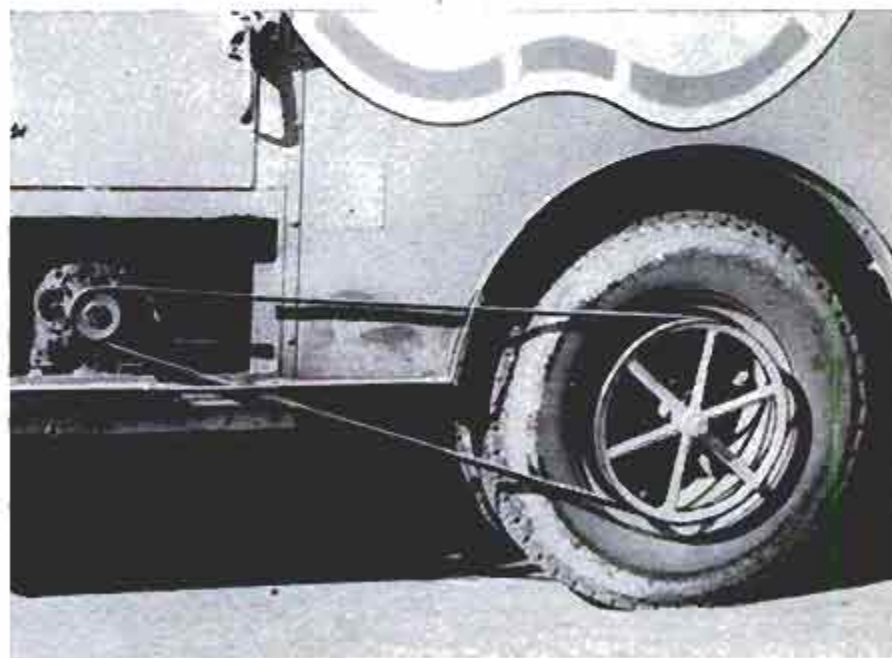





## WHAT'S NEW FOR Your Home

**TWO-IN-ONE OVEN**, when divider is in place, permits cook to broil food at one temperature in top section while baking pastries at another temperature in the bottom unit. Divider removed, the entire space serves for broiling or baking. French doors provide access. Automatic or manual controls on oven allow homemakers to leave the kitchen while food cooks

Frigidaire Div., General Motors Corp., Dayton 1, Ohio

**SNAP FASTENERS** will snap closed and stay closed, after having been renewed by a heavy, nickel-plated steel device. This product is made for regrouping fingers of the receiving part of the fastener, which have become spread apart by normal use and laundering of sleepers, creepers, pajamas, shorts, shirts, jackets, work uniforms and similar clothing

Sauber Mfg. Co., Snap-E Div., Virgil, Ill.



**NO-STOOP DUSTPAN** prevents backache from bending. By pressing with the foot on the tab beneath the dustpan handle, the housewife forces the front lip of this device to hug the floor and prevent dirt from escaping. The housewife moves the dustpan merely by shifting it with her foot. A reverse lip retains dust in the pan, which is high-impact plastic

Reliance Products Sales Corp., Woonsocket, R.I.

**UNUSED SPACE UNDER BEDS** can be put to work. Attach a 30 by 36-inch drawer (5400 cubic inches of storage space) or two 24 by 30-inch drawers (3600 cubic inches of storage space each) to single or double wood or metal beds. Dustproof and fastened without tools, drawers ride off the floor and on their own tracks. Drawers are five inches deep and have covers

Nash Mfg. Co., 10024 Carnegie Ave., Cleveland 6, Ohio







**RING-TYPE CLOTHESPINS**, while allowing the hands freedom for work, can be adjusted for desired tension by bending the bottom of the pin in or out. Plastic, these pins can be kept on clotheslines by pushing them through to the ringlet. No smudge or pull marks, splinters, snags or tears mar the wash

Ringlet Clothes Pin, Inc., West Boylston, Mass.

**WASHER-DRIER** equipment fits into space 25 inches wide if stacked with units one on the other. Combinations include mounting washer and drier free standing side by side, built into the wall, or under standard-height counter surfaces. Most convenient installation height is 30 inches above the laundry floor

Westinghouse Appliance Div., Mansfield, Ohio



**FAST-PEELER** made with a stainless-steel cutter, removes a continuous thin strip of peeling in a groove down the middle of an orange, grapefruit or tangerine. The fruit can be taken easily from the peeling remaining. Homemakers, needing an effective garnish for the family feast, can use the peeled strip

Impact, Inc., 2108 Payne Ave., Cleveland 14, Ohio



**FURNITURE KIT**, complete with glue, nails, screws and instructions, needs only a do-it-yourselfer and his screwdriver and hammer to assemble the bedroom or living-room piece ordered. Kit provides predrilled Appalachian ash units with stain, sealer, shellac, sandpaper, cloth, brushes, steel wool

Show-Off Inc., Jamestown, N. Y.







Bell 47J Ranger, capable of carrying more than 1000 pounds of payload, will be delivered early in 1957

## Quick-Change Kits Convert Helicopter for Different Uses

Called the Ranger, Bell Aircraft Corporation's new commercial helicopter is a convertible. Powerful enough to carry more than 1000 pounds of passengers or cargo, the plane can be converted through

the use of quick-change kits from a business craft to a cargo craft, to a two-litter ambulance or to a rescue helicopter with an internal hoist. The helicopter will be ready for delivery early in 1957.

Below, left, Ranger set up as two-litter ambulance. Right, converted to flying office for business executive





# Convair Rocket Sets Record

DESIGNED to race through a simulated rainstorm at supersonic speeds, a Convair rocket unit recently set a world's record for recoverable sleds of 1560 miles per hour. This mark was made on the 10,000-foot track at Edwards Air Force Base in California. Scheduled tests at double the speed of sound will feature a unit equipped with 12 rocket bottles (seven on the main sled, five on a pusher sled). The latter accelerates the test unit to 620 miles per hour on the first 950 feet of track, prior to main-sled blast of 25 times the force of gravity.

Weighing 800 pounds, the sled has four steel slippers keeping it on the track for the 9½-second run. A miniature broadcasting set beams acceleration data. Recording oscillographs measure sled speed by registering intervals to .0001 second between 50-foot track lengths. Rainfall is simulated by controlled sprinkler nozzles on six-foot stands along 1200 feet of track. A built-in "water brake" stops the sled.



Brig. Gen. J. S. Holtner, commander of Edwards Air Force Base Flight Test Center, looks over main rocket sled. Below, test starts

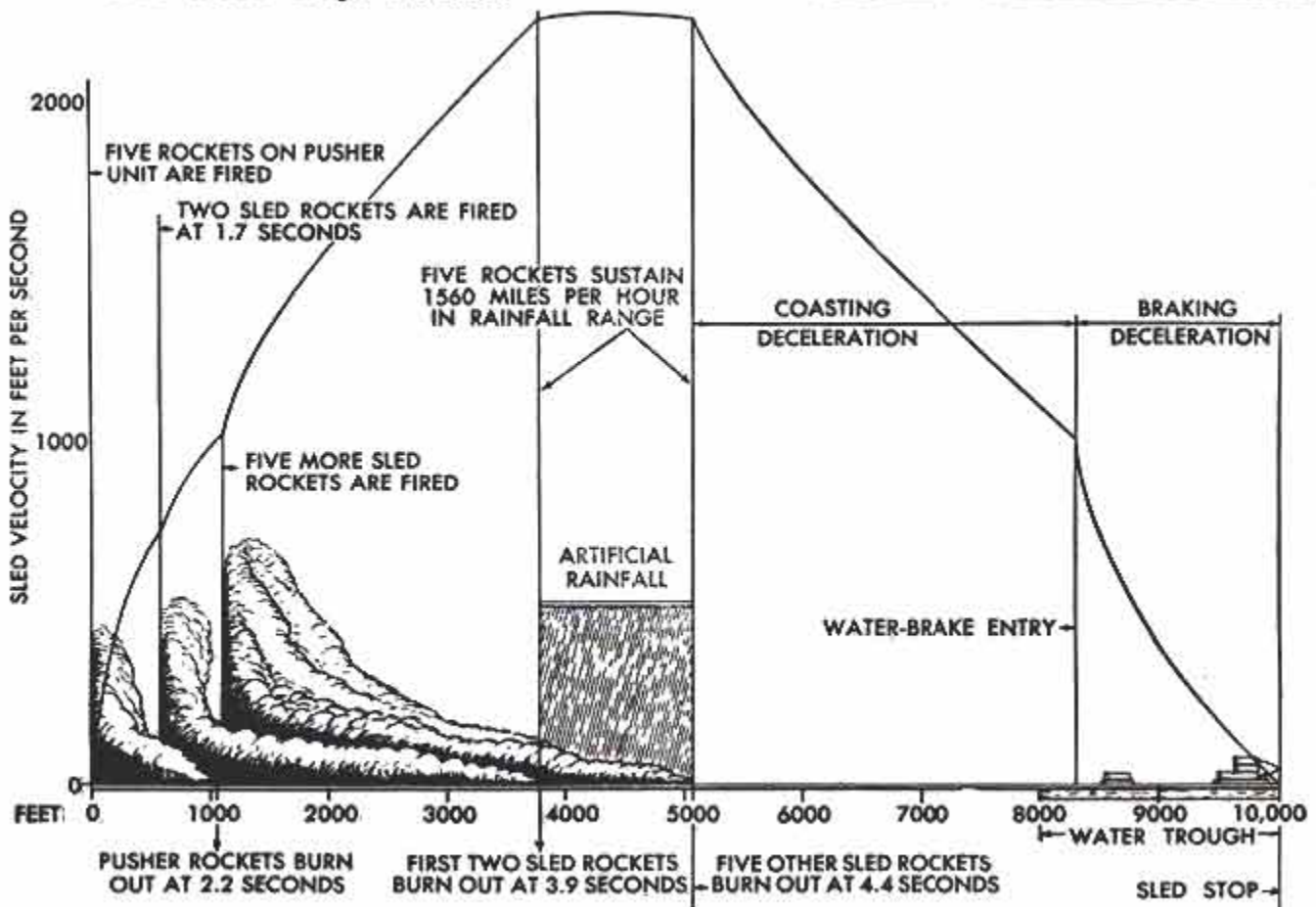



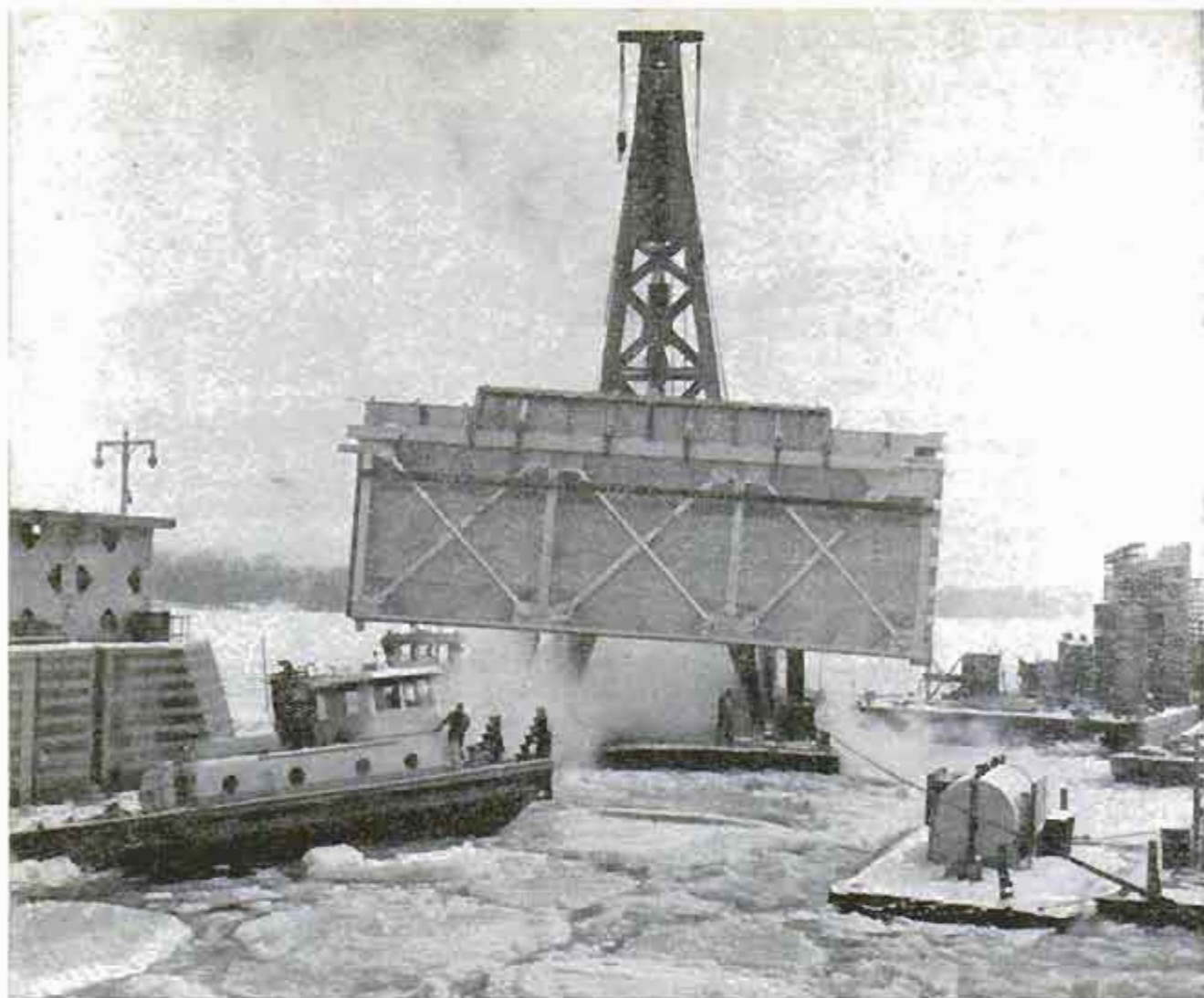

Diesel tender *Coon* clears path for U. S. Corps of Engineers' derrick boat *Hercules*, whose 87-foot boom can lift 125 tons. With reconditioned 70-ton gate leaf aloft, *Hercules* edges into lock chamber for reinstallation

## ***IT'S A COLD DAY When They***

Pikemen keep ice from piling up ahead of *Hercules* inside lock chamber. Propeller wash from three diesel tenders was required to keep ice moving down sides of derrick boat. Lower edge of gate leaf is top left







In ice three feet thick and minus-17 weather, tender *Bates* nudges barge from lock chamber, as *Hercules* enters

**E**ACH LOCK-CHAMBER miter gate in the 27 government locks and dams on the Upper Mississippi receives a face lifting every 15 years. In 20-below-zero temperatures and with ice three feet thick, military engineers work from December to mid-March to guarantee that five million tons of shipping move in the 8½-month navigation season. Lock chambers, con-

taining upper and lower gates of two leaves each, can be "de-watered" by placing temporary dams at the far end and jacking gate leaves from chamber floors. Or, a single temporary dam at the upper chamber's end retains pool level, while derricks transfer leaves from water to barge for sandblasting, repair, paint and new quoin-seal installation. ★ ★ ★

## *Repair Those Mississippi Locks*

Diver goes into 14 feet of water to inspect and clean pintle on which gate leaf pivots. Pikeman will keep ice from fouling air line. Temporary dam, placed above upper gate before removal for repairs, is in background





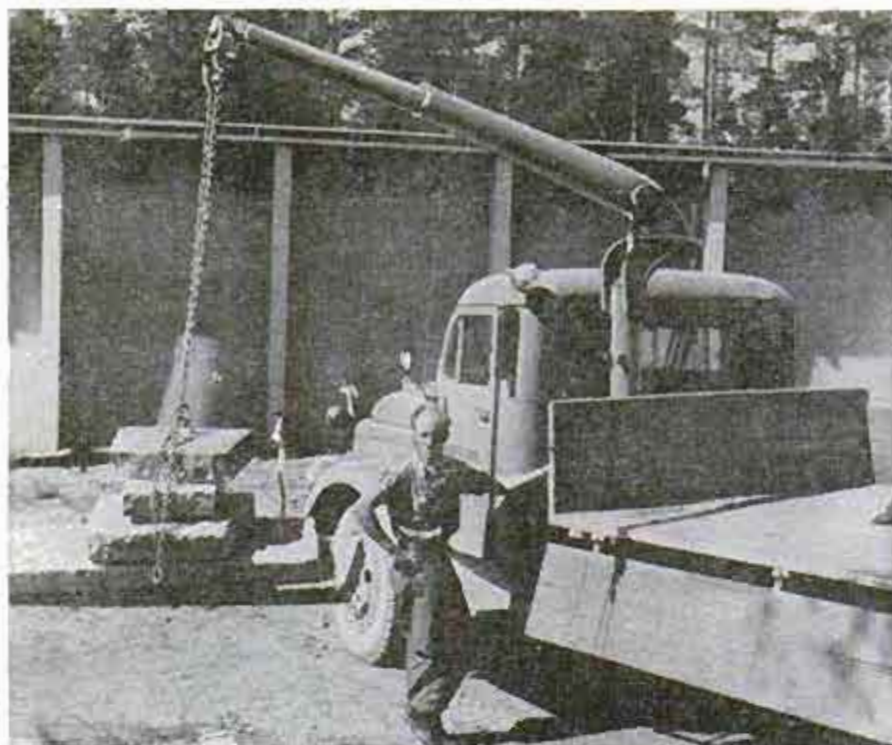

## One-Man Loading With Truck Crane

Built in Sweden and licensed for manufacture in other European countries, a hydraulic crane that can be attached to most trucks permits one man to do the loading and unloading of cargoes. The crane requires only 7½ inches of space in back of the truck cab and, when retracted, extends 7½ inches above the roof. Accessories make it possible to move any type of load, including sand and gravel. Hydraulic leg supports prevent tipping of the truck when heavy items are lifted.

## Engine of Test Truck Slides Out for Servicing

Engine and transmission of a pilot-model truck, tested by Fruehauf Trailer Co., are mounted on sliding rails and pull out like the drawer of a desk. The whole unit can be replaced in two hours. Normal maintenance work is easier and less expensive. The engine powers a new tank trailer which has no frame in the conventional sense. Instead, the power package, wheels and axles are built into the tank itself to save weight. The trailer is eight inches wider than it is high. Another Fruehauf trailer handles bulk flour as if it were a liquid, loading and unloading it by hose.



Above, this is a tank car, but the "liquid" it carries is dry! It loads and unloads bulk flour by pumping it through a hose

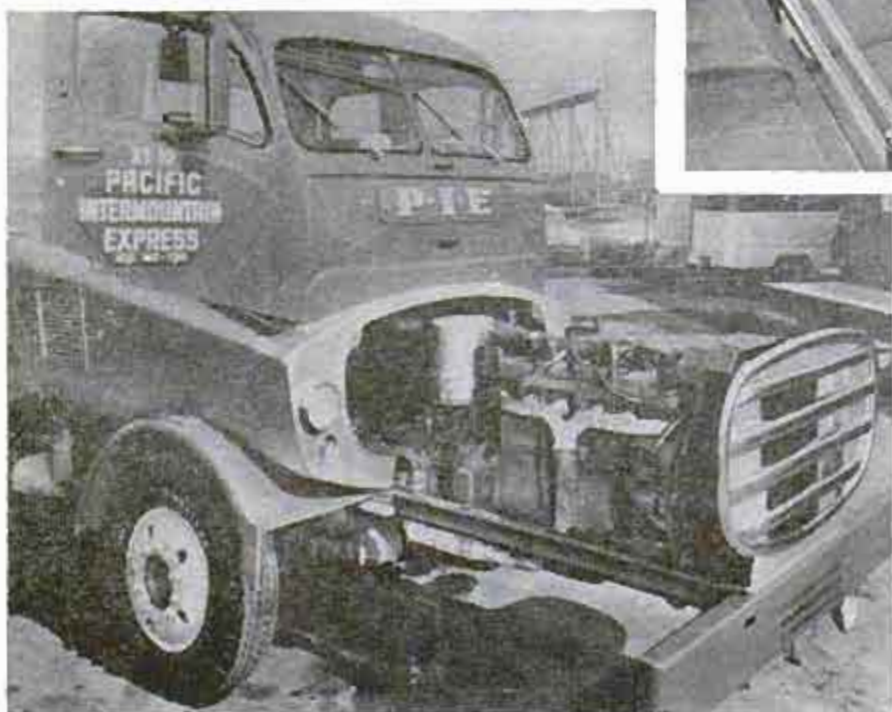

Left, handy for the mechanic is a pilot-model truck. To service it, he merely disconnects the drive shaft and pulls out the engine just like a desk drawer



Helicopters are ideal for spreading insecticides over huge land areas including forests. Downwash from rotor deposits mist from spray-boom's nozzles in even swath  
U. S. Department of Agriculture photos



*Insects ceaselessly fight to take over the earth. In the second of three articles on the farmer's greatest enemies, a top entomologist pins down*

## GOAL NO. 2

# WINNING THE WAR AGAINST INSECTS

By **W. L. Popham**, *Director, Crops Regulatory Programs, U. S. Department of Agriculture*

**I**NSECTS NEVER TIRE in their ceaseless battle against man over the inheritance of the earth. Recently scientists have come up with some startling new weapons for farmers to use in this elemental struggle for survival.

Here are some examples:

Treated cotton seeds are growing into plants that actually bite back at the insects. The plants have a built-in insecticide. This year, cotton growers lucky enough to get some of the chemically treated seed achieved early season insect control without so much as hitching up the sprayer or duster.

In the Midwest, up-to-date farmers are growing varieties of wheat with a built-in, genetic resistance to that pest, the Hessian fly.

Out West, specialists are using a new technique to put a stopper on the khapra beetle, one of the biggest insect threats ever to reach our shores. Warehouses filled with

Scientist releases imported bugs which become parasites on corn borers. Such insects help kill out borer infestations





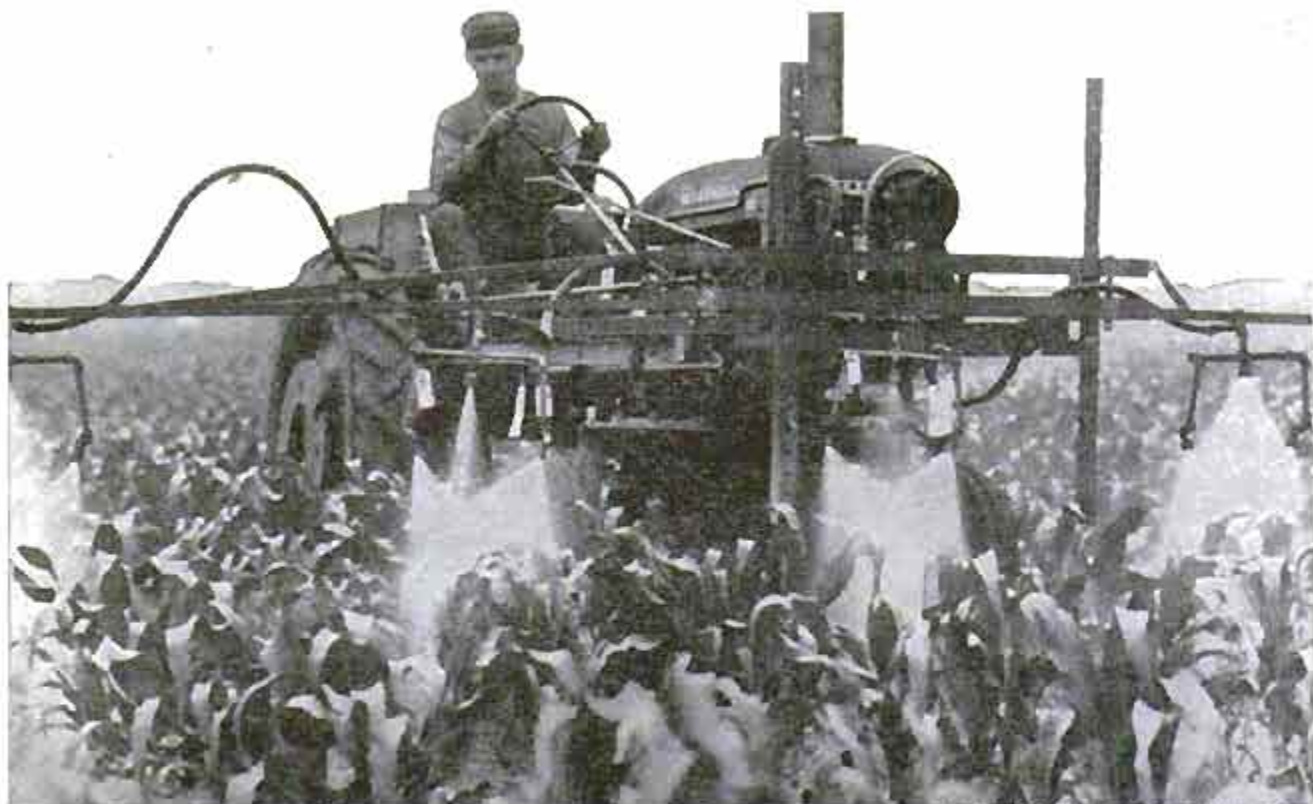

U. S. Department of Agriculture photo

**High-clearance sprayers spread DDT without damage to growing corn to help keep the corn borer under control**

stored grains and seed—and khapra beetles—are swathed in as much as  $9\frac{1}{2}$  acres of gas-tight plastic, and then fumigated.

Eastern homeowners are actually spreading a contagious disease to kill off Japanese beetle grubs. They are dotting their lawns with disease spores which spread death only to Japanese beetle larvae and certain other white grubs. There's an epidemic, and the Japanese beetle disappears.

### Controls for Most Insects

If you could line up the more than 10,000 insect pests of the United States, you could jot down a control measure for nearly every kind. A hundred years ago, our forefathers would have been hard put to control a tenth of them. That is one way to measure progress in our fight against pests.

The fantastic ability of insects to reproduce and their equally fantastic capacity

**Flexible tubes of a rotary duster apply insecticide to both sides of cabbage plants. Below right, khapra beetle, today's biggest insect threat, is killed by fumigating entire warehouse swathed in gas-tight plastic**

H. D. Hudson Mfg. Co. photo







Young trees, subject to insects that resist normal sprays, are treated with a potent gas under huge tents

for survival are two of the reasons that our successes against them seldom represent total victory. Here in the United States, insects still destroy an estimated \$4,000,000,000 worth of our agricultural production each year.

Nor is there much that is spectacular underlying the successes. Victory usually comes from study, hard work and try-and-try again.

Responsibility for finding ways of controlling insects falls on the entomologist—the insect scientist—but the total struggle frequently involves chemists, engineers, plant and livestock authorities, the government, industry and farmers. Success often requires the teamwork of all of these. An example is the case of the European corn borer, our number-one corn pest.

There was hardly a stir among farmers

Recent development is the mist blower for treating large areas and tall trees. Below right, each man wears one repellent-treated sock. Wood ticks, carriers of Rocky Mountain fever, will not climb legs of treated socks

David C. Kennedy Co. photo

U. S. Department of Agriculture photo







Shipments of plants from around the world are inspected for destructive insect pests at our ports of entry

when in 1917 the corn borer was discovered for the first time near Boston. But as the pest gained a foothold and began to move in on the Corn Belt the need for "doing something" became obvious.

Beginning to do something meant learning about the insect, for then as now, effective control methods were built upon a knowledge of the pest—how it lives, reproduces and adjusts to environment.

For example, our scientists found that borers spent the winter in the stalks and other remnants of corn harvest left in the field; that if these stalks were burned or buried deep enough the borers could not

survive the winter, and their life cycle would be broken. This bit of knowledge was the key to a U. S. Department of Agriculture quarantine levied against the corn borer in 1927. Stalk clean-up by burning and deep plowing slowed the spread of the insect, but not well enough some believed to warrant the cost of the program. The quarantine was lifted in 1933. The corn borer quickly spread across the Corn Belt.

#### No Natural Enemies

Research continued and our scientists discovered a primary reason for the borers'

(Continued to page 228)

Modern speed sprayer replaces old hose and nozzle in fruit orchards to fight new and old insect enemies

John Bean Division, Food Machinery and Chemical Corp. photo





# One-Piece Steel Roof Covers Auditorium

HIGH construction costs, the biggest problem in the building of schools today, have been offset by a unique type of construction in which sheet-steel roofs of unique sway-back design are used. The first roof of this type has been installed on the auditorium of new St. Patrick's High School in Kankakee, Ill. The architects say that the cost is 25 percent lower than conventional construction. Similar roofs are planned for an additional four auditoriums to be built in the near future.

The roofs are made of  $\frac{3}{8}$ -inch steel plates welded into a vast single sheet. The weight of the steel is supported around the edges of the roof, which is 108 feet in diameter and from the air looks like a gigantic hub cap. The rim of the roof rests on 24 slender steel columns which need no buttressing.

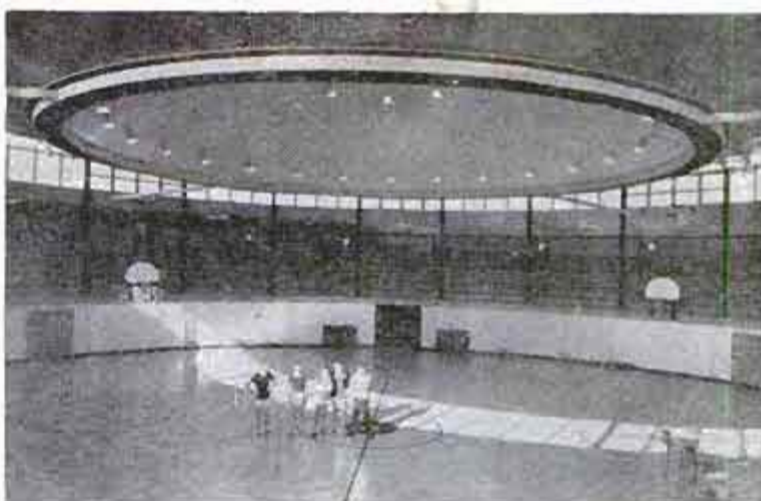

Tensions on roof are similar to those on spokes of wheel. Roof cannot collapse because weight pulls down on supports

During construction, the concave roof was tested by filling it with water. Such a pool, weighing 315 tons, would form only if 12 inches of rain fell while all of the roof drains were clogged.

The elimination of internal supports gives spectators in the auditorium an unobstructed view of the basketball floor. The auditorium seats 2200.

Water up to five feet deep is run onto roof during tests. Steel dome at center is 50 feet in diameter



Classrooms in school are covered by ordinary flat roof and are wedge shaped around edge of auditorium







U. S. Army photos

## Helmet for GIs Contains Two-Way Radio

GIs may soon be "talking through their hats." The Signal Corps Engineering Laboratories have developed a radio helmet for the individual rifleman. The helmet, which resembles a football player's headgear, contains a two-way radio that weighs only a pound. The set consists of two packages

about the size of a deck of playing cards, one containing the batteries and earphone, the other the transistors and circuits. The rifleman talks into a microphone that fits into the helmet when not in use. The radio is designed for short-range use, but an antenna increases the range to a mile.



## Tractor Opens Gate In Electric Fence

Consisting of four metal rods that are hinged so they block the opening, an electric-fence gate can be driven through without requiring the driver to leave the tractor seat. The rods are connected to the usual electric fence and contain the normal electric charge to keep animals from pushing through. The rubber tires of the tractor or car prevent shock to the driver. Spring action closes the gate behind the vehicle.



## Water Purifier - *see attached*

Taste and odor in drinking water can be destroyed by chlorine dioxide, an effective bactericide that does not leave chlorine taste or smell. This chemical takes color out of water containing dissolved iron or manganese and is harmless to humans and animals in the minute quantities used in water treatment.





Up to 30 men can sleep in this tent which can be used as storage shed, office space or temporary housing

## Inflatable, Rubberized Tent Serves for Storage or Shelter — see "A"

Designed originally for military purposes and to serve up to 15 years, an inflatable rubberized tent can be used as garage, storage shed, temporary office or home, first-aid shelter or as exhibit housing. It sleeps 30 men. The unit consists of semicircular arches, inflatable to provide nine feet of headroom at the tent's center over the 30 by 19 feet in floor area. Col-

lapsed for transport, the package is four feet six inches long, 1½ by 1½ feet high and wide and 100 pounds in weight. Windows are clear, flexible plastic, easily opened if needed. Doors at either end of the tent can be closed or opened from each side by zipper fasteners. Hooks provide support for electric and telephone wires. The tent floor is detachable.

## Toy Warfare Goes Modern With Electronic Cannon

Warfare on the toy level is almost as modern as the real thing, as shown by a toy electronic cannon that fires at the push

of a button. Mounted on a realistic truck body, the cannon's mount can be turned and the gun raised or lowered by push buttons. A dial on the truck indicates the elevation of the gun to the junior cannoneer. When fired, the gun shoots a harmless, plastic, sponge-rubber-nosed projectile. Current to operate the gun is supplied by two flashlight batteries.



## Chicago Midway Sets Record In Airport Plane Movements

Chicago's Midway airport led the world with 381,737 plane movements in 1955. This volume equaled combined air traffic of London, Paris, Rome, Copenhagen, Oslo and Geneva, with 8886 movements left over. New York's LaGuardia and Chicago's Midway terminals handled more traffic last year than these European cities, plus Amsterdam, Brussels, Zurich, Hamburg and Stockholm, with remaining volume equaling that of Portland, Me.



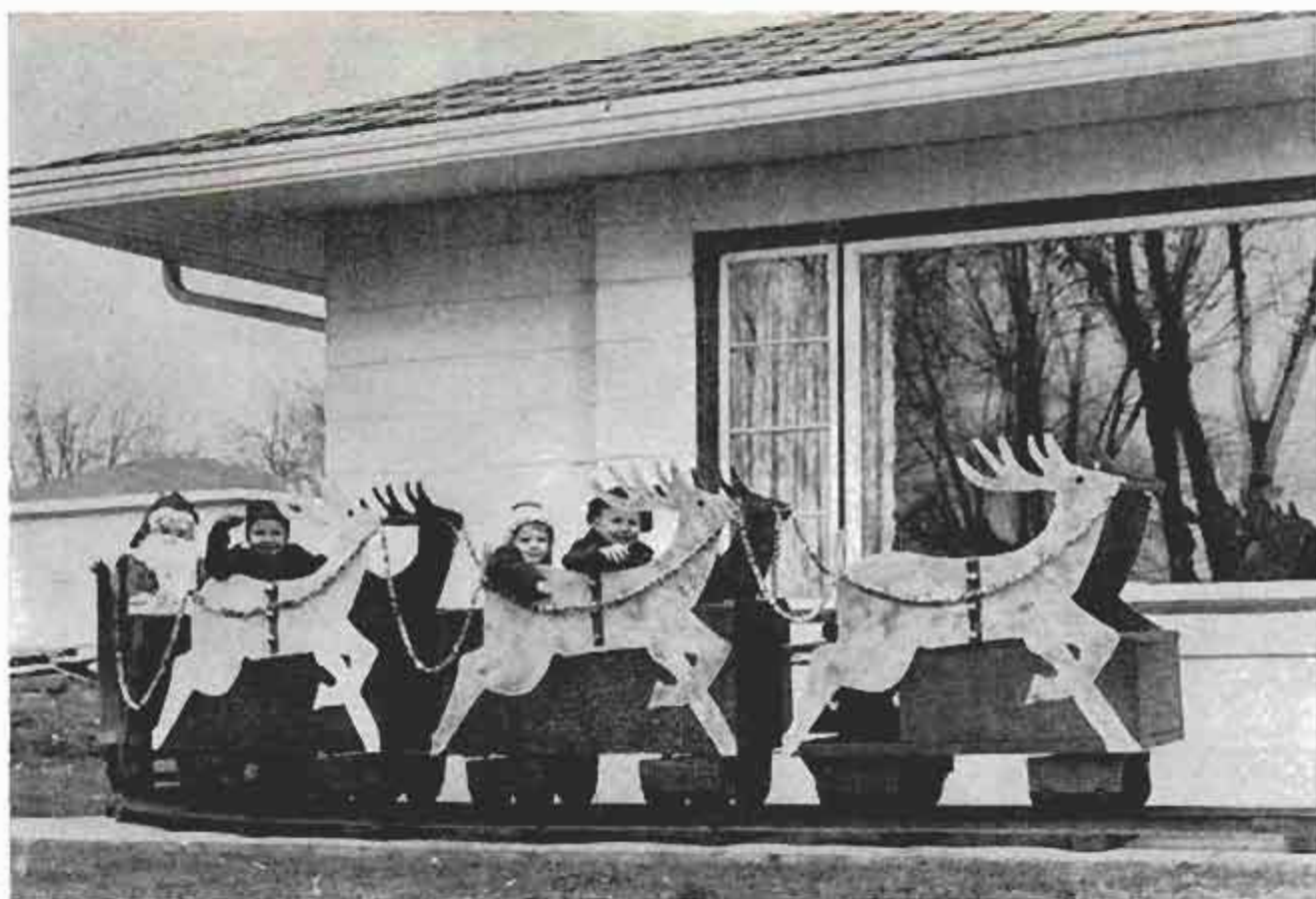

## Santa Claus Express Encircles Home During Holidays

Christmas time in Jefferson, Wis., means rides on the "Christmas Express" for the children of the town. The Christmas Express is a child-sized train, decorated with cutouts of reindeer and a sleigh, which runs on a track encircling the home of its builder, Robert C. Hearne. Built originally in time for the holiday season of 1954, the train has become an annual affair. It was designed by Hearne, who cast the wheels

in the foundry where he is employed and built the rest of the train up out of steel, wood and composition board. Powered by a 1½-horsepower gasoline engine, the train runs on a 170-foot track which completely encircles the house. The track is made of 12-gauge iron strips bent into channel form. As an added festive touch, the noses of the reindeer light up. A standard automobile battery provides current for these lights.



## Toy Fire Engines Really Pump Water

Latest development in realistic toys is a toy fire engine which is connected to a tiny water hydrant, which in turn is attached to a garden hose. Miniature firemen can have plenty of fun, squirting the tiny hoses at imaginary fires and at each other. The hose can shoot a stream of water 25 feet with pressure on full.

Water sprayed from an airplane extinguished a 50-acre forest fire near Wenatchee, Wash., in the first case on record.



# Radio Television Electronics



Novel amplifier permits hands-free telephoning and spot conferences. Incoming speech is amplified to normal-hearing volume and return conversation from anyone nearby is automatically directed into handset



You can change TV stations from distances up to 20 feet from your set with this remote-control tuner called IT. Channel-changing portion consists of a reversible d.c. motor which can be clamped to the channel-selector shaft of most sets. Installation requires only a special key which is supplied with each unit. Finger-tip pressure on touch bar of control unit changes channels in any desired direction

## New Products

New electrostatic speaker claims flat frequency response from 400 to over 20,000 c.p.s. with less than 1 percent harmonic and intermodulation distortion. Accompanying divider network matches the 16-ohm output of any high-fidelity amplifier. It provides the polarizing voltage required by the electrostatic speaker and sends the proper signals to this unit and to any low-frequency woofer with which it will be used



Records will sound better and last longer when tiny Dis-Charger, Fig. A, is clipped to record-player tone arm. Unit draws off static charge as record is played, releasing injurious and noise-producing dust clinging to record grooves. Fig. B: New record file solves storage problem for hi-fi records. Discs are held vertically in numbered rubber slots and ejected by slight upward pressure on movable selector arm

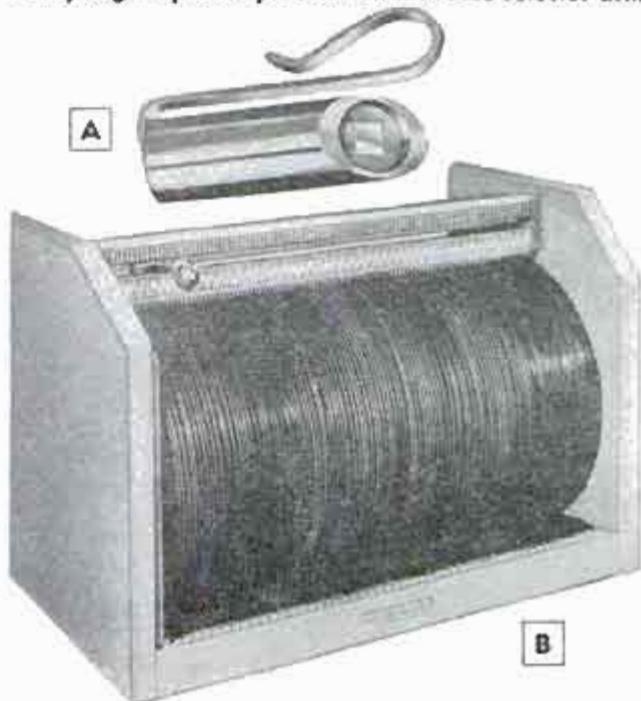



# MAGIC MIKE

(A SAFE AND SIMPLE  
WIRELESS BROADCASTER)

By Otto Fried

**W**IRELESS broadcasters have provided countless hours of fun for young and old for many years. These simple devices permit you to make announcements and play phonograph records through your radio from a remote location without any direct connection to the radio itself. The circuit shown here differs from many similar units in that it is battery operated. This eliminates the shock hazard often associated with line-powered units and provides freedom of location not limited by the availability of line outlets.

There are practically no critical components in the circuit and many experimenters may already have most of the required parts, or suitable equivalents. Even the tubes could be replaced with regular 7-pin miniature 1S4s, such as used in most portable radios. The primary advantage of the subminiature tubes actually employed is the low current drain which considerably increases battery life.

## Alternate Circuits

The electrical schematic diagram of the broadcaster is shown in Fig. 1. The model was designed only for voice broadcasts, but the addition of only four extra parts, wired as shown in Fig. 4, will enable you to broadcast phonograph records as well. To find sufficient space on the front panel for mounting the additional parts, the 67½-volt battery, B2, can be replaced with a



## LIST OF MATERIALS

**RESISTORS** (all ½-watt): R1=39,000 ohms; R2=82,000 ohms; R3=470 ohms.

**CAPACITORS:** C1=.01-mfd. 200-v. paper; C2=50-mfd. 25-v. electrolytic; C3=100-mmfd. disk ceramic; C4=50-mfd. 6-v. electrolytic; C5=70-480-mmfd. mica trimmer.

**MISCELLANEOUS:** SP=3-in. speaker, RCA 231S1 or equiv.; T1=Input transformer, Stancor A4744, 4-ohm pri. to 25,000-ohm sec.; T2=2-winding oscillator coil, Miller 5480-H; L1=5.5-hy. 50-ma. filter choke; V1, V2=1AC5 tubes; B1=1.5-v. standard flashlight battery; B2=67½-v. battery; RFC1=2.5 mhy. r.f. choke; S1=s.p.s.t. toggle switch.

**HARDWARE:** Plastic case, Waldom BC-140; bracket for B1; subminiature 8-prong sockets (2); insulated binding post; aluminum for front panel and bracket; solder lugs (2); 1-terminal tie point; battery connectors for B2; fiber washers (2); machine screws; hex nuts; hookup wire, rosin-core solder.

## ADDITIONAL REQUIREMENTS FOR PHONO CIRCUIT

J1=Phono pin jack; S2=S.p.d.t. switch; R4=1-meg., ½-w. resistor; C6=.01-mfd. 200-v. paper capacitor.

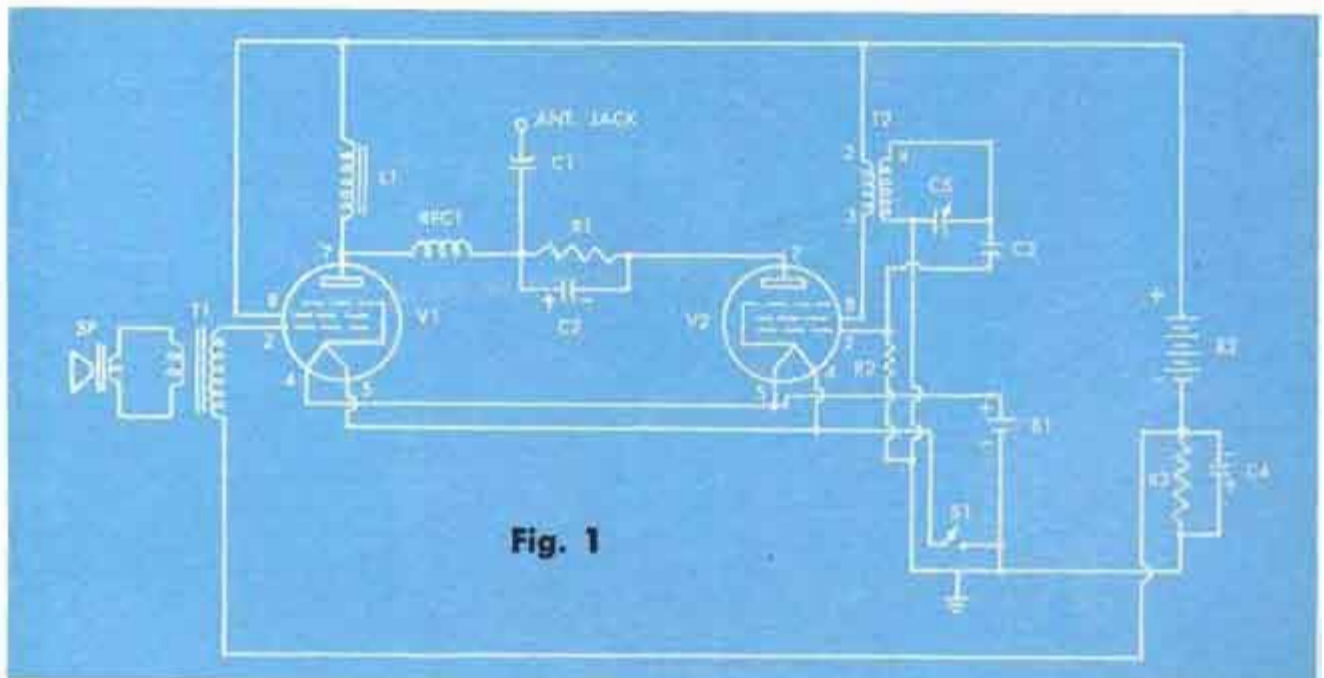
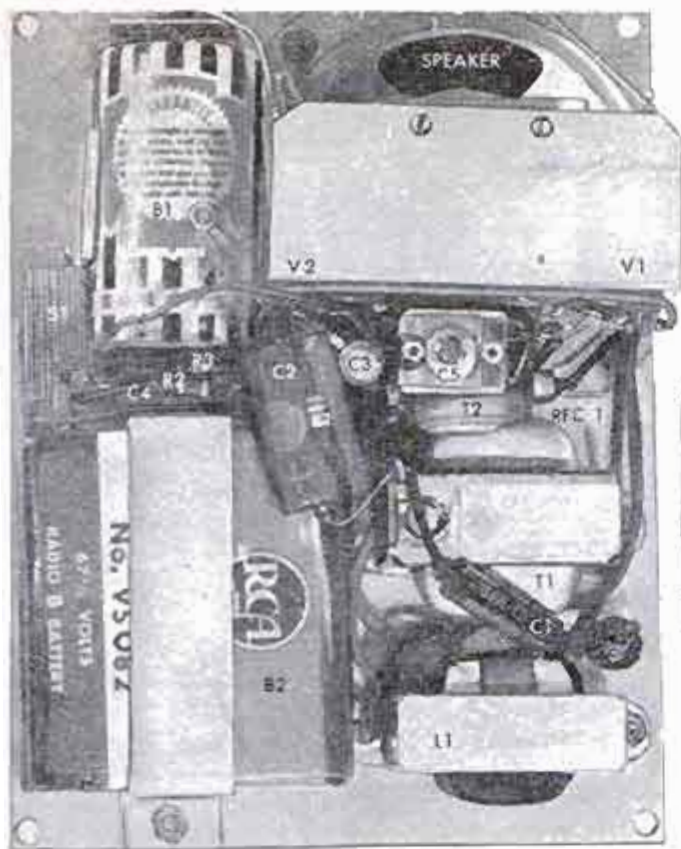

Fig. 1





Photo, above, shows completed wireless broadcaster with all parts mounted on aluminum front panel. Point-to-point wiring and method of mounting tube socket bracket to speaker are shown in pictorials

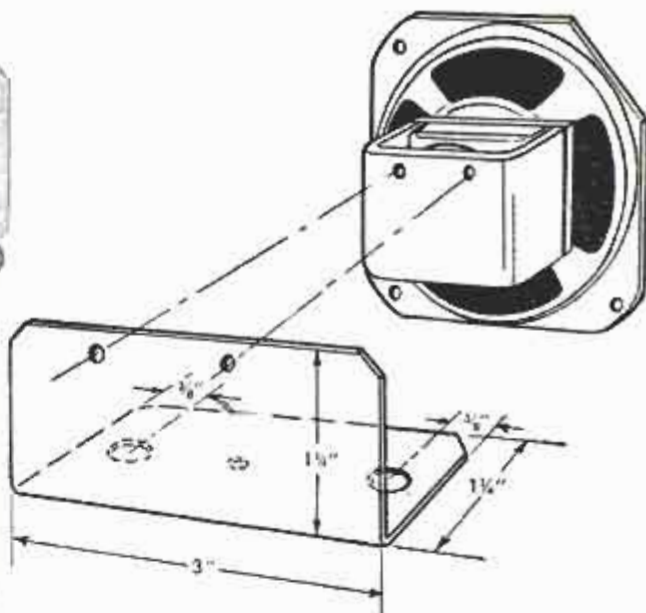
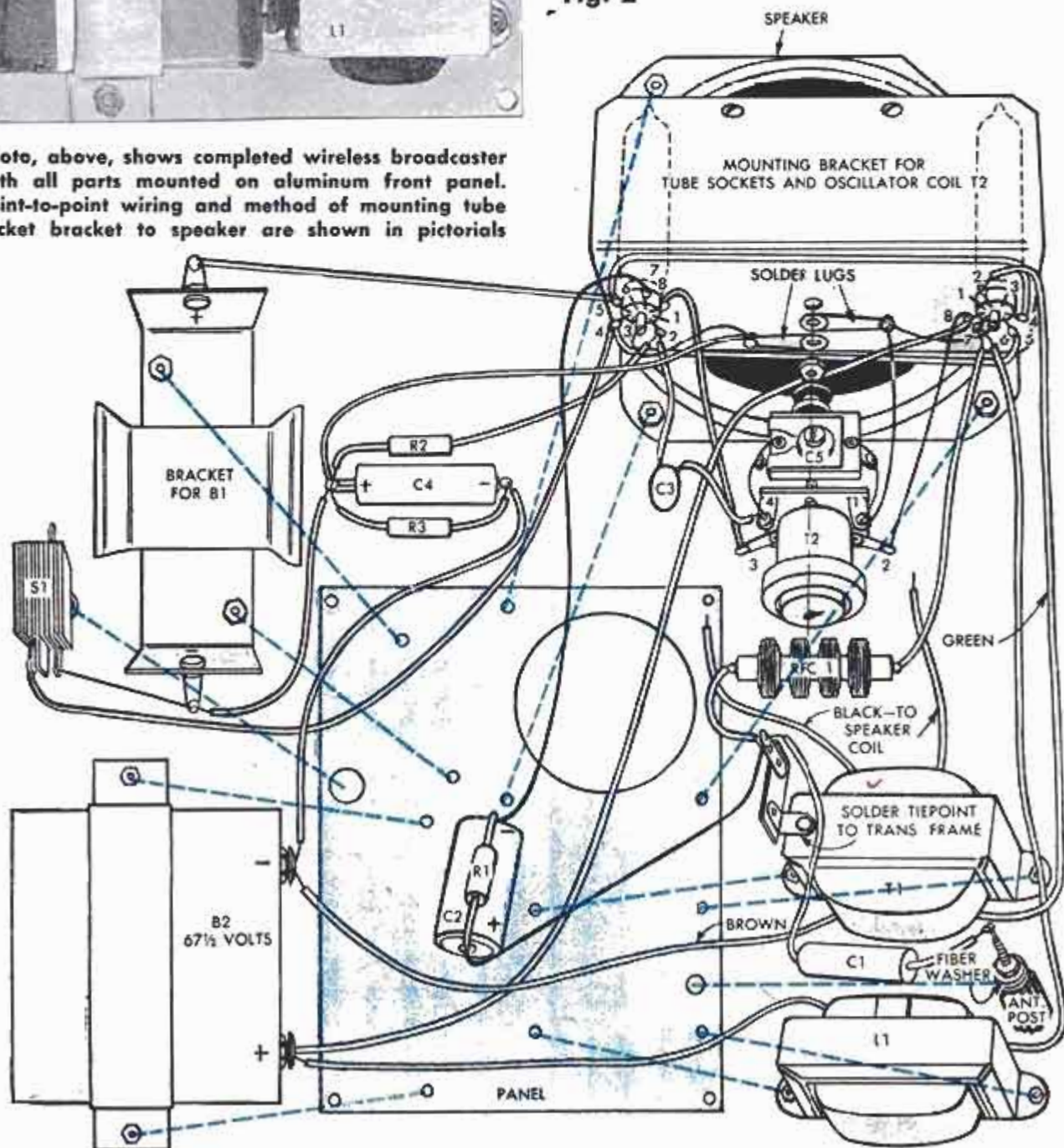
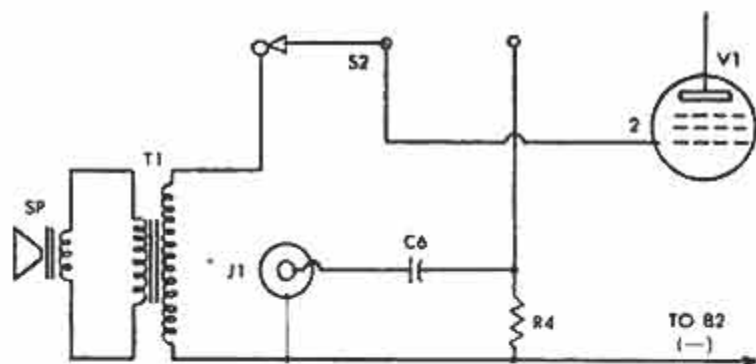
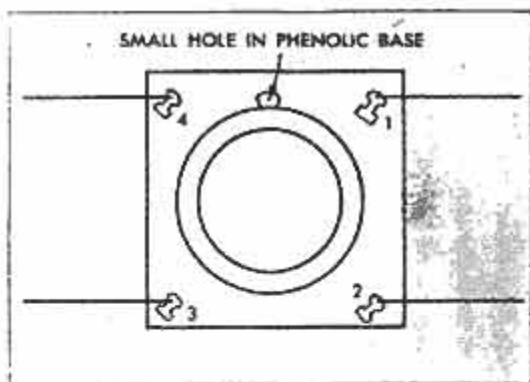

Fig. 2







Figs. 3 and 4, above, show oscillator coil lug numbers and circuit changes for voice and phono broadcasts

smaller hearing-aid type. If you wish to use the unit only as a record broadcaster, the speaker and input transformer may be omitted, and a direct connection from the junction of R4 and C6 to the control grid of V1 should be made.

### Construction Hints

Before starting the construction, it is a good idea to collect all the necessary components and fit them on the front panel in the proper positions, see Fig. 2. You can then drill the necessary panel holes. Both the panel and the tube-socket mounting bracket can be made from a piece of  $\frac{1}{16}$ -in. aluminum which is easily cut and drilled with ordinary hand tools.

Begin the assembly by mounting the tube sockets and oscillator coil. The sockets have no retainer clips, but they fit snugly into their  $\frac{3}{8}$ -in. holes. Before mounting the oscillator coil to the bracket, place two fiber washers, a hex nut and two solder lugs, in that order, on the threaded shaft of the coil. Then insert the shaft through the bracket hole between the two tube sockets and fasten it securely with another nut. The coil should be oriented so that the small hole in its phenolic base, Fig. 3, faces away from the panel.

The binding post which serves as antenna connector must be insulated from the metal panel by means of insulating fiber washers. Since the speaker is mounted at the edge of the panel, the upper right corner of the speaker frame must be clipped off so that the panel can be fastened to the case. A perforated metal grille inserted between the speaker and the panel will protect the speaker cone from damage and add a pleasing appearance to the completed unit.

The trimmer capacitor, C5, should be mounted between lugs 1 and 4 of the oscillator coil by bending the capacitor tabs so that they will make direct contact with the lugs. This makes a rigid assembly so that the capacitor will not move during adjustment. Before fastening the completed panel to the case, drill a 1-in. hole in the back

wall of the case, opposite the trimmer capacitor, so that this unit can be adjusted from the outside.

### Adjustment

To determine if the oscillator of the broadcaster is operating, connect a short wire to the antenna post, turn the broadcaster on, and bring it close to a radio which is tuned to a station between 600 and 1400 kc. Then, using a screwdriver, adjust the trimmer capacitor through the hole in the rear of the case. At some point, a loud whistle will be heard in the radio, indicating that a signal is being generated.

Now tune the radio to an "empty" spot on the dial (where no station is heard) and readjust the trimmer capacitor until you hear a background hiss through the radio. This indicates that the broadcaster and radio are tuned to the same frequency, and it is merely necessary to talk into the speaker of the broadcaster in order to be heard through the radio. It may be necessary to touch up the radio tuning slightly for best reception.

### Using Your Broadcaster

A wireless broadcaster is in reality a miniature radio station. Its use is sanctioned by the Federal Communications Commission only if the power output from this device is small enough so that no interference is caused to neighboring radios. The range of the unit, therefore, must be limited to approximately 50 feet. Normally, this range can be obtained with a wire 10 or 15 feet long attached to the antenna post of the broadcaster. Never use an antenna longer than necessary to give good results through your own radio.

The length of the antenna will slightly affect the frequency of the broadcaster signal. It might be necessary, therefore, to change the setting of the radio or to retune the trimmer capacitor, C5, whenever you use a different antenna. A little experimentation will acquaint you with the characteristics of the unit, and you'll agree that the results are worth the effort. ★ ★ ★





*Gift wrapping as the experts do it is neat and conservative, and often symbolizes the occasion or the hobby, vocation or personality of the recipient*

"Sasbeen" Ribbon photo

# Gift Wrappings

**I**T'S THE GIFT that counts, of course, but it's the wrapping that makes the first impression and sets the stage for lively anticipation. Two important factors to keep in mind when gift wrapping are neatness and simplicity of design. It is better to be "awfully simple than simply awful." Notice in the examples given that the

By  
**James Larson**

Creasing the paper at the edges squares the wrapping

**2**

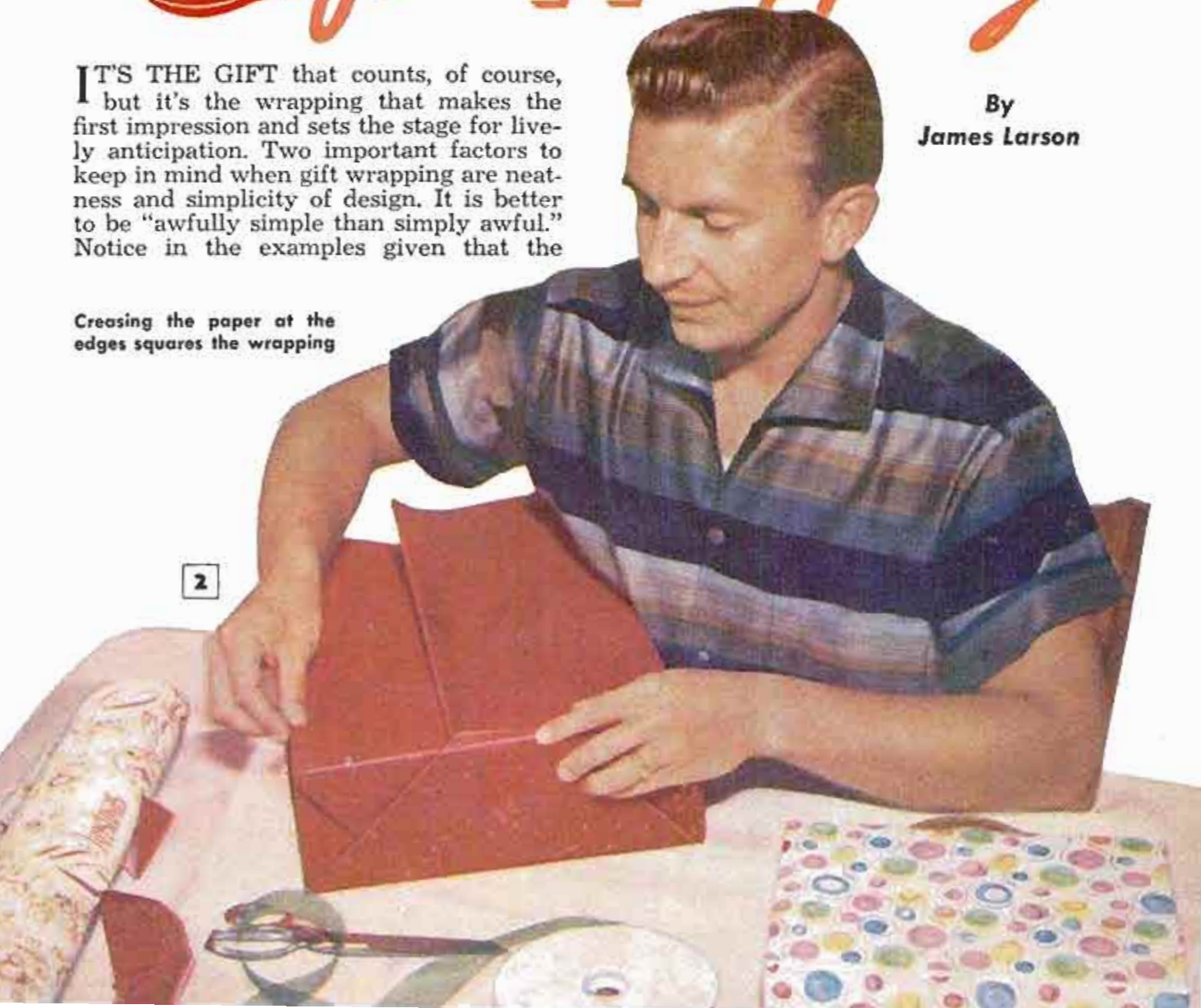





3

Above, silverware gift personalized by using three pieces as decoration. DAD spelled with cigarettes

designer depends on the paper for coloring and not on ribbon decoration. Also notice that mostly metallic papers are used, their plain colors being highlighted by simple decorations of ribbon bows or practical, useful objects peculiar to the occasion, or to the personality, hobby or vocation of the recipient.

Figs. 3, 12, 14 and 15 are good examples of wrappings designed for the occasion. In Fig. 3, Dad's birthday gift is wrapped with paper in a conservative color. A little ribbon decoration and lettering done with cigarettes completes the package. For a bridal shower or wedding-anniversary gift of silverware, three pieces of silverware stitched to the wrapping and augmented with a ribbon bow definitely key the gift package to the occasion.

What could be more appropriate for a baby-shower gift than a stork decoration as in Fig. 12? The stork is shaped from a



4

Small gift package gains stature when wrapped as above and tied with artificial flowers. Package at right wrapped with velour paper. Shirt cuffs and collar are simulated with the same paper. Tie is ribbon with silver cord for clasp. Stitching is imitated with glitter glued on, and cuff links are small tree ornaments. Below, metallic-paper wrapping decorated with dime-store glass flowers produces a colorful package of unusually neat appearance



5

6





large safety pin. Bits of stiff ribbon through the eye of the pin simulate wings; a round toothpick takes care of the beak from which is hung the paper diaper carrying a tiny doll or the name card.

A wrapping symbolic of his hobby or vocation will tickle the vanity of any man. Such a wrapping is not intended to give an inkling as to what's inside nor represent the gift itself. Examples given in Figs. 1, 6, 8 and 10 should start you off. The "candy cane" saw decoration pictured in Fig. 1 is ideal for the handyman. It is a keyhole saw wrapped in red paper and then wound spirally with narrow white ribbon. A ribbon poinsettia adds the floral effect.

Tree decoration at right formed with Hawaiian lei glued on and ornamented with small tree ornaments and silver cord with star at top. Below, artificial fishing fly symbolizes recipient's hobby. Hook should be shielded



Alex's Floral Supply photo

7



"Sasheen" Ribbon photo

8

A corsage of live or artificial flowers is an ideal decoration on a gift preceding a social engagement. The corsage can be removed and worn



9

For a gift to a man who has a home workshop, try the wrapping below. The decoration is a circular-saw blade. "Sasheen" ribbon forms bow, which is wound to simulate wheel spokes

"Sasheen" Ribbon photo



10



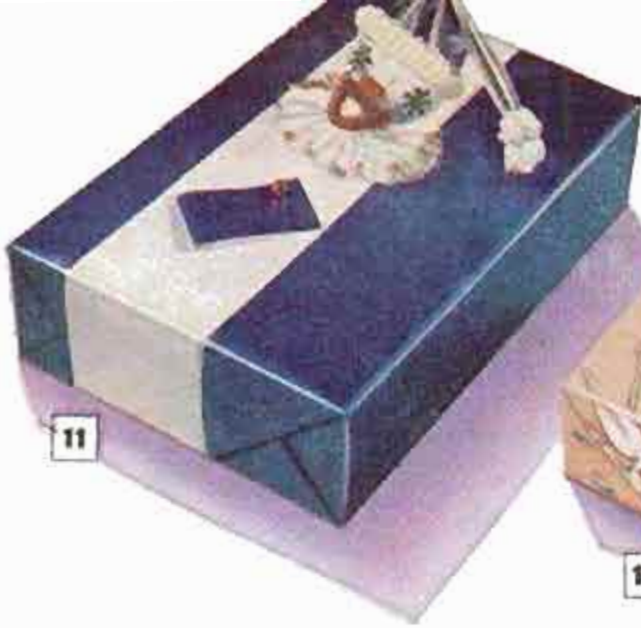

11



12

Metallic paper, a Santa Claus head and a wide ribbon band combine to produce the neat, attractive wrapping above. What could be more appropriate for the baby-shower gift than the stork decoration at the right? The stork is bent from a safety pin, wings are stiff ribbon and the beak a round toothpick. Paper diaper holds a tiny doll

Aleen's Floral Supply photo



13



Aleen's Floral Supply photo



Aleen's Floral Supply photo

14

Packages above show what can be done with colorful paper and simple decorations. Left-end package is decorated with Puffed Wheat and ribbon, while the one at the right end is done with Styrofoam and artificial leaves. Wrappings below are ideal for Christmas packages

Aleen's Floral Supply photo

15





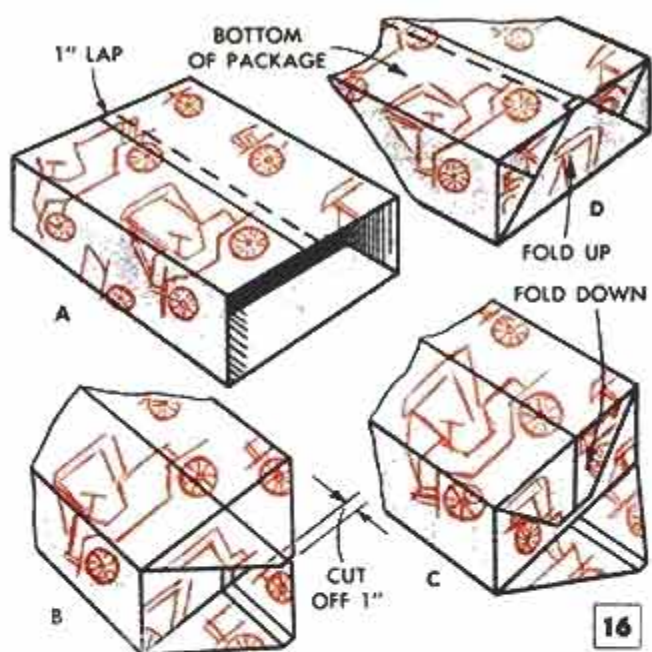

Steps in wrapping packages to get neat square ends

For the sport-shirt fancier, try the wrapping shown in Fig. 6, which also gives the key to the shirt inside. The package is wrapped in velour crepe paper or similar material, after which collars and cuffs are simulated with the same material and glued in place. Stitching is imitated with glitter glued on, and cuff links are tiny ornament balls glued in place. The tie is ribbon with gold cord for the clasp.

The standard, but welcome, necktie gift shown in Fig. 8 becomes more personalized when decorated with a practical symbol of the receiver's hobby—in this case a colorful fishing fly. Point of the hook should be shielded with several wrappings of cellulose tape.

Fig. 10 is a wrapping for the "Big Wheel" with a power saw in his home shop. Done in a wheel motif complete with ribbon spokes, the decoration on this package is a circular-saw blade. Cellulose tape is

This method of wrapping makes small package larger

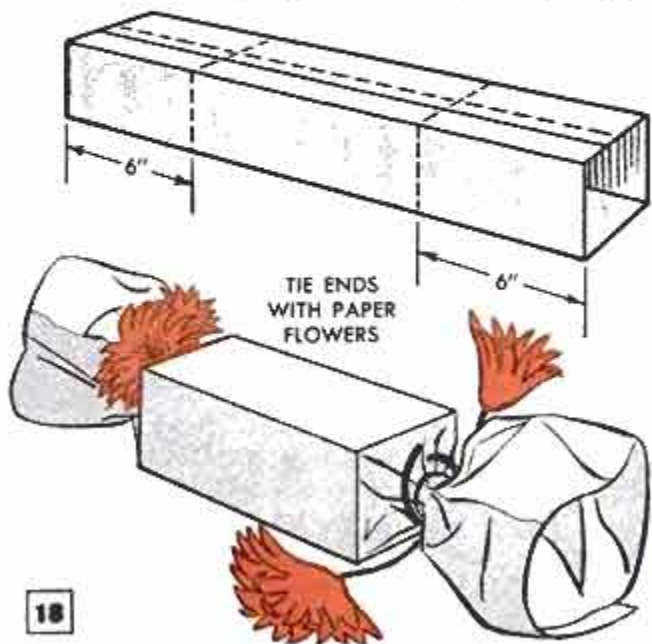

18



17

Amount to cut off varies with different packages

folded over the saw teeth to prevent possible injury.

Your "precious things come in small packages" type of gift that always seems so inconspicuous in size will increase in stature if wrapped as in Figs. 4 and 18. Paper or other artificial flowers are used as ties at the ends. Other ties suitable to the occasion may be used.

For a gift preceding a social engagement the package in Fig. 9 depicts a dual-purpose decoration. The package is wrapped in metallic paper and decorated with a corsage of live or artificial flowers, which are removed and worn by the recipient.

When wrapping Christmas gifts it is hard to beat the simplicity and good taste of the wrappings shown in Figs. 7, 11, 14 and 15, and the right and left-hand packages of Fig. 13. The white tree, Fig. 7, is shaped with a Hawaiian lei glued in place

Using folded strip of wrapping paper as name card

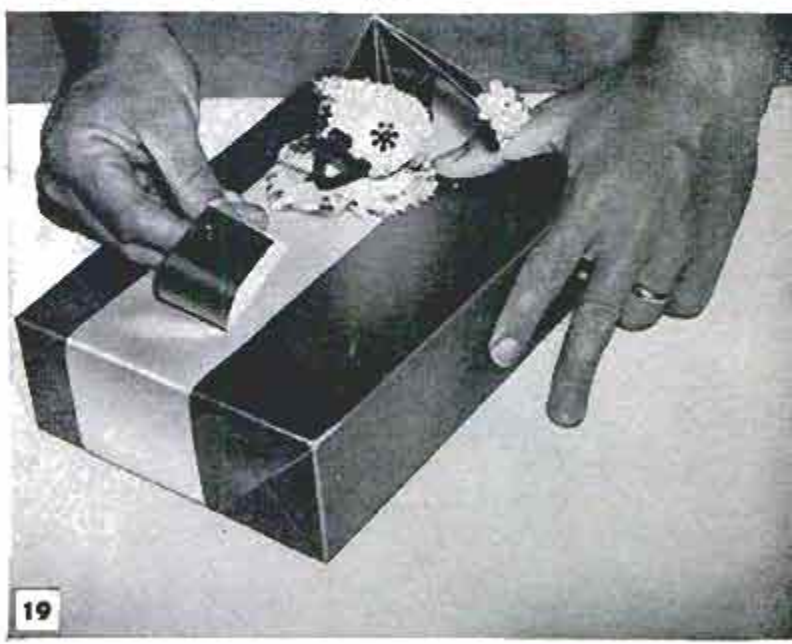

19



Word NOEL spelled out on base-metal trays. Metal is available at most hobby shops. Letters are outlined with glue, then sprinkled with glitter. Ribbon streamers complete this unusual wrapping



Aleen's Floral Supply photo

and ornamented with small tree ornaments, silver cord and a small gold star. In Fig. 11, a Santa head and white ribbon contrast with a blue metallic paper to produce a neat effect. Notice in Fig. 19 how a folded strip of the paper serves as the name card.

The two Christmas packages of Fig. 13 are very easy to wrap. The snowman is made of Puffed Wheat kernels and decorated with a marshmallow hat and red cinnamon-candy buttons. Arms, ear muffs and hat top are chenille, all glued in place. The lantern decoration in the right-hand detail is shaped from half-round pieces of Styrofoam, sprayed with gold glitter and completed with dime-store leaves and ribbon. Candle flame is a piece of red chenille.

Notice in the two center wrappings of Fig. 13 how simple ribbon decorations relieve the lines of striped paper.

Fig. 14 shows what can be done with gold metallic paper, Styro-

foam eggs, gold cord, sequins and evergreen sprigs. The eggs are shaped to resemble tree ornaments, colored and then decorated with pearl-headed pins and sequins.

Green metallic paper, artificial snow and small pine cones are combined to produce the wrapping in Fig. 15. The green-fern effect is achieved by using a flattened fern as a stencil and spraying the snow over it.

The word NOEL is spelled out on the package in Fig. 20 on base metal, obtainable from hobby shops. The metal is formed into trays. Each letter is first drawn on a tray with glue, then sprinkled with glitter and the surplus shaken off, allowing a little to adhere to the wrapping paper. Trays and ribbon are glued to the wrapping.

When designing a gift wrapping remember the plainer the paper the more elaborate the decoration may be, and the busier the design the more conservative must be the decoration. But no matter how well the design is worked out, the whole effect will be lost if the package is not wrapped neatly.

Fig. 16 shows one method of wrapping. First, size the wrapping carefully to the package, allowing 1 in. overlap in width, and letting the ends project an amount equal to the thickness of the package plus  $\frac{1}{4}$  in. Then proceed as indicated by steps A, B, C, D, cutting off one flap as in Fig. 17.

The wrapping method illustrated in Fig. 21 shows how to fold a wrapping without cutting the ends, but requires accuracy to produce a neat package.

After folding and securing one end of the wrapping, creasing the edges as in Fig. 2, especially on metallic papers, squares the package for neater appearance.

★ ★ ★

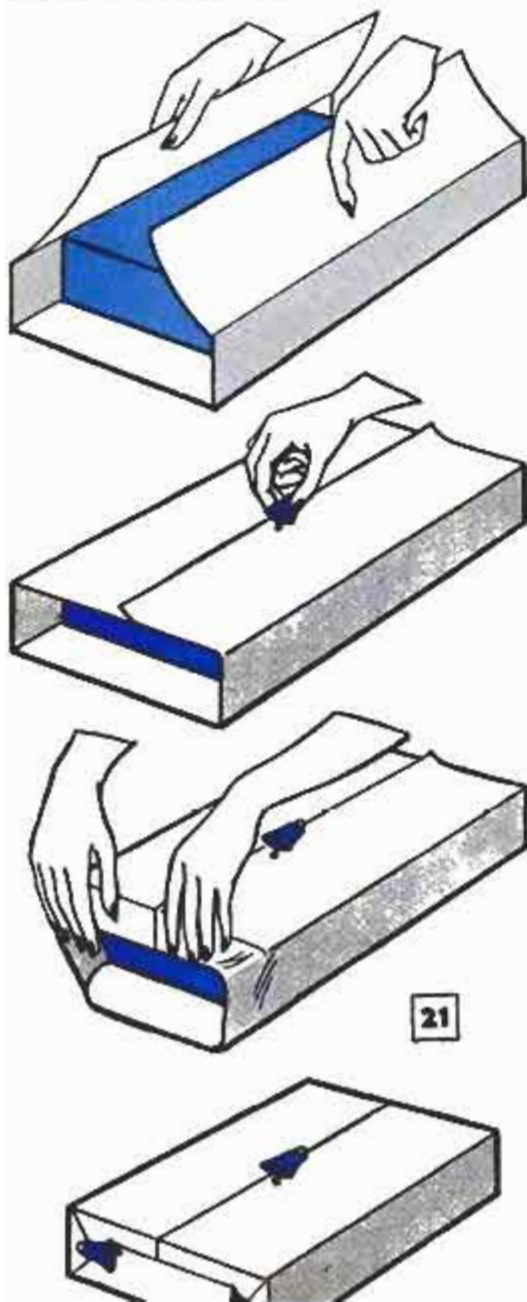

Steps in wrapping gift without cutting the ends of the paper



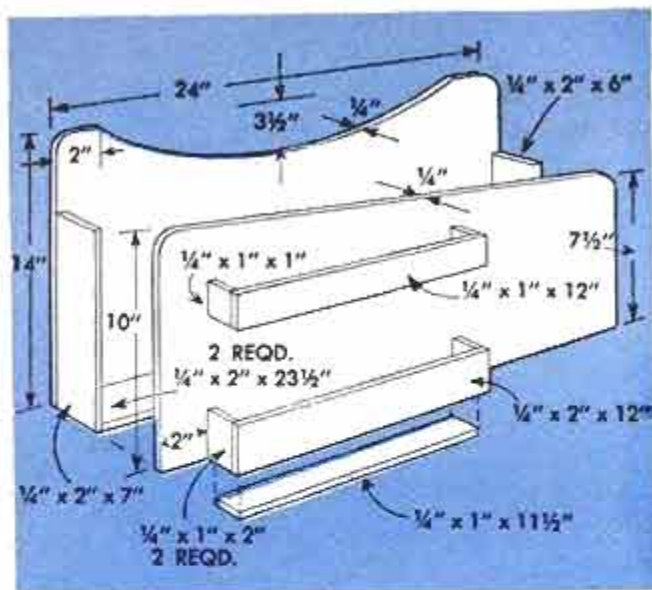

## Wall-Type Magazine Rack Held at Eye Level

With this magazine rack mounted on the wall next to your favorite easy chair, reading material is held at eye level for easy selection. All parts are cut from  $\frac{1}{4}$ -in. plywood to the dimensions indicated in the detail. Sand smooth all edges that will be

exposed in the finished assembly, and check the pieces for proper fit before assembling the rack. Glue the pieces together, reinforce with brads or wood screws and finish the rack with stain and varnish. Ted Fenn, Chicago.



## Three-Dimensional Star Ornaments Made From Aluminum or Tin Foil

Attached to the branches of a Christmas tree with bits of wire, these star ornaments shine brightly when viewed from any direction. Use aluminum-coated insulation paper or heavy tin foil, and lay out circles of various sizes on one side of the material. Adjust the compass and divide each circumference into five equal parts. Then draw lines between the points to form a star and cut them out accordingly. Staple two identical stars together at the center and fold them apart for a three-dimensional effect.—Ken Murray, Colon, Mich.

## Wall-Mounted Aquarium Made From TV Lens

This intriguing three-dimensional aquarium mounted on a wall at eye level is made from a liquid-filled magnifying lens such as is used to enlarge the picture of a small television set. The first step is to drill a hole in the bottom of the lens and drain the oily liquid. Next, saw off the upper portion of the plastic lens as indicated and clean the inside. Then, cement a drain tap in the hole at the bottom and mount the aquarium with screws.—Robert Benderoth, Whippany, N. J.

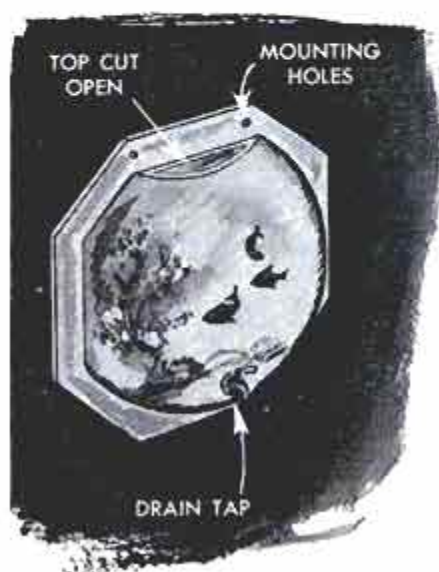



# Handy Snack Tray for Serving Television Viewers

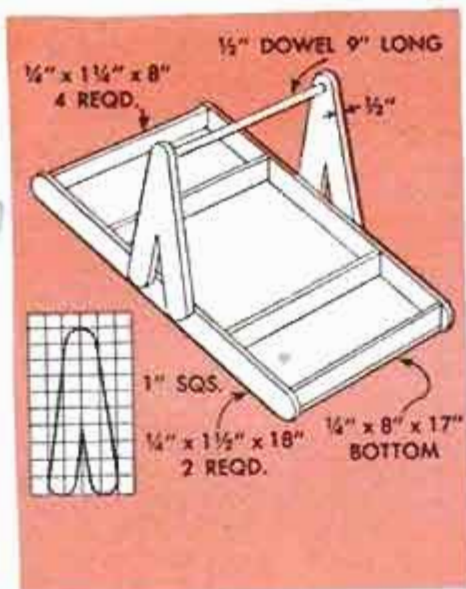

With this handy tray the housewife can save steps when serving a snack to guests watching TV. Unlike ordinary serving trays which require two hands for carrying, this tray has a dowel handle over the center of the tray. End supports for the handle are cut to the shape indicated after first drawing on the wood from a full-size paper template. The tray itself is assembled from pieces of  $\frac{1}{4}$ -in. plywood.

## Light Bulb Kept Tight

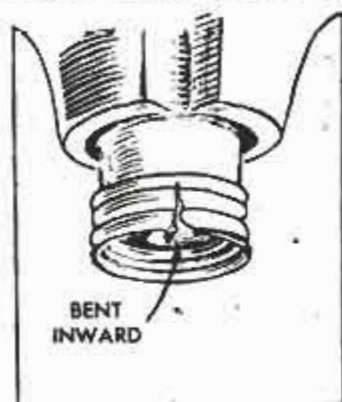

When a light bulb in a rigidly fastened socket frequently becomes loosened because of vibration, a slight alteration in the socket will eliminate the problem. Disassemble the socket to get at the thread-forming

portion and make a cut,  $\frac{1}{4}$  to  $\frac{3}{8}$  in. long, in the socket as indicated. Then bend one edge of the cut inward so that it bears against the lamp base, allowing the bulb to be screwed into the socket, but resisting motion in the opposite direction.

## Determine Area of Odd Shape By Weighing Hardboard Cutout

The area of a flat surface that has an irregular shape can be determined easily by tracing and cutting the shape from a piece of hardboard, then dividing the weight of the cutout by the known weight per sq. in. of the hardboard. As an example:

Size of hardboard—15 x 10 in.

$15 \times 10 = 150$  sq. in. (total area)

Weight of hardboard—22.5 oz.

$22.5$  divided by  $150 = .15$  oz. per sq. in.

Weight of cutout—12 oz.

$12$  divided by  $.15 = 80$  (area of irregular shape in sq. in.)

The same method can be used to determine the area of large surfaces, such as a lake, except that the tracing must be an accurate reproduction made from a map with a scale of at least 1 in. equaling 1 mi.

## Lazy Suzan Keeps Small Tools Handy

Screwdrivers, punches, wood chisels and other small tools will be readily at hand if they are kept in a rack like this one. Movable from place to place, it also rotates for easy tool selection. The rack is made of wood, the holes in the disk varying in size according to the tools kept in them. Bore the holes for the tools from both sides to prevent chipping.—Victor H. Lamoy, Upper Jay, N. Y.

☐ A piece of aluminum foil beneath the scarf on a dresser or vanity table will protect the furniture finish against stains and damage from spilled cosmetics.

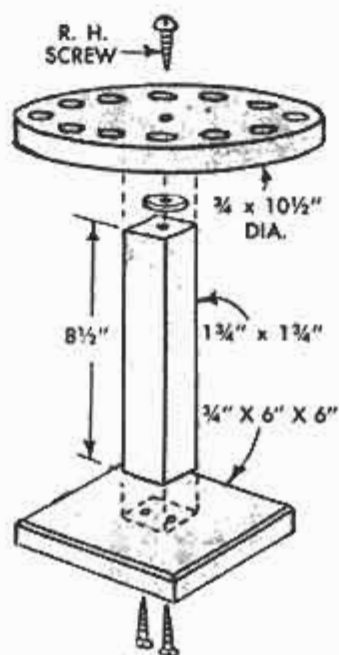



## Twin Easel Provides Ample Work Space for Two Young Artists

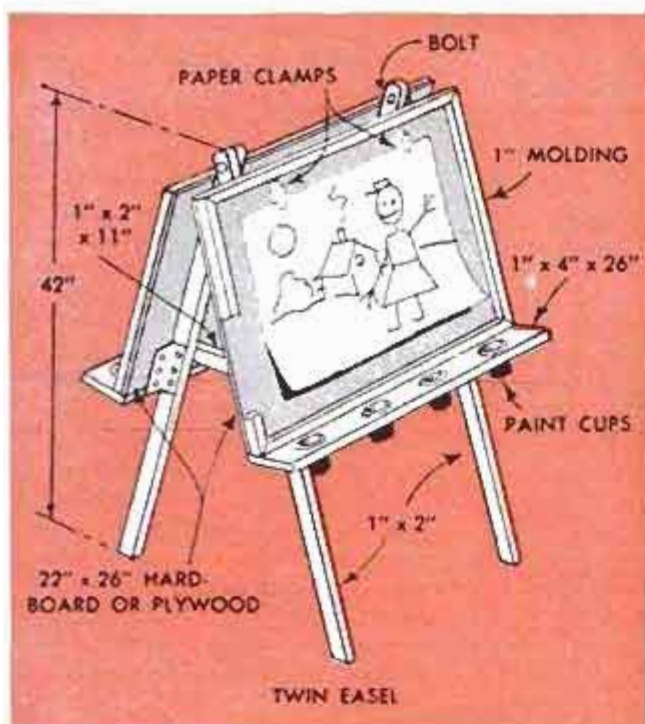

For your next home-workshop project, why not make this double easel for your children, or as a gift for other young artists? If they like to paint, they will appreciate having an easel of their own, and it will give them an incentive as well. Instead of scattering material all over the dining-room table, or elsewhere, they will have a definite place to do their painting. The twin easel in the photo above was not designed to fold, but hinged brackets in place of the cross braces will make it collapsible. The four legs are each 42 in. long and cut from 1 x 2-in. stock, which is

also used for the cross braces. Two pieces of plywood, 22 x 26 in., provide the work surfaces, and are framed with 1-in. molding. Trays are made from two pieces of 1 x 4-in. stock 26 in. long which have four large holes drilled in them to accommodate paint cups. The trays are screwed to the plywood panels which are attached to the legs with L-shaped brackets. Legs are joined at the top with  $\frac{1}{4}$  x 2-in. bolts, which also are used for the braces, installed 18 in. down from the top. Protect the wood with a hard-gloss finish that will prevent staining and permit spilled paint to be wiped off easily.

## Shield Protects Wooden Surface From Glancing Hammer Blow

When assembling finished parts with nails this shield will protect the surface from a glancing hammer blow. In a square of  $\frac{1}{8}$ -in. hardboard, drill a hole large enough for the nailhead to pass through. Place the shield on the surface of the work as shown, and drive the nail flush. Remove the shield and seat the nail with a nail set. A thick rubber tile will do too.

## Car-Trunk Lock Altered to Permit Removal of Key When Lock is Open

If the key to the trunk of your car cannot be removed when the trunk is open, place the key in the lock, turn it to the unlock position and yank it straight out with a pair of pliers. In most cases, the burr which prevents removal of the key will be broken off by the key as it is pulled free.

David Dawson, New Berlin, N. Y.





WTMS 0

# LACHLAN MACLEAY

## THE TOWBOAT THAT MASTERED THE WILD MISSOURI



Federal Barge Lines, Inc., photo

Federal Barge Line's new Missouri River towboat, the LACHLAN MACLEAY, celebrated her maiden voyage May 1956 by pushing a record-breaking 9000 tons of freight in 11 barges to Kansas City. Especially designed for the shallow, fast-winding Missouri, the MACLEAY is equipped with four propellers, each powered by a 900-hp. diesel engine, and 10 rudders. Although she measures 162 ft. long and 45 ft. wide, she draws only 5½ ft. of water. Her four stacks make her unique among river towboats and quickly identify her

By Louis Martin Reitz

### PART I—THE HULL

SAND BARS of the Big Muddy mean nothing to the towboat *Lachlan Macleay*. When she runs into one of the many that block the shallow channels of the swift Missouri, she simply changes from a pusher to a puller. Here at the head of the tow she literally washes away the river road block with her four huge propellers to clear her loaded barges. Unique in towboat design, the *Macleay* is equipped with 10 rudders. One is mounted aft of each propeller to guide the towboat when going forward and three smaller, backing, or

flanking, rudders are mounted ahead of each pair of propellers to steer the *Macleay* when her four powerful engines are reversed. Fitted with towing knees at both bow and stern, she can handle tows up to 1000 ft. long with a cargo capacity of nearly 10,000 tons.

#### Modeling the Hull

This 18-in. prototype is built to the scale of approximately 1/8 in. to the foot. You have a choice of carving a keel model as described here, or a simplified water-line

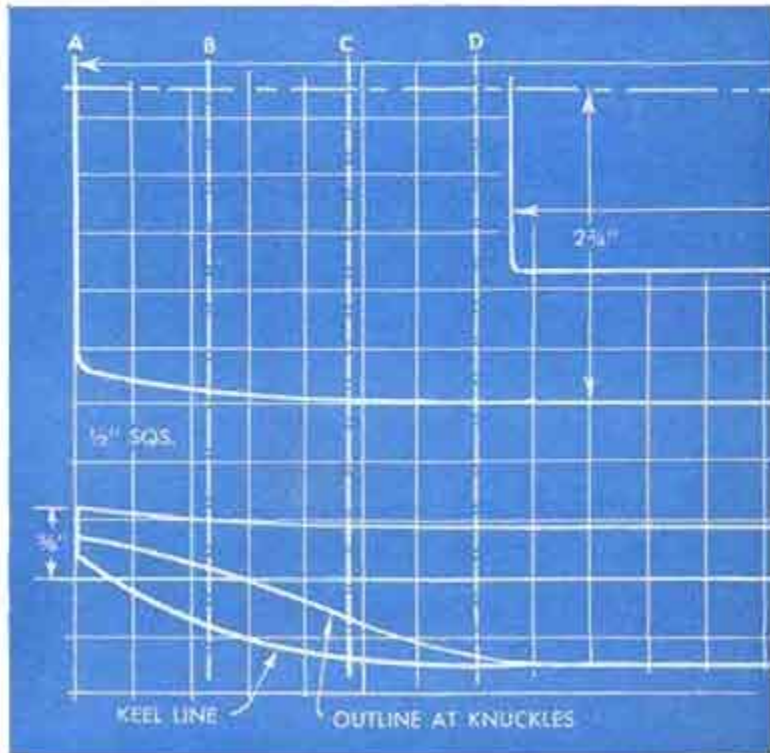
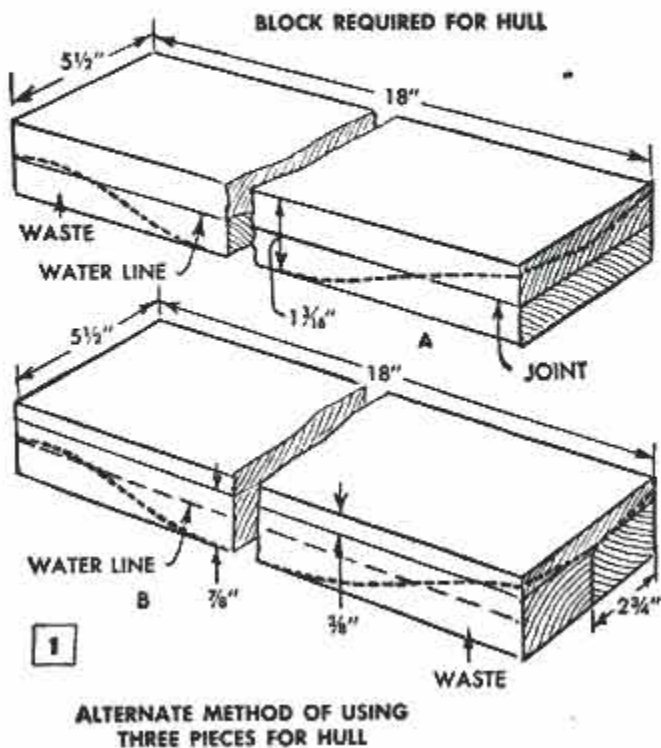



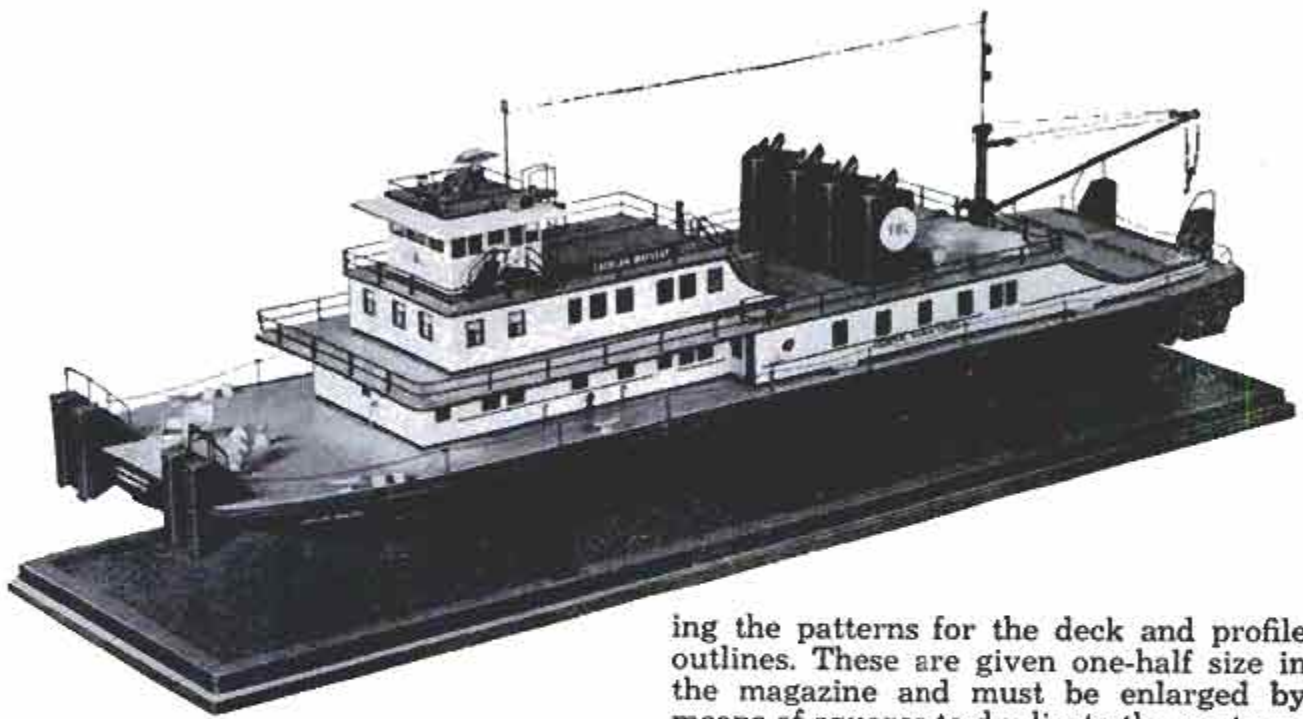

model. Fig. 1 shows two ways to build up the block for the hull. The original model was carved from a two-piece block as in detail A, letting the joint serve as the water line. This method also permits the center of the upper layer to be cut out to lighten the model, after which a piece of hardboard is used as a deck. Where a bandsaw is not at hand for sawing a block 5½ in. wide, you might find it easier to work with a block consisting of three pieces as in detail B, in which case the two lower parts can be sawed and carved separately before gluing the three together. Of course, if you prefer, you can start out with a single solid block.

Follow the drawings in Fig. 2 for mak-

ing the patterns for the deck and profile outlines. These are given one-half size in the magazine and must be enlarged by means of squares to duplicate the contours at the bow and stern. Mark off on the patterns the locations of the station lines A, B, C, etc., as well as the locations of the holes for the rudder and wheel shafts. For the most part the hull is "brick shape" and maintains the same deck contours at the stern and bow.

#### Tunnels Can Be Omitted

On the underside of the hull at the stern are recesses called tunnels in which the wheels, or propellers, are mounted. This is a feature of the *Macleay* which permits the use of propellers some 12 in. greater in diameter than the normal draft of the boat. As the propellers are mounted to bring the blades just even with the bottom of the hull, the tunnels provide necessary

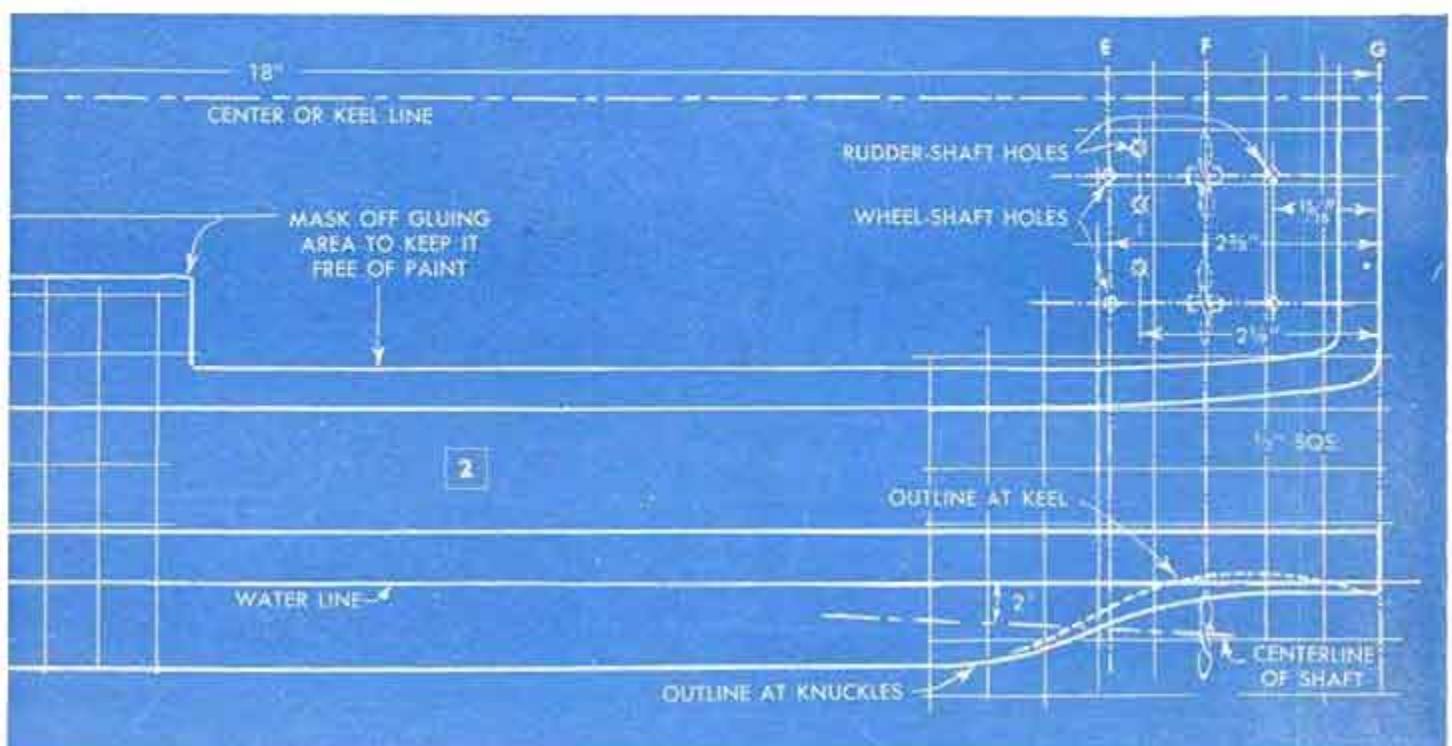



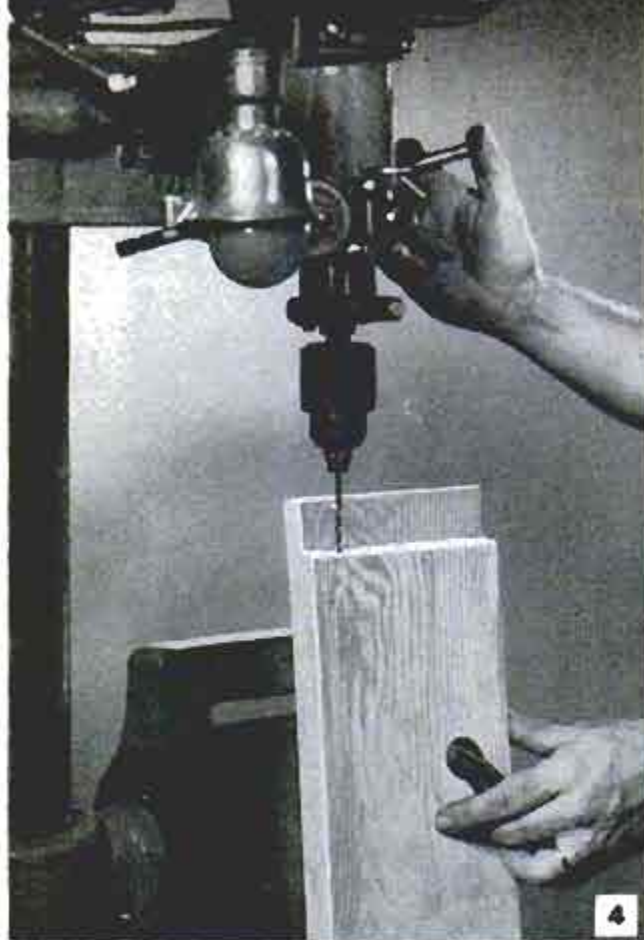

4

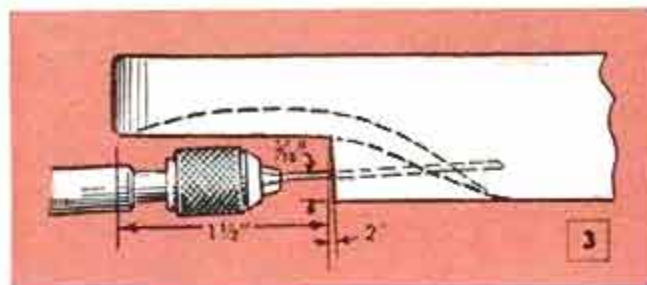

3

clearance for the prop blades at the top. When the boat is not under way, the tunnels, being above the water line, are filled with air, but once the propellers start churning, they pull water into the tunnels. Reproducing the tunnels on the model requires extra work and they can be left off if you wish, without spoiling the appearance of the model in any way.

Now trace the deck plan on the hull block and mark the locations of the wheel and rudder-shaft holes. Saw off the rounded corners at the bow and stern and tack these waste pieces back on temporarily so that all of the profile outline can be traced on the edges of the hull block. Next, drill the rudder and wheel-shaft holes through the block. The holes for the propeller shafts should be drilled at this time too. Figs. 3 and 4 show how this is done by first sawing a notch on the underside of the stern. This provides a flat surface for starting the holes and drilling them at the required 2-deg. angle.

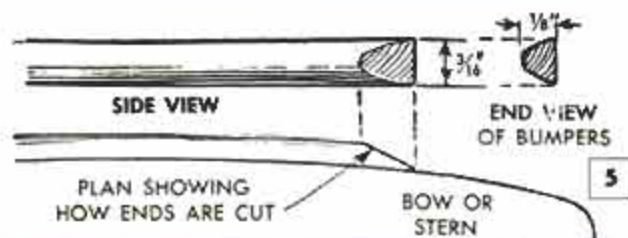

5

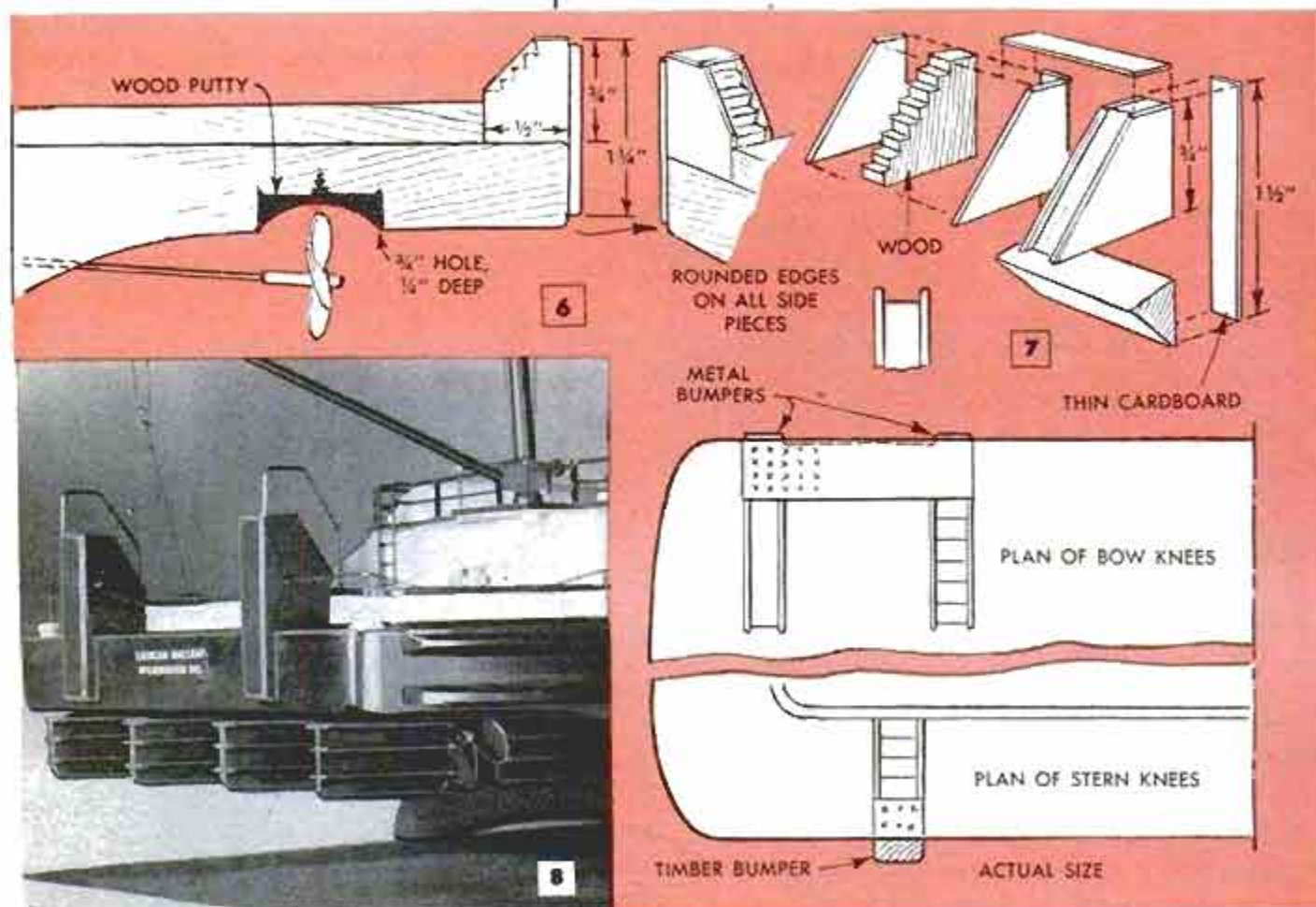

6

ROUNDED EDGES ON ALL SIDE PIECES

7

METAL BUMPERS

THIN CARDBOARD

PLAN OF BOW KNEES

PLAN OF STERN KNEES

TIMBER BUMPER

ACTUAL SIZE

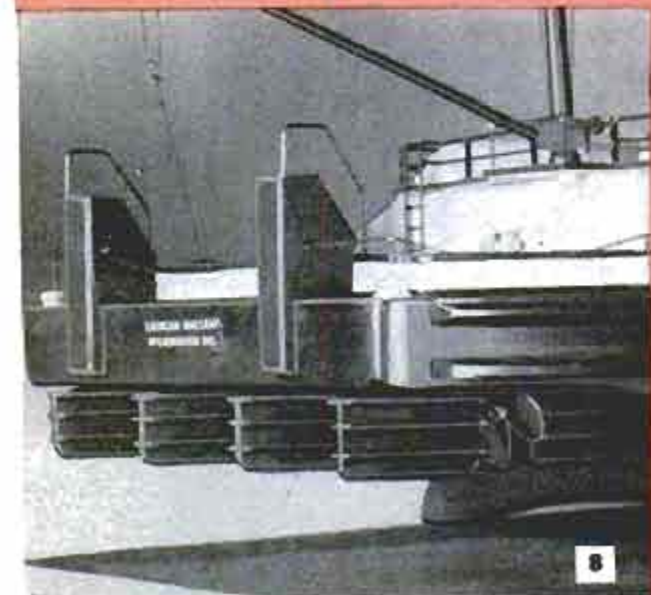

8



Before you can start carving the hull you must make a set of carving templates. These are given actual size in Fig. 9 to make it easy to trace them off onto thin cardboard. In studying Fig. 2 you will notice that the hull between stations D and E maintains a rectangular cross section, the lower edges, or knuckles, being merely rounded. There is a separate template included for checking this portion of the hull.

The templates represent the sectional shape of the hull at each respective station line and are used to check the contour at these points as the carving progresses. While the templates are given as half-templates, and can be used in this form, they can be drawn their full width. A centerline is marked on each one and this point is held in line with a centerline drawn on the underside of the hull when the template is used to check the contour.

With the profile outlines on the edges of the hull block start roughing away the waste from these lines down to the keel, or centerline. A sharp chisel, a wood rasp and sandpaper can be used for this. A gouge will be needed to form the tunnels at the stern. If the tunnels are omitted, clearance for the propellers can be provided by boring a  $\frac{3}{4}$ -in. hole in the underside of the stern above each propeller as shown in Fig. 6. Wood putty can be used to dish the hole.

The bumpers are next. These are applied to both port and starboard sides of the hull and are shaped as indicated in Fig. 5, two being applied on each side with glue,  $\frac{3}{8}$  in. apart. At this point, fill all holes and dents with wood putty or patching compound. When dry give the hull a careful sanding with medium and then fine-grade sandpaper.

The *Macleay* is one of the few towboats equipped with towing knees fore and aft and its knees are purposely made high so they will make contact with a barge whether it be loaded or empty. Fig. 7 details the knees for the model. Single knees are added at the stern, while double ones are fitted at the bow. The actual-size plan views in Fig. 7 show where the respective knees are located. Each one is fitted with a handrail.

#### Prime the Hull Now

This is a good stage to give the hull a priming coat. For this you

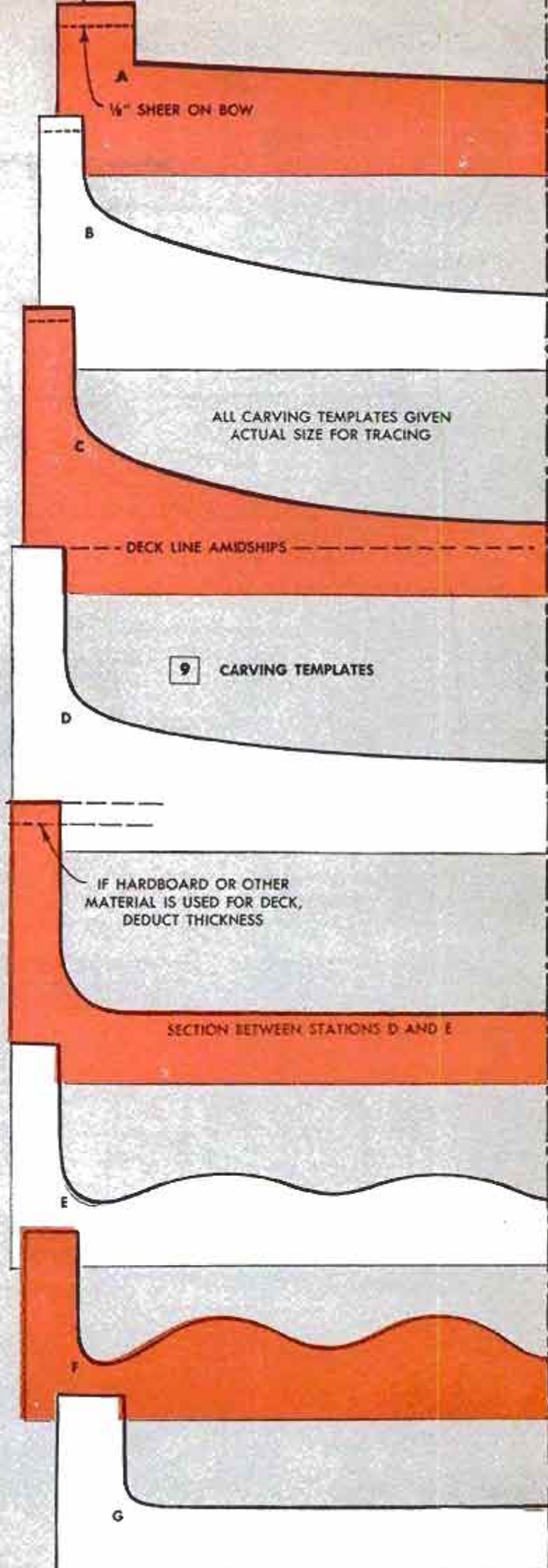



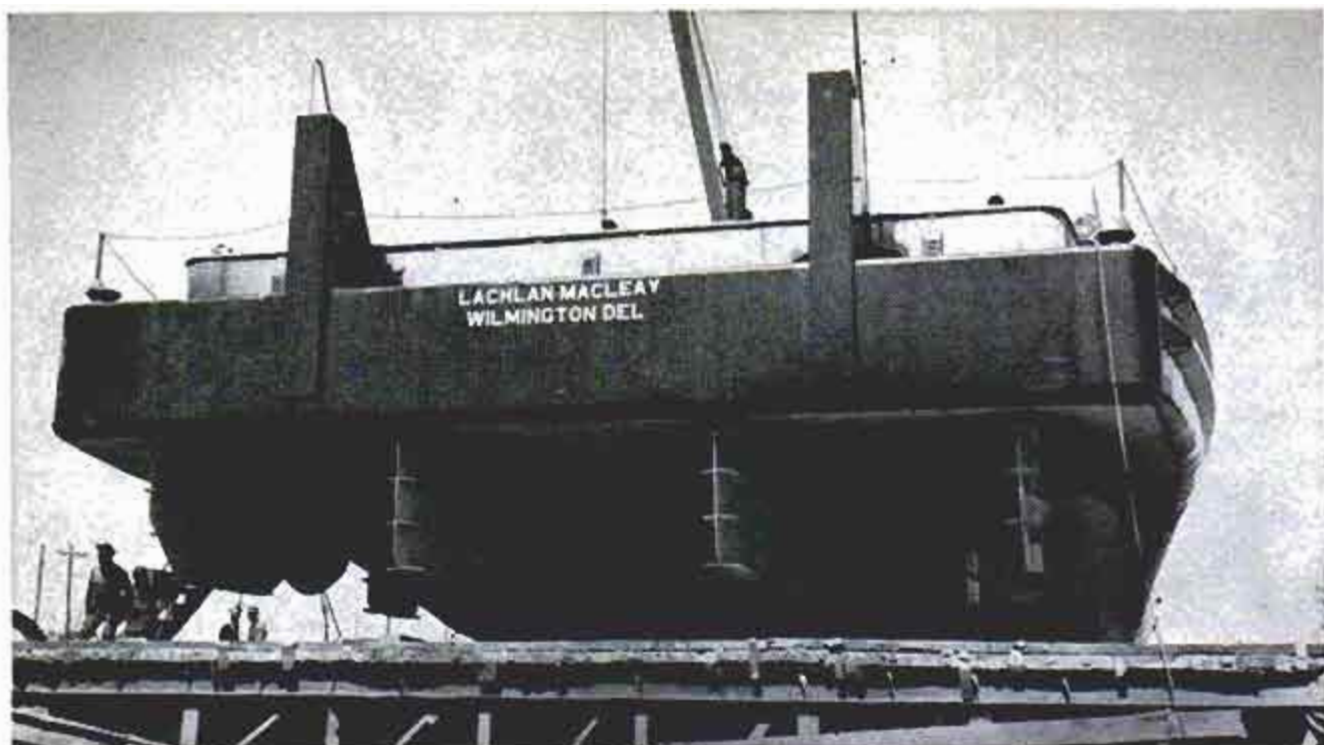

Stern view of the *Macleay* in dry dock shows her four giant 80-in. propellers and four of her ten rudders

can use wood filler, primer or even shellac. Apply several coats and after each is thoroughly dry sand the surface between coats with 4/0-grade paper.

The four propellers and ten rudders come next. These are detailed in Figs. 8 and 10 and are shown actual size for tracing. The ends of the propeller shafts are supported by V-struts that are formed from thin sheet metal. The propeller housing is simulated with a piece of  $\frac{1}{8}$ -in. dowel and a tiny brass nut cemented to the end is used to represent the huge nut that holds the propeller on the shaft. Each pro-

peller is cut from sheet metal and then twisted to give pitch to the blades. The rudders are made by cementing the flat section of toothpicks to cardboard.

Start giving your model its final paint job. The best job is had with a small spray gun and lacquer. The hull should be painted black, including the towing knees and their steps. The deck is done in medium gray. Avoid applying too thick a coating, especially in the case of details. This is particularly so in the case of handrails. Apply just enough to cover.

(To be continued)

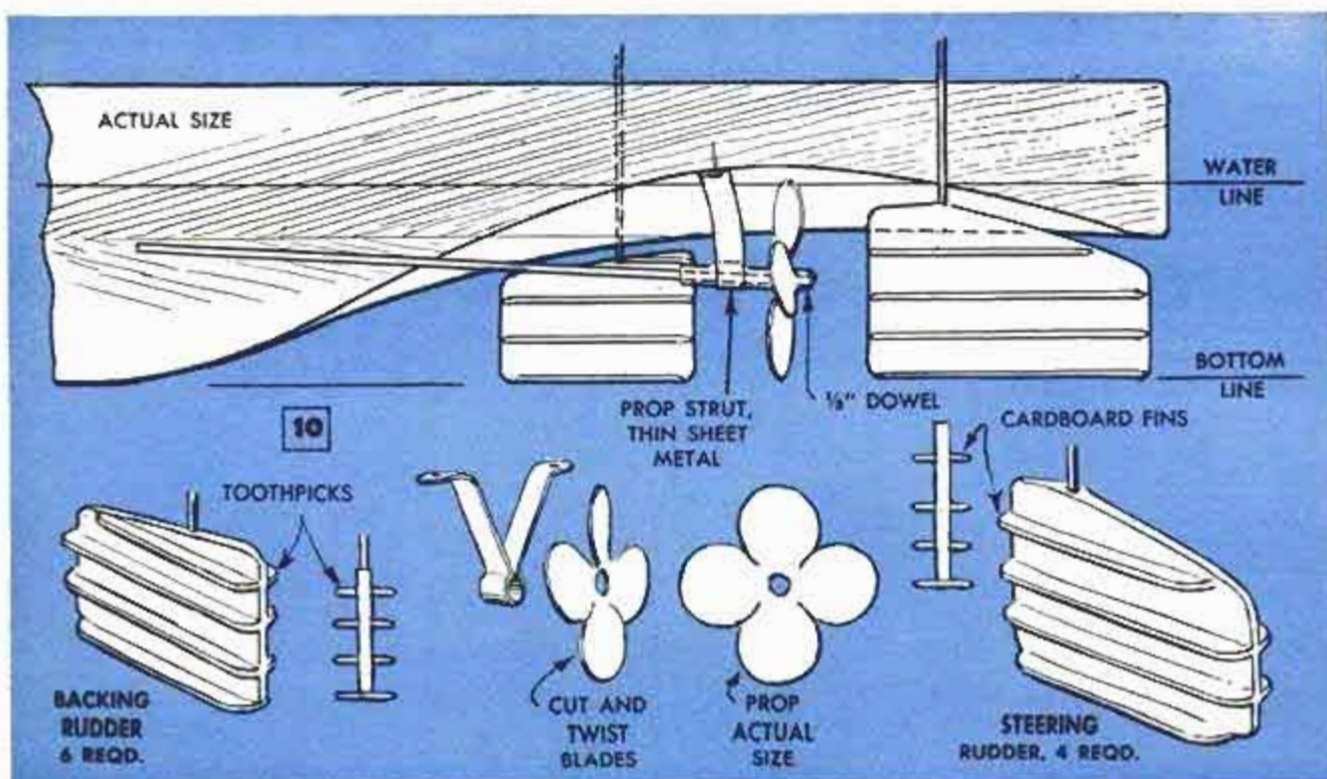



WTM 58

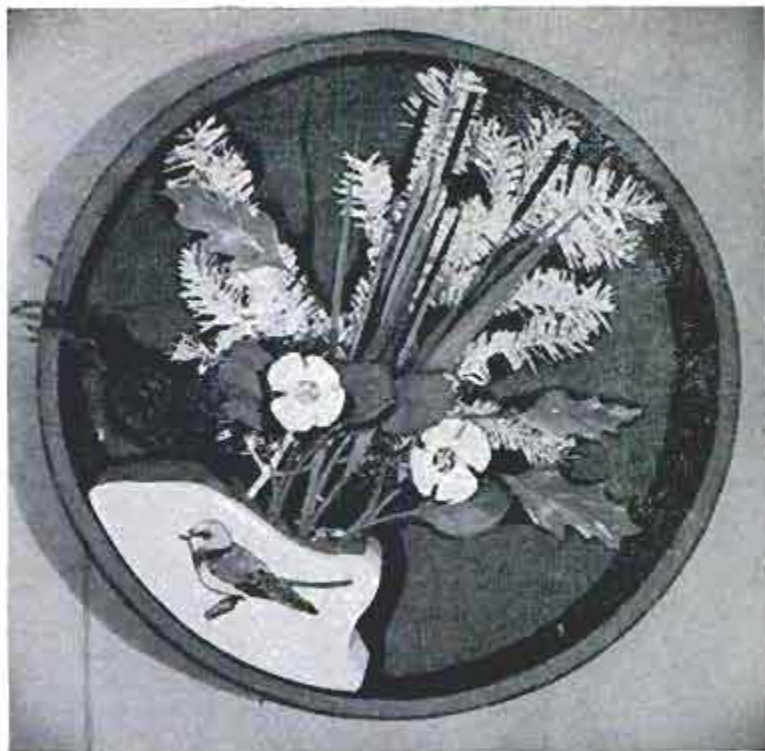

# ORNAMENTAL SHADOW BOX

By Dick Hutchinson

CIRCULAR IN SHAPE, and containing a wooden vase that appears to be ceramic, this unusual shadow box is an ideal project for the craftsman who enjoys using a jigsaw. The circular frame is made by assembling a five-sided frame of 2 x 4s and gluing them to a 13½-in. square of ½-in. plywood. When the glue has thoroughly dried, the frame is sawed to shape. The plywood provides a one-piece reinforcing ring (A) on the back edge of the frame. Next the inner surface of the frame is sanded and a 13-in. disk of ¾-in. plywood is cut and glued to the back of the frame. The outside surface of the shadow box is sanded, including the edge of the backing disk. The vase next is cut to shape and drilled to accommodate artificial flowers. A recess can be cut in the front of the vase, and the bird can be hand-carved and painted, or a decal can be used. Trace outline of vase on back inside surface of the box, and paint all but that area a flat black. Vase is painted white, then glued in place.

RING AFTER SAWING

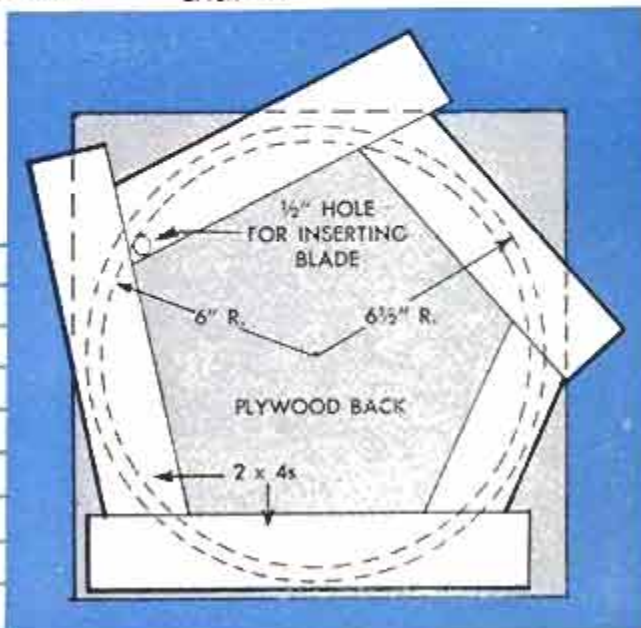
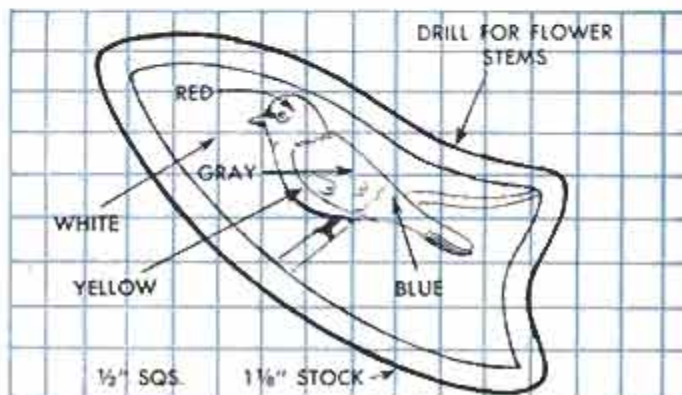
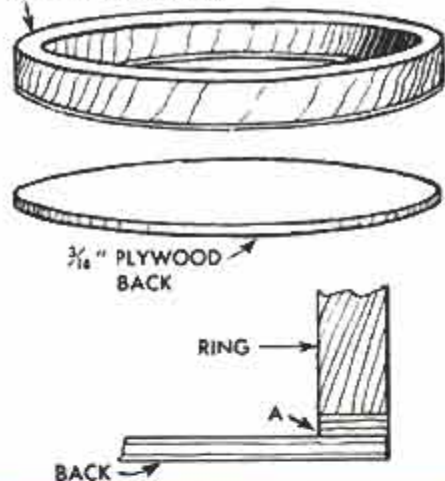



## Power-Line Insulators Become Novel Candleholders



The candleholders shown in the photograph are actually inverted porcelain insulators of the type commonly used on high-voltage power-line poles. A small threaded hole at the center, used for turning the insulator onto a wooden dowel set in the crossbar of the utility pole, is just right for holding a candle. Smaller-diameter candles can also be held if the hole is reduced in size by lining with aluminum foil. Fill the recessed area surrounding the sleeve that contains the candle with potting soil and plant ivy or other vegetation. To prevent the underside of the insulator from marring the surface on which it rests, glue felt to the four legs. You should be able to get used insulators from your local power company.—Kenneth L. Lucas, Redwood City, Calif.

## Broken Chair Rung Repaired With Dowel and Coil Spring

When a chair rung breaks close to one end it can be repaired by using a short dowel and a compression spring. Cut the rung straight across inside of the break and center-drill a 1½-in.-deep hole in it the same diameter as the mortise in the leg of the chair. Then cut a dowel and a compression spring of the same diameter equal in length to the depth of the hole in the rung. With a file, turn a tenon on one end of the dowel to fit inside the spring. Apply glue to the mortise and slip the spring and dowel assembly into the hole in the rung. Then with the dowel depressed, fit the rung back in position. When the dowel is released it will seat itself.

Bruce D. Stewart, Winder, Ga.

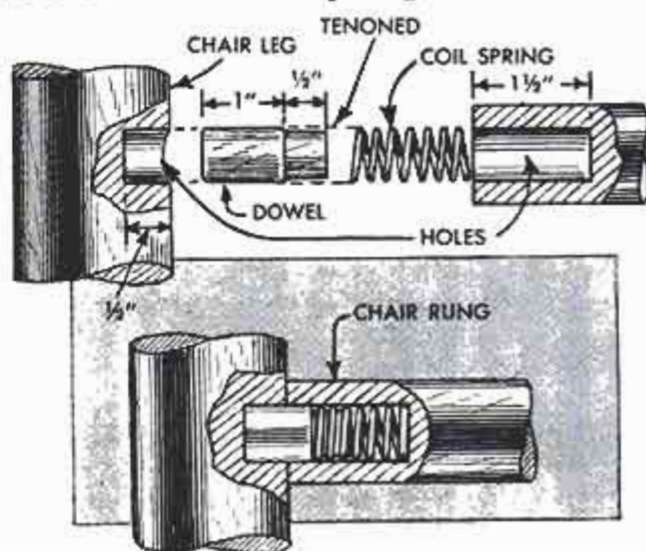

## Wire Cutter Pulls Tacks



Having a large number of carpet tacks to pull, and no tack puller at hand, one housewife discovered that a small wire cutter similar to that shown would do the job. The jaws of the cutter are squeezed together under the head of a tack, and with the help of a small stick or pencil for fulcrum, the tack is pried out.

Victor H. Lamoy, Upper Jay, N. Y.

## Applicator From Shoe-Polish Can Prevents Rust on Tools

Many craftsmen faced with the problem of preventing corrosion or rust on tools will find this oil applicator helpful. Roll enough felt weather strip into a pad that will fit snugly inside a shoe-polish can. Then saturate the pad with oil. Take the pad, using the can as a handgrip, and spread a film of oil over the tools. When completed, place the lid of the shoe-polish can over the pad. The lid not only stays on tight over the pad in the shoe-polish can, but also keeps it oily and clean for many more uses.

Arthur Patterson, Minneapolis, Minn.





## Fabric-Covered Frame Dresses Piano Back

By Hi Sibley

Does your upright piano present a furniture-arrangement problem because the unattractive back cannot face the center of a room? Here is a solution to the problem that not only will hide the back but will make it a part of the overall room decor. Simply cover a wooden frame with drapery material and hang it on L-hooks turned into the back of the piano. Dimensions of the drapery frame should be slightly less over all than those of the piano back. Use  $\frac{3}{4}$  x  $1\frac{1}{4}$ -in. stock and half-lap the joints. Cross-bracing is necessary to prevent buckling when the fabric is stretched and tacked.

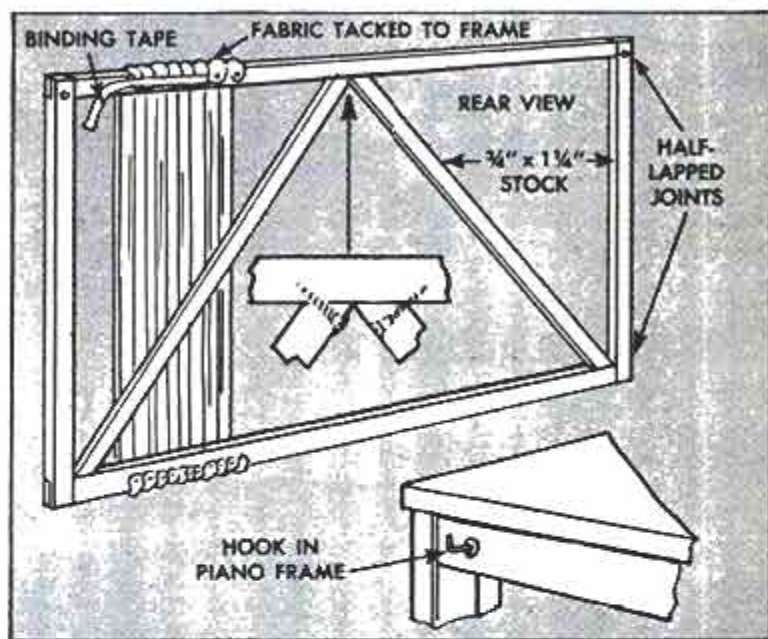

## Easy Way of Locating Screws When Silencing Squeaky Floors

Hardwood floors that develop squeaks can be silenced effectively by driving short wood screws up from the basement or crawl space. The problem, of course, is spotting the screws directly under the loose boards. The best way to do this is to use a magnetic compass and a magnet. The magnet is placed on the floor at the spot where the

squeak occurs and the compass is held below the floor. The magnet will attract the needle of the compass and make it easy to tell when you are directly under the magnet and the loose boards. Be sure that the screws are short enough so as not to pierce the top surface when pulled up tight.

W. G. Eslick, Wichita, Kans.



# SOLVING Home Problems



**HALVES OF WOODEN CLOTHESPIN** screwed to back of broom-closet door make dustpan holder. Split clothespin with saw and sand edges smooth

**WAXED-PAPER STRIP** folded and placed over Thermos-bottle cork prevents cork from loosening. Simply stretch folded strip tightly over cork, hold ends of strip and screw the bottle cap tightly in place



**SPONGE-RUBBER BALL** pressed over top hook of a garment hanger holds coats, sweaters and caps securely and at the same time prevents stretching of delicate fabrics due to small area of hook tip



**PAPER CUP** is just the right size for molding nontip party candles. Just save candle stubs of all lengths, place one of the right length in the center of paper cup with wick. Melt stubs and fill cup



**CAKE TIN** is made into a handy Lazy Susan by placing a drop of solder at center on underside to serve as a pivot point. Placed on a cupboard shelf, tin holds bottles of food extracts and packaged spices

**PAPER DOILY** makes a novel cake decorator. Try it next time you frost a cake. Spread frosting (chocolate is best, due to dark color), press the doily over it lightly, sift powdered sugar and lift off carefully

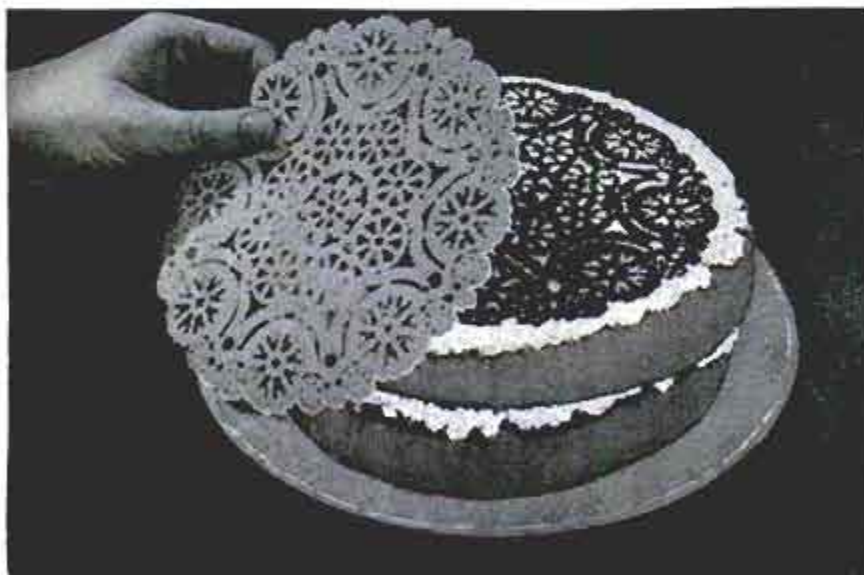





**CLOSET-DOOR HINGES** that squeak can be lubricated with soap. Rub barrel of hinge with soap cake, which will not stain clothing brushed against it

**DRAWER DIVIDERS** of unusual construction require no nails, screws, or cleats for installation. The notched ends of dividers drop into slots cut in end pieces which are fitted into the drawer at front and back. End pieces should fit snugly

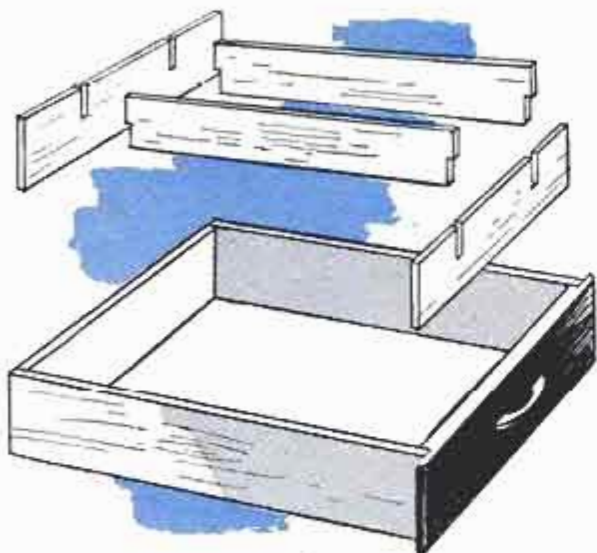

**LEATHER TONGUES** of those comfortable hiking shoes sometimes slip to one side or the other and cause pressure on the instep. This can be prevented by cutting two adjacent slits near top of tongue and threading lace through as shown



**MIXTURE OF LEMON JUICE AND SALT** rubbed into the breadboard occasionally will act as a mild bleach to keep board clean and white. Use slice of lemon and dry salt



**ADHESIVE-TAPE SPOOL** is just the right size to hold tape measure that gets kinked and frayed when stored loosely in sewing kit. Snap cover keeps tape measure in place

**METAL LEGS** of tubular furniture, also bench legs of pipe, are often fitted with crutch-tip "silencers." Thin edge of tube or pipe may cut through rubber tip in time. This is prevented by inserting a metal washer in each tip



**CAKE TIN** partly filled with hot water keeps a plate of food warm for a fairly long period of time. Not as effective as a chafing dish, of course, but it will do in an emergency. It's a good idea to place tin on hot pad

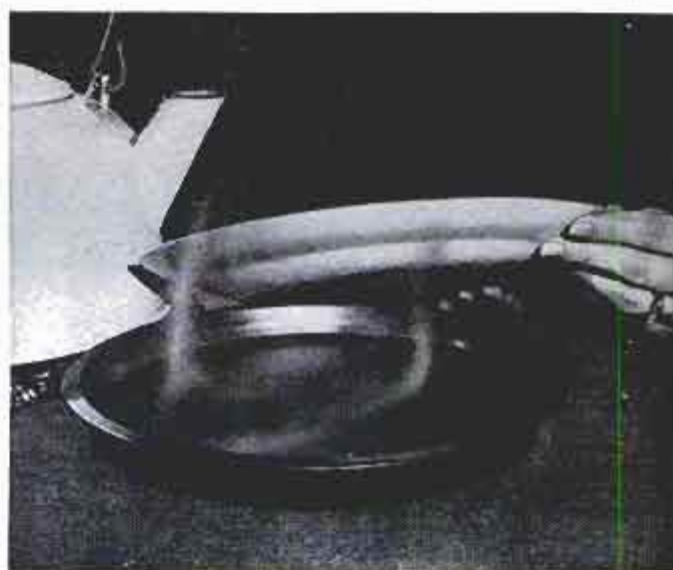



## Clothespins Replace Thumbtacks on "Bulletin Board"



Several spring-type clothespins screwed to a strip of wood make an ideal "bulletin board" for youngsters. Almost any size picture, one of their own or one cut from a newspaper or magazine, can be accommodated by the row of pins as shown. An advantage of this method is that there are no thumbtacks or push pins for the children to misplace, as there would be with a regular bulletin board.—Karl Greif, Vestal, N. Y.

☐ Your children's new shoes can be made less slippery by roughening the soles with a metal-bristled suede brush.

## Bubble Lamp on Switch Plate



When the basement lights frequently were left on all night even though the switch plate was fitted with a signal lamp, one homeowner added the upper portion of a Christmas-tree bubble lamp. The latter is cemented to the metal shield

on the signal lamp. When the signal lamp is lighted, indicating the basement lights are on, the Christmas-tree lamp begins bubbling to attract attention.

Grover Brinkman, Okawville, Ill.

## Tumbler Serves as "Spotting Block" When Removing Stain From Cloth

Next time you want to remove a fresh stain from clothes quickly, place an inverted cup or tumbler under the fabric to serve as a "spotting block." The fabric is pulled down the sides of the tumbler and held in position with a rubber band. It then is easy to hold the cloth and tumbler with one hand while rubbing the stain with the other.



## Ordinary House Bricks Become Decorative Book Ends

Attractive book ends can be made by wrapping ordinary bricks in brightly colored and patterned paper. Wrap the bricks as you would a package, first in brown kraft paper and then in the decorative paper. Cellophane tape can be used to seal

both coverings, or you can make a hidden glued seal for the outer paper. Bookbinding material, gift wrapping, cloth and wall-paper, as well as foil, can all be adapted for this purpose.—R. Teiser and C. Harroun, San Francisco, Calif.





# Student's Desk-Bookcase Folds Flat

By Doris Fry Wiley



When folded this desk is only 6 in. thick, yet it opens out to provide a top 24 x 30 in. The drawing board and its support are optional items needed only for an art student. There is ample storage space for books and school supplies on the three shelves

WHEN YOUR college student comes home for Christmas vacation have this desk ready for the return trip. It folds flat for transportation or storage, and is ideal for a student sharing cramped quarters. The desk is made from  $\frac{1}{2}$ -in. plywood, except for the drawing-board support which is  $\frac{3}{4}$ -in. solid stock. The support and drawing board are optional features that should be included only for an art student who requires them. To permit the sides of the desk to fold inward flat against the back, use offset hinges, or attach regular butt hinges to spacer blocks that are the thickness of the shelf cleats. The 1-in. offset in the joint of the desk top allows it to fold down over the sides when they are folded against the cleats. The opened sides are positioned at right angles to the back by stop blocks on the underside of the top, and are held open by the shelves which slip onto the cleats. To fold the desk, first remove the shelves, then fold the sides in and the top down. Finally, invert the unit and place the shelves on edge on the overhang of the top.

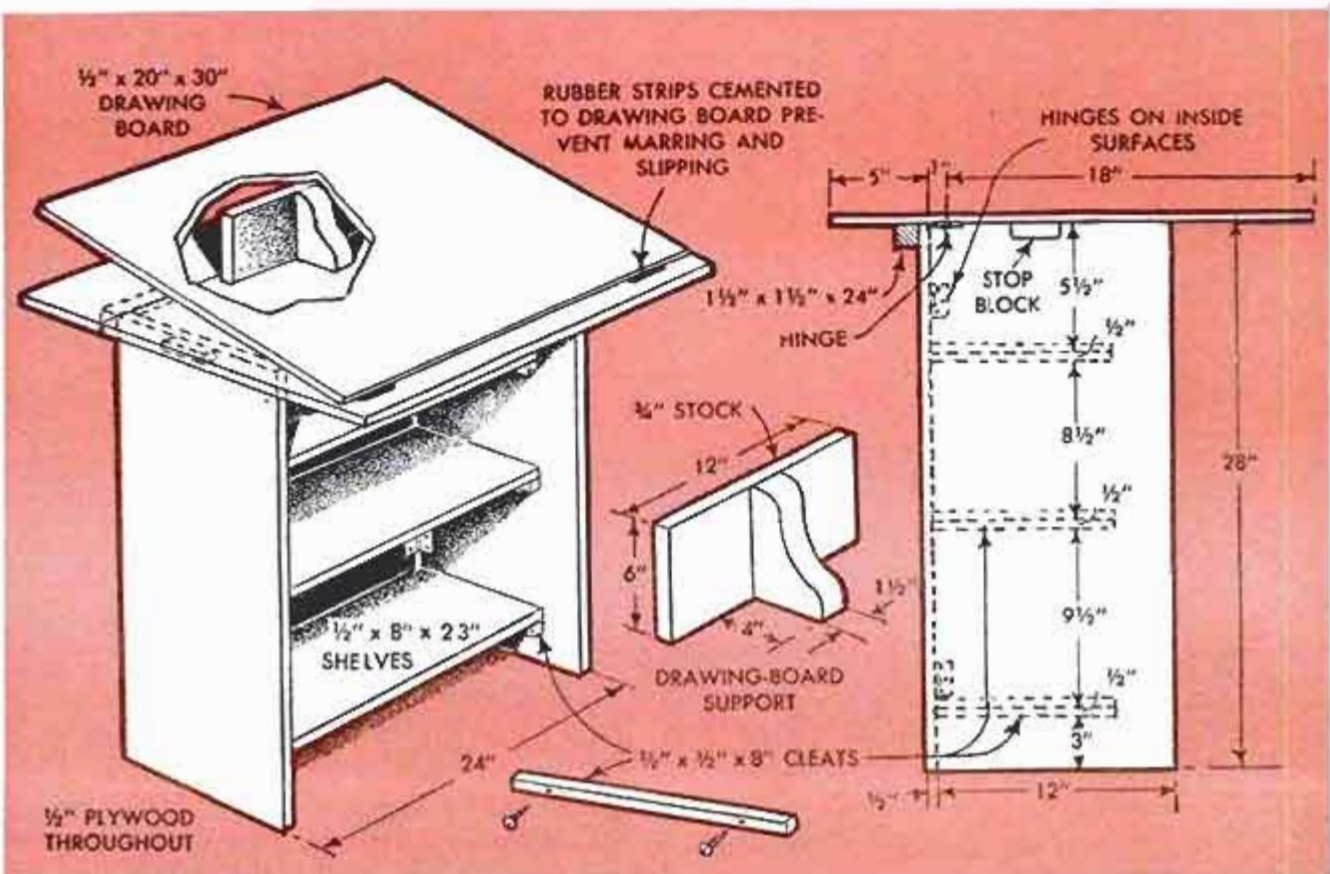



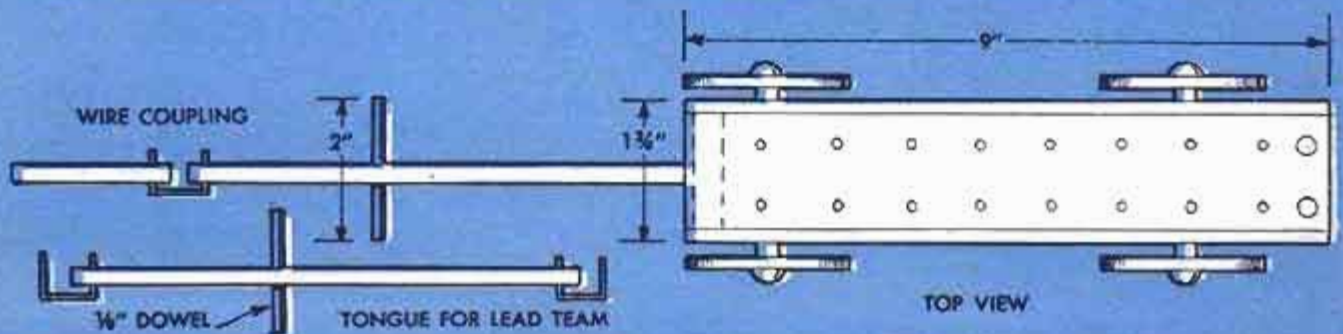
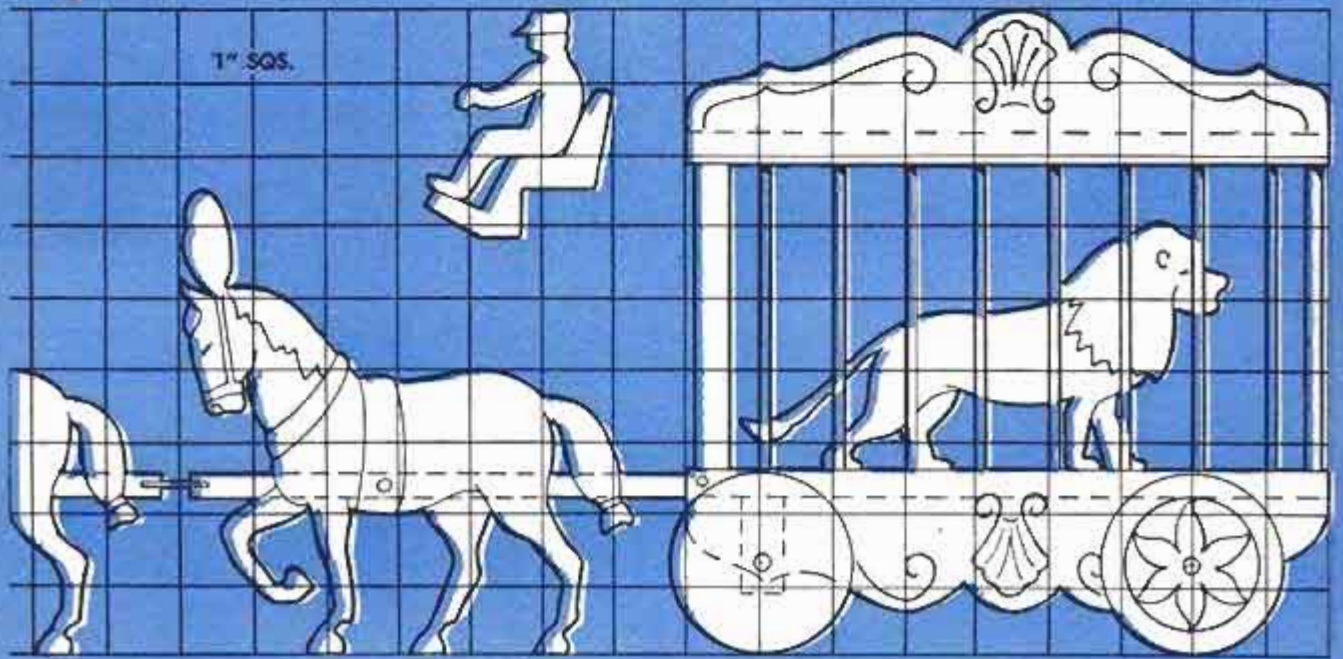
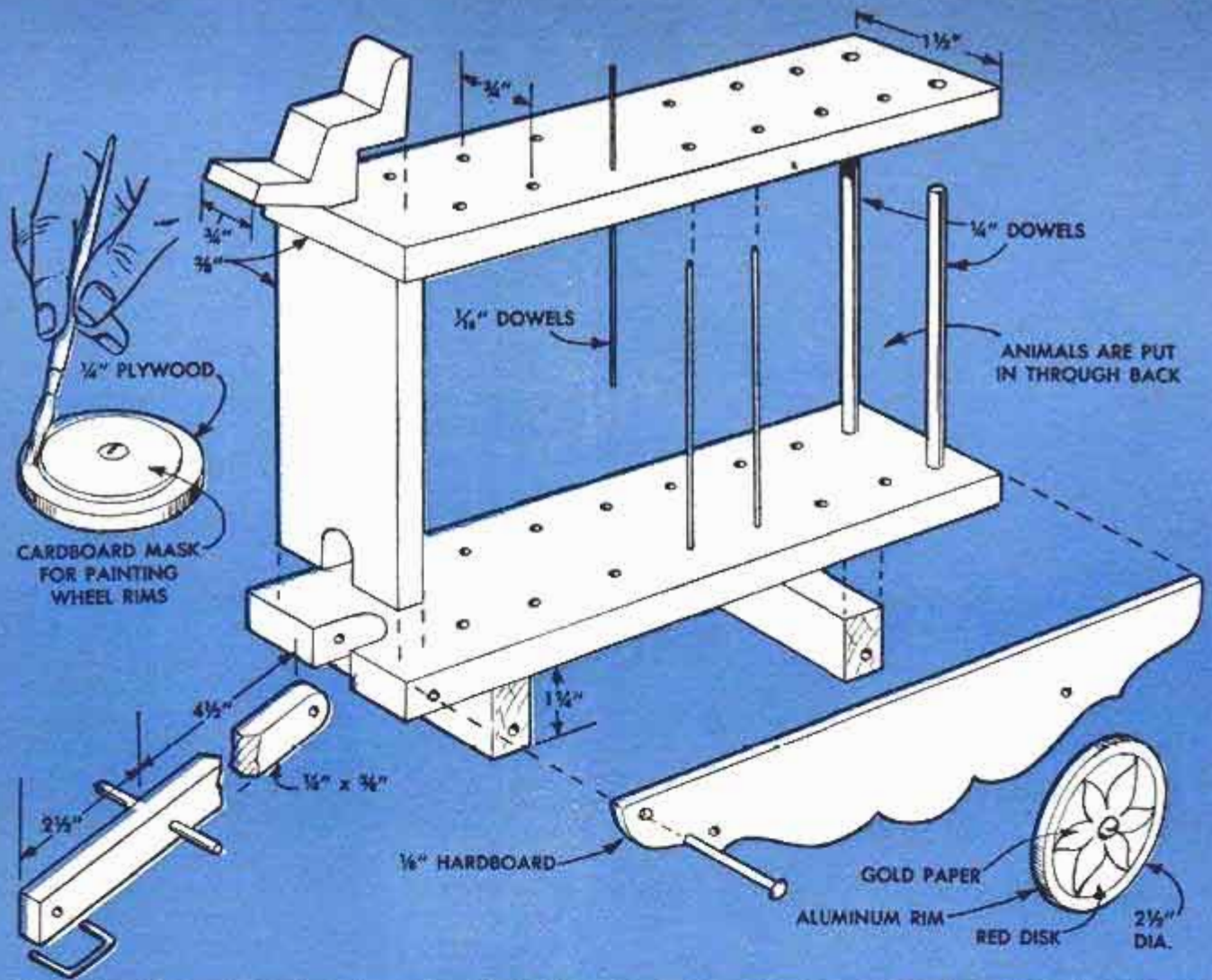



# CIRCUS WAGON

## With Animal Cutouts

By Hi Sibley

**P**RANCING HORSES and wild animals interest almost any child, and when they are combined with a gaily colored circus wagon, the result is an exciting toy that will provide hours of playtime fun for any youngster who receives it. Simplicity of construction is the feature that will be appreciated by the builder of the wagon, as it requires only a couple of feet of stock lumber, some 1/8-in. hardboard and a few short dowels. The top and bottom of the wagon are drilled in one operation, assuring alignment of the holes for the cage bars. If perfectly round wheels are desired and no wood-turning lathe is available, cut 1/4-in. slices from a 2 1/2-in.-dia. dowel instead of using 1/4-in. plywood as suggested. The ornamental side pieces of the wagon are jigsawed in pairs or, if a number of wagons are to be made, can be "mass produced" by sawing a stack of pieces at one time. The horses, wild animals and the driver are jigsawed from 1/8-in. hardboard. The driver is cemented in position on top of the wagon. To support animals and horses in a vertical position, cut bases of 1/8-in. hardboard and cement to their feet.



Bases for the animals must be narrow enough to permit them to be inserted in the back of the cage. To save time in making the animals, pictures can be cut from a child's animal book or from magazines and cemented to hardboard, then jigsawed to shape. Paint the side pieces of the wagon blue with gold decorations. The front of the wagon is red, the cage bars are black and the floor is gray. Horses are cream colored and have red harnesses and plumes. Horses are held in harness by drilling holes through the belly bands so they can be slipped over the dowels in wagon tongues. Enlarge animals to suit wagon. ★ ★ ★

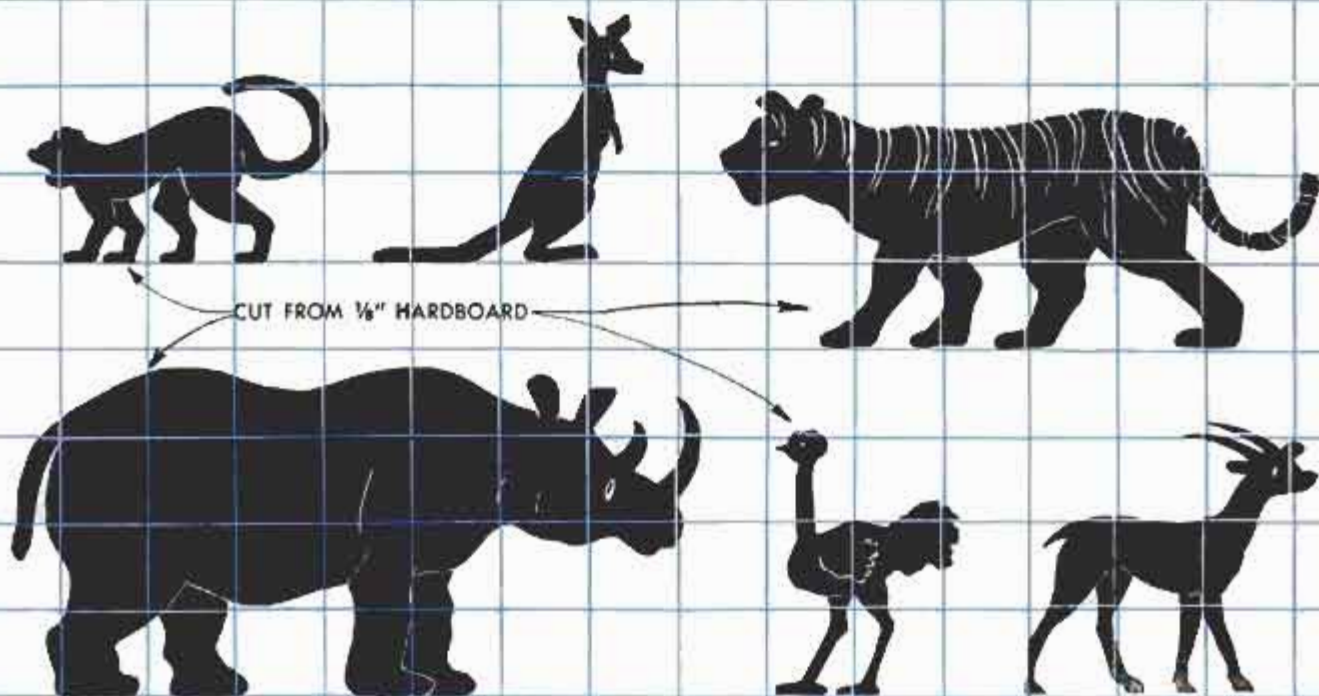



## Prick Punch Tightens Loose Screening in Aluminum Frame

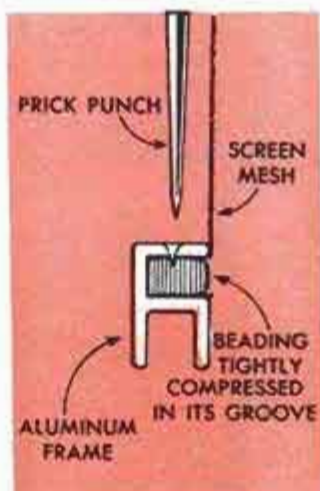
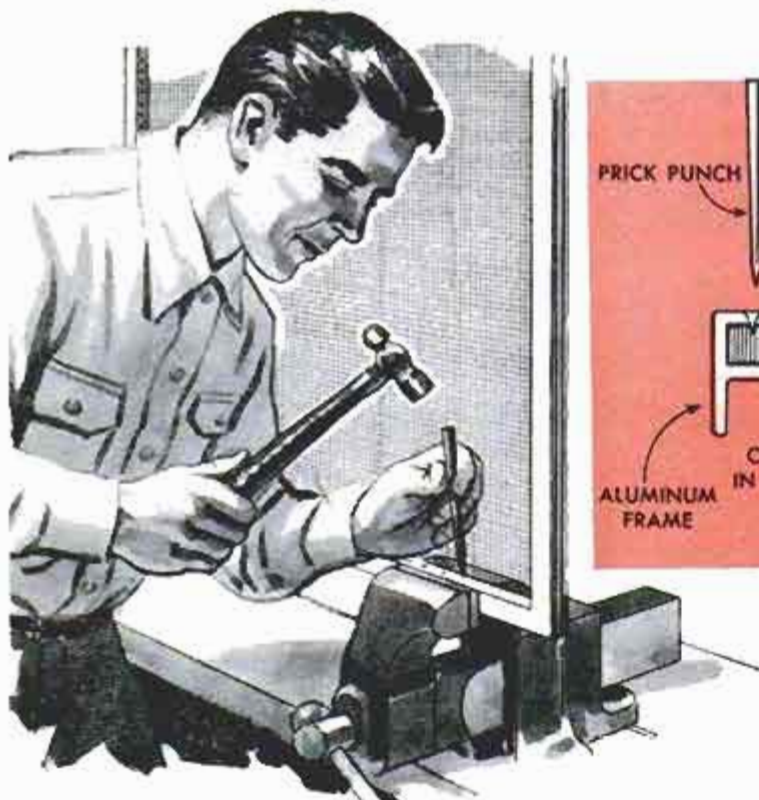

Loose screen wire in combination windows and doors, which is held by a retaining bead, may be tightened by means of a series of punch marks along the inside edge of the frame as shown. To do this, punch deep indentations 1 in. apart along the inside of the frame, using a prick punch. The burrs formed by the indentations penetrate the mesh and beading to prevent the screening from being pulled loose. If the screening is exceptionally loose, remove the beading on three sides and restretch the material. When reinstalled, punch the framing as indicated above.—Andrew Vena, Philadelphia, Pa.

## Knife Frees Sticking Piano Keys

When two adjacent keys on a piano tend to stick together, slip a thin knife blade between them at the inner end and draw it forward. This will usually dislodge the hair-pin, straight pin or scrap of paper that has been causing the binding. If no obstruction is found, depress one key at a time and work it from side to side. Persistent sticking may be due to trouble within the instrument and should be repaired by a piano tuner.

C. S. Onderdonk, Jr., Margate City, N. J.

## Handle for Razor-Blade Scraper

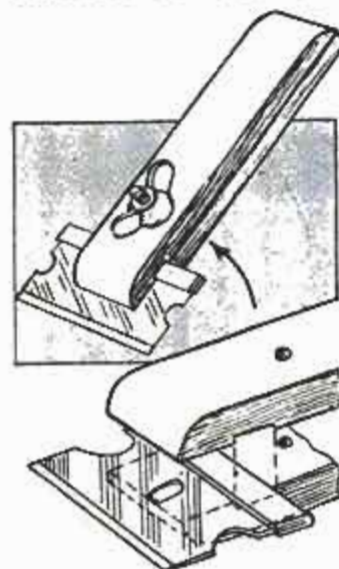

Consisting of two strips of wood  $\frac{3}{16} \times \frac{3}{4} \times 4$  in., this handle will accommodate almost any single-edge razor blade. A notch is cut near the end of each strip to receive the "spine" of the blade and the strips are tapered as indicated. A screw and wing nut are used to hold the strips together against the blade. You'll find

it handy for scraping paint from glass.

P. Casperson, El Cajon, Calif.

## Glass Christmas-Tree Ornaments Shatterproofed With Shellac

The unpleasant job of picking up tiny pieces of broken Christmas-tree ornaments can be avoided if you make them shatterproof. To do this, pour a little white or orange shellac inside the ornament, swirl it around and pour out the excess. Allow it to dry overnight before replacing the hanger device. The hardened film of shellac will hold broken pieces together when the ornament is dropped. Lacquer should not be used for this treatment since the solvents might dissolve the coloring matter with which the insides of some ornaments are tinted.





# TWO-TONE CANDLEHOLDER

By Shep Shepherd

HERE'S AN INTERESTING candleholder that blends with both light and dark wood furnishings. It has a top section comprised of a 1/4-in. piece of dark wood sandwiched between two lighter pieces of 1-in. stock, and a base with a reverse combination.

To make it, you will need two templates, the one for the top pieces being a segment of a 12 1/2-in. circle with a chord of 11 in. and the bottom template a segment with a 6-in. chord, which is cut from a 10-in. circle. First draw the two circles. Then, placing a ruler across each one, mark a straight line of the required length which touches the circle at both ends. Cut out the templates and trace them on one of the pieces of each section. Then nail the three pieces of each section together, placing the marked piece face up on top and cut them out on a bandsaw or jigsaw. Separate the pieces and sand the sides but not the edges, checking for proper fit. Apply glue to the joining surfaces and clamp each section together. When dry, sand the edges flush and apply a coat of varnish. Using two wood screws, fasten the base to the top at the exact center of their respective arcs. Drill 3/4-in. holes 1 in. deep in the top edge and varnish the holder again.

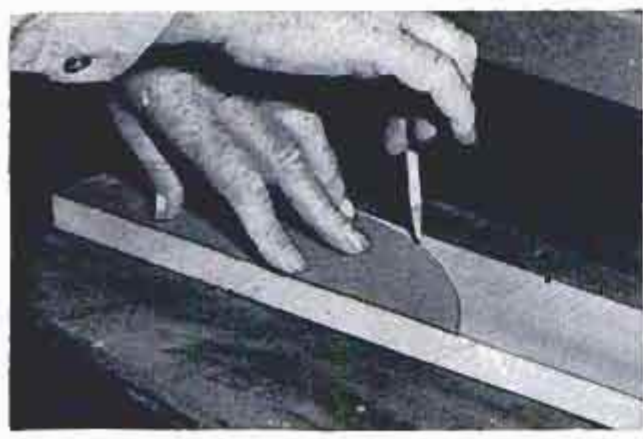
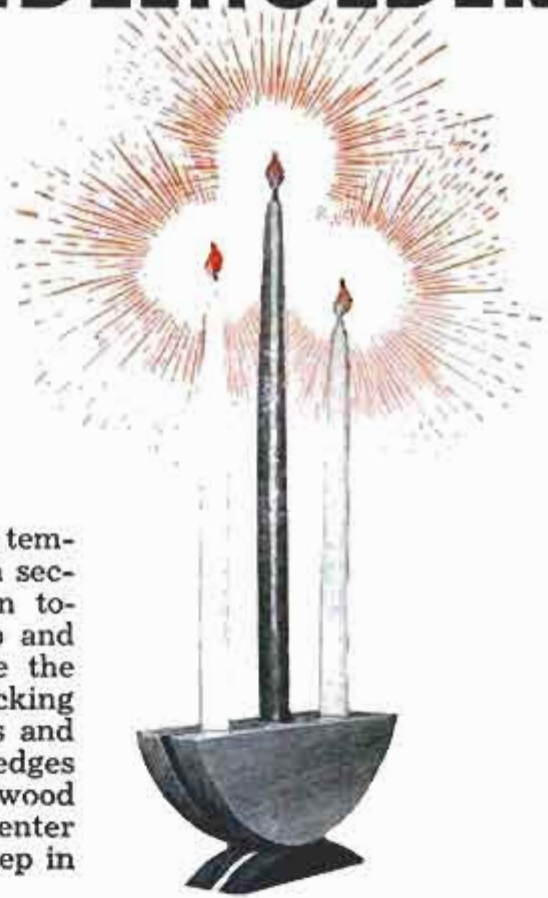

A template is used above to outline matching pieces while below is shown the curved base being attached

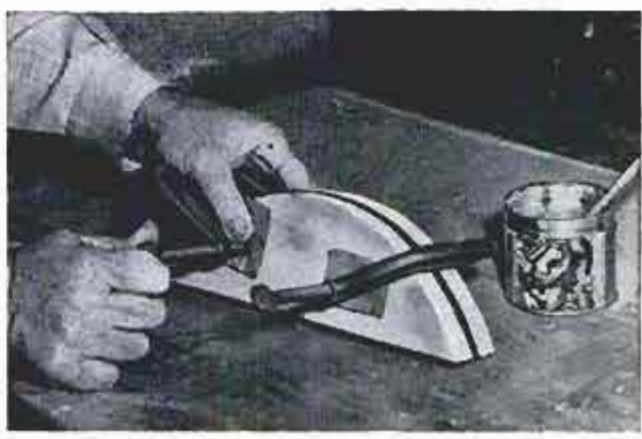

Glue is applied and the three pieces clamped together. Candle holes are drilled after attaching the base

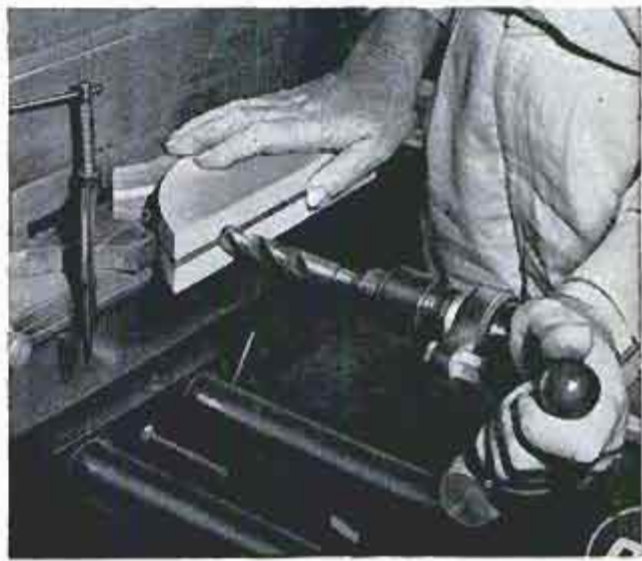
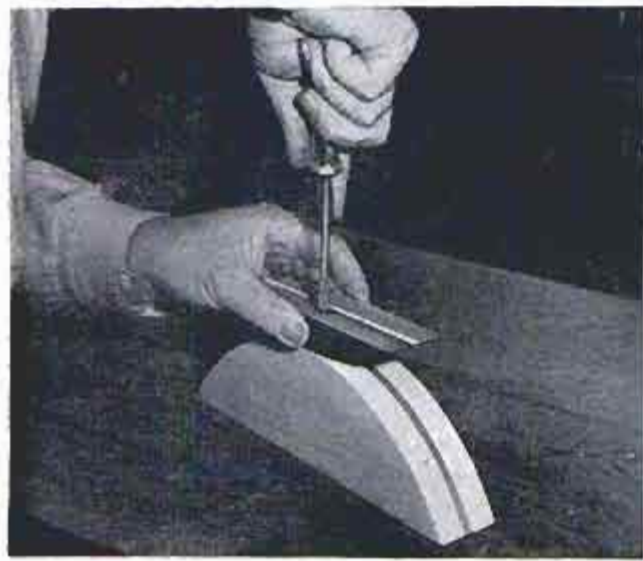



# Decorate with Christmas Bells



**G**LASSWARE, TIN CANS and kitchen utensils are the basic materials for these attractive Christmas bells that are combined with more conventional materials to produce striking effects. In the upper illustration on this page, the young lady shows a Christmas bell that actually is a food grater. The bell clapper is a wooden mixing spoon. After the holidays, the utensils, newly purchased for their decorating task, can be sent to the kitchen for more prosaic duties.

The other pictures on this page show bells made from plastic funnels, available in a variety of sizes and colors at the local ten-cent store. The funnels are suspended from an evergreen wreath on colored ribbons and decorated with gaily colored bows. Regular glass Christmas-tree ornaments act as clappers. Goblets, because of their shape, lend themselves naturally to representing bells when inverted, as shown in the upper photo on the opposite page. Here again, a small Christmas-tree ornament is used for a clapper. A ring of tinsel, plus a paper flower, is used to decorate the neck of the goblet, and a candle, on which are pasted cutout figures, sits on top of the inverted goblet to provide a centerpiece.

Empty tin cans are another source for bells. After they have been washed clean, a hole is punched in the bottom to receive a knotted length of ribbon that is used both to hang the "bells" on a cluster of evergreen bows, and to hold the tree-ornament clapper. Christmas wrapping paper is pasted to the outside of the tins. Another item from the kitchen which seems unrelated to Christmas, but which has a bell shape, is an egg whipper of the type formed as a wire helix. Very little modifying is necessary on the whipper, since it becomes an abstract representation of a bell simply by adding a clapper. A ribbon tied to the handle provides a means of hanging it. ★★★

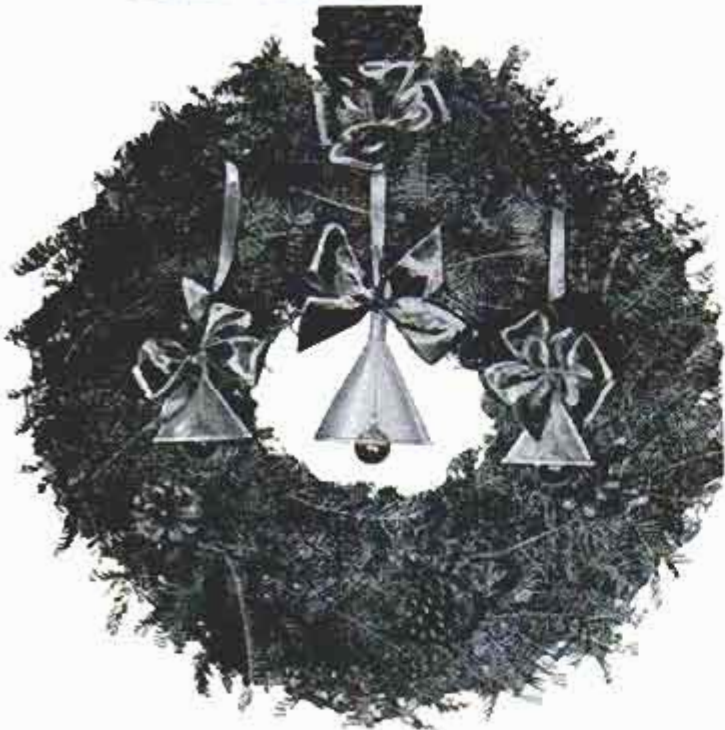

Upper photo shows a bell that is simply a food grater with a wooden mixing spoon for a clapper. The two lower photos illustrate bells made from plastic funnels. Christmas-tree ornaments provide the clappers





Goblets have a natural bell shape, readily lend themselves to being made into Christmas bells. Clapper is a Christmas-tree ornament suspended from length of ribbon cemented to bottom of inside of goblet. A ring of tinsel and a paper flower add color to the bell, a decorated candle makes it a gay centerpiece



Tin cans are still another source for bell material. Knotted lengths of ribbon threaded through holes punched in the bottoms of the tins hold tree-ornament clappers and permit suspending bells. Holiday wrapping paper is pasted over the outside of the tins



Modern and fanciful are these abstract representations of bells that are made from egg whippers. The wire-coil whippers require only the installation of clappers to become bells. Although definitely modern in design, the bells are compatible with traditional materials, as is shown in the photo







### Gifts Hung on Christmas Tree With Drapery Hooks

To lend an additional note of festivity to the Christmas-gift tradition, as well as enhance the tree decor, hang small gifts on the tree. This is done easily by fitting drapery hooks to the cord or ribbon used to tie the gifts. The hooks also can be used for other holidays and celebrations throughout the year to hang festoons, garlands and other decorations.

### Conical Christmas Ornaments

With a few scraps of reflective paper you can make these bright, unusual Christmas-tree ornaments. Cut the material in circles and then cut each circle in half. Shape one half into a cone, by drawing the two corners together, and staple the edges. The conical bottom is made from the other half of the circle of material overlapping the edges. Install a string loop in the top for hanging, and then glue the bottom up inside, as shown in the illustration.



# Christmas-Tree Rotator

By John R. Stone

WHY NOT SURPRISE the children this year with a Christmas tree that displays all of its gay ornaments and sparkling tinsel while it rotates slowly to the tune of soft yuletide music? With a television-antenna rotator modified to turn in one direction only, some simple wiring and a few common parts the novel rotator can be assembled in a few evenings.

The heart of the unit, the rotator, can be purchased reasonably at any electronics surplus store. Since most TV rotators are designed to turn 360 to 370 degrees and then reverse, it is necessary to remove one of the stop lugs from the unit as shown in Fig. 4, to permit continuous turning. Another lug positioned lower on the shaft, that actuates a switch for an indicating light on the control box, need not be removed.

### Control Box Modified

Modification of the control box is next. The spring-return switch on the box must be replaced with an ordinary on-off toggle switch. First, take the bottom off the control box to gain access to the screw holding the original switch. Remove the wire under the screw and the switch. Then, replace the old switch with the on-off toggle switch and reposition the wires as shown in Figs. 1 and 2.

To provide a means of supplying current to the tree lights, two copper contact rings are stapled to a 5-in.-dia. disk cut from hardboard and mounted on the rotator casting. Another 5-in. disk is fitted with an electrical outlet with  $\frac{1}{8}$  x 1-in. brass strips attached as shown in Fig. 5, and mounted on the rotator shaft.

Any tree stand that will accommodate the rotator and is sturdy enough to safely support the tree will be satisfactory. For a 5-ft. tree the base should be at least 18 in. square and can be made of two lengths of 2 x 4 crossed at the center and half-lapped to lie flat on floor. A  $1\frac{3}{8}$ -in.-dia. hole drilled in the center and fitted with a 6-in. length of steel pipe provides the mounting for the rotator, to which it is clamped securely as shown in Fig. 6.

A cabinet made of plywood as shown in Fig. 3, is used to cover the entire unit. For music, a record player is hid behind the tree and turned on with the rotator. ★★★



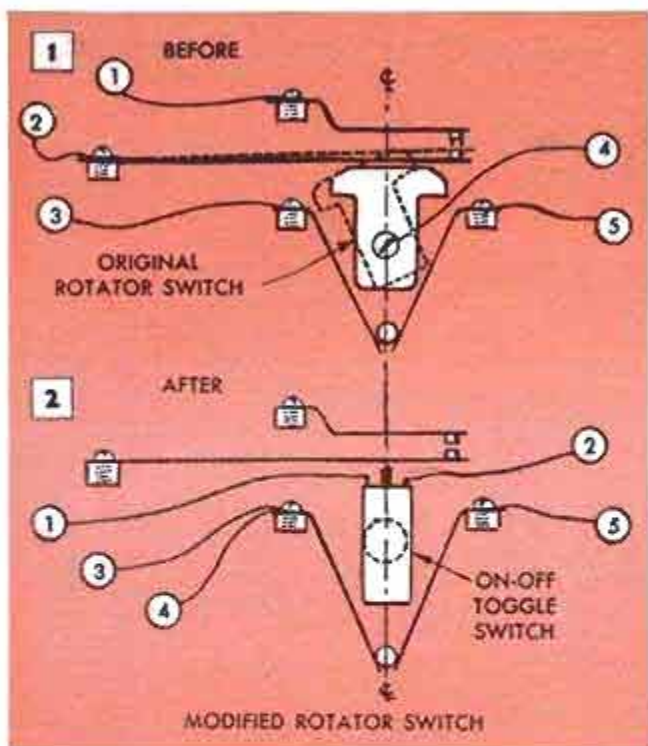

Above, repositioning of three wires and installation of toggle switch complete control-box modification

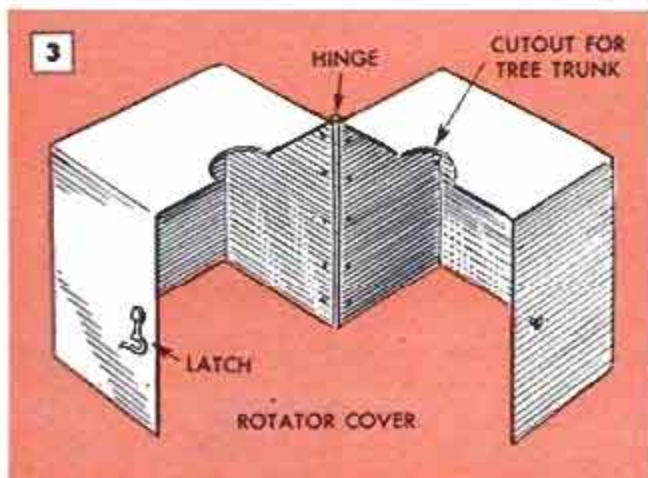

Above, easily removed rotator cover protects unit and prevents contact with moving parts. Below, for continuous supply of current to tree lights, contact rings must be in accurate alignment with brushes

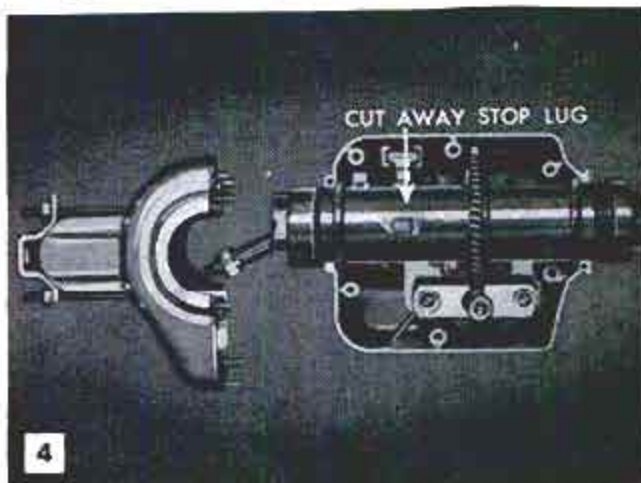
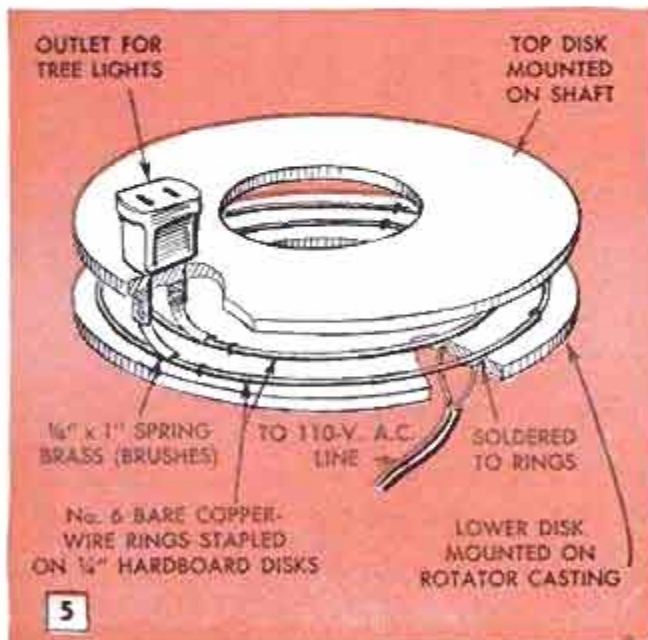

After main stop lug is removed, above, shaft turns continuously in same direction. Below, mounting for unit consists of wooden support block under housing and steel-pipe upright anchored in tree stand

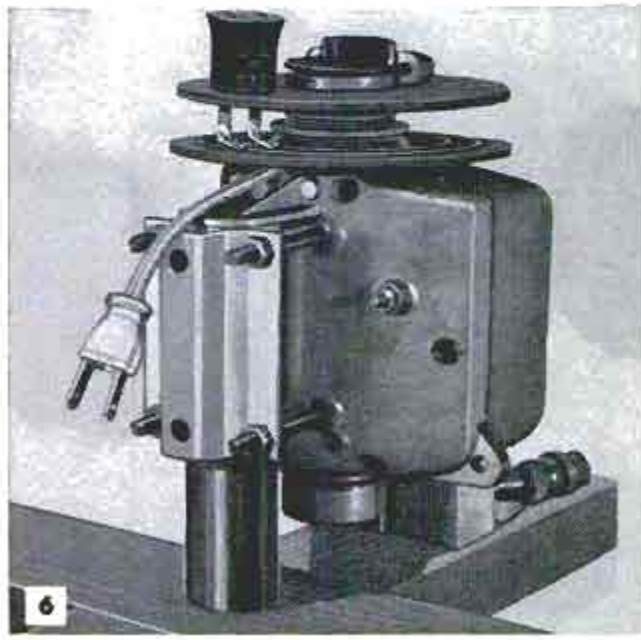



# Aluminum Reflector for Portrait Photography

A sheet of aluminum roofing material, 30 x 36 in., nailed to a wooden frame and mounted on a camera tripod as shown,

serves as an excellent reflector for home portrait photography. A socket is attached to the center cross piece of the framing so

that the reflector can be removed easily from the tripod for storage. If a socket is not available, one can be made by soldering a 1/4-in. stove-bolt nut on a large washer and drilling three holes along the outer edge of the latter. A plated washer and nut should be used for this purpose. A ball and socket arrangement on the tripod head permits the photographer to direct reflected light where it is desired on a subject. Such a reflector is ideal when only one flash or flood lamp is used.—H. J. Kennard, Gonzales, Tex.



## Ready-Made Napkin Rings

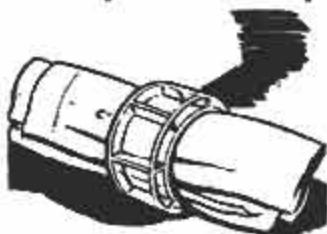

When the last of a roll of cellulose tape in a dispenser has been used, salvage the plastic ring and use it as an attractive napkin ring. To add

color, paint the inside surface of the ring with nail polish, or apply decals to the outside surface.

H. B. Walters, Los Angeles, Calif.

## Clothespin Floats Boat Key

A boat key will be easy to locate in your coat pocket, and also will float if accidentally dropped into the water, if it is pivoted in a common clothespin as indicated. File the threaded end of the bolt or screw flush with the nut and peen it to prevent the nut from coming off.



## Proper Humidity Protects Both Health and Home

Is your home difficult to heat? Does it seem your family has too many colds during the course of a winter? Lack of humidity in the home may be the reason. Tests have shown that the average home is drier in the winter than the Sahara Desert. One of the reasons for this is that a home is built to permit a constant change of air from the outside to prevent an accumulation of stale air. Outside winter air is dry and immediately begins absorbing moisture when it enters a warm house. Loosened joints in furniture and peeling wallpaper are two more noticeable examples of the damage caused by dry air. When someone sneezes in a room with low humidity, the sneeze carries into the air thousands of tiny droplets that contain germs, salt and water. Dry air immediately begins absorbing the moisture from the droplets and the germs are

suspended in the air, waiting to be inhaled by someone else. In properly humidified air, the droplets are kept intact and the salt-and-water solution in them destroys the germs before they can cause trouble. When dry air absorbs moisture from the skin, a person feels chilled and a higher room temperature is required to maintain comfort. Properly humidified air will permit keeping a home several degrees cooler, with a subsequent saving of fuel. Modern humidifiers are easily installed in a heating plant, are automatically filled with water from the house water supply and require cleaning only once a year. Their cost is moderate and is saved many times over in lower fuel bills, less maintenance and the prevention of damage to a home and its contents.—The Humidifier Association, Cleveland, Ohio.



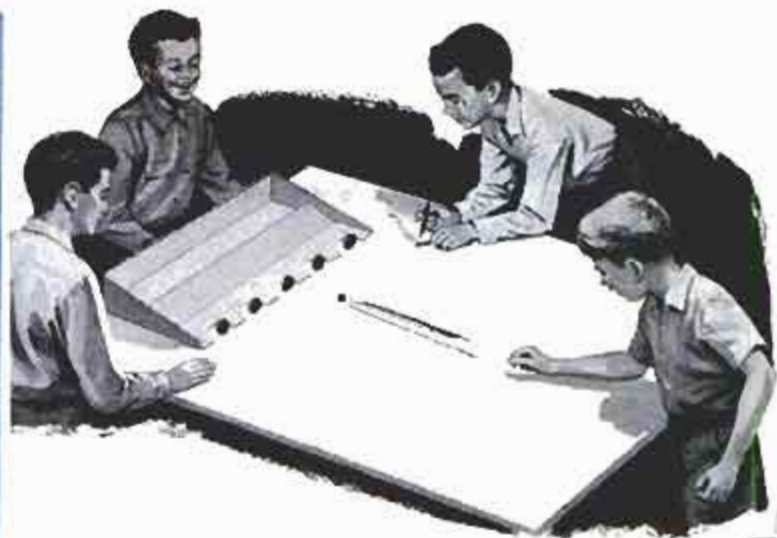
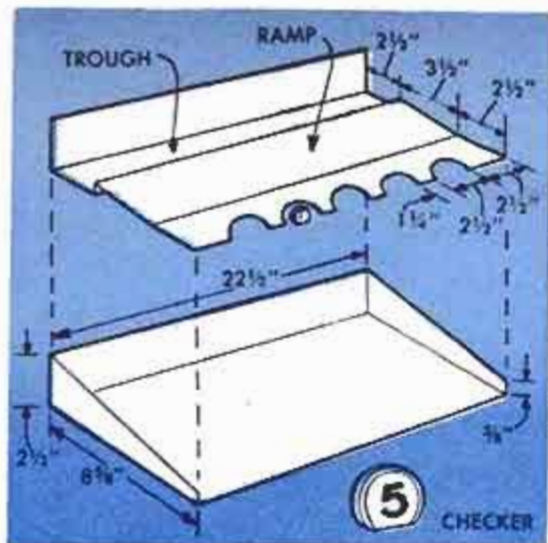

## Marble Game Quickly Improvised for Evening's Fun

Here is an interesting game that anyone can make and play the same evening. The only materials required are two pieces of stiff cardboard, five checkers and 10 colored-glass marbles. Cut and bend the cardboard according to the dimensions given above and glue the two pieces together. A flat spot is cut on the circumference of each checker for a base and a number taken from a calendar pasted on one side.

The game may be played on a large table or on the floor. One player stands behind the game and arranges the five numbered checkers in any order he chooses with the

numerals facing himself. His opponent, standing behind a line 6 ft. from the game, tries to guess which checkers have the highest numbers and knock them down first with the 10 marbles at his disposal. Should he upset all five checkers before using all the marbles, the checkers are set up again for the remaining marbles. After the score is tallied, the positions of the players are reversed and the playing continued. Any number of contestants may play and special rules or handicaps introduced as desired.

Frank Shore, New York City.

## Washers Level Furniture To Prevent Wobbling



When a piece of furniture wobbles because of variation in the lengths of its legs it can be steadied by using shims or washers. Remove the glide or dome from the short leg and insert sufficient shims or washers under it to lengthen the leg, then replace the dome. On furniture equipped with casters, slip washers down over the shank of the caster to produce the same result.

Remove the glide or dome from the short leg and insert sufficient shims or washers under it to lengthen the leg, then replace the dome. On furniture equipped with casters, slip washers down over the shank of the caster to produce the same result.

## Removing an Asphalt Tile

Removing an asphalt tile without damaging those adjacent to it can be done with the aid of an electric iron. Place a piece of wrapping paper on the tile to protect the sole of the iron, then thoroughly heat the tile so it becomes pliable and lifts easily.

## Paper-Backed Aluminum Foil Is Metallic Gift Wrapping

Expensive-looking metallic wrapping paper can be made easily with aluminum foil. Coat the dull side of the foil with clear shellac and, as soon as it becomes tacky, join it to a sheet of strong white paper. Secure perfect bonding by rolling it with a print roller, or with a rolling pin.





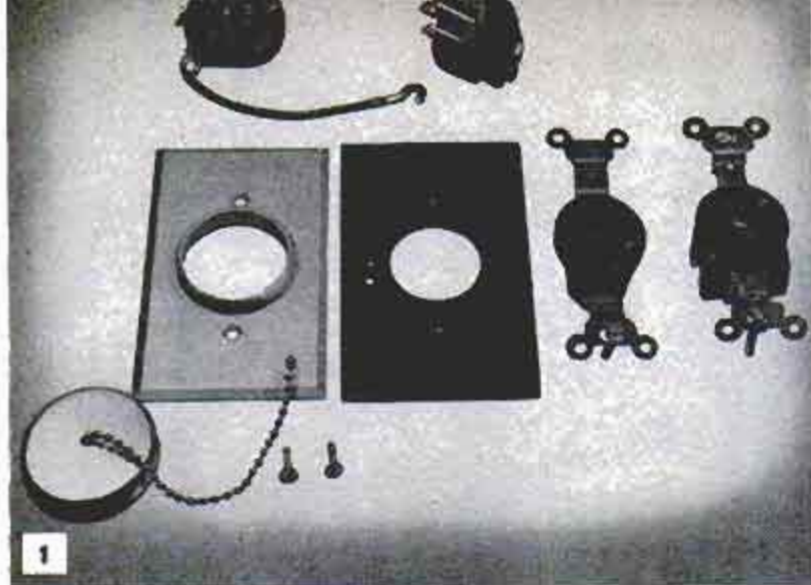

Weatherproof outlet shown above has screw cap used to close opening when not in use. Next to rubber gasket is conventional receptacle for two-prong plug; at far right is receptacle for three-prong grounding plug. At top is grounding adapter and plug for conventional outlet receptacle

Above right, 1/2-in.-dia. extension cord, No. 14 wire with three-prong, ground wire attached is suitable for heavy current load and amply protected against weather. Ground wire permits metal parts of floodlighting units and other equipment not carrying current to be grounded for safety



## PROTECT YOUR

ONE ENTHUSIASTIC HOMEOWNER worked an entire December afternoon installing a lighted star on the peak of his house only to find — after the extension ladder had been returned to the garage — that the lamp at the highest point on the star was not burning. Typical luck? Maybe. But he could have avoided another ladder session by following this simple suggestion: Before installing outdoor Christmas lights, first screw each lamp firmly into its socket and then test the entire string. Thus, burned-out lamps, defective wiring, plugs and receptacles can be spotted before installing them in places difficult to reach. Or the homeowner might follow the practice of commercial displayers by using, each season, only new lamps in sockets that are to be mounted in hard-to-reach places to minimize the likelihood of any burn-outs.

There is more to outdoor lighting than the mere arranging of lamps to form pretty patterns or to illuminate an attractive bit of shrubbery or detail of your house. Before the lamps can put on their show of brightness and color, they must be supplied with electric current; and to get that current to them requires wires, plugs, sockets,

outlets, fuses and switches that are designed to withstand moisture.

### Weatherproof Receptacles

The recommended way of supplying current to outdoor-lighting systems is by means of weatherproof receptacles placed outside the house. There is a flush type that mounts on a standard box, with a rubber gasket under it and a screw cap for keeping moisture out when nothing is plugged in, Fig. 1. Another type of outdoor receptacle is contained in a metal housing having a hinged lid to keep out rain and moisture. Weatherproof outdoor switches are available for controlling such outlets.

A three-prong grounding-type receptacle, Fig. 1, right side of photo, recommended for such outlets permits plugging-in of a cord having a ground wire, so that metal parts of floodlighting units and other equipment that do not carry current can be grounded for safety. If all available outlets are of the conventional two-wire type, there is available a grounding adapter for use between the outlet and three-pronged grounding cap, Fig. 1, top of photo. This adapter has a short length of flexible





# Christmas Lighting

wire that is connected to the outlet box which in turn should be connected to a water pipe or other ground.

The practice of getting current from indoor lights by running wires through doors and windows, even when the wires are protected by inserted boards or other devices, is not recommended. If it is neces-

sary to use an extension cord outdoors, it should be of a type suitable for use in wet locations, and should be large enough to carry the load without overheating. Plugs, connectors (current taps), and other attachments should be weather resistant as well. With ready-made portable rubber-cord sets, covering of cord and attachments

Fused plug disassembled to show cartridge fuses installed between plug prongs and wires for extra protection of Christmas-light string

Rubber washers used between outdoor lamps and sockets keep water out. Avoid connecting a lamp set in such a way that it carries a heavy current to other lamps

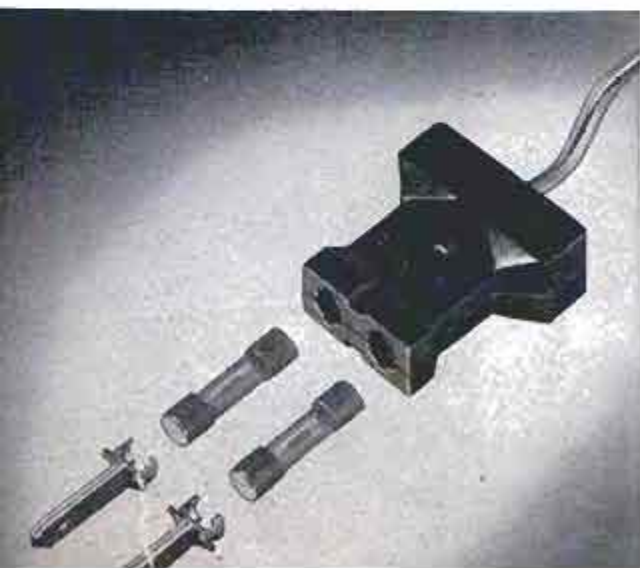



often is vulcanized to make a one-piece job. At one end, the cord has a suitable grounding plug, Fig. 2. On the other end there is a current tap to match the plug on the unit being served.

When the available extension cord is itself waterproof, but its plug and connector are not, or are doubtful, you can weatherproof the latter two by wrapping plastic or rubber sheeting around them as shown in Fig. 5. Another method is to wrap the extension-cord connector and the plug of the attached lamp string, plus an inch or two of each wire with friction tape. If you install plugs and cord taps yourself, use weatherproof molded types and apply a seal around the cord where it enters the attachment.

### Safe Circuit Load

The amount of electricity (in amperes) a branch circuit, such as is commonly used for Christmas lighting, can handle safely is limited by the size of wire used; and the ampere rating of the fuse or circuit breaker should be such as to keep the current within that limit. When a circuit is fused for 15 amperes the total electrical load should not exceed 1800 watts for each receptacle; 2400 watts for a 20-ampere-fused circuit. To compute the load, merely add the wattage of all lamps and any other electrical devices that may be operating on the same circuit. Overloading may show itself by frequent blowing of fuses. When the fuses used on a circuit pass more amperes than the size of wire can handle, the wire will feel hot. Even on a circuit that

closely approaches an overloaded condition, the wires and connectors may feel quite warm.

### Christmas-Lamp Sets

A typical Christmas-lamp string suitable for outdoor use consists of a pair of flexible wires with outdoor-type sockets and plugs. Rubber washers are used to prevent water from entering the sockets around the bulbs as shown in Fig. 4. One end of the cord is fitted with a two-pronged plug for connecting to a receptacle while the other end usually has a connector so another string can be added. If the lamps are mounted on metal cutout forms or other metal supports, it is advisable to connect all isolated metal frames, etc., to a ground wire, since grounding wires are not incorporated into lamp sets. Use wire no smaller than No. 14 for this purpose. Also, avoid connecting a small-wire lamp set in such a way that it will have to carry a heavy current to other lamps.

Christmas-lighting sets having plugs equipped with tubular fuses, as shown in Fig. 3, have one fuse for each prong, making it necessary to check both of these fuses if the lamps do not burn.

A typical Christmas-light flasher, Fig. 6, is a device which is connected between a lamp and a source of current for the purpose of making the lamp flash at intervals. After connecting a flasher, give it a little time to warm up, since it operates much like a thermostat.

Although less convenient to install than the pin-type, the pigtail socket sometimes

Plastic sheet of type used for food containers is wrapped, tied and taped around plug and connector to assure waterproof connection between lamp string and extension cord

Light flasher installed between connector and plug of two light strings will cause lamps in string at left to flash 15 times per min.

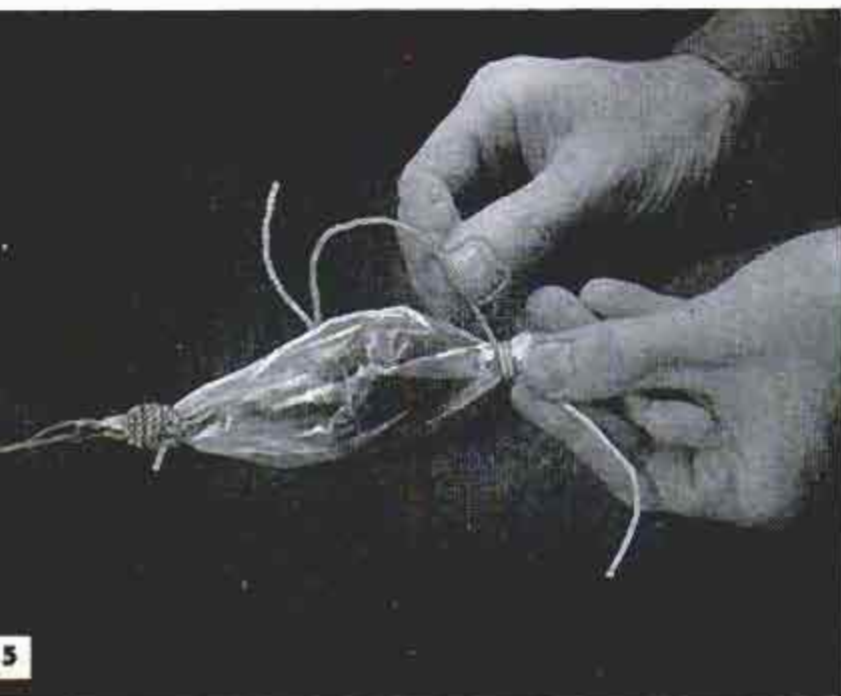



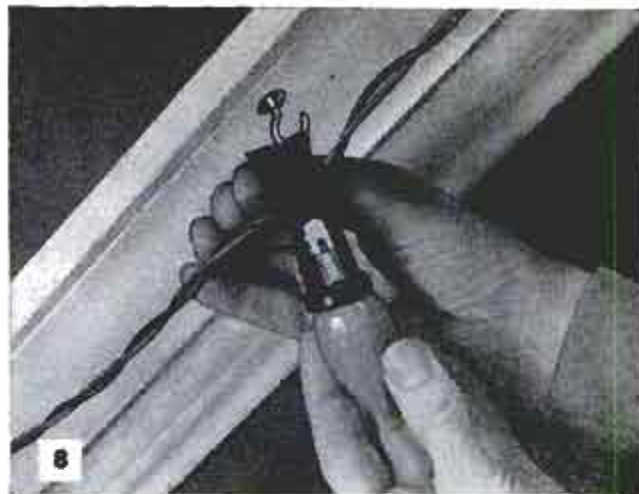
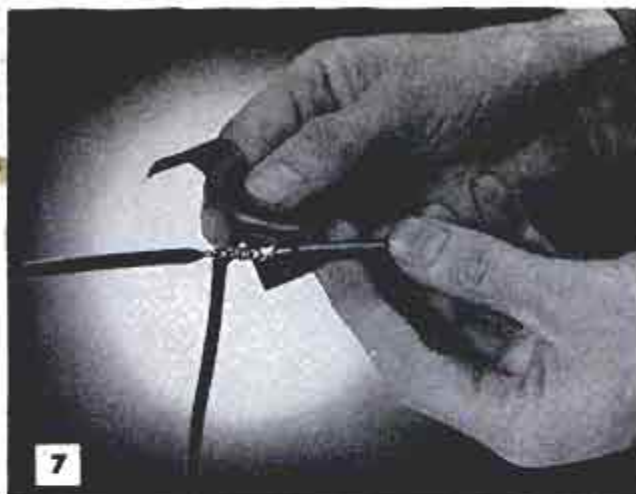

**7** When connecting pigtail socket to continuous current-carrying wire, bared end of pigtail is coiled around wire, then soldered and insulated again

**8** Cup hooks provide best support for Christmas-lamp strings when installed along roof gable. Wires are tied to hook with tape at junction with socket

is used for making lamp strings, streamers and other lighted displays because it occupies less space and can be made without special materials. To splice a pigtail to a continuous wire, Fig. 7, remove about 1 in. of the insulation from the pigtail and wrap it in a tight spiral around the bared section of the continuous wire. Solder the joint securely and reinsulate it.

can be protected by placing strips of wood over them as shown in Fig. 9, with L-shaped pegs bent from light rod and pushed into the ground to anchor the boards. Another means of protecting a flexible cord is to run it through an old garden hose slit lengthwise. When two cords are connected, the joint can be waterproofed with rubber tape. ★ ★ ★

Lamp strings can be fastened to buildings either by means of insulated staples or brass cup hooks, Fig. 8. Hooks are the preferred fastening because staples have to be pulled out to release wires, leaving small holes in the wood while the hooks can remain permanently.

When using flexible waterproof cords on the ground to supply lighting units, they

Extension cord is protected by wooden strips held in position over cord by L-shaped rods driven in ground. Or cord can be placed in slit garden hose

Photos and information courtesy General Electric Co.



**9**



## Electronics Probing Tweezers Are Excellent Print Tongs

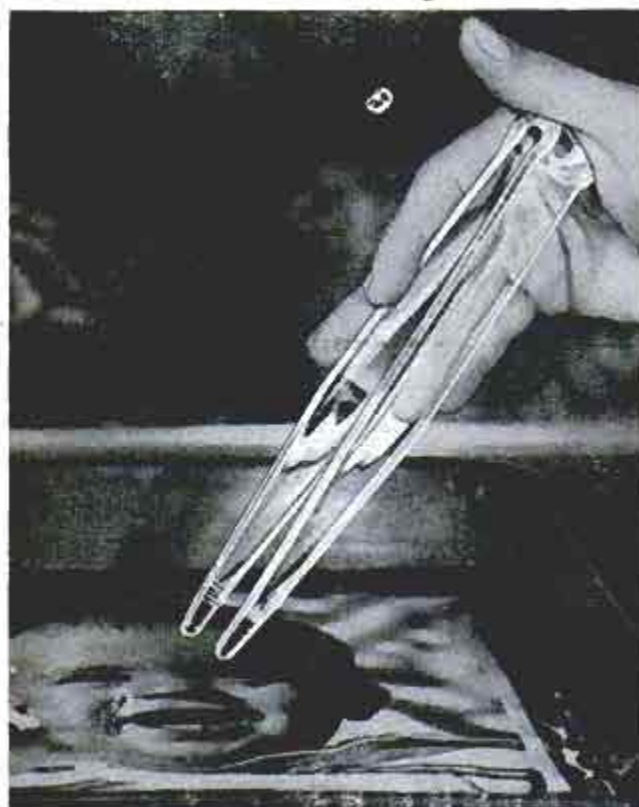

Probing tweezers used by electronic technicians are ideal for use as photoprint tongs. Available at radio and television supply houses, the tongs are larger than standard print tongs and have serrated tips, which permit easier handling of wet prints.

Robert C. Wilson, Brentwood, Mo.

## Foil Streamers for Decoration

For party decorations or for trimming a Christmas tree, use kitchen aluminum foil to make reflective streamers. Place a few sheets of the foil together and trim the corners to form a disk shape. Starting from the outside edge cut continuous ribbons any desired width, and for added length join ends together with cellophane tape.

Ken Murray, Colon, Mich.



## Hardware Cloth Permits Wheel Traction on Ice

When placed under the rear wheels, two pieces of  $\frac{1}{2}$ -in.-mesh hardware cloth, 1 ft. wide and 3 ft. long, are handy for getting a car away from the curb on icy pavement without sliding into adjacent cars. The cloth can be folded or rolled into a small package for storing in trunk.



## Small Hektograph Duplicator

Ends from gelatin-covered paper rolls used in flat-bed duplicators can be salvaged for use as small hektograph duplicators. Tack a piece to a smooth board and write or draw on the surface with a special pen or pencil made for this use. Up to 75 copies can be reproduced from this master by pressing one sheet of paper at a time down over it and absorbing the impressions.

H. N. Webster, Nutley, N. J.



## Better Blueprint Reproduction With Colored Carbon Paper

Blueprint or blue-line reproductions of typewritten letters and drawings seldom are clear either because of the opacity of the paper or because a worn typewriter ribbon was used. Although backing up the paper with blue carbon paper will improve the quality of the reproduction, a better result is obtained when the paper is backed up with yellow, orange or red carbon paper. The latter three colors will produce a much stronger line in a reproduction.

L. E. Reichenbaugh, Tulsa, Okla.

☐ To obtain good results when painting, the air must be warm and dry with a 40-deg. or higher temperature. The surface being painted should also be dry, free from dirt and preferably located in the shade.





"Working end" of den has typewriter and file drawers within easy reach under ample desk-counter top

## Decorate With Hardwood Plywood

### PART III—Conclusion

WHEN DECORATING your home with hardwood plywood as described in the October and November issues of *Popular Mechanics*, an effective treatment of the den or study is a wall covering of flat-sliced oak. The fine, distinctive grain creates an

"Relaxation corner" of teen-age girl's room contains record player and radio as well as handy bookshelves

atmosphere conducive to quiet reading or study.

Here the grain of the plywood was run horizontally instead of vertically to make the room appear larger. Except for the meeting edges (which were beveled), these

Dressing-study corner has large desk, built-in drawers and walk-in cedar-lined closet and blanket storage







Accurate cutting of shelves allows a snug fit and assembly to integrated unit without nails or glue



After assembling hangers as below, draw all fasteners tight. Make sure all threaded rods are vertical

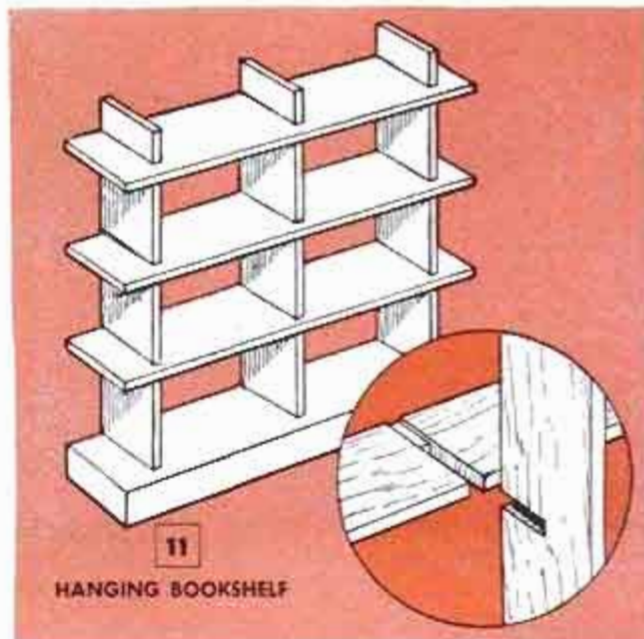

panels were not grooved as were the mahogany panels in the living room. The built-in features of the den (bookshelves, wall map and large desk) relieve the plainness of the unbroken wall panels.

The counter top, which extends 9 ft. along one wall and 10 ft. along another, is 30 in. deep—deep enough to cover cabinets for hi-fi components with ample record storage, typewriter swing-out unit, file drawers, plus 12 other drawers for the many items desired in a "working study."

### Hanging the Bookshelves

While the counter, drawers and cabinets are of standard assembly, the bookshelf units, because of their weight, presented a mounting problem. This was solved by suspending them from the ceiling joists.

Built of  $\frac{3}{4}$ -in. hardwood plywood in egg-crate construction, Figs. 10 and 11, the shelf units were suspended with hangers made from stock items from the local hard-

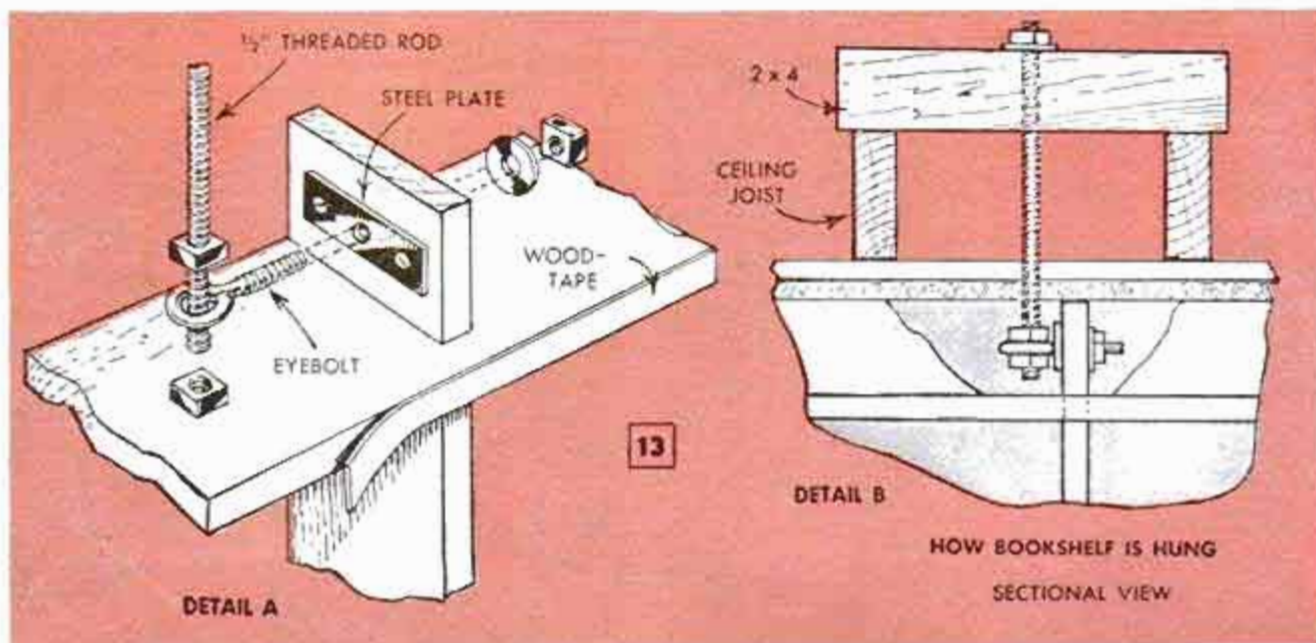





Closest wall, rear, has extra door above bed for access. Door holds socks and handkerchiefs on back

ware store. Figs. 12 and 13 show how steel mending plates were bolted to both sides of the vertical members of the units to take an eyebolt drawn up tight. Then a 1/2-in. threaded rod was affixed as shown in Figs. 12 and 13.

At this point, raise the bookshelf so that the rod ends touch the ceiling. Mark the rod positions and drill through the ceiling for insertion of the rods up through lengths of 2x4s drilled edgewise and long enough to bridge two ceiling joists.

Before raising the shelf unit into place, cut 2x4s to a length that will permit wedging underneath the unit to hold it. When in position, secure it as shown in detail B, Fig. 13.

In the event the floor above is not open, use heavy duty hanger bolts run through the ceiling and into the ceiling joists. Space them accurately so that when the shelf is raised, they will pass through the eyes of the eyebolts. Draw tight with washers and nuts.

Once the shelf unit is firmly in position against the ceiling, the bottom can be fastened against the wall by long finishing nails or wood screws, driving them at an

Simple desk top for five-year-old will have drawer units and other appointments added as need arises





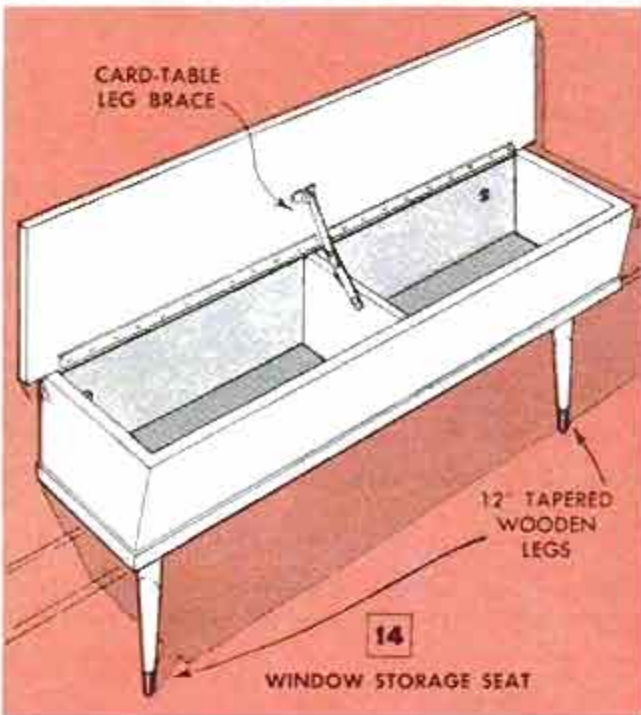

Window seat holds much that is "vitally necessary" to a teen-ager. Brace keeps lid open when desired

angle up from the bottom shelf and into a wall stud.

The bottom shelf can be faced with an apron of  $\frac{1}{4}$ -in. plywood, 2 in. wide, to match the paneling. This apron covers the edge of the plywood as well as partially hiding the strip-lighting fixture placed under this shelf to illuminate the counter top. The space between the ceiling and the upper surface of the top shelf can be finished with a soffit cut from matching plywood and glued to the edges of the vertical members of the shelf. The soffit also hides the hangers and keeps dust from collecting in this area.

The shelves are given the final touch, carpenterwise, by covering the end grain with Woodtape, as was shown in the November issue.

### Boy's Room in Walnut

The boy's room was paneled in flat-sliced walnut. The grain of the walnut is vertical, allowing the repetitive pattern to be shown to its best advantage. Built-ins include a desk, combination blackboard and a train board which, as a boy's interests change, can be used as a worktable for hobbies. Both the table, which is hinged to the wall, and the desk are made of  $\frac{3}{4}$ -in. hardwood plywood to match the wall paneling.

A money-saving feature in the children's bedrooms was introduced in the use of stock pine trim (base, cove and door trim). The grain will, of course, differ and if, after finishing the trim along with the paneling, you do not like the effect, cover the trim with a paint that will harmonize with or accentuate the paneling.

Space under the eaves was utilized for a cedar-lined closet. To facilitate removal of clothes, especially shirts and short suit coats, a door was built into the wall above the pillow level of the bed (see photo, page 199). This cabinet-type door has 4-in.-deep shelves on the back to hold handkerchiefs and socks.

### Girl's Room in Birch

Birch with its graceful grain was used to panel the room for a teen-age girl. Probably more so than the straight grains of oak and mahogany, the birch lends itself to such feminine built-ins as a vanity, and yet preserves a dignity that appeals to adults.

The normal structural features (which should be utilized in any attic remodeling) permitted many built-ins such as a walk-in cedar-lined closet (see page 197, lower right photo), built-in drawers and a 6-ft.-long desk. Other features include a vanity, bookshelves, storage headboard and window seat, Fig. 14, made of  $\frac{3}{4}$ -in. plywood and covered with a cushion.

### Hints on Hardwood Plywood

In Parts I and II, as well as in this concluding article, an attempt has been made to show how hardwood plywood, with many different grains available, can be used by the homeowner to beautify and increase the value of his home.

However, two things should be kept in mind when using these fine woods. First, it is wise to keep all woodworking tools sharp. This is important.

Second, fine woods should have fine finishes. Choose yours with care and apply it according to the manufacturer's instructions. A fine finish will bring out the grains inherent in these plywoods and will provide a surface that requires a minimum of maintenance. ★ ★ ★





## Measuring Spoons and Cups Aid in Preparing Medicines

Keep sets of measuring spoons and cups in your bathroom medicine chest for giving accurate doses of medicine. The cups will also prove handy for mixing or diluting concentrated medicines.

Mrs. Michael Fey, New York City.

## Paper-Clip Ornament Hangers

Ordinary oblong paper clips pulled apart lengthwise into an S-shape may be used very successfully in hanging Christmas-tree ornaments. Put the narrow end through the metal loop on the ornament and slip the other end over the branch of the tree.

## Aluminum-Foil Decorations Applied on Gift Packages

A novel way of decorating gift packages and greeting cards is to apply designs cut from aluminum foil. Coat the dull side of a large sheet of the foil with white shellac. After it is dry, use a pair of scissors to cut the designs from several thicknesses at a time. To apply the decorations, lay them in place with the coated side down and press with an iron set at "silk" heat. The design will adhere immediately.

Ken Murray, Colon, Mich.



## Keep Wooden Pegs Around Shop For Miscellaneous Uses

A collection of small wooden pegs is a handy addition to any workshop, the pegs being useful for plugging holes and as midget dowels for use in place of nails. Made from scrap pieces of wood, both round and square pegs should be included in the collection. Roughly square each one, and point one end with a pocketknife. Round pegs can be made by driving a square one through a round hole in a piece of steel. Suitable diameters are from  $\frac{1}{16}$  to  $\frac{3}{16}$  in. and in lengths from  $\frac{1}{4}$  to  $\frac{3}{4}$  in.

Walter E. Burton, Akron, Ohio.



## Checkbook Used as Photo Album

Empty travel-check folders provide ideal pocket photo albums. Make your photo size  $2\frac{1}{4} \times 2\frac{3}{4}$  in. on a sheet of 3 x 4-in. single-weight paper, then trim the paper so there is a  $\frac{3}{16}$ -in. border on three sides and a  $\frac{7}{16}$ -in. border on the other side. In the wide side punch two holes  $1\frac{5}{8}$  in. apart so they fit over the clasps in the folder. Assemble the photos in the folder, fold down the clips and the album is completed.

Don Honick, Chicago.





### Aluminum-Foil Drapery "Linings" Keep Trailer Interiors Cooler

Sheets of aluminum foil now are being used as functional "linings" for drapery and Venetian blinds in mobile homes during hot, sunny weather. The metal foil reflects the rays of the sun and measurably reduces the heat transmitted through the windows into the interior of the trailer homes.—Ed Packer, Oak Park, Ill.

### Removing Tight-Fitting Cork

When you have difficulty removing a cork from a beverage bottle, even with a corkscrew, try the following stunt to simplify the task: Hold the end of the bottle neck over a flame of the kitchen range for about a minute, rotating it slowly. The heat will cause the glass to expand, and usually the cork can be removed easily with a gentle tug.

Herbert Kondo, Champaign, Ill.

### Dowel Inserted in Hose Provides Toy Wheels

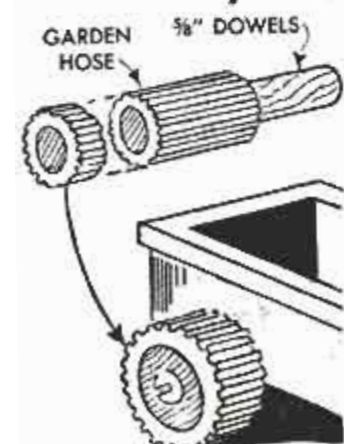

quantity of wheels in a short time. Holes for the nail or screw axles were drilled in the wheels.

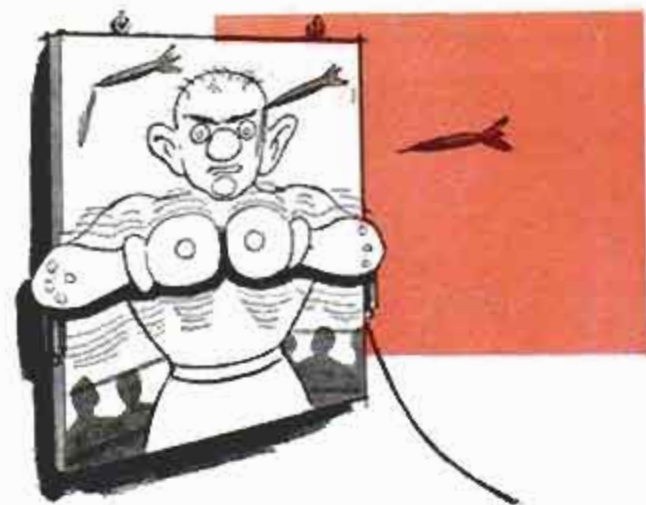

## TRY YOUR LUCK

By Howard P. Wyranch

**T**HROWING DARTS is a lot more exciting and competitive when you have to get the jump on your opponent's reaction and timing. That's what it takes to score on either of these novel electric dartboards which are animated and triggered by a player who tries his best to block his opponent's shots during each turn of play.

The bat is the animated part of the baseball dartboard and the details on the opposite page show how it is pivoted and actuated by a solenoid which is wired to a doorbell transformer and push button in the manner indicated. Pressing the doorbell button energizes the solenoid and in turn swings the bat across the board. Regulation baseball rules are followed. The pitcher throws the darts trying to hit the strike zone and not the bat, at least not in the hit zone. The batter works the doorbell button and tries to swing the bat to inter-

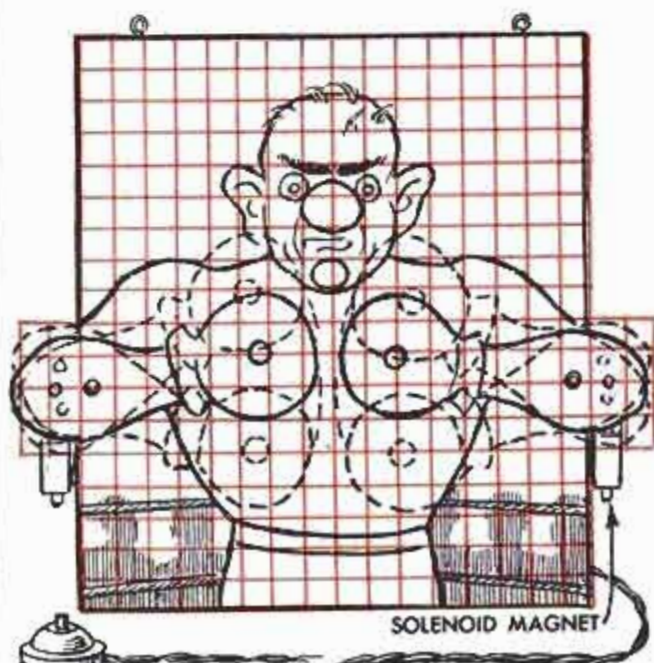



WTM 58



# WITH AN ELECTRIC DARTBOARD

cept the dart and get a hit. A dart that misses the strike zone is a ball. Letters HPB mean hit by a pitched ball; OS means out stealing; POB means picked off base and SB (partly hidden by bat) means stolen base. Score is kept on a separate playing-field scoreboard. DP on the bat means double play; FO means flied out; HR stands for home run and so on.

by two solenoids. Five darts are thrown by each player each round and points are scored as follows: Five for a punch to the body and 10 to the head. Five points are lost for each dart blocked by the moving arms. If the red button on the chin is hit, a KO is scored, but if the blue circle is hit on either glove, the player is kayoed. A dart below the belt penalizes the player 10 points and two darts below the belt forfeit the round. ★ ★ ★

The boxing dartboard has two moving parts, the boxer's arms, which are actuated

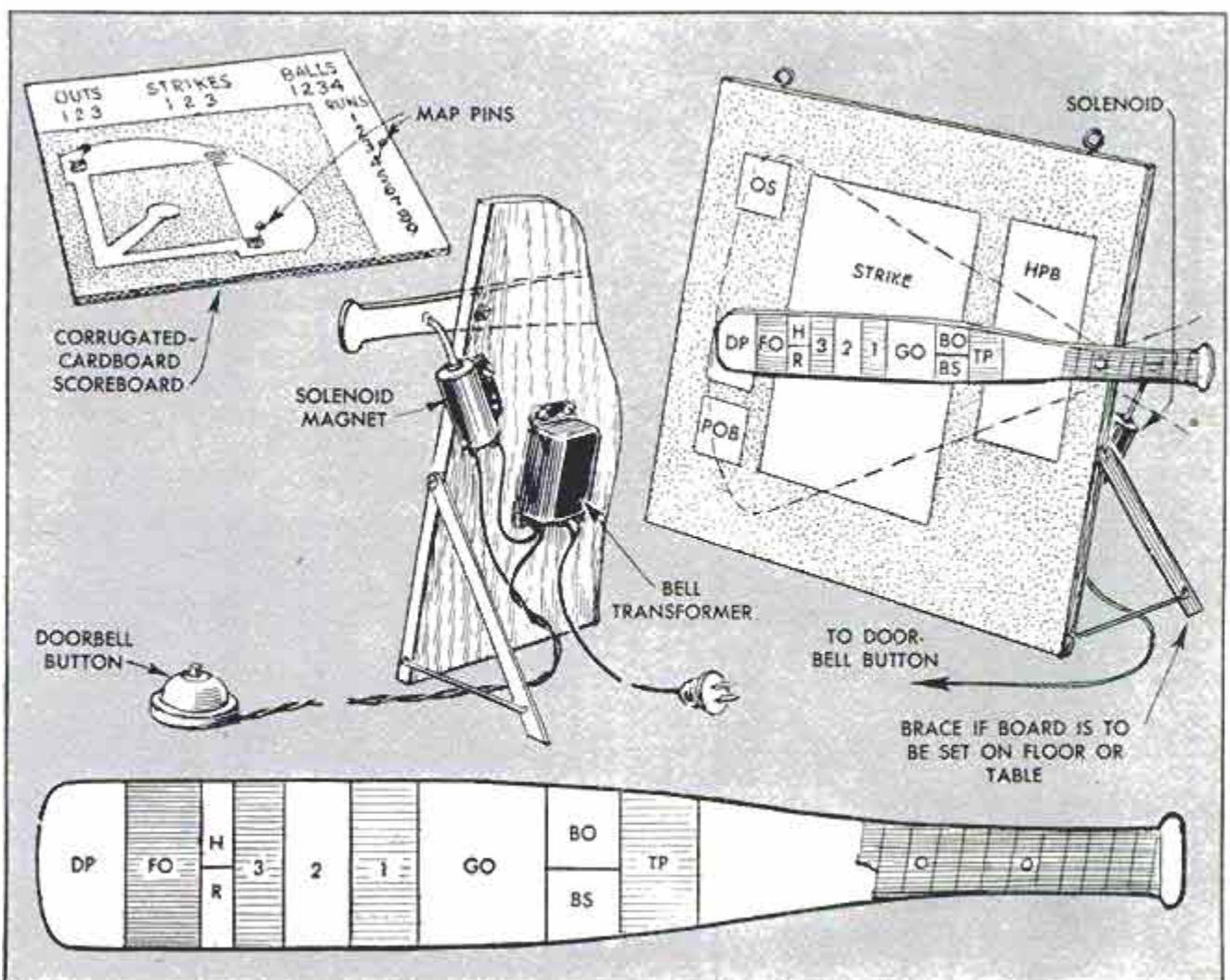



## Adjustable Eyebolts Eliminate Sagging Clotheslines

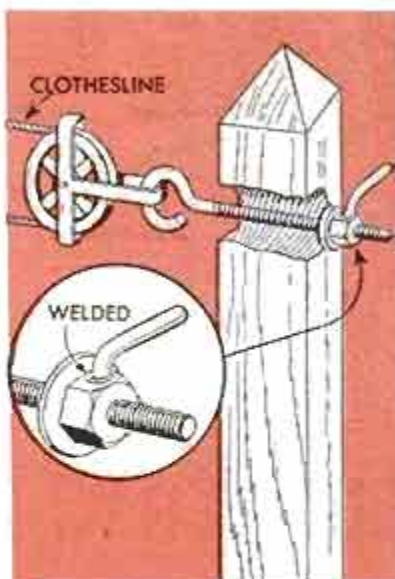

A continuous clothesline strung on pulleys can be kept from sagging if eyebolts are used in place of eyescrews for holding the pulleys. Each eyebolt is equipped with a special nut that has a handle welded to it as shown in the detail. Whenever the clothesline becomes a little slack a few turns with the handle draws the eye of the bolt closer to the supporting post and tightens the clothesline.—W. J. Shupenia, Smoky Lake, Alta., Can.

## Modern "Silver Fox" Finish For Hardwood Furniture

If you would like an unusual and attractive finish for modern furniture built in the home workshop, try "silver fox." The finish works best on wood that has an alternating hard and soft grain, such as close-grained white oak, ash and certain types of mahogany. After sanding the wood smooth, wipe it with a damp cloth to raise the soft grain. Allow it to dry for 24 hr., then resand. Now, mix black lacquer, 1 part, to thinner, 2 parts. Spray or brush eight or nine coats of the thinned lacquer on the wood at about 15-min. intervals. Let the lacquer dry thoroughly, then smooth carefully with fine sandpaper. When the black lacquer is very smooth on the hard part of the grain wash the surface of the wood with water. Wipe off the extra moisture with a dry cloth. After the moisture has completely dried, wipe on white flat paint or white paste filler. Remove the surplus white paint from the hard grain with a cloth dampened with turpentine. The wood now should appear to have a basically black surface with white lines following the grain of the soft portions. Allow the finish to dry overnight, then apply four or five coats of clear lacquer. Rub the lacquer with pumice and a soft cloth and apply several coats of paste wax.

James R. Nolan, Fort Worth, Tex.

### *Two unpainted chests*

that you buy ready-made take all the work out of building the smart vanity table featured in the January Craftsman section. You simply bridge the tops with a lift-off drawer assembly, paint it to suit your fancy and the job's done

## Rubber Tip Holds Cane On Edge of Table

To prevent a cane from slipping off when hung on the edge of a table, place a rubber tip on the curved end. Another tip placed on the bottom of the cane will steady it when walking on a glazed surface.

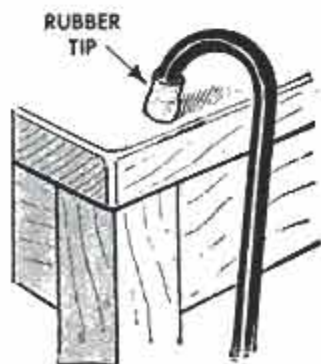

## Rubber Band Holds Toothpick On Bottle Neck When Pouring

Holding a toothpick over the mouth of a bottle to permit pouring a narrow stream of liquid into a smaller container can be done more easily if a rubber band is snapped lengthwise around the bottle as shown. Using the band, rather than a finger, lets you see what you're doing.

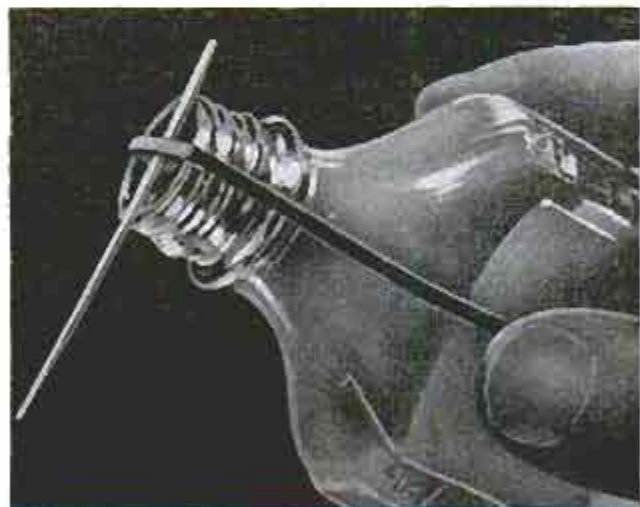





# SHOP NOTES

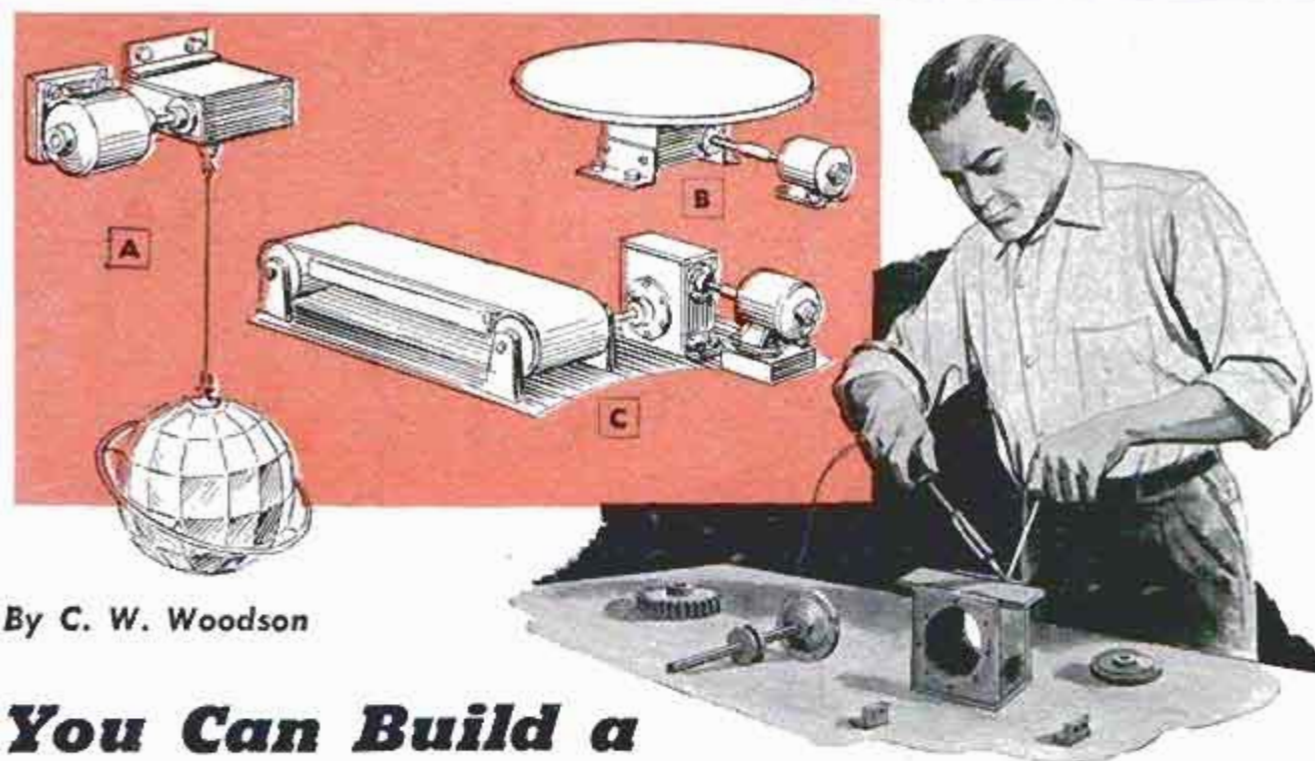

By C. W. Woodson

## You Can Build a SPEED REDUCER

BY USING various gear combinations, both single and compound reductions, it is possible to build a speed-reducing unit to suit almost any purpose such as operating timing devices, animated signs, rotating window displays, moving belts and various other slow-moving installations. Sketches A, B and C above suggest different applications of reducing units.

With different types of gear trains ratios up to 3000 to 1 are practical, the higher ratios being obtained by compound gearing using a double set of worms and worm gears. The lower ratios are achieved with spiral miter gears, or a pinion and bevel gears. The lower ratios are achieved with a worm and worm-gear combination usually is used, the advantage of the worm gear being its comparatively small size, which makes it possible to house it in a small gearbox. For single-reduction drives

where the input and output shafts can operate at right angles, the single-thread worm and worm gear are perhaps the most suitable for light duty. With the single-thread worm-and-gear combination, the gear is moved a distance equal to the thickness of one gear tooth at each complete revolution of the worm.

Taking as a typical example a worm gear having 50 teeth, this size gear will give a 50 to 1 reduction when driven by a matching single-thread worm. Put another way, one complete revolution of the worm gear will require 50 revolutions of the worm. Much greater reductions in output-shaft speed are possible with gears of the same ratio by driving from a small pulley on the motor to one of larger diameter on the input shaft of the reducing unit, although, of course, the gear ratio remains the same.

When planning any type of installation

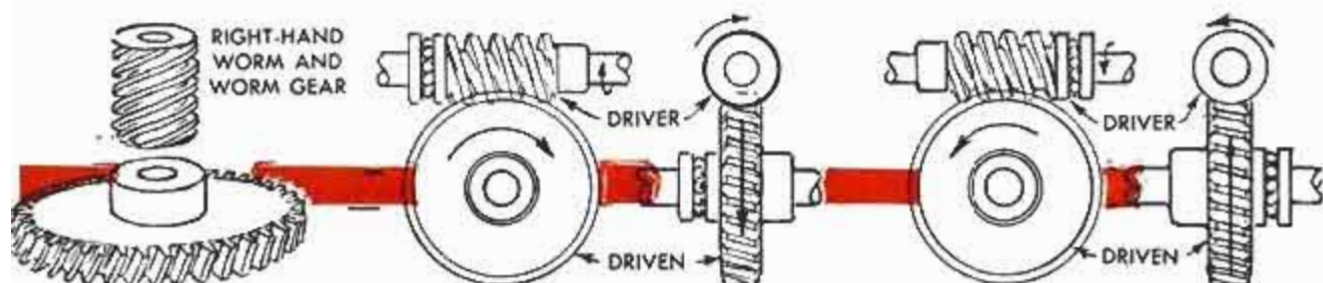



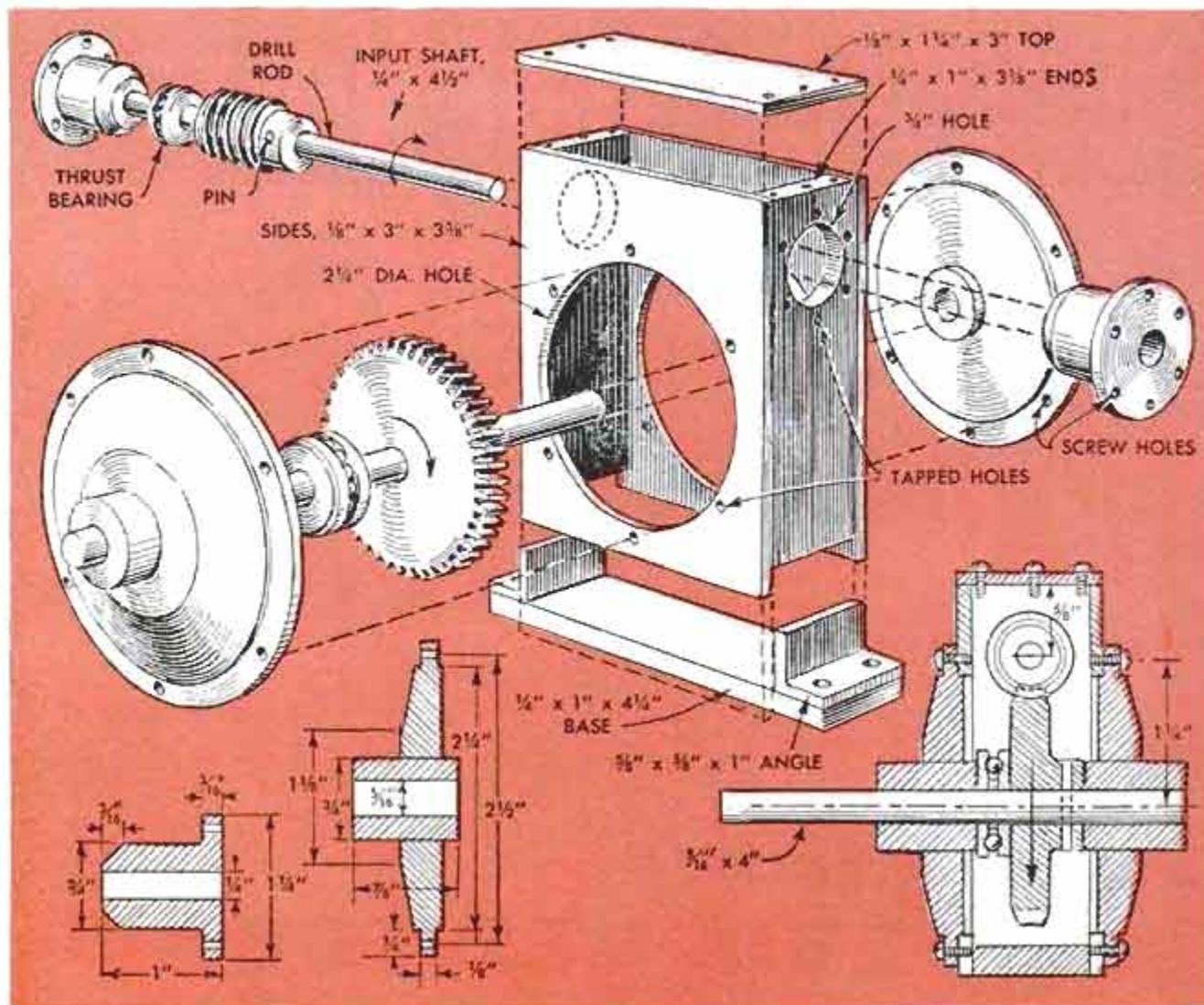

utilizing a gear-reduction unit, it is necessary to decide beforehand whether to use a direct-connected motor drive to the input shaft through a flexible coupling or a V-belt drive from the motor to the input shaft of the reducing unit.

Reduction gears should always be mounted in an oil-tight housing so that they can be run in oil. Small gear-reducing units are easily made by using stock worms and worm gears and mounting these in a steel or brass housing as detailed above. This unit is fitted with plain bearings on the input and output shafts, the thrust being taken by ball thrust bearings on both the output and input shafts. The shafts are mounted in simple flanged bushings which are attached to the outside of the housing with screws. The housing is made from  $\frac{1}{8}$

and  $\frac{1}{4}$  in. brass plates joined with soft solder, which has sufficient strength for a housing of the dimensions given. The top is attached with screws to provide access to the interior of the housing and for replenishing the supply of lubricant. As dimensioned, the reducing unit detailed above is designed to be direct-driven by a  $\frac{1}{12}$ -hp. motor. By making proportionate increases in sizes of the gears and housing the same general design can be utilized in making much heavier units. In the larger sizes the parts should be joined with screws rather than solder. All joints should be fitted with oilproof gaskets. On the larger units there will be a considerable reduction in frictional drag if ball bearings are used instead of sleeve bearings although, of course, more machining is necessary. ★ ★ ★

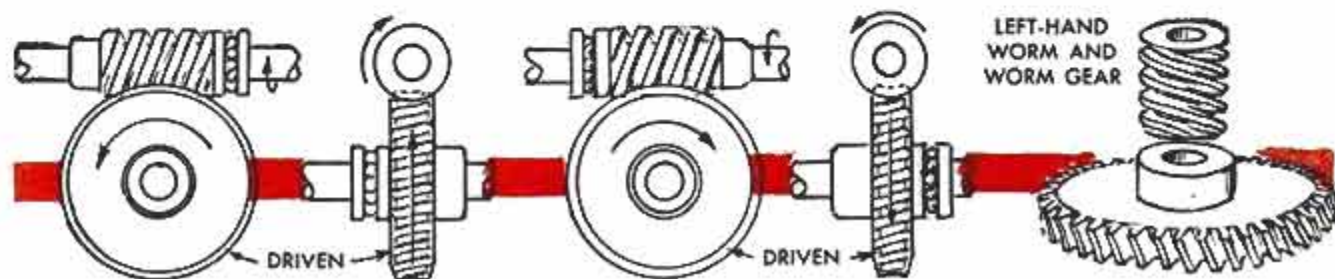



## Improvised Surveying Level Requires Only Pail of Water

When you need a surveying level for such jobs as grading your yard, or for laying draitile, you can improvise one from a pail of water that will be accurate enough for all practical purposes. Place the pail on high ground and adjust it until the water is the same distance from the rim at three equidistant points around the rim. Sight from a pole, such as a clothesline prop, across the leveled rim of the pail to another pole as indicated. A friend can mark the other pole at the point where you sight, and the relative heights at the lower ends of the poles can then be determined by measuring down from the marks.

R. G. Cooper, Trenton, Ont., Can.

### Heat Restores Ink Flow

If ink in a ball-point pen does not flow freely, hold the point end of the pen in the palm of your closed hand for a minute or two. The heat from your hand will soften the dried ink in the pen and allow it to flow.—Frank A. Javor, North Bergen, N. J.

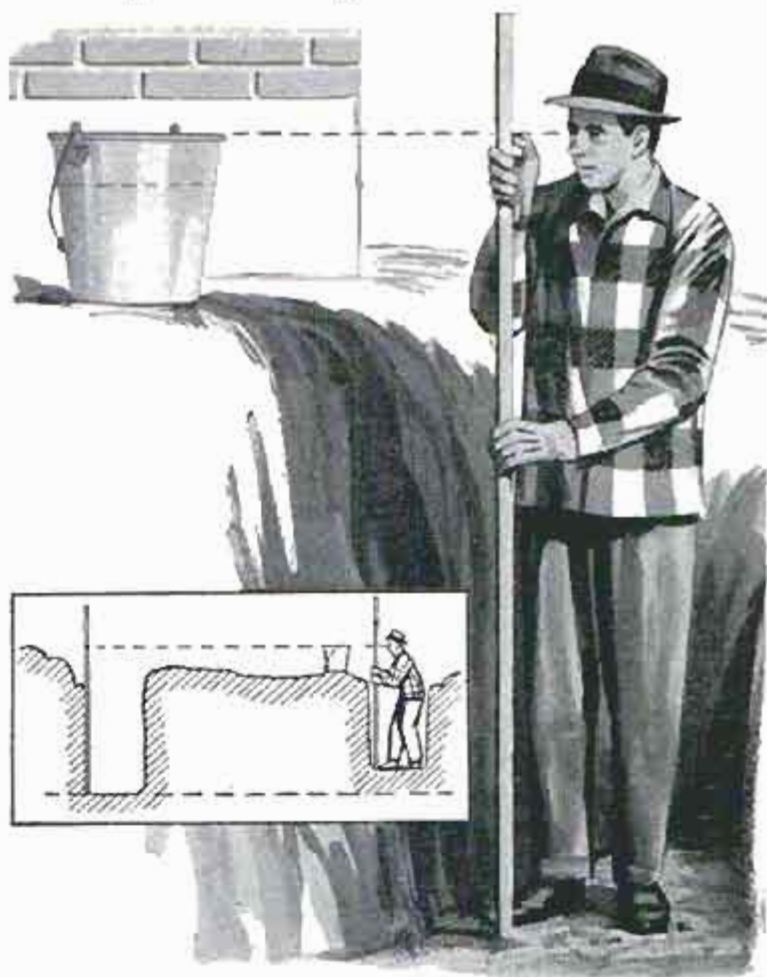

## FIX-IT-YOURSELF TELEVISION MANUAL

*For less than the cost of most new parts,  
you can learn how to maintain your TV  
set — and make many repairs yourself!*

**INCLUDES LATEST DATA ON COLOR AND  
ULTRA-HIGH-FREQUENCY TELEVISION**

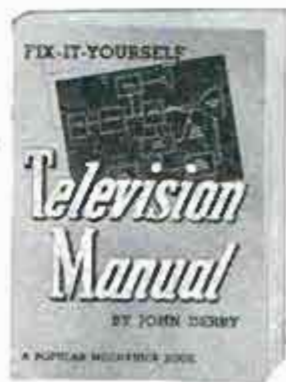

### Complete, Reliable, Authoritative

John Derby, famous electronics engineer, has written another fact-filled, money-saving book. ALL ABOUT TELEVISION was bought by 200,000 savings-minded people, and the demand for it is larger than ever. But, with so many new developments in the field, Mr. Derby and Popular Mechanics Press realized a completely new book should be published. One aimed directly at the man who wants to make his own repairs.

### Covers the Entire Subject

TELEVISION MANUAL will tell you, with no technical doubletalk, *everything* about television transmission and reception. It will expand your knowledge and enable you to handle 3 out of 4 TV repairs. Never again will you not understand what you're doing with a TV set. You'll know whether to call a professional or do the job yourself.

### All the Latest information

Now you can learn how color TV works, how to care for, and how to enjoy most fully that color set when you get it. TELEVISION MANUAL will show you how to take advantage of the new UHF networks and how to convert your present set to ultra-high-frequency. It will answer almost any question you may have about television.

### MONEY-BACK GUARANTEE

TELEVISION MANUAL is guaranteed to satisfy you, to save you money—if not, you can return it within ten days for a full refund of the purchase price. So send your order, with a remittance of only \$3.00, *today!*

### Popular Mechanics Bookshop

208 East Ontario Street  
Chicago 11, Illinois



# Christmas Shopping



1

**1. BOY-SIZE TOOL CHEST** comes complete with all basic hand tools needed for building craft projects in wood. Chest, or cabinet, is designed to hang on wall, provides safe, accessible storage for all tools in the kit, which includes new "dial an angle" rule  
A. C. Gilbert Co., New Haven, Conn.



2

**2. PORTABLE ELECTRIC DRILL** is especially suited to needs of the homeowner, electrician, sheet-metal worker and plumber. Handles any accessory adapted to use with 1/4-in. portable drills. Pistol grip gives positive control on a wide variety of operations  
Mall Tool Co., 7740 S. Chicago Ave., Chicago 19

**3. PORTABLE ELECTRIC HANDSAW** is one of the smallest portable-power units available. Blade is 4 1/4 in. in dia., cuts 1-5/32 in. deep in 90-deg. position. Blade tilts to 45 deg. Extra-wide soleplate permits right or left-hand cutoffs, makes unit easier to guide  
Skil Corp., 5033 Elston Ave., Chicago 30

**4. TILTING-ARBOR SAW** has several new features. Motors up to 3 hp. can be mounted on the single-trunnion tilting assembly. Arbor takes 10-in. blades. Ripping fence rolls across table on ball bearings and locks at any point. Depth gauge is new, accurate  
Yates-American Machine Co., Beloit, Wis.

**5. PORTABLE ROUTER** with newly developed accessories is becoming one of the most versatile tools in the shop. New guide permits greater range on both curved and straight routing. Extreme high speed of cutters results in clean, sharp moldings and grooves  
Stanley Electric Tools, Div. of Stanley Works, New Britain, Conn.

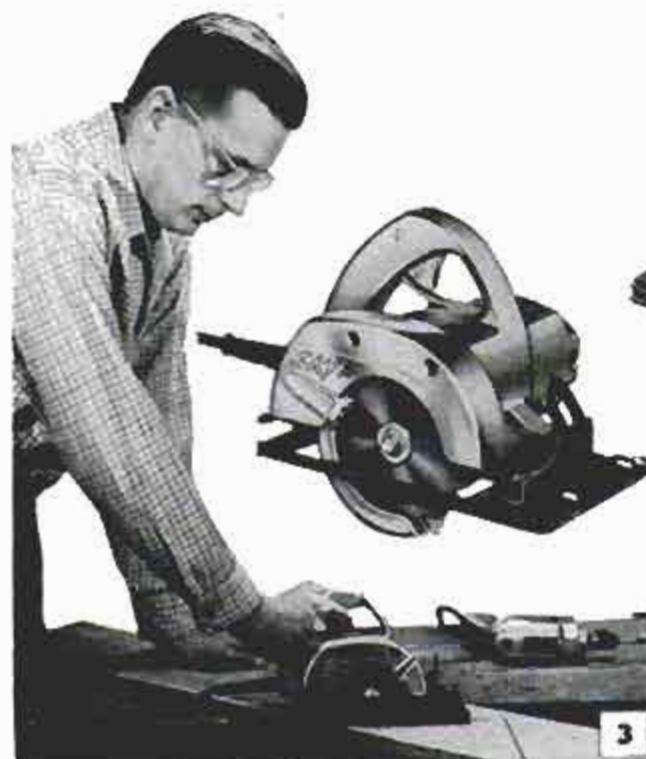

3

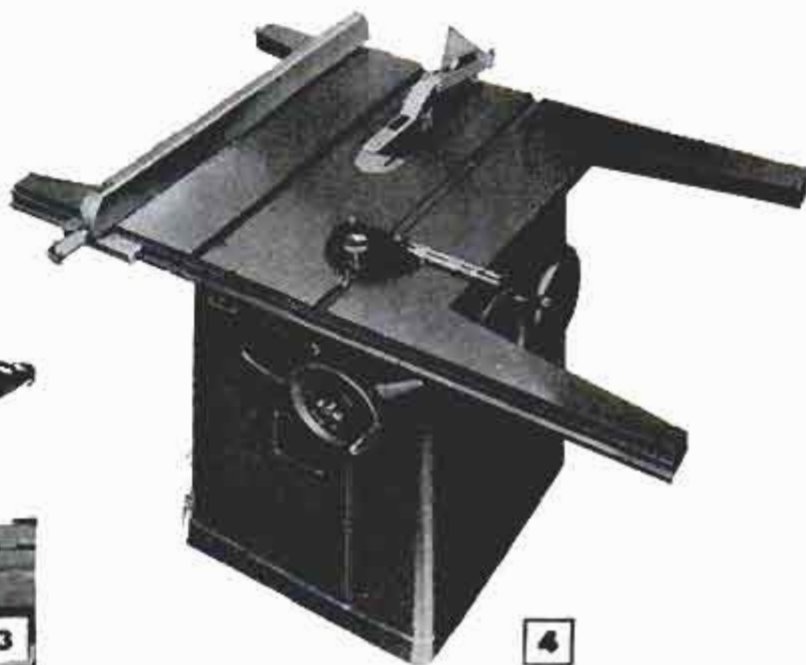

4



# for Tools

**6. NEW BENCH-TYPE CIRCULAR SAW** is fitted with a  $\frac{3}{8}$ -in. arbor that raises, lowers and tilts with single handwheel. Comes with or without floor stand. Table is 20 x 27 in. (without extensions) with 15 $\frac{1}{2}$  in. of table surface in front of 10-in. blade. Fence is self-aligning  
 Montgomery Ward, Chicago 7

**7. RADIAL SAW** does all operations on the top of the work rather than from the underside. This unit has dual-voltage motor which operates on 115 or 230 v. with a simple wiring change. Has double overarm, secondary arm pivoting over center of worktable. Takes 9-in. blades  
 Delta Power Tools Div., Rockwell Mfg. Co.,  
 400 N. Lexington Ave., Pittsburgh 8, Pa.

**8. JIGSAW** has one-piece cast-iron frame. Blade is driven by a yoke-type eccentric mechanism having a nylon slide. This type of drive gives very smooth operation at high speeds. Blade rotates to any desired position. Frame has 16-in. capacity  
 Duro Metal Products Co., 2651 N. Kildare Ave., Chicago 39

**9. TOOL TOTE** comes as a precut kit or as a completely assembled, finished unit. Center panel provides hanger space for all tools needed in household kit. Saw slides into specially made "scabbard." Trays provide space for finishing materials  
 Yield House, North Conway, N. H.

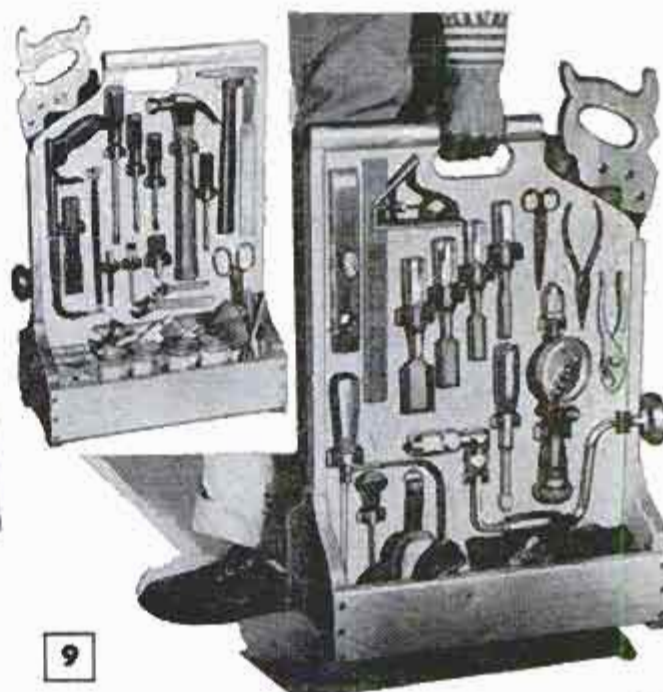
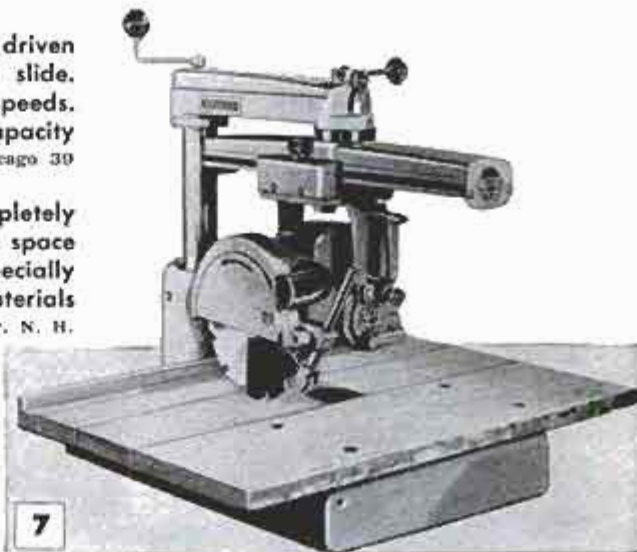
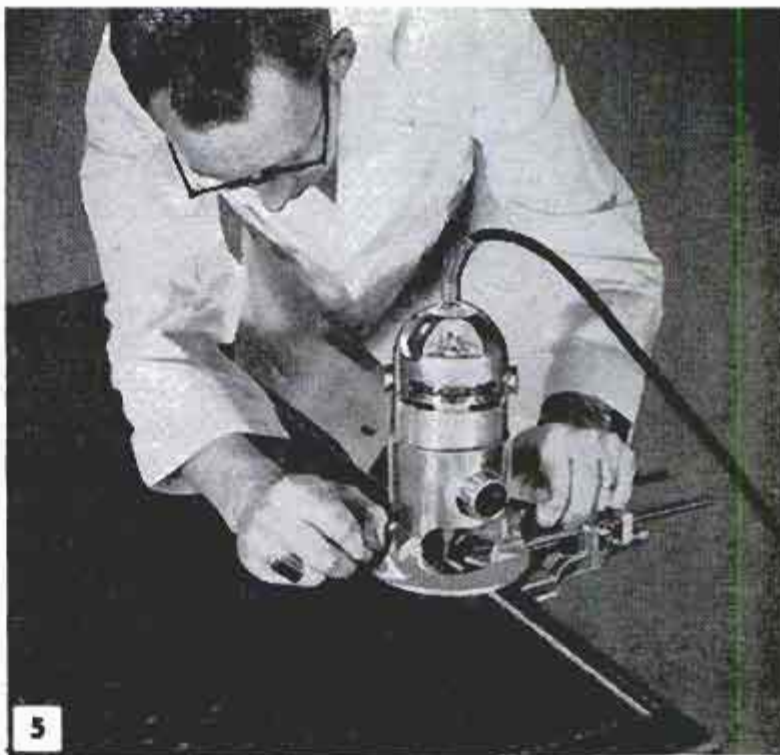



# More Christmas Shopping

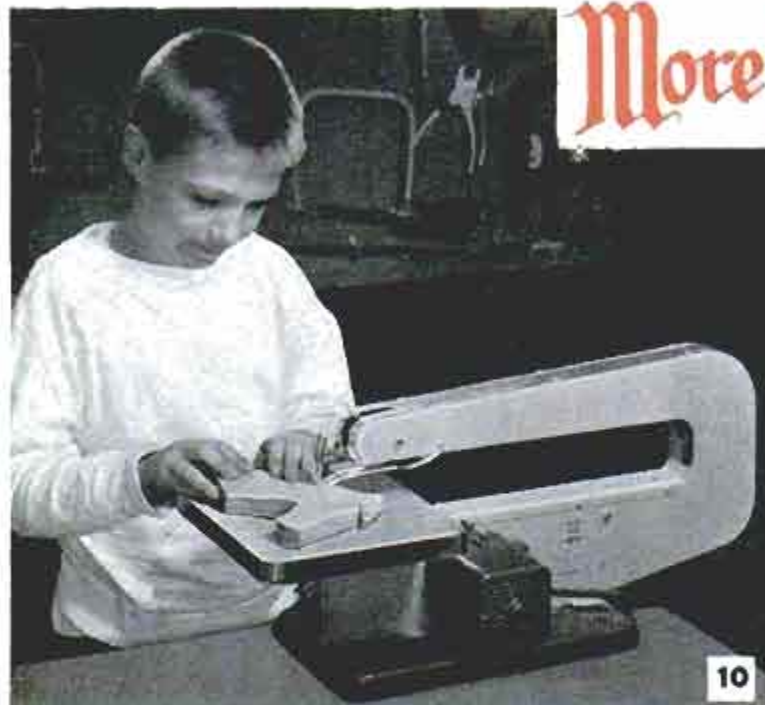

**10. JIGSAW** has a built-in motor of the rotating-armature type. Distance between blade and frame is 15 in. Cuts stock up to 1¾ in. in thickness. Table tilts to 45 deg., also raises and lowers, making it possible to equalize wear on blades when cutting thin hardwood or extremely intricate scrollwork. Has novel type safety blade guard

Dremel Mfg. Co., 2420 18th St., Racine, Wis.

**11. OSCILLATING SANDER** makes 3450 orbital sanding strokes per minute, gives a mirror-smooth finish on hard and soft woods. Pad is sized to take just ½ of a standard sheet of sandpaper. Motor operates on 115-v. a.c. only, gives plenty of power for heavy, continuous sanding. Comes with 3-wire cord, weighs 7½ lb.

Portable Electric Tools, Inc.,  
320 W. 83rd St., Chicago 20



**12. VIBRATOR-TYPE MOTOR** drives this jigsaw at high speeds, producing smooth, clean cuts on scrollwork that do not require sanding before finishing. Has 15-in. throat capacity, the blade cutting to the center of stock 30 in. wide. Uses 4-in. pin-end blades. Hook-type blade holders are adjustable

Synco Corp., Oxford, Mich.



**13. FLOOR-TYPE CIRCULAR SAW** with tilting arbor has new type sliding table extension that provides rigid support for crosscutting extra-long pieces of stock. Rails carrying the sliding extension can be mounted to extend either right or left, or centered on table to extend an equal distance from both edges

Magna Power Tool Corp., Menlo Park, Calif.

**14. MICROSCOPE** makes a lasting and practical gift for students with a scientific turn of mind. Fitted with a triple revolving objective turret giving 100, 200 and 300-power magnification simply by turning the turret to any one of the three positions giving the power desired. Kit includes sample slides

Jal-Mar, 115 W. 42nd St., New York City 36

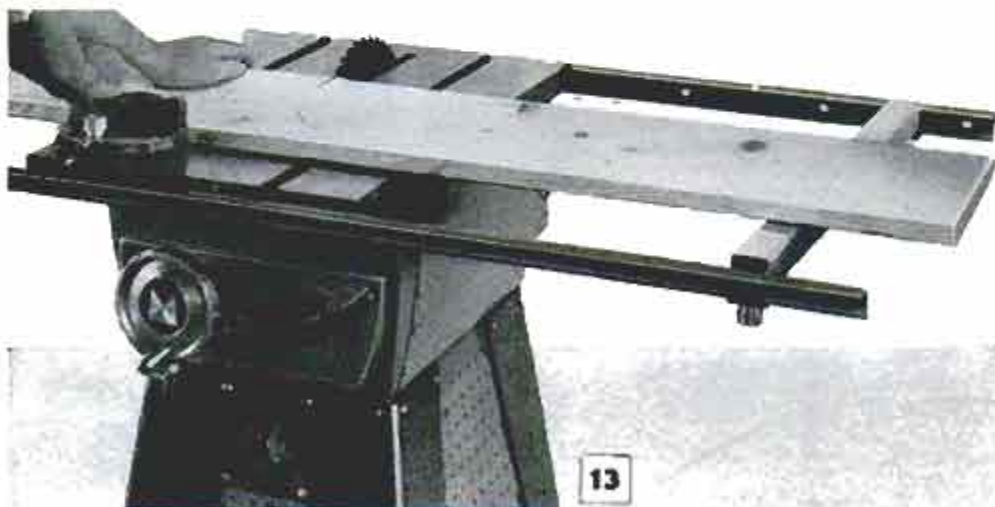



# for Tools

**15. METAL-TURNING LATHE** for your workshop swings 10 in. over the bed, 6¼ in. over the cross slide. Takes 28 in. between centers with 4-ft. bed. Available with motor and countershaft mounted behind headstock as pictured, or on cabinet stand with motor and countershaft underneath

South Bend Lathe Works,  
South Bend 22, Ind.

**16. 3-WHEEL BANDSAW** gives 2-wheel bandsaw capacity in a much more compact and efficient design. All moving parts except cutting teeth of blade in working area are entirely enclosed. Frame is cast iron. Guards are formed from heavy sheet metal

Sears, Roebuck & Co., Chicago 7

**17. COLD-GLUE INJECTOR** forces any liquid glue into loose joints of chairs and cabinets at high pressure, making it an indispensable tool for craftsmen and furniture rebuilders. Injector nozzle, or tip, is tapered, enters small hole drilled into joint at an angle. Pressure on plunger forces glue through the hole into the loose joint. Joint is immediately clamped and held tight until glue is dry. This procedure makes it unnecessary to disassemble the unit

The Drumcliff Co., Dept. L-81, Towson, Md.

**18. PORTABLE ELECTRIC SAW AND DRILL KIT** includes a working drawing showing how to build the compact cabinet-bench unit pictured. Bench top folds inside cabinet which contains compartments and perforated hardboard panels for tool storage in addition to space for storing the drill-saw kit shown on bench

Black & Decker Mfg. Co., Towson, Md.

**19. COMBINATION POWER SHOP** does all the operations necessary in basic cabinet construction. Takes up only a corner of the basement or garage. Accessories for sanding, grinding, cutting moldings, faceplate turning and drilling are available, also jointer pictured and a special table extension for long stock

Power Tools, Inc., Beloit, Wis.

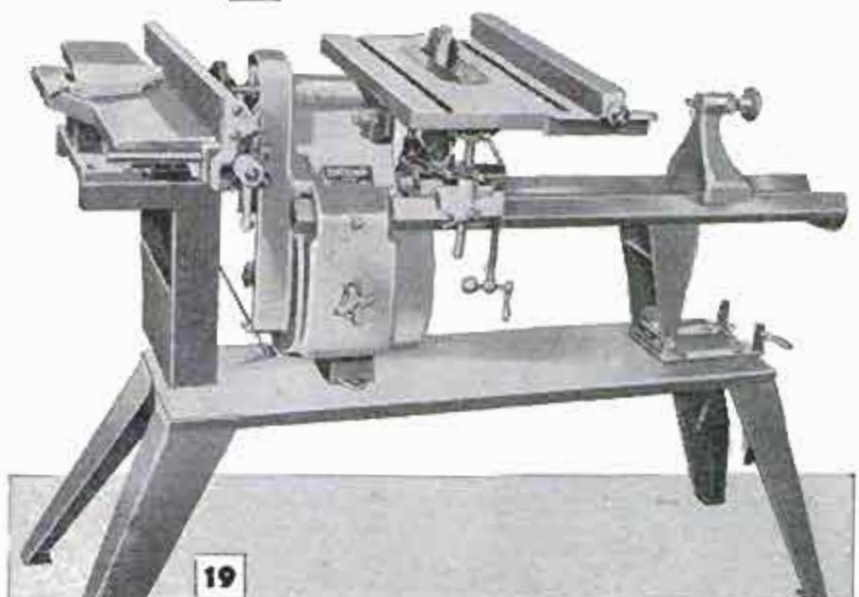
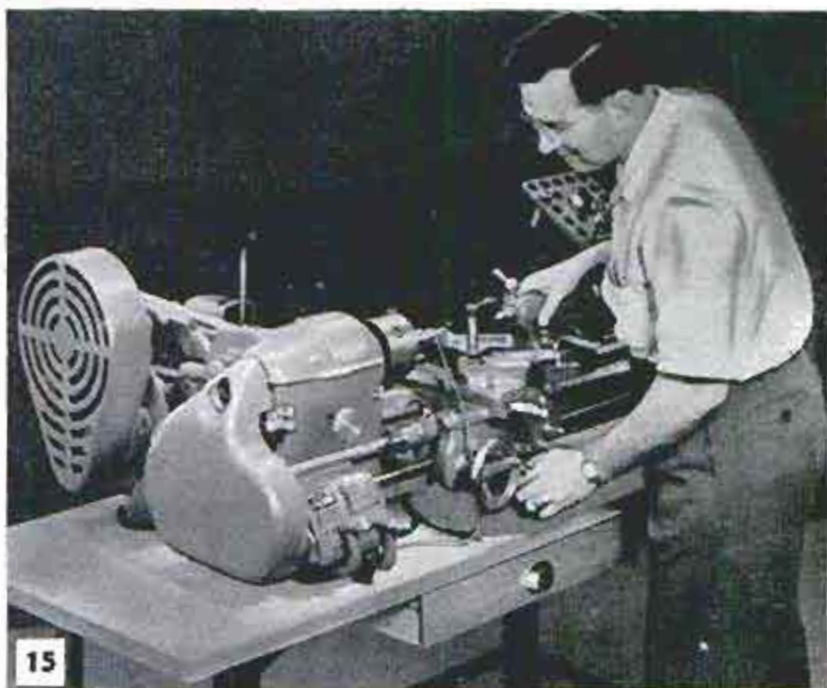



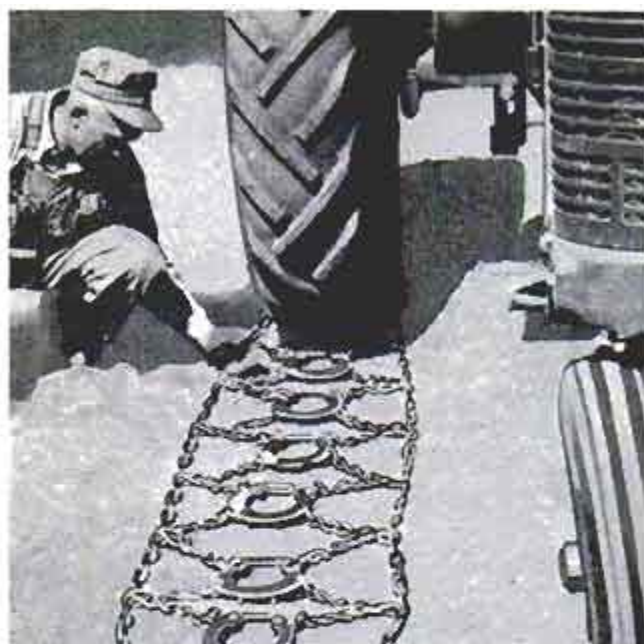

### Horseshoes on Tractor Chains Improve Traction on Ice

More traction on frozen ground and ice is provided by this set of tractor chains that has heavy horseshoes welded to the cross chains. An extra set of chains was attached to the same links as the original cross chains, then both were cut at the center to permit installation of the horseshoes. The cut cross chains are positioned in V-shapes as indicated so that each horseshoe is held at four points.

A. M. Wettach, Mt. Pleasant, Iowa.

### Steel Wool Grips Tubing in Vise

To hold metal tubing in vise jaws that are worn, or which are not exactly parallel, seat the tubing in a folded steel-wool pad. When placed in the vise, the tubing will be gripped firmly, and yet be protected from damage by the cushioning pad.

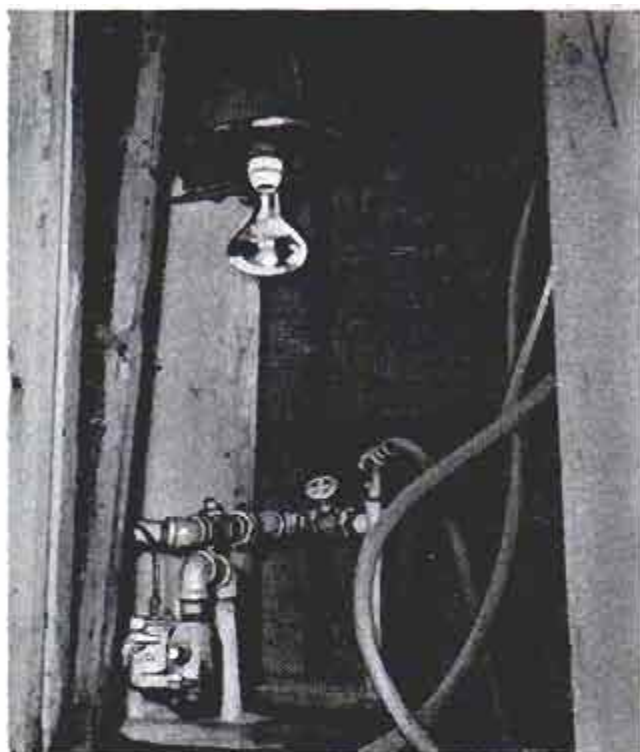
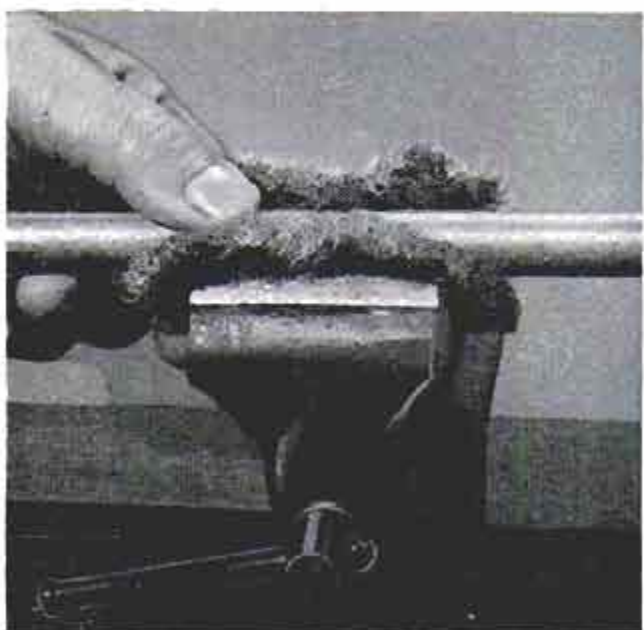

### Pump House Warmed by Heat Lamp Ends Worry Over Frozen Pipes

To prevent water lines from freezing in his pump house one farmer installed the heat-lamp fixture shown in the photograph. A porcelain light socket was mounted in the center of a metal lid from a 5-gal. grease bucket, which was then suspended from the ceiling with wire tied through the loop flanges on the edge of the lid. The walls of the pump house are insulated to protect against average cold, but during severe cold weather a switch located in the farmhouse is used to turn on the heat lamp.

C. F. Marley, Nokomis, Ill.

### Expanding Lathe Mandrel Is Quick Acting

When turning small parts this simple lathe mandrel, made from a discarded tapered-shank twist drill, will speed up repetitive work by its easy method of mounting.

Turn the wide end to the diameter of the hole in the work, and center-drill this end as indicated by the dotted lines in the detail. Then cut this same end lengthwise into three expandable fingers. When the work has been mounted on the mandrel, the tail-stock lathe center is forced into the tapered hole expanding it sufficiently to securely hold the work for light lathe operation.

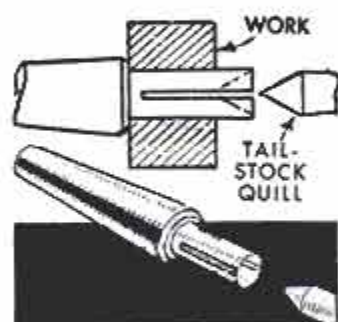



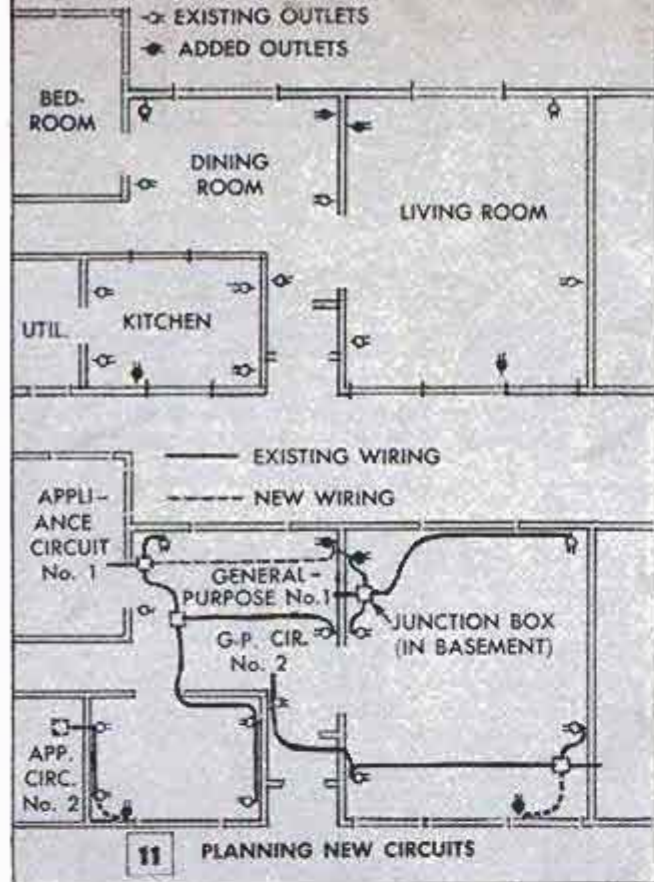

# Is Your Wiring Adequate?

## PART II

By J. B. Mullen

**M**ANY OLDER HOMES have 110 or 115-v. electrical service and the current that can be safely drawn from such existing systems is usually no more than adequate to handle the normal number of lighting fixtures and appliances which have been common for a number of years, and which are designed for comparatively low current requirements. Usually such systems were installed with the minimum number of circuits and convenience outlets and fall far short of present-day needs.

When newer appliances of heavy current requirements are to be added to the household equipment, it is important to plan adequate main and branch electrical service. Usually it is recommended that 3-wire service be installed from the power source to the service panel, making 115-230-v. current available at the main entrance switch. From this point on, the answer to the question of whether to rewire the house completely or to install new branch circuits is dependent on several factors and can be determined only by a complete survey of the existing installation. Inspection of existing wiring should include examination of wire splices and insulation in all junction boxes. Switches that fail to act

positively on make and break should be replaced, as defective switches may heat to the danger point if left on over long periods of time. Note also the length, location and number of extension cords that are normally used with the existing wiring, keeping in mind that all ordinary extension cords are No. 18 wire and will handle only limited current. Examine the system carefully to determine whether or not it is properly grounded. In some early installations the neutral, or grounded, wire was fused. This should never be done, as a blown fuse on the grounded, or neutral, wire removes the protection of grounding beyond that point.

A survey of the existing wiring conducted in the manner described (see also Part I of this series) will indicate wiring defects, show where new outlets are needed (also how many) and whether it is practical to regroup outlets into new circuits. Where additional outlets are necessary to bring the installation up-to-date, it will help to begin by making a simple floor plan, Fig. 11, indicating by symbols the existing outlets and those to be added.

Fig. 20, detail A, the upper plan, shows the wiring of four general-purpose circuits in a home. Circuits No. 3 and 4 are adequate, but circuits No. 1 and 2 are found to be overloaded. Because of this it is decided to take parts of these two circuits



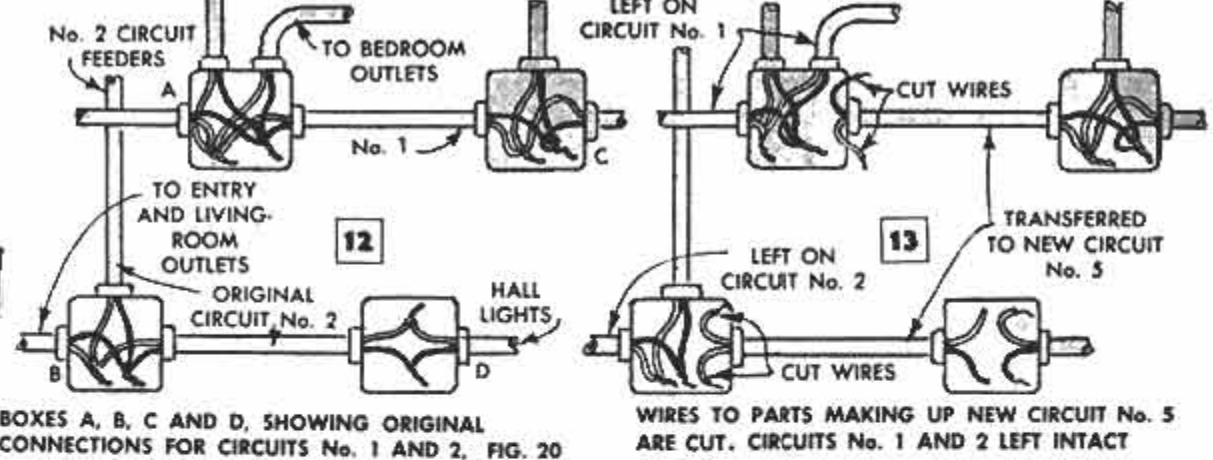

BOXES A, B, C AND D, SHOWING ORIGINAL CONNECTIONS FOR CIRCUITS No. 1 AND 2, FIG. 20

WIRES TO PARTS MAKING UP NEW CIRCUIT No. 5 ARE CUT. CIRCUITS No. 1 AND 2 LEFT INTACT

### POINTS TO CONSIDER WHEN PLANNING LOCATIONS OF OUTLETS, LIGHTS AND SWITCHES

FOR	CONVENIENCE OUTLETS	SPECIAL OUTLETS for	PERMANENT LIGHTING	SWITCHES	
Living Room Recreation Room General Living Areas	Placed so that no point along floor line of usable wall space is more than 6 ft. from an outlet	FM radio Television Room air conditioner	From ceiling, wall, cove or valance lights Switched convenience outlets may be substituted in living rooms	On latch side of each frequently used doorway  Rooms with entrances more than 10 feet apart should have multiple control switches	
Dining Areas	Near hostess' chair. Placed so that no point along floor line of usable wall space is more than 6 ft. from an outlet. One above counter or table space when next to wall		Ceiling light over table		
Bedrooms	Place outlets on each side and within 6 ft. of each bed location. Apply Living Room rule to remaining space	Room air conditioner	From ceiling, wall, cove or valance lights		
Kitchen	For each 4 ft. of work counter For refrigerator For planning desk At table space	Electric range Dishwasher-disposer Home freezer Clock Ventilating fan	Provide general light and light over sink Others over work counters as needed		
Laundry	For hot-plate, etc.	Automatic washer Electric drier Iron or ironer Ventilating fan	At washing area At ironing area		
Bathrooms	Adjacent to mirror	Built-in heater Ventilating fan	Light both sides of face at mirror One in enclosed shower compartment		
Hallways	For each 15 ft. of hallway		One at least; two in long halls		
Entrances	Near front entrance (weatherproof)		At front entrance At trades entrance		Inside front entrance Inside trades entrance
Stairways			Light at head and foot		Switches at head and foot for each light
Closets			For each closet		
Porches, Terraces, Patios	For each 15 ft. of usable outside wall (weatherproof)		For each 150 sq. ft. of porch	Inside door to porch	
Utility Room or Basement	One at workbench One near furnace	Fuel-fired heating equipment Electric water heater	For each enclosed space At workbench Near furnace At foot of basement stairs	At head of stairs or at entrance	
Attic	One for general use	Summer cooling fan	One for each separate space	At bottom of stairs	
Garage or Carport	One for general use	Food freezer Workbench Door opener	Interior light Exterior light if detached garage	At door Multiple switches at garage and house	

NOTE: The requirements given here for number and placement of outlets, lights and switches are the bare minimum requirements. For additional suggestions and more details,

ask your electric power supplier or an experienced electrical contractor about the accepted Standards of Wiring Adequacy, approved by the National Adequate Wiring Bureau.

Table courtesy National Adequate Wiring Bureau



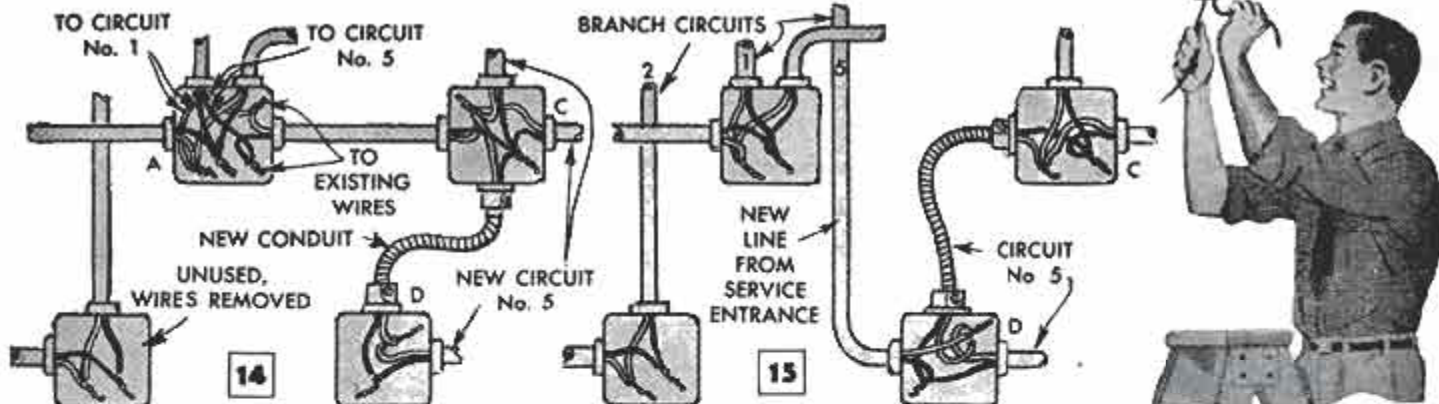

14 WIRES FISHED THROUGH EXISTING CONDUIT FEED NEW BRANCH. CABLE CONNECTS TO PART OF OLD CIRCUIT No. 2

15 ALTERNATE METHOD: CONDUIT FROM MAIN FUSE CENTER FEEDS NEW CIRCUIT. UNUSED CONDUIT, WIRES, PULLED OUT

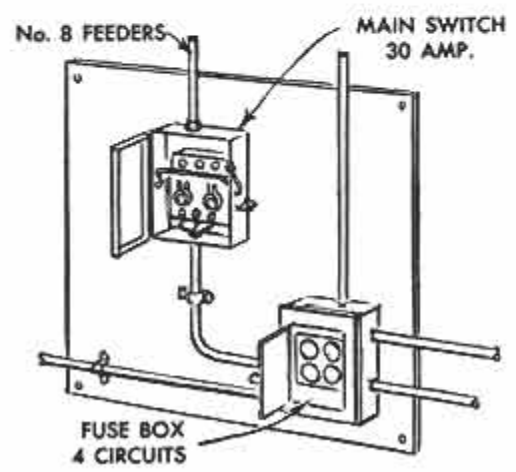

16 SERVICE, MAIN SWITCH AND BRANCH CIRCUITS INADEQUATE

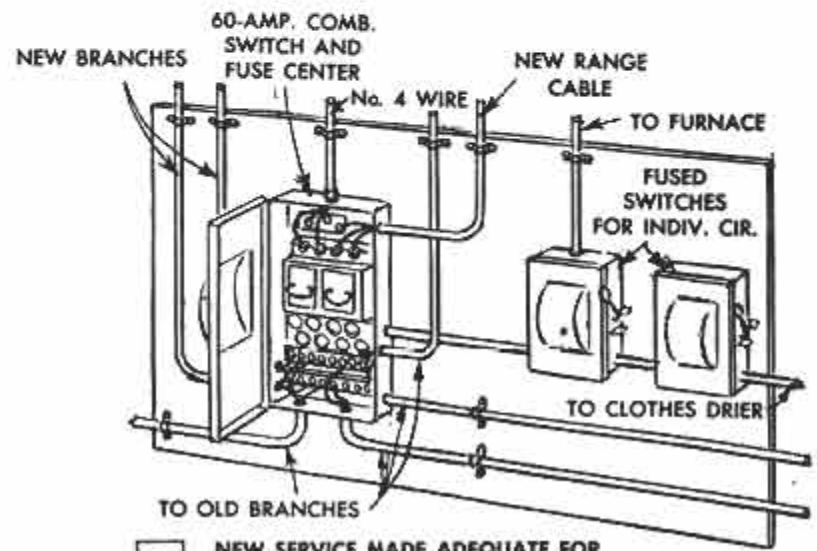

17 NEW SERVICE MADE ADEQUATE FOR PRESENT AND ANTICIPATED LOAD

and make a new circuit, No. 5, in the lower plan. Figs. 12 to 15 inclusive show how this can be done. Boxes A and B, Fig. 12, are opened and the wires to the parts of the old circuits beyond these points are cut. In some cases, additional wires can be fished through the same conduits from the service entrance to feed the new circuit, Fig. 14. In this instance, new wires from the fuse box are brought through junction box A to junction box C. The separated part of the old circuit No. 2 is connected to the new circuit by means of a new length of conduit running from box D to box C. An alternate method is to run a new conduit from the fuse box to box D and then to box C, Fig. 15. All conduits and cables not used should be removed, as they can no longer serve any practical purpose in the installation.

The plan for added circuits and new outlets may require that changes be made at the "service entrance," the term quite generally applied to the main service panel on which are mounted the main switch and fuse cabinet for the branch circuits. The units shown in Fig. 16 are more or less typical of the service entrance in older installations. Changes can be quite simple or more involved, depending on what extent it is necessary to enlarge the system. Variations, according to the requirements, are

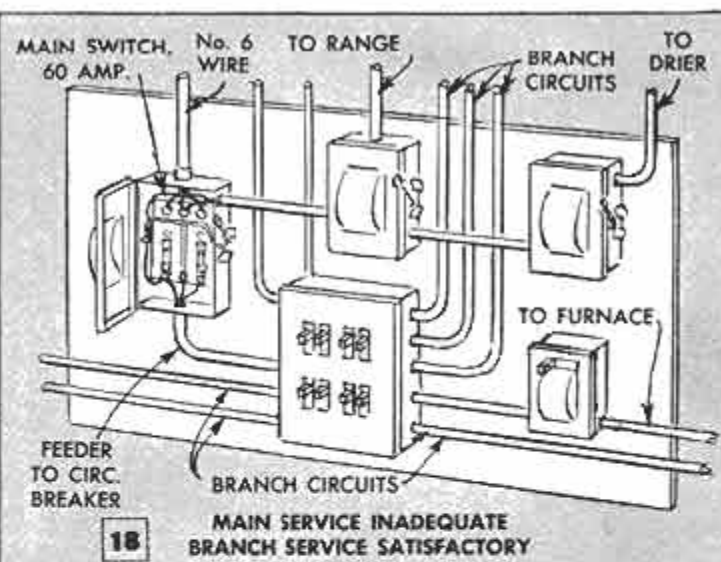

18 MAIN SERVICE INADEQUATE BRANCH SERVICE SATISFACTORY

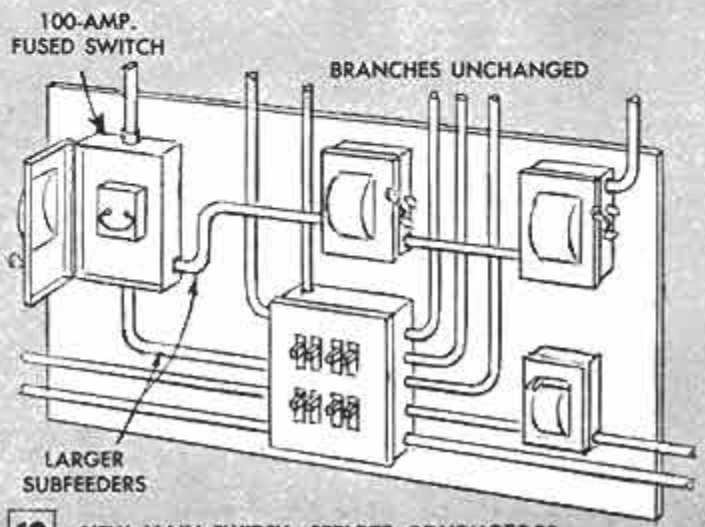

19 NEW MAIN SWITCH SERVICE CONDUCTORS



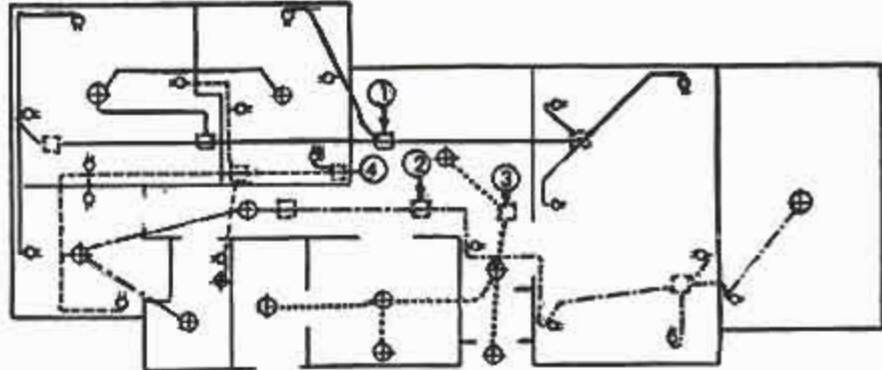

SYMBOLS	CIRCUITS
○	1 ———
⊕	2 - - - -
①	3 ······
⊞	4 - - - -

A. ORIGINAL WIRING OF GENERAL-PURPOSE CIRCUITS. CIRCUITS No. 1 AND 2 ARE OVERLOADED. REFER TO FIGS. 12, 16 AND 17. SWITCHES, APPLIANCE CIRCUITS OMITTED

B. PARTS OF OLD CIRCUITS No. 1 AND 2 ARE CUT OFF, COMBINED IN NEW CIRCUIT No. 5. CIRCUITS No. 3 AND 4 NOT SHOWN

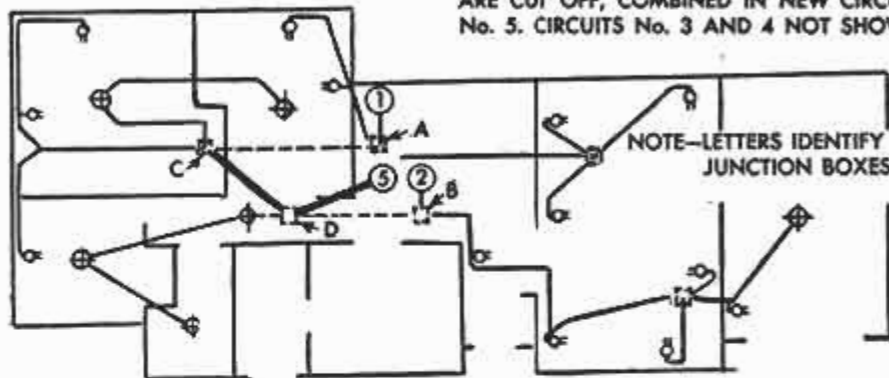

20 REGROUPING OF OUTLETS AND ADDITION OF NEW CIRCUIT

KEY	
———	OLD WIRING USED
- - - -	OLD WIRING REMOVED
———	FEEDERS TO NEW CIRCUIT No. 5

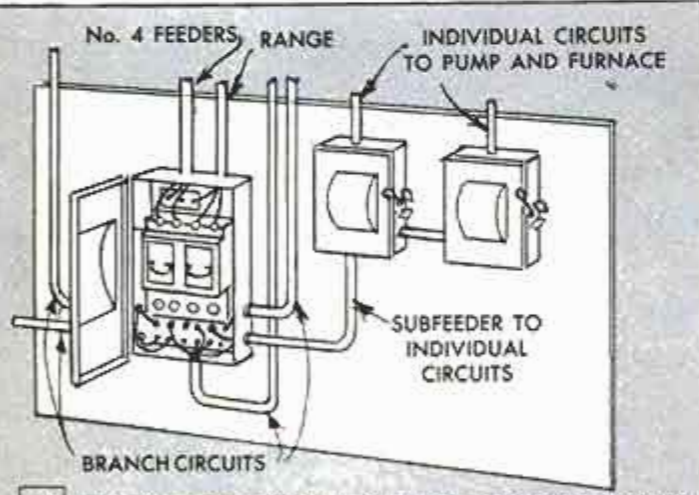

21 FEEDERS LARGE ENOUGH, BUT NOT ENOUGH BRANCHES

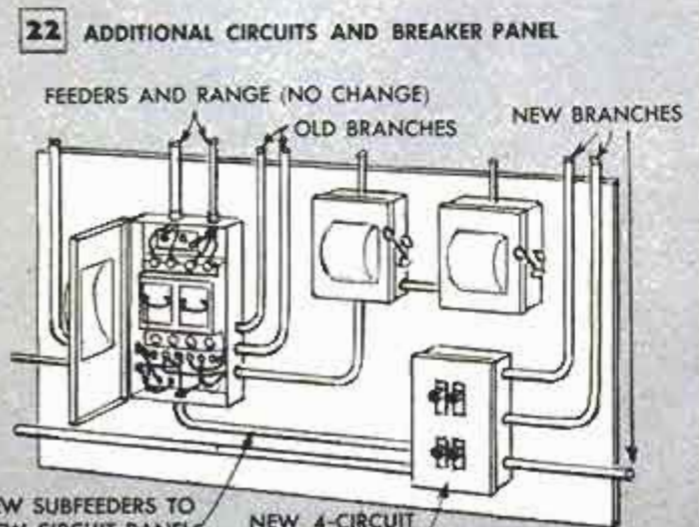

22 ADDITIONAL CIRCUITS AND BREAKER PANEL

shown in Figs. 17, 18, 19, 21 and 22. Usually the installation in Fig. 17 is considered adequate for a 60-amp. service with fused switches on the individual circuits and main feeders of No. 4 wire. In making any change it's usually best to begin with a combination unit. This consists of a main switch and fuses and branch circuit fuses or circuit breakers, all enclosed in a single cabinet, or box, as such a unit is commonly called.

In planning additions to an existing installation always consider the necessary "balance" of the main service and branch service. Fig. 18 is an example. Fig. 19 shows the installation of a new main switch and service conductors, No. 2 feeders and larger subfeeders being installed to provide adequate main and branch service. Fig. 21 shows a panel with adequate main service but not enough branches to take care of requirements. Fig. 22 shows how a breaker panel and additional circuits are added to provide for present and possible future needs.

It should be understood, of course, that the methods detailed are purely representative and are not intended to in any way supplant the recommendations of your electrician or any electrical code. ★ ★ ★



# Cross-Drilling Registering Holes in Round Stock

When more than one piece of round stock is to be cross-drilled, and the holes must register, the first piece can be used as a drill guide or template, when mounted in a V-block as shown. Both support bars must be of equal diameter to assure perfect register. The three setups detailed show how the diameter of the stock to be drilled may vary without changing the position of the hole. When holes to be drilled are larger than one fourth the stock diameter there is danger of the bit damaging the V-block as it breaks through. To avoid this make the setup on two V-blocks and space them enough to clear the drill bit.

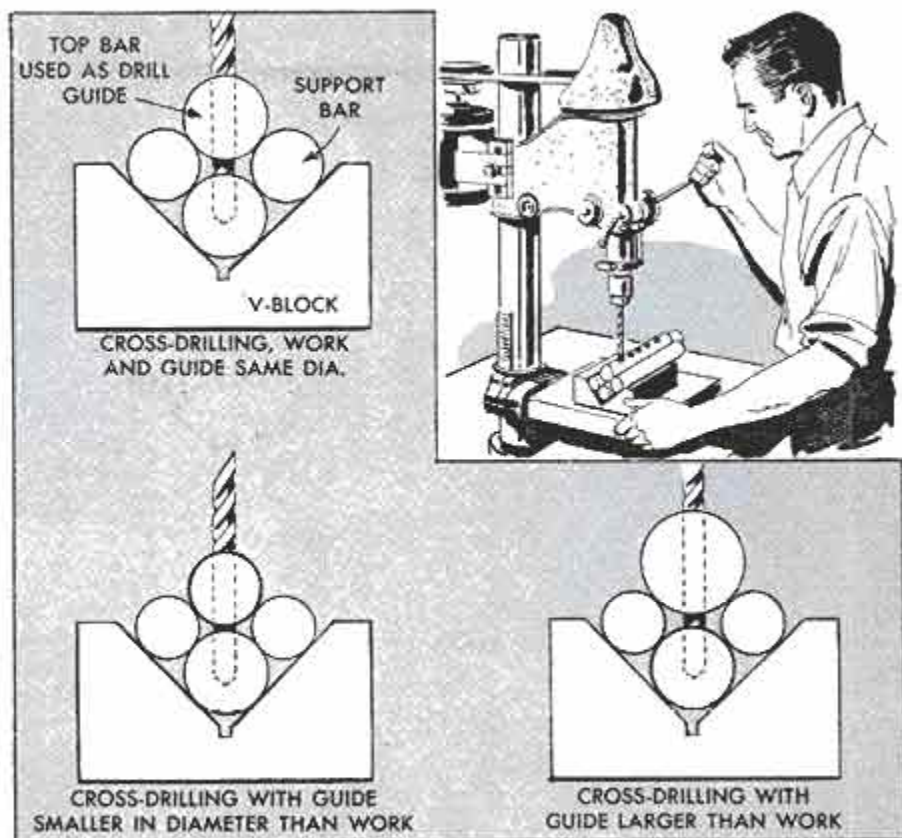

## Surface Grinder Work Kept Cool In Soluble Oil and Water Bath

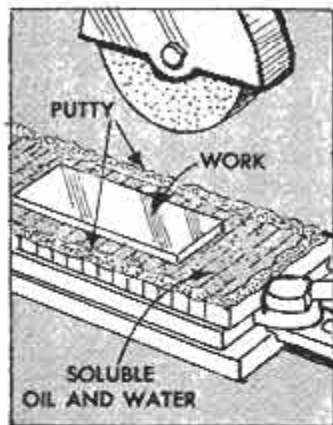

When grinding flat work on a surface grinder build a wall of putty along the edge on top of the magnetic chuck and fill the recess with soluble oil and water. The solution will keep the work cool and prevent it from warping.

## Magnetic Tray Separates Parts

Separating brass and steel nuts, bolts, washers and the like is a quick job with an easily built magnetic separator. A horseshoe magnet is fitted into a slot cut in a triangular-shaped block at right angles to the sloping face. A tapered aluminum tray, which is hinged at the top edge of the block, is shaped so its edges touch the inside corners of the projecting poles of the magnet. When small parts made of mixed metals are poured into the upper end of the tray, parts made of nonferrous metals slide off the tray at the lower end. Those of ferrous metals, such as steel and iron, are retained between the magnet poles.

## Safety Switch for Home Workshop

Children as well as adults can be protected against injury from power tools in the home workshop when a master switch and warning light are installed outside the shop entrance. The switch should be mounted in a box fitted with a cover that can be locked shut. When not working in the shop the switch is turned off and the cover locked preventing operation of the tools. The warning light works together with the switch and indicates when the shop is in use and serves as a reminder to turn off the power when leaving.

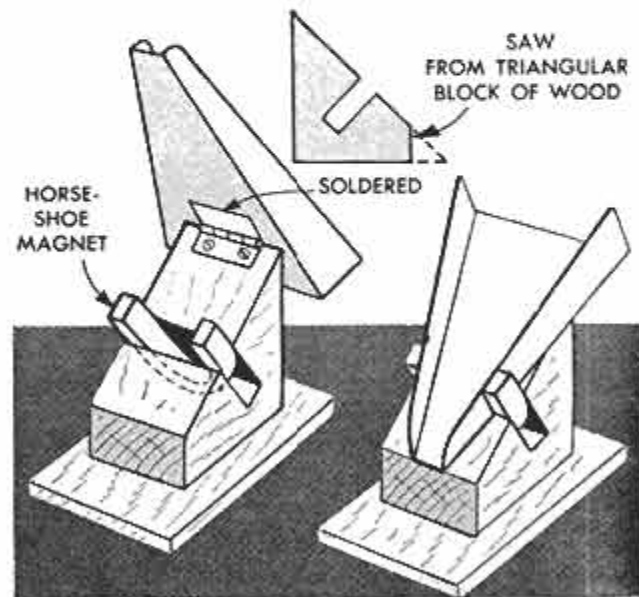



SN 58

# HOW WOULD



**1. Q—You have made a decorative box and want to finish it with a raised, textured grain. How can a drill press be used to produce this finish?**

**A—**Create the finish by brushing the wood with a coarse wire brush fitted on an arbor and chucked in the drill press. The arbor can be a threaded rod or a long bolt on which the brush is held by nuts. Safety goggles are a must for this operation

**2. Q—Pegged joints will add strength to drawers made for furniture. What is an easy way to line up the dowel holes in various parts of the assembly?**

**A—**Line up and clamp the parts as pictured, holding them on either a horizontal or vertical drill press. Drill the first hole and insert the first peg to assure alignment, then drill the rest of the holes as indicated in the inset photograph

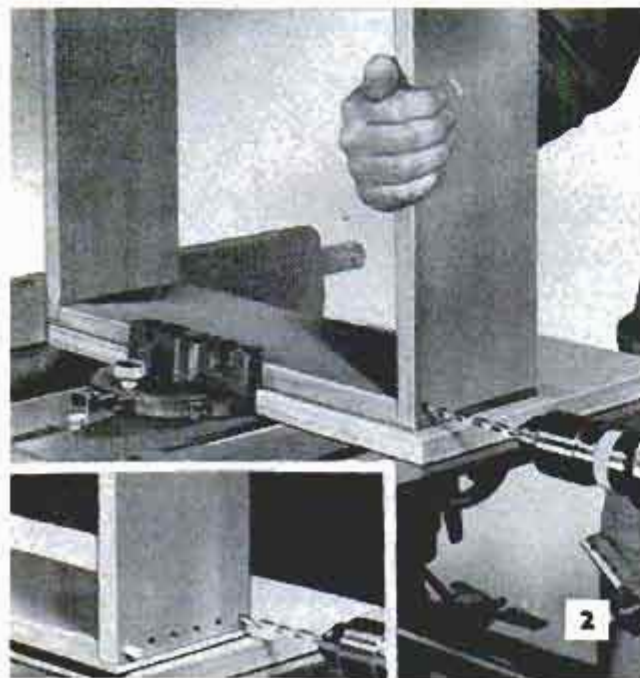

**3. Q—Dowels used for "pegging" a joint should have spiral grooves in them to permit stronger gluing. How can a drill press be used to cut the grooves?**

**A—**Make a jig consisting of a block of wood with a hole bored through it to accommodate the dowel, and clamp it to the table. A 1/16-in. router bit in the drill press cuts a shallow groove in the dowel as it is pushed through the block and rotated

**4. Q—What drill-press accessory can be used to make dowels to match a piece of work, and how can dowels be cut directly onto a work piece?**

**A—**A plug cutter is used to cut the dowels from a scrap piece of the wood used for the job as shown in the inset. Dowels are formed on the ends of work pieces by the cutter. Corners are sawed off squarely to shoulder the ends

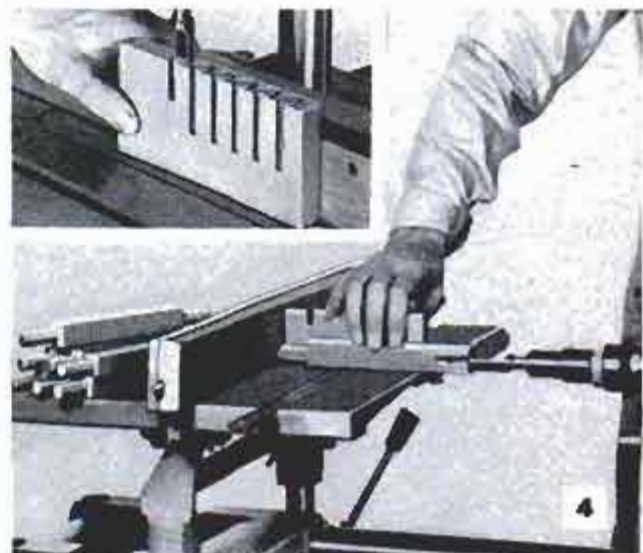
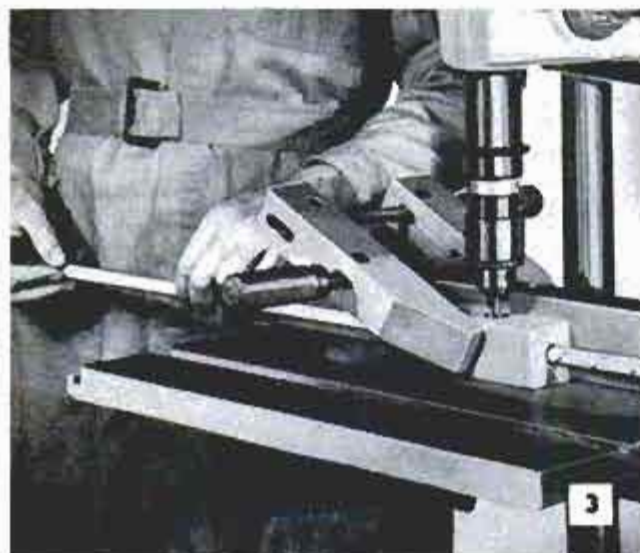



# YOU DO IT?

**5. Q—After making a wooden wheel or disk it is necessary to cut a groove in the outer edge. How can a drill press be used to cut the groove?**

A—A pivot jig fitted in the slot of a tilting drill-press table will permit the wheel to be rotated under a router bit chucked in the press. If there is no center hole, use a "V block" consisting of two 2 x 4s on which the wheel is rotated under the router bit

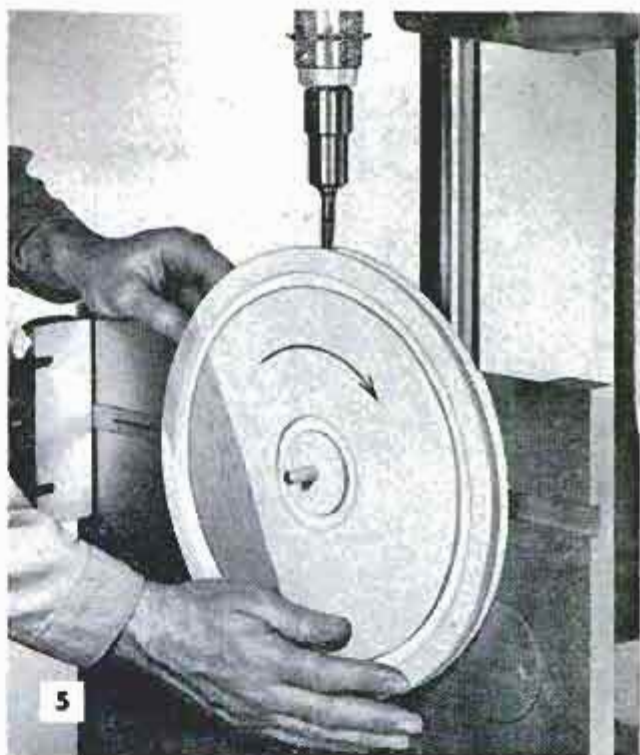

**6. Q—How can holes be drilled accurately in the center of a number of wooden dowels that are to be used as drawer handles?**

A—Drill a hole in a block of wood large enough to accommodate the dowels, then cross-drill the block at right angles to make the jig shown. The jig holds the drill bit in a vertical position so it will not slip off the rounded surface of the dowel

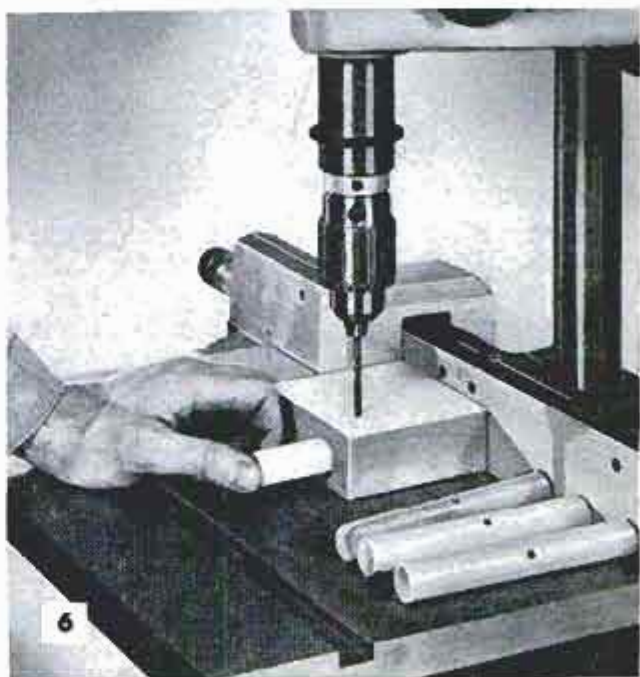

**7. Q—What tool is used for cutting large holes—1-in. dia. and larger—on a drill press, and what is the prime safety factor to be observed when it is used?**

A—Large holes are cut, rather than bored, by the use of a fly cutter as shown. The cutter is adjustable to any diameter within the limits of the extension arm. For safety, the work always should be clamped firmly to the table of the drill press

**8. Q—What simple setup can be used on a drill press to accurately drill holes all around the edge of a large-diameter wooden disk or wheel?**

A—Equip the drill-press table with a pivot pin to fit a center hole in the wooden disk, or temporarily drive a wood screw through the center, so the disk can be rotated past the drill bit. This will work with either a vertical or horizontal drill press

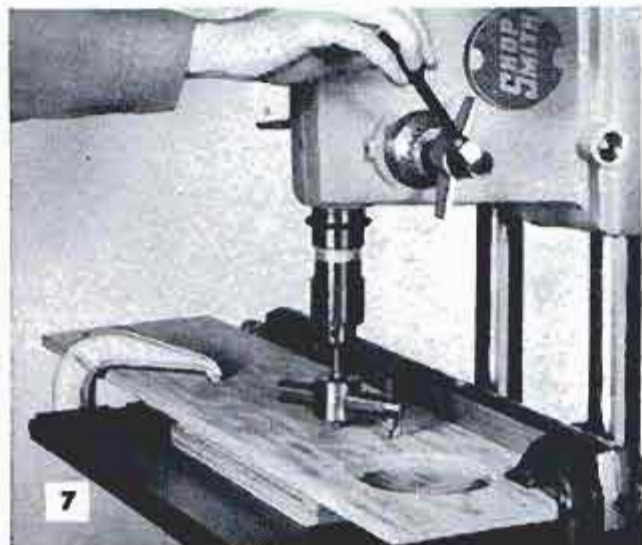



## Roller Chain Clamped in Vise Holds Pipe for Threading



When a pipe vise is not at hand, a length of roller chain, such as bicycle chain, clamped in a bench vise will hold a length of pipe for threading. Loop the chain over the pipe as shown and when the jaws of the vise are closed the chain will be pulled tight around the pipe.

Victor H. Lamoy, Upper Jay, N. Y.

## Rubber Tip on Speed Indicator Provides Better Shaft Contact

Most speed indicators are equipped with small tips, which may slip and be difficult to center on large work. In such cases a rubber nipple, of the kind used on auto distributors, slipped over the end of the indicator shaft, will provide a much larger pressure surface when it is brought in contact with a large, slow-speed shaft.



## Notched Eraser Polishes Rods

An abrasive ink eraser can be used to polish slender metal rods rotated in a lathe or drill press. Notch the eraser at one end with a hollow leather punch or a round file to an arc slightly smaller than the diameter of the rod to be polished. When held against the rod, the notch keeps the eraser from slipping off the work, and the smaller arc creates friction for polishing, allowing also for wear.



## Barn-Door Stanchion Gate

Just swing this stanchion gate across the doorway of the barn to catch and hold any calf, steer or cow. Strap hinges are welded to one side of the gate and slip over heavy screw hooks placed in the doorframe. The other side of the gate is equipped with a latch which locks into the frame, or into the opposite door of a double opening. The stanchion is closed by pulling on a rope, and is held closed by a catch which slips into an adjustable clamp. Lifting a bar on the catch frees it, releasing the animal. A spring on the end of the stanchion bar returns it to the open position.







**AS A MAN OF MECHANICAL ABILITY  
YOU CAN TRAIN IN YOUR SKILL...  
ADVANCE IN YOUR GRADE...  
DOING WORK THAT YOU LIKE...  
WHILE PREPARING FOR YOUR FUTURE  
IN THE UNITED STATES AIR FORCE!**

**You go places  
faster  
in the  
U. S. AIR FORCE**

**PASTE COUPON ON POSTCARD and mail to**

**Airman Recruiting Information Branch  
Box 2202, Wright-Patterson AFB, Ohio**  
Please send more information on my opportunities for  
enlisting in the U.S. Air Force. I am between the ages  
of 17-34 and reside in U.S.A. or possessions.

Name \_\_\_\_\_

Address \_\_\_\_\_ Age \_\_\_\_\_

City \_\_\_\_\_ Zone \_\_\_\_\_ State \_\_\_\_\_



# The happiest gifts

(And your Kodak dealer will gladly help you

## Complete ready-to-use photoflash outfits . . .



Exciting outfit for beginners, takes snaps 'round the clock: Brownie Holiday Camera, flashholder, batteries, bulbs, film. Complete Brownie Holiday Flash Outfit, **\$9.95**. Camera alone, **\$4.95**



Brownie Hawkeye makes 12 snapshots per roll of black-and-white or color film. No "settings" to make. Just aim 'n shoot! Brownie Hawkeye Flash Outfit complete, **\$13.95**. Camera alone, **\$7.45**



Kodak Duaflex IV Camera lets you see exactly what you get *before* you snap! Kodak Duaflex IV Flash Outfit complete, **\$22.50**. Camera alone, **\$15.95** (Deluxe Duaflex IV  $f/8$  Flash Outfit, **\$33.75**)

## Deluxe Kodak gifts for color-slide fans . . .



Thrifty, capable Kodak Pony 135, Model C, features fast  $f/3.5$  lens,  $1/300$  shutter, easy operation. With flashholder and case, Kodak Pony 135 Outfit complete, **\$49.65**. Camera alone, **\$33.75**



Kodak Signet 40 Camera, the superb new pacesetter in its field, features  $f/3.5$  lens,  $1/400$  shutter, unusual handling ease. Kodak Signet 40 Camera, flashholder with 3- and 4-inch reflectors, **\$65**



Kodak Stereo Camera makes 3-dimensional color slides snapshot-easy. Finest quality throughout. Kodak Stereo Outfit (camera, Stereo Viewer I), **\$97.25**. Camera alone, **\$84.50**. Viewer I, **\$12.75**



Kodak Retina IIIc Camera—world famous for top versatility. Built-in light meter . . .  $f/2$  lens. Accepts complete family of Kodak Retina aids. Kodak Retina IIIc Camera, **\$190**; Retina IIc, **\$139.50**

## To project color slides big-as-life . . .



Kodaslide Signet 300 Projector with Automatic Changer. Gives big-screen sparkle to any  $2 \times 2$  color slide. Blower keeps slides cool. **\$69.50**

Kodaslide Signet 500 Projector. Same superb optics, top-quality versatility of Signet 300 (above), but with 500-watt lamp for extra-bright pictures at long range. **\$82.50**. Many Signet models to choose from.



# come from Kodak!

choose just-right photo gifts for everyone...)



**Cine-Kodak Showtime 8 Projector**  
—Ultra-bright beam for sparkling big-screen 8mm pictures. Quiet, e-a-s-y operation. Built-in case. Lifetime lubricated. Only **\$115**

**8mm home movies—finest family gift of all...**



Amazingly low-cost outfit for indoor-outdoor movie-making. **Brownie Movie Camera f/2.7** handles with snapshot ease. **Brownie 2-Lamp Movie Light** attaches right to the camera. **Brownie Movie Camera Kit f/2.7** complete, **\$34.90**



**Brownie Movie Camera, Turret f/1.9**, gives you 3-lens versatility at a 1-lens price! Takes regular, wide-angle, and telephoto movies *in full color*. Only one easy setting to make, then aim 'n shoot. It's just as easy as taking snapshots. Only **\$79.50**



Complete movie-making outfit, with everything needed for taking and showing 8mm full-color movies: easy-to-use **Brownie Movie Camera** with fast **f/2.3** lens, a versatile **Brownie Movie Projector**, and a handy preview screen. **Brownie 300 Movie Outfit** complete, **\$99.50**

## Kodak photo aids

Popular sizes of black-and-white roll film, from 45¢; color film, from \$1.

**For movie makers:** Kodachrome 8mm Film, \$2.40; new Brownie Movie Titler Outfit, \$14.95; Kodak Converters for Brownie Movie Camera: Wide-angle, Telephoto, \$16.95 each. **For color-slide fans:** Kodalite Dial-Lite Viewer, \$12.95; Kodalite Pocket Viewer, \$1.95; Kodalite 400 File Box, \$5.75. Kodak Filter Kits, custom-made for still or movie cameras, from \$6. Kodak Photo-Hobby Outfits, from \$9.95. Photo books—all subjects—from 35¢. Many other gifts to choose from.



**If it's made by Kodak—you know it's good!**

*Prices are list, include Federal Tax where applicable, and are subject to change without notice*

**EASTMAN KODAK COMPANY** Rochester 4, N.Y.

**Kodak**  
TRADE-MARK



# Nicholson Joint Quiz

How many of these woodworking joints do you know?

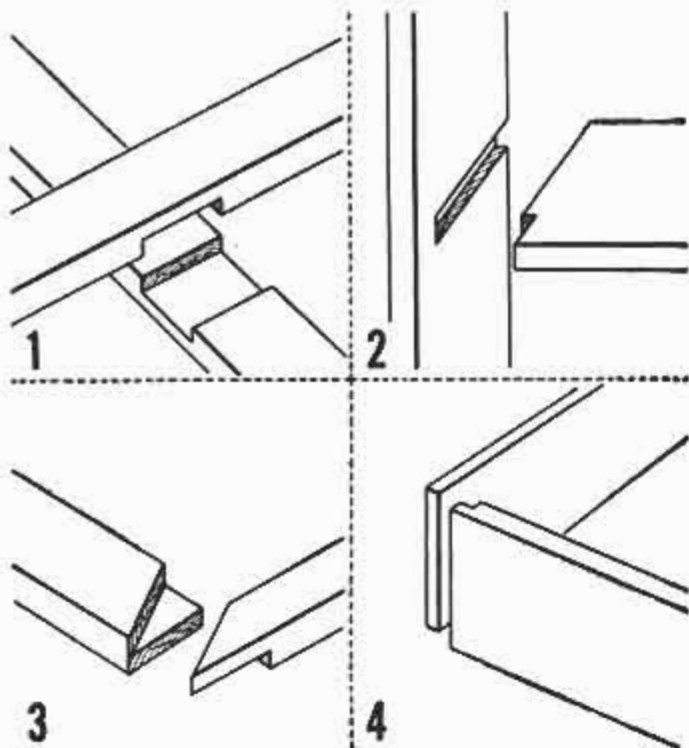

Answers: 1. Cross lap. 2. Blind dado. 3. Mitered half lap. 4. Rabbet.

You home workshop hobbyists use joints in practically every project you undertake. And if you're hep, you also use Nicholson or Black Diamond cabinet files and rasps to make those joints fit as snugly as possible. Even the most accurately cut joints require that extra touch of smoothness that only fine files can produce—files by Nicholson and Black Diamond.

**FREE!** "File Philosophy," 49-page book on types, use and care of files. Excellent handbook for the do-it-yourselfer. Write for your copy soon.



**NICHOLSON FILE COMPANY**  
Providence 1, R.I.

(In Canada: Nicholson File Company of Canada Ltd., Port Hope, Ontario)



**NICHOLSON FILES**  
A FILE FOR EVERY PURPOSE

# Clinic for Homemakers



As a service to our readers in solving the hundreds of problems pertaining to a home—inside or out—the editors of *Popular Mechanics* invite you to present your problems to The Clinic Editor for help and advice. Address your questions to The Clinic Editor, *Popular Mechanics Magazine*, 200 East Ontario Street, Chicago 11, Ill.



## Faulty Receptacle

**Q**—Recently I noticed, quite by chance, that the plug on a light cord was rather hot to the touch. The plug seems to be in good condition, also the cord, which is connected to a 150-w. lamp. Why does the plug heat, when it is not overloaded? What should I do about it?  
L. K., Pa.

**A**—Poor contact between the prongs of the plug and the spring contacts in the receptacle is one common cause of heating of the plug. Faulty contact results in arcing, and while this may be very slight, it still is sufficient to generate considerable heat over a period of time. You may be able to remedy the trouble temporarily by bending the prongs of the plug slightly. As a rule it is best to replace the receptacle at the outset, as heating due to a defect at any point in the wiring system increases the fire hazard. Replacing a faulty receptacle is a fairly simple procedure, but unless you feel fully qualified, call your electrician. If you do the job yourself, be sure to open the main switch at the service entrance before removing the cover from the receptacle.



## Lumber Rack

**Q**—I want to build a lumber, or stock, rack for my basement workshop. I want the rack attached to the wall which is built with an offset, the 2x6 sill being exposed. Do you have a suggestion for making a rack of this type?  
E. H., Ore.

**A**—We are assuming from your description that the wall is either poured concrete or concrete masonry to the grade level and that the studding extends down to the sill, a part of the total basement height being above grade. If this assumption is correct then one way is to determine the length of the rack required, stand 1x2 strips, preferably hardwood, on the floor against the wall and mark the upper ends flush with the top of the sill. Cut to length. Be sure to mark the location of each strip on the wall, as there may be some variation in length. Plan to locate the strips about 3 ft. apart along the wall. Next, cut pieces from the same stock about 10 in. long, the same number of short pieces as there are long pieces. Screw one end of each short piece to the top of the sill so that the strip projects out at right angles to the

(Continued to page 226)



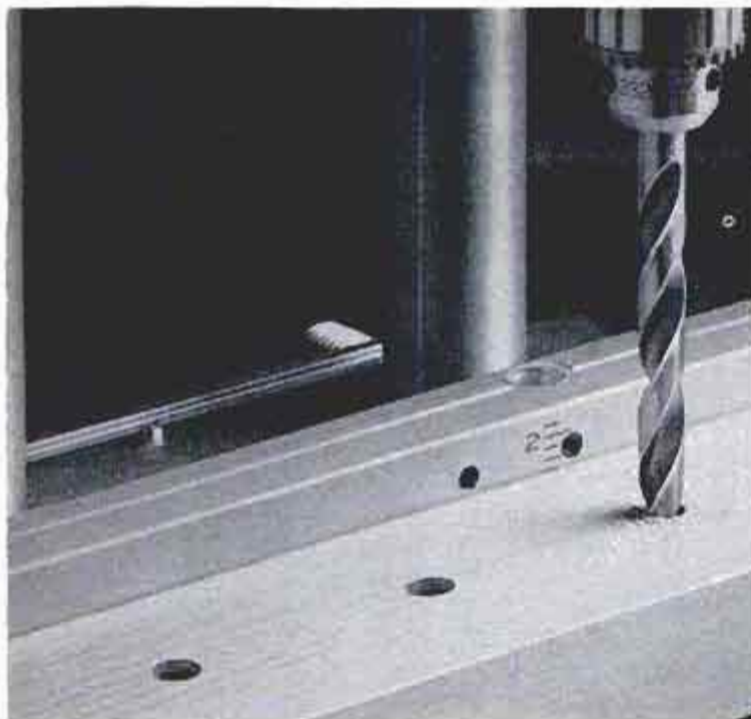

**NO MORE STALLING!  
NO MORE BURNING!**

This year give him **SHOPSMITH**—the complete workshop in one unit!



**EXCLUSIVE  
SPEED-DIAL**

SHOPSMITH® as a Vertical Drill gives you more advantages than any other drill press! Exclusive Speed-Dial control with Power-Shift gives you unmatched accuracy and safety. You dial correct drill speeds from powerful 700 rpm for large bores or metal, to 5200 rpm for plastics and small bores.

In addition, SHOPSMITH is *all* the five major power tools you need to complete any job: 9" Saw, 12" Disc Sander, 16½" Vertical Drill, 34" Lathe, and unlimited-capacity Horizontal Drill — all in one compact unit! The built-in ¾ hp motor, all belts and pulleys, are enclosed for safety. See SHOPSMITH demonstrated at leading hardware and department stores, or at any Montgomery Ward store.



MAGNA POWER TOOL CORPORATION  
America's Finest Power Tools

® T. M. REG.

**CHRISTMAS  
SPECIAL!**

Buy your Shopsmith in December and  
get 10 FREE WOODWORKING LESSONS!



**Mail Coupon for 3 free books**

- 1** "Project Digest," 36 pages of modern woodwork projects.
- 2** The valuable home-shop guide: "What to Look for When you Buy Power Tools."
- 3** Illustrated 20-page SHOPSMITH catalog.

**MAGNA POWER TOOL CORPORATION**  
Dept. 501-M, Box 2808, Ft. Wayne, Indiana, or Menlo Park, Calif.

Name \_\_\_\_\_

Address \_\_\_\_\_

City \_\_\_\_\_ Zone \_\_\_\_\_ State \_\_\_\_\_

If you own SHOPSMITH check whether model Mark 5 \_\_\_\_\_ or 10ER \_\_\_\_\_

**ONLY SHOPSMITH LETS YOU COMPLETE THE JOB!**



## HOW TO FINISH-OFF YOUR ATTIC



### The Fiberglas Do-It-Yourself Bug makes it easy to do . . . with this FREE book!

It's a simple job to finish your attic, add an extra room, enclose a porch or build a screened patio, when you use this 16-page book as a guide. Complete step-by-step instructions take you from start to finish in easy stages and with lots of pictures.

The book even shows how fuel savings *alone* can pay for all the insulation . . . if you install the necessary amount of Fiberglas\* Insulation. You'll find out why you need *fully* adequate insulation—not just minimum amounts—to enjoy low-cost comfort *all year 'round*. So for the *easy* way to add a room or finish an attic, and the *right* way to fully insulate for a warmer house in winter at lower fuel cost, and a cooler house in summer, rush this coupon for your **FREE BOOKLET** today!



OWENS-CORNING  
**FIBERGLAS**

\*T.M. Reg. Owens-Corning Fiberglas Corporation

Owens-Corning Fiberglas Corporation,  
Dept. 178-L, Toledo 1, Ohio

Please rush me a FREE copy of the Fiberglas "How To Do-It-Yourself" book.



Name.....

Address.....

City.....Zone.....State.....

(Continued from page 224)

wall. Each short piece should be located at the point where each long piece is to be placed, the wall having been previously marked. Then simply place the long piece under the projecting short piece and drive a screw into the end of the long piece. This gives you a vertical strip standing against the wall with the short piece projecting 10 in. from the wall to form a top shelf, or rack. Proceed in the same manner at each spacing. Then screw shelf brackets to the vertical strips, spacing them vertically as desired.



### Cementing Glass

**Q**—Is it possible to cement cracked glass successfully? I want to salvage a cracked glass panel which is very old and has been hand-painted with a very attractive design which I wish to preserve if at all possible. The panel is about 8 x 12 in. and a corner has been broken out. I want to cement it if possible and replace in the old frame in which it was originally fitted. Can it be done?—C. S., Me.

**A**—Yes, but it's a tricky job at best. If the break is clean and the edges unchipped the chances of success are somewhat improved. It will not be possible to conceal the break entirely. It will be visible when the panel is viewed at an angle. If you wish to try, then perhaps the best way is to place the panel on a level, flat surface with a single sheet of paper underneath. The paper must be flat. Do not use a sheet that has been folded. There are a number of cements suitable for joining glass, but we believe you would have better success by using an ordinary household cement. Place the cement on both joining edges of the glass and wipe off the excess. Allow the cement to set to the tacky stage, then press the joining edges of the glass together, making sure that they are not offset at any point. Be sure to allow plenty of time for the cement to dry before moving the panel.

### Lawn-Sprinkler System

**Q**—I'm thinking about installing a lawn-sprinkler system this coming spring, using plastic pipe underground. What troubles me is the possibility of freezing damaging the pipe and how to provide for draining the system after the season's use. Will freezing break plastic pipe, and will it be necessary to provide for draining the system? I am planning to lay the pipe in trenches about 16 in. deep with a sufficient number of sprinkler heads to cover the entire lawn.—C. C., Ky.

**A**—Ordinarily plastic pipe is sufficiently flexible to prevent its bursting should the water in the pipe freeze. However, there are other factors such as the nature and type of soil in which the pipe is laid and the heaving action of frost. The latter action may be sufficient to cause breakdown of the pipe sections, one reason being that when subjected to prolonged cold plastic pipe becomes rather brittle. If the pipe is filled with water at the time of freezing, slight movement of the earth due to frost action may break it. For these reasons we think it would be advisable to provide a means of draining the entire system at the end of each sprinkling season. In a level lawn this may pose something of a problem, but usually it is possible to connect the system to the basement drains or to a nearby natural waterway. Of course, it will be necessary to provide a shut-off valve in the line leading to the drain, also it will be necessary to calculate the fall to the drain from all areas of the lawn in order to assure complete drainage of the system when the valve is opened. Before making the installation we suggest that you get in touch with the manufacturer of the pipe you intend to use and get his recommendations for this type of installation. Also, it might be helpful to ascertain the average frost line for your locality so that trenches can be dug to the proper depth.



**ALL WRAPPED UP FOR YOUR CHRISTMAS!**  
 DISSTON'S World-famous D-23 hand saw—only \$895  
 DISSTON-CARLSON 10 ft. Steel Tape Rule—only \$325  
 Both together . . . \$1220



## Disston tools make fine gifts for the whole family!

DISSTON CARLSON steel tape rules are sturdy, easy to read, famous for high quality. The #3310 has a 10-foot reach; is 3/4" wide; has patented swing tip and 10-second blade change features.



### A tip for FATHERS

If your youngster has his eye (and his hands) on your tools, you can make his Christmas merrier with a grown-up gift of a Disston D-23 Hand Saw and a Disston Carlson Rule. He'll get a lifetime of satisfaction from these fine tools. And both you and your son will find you have more family fun when you join forces and "do-it-together."



### A hint for SONS

Wondering what to get Dad for Christmas? How about a Disston D-23 Hand Saw and a Disston Carlson Rule? Dad will really appreciate these

fine gifts—and be proud of you for being smart enough to buy Disston. Disston, you know, is the saw carpenters use. If Dad already has a 5½-pt. or 8-pt. Disston, get him a 10-, 11-, or 12-pt. for fine finishing work.



### AND a word for MOM!

You can keep *all* the men in your family happy, Mom, with Disston tools for Christmas. (It's a good way to get some work done around the house, too.)

*Prices vary slightly in some localities.*

**SEE . . . TOUCH . . . and TEST**

these and other fine Disston Tools  
 at your favorite hardware or tool store.  
 Stop in tomorrow . . .

**DISSTON-HKP**  
 Henry DISSTON DIVISION  
 H. K. PORTER COMPANY, INC.  
 Philadelphia 35, Pa.



# Looking for Something?



## BUILDING MATERIALS



## FROM BRICKS TO ROOFING MATERIALS WHATEVER YOU NEED

Find It Fast  
In The  
Yellow Pages



Ads with this emblem make your shopping easier

## Goal No. 2

### Winning the War Against Insects

(Continued from page 152)

unusual ability to develop huge populations in American cornfields. The borer had arrived in the United States unattended—it had left its natural enemies on the other side of the Atlantic. In 1920 scientists of the Department of Agriculture began a search that lasted for two decades and resulted in the successful introduction from Europe of several parasitic flies and wasps that prey upon the borer. Today these beneficial insects, working practically unnoticed in our cornfields, are proving quite successful in holding down borer infestations in the eastern states, and effecting limited but growing control of borers in the Corn Belt.

In further evidence of the value of basic knowledge: Modern control methods in general use by Corn Belt farmers take into account the fact that throughout the Midwest there are two broods of the borer each growing season. The first brood feeds in the leaf whorls and on the silks and ears; the second tunnels into the stalks and ear shanks of maturing corn. Entomologists have searched out corn plants that inherently discourage leaf feeding by the first brood borers. They have found other plants with enough stalk strength to withstand tunneling by the second brood. It is reasonable to expect that one day varieties of corn highly resistant to attack by the corn borer will be widely grown in this country.

Corn strains with these resistance characteristics are being combined into high-yielding commercial hybrids. Chemists have developed certain chemicals into highly effective borer-killing insecticides to knock out the first brood before it begins feeding; engineers have developed high-clearance machines that deliver sprays into the leaf whorls of young plants without mechanical damage to the crop. This year farmers are using a new weapon—DDT granules—that they can sift into the leaf whorls from a rig that looks like a grain drill on stilts.

The corn-borer story serves to illustrate that despite our achievements with methods, materials and machines we can only insure our well-being in the face of such menacing pests by constantly searching for better weapons and by the farmer's effective use of those weapons.

Now let's take a more analytical look at our original "success" stories about cotton insects, the Hessian fly, and the khapra and the Japanese beetles.

Thimet, developed by the American Cyanamid Company, is a systemic insecticide

(Continued to page 230)



# PERFECTLY BALANCED for easier one-hand operation!

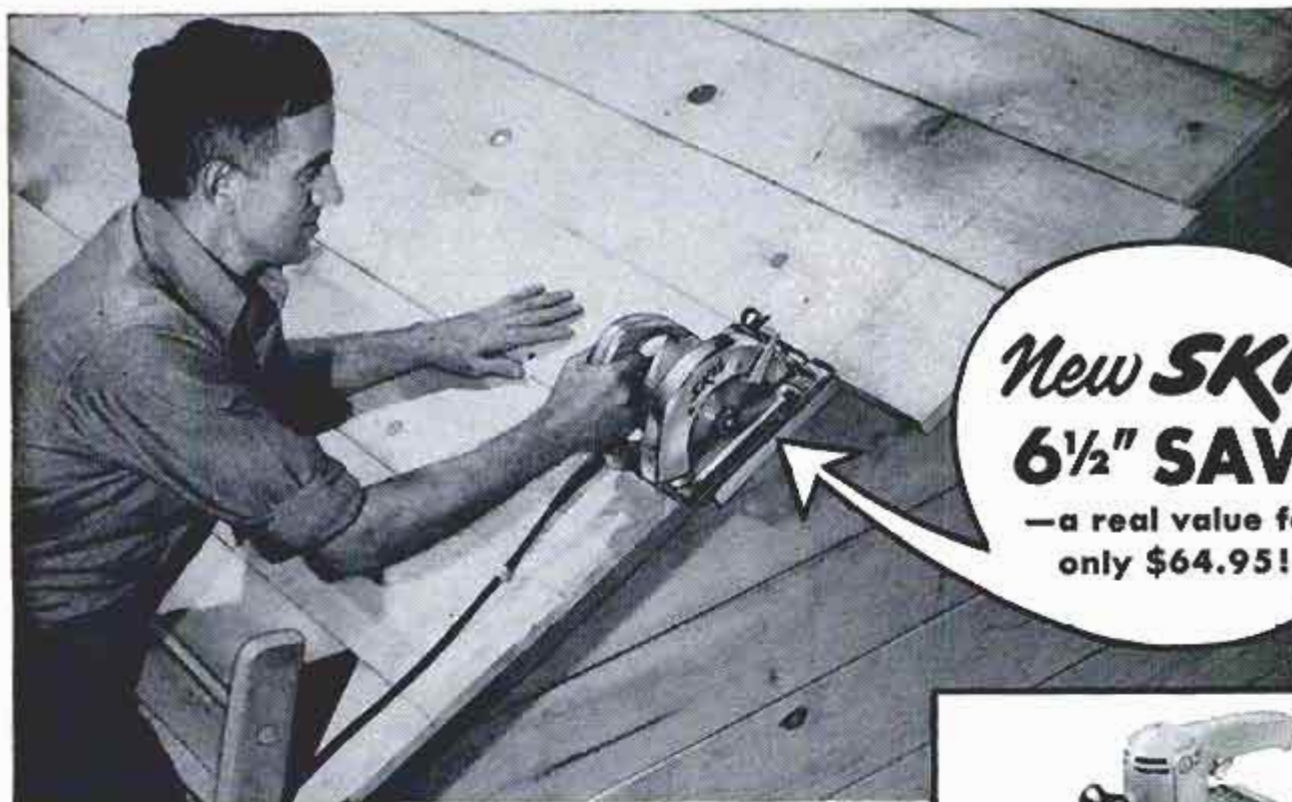

**New SKIL  
6 1/2" SAW**  
—a real value for  
only \$64.95!

Any experienced craftsman will tell you that a power saw should be *easy to handle . . . powerful . . . able to make all cuts with quick, simple adjustments*. Because the SKIL Saw is superior in all these ways, it is the favorite of those who know tools best.

For example, the SKIL Saw *balanced design* lets you cut faster and much easier. Take a SKIL Saw in your hand . . . it's always in a level, horizontal position, and the other hand is free to hold the work.

In every detail, SKIL Saw gives you the *feel and performance* of a quality tool. Its telescopic automatic blade guard for greater safety . . . fingertip bevel and depth adjustments for flexibility of use . . . hardened steel helical gears for full power and longer life—are just a few of the many valuable features that make the SKIL 6 1/2" Saw outstanding.

See it and other famous SKIL Tools at your hardware or lumber dealer today.



**SKIL Orbital Sander—  
Model No. 592**

Sands flush into corners . . . right up to vertical edges. Abrasive paper clamps hold up to six sheets for fast paper changes. TUF-TEX finish for sure grip. Only \$49.95.



**SKIL Drill Kit—  
Model No. 587**

Use it for drilling, sanding, grinding, polishing, and many other household jobs. Includes Model 549 Drill with geared chuck, 10 accessories, carrying case. Only \$29.95.

• • • • •

**LOOK** for this SKIL Tool Center Display at your local hardware or appliance dealer . . . or any leading department store . . . for the finest in power tools.

**OVER ONE MILLION  
SKIL SAWS IN USE**



Made only by SKIL Corporation  
formerly SKILSAW, Inc.  
5033 Elston Avenue, Chicago 30, Illinois  
3601 Dundas Street West, Toronto 9, Ontario  
Factory Branches in ALL Leading Cities







© Wynn Oil Company 1956

FOR  
MAKING  
**WYNN'S FRICTION PROOFING**  
**NUMBER ONE!**

The Sixth Popular Mechanics Automotive Study to find brand preferences among its readers, lists Wynn's Friction Proofing as the number one additive on the market.

If you aren't using Friction Proofing\* in your car--try it today. Make your car a Wynner and you'll know why Wynn's Friction Proofing is at the top of the list with readers of this magazine . . . people who *really* know cars.

The proof of Friction Proofing\* is in the performance--greater horsepower, quicker starts, less gas and oil consumption . . . and, Friction Proofing\* is a safeguard against costly repairs to engines, radiators and transmissions. Ask your garageman, service station or new car dealer for the finest--Wynn's Friction Proofing--the can with the red and black bullseye.

*Also available in Canada and everywhere in the free world.*

\*Friction Proofing is Wynn's trade mark for its exclusive metal conditioner which reduces friction between moving metals by chemically smoothing and sealing the surfaces. Manufactured by Wynn Oil Company, 1151 West Fifth Street, Azusa, California, U. S. A.

that "bites back." It is one of the newest and perhaps the most powerful single weapon ever directed against cotton pests. Unlike other cotton insecticides, Thimet is not sprayed or dusted upon the growing cotton. Instead, seed is treated with the chemical, usually by seed suppliers. An organic phosphate, Thimet is absorbed into the seed and grows up with the plant. Thus, being in the "system" of the plant, rather than a surface veneer of spray or dust, Thimet does no harm to beneficial insects, cannot be washed away by rain. But for nine weeks or more, plants sprouting from the seed so treated will kill thrips, aphids and mites. It has even proved lethal to the boll weevil when he moves into the field before Thimet's killing power wanes.

The Hessian fly is an old-timer--and a long-time enemy of the man who grows wheat and barley. It is believed to have reached the United States in 1776 on the bedding straw of Hessian soldiers.

Farmers throughout the winter-wheat belt annually save themselves about \$60,-000,000 by carefully following two simple, but fundamental, practices: They seed their wheat late enough in the fall so that the autumn generation of flies is denied green sprouting grain upon which to lay eggs; they plant varieties of wheat of a genetic make-up that resists feeding by the fly.

The khapra beetle, an "inside" insect that attacks stored grains and seeds, is a newcomer to the United States. It was first discovered in a warehouse in Tulare County, Calif., in 1953. The khapra beetle is so tiny that it can hide in cracks that insecticide sprays won't penetrate; so prolific that a single pair can produce literally millions of offspring in a period of six to eight months; so destructive that it could become America's worst stored-grain pest. Unlike the casual reception given the corn borer, state and federal officials moved in rapidly on this insect. They carried out a survey to define the limits of infestation and established a quarantine to prevent further spread. They have pinned it down to some 410 grain and seed storage structures in California, New Mexico.

Scientists found that the beetle could be killed with a high-powered fumigant, methyl bromide. But how was a gas of this kind to be distributed evenly throughout a tremendous storage building? All it required, they found, was enough fumigant, enough gas-tight plastic and adequate means of circulating or distributing the gas within the enclosure. Made-to-order nylon plastic tarps, clamped together with airtight seams, are spread over acres of buildings, then fans circulate tons of fumigant.

(Continued to page 231)



ASSEMBLE YOUR OWN

**Electro-Voice®**

HI-FI SPEAKER CABINET

It's easy and economical. Take your choice of seven KD speaker cabinets priced from \$26 to \$118. You save as much as 50% when you do it yourself. Kits contain everything you need—pre-cut, partly-assembled parts, screws, glue, and easy-to-follow instructions.

If you prefer, buy just the illustrated instruction book, get materials from local suppliers. Instruction books, 75c to \$1.50.

Give your Electro-Voice speaker cabinet a fine furniture finish. Finishing kits, \$5. Decorative Metal Trim kits from \$4.80.

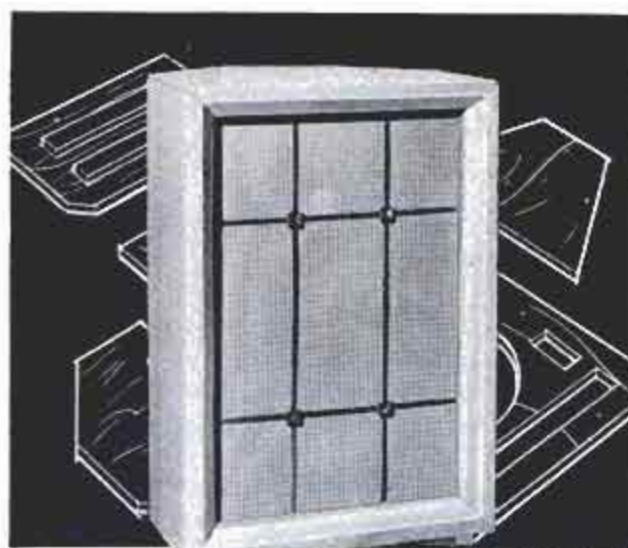

Aristocrat

Assemble Your Electro-Voice Speaker System Step-by-Step

**Practical Electro-Voice Building Block plan** lets you start with an E-V coaxial loudspeaker, add matched, compatible components whenever your budget permits.



**Hear the difference in speakers.** Dial the E-V Systems Selector at your E-V Dealer's, hear the improvement each matched component makes as you build from a single speaker to a multi-speaker Electro-Voice high-fidelity system.

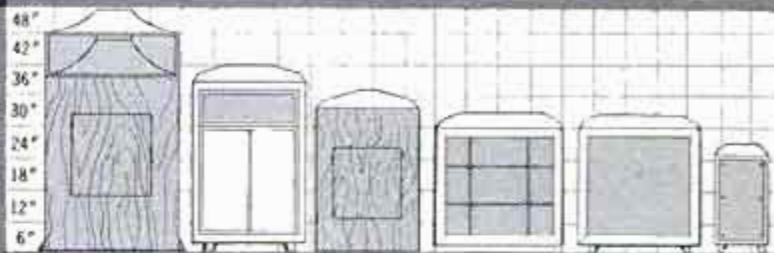

Patrician IV    Centurion    Georgian    Regency    Empire    Baronet

WRITE FOR BULLETIN PM612

**Electro-Voice**

ELECTRO-VOICE, INC.  
BUCHANAN, MICHIGAN

Export: 13 East 40th Street, New York 16, U. S. A. Cables: ARLAB  
Canada: E-V of Canada Ltd., 1908 Avenue Road, Toronto, Ontario

In 48 hours the job is done. So far, these teams have eradicated the beetle from 68,055,203 of the 108,737,000 cubic feet of storage found to be infested.

### Most Annoying Pest

If you are not acquainted with the Jap beetle, you probably live where it doesn't. It's hard to imagine a more annoying, more destructive pest. Throughout eastern United States where it currently operates at a cost to inhabitants of several million dollars a year, the beetle makes visible and violent trouble from May through September. It has a taste for 275 different plants, takes pernicious pleasure in spattering a line of fresh wash and can panic the most steely nerved man by slipping inside his collar. When the beetle isn't winging about it is below ground in the form of a white grub gorging on the roots of lawn grasses.

Shortly after the beetle was found in the United States—in 1916 at Riverton, N. J.—its eradication was attempted, but because of the inadequacy of controls available at the time, failed. It has been under federal and state quarantine continuously—a program of commodity and vehicular inspection has slowed its progress so that today the infestation is confined to the East. It is surprising that the spread has not been much more rapid, because the Jap beetle

is a great hitchhiker. The grubs can be moved about in the soil on the roots of plants; the adults ride in cars, trucks, trains, buses and airplanes. Quarantine inspectors keep close tabs on airports and frequently, by quick action, wipe out infestations at or near these points.

Scientists meanwhile have had marked success in developing ways of controlling this pest. They have imported from Japan wasps that parasitize the beetles; they have found DDT and methoxychlor sprays and dusts effective against the adults. A half-dozen organic insecticides washed into the soil will kill the grubs. Most remarkable, however, has been the development of the so-called milky disease as a control. USDA entomologists found that they could exploit a weakness in the make-up of the beetle: its susceptibility to a spore-forming fungus. They learned how to obtain large quantities of disease spores by artificially infecting insects, then after proper incubation grinding the bodies and mixing the resulting product with a suitable dust carrier. A spot of spore dust every two or three feet on the lawn will penetrate into the soil and slowly but surely kill off the grubs beneath. Once there, it will kill as long as there are grubs for it to attack.

The success with milky disease has set

(Continued to page 234)



# **NEW!**

## **MAGNA INTRODUCES LARGEST CAPACITY SAW-JOINTER**

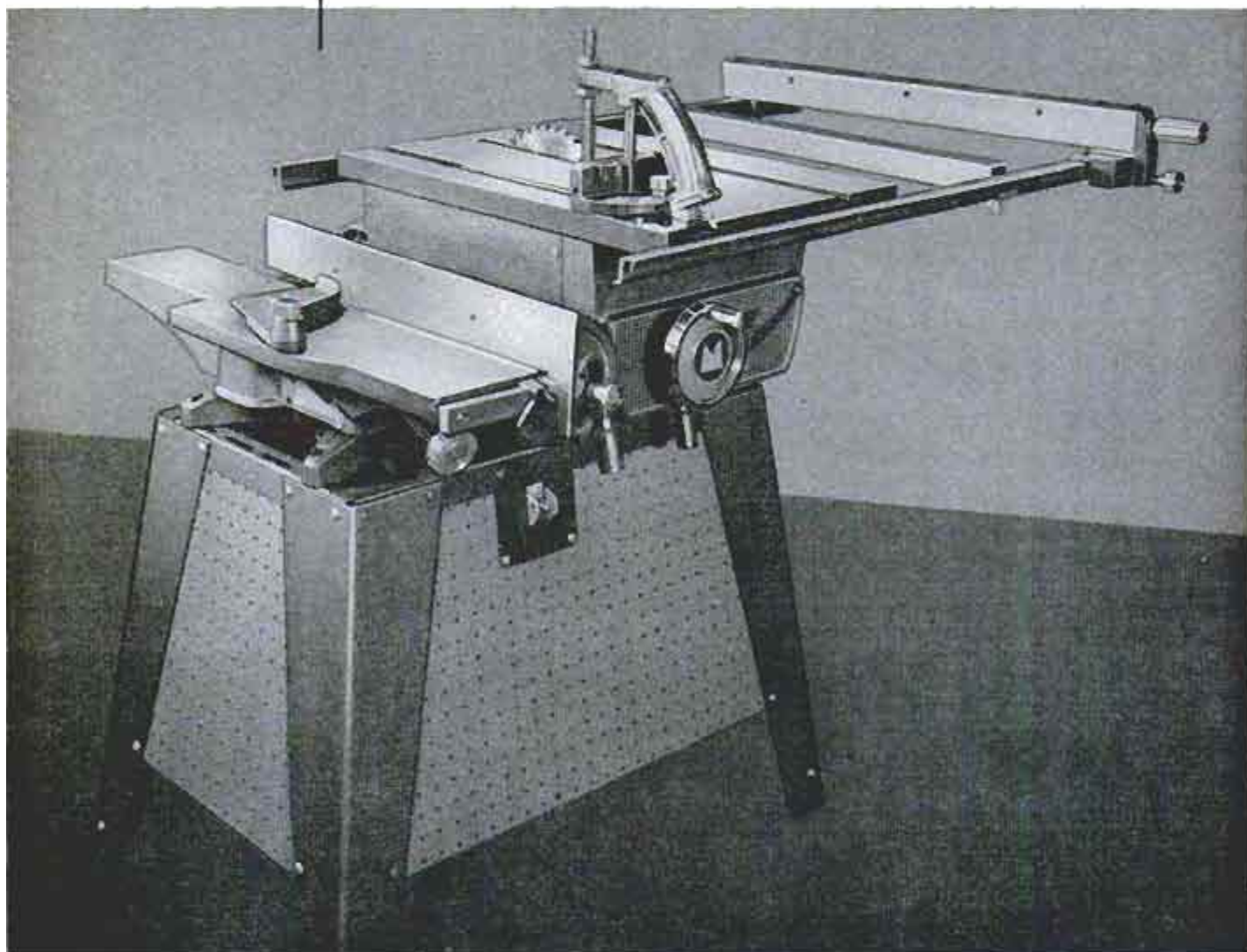

**OPERATES  
WITH SAW BLADE  
AT ANY  
HEIGHT!**

The new Magna Saw-Jointer combines two of America's finest power tools: the revolutionary new Magna 9-in. Saw with "The Helping Hand"—a built-in extension which makes the largest effective table on the market; and the big Magna 4-in. Jointer with the longest table and largest fence in its class. The Jointer operates at *any* height of the saw blade, eliminating frequent adjustment required by other saw-jointer combinations. You can buy the Magna 9-in. Saw now and convert to this big Saw-Jointer later, with the inexpensive Magna Saw-Jointer Adaptor Kit.

**Own the Magna Saw-Jointer for as little as \$3 a week!**



# MAGNA 9-in. Saw with "The Helping Hand"

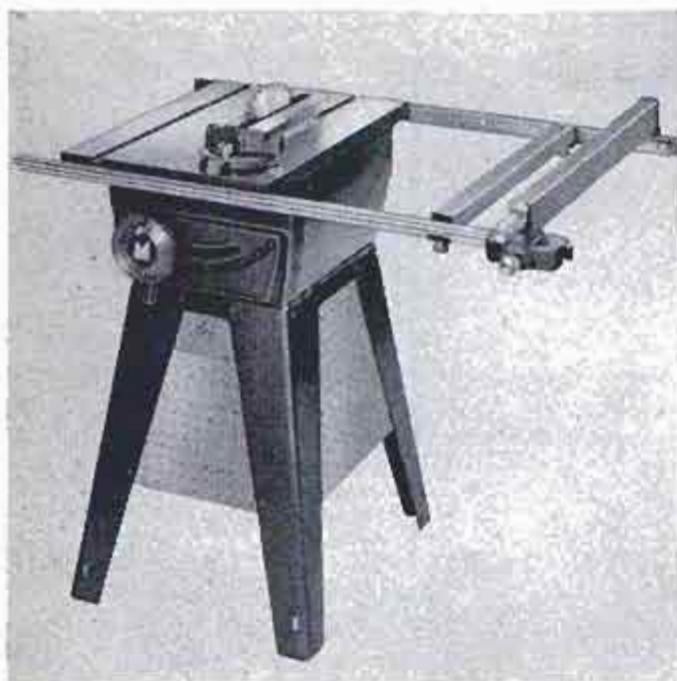

The only tilt arbor saw with "The Helping Hand"—a built-in extension which makes the largest (34" x 24") effective table on the market, allows bigger rip and cross-cut capacity than any other saw • Epicyclic Speed-gear Control gives you full 45° tilt with only 10 turns of knob, (40 to 60 turns on other saws!) • Single-knob control—push for projection, pull for tilt • Self-aligning Fence locks front and back with single knob • colored Safety Zone Table Insert cannot catch work piece • exclusive pressure-cast tub front bolted rigidly to table, coordinates all controls • externally adjustable Tilt Stops • 3 Auto-stops on Miter Gauge • Magna Saw-Jointer Adaptor Kit contains all you need to convert to Magna Saw-Jointer!

MAGNA 9-IN. SAW (without motor or stand) — ONLY \$99.95!

## MAGNA 4-in. Jointer with Longest Table, Largest Fence

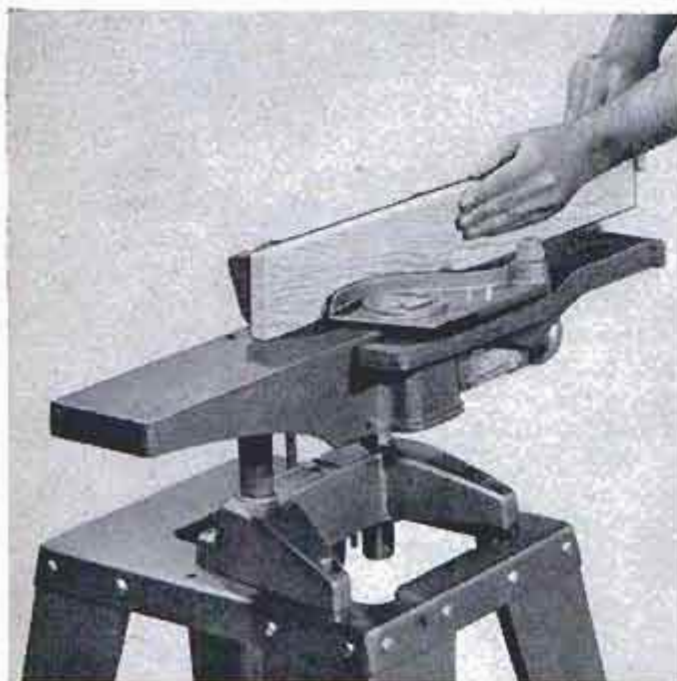

The big, heavy-duty Magna 4-in. Jointer gives you the longest (28") table, and largest (3" x 21 3/4") fence of any 4" jointer • Adjustable in-feed table, fixed outfeed table • One-knob Fence Lock controls tilting of fence • Auto-stops at most used angles • One-piece fence casting is far more rigid, larger (21" x 3") • 3 high-speed safety tapered steel knives are individually micro-adjustable • spring-controlled Safety Guard can be used on other side of fence when rabbeting.

MAGNA 4-IN. JOINTER (without motor or stand) ONLY \$49.95!

**OWN THE NEW MAGNA SAW-JOINTER  
FOR AS LITTLE AS \$3 A WEEK!**



MAGNA POWER TOOL CORPORATION  
America's Finest Power Tools

® T. M. REG.

### MAGNA POWER TOOL CORPORATION

Dept. 801-M at factory nearest you:  
Box 2808, Fort Wayne, Indiana, or Menlo Park, Calif.

Please send me a free 16-page Magna-Line catalog.

Name \_\_\_\_\_

Street Address \_\_\_\_\_

City \_\_\_\_\_ Zone \_\_\_\_\_ State \_\_\_\_\_



the plier you'll reach for  
9 times  
out of 10\*

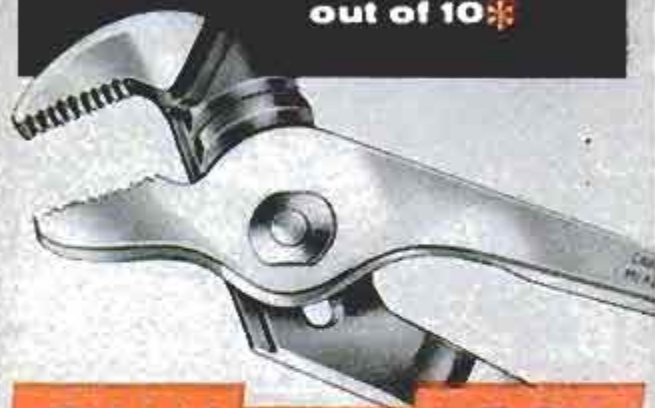

CHAN NEL LOCK

No. 420

\*because no other plier  
does so many jobs so well

GRIPS LIKE A  
PIPE WRENCH

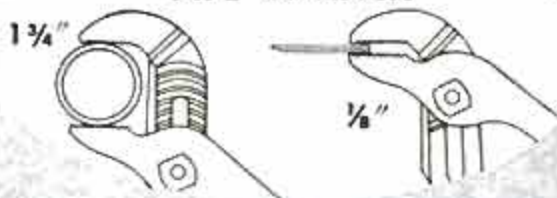

Mechanics tell us that our Channellock No. 420 is the handiest plier of them all . . . the plier they reach for more often than any other. They like its all 'round usefulness . . . its pipe-wrench grip . . . its big jaw-opening . . . its streamlined design for hard-to-get-at jobs. And you'll like Channellock for the same reasons. Ask your hardware man for a Channellock 420.

BE SURE IT'S A GENUINE CHANNELLOCK



CHAMPION DEARMENT TOOL Co. MEADVILLE, PA.

scientists hot on the trail of other diseases for use against other insects. In the Southwest, growers can control the alfalfa caterpillar by treating it to a virus disease applied with field sprayer or by plane. In preliminary studies, diseases have shown great promise against such forest insects as the European and Virginia pine sawflies; against our chief orchard pest the codling moth, and against several important insect pests of vegetables and corn. One big advantage of spreading bug diseases over using insecticides: The diseases offer control without danger to man and animals.

Still other weapons that entomologists have found useful against insects include materials that attract and materials that repel the pests, and atomic energy.

#### Baits for Insects

Attractants are not a new idea (grandfather used poisoned baits to control cockroaches), but they are getting new emphasis. Fly baits—generally a mixture of insecticide and sweetening—are in use on dairy and poultry farms and at city dumps and other urban locations where flies breed. Attractants are proving a key weapon in the all-out effort to eradicate the recently discovered Florida infestation of the Mediterranean fruit fly. There, two attractants are in use—a hydrolyzed protein that is particularly attractive to the female flies, and oil of angelica, an ingredient of perfumes and liqueurs that draws the males.

At the other extreme are the chemicals that keep the bugs at bay. There are several good mosquito repellents on sale at the drugstore, but none that compares with a USDA-developed chemical now under test by our armed forces. This repellent, which can be rubbed on exposed parts of the body or impregnated into clothing, not only repels six species of mosquitoes, but does so two to three times longer than standard repellents. It also repels chiggers, ticks, fleas, deer flies and stable flies.

The use of radioactive tracers that measure the flight of insects or the movement of insecticides within an insect, a plant or an animal, has become a useful research tool. In at least one instance, however, atomic energy has had direct application in insect control.

Since 1933 when the screw worm, a vicious attacker of livestock, was inadvertently established in the Southeast by a shipment of infested cattle from the West into Florida, entomologists have been seeking some way to eradicate it—and thus end its annual \$10,000,000 tax on the livestock industry. Atomic energy may supply the answer. Study showed the scientists that

(Continued to page 236)



# Greatest things on rails . . .

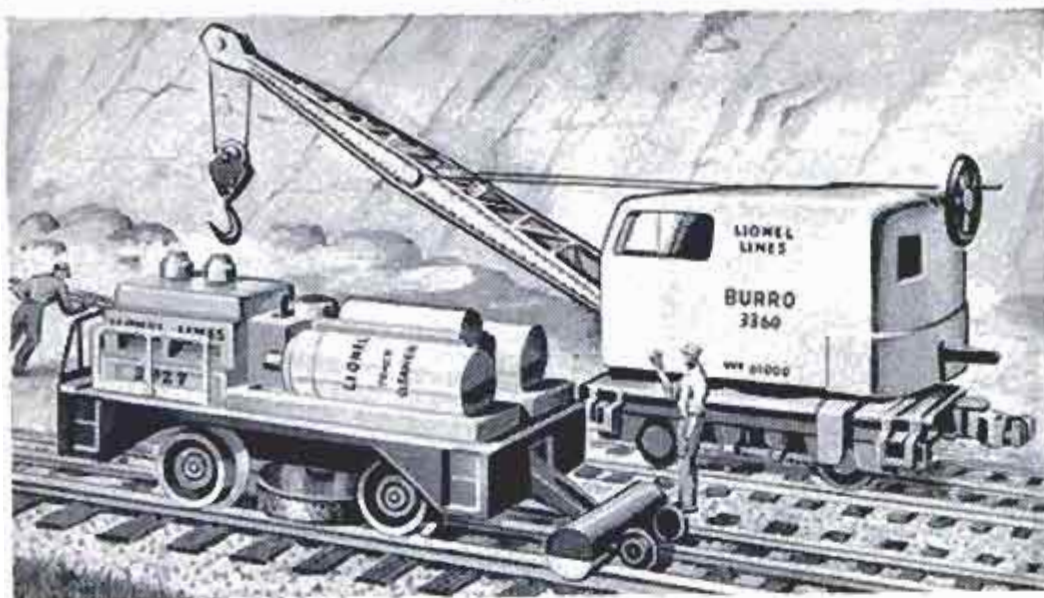

## new operating burro crane

**No. 3360.** A real work-horse! Self-propelled, it can actually pull its own work cars! Rotating cab and working boom!

## new track cleaning car

**No. 3927.** This car will actually wash and wipe track. When pulled by loco, motor-driven rotating brush cleans track with Lionel "Track-Clean", NO OTHER TRACK FLUID SHOULD BE USED.

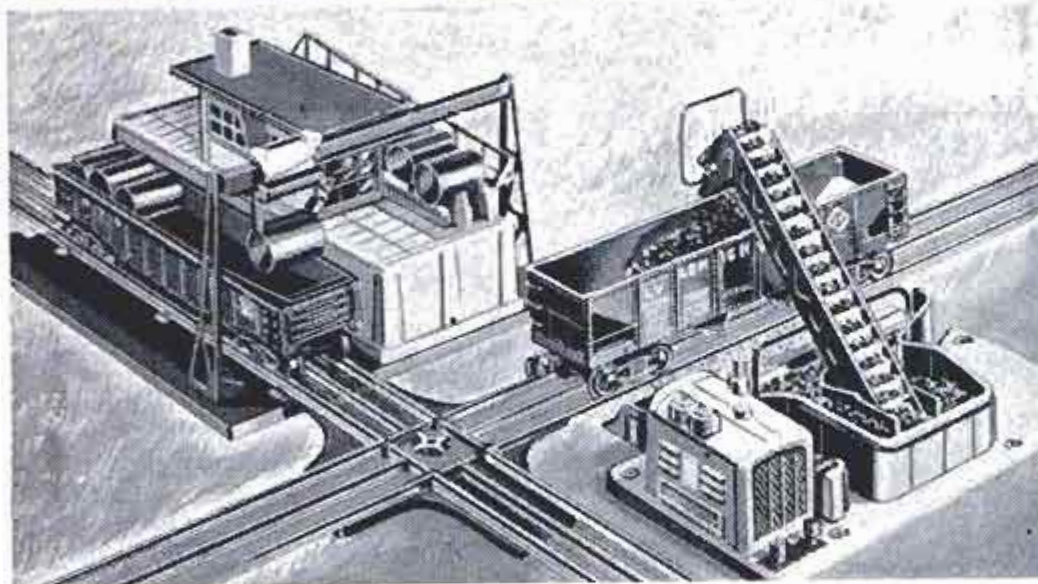

## new operating culvert loader

**No. 342.** Puts a heavy-duty look in your yards. Traveling crane picks pipe sections off platform, loads them into gondola car. Workmen's shack houses remote control mechanism!

## operating diesel- type coal conveyor

**No. 397.** Carries coal from bin and loads into car by remote control! Includes coal, controller, connecting wires! Car not included.

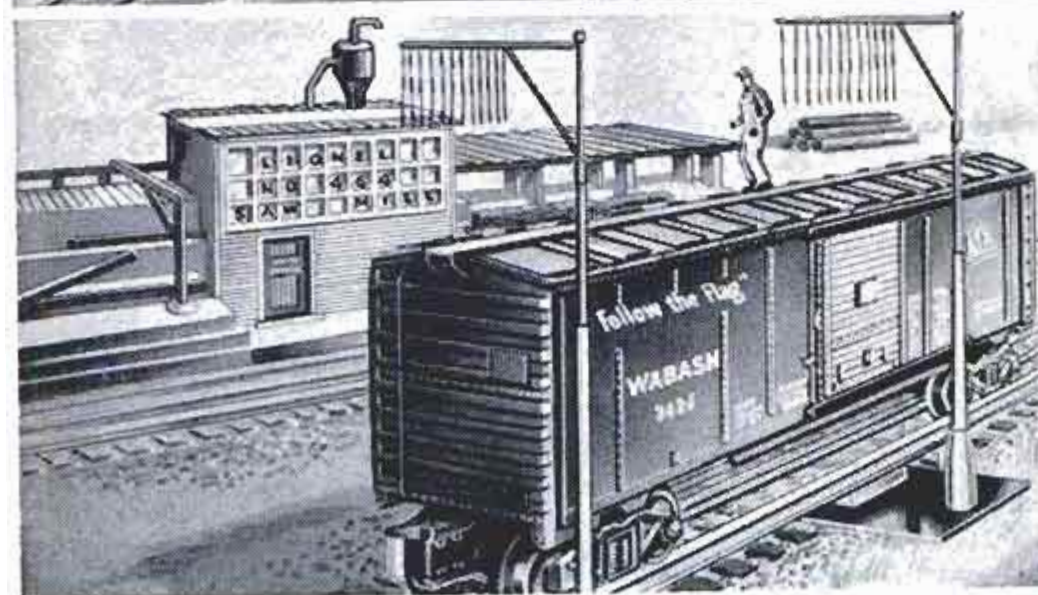

## new operating lumber mill

**No. 464.** Conveyor belt picks up logs in bin via remote control, feeds 'em into mill, and delivers dressed lumber. Complete to sound of buzz saw.

## new operating brakeman car

**No. 3424.** Low bridge warning signal pole makes man fall to avoid being hit. Second pole brings him up-right! Includes car and warning signal poles.

# and now LIONEL has 'em!

The Lionel Corporation, 15 East 26th Street, New York 10, N. Y.



exposing male screw-worm flies to radioactivity (gamma rays from radioactive cobalt) would make them sexually sterile, but otherwise would not affect their normal activity. They found too, that female flies would readily mate with the sterile males, but would produce only infertile eggs. Why then, USDA scientists reasoned, could not great numbers of male flies be sterilized and released to infiltrate the natural screw-worm population? Theoretically, one release would reduce the number of fertile eggs deposited in proportion to the ratio of the number of sterile to normal males. If there were 10 times as many sterile as normal males, one tenth as many fertile eggs would result. A second release would cut even deeper into the natural population, and eventually, after enough releases, the natural population would no longer exist.

Two years ago, USDA entomologists, with the consent and encouragement of the Dutch Government, tried out this theory on the screw-worm-infested West Indies island of Curacao. Releasing the sterile males at the rate of 400 per square mile at twice-a-week intervals, they accomplished eradication within four months. They are now drawing up plans to attempt the eradication of the screw worm from southeastern United States.

Whether it be atomic energy or deep

plowing, entomologists overlook no bet in insect control. Generally, though, they depend upon insecticides as their chief weapon.

A great deal has been written about the chemical revolution in insect control that began with the development of DDT during World War II. Since then more than a score of powerful organic chemicals have bolstered man's insect-fighting arsenal. One is aldrin, a chlorinated hydrocarbon that has been responsible for fantastically effective control of grasshoppers. As little as two ounces of the insecticide has killed millions of these pests.

Today, Americans are fighting insects at a cost of hundreds of millions of dollars each year. They are spending additional millions for entomological research and for large-scale insect-control programs.

Tomorrow, the cost may be even greater if we wish our high standard of living to continue or improve. Our growing population, our increasing world responsibilities, and our limited and gradually diminishing natural resources force us into ever-greater competition with insects for our food, our possessions and our health. There is no doubt that man will ultimately—perhaps completely—triumph, but remaining uncharted courses are many—and there must be no relaxation in our efforts. ★★

ALL THESE PRESENTS JUST FOR ME?

I LOVE YOU BOYS, REALLY! BUT... YOU SEE...

SMELLS GRAND!  
PACKS RIGHT!  
SMOKES SWEET!  
CAN'T BITE!

A PIPE SMOKIN' MAN ALWAYS WINS WITH ME!

IT'S SIR WALTER RALEIGH-NATURALLY!

SIR WALTER RALEIGH'S BLEND OF CHOICE KENTUCKY BURLEYS IS EXTRA-AGED TO GUARD AGAINST TONGUE BITE. XMAS-WRAPPED... IT MAKES A PERFECT GIFT.

It costs no more to smoke the best!

SIR WALTER RALEIGH  
SMOKING TOBACCO  
FOR PIPS AND CIGARETTES





**Santa Says:**

**"A WONDERFUL HOBBY  
WORKSHOP GIFT"**

**JUST DIAL  
40 DIFFERENT  
WIDTHS ON  
ANY SAW!**

**WITH Warren SAWING WASHERS**

**DADO**  
Cut 40 smooth, accurate, parallel grooves - any angle, with your present saw blade. Dial desired width with Micromatic adjustment. Leave on saw for straight cuts. Sizes to fit your arbor -  $\frac{1}{2}$ ",  $\frac{3}{8}$ ",  $\frac{3}{4}$ ", 1"  
A perfect gift for woodworkers. See your dealer or write!

**ONLY  
\$4.95  
PER  
SET**

SEND FOR FREE BOOKLET

**WARREN WASHERS COMPANY**

DEPT. 32 • BOX 98 • NORTH END STATION • DETROIT, MICH.

No Vial Leaks if you accidentally drop the

**New EMPIRE Level**

Light Magnesium or Aluminum...  
24", \$8.00; 28", \$9.00;  
48", \$14.50.



with  
**Magnified Crystal Vision**

See your dealer or write:

10930 W. Potter Rd.  
Dept. PM, Milwaukee 13, Wis.

**EMPIRE LEVEL MFG. CO.**

**Today's BEST Oils start with  
Nature's BEST Crude...**

Insist on a **PENNSYLVANIA**  
Brand of **Motor Oil**

SEND FOR  
**FREE  
CATALOG**



**Money-Making Tools!**

It's easy to own the same "pay-off" tools used and endorsed by America's top-earning mechanics! You can start building your own kit with basic Snap-on sets—add others any time. Never sold in stores—direct to users only. Send today for free catalog!

Snap-on Tools Corporation  
8062-L 28th Ave., Kenosha, Wis.



**do it  
faster -  
better**

save up to **50%**

with

**UPSON  
BOARDS**

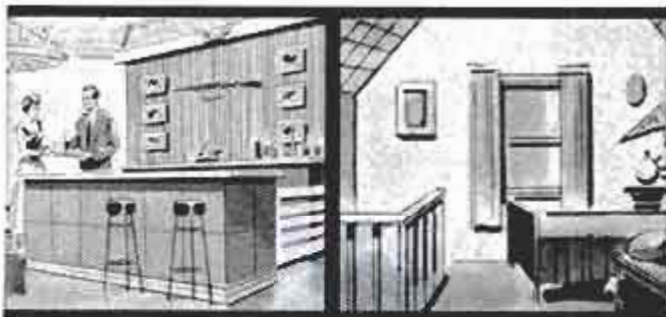

Making a fun room is easy and inexpensive with Upson Boards.

From unfinished attic to beautiful extra room with crackproof  $\frac{1}{4}$ " or  $\frac{3}{8}$ " Upson Boards.

There is no end to the fine, beautiful jobs you can do with Upson Wall Board. Here are just a few:

**Add-A-Room • Attics • Basement Walls and Ceilings • Built-ins • Cabinets • Chests • Closets • Cut-out Toys • Doll House • Door Panels • Drawer Bottoms • Garage Walls and Ceilings • Model Train Tables • Play-Store • Recreation Room • Storage Walls • Toy Chest • Wardrobes**

Light and strong, Upson saws cleanly. Sands smoothly. Paints beautifully. Assures you of a quality finished job for less money. You'll be amazed with the results. Ask your lumber dealer about Upson Board's large variety of thicknesses and sizes. Won't split, splinter or crack. From  $\frac{1}{10}$ ",  $\frac{3}{16}$ ",  $\frac{1}{4}$ ",  $\frac{3}{8}$ " to waterproofed, super-strong  $\frac{3}{8}$ " for outside use. Pebbled, smooth and striated surfaces. Sizes from 4' x 6' to huge 8' x 20'. Saves up to 50%. Costs 50% less than plywood of same thickness. To be sure of best results, always ask your lumber dealer for Upson Board by name.

**Order Now - Special price**

**DISPOSABLE  
Sanding Discs**



**3 for \$2.00**

Fits any 8" power saw. Faced with Aluminum Oxide Abrasive. One side coarse grit. Other side fine. Use on wood or metal. Order now. Upson Co., 4410 Upson Point, Lockport N. Y. Sent postpaid.





the **GIANT**

with the delicate appetite

under the hood of your car



IT'S A

**CARTER**



**4-BARREL CARBURETOR**

When you drive at slow speeds, two of the barrels remain closed. But, when you "step down" for added power, all four barrels open to feed your car engine the proper mixture of fuel for full horsepower.

This amazing 4-Barrel Carburetor is an example of CARTER pioneering to give you more power from modern engines and modern fuels. You can keep this power like new for years by having your car regularly serviced wherever you see this sign,

or look under **CARBURETOR** in the classified section of your phone book.



**CARTER CARBURETOR**

DIVISION OF **GCF** INDUSTRIES  
INCORPORATED  
ST. LOUIS 7, MISSOURI

## There's a Nice Future in Mink

(Continued from page 121)



Horsemeat is sliced, ground and fed to mink after being mixed with a cereal. Ranch feeds 2000 mink

A female has very sharp teeth and is vicious when with kits. We always wear heavy leather gloves in handling them. One of my former employees, weighing 250 pounds, was afraid of the mink, and of course they knew it. Whenever he handled them they would squirm and try to bite. One day he dropped one and without stopping to look, headed for the feed room. It was a sight to see that 250-pounder running like mad with a three-pound mink close on his heels.

### Sales Start in August

There are many types of mink, but we specialize in Kobuks, Gothiers, Stewart-blues and Sapphires. The sale of live mink starts in August with the majority being sold from September on. Most of the mink, however, will be pelted and their skins sold at auction through the large fur houses.

Pelting starts in November, depending on climate. When it is cold and moist, mink "fur up" quicker, meaning the fur is prime. All mink do not fur up at the same time, making it easier to handle them.

Quality of the fur determines what mink to pelt. Also, any female that didn't produce quality kits or was a poor mother is pelted; males that weren't aggressive in breeding also lose their skins. This is the time to weed out the herd and keep only mink that will improve the stock. I seldom keep mink more than three years because

(Continued to page 240)



# CRESCENT TOOLS

## \* in Christmas Boxes



See your hardware dealer

**CRESCENT TOOLS**  
*Give Wings to Work*

**YIPEE - A SAWHORSE IN A Jiffy**

Jiffy Brackets and 2x4s are all you need. Set up and knocked down in a jiffy—no nails, screws, or bolts required. Easy to move or store. Sold by hardware and building supply stores everywhere, or order direct.

GRAND HAVEN STAMPED PRODUCTS CO. Grand Haven, Mich.

## MAGNETS

5 Assorted Size Magnets \$1.00. Powerful Pocket Magnet W/ case \$1.00. Hot Pad Magnets—large size 8/\$1.00. Bulletin Board Magnets 8/\$1.00. Slender Magnets—pencil type 2/\$1.00. Retrieving Magnets—extra power, heavy duty—30 lb. pull \$4.00, also 50-75-100 lb. pull.

Explore, learn Electricity, Magnetism, Electro magnets, complete kit and instructions with 22 experiments and models... \$3.95

**TRANSISTOR RADIO KIT**—all parts & instructions—powerful... \$7.95

Also—Rods, discs, bars, horseshoes. Send stamp for catalog—Specify your requirements—100% SATISFACTION GUARANTEED.

PARK MAGNETS, 2612, 1557 GREENBAY RD., HIGHLAND PARK, ILL.

## SAVE MONEY ON YOUR COMPRESSED AIR

buy this complete  
**SMITH 45-P air compressor**



Right for spray painters, plumbers, contractors, monument shops, tire changing trucks, maintenance shops, quarries, utilities, many other users. Delivers 45 plus cu. ft. per minute; pressure up to 150 PSI. Powered by Wisconsin 4-cyl. air-cooled engine; uses less than 1 gal. gasoline an hour! Most compact, biggest-value compressor for its capacity anywhere! Other models to 230 cfm.

write for  
**FREE**  
brochure

**GORDON SMITH & COMPANY, Inc.**  
411 College Street, Bowling Green, Ky.

**WORK MORE AT EASE IN**

**Anvil-Brand**

HARD TO BEAT

and

**Tom Long**



Don't you get more joy out of any job when you're dressed in easy comfort?

It's the best of reasons for working in Anvil Brand tough utility clothes and Tom Long durable casual wear.

Here are two brands expressly built for active men, in separate or matching shirts and pants, dungarees, coveralls and hobby styles; tough materials assuring longest wear.

You have a treat coming when you outfit in Anvil or Tom Long. At leading stores.

**ANVIL BRAND FACTORIES** HIGH POINT, N. C.



Why fight traffic  
or bus crowds?

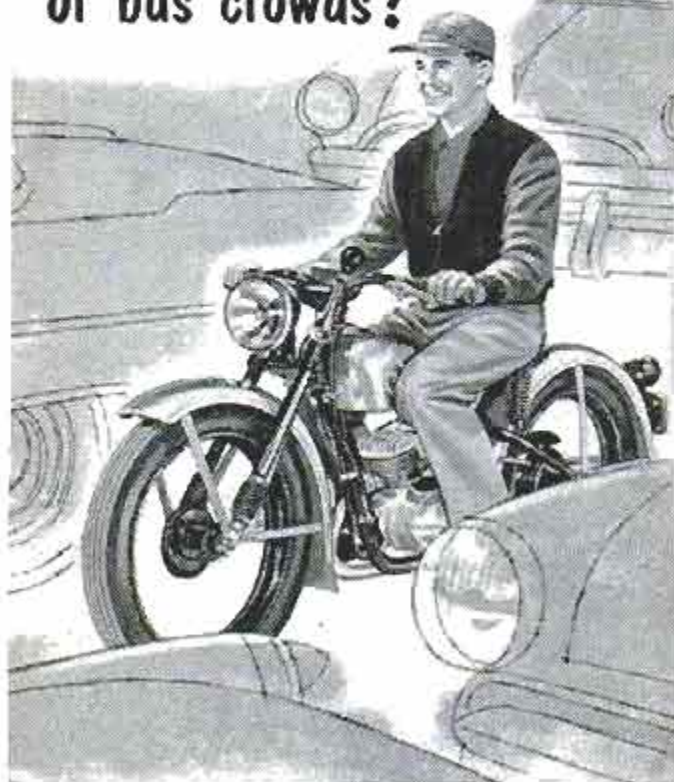

it's fun to whisk to work on  
a Harley-Davidson

**HUMMER**

... and it costs only pennies a week!

It's healthy, invigorating and practical, too, to ride a Hummer to work. You wheel down narrow lanes, pass up traffic snarls, never have to worry about parking. And a Hummer gets up to 100 miles per gallon... costs only a fraction of owning and operating an auto. Pay as little as \$17.00 per month after minimum down payment. And that includes fire, theft and collision insurance; local taxes; freight and carrying charges. See your dealer or write for details.

**For Christmas...**

**GIVE YOUR SON A HUMMER**

You make only the small down payment... the Hummer can help him earn enough to cover the low monthly payments, have pocket money too!

**HARLEY-DAVIDSON MOTOR CO.**  
DEPT. P, MILWAUKEE 1, WISCONSIN

in that time they are outdated by new kits.

Mink selected to lose their skins have been exposed to the weather in the outdoor pens, making their fur thicker. When killing, the fur must not be damaged and death is usually accomplished by breaking the neck or using gas.

Skinning a mink is not hard, but the beginner would be wise to study his mink brood carefully or have help from an experienced skinner. After the mink are killed, the skins are scraped, cleaned and put on pelt boards to dry. The skin must be snug on the board but not stretched. It will dry in about 24 hours.

Meanwhile the sale of live mink continues. I ship all over Canada, the United States and England. Mink are shipped in special crates with food enclosed and must be watered daily during shipment. The largest sale ever made to one buyer was 15 mink for \$4000 to a beginner in England. The last I heard he had a fine ranch and one of the largest in England.

Most beginners buy one male and three females, and prices vary according to the type selected. Gothiers and Stewart-blues are worth \$100 each, Kobuks bring \$150 and Sapphires cost \$300 each. We have about 400 mink for sale this year and expect to pelt 1400, with pelts bringing an average of \$30 each.

Many times each year I sell breeder stock to beginners and they always ask for any special information I might have. The best advice I know is always to buy the best breeder stock available. If you don't have enough money for quality stock, wait until you do. Next, have the pens ready for the mink and always keep pens, food and mink clean and dry. With this information, a fondness for animals and an authoritative book on mink anyone can become a successful mink rancher. ★ ★ ★

### Samples of Air Brought From Space

Army Signal Corps scientists have captured six bottles of air from the borderline of outer space—75 miles up. The precious samples were gathered by steel bottles in the nose cones of two 20-foot Navy-developed Aerobee rockets launched from the White Sands Proving Ground in New Mexico. The special bottles popped open one at a time as the rockets reached peak altitude, then snapped shut, each trapping eight quarts of thin air. They were then parachuted to earth. From the air, scientists hope to learn whether or not common gases begin separating into layers at high altitudes.



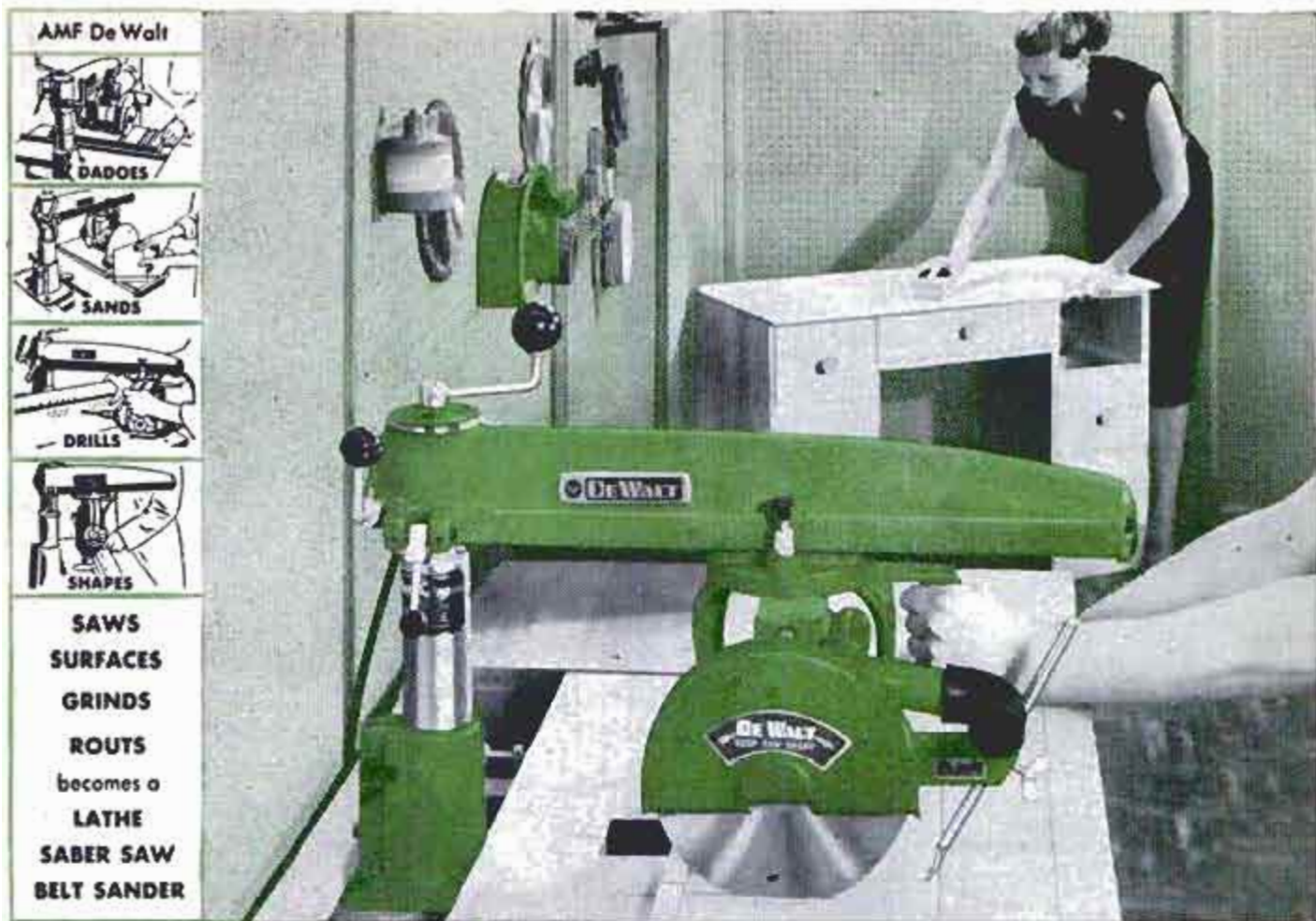

Only \$239 delivered, complete with 9" saw blade and 3/4 hp motor

## Only AMF DE WALT makes making things so easy!

With a versatile AMF DeWalt® Home Power Shop, you can make home repairs, build furniture, handle even major projects like a *professional!*

AMF DeWalt is the *first* all-purpose power tool designed on the modern mechanical arm principle that outmodes all other power tools. It's actually 12 professional power tools in 1—a *complete home workshop!*

- **Arm swings and locks at any position** for miter cuts—gives easier, safer *top-side cutting* that eliminates errors... you see your mark *and* your cut.

- **Builds into workbench!** Because entire arm *swings clear* of work area, you can cut and assemble on the same work bench! *Save valuable space* and get *extra convenience too!*

- **Powerful 3/4 hp motor is U.L. Approved**—guaranteed for full year—tilts and turns to any angle.

Motor carriage rolls smoothly on ball bearings in protected trackways. Simply change circular tool on direct-drive motor shaft and you have another power tool—at *no added cost!*

- **Superior safety and accuracy!** Exclusive DeWalt Safety Key Switch prevents unauthorized use. DeWalt's patented design and rugged precision construction provides safety *and* unmatched accuracy that assures years of superior workmanship.

**INSIST ON A DEMONSTRATION.** See why, *feature by feature*, AMF DeWalt is the finest home power shop you can buy. A small down payment on DeWalt's Easi-Budget Payment Plan\* will put an AMF DeWalt in *your workshop now.*

**OWNERS!** Valuable new *Owner's Manual* just off the press, "Easy Ways to Expert Woodworking," \$4.95 postpaid. Order yours today!

\*Does not apply in Arkansas or outside U. S. continental limits

SEND COUPON FOR FREE ILLUSTRATED BOOKLET!

AMF DeWalt Inc., Dept. PM-612, Lancaster, Pa., Subsidiary of AMERICAN MACHINE & FOUNDRY COMPANY

Another  Product

Please send FREE colorful illustrated 20-page Booklet

Name \_\_\_\_\_

Address \_\_\_\_\_

City \_\_\_\_\_ Zone \_\_\_\_\_ State \_\_\_\_\_





# »»»»» MERCURY PIONEERS TWO

## 1. World's first 6 cylinder 60 h. p. outboard!

### NEW MARK 75 MARATHON

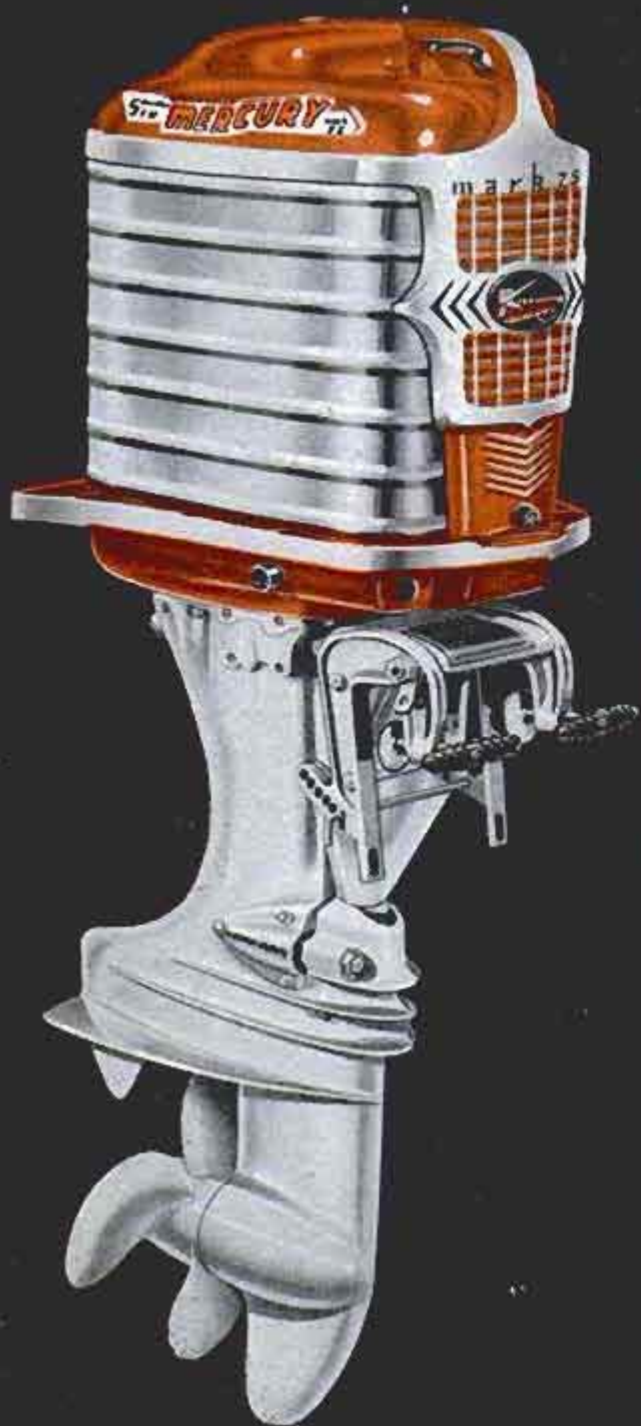

● Now in production! Real outboard power—and safer, smoother, more maneuverable than any engine you've ever handled! Revolutionary 6-cylinder design... a firing impulse every 60 degrees of crankshaft rotation... the smoothness and flexibility of the finest foreign sports cars... single lever control... greatest operational ease of any outboard... direct reversing... with no bulky reverse gears! With super hot ignition, these 6 cylinders start instantly, idle smoothly and slowly... give new definition to low speed operation.

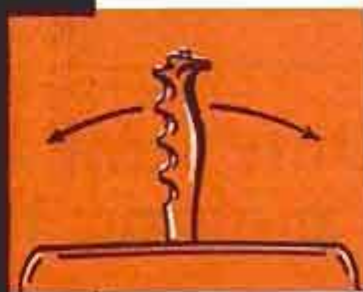

**NEW SIMPLIFIED SINGLE LEVER CONTROL.** Throttle, reverse, neutral all on finger-tip remote control.

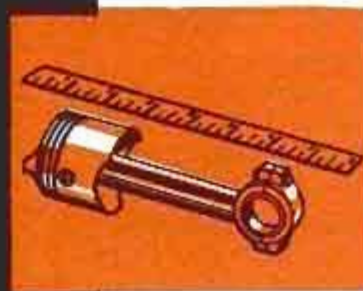

**16 $\frac{2}{3}$ % LESS PISTON SPEED.** Slow-travelling, short-stroke pistons prolong engine life. Other engines, even at lower rpm, have up to 20% more piston speed than this built-to-last Mercury Mark 75 Marathon!



**EQUAL TO A V-12 IN SMOOTHNESS!** Naturally, a 6-cylinder 2-cycle engine has the same number of firing impulses per revolution as a 12-cylinder 4-cycle V-12! Mercury's famous Full-Jeweled Power\* guarantees smooth power longer, too!

\*Anti-friction ball and roller bearings throughout.

# MERCURY OUTBOARDS for 1957 »»»»»



# REVOLUTIONARY NEW OUTBOARDS!

## 2. New 10 h.p. Mercury for super-slow trolling!

### NEW MARK 10 TROL-TWIN



• The new Mercury Trol-Twin was designed expressly for fishermen! New glide-angle underwater structure slides smoothly over stumps, rocks and through thickest weeds, puts cylinders at their best idling angle for hours of slow trolling. Single lever control . . . throttle, neutral and reverse all on one-hand control. Big displacement for power to plane your boat . . . get fishing fast.

Prop-Jet Exhaust buries exhaust under water and with it the sound. Ask your Mercury dealer about his new easy terms today! You'll be glad you did.



**FINGER-TIP TROLLING.** Just flick the exclusive Speed-r-Troll Switch! No ordinary throttle can give you idling speeds as low as this . . . or so steady!



**ONE-HAND CONTROL!** Twist the tiller handle for speed. Twist again for neutral or reverse. One control does everything.



**EXHAUSTS THRU PROPELLER HUB!** Exclusive Mercury Prop-Jet Exhaust buries exhaust under water . . . leaves it far behind.

Write today for complete color catalog

©KIEKHAEFER CORPORATION 1956

KIEKHAEFER CORPORATION • Fond du Lac, Wisc.

# 12 NEW MODELS >>> 6 to 60 HORSEPOWER



**NOTHING TO  
WEAR OUT**  
but the sand paper!



**No. 900  
HEAVY  
DUTY  
SANDER**

Outsands, outlasts others. Exclusive "no jump" Multi-Motion action. Get this modern "King of Portables."

**\$39.95**

That's because both sanders are super-powered with the famous Syncro Reciprocating Motor—today's greatest research triumph! This unique, direct-drive motor has no belt, cam, gears; no rotating parts to wear out. It is guaranteed against burn-out during ownership. Syncros are so easy to use, so powerful, durable! Why push and "fight" old-fashioned portable sanders when Syncro Multi-Motion sanding—with genuine Syncro Reciprocating Motor—is yours so economically? See at tool dealers—write for Catalog, Reciprocating Motor data!



Model 900 sands edges without splintering wood.

No fan to cause "sanding-dust" cloud.

Ideal for heavy duty dry wall jobs.



**No. 504  
FINISH SANDER**

Sand the latest way! Feather-light. Powerful. Easiest for vertical use. Exclusive Multi-Motion action. So economical!

**\$19.95**  
with Genuine  
Reciprocating  
Motors

**SYNCRO**  
SANDERS

**SYNCRO CORPORATION**

Dept. 1-96, Oxford, Michigan U. S. A.

WORLD'S LARGEST RECIPROCATING MOTOR MAKERS

**White Land of Mystery**

(Continued from page 112)



Photo theodolite permits surveyor to photograph his sightings, make his calculations later from photos

As you read this, Chet Twombly, IGY physicist, periodically climbs a ladder from subsnow quarters at Little America to an enclosed, heated tower. He peers up at the night sky through plastic domes to watch antarctica's most spectacular phenomenon of all—the aurora australis, south-polar counterpart of the northern lights. Beside him, an all-sky camera, slung above a convex mirror reflecting the horizon-to-horizon display, takes continual movies of the vivid shifting draperies and rays of green, pink and purple lights that fill the sky. Most unreal and indescribable of all natural phenomena, the aurora is thought to be caused by charged particles streaming in from solar storms to the earth's ionosphere. Caught up in the earth's magnetic field, the particle streams funnel toward the magnetic poles where they bombard ionospheric gases, creating luminous glows—much the same way electron streams excite the gas in a neon tube.

The aurora holds considerable interest for IGY scientists since ionospheric storms are closely linked to radio blackout—a treachery especially peculiar to polar regions but felt all over the world.

Tied in with the aurora and radio interference is the earth's magnetic field, with

(Continued to page 246)



# IDEAS FROM WELDWOOD



**The Sail Scooter.** Sporty sailer you can build at lowest possible cost. Sail Scooter is portable, can be carried on top of your car.



**Sportsman's Cabinet.** 2-sided cabinet on swivel base. One side holds clothes, shoes, etc. Opposite side for tackle, rifles, shells.



**Kitchen Cabinets.** Pattern has all information to build cabinets, broom closet and sink enclosure. 200 sizes of cabinets specified. Step-by-step directions.



**TV and Hi-Fi Enclosure.** Cabinet (right) has turntable, space for tuner, amplifier. Cabinet (left) holds speaker. Center holds TV set.

## Projects of the Month

This month we're suggesting four money-saving projects. They're all *simple* to make with Easi-Bild patterns, and Weldwood plywood.

Easi-Bild\* patterns are *full size*. You just trace the pattern, cut out the pieces, and assemble. If you know a saw from a hammer, you can build any of the 250 Easi-Bild projects. (See coupon for details.)

When you send for the patterns, or buy them at a store, you'll see the name "Weldwood" on the list of materials. In top grade plywoods . . . in beautiful hardwoods . . . in finishing materials like Firzite® and Satinlac® . . . and in glues and Contact Cement, Weldwood products are favorites of amateur and pro. For any project—any need—rely on Weldwood products, and the dealer who sells them.

W. M. Reg. Easi-Bild Pattern Co.

## This month's hint

If you don't have a vise—or four hands—nailing together picture frames or anything else with mitered corners is a problem.

To make the job easier apply Weldwood Contact Cement to all joints and let it dry (follow directions on container). Then, simply press the pieces together. The frame will bond instantly and solidly and you'll have no trouble putting in necessary nails.

—C. D. H., Lumberton, North Carolina.

## The Weldwood Question Box

**Q.** I'm doing cabinetwork at home. What kind of plywood is best?

**A.** You can use fir, pine or hardwood plywoods (like mahogany, oak, etc.). The hardwoods are the best looking. But, if you're going to paint, take a tip from cabinetmakers and choose Weldwood Old

Craftsman Pine Plywood. It's easy to work and paint. There's no discoloration and much less grain "showthrough." Weldwood Old Craftsman Pine doesn't need as much sanding, paint or painting time.

The choice of materials is up to you. But remember—the "pros" pick pine!

United States Plywood Corporation, Pattern Dept.  
P.O. Box 215, Pleasantville, New York

Please send me the following checked items:

- Pattern #272—TV and Hi-Fi Enclosure (\$1.00)
- Pattern #201—Kitchen Base and Wall Cabinets (\$1.00)
- Pattern #248—The Sail Scooter (\$1.50)
- Pattern #266—Sportsman's Cabinet (\$1.00)
- 57-page Pattern Catalog (55¢)

PM 12-56

NAME.....

ADDRESS.....

CITY.....STATE.....

  
**Weldwood**®

A product of

United States Plywood Corporation

Weldwood—The Best Known Name in Plywood





All men welcome a Lufkin tape or tape rule — the brand preferred by professionals. Each is conveniently packaged in a re-usable plastic box with decorative Christmas band — ready to give.

**LUFKIN** WHITE CLAD MEZURALL 10' TAPE RULE \$1.49 

Ideal for the handyman. Snow white tape, bold black figures, polished metal case.

**LUFKIN** WHITE CLAD SUPER MEZURALL 10' TAPE RULE \$2.39 

For the home craftsman. Extra strong — extra wide for unassisted measurements. Self-adjusting end hook.

**LUFKIN** WHITE CLAD BANNER 50' STEEL TAPE \$4.98 

For accurate long measurements. Handsome maroon vinyl case. Snow-white line with jet black markings.

SOLD BY HARDWARE, LUMBER AND TOOL DEALERS  
**THE LUFKIN RULE COMPANY**  
Saginaw, Michigan

poles in the arctic and antarctic. Both poles and lines of force shift occasionally. In recent years the north magnetic pole moved hundreds of miles from northern Canada to the west coast of Greenland. The south magnetic pole is somewhere out on the ice prairie in Wilkes Land, west of McMurdo Sound. Tedious methods have been used to pinpoint these elusive spots. But until now, no one has done better than make a close approximation.

This year Rochus Vogt, a young nuclear physicist from Heidelberg University working under Fulbright grant at the University of Chicago, nailed them down by a unique method. In a specially built steel shack on the USS *Arneb's* stern weather deck, Vogt stood guard over nuclear counters that clicked off a crackling barrage triggered by cosmic particles penetrating the earth's atmosphere. "Around the magnetic equator, lines of magnetic force far out in space deflect cosmic rays, so fewer particles get through," he explains. "But at the poles, where lines of force funnel into the earth, particles penetrate in vast quantities, which incidentally accounts for the auroral displays." By plotting counts collected down through the Pacific to Antarctica, up through the Indian Ocean on the trip home, and using data previously collected during a north-south Atlantic voyage, Vogt had three pole-to-pole profiles showing cosmic-ray penetration of the earth's magnetic field. Then by applying mathematical formulas, the three sets of particle-count curves were projected to junction points in Greenland and Antarctica—dead centers of the magnetic poles. Vogt's figures proved the earth's magnetic grid, as previously plotted, was slightly askew—a fact important to some missile designs, the radio and electronics field, and invaluable to further magnetic and cosmic-ray studies during the IGY.

While men like Vogt and Twombly hit at the causes of cosmic interference, other men during Deepfreeze tackled it from an immediate practical level. Amory H. "Bud" Waite, electronics engineer for the Army Signal Corps Laboratories, rumbled over the snowfields with five companions in a Weasel laden with a new lightweight backpack radio with disjointed antenna that snaps into a 12-foot whip at the flick of a wrist. On the barrier near Little America, these men set up a private camp composed of two insulated huts.

Out on the ice desert, Waite and his boys dug holes in the snow and sank 30-foot transmitters out of sight. They busied themselves sending signals at frequencies from 40 to 10,000 megacycles over, through

(Continued to page 248)





So light, a card table can be your workbench.

## The Whole Family Has Fun!

— with your gift of a **Dremel Moto-Jig Saw**

There's no finer gift than a Dremel Moto-Jig Saw. It adds new thrills to woodworking—makes it a happy family hobby. It's good, constructive recreation and very educational for children—teaches them to be creative.

### It's Super Safe

Only Dremel has a specially designed blade guard that keeps young fingers away from the blade—makes it **SUPER SAFE**. Now the whole family can enjoy working with a power saw. It's portable too—even a card table can be your work bench. These features have made Dremel the No. 1 choice for handicraft work in cub scouting, elementary schools, churches, 4-H clubs, etc.

### A Professional-Quality Tool

A precision-built craftsman's saw—not a toy. It's run by a powerful **ROTARY MOTOR**—not a reciprocating vibrator. The new **ROCKER-ACTION** principle actually outperforms all others, even much more expensive ones. It practically eliminates blade breakage. Cuts  $1\frac{3}{4}$ " wood. Absolutely no maintenance or burnout problem.

### Prove it to Yourself

Go to your hardware or hobbycraft store. Inspect the Dremel Moto-Jig Saw closely—compare it with others before you buy. You'll find Dremel is far superior in every way. Invest in wholesome, family fun—buy a Dremel Moto-Jig Saw.



### Model 15

15" throat—cuts to center of 30" circle

**\$29.95**

### Model 8

8" throat—cuts to center of 16" circle

**\$23.50**

Prices include **ROTARY MOTOR**



New, Exciting Pattern Packets. Eight new, Pattern Packets supply you with plenty of useful, interesting things to make.

Get started now by ordering Packet No. 1. It includes full-size patterns for 16 projects (tie rack, earring holder, two games, etc.) Send coupon with 75c today. Write for folder on other packets.

**SEE YOUR DEALER.** If he can't supply you, order direct on 5-DAY trial, money-back GUARANTEE!

### ONLY DREMEL HAS THESE FEATURES

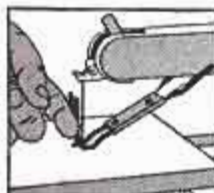

Super-safe blade guard protects young fingers from injury.



Table tilts for bevel cutting. Table can be raised or lowered also to utilize every part of the blade.

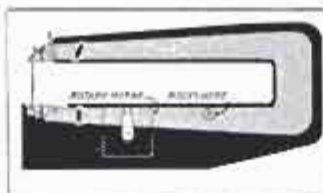

New **ROCKER-ACTION** principle replaces old-fashioned spring-tension assembly. Blade remains uniformly taut—cuts faster—blades rarely break.

**DREMEL MFG. CO., Dept. 116M, Racine, Wisconsin**

Enclosed is  check  money order for \$\_\_\_\_\_ in full payment for one Model\_\_\_\_\_ Dremel Moto-Jig Saw. If not satisfied, I can return it in 5 days and get my money back.

Enclosed is \_\_\_\_\_c for Pattern Packet No. 1.

Send me free  Folder on 8 Pattern Packets  Power Tool Catalog.

Name \_\_\_\_\_

Address \_\_\_\_\_

City \_\_\_\_\_ Zone \_\_\_\_\_ State \_\_\_\_\_



# Soldering is Easy



with  
INSTANT STARTING

# Lenk

LIQUEFIED **LP** PETROLEUM  
**Torch**



only **\$2.95**

THE ONLY THROW-AWAY FUEL CONTAINER WITH SELF-SEALING SAFETY VALVE.

- Here's what you can do.
- regular soldering, sweat fittings,
  - silver soldering, refinish furniture,
  - remove paint and putty

Available at Hardware Counters Everywhere

Write for FREE Soldering Instructions

THE **Lenk** MFG CO.  
BOSTON 15, MASS.



(Pattern No. 568 —  
50¢ Stor-All Workbench)

need a

## STOR-ALL WORKBENCH?

Build it yourself the Easi-Bild\* Pattern way. You don't need any skill or experience, just follow the pattern.

Trace simplified pattern on wood; saw, and assemble. The pattern lists materials and shows each step of construction.

For a complete new catalog of over 250 illustrated Easi-Bild Patterns—send 35¢ to EASI-BILD, Pleasantville, New York.

\*T.M. Reg. Easi-Bild Pattern Company

## EASI-BILD PATTERNS



Easi-Bild Patterns specify PLASTIC WOOD for a real professional job. Handles like putty—hardens into wood.

**"PLASTIC WOOD"**

and under the snow at depths down to 30 feet. "Signals travel more than twice as far over frozen terrain as they do over temperate hills and fields," Bud says. "And through the snow we can get distance." If it works, auroral disturbances will never trouble polar explorers again. Signals will propagate through Antarctica's top layers of snow, bouncing back and forth between surface and ice layers beneath to all parts of the continent—disrupted only by crevasses and mountains jutting through the icecap.

Antarctica's icecap is a feature that will come under the close scrutiny of IGY glaciologists. The great continental glacier, formed by eons of snowfall compacted into a six-million-square-mile blanket that may be nearly two miles thick in spots, flows outward constantly like pancake batter on a cold griddle. The expedition's "Mr. Ice," Doctor Siple, spent days skiing across the barrier. The continental glacial ice, he says, spreads outward at a rate of 4½ feet a day clear around the continent. Great pieces crack off the edges with deep, booming roars each year and float northward as icebergs, some of them hundreds of square miles in area.

IGY glaciologists are bringing core drills to Antarctica to probe through the thick cap so that layers may be studied and age of the icecap determined. Samples of snow can be tested for age by several methods. Each antarctic summer produces "melt lines"—thin bands of solid ice in the snow—that can be counted visually. But Ernie Wood, IGY scientist with Deepfreeze, used a newer method this year. Taking samples from deep in the icecap, he melted them and drained the water into plastic bottles. These, sent to the University of Chicago, will be tested for radioactivity. Tritium in the snow, emanating radiation with a known half-life, will reveal when the snow fell—even though it may have been blown to its present location by howling winds.

The changing, rumbling coastal ice of Antarctica is earth's last outpost of life. A few miles beyond the barrier cliffs nothing moves or grows except the wind and perpetually drifting snow. But the continent's edges swarm with creatures that draw a living from the sea. Expedition biologists, with pronged crampons clamped to their boots, scaled glaciers and ice cliffs on the trail of petrels, penguins and skua gulls. The latter, with four-foot wingspread, are voracious scavengers that live on the periphery of penguin rookeries, stealing eggs and chicks which they carry off and devour. They have a trying habit of dive-bombing people who come close to their nests.

(Continued to page 250)



# "WE PAID FOR OUR HOME with a Foley Saw Filer"



Here is the true story of Leslie Patrick—as told by his wife, who wrote us about their success in a town of 12,000.

"I can truthfully say that when Mr. Patrick got his Foley, he made a good and wonderful investment. When we moved here in March, 1946, we had only a Model A Pickup and all our belongings were in it. Since then, my husband has done so well with his Foley Saw Filing Machine and repair shop that we bought a house and paid for it and have two nice boys; bought a new car and built an addition to our house; and he has got a lot of new machines in the shop that a person needs in business. Nicest of all, it is all paid for."

## Make up to \$3 or \$5 an hour

With the Foley Automatic Saw Filer you can sharpen hand, band, and circular saws just like new. Start in spare time, in your garage or basement. No experience needed. Build up a steady, repeat CASH business which will buy YOU a home or new car. Send coupon for FREE BOOK—"Money Making Facts". No salesman will call.



FOLEY MFG. CO., 1216-6 Foley Bldg., Minneapolis 18, Minn.

Send Free Book "Money Making Facts".

Name \_\_\_\_\_

Address \_\_\_\_\_

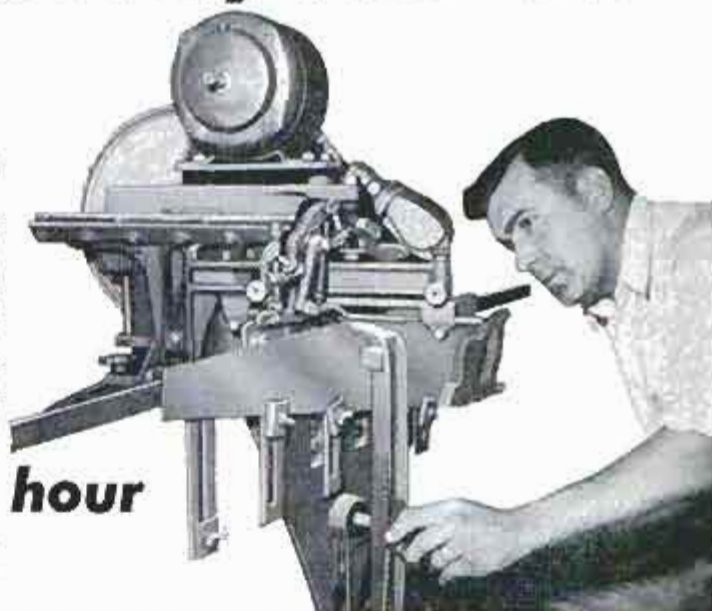

## "FIRE UP"

YOUR ENGINE AT ALL SPEEDS WITH  
AUTO-LITE RESISTOR SPARK PLUGS WITH

## POWER TIP

LOOK FOR THE PROTRUDING TIP!

### NEW, IMPROVED CALCULATOR FOR WOODWORKERS only 25c

Instantly gives information on lumber, nails, concrete mixes, painting materials, etc. Convenient, simple to read. Just set dial for nail specifications, to convert linear to board feet, find bit sizes for screws, compare characteristics of woods. 6" diameter heavily varnished cardboard. Send 25c, no stamps, please to Greenlee Tool Co., 2112 Columbia Avenue, Rockford, Illinois.



Protect your home against  
power interruptions  
with an...

## ONAN Emergency ELECTRIC PLANT

Provides dependable stand-by electricity for heating system, pumps, freezer, lights, appliances. Keeps home safe, livable. Automatic start and stop. Find out how little it costs!

Write for Folder!

**D. W. ONAN & SONS, INC.**  
3652 University Ave. S. E. • Minneapolis 14, Minnesota

A SIZE FOR EVERY NEED  
500 to 75,000 watts.  
Compact, quiet-running.  
Gasoline-powered  
Priced from \$255.00

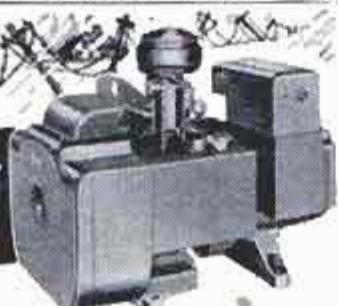

## Miracle Tool that does Everything!

...Everywhere  
around the house!



## A Whole Tool Kit...by Itself!

A turn of the End-Screw transforms trim, gleaming Vise-Grip into a Locking Wrench... Super-Pliers... Pipe Wrench... End Wrench... Clamp... or Wire Cutter! Magic double-lever action provides 2,000 lbs. gripping strength—locked on by a squeeze of the hand. Does more jobs easier than any other tool made! 7" and 10", cutter optional, \$1.85 to \$2.60. At your favorite hardware store.

PETERSEN MFG. CO., Dept. M-12, DeWitt, Nebr.





**BETTER PERFORMANCE**  
IN ALL KINDS OF WEATHER

Whether it is 100 in the shade or 30 below zero, your car will start quicker and run better with a Bendix\* Electric Fuel Pump. It's easy to install and costs less per mile of operation than any electric fuel pump on the market. Sold by independent garages and service stations.

\*REG. U. S. PAT. OFF.



**FREE:** A descriptive folder is yours for the asking. Write today.

**Bendix**

**ELECTRIC FUEL PUMP**

Grand Prix Winner

ECLIPSE MACHINE DIVISION, BENDIX AVIATION CORP.,  
ELMIRA, N. Y.



**SEALS  
HEAT  
IN...**

**SEALS  
COLD  
OUT**



Get a warmer, more comfortable home AND save up to 20% on fuel costs with INNER-SEAL weather stripping on your doors, windows, storm windows!

INNER-SEAL is waterproof, tough, flexible; easy to install; lasts for years. Spring steel wire molded in neoprene-coated sponge rubber assures tight seal. Has Good Housekeeping guarantee.

Buy it in exact-length "do-it-yourself" paks or in bulk at hardware, variety stores, building suppliers. Get free weather stripping booklet "Why Shiver" from dealer or write Dept. PM.

**BRIDGEPORT FABRICS, INC.**

200 HOLLAND AVE., BRIDGEPORT 9, CONN.

Four kinds of seals from little gray crab-eaters to 500-pound Wedells bask beside cracks in the bay ice. Having seldom seen men, none of Antarctica's creatures fear them. We patted the stomachs of lazy seals and sat on them, drawing no response beyond a grunt or resentful glance.

One stomach you don't pat is the sea leopard's. Cousin to the seal, this 12-foot spotted monster moves swiftly across the ice and will attack people at the slightest provocation. Great jaws with sharp, reptilian teeth can inflict serious damage. These, and the killer whales that cruise along the ice edge, bumping it to knock off seals or people which they eat with equal relish, are the Antarctic's dangerous creatures.

One of the first scientists ashore was Dr. Oliver L. Austin, Jr. The stocky polar veteran headed out across the ice for a penguin rookery. With him went a few assistants and 500 U. S. Fish and Wildlife legbands.

The rookery is on a ridge of bare volcanic ash under the lip of an ancient glacier on Cape Bird. Up on top the party found some 50,000 Adelie penguins on pebble nests crowded a foot or two apart. All were busily engaged in hatching out a summer crop of fuzzy chicks.

Of 17 varieties of waddling dress suits that inhabit the Southern Hemisphere, Antarctica boasts only two. The familiar Emperor is the deluxe model, growing to 40 inches and often weighing 90 pounds. The smaller Adelie reaches a scant 18 inches and tips the scale at about 12 pounds.

Penguin welcome parties waddled down the 300-foot slope to greet Austin, waving flippers and hamming it up. Though curious enough to approach within two or three feet of people, penguins resent being picked up.

On short hikes penguins walk upright, handling flippers like balancing poles. On long hauls, when tired or frightened, they toboggan, propelling themselves by paddling their toes against the snow and using their flippers like oars.

Both male and female penguins take turns insulating eggs against polar frigidty during the 40-day incubation period. The phenomenal energy required to incubate an egg in sub-zero weather is something ornithologists would like to know more about. Even more fantastic is the Emperor penguin, who breeds during the long antarctic night when winter temperatures often hit 80 below. Boy and girl Emperors, up to their necks in snow, hold the eggs on top of their feet and squat on them. Eggs are passed from one to the other beneath the snow.

(Continued to page 252)





**FULL 2 AMP. RATING.** This husky 1/4" drill packs power way beyond its size. It's light, compact, smooth running. No. 1814 Drill with Geared Key Chuck . . . . . \$27.50



**12 TIMES FASTER** than hand sanding. Does wet or dry sanding on wood or metal. Sands in any direction. Leaves no marks. No. 580 Orbital Sander . . . \$49.50



**FASTEST-CUTTING JIG SAW** in its field. Exclusive Millers Falls "angle" blade gives cleaner, smoother performance in either wood or metal. No. 480 Jig Saw . . . . . \$49.50



**NEW DRILL-SAND-SAW KIT.** Includes a 1/4" "Dyno-Mite" Drill, direct mounting Jig Saw Attachment, and sanding, polishing and buffing accessories. No. 4 Power Tool Kit . . . . . \$44.95



**TOP-QUALITY BASIC DRILL KIT.** Contains 1/4" "Dyno-Mite" Drill, flexible rubber pad, polishing bonnet, rubber pad adapter, and 2 sanding discs. No. 5 Electric Drill Kit . . . . . \$29.95



**UNIQUE PORTABLE POWER WORKSHOP KIT.** The 1/3 h.p. "Dyno-Mite" 888 Power Unit and accessories, with Orbital Sander Attachment, Jig Saw Attachment, Circular Saw Attachment and 6-piece Power Bit Set. No. 3888 Power Workshop Kit . . . . . \$99.95

Whether you're giving or getting—

*this Christmas make it—*



**"DYNO-MITE" JIG SAW ATTACHMENT.** Fits any 1/4" electric drill. Saws straight lines, curves, irregular cuts. With 2 wood cutting and 2 metal cutting blades. No. 2140 Jig Saw Attachment . . . . . \$11.95



**FAMOUS "DYNO-MITE" POWER WORKSHOP KIT.** Start with the 1/3 h.p. No. 888 Power Unit. It's 3 tools in 1: 3/8" drill, 6" sander, 6" polisher. **\$44.95**

**ADD THESE AND MANY OTHER ATTACHMENTS AS YOU NEED THEM**



**MILLERS FALLS**  
**DYNO-MITE POWER TOOLS**

*Finest Power Tools Made*  
FOR HOME AND INDUSTRY

FREE FOLDERS at your dealer's, or write: MILLERS FALLS COMPANY, Dept. PM-17, Greenfield, Mass.



free

world's most complete  
electronic buying guide

## ALLIED'S 1957 ELECTRONIC SUPPLY CATALOG

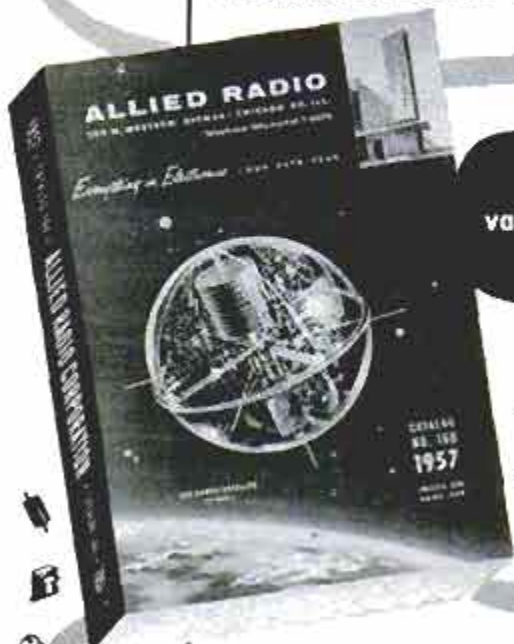

356  
value-packed  
pages

SAVE on  
Everything  
in  
Electronics

World's Largest Stocks...  
Everything For Experimenters,  
Builders, Amateurs, Servicemen,  
Engineers & Hi-Fi Hobbyists

Send for ALLIED'S value-packed 356-page 1957 Catalog. Save on everything in Electronics: Hi-Fi systems and components; latest builders' kits (see the famous KNIGHT-KIT line); recorders and phono equipment; TV tubes, antennas, accessories; Amateur station equipment; test instruments; industrial electronic equipment; plus the world's largest stocks of parts, tubes, transistors, tools and books. Save on everything in Electronics—send today for your FREE 1957 ALLIED Catalog!

Everything in Electronics  
From One Reliable Source

Our  
36th year

## ALLIED RADIO

ALLIED RADIO CORP., Dept. 5-MM-6  
100 N. Western Ave., Chicago 80, Ill.

Rush FREE 1957 ALLIED 356-Page Catalog

Name \_\_\_\_\_

Address \_\_\_\_\_

City \_\_\_\_\_ Zone \_\_\_\_\_ State \_\_\_\_\_

In late summer when the chicks mature, the whole colony heads north through sea ice, following shrimp. With his 500 Adelies banded, Austin hopes to track some of these wanderers and determine something about penguin life span, about which little is known. He also hopes to put aero-medical men on their trail during the breeding season to learn where they get their phenomenal resistance to cold. "There could be a practical application for us in cold weather adaptation, via food and clothing," he says.

A wide variety of new polar tools and techniques have been tested in Antarctica. Navy hydrographers, perched on volcanic pinnacles around McMurdo Sound, charted stations for making new, accurate maps of the area. Explorers still are using charts drawn by early British expeditions. This year, a Marine surveyor experimented with a new photo theodolite, which takes pictures of sightings that can be charted later in a laboratory.

New ideas in cold-weather clothes and gear were seen everywhere throughout Deepfreeze ships and camps. Doctor Siple has a heat-radiating sleeping-bag pad he devised and will take with him to the South Pole base for testing this year. Liquid, warmed from any nearby source, is circulated through a pad by motor.

There are plastic goggles without lenses, consisting of a barrel about four inches long projecting from the eyes. They are designed to prevent tears due to wind. A mountain-climbing party tested new water-repellent clothing insulated with perforated plastic. Designers claim it will allow body moisture to escape without letting heat out or cold in.

How many of these ideas will wash out is anyone's guess. But the big push is on to make the silent continent a safer place for men to live and work. ★ ★ ★

## Loudspeakers to Give Tornado Warning

Experiments are being conducted by the U. S. Weather Bureau to test Doppler radar, in the hopes of discovering the coming of a tornado before its lethal funnel is formed. Doppler radar spots its target by its relative speed. The high speed of the tornado winds, contrasted to the quieter air around them, would produce an audible sound on Doppler radar sets. The new equipment is expected to give not only a screaming warning of a tornado's approach, but also to indicate its bearing within one degree, and its speed and direction of movement. Advance knowledge of these storms would save lives, prevent damage.



**SATISFACTION**  
Unconditionally  
**GUARANTEED**

**SURPLUS & NEW MANUFACTURE EQUIPMENT**

**GROBAN'S**  
**SPECIAL BARGAINS**

Write for  
**FREE 1957**  
**CATALOG**

**300 AMP. D. C. GENERATORS**  
IDEAL FOR WELDING GENERATORS

**ITEM #91** Type R-1, rated 300 Amps. — 30 Volts. Mfd. by General Electric & Ford, Government Acquisition Cost \$380.00. Shpg. wt. 35 lbs. Dimensions: 16" x 10" x 7". Complete with instructions to connect as Welder. **35.00**  
F.O.B. Chicago.

**ITEM #90** — When connected as a welder, this unit will deliver 200 amps for a sustained period and 250 amps for intermittent service. This generator is widely used for shop-built portable welders. Rated 200 amps, 28 volts, 2500 R.P.M., using 10 H.P. Dimensions: 15" L. x 6" W. x 8 3/4" H. Splined drive shaft. Gov't. Acq. cost \$300.00, Shpg. Wt. 51 lbs. F.O.B. Chicago. **22.50**

**ITEM #99** — 12 V. — 50 Amps. — Leaver-Neville generator for autos, trucks, road machinery, boats and battery chargers. Precision aircraft quality construction, with life-time grease sealed ball bearings and heavy insulated windings. Standard 4-bolt square mounting flange, spline shaft. Dimensions: 16" L. X 8 1/2" Dia. Wt. 23 lbs. Gov't. Acq. cost — \$92.00  
New . . . F.O.B. Chicago **16.50**

**MULTI-PURPOSE HYDRAULIC PUMP OR MOTOR**

**ITEM #55** Silent, high efficiency, Helical Gear Type Ball Bearing Hydraulic Pump or Motor. Rated 8 Gal. Per Min. At 1500 R.P.M. — Delivers 1000 P. S. I. Using 6 H.P. — Reversible Rotation — 3/4" Pipe Thread Inlet and Outlet Ports — 1/4" Drain Port — 3/4" shaft with keyway and flat for either direct or pulley drive. Dimensions — 5 3/8" high, 7 1/4" long, 5 1/8" wide. Shipping weight 18 lbs. F.O.B. Chicago. **45.50**

**DOUBLE ACTION HYDRAULIC CYLINDERS**

**ITEM #31C** — 3 1/2" bore, 11" stroke. Alloy steel cylinder wall. Micro-Honed and all steel 1 1/2" diameter piston rod, 19 1/2" over-all length closed. Clevis mounting at base and shaft. Will lift 9625 lbs. with 1000 PSI Pump Pressure. Uses 3/8" tubing fittings. (Fittings to pipe thread: two 3/8" MPT @ 35c.) A \$102.00 value. Shipping weight 11 lbs. FOB Chicago. **25.00**

**ITEM #16-C** — 1 1/2" bore, 26" stroke. Will lift 1760 lbs. with 1000 lbs. pump pressure. Great for hay loaders, etc. 1" stainless steel piston rod. Postpaid. **16.95**

**BRAND NEW 1957! FACTORY-TO-YOU-VALUE PORTABLE ELECTRIC LIGHT PLANTS**



**ITEM #1008-B**  
Dimensions: Length 20 1/2" Width 12" Height 16"  
**POWER TO OPERATE:**  
• Water pump, Radio, Lights, Air-conditioner • Refrigerator, Deep Freezer, Incubator • Electric Saw, Electric Drills, Pipe Bender

**Compact—Fits in the Trunk of Your Car**  
**FULL 1000 WATTS** continuous duty, 115 Volts, A.C. 60 cycles, 9 amps. Powered by husky Briggs-Stratton engine with recoil starter. Engine and generator operate at 3600 R.P.M. for maximum efficiency at minimum weight. Both units are mounted on steel base, with heavy sheet metal belt guard. Generator is self-regulating, and is equipped with outlet box containing fuse and 2 A. C. convenience receptacles. Cost only 5c an hour to operate. Shipping wt. 100 lbs. (Regular price \$225). You save \$65.50. Now only, F.O.B. Chicago. **159.50**

**700 WATT—GENERATOR SET**—same as above, slightly smaller—with Briggs-Stratton Engine—Model 708—F.O.B. Chicago. **129.50**

**ITEM #2008—2000 WATTS** 115 V. A.C. generator set, powered by husky, fast starting Briggs-Stratton engine. Mounted on portable steel carrying base for easy handling. Just right for small cottage and cabins needing inexpensive 2000 Watts of electricity. Ship. Wt. 100 lbs. F.O.B. Chicago **295.00**

**GENERAL ELECTRIC "MAZDA" 300 WATTS 5 1/2" Sealed Beam 110 V. SPOTLIGHTS**

**THROWS A BEAM TO 1000 FT.**  
Item #418



Uses conventional 110 Volt current — Fine for lighting up drive-ways, signs, parking lots, displays, garages. Built for use as Flashing Signal for U.S. Navy — to stand heavy surge loads. Shipping Wt. 2 lbs. U.S. Gov't. Cost \$12.68 ea.  
Now **2.50** Post-paid  
Each . . . . .  
Lots of 3 — 6.00, Postpaid

**U.S. NAVY ALL BRONZE CENTRIFUGAL PUMP**



These all bronze Centrifugal Pumps are ideal for use as marine bilge pumps, circulating pumps, fire protection or irrigation, car-washing, dewatering, basement sump pumping, lawn sprinkling. Will pump water, oil, brine, gasoline, DDT and sulphur compounds. Equipped with 6" adjustable "V" pulley, 2" dia. inlet and outlet, 180 GPM capacity. Inlet and outlet take hose with 2 1/4" inside diameter. Dimensions: 11" x 8" x 11".

Total head-feet	Speed	H.P.	GPM
25	1600 RPM	3/4	180
35	1600 RPM	1 1/4	90
20	2400 RPM	1 1/2	75

Back plate may be rotated for most convenient inlet position. Gov't acquisition cost \$96.00. Shipping weight 31 lbs. F.O.B. Chicago. **29.50**

**HOBART 2 H.P. 12-24 VOLT ELECTRIC MOTOR**

**ITEM #315**—Rated 24 volts D.C. 90 amps, 4000 R.P.M. Has 1/2" spline shaft on both ends of motor. Ball bearing construction, as specified for use with electric wheelchair design Popular Mechanics March issue, 1953. Convertible for use on 6 to 12 volts. Shipping Wt. 21 lbs. Dimensions: 11" x 5" x 6 1/2". F.O.B. Chicago. **13.00**

**1-H.P. —12 Volts—100 Amps ELECTRIC MOTOR 5600 RPM**  
Double shaft, ball bearing construction. ITEM #308.  
F.O.B. Chicago. **12.50**

**ORDER DIRECT FROM AD SATISFACTION GUARANTEED**  
Send Payment Or Purchase Order Today  
For Phone Orders call **Webster 9-3793**

**Brand New! 5-TON BLACKHAWK HYDRAULIC LIFT KIT**

Now Only **38.95** Complete

**THE COMPLETE KIT**  
For—• Dumping farm wagons  
• Adjusting depth of plows  
• Hydraulic press • Hydraulic jack • Snow plow

**KIT CONSISTS OF:**  
1—Brand new Blackhawk Model P-151—Hydraulic hand pump with built-in oil tank and release valve. Rated from 1200 P.S.I. — to 8400 P.S.I. — 20" handle. Dim. 8"x6"x6" Item #22. **22.50**  
1—6 Ft. length double wire braid rubber covered hydraulic hose—tested to 20,000 lbs. Item #2784. **3.95**  
1—Hydraulic Cylinder, 3" bore, 8" stroke. Husky 3/4" solid steel shaft. Will lift 10,000 lbs. using pump pressure. Clevis mountings that take 3/4" diameter pins. May be used for double action service. Item #419 **\$12.50**  
2—Qty. non-foaming hydraulic fluid. All necessary hydraulic fittings. Total ship. wt.—40 lbs. **1.00**

**COMPLETE KIT PRICE. 38.95**  
**ALL OF ABOVE INCLUDED F.O.B. Chicago**



**GROBAN FOUR-WAY OPEN CENTER HYDRAULIC CONTROL VALVE**

**ITEM #126**—Four-way open center control valve, with built-in adjustable relief valve factory set at 1000 P.S.I. Spring loaded neutral position. For use with one double acting cylinder. In neutral position cylinder is locked and pump unloaded. Can be used as single unit or mounted in series. Has 3/4" pipe thread inlet and outlet. 1/2" pipe thread cylinder ports. Finger grip handle. Ship. wt. 10 1/2 lbs.  
**AN OUTSTANDING BUY!**  
F.O.B. Chicago. **21.50**



**1/4" Metal Stamping Set STAMP YOUR NAME ON WOOD OR METAL!**



Full alphabet A to Z, "&" and period. Precision hand trimmed deep cut, hardened STEEL STAMPS—in fitted Wooden Box—made to rigid U. S. Navy specifications by Young Bros.—Comparable to sets selling for \$27.00. Shipping Wt. 5 lbs. F.O.B. Chicago. **5.95**

**GROBAN SUPPLY CO.** Dept. PM-12  
1139 S. WABASH AVE., CHICAGO 5, ILL.



## 24 Drilling Combinations with Parker No. 4 Wood Screw COUNTERSINK BIT SET



Drills and countersinks to flush, putty or plug depths for 8 most popular screw sizes. Depth-a-dapter adjusts easily on all 4 bits.

At your hardware Dealer's **Only \$1.70 per set**

**PARKER MANUFACTURING CO.**  
WORCESTER 1, MASS., U.S.A.

## READY CUT HOMES

**\$2150 AND UP DIRECT FROM MILL**

YOU SAVE the items which help make today's building cost expensive: high labor cost, contractor's profit and overhead, insurance, architect's fees. Cut-to-Fit eliminates usual lumber and material waste, also costly mistakes. Anyone can assemble. Simple, easy-to-follow plans furnished and each part numbered. Complete with all lumber, roofing, nails, glass, hardware, paint, doors, windows. Freight paid. Low-cost building plans sold separately if desired. 57 Homes and Floor Plans.



5 EASY PAY PLANS  
COLOR CATALOG



**INTERNATIONAL MILL & TIMBER CO.**  
Dept. PM126 Bay City, Mich.

## General Motors Offers Three All-New Cars

(Continued from page 105)

construction. The tailfins are changed; no longer is the taillight assembly uppermost. Now the fins are tall, slender airfoils and taillights are mounted low, just above the bumper. Front bumpers have conical rubber inserts in the tips of bomb-size bumper guards.

Eldorado models have rear fenders not unlike those of the Firebird gas-turbine car. Two models are available, the Biarritz convertible and the Seville hardtop—the Brougham will be out in February). Both have rear-end styling more suggestive of a competitive sports car than a boulevard charmer.

### Oldsmobile

Oldsmobile, too, has sharply increased displacement and horsepower. The V8 engine has 371 cubic inches (seven more than Buick or Cadillac). It develops 277 horsepower. Four-barrel carburetion is standard on all models. Compression is 9.5 to 1.

Printed circuits are used in the dashboard wiring, a first in the industry, says Olds. Instead of 14 separate connections, there is only one—a plug-in one at that. This simplifies assembly and virtually eliminates short circuits under the dash.

Brake drums are flanged to reject heat and minimize fading in high-speed stops. Water deflectors keep linings dry under the worst wet-weather conditions.

The propeller shaft is of three-joint design to permit lowering the body in the rear end, as an added virtue, to reduce gear noises.

Heater controls are power operated, another Oldsmobile first, and warmup time is cut sharply by a novel system of blowing warm air directly on the driver during the first moments of operation. Once he is warm, the heater is changed to indirect heating to warm the whole car. With this system, you feel heat 30 percent sooner than usual.

Other engineering changes include aluminum main bearings (in all but number five), aluminum rod bearings, new cams, larger hydraulic valve lifters and an exclusive antivarnish feature to prevent sticking. Pistons now have closed skirts and valves, intake and exhaust, are larger.

### Pontiac

They're gone—the Silver Streaks, that is—for the first time in over 20 years. And without them, the Pontiac looks wider and lower.

(Continued to page 256)





## Useful bookshelf-desk of Western Pine is beautiful, easy to build

Built in, or as a separate piece of furniture, this good-looking unit combines a wealth of useful features.

Straight-grained, smooth-textured and economical, the mellow Western Pines cut cleanly with either hand or power tools, take any paint or stain beautifully. Left natural, they may be waxed then rubbed to a silken natural glow.

See these carefully selected, well-seasoned woods at your local lumber dealer's.

## The Western Pines

**Idaho White Pine**

**Ponderosa Pine**

**Sugar Pine**

and these woods from the Western Pine Mills  
 WHITE FIR • INCENSE CEDAR  
 RED CEDAR • DOUGLAS FIR  
 ENGELMANN SPRUCE  
 LODGEPOLE PINE • LARCH

are manufactured to high standards of seasoning, grading, measurement  
 Today's Western Pine Tree Farming Guarantees Lumber Tomorrow



FREE! New booklet of bright ideas!

"FRIENDLY HOME IDEAS IN WESTERN PINE"—85 photographs, many in color, feature traditional and contemporary ideas for building, decorating and remodeling using cheerful Western Pines. Write for your FREE copy to WESTERN PINE ASSOCIATION, Dept. 531-N, Yeon Bldg., Portland 4, Ore.

# There's Big money in arc welding!



**INVESTIGATE these money-makers TODAY!**

200 amp. light weight, low cost "BANTAM CHAMP" is specially designed to let you do production and repair work in your own shop.

200 amp. TRANSFORMER AC welder for operating on single phase 220 volt power. Ideal for shops that would like to do production and repair work.

200 amp. "HUSKY BOY" welds anywhere. It's light, rugged, compact—easily mounts on your truck or trailer for traveling to emergency repair jobs. Portable mountings also available.

Air-cooled engine driven arc welder and power plant for auxiliary lighting, power for tools & motors plus WELDING—a money-maker anywhere!

Welding lessons book, 200 pages self-teaching... only \$1.00

**Check the COUPON! investigate these money-makers today**

**See how it pays** with the new low cost Hobart welder. One of these easy to use models can become your key tool, in fact, the very method of putting you in business and more money in your pocket. Double earnings doing construction work. Cash in on the big demand for emergency repair work. Now is the time to get started. Get a HOBART welder. Hobart Brothers Co., Box M-126, Troy, Ohio, Ph. 21223. HOBART TRADE SCHOOL... learn arc welding quickly by actual on-the-job experience. Complete or partial courses. G.I. approved. Non profit.

**Hobart** "One of the world's largest builders of arc welders and arc welding equipment."

**HOBART BROTHERS CO., BOX M-126, TROY, OHIO**

Without obligation, send complete details on:

200 amp. "Husky Boy"       200 amp. Transformer

200 amp. "Bantam Champ"       AC Power—AC Welder Comb.

"Vest Pocket Guide for Welders"

Name \_\_\_\_\_

Address \_\_\_\_\_

City \_\_\_\_\_ State \_\_\_\_\_



THE SURE  
WAY TO  
**KNOW**

YOU ARE  
BUYING A FINE  
POWER DRILL

For top performance, choose the power drill equipped with a Supreme Chuck. The finest in quality and precision. Or replace your old style chuck with a Supreme. See your hardware dealer.

**Supreme Chucks**  
BRAND

SUPREME PRODUCTS CORP., 2222 S. CALUMET, CHICAGO 16



**SCREWDRIVERS**  
*feel good in your hands*  
you do a better job...  
faster...easier

When you need screwdrivers, get good ones... P & C. They're tops in quality: fire resistant, shock-acid-hammer proof, handles that are U. L. Approved. Finest analysis steel bits.

Buy your screwdrivers from the colorful P & C Tool Merchandisers, in more than 12,000 stores coast to coast. Send 10c for catalog.



**P & C TOOL COMPANY**

Dept. H-5, Box 5926 • PORTLAND 22, ORE.

Like Chevrolet, Pontiac retains the same body shell as last year. This limits the amount of lowering that can be done, but car height is down somewhat thanks to the 14-inch wheels.

Big Pontiac news is engineering. Horsepower is up sharply to 252 with two-barrel carburetion, 270 with four-barrel. Displacement is 347.04 cubic inches. The new crankshaft (necessary because of increased stroke) has enlarged bearing diameters and increased rigidity. Pistons are new. Pontiac now vents its intake valves to the atmosphere to minimize the chance of oil being sucked into the combustion chambers during coasting (you smell the bad results of this suction when the car ahead of you begins to coast and clouds of oil smoke pour from the tailpipe).

The block is new and more rigid. The distributor has been redesigned and has a window opening for adjustments while the engine is running. Radiator pressures are now 13 pounds (up from 7 last year) to raise the boiling point about 31 degrees.

Styling changes include a completely new rear-fender design with bold, distinctive taillights and a projectilelike ornament as part of the side treatment. The front grille is all new, but most noticeable is the absence of the chrome striping that has said "Pontiac" for years. ★ ★ ★



### Christmas-Tree Bagger

Christmas trees can be packaged by forcing them through a special funnel into a polyethylene bag, where they will stay fresh for months. When the wrapping is removed and the branches pressed down, the tree resumes its natural shape.

☐ Although water covers almost three fourths of the earth's surface, man takes scarcely more than one percent of his food from inland waters and the sea.



## REAL HE-MAN XMAS GIFTS— ELECTRIC MOTORS AND KITS

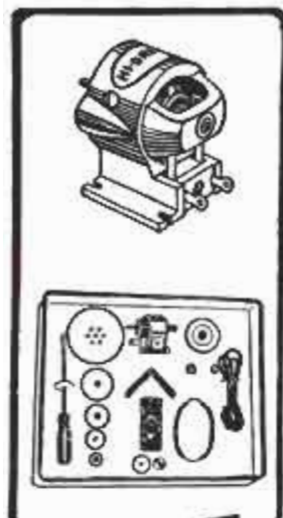

These safe, practical and educational battery-operated gifts will bring joy to hobbyists of all ages—will put life into toys and models—will operate research and small industrial equipment. With gear trains these motors will develop tremendous power. There's a gift for someone you know in this list. Order today.

- \*No. 8-100 Hi-Drive Motor, 3-6V. . . . . \$2.50
- \*No. 9-100 Same for 12V. . . . . \$3.00
- No. 3-100 Tiny Atom Motor, 1 1/2-3V. . . . . \$2.50
- No. 3113N Tiny Atom motor assembly kit with many acc. . . . . \$3.50
- No. 1300N Small accessories kit. . . . . \$1.00
- No. 3700 Large accessories kit. . . . . \$3.00
- \*No. 4000 De Luxe accessories kit with motor. . . . . \$5.00
- No. 700 Super-Power kit with motor, speed reducer, all accessories. . . . . \$10.00
- No. 88 Kit of 8 pulleys—2 belts. . . . . \$2.00
- No. 3000 Vari-speed gear unit. . . . . \$4.00
- No. 1049 Gear train with Hi-Drive motor No. 8-100. . . . . \$5.95
- Same with No. 9-100 Motor. . . . . \$6.45
- \* Item illustrated. Ask for FREE Cat.

All Wilson's motors have Permanent Alnico Magnets.

Remit with order and we pay postage in U.S.A. No C.O.D. Add 3% Sales Tax for delivery in Ohio. Write Dept. PM.

For quick delivery see your local dealer — or order direct



**WILSON'S OF CLEVELAND**

425 Lakeside Ave., N.W. • Cleveland 13, Ohio

## GENUINE ALNICO MAGNETS

AMAZING, PERMANENT, NON-ELECTRIC, HIGHLY PRACTICAL. Conduct interesting experiments. Hundreds of uses. Retrieve valuable steel items such as guns, tackle from fresh or salt water; tools from tanks & drains. **GUARANTEED.** Try any magnet one week. Money back if you are not well-pleased.

- No. M-710 Has pull of 225 lbs. on flat steel block. . . . . \$16.50
- No. M-625 Has pull of 125 lbs. on flat steel block. . . . . \$9.50
- No. M-575 Has pull of 75 lbs. on flat steel block. . . . . \$6.50
- No. M-500 Has pull of 50 lbs. on flat steel block. . . . . \$4.50
- No. M-47 Hot Pad Magnets, 10 for \$1.00. . . . . \$10.00
- No. M-35 Hobbyist assortment of 8 small magnets. . . . . \$1.50

Send M.O. or check. We pay postage. Sorry no C.O.D.'s.

MIAMI MAGNET COMPANY, 3240 N.W. 27th Ave., Miami 42, Fla.

FOR BETTER REFINISHING JOBS USE



**Klean-Strip**  
PAINT REMOVER

- Non-inflammable
- Removes any finish
- Fast • Non-messy
- Needs no neutralizing

"Peels Off Paint"

SAY YOU SAW IT IN  
POPULAR MECHANICS

## 1 Bit to DRILL • REAM • SAW

IN SHEET METAL, WOOD, ANGLE IRON, TRANSITE, BAKELITE, etc.



Fits any 1/4" or 1/2" electric drill or drill press

Drills own 1/4" starter hole; cuts straight, curves, or angles. Made of finest High Speed, abrasion-resistant steel. Easy to use.

Replaces \$50 worth of cutting tools

New, Low Price

Money-Back Guarantee

**\$2.95** post paid  
3 for \$8.50

FINE FOR XMAS GIFTS

Specify Bit for: Wood, Heavy Metal, All-Purpose

Check or Money Order **INTERNATIONAL TWIST DRILL CORP.**  
DEPT. 12-M 618 Wyandotte, Kansas City, Mo.

DEALER INQUIRIES WELCOME

**TOOLKRAFT CORPORATION**  
400 Plainfield St., Springfield, Mass.

Please send me the following:

Free folder on complete line of Darra-James power tools.

Free folder on Darra-James MotorTools.

Name of my nearest dealer.

Power Tool Handbook. I enclose 10¢ to cover handling and postage.

NAME \_\_\_\_\_

STREET \_\_\_\_\_

CITY \_\_\_\_\_ ZONE \_\_\_\_\_ STATE \_\_\_\_\_

**THIS COUPON brings you  
the most exciting news in Power Tools!**

**AT LAST!**



**MotorTools**

specially designed to bring you  
today's most wanted features in Power Tools!

...Power Packed Beauties with **BUILT-IN-MOTORS**

**CONVENIENT:** Darra-James MotorTools take the guesswork out of choosing the proper motor. They come equipped complete with Timing Belt, Pulley, and G. E. Motor with Cord, Plug, and Switch. **ABSOLUTELY NOTHING TO BUY.** Everything is built to the most rigid factory specifications. **TIME-SAVING:** Since each tool comes equipped complete with motor and accessories, there's nothing to mount — thus, no time lost. **SIMPLE TO OPERATE:** Just plug in, flip the switch and operate . . . as easy as running a toaster. **MOVABLE:** Each MotorTool is compact and can be carried quickly and easily from one place to another . . . move the tool to the job . . . NOT the job to the tool! **RUGGED:** Entire tool is constructed of heavy-duty cast iron to assure many years of trouble-free service. **CHOICE OF COLORS:** Darra-James MotorTools are available in either popular Slate Gray or new Woodland Green to enhance the beauty of your home workshop. **ECONOMICAL:** Darra-James MotorTools cost less than similar tools and motors purchased separately.

All Darra-James Power Tools can now be purchased  
for **ONLY 10% DOWN** through  
our convenient credit plan



8" TILTING ARBOR SAW  
(Model 825)

A quality tilting arbor saw at a minimum price • Cuts stock 2-9/16" thick • With extensions, rips to center of 33" panel • Motor, guard, and splitter tilt with blade to 45° • Precision-ground cast iron table (16" x 20") stays flat • Lifetime ball-bearing arbor unit • 3/4 H.P. continuous duty G. E. motor

\$114.95

4 1/2" JOINTER  
(Model 845)

Uniquely synchronized to maintain constant distance between table and blades at any depth of cut • Rabbits up to 1/4", planes any board up to 4 1/2" wide • Tables adjust individually for perfect alignment • Ball-bearing construction • U. S. Rubber Power-Grip Timing Belt Drive • 1/2 H.P. continuous duty G. E. motor



\$84.95

8" TILTING ARBOR SAW  
(Model 815)

An economy saw that will perform all operations of high-priced models • Cuts stock 2 1/2" thick, rips to center of 18" panel • Blade, guard, and motor tilt to 45° • Table and work stay flat • Precision ball-bearing arbor unit • 3/4 H.P. continuous duty G. E. motor



\$89.95

Ask your dealer about the complete line of Darra-James standard power tools



YOU'LL BE AS BUSY AS A BEAVER WITH DARRA-JAMES POWER TOOLS!



## FROM ALL OVER THE WORLD...

news you want to hear  
with a



### hallicrafters Model S-38D—Only \$49.95

It's a fascinating, exciting hobby to listen in on the whole wide world by short wave with Hallicrafters S-38D radio. With this exceptional receiver you enjoy not only standard broadcasts . . . but can choose from the 3 international short wave bands. You, too, will praise the performance of Hallicrafters S-38D radio . . . the choice of countless governments as well as radio experts the world over. Hear the S-38D at your nearest Electronic Parts Distributor today—\$49.95 . . . or write

# hallicrafters

CHICAGO 24, ILLINOIS



NEW SIOUX

### 1/4" DRILL KIT

Here's the powerful SIOUX 1/4" electric drill with accessories for sanding, drilling, grinding, sharpening, wire brushing, polishing, cleaning, etc., all in a handsome, fitted metal case that hangs on the wall or goes to the job... \$41.75 Complete Drill only \$24.95



WRITE TODAY FOR MORE INFORMATION

ALBERTSON & CO., INC., SIOUX CITY, IOWA, U.S.A.

## An Engineer Looks at the New Cars

(Continued from page 101)

new nor exclusive, being used on virtually all cars this year). Ball joints provide for the vertical motion required by springing and the horizontal motion required for steering. The lower control arm is now in two sections, the forward section being sort of a strut.

The conventional coil spring has been replaced by a torsion bar coupled at the front to the lower control arm and fixed at the rear to the frame, with an adjustment to compensate for any sag that may take place as the car ages. This is new and is the only torsion-bar suspension on a domestic car this year.

Suspension is still by conventional upper and lower control arms (parallelogram type) and there should not be much change in ride and handling. More important is the fact that the entire suspension and steering system is isolated in rubber—this does much to eliminate the transmission of road shock into the car.

### Four Headlights

Four headlights are optional in several makes and standard on at least one. In a typical system with four lights arranged horizontally, high-beam lighting is provided by all four lights and total power is 150 watts instead of the 100 common to two-light cars.

On the low beam the two outboard lights deliver a total of 100 watts instead of the 80 watts put out by low-beam systems previously in use. With the increased power there is, of course, more light on the road, but probably no more than could be obtained with a two-light system of equal power. Glare for the oncoming driver is certainly not less and may be more.

The best of present-day generators delivers about 420 watts. Unless this capacity is increased there will, of course, be less power available for battery charging, heater, radio and other accessories. To take care of cars with the new system, service stations will have to stock two additional types of light units, in addition to the two they already carry for the present six and 12-volt cars.

## Find 40-Million-Year-Old Eggs

A bird's nest, containing 13 fossilized eggs laid about 40 million years ago, has been found on a ranch near Crawford, Neb. X rays, seeking embryos in the eggs, may determine size and shape of these ancient birds.



**FINISH CONCRETE OR MASONRY WALLS  
WITH WALLBOARD OR WOOD PANELS—  
Do It Yourself  
this easy,  
low-cost way!**

Just attach *Gemco Anchor Nails* (16" apart) to walls with waterproof *Tuff-Bond Adhesive*. These will hold furring strips securely in place. Then nail wallboard or wood panels to furring strips... and the job is done. It's that simple! All you need is the *Gemco Anchor Nail Kit*... at better dealers everywhere. If your dealer cannot supply you, write...

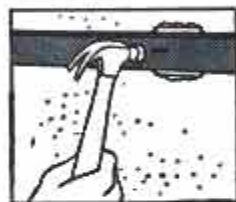
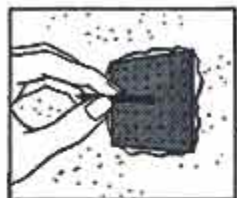

Goodloe E. Moore, Incorporated, Danville 2, Ill.

- ★ COMMERCIAL
- ★ FARM AND HOME
- ★ HOSPITAL



Write for FOLDER today!

**LOW COST  
Katolight  
ELECTRIC PLANTS**  
PROVIDE PORTABLE OR STANDBY  
POWER ANYWHERE... ANYTIME!

Permit uninterrupted operation of electrical equipment despite power failure. Extra high overload capacity. Durable built for long dependable service.

A FULL LINE FROM 350 WATTS TO 75 KW-UP.  
KATOLIGHT CORPORATION Box 891-22, Mankato, Minn.

*Six or V-8  
the going is great!*  
**'57 FORD**

**FAIRGATE'S  
NEW  
Graduated  
T-SQUARES**



(FOR QUICK SQUARING AND EASIER MARKING)

ALL-METAL • STRONG AS STEEL • NON-RUST • FEATHER-LIGHT • EASY TO HANDLE	24"—\$5.50
	30"—\$6.00
	36"—\$6.75
	42"—\$8.25

SEND FOR FREE CIRCULAR

THE FAIRGATE RULE CO.  
COLD SPRING, NEW YORK Dept. P.M.

**FAST**

is the word for these efficient little  
**RIGID**  
**Drop-Head Dies!**



**Easy threading of your 1/8" to 2" pipe**

Size head you want snaps into ratchet drive ring from either side—can't fall out. Dies reverse easily for close-to-wall threading. Ask for **RIGID** No. 00R for 1/8" to 1" pipe, or any combination of sizes to 2" pipe to fit your needs. Bolt die heads also, 1/4" to 1", fit your 00R. Free carrier with sets. For your shop, for your home—buy this handy threader at your Hardware Store.

Famous **RIGID** Pipe Wrench also gives you most service for your money!



The Ridge Tool Company, Elyria, Ohio, U. S. A.



# FOR BEST RESULTS USE *Atlas*

## *Atlas*

### 15" DRILL PRESS

The most useful tool for your shop — and America's greatest drill press value! With accessories, it gives you a whole shop full of tools . . . for mortising, carving, routing, sanding, and buffing as well as drilling. And Atlas is built to last you a lifetime — with exclusive "floating-drive", six-splined spindle and drive sleeve, 4 sealed-for-life ball bearings and extra-heavy construction throughout for maximum rigidity and accuracy! See it — compare it before you buy!



## *Atlas* BELT and DISC SANDER

This versatile tool is the ideal sander for shop use. It sands boards of any width, flat surfaces, angles, curves — metals, plastics. Has 10" diameter disc. 4" belt operates in both vertical and horizontal positions. Table tilts 45° and can be used with either disc or belt. Table is precision ground for smooth work feeding, and grooved for mitre gauge to simplify duplicate work. New heavy-duty, pyramid metal stand comes completely assembled, ready for use . . . has thick wood top . . . fully encloses motor and belt. See it at your Atlas dealer's!

WRITE FOR ILLUSTRATED LITERATURE



*Atlas Press Company*

12-24 N. Pitcher St., Kalamazoo, Mich.

QUALITY MACHINE TOOLS SINCE 1911

## Glass Triangles Reduce Noise

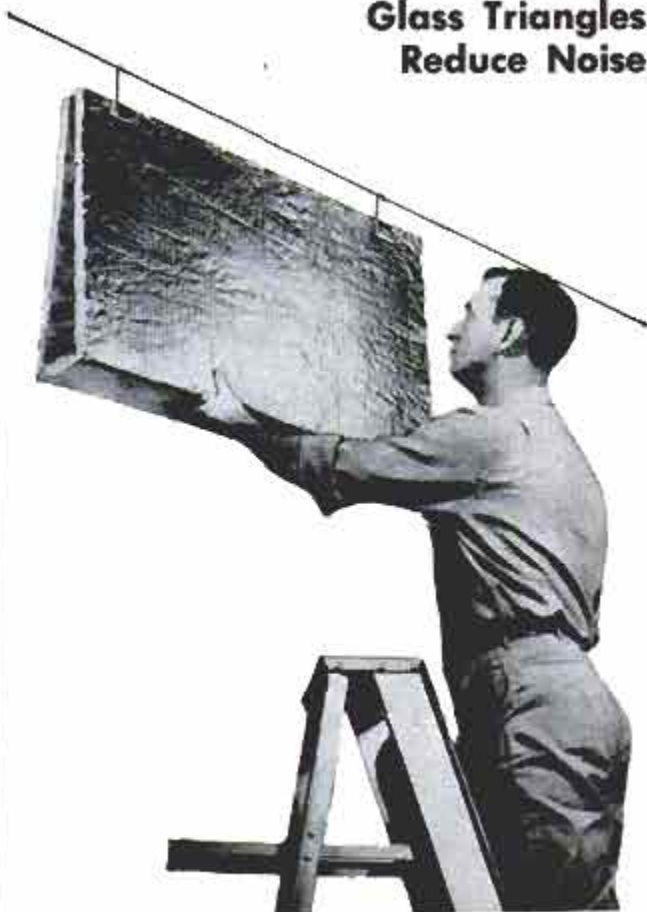

Suspended, wedge-shaped, glass-fiber baffles can reduce noise in industrial areas by 60 percent. Millions of air pockets in these units break up and dissipate low and high-frequency sounds where lights, ventilators, or sprinklers prevent continuous use of sound-absorbing material. Each baffle weighs one pound and is three feet long, two feet high and six inches deep across the bottom. This product is reported incombustible, vermin and rot-proof, and impervious to bacteria or mold. Applications include auditoriums and gyms.

## "Stained-Glass Window"



With a new kit you can make your own "stained-glass window" for Christmas. The decoration depicts The Nativity. The kit includes five colored - cellophane cutouts and a sheet of clear acetate. The cutouts fit together like the parts of a jigsaw puzzle and are cemented to the acetate.



## DRILL STAND & SHARPENER

Fits all portable drills; converts drill to bench grinder. Sharpens round shank drills from 3/32" to 1/2" diameter. Grinds 4 different drill point angles. Recessed guides eliminate use of protractor or fussy set-up work. Stand, \$6.95. Sharpener, \$2.95. Complete set includes stand, sharpener, wheelguard, clamp for drill, grinding wheel, arbor... **\$8.95 PPD.**

## SAW SHARPENING IS EASY

Super Filer No. 11 joints and sharpens hand and circular saws 6" to 10" with all teeth correct in height, depth, pitch, bevel. When file hits steel roller teeth are finished. Saw runs true with no side pull. **\$9.95 PPD.** Includes 8" file.....

TRU-CIRCLE saw set automatically sets teeth at 10° or more. **\$2.95 PPD.**

## SUPER SAW FILER No. 6

Automatically controls depth, angle, pitch for all saws. Precision made and calibrated. Use in any vise or clamp. Includes file... **\$6.50 PPD.**

## DOWEL CENTERS

Centers inscribe exact location for opposite holes. Pairs for 1/4", 3/8", 1/2" holes. **\$1.00 PPD.**

MONEY BACK GUARANTEE

SEND FOR FREE CATALOG

A. D. MCBURNEY, 5908 Hollywood Blvd., Hollywood 28, Cal., Dept. A-126

SMALL! POWERFUL!

## ECONOMY TRACTOR



Thousands in Use Write for complete details. Engineering Products Co. 915-K-12 Niagara Ct. Waukesha, Wisconsin

Unequaled value! Low price! America's finest tractor. Ruggedly built. Easy to operate. 700 lbs. Borg-Warner clutch, trans. and diff 140 to 1 reduction. 40% more drawbar pull than ordinary tractors 8-1/4 H. P. engine. 20 quick change implements. HOOD, FENDERS.

## Exclusive Double-Bearing HEAVY-DUTY PUMPS

IRRIGATE • DRAIN • CIRCULATE • SPRAY  
Up to 7,500 GPH. 3,000 GPH from 25' well. Use 1/4 to 1 HP motor, 1 1/4" inlet; 1" outlet. Stainless shaft. TYPE X-2 oilless bronze bearings. Won't rust. **\$10.95**  
TYPE XB—Ball bearing model..... \$12.95  
Postpaid if cash with order. Rush your order today  
MONEY BACK GUARANTEE  
Centrifugal and Gear Pumps in All Sizes  
LABAWCO PUMPS, Belle Mead 2, N. J.

## BUILD YOUR OWN ARC WELDER

WE SHOW YOU HOW to build powerful D.C. Welders from surplus aircraft generator. Light or heavy work. Easy to build at low cost. Worth hundreds of dollars. PLANS 35c. SEND TODAY. Includes FREE Surplus, Welder, Electrical catalogs.

LEJAY MFG. CO., 2907 EMERSON AVE. SO., MINNEAPOLIS, MINN.



128 PAGES Many in full color

packed with rare, fancy & imported woods... veneers, plywoods, patterns, tools, ornaments, hardware... everything for the woodworker.

## Get This NEW Catalog of WOOD & WOODWORKING EQUIPMENT

WORLD'S LARGEST SELECTION OF FINEST DOMESTIC AND IMPORTED WOODS... MOULDINGS, HARDWARE, TOOLS—ALL AT LOW MONEY SAVING PRICES!

Your complete wood buying guide and project book. Craftsman is your best, most complete source of finest kiln-dried domestic and rare imported woods, beautiful wood inlays, colorful bandings, matched plywoods, embossed mouldings, carved ornaments, newest woodworking tools, "hard to find" cabinet hardware and fittings... more than 1,500 items! Packed with newest scroll saw patterns, project ideas & money making plans. Enclose 25c (refunded with first order) to help pay mailing, handling cost. Write now! Craftsman Wood Service Co., Dept. A-1, 2728 S. Mary Street • Chicago 8, Ill.

# Starrett TOOLS

• the ideal gift for  
MECHANICS • MACHINISTS • CRAFTSMEN  
HOBBYISTS • STUDENTS

For that man or boy who works with tools — on the job or as a hobby — there's no finer gift than genuine Starrett Tools. Your Starrett distributor or tool store will gladly suggest appropriate items.



No. 436RL 0-1" Micrometer

No. 565 Drive Pin Punches

No. 9 12" Combination Set

No. 815 Toolmaker's Hammer with Magnifying Glass — can be Personalized with Name

No. 902 Set of Tools for Students, Apprentices

The Starrett Book For Student Machinists

## 3000 GIFT IDEAS

Your Starrett distributor or tool store will gladly show you these and more than 3000 other gift-worthy items in the complete Starrett line. Or write for Starrett gift suggestions folder. Address Dept. AP

THE L. S. STARRETT COMPANY  
Athol, Massachusetts, U. S. A.



# Starrett

MECHANICS' HAND MEASURING TOOLS AND PRECISION INSTRUMENTS • DIAL INDICATORS • STEEL TAPES  
PRECISION GROUND FLAT STOCK • HACKSAWS  
HOLE SAWS • BAND SAWS • BAND KNIVES



Big gift values  
priced under \$5



**IRWIN  
EXPANSIVE BIT**  
only \$3.15

Bores up to 35 standard size holes, 1/8" to 3". Clean and easy cutting. Extra cutter included.

Santa Claus himself couldn't have thought of anything nearly so practical for Christmas giving. World famous Irwin wood-boring tools make gifts men remember for years — in the home, on the farm or job. Modestly priced, precision-made, highly polished, handsomely gift packaged, too. See your independent hardware dealer soon.



**IRWIN  
SPEEDBOR "88" SET**  
only \$4.50

New spade-type bit with exclusive hollow ground point gives more cutting power to 1/4" electric drills. Size markings on head. Set of 6 in durable plastic case, 3/8" to 1".

**IRWIN**

Wilmington, Ohio

the original solid  
center auger bit  
•  
screw drivers  
screw driver bits

**ONE-MAN SAWMILL** LOW \$50.00 AS... \$5.00 DOWN

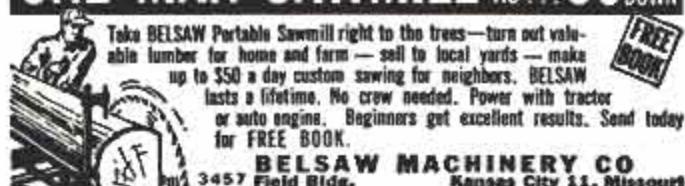

Take BELSAW Portable Sawmill right to the trees—turn out valuable lumber for home and farm—sell to local yards—make up to \$50 a day custom sawing for neighbors. BELSAW lasts a lifetime. No crew needed. Power with tractor or auto engine. Beginners get excellent results. Send today for FREE BOOK.

FREE BOOK

**BELSAW MACHINERY CO**  
P.O. 3457 Field Bldg. Kansas City 11, Missouri

**U-MAK-IT BOAT KITS**



SAVE 1/2 THE COST

Now added to  
the famous  
**U-Mak-It Boat  
Kit line—Easy  
to assemble  
LAPSTRAKE SKIFF KITS**

Greatest line of  
kits in our 29 years  
of boat kit pioneering.

30 models — prams, row-boats, runabouts, cabin cruisers and the new lapstrake skiffs.

**SEND FOR ILLUSTRATED CATALOG**

showing all models 8' to 23', prices, construction details, accessories, hardware, trailers, motors, all you need to build your own!  
**SEND 25¢ (coin) for postage & handling**



**U-MAK-IT products** 703P Whittier St., Bronx 59, N.Y.



### Aluminum Expansion Poles

Aluminum poles that contain expansion springs can be placed anywhere in a room to support photo lamps and backgrounds, bulletin boards or advertising displays. After a pole is adjusted for ceiling height it is simply pushed into place, and may be removed just as rapidly. The 1 1/2 inch column can't be knocked over and is sturdy enough to be climbed. Rubber pads on the ends protect the floor and ceiling. Various clamps may be attached for holding cross-bars, shelf supports, photo equipment or perforated hardboard.

### Electronics Lick Heat Barrier

High-temperature, "heaterless" tubes and electronic circuits that work well while "red hot" have provided a scientific lever for the break-through of heat and radiation barriers.

Electronic circuits, functioning in heat of 900 to 1500 degrees F., now make possible the elimination of bulky, power-consuming cooling units needed in high-speed space flight by guided missiles, satellites and supersonic aircraft.

Similar circuits, installed in nuclear-power-reactor controls for a 1000-hour test by General Electric, have withstood 90 percent of maximum reactor radiation and temperatures of 842 degrees F.

Heaterless tubes at constant high temperatures do not need the power supply normally required to heat filaments in vacuum tubes.



ANYONE can be an EXPERT with

**deft**

**WOOD FINISH**

Deft SEALS, PRIMES, FINISHES. Dries in 30 min. No thinning, nothing else to use. BAR TOP, semi-gloss interior finish.

Free Booklet

Be GOOD to your WOOD, DEFT-finish it.  
DESMONDS, 1826 W. 54, LOS ANGELES 62, CALIF.



**Metal Turning Lathe for Model Makers**



SEND FOR FREE FOLDER describing the new Lathe for Model Makers. 15 1/4" bed with 4 1/2" swing; 7" between centers. Guaranteed. Only \$35.00

f.o.b. Lansing.  
Rosemoor Manufacturing Co.,  
2501 Bernice Rd., Lansing, Ill.



**G E A R S**

In Stock - Immediate Delivery  
Gears, speed reducers, sprockets, thrust bearings, flexible couplings, pulleys, etc. A complete line is carried in our Chicago stock. Can also quote on special gears of any kind. Send in your blueprints and inquiries.

Send for Complete Catalog No. 10  
**CHICAGO GEAR WORKS**  
440-50 N. Oakley Blvd., CHICAGO 12, ILL.

**Guaranteed Auto Parts  
at Western Auto**

**BIG MONEY SAVING BARGAINS**

TANK Mounted 1/2 H.P. AIR COMPRESSOR on Wheels \$79.00—3/4 H.P. \$97.00—Gov't. Surplus GAS ENGINES 1 H.P. 2 cycle \$20.00—1 1/2 H.P. Briggs \$41.00—3 H.P. Briggs \$69.00—5 H.P. AKN Wisconsin \$89.00—EXHAUST FANS 110V—60 cy. 12 in. Blade Square Panel Mtd. \$10.50—16 in. Blade Square Panel \$15.00—18 in. Blade Round Frame \$20.00—24 in. Blade Round Frame \$25.00—1 Cylinder 1/2 H.P. 2.5 cfm AIR COMPRESSOR \$19.00—1 Cylinder 3/4 H.P. 4.5 cfm AIR COMPRESSOR \$27.50—TWIN CYLINDER 1 H.P. 9 cfm AIR COMPRESSOR \$52.00. All Prices Fob. Chgo. Money Back Guarantee  
C. MARSHALL SALES, 3546 Fullerton Ave., Dept. P-12, CHICAGO 47



**\$50.00  
PER  
DAY  
AND  
MORE**

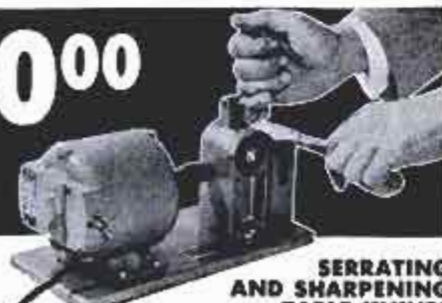

**SAW-KEEN** PORTABLE, ELECTRIC, EASY - TO - OPERATE  
Be your own boss, work anywhere, full or part time. Every restaurant, hotel, drive-in, etc., repeat customers. Serrated (saw-edged) table and steak knives in great demand. \$98.50 investment returns first week. Guaranteed. Write today for proven daily profit plan.  
**CUTTER-CRAFT** 58-S SOUTH RAYMOND PASADENA 1, CALIF.



you know  
this means  
quality\*...

**NOW LET'S TALK PRICE!**

**YOU:** Can I get a better 6 1/2" power saw at any price?

**US:** Not to our knowledge, or to the knowledge of a famous research institute.

**YOU:** Well, how much do I save?

**US:** Anywhere from \$10 to \$20! And it has ball bearings for smooth running, a full horsepower motor and the exclusive Automatic Safety Clutch, which increases the work life of the Pet saw up to 15 times.

**YOU:** How?

**US:** It eliminates motor burnout, the major cause of saw damage, and kickback, the major cause of accidents. This Pet saw is really the best buy on the market. Only \$49.95. At your hardware dealer's.

\* report by a famous research institute proves that this Pet saw equals or excels any other make, regardless of price!

**NEW!**

Exclusive Automatic Safety Clutch adds up to 15 times more work life!

**NEW!**

1 h.p. Universal ac/dc motor develops 4850 r.p.m.!

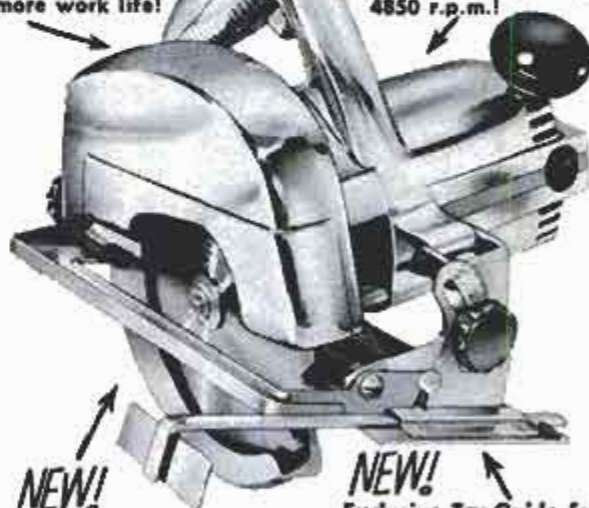

**NEW!**

Retracting lever on automatic blade guard!

**NEW!**

Exclusive Tru-Guide for right, left or on-line sawing—stops guesses!

Those who depend on their tools depend on

**JOB TESTED**



T. M.  
**PORTABLE ELECTRIC TOOLS, Inc.**  
Chicago 20, Illinois



**Build it Yourself!** Furniture • Furnishings • Work Benches • Children's Toys • Shelves • Boat • Cupola • Weathervane • With

**Popular Mechanics NEW**

# FULL SIZE PATTERNS

## Authentic Designs by Professional Designer

Now save money and turn out professional-looking jobs in your own home. Merely trace any of these patterns on lumber, saw, smooth the edges and assemble—that's all there is to it. Every pattern has been proven for design and correct fit. Each nail, screw, dowel and bolt is clearly located on the pattern. You can't go wrong. Order from the listings below today!

## 24 Money-Saving Patterns...



104. Modern Step Table



101. CRUSETTE. 12 Foot Utility Outboard

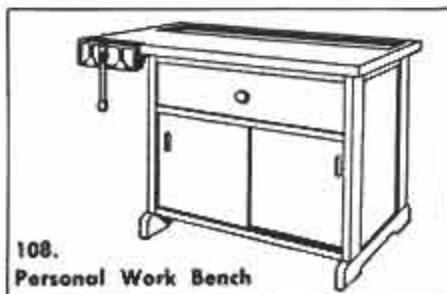

108. Personal Work Bench



102. Trundle Beds

- #101. Utility Outboard. Build this runabout at amazing savings with ordinary hand tools. Length 12 feet, beam 4½ feet. Complete material list and instructions included. Four patterns ..... \$2.00
- #102. Trundle Beds. Space-saving beds that are safer for young people. 90 x 45½ inches. Top bed 40 inches, lower bed 23 inches high. Three patterns in set ..... \$1.50
- #103. Modern Cocktail Table. Matches 104 (illustrated). 40 x 19 inches, 15½ inches high. Plank top and metal grill inserts in sides. One pattern ..... 50 cents
- #104. Modern Step Table. Companion piece to 103. This handsome table is 28 x 18 inches, upper step 24 inches high. Complete in one pattern ..... 50 cents
- #105. Toys for the Children. "Giraffe Drawing Board" and "Bucking Bronco" riding toy. Pattern includes painting suggestions. One pattern ..... 50 cents
- #106. Juvenile Chest Robe. Has hanging storage space, two drawers and shelf, 30 inches wide, 18 inches deep, 39 inches high. Two patterns in set ..... \$1.00
- #107. Cupola and Weathervane. 24 x 24 inches, 34 inches high, plus height of vane, which is made of metal or tempered hardboard. One pattern ..... 50 cents
- #108. Personal Work Bench. This compact, sturdy work bench has sliding doors and a drawer. Top is 44 x 20 inches, 35 inches high. Lots of work space in small area. Two patterns in set ..... \$1.00
- #109. Valances and Trims. Twelve designs for nearly all requirements. Merely trace patterns on the wood, saw and assemble. Finishing suggestions given. One pattern ..... 50 cents
- #110. Decorative Wall Shelves. Two designs. Modern shelf with metal trim is 28 x 16 x 8 inches. Traditional shelf is 29½ x 16 x 8 inches. One pattern ..... 50 cents
- #111. TV Chair. Seat 22 inches deep, 24 inches wide. Overall, 27½ x 32½ inches, 26½ inches high. Sagless springs and foam rubber. Two patterns in set ..... \$1.00
- #112. Modern Tub Chair. Seat 22 inches deep, 24 inches wide. Overall, 28 x 27 x 27 inches. Sagless type springs and foam rubber. Two patterns in set ..... \$1.00

- #113. Sofa Bed. A sofa by day, a comfortable bed for one at night. 78¾ x 29¾ inches, 33 inches high, with removable bolster. Uses 4½ inch standard foam rubber or other mattress. Two patterns in set ..... \$1.00
- #114. Love Seat. Uses sagless type springs with foam rubber padding, 48 inches between arms, 21 inches deep. Overall, 55½ x 29 inches. Two patterns in set ..... \$1.00
- #115. Corner Table. Use with tables 103 and 104 for handsome grouping, or alone. 29½ x 29½ inches, 18 inches high, plus an 8 inch diagonal step. One pattern. 50 cents
- #116. Palette Coffee Table. Using bandsaw, you can make this in one evening. 31½ x 41½ inches at widest point. Finishing suggestions and materials list included. 50 cents
- #117. Traditional Magazine Rack. Graceful design. 8 x 15½ inches, 14 inches high, using ½-inch thick plywood. Sanding and finishing instructions. One pattern ..... 50 cents
- #118. Three Metalcraft Projects. Coach lamp, "jeweled" lamp, hanging planter in brass, copper or bright tin. Smartly styled. No experience needed. Two patterns ..... \$1.00
- #119. Twin-Bed Headboard. Give your twin bed a new look with this attractive headboard.

Modern; simple lines. Angled front panel has sliding door. Standard twin-bed size. One pattern ..... 50 cents

#120. Modern Night Stand. Step style. Overhanging top for lamp, etc., with space below for books. Roomy drawer at bottom for storage. Base is 14 x 20 inches, Top shelf 9½ x 20 inches. Height: 23½ inches. Complete instructions. One pattern ..... 50 cents

#121. Jolly Santa Claus. A Christmas lawn cutout to cheer the passerby. Trace pattern on wood, prime paint, fill in face and clothing details, paint. One pattern ..... 50 cents

#122. Sleigh and Reindeer. For lawn or roof. Reindeer 26 inches wide, 35 inches high. Sleigh with Santa 40 inches wide, 30 inches high. Use cord for reins. Use reindeer singly or in series. Two patterns ..... \$1.00

#123. Children's Dinette Set. Chair and table set ideal for the playroom. Table 20 x 28 inches, 21 inches high. Chair seat 12 x 13½ inches, overall height 22 inches. One pattern ..... 50 cents

#124. Shoeshine Boxes. Two designs, one of square step shape which can double as step stool, the other a half oval design. Ample room in each to hold polishes, cloths, brushes. One pattern ..... 50 cents

## Order Blank for Popular Mechanics Patterns

Popular Mechanics Press • 200 E. Ontario St. • Chicago 11

Send postpaid Popular Mechanics Full Size Patterns as indicated below. Remittance for \$\_\_\_\_\_ enclosed. I understand that any pattern which does not please me may be returned within 7 days for full refund. Dept. 1256

Gentlemen: Please send me Full Size Patterns numbers:  
 101 102 103 104 105 106 107 108 109 110 111 112 113 114  
 115 116 117 118 119 120 121 122 123 124  
 (circle numbers desired)

Name \_\_\_\_\_  
 Address \_\_\_\_\_  
 City \_\_\_\_\_ State \_\_\_\_\_



**BUILD YOUR OWN POWER TOOLS-**  
**With GIL-BILT PARTS-PLAN KITS**

**PLANS only \$1.00 EACH POSTPAID**



**10" TILT/ARBOR SAW**  
 Sturdy wood, steel, and aluminum construction. NEW DEPARTURE ball bearings. Capacity and performance of floor saws selling for \$150.00 and up. Plans, all metal parts in kit with 10" comb. blade \$25.90, less blade \$22.95. F.O.B. St. Louis. Detail PLANS—PATTERNS only \$1.00 postpaid.

**12-IN. BAND SAW**  
 Ball bearing drive, rigid cast aluminum wheels, rubber tires. Handles stock up to 6 inches thick. Cuts to center of 24" circle. 18 x 18 inch tilt table. Capacity and performance of band saws selling for \$80 and up. Plans and all metal parts in kit with 1/4" blade \$23.95. Detail PLANS—PATTERNS only \$1.00 postpaid.



For shipments up to 600 miles, add 5%; over 600 add 10%. Amount in excess of actual postage will be refunded. Also Build-it-yourself 18" Band Saw, 4" Belt Sander, Shaper, 8" Tilt-Table Saw. Simplified plans, build easily with hand tools only. Advertised and sold for 8 years, over 30,000 units in use. Money back Guarantee. FREE CATALOG.

**GILLIOM POWER TOOLS** DEPT. 80-M, LAMBERT FIELD ST. LOUIS 21, MISSOURI

**SPEED REDUCER-CLUTCH COMBINATION**  
*Farm and Industrial* **TRANSMISSION**

**Brand New SURPLUS!**  
 Gov. Cost \$262.00  
 Only \$69.50 PREPAID



**Speed Reducer Alone worth triple this price!**  
**FULLY GUARANTEED**  
 • Reduces speed at a 3-to-1 Ratio  
 • 2 Independent Outlet shafts, each separately controlled by its own Clutch  
 • Rated up to 3.6-HP (electric) or 7.5-HP (gas engine)  
 • Ball and Taper Roller Bearings thruout for smooth, quiet operation

There are unlimited farm and industrial uses where this **SPEED REDUCER-CLUTCH COMBINATION** can be utilized when low speeds are required—for starting heavy loads—or—for engaging and disengaging machine operation without stopping the input drive. Use with any 3/4-HP to 3.6-HP motor (or 1-HP to 7 1/2-HP engine). With input speed of 1800 RPM, ratio of 3-to-1 gives approx. 580 RPM output speed (or can be belt driven to give any desired speed). Clutches are of double disc design with non-burning asbestos friction rings... and have simple one point adjustment to take up for any wear. Close grain cast iron and steel construction. Standard foot mountings.

Can be easily adapted to present drives—or for building special equipment that increases production and saves valuable man hours. A unit of this type is rarely available and hard to obtain **AT ANY PRICE!** Its versatility makes possible the mechanization of operations that would ordinarily be too expensive to modernize. Some of the countless applications are: machine tool drives; construction and farm machinery and equipment; winches, lifts, hoists, etc. **A REAL ENGINEERING ACHIEVEMENT IN EFFICIENCY AND COMPACT DESIGN.** Weight 108 lbs. Approx. size, 17 1/2" long x 8" wide dia.

**ORDER DIRECT FROM ADI We Pay Shipping Costs!**  
**FREE Catalog of Hydraulics, Generators, Other SURPLUS**  
**ROBERTS ELECTRIC CO., Dept. PM-528, 849 W. Grand, Chicago 22**

**"Remember Me"**  
**JOIN THE MARCH OF DIMES**  
 IN JANUARY

**New Deluxe Fixkit... from Black & Decker**  
 21 pieces! Famous B&D 1/4" Drill with home-tested accessories; attachments to drill, sand, buff, polish, grind. Do home repairs fast, easy. At your dealer's now.  
**SPECIAL \$34.95**  
 Save \$4.00

**Black & Decker** World's largest maker of portable electric tools

**CHESTLITE THE EMERGENCY LIGHT THAT FREES BOTH HANDS FOR WORK.**

Chestlite provides the light and extra hand to meet emergencies and the numerous after-dark activities of campers, boy scouts, mechanics, repairmen, etc. Skin divers use them, too. Because Chestlite works perfectly under water. Chestlite has complete acceptance of the U. S. Government for civil defense and the U. S. Bureau of Mines.  
 Wonderful for Xmas Gifts. **\$3.25 pdd**  
 Money back guarantee. Order yours today from... (less batteries)  
**Chestlite Div., Emergency Lights, Inc.**  
 Dept. 12P, 620 W. Anaheim, Long Beach 13, Calif.

**GET THE HABIT OF READING OUR CLASSIFIED ADS.**  
 Wonderful Opportunities Amazing Bargains

**MONEY for MEN ALL FREE**  
 DATA

THE PLASTEX Industry needs manufacturers on small scale and for big production of Lamp and Clock Stands, Art Goods and Novelties in Plastex and Marble imitation. Experience unnecessary. Use material makes regular 10c store sellers. Rubber moulds furnished for speed production. Small investment brings good returns. We are now placing big Chain Store Orders with manufacturers. Ambitious men have chance for real prosperity. Our Free booklet will interest and benefit you.  
**PLASTEX INDUSTRIES, Dept. A**  
 3400 Third Ave. New York 56, N. Y.

**AMAZING NEW PERSONAL POCKET RADIO**  
 LISTEN IN PRIVATE WHILE YOU WALK!

SMALLER AND LIGHTER THAN ANY TRANSISTOR "POCKET RADIO!" WL only 1/2 lb. Size 1" x 2 3/4" x 1 1/4" complete. Black Gold breakproof plastic case. POSITIVELY NO HOOPS OR WIRES NEEDED! BUILT IN 1000 MILE ANTENNA! Soap in flashlight batteries lasts for months. \*Glow in the Dark! Easy to use top controls (while walking, riding, etc.). Has special tiny, soft plastic almost invisible ear-plate—LETS YOU ALONE LISTEN ANYTIME, ANYWHERE without anyone else knowing you are hearing radio music, sports, news, weather, etc. **GUARANTEED TO WORK ANYWHERE RADIO CAN BE USED. ONE YEAR SERVICE GUARANTEE.**

**SEND ONLY \$5.00** (ex. mo) and pay postman \$14.95 plus postage on delivery or send \$19.95 for postpaid delivery. A REAL \$39.95 VALUE! AVAILABLE NOW ONLY FROM US AT HALF PRICE WHILE OUR SUPPLY LASTS. American made! You can always get repairs if ever needed. NOT AN UNWORKABLE INCOMPLETE KIT OF PARTS OR PLAYTHING. A REAL MIDGET PERSONAL POCKET SIZE RADIO. Get yours now—Listen when you want without bothering others. Price will go up soon so rush your order now for YOUR TINYTONE POCKET PERSONAL RADIO. Available only from  
**WESTERN RADIO Dept. APM-12 KEARNEY, NEBR.**

**THE CHRISTMAS GIFT FOR LIFETIME ENJOYMENT**  
**WELD IT YOURSELF IN A JIFFY!**

Weld, Cut, Brase, Solder; Iron, Steel, Brass, Bronze, Aluminum and other metals safely and easily. Make your wrought iron furniture, porch railings, fences, knock-knacks and other metal specialties. With this fine equipment anyone can do professional-like work with little practice. Tool and equipment breakdowns are annoying and costly. Don't let them bother you. The Dynamic will pay for itself quickly in both time and money and is designed to operate from any properly wired 110 volt AC line.

Order your Dynamic Industrial type transformer Arc Welder for Workshop or Industrial use today. Order from this ad. Literature on larger equipment available on request.

**EASY PAY PLAN**  
 Low down-payment. Pay as you weld. Money back guarantee. Send for details. Complete outfit.  
**Only \$38.50**  
 F.O.B. Factory

**DYNAMIC WELDER COMPANY, 1808 S. Federal Street, Dept. D2-N, Chicago 16, Illinois**



**WAR SURPLUS** AND OTHER **SAVINGS** **SAVE** UP TO **90%**



**ARC WELDER KIT \$27.95** — build your own Complete make-up package consisting of 1 Aircraft DC Generator, Electric Auto-Lite 160-240 Amps, 24 Volt, RPM from 2600 up, 1 Rheostat, 1 Giant Toggle Switch, 1 Ammeter, 1 Shunt, 0 to 240 Amps, 1 Voltmeter, 0 to 30 Volts, 1 Electrode Holder, 1 Welder's Shield, 1 Voltage Regulator, Wiring diagram for hookup as welder, Wt. under 100 lbs. Approx. GOVT. COST \$475. Like new, perfect . . . \$27.95.

DC Generator (only) — same as above . . . if purchased separately: \$12.50.

**R1 GENERATOR KIT** Jack & Heints or GE. Rated 300 Amps, 24-32 Volts. With same items as above incl. 300 Amp Ammeter. Approx. GOVT. COST for kit \$600. Complete kit only \$39.95. Wt. 60 lbs.

**HEAVY-DUTY RHEOSTAT** Designed for heavy-duty use with Air Force heated suits. Ideal for regulating voltage on electric welders, model trains, lights, generators, electric blankets; controls soldering irons, photoflood lamps, etc. Rated 5.75 ohms, 100 watts with double windings & dual female 25 amp, 125 volt receptacles. Size: 7" H x 3 1/4" W x 1 3/4" D. Shpg. Wt. 2 1/2 lbs. Approx. GOVT COST \$25. Brand new, only \$1.95.



**BENDIX AIRCRAFT COMPASS** For boats, trucks, cars. By Pioneer Instrument Co., div. Bendix. Mark VIII. Graduated in increments of 1°; 360°. Major graduations every 5°. Magnetic. Can be lighted with 6, 12 or 24 volt standard bulb. Flush panel mounting. Approx. GOVT. COST \$250. Perfect . . . \$10.95 ppd. (Great Xmas Gift.)



**BENDIX PUMP & MOTOR**

Can be used for pumping fuel, oil or where-ever hydraulic pressure is required. Pump has 1" connections, built-in relief valve, adjustable up to 1500 lbs. Max. capacity 6 GPM, 1 1/2 H.P., 24 volt motor, 4000 RPM. Can be used on 12 to 36 volts. Approx. GOVT. COST \$350. NEW — \$10.95.



**AUXILIARY POWER PLANT** Model C-2, Navy type 1. Engine comes complete with spark plugs, generator self starter, voltage regulator, reverse current relay, silencer case, dual scintilla magnets, Stromberg carburetor. Use as portable welder. Develops 300 amps & more. Capacity up to 7 1/2 KW. Engine 14.5 HP. Up to 7500 Watts. Terrific as standby power supply, in boats, to power small cars, as a complete lighting system. Operates all DC equipment. Like NEW, all engines checked & run before shipment. Wt. eased 360 lbs.; wt. net 130 lbs. Approx. GOVT. COST \$4590. Now only \$137.75.



**WOOD PROPELLER** Originally intended for gov't radio & target planes. Now the perfect "prop" for den, trophy room, game room or boy's bedroom. Clock, barometer or photo can be inserted easily into center (complete with mounting holes). Top grade bird's-eye maple; flawless, smooth, highly varnished; 30" tip to tip. Can be used to operate ice sleds, etc. Approx. GOVT COST \$57. New—\$3.95. (Great Xmas gift.)



**MICROMETERS** Chrome plated, precision engineered, carefully tooled to give long life. All new 0-1" cap. \$2.25 ea., 1-2" cap. \$3.50.



**NEW IMPROVED MAUSER-TYPE VERNIER CALIPERS** Quick, handy, accurate. 6" Vernier Calipers. Glass hardened, lapped measuring surfaces. Fine engraved scales—1/1000" and 1/10mm for inside, outside & depth measurements. Friction thumb release. Larger capacity. 2 gib adjustments. Reg. \$25. Now only \$7.95. Leather case \$1 extra.

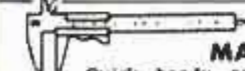

**NEW! BIG CATALOG** Largest ever . . . just out . . . new low prices. Send 25c for your copy today. Prices F.O.B. Culver City unless otherwise stated. Check, cash or money order. 50% deposit for C.O.D.

**AIRBORNE SALES CO., INC. DEPT. PM 1256**  
8501 Stellar Drive, Culver City, Calif.

SAY YOU SAW IT IN  
POPULAR MECHANICS



**MUFFLER TROUBLE?**

Repair muffler and exhaust leaks with finger and thumb in ten minutes. No tools — no mixing. Withstands heat and vibration. Stops carbon monoxide gas poisoning. \$1.69 can. Canada, \$1.79.

**HOLT'S Gun Gum MUFFLER SEAL**

At Auto Accessory and Parts Replacement  
Stores, or write us for Full Details.

**TREGLOWN CO., INC., Fanwood 109, N. J.**  
IN CANADA: Treglown, Ltd., 1366 Greene Ave., Montreal 6



**Fast-Take-Off Rocket**

In just two seconds a new rocket can reach several times the speed of sound. The rocket was developed for research by the Air Force on missile shapes, the thermal barrier and rocket stability. It is a two-stage rocket using a solid propellant. In operation it is fired from a 16-foot portable launcher. When the first stage burns out, it falls away and the second stage boosts the rocket to maximum velocity. Later the fins of the second stage are blown off, causing the rocket to tumble to earth at about 100 miles per hour.

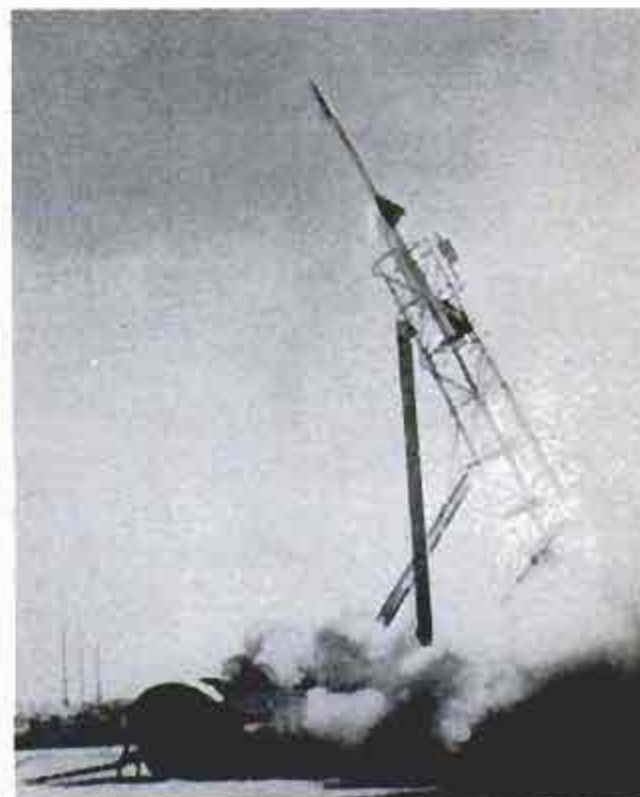



**AGAIN CONSTANTINE BRINGS YOU  
AMERICA'S NEWEST AND FINEST**

# WOOD

**TOOL, MATERIAL  
AND CRAFTSMAN  
SUPPLY MANUAL**

The experience of over 145 years of supplying industrial, commercial and hobby woodworkers at lowest prices has gone into publishing this new book. Tells how to veneer, join, make inlays, inlay pictures, finish wood. Lists over 2,000 hardware items. Full of ideas and projects. Send 50c now (refunded on 1st order) for mailing & handling.

**CONSTANTINE'S  
MANUAL-CRAFTSMEN**

**126 Pages  
Natural Color**  
Rare and fancy woods, veneers, inlays, carvings, hardwoods, plywoods, plans, patterns, hardware, upholstery items. Finishing materials. Every hard-to-get item for the woodworker.

**SEND TODAY**

**ALBERT CONSTANTINE & SON, Inc.**  
2056F EASTCHESTER ROAD NEW YORK 61, NEW YORK



## EXPLORE FOR TREASURE!

Find gold, silver, coins, jewelry, battle relics! Treasure-Metal-Mineral Detectors. M-SCOPE. Used worldwide for Treasure Hunting. Mineralights, Geiger, Scintillation Counters. Prices from \$14.75. Fully GUARANTEED. Time Payment Plan. FREE Treasure and Uranium booklets. New outfitting catalog. **FISHER RESEARCH LAB., INC.** Dept. PM-1. Palo Alto, Calif.

## POWER HACKSAW \$58.50



Send for full details and name of nearest dealer.

**LESS MOTOR**  
F.O.B. Benton Harbor  
● Rugged cast iron construction. Wt. 56 lbs., bronze bearings. Draw cut. Auto. return lift. Auto. shut-off. Vise swivels 45°. Cap. 4"x4".

**EXCEL MACHINE TOOLS BENTON HARBOR, MICHIGAN**

## 180° OFFSET DRIVE

88 TO 1 REDUCTION GEAR

For use where tremendous power at low take-off RPM is desired, 6 gears rotate on self-lubricated Hi-Speed Ball Bearings. 3/8"x1 1/4" shafts. 5"x6"x6" overall. \$9.96 Postpaid. Use with fractional H.P. motor. FREE Instructions! New '57 Surplus Catalog sent FREE!



**KARL ORT, Dept. 12PM, York, Pa.**

## SENSATIONAL NEW HIGH SPEED DRILL MASTER

NOW turns the ordinary shop drill into HIGH SPEED DRILL PRESS at a big saving. When DRILLMASTER is used on a 5,000 rpm drill press its top speed will be 20,000 rpm. Does the work of expensive high speed drill presses on brass, aluminum, plastics and cast iron where high speed drilling is necessary. Available for work of any size runs. Fits any 3/4" chuck holding drills from 5/32 to #80. Shafts are heat treated and ground. Ball bearings and oil impregnated bearings and gear train are housed in cast aluminum. Precision made throughout. **\$62.50** Feb. Chgo. Wt. MAIL ORDER TODAY only. **ON C.O.D. ORDERS WE REQUIRE A 10% DEPOSIT. 2¢**  
**DIRZIUS MACHINE SHOP "I", 1423-25 So. 52nd Ave., Cicero 50, Ill.**



## Wholesale! TOOLS! GUNS! CAMERAS!

AGENTS - BUY TOOLS, PHOTO EQUIP., SPORTING GOODS, JEWELRY AND THOUSANDS OTHER NATIONALLY ADVERTISED PRODUCTS AT BIG DISCOUNTS. BIG PROFITS SELLING TO OTHERS.

POSTCARD BRINGS FREE COPY "THE WHOLESALE PLAN"

**AMERICAN BUYERS SERVICE**

HERTEL STATION, DEPT. 15, BUFFALO 16, NEW YORK

Get up to  
**40% off**



## Heavy Duty Bench Type ALLEN PUNCH PRESSES

Model B-5  
5 ton  
**\$199.50**  
fob  
less motor

Many Popular Models  
1 to 5 ton capacities  
Moderate in price  
Fully guaranteed  
See Your Supply Dealer or write for Free catalog showing all models with descriptions and prices.

**ALVA ALLEN INDUSTRIES, Dept. PM, Clinton, Mo.**

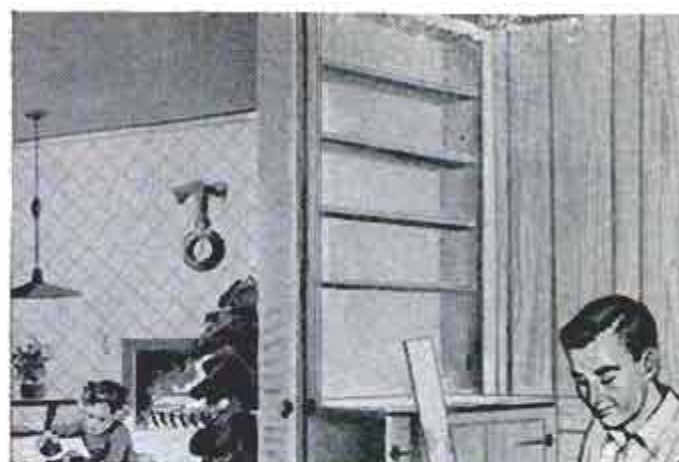

**\$159.50** (for 8" saw, less motor, guard, and extensions)

As your budget grows, add 1/2" jointer (\$59.00), 10" sander (\$16.00). Prices will vary in some areas

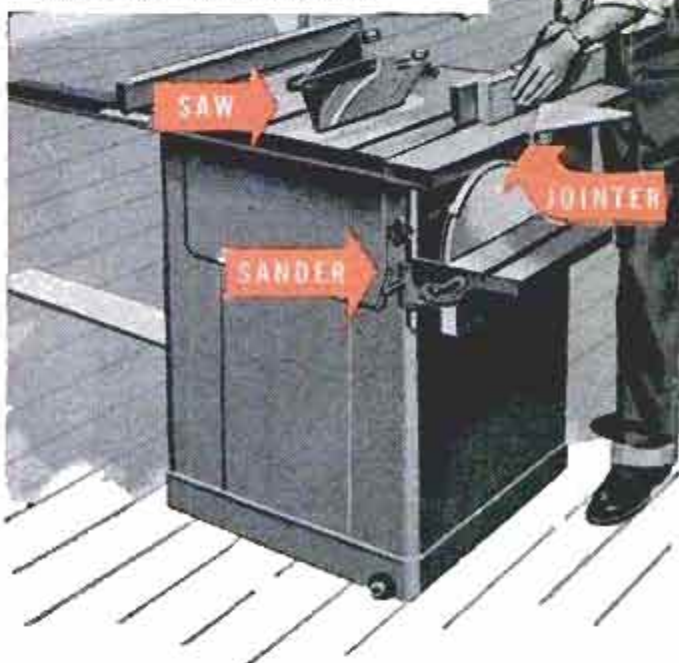

## Mobile workshop preferred by professionals

**Gift idea by YATES-AMERICAN**

1 Quickest change-over from saw to jointer to sander.

2 Compactness with capacity.

3 Quality features—patented feather-touch rip fence.

Take a cue from the craftsmen. See your Yates-American dealer today, or write for colorful catalog.

**YA** Yates-American

BELOIT, WISCONSIN  
Department P, 781 N. Fourth Street



# "ARCO JIG-SAW"

WITH EXCLUSIVE NEW  
CIRCLE-  
CUTTER  
& RIP  
GAGE!



## "ARCO JIG-SAW" IS A PORTABLE SAW AND CAN BE USED AS A TABLE SAW!

(with "Arco Stand" shown at right).  
"Arco Jig-Saw" guaranteed to fit any  
1/4" drill with Adjustable Circle-Cutter  
& Rip Gage saves hours of work—assures  
professional results. Cuts perfect  
circles up to 20" diam., rips accurately  
up to 10" wide. Cuts intricate pat-  
terns—however large—in plywood,  
plastics, metals—even zips thru 2x4's!  
Has same capacity & cutting  
speed as 855 jig saws.  
"Air-Jet" blows away saw-  
dust. Includes blade. . . .

**\$10.95**

"ARCO STAND" — Casting &  
Clamp . . . . . \$2.95  
6 Extra Assorted Blades . . . \$1.95  
At Your Dealer or try it on our 10-day  
Unconditional Money Back Guarantee.  
Send check, M.O. (ppd), C.O.D. & Post.

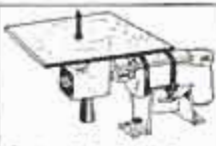

Converts to Table Saw



Ripping with Gage

**ARROW METAL PRODUCTS CO.**  
Dept. PM-12, 146 WEST BROADWAY, NEW YORK 13, N.Y.

**EXTRA  
VALUE**



Value "plus" is built into  
every Gerstner Chest to guar-  
antee long life and real service.  
Free Catalog.

**GERSTNER TOOL CHESTS**  
456 Columbia St., Dayton 7, Ohio



• Save your heart! . . . Powerful Gravelly  
Tractor with push-button starter, 48-inch  
Snowplow attachment takes all the work  
from snow removal!

### 23 DIFFERENT TOOLS

• 23 attachments to save your time and  
work all year long. *Easy Pay Plan . . .*  
*only 20% down, 18 months on balance.*

Write today for FREE 24-page  
"Power vs Drudgery" Booklet.



**GRAVELLY TRACTORS, INC.**  
BOX 1263 DUNBAR, W. VA.

**FIELD-TESTED FOR 34 YEARS**

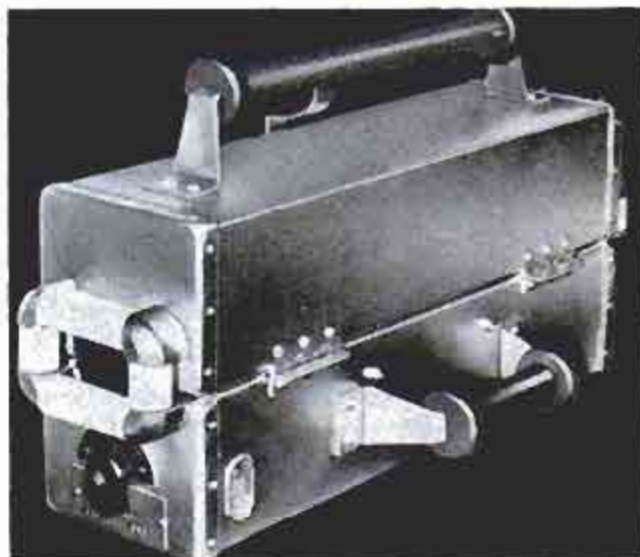

## Heater Softens Plastic

Plastic handrailing material may be made more flexible for laying if, prior to installation, the plastic is drawn through an infrared-lamp heating device. Plastic does not come in contact with these lamps, which work on a 750-watt 220-volt system. Heat from the unit may be regulated from 150 to 300 degrees C. Cool plastic is rewarmed by opening the device and redrawing the material under the lamps.

## Pure Silicon for Hot Missiles

Silicon, so pure that it has one part of contaminant in six billion parts of silicon, has answered the need by guided missiles and aircraft for materials which function in higher temperatures. This degree of purity is equivalent to having one kernel of corn in 10 railroad carloads of wheat. Pure silicon is used in construction of transistor electronic-circuit components. Present transistors, made from germanium, work in heat of 200 degrees F. Sufficiently pure silicon would be used in electronic components up to 600 degrees F.



# GIGANTIC MAIL SALE

WAR SURPLUS  
EXCESS INVENTORY  
BANKRUPT STOCK

## ARMY POWER PLANTS

• Amazing buys surplus Army and factory-to-plant pumps and generators. Save to 80%.

- 1000-w, 115-v, 60-c \$179.50 Ppd.
- 2000-w, 115-v, 60-c \$269.95 Ppd.
- 3000-w, 115-v, 60-c \$299.50 FOB.
- 5000-w, 115-v, 60-c \$497.50 FOB.

Many other plants, generators. Get catalog.

## HYDRAULICS—PUMPS—AIR COMPRESSORS

• Bargains in surplus finest quality hydraulic pumps, cylinders, valves. Also irrigation pumps, plastic pipe-fittings, and air compressors, air tanks, regulators, gauges, paint spray, etc. All in free catalog.

- Farm hyd. cylinder, \$14.41, 1500-lb. gauge, \$3.49.
- Blackhawk hyd. system \$23.95.
- Control valve \$12.95.
- Air Compressor \$19.95.
- Air Tank \$8.79.
- Gauge 100-lb. \$1.89.
- Air Regulator \$3.29.
- Air Filter \$2.99.
- Many other air items.
- Irrigation Pump 2 1/2" \$44.37.
- Plastic Pipe 1 1/2" 86, 3/4" 12c, 1" 20c.
- Rotary Gas Pump \$41.96.

All of the above prepaid.

## MAMMOTH AIR FORCE FRESNEL FLOODLIGHT

• Makes spectacular advertising light. Multi-element hi-flux optical lens. Powerful 1000-w, 115-v bulb. Built-in AC motor cooling fan. Reflective lens. Outer dispersing lens. Size 44"x31"x29", with two bulbs. Use on roof, marquee, parking lots, etc. Attracts crowds. Govt. cost \$860. SALE..... \$44.61 Ppd.

## GIANT ADVERTISING AIR KITE

• One of the Army's secret weapons. Used to entangle enemy aircraft. Made of strong silken fabric. Collapsible frame. Set up in 15-min. Easy to launch even in light wind. Size 14'x10'x3'. Wt. 20 lbs.

- Wonderful spectacular advertising unit. Will haul banners aloft, pull boats, etc. Govt. cost \$140. SALE \$13.99 FOB

## PORTABLE ARMY BLOWER HEATER

• Hi-capacity engine driven portable (on wheels) blower-heater. Burns gasoline. Tremendous heat 100,000 btu. Use for heating bldgs., under construction, starting frozen-up equipment, etc. Contractors, farmers corn drying, barn warming, etc. New condition, perfect. Size 30"x48"x34". Wt. 198 lbs. Govt. cost \$525. SALE..... \$92.75 Ppd.

## World's Largest Searchlight

G.E. • Genuine new condition 800,000,000 candle power light. Has world's largest (5-ft. diameter) parabolic spun copper reflector with ultra-expensive rhodium plating. Has marvelous control motor system for revolving or tilting. Uses Std. 600x10 tires.

- Designed for carbon arc use with 100-v, 150-amp DC plant (not furnished) but can be changed to ionized gas or giant size incandescent for spectacular revolving light effects.
- Used for "power-from-the-sun" experiments by leading colleges. Size 87"x66"x100".
- Amazing, spectacular, wonderful units. Actual Govt. cost \$32,000. SALE, \$449 FOB

## AC-DC 115-V and 28-V GENERATOR

• Air Corp ball bearing unit. Puts out 115-v, 1500-w 800-c, AC and 30-v, 125 amp DC.

- Makes good small welder, battery charger or will furnish 115-v for lights, stove, iron, etc. Size 6"x9"x15". Wt. 50 lbs. Full instructions. Govt. cost over \$200. SALE \$16.76 FOB

## HOME LABORATORY EXPERIMENTAL KIT

• Amazing buy for men or boys. Make 100s fascinating experiments. Keep up with science. Have your own home laboratory. Build fire and burglar alarms, make real Geiger uranium detector, eaves dropping unit, fish shocker, etc.

- Consists of over 35 items. 115-v, AC generator, Weston meter, geiger tube, motor, AC bell, relay, capacitors, etc. Booklets, Home Laboratory Bench, Geiger Counter, Experimental Instructions, etc. Hi-class Govt. material. Wt. 9 lbs. Est. Govt. Cost over \$60. SALE, \$6.98 FOB

## SPECIALS FROM PREVIOUS ADS (All Prepaid)

- Automatic 100 line Switch with dial \$13.71
- Surveyors-Contractors Level and rod 46.50
- Gear Reduction Hand Winch 1000-lb. cap 8.95
- Desk Telephone (make antique lamp) 1.99
- Dial Handset Phone (main line or ext.) 13.61
- Farmers 5-Row Complete Crop Sprayer 97.50
- Furnace Twin Blower 115-v 60-c 1/2 hp 38.97
- Navy Ball Bearing Centrif. 1 1/2" Pump 24.61
- Govt. Wind-Velocity Receiver Units 12.79
- G.E. Motors, 1 1/2 hp 115-v 60-c 1-phase 44.39
- Motor Driven Hydraulic Pump 12-v 44.05

100s amazing buys in new winter catalog

## SPECIAL OF THE MONTH! FARM & INDUSTRY GASOLINE PUMP

• Finest Erie gas and fuel oil pump. Very fast 10 g.p.m. Fine for pumping from barrels or tanks into trucks, tractors, etc.

- Expensive highest quality unit by a leading company. Wonderful for farm. Easy to use, simply screw 3/4" iron pipe into threaded port and stick in hbl. Connect hose to outlet. Handle works back and forth very easy. Size 6 1/2"x7 1/2"x17". Wt. 53 lbs. \$9.71

List \$25. SALE..... \$9.71 FOB

6-ft. Oil Proof Output Hose and Fittings \$3.45

## INVALID CHAIR—BOY'S AUTO MOTOR

• Marvelous ball bearing battery (6 or 12 v.) electric gear reduction motor. Makes wonderful amazing electric drive for boy's auto, invalids chair, etc. Also useful for factory electric lifts—trucks, etc.

- Gear ratio 40 to 1. Hi-torque. Finest precision gears. Fully reversible. Buy of the year. Est. Govt. Cost over \$150. Sale, \$14.99 F.O.B.

## GOLF and PERSONNEL CARRIER MOTOR

• Amazing buy! Use for golf carts, factory personnel carriers, boy's auto, and 100s other uses.

- Powerful expensive ball-bearing gear reduction motor runs on any 6-v or 12-v storage battery. Powerful high torque. Shaft speed 150-300 rpm. Full instr. Easily reversible. Wt. 34 lbs. Size 7 1/2"x9"x14". Est. Govt. Cost \$250. SALE, \$19.46 FOB

## 6-VOLT or 12-VOLT ELECTRIC WINCH

• Powerful marvelous 100-to-1 ratio fully reversible all ball bearing gear reduction winch. Runs from car, truck or boat battery.

- Load capacity 1000-lbs. on 6-v, 2000-lbs. on 12-v. Holds up to 40' cable. Cuts truck loading time in two. Farmers use for wagon dumps, machinery hoist, on jeeps or cars to pull out of mud, etc. Govt. cost \$280. SALE . . . \$46.71 FOB

## ORDER FROM AD or write for big new WINTER CATALOG 1000s items at tremendous savings. We pay frt. except where FOB.

**BURDEN SALES COMPANY**  
814 "O" St. LINCOLN, NEBRASKA

## AUTOMATIC

MAKES NEW PROFITS

Cuts new teeth in 50 seconds—any size 4 to 16 points. Old teeth fall off as chips. Easy to operate. A perfect job.

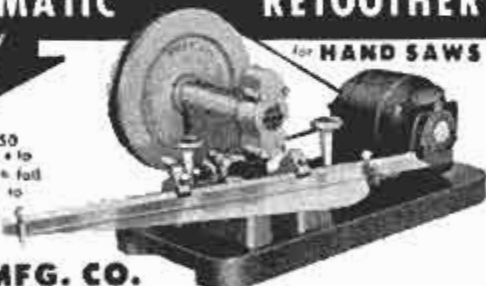

**BURR MFG. CO.**

8933-D VENICE BLVD. LOS ANGELES 34, CALIFORNIA

## RETOOTHER

for HAND SAWS

## IDEAL CHRISTMAS GIFT FOR ANY MAN

WELD BRAZE  
SOLDER CUT



4WAY  
ONLY \$14.75  
f.o.b. factory

WELDER

Complete with Twin Carbon Arc Torch and accessories... to handle all metal-craft work.

Acclaimed by thousands of Homeowners, Mechanics and Hobbyists as the welder of 1001 uses. Easily operated from properly wired 110 volt AC or DC line. The ideal gift with a life-long use... Order today on 10 day money back guarantee.

**FOUR-WAY WELDER CO., Dept. F2-N**  
1810 S. Federal St. • Chicago 16, Ill.

## EARN GOOD MONEY—Spare or Full Time IN A BUSINESS OF YOUR OWN...

### SMALL INVESTMENT — NO EXPERIENCE NEEDED

Thousands of men are making big money in their own business. You too, can have a fine income with an assured future in spare or full time with the Universal lawn mower grinder. Investigate our success plan now, it includes everything you need plus facts on how others have earned over \$3,600 in one season, working part time. Act now! Mail coupon today!

**ROGERS**  
MANUFACTURING CO.  
Lindsey, Ohio

ROGERS MFG. CO., Dept. M-126, Lindsey, Ohio  
Gentlemen: Rush me FREE details on easy inexpensive way to get into my own business.

Name \_\_\_\_\_  
Address \_\_\_\_\_  
City \_\_\_\_\_ State \_\_\_\_\_





## New "PULL-GEAR" SPEED-REDUCING PULLEY



**Provides Correct Speed and Power to Drill Up to 1 3/8" with 1/2 H.P. Motor**

Amazing new internally geared speed reducer doubles drill press capacity. Greater power, greater efficiency, greater productivity.

Provides the correct speed and power for larger drilling, reaming, tapping and boring on light presses. Easily installed in five minutes. Adaptable to all type machines. Spindle speed range approx. 45 to 3000 RPM. Made in 3 motor shaft sizes: 1/2" — 5/8" — 3/4". Write for literature.

WRITE FOR LITERATURE

**THE PULL-GEAR CO.**

25427 Mound Road  
Center Line, Mich.

## UTICA'S MAGIC BUTTON

makes the difference



UTICA's brand new SELECT-O-LOCK adjustable wrench gives you two tools in one. Push the magic button—the wrench is locked—just like an open end wrench. Pull the magic button, it's a conventional adjustable wrench.



Push—it's Locked!



Pull—it's Unlocked!

See the new SELECT-O-LOCK, No. 93, adjustable wrenches in 6-8-10 and 12 inch sizes at your hardware dealer.

\*PATENTED



THE HALLMARK OF QUALITY

## Revolutionary CAMPBELL "TRACTION KLIPS"



Tuck Klips under rear wheels • Roll on, they grip instantly

On or off in 10 seconds! Sensational new emergency "Traction Klips" that get you quickly out of ruts, up slippery hills or driveways, away from icy curbs. A "must" for your car when you're "off the beaten track." Handy lever flips them off in a jiffy. Made of long-wearing spring steel. Send for your set—NOW! Don't ever again be stuck in snow, ice or mud.

Send...  
**\$4.95**

**CAMPBELL CHAIN Company**  
York 1, Pa. Makers of Campbell  
Lug-Reinforced Tire Chains.

Shipped prepaid  
SPECIFY TIRE SIZE!



## ELECTRIC WELDER

AC or DC  
110 Volts

The "Little Marvel" all-metal welder, 5-year written guarantee. Welds 1/8" metal or money back. Repairs tanks, tools, fenders, machine parts, etc. Complete with everything—rods, unit, eye shield, directions. \$6.95 plus 50c postage. Flame torch accessory for soldering, cutting, brazing \$3.95 complete with carbons, brass rods, flux. \$2.00 Deposit on C.O.D. 75 ampere 1/4 inch Transformer Welder \$21.95 F.O.B.

ESSAY MFG. CO., Dept. 51, Quincy 69, Mass.

**\$6.95**  
Complete

ALSO  
Adult  
Eshelman  
2 Pass.  
SPORT  
& GOLF  
CARS  
Fraction  
of cost  
of most  
other  
cars.

**ESHELMAN**

## CAR SNOW PLOW

CLEAR ROADS & DRIVEWAYS



Bolts on to car or truck bumpers easily. Clears snow 12" deep and 72" wide. Lightweight and sturdy. Order now, or write for free catalog.

Dept. SP-212, ESHELMAN,  
109 Light St., Baltimore 2, Md.  
SHIPPING POINTS:  
Baltimore, Chicago, Reno

## HELPFUL BOOKS

Send post card asking for FREE catalog

Popular Mechanics Press, 200 E. Ontario, Dept. 601, Chicago 11

## FIND HIDDEN RICHES!

NOW—find buried treasure, gold, silver, and metal objects, with sensational 3 1/2-lb. locator—GOLDAK'S "FIND-IT" ... only \$49.50 complete with earphones, batteries, instructions.



Manufacturers of metal detection devices since 1933

Write for FREE literature—full line metal, mineral locators, geiger and scintillation counters.

**GOLDAK CO.** 1542-12W. Glenoaks Blvd., Glendale, Calif.

## DO EVERY FASTENING JOB 10 TIMES FASTER!

Amazing one-hand operation, 10 times faster than hammer & nails. Can't jam.



At your local hardware dealer or lumber yard

**ARROW**  
DO-IT-YOURSELF  
TACKER, No. T-50

for ceiling tile, insulation, wire fence & every home job

Arrow Fastener Co., Inc., 1 Junius St., Brooklyn, N. Y.



## SAVE MONEY on LUMBER

with the **LOW-COST BELSAW PLANER**

### Convert Rough and Random Size Lumber into Cabinet Finished Stock

Now anyone can make perfect cabinet finished stock from low-cost rough lumber... any size up to 12 1/4 inches wide and 6 inches thick. Turn out high grade finished material at a fraction of the cost you pay lumber yards. Big 42-inch-long bed makes it easy to plane heavy, wide and long pieces... BELSAW self-feeds at 14 to 34 feet per minute.

### USE THIS ONE LOW-COST MACHINE for Planing, Jointing, Sawing, Milling, Tongue and Groove.

You can easily make flooring, siding and many other popular patterns with your Belsaw. Your Belsaw quickly pays for itself with savings on raw materials and profits on finished stock... a highly profitable machine for custom work. Compare Belsaw with any 12-inch planer on the market... Belsaw gives you more essential features—yet costs you \$50 to \$125 less than others.

Send Today for Free Literature on the Belsaw Multi-Duty Planer.

**BELSAW MACHINERY CO 2057 Field Bldg. Kansas City 11, Mo.**

## NOW You Can DRILL, SAW, REAM, CUT ... ALL WITH ONE BIT!

Beaver's new improved Hi-Speed side cutting drill bit can be used on any electric drill, drill press, lathe, etc. Made from the finest American hi-speed steel. 3 1/4" long, 2" side cutting section, 1/4" diameter. Designed to cut steel, wood, plastic, aluminum, etc. **MONEY** back guaranteed. Specify types desired. All Purpose, Wood and Heavy Metal. **BUY** From Your Dealer or send check or money order today. Dealer inquiries invited. Ideal Xmas Gift.

**BEAVER DRILL & TOOL CO., 3008 McGo Trafficway, Kansas City, Mo.**



**BEAVER HI-SPEED-SAW DRILL BITS**

ONLY **\$2.45** each 3 for **\$7.00**

### BUILD FINE GRANDFATHER CLOCK NOW

The simple sensible Red-i-Kut way as thousands have — **SAVE HALF SHOP TESTED PLANS "SPIRIT OF THE CENTURY"** Narrow waist 83" tall or stately straight side **"SPIRIT OF AMERICA"** **EASY-TO-FOLLOW** photopack plans tell all—plus **BROCHURE** of heavy brass weight Westminster, tube chime, movements, gorgeous bronze-silver dials, 3/4" solid mahogany case kits. Send **\$1.00** today—Both plans **\$1.50** NOW.

**Kuempel Chime Clock Works, 28 Kuempel Bldg., Minneapolis 16, Minn.**

### DIGS 2" TRENCHES to 18" DEEP

New Model B DITCH WITCH digs 2-in. trenches to 18-in. deep. Perfect for lawn sprinkler systems, utility service lines. Digs straight, curved and cornered trenches in all soils, even rocky and frozen. **Low Cost! Write for new Bulletin. THE CHARLES MACHINE WORKS 620 B Street Perry, Oklahoma**



## FOR STUCK LOCKS

Best year-round protection against lock failure from sticking - rust - freezing. The modern method endorsed by lock experts—at service stations, hardware, auto supply, variety stores and super markets, everywhere. 4-oz. Drop or Stream can only 49c.



**Graphited LOCK FLUID**



AMERICAN GREASE STICK CO. MUSKEGON, MICHIGAN

## LOOK! All New - All Precision - All Deluxe SUPERSHOP MODEL X

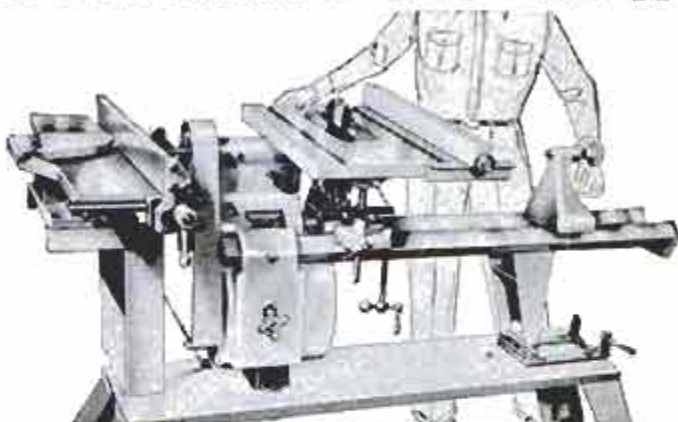

8" SAW

**WE PAY ALL FREIGHT FOR YOUR FREE HOME TRIAL**

**ONLY \$139.50 EASY PAY PLAN**



Vert. Drill Press



Hor. Drill Press



8" Sander



30" Lathe

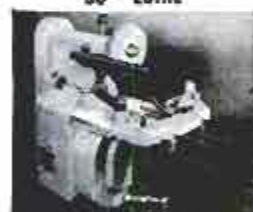

5" Grinder

Never before have you seen so much deluxe, precision-built power tool workshop at any price! Designed for the man who wants the best. Massive cast and precision-machined headstock, self-centering inverted "V" bedways (like precision metal lathes), exclusive non-friction speed changer, extra-large cast and precision-ground saw table. 100% ball bearing, lifetime-lubricated. You save by ordering direct from factory. You are invited to test Supershop Model X in your home **FREE**. Mail coupon or postcard for **FREE** brochures, photos, details, specifications, accessory list — and amazing freight prepaid **FREE HOME TRIAL PLAN**. All free.

**MAIL COUPON OR POSTCARD TODAY**

**POWER TOOLS, INC. 190 Yates Avenue**

Beloit, Wisconsin

NAME \_\_\_\_\_

ADDRESS \_\_\_\_\_

CITY \_\_\_\_\_ STATE \_\_\_\_\_



# JEEPS

and 4 Wheel Drives **NEED FREE-LOCK HUBS**

**FRONT DRIVE WITH FREE-LOCK**

**LOW OPERATING COSTS**



IN 2-WHEEL DRIVE NO PARTS MOVING!

**FRONT DRIVE WITHOUT FREE-LOCK**

**HIGH OPERATING COSTS**

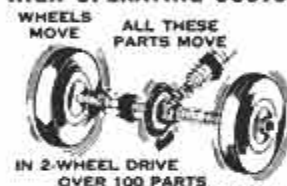

IN 2-WHEEL DRIVE OVER 100 PARTS MOVING—WEARING!

**EASILY INSTALLED ON EACH FRONT WHEEL**



and by a quick easy finger tip turn of the lock-control engage or disengage the front wheels from the front drive axles. Results in free wheeling the front wheels in 2-wheel drive, or fast engaging for 4-wheel drive. When front wheels are free wheeling, front drive is idle... **STOPS FRONT-DRIVE WEAR, INCREASES VEHICLE POWER, and gives MORE MILES PER GALLON OF FUEL.**

Buy from your Dealer  
**WRITE FOR FREE FOLDER**

**FREE-LOCK CORPORATION**

5801 N. Federal Blvd., Denver 11, Colo.  
EASTERN OFFICE: 360 Willoughby, Brooklyn 5, N.Y.

## BARRON Drill Press TOOLS



**ROTARY PLANER**  
Planes • Rabbits  
Tenons • Panels  
Routs • Bevels

Only \$8.50

Shipped Prepaid - Complete

**FOR WORKSHOP AND INDUSTRIAL USES...**

• Over 40 precision built woodworking tools and accessories... Hi-Speed Router Bits—Rotary Surface Sanders & Drum Sanders—Safety Shaper Cutters—Dovetail Cutters—Large Auxiliary Metal Tables—Spindle Adapters—Handy Bench Vises. Many other items indispensable for accurate, useful, versatile workshop use. Every tool sold on complete satisfaction or money back. Write for special folder—"24 Extra Uses for Your Drill Press."

**WRITE FOR FREE WORKSHOP GUIDE**

**BARRON TOOL CO. INC.**

300 Architects Bldg., Detroit 1, Mich.

## Grips the screw!

Drives it too!

**Quick-Wedge SCREW-HOLDING SCREWDRIVER**



2" to 14" blades, 4 bit sizes  
Available with shockproof plastic covered tubing  
Unconditionally guaranteed

**ASK FOR IT AT YOUR DEALER**

Kedman Co., 233 So. 5th W., Salt Lake City

## Automatic Saw Set...

**MAKE EXTRA PROFITS!**

Set 400 teeth per minute on hand or band saws, 4 to 16 point, with the BeMaCo Automatic Saw Set. Fast, accurate, true hammer-anvil action sets teeth uniformly, eliminates tooth breakage. Used profitably by saw shops and manufacturers everywhere. Every machine positively guaranteed! Write for details—today!

Saw Machine Division 25-C

**BEAVER MFG. CO.**  
800 ISIS AVENUE • INGLEWOOD, CALIF.

## ONE-BAG MIXER THAT TRANSPORTS



Universal Transmix® transports, mixes and dumps cement, silage, dirt, etc. P. T. O. driven—no gears or chains. Can be installed or removed in 15 minutes. Fits Ford, Ferguson, AC-WD, IHC Super C, H&M, Case VAC, J. D., -40, Oliver 55, and other 2- and 3-plow tractors. Unconditionally guaranteed. See your dealer or write, giving tractor model, to

**UNIVERSAL PULLEYS COMPANY**  
349 NORTH MOSLEY • WICHITA, KANSAS

## Find HIDDEN TREASURES

GOLD, SILVER, PRECIOUS METALS with the Famous Model 27 Metal Detector. Lightweight, ultra-sensitive, low cost. None finer. Also GEIGER COUNTERS for uranium and the VIOLITE for lungsten. INFORMATION FREE

THE *Detectron* CORP.  
5528 Vineland Ave., No. Hollywood, Calif.



## MIDGET CAMERA \$2.98

Amazing! Smaller than a pack of cigarettes and yet takes real sharp pictures. Not a toy. Complete with case. Send cash, check or money order to **RUBINS, 1056 Moe Avenue, Bronx 59, N. Y. C.**

New Long Lasting Combination Blade  
**Roc-Edge 6" SAW \$1.49**  
BLADE  
7" \$1.59  
8" \$1.69  
Fits any power saw. At all Hardware Stores

**make your own Gems 32.50**  
The Gem Maker comes complete with all necessary equipment, including a super-charged diamond blade for sawing, and all wheels for grinding, shaping and polishing; also complete instructions. The complete equipment as shown, less motor and belt, for only \$32.50. c.o.b. Burlington, Wisconsin. Write today for information and literature.  
**B & I MANUFACTURING CO.**  
Dept. P, Burlington, Wis.

**SPARE-TIME MONEYMAKING OPPORTUNITIES**

**READ OUR CLASSIFIED ADS**

HUNDREDS OF BARGAINS

AMAZING OFFERS





**2½x - 4x or 6x RIFLESCOPES**  
10 DAY MONEY BACK GUARANTEE

**IDEAL GIFT for DAD or SON**  
10 DAY MONEY-BACK GUARANTEE  
YOUR CHOICE! SAME PRICE!  
INCLUDING MOUNT

**NEW PAL-MASTER SCOPES**  
for TARGET - BENCH REST or HUNTING

Choice of 3 different powers at the same LOW PRICE! **ONLY 995** WITH MOUNT

- COMPARE THESE QUALITY SCOPE FEATURES:
- 1—ADJUSTMENTS Positive Internal, Direct reading Windage & Elevation-Knobs.
  - 2—LENSES Top quality Optical Glass—precision ground, polished, color corrected, no distortion, hard coated glass-to-air surfaces.
  - 3—EYE RELIEF 2½" to 4½" Safe on heavy recoil.
  - 4—RETICLE Sharp, Clear Cross-Hair.
  - 5—FOCUS is Lock-Tight. Won't "shoot off."
  - 6—BARREL Rustproof, Extra Durable Steel.
  - 7—Guaranteed to perform perfectly on ANY RIFLE.
  - 8—Made by leading American Optical firm.

MOUNT INCLUDED with SCOPE  
SIDE or TOP MOUNTS available with scope to fit most rifles. When ordering specify type mount, gun model number and brand.

**20 POWER x 40mm SPOTTING SCOPE WITH TRIPOD & CASE**

Imported directly by Palley's. The finest spotting scope for the money that we have seen. A FULL 20 POWER MAGNIFICATION yet small enough to fit easily in your gun case, knapsack, etc. Has precision ground and polished lenses and prisms throughout. With fully coated objective lens. Eye-piece is fully adjustable. Comes with a sturdy tripod and special leatherette carrying case with zipper enclosure. Weighs only 15 oz. Overall length 8½"



**NEW 2995 VALUE**  
IDEAL FOR HUNTER-TARGET-ETC.

**NOW ONLY \$1995**

**NEW ILLUMINATED MAGNIFIER**



Provides 5 POWER magnification with brilliant illumination for precise inspection of any substance, material or specimen. The head contains a 50 MM lens and has internal calibrated scale to show relative size of subject. Body is nickel plated metal and holds 2 flashlight batteries. Head is molded bakelite. Takes a regular flashlight bulb.

**ONLY 495**

**NEW 4-6 or 10 POWER EYE LOUPES**

A 4X & a 6X lens are interchangeable for either power or can be combined for 10X in this one handy two-piece unit.

**125**

**PALLEY 60 to 450 POWER MICROSCOPE**

with ILLUMINATED SUB-STAGE MIRROR and TRIPLE TURRET

Take advantage of our tremendous foreign purchase. Ideal for use by the Amateur, Scientist, Student, in Home Laboratory for study of insects, tissue, minerals, microbes, liquids, etc. ORDER TODAY!!

**CHECK THESE FEATURES...**

- Microscope has triple revolving turret with 10X, 20X and 30X, precision ground and polished lenses—Two interchangeable eyepieces of 6X & 15X—New Patented Sub-Stage with built-in light, needs no external light—Large sub-stage mirror for external light—All-metal body, precision made, inclines through 90°—Fitted hardwood case and 3 glass slides. ORDER NOW!!



HAS 60, 120, 150, 180, 300 and 450 POWER MAGNIFICATION

**ONLY 1295**

FREE with MICROSCOPE—8 Pc. DISSECTING SET with hardwood case. Has Scalpel, Scissors, Tweezers, etc.

**SAVE PALLEY 100 - 200 - 300X MICROSCOPE BUY NOW**

Perfect GIFT for STUDENT—AMATEUR SCIENTIST  
A triple revolving, objective lens turret allows selection of 100, 200 or 300 POWER magnification. Has fine, ground and polished lenses and ALL METAL construction. This instrument is NOT A TOY! Right or left hand rack & pinions make smooth, precise adjustments. Body inclines 90°.



**795**  
WAS 1295 NOW

**3400 RPM-½ HP POWER SAW**  
**RIPS - CROSSCUTS**  
**CUTS A FINISHED 2x4 LIKE A KNIFE THROUGH BUTTER**



COMPARES TO SAWS SELLING UP TO \$49.50 **1998** Complete with 5-1/2" Blade

A rugged, professional type, adjustable saw. Will cut any angle from 0 to 45°. Has an adjustable (0 to 6") rip fence. Safety-trigger switch on handle. Full ½ HP Universal AC-DC, 110-120 Volt, 60 cycle motor. Weighs only 6½ lbs. Thousands already sold. Your satisfaction guaranteed

EXTRA SAW BLADES—Available in Rip, Crosscut or Combination. Please Specify **235A.**

**NEW POWER SAW BENCH TABLE**

This sturdy, precision made bench-saw table converts our famous power saw (above) to a handy bench saw. Permits angle and bevel cuts, rip, crosscut & comes with rip fence and mitre guide. 14"x 16" table, 6" high.

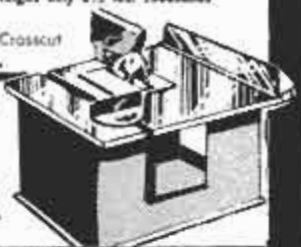

**NEW ONLY 995**

**NEW DRILL DRIVEN BAND SAW**

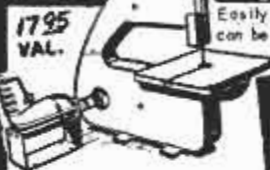

Easily driven by the 1/4" electric drill shown above and can be adapted to any other similar drill. Saws straight lines or curves. Makes canisters, cabinets, toys, etc. Full 10" throat, cuts to the center of 20" board. Has a tilt table, ball bearings, adjustable high impact, phenolic pulleys, 3/16" saw steel blade, die-cast aluminum housing & many other

**1288**

**GENUINE SELECT PHILIPPINE MAHOGANY PLYWOOD DIRECT FROM IMPORTER**

For Fine CABINET WORK, FURNITURE, Paneling DENS, OFFICES, HOTELS, etc.

Our prices are LESS THAN DOMESTIC PLYWOOD at WHOLESALE. This selected LUAN MAHOGANY meets the most rigid specifications. It is WEATHER and WATER RESISTANT. You'll be amazed at the beauty of this fine wood. Its rich golden elegance will thrill you. Rotary cut for beauty of grain. Both sides sanded and ready to use. Bonded with finest resin adhesive. Face side unjointed.

Available in three thicknesses—3mm (approx. 1/8"), 4mm and 1/4". ALL orders shipped by special Truck for lowest rates. No order accepted for less than 100 lbs. — equal to (4) 1/4" sheets, (2) 4mm sheets or (5) 3mm.

**FREE SAMPLE ON REQUEST**  
3MM (1/8") x 3 FT. x 6 FT. \$500 VALUE **179** PER SHEET  
MINIMUM ORDER 8 SHEETS  
1/4" x 4 FT. x 8 FT. **950** VAL. **449** PER SHEET  
MIN. ORDER 4 SHEETS

**SAVE 50% ON TRANSLUCENT FIBERGLAS PANELS**

Ideal for the home or office and in new construction. Finest quality in many widths and lengths. A variety of colors to suit every taste. Send for a FREE SAMPLE and booklet, Worth 85¢ per sq. ft.

**ONLY 49¢**  
SQ. FT.

**18" HYDROPLANE**

Made of special pre-formed hardwood. Single-step design. Fast and easy construction. Kit includes all parts plus metal frame, plastic windshield. Designed to use miniature outboard motor below.

**OUTBOARD MOTOR**  
Runs on two flashlight batteries. Enough power to drive boats up to 18" long. Tilt-swivel mount.

**495**

**259**

**12 INCH ELECT. BOAT WITH MOTOR**

A complete boat kit with hardwood hull and deck finished and ready for final assembly. Kit includes the electric motor, flexible coupling, drive shaft with propeller, adjustable rudder, windshield, electric spotlight, hardware and trim. Motor & spotlight operate from two standard flashlight batteries.

**395**

**23" WINGSPAN F-51 MUSTANG U-CONTROL AIRPLANE ½ CLASS ONLY 395**

The famous Mustang Fighter of World War II. An excellent model for the beginner in control-line flying. Easy to build and fly. Kit has many pre-cut and shaped parts for easy, accurate assembly plus large pictorial instructions. Gas powered.

**FREE CATALOG OF MODELS**

Fully illustrated showing other models, accessories and supplies plus outdoor & camping gear, microscopes, etc. Write for folder C-8 today!

**Palley's**

TERMS: Send Check, Cash or Money Order. 30% Deposit with C.O.D. Prices F.O.B. Los Angeles, Calif. Warehouse.  
2263 EAST VERNON AVE. DEPT. PM-12 • LOS ANGELES 58, CALIF



**The Chief** ... for a Man with a Hobby Shop

**TOOL CHEST**

Perforated Hardboard, 32" x 32" x 6" Shipped KD  
31 Piece Tool Hanger Kit \$1.39



**\$9.95**  
F.O.B. DETROIT

Keeps all tools neat and handy

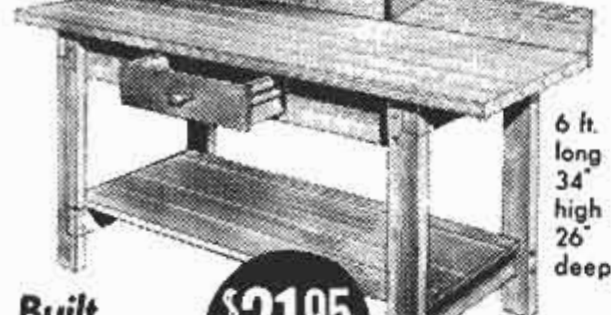

6 ft. long  
34" high  
26" deep

**Built to Last a Lifetime:**

**\$21.95**  
F.O.B. DETROIT

**WORK BENCH**

with Bottom Shelf and 18" Sq Drawer. 2" x 6" Solid Plank Grooved and Dovetailed Top and 1" x 8" Back Rail, Shellacked to a Smooth, Satiny Finish Shipped with Bolts, Nuts, Screws, with ABC Chart for Quick and Simple Assembly

**MOHAWK LUMBER & SUPPLY CO.**

14525 W. Chicago Blvd., Detroit 28, Mich. (M)

Enclosed  Check  Money Order for \$ \_\_\_\_\_  
Ship \_\_\_\_\_ CHIEF WORK BENCHES @ 21.95 each.  
\_\_\_\_\_ TOOL CHESTS @ 9.95 \_\_\_\_\_ HANGER KITS @ 1.39.

\$5 deposit with C.O.D. orders  
 FREIGHT  EXPRESS  
Name \_\_\_\_\_  
Address \_\_\_\_\_  
City \_\_\_\_\_ State \_\_\_\_\_

Use this to order

**MORE \$\$\$ PER HOUR WITH MODERN IMPROVED LAWNMOWER SHARPENER**

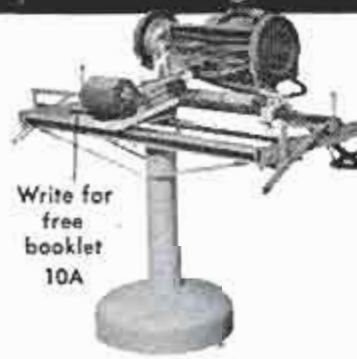

Write for free booklet 10A

Grinds All Reel Type Mowers  
Hollow Grinds or Flat Grinds Bed Knives

Engine, oil, or gasoline are not removed from power mowers. Wheels, handle and roller remain in place. Modern's precision grinding assures repeat business. 100% Steel Construction

Compare Before You Buy

Faster—Easier to operate

NO CHANGE IN PRICE FOR OVER 10 YRS  
**\$263.00** Complete with 1/2 H.P. Motor  
f.o.b. Pasadena, Calif.

**MODERN MFG. CO.**

160 N. FAIR OAKS, PASADENA, CALIF.

**FUN-WORK YARD TRACTOR WHEEL-HORSE RIDE-AWAY**



Turn work into FUN! Do a dozen back-breaking jobs in a jiffy. Yard-size tractor with 5 forward speeds and 1 reverse. 3 1/2 hp (or 2 1/2 hp) engine. Heavy channel steel chassis. Mow 5-foot swath at 5 mph. Plow snow, cultivate, haul compost, pull any of 22 attaching tools for yard and garden. Write for details, and name of dealer.

SENSATIONALLY **\$299.50**  
PRICED AT F.O.B. Factory

**WHEEL-HORSE PRODUCTS**

2644-B Dixieway North

South Bend, Indiana

**POWERCORD\***

**AMAZING ROPE S-T-R-E-T-C-H-E-S TWICE ITS LENGTH! ONLY 25c FOOT**

Now—make your own bicycle, motor bike, car top, trunk lid, or truck-load tie-downs for luggage, ladders, tarps, boats, work and sports equipment, etc. Amazing double cover **POWERCORD** (stronger than rope) stretches 100% and holds everything secure under constant, powerful tension. Choice of large 1 1/2 inch regular, or locking, plated steel hooks with applying rings—30c each. Order length **POWERCORD** and hooks wanted. Send cash, money-order or check. Add 25c postage. Money back if not delighted. \* (Copyright)

**HOLTITE MFG. CO., Dept. M-50**  
210 SO. CLINTON ST. CHICAGO 6, ILL.



**BRONZE FOUNDRY**

Schools and Home Workshops

Make your own castings of aluminum, copper, bronze, silver. Foundry sets are available in three sizes including 2400 Deg. F. blast furnaces. \$26.50; \$33.50; and \$46.00 f.o.b. Marysville, Kans. Free Circular.

**KANSAS CITY SPECIALTIES CO.** P. O. Box 6022, Dept. P-12 MARYSVILLE, KANS.

Works in seconds!

**Loosens Rusted Bolts nuts, screws, "frozen" parts!**

**LIQUID WRENCH**

AT HARDWARE STORES, GARAGES SERVICE STATIONS EVERYWHERE

For information write manufacturer  
**Radiator Specialty Co., Charlotte, N. C.**



**SAY YOU SAW IT IN POPULAR MECHANICS**

**"DO IT YOURSELF"**

IT'S EASY WITH

**KESTER SOLDER**

Soldering's really a "cinch"... when you use time-tested, reliable **KESTER**... available everywhere.

**FREE!** "Soldering Simplified"... 16-page how-to-solder booklet. At your dealer or write direct.

**KESTER SOLDER COMPANY**  
4251 Wrightwood Avenue Chicago 39, Illinois





## PORTABLE LIGHT PLANTS

### GIANT 2500 WATT PLANT

110-120 v. 60 cyc. AC. Absolutely the best made—exclusive dynamically balanced armature; heavy windings develop up to 5000 watt overload for motor starting. Skid mounted—portable. Powered by an easy starting Briggs or Wisconsin 6 HP engine—complete with all accessories; engine easily disconnected for other uses. Big outlet box, voltmeter, no wiring necessary. Ample current for all purposes. Factory warranty. (Item 31) Wt. 210 lb.

Reg. price \$585. Special at..... **\$299.50**

Same plant with electric self starter (Item 31a)..... **\$359.50**

Generator only and control box..... **\$169.50**

**DUAL VOLTAGE 110-220** available on any of above models for \$28.00 additional.

### POWER-FLO 3500 WATT

115-230 v. 60 cyc. AC. A rugged power plant for heavy duty use. Duplex power distribution provides both 115 v. and 230 v. output at the same time if desired. Powered by a big 8 HP Wisconsin engine with triple V belt drive. Has built-in overload protection. A dependable plant for either standby or regular service. Equipped with electric self-starter. (Can also be started by rope) and plug-in outlet box. (Item 198) Wt. 310 lbs.

Factory price..... **\$439.50**

**GENERATOR ONLY** belt driven..... **\$239.50**

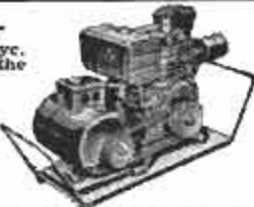

(Item 198) **\$439.50**

(Item 22) Wt. 110 lbs. Reg. \$475. Factory price..... **\$239.50**

**1750 Watt Plant** Powered by 4.5 Briggs engine. Electric starting & battery charging built-in! Factory price... **\$279.50**

Get the best at **MASTER MECHANIC'S** bedrock factory prices!



(Item 24) **700 WATT PLANT**  
115 v. 60 cyc. AC. Powered by a rugged 2.2 HP. easy starting Briggs engine. No wiring necessary; just plug in and operate. Plenty of current for any oil burner, freezer, brooder, emergency lights, etc. which require up to 700 watts. Ideal for television and radios. Complete with voltmeter and built-in winding to charge 6 v. auto batteries. (Item 24) Wt. 75 lbs. Easily fits in car trunk. Be prepared if storm knocks out power lines. Regular \$275.00 value..... **\$143.50**

**1200 Watt Plant** (Item 45) same as Item 24 but larger generator and engine with 500% greater output..... **\$199.50**

**MASTER-LITE 2500 Watt Plant** 110/120 v. 60 cyc. AC. A powerful plant, ruggedly constructed and yet designed for easy portability. Can be started by rope or built-in 12 v. electric push button starter. Built-in winding to charge battery. Powered by a big 4.5 HP Briggs engine, complete with all accessories. Includes control box, voltmeter, and handy plug-in power receptacle. An ideal plant for permanent or stand-by service. Wt. 225 lb. Reg. price \$645.00. (Item 21) Factory Price..... **\$329.50**

**DUAL VOLTAGE 110/220** for Item 21—\$30 additional. We make every type and size of light plants—Write, giving us your requirements!

## PORTABLE BOOM HOIST

Here is a big 3000 to 10,000 lb. capacity boom hoist at a fraction of the actual cost to the Gov't.—that can pay for itself on one job! Entire hoist is made of high strength alloy steel. Can be mounted as a stationary crane in yards or on buildings; or as a mobile crane on trucks for use as a wrecker. Massive telescoping steel boom is quickly extended from 10 to 20 ft. with a built-in winch. Ideal for erecting buildings, hoisting materials, loading machinery, unloading RV cars, lifting boats from water, laying in sewer pipe, etc. (Item 80) Wt. 850 lbs. Orig. cost over \$350. Special F.O.B. Shelby, Ohio..... **\$89.50**

## EXTENSION CORD

Heavy duty and very flexible. Neoprene 14-2 cable. 20 year quality. Wt. 12 lbs. (Item 185) 100 ft. Complete with rubber plug and outlet. A terrific buy at only **\$8.95**

**No. 10-2 POWER CABLE.** Heavy duty, very flexible 20 ft. with male and female fittings. Wt. 4 lbs. (Item 818a)..... **\$5.15**  
20 ft. without fittings (Item 818a)..... **\$4.15**

**No. 12-2 POWER CABLE.** Very flexible rubber covered special outside shield for grounding power tools, etc. 50 ft. (Item 199) Wt. 8 lbs. **\$6.95**. 100 ft. (Item 200)..... **\$12.95**

**No. 8-2 Conductor Power Cable.** 30 ft. heavy duty, very flexible rubber covered with male & female plug (Item 817)..... **\$12.95**

## GIANT METAL SHEARS

"PEKTO"  
Nine inch cutting blade made of special high carbon alloy steel, perfectly aligned and ground. Easily cuts steel plate up to 12 gauge or 1/8" thick. Overall length 40". Wt. 23 lbs. (Item 156) Regular **\$40.50**. While they last..... **\$14.95**

## LESS THAN WHOLESALE



**MASTER DC ARC WELDERS**  
Now! a portable rugged, industrial type welder with terrific performance, yet at a price hundreds of dollars less than you'd expect. Senior model made for years of trouble-free, continuous service. High capacity DC welding unit enables you to tackle any job with confidence—easily welds anything up to 2" plate using from 1/16" to 1/4" rods. Built-in stabilizer and cooling system makes arc easy to strike and hold. Dual control rheostat provides low heat soldering, brazing and welding from 30 to 300 amps. Complete with instructions, guarantee and triple V-belt or flat pulley. Easy to hook up and easy to operate. **WELDER ONLY — DUAL CONTROL MODEL.** Same as above, but drive with your tractor, Jeep or gas engine of 14 HP or more. (Item 28a.) Wt. 110 lbs. \$459 value..... **\$119.50**  
**WELDER ONLY—INDUSTRIAL MODEL** same as above but with ceramic rotary type rheostat providing 74 different heat settings for all types of welding (Item 28b) \$500.00 value..... **\$139.50**  
**COMPLETE POWER MASTER** (Illustrated above) powered by a 14.6 hp., air cooled Wisconsin engine. Wt. 480 lbs. (Item 280) Compares with welder costing \$1200. **\$449.50**  
**Factory Special..... \$449.50**  
**WELDING KIT.** Two 10 ft. leads, welding helmet, electrode holder, ground clamp. **\$10.50**  
Sold only with welder at..... **\$10.50**

## Rugged, ball bearing WINCH

Sturdy ball bearing winch—super tough aluminum alloy construction. Powered by an easy starting 2 1/2 HP Briggs gas engine thru gear reduction drive—it exerts up to 3000 lbs. of terrific force for hoisting materials or pulling. Combination gear and pulley reduction results in tremendous multiplication of engine power. Idler pulley clutch arrangement and built-in drum brake (with ratchet hand lever) enables operator to ease loads down gently and lock at any point desired. Drum handles 400 ft. of 3/8" cable or 600 ft. of 1/2" cable. Ideal for contractors, farm implement trailers and unlimited other uses! (Item 795) Wt. 125 lbs. Only..... **\$149.50**  
**HAND WINCH**—Same winch with large crank handle for extra leverage and 2 speed drive. (Item 794) Wt. 60 lbs. **\$59.50**

## HEATING & VENTILATING FAN

(Item 10) Easily installed in furnace pipes. Forces even heat to all rooms. Over range moves kitchen smoke and odors. Powerful, continuous duty motor, 110-120v. AC. Mount in wall or ceiling to ventilate any area. Quiet, super-efficient fan moves huge volume of air. (400 to 600 CFM).  
8" Pipe, Wt. 8 lb..... **\$6.85**  
9" Pipe, Wt. 6 lb..... **\$7.85**  
10" Pipe, Wt. 1 lb..... **\$8.85**  
12" Pipe, Wt. 8 lb..... **\$9.85**  
**HEAVY DUTY FAN.** Semi-enclosed motor, suitable for spray booths, restaurant exhausts, poultry houses, etc. 10" Fan, wt. 8 lbs. (Item 10E)..... **\$11.95**  
12" Fan, wt. 10 lbs. (Item 10D)..... **\$12.95**  
**HIGH SPEED BARN FAN** similar to above, but larger, high speed motor moves huge volume of air.  
12" Fan (Item 10F)..... **\$14.95**  
14" Fan (Item 10G)..... **\$17.95**

## JET STEAM MASTER

Now, a super efficient portable steam generator that produces live steam at 100 lbs. pressure in 30 seconds from a cold start! Produces large volume of high pressure steam on 2 pints of fuel oil. Instantly cleans sticky grease, dirt, rust, old paint, etc. off implements and road machinery. Pays for itself in a few weeks. Sterilizes soil. Sterilizes as it cleans—milk equipment, etc. Fully automatic—oil fired with new, built-in lifetime bronze water circulating pump. Draws water from faucet or bucket. Simple and safe—anyone can use it; built-in safety valve. Complete with 12 ft. of hi-pressure steam hose and new triple efficiency steam gun that automatically mixes in soap solution if desired. Wt. 250 lbs. Item 463. **\$349.50**  
Special factory price..... **\$349.50**

## 52 pc. SOCKET SET

Highest quality, guaranteed non-breakable sockets made by Husky. Beautifully matched chrome thin wall alloy absolutely the best. Contains a complete set of 28 sockets in 1/2" drive, 3/4" drive and 1" drive, plus all necessary extensions, handles, speeders, reversible ratchets, etc.; all unexcelled, guaranteed. A beautiful set of tools that will handle any job; in a big doghouse steel box. Wt. 17 lbs. (Item 205) **\$27.95**  
List price \$69.00. Factory special.....

## Double Acting Hydraulic Cylinder

A powerful cylinder mfr'd. by Massey Harris which develops both a pushing and a pulling action. Will push 8,100 lbs. with a 1000 PSI pump pressure. Cylinder is 3 3/4" O.D. with 8 1/2" stroke—standard heavy duty clevis on both ends. Has standard 1/2" pipe thread openings. Can be used for tilting buckets or blades, raising or lowering implements, hydraulic presses, etc. Can also be used as an air cylinder. (Item 802) Wt. 17 lbs. Reg. \$68 value, Special..... **\$14.95**

## HYDRAULIC HOSE COUPLERS

Connect or disconnect hydraulic lines without loss of oil. 1/2" pipe threads. (Item 819) per set..... **\$4.95**

## 9 TON HYDRAULIC PRESS

A tremendously powerful hydraulic press, capable of exerting 18,000 lbs. pressure. Pays for itself many times over—straightening bent connecting rods, king pins, crankshafts, axles, link pins and bars—or pushing out frozen bearings and bushings. Developed pressure under precise control and visible at all times on accurate gauge. Complete with both large and small anvils and fits to straighten any kind of curve or bend. (Item 464) Wt. 110 lb. Actual list price \$305. Our special close-out price..... **\$69.50**

**SCREW TYPE PRESS** Nine ton capacity. See Nov. Pop. Mech's ad for details—write. Complete, Wt. 150 lbs. (Item 797)..... **\$49.50**

Send check or M.O. Prices f.o.b. Factory. 10 day Money back guarantee. SEND 10c for... **BIG 1957 Catalog**  
**MASTER MECHANIC MFG. CO.,** DEPT. 58-2 Burlington, Wis.



# SOUTH BEND

## 13" Precision Lathes



### for accurate, low-cost machining

These lathes are popular in the toolroom, production shop, or wherever varieties of precision parts are machined. Users prefer them for their simplicity and practically effortless handling. Job set-ups and tooling changes are made so quickly and easily that down-time is held to a minimum. A very complete line of attachments ~~simplifies tooling.~~ Send coupon for complete information.

### SPECIFICATIONS

**Swing**—13 $\frac{1}{8}$ " over bed and saddle wings, 8" over cross slide.

**Distances Between Centers**—28", 40", 52" maximum.

**Collet Capacity**—1" maximum (Collets interchangeable with South Bend 10"-1" Collet, 14 $\frac{1}{2}$ ", 16" and 16-24" lathes).

**Spindle Speeds**—Six to Sixteen 40 to 940 r.p.m. or 20 to 940 r.p.m. approximately.

**Power Longitudinal Feeds**—48 R.H. or L.H., .0015" to .0841".

**Power Cross-Feeds**—48, .0006" to .0315".

**Thread Cutting**—48 R.H. or L.H. pitches, 4 to 224 per inch.





### HARDENED BED WAYS

Hardened and precision ground bed ways can be supplied in lieu of regular at small extra cost—also hardened and ground cross-feed screw.



PLEASE SEND INFORMATION CHECKED:

- |                                                                                     |                                                                                     |                                                                                     |                                                                                      |                                                                                       |                                                                                       |                                                                                       |
|-------------------------------------------------------------------------------------|-------------------------------------------------------------------------------------|-------------------------------------------------------------------------------------|--------------------------------------------------------------------------------------|---------------------------------------------------------------------------------------|---------------------------------------------------------------------------------------|---------------------------------------------------------------------------------------|
|  |  |  |  |  |  |  |
| <input type="checkbox"/> 9" and 10" BENCH LATHES                                    | <input type="checkbox"/> 10" to 16-24" FLOOR LATHES                                 | <input type="checkbox"/> DRILL PRESSES                                              | <input type="checkbox"/> $\frac{1}{2}$ " & 1" Collet TURRET LATHES                   | <input type="checkbox"/> TOOL GRINDERS                                                | <input type="checkbox"/> 7" BENCH SHAPERS                                             | <input type="checkbox"/> MILLING MACHINES                                             |

Name \_\_\_\_\_ Street \_\_\_\_\_  
City \_\_\_\_\_ State \_\_\_\_\_

Building Better Tools Since 1906 • SOUTH BEND LATHE • South Bend 22, Indiana



# DAD!

## DO YOU KNOW THIS ABOUT AIR RIFLES?

Do you know new Daisys use the same spring-type (non-lethal) shooting action they did when you were a boy? That today Daisys are approved for shooting in marksmanship training programs of Boy Scouts of America, National Rifle Association, and Hunter Safety Program? That Daisys are now used in schools, camps, air rifle clubs, homes to more safely, economically teach, learn proper gun handling? Dads even use them for easy home target practice. Let's get one for Christmas!



### And Dad...



\*Price subject to change without notice. Higher in Canada.

Model #4  
\$8.50



The spring-type  
Daisy Air Rifle is

## SAFEST OF ITS KIND

A Daisy is not a pneumatic, gas or compressed air gun. It cannot be "pumped up" to increase power. A Daisy is a low "factory-limited" power short-range spring-type air rifle—safely used by millions of youngsters every year since 1888! It is therefore the best and safest gun of its kind for teaching and for learning safe, proper gun handling and marksmanship. Priced LOW. Buy at hardware, sports goods, department or national chain stores.

### AWARDS I Can Earn With My SPRING-TYPE Daisy



NATIONAL RIFLE  
ASSOCIATION  
MEDALS



BOY SCOUTS  
OF AMERICA  
MARKSMANSHIP  
MERIT BADGE

## SPECIAL OFFER! 128 Page Gunbook FREE with Club Brochure!

**GUN BOOK:** Gun Section pictures America's most famous historical rifles, pistols—each described by a gun collector authority. Also comics, BB Gun Manual, cowboy-ranch cartoons, jokes. Regular price, 25c, but yours FREE with order for Club Brochure—while 128-page Gun Book supply lasts!

**CLUB BROCHURE:** Big 16-page book tells how to organize, conduct a junior air rifle club; explains how parents, communities, children all benefit from this popular new 15 foot spring-type BB gun marksmanship program. Price: 10c postpaid (including Gun Book, Daisy Catalog.)

All 3 For  
**10c**



For Christmas and Year-Round Fun!

# DAISY SPRING-TYPE TRAINING AIR RIFLES

DAISY MANUFACTURING CO., Dept. 1896, Plymouth, Michigan, U.S.A.  
THE SAFEST JUVENILE TRAINING RIFLE OF ITS KIND

**DAISY MANUFACTURING COMPANY**  
Dept. 1896, Plymouth, Michigan, U.S.A.

Gentlemen: Send postpaid literature checked below for which I enclose proper remittance.

10c (in coins) for Gun Book, Club Brochure, Catalog.

3c in unused stamps for Daisy Catalog only (to cover our postage-handling cost.)

Name \_\_\_\_\_

St. & No. \_\_\_\_\_

City \_\_\_\_\_

Zone \_\_\_\_\_ State \_\_\_\_\_

Adult  Boy (Age) \_\_\_\_\_  Girl (Age) \_\_\_\_\_



Now...the perfect trio of **WELLER TOOLS**  
 to **GIVE** or **RECEIVE** for **CHRISTMAS**  
**SAWING • SANDING • SOLDERING**

With one or more of these faultless Weller tools, inexperienced amateurs as well as able handymen and hobbyists can do *hundreds* of homecraft jobs easily, quickly, successfully.



\$19.95



\$14.95



\$7.95

**WELLER SABRE SAW**

Portable Jig Saw. Seven saws in one. Cuts wood up to 1" thick, do-it-yourself aluminum, composition board, plastic, etc. Makes its own starting hole. Cuts curves, circles (as tight as a coin), intricate shapes. Exclusive strain-relief design eliminates blade breakage. Reciprocal action. Combination knob and handle grip for positive control. Polished aluminum housing. 3 blades and wrench included. Nothing like it at anywhere near its price. Guaranteed. Model 800

**WELLER POWER SANDER and POLISHER**

Sands down old paint in a jiffy. Puts satin-smooth finish on new wood... but fast. Readies old furniture for refinishing by removing scars, stains and other blemishes. 25 square-inch sanding area—twice that of comparably priced sanders. Straight-line action. Makes 14,400 power strokes a minute. Sands with the grain. Goes all the way into corners. Fits under low places. Guaranteed. Model 700

**WELLER COMPLETE SOLDERING KIT**

Latest type Weller Gun. Heats in 5 seconds. Triggermatic control. 2 spotlights to light up work. Joins metal parts. Makes electrical connections. Seals leaks and seams. Kit includes Soldering Brush to clean connections, Soldering Aid to twist wires, famous Kester Solder. Another practical do-it-yourself home tool to give or receive this Christmas. Guaranteed. Model 8100K

AVAILABLE FOR CHRISTMAS FROM YOUR HARDWARE DEALER

*Weller*

**ELECTRIC CORP. • EASTON, PA.**

Look for this name—it's your guide to quality in small power tools