

NOV. 1956

FIRST OF THE '57 CARS

35 CENTS

POPULAR MECHANICS

MAGAZINE

WRITTEN SO YOU CAN UNDERSTAND IT

REGD. TRADE MARK, GREAT BRITAIN, NO. 40826

REG. U.S. PAT. OFF.



IN THIS ISSUE

- Six pages of Christmas gift ideas
- A look at the Soviet Navy
- Roundup of the new TV sets
- How dangerous is fall-out?

FOR HOME CRAFTSMEN

ACTION



*starts
with AC...*

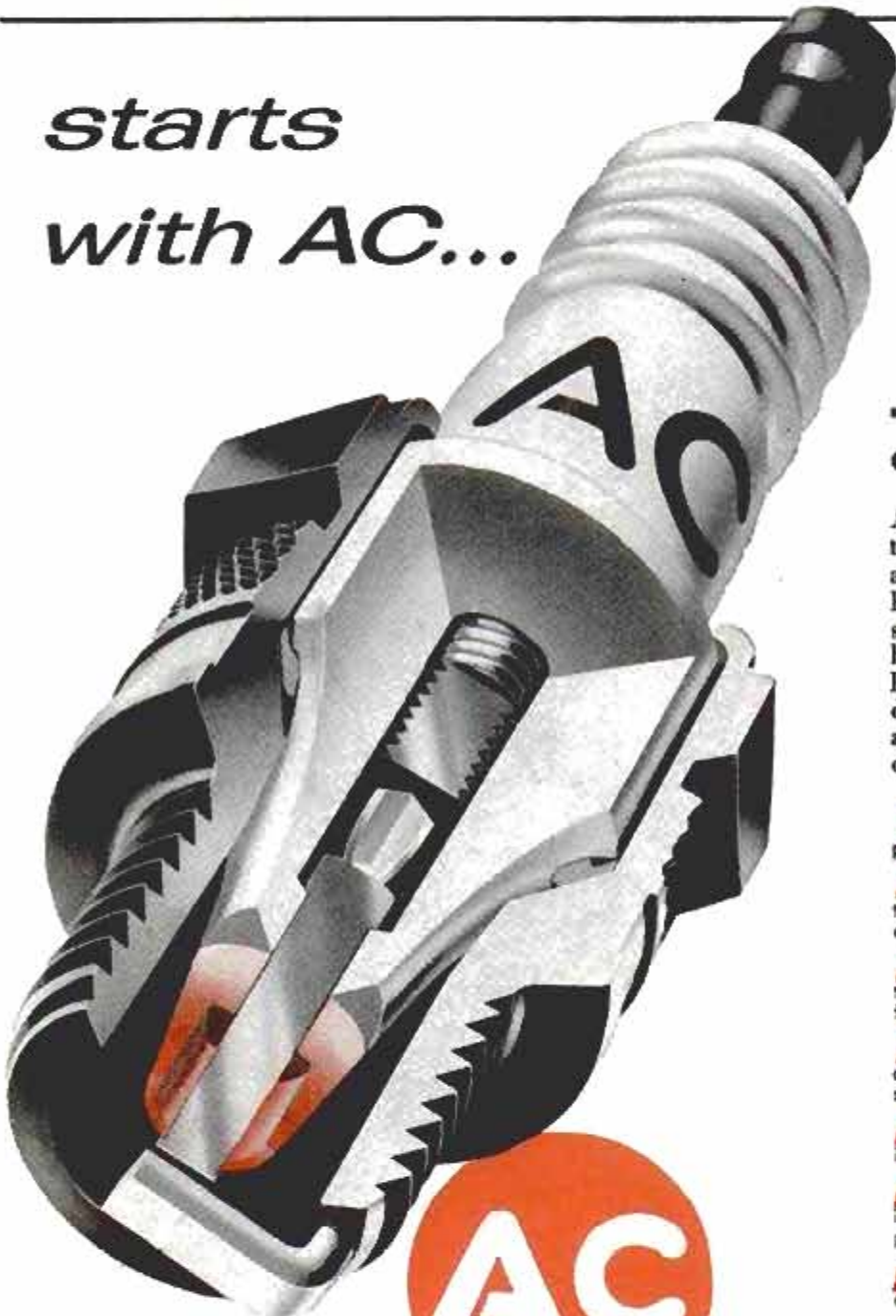

...the spark plug others follow!

AC Spark Plugs paced the modern trend to high-compression engines and high-octane fuels! AC Spark Plugs pioneered the most impressive list of advances in ignition history! There's an out-ahead AC Hot Tip Spark Plug specifically designed to get the best performance from your car's engine. Insist on AC Spark Plugs.

FIRST with the stronger, one-piece heat-sealed shell construction.

FIRST in welded side electrode construction for better heat and electrical conductivity.

FIRST to incorporate a resistor element for elimination of radio interference from ignition.

FIRST with fused metal-ceramic seal to stop center-wire compression leakage.

FIRST in the use of unglazed insulator tip to resist lead attack.

FIRST with the aluminum oxide insulator in the United States—a patented AC composition!

FIRST to use greater "scavenging" area between insulator and shell.

FIRST with the long, thin, recessed, quick-heating insulator tip—the AC Hot Tip—an AC exclusive!

FIRST with the copper-core electrode to improve performance under special high-temperature operating conditions in commercial applications.

hot tip spark plugs

CHANGE AT LEAST EVERY 10,000 MILES



AC SPARK PLUG  THE ELECTRONICS
DIVISION OF GENERAL MOTORS

Texaco Tips On Car Care



For greater driving safety

have your car's underside checked carefully for holes in the tail pipe or muffler caused by rust or corrosion. If any exist, combustion fumes can seep into your car—and that's particularly dangerous in winter when you often drive with all windows closed. Your nearby Texaco Dealer will gladly make this check for you.

For a cleaner, livelier engine...

use Texaco's amazing new motor oil—*Havoline Special 10W-30*. It's light for quick cold starts, yet has body to protect against engine heat. In any season, it assures clean, power-packed performance... added gasoline mileage. So change now and change regularly to *Havoline Special 10W-30*. It's the motor oil that thinks for itself... saves you thinking about seasonal grades. Get it from your Texaco Dealer, the best friend your car has ever had.



it's
"light"
for
cold
starts

has
"body"
to
withstand
heat



TEXACO DEALERS IN ALL 48 STATES

Texaco Products are also distributed in Canada, Latin America, and Africa

THE
TEXAS
COMPANY

A TRIUMPH OF TELEPHONE TECHNOLOGY

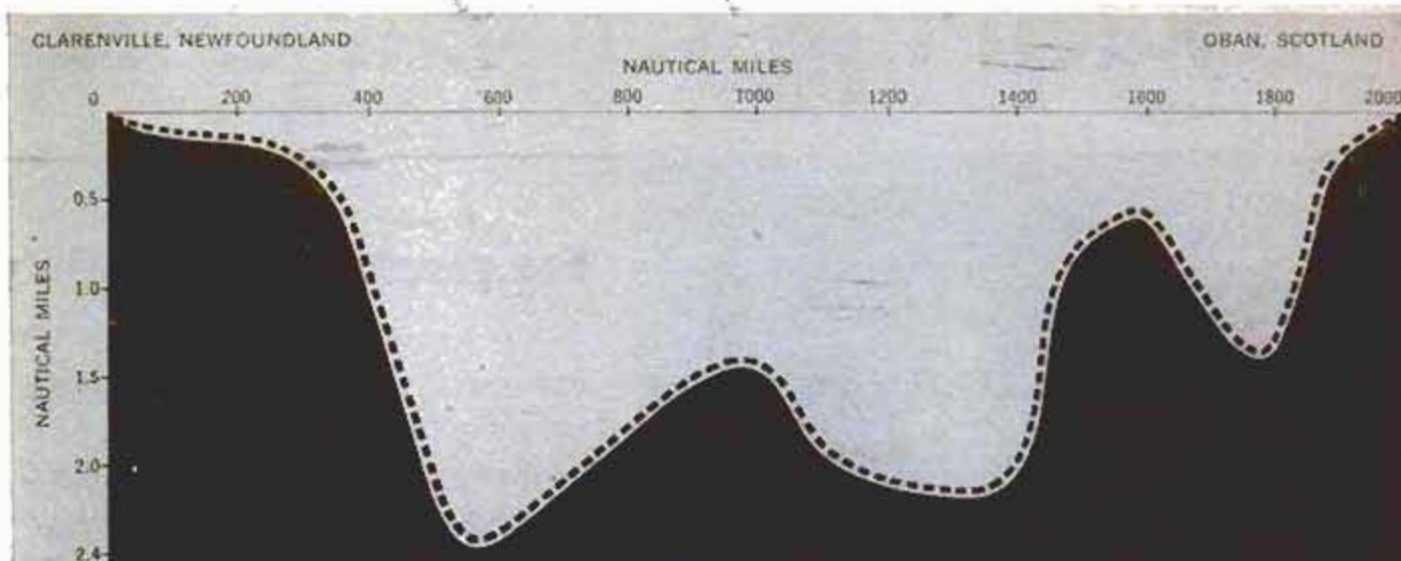

Contour of ocean bed where cable swiftly and clearly carries 36 conversations simultaneously. This is deep-sea part of system — a joint enterprise of the American Telephone and Telegraph Company, British Post Office and Canadian Overseas Telecommunications Corporation.

A great new telephone cable now links North America and Europe—the first trans-oceanic cable to carry voices.

To make possible this historic forward step in world communications, Bell Laboratories scientists and engineers had to solve formidable new problems never encountered with previous cables, which carry telegraph signals.

To transmit voices clearly demanded a much

wider frequency band and efficient ways of overcoming huge attenuation losses over its more than 2000-mile span. The complex electronic apparatus must withstand the tremendous pressures and stresses encountered on the ocean floor, far beyond adjustment or servicing for years to come.

Here are a few of the key developments that made this unique achievement possible:



More than 300 electron tubes of unrivaled endurance operate continuously, energized by current sent from land.



Precisely designed equalizing networks and amplifiers compensate for the loss in the cable every 40 miles and produce a communication highway 144 kc. wide.



A unique triple watertight seal protects the amplifiers from pressures as high as 6500 pounds per square inch.

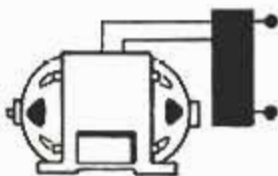

Power supplies of exceptional reliability send precisely regulated current along the same coaxial that carries your voice to energize the amplifying units.



BELL TELEPHONE LABORATORIES

World center of communications research and development

Popular Mechanics Magazine

Registered in U. S. Patent Office and Canada

H. H. WINDSOR, Founder

H. H. WINDSOR, JR., Editor and Publisher



Next Month

ANY BUGS in those cabbages? They'll soon bite the dust from that duster. In this issue we present the first of three articles by top authorities on the farmer's natural enemies—weeds (page 165), insects (December) and plant diseases (January). Here's down-to-earth information for the farmer on the latest weapons in his arsenal. But there's fare for the town dweller, too: How to maintain a weed-free lawn, how to get rid of that stubborn stump, the finest mosquito repellent ever discovered.

Published monthly by Popular Mechanics Company, 200 E. Ontario St., Chicago 11, Ill. H. H. Windsor, Jr., president; Wm. Harrison Petridge, exec. vice-pres.; Franklin S. Forsberg, operations vice-pres.; D. F. Windsor, vice-president and secretary-treasurer; H. H. Windsor III, vice-president; W. T. Windsor, vice-president; Joseph R. Buell, Jr., advertising manager; Alan M. Deyoe, circulation manager. Single copy in the United States and Canada, 35 cents; subscription rates in the United States and possessions, Canada, Philippines and countries of the Pan-American Postal Union, 1 year \$3.50; 2 years, \$6.00; 3 years, \$8.00. To all other countries add \$1.00 a year over United States prices for overseas postage. If you plan to move, notify us at least 30 days in advance so you will not miss an issue. Give both your old and new addresses. Entered as Second Class Matter, September 15, 1903, at the Post Office at Chicago, Illinois, under Act of March 3, 1879. Entered as Second Class Matter at Post Office Dept., Canada, Registered as Second Class Matter at the Post Office at Mexico, D. F., Mexico, June 20, 1950. Copyright 1956 by Popular Mechanics Company. Copyright under International Copyright Union. Copyright in France. All rights reserved under Pan-American Copyright Union. Printed in the United States of America.

IMPORTANT NOTICE—It is the intention of this magazine to provide its readers with information regarding the latest developments in the mechanical arts. We take no responsibility as to whether the disclosures contained in our articles are covered by patents and advise readers to investigate this subject before making, using, or selling any of the products, machines, or processes described in order to avoid possible liability for patent infringements.

NOVEMBER 1956

Volume 106

NOVEMBER 1956

Number 5

Address all communications to: 200 E. Ontario St., Chicago 11, Ill.

Managing Editor.....	Roderick M. Grant
Assistant Managing Editor.....	Wayne Whittaker
Shop Notes and Crafts Editor.....	James R. Ward
Radio-Television, Electronics Editor.....	Lothar Stern
Associate Editor.....	Clifford B. Hicks
Associate Editor, Automotive.....	Arthur R. Railton
Associate Editor, Shop Notes and Crafts.....	Wayne C. Lecky
Associate Editor, Shop Notes.....	W. Clyde Lamme
Assistant Editor, Crafts.....	Jay W. Hedden
Assistant Editor, Makeup.....	John C. Dolan
Automotive Correspondent.....	Leo Donovan
Art Director.....	Frank Beatty
Assistant Editors—Leonard F. Hiltz, Emily M. Rice, Earl F. Wobeck, Robert E. Dorsett	
Eastern Editor.....	Richard F. Dempewolf
Empire State Bldg., Room 2906, New York City 1	
Western Editor.....	Thomas E. Stimson, Jr.
Suite 1010, 3460 Wilshire Blvd., Los Angeles 5, Calif.	
London Manager.....	Douglas W. Wedderspoon
Eagle House, Jermyn St., London S. W. 1, England	
Director, Bureau of Information.....	Allan Carpenter
200 E. Ontario St., Chicago 11	

Advertising Offices

Chicago: 200 E. Ontario St., Whitehall 4-0100; New York: Empire State Bldg., 350 Fifth Ave., Longacre 5-7580; Detroit: General Motors Bldg., TRinity 5-8711; Cleveland: Hanna Bldg., 1422 Euclid Ave., Prospect 1-0456; Los Angeles: 3460 Wilshire, DUnkirk 2-8458; San Francisco: Russ Bldg., 235 Montgomery St., YUkon 2-0823.

In This Issue . . .

How Dangerous Is Fallout? - - - - -	97
1957 New-Car Parade - - - - -	106
Christmas Shopping Center - - - - -	116
Detroit Listening Post - - - - -	122
Giant Blowers Cool Cascade Tunnel - - - - -	124
Keeping Up With the Atom - - - - -	126
Ships of All Ages - - - - -	128
Algae for Lunch - - - - -	134
Here's How to Split a Giant Redwood - - - - -	138
Their Job Is to Guard Your Health - - - - -	142
Soviet Fleet Ranks No. 2 - - - - -	147
Obstacle Course for Trail Riders - - - - -	157
Goal No. 1—The Weed-Free Farm - - - - -	165
Radio, TV and Electronics - - - - -	177

For the Craftsman . . .

Knotty-Pine Hutch Cabinet - - - - -	181
Decorate With Hardwood Plywood—Part II - - - - -	185
Bristle Brush-Up - - - - -	190
Solving Home Problems - - - - -	194
Calibrate Your Enlarger - - - - -	198
Crazy Jigsaw Block Puzzle - - - - -	206
Is Your Wiring Adequate?—Part I - - - - -	214
How Would You Do It With Your Drill Press? - - - - -	230
Shopping for Tools - - - - -	234
On the Market - - - - -	236

See pages 90, 92 and 94

for other items and manufacturers of available products

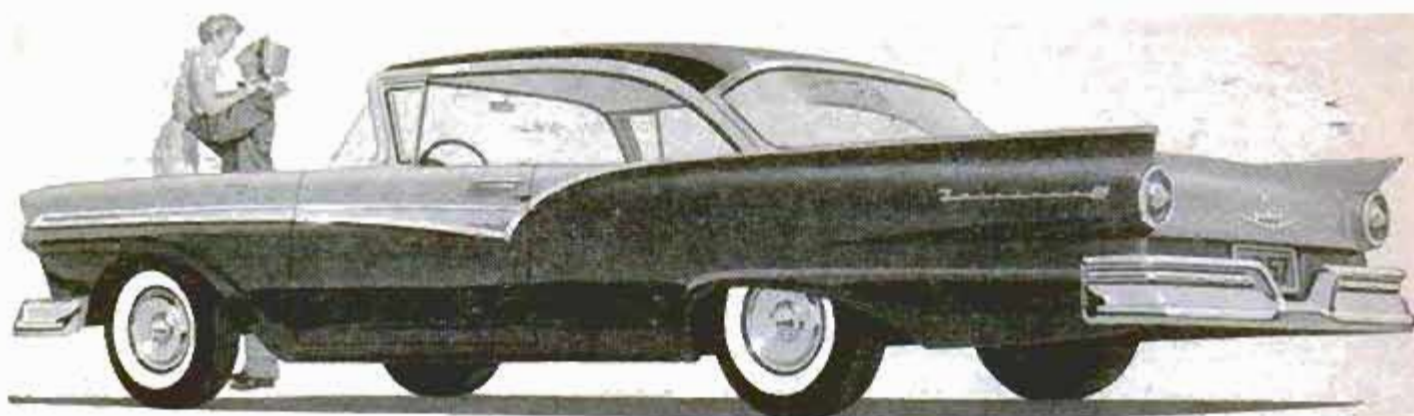

What put the magic in

The big news from Detroit this year is the magic of the "Inner Ford" for '57. The magic begins with a bow-shaped frame that sweeps out and dips down between the wheels. Side rails flare out almost 13" further than in '56. Passengers are within (but still above) the contour of the frame.

Side rails thus serve as concealed "side bumpers" of immense strength. This new contoured frame provides the '57 models with the most rugged foundation of any Ford yet.

Ford's new sculptured-in-steel body is secured to this rugged frame by 20 unique



The contoured frame is a ladder-type structure with heavier box section side rails and 5 cross members. Torsional rigidity of this '57 frame is as much as 27 per cent greater.

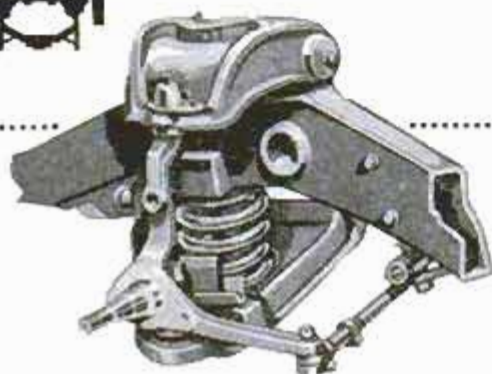

4-way ball-joint front suspension has been further advanced. New lower suspension arms are swept back so front wheels step over bumps rather than into them . . . a 4-way action for a softer ride.



The magic of the Ford Silver Anniversary V-8's for '57 is centered about the words "deeper breathing." New larger intake valves, king-sized manifolds, and higher lift camshafts help provide a larger volume of fuel-air mixture, thus allowing for superior engine performance . . . up to 245 hp. The popular Mileage Maker Six, the most advanced Six in the industry, has been boosted to 144 hp.

FORD Division of

POPULAR MECHANICS



the new kind of FORD?

live-rubber body mounts. This helps the '57 Ford to give you the solid, silent kind of ride you expect to find only in more expensive cars.

There's magic in three high-performance Silver Anniversary V-8's with up to 245 hp. The new low silhouette carburetor and

higher compression combustion chambers are just a few of the new V-8 engine features that you'll appreciate.

See your Ford Dealer soon. He'll gladly give you the full story of Ford magic for '57, and let you action-test this *new kind* of car with the Touch of Tomorrow.



Even-keel rear springs are longer-leaved and out-board mounted for wider stance, greater stability.



New deep-offset hypoid axle has exclusive straddle-mounted pinion for greater torque capacity, quieter operation and longer life.



Centrifugal-vacuum distributor for V-8's has long-lived ventilated points. Breaker plate rotates on full ball bearings for split-second response to changing engine requirements.



Carburetors are low silhouette type. They give a more homogeneous mixture for better starts.



Air cleaner used with Ford's new carburetor has re-usable pleated fibre filter; offers easier maintenance and more filtering area.

FORD MOTOR COMPANY

NOVEMBER 1956

5

NEW... FOR YOUR Precision Jobs



PROTO PROFESSIONAL-QUALITY ELECTRONICS HAND TOOLS!



IF YOU'RE IN ELECTRONICS... industrial or service... you need the rugged strength, firm grip and perfect balance found in this broad line of job-engineered tools. Many tough problems can be made easier with PROTO:

Hex Nut Drivers • Pliers • Screwdrivers • Wire Strippers • Nippers Snips • Ratcheting Wrenches Midget Wrenches • All-Angle Drill Grab-Alls • and many other tools.

See them—buy them off the merchandiser at your PROTO dealer's today. Send 10¢ for catalog of entire line to
PROTO TOOLS

2223 Santa Fe Ave., Los Angeles 54, Calif.
Eastern Factory, Jamestown, N.Y.
Canadian Factory, London, Ont.

5689



ACROSS THE DESK



To the Editor:

Although electrically driven, a novel model train needs neither batteries nor transformers. Electric current is supplied by a hand generator connected to the rails,



which carry the current to the locomotive. The faster the handle is turned, the greater the speed of the train.

Charles Arthur Oldroyd,
Barrow-in-Furness,
Lancs., England

Life on a Russian Warship

Russian navy ships even "smell different," reports British artist, George H. Davis, who inspected the soviet cruisers *Ordzhonikidze* and *Sverdlov* as well as destroyers of the *Skoryi* class when they visited England recently. After his visit aboard the ships, Mr. Davis prepared for *Popular Mechanics* the drawings presented on pages 148-151.

"The ships are very well found and very clean," the artist writes us, "though the 'smell' of the ship is different to that of a British ship." Having visited many foreign vessels, he asserts that each one has its distinctive smell.

His report to *PM* brought interesting comments on life aboard a soviet warship.

"In the big cruisers of the *Sverdlov* class," says Mr. Davis, "the officers are accommodated amidships; there are two and four-berth cabins just as comfortable as those in American or British ships.

"The crewmen eat and sleep in their main quarters forward and aft. Russian

(Continued to page 8)

THIS FREE BOOK

will prove that you can become an expert

ACCOUNTANT...AUDITOR

OR C.P.A.

GET THIS BOOK FREE!

We offer you this free book so that you can prove to yourself that you CAN master Accounting—quickly, thoroughly—in spare time at home.

You will see exactly how LaSalle's famous "Problem Method" works...how you are led step-by-step through actual accounting work—learning by doing and not by study of theory alone. First you tackle easy problems, then more difficult ones—until soon you master them all. And at every step you have the close personal guidance of LaSalle's large staff of C.P.A. instructors.

One out of every 13 of all C.P.A.'s in the U.S. has been trained by the LaSalle Problem Method

PREPARE FOR A HIGH-PAY POSITION

If you were an expert accountant right now, chances are you would find yourself among the highest-paid of all professional men and women. Accountants earn more than many men in other major professions.

There are several big fields of opportunity open to men and women trained in Accounting...opportunities that are wide open and highly inviting, offering maximum income and job security in good times or bad. And under LaSalle's "Problem Method" you can start earning while still learning—either in spare-time or full-time employment...or in business for yourself with no capital required.

Get the latest information by sending for our illustrated booklet, "Accountancy, The Profession That Pays". The coupon at right will bring it to you without cost or obligation. LaSalle Extension University, 417 S. Dearborn St., Chicago 5, Illinois.

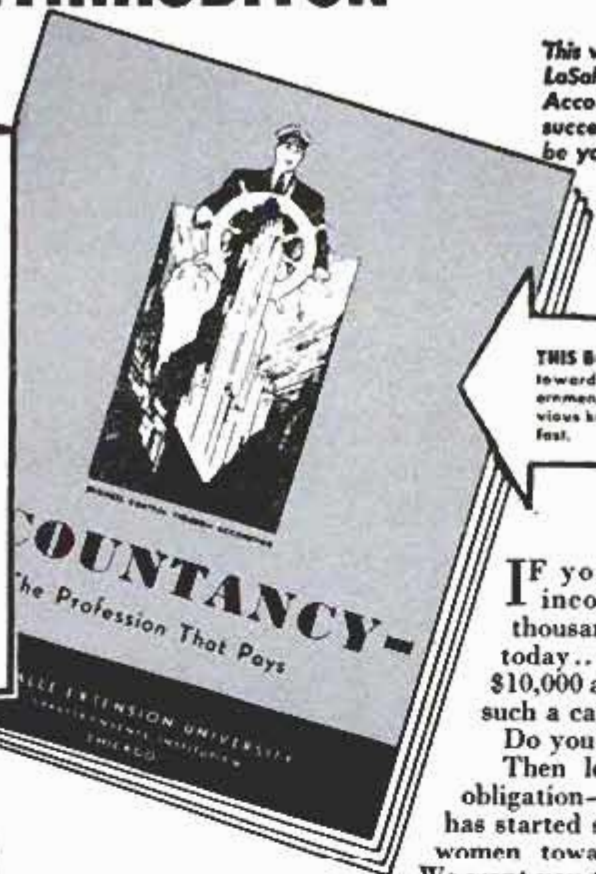

This well-paid LaSalle-trained Accountant's success could be yours.



THIS BOOK HAS STARTED HUNDREDS OF THOUSANDS toward well-paid accounting careers—in business, government, and public practice as C.P.A.'s. Even without previous knowledge, progress is rapid—earning power climbs fast.

If you have been envying the high incomes and good jobs enjoyed by thousands of men and women Accountants today...incomes ranging from \$4,000 to \$10,000 and more per year...why not launch such a career for yourself?

Do you doubt that you can?

Then let us send you—without cost or obligation—the same book with which LaSalle has started several hundred thousand men and women toward successful accounting careers.

We want you to see for yourself how this remarkable method, originated by LaSalle, makes Accounting simple, interesting, practical, and certain...how it leads you step-by-step to a complete mastery of Accounting—

and on up to the Certified Public Accountant Certificate if you so aspire.

It doesn't matter whether you've had previous bookkeeping experience, or whether you don't know a debit from a credit. Whether you wish to qualify as an expert accountant, advanced accountant, cost accountant, auditor, government accountant, income tax specialist, or public accountant...you'll find in LaSalle's Problem Method the exact plan to prepare you rapidly and inexpensively—in spare hours at home—without losing a day from your present job.

So right now, today...if you are an adult, employed, and earnestly ambitious for rapid advancement in one of the highest paying professions...send your name and address on the coupon below. We'll send you free our latest book outlining today's career opportunities and how you can qualify for them. A coupon like this has started many thousands toward greater success. It can do the same for you. Mail it today!

Member, National Home Study Council

Clip Coupon... Mail TODAY!

LaSalle Extension University... A Correspondence Institution
Dept. 1164H, 417 S. Dearborn Street, Chicago 5, Illinois

YES, I want to see how LaSalle's "Problem Method" works...how I can qualify for high-pay Accounting positions. Send your book, "Accountancy, The Profession That Pays"...with

This One

Name.....

Street Address.....

City, Zone & State.....

Present Position.....



NTOL-CH6-REAN



Constellation
Slide Projector
and Graphic 35

Look

YOU NEED BOTH FOR COLOR!

The famous Graphic 35 to take 'em—and the great new Constellation slide projector to show 'em! The new Constellation projects your color slides with lifelike brilliance and unequalled color quality. It's the only automatic projector with a powerful 500 watt lamp and *electric* remote control selling for less than \$100. You'll find it a perfect companion to the Graphic 35 featuring . . .

PUSH-BUTTON FOCUSING . . . the fastest focusing method ever developed. Your forefingers rest comfortably on the convenient push-buttons, your middle finger on the trigger-acting Body Release Lever. Fast *f/2.8* lens, and Spectramatic Flash Settings for indoor flash pictures. Here is the perfect combination for picture-taking-and-showing brought to you by the makers of the famous Pacemaker Speed Graphic. You can have either or both for as little as 10% down.



GRAFLEX®

Price-Winning Camera

A SUBSIDIARY OF



**FREE
FOLDER
MAIL COUPON
TODAY**

Graflex, Inc., Dept. PM-116C
154 Clarissa St., Rochester 8, N. Y.

Please send me free folder on the Constellation
and Graphic 35.

NAME _____

ADDRESS _____

CITY _____ ZONE _____ STATE _____

(Continued from page 6)

seamen sleep in cot beds which fold to the walls. The petty officers have comfortable recreation rooms and cabins. There is, of course, considerable political propaganda in the Propaganda and Recreation Hall.

"Both officers and men are well fed and the big galley that feeds the crew and the smaller one for the officers have to supply the wants of 1050 officers and men.

"The sailors are called at 6 o'clock, do physical training at 6:15 and breakfast at 7. At 8 a.m. the whole crew turns out for the hoisting of the flag. For the rest of the morning they go about their various duties including scrubbing of the wooden decks (using a primitive type of birch broom). At noon the bugle calls the men to their main midday meal consisting of an excellent three-course lunch. Unlike the British navy (but like that of the United States) the ships are 'dry'; that is, no intoxicating liquor is used in men's quarters or ward-room. There are, however, soft drinks to be bought and of course the beloved ice cream. After dinner there is a so-called 'rest period,' then more work until 5 p.m. and at 6, supper is served. After supper those not on necessary duties are able to do more or less as they please within the scope of discipline; instrument playing and dancing are popular recreations and chess is popular with the older men."

Mr. Davis noted that the Russian sailors are not large, heavy men as often thought to be the typical Russian physique, most of the seamen actually being lightweight and five feet six to nine inches in height. He described the vessels as "happy ships" and was amused to observe that the commander always addressed the men as "Comrades," and when the petty officers met him in the morning they first saluted and then shook his hand.

Aboard the big cruisers Mr. Davis saw a large number of cadet "officers in the making," distinguished by a peaked cap instead of the sailor's round cap with black back ribbons. He commented on the extreme "bagginess" of the officers' trousers which "certainly does not add to the smartness of their uniforms."

☆☆☆

From 100 miles northwest of Vancouver, B. C., a strange mystery of nature has defied eight years of scientific investigation. During severe winters there collects on the waters of Bute Inlet, one of the fiords which indent that mountainous coastline, a unique wax of undetermined origin. Under the right weather conditions, it gathers in "ton lots" on the surface or the beaches.

(Continued to page 10)

ARE YOU TOO OLD TO LEARN?

not at all, scientists say

New tests show that: your ability to think increases with age; your powers of deduction are greater; your judgment is better.

In the I. C. S. files are thousands of cases of men and women of every age. Their successes, their promotions, their raises prove that men and women past school age can learn!

I.C.S. GIVES YOU EXPERT GUIDANCE FREE! Do you have the feeling you're "stuck" in your job? Your trained I.C.S. counselor will appraise your abilities, help you plan for the future.

IT'S NEVER TOO LATE TO GET STARTED! You study with I.C.S. at home, in your spare time. There's no interference with business or social activity. Famous I.C.S. texts make learning easy. Don't delay. Pick your field from the coupon below. And mail it today!



3 FREE BOOKS

36-page, pocket-size guide to advancement, a gold mine of tips on "How to Succeed." Big catalog outlining opportunities in your field of interest. Also sample lesson (Mathematics).

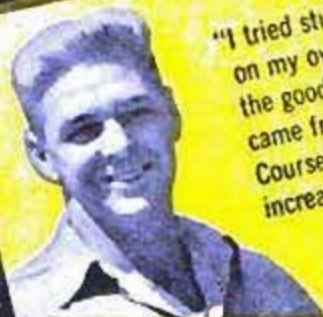

"I tried studying my work on my own, but I never got the good out of it that came from my I. C. S. Course. My salary has been increased 73.3%!"

E.L.B.
Ohio

"I am president of a small corporation. A year ago I enrolled with I. C. S. as the most practical means available to me to learn what I needed."

W.J.A.
Michigan



"It's been so long since I went to school, I've forgotten much. But now that I'm taking an I. C. S. Course, I have confidence in my ability again."

H.A.R.
New Jersey



Actual statements.
Posed by models.

For Real Job Security—Get an I. C. S. Diploma!

I. C. S., Scranton 9, Penna.

Member, National Home Study Council

INTERNATIONAL CORRESPONDENCE SCHOOLS

65TH
YEAR

BOX 99626L, SCRANTON 9, PENNA.

(Partial list of 256 courses)

Without cost or obligation, send me "HOW TO SUCCEED" and the opportunity booklet about the field BEFORE which I have marked X (plus sample lesson):

ARCHITECTURE and BUILDING CONSTRUCTION

- Air Conditioning—Refrig.
- Architecture
- Architectural Interiors
- Building Contractor
- Building Estimator
- Building Maintenance
- Carpentry and Mill Work
- Heating
- Painting Contractor
- Plumbing
- Reading Arch. Blueprints

ART

- Cartooning
- Commercial Art
- Fashion Illustrating
- Magazine Illustrating
- Show Card and Sign Lettering
- Sketching and Painting

AUTOMOTIVE

- Auto Body Rebuilding
- Auto Elec. Technician
- Auto-Engine Tune Up
- Automobile Mechanic

AVIATION

- Aeronautical Engineering Jr.
- Aircraft & Engine Mechanic

BUSINESS

- Advertising
- Bookkeeping and Accounting
- Business Administration
- Business Correspondence
- Public Accounting
- Creative Salesmanship
- Federal Tax
- Letter-writing Improvement
- Office Management
- Professional Secretary
- Retail Business Management
- Sales Management
- Stenographic-Secretarial
- Traffic Management

CHEMISTRY

- Analytical Chemistry
- Chemical Engineering
- Chem. Lab. Technician
- General Chemistry
- Natural Gas Prod. & Trans.
- Petroleum Engineering
- Plastics
- Pulp and Paper Making

CIVIL, STRUCTURAL ENGINEERING

- Civil Engineering
- Construction Engineering
- Highway Engineering
- Reading Struct. Blueprints
- Sanitary Engineering
- Structural Engineering
- Surveying and Mapping

DRAFTING

- Aircraft Drafting
- Architectural Drafting
- Electrical Drafting
- Mechanical Drafting
- Mine Surveying and Mapping
- Plumbing Drawing and Estimating
- Structural Drafting

ELECTRICAL

- Electrical Engineering
- Electrical Maintenance
- Electrician
- Contracting
- Lineman

HIGH SCHOOL

- Commercial
- Good English
- High School Subjects
- Mathematics

LEADERSHIP

- Foremanship
- Industrial Supervision
- Leadership and Organization
- Personnel-Labor Relations

MECHANICAL AND SHOP

- Gas—Electric Welding
- Heat Treatment
- Metallurgy
- Industrial Engineering
- Industrial Instrumentation
- Industrial Supervision
- Internal Combustion Engines
- Machine Design-Drafting
- Machine Shop Inspection
- Machine Shop Practice
- Mechanical Engineering
- Quality Control
- Reading Shop Blueprints
- Refrigeration
- Sheet Metal Worker
- Tool Design
- Toolmaking

RADIO, TELEVISION

- Industrial Electronics
- Practical Radio TV Eng'ng
- Radio and TV Servicing
- Radio Operating

(plus sample lesson):

- Television Technician
- RAILROAD**
- Air Brake Equipment
- Car Inspector
- Diesel Engineer & Fireman
- Section Foreman
- STEAM AND DIESEL POWER**
- Combustion Engineering
- Diesel—Elec.
- Diesel Eng's
- Electric Light and Power
- Stationary Fireman
- Stationary Steam Engineering
- TEXTILE**
- Carding and Spinning
- Cotton, Rayon, Woolen Mfg.
- Finishing and Dyeing
- Loom Fixing
- Textile Des'ing
- Textile Eng'g
- Throwing
- Warping and Weaving
- MISCELLANEOUS**
- Domestic Refrigeration
- Marine Engineering
- Ocean Navigation
- Professional Engineering
- Short Story Writing
- Telephony

Name _____ Age _____ Home Address _____

City _____ Zone _____ State _____ Working Hours _____ A.M. to P.M. _____

Occupation _____ Canadian residents send coupon to International Correspondence Schools, Canadian, Ltd., Montreal, Canada. . . . Special tuition rates to members of the U. S. Armed Forces.



the first power hone
for hobby workshop
and kitchen

LECTRO-HONE

**SHARPENS
TOOLS, CUTLERY, SCISSORS
BY GENTLE HONING
NOT HARSH GRINDING**

Here's the smooth, gentle honing action of a fine-grained oil stone—harnessed to a precision engineered electric motor geared to turn the stone at the correct speed for perfect honing, instead of harsh grinding that wears away and misshapes blade edges (see microphoto). Adjustable tool rest and angle guide assures accurate honing. Two-purpose stone has fine and extra-fine sides. Size 4" high x 6 1/4". Price: \$19.95.



Unretouched microphotos
of knife blades
magnified 120 times.



ORDER BY MAIL

under full money-back warranty, or at your favorite store.

WARREN SALES COMPANY

Box 161A, Cranford, New Jersey

Manufactured by E. F. Britten & Co., Inc. • Cranford, N. J.

(Continued from page 8)

Hundreds of scientific tests have been made on this substance by the Institute of Oceanography of the University of British Columbia and by the Pacific Fisheries Experimental Station of the Fisheries Research board of Canada. It is amber-colored both as a solid and a liquid, with a melting point of 50 degrees F. Chemical analysis has shown it to be essentially a wax (fatty alcohols combined with fatty acids), but with only a trace of the glycerides typical of fish and marine-animal oils or of the hydrocarbons inherent in the petroleum. It cannot even be stated whether it is of animal, vegetable or mineral origin.

Among the theories that have been advanced and rejected for substantial reasons are: 1. That it is derivative from sperm or other animal oils; 2. That it is decomposed ambergris; 3. That it is the remains of rotting explosives; 4. That it is a product of decomposed local trees, washed down by the mountain rivers; 5. That it comes from a seaweed.

A similarity in the chemical composition of this peculiar substance and that of the seeds of certain of the sagebrush family of California and Nevada has raised speculation as to whether, possibly, the remains of semitropical vegetation from some former geological era lie rotting in the deep ocean trough of Bute Inlet.

E. Jervis Bloomfield,
Toronto, Ont., Can.



Learn Radio-Television

Servicing or Communications by Practicing at Home in Spare Time

N. R. I. SENDS kits with which you practice building circuits common to Radio and TV sets. You LEARN-BY-DOING to locate Radio-TV troubles. As part of N. R. I. Servicing Course, you build Vacuum Tube Voltmeter and AC-DC receiver. Use VTVM to conduct experiments, earn extra money fixing sets in spare time.

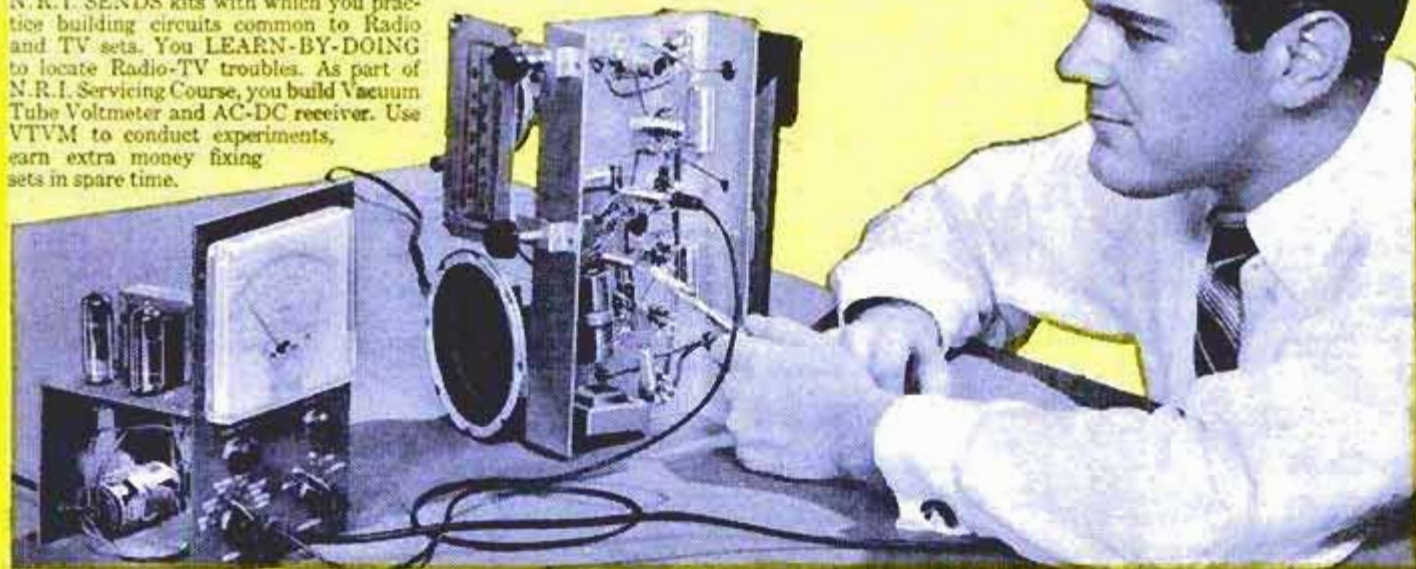

RADIO-TV BROADCASTING (see above) offers important positions as Operators and Technicians. **RADIO-TV SERVICING** Technicians (see below) needed in every community. Their services are respected, their skill appreciated.



Fast Growing Field Offers You Good Pay, Success, Bright Future

Bigger than ever and still growing fast. That's why Radio-TV has special appeal to ambitious men not satisfied with their job and earnings. More than 4,000 Radio and TV stations. More than 150 million home and auto Radios, 40 million TV sets. Color TV promises added opportunities. For the

trained man, there are good jobs, bright futures in Radio-TV Servicing or Broadcasting. Training PLUS opportunity is the ideal combination for success. So plan now to get into Radio-TV. The technical man is looked up to. He does important work, gets good pay for it. Radio-Television offers that kind of work. NRI can supply training quickly, without expense of going away to school. Keep your job while training. You learn at home in your spare time. NRI is the OLDEST and LARGEST home study Radio-TV school. Its methods have proved successful for more than 40 years.



J. E. SMITH
Founder

Added Income Soon - \$10, \$15 a Week in Spare Time

Soon after enrolling, many NRI students start to earn \$10, \$15 a week in spare time fixing sets. Some pay for their training and enjoy extra luxuries this way. Some make enough to start their own Radio-TV shops. NRI training is *practical*—gets quick results. Easy to understand, well illustrated lessons teach you basic principles. And you LEARN-BY-DOING by practicing with kits of equipment which "bring to life" things you study.

Find Out What NRI Offers

NRI has trained thousands for successful careers in Radio-TV. Study fast or slow—as you like. Diploma when you graduate. Mail coupon now. Paste it on a postcard or mail in envelope. **ACTUAL LESSON FREE.** Also 64 page catalog that shows opportunities, shows equipment you get. Cost of NRI courses low. Easy terms. **NATIONAL RADIO INSTITUTE, Dept. 6MA, Washington 9, D. C.**

N.R.I. TRAINED THESE MEN FOR SUCCESS



"I was repairing Radios by 10th lesson. Now have good TV job." **M. R. LINDEMUTH, Fort Wayne, Ind.**



"Doing spare time repairs on Radio and TV. Soon servicing full time." **CLYDE HIGGINS, Waltham, Mass.**

"I had a successful Radio repair shop. Now I'm Engineer for WHPE." **V. W. WORKMAN, High Point, N. C.**



"There are a number of NRI graduates here. I can thank NRI for this job." **JACK WAGNER, Lexington, N. C.**



VETERANS Approved Under G. I. Bills

SEND FOR BOTH FREE

National Radio Institute

Dept. 6MA, Washington 9, D. C.

Mail me Sample Lesson and 64-Page Catalog FREE. (No salesman will call. Please write plainly.)

Name _____ Age _____

Address _____

City _____ Zone _____ State _____

Approved Member National Home Study Council



SAVE
up to
66%

AMAZING BARGAINS

SAVE
up to
66%

NEW...HI-POWER All Purpose Professional SPRAYER



NOT \$29.95
Save 66%
OUR PRICE
9.95

- Paints
- Insecticides
- Exterminates
- Mothproofs
- Lubricates

SAVE TIME
SAVE LABOR
SAVE MONEY

Complete Kit — No extras to buy!

Thoresen's greatest discount bargain in the last 10 years! Now . . . don't pay \$29.95 for a professional all-purpose, fully automatic Spray Gun. Our cash price only \$9.95. You save 66%—a full \$20! This amazing bargain is made possible because of a special deal with the manufacturer of this nationally famous Hi-Power automatic Sprayer.

**CUTS PAINTING TIME 75%
SAVES YOU HUNDREDS OF DOLLARS!**

Why pay professional painters \$20 to \$50 a room? With this Sprayer you turn out quality jobs for mere pennies!

THROW AWAY THOSE SLOPPY PAINT BRUSHES!

No more backaches! No more brush cleaning! Just plug in this Hi-Power Spray Gun. Press the button and paint automatically. You'll turn out a clean satin-smooth job the very first time! No streaks! No dripping! No brush marks! Reaches corners, deep cracks, rough and pebble surfaces . . . far easier than a brush.

ONE-THOUSAND-AND-ONE USES!

Use it around the house, shop, garden, garage. Use it to paint walls, ceilings, floors, stairs, chairs, furniture, screens, garden tools, garage doors, boats, toys, etc. Use it to spray insecticides on flowers, plants, shrubs! Use it to exterminate flies and mosquitoes . . . to mothproof clothes . . . to touch-up scratches on auto fenders—even to lubricate under the chassis! This powerful Spray Gun takes paint, enamels, lacquers, varnishes, shellacs, insecticides, disinfectants, polishes, deodorants, fungicides, agents, liquid fertilizers, light oils, water, etc. Needs no tank or air compressor. Has built-in strainer—cannot clog or drip—cleans itself in seconds—cannot break in use—it's absolutely safe! Built to last a lifetime and doubly guaranteed by its famous manufacturer and by Thoresen's. Limit one per customer at this rock bottom price.
No. 102 9.95

THORESEN'S, Dept. 6-M

352 Fourth Avenue, New York 10, N. Y.

RUSH the items checked below on 7 day free home trial, money back guarantee. If not delighted with the merchandise, I will return in 7 days for full refund.

- Payment enclosed.
- Send C.O.D., I'll pay charges.
- No. 102—Professional Sprayer \$9.95
- No. 114—Midget Utility Knife \$1.98
- No. 66—Powerhouse Binoculars \$4.98

Name _____

Address _____

Town _____ State _____

CANADIANS: Order direct from Thoresen Ltd., Dept. US-6, 45 St. James Street, W., Montreal 1, P.Q. Same money back guarantee. No extra for tariff.

\$5 VALUE



LITTLE GIANT
Utility Knife
9-IN-1 ONLY **1.98**

Now for short time only—this famous imported utility knife—a \$5 value—at a sensational low price—only 1.98. A life-saver in many emergencies. Hardly 2 1/4" across, yet it gives you 9 quality tools including a screwdriver, awl, corkscrew, can opener, ice pick, scissors, jackknife. Each tool is easy to open, easy to use. Replaces that multitude of tools and gadgets you can't find when you need them. High quality, stainless steel, assures years of rugged use. Ideal gift for hunters, electricians, carpenters, handymen, specialists or just plain Mrs. Housewife.

No. 114 1.98

POWERHOUSE "GIANT"



ONLY
4.98
WITH
CASE

25 TIMES
AREA MAGNIFICATION

Thoresen sold over 1,000,000 German binoculars in recent years. Because we are the world's largest importer of these glasses, we can buy for less and sell for less. That's why we can NOW offer you this 12.95 binocular for only 4.98. The POWERHOUSE "GIANT" is now 7 ways better: 1. High structural strength without tiring weight. Only 12 ozs. 2. Aluminum draw tubes for smoother, faster focusing. 3. Folds to your eye width. 4. Precision-Ground Lenses NOT PLASTIC! 5. Objective lenses interior coated with magnesium fluoride. 6. Extra large 50-mm objective lenses give you viewing even in moonlight. 7. New 5 x 50 power system gives you 66% more power than original model. You get better views whether it's one or 25 miles away. Use on hunting & fishing trips, the races, bird watching, etc. Always have a "ringside" seat at sports events.

No. 66 4.98

INVENTORS

Learn how to protect your invention. The U. S. Patent Laws provide that any new and useful art, machine, article of manufacture, or composition of matter, or any new and useful improvement thereof, may be patented if the act of invention is involved. Therefore, every inventor with a valuable invention should take advantage of the Patent Laws and proceed for patent protection in order to safeguard his rights.

A patent gives the inventor the exclusive right to prevent others from making, using, or selling the invention claimed in the patent for a period of seventeen years.

The Patent Laws were enacted for the benefit of the inventor to give him protection for the features of his invention which are patentable. These features must be properly and concisely set forth and claimed in a formal application for patent, in order to comply with the requirements of the Patent Laws. For that reason, unless the inventor is familiar with patent matters, he should engage a competent registered patent attorney or agent to represent him. We are registered to practice before the U. S. Patent Office and are prepared to serve you in the handling of your patent matters.

A specially prepared booklet entitled "Patent Guide for the Inventor", containing detailed information with respect to patent protection and procedure, together with a "Record of Invention" form will be promptly forwarded to you without obligation upon request.

CLARENCE A. O'BRIEN & HARVEY JACOBSON

Registered Patent Attorneys

61-L DISTRICT NATIONAL BUILDING

WASHINGTON 5, D. C.

1957 ALLIED ELECTRONIC SUPPLY CATALOG

free!

356
value-packed
PAGES

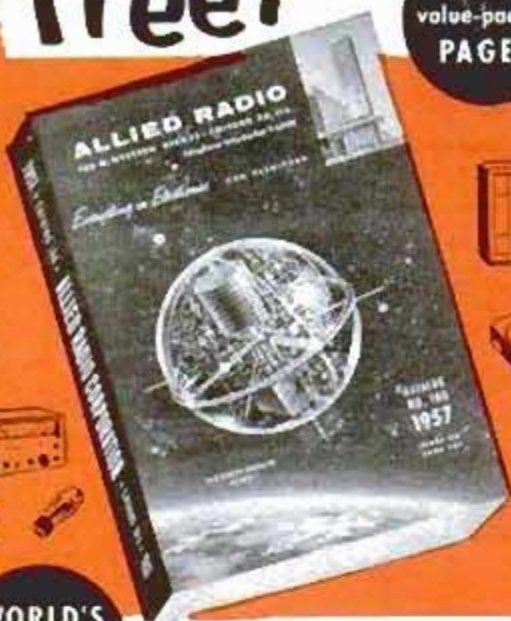

WORLD'S
LARGEST
STOCKS

SAVE ON EVERYTHING
IN ELECTRONICS

Everything for Experimenters, Builders, Amateurs, Servicemen, Engineers and Hi-Fi Hobbyists

Save on *everything* in Electronics: Hi-Fi systems and components; latest builders' kits (see the famous KNIGHT-KIT line); recorders and phono equipment; TV tubes, antennas, accessories; Amateur station equipment; P.A. systems; test instruments; industrial electronic supplies—plus *everything* in parts, tubes, transistors, tools and books. Get more for your money—send today for your FREE 1957 ALLIED Catalog!

Everything in Electronics
From One Reliable Source

Our
36th
year

Send
for FREE
Catalog

ALLIED RADIO

ALLIED RADIO CORP., Dept. 5-L-6
100 N. Western Ave., Chicago 80, Ill.

Rush FREE 1957 ALLIED 356-Page Catalog

Name _____

Address _____

City _____ Zone _____ State _____

Famous 15 and 17 Jewel BULOVA WATCHES \$16.95 PLUS TAX

PRACTICALLY WHOLESALE TO YOU



UNLIMITED SERVICE GUARANTEE

WHY PAY \$59.50?
SAVE \$42.55

Also Choice of a BENRUS
or GRUEN or WALTHAM
or ELGIN WATCHES

You get these unredeemed SERVICE guaranteed Bulova and other movements in latest style Yellow Gold Cases at this sensationally low price because we bought out huge surplus STOCKS of leading New York and Md. jewelers. Order now while they last. Specify make preferred and whether men's or ladies'. Only \$16.95 plus \$1.70 tax. Order right now. **FREE TRIAL OFFER! WEAR AT OUR RISK!** Money back guarantee in 10 days if not delighted.

SEND ONLY \$1
with order. Pay
balance C.O.D.,
plus postage.
Or enclose \$16.95
plus \$1.70 tax, we
pay postage.

Handsome Expansion
Band with orders at no extra cost.

MARYLAND DISTRIBUTORS, Dept. 14

501 E. Baltimore St. Baltimore 2, Md.
Write For Free Watch and Diamond Ring
Catalog — Practically Wholesale Prices

UNLIMITED
Service Guaranteed
17 Jewel Swiss
WRIST WATCH

Worn by Army, Navy
& Marines.
WHY PAY \$50?

Plus
Here \$14.95 \$1.50
Only Tax.

New Incublock,
Shock-Protected
Water & Dust Tight

AIR MAIL XMAS DELIVERY GUARANTEED



Sold by
25,000 stores

Home Craftsmen And Do-It-Yourself Fans—

You're dressed for the job — and neatly, too — when you wear N&W work and leisure clothes. Full line for men and women.



N&W INDUSTRIES, Inc. Lynchburg, Virginia
Jackson, Mississippi

NOW NO ONE CAN KEEP A SECRET FROM YOU!
20x-40x-60x TELESCOPE

only \$269
postpaid

Amaze your friends...
See what they're doing—
without being seen!
Special: Order now, get
Free carrying case



3-range all metal telescope magnifies up to 60 power. Watch ball games, look at the moon, stars, animals, distant buildings... up close. Rotating eyepiece, bright chrome-like tube, made for long use. Good on hikes, camping trips, can use either 20x, 40x, or 60x power instantly. Opens to 3-times its length. No assembling, ready-to-use, no special instructions required. Money back guarantee. Send cash, check or money order to:

I. J. STONE, Dept. TB 11, 1616 Oak St. • Santa Monica, Calif.

Say You Saw It in Popular Mechanics



Make \$5.00 an Hour
**CASH
PROFIT**
The Day You Start!

Start Your Own Business
at Home... Sharpen
Household, Garden and
Shop Tools in Spare Time

Turn your spare time into Big Cash Profits with the new Belsaw Sharp-All. No experience needed to sharpen knives, scissors, shears, ice skates, mower blades, hedge trimmers, axes, chisels and circular saws... just about any household, garden and shop tool. Your own CASH business. No inventory... no calls to make.

Learn how easily you can start your own spare time business. Amazing low cost easy-payment plan. Send postcard for

FREE BOOK

BELSAW SHARP-ALL CO., 717 Field Bldg., Kansas City 11, Mo.



What's your boss saying about you?

The door is usually open. Today it's closed.

They're talking about you . . . about your future. You don't have to hear to know what they're saying. Because there's nobody who knows more about you and your present job than you.

O.K. . . . So you have "experience." Five years on the same job.

Have you *mastered* the job . . . learned everything there is to know about it?

If your answer is "yes," success is right around the corner. But if the answer is "no," then your experience doesn't amount to much. And chances are these things are true about you: you just "coast" along with things . . . you do nothing and go

home all tired out. BEWARE! Those are danger signals. Unless you take a fresh look at things, you'll be doing the same job at the same salary for the next five years. And the next five.

What you can do about your future

If you want to succeed . . . make more money, earn the respect of your family and community . . . you have to take the bull by the horns. Success doesn't just come along. You have to meet it halfway. So act NOW and make your experience mean something. Add I. C. S. training to your record and start going places. Do it at home, in your spare time, for a few cents a day.

Does it work? These facts answer that. A recent survey shows that in a single 120-day period, 1973 I. C. S. students were promoted to better jobs. If you had acted a year ago, one of them could have been you. So mail the coupon below today.

Pick your favorite subject

256 I. C. S. courses to choose from. 203 expert I. C. S. instructors to give you personal help. No time or expense going to and from classes. No interference with business and social life.

Your first step

Sit down *right now* and fill out the coupon below. Check your favorite subject. I. C. S. will send you FREE and without obligation of any sort, three books. One, "How to Succeed," tells you how to start climbing to the top. Second book outlines the opportunities in the field of your choice. Also, a free sample lesson in basic mathematics.



For Real Job Security—Get an I. C. S. Diploma! I. C. S., Scranton 9, Penna. Member, National Home Study Council

INTERNATIONAL CORRESPONDENCE SCHOOLS

65TH YEAR

BOX 45626L, SCRANTON 9, PENNA.

Without cost or obligation, send me "HOW TO SUCCEED" and the opportunity booklet about the field BEFORE which I have marked X (plus sample lesson):

- | | | | | |
|--|---|--|---|---|
| <p>ARCHITECTURE and BUILDING CONSTRUCTION</p> <ul style="list-style-type: none"> <input type="checkbox"/> Air Conditioning—Refrig. <input type="checkbox"/> Architecture <input type="checkbox"/> Architectural Interiors <input type="checkbox"/> Building Contractor <input type="checkbox"/> Building Estimator <input type="checkbox"/> Building Maintenance <input type="checkbox"/> Carpentry and Mill Work <input type="checkbox"/> Heating <input type="checkbox"/> Painting Contractor <input type="checkbox"/> Plumbing <input type="checkbox"/> Reading Arch. Blueprints <p>ART</p> <ul style="list-style-type: none"> <input type="checkbox"/> Cartooning <input type="checkbox"/> Commercial Art <input type="checkbox"/> Fashion Illustrating <input type="checkbox"/> Magazine Illustrating <input type="checkbox"/> Show Card and Sign Lettering <input type="checkbox"/> Sketching and Painting <p>AUTOMOTIVE</p> <ul style="list-style-type: none"> <input type="checkbox"/> Auto Body Rebuilding <input type="checkbox"/> Auto Elec. Technician <input type="checkbox"/> Auto-Engine Tune Up <input type="checkbox"/> Automobile Mechanic | <p>AVIATION</p> <ul style="list-style-type: none"> <input type="checkbox"/> Aeronautical Engineering Jr. <input type="checkbox"/> Aircraft & Engine Mechanic <p>BUSINESS</p> <ul style="list-style-type: none"> <input type="checkbox"/> Advertising <input type="checkbox"/> Bookkeeping and Accounting <input type="checkbox"/> Business Administration <input type="checkbox"/> Business Correspondence <input type="checkbox"/> Public Accounting <input type="checkbox"/> Creative Salesmanship <input type="checkbox"/> Federal Tax <input type="checkbox"/> Letter-writing Improvement <input type="checkbox"/> Office Management <input type="checkbox"/> Professional Secretary <input type="checkbox"/> Retail Business Management <input type="checkbox"/> Sales Management <input type="checkbox"/> Stenographic-Secretarial <input type="checkbox"/> Traffic Management <p>CHEMISTRY</p> <ul style="list-style-type: none"> <input type="checkbox"/> Analytical Chemistry <input type="checkbox"/> Chemical Engineering <input type="checkbox"/> Chem. Lab. Technician <input type="checkbox"/> General Chemistry <input type="checkbox"/> Natural Gas Prod. & Trans. <input type="checkbox"/> Petroleum Engineering <input type="checkbox"/> Plastics <input type="checkbox"/> Pulp and Paper Making | <p>CIVIL, STRUCTURAL ENGINEERING</p> <ul style="list-style-type: none"> <input type="checkbox"/> Civil Engineering <input type="checkbox"/> Construction Engineering <input type="checkbox"/> Highway Engineering <input type="checkbox"/> Reading Struct. Blueprints <input type="checkbox"/> Sanitary Engineering <input type="checkbox"/> Structural Engineering <input type="checkbox"/> Surveying and Mapping <p>DRAFTING</p> <ul style="list-style-type: none"> <input type="checkbox"/> Aircraft Drafting <input type="checkbox"/> Architectural Drafting <input type="checkbox"/> Electrical Drafting <input type="checkbox"/> Mechanical Drafting <input type="checkbox"/> Mine Surveying and Mapping <input type="checkbox"/> Plumbing Drawing and Estimating <input type="checkbox"/> Structural Drafting <p>ELECTRICAL</p> <ul style="list-style-type: none"> <input type="checkbox"/> Electrical Engineering <input type="checkbox"/> Electrical Maintenance <input type="checkbox"/> Electrician <input type="checkbox"/> Contracting <input type="checkbox"/> Lineman <p>HIGH SCHOOL</p> <ul style="list-style-type: none"> <input type="checkbox"/> Commercial <input type="checkbox"/> Good English <input type="checkbox"/> High School Subjects <input type="checkbox"/> Mathematics | <p>LEADERSHIP</p> <ul style="list-style-type: none"> <input type="checkbox"/> Foremanship <input type="checkbox"/> Industrial Supervision <input type="checkbox"/> Leadership and Organization <input type="checkbox"/> Personnel-Labor Relations <p>MECHANICAL AND SHOP</p> <ul style="list-style-type: none"> <input type="checkbox"/> Gas—Electric Welding <input type="checkbox"/> Heat Treatment <input type="checkbox"/> Metallurgy <input type="checkbox"/> Industrial Engineering <input type="checkbox"/> Industrial Instrumentation <input type="checkbox"/> Industrial Supervision <input type="checkbox"/> Internal Combustion Engines <input type="checkbox"/> Machine Design-Drafting <input type="checkbox"/> Machine Shop Inspection <input type="checkbox"/> Machine Shop Practice <input type="checkbox"/> Mechanical Engineering <input type="checkbox"/> Quality Control <input type="checkbox"/> Reading Shop Blueprints <input type="checkbox"/> Refrigeration <input type="checkbox"/> Sheet Metal Worker <input type="checkbox"/> Tool Design <input type="checkbox"/> Toolmaking <p>RADIO, TELEVISION</p> <ul style="list-style-type: none"> <input type="checkbox"/> Industrial Electronics <input type="checkbox"/> Practical Radio TV Eng'ng <input type="checkbox"/> Radio and TV Servicing <input type="checkbox"/> Radio Operating | <ul style="list-style-type: none"> <input type="checkbox"/> Television Technician <p>RAILROAD</p> <ul style="list-style-type: none"> <input type="checkbox"/> Air Brake Equipment <input type="checkbox"/> Car Inspector <input type="checkbox"/> Diesel Engineer & Fireman <input type="checkbox"/> Section Foreman <p>STEAM AND DIESEL POWER</p> <ul style="list-style-type: none"> <input type="checkbox"/> Combustion Engineering <input type="checkbox"/> Diesel—Elec. <input type="checkbox"/> Diesel Eng's <input type="checkbox"/> Electric Light and Power <input type="checkbox"/> Stationary Fireman <input type="checkbox"/> Stationary Steam Engineering <p>TEXTILE</p> <ul style="list-style-type: none"> <input type="checkbox"/> Carding and Spinning <input type="checkbox"/> Cotton, Rayon, Woolen Mfg. <input type="checkbox"/> Finishing and Dyeing <input type="checkbox"/> Loom Fix'g <input type="checkbox"/> Textile Des'ng <input type="checkbox"/> Textile Eng'g <input type="checkbox"/> Throwing <input type="checkbox"/> Warping and Weaving <p>MISCELLANEOUS</p> <ul style="list-style-type: none"> <input type="checkbox"/> Domestic Refrigeration <input type="checkbox"/> Marine Engineering <input type="checkbox"/> Ocean Navigation <input type="checkbox"/> Professional Engineering <input type="checkbox"/> Short Story Writing <input type="checkbox"/> Telephony |
|--|---|--|---|---|

Name _____ Age _____ Home Address _____

City _____ Zone _____ State _____ Working Hours _____ A.M. to P.M. _____

Occupation _____

Canadian residents send coupon to International Correspondence Schools, Canadian, Ltd., Montreal, Canada. . . . Special tuition rates to members of the U. S. Armed Forces.

Make Money Fixing Electric Appliances



Actual Lesson FREE Fast Growing Field Offers Good Pay, Security Interesting Work

Learn at Home in Spare Time

Earn more money. Enjoy doing important, interesting work. Learn Electrical Appliance Servicing. This is a field of increasing opportunity. Today there is an average of more than ten appliances in every wired home. More than eighty million additional appliances, valued at about 8 billion dollars sold in one year. Find out more about this great, growing field. Find out how NRI can train you, at home and in spare time to be an Appliance Service Technician. See how you can start soon to make extra money servicing appliances.

Add to Your Income Soon After Enrollment Opportunities Increasing for Service Technicians

NRI Training is practical, thorough. You get easy-to-understand lessons, and NRI supplies parts to build professional type Multi-Use Tester. Use it to get practical experience. Soon, you can add to your income by servicing appliances. Build a profitable "sideline" for your spare time—qualify for a good job—develop a business and be your own boss. As an Appliance Service Technician, your opportunities are broad—your services wanted, gladly paid for, highly regarded in your community.

Appliances are necessary to comfortable, convenient living. Owners pay well to keep them in repair. The field is amazingly big. In addition to major appliances such as electric ranges, air conditioners, refrigerators, there are over 40,000,000 electric irons, 5,000,000 electric blankets, 15,000,000 coffee makers, plus more millions of vacuum cleaners, fans, toasters, mixers, etc.



Learn and Earn with Tester Diploma when You Finish

Locate appliance troubles easily with Tester you build. For only \$2.50 with enrollment and \$5 per month get training including Tester. Mail coupon for Sample Lesson and Book—your first step toward more interesting work, bigger earnings. Address NRI, Dept. AM6, Washington 9, D. C.

TESTING APPLIANCES FOR ELECTRICAL TROUBLES

NATIONAL RADIO INSTITUTE
WASHINGTON, D. C.

Over 40 Years Experience Backs Up NRI Training

How to Learn SERVING ELECTRICAL APPLIANCES

Find Out What Appliance Repair Offers You

Mail Coupon FOR LESSON AND BOOK FREE

National Radio Institute
Dept. AM6, Washington 9, D. C.

Please send me Electric Appliance Servicing Lesson and Book FREE. (I understand no salesman will call.)

Name..... Age.....

Address.....

City..... Zone..... State.....

APPROVED MEMBER, NATIONAL HOME STUDY COUNCIL

INVENTORS

If you believe that you have an invention, you should find out how to protect it. The first step is to have a search made of the prior pertinent U. S. patents. If a report on this search indicates that the invention appears patentable you can apply for a patent, and the specifications and claims should be prepared.

The firm of McMorrow, Berman & Davidson, with offices in Washington, D. C., is qualified to take the necessary steps for you. We can make a preliminary search on your invention, advise you whether we think it can be patented, and prepare your application for patent.

Unless you are fully familiar with the U. S. Patent Laws, we recommend that you engage the services of a Registered Patent Attorney to protect your interests. The patent laws are *your* laws. A patent gives you the right to prevent others from making, using or selling the invention claimed in your patent for a period of 17 years.

Use these patent laws for your protection. Investigate whether your invention can be patented. If you have what you believe to be an invention, we suggest that you have this firm make a search for you:

Send for a copy of our Patent Booklet entitled "How To Protect Your Invention," containing information about patent protection and patent procedure. Along with this we will also send you an "Invention Record" form, for your use in writing down and sketching details of your invention. We will mail them promptly. No obligation. They are yours for the asking.

McMORROW, BERMAN & DAVIDSON

Registered Patent Attorneys

PATENTS • COPYRIGHTS • PATENTS

1353 VICTOR BUILDING, WASHINGTON 1, D. C.

BEST BARGAINS OF THE YEAR

Regular 49½¢ Plastic Storm Windows

CUT PRICE ONLY

19½¢

10.8 sq. ft. size

No Tools • No Screws
No Nails • No Hooks

♦ JUST PRESS ON ♦



Over 2,000,000 Sold for 49½¢

Storm Windows need not cost up to \$14. **TRANS-KLEER**—amazing flexible product developed by million dollar factory seals out wintry blasts for pennies. Costs only 19½¢ per standard 10.8 window! Transparent as glass. Won't chip, peel or rattle. Weighs ounces, yet has over 2000 lbs. tensile strength per cubic inch by laboratory test! Non-porous . . . resists snow, sleet, rain, humidity up to 53 degrees below freezing. Easy! Quick! Cut & fit window. Press on Adheso border! When winter's over fold away like cloth.

Shipped flat in rolls measuring 36" x 432"—108 sq. ft.—enough for 10 standard windows. Regular price \$4.95. Our bargain price, direct to consumer—only 1.98—complete with Adheso border. 2 rolls only 3.50. Supply at this cut price limited.

No. 74, Complete Kit 1.98

NEW 1956 MODEL SPECTOSCOPES



99¢

Originally 1.98

Over a half million people paid \$1.98 for these famous Spectoscopes. They're the binoculars you wear like eyeglasses. Use all day without fatigue. Wonderful for watching sports, theatre, TV, racing, public events. Sharp individual focusing for each eye. Gives magnified close-up viewing. Powerful, clear, sharp images. No blur or distortion. Made in Western Germany to precision standards. No. 90 99¢

THORESEN'S, Dept. 6-MC

352 Fourth Avenue, New York 10, N. Y.

RUSH the items checked below on 7-Day free home trial money back guarantee. If not delighted with the merchandise I will return it in 7 days for full refund.

- Payment enclosed. Send postage and tax paid.
- Send C.O.D. I'll pay charges.
- No. 74 Storm Windows—\$1.98
- No. 90 Spectoscopes—99¢
- No. 80 Black Forest Hunting Knife—99¢ plus 21¢ post.: \$1.20

Name _____

Address _____

Town _____ State _____

CANADIANS: Order direct from Thoresen Ltd., Dept. UN-6M, 45 St. James Street, W., Montreal 1, P. Q. Same money back guarantee. No extra for tariff.

BLACK FOREST

HUNTING KNIFE

Nationally Advertised

at

3.95

Handsome
Rec or Den
Decoration

- Rugged Korium Steel!
- Extra Sharp!
- Lasts a Lifetime

Bargain!

NOW

99¢

plus post.
WHILE THEY LAST



10
INCHES
OVERALL

Over 100,000 sportsmen paid 3.95 for this internationally famous hunting knife. Now . . . for a short time you can get one for only 99 CENTS plus postage. This amazing offer is made to win 20,000 new customers. This is the original and genuine **BLACK FOREST**—the world's most famous hunting knife—its rugged beauty has been won recognition for design thruout Europe and America. Has dozens of uses both in the field as well as at home. Very sharp—allows you to skin an animal in minutes. Use it for carving roasts too! So handsome! So practical! It's the biggest bargain! Leather scabbard yours **FREE!**

No. 80 99¢ plus 21¢ postage 1.20

THESE MEN ARE GETTING PRACTICAL TRAINING IN **ELECTRICITY**

—**ELECTRONICS**

On Real:



**A.C. and D.C. MOTORS
GENERATORS
SWITCHBOARDS
CONTROLLERS
WIRING JOBS
APPLIANCES
ELECTRONIC UNITS**

(Shown at left—Instructor explaining operation and testing of a large Motor Generator in our A.C. Department.)

AND **TELEVISION-RADIO**

On Real:

**TELEVISION
RECEIVING SETS
Including Color TV
AM and FM RADIO
RECEIVERS including
AUTO RADIOS
TELEVISION TEST
EQUIPMENT**

(Right — Instructor helping students check the wiring and trace circuits of television receivers.)

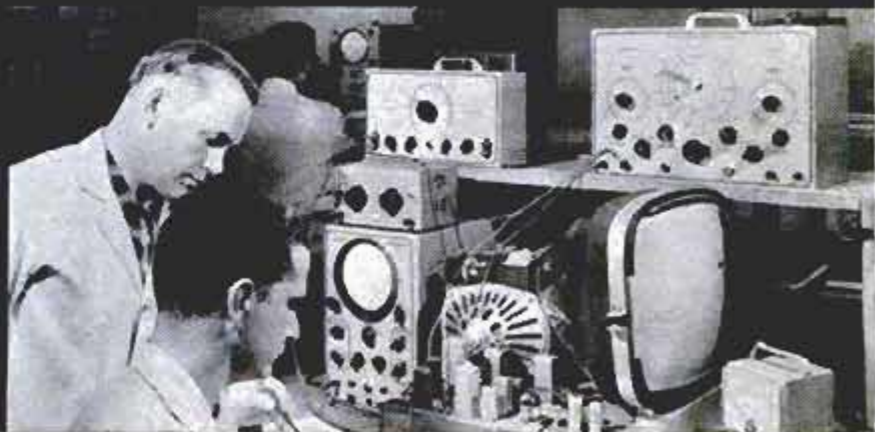

Train in the great **SHOPS** of **COYNE**

Largest, Oldest, Best Equipped School Of Its Kind In The U. S.

Whether 17 or up to 45 years of age, prepare for your future now. Don't be satisfied with a "No Future" job. Train the Coyne way for a better job in a field that offers a world of opportunities in the years ahead.

FINANCE PLAN Enroll now, pay most of tuition later. Part-time employment help for students. **WE TRAIN YOU IN CHICAGO** on real equipment. Trained instructors show you how, then you do practical jobs yourself. No previous experience or advanced education needed.

CLIP COUPON NOW for big new illustrated Coyne book "Guide to Careers in ELECTRICITY and TELEVISION-RADIO". No obligation; no salesman will call. Get vital facts now! **Training in Refrigeration and Electric Appliances can be Included.**



*Mail Coupon for
Big Free Book*

Training Offered
to **VETERANS**
and
NON-VETERANS
Alike

**B. W. COOKE, President
COYNE ELECTRICAL SCHOOL**

500 S. Paulina St., Chicago 12, Ill. Dept. 86-72H

Send **FREE** book and details of all the training you offer. This does not obligate me and no salesman will call. I am especially interested in:

- ELECTRICITY-ELECTRONICS**
 TELEVISION-RADIO

NAME.....

ADDRESS.....

CITY.....STATE.....

B. W. COOKE, Pres. **COYNE** FOUNDED 1899
ELECTRICAL SCHOOL

A TECHNICAL TRADE INSTITUTE OPERATED NOT FOR PROFIT
500 S. PAULINA STREET, CHICAGO, Dept. 86-72H
ELECTRICITY ★ RADIO ★ TELEVISION ★ REFRIGERATION ★ ELECTRONICS

FOR A REAL JOB OR A
BUSINESS OF YOUR OWN



LEARN
**OIL BURNER
SERVICING**

at home—in your spare time!

GET THE FACTS FREE!

Let us send you — without obligation — a Sample Lesson plus all the information you'll need to get you started on the road to success in the automatic oil heating field. Let us prove to you that salaries are higher, opportunities greater, advancement quicker in the fast-growing Oil Burner industry.

5 PROGRAMS IN ONE. We offer you a complete and approved training program — available at no other school — prepared with the co-operation of America's leading heating system manufacturers. Covers Installation, Operation, Maintenance and Service plus Electrical Controls, Firebrick Construction and Sheet Metal Fabrication. Even includes a "Special Business" Plan to help you start your own service shop.

START NOW . . . TODAY! Put your spare time to work. Learn a skilled trade. No previous experience or special education required. Earn while learning, doing part-time jobs in your own area. Low tuition. Tools furnished. Send coupon now. No obligation.

MASS. TRADES "Training Thousands since 1936"

RESIDENT SCHOOL — APPROVED FOR VETS
LICENSED BY MASS. DEPT. OF EDUCATION



Member — Oil Heat
Institute of America



Write NOW for
FREE SAMPLE

lesson and booklet.
No obligation. Use
the coupon below.

MASS. TRADES
161-A High St., Boston 10, Mass.

Please rush **FREE** booklet and Sample Lesson on **OIL BURNER SERVICING**. I understand there is no obligation.

Name Age.....

Address

City Zone..... State.....

TRAINING AVAILABLE IN CANADA

**GIVE THE GIFT OF
LANGUAGE**



IT'S FUN TO LEARN

by **LINGUAPHONE**

The World's Standard Conversational Method

SPANISH (American or European) • **FRENCH** • **GERMAN**
ITALIAN • **RUSSIAN** • **JAPANESE**

34 languages available for FREE TRIAL AT HOME

A Linguaphone Recorded Language Set is a lasting gift—an invaluable asset in business, travel, school, armed services and social life. With LINGUAPHONE's life-like recordings, you LEARN any language the same easy, natural way you learned your own. AT HOME you hear 8 to 22 of the world's best native language teachers, both men and women, speak. You listen — you Understand — YOU SPEAK! Over a million home-study students. WRITE for **FREE Book**; also details of **FREE TRIAL**.
LINGUAPHONE INSTITUTE, T-143-116 Rock. Plaza, N. Y. 20

**"We're looking for people
who like to draw..."**



says Norman Rockwell, one of America's 12 Most Famous Artists. If you like to draw, you may have talent to become a successful artist, spare or full time. Find out with our remarkable 12-page Free Art Talent Test. Thousands paid \$1 to take it. Get it **FREE**. No obligation. Send your name, address, age to: Famous Artists Schools, Dept. 6-M, Westport, Conn.

**Secrets of VENTRILOQUISM
Now Revealed!**



Easy to learn in 60 to 90 days with our Home Study Course. **RESULTS GUARANTEED.** Make Money! Be Popular! Have Fun! Big Opportunity! Radio, Television, Stage Appearances! For **FREE** information regarding price and terms **WRITE**. You must state your age. Dummy Catalog 25c.
FRED MAHER SCHOOL OF VENTRILOQUISM
Box 36, Studio PM-11 Kensington Station
Detroit 24, Michigan



**WORLD'S LOWEST PRICED
ADDING MACHINE**

Counts up to 999,999,999
IDEAL FOR BUSINESS AND PERSONAL USE—GUARANTEED ACCURATE. Not a toy. Operates with only a finger flick. Adds, subtracts, multiplies, divides. Counts up to one billion. Pays for itself over and over. Ideal Gift—for Business, Income Tax and School use. **MONEY BACK GUARANTEE.** Send name and address. Pay postman only \$2.95 plus postage. Beautiful rich-looking Leatherette Case included at no extra cost. Money back in 10 days if not delighted. **AGENTS WANTED.**

CALCULATOR MACHINE COMPANY
P.O. Box 126, Dept. N-36, Huntingdon Valley, Penna.

RUPTURED? Write for New Relief **FREE!**

ENJOY NEW FREEDOM

of action, peace of mind and comfort at work or play. Proven, patented **MILLER** holds your rupture back Day & Night—will bring you **lasting relief!** Has helped thousands of others! For **FREE** facts in plain wrapper—

Send Name and Address to
FRED B. MILLER, DEPT. 1N
Manufacturer, HAGERSTOWN, MARYLAND



ENTIRELY DIFFERENT

NOW...get EVERYTHING YOU NEED
to prepare to earn REAL MONEY in

TELEVISION

...one of America's
BRIGHTEST
Opportunity Fields



Enjoy highly interesting work
...and a wonderfully promising future

America's great billion dollar Television field now offers you a chance of a lifetime to get started toward a good job or your own profitable business. With so many new TV stations coming on the air, Television is expected to grow as never before! Millions of TV sets must be produced, tested, installed and serviced. And Television is only one branch of this vast opportunity field of Electronics—for which DTI's amazingly effective training prepares you.

Right in your own home you may now get one of today's most interesting... PRACTICAL WAYS to prepare for your start in TELEVISION, including Radio and Electronics. No previous experience or advanced education are needed—because DTI brings you a 3-WAY COMBINATION method that speeds your understanding and progress. You (1) Learn from well illustrated lessons, you (2) Learn by Seeing from DTI's wonderfully effective home movies and (3) you Learn by Doing from electronic parts that provide the practical experience you need.

You get and KEEP the same type of basic electronic equipment used in our modern Chicago Training Laboratory. You get home training that includes the knowledge and experience gained from training thousands of students first hand. In other words, you get LABORATORY TYPE TRAINING... RIGHT IN YOUR OWN HOME. But why not get the whole exciting story. Mail coupon today.

If preferred, you can get ALL of your training in DTI's CHICAGO LABORATORY... one of the nation's finest. Write for details

EMPLOYMENT SERVICE

Get an honest-to-goodness EMPLOYMENT SERVICE to help you get a good job after graduating — or assistance in starting your OWN TV-RADIO SALES & SERVICE BUSINESS.

MILITARY SERVICE

If you're subject to military service, the information we have for you should prove very helpful. Mail coupon today.

EARN AS YOU LEARN

After you get part of DTI's training, with equipment at home, you may then, in your spare time, begin to earn real money servicing Radio and TV sets.

300 EXPERIMENTS

Build over 300 fascinating experiments from 16 BIG SHIPMENTS of Electronic-Radio parts which you KEEP. You build and operate Television circuits, Radio receiving circuits, a wireless microphone and many other major projects — all designed to provide outstanding practical experience at home.



HOME MOVIES

Thanks to this exclusive DTI home training aid, many important Television-Radio fundamentals quickly become "movie clear." Now you can actually see electrons on the march and other "hidden actions" — a wonderful advantage that's almost like having a teacher in your home.



BUILD YOUR OWN TEST EQUIPMENT

As part of your home laboratory project you build and keep a quality 5-INCH oscilloscope and a Vacuum tube Voltmeter. You will find this equipment ideal for helping you earn in your spare time while a student — and later when working full time in the field.



BUILD AND KEEP A BIG 21" TV SET

For added practical experience, you build and keep this top quality 21 INCH TV Set that provides TV reception at its finest. (DTI offers another home training but without the TV set.)



SEND FOR FACTS TODAY!

89 WAYS TO EARN MONEY IN TELEVISION RADIO ELECTRONICS

DeVry Technical Institute
4141 BELMONT AVE.

CHICAGO 41, ILLINOIS DEPT. PM-11-M

I would like your Opportunity Bulletin showing "89 Ways To Earn Money in Television-Radio-Electronics"; also, complete facts about the training opportunities made possible by your organization.

Name _____ Age _____
(PLEASE PRINT)
Street _____ Apt. _____
City _____ Zone _____ State _____
995 DTI's training is available in Canada.



Member of National Home Study Council

"One of America's
Foremost Electronics
Training Centers"



DEVRY TECHNICAL INSTITUTE

CHICAGO 41, ILLINOIS

FORMERLY

DEFORREST'S TRAINING, INC.

**I EARN CASH
DOING REPAIR JOBS
WHILE I TRAIN!**



CTI training in Auto Mechanics is so practical that many students do repairing in spare time, earn up to \$15 a week and more. *CTI training pays its own way!*

AUTO MECHANICS

**EARN GOOD PAY
ENJOY SECURITY**

A Trade You Can Learn at Home

Now hear this: if you want to earn up to \$125 a week or more, or open a shop of your own! The auto industry is America's greatest. No wonder! There are over 60 million cars and trucks on the road, and a third are in the "heavy repair" classification. Each year, over 7 million new vehicles are produced. As a result, there's a severe shortage of skilled mechanics—and too few are training to fill the vacancies. What an opportunity for you! Yes, you can have one of those high-pay, steady, life-long jobs. How? *By training at home in spare time!*

The CTI Shop-Method Home Training Plan gets you ready for success in months—not years. You get easy-to-understand picture lessons, as well as valuable tools and a tune-up kit (see below). You learn to repair engines, transmissions, brakes, and the various systems—cooling, lubricating and electric. And that isn't all: *If you want additional training in Diesel Mechanics or Body-Fender Rebuilding, you get it (without extra cost).* Why not get all the facts? You can, by just filling out and mailing the coupon. We'll send two FREE BOOKS that show how you can fit into America's No. 1 industry.

You Practice with Tune-Up Kit and Tools



Only CTI sends this professional Tune-Up Kit. It includes a Compression Tester, a Vacuum Gauge and Fuel Pump Tester, an Ignition Timing Light, and a portable steel case. Instruments locate engine troubles quickly, help you get valuable practice.

You get this top quality set of mechanic's tools. You'll need tools to practice and for experience, and to earn money spare time. Tools increase your interest, stamp you as a "pro." *You get both the Tune-Up Kit and the set of tools as part of your training—no extra cost.*



MAIL COUPON TODAY!

COMMERCIAL TRADES INSTITUTE

1400 Greenleaf Ave. Dept. A-390
Chicago 26, Ill.

Send your Auto Mechanics book and Sample Lesson. Both FREE.

Name _____ Age _____

Address _____

City _____ Zone _____ State _____

Member National Home Study Council



**INSURED TIRE SERVICE
POPULAR BRANDS**

FREE INSURANCE POLICY given with each used tire sold. We guarantee the amount of service you pay for.

NO WHERE CAN SUCH QUALITY BE FOUND AT SUCH LOW PRICE!

SPECIAL! Deduct 10% on orders for Two or More used tires

YOU CAN'T LOSE!!

GOODYEAR SUBURBANITE TYPE SNOW TIRES
New Tire Guarantee—Factory Rebuilt
BEST WINTER TRACTION OF ALL!

670x15	\$9.95	710x15	650x16	650x15	\$10.90
600x16		760x15	800-820x15		

Super Quality — Rugged Performance — 6 Months Insured Service

600x16	\$3.65	670x15	\$3.95	700x16	\$4.45	760x16	\$4.75
650x15	3.85	670x16	4.05	710x15	4.35	820x15	4.95
650x16	4.25	700x15	3.95	760x15	4.45	550x17	4.65

Supreme Quality — Nothing Finer — 12 Months Insured Service

600x16	\$5.25	475x19	\$5.45	700x15(6)	\$10.45	700x20	\$12.50
600x16(6)	6.75	640x15	4.95	750x16(8)	15.95	750x20(8)	15.50
650x16	5.75	670x15	5.35	700x17	11.95	750x20(10)	17.50
650x16(6)	7.25	710x15	5.45	750x17	16.45	825x20	21.50
700x16	6.35	760x15	5.95	750x15	10.95	900x20	20.45
750x16(6)	8.45	800x15	6.35	30x5	11.25	1000x20	19.95
550x18	4.95	820x15	6.35	600x20	10.95	1100x20	21.25
550x17	4.75	550x15	5.35	650x20	11.75	1000x22	21.95
650x15	5.25	670x16	5.15	32x6(8)	11.95	1100x22	22.75
700x15	5.35	700x16(6)	10.25	32x6(10)	12.75	1100x24	25.95

Whitewalls \$1.00 extra.

MIDLAND TIRE SALES

Speedy shipments on Mail Orders. F.O.B. Chicago. Insurance policy sent with each order. Deduct 10% on orders for 2 or more used tires. Send CHECK or MONEY ORDER.—No COD's.

3701 S. Normal, Dept. PM-52, Chicago 9, Ill.

GIANT BALLOONS

The best! Surplus US Govt. (new over-age) Neoprene weather target balloons. **FOR FUN**—Great in backyard, at parties, picnics, fairs. Young & old enjoy 'em! **FOR ADVERTISING**—Attract big crowds to business openings, civic events, trade shows, exhibitions. Paint 'em with a sales message and they'll pay off for you! **FOR PROMS**—Makes any high school or college prom more festive. Real cool!

Approx. inflated sizes:
3 ft. dia., 49¢—5 ft. dia., 99¢
10 ft. dia., \$1.59—13 ft. dia., \$1.95

Postage paid on prepaid orders. Cal. res. add sales tax.

VOLUME SALES CO., War Assets Division
3930 Sunset Blvd., Dept. PM1156, Los Angeles 29, Calif.

LEARN WHILE ASLEEP!

PHENOMENAL RESULTS! \$2 rushes fact-filled instruction book. "Sleep-Learning—Its Theory, Application & Technique. Guaranteed. RESEARCH ASSOCIATION, P.O. BOX 610-AA, Omaha, Nebr.

**IT'S EASY...
MAKE MONEY IN PHOTOGRAPHY**

If you are over 17—good pay and fascinating work await you in photography! Start making money quickly in sparetime—step into your own studio or exciting career job. **LEARN-BY-DOING** method trains you at home! Write TODAY for FREE catalog. Also Resident Training. Co-ed. 47th Year. Approved for Veterans.

NEW YORK INSTITUTE OF PHOTOGRAPHY
Dept. 49, 10 West 33 Street, New York 1, New York

47th YEAR

"How to Go into Business for YOURSELF"

If you know a trade or occupation—why not go into business for yourself? Why not make the profits others are now making?

IT'S EASY TO START A NEW BUSINESS. It's easier than you think—once you learn the 9 easy steps of building a new business of your own. National Business Consultants has shown over 5000 others how to be successful—let us show YOU too. We guide you every step of the way with sound, proved simple business practices. **EXPAND YOUR OWN BUSINESS.** Learn our tested, profit-making methods for business success. If you already own a business, let N.B.C. guide you too. You'll be amazed. **SEND FOR FREE BOOKLET TODAY!** "How to Start a Business" is jam-packed with revealing information. In easy-to-understand language it explains how to start and make any kind of business profitable. Free for the asking! Sent to you in confidential plain envelope. *Just write:*
NATIONAL BUSINESS CONSULTANTS, Office P-11, Los Angeles 61, Calif.

BOTH FREE!
Rush Name on Postcard Today!

LOOKING FOR JOB SECURITY AND SUCCESS?

LET MY STUDENTS AND GRADUATES TELL YOU

ABOUT MY TRAINING —

\$60 A WEEK IN SPARE TIME



I have the skill and know-how to do the work I love best and to enjoy better things in life, thanks to RTTA. I am working at TV servicing and making \$60 a week sparetime.

Harold Gimlen, Flint, Mich. 4/21/54

HAS OWN BUSINESS



I have a shop at home and have been working on radio and TV after working hours of my regular job. I average \$50 a week for this part time work. RTTA training helped me in making extra money and giving me experience in the electronic field.

Richard Hennis, Little Rock, Ark. 4/20/54

L. C. Lane, B.S., M.A.
President, Radio-Television Training Association, Executive Director, Pierce School of Radio & Television.



AIRCRAFT INSPECTOR



With RTTA training and through repairing radios and televisions for the right people at the right price, I was able to make the right contacts. I am now an Inspector for Douglas Aircraft at about \$125 a week.

Hugh Maddox, Los Angeles, Calif. 4/20/54

SERVICE MANAGER



I manage two radio and television shops, one here and one in Pompano Beach. RTTA training increased my knowledge of TV circuits and showed me new, quicker methods of repairing. Lessons as presented are very concise and clear.

William Phillips, Fort Lauderdale, Fla. 4/22/54

ELECTRICAL TESTER



RTTA training has helped me understand TV and many variations of simple circuits. The course covers all subjects very clearly. I am now an Electrical Tester for Western Electric Co. at \$83.42 a week.

Raymond Lapan, Burlington, N. C. 1/20/54

REPAIRED EVERY SET



RTTA training helped me to understand TV more thoroughly. I have repaired every set that I was called on to repair.

Andrew Busi, Jr., Iselin, Pa. 4/21/54

— ABOUT MY EQUIPMENT

YOU GET ALL THIS EQUIPMENT



"... a money making little gem."

I have completed kit #6 and was amazed at how it works. I shared it to a friend of mine and he asked me to set it up for one of the picnics his social club was having. That sure is a money making little gem.

John Fernandez, Fresno, Calif. 4/22/54

"We get excellent pictures..."

I would like to compliment you on an excellent and complete course. We get excellent pictures on my TV set from WSYR (Syracuse, N.Y.), approximately 110 air miles away. The set is working good and I have had to replace only three tubes since I assembled it two years ago.

Larry H. Stafford, Kingston, Ont., Canada 7/2/54

"... very good reception..."

I have really enjoyed the course and have come a long way in TV servicing. I am getting very good reception on my TV station considering that the nearest VHF station is 120 miles.

J. W. Nanton, Jr., Henderson, Texas 7/12/54

YOU, TOO, CAN GET A BETTER-PAYING JOB IN THE EVER-EXPANDING RADIO-TELEVISION-ELECTRONICS FIELD

Why limit yourself and your earnings because of your lack of training. Learn **AT HOME** in your **SPARE TIME** to be an electronic technician, television repairman, or studio technician. You don't need any experience whatsoever. Many students earn up to \$25 weekly in spare time while learning.

After you finish my Radio-FM Television Course or FM-Television Course you can have, if you want it, two weeks of laboratory training at my associate resident school in New York City—AT NO EXTRA COST.

If you have had previous radio and television experience you can take my practical TV Studio Technician Course to qualify for a good-paying job in a TV studio.

Write to me today and let me show you how you can begin now to put yourself on the road to a better future.

VETERANS!

My school fully approved to train veterans under new Korean G.I. Bill. Don't lose your school benefits by waiting too long. Write discharge date on coupon.

YOU GET THESE FREE



MAIL THIS COUPON TODAY!

Mr. Leonard C. Lane, President
RADIO-TELEVISION TRAINING ASSOCIATION
Dept. PM-10C, 52 E. 19th St., New York 3, N.Y.

Dear Mr. Lane: Send me your NEW FREE BOOK, FREE SAMPLE LESSON, and FREE aids that will show me how I can make TOP MONEY IN TELEVISION. I understand I am under no obligation.

(PLEASE PRINT PLAINLY)

Name _____ Age _____

Address _____

City _____ Zone _____ State _____

I AM INTERESTED IN:

- Radio-FM-TV Technician Course
 FM-TV Technician Course
 TV Studio Technician Course

VETERANS!

Write discharge date

Radio-Television Training Association

52 EAST 19th STREET • NEW YORK 3, N. Y.

Licensed by the State of New York • Approved for Veteran Training

NOVEMBER 1956

WHAT ALL AUTO MECHANICS WANT TO KNOW

1664 PAGES



This Big Practical Book gives full information with working diagrams covering principles, construction, ignition, service & repair of modern cars, trucks and buses.

Diesel Engines, Hydramatic & Fluid Drives Fully Explained. A complete Guide of 1664 Pages, over 1500 illustrations showing inside views of working parts & instructions for service jobs.

IT PAYS TO KNOW
\$4 COMPLETE • PAY \$1 A MO.
 TO GET THIS ASSISTANCE FOR YOURSELF SIMPLY FILL IN AND MAIL COUPON TODAY.

Every Mechanic can Step Up his Skill with AUDELS GUIDES. Containing Practical Inside Information in a Handy Form. Covers facts and figures of your Trade. All illustrated and explained. Books sent to you for 7 DAYS FREE EXAMINATION. Send No Money Nothing to Pay Postman. Check Books Wanted - Mail Today.

MAIL ORDER

AUDEL, Publishers, 49 W. 23 St., New York 10, N.Y.

Please send me for FREE EXAMINATION books marked (x) below. If I decide to keep them I agree to mail \$1 in 7 Days on each book or set ordered and further mail \$1 monthly on each book or set until I have paid price, otherwise I will return them.



Check NOW!

You Can Look Over Any Guide In Your Own Home

Start the Easy Payments If Satisfied

MAIL THIS TODAY



- HOME APPLIANCE SERVICE GUIDE, 800 Pages \$4
- AUTOMOBILE MECHANICS GUIDE, 1664 Pages. 4
- TRUCK & TRACTOR GUIDE, 1299 Pages . . . 4
- DIESEL ENGINE MANUAL, 575 Pages . . . 2
- MACHINISTS HANDY BOOK, 1650 Pages . . . 4
- WELDERS GUIDE, 600 Pages . . . 1
- BLUE PRINT READING, 440 Pages . . . 2
- MATHEMATICS & CALCULATIONS, 700 Pages. 2
- SHEET METAL PATTERN LAYOUTS, 1100 Pages 4
- SHEET METAL WORKERS HANDY BOOK, 388 Pgs. 1
- MECHANICAL DRAWING GUIDE, 160 Pages . . . 1
- MECHANICAL DRAWING & DESIGN, 480 Pages 2
- TELEVISION SERVICE MANUAL, 434 Pages . . 2
- RADIO MANS GUIDE, 1080 Pages . . . 4
- ELECTRONIC DEVICES, 216 Pages . . . 2
- ELECTRIC MOTOR GUIDE, 1000 Pages . . . 4
- WIRING DIAGRAMS (Light & Power), 272 Pgs. 1
- ELECTRICIANS EXAMINATIONS, 250 Pages . . 1
- ELECTRIC POWER CALCULATIONS, 425 Pages. 2
- HANDY BOOK OF ELECTRICITY, 1440 Pages. . 4
- ELECTRIC DICTIONARY, 9000 Terms . . . 2
- ELECTRIC LIBRARY, 7000 Pages (12 Book Set) 18
- REFRIGERATION & Air Conditioning, 1280 Pgs. 4
- MILLWRIGHTS & MECHANICS GUIDE, 1200 Pgs. 4
- POWER PLANT ENGINEERS GUIDE, 1500 Pages 4
- ENGINEERS & FIREMANS EXAMS, 525 Pages . 1
- PUMPS, Hydraulics & Air Compressors, 1658 Pgs. 4
- OPERATING ENGINEERS LIBRARY (3 Books) . 9
- CARPENTERS & BUILDERS GUIDES (4 Book Set) 6
- PLUMBERS & Steamfitters Guides (4 Book Set) 6
- MASONS AND BUILDERS GUIDES (4 Book Set) 6
- PAINTERS & DECORATORS MANUAL, 450 Pgs. 2
- HOUSE HEATING GUIDE, 1000 Pages . . . 4
- OIL BURNER GUIDE, 384 Pages 1

Name _____
 Address _____
 Occupation _____
 Employed by _____

PUMP WATER FAST!

Drains Wash Tubs, Cellars, Cisterns. Famous #7 pumps 2800 gph. 420 gph. at 75' high or 1600 gph. from 25' well. Sturdy rustproof alloy metal. Six blade impeller. 3/4" inlet, 1/2" outlet. Standard pipe threaded. Uses any 1/4 to 1/2 H. P. Motor. Will not leak or clog. Iron clad guarantee. Send check, M.O., or sent C.O.D. **\$795** IN U.S.

Irrigate, Fill Tanks, Draw Well Water. Heavy duty #8 pumps 7000 gph. 1000 gph. 75' high 3000 gph. from 25' well. Rustproof alloy metal. 8 blade impeller. 1" inlet, 1" outlet. Standard pipe threaded. Will not leak or clog. Iron clad guarantee. Send check, M.O., or sent C.O.D. **\$1195** IN U.S.

Free Catalogue—Gear Pumps, Large Centrifugal Pumps, Deep and Shallow Well Pumps, Sump Pumps.

MOORE MANUFACTURING CO.
 SWEDSBORO 1, NEW JERSEY

Shrinks Hemorrhoids New Way Without Surgery

Science Finds Healing Substance That Relieves Pain—Shrinks Hemorrhoids

For the first time science has found a new healing substance with the astonishing ability to shrink hemorrhoids and to relieve pain—without surgery.

In case after case, while gently relieving pain, actual reduction (shrinkage) took place.

Most amazing of all—results were so thorough that sufferers made astonishing statements like "Piles have ceased to be a problem!"

The secret is a new healing substance (Bio-Dyne*)—discovery of a world-famous research institute.

This substance is now available in suppository or ointment form under the name Preparation H.* Ask for it at all drug counters—money back guarantee. *Reg. U. S. Pat. Off.

Learn ACCOUNTING Business Administration

Bookkeeping, secretarial and allied subjects at home in your spare time or attend nationally approved resident school. Write for FREE Success Book giving complete details on courses, plans, rates and employment opportunities. G.I. approved. Write Dept. A.

Hills BUSINESS UNIVERSITY AND EXTENSION SCHOOL
 619 W. MAIN ST., OKLAHOMA CITY 2, OKLAHOMA

Sensational FOG-STOP Windshield Cloth

Amazing Discovery! Autoists will over new FOG-STOP Windshield Cleaner. Simply glide over windshield chemically-treated Mitt—no once glass sparkles crystal clear. Blurry mist, frost, sleet, snow disappear like magic. Stays lasting. Sells like wild!

SAMPLES FOR AGENTS Sample offer sent immediately to all who send name at once. Hurry. Postcard will do. **SEND NO MONEY—just your name.**
KRISTEE CO., Dept. 693, AKRON 8, OHIO

HELPFUL BOOKS

Send post card asking for FREE catalog
 Popular Mechanics Press, 200 E. Ontario, Dept. 601, Chicago 11

ATTENTION HOME WORKERS WE NEED YOUR PRODUCTS

ALL NEW PLAN!! Salesman established in every area to sell Cascraft products manufactured by home workers. Also men wanted for participation in spare-time subcontract plan to help fill huge demand. We supply full instructions, tools, materials, everything—you fill orders for special luggage and all types of portables. No previous experience necessary. Free details. **ABARSI, Dept. AM, 807 W. Sunset Blvd., Los Angeles 12, Calif.**

Venus di Milo 10¢

Ancient Greece stamps! Venus stamp (illustrated) plus Alexander the Great, bullfight, Olympic victory, Greek gods, etc. Complete, 10¢ with approvals.

WINTHROP STAMP CO., Dept. PM 11, Groton, Conn.

Learn PHOTOGRAPHY at Home

Splendid opportunities. Prepare in spare time. Practical basic training. Long-established school. Send for free book, "Opportunities in Photography." No obligation. **American School of Photography, 835 Diversey Parkway, Dept. 1358, Chicago 14, Ill.**

NATIONAL SCHOOLS

proudly presents

FOR MEN WHO WANT TO EARN MORE MONEY

TELERAMA • ALL 8 BRANCHES OF TELEVISION • ELECTRONICS • RADIO

IN ONE DYNAMIC, MODERN SHOP METHOD, HOME TRAINING COURSE

Registration applied for

Another great advance in **HOME STUDY TRAINING**. Let National Schools, of Los Angeles, a practical Technical Resident Trade School for over 50 years, train you at home by Shop-Method, for today's unlimited opportunities in **ALL 8 BRANCHES** of the Television, Electronics, Radio Industry.

Check all you receive in *One Master Course* at One Low Tuition

1. Television — Including Color TV
2. Radio — FM and AM
3. Industrial Electronics
4. Sound Recording and Hi-Fidelity
5. Preparation for FCC License
6. Automation
7. Radar and Sonar
8. Communications

ALL OF THIS MODERN, NEWEST, PRACTICAL EQUIPMENT IS YOURS TO KEEP!

- Parts to Build a modern TV set, including large screen Picture Tube.
- Parts to build a powerful Superhet Receiver, standard broadcast and short wave.
- Parts to conduct many experiments and build Continuity Checker, RF Oscillator, TV Circuits, Audio Oscillator, TRF Receiver, Signal Generator.
- Professional Multitester
- These are a MUST for all technicians.

YOU DO MANY PRACTICAL JOBS.

You do servicing, circuit analysis and many other down-to-earth experiments. You build a modern TV set from the ground up ... with equipment kits we give you, including a new large screen picture tube and professional Multitester, at no additional charge.

EARN AS YOU LEARN! Many of our students earn their entire tuition and more in Spare Time jobs we show them how to do while learning. **YOU GET GRADUATE ADVISORY SERVICE, TOO.**

ALL YOURS TO KEEP



L. J. ROSENKRANZ
President of NATIONAL SCHOOLS



This Master-Shop-Method course is completely up-to-date. Here in Los Angeles, the TV and Electronics center of the world, we are able to keep in constant touch with the industries' latest developments. As a student, you will quickly master all phases at home ... in your spare time. Your earning power will grow with every lesson. Just as thousands of National Schools graduates do every day, you can handle servicing, manufacturing, repairing, hundreds of other jobs, or make good money in your own business. **SECURE YOUR FUTURE—NOW. SEND COUPON BELOW.**



IN THESE MODERN TV STUDIOS, SHOPS AND LABORATORIES, your Shop Method Home Study Course was developed by experienced instructors and engineers. What an advantage that is to you at home — each lesson is tested, proved, easy to understand. You can master the most up-to-date projects, such as color TV set repair, printed circuits — even prepare for F.C.C. License and industrial electronics without taking a special course. **TAKE YOUR FIRST STEP NOW TO A TOP-PAY JOB IN TV, ELECTRONICS, RADIO. SEND COUPON BELOW TODAY.**



APPROVED FOR VETERANS AND NON-VETERANS

NATIONAL SCHOOLS

4000 S. FIGUEROA ST., LOS ANGELES 37, CALIF.
187 N. LA SALLE ST., CHICAGO 1, ILL.

IN CANADA: 811 W. Hastings St., Vancouver, B. C.

NATIONAL SCHOOLS

TECHNICAL TRADE TRAINING SINCE 1905
Los Angeles, California

GET FAST SERVICE — MAIL NOW TO OFFICE NEAREST YOU!

NATIONAL SCHOOLS, DEPT. RB-116
4000 S. FIGUEROA ST., LOS ANGELES 37, CALIF. OR 187 N. LA SALLE ST., CHICAGO 1, ILL.
Rush free TV-Radio "Opportunity" Book and sample lesson. No salesman will call.

NAME _____ BIRTHDAY _____ 19 _____

ADDRESS _____

CITY _____ ZONE _____ STATE _____

VETERANS: Give Date of Discharge _____

FREE!

Fully illustrated "CAREER" BOOK in TV, Radio, Electronics. AND actual Sample Lesson—yours at no cost, no obligation **SEND COUPON NOW—TODAY!**



WHAT SECRET POWER DID THIS MAN POSSESS?



BENJAMIN FRANKLIN
(A Rosicrucian)

WHY was this man great? How does anyone—man or woman—achieve greatness? Is it not by mastery of the powers within ourselves?

Know the mysterious world within you! At-tune yourself to the wisdom of the ages! Grasp the inner power of your mind! Learn the secrets of a full and peaceful life!

Benjamin Franklin—like many other learned and great men and women—was a Rosicrucian. The Rosicrucians (NOT a religious organization) first came to America in 1694. Today, headquarters of the Rosicrucians send over seven million pieces of mail annually to all parts of the world. Write for YOUR FREE COPY of "The Mastery of Life"—TODAY. No obligation. No salesmen. A non-profit organization. Address: Scribe W.Q.W.

THIS BOOK FREE!

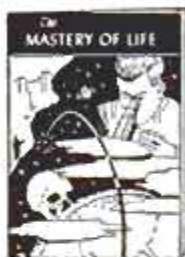

The ROSICRUCIANS

SAN JOSE • (AMORC) • CALIFORNIA

—SEND THIS COUPON—

Scribe W.Q.W.
The ROSICRUCIANS (AMORC)
San Jose, California
Please send me the free book, *The Mastery of Life*, which explains how I may learn to use my faculties and powers of mind.

Name _____
Address _____
City _____

BECOME AN EXPERT IN TRAFFIC and TRANSPORTATION

TODAY qualified men in this field earn \$4,000 to \$10,000 and up. Thousands are needed. We train you in spare time at home for executive positions in Traffic Management.

LaSalle's complete Traffic and Transportation program gives you a thorough knowledge of this field. Program covers Transportation Agencies—How to Ship by Rail, Express, Water, MOTOR TRUCK, Air, Freight Forwarder and Mail Carriers.

Investigate the splendid opportunities available. Low cost-easy terms Placement counsel and help. Write today for FREE 48-page book "Traffic and Transportation—the Fast Growing Profession."

LASALLE EXTENSION UNIVERSITY
A Correspondence Institution
417 S. Dearborn St., Dept. 1164T, Chicago 5, Illinois

See the Greatest Show on Earth with this GIANT ASTRONOMICAL TELESCOPE

\$15.00
FULL PRICE



Delivered ready for use. Has 45X, 75X and 100 power individually mounted eyepieces with brass focusing tube plus sun projector lens for observing sun spots and solar storms. Steel telescope tube 50 in. long. Rigid 6 ft. tripod adjustable to any height. Steel forked mounting with closely machined aluminum tripod head assembly assures extra fine adjustments. This professional type instrument provides full power with clear vision at all times. See the moons of Jupiter, our own moon, planets, milky way, double stars, star clusters, etc. All for only \$15.00 FOB Mattituck. Sent express. COD orders require \$5.00 deposit. Satisfaction guaranteed. 200X and 400X eyepieces available at \$2.00 ea.

SUFFOLK SCIENCE SERVICE
Dept. TD-11 MATTITUCK, N. Y.

MAKE TREMENDOUS PROFITS

Have fun! Earn Big Money! Cast plaster figurines, bookends, plaques, novelties at home in your spare time with X.L. rubber molds! NO EXPERIENCE NEEDED! Molds and rubber for 3 molds, only \$1.50 p/d. Send 25c (refunded with order) for 40 page catalog now!

PLASTIC ARTS STUDIO 3403 SO. MADISON, DEPT. PM2
MUNCIE, INDIANA



SEND FOR THIS FREE!

Make money. Know how to break and train horses. Write today for this book FREE, together with special offer of a course in Animal Breeding. If you are interested in Galting and Riding the saddle horse, check here () Do it today—now.

BEERY SCHOOL OF HORSEMANSHIP
Dept. 11011 Pleasant Hill, Ohio

MEN!! TRAIN NOW FOR A BIG PAY FUTURE

Be a Trained Diesel Man

- Diesel Construction
- Diesel Engine Repairman
- Diesel Operator
- Industrial Maintenance
- Auto Engine Rebuilding
- Bus & Truck Maintenance



Go places with DIESEL! Farms, factories and power plants, trains, ships, trucks, busses all use DIESEL POWER... all need DIESEL-trained men! You can start your DIESEL training at home, in spare time, with tested, proved UFI training. Course includes practical work on Diesel engines under skilled instructors. You learn the operation, maintenance, servicing of all types of Diesel engines, PLUS Scientific Motor Tune-up.

ACT NOW! If you have mechanical ability, YOU'LL LIKE DIESEL! High School diploma not necessary. Write now for FREE book, "EARNING POWER IN DIESEL."

UTILITIES ENGINEERING INSTITUTE, Dept. DC-62
2521 Sheffield Ave., Chicago 14, Ill. (Founded 1927)

Free!

WITH THIS OFFER

60% to 75% of all TV failures are caused by faulty tubes. This amazing new giant-sized "Detect-O-Scope" tells you, at a glance, exactly how to spot bad tubes in any TV set. Saves time, money — makes you an "expert" TV trouble-shooter! Gives

YOURS FREE WITH THE FAMOUS MANUAL DESCRIBED BELOW

Amazing New TV "DETECT-O-SCOPE"

Enables You to
**Spot Bad TV Tubes
in a jiffy!**

identification numbers of tubes that may be causing trouble; shows you how to locate, check and replace them safely. 16 x 21 inches; copy-righted. Sells for \$1.00 but yours absolutely **FREE** on this offer!



FIX TV AND RADIO SETS RIGHT AWAY

—even if you never fixed a lamp or doorbell before!

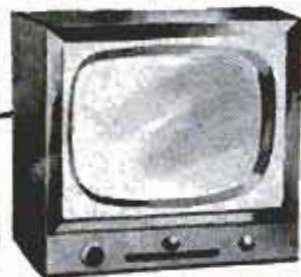

**McGraw-Hill's Amazing New
Low-Cost Instruction Manual Skips
Hard-to-Understand "Theories"
and Formulas — Tells HOW-TO-DO-IT in PLAIN ENGLISH**

AT LAST—a well-known **EXPERT** tells you in **PLAIN ENGLISH** how to fix TV or radio sets! Right from the very first chapters you can start doing simple repairs... and before you're **HALF** way through the manual, you can fix **HALF** the television and radio sets that you encounter. In just a few weeks you can start fixing your own and friends' sets... even start your own money-making business at home.



Save Money on Your Own Set
Save \$50 to \$100 a year installing and servicing your own set.

NO complicated formulas! **NOT** a study book! Deals only with parts that go wrong in sets — tells **HOW** to find the trouble! — and the **EASY** way to **FIX** IT!

Why It's So EASY

John Markus, Associate Editor of Electronics Magazine, spent **FOUR** years making this one-volume manual practical and easy-to-follow—even for the most "unhandy" beginner. A-B-C

directions and 700 clear photos, diagrams, and drawings show exactly **WHAT** and **HOW** to fix, step-by-step. Includes everything you need to know: *where* and *how* to buy tubes and parts; where and how to get an official circuit diagram of any set; how to choose and use basic tools; how to test tubes **WITHOUT** a tube tester; how to use 58 common TV controls; simple "cures" for

pickups, install and check antennas—and much more.

SEND NO MONEY

Mail coupon **NOW!** If book doesn't pay for itself in 10 days, don't keep it! **McGraw-Hill Book Co., Dept. PM-11, 327 W. 41 St., New York 36, N. Y.**

TELEVISION AND RADIO REPAIRING

TRY IT
FREE
ON YOUR OWN SET
FOR 10 DAYS

PARTIAL CONTENTS

How to Remove and Replace Tubes • Testing Tubes without a Tester • Using a Table Tester • Power Supply Troubles • How to Test and Replace Resistors, Controls, Switches, Condensers, Coils, Transformers • Speakers • Phono Pickups • Antennas and MUCH MORE.

**McGraw-Hill Book Co., Dept. PM-11,
327 West 41st St., New York 36, N. Y.**

Send the TV Detect-O-Scope **FREE** with Markus' *Television and Radio Repairing* for 10 days' trial. If not delighted, I may return book, pay nothing. Otherwise, I will send only \$1.95 plus few cents shipping; then 3 monthly payments of \$2. Detect-O-Scope is **FREE** in any case.

Send Profitable Radio Troubleshooting, by Marcus & Levy, for 10 days' trial. If I keep it, I will send only \$1.95 plus shipping; then two monthly payments of \$2 each.

Name
Address.....
City..... Zone..... State.....

SAVE MONEY. Check here if enclosing \$7.95 for first book, or \$5.95 for second book **WITH** coupon. Then **WE** pay shipping costs. Same 10-day return privilege. (Offer good in U. S. A. only.)

Tells HOW To "Cash In" ON THE BIG DEMAND FOR RADIO-TV REPAIRMEN

Over 25 million TV sets... over 100 million radios! Make nice extra money just fixing sets for friends and neighbors in your spare time... or start your own full-time repair business.

Book tells exactly how to get started; which tubes to stock; how to make a service call. Actually start fixing sets and making money before you're half-way through book.

ALSO TRY THIS BOOK FREE!

PROFITABLE RADIO TROUBLESHOOTING, by Marcus & Levy. Shows how to get to causes of troubles quickly, by expert methods; how to start and run your own business; customer-relations, and much more! 344 pages, 147 illus.

Yours FOR
JUST \$1.00



This \$4.95 Regular
Size Presto
Fire Extinguisher
for Letting Us
Prove How You Can
MAKE UP TO
\$1,000 A MONTH



Charles Kama had NO sales experience until he took up PRESTO, Science's New "Midget Miracle" Fire Extinguisher. He did so well he was featured as "Salesman of the Month" on the front cover of a national sales magazine. He said: "I'm making more than \$1,000.00 a month—and haven't touched bottom yet."

Why do we make this amazing offer? Because we're certain that once you actually use a PRESTO to put out a demonstration fire—you'll realize why it "sells on sight!" An Ohio man made \$75.56 THE VERY FIRST DAY! A Florida salesman earned \$600.00 in 1 month. A New Hampshire man added PRESTO as a sideline and picked up an extra \$1,800 in 20 months.

Most people who see the PRESTO in action want one or more—ESPECIALLY WHEN THE PRICE IS ONLY \$4.95 EACH! Lightweight PRESTO does the job of bulky extinguishers that cost 4 times as much and are 8 times as heavy. The secret is a startling chemical, 1.5 to 6 times as effective as ordinary extinguisher chemicals on an equal weight basis. Makes possible an extinguisher so light, so handy—even a child can use it. Just a twist of the knob and flames disappear. "Sells on sight" to owners of cars, homes, stores, offices, factories, and to stores for re-sale. Guaranteed for 20 years! OVER TWO MILLION ALREADY SOLD!

Mail Coupon with \$1 for Your PRESTO

Mail coupon with \$1 TODAY—and we'll send you a Regular \$4.95 PRESTO at no additional cost. If not amazed, return PRESTO and we'll refund your \$1.00. Or keep it at big saving when you order 6 or more. You can't lose—you risk nothing. We'll also send you FREE a complete Sales Kit to help you get started. Mail coupon now to MERLITE INDUSTRIES (Presto Div.), 114 E. 32nd St., Dept. X-15N, New York 16, N. Y.

MERLITE INDUSTRIES (Presto Div.) Dept. X-15N
114 E. 32nd ST., NEW YORK 16, N. Y.

I enclose \$1.00 for which please send me regular-size \$4.95 PRESTO as a demonstrator. I agree to demonstrate it to myself and friends. This sample becomes mine to keep at no additional cost when I send you order for 6 or more Prestos. If I decide NOT to sell, I will return the PRESTO to you and you will refund my \$1.00.

Also send me absolutely FREE Complete Sales Kit containing everything I need to get started making good money introducing the PRESTO in my locality.

Name _____
Address _____
City _____ Zone _____ State _____

IN CANADA: Mopa Co. Ltd., 371 Dowd St., Montreal 1, P. Q.

SAVE 75%
ON



WORK CLOTHES!
SURPLUS STOCK FROM MIDWEST SUPPLY FIRM!
Terrific values you've got to see to believe!

SHIRTS 79c
Made to sell for 2.99! Now only 4 for \$2.99

What a buy! 4 for the price of one! These shirts, though used, are washed, sterilized and ready for long, tough wear. In blue, tan or green. Send neck size, 1st and 2nd color choice.

PANTS to match Unbelievable 99c
Bargains! Sold for 3.95. Now only 4 for \$3.75
Send waist measure and inside leg length.

COVERALLS... wear 'em used and save \$2.29
plenty! Originally 6.95. Now only 3 for \$6.75
Send chest measurement.

SHOP COATS... fully reconditioned. \$1.79
Take advantage of this rock-bottom price. Send chest measurement. Now only 3 for \$5.00

SATISFACTION GUARANTEED! Your money back if you can beat these bargains anywhere! You can't lose so order TODAY for immediate delivery! Send \$1.00 deposit on C. O. D. orders. Add 25¢ postage and handling on prepaid orders.

GALCO SALES CO. Dept. 1311
7120 Harvard Ave. • Cleveland 5, Ohio

TELEPHONES



Desk Stand Style
Slightly used but in excellent condition

Many Valuable Uses
Inter-House Phones House to Barn, etc.
Loud Speakers Microphones
Educational Purposes, Toys, etc.

Come complete, ready to use with wiring diagrams included. Two complete for only \$5.00 **\$2.75** Postpaid in U.S.A.

TELEPHONE LAMP KIT—with illustrated instructions for making Desk Telephone Lamp including all parts (harp, nipples, push switch, cord, plug, etc.) . . . \$6.50 Fpd. (Shade is not included).

MICROPHONE, Dept. X-4402, 1760 W. Lunt Ave., Chicago 26, Ill.

Don't Neglect Slipping FALSE TEETH

Do false teeth drop, slip or wobble when you talk, eat, laugh or sneeze? Don't be annoyed and embarrassed by such handicaps. **FASTEETH**, an alkaline (non-acid) powder to sprinkle on your plates, keeps false teeth more firmly set. Gives confident feeling of security and added comfort. No gummy, gooey, pasty taste or feeling. Get **FASTEETH** today at any drug counter.

Say You Saw It in Popular Mechanics

YOURS FREE!
VUER-PROJECTOR & Full Color Slide Kit—Authentic \$4.95 Value!



If You're Interested In BREEDING TROPICAL FISH For Profit & Pleasure

This handsome, precision-viewing instrument and color slides are yours FREE—just for showing your interest in Tropical Fish Breeding! See gorgeous BETTAS, colorful TETRAS, exotic ANGEL FISH, etc., in the vibrant beauty of full color! Convince yourself Tropical Fish Breeding is the profitable, easy-to-start home business for you! Breed them in your living room, spare-room, nursery. Success is assured because we'll buy every fish you produce! No experience or costly equipment needed. Start spare-time, on a "booster"—build a \$10,000 home business! Investigate!

Write today for FREE details on "Profit-Proven" Success Plan & Vuor! (If under 17, ask for plan A.)

TROPICAL FISH BREEDERS OF AMERICA
Dept. D-11
Los Angeles 61, Calif.



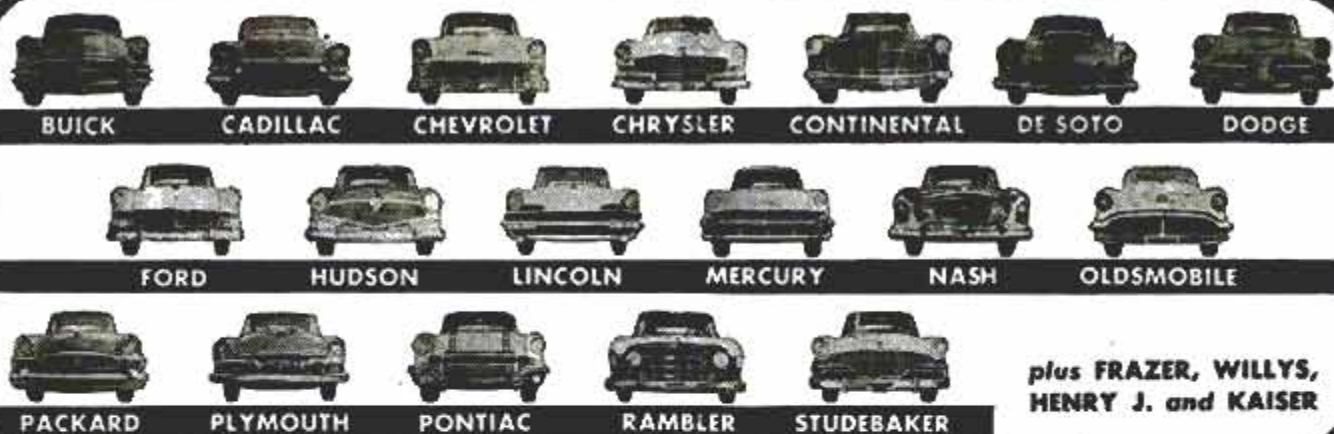

Tune Up, Pep Up, Fix Up ANY CAR!

NOW! Even beginners can handle practically ANY job on ANY make, model or part!



Keep 'em running like clockwork!

There's a secret to fixing cars . . . and this world famous Chilton "ALL CARS" Manual is it! With it, you can handle practically any job faster, easier and better than you may have dreamed.

From engines to transmissions . . . from power steering to overdrives . . . from carburetors to ignitions . . . it tells you just what you need to know . . . shows almost every operation step by step in almost 3000 big, clear pictures. Using your Chilton Manual is like having the 19 Chilton experts who prepared it standing beside you. Just follow their simple instructions and it is next to impossible to go wrong . . . even on the toughest jobs!

PRACTICE 10 DAYS FREE!

No guess work! No lost time! Just look up the make, model and part you want to fix. Trouble-shooting charts help you locate what's wrong. Then every step of making needed repairs or adjustments is explained in a way you're sure to understand. "Minor" details, often so puzzling to beginners, are made crystal clear.

You'll find this giant Manual in almost every car shop . . . because it saves loads of time even for the experts. You'll find it in schools, in Army-Navy training . . . and wherever beginners are fixing CARS BECAUSE IT MAKES EVERY JOB SO EASY TO DO.

From beginning to end, the Chilton "ALL CARS" Manual is a complete practical working guide by Chilton's Motor

Age and Automotive Industries magazine experts. It is based on actual shop experience. It shows how to handle jobs with standard tools under ordinary conditions.

You learn work-saving shortcuts. You learn what mistakes to avoid. In many cases, Chilton even takes into account the wear of parts on old cars and gives you "wear adjusted" specifications for best possible car performance. Covers every model of above 22 leading makes from 1940 through 1956—over 650 models in all.

Contains over 800 pages; 53 Trouble-shooting Charts; 397 Quick Check Data Tables; almost 3000 specially-taken pictures; and thousands upon thousands of parts and repair specifications.

Chilton Shows
You How in this
GIANT NEW
4³/₄ lb. EDITION
of the world's
most famous car
repair manual

BY THE WORLD'S LARGEST
AUTOMOTIVE PUBLISHER

Gives how-to-do-it instructions on jobs like these for EVERY model of the above cars from 1940 to 1956:

Alignment; Seat Adjusters; Automatic Windows; Axles; Bearings; BRAKES; CARBURETORS; CLUTCHES; COOLING; Crank Shafts; Cylinders; DIFFERENTIALS; Drive Shafts; Electric Taps; ENGINES; Frames; FUEL PUMPS; GENERATORS; Horns; IGNITIONS; Knocks; Oil Seals; Overheating; OVERDRIVES; Pistons; POWER STEERING; Radiators; REGULATORS; Shock Absorbers; SPEEDOMETERS; STARTERS; STEERING; TIMING; Tire Wear; TRANSMISSIONS; TUNE-UPS; Universals; VACUUM PUMPS; Valves; Wipers; WIRING . . . and all the rest!

MAIL COUPON! See for yourself how easy it is!

Dept. PM-116, THE CHILTON COMPANY, 5605 Chestnut St., Philadelphia 39, Pa.

Send me the giant new 4³/₄-pound CHILTON "ALL CARS" SERVICE MANUAL (Price \$6.95) for 10-day FREE EXAMINATION. If I like Manual, I will then promptly remit \$1.95 (plus 45c postage and handling); then send \$2.50 each month for two months. Otherwise, I will return Manual postpaid in 10 days and owe you nothing.

SAVE!

Name

Send \$6.95 with order and we pay postage-handling charge. Some 10-day return privilege with money refunded.

Address

City, Zone, State

(Outside U.S.A.—Price \$8.95 cash with order. 10-day return privilege with money refunded.)

Chilton Books are sold by leading book stores

DRAFTSMEN



CASH BIG PAY CHECKS!

Train Now for more success, greater security

LEARN AT HOME IN SPARE TIME (or at college in Chicago)

Check the want ads in any newspaper—SEE the big-pay opportunities open to you as a draftsman. What's more, you can learn this well-paid, prestige profession at home—quickly, easily! No special talent needed. Get complete, step-by-step Chicago Tech lessons in the mail, spend a few pleasant hours studying each week. In a short time you'll be a well-trained draftsman, ready to take your pick of many good jobs. Act now!



Free Information—Mail Coupon Today!

Get FREE TRIAL LESSON plus information about C.T.C. practical training. Learn what successful Chicago Tech graduates say about high pay and opportunities in drafting. No charge, or obligation.

CHICAGO TECHNICAL COLLEGE

P-254 Tech Bldg., 2000 So. Michigan Ave. Chicago 16, Illinois

Mail me FREE lesson with facts about big opportunities in DRAFTING.

Name _____ Age _____

Address _____

City _____ Zone _____ State _____

Not Satisfied With Your Present Earnings?

Investigate

This NEW 2 in 1 BUSINESS OPPORTUNITY

- Popular, Money-Making HOT DRINK and HOT SOUP Venders
- Handle Either or Both Types
- We Train You, We Set Up Routes

Eye-catching, easy-to-operate vending machines serve delicious, nationally known Hot Drinks (3) and Piping Hot Soups (5)! Our factory experts set up routes, train you to operate this year-round, big-volume business. NO SELLING! A minimum cash investment of \$1200.00 required. Up to 75% of equipment costs can be financed. Operate full or spare time.

How many machines can you handle? 10 units, doing nat'l 1954 average, would pay approx. \$13-\$16,000 yearly!

Write or wire giving age, address and phone. Details FREE. No obligation!

SUPERIOR DISTRIBUTING CORP., Dept. CB-11
4555 E. Warren Ave., Denver 22, Colo.



SEND FOR Free Record

START SPEAKING FRENCH OR SPANISH ALMOST OVERNIGHT!

HERE'S the easiest way to learn FRENCH, SPANISH, Russian, German, Italian, Japanese or Brazilian. Listen to FREE 2-sided non-breakable record. Let your eyes follow words in FREE sample lesson. Almost at once you'll be chatting in a new language with a perfect accent! That's all you hear! No dull, tedious work. Just listen—imitate! It's that easy! Offer may end soon. Rush 25c to help cover cost of special packaging, shipping, State language you want. We'll also send free information on full Cortina course. CORTINA ACADEMY, Dept. 6411, 136 W. 52nd St., New York 19.



TASOPE PHOTO-ENGRAVING PLANTS



Material Cost Of This Cut 30c Selling Price \$1.00 And Up

Establish your own profitable PHOTO-ENGRAVING business. Make cuts for newspapers, printers, and advertisers. Make etched name plates, plaques etc. Instructions furnished, no experience necessary. Sold direct from factory since 1931. First five hundred cuts sold locally or by mail will pay for plant and pay you well for your time. Write for FREE catalog.

TASOPE, DEPT. PM-11, AURORA, MO.

LAW FREE BOOK THE LAW TRAINED MAN

Write today for a FREE copy of illustrated law book, "THE LAW TRAINED MAN," which shows how to earn the professional Bachelor of Laws (LL.B.) degree through home study of the famous Blackstone Law Course. All necessary books and lessons provided. Moderate cost; convenient monthly terms. Write for FREE law training book today.

Blackstone School of Law, 225 N. Michigan Ave.

Founded 1890

Dept. 58 Chicago 1, Ill.

STUDY TO BE A DOCTOR of Psychology or Metaphysics

Obtain a Ps.D., Ms.D., or Ph.D. Be a Teacher, Lecturer or Accredited Practitioner. Teach others how to achieve Health, Happiness and Contentment. Chartered by State. Correspondence Courses only. Write for FREE book telling how.

THE NEOTARIAN FELLOWSHIP

Desk 8, Pickwick Building

Kansas City 6, Missouri

JEEP OWNERS

STA. WAGONS • JEEPSTERS • PICK-UPS!

RE-POWER with Ford 6 or V-8 engines. Our F-J ADAPTOR-CONVERSION KITS fit ALL Willlys Jeeps including 1956. Kit No. 4-K for 1949-56 Ford engines in 1954-56 Pickups & Sta-Wagons priced at \$52.85 incl. Fed. tax. Kits for 1932-56 Ford engines in ALL other Willlys Jeeps . . . \$43.25 Tax incl. Write today for free details or send check or M.O. for prepaid shipment. Tell us year engine you will use and whether 2 or 4 Whl-Dr. ORDER NOW FOR EARLY SHIPMENT.

HOOSIER MACHINE PRODUCTS CO.

312 S.E. 6th St.

Pendleton, Oregon

SAVE GAS, GEARS, TIRES ON YOUR 4-WHEEL DRIVE!



Stop Front End Drag in 2 W. D.

Get maximum use of your vehicle with these famous hubs! They "take out" the front end in 2-wheel drive, give your vehicle "pick-up" economy, pep, speed, power, handling ease; stop front end gear whine, shimmy. 4-wheel drive as usual, when you need it—automatically, as you shift, with Warn Lock-o-matic, manually with Locking hubs. Models for all makes 4 w.ds. to 1½ tons at truck dealers everywhere, or write:

WARN MFG. CO., Riverton Box 5064-A11, Seattle 88, Wn.



WARN HUBS

TRAIN FOR GOOD PAY IN A FIELD THAT ISN'T CROWDED!



NOW! you can LEARN ELECTRIC MOTOR REPAIR
 ... A good-paying, modern profession



OPPORTUNITIES EVERYWHERE!

Don't drift into a rut! Don't train for something that everybody and his brother are studying! Consider the facts. . . . The average small home has at least 11 electric motors! Big homes have many more—in phonographs, recorders, oil burners, refrigerators, washers, fans, clocks, mixers, cleaners, air conditioners, etc., etc. Millions more in office, industrial, mining, and transit equipment. Be the well-paid expert who can keep them working!

... for only \$6

FOR THE COMPLETE TRAINING . . .

COVERS EVERY MOTOR TYPE IN COMMON USE

Every day, more and more electric motors and motor control systems are being used BOTH in industry and in home appliances. The expert who can install and keep them working properly is a valuable man in this Electrical Age. The pay is surprisingly good. The field is tremendous—and growing rapidly. Trained men find opportunities everywhere for full or part time work. **ELECTRIC MOTOR REPAIR**, the big 560-page training course book teaches you the work step by step—quickly and easily—at home in spare time. There is no other book like it. Ideal for beginners or for actual bench use in busy shops. Over 100,000 copies already in use in leading vocational schools, shops, and for home study.

FREE STUDY GUIDE

A unique Study Guide booklet of 500 practical motor study questions—priced and sold separately at 25c—is yours **FREE** with your request to examine **ELECTRIC MOTOR REPAIR** book. Makes learning easier—speeds up the work! See coupon.



SHOWS YOU HOW . . . Every Step of the Way!

Based on what you can learn quickly at home from **ELECTRIC MOTOR REPAIR** you can train for prompt profitable installation, servicing, repairing and complete rewinding of practically any motor in use today.

You learn fast! You learn right! Every subject is clearly explained by text AND ALSO by more than 900 illustrations and diagrams. You not only read what to do—you SEE how it is done. Quick reference guides tell you how to handle specific jobs. When a certain motor comes in for repairs, just look it up. **ELECTRIC MOTOR REPAIR** tells you what to do—and exactly how to do it.

ELECTRIC MOTOR REPAIR is designed for use right at the service bench. Unique Duo-Spiral Binding divides the book into

two sections so that both text and related diagrams can be viewed together. An instructor standing by your side could hardly do better! **ELECTRIC MOTOR REPAIR** covers the entire field—from alternating- and direct-current motors and generators, etc. to mechanical and electrical and electronic control systems. Right down the line, it explains trouble diagnosing, repair, rewinding and maintenance in a way you can easily understand.

LEARN FAST . . . no lessons to wait for! EARN WHILE YOU LEARN

Practice by repairing motors for friends, neighbors or nearby business houses. Earn while you learn this profitable, fast-growing business!

If sold as a course and sent to you in lesson form, you'd regard **ELECTRIC MOTOR REPAIR** as a bargain at 10 times the price! Instead, you get it all at once—for only \$6. You learn fast . . . and right. Here are just a few of the motor types that are fully covered:

- Split-Phase Motors
- Capacitor Motors
- Repulsion-type Motors
- Polyphase Motors
- Alternating-Current Motor Controls
- Direct-Current Armature Winding
- Direct-Current Motors
- Direct-Current Motor Controls
- Universal, Shaded-pole, and Fan Motors
- D-C-Generators, Synchronous Motors and Generators
- Electronic Motor Controls . . .



Send No Money! PRACTICE 10 DAYS FREE!

Dept. PM-116, RINEHART & COMPANY, Inc., 232 Madison Ave., New York 16, N. Y.

Send me the 560-page **ELECTRIC MOTOR REPAIR** home-training book:

- \$6.00 enclosed in full payment; or
- Send C.O.D. for \$6.00 plus postal charges; or
- Send on **10-DAY FREE EXAMINATION** and I will then remit \$6.00 plus small postage and handling charge, or return book postpaid in 10 days.

On cash and C.O.D. orders, book may be returned in 10 days if unsatisfactory and your \$6.00 will be refunded.

Name _____

Address _____

City, Zone, State _____

(Outside U.S.A. \$6.50 cash only—same return privilege)



YOU
can
acquire

LAW NIGHTS AT HOME!
LL. B. DEGREE

LaSalle's famous Law Library—used as reference in many Law libraries and Law offices—has enabled thousands to master Law surprisingly fast, in spare hours at home, for business and professional advancement.

These 14 remarkable volumes, compiled by leading professors and lawyers, cover the whole basic field of Law in condensed, orderly, simplified manner.

You advance rapidly with this great library, plus special lectures furnished. We guide you step-by-step with personalized Problem Method of instruction . . . you learn by doing—handling legal problems—not by memorizing rules.

Send for two FREE booklets, "Law Training for Leadership," and "Evidence," answering questions about Law and its value to you, and telling how LaSalle Law graduates are winning rapid advancement in business and public life. Mail coupon below. No obligation.

LA SALLE EXTENSION UNIVERSITY
A Correspondence Institution

417 S. Dearborn St. Dept. 1164L Chicago 5, Ill.

Send me your two FREE booklets described above, without obligation.

Name.....Age.....
Street.....
City, Zone & State.....

The finest of Gifts...

ENCYCLOPAEDIA BRITANNICA

Tells How You Can Learn to

FREE BOOK MOUNT BIRDS!

Learn At Home
Men, Boys, Hunters, Fishermen, mount and save your lovely wild-game trophies. Be a Taxidermist. Mount Birds, Animals, Heads, Fish, Tan skins. YOU learn easily, quickly in spare time. Have a grand home-museum. The finest and the greatest hobby known, for sportsmen. Fun, real profits.

FREE BOOK
Yes, FREE. Beautiful strange, valuable Book, telling all about Taxidermy. Contains over 100 beautiful game-pictures. And it's yours FREE, if you rush your request. You can mount all kinds of wild-game, and common specimens too. We can positively TEACH YOU. So GRASP this opportunity. RUSH letter or postal for this amazing FREE BOOK. Don't delay. State your AGE. N. W. SCHOOL OF TAXIDERMY, 2511 Elwood Bldg., Omaha 2, Neb.

SCIENTIFIC CRIME DETECTION



There's a Thrill in Bringing a Crook to Justice.

A Steady Pay Profession Good Times or Bad.

We have taught thousands this exciting, profitable, pleasant profession. Let us teach you, too, in your own home. Learn

Finger Printing, Firearms Identification, Police Photography and Criminal Investigation thoroughly, quickly and at small cost.

Over 800 of All U. S. Bureaus

of Identification employ students or graduates of I. A. S. You, too, can fit yourself to fill a responsible crime detection job with good pay and steady employment. But don't delay—get the details now. Let us show you how easily and completely I can prepare you for this fascinating work, during spare time, in your own home. You may pay as you learn. Write today, stating age. No salesman will call.

(A Correspondence School Since 1916)

Be A FINGER PRINT Expert

FREE!!!
Send for Thrilling BLUE BOOK OF CRIME

INSTITUTE OF APPLIED SCIENCE

1920 Sunnyside Ave., Dept. 1358, Chicago 40, Ill.

MEN WANTED

Earn \$100 Per Week and up
AUTO DIESEL MECHANICS

Master a trade with a future—learn Auto-Diesel mechanics in our shops. You learn with tools on real equipment. Earn while you learn. Many of our graduates earn \$100 per week and up. No previous experience necessary. Day and night courses. Approved for veterans. Write for free bulletin.

NASHVILLE AUTO-DIESEL COLLEGE

226 7th Ave., N., Dept. 75

Nashville 3, Tenn.

250 POWER.....



Complete Telescope Lens Kit only \$3.49 postpaid

Conquer space, Explore the Universe, Planets, Moon Craters, New Stars, etc. Complete Lens Kit consists of 80 inch focal length ground and polished objective lens, eyepiece lenses for 50 POWER, 100 POWER, 150 POWER, 200 POWER, 250 POWER, and all necessary lens fittings. Easy to make from simple step by step instructions. (Triod and mount not included.) Money back guarantee.

BUSSE SALES CO., Hartford 1, Conn., Dept. PM 51

LEARN PLASTICS



COMPLETE LOW COST SHOP METHOD HOME TRAINING NOW AVAILABLE

Get in on Big Money opportunities in Plastic molding, casting, forming, carving, etc. Earn as you learn with Interstate's professionally prepared course. All plastic materials furnished.

WRITE FOR FREE BOOKLET

INTERSTATE TRAINING SERVICE
DEPT. C-3, PORTLAND 13, OREGON

Say You Saw It in Popular Mechanics

BIG MONEY in your own DRY CLEANING BUSINESS

MEN! WOMEN! Let us show you how to open up your own Dry Cleaning shop. **Learn AT HOME, in spare time.** You'll be amazed to learn that you can go into this fast-growing business with next to no cash at all. Experience unnecessary. Easy-to-understand lessons. Convenient time-payments. Write for **FREE** details. **Imperial School of Dry Cleaning, Dept. PM-11 1700 Touhy, Chicago 26, Ill.**

FALSE TEETH
KLUTCH holds them tighter

KLUTCH forms a comfort cushion; holds dental plates so much firmer and snugger that one can eat and talk with greater comfort and security; in many cases almost as well as with natural teeth. Klutch lessens the constant fear of a dropping, rocking, chafing plate. 35c and 60c at druggists . . . If your druggist hasn't it, don't waste money on substitutes, but send us 10c and we will mail you a generous trial box.

KLUTCH CO. Box 693-K ELMIRA, N. Y.

RCA offers you the
 finest training
 at home in
Radio-TV
 electronics,
TV servicing,
Color TV

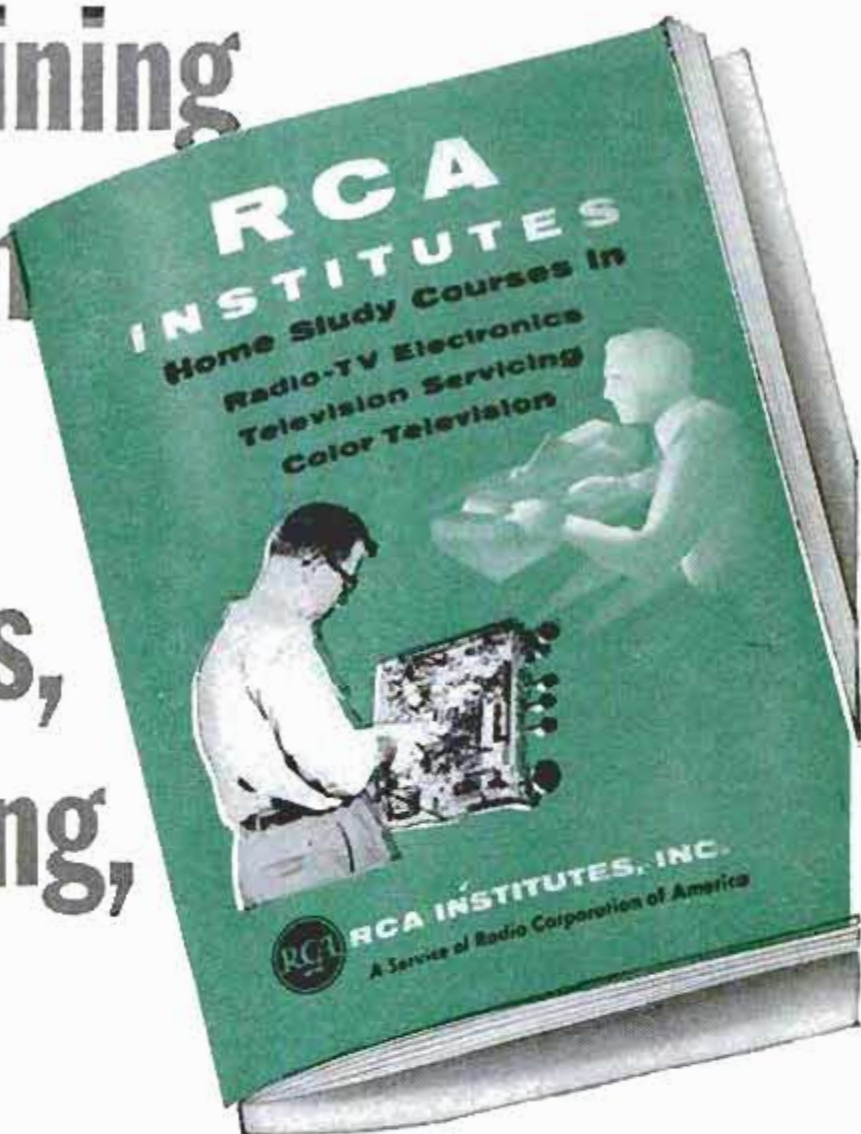

**SEND FOR THIS FREE
 BOOK NOW!**

The instruction you receive and equipment you get (and keep) will start you on your way. Pay-as-you-learn. You pay for only one study group at a time. This 52 page book contains complete information on Home Study Courses for the beginner and the advanced student.



RCA INSTITUTES, INC.
 A SERVICE OF RADIO CORPORATION OF AMERICA
 350 WEST FOURTH STREET, NEW YORK 14, N.Y.

RCA Institutes, Inc., Home Study PM116,
 350 West Fourth Street New York 14, N. Y.
 Without obligation, send me FREE CATALOG
 on Home Study Courses in Radio, Television
 and Color TV. No salesman will call.

Name
 Please Print
 Address
 City Zone State

VETERANS
 KOREAN G. I.
 P. L. 550
 CHECK HERE
 ()

Inventors

Take these necessary preliminary steps promptly to protect your invention by applying for a United States patent—

Sketch and describe your invention. Sign, date and have this disclosure witnessed by two people who understand your invention. Have us make a preliminary search among U. S. patents already granted for similar types of invention. We then report to you on the probable patentability of your invention and recommend your further course of action.

Write for our instructive booklet, "Patent Protection for Inventors" and our convenient "Evidence of Invention" disclosure form. No obligation.

VICTOR J. **EVANS & Co.** *Merlin M. Evans*
REGISTERED PATENT ATTORNEY
230-M MERLIN BUILDING, WASHINGTON 6, D. C.

TRAINED MEN NEEDED!

BIG PAY!—GOOD FUTURE!

- DIESEL ELECTRONICS
 AUTO AUTOMATION

NEVER BEFORE has the opportunity been so good for the properly trained mechanic and technician to step into **BIG PAY POSITIONS** with rapid advancement and future security virtually assured.

YOUR SUCCESS depends on the quality of training you receive... and the reputation of the school you attend.

YOUR GUARANTEE we are giving the best in mechanical and technical training is proved by the fact... we have a waiting list of good pay positions for our graduates, with leading companies throughout the United States.

RESIDENT SHOP TRAINING is easier and costs less than you may think! We provide you with housing and part-time jobs while in school, plus free nation-wide placement service for graduates.

Check subject above in which you are interested and mail for

FREE BOOKLET

BAILEY
Technical Schools

Veteran Approved

1634 S. Grand, St. Louis 4, Mo.

Name _____ Age _____
Street _____
Town _____ Zone _____ State _____

Super All Channel TV RECEPTION Powerful IN ALL DIRECTIONS

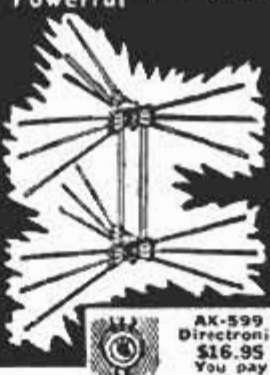

Rocket DIRECTRONIC MOTORLESS TV ANTENNA
360° Electronically Switched Beam
• No Motors • No Ghosts
• No Roof • Flick of
Orientation Switch Clears
• No Electric Picture Instantly
Power

In the city or in an ultra-fringe area, the Directronic will outperform ordinary antennas. Only the Motorless 360° Directronic TV Antenna offers "around the compass" reception WITHOUT Rotors. Clarity of picture will amaze. It's so bright, so sharply defined. AX-599 "Serviceman's Army" contains Hi-Pace milled insulator of extremely high tensile strength, 1/4" hi-tensile aluminum alloy elements, 1 set of connecting stubs (3), Universal U-clamps for masts to 1 1/2", Directronic Beam Selector, 75 feet of Tri-X Cable. 25% deposit on C.O.D. orders, please. Money Back Guarantee.

NATIONAL ELECTRONICS OF CLEVELAND
6608 Euclid Ave., Dept. P-11 Cleveland 3, Ohio

LEARN LOCKSMITHING

Learn this fascinating, profitable trade from experts in your spare time at home! Age or physical handicap no disadvantage. Year around, steady income. Full or part time. Practical, illustrated lessons. You can make money even while learning! All materials and special tools supplied without extra charge.

INSTITUTE OF LOCKSMITHING, Dept. P-84
15 PARK AVENUE RUTHERFORD, N. J.
Lic. by N. J. State Board of Education
Approved for Veterans

It's EASY to play The MUSICAL SAW

the Glass-O-Phone the Jazz-O-Nette, Musical-Pitchfork, Flute-O-Phone

If you can whistle or hum a tone, you can play these remarkable Novelty Instruments. They are played entirely by ear. Low priced. Write for FREE literature.

MUSSELL & WESTPHAL, Est. 1921
10 FORT ST., FORT ATKINSON, WISCONSIN

MECHANICAL DENTISTRY

A profession offering unlimited opportunities. Most modern and complete course embracing every branch from Plate to Porcelain Work, which prepares you to work for Dentists or start your own business. Individual instruction—practical training in day or night school. No books—no classes. Catalog upon request.

MCCARRIE SCHOOL OF MECHANICAL DENTISTRY
207 N. Broad Street Dept. 59 Philadelphia 7, Penna.

BUY IT WHOLESALE!

GET UP TO 40% OFF

Agents—Start Buying Service at Home. Get big-name merchandise for clients up to 40% off. Sales easy as you can give sizeable discounts, still make fat commissions. Postcard brings FREE COPY "The Wholesale Plan."

FREE! THE WHOLESALE PLAN!

American Buyers Service

HERTEL STATION, DEPT. R, BUFFALO 16, N. Y.

SPARE-TIME MONEYMAKING OPPORTUNITIES READ OUR CLASSIFIED ADS HUNDREDS OF BARGAINS AMAZING OFFERS

Better Than Your Own SHOE STORE AT HOME

No investment, no experience needed. Just show magic cushion comfort to friends, neighbors, co-workers. Advance commissions to \$4.00 a pair, plus Cash Bonus, Paid Vacation, \$25.00 Reward Offer. Outstanding values for men, women, children. Money back guarantee. Shoe samples supplied without cost. Write TODAY for FREE new 84 page catalog and full details.

TANNERS SHOE CO., 186 BROCKTON, MASS.



Two-Eyelet Hit With Cushioned Comfort

NEW - - EXCLUSIVE !

SOMETHING NEW AND DIFFERENT FOR THE 160,000,000 AMERICAN PEOPLE

DIRECT FROM THE FACTORY TO YOU
COMBINATION ORDER - - - - EACH \$9.99



Into Your Food

CULTURED MUSHROOM SALT
HI-QUALITY MUSHROOM SALT
NU-STLE MUSHROOM SIZONING
VERY ECONOMICAL, TOO

READY FOR EVERYDAY USE AND GIFTS
IT MAKES A YEAR ROUND SURPRISING GIFT ... A GIFT FOR WEDDINGS, CHRISTMAS, MOTHER'S DAY, FATHER'S DAY, BIRTH-DAYS, ETC. A GIFT FOR ALL PURPOSES—IT IS DIGNIFIED, TASTY, DELICIOUS FOR ALL FOODS.

RECIPE INSTRUCTIONS ON ALL SHAKERS

A new, convenient way for roasts, steaks, chops, chicken, stews, chop suey, ham and eggs, bacon and eggs, omelets, fricasses, wild game, fish, spaghetti, macaroni, meat sauces, noodles, vegetables, macaroni spaghetti, noodle sauces, gravies, soups, meat balls, fowl, etc.—TASTY APPETIZING FOR SANDWICHES TOO.

3 NEW FLAVORS MAKE TASTY DELICIOUS MEALS, TRY IT AND SEE FOR YOURSELF. OH WHAT PEP AND ZEST!

Cultured Mushroom Salt, 1—1 oz. Fancy Shaker; Hi-Quality Mushroom Salt, 1—1 oz. Fancy Shaker; Nu-Stle Mushroom Sizing, 10—1½ oz. Fancy Shakers. 12 Shakers will FLAVOR 480 to 720 MEALS. Handy—Economical, too

DIRECT FROM THE FACTORY TO YOU
COMBINATION ORDER - - - - EACH \$9.99

MAIL ORDERS ONLY

We Ship in Beautiful Shakers and Beautiful Shipping Boxes
FOR YOUR OWN USE AND TO GIVE FOR GIFTS

SELECT YOUR ORDER FROM THESE CONVENIENT SIZES

PLEASE CHECK ONE {
Send me 12 fancy shakers in 1 combination order \$ 9.99
Send me 24 fancy shakers in 2 combination orders \$19.98
Send me 36 fancy shakers in 3 combination orders \$29.97
Send me 48 fancy shakers in 4 combination orders \$39.96
Send me 60 fancy shakers in 5 combination orders \$49.95
Send me 72 fancy shakers in 6 combination orders \$59.94

WE PAY SHIPPING CHARGES—51c Shipping and Handling Charges are Included in Above Prices

Cut off Here **WASHINGTON MUSHROOM IND. INC., FACTORY** Cut off Here

Dept. 2-B 2954 Admiral Way, Seattle 6, Wash. Date.....

Enclosed \$..... P.M.O. Bank M.O. Express M.O. Certified Personal Check

Send me..... combination order or orders.

Name.....

R.F.D. or Street..... City or Town..... State.....

AVOID THE RUSH—SEND YOUR ORDER TO-DAY—NO C.O.D.'s, PLEASE
All U.S.A. and Foreign Copyrights Herein are Reserved—U.S.A. Copyright 1956

Here's the Kind of MEN I Build!

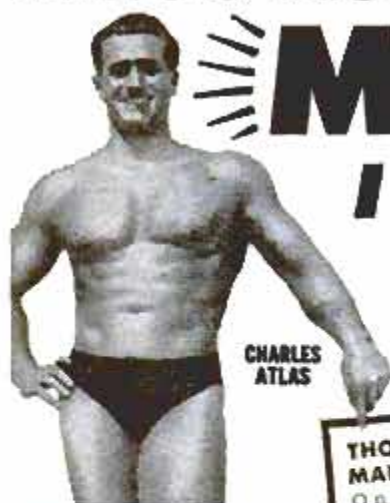

CHARLES
ATLAS

Will You Let Me
PROVE I Can Make
YOU a New Man?

THOMAS
MANFRE

One of
Charles Atlas
pupils...win-
ner of Atlas
Championship
Trophy.



I don't care how old or young you are, or how ashamed of your present physical condition you may be. Just give me 15 minutes a day, and I'll start giving you RESULTS that you can SEE, FEEL, and MEASURE with a tape! I can broaden your shoulders, strengthen your back, develop your whole muscular system INSIDE and OUTSIDE! I can add inches to your chest... give you a vise-like grip... make your legs powerful... help

run your body so full of strength, red-blooded wis-

domy your friends will be amazed! WRITE FOR FREE BOOK. 32 pages about how "Dynamic Tension" changed me from 97-lb. weakling into "World's Most Perfectly Developed Man"—and what I'll prove it can do for YOU. CHARLES ATLAS, Dept. 811, 115 E. 23rd Street, New York 10, N.Y.

CHARLES ATLAS, Dept. 811, 115 East 23rd St., New York 10, N. Y. Send me—absolutely FREE—a copy of your famous book—32 pages, crammed with photos and valuable advice.

Name _____ Age _____
Address _____
City _____ State _____



FREE BOOK

BE A CLAIM INVESTIGATOR



INVESTIGATE ACCIDENTS! Many earning \$750 to \$1000 a month. Thousands of insurance companies, airlines, steamship lines and Government Offices need Claim Investigators. Also big opportunities for your own spare time business. We train you at home. National Placement Service FREE of extra charge. Bill King writes: "Your course has paid off for me with large earnings. You can quote me—your Adjuster Training Course is worth many times the cost." Write TODAY for FREE book.

UNIVERSAL SCHOOLS

University Park, Dept. PM-11, Box 8202, Dallas 5, Texas

STATEMENT REQUIRED BY THE ACT OF AUGUST 24, 1912, AS AMENDED BY THE ACTS OF MARCH 3, 1933 AND JULY 3, 1948 (Title 39, United States Code, Section 233) SHOWING THE OWNERSHIP, MANAGEMENT, AND CIRCULATION of Popular Mechanics Magazine published monthly at Chicago, Ill., for October 1, 1956.

1. The names and addresses of the publisher, editor, managing editor, and business managers are: Publisher, Popular Mechanics Company, 200 E. Ontario St., Chicago 11, Ill.; Editor, H. H. Windsor, Jr., 200 E. Ontario St., Chicago 11, Ill.; Managing editor, R. M. Grant, 200 E. Ontario St., Chicago 11, Ill.; Exec. V.P., W. H. Fetridge, 200 E. Ontario St., Chicago 11, Ill. 2. The owner is: (If owned by a corporation, its name and address must be stated and also immediately thereunder the names and addresses of stockholders owning or holding 1 percent or more of total amount of stock. If not owned by a corporation, the names and addresses of the individual owners must be given. If owned by a partnership or other unincorporated firm, its name and address, as well as that of each individual member, must be given.) Popular Mechanics Company, 200 E. Ontario St., Chicago 11, Ill.; H. H. Windsor, Jr., 200 E. Ontario St., Chicago 11, Ill.; H. H. Windsor, Jr., Trustee for H. H. Windsor III and Wm. F. Windsor, 200 E. Ontario St., Chicago 11, Ill. 3. The known bondholders, mortgagees, and other security holders owning or holding 1 percent or more of total amount of bonds, mortgages, or other securities are: (If there are none, so state.) None. 4. Paragraphs 2 and 3 include, in cases where the stockholder or security holder appears upon the books of the company as trustee or in any other fiduciary relation, the name of the person or corporation for whom such trustee is acting; also the statements in the two paragraphs show the affiant's full knowledge and belief as to the circumstances and conditions under which stockholders and security holders who do not appear upon the books of the company as trustees, hold stock and securities in a capacity other than that of a bona fide owner. 5. The average number of copies of each issue of this publication sold or distributed, through the mails or otherwise, to paid subscribers during the 12 months preceding the date shown above was: (This information is required from daily, weekly, semi-weekly, and tri-weekly newspapers only.) Not daily publication. H. H. Windsor, Jr., Editor. Sworn to and subscribed before me this 5th day of September, 1956. Harry P. Cora, Notary Public. (My commission expires March 7, 1960.)

INVENTORS

PROTECT YOUR INVENTION BY A U. S. PATENT. SEND FOR FREE "INVENTION RECORD" FORM AND "PATENT INFORMATION EVERY INVENTOR SHOULD HAVE."

CARL MILLER
REGISTERED PATENT ATTORNEY

WOOLWORTH BLDG., 36th FLOOR, 116A
NEW YORK CITY

INVENTORS

Whether an invention is patentable can be substantially determined by a search of the U. S. Patent records. Without obligation, write for information explaining the steps you should take to secure a patent.

JOHN N. RANDOLPH

Registered Patent Attorney

201 Columbian Building, Washington 1, D. C.



INVENTORS

U. S. Patents protect your inventions. Our free book of "Instructions on Patent Procedure for Inventors," also "Certificate of Invention" form sent without obligation.

C. A. SNOW & CO.

REGISTERED PATENT ATTORNEYS

428 SNOW BUILDING WASHINGTON 1, D. C.

INVENTIONS WANTED

If you want to market, or sell, your invention for cash or royalties, write for our Free Booklet. Send no drawings. We also welcome hearing from firms, or private capital, wishing to review inventions in any field. We will be glad to send notice of our clients' inventions.

GLOBAL MARKETING SERVICE

2420 77th Ave. Dept. PD Oakland 5, Calif.

INVENTORS

Send for
PATENT INFORMATION
Book and
INVENTOR'S RECORD
without obligation

GUSTAVE MILLER

116-PM WARNER BUILDING
WASHINGTON 4, D.C.

REGISTERED PATENT
ATTORNEY

ASSOCIATE EXAMINER
U.S. PAT. OFF. 1922-1929

Patent Attorney & Advisor
U. S. NAVY DEPT. 1930-1947
PATENT LAWYER

SPARE-TIME MONEYMAKING OPPORTUNITIES
READ OUR CLASSIFIED ADS
HUNDREDS OF BARGAINS AMAZING OFFERS

INVENTORS

I shall be pleased to furnish you, upon request, with full information relative to patent procedure—without any obligation on your part.

PATRICK D. BEAVERS

Registered Patent Attorney

934 Columbian Building Washington 1, D. C.

Get "The Most" in Pay and Job Security— LEARN AIR CONDITIONING & REFRIGERATION

MAKE HOME YOUR TRAINING SHOP



BUILD A REFRIGERATOR,
AIR CONDITIONER,
FREEZER or
MILK COOLER

You Practice with 23 Kits

You learn fast because CTI sends you 23 kits. Illustration shows heavy-duty ¼ h.p. refrigeration high-side which you will build—and keep. Only CTI sends these kits.

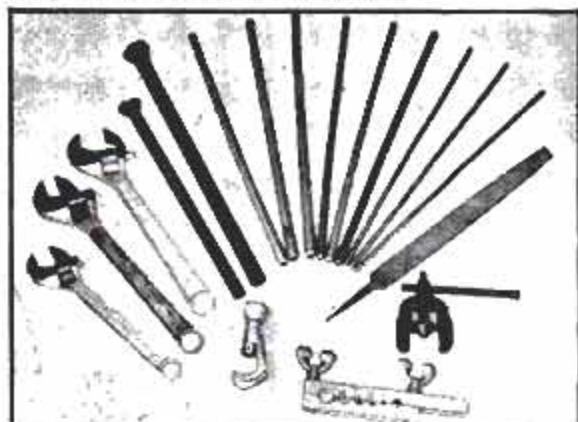

You Get Professional Tools

Here are tools included in just one kit. You get other tools, tubing, much equipment. Tools develop your interest and skill, speed up training.

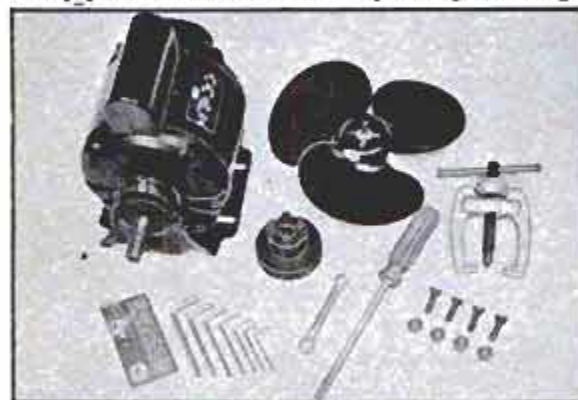

You Learn in Easy Stages

Another kit, which includes motor, fan, pulley, service tools. Kits are sent on a planned schedule to help you learn in easy stages. There's no other training like this!

A GOOD JOB, MORE MONEY, BRIGHT FUTURE

—all three can be yours in the Air Conditioning & Refrigeration field! Thousands of mechanics are needed to repair and service the 150 million units in use—and the six million air conditioners, freezers and refrigerators that are produced each year. You can earn up to \$125 a week—and more—if you are trained. For information on how to get this training, just fill out and mail coupon below. No obligation!



R. C. Anderson
President CTI

A New, Easy Way to Learn in Months

CTI training is quick and effective because it is practical. You learn by doing. During the course of your training, you receive 23 big kits, including tools. You practice with these kits, get valuable experience. For instance, you do 10 complete service and trouble-shooting jobs with CTI kits. You assemble a heavy-duty, commercial type, ¼ h.p. high side (illustrated at left). You build an air conditioner, refrigerator, freezer or milk cooler—and you keep and use this valuable unit! Only CTI sends you these fine tools and kits—helps you get real on-the-job training! And all this fine equipment is yours at no extra cost! With CTI training you can start out as a mechanic and avoid years of work as a lower-paid apprentice.

Earn Good Income as You Train, too

CTI training is so practical that students often work in spare time repairing air conditioners and refrigerators. They add to their income this way. Some get jobs with local dealers; others work on their own. Many students go in business on graduation. A number get full-time jobs while they're students.

A Wonderful Opportunity to Be the Boss

If you want to own a business, Refrigeration offers you opportunity for success. Since most jobs are service calls, you can build up a list of potential customers. Very little capital is needed to start.



Mail Coupon For Two FREE Books

Mail coupon below for two books which give you complete information. One is entitled *Success in Air Conditioning and Refrigeration*. The other is a *Lesson Sample*. Both FREE.

DO NOT DELAY—MAIL THIS TODAY

Mr. R. C. Anderson, President Dept. R-312
COMMERCIAL TRADES INSTITUTE
1400 Greenleaf Ave., Chicago 26, Ill.

Mail me SUCCESS BOOK and LESSON SAMPLE. No cost or obligation.

Name _____ Age _____

Address _____

City _____ Zone _____ State _____

Member National Home Study Council



FREE 1957 CATALOG!

Over 15,000 bargains
in the fields of Hi-Fi,
Radio, Television
and Electronics!

Send for Your
Copy Today!

E-Z TERMS!
Only 10% Down
Top Trade-Ins
Up to 50% Savings
on More Than
800 Guaranteed
Reconditioned
Eqpt. Items!



WORLD RADIO LABORATORIES

The World's Largest Distributor of Amateur Radio Eqpt.
3415 W. Broadway — Council Bluffs, Iowa
Leo I. Meyerson

PERSONALIZED SERVICE

MAIL HANDY COUPON

WORLD RADIO LABORATORIES, INC. PM-11
3415 W. Broadway — Council Bluffs, Iowa

PLEASE RUSH ME: Free Catalog Hi-Fi Booklet
 Info on Kits Recond. Eqpt. List

NAME _____

ADDRESS _____

CITY _____ STATE _____



... TURN CONCRETE INTO GOLD!



MAKE UP TO \$75 A DAY IN YOUR OWN BUSINESS

If you want to have your own business — to start a business on your own — here's your big opportunity! New high speed, low cost General block machine produces up to 1,000 concrete blocks a day. Sell all you make to builders, supply houses, and others for homes, factories, buildings, garages. Cash in on the building boom! You can make profits of 100% to 150% — up to \$75. a day! General block machine equipped with 1/2 h.p. electric motor — or can be supplied with gasoline engine — works anywhere, in little space, indoors or out. Operates from ordinary house light socket. Simple, foolproof 3 step operation — so easy a child can do it. Makes superior 3 core blocks any size from 4" to 12". Also makes chimney, sash, corner and other types. Blocks meet any building code anywhere in the country. Materials — sand, water, cement, available anywhere. Simple illustrated operating instructions and mixing formulae for cement and cinder blocks supplied with each machine. Write for FREE folder with full information.

**MOTOR
DRIVEN**

R.L.T. of
New York City re-
ports: "MY GENERAL
BLOCK MACHINE
PAID FOR ITSELF
IN FIRST 2 WEEKS!"
Hundreds now in
use the world over!
Write for FREE details today!

EXTRA Amazing illustrated

book gives floor plans for 6 sensational concrete block bungalows. Tells how to lay blocks, lay out building lines, mix concrete, build steps, porch and concrete floors all at great savings. Written by experts. Can save many times the cost of the machine! Get it now! No strings attached. Send \$1.

BOOK SENT FREE IF YOU BUY MACHINE.
\$1 REFUNDED IF YOU BUY LATER.

GENERAL ENGINES CO.

DEPT. M-116, ROUTE 130, THOROFARE, N. J.



FREE! to prove that in
Only 15 Minutes
you can start to



PLAY PIANO

with BOTH hands . . . this **Marvelous New Way**
Send for free Sample Lesson today! I will include 5 simple
"play-at-once" songs—a Note Selector for your right hand—
and my Patented Automatic Chord Selector to strike simple
bass chords instantly with your left hand. No "tricks" in my
tested, proven method. You actually learn by playing simple
single note melodies with one hand, while striking beautiful
simple resonant bass chord accompaniments with the other.
No tedious scales. No boring exercises. No dreary practice.
Just delightful enjoyment. Simply send name, address, and
10c for postage and handling to:
DEAN ROSS, 45 West 45 St., Studio A-9801, New York 36, N.Y.

SAVE
MONEY!

FREE BARGAIN BOOK

CENTRAL CAMERA CO.
PHOTOGRAPHIC HEADQUARTERS SINCE 1899
Save money on all photographic equipment. Send for Cen-
tral Camera Co. FREE Photographic Bargain Book today.
CENTRAL CAMERA CO.
Dept. A-11 230 S. Wabash Chicago 4, Ill.

RHEUMATISM

NEURITIS • SCIATICA • LUMBAGO

Why continue to suffer agonizing pains when
usual remedies have failed. Learn how
thousands have been successfully treated by
an amazing new method which is fully ex-
plained in our New FREE Book. Don't wait.
Write today. No obligation.
EXCELSIOR INSTITUTE, Dept. C9806, Excelsior Spgs., Mo.

PLEASE
SEND ME



for the
time checked.
I am enclosing . . .

- 1 year \$3.50
 2 years \$6.00

name _____

address _____

city _____

zone _____

state _____

Hand this order to your newsdealer or send it to
POPULAR MECHANICS
200 East Ontario St. Chicago 11, Ill.

SHORTHAND IN 6 WEEKS

Write 120 words per minute
Age no obstacle—LOWEST COST

Famous SPEEDWRITING shorthand. No symbols; no machines; uses ABC's. Easiest to learn and use. Fast preparation for a better position. Nationally used in leading offices and Civil Service. 120 words per minute—50% FASTER than Civil Service requirements. Over 350,000 taught by mail or through classroom instruction. The very low cost will surprise you. Typing available. 34th Year. Schools in over 400 cities in U.S., Canada, Cuba, and Hawaii.

Write For Free Booklet To: School of

Speedwriting
Dept. 1511-6, 55 W. 42 St., N.Y. 36

DID YOU SEE
READER'S DIGEST
ARTICLE ON

REAL ESTATE BE A BROKER

PAYS BIG! SEND FOR FREE, BIG, ILLUSTRATED CATALOG NOW! Graduates report making substantial incomes. Start and run your own business quickly. Men, women of all ages, learn easily. Course covers Sales, Property Management, Appraising, Loans, Mortgages, and related subjects. STUDY AT HOME or in classrooms in leading cities. Diploma awarded. Write TODAY for free book! No obligation.

Approved for World War II and Korean Veterans
WEAVER SCHOOL OF REAL ESTATE (Est. 1936)
2020R Grand Avenue Kansas City, Mo.

FREE
BOOK
TELLS
HOW

GIANT STAMP ZOO FREE!

Snakes, Leopards, Rhinoceros, Zabu, Koalabear and other fierce jungle beasts. Approvals. Send 10c for handling. FREE STAMP MAGAZINE.

LINCOLN STAMP COMPANY,
St. Catharines 57, Ont., Canada



Exclusive Double-Bearing HEAVY-DUTY PUMPS

IRRIGATE * DRAIN * CIRCULATE * SPRAY
Up to 7,500 GPH, 3,000 GPH from 25" well. Use 1/4" to 1" HP motor, 1 1/4" inlet; 1" outlet. Stainless shaft. TYPE X—2 oilless bronze bearings. \$10.95

Won't rust. \$12.95
TYPE XB—Ball bearing model. \$12.95
Postpaid if cash with order. Rush your order today

MONEY BACK GUARANTEE
Centrifugal and Gear Pumps in All Sizes
LABAWCO PUMPS, Belle Mead 2, N. J.



SAY YOU SAW IT IN
POPULAR MECHANICS

BIG NEW
WHOLESALE
CATALOG
FREE!

WRITE TODAY FOR
FREE CATALOG
SEND POSTCARD

**AGENTS—Now Save Up to 50%
on Nationally Advertised Products**

Use this big, new FREE CATALOG to buy all kinds of big name merchandise at terrific savings.

Set yourself up in business—make money in your spare time.

EVERGREEN STUDIOS

Dept. 64, Box 846

Chicago 42, Ill.

AMAZON JIVARO

SHRUNKEN HEAD

Amazing replica of fabled native curios with a legend that owners have good luck. A strong stomach helps too because these 4" heads defy detection from just a few feet away, with remarkably true skin and hair. Sensational to hang in the car, den, bar. Have fun with this guy who got pickled once too often.

\$150
ppd.

GREENLAND STUDIOS, Dept. 25
5858 Forbes St. Pittsburgh 17, Pa.



Your SUCCESS IS OUR BUSINESS

WE CAN HELP YOU SUCCEED IN DRAFTING!

Design your own secure future. Acquire the skill of being able to put lines of design onto drafting paper for the construction, development and improvement of buildings, airplanes, machinery, electrical products, etc., in fact, everything that is man made.

Enjoy a knowledge that assures you top wages; interesting, exciting work; and permanent employment in America's most respected profession—DRAFTING.

CTS Professional Drafting training includes professional drafting instruments, equipment, supplies and a portable drafting table. These and easy-to-understand illustrated Lesson Manuals are all sent to you on a pay-as-you-learn plan.



IN RADIO-TELEVISION

CTS training is complete training. Don't be content with less. Gain the "know how" for installing, maintenance and servicing of Radio-Television, Radar, Sonar, and other Electronic equipment.

Gain complete training—Christy training. Learn in your spare time the technical side of Electronics by building valuable electronic test equipment, making exciting Electronic tests. CTS will supply you electronic testing instrument kits, and illustrated lesson manuals showing you step by step servicing procedures. Send for FREE book, sample lesson Manuals and Pay as you Earn form.



or in ELECTRIC APPLIANCE REPAIR



Millions of electrical appliances, electrical factory machines and electrical farm equipment, in all parts of the country, need servicing and repair.

We train you for making such repairs. Supply you with the "CHRISTY" Electronic Trouble Detector, and Illustrated Lesson Manuals showing how to quickly make needed repairs.

With CTS you also learn how to solicit business, what to charge, how to make power tools from spare parts. Earn As You Learn Electric Appliance Repair. Christy Trades School, Dept. DBT-6003, 4804 N. Kedzie Ave., Chicago 25, Ill. MAIL COUPON FOR FREE BOOK

CHRISTY TRADES SCHOOL, Dept. DBT-6003
4804 N. Kedzie Ave., Chicago 25, Ill.

Send me FREE Book and special Pay Later Form as indicated:

- PROFESSIONAL DRAFTING
- ELECTRIC APPLIANCE REPAIR
- RADIO, TELEVISION, RADAR, SONAR, ELECTRONICS

Name Age

Address

City Zone State

Some make more, some less; T. THORN reports:

\$690 gross in single
MONTH
IN MY OWN BUSINESS!

Start your own business!

Here's YOUR chance to start a money-making, year-'round business of your own and make the success you've dreamed about.

R. O. Donnelly took in \$40 in seven hours. O. W. Ware landed a \$750 hotel job. J. S. Corbit grossed \$279.50 his first month. Homes, hotels, offices, clubs, offer you big profit possibilities. Auto upholstery also.

NO SHOP OR OFFICE NECESSARY. You clean furniture on customers' premises. No hauling. No high rents. Supplies inexpensive; operate from your home. What you take in is mostly profit.

• If you want to be your own boss—free from layoffs, strikes and bosses, we will help you to start and succeed. Don't delay...read the facts, then decide for yourself.



MAIL COUPON TODAY FOR FREE BOOK

VON SCHRADER MFG. CO.
E 10 "D" Pl., Racine, Wisconsin

Without obligation rush your **FREE** booklet about how I can start my own permanent, profitable electric Upholstery Cleaning business.

Name _____

Address _____

City _____ Zone _____ State _____

NEVER AT THIS LOW PRICE!

GENUINE 120-POWER ACHROMATIC TELESCOPE

with Coated Lens and
3-POWER FINDER attached

ONLY
\$18.95
PREPAID

EXTRA BONUS GIFTS:

- 108 page book, "Discover The Stars"
- Magic Star Finder Dial
- 220X & 400X Eyepiece lenses

BRING THE MOON, PLANETS, STARS, PEOPLE 120 TIMES CLOSER, CLEARER, SHARPER.

Never before has an ACHROMATIC 120X telescope with range finder and tripod sold for anywhere near this amazing low price! Now you can not only explore the heavens and bring the moon, planets, stars, etc. 120 times closer, but you can also observe all distant objects, people, ships, etc. too, because all pictures are erect, and not upside down as in all astronomical telescopes. The kind of needle-sharp color-free viewing only a genuine achromatic lens can bring you. Ready for immediate use. Its 5 precision lenses bring you viewing at 40X—80X—120X, the tubes extend to 43", made of jet bakelite, finished in camera bellows black (for sharper, clearer images). Trimmed with gleaming brass. The 3 power finder scope mounted on main tube is a feature usually found on more expensive telescopes—brings difficult objects on target before observing with main scope. For extra stability 5 ft. hardwood folding tripod is equipped with heavy cast iron head fitted with Criterion's famous 360 degree all aluminum mount that locks instantly in any position. Obtainable only from Criterion, shipped prepaid. 4-Bonus gifts—108 page book "Discover The Stars," magic star finder dial that aids in locating stars ANYWHERE at ANY TIME of the year, and 220X and 400X eyepiece lenses included free of any cost for experiments. You must be completely satisfied with this super offer or your money back in full. Shipped to you complete, nothing else to buy, at the amazing low price of \$18.95. Without tripod \$14.95.

Send cash, check, or money order today to:
Dept. PMA8, Criterion Co., 331 Church St., Hartford, Conn.

23 YEARS AT THIS ADDRESS
TUBE FREE WITH EVERY PASSENGER TIRE
LOW OVERHEAD—LARGE VOLUME SALES & SMALL PROFITS
BRING YOU THESE "LOWEST PRICES."



TIRE INSURANCE REPLACEMENT GUARANTEE SENT

Our entire stock of very slightly worn EXTRA MILEAGE TOP GRADE Tires, (Written Insurance Guarantee). SEND AD

EVERYBODY MAY TAKE **20% off** ON EVERY TIRE



12 MOS. WRITTEN GUARANTEE. WHITE WALLS \$1.00 EXTRA
Selected for Toughest Jobs—Prices Shaved to the Bone
FREE TIRE with every 2 or more Black 4-Ply Car Tires

ADJUSTMENT TIRES				Released by "Co." Adjusters	
600-16	\$6.22	475-19	\$6.42	700-15(6)	\$8.42
600-16(6)	8.22	640-15	6.52	750-16(8)	12.92
650-16(8)	8.22	670-15	6.42	700-17	10.72
750-16(6)	10.12	710-15	6.42	750-17	12.72
350-18	6.22	760-15	6.52	825-15	18.92
350-17	6.22	800-15	6.72	600-20	11.72
650-15	6.52	820-15	6.72	650-20	11.92
700-15	6.52	700-16(8)	8.72	750-15	13.92
				1000-20	19.82
				1000-22	20.92

"EXTRA SPECIAL" Fully guarantee "AAA" Grade, FREE TIRE with 2 or more of these. W.W. \$1.00 Extra. Factory Tested Tube given. **GIANT TIRE SALE**

600-16	670-15	710-15	760-15	800-15	820-15
tire & tube	tire & tube	tire & tube	tire & tube	tire & tube	tire & tube
\$8.92	\$8.92	\$8.92	\$8.92	\$8.92	\$8.92

SNOW TIRES \$10.72 ORDER ANY 4 PLY PASSENGER SIZE 12 MO. GUAR. BLACK WALL
Thousands of tires shipped all over the U.S.A. All tires shipped F.O.B. Phila. Send Check or M.O. with this ad. Dept. 2. No C.O.D.
STANDARD 834 N. Broad St., Philadelphia 30, Pa.

TV Strong man
DAN LURIE
says



Send for FREE Catalog

\$10,000 REWARD

If correct use of my new body building course fails to build you a "HE-MAN" BODY The secret is in my revolutionary, exclusive Body Mould system. Yours FREE with famous

DAN LURIE BARBELLS

Scientific! Fastest, surest method known—beats all other training methods. Results guaranteed. Special low prices.
50 lb. set \$ 8.48 a 100 lb. set \$13.98
150 lb. set \$20.48 a 200 lb. set \$25.98
13c per lb. F.O.B. 50% Deposit required

DAN LURIE BARBELL CO.

52M11 Bristol St., Dept. 659L, B'klyn, 12, N. Y.



Grow authentic, LIVE dwarf trees!
Fascinating hobby! Profitable business!

GROW MINIATURE TREES
SEND FOR FREE SEED & INFORMATION!

MINIATURE NURSERY CLUB
Dept. J-11, P.O. Box 8794,
Los Angeles 8, Calif.

GET THE HABIT OF READING
OUR CLASSIFIED ADS.

Wonderful Opportunities Amazing Bargains

LEARN METALCRAFT
and JEWELRY MAKING



Low Cost Home Training Now Available

Make money. Learn profitable skills and arts of decorative metal and jewelry crafts. Course is complete. Professionally prepared. Easy to master. Special tools and materials furnished.

Write for Free Booklet **INTERSTATE TRAINING SERVICE**
DEPT. K-3 PORTLAND 13, OREGON

SKI KIT
\$18.00
SAVE 1/2

IDEAL CHRISTMAS GIFT



Simply assemble and finish our new water ski kit and you have a pair of skis worth twice the price of the kit. Skis are 7 ply moulded plywood, 67 1/2" long, 7" wide, 3/8" thick. Sturdy rubber foot pieces. All parts plus instructions included — \$18.00. Order from your Michigan dealer or MICHIGAN WHEEL CO., Dept. P-11, Grand Rapids, Mich. C.O.D. orders accepted.

ATTENTION: MEN 17 to 55

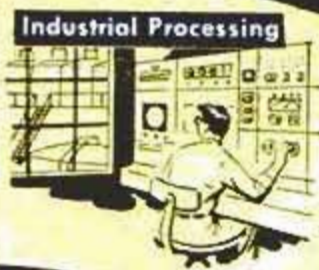

Does your present job offer advancement?

PREPARE NOW AT HOME FOR A PROFITABLE CAREER IN AUTOMATION ELECTRONICS!

PRACTICAL NEW TRAINING METHOD IS THOROUGH, DOWN-TO-EARTH!

In plant after plant, many machines are being designed to run themselves. This is called "Automation." The jobs of some men who used to run these machines are gradually disappearing. Every year sees more changes; more unskilled jobs being replaced. But it's making many new jobs too—good-pay, solid-future jobs in plants, offices and elsewhere—for men who are trained in Automation Electronics.

NOW IS THE TIME TO GET YOUR TRAINING
The design, operation and maintenance of controls that regulate the new "automatic equipment," is a promising field of the future. It's still uncrowded. There's time to get in on the ground floor if you act now.

NO PREVIOUS TECHNICAL TRAINING NEEDED
Many men 17 to 55, regardless of present job, even men without previous technical training or advanced education, can train for good jobs in Automation Electronics. DeVry Technical Institute offers effective training in your own home with movies, plenty of practical equipment and easy-to-read texts. Or get all of your training in DeVry's large well-equipped training laboratories in Chicago... one of the finest of its kind!

WE HELP YOU GET STARTED IN THE FIELD
When you've completed the DTI training, you'll have the know-how—the practical training you need to hold down a good job in Automation. Our effective Employment Service will help you get

started toward many wonderful and exciting opportunities. You have nothing to lose—and much to gain. Send that coupon now so we can tell you about it.

MANY SUCCESSFUL GRADUATES
For 25 years, DTI has been building men for better jobs. Our files contain many letters from men who have won success in electronics and who give much credit to their DTI training.

GET INTERESTING NEW BOOKLET
The interesting story of "Automation and YOU" is yours for the asking. Simply fill in... mail the coupon. See how DeVry's training programs may prepare YOU for a start in this coming new field.

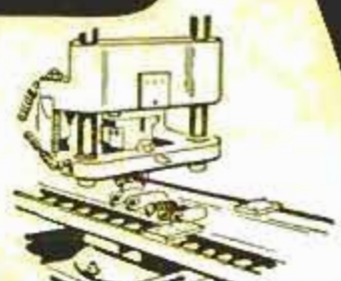

Making Electronic Devices



Recording and Billing



GET THIS BOOKLET FREE

DeVRY TECHNICAL INSTITUTE, Dept. PM-11A-M
4141 Belmont Avenue, Chicago 41, Ill.

I would like further information about the newer Electronic opportunities in AUTOMATION, also facts on how you may help me to prepare.

Name _____ Age _____
Please Print
Street _____ Apt. _____
City _____ Zone _____ State _____
1040 DTI's training is available in Canada

One of America's Foremost Electronics Training Centers



Member of National Home Study Council

DEVRY TECHNICAL INSTITUTE
CHICAGO 41, ILLINOIS
FORMERLY
DEFOREST'S TRAINING, INC.

**WE PAY \$3.50 LB.
GUARANTEED MARKET
WANTED
MEN AND WOMEN**

GROW MUSHROOMS

Cellar, shed and outdoors.
Spare or full time year round.

We pay \$3.50 per pound.

WE PAID John Betts
\$9,999.90 He started as an
Amateur

Write for . . .
FREE BOOK

**WASHINGTON MUSHROOM
INDUSTRIES, INC.**

DEPT. 290

2954 ADMIRAL WAY SEATTLE 6, WASHINGTON

**ENGINEERING DEGREE IN
27 MONTHS**

B. S. DEGREE IN

**Aeronautical, Chemical, Civil, Electrical, Mechanical
and Electronic Engineering (inc. Radio and TV)**
Big Demand for Graduates

Hundreds of young men are earning B. S. ENGINEERING DEGREES annually in this recognized institution—year around classes optional. Also B.S. in 36 mo. in Mathematics, Chemistry, Physics. New terms start quarterly. Many students earn a major part of their college expenses in this large industrial center. Low tuition. Competent instruction.

Thorough, intense practical program. Modern, well-equipped laboratories including new physics laboratory and modern wind tunnel. Individualized instruction emphasized. Government approved for G.I.'s. Engineering Science preparatory courses.

Students from 48 states and 21 foreign countries. Enter December, March, June and September. Send coupon for free catalog and full information. Enroll now.

INDIANA TECHNICAL COLLEGE

5116 E. Washington Boulevard, Fort Wayne 2, Indiana

Please send me free information on 27 MO. B.S. DEGREES in:

Aeronautical Chemical Civil Electrical
Mechanical Electronics

on 36 MONTH B.S. DEGREES in:
Mathematics Chemistry Physics

Name _____

Address _____

MAKE \$5 PER HOUR WITHOUT A PRINTING PRESS
PRINTING **REVOLUTIONARY NEW SCREEN METHOD**
complete "BIG MONEY" Plan and SAMPLE!

PRINT colorful signs, posters, banners, fabrics, wall paper, show cards—ANYTHING! Print on any surface. NO printing press or special equipment is needed with this amazing "approved" new printing secret. 300% profit on nearly every job. Easy to learn —NO EXPERIENCE or art ability necessary. Exceptional opportunity. Complete illustrated detailed plan and colorful sample FREE—Write:

SCREEN-PRINT COMPANY, Dept. 211
15127 S. Broadway, Los Angeles 61, Calif.

EARN AT HOME
SPARE or FULL TIME

ASSEMBLE A BIG 100 POWER 3" REFLECTING TELESCOPE

... With this complete 87 piece "Do-It-Yourself" Kit. See the moon, stars close up, or view terrestrially. Kit includes: 3" f/10 aluminized and over-coated. Spherical Mirror—60X Eyepiece and 100X Barlow Lens—Crossline Finder, sturdy 40" Tripod—fork type Equatorial Mount. Complete instructions furnished. Order by Stock No. Send check or M.O. Money back guarantee. Shipping **\$29.50** f.o.b. weight 10 lbs. Stock No. 85,025-H. Ask for FREE catalog M Barrington, N. J. **EDMUND SCIENTIFIC CORP., Barrington, N. J., U.S.A.**



\$ OWN A BUSINESS \$
SPARE TIME — FULL TIME

Earn from \$3000 to \$20,000 yearly. We specialize in putting people in business. We train you, guide you and furnish you with everything needed. If any of these businesses interest you be sure to see our offer: Mail Order, Insurance, Photography, Real Estate, Bookkeeping or Collection. One hour each evening is all you need. We take care of the rest. Write today.

\$ NATIONWIDE BUSINESS INSTITUTE \$
DEPT. M-11 618 SAVANNAH COLUMBUS 4, OHIO

Write Like This Complete OUTLINE FREE!
MIRACULOUS IMPROVEMENT in your Penmanship in six hours practice with Grooved Letters. No failures. Inexpensive. No charges unless you're satisfied after 6 hours practice.
WRITE OZMENT BOX 668 34-P. ST. LOUIS, MISSOURI



Easy to make your own BOWS—ARROWS—EQUIPMENT

Illustrated Hand-Book 84 pgs. \$1, tells you how! Large Colored Catalog 5c—Send for it!

Ask your dealer for "Stemmler's Archery" (Oldest Mfr. in U.S.A.)

L. E. STEMMLER CO.
Manorville (Box 1) L. I., N. Y.

Say You Saw It in POPULAR MECHANICS

CABINET MAKING



LOW COST HOME TRAINING COURSE FOR BEGINNERS & ADVANCED CRAFTSMEN

Make money. Learn skills and secrets of fine woodworking and tool use. Professionally prepared shop method training tells and shows how. Covers everything. Easy to master.

INTERSTATE TRAINING SERVICE
DEPT. F3, PORTLAND 13, OREGON

FREE AMAZING NEW BOOK "HOW TO ANSWER ADS"



Never before have you seen anything like this. Tells you in simple language the correct way to answer ads. Gets you quicker replies—better results, and greater satisfaction. Will save you time and money and it's ABSOLUTELY FREE. No obligation whatever. Every reader of advertising should have this booklet. Send a postcard for your copy NOW. F. W. Johnson, Popular Mechanics Magazine, Room 600-A, 204 East Ontario Street, Chicago 11, Illinois.

Who Couldn't MAKE UP TO \$1,500 in a Month with this Proven "MIRACLE FOR MOTORS?"



Daring "You-Be-Judge" Guarantee Wins Fast Big Orders from Motorists for Sensational New MOTOR OVERHAUL!

Make biggest money of your life, spare time or full time, introducing amazing new Motor Overhaul in your locality. Needed by 60 million cars and trucks. Just add to oil, drive at once; see, hear, feel immediate improved engine performance, more pep, power, and pickup. Motorists and fleet owners order fast when you say, "Your money back if, IN YOUR OPINION, you don't get the improvement you expect. You be the judge!" MOTOR OVERHAUL surprises them, gives more than they expect, and they give you big automatic REPEAT ORDER BUSINESS that grows bigger every month! Fleet owners order 6 to 12 dozen at a time at \$2.98 each and you make up to \$1.78 profit each! Who couldn't make up to \$1,500 and more in a month with miraculous MOTOR OVERHAUL?

Independent Testing Lab Proves MOTOR OVERHAUL Increases:

- Motor Compression up to 58%
- Gas Mileage up to 54%
- Oil-Saving Efficiency up to 90% . . . and

EXTENDS ENGINE LIFE FOR YEARS!



FREE Write NOW for big-profit Sales Kit, everything you need for lifetime business introducing MOTOR OVERHAUL in your area—money-making plans, copy of Lab Test Report, "You-Be-Judge" Guarantee. All FREE.

POPE CHEMICAL CO., 224 W. HURON ST., DEPT. L-3 CHICAGO 10, ILL.

HOW TO FIX ANY CAR

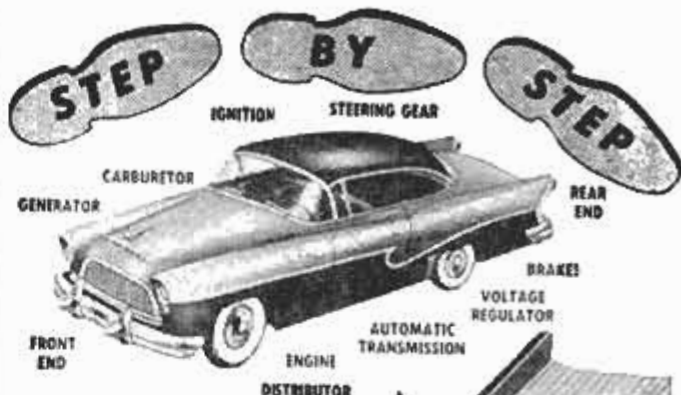

FREE 7-DAY TRIAL

ANY tune-up, service or repair job on ANY car can be as easy as A-B-C . . . when factory experts show you how-to-do-it one step at a time. That's why no job's too tough to handle when you've got MOTOR'S brand-new AUTO REPAIR MANUAL at your elbow!

Book "starts from scratch" — tells you WHERE to start, what TOOLS to use. Whether you're a beginner or an expert mechanic—you can "breeze through" ANY repair on ANY make or model car built from 1946 through 1956!

Everything You Need to Know in 1000 Big ILLUSTRATED Pages!

NEW, REVISED, 1000-Page Edition contains the "meat" from over 160 OFFICIAL shop manuals—simplified for YOU. 23,436 essential repair specifications on over 737 chassis models. More than 2,900 "this-is-how" pictures. 225,000 service and repair facts. Leads beginners every step of the way. Time-saving factory repair procedures for experts. Instructions and pictures so clear you CAN'T go wrong. Used by U. S. Army and Navy. 2,000,000 COPIES SOLD!

Try Book FREE 7 Days

SEND NO MONEY! Pay postman nothing. Make Manual PROVE to you what it's got. Unless you agree this is the greatest time and work saver you've ever seen—return book in 7 days and pay nothing. Mail coupon today to MOTOR BOOK Dept., Desk 11, 250 W. 55th St., N. Y. 19

**MOTOR'S
AUTO
REPAIR
MANUAL**

Covers 737 Models
—1946 thru 1956

Buick	Imperial
Cadillac	Jeep
Chevrolet	Kaiser
Chrysler	Lincoln
Clipper	Mercury
Continental	Nash
Crosley	Oidmobile
De Soto	Packard
Dodge	Plymouth
Ford	Pontiac
Frazier	Rambler
Henry J	Studebaker
Hudson	Thunderbird
	Willlys

**Same FREE offer on MOTOR'S
New Truck Repair Manual**

Brand new! Covers EVERY job on EVERY popular make gasoline and Diesel truck made from 1946 thru 1956. FREE 7-Day Trial. Check proper box in coupon.



MAIL COUPON NOW FOR 7-DAY FREE TRIAL

MOTOR BOOK DEPT.

Desk 11, 250 W. 55th St., New York 19, N. Y.

Rush to me at once (check box opposite book you want):

MOTOR'S New AUTO REPAIR MANUAL. If O.K. I will remit \$2 in 7 days, \$2 monthly for 2 months and a final payment of \$5c (plus 35c delivery charges) one month after that. Otherwise I will return the book postpaid in 7 days. (Foreign price, remit \$9 cash with order.)

MOTOR'S New TRUCK REPAIR MANUAL. If O.K. I will remit \$2 in 7 days and \$2 monthly for 3 months, plus 35c delivery charges with final payment. Otherwise I will return book postpaid in 7 days. (Foreign price, remit \$10 cash with order.)

Print Name..... Age.....

Address

City..... State.....

Check box and save 35c delivery charge by enclosing WITH coupon entire payment of \$4.95 for Auto Repair Manual (or \$8 for Truck Repair Manual.) Same return-refund privilege.

**earn \$15
HOUR as TAX EXPERT**

Our students earn as much as \$3,000 in 3 short months preparing income tax returns in spare time. Also operate lucrative year-round Business Tax Service. Dignified home-office business. Experience unnecessary. We train you; help you start. State approved home training program. Write today for free prospectus.

UNION INSTITUTE, 68 Hudson, Hoboken 20P, N. J.

14' Model Pictured

42 TOP PERFORMING MODELS, 8' thru 18'

... from \$39.25 incl. frt.

Runabouts, Cruisers, Convertibles, Fishing, etc. for every purpose with modern styling, advanced design. No experience necessary, amateurs can easily assemble. Save 1/3 to 1/2 "factory-built" prices!

FIBERGLAS, TRAILERS, ACCESSORIES

FREE! BOAT KIT CATALOG

LAGER INDUSTRIES, INC. DEPT. B-11 3404 Lyndale S. Minneapolis 8, Minn.

SAY YOU SAW IT IN POPULAR MECHANICS

HOW TO TURN Concrete INTO Gold

\$2.00

A MUST FOR EVERYONE CONCERNED!

This MANUAL Tells You How To Make Handsome Profits From Concrete Items YOU CAN MAKE

All you need is a mold or two and a little determination. This Manual contains large, clear pictures, gives prices and description of more than 200 different molds you can buy direct from the manufacturer, AND... priceless trade secrets that make production a snap. Take the first step Today!!!

SEND ONLY \$2.00 FOR YOUR COPY (Rushed to you by First Class Mail!)

CONCRETE MACHINERY COMPANY, INC.
Dept. PM Hickory, N. C.

PACK POUNDS AND INCHES OF STEEL MUSCLE ON YOUR BODY IN 30 DAYS!

OR IT DOESN'T COST YOU A CENT



You have nothing to lose but your own weakness!

Whether you're young or old, thin or fat, we guarantee you will add inches of solid muscle to your arms, chest, shoulders, legs and back in 30 short days—or your money back. All you do is follow the tested and proved HERCULES System of Bodybuilding 15 minutes a day and watch your muscles and internal power grow fast.

HERCULES Barbells feature unique revolving action for easier handling... greater muscle growth. Complete with all charts and instructions plus lifetime bodybuilding advice.

BUY DIRECT FROM HERCULES AT FACTORY PRICES! SAVE MONEY!

FROM \$898

MAIL COUPON TODAY FOR FREE ILLUSTRATED SET OF MUSCLE BUILDING EXERCISES!

HERCULES BODYBUILDING INSTITUTE
188P Woodward St., Jersey City, N. J.

Please send me FREE set of exercises.

Enclosed also find \$..... In full payment for the set I have checked below. Rush it to me at once!

<input type="checkbox"/>	50 lb. Junior Gym Set.....	\$ 8.98
<input type="checkbox"/>	100 lb. Senior Gym Set.....	18.98
<input type="checkbox"/>	150 lb. Power-pak Set.....	25.00
<input type="checkbox"/>	200 lb. Titan Set.....	37.50

NAME

ADDRESS.....CITY.....STATE.....

(All outfits shipped promptly F.O.B. Brooklyn. Sorry, no COD'S)

UNCONDITIONALLY GUARANTEED. YOUR MONEY BACK IN 10 DAYS IF NOT SATISFIED!



FREE BOATING BOOK

Your name on a postal card will bring to you, postpaid, this most interesting and informative booklet on boating. You will enjoy its factual statements and its down to earth good sense.

Drop us that card today!

AERO-CRAFT Dept. No. A-7
St. Charles, Mich.

WE GUARANTEE:

If you spend twice as much... you can't buy or build a finer Precision Reflector Telescope... than the

4" DYNASCOPE REFLECTOR

ONLY \$495 COMPLETE



F.O.B. Hartford, Conn.
Shipping weight 14 lbs.
Express Charges Collect

Yes, we'll guarantee that the 4 inch Dynascope Reflector, world acclaimed by schools, universities, planetaria, is the finest professional telescope available under \$100! Complete with new improved Combination Equatorial and Altazimuth Mount with Free Moving Polar Axis Rod—three Achromatic Eyepieces, 65X, 130X, and 167X—4-inch Parabolic Mirror—4-power Achromatic Finder Scope—Rack and Pinion Focusing—and Hardwood Folding Tripod! Try it yourself—at our risk! You'll be thrilled. You'll agree that you can't duplicate this superb instrument anywhere else at double the price—or send it back within 30 days for full refund. Send check or money order today!

Other Reflector Telescopes 3" to 6", \$29.50 to \$250.00
Send for FREE Illustrated Brochure

THE CRITERION MANUFACTURING CO.
Manufacturers of Quality Optical Instruments
Dept. PMD2, 331 Church St., Hartford 1, Conn.

WAR SURPLUS BARGAINS!

STARK'S

WAR SURPLUS BARGAINS

\$500,000.00 INVENTORY for QUICK LIQUIDATION

Surplus items—hundreds of items for home, shop, factory, farm and outdoor use. New items, used items, reconditioned items—all at tremendous savings—all priced for quick sale.

Page After Page of Values

This big catalog flows page after page of amazing money saving values. Write for your copy today. Send 10c in cover postage, mailing, etc. Write today! SEND TODAY FOR YOUR COPY

10c

STARK'S 212 W. Madison St.
Dept. PM-5611
CHICAGO 6, ILL.

PORTABLE CAR COVER Heavy Vinyl Plastic (formerly \$8.95)

Protect Against RAIN • SUN • DUST

Long-lasting plastic, folds compactly, off and on in a jiffy, sturdy elastic binding gives extra security. State make, model and year



Send \$6.95 plus 35¢ postage and sent C.O.D.
Extra Heavy Plastic Gauge \$8.95 + 45¢ postage.
BEA SALES, Dept. B-4, 125 E. 46th St., New York 17



sculp-metal

IT MODELS LIKE CLAY—HARDENS INTO METAL!

1001 USES IN ARTS & HOBBIES
Send 10c for handbook:
working in sculp-metal

the sculp-metal company
701-H Investment Bldg. Pittsburgh 22, Pa.

Learn LANDSCAPE GARDENING

A thorough, interesting home study Course for those who wish to become a Landscaper, Garden Consultant, Contractor or Designer for profit or pleasure. Write today for FREE Booklet.

NATIONAL LANDSCAPE INSTITUTE
Dept. M-116, 310 So. Robertson Blvd., Los Angeles 48, Calif.

ELECTRIFY YOUR SEWING MACHINE! NEW LOW PRICE!

Buy direct and save! Kit comes fully wired, installed in a jiffy. Fits all machines. ALL-NEW PARTS! Guarantee

• AC-DC Motor & bracket • Multi-speed foot control • Cord set & block • 115 v 60 c • Full instructions • Steel pulley & belt

BONUS: 10 day free trial. Reg. \$2.95 Sew-Lite given FREE with kit. Reg. \$2.95 plinking shears only \$1 with order. Send no money. Kit sent C.O.D. Or send money order and we'll pay postage. State whether wheel on your machine turns towards or away from you. Shipping wt. 6 lbs.

SENIOR SEWING MACHINE CO., Box 142, Dept. PM110, Bklyn 6, N. Y.

FREE! LAFAYETTE CATALOG

- WORLD'S LARGEST HI-FI CENTER
- MORE VALUE—MORE ITEMS
- EVERYTHING IN ELECTRONICS

NAME

ADDRESS

CITY ZONE

STATE

Lafayette Radio
DEPT KJ

165-08 Liberty Ave.
JAMAICA 33; N. Y.
CUT OUT AND MAIL TODAY!

BEST JOBS ARE FILLED BY ALLIED TRAINED MEN

Yes, you can train now for the best paying jobs, and become one of the Builders of Industry! Due to the great present day industrial expansion programs throughout our country, Industry has been clamoring for Allied-trained men to fill important jobs. Shortages of Draftsmen, Designers, Tool Engineers, Machinists, Tool and Die Makers are so wide spread that you can pick one of these highly paid key jobs and then look forward to a life of security and success. Get started now—take advantage of these opportunities to earn good money—to build for your security and success.

Foundation of Industry is Built by the:

**DRAFTSMAN
MASTER MACHINIST
TOOL-DIE MAKER
TOOL-DIE DESIGNER
TOOL ENGINEER
MACHINE DESIGNER
MECH. ENGINEER**

Allied is the outstanding school of its kind—the foremost school in its field. Allied is approved by Industry, Department of Registration and Education, Department of Public Instruction, State of Illinois, Department of Justice for Foreign Students, and the Veterans Administration. Accredited by Central Schools Association.

**Train at Home in Your Spare Time
or at The Allied Institute in Chicago**



Free employment service and housing assistance all through your training period and after your graduation. Our industrial contacts cover the U.S.A.

Allied's training program permits you to study right at home in your spare time or at the Allied Institute's fully equipped shops and laboratories. You can begin your training in short courses and continue progressively to a Bachelor Degree in 26 months.



SEND FOR **FREE BOOKS**

**ALLIED SCHOOL
of Mechanical Trades
1338-42 South Michigan Ave
Chicago 5, Illinois**

ALLIED SCHOOL of MECHANICAL TRADES

*Allied Institute of Technology
1338-42 South Michigan Ave., Dept. PM 11, Chicago 5, Illinois*

Gentlemen:

Mail me FREE BOOKS explaining ALLIED'S courses of instruction, and FREE SAMPLE lesson.

I am interested in resident training home study

VETS write in date of discharge _____

Name _____ Age _____

Address _____

City _____ County _____ State _____

I'll Send You This Handsome SAMPLE CASE—FREE!

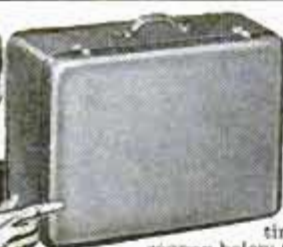

Make up to
\$30⁰⁰ in a Day!

Your Own
Tailored Suits
Without 1¢ Cost

If you want to make more money, spare time or full time, rush the coupon below today for this big, valuable tailoring Sample Case packed with 150 beautiful, big-value suit and overcoat samples. Just show the samples and last-minute styles to friends, fellow-workers, others. Take their orders for fine made-to-measure clothes—and pocket BIG CASH PROFITS in advance. No experience, no tailoring knowledge needed—and no money needed, ever. WE SUPPLY EVERYTHING FREE... sample case, sample suitings, equipment, complete instructions. Start making money first day!

Use Spare Evenings... Weekends... Make Money... Get Suits!

It's easy to make money taking orders in just spare time—lunch-time, evenings, weekends. When men see the fine fit, quality and value of our suits—THEY ORDER! So we make it easy for you to get your own personal suits and overcoats without paying even one penny. Don't wait! Rush coupon with your name, address, and age for FREE Sample Case.

PIONEER TAILORING COMPANY
Dept. A-1116, Congress & Throop Sts., Chicago 7, Ill.

PIONEER TAILORING CO., Dept. A-1116
Congress & Throop Sts., Chicago 7, Ill.
Please rush ABSOLUTELY FREE the valuable Sample Case with suit fabrics and style display. Include instructions, money-making plans and details for getting my own suits without paying one cent.

Name..... Age.....
Address.....
City..... State.....

MAIL ORDER SPECIAL



GASOLINE

\$9⁵⁰

CAMP STOVE

ORIGINAL COST \$80

Ideally suited for drying plaster or paint in new construction

BRAND NEW U. S. ARMY FIELD RANGE Burner Unit, approx. 50,000 B.T.U. complete w/2 extra generators, unit as pictured. Cook on it, use as cabin heater. Shipping wgt. approx. 55 lbs. Size: 21½" lg., 19" w., 9½" h.

SPECIAL NEW ARMY MACHETTES.....\$1.95
FOLDING FOX-HOLE SHOVELS.....\$1.00
FOX-HOLE PICK-MATTOCK.....\$1.00

All prices FOB Memphis—order now. Supply limited

J. P. DAVIDSON CO.

104 N. Front

Memphis, Tenn.



New HOME-IMPORT BUSINESS!

Men—Women. We show you how to import big-profit items at amazing low foreign prices (examples at left). Your home is your office. Get list of 157 Imports FREE! Full or spare time business by Mail Order. Or take volume orders from stores. Import jewelry, clothing, sporting goods, hardware, etc. NO EXPERIENCE OR INVESTMENT IN PRODUCTS NEEDED. Without obligation send today for complete details and list of 157 imports FREE! Air mail reaches us over night. THE MELLINGER CO., 1717 Westwood Boulevard, Dept. F25B, Los Angeles 24, California.

Clocks 65¢
in Germany—
\$5 value
in U.S.A.

Finish HIGH SCHOOL AT HOME

Complete 4 Yrs. in 12 Months

Learn More! Earn More! Enter professional or technical schools. Advance Socially. Live a Happier, Fuller Life. Individual Courses or complete schedule. WRITE FOR SCHOOL BULLETIN.

ACADEMY FOR ADULTS

30 W. Washington, Dept. PM-116, Chicago, Ill.

60 POWER TELESCOPE \$3.98

VARIABLE EYEPIECE 20X-40X-60X — BRASS BOUND NEW! Three telescopes in one. 3 different magnifications. 20 power for ultra-bright images with 40 and 60 power for extra long range. Guaranteed to bring distant objects, people, sport events, ships, moon, stars, etc. 80 times as close.



Most powerful for any where near the moon. 5 sections. Closes to 1 ft. long. Contains 4 ground and polished lenses. Also used as a powerful compound microscope. Directions included. Mass production enables us to offer this instrument at amazing price of \$3.98 complete. Money back guarantee. We pay postage. Get yours now. CRITERION CO., 331 Church St., Hartford, Conn., Dept. PMB 40

RADIO Engineering. All phases radio & electronics theory & practice; television; FM; broadcasting; servicing; aviation, marine & police radio. Prepare for good pay; 18-month course. Graduates in demand by major companies. Enter Jan., March, June, Sept. Regular campus life. Write for catalog. VALPARAISO TECHNICAL INSTITUTE, Dept. D, Valparaiso, Ind.



26" OPERATING SCALE MODEL SUBMARINE Heavy duty spring motor drives twin propellers, thru sealed gears, running in oil. Water ballast chamber with air valve control for diving or operating submerged. ALUMINUM HULL. BRASS DECK TRIM.

CONSTRUCTION KITS AND ASSEMBLED MODELS Price Range \$5.95 to \$18.00. Send 3¢ stamp for detail literature. WESTLAKE MODEL CO. Dept. P6 Ventura, Calif.

Say You Saw It in Popular Mechanics

Enjoy the Fascinating Story of the Horseless Carriage in



Popular Mechanics 166 Illustrations AUTO ALBUM

The most intriguing book about the automobile ever printed. It's thrilling, fascinating and informative. From the very first gasoline-propelled buggy to the cars of today and the atomic auto of the future. The first cars—the men who made them—the scrambled start and the development of the fabulous auto industry—the story of auto racing—the growth of the Nation's highways. 166 thrilling action pictures—old-time cars—racing cars—early auto advertising—automotive oddities. Roll call of names of more than 2000 autos made in the U.S. included. Ideal gift book. Cloth bound, only \$3.00 by mail. Money back if not pleased. Paper covered edition \$1.00 at newsstands. POPULAR MECHANICS PRESS, Dept. PM-1156 200 East Ontario Street Chicago 11, Illinois



FREE! BRITISH CARIBBEAN STAMPS

plus new, rare
BONUS OFFER!



RUSH COUPON NOW for our newest offers! Big free collection of scarce, attractive British Caribbean Stamps, our popular Collector's Guide. PLUS, for the first time, our new, once-in-a-lifetime, valuable "British Empire Bonus Packet." Direct from our agents all over the world — unusual, seldom-seen stamps: Coronations, Jubilees, Royal Visits, Commemoratives. Think what a grand addition these will make to your collection. How they'll grow in value. And this whole offer is FREE!

ACT NOW! Be sure of your free handsome stamps from the romantic lands of the pirates, Ponce de Leon, the landing site of Columbus — the fascinating Caribbean. Bahamas, Trinidad, Barbados, Antigua, Guiana, many more. Plus your Bonus Packet of topical, pictorial, bi-color stamps galore. All genuine, all different, all free!

ALSO FREE! We'll include other offers for your free inspection plus FREE copy of STAMP COLLECTOR'S GUIDE. Tells how to find rare stamps, trading tips, other important facts. Supply limited, so we can give you only one packet. If coupon has been clipped, write GARCELON STAMP CO., Dept. 11PMC Calais, Maine — and do it today!

MORE! BIG BONUS EMPIRE PACKET!

Exclusive. Fine collection Empire Stamps made up from small quantities received daily from our agents all over the world. No two packets alike — new, old issues — unusual out-of-the-way stamps — many VALUES and COLLECTOR'S ITEMS. Write today.

GARCELON STAMP CO., Dept. 11 PMC
Calais, Maine. RUSH Caribbean Stamps, Collector's Guide, BONUS PACKET, other offers. Enclosed 10c for postage, handling. (PLEASE PRINT)



ACT NOW!

PEE WEE BATTERYLESS "LIFETIME" RADIO



SEND ONLY \$2.00... all ok. mo. and pay postman \$4.99 COD postage on arrival or send \$6.99 for postpaid delivery. SENT COMPLETE READY TO LISTEN WITH LIFETIME GUARANTEE. Nothing extra to buy — ever. Available only from: MIDWAY COMPANY Dept. WPM-11 KEARNEY, NEBRASKA

REALLY WORKS — FOR LIFE!
Works WITHOUT TUBES, BATTERIES OR ELECTRICAL PLUGS. Will never run down or burn out! World's smallest. SMALLER THAN A PACK OF CIGARETTES! GUARANTEED TO RECEIVE LOCAL RADIO STATIONS ANYTIME—ANYWHERE YOU GO! Sensational new Ferrite Selective Tuner — Formica Crystal diode, Super SPEAKERPHONE, durable black and gold plastic case.

BE YOUR OWN MUSIC TEACHER

Send for Free Book Telling How Easily You Can Learn Piano, Guitar, Accordion, ANY Instrument This EASY A-B-C Way

NOW IT'S EASY to learn music at home. No tiresome "exercises." No teacher: just START RIGHT OUT playing simple pieces. Thousands now play who never thought they could. Our pictured lessons make it easy as A-B-C to learn to play popular music, hymns, classical, and any other music. Only a few cents a lesson. Over 900,000 students! (Our 58th successful year.)

Mail Coupon for FREE BOOK

Find out why our method can teach you quickly, easily, inexpensively. Write for 36-page illustrated book. No obligation. Mention your favorite instrument. Just mail coupon below.

U. S. SCHOOL OF MUSIC
Studio 3011
Port Washington, N. Y.



U. S. SCHOOL OF MUSIC, Studio 3011, Port Washington, N. Y.

Please send me Free 36-page illustrated Book. I would like to play (Name instrument).

Instrument _____ Have you _____
Instrument? _____

Name _____ (Please Print)

Address _____

MONEY in WORMS

Big money made raising fishworms and crickets. Billions used yearly—unlimited market—sell by mail—We teach you how to raise and where to sell. Learn about our new, exclusive 6 to 12 inch African Redworm—in demand everywhere. Free Literature. CARTER WORM RANCH, PLAINS, GEORGIA

Want to pass a U. S.

CIVIL SERVICE TEST?



MEN — WOMEN, 18-55. Thousands of positions open. Prepare NOW for next examinations. Write immediately for free 36-page book, with list of many positions and particulars telling how to prepare. Grade school education often sufficient. Veterans get preference.

FRANKLIN INSTITUTE

(Not Government Controlled)

Dept. A-93, Rochester 4, N. Y.

GET INTO HOME BUILDING AND CONSTRUCTION

MAKE BIG PAY OR START IN BUSINESS

Over 300,000 new jobs open each year. You can earn up to \$4 an hour by remodeling or building homes.

TRAIN AT HOME IN SPARE TIME

Over \$20 billions will be spent this year in home remodeling alone. Five out of every ten homes need repairs or modernization. *Make big money in a better job or a business of your own.* HBTI trains you at home in your spare time. Our new, *Job-Applied method* makes every step easy. Learn every phase from doing the actual work to full-scale contracting.

EASY TO EARN AS YOU TRAIN

Get valuable experience and earn extra cash in your spare time building dormers, stairways, attics, etc. Find out how to earn as you train. *Just mail coupon below. Act today!*

MAIL TODAY - 2 FREE BOOKS

HOME BUILDERS TRAINING INSTITUTE, Dept. HB-119
1400 Greenleaf Ave., Chicago 26, Ill.
Send free Success Book and Sample Lesson. No cost or obligation.

Name _____ Age _____
Address _____
City _____ Zone _____ State _____

"I DOUBLED MY INCOME — Am My Own Boss — in CUSTOM UPHOLSTERY"



Leonard Schroeder, Former Low Paid Accountant—Increases Earnings 110%

"I was an accountant earning a meagre salary before UTS training in upholstery. Upon graduating, I got a much bigger paying job as an upholsterer. Now I've better than doubled my income in my own business."

WHAT DO YOU WANT? Your own Profitable Business—A Steady Job—Substantial Sparetime Earnings—A More Secure Future? They're all Waiting for YOU in the Big-Opportunity Field of Custom Furniture Upholstery.

The big nationwide housing boom has created a great demand for trained upholsterers. Prepare for this well-paid trade—easily, quickly. You can earn as you learn to make good money all year 'round at home, in your own shop, or in a well-paid job. The practical N. Y. State-approved UTS Course teaches you professional custom furniture upholstery, reupholstery, slip-covers, furniture finishing, window cornice, cushion, and drapery making. Course includes—FREE—All tools, complete frames and materials. You make 3 beautiful upholstered pieces, yours to keep or sell.

FREE ILLUSTRATED BOOK — FREE SAMPLE LESSON!

Our FREE book, "YOUR NEW WAY TO A SUCCESSFUL CAREER" with FREE Sample Lesson shows you how. **WRITE TODAY!** Training in N. Y. School also available. UTS, Dept. ES-305, 721 B'way, N. Y. 3.

MATERIALS FREE WITH COURSE YOU MAKE



SLIPPER CHAIR
CLUB CHAIR
OTTOMAN
PLUS SLIP COVERS
Yours to keep or sell

MAIL COUPON TODAY

APPROVED FOR VETERANS

UPHOLSTERY TRADES SCHOOL, Dept. ES-305
721 B'way, N. Y. 3

Please send me FREE book with FREE Sample Lesson. No obligation—no salesman will call.
 Home Study In N.Y. School Training

Name _____ (Please print plainly)
Address _____
City _____ Zone _____ State _____
 Check if Korean Veteran

Profitable Future Now Open to You in WATCH REPAIRING

Train at Home in Spare Time for High Pay or Profitable Business Opportunities

Remarkable Sweazey Plan shows you how to repair Swiss or American Watches. No previous experience necessary. Job Guide program starts you making repairs right away. Survey shows part time watchmakers reported hourly rates up to \$6.00 per hour. Includes training to help you get started in business. Get facts today. Send for colorful **FREE BOOKLET** and **FREE SAMPLE LESSON**. Here is professional training from famous, long established institution. Founded 1908. Write today — no obligation.

CHICAGO SCHOOL OF WATCHMAKING
2330 N. Milwaukee, Dept. 1116, Chicago 47, Illinois

FREE CATALOG & SAMPLE LESSON

BRONZE FOUNDRY

Schools and Home Workshops

Make your own castings of aluminum, copper, bronze, silver. Foundry sets are available in three sizes including 2400 Deg. F. blast Furnaces. \$22.50; \$29.50; and \$42.00. f.o.b. Marysville, Kans. Free Circular.

KANSAS CITY SPECIALTIES CO. P. O. Box 6022, Dept. P-11 MARYSVILLE, KANS.

DRAW The First Day! NO LESSONS! NO TALENT!

New Amazing Invention—"Magic Art Reproducer." You can draw Your Family, Friends, Anything From REAL LIFE—Like An Artist Even if You CAN'T DRAW A Straight Line! Anything you want to draw is automatically seen on any sheet of paper thru the "Magic Art Reproducer." Then easily follow the lines of the "picture image" with a pencil for an original "professional looking" drawing. Also reduces or enlarges. **SEND NO MONEY!** Free Trial Pay Postman on delivery \$1.98 plus postage. Or send only \$1.98 with order and we pay postage. Money Back Guarantee.

NORTON PRODUCTS, Dept. 101, 296 Broadway, N. Y.

RADIO CONTROL YOUR MODEL PLANES BOATS CARS

"CUSTOM MIDGET" RADIO \$9.98
LICENSE FREE BAND
OPERATES SAME AS \$50.00 SETS. INCLUDES LONG RANGE TRANSMITTER RADIO, RECEIVER RADIO AND CONTROL ACTUATOR ALL 3 BUILT ASSEMBLY WITH OUR PARTS AND PLANS \$9.98. PLANS ALONE \$1.

RADIOMODELS BOX 36 DEPT. PM BALTIMORE 6, MARYLAND

DETAILED INFORMATION AND RADIO CATALOGUE 25c
SPECIAL "SUPPLY SOURCE DIRECTORY" & \$7.00 SUPPLY COUPON... \$1.00
BOOK "RADIO CONTROL OF MODEL AIRCRAFT" CONTAINS 14 PLANS \$3.98
RADIO CONTROL GARAGE DOOR DETAILS... \$1.00

BOAT KITS

12 Models as low as \$39.95 (freight included). Fiberglass boat covering kits, marine supplies, etc. Free folders.

Taft Marine Woodcraft
DEPT. PM-11 636-39th Ave. N.E., Minneapolis 21, Minn.

ONLY \$545 (freight included) **FREE FOLDER**



Say You Saw It in POPULAR MECHANICS

RUPTURED

BE FREE FROM TRUSS SLAVERY

Why put up with wearing a gripping chafing unsanitary truss when there is a new modern **NON-SURGICAL** treatment that is designed to permanently correct rupture. Write today for our New **FREE** Book that gives facts that may save you painful and expensive surgery, and tells how non-surgically you may again work, live, play and love and enjoy life in the manner you desire. There is no obligation.

Excelsior Hernia Clinic, Dept. 8305, Excelsior Springs, Mo.

POPULAR MECHANICS



C7

Colorcreting Can Be Your Big Opportunity

Local Colorcretors are Needed Everywhere

Colorcreting is a small investment enterprise, rich in sales potentials, high in income possibilities. Work is easy and fascinating. No experience required; we supply complete instructions.

Colorcreting is a building-beautifying process, with Colorcrete being pneumatically applied to new or old masonry surfaces such as concrete or stucco. Lasts indefinitely — 25 years or more. Easily cleaned. Gleaming white, or a choice of 30 colors.

Colorcrete equipment is compact and portable. Easy to operate and practically wear-proof. Easy-payment terms when desired. Write at once for Opportunity Book.

COLORCRETE Colorcrete Industries, Inc.
570 Ottawa Ave., Holland, Michigan

IN CANADA: DUNN MASONRY MACHINERY LIMITED
1020 Dundas Highway, Cooksville, Ont.

WHEELS WHEELS WHEELS

- 7" Disc Wheel 3/4" Tire 1/2" sleeve.....45c ea.
 - 8" Disc Wheel 1 1/8" Tire 1/2" sleeve.....70c ea.
 - 7" Disc Wheel 1" Tire 1/2" ball bearing.....80c ea.
 - 8" Disc Wheel 1 1/8" Tire 1/2" ball bearing.....\$1.00 ea.
 - 6" Disc Wheel 1.50 semi-pneum. Tire 1/2" B.B.....\$1.35 ea.
 - 8" Disc Wheel 2" semi-pneum. T. 1/2" B.B.....\$1.50 ea.
 - 10" Disc Wheel 1.75 semi-pneum. T. 1/2" B.B.....\$1.50 ea.
 - 10" Disc Wheel 2.75 semi-pneum. Tire 5/8" B.B.....\$3.50 ea.
 - 12" Disc Wheel 1.75 semi-pneum. T. 1/2" B.B.....\$1.85 ea.
- Above wheel prices include hub cap. Plus Postage. C.O.D.'s accepted.
AXLES—Sizes 5/16 in., 3/4 in., 1/2 in.—Cut to size—End holes drilled.

UNITED WHEEL STAMPING CO.
11915 S. MARSHFIELD AVE., PM-11, CHICAGO 43, ILLINOIS

NEW BENJAMIN SUPER CO2 GAS CARBINE—\$15.95*

HI-LO (2 Stage) Jet Power
Cal. .177 or .22
RIFLED
Shoots
Pellets
& Darts

Illustrated—Deluxe Model Benjamin Super CO2 Carbine Gas Rifle with Custom Stock—\$18.95
IDEAL FOR TARGET AND SMALL GAME SAFE—ECONOMICAL—ACCURATE

CONVENIENT—PRACTICAL—NON TOXIC. EASY TO OPERATE—NO PUMPING—NO FLINCHING.
Get 40 SHOTS from each 10¢ STANDARD SIZE CO2 (Soda) CARTRIDGE. Up to 3/4" Penetration. Ask your Dealer for Demonstration.
*Same as Model Pictured above except with Regular Stock.

BENJAMIN AIR RIFLE CO., 896 MARION ST., ST. LOUIS 4, MO., U.S.A.

Say You Saw It in POPULAR MECHANICS

don't envy TALL men ...be one!



Stop having to look UP to tall men. Be almost 2 INCHES TALLER yourself, instantly—in "ELEVATORS" amazing height-increasing shoes. Handsome as other shoes, they are fashioned so

only you know you're wearing them. Everyone notices the improvement.



For FREE Booklet and Dealer's name write to: STONE-TARLOW CO., INC., DEPT. PM-11, BROCKTON 68, MASS.

SAM HANKS, famous race driver-mechanic says: "I'd like a NATIONAL SCHOOLS trained mechanic on my crew ... any employer would!"

Sam Hanks holds American Closed Course record (182.5 M.P.H.); also many state and national racing titles. At Indianapolis he was 2nd last year, 3rd in '52 and '53.

MASTER ALL ENGINES AT HOME IN YOUR SPARE TIME NATIONAL SCHOOLS AUTO MECHANICS & DIESEL COURSE INCLUDING FUEL INJECTION

YOU GET AND KEEP ALL THIS EQUIPMENT



Complete set of professional Tools and All-Metal Tool Box. Same top-quality equipment used by expert mechanics everywhere. Use them, display them proudly.



"Motor Analyzing Set" contains Standard Engine Vacuum Fuel Pump Tester, Remote Starter Switch, Modern Timing Light, Standard Compression Tester. Plus compact carrying case & instructions.



Top-quality Socket Wrench with Fittings. Real professional tools you'll use during your lifetime career in repairing, all types of engines, from foreign cars to big diesel jobs.

"I've worked alongside National Schools-trained mechanics," reports Sam Hanks. "They're tops, because they get all-around training, and they know how to repair fast and right the first time. No wonder National Schools graduates command top pay."

Earn as you learn men! We'll show you how. Streamlined lessons, diagrams, manuals, latest equipment, practical methods prepare you for hundreds of jobs in scores of industries. Free Placement Assistance. Send coupon now.

FREE! VALUABLE BOOK & SAMPLE LESSON JUST SEND COUPON

Approved for GI Training.

NATIONAL SCHOOLS

Los Angeles 37, California
CANADA: 811 W. Hastings St., Vancouver, B. C.

NATIONAL SCHOOLS

TECHNICAL TRADE TRAINING SINCE 1903
LOS ANGELES 37, CALIFORNIA

NATIONAL SCHOOLS, Dept DB-116
MAIL NOW TO OFFICE NEAREST YOU

4000 S. FIGUEROA ST. OR 187 N. LA SALLE ST.
LOS ANGELES 37, CALIF. OR CHICAGO 1, ILL.

Send for FREE Auto-Diesel Opportunity Book and Sample Lesson.

NAME _____ AGE _____
ADDRESS _____
CITY _____ ZONE _____ STATE _____

Check if interested ONLY in Resident Training at Los Angeles.
VETERANS: Give date of Discharge _____

HOW TO GROW ORCHIDS IN YOUR OWN HOME!

NO GREENHOUSE NEEDED

- ANY CLIMATE - MAINE TO CALIFORNIA ...

YEAR 'ROUND!

BIG PROFITS SPARE OR FULL TIME



"Very pleased with Schirmer's Course. It contains so much information..."
James Costa - OHIO

Fill your home with gorgeous Orchids. Huge purple Cattleyas, exquisite Cymbidiums - dozens of others! Many grow without soil, getting food from the air. White Orchids, yellows, greens, every rainbow color. No equipment needed. Start on table or window ledge.

SUCCESSFUL HOME GROWER SHOWS YOU HOW! Complete instructions show you step-by-step how he and his wife started with a few plants and developed a big-profit home-business - grew an Orchid collection now worth a fortune. Learn how orchids multiply, how one plant may become many, each as valuable as the first. No big investment or overhead. Takes but a few minutes a week.

Big-profit orders for plants and flowers come from individuals, florists, hotels, clubs, etc. Year 'round gift. Millions sold by Mail-Order.



Orchids have rewarded me richly - thanks to Tropical Flowerland.
L. V. SMART - Colorado

COMPLETE INSTRUCTIONS AND BLOOMING-SIZE ORCHID PLANT MAY BE EXAMINED IN YOUR HOME - NO OBLIGATION TO BUY A THING! Secrets of the experts in simple language, jam-packed with "show-how" drawings, magnificent full-color pictures of Orchids. Send No Money. Write NOW for your FREE FACTS that show you how to learn to grow Orchids at home. Airmail is quicker.

TROPICAL FLOWERLAND, Dept. 31N

100 So. Vermont Ave., Los Angeles 4, Calif.

Multi-Million Dollar Business Now Being Split Up Among Home Operators in Small Communities

Inexpensive Table Top Machine Pays Profits UP TO \$9.20 AN HOUR

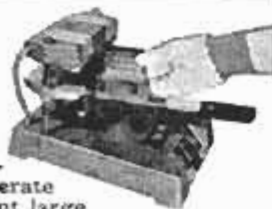

The multi-million dollar Rubber Stamp Business is now being taken over by small home operators throughout the U.S. Men and Women who operate this inexpensive machine can turn out large numbers of Rubber Stamps with special wording of all kinds. Material costing only 27c makes a stamp that sells for \$1.80. The machine is easy for anyone to operate. It molds as many as six Rubber Stamps at a time, each with different wording such as names, addresses, notices, stock numbers, prices and other 'copy' needed by offices, factories and individuals. At full capacity, it can earn as much as \$9.20 an hour for the operator! You don't need experience to get into this big profit business at home. We supply everything, including complete instructions and eight ways to get orders for stamps coming in fast. Start making up to \$9.20 in one hour right away. We'll mail full particulars FREE and no salesman will call. Be first in your locality. Rush coupon.

RUBBER STAMP DIV., 1512 Jarvis Ave., Dept. R-211, Chicago 26, Ill.

RUBBER STAMP DIV., Dept. R-211 FREE!
1512 Jarvis Ave., Chicago 26, Ill.

Please mail all facts showing how I can get started in the profitable Rubber Stamp business at home in spare time. Everything you mail me is FREE and no salesman will call.

NAME _____

ADDRESS _____

CITY _____ Zone _____ STATE _____



100X Area Magnifying Projector

- Enlarges Pictures, Printing, & Objects - Full Color!

NEW! Electric Magna-Vue Optical Instrument projects & enlarges clippings, pictures, sketches, objects in full natural color, correctly & readable. Project on wall, screen or table. **MAGNIFIES 100 AREAS.** Enlarges any material up to 3 1/2 x 4 in. to 32 x 40 in. For home, school, class, business, shop use. Also make signs, sketches easy from any copy. Enamelled steel, 10x7 1/2 in. high. Quality 2" focusing lens. Operates on standard 110 volt current. Money back \$4.98 guarantee. Price Postpaid.

JOHNSON SMITH CO., Dept. 399, Detroit 7, Mich.

Catalog of 3100 Novelties 10c

Send 10c for amazing catalog of novelties, live animals, scientific supplies, hobbies, funmakers, planes & boats, looms, magic tricks, joke articles, unusual seeds, gadget timesavers, cameras, optical goods, projectors, movies, lucky jewelry, religious novelties, disguises, musical instruments, stamps, coins, puzzles, fortune tellers, radios, auto & bike accessories, telescopes, magnifiers, compasses, banks, smokers' gadgets, artists' supplies, printing sets, engines, motors, shockers, knives, billfolds, guns, rifles, sports, books, games, plants, etc. Send 10c (3 for 25c - get for friends!).

JOHNSON SMITH & CO. Dept. 399 Detroit 7, Michigan

CONCRETE BLOCK HOME PLANS

\$1900 DUPLEX



Build your own 24'x36' duplex complete with central heating for \$1900. Easy to follow plans drawn especially for amateurs. No block cutting necessary. Slab floor, rock wool insulated, forced warm air heating - 75,000 BTU furnace and prefabricated system available at tremendous saving. Each side contains 11'x17' living room and kitchenette, 10'x11' bedroom, 6'x9' bath, and five closets. Genuine blueprints, scale 1/4" = 1'.

Instructions, and material cost list, \$2.00 ppd. \$1150 GARAGE APARTMENT, 22'x24', Liv. room, kit, two bedrooms and bath. Double garage below. Plan \$1.00. \$2500 RANCH HOME, 25'x48', Liv. room, kit, bath, two bedrooms, den with fireplace, utility room, garage, central heating. Plans \$2.00. Quality assured by money back guarantee.

MEMBER ARKANSAS HOME BUILDERS ASSOC. BAILEY BUILDERS 7608 Harmon Drive Little Rock, Ark.

Own Your Own Business \$10,000 A YEAR!



Largest radiator-servicing equipment mfr. will help you set up RADIATOR SERVICING shop. Give free factory training, consultation service. 1,065 shops now operating. America's fastest growing automotive business. Inland national advertising helps keep 'em busy - many make \$10,000-\$15,000 a year. After small down payment income soon pays for equipment. Write for FREE folder. "Want a business of your own?"

INLAND MFG. CO., Dept. PM11, 1108 Jackson St., Omaha 2, Nebr.



SURPLUS SALE

\$39.50 NEW TOOL POST GRINDERS REGULAR PRICE \$125.00

Less Grinding Wheel 1-6 H.P. MOTOR TAKES WHEELS UP TO 4 1/2" x 4" EXTRA QUILL INTERNAL OR INTERNAL \$19.50

MONEY BACK GUARANTEE

EDWARD J. NOLAN, PULASKI, NEW YORK

new catalog for the handyman

GET THIS 100 PAGE CATALOG TODAY

Bigger than ever - expanded sections with information and illustrations on new supplies, new projects and unusual products that make interesting items easier to make. Big sections on plans, hardwood, plywood, veneers, furniture trim, cabinet hardware, lamp parts, finishing material, many others.

Enclose 25c to cover cost of postage and handling which will be refunded with your first order.

Minnesota Woodworkers Supply Co., Dept M-1 1713 Olson Highway, Minneapolis 5, Minnesota



**Do YOU Want to Qualify for
A BETTER JOB AT BIGGER PAY?**



CLIMB TO SUCCESS!

in Spare Time at Home

• Jobs are calling—calling to those who want more responsible jobs, in bigger pay brackets, with increasing chances for promotion—and who have the ambition to devote some of their spare time to acquiring necessary knowledge and skill. As little as just a few hours a week, in time you can easily spare, can produce surprising results in lifting you up to higher and higher levels of employment, income and security—even eventually to management positions or a business of your own. In the coupon below are listed some of the large number of training opportunities offered by AMERICAN SCHOOL—now in its 59th year. Check the one that interests you most and fill in your name and address. Or if you prefer some other career, write the subject in the margin. Then mail the coupon without delay.

—FULL INFORMATION...NO COST...NO OBLIGATION—

AMERICAN SCHOOL, Dept. G845, Drexel at 58th, Chicago 37, Ill.

Without obligation, please send FREE and postpaid, full particulars about the subject checked below.

- | | | |
|--|---|---|
| <input type="checkbox"/> Accounting | <input type="checkbox"/> Contracting | <input type="checkbox"/> Mechanical Engineering |
| <input type="checkbox"/> Apprenticeship Courses | <input type="checkbox"/> Diesel Technician | <input type="checkbox"/> Mechanical Technology |
| <input type="checkbox"/> Architecture & Building | <input type="checkbox"/> Drafting—Building Trades | <input type="checkbox"/> Metalworking Courses |
| <input type="checkbox"/> Automotive Technician | <input type="checkbox"/> Drafting—Machine Trades | <input type="checkbox"/> Plumbing—Practical |
| <input type="checkbox"/> Better Foremanship | <input type="checkbox"/> Electrical Engineering | <input type="checkbox"/> Private Secretary |
| <input type="checkbox"/> Blueprint Reading | <input type="checkbox"/> Electricity—Practical | <input type="checkbox"/> Retail Merchandising |
| <input type="checkbox"/> Bookkeeping | <input type="checkbox"/> Electronics—Industrial | <input type="checkbox"/> Salesmanship—Outside |
| <input type="checkbox"/> Business Management | <input type="checkbox"/> HIGH SCHOOL COURSES | <input type="checkbox"/> Sheet Metal Work |
| <input type="checkbox"/> Civil Engineering | <input type="checkbox"/> Machinists | <input type="checkbox"/> Tool Making |

Name _____ Occupation _____

Home Address _____ Age _____

City _____ State _____

Canadians: Write American School, Dept. G845, 6083 Sherbrooke St. W. Montreal

Also Eshelman
TRACTORS.
Riding ROTARY
MOWERS.
ROTARY
TILLERS
at amazing
savings.

ESHELMAN TWO PASS CHILD'S AUTO MODEL 2HP

50 MILES PER GALLON GAS
UP TO 15 MILES PER HOUR

STURDY, SAFE "Commended by Parents' Mag." Also 2 Pass. Adult Sport and Golf Cars at a small fraction of the cost of most other cars. Write for Free Literature and Rider Agent Plan. Dept. MC-511, ESHELMAN CO., 109 Light Street, Balto. 2, Md.

Shipping Points: BALTIMORE - CHICAGO - RENO

HEAVY OILIPH-BALL BEARINGS PUMPS MILLIONS OF GALS.

695 **CELLAR & SUMP DRAIN** 2800 G.P.H. Pump, Stand, Legs, Coupling, Hardware. **\$11.45**

IRRIGATE, SPRAY, DRAIN OR FILL ANYTHING—ANYWHERE! Will not Rust—Clog—or Leak. Patented Seal. Pumps 2800 gph, 420 gph at 75' high or 1600 gph from 25' well. Six blade impeller. Threaded for pipe. 3/4" inlet, 1/2" outlet. Use 1/4 to 3/4 hp motor. . . . 7500 gph 8.95 Heavier 11.95

Check MO or COI—Lifetime Trade Guarantee
FREE Literature—Comparison Charts

U. A. T. ENG. & MFG. CO. HICKSVILLE, NEW YORK

LEARN MEAT CUTTING AT NATIONAL

Pay After Graduation



The steady dependable trade of Meat Cutting taught easily in 8 short weeks. YOU LEARN BY DOING under actual meat market conditions in big modern school at Toledo.

For beginners or men with experience. Get a profitable store of your own. Remember, PEOPLE MUST EAT! Big pay jobs. Free employment help. Thousands of successful graduates.

Buying, cutting, percentage, pricing, advertising, selling, etc. A complete retail meat education. National School established 33 years. Get National training NOW. Pay your tuition in easy weekly payments

after you graduate. Send coupon for FREE 52 page school catalog — TODAY. G.I. approved.

National School of Meat Cutting, Inc., Dept. 50-K, Toledo 4, Ohio

Send me your FREE school catalog on National Training at Toledo in Meat Cutting, Meat Merchandising and Self Service Meats. No obligation. No salesman will call.

Name _____ Age _____

Address _____

City _____ State _____

Approved for training Korean Veterans

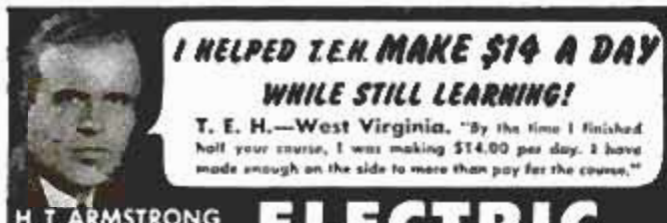

**I HELPED T.E.H. MAKE \$14 A DAY
WHILE STILL LEARNING!**

T. E. H.—West Virginia. "By the time I finished half your course, I was making \$14.00 per day. I have made enough on the side to more than pay for the course."

H. T. ARMSTRONG

Learn **ELECTRIC APPLIANCE** REPAIR & SERVICE

WE TEACH:

How to Repair
Washing Machines
Vacuum Cleaners
Electric Ranges
Lamps, Motors,
Irons, etc.,

REFRIGERATION
and
House Wiring
At Home
In Your
Spare Time!

For a man handy with tools, and happiest when working with his hands, OPPORTUNITY is Wide Open Today in this great and growing field. Everyone is a customer for the man trained to service electric appliances.

Open Your Own Shop

Our practical Home Course teaches you this business from A to Z—preparing you to take a well paid job or open your own shop. You can actually start in your basement or garage with the tools we send you . . . before finishing.

We
Include An
**ELECTRICAL
APPLIANCE
TESTER**

A Big Kit of Tools
at NO EXTRA
COST

MAIL THIS COUPON for FREE BOOK

H. T. ARMSTRONG
PACIFIC TRAINING SCHOOLS Dept. P-5611
11029 S. Vermont, Los Angeles 44

Dear Sirs: Please send me, without obligation, your free booklet and complete details.

Name _____
Address _____
City _____ Zone _____ State _____

Do you work all day with
COLD FEET?

NOW,
at last, a new,
modern, low
priced electric
foot warmer
that will keep
you healthy,
happy and
comfortable



Help prevent colds with...
ELECTRO MAT

Check stand cashiers, secretaries, assembly line workers, housewives, office workers, theatre cashiers, machine operators, telephone operators, and many others throughout the country are now singing the praises of the Electro Mat. There is no further need to work all day with cold feet. Many colds, causing absenteeism and irritability, can be directly traced to cold feet. **Safe and Economical**

Size 14" x 21"
light-weight
portable

Consumes less
power than a 75
watt light bulb.
Mail your check
or money order
today for **ONLY**

\$7.95

Delivered

PETERSON RUBBER MAT CO.
5508 N. Halifax Arcadia, California

Please send me ___ Electro Mats at \$7.95 each
IMMEDIATE SAVING.

If 6 or more ordered, price is only \$6.95 each.

C.O.D. Enclose \$1.00 deposit with order.
 Prepaid

Name _____
Address _____
City _____ State _____

PLEASE PRINT CLEARLY



PLASTIC SANDWICHES

MAKE \$18.00 AN HOUR
with the new **PLASTIC SANDWICH MACHINE**

This new remarkable **PLASTIC SANDWICH MACHINE** does a permanent, beautiful, professional, protective lamination job in exactly four minutes' time! Amazing earnings possible in your own studio permanently sandwiching **PHOTOS** and **CARDS** of all kinds, clippings, etc., between sheets of clear plastic. Sandwiching machines from \$35.00 up. Rush name for **FREE** sample & illustrated literature.

PLASTICAST CO.

6612 N. Clark

Dept. LM-701

Chicago 26, Ill.

**ENGINEERING
DEGREE IN
27 MONTHS**

B. S. Degree, Aero., Chem., Civil, Elec., Mech., & Electronic Engr. (inc. Radio & TV), B.S. degree in 36 mo. in Math., Chem., Physics, Prep. courses. Low rate. Earn board. Large industrial center. Students from 48 states, 21 countries. Demand for grads. G.I. appr. Enter Dec., March, June, Sept. Catalog. 1611 E. Washington Boulevard Fort Wayne 2, Indiana

INDIANA TECHNICAL COLLEGE



SAVE 50% - Sturdy Steel Shelving

Buy Direct from the Factory
Home • Office • Industry
Adjustable • Will Hold 2,000 Lbs.
LAST CAPACITY AS LISTED
Cost 1/2 as much as wood

Strong, practical, fireproof, portable, 75" high, 36" wide, 12" deep—complete with 4 uprights, 3 shelves, braces, bolts—ready to assemble yourself, in minutes. Money-back guarantee. Shipping weight 50 lbs. 18" Shelf Units, \$12.88

RELIABLE Mfg. Dist., Dept. PM-11 8000 E. Wash. St., Indianapolis 10, Ind.

SALESMEN WANTED

Earnings \$5000 to \$8000 per year, calling on hardware stores and lumber yards, selling and installing Popular Mechanics show windows. No window trimming experience necessary (we train you) but selling experience essential. Must have automobile. Average territory consists of about 5 counties. Salesmen have exclusive territory. Home every night.

Not a get rich quick scheme but steady dignified work by which a skilled, industrious salesman can earn a good living. This company, in cooperation with Popular Mechanics and the leading manufacturers of tools, equipment and materials, offers retailers traffic-stopping window displays to retail hardware stores and lumber yards at a nominal cost. All equipment furnished. Endorsed by many retailers, jobbers and manufacturers. Much repeat business. Extras offer additional earning opportunity. Desirable but not necessary to have knowledge of hardware and lumber lines. Personal training given.

For details write, giving all the facts about yourself. If your letter indicates that you might qualify, an appointment will be made for an interview.

WINDOW DISPLAYS, INC.

1580 SHERMAN AVENUE

EVANSTON, ILLINOIS

133 PIECE SURPLUS \$2 POWER TOOL SET



Brand New—U. S. Gov't Surplus
Once in a Lifetime Bargain on Power
Tool Accessory Set.
Guaranteed \$11.00 Retail Value—
Now Yours for only \$2.00.
A must for every homeowner,
hobbyist, craftsman and carpenter.

12½ Million Tools—Less Than 2 Cents Each

Now the famous Blue Steel Tool Co. can make this fabulous offer because they just bought out an entire U. S. Gov't. Surplus warehouse—12½ million tools in all. Every single piece is absolutely and completely guaranteed to be of the first professional and industrial quality. If bought separately would cost you at least \$11.00. But now yours for only \$2.00, less than 2 cents apiece.

You can use this U. S. Gov't. surplus bargain 133 tool set with any electrical drill... any flexible shaft... any grinder. And here's what you get in this guaranteed \$11.00 retail value... for only \$2.00. Grinding wheels—sanding cartridges and discs—steel cutters—mandrels—burnisher—mounted stones—knife edge rubber wheels, etc.

You'll find thousands of uses for this set around the house, for home repairs, hobby work, tool-shop work, wood, metal and plastic hobby work. You'll use it for sanding, grinding, buffing, polishing, carving, burnishing, etching, milling, cleaning, cutting off, hole cleaning, deburring and hundreds of other jobs.

You must order now to make sure you get this tool bargain of a lifetime.
Send \$2.00 and 25c for postage and handling for one 133 piece set—\$4.00 for (2) 133 piece sets or \$6.00 for (3) 133 piece sets.

Because of the large number of tools we must ask for 25c for postage and handling on all one set orders. We absorb these costs on 2 or 3 tool set orders.
You will refund us money if I am not satisfied.

BLUE STEEL TOOL CO., DEPT. HR-5, HARTSDALE, N. Y.

Children's KNOCKDOWN PLATFORM ROCKERS

Springs, Duran, Lumber, etc. 100% parts. Make this for Christmas. Matching ottoman \$1.00 each, both p.p. Send check or money order to



\$6.75 Each

CARPENTER FURNITURE CO.,
P.O. BOX 3173 BIRMINGHAM, ALABAMA

GLUE INJECTOR



Make loose furniture joints good as new with this pocket-size, all metal glue injector. Complete with fine tool-steel drill. Directions included. Repairs tables, chairs, toys, etc. without disassembly. Dozens of uses.
\$2.00 ppd. Money-back guarantee
DRUMCLIFF CO., DEPT. M-40, TOWSON 4, Md.

Say You Saw It in Popular Mechanics



DON'T SWAP SAFETY FOR "DISCOUNTS"

Cheaper PRICED Tires are Cheaper GRADE Tires

FREE This pictured Tire Ash Tray given with 2 or more tires

We always try to ship your favorite brand (Not Recaps)
GOOD YEAR Goodrich, U. S. General, Firestone & others, worn slightly.

12 MO. GUARANTEE I replace FAST any defective tire, frt. excl.

600-16	\$5.78	670-15	\$5.68	700-20	\$8.98	600-16(6)	\$5.68
650-16	6.18	710-15	5.88	750-20	9.88	650-16(6)	6.48
700-16	6.28	760-15	5.88	825-20	16.58	700-16(6)	7.08
640-15	5.68	800-15	6.18	900-20	15.58	700-16(6)	7.88
700-15	5.48	820-15	6.18	1000-20	17.28	750-16	7.58
W.W. \$1. Extra		700-17	9.98	1100-20	17.28	750-17	12.98

SUBURBANITE SNOW & others, Mud-Grip, Retreaded & Slightly used. 12 Mo. Guarantee **\$6.66** any car
If you do not want the free tube — **TAKE \$1 OFF** each tire ordered!

900-16 MIL. MUD-GRIP, Guar. 12 MOS. \$13.39
Send Ck. or M.O. & Ad for fast shipment. F.O.B. Phila. I select your tires as if my future depended on it!

MARVIN BLATT 6th & Spring Garden Philadelphia, Pa. **CO. ADJUSTED TIRES. LIFETIME GUARANTEE \$7.95** WHITE WALLS any \$1. Ext.

DIESEL MECHANICS IN DEMAND

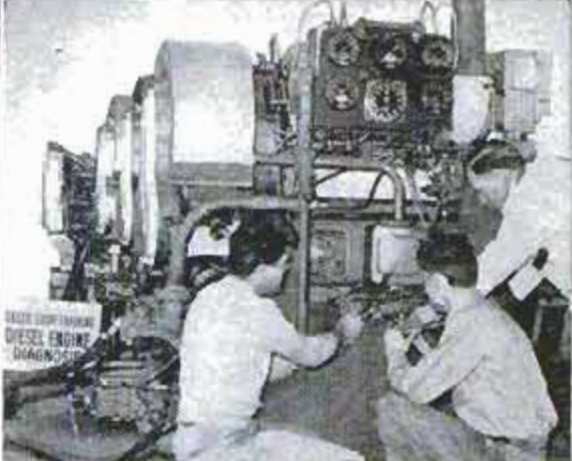

Learn to earn big pay in DIESEL in our large, modern equipped Chicago school and shop. No previous experience or training necessary. We help you find living quarters and part time job while in school. Complete, practical courses taught in the following trades, under the supervision of experienced, expert technicians.

APPROVED FOR CIVILIANS OR GI'S

— CHOOSE YOUR TRADE —

CHECK HERE	WEEKS
<input type="checkbox"/> DIESEL MECHANICS	20
<input type="checkbox"/> AUTO MECHANICS	20
<input type="checkbox"/> BODY & FENDER	16½
<input type="checkbox"/> GAS-ARC WELDING	4 - 12
<input type="checkbox"/> REFRIGERATION	13½
<input type="checkbox"/> AIR CONDITIONING	8½
<input type="checkbox"/> MACHINIST TRADE	30
<input type="checkbox"/> ADVANCED MACHINIST (includes tool & die)	32½
<input type="checkbox"/> PIANO TUNING & REPAIR	36

CHOOSE YOUR ENGINEERING COURSE

These courses are intended as terminal education for men who wish to enter the Diesel-Automotive and Refrigeration-Air Conditioning fields as technicians. These courses are designed to prepare men for supervisory positions. Students with a high school education, or equivalent, will be accepted.

<input type="checkbox"/> DIESEL AUTOMOTIVE ENGINEERING	2 years
<input type="checkbox"/> REFRIGERATION & AIR COND. ENGINEERING	18 months

FREE EMPLOYMENT HELP

Start your career with Greer by checking your interest above and mail coupon for complete information at no obligation.

NAME _____ AGE _____
STREET _____
TOWN _____ ZONE _____ STATE _____

Established 1902 — Over 50,000 Graduates.
54 years of continuous trade school experience to guide your training.

GREER SHOP TRAINING
Box K, 2236 S. Michigan Ave.
Chicago 16, Illinois



20 YEARS OLD!

He's already an

ELECTRONICS ENGINEERING DESIGNER

Out of high school just 2 years ago, this young man has already started a fascinating, highly rewarding career in electronics engineering. No matter whether you are now 18 years old—or 28—a 26-month Embry-Riddle education will prepare you for a quick start in this lucrative professional field.

Electronics Engineering Design course concentrates on essential technical studies and practical projects. With the aid of top flight Embry-Riddle instructors you'll master many absorbing fundamentals—Microwaves and Radar, Servomechanisms, Industrial Electronics and Television, to mention a few of the subjects.

The demand for trained engineers is greater than the supply—and will be for years! So take the first step now—mail this coupon. And remember, study and play in Miami's perfect year-round climate is stimulating and exciting.

FOUNDED 1926



Training Authorized under G.I. Bills

Embry-Riddle International
SCHOOL OF AVIATION
MAIL THIS COUPON TODAY

DEAN OF ADMISSIONS, Dept. 99
Embry-Riddle School of Aviation, Miami 30, Florida
Without obligation, please send FREE and postpaid full particulars.

- ELECTRONICS ENGINEERING DESIGN
 AERONAUTICAL ENGINEERING DESIGN

Name..... Age.....

Address.....

City..... State.....

I am a (check one) Veteran Non-Veteran

You Can Depend On STRONGER Yet SAFER ANACIN to relieve PAIN

Won't Upset The Stomach

Anacin® not only gives stronger, faster relief from pain of headache, neuritis and neuralgia—but is also safer. Won't upset the stomach and has no bad effects. You see, Anacin is like a doctor's prescription. That is, Anacin contains not just one but a combination of medically proven, active ingredients. Scientific research has proved no single drug can give such strong yet such safe relief as Anacin. Buy Anacin Tablets today!



FIX home & car APPLIANCES YOURSELF

NEW! **EICO® REDI-TESTER**
KIT \$12.95 Factory-wired \$15.95

Multi-range ac/dc voltmeter, ammeter, ohmmeter, wattmeter, leakage checker. Locates defects in appliances, air-conditioning, furnace control, TV, radio, car batteries, generators, etc. Easy step-by-step instruction book. Send Check or M.O., specify Kit or Wired. Or write for neighborhood distributor's name & FREE catalog P23-11 describing EICO's 50 professional kits & instruments.

Electronic Instrument Co., Inc., 84 Withers St., Bklyn 11, N. Y.



make your own *Gems* 3250

The Gem Maker comes complete with all necessary equipment, including a super-charged diamond blade for sawing, and all wheels for grinding, shaping and polishing; also complete instructions. The complete equipment as shown, less motor and belt, for only \$32.50, r.o.b., Burlington, Wisconsin. Write today for information and literature.

B & I MANUFACTURING CO.
Dept. P, Burlington, Wis.

ARTHRITIS—RHEUMATISM VITAL FACTS EXPLAINED

FREE DESCRIPTIVE BOOK

How crippling deformities may be avoided. This amazing FREE BOOK explains why ordinary methods give only temporary relief—if that. Describes a drugless method of treatment successfully applied in thousands of cases. Write for this 36-page FREE BOOK today. No obligation.
BALL CLINIC, DEPT. 756, EXCELSIOR SPRINGS, MO.

Build a MOLDED PLYWOOD RUNABOUT With This Complete Kit...



by America's largest maker
of molded plywood hulls

Save 75% construction time. Molded plywood hull has strength of steel of same weight... assured precision fit... no complex forms to erect... no framing... no planking. Pre-cut all mahogany parts mean factory built appearance inside and out.

Cruiser semi-kits also available.

See your dealer or write
for information to



U. S. MOLDED SHAPES, INC.

651 Market St. S.W.

Grand Rapids 2, Michigan

WORLD'S
BEST
WANT-AD
MEDIUM

CLASSIFIED ADVERTISEMENTS



Advertisements in this section \$1.25 per word, each insertion, minimum 10 words, payable in advance.

To be inserted under proper classification, copy must be in our office the 20th of the second month preceding date of issue

F. W. Johnson, Manager, Classified Advertising

Popular Mechanics Magazine, 200 East Ontario Street, Chicago 11, Illinois

YOU'LL PROFIT

By reading and answering the classified ads in this section. Hundreds of opportunities for you to make and save money

AUTOMOBILES, MIDGET CARS

BUY Surplus jeeps, trucks; direct from government. List \$1.00. Box 1842AY, Hartford 1, Connecticut.

NON-Profit organization offers automobile literature—Old, new and foreign; dealer books; service manuals, glossy photographs; free motor magazines. Write today; get on free mailing list. Auto Maniacs, Stockbridge, Mich.

NEW 1957 Automobiles—Up to 25% off retail prices. Meder, 550-PM Fifth Avenue, New York City 36.

CROSLY Parts and accessories. Van's Sales & Service, Midlothian, Illinois.

BUILD Midget auto, drawings, pictures, parts list \$1.00. Lee's Midget Autos, Avila-Beach, California.

AUTO SUPPLIES AND EQUIPMENT

FORD T and A parts? Try best source old car parts anywhere. Wisneski, Milwaukee 7, Wis.

JEEP Tops, American-foreign convertible tops. Free catalogue. Mor-Nan, Box 123, Boston 14, Mass.

NEW 1909-1934 Ford parts. Free catalog. Huber, 15 Emerson, Clifton, New Jersey.

TIRES, First line. 50% off. Road hazard guarantee. Free catalog. Atco, 400 Boulevard, New Haven, Conn.

FREE Information. Garage door operator made with your motor. Best Tools, Inc., Box 92, Berwyn, Illinois.

SAVE Money on jeep and army truck parts. Large inventory. Catalogs for jeep or GMC. American Auto Parts Co., 1830-PM Locust, Kansas City, Mo.

AMAZING Bargain offer! The famous General Electric auto engine heater for cars, trucks, tractors, assures incredibly fast, easy starts at sub-zero temperatures. Listed \$8.95—Our extra-special only \$3.95, postpaid, prompt shipment. Dealers, agents wanted. First order brings you sensational 500% profit plan. Hurry, secure your territory! "GE Engine Heater Sales," Milwaukee 7, Wisconsin.

TIRES At tremendous savings. Tractor, grader, truck, aircraft, army surplus, and passenger. Send for free catalogue. Duddy's, 152 N. Beacon St., Boston 35, Massachusetts.

AUTO Accessory and parts catalog. 1956 edition—all new! 180 pages. Save up to 50%. Over 75,000 items, including Hollywood accessories, hi-speed equipment, rebuilt engines, all parts and accessories for all cars and trucks! Hard-to-get parts! Send 25¢ (refundable). J. C. Whitney, 1919-PM Archer, Chicago 16, Ill.

TIRE Bargains! Fantastic savings on famous brands—New and used snow treads, regular passengers, trucks, militarys. Guaranteed! Fast delivery! Free list of prices, sizes. Belmont, 1001-PM Spring Garden, Philadelphia 23, Penna.

FREE! New catalog. Speed, power, mileage increasing equipment. Discounts! **Almquist Engineering**, Milford PM5, Penna.

MOTORIST Save gasoline. Vacumatic overrich mixtures. For free particulars, how to install on your car for introducing write, Vacumatic, Dept. 864, Wauwatosa, Wis. Salesmen wanted.

JEEP Owners—V8 power. Read Jeep owners ad, page 30.

LATEST Custom accessories. Items not in stores. New low prices. Continental tire kits, push-button doors, trunks, etc. New illustrated catalog, biggest ever, 25c. Eastern Auto, 3319-A South Grand, Los Angeles 7, California.

GAS Mileage: Three simple ways to improve your cars' fuel economy, \$1.00. Mileage, P.O. Box 781, Minneapolis, Minn.

NEW And used parts at savings. Complete guaranteed parts service for all models cars and trucks—1924 and later. Largest in the West. Army parts specialists. No catalog. Submit your needs for quotations. Fast mail order service. Pioneer Auto and Truck Parts Co., 734 W. 13th Ave., Denver, Colorado.

CAR Burning oil? Losing compression? Try Clifford's Compression Seal. Tube, \$2 postpaid. Clifford's Engineering, 452 Claim, Aurora, Illinois.

PISTONS. Olds 4" plus. Chevrolet 3 7/8". deflector top. \$41.00 a set. Dempsey Wilson Camshaft Co., 4667 Rosecrans, Hawthorne, Calif.

AUTO TRAILERS

EXCEPTIONAL Expanding eight foot trailer. Accommodates family of five. Build yourself. Literature 10¢. Framar Company, Wilmington, Mass.

CAMP Trailer, collapsible, sleeps 4, easily constructed. Plans \$1.00 complete. Mussnug, Box 74, Bethel, Connecticut.

MOTORCYCLES, BICYCLES, MOTORSCOOTERS AND SUPPLIES

MOTORCYCLE Equipment service. bulletins. 10¢. Wichita Cycle Co., 813 Ohio, Wichita Falls, Texas. Our 31st year.

SMITH Motorwheel midget car \$45; three wheeled motorscooter \$25; Doodlebug \$20; 3 h.p. engine \$4. Cushman \$12.50. Powell motorcycle less engine \$20. (Mail-order only). Send 25¢ (35¢ for first class mailing) for directory-catalogue Number 74, just out, listing these and hundreds of other bargains in new and used midget cars, motorscooters, homebuilders parts, plans, etc. Midget Motors Directory, Athens, Ohio.

BICYCLE Supplies. Substantial savings. Free delivery. Attleboro Cycle, Attleboro, Massachusetts.

PARTS For Cushman, Doodle-Bug, Salisbury, etc. Send make, model, 25¢ for price list. Motor Scooter Parts Co., Dept. P10, Box 7211, Indianapolis 1, Indiana.

RECONDITIONED Motorcycles and motors. Chromium accessories. Complete stock Indian parts. Expert rebuilding. Fast service. Indian Motorcycle Sales, Kansas City 27, Missouri.

HARLEY-Davidsons—Used bargains, shipped prepaid. New, used parts, accessories for current and obsolete models. Bulletin, catalog 25c. Knuth's (factory dealer), 2491 Pond du Lac, Milwaukee, Wis.

AVIATION

HELICOPTERS—1 And 3 man. Aviation marvels. Construct own. Plans \$3.50, \$6.50 respectively. Amalgamated Helicopter, Box 384 Windsor, Ont., Canada.

AVIATION Jobs—Companies to contact. Airlines, feeder lines, corporation aircraft, crop dusters, etc. Guaranteed reports. \$2.00. Aviation Division, Suite 206-PMA, Brown Building, St. Louis 5, Missouri.

AVIATION Surplus bargain catalogue. One dime. Box 22PM, Thomasville, Penna.

PROPELLERS. Plans, supplies by world's oldest and largest manufacturer of special design airboat and snowplane propellers. Latest designs. Prompt delivery. Satisfaction guaranteed. 48 page catalog 25¢. Banks-Maxwell, Box 3301E, Ft. Worth 5, Texas.

BATTERIES, GENERATORS

EDISON Nickel storage batteries. Any voltage, any amperage. Unconditionally guaranteed. Power plants, generators, motors. Literature. Hawley Smith Co., Croton Falls 1, N. Y.

ELECTRICAL SUPPLIES

RECTIFIER Changes 115 volts a.c. to 12 volts 2 1/2 amps d.c. Operates model trains, charges batteries, electroplates. Circular. Ready to use \$6.95 postpaid. Addem Products, Box 876E, Dunedin, Fla.

LAMP Parts—Wholesale catalog. For repairing, converting, and mounting. Lamp Specialties Co., 322 Washington, Newark 2, New Jersey.

LAMPS—Parts catalog showing wiring instructions, 25¢. Gyro Lamps, 5402P Clark, Chicago 40.

ELECTRIC Pencil: Engraves all metals \$2.00. Beyer Mfg., 10511-H Springfield, Chicago 43.

LAMP. Electrical parts, wholesale. Thousands of items for repairing, converting. Catalog 25¢. Brown Lamp, Box 305, Clayton 5, Mo.

WELDING, SOLDERING, PLATING

ACETYLENE Welding outfits new \$54.50; used \$34.50; arcwelders \$56.50. Eagle Welding, Dept. PM, 5085 Broadway, Chicago 40, Ill.

ALUMINUM Soldering. Lam Flux. Solders aluminum like other metals. \$2. No c.o.d. Lampe, Box 371, Lindenhurst, N. Y.

A.C. Welders. 4 sizes. Lowest prices. Free literature. Holgerson's Serv., Canton, Kan.

WELDERS, 110/220, \$39.50. Morris, 1070 Inner Drive, Schenectady 3, New York.

ELECTROPLATING Equipment, anodes and solutions for all types of plating. Instructions. Assemble your own plater and save. Free catalog. Ramyr, Dept. E-4, 1624 East First Street, Los Angeles 33, California.

"BUILD-UR-OWN" a.c. welder and a.c. power plant with a good used engine and low cost Hobart generator. Welds anywhere and supplies 5KW stand-by power for any emergency. Write Hobartweld, Box M-1163, Troy, Ohio.

LEARN Welding. Arc or torch manuals \$1.00 each. Marnel, Box 7642, Denver 15, Colorado.

MACHINERY, TOOLS, SUPPLIES

WOODWORKERS — Request free copy Homeshop Notes plus new money saving precision tool catalogue. Lee Tools, Box 22PM, Rochester 17, N. Y.

LAWNMOWER Sharpeners New, \$59.75 to \$259.50 until Jan. 1. Turner-Cline, 430 Yellowstone, Pocatello, Idaho.

HARD To get tools for toolmakers and machinists. Transfer punches, parallels, angle plates, edge finders, and many other wanted tools. Send for free catalog. Ponto Tools, Box D, Lencadia, Calif.

HARDWARE, Tools, taps, dies, drills, motors, steel, brass, drill rod. Free catalog. Terek, 6304 Patterson, Chicago 34.

TRIANGLE Problems? Solve with your "Trigster" trigonometrer. Work 2 slides, read answer direct—in seconds. No formulas, no computations. Splendid gift! Free literature: Vanora Products, M-11, P. O. Box 8485, Kansas City, Missouri.

ENGINES, MOTORS, DYNAMOS

REWIND Motors yourself. Complete instructions \$1.00. Lewis Mfg., Howell, Michigan.

WINDING Data. 275 motors, single and three phase, \$1.10. Data Company, Box 7631, Kansas City 28, Mo.

INJECTOR Used parts wanted. GM71-110. Bares, 7120 Carnegie, Cleveland 3, Ohio.

1/2 HORSEPOWER Electric motors, a.c. 110, used, good \$5.00 each. f.o.b. Plant Machinery Corp., Richmond & Norris Sts., Philadelphia 25, Penna.

SMALL Electric motors. Bargains. Literature free. Kitco, Dept. 7, Box 212, Monroe, Wisconsin.

A.C. Generators; 750 watt, \$42.50; 1500 watt, \$67.50. Motors: 5 horse, \$110; 3 horse, \$87.50; 1 horse, \$38.50. Butler, 1885 Milwaukee, Chicago.

BOATS, OUTBOARD MOTORS

NEW, Used, rebuilt marine motors. Marine conversions, fittings. Free catalog. Stokes Marine Supply, Dept. 24, Coldwater, Michigan.

APPROVED Underwater modern marine conversions. Ford and Jeep. Gershel, Oceanside, N. Y.

FIBERGLASS Boat coverings wholesale prices. Free literature, samples. Seifert's, Box 31M, DePere, Wisconsin.

FIBERGLAS Permanent boat water-proofing. Special 25% summer discount. Complete kits, \$9.45 up. Guaranteed materials. Easy application. Full instructions. Free literature. Ajax Plastics, Dept. PM, P.O. Box 1323, Fort Worth, Texas.

MARINE Conversions for Ford and Jeep engines. Catalog 25c. Lehman Manufacturing Company, 972D Broad Street, Newark 2, New Jersey.

FORDS And Jeeps 100% marine engines with famous Convo-Kits. Deluxe catalogue 25c coin. Osmotors, 3627B Lawrence, Philadelphia 40, Penna.

BOAT Plans—Full size patterns. Frame kits. Modern inboard and outboards for amateur builders. Complete new catalog 50¢ or specify requirements. Glen Designs, Box 568, Compton, Calif.

"GLASBOTE" Plastic and glass cloth for boat covering. Complete information and material price list free. Buchanan Plastics, 1728 Hamilton Road, Okemos, Michigan.

FULL Size, cut-to-shape boat patterns, blueprints, 7 1/2-38 feet. New 1956 illustrated 85 page "Build-A-Boat" catalog of naval architect-designed cruisers, runabouts, sloops, skiffs, outboard boats, sailing, racing, houseboats, 50¢. 1956 "How to Build a Boat" booklet, \$2.50. Cleveland Boat Blueprint Co., Dept. A-66, Box 1651, Cleveland 4, Ohio.

MARINE Conversion, Willys to Cadillac, engines, kits and parts. Catalogue and conversion hints free. Barr Marine, 2706 Castor Avenue, Philadelphia 34, Penna.

FREE Catalog! Boat kits, trailers, fiberglass, marine hardware. Luger Industries, Dept. M11, 3404 Lyndale South, Minneapolis, Minnesota.

PLANS Catalogs; powerboat 50¢, sailboat 25¢, fiberglass, MarinerCraft, Box 161-M, Brighton, Mass.

ATHLETIC EQUIPMENT, BODY BUILDING COURSES

DISABLE Any bully, with two fingers. Secrets, Ju-Jitsu, 96 pages, illustrations, \$1.50. Seico, Box 38, Cooper Station, New York 3, N. Y.

GREAT Strength easily obtained. Write Joseph Dryer, Box 5327, Chicago 80.

FEET. Leg muscles hurt? We can help you! Famous Perrins method rebuilds and renews tired muscles. Activates and normalizes circulation. Intensifies nervous forces. No electricity. No internal medication. No massage. No special or expensive equipment. No continuing treatment. Increase your efficiency and complete health. Results are lasting. Write for free information. No obligation. Orning Company, 1017 13th Street, Des Moines, Iowa.

BARBELLS, Dumbbells, Courses. Free catalogue. Good Barbell Co., Reading, Penna.

OUTSTANDING Physical development! New guaranteed system uses only a rope! Strength, health, gain, reduce. Valuable booklet free. Roperclase, 4834 Art St., Room 205, San Diego 15, California.

SPORTING GOODS, GUNS, FISHING TACKLE, ARCHERY, TRAPPING

FREE Fishing catalog—132 pages. Over 3000 hard to find fishing specialties. Netcraft Company, Dept. PM11, Toledo 13, Ohio.

FREE Giant handbook! "How to Bow-hunt and Bowfish" 100's revealing secrets! Also tells how to improve shooting accuracy, select best equipment, make your own tackle, etc. Illustrated! Yours free with large bargain catalog. (Save 50% on archery equipment!). Send 25¢ to cover mailing expenses refunded on first purchase. Supply limited! Hurry! Malibu Archery, 1036RNR South La Brea, Los Angeles 19, California.

DIVING Equipment for skin divers and professional divers. Send 25¢ for catalog and decompression chart. Desco, 212 N. Broadway, Milwaukee 2, Wisconsin.

5000 BARGAINS. Firearms, binoculars, war relics. Catalog 50¢. Smith Firearms, Rummehede, N. J.

SAMPLE: 25c Copy of "The Archers' Magazine." Send 10c. 1200 Walnut Street, Philadelphia 7, Pennsylvania.

MOLDS For fisherman's sinkers, jigs, squids, casting and spinning lures. Free catalog. Sweet's Molds, Tonawanda 1, New York.

FORTUNE Possible raising crickets and 12 inch African fishworms. Free literature. Carter Ranch, Plains, Georgia.

CAMPING Equipment, tents. Direct from manufacturer. World's largest selection. Send 15¢ for 120-page 1956 tent and camping equipment catalogue-handbook. Morsan Tents, 10-21R, 50th Ave., Long Island City 1, New York.

\$10,000 YEAR Possible, earthworms, 32-page booklet tells how, 35¢. Missouri Earthworm Research, Box E6851, Kansas City, Missouri.

180 PROFUSELY Illustrated pages antique pistols, swords, daggers, armor, etc. 50¢ Robert Abels, M86Q Lexington Ave., New York City 21.

HOW To catch fish, scent secrets. 10¢. Johnston's, 312 Lake Avenue, Ithaca, New York.

FIELD Duck and geese decoys. None better. Details free. South End Lumber, P.O. Box 434, Brandon, Manitoba, Canada.

CAMPERS, Scouts. Send \$5.95 new all in one camping knife kit. Guaranteed. Stainless steel. Compact utensils. Camper, P.O. 53PM, Glendora, California.

FREE—Giant 1957 wholesale sporting goods catalog. Lowest wholesale prices. Complete line of cameras, sporting goods, appliances, outdoor items. Write today. Santa Fe Distributing Co., 1321 Main St., Dept. PM, Kansas City, Missouri.

AMMUNITION, 50% Discount. List 10¢. Firearms, 1517 Gardner, Los Angeles 46, Calif.

AUTHENTIC Primitive weapon reproductions. Spears, cross-bows, edged weapons, etc. Colorful. Deadly. Decorative. 10¢. Primitive Weapons, Pevely, Missouri.

"STRIKE" Liquid lure. Best invention since the fish hook. Amazing! Guaranteed. \$1.25 bottle. Modern, 500 Lafayette Building, Syracuse, New York.

20 BEAUTIFUL Flatface plastic spinning lures. Complete kit \$3.00. Retail value \$20.40. Quaker City Mfg. Co., 3514-24 N. Lawrence St., Philadelphia 40, Pa.

1,000,000 GUNS, Accessories, Colts, Lugers, Mausers, P38's, Winchesters, swords, armor. Super catalog 50¢. Agramonte's, Yonkers 2G, N. Y.

JEOP Owners — V8 power. Read Jeep owners ad, page 30.

BINOCULARS, TELESCOPES, MICROSCOPES, MAGNIFIERS

BUILD Your own reflector telescope. Complete kit; mirrors, eyepieces, tripod, all other accessories. Request free illustrated literature. Criterion Manufacturing, Dept. KPM23, Hartford, Conn.

SALE! United binoculars. Ideal Christmas gifts. \$3.95 to \$250.00. Free 56 page binocular-telescope catalog. United, 9043 S. Western, A-908, Chicago 20. Dealers wanted.

MICROSCOPES, 100X below import cost. Reg. \$4.95. Now \$1.95 plus 50¢ pp. Rush order, limited quantity. Magnification Instrument Co., 2 East 45 St., New York City.

400X Telescopes easily made. Kit includes focusing tube, erector, five finished lenses and building instructions — \$3.75. Free booklet on completed telescopes, tripods, mirrors, lens kits, etc. Suffolk Science, Mattituck 3, New York.

BINOCULARS, Telescopes, microscopes. Terrific values \$3.98 up. Request free money-saving catalog. Criterion, Dept. P48, Hartford, Conn.

REFLECTING Telescope, 60X, completely assembled \$29.75. Guaranteed observatory clearness. Free information. Skyscope, 475 Fifth Avenue, New York City 17.

AMAZING Prices, precision binoculars and gunsopes. Free trial. Folder, "Binocular Selecting," catalog free. Prentiss Importers, Mercury Bldg., West Los Angeles 25, Calif.

DYNASCOPE—Sensational new reflector telescope. Send for details. Criterion Co., Dept. DP26, Hartford, Conn.

REFLECTING Telescope mirrors and kits. Universal Precision Co., Box 187, Sunbury, Penna.

REFLECTOR Telescope kits \$6.25 (3") to \$175 (12"). Mirrors, cells, focusing mounts, tripods, eye systems. Anything, everything in telescopes. Free catalog. Also ready to use telescopes from \$25. Esco Products, Oakridge, New Jersey. Showroom, 166 Church Street, New York City.

NEW Bifocal magnifying glass. German made. 3 1/2" dia. Plexiglass handle, zippered pouch. \$7.95. Atlantic Import, 1302 Cadillac Tower, Detroit 26.

JOE'S Binoculars, 4827 Second, Detroit 1, Michigan. Lowest prices, all sizes, binoculars, microscopes, telescopes catalog.

MICROSCOPES, Telescopes, binoculars, surveying, everything optical, photographic. Importers prices. 25¢ catalog. Magnification Instrument Co., 2 East 45 St., New York City.

MICROSCOPE Catalog free. Research Scientific Supplies, 60 Wall St., New York City 5.

WAR Surplus bargains: Millions of lenses, instruments, telescopes, binoculars, components and complete line of astronomical telescope items. World's greatest optical market place! Send only \$1.00 for beginner's 10-lens kit and big instruction booklet Stock 2-CH. Write for catalog CH, free! Edmund Scientific Corp., Barrington, New Jersey.

PETS—DOGS, BIRDS, RABBITS, HAMSTERS, ETC.

1000 BRED Mink. Booklet, plans 25¢. Lake Ontario Ranch, Gravel Road, Webster, N. Y.

FREE Book. Grow mushrooms. Guaranteed market. Mushrooms, Dept. 171, 2954 Admiral Way, Seattle, Wash.

UNUSUAL Pets. Baby monkeys, ocelots, kinkajous, skunks, etc. Send 10¢ for complete price list. Nature at Home, 4001 W. Pico, Los Angeles, California.

BEAUTIFUL Pure white pedigreed police puppies. Ansonia Kennels, Mose, N. Dak.

HUNTERS! Raccoon Mountain and Short Creek kennels now combined. Large number of coonhounds, foxhounds, rabbit-hounds, beaglehounds, bird-dogs, puppies. Free literature and pictures. Trial. Dures Thomas, Owner, Box 464, Boaz, Alabama.

HAMSTERS, Pair \$2.95. Free booklet. Jer-Fre's Hamstery, 2425 Hoyt, Muskegon Heights 13, Mich.

MINK Raising information free. Complete. Lake Superior Mink Farm, Superior, E.E. Wisconsin.

RAISE Rabbits successfully by knowing facts. 48 page illustrated book describing 25 breeds. Housing, feeding, breeding, marketing, etc. Plus bulletin. 25 cents. American Rabbit Association, 36 Arba Building, Pittsburgh, Penna.

STANDARD Rabbit Journal, Milton 3, Penna. Year \$1.00. Sample dime. Beginners manual 25¢.

RAISE Mink: Free booklet, pen plans. Inside secrets, feed, care. Mink are money makers. Investigate today. Lawrence Mølgard, Brigham City 12, Utah.

MAKE Money raising chinchillas, mink, nutria, rabbits, cavies for us. Free catalog. Keeney Brothers, New Freedom 2, Penna.

SPORTSMEN: World's largest kennel offers 500 Pointers, Setters, Straight Cooners, Combination Hounds, Rabbit and Squirrel Dogs, Beagles, Fox and Wolf Hounds. Trial. Prices reasonable. Catalogue free. Smokey Mountain Kennels, Cleveland, Tennessee.

HAMSTERS, Golden: young, \$3.00 pair. Fully developed \$4.00 pair. Adirondack Hamstery, Prospect 160, New York.

HUNTERS. Fine hunting hounds. Reasonable. Trial. Free list, pictures. Okaw River Kennel, Cowden, Illinois.

RAISE Rabbits on \$500 month plan. Plenty markets. Free details. White's Rabbitry, Dept. 120, Mount Pleasant, Michigan.

WILD Animal pets—Mammals, birds, reptiles. Catalog 10¢. Ray Singleton, Rattlesnake, Fla.

AQUARISTS! Liver tropical fish food 25¢. Peekskill Pet Supply, Peekskill, N.Y.

PLANTS, SEEDS, BULBS, NURSERY AND GARDEN SUPPLIES

TREES And shrubs—Raise your own from seed for shade, windbreak, snow fence, ornament, erosion control, etc. For free planting guide, price list, write Woodlot Seed Company, Norway 9, Michigan.

HONEY Bush, 50 seed \$1.00. Mammoth pecans, three pounds, \$3.95. Gladhaven, Sebastopol, California.

WORLD'S Greatest cash crop. Free information. Write Ginseng Gardens, Asheville, N. C.

FARMS, FARM LANDS, REAL ESTATE

FALCON Dam resort—Site at Zapata, Texas. No money down and \$7.50 per month buys beautiful lot adjoining city. Full price only \$149.50. All utilities, including city water. Ideal for vacation or permanent living. Write for free photos. G. Matlock, Pipe Creek, Texas.

FLORIDA Bargain homes. Low taxes. Cummins Realty Agency, Box 848, Eustis, Florida.

BIG Strout catalog! Mailed free! Farms, homes, businesses, bargains galore! Accurate, reliable descriptions of over 3000 properties in 36 coast-to-coast states! Livestock, equipment often included, many with low down payments and easy terms! World's largest. Serving you 56 years! Depend on Strout Realty, 7-MF S. Dearborn St., Chicago 3, Ill.

HOMESITES \$15 Monthly—California's finest garden section. Morro Bay's scenic shores. Wonderful fishing, boating. Fertile soil, softest water, temperate climate, congenial community. Free literature. Richard Otto, Department M, San Luis Obispo, California.

FLORIDA. Nice homesites, \$245 at \$10 monthly. Folder free. Howard Vernor, DeLand, Florida.

FREE Information. Government land. U.S., Alaska, Sledge Surveys, Macon, Mississippi.

OZARKS! \$8 Acre. Listings, information free. Write: Armstrongs, Shook, Missouri.

FLORIDA Lakefront homesites. Easy monthly payments. Complete literature free. Write Box 1311, Eustis, Florida.

FLORIDA'S Finest homesite bargain—80 by 135 feet for \$240; pay \$10 monthly. Near booming Panama City pleasure resort. Wonderful fishing, hunting. Limited offer on money-making tung groves; terms to suit you. Booklet free. Wendell Wood, Fountain, Florida.

POULTRY, FARM SUPPLIES

POULTRY Farmers, broiler growers, turkey raisers read the new American Poultry Journal for latest ideas and greater profits. 12 months, 50¢. Special offer, 4 years \$1.00. American Poultry Journal, 180 North Wabash, Chicago.

PROFITABLE OCCUPATIONS

BUY Wholesale thousands nationally advertised products at big discount. Free "Wholesale Plan." American Buyers', Hertel Station, Buffalo 16-B, N. Y.

HOME Mailorder beginner's manual, sources, methods, opportunities, 25¢. Car-nahan Bros., 9610 Acacia, Fontana, Calif.

MAKE Money writing short paragraphs! No tedious study. I tell you what to write, where and how to sell; and supply list of editors buying from beginners. Many small checks add up quickly. Write to sell, right away. Send for free facts. Benson Barrett, Dept. CP-27-Y, 7464 Clark, Chicago 26.

MUSHROOMS Grown boxes Manureless process. Spawn \$1.00. Gordons, 553 William, Winnipeg, Manitoba.

FREE Book. Grow mushrooms. Guaranteed market. Mushrooms, Dept. 99, 2954 Admiral Way, Seattle, Wash.

HOW To fix watches overnight. Do-it-yourself method. 70 drawings, 65 troubles, wholesalers listed. Manual \$1.00. Guaranteed. Weber Service, Box 2489, Denver 1, Colorado.

VENDING Machines—No selling. Operate a route of coin machines and earn amazing profits. 32-page catalog free. Parkway Machine Corporation, Dept. 25, 715 Ensor Street, Baltimore 2, Maryland.

RAISE Rabbits on \$500 month plan. Plenty markets. Free details. White's Rabbitry, Dept. 121, Mount Pleasant, Michigan.

WHOLESALE Catalog! 30-80% discounts! Appliances, musical instruments, typewriters, tools, watches, jewelry, cameras, housewares, etc. Consolidated Distributors, 1300-14 Main, Clifton, New Jersey.

YOUR Own wholesale business without investment. Free catalog. Norris, 487-X Broadway, New York City.

BE Your own boss. Start a buying service. Buy wholesale thousands nationally advertised products. Make big profits from over 3,000 suppliers. Free details. Associated Wholesalers, 1916-DD Starr, Burlington, Iowa.

BE The Popular Mechanics representative in your neighborhood and earn big profits in your spare time. Write Popular Mechanics Magazine, Room 408M, 200 E. Ontario St., Chicago, Ill.

BUY Wholesale! Discounts to 80%! Appliances, cameras, sporting goods, tools, watches, housewares, etc. Free catalogs. Buy-Rite, Box 258-C, Hawthorne, New Jersey.

FOREIGN Jobs—Latin America, Alaska, Canada, up to \$1500 monthly. Up-to-date 1956 foreign service directory gives complete information; hot list of firms hiring for military and civilian construction, aircraft, oil, exporters-importers, mining, \$1.00. How-when-where to apply. 9th successful year! Global Reports, Box 883-S, Hollywood 28, Calif.

RAISE Pheasants on \$100 week plan. Little capital and space can make you independent. Free details. Great Central System, Columbus 1, Kansas.

MAKE New greaseless doughnuts in kitchen. Sell stores. Free recipes. Michael Ray, 3605 South 15th Ave., Minneapolis 7, Minnesota.

FORTUNE Possible raising fishworms and crickets. Free literature. Carter Wormery, Plains, Georgia.

AUCTIONEERING—Home study course. Diploma granted. Auction School, Ft. Smith, Ark.

FREE Book "505 Odd, Successful Businesses." Work home. Pacific, Oceanside, Calif.

MAKE Flexible molds. Cast plaques, figurines. Free sample. Tooker, 630-M Chestnut, Hamilton, Ohio.

WELDING Pays big money. Learn easily at best equipped school in country. Non-profit school with low cost training. G.I. approved. Write Hobart Trade School, Box M-1182, Troy, Ohio.

FUN, Profit. Make child's picnic, play tables; separate benches. Plans 25¢. Fabrications, Ellenville, N. Y.

JOB Guidance. What jobs are you suited for? Approved methods. Request free questionnaire. National Guidance Service, Landisville, Penna.

COPYRIGHTED Reports on best paying jobs with travel, adventure, promotions. Construction, aviation, shipping, laborers, clerical, trades, supervisory, factory, unusual opportunities. Many types of work. Skilled and unskilled. Foreign and state-side openings for men and women. Only \$2.00 (\$2.25 airmail), including registration-advisory service. Satisfaction guaranteed. Included absolutely free: Special reports on Alaska, Spanish airbase construction, South American opportunities and husband-wife foreign jobs. Research Services, Suite 207-PMO Brown Building, St. Louis 5, Missouri.

919 SECRETS! Free plan "Secret Journal Hidden Dollars." Work home, weekends! Publico-M, Oceanside, Calif.

MAGAZINE Subscriptions—Largest commissions, bonus. Qualified Agency, 451LA Kingston, Brooklyn 25, N. Y.

REPAIR Porcelain on appliances. Much needed service! Profitable! Free information! Enamel Repair, 422 Prospect, Buffalo 1, New York.

FREE Folio "\$5,000-\$45,000: Unlimited Vacations." No merchandise. Unknown! Work home, sparetime! Haylings, Carlsbad, Calif.

FORTUNES Made raising fishworms. 100 \$1.00. Manual 50¢. Literature free. Three Oaks Ranch, Dresden, Tenn.

PRESERVE Flowers indefinitely. Free details. Spera, Box 598, Toronto 1, Canada.

BUY Wholesale for yourself, resale. Free literature. Box 6011-DDD, Chicago 80.

BOOKS, PERIODICALS, PICTURES, POSTCARDS

BOOKS, Essays and lectures! Unusual, odd information you cannot get elsewhere. Many, only one copy each. New list free. Now ready. Rush name. J. Houston Mupin, 201 North Hyatt St., Tipp City 5, Ohio.

SPARETIME Repeat profits taking subscriptions all magazines. Good commissions. Exceptional special offers. Cassell Agency, Boynton Beach, Florida.

BOOKHUNTERS! Rare, rare, miscellaneous books. Atlantic Book Service, Cedar Street, Charlestown 29, Mass.

JOHN Friend, bookfinder, can get the book you want. Free search service. Box 197PM, Cardiff, Calif.

NATIONAL Geographic Magazines, 1888-1956. Periodical Service, Box 465-PM, Wilmington, Delaware.

BOOK Catalog, 1000 interesting titles. Send 10¢. Books Publishing Co., Amityville 3, N. Y.

OUT-Of-Print books at lowest prices! You name it—we find it! Fast service. No obligation. International Bookfinders, Box 3003-PM, Beverly Hills, Calif.

"SCIENCE Milestones." Records march of science starting 400 years before Christ, right up to date. Amazing facts revealed, 312 pages packed with startling information that will thrill you. A real history of science. \$5.00. Literature free. Popular Mechanics Press, 200-5M East Ontario St., Chicago 11, Ill.

RARE Magazines, catalog 10¢. Nationwide Exchange, Box 1375-F, San Antonio 6, Texas.

BRITISH Book bargains—All subjects. Catalog 10¢. Transbooks, Box 22PMF, Brooklyn 26, N. Y.

BOOKFINDERS! All subjects. Send wants! Jaher Book Service, 183 Hazelwood Drive, Westbury, N. Y.

FREE: Exciting catalog packed with books covering most everything. Think of it—From cover to cover you will find described and illustrated hundreds of books telling how to fix and how to build almost anything. How to remodel your home; do your own decorating, plumbing, electrical work. Simplified books covering concrete work, carpentry, painting, furniture making and refinishing. How to build your own boat, home workshop tools. Best books on photography, welding, hobbies, homecraft. How to make a home freezer. Send for your free copy now. Popular Mechanics Press, 200-BC East Ontario St., Chicago 11, Ill.

GAMES, TOYS, NOVELTIES

NUKENO: End all dull parties with the world's greatest card game. America's finest entertainment. Exciting, educational. Postpaid \$1. Hackbarth Enterprises, Fayetteville, New York.

MAGIC TRICKS, PUZZLES, JOKER NOVELTIES

BE A magician! Large professional catalog of latest tricks. 35¢. Ireland, C-109 North Dearborn, Chicago 2, Illinois.

3100 NOVELTIES. Jokes, tricks, gadgets, funmakers, hobbies. Big catalog 10¢. Johnson-Smith, D-407, Detroit 7.

VENTRILLO. Professional voice-throwing instrument and catalog 25¢. Box 971-PM, Philadelphia 5.

WOODEN Nickels, catalog, trick, 10¢. Magico, Box 1375-P, San Antonio 6, Texas.

DOLLAR Magic set free with catalog 25¢. 4462-PM Germantown, Philadelphia.

WORLD'S Finest professional magic. Joker novelties. Giant illustrated catalog 10¢. Top Hat, Evanston 12, Illinois.

500 TRICKS. Douglas famous 120-page catalog, only 10¢. Fastest service to magicians for 30 years. Send 10¢ today. Douglas Magician, Dept. 1, Dallas, Texas.

SMOKEBOMBS 25c. 7 For \$1.00. Terrific! 4463-PM Greene, Philadelphia 44.

FREE Trick and professional catalog of 600 tricks, \$1.00. Terry's Magic Studio, 1921-66th Street, Brooklyn 4, New York.

SENSATIONAL Magician's wand 25c. Vanishes handkerchief! Catalog included. Box 1352-PM, Philadelphia 5.

PROFESSIONAL Catalog, 175 pages, 25c. Williams, 900 Plymouth, Ellwood City, Penna.

VENTRILLOQUIAL Course \$1.00. Figure catalog 35¢. Magic catalog 50¢. Finis, 624 West Third, Waterloo, Iowa.

SVENGALI Trick deck free with catalog 50¢. 1746-PM Market, Philadelphia 3.

HINDU String trick, now 50¢. Minge's, 6775 Ash, Derby, Colorado.

FREE Dollar mystery cigarette case plus magic catalog \$1.00. Henry Seltzer, 1639 Fulton Avenue, Bronx 57, New York.

COMPLETELY Illustrated 500 trick magic catalog 25¢. Stowell, Woodstock, New York.

COINS, TOKENS, CURRENCY

\$4,000.00 FOR 1913 Liberty head nickel. Dimes 1894-S, 1895-O, 1916-D. Quarters 1827, 1896-S, 1901-S, 1913-S, 1923-S. We pay \$10.00-\$2000.00. Certain dates—Lincoln cents, \$75.00. Indianheads, \$80.00. Large cents, \$300.00. Eagle cents, \$325.00. 2¢ pieces, \$70.00. 3¢ pieces, \$90.00. Half-dimes, \$500.00. Shield nickels, \$120.00. 1875 Canadian quarter, \$50.00. Hundreds of others worth \$10.00-\$1000.00. Wanted—Half dollars, dollars, gold coins, paper money, etc. Know their true value. Our large illustrated guarantee buying-selling catalogue, giving complete all coin information—send \$1.00. Purchase made from catalogue-holders only. Catalogue dollar refunded on \$20.00 sale. Worthycoin Corporation, Leaders Numismatic Quotations, K-212-C, Boston 8, Massachusetts.

OLD Money wanted. Do you know that coin collectors pay up to \$100.00 for certain U. S. cents? And high premiums for all rare coins? We buy all kinds. Send 4¢ for large coin folder. May mean much profit to you. Numismatic Co., Dept. 20, Fort Worth, Texas.

\$50.00 FOR Certain Lincoln pennies; Indianheads \$100.00. Booklet showing prices paid, 25¢. Lincoln Coins, D-29, Glendale, Arizona.

BRILLIANT Uncirculated complete sets—Jefferson nickels \$19.95; Roosevelt dimes \$14.95; Franklin 1/2 \$27.50. Beautiful foreign sets—Cambodia \$1.00; Camaroons 90¢; Dominican Republic \$2.95; Irish animals \$2.50; Laos 95¢; Saarland \$1.95; Tahiti \$1.00; Viet Nam 95¢; Giant bargain catalogue 50¢. Bebee's, 4514 North 30th, Omaha 11, Nebraska.

101 DIFFERENT Foreign bills, \$1.00 postpaid. Dwight Musser, Dunbar, W. Va.

OLD Coins, currency bought, sold. Large list 10¢. Thos. J. Settle, Box 1173, Church Street Station, New York 8, N. Y.

LARGEST Coin magazine, 180 pages, 35¢. Scrapbook, 7320-J Milwaukee, Chicago 31.

36 DIFFERENT Foreign coins \$1.00. Robbins, 1007 Cleaveland, Montgomery 8, Alabama.

FIVE Foreign coins from Switzerland, Belgian East Africa, etc., plus foreign banknote, only 10¢ with coin approvals. Littleton Coin Company, Littleton R1, New Hampshire.

6-IN-1 Special: Magnifying glass; check list; 25 coin envelopes; giant 60 page bargain catalog; ten different Indian pennies; Mexican ten-peso; All six, \$1.00 postpaid. Ben's Coin Shop, 31 North Clark, Chicago 2, Illinois.

FREE! Foreign coin, banknote and coin collectors illustrated catalog to approval service applicants. Send 3¢ postage. Tatham Coinco, Springfield 30, Mass.

SAN Francisco mint closed! Made only cents and dimes in 1955. In short supply and great demand. One each, brilliant uncirculated, for 25¢. Free coin lists with order. Bryson Stamp & Coin Company, 612 White, Toledo 5, Ohio.

BARGAIN Lists, Indianhead cent, 10¢. Economy Sales, 157 Dean, Mansfield, Mass.

U. S. Large cent, 2¢ piece and bargain list, only \$1. Delmaco, Box 1123, Wilmington, Del.

MORGAN Dollars, 1878-87-90-91-97S \$2.00 ea. New illustrated catalog 25¢. Shultz, Box 746, Salt Lake 10, Utah.

THOUSANDS Foreign coins. Lists 6¢. Benson, 2526 Middle Road, Davenport, Iowa.

44 DIFFERENT Coins, \$1.00. 100 different coins, \$2.50. 100 different bills, \$1.00. Oddehon, Box 482, St. Louis, Mo.

COMMEMORATIVE Half dollar uncirculated, \$1.00. Bargain lists free. Sayers, 1000 East Unaka, Johnson City, Tennessee.

40 DIFFERENT Foreign coins \$1.00. Adelphia, 902 Filbert, Philadelphia 7, Penna.

YUGOSLAVIA, Bolivia, Mexico, Finland, Germany—all 10¢. Jolie, 126, Roslyn Heights, N. Y.

GET Profit and pleasure in collecting old coins. Send 10¢ for 56-page illustrated coin catalog. You'll be delighted with it. Send for it now. B. Max Mehl, 370 Mehl Building, Fort Worth, Texas. Largest rare coin establishment in U.S. Established 56 years.

UNCIRCULATED Rolls 1955B, 1955D dimes \$7.00; 1955D quarters \$15.00. Jack Turner, Prescott, Ariz.

LINCOLN Cents 1910-S, 1913-S, 1921-S, 1923-S, 1924-S, 1933-D all for \$2. Gasser's, Box 34615, Los Angeles 34, Calif.

GUARANTEED Buying price catalogue, 50¢. Days, West Baldwin, Maine.

\$20.00 PAID For only two Lincolns. Send 25¢ for complete details and other big cash premiums paid for Lincoln pennies. Ferguson, P. O. Box 15, Fort Lee, New Jersey.

STAMP COLLECTING

FREE! Giant catalog offering thousands of bargains. Sent with beautiful approvals. Jamestown Stamp Co., Dept. E11PMC, Jamestown, N. Y.

225 STAMPS For only 10¢! This mammoth value includes airmails, pictorials; stamps from strange countries cataloging up to 25¢ each! Also approvals. Mystic Stamp Company, Camden 80, New York.

100 YEAR Old United States classics, all Roosevelts and all other United States and foreign stamps are yours on approval. Send for trial selection with 10¢ for 50 diff. United States. Globus, New York 10, N. Y., Dept. 213.

CANADA—Newfoundland collection including early issues, commemoratives, pictorials and high values. Plus set of fascinating triangle stamps. Plus set of unused British Colonies. Plus large stamp book. All four offers free. Send 10¢ to cover postage. Empire Stamp Corp., Dept. PM, Toronto, Canada.

WOW! 135 All different Germany 10¢. Zeppelins, semi-postals, airmails, high values. Big bargain lists and approvals included. Jamestown Stamp, Dept. A11PMC, Jamestown, N. Y.

DEALERS—Wholesale list. Postage 3¢. Frank, 5031 Queensberry, Baltimore 15, Maryland.

WILL Send you 20,000 collection, 1/2¢ to 3¢. Many free. Cut Rate, Blue Springs 8, Missouri.

PROFITABLE Stamp dealing quickly learned. Tournau, 6462 83rd Place, West Forest Hills, New York.

FIRST U.S. set. Among world's prettiest. Only 10¢. Approvals. Welles, Box 1246-R, New York City 8.

MIXTURE, 1/4 Lb. oil company's unpicked foreign mail, \$1.00. Box 6172, Houston, Texas.

2 SCARCE Souvenir sheets. Choice commemoratives. Rare value, only 10¢, with foreign approvals. Variety Stamps, 57-R Circuit, Newton Highlands 61, Mass.

1500 STAMPS \$1.00 On and off paper. Good variety. World wide. Many pictorials. No approvals follow. Satisfaction guaranteed. Whalen, 1435 First Ave., Oakland 6, Calif.

TEN Israel, Egypt, free to approval applicants. Americana, Box 1560, North Miami, Florida.

U.S., Canada, Newfoundland price list, 700 illustrations, 10¢. Thom, 4808—15th Ave., Minneapolis 17, Minnesota.

100 BEAUTIFUL Hungarian pictorials, cataloging over \$5.00. All different. All beauties. Only 25¢ with approvals. Mark Stamps, 4628 N. Hollywood Avenue, Milwaukee 11, Wisconsin.

FIVE Triangles free to approval applicants. Rare, Box 533, Coconut Grove Station, Miami 33, Florida.

WESTERN Hemisphere approvals. List countries wanted. P.O. Box 11, Montreal 28.

MINT U.S. plate blocks. Bargain approvals. Kuehl, 3125 East K, Tacoma 4, Washington.

U.S. Price list free. Peter Wetterquist, 1635—13th Ave., Rockford, Illinois.

CHRISTMAS Seals, 25 years 10¢. Thompson, 106 Ocean, Santa Cruz, California.

FREE! 55 British Colonies. 5¢ handling. Approvals included. Kensington Stamps, Buffalo 15, N. Y.

FREE! 25 Different India. Wilbur Craig, 302 State, Camden 2, N. J.

10 PANAMA 10¢. Worldwide 2¢ approvals. Moffat's, 740-A Milton, Rock Hill, South Carolina.

INTERESTING Grab pack 25¢. Approvals. Klondike, 682 Jefferson, Elgin, Illinois.

INDIA, 50 Different scarce items only 10¢. Imagine 1/14th catalogue! Approvals. William Penn Stamp Co., Box 303, Philadelphia 5, Penna.

275 STAMPS Only 10¢ with foreign or U.S. approvals. Wm. Rice, 87 Washington Ave., Kingston 1, N. Y.

SMALLEST Stamp! Giant, midget triangles. Others, 3¢ to approval applicants. Delton Page, Box 201X, East Paterson, New Jersey.

ECONOMICAL 1/2¢, 1¢, 2¢, Approvals. 22,000 varieties. Dressel, Box 128-N, West Englewood, New Jersey.

500 WORLDWIDE Mixture. Big variety, 25¢. Monjar, Fairmount, Cincinnati 14, Ohio.

50 DIFFERENT U.S. commemoratives 25¢; 135, \$1.00 with approvals. Harold Holub, 18 East 198th Street, New York 68, N. Y.

100 FOREIGN, 20 U.S. commemoratives, 10¢. Approvals. Weckerling, 3210D Hancock, Austin 3, Texas.

FREE! Seven short sets! Approvals. Gernert, 4235-2 Alton, Louisville 7, Ky.

3 UNUSUAL Sets, plus packet \$1.00. Stamp Club, Overpeck, Ohio.

50 DIFFERENT Juvenile stamps \$1. Ernst Schmid, Hauptpostfach 255, Zürich, Switzerland.

TOPS! Free book, "How to Collect Stamps." Send for your copy today! Approvals. Littleton Stamp Co., Littleton, El. N. H.

100 DIFFERENT U.S. stamps 50¢. Perry, 1440 West 13th, Chicago 8.

FREE! Odd colorful San Marino's Columbus pictorial set, temptingly priced approvals. Phil, 74 Birch, Lewiston, Maine.

FAMOUS Men, jungle scenes, zoo, United States commemoratives, 100 others. Ten cents with request for thrifty approvals. Casner Stamps, 247-A Riverside, El Paso, Texas.

INDIA—Hundred different, \$1. Bosco Perelra, Box 996, Bombay, India.

FREE Price list over 1000 packets! Typical offers—All different: 500 worldwide 75¢; 1000, \$1.50; 2000, \$4.00; 150 Jugoslavia \$1.00; 150 Japan 75¢; 500 Germany \$1.20; 100 Australia \$1.00; 500 China \$1.70; 100 Russia 80¢. No approvals included. Banthos, Box 122PM, New York City 4.

500 DIFFERENT 25¢ with approvals. 2000 different \$3.00. Park, 101 Rochelle Ave., Rochelle Park, N. J.

FREE! Scarce Revolution set. Bargain approvals. Sadler Stamp Exchange, 611 Carolina Ave., Norfolk 8, Va.

NEWFOUNDLAND, 15 Different free after dollar purchase from approvals. Day Stamp Co., Box 102, Moncton, N.B., Canada.

UNITED States. Fine mint airmails. #C7, #C8, #C9, #C10. Only \$1.00. Approvals accompany. Whiton Paine, Westport 11, Connecticut.

BIG Lively stamp magazine 10¢. Amazing U.S. philatelic novelty included free. Chambers Stamp Journal, 15115 Warwick, Detroit 23, Michigan.

ABSOLUTELY Free your choice any volume Scott's International albums. Scott's catalogue, Master global albums. Quickly, easily earned when you buy our sensational foreign approvals. Write for details with trial selection. Bargain Stamps, Redlands, California.

EVERYTHING Goes. Tremendous unsorted accumulation. Collections, odd lots, etc. Closing out cheap. Lists free. Alateio. Maynard, Massachusetts.

MINT B.W.I. selection plus 50 different free with approvals. Stamp Imports, Peterborough, Ontario, Canada.

3000 DIFFERENT \$4.00. Approvals. Jacobsen, 4395 Broadway, New York 40, New York.

1957 U.S. Illustrated catalogue free. Stone's, 192 Washington, Boston 8, Mass.

EIGHT Famous places plus 50 others, 10¢ with approvals. Bennett, Candor 3, New York.

RARE Nepal, 200 others, 10¢. Approvals. Seat, 622 Texas, Durant, Oklahoma.

FREE! Monaco "triangle." Pakistan! Madagascar! Togoland! Approvals. Keating, 2520-P Boulevard, Jersey City, N. J.

100 DIFF. France, 10¢ with approvals. Corzine Stamps, 19620 Lamont, Detroit 34, Michigan.

JUMBO Approval collection. United States, Canada, British Colonies. Enclose 25¢. Peterson, Box 31, St. Paul 2, Minn.

GRACE Kelly, Prince Rainier wedding set, 10¢, approvals. Donell, Box 45 485, Los Angeles 45.

PRECANCELs, 100 Different collectable copies \$1.00. Deitzer, 3551 Werk, Cincinnati 11, Ohio.

50 FRENCH Colonies 20¢. Approvals. Roy Farr, 455 King William, Hamilton, Canada.

FREE Cyprus set with approvals. Ampco, Box 4207, St. Louis 16, Mo.

25 VALUABLE Israel 20¢. Approvals. Vail, Box 134, Hicksville 1, N. Y.

FREE! 50 Different foreign, with approvals. George Connelly, 349 Hanover, Portsmouth, N. H.

1000 HINGES, Olympics, bargain lists 10¢. Approvals. Buckey, 208 Ludlow Bldg., Dayton 2, Ohio.

50 DIFFERENT British Empire 10¢, with selected approvals. Ziembay, 3108 W. 44th St., Chicago 32, Ill.

MINT Canadian, Pakistan, face value lists 25¢. King, 330 Alexander, Kamloops, B. C., Canada.

TEN Free, first book 500 2¢ approvals. Hadrian, 12 East 31st Street, New York City 36.

FREE, 5000 Different. Details, samples, 25¢. Flint, Box 66M, Fall River, Mass.

TRIANGLES! Triangles! Triangles! Yes, a beautiful collection of triangles containing Monaco early transportation, Monaco modern transportation, San Marino flowers, Pope Pius triangles, San Marino sports, Hungary birds, South Moluccas fish, Nicaragua volcano. All total 25 different triangles just 25¢ to approval applicants. J. C. Menifee, Dept. R84, 4307 Butler Place, Oklahoma City, Okla.

BUY Stamps at face, from 100 countries throughout world. Details, \$1.00. Bedard Publications, Box 637-A, Detroit 31.

OVER 1000 Different, \$1.00 with approvals. Louis Golden, 6721 Eastwood, Philadelphia 49, Penna.

PACKET Of quality stamps 5¢ with approvals. Superb. P. O. Box 7375, Philadelphia 4, Penna.

TRAINS, Ships on stamps. Send 25¢ for fascinating collection. Request approvals. Ed Roper, Coatesville, Penna.

MONACO Nudes complete mint 10¢. Approvals. Royal Stamp Company, Tamaqua, Penna.

100 DIFFERENT Austria 10¢. Approvals. Aronson, Box F, Newton Centre 59, Mass.

FIFTY Different British colonials. Plus dozen Confederates (facsimiles) dime! Approvals. Gene's, 1707 N. Congress, Austin, Texas.

UNITED States commemorative collection containing 33 different—10¢. Approvals. White, 516-A Avenue L, Brooklyn 30, New York.

100 DIFFERENT Switzerland 25¢. Approvals. Aronson, Box F, Newton Centre 59, Mass.

30 DIFFERENT Commemoratives 1893 up 10¢. U. S. approvals. K&B, Box 70, Brooklyn 23, N. Y.

TRAVEL Through 50 countries! A virtual world cruise! 50 stamps, each from a different country, Abyssinia to Zanzibar. Bargain unsurpassed! To new approval applicants, 5¢. Avalon Stamp Co., Dept. M, Springfield, Mass.

TWO \$5.00 U.S. stamps plus 20 different, 10¢ with U.S. approvals. Irwin, Box 1105, Brooklyn 30, N. Y.

SELL Your surplus good grade stamps. Write, describing fully what you have. Vanroy Shirk, Lebanon, Pennsylvania.

FREE! Catalog! About stamps. Illustrated. Free! The Stampmart, Hartford 1, Connecticut.

FREE United States price list. Mark Hanna, 335 Fifth Ave., Pittsburgh 22, Penna.

50 DIFFERENT Argentine 10¢. Approvals. Reuter, 611 W. 40th Pl., Los Angeles 37.

OLD Scarce U.S. seconds on approvals. Slight imperfections, lowest prices. Hernefield, Clintonhill Sta., Newark 8, N. J.

U. S. Classics. Over 50 yrs. old. 15 selected old-timers. Missing in biggest collections. All 15 at less than 1¢ each. 10¢ with approvals. Jaro, Box 246-T, New York City 8.

50 DIFFERENT United States 5c with bargain approvals, lists. Bookman, Box 3245-M, Madeira Beach, Fla.

AMAZING Offer! 200 United States stamps—including commemoratives, airmails, high denominations to \$1.00. Only 10¢ to approval applicants! Illustrated bargain lists free. Mystic Stamp Co., Dept. 30, Camden, New York.

WORLD'S Largest stamp (7 1/2 x 14 inches). A real curiosity! Retail for 50¢, only 3¢ to approval applicants. Tatham Stamp Co., Springfield 30, Mass.

100 OLD United States between 1861 and 1935, \$1.00. Roush Stamps, 51 Chestnut, Mansfield, Ohio.

MINT Commemoratives at face! Send 25¢ for surprise packet of all different, mint U.S. commemoratives. Mint U.S. approvals too. Western, Box 1689P, Salinas, California.

UNITED States approvals. Select copies, used—mint. Kingsbury, Fairfax, Vermont.

ICELAND 10 Different beautiful stamps for only 10 cents to applicants for our good old fashioned approvals. Old Colony Stamp Co., Dept. A, Milford, Connecticut.

100 DIFFERENT China 10¢. Approvals. Coast, P.O. 2187H, Santa Ana, California.

FREE! Monaco wedding stamps, given applicants for approvals. Exotic, Box 482-MM, Coral Gables 34, Florida.

1-2¢ EACH! Thousands of exciting worldwide stamps. Free examination. Cole, Box 223-A, Buffalo 21, N. Y.

SELL Stamps to our readers. Your ad in this space will be read by thousands of stamp buyers. I'll prove that to you. Write now for Folder "S." F. W. Johnson, Classified Advertising Manager, Popular Mechanics, 200 E. Ontario St., Chicago 11, Ill.

300 DIFF. World wide 25¢, plus surprise packet. Packet list free. Econopackets, Box 168, Riverside 9, Calif.

14,000 DIFFERENT—Yours on our streamlined systematic club plan for only 50¢ weekly. Big shipment every two weeks. Details free. L. G. Ware, Baldwin 75, New York.

FREE United States illustrated catalog. Bailey, 45 Bromfield, Boston, Mass.

SWITZERLAND Prize package! 50 different, including trains, bridges, castles, commemoratives, bi-colors, pictorials. All for 10¢ with approvals. Molzan, 720 Pomona, El Cerrito 8, California.

AMERICAN Commemoratives; Colonial pictorials; Asian topicals; with surprising approvals. Bristol, Canton Center, Conn.

U.S. Flag, \$5.00 stamps, 25 different collection. Only 10¢. Approvals. Willett Stamps, Box 390-A, Mount Kisco, N. Y.

FREE Stamps with our low priced worldwide approvals. Postage paid both ways. Write now, P. Roy (B), 160 St. Johns Place, Brooklyn 17, N. Y.

GIANT Approvals, thousands different, 1¢ and 2¢ each. Wahl's Stamp Exchange, 7088P Farragut, Chicago 31, Ill.

300 DIFFERENT Given free with approvals. Particulars. Windsor Stamps, 8834 Cornell Ave., Chicago 17.

INTRODUCING Our better United States approvals, we offer 15 most wanted United States stamps, including Columbian, Pan-Pacific, bi-centennials, Army Navy, famous Americans, airmails, other commemoratives; everything 10¢. Ocean Stamps, Box 64-PM, Brooklyn 29, N. Y.

WONDERFUL Offer. 7 complete mint sets only 10¢ with approvals. Reich (M26), 1033 Lawrence, Chicago 40.

90,000 STAMPS Disposal sale: Assortment 40 cts. Big lot \$1. Extra special better stamps \$2. Giant assortment \$5. Persil, 436 N. Y. Ave., Brooklyn 25, N. Y.

PENNY Approvals that satisfy. Robert Moed, P.O. Box 62, Brooklyn 29, N. Y.

70 DIFFERENT U.S., included 35 commemoratives, 25¢. No approvals. Seidenberg, Appleton, Wisconsin.

12,000 PENNY Approvals waiting for you. Many from exotic countries, pictorials, airmails, new issues. Tilbury, Box 862, Newark 1, N. J.

U. S. Mint specials! 13 different commemoratives, 25¢; flag set, complete, \$1.00. Free price list. Brooks, 2352P East 23rd Street, Brooklyn 29, New York.

U. S. Revenues on approval. El Jay Stamps, Box 286, New York 36, New York.

FREE, Mint British Colonies from North Borneo, Caymans, Seychelles, Dominica, Papua, New Guinea, Sarawak, Brunel. Free with approvals. Viking, Great Neck 8, N. Y.

SOUVENIR Sheet Russia 1937 10¢ with approvals. Kingman, 30 Empire, Yonkers 4, N. Y.

FINLAND 1944 Red Cross, complete mint set 25¢. Approvals. Ralph Rice, 15 Longlane, West Hartford 7, Connecticut.

WEDDING, Pipex, triangles, animals, free with approvals. Choice, Box 366, Miami Beach 39, Florida.

WEIRD Diamond shape coffee stamps. Lovely flower triangle! First American big commemorative. Greenland, idol dancer, etc. Free with approvals. Capital Stamp Co., Ferrysburg 2, Mich.

STAMP Collecting outfit, includes packet worldwide stamps, package hinges, watermark detector, millimeter gauge. Everything 10¢ with approvals. Lorain Brown, Marion 1, Michigan.

ANTIQUES, RELICS, INDIAN GOODS, CURIOS

10 ANCIENT Arrowheads \$2.00. Grooved tomahawk \$3.00. List free. Lear's, Glenwood, Arkansas.

SELECTED War arrowhead \$1.00. List 5¢. H. Talburt, Calico Rock, Ark.

SCALPING Knife, spearhead, thunderbird \$4.00. Catalog free. Arrowhead, Glenwood, Arkansas.

ILLINOIS "Gesundheit" — Disposing of \$300,000.00 collection of 500 historical firearms: revolutionary, civil, Indian war, flintlocks, muskatoons, swords, bayonets, bullet molds, powder flasks, Kentucky rifles, pepperboxes, dueling pistols, 50,000 Indian relics, collectors cartridges, coins, Confederate money, Agates, minerals, fossils, mounted birds, animals, deerheads, gold dollars, bo-wood, violin wood, blorhorns, dauquerrotypes, a 400 page catalog would not list everything. Send 35¢ for profusely illustrated catalog. Heike's, Wenona, Illinois.

HUNDRED Choice antique, classic, 8x10 auto photos! Detailed list, dime! Send dollar; \$2.50 for three! Guaranteed satisfaction. J. W. Roberts, Cambridge City, Indiana.

SPECIAL. 4 Selected arrowheads. \$1.00. Smith, 841 N. Tacoma, Indianapolis 1, Indiana.

PRECIOUS STONES, MINERALS

URANIUM Ore, one full pound (fluorescent), with literature. No c.o.d.'s. De Ment Laboratories, 5919 S.E. 72d Ave., Portland 6, Oregon.

CHRISTMAS Jewelry gifts. Make them yourself. Easy. Profitable. Free bargain list—gems, supplies, projects. Ten polished gems, baroque shaped, \$1.00. Five uncut gems, including sapphire, \$1.00. O'Brien's, 1116M Wilcox, Hollywood 38, California.

GEMSTONES. Mineral specimens. Every variety. Lowest prices. Free booklet. Plummer's, 4720 Point Loma Ave., San Diego 7, Calif.

GENUINE Peridots or amethyst from Arizona. Tumble polished, 10 for \$1.00. Luther Martin, Box 191, Parker, Arizona.

GENUINE Pieces Devonshire era fossils—\$1.00. Buriello, Maryland, New York.

OPALS, Sapphires airmailed direct from Australia. Collection 12 rough Australian gems \$5 and \$10. Send cheque or international money-order. Free catalogue. Australian Gem Trading Co., 49 Elizabeth Street, Melbourne, Australia.

AGATES, Gems, machines. Free list. Northwest Gems, 2819 North Warner, Tacoma 7, Washington.

CUT Gems, make jewelry—For profit or fun. 100 page magazine tells how: where to get supplies. Sample 25¢ or request free literature. Lapidary Journal, Del Mar 2, Calif.

HOBBIES AND COLLECTIONS

AMAZING Device grows large, water-soluble crystals. Complete with chemical \$3.95. Crystocraft Company, College Station, Texas.

COLLECTORS Matchbook covers, 100 different unused, \$1.00. Catalog 25¢. Album \$3.00. Charles Edelman, 1311-C East 84, Cleveland 3, Ohio.

MILITARY Miniatures, Civil War. Custer's Cavalry, American Revolution and U. S. Marines. Illustrated catalog 25¢. Bussler Miniatures, Dept. Z, 40 Howe St., Quincy 69, Mass.

INVENTING Can be an interesting and profitable hobby. Write for complete particulars. Institute of American Inventors, Dept. 40-E, 635-F St., N.W., Washington 4, D. C.

NAZI Insignia, 12 different \$1.00. Medals, patches, armbands, flags, daggers. Illustrated lists, 10 cents. Medcrafts, Box 532, Victoria, B.C. 2, Canada.

FREE — "Learn & Earn" leathercraft catalog. Tandy Craft Center, 35 E. 14th, Dept. E, New York, N. Y.

HOBBIES, Crafts, models. Catalog 10¢. Daters, 821 Divisadero Street, San Francisco 17, California.

CHRISTMAS, Charity seals. Sample lot 25¢. Eckert, 5045 Warwick, Chicago 41.

ELECTRICITY, Magnetism, Fundamentals; experiments galore. Materials furnished. Learn by doing. Ideal gift. Free details. Technifun, 8420 Cedarbreak, Houston 24.

CAMERAS, PHOTO SUPPLIES

BUY Wholesale nationally advertised cameras, photo supplies, thousands other products at big discount. Free "Wholesale Plan." American Buyers, Hertel Station, Buffalo 16-E, N. Y.

PHOTOGRAPHY For pleasure or profit. Learn at home. Practical basic training. Long established school. Free booklet. American School of Photography, 835 Diversey Parkway, Dept. 3441, Chicago 14.

ARGUS C-3 outfit \$49.90. Discounts to 60%. Photo equipment, appliances, free catalog. Mailers Mart, Box 135-PM, Pelham, New York.

CAMERAS, Lenses, enlargers, projectors and accessories. Take up to 15 months to pay. Highest trade-ins and low, low discount prices. Fastest credit service anywhere within U. S. on orders from \$50 to \$5,000! Write for free catalog. Grand Central Camera, Dept. A, 1 East 43rd St., New York 17, N. Y.

FREE! Free! Free! Bargain book. Big savings—Still, movie camera, equipment and supplies. Photographic headquarters since 1899. Central Camera Company, Dept. 11-1, 230 S. Wabash Ave., Chicago 4, Illinois.

BASS Says: Quality cameras since 1910. When in Chicago visit the camera cross roads of the world, or write us for your favorite equipment, new or used. Satisfaction guaranteed. Bass Camera Co., Dept. AG, 179 W. Madison St., Chicago 2, Ill.

20 TO 75% Discount everything photographic, gift-ware. Free catalogue. Dart, 3812E Atlantic Avenue, Brooklyn 24, New York.

GIGANTIC Savings! Film, paper, aerial cameras, supplies. Request free 1956 bulletin. Supreme Photo, 11 Broadway, Dept. PM, New York City 4.

OIL Coloring photographs—A fascinating hobby or profitable sideline for those with artistic talent. Learn at home. Easy simplified method. Free booklet. National Photo Coloring School, 835 Diversey Parkway, Dept. 3438, Chicago 14.

CAMERA Fans—Make money with camera. 5 professional profit maker plans—Plus addresses of over 300 best markets for photos \$1.00. Guaranteed. H. Bishop, 405 2nd St., Neenah, Wis.

PHOTO FINISHING

QUALITY Kodak finishing, 8 exposure roll 35¢; 12 exposure 50¢; 16 exposure 60¢. Reprints 4¢. Fast service. Guaranteed quality. 40 years continuous operation. Be a satisfied customer. We do color. Send for mailers. Mail Order Photo Service, Box 297, Watertown, Wisconsin.

TOP Quality. Fast service. 8 jumbos 35¢. 16 contacts 40¢. Reprints—Jumbos 4¢; contacts 3¢. Satisfaction guaranteed. Free mailers, circulars. Fast-X-Photo, Box A, Jersey City, New Jersey.

FREE Superpak album with 8 jumbos only 35¢. 12—50¢. Prompt superior service. Quality guaranteed. Mailers and circulars free. Grand Fotos, GPOB 1410, New York City 1.

8-HOUR Service on deluxe jumbo prints 8-exposure roll developed and 8 jumbo prints 40¢, 12 exposure 55¢, 16 exposure 70¢; 35mm. 20 exposure 75¢, 36 exposure \$1.25. Jumbo deckle edge reprints 4¢ each. Contact prints made if specified. Bay Photo Service, P.O. Box 210, Oakland, California.

10 PHOTO Christmas cards 80¢. Sample 10¢. Try us once! Fast service! Top quality! 8 enlarged dated prints from your roll 25¢; 12-35¢ (trial offer). Reprints 4¢. Kodacolor specialists: Roll developed 90¢; prints 32¢ each. Free mailers. Willard Studios, Box 2553G, Cleveland, Ohio.

TEN 5x7—\$1.00. Send negative. Huffman, 309 Water, Whitesboro, Texas.

PHOTOS Copied, 20 wallet-size deluxe prints \$1.00. Original picture returned. Send any size photo or negative. Federal Wallet-Size Photo Co., Dept. PM-6, P.O. Box 2448, Kansas City 6, Mo. (No c.o.d.'s please).

NO Charge developing rolls. Pay for good prints only. Jumbos 4¢. Contacts 3¢. Failures refunded. Returned same day. Satisfaction guaranteed. Square Deal Photos, Hutchinson, Kansas.

ENLARGEMENTS' Eight 5x7's or five 8x10's. \$1.00. Willard Enlargers, Box 967, Little Rock, Ark.

TWO Beautiful prints from each picture on roll. 8 exposure 40¢; 12 exposure 50¢. Thirty-five years of satisfied customers. Quick service. Lens Photos, Dept. J-4, Janesville, Wis.

GIVE Personalized photo Christmas cards. New, wide selection to choose from. Get complete information and samples. Write Lincoln Studios, Dept. K, Box 13, Lincoln, Nebraska.

AMAZING Values! Enlargements, finishing. Free catalogue. Reproductions, 417-19 Broadway, Joliet, Illinois.

TRIAL Offer—8 jumbos 25¢, 12—35¢. Thrifty Photo, PM116, Box 275, San Francisco 1, Calif.

TWO Beautiful enlargements from each picture on roll. 8 exposures 55¢, 12 exposures 75¢. Cut Rate Photos, Dept. B-4, Janesville, Wis.

EKTACHROME Processing — \$1.00. Transparencies printed, 2X 45¢; 3X 65¢. Photocolor Laboratory, P.O. Box 617, Toledo 1, Ohio.

ENLARGEMENTS, Heavyweight eight 5x7's or five 8x10's. \$1.00. Jack Koons, Huntington Mills, Luzerne County, Pennsylvania.

NEGATIVES Reprinted 2¢. 35 reprints \$1.00. Linkie's Photos, High Point, North Carolina.

MOTION PICTURES AND SOUND EQUIPMENT

FREE! Blackhawk's big sale catalog new and used 16mm., 8mm. films; 2"x2" color slides; used 16mm. sound projectors. Biggest stock in U.S.A. Blackhawk Films, 1700 Eastin, Davenport, Iowa.

MOVIES; Movies; movies: 8 and 16 mm. B & W and color. Free gift and list sent in well sealed envelope. G & M Films, Box 4161, Glendale, California.

SAVE 50%! Guaranteed-fresh color, b.&w. movie film! 8mm., 16mm. Free catalog! Eso-R, 47th Holly, Kansas City 12, Missouri.

TAPE Recorders, slide projectors, wholesale! Unsurpassed value! Don's, Box 5116, Orlando, Florida.

16MM. Sound-used projectors and films. Rental, sale, exchange, bargain prices. Free lists. Also 8 mm. Specify film size. National Cinema, 71 Dey Street, New York City.

8-16MM. Films. Free catalogue (with sample film 10¢). Garden, 690 Howard Avenue, Brooklyn, N. Y.

5,000 8-16MM. Movie films. Free catalogues. International, Greenvale, N. Y.

TAPE Recorders, tape. Unusual values. Free catalog. Dressner, 69-02M 174 St., Flushing 65, N. Y.

MOVIE Camera film: 8mm. roll \$1.50, 16mm. 100' \$3.00. Free processing. Better Films, 742 New Lots, Brooklyn, N. Y.

RECORDERS, Tapes; wholesale. Free catalogue. Carstan, 215 E. 88, New York City 28.

HI-Fidelity magnetic tape. 7" 1200 foot roll, 3 for \$4.95; 7" 1800 foot roll, 3 for \$5.95. Add 50¢ postage. Money-back guarantee. Florman & Babb, 68 W. 45th, New York City.

WILD Life films. Buy direct from studio at tremendous savings. Kodachrome, b&w 8 and 16mm and 2x2 slides. Free illustrated brochure. Wild Life Films, 5614-A Cahuenga Boulevard, North Hollywood, California.

16MM Feature film sale. Rentals \$3.95. Sound Films, Box 262, Chicopee, Mass.

MUSIC AND MUSICAL INSTRUMENTS

PLAY Piano the first day! Copyrighted secret. Details free. Miracle Method, Box 5203P, Phoenix, Arizona.

SONGWRITERS. Free booklet successful songwriting. Gateway Songs, Box 2470, Hollywood 38, Calif.

POEMS Wanted for new songs. Send poems. Free examination. Immediate consideration. Songcrafters, Arcade Station, Nashville, Tenn.

POEMS, Songs wanted! Free examination. Bengol, 93 Jefferson, Chelsea 50, Massachusetts.

ACCORDIONS. Wholesale to everyone. Save up to 60%. All national known brands. Free catalogue. Del Principe, 29 South Cicero, Chicago 44.

POEMS Wanted for new songs. Send poems. Immediate consideration. Crown Music Company, 1476 Broadway, New York City 36.

WRITE Songs. Big money and reputation. Write for information. J. Gordon Pub. Co., 4700 South California Avenue, Chicago.

VIOLINMAKERS. Repairers. Fine tone wood, and all violin supplies. Send for free wholesale price list. International Sales, 414-MPM E. Baltimore St., Baltimore 2, Maryland.

SONGPOEMS And lyrics wanted. Mail to: TinPan Alley, Inc., 1650 Broadway, New York 19, N. Y.

SWISS Musical movements, \$1.90. Helax, 218 West 72nd Street, New York 23.

WHOLESALE Catalog! 30-80% discounts! Appliances, musical instruments, typewriters, tools, watches, jewelry, cameras, housewares, etc. Consolidated Distributors, 1300-34 Main, Clifton, New Jersey.

DISCOUNTS. Instruments, accessories, national brands. Tempo Music, 37 Cutler, New London, Connecticut.

SONGS Into dollars. Share \$29 million dollars yearly for new songwriters, song-poets. Songs composed, published, promoted by famous firm. Information, appraisal free. Send to Nordyke Publishing, 6000 Sunset, Hollywood 28PM, California.

SONGWRITERS: Recording company wants new songs. Royalty basis. National sales, promotion if selected. Send material. Music Makers, Dept. E-26, Box 2507, Hollywood, Calif.

1956 **ACCORDIONS** — Wholesale. Free catalog. American Accordion Center, PM-11, 5329 Belmont, Chicago.

ACCORDIONS — Direct from importer. Save 50% and more! Free trial. Lifetime guarantee. Trades accepted. Free catalog. Write Accordion Manufacturers, Dept. 116R, 2003 Chicago, Chicago 22 Illinois.

FREE Records of your song. Your words, my melody. Free information. Johnny Mack's Melody Mart, 1094 West 39th Street, Dept. A, Los Angeles 37.

POEMS Wanted for musical setting and recording. Immediate consideration. Send poems. Five Star Music Masters, 630 Beacon Building, Boston.

MUSIC Printing. Songs printed. Melodies furnished. Dorby Music Printers, Box 354, Morristown, New Jersey.

RADIO, TELEVISION AND ELECTRONICS

WHOLESALE: Phonographs. Radios. Tape recorders. Catalogue 25¢ (refundable). Towers, 155, Philadelphia 5.

FREE 356 Page 1957 radio, TV, Hi-Fi, electronics catalog! World's largest stocks, lowest prices. Everything for experimenters, builders, amateurs, servicemen. Latest build-your-own famous Knight-kits, Hi-Fi, phones, recorders, P.A., TV accessories. Thousands of parts, tubes, test instruments, tools and books. Write for free copy! Allied Radio Corp., 100 N. Western Ave., Dept. 34-L-6, Chicago 80, Illinois.

WALKIE-Talkie. Build wireless two-way portable radiophone for less than \$10.00. Plans 50¢. Springfield Enterprises, Box 54-B11, Springfield Gardens 13, New York.

ARMY Throat microphone, new, 50¢. Surmer, Box 118, Jersey City 4, N. J.

EXPERIMENTERS: Make hi-fidelity, self-powered radio receiver. Runs phones or loudspeaker. Low initial cost. Operating expense zero. Plays forever. Rush 50¢ for fully diagrammed descriptive literature. Double your money back if not satisfied. Act now! Janacek, Dept. B, 373 East 155th St., New York 55, N. Y.

WALKIE-Talkie plans, \$1.00. Fabco Electronics, 7400 Jackson Park, Birmingham, Michigan.

SURPLUS Walkie-talkies, radar, short-wave, parts. Fantastic prices. List 5¢. Meshna, Malden 48, Mass.

UNUSUAL Values in mobile sound equipment. Granville Heard, Ontonagon, Mich.

TV-Tube brightener—Adds new life to weak picture tube. Guaranteed. Simple installation without tools. \$2.00 postpaid. Murhall, 608 S. Dearborn, Chicago 5.

ENJOY 3 Color television screen now. Easily attached. Every black-white program seen in beautiful colors. Send \$1.25. Screen size 17" or under; \$2.00, 21"; \$2.50, 24". Prompt shipments. Satisfaction guaranteed. Zingo Products, Johnstown 2, New York.

CRYSTAL Radio builders. Free information. Huilet, 305 Hope, Lakewood, N. J.

CRYSTAL Radio kit \$1.00, preassembled \$1.25, phone \$1.75; catalogue. Clearco Crystal Company, 2966 North 4th, Milwaukee 12, Wisconsin.

TRANSISTORIZED F-M radio kit \$9.95. Ekeradio, 646 North Fair Oaks, Pasadena, California.

BUSINESS OPPORTUNITIES

EXTRAORDINARY New mail order ideas, opportunities. Specific methods, products, projects, sources. Authentic, reliable. Free information: Business-Fax, Box 1024-C, Galveston, Texas.

OPERATE Statement mailing service from your home as our representative. Material furnished. American, Mt. Airy, Maryland.

BUY Wholesale; go into business for yourself. Tremendous discounts on name brand merchandise. Jewelry, household items, appliances, etc. Free wholesale catalog. Normandy Distributing Corp., Dept. PM, 133 Fifth Ave., New York, N. Y.

VENDING Machines—No selling. Operate a route of coin machines and earn amazing profits. 32-page catalog free. Parkway Machine Corporation, Dept. 26, 715 Ensor Street, Baltimore 2, Maryland.

LEARN Sewing machine repairing easy. Neighborhood sparetime gold mine. Supplies! Free brochure. Taylor Service, Box 2126, San Bernardino, Calif.

PLATE Baby shoes, jewelry, gifts, bronze and colored pearl. Free booklet. Platex, 11029 South Vermont, Los Angeles 44.

RAISE Rabbits on \$500 month plan. Plenty markets. Free details. White's Rabbitry, Dept. 122, Mount Pleasant, Michigan.

HOW To make up to \$100.00 a week in spare time—by mail. Tested, money-making plan. Free details. Personal Press, 1412-PM Great Northern Bldg., Chicago 4, Illinois.

FREE Literature describing moneymaking mailorder plans. National Service, Richland, Georgia.

FREE! Complete mailorder business. Terrific profits! No investment! VitaMins, 2908PM Beverly, Los Angeles 57.

MAIL Order opportunity. Tested. We supply everything. Details. Girard's, Azusa, Calif.

IMPORT. Mail order opportunities. Mail-order laws and regulations. Complete \$1. Details, stamp. Will Riet Co., 107F Ilford Ave., North Arlington, New Jersey.

GROW Orchids at home—Profitable, fascinating. Year 'round, Maine to California. No greenhouse. Gorgeous cactileyas, cymbidiums, etc. Successful home grower shows you how. Full details free. Flowerland, 100 So. Vermont, Los Angeles 4.

YOUR Own name brand business. No investment; no inventory. Part time or full time. Sell famous brands of appliances, housewares, silverware, radios, vacuum cleaners, lamps, tools, clocks, watches, jewelry, etc., etc., over 1000 items. Join thousands of successful independent dealers. Send for free catalog and dealer price list. H. B. Davis Corp., Dept. 11, 145 W. 15 St., New York City.

BUY Wholesale! Discounts to 80%! Appliances, cameras, sporting goods, tools, watches, housewares, etc. Free catalogs. Buy-Rite, Box 258A, Hawthorne, New Jersey.

COLORGLAZED Concrete pottery made without molds. Patented method. Cemetery products, novelties, tiles. Basement leak-sealing. Money-making projects. Booklet, details free. Men only. National Potteries Company, Grand Rapids, Minnesota.

\$800 CASH, Plus commission, collecting magazine subscriptions. Rare list 25¢. Warner, Box 1085, Bridgeport, Conn.

YOU Can make money for Christmas in spare time taking magazine renewal subscriptions. No capital or experience necessary. All supplies furnished. Write today! McGregor Magazine Agency, Dept. 500B, Mount Morris, Illinois.

IMPORT-Export opportunity, profitable, world-wide, mail-order business from home, without capital; or travel abroad. Established world trader ships instructions for no-risk examination. Experience unnecessary. Free details. Mellinger P701, Los Angeles 24.

MAKE Flexible molds. Cast plaques, figurines, free sample. Tooker, 630-R Chestnut, Hamilton, Ohio.

11,000 NEW Prospects daily. Baby record books, shoes, albums. Sell mailorder. Everything furnished. Free literature. No-Co-Ro, Capitola, California.

LIQUID Rubber, make flexible molds. Free sample. Chaney, 1130 E. 16th St., Jacksonville 6, Fla.

WHOLESALE Catalogue! Appliances, cameras, watches! Cam Company, 6806PM 20th Ave., Brooklyn 4, N. Y.

MONEY In saw and lawnmower sharpening sparetime at home. Free book. Virgil Foley Company, Columbia Heights, Minnesota.

POPCORN And potato chip equipment. Eakins, Box 933-A6, Springfield, Ohio.

FREE Folio "\$5,000-\$45,000, Unlimited Vacations." No merchandise, equipment. Unknown! Work home, sparetime! Haylings, Carlsbad, Calif.

\$350 WEEK Cleaning venetian blinds. Patented machinery. Free literature. Robinson, 7213B, Indianapolis 1, Indiana.

NATURAL Molding rubber, extra thick. Free sample. W. Wooley, 115-A Donald, Peoria, Illinois.

BIG Profits raising fishworms and crickets. Free literature. Carter Farms, Plains, Georgia.

FIX Typewriters. Inexpensive home course teaches factory secrets. Free booklet. Write, Typewriter, Tarentum 1, Penna.

\$70 WEEKLY—Home, spare time. Simplified mail bookkeeping. Immediate income—easy! Auditax, 34757A, Los Angeles 34.

\$150 WEEK—Easy! Start home Venetian blind laundry. Revealing book free. A. T. Co., 101 S. 44th, Philadelphia 4, Penna.

WANT To make big money at home? \$5 profit in an hour possible with invisible reweaving. Make tears, holes disappear from clothing, fabrics. Steady year-round demand from cleaners, laundries, homes. Details free. Fabricon, 6334 Prairie, Chicago 19, Illinois.

BRUSH Plating outfits for plating articles in the home and shop. No tanks necessary. Good income spare or full time. Free particulars. Gunmetal Co., Ave. H, Decatur, Illinois.

\$0 PROFIT Baking new greaseless doughnuts in kitchen. Grocers buy daily. Free recipes. M. Ray, 3605 South 15th, Minneapolis 7, Minnesota.

MAKE 80¢ Profit on every dollar selling merchandise by mail. Everything furnished. Write: Eastern, Box 142-A, Boston 24, Massachusetts.

\$1,000 MONTHLY Possible in collection agency business. Free details. Write Cole Associates, Syracuse 2, N. Y.

TO \$100.00 Weekly. Sparetime, home operated mailorder business. Successful beginner's plan. Everything supplied. Lynn, 10420-M National, Los Angeles 34.

MAILORDER! Succeed with something new that everyone wants. Free information. MCB, 1221P W. Minnehaha Pkwy., Minneapolis 19, Minn.

FREE Book "\$50 Odd, Successful Businesses." Work home. Expect something odd! Pacific, Oceanside, Calif.

WHOLESALE Buyers! New 1956 "blue book" gives names of over 3000 jobbers, manufacturers who supply anything. Free details. Associated Wholesalers, 1016-D Starr, Burlington, Iowa.

REBUILD Batteries; repair dolls; make rubber stamps; "60 Ideas" free. Universal, Box 1076-A, Peoria, Ill.

OPERATE Mailorder folio business! Free details. Ballard's, 425 East Catherine, Louisville 3, Ky.

RAISE Nutria—Vegetarian; raise mink, carnivorous. Individually or combined, potential terrific. Voigt Farms, Atlanta 2, Texas.

PLASTERCRAFT Molds, liquid rubber, plasters, flocks, candle supplies. Catalog and manual free. Blue Rapids Supply, Blue Rapids, Kansas.

BIG Profits, selling, John Raper line guides. Makes any fishing pole a fly rod. Literature free. John T. Raper Mfg. Co., Fairfield, N. C.

EARN \$10,000 Yearly raising Angora rabbit wool for us. Information 25¢ coin. American Angora Company, Malta 12, Montana.

SPECIALIZED Magazines, 5,166 different publications—All businesses, trades, vocations, professions, sports, hobbies, etc. Free list. Write today. Commercial Engraving Publishing Company 34C North Ritter, Indianapolis 19, Indiana.

CASH From sawdust. Seventy methods. Tin-cans, thirty methods. Newspapers, eighteen methods. Instructions 50¢ each. All three \$1.00. Charles Company, 12-DXV, Norwood, Ohio.

INTERESTED Mailorder? Samples leading publications in field 25¢. Palm, Box 1221, Baton Rouge, La.

846 FROM Square foot plywood with your jigsaw. Woodart, Bridgewater, Mass.

OWN Your own printing press. Earn \$225 a month or more. No experience needed. Same presses used by schools, greeting card companies and others. Send 25¢ for Start-A-Business booklet. Tells all about it. Explains how you can set up a profitable printing business with the famous Craftsman plan. Send to: Craftsman Machinery Company, 75 W. Dedham Street, Boston, Mass.

BE A landscape contractor. Make \$20 to \$60 a day. Start with smaller projects and work into larger jobs. We show you how. Easy-to-follow home study course. Write for free book. National Landscape Institute, Dept. M-116-C, 310 S. Robertson Blvd., Los Angeles 48, Calif.

BREED Rare tropical fish at home. Earn big money! Learn secrets! Help fill huge demand. Amazing opportunity! Free plan. Tropical Fish Breeders, Los Angeles 61, Calif.

MINK Raising information free. Complete. Lake Superior Mink Farm. Superior, EE1, Wisconsin.

NEWEST Spare, full-time home business. \$5 to \$10 hour possible. Paint with suede—The finish with touch and eye-appeal. Beautiful auto dashboards, signs, radios, toys, figurines, lamps—1001 others. Complete, step-by-step instructions sent for no-risk examination. Free details. Coast, Los Angeles 61.

WHOLESALE Catalog! 30-80% discounts! Appliances, musical instruments, typewriters, tools, watches, jewelry, cameras, housewares, etc. Consolidated Distributors, 1300-11 Main, Clifton, New Jersey.

ADVERTISING Book matches—Cash in on big demand; sell union label matches. Cuts for all businesses and political parties. Free powerhouse selling kit, low prices, protection guaranteed on repeat orders. Cash commissions. Superior Match Co., Dept. MX-1156, 7530 Greenwood, Chicago.

ALL New plan! Subcontract Casecraft work at home. Also manufacture for salesmen selling your products nationally. We supply complete instructions, tools, supplies, everything. Free details. Abars!, 807-BM W. Sunset, Los Angeles 12, Calif.

INTERNATIONAL Mailorder business. Complete setup service—Not just instructions. Hermes, 152 West 42, New York City 36.

START A buying service, buy wholesale thousands nationally advertised products. Make big profits selling at sizable discounts. Postcard brings details. American Buyers, Hertel Station, Buffalo 16-C, New York.

COPUBLISH Mail Sale Advertiser, leading mail order paper. Details, latest copy, dime. Vanroy Shirk, Lebanon, Penna.

BUY Wholesale! Resell at big profits. Brand name merchandise—Appliances, cookware, housewares, watches, jewelry, dry goods, clothing, sporting goods, toys, gifts, etc. Free 1957 color catalog with confidential cost sheet. Merit Home Products, Dept. PM-11, 107 Manhattan Ave., Brooklyn 6, New York.

GROW Expensive herbs for us! Big profits home-business of your own. Year around profitability! We supply everything necessary! Send for free rare seeds and revealing plan. National Herb Exchange, Dept. NR, Gardena, Calif.

"HOW To Start a Business" booklet sent free! If you know any trade, go into business for yourself! Learn the 9 easy steps to follow. We've guided 5,000 others to success. Revealing free booklet yours for the asking! Write! National Business Consultants, Office NR, Los Angeles 61, Calif.

OPERATE Restaurant or diner. Free booklet reveals plan. Write Restaurant Arts, BU-111, Fremont, Ohio.

LEARN Hand spinning. Good market, profit, for work. Angora House, PM, Springfield, Illinois.

BECOME Tax consultant. Graduates earn \$3,000 every tax season preparing returns evenings. State approved. Union Institute, 68 Hudson, Hoboken, 2P, N. J.

MAIL Order advertising agency executive reveals sensational no-risk advertising and merchandise methods. Start in office or home; minimum capital; positive profits. Free details: Impact! 2108 Payne, Dept. 11-11, Cleveland 14, Ohio.

GET The real dope on raising needed capital. Write Enterprise Bureau, SAK Bldg., Syracuse 2, N. Y.

HAVE Profitable home mailorder business selling quilt pieces, remnants—Full, sparetime! Over 20,000,000 repeat prospects! Rush name for details of this amazing moneymaking business today! Coleman, Box 821-A, Newark 1, N. J.

FREE Book. Grow mushrooms. Guaranteed market. Mushrooms, Dept. 172, 2954 Admiral Way, Seattle, Wash.

MAKE Profitable products. Easy mail-order sales. Knowhow free. International, 6347 Parnell PM11, Chicago 21, Illinois.

SPARE. Full-time. \$5-\$200 profit per order. Name brand appliances, cameras, etc. No inventory. Free details. Happy Homes, Dept. P-11, 366 Hempstead Ave., West Hempstead, N.Y.

MANUFACTURE—Polishes, cleaners, cosmetics, anything. Literature free. Kemixer, Park Ridge, Ill.

MAKE Big money raising quality chin-chillas. Blend-trust graded. Terms available. Marvin Koehler, Thorndale, Texas.

IMPORT Your own fast selling products in small lots. Also, start highly profitable mail order business using international drop-shipment method. Capital unnecessary. Free details. Georgia Overseas Trading Company, Dept. W, 715 Persons Building, Macon, Georgia.

FRANCHISE Make profits! Become exclusive distributor, dealer, agency operator. Request information. National Franchise Reports, 333 North Michigan, Chicago 1.

EARTHWORMS: Easy backyard business. Tremendous demand. 600% profit. Instruction book 50¢. 1000 young breeders \$4.50 postpaid. Starr Earthworm Farms, Orland, Calif. America's most publicized grower.

BE Appointed state notary public now. Write, Stationers, Boerne, Texas.

FREE "How to Start Your Own Mail Order Business." Exclusive franchise, catalogs, top mail order items drop-shipped for you. Mail Order Associates, Paramus 4, New Jersey.

BUY Wholesale almost anything. Send \$1.00 for catalog. Refunded with first order. Harbor City Wholesale, Box 133, Muskegon, Mich.

IMPORT-Export! Mailorder opportunities. Details. Warner, Box 6, Fort Scott, Kansas.

BIG Profits. Operate electric motor repair shop at home. Spare time. Lincoln School, Box 52, Hempstead, N. Y.

RECEIVE Big mail, and I will mail 100 of your circulars, all for 10¢. Haley's Mail Service, Manheim 44, Penna.

SPLENDID Mail order opportunity. Write Thomas Bond, 1637G West Vernon, Phoenix, Arizona.

HIGHEST Commissions all magazines. Free catalogue, supplies, prizes, exclusive extras. Subscription Service Co., Box 2070, Birmingham, Alabama.

WE Love our mailman—He leaves over \$1000.00 monthly in our rural mailbox. My college professor husband drafted a scientific home mailorder method. We bought a Texas ranch, live as we always wanted. Now we sell the Ranch Mailorder Method. Operates anywhere. Inquire: Eveningshade Ranch, Boerne, Texas.

START Identification tag business. Clearview Co., 172 Stanton St., New York City.

REAL Diamond rings. Sell direct. Make big middleman's profit. No investment. Experience unnecessary. Free catalog, details. Gleamlight, 109-C North Columbus, Mount Vernon, New York.

MAKE, Sell perfumes, household products. Jordan, 743 South Dorrance, Philadelphia 46, Penna.

"I Earn \$400.00 a week." I've learned an amazing new method of printing colorful signs, banners, cards, posters, glassware—anything. No printing press or other expensive equipment is necessary! Big money-making opportunity for anyone. Write for my secret and revealing home-business plan, you'll be amazed! Mr. Anderson, Screen Print Company, Dept. NR, Los Angeles 61, California.

INCREASE Your income. Free literature. Bercher, Box 500, Shreveport, Louisiana.

BUILD For the future. Address Bailey, Box 604, Inglewood, California.

\$10,000 OPPORTUNITY. No experience. Franchise \$1. Moneyback guarantee. Strategy, 6228M, Charlotte 7, N. C.

"MAILORDER Laws and Regulations." \$1.00. Explains licenses, taxes, legal requirements. Tasker, 105 East Custis, Alexandria, Virginia.

WANTED: Home producers, to be subcontractors. Cast plastic products for manufacturers in our clearing house service. Thousands of easily made items required. Cash in at home, without previous experience. Plastic Service Associates, Dept. 11-PM, East Boston 28, Massachusetts.

40 MILLION Auto accidents past 12 months means urgent need for claim adjusters. Terrific opportunities your own full or part time business. Allen made \$2,000.00 in ten weeks. Free book now! Universal Schools, 6801 Hillcrest, PM11, Dallas 5, Texas.

MAKE Money growing miniature trees on your window sill. Free seed and plan. National Nursery, Dept. M-NR, Inglewood 4, Calif.

DO You like money? Then get into the mailorder business! I'll show you how for only \$2.00. Guaranteed satisfaction. W. Adams, Box 5415, Chicago 80, Illinois.

919 SECRETS! Free complete plan "Secret Journal Hidden Dollars." Work home successfully, weekends! Publico-M, Oceanside, Calif.

CAPITAL Found by my magnetic ads or money back. Complete folio \$1.00. Tucker, 3633-A, Warder N.W., Washington 10, D. C.

COPUBLISH Mail Sale Advertiser, leading mail order paper. Details, latest copy, dime. Mail Order Field, P.O. Box 11, New York 60, N. Y.

NEED Money? Ever thought of sharpening saws or lawnmowers? Send for free literature on the best machines made for the purpose, including shop layouts. Max Mfg. Co., 138 Stockton Ave., San Jose 26, California.

FORMULAS For latest money-making discoveries. New! Good! Valuable literature free! Miller, Chemist, 1517-E, Tampa, Florida.

BARBECUE Pits, incinerators, patio stones. Sandstone finish. Prefabricated. Forms inexpensive. Big profit. Pictures and data. 50¢. Poo Bradford, 324 Carolina Dr., El Paso, Texas.

LEARN Real estate by listening to records. L. Institute, Brookline 48, Mass.

MAIL Catalogues featuring real merchandise. Charles, Box 32-P, New York 63, N. Y.

JOBS Paying to \$350 weekly now available on overseas and American projects, men and women, all trades. Transportation paid. Free information. Write Transworld, Dept. M11, 200 W. 34 Street, New York 1, N. Y.

FREE Mail order plan, catalog, samples! Sutton Printing, Box 853-D, Waycross, Georgia.

MAKE Attractive, durable, building plastic, easily, 800% profit. Exclusive district. Bays Laboratory, Oklahoma City 9.

MINIATURE Golf—Own your own business. Complete details and illustrations. Send \$2.00 to Lil' Putt Miniature Golf, Box 294, Rock Island, Illinois.

\$10 PER Hour net profit in monument cleaning business. Free details. X-Perf Monument Cleaning, 466 Potomac, PM-1, Buffalo 13, N. Y.

MAIL Order Manufacturing Guide. Complete details 30 products anyone can manufacture, wholesale. Ideal mail order sellers. 25¢. Albert Daufeldt, Atalissa, Iowa.

I'LL Set you up in your own business free! The "free" means without investing in merchandise or advertising. Free details. Mail Order Field, Box 11, New York 60, N. Y.

PORTABLE Garbage disposal sells itself! Earn \$2135 monthly, 100% profit. No installation UL approved. Retail \$39.50. Choice territories. Free demonstrator offer, kit. Write today. New-Home Co., 4B, P.O. Box 840, Beverly Hills, Calif.

FLORIDA Opportunities! Hundreds of jobs, businesses, farms, groves, homes. Free details; Florida Opportunity Journal, Vero Beach 14, Florida.

YOU Can own business. Over 100 proven plans. Send \$2 to J. Whitmarsh, 462 Central, Lake Orion, Mich.

YOU Can start own business. Home office. Send 10¢ folder. Plans never failed. A & B Products, Box 422, Station A, Columbus 1, Ohio.

OPERATE Mail-order book shop. Pleasant, profitable. "Directory of Wholesale Book Sources"—\$1.00 postpaid. Artcraft, Box 8038, West Palm Beach 1, Florida.

826,500 SALES in two weeks! Amazing radio-mail order method. Free details. Broadcast Service, 1412-NP Great Northern Building, Chicago 4, Illinois.

FORMULAS: Twelve different. Hair tonics, shampoos, lotions, creams, \$1.00. Hendrix, 806 Maple, Carrollton 4, Ga.

HIGHLY Profitable home business opportunity! Delightful interesting work. Free literature. Stanwilco, Postoria, Ohio.

CASH Income collecting local information. No selling. Free details. Dorsitt, 2215 So. Walnut, Muncie, Ind.

MAIL Order business. Make money in a ready made mail order business with repeat income. Orders come direct to you with a big profit on every sale. Only \$1.00. Collective Enterprises, P.O.B. 179, Murray Hill Station, New York 16, N. Y.

WHOLESALE: 850,000 Items. Supply source directory 25¢. Idealer, Park Ridge, Illinois.

I Want to send you proof of the wonderful pulling power of Popular Mechanics classified pages. What's your proposition? Write me today. Include literature if possible. F. W. Johnson, Manager Classified Advertising, Popular Mechanics Magazine, 200 E. Ontario St., Chicago 11, Ill.

MONEYMAKING OPPORTUNITIES

SELL Titania gems. Far more brilliant than diamonds. Catalog 10¢. Diamonite, 2420-M 77th, Oakland 5, California.

BUY Wholesale! Save 66%! Appliances, furniture, jewelry, toys, sporting goods, tools. Free details. National Buyers Service, Box 3338EB, San Francisco.

RAISE Rabbits on \$500 month plan. Plenty markets. Free details. White's Rabbitry, Dept. 123, Mount Pleasant, Michigan.

MIMEOGRAPHING Services pay sensational local profits. Exciting secret plans exposed! Rush name. Mozelle Mimeo Shop, Bonham, Texas.

VENDING Machines—No selling. Operate a route of coin machines and earn amazing profits. 32-page catalog free. Parkway Machine Corporation, Dept. 27, 715 Ensor Street, Baltimore 2, Maryland.

PLEASANT Profits—Let us show you how to start your own complete scissors and tool sharpening business. Free details. Serr-Edge Inc., 9729 Lorain, Cleveland 2, Ohio.

IMPORT Opportunities, full details 10¢. Value Imports, 1215 East 93 St., Brooklyn 36, N. Y.

FRAUDS To watch out for. Avoid being swindled. 25¢. Barnes, Box 332, Glens Falls, N. Y.

"TEN Years in Mail Order" can save you money. \$1.00 or send for details. Modern Enterprises, 517 Beechtree Dr., Cincinnati 37B, Ohio.

LEARN Technical Metaphysics and insure your future. Easy, inexpensive correspondence course. Simplest method known. Diploma. Write: Premier College of Technical Metaphysics, 2532 McKenzie St., Vancouver 8, B. C., Canada.

EARN Money evenings copying and duplicating comic cartoons for advertisers. Adservice, Argyle 1, Wisconsin.

PRIZE Contests provide fabulous and confidential home income opportunities! Here's how and where to win your share! Send stamp! National Contest Bulletin, Box 2885-P, Miami 16, Florida.

FORTUNE Possible raising, fishworms and crickets. Free literature. Carter Hatchery, Plains, Georgia.

START A profitable subscription business in spare time! We need men and women (young or old) as representatives for all leading national magazines. Liberal commissions on all subscriptions. Supplies free. Send this ad with your name and address to: Agency Bureau, Dept. PM, Hearst Magazines, 250 West 55th St., New York 19, N. Y.

EARN \$50.00 Daily making mats, shoes and mud guards from old tires. S and S Patents Inc., 1307 North Clark St., Chicago 10, Ill.

WHOLESALE Catalog! 30-80% discounts! Appliances, musical instruments, typewriters, tools, watches, jewelry, cameras, housewares, etc. Consolidated Distributors, 1300-27 Main, Clifton, New Jersey.

100% PROFIT. No investment. Stamp brings details, samples. Miller, Box 584, Brooklyn 1, New York.

DOLLARS Every day! Amazing new magic mail plan. Set-up free. Miller, Box 588X, Oshkosh, Wis.

GENERAL Contest Bulletin. Lists contests monthly. Sample, 25¢. 1609½ East 5th, Duluth, Minn.

EARN Big profits—Assemble our hand tooled copper planters, wall plaques, many other items. We furnish materials and instructions. Write for free catalog. Steward, Inc., Box 1082, Decatur, Georgia.

MAKE \$5,000 Yearly spartime raising mink, chinchillas, nutria, etc. Free booklet reveals proved plans. Write Furs, 588 Mt. Pleasant Road, Toronto 1, Canada.

START A buying service, buy wholesale thousands nationally advertised products. Make big profits selling at sizable discounts. Postcard brings details. American Buyers, Hertel Station, Buffalo 16-D, New York.

READ Progressive Mailtrade, the magazine that tells how to make money by mail. Dime brings sample and special offer. Progressive Mailtrade, Box 357, Sheboygan, Wisconsin.

RAISE Money for church, club, school. New plans. Free details. Theron Fox, 1296½ Yosemite, San Jose, Calif.

MEN-Women! Start money-making plastic laminating business at home in spare time. Material that costs 11¢ brings back \$2.58. No canvassing or selling but mail orders bring in \$20 a day. Write for full particulars free. Rush name on postcard to Warner, Room 711, 1512 Jarvis, Chicago 26, Ill.

SELL First quality nylon hosiery and lingerie. Continental Wholesale Company, Box 1047, Reidsville, North Carolina.

CONTESTANTS! Contests, helps, Write. Contests, 166 Catherine St., Red Bank, N. J.

MAKE Money writing short paragraphs! No tedious study. I tell you what to write, where and how to sell; and supply list of editors buying from beginners. Many small checks add up quickly. Write to sell, right away. Send for free facts. Benson Barrett, Dept. C-27-Y, 7464 Clark, Chicago 26.

MEN And women wanted to start home business in spare time with little table-top rubber stamp machine. Easy to earn up to \$9.80 an hour without previous experience. Full particulars free by mail. Send postcard to Roberts, 1512 Jarvis, Room 711, Chicago 26, Ill.

FREE Book. Grow mushrooms. Guaranteed market. Mushrooms, Dept. 173, 2954 Admiral Way, Seattle, Wash.

ATTENTION Typewriter owners. Make handsome profits. Write today. Groves Company, 682, Hastings 8, Nebraska.

START Big-pay business at home in spare time. No experience needed to operate little table-top machine for bronzing baby shoes. Make \$5.46 profit on every pair. Full particulars free. Send postcard to Mason, 1512 Jarvis, Room 711, Chicago 26, Ill.

NEED Products? Salesmen? Markets? Details free! Sayer Associates, 1129-C2 Vermont, Washington 5, D. C.

TURN Spare time into extra cash! Write for free folder, describing interesting, home moneymaking opportunities! Strike, Route 2, Chilhowie, Virginia.

PLAN Preview, opportunity seekers' newsletter. Guaranteed different. Harry, 68 Woodfern, Scarborough, Ontario.

100 JOBS At home. Free booklet. Good Will, 12 Montclair, Cap Madeleine, P.Q., Canada.

MAKE Money with your camera! Send \$1.00 to Kruegers, P.O. Box 820, Delavan, Wisconsin.

JOIN. Book repair club. Make money. Martin, Colgate, N. Dak.

AMAZING Profits, Security. Free information. National, 9128-P S.W. 26th, Portland 19, Oregon.

"MONEY Getter's Bulletin," sample 25¢. Donovan, 791 Greenbelt, Levittown, N. Y.

SELL Books by mail. Literature free. Royal, Box 368-X, Cleveland 27, Ohio.

INCREASE Your income! Many profitable opportunities! Write George A. Talbot, Norwood, Mass.

918 SECRETS! Free complete plan "Secret Journal Hidden Dollars." Work home successfully, weekends! Publico-M, Oceanide, Calif.

TYPISTS! Make money at home. Mailing, 2 Madison, Greencastle, Indiana.

500% PROFIT. Mailorder item for 60,000,000 daily users. Free details. Auro Laboratories, 939 Huntingdon, Philadelphia 33.

MONEY In bronzing baby shoes. Details free. Nelson, 6344 Logan South, Minneapolis 23, Minnesota.

FREE Folio "\$5,000-\$45,000, Unlimited Vacations." No merchandise. Unknown! Work home, spartime! Haylings, Carlsbad, Calif.

MING Trees—How to make, sell, obtain materials. Booklet airmailed \$2.00. Yung, PK 45, Vekaleter, Ankara, Turkey.

MAILORDER Instruction, sources, printing. Booklet 25¢. L. C. Sales, 17 South 9th, Wilmington, N. C.

FREE Book "505 Odd, Successful Businesses." Work home. Pacific, Oceanide, Calif.

APPROVED Safety shoes. Sell co-workers top quality, comfortable, light weight Bronson "Cushion" Safety Shoes with iron-clad guarantee. No investment. Details free. Write Bronson Safety Shoes, Minneapolis 8, Minnesota.

GET Dollars in your mailbox. It's easier than you think! Send \$1 for "Words That Work." House of Better Books, 722PM East Silver Spring, Milwaukee 17, Wis.

AMAZING Book gives 2000 tested ideas you can write and sell to newspapers, magazines. Thousands helped. \$2.50. Perennial, 292 Lexington, New York City.

INCOME Tax instructions amazingly simplified. No lessons. \$5-\$10 per hour spare time. Particulars free. Reynard, Box 1265-A, Peoria, Ill.

HOME Business, mailing literature. Vosacek Printing, 4444PI Ute, San Diego 17, Calif.

HOW To make money in real estate with a small investment of capital. \$1.00. Forest Wodtli, R.R. 1, Box 2738, Sweet Home, Ore.

EXPORT — IMPORT

IMPORT Direct. Beautiful cigarette lighters 23¢ f.o.b. any U.S. port. Sample \$1. U.S.S. Importers, 565 N. Coles Ave., Maple Shade, N. J.

INTERNATIONAL Import index lists new exclusive imports. Free copy. International, Box 636, Newark 1, N. J.

FORMULAS, PLANS, ETC.

PRODUCT Analysis, manufacturing formulas, processes developed. Moderate fees. Plastics, Box 1574, Boston 4, Mass.

PRACTICAL Formulas. Lists free. Cummings, Chemist, Gordon Ave., Syracuse 4, N. Y.

LATE Modern manufacturing formulas. List free. Moon Chemical, Martville, New York.

FORMULAS; All kinds, latest, best. Literature free. Kemixal, Park Ridge, Ill.

FREE Formula catalog. Anything analyzed \$35.00. Western Chemical, Salem, Oregon.

FORMULAS For latest money-making discoveries. New! Good! Valuable literature free! Miller, Chemist, 1517-D, Tampa, Florida.

PLASTICS

PLASTIC Sheet, rod, tubing. Catalog 10¢. Coleman Sales, 5926 Cornell, Dearborn, Michigan.

LEARN Plastics fabrication for spare time income. Low cost home training now available. Write for free booklet. Interstate Training Service, Dept. D-3, Portland 13, Ore.

REPAIR Kit welds broken or cracked plastic articles. Restores original finish. Complete kit \$3.00. Free information. Rayther, Box 271, Station B, Toledo, Ohio.

NEW Liquid casting plastic, clear, colors. Embed real flowers, insects, photos, coins. Saw, drill, carve. Send 25¢ for handbook, "How to Cast with Liquid Plastic," and proved success plan showing how to make money at home. Castolite, Dept. M-101, Woodstock, Ill.

PLEXIGLAS, Lucite. Square foot cost. 1/16", \$1.15; 1/8", \$1.20; 3/16", \$1.58; 1/4", \$2.21, 3/8", \$3.23; 1/2", \$4.36. Colors add 10%. Send 15¢ for postage. Aristocrat Plastics, 23-25 Sussex Avenue, Newark, N. J.

BOXES, Plastic. Free list. Althor, 170 Bay 23 Street, Brooklyn, N. Y.

CHEMISTRY

ILLUSTRATED Catalog: Chemistry, mineralogy, biology 20¢. Tracey Laboratories, Evanston, Illinois.

CHEMICALS And apparatus for industrial, analytical, and private laboratories. Catalog 25¢. Dept. M-50, Biological Supply Co., 1176 Mt. Hope Ave., Rochester 20, N. Y.

BOOKLETS: 60 pages each! "Beginners Chemistry," "Chemistry," "Einstein's Relativity," "Physics," "Atomic Theory," "Electron Theory," "Scientific Oddities," "Light," "Sound," "Heat," "Electricity," "Radio," "Astronomy," "Useful Tables," "Geometry," "Mathematical Oddities," "Scientific Terms." Order by titles, 10¢ each. Franks, 3121 South Racine, Chicago 8.

SPECTROSCOPE For quick analysis \$3.00. Book 200 electric stunts \$1.00. Kutting, 26278 Arastradero, Los Altos, Calif.

CHEMISTRY-Science magazines. Literature free. Lankton, Box 5126-C2, Lansing, Mich.

ANALYZE Like professionals do. Kit \$5.00. Steiner, Suite 940, 127 N. Dearborn St., Chicago 2, Ill.

CHEMICALS, Supplies catalog. 25¢. Laboratory Sales, Box 161-E, Brighton, Mass.

AMAZING New book of science. Experiments, formulas and catalogue of laboratory supplies. Only 25¢. National Scientific Co., Dept. PM-11, 500 W. Road, Lombard, Illinois.

AGENTS WANTED

YOU'LL Simply coin money introducing new amazing invention Hove-O-Matic. Prevents vapor-lock. Stops flooding. Eliminates traffic stalling. Makes motor purr like kitten. Motorists wild about it. Free catalogue. Hove Engineering Co., 529 S. 7th Street, Minneapolis 15, Minn.

EXTRA Cash in your spare time. No experience needed. Just show superb Elmira Christmas cards, name imprinted. Samples on approval. Bonus. Free box of cards; also 50% profit on first order. Elmira Greeting Card Co., 295 Clinton, Elmira, N. Y.

PRINTING, Advertising salesmen—Excellent moneymaking sideline selling decalcomania name plates, small quantities. Automobile initials, sign letters. Free samples. Ralco, XL, Boston 19, Mass.

GOLDMINE Of 600 money makers. Copy free. Specialty Salesman Magazine, Desk 5-B, 307 N. Michigan, Chicago 1.

AGENTS—300% Profit selling genuine gold window letters; stores and offices. Free samples. Metallic Sign Letter Co., 431-D North Clark, Chicago.

YOUR Ad in this space will get some good agents for you. Yes, I'll prove it. Write for Folder "A" right now. F. W. Johnson, Classified Advertising Manager, Popular Mechanics Magazine, 200 E. Ontario St., Chicago 11, Ill.

BUY Wholesale thousands nationally advertised products at big discount. Free "Wholesale Plan." American Buyers, Herzel Station, Buffalo 16-A, N. Y.

START Your own business on credit. Your own boss. 1598 dealers sold \$5,000 to \$32,000 in 1955. We supply stocks, equipment on credit. 200 home necessities. Sales experience unnecessary. Pleasant, profitable business backed by world-wide industry. Write Rawleigh's, Dept. K-U-PPM, Freeport, Ill.

BIG Money-making opportunity. Exclusive line work uniforms. Jackets, pants, shirts, coveralls. Advertising embroidered. Every business prospect. Outfit free. Master Co., 423 Water, Ligonier, Ind.

BIG Profits selling ties (\$2.00 value) \$6.50 dozen. Free catalog. Empire Cravats, 611-PM Broadway, New York 12.

EXCLUSIVE Line of personal initialed buckles, belts, cap badges, 3,000 emblems, etc. Hook-Fast, Dept. PM, Roanoke, Va.

FOG-Stop windshield cloth. Instantly removes blurry mist, frost, sleet, snow. Stops windshield fogging. Samples sent on trial. Kristee Co., Dept. 55, Akron 8, Ohio.

SELL Profitable personalized rugs. For information write Bobby's, Dept. M10, Manitou Springs, Colorado.

BUY Wholesale! 100,000 name brand products! Save 66%! Big profits selling others spare time! Free details! National Buyers Service, Box 3338EE, San Francisco.

EXCLUSIVE Distributorships. Top quality low cost English chamois. Babrok, Hudson Falls, N. Y.

YOU Can make money for Christmas in spare time taking magazine renewal subscriptions. No capital or experience necessary. All supplies furnished. Write today! McGregor Magazine Agency, Dept. 500A, Mount Morris, Illinois.

FREE! Beautiful feather pictures 200% profit! Apartado 9036, Mexico 1, D. F.

YOUR Own business—Used suits \$1.50, overcoats 65¢, mackinaws 35¢, shoes 12½¢, ladies coats 30¢, dresses 15¢. Enormous profits. Catalog free. Nathan Portuoy Associates, 605-AA West 12th Place, Chicago 7.

GOLD Or silver letters, numbers. Windows, doors, trucks, 1" to 6", 500% profits. Free samples. Atlas-T, 544 West 79th, Chicago 20.

\$1.00 PROFIT Selling \$2.95 photo enlargement deal. Allen Studio, Riegler Bldg., Little Rock, Ark.

CALIFORNIA Sweet smelling beads. Sensational sellers. Particulars free. Mission, 2328-PM W. Pico, Los Angeles 6, California.

TREMENDOUS Profits! Every man, woman and child a customer. Used suits \$1.50, pants 35¢, dresses 20¢, shoes 20¢. Operate from store, home, car. Free catalogue. Superior, 1250-A Jefferson, Chicago 7.

FAST Selling money makers! Metallic ironing board cover; purse-shopping bag; many others including \$1 retailers. Quality Products, Dept. A, Box 748, Passaic, N. J.

REDUCING Machines. Factory agents. 100% profit. Exclusive. Mary-Mac, 1012 Powhatan, Dallas 2, Texas.

SCHOOL Seniors—Be popular with classmates. Have spending money galore. Details free. Craftcards, Box 233-L, Pittsburgh 19, Pennsylvania.

LIFETIME Repeat business. Agents, salesmen, crew managers, sparetime workers, distribute our discount catalog. Name brands. Receive commission for lifetime. Catalog, instructions \$1.00. Information free. Save yourself up to 80%! Smart Shoppers' Club, 1354 Emory Road, Atlanta 6, Georgia.

REAL Diamond rings. Sell direct. Make big middleman's profit. No investment. Experience unnecessary. Free catalog, details. Gleamlight, 109B No. Columbus, Mount Vernon, N. Y.

INCREDIBLE Manufacturers prices. \$12.99 kitchenware set \$1.99. Free literature. Allclear, Merrick Rd., Rockville Centre, N. Y.

CLEANS Windows without mess. Strange "dry" cleaning-cloth. Replaces liquids. Windows gleam. Samples sent on trial. Kristee Co., Dept. 57, Akron 8, Ohio.

\$1,000.00 A Month for making dramatic 3-second demonstration of amazing lightweight Presto fire extinguisher. New chemical used by airforce snuffs out fires instantly. Only \$4.95. Terrific commissions. Millions want it. Free kit. Merlite, 114 E. 32nd, Dept. P59N, New York City 16.

MEN, Women, make money spare time plus new car as bonus for encouragement. Amazing hosiery guaranteed to wear without holes, snags, and runs, or replaced free. For example, lovely 60 gauge nylons guaranteed for as long as 1½ years, or replaced free. Write Wilknit, 20611 Wash., Greenfield, Ohio.

SELL Unique imports. Large profits. No investment. Write Bond Specialties, 1637A West Vernon, Phoenix, Arizona.

YOUR Ad in this space will get some good agents for you. Yes, I'll prove it. Write for Folder "A" right now. F. W. Johnson, Classified Advertising Manager, Popular Mechanics Magazine, 200 E. Ontario St., Chicago 11, Ill.

GADGET-Novelty wholesale catalog 10¢. Dohn-Marks, 2308BU South Ninth, Maywood, Ill.

MAKE Profitable products. Easy mail-order sales. Knowhow free. Imseo, 6347 Parnell, PM11, Chicago 21, Illinois.

NEW Invention. \$4.95 fire alarm, paying up to \$1,100 a month. No wiring. Unlimited market. Dramatic demonstration. Free kit. Merlite (Alarm Div.), 114 E. 32nd St., Dept. P-62N, New York 16, N. Y.

IF You're interested in making money in selling, see the hundreds of exceptional opportunities in Salesmen's Opportunity Magazine. Send name for your copy, absolutely free. Tell us what you're selling now. Opportunity, 848 N. Dearborn, Dept. 30, Chicago 10, Illinois.

BRILLIANTIZE—Amazing new cleaner works like magic. Cleans copper, silver, other metals instantly. Safe for delicate items. Tremendous profits! Details free. Stephenson's, Box 435, Ames, Iowa.

HEAVY Duty work aprons. Every mechanic buys. 75% profit. Sample \$1.25 p.p. Elmore Smith Co., 486-10th Ave., New York 18, N. Y.

EASY Handwork makes fast-selling articles. Sample free. Sunmade Company, Brockton 64, Massachusetts.

AMAZING 500% Profit offer. See under "Auto Supplies." GE Engine Heater Sales, Milwaukee 7.

SELL Tele-muffs. Personalized. Plain. Good profits. Ru-Co, 5-Ruz-Mar, Goleta, Calif.

MAKE Contacts for us and earn tremendous profits. No experience, no selling necessary. Addresses supplied. Write for details. Box 5073, Los Angeles 55, Calif.

SELL Television bases. Details 104. Dixie Wood Works, Belton, S.C.

BUY IT WHOLESALE

MEN'S Suits. Nothing like it in America. Year round gabardine. Blue, gray, tan, charcoal, brown sizes 34-44. Regulars, shorts, longs, \$19 each—2 for \$37, postage prepaid. Money refunded if not satisfactory. Trend Clothing Company, Box 1014, Baltimore 3, Md.

WHOLESALE Catalog! Appliances, cameras, watches. Distributors, Box 106A, Hudson, New York.

\$1.00 BRINGS Wholesale catalog and \$1.00 merchandise certificate. Radaker, 510 Park Ave., Anderson, Ind.

BUY Wholesale nationally advertised appliances, radios, watches, etc. Catalog \$1.00 (refundable). D'Auria, Box 355-PM, Jackson, Michigan.

FREE Wholesale catalog. Name brand appliances, furniture, cameras, watches, luggage, tools, toys, sporting goods. Make Christmas savings-profits! Housewares, 924-P West 79th Street, Chicago 20.

BUY Wholesale! Discounts to 80%! Appliances, cameras, sporting goods, tools, watches, housewares, etc. Free catalogs. Buy-Rite, Box 258 D, Hawthorne, New Jersey.

WHOLESALE Catalog! 30-80% discounts! Appliances, musical instruments, typewriters, tools, watches, jewelry, cameras, housewares, etc. Consolidated Distributors, 1300-20 Main, Clifton, New Jersey.

FREE Gift catalog. Wholesale catalogs, name brands. Edith's, Deep River, Conn.

WHOLESALE! Catalog! Appliances, housewares, jewelry! Postcard! Midwest, M-156-M, Pontiac, Ill.

FREE Catalogs by using directory of 500 wholesale sources. \$1.00. K-C Sales, 838 South 12th St., Newark 86, N. J.

FREE Wholesale catalog! Appliances, watches, gifts, etc. Myers Company, 1745 High, Topeka 2, Kansas.

GUARANTEED Finest diamonds wholesale. Free literature. Wagner & Wagner, 78 Argyle, North Arlington, New Jersey.

BIG Multicolor wholesale catalog! Appliances, cameras, clothing, watches, jewelry. Name brands. Huge discounts. Postcard Selbyco, Decatur 162, Illinois.

BUY Wholesale, resell at a good profit. Free catalog. Fast mail order seller. Metal bird feeders, bird houses. Specialty Products Manufacturing Company, Box 236, Cassopolis, Michigan.

WHOLESALE Catalog! Appliances, cameras, watches. Free gift. Régner, Box 46, Cathedral Station, New York City.

GENUINE Black Forest clock, hand-carved antique walnut \$4.65; Black Forest weather house prophet \$3.85. Direct from Germany. Catalog free. Star Import-Export, 2389 1/2 29th Street, Akron 14, Ohio.

FREE! Illustrated wholesale catalog. Save and earn money on over 1000 most popular, brand-name housewares and appliances. Tremendous discounts. Send \$1 (refunded with first purchase) to: Shop Smart Ltd., Dept. 111, Box 687, Newark 1, New Jersey.

BUY Wholesale, 30 to 80% discounts. Brand name nationally advertised merchandise. Giant catalog 98¢. Clark Sales, Dept. 2, 8315 Whitewood, Detroit 10, Mich.

WHOLESALE. 17-Jewel watches. Folder sent free. Wm. Lipscomb, 118 Haviland, Greenville, S. C.

WHOLESALE—Ball point pens, solid perfumes. Traxler, Box 118, Rockford, Ill.

SALESMEN—DISTRIBUTORS

GET New shirt outfit free! Make \$90.00 weekly on 5 average orders a day. Famous quality made-to-measure dress and sport shirts at \$3.95 up sell fast to all men. No experience needed. Full or part time. Write Packard Shirt Co., Dept. 333, Terre Haute, Ind.

ADVERTISING Book matches—Cash in on big demand; sell union label matches. Cuts for all businesses and political parties. Free powerhouse selling kit, low prices, protection guaranteed on repeat orders. Cash commissions. Superior Match Co., Dept. M-1156, 7530 Greenwood, Chicago.

NEW Jobs open in selling! Send name, address for five free issues of Opportunity Magazine's money-making guide, listing hundreds of companies who'll pay you well, full or part-time. No experience needed. Opportunity, 850 N. Dearborn, Dept. 17, Chicago 10, Ill.

CALENDARS. Advertising novelties, matches. All styles, including religious, varnished, 12 sheet, girls. Hundreds of advertising novelties, book matches, etc. Fleming Calendar Co., Sales Division, 6539 Cottage Grove, Chicago 37, Ill.

MONEY-Making opportunity! Take big profit orders for world famous patented varieties fruit trees. Also flowering shrubs, roses, vines. Big sales outfit free. Stark Bro's, Desk 30157, Louisiana, Missouri.

FREE Facts about the art of sales resistance. To survive—Know the tricks. Write Countersalesmanship, Dept. D1, 120 Boylston St., Boston 16, Massachusetts.

BUILD Sales by recruiting productive distributors selling direct or to retail outlets. Secure most concentrated circulation through classified columns of Salesman's Opportunity. Write for facts. Gilbert, Salesman's Opportunity, Room 1700, 850 N. Dearborn, Chicago 10.

CHESTLITE And instant light. No competition. Buyers everywhere. Write for particulars. Substantial profits. Emergenx Lights Inc., 620 W. Anaheim St., Long Beach 13, California.

TAPE Recording! Exceptionally profitable opportunity in your area. Free information. Baron's, Lynden, Washington.

SALESMEN And agents wanted. Sell our beautiful line of dolls. Real money making opportunity. Prospects everywhere. Send for catalog. Glazer Mfg. Co., 93 19th Street, Brooklyn 32, N. Y.

STOCK Signs—Attractive, fast selling, various colored backgrounds, large profits. Fifteen samples one dollar. Details free. F. I. Adams, 158 Roberta Road, Ormond Beach, Fla.

BRAND New product. 250% profit. Vita-Cell Corporation, 929 Sheridan, Saginaw, Michigan.

WHOLESALE—Get the big merchandise—Furniture, appliances, T.V.'s, clothing, tools, auto accessories; most anything. Save half. Literature free. Associated Wholesalers, 1016-DY Starr, Burlington, Iowa.

FRESH Flower fragrance gold baskets. Proven successful money-makers everywhere. Send \$1.00 for demonstrator. Evans', 5930 Comey, Los Angeles 34, Calif.

ONE Monument sale weekly earns \$200 or more. Jones Monumental Works, St. Cloud, Minn.

FREE Catalog ladies' handtooled handbags. Garza, Apartado 82, Tampico, Mexico.

BIG Money daily: Two minute demonstration makes easy sale. Demonstrate and sell Campbell's Gro-Green with Dietene fertilizer and nitrogen solutions. Only company manufacturing all formulas for all fertilizer needs. Est. 1928. Free sample and demonstrating kit free. Full or part time. Campbell Company, Rochelle 228, Illinois.

NEW Invention, \$4.95 fire alarm, paying up to \$1,100 a month. No wiring. Unlimited market. Dramatic demonstration. Free kit. Merlite (Alarm Div.), 114 E. 32nd St., Dept. F-62N, New York 16, N. Y.

WILL You wear new suits and topcoats without one penny cost and agree to show them to friends? You can make up to \$30.00 in a day even in spare time, without canvassing. Progress Tailoring Co., 500 South Throop St., Dept. A-326, Chicago 7, Illinois.

MAKE Up to \$800 in month with sensational new invention for autos, trucks. Saves 54% gas; increases power 58%. Free plan. Pope, 224 W. Huron, Dept. L-58, Chicago.

AD Matches! Sell amazing designs—10, 20, 30, 40 and 240-light book matches. Bigger spot cash commissions; every business a prospect. Low prices for high quality. Repeats. Start without experience; men, women; full, part time. Buy nothing! Sales kit furnished. Match Corp., Dept. PM-83, Chicago 32, Illinois.

\$1,000.00 A Month for making dramatic 3-second demonstration of amazing lightweight Presto fire extinguisher. New chemical used by airforce snuffs out fires instantly. Only \$4.95. Terrific commissions. Millions want it. Free kit. Merlite, 114 E. 32nd, Dept. P-59N, New York City 16.

SELL New threading tool to machine, maintenance, model shops. Box 63, Maywood, Ill.

FISH Lure, easy sales, free details. Zerk, 210 East Fayette, Syracuse, N. Y.

BIG Profits selling new sensational revolutionary Speed Glo auto wax to service stations, garages, dealers. Excellent repeat business. Sample \$1. Rego, 32-28 Greenpoint, Long Island City 1, N. Y.

SELL Dealers and direct. Carded dollar "snap on" driving glasses. 100% profit. Write Bickel Company, 803 South Boulevard, Oak Park, Illinois.

EMPLOYMENT INFORMATION

CALIFORNIA Employment lists, Los Angeles, San Diego, \$1.00, both \$1.50. Special "non-skilled" lists \$1.00. Cal Employment, 875 Orange, Coronado, Calif.

COPYRIGHT Reports on best paying jobs with travel, adventure, promotions. Construction, aviation, shipping, laborers, clerical, trades, supervisory, factory, unusual opportunities. Many types of work. Skilled and unskilled. Foreign and state-side openings for men and women. Only \$2.00 (\$2.25 airmail), including registration-advisory service. Satisfaction guaranteed. Included absolutely free: Special reports on Alaska, Spanish airbase construction, South American opportunities and husband-wife foreign jobs. Research Services, Suite 207-PMJ, Brown Building, St. Louis 5, Missouri.

CLASSIFIED Sections, San Francisco, Oakland, Sacramento, Stockton, \$1.98. Central Forwarding, Box 1392, Stockton, California.

ALASKAN Jobs! Gigantic construction projects. Names, addresses companies hiring. Thousands skilled, unskilled needed. High wages. Salary information. Alaskan map, sample application included. Home-steading, mining, fishing, lumbering, aviation, railroad job information. \$2.00 complete. Alaskan Opportunities (PM) Box 362, Kenmore, Wash.

JOB Information. High pay. South America, the Islands, U.S.A., foreign countries. All trades. Clerical, labor, engineers, drivers, others. Women also. Companies pay overseas fare if hired. Write Section 92F, National Employment Information, 1020 Broad, Newark, N. J.

OVERSEAS And stateside employment leads. Now hiring for aviation, construction, shipping, truck drivers, laborers, mechanics, clerks, many types work. Skilled and unskilled to \$1500.00 monthly possible with overtime and transportation. Guaranteed reports \$2.00. Traveljobs, Suite 206-PMA, 8008 Carondelet, St. Louis 5, Missouri.

FOREIGN. Alaskan, U.S.A., job opportunities! To \$1500.00 monthly! Million Americans employed overseas. Copyrighted reports. Who to contact for highest paying jobs. Laborers, trades, truck drivers, office, engineers, many others. 52 countries—St. Lawrence project, Spain, Latin America, northern projects, Europe. Year registration-advisory service. Application forms. Unconditional money-back guarantee! \$2.00 (airmailed \$2.25) c.o.d.'s accepted. International Reporter, St. Louis 1-PM, Missouri.

PABULOUS Washington, D.C. Sunday classified lists, jobs galore. Send \$1.00. Jack B. Johnstad, 2123 Elvira St., Fayetteville, N.C.

\$8000.00 YEARLY. America's newest profession. Breeding cows artificially. Technicians needed in 48 states. Free education. Information \$1.00. Insemination, Box 683, Proctor, Minn.

EDUCATIONAL AND INSTRUCTION

LEARN Lost art of striping with the Sword striping brush. Illustrated detailed manual \$1.00 postpaid. Also full line reproduction toleware for decorating. Write Trays, New Market, Va.

STUDY Spanish by mail. Easy method of learning correct pronunciation. Verbs and grammar learned by conversational method. Pay as you learn. One dollar per lesson. Send for full particulars today. Or send one dollar for first lesson and begin to speak Spanish at once. Academy of Languages, Thirty-Eight East 57th Street, New York 22, N. Y.

DRAW Pictures by "touch" system. It really works. \$2. Ken Stover, 7752 California Avenue, Riverside, California.

WELDING Training pays at Hobart Welding School, Box M-1161, Troy, Ohio. VA contract. Best equipment. Catalog free.

IMPROVE Your personality in only 7 days or double your money back. New speed-method makes learning easy. Send for free details today. Human Relations, 2149 Melante Dr., N.E., Atlanta 5, Ga.

USED Correspondence courses, books bought, sold, rented, catalog free. Myrtle Vernon, 624 Mohawk, Rossville, Ga.

WANTED: More new writers for TV-radio, magazines, business publications, motion pictures. Learn at home for extra income or exciting full time career. Many students earn while learning. Professional instruction. Send today for free lesson and book. Palmer Institute of Authorship, Desk TM-116, 1680 N. Sycamore, Hollywood 28, California.

BECOME A doctor. Belong to esteemed profession. Full information, schools, requisites, shortcuts, etc. Save time, money, errors. Start right. Mail \$1.00 now for complete guided details. Professional Development, Box 1277, Sherman Oaks, California.

FINGERPRINT Training. Alabama School of Fingerprinting, Box 185-A, Fairfield, Alabama.

SPEAK. Sing with power, personality. Home self-training method on records. Amazing details free. Canfield, 2018-A 5th Ave. South, Minneapolis 4, Minn.

PIANO Tuning pays. Big money in spare time. Learn at home in 30 days. No musical knowledge necessary. Phonograph, records, tools and instructions furnished. Personal instructions available. Free catalog. Capital Tuning School, 16 Southwest Second, Fort Lauderdale, Fla.

SCIENCE Of memory simplified. Volume one of Memorology free. Memorology Studio, 2016 Sunnyside Ave., Chicago 25, Ill.

HAND Engraving; learn at home. Write Box 116, Mishawaka, Ind.

ENGINEERING. Home study. Midwest Engineering School, 10923 Hillcrest, Hickman Mills, Missouri.

STUDY For Doctor's degree of psychology, metaphysics and divinity. Correspondence courses only. College of Divine Metaphysics, Dept. P-M, 2811 North Illinois, Indianapolis 8, Indiana.

LEARN Mineralogy at home. Diploma course. Fortunes now being made in uranium and other minerals. Free catalog. Mineral Science Institute, Desk 2, 159 East Ontario, Chicago 11.

HIGH School diploma at home. Licensed teachers — Approved materials. Southern States Academy, Box 144-MX, Station E, Atlanta, Georgia.

BE A real estate broker. Study at home. Write for free book today. GI approved. Weaver School of Real Estate, 2018P Grand, Kansas City, Missouri.

EARN While you learn. Auto and diesel mechanics master this top paying trade. Many graduates earn \$100 a week and up. Approved for Korean veterans. For free information write Dept. No. 256, Nashville Auto-Diesel College, Nashville 3, Tenn.

SWEDISH Massage. We train you at home. Earn big profits from your own private practice or work with hospitals and doctors. Free catalogue. National Institute, Desk 4, 159 E. Ontario, Chicago, Ill.

USED Correspondence courses and educational books bought, sold, rented. Free catalog. Educational Exchange, Menlo, Georgia.

BOOKS. Free 1956 catalog, 100 pages Text, vocational, educational, instructional subjects. Millions of volumes, new and used. Bargain prices. Books bought. Est. 1902. Long's College Book Co., Dept. PM, Columbus 1, Ohio.

BOOKS: Hundreds of subjects. Big catalog free. Popular Mechanics Press, 200-BC East Ontario St., Chicago 11.

HELP Yourself to abundant living. Our courses have aided students to richer fuller lives. Learn secret of contentment, happiness. Earn degrees Ps.D., MsD. Write for free book. College of Universal Truth Correspondence School, 23-C E. Jackson, Chicago.

USED Correspondence courses and books sold and rented. Money back guarantee. Catalog free. (Courses bought.) Lee Mountain, Pisgah, Alabama.

MIDLAND Linotype School. Charles City, Iowa. Civilian and veteran courses. Free placement. Established 1909.

PIANO Tuning pays. Learned easily at home. GI approved. 59th year. Free booklet. Niles Bryant School, Dept. P, 3731 Stockton, Sacramento 20, Calif.

ENGINEERING Degrees earned by home study. (Residential courses also available). American College of Engineering, Box 27724-B, Hollywood 27, California.

EARN Degree. Free bulletin. Homestudy only. Midwestern Bible School, 1060 Broadripple, Indianapolis.

SECRET Investigation. Experience unnecessary. Investigators particulars free. George Wagner, M125 West 86th, New York 24.

FINISH High school at home, spare time. No classes. Diploma awarded. Write for free catalog. Wayne School, Catalog HF-69, 2527 Sheffield, Chicago 14.

BOOKKEEPERS! Increase your earnings! Operate your own simplified "Dollar-A-Week" bookkeeping and tax service. Full or spare time. Details free. No obligation. Ellis, Box 200, Cedar Grove, North Carolina.

WANT A diesel job? New opportunities to increase income. Higher pay. More money. We can help you qualify. Tools. Shop method home training. Write today! Diesel, Tractor, Heavy Equipment Division, Interstate Training Service, Dept. B-3, Portland 13, Oregon.

I Want to send you proof of the wonderful pulling power of Popular Mechanics classified pages. What's your proposition? Write me today. Include literature if possible. F. W. Johnson, Manager Classified Advertising, Popular Mechanics Magazine, 200 E. Ontario St., Chicago 11, Ill.

INVESTIGATOR Training. Phillips Secret Service System, 1917-B North Kenneth, Chicago 39.

FREE Book. Grow mushrooms. Guaranteed market. Mushrooms, Dept. 174, 2954 Admiral Way, Seattle, Wash.

COMPLETE Your high school at home in spare time with 59-year-old school. Texts furnished. No classes. Diploma. Information booklet free. American School, Dept. X845, Drexel at 58th, Chicago 37, Illinois.

GIRLS. Women. Practical nurses needed. Learn profitable career at home easily. Many earn while learning. High school not required. Free booklet. Wayne School, 2525 Sheffield, Dept. FG-29, Chicago 14.

HELP Yourself! Solve personal problems by self-mastery. Free information. The Leavitt Science, Clinton, Illinois.

U. S. Civil Service tests! Training until appointed. Men-women, 18-55. Start high as \$340.00 month. Experience often unnecessary. Get free 36-page book showing jobs, salaries, requirements, sample tests, benefits. Write today Franklin Institute, Dept. A-24, Rochester, N. Y.

BARGAIN. Exciting Little Library booklets, 25¢ each. Tool making, painting, welding, home improvement, games, models, plastics, lamp making, glass blowing, boats, photographs. Free catalog. Popular Mechanics Press, 200-LB East Ontario St., Chicago 11.

OWN Collection agency office. Pays big. Free details. Franklin Credit, Roanoke 7, Virginia.

LEARN Camera repair. Easy, complete, approved home-study course. Free illustrated booklet. National Camera Repair School, Dept. L-11, Englewood, Colo.

WANT Higher pay, a career? New, scientific method helps get the better job you want quickly, easily. Complete, revolutionary, job-getting kit—\$1.00. Career Enterprises, Suite 905-D, 1418 Walnut, Philadelphia, Penna.

HANDWRITING Analysis now accepted in college, business, industry. Our men, women who use grapho analysis spare, full time earning more money, getting prestige, success, happiness. Uncrowded, fascinating field for intelligent men, women anxious to get ahead. We need more members. Investigate this growing field where you give a real service to your fellow man. Opportunities unlimited. Free sample lesson and information to all over 21. Write today! Igas, 2307 National Station, Dep't. 615, Springfield, Missouri.

WANT Strong, masculine voice? Send for free booklet. Perfect Voice Institute, 210 South Clinton, Studio 2LU-2, Chicago 6.

PLAYS, STORIES, MANUSCRIPTS

ALL The world loves an author. If you write, we appraise/sell. Write/phone. Daniel S. Mead, Literary Agt., 419 Fourth Ave., New York City 16; OR 9-1150.

WANT Your book published? Learn how we publish, advertise, promote, distribute. Many successes. Free booklet PM. Vantage, 120 West 31, New York City.

WANTED: Book manuscripts, all subjects considered. Greenwich Book Pub., Atten. Mr. Zealand, 489 Fifth Ave., New York City.

SPECIAL SERVICES

INFORMATION On anything. Ferguson Research Specialists, 116-14 141 St., South Ozone Park 36, N. Y.

ARTISTS' SUPPLIES

IF Interested in artist frames, canvas, canvas boards, Red Sable brushes, etc., be sure to get our money saving price lists before buying. International Sales Co., 414-APM E. Baltimore St., Baltimore 2, Md.

CARTOONING, COMMERCIAL ART, SHOWCARD & SIGN PAINTING, TATTOOING

LEARN Sign painting at home. Particulars free. Bolger, 148 Concord, River Edge, New Jersey.

YOU Can entertain with chalk talks. Catalog 10¢. Balda The Cartoonist, Oshkosh, Wis.

PAINT Signs—Master die cut, outline letter patterns. Complete assortment 1 1/2" to 12" high, prepaid \$2.00. Eyerly, 563, Newton, Iowa.

LEARN Sign painting at home. Free talent test. Ben Kerns, Box 812-PM, Greenville, S.C.

BASIC Art training at home. Write for free talent test. Students' Art Club, Kennebunkport, Maine.

"HOW To Make Money With Simple Cartoons." A book everyone who likes to draw should have. It is free; no obligation. Simply address Cartoonists' Exchange, Dept. 911, Pleasant Hill, Ohio.

DRAW Your way to fame. Free information. Cartoons-of-the-Month, Roslyn, New York.

YOU Can master cartooning through the "Old Masters" of American magazine cartooning, free details. Booksleuth, 192 North Clark St., Chicago 1, Illinois.

ADVERTISING AGENCIES, LETTER WRITERS, FOR ADVERTISERS

ADVERTISING Ratebook leading newspapers, magazines, free. Chicago Advertising Agency, Chicago 4.

NAMES. Farmers, rural, etc. on gummed labels, 1¢ each. Welland Allen, 2429 Workman Street, Los Angeles 31, California.

1000 LIVE Names \$1.00. Cuiabeth, 1519 Dean Ave., Rome, Ga.

50 WORD Ad 30,000 bulletins printed, mailed \$6.00. You get 1000. Associates, Box 3128-R, Kingsport, Tenn.

OPPORTUNITY Seekers, home workers. Guaranteed list on gummed labels \$9-1000. Massow, 166 Kenilworth South, Hamilton, Ont.

MAILING Lists \$5.00 1000. Okay Service, Box 215, R. 4, Marshfield, Wis.

WANT More business? Here's an amazing opportunity to increase your sales. Talk to thousands of interested readers of "Mechanica Popular." Our Spanish Edition covers the Latin American countries like a blanket. They're real mailorder buyers. Classified rate 75¢ per word. Try an ad in our next issue. Classified Advertising Department, Popular Mechanics Magazine, 200 East Ontario Street, Chicago 11, Ill.

ADVERTISING. Result-getting ads prepared, placed newspapers, magazines, radio, anywhere! Lowest rates. Catalogue free. Baker Advertising Agency, 189 W. Madison, Chicago 2.

MAILING Lists most any classification \$5.00 1000. Your circulars mailed with ours \$4.00 1000. Write for our literature. Dixie Mailers, King, N. C.

ADVERTISE: 24 Words, 100 Canadian newspapers \$5.50. Lists free. Advertising Bureau, 10511-C Springfield, Chicago 43.

FREE! 1956 Advertisers Rate and Data Directory. 52 pages! E. H. Brown Advertising Agency, 20 N. Wacker, Chicago 6.

RUBBER STAMPS AND OFFICE SUPPLIES

POCKET Stamps. 3 lines—\$1.00 postpaid self-inking guaranteed. W.J.W. Specialty, 8464 Manhattan, Detroit 11, Michigan.

CHRISTMAS Stamps! Also stock, made to order. Ravis, 5905 Ellsworth, Dallas 6, Texas.

FREE Style list stock stamps. Criterion, Box 2326, Denver 25, Colo.

THREE Lines \$1.00 postpaid. Free stamp pad. Barber, Marengo, Ohio.

TYPEWRITERS, DUPLICATORS, OFFICE DEVICES

RECONDITIONED Typewriters, duplicating, printing devices. \$25.00 up. Supplies. Appliances, DixieGraph, King, N. C.

PORTABLE Mimeograph! Uses no stencil, no ink. The newest, cleanest, smallest, lightest and cheapest. Weight 15 pounds. DuPont Distributors, P.O. Box 695, Dept. A, New York 1, N. Y.

PRINTING, MULTIGRAPHING, MIMEOGRAPHING, GUMMED LABELS

1,000 RAISED Letters business cards \$3.50. Samples. Pioneer, 195-K, Quebec, Island Park, N. Y.

100 LETTERHEADS, 8 1/2 x 11 Watermarked, and 100 6 3/4 envelopes, carefully printed, \$2.00. Postpaid. Race Printers, Hudson, New York.

DISTINGUISHED Business cards, thousand \$2.85. Jaehler, 223 Woodworth, Yonkers, N. Y.

1000 EMBOSSED Business cards \$2.95. Decco Service, Box 3315-M, St. Louis 3.

500 MINIATURE Letterheads (4 1/2 x 6) \$2.25. Request samples. Townsen, Box 242PM, GPO, New York City 1.

100 BUSINESS Cards, neatly printed, \$1.00. Arthur Grote, Walkerton, Indiana.

SALES Books, bill books, envelopes. Printing for every business. Eddirose, Bronx 72, N. Y.

100 LETTERHEADS 5 1/2 x 8 1/2, 100 Envelopes three lines, both printed same \$1.75, add 25¢ postage. Sheldon, 115 Ninth, Philipsburg, Penna.

RAISED Letter business cards. Free literature. Scull's Printing, Wildwood, New Jersey.

CIRCULARS, Booklets, letterheads, statements. Estimates, anything! Loneim Printers, Paulding, Ohio.

OFFSET Printing \$6.50 — 1000. 8 1/2 x 11, 16 lb. National Letter, 251 W. 42 St., New York City 36.

MIMEOGRAPHING—Letters, pricelists, formulas, instructions. Lowest prices. Lem's Letter Shop, 5710 Stanton, Detroit 8.

ADS Running under this heading sell printing. Ask me for proof. I'll gladly send you amazing facts. Ask for Folder "P." F. W. Johnson, 200 E. Ontario St., Chicago 11, Ill.

FREE Catalog business, personal printing. D. M. Press, Sebastopol, California.

BUSINESS Printing. Reasonable. Catalog free. Howprint, 723-G Eunice, Webster Groves 19, Missouri.

QUALITY Printing at wholesale prices. Catalog, samples, free. Bryan & Allen, 503 Williams Ave., Panama City, Fla.

BUSINESS Printing, offset, mimeographing. Samples. D'Yarmett, 285 Cypress, Columbus 23, Ohio.

BUSINESS Cards wholesale. Leather sales kit \$2.00 (refundable). LeMon's, 1467 East 48th, Salt Lake City 17.

GOOD Printing. 1,000 3x6 circulars printed, up to 125 words (blank backs), only \$1.50 postpaid. 5,000, \$5.00. Both sides add 50% extra. Order direct from ad. Ewell E. Farley, Harlan, Ky.

CATALOG, Letterhead folio. Printing, mimeographing. Carol, 1863 Edgewood, Norfolk 3, Virginia.

FAST Service! 100 8 1/2 x 11 letterheads, \$2.00 postpaid. Bass Press, Knox, Indiana.

OFFSET Letterpress, mimeographing. Economical prices, samples. Litho-Press, Madison, Tenn.

500 GUMMED Labels, 15 words 50¢. Lewis, 8 Scott, Utica, New York.

1000 QUALITY Printed business cards, \$2.50, postpaid. Free samples. Mersand Press, 310 Kings Highway, Brooklyn 23, New York.

RICH, Distinctive, quality printing. Reasonable prices. Hamel-Printer, Suite 1103, 210 Fifth Avenue, New York 10, N. Y.

WANT More business? Here's an amazing opportunity to increase your sales. Talk to thousands of interested readers of "Mechanica Popular." Our Spanish Edition covers the Latin American countries like a blanket. They're real mailorder buyers. Classified rate 75¢ per word. Try an ad in our next issue. Classified Advertising Department, Popular Mechanics Magazine, 200 East Ontario Street, Chicago 11, Ill.

PRINTING OUTFITS AND SUPPLIES

DO Your own printing. Save money. Simple rules. We supply everything. Print for others; good profit. Raised printing like engraving too. Have home shop. Details free. Kelsey Presses, V-11, Meriden, Connecticut.

PRESSES, Type cabinets, supplies. List for stamp. Lincoln Press Company, 220-L Hartwell, Fall River, Mass.

RUBBER Stamp making presses, hydraulic operated, electrically heated. 3 sizes 5"x8" 8"x12", 10"x15". Complete starting outfits. All kinds supplies. Custom Manufacturing, 601 N. Jefferson, Springfield, Missouri.

MAKE Your own self-molding rubber stamps and printing cuts. Plexirubber, Argyle 1, Wisconsin.

PATENT ATTORNEYS

INVENTION Record form free and "Patent Information Every Inventor Should Have." Carl Miller, Registered Patent Attorney, Woolworth Building, New York.

C. A. Snow & Co.—M427, Snow Building, Washington 1, D. C. Registered Patent Attorneys. Write for information.

INVENTORS: Without obligation, write for information explaining the steps you should take to secure a patent. John Randolph, Registered Patent Attorney, 203 Columbian Bldg., Washington 1, D. C.

INVENTORS: When you are satisfied that you have invented something of value write me, without obligation, for information as to what steps you should take to secure a patent. Write Patrick D. Beavers, Registered Patent Atty., 935 Columbian Bldg., Washington 1, D. C.

PATENTS. "Proof of Invention" free. E. E. Vrooman, Registered Patent Attorney, 507 McKim Building, Washington 5, D. C.

"INVENTOR'S Guide" and "Record of Invention" free on request. Frank P. Ledermann, Registered Patent Attorney, 154 Nassau Street, New York City.

INVENTORS—If you believe you have an invention, you should find out how to protect it. The firm of McMorow, Berman & Davidson with offices in Washington, D. C., is qualified to take the necessary steps for you. Send for copy of our patent booklet "How to Protect Your Invention." We will also send you an "Invention Record" form. No obligation. They are yours for the asking. McMorow, Berman & Davidson, Registered Patent Attorneys, 134-D Victor Building, Washington 1, D. C.

INVENTORS — Take these preliminary steps toward patent protection. Sketch and describe your invention. Sign, date and have this disclosure witnessed by two people who understand your invention. Have us make a preliminary search among U.S. patents already granted for similar types of invention. We report on the probable patentability of your invention and recommend your further course of action. Write for our instructive booklet, "Patent Protection for Inventors" and convenient "Evidence of Invention" disclosure form. Victor J. Evans & Co., 231-M Merlin Building, Washington 6, D. C.

PATENTS — Irving L. McCathran, 315 McLachlen Bldg., Washington 1, D. C. Registered Patent Attorney.

REGISTERED Patent attorney offers services. Sanders, 6430 Evans, Chicago 37, Illinois.

INVENTORS: Learn how to protect your invention. Unless the inventor is familiar with patent matters, he should engage a competent registered patent attorney or agent to represent him. We are registered to practice before the U.S. patent office and prepared to serve you in handling your patent matters. "Patent Guide for the Inventor" containing detailed information concerning patent protection and procedure with "Record of Invention" form will be forwarded to you upon request—without obligation. Clarence A. O'Brien & Harvey Jacobson, Registered Patent Attorneys, 61B-K District National Building, Washington, D. C.

FOR INVENTORS

INVENTION Record form free and "Patent Information Every Inventor Should Have." Carl Miller, Registered Patent Attorney, Woolworth Building, New York.

LEADING Manufacturers; any line: 15—\$2.00. Russell Tupper, Sandwich, Mass.

SELL Your invention now! Send \$3.00 and information regarding field of invention. We'll send large, comprehensive list of interested buyer-manufacturers selected by experts for your invention. Proven. Free bonus booklet with order "How to Market Your Invention." Winsor, Box 171, Dept. A, Albuquerque, N. M.

IDEAS Developed for products and your profit with effective patent protection at low definite cost. Foreign patents: Canadian patents filed \$100.00. 30 yrs. in business. Joseph O'Brien, Patent-Development Engineer, 132 Nassau St., New York 38, N. Y.

SEARCHES—Put your patent searches in the hands of a registered patent attorney or agent, as he qualifies to give a worthwhile patentability report. Record of invention form upon request and information on patent protection. Patrick D. Beavers, Registered Patent Attorney, 936 Columbian Bldg., Washington 1, D. C.

INVENTORS: Information on patent procedure furnished on request, without obligation. John Randolph, Registered Patent Attorney, 203 Columbian Building, Washington 1, D. C.

"INVENTOR'S Guide" and "Record of Invention" free on request. Frank P. Ledermann, 154 Nassau Street, New York 38, N. Y.

PATENT Searches \$5.00. 48-hour service. Free invention protection forms. Write Raymond L. Smith, Patent Searcher, 620 Sheraton Building, Washington 5, D. C.

INVENTORS! Have you good patentable idea? Write Mr. Metzler, 11 West 42nd, New York City.

PATENT Searches \$5.00. 48-hour airmail service. Invention protection forms free. Write Patent Engineering Service, 711 14th Street N. W., Washington 5, D. C.

INVENTORS: Learn how to protect your invention. Unless the inventor is familiar with patent matters, he should engage a competent registered patent attorney or agent to represent him. We are registered to practice before the U.S. patent office and prepared to serve you in handling your patent matters. "Patent Guide for the Inventor" containing detailed information concerning patent protection and procedure with "Record of Invention" form will be forwarded to you upon request—without obligation. Clarence A. O'Brien & Harvey Jacobson, Registered Patent Attorneys, 61A-K District National Building, Washington, D.C.

INVENTORS: Test the commercial value of your patented or unpatented inventions, quickly and inexpensively. Write for free information. Institute of American Inventors, Dept. 40-B, 635-F St., N.W., Washington 4, D. C.

PATENT Searches \$4.00. Accurate, reliable airmail reports. Free protection forms. Write us first! Patent Service Institute, Albee Building, Washington 5, D. C.

PATENT Searches, including copies of nearest patents, \$6.00. Reports airmailed within 48 hours. More than 100 registered patent attorneys use my service. For free invention protection forms, write Miss Ann Hastings, P.O. Box 176, Washington 4, D. C.

PATENT Drawings expertly prepared. Frank Fleisher, 136 Othoridge Road, Lutherville, Maryland.

INVENTORS—This firm is registered to practice before the United States Patent Office and available to assist you in the preparation and prosecution of your patent application. "Patent Protection for Inventors" booklet containing detailed information and steps to take toward patent protection sent promptly upon request. No obligation. Victor J. Evans & Co., 232-M Merlin Building, Washington 6, D.C.

INVENTORS Assistance, forty years service. Write American Commercial Men's Association, Box 642, Evanston, Illinois.

INVENTORS—Send for free patent information book and inventor's record. Registered Patent Attorney, Associate Examiner, Patent Office 1922-29, Patent Attorney & Advisor, Navy Department 1930-47. Gustave Miller, 116A Warner Building, Washington 4, D. C.

INVENTORS—If you believe you have an invention, you should find out how to protect it. The firm of McMorro, Berman & Davidson with offices in Washington, D.C., is qualified to take the necessary steps for you. Send for copy of our patent booklet "How to Protect Your Invention." We will also send you an "Invention Record" form. No obligation. They are yours for the asking. McMorro, Berman & Davidson, Registered Patent Attorneys, 134-C Victor Building, Washington 1, D. C.

INVENTORS, Models produced, tested and developed. Advice as to patentability. Weede Machine Company, West Meadow Rd., Rockland, Maine.

PATENT Dissallowed? Don't give up, structure guaranteed. Write M. Schrader, Red Bud, Illinois.

HANDBOOK: How to Make the Million Your Idea May Be Worth. Information every inventor should know by a firm who knows. \$1.00 postpaid. Money back guarantee. Cosom Industries, 6012 Wayzata Boulevard, Minneapolis 16, Minnesota.

INVENTIONS WANTED

TOY Ideas wanted by large, well-rated manufacturer. For prompt action, submit sketch, model or description to M. J. Lee Co., 2222 So. Michigan Ave., Chicago 16, Ill.

INVENTIONS Promoted. Guaranteed plan. Write for free booklet "Your Invention." Kessler Corporation, 5111W, Fremont, Ohio.

INVENTIONS Wanted: Free Thomas Edison's formulas for success. American Congress Inventors, Dept. 3021MC 4CPA, Box 1481, Milwaukee 1, Wis.

INVENTIONS Wanted. Patented or patent pending. 25 years experience promoting inventions. National Service Bureau, 3120 Meramec, St. Louis 18, Mo.

INVENTIONS Wanted. Patented; unpatented. Tremendous manufacturers lists. Global Marketing Service, 2420 77th, Oakland 5, California.

INVENTORS. Give us the opportunity to explain our selling plan for your invention, gadget or device, patented or unpatented; free particulars available upon request. Demarest and Demarest, Box 95, Battle Creek, Michigan.

SUPERIOR Promotions. Patented; unpatented inventions. Free, informative booklet, guidance. Superior, 338-344 North Rodeo, Beverly Hills, Calif.

INVENTIONS Promoted. A-1 service for years. Adam Fisher Co., 5418 Idaho, St. Louis, Mo.

INVENTORS: Hundreds of manufacturers have requested our assistance in locating marketable new products. Complete information free. Institute of American Inventors, Dept. 40-D, 635-F St., N.W., Washington 4, D. C.

AMERICA'S Largest invention exhibition. Act now for display space. Dates, March 9-17, inclusive 1957, San Francisco Civic Auditorium. Write, California Inventors Association, 681 Market Street, San Francisco 5, California.

CASH Buyers for inventions. Write National Inventors Institute, Box 7007, Cleveland 28, Ohio.

MANUFACTURING

WOOD, Composite products. Small lot manufacturing. Lee, 719 Moore St., Bristol, Va.

MODELS—Small lot manufacturing. Metals, plastics, etc. Milburn, Burlington, Kentucky.

MODELS, MODEL SUPPLIES

POWER Models. Unusual steam gasoline and traction engines, fittings, metals. Comprehensive catalog \$1.00. Chas. Cole, Ventura, Calif.

SHIP Model kits and fittings including clippers, trawler, fishermen, frigates, privateer, radio control tug, etc. Send 25¢ for 1956 catalog. Model Shipways, Box 85, Bogota, N. J.

BUILD Miniature passenger hauling live steam locomotive with file and drillpress. We do machine work, you bolt it together. Catalog 50¢. Little Engines, Lomita, Calif.

SHIP And yacht model fittings; blueprints. Send 35¢ for illustrated catalog listing hundreds of items. A. J. Fisher, 1002-1 Etowah Ave., Royal Oak, Mich.

SHIP Models. Most complete line in New England. Kits, fittings, plans, books, tools, engines, motors. Illustrated catalog 30¢. James Bliss & Co., Inc., Dept. SM, 342 Atlantic Ave., Boston 10, Mass.

BALSA Wood and model aircraft. 40-page catalog 25¢. Sig Co., Montezuma, Iowa.

LIONEL, American Flyer trains sold, repaired. Big discounts. Bulletin free. Catalog 25¢. Mack Bros., 2043-P Chicago Ave., Chicago 22.

GEARS And model supplies for the inventor. Send 10¢ for catalog. Pierce Model Works, Tinley Park, Ill.

FLEISCHMANN Live steam engines and HO model railroads. Catalog 50¢. Merzbach, 545 Fifth Avenue, New York City 17.

HOME CRAFTSMEN

LEATHERCRAFT. Send 10¢ for new 76-page catalog of tools, supplies, kits, including metalcrafts, enameling, ceramics, all other crafts. Complete stock. Reasonable. Since 1910. Sax Bros., Dept. PM1, 1111 N. 3rd, Milwaukee, Wis.

FREE. Complete illustrated catalog. leathercraft kits, supplies. J. C. Larson Co., 820 S. Tripp, Dept. 6627-L, Chicago 24.

18 FULL-Size patterns. Save money with easy-to-use, professionally designed full-size patterns. Make money selling beautiful, useful furniture. Make modern step and cocktail tables; metal lamps; cupola; 12-foot outdoor. All patterns test-built; sold with money-back guarantee. Get your free list of these convenient, economical patterns today. Popular Mechanics Press, 200-HH E. Ontario Street, Chicago 11, Ill.

SHREDDED Latex foam rubber. Wonderful for pillows, cushions, upholstery. Also top grain scrap leather. For prices write Almond Upholstery Co., Almond, New York.

LEATHERCRAFT. Copper enameling, mosaic tile, shellcraft, metal tooling, beadcraft, many more crafts. Free big catalog. Kit Kraft, Dept. 2311, Studio City 1, Calif.

BUY Wholesale nationally advertised power, hand tools, thousands other products at big discounts. Free "Wholesale Plan" American Buyers', Hertel Station, Buffalo 16-P, N. Y.

AROMATIC Red cedar lumber. Small lots shipped anywhere. 1/2" and 3/4". Red Cedar Products, Robertsville, Mo.

VIOLINMAKERS. Good seasoned European wood, tools, instructions. Catalogue 10¢. Premier Violin Supplies, 309 West Fourth St., Los Angeles 13, Calif.

FINISHING Wood, genuine wood finished panels, available 32 colors. Free information. Gaston Finishes Company, Bloomington, Indiana.

MONEYMAKING Projects for woodcraft shops. Northland Products, Route 1282, Rockland, Maine.

JIGSAW Patterns for boys! Large variety, gifts, novelties, usefuls, pinups, lawn ornaments. \$1.00. Pauls Plans, 4633 North 18th, Milwaukee 9, Wisconsin.

OVER 900 Woodworking projects. Books and patterns. Free catalog. Craftsman, 115-C Worth St., New York City 13.

STYLECRAFT Sure fire hits. "Pre-traced" leather kits, Handbags, billfolds, filigree belts, over fifty other projects. Patterns on leather. Why trace? Just carve, assemble and lace. Large assortment "precarved" kits also available. Send 25¢ for catalog, free folder. Refunded first order. Apache Leather Company, 2804 E. Washington St., Phoenix, Arizona.

KNOCKDOWN Cedar chests and lumber. Free price list. Bedford Lumber Company, Shelbyville, Tennessee.

ALL Crafts, supplies. Large free catalog. National Handicraft, 199 William Street, New York City 38.

FREE Catalog. 1560 patterns and designs. Craftplans, 1321-A South Michigan, Chicago 5.

WOODWORKING And cabinetmaking course for beginning and advanced home craftsmen. Only complete low-cost home training program available. Write for free booklet. Interstate Training Service, Dept. G-3, Portland 13, Ore.

I want to send you proof of the wonderful pulling power of Popular Mechanics classified pages. What's your proposition? Write me today. Include literature if possible. P. W. Johnson, Manager Classified Advertising, Popular Mechanics Magazine, 200 E. Ontario St., Chicago 11, Ill.

129 NEW Full-size jigsaw patterns. Artist-drawn. \$1. Craftplans, 1321-A South Michigan, Chicago 5.

LEARN Art metalcraft and jewelry making. Complete, inexpensive, home training course now available. Special tools and materials furnished. Write for free booklet. Interstate Training Service, Dept. L-3, Portland 13, Oregon.

FREE "Do-it-yourself" leathercraft catalog. Tandy Leather Company, Box 791-Q17, Fort Worth, Texas.

SWISS Musical movements, wheels for toys, flocking materials, patterns. Illustrated catalog 50¢ (refunded). Walters Hobby Shop, 207M French, Utica 4, New York.

SHELLCRAFT Supplies. Highest quality. Lowest prices. Large catalog free. Pace's, Box 2791, Bradenton, Fla.

119 JIG Saw patterns. Full size, just trace on wood and saw. Clever original designs. \$1.00 postpaid. Burgess Vibrocrafters, Dept. C-25, Grayslake, Illinois.

101 FULL-Size patterns. Smart, new, gifts, novelties, lawn figures, shelves, action windmills, alphabets. Plus "Make Money Jig Sawing." Only \$1.00. Mastercraft, 115M, 7041 Olcott, Chicago 31, Ill.

DO-IT-Yourself! New hobby and home-workers guide lists thousands of items for crafts and home money making projects. Associated, 1016-DH Starr, Burlington, Iowa.

3-DIMENSIONAL! Modern! Life-sized, outdoor reindeer to make of plywood. Full-size pattern with easy instructions. Disassemble for storage. Christmas money-maker. Send \$1.00. Pooker Patterns, Box 653, Chehalis, Washington.

LAMP Size cypress knee with nipple installed \$2.00. Cy Products, Dept. 2-Z, Lafayette, La.

ARIZONA Bargain: Five beautiful polished reconstituted turquoise gemstones and findings-gemstone price list all for only 25 cents. Melcrafts, Box 27, Cactus 2, Arizona.

DO IT YOURSELF

WALLPAPER Rooms yourself. Catalog, complete instructions 10¢. Gury Studios, Box 118M South Orange, N.J.

BUILD Inexpensive concrete blockmaker—Motor, hand. Write. C. Lee, Mountain View, Oklahoma.

NOVELTY Jewelry, parts and findings assorted \$1.50 pound. Imported stones 1000 assorted \$3.00. Beads imported assorted \$1.00 pound. Pearls assorted \$1.00 pound. Add 25¢ for postage. Merchandise, 19-E 16th Street, New York 3, N. Y.

CONVERT Any heating main into a radiator. Write for details. Bildavevector Co., Inc., P.O. Box 233, Wallingford, Conn.

18 FULL-Size patterns. Save money with easy-to-use, professionally designed full-size patterns. Make money selling beautiful, useful furniture. Make modern step and cocktail tables; metal lamps; cupola; 13-foot outboard. All patterns test-built; sold with money-back guarantee. Get your free list of these convenient, economical patterns today. Popular Mechanics Press, 200-HH E. Ontario Street, Chicago 11, Illinois.

MAGNETIC Toy. Educational and fun. Easy to make. J. Borsas, 8683 Louise, Allen Park, Mich.

DIFFERENT. Decorative, inexpensive fence. Free literature. 2205 Eveningside, Topeka, Kansas.

CHAIR Caning kits. Tools, supplies, instructions \$2.00. Newell Workshop, Woodstock, N. Y.

MINIATURE Chippendale spinning wheel picture plans, easy to follow with simple instructions, 7½" high. Sent postpaid anywhere in the U.S., \$2.00, send check or moneyorder to Craftshop, 1353 Olive Way 1, Seattle 22, Washington.

WEAVE A Christmas wreath. Evergreen, holly, cedar boughs. Twelve-inch metal frame, directions. \$1.00. Dick's, 2311 West Sixth Street, Topeka, Kansas.

ROTARY Mower units, bases, wheels, etc. Free literature. H & T Manufacturing Co., Spirit Lake, Iowa.

LAMP And lantern kits. Free illustrated literature. Bruce Specialties, Dept. 11M, RR-1, Box 305, Hartland, Wis.

BUILD Your own power tools, everything for the home workshop, free catalogue. Hawthorne Company, Otsego, Mich.

CLOCK Movements—Gorgeous dials, plans, kits. See ad page 291.

WATCHES, OLD GOLD, JEWELRY

10 WATCHES \$18.00. Minor repairs. Catalog 20¢. Berkwit, 1150 Castle Hill, New York City 62.

USED And new watches \$2 up. Free list. Southern Watches, Gray, Georgia.

WATCHES. New, factory guaranteed Bulova, Benrus, Gruen, Helbros, Hamilton. Save to 80%. Free price list. Morning Star Sales, 62 Rosalie, Clifton, N. J.

WATCHMAKERS'—Jewelers' supplies, instructions. Catalog 20¢. Bengale Company, Culver City, California.

HIGHEST Cash for old gold, broken jewelry, gold teeth, watches, diamonds, silverware, spectacles, platinum, mercury. Free information. Satisfaction guaranteed. Rose Refiners, Heyworth Bldg., Chicago 2.

COSTUME Jewelry supplies. Catalog and samples. 35¢. Largest line in America. Milady-Pair Co., G.P.O. Box 1328, New York City 1.

WATCHES—Promptly, completely, expertly reconditioned, \$4. Satisfaction guaranteed. Freeman's Jewelry, Rosston, Okla.

RHINESTONES. Jewelry settings, copper enameling, hobby kits. Illustrated catalog 10¢. J & M Novelties, Dept. CM-3, Griffith, Indiana.

DIAMONDS. Save over ½. Factory direct. Postcard. Hedges, Amityville 187, N. Y.

WATCHMAKER'S Tools, materials, supplies, watches. Catalog. Gales, Box 1000, Chicago 90, Illinois.

WATCH And clock repairing books. Free information. North American, Dept. 16L, 2320 N. Milwaukee, Chicago 47, Illinois.

TOBACCO, SMOKERS' SUPPLIES

RONSON Type lighters. \$1.00 postpaid. Plesko's, Sta. B, Superior, Wisconsin.

TURN Spare hours into dollars. Pipe-making instructions. Tools, supplies. Walter Miller, Germantown, Ohio.

CIGARETTE. Pipe or natural leaf tobaccos. Jolley Farms, Dresden, Tenn.

RAZORS, BLADES, SHARPENING

GUARANTEED Double edge blades. 100 postpaid \$1.00. Blades, Box 205, David City, Nebr.

120 FINEST Quality, double edge blades \$1.50 postpaid. Guaranteed. Free samples. Kalnals, 1934 N. Hoyle, Chicago 47, Ill.

FOR THE HOME

PROTECT Your family. Make your door locks burglar proof with a lock guard to fit your present lock. Simple to attach. Send \$2.98. Modern Products, Box 234, Union City, N. J.

WEATHERVANES. House signs, reflecting letters. Aluminum. Free literature. Leehigh, 1932 Newcastle Avenue, Westchester, Illinois.

FOAM Rubber furniture cushions. Factory seconds. 50% discount. Free catalog. Perma-Foam, 236C Rhode Island Ave., East Orange, New Jersey.

BE Your own plumber. You can. Few inexpensive tools and our instructive book, "Home Plumbing Guide," shows and tells you how. Hundreds of photographs and diagrams. Easy to follow. 160 pages. \$3.50. Catalog free. Popular Mechanics Press, 200FG East Ontario St., Chicago 11, Ill.

OF INTEREST TO WOMEN

"8 MISTAKES Parents Make." Every parent should have this new book about child training. It is free; no obligation. Simply address Parents Association, Dept. 6711, Pleasant Hill, Ohio.

FREE Book. Grow mushrooms. Guaranteed market. Mushrooms, Dept. 176, 2954 Admiral Way, Seattle, Wash.

WANT To make big money at home? \$5 profit in an hour possible with invisible reweaving. Make tears, holes disappear from clothing, fabrics. Steady year-round demand from cleaners, laundries, homes. Details free. Fabricon, 8332 Prairie, Chicago 19, Illinois.

DRESSES 24¢; Shoes 39¢; men's suits \$4.95; trousers \$1.20. Better used clothing. Free catalog. Transworld, 164-S Christopher, Brooklyn 12, N. Y.

SELL Fine fabrics. Get yours wholesale. Box 863, Norwalk, Conn.

BOOKS: Hundreds of subjects. Big catalog free. Popular Mechanics Press, 200-BC East Ontario St., Chicago 11.

FREE—Big new wholesale catalog! Up to 50% saving for you, family, friends on nationally-known gifts, jewelry, toys, appliances. Christmas cards, etc. Also make money selling part time! Write: Evergreen Studios, Box 846-D, Chicago 42, Ill.

PROFITABLE Home business. Make fast-seller chenille monkey trees, dolls, flowers. Terrific holiday demand. Information free. Velva, Bohemia 16, N. Y.

LEARN Decadent cake decorating. Details free. Deco-Secrets, Venice 3, Calif.

UNION Looms for profitable weaving. Weave rugs at home for neighbors on \$69.50 Union loom. Thousands doing it. Booklet free. Carlecraft Co., Polk St., Boonville, N. Y.

CASH Paid for box tops! Some, 25¢! Inquire: Boxtops-3, Cedar Hill, Texas.

FREE Catalog, showing complete equipment for cake decorating and unusual baking. Ateco tubes and syringes. Many outstanding instruction and recipe books, pans and molds to make your baking really different! A new customer writes, "I'm thrilled to death with your catalog—the most interesting wish book I've ever seen!" Baking makes perfect hobby or profitable home business. Maid of Scandinavia, 3245-U Raleigh, Minneapolis, Minnesota.

FREE Recipe booklets. Colorful, exciting! 116 listed, 25¢. Galloway, 304 S.W. Hamilton, Portland 1, Oregon.

WANTED—MISCELLANEOUS

SCRAP Mercury (quicksilver) containers supplied—Tantalum, tungsten, silver, platinum. Metallurgical Products Company, Established 1909, 35th & Moore Sts., Philadelphia 45, Penna.

\$1.75 PAID For old electric razors, brand names, working or not. Terry Burke, 256 Howard, Brockton 14, Mass.

CASH For antique northwest coast totems, masks, carvings. Send photos. Robert Stolper, 8852 Cynthia, Los Angeles, California.

BOOKS: Hundreds of subjects. Big catalog free. Popular Mechanics Press, 200-BC East Ontario St., Chicago 11.

PERSONAL

"HOW Can I find out?" You can! Information confidentially developed. Any matter, person, problem. Worldwide. Officially licensed. Established 1922. William Herman, 170 Broadway, New York City.

BORROWING By mail. Loans \$100 to \$600 to employed men and women. Easy, quick. Completely confidential. No endorsers. Repay in convenient monthly payments. Details free in plain envelope. Give occupation. State Finance Co., 323 Securities Bldg., Dept. E-227, Omaha 2, Nebraska.

MONEY To loan. Entirely by mail. \$100 loan repayable \$6.75 per month. \$300 loan repayable \$19.95 a month. Loans made to \$600. Learn how the air mail way. State amount you need. Write Money-To-Loan, Dept. 658-V, 2014 Dakota Ave., South Sioux City, Nebraska.

VALUABLE Papers stored safely. Loss impossible. Free details. Veteran's Records Holder, 121 N. Charles, Charles Town, West Virginia.

BUY Vitamins direct. Amazing savings. Catalog free. Matoska, White Bear, Minn.

RESURRECTION On earth, not heaven! Free! Write: Harvest, Jefferson City 5, Mo.

ARMS On your family record, \$1.00. Colored \$1.50. Flaherty, 227 Pine, Holyoke, Massachusetts.

VITAMINS. Save 40%. Free catalogue lists all formulas and brands. Mention product now using for free sample. Vitamin Specialty, Philadelphia 40, Penna.

REVEALING Personal handwriting analysis—Character, personality, talents, \$1.00. Eleanor Merriam, Box 1363-P, Chicago 90.

HEAR Better with your hearing aid. Free booklet. Wallace Cheek, Gloucester, Mass.

MORE Money, better job, happier life can be yours. Our psychological tests will show you how. For free information write National Counselors, 18505 W. Eight Mile Road, Detroit 19, Michigan.

HAVE New York City address. Remailing 25¢. Also forwarding, shopping. Betty, 510 East 11th Street, New York City.

BOOKS: Hundreds of subjects. Big catalog free. Popular Mechanics Press, 200-BC East Ontario St., Chicago 11.

REMAILING SERVICE

MONTREAL 34, Que., Canada. Remails 35¢. R. Cote, 1567 E. Laurier.

ORIENT And Pacific islands. Letters re-aimailed \$1.00 each. Capt. H. F. Williams, 442P Merritt Ave., Oakland 10, Calif.

MEXICO Or San Diego remailing 25¢. San Diego Sunday classified \$1.00. Also shopping. Miller, 3993 Alabama, San Diego 4, Calif.

BALTIMORE Or Washington Sunday classified \$1.00. Letters remailed 25c. Collector's, Box 131, Glen Burnie, Maryland.

ALOHA! Six Honolulu viewcards \$1.00. Remailed free. Receiving-forwarding \$2.00 month. Write: Fobel, 3132PB George Street, Honolulu.

ALASKA Remails 25c. Mae Armstrong, Box 491, 414 Grant, Ketchikan, Alaska.

GLAMOROUS Hollywood remails, 25c. Station 4, Box 184, North Hollywood, Calif.

HOLLYWOOD—Long Beach remail 25c. Receiving-forwarding address \$2.00 month. Information, research \$1.00. Lenormand, 722 Magnolia, Long Beach, California.

LETTER Remailing, receiving-forwarding address for rent. McLaughlin, 800 Stewart, Columbus 6, Ohio.

MAIL Received-forwarded. \$3 month. Hedgpath, Box 830, Alhambra 23, Calif.

COLUMBUS, Ohio. Remails 25c, etc. John Volan, 1437 N. High St., Columbus 1, Ohio.

REMAILS—Santa's Village \$1.00. Niagara Falls, Toronto 25c. Box 66, Sta. D. Toronto, Canada.

SOUTH Bend remailing 25c. Forwarding rates. Schaut, 619 Kamms, Mishawaka, Indiana.

LETTERS Retailed from San Francisco 25c each. Keith Service, 773-A Dolores.

HONOLULU Remailing, 25c. Kuroda, Suite 100, 1154 Bishop Street, Honolulu 13, Hawaii.

TREASURE FINDERS

URANIUM, Gold, silver treasure. New power-packed highly sensitive metal detectors, Geiger counters and mineralights. Kits and assembled models from \$12.50. Lightest weight, guaranteed, free literature. Electronic Applications, Dept. M, Box 8, Arlington 10, Virginia.

TREASURE, Metal, mineral detectors. M-Scope. Used worldwide for treasure hunting. Mineralights, Geiger, scintillation counters. Prices from \$14.75. Fully guaranteed. Use our time payment plan. Free booklets on treasure hunting, uranium prospecting. Free catalog. Fisher Research Lab. Inc., Dept. PM-CI, Palo Alto, Calif.

FIND Buried treasure, gold and silver, with Goldak's sensational 3 1/2 lb. "find-it" locator, only \$49.50. Write for free literature on complete line of mineral, metal locators; Geiger and scintillation counters. Goldak, 1541 W. Glenoaks Blvd., Glendale, Calif.

12 TREASURES Lost in Oregon. Descriptions, maps. \$2.00. 1124 S.W. Second, Portland 4, Oregon.

GOLD, Silver, metal detectors. Geiger counters for uranium, Violites. Sensational new fully guaranteed models. None finer. Information free. Detron Corp., 5528 Vineland Ave., North Hollywood, Calif.

JEEP Owners — V8 power. Read Jeep owners ad, page 30.

TREMENDOUS Savings. New and used scintillation, geiger counters, and metal detectors. All makes, terms, trades, no interest. Free list. Atomic Sales, Service, Box 144, Sweet Home, Ore.

FOR SALE—MISCELLANEOUS

AMERICAN Flyer train equipment, up to 60% discount. All size transformers, engines, etc. Rush 10c for catalog. Discounts of Virginia, 118 South Wayne Street, Arlington, Virginia.

DO It yourself. What? Repair TV, build furniture, make barbecue, plumbing repairs, build boats, do house wiring, remodel home, lay tile, modernize kitchen, repair home, and scores of other things you can do yourself. Books covering each subject, only 25c. Send for descriptive list. It's free. Popular Mechanics Press, 200-LB East Ontario St., Chicago 11, Ill.

WAR Surplus bargains! New government releases arrive constantly. Save up to 80%. Blankets, boots, cots, tents, wearing apparel. Send for free war surplus catalog. Sioux Falls Surplus Store, Sioux Falls, South Dakota.

HEARING Aid batteries, wholesale. Free list. Habs, Box 51, York, Penna.

SAVE Up to 50% on new Lionel trains. Send 10c for illustrated catalog. Gammerman's, Dept. B, 3808 Eastern Avenue, Baltimore 24, Maryland.

SMALL Imported "pen-knives" \$1.00 dozen, \$8.00 gross. Four blades, colored handles (two inches), light weight. Distributors: 121 Winkler, Houston 17, Texas.

HEAR Again only \$17.95 without batteries, cords, wires. Free details. Vibraphone Company, Dept. PM, 361 East 2nd South, Logan, Utah.

ARMY Bearpaw snowshoes with harness, excellent condition, \$12.95. Men's 10" zipper overshoes, new, \$4.95. New army G.I. pocket gas stoves \$9.95. Army combat boots, very good, used, \$3.50. Army felt shoes used, very good, \$3.95. Postpaid, no c.o.d.'s. Glens Army Navy Store, Grand Rapids, Minnesota.

\$15.00 NEW Army officers shoes \$5.00. 9 1/2 b, 10b only. Used duffel bags \$1.00. Allied, Box 183, Everett, Mass.

BOOKS: Hundreds of subjects. Big catalog free. Popular Mechanics Press, 200-BC East Ontario St., Chicago 11.

CHRISTMAS SUGGESTIONS

LARGE Box 25 beautiful assorted toys. Will fill many Christmas stockings. \$6.00 value, \$2.00. 3 boxes \$5.50. Postpaid. Toyland, 5139 North Clark, Chicago 40.

MISCELLANEOUS

SELL! Buy! Trade! Anything. Write: "Trading Post Magazine," 525 Dewey, Jackson 40, Michigan.

LAZY Susan bookcase lamps. Profitable. Beautiful Christmas gift. Details. Key Supply, 5764B N. Lacey, Chicago 30, Ill.

"HOME Improvement Guide." New, amazing 192 page volume. Packed with ideas, plans for remodeling, decorating, landscaping, built-in projects. \$2.50 pre-paid. Popular Mechanics Press, 200-HG East Ontario St., Chicago 11.

CAPITAL Seekers: Learn how to raise cash for any product, proposition or invention. Details free. Knott, 109 St. Stephen, Boston 15.

FREE Book. Grow mushrooms. Guaranteed market. Mushrooms, Dept. 175, 2954 Admiral Way, Seattle, Wash.

DO It yourself. What? Repair TV, build furniture, make barbecue, plumbing repairs, build boats, do house wiring, remodel home, lay tile, modernize kitchen, repair home, and scores of other things you can do yourself. Books covering each subject, only 25c. Send for descriptive list. It's free. Popular Mechanics Press, 200-LB East Ontario St., Chicago 11, Ill.

TOKYO! Get your gifts from Japan for Christmas. Last day shipment Nov. 25. Kimonos, jewels, model engines, etc. Information \$1.00. Clarence Yamagata, 202 Naka 7 Bldg., Marunouchi, Tokyo.

BACKYARD Bonanza raising earthworms! Get \$10 orders, keep \$8! Raising, marketing instructions, 10c. Oakhaven-M, Cedar Hill, Texas.

WHOLESALE Catalog! 30-80% discounts! Appliances, musical instruments, typewriters, tools, watches, jewelry, cameras, housewares, etc. Consolidated Distributors, 1300-13 Main, Clifton, New Jersey.

LEATHER Jackets renovated, expertly. Free circular 8. Berlew Mfg. Co., Freeport, New York.

WANT More business? Here's an amazing opportunity to increase your sales. Talk to thousands of interested readers of "Mechanica Popular." Our Spanish Edition covers the Latin American countries like a blanket. They're real mailorder buyers. Classified rate 75c per word. Try an ad in our next issue. Classified Advertising Department, Popular Mechanics Magazine, 200 East Ontario Street, Chicago 11, Ill.

YOU'LL Never fall asleep playing Country Auction. Fast-moving, action-packed board game. \$2.95 postpaid. Details free. Everett, 1900 N. Keeler Ave., Chicago 39, Illinois.

RECEIVE Magazine samples, mails, catalogues, offers from everywhere. Get listed 25c. Rorick, Cincinnati 26, Ohio.

STUPENDOUS Mental power. Adults. Details 3c. Delmar Wisdom, 846 Sunny-side, Chicago 40.

CIGARETTES—Make 20 for 9c. Facts free. Moberly, Box 810, Owensboro, Ky.

YOUR Name wanted. We'll send 1000 publishers, mailers, wholesalers your name, on our list one year 25c. Dixie Mailers, King, N. C.

CESSPOOLS, Septic tanks, outhouses, clogged drains, cleaned, deodorized without digging, pumping. Sursolvent reduces contents. Reclaims leachability. Old systems work like new. Free details. Electric Sewer Cleaning, Allston 34, Mass.

70 BIBLE Lessons, 25c. Bulletin, Box 87, Cathedral Station, New York City 25.

LEFT Handed? Send for free list of articles made special for left hand use. Make ideal gifts. Left Hand Products, Box 402, Warren, Ohio.

BUY Wholesale! Discounts to 80%! Appliances, cameras, sporting goods, tools, watches, housewares, etc. Free catalogs. Buy-Rite, Box 258-B, Hawthorne, New Jersey.

BARGAIN. Exciting Little Library booklets, 25c each. Tool making, painting, welding, home improvement, games, models, plastics, lamp making, glass blowing, boats, photographs. Free catalog. Popular Mechanics Press, 200-LB East Ontario St., Chicago 11.

ELECTROLUNCH—Electric lunch bucket. Electric Lunch Kit Distributors, Box 53, Waukegan, Illinois.

AIR-Remail, with Olympic badge, \$1.00. Plus boomerang \$3.00. Mitro. GPO 1915, Sydney, Australia.

ENGRAVING Trophies, name plates, bracelets, lighters. Price list. Write Little Falls Engraving, 175 East Main St., Little Falls, New Jersey.

GETTYSBURG Address from Gettysburg 50c. Letters remailed 25c. Box 241, Gettysburg, Pennsylvania.

BEAT Muggers, hoodlums. Learn judo. 50 simple knockout tricks. Complete course \$1. Fedrinick, 31 Norfolk, New York City.

LUKE 12:31, 10; 7:30. Whitcomb, 308 Sycamore, Newport News, Va.

BOXES, Rigid, plastic. Nice assortment 8 for \$1.00. Otto Products, 415 Howard, Lapeer, Mich.

GENUINE Leather braided belts—Brown, beige, black. All sizes, \$1.00. Suspenders, \$1.50. Merriettes Specialty Shop, P.O. Box 428a, Albany, N. Y.

BUY Your gift now. \$19.95 lady's necklace, bracelet and earring set. Send \$5.95, pay balance \$1.00 monthly. Frank Jones Sales Co., Rt. 2, Big Sandy, Texas.

REMODEL Your own home. Save hundreds of dollars. New, amazing book shows you how. Written so you can understand it. Step by step instructions make it easy. Fully illustrated, 400 photographs, hundreds of diagrams, 160 pages, \$2.95. Literature free. Popular Mechanics Press, 200-RH East Ontario St., Chicago 11, Ill.

WONDERFUL. See in third dimension with nothing but the photos and your eyes. 3 samples 30c. U.S.A. Joaquin R. Patron, Apartado 1, Campeche, Camp., Mexico.

HOUSEHOLD Bargains. Catalogue 10c, deductible. Household Industries, Sebastopol, California.

SAVE On vitamins—Fine products. Feel more vigorous, younger, better! Free catalogue. Vitamin-Center, Drawer 2318P, Detroit 31.

GERMAN Address lists, anything manufactured, \$1.00. Burke Associates, Manchester, Mass.

I Want to send you proof of the wonderful pulling power of Popular Mechanics classified pages. What's your proposition? Write me today. Include literature if possible. F. W. Johnson, Manager Classified Advertising, Popular Mechanics Magazine, 200 E. Ontario St., Chicago 11, Ill.

HARD Remembering? I'll remember for you. Details. Heyer, 36-11 Raven, Levittown 4, New York.

RECEIVE Samples, magazines, catalogs, opportunities, 10c. Star Mailers, Leming, Texas.

Pyroil "A" add to gas...3 oz. can 25¢...30¢ in Canada
at your service station



FREES STICKY VALVES ADDS PEP AND POWER

Removes carbon & lead deposits, reduces friction, increases compression 15%. Prevents ping, lubricates upper engine. Save... buy pints and quarts at all auto supply stores. Write for trial offer today, Dept. PM-116,



Pyroil Company Inc., La Crosse, Wis.
Toronto, Canada

Super Lubricants • World Famous Since 1929

NEWER CAR \$100!

Sounds impossible? Not at all! Some of the nation's leading businessmen do it. You can, too—IF you know the inside facts. YOU can purchase a newer car each year for \$100—OR LESS! "AUTOMOTIVE BUYING REPORT," written by a licensed, bonded automobile dealer tells how. Get authentic facts, figures, information, actual dealers' wholesale prices never before exposed! Stop losing \$500, \$800, \$1000 yearly on car depreciation! If you have ever wanted a later model car and felt you couldn't afford it, or if you've ever lost money trading cars—this is for you. Let others pay high prices for their cars, you don't have to! Send one dollar for "AUTOMOTIVE BUYING REPORT" and be driving a newer car next week. We GUARANTEE to save you hundreds of times over this small cost—OR YOUR MONEY BACK! Send \$1 for your copy to: KEMP MOTOR CO., Dept. 11M, 2015 N.E. 18th St., Ft. Lauderdale, Florida.

BOAT PLANS-PATTERNS FRAME KITS

A modern up to date series of inboard and outboard designs for the amateur builder. State specific size and type or send 50c for BIG NEW CATALOG.



marine **GLEN** designs Box 568T Compton, Calif.

AMBROID ALL-PURPOSE CEMENT

Ideal for Hobbies, Workshop, Household Repairs, Sports Equipment, Archery. Waterproof, Quick Drying, Extra Strong. See your Hardware or Hobby Dealer.

AMBROID CO., Weymouth 88, Mass.

SURE FIRE RONSON TYPE GIFT LIGHTER



Most popular cigarette lighter, improved for service by precision factory, under expired Ronson patent. Now sold at less than one-third former price! Imported. Money refunded in five days with return of lighter. Send \$2.00 now to

IDEAL PRODUCTS CO., 132 Nassau St.,
New York 38, N. Y. Est. 20 yrs.

ELECTROPLATE IT YOURSELF!

NOW using NEW plating kit. It's easy to electroplate any object with the same LUSTER and DURABILITY as done by the most expensive equip. Complete kit and instructions on plating metal and non-metal objects, with Nickel, Chrome, Copper, Gold, etc. ONLY \$5.95. SEND NO MONEY—everything sent C.O.D. plus postage. OR send \$5.95 now and receive it postpaid. Money back in 7 days if not satisfied.

M. Z. SALES CO., Dept. G-9, 113 W. 42nd St., New York 36, N. Y.



Become an Electrical Engineer at MSOE in Milwaukee

Electronics Communications
Electrical Power
Industrial Electronics

Join the Engineering team! Over 50% of the nation's industrial leaders began their careers with engineering training. Jobs are waiting for well-trained men.

Milwaukee School of Engineering's educational program of technical institute and collegiate engineering courses offers you step-by-step advancement. Save a valuable year through MSOE's optional year-round study system. Prepare yourself for the opportunities ahead in one of these MSOE courses:

Engineering
(Bachelor of Science degree in Electrical Engineering)

Engineering Technician
(Associate in Applied Science degree)

MSOE also offers courses in mechanical engineering and technology.

MSOE's complete, modern facilities include specialized technical laboratories and equipment, visual aid theater, and amateur radio station. Courses approved for veteran training. 50,000 former students. Excellent placement record for graduates.

4 TERM OPENINGS YEARLY
JANUARY, APRIL, JULY, SEPTEMBER

Clip and Mail Today!



MILWAUKEE School of Engineering

Milwaukee 1, Wisconsin MS-36
Dept. PM-1056, 1025 N. Milwaukee St.

I am interested in: (Please print)

- Electrical Engineering course
- Engineering Technician course
- Mechanical Engineering

Name.....Age.....

Address.....

City and State.....

If veteran, date of discharge.....

SAVE HUNDREDS OF DOLLARS with HOME-A-MINUTE "KIT"

This is not something to fool around with.

**A Hard Hitting System
of Saving Big Money**



Design and build your New Home, Attic Flat, Extra Bedrooms or Remodeling—IN MINUTES—with dozens of fiber partitions, Doors, Windows, Kitchen Cabinets, made to 1/4 inch scale same as blueprint. THEN, BELIEVE IT OR NOT, YOU, THE LAYMAN, who knows nothing about building, can estimate your own costs—IN MINUTES—after you adjust charts to local prices.

Don't build anything until you get this "KIT" if you want to save money. Handbook tells you how. This information should not pass you by. Complete "KIT" \$3.95 post., if COD plus postage and \$1 deposit required. Handbook without "KIT" \$1.95 or free literature. Money back guarantee. Return in 10 days.

SPECIAL NOTICE!—As a builder, controlling over 3 million dollars worth of home construction, we will ATTEMPT, but not promise, to obtain a special discount to you for your building materials on your new project, thru your favorite, local, Lumber Dealer. Details with "KIT."

R. B. HALL & CO. 2825 N. 69th St. MILWAUKEE 10, WIS.



FREE!

1. URANIUM TESTER!
2. CHEMICAL PUZZLE!
3. POLAROID ANALYSER KIT!

An amazing URANIUM TESTER, a fascinating CHEMICAL PUZZLE (worth \$2.50 if you can solve it and a valuable POLAROID ANALYSER KIT, all FREE with our great new catalog of OPPORTUNITIES IN CHEMISTRY! Learn BAKING, How To Make Precious SYNTHETIC GEMS, PRACTICAL CHEMISTRY, HORTICULTURE (Florist), AXMINDEMY ADHESIVES, MOULDABLE & CASTING COMPOSITIONS, PLASTICS, ELECTRO-PLATING, COSMETICS, PERFUMES, MINERALOGY, CHEMICAL PRINTING, CRIME LAB., How To Convert WATER into GAS! Complete courses and instructions from \$2.00 and up! Easy payment plan. Send 25c today for CATALOG, details, Uranium Tester, Chemical Puzzle and Analyser Kit! NATIONAL SCHOOL OF CHEMISTRY, P.O. BOX 608-P, Redwood City, Calif.

TALK - LISTEN - AROUND THE WORLD!



RADIO AMATEUR TRANSMITTER-RECEIVER!
SENDER AND RECEIVER THOUSANDS OF MILES on Amateur 80 and 40 meter bands—also, Aircraft and foreign bands (3 to 8 mc.). PORTABLE SELF-CONTAINED BATTERY POWERED! NO AC PLUG-INS. NO DANGEROUS HI-VOLTAGES. Low cost battery lasts for MONTHS. Crystal controlled transmitter—Power input up to 5 watts—ENOUGH TO TALK 1 MILE OR 1000. REGENERATIVE RECEIVER pulls in weakest stations. Front Panel Send-Receive switch— or complicated hookups. Uses any standard antenna. Size only 6"x4"x4" Wt. 3 lbs. TESTED—PROVEN—SIMPLIFIED—PRACTICAL—SAFE for radio beginners (NOVICE). Easy to get license. Full information included.

No troublesome relays. SEND ONLY \$5.00 (bill, check, mo) and pay postman \$9.95 C.O.D. postage on arrival or send \$14.95 and we will send postpaid. Complete kit includes all parts, tube, coils, full instruction, less batteries and crystal— or COMPLETELY WIRED AND TESTED FOR \$19.95! Steel cabinet \$2.00 extra. Rush order today—NOW!
WESTERN RADIO DEPT. BNM-11 KEARNEY, NEBRASKA

High School at Home

MANY FINISH IN 2 YEARS

No classes. No time wasted going to and from school. Progress as fast as your time and abilities permit. Standard H. S. texts supplied. Thousands enroll each year in this 59-year-old school. Send for FREE descriptive booklet.

**AMERICAN SCHOOL, Dept. H845
Drexel at 58th St., Chicago 37, Ill.**

Without obligation, please send FREE descriptive booklet.

Name.....
Address.....

Complete Canadian Courses available. Write American School, Dept. H845, 6083 Sherbrooke St. W., Montreal

FREE BOOK-FREE SERVICE

2,000 BUSINESSES, FARMS, INCOME
PROPERTIES FOR SALE THROUGHOUT U.S.

State what you want—where you want to locate. We'll advise owners FREE. No commission or fee to pay us. No salesman will call. Write today. U.S. BUYERS' REPORT, 5410A Wilshire Boulevard, Los Angeles 36, Calif.



MASTER MIND!

Learn Short-Cut Mathematics
Juggle figures, do baffling number tricks. Make people gasp at your marvelous lightning-quick mind. Multiply 4 figures by 4 figures without using old-fashioned multiplication! Big cloth-bound volume; fully illustrated course for self-instruction.

Sharpen up Your Brain Power
Includes worked-out problems, answers, etc. Sensational bargain, only \$3.95 postpaid or COD plus postage. Satisfaction guaranteed or refund. Order this amazing "Short-Cut Mathematics" today!

NELSON-HALL CO., 210 S. Clinton St. Chicago 6, Ill. \$3.95 Complete

HAVE YOU SEEN IKE?

MONACO COLLECTION incl. EISENHOWER ISSUE — 25¢

Lincoln, Washington, Roosevelt, White House, The Capitol, all included in this fabulous lot with the complete postage set of 5 Grace Kelly wedding stamps, triangles, diamond-shaped, Saints, Helicopter, etc. Everything together with a 48 Page Stamp Dictionary for only 25c to introduce our bargain approvals.



STAMPEX CO., Box 47-AM, White Plains, N. Y.

MINK \$25.00 EACH

BRED FEMALES FOR SPRING DELIVERY
BOOK "DOMESTIC MINK" \$1.00
HARRY SAXTON'S MINK RANCH, Bemus Point, N. Y.



MAKE A "Stradivarius" VIOLIN

- For Pleasure
- For Profit
- For Your Own Use

You Can Do It at Little Cost!
It's Easy! It's Fun!

Here is the "top" of all home crafts projects. Make a violin—a replica of a famous "Strad"—the original of which sold for \$80,000.00. Joe Reid who has made hundreds of fine violins makes the job so easy—so inexpensive—in his new book, "You Can Make a 'Stradivarius' Violin." You don't need any tools. Reid shows you how to make all the tools you need from old table knives, worn out files, sheet metal, etc. Eight full-size plans, 16x23 inches, folded into the book give you every detail in actual size.

Violins Bring High Prices
Make a violin and you probably will never want to sell it. But good tone modern violins bring terrific prices, yet the materials cost comparatively little. With Reid's plans and step-by-step instructions you can make such a violin for yourself. 15 chapters guide you in selection of wood, fashioning the belly, back, sides, mold, lining, neck, scroll, purfling. Other chapters cover varnishing, finishing, stringing. Others show how to make tools and clamps at little or no cost.

Order Book Today. Money Back if Not Satisfied.
Make your own violin for pleasure or profit. Get book and plans now. Clip this ad and mail with check, money order or cash for only \$3.50 or we will ship C.O.D. Money back in 7 days if not satisfied.

FULL SCALE PLANS INCLUDED
Working plans, drawn to full scale, are included in a special pocket inside the book where they may be withdrawn for quick and easy reference.

**Complete Instructions
8 Actual Size Plans
How to Make the
Tools You Need
Where to Get the
Materials**

You trace or work direct from actual size plans. No measurements to translate or confuse you. You see the entire violin in the plans. You read the how-to-do-it instructions in the book.

\$3.50 Cloth Bound

POPULAR MECHANICS PRESS Dept. 1156 200 E. Ontario St., Chicago

Free! SCARCE "TRIANGLE" COLLECTION



Start TODAY to enjoy an exciting new hobby! Get this big, valuable collection of gorgeous, multi-colored triangle shaped postage stamps . . . brought to you from strange and mysterious lands in the wilds of Africa, enchanting Europe, exotic Latin America, etc. All genuine, all different—picturing man-eating reptiles, jungle birds, action-packed sports, ancient clipper ships; PLUS scarce airmails, fabulous commemoratives, giant and midget-sized stamps. EXTRA! Bargain Catalog, "Collector's Manual" plus other exciting offers for your inspection. Enclose 10c for mailing costs Supplies limited. ACT NOW!

JAMESTOWN STAMP CO., DEPT. H11PM, JAMESTOWN, N. Y.

TECHNICAL EDUCATION

• Air Conditioning and Refrigeration Technology • Diesel Technology • Drafting Technology • Electrical Technology • Electronic Technology • Excellent faculty, accredited curricula, extensive counseling and guidance, full college activities, job placement service, G.I. approved. Opportunity to continue education and earn a B.A.S. degree. Open to high school graduates or equivalent. Feb., June and Sept. semesters. Write for free brochure.

COLLEGE OF TECHNOLOGY, University of Houston
DEPT. 186, 3801 Cullen Blvd., Houston, Texas



ELECTRIC MOTOR
\$1.50

110 Volt AC
FREE 100 PAGE CATALOG

2 SAW BLADES

Genuine Simonds COMBINATION BLADES
List \$7.00
\$1.50
6" diam. 1/2" arbor



PENNA. WHOLESALE DISTRIBUTORS
104 N. 6th ST. PHILA., PA.

WHAM-O

\$1.50

HITS LIKE A RIFLE—KILLS RABBITS, SQUIRRELS
Powerful, silent, accurate for hunting, target, rousting pests.
Sportmen's shops sold world over.

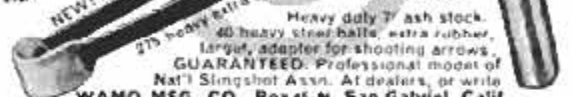

HUNTING SLINGSHOT

NEW! Surgical quality pure DUM-BULL rubber
2 1/2 heavy extra steel balls 98c
Heavy duty 7" ash stock
40 heavy steel balls, extra rubber
Large, adapter for shooting arrows.
GUARANTEED: Professional model of Nat'l Slingshot Assn. At dealers, or write
WAMO MFG. CO., Box 45-N, San Gabriel, Calif.
FREE catalog on crossbows, knives, games, pistols, etc.

not everyone does as well, but E. O. Lockin, who started a business of his own, reports...

for 12 months I've averaged
\$800 PER MONTH INCOME—
most of it clear profit for me!

• Mr. Lockin expresses his grateful thanks for the opportunity to make a decent living on his own. Many men have discovered how to be independent, to be free of bosses and layoffs. L. A. Eagles grossed more than \$200 his first week. R. E. Traynor says, "I made \$62 gross in one day." Others report gross up to \$12,000 per year.

How much you make depends largely on you. You need no special skill, no large investment. Can start part time until you have full time.

No shop necessary

Our Electric Rug Washer cleans rugs, carpets right on floor . . . helps to show their natural color and beauty. So efficient and safe, used by largest hotels and railroads.

You take no risk. Machines fully guaranteed. Mail coupon today for complete information including how to start making big profits in your own business.



VON SCHRADER MFG. CO.
RACINE, WISCONSIN

You, too, can start your own business. No special skill, no large investment required. Mail coupon today for interesting FREE book.

VON SCHRADER MFG. CO.,
E10 "R" Pl., Racine Wisconsin

Send at once (no obligation) your FREE booklet containing information about your Electric Rug Washer and how I can start my own permanent, profitable business.

Name.....

Address.....

City.....Zone.....State.....

Say You Saw It in POPULAR MECHANICS

Auto Service Men . . .

STEP UP YOUR PAY!



New Sun School
Makes it
Easy!

Be an EXPERT in Scientific Engine Tune-Up and Service!

Sun-trained experts in the use of electronic engine test equipment are in demand now! They MAKE MORE MONEY because they know how to use the "tools" which can quickly and profitably keep today's complex engines tuned up to their full power and economy levels!

You Can Provide This Service and Increase Your Earnings—
it's easy the Sun way!

Sun Electric Corporation, Chicago—world's largest

Costs are LOW . . . plan NOW to increase your skill and position in the industry! Send for complete information . . . FREE Brochure!

manufacturer of automotive test equipment—Now offers a completely new service training program. Train with specialists in the fully-equipped Sun Technical Training School, at Sun's Chicago headquarters. Learn the latest on any or all of these subjects:

- Test Equipment Operation . . . on Modern engines! You use every piece of Sun equipment!
- Automotive Electricity . . . full coverage with accent on generators and regulators!
- Modern Tune-Up Procedures . . . Carburetion—how to do it fast, accurately, prevent comebacks!
- Service Merchandising . . . how to sell all work needed by customer!

G. I. Bill Approved!

Sun Electric Corp., Dept. PM-8
Marion & Avondale Ave., Chicago 31, Ill.

NAME _____
COMPANY _____
ADDRESS _____
CITY _____ ZONE _____ STATE _____

Train at Home or in the Big Allied Shops AIR CONDITIONING HEATING & REFRIGERATION

ALLIED offers YOU the finest training for one of the greatest industries of our time. You can be sure of the quality of ALLIED training—resident training on a wide variety of equipment—and Home Study training that has behind it a great resident school.



BIG KITS

ALLIED TRAINING PREPARED WITH COOPERATION OF INDUSTRY
Only a school with the established reputation of ALLIED could have been given the cooperation by leading industries in the Air Conditioning, Heating and Refrigeration fields which has made this training so outstanding.

You Are Supplied Shop-Work Kits if You Prefer to Train at Home Right in your own home you do practical air conditioning and refrigeration work made possible by ALLIED training. You build an Air Conditioner, Freezer, or other units of your choice.

Send Today for Free Sample Lesson and Book

Air Conditioning and Refrigeration are changing the living habits of millions of people. Plan to get into this great industry now—it's your chance to go up to higher and still higher earnings or build a successful business of your own. Get the facts about ALLIED training and how you can be helped. Mail the coupon for free book and sample lesson—no obligation.

ALLIED SCHOOL OF MECHANICAL TRADES
ALLIED INSTITUTE OF TECHNOLOGY
1338-42 South Michigan Ave., Dept. PM-11A, Chicago 5, Ill.

Gentlemen:
Mail me FREE BOOKS explaining ALLIED'S training program in AIR CONDITIONING, HEATING, and REFRIGERATION.

I am interested in resident training home study

Name _____ Age _____

Address _____

City _____ State _____



MAKE STRIPES with new PAINT PEN

Straight, curved, single or double
With any color paint, stripe furniture, bikes, autos, model planes, toys, linoleum, wallboard. Clean, crisp decorative lines. Can't clog or smear. Also use with glue, tempera, textile paint or underglaze...on wood, glass, plastic, ceramics, metals, fabrics and paper. Ask your dealer or order direct.

Single
1/16" stripe \$1.25
model

Other single
stripe models \$1.75
ea.
1/8", 1/32", 3/64",
5/64", 3/32" & 1/8"

Complete Kit \$5.00
(all 7 tips)

Extra tips 90c ea.

Extra 1/4" tip...\$1.20

DEALERS
Master paint
striping tool
in display
carton. Write
for discounts.

HOBBY
"Professional"
results every
time. Simple,
easy to use.
Order now.

MFRS
Ask about
heavy duty
industrial
striping
tools.

DOUBLE STRIPE MODEL
5 COMBINATIONS \$3.25

WENDELL MFG. CO. 4234 LINCOLN AVE., Dept. 323
CHICAGO 18, ILLINOIS

Say You Saw It in Popular Mechanics

AMAZING NEW PERSONAL POCKET RADIO



LISTEN WHILE YOU WALK DOWN THE STREET!

Slips in any pocket—wt. only 7 oss. Size 2 1/2"x4 1/2"x1 1/2". Beautiful Black Gold Plastic Case. NO HOOKUPS—NO WIRES—NO PLUG-INS! Self-contained, 150-hour life flashlight batteries and BUILT-IN ANTENNA. POSITIVELY NO AERIAL HOOKUPS EVER! GUARANTEED RECEPTION OF RADIO STATIONS TO 50 MILES up to 1500 miles for powerful stations! New patented Super-regenerative Diode tube and transformer audio stage for sharp selectivity and sensitivity! Easy to use top tuner (while walking). Tiny, plastic personal ear plug.

LET'S YOU ALONE LISTEN WHILE YOU WALK, VISIT, WORK, RIDE OR SLEEP ANYTIME—ANYWHERE. MONEY-BACK GUARANTEE AND ONE YEAR SERVICE GUARANTEE.

SEND ONLY \$5.00 (ck, mo) and pay postman \$14.95 plus postage on delivery or send \$19.95 for postpaid delivery. GET YOUR TINYTONE REAL POCKET RADIO now and be ready to listen to Civil Defense Alarms, news, music, sports, etc. on a moment's notice without bothering those around you. NOT AN UNWORKABLE, INCOMPLETE KIT OR PLAYTHING. BUT A REAL POCKET RADIO! Shipped complete with batteries—Ready to Listen! Available only from: WESTERN RADIO, Dept. APM-11, Kearney, Nebr.

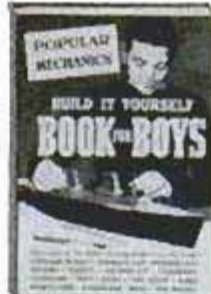

Every Boy Should Have This Build-It-Yourself Book for Boys!

It's natural for boys to want to make things—to fuss with tools—to fashion the kind of things "kids" want. So give boys the Build-It-Yourself Book for Boys. Encourage a youngster to express himself through the sensational new Popular Mechanics book that shows how to make 56 different things every boy dreams about. It covers science, mechanics, electricity, modeling and other fields. 192 pages of easy-to-follow instruction and 469 how-to-do-it pictures.

56 Toys, Games, Gadgets, Models, Boats, Electrical Devices, Cars and Other Things Boys Can Make at Home

How to make—Airplane Models, Aquaplane, Archery Kit, Bird Houses and Shelter, Boats, Bobsleds, Boomerangs, Cannon Toy, Electric game, Electric Motors, Garage Toy, Helicopter Toy, Hunting Knife, Hydroplane Model, Kites, Log Cabins, Marble Game, Microscope, Printing Press, Radio Sets, Rafts, Railroad Modeling, Shooter, Scooter, Sidewalk Cars, Sprinkler Truck, Squirrel Gun, SS United States Model, Surfboard, Tank Toy, Taxidermy, Telegraph Set, Telephone, Tree House, Water Skis, Weather Instruments, Toboggan, Worktable. Build-It-Yourself for Boys sent postpaid for \$2.50 or COD, charges additional. Money refunded if you are not pleased after 5 days' use. Mail order to address below.

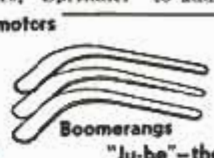
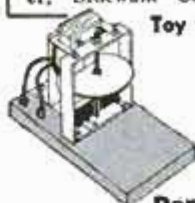

POPULAR MECHANICS PRESS
Dept. 1156, 200 E. Ontario St., Chicago 11

SEND ME



every month so I am sure to see each new issue. Here's

- \$3.50 for 1 year
- \$8.00 for 3 years

name _____

address _____

city _____ zone _____ state _____

Hand this order to your newsdealer or send it to
POPULAR MECHANICS
200 East Ontario St. Chicago 11, Ill.

Get into... PLASTIC LAMINATING AT HOME!

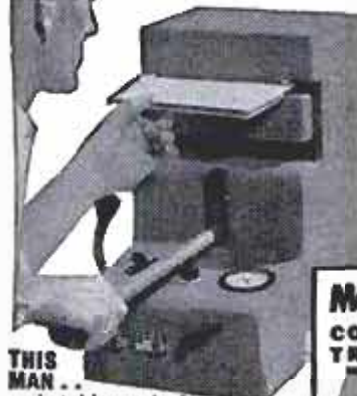

THIS MAN...
... is taking out of the machine a Plastic Sealing Job — ordered by mail — only 11¢ in material cost brings back \$2.58 in cash by mail. Capacity of machine: \$25.00 profit per hour of operation.

Get **ORDERS** and **CASH** from your mailman—do work in **SPARE TIME** at home—or expand into **FULL TIME** business. Send coupon for Free facts about the newest and most fascinating of all home operated businesses. For the first time a simplified machine brings the fabulous profits of **Plastic Sealing and Plastic Laminating** within the reach of the small operator. Anyone can learn to operate the machine with a few minutes practice—then with our **Magic Mail Plan** can get mail orders pouring in daily with cash in every envelope. **No canvassing—no selling.** We even

Make \$20 to \$30 a Day by...
MAGIC MAIL PLAN!

supply the circulars you mail to bring back cash and orders. Don't waste a minute. Rush your name. We'll send you **FREE** and postpaid, pictures, prices, details, and all the facts you need to start. Mail coupon or send name on postcard. No charge. Warner Electric Co., 1512 Jarvis Av., Dept. L-1011, Chicago 26, Ill.

Make Thousands of Beautiful Art Creations

COSTUME JEWELRY • CIGARETTE BOXES TRAYS • CANDLESTICKS • COASTERS LAMP BASES • BOOK ENDS... ALL IN SPARKLING COLORED PLASTIC



WARNER ELECTRIC CO., 1512 Jarvis Av. Dept. L-1011, Chicago 26, Ill.
At no cost to me, please rush complete details postage prepaid. I am under no obligation.

Name.....

Address.....

City.....Zone.....State.....

100 BEST Woodworking Projects

Selected by Popular Mechanics Editors

Enjoy the fun of making things. Revel in the pride of the craftsman when neighbors and friends admire your handiwork. Get **100 BEST WOODWORKING PROJECTS**, complete with simplified instruction, plans, diagrams and more than 400 how-to-do-it pictures. Make all kinds of furniture — chairs, tables, desks, bed room furniture. Make baby carriages, clock cases, lamps, book shelves, fireplaces, attic ladder, folding screen, kitchen accessories, games, swings, storage bins, garden sets, etc., at little or no cost. Send only \$2.00 with name and address today. Money back if not pleased.

POPULAR MECHANICS PRESS, Dept. PM-1156 200 E. ONTARIO STREET CHICAGO 11, ILL.

The "Must" for All Home Workshops



DEVELOP A HE-MAN VOICE!

Write for **FREE** book "How to Strengthen Your Voice for Greater Success" by Eugene Feuchtinger. No obligation. Book will be mailed at once in plain wrapper, postpaid. Just send your name and address. State age. **PREFECT VOICE INSTITUTE, 210 S. Clinton St., Studio LU-2, Chicago 6, Ill.**

SAY YOU SAW IT IN POPULAR MECHANICS



instead of a job
... train for a Career



Industrial growth . . . automation . . . technical advances create career opportunities for engineers, accountants, management experts. Share rewards awaiting college-trained men. Important firms visit campus regularly to employ Tri-State College graduates. Start any quarter in this world-famed college. *Approved for veterans.*

Bach. of Science degree in 27 months

In Mechanical, Civil, Electrical, Chemical, Aeronautical, Radio (TV-Electronics) Engineering. In 36 Months a B.S. in Business Administration (General Business, Accounting, Motor Transport Management majors). Capable students may accelerate. 36-weeks course in Drafting. *Intensive program: technical fundamentals stressed: comprehensive courses with more professional class hours. Small classes: personalized instruction. For earnest, mature students whose time and budget require accelerated courses and modest costs. Preparatory courses. Beautiful campus in friendly college town. Well-equipped, new and modernized buildings and laboratories. Enter Jan., March, June, Sept. Write Jean McCarthy, Director of Admissions, for "Your Career in Engineering and Commerce."*



TRI-STATE COLLEGE

4116 College Avenue • • • Angola, Indiana

GROW WITHOUT SOIL

YOU can grow vegetables, flowers, or rare plants without soil (**HYDROPONICS**) every day of the year. Start this fast, clean, **EASY** way to grow any plant for fun or **PROFIT** now. Big returns from small space. Send \$1.00 today, at our risk, for generous trial supply and copy of **Modern Hydroponics Course** sent postage prepaid. Start where others from every state are succeeding in this new wide open field.

GILBERT CO., Box 606, 525 Spruce St., San Diego 3, California

WHOLESALE Electric Guitars - Parts - Factory to You

Solid-body Spanish, amplifiers, double-necks, single-necks, triple-necks, 4-necks, solid-body mandolin, pickup mikes, non-electric instruments, etc. 1957 Models Wholesale. **FREE CATALOG.** Free home study course with instruments. Parts & plans available to build your own.

CARVIN CO., Box 287, PM-11, Covina, Calif.

Do You Like art?

DRAW FOR MONEY!

Our Simple Method Proves You Can Learn to Draw at Home in Spare Time

YOU can learn Commercial Art, Designing, Illustrating, Cartooning, etc. . . . right at home, in spare time. No previous art training necessary. Soon be your own boss — work at home, pick your own working hours. Or earn big money as staff artist for advertising agency, newspaper, magazine, dept. store, etc. Or make Art a profitable hobby. Earn while you learn. 22-piece art outfit given with your first lesson **AT NO EXTRA CHARGE.** (School est. 1914.)

FREE BOOK, "ART FOR PLEASURE AND PROFIT." Describes our methods. Lists opportunities. Tells what our students say. No obligation. So mail coupon at once. **Free Talent Test.**

Washington School of Art
Studio 1411, Port Washington, N. Y.
Send me—**FREE**—your valuable illustrated Book, "Art for Pleasure and Profit." No obligation. No salesman will call.

Name.....Age.....
(PLEASE PRINT PLAINLY)
Street.....
City.....Zone.....State.....

A "Must" Book for Boys of All Ages and
the Greatest Gift Book of All Time!



BOY MECHANIC

Give the
Boy Mechanic
for Christmas
and other Gift
Occasions

FREE Any Name Stamped
in Gold on Cover
Any name you wish will be stamped in gold on the
cloth bound front cover FREE if you remit with order

NEW!

Fascinating! Educational!

How to Make Things That Work and Go!

This is it, fellows! Here's the exciting book you have been waiting for. Get the brand new Popular Mechanics **BOY MECHANIC** for yourself or be sure you get it soon for a gift. You know it's the fellow who can do things—make things that "work" and "go" who is the kingpin in every school and neighborhood. Enjoy this popularity yourself. Learn what to do—what to make—how to make it—with the **BOY MECHANIC**. Have fun with outdoor projects and gadgets; models of every type; your own scientific experiments and instruments; all kinds of craft work with wood, metals, plastic, etc; easy to make toys for yourself and others.

Something for Every Place, Time and Season

Think of it! More than 500 wonderful ideas you can use, selected by Popular Mechanics editors. Projects for the home workshop; in camp; on land and water and in the air. Projects for summer and winter and in between. More than 1100 pictures and diagrams show you exactly what to do and how to do it. It's a big, fascinating and helpful book that will give you hours and hours of fun and show you how to make so many of the things you have always wanted.

A Grand Big Book!

Beautifully Bound in Library Cloth and Personalized With Your Name in Gold on the Cover



308 Pages

Packed with fascinating pictures and practical how-to-do-it information on outdoor projects, models and model making, spare time crafts, workshop fun, simplified science, toys, etc.

1100 Pictures

Photographs, Drawings, Diagrams, Plans and Construction Details. The most elaborately illustrated "What to Make" book ever printed.

Rush Coupon Today!

Be the first in your neighborhood to get the **BOY MECHANIC** by mailing the coupon today. Only \$3.95 postpaid. And we'll stamp your name (or any other name if a gift) on the cloth bound cover in gold FREE if remittance accompanies order. Be sure to PRINT name for gold stamping and mail order today.



Model Airplanes, Railroads, Ships, in Model Section



Fascinating Tin Craft, from Indoor Crafts

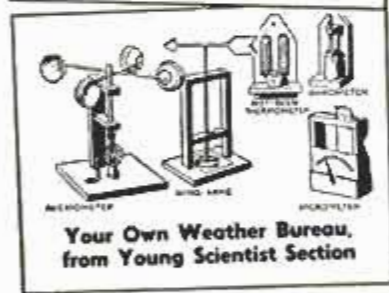

Your Own Weather Bureau, from Young Scientist Section

Some of More Than 500 Articles in Boy Mechanic

- Build a Soap Box Derby Racer — Coasting in a Sidewalk Jeep — Aero Driven Ice Boat — Eight Repair Kinks for Your Bicycle — Sea Scout Dinghy — Control Line Flying Model Planes — Model Racing Yacht — Model Railway Small-Space Track Layout — Leathercraft — Tin Can Craft — Useful Articles from Hammered Copper — Jackknife Animal Carving — Easy to Make Hand Puppets — Art With the Typewriter — Dog Quonset Hut — Bird Houses and Cages — Home Laboratory Short Cuts — Your Own Weather Bureau — Toy Electric Motors You Can Make — Fun With Common Gases — 100 Power Microscope — Six-in-One Puzzle — Magnetic Theatre — Turkey Hunt Dart Game. And hundreds of others.

**POPULAR MECHANICS PRESS, Dept. 1156
200 E. Ontario Street, Chicago 11, Ill.**

Send me at once _____ copies of the **BOY MECHANIC** at \$3.95 each.

- Remittance enclosed. Stamp name in gold and send postpaid.
- Send COD. I will pay postman plus delivery charges.

Name _____

Address _____

City _____ State _____

Print name on this line for gold stamping. Use margin for additional names.

OWN Your Own Business



PATENTED
PORTABLE
EQUIPMENT

\$5 per hour

Clean and Mothproof rugs and upholstery "in the home," office, institution. If now employed, you can operate in spare time and build a permanent full-time business.

Alert dealers can gross \$5 hourly profit on service they tender plus \$3 on EACH serviceman. We locally train and assist you. Easy to learn . . . quickly established.

DURACLEAN cleans by absorption! No scrubbing, soaking or shrinkage. Dirt and grease vanish . . . matted pile rises . . . colors revive. Furnishings used again same day.

DURAPROOF resists moths and carpet beetles. Your service backed by an International Money Back 6 Year Warranty.

We furnish enough material to return your total investment. Send TODAY for FREE booklet explaining details and EASY TERMS.

DURACLEAN CO., 6-16N DURACLEAN BLDG. DEERFIELD, ILL.



Have a Motorized Shop at Low Cost Make Your Own POWER TOOLS

Popular Mechanics Book Shows How to Make 60 Machines from Scrap and Discarded Materials

Get SIXTY POWER TOOLS AND HOW TO BUILD THEM, the sensational new Popular Mechanics book. Build your own lathe, drill press, sander, circular and band saw and other power tools at a cost of only a few dollars each. Use old auto parts, pipe and wood and odds and ends that cost little or nothing. Every detail of construction is given in plain language you can understand and follow. Hundreds of pictures and plans show every step to follow in making the power tools you want. Clip this ad and mail with name, address and only \$2.50, or we will send C.O.D. (U.S.A.). You'll be amazed with the fine, practical tools you can make and how little they cost. Your money back if you return the book in 7 days. Order today.

POPULAR MECHANICS PRESS, Dept. 1156, 200 E. Ontario St., Chicago 11



Over 250 Pictures

WANT HIGH PAY and STEADY WORK?

Get into

DIESEL AND HEAVY EQUIPMENT

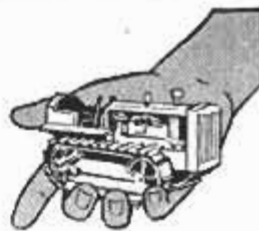

We are now accepting men to train for Diesel and Heavy Equipment. High pay and future security are the benefits of a trained and qualified Diesel man. If you have mechanical aptitude, write to us for free information without obligation as to how you may become a part of this rapidly expanding industry in . . .

- DIESEL MECHANICS
- DIESEL PARTS
- DIESEL OPERATION
- DIESEL SALES

MAIL THIS COUPON TODAY!

We will give you complete details about possibilities for you in the Diesel and Heavy Equipment field, without cost or obligation. Fill in the information below, or write at once to:

TRACTOR TRAINING SERVICE, INC., Dept. PM-10

1925 E. 53rd St., Chicago 18, Illinois or
3334A Bloor St., West, Toronto 18, Canada

Gentlemen:

I would like all the facts about opportunities for me in Diesel.

NAME _____ AGE _____

ADDRESS _____

CITY & STATE _____

Say You Saw It in Popular Mechanics

Learn All About Cars!

AUTO MECHANICS—AUTOMATIC TRANSMISSIONS
ACETYLENE AND ARC WELDING
BODY AND FENDER REPAIR

Day-Night School 30 Years in the Same Location

WOLVERINE SCHOOL OF TRADES

Approved Under the G. I. Bill of Rights by the State Board of Education

WOLVERINE SCHOOL OF TRADES, Dept. PM
1400 West Fort St., Detroit 16, Mich.

Name _____

Address _____

City _____ State _____

SAVE \$ ON U\$ GOV'T \$URPLUS\$

Our publication "Government Surplus Sales" lists hundreds of items for sale by the U. S. Government at tremendous savings, as low as 1c on a \$1.00.

These are samples of the savings that are being made:

LIFE BOAT \$12.00	GRINDER \$4.69	SHAPER \$15.00	DUMP TRUCK \$76.77
TRACTOR \$75.00	TYPEWRITER . . . \$7.51	FREEZER \$50.00	SPRAY PAINTER . . . \$15.25
	MOTOR \$4.00		

Hundreds others listed in our bulletin "Government Surplus Sales" and may be purchased direct from U. S. Government. Hunting, Fishing, Camping, Sporting Equipment, Photographic Equipment and Supplies, Radio and Electronic Equipment, Amphibious Trucks, Jeeps, Bots, Motors, Binoculars, Plumbing, Electrical Equip., Cars, Power Tools, Machinery, Chemicals, Furniture, Office Equipment, Supplies, Scrap, Etc.

How may you receive our bulletin "Government Surplus Sales?" By sending \$1.00 to
GOVERNMENT SURPLUS SALES, P. O. Box 169, Department 8-5, East Hartford 8, Conn.

Submarine Hull Sections Are Automatically Welded Together

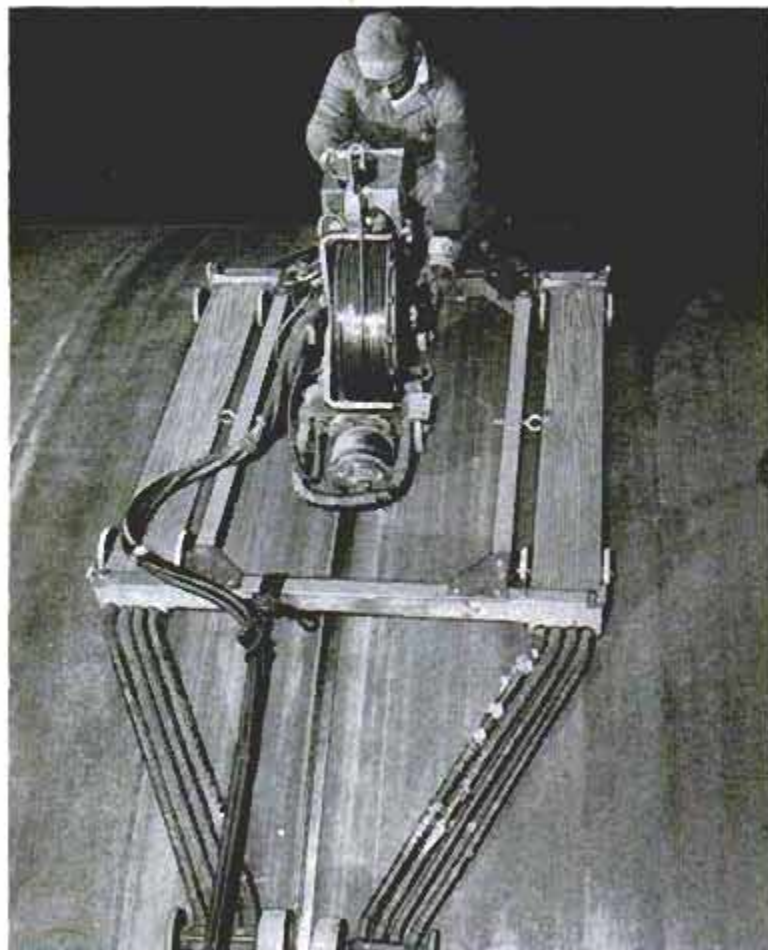

Huge 20 to 60-ton sections of the hull of the *Nautilus* were butt-welded together by a new welding process developed for the job. The sections of the hull were mounted on rollers and revolved under a stationary automatic-welding machine. Three passes on the machine over a 100-hour period were sufficient to complete the joining of the sections. The same job done by older methods would have required 300 hours of labor. The process was also used on the second atomic submarine, the *Seawolf*, and will be used on the *Skate*, third atomic submarine to be built.

Special "Help" Flag For Handicapped Drivers

Colorado's state legislature, recognizing that a handicapped person who has car trouble on the road needs aid, has authorized the use of a special flag. The flag consists of a large letter H in red on a white background, easily seen by a passing motorist.



HELICOPTER BUILD YOUR OWN

Now you can fly and own your own economically built 1 man helicopter. Be an aviator. With this easily flown scientific marvel you can take long trips or earn extra money. This low cost, proven safe machine with either jet or piston engine can be built in your spare time from our plans or kit parts. Carries easily obtained experimental license. Don't delay, order your plans for this cheaply built model today. Guaranteed.

COMPLETE BUILD OWN PLANS . . . \$5.00

Blueprints \$7.00 3 Passenger plans \$10.00

GENERAL AVIATION OF CANADA
BOX 384 WINDSOR, ONT. CANADA

Soldering is Easy

with

INSTANT STARTING



Lenk

LIQUEFIED **LP** PETROLEUM

Torch

only **\$2.95**



THE ONLY THROW-AWAY FUEL CONTAINER WITH SELF-SEALING SAFETY VALVE.

Here's what you can do:

- regular soldering.
- sweat fittings.
- silver soldering.
- refinish furniture.
- remove paint and putty.

Available at Hardware Counters Everywhere

Write for FREE
Soldering Instructions

THE *Lenk* MFG CO.
BOSTON 15, MASS



UNIMAT 10 IN 1 COMPLETE WORKSHOP

CRAFTSMEN, MODEL BUILDERS, HOBBYISTS AND INVENTORS all over the world are choosing this unique and extremely versatile electric tool for machining small parts from steel, brass, wood, aluminum and plastic. Highly acclaimed because of its precision results, UNIMAT offers these serious craftsmen many other worthwhile advantages.

UNIMAT BASIC UNIT (shown) INCLUDES: 1—a Precision lathe and all accessories necessary to convert it quickly and easily into a 2—Drill Press; 3—Hand Drill; 4—Polishing and Grinding Machine; 5—Tool Grinding Machine; 6—Milling Machine. With the Basic Unit you also get these 13 accessories Free: AC/DC Power Motor, with reduction pulleys (11 speeds—375 R.P.M. to 9200 R.P.M.); self-centering universal three-jaw "Cushman" lathe chuck with reversible jaws (int 2 1/2" Dia.); 3/8" Drill Chuck; Pivoting Tool Holder; Grindstone Holder; Lathe Dog; Face Plate, 2 centers; Allen Wrench; Easy-to-follow instruction manual, all packed in sturdy wood veneer carrying case!

ADDITIONAL ATTACHMENTS are available for further versatility of your Basic Unit: 7—The Jig Saw; 8—Threading Attachment; 9—Circular Saw; 10—Indexing and Dividing Attachment. All attachments can be ordered individually with the Basic Unit, or at any time! (Attachments not shown.)

PORTABLE AND COMPACT—two more reasons for its great popularity. All operations require little working space and are performed on just one base. There is also high quality built into this unique machine tool. The ball-bearing headstock spindle has a 1/2" O center. It also features a built-in rack, so that the headstock spindle can be adjusted 1" in either direction. This feature gives the drill press its stroke when in the upright position. The tailstock is threaded and will take either lathe or drill chuck. Constructed of high quality hardened and ground steel and a cast iron ribbed lathe bed. UNIMAT adds up to a top notch machine tool that will enable you to create a limitless variety of objects—from just about any kind of stock material.

UNIMAT BASIC UNIT COSTS ONLY \$99.50 and can be obtained on a budget plan for as little as \$49.50 down, and \$10 a month for 5 months. There's no charge for this service. It is shipped prepaid East of the Mississippi. West thereof, a slight charge is necessary. Additional literature is also available for only 10¢ to cover mailing costs. Look into this amazing precision tool today. It will prove worth your while.

Mail your order today to Dept. PM-116 Dealer Inquiries Invited!
AMERICAN EDLSTAAL (AMSTERDAM) INC.
 350 Broadway New York 13, N. Y.

Say You Saw It in Popular Mechanics

"SEA CRAFT"

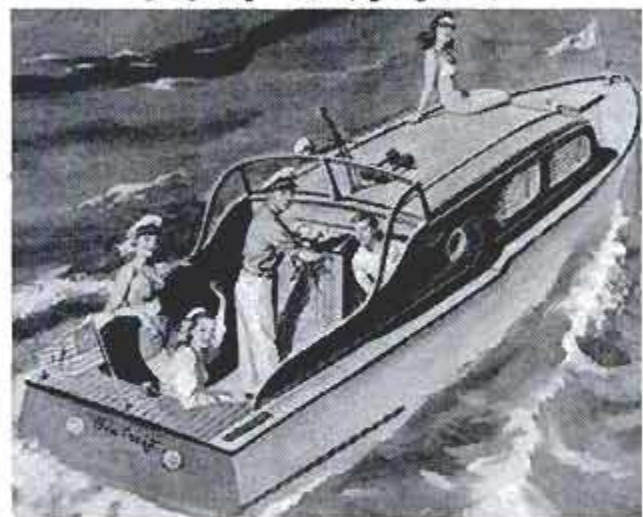

Build this luxurious cabin cruiser yourself and save money. What a beauty it is! A 25-foot boat readily adaptable as a sport fisher, express cruiser, or utility boat. Cruises effortlessly at 15 knots with a marine engine or converted auto motor. Its spacious cabin sleeps four and has a galley complete with fresh-water tank, sink, and cook stove. Has open cockpit large enough for fishing, lounging, etc.

During war the Coast Guard used "Sea Craft" for ship-to-shore travel. Order today your complete set of seven large-size blueprints scaled 1 inch to the foot. These, plus a 40-page two-color illustrated booklet giving step-by-step instructions, only \$10.00.

POPULAR MECHANICS PRESS
 200 EAST ONTARIO ST., Dept. 1156, CHICAGO 11, ILL.

SAVE 1/2 ON ACCORDIONS • SAVE 1/2 ON ACCORDIONS

BUY DIRECT and
SAVE UP TO 1/2
 on ITALIAN ACCORDIONS
EASY TERMS



AMAZING NO RISK OFFER...
 Now you can afford a world famous Accordion of finest tone and breathtaking beauty! Low wholesale prices save you half and more.

5 DAYS FREE TRIAL

ACT NOW! FREE—

- Music Stand
- Home Study Course
- Deluxe Case
- Lifetime Guarantee

COLOR CATALOG FREE
 Mail Coupon

MONEY BACK GUARANTEE

Buy direct from world's largest dealer. Save 50% or more, 30 newest models to choose from. Extra bonus gifts if you buy now. Satisfaction guaranteed, or money back. Trade-ins accepted. Low down payment; pay little as \$10.00 a month. Try before you buy on FIVE DAY TRIAL. Rush coupon now for FREE color catalog and wholesale price list. Write TODAY.

Accordion Manufacturers and Wholesalers Outlet, Dept. R116
 2003 W. Chicago Ave., Chicago 22, Ill.

Accordion Manufacturers & Wholesalers Outlet
 2003 W. Chicago Ave., Dept. R116, Chicago 22, Ill.
 Send FREE Color Catalog and price list.

NAME _____

ADDRESS _____

CITY _____

STATE _____

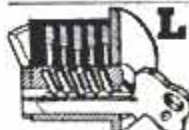

LOCKSMITHING

Practical Up-to-Date Course — ONLY \$5.95

53 illustrated self-instruction lessons. Easy to learn. Full price only \$5.95 postpaid—or COD plus postage. Satisfaction guaranteed or full refund! **NELSON HALL CO., 210 S. Clinton St., Dept. LU-2, Chicago 6, Ill.**

AMAZING! Secret Spy CAMERA



It's a CAMERA!
 It's a LIGHTER!
ONLY \$2.98

Complete with roll film

TAKE PICTURES UNDETECTED!! Now you can take pictures while lighting your own or someone else's cigarette—WITHOUT BEING SUSPECTED! Others think you're just using the lighter, BUT ACTUALLY YOU'RE TAKING PICTURES WITHOUT THEIR KNOWLEDGE! Patterned after the long-secret spy camera used by secret agents, it's a dependable lighter in addition to being a precision-made camera that takes 28 clear, detailed pictures at a moment's notice. Same size as an ordinary cigarette lighter; fits vest pocket.

SATISFACTION GUARANTEED OR MONEY BACK

High quality lens takes close-ups or distance photos that enlarge beautifully. Allows you to get natural, unposed pictures at parties, home or out-of-doors. No complicated adjustment necessary; easy to operate camera takes 20 photos per roll, that can be developed anywhere. Comes to you complete, ready to operate. Send check, money-order or cash. Add only 20¢ to each order for postage and handling. No C.O.D.'s please. **\$1.00 SPECIAL — Extra Film, 6 rolls for only.....**

DOBBS PRODUCTS CO., 1251 So. Wabash Ave., Dept. 471, Chicago 5, Ill.

PAY RAISING—EXTRA MONEY BOOKS

specializes in supplying outstanding self-help books on many subjects. Send for our FREE catalog.

Use these books to prepare for a better job—bigger pay—to start a profitable spare time or full time business of your own, improve your home, or start a hobby. Popular Mechanics specializes in supplying outstanding self-help books on many subjects. Send for our FREE catalog.

PROJECTS IN METAL

44 make-it-yourself articles, fireplace sets, chimney and shutter ornaments, lanterns and lamps, iron tables, mail boxes, decorative novelties, etc. More than 300 photographs and working drawings. 96 pages. . . . \$1.00

METAL NOVELTIES

Hand-wrought copper, pewter, brass, iron, etc. How to make attractive desk sets, ash tray, book ends, serving tray, candlesticks. 37 different articles are described. More than 200 photographs and easy to follow instructions. 88 pages. \$1.00

THE COMPLETE BOOK OF GARDEN MAGIC

Contains the gardening experience of 25 years. 17 full color plates. 334 pages \$3.95

NEW AMERICAN HOMES

A beautiful plan book of larger homes, containing 88 designs. . . . \$1.00

MODERN KITCHEN CABINETS

You can remodel your kitchen by building up-to-date cabinets. . . . \$2.00

THE VETERINARY ADVISER

Furnishes simple practical advice relative to the prevention and treatment of the common ailments of farm livestock including horses, cattle, sheep, swine and poultry. illus. . . . 98¢

BETTER HOMES AND GARDEN COOK BOOK

Best seller cookbook. . . \$3.95

SCIENCE OF WATCH REPAIRING SIMPLIFIED

Brings out difficult problems and explains them in a simple manner. . . . \$3.00

FASCINATING PEN FLOURISHES

You can start at the beginning and make the simplest strokes and finish with the highest degree of skill attained in this art. . . . \$1.00

HOW TO MAKE CARTOONS

The History and technique \$1.00

HOW TO SUCCEED WITH BEES

More than 190 successful plans to produce big crops of honey. 96 pages. . . . \$1.00

HOW TO BUILD FENCES AND GATES

A Sunset Book. How to select the best fence or gate, how to do-it plans. 225 pictures \$1.50

HOW TO PLAN AND BUILD YOUR FIREPLACE

A Sunset Book. Working drawings for construction of residential fireplace and chimney. . . . \$1.00

PROPAGATION OF PLANTS

Every conceivable method of budding and grafting is plainly described by text and picture. A handy reference book for nurserymen, greenhouse-men, experimenters, teachers. Profusely illustrated. 639 pages. . . . \$4.50

OUTDOOR MECHANICS

Easy to follow instructions for the home owner who wishes to beautify his home grounds. Build outdoor recreational facilities and living conveniences that will extend the walls of your home to include the greatest possible living enjoyment for the entire family. . . . \$5.95

ESTIMATING FOR THE BUILDING TRADES

The most complete and practical book ever seen on the estimating of all material and labor costs for every phase of the building trades as related to residences and other moderate sized buildings. . . . \$6.75

BIRD HOUSES, FEEDERS, BATHS

There are hundreds of designs to choose from, a variety of only the best examples and can be made from a wide range of materials—lath, scraps, logs, celluloid, concrete, metal, etc. 80 pages, illus. . . . \$1.00

LEATHER PROJECTS

A series of better than average articles on tooled leather in the modern manner—with eight items on tooled leather, eleven for the ladies, and three interesting descriptive pieces on leather chasing. More than 400 photos and drawings. 88 pages. . . . \$1.00

BLUEPRINT READING FOR THE BUILDING TRADES

2nd edition. 111 pages 69 illus. A standard reference for the building tradesman. \$1.75

CARPENTRY

3rd edition. This popular revision contains a special new section on farm buildings. 441 pages. . . . \$2.50

HOW TO PLAN A HOUSE

The why and the how of home designs. Stimulating, creative ideas that are practical and easy to understand. 400 illus. 384 pages. . . . \$6.95

HOW TO REMODEL A HOUSE

Fundamental factors influencing remodeling—factors which if overlooked may lead to discomfort, inefficiency and even structural weakness. . . . \$6.38

PRACTICAL MATHEMATICS

2nd edition. Glenn M. Hobbs, Dalzell, McKinney. The ways and means of acquiring and retaining the arithmetic skills that are so important in everyday life. Includes simple equations, graphs. . . . \$3.00

100 WAYS TO BE YOUR OWN BOSS

A practical expert guide to small business that can be started with \$200 to \$5,000 including exceptional little-known opportunities in profitable unexplored fields. \$2.49

HOUSEHOLD MECHANICS

An ideal "fix-it" book that tells clearly and simply how to get after home maintenance troubles. Includes material on painting, care of electrical appliances, care of doors and windows, water supply. Has excellent actual job projects, graphically presented. 241 pages. . . . \$3.50

CARPENTRY & JOINERY

A beginner's text on the principles of modern residential construction. Anyone with a set of tools and building materials can, by following the author's directions, learn modern carpentry. . . . \$4.75

HOUSE CONSTRUCTION DETAILS

For journeymen carpenters and house carpenters who work from stock plans and wish to make changes. It is a working guide in detailing every step in house construction. . . . \$4.75

TOOL DESIGN

This practical education in tool designing stimulates the inventive ability and provides the reader with up-to-date practice in the field of modern production. 498 pages, 450 illus. . . . \$5.00

POPULAR TOOLS AND MATERIALS

Describes over fifty of the hand operated tools in most common use. A wealth of information to school children of nine years of age and up. Material is attractively presented, accurate and timely. . . . 98¢



Portable Kerosene Heater

Heat equal to that thrown off by three one-kilowatt electric space heaters is said to be produced by a kerosene heater that burns for 17 hours on one gallon of fuel. Smokeless and odorless, it can be adjusted for different temperatures. The fuel tank, which looks something like a dinner pail, is detached for easy filling. Made in England, the heater was exhibited at a recent British Industries Fair.

Wristband for Bowlers

Bowlers troubled with flexing wrists at the instant of delivery may solve this difficulty by strapping on a new leather device that fits like an ordinary wristband. An aluminum insert, cushioned in foam rubber, lies along the back of the hand to provide rigid support. Natural follow-through after release of the ball permits the thumb to come out first, resulting in proper lift, correct top spin and an effective hook. More than 22 million bowlers are expected to patronize the nation's 60,000 certified bowling lanes this year.



Fidelity Products Co., P.O. Box 886, Canton, Ohio

MAIL THIS COUPON TODAY

Check the books you want, write your name and address below, and mail this advertisement with money order or check. Outside U. S. A. include 15% additional for shipping charges. Books selected will be mailed promptly on our "money back if you're not entirely satisfied" guarantee.

Name _____
Address _____
City _____ State _____

Mail to **POPULAR MECHANICS PRESS**
DEPT. 1156—200 E. ONTARIO ST., CHICAGO 11, ILL.

MEND METAL AT HOME with DEVCON

The Plastic Steel

80% STEEL—20% PLASTIC

DEVCON and a putty knife . . . tools for 1001 home repairs. DEVCON bonds steel to itself or to aluminum, bronze, brass, iron, wood, porcelain, glass, concrete and other surfaces. For home . . . farm . . . garage . . . or marine use, DEVCON fixes radiators, washing machines, cracked engine blocks . . . just about anything! Easy to use, DEVCON saves dollars!

HARDENS IN 2 HOURS
EVEN UNDER WATER



\$1.98 per kit enough for several projects
Also—1 lb. packages for big jobs—\$3.95
At leading hardware and hobby stores—write for free literature

DEVCON CORPORATION
175 Endicott St., Danvers, Mass.

ESHELMAN ELECTRIC STARTER GENERATOR

Push-Button Starting For Small Engines
Generator Charges Battery As Engine Runs

Electric starter ends pull cord or crank starting. For tractors, pumps, mowers, etc. Powered by 12 volt car battery. Trouble free, V-belt drive. Battery operates lights, radio. Generator recharges battery as motor operates. Write for free literature. State engine make.
Dept. 50-511, ESHELMAN, 109 Light St., Balto., Md.



Shipping Points: BIRMINGHAM • CHICAGO

Print Your Own
Cards, stationery, circulars, etc. Save money. Print for Others, Good Profit; easy rules sent. Raised Printing like engraving, too. Junior press \$15; Senior \$29 up. Sold direct from factory only. We furnish everything. Write for free details.
KELSEY PRESSES, Y-37 Meriden, Connecticut

HOW TO GLUE BETTER!

- 1) USE ROGERS GLUE
- 2) Be sure parts to be glued are clean, free from old glue etc.
- 3) Apply a thin, uniform film of glue to parts.
- 4) Finally, clamp the glued parts tightly together.

SPECIAL OFFER: Send only 15 cents for a full-size jar of Rogers Glue and receive, absolutely free, "Rogers Book of Woodworking Shop Notes" for 1955 and a set of new woodworking plans. Write — Rogers Isinglass & Glue Co., Gloucester, Mass. Ask for Rogers Glue at Your Local Hardware Store.



Over 3,885
lbs. Actual
Tensile
Strength per
Square Inch

ROGERS
The best LIQUID FISH GLUE
GLOUCESTER, MASS.



Hunters-Shooters

Now YOU can HAVE

The Original
AMAZING



ITHACA RAYBAR SIGHT

on Your
Favorite Shotgun

- Helps you get "on target" Faster and stay on!
- It works on a scientific light-gathering principle that is actually amazing . . . No More Misses because of poor light. You can improve your shooting under any outdoor lighting conditions: Dawn, Dusk, Rain or Fog.

IT'S THE FIRST MAJOR IMPROVEMENT IN SHOTGUN FRONT SIGHTS IN HISTORY. IT'S YOUR SIGHT THAT NEVER FAILS.

FITS ALL SHOTGUNS

Only **2.95** Each
INSTALLATION EXTRA

AVAILABLE AT YOUR FAVORITE
DEALER'S OR GUNSMITH

Send 25c for Booklet on Shooting Tips and Featherlight Information.

Since 1880 — Great Guns

ITHACA GUN CO. Inc.

Dept. 18 S ITHACA, N. Y.

200 Amp. WELDER



General Electric 200 Amp. 28 volt D.C. ball bearing, forced air cooled H.D. Generator direct connected to Clinton 9+ H.P. 4 cycle air cooled Engine with enclosed automatic governor plus manual control. Built in reactance coil, welding heat control with variable field rheostat. Mounted on rigid channel steel base with carrying handles. A portable highly engineered compact welder that can be transported in the back of most any automobile. Complete in new fully tested

operating condition with 2-15 ft. welding leads, electrode holder, ground clamp and helmet. A \$500.00 value for . . . **\$298.00** cash. FOB.

HUNT MECHANICAL ENGINEERING SERVICE
BOX 207PM, OLDSMAR, FLORIDA

Portable X-Ray Unit Probes Airliners for Increased Safety

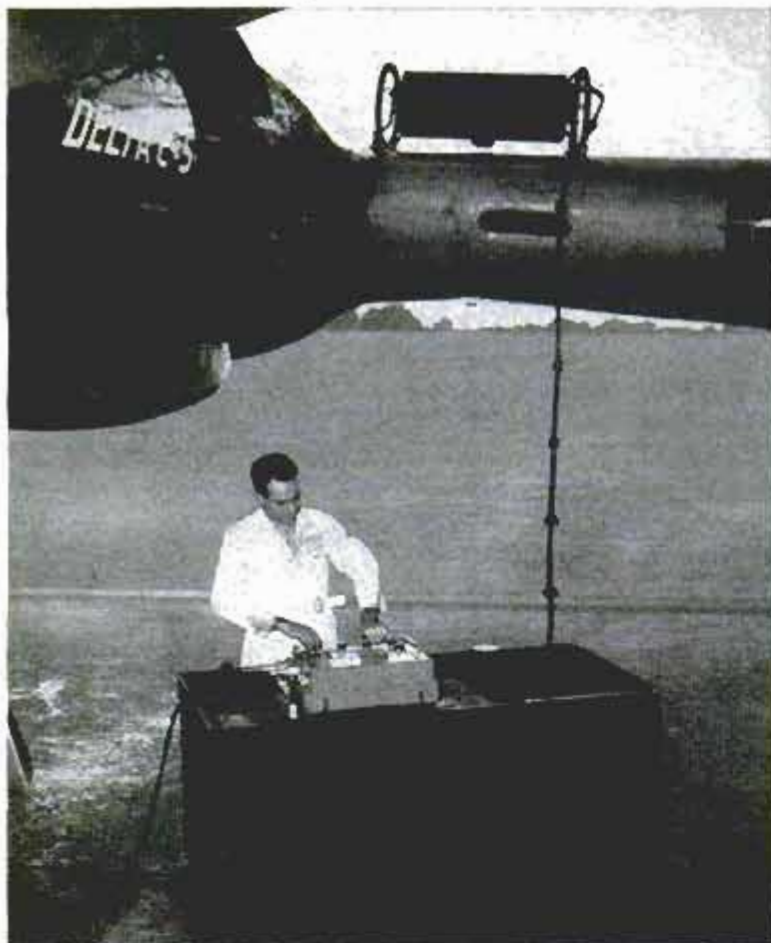

Increasing safety and cutting the cost of keeping up their equipment, airlines are now using portable X-ray equipment to look under the skins of their airliners. Damaged, cracked or weakened frame members can be discovered without dismantling the plane. Delta-C & S Air Lines estimates that costs of inspection at overhaul were cut enough to pay for the cost of the X-ray equipment the first year of its operation. The equipment is small enough to be loaded aboard a passenger plane and flown to distant points.

It's a Smaller World . . .

New calculations show that the earth's radius at the equator is 420 feet smaller than has been thought. The new figure is 6,378,260 meters, or about 3957 miles, according to the Army Map Service. The correction will make possible more exact predictions of the orbits of artificial satellites and locate more precisely the targets for guided missiles.

JEEPS

and 4 Wheel Drives NEED FREE-LOCK HUBS

FRONT DRIVE WITH FREE-LOCK

LOW OPERATING COSTS

ONLY WHEELS MOVE
ALL PARTS STOP



IN 2-WHEEL DRIVE NO PARTS MOVING!

FRONT DRIVE WITHOUT FREE-LOCK

HIGH OPERATING COSTS

WHEELS MOVE
ALL THESE PARTS MOVE



IN 2-WHEEL DRIVE OVER 100 PARTS MOVING—WEARING!

EASILY INSTALLED ON EACH FRONT WHEEL



Buy from your Dealer
WRITE FOR FREE FOLDER

FREE-LOCK CORPORATION

5801 N. Federal Blvd., Denver 11, Colo.
EASTERN OFFICE: 360 Willoughby, Brooklyn 5, N.Y.

and by a quick easy finger tip turn of the lock-control engage or disengage the front wheels from the front drive axles. Results in free wheeling the front wheels in 2-wheel drive, or fast engaging for 4-wheel drive. When front wheels are free wheeling, front drive is idle . . . STOPS FRONT-DRIVE WEAR, INCREASES VEHICLE POWER, and gives MORE MILES PER GALLON OF FUEL.

YES! SEND

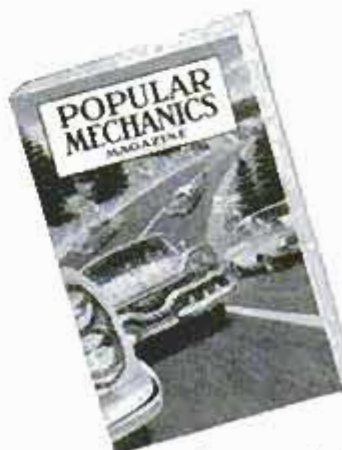

directly
to my door
every month

I am enclosing

- \$3.50 for 1 year
 \$8.00 for 3 years

name

address

city

zone

state

Hand this order to your newsdealer or send it to
POPULAR MECHANICS
200 East Ontario St. Chicago 11, Ill.

**MORE \$ \$ \$ PER HOUR WITH
MODERN IMPROVED
LAWNMOWER SHARPENER**

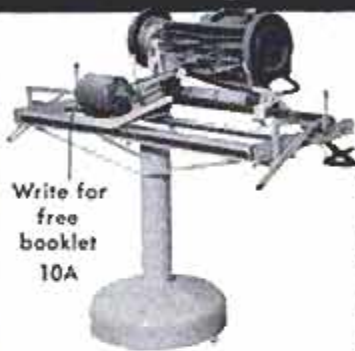

Write for
free
booklet
10A

Compare
Before You Buy

Grinds All Reel
Type Mowers
Hollow Grinds or
Flat Grinds Bed Knives

Engine, oil, or gasoline
are not removed from
power mowers. Wheels,
handle and roller re-
main in place.
Modern's precision
grinding assures re-
peat business.
100% Steel Construction

Faster—Easier to
operate

NO CHANGE IN PRICE FOR OVER 10 YRS

\$263.00 Complete with 1/2 H.P. Motor
f.o.b. Pasadena, Calif.

MODERN MFG. CO.

160 N. FAIR OAKS, PASADENA, CALIF.

Popular Mechanics Book for Pleasure or Profit

23 BOATS You Can Build

Build the boat you have always wanted. Build it for fun or to sell at a profit. Get Popular Mechanics 23 BOATS YOU CAN BUILD — row boats, canoes, sail boats, power boats and other craft including a 25 foot cabin cruiser. Book includes more than 500 photos, plans, diagrams and working drawings, plus step by step instruction that anyone can follow. Only simple tools needed. Material list of lumber, hardware, fittings, etc., included. Order today under money-back guarantee. Only \$2.75 postpaid.
POPULAR MECHANICS PRESS, Dept. 1156, 200 E. Ontario St., Chicago 11

\$2.95 OR 2 FOR \$5.00!

TESTED AND GUARANTEED

Write for free list on all types of telephones.
Shipments F.O.B.
TELEPHONE ENGINEERING CO., Dept. B116, Simpson, Pa.

**GIVE GOOD CHEER THROUGHOUT THE YEAR
HULL AUTO COMPASS**

All on your gift list who receive a HULL AUTO COMPASS will find it a cheerful, welcome companion on every motoring trip... assurance of direct, speedy travel to every destination. Insist on HULL, famous for lasting accuracy, true professional instrument service.



Beaconlite
ILLUMINATED
\$6.50

Streamline
NON-ILLUMINATED
\$4.95

At Your Dealer's
Write For
Literature

HULL MFG. CO. P.O. Box 246 D-11 Warren, O.

**Install this superior
HYDRAULIC EQUIPMENT
Yourself!**

Smooth-acting directional control valves — excellent feathering characteristics — minimal restrictions — performance comparable to the best... High performance hydraulic motor which may be used as pump — 16 gal. capacity at 1000 RPM and 1000 psi — May be used in combination to provide a fluid power transmission with a 10 HP capacity. Valve, \$16.95. Motor-Pump, \$56.50. Hydraulic Oil Reservoir with dual half-plate, three 3/4" SPT female ports, 5-10-15-25 gal. capacities. Price, 5-gal. \$9.95. Shpg. Wt. 15 lbs. For each add 1 5-gal. capacity, add \$4.50 and 8 lbs. wt. Set up your own hydraulic systems for post-hole diggers, loaders, unloaders, stackers, dumping equipment, automatic lathe feeds, home shop presses. Sold by units or package, including tanks.

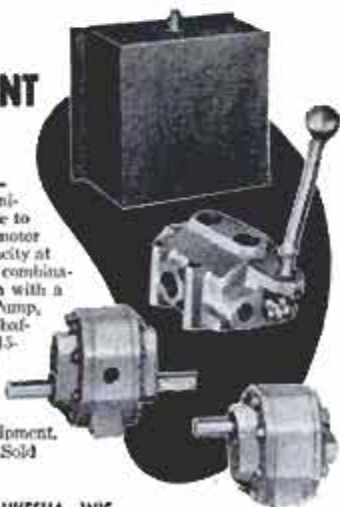

OIL POWER CO., BOX 172, WAUKESHA, WIS.

**Mammoth
1956 Wholesale
Tool Catalog**

TOOL CATALOG



YOUR NAME



The opportunity now awaits you to own and operate your own business on a part time or full time basis in the lucrative field of **HARDWARE, HAND TOOLS, POWER TOOLS, MOTORS, PAINTS, etc.,** or **BUY TOOLS FOR YOUR INDUSTRIAL OR INSTITUTIONAL USES.**



Buy Nationally Advertised Tools for Resale or Industrial or Institutional Use

NO INVESTMENT REQUIRED. BUY AS YOU NEED IT. A MILLION DOLLAR INVENTORY AT YOUR FINGER TIPS.

Discount
UP TO **50%**

\$1.00 refund on first purchase or refund if you are not 100% satisfied.

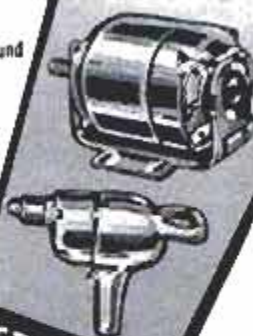

Every one needs tools. Meet the demands of the growing "Do-it Yourself" markets. Sell direct from the jumbo buying guide—your cost is known only to you.

**JUST FILL OUT
COUPON**

ENCLOSE \$1.00 FOR DEALER'S 1956 MAMMOTH TOOL CATALOG.

SILVO HARDWARE COMPANY

Dept. PM-11, 108 Market St., Philadelphia 6, Pa.

I am enclosing \$1.00. Rush me your dealer's mammoth Catalog Today. If I am not completely satisfied with your plan, I understand that I can return the Dealer's Catalog for refund, and if I decide to order, my \$1.00 will be deductible from my first order.

NAME
ADDRESS
CITY ZONE STATE

NEW! U-MAK-IT LAPSTRAKE BOAT KITS

Now . . . Lapstrake Skiff Kits, tool Rugged, Smartly Styled, Seagoing & Unbelievably Easy to Assemble.



Simple interlocking lapstrake planking, a construction found in the finest custom built boats, adds superior performance and beauty.

SEND FOR ILLUSTR. CATALOG

showing all models 8 to 23' prams, rowboats, outboards, cabin cruisers, skiffs, also accessories. All you need to build your own.

SEND 25¢ (coin) for postage & handling



U-MAK-IT products 703P Whittier Street
BRONX 59, NEW YORK



Robot Tolltaker

Motorists crossing the Paseo Bridge in Kansas City, Mo., drop coins into the hopper of an automatic tolltaker. The machine then switches a signal light to green and a tape-recorded voice thanks the driver. The tolltaker does the work of three men over a 24-hour period.

Easy-on Bumper Hitch

You can install a new bumper hitch in a few seconds without using any tools. The hitch is clamped in place with two roller chains. The ball can be raised, lowered or tilted to place it in the proper position. Three models are available to fit any truck or car bumper.

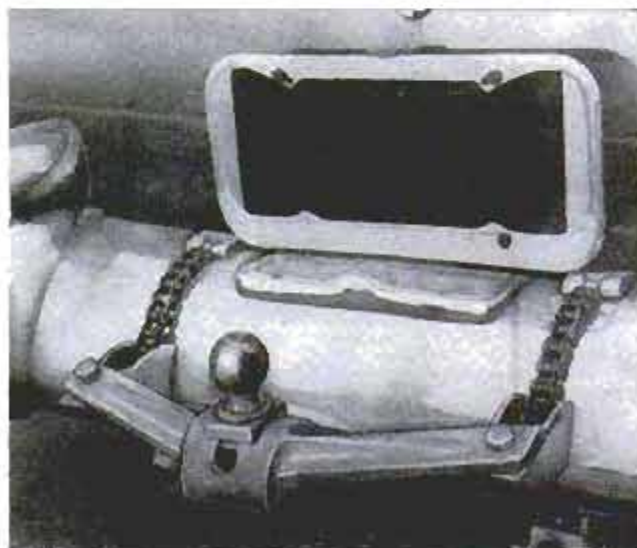

Superior's New Model 70 UTILITY TESTER[®] FOR REPAIRING ALL ELECTRICAL APPLIANCES MOTORS • AUTOMOBILES • TV TUBES

As an electrical trouble shooter the Model 70:

- Measures A.C. and D.C. Voltages, A.C. and D.C. Current, Resistances, Leakage, etc.
- Will measure current consumption while the appliance under test is in operation.
- Incorporates a sensitive direct-reading resistance range which will measure all resistances commonly used in electrical appliances, motors, etc.
- Leakage detecting circuit will indicate continuity from zero ohms to 5 megohms (5,000,000 ohms).
- Will test toasters, irons, Broilers, Heating Pads, Clocks, Fans, Vacuum Cleaners, Refrigerators, Lamps, Fluorescents, Fans, Switches, Thermostats, etc.
- Will test all TV tubes for open filaments, inter-element shorts, burned out tubes, etc.



As an Automotive Tester the Model 70 will test:

- Both 6 Volt and 12 Volt Storage Batteries • Generators • Starters • Distributors • Ignition Coils • Regulators • Relays • Circuit Breakers • Cigarette Lighters • Stop Lights • Condensers • Directional Signal Systems • All Lamps and Bulbs • Fuses • Heating Systems • Horns • Also will locate poor grounds, breaks in wiring, poor connections, etc.

Handsome round-cornered molded bakelite case, 3 1/4" x 3 1/4" x 2 1/4". Complete with all test leads. Also included is a 24 page book giving detailed instructions for testing all electrical appliances, automotive equipment, TV tubes, etc. Only **15⁸⁵**

SHIPPED ON APPROVAL
NO MONEY WITH ORDER — NO C. O. D.

Try it for 10 days before you pay. If completely satisfied then send \$3.85 and pay balance at rate of \$4.00 per month for 3 months — No Interest or Finance Charges Added! If not completely satisfied, return to us, no explanation necessary.

MOSS ELECTRONIC DIST. CO., Inc.
Dept. D-298, 3849 Tenth Ave., N.Y. 34, N.Y.

Please rush me one Model 70. If satisfactory I agree to pay \$3.85 within 10 days and balance at rate of \$4 per month until total price of \$10.85 plus postage is paid. If not satisfactory, I may return for cancellation of account.

Name _____
Address _____
City _____ State _____

most amazing blade you ever saw!

Tyler SPYRAL BLADE

SAWS METAL, WOOD, PLASTIC, ETC.
up or down, right or left, even in circles!



Does what no other Blade can Do. Fits Standard Coping Saw or Hacksaw Frames. NO special adapters needed! World's safest saw blade.

You'll find hundreds of uses for Tyler Spyril Blades. There's nothing like them! The first important improvement in blades since the invention of the saw. Fun to use... cuts so fast and easy; no chipping or tearing—leaves clean smooth edge.

Ask for TYLER SPYRAL BLADES at
HARDWARE, LUMBER, AUTO & VARIETY STORES
Everywhere

TYLER MANUFACTURING CO. 1005 W. Arbor Vitae Ave., Inglewood, Calif.

SPECIAL • HOW TO TOOL LEATHER 25¢

Step-by-step instructions, shows exact tool to use, and how to use it. "The Fundamentals of Leather Carving", Special introductory offer 25c ppd.

FREE 64-page Leathercraft Catalog.

Tandy Leather Co., P. O. Box 791, XZ Fort Worth, Texas.



How to Build Your Own GARAGE



Save as Much as 50%
of Usual Construction Costs

Get Popular Mechanics' brand new book *How to Build Your Own Garage* by Wayne Leckey, Assistant Shop Notes Editor, and find out how you can build your own garage at savings of 50% of usual cost. Leckey tells in famous step-by-step instructions and shows in big, clear photos, drawings and diagrams how to perform every building operation from laying the concrete to installing the final trim. There are 25 designs. Brick, frame, and concrete block fully covered. Send \$3.50 for your copy. 7-day money back guarantee.

POPULAR MECHANICS PRESS, 200 E. Ontario, Chicago 11, Ill.

THE SURE
WAY TO
KNOW

YOU ARE
BUYING A FINE
POWER DRILL

For top performance, choose the power drill equipped with a Supreme Chuck. The finest in quality and precision. Or replace your old style chuck with a Supreme. See your hardware dealer.

Supreme Chucks
BRAND



SUPREME PRODUCTS CORP., 2222 S. CALUMET, CHICAGO 16

New Deluxe Fixkit. . . from Black & Decker
21 pieces! Famous B&D 1/4" Drill with home-tested accessories; attachments to drill, sand, buff, polish, grind. Do home repairs fast, easy. At your dealer's now. **\$34.95**

Save \$4.00

Black & Decker® World's largest maker of portable electric tools

Also Eshelman
2 Passenger
SPORT &
GOLF Cars
Costs small
fraction of
most other
cars.
4 times more
gas mileage
Write for FREE
Literature and
Rider Agent
Plan.

ESHELMAN TRACTORS

LOW AS \$99

Plows • Cultivates • Saws
Dozer • Harrows
• Snow-Plow • Rolls
• Maults • Mows • Tills
Eshelman Tractors,
Tillers, Riding Rotary
Mowers for Better
Lawns and Gardens.
Advertised in GOOD
HOUSEKEEPING, Thou-
sands of Satisfied Users.
Dept. R-511, ESHELMAN, Balto. 2, Md. \$605



Shipping Points: BALTIMORE • CHICAGO • RENO

Say You Saw It in POPULAR MECHANICS

Build Your "Dream Porch"

Now, you can do-it-yourself with low-cost SUN-SASH Louvred Windows. They fit any size opening and are installed easily, inexpensively in a matter of minutes. You'll have a cool porch in summer; an extra room for winter use. Send for our free booklet, "Louvred Window Ideas" illustrating over 50 ways to use SUN-SASH for every room in your home.

Mail
Coupon
Today!

SUN-SASH Company, Dept. PM-3
38 PARK ROW, NEW YORK 38, N. Y.

Name.....
Address.....
City.....State.....

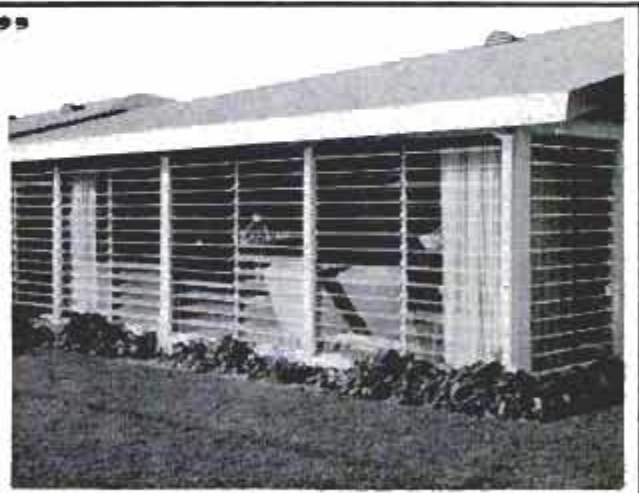

The Chief

...for a Man with a Hobby Shop

TOOL CHEST

Perforated Hardboard, 32" x 32" x 6" Shipped KD

31 Piece Tool Hanger Kit \$1.39

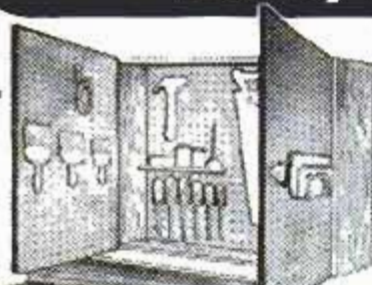

\$9.95

F.O.B. DETROIT

Keeps all tools neat and handy



6 ft. long
34" high
26" deep

Built to Last a Lifetime:

\$21.95

F.O.B. DETROIT

WORK BENCH

with Bottom Shelf and 18" Sq. Drawer. 2" x 6" Solid Plank Grooved and Dovetailed Top and 1" x 8" Back Rail, Shellacked to a Smooth, Satiny Finish. Shipped with Bolts, Nuts, Screws, with ABC Chart for Quick and Simple Assembly.

MOHAWK LUMBER & SUPPLY CO.

14525 W. Chicago Blvd., Detroit 28, Mich. (M)

Enclosed Check Money Order for \$_____

Ship _____ CHIEF WORK BENCHES @ 21.95 each.

_____ TOOL CHESTS @ 9.95 _____ HANGER KITS @ 1.39.

\$5 deposit with C.O.D. orders

Name _____

Address _____

FREIGHT EXPRESS

City _____ State _____

Use this to order

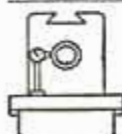

SIMPLIFY PREVENTIVE MAINTENANCE WITH MACHINE TOOL RECONDITIONING & THE ART OF HAND SCRAPING (2nd printing)

SEND FOR FREE FOLDER DESCRIBING ILLUSTRATED BOOK
MACHINE TOOL PUBLICATIONS, 382 Holly Ave., St. Paul 2, Minn.

115 Volt, A. C., ELECTRIC GENERATORS

60 Cycle, Single Phase, Continuous Duty



750 Watt Cost \$115.00 **\$59.50** P.P.D.

1000 Watt Cost \$150.00 **\$79.50** P.P.D.

1750 Watt Cost \$185.00 **\$99.50** P.P.D.

BRAND NEW SURPLUS FULLY GUARANTEED

Ideal as a permanent or stand-by unit for electricity IDENTICAL to house current. Perfect for farms, camps, aboard ship, oil fields, mines, etc. Easily handles lights, refrigerator, deep freeze, oil burner, radio; power for saws, floodlights, drills, pumps, etc.

All ball bearing. Operates at 3600 R.P.M. Drive with 2 HP to 3 1/2 HP or larger engine—or use power take-off. Voltage self regulating. Standard base mounting. Two outlets. Modern, compact design. Tremendous overload capacity. Operates in either direction!

SUPPLY LIMITED! WE PAY SHIPPING! ORDER FROM AD FREE CATALOG OF OTHER SURPLUS, HYDRAULICS

ROBERTS ELECTRIC CO., Dept. PM-518, 849 W. Grand, Chicago 22, Ill.



Cyclists race to "nowhere" as dial shows who won

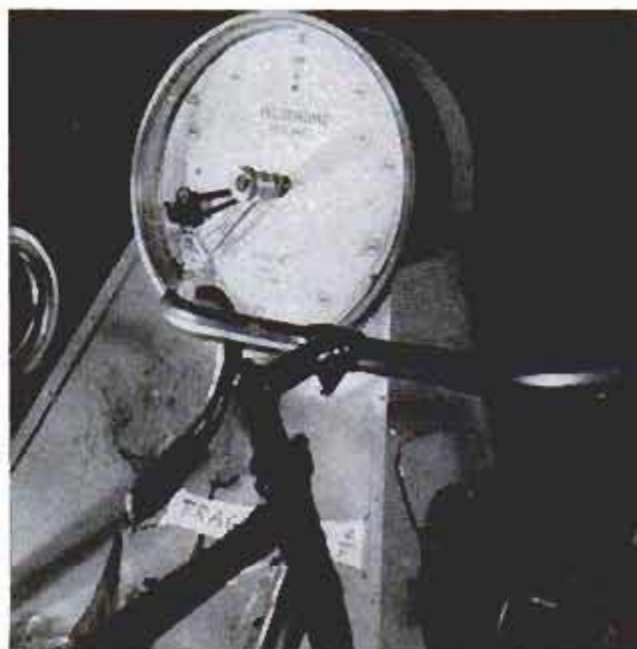

Bicycle Racers Go Nowhere

Cyclists in Italy can race to exhaustion without getting anywhere. A new recreation machine has the rear wheels, seats and handle bars from two racing bikes mounted on a frame. As the cyclists pedal, the wheels turn without going anywhere. A dial in front of the competitors shows which man is ahead in the race.

X-Ray-Proof Safe Lock

Experiments having indicated that combination locks can be "read" by taking X-ray photographs of a safe, Sargent and Greenleaf, Inc., of Rochester, N. Y., has announced development of an X-ray-proof combination lock.

The **FINEST** value we've **EVER** offered!
PRECISION 7 x 50 PRISMATIC BINOCULARS
 Genuine Leather Case, Accurate Built-in Compass
 at the lowest price we've ever offered!

Imagine! Now you can enjoy all your favorite sporting events—baseball, track, etc.—from a front row seat! These powerful "Zeiss" type, Navy model binoculars bring far-away objects right up close! Precision made by one of Japan's most famous camera names . . . to high standards. 50mm. objective lens provide wide field and greatest illumination. Use for yachting, hunting, bird watching, etc. Individual focus eye pieces. Same type binocs sell for much more, everywhere! Also Available—7x35 prismatic binoculars with same outstanding features as above.



ONLY \$24.95
 Plus 50c pp., hdlg.

ONLY \$20.95
 Plus 50c pp., hdlg.

Both binocs have genuine leather case, built-in precision compass, eye-piece covers, polishing cloth.

Stickleback Drill Router

The Only Tool That Drills, Enlarges, Routs—Using Any Conventional 1/4" Drill!

2 3/8" long 1/4" dia. **\$1.25** ppd.
 4 1/2" long 1/4" dia. **\$1.40** ppd.
 Set of 2 **\$2.50** ppd.

Just snap this versatile tool into your 1/4" electric hand drill, or any drill press . . . It not only drills holes in seconds—but also acts as a saw! And as a router for making funnel shaped holes! Can be used on lumber, plywood, plasterboard, masonite, leather, rubber, etc. Not for metal or masonry. Made from hi-grade tool steel, you'll find this is one of the most useful tools you ever had! Buy the set of 2 and save!

Save \$25 on this unused

GOV'T. SURPLUS
**STAINLESS STEEL
 CHISEL & GOUGE SET!**

Regularly \$30 . . . **\$5.00** ppd.
 NOW complete 4 piece set only . . .
 singly per chisel or gouge **\$1.50** ppd.

This 4 pc. surgical steel chisel and gouge set, never used, still in its original packing—only \$5! Less than the price you'd pay for ordinary chisels! The finest quality tools you can buy for cutting, carving and whittling wood! If they weren't gov't. surplus, you'd expect to pay \$30 a set—\$7.50 each tool! Originally made for surgical use from the finest heavy chromed surgical steel, they'll last a lifetime!

**CHROME VANADIUM
 29 Pc. DRILL SET**



Special-ly made for speed drilling. In sturdy plastic tool roll. Finest alloy steel drills hardened to the sharpest, longest lasting cutting edge obtainable; will easily and cleanly bite through hardwoods, plastics, aluminum, iron and the toughest steels. Unconditionally guaranteed for thousands of drillings. Full jobber length.
 Sizes by 64ths from 1/16 to 1/2". **NOW \$6.49** ppd.
 Also available with Turned Down Shanks to fit all 1/4" drills. In individual pocket roll. **\$8.95** ppd.

**60 Pc. Set Wire Gauge
 CHROME VANADIUM DRILLS**



Top quality high test Chrome Vanadium Drills designed for speed drilling through toughest steels, woods, plastic, iron and aluminum. Precision ground, long-lasting cutting edges. Guaranteed to give years of satisfaction. A full 60 pc. set. Nos. 1 through 80.
A \$14.95 value—NOW ONLY \$5.40
 plus 35c pp. & hdlg.
 Same set above available with Hoot Metal Index container—Only **\$6.65**
 plus 35c pp. & hdlg.



FOR JEWELERS, OPTICAL WORKERS, HOBBYISTS, CRAFTSMEN OF ALL KINDS! These superb German instruments are of deep-forged, heat-treated high quality tool steel, fabricated to most exacting specifications. All-over ground and polished to smooth hard surfaces. Smooth working joints with just the right tension. Jaws meet perfectly to safely and securely hold even the most delicate objects in the hard-to-reach corners and angles. Each plier is 4" long and a veritable gem of precision and strength.
75c ea.—all 7 for \$5.00 ppd.

**75c ea. for Finest Imported
 PRECISION PLIERS**

- Flat Nose
- Combination Cutter
- Diagonal Cutter
- End Cutting Nippers
- Round Nose
- One Side Flat
- Round
- Snipe

Send check or money order. If C.O.D. fees extra. Money Back Guarantee

SCOTT-MITCHELL HOUSE, Inc., Dept. M-264, 611 B'way, N.Y. 12, N.Y.

ARMY & NAVY TYPE TANKER JACKET
A SUPERB VALUE. Water repellent, zipper fly front, knit collar, cuffs and waistband, stitched panel back. Ideal for Farmers, Lumbermen, Truck Drivers, Sportsmen, etc. In Navy Blue or Olive Drab. Sizes 34 to 44. Larger Sizes 10% extra. Available also in boys' sizes 10 to 16. Send check or M.O. Satisfaction Guaranteed.
MARCO SURPLUS, Dept. 11, 540 S. State, Chicago 5, Ill.

don't say glue . . . say "Yoo-Hoo"
UHU®
GLUES EVERYTHING BETTER!
 At variety, hardware, magazine & newspaper stores

Christmas LAWN CUTOUTS
 Give a cheerful greeting to passersby! These jolly cutouts are easy to make, fun to display, children love them! Just cut to pattern 1/4-in. exterior plywood or hardboard, prime, draw in features and clothing detail from pattern, paint in gay colors. That's all there is to it!
Order These FULL-SIZE PATTERNS!
 Plan #121. Jolly Santa. Always a favorite. **50c**
 Plan #122. Sleigh & Reindeer (for lawn or roof) **\$1.00**

POPULAR MECHANICS PRESS
 Dept. 1156, 200 East Ontario Street, Chicago 11, Illinois
 RUSH Plan #121 Plan #122. I enclose.
 Name _____
 Address _____
 City _____ Zone _____ State _____

GOTTA COMMON CAR COMPLAINT?

- Hard starting
- Engine dies
- Rough idle
- Jerky acceleration
- Low gas mileage

FUEL PRESSURE REGULATOR
\$6.95

You need a MILESMASTER®

Milesmaster cures engine troubles. It regulates fuel pressure. Keeps raw gas from flooding engine and washing lubrication off cylinders and pistons. Reduces so-called vapor lock. Prevents crankcase dilution which forms harmful gums. Eliminates ignition fouling. Saves wear and tear on carburetor float and needle.

New motoring thrills
 If you want a new thrill from smooth, step and go, economical engine operation, have your dealer install a Milesmaster. Save its cost in first few thousand miles.

MILESMASTER, INC.
 Factory and Sales: Box 46, Exeland, Wis., U.S.A.
 Executive Office: Suite 703
 6 N. Michigan Ave., Chicago 2, Ill.

What MILESMASTER does for your car

- Saves gas
- Reduces wear
- Prevents dilution
- Provides smooth idle
- Eliminates flooding, percolation, vapor lock
- Filters the fuel
- Traps steel and rust particles

Money Back Guarantee
 Have your dealer install MILESMASTER ON your car. Drive it for two weeks. If not completely satisfied, your money will be refunded in full. MILESMASTER, INC.

Any man will enjoy new

AIROGRATE

YELLO-BOLE

1. Smokes sweeter!

Imported briar bowl lined with *real honey*. Starts caking the instant you light up. Hence, no break-in.



2. Smokes drier and healthier!

Metal grate condenses moisture, tars, nicotine. No wet heel.



3. Smokes cooler!

Air-vented chamber draws in fresh air. Aluminum fins and shank throw off heat, cool the smoke.

Famous honey-lining!



\$250

Extra interchangeable bowls—\$1.25 each

"Icepak" Set—Airograte Yello-Bole Pipe plus two extra bowls, \$5.00

FREE BOOKLET! "How to enjoy a pipe." Write Yello-Bole, Dept. 23, New York 22

BY THE MAKERS OF KAYWOODIE PIPES

1 Bit to DRILL · REAM · SAW

IN SHEET METAL, WOOD, ANGLE IRON, TRANSITE, BAKELITE, etc.



Fits any 1/4" or 1/2" electric drill or drill press

Drills own 1/4" starter hole; cuts straight, curves, or angles. Made of finest High Speed, abrasion-resistant steel. Easy to use.

Replaces \$50 worth of cutting tools

New, Low Price

Money-Back Guarantee

\$2.95 post paid
3 for \$8.50

FINE FOR XMAS GIFTS

Specify Bit for: Wood, Heavy Metal, All Purpose

Check or Money Order **INTERNATIONAL TWIST DRILL CORP.**
DEPT. 11-M 618 Wyandotte, Kansas City, Mo.

DEALER INQUIRIES WELCOME



Direction Finder in Subway

Printed directions for getting anywhere on New York City's complex subway system are issued by a new machine in Times Square Subway Station. Just press the right button on the rectangular steel unit and out pops a piece of paper telling you what train to take and what transfers are necessary. Similar machines may be installed throughout the city.

Bipod for Small Cameras

Two built-in legs, with the camera acting as a third support, combine to form a bipod for 35-millimeter cameras. Several inches long and folding next to the camera bottom when unused, the legs are slotted to permit camera adjustment for angles and surfaces.

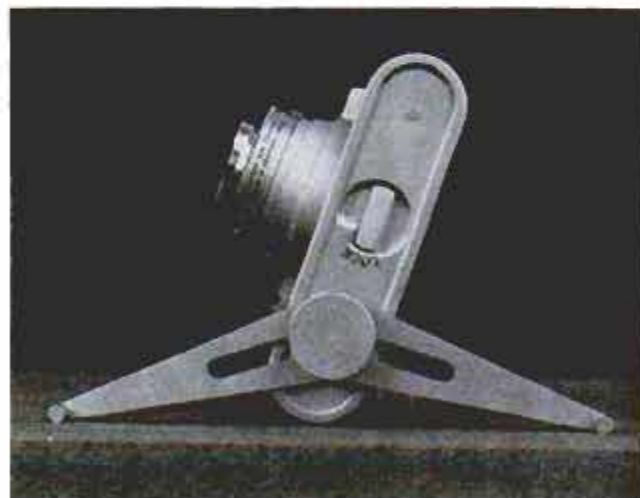

NOW... 2 Models of Estwing Unbreakable Hammers

Both Built to Last a Lifetime...

NEW Tubular Handle Design

Solid Forged Head Fused into High Alloy Tube
Strongest where Strain is Greatest
Cushion Grip of Neoprene - Plyolite



Holiday Gift Boxed at no Extra Cost!



\$4.25

Favorite of Craftsmen for 35 Years

Head and Handle Forged in One Piece

Famous Leather Cushion Grip



Holiday Gift Boxed at no Extra Cost!



\$4.75

AT ALL HARDWARE STORES

Made and Guaranteed by Estwing . . . Inventors and only Specialists in Unbreakable Hammers and Hatchets . . . ESTWING MFG. CO., Rockford, Ill.

MONEY MEN ALL FREE

THE PLASTEX Industry needs manufacturers on small scale and for big production of Lamp and Clock Stands, Art Goods and Novelties in Plastex and Marble imitation. Experience unnecessary. Lic material makes regular 10¢ store sellers. Rubber moulds furnished for speed production. Small investment brings good returns. We are now placing big Chain Store Orders with manufacturers. Ambitious men have chance for real prosperity. Our Free booklet will interest and benefit you.

PLASTEX INDUSTRIES, Dept. A
3400 Third Ave. New York 56, N. Y.



AMAZING LOCK PICK

Opens pin tumbler locks like magic. Easy to make and use. Complete illustrated instructions for making. \$2.95. LOCKSMITHS, FIXIT MEN, tough locks become simple. LOCK SERVICE, P.O. Box 2252, San Diego 12, Calif.

Mechanic Maker LATHE AND DRILL PRESS COMPLETE WITH MOTOR



Makes 1001 items of wood or plastic. For youngsters 7 to 70. Learn modern machine tools. Develop mechanical and creative skills.

EDUCATIONAL! SAFE! EASY! FUN!

DRILL PRESS weighs 9 lbs., 13 1/2" high, adjustable table and drill head, drills to 1/4" holes, \$24.95. LATHE weighs 14 1/2 lbs., 13" between centers, 6" swing, \$34.95 Manual Feed; \$39.95 Auto Feed. Free Instruction Booklet. Complete with 1/35 HP Motor for AC house current. At hardware, hobby dealers, dept. stores. Or order direct from factory—sent postpaid if paid in full. Or send \$3, pay postman for balance plus postage and C.O.D. fee.

Free Catalog WINKLE MFG. CO.
3751-A Montgomery Rd. Cincinnati 12, Ohio



Now! a SCREW DRIVER with

4 TIMES THE DRIVING POWER



RATCHET Palm-Grip Makes Screw Driving EASY



HOME



ELECTRICAL



HOBBY



The Palm-Grip Interchangeable Ratchet snap - fits into the steel socket of the shock proof plastic handle. The user can change to various size drivers quickly and easily.

The extra radius of the Palm-Grip Ratchet greatly increases leverage, enabling FOUR TIMES the full turning power at the extreme end of the driver. With ratchet removed, Palm-Grip drivers are quality, conventional hand tools.

PALM-GRIP QUALITY TOOLS

A variety of 40 different hand tools fit the Palm-Grip Ratchet. Conventional, Phillips, Frearson and Clutch type screw drivers, also nut drivers and socket adapters. Women marvel at the added power it offers with comfortable grip.

Look for this display at Hardware, Electrical, Auto and Building Supply Stores or write for free descriptive folder.



RATCHET DRIVERS

KIPTON INDUSTRIES, INC.
ROYERSFORD, PA.



SPRAY PAINT the EASY WAY!

Unique BECKER CO₂ SPRAY GUN

Goes to the Job . . .

Without Attachments!

No Hoses, Wires, Compressors!
At last—a completely portable
spray gun you can carry to the job
as easily as a water pistol. Powered
by CO₂ cartridges . . . provides up
to 1,000 lbs. pressure. Container
holds 21 oz. of liquid, reloads in a
flash. Nozzle adjusts from stream to
finest spray. At your dealer's or
order direct. Remit in full for post-
paid shipment. Or send \$2 now,
pay postman balance plus COD fee.

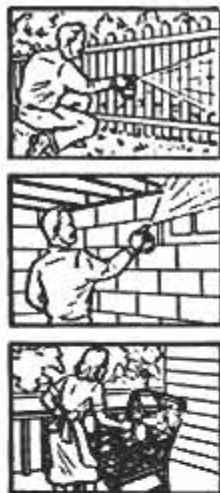

SULLIVAN-BECKER CO.

Dept. 116 L. KENOSHA, WIS.

BUILD

IT

YOURSELF

Heathkit BROADCAST BAND RECEIVER KIT

Have you ever experienced the thrill of building your own radio? Invest a few of your dollars—a few hours of your time, and build a truly worthwhile broadcast band receiver. Transformer operation eliminates potential shock hazard characteristic of "economy" AC-DC sets. Operates as radio, phono, amplifier, or tuner. Fine tone quality, excellent sensitivity. Simplified Construction Manual outlines basic theory of radio principles. Actually a radio course in itself. Price includes tubes—speaker—chassis, etc. Every part you need! Order your Heathkit Radio Kit today.



MODEL BR-2

incl. fed.
excise tax
(Less Cabinet)

\$19.25

SHPG. WT. 10 LBS.

OTHER "BUILD IT YOURSELF" Heathkits

Oscilloscope
Vacuum Tube Voltmeter
Signal Generator
Amateur Transmitter
Communications Receiver
Multimeter
Handitester
Hi-Fi Amplifier

Hi-Fi Preamplifier
Battery Eliminator
Signal Tracer
Tube Checker
(and over 50 others)

WRITE FOR
Free CATALOG



HEATH COMPANY

A Subsidiary of Daystrom, Inc.
BENTON HARBOR 17, MICH.

WHERE-TO-BUY-IT INDEX

Source of supply appears after items commercially available

AUTOMOTIVE

Easy-on bumper hitch (Universal Products, Inc., 1137 Annunciation St., New Orleans, La.)	84
Weird-looking hot rods compete in drag races	123
Sports timer for rallies (Nisinger Corp., 146 E. 74th St., New York City 21)	137
Auto burglar alarm (Chicago Alarm and Signal Mfg. Co., 2252 W. 111th Place, Chicago 43)	141
Three-wheel car gets 80 miles per gallon (Bassons Industries Corp., 1432 W. Farms Rd., New York City)	152
Homemade auto is curvacious, has "eyes" for headlights	294

AVIATION

Portable X-ray unit probes airliners for increased safety	86
Compounds de-ice planes	101
Ramjet helicopter rotor chases frost from citrus groves	137
Helicopter-liner carries 25 persons	141
Navy helicopter used for minesweeping	146
High-temperature lubricants developed for aircraft	153
Transport "Propelloplane"	153
Flying laboratory for jet-pilot study	163
Rare World War I fighter flies again	169
Canadian radar network to control airspace	171
Windshield rain repellent (Foster D. Snell, Inc., 29 W. 15th St., New York City)	171
Quieter airline flights	274

CONSTRUCTION

Nail-on bricks look authentic (Ludowici-Celandon Co., 75 E. Wacker Dr., Chicago 1)	140
Spiked-cone ditch digger gouges trench four feet deep (Jetco Corp., Alhambra, Calif.)	140
Wood arches 294 feet long glued together in shop	146
Oval sewer pipe can pass through section of same size (Concrete Products Div., American-Marietta Co., 101 E. Ontario St., Chicago 11)	162

MISCELLANEOUS

Robot tolltaker	84
Bicycle racers go nowhere	86
Direction finder in subway	88
Clock in a bottle	101
Soap made in one hour instead of eight days	101
Pressed oyster shells form wall panels (KappaShell Co., 121 W. 17th St., New York City)	103
World's "biggest" marine diesel engine has 13,200 horsepower	115
Pep fills itself (The Parker Pen Co., Janesville, Wis.)	115
Gauge-block tester finds ten-millionth-inch variance	115
Christmas Shopping Center—	
Cartridge boxes	116
Wrought-iron folding table	116
Electric shoe polisher	116
Scale model of Hiller flying platform	116
Knitting aid	117
Battery-operated cottage lantern	117
Tiny fire alarm	117
Re-create Nantucket Lightship from kit	117
Sixteen-millimeter movie projector provides sound	118
Osterizer for children	118
Dual-purpose bag keeps foods hot or cold	118
Noiseless cutlery tray	118
Stereo viewer for the 3-D fan	119
Model hydroplane	119
Exposure meter	119
Play tent or back-yard umbrella	119
Portable duck blind	119
Plastic gun	120
Plastic pegged board	120
Plastic unsinkable boat	120
Toy control panel	120
Camera for family photographer	120
Magic movie mirror for phonograph	121
Malted-milk mixer	121
Crashproof flying model	121
Lawn sweeper for tiny tractor (Wheel-Horse Products, 2643 Dixieway North, South Bend 17, Ind.)	123
Imagination in the classroom	127
Pencil serves as gauge	141
Plastic-foam floats are boat landings and swim rafts (Fred S. Gilley, Satuit Marine Float, 7 Porter Rd., Scituate, Mass.)	141
Book aquarium	152
Type changed with tweezers on versatile typewriter (Remington Rand, 315 Fourth Ave., New York City 10)	152

(Continued to page 92)



Space Thermometer

Scientists can take the temperature of the moon or of a manmade satellite with a tripod instrument no bigger than a large camera. The Radiometer, developed by Barnes Engineering Co., collects infrared radiation from the object and converts the received energy into electrical signals that can be translated into a temperature reading. Preliminary uncorrected readings of the moon showed it to be 248 degrees Fahrenheit on its sunlit portion and minus 302 on its dark portion. Earthly studies can also be made of rockets and missiles in flight, of speeding tires and fragile objects like electrical filaments that can't be touched.

Color Radar for Ships

Ship-radar operators often have difficulty during rough weather in separating nearby ships from the reflection of the sea on their scopes. To remedy this situation, David Sunstein, of Cynwyd, Pa., has invented a color radar system, based on the principle that signals reflected from a target such as a ship are ordinarily of greater amplitude than those reflected from land masses or the sea. Taking advantage of this difference, the inventor has made a radar-scope which shows the target in one color and the surrounding environment in another, making it easy for the operator to pick out the ship's reflection in the sea.

Tracer radioisotopes were used in studies at the Rock Island Arsenal to give fast and accurate measurements of the rate of wear of a machine-tool bit.

No other power tool offers you
so **MUCH** for so little

DYNO-MITE POWER WORKSHOP



Start with the
No. 888
POWER UNIT

1/3 h.p.

completely equipped as

- 3/8" Drill
- 6" Disc Sander
- 6" Polisher

ONLY
\$44.95

THEN ADD THESE INEXPENSIVE ATTACHMENTS AS YOU NEED THEM



Bench Stand
\$4.45



Bench Sander
\$9.95



Bench Grinder
\$7.95



6 1/4" Bench Saw
\$29.45

Table Extensions
\$6.30 per pair
Saw Guard, \$2.95



Orbital Sander
\$17.45



Jig Saw
Table, \$2.25



7-to-1
Speed Reducer
\$13.50



Drill Press
Stand
\$22.50

6" Portable Saw
\$18.95



Drill Press Vise
\$6.50



FREE FOLDERS!

Ask for them at your hardware dealer's or write:

MILLERS FALLS TOOLS

SINCE 1868

MILLERS FALLS CO., Dept. PM-16, Greenfield, Mass.

WOLVERINE PIGSKIN WORK GLOVES



Must Be
BEST
OR YOUR
MONEY
BACK

Only Wolverine uses choicest domestic pigskin triple-tanned kid-soft to give you comfort unequalled in any other work gloves. Soft? You bet...even dry out soft but man how they do wear.

WEAR A PAIR 7 DAYS
... your money back in full if you don't agree they're the best work gloves you ever wore.

Write for free catalog and name of dealer, to
WOLVERINE, Box PM-112, Rockford, Mich.

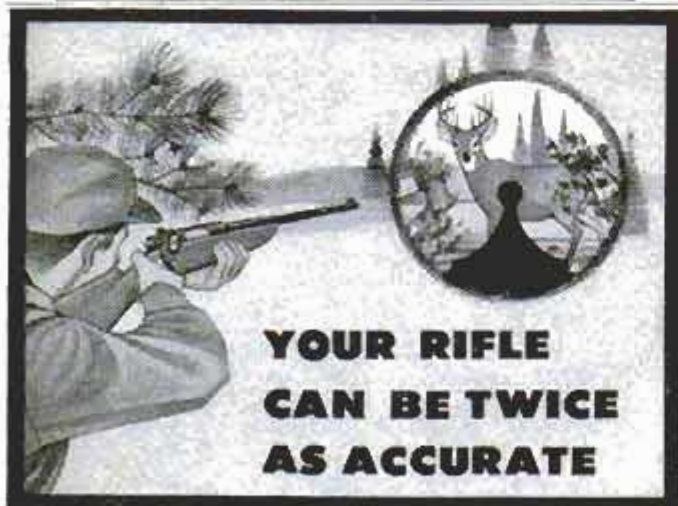

**YOUR RIFLE
CAN BE TWICE
AS ACCURATE**

Open rear sights cut the accuracy of modern guns and ammunition in half. Lyman precision receiver sights deliver all the accuracy built into your rifle.

SPECIFY LYMAN SIGHTS With a receiver and front sight combination for all popular rifles, you can have Lyman Sights for your gun for as little as \$6.50. You can't buy more accuracy at any price!

FREE CATALOG Discover how you can double your shooting accuracy. Send for free, full-color 24-page catalog. Describes all Lyman Products for Shooters.

THE LYMAN GUN SIGHT CORP.
MIDDLEFIELD • CONNECTICUT

(Continued from page 90)

Grooved fluorescent lamp twice as bright (General Electric, Nela Park, Cleveland 12, Ohio).....	153
Compressed-air floodlight can't cause explosions (Copco Eastern Ltd., 151 Linwood Ave., Paterson, N.J.).....	156
Gelger with transistors fits shirt pocket (Lake Engineering Co., Ltd., Willowdale, Ont., Can.).....	156
"Portable" cobblestones used in Parisian movie scenery.....	156
Grip wheels dig into ice to prevent slipping.....	163
"Siamese" ships launched together.....	163
Barrage balloon answers question: how high does a fly fly?.....	164
Electric eye on camera sets correct lens opening (Bell & Howell Co., 7100 McCormick Rd., Chicago 45).....	170
Huge plastic tarpaulin lines pond to prevent water seepage.....	170
Pocket vacuum cleaner takes lint from clothes (Leonard Lesley, Morton's, Dept. F92, 312 7th St. N.W., Washington 4, D.C.).....	171
Infrared lamp over balcony makes January like June.....	174
TV camera in drone "peers" over enemy lines.....	174
"Trainfire" rifle course simulates combat.....	176
Thick-shelled eggs coming to market.....	260
Shotgun quickly "ages" chair for antique collection.....	292
Fatigue is responsible for many farm accidents.....	292

PHOTOGRAPHY

Bipod for small cameras (Duba-Matic Camera Products, 14755 Agnes St., Wyandotte, Mich.).....	88
Gunstock for camera eliminates "jitters" (Comstock Corp., Dept. MP, Box 652, Boston 2, Mass.).....	282
Self-developing camera now takes transparencies (Polaroid Corp., Cambridge 39, Mass.).....	288

SCIENCE

Cube measures mercury density.....	153
Mill turns organic wastes into money (Sterling Drug Inc., 1450 Broadway, New York City).....	162
Cellophane aids plants.....	164
Kit tests uranium samples while in the field.....	164
Potent insecticide.....	170
Lamprey poison in Great Lakes may save trout.....	176
Radiation detector clipped to clothes (Pacific Transducer Corp., 11836 W. Pico Blvd., Los Angeles, Calif.).....	254

Craftsman and Shop Notes Index

FARM

Cracked turkey eggs patched with tape for hatching.....	228
Utility box on corn planter holds seed and spare parts.....	228
Mineral-feed trough from drum.....	228
Straw-insulated hog shelters used the year around.....	228
Tire tread on farm equipment permits highway travel.....	232
Water gun subdues brooding hen.....	232
Starting farm-equipment motors.....	232

HOUSE AND HOME

Roll-fed telephone note pad.....	192
Quickie bonbon server.....	192
Garage door protected by roll-type weather stripping.....	196
Base of kitchen cabinet rabbeted to receive edge of floor tile.....	204
Update that radio-phono cabinet.....	205
Golf tees support vine on mantel trellis.....	208
Tie rack made from wire hanger.....	210
Bed-storage headboard.....	211
Draft-free ventilation provided by arrangement of windows.....	220
Custom cabinet pulls.....	227

HOUSEHOLD HINTS

Tape underside of range to prevent damage.....	188
Solving Home Problems—	
Clip recipe cards to back of cabinet door.....	194
Nylons can be snagproofed for travel.....	194
Cup hooks keep dress belts handy.....	194
Legible address on package written with matchstick.....	194
Plastic bottle pump easily cleaned.....	194
Paint masking for doorknobs.....	195
Fountain pen makes good one-drop oiler.....	195
Cookie tin placed on floor catches drippings from wet galoshes.....	195
Fiber door mat will stay in place if laid over roll roofing.....	195
Small screw hook will anchor flowerpot on sloping window sill.....	195
Heat from light bulb in trouble lamp will shrink wood in drawer.....	195

(Continued to page 94)

For those who want the best in model railroading

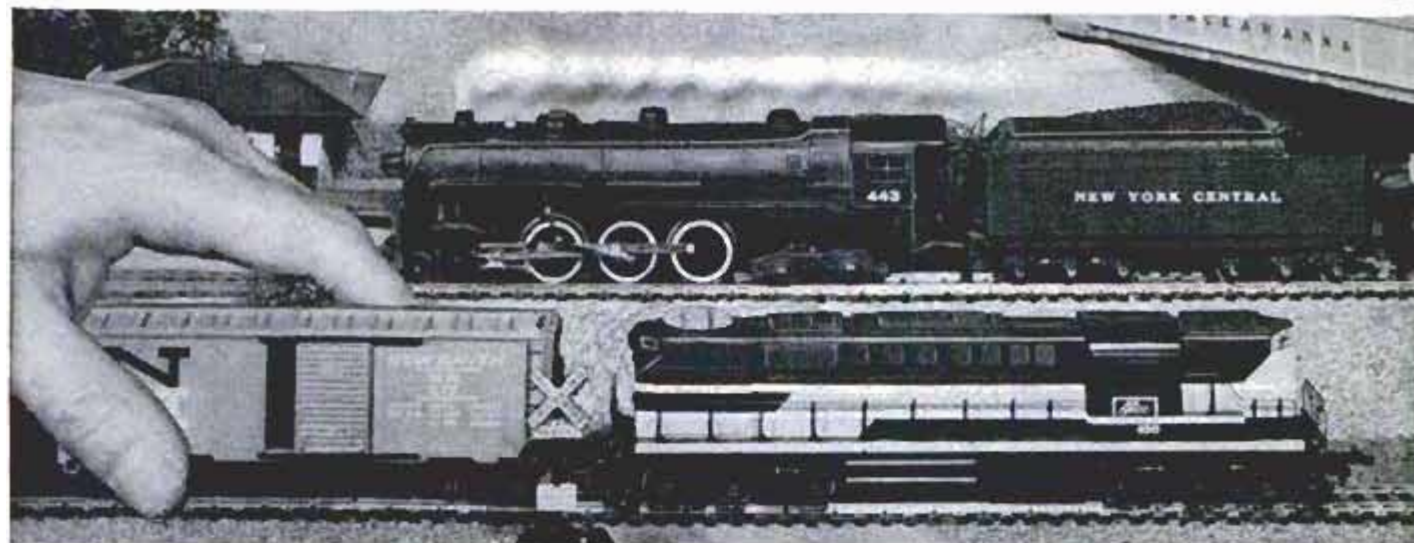

If you've never tried it, the fun of model railroading with Gilbert "HO" Gauge Trains can only be imagined. Picture a complete model pike, with passenger and freight yards, multi-train operation and lots of railroad equipment, in a space the size of two card tables! Easy to use, compact for storage.

There are several makes of "HO" trains, but only Gilbert locomotives puff real smoke, have choo-choo sound effects and built-in electronic whistles. Send for free catalog today.

GILBERT "HO" TRAINS

The A. C. Gilbert Company, Dept. 108
New Haven 6, Connecticut

Please rush free Gilbert HO Catalog.

Name _____

Street _____

City _____ Zone _____ State _____

x-acto
KNIVES • TOOLS
HANDICRAFT KITS

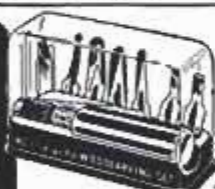

NO. 77
VIZI-DOME
WOODCARVING
SET \$3.60

X-ACTO, INC.
48-41 Van Dam St.
Long Island City, N. Y.

Send 20¢ for 28-page Catalog

ALSO
Eshelman
2 Pass.
SPORT
& GOLF
CARS
Fraction
of cost of
most
other
cars.



ESHELMAN CAR SNOW PLOW
CLEARS ROADS & DRIVEWAYS

Bolts on to car or truck bumpers easily. Clears snow 12" deep and 72" wide. Lightweight and sturdy. Order now, or write for free catalog.

Dept. SP-211, ESHELMAN,
109 Light St., Baltimore 2, Md.
SHIPPING POINTS:
Baltimore, Chicago, Reno

For
QUICK STARTS
in any weather...
install a
Stewart-Warner
electric fuel pump



—for cars, trucks and buses

Enjoy dependable *fast* starting every time you step on your starter! From the moment you turn your key, the Stewart-Warner

Electric Fuel Pump delivers a steady, uninterrupted flow of gas to your engine. Ends vapor lock, gives positive starting and more reliable performance the year 'round, regardless of weather. Operates independently of engine. Easy to install. In use today on hundreds of thousands of vehicles. Ask about the Stewart-Warner Electric Fuel Pump at your garage or car dealer today!

STEWART-WARNER

Also manufacturers of Speedometers, Tachometers
and Gauges for Automotive, Farm and Marine Use
Instrument Division, Dept. N-116
1840 Diversey Parkway, Chicago 14, Illinois

**TO SET A TREE CAN BE A SIEGE BUT . . .
WITH CHRISTMAS EASE IT'S JUST A BREEZE**



YOU DON'T NEED TOOLS TO SET A TREE WITH THIS STAND. And in only minutes, too! Large 24" base ring has three adjustable guy rods with barbed hooks to plumb and accommodate any shape of tree and any branch formation. No cutting or trimming necessary —no sacrificing lower branches. As the turnbuckles on the guy rods are tightened, a spring tension is developed in the base which prevents accidental tipping of the tree.

Lifetime, welded steel construction, finished in bright red, with detachable green water pan.

MAKES A PERFECT GIFT!

\$4.95 Satisfaction Guaranteed
Post-paid

SEND CHECK OR MONEY ORDER, NO C.O.D.'s, PLEASE.
PA. RESIDENTS PLEASE ADD 5% SALES TAX.

DAVIS, P. O. Box 106, Morgan, Penna.



Cher Boys Christmas Greeting. Full size EAST-BILD® Pattern #562. Just trace, saw, assemble. Only 50¢. Send cash or money order to Elmer's Pattern Dept. P-116, P.O. Box 215, Pleasantville, N. Y. *T.M. Reg. East-Bild Pattern Co., Inc.

Build this lighted holiday greeting with **ELMER'S® Waterproof Glue**

Let this colorful outdoor decoration add to your Christmas cheer. Build it fast and durable with a full-size pattern and Elmer's Waterproof Glue. Resistant to weather, acids, rot, alkali, fungus, this is the completely waterproof glue used by boatbuilding experts.

Build or repair furniture with **ELMER'S® GLUE-ALL**

Use Elmer's fast-drying glue to make joints as strong as wood itself. Handy squeeze bottle speeds job. Ideal for wood, pottery, leather, cloth.



Bond plastic laminates to plywood with **ELMER'S® CONTACT CEMENT**

Does a professional job quickly without clamps, nails, presses. Highly resistant to heat, water. Outperforms other contact cements in stress tests.



At hardware, lumber, paint, marine supply dealers. Product of The Borden Company, Chemical Division.



IF IT'S **Borden's** IT'S GOT TO BE GOOD

(Continued from page 92)

Deep bowl traps beetles.....	201
Bottle caps in flowerpot serve as drainage material.....	204
Painting sequence for door.....	204
Doors kept from swinging shut.....	210
Replacing a paring-knife handle.....	212
Temporary towel rack for guests made from dowels and cord.....	212
Small picture frame held erect with L-hook or bent wire.....	220

MISCELLANEOUS

Modeling clay cleans type.....	184
Reinforcing loose-leaf pages with cellulose tape.....	184
Neat stick-on labels from tape.....	188
"North Wind"—boy-size iceboat.....	189
Towel speeds evaporation rate of radiator humidifying tank.....	190
Paint code identifies keys.....	190
Rocket ship and launching station.....	193
Measuring distances by pacing.....	196
Straps cut from inner tube hold heavy rubbers on shoes.....	196
Sewing "caddy".....	197
Guard for spike file.....	201
Feeding station provides food for squirrels.....	201
Stamp obliterates lettering.....	204
Prevent child's balloon from drifting away.....	204
Chalk wrapped with tape keeps hands free of dust.....	208
Battery clip warning flag permits quick attachment.....	213
Rubber stamping in many colors.....	220
Polar pony.....	221
Ice preserves cut flowers.....	222
Pickup truck has combination carrying rack on front bumper.....	232
Peep-sight level measures tree height.....	233

PHOTOGRAPHY

Auxiliary flash unit improvised with extension cord and dish pan.....	188
Ear syringe used to blow lint from camera-lens parts.....	196
Making a print-mounting rule for centering.....	208
Portrait diffusion.....	209
Heat reseals original wrapper around exposed-film roll.....	210
Retouching case.....	213
Print contrast controlled by brighter bulb.....	213
Breaking in newly mixed developer.....	220

TOOLS

Slot in board holds T-square.....	192
V-clamp holds round stock for end-drilling.....	229
Razor-blade knife improvised from small C-clamp.....	229
Shopping for Tools—	
Automatic drill-press feed.....	234
Sander-scraper.....	234
Heavy-duty saw.....	234
Miter dowseling jig.....	234
Universal welding vise.....	235
Multiple die holder.....	235
Work-holding clamps.....	235
Flexible wiring system for small shops.....	235
Adjustable countersink for screws.....	235
Sanding-disk kit.....	235

WORKSHOP HINTS

Anchoring screws in end grain.....	188
Dowel plugs aid mortise drilling.....	190
Threaded studs removed by using two nuts.....	192
Standard pipe and bolts make lightweight tie rod.....	197
Linseed-oil dip eases nail driving.....	200
"Magnet mop" picks up metal parts.....	200
Shingles angle-cut uniformly.....	208
C-clamp serves as trammel for cutting glass disks.....	210
Plane has wood guide fence for edge-planing accurately.....	222
Centering milling cutter.....	226
Metal rib stiffens hacksaw blade for cutting in confined place.....	226
Metal cut in "wood sandwich".....	226
Tubing bent with pulley.....	229
Drill-bit size marked legibly on paper tab glued in flute.....	229
On the Market—	
Porcelainlike enamel.....	236
Concrete glue.....	236
Flush door hinge.....	236
Home fire extinguisher.....	236
Metallic putty.....	236
Metal posts join in sections to make modern furniture.....	236

POPULAR MECHANICS

SENSATIONAL

FACTORY-TO-YOU OFFER!



12 pc. EMERGENCY KIT

Provides Personal & Family Protection In the
AUTO, HOME, FACTORY, OFFICE

KILL FLAME REVOLUTIONARY NEW FIRE EXTINGUISHER

- **KILLS ALL FIRES** - Electrical, Grease, Gasoline, etc.
- **SAFE** - Does not contain Carbon Tetrachloride, CBM, or any other toxic or injurious ingredient. Incorporates latest developments
- **SUPERIOR** - Can't stick or jam. Even a child can use it.
- **VERSATILE** - Excellent for breaking auto engine vapor locks, and drying out distributor caps, spark plugs. (Fits in glove compartment).

2 prs. All-Purpose UTILITY GLOVES

DURABLE, RE-USEABLE,
PERFECT HAND PROTECTION



All-Weather WINDOW SCRAPER

DISPOSES OF ICE, SNOW, SLEET, MUD

Emergency FIRST AID KIT

FOR PROMPT
TREATMENT
OF CUTS
AND BRUISES



FREE!

WHEN YOU ORDER NOW!
HANDY NICKEL-PLATED WALL RACK
TO MOUNT FIRE EXTINGUISHER!



MAKES A PERFECT CHRISTMAS GIFT!

4 All- Weather

ROAD FLARES



BRIGHT, LIFE-SAVING FLARES — Easy to ignite, water-proof, burns in wind or rain. Neat, clean, convenient for women. Tape it on your spare tire for nighttime emergency tire change use. Re-useable.

DIRECT FACTORY PRICE!

\$2.50

plus 50¢
for handling

regular
\$4.95
value

MONEY BACK GUARANTEE

ALLCHEM MFG. CO., Inc. Dept. PM-1
15 West 39th St., New York 18, N. Y.

Please rush EMERGENCY KIT at \$2.50 plus 50¢ for handling. Please ship prepaid. Full purchase price refunded if not satisfied.

NAME.....
(please print)

ADDRESS.....

CITY..... STATE.....

Does your car have that

“held
back”

feeling?



Get back that wonderful “new-car feel”...the eager, responsive engine power you want! Take your car to your Doctor of Motors—your skilled mechanic—for a diagnosis. If new rings are needed, ask for Perfect Circle 2-in-1 Chrome piston rings.

In Perfect Circle's 2-in-1 Chrome set, the top compression ring was specially designed to perform where pressures are greatest, heat is highest,

and lubrication is poorest. The new Type “98” oil ring assures a uniform pressure against the cylinder wall, plus a side sealing action on the ring groove. And both rings are plated with thick, solid chrome that resists wear, more than doubles the life of cylinders, pistons and rings.

Regain that full power—that satisfying “new-car feel”—plus positive oil control. See your Doctor of Motors.



Better Mechanics everywhere install

PERFECT CIRCLE

2-in-1 Chrome piston rings... *The Standard of Comparison*

Perfect Circle Corporation, Hagerstown, Ind.; The Perfect Circle Co., Ltd., Don Mills, Ont.

By Clifford B. Hicks

BACK IN MARCH 1954, an unfamiliar word cropped up in the headlines. On that day a small island in the Pacific was sucked into the ugly fireball of a hydrogen bomb. Scientists found that the island fell to earth as radioactive particles. An area of 14,000 square miles was so contaminated with this radioactive dust that it was temporarily unsafe for human habitation. This island that fell from the sky in a rain of radioactivity was called fallout.

Since that day, everyone from teen-agers in soda fountains to diplomats in secret halls have discussed the effects of fallout. As the word has become more familiar, it somehow has become more sinister and mysterious.

Yet there's little mystery about fallout. Scientists and Civil Defense officials know a great deal about it, and are determined to spread that knowledge as far as possible. They realize that people who know the facts on fallout will respond intelligently to the problems fallout creates. Here are their answers to basic questions:

WRITTEN SO YOU CAN UNDERSTAND IT
VOL. 106 NO. 5



**HOW DANGEROUS
IS FALLOUT?**



Special tower on this ship carried instruments for measuring the fallout during a recent weapons test

"Fountain pen" dosimeter permits a soldier to make quick reading of gamma rays he may have absorbed



Just what is fallout, anyway?

When a hydrogen bomb explodes, the parts of the bomb itself are blown into highly radioactive dust. Other dust particles in the air are also made radioactive. If the fireball touches the ground, tons of earth and debris are sucked up into it and made radioactive. These particles, most of them so small they are invisible, spear upward into the mushroom cloud as high as 25 miles. As they are carried downwind, they gradually fall back to earth. The settling of these radioactive particles on the earth's surface is called fallout.

After the bomb explodes, how soon does this radioactive rain start falling?

Some particles from the explosion early in 1954 no doubt are still drifting through the stratosphere. However, almost all the particles fall within a period of several hours. Consider the 1954 test: At a point 170 miles from ground zero, the fallout began about eight hours after the burst and continued for several more hours.

How far do the particles travel?

It depends on several factors, such as the size of the bomb, the height of the explosion, the velocity of the winds at all levels up to 80,000 feet and the weather conditions. An air burst, for example, causes negligible fallout because only the products of the bomb itself, plus particles naturally in the air, become radioactive. A ground burst draws up a great amount of radioactive debris. The size of the particles and the velocity of the wind determine how far the dust will travel. Rain causes the particles to fall at a faster rate, producing a rainout.

Fallout particles may travel clear around the earth. But if you consider only the danger area—the area where fallout can have serious to lethal effects—then you can calculate some fairly precise answers. Consider the 1954 test again: In a cigar-shaped belt about 140 miles long and 20 miles wide, the radiation would have been fatal to most persons remaining there for 24 to 48 hours.

Why specify "24 to 48 hours"?

A couple of reasons. In the first place, the longer a human being is exposed to radiation, the more damage is done. Just think of it in terms of a sunburn.

In the second place, the radioactivity of these fallout particles declines with the passage of time. The rate of this "decay" depends upon the type of particle, and there are about 90 different radioactive "species" created by the bomb. Some become harmless in a fraction of a second, but others may remain dangerous for



Weather forecasts now make it possible to predict fallout patterns. Map above left shows pattern if a nuclear bomb struck Pittsburgh at a particular moment. At right is predicted pattern exactly 24 hours later

hundreds of years. Fortunately, most of these radioactive species decay fairly rapidly. The rate of radiation one hour after the burst in an area of intense fallout concentration is extremely dangerous. Twenty-three hours later, as little as two percent of that radiation may remain.

What about those "radioactive fish"?

As indicated above, a very small percentage of this radioactive debris has an extremely long life. It's possible, though very unlikely, that a fish would take up one of these long-life particles. It's even more unlikely that a fisherman would catch that particular fish in the vastness of the ocean. Unlikely, but possible.

Can long-life particles be produced deliberately?

Yes, indeed, which is the reason, in addition to its awesome power, that the H-bomb can be such a terrible weapon. For example, the bomb can be encased in strontium. Radioactive strontium has a half-life of approximately 28 years (half its power will be gone in that length of time), so the stuff would continue to be dangerous for several generations.

What's the principal danger from these radiations?

In large doses they are fatal. In smaller doses they can produce lifelong disabilities.

During the recent H-bomb tests, rockets penetrated radioactive cloud to pick up information on fallout





Computer UNIVAC now is working regularly to predict fallout patterns and intensities for the Civil Defense Administration

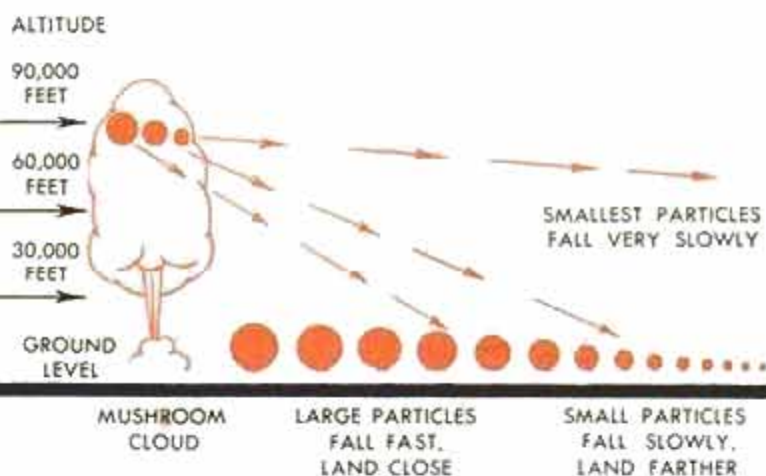

Of many factors that affect the fallout pattern, the size of the particles is one of the most important. Diagram shows how smallest particles travel farthest from the radioactive cloud

"Sky scanner" is a new instrument now being used by the AEC to detect radioactivity in the air. The scanner is especially useful in tracing clouds which contain gamma radioactivity

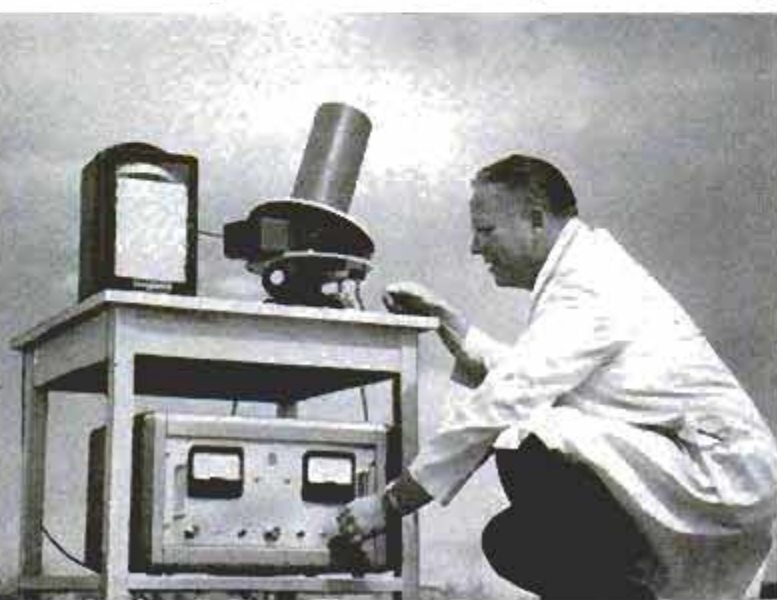

But even in still smaller doses they may have a profound effect. Though they may seem to have no effect on a person, they may alter his reproductive genes, causing harmful mutations to be passed on to his children. They, in turn, will inevitably pass them on to their children, and so on.

Is there any chance that weapons tests will increase radioactivity in the atmosphere to a point where it is dangerous?

Radioactivity is measured in roentgens. Total radiation over the first 30 years of a person's life should be kept to 10 roentgens, according to the Genetics Committee of the National Academy of Sciences. On the average, the committee says, we now receive 4.3 roentgens from natural radiation and 3 or 4 roentgens from medical X-rays in 30 years. It further states that we definitely have been receiving increased radiation from fallout as a result of weapons tests during the past five years. However, this increase is not dangerous at its present rate. According to the committee, it could be dangerous if weapons tests were stepped up considerably.

Has anyone made specific studies of fallout—from bomb tests—in the United States?

Yes. The AEC maintains a fallout-monitoring network of some 88 stations throughout the world, including 26 in the United States. (Incidentally, this network is one way government officials learn of secret bomb tests in Russia.)

The AEC recently released a report based on figures from these monitoring stations. The report shows that the gamma dose (the type of radiation that can alter the genes and thereby affect heredity) from fallout is about three percent of the gamma dose from natural sources.

The total fallout, including all types of fission products, is measured in millicuries. The report shows that the highest accumulation has been at Grand Junction, Colo., with 740 millicuries per square mile. The lowest recorded accumulation was in Nigeria with 33 millicuries per square mile.

(Continued to page 278)

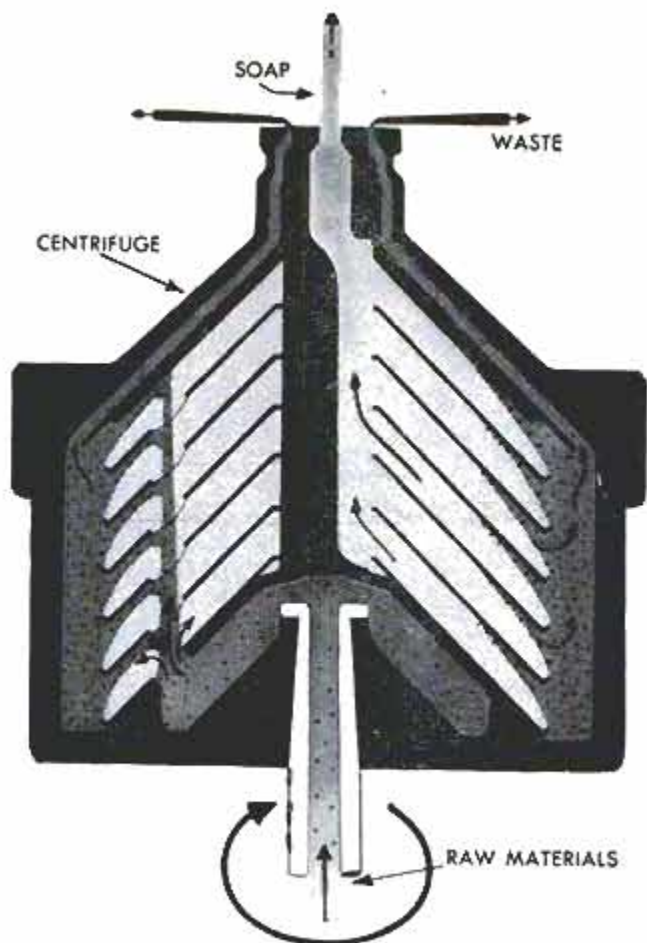

American-Swedish News Exchange photos

"Centripure Process" requires comparatively small space. Cutaway of centrifuge shows how soap flows in it

Soap Made in One Hour Instead of Eight Days

Automation has come to soap manufacturing via a process developed in Sweden. Conventional methods take from eight days to two weeks to make soap. With the new process, soap of high uniform quality is made in less than 60 minutes. Raw material is fed into the bottom of a specially

designed centrifuge and saponification takes place in about 20 minutes. Then the soap is passed on through four stages in which it is washed, electrolyte added and spent lye is removed. Solid impurities are continuously removed during the process. Coloring and other ingredients are added.

Clock in a Bottle

Using a method that he has evolved for putting models into bottles, Norman D. Brookes of Luton, England, has constructed and assembled a battery-driven electric clock inside a gallon jug. Using parts designed to pass through the one-inch-diameter neck, he first assembled the clock outside the bottle so that it could be timed and adjusted before it was taken apart and reassembled in the bottle with the aid of surgical forceps and special screwdrivers. The project took a year to complete.

Compounds De-Ice Planes

De-icing compounds which can be brushed or sprayed on planes and may eliminate heavy and expensive de-icing equipment are being developed for the Air Force at Armour Research Foundation, Illinois Institute of Technology, Chicago.





Roll-Up Sides Speed Loading

Two men with lift trucks can load a new 10-door boxcar in 10 minutes. Five doors on each side roll up out of the way like overhead garage doors to permit direct loading by the trucks. Hand loading of the conventional boxcar requires 10 to 16 hours, so the car only averages two hours of traveling time out of the 24. The new five-compartment car is expected to average at least 6 out of 24 hours, thereby doing the work of three standard boxcars. Elimination of unnecessary handling cuts freight damage. The multiple compartments reduce the shifting of cargo in transit and permit segregation of shipments as to items and destination. The car, not yet in production, has floors, ceilings, bulkheads, walls and door panels made of a strong, lightweight plastic sandwich.

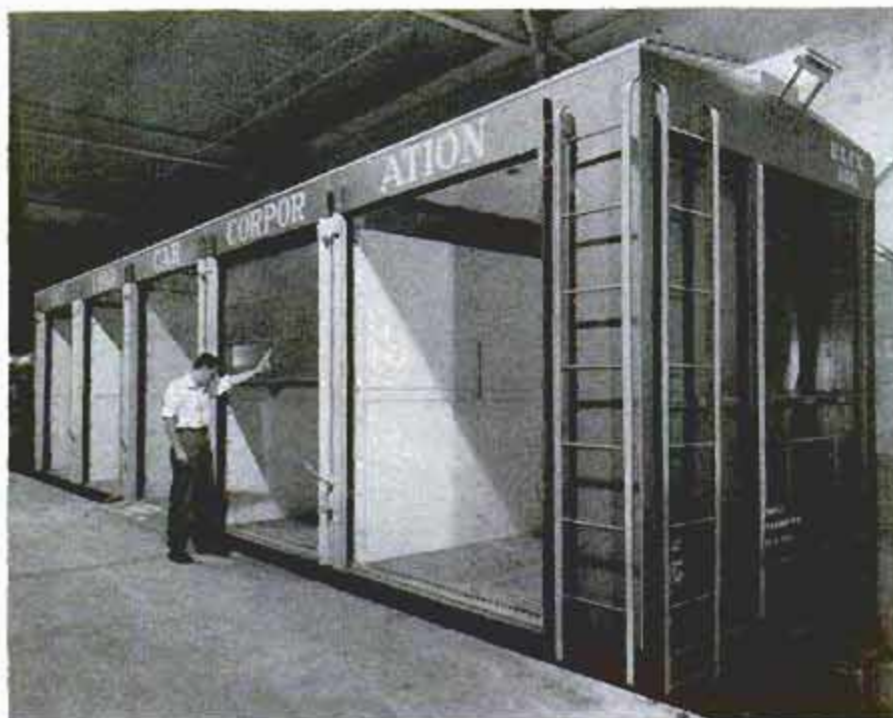

Surgery Sponges

Surgical sponges made of dextran, a derivative of sugar, can safely be left inside a patient to be absorbed after they have stopped the blood or kept a therapeutic agent at a given point.

Metal "Palm" Grips Fish

Anglers can handle their catch easily without danger of gill or fin cuts with a new fish holder. The fisherman seizes the fish in a spring-action metal clamp that fully protects his hand. Tiny prongs on the inside of the clamp hold the fish while the hook or plug is removed and the fish put on a stringer.

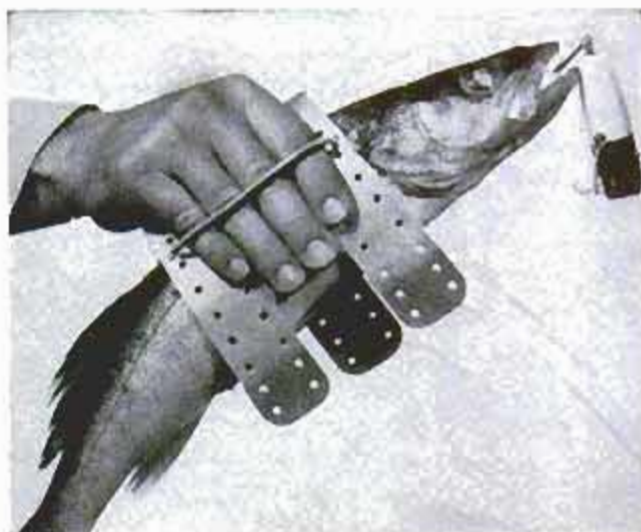

If you do not find the information you need in the WHERE-TO-BUY-IT INDEX, starting on page 90, sources of further information are available without charge from Bureau of Information, *Popular Mechanics Magazine*, 200 E. Ontario St., Chicago 11

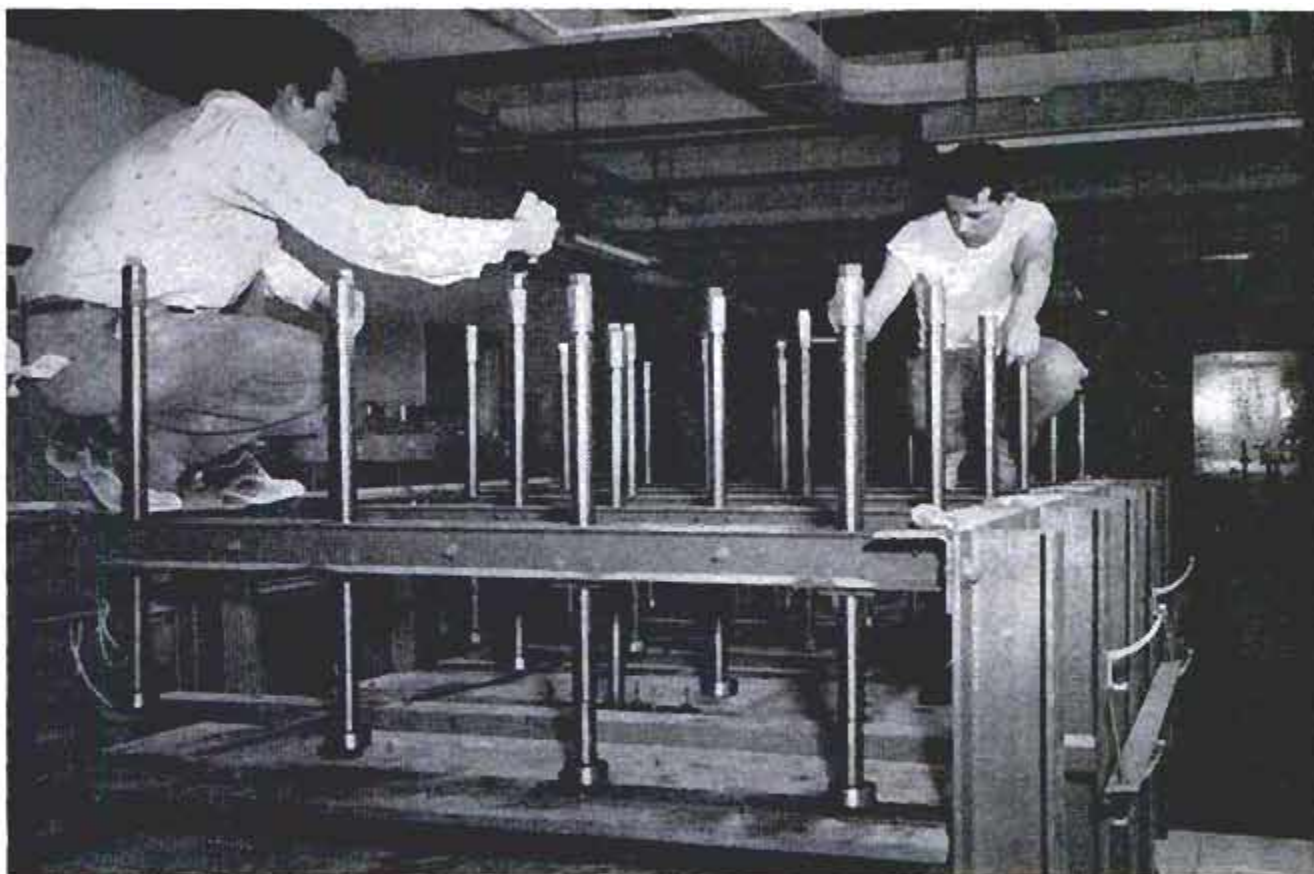

Oyster-shell panels are placed in big hydraulic press for flattening. Then come burnishing and trimming

Pressed Oyster Shells Form Wall Panels

MOTHER-OF-PEARL wall panels are made of specially prepared oyster shells fastened to a thin backing. This iridescent paneling is applied like wallpaper. The panels were developed originally by Irving Kay of New York as a specialty product for high-priced decorators, but he has recently gone into quantity production. Imported from Australia, the oyster shells are first soaked for many days, then flattened in huge hydraulic presses, burnished and trimmed. The pearly disks are then fitted individually to a base material and set in adhesive. After several days, the rough panels are trimmed to size and the surfaces smoothed over. Through the application of heat and other processes, the panels can be formed to any shape. Aside from wall use, the material is effective as a furniture inlay or for automobile interiors. The biggest wall to be covered with the paneling is in the lobby of the Fontainebleau Hotel in Miami. This project cost \$150,000. The paneling, called KappaShell, sells for \$6 a square foot. It is used in President Eisenhower's personal plane and in the homes of many celebrities. The company's latest job in Europe is a room in Prince Rainier's Monaco palace.



After soaking and heating, shells are covered with special adhesive and attached to backing material. Below, David Kay, the originator, inspects a newly installed wall of the overlapped iridescent shells



1957 NEW-CAR PARADE



Clean and slender are words that describe the new Chrysler. These views of the New Yorker two-door hardtop seem to prove it. Four headlights are available if you wish

Chrysler Family Makes Debut



CHRYSLER'S style theme for 1957 is the dart or wedge. These all-new, freshly styled beauties have a definite airplanish look with down-pointing noses and up-pointing tails. Let's look at them in order.

The Imperial offers a convertible for the first time. Its hardtop models have distinctive landau-type roofs of stepped-up design that give them a "Park Avenue" look.

CHRYSLER





Horizontal lines characterize De Soto's grille

Four headlights are optional. Windshields are double wrapped, being curved vertically as well as horizontally. Windows in the doors are also curved, swinging upward and inward.

Tailfins are emphasized by a sharply sloping rear-deck lid (which the buyer can get with a simulated spare-tire cover embossed on it). There are no up-sticking taillights on Imperial fenders this year. Instead the gunsight theme has been worked into the trailing edge of the fenders themselves. Tailfins are getting so high these days that to mount taillights atop them would raise the lights almost to roof level!

Over-all height of the Imperial has been reduced three inches without sacrificing headroom. Seat height is reduced, however; especially the front seat, which is lower by 2.6 inches.

The car is actually more than five inches shorter than last year. Wheelbase is down to 129 inches, over-all width is increased by 2.4 inches and front overhang reduced 2.4 inches.

Fourteen-inch wheels are standard (this is true on all Chrysler Corporation cars).

Engine displacement is 392 cubic inches. It develops 325 horsepower.

Chrysler Adds Series

Chrysler has added a new series to its line. Both the Saratoga (the added series) and Windsor have a 354-cubic-inch V8 engine (the single-rocker-arm-shaft design); the New Yorker has the 392-cubic-inch V8 (double-rocker-arm-shaft design).

Dodge's two-toning takes advantage of the spectacular tailfins



DE SOTO



Above, De Soto has simplified its rear-end styling. Below, Dodge features a bold, dramatic front end



DODGE



IMPERIAL

Imperial has a completely individual body styling. Note the unusual wrap-over roof treatment at the rear

Horsepowers are as follows: Windsor 285 horsepower; Saratoga 295; New Yorker 325.

The Chrysler frame is longer this year, although wheelbase is unchanged at 126 inches. The following innovations are common to the whole line: Torsion-bar front springs; ball-joint front suspension and antidive braking; renewable paper filters in air cleaners; step-down design to provide lower center of gravity and added headroom; flush-mounted air intakes at base of windshield; centerplane brakes;

dash-mounted rear-view mirrors to eliminate a dangerous blind spot; horizontal placement of spare tires in trunk of all except station wagons, and larger, sharply raked windshields.

Stylewise, the tailfins are the most emphatic element at Chrysler Division with the clamshell headlight framing being a close second. Four headlights are optional.

The roof is grooved slightly around its edges and the drip rail is of bright metal to emphasize the low roof line. An unusually large curved rear window in all

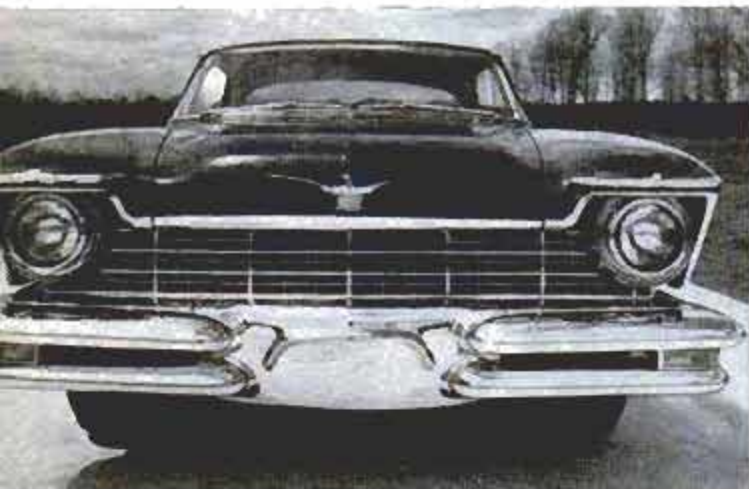

Imperial, too, has four headlights at buyer's option

Also optional is simulated tire cover on trunk lid

Torsion-bar springs are used on front ends of all Chrysler Corporation cars. They extend about halfway back

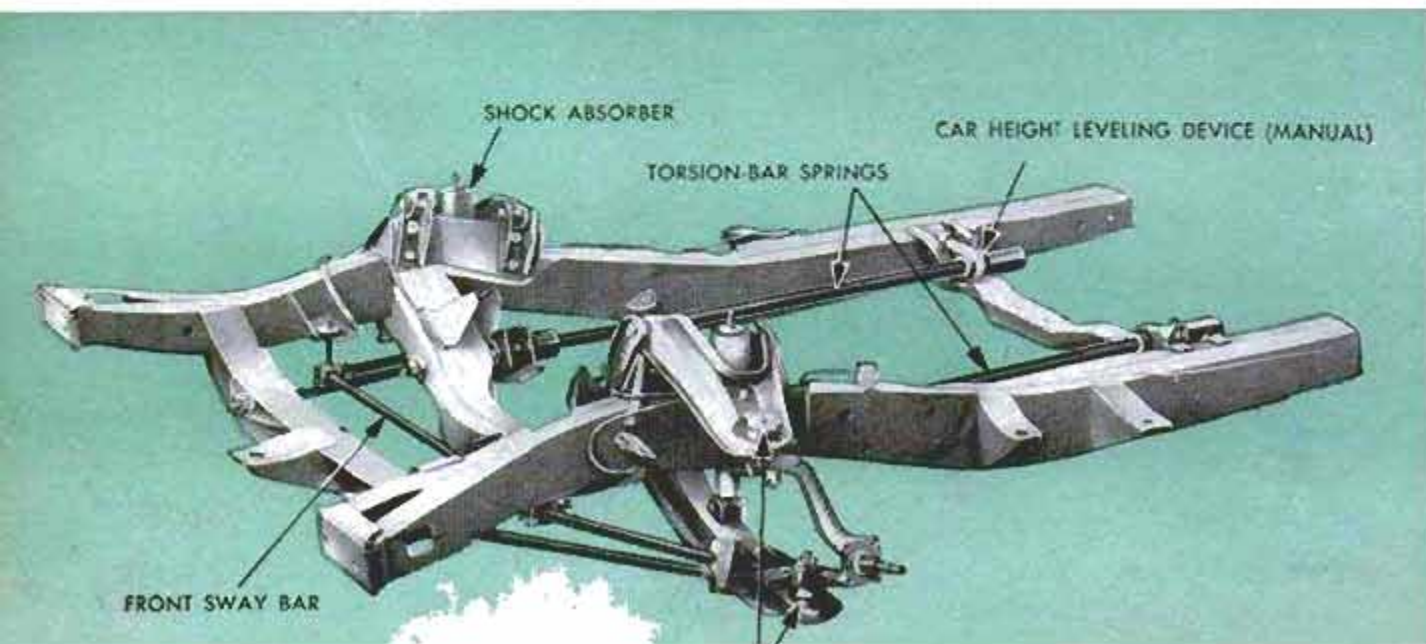



Once Plymouth could be called dowdy. But those days are gone forever!

PLYMOUTH

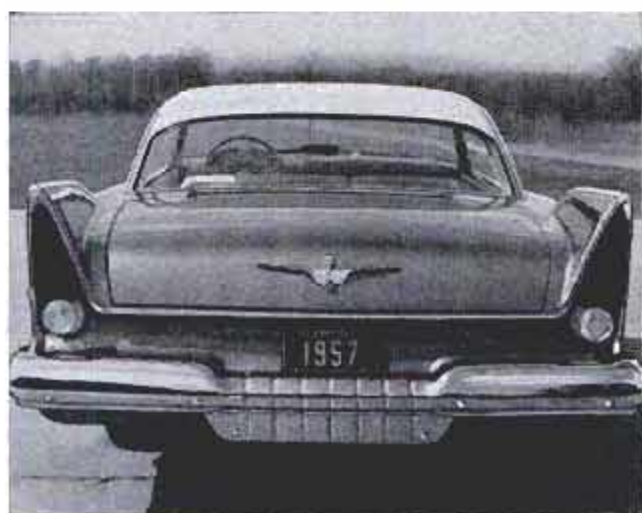

Rear view of the Plymouth emphasizes its clean lines

hardtops makes the roof look very light and slender. All convertibles from Plymouth to Imperial have compound-curved windshields.

The aluminum grille on the Chrysler has a series of horizontal lines. No hood ornament is furnished although dual fender ornaments are optional if you insist on decorating the uncluttered sheet metal.

Rear windows in four-door sedans pivot outward for ventilation.

The 1957 Chrysler is actually shorter than last year's model, hard as it is to believe. The lower lines fool the eye.

De Soto Also Adds Series

De Soto has a new series for 1957, the
(Continued to page 280)



Headlights are outboard; parking lights are inboard

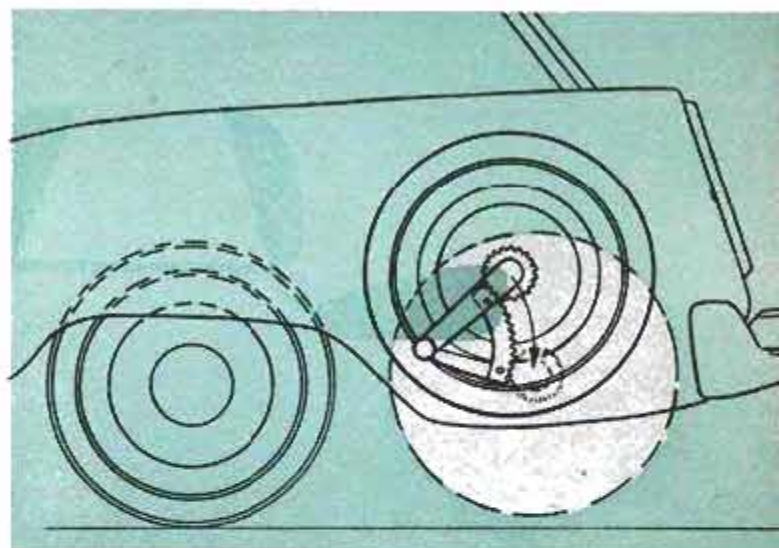

Plymouth wagons have a locked compartment in rear for valuables. Spare tire and gas tank are mounted within rear fenders. The third seat faces rearward

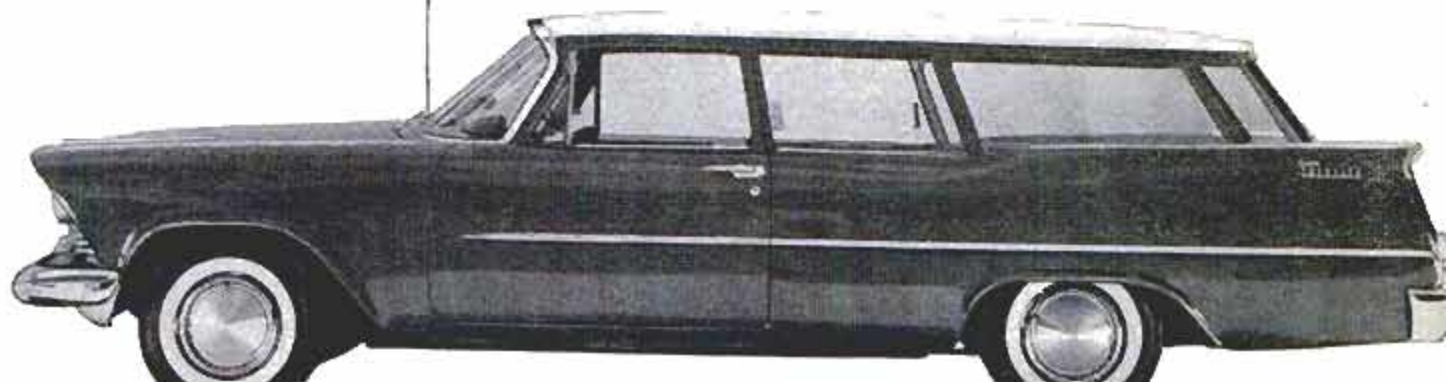



Chevrolet Gets Fins, Optional Fuel Injection



Top, 210 four-door hardtop. Above, Bel Air two-door



Two wind-splitters replace the usual hood ornament

BIG NEWS at Chevrolet is mechanical. For the first time, fuel injection is offered (at extra cost, to be sure) on a low-price production model.

Whether the price of the injection system (unknown at this writing) will scare buyers away is anybody's guess, but it will boost V8 output to 283 horsepower or one horsepower per cubic inch, a remarkable ratio for a production engine.

Style changes are less exciting. Bold tailfins have been added and front grille and bumper are more impressive. Over-all, the cars are 2½ inches longer, but extended fenders, front and rear, make it seem longer. Bodies are lower by more than an inch and 14-inch wheels are standard.

The new triple-turbine automatic transmission features a variable-pitch stator plus a hill retarder that provides braking during downhill runs. This transmission, Chevrolet claims, delivers nearly twice the torque multiplication of a standard converter and shifts without jerks.

Fresh air is taken into the passenger compartment through intakes directly above each headlight, eliminating the slot at the base of the windshield. Ducts carry the air along the fenders into openings at

Below, Bel Air four-door wagon. Arrow points to the location of gas-filler tube behind flap in tailfin

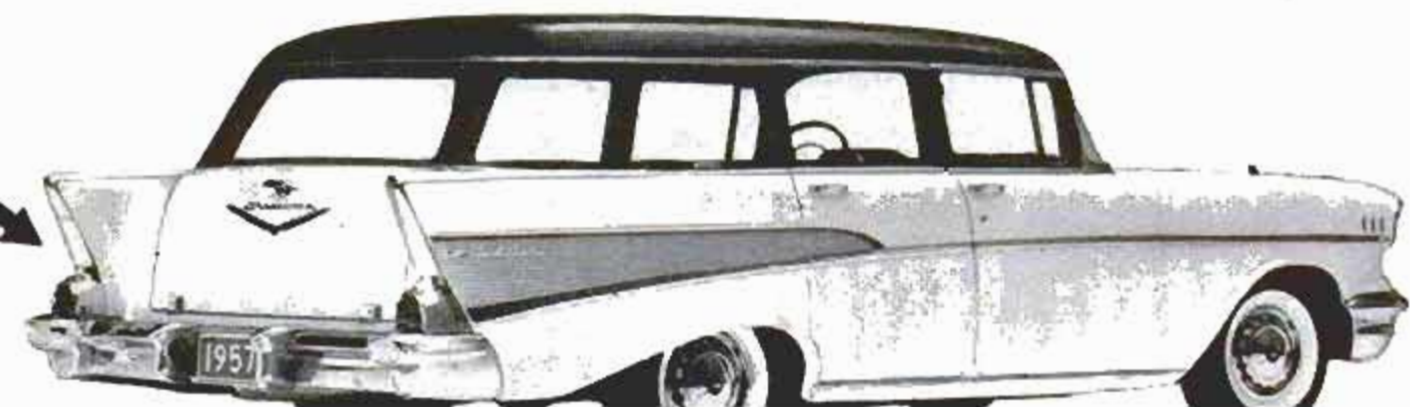

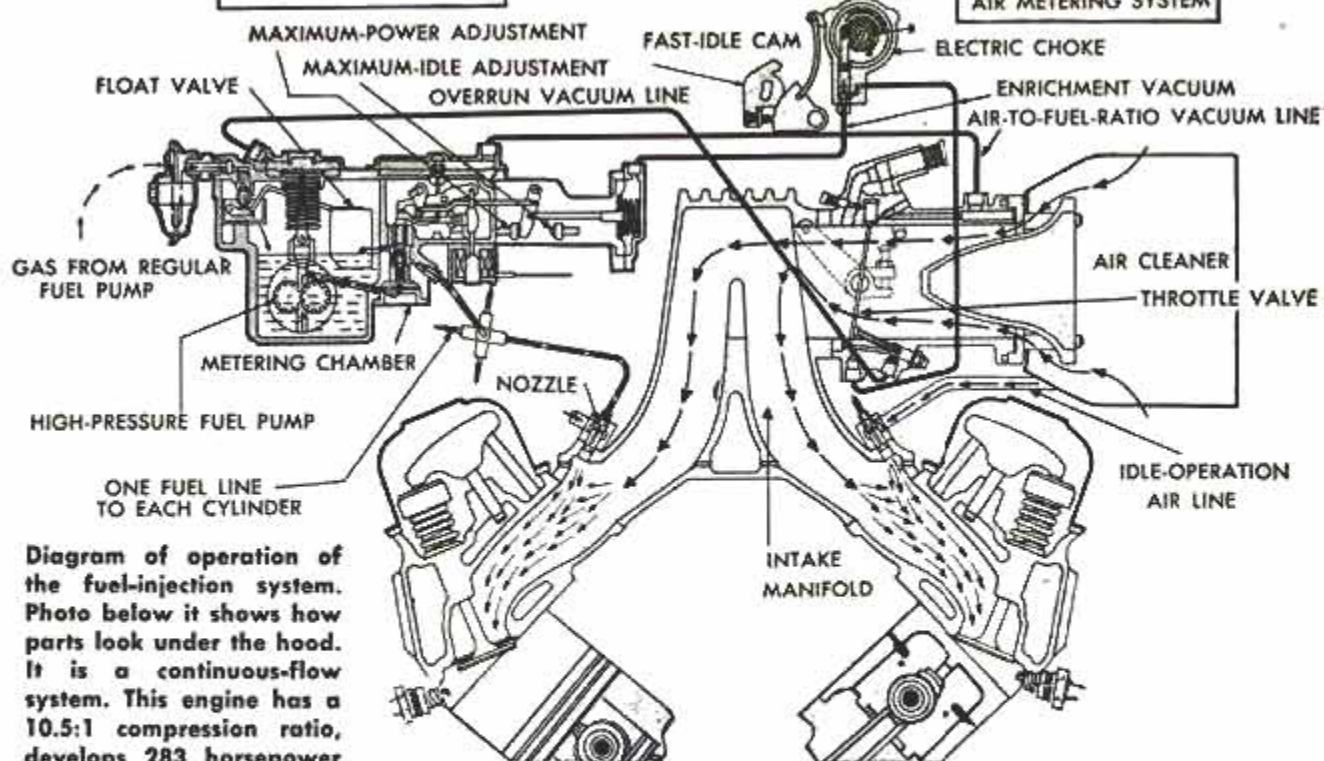
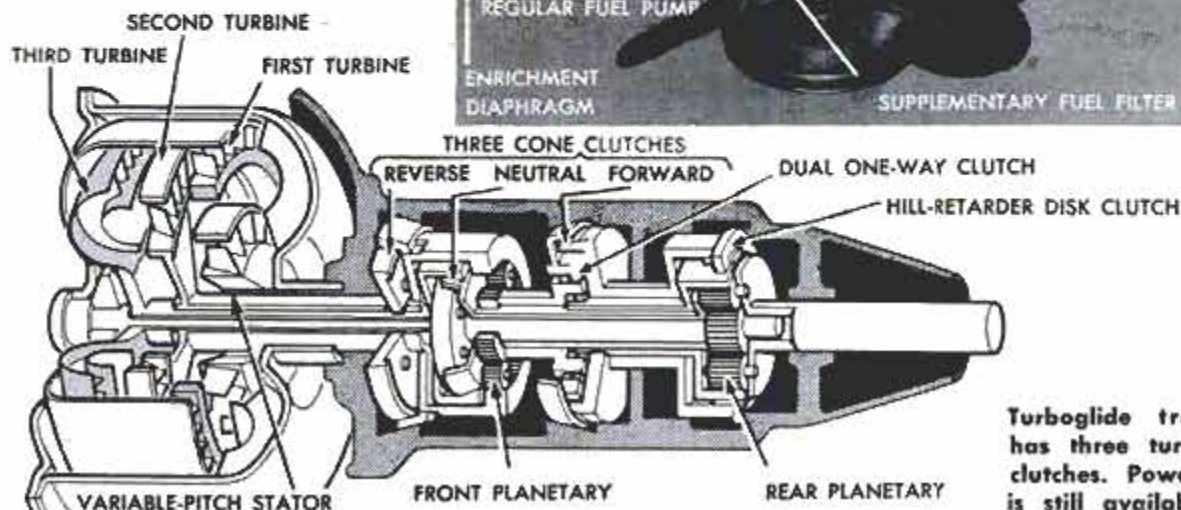
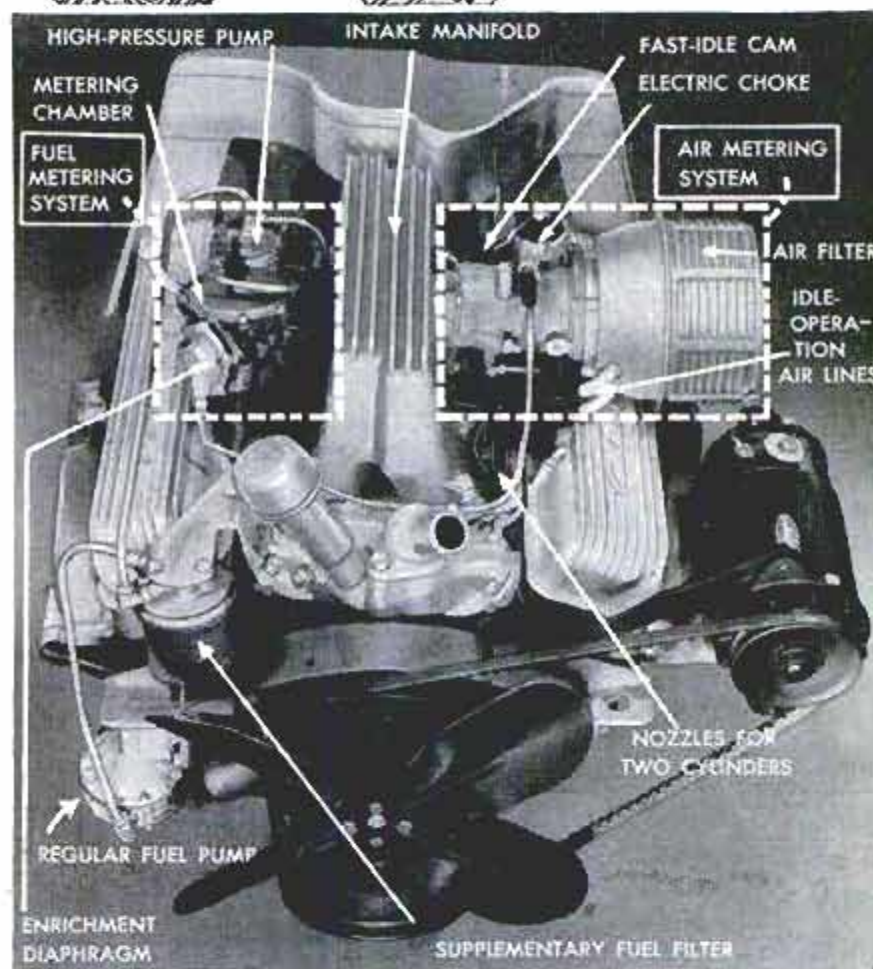

Diagram of operation of the fuel-injection system. Photo below it shows how parts look under the hood. It is a continuous-flow system. This engine has a 10.5:1 compression ratio, develops 283 horsepower

the ends of the dashboard.

Horsepower on Chevrolets ranges from 140 on the six-cylinder model to 283 on the fuel-injection V8. Between these extremes are 162, 185, 220, 245, 250 and 270 horsepower, enough variety to satisfy just about everybody.

Fuel injection and carburetion differ in that an injection system squirts gasoline into the manifold at the intake valve of each cylinder, assuring even distribution. In a carburetor system, gasoline is mixed with air at a central point (the carburetor) and the mixture sucked into the cylinders through long and restricted passages, resulting in starvation of some cylinders. ★ ★ ★



Turboglide transmission has three turbines, cone clutches. Powerglide unit is still available as well

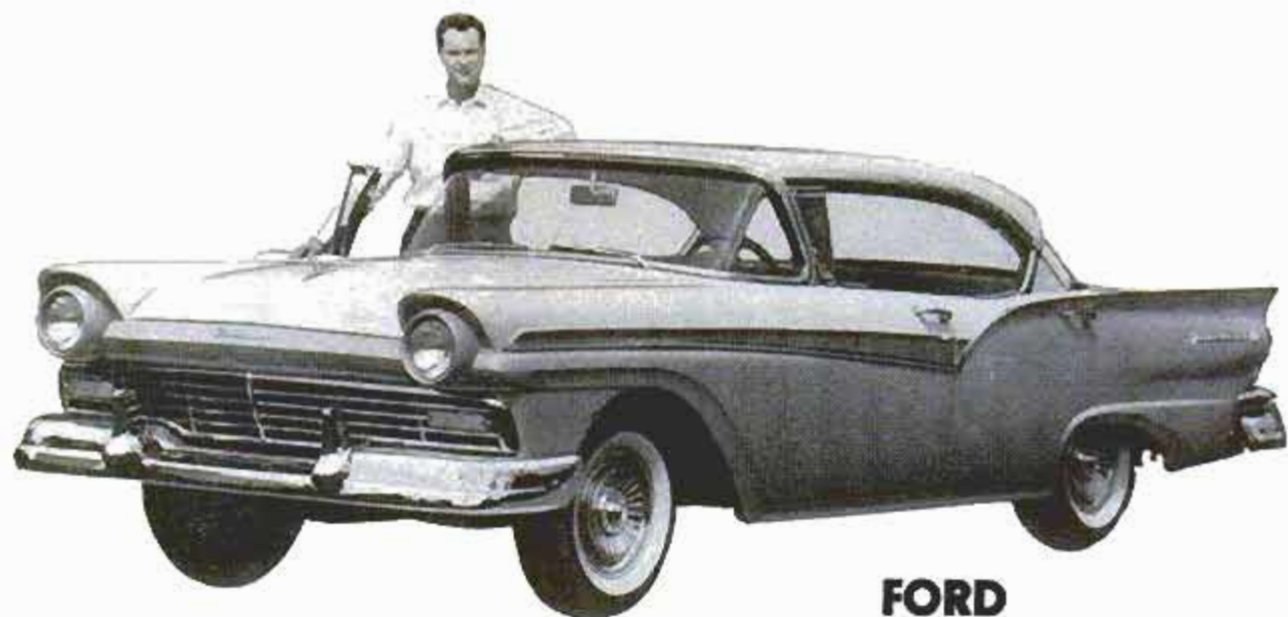

FORD

Ford Family Is Lower, More Powerful



Fairlane tailfins flare outward from larger lights



Above, four-door hardtop is 9 inches longer. Below, wagon has sculptured roof. Note the low hood line

LOW, THAT'S THE WORD for the 1957 Ford. If you require proof, look at the photograph at the top of the page. That man has both feet on the ground!

Fairlane models (like the four-door hardtop above) are four inches lower than in 1956. Custom models are three inches lower. To do this, Ford uses a flared frame, step-down in rear, sharply offset rear axle.

They are all longer, too. Fairlanes are nine inches longer, Customs three inches longer.

There are two wheelbases this year. The Fairlane series has 118-inch wheelbase (2½ inches more than 1956) and the others have 116-inch wheelbase (½ inch more than 1956).

Horsepower continues upward. Tops in the Ford line is a 245-horsepower V8 available on all models. Also available are the 212-horsepower V8, 190-horsepower V8 and 144-horsepower six.

Styling changes are striking and represent the most complete change since the war. Total cost of tooling, development and introduction is said to be \$209,000,000.

Fairlane models feature boldly sculp-





MERCURY

tured ribs that flare out from the center of the body ending above large circular taillights (which are about the only characteristically Ford part in the new styling). Custom models have similar styling, but more subdued lines.

Flatter front fenders and a much lower hood (which, incidentally, is hinged at the forward edge for safety and better en-

gine access) combine to give the car a road-hugging appearance. Windshield shape is changed, the corner posts canting forward sharply. Heater air is drawn through an intake at the base of the windshield.

Station wagons are lower this year and have a sculptured effect on the roof to lessen the "panel truck" look.

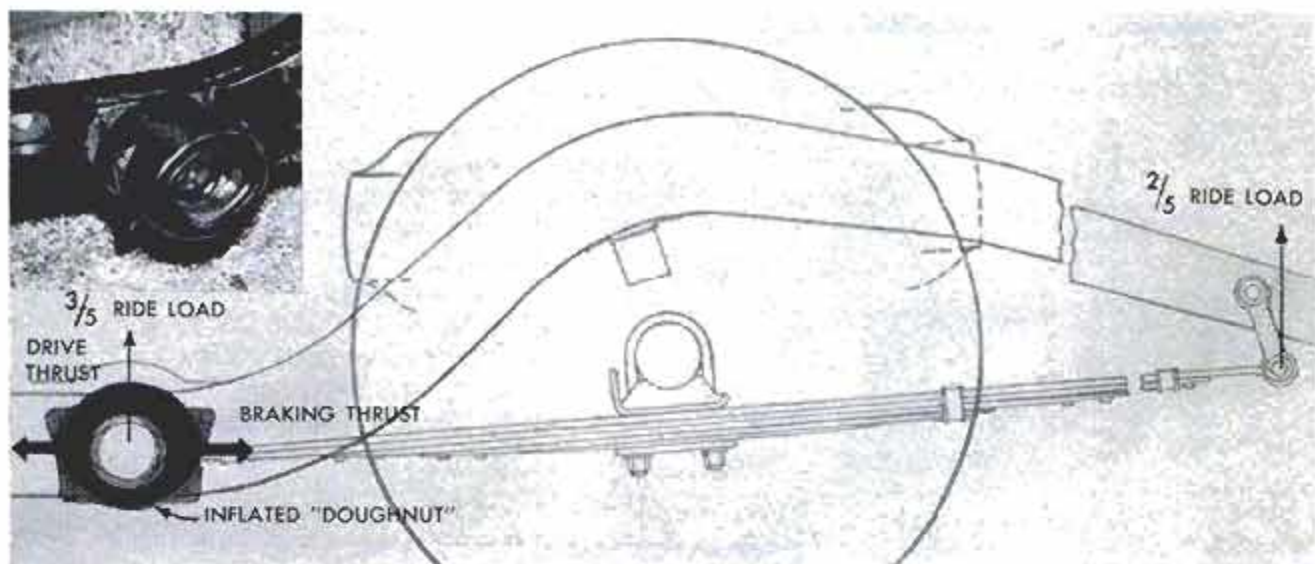

Above, drawing of air-filled spring hanger. Insert, upper left, shows how it fastens to frame. Below, the Mercury four-door hardtop is 56.4 inches high





MERCURY

Above, four-door Colony Park wagon is pillarless and has extra-large windows. Roof panel is grooved



To service paper air filter, lift out and shake it



LINCOLN

Steering-wheel position has been lowered one inch and the wheel made smaller so short drivers don't have to look between the spokes.

Ford is bigger all around—even the gas tank has been enlarged. It now holds 20 gallons.

Mercury Goes All Out

Things are changed at Mercury also. A look at the styling proves it. It is a bold approach that is unmistakably different. But under the sheet metal are the parts that really matter and bold developments are there too.

A unique approach to air suspension is an air-filled doughnut inside which the forward end of the rear spring rides. Mercury engineers say that 80 percent of the rear-end vibrations are transmitted through forward spring hangers. By insulating the springs inside a pair of rubber tires (about the size of baby-buggy tires) they discovered they could keep most of the vibrations out of the body.

These forward hangers also thrust the car forward on acceleration and retard the car during braking. The air-filled rubber

(Continued to page 284)

Lincoln offers four headlights for country driving. Left, canted rear fenders end in triangular lights





HUDSON

American Motors Gets V8 Across the Board

AMERICAN MOTORS now offers V8 engines in all three—Hudson, Nash and Rambler. For economy buyers, Rambler alone retains a six.

Horsepower is up: Hudson and Nash have 255 horsepower; the Rambler V8 has 190; the Rambler six 125 horsepower (135 optional). Dual exhausts are standard on the big cars.

Nash features four headlights, arranged in vertical pairs in the fenders (grille-

mounted lights of 1956 have been dropped). All four lamps operate on high beam, only the top two on low beam. Combined, the four smaller lamps project light 100 yards farther down the road.

Hudson enlarged rear-fender fins and moved aluminum insert to the front fender.

Rambler still has 15-inch wheels, the two big cars going to 14 inchers. Roof lines on the big cars are lower by 1¼ inches, decreasing over-all height by two inches.



NASH

Top, Hudson Hornet four-door sedan. Above, the Nash Ambassador four door. Below, Rambler pillarless wagon



RAMBLER



STUDEBAKER

Enlarged two-toned tailfins are new on Golden Hawk, above and below

Riding comfort under any load condition results from the variable-rate front springs, which have unequal spacing between the coils

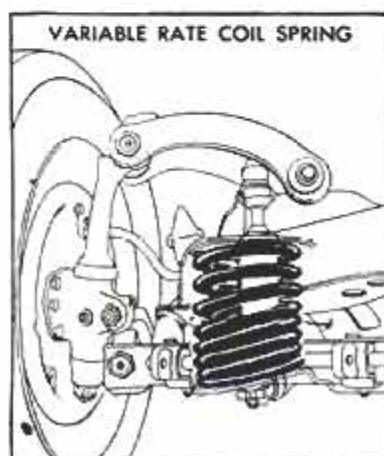
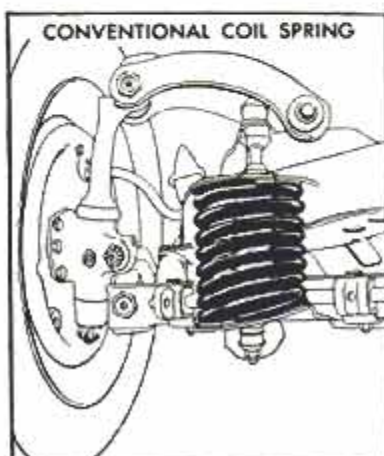

Golden Hawk Is Supercharged

STUDEBAKER'S Golden Hawk, the family-size sports-type car, is supercharged for 1957. The blower rams about 30 percent more air-gas mixture into the cylinders, boosting output to 275 horsepower. Last year's big Hawk had 275 horsepower also, but to get it required the 352 cubic inches of the Packard V8. The 1957 Hawk develops the same power with a smaller 289-cubic-inch Studebaker V8.

Optional throughout the line, on sedans as well as Hawks, is a nonslip differential that reduces slippage on icy spots.

Riding comfort is improved on all models by variable-rate front coil springs. As load increases, action becomes stiffer.

Styling changes are minor: The Hawk has new tailfins, the sedans have grille and trim changes. A four-door station wagon has been added to the line.



New for '57 is the four-door Broadmoor wagon. It has helper springs in the rear to handle heavy loads

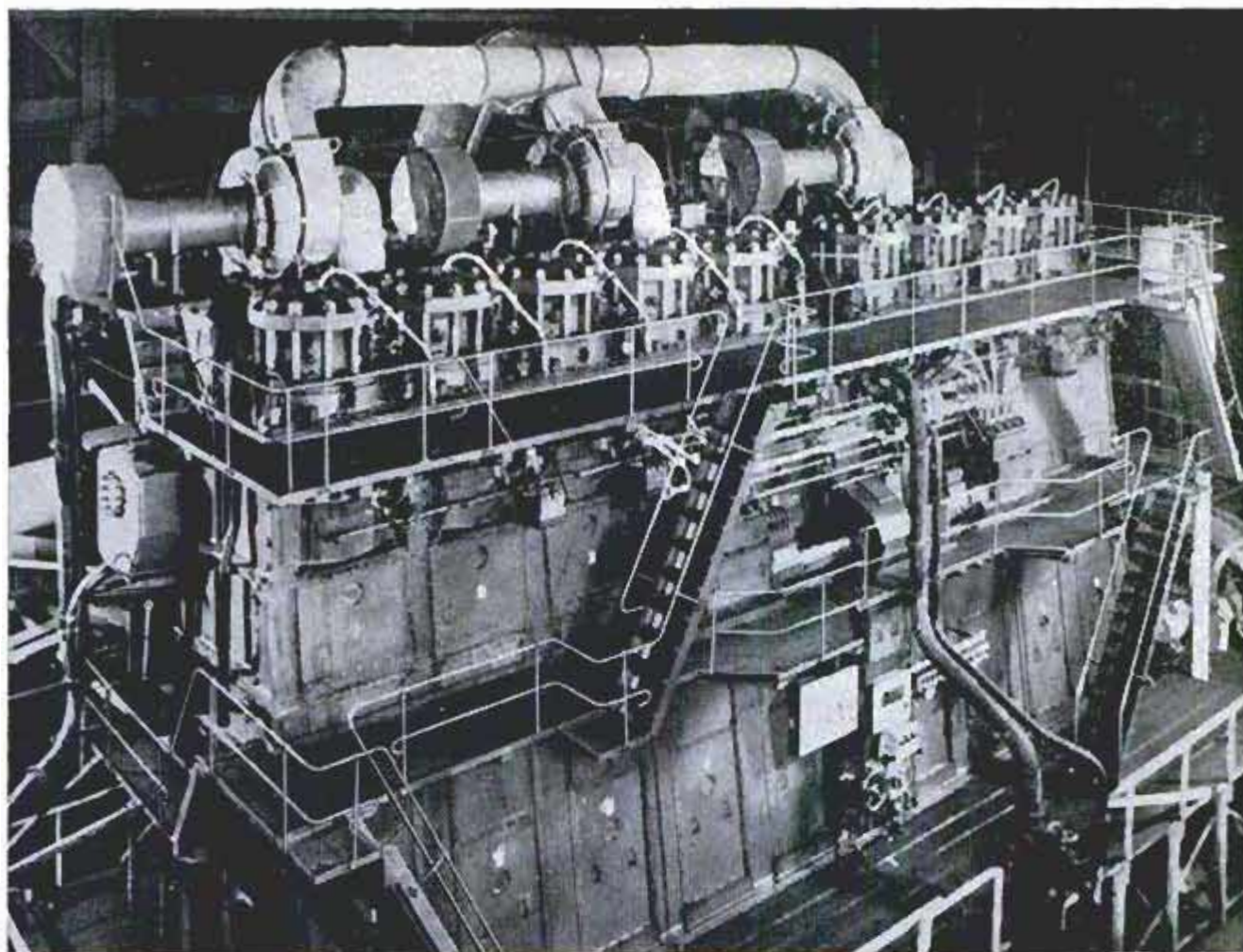

World's "Biggest" Marine Diesel Engine Has 13,200 Horsepower

Biggest marine diesel engine in the world, according to its owners, is the one recently installed on the Japanese cargo boat *Sadu Maru*. The mammoth unit has a

maximum horsepower of 13,200. The nine-cylinder engine is believed to develop respectively the largest total and per-cylinder output yet recorded.

Fountain Pen Fills Itself

Just dip a new fountain pen into a supply of ink and in 10 seconds it will fill itself with enough ink for 7000 words of writing. The pen, made by Parker, has no filling lever or tube. Ink is drawn up into the chamber by capillary attraction. The chamber is covered with a special material that sheds ink, eliminating the need for wiping the pen when it is withdrawn.

Gauge-Block Tester Finds Ten-Millionth-Inch Variance

Light waves, heart of a device measuring the length of precision-ground gauge blocks, can find variances as small as a ten-millionth inch or about one thousandth the thickness of human hair. Micrometers and calipers are checked against master, metal gauge blocks in tolerance control of mass-produced machine parts for guided-missile, jet-aircraft and machine-tool industries.



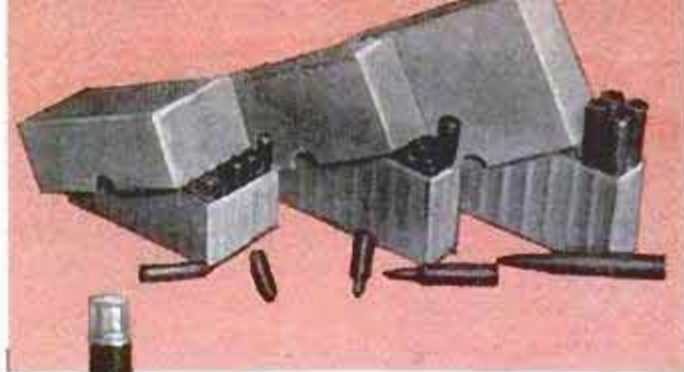

CARTRIDGE BOXES made of a tough plastic and guaranteed not to wear out make a fine gift for the shooter, in white or green
 Brad's Gun Shop, 204 Caladium St., Lake Jackson, Tex.

FOLDING TABLE of wrought iron combined with basket is unusual gift. Folded table is basket handle. Basket also folds
 All Purpose Table, Inc., 22 West First St., Mount Vernon, N.Y.

Christmas

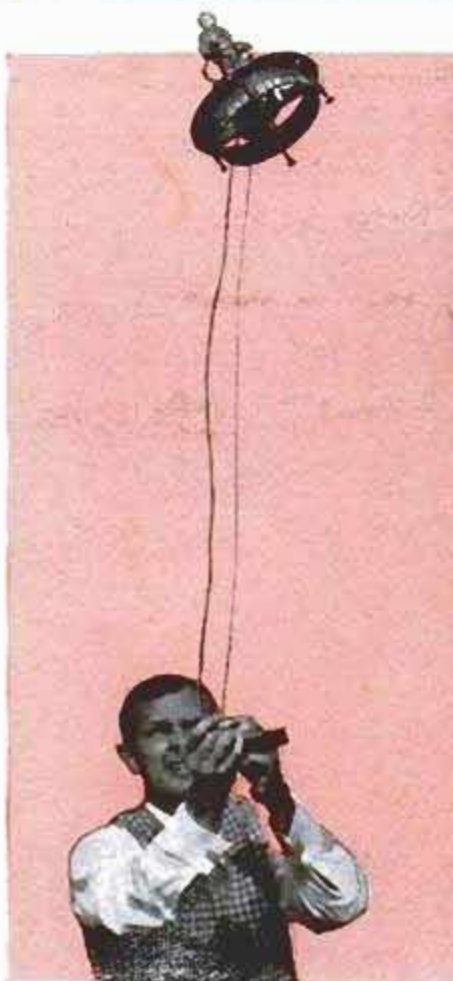

ELECTRIC SHOE POLISHER, called "Shuvalay," will appeal to the man who wants to be well groomed. Polisher fits the hand, has a convenient finger-tip switch. It comes with two brushes and can be used on furniture and wooden items as well as on leather

Portable Electric Tools, Inc., 320 West 34th St., Chicago 24

SCALE MODEL of the Hiller flying platform, built for the Navy, should delight any boy. Flown on control line, flying platform climbs, hovers and turns left or right at the will of the operator. Ducted fan is powered by tiny air-cooled gasoline engine

Wen-Mac Corp., 11511 Tennessee Ave., Los Angeles 64, Calif.



KNITTING AID helps to insure uniform stitches and should be a welcome gift for any woman who knits. Little plastic device holds the yarn at the proper tension and keeps it clean by holding it away from the hands. Speeds knitting along, too

Smith Sales Co., 2962 S. Hancock St., Denver, Colo.

COTTAGE LANTERN, battery-operated, was designed to replace old-fashioned gasoline and kerosene lamps, should make a hit with outdoorsmen. Twin battery is self-contained and attached to the light head by two screw caps. No wire or spring contacts are needed. Light head comes finished in copper or chrome

Burgess Battery Co., Freeport, Ill.



Shopping Center

TINY FIRE ALARM that plugs into a wall outlet will please the homeowner who has everything. It uses no electricity except when shrieking a warning in the event of fire or overheating. Alarm sounds when air reaches 140 degrees, continues until air drops to 100

Laramie Chemical Corp., 290 Main St., Stamford, Conn.



MOST FAMOUS SHIP of her kind, the Nantucket Lightship, has been re-created as 17-inch model, and both father and son would be happy with a kit from which to build her. Loaded with authentic detail, kit contains 180 plastic pieces, needs no tools for assembly

Pym Plastics Corp., Union, N.J.





SIXTEEN-MILLIMETER MOVIE PROJECTOR permits amateur movie makers to add background music and comments to their films without special equipment or an elaborate sound studio. In simplified terms, projector combines principles of tape recorder and movie projector into one compact unit. Inexpensive magnetic stripping is added to the developed film to make the recording possible

Eastman Kodak Co., Rochester 4, N.Y.



OSTERIZER FOR CHILDREN is battery operated, really works, yet is safe. For Christmas, one will be given away with purchase of Deluxe Osterizer—so Dad can get gifts for Mom and daughter at same time

John Oster Mfg. Co., Milwaukee, Wis.

Christmas Shopping

DUAL-PURPOSE BAG is designed to keep hot foods hot and cold foods cold—at the same time. Insulated carrying bag has two inner bags which also are insulated. Hot foods are packed in one, cold foods in the other. With double insulation, cold foods stay chilled six to eight hours, and hot foods maintain temperature four to six hours. Bags are washable

Nappe Smith Mfg. Co., Farmingdale, N.J.

NOISELESS CUTLERY TRAY brings quiet and order to the household kitchen. Compartmented to hold knives, forks, spoons and extra kitchen tools, the tray is made of a soft cushiony material that silences the clatter of the silverware. It was designed to fit easily into standard cabinet-sized drawers and comes in four colors—red, yellow, pink and turquoise

The Wooster Rubber Co., Wooster, Ohio





STEREO VIEWER for the 3-D fan holds 24 slides and feeds them automatically. Uses battery or alternating current.
The Weston Co., Inc., 11 E. 47th St., New York City

MODEL HYDROPLANE, powered by tiny air-cooled gasoline engine, is 18 inches long. Comes assembled; ready to run
Wen-Mac Corp., Los Angeles 64, Calif.



EXPOSURE METER for photographers has booster permitting use in dim light. Booster is auxiliary light cell, in its own case, which plugs into underside of the meter. It boosts low-light sensitivity of meter 400 percent

Kanematsu New York, Inc., 150 Broadway, New York City

Center

PORTABLE DUCK BLIND, made of 10,000 pieces of raffia, was designed to fit a folding boat made by the same manufacturer. The raffia fits over an anodized, nonrusting aluminum frame. Using this boat-and-blind combination, the duck hunter can shoot over his decoys comfortably and retrieve those that fall in deep water. He can move easily to new spots
The Porta Co., Inc., 32 Neponset St., Canton, Mass.



PLAY TENT or back-yard umbrella or even a beach umbrella—this convertible, portable play shade can be all three. Attaches to clothes pole or any post in seconds; folds into three-foot pack
The Play-Shade Co., 111 S. 13th St., Garland, Tex.



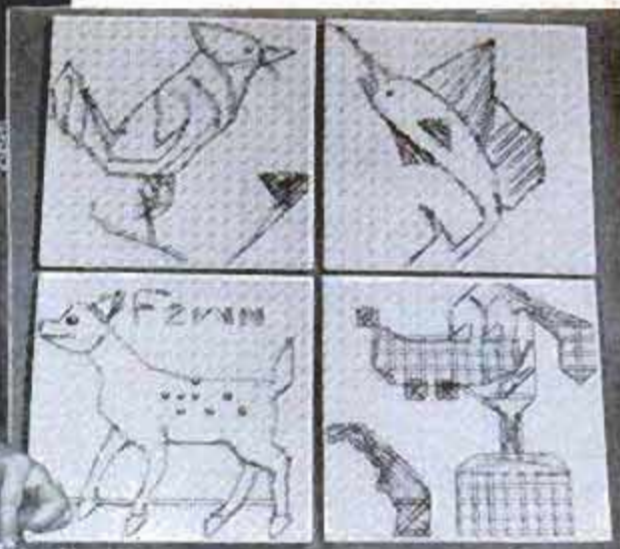

PLASTIC PEGGED BOARD permits youngsters to work out various designs with rubber bands. The board is 10 inches square and colored rubber bands are supplied with it. Conceived originally as entertainment, it also can be used as an aid in physical therapy, restoring manual dexterity

Klotz Corp., P.O. Box 147, Chelsea, Mich.

Christmas Shopping



PLASTIC UNSINKABLE BOAT for children is five feet long. Deck and hull are made of high-impact polystyrene. Inner chamber is filled with Styrofoam. Can withstand rough treatment, yet needs no upkeep. Red deck and white hull; comes with anchor rope

Harbor House, Box 421, Dept. B-12, Saline, Mich.

PLASTIC GUN (lower left) shoots table-tennis-type balls. It works with an easy pumping action and has no springs or levers. Barrel and ammunition are of nonshattering Tenite plastic. When the rubber nozzle is flipped back, 15 balls can be loaded at once

Aek-Aek Inc., 18101 East Ten Mile Rd., East Detroit, Mich.



TOY CONTROL PANEL of "atomic-powered submarine" enables junior captains to be navigators. Battery power steers course as undersea map slides by opening

Alperi-Macine Co., 644 Madison Ave., New York City 22





THIS CAMERA, low in price and high in style, will provide family photographer with box-camera simplicity and economy
Sawyer's Inc., P.O. Box 490, Portland 7, Ore.

MAGIC MOVIE MIRROR, placed over special record on 78 r.p.m. phonograph causes figures to move in time with music
Childhood Interests, Inc., Roselle Park, N.J.



for Juniors

MALTED-MILK MIXER is a toy that does the job like its bigger counterpart. Operated by a flashlight battery, it is strong enough to break up ice cream added to malted-milk mixture, yet is safe for children. When the aluminum cup, which is included, is put in place, the mixer starts automatically
Aluminum Goods Mfg. Co., Manitowoc, Wis.

CRASHPROOF FLYING MODEL of the 1956 Beechcraft Bonanza is made of Duraflex plastic and comes fully assembled with tiny gasoline engine already installed. Durable plastic parts snap back into shape when bent, and will not shatter on impact. Engine has tiny pull-cord starter for quicker, easier starts
Wee-Mac Corp., Los Angeles 64, Calif.



Detroit Listening Post

By Leo Donovan



WHILE YOU ADMIRE the 1957 automotive beauties (many of which are in this issue), here's something to think about:

You can now drive on toll roads from New York to the outskirts of Chicago without seeing a single stop light. And you're not allowed to drive over 70 miles per hour legally anywhere along the way. In fact, only in certain parts of Pennsylvania can you hit 70. Most of the way, the limit is 65 (Ohio and Indiana) and 60 (New Jersey).

So what? you ask. Here's the point: With no stop lights, how can you demonstrate the remarkable acceleration of your new 300-horsepower beauty? With these speed limits, where can you let the power plant stretch its muscles? With broad, multilane highways all the way where will you use the fast-passing ability for darting in and out of traffic? Your 300-horsepower beauty (and perhaps you, too) will arrive at your destination utterly frustrated!

Yet engines get bigger, horsepowers higher. It's a strange business!

Prices Are Up

Industry observers, who have a hunch that customers will resist the higher prices on 1957 cars, feel that this could result in a less frenzied sales market. The reason? They feel manufacturers will cut back production to prevent big inventories.

They see no chance of manufacturers cutting prices. Nor will dealers cut margins to absorb increases. Because dealers have fewer 1956 models to unload, their chances of making money next year are said to be improved. And that is without figuring on a boom year in sales.

General Motors seems to be taking a somewhat restrained attitude toward the competitive struggle for sales. As a result, Ford and Chrysler may pick up a few percentage points in the 1957 scramble.

Right now, General Motors is selling over 50 percent of the market and that's about as big a piece as is considered proper at this moment. Restraint in merchandis-

ing (such as, for example, the absence of a 1957 Motorama) by GM might also give the independents a chance to improve their position.

Better Quality Controls

One result of the dealers' revolt against factory practices was a guarantee by the companies to pay dealers the full cost of new-car preparation and repair services during warranty periods. To keep such charges from becoming astronomical, manufacturers are expected to clamp down on quality control on the assembly line and in parts manufacturing. The real winner in this clamp-down is, of course, you—the customer. Your 1957 car should be better made than those of recent years.

Making predictions can be dangerous because nothing is definite until the car is on the street. Here are some examples of quick switches in recent weeks:

One car was set for a new automatic transmission. It was to have plenty of pick-up plus unparalleled smoothness. Factory engineers worked out drawings, photographers took pictures, everything was set to publicize this new achievement. Then, without warning, the whole thing was canceled. Lots of words had to be "eaten" (and rewritten) and pictures discarded.

Another car had its engineers sitting up nights figuring out a neat, compact solution to the spare-tire problem. They came up with a lightweight, easy-to-use tire that was carried deflated in a small box in one corner of the trunk. Provisions for quick inflation were perfected. The thing worked fine. Engineers beamed. Pictures were taken. Then, bang, the project was tossed out the window.

Here's another example: One 1957 car had most of its publicity artwork completed at great expenditure of time and money. Suddenly the boss decided to get rid of an important piece of trim—a piece that is as obvious as a fat man in a jockey room. (It, incidentally, has been part of the car for many years—can you guess which car it is?) His decision meant throwing away piles of photographs and starting over.

That's the sort of thing that goes on in every company right up until announcement day. It's no wonder the press agents have a weary look at this time of year.

Rumor is that Pontiac will bring out an expensive sports-type car with plenty of horsepower and, no doubt, fuel injection. Chevrolet's optional fuel injection, by the way, was one of the industry's best-guarded secrets. The day the news leaked out, one top engineer in the division confessed it was as new to him as to the inquiring reporters!



Although you might not recognize it, this coupe has a Fiat body. The front wheels were moved forward on an extension of the frame to place more weight on the rear wheels. This enables the car to get better traction

Weird-Looking Hot Rods Compete in Drag Races

Some of the oddest-looking cars in the world show up at the National Championship Drag Races. These souped-up, cut-down hand-fabricated speedsters resemble the automobiles that most citizens drive only in that they have four wheels. Everything else has been modified in the interest of speed. The only other consideration designers keep in mind is the safety regulations set up by the National Hot Rod Association, requiring roll bars and other forms of protection for the driver in the event of an accident. These cars may be weird, but they are fast.

Front car is of "slingshot" design, with driver behind rear wheels. Rear car is 1932 Ford with Cadillac engine, Hydra-Matic

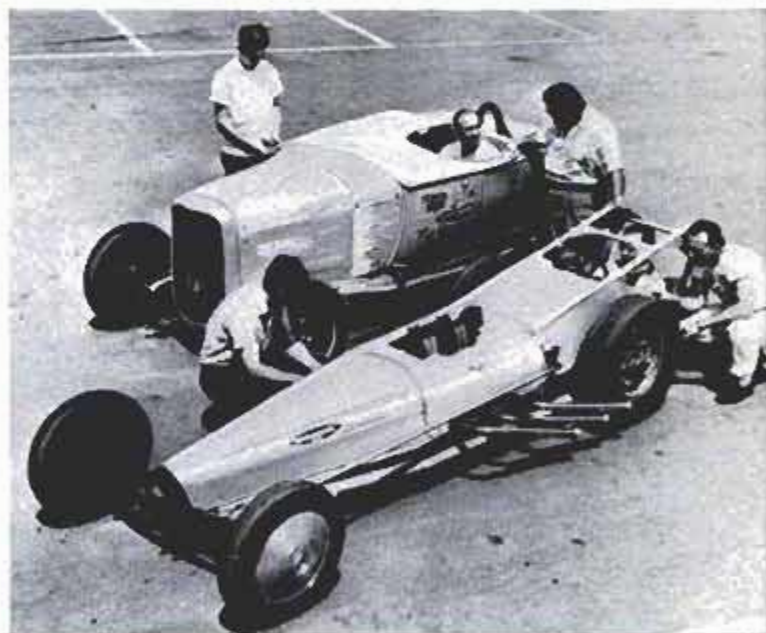

Lawn Sweeper For Tiny Tractor

From his seat on a miniature tractor the homeowner can sweep up leaves and dump them in a pile for burning. The sweeper, hitched to the rear of the tractor, is dumped by pulling on a cable fastened to the tractor seat. The sweeper can be backed into position for dumping the load of leaves in the hopper.

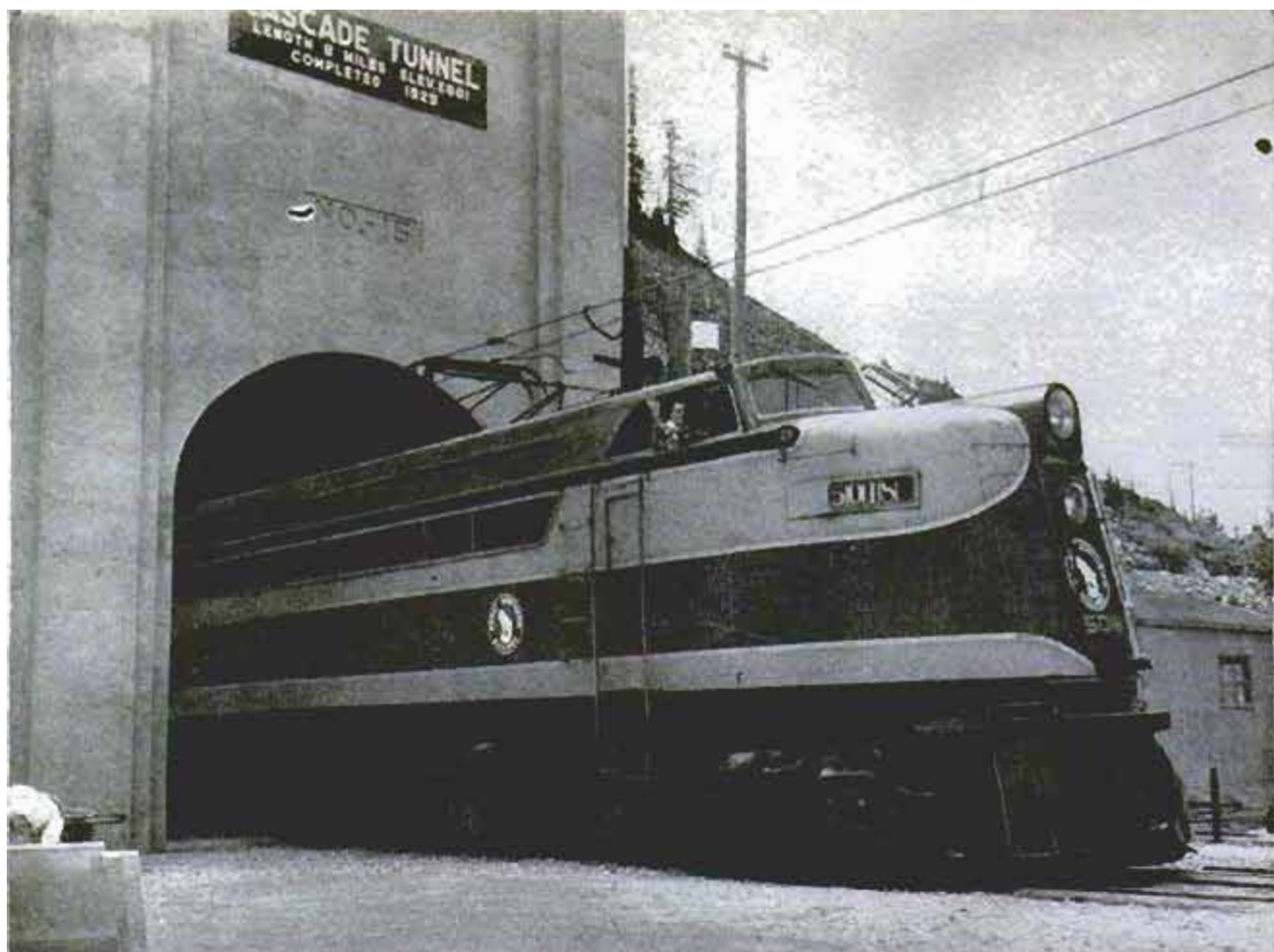

Last electric locomotive, called "The Box Ox," passed through tunnel late last summer. Diesels took over

Electric Line Gives Way to Diesels as GIANT BLOWERS COOL CASCADE TUNNEL

By Hu Blonk



ENDING nearly half a century of electrified operations in the Cascade Mountains, a unique engine-cooling system has been put into operation at the longest railroad tunnel in the Western Hemisphere, allowing heavily loaded, diesel-driven trains to move uphill through the eight-mile bore. The ventilating scheme, costing \$650,000, blows outdoor air into the long tunnel through big fans installed behind a steel door in the east portal.

Railroad men say there's nothing like it in the world.

Until the ventilation problem was solved last summer, the Great Northern Railroad was required to employ a 74-mile electri-

Big intake fans, seen from inside the tunnel, pull air in from outside and force it through the tunnel



fied zone in the high mountains between Wenatchee, Wash., on the east slope, and Skykomish, Wash., on the west, to drive its heavy freight trains through the bore.

Basic units in the ventilation system are two six-foot fans, each powered by an 800-horsepower electric motor and turning at 1150 revolutions per minute. A special control station and powerhouse has been erected near the east portal to house the motors, electric switches and control mechanism.

The east portal of the tunnel has been reconstructed to house a steel drop door which prevents the air blast from circulating out the near portal and back to the fans. When a heavy-tonnage freight train enters the west portal of the 41,152-foot tunnel, the operator engages the master control, closing the east portal door and starting one of the fans, which forces approximately 220,000 cubic feet of air per minute against the oncoming train.

Prior to ventilating the tunnel, diesel operation of full-tonnage trains was not practical because of overheating of engines. Lighter trains do not require assistance from the cooling system, and all trains westbound downgrade operate without the fans. After a train has passed through the tunnel in either direction, both fans are operated to change completely the air within the bore.

Automatic features of the tunnel include a switch which opens the door and turns off the fans when a train approaches within 3250 feet of the closed portal. A stop signal is provided in the event the door should fail to open. ★★★

☐ Over 100 substances are now packed in self-spraying aerosol containers, bringing the total value of aerosol products produced in the United States and Canada last year to \$250,000,000.



Each intake fan is capable of pushing 220,000 cubic feet of air per minute into the tunnel. Blast cools hard-working diesels

In order to seal off east end of tunnel, so air is forced to travel the length of the bore, steel drop door was installed

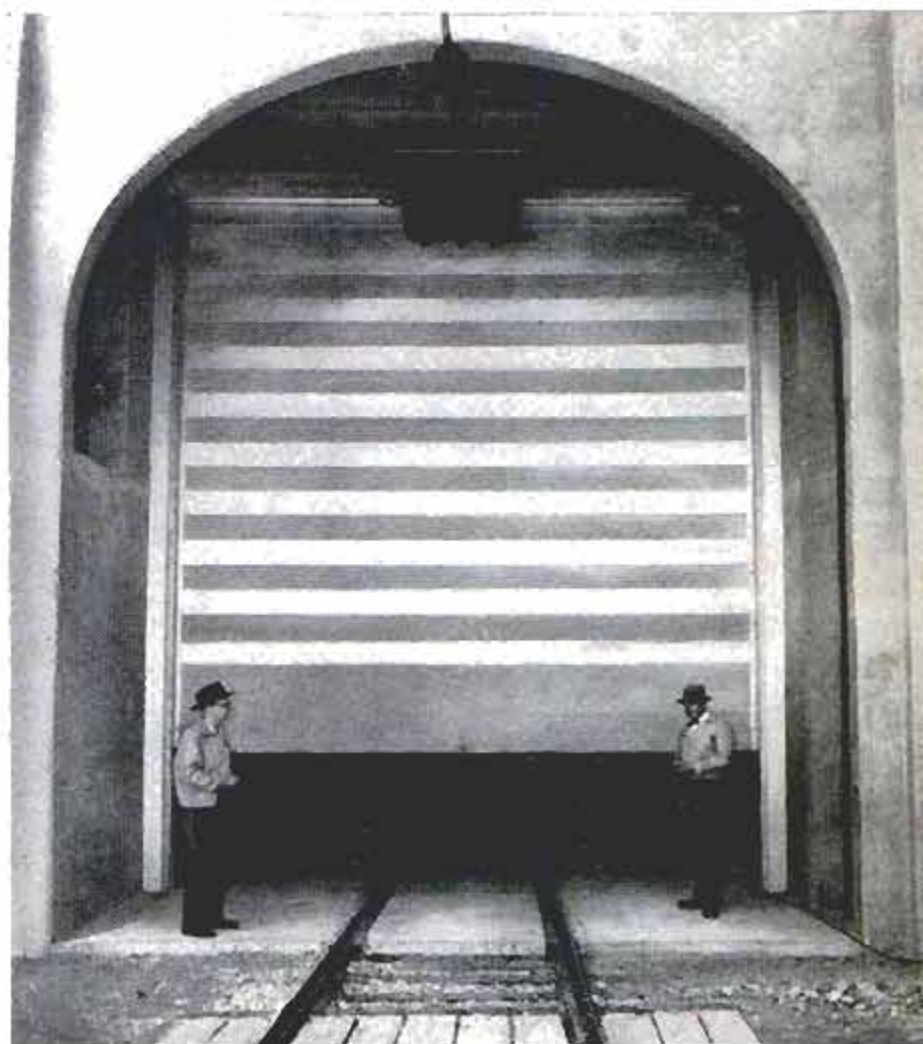

KEEPING UP WITH THE ATOM

RESearch at the University of Houston may turn out to be of great importance to the farmer. Laron Golden and C. B. Johnson, shown at right, are using radioactivity to study the role of phosphorus in plant growth. Phosphorus is one of the essential elements because no plant can grow without it. Yet it readily "marries" many other elements in the soil, making it unavailable to plants. Johnson and Golden are using radioactive fertilizer to check how much phosphate is taken up by plants within a given period. So far their tests indicate that it is best to place phosphate fertilizer in concentrated bands to prevent all of it from being lost by "marriage" to other elements.

☆☆☆

RADIATION is now being used on an experimental basis to change sawdust into cattle feed . . . to waterproof shoes . . . to convert paraffin into a rubberlike substance . . . to combine two chemicals into a potent insecticide . . . and to produce a new kind of foam plastic.

☆☆☆

IN ITS 20th semiannual report, the Atomic Energy Commission gave the first details of research to obtain power from a controlled H-bomb reaction. The report points out that deuterium (double-weight hydrogen), if fused with other elements, could be an almost limitless source of energy, as it occurs in great abundance in sea water. Temperatures of 100 million degrees C. would be needed to fuse the deuterium. The biggest problem is finding a chamber for this reaction.

Dr. Hsue-Shen Tsien of the California



Institute of Technology has calculated that one small "H-bomb power plant" would produce more than five times the electrical energy produced in the United States in 1954.

The AEC report states "it is probable that success will be achieved eventually."

☆☆☆

THOSE "ATOMIC CANNON" below appear to be blasting away into the night. Actually they are tubes extending down into a 20-foot pool of water for highly radioactive fuel elements. The glowing uranium slugs bombard materials lowered into the tubes. The materials then are checked by General Electric scientists at the Hanford atomic plant to determine their change under high-energy radiation.

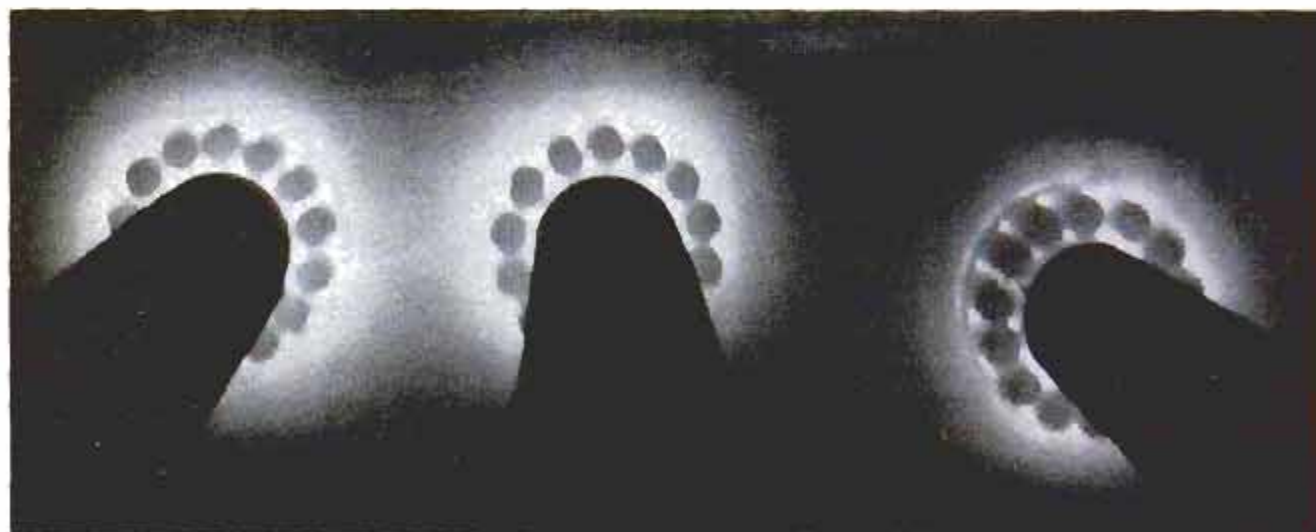

Imagination

in the Classroom

IN A CLASSROOM in Sauk Rapids, Minn., the engineers and designers of the future are already at work building the machines of their era. The instructor responsible for this forward-looking activity is Alfred Lease, industrial arts teacher, who believes in encouraging the imagination of his students.

Backed by his encouragement, the class has produced such items as "Lease's Lemon," a flying saucer with a 5½-foot diameter, operated by torque, that really flies; a glider-helicopter, built of around-the-shop parts, which actually flies when towed by a car at a speed of 23 miles per hour; and, Herbert Watt, a mechanical man who walks, talks, hears, drinks and does other amazing things.

The flying-saucer frame is made of balsa wood and is powered by two electric motors. Operated by a remote-control panel, the saucer rises vertically on both motors spins when one of the motors is slowed up. The development of the device is so simple that Lease wonders how it has been overlooked. "Torque power is cheap," he says. "It's surprising that not too many have used it before."

The helicopter was made from commercially supplied plans and built from available parts such as the ⅜-inch pipe used for the frame. Towed by a car at 23 miles an hour, it is released for its gliding flights.

Herbert Watt, the robot, is the second mechanical man to come from this classroom, and is a very capable fellow. He is operated by remote control.

Frame of flying saucer shown at top of page is made of balsa wood and parts of a toy construction set. It has two motors

Herbert Watt, the mechanical man, is operated by remote control. Operator wears earphones to hear what Herbert is hearing

Helicopter-glider is towed to flying speed, then released to free flight. Rotors must be started by hand before towing begins

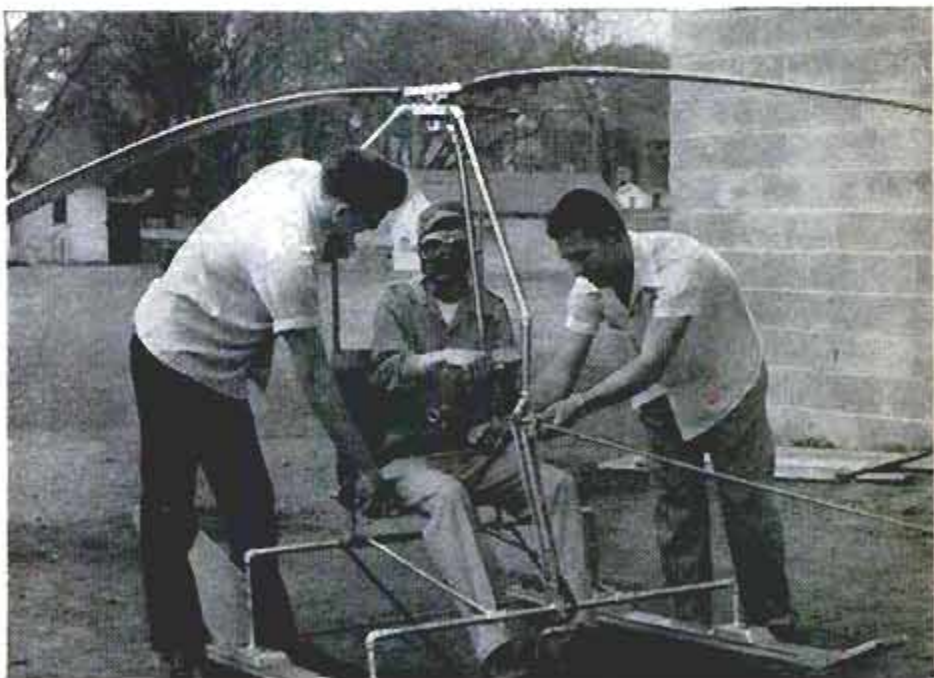

ON THE NEXT five pages we present a feature article on the magnificent ship models of the Musee de la Marine in Paris. *Popular Mechanics* is making available to its readers a portfolio of plans for each of the four ship models shown below. Each portfolio contains: a general 36-page instruction book; a specific instruction book covering the history and characteristics of the prototype, along with construction details; large-size actual photographs of the finished model. For a free descriptive brochure on these plans and their prices, write Popular Mechanics Press, Dept. 80, 200 East Ontario St., Chicago 11, Illinois.

Marie Jeanne
Commercial
Fishing Smack

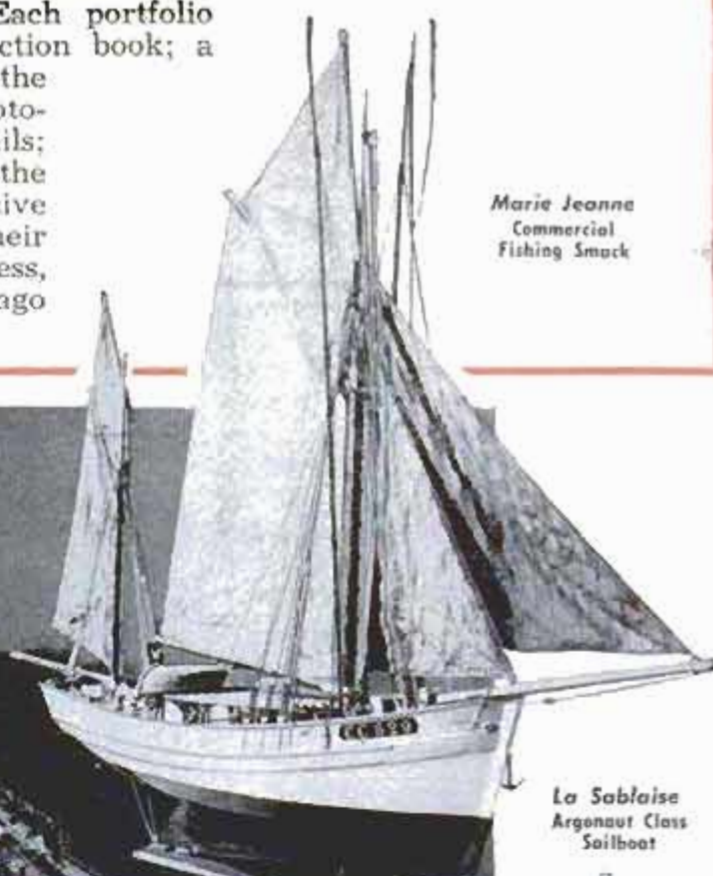

La Sablaise
Argonaut Class
Sailboat

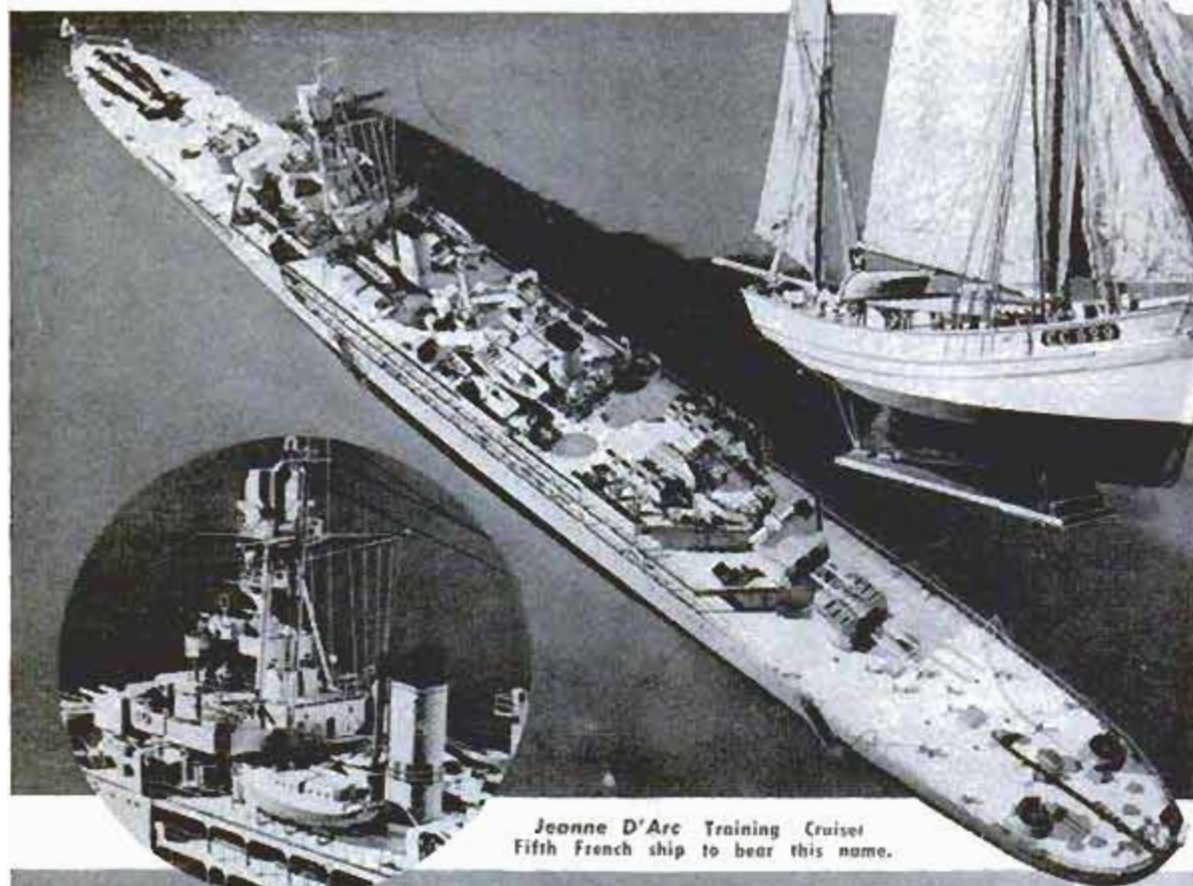

Jeanne D'Arc Training Cruiser
Fifth French ship to bear this name.



Le Terrible Light Cruiser • Momentous World War II Record



Rigging a model calls for a watchmaker's precise touch. Tiny rope has same number of strands as the original

In the shadow of the Eiffel Tower is the world's smallest shipyard, a fabulous little workshop where craftsmen of the Musee de la Marine build miniature

SHIPS OF ALL AGES

By Robert Sage

Fine detail shows up on *La Royale*, a Venetian galley that carried 378 rowers, 150 sailors and 200 soldiers

Photos by Gene Penn

IF YOU ARE a newcomer in Paris, one of the first places you are likely to go is the Place du Trocadero to enjoy the wonderful view of the Eiffel Tower and the wide panorama of the city.

Beside you, as you stand looking at the sight, are the two majestic wings of the Palais de Chaillot, curving out like halves of a gigantic, broken horseshoe.

The acres within these wings house four unusual museums and a number of other things. Among the "other things," on the top floor of the west wing, is perhaps the smallest and most versatile shipyard in the world.

When I visited this extraordinary place recently, the finishing touches were being put on a 14,000-ton aircraft carrier; a beautiful galley was at the halfway stage; the rigging was being repaired on an obsolete "floating battery"; the seats were being fitted into a lifeboat; and three Breton fishing smacks had just been completed.

This and other activities were being carried out by a chief and 15 craftsmen. Everything, of course, was in miniature,

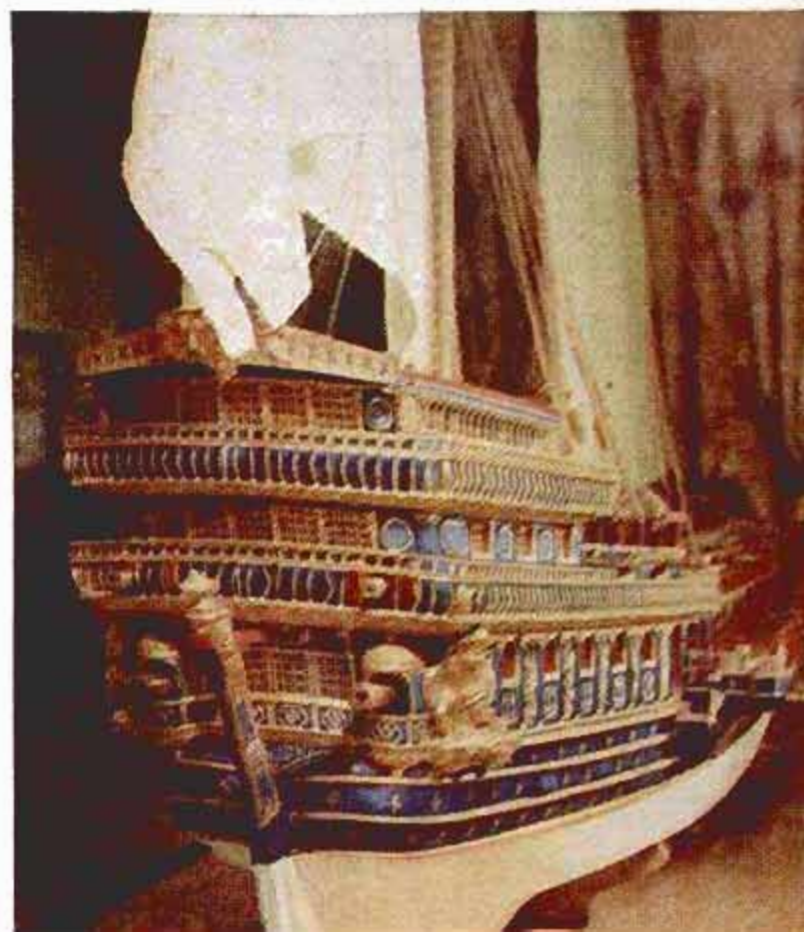



Recent model, the *Arromanches*, carries 35 guns, is complete even to tiny cranes and a miniature helicopter



Exquisite model has Neptune sitting on prow. Original boat was built for Napoleon to inspect a harbor

for this "shipyard" was the neat, airy little workshop that makes the admirable model vessels exhibited two floors below in the French Navy's famous *Musee de la Marine*, or Naval Museum.

The aircraft carrier, a $\frac{1}{100}$ scale model of the *Arromanches* (formerly the British *Colossus*), had been covered with a plastic hood while its 35 pieces of artillery were being made. At various benches, workers were busy fashioning tiny bits of gear with a watchmaker's precision. Before them were midget "lumber piles" of boxwood, maple and basswood. Their tools were few — mainly a jigsaw, some sharp little knives, a bit of sandpaper that served as a plane,

French sailors look over model of clipper ship that shattered records by crossing the Atlantic in 13 days



and a bottle of glue that did the work of nails, screws, bolts and rivets.

Craftsmen Are Authorities

Several of these craftsmen, I learned, are authorities on naval archaeology and students of the innumerable 18th-century treatises on sails, rigging, shipbuilding, naval artillery and marine history. Some are regular sailors, others civilian specialists from the navy yards at Brest and Toulouse.

In this pleasant workshop they have recaptured something that is becoming more and more rare—the old-time artisan's love of his craft, his pride in work well done. Here time doesn't count; neither does profit or loss. A job must be done perfectly, whether it requires a month or two years. Roughly speaking, it takes as long for this workshop to turn out a model as it would for a real shipyard to produce the original.

The making of a model starts with detailed plans of the entire craft and its visible gear, drawn rigorously to scale by the workshop's chief, Marcel Caudrelier. To draft the plans of a ship when a model exists is not a superhuman feat, although it is a meticulous one. Similarly with a ship of which the full-scale plans are available. But many of the models are made for the first time, and often part or all of the plans have disappeared or cannot be obtained.

In such cases, Caudrelier gathers every document he can find—photographs, drawings or paintings, written descriptions, partial plans, anything that may yield a little information.

When these have been assembled his real work starts. Not only must he draw the over-all plans of the vessel, but he must prepare detailed plans of every part, and often whole sets of plans for a single accessory.

I got some idea of the incredible labor involved when he showed me a tiny gun to be placed on the deck of a warship. Although the gun was only about an inch high and the barrel not much bigger around than a pin, 37 separate pieces were required for its construction, and each of these pieces called for a detailed plan about six inches square.

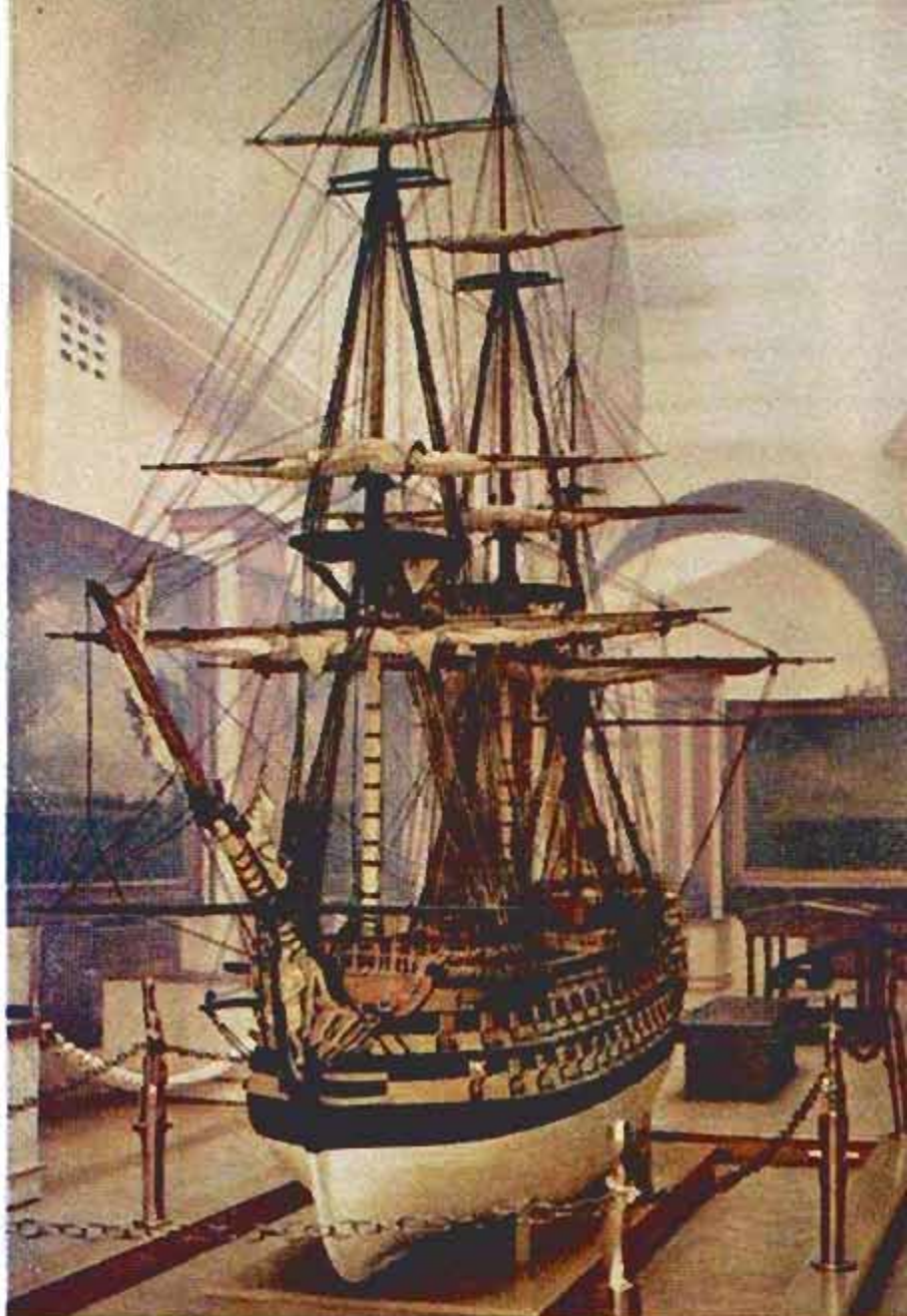

Second-largest model is 124-cannon man-of-war. Model was built 250 years ago for the nautical instruction of young Louis XV

Here's a cross section of the bathysphere in which a pair of French naval experts made a record descent of 13,500 feet



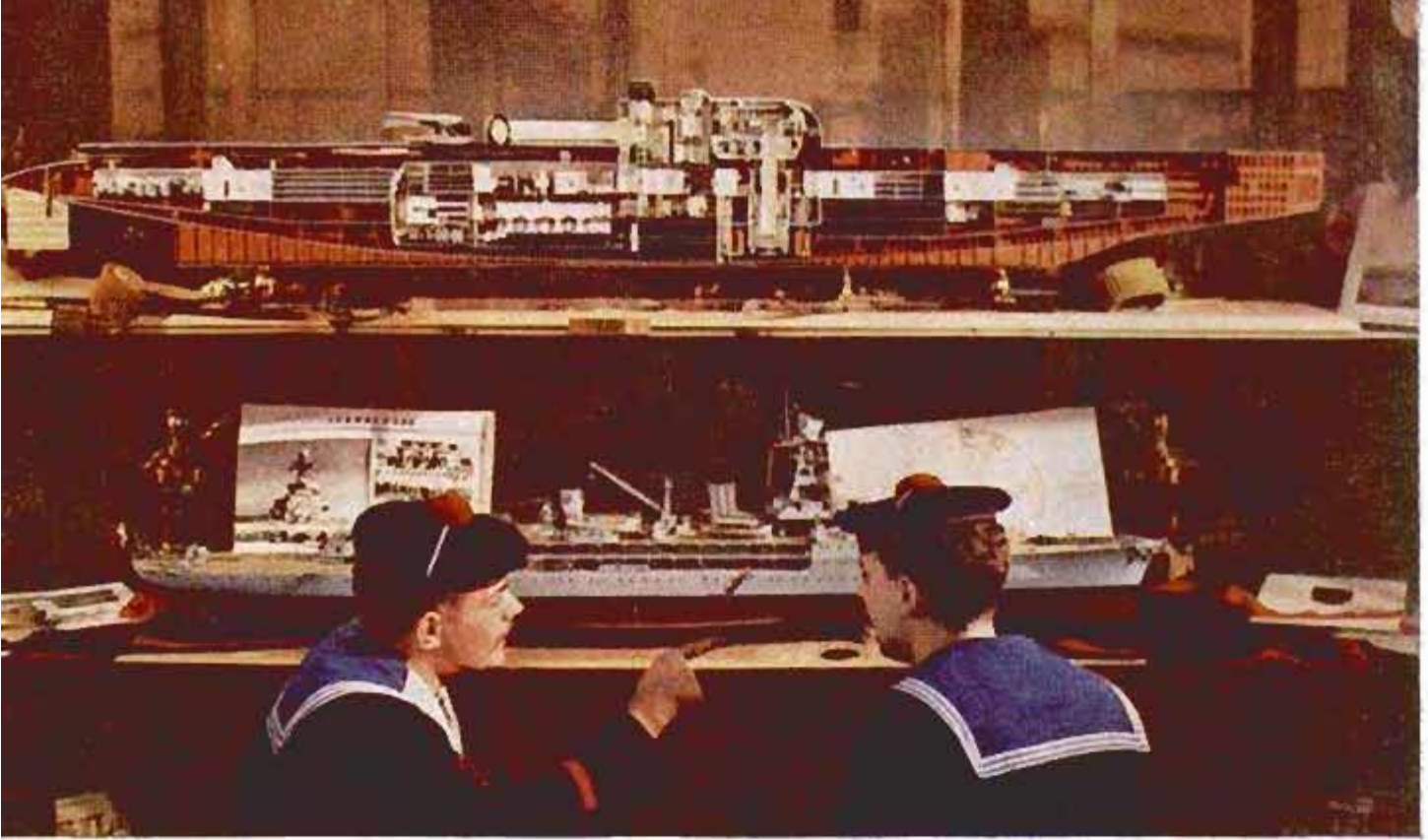

One of the most complex displays is cross-section model of the giant prewar French submarine *Surcouf*, which sank in a collision in 1942. Note reconnaissance plane. Below it is a model of a modern ocean liner



This dainty little ivory ship, the *Ville de Dieppe*, was presented to Marie Louise, second wife of Napoleon, by city of Dieppe upon the birth of a son in 1811

Old books and yellowed drawings reveal details of the ancient ships to the craftsmen. Sometimes weeks of research may turn up only one of ship's dimensions

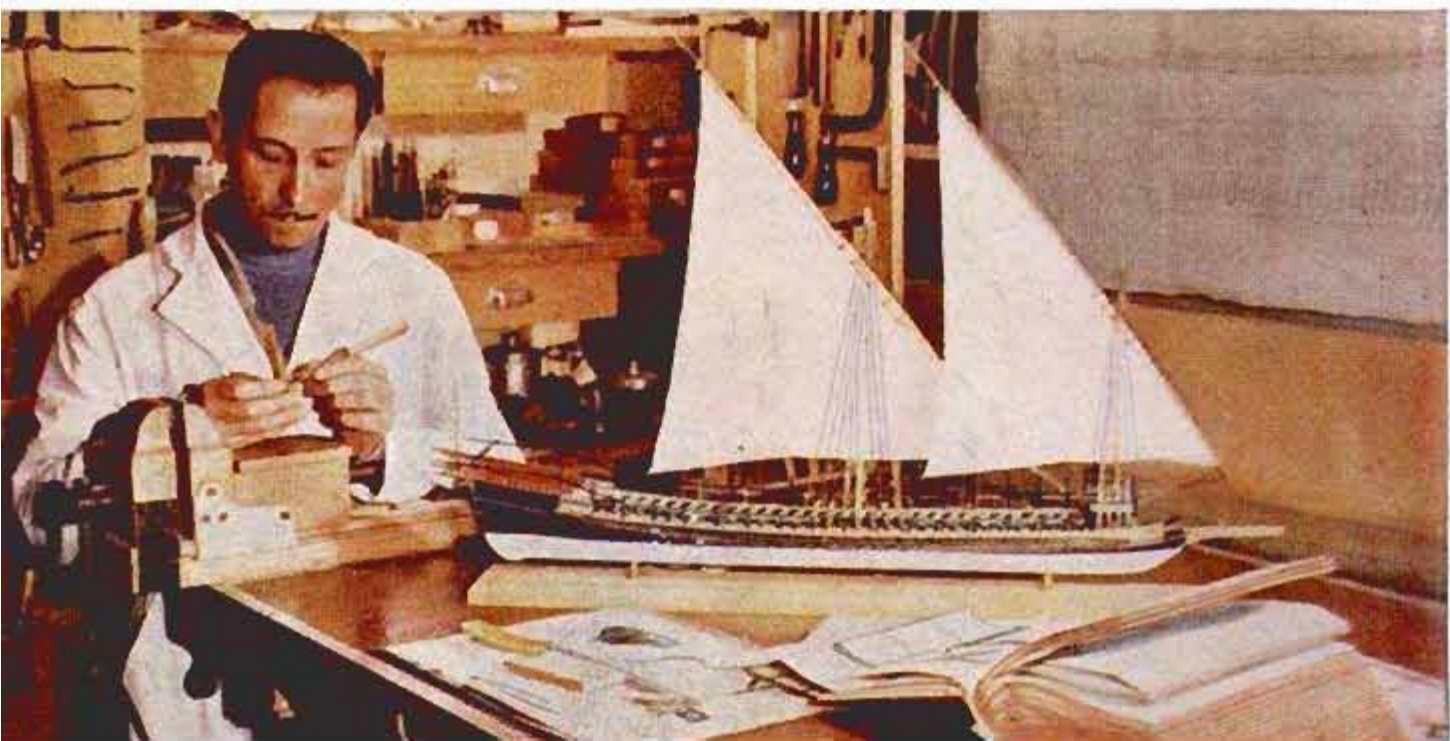



Gloire, a steam-driven ship that made history, was built in 1859. It was the world's first armored vessel

The many problems that come up in reproducing microscopic objects have long since been solved. The museum's special paint, *maquettine*, spreads over the tiniest parts without gumming, and the workshop manufactures the string-thick rope used in the rigging. The rope has the same number of strands and the same diameter, in scale, as the original.

Every portion of a "collection model" is made by hand but, in the case of "series

models," when a lifesaver, a piece of artillery or any other accessory is to be repeated several times, the work is simplified by manufacturing the necessary number of plastic copies from a handmade prototype. On the model of the prewar French battleship *Richelieu* (scale $\frac{1}{300}$), there are no less than 317 plastic accessories.

The museum's workshop "mass produces" certain models in series of 10. The
(Continued to page 242)

First steamboat was built in France, 16 years before Robert Fulton's. This model still runs under its own power



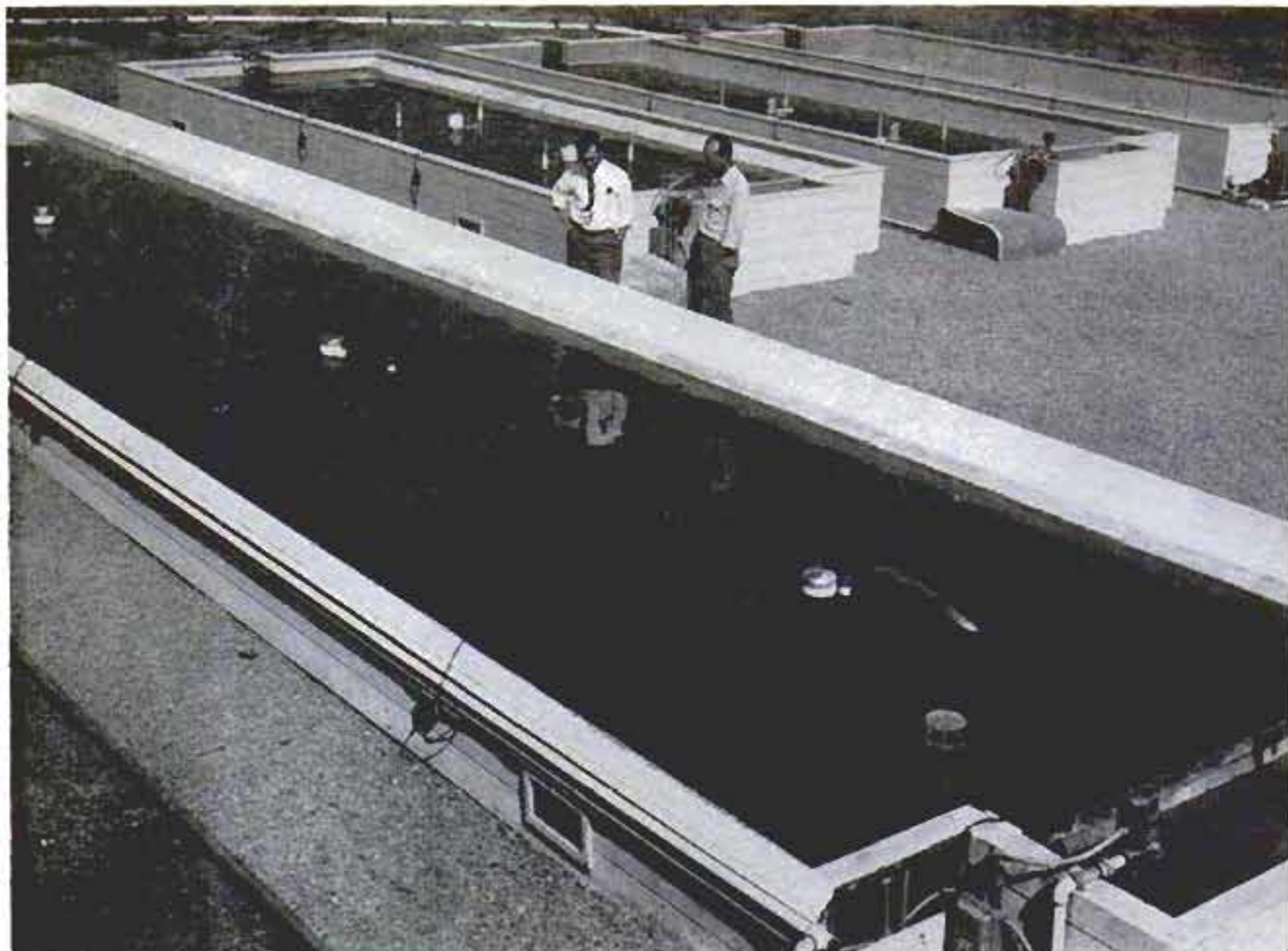

Sewage is pumped slowly through concrete tanks where it is exposed to sunlight to promote growth of algae

Clear water, usable in industry or agriculture, is one of the end products of the algae-growing process. Beaker at left shows water after processing. Beaker at right contains water with algae growing in it

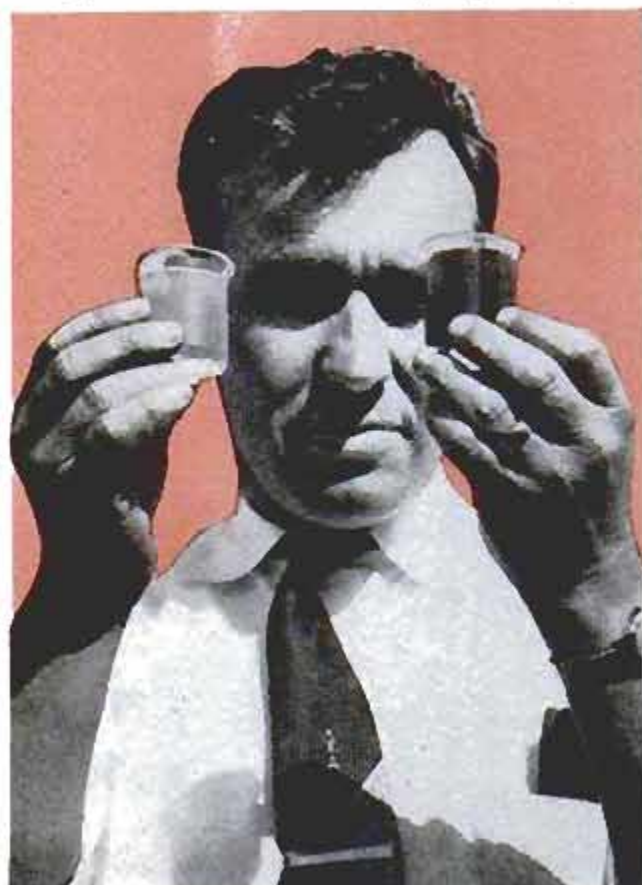

ALGAE

By Thomas E. Stimson, Jr.

ENGINEER SCIENTISTS at the University of California are studying a new food that has some fantastic properties.

It costs nothing, or less than nothing, to raise.

It can be grown at the rate of 30 to 40 tons per acre per year, as against an average of less than two tons per acre, dry weight, for field crops.

It is more than 50 percent protein. In fact it is higher in protein, fat and vitamin content than any other vegetable substance except a few seeds.

It is grown in tanks or ponds yet requires less than a hundredth of the water used in ordinary agriculture to produce an equal amount of protein.

It is a good energy food for humans although it is looked upon mainly as a food supplement for domestic animals. Chicks gain weight by more than four percent per day on it. Pigs and cattle thrive when it is

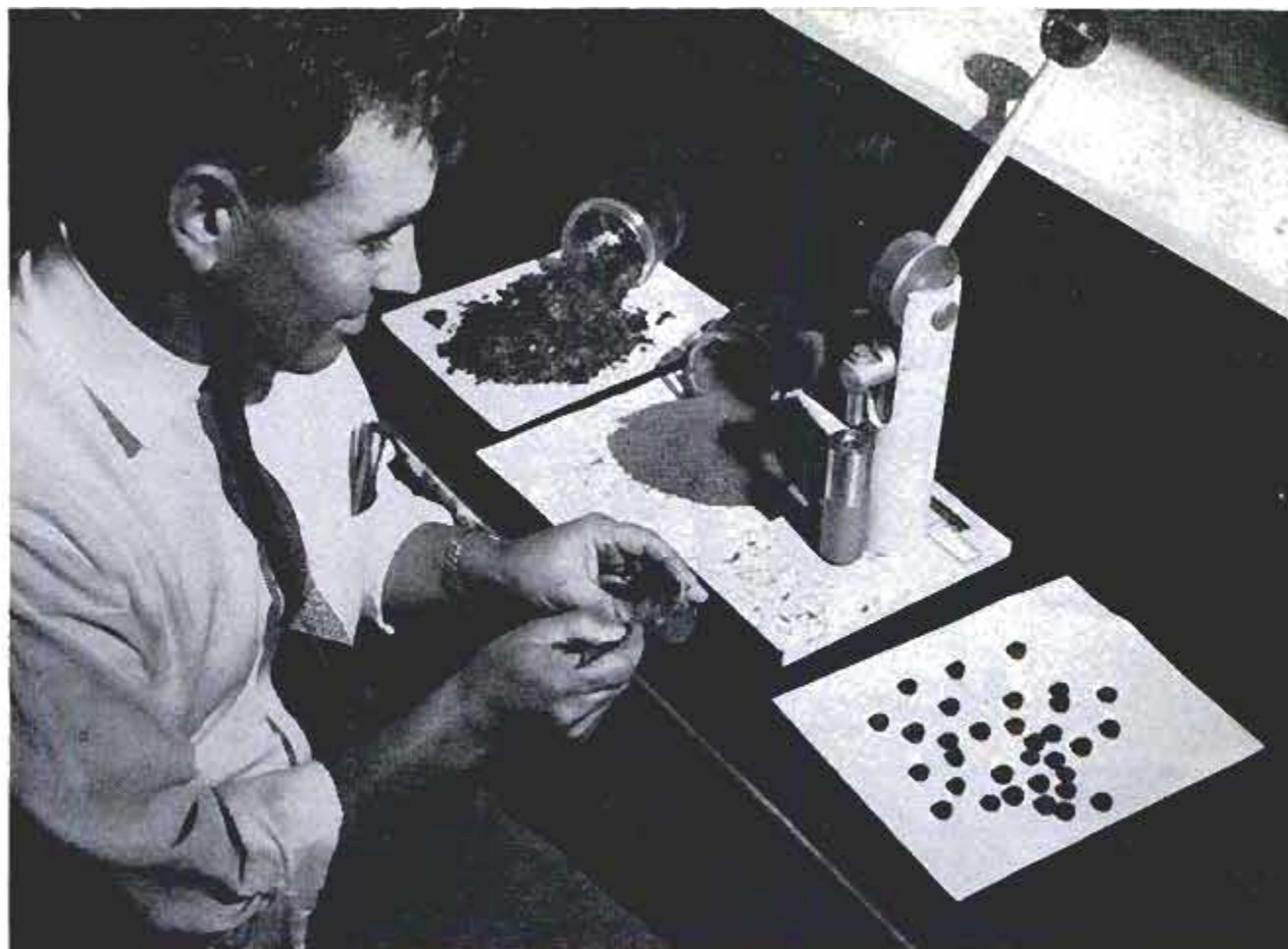

Flaked algae, left, are converted to powder, then pressed into pellets for use as supplemental animal food

FOR DINNER

added to ordinary cellulose feed. Dogs and cats love it.

Produced in either powder or pellet form, it is dark green, almost black, in color. It has a flavor something like grass or alfalfa.

This remarkable substance consists of algae that are grown in sewage ponds, then harvested and dried. Algae are common unicellular plants, comparable to a "scum," that grow in warm, quiet waters. They not only flourish in sewage ponds, they aid in converting the sewage into water that can be used in irrigation, industry or, after filtering and chlorination, as drinking water.

The story of algae as a food is one in which two different branches of science contributed their findings to reach some brand-new conclusions.

About 10 years ago research people who were studying photosynthesis became excited over the efficiency with which some green algae use sunlight for growth. Dr. H. A. Spoehr, of the Carnegie Institution, and others made precise studies with the

strain known as chlorella. They found that chlorella has high food value and that it grows rapidly in sunlight when supplied with carbon dioxide and nutrients. Pilot plants were built and many of the problems in growing and harvesting were studied.

Large chlorella farms were envisioned for sunny desert regions on land that was otherwise of little value. Using little water, such a farm would grow its algae in plastic tubes laid on the ground or on the roofs of buildings. Circulating the algal cultures through the tubes, and harvesting the product would all be automatic.

Recently engineers of the Arthur D. Little Company of Cambridge, Mass., surveyed the financial aspects of these proposals. The engineers based their studies on a hypothetical 100-acre farm that would use some 63 acres as growth areas.

Counting all the automatic machinery, it was estimated that the 100-acre farm would cost \$3,220,000. The farm would produce some 35 tons of dry algae per acre per year



Research apparatus measures the gases given off by the dried algae after treatment for use as a fuel

at a cost of 25 cents per pound. With certain economies and further research it was thought that this cost could be reduced and that the algae could be produced at a profit if sold at 25 cents per pound.

However, some cheap proteins such as yeast cost even less. The final conclusions of the engineers were that commercially grown algae can't compete with cheaper proteins at present, but that eventually the algae may become a major factor in the world's food supply.

Meanwhile some entirely different studies were being made at the University of California. Harold B. Gotaas, professor of



Extracting algae from water with separator, above, is not as economical as chemical precipitation method

sanitary engineering, Wm. J. Oswald, assistant research engineer, and Clarence Golueke, assistant research biologist, teamed up to investigate a phenomenon that sometimes occurs in sewage ponds. These ponds are areas in which sewage is stored until natural bacterial action has converted wastes into harmless materials.

It had been observed that in some ponds the conversion process took place much more rapidly than in others. These special ponds had one thing in common: All of them supported flourishing growths of green algae. It was speculated that the

(Continued to page 262)

Model of a pilot plant designed for use in desert areas where algae would be produced with a minimum of water

Photograph from Arthur D. Little, Inc.

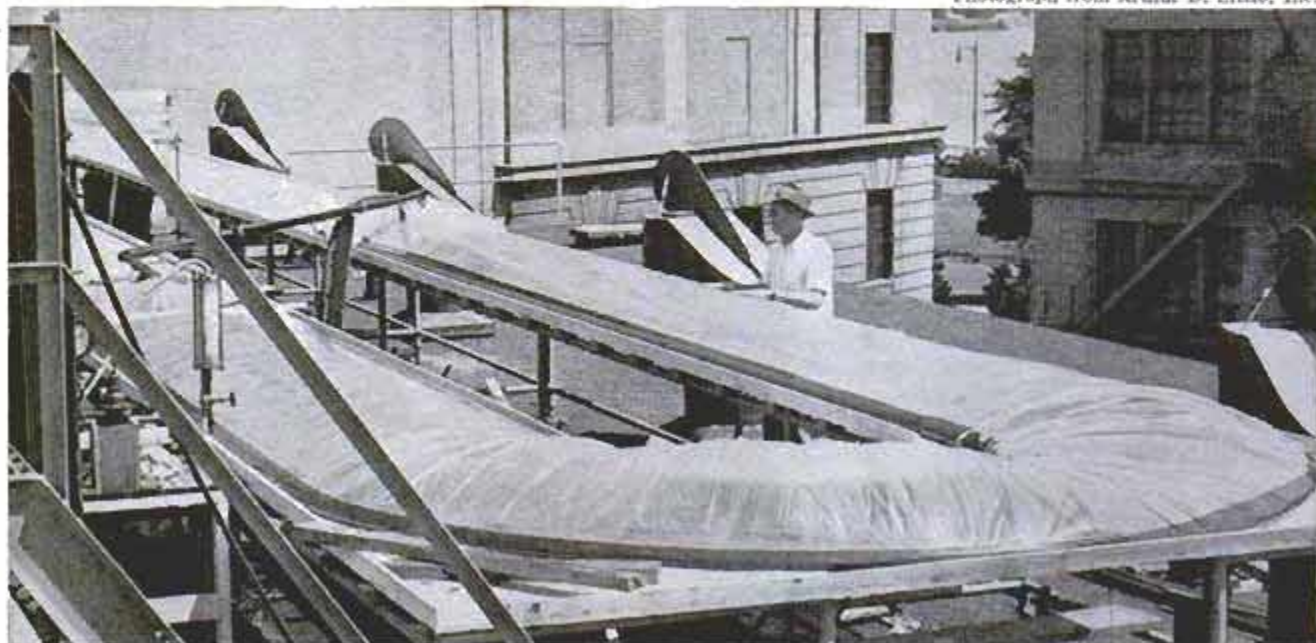

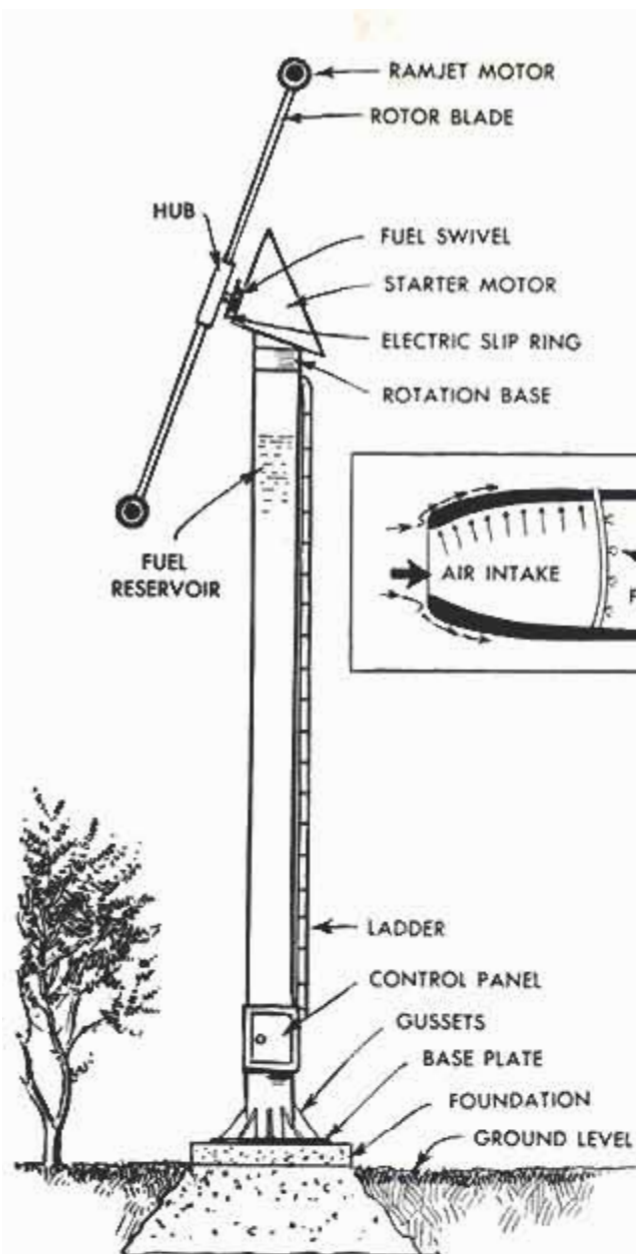

Ramjet Helicopter Rotor Chases Frost From Citrus Groves

Frost is kept from 10 to 15 acres of citrus trees by a ramjet helicopter rotor mounted on a 35-foot tower. The small rotor-tip jet engines release heat to warm the air as they turn the rotor to create an air blast. The cylindrical tower acts as a standpipe to hold 680 gallons of fuel oil or gasoline to feed the ramjets at a maximum rate of 105 gallons per hour. Below 26 degrees, the

rotor would turn almost all the time. The wind machine is operated by touching a starter button, switching on a spark plug and dialing a fuel knob for the desired heat. A truck starter mounted atop the tower revs up the rotor to operating speed. The unit, not in production, was designed by Hiller Helicopter engineer Joseph Beckett.

Sports Timer for Rallies

Auto enthusiasts who take part in rallies will appreciate a mechanical copilot that tells the driver whether he is ahead or behind schedule. There are two dials on the instrument. The driver sets one dial to the average speed he must maintain to keep his schedule. The other dial, consisting of a clock and a third-hand indicator, informs him how much ahead or behind schedule he is at that moment.

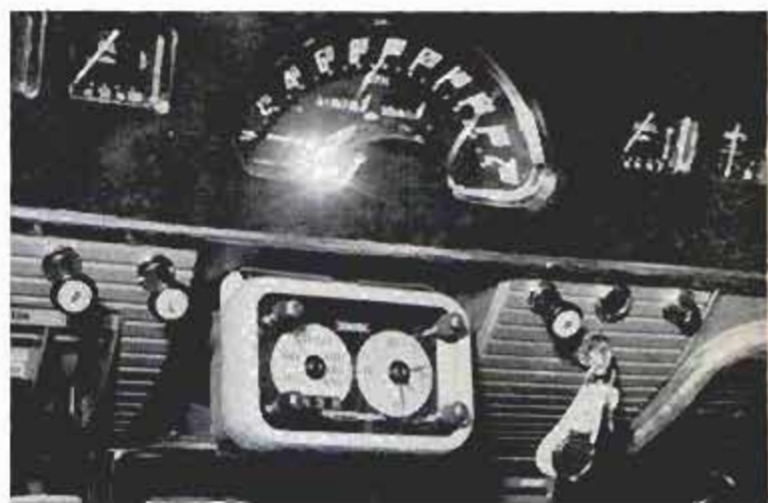



Redwood log is held by one tractor, while second prepares to drive wedge

Here's How to Split A Giant Redwood

By Lola Ann Weaver

Specially made steel wedge is mounted on a U-frame that fits over shaft of winch, which lowers it into place



LOGGING a redwood forest presents problems not found in forests of smaller trees, the Ladew Timber Company of Orick, Calif., found when they began operations among the giants. Because of the load limits, most redwoods are too large to haul even over our modern highways. They must usually be split and hauled in sections. A truck loaded with a smaller-diameter redwood can sometimes add half of another without being overloaded. The result is a great many trees being split in the woods. Blowing them apart with dynamite, sawing them lengthwise, sledging and hand wedging or picking them up and dropping were methods that not only wasted time, but the split couldn't be controlled and a valuable log might be damaged.

By fabricating a steel wedge and installing it on the rear of a big crawler tractor, these loggers found a simple remedy for this problem. It is made of one-inch by eight-inch steel stock 40 inches long — sharpened to a knife edge. It rotates on a three-inch swivel shaft and is mounted on a U-frame of one by eight-inch steel stock which fits over the shaft of the logging winch. The winch cable is used to lower the wedge into splitting position or raise it out of the way when the tractor is used for other duties. If the winch cable is needed for bringing in logs, it can be unhooked from the wedge.

In operation the redwood to be split is held in the arch of a companion tractor. The wedge is swiveled and can be raised or lowered so the split will occur exactly where required when the wedge is forced into the end of the log. ★ ★ ★

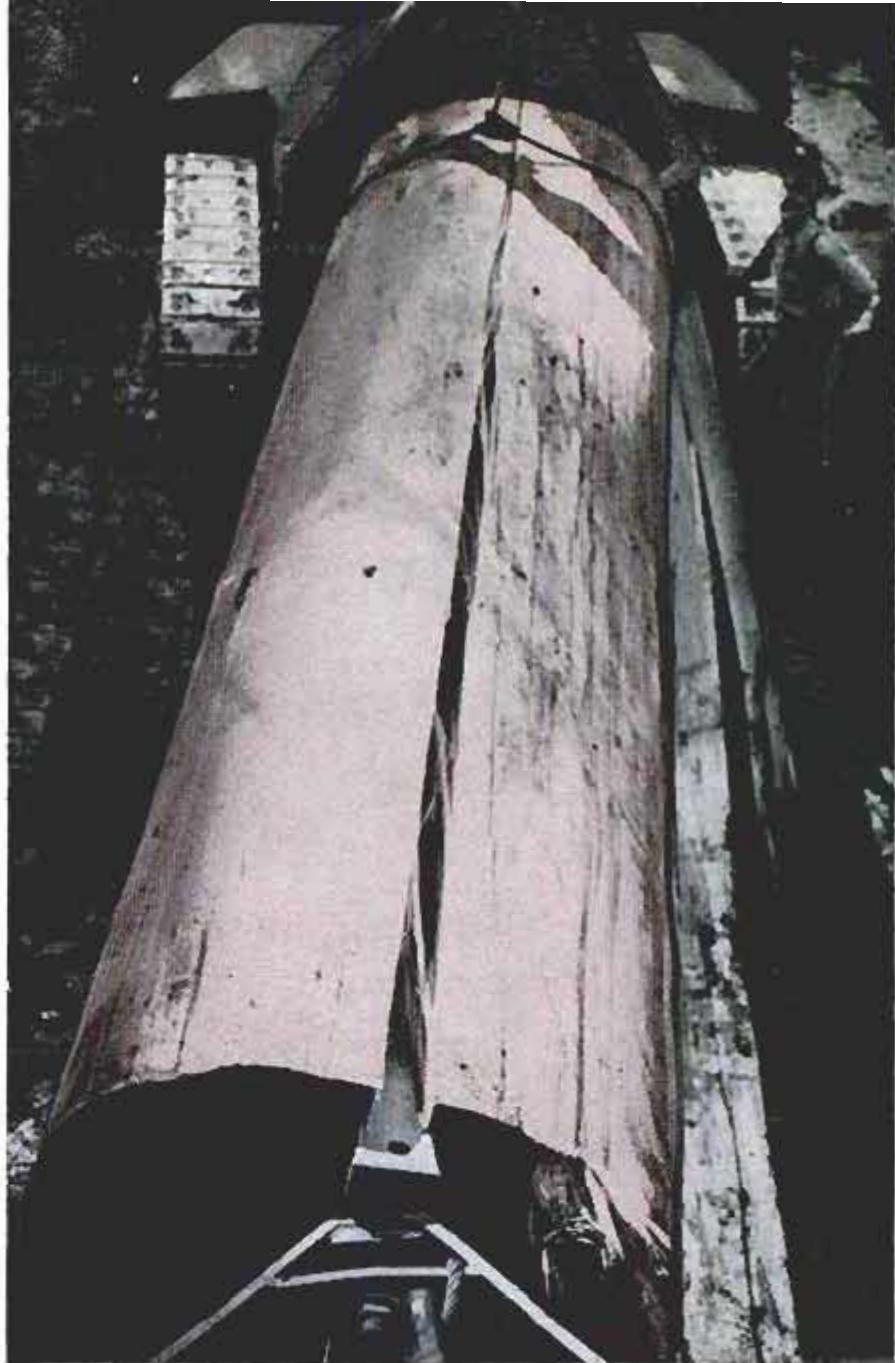

Split in redwood log can be controlled accurately when wedge is used. Older methods for splitting included blowing log apart with dynamite, picking it up and dropping it, and sawing; these took longer, damaged logs



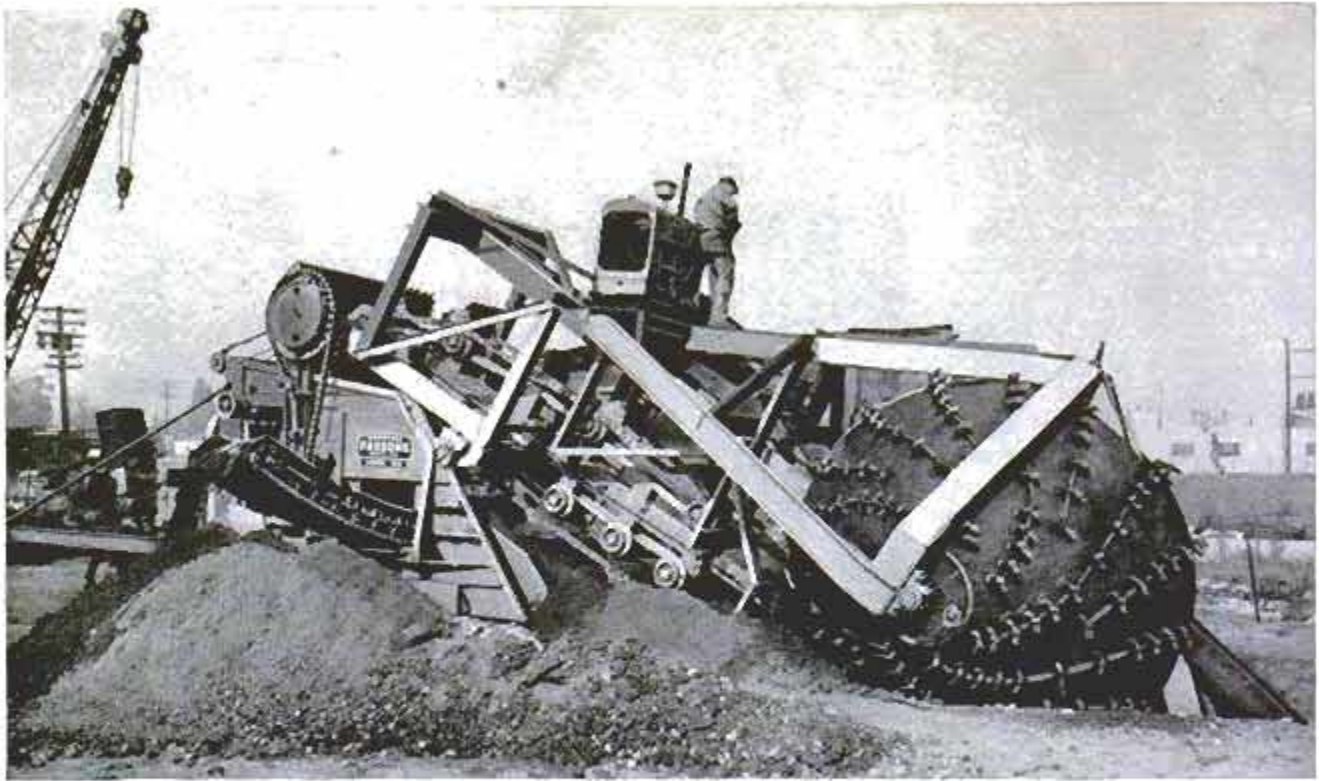

Spiked-Cone Ditch Digger Gouges Trench Four Feet Deep

Two giant steel cones with rows of sharp teeth rotate to scoop earth onto the conveyor of an irrigation-ditch digger. The

digger cuts a narrow trench four feet deep. It is expected to speed ditch construction on a project in California.

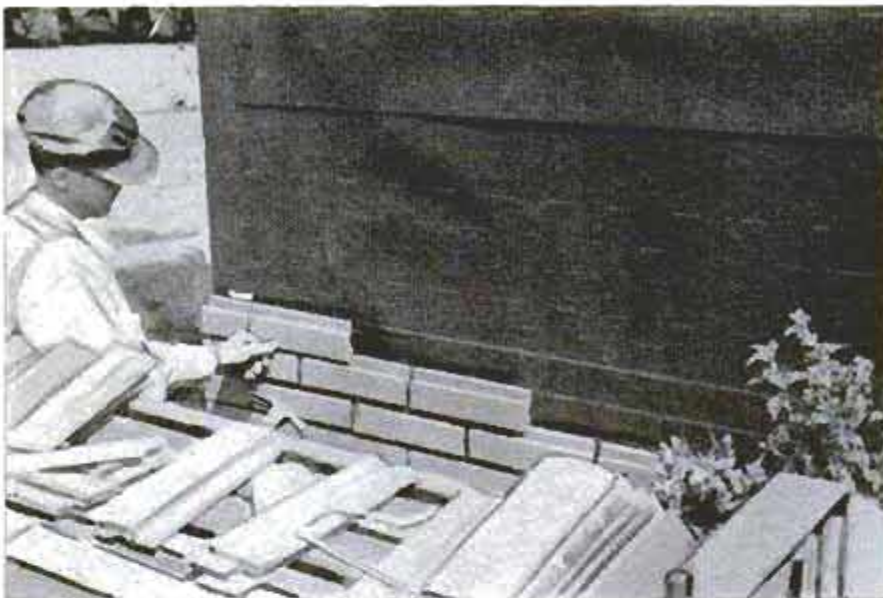

Facing goes on quickly, can be applied by amateur. Below, finished house



Nail-On Bricks Look Authentic

You can "lay" a new brick facing accurately and speedily with hammer and nails. Made of hard-burned ceramic clay, the ~~2 1/2 inch~~ thick veneer comes predrilled for the nails. After the first course is laid, the succeeding courses are self-aligning. The hard, vitrified surface of the brick is impervious to moisture and can be wiped clean as easily as a wall tile. A masonry saw or guillotine cutter is used to make the bricks fit around doors or windows. The joints are automatically sized. Mortar is applied to joints to complete the realistic effect of the ceramic facing.

When framing pictures, you can now employ a special nonreflecting glass that permits better visibility from any angle.

Plastic-Foam Floats are Boat Landings and Swim Rafts

High buoyancy is a feature of a prefabricated marine float made of foam plastic. Each cubic foot of the plastic has a lift factor of 55 pounds. The float, which comes in various sizes, is clad in a wooden shell and is available as a complete unit as well as in knockdown form, assembled from a kit. Five by 10-foot, 6 by 12-foot and 20 by 30-foot floats are being made for use by swimmers and as boat landings. Skids on the bottom ease the job of launching and removing the floats from the water.



Helicopter-Liner Carries 25 Persons

New York Airways is negotiating with the Bell Aircraft Corporation for delivery of Bell's projected D-216 passenger-carrying helicopter. Now on the drawing boards, the helicopter is designed to carry 25 passengers and all forecasts indicate it will reduce operating costs to about 10 cents per available seat mile. Powered by three gas-turbine engines, the D-216 will provide the first "one engine out" performance for a helicopter, since any two of its three engines will

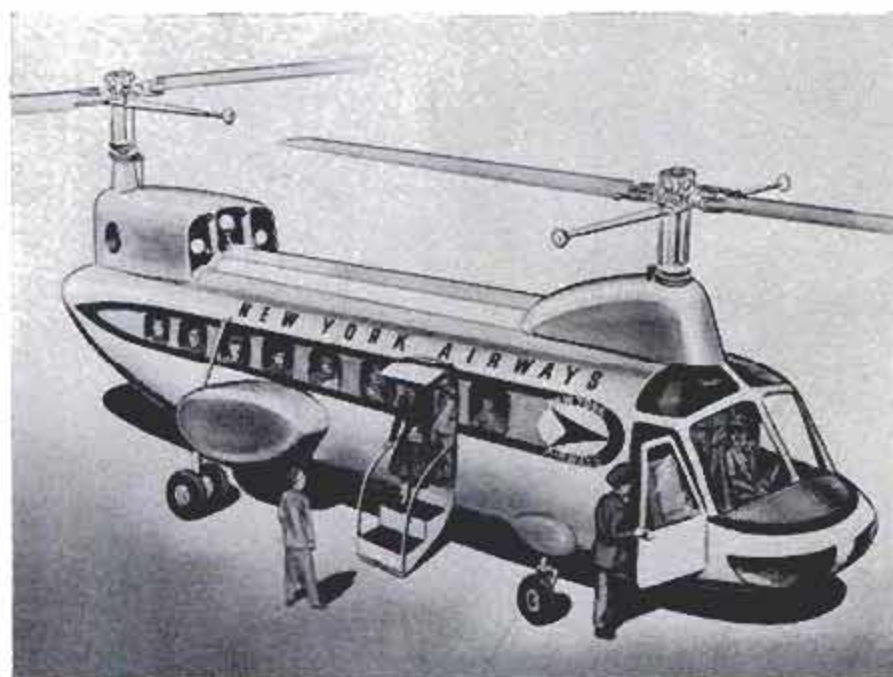

deliver sufficient power to lift its maximum payload. First deliveries of the D-216 can be made within 36 months after contracts are signed.

Auto Burglar Alarm

Set off by any drastic movement of the car body, a burglar alarm sounds the horn automatically, frightening thieves away. Two mercury switches are used to trigger the alarm. One is mounted to the underside of the hood, the other to the underside of the trunk lid. If either is raised, the horn is set in operation. Should the thief jack up the car to steal a tire or wheel, the alarm sounds. Installation is simple. A dash-mounted switch cuts the system when its protection is not needed.

☐ Bogota will be the site of Colombia's first laboratory center devoted specifically to technological research in industry, agriculture and mining.

Pencil Serves as Gauge

You can use a mechanical pencil made in Germany as a handy gauge to measure the size of bolts and other small objects. The pencil clip fastens to a sliding jaw that snugs up against the object being measured. The pencil, plated in chromium, silver or gilt, has a four-inch measuring scale as well as a metric measuring scale.



Their Job Is to Guard Your Health

BY
GEORGE LAYCOCK

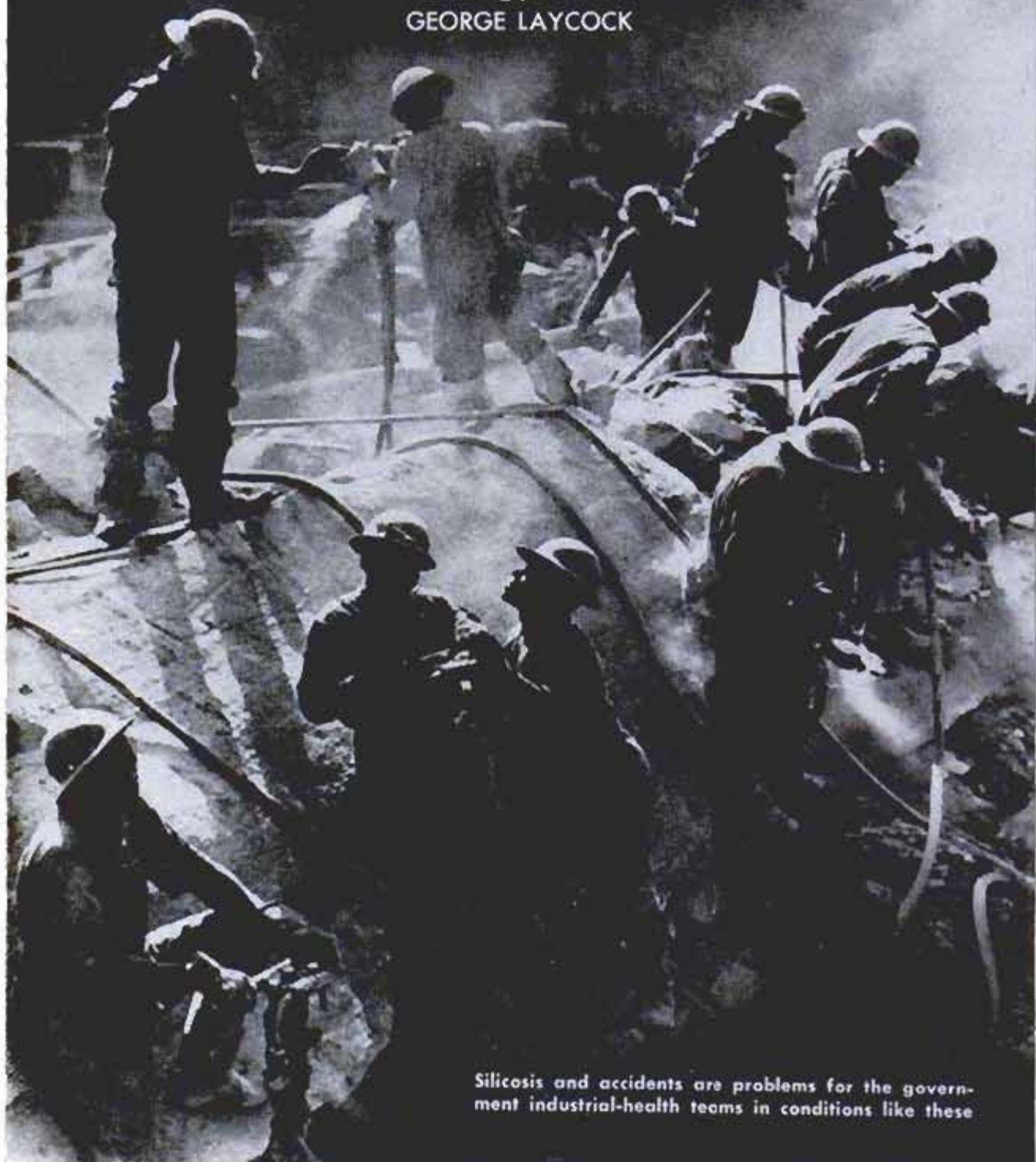

Silicosis and accidents are problems for the government industrial-health teams in conditions like these

YOU MAY NOT REALIZE IT as you go about your daily work, but it's a big job to guard the health of America's working force. Our industry has grown increasingly complex. Whole new industries have blossomed. Men are working with more new materials and chemicals than ever before. And every job in American industry has its hazards.

Protecting the workman's health has become a profession in itself. Whole laboratories, staffed with specialists and equipped with the latest scientific devices, are the scenes of research aimed at making your job safer. Some of these laboratories are operated by industry, some are privately operated, some are government research programs. In Cincinnati, for instance, is the federal government's Occupational Health Field Headquarters, the government's center of industrial-health research for the whole country. Here some 70 physicians, industrial hygienists, chemists, engineers and technicians labor in the search for ways to make industrial jobs safer.

Recently two of the nation's largest railroad companies called on the Department of Health, Education and Welfare to help them solve a problem. Company officials were concerned by an increase in skin poisoning among their shop workers. Sores on hands and arms were causing discomfort and loss of time and efficiency. The request



Microphone (red circle) in noisy factory picks up sound for recording on tape for laboratory study

Study of mining dust is made at site by government health inspectors in the fight to stop silicosis





Firestone News Service photo

Industrial hygienist for rubber company takes sample of dust near workman who applies pigment to tires

was passed on by Washington to the field headquarters in Cincinnati.

A few days later a small team of specialists showed up in the shops. After some detective work they traced the trouble to chromate being added to diesel radiators as a rust preventive. The solution is also widely used in air-conditioning systems.

Before they left the scene the industrial-health specialists had laid down a program

to clear up the chromate poisoning. They suggested that the shops substitute a different rust inhibitor, one without chromate. They also recommended that the workmen use a milder cleansing agent on their hands and arms and that they wash more often. As final insurance they suggested protective gloves and sleeves, as well as protective ointments for the workmen exposed to poisons. The trouble was cured.

Exposure chambers in government laboratory house animals exposed to polluted air of factory atmosphere

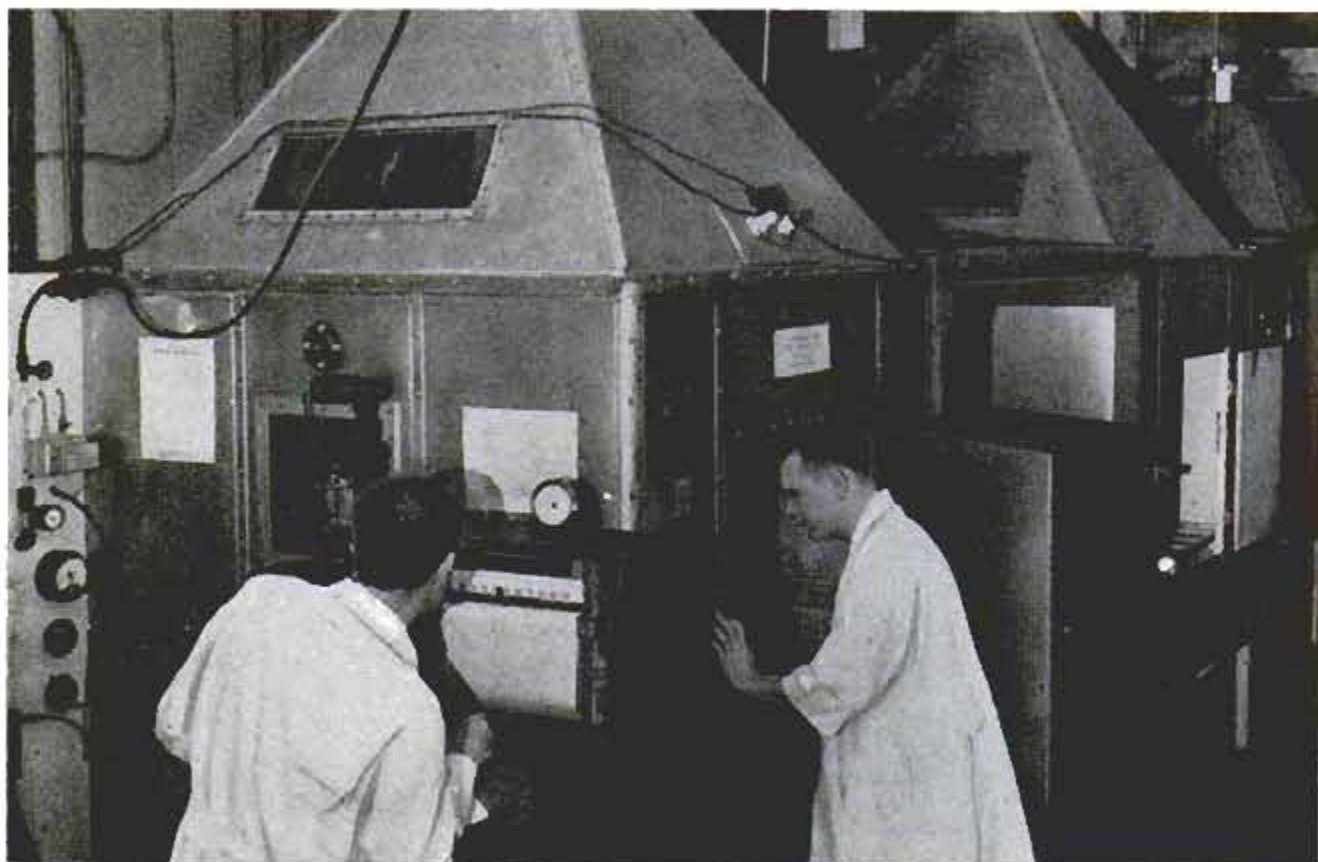

These specialists are accustomed to measuring and working with infinitesimal amounts of poisons. For instance, if they're measuring carbon monoxide in the air they know that the maximum safe level is 100 parts per million for eight hours' exposure. Rates of poisoning which to the average workman seem harmless are known by industrial-health workers to be hazardous.

The problems these industrial-health specialists cope with come in wide variety. Not long ago Juan A. Gonzalez, of Puerto Rico's Department of Health, shipped off to Cincinnati some seeds from a native plant called Indian licorice. Mr. Gonzalez was worried lest the seeds were poisonous.

And this might well concern him. Native Puerto Rican artisans were fashioning the seeds into costume jewelry, especially earrings, which were being sold to American women. If they were poisonous, both the workers and buyers were taking a chance.

At the Occupational Health Field Headquarters, samples of the highly polished and colorful seeds were fed to rabbits, dogs and rats. Within 24 hours one of the test rabbits was dead and the other animals were seriously ill. Newspapers across the country carried the story and the poison-bearing costume jewelry disappeared from the market.

500 Million Days Lost

But most of their research efforts are aimed at industrial plants, mines and agriculture. As our industrial technology has grown so has our need for better protection for the workman's health. American workmen lose about 500 million man-days a year to sickness and injury. This represents a loss of billions of dollars to both workmen and industry.

Industrial-health experts estimate that only about one out of every four American workmen labors in a plant that has a good medical program.

The Department of Health, Education and Welfare estimates that there are some 22,000 well-defined occupations. Three fourths of these call for working with machinery or dangerous substances. The carpenter carrying wood, or the office worker using a duplicating fluid, may suffer a skin disease. The machine worker may be injured by the cutting oils he uses. The stonecutter or miner may suffer silicosis which is caused by breathing quartz dust. Grocers, cannery workers and meat packers sometimes contract skin ailments from the materials they handle. The life guard at the neighborhood swimming pool may contract a fungus disease from the water.

The variety of occupational troubles makes a long and growing list. But most of

(Continued to page 256)



Woman operator of sand slinger wears a protective dustproof nose guard and goggles. Below, workman in rubber tank breathes fresh air piped to helmet





Wood Arches 294 Feet Long Glued Together in Shop

Wood arches 294 feet long—a record length—and nearly eight stories high at their center span a clear distance of 242½ feet to support the four-inch wood roof of a new building near West Palm Beach, Fla. The arches, “shop grown” in Arkansas by

gluing and molding together ordinary sizes of lumber, were manufactured and shipped in four sections, then joined at the Riviera Beach, Fla., building site. They vary in depth from 26 inches at the base to 46 inches at the point of maximum stress.



Navy Helicopter Used for Mine Sweeping

Navy tests have shown that the use of the helicopter as a mine sweeper is a major contribution to the solution of its problem of keeping sea lanes open. During the tests, an HSL-1 helicopter towed a 300-ton salvage derrick about the water with ease. When modified for mine sweeping, the HSL-1 will permit aerial sweeping of large areas with much greater safety for both personnel and equipment.

Please Pass the TV Signal

Airliners crossing the Atlantic could be the vehicles for transmitting London telecasts to New York television viewers and vice versa under a system patented recently by a New Jersey man. The TV signals would be relayed from plane to plane and would require departure of 24 transoceanic planes daily from New York and London at one-hour intervals. Patent rights have been assigned to Bell Telephone Laboratories, which have no plans for it at present.

Soviet Fleet Ranks No. 2



OF THE THREE largest naval fleets in the world today, the Russian navy is now numerically in second place, far inferior to the United States fleet, but considerably larger in numbers than that of Great Britain. The Russian fleet is an attacking force, whereas the U. S. Navy is equipped for both attack and defense, and the British navy is primarily a defense fleet.

There are great differences in the composition of the three fleets. Both the United States and Britain have fine modern aircraft carriers in some numbers, for example, while the Russians have not commissioned a single vessel of this type. Their big fleet of new-type heavy cruisers of the Sverdlov class is designed for attack and for commerce raiding, and not for action against their opposite numbers in the United States fleet, or the smaller, older ships of the British navy. Russian destroyers of the Skoryi class are fine modern ships, fast and well armed, and are designed to lay mines as well as perform the other duties of their class. The mines are released through doors in their square sterns.

The most numerous type of ship flying the naval ensign of the Soviets is their mighty fleet of underwater craft. The number of submarines possessed by Russia is a closely guarded secret, but it is well known that recently a considerable number of very large ocean-going types with a submerged displacement of 2900 tons, a length of 320 feet and a cruising range of 20,000 miles, has been built. In addition to this type, a large number of the smaller seagoing patrol type of 1600 tons submerged displacement with good speeds both on the surface and submerged is being built.

It is generally known that at the moment

the Russians have about 100 undersca boats in various stages of construction. Conservative estimates say she has well over 400 subs in commission—and the estimates run all the way to 800. Some of these are obsolete and of little fighting value.

Russia's battleships, at least two of her cruisers and several of her destroyers also are victims of obsolescence. That is why the Russians could boast not long ago that they were reducing the size of their fleet. Most of these old ships could be pruned out early and sent to the scrap heap without impairing the fighting efficiency of the fleet.

Frigates are the most numerous type of vessel in the British navy today, a popularity earned as a result of the splendid work done by this type of ship during World War II. In the U. S. Navy, frigates and patrol ships doing similar work reach a total of at least 311 vessels of all sorts and sizes. A considerable number of the fast frigates flying the white ensign of the British navy are converted destroyers which have raised freeboards for improving their sea-keeping qualities—which partially explains the scarcity of destroyers in the British navy.

The Russians have neither a large nor an up-to-date fleet of frigates, their boats being largely ex-enemy vessels and small patrol boats. Rumors say that two new types are under construction, but it is obvious that in a navy designed for attack, the frigate and the seagoing patrol vessel can have but a small role to play.

The paintings on the following pages, made especially for *Popular Mechanics Magazine* by G. H. Davis in England, give an approximation of the numbers of the main classes of fighting ships in the Soviet navy today. ★ ★ ★

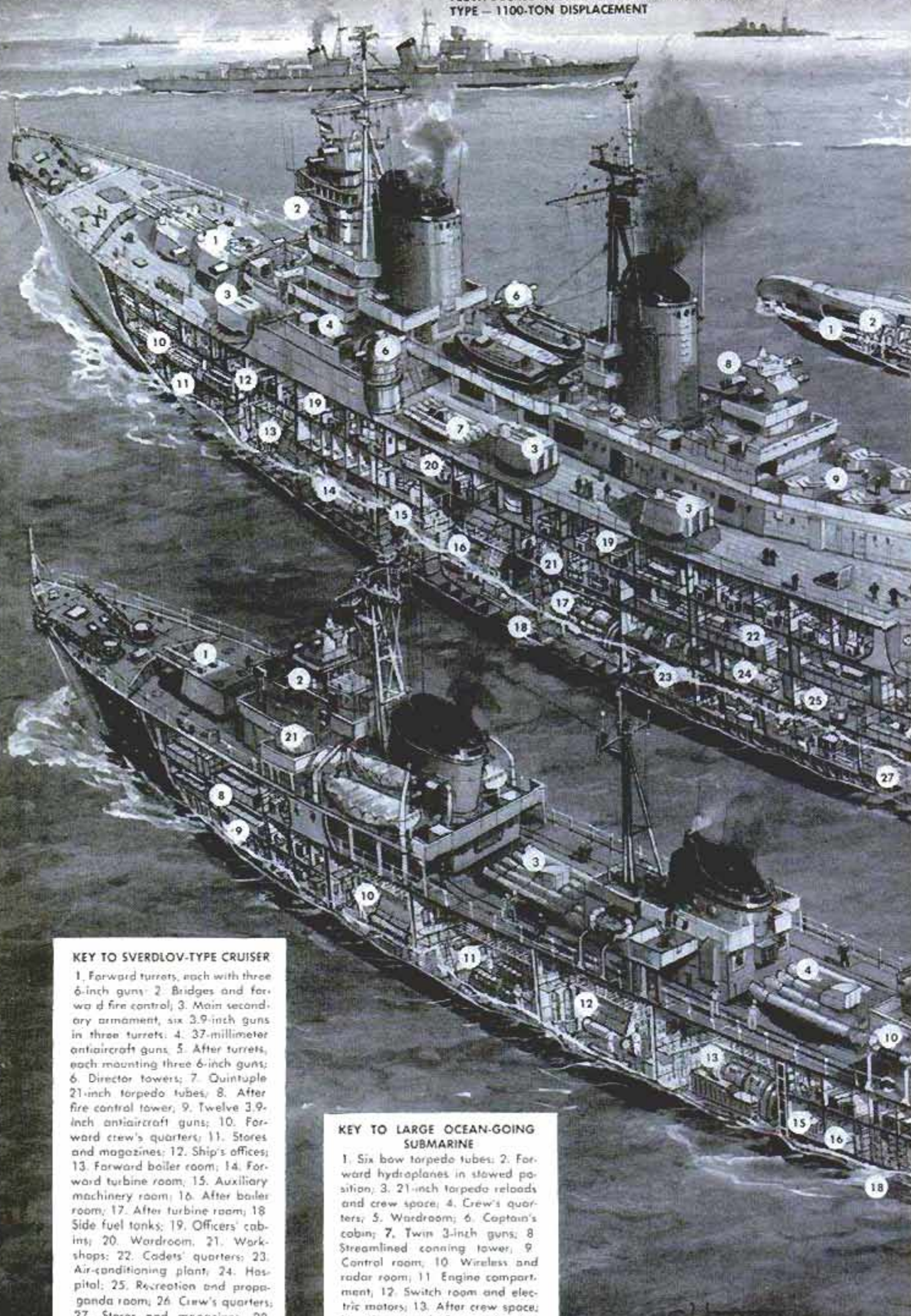

KEY TO SVERDLOV-TYPE CRUISER

1. Forward turrets, each with three 6-inch guns; 2. Bridges and forward fire control; 3. Main secondary armament, six 3.9-inch guns in three turrets; 4. 37-millimeter antiaircraft guns; 5. After turrets, each mounting three 6-inch guns; 6. Director towers; 7. Quintuple 21-inch torpedo tubes; 8. After fire control tower; 9. Twelve 3.9-inch antiaircraft guns; 10. Forward crew's quarters; 11. Stores and magazines; 12. Ship's offices; 13. Forward boiler room; 14. Forward turbine room; 15. Auxiliary machinery room; 16. After boiler room; 17. After turbine room; 18. Side fuel tanks; 19. Officers' cabins; 20. Wardroom; 21. Workshops; 22. Cadets' quarters; 23. Air-conditioning plant; 24. Hospital; 25. Recreation and propaganda room; 26. Crew's quarters; 27. Stores and magazines; 28. Fuel-oil tanks in double bottom

**KEY TO LARGE OCEAN-GOING
SUBMARINE**

1. Six bow torpedo tubes; 2. Forward hydroplanes in stowed position; 3. 21-inch torpedo reloads and crew space; 4. Crew's quarters; 5. Wardroom; 6. Captain's cabin; 7. Twin 3-inch guns; 8. Streamlined conning tower; 9. Control room; 10. Wireless and radar room; 11. Engine compartment; 12. Switch room and electric motors; 13. After crew space; 14. After torpedo flat; 15. Snorkel stowed

NEW TYPE FLEET DESTROYER, FLUSH-DECK,
WITH 2100-TON DISPLACEMENT

SEAGOING PATROL SUBMARINE MAKES OVER 20 KNOTS
SURFACED AND 16 SUBMERGED. DISPLACES 1600 TONS

LARGE OCEAN-GOING SUBMARINE OF THE LATER "K" CLASS
DISPLACES 2900 TONS, HAS RANGE OF 20,000 MILES. MAKES
22 KNOTS ON SURFACE, 17 KNOTS SUBMERGED

LATEST TYPE OF HEAVY CRUISER, SVERDLOV CLASS, DISPLACES
17,000 TONS. IT IS 689 FEET LONG, HAS RANGE OF 8000 MILES
AT 20 KNOTS. DEVELOPS 130,000 HORSEPOWER AT 35 KNOTS

**KEY TO SKORYI-CLASS
DESTROYER**

- 1 Forward turret, twin 5.1-inch guns; 2 Bridge and forward fire control; 3 Forward quintuple 21-inch torpedo tubes; 4 After quintuple 21-inch torpedo tubes; 5 After fire control; 6 After 3-inch gun turret; 7 After turret, twin 5.1-inch guns; 8 Crew's quarters; 9 Stores and magazines; 10 Forward boiler room; 11 Forward turbine; 12 After boiler room; 13 After turbine; 14 Officers' cabins; 15 Fans; 16 Cold-storage rooms; 17 Storerooms and magazines; 18 Fuel-oil tanks in double bottom; 19 Fresh-water tanks; 20 Mine doors; 21 Forward 3-inch gun turret

MODERN DESTROYER OF SKORYI CLASS (U.S.S.R. HAS AT LEAST 70
OF THESE) DISPLACES 3000 TONS FULLY LOADED, DEVELOPS 70,000
HORSEPOWER AT 38-40 KNOTS, IS 393½ FEET LONG

U.S.A.
14 14+3 BATTLE CRUISERS

BATTLESHIPS

1 SHIP "NOVOROSSISK" (EX-ITALIAN)
23,622-TON DISPLACEMENT



U.S.A.
23 OVER 10,000-TON
DISPLACEMENT

CRUISERS

22 SHIPS SVERDLOV CLASS,
17,000-TON LOADED DISPLACEMENT



U.S.A.
50 UNDER 10,000-TON
DISPLACEMENT

7 SHIPS OF KIROV CLASS, 8800-TON STANDARD DISPLACEMENT

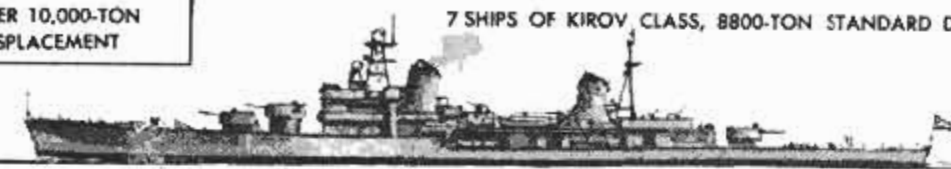

1 SHIP "ADMIRAL MAKAROV" (EX-GERMAN)
7600-TON STANDARD DISPLACEMENT



U.S.A.
349

24 SHIPS, NEW FLUSH-DECK ESCORT
TYPE 1100-TON DISPLACEMENT

OVER 70 VESSELS OF SKORYI
TYPE, 2200-TON DISPLACEMENT

DESTROYERS



22 VESSELS R AND S TYPES
DISPLACEMENT 1800 TONS

7 VESSELS G CLASS, 1500 TONS



2 VESSELS, EX-ITALIAN ARTIGLIERE CLASS
1730-TON STANDARD DISPLACEMENT

7 LENINGRAD CLASS
1800-TON DISPLACEMENT



U.S.A.
208

NEW CONSTRUCTION
VERY LARGE OCEAN-GOING TYPE
2900 TONS SUBMERGED

AT LEAST 100 BOATS
OF VARIOUS TYPES ARE
UNDER CONSTRUCTION

NEW CONSTRUCTION
IMPROVED K CLASS
2200 TONS SUBMERGED

SUBMARINES



NEW CONSTRUCTION
SEA-GOING PATROL TYPE
1100 TONS SUBMERGED
CONSIDERABLE NUMBER BEING BUILT

12 BOATS, EX-GERMAN TYPES,
1200 TONS SUBMERGED

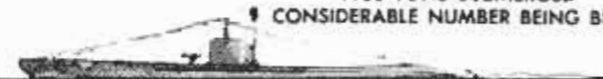

24 BOATS OF THE L MINE-LAYING CLASS,
1400 TONS SUBMERGED

72 BOATS, EARLY M CLASS,
200-300-TON DISPLACEMENT

NEW CONSTRUCTION,
EXPERIMENTAL MIDGET
SUBMARINES, NUMBER UNKNOWN

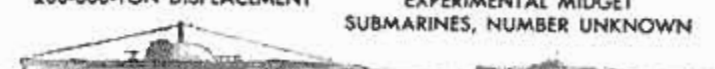

U.S.A.
311

NEW CONSTRUCTION,
FAST DEEP-SEA FRIGATES
(NUMBER UNKNOWN)

BERKUT CLASS

FRIGATES

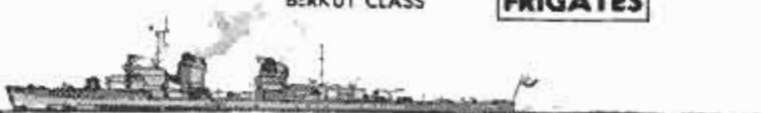

U.S.A.
242

COAST DEFENSE VESSELS
VYBORG (EX-FINNISH) 3900 TONS

14 VESSELS, EX-GERMAN M-3 CLASS
700-TONS

MINE

TRAWLER TYPES IN
CONSIDERABLE NUMBERS

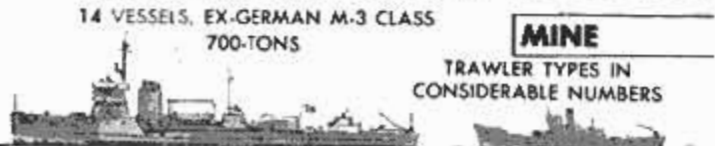

LARGE MINE LAYER, "MARTY,"
6900 TONS

NUMEROUS EX-JAPANESE TYPES
OF VARYING DISPLACEMENTS

NEW
CONSTRUCTION **MINE**



2 OLD SHIPS "SEVASTOPOL"
AND "OKTYABRSKAYA
REVOLUTSIYA,"
ABOUT 23,600-TON
DISPLACEMENT

BRITAIN
5



5 SHIPS, TCHAPAYEV CLASS,
11,500-TON STANDARD DISPLACEMENT

OVER 10,000-TON
DISPLACEMENT **BRITAIN**
1



1 SHIP "STALINGRAD" (EX-ITALIAN),
7527-TON STANDARD DISPLACEMENT

UNDER 10,000-TON
DISPLACEMENT **BRITAIN**
22



2 OLD CRUISERS, KRASNI-KAVKAZ CLASS
DISPLACEMENT ABOUT 7000-8000 TONS



NEW FLUSH-DECK FLEET DESTROYERS,
STANDARD DISPLACEMENT 2100 TONS,
NUMBER UNKNOWN

1 SHIP, LARGE EX-JAPANESE,
2701-TON DISPLACEMENT

BRITAIN
76



2 V CLASS VESSELS,
200-TON DISPLACEMENT

11 VESSELS S CLASS,
1686-TON STANDARD DISPLACEMENT



6 SHIPS, EX-GERMAN TYPES
OF VARYING TONNAGE

5 OLD BOATS OF URITSKI CLASS,
1150-TON STANDARD DISPLACEMENT



19 BOATS K CLASS,
2062 TONS SUBMERGED

EARLY K CLASS,
NUMBER UNKNOWN

BRITAIN
59



5 BOATS, EX-GERMAN SEEHUND CLASS,
800-1000-TON DISPLACEMENT

72 BOATS CHUKA CLASS,
700-800 TONS SUBMERGED



91 BOATS OF LATER M CLASS
300 TONS SUBMERGED

1 EX-ITALIAN BOAT, 900 TONS SUBMERGED



ESCORT AND PATROL VESSELS

90 PATROL BOATS, KRONSTADT CLASS,
300-TON DISPLACEMENT

MANY EX-GERMAN, ITALIAN
AND JAPANESE FRIGATES
1250 TO 2000 TONS

4 EX-JAPANESE
ESCORT
DESTROYERS

BRITAIN
202



SWEEPERS

A NUMBER OF EX-GERMAN,
JAPANESE AND ITALIAN
TYPES IN USE

40 VESSELS,
FUGAS CLASS

100 COASTAL SWEEPERS
OF THE T-301 CLASS

BRITAIN
315

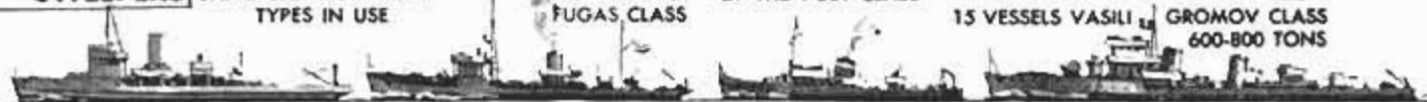

LAYERS

FAST MOTOR
TORPEDO BOATS

MANY RUSSIAN-BUILT
AND EX-JAPANESE
SUBMARINE CHASERS

MOTORBOATS

NUMEROUS MOTOR GUNBOATS OF
VARIOUS TYPES

NEW CONSTRUCTION
MANY LARGE, FAST
MOTOR TORPEDO BOATS



A LARGE NUMBER OF OTHER TYPES ARE CAPABLE OF MINE LAYING



Three-Wheel Car Gets 80 Miles Per Gallon

You can go 70 miles per hour in the Star, a three-wheel car that gets up to 80 miles per gallon of gas. Built by an American firm, it is powered by a one-cylinder German engine. The streamlined body is made of molded glass fiber. Less than three feet high, it is 10½ feet long, 50 inches wide and weighs only 400 pounds.

With two seats and an open deck at the rear for luggage, three-wheel car has body of molded glass fiber

Type Changed With Tweezers On Versatile Typewriter

One typewriter that features interchangeable type can now do the work of several machines. The interchangeable type, available with mathematical signs, chemical symbols, foreign-language symbols, special type fonts, company trade marks or other special-order symbols, can be inserted quickly by the typist. With tweezers, the typist removes the old type from the type bar, selects a new type and locks it in place. A spring-retainer clip on each type block locks the block into place in accurate alignment. The new, versatile typewriter has a 44-character keyboard and provides four extra characters with section and paragraph marks, a plus sign and an equal sign.

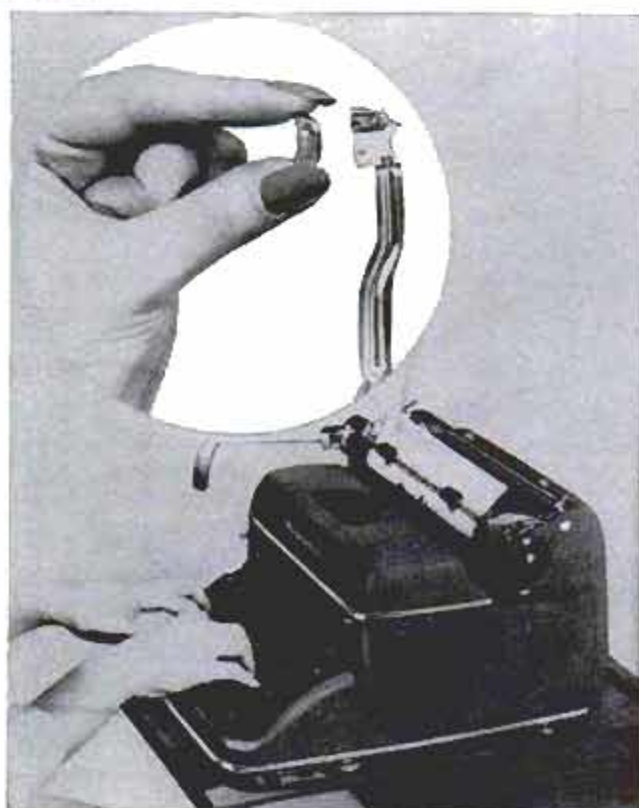

Book Aquarium

Latest thing in children's books is one containing a flat, plastic, water-filled aquarium containing artificial fish. One page holds the aquarium. By changing the other pages, the young viewers see a different underwater scene. The novelty was shown at the Frankfurt, Germany, Spring Fair.

¶ A Japanese-language telegraph printer patented in the United States is designed to print more than 2300 characters.

Grooved Fluorescent Lamp Twice as Bright

Light output of a new grooved fluorescent lamp is twice that of present lamps of the same length. The new, higher-wattage lamp maintains the same efficiency as the older lamps but increases the concentration of light. The grooves increase the area of lighted tube surface and decrease the absorption of light by mercury vapor inside the tube, allowing more radiation to escape. Designed for new installations only, the lamp requires different ballast equipment and a different fixture. The standard 200-watt tube is eight feet long, but four-foot lamps

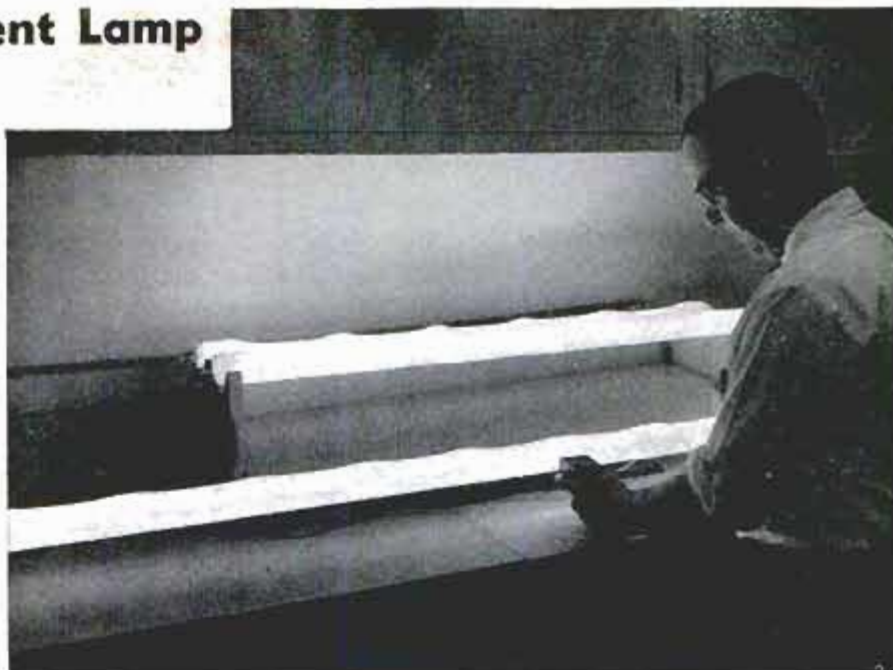

will be made and six-foot lamps may be developed for street lighting. Other uses will include outdoor floodlighting and signs.

High-Temperature Lubricants Developed for Aircraft

Making another assault on the thermal barrier, General Electric Company has announced that its chemists are on the verge of finding high-temperature aircraft lubricants that will operate between 1000 and 2000 degrees, F. The upper limit in present-day lubricants is around 500 degrees in hydraulic systems and 350 degrees in bearings. The biggest problem facing the chemists working with the new compounds is that, while they flow at red heat, they freeze at around 400 degrees—the point where other lubricants boil.

Cube Measures Mercury Density

Fifteen London scientists have constructed a nearly perfect cube of tungsten-carbide with cobalt to measure the density of mercury. The 22-pound, 3½-inch-square cube, which has “no fault that affects its volume by as much as one part in 100 million,” is floated in mercury during the measuring process. It was polished with diamond dust. During the last stages, it was submerged just below the surface of melted paraffin. Differences in light reflections enabled the scientists to make contour maps of the face with contours at an interval of 1/1,000,000 inch.

Transport “Propelloplane”

Army officials are studying drawings of a proposed “Propelloplane” transport that could land a large number of troops in a small jungle clearing or on a tiny mountain plateau. The plane, equipped with Pogo-type propellers, would employ a pivoting wing to take off, land and hover like a helicopter. Once in the air, the wing would assume a conventional horizontal position. The design was by Hiller Helicopter.

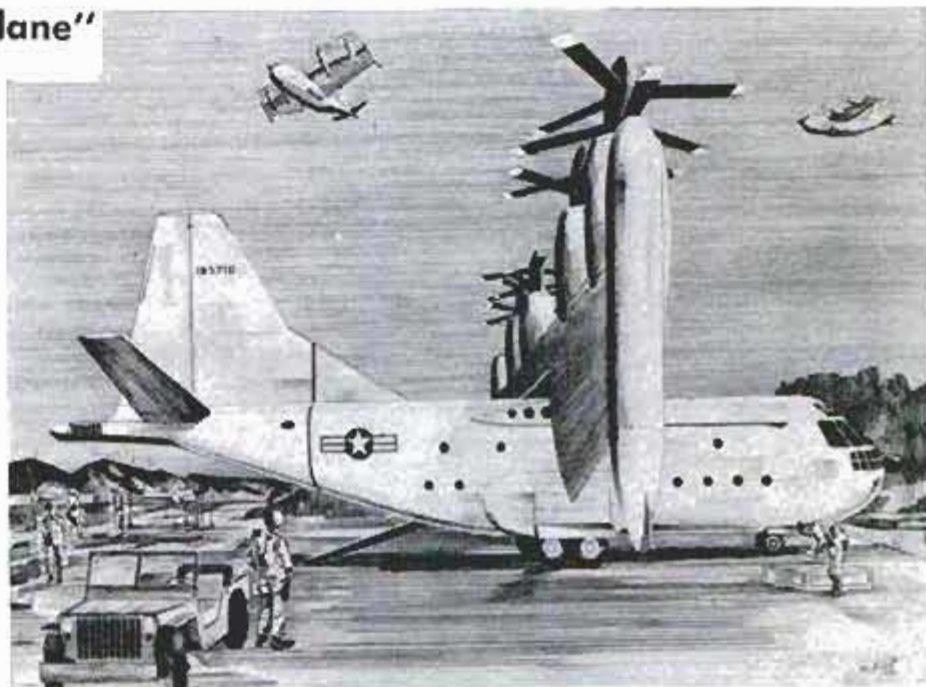

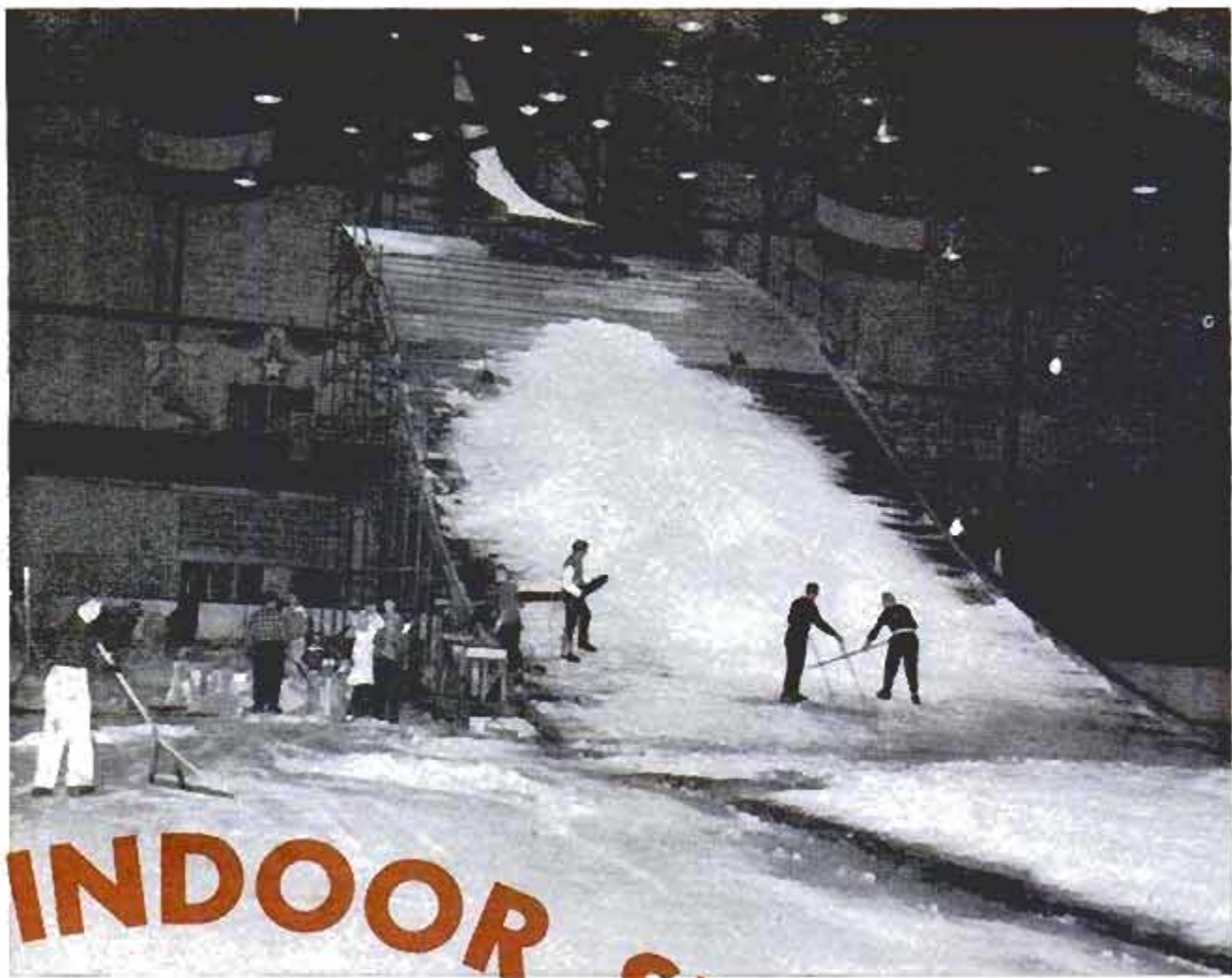

INDOOR

Skiers test crushed ice on landing area built up over seats. Take-off for jump is just under lights

SKI JUMP

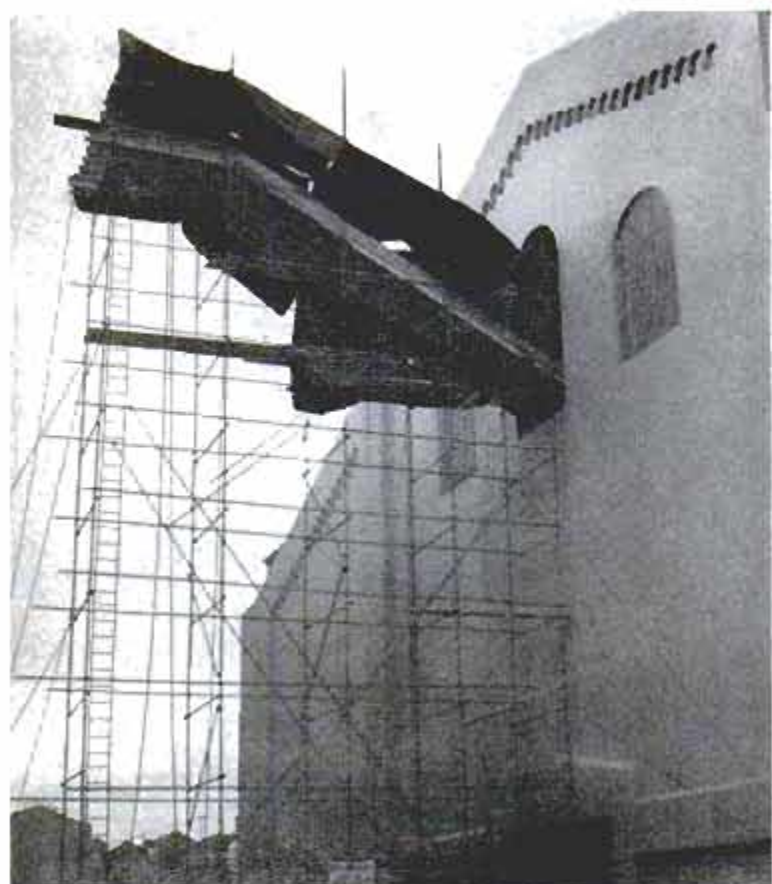

SEATTLE'S WINTER carnival features an indoor ski-jumping contest in the Civic Ice Arena that leaves spectators breathless. The jumpers zoom through a hole high in the wall of the arena, hurtle down a frost-planked runway beneath the girders and take off into space just below the highest lights. The slide is 120 feet long, 36 feet wide and has a 35-degree pitch. It is 75 feet high at its summit outside the building. One of the bricked-in windows, high on the arena wall, is removed to accommodate the slide. (The hole is bricked up again after the carnival.) The landing area terminates on the arena floor which is cov-

Supported by scaffolding, top of the ski slide projects through a window high on arena wall. Here jumpers start on their 120-foot run for take-off under girders



Photos by Howard E. Jackson

Slalom competitor Jeanette Burr zigzags between flags on landing area built up over arena seats. Over 200,000 pounds of crushed ice are used to cover the ski run and landing area at Seattle's gala winter carnival

ered with shaved ice. Over 200,000 pounds of ice are needed to cover the slide, decking and landing area.

Because the arena is used by the Seattle Americans' hockey team, the ski jump has to be put up and taken down in a few hours. Erection starts at 10:30 p.m. after a game and must be completed by noon the next day for the ice-coating operation to get under way. The outdoor section is constructed the day before. The work is done by a 65-man crew. Disassembly takes only six hours.

Only the world's best jumpers compete in this indoor event. The Norwegian jumper, Rolf Helle, performs somersaults on six-foot skis because his regular eight-footers might clip a girder as he turns over. Exhibition slalom running is performed on the ice-covered landing area. ★ ★ ★

Indoor ski run is wide enough for double jumpers (Wilmer Hampton and Kjell Bakke) shown soaring off high above spectators in the top-row seats of highest balcony





Geiger With Transistors Fits Shirt Pocket

Uranium prospectors now can carry a geiger counter around in their shirt pockets. Transistors cut down the size and weight of a new geiger counter which operates on two pen-type flashlight batteries. The instrument is only 2½ inches wide and 5 inches long, and weighs 15 ounces.



Compressed-Air Floodlight Can't Cause Explosions

Compressed air furnishes the power to light an explosionproof floodlight. Used in areas of mines and refineries where electricity is not available, the 22-pound unit is connected to an air line that drives turbo-generators inside. The exhausted air cools the 150-watt, 12-volt lamp.

"Portable" Cobblestones Used in Parisian Movie Scenery



Parisian citizens were curious about the new type of pavement being put on one of their streets. Workmen laid down interlocking sections of pavement resembling ancient cobblestones like pieces of carpeting. The new pavement didn't seem like much of an improvement to them. Then it was explained that a motion-picture company was about to film a movie sequence set in the streets of Paris 100 years ago, and the streets at that time were paved with cobblestones. The portable pavement being laid was only a part of the scenery.

Tests over a three-year period indicate that plastic pipe used for water supply does not affect the color, odor or flavor of the water, does not introduce any toxic substance or interfere with chemicals added to the water.

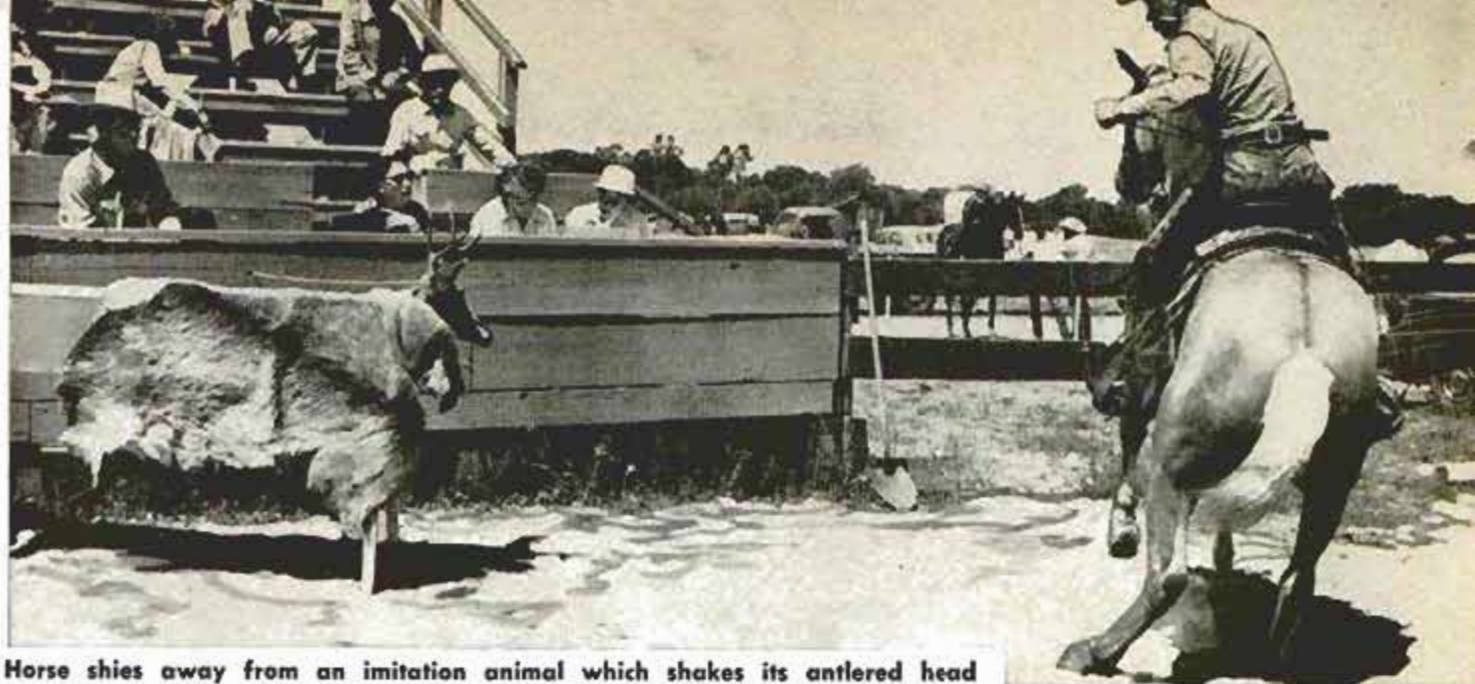

Horse shies away from an imitation animal which shakes its antlered head

Obstacle Course for Trail Riders

By F. Leland Elam

ONE OF THE fastest-growing sports in the United States is the combination of open-country trail riding and trail-class competition in horse shows. Any horse lover can participate with an ordinary saddle horse, plus the time and effort necessary to condition him properly.

This upswing in trail riding during the past three years is putting at least a half million horses on the trails annually, and has developed the trail-horse class until it has the greatest number of entries and is the most competitive and entertaining horse-show event.

Trail classes are good competitive rides

that serve as a training ground for the trail horse. In these classes the horse and rider are subjected to the type of obstacles that they will encounter on the trail.

One of the leading areas for developing trail-horse competition and education in the show arena is the Pacific Coast. A hub for the development has been Sacramento, Calif. Here the Sacramento County Horsemen's Association, The Greenies, Gold Trail Mounties, Sacramento County Sheriff's Posse, American River Riders and Sacramento Ladies Mounted Patrol—all organizations that are a part of the California State Horsemen's Association—have combined their talents to develop some of the most efficient devices for trail-horse education and competition. All their units are

All kinds of gates are encountered on the trail. Rider should be able to open gate, pass through and close it from the saddle

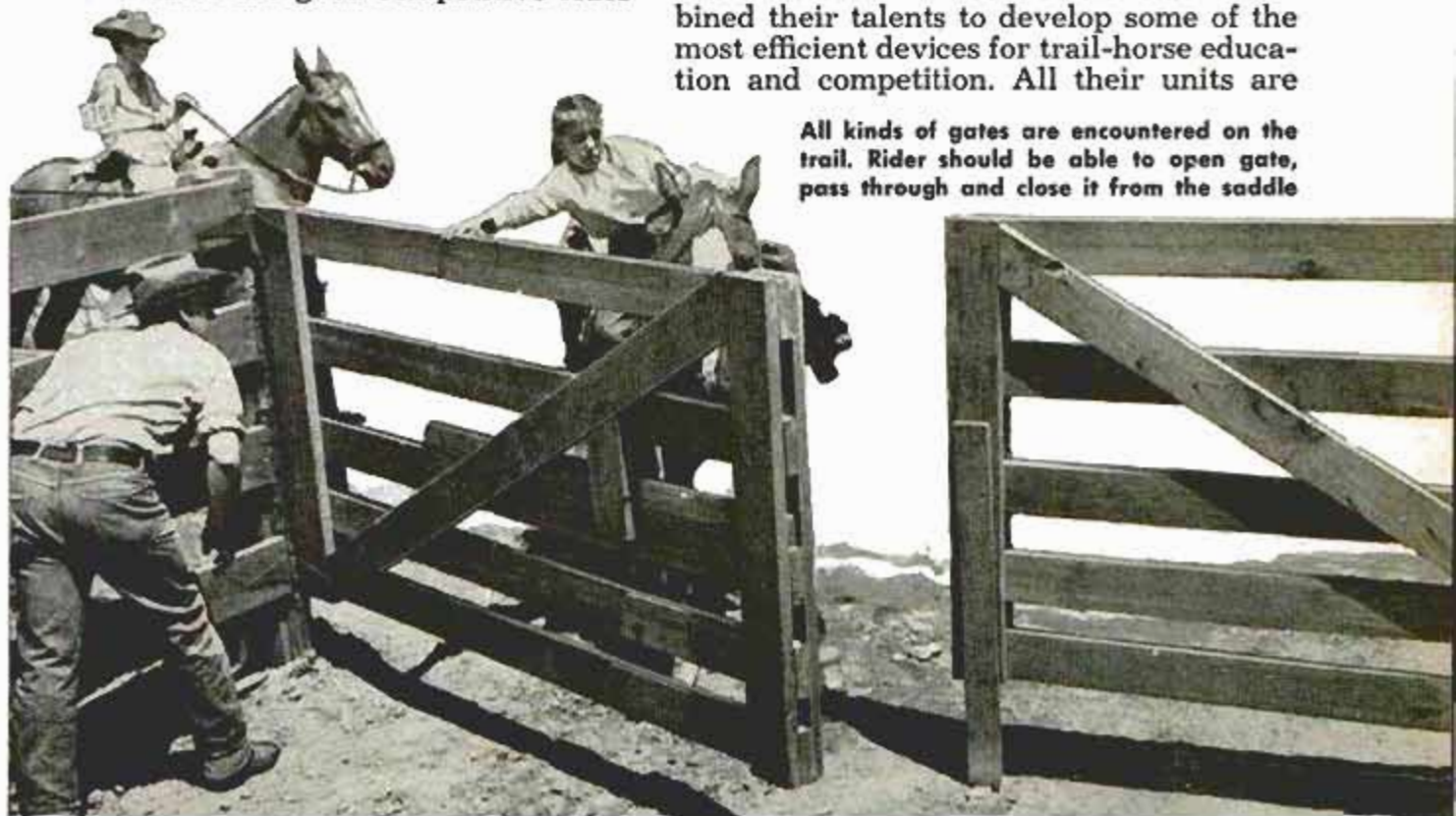

Combination of gate, low hurdle and waving flag makes frightening obstacle to horse. Rider leads mount through hazard

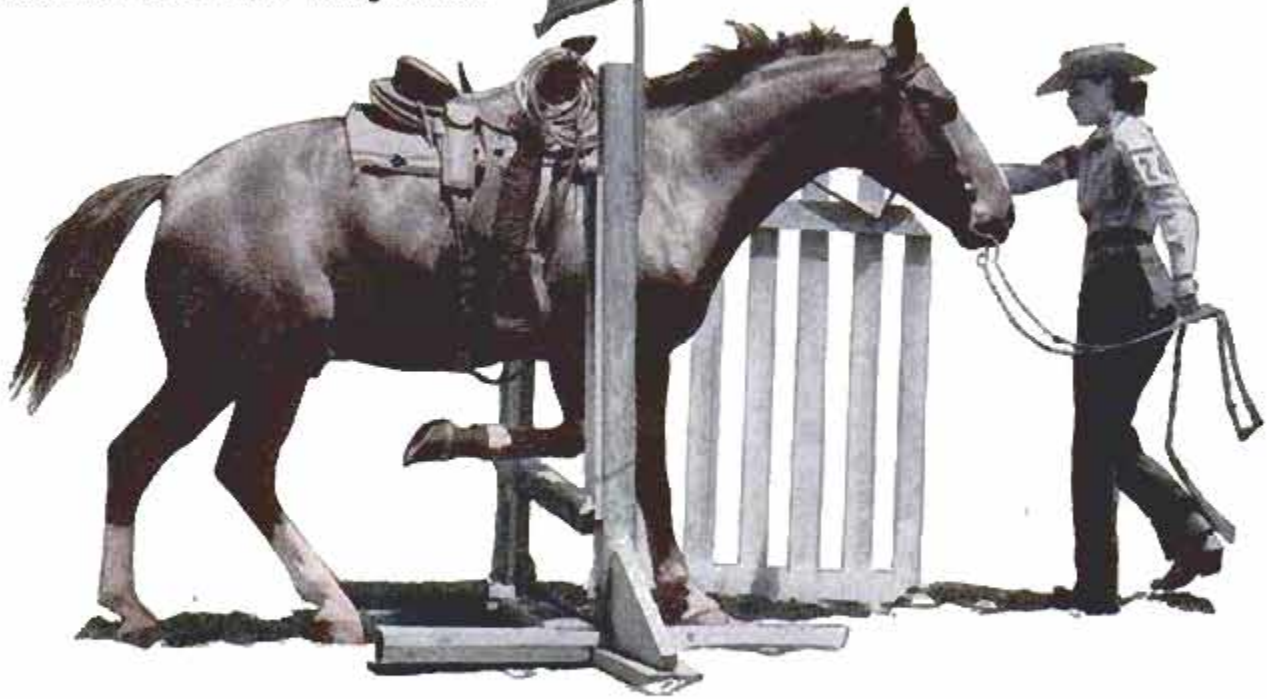

designed to simulate open-country trail conditions.

The upswing in open-country trail riding is pointed up by the fact that controlled trails hundreds of miles long are being or have been set up in many states. California has a nearly completed trail that is 3000 miles long. Many other states, including Vermont, Iowa, Florida, Texas, Arizona, Colorado, Nevada, Oregon and Washington have similar trails completed or nearing completion.

Rider opens this type of gate from the saddle and passes through. Horse overcomes fear of the balloons

The trail-class obstacles are ideal for training both the horse and rider. The rider must learn to direct his mount over, around or through the obstacle and the horse must learn to recognize the directions and obey them instantly.

Training Forestalls Trouble

This training eliminates much trouble and danger for the rider on the open trails. It sets up a proper understanding between the man and his mount.

In this tough hazard the horse must back between two standards, then turn and back between two more



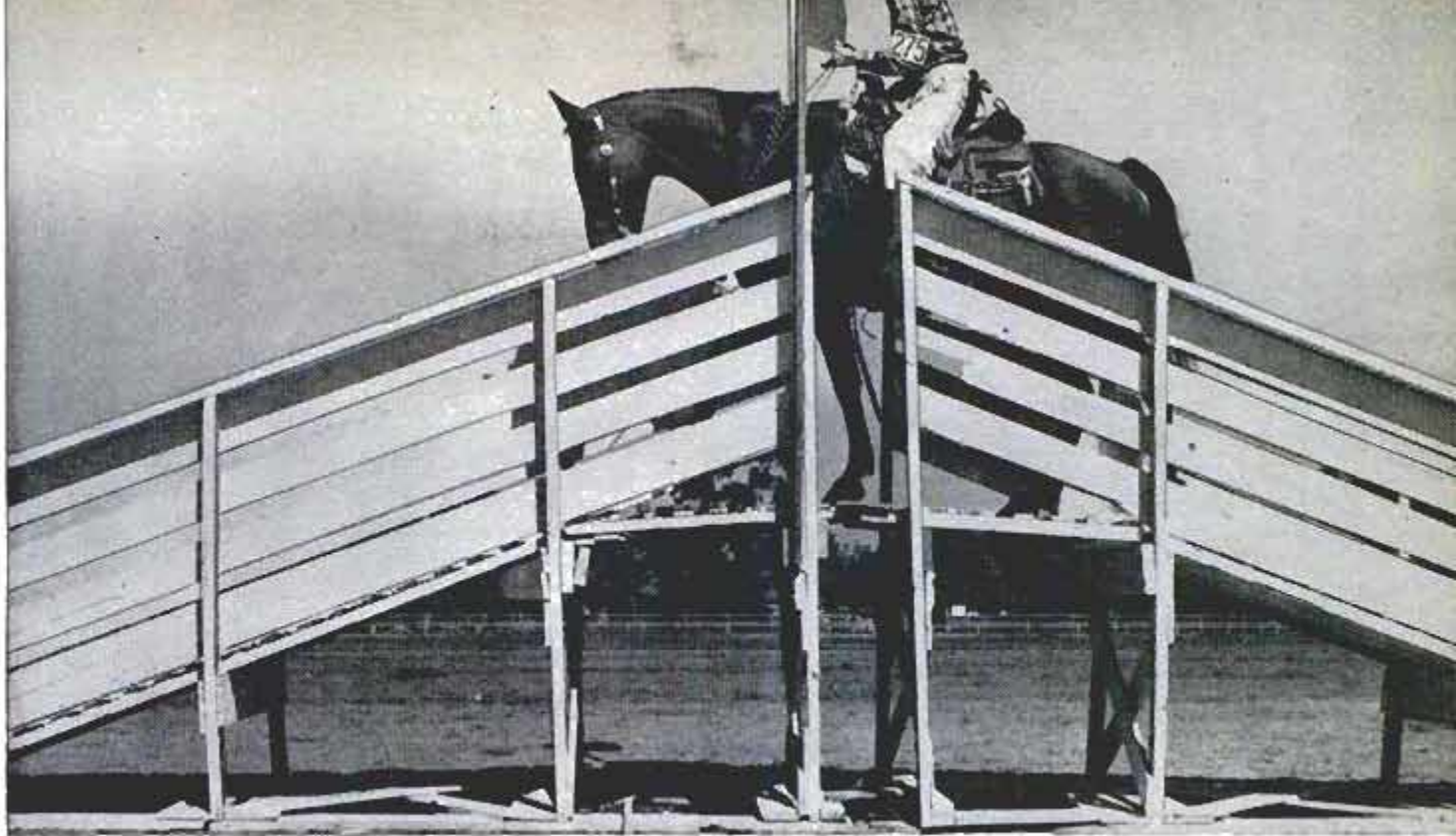

Bridges of various types may be encountered in open-country trail riding so they are included in the course

Horsemen who set up hazards for trail classes take into consideration all phases of trail riding and build their obstacles to simulate as many of them as possible.

Gates are important in a trail class, for gates of varying types will be encountered on any trail ride. The good trail rider is able to open nearly every type of gate, ride through it and close it without dismounting.

A trail horse should go willingly under branches, through heavy brush or other close quarters. He should not balk at bridges of any type, whether high or low, with railings or without, wide or narrow.

On the trail there is always the chance of coming upon a wild animal, dead or alive, or upon the spoor of one that has passed recently. What will be the reaction of the horse when this happens?

There are a number of methods of testing a horse and rider on this problem. One is to make an imitation animal by fastening the hide of a deer over a rack. A deer head is mounted on the end of the rack on a swivel. A spring is attached to the rack and head at one side, and a rope is fastened to the other side at the antlers. This gives movement to the head. The figure is set at a point where the horse will come across it when he has to

Eyes flare as this mount is called on to carry two riders. Horse becomes accustomed to the extra weight during course



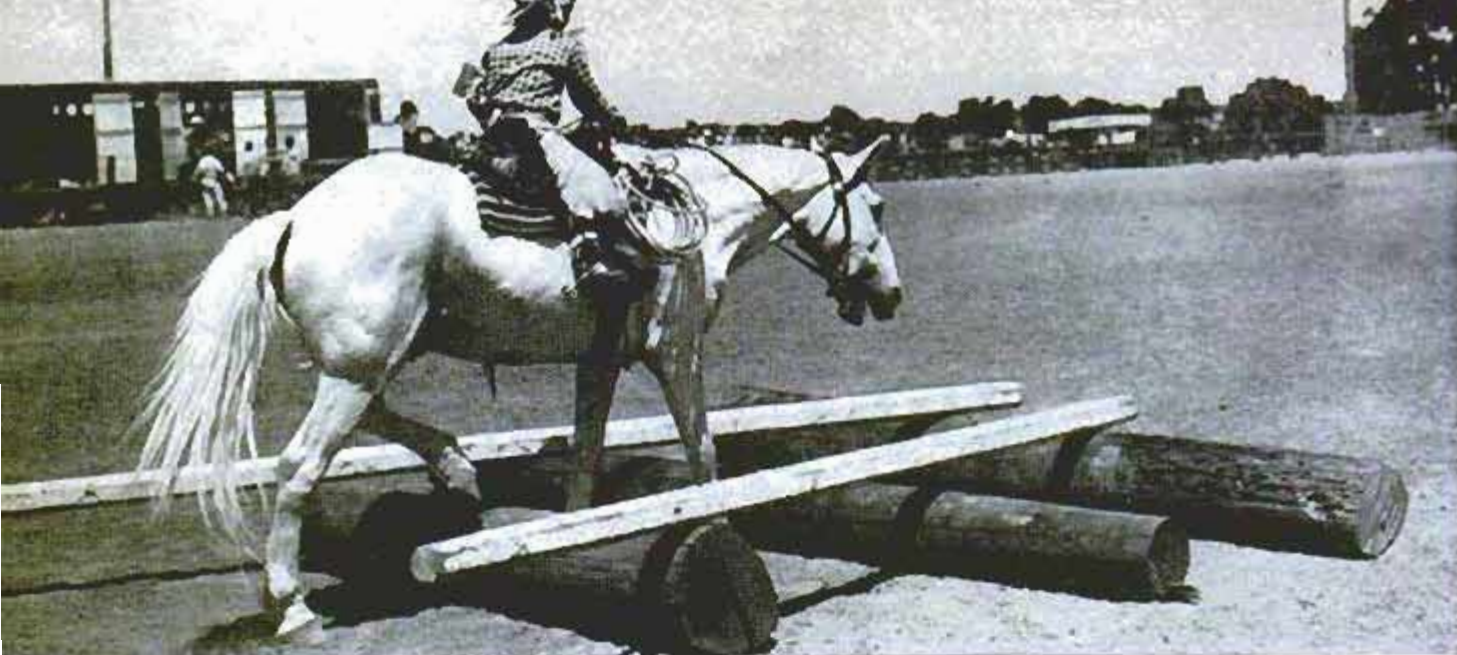

Youngster negotiates intricate hazard on her mount. Narrowing rails of obstacle tend to frighten the horse



Here's a real obstacle. Galloping horse suddenly spots an "animal" at same time it leaps across three posts. Going may be rough on the trail. Here the horse moves steadily through thick brush between bales of hay



advance to some other obstacle such as a bridge, gate or heavy brush. As he approaches, the rope is pulled and the head moves. The spring snaps the head back to proper position.

The trail horse can be thoroughly startled by this development, but in his training he must be taught to overcome the fear and follow the orders of the rider.

Close Quarters

On the trail the horse is quite often called upon to pass through close quarters. One way to teach this is to set panels close together so the animal must pass between them, making a right-angle turn in doing so.

Backing up on the trail is often necessary and it can be in very tight and crooked quarters. One way to teach this is to set up four standards. Two of them must be backed between, then the horse must swing off at almost a right angle to back between the other two.

What will the horse do if he is called to carry double? He may have to do so on the trail, and every trail rider should first find out in the show arena what the reaction will be. Carrying double may not bother one horse while the next will really balk at the additional weight. The arena is the proving ground where the horse learns he must carry double if his rider wants him to.

Disturbing Noises

On the trail occasionally the horse may be required to carry something that makes a disturbing noise. To simulate this, rocks are placed in a bucket. The horse is shown the bucket and the rocks are rattled. Then the rider mounts and during the ride continually rattles the rocks. Thus the horse is trained to know that noise on his back will not hurt him.

Bridges can present additional problems for it is not unusual for small animals to scurry across them, or for larger animals to bound out from under them as they are approached. Brush that hangs over the bridges can also be a problem. In the show arena obstacles to help solve these are set up.

(Continued to page 254)

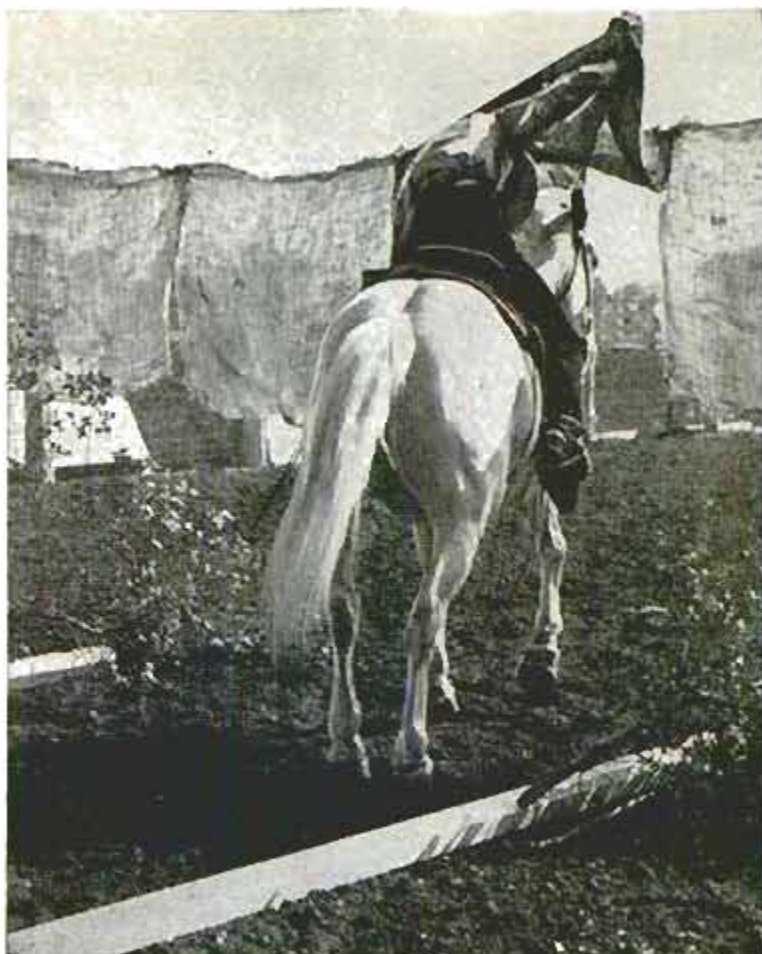

Firm hand is needed by the rider to persuade horse to pass beneath flapping burlap. Sudden breeze may "spook" the horse

Horse and rider pass through an intricate maze of fencing while a judge marks down his criticisms during show's trail-class event

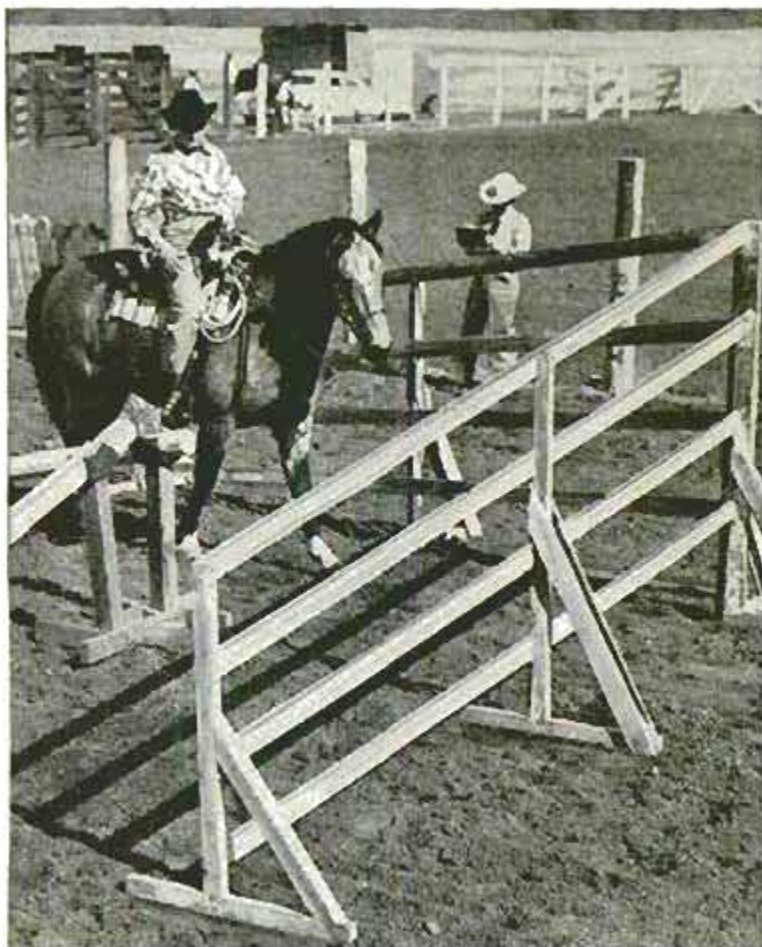

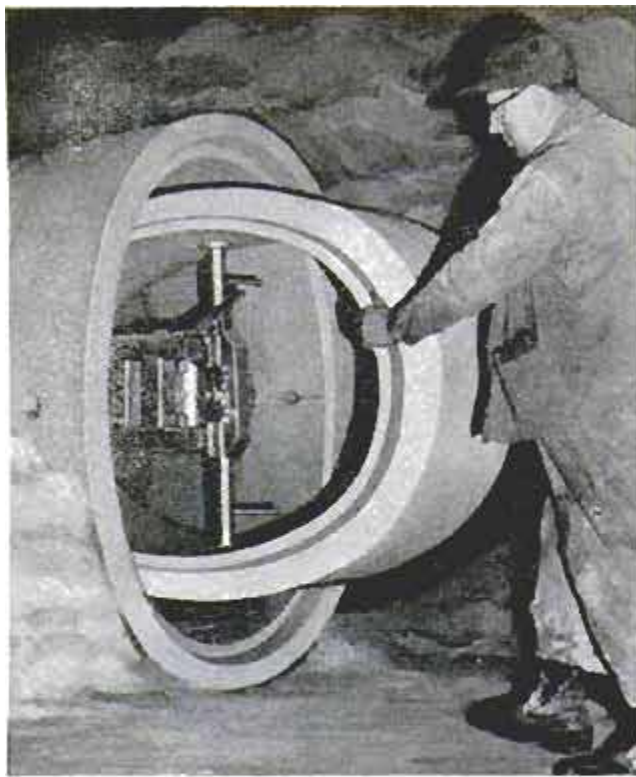

Pipelayer grasps end of pipe section as it emerges from tunnel. He will turn it into setting position

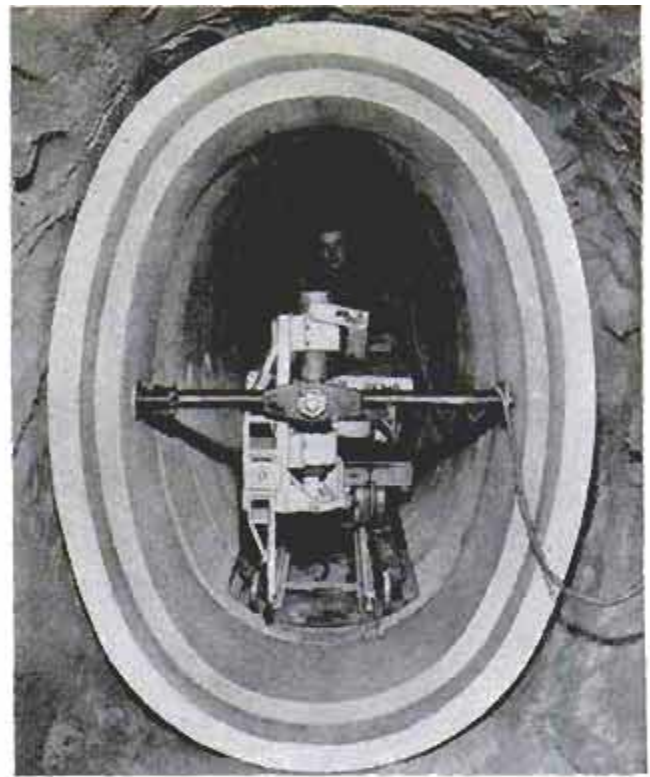

Pipe is still supported by carrying arm of rail car which reverses to set pipe against its neighbor

Oval Sewer Pipe Can Pass Through Section of Same Size

Tunnelers installing deep sewer mains can carry sections of a new oval-shaped pipe through the just-completed portion of the main. The ratio of height to width gives it this advantage over circular pipe. Forms and bracing for finished work are eliminated, which makes for greater safety and

lowered construction cost. Pipe sections are carried through the newly laid main on a car running on a track. At the end of the main, the car supports the section while the pipelayer easily turns it into position. Then the car backs the section of pipe up and sets it in place.

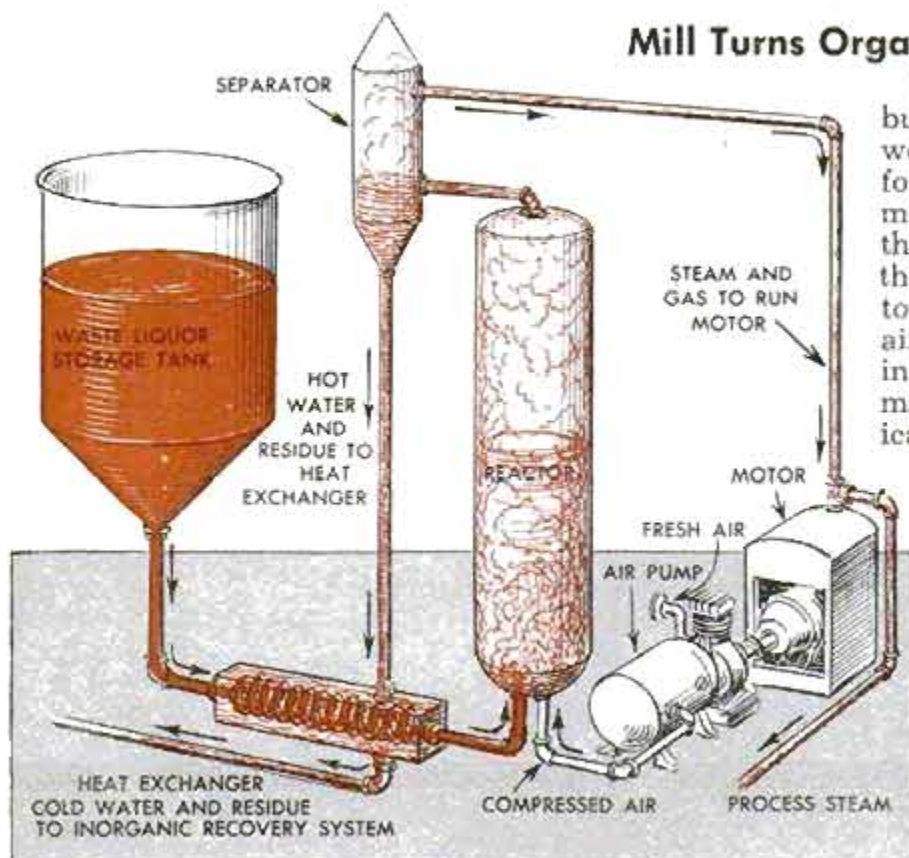

Mill Turns Organic Wastes Into Money

Waste pulp liquors will be burned to produce \$1,000,000 worth of steam power a year for a new Norwegian paper mill. An American invention, the Zimmerman process, flows the dissolved organic waste into a reactor with compressed air. In the reactor, the oxygen in the air "burns" the organic material in a flameless chemical reaction. The heat generated is transmitted to the water in the waste to form steam. The steam, plus nitrogen and carbon dioxide that come from the air, is used to make power. Inorganic materials are recovered in a later step. The process can purify sewage and other organic wastes that are now polluting many streams.

Flying Laboratory For Jet-Pilot Study

Once in the air, a T-29 airliner that serves as a flying laboratory is controlled by a second pilot seated in a cockpit installed in the transport's main cabin. The cockpit and complete electronic control system he operates are those of the F-102 jet interceptor, which employs radar to seek, find and destroy an enemy despite darkness or fog. Hughes Aircraft engineers working on an improved control system study the operation of the system in flight while a psychologist observes the pilot's performance. The transport flies at one fifth the cost of the jet fighter, which couldn't carry even one of the several experts who study a spread-out nonminiaturized version of the control system in the big plane. With the flying lab-



oratory, the engineers can make a series of modifications or adjustments during one flight and observe their effect.



Grip Wheels Dig Into Ice To Prevent Slipping

Wheel slipping in snow and ice is prevented by a cog wheel that is lowered into place against the molding of the rear tire. The wheel's teeth fit accurately into the molding of certain tires so that the wheel turns with the tire. The half-inch teeth dig into snow or ice to give the tire a firm grip. Fixed to the car or truck axle, the grip-wheel unit is raised and lowered by a simple lever connected to the hand brake. The grip wheel does not affect the movement of the car. It is made in Sweden.

"Siamese" Ships Launched Together

Two supply vessels, each 135 feet long and 32 feet in beam, were launched simultaneously at Pascagoula, Miss. They were built in 54 days and are destined to service the oil rigs in the offshore oil fields of the Gulf of Mexico. The launching was actually a "Siamese-twin launching," since both vessels were temporarily welded together and rested on the same cradle for the unique ceremony.

Held together by frame welded between them, sister ships are launched





Crew makes final preparations to launch wartime barrage balloon which will carry fly trap to 1000 feet



Copyright by Mirrorpic

Trap 10 feet long harvests about 7500 flies per day, which are sucked into bag by powerful electric fans

Barrage Balloon Answers Question: How High Does a Fly Fly?

What kinds of flies fly high and how high does a fly fly? These two questions are being answered in England with the aid of a wartime barrage balloon. "Katy," the balloon, goes up 1000 feet each day carrying a trap 10 feet long. Flies are sucked into

the trap by powerful electric fans. Katy's harvest is about 7500 flies per day. Her activities are part of a program aimed at improving crop-spraying methods. When more facts are available about flies' habits, it will be easier to eliminate them.



Kit Tests Uranium Samples While in the Field

Uranium prospectors can test samples in the field with a pocket viewer that is part of a kit. Minerals to be tested are made into beads with chemicals and a blowtorch from the kit. The beads are placed in a plastic chamber in the viewer, and the prospector peers through an eyepiece enclosing a magnifying lens. Sunlight passing through an ultraviolet-ray filter lens strikes the beads and causes them to fluoresce if they contain even one part in 10 million of uranium. Over 30 minerals that activate a geiger counter don't pass this test.

Cellophane Aids Plants

Waste cellophane can prove valuable to the farmer and gardener, tests at Rutgers University show. Shredded into flakes and impregnated with fertilizer salts, it prevents leaching. Used as a mulch, cellophane flakes stop evaporation, protect the soil and control weeds. Waste cellophane, mixed with limestone and fertilizer, can be composted to produce a product with the qualities of commercially cultivated peat.

Mesquite—bane of the Southwestern rancher—here has been given an aerial treatment of 2,4,5-T. Ranchers examine the lush stand of grass that came up when mesquite died

The farmer has three great enemies: Weeds, insects and plant diseases. This is the first of three articles on the weapons being developed to conquer them.



Texas Agricultural Experiment Station photo

By C. J. Willard

*Professor of Agronomy, The Ohio State University and
Ohio Agricultural Experiment Station*



Prof. C. J. Willard

SOMEDAY THE FARMER may have at his fingertips an arsenal of chemical weapons that will kill every growing plant on the land—except those he is cultivating. That's the goal of his ally, the weed-control specialist, whose dream of the weed-free farm now seems possible of attainment.

Just look what's happened in weed control since 1944. Before that, the "man with the hoe" was the symbol of the farmer all over the world. True, in advanced countries the power of the horse or the tractor had replaced the muscles of the man, but the method was still the same: grubbing weeds out of the

Here's striking evidence of the value of weed killers. Right half of field was treated before sugar beets were planted. Note the tangle of weeds at left

Great Western Sugar Co. photo





Soil Conservation Service photo

ground. The few chemicals used to control weeds were chiefly the soil sterilants: Common salt, sodium arsenite and sodium chlorate. No one had developed a practical selective weed killer.

Suddenly, in 1944, this was changed. The years since then have witnessed perhaps the most rapid advance in farming methods since a shaggy cave man planted a seed to become the first farmer.

The spark that touched off this revolution was the discovery of the weed-killing power of a long-handled chemical—2,4-dichlorophenoxyacetic acid. Today we just call it 2,4-D. This chemical has many close relatives, among which MCP and 2,4,5-T are also widely used for weed killing.

Magic Chemicals

Here was a startling discovery. When these magic chemicals were applied to the tops of plants at rates of only $\frac{1}{4}$ to 2 pounds per acre, certain species of plants shriveled and died, yet others were barely affected. Thus it became possible for a farmer to kill most broadleaved weeds in his corn, wheat or rice field without harming his crop.

Since then scores of weed killers tailor-made for certain crops have been developed. We have come to the startling realization that we can find selective herbicides for almost any weed-killing job, and only the lack of a profitable market will prevent us from doing so.

The goal of the weed-free farm may be far in the future, shrouded by years of lab-

TREE AND BRUSH



Texas Agricultural Experiment Station photo

Ammate, one of the deadliest of brush killers, can be applied in dry form or in a strong water solution to a "cup" made by prying out chip between ax cuts

←New machine, powered by a gasoline engine, makes a neat cut to girdle a tree. Such a cut will kill the tree, but application of 2,4,5-T will hasten the job

oratory work and field testing by many crop-control scientists, but at least it seems possible to attain.

I am asked two questions more frequently than all others put together: "What shall I use to kill the weeds in my lawn?" and "What is there about a weed killer that will kill one plant and have almost no effect on the other?" Let's leave the weeds in the lawn for a moment and discuss the second question.

Suppose you spray a 2,4-D solution on a cornfield overgrown with giant ragweed and bindweed. A few days later the annual ragweed and the perennial bindweed are

Comparative amounts of weed seed and wheat from equal areas, unsprayed (top) and treated (bottom)

Oregon Agricultural Experiment Station photo



KILLERS



Texas Agricultural Experiment Station photo

Want to kill a stump? Apply dry Ammate liberally to fresh cuts in top. There'll be no resprouting here

dead, yet the corn appears unharmed. What has happened inside these three plants?

A possible answer is that the physical structure of the plants is so different that one catches and absorbs more of the spray than the other. But that isn't the basic reason.

Different Enzyme Systems

The plants react differently because they have different enzyme systems. The total enzyme systems of a plant or animal direct its entire life. The 2,4-D has a disruptive effect on some enzyme systems but not on others.

Since all species of plants have different enzyme systems, weed killers may have a different and specific effect on each species. In effect, it is the plant that makes the selection and not the chemical. These ef-



Tabs of blotting paper are soaked in sodium arsenite—a deadly poison—and inserted beneath the bark

fects are so specific that we often need to make recommendations for each variety of a particular crop. There are also varieties of weeds which may respond differently. This may well be a reason for conflicting results. At least, it is thus absolutely essential for satisfactory recommendations to identify the particular weed in the crop.

Herbicide action may vary with the weather, the concentration, the method of application and other factors, and may thus endanger the farmer's crop.

It is commonly believed that 2,4-D does not affect corn, yet in one experiment the yield of corn was reduced from 80 bushels to two bushels per acre by one application. This was the wrong formulation, at the wrong time, in the wrong concentration, by the wrong method, but it serves as a warning of what can happen.

Not long ago, following three years of

2,4-D makes a clean sweep of mustards in small grain. At left is a treated field; right, an untreated one





Texas Agricultural Experiment Station photo
Latest method of controlling Johnson grass, enemy of the cotton farmer, is to spot-treat it with oil. Below, nozzle extensions on boom will keep much 2,4-D off corn which is to be sprayed after it is a foot high
 Illinois Agricultural Experiment Station photo

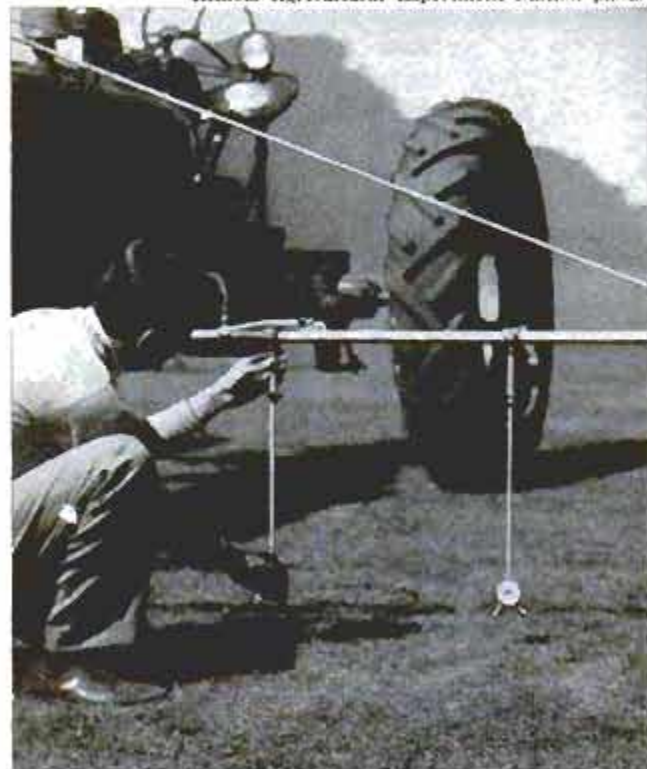

Texas Agricultural Experiment Station photo
Tractor is equipped with solenoid-release valves. Riders spot Johnson grass, douse it with herbicide

hard work at a half-dozen different experiment stations, a new weed killer was marketed for use on cotton. During the year it was introduced, unusual weather conditions caused the herbicide to kill thousands of acres of cotton. The herbicide is still a good one, but its reputation has never recovered from this blot. A similar experience is possible with most herbicides now in use.

The usefulness of a herbicide depends as much on the way it is applied as the chemical itself. The first 2,4-D sprays were applied in up to 320 gallons of water per acre. Heavy tanks mashed down the crops. Then Harold A. Waters tried the simplest possible approach. To an ordinary paint-spraying nozzle he attached a low-pressure pump, and proved that only 5 to 10 gallons of water per acre could apply the herbicide accurately.

Apply as Droplets

Because modern herbicides are so powerful, we must apply them so that they do not drift and injure desirable plants. They should be applied not as mists, but in droplets which tend to *fall* to the plants. The inexpensive low-pressure pump with what is now known as a weed-control nozzle is ideal for this purpose.

Here are the most up-to-date recommendations for killing weeds in various crops:

Lawns. 2,4-D in a dilute drenching spray is basic. You can even apply it with a sprinkling can, provided you do not use the can later to water the flowers. There

(Continued to page 266)



Morse Scout S4B, 1916 U.S. Army fighter, stands on Wisconsin airfield

Rare World War I Fighter Flies Again

By Phil McCafferty

WHEN Dwight Woodard, a Richland Center, Wis., airport operator, heard one of his students tell of a plane he'd seen in a northern Wisconsin barn, he could hardly wait to see it—especially after the student told him, "There must have been something wrong with it because when we turned the prop, the whole engine turned around." To Woodard, this meant a famous old French Le Rhone rotary engine, unique in that the crankshaft was stationary while the engine and propeller rotated around it.

The plane proved to be a Thomas Morse Scout S4B, and Woodard bought the shell. Woodard spent thousands of dollars and hours searching for parts and rebuilding the ship.



Above, Richland Center, Wis., airport operator Dwight Woodard sits in cockpit of his prize. Below, left, cowl-mounted machine guns in place. Note lack of instruments; pilots depended on "seat of pants" flying instead of instruments. Below, right, old French Le Rhone rotary engine, in which shaft is stationary, and engine turns around it

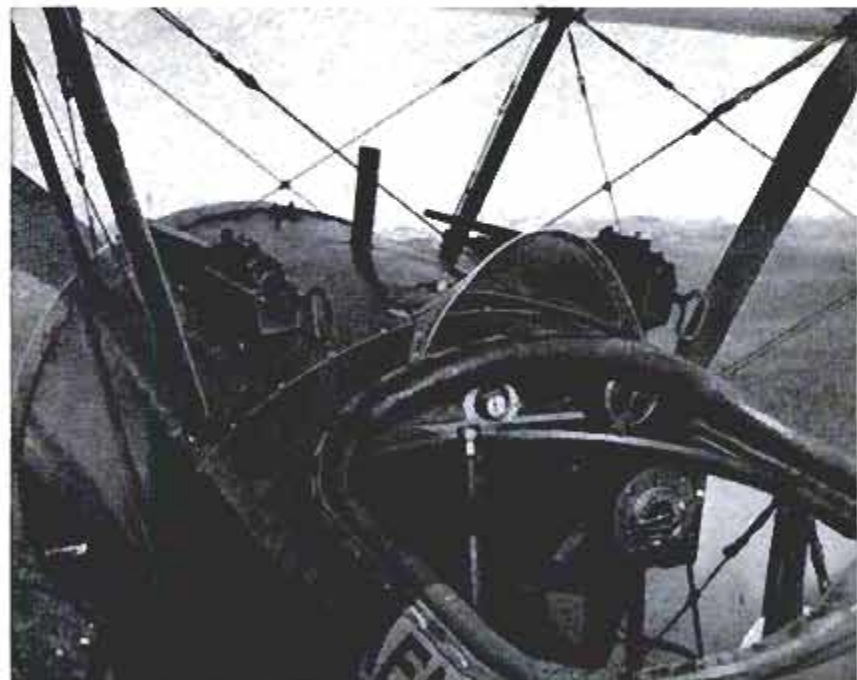



Electric Eye on Camera Sets Correct Lens Opening

Fully automatic, a new movie camera has a battery-operated mechanism that sets the lens opening to the precise amount the lighting requires for perfect exposure. An electric eye "reads" the lighting conditions and sets the diaphragm as conditions change. If subject moves from bright sunshine into the shade, the exposure is automatically corrected while the camera operates. No attention by the photographer is necessary. Another feature of the automatic camera is a warning signal that pops up in the view finder whenever the amount of light becomes too low for proper exposure, thus preventing waste of film. Current for the exposure-adjusting mechanism is provided by six tiny batteries, similar to those used in hearing aids. The life of the batteries is a minimum of one year. The camera, a Bell and Howell product, has a 20-millimeter f:1.9 lens. Wide-angle and telephoto attachments are available.

Huge Plastic Tarpaulin Lines Pond to Prevent Water Seepage



Waterproof plastic tarpaulin, above, is used to cover nearly half an acre of the dry bed of a manmade pond. Below, pond no longer seeps away



When a manmade pond at Clemson College, Clemson, S. C., seeped away, agricultural engineers lined the cavity with waterproof plastic. Strips of Krene plastic, often used for shower curtains, were heat-sealed together to produce a tarpaulin to cover almost half an acre. The plastic liner, which came through the winter undamaged, eliminated the three-inch-a-day drop in water level. Similar liners may be used to hoard water for livestock and irrigation purposes. During a dry period, the water thus saved might spell the difference between crop failure and survival.

Potent Insecticide

Extracted for the first time, a potent new hormone holds promise of an insecticide against which pests cannot develop resistance. The hormone, extracted from insects at Harvard University, prevents metamorphosis.

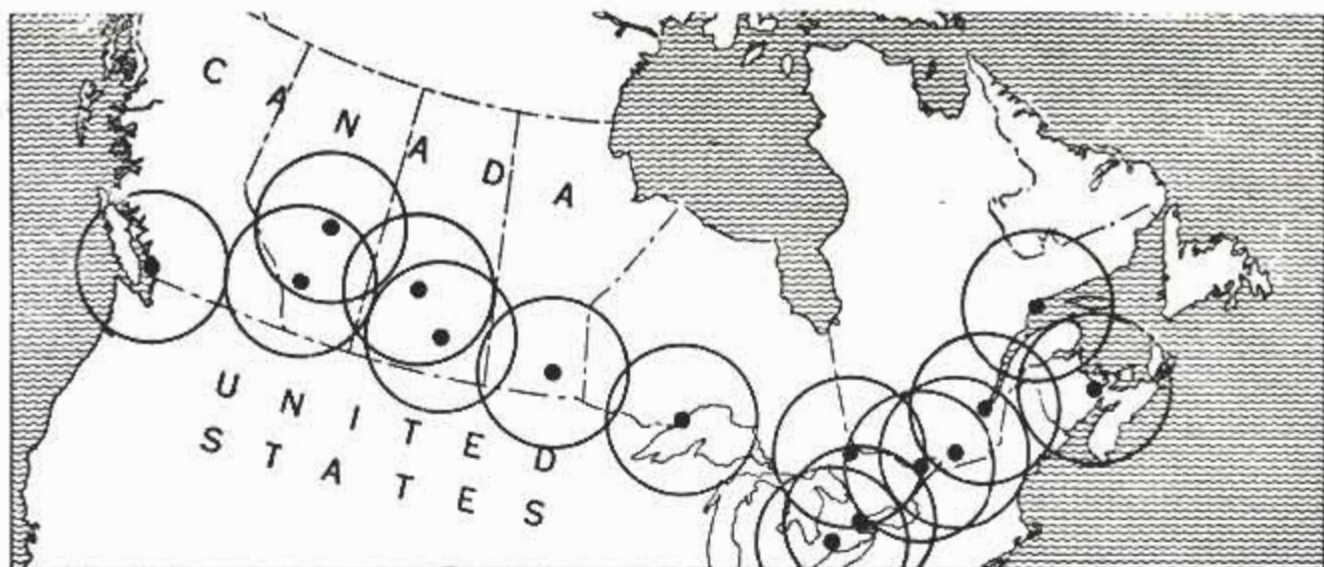

Below, electronically generated map of the control area is projected on AASR screen at flip of switch

Canadian Radar Network To Control Airspace

Like the rest of the world, Canada's air transport traffic has shot up in volume in recent years—and absolute control of all planes in the air has become essential. To accomplish this, the Canadian government is installing a network of radar at 15 major airports stretching across the country. The equipment, called Airport and Airways Surveillance Radar, will permit each airport to track planes within a 200-mile radius. The AASR system has improvements which enable it to track planes even in bad weather without a cluttered-up screen, and which filter out all unmoving objects so that a moving plane is easily spotted on the scope.



Pocket Vacuum Cleaner Takes Lint From Clothes

You can brush lint and dust from your clothes with a pocket vacuum cleaner that looks like a flashlight. Two flashlight batteries power a tiny suction motor in the head to draw dust into a small bag. The vacuum created is not powerful, but serves principally to prevent dust brushed free from being scattered about the room. The circular brush on the head is swept across the cloth like a whisk broom.

Windshield Rain Repellent

Raindrops roll off an airplane windshield coated with a substance that ends the need for wipers. Made of silicones and waxes, the hard coating, to which raindrops can't stick, is applied in 15 minutes and lasts for several days of heavy rain. The wind and speed of the plane also help sweep the raindrops away. Although not adaptable for autos because of their slow speed, it may eliminate salt-spray crust on boats.



SHIP SPEARS SHARK



Huge 30-foot basking shark is almost cut in two by sharp-edged ram. The sharks, floating lazily near the surface of the water, are no match for the skillfully handled vessel, which heads directly into a

school and catches an individual shark before it is aware of its plight. The hinged ram is carried above the water line in a closed position when not in use. It has a sharp point and a keen upper cutting edge

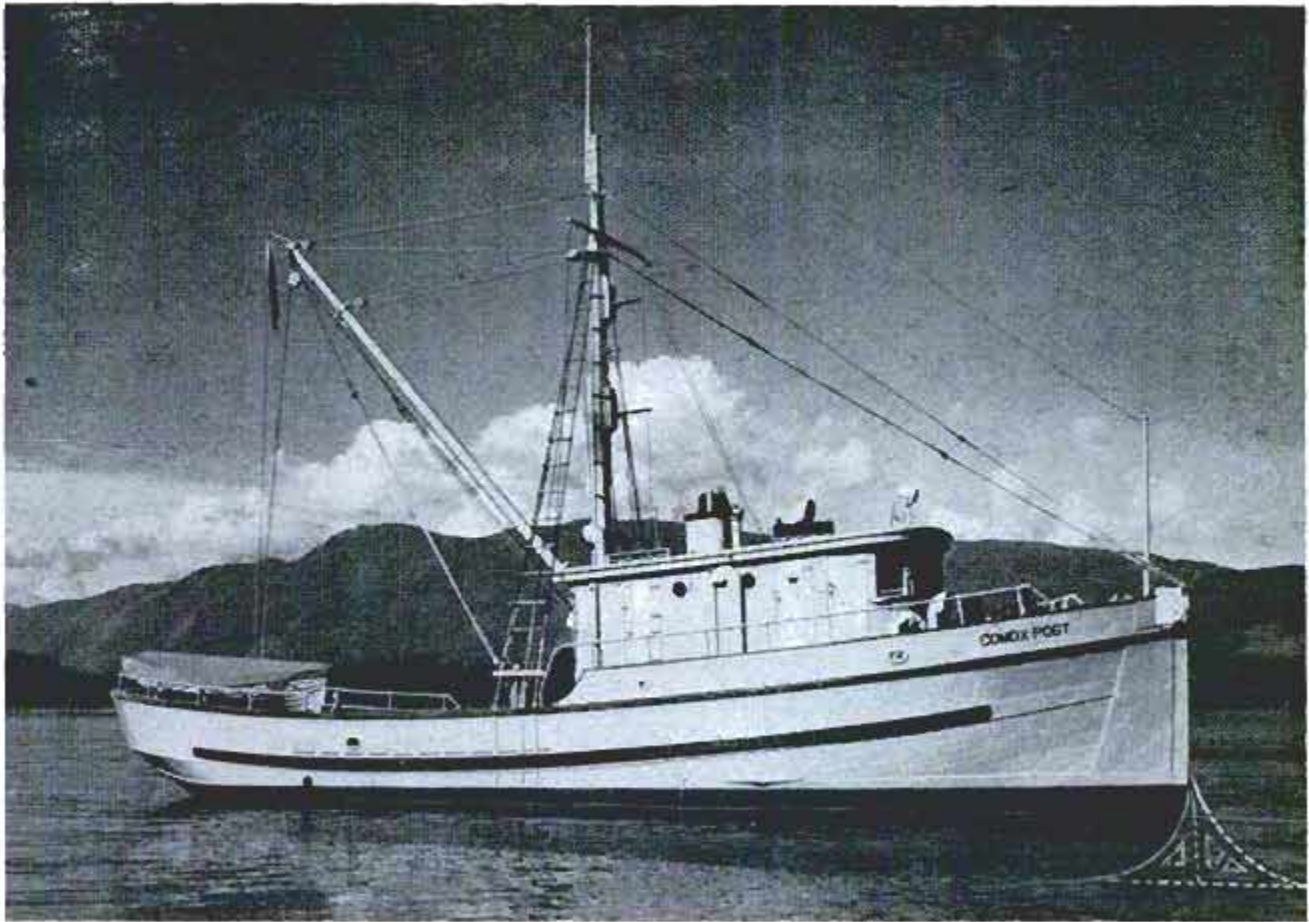

Dotted white lines on the prow of the Fisheries Department vessel *Comox Post* indicate outline of shark spear

BASKING SHARKS, the bane of the salmon fisheries along the British Columbia coast, are being chased and speared by a vessel mounting a knifelike ram on its prow.

In the first month that the Canadian Fisheries Department's *Comox Post* was fitted with the ram, it killed nearly 50 sharks. Eighteen were speared in a single day in Barkley Sound on the west coast of Vancouver Island.

Basking sharks, named for their habit of floating lazily near the surface, attain a length of 30 feet. When one becomes entangled in a salmon net, it can tear it apart in minutes, destroying hundreds of dollars' worth of webbing. Trolling gear is also damaged when the hooks catch in the sides of the monsters. The sharks feed on the same food as salmon, frequent the same areas and are usually at greatest numbers during the height of the sockeye-salmon-fishing season. Up to 50 may gather in an area where salmon are feeding making it impossible for the fishermen to put down their nets.

The sharks, which have no commercial value, have been a problem for many years. Harpooning has proved to be successful but slow. Rifle fire is ineffective and a danger to nearby fishermen.

Now, when a group of sharks is sighted, the *Comox Post* steers directly for the

school, picks out an individual floating near the surface, and rams it. This not only reduces the shark population, but breaks up and scatters the school, making it reasonably safe for fishermen to operate in the immediate area.

The triangular ram when not in use is carried like a closed clasp knife above the water line. For operation, it is lowered from a hinge by a cable so its point and cutting edge are just beneath the surface of the water. Chain braces on either side of the bow keep it firmly in position. ★ ★ ★

Ram lowered to killing position. Chains brace it

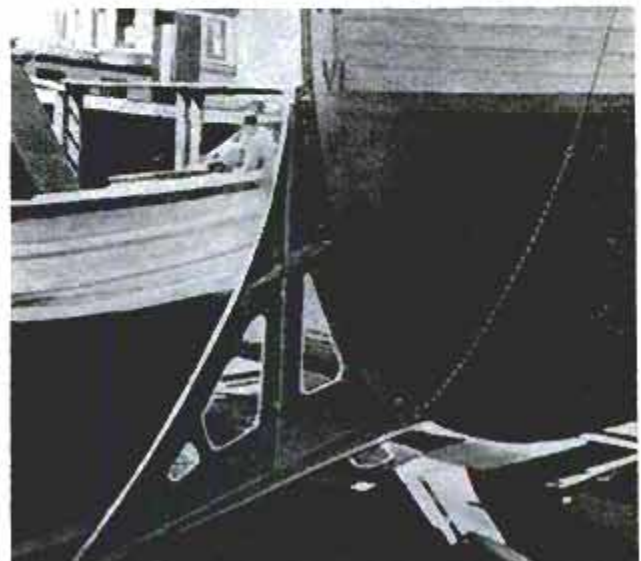

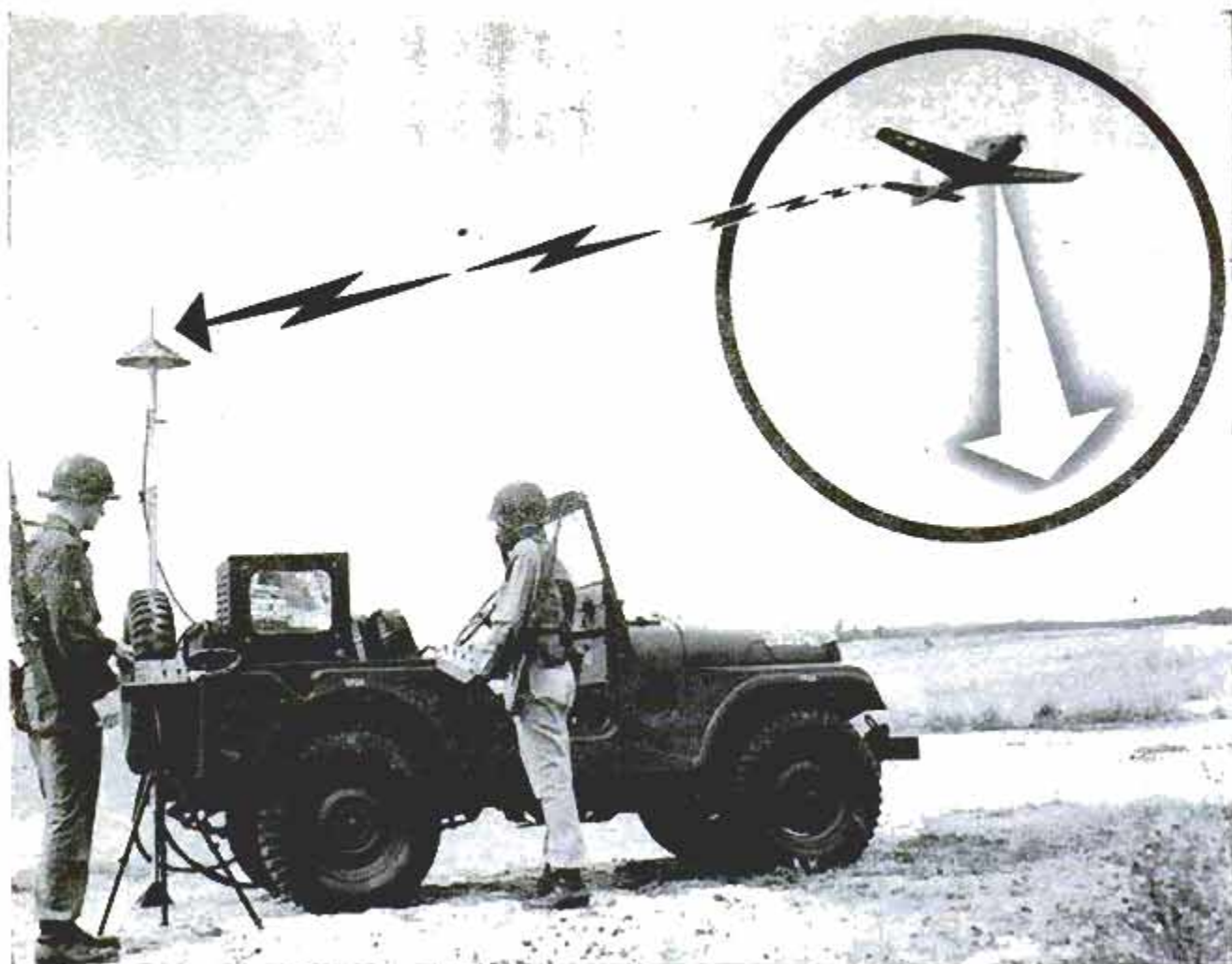

TV Camera in Drone "Peers" Over Enemy Lines

Army combat commanders can peer over enemy lines with a TV camera mounted in a remotely controlled plane. An L-17 was fitted with a 42-pound autopilot that enables a ground operator to regulate its flight, landings and take-offs within a 25-

mile range. TV pictures of strategic territory beneath the plane are relayed to a monitor set at the 250-pound ground station, which can be carried in a Jeep. It includes radio links for commanding the drone. Still photos can also be made.



Infrared Lamp Over Balcony Makes January Like June

Gerald M. Loeb, Wall Street investment broker, likes to sit on the balcony of his home in Redding, Conn., in shirt sleeves the year 'round. He is able to do this in comfort since he suspended a 5000-watt infrared waterproof heater over the balcony which is on the south side of his house. The balcony is perfectly comfortable on the coldest winter day, Loeb reports, unless a high wind is blowing across it.

☐ Steelmaking furnaces in the United States at midyear had produced more than one billion tons of ingots and steel for castings since the end of World War II.

50 YEARS AGO IN PM
FROM OUR NOVEMBER 1906 ISSUE



MOTOR SWIMMING WITH FOOT AND GAS ENGINE POWER

What with automobiles and motor boats to ride in, motor skates to walk on, and a screw propeller to push a swimmer through the water, it begins to look as though the class in physical culture had little to do but enjoy itself, while a gasoline engine does the work. Of all the varied applications of the gas motor the swimming outfit is the most unique. Its utility would seem quite doubtful, but as a curiosity or amusement it is worth knowing.

M. Constantini, of Paris, who invented the motor skate, has brought out a motor swimming device which, the Scientific American says, consists of "a waterproof casing containing a gasoline motor which drives a screw. The machine is strapped to the swimmer's back and propels him through the water" at a rate faster than he would

swim, and, of course, without physical exertion. Air bags are used to float the machinery.

An American has also invented a swimming machine, but in his case the swimmer must furnish the motive power himself. This device is capable of considerable speed with comparatively small effort. The operator stretches at full length upon a float which is pointed at the forward end. The propeller is driven by gearing driven by means of foot pedals similar to the pedals of a bicycle. Another float over the machinery serves to support it in the water. This arrangement permits the swimmer to keep his head out of water and to undertake long distances. When tired one has simply to cease working the pedals until rested.

BICYCLE POWER FOR RUNNING MINIATURE TRAINS

Remove the front wheel from the bicycle and in its place fix a seat as at A in the sketch. Take the tire off the back wheel and run a small leather belt around the wheel to transmit power to the dynamo, B, which is connected up, as shown, and causes the little electric car to run when the wheel is operated. — Contributed by Clifford B. Brainerd, Chevy Chase, Md.

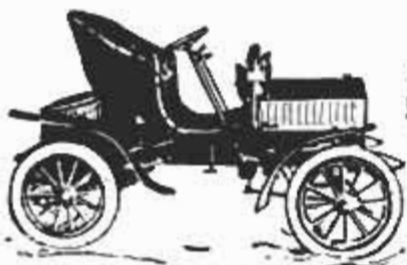
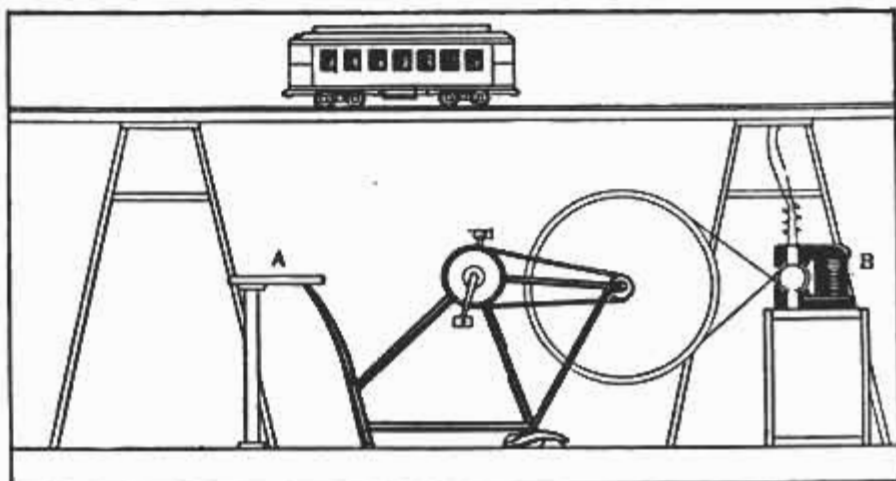

AUTOMOBILES \$100 AND UP

We will mail our large Illustrated Bargain Sheet of new and slightly used Automobiles on receipt of your name and address. This sheet shows accurate photographic views of more than 50 Automobiles offered as low as \$100. Write plainly to

H. GRAHAM CYCLE CO., Inc.

Established 14 years.

601-603-605 Madison Street, CHICAGO, ILL



U. S. Army photos

In the new course, recruits fire from foxholes and from behind trees while wearing helmets and combat gear

"Trainfire" Rifle Course Simulates Combat

Stationary targets are replaced by man-size targets that pop from ground



Army recruits in the near future may be given a much different course in rifle marksmanship. A new course, called "trainfire," is under test by the Army. The goal of the course is to reproduce in training the marksmanship problems that the rifleman will face in combat. Instead of stationary targets at known distances, the new program uses man-size silhouette targets, some moving and some stationary, that pop up at unknown ranges. The rifleman also is trained to fire from foxholes and from behind trees, rather than from the formal body positions of the existing course. The new system cuts the marksmanship course from 86 hours to 74 hours.

Lamprey Poison in Great Lakes May Save Trout

Trout-destroying sea lampreys may be cleaned out of the Great Lakes with a chemical developed by the U.S. Fish and Wildlife Service. Dissolved in the spawning beds, it kills the lamprey larvae. If the

chemical proves harmless to other fish and animals, it will see widespread use. The eellike parasite has lowered the trout catch in Lake Michigan alone from a \$3,000,000 peak to an all-time low of \$1500.

TV PARADE FOR 1957

WITH AN ESTIMATED five out of seven American homes already equipped with television, manufacturers in '57 are striving to place a second set in every household. If you already have a

large-screen receiver, you will be interested in the low-cost portables; if your present set has a small screen, the new features may tempt you to buy a larger unit. Here is a sampling of TV for '57.

PORTABLES REVERSE TV TRENDS. Reminiscent of TV's earliest days are small-screen portables included in most 1957 lines. New sets, however, have cases to match the small picture tubes, and improved circuitry provides reception in most areas with attachable indoor antennas. Separately available converters adapt portables for use in cars and boats.



A



B



C

Emerson's unique 8 1/2-in.-screen set (A) has AM radio and phono jack, costs \$124. RCA's 8 1/2-incher (B) is smallest, measures about 8 by 10 by 13 in., costs \$125 with detachable stand and disappearing antenna. Only slightly larger, Admiral's 10-in. models (C) start at \$99.95. Among larger sets, 14-in. Du Mont (D) has utmost in sensitivity with Cascade tuner and three i.f. stages. Motorola's price leading 14-in. models (E) start at \$99.95. Also available are some 17-in. portables

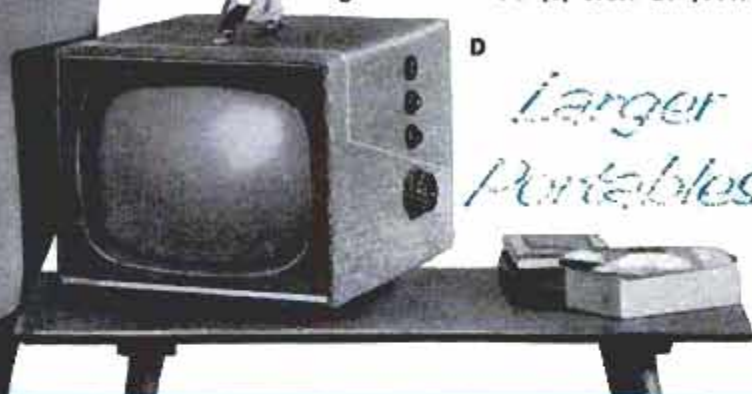

Larger Portables



E

Custom Accessories for TV Portables

Special accessories are available for most portable television sets. These include covers, stands and bases, and attachable "rabbit ear" antennas. Antennas can be adjusted to any angle and fold away when not in use.

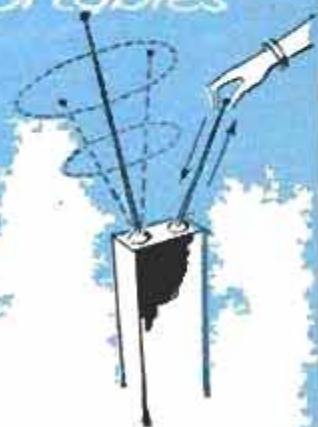



The Admiral Corp., first to announce the planned production of a color set below \$500, is now exhibiting this color consolette at a cost of \$499.95



RCA leads the color field with 10 new models. Prices range from \$495 for above table model (stand extra) to \$850 for consoles with hi-fi sound systems

Color Highlights

That color is here to stay is demonstrated by the ever-increasing number of color broadcasts. Most major TV manufacturers have included at least two color models in their 1957 line. Sharp price reductions which have cut the cost of color TV by as much as \$300 are expected to spur sales. Color sets are completely compatible and will provide black-and-white reception of noncolor broadcasts.

Among the latest in color TV is the Westinghouse console featuring the first 22-in. color tube (others are 21-in.). Price still unannounced. The Magnavox \$950 Contemporary, lower left, contains 10-watt hi-fi amplifier with four separate speakers. Of special interest is the Magnavox Gold Seal guarantee providing a full year's parts warranty plus three months' free service. Hoffman's \$775 hi-fi model is shown below, right

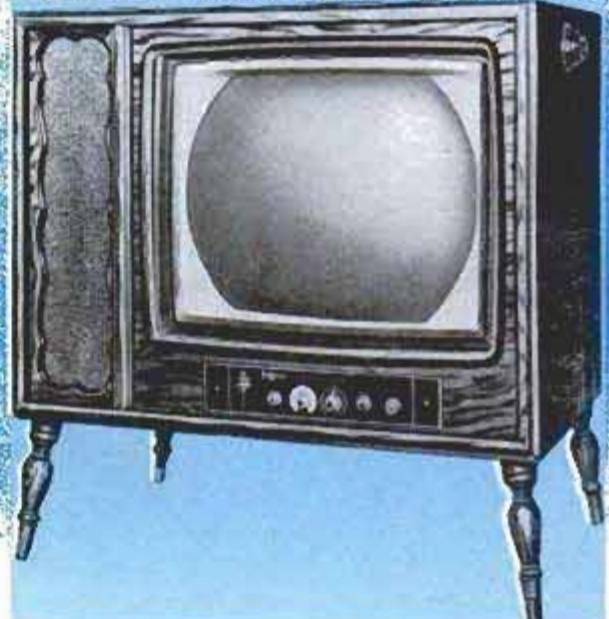
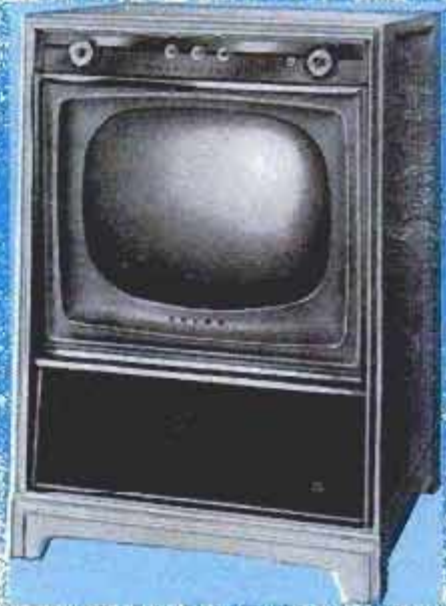

Which is the Console?



Table models take on a new look when placed on special bases designed to give them that "console" appearance. In fact you may not even recognize the true console. General Electric's \$249.95 model 21T160, upper right. Set at left is GE's table model selling for \$189.95 on a matching base. Center set is Motorola table model with swivel

base. Equivalent consoles usually include larger speakers for improved sound but are higher in price than table models with matching base. Both GE sets shown feature push-button on-off switches and power tuning. Motorola receiver has push-button on-off only, but is also available with power tuning. Sets have 21-in. picture tubes

Latest in Black and White TV

Automation in assembly as well as operation is the keynote of many 1957 sets. While automatic assembly reduces production costs, automatic operation takes the work out of set adjustments. Just touch a button to turn the set on and sound and picture appear at the same volume and brightness level as when the set was previously turned off. Touch another button and the channel selector automatically rotates to the next station. Excellent stability reduces need for "fine tuning" although such controls are still provided.

In lieu of touch-tuning, Zenith offers remote control as standard equipment in higher-priced models. Set at right costs \$359.95

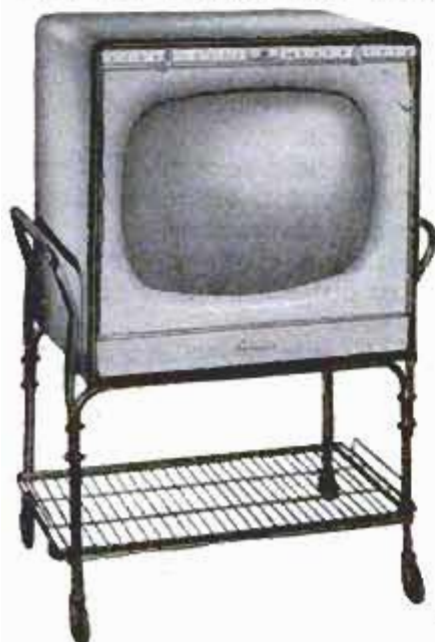
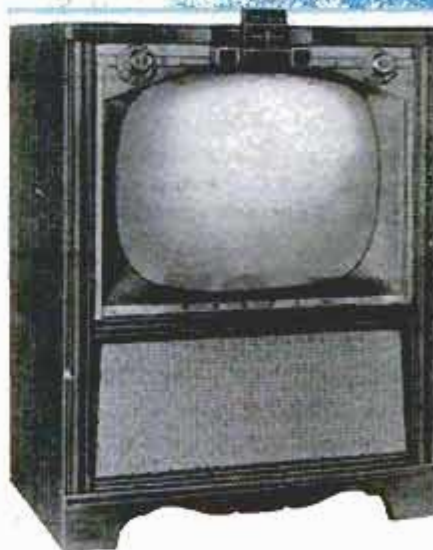

Sylvania's exclusive "Cabinet of Light," featured in all models, illuminates entire cabinet front with soft fluorescent glow. 21-in. table model, left, with push-button on-off switch and ratchet tuning, sells for \$289.95



No controls are visible on Crosley console, right, which costs about \$340. Knobs are hidden beneath hinged lid shown in above sketch. Touch bar to right of lid automatically selects stations. Similar bar on the other side turns the set on and off

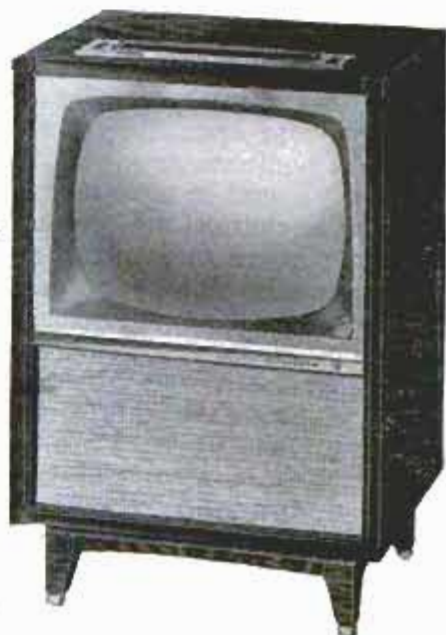



Remote control is optional in most 1957 lines. Du Mont unit (A) permits station selection, brightness and volume control and audio muting. In addition to these controls, Emerson's model (B) has built-in per-

sonal speaker. Zenith Space Commander (C) and Motorola's Transituner (D) are "wireless." Transituner is used only for station selection. Space Commander is standard equipment in some Zenith sets

Tips on TV Buying

Considering the many new TV models, it is interesting to note that despite widely varying prices most sets of any particular manufacturer are built around a single chassis. In only a few instances is there a difference in basic chassis design of the highest-priced units and that of the medium and low-priced lines (excluding the small-screen portables). Since it is chassis design which largely determines picture quality, the varying prices are due chiefly to features which contribute more to appearance and operating convenience than to actual performance.

When viewed in demonstration rooms, a casual observation may reveal little difference in picture and sound quality of different brands. Yet, some units may provide better performance than others under certain conditions. Here are a number of "look and listen" tests you can make to assure lasting satisfaction with your final selection.

1. Tune in a strong station on several sets and adjust *brightness* and *contrast* controls for best picture. A good picture has all the detail of a sharp, glossy photograph. Carefully compare picture quality of the various sets.

2. Rotate brightness control to maximum. Picture should remain in sharp focus with little or no "blooming" (enlargement of image).

3. Turn contrast control to maximum and watch for evidence of picture "bending" or an annoying raspy buzz in the speaker.

4. Rotate fine-tuning control. Picture and sound should remain good over several degrees of rotation.

5. Change stations. Picture contrast and sound volume should remain relatively constant on all channels.

6. Rotate horizontal-hold control. Picture should remain steady, without distortion, over a large portion of the control.

7. If available, plug a motor-driven appliance into nearby outlet. Picture should remain steady.

8. Turn volume to minimum and listen for any hum which may be audible a few feet from the set. Turn volume to higher-than-normal listening level and compare the over-all tone quality of the various sets.

Any set scoring high in the above tests is likely to perform well in your home, providing it is properly installed and adjusted, and used with a satisfactory antenna system.

the

POPULAR
MECHANICS

WTM 58
CRAFTSMAN



KNOTTY-PINE HUTCH CABINET

By Hi Sibley

HERE IS A PROJECT designed especially for the home craftsman. The original was made of knotty pine, but any wood with an interesting grain is suitable. Glue, dowels and screws are used to assemble the unit.

Start construction by assembling the base. Storage shelf, ends and counter top are made by edge-gluing equal length boards. Clamp them together until dry and then sand the surfaces flush. Ready-made

panels often can be obtained from your lumberyard. The shelf in the storage area rests on $2\frac{3}{4}$ -in. cleats to bring it to the level of the bottom of the door opening. Drawer rails are made from four pieces of 1×2 , $15\frac{1}{4}$ in. long, and rest on cleats front and back. The front cleat is a $31\frac{1}{2}$ -in. length of 1×3 , and is positioned to bring the top edge 20 in. up from the floor. Front panels are screwed to cleats from the inside. Cut the doorframe members to fit flush with the edges of the front paneling, mitering them at the corners. Either solid paneling

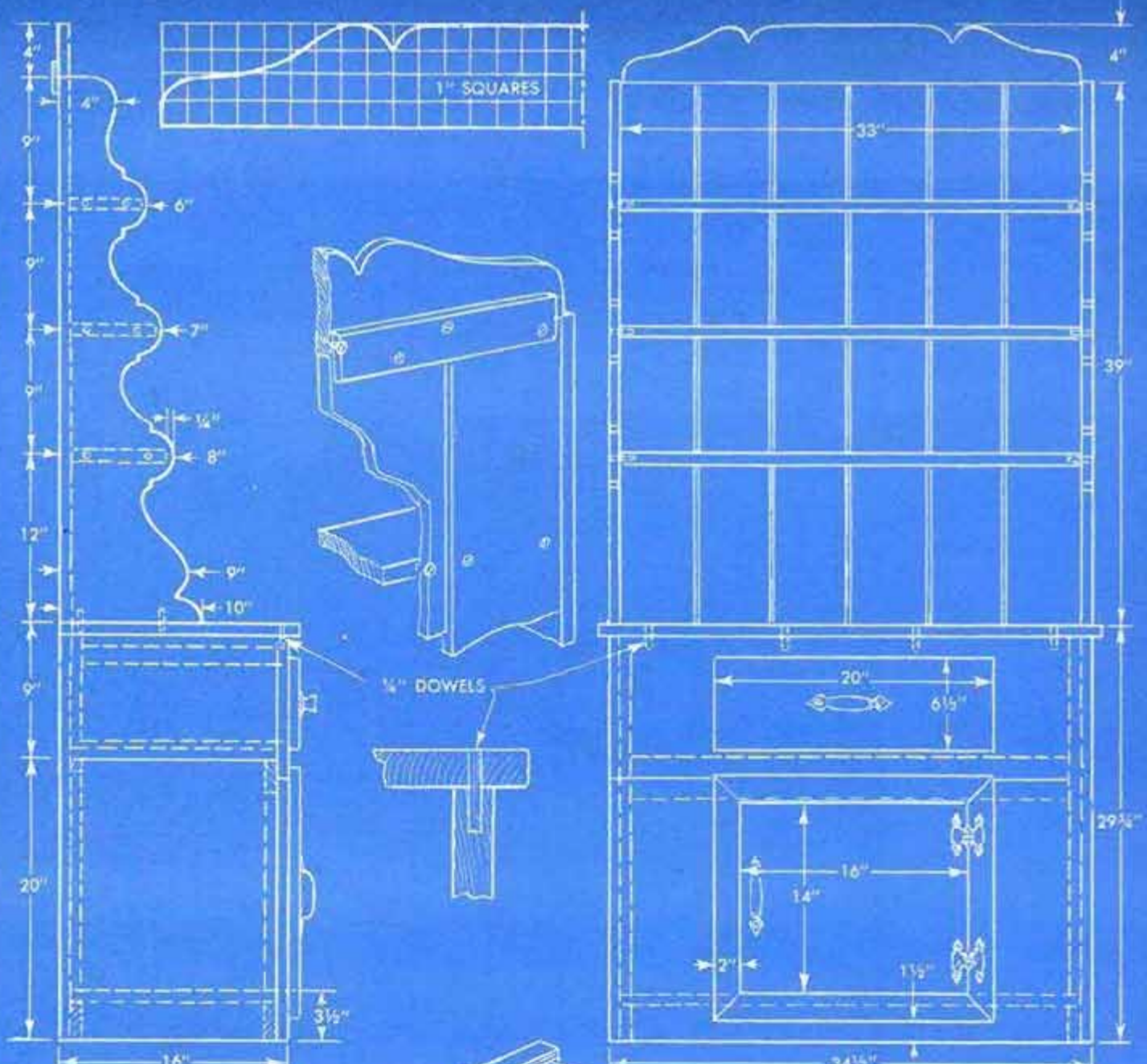

SIDE-VIEW DETAIL

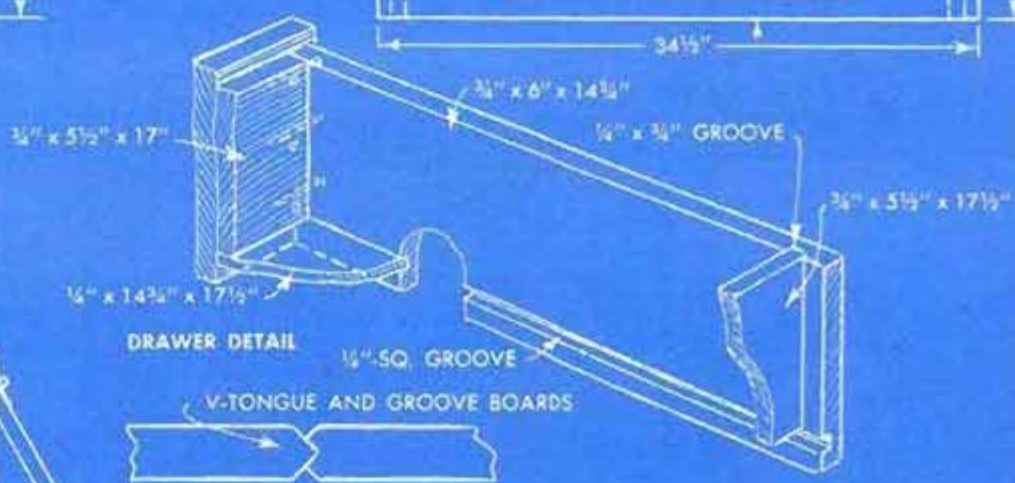

DRAWER DETAIL

BACK-PANEL DETAIL

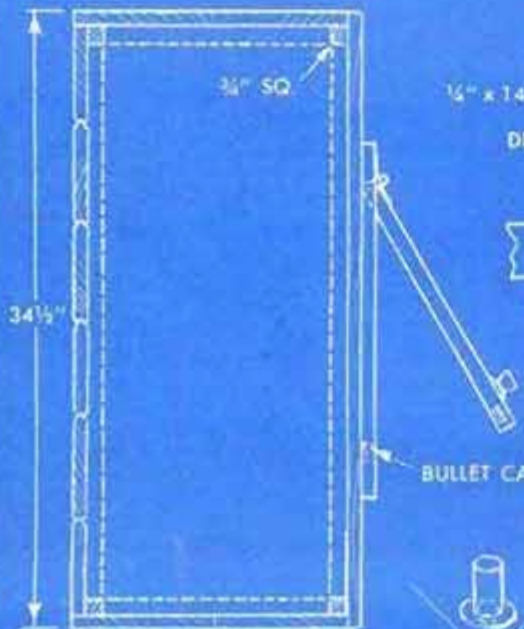

CROSS SECTION OF BOTTOM STORAGE AREA

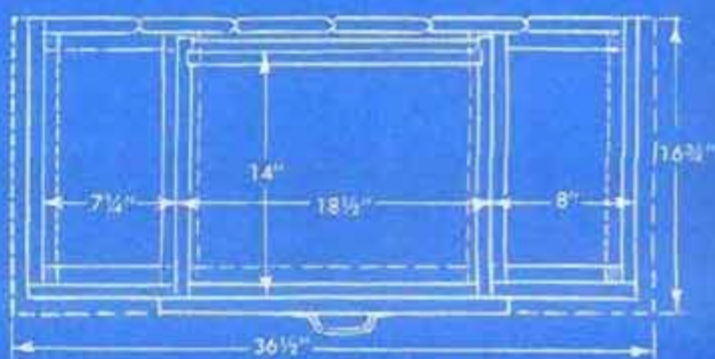

CROSS SECTION AT DRAWER LEVEL

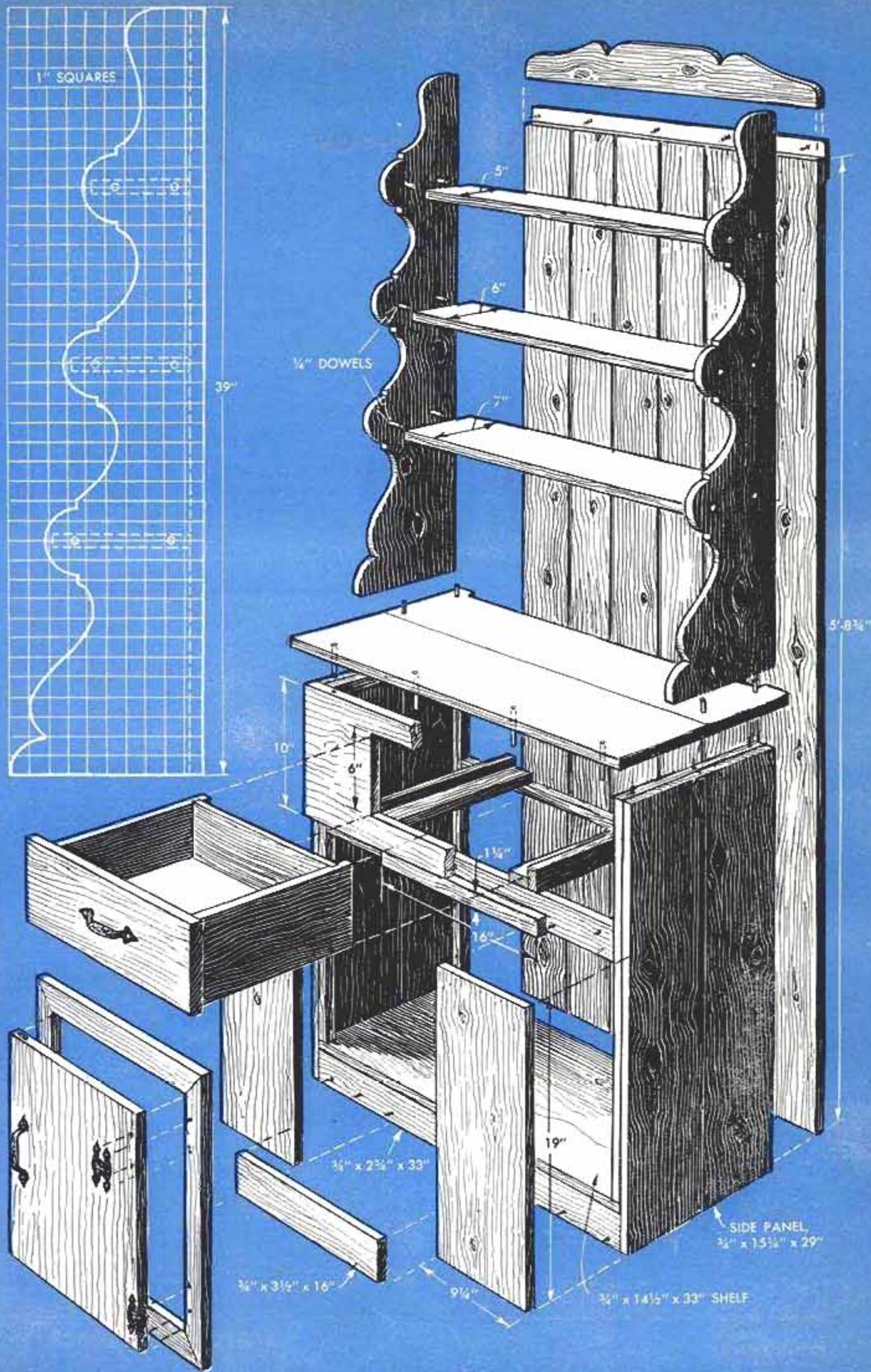



Yates-American photo

Butting end of front panel is sanded smooth for a tight joint. Exposed panel ends are also sanded

or $\frac{3}{4}$ -in. pine-faced plywood may be used for the flush door. Wrought-iron hinges and handles add to the rugged appearance of the cabinet. The drawer can be made without mortised joints by cutting the sides $\frac{1}{4}$ in. narrower to allow the plywood bottom

Reinforcing Loose-Leaf Pages With Cellulose Tape

If loose-leaf pages or spacers are subject to heavy use, try reinforcing the holes with a bit of ordinary cellulose tape. Fold a small piece of the tape over the hole and then repunch the hole.



to be screwed to the lower edges. Recess the screwheads so they will not wear the rails. The back is then fastened between the sides flush with the rear edges. Dowels are used to join the counter top to the base along the front edge. Wood screws driven up through cleats anchor it along the sides. Cut a recess in the back edge of the top $\frac{3}{4}$ in. wide by 33 in. long to accommodate the back paneling.

Six pieces of 6-in. V-tongue-and-groove pine $68\frac{3}{4}$ in. long form the back of the cabinet. Fasten them to the cleats and top panel of the counter with wood screws. Then cut out the two upright supports for the shelves. By temporarily nailing the two pieces together they can both be cut at the same time with a bandsaw. If a scroll or coping saw is used, cut one and use it as a pattern for the other. Fit the shelves between the uprights before fastening them to the counter. Dowels are used to fasten the shelves to the uprights and for joining the assembly to the counter top. Reinforce all shelves with screws driven in from the rear side of the back. Measure the height of the shelves closely and mark the back with horizontal chalk lines to prevent missing the shelves with the screws. Scroll-cut the top piece and join it to the cabinet with a cleat screwed to the top of the rear paneling as shown. ★ ★ ★

Modeling Clay Cleans Type

Ordinary modeling clay is effective for cleaning type on a typewriter that may have become clogged with dirt and ink. Using a piece about the size of a walnut, work it in your fingers until pliable and then press it onto the keys a section at a time. Roll it off as shown, folding the soiled area back into the ball, and rework the clay before cleaning the next section. A small piece will last for many cleanings.

Robert L. Hay, St. Petersburg, Fla.





Decorate With Hardwood Plywood

WHILE THE USE of hardwood-plywood panels on the walls alone will provide beauty and warmth for any room, the use of suitable built-ins will add much to the interest and practicability of a room.

For instance, the use of a planter-

Drill holes for dowels in planter top for snug fit, making sure to drill only halfway through plywood

PART II

island, as above, gives the effect of a small entry hall without taking any apparent space from the room. The use of indirect lighting adds a dramatic touch to the plantings, the ceiling and down onto the books.

The planter was built completely from

Cutaway drawing shows relation of various parts of planter. Toe space at base prevents marring of finish

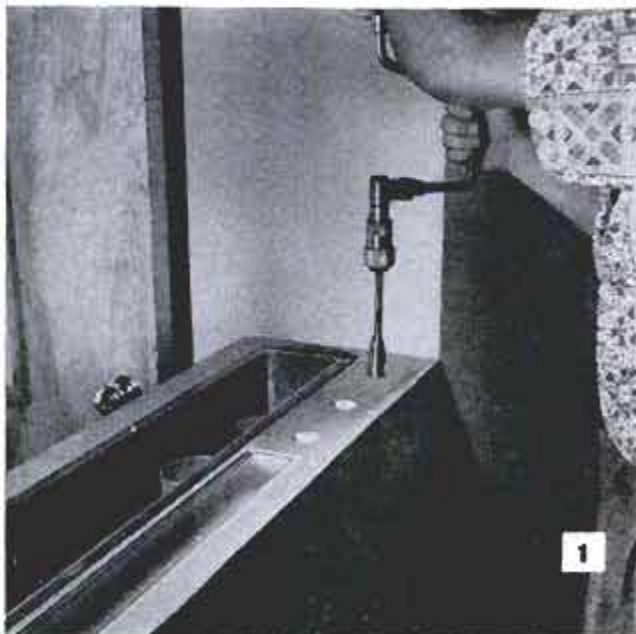

1

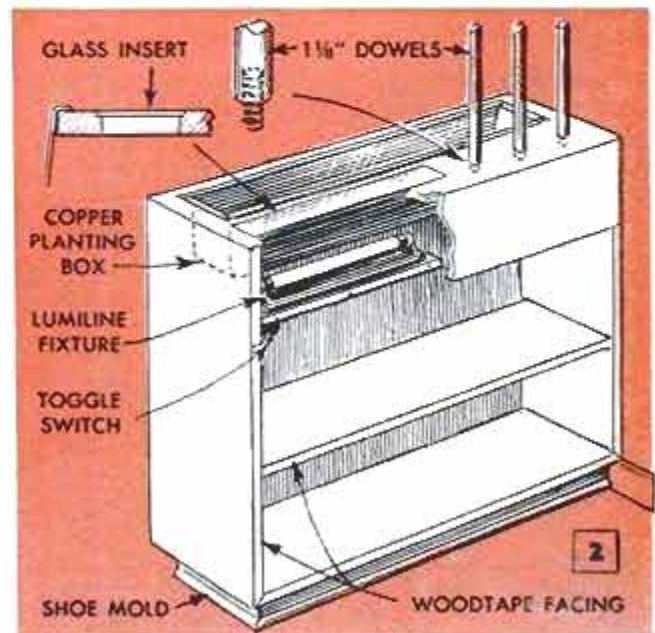

2



Although hardwood plywood has smooth surface, sand lightly before finishing. Sand the millwork, also

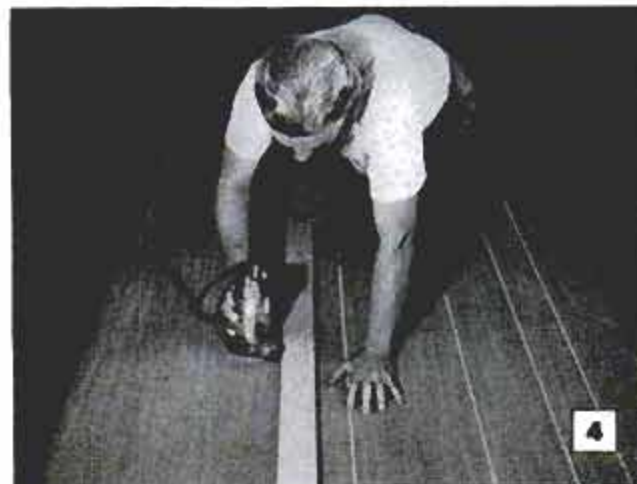

Running the grooves is simple task, but care must be exercised to keep grooves straight, correct depth

When necessary to leave plywood edge exposed, cover grain ends with Woodtape applied with special solvent



$\frac{3}{4}$ -in. plywood, faced two sides. The base consists of a frame of 4-in.-wide plywood, mitered at the corners so that the plywood stands on edge. This is fastened to the regular flooring with screws and glue blocks, after which a shoe mold is added. Make the base frame about five inches less in over-all size than the unit for toe space.

Then, carefully cutting all pieces of the planter to size, miter all butting edges. This allows them to be joined without the end grain showing. However, on the edges of the open book shelves, covering the end grain can be done, as here, by the use of Woodtape. Easily applied, photo 5, this product provides a simple answer to the problem of covering end grain.

When assembled, make a cutout in the top for a copper planting box. In this instance, the depth of the box is 8 in.; length and width will vary with your plan. The local sheet-metal shop will make the box if you have no facilities. Instruct them to put a 1-in. lip around it as this becomes the sole support.

The Lumiline fixture is mounted on a suitable shelf, screwed to the inside of the planter, beneath which is placed the toggle switch. Placing the switch as shown in drawing 2 keeps it handy yet unobtrusive. For the glass insert over the light fixture, use translucent diffusing glass. Do not use clear glass. Rabbet the top of the planter to take the glass flush.

When installing the large dowels that reach from the planter top to the ceiling, drill blind holes just large enough to take them with a snug fit, photo 1. Cut the dowels $\frac{1}{8}$ in. longer than the actual distance from the top of the planter to the ceiling. Then drill a hole in one end of each pole and insert a spring, as shown in Fig. 2. This feature has several advantages in that it

Occasionally grooves may be fuzzy. Sand lightly with block wrapped in sandpaper, held at 45-deg. angle



solves the problem of how to affix the ceiling ends of the poles, plus the very good feature of easing any future painting of the ceiling. The poles can be removed quickly at any time, and yet the springs hold them firmly in place.

The grooving operation explained last month and shown in this issue, photo 4, should be done with care to produce straight and even lines. Occasionally a groove will be fuzzy on its inner slopes. Sand lightly with fine-grit paper wrapped around a block of wood.

Construction of the plate rail, Fig. 7, is similar to that of the planter. The depth of the unit is four inches and, in this case, the shelves were dadoed into the sides.

As with the planter, plan and install your wiring beforehand. Hardwood plywood, while beautiful in its natural state, is enhanced by proper finishing. Preparation of the plywood for finishing is accomplished with light sanding and thoroughly removing all dust. Then, using cheesecloth or other lintfree cloth, wipe on a stain (in this application, a charreuse stain was applied to remove the red coloring of the mahogany). Wipe the stain *with* the grain. As soon as the stain "takes," wipe surface clean before starting a new section. It is advisable to experiment on a scrap piece of the paneling to make certain you have the color desired.

(Continued next month)

Finishing operations, photos 8 and 9, start with stain of desired color, wiped with the grain then filler wiped against grain, allowing ample drying time. Final finish ends up as satiny smooth luster

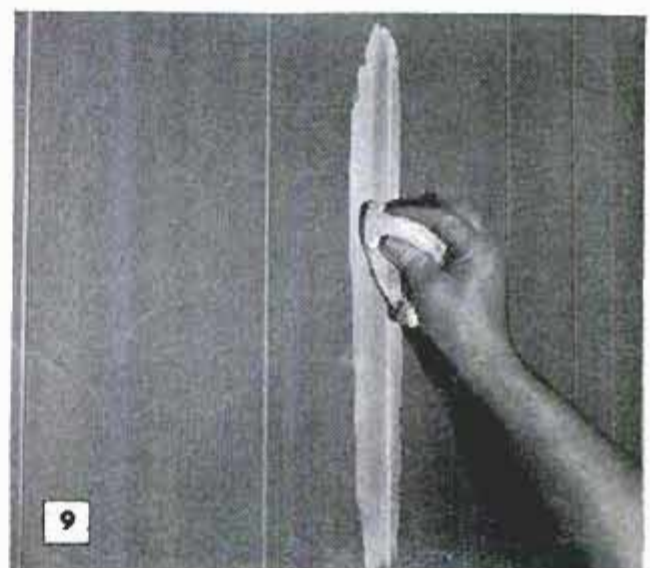
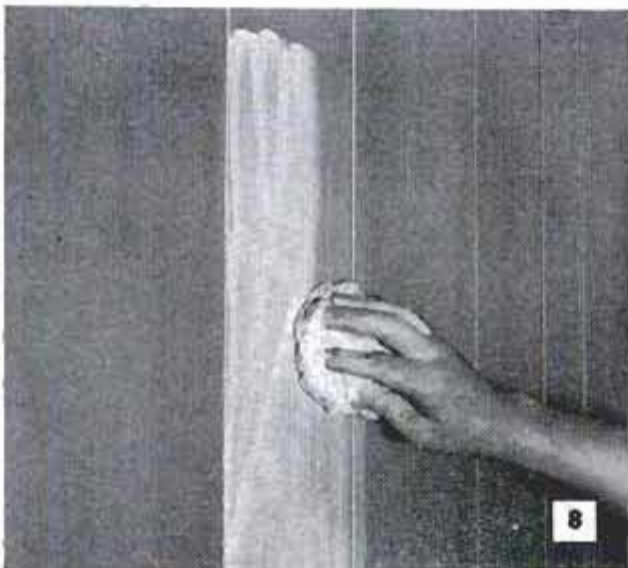
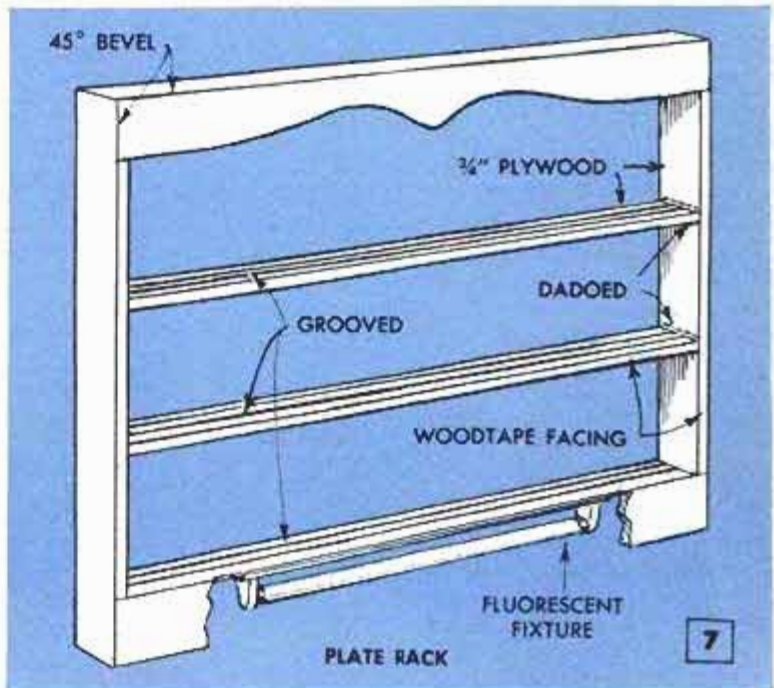
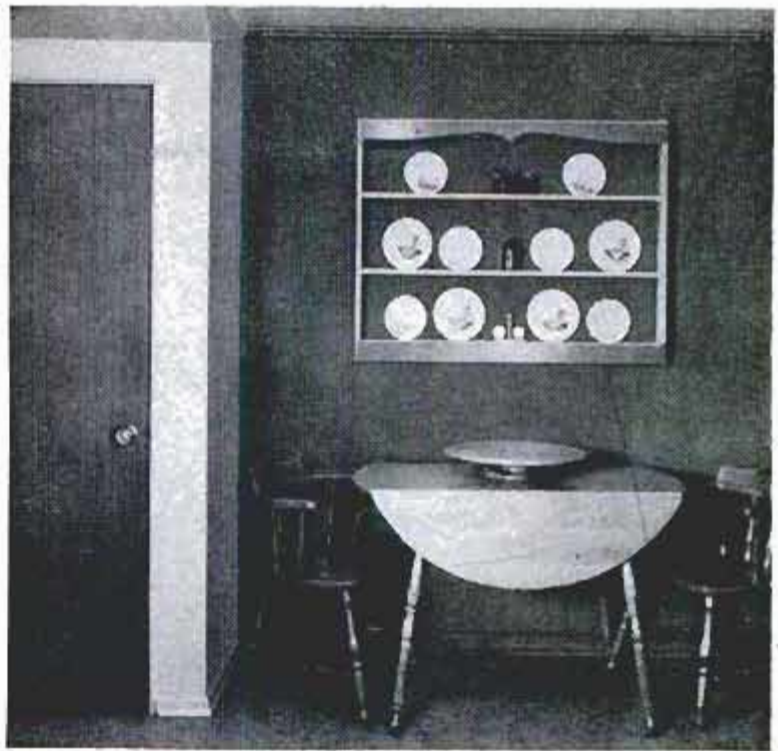

Tape Underside of Range to Prevent Damage



When moving a kitchen range to clean behind it, sharp, burred edges on its underside may cause ugly gouges in the floor covering. To avoid this, apply a felt or fabric tape to the edges on the underside. Apply the tape with a waterproof cement, or use a self-adhering fabric which will not become loosened when water-soaked while the floor is being mopped.

☛ To clean plaster figurines, vases, etc., dip them in a starch-and-water solution. When the starch is dry, brush it off with a soft-bristled brush.

Auxiliary Flash Unit Improvised With Extension Cord and Dish Pan

When you wish to make a two-flash shot and have only one reflector, insert the second lamp in an extension-cord socket and clip it to the edge of a white dish pan as shown. An adapter may be used in the extension-cord socket which is set in the "on" position so it can be operated from the camera, though some distance away.

Ken Murray, Colon, Mich.



Neat Stick-On Labels From Tape

Labels that stick firmly to fishing-tackle boxes, suitcases, raincoats and children's school clothing are made easily from medical adhesive tape. They may be hand lettered or typed. Stick the blank label on waxed paper; the kind that is used for wrapping food is fine. The paper should be of such a size that it can be inserted in a typewriter. Type the required identification on the label. It will now pull easily from the waxed paper, but will stick firmly to any dry surface that is not waxed or oiled.

Charles H. Coleman, Aurora, Ill.

Anchoring Screws in End Grain

Where a strong joint must be produced by driving wood screws into end grain, there will be very little tendency for the screws to loosen if they penetrate a dowel as shown. The dowel is coated with glue and driven to a snug fit in the hole. Pilot holes for the screws should be drilled through the dowel to prevent splitting.

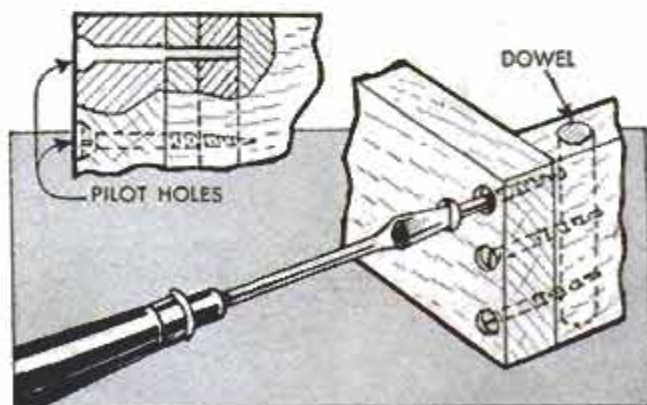

"NORTH WIND"— Boy-Size Iceboat

IT'S A SAFE, sharp performer on the blue ice of a frozen pond; a speedy wind-driven sled on level stretches of hard snow. You don't have to run directly before the wind. You can sail on the quarter with a following wind as much as 30 deg. off the course. The swinging sail boom and front steering give close control on fast runs.

The frame, seat, seat back and seat risers are cut from $\frac{3}{4}$ -in. pine, but the mast, strut and sail boom should be hardwood. Oak, $\frac{1}{2}$ in. in thickness, is just right. Only clear, straight-grained stock should be used. Cut the runners (all three are identical) from 1 or $1\frac{1}{8}$ -in. white pine and groove for the $\frac{1}{4}$ -in. round steel shoes. Notch the runners for the running bar, or spacer, and the steering bar. Countersink the head of the pivot bolt in the front runner. Join fixed parts with screws and glue. When joining, care must be taken to align the notched ends of the seat board and the frame vertically, so that the mast will stand perpendicular. Note that the bolts holding the mast, also the bolt on which the boom pivots, are fitted with wing nuts. Finish the mast and boom in natural color with spar varnish and the other parts with a sealer and colored gloss enamel.

Geo. W. Blow, Arlington Heights, Ill.

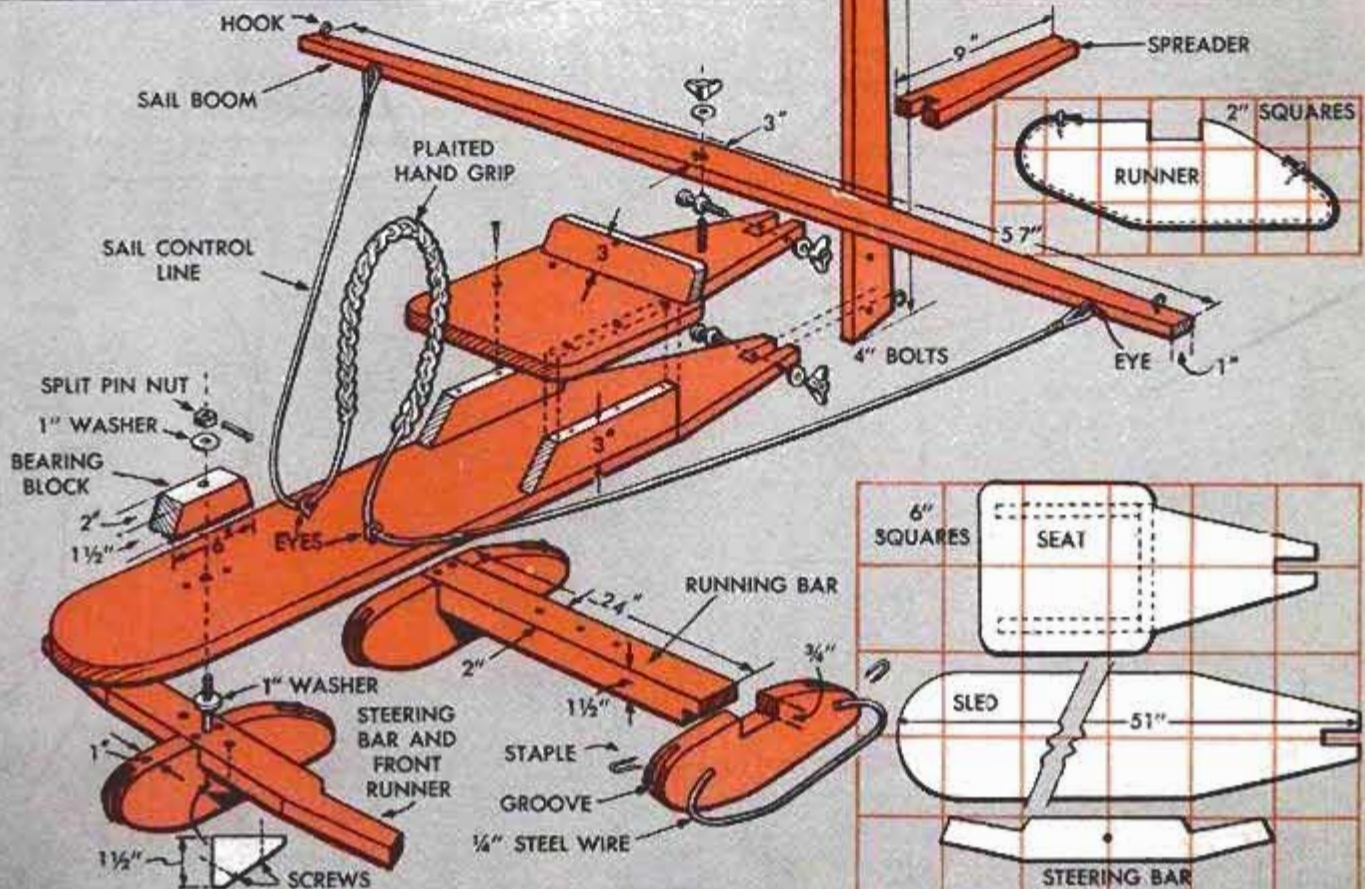
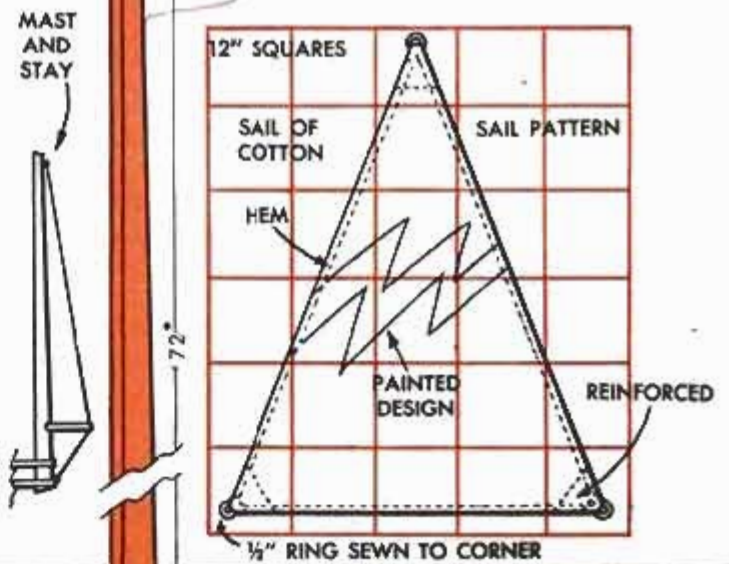

Paint Code Identifies Keys



The confusion of fumbling through a fistful of keys to find the right one, or telling someone else by phone which key to use, is avoided by painting a color code on matching key and lock. Paint a stripe on the lock, and apply a matching color to

the key. For more than a few locks use a combination of two or more colors, striping the lock and key similarly.

Dowel Plugs Aid Mortise Drilling

Mortises, formed by drilling a series of holes, can be made easier and neater by plugging each hole as it is drilled with a dowel slightly longer than the depth of the hole. The holes can then be drilled closer together leaving less wood between them to be chiseled out. After all holes are drilled the dowels may be pulled out with a pair of pliers and the mortise chiseled clear.—P. Casperson, El Cajon, Calif.

Towel Speeds Evaporation Rate Of Radiator Humidifying Tank

A turkish towel draped over a coat-hanger-wire frame as shown, and fitted in a radiator water pan, will greatly accelerate the rate of evaporation to increase humidity inside the house. The towel, which acts as a wick, may become hardened with lime in a few weeks and will have to be replaced.—Ed Packer, Oak Park, Ill.

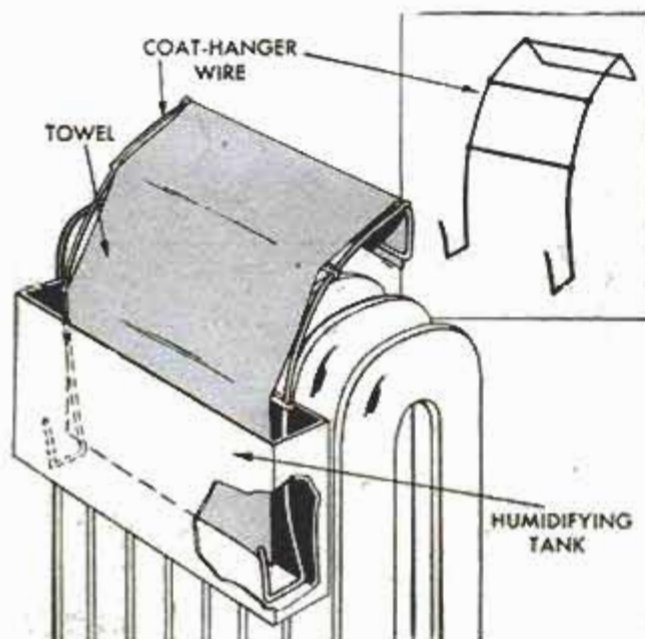

Tighten loose handle on household brush by spreading twisted wire and gluing tang back in handle

Bristle Brush-Up

Cork washer placed at bottom of threaded hole in push broom prevents handle from working loose

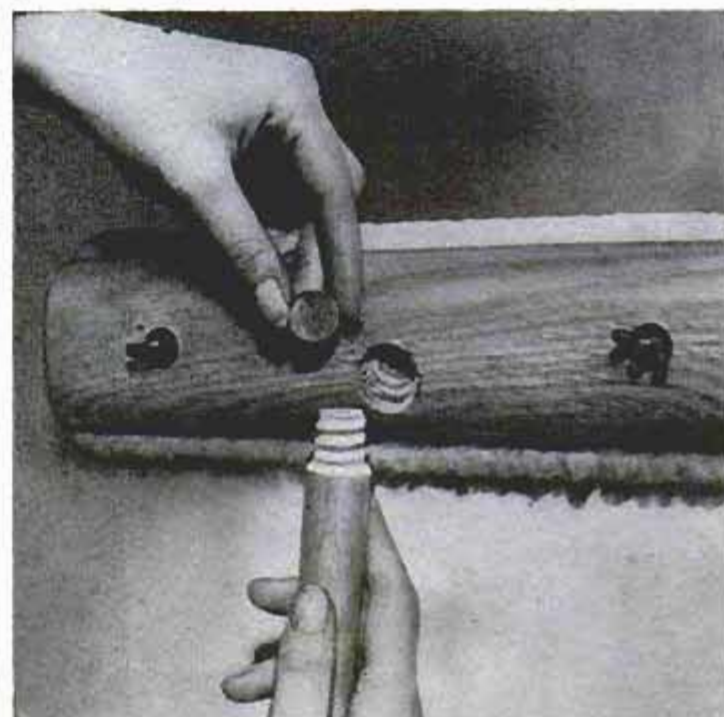



Half of hollow rubber ball slipped on brush handle prevents paint from running down handle onto fingers. Simply cut ball in half, punch hole in center of one of the halves and push it on handle as shown above



Photograph upper right, use wire brush to clean threads, string, etc. from carpet sweeper or vacuum-cleaner brushes. Avoid pricked fingers when cleaning wire brush by touching lighted match to wire bristles only

Lower left, when storing paintbrush in turpentine, drill hole in handle and hang it on wire arm so bristles do not touch bottom of can. Arm is piece of wire hanger shaped as shown and soldered to bottom of container



It is easier to clean paintbrush when wire-mesh disk is placed on two blocks on bottom of can of cleaner and bristles are flexed against mesh as in lower center photo. Paint washes off and settles to bottom of can

Lower right, one ordinary and one spring-type clothespin nailed together as shown form adjustable holder for small paintbrush when slipped on rim of jar. Drill small hole for nail to prevent clothespins from splitting

Above, old typewriter-eraser brush with bristles trimmed short so they are stiff and compact serves as handy applicator for paste-type shoe polish. The small brush is especially useful for spreading polish on two-tone shoes with intricate patterns and around soles and fabric insets



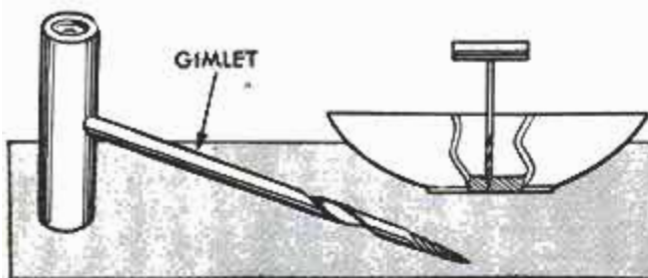

Quickie Bonbon Server

With a 15-cent gimlet and a 6-in. wooden bowl you can make an attractive little candy dish almost as quick as you can say bonbon. Simply turn the gimlet into center of the bowl and leave it there for a handle. It is easier to start the gimlet if a small pilot hole is first drilled through the bowl. A coat of clear lacquer on the steel part of the gimlet will keep the metal shiny. A disk of felt may be glued to the bottom of the bowl to prevent marring.

Threaded Studs Removed By Using Two Nuts

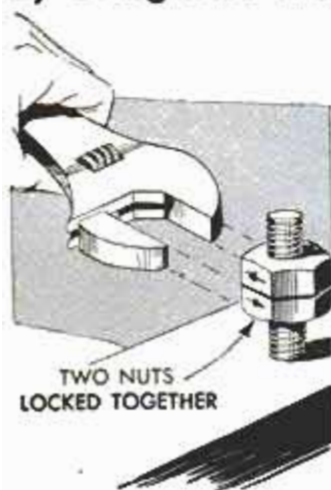

When only the threaded portion of a stud is accessible, use two nuts turned together tightly on the stud to remove it without damaging the threads. Fit a wrench on the lower nut and turn off nuts and stud together. Heating a tight stud often helps to loosen it.

When making boiled starch, drop a little paraffin in it. Clothes starched with this solution will have much less tendency to stick to the soleplate of an iron.

Slot in Board Holds T-Square

A T-square may be kept conveniently at hand and yet out of the way by hanging it in a notch cut on the edge of the drawing board. The notch should be near the top of the board and may be lined with felt to protect the T-square edges. An additional piece of felt on top of the board extending beyond the cut will prevent disalignment of the crossbar should the T-square be accidentally dropped into the slot. Sponge rubber may be used in place of felt.

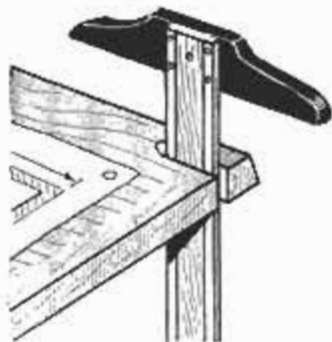

Roll-Fed Telephone Note Pad

Heavy sheet metal was used to make this telephone note pad which is equipped with a roll of adding-machine tape as a paper supply. The roll rotates on a 1/4-in. bolt fitted between two pieces of sheet metal welded to the bottom of the L-shaped writing surface. The paper passes up through a slot at the back of the writing table and under a bar welded near the front edge, which also aids in tearing off used paper. Sheet-metal clips welded to the side of the holder grip a pencil, and the entire assembly is attached to the wall with screws through the right-angle flange of the top piece. File all exposed edges on the sheet metal smooth and apply one or two coats of enamel to the completed unit so it will harmonize with the color scheme of the kitchen.—E. V. Reyner, Townsend, Mont.



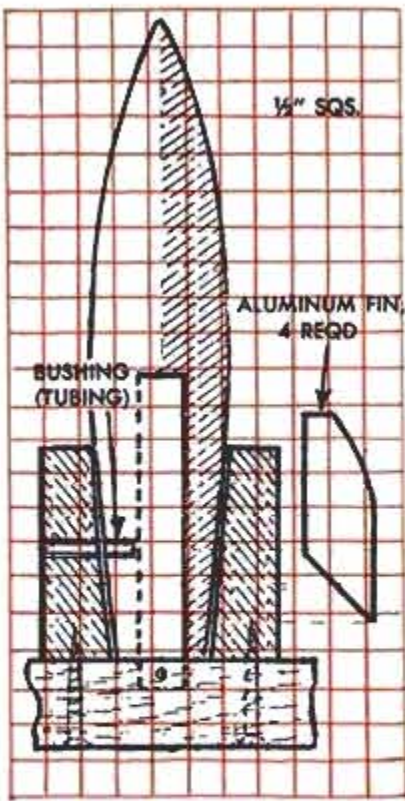

Rocket Ship and Launching Station

By
Hi Sibley

YOUNGSTERS will be delighted with this "toy of tomorrow" that features a fast-flying, lightweight balsa rocket ship that has aluminum tail fins to guide it in flight. Power for the ship is supplied by a coil compression spring concealed in the launching tower. Rocket take-off is controlled by pulling a spring-loaded trigger rod that extends through the "spaceship station." When the ship is pushed down into the tower so that it compresses the spring, one end of the trigger rod fits into a hole in the ship and holds it in place un-

til released. To prevent wear in the soft balsa wood of the hull, the hole is bushed with a short length of small-diameter tubing. Drill a 5/8-in.-dia. hole 4 1/2 in. deep in the end of the balsa block used for the hull, then cut the slots for the tail fins. After the hull has been shaped and the fins cemented in place, bind the end of the hull with thread as indicated. Brush a coat of shellac on the thread and over the hull to seal the wood. Aluminum paint is applied over the shellac to give the spaceship hull a more authentic metallic appearance.

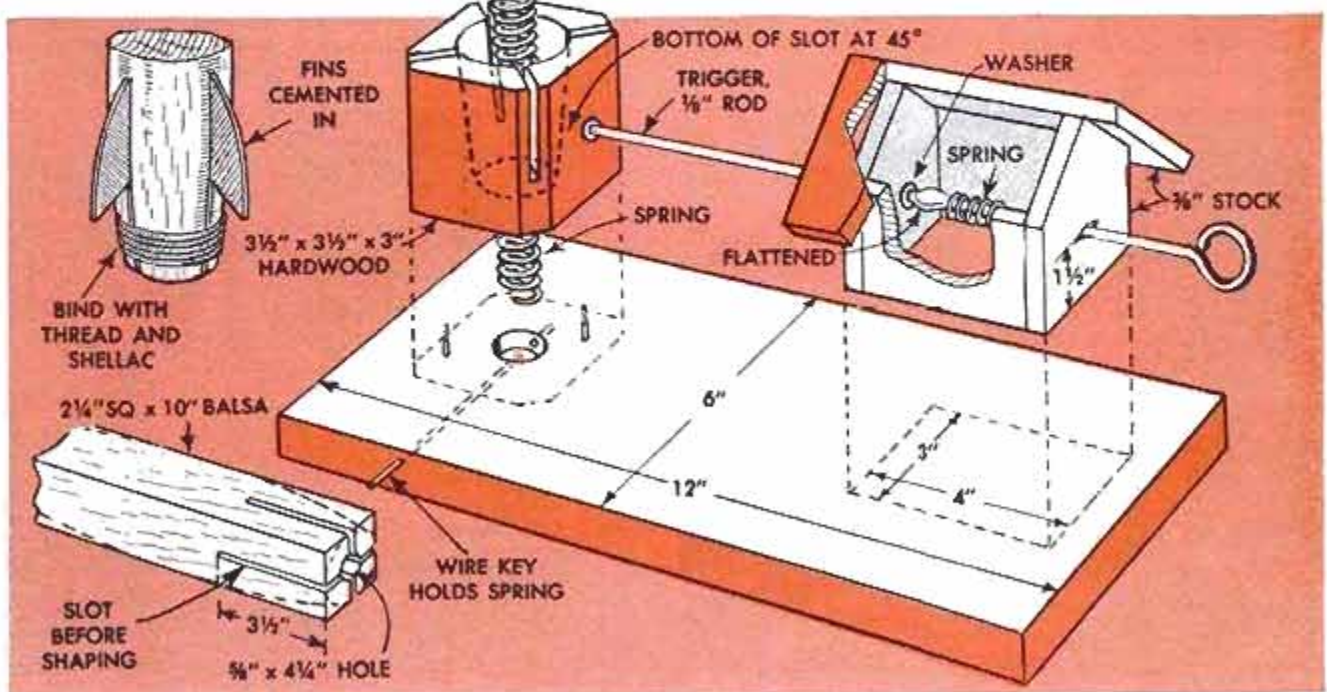

SOLVING Home Problems



RECIPE CARDS and clippings of new recipes have a way of slipping to the floor or curling at the corners. Prevent this by attaching the card or clipping to the back of a cabinet door with pins or brads



NYLONS can be snagproofed for travel or storage in a drawer or handbag simply by folding neatly and inserting in an ordinary letter-size envelope. Label envelope so that it is not accidentally discarded

CUP HOOKS screwed into the back of a closet door, or into the wall or edge of a shelf, keep dress belts handy and always in good order. Each hook will hold two or more belts hanging by the buckles as illustrated. Space the hooks about 3 in. apart

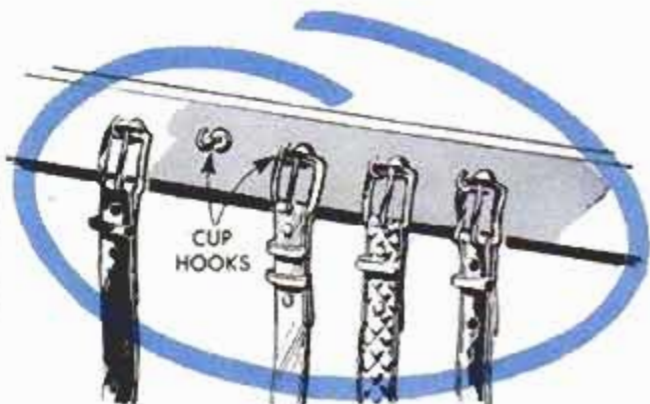

LEGIBLE ADDRESS on a large package is easily written with a matchstick dipped in ordinary writing ink, or India ink if you have it at hand. Matchstick scribes line much heavier than that of a pen. There's less danger of blotting if letters are printed freehand



PLASTIC BOTTLE PUMP of the type used with lotions and other thick liquids is easily cleaned by inserting in a tumbler of warm water with detergent. A few strokes restore pump to original effectiveness



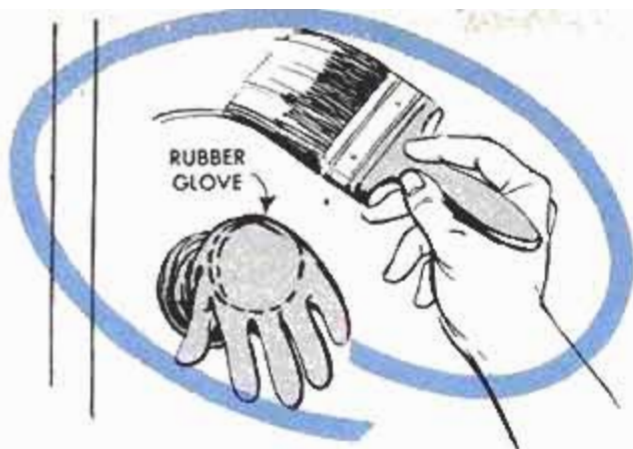

EFFECTIVE PAINT MASKING for doorknobs with round plates can be made from toy balloon or a discarded rubber glove. Just slip the balloon or glove over the knob and hold in place with cellulose tape

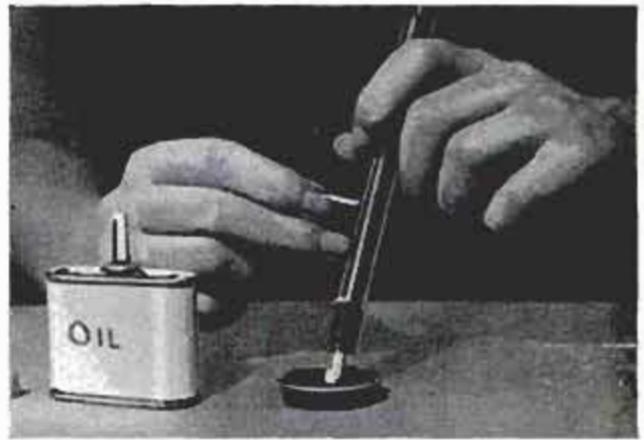

FOUNTAIN PEN makes good one-drop oiler, especially a pen on which point has been damaged and is no longer worth repair cost. Fill with light oil and use for lubricating sewing machines, small motors



LARGE COOKIE TIN placed on floor of utility room or hallway catches water dripping from wet or snow-covered galoshes, rubbers and umbrellas, prevents water stains on the floor or rug. If used in hallway, tin should be placed near wall or in corner

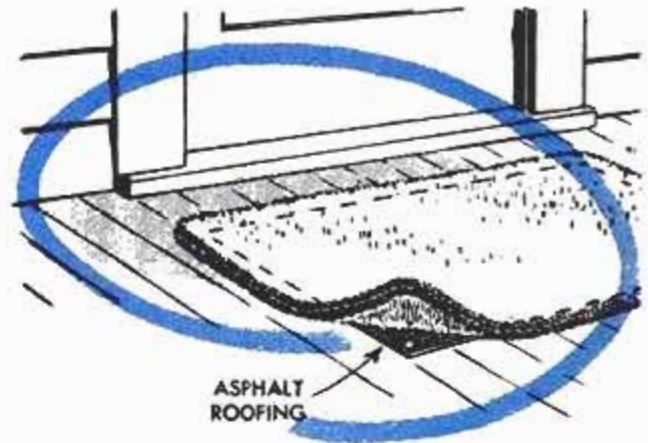

FIBER DOOR MAT will stay in place if you lay it over a piece cut from surfaced roll roofing and tacked to porch floor. The piece of roll roofing should be about 2 in. smaller each way than the over-all size of the mat, so that mat conceals it at all times

SMALL SCREW HOOK, or L-hook, will anchor a flowerpot safely on a sloping window sill. Determine the location of the flowerpot, allowing space for sash to close, then drive screw hook into sill. Place flowerpot so hook enters hole in bottom as shown



HEAT FROM SMALL LIGHT BULB in trouble lamp will shrink wood in a drawer sufficiently so that it can be fully withdrawn and edges planed for an easier fit. Just pull the drawer out as far as it will go without forcing unduly and place lamp inside

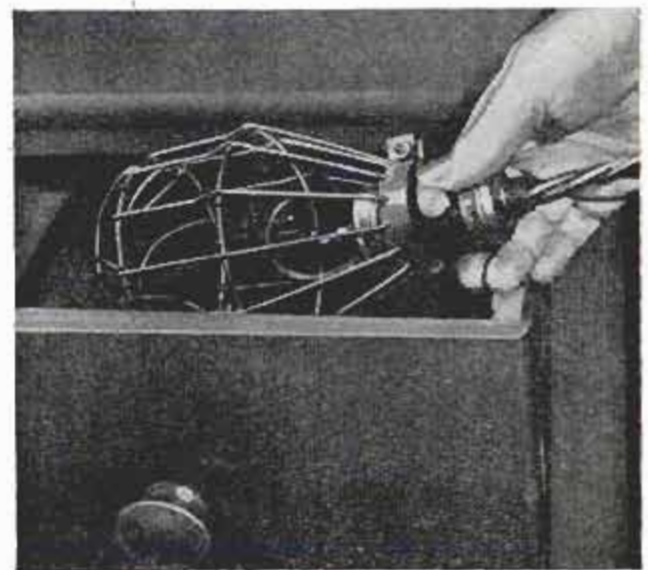

see ad, Jan 55, 251

Garage Door Protected by Roll-Type Weather Stripping



Tacked to the bottom edge of a wooden overhead garage door, roll-type weather stripping proves beneficial in three ways. First, as weather stripping, it helps to keep the door closed tightly, shaping itself to the floor and preventing drafts. Second, it prevents the door from contacting the floor, so that moisture is not absorbed that may cause loosening of the paint and rotting of the wood. Third, it reduces the noise of the door striking the floor, and serves as a shock absorber. Since the weather stripping raises the door a trifle from its original position, compensating adjustments may have to be made in the latching mechanism of the door hardware.

It is possible to write black on a glass or bright metal surface with a steel pen by using an ink consisting of water glass, 1 to 2 parts and liquid India ink, 10 parts.

Ear Syringe Used to Blow Lint From Camera-Lens Parts

The last step in cleaning a camera is to remove the lint that has settled on the lens. A small ear syringe provides an effective means of blowing the lint from the camera. Blowing with the mouth also helps to remove the debris, but the breath deposits moisture on the camera parts where it may cause trouble later.

Frank A. Javor, North Bergen, N. J.



Straps Cut From Inner Tube Hold Heavy Rubbers on Shoes

Farmers and other outdoor workers who wear heavy rubbers that might be pulled off in deep mud can prevent this by wearing rubber-band straps cut from an inner tube. Each band is slit about half its length as shown. The wide portion of the band fits across the bottom of the foot while the slit portion fits over the instep and around the heel.

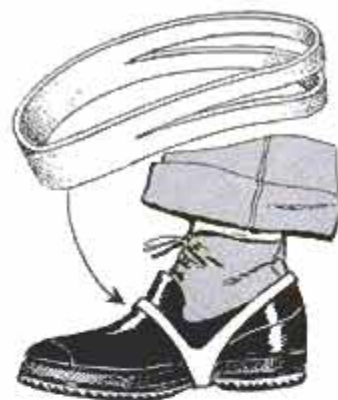

Measuring Distances by Pacing

Measuring such distances as the length of a driveway or the width of a plot of ground can be done fairly accurately by pacing, if the average length of your stride is known. To determine this factor, measure a distance exactly 100 ft. long and walk it several times, counting the number of steps required. As an example: If you walk the 100 ft. in 38 paces, your pace would be 2.63 ft. The number of your paces multiplied by this number then would produce the approximate length of any definite distance paced.—O. H. Hampsch, Oak Park, Ill.

Sewing "Caddy"

It may look like half of a manmade satellite, but it's actually a down-to-earth holder for sewing needs. Made from a 6-in. wooden bowl, dowel pegs, an empty spool and a cork, the unit shown below proves handy for any sewing job. Thread-spool pegs $\frac{3}{16}$ in. in diameter and $1\frac{1}{2}$ in. long are glued into holes drilled at an angle of 50 deg. from horizontal. A longer dowel runs up through the center of the cork pin-cushion and through an empty spool that provides a handle. The dowel projects above the spool to form a thimble rest.

Walter E. Burton, Akron, Ohio.



Peg holes are drilled with bowl supported on an angled drill-press table. A nail driven through a hole in the center of bowl and into a board permits bowl to rotate for uniform drilling

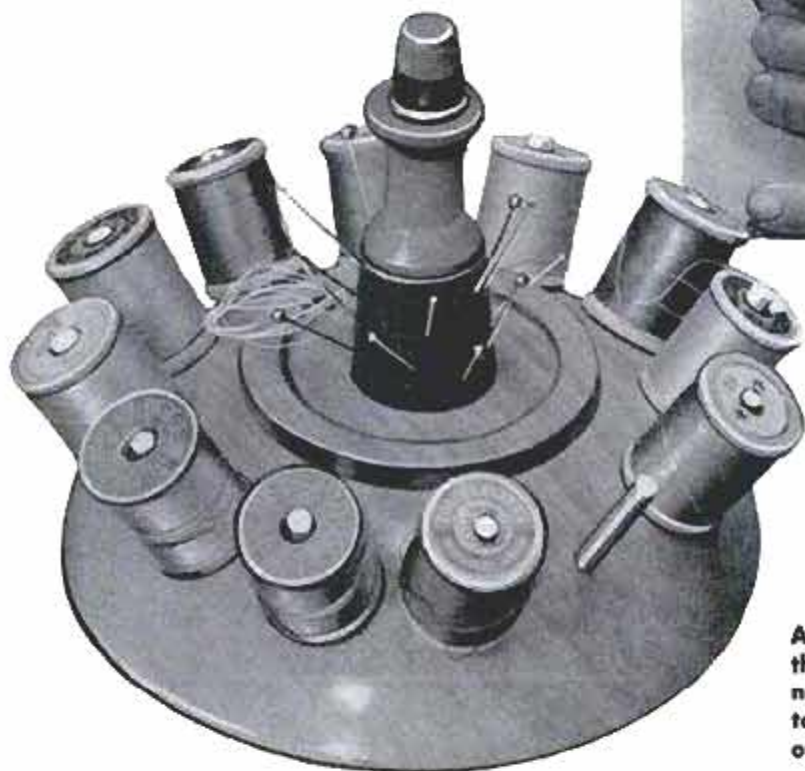

An array of sewing needs is at hand on this completed "caddy" (left). Pins and needles project from a cork at the center, topped by a handle and thimble. A circle of pegs on base holds spools of thread

Standard Pipe and Bolts Make Lightweight Tie Rod

When ready-made tie rods are not available, a quickly assembled tie rod can be made from standard pipe with short bolts fitted in the ends. To do this, first cut two rings for each tie rod off the end of the pipe stock. Then cut the pipe to the desired length, saw two crosswise cuts in the ends, insert the bolt head and bend in the cut sections. After the ring is slipped over the bent sections of the pipe and tightened, the tie rod is ready for use.

Charles H. Willey, Penacook, N. H.

☐ A white, cloth window shade, fitted in regular shade brackets screwed to the wall of a recreation room, provides a substitute projection screen for home movies. When not in use, the screen can be rolled up out of the way.

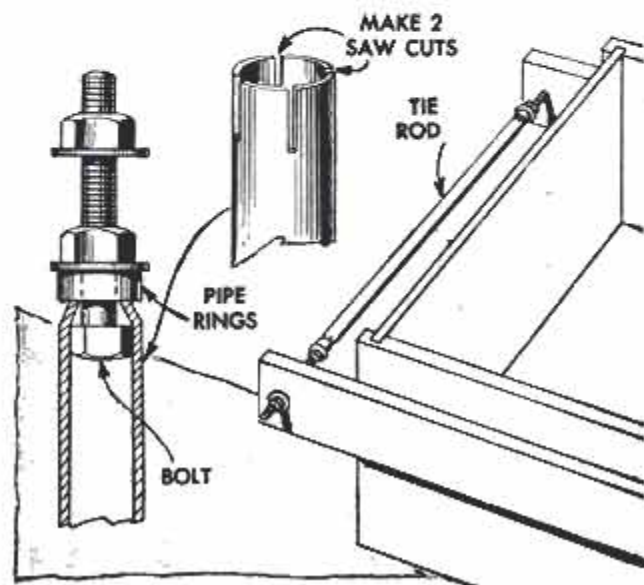

Photokinks 30

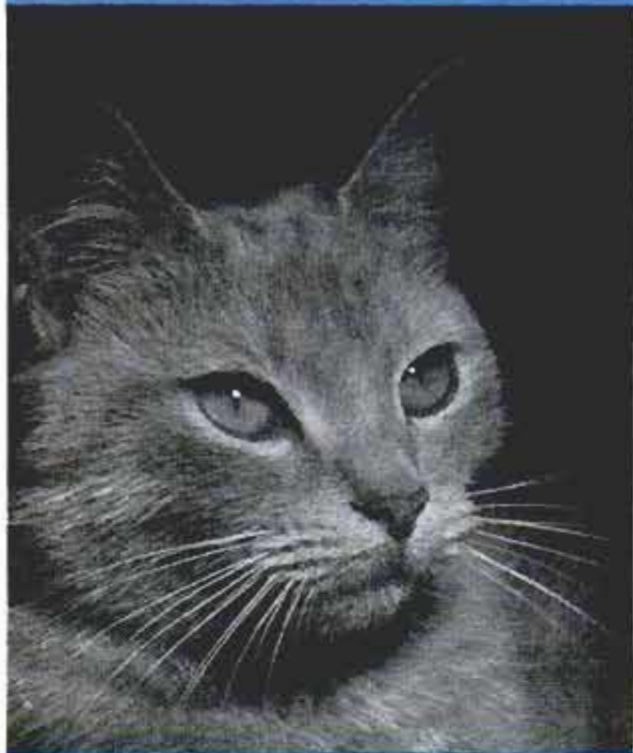

Calibrate Your Enlarger

By Joseph Foldes

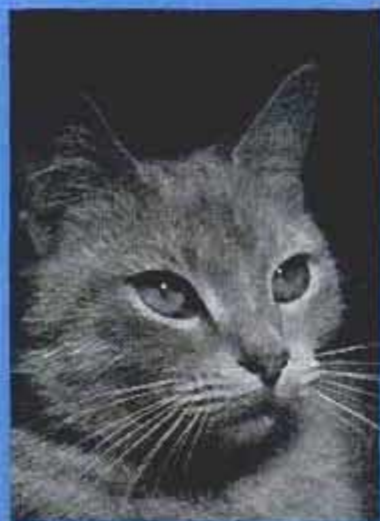

1

WHEN MAKING several different sizes of enlargements from the same negative, considerable time and darkroom materials can be saved when you work with a calibrated enlarger and use the table of enlarging ratios shown below. You then will get good quality prints having consistently uniform tone values, Fig. 1, without having to make several test strips for each change of print size.

Calibration Scale

First, make the calibration scale, so that you know how many times (diameters) a negative is being enlarged. To establish the number of times of enlargement for any one position of the enlarger head, draw a line 1 in. long on a piece of clear negative or tracing paper as shown in Fig. 6, and place it in the negative carrier. Focus the line on the easel with the enlarger head lowered to give the minimum number of times enlargement to the nearest half unit. Then, raise the enlarger head and mark each intermediate position on the upright or support—2, 2½, 3, 3½, etc., until the enlarger is as high as it will go. If more than one lens is used with the enlarger, a different scale must be made for each of them. The aperture must be the same for all tests and prints.

Fig. 2 shows a calibrated Omega DII enlarger with a strip of white adhesive tape attached to the right-hand supporting beam and the calibration scale marked on the tape in India ink. Select any part on the enlarging head that slides on the upright

Enlarging-ratio numbers are number of times (diameters) projected image is larger than negative

Enlarging ratio as read on calibrated enlarger	Guide No.	Enlarging ratio as read on calibrated enlarger	Guide No.
1½	1	8½	14.5
2	1.5	9	16.5
2½	2	9½	18
3	2.5	10	20
3½	3.5	10½	22
4	4	11	23.5
4½	5	11½	25
5	6	12	27
5½	7	12½	29
6	8	13	31
6½	9	13½	33.5
7	10	14	36
7½	11.5	14½	38
8	13	15	41

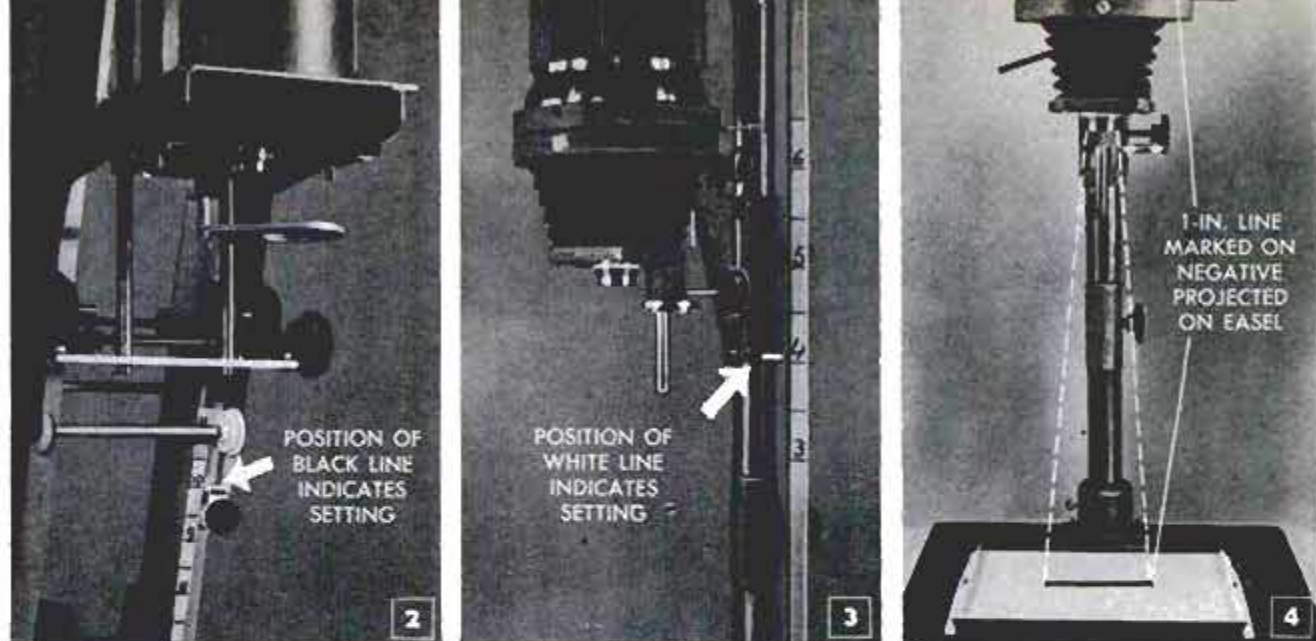

When calibrating enlarger like Omega DII, Fig. 2, attach scale to upright. Fig. 3, affix scale on wooden strip for other enlargers. Fig. 4, 1-in. line on negative projected on easel determines the enlarging ratio

and scribe a pointer or index line on it for use as a point of reference when adjusting the enlarger to the desired setting. For the Omega DII enlarger, the upper edge of the locking block is used as a pointer. Since it has a light-colored surface, a black line is painted along the upper edge for easier reading.

On some enlargers it is impossible to attach a suitable material on the upright for marking the scale because it would interfere with raising and lowering of the enlarger head. In this case, mark the scale on a thin strip of wood and hold it next to the upright each time a setting is changed as shown in Fig. 3, or fasten the strip to a

wall bracket positioned so that it is adjacent to the upright for easy reading.

Correct Exposure

To get the proper exposure for any size enlargement, first make a print by the test-strip method, noting the number of times of enlargement and exact exposure time required for a good quality print. Look up the guide number for the test print you have just made, using the table shown and then the guide number for the enlargement about to be made. To arrive at the new exposure, multiply the new guide number by the exposure in seconds of the test enlargement. Then divide the result by the old

3 Determining right exposures for different size enlargements by test-strip method, or by guess, often results in prints that are over or under-exposed as shown in photos below. Use of calibration saves time and assures uniform exposure



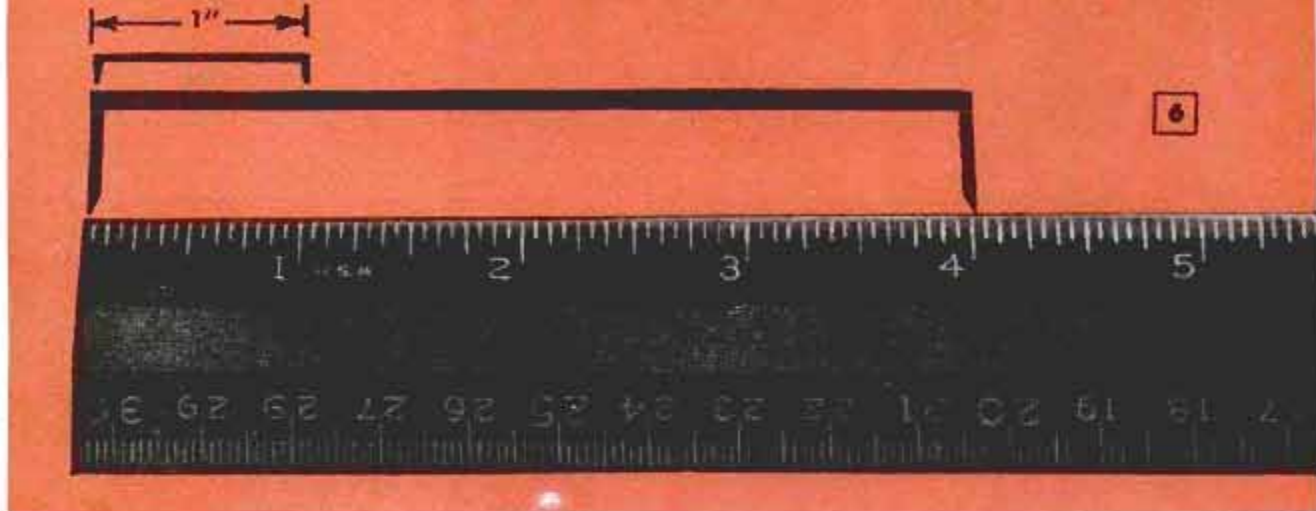

To establish number-of-times enlargement for any one (drawn on clear negative or tracing paper) on easel. position of the enlarger head, project a 1-in. line. The 4-in. line above indicates 4-times enlargement

guide number which will give the correct exposure in seconds for the new enlargement. The same procedure applies if the print is larger or smaller than the first (test) print. When an exposure is made with the enlarger head set between lines, 5½ and 6, for example, make a corresponding adjustment in the guide number.

Variables That Affect Prints

Since the speed or scale of contrast varies with the different types of papers, it is necessary to make one test print for each type and grade. The speed of even the same paper may vary somewhat if it is taken from a different lot, making it necessary to

run a test print beforehand for good results.

The illumination and optics used in an enlarger may introduce slight variations, but they are usually insignificant. If it is found that your enlargements turn out consistently darker or lighter than the test print, make an allowance for it by increasing or decreasing the new exposure slightly as the case may be. Other factors entering into the determination of length of exposure are density of negative, color of negative and duration of development. Negatives of medium density and with good tone values simplify developing work. Also, follow through with accurate and uniform timing when processing prints. ★ ★ ★

Linseed-Oil Dip Eases Nail Driving

Nails that are dipped in linseed oil can be driven more easily. This treatment is especially helpful when hard or tough woods are used. The oil also prevents rust-

ing, which damages the wood fibers and reduces the holding power of the nail.

Frank A. Javor, North Bergen, N. J.



"Magnet Mop" Picks Up Metal Parts

Nuts, bolts and other metal parts are easily retrieved from the floor with this magnetic mop made of one or more bar or dowel magnets taped to the end of a broom handle. Use adhesive tape and attach a magnet crosswise at the end of the handle, adding additional magnets end to end at the sides for wider coverage.



☞ It's unnecessary to mat a water-color painting for framing if, before it is painted, masking tape is used to completely cover the margins, leaving only the area to be painted visible. The tape will prevent splashes and paint runs on the margin, and it provides a good surface on which to test colors and shape your brush.

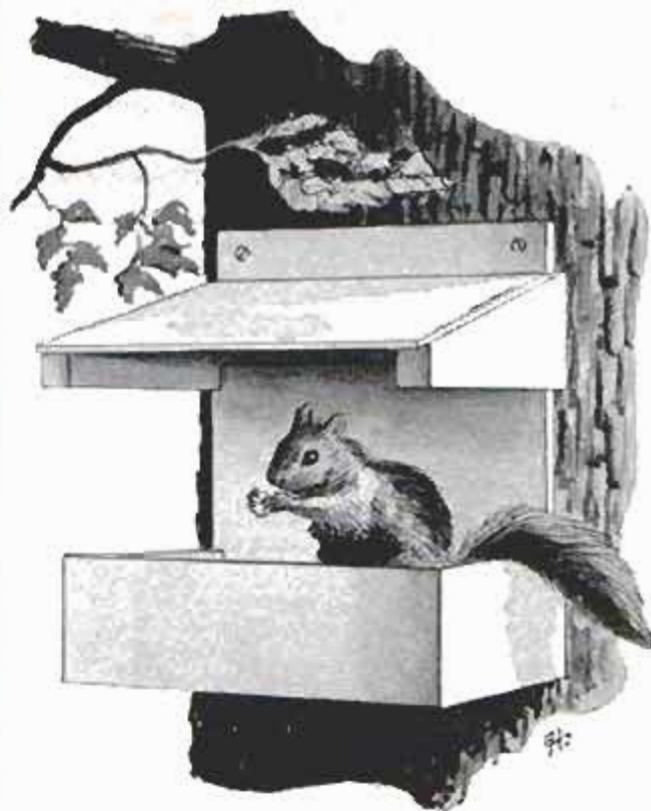
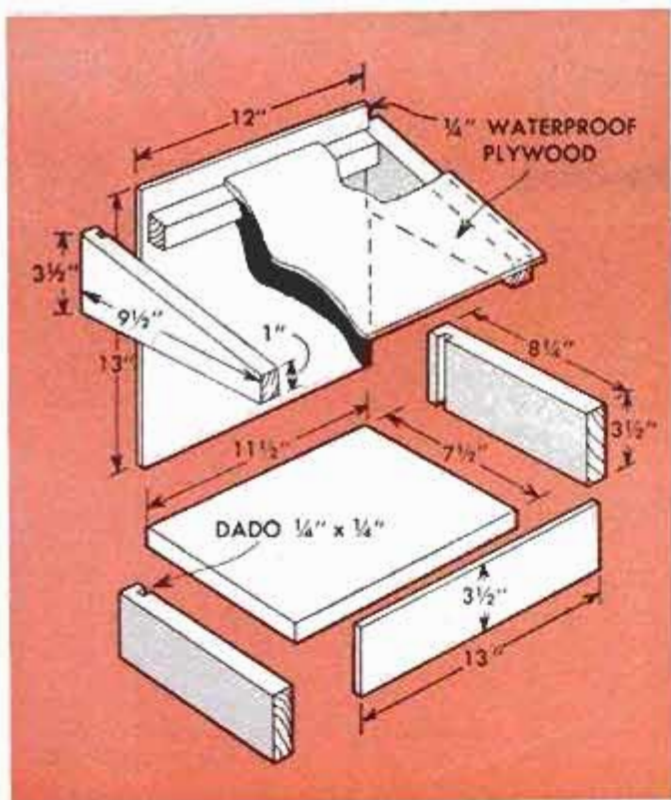

Feeding Station Provides Food for Squirrels

Squirrels will appreciate this feeding station, especially during winter months, to supplement their cache of nuts. Waterproof plywood is used for the back, roof and front panel; and standard 1-in. stock for the remainder of the pieces. The roof cleat is 11½ in. long and beveled on one

side to fit the angle of the roof, which is 10 x 13 in. In assembling, first attach the floor and cleat to the back panel. Then install the sides and rafters which have been grooved to fit the edge of the back. Finally, nail on the roof and front panel.

Gilford C. Whipple, Binghamton, N. Y.

Deep Bowl Traps Beetles

MOIST COOKIE OR
CRACKER CRUMBS



Beetles that inhabit a basement can be trapped in a bowl with deep, smooth sides, such as the one shown. To make the wooden base with uprights, which provide an easy means of entering the bowl for the insects, tack two wooden blocks to one edge of a

larger block as shown. Place moist cookie or cracker crumbs inside the bowl to attract the beetles. Pour insecticide over the beetles to destroy them.

Arthur Trauffer, Council Bluffs, Iowa.

❑ Instead of using tacks or nails to repair loose linoleum, clean the floor underneath and apply a waterproof cement. Weight the linoleum until dry, washing off any cement that may ooze out along the edges.

Guard for Spike File

Injury from a spike file can be avoided by equipping it with a guard as shown in the photo. This is nothing more than a strip of light sheet metal bent as indicated and screwed to the base of the spike.

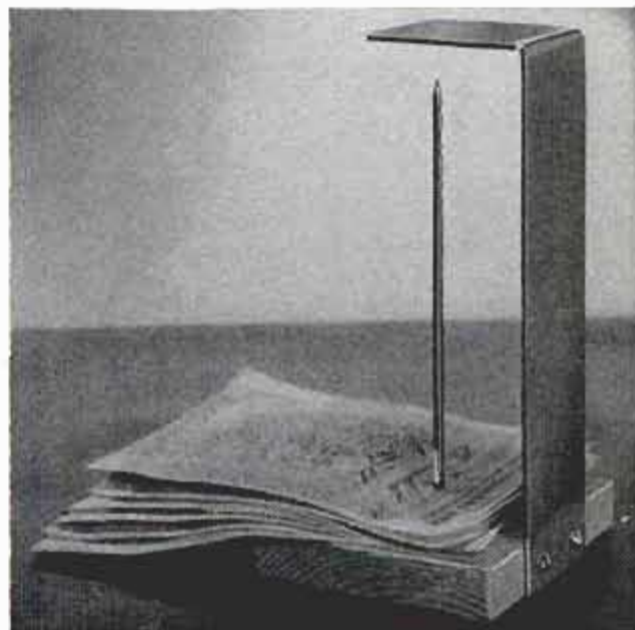

Candle Story

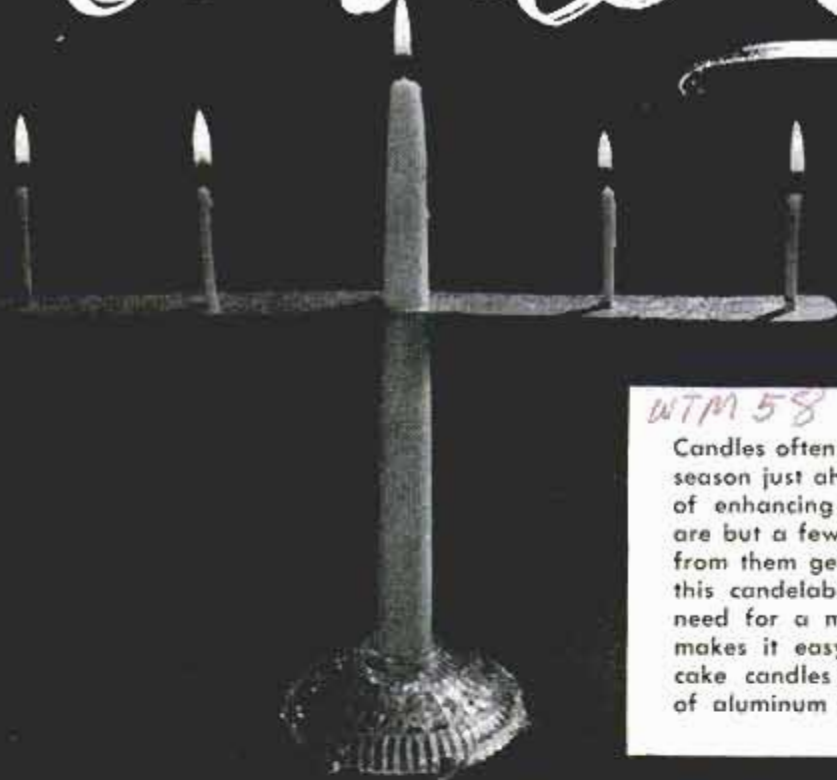

WTM 58

Candles often make the setting, and with the holiday season just ahead why not start now to devise ways of enhancing the candles you will use? Following are but a few suggestions you may wish to try, and from them get ideas of your own. Take for example this candelabra. Not only does it meet last-minute need for a multiple candleholder, but its simplicity makes it easy to store when not in use. The four cake candles are turned into holes cut in a strip of aluminum which fits over a standard-size taper



Colored "drippings" may be applied easily to a candle by holding a crayon over the flame until soft and then touching it to the top of the candle. Heat will cause the spot of color to run slowly down the side

Add originality to your candles by cutting a spiral groove in them with a wood gouge or similar tool. On colored candles the gouging will produce a two-tone effect as they are usually white inside



A candle which is lit by striking it as you would a match will surprise holiday guests. To prepare it, snip the wick short and dip it in a paste made by soaking the heads of book matches in a little water

If the candles which you saved from a previous occasion have become soiled and embedded with dirt, try cleaning them with denatured or rubbing alcohol. Moisten a soft cloth and wipe the candles thoroughly





Adhesive-tape spools from the medicine cabinet are excellent emergency candleholders for holiday parties. Decorate the outer ring with a length of colored cloth ribbon as shown



A portable electric candle can be made by fitting a flashlight in a length of mailing tube. Cut a slot in the tube for access to the switch, and tape colored cellophane to top to represent flame



Candles can be made to release bursts of fragrance at intervals while they are burning if perfume is injected into tiny holes drilled in the sides of them. Seal the perfume in the holes with shavings from the candle



To make a reflective candlestick holder cut a 5-in. disk of stiff paper with a 1-in. hole in the center, cover it on one side with aluminum foil, and staple it together to form a shallow inverted cone. Then place a candle in the center hole and fill the inside of the cone with plaster or putty to steady the candle

Inexpensive decals offer an easy way of decorating candles. Soak the decals in water for a few minutes and then slide them on the candles, pressing them dry with a soft cloth. If the decals do not stick, remove them, apply a coat of shellac to the candles and then press the decals against the wet shellac



Bars of paraffin are easily converted into novel candles by heating, shaping and inserting small cake candles in them. Warm the bars in your hands or in water of 100 deg. or less before shaping. Use a gimlet or drill to make the holes for the candles. Shellac applied to the paraffin will prevent dripping

Ordinary liquid food color to which has been added an equal amount of denatured alcohol can be used to color candles. Apply the color by dipping or with a cotton swab. Designs and names may be also drawn on the candles with a small brush. To remove the color hold the candles under running cold water



Prevent Child's Balloon From Drifting Away



Next time your child has a balloon to play with, prevent it from drifting away by tying an empty wooden thread spool to the end of the string

Base of Kitchen Cabinet Rabbeted To Receive Edge of Floor Tile

Floor tile and linoleum can be fitted easily around a floor cabinet in the kitchen if the bottom outside edge of the cabinet is rabbeted to receive the floor covering. Before the cabinet is installed, the rabbet is cut $\frac{3}{16}$ in. up from the bottom and approximately $\frac{1}{2}$ in. deep. The undercut will allow up to $\frac{3}{8}$ -in. variation.

Victor H. Lamoy, Upper Jay, N. Y.

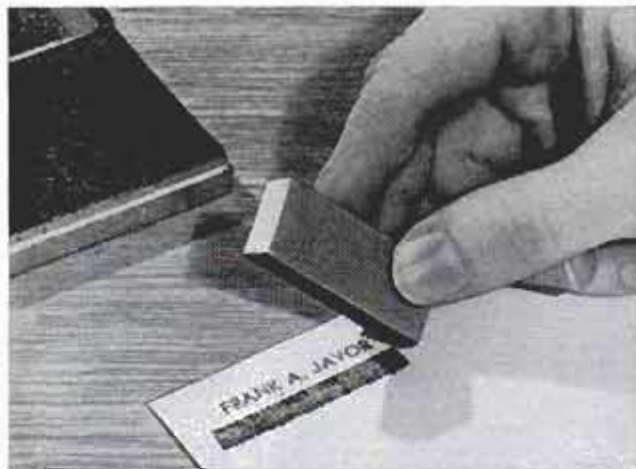
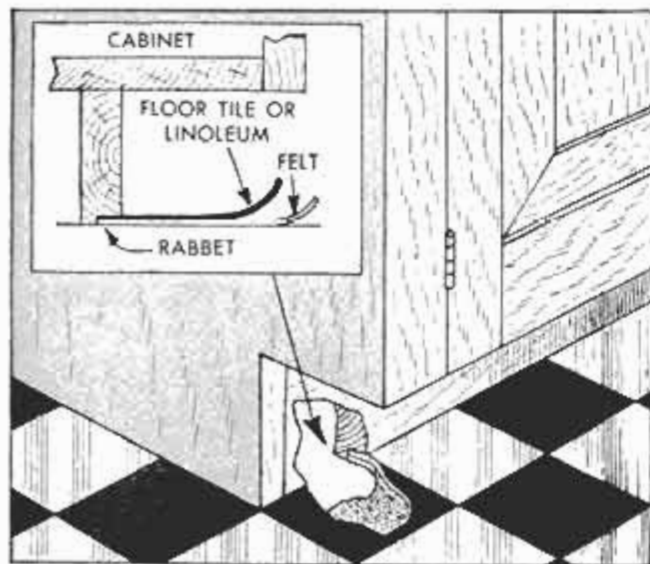

Stamp Obliterates Lettering

An old address or outdated price is easily blocked out with an eraser and stamp-pad ink. The eraser can be cut to the required size with a razor blade and used the same as a hand stamp. A wooden handle can be glued to the eraser if desired.

Painting Sequence for Door

Visible paint overlaps can be avoided when finishing a paneled door if the proper sequence is followed. Paint the molded edges first, working away from the corners, and then cover the panels. If any paint gets on the rails and stiles while doing the recessed areas, wipe it off immediately. After finishing the panels, start at the top crossrail and work down the vertical stiles, painting each rail as you come to it. Center stiles are painted down together with the outer stiles. Finish by painting the leading and trailing edge, being sure not to get paint on the opposite side of the door. Brush marks in enamel are avoided by using paint of the right consistency and working in a temperature above 65 deg. Paint should be applied sparingly so it does not sag or run, but enough must be used to cover the surface to eliminate touching up.

Bottle Caps in Flowerpot Serve as Drainage Material

When pebbles or ceramic fragments are not available for use as drainage material in the bottom of a planter or flowerpot, metal bottle caps make a good substitute. Place them crimped edge down to cover the entire bottom of the container, thus assuring adequate drainage.

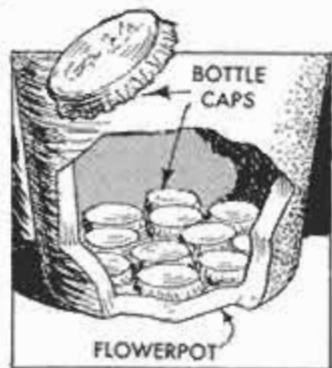

Mrs. Lee Figg, Indianapolis, Ind.



UPDATE THAT RADIO-PHONO CABINET

By William M. Avery

RATHER THAN REFINISH or rebuild that old radio-phonograph cabinet, why not build a "slip cover" for it, using wood and styling that match furnishings either in the den or family room? The cabinet pictured above at the right is made with a top section recessed in a manner similar to a dry sink which provides space for natural or artificial greenery. It is made of selected knotty pine and is designed to fit over the old cabinet pictured at the left, making it unnecessary to reassemble the record player and radio units. The alternate designs, center, suggest a traditional type and one of more modern lines with an island base. As will be seen from the detail the construction of the slip-over cabinet is simple, involving little more shop work than building a box. No dimensions are given. Access to records, the radio-control panel and record-player "drawer," will have to be carefully planned. In the cabinet pictured, the left-hand door is a false drawer front attached to the record-player slide. In this case, false hinges were used. For the alternate designs shown, plywood, faced in the wood desired, can be used for the sides and top.



Knotty pine and dry-sink styling go together in this cabinet

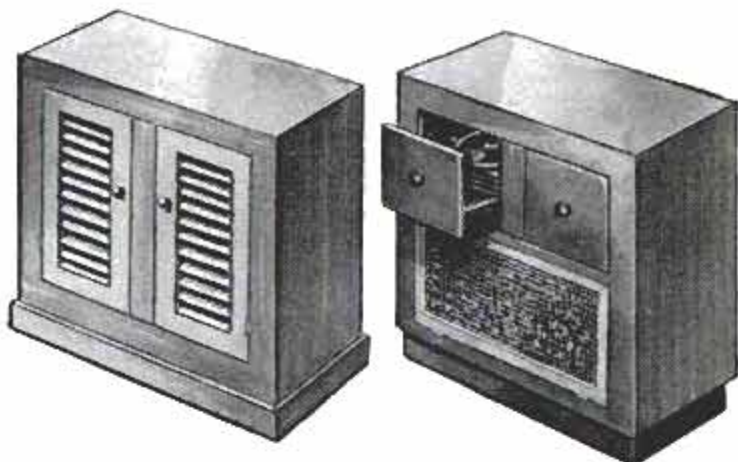

ALTERNATE DESIGNS

Here you have a choice of simple modern or traditional design

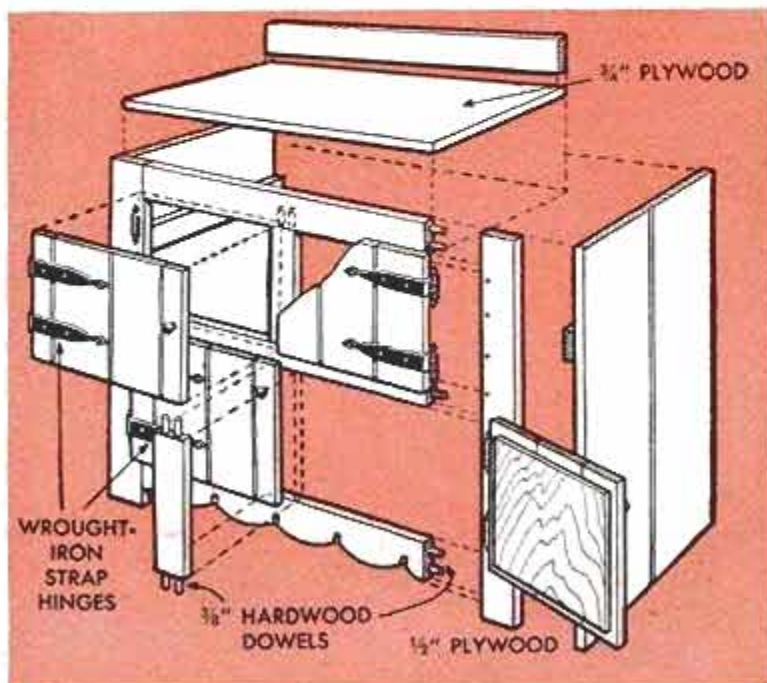

CRAZY JIGSAW

By *Richard Garland*

An interesting pattern of interlocking curls is first drawn on two sides of a block of balsa wood as shown in the photo (left). Make the loops fairly large to avoid sharp turns with the jigsaw blade. A soft lead pencil should be used to draw lines so that marking indentations are not left in wood

Two cuts are made lengthwise along the block following the lines drawn on one side which produces three irregular-shaped strips. Before making the cuts remove the hold-down assembly from the saw. The saw table should be tilted slightly for all cuts, one degree is enough, so that pieces can be assembled from one side only

Fitted back together, the three strips are turned 90 degrees, bringing the other marked side up, and then clamped between two pieces of flat stock to prevent side-ward motion. An extra C-clamp is kept handy for clamping the work behind the blade when the front one is removed. Feed the work slowly, keeping it flat on the table

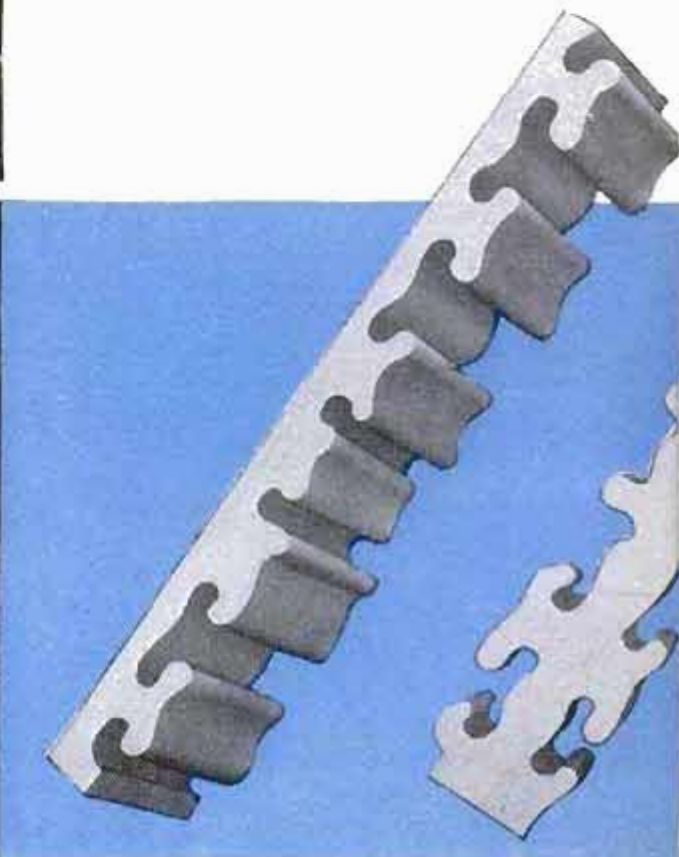
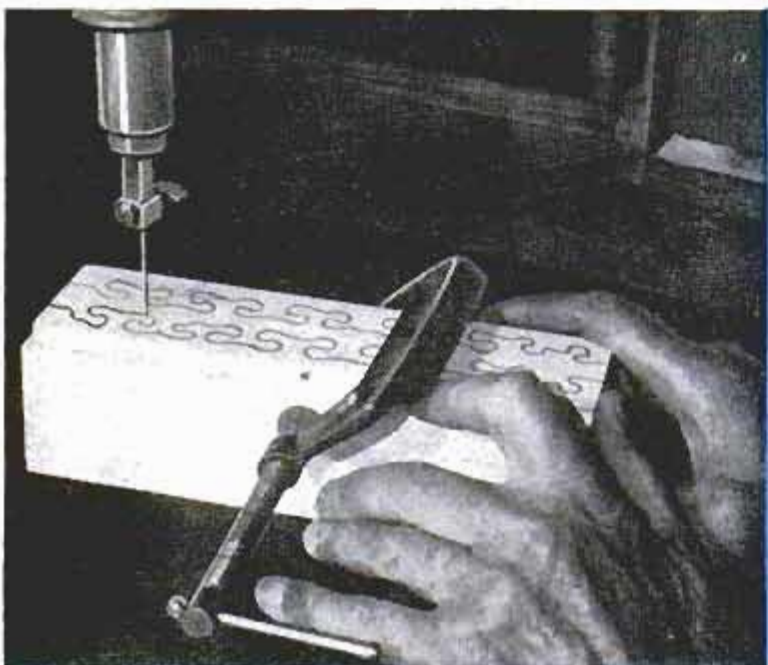
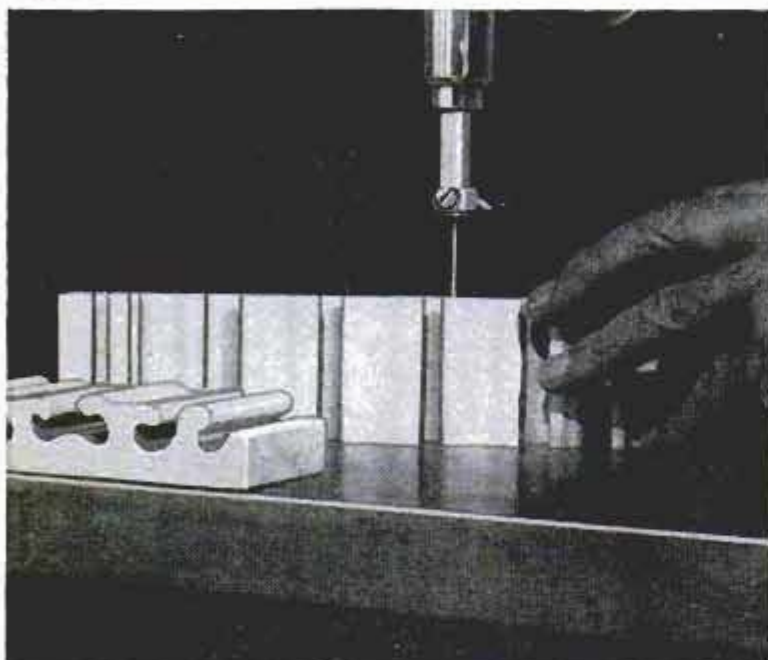
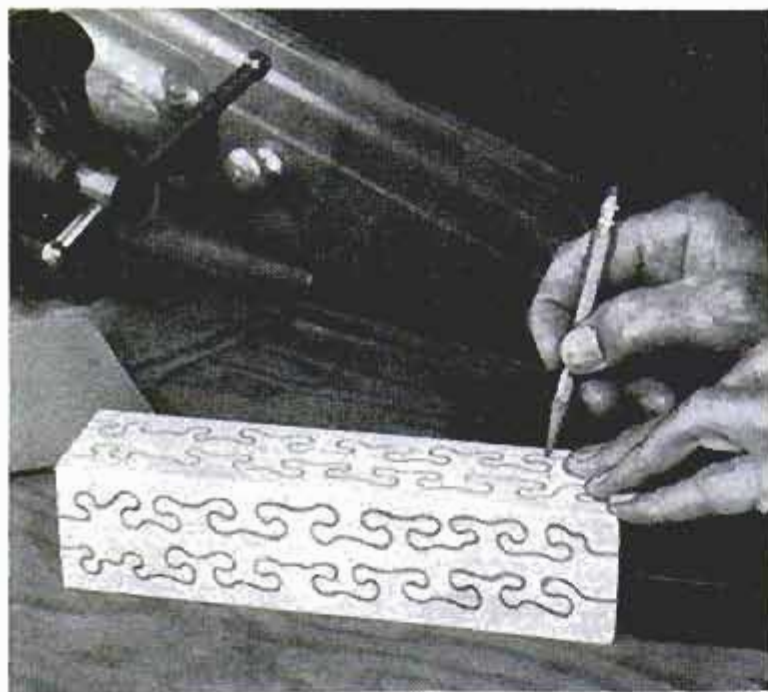

BLOCK PUZZLE

HERE'S A PUZZLE for you to make which has a two-fold purpose; the first being a lesson in making intricate cuts with a jigsaw, and then hours of entertainment as you and your friends try to put the pieces back together. There are only two requirements for making the puzzle: access to a jigsaw and plenty of patience.

To start with, you'll need a piece of balsa or other softwood at least 2 in. square and 6 in. long. A pattern of interlocking loops is drawn on two sides of the block, and the jigsaw used to cut along the lines. Run the saw as slowly as possible with considerable tension on the blade. Feed the work gradually so the blade does not run off the line or break. If one should break, insert the new blade in the work at the point from which the cut was started. A small magnet will retrieve the bottom end of the broken blade if it cannot be reached with your fingers. Cuts should be made with a slight bevel, so a specific order has to be followed to assemble the puzzle.

★ ★ ★



Each of the nine strips formed by cutting the block lengthwise may then be crosscut into smaller pieces making this unusual puzzle even more complicated to put together

Pictured below are six strips as they appear before being cut apart. Crosscuts are made so that the pieces will interlock when put together. As each piece is cut out place it on a table in proper sequence so that the entire puzzle can be quickly assembled to check for fit. Chips caused by overlapping cuts are discarded, creating the effect of missing pieces when the puzzle is being assembled

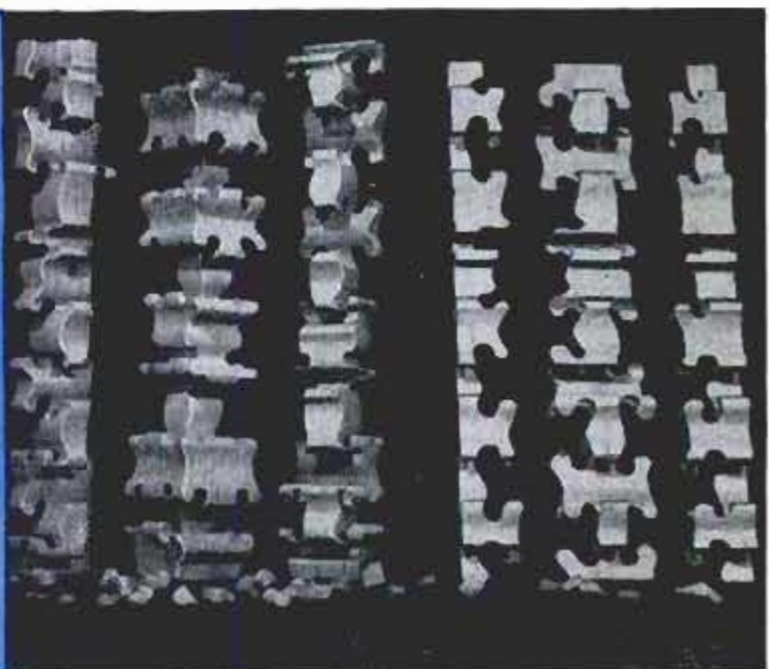

Making a Print-Mounting Rule for Centering

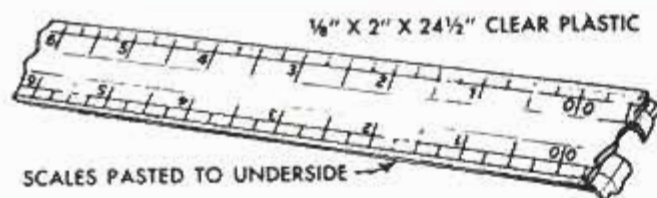

Prints can be placed in the exact center of a mount quickly and easily with a plastic rule like the one shown in the illustration. It is made from a $\frac{1}{8}$ -in.-thick strip of clear plastic $24\frac{1}{2}$ in. long by 2 in. wide. Two scales drawn on stiff paper are glued to the underside of the rule so they can be read through the plastic. The scales start at zero in the center and extend 12 in. in both directions. To use, place the print on the mount. Then place the rule on top of the print and adjust both the print and mount until opposite edges line up with identical markings on the rule. Then there will be an equal margin on both sides of the print. The same procedure is used to establish the top and bottom margins.

Roy Hancock, Portsmouth, Va.

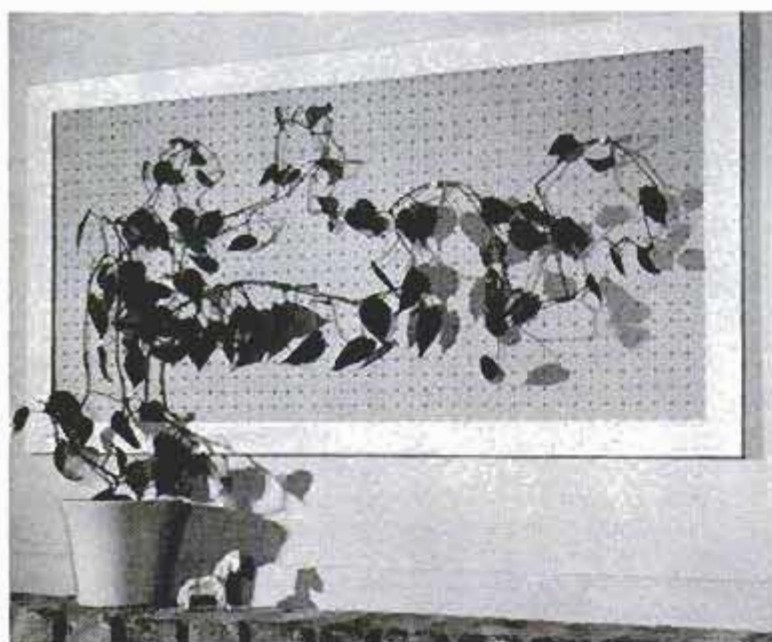

Golf Tees Support Vine On Mantel Trellis

Climbing plants kept on a mantel are suspended nicely with golf tees set into the holes of this trellis which is made from a sheet of perforated hardboard and framed with door trim. Rabbet the edge of the casing to fit the hardboard. The trellis may be finished with contrasting colors, or the panel painted to match the room decor and the frame finished clear. To hang the trellis on the wall, use two large L-hooks which will fit into the holes of the hardboard. Pointed ends of tees may have to be cut off.—William C. Eymann, Palo Alto, Calif.

Shingles Angle-Cut Uniformly

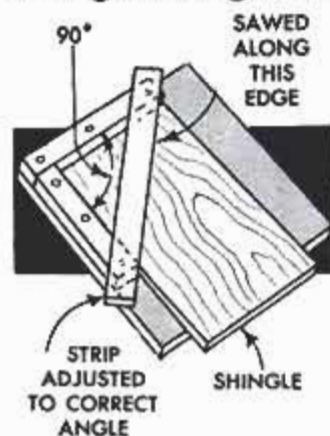

This miter box for shingles aids in making uniform diagonal cuts at the correct angle so that shingles will fit evenly at roof hips and valleys, and on gable-end walls. The guide strip is fastened to two strips of wood nailed at right angles on a large panel. With one

end free, the guide strip is aligned with a mark on the first shingle to be cut, and is then nailed in position. From then on make each diagonal cut in the fixture running the saw along the guide strip.

Chalk Wrapped With Tape Keeps Hands Free of Dust

To keep fingers free of chalk dust when writing on a blackboard, wrap the chalk spirally with electrician's plastic tape. As the chalk wears down, the tape is unwound to keep the end clear. The tape helps to prevent the chalk from breaking.

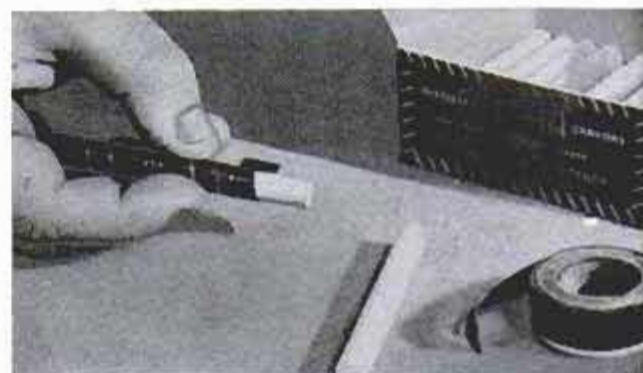

PORTRAIT DIFFUSION

IT IS JUST AS EASY to make a diffused portrait with a contact printer as it is with an enlarger, when a thin sheet of clear plastic the same size as the negative is used between the negative and print paper during the exposure. The ability of transparent plastic to diffuse light slightly is sufficient to soften harsh lines, conceal skin blemishes and reduce contrast generally. For most negatives, clear plastic .095 in. thick will provide adequate diffusion. Thin or extremely contrasted negatives require plastic that is slightly thicker to obtain enough diffusion.

If a heavily diffused print is desired, such as the one at the bottom of this page, it may be necessary to use plastic double the thickness needed to produce a portrait that is only moderately diffused—photograph above drawing. The photograph at the top of the page was printed without the plastic. Be sure the plastic is free of scratches and internal defects, which might cast a shadow and appear as a light streak or spot on the print. When not in use, store the plastic sheets in sheet-film boxes to keep free of lint.—Don Honick, Chicago.

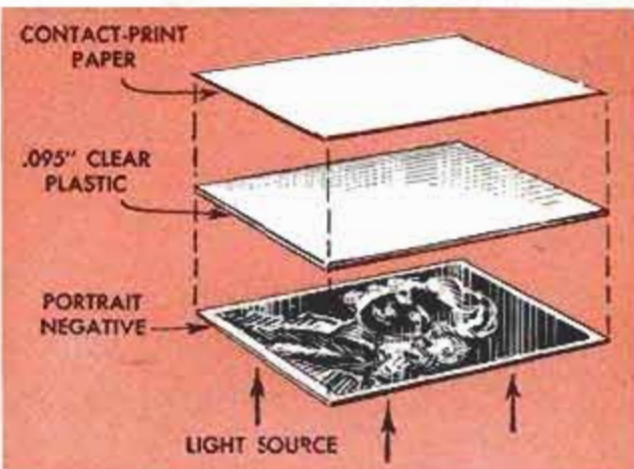

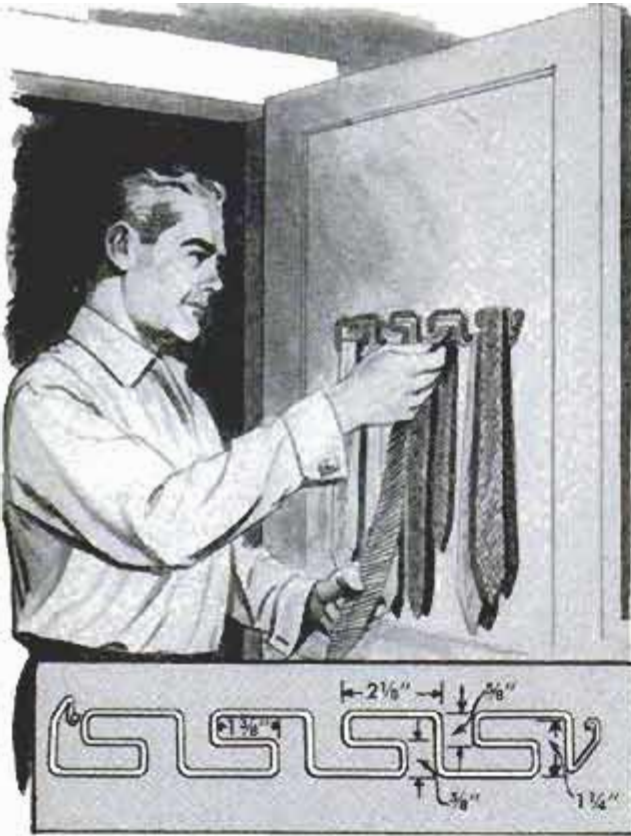

Tie Rack Made From Wire Hanger

The only material needed to make this novel tie rack is a wire coat hanger or similar heavy wire. First, straighten the wire and then bend it according to the design and dimensions shown in the detail. Repaint the rack and screw it to a wall or door inside the closet. At least two dozen ties can be hung on the rack at three different levels for easy selection.

Frank Shore, New York City.

Heat Reseals Original Wrapper Around Exposed-Film Roll



Film purchased in a moistureproof foil and plastic wrapper can be resealed in the original package, after the roll has been exposed, by using a warm iron. When first opening the package, remember to cut only a narrow strip from the laminated seal, leaving sufficient adhesive to be heated and pressed together when resealing.

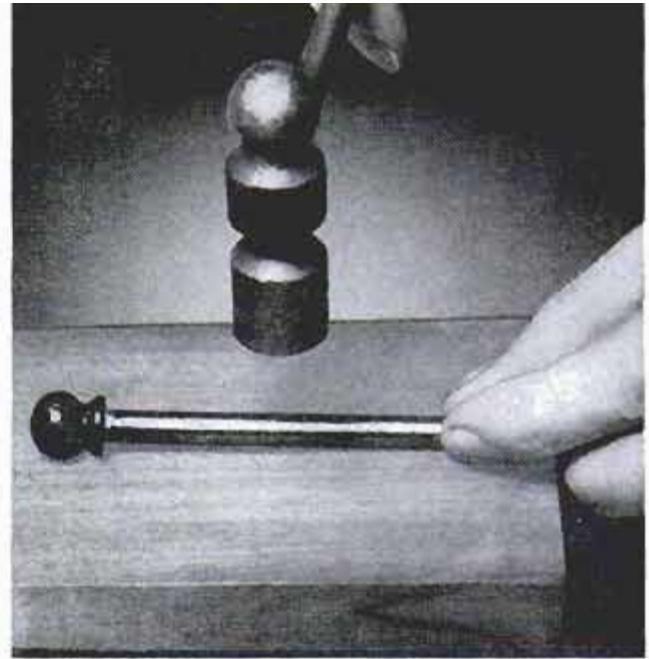

Doors Kept From Swinging Shut

Doors that swing partly shut can be a hazard, particularly in the dark when their position cannot be determined. This situation is remedied without the use of door checks or stops by merely removing one or both of the hinge pins and bending them slightly. The friction of the bent pin will hold the door at any set position.

William Swallow, Brooklyn, N. Y.

C-Clamp Serves as Trammel For Cutting Glass Disks

You can improvise this glass-disk cutter in a few minutes. The clamp pivots on a suction cup equipped with a stud which fits into a hole drilled in the clamp at the handle end. Grip the glass cutter with the clamp, inserting a spacer block between the cutter and the stationary jaw when circles of smaller diameter are cut.

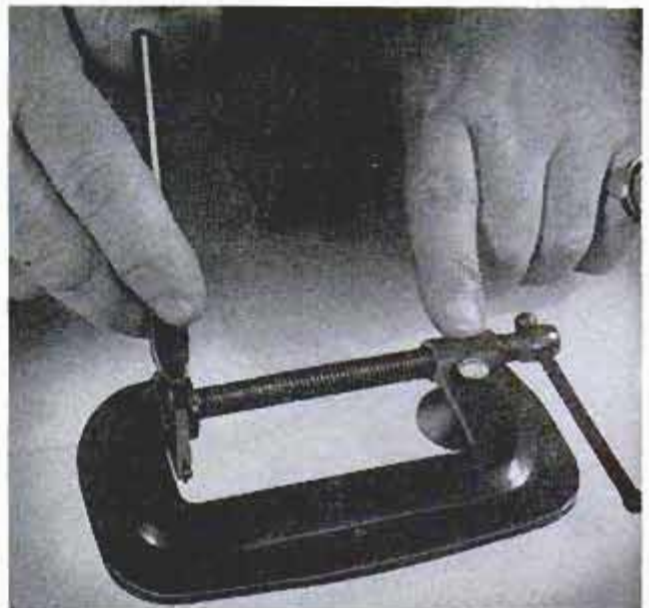

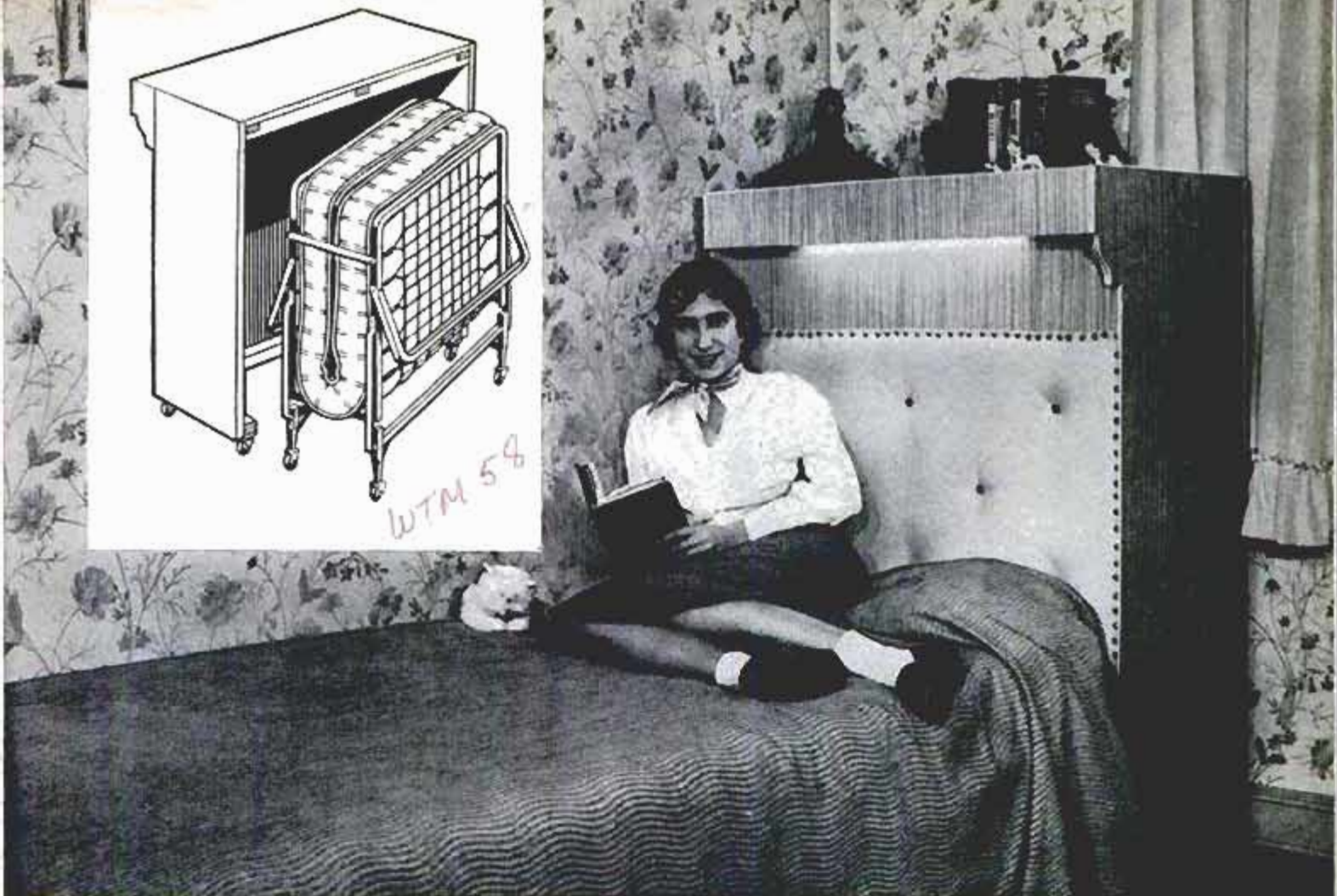
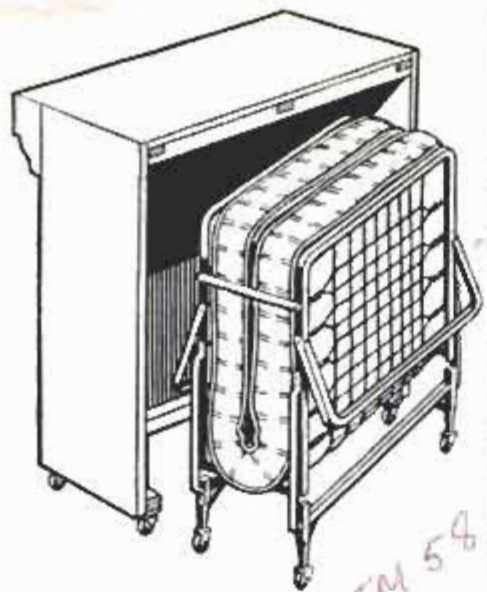

BED STORAGE HEADBOARD

A ROLL-AWAY BED for a week-end guest may be stored in this movable headboard, which can be dimensioned to fit any size folding bed. To make it, construct the upper and lower framework first, using 2 x 2-in. stock. Reinforce the corners of the lower frame with metal angle plates. Then cut the plywood panels to size, miter them at the vertical joints, and fasten them to the frames at top and bottom. Note that the top panel extends out over the fluorescent light fixture. Mount the fixture at the top of the front panel and run the cord through a hole, tacking it to the inside of the enclosure. Fasten the ends of the light shade to the front panel with dowels and nail the front of the shade to the top and ends. Tack a 1-in.-thick blanket of sponge rubber to the front of the headboard and cover it with a sheet of heavy plastic, which is tacked in place with ornamental upholstery nails. Now, turn the headboard upside down and install the casters, preferably piano casters which have a horizontal mounting plate. Turn the headboard back up on its wheels and finish it to blend with room decor.

Ralph Treves, Jamaica Estates, N. Y.

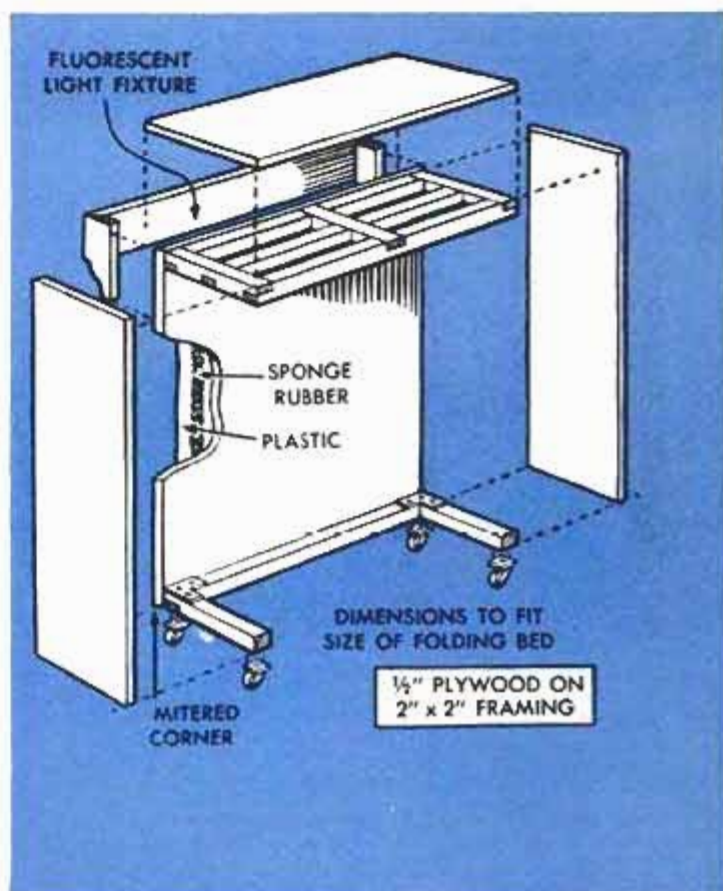

Temporary Towel Rack for Guests Made From Dowels and Cord

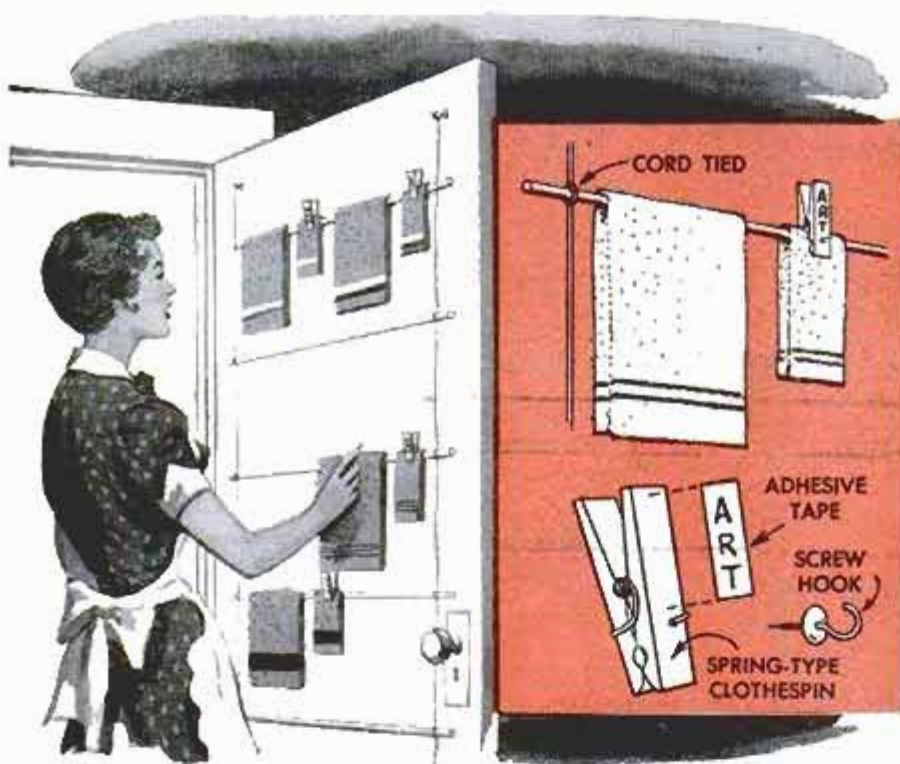

This temporary towel rack solves the problem of hanging towels and washcloths for overnight guests in a home with limited bathroom accommodations. The rack, which consists of five $\frac{1}{4}$ or $\frac{3}{8}$ -in. dowel crossbars tied to two lengths of cord and suspended from screw hooks as shown, can be stored in a drawer when not in use. To identify matching towels and washcloths attach a piece of adhesive tape, with a guest's name or initials on it, to a spring-type clothespin and clip the latter on the appropriate washcloth. Paint crossbars and clothespins a matching color.

Replacing a Paring-Knife Handle

A broken handle on a paring knife can be replaced with two pieces of tempered hardboard. First remove the broken handle and use it as a pattern to cut the new pieces. Place them together in a vise and cut a slot in their abutting surfaces to accommodate the shank of the knife. Drill holes in each piece coinciding with those in the shank, apply waterproof glue to the adjoining surfaces, and fasten the new handle to the shank with brads, driving them through the holes. Clamp the handle together until dry and then file the brads flush with the surface of the handle. Sand edges of the handle smooth with fine abrasive paper. Courtesy of Masonite Corporation.



Wrap Your Gifts . . .

to symbolize the occasion or the recipient's hobby, vocation or personality. Look for the full-color story in next month's issue that shows how the experts gift wrap to glamorize the packages and also how they add inexpensive decorations that tend to personalize your gift package.

Battery Clip on Warning Flag Permits Quick Attachment

No time is wasted in tying or wiring a red warning flag to the end of a projecting load on a car or truck when the flag is attached to a large battery-cable clip that permits it to be snapped on or off in a moment. The flag can be attached to the clip by threading one corner of it through the cable end of the clip and knotting it as shown. If the flag has a grommet in one corner, twist a wire loop through the clip and the grommet. The clips can be purchased at most auto-supply stores.





The cover is held open by two arms resting against cleats on underside



Retouching is done with cover of case open so that light can shine through the ground glass and illuminate the negative

RETOUCHING CASE

By Don Honick

You can do retouching of negatives almost anywhere with the aid of this portable retouching stand. Its glass-fitted cover is designed to be supported at an angle which permits negatives placed against the glass to be backlit, and there is plenty of room inside the case for retouching equipment and materials.

Cut out the pieces for the case from $\frac{1}{4}$ -in. plywood according to the dimensions given in the detail, right. After sanding the edges, glue and nail the pieces together as indicated. A 5 x 7-in. hole is cut in the cover for a sheet of frosted glass. Glue cleats around the opening on the inside edges on which to rest the glass, and then glue the glass to the cleats. Cut two identical support arms from $\frac{1}{4}$ -in. plywood and bolt them to the sides of the case so they will fold inside when the cover is closed, and will position the cover at a 60-deg. angle when it is open. The ends of the arms rest against $\frac{1}{2}$ -in.-sq. cleats glued to the underside of the cover. Hinge the cover to the case and install a hasp and handle. A strip of elastic tacked inside the case will keep retouching fluids from sliding around when the case is carried. Cement a felt disk to each corner of the case bottom to prevent it scratching a table.

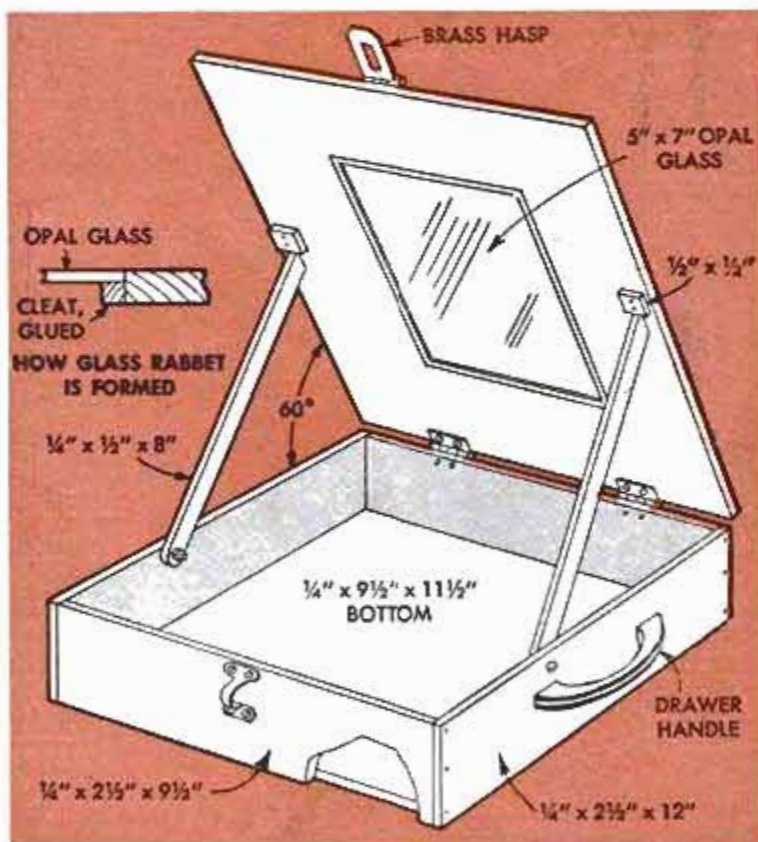

Print Contrast Controlled By Brighter Bulb

When making prints with a condenser enlarger, greater contrast can be produced by using a bulb that will give the brightest workable light. Most condenser enlargers will take bulbs of high or low light intensities. With a brighter bulb you can reduce the enlarger aperture so that the depth of field will help conceal slight buckles in the negative being printed.



IS YOUR Wiring Adequate?

PART I

By J. B. Mullen

INCREASING USE OF home electrical appliances and also the higher current requirements of newer-type individual appliances make the wiring of many older homes inadequate to handle the load safely. Compare, as an example, the 300 to 500-watt rating of earlier electric irons with a modern iron which requires up to 1000 watts. The same increase in current requirements is true of certain other appliances. Also, the regular electric service of 20 or more years ago was planned before such electrically operated units as clothes driers, water heaters, home-shop power tools, kitchen ranges and air conditioners

became standard household equipment.

Wires carrying current throughout the house have a certain resistance to the flow of current. This is greater for the smaller sizes of wire and less for the larger sizes, Table I, also Fig. 2. Thus when planning an all-new service, or additions to an older service, the wire size becomes important. Voltage drop on inadequate supply lines not only reduces the actual voltage available at the appliance, it also sets a definite limit to the amount of current that can be carried safely by a wire of a given size.

Table I gives safe capacities for the common sizes of house wiring, also the voltage

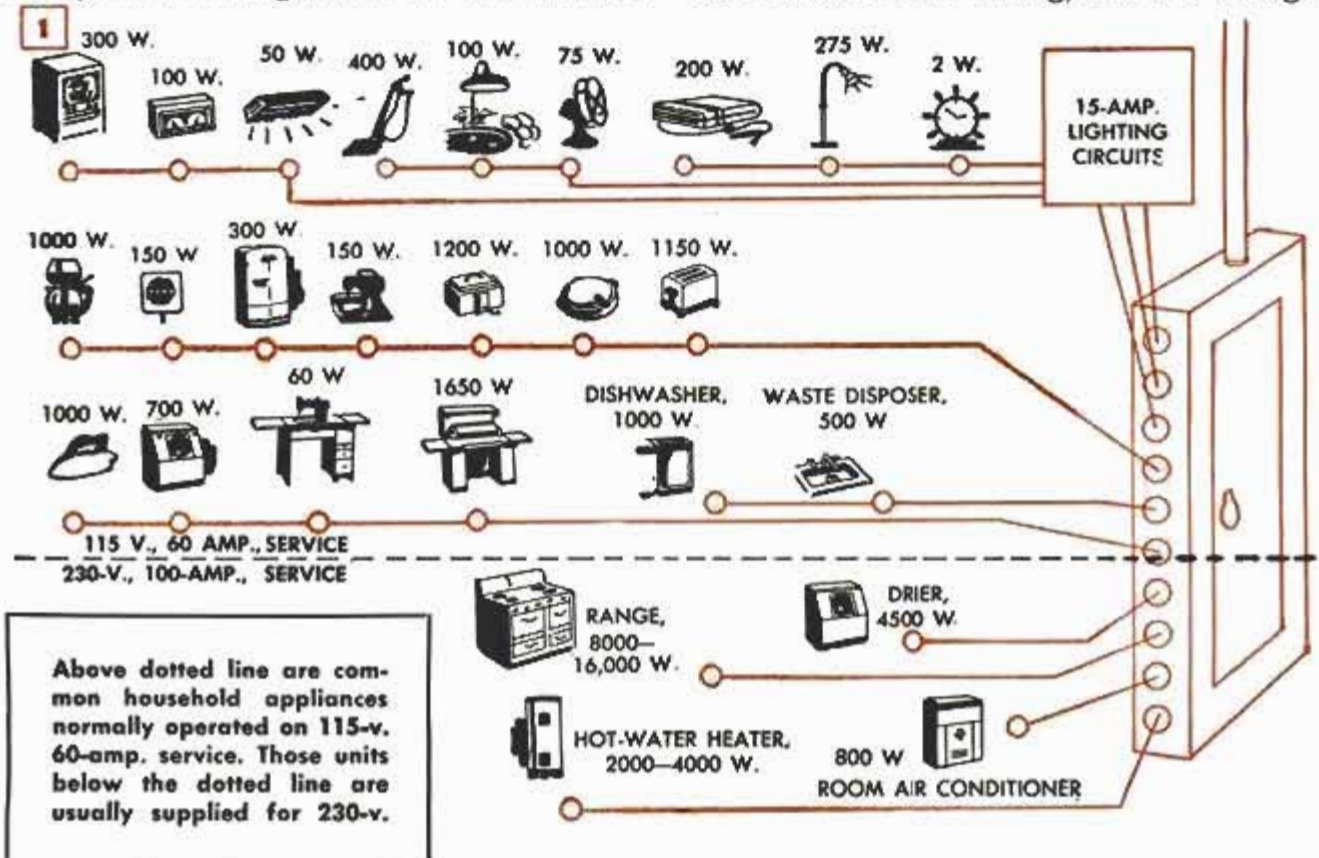

WIRE SIZE (No.)	RESISTANCE (ohms per 1000 ft.)	MAXIMUM AMPS (indoors)	VOLTAGE DROP PER 50' OF CIRCUIT AT MAX. AMPS	POWER LOSS PER 50' OF CIRCUIT AT MAX. AMPS
14	2.621	15	3.9	59
12	1.650	20	3.3	61
10	1.036	30	3.1	93
8	0.6574	40	2.6	105
6	0.4105	55	2.3	124
4	0.2588	70	1.81	127
3	0.2054	80	1.64	131
2	0.1618	95	1.53	138
1	0.1290	110	1.42	156
0	0.1019	125	1.27	159

RATING OF RANGE	WATT-DEMAND LOAD	CURRENT DEMAND (at 230 v.)	WIRE SIZE OF RANGE FEEDERS (No.)
Up to 12 KW	8,000 w.	34.8 amp.	8
12-13 KW	8,400 w.	36.6 amp.	8
13-14 KW	8,800 w.	38.2 amp.	8
14-15 KW	9,200 w.	40.0 amp.	8
15-16 KW	9,600 w.	41.7 amp.	6
16-17 KW	10,000 w.	43.5 amp.	6
17-18 KW	10,400 w.	45.2 amp.	6
18-19 KW	10,800 w.	47.0 amp.	6
19-20 KW	11,200 w.	48.7 amp.	6
20-21 KW	11,600 w.	50.4 amp.	6

drop at these currents per 50 ft. of circuit. Voltage drop should not exceed 2 percent on branch lines with lights or 5 percent under any conditions. A drop in voltage greater than these percentages is not only power wasted, it can become a hazard. Electric power is measured in watts and many appliances have the rated wattage and voltage stamped on the name plate. From this it is possible to calculate current requirements (amps.) simply by dividing the watts by the voltage. On fractional-hp. motors in such sizes as are used on household appliances, the amperage usually is stamped on the name plate. Using this information it is possible to determine the total current requirements of a number of appliances. Fig. 1, which is purely representative and not intended to be in any way typical, pictures the appliances commonly operated on the 115-v., 60-amp. service, the branch lines

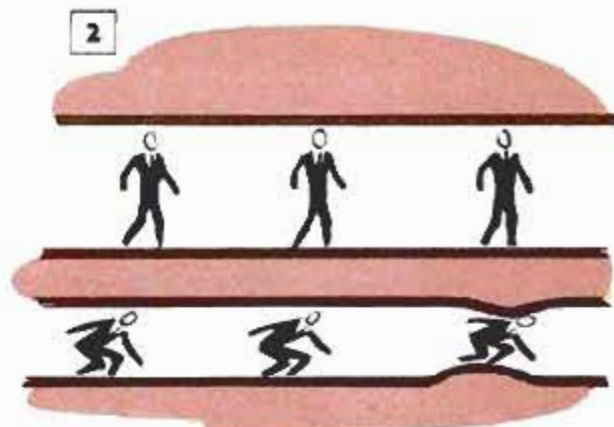

- MINIMUM NUMBER OF GENERAL-PURPOSE CIRCUITS
- FLOOR AREA = (24 x 10) + (28 x 15) + (27.5 x 23)
= 240 + 420 + 632 = 1292 SQ. FT.
 - WATTS LOAD = 3 WATTS PER SQ. FT.
= 3 x 1292 = 3900 WATTS
 - (A) USING 15-AMP. CIRCUITS (No. 14 WIRE)
No. OF CIRCUITS = $\frac{3900}{1725} = 2.3$, OR 3 CIRCUITS
(B) USING 20-AMP. CIRCUITS (No. 12 WIRE)
No. OF CIRCUITS = $\frac{3900}{2300} = 1.7$, OR 2 CIRCUITS

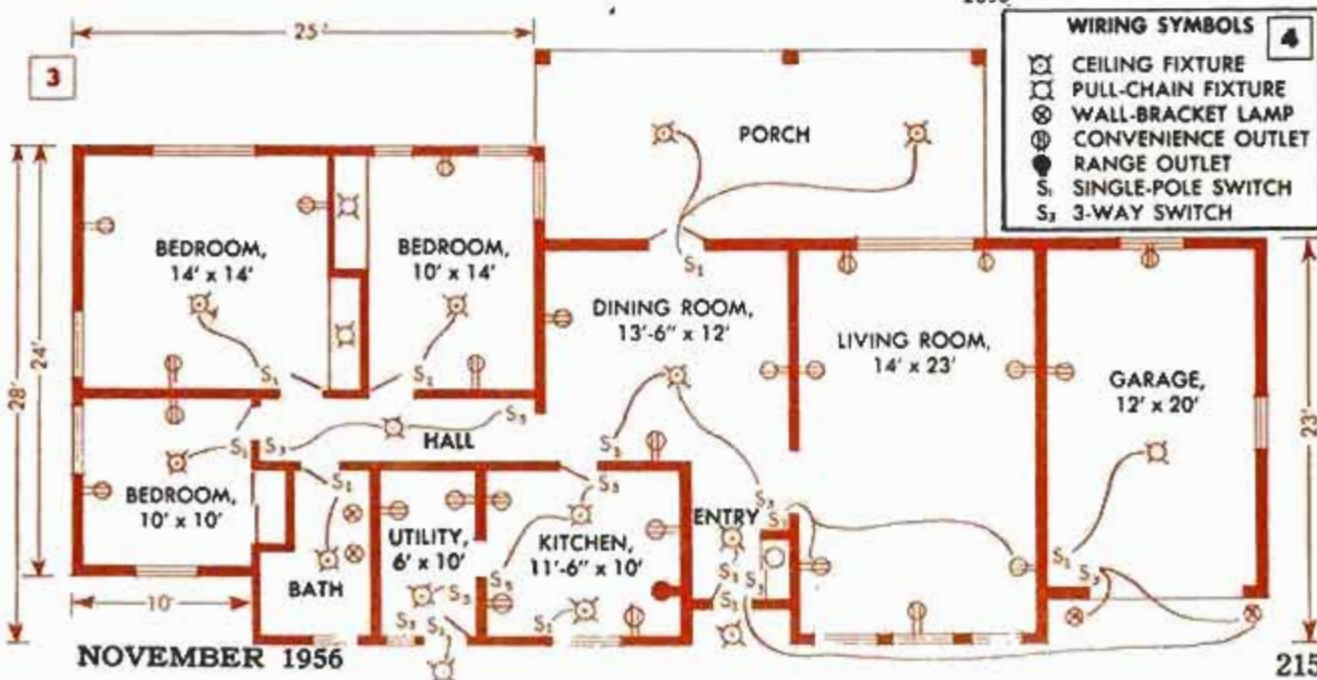

TABLE III
CURRENT-CARRYING CAPACITY OF FLEXIBLE CORDS AND FIXTURE WIRE

WIRE SIZE	OHMS PER 1000 FT	ALLOWABLE CURRENT, FLEX CORD	VOLTAGE DROP PER 50-FT. LENGTH OF CORD (a)	MAXIMUM USE FACTOR (AMPS x LENGTH) (c)	ALLOWABLE CURRENT, FIXTURE WIRE (b)
18	6.630	7 amp.	4.0	430	5 amp
16	4.174	10 amp.	4.2	680	7 amp
14	2.621	15 amp.	3.9	1100	—
12	1.650	20 amp.	3.3	1740	—

(a) At maximum allowable current
(b) As used to connect individual light fixtures to circuit
(c) For 5% voltage drop

being fused to 15 amps. Such units as the electric range, clothes drier, water heater and certain types of air conditioners require a 230-v., 100-amp. service.

The amount of current available at each outlet depends on the wire size of the supply lines, the number of branch lines carrying current to outlets throughout the house and also on the number of taps into current flowing to each branch line. With an inadequate service, overloading of one branch in effect robs others of current and may cause a voltage drop below the nominal limits throughout the system. Wattage used up in line loss heats the wires. The resistance of the overloaded wires increases as they warm up. Thus if overloading goes beyond safe limits for an appreciable length

of time the wires may heat to the point of igniting the insulation. Over a long period of time there is equal hazard in the cumulative effect of a continuing overloaded condition, which is certain to cause a breakdown of the insulation.

When planning an adequate service for an older home, decide on the number of additional outlets, lights and switches. Then you can plan the special-purpose circuits and other wiring which are to be added. Figs. 3 and 4 suggest a procedure in planning. Minimum standards call for one outlet for each 20 ft. of wall, but usually it is better to reduce this to one outlet for each 12 ft. of wall, or simply plan enough outlets so that no point on a usable wall is more than 6 ft. from an outlet, and in the kitchen about 4 ft.

In older homes most of the branch circuits are general-purpose circuits supplying both lights and outlets for appliances.

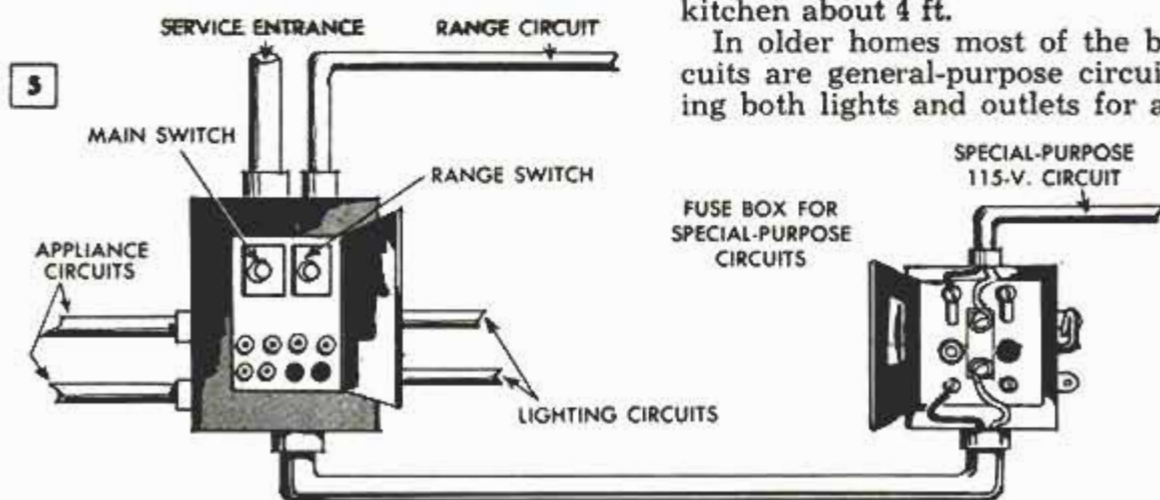

TABLE IV
WHEN TO USE INDIVIDUAL BRANCH CIRCUITS

	CLASS OF EQUIPMENT	EXAMPLES
NECESSARY	Equipment over 16 amp.	Range, clothes drier
CONVENIENT	Equipment vital to home operation	Water pump, furnace
DESIRABLE	Motors, and appliances with large motors	Workshop, home freezer

Usually these will have a capacity of 15 amps., depending on the wire size. This means that the maximum power that can be taken from them is about 1725 watts, less if the wire size is smaller than No. 14. Modern homes will require at least one appliance circuit for outlets in the kitchen, dining room, breakfast room and laundry to handle heavy-current appliances. These outlets usually are wired with No. 12 wire and fused for 20 amps. The appliance circuit should carry all outlets in these rooms (except clock outlets), but no outlets in any other rooms and no light fixtures. Note Tables IV and V, the latter summarizing specifications for branch circuits.

A check list of the actual load on general-purpose and appliance circuits, of which Table VI is a sample, is helpful in planning wiring layout and calculating the total amperage. Note also Tables IV, VII and VIII in this connection.

Individual appliances drawing over 16 amps., such as a range, water heater and the electric drier, require special circuits, Fig. 5. Independent circuits, although not necessary, are desirable for large motors, or groups of motors, such as power tools in the home shop. Independent circuits prevent dimming of lights due to the heavy starting current required by the larger motors. When making up the check list of outlets, lighting fixtures and the wattage of lamps and appliances, include all those appliances you may add in the future. Where two appliances are of a type never used simultaneously, list only the one with the highest wattage. Convert watts to amps. by

TABLE V
BRANCH-CIRCUIT SPECIFICATIONS

Type of Circuit	General-Purpose Branch Circuit		Appliance Circuit		Individual-Appliance Circuit		
	15 amp.	20 amp.	20 amp.		15 amp.	20 amp.	30 amp.
Max. rating	15 amp.	20 amp.	20 amp.		15 amp.	20 amp.	30 amp.
Wire size (minimum)	14	12	12		14	12	10
Size of fuse (maximum)	15 amp.	20 amp.	20 amp.		*15 amp. 20 amp. 30 amp. not over 150% of appliance rating		
Required rating of outlet receptacles	15 amp.	15 20	15 20	15 20	15 amp.	20 amp.	30 amp.
Max. rating of appliance connected to a receptacle	12 amp. 1380 w	12 16 1380 1840	12 16 1380 1840	12 16 1380 1840	12 amp. 1380 w	16 amp. 1840 w	24 amp. 2760 w
Max. rating of permanently connected appliances	7.5 amp.	10 amp.	10 amp.		15 amp.	20 amp.	30 amp.
Lamps permitted on circuit?	Yes	Yes	No		No	No	No

TABLE VI
CHECK LIST OF ACTUAL LOAD
ON GENERAL-PURPOSE AND APPLIANCE CIRCUITS

Room	No. of Outlets	Fixtures and Appliances	Watts	Amperes	
				Gen. Purpose Circuits (a)	Appliance Circuits (b)
Living room	7	Table lamps (6)	1020	8.9	
		Radio	75	.7	
		TV	300	2.6	
Entry hall	1	Ceiling light	100	9	
Hall closet	1	Ceiling light	60	5	
Kitchen	7	Ceiling lights (2)	150	1.3	
		Toaster—1000 w.			
		French fryer—1050 w.	1050		9.1
		Waffle iron—600 w.			
		Mixer	120		1.1
		Iron	1000		8.7
		Refrigerator	300		7.0
Ventilator	150		1.2		
Coffee maker	525		4.6		
Dining room	4	Ceiling light	150	1.3	
Hall	1	Ceiling light	100	9	
Attic	1	Ceiling light	60	.5	
Bedroom No. 1	4	Ceiling light	120	1.1	
		Radio	60	.5	
		Table lamp	100	.9	
Closet	1	Ceiling light	60	.5	
Bedroom No. 2	4	Ceiling light	120	1.1	
		Table lamps	120	1.1	
Closet	1	Ceiling light	60	.5	
Bathroom	3	Ceiling lights (2)	180	1.6	
		Portable heater	600	5.2	
Basement	3	Lights (7)	630	5.5	
		Freezer	350		4.8
Laundry	2	Washing machine	700		7.0
		Ironer	1500		13.0
Porch, outside	1	Lights (3)	220	1.9	
TOTAL				37.5	56.5

Total current: 94.0 amp.
Equivalent watts: 94 x 115=10,800 watts

CHECK LIST - TABLE VII
EQUIPMENT ON INDIVIDUAL CIRCUITS

Equipment	Rating	Amperes		Watts Demand on Branch Circuit
		115 Volts	230 Volts	
Clothes drier	4500 w.		19.5	4500
Workshop Saw	3/4 hp., 10.2 amp.	16.2		1860
Jointer	1/3 hp., 6.0 amp.			
Drill press	1/4 hp., 4.6 amp.			
Water pump	1 hp.		5.3	1220
Furnace	1/6 hp.	2.9		885
	1/4 hp.	4.8		
		<u>7.7</u>		
Total of equipment on individual circuits (except range)				8465
Range	10.6 KW			8000*

* Range demand figured separately, as shown in Table II.
(Watts demand on all other branch circuits equal to appliance rating.)

TABLE VIII
GENERAL-PURPOSE CIRCUITS

- (A) Using 15-amp (No 14 wire) circuits:
 No of circuits = $\frac{\text{AMPS}}{10}$
 $= \frac{37.5}{10} = 3.75$ or 4 circuits
- (B) Using 20-amp (No 12 wire) circuits:
 No of circuits = $\frac{\text{AMPS}}{15}$
 $= \frac{37.5}{15} = 2.5$ or 3 circuits

APPLIANCE CIRCUITS

- (20-amp., No 12 wire, circuits)
 No. of circuits = $\frac{\text{AMPS}}{15}$
 $= \frac{56.5}{15} = 3.8$ or 4 circuits

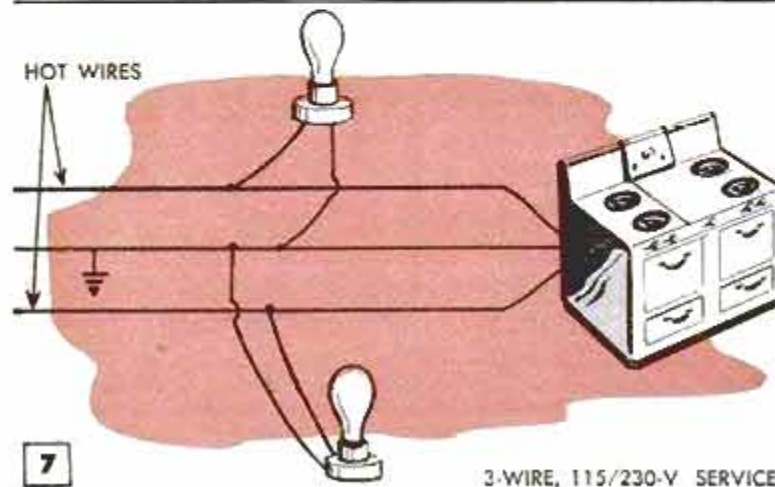
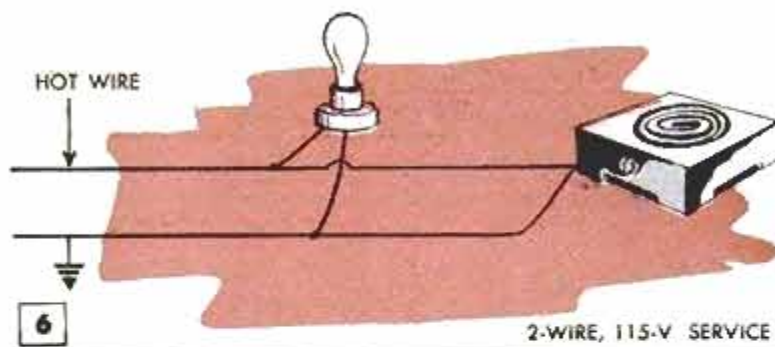

dividing the total by the line voltage and you have the current requirement. Since the load connected to any branch must not exceed its capacity—better slightly under full capacity—you can easily determine the number of branch circuits required to carry the estimated load. This method is reasonably accurate when estimating wiring requirements for both old and new homes, but before actual work is carried out you must make sure that the procedures are in accordance with local and national electrical codes.

When you plan to increase the demand on an existing installation the wire size, service capacity and the type of service, whether 2 or 3-wire, are important considerations. Appliance circuits on No. 12 wire are now required in most localities. Circuits on which lights are used cannot be fused for more than 20 amps. See Table V. Special-purpose circuits, Fig. 5, for larger appliances should use the size of wire required by their current demand. The total current requirement generally is used in determining the size of service-entrance conductors and the amp. rating of the service-entrance switch and the fuses required. The current demand of a range is determined separately from Table III and added to the other requirements. In figuring a new service entrance, either for new construction or for an existing installation, it's best to anticipate possible future demand and go beyond that required at present, both in wire size and type of service.

At present electricity is supplied to homes either by 2-wire 110, 115 or 120-v. systems or by 3-wire 110/220, 115/230 or 120/240-v. systems, 115/230-v. being perhaps the most common of the 3-wire services. The 2 and 3-wire systems are diagrammed in Figs. 6 and 7. The 3-wire system provides both voltages and should be installed wherever possible as it offers several advantages. Because the 3-wire system doubles the voltage, smaller wires can be used from entrance to main switch. Smaller fuses are required. As an example, a 13,000-watt service would require 120-amp. fuses and main switch and No. 0 wire size on a 2-wire, 115-v. system. The same

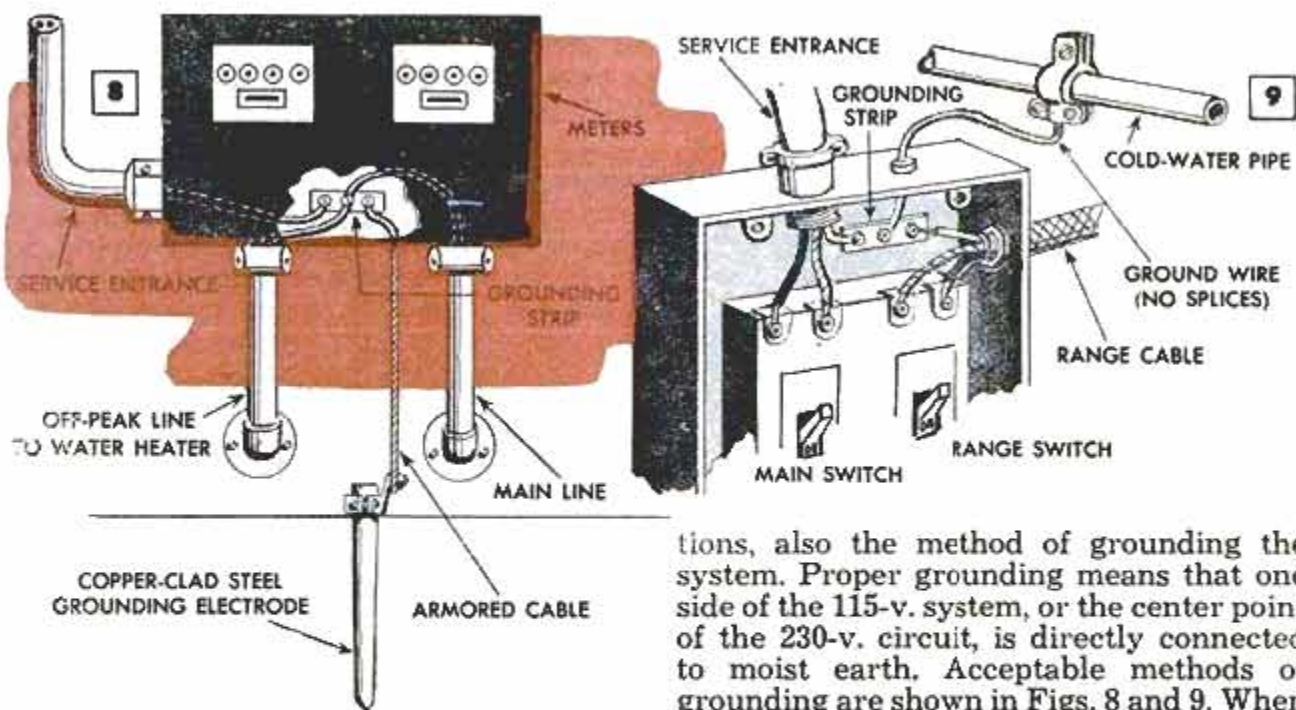

service would require only 60-amp. fuses and No. 4 wire on a 3-wire 115-230-v. system. Appliances which take a heavier current, also larger shop motors, usually are designed for 230-v. current. Motors of $\frac{1}{2}$ hp. and larger generally are arranged for operation on either 115 or 230-v. current. On the higher voltage the units require less current and can be operated with smaller sizes of wire.

Grounding is simple and 230 v. can be obtained even though the potential at no point exceeds 115 v. above ground. The 3-wire system also provides a better-balanced load condition. Most power suppliers require a 3-wire installation when new wiring is added to existing systems.

Existing installations, especially those in older homes, should be carefully checked over before planning new additions to the service. Condition of the existing wiring and the wire size are important considera-

tions, also the method of grounding the system. Proper grounding means that one side of the 115-v. system, or the center point of the 230-v. circuit, is directly connected to moist earth. Acceptable methods of grounding are shown in Figs. 8 and 9. When special-purpose circuits are added to an existing system, wiring through the special-purpose fuse boxes must be properly carried out. Fig. 10 shows acceptable methods. (To be continued)

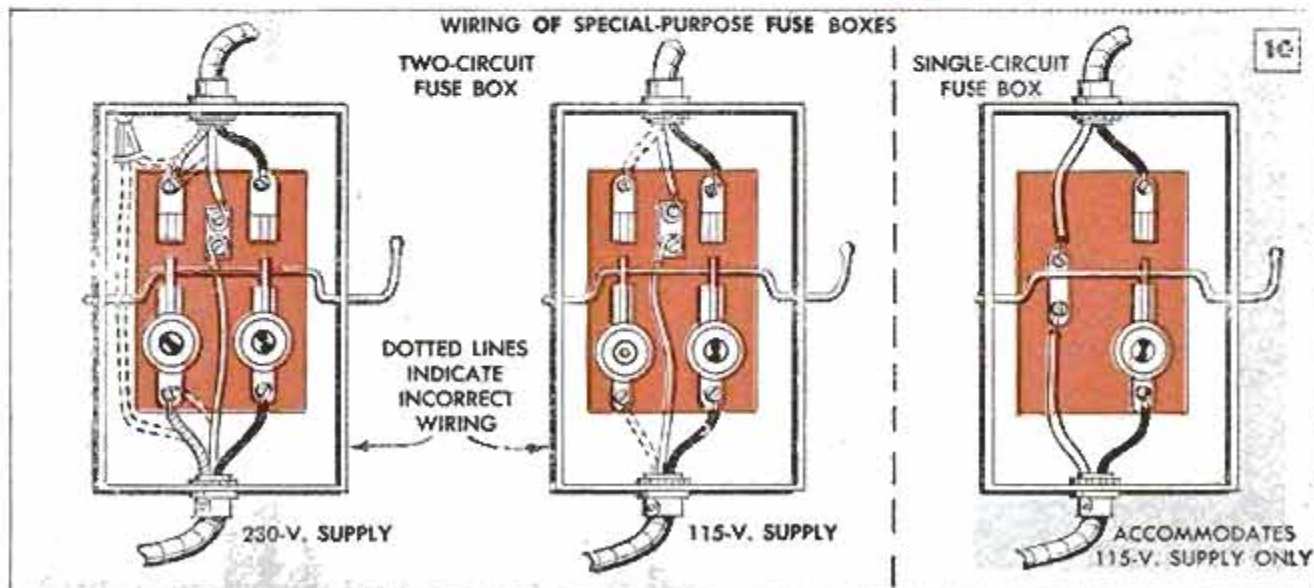

Draft-Free Ventilation Provided by Arrangement of Windows



Dry, draft-free ventilation, even during a heavy rainstorm, is possible if your home has double-hung sash that are fitted with combination storm windows. Arrange the storm window as shown, with the screen at the bottom and the glass at the top. Then close the lower half of the inner window and partly open the upper half. The idea is especially useful if you must be away from home when rain is anticipated.

Arthur A. Peterson, Royal Oak, Mich.

Small Picture Frame Held Erect With L-Hook or Bent Wire

Screwed into the lower edge of a small wooden picture frame as shown, an L-hook will support the picture at a slight angle. A larger frame can be supported in a similar manner by means of a U-shaped wire held with wood screws.

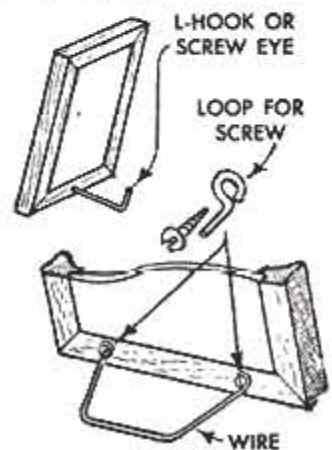

Breaking in Newly Mixed Developer

When starting to use a fresh batch of developer, whether for prints or negatives, it is best to start the chemicals working with a dummy sheet of emulsion. In the case of printing, if the developer has not been "mellowed," it may give a false timing. When developing negatives, the fresh light action of the chemicals combined with the lack of a "stabilizer" would otherwise tend to spot the negatives and cause extreme contrasts. There is no added expense in the conditioning process, since you can use scraps of previously exposed paper or film which you normally throw away. If a sheet of exposed paper the same size as the developer tray is left in the bottom of the tray, as shown, it will aid in determining contrasts when developing prints.

Robert C. Florian, Chicago.

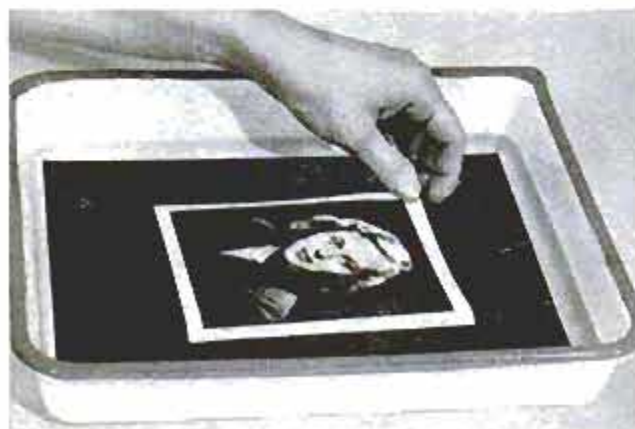

Rubber Stamping in Many Colors

When you wish to make rubber-stamp markings in a particular color, liquid food coloring makes a suitable ink for moistening the stamp pad. Several colors may be combined for a particular shade, mixing three parts of color to one part of glycerin. A temporary pad for a particular color can be made with a few layers of flannel cloth placed in the top of a flat pocket-size tobacco can.—Ken Murray, Colon, Mich.



POLAR PONY

By Hi Sibley

JUNIOR WILL HAVE FUN sailing across the ice on his polar pony with an umbrella tail filled by the wind pushing him along. If there's no wind, he can ride it like a scooter or have someone push him. Head, body, legs and footrest are cut from $\frac{3}{4}$ -in. outdoor plywood. The brace for the rear runners is cut from 2-in. stock as is the seat which is drilled and slotted at the back to provide a clamp for the umbrella tip. Large butt hinges join the sections of the pony and provide a positive method of steering.

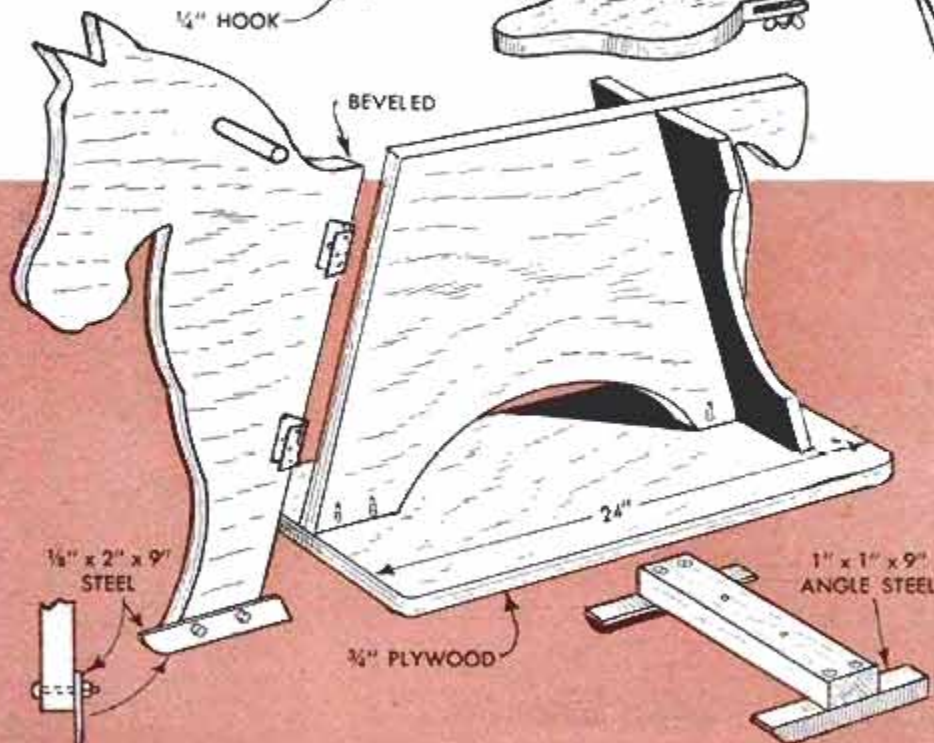
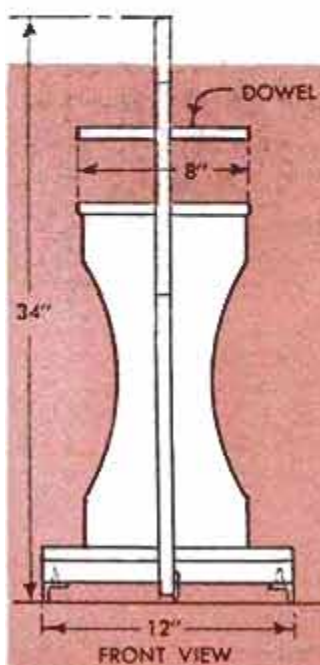
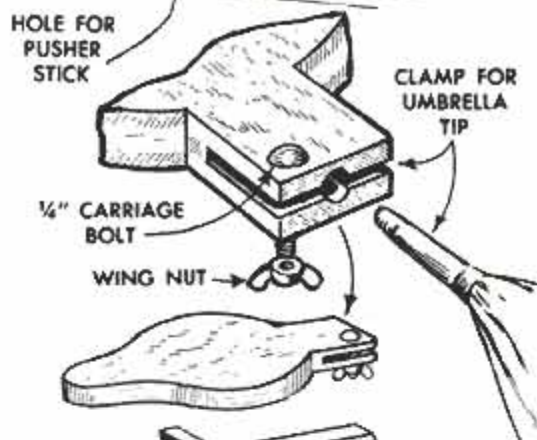
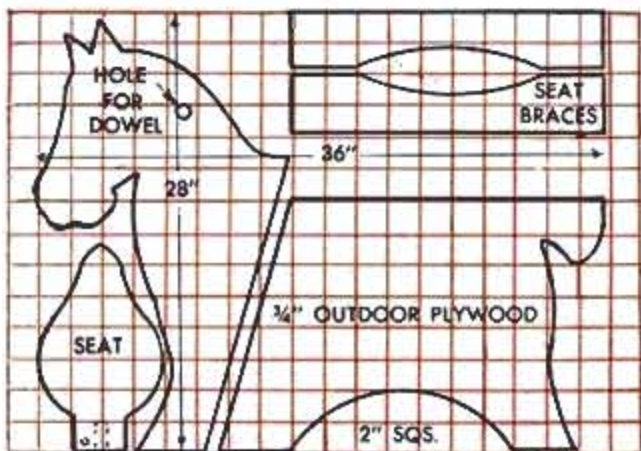
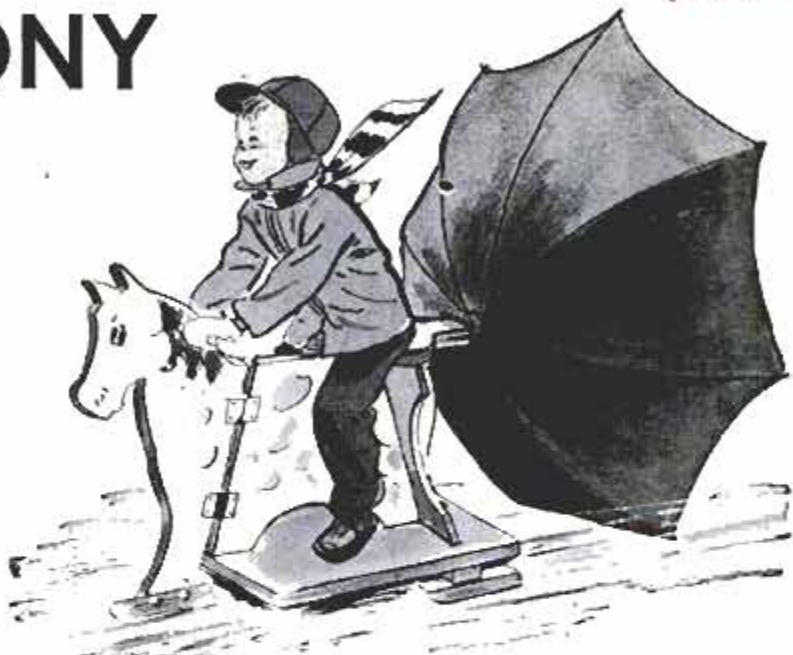

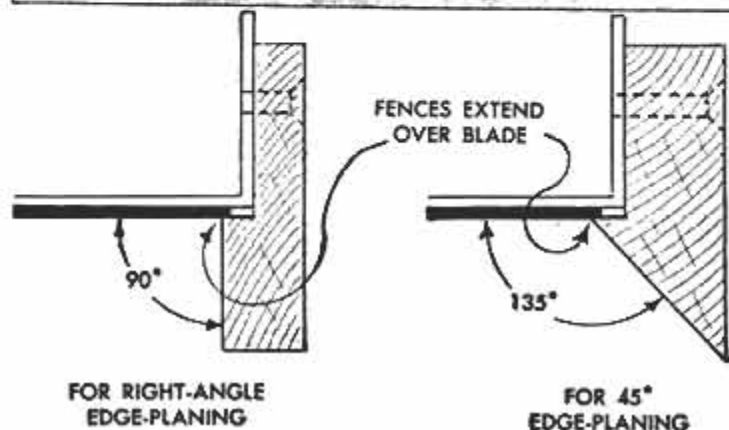
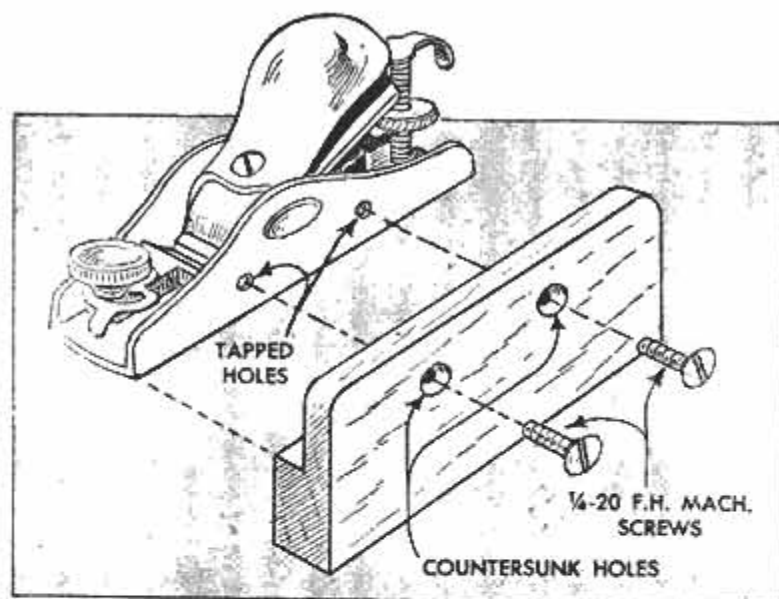

Plane Has Wood Guide Fence For Edge-Planing Accurately

Square or angular edge-planing can be done more accurately if a fence is attached to the side of the plane. Close-grained hardwood should be used for the fence, which is rabbeted along one side so that the block extends under the bottom edge of the plane slightly. Matching holes are drilled in the fence and plane, those in the latter being tapped for 1/4-20 screws. Sand the surface of the block that contacts the work smooth and apply a coat of wax to minimize friction.

Ice Preserves Cut Flowers

When packed with ice in a long box lined with aluminum foil, cut flowers may be transported by car. Place the flowers on the foil which is run lengthwise in the box, pack ice cubes between the stems and seal the foil around the flowers. The ice will keep the flowers fresh and moist, and the foil will prevent water from dripping.—Mrs. Leslie K. Schultz, Cicero, Ill.

Beautiful, Useful Furniture You Can Build WITH FULL-SIZE PATTERNS

You can make sturdy, good-looking furniture, toys, valances, metal lamps—even a 12-foot utility outboard with *PM Full-Size Patterns*. They were all drawn by a professional designer and built in our shop to test fit of parts and construction details.

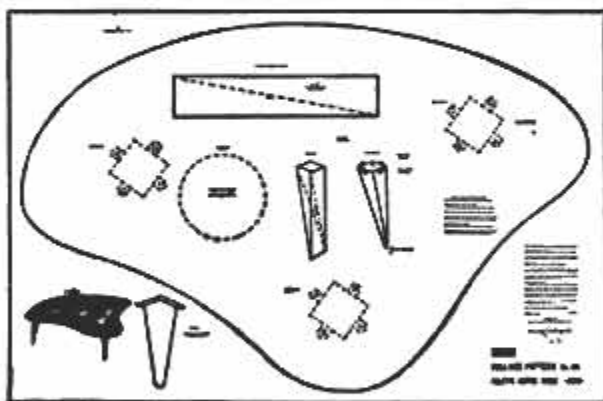

No. 116. Palette Coffee Table

Above is an actual photograph of Pattern No. 116, a Palette Coffee Table, which is 31½ x 47½ inches at its widest points. It can be made in one evening, if you have a bandsaw for making the curved cuts. Pattern includes complete construction and finishing details. 50c.

Modern Cocktail Table, No. 103. This table is 40 x 19 inches; 15½ inches high. With its metal grill inserts and plank top, it's modern in design and solid as a rock. One pattern—costs only 50 cents.



Love Seat, No. 114. Designed in the Lawson style, this love seat goes with either modern or traditional settings. Uses sagless-type wire springs and foam-rubber padding. Two patterns in the set: \$1.00.



Trundle Beds, No. 102. These beds save space and are safer for youngsters as there is no ladder to climb; have storage headboards, and use standard-size mattresses. Three patterns: \$1.50.



Order today! And ask about the other 20 patterns, all guaranteed to be good—or your money back!

POPULAR MECHANICS PATTERNCRAFT

200 EAST ONTARIO STREET
CHICAGO 11, ILLINOIS

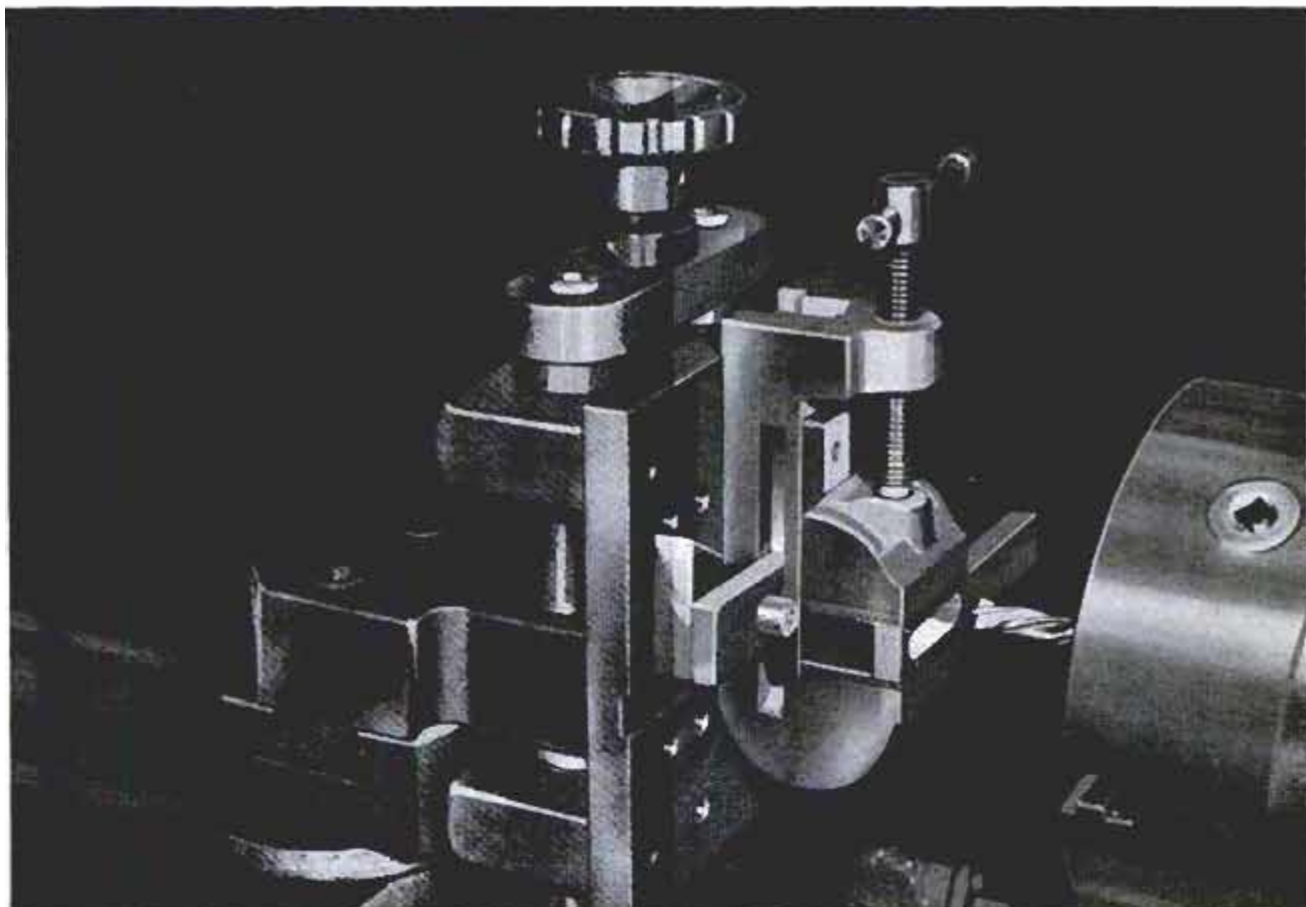

Your lathe becomes a milling machine with this attachment. Unit mounts on compound, replaces the tool post

MILLING ATTACHMENT *for your lathe*

By J. C. Magee

BUILDING A MILLING ATTACHMENT for your lathe is like adding a small milling machine to your metalworking equipment. Nearly all machining on the attachment can be done on the lathe, the only exceptions being certain tapping and filing operations. The attachment pictured above and detailed on the following pages has been especially designed with round slides to eliminate cutting of dovetail slides, an operation difficult to carry out in the small shop with limited equipment. The unit is made with a flat mounting plate grooved on one face for locating work in a true horizontal plane. The location of the groove and the pattern of tapped holes for mounting work, vises and other fixtures is not given, as these must be arranged according to the requirements of the operator.

Before you begin construction note three dimensions carefully, the diameter of the drill-rod slides, the hole diameter on the top and bottom spacer bars and the hole diameter on the mounting bracket. Polished drill rod generally is held to very close tolerances in manufacture, but where you have to machine parts to a sliding fit and a press fit on two rods it is necessary to know the precise diameter of the rods throughout the length. Check carefully with a micrometer. If, for example, both rods check 1.000, or slightly under, then you can hold the hole dimensions in the spacer bars to 1.0005, rather than the 1.005 indicated on the details.

The hole dimension on the mounting bracket, .9997, is calculated to give a press fit of the rods, but it also is dependent to

some extent on the mike reading of the rods. If the rods are over (a 1.000-plus reading on the mike) then it may be necessary to increase the hole diameters in the mounting bracket slightly in order to obtain a press fit without heating.

Construction of the attachment can be simplified by boring the top and bottom spacers and the mounting bracket to a close fit on the rods and then using set-screws to hold the rods in the mounting bracket. This procedure will give you an attachment sufficiently accurate for all practical work but not for jobs calling for a high degree of precision. Note that the upper ends of the rods are shouldered $\frac{1}{8}$ in. and the holes in the top plate are counterbored to take the projections. Note also that the arbor flange fits into a counterbore in the top plate. The arbor thread can be right or left-hand as desired. Some operators prefer a left-hand thread on a raising and lowering screw, or arbor. On the original attachment, holes in the upper ends (shouldered ends) of the rods, or slides, were tapped for $\frac{5}{16}$ -in. screws and are so specified in details at the right. However, there is less danger of distorting the projections when hand-tapping the holes if the ends of the slides are drilled and tapped for $\frac{1}{4}$ -20 screws as indicated on the opposite page.

The top spacer bar is slotted after boring, the slots running in from the edge at an angle of 30 deg. Note that the holes for the clamping screws are drilled body size from the edge to the slots. Beyond the slots the holes are drilled tap size. This procedure is necessary to permit a clamping action on the drill-rod slides when the screws are tightened.

It is necessary that the bores in the spacer bars and mounting plate be located precisely, especially the spacing of the holes. To handle such a job with the required accuracy, machinists generally use tool-maker's buttons which are center-drilled and hardened and ground to close dimensions. However, shop-made tool-steel buttons will serve the purpose if you take time to do an accurate job of turning to size. In practice, the buttons are indicated (with a dial indicator) after the work is mounted on the lathe faceplate. As the first step, locate the hole centers, using a scribe on a surface plate. Prick-punch the hole centers, recheck, and then drill and tap for 10-32 screws as in the lower right-hand detail on the opposite page. Mount the buttons on the work and clamp lightly to the large faceplate, counterbalancing with a weight. Then indicate one button (with a dial indicator), shifting the work until the button runs dead true. Clamp the work securely to the faceplate, recheck after

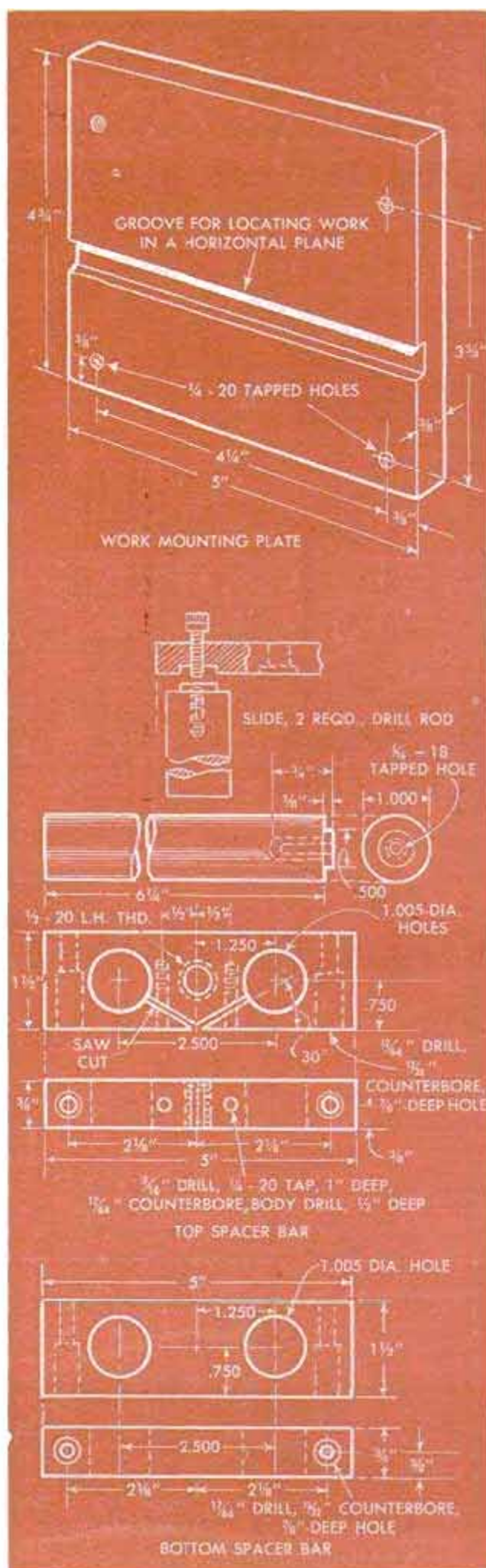

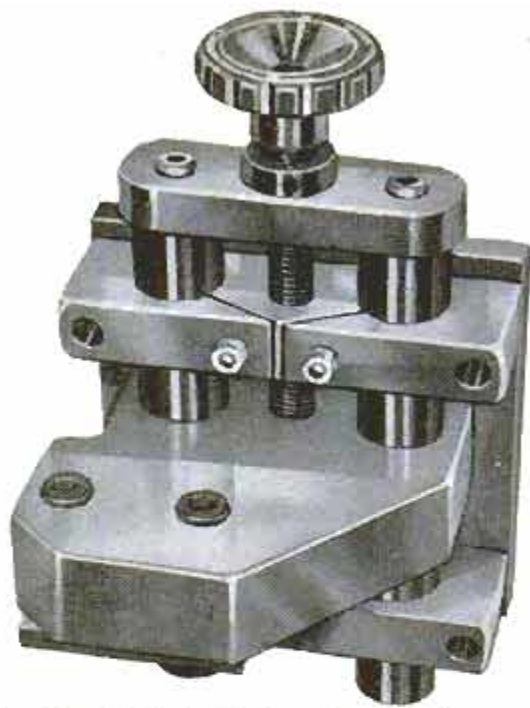

Here's the finished attachment ready to mount on the lathe. Note the slotted bar and clamping screws

clamping, then remove button, leaving work centered for boring. Indicate each button in this manner before boring the hole.

Dimensions of the clamping plate are laid out to fit the compound of a 9-in. lathe. Be sure to check measurements of the compound T-slot before making this part to fit your own lathe, as it may be necessary to alter the dimensions to assure correct mounting. The plate should be a close sliding fit in the compound T-slot.

On the original unit the top plate was machined from brass. Use of brass makes a somewhat easier operating unit, as the top plate serves as a thrust bearing for the arbor. However, use of brass is not essential. Steel of the type known to the trade as "free machining" is probably best for making the spacer bars, mounting bracket, top plate and clamping plate. Although the mounting bracket can be cut to the rough shape with an ordinary hacksaw, it may be possible to order it flame-cut and thus save considerable labor and time. If this is done all that will be necessary is to clean up with a file and round the corners.

The handwheel, or palm wheel, shown in the upper right-hand detail on the preceding page, can be made as indicated, or a ball crank substituted. Many users will prefer a ball crank, although a palm wheel gives a somewhat closer control for fine settings of the work-mounting plate. ★★

☐ Concentrate the light in your workshop, if it is equipped with only a bare bulb, by using one of the small deep foil plates used for freezing food. Cut a round hole in the center and slide it over the small end of the bulb.

Centering Milling Cutter

When cutting keyways, the milling cutter can be centered accurately over the work by using a short piece of drill rod as a gauge. To arrive at the diameter of the drill rod to be used, subtract the width of the cutter from the diameter of the work and

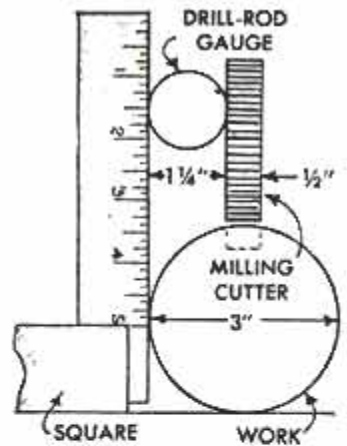

divide the remainder by 2. Place the gauge between the side of the cutter and the vertical edge of a toolmaker's square which is butted against the side of the work. Adjust the worktable of the mill until the gauge just touches both the cutter and the square.

Metal Rib Stiffens Hacksaw Blade For Cutting in Confined Place

When it is necessary to use a hacksaw blade without the frame, a section of umbrella rib crimped over the back of the blade will help stiffen it so it won't buckle when being used. Use pliers to pinch the rib over the edge of the blade and then bind the two together at the ends by wrapping with several turns of friction tape. The taped ends also will provide a better grip on the blade.

Metal Cut in "Wood Sandwich"

Thin-gauge sheet metal can be hacksawed without being twisted, or breaking the saw blade, if the metal is sandwiched between two scraps of wood and clamped in a vise. Mark a line on the metal, offset 1 in. from the line to be cut, and align it with the edge of the wood. The cut is then made 1 in. from the end of the wood.

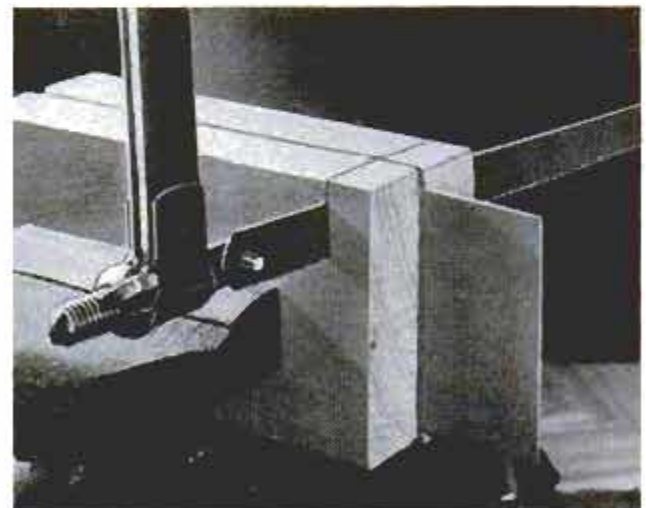

CUSTOM CABINET PULLS

By Ralph Treves

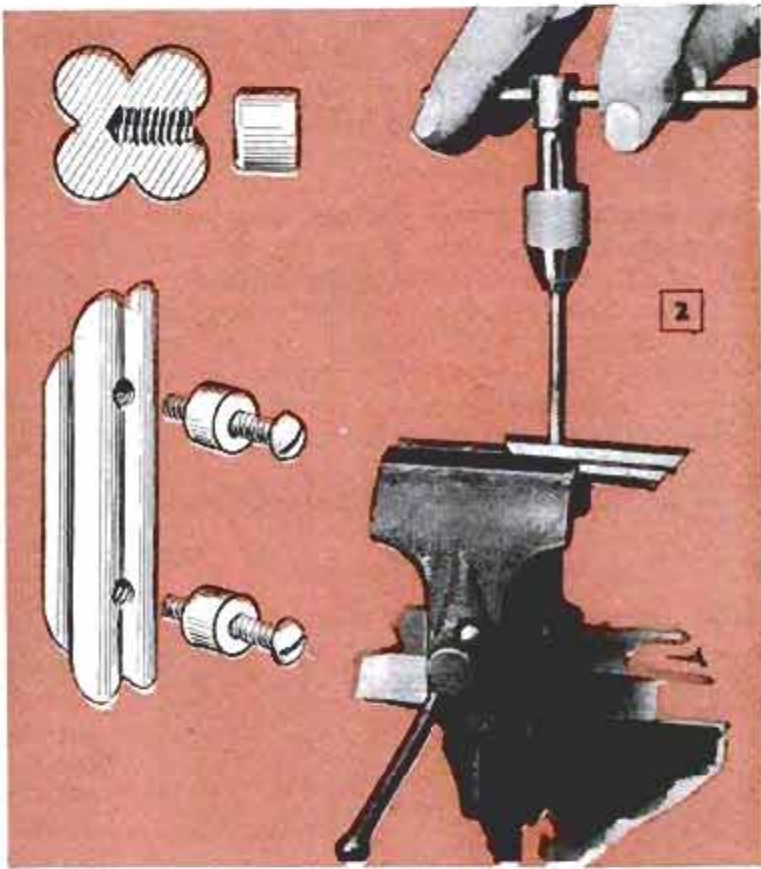
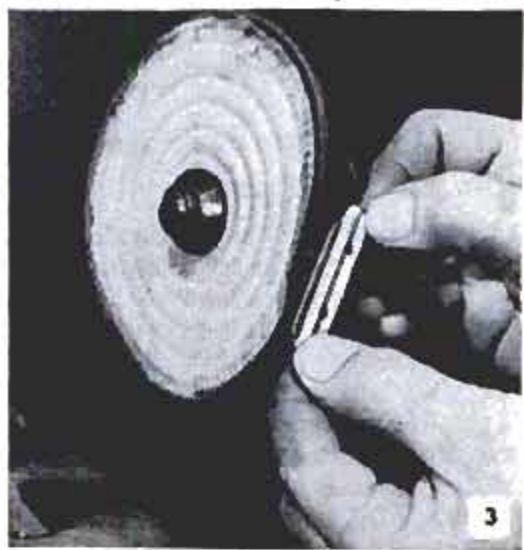
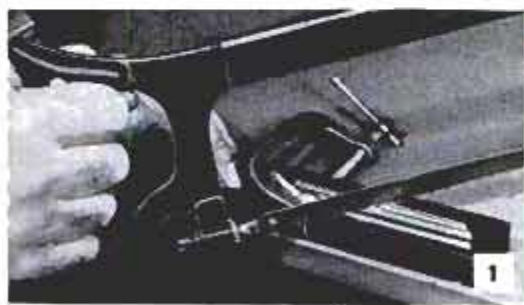

IF YOU PREFER something beside stock types of door and drawer pulls, there are many solid-brass fittings and stock of various shapes that can be made into distinctive hardware. Among the fittings that can be used are such things as boat hardware to provide a nautical motif for a game room or a boy's room. Another example would be to use small door knockers as pulls. Solid-brass stock is available in a variety of shapes, including flats, rounds, hexagons and special shapes, such as the stock used to make the door pulls illustrated in this article. This latter type stock usually is sold in odd lengths, and is handled by hardware stores catering to the hobbyist and do-it-yourself craftsman. If stock of an unusual shape is used, cut the ends of the pulls at an angle, so the unusual design is accented. To saw accurate angle cuts,

make a miter box from a metal channel, as shown in Fig. 1, and clamp the stock to one side. Fig. 2 details the method of attaching the pull to the door or drawer. Blind holes are drilled and tapped on the back sides, then spacers, which are short lengths of brass round stock drilled through, are fitted between the pulls and the surfaces to which they are attached. The screws are driven into the pulls from inside the doors so they do not show. To obtain a high polish on the brass, first clean it with steel wool, then buff it on a buffing wheel, Fig. 3, using jewelers' rouge. Do not use brass polish, since the metal must be perfectly clean to receive clear lacquer or plastic spray. Application of either of these two materials will assure that the brass stays shining and corrosion-free for years, eliminating the need for frequent polishing.



Straw-Insulated Hog Shelters Used the Year Around

Hoghouses are made usable the year around by one farmer who packs a heavy layer of straw around three sides of the buildings. The straw is held in place by wooden fencing kept upright by stakes driven into the ground. During cold weather, fattening hogs are kept in the buildings; then later, early-farrowing sows use the insulated shelter.

A. M. Wettach, Mt. Pleasant, Iowa.

Utility Box on Corn Planter Holds Seed and Spare Parts



Extra sacks of corn and fertilizer, as well as tools and spare parts, are carried in the utility box mounted on this tractor-drawn corn planter. The uprights supporting the box are 3-ft. lengths of steel angle bolted to convenient points on the planter frame. Angle cross pieces support the box, the size of which is determined by the spacing of the supports.

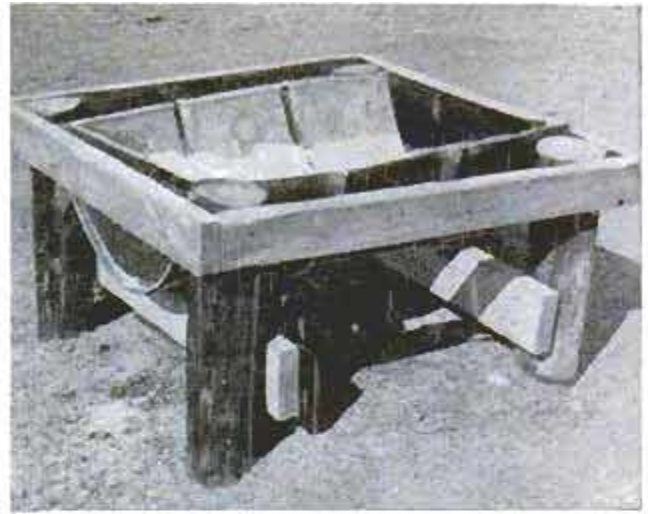

Mineral-Feed Trough From Drum

This trough for mineral feeding of livestock is braced solidly in a frame of cedar posts and heavy lumber. The trough is an oil drum that has been cut lengthwise as shown, and supported on two pieces of 2 x 6 lumber nailed on the inside of the posts. The top framing is 2 x 4s which are just the right length to hold the drum firmly between the four posts.

C. F. Marley, Nokomis, Ill.

Cracked Turkey Eggs Patched With Tape for Hatching

Turkey eggs that ordinarily cannot be used for hatching purposes because of cracked or "toe marked" shells are repaired with cellophane tape by one turkey breeder who reports successful incubation of 55 percent for the taped eggs. Almost any size crack can be sealed with tape so that it can go through a hatching process. Small cracks and thin shells can be detected at the time of candling and taped before any further damage occurs.

F. L. Elam, Sacramento, Calif.



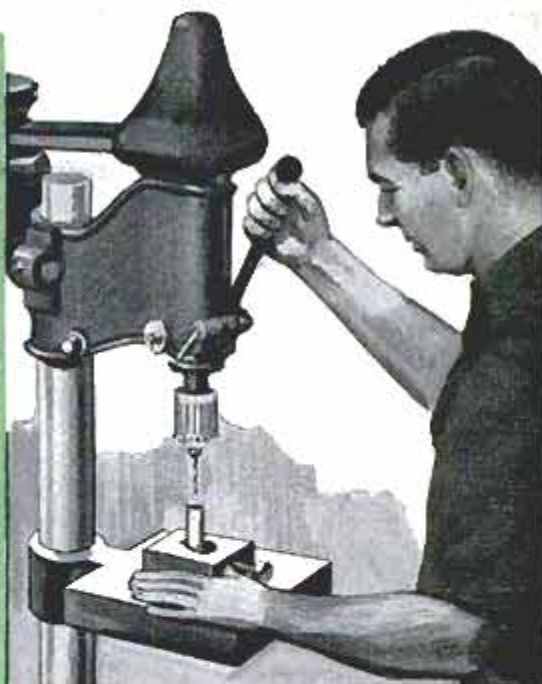
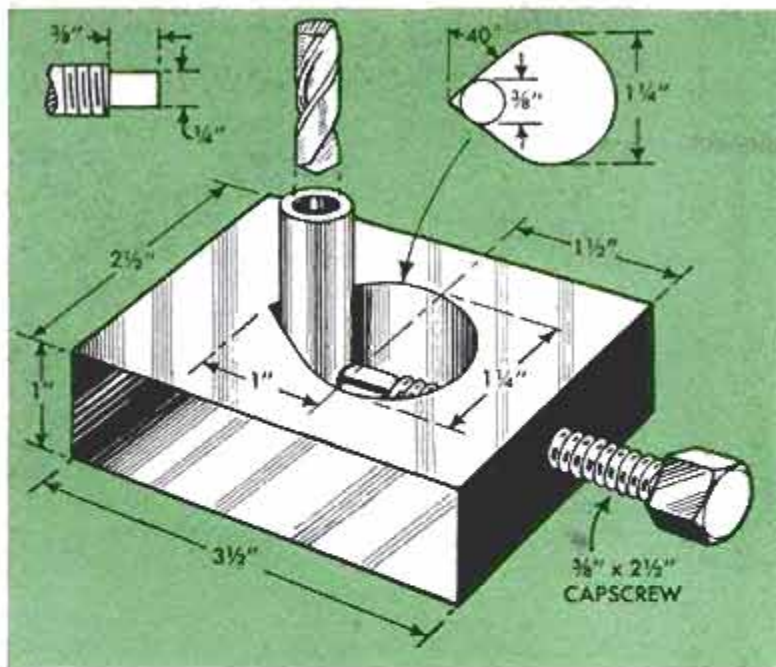

V-Clamp Holds Round Stock for End-Drilling

This shop-designed V-clamp was originally made to release a lathe for other work and permit fast end-drilling of short lengths of round stock on a drill press. Using the same design principle, dimensions can be altered to suit any special purpose. As detailed above, the clamp is suitable only for short length of stock not exceeding 1 in. in diameter. The steel clamp

block should be finished all over either by filing or milling. Special care must be taken when elongating the center hole to form the vee, or crotch. The clamp screw can be any handy size, but in any case the end should be shouldered and squared in the lathe and preferably hardened so that it will fit squarely against the workpiece.

C. W. Woodson, Chicago.

Razor-Blade Knife Improved From Small C-Clamp



A small C-clamp fastened over a razor blade will serve as a handle when cutting paper or cardboard. The clamp anvil will slide easily along the surface of straightedge and make clean cuts.



Tubing Bent With Pulley

Recently faced with the problem of bending 48 U-tubes on a 2-in. radius for the cooling coil of an air conditioner, and finding conventional tube-bending devices unsuitable, I tried one idea that worked perfectly. I used an ordinary V-pulley of the right diameter and clamped it by its hub in a vise. Then, by hand I wrapped the pieces of tubing around the wheel. Perfectly round, smooth bends were obtained because the V-shaped walls of the wheel supported the tubing on each side.

J. F. Dundovic, Minneapolis, Minn.

Drill-Bit Size Marked Legibly On Paper Tab Glued in Flute

The drill-bit size written on a paper tab and then cemented in a flute is easier to read than the numbers stamped at the top of the shank which wear off from extensive use. Twist drills down to a No. 30 can be marked in this manner.

SN 58

HOW WOULD WITH YOUR

By Chris Nelson
PART I

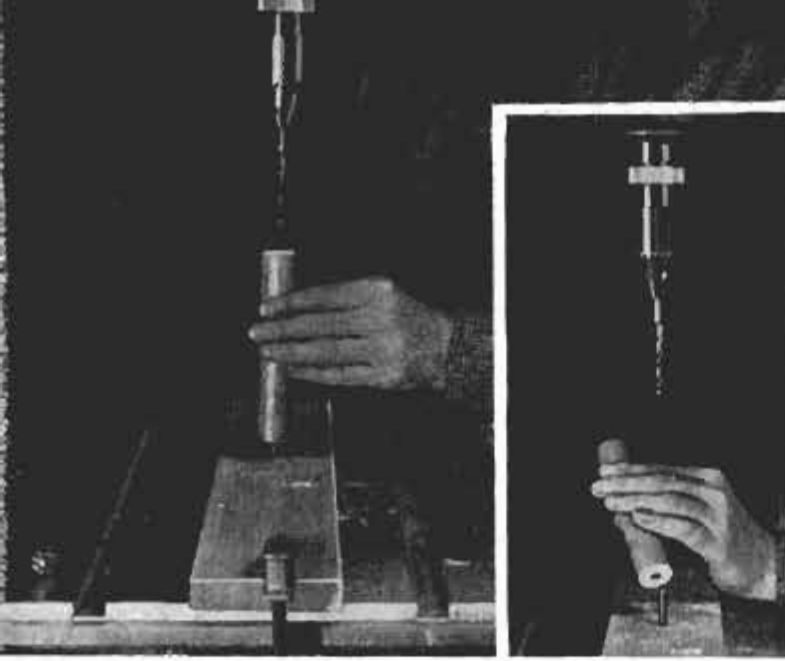

Q—How do you drill a hole in a piece of wood that is thicker than the drill bit is long?

A—MAKE A POSITION JIG so that you can drill from both sides of the work and keep the holes aligned. To make the jig, clamp a board to the drill-press table and drill a hole in it of the same diameter as the hole to be drilled in the workpiece. Next, drill a hole in one side of the work, then invert it over a short length of dowel fitted in the hole in the board. The hole drilled from the opposite side of the work now will be in perfect alignment

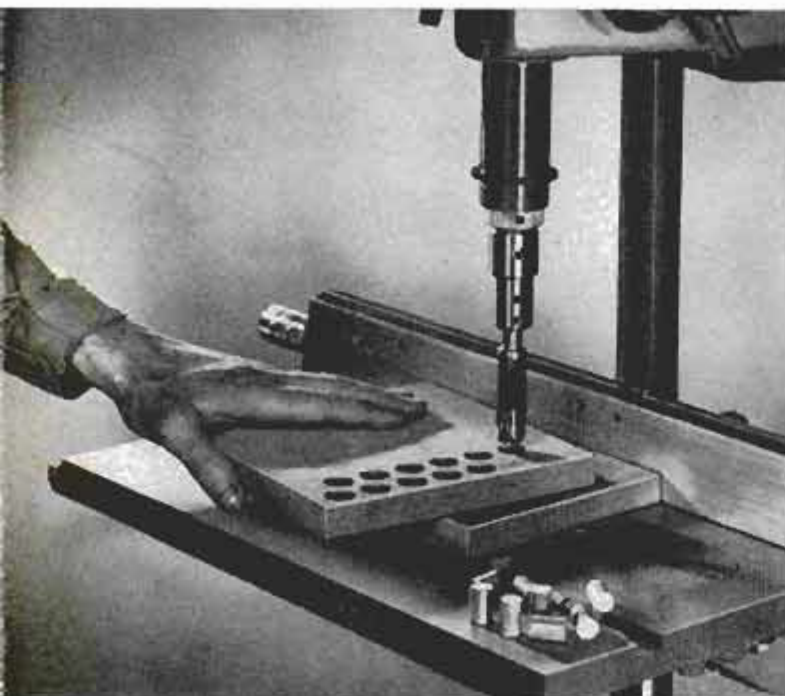

Q—What drill-press accessory is especially useful when building furniture where it is necessary to cover the screwheads for a more finished and professional appearance?

A—THE TOOL YOU NEED is called a plug cutter. In effect it is a hollow drill that produces plugs equal to its inside diameter. Plugs are cut from the stock used for the furniture and driven into counterbored holes in which the screws have been driven. The plugs are allowed to project slightly, then sanded flush. Other uses for the plugs include the repair of screw holes that have become oversize. The hole is bored out large enough to accept a wooden plug wiped with glue. A pilot hole then is drilled in the plug and the screw is reinserted

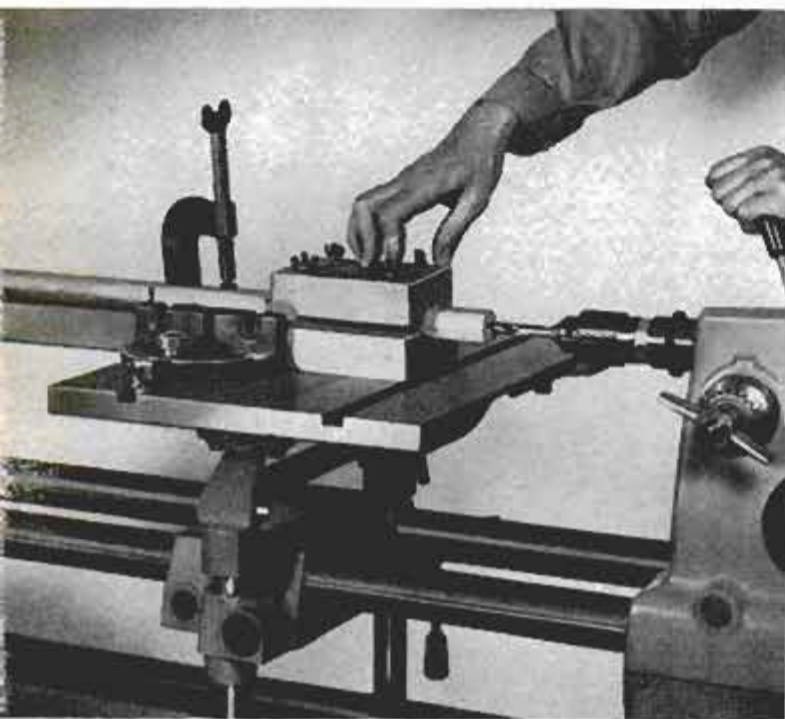

Q—To assure accuracy when drilling a hole down the center of a dowel, rod or other cylinder, what procedure should be used on a drill press?

A—MAKE A CLAMP, consisting of two wooden V-blocks cut on a table saw and held together with bolts and wing nuts. On a vertical drill press it will be necessary to attach the clamp to some sort of a base to hold it vertical. If you have a combination power tool that can be set up as a horizontal drill press, a base will not be necessary, as the work can be clamped to the table as shown in the photograph. Another advantage of the horizontal drill press is that work of almost any length can be end drilled

YOU DO IT DRILL PRESS?

Q—What setup on a drill press will permit accurate drilling of holes to receive splayed legs for a table?

A—CLAMP TWO PIECES OF WOOD to the drill-press table to form a V-block, or, as shown in the photograph, if your drill-press table has a miter gauge, use it for one side of the V-block. Adjust the table to the desired angle, then drill all four holes. This method also can be used for round work by drawing a radius through each hole location and keeping it aligned with the drill bit while drilling the hole

Q—When using a mortising attachment on a drill press to make a side mortise, which is a mortise that is flush with one surface of the stock, how can you prevent the chisel from creeping sideways in the wood?

A—PLACE A PIECE OF WOOD between the workpiece and the fence as shown in the photograph, so the chisel will bear against it and stay aligned. If your drill-press table is not equipped with a fence, clamp a strip of wood to the table to act as one. Although the photograph indicates that the work is being held by hand, for safety and greater accuracy, both the workpiece and the piece of wood used to keep the chisel aligned should be clamped to the fence

Q—To make a joint by which two pieces of wood can be joined in a sliding arrangement, what drill-press attachment can be used?

A—A DOVETAIL CUTTER does the job nicely. To cut the slot accurately for the slide, make a setup like the one shown in the large photograph. A fence—which can be a strip of wood clamped to the drill-press table—is used to guide work under the cutter and the work then is held in alignment by a clamp arrangement as indicated. The dovetail tenon is cut in a similar manner as illustrated in the inset photograph. To assure that the wooden members will slide freely, cut the tenon sufficiently undersize to provide clearance, should the wood expand from moisture

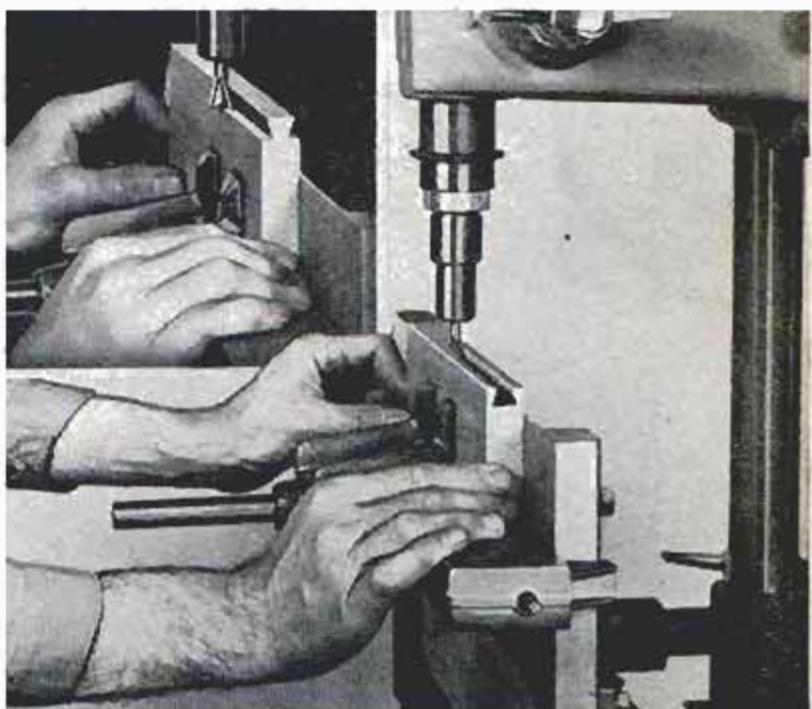
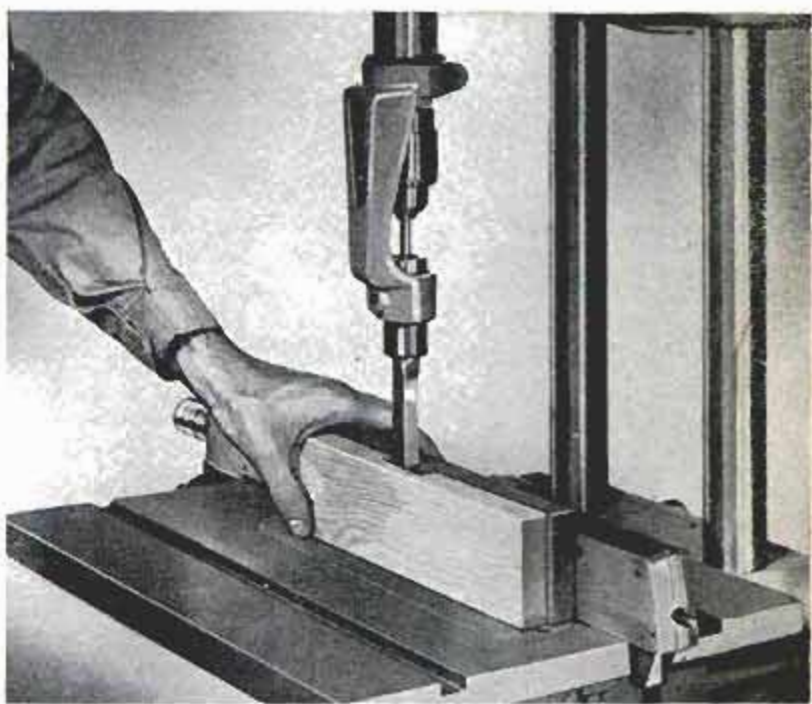
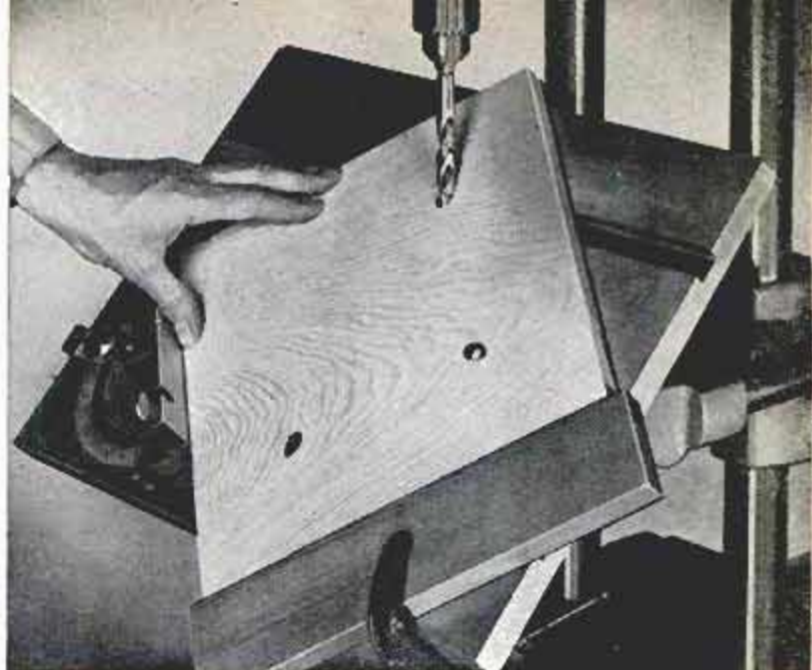

Pickup Truck Has Combination Carrying Rack on Front Bumper

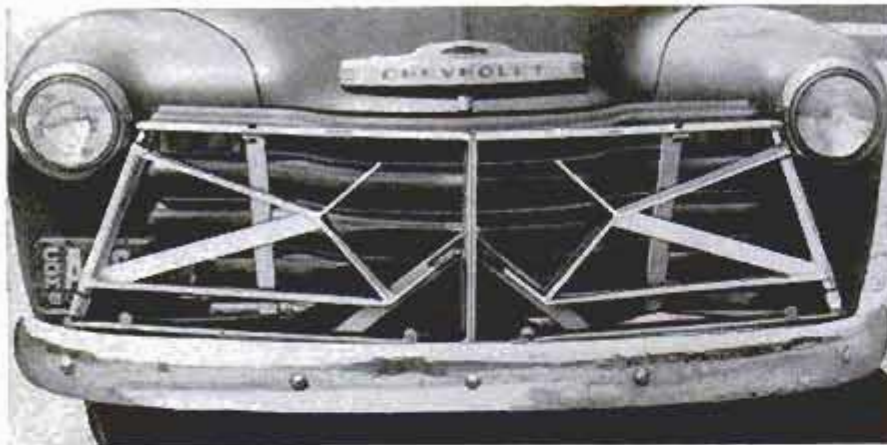

The combination carrying rack and grill guard fitted on the front bumper of the pickup truck shown is made of welded steel and is designed to carry boxes, barrels, bags of feed and other objects when the rack is lowered. When it is up the rack serves as a sturdy grill guard. Also, a pivoted bracket can be swung out on either side of the truck for carrying pipe or lumber. Angle iron and flat steel are used for the framework of the unit. The two end bars are $\frac{3}{4}$ -in. pipe that reinforce the rack and serve as shafts for the pipe-carrying extensions. The rack can be raised or lowered by means of simple hinges that are fastened to the bumper supports. The lowered rack is supported by the bumper.—F. Leland Elam, Sacramento, Calif.

Tire Tread on Farm Equipment Permits Highway Travel

One farmer solved the problem of moving his steel-tired farm equipment over blacktop and concrete highways by removing the steel lugs and installing old tractor-tire treads on the wheels. The tires are cut apart and the flat part of the casing riveted to the steel rims as shown. The deep tread still provides sufficient traction for most operating conditions and permits a softer ride over hard surfaces.

Grover Brinkman, Okawville, Ill.



Water Gun Subdues Brooding Hen

When an angry brooding hen hinders the collecting of eggs from a laying nest a squirt or two from a water pistol usually will discourage her. The hen may eventually be trained not to sit on the nests provided for egg laying.

Starting Farm-Equipment Motors

Starting motors on mechanized farm equipment is no longer a difficult task for one farmer who welded a pulley on the shaft of a hand crank to use for this purpose. Driven by a flat belt



and powered by a tractor, the pulley simplifies starting the motor on a combine, elevator or other farm equipment. In cold weather it more readily overcomes the drag of heavy crankcase oil and in hot weather counteracts vapor lock almost immediately. The handle end of the crank, beyond the pulley, is cut off and discarded since it no longer is used.

Peep-Sight Level Measures Tree Height

By Walter E. Burton

HERE'S A TOOL which not only aids in laying out a driveway or leveling a plot of sloping ground but also can be used to measure the height of a tree or structure too difficult to measure by other means. It consists of a 12-in. spirit level, two angle-brace sights, a protractor and a weighted pointer. Assembled as shown in the photo at the right, the unit may be fastened to a camera tripod. Precision sights may be purchased for mounting on the level, but relatively accurate sights can be made from two 1-in. angle brackets as shown below and at the right. The protractor is fastened to the side of the level with its center point $2\frac{3}{8}$ in. from the front end and $\frac{1}{2}$ in. down from the top. Cut the pointer from thin metal to the pattern given in the detail. An adjustable balance weight for the pointer is made from a bolt and two cap nuts. Suspend the pointer from a nail driven into the level at the center point of the protractor. For tripod mounting, recess a mending strip in the bottom edge of the level, centering it 5 in. from the sighting end. Drill and tap a hole through the strip to accommodate the mounting screw of the tripod. To measure the height of an object a known distance away follow the formula given below:

$$\text{Tangent of angle } A = \frac{C}{B}$$

$$C = \text{Tan } A \times B$$

$$\text{Height} = C + D$$

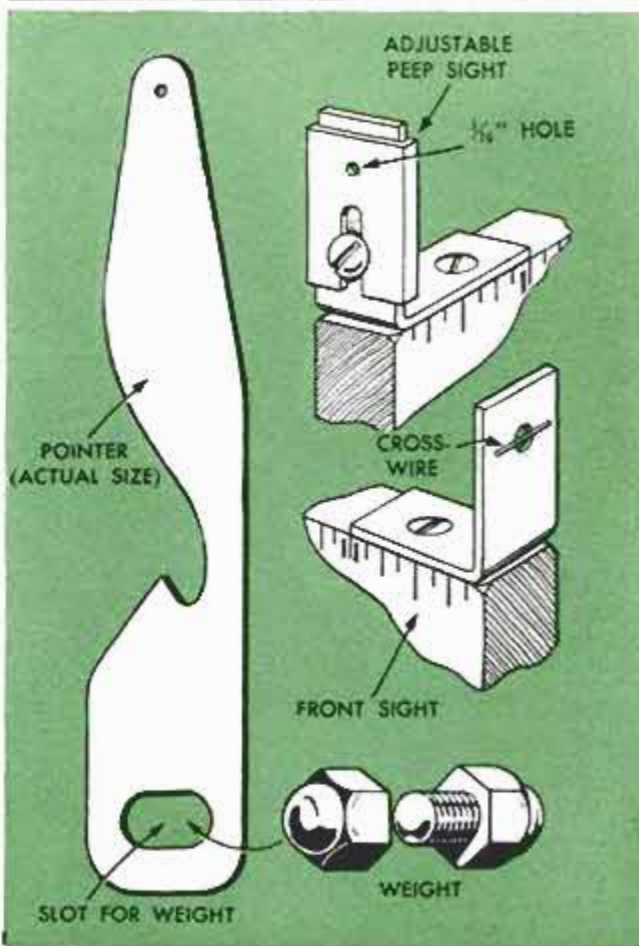
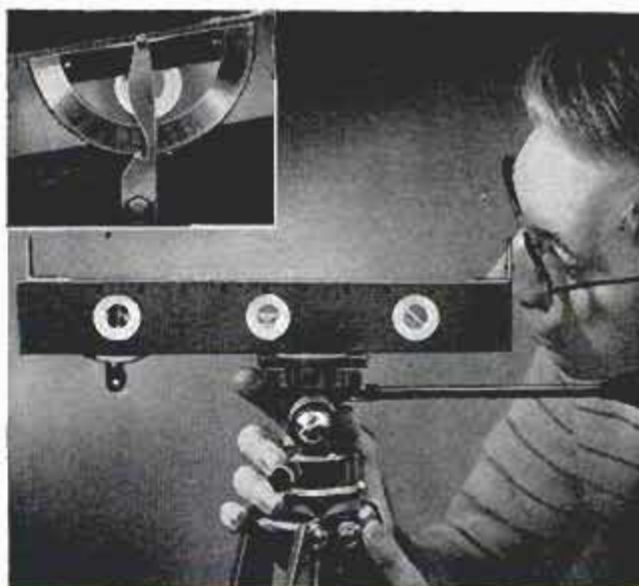
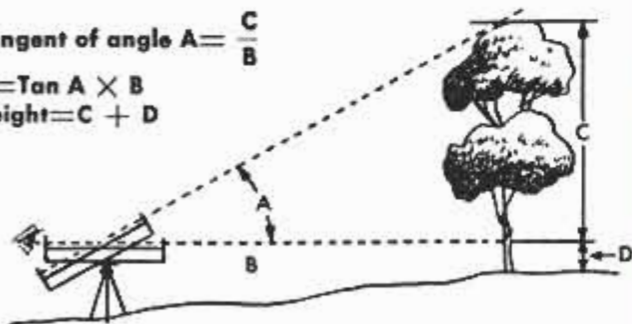

SHOPPING FOR TOOLS



1. AUTOMATIC DRILL-PRESS FEED has 3-cycle air-operated traverse, hydraulically controlled drill feed and automatic return to starting position. Foot-pedal control permits use of both hands. Drill can be operated manually, full automatic, or manual approach and automatic drill

General Pacific Corp., 8740 Washington Blvd.,
Culver City, Calif.

2. SANDER-SCRAPER comes with a double-edged scraper blade and attachment for holding a 2½ x 9-in. sandpaper strip. Change from scraper to sander is made by loosening knob and replacing blade with shoe and sandpaper strip. Knob and handle are designed for easy two-handed grip

Hyde Mfg. Co., Southbridge, Mass.



3. HEAVY-DUTY SAW has 6½-in. blade that will cut through a 2 x 4 at 45 deg. with ¼ in. or more of blade to spare. Calibrated quadrant gives angle settings from 0 to 45 deg. Ripping guide has wide shoe for easier control. The built-in chip deflector and open-end handle are new features

Black & Decker Mfg. Co., Towson 4, Md.

4. MITER DOWELING JIG has been especially designed for drilling accurate dowel holes in mitered stock ¾ to 1¼ in. in thickness. Hardened-steel drill guide has 4¼-in. holes spaced ½ in. apart, making it possible to drill dowel hole at any desired point. Use with hand drill or drill press

Gunver Mfg. Co., Manchester, Conn.

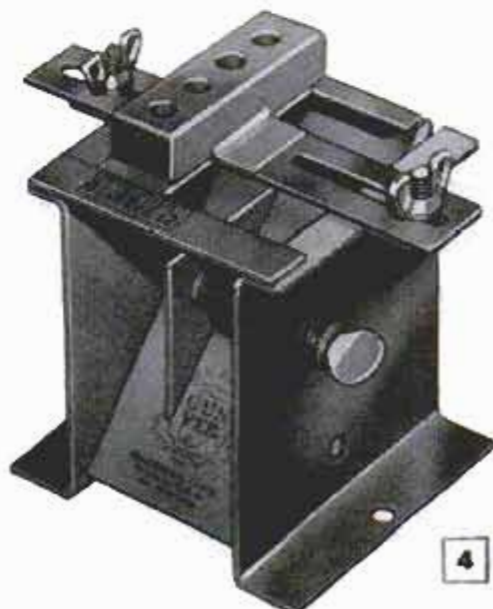
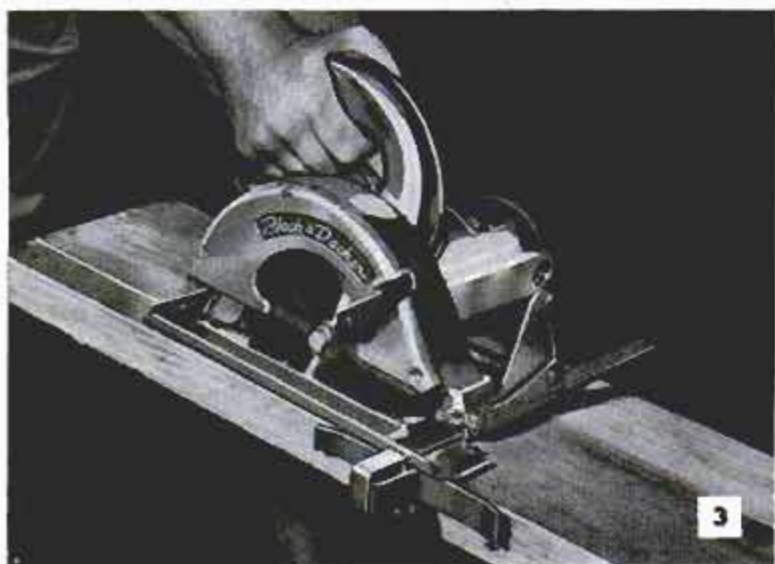

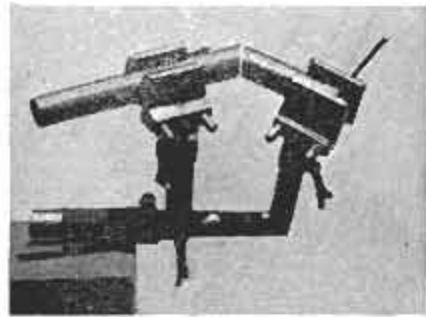
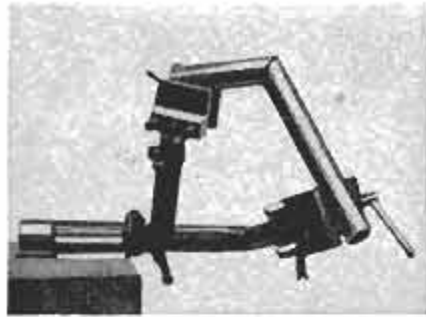
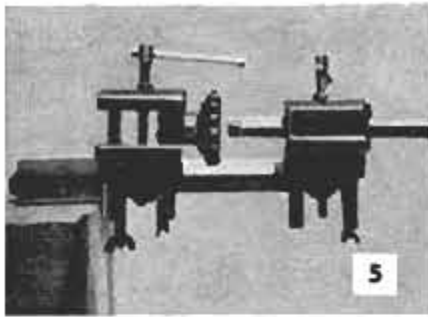

5. UNIVERSAL WELDING VISE holds small work in almost any position required and at a convenient height. When locked in place the work can be rotated through 360 deg. vertically to locate the work in a "down hand" position. Two swiveling vises mounted on tubing slide in or out. Complete unit weighs 22 lb.

D. W. Shurtz, 1346B Melrose Ave., Modesto, Calif.

6. MULTIPLE DIE HOLDER comes as a set of 3 holders, each containing 6 threading dies to cut 18 thread sizes from 1/8 to 1/2 in. NC and NF, including 1/8 and 1/4-in. pipe threads. Handy at the lathe where work requires cutting several sizes of threads

Mohr Tool & Mfg. Co., Box 63, Maywood, Ill.

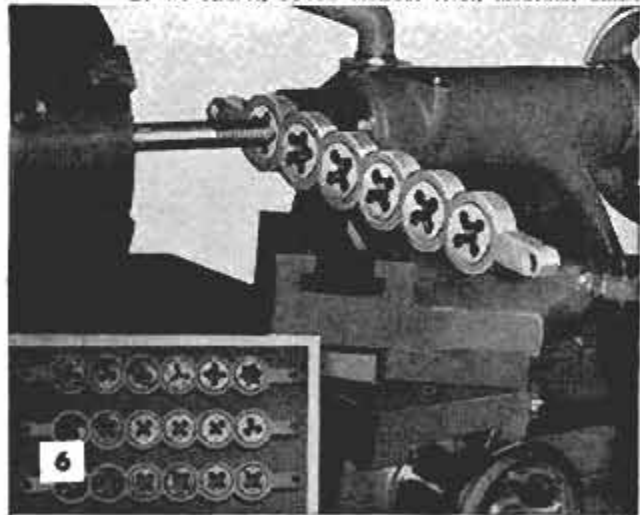

7. WORK-HOLDING CLAMPS are designed for use in holding work on a drill-press table. Holes are drilled near each corner of table and leg of J-clamp inserted. Work is placed under clamp pad and a light tap on bend of clamp locks it in place

Delta Power Tool Div., Rockwell Mfg. Co., 448 N. Lexington Ave., Pittsburgh 8, Pa.

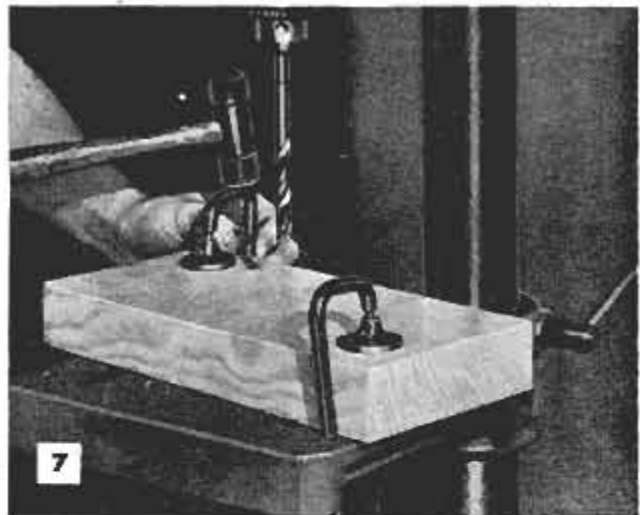

8. FLEXIBLE WIRING SYSTEM for small shops can be built up by using two or more of these 8-ft. power cords. Each cord comes with plug and twin outlet box, one outlet "hot," the other switch-controlled. Outlet box has mounting hole for easy attachment

Unilectric, Inc., Milwaukee, Wis.

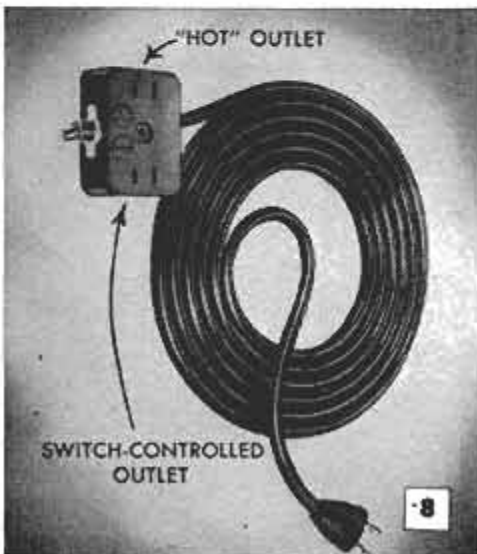

9. ADJUSTABLE COUNTERSINK for screws employs standard twist drill (for pilot hole) which can be adjusted to suit different lengths of screws of same shank size. Countersinks for flatheaded screws, counterbores for plugs. Available for screws No. 6 to 12

Durabilt Metal Products Co., 709 Sip St., Union City, N. J.

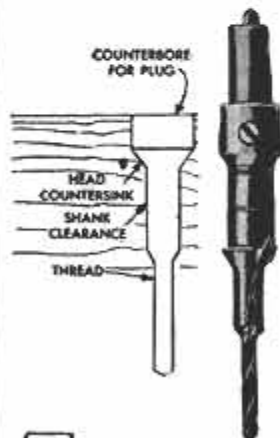

10. SANDING-DISK KIT consists of 8-in. disk, and cutter for cutting disks from abrasive sheets. Disk has rubber facing with a pattern of vacuum cups which holds abrasive disk in place. When used on saw, both sides of disk can be faced with abrasive

The Speed Corp., 4734 N. Albina, Portland, Ore.

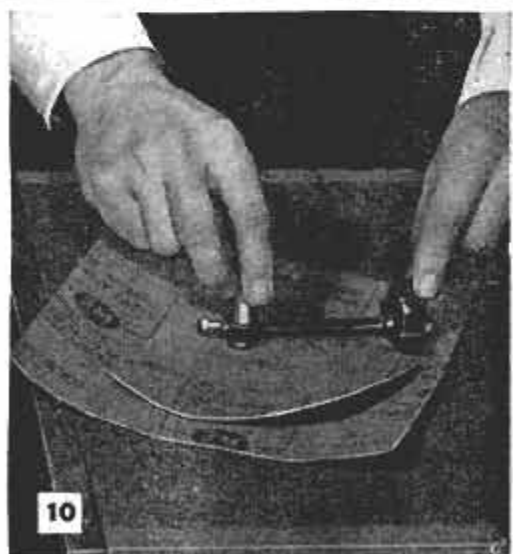



On the MARKET

FOR THE DO-IT-YOURSELF

PORCELAINLIKE ENAMEL is especially effective for renewing and leakproofing old laundry tubs. Not affected by detergents, soap or bleaches. Spread with a brush, spray or cloth swab. Levels and hardens without brush marks. Comes in white and several colors, and is available as kit

EV-B-Shield Co., Joppa, Md.



CONCRETE GLUE is made for bonding new concrete to old, renewing steps and walks that have been chipped. Also bonds other material to concrete

Red-E-Crete, Inc.,
1001 Aviation Dr.,
Glendale 3, Calif.

FLUSH DOOR HINGE eliminates face framing from cabinet work, making it possible to cut an entire cabinet front from one piece of plywood

Washington Steel Products, Inc.,
1940 E. 11th St., Tacoma 2, Wash.

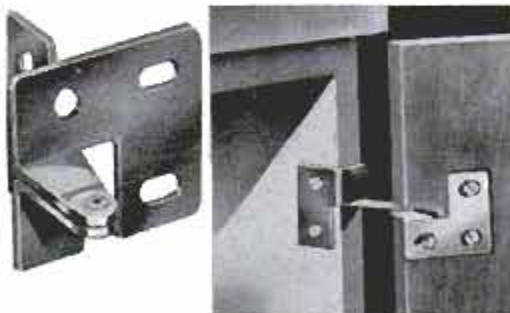

HOME FIRE EXTINGUISHER operates automatically when fire in the room raises temperature to 165 deg. Room is immediately filled with dense, flame-smothering fog. Effective on all common types of fires: Electrical, grease, paper and wood. Pressurized container comes with bracket

Cyemba Sales Co., Derby, Conn.



METALLIC PUTTY contains aluminum powder and must be mixed with a curing agent before use. Spreads easily and bonds to metal surfaces. Does not shrink or crack and can be machined or polished to a brightness approaching that of aluminum. Resists acids, alkalies; not affected by water

Smooth-On Mfg. Co., Jersey City, N. J.

METAL POSTS, or legs, that join in sections enable craftsmen to build modern furnishings with a minimum of time and equipment. No screws, nails or glue is needed. Leg sections available in varying lengths

Consolidated Aluminum Corp., 241 Shoreland Bldg., Miami, Fla.

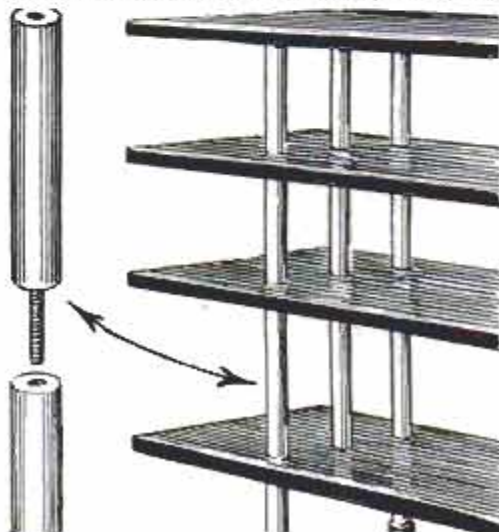



Step out with the New Kodak Signet 40 Camera

It's the color-slide camera specially designed to get the most out of today's fast Kodak Films and the new midget flashbulbs!

You'll step out with confidence with a smart new Kodak Signet 40 Camera. It has the picture-taking range and smooth handling ease that lets you "get" color slides that others miss!

Ask your dealer about the Signet 40's superb $f/3.5$ Ektanon Lens and Synchro 400

Shutter, $1/5$ to $1/400$ second. Have a look at its exclusive dual-reflector flash system. Discover for yourself how fast you can sight, focus, shoot, and advance the films—with *all controls* at your finger tips.

The Kodak Signet 40 Camera, complete with flashholder and dual reflectors, is only \$65.



Dual reflectors for M-2 or #5 and #25 bulbs

Fast, handy, positive finger-tip controls

Rapid thumb-lever film advance

Combined rangefinder and viewfinder

Price includes Federal Tax and is subject to change without notice

EASTMAN KODAK COMPANY . . . Rochester 4, N.Y.

Kodak
TRADE MARK

HOW TO INSULATE AN UNFLOORED ATTIC



The Fiberglas Do-It-Yourself Bug makes it easy to do . . . with this FREE book!

It's a simple job to finish your attic, add an extra room, enclose a porch or build a screened patio, when you use this 16-page book as a guide. Complete step-by-step instructions take you from start to finish in easy stages and with lots of pictures.

The book even shows how fuel savings *alone* can pay for all the insulation . . . if you install the necessary amount of Fiberglas® Insulation. You'll find out why you need *fully* adequate insulation—not just minimum amounts—to enjoy low-cost comfort *all year 'round*. So for the *easy* way to add a room or finish an attic, and the *right* way to fully insulate for a warmer house in winter at lower fuel cost, and a cooler house in summer, rush this coupon for your **FREE BOOKLET** today!



OWENS-CORNING

FIBERGLAS

*T.M. Reg. Owens-Corning Fiberglas Corporation

Owens-Corning Fiberglas Corporation,
Dept. 178-K, Toledo 1, Ohio

Please rush me a FREE copy of the Fiberglas "How To Do-It-Yourself" book.



Name.....

Address.....

City.....Zone.....State.....

Clinic for Homemakers



As a service to our readers in solving the hundreds of problems pertaining to a home—inside or out—the editors of *Popular Mechanics* invite you to present your problems to The Clinic Editor for help and advice. Address your questions to The Clinic Editor, *Popular Mechanics Magazine*, 200 East Ontario Street, Chicago 11, Ill.

Plaster Stain



Q—We've just moved into a new home and we notice a reddish-brown streak on the plastered ceiling of the living room. It cannot be removed by washing and on close examination it appears to be in the plaster and not on the surface. The room has not yet been painted. What could cause this?—B. H., Mass.

A—Judging from your description we would guess offhand that the streak is a sap stain from one of the ceiling joists, or is caused by a slow leak in the roof, or by some foreign substance which found its way into the plaster at the time of mixing and did not show up as a discoloration until the walls dried out. This is a comparatively rare occurrence, but it is a possibility to be considered. If there is a leak and the streak is due to the presence of moisture, repairing the leak may or may not eliminate the discoloration. We would suggest that you first make sure that the plaster is dry, then sand the discolored area lightly with medium and fine sandpaper. The chances are good that this treatment either will remove the discoloration entirely or at least reduce it to such an extent that it will not show under paint. After sanding, coat the area with white shellac.

Screens Rust



Q—Two years ago I purchased ready-made galvanized window screens and while taking them down this fall I noticed rust spots on some of the lower panels. I was rather surprised as I thought galvanizing would protect the screen for at least 5 years. I coated the frames with spar varnish. I don't want to use paint if avoidable. What other protective coating can I use?—C. N., Mich.

A—We would, of course, recommend painting the screen wire and frames, as the pigment finish is perhaps the more durable when compared with any clear finish. However, if you wish to retain the original natural wood finish then, of course, a transparent finish must be used for refinishing. Spar varnish will give reasonably good service on the screen frames and it also can be used on the

(Continued to page 240)

IS YOUR CAR AN OVERHEAD-VALVE V-8? Here's proof that only new **Power Tip** can "fire up" your engine at all speeds!

Why was new POWER TIP developed?

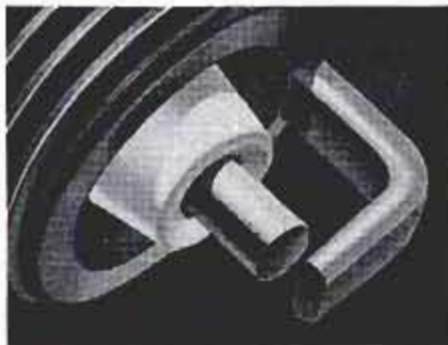

Ordinary plugs frequently fail to give top performance in today's higher-compression, higher-horsepower engines in both city and highway driving. New Power Tip was designed especially to give top performance and economy at *all speeds*.

What does it do for low-speed driving?

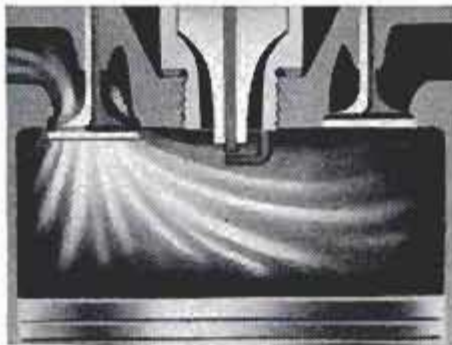

Power Tip extends into the heart of combustion—gets hot fast and *stays* hot at low speeds. Hot projecting tip burns away carbon and oil deposits—prevents low-speed fouling, commonest cause of sluggish engine performance and slow starting.

Does it stop high-speed pre-ignition?



In high-speed, turnpike driving, amazing Power Tip *takes full advantage* of the cooling, refrigerating action of the richer air-fuel mixture at wider throttle. This "charge-cooling" effect cools projecting Power Tip and *checks* destructive pre-ignition.

How is POWER TIP different?



Ordinary Plug Tip

New Power Tip

Projecting center electrode and ceramic tip . . . the Power Tip . . . extends spark gap in toward the center of the combustion chamber. Fuel burns more evenly and completely—"fires up" engines for peak performance and economy at *all speeds*.

Who can use new POWER TIP?



You can, if you own a car with an overhead-valve V-8 engine. Power Tip was tested and *proved* in almost every make of today's cars. It is the *only* spark plug ignition-engineered for today's higher-compression, higher-horsepower V-8 engines.

Is it available now for all cars?

Power Tip fits all these cars with overhead-valve V-8 engines: Buick, Cadillac, Chevrolet, Chrysler, De Soto, Dodge, Plymouth, Hudson, Imperial, Ford, Lincoln, Mercury, Nash, Oldsmobile, Packard, Pontiac, Studebaker.



AUTO-LITE RESISTOR SPARK PLUG WITH POWER TIP

Auto-Lite manufactures over 400 products, including Spark Plugs, Batteries, Wire and Cable, and Automotive Electrical Systems . . . sold throughout the United States and Canada.

Care and Feeding of Engines



BY
S. P. CORP

CRANKCASE DILUTION

Driving habits can contribute to sludge in your crankcase and sluggishness in your engine. Slow speeds and short trips keep the engine too cool to vaporize the normal condensation. Sludge results. You can help correct this by changing oil oftener, draining out the water with the drained oil. Also, you can increase engine operating temperature by using a 180° thermostat—in which case, use only permanent anti-freeze. Sluggish operation may also be caused by a thermostat which is stuck in the open position. If your water gauge shows engine to be operating at less than 180°, have thermostat checked or replaced with a new one.



SLUDGE IN THE CRANKCASE

MANIFOLD HEAT CONTROL VALVE

The job of the manifold heat control valve is to heat the fuel mixture during engine warm-up, while the valve is closed. It should open thermostatically as soon as the engine is warm. If it is stuck and stays closed, the fuel stays too hot and too lean, the engine may miss, the effect of a good tune-up be ruined. Don't blame spark plugs until you check this valve, which is mounted in exhaust manifold below the carburetor. (In Ford V-8's, it is in the cross-over pipe ahead of the right manifold.) If you find this valve is stuck, free it by lubricating with a mixture of kerosene and soda, or use a good carburetor cleaning fluid.

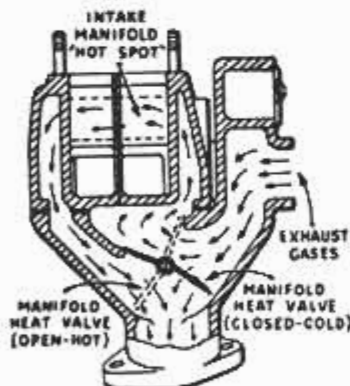

MANIFOLD HEAT CONTROL

YOU NEED THIS FREE MANUAL

Write for your free copy of "Care & Feeding of Engines," a 24-page illustrated handbook of engine care which may save you a lot of time and money. When you re-ring, be sure to use SEALED POWER KromeX Ring Sets. Their chrome faces fight heat and friction, and they seat fast, control oil immediately, and give you double ring life. Sealed Power, Dept. G-11, Muskegon, Mich.



Sealed Power

PISTON RINGS

(Continued from page 238)

screen wire to give fair protection against corrosion. Although it can be applied to the wire mesh with a small brush, it is better to make an applicator by tacking a strip of pile carpet (a strip cut from an old rug is just the thing provided it is clean) to a block of wood. With this type of applicator you can apply the varnish uniformly to the screen wire. Before refinishing, clean rust from the wire with a stiff-bristle brush. A suede shoebrush is just the thing. To avoid extensive rust damage it's a good idea to refinish the screens as soon as possible after you take them down.

Trimming Evergreens



Q—I have several large evergreens on my property which have grown to a height of about 20 ft., some higher, and now the lower branches on nearly all of these trees seem to be dying out. The trees are what I would call uniformly well-shaped individual specimens and I would like to preserve them if possible. I've thought of trimming them out to a height of 5 ft. or more above ground but have been advised against it. Is there any reason why these lower branches should not be removed? Will the trees be harmed in any way?—A. L., Mo.

A—What kind of evergreens? Unfortunately, you did not say and that makes it difficult for us to give you a definite answer. There are many different forms, or types, of evergreens and pruning, trimming or shearing procedures must be varied to suit. You say your evergreens have grown to a height of 20 ft. or more and that would ordinarily indicate they are of the medium or tall-growing pyramidal type. As a rule the various types require very little trimming or shearing except perhaps to correct growth faults that develop as a result of injury or from other causes. However, there may be some reason to consider pruning the lower limbs of an older tree such as the blue spruce, for example, older specimens of which often have lower limbs practically defoliated from the trunk well outward toward the tips. Generally this is a natural growth process, but sometimes more extensive defoliation is due to what is known as needle cast, which may be caused by any one of several types of fungi. Defoliation of lower limbs gives the tree a scraggly appearance which may justify cutting these off to the height you suggest. When this is done, care must be taken not to damage the bark. Ordinarily pruning of this kind should be carried out in the late fall.

Waterproof Concrete-Masonry Walls

Q—I'm planning a home and intend to begin construction next spring, using blocks for the walls and a concrete-slab floor. Cinder blocks seem to be the cheapest in this locality, but I'm doubtful about using them as I'm told they are not waterproof. What are your recommendations?—K.B., Tex.

A—Cinder blocks are quite widely used in light building construction, both in residential and industrial types. In regular building practice the outside of the wall is finished with cement plaster or cement stucco and coated with a transparent waterproofer. However, for home construction we would tend to favor the use of standard concrete blocks made with cement, sand and gravel or other aggregates used in the regular heavyweight blocks, or lightweight blocks made with light aggregates other than cinders. We think you would find either of these more satisfactory in the long run. To assure a sound, durable wall good practice in concrete-masonry construction must be carried out in all details.



FREE! MASONITE PLAN

shows how to make 18 CHRISTMAS projects!



You don't have to be an artist! Just follow the diagrammed pattern and presto! There's jolly Santa big as life—or bigger, if you choose.

Want to build the Nativity scene for the yard? Or a make-believe fireplace for the living room? Masonite's free plan has these patterns, plus carolers, elves, bells, bows, candles and all the other traditional Christmas themes.

It's fun working with Masonite® panels. They have no knots or grain...won't splinter or crack. They cut cleanly with hand or power tools. And they take all kinds of beautiful finishes.

Durable? Your Christmas cutouts will last for years and years. Weather won't hurt them. In fact, these are the same dense and rigid panels builders use for houses, such as the one in our illustration. Ask your lumber dealer about Masonite panels. And send the coupon now for an early start on your own colorful Christmas decorations.



©Masonite Corporation—manufacturer of quality panel products



FREE PLANS!

MASONITE CORPORATION
Dept. PM-11, Box 777, Chicago 90, Ill.
In Canada: Masonite Corporation,
Gatineau, Quebec

Please send me your free folder and more information about Masonite.

Name.....
Address.....
City.....State.....
Zone.....County.....

KLEINS

mean a better job

201—NE
Side Cutting
Plier



301
Long Nose
Plier

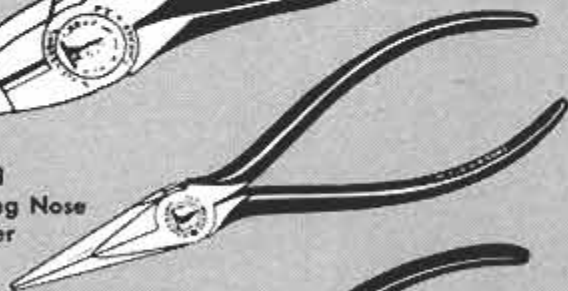

202
Oblique Cutting
Plier

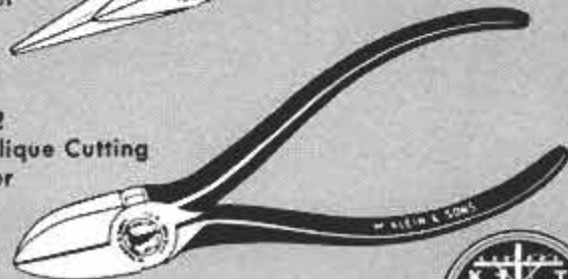

Here are three pliers that will help you do a better job—three tools that should be in every workman's kit.

Klein pliers are recognized by electricians, linemen and good workmen everywhere as the standard of comparison by which other pliers are judged.

The work you do is only as good as the tools you use. Be sure the tools on your bench or in your kit include genuine Kleins, famous for quality "since 1857."



Your hardware store has Kleins in stock or can get them for you quickly. Look for this new display board. It shows the most popular items in the Klein line.

Mathias **KLEIN** & Sons
Established 1857 Chicago, Ill., U.S.A.
7200 McCORMICK ROAD • CHICAGO 45, ILLINOIS

Ships of All Ages

(Continued from page 133)

Richelieu, the first of these, came out in 1946, and since then many other vessels of all types have been "prefabricated."

An exquisite little "mass produced" Mediterranean xebec, for example, was among the wedding presents received by Prince Rainier and Grace Kelly.

One of the first exhibits you will see as you enter the Musee de la Marine is a magnificent model of a frigate mounted on a pedestal and sealed in a dustproof glass case a yard high. The price of this, including the case, is about \$300. The same model made to order commercially would probably cost between \$2000 and \$3000.

Model for Nonexistent Ship

Next to the frigate, you will see one of the richest and most precious exhibits of the entire collection. It is an exquisitely decorated and fully rigged model (scale $\frac{1}{36}$) of a 17th-century 124-cannon ship of the line called the *Louis XV*. No actual French man-of-war ever bore this name, but the model, perfect in every one of its luxurious details, was specially made for the nautical instruction of the youthful Louis XV some 250 years ago.

A little less elaborate but equally beautiful are the museum's models of galleys. These craft were usually about 155 feet long, with a beam of some 20 feet. Most of the deck space was taken up by 25 or 30 rough benches, divided by a catwalk along which a guard patrolled. Approximately 250 galley slaves, chained to their places, tugged at the oars, and the moment one of them weakened, the guard's lash cracked across his bare back. Safely removed from the filth and stench of the human engines, the officers stuck to their quarters in the delicately decorated poop.

First Steamboat

We Americans are prone to think of Robert Fulton as the inventor of the steamboat, but Fulton himself never made any such claim, for he was well aware that in 1776, 16 years before he demonstrated his boat on the Seine, the Marquis de Jouffroy d'Abbans had launched a successful boat propelled by steam. Later the Frenchman built a larger steamboat, which for many years maintained a regular service on the Saone River between Macon and Lyon.

The museum possesses a model of one of Jouffroy d'Abbans' early steamboats, so well constructed that, after 175 years, it can still run under its own power.

France's first propeller-driven ship was

(Continued to page 246)



Do your Christmas hinting early!

When the little woman asks for gift ideas, let her know you'd like Thor SpeedTools, the finest tools ever built for home workshop use. Thor is the largest exclusive manufacturer of portable air and electric tools. Every Thor SpeedTool brings the power and precision, the balance and durability you expect from Thor's quality reputation. SpeedWay Manufacturing Co., a division of Thor Power Tool Co.



THOR 3-STAR CHRISTMAS SPECIAL

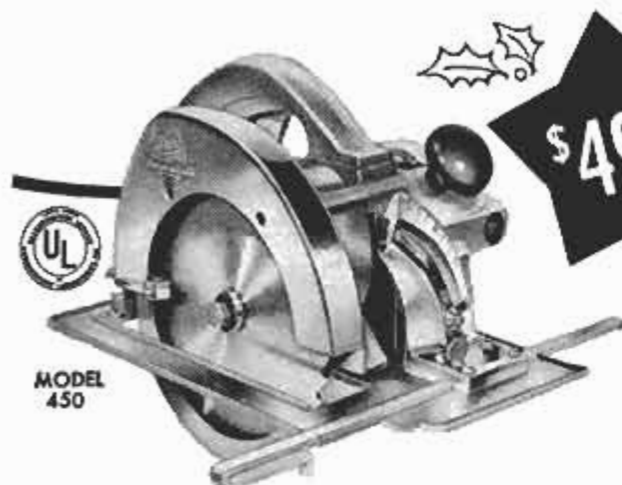

MODEL 450

\$49⁹⁵



MODEL 25

\$24⁹⁵

This new Thor 6 1/2" SpeedSaw is a must for building furniture, cupboards, closets, built-ins. Its Thor-built stall-proof universal motor takes the blade easily through a 2 x 4 at 45° angle. Other Thor SpeedSaws from \$29.95 to \$64.95—all top values!

Whether you're making 1/4" holes in steel or 1/2" holes in hardwood, this new Thor 1/4" SpeedDrill does it faster and easier, thanks to its extra power. Long grip means easy handling. Other Thor Speed-Drills from \$16.95 to \$65.00, many in kits.



MODEL 15TK

\$34⁹⁵
COMPLETE
KIT

Here's the world's most popular electric sander, in a complete Thor SpeedSander Kit, to help you do a truly professional job refinishing antiques, smoothing unpainted furniture, or polishing to a high gloss. Other SpeedSanders, \$24.95 to \$54.50.



THOR POWER TOOL COMPANY, Aurora, Illinois

Branches in all principal cities

World's largest exclusive manufacturer of portable air and electric tools



BEFORE-DARK PHOTO OF FOOTBALL FIELD—where the after-dark Headlamp Comparison Test photos,

Now...twice the light for

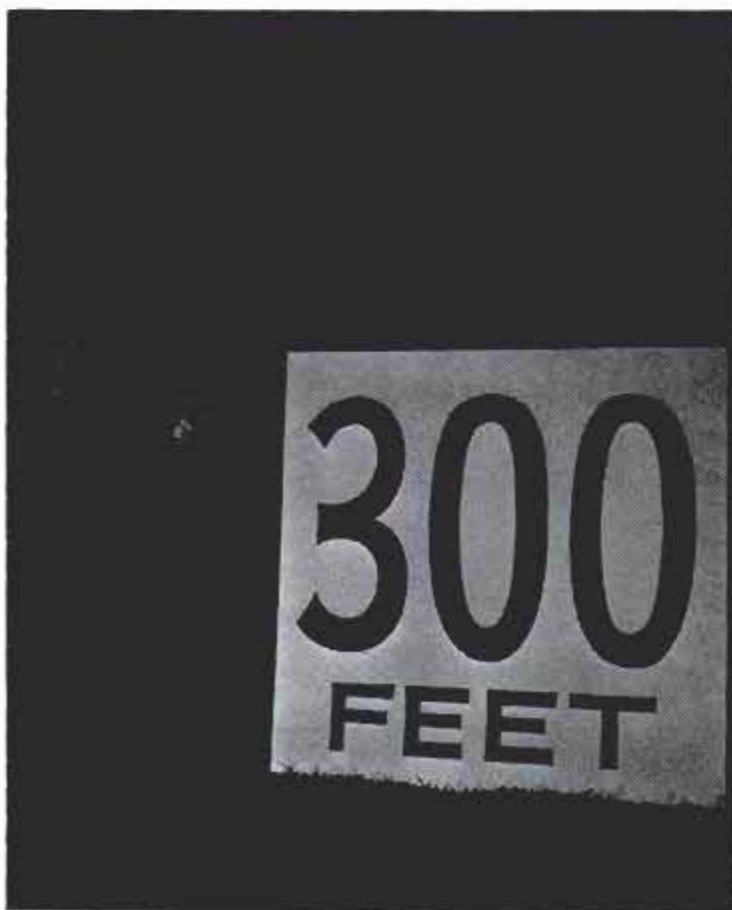

OLDER TYPE SEALED BEAM HEADLAMPS—
Student barely visible at 300 feet.

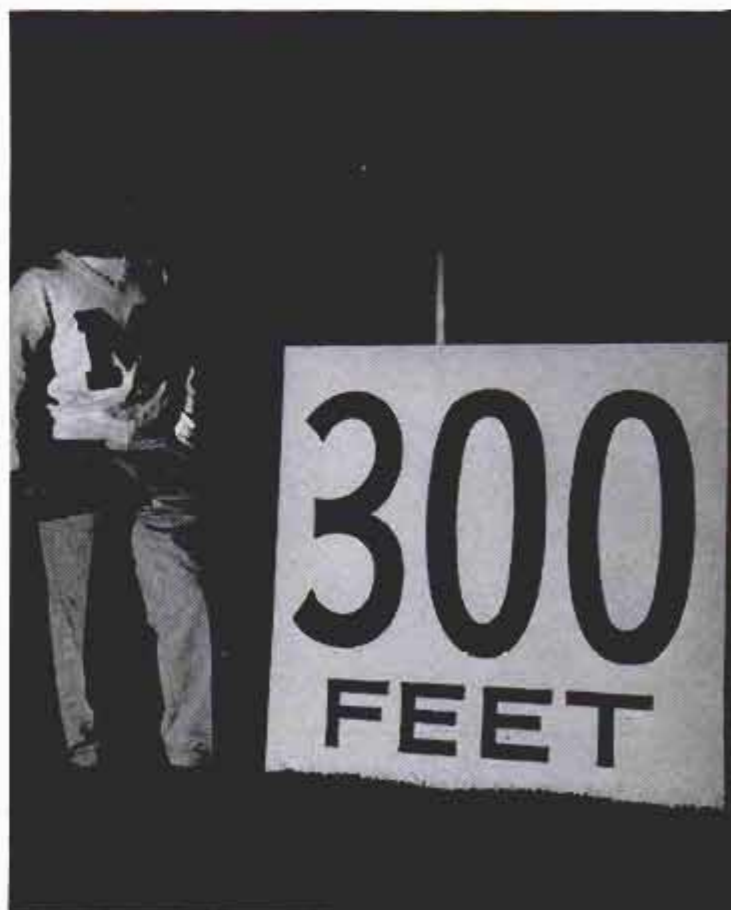

NEW GENERAL ELECTRIC *All-Weather* HEADLAMPS—
Twice as much light at 300 feet and beyond!

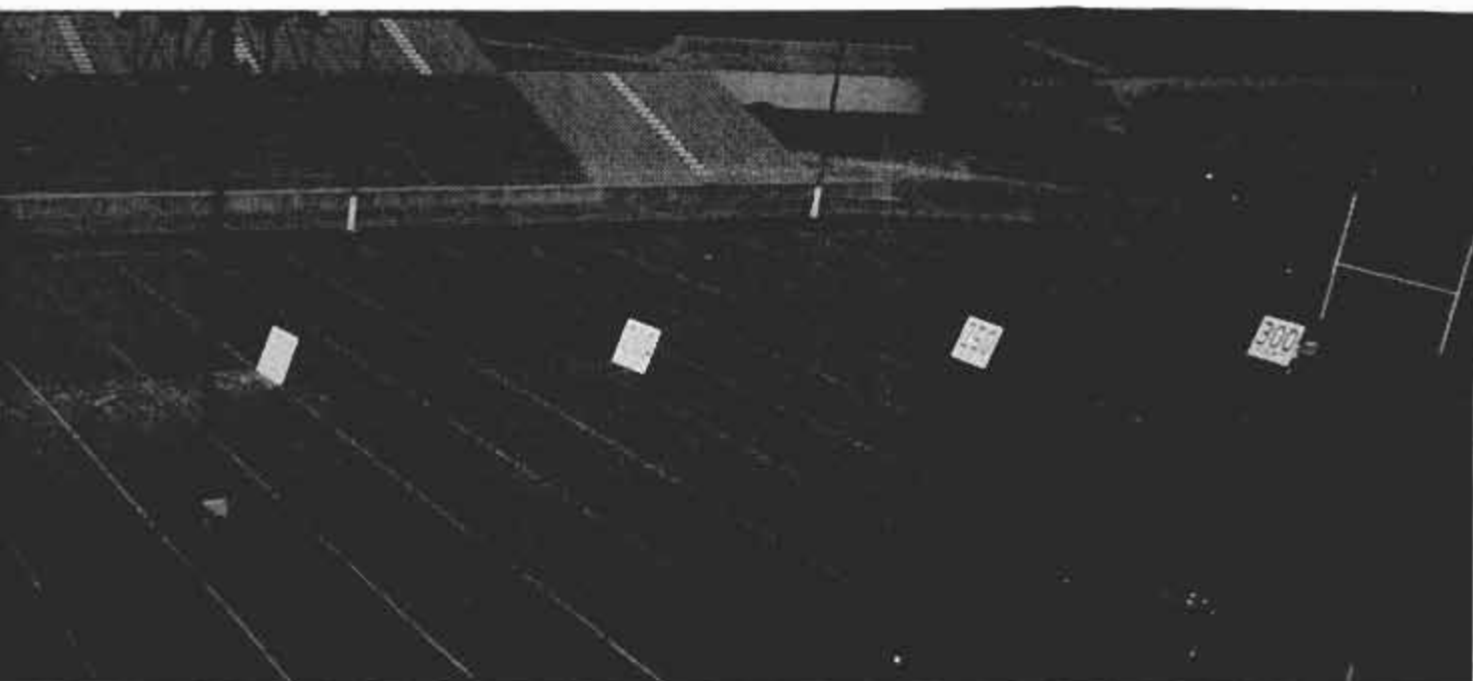

below, were made. Student-model stands at the marker, a full 300 feet from the car headlamps.

safer driving at night!

LOWER BEAM OF NEW G-E *All-Weather* HEADLAMPS GIVES TWICE THE LIGHT 300 FEET AHEAD ON YOUR SIDE OF THE ROAD!

Why 300 feet? Because at 300 feet, and at normal speeds, you should see objects *clearly*. Good visibility at that distance is easy with *upper* beams—yet, traffic conditions force you to rely most on the *lower* beam. That's why G. E. redesigned its headlamp lens, upped the wattage, redistributed light in the lower beam. The "Headlamp Comparison Test", pictured at left, shows that you see better at this critical seeing point with G-E *All-Weather* Headlamps—*photographic proof that you can get twice the light for safer driving at night!*

See Better In Fog, Rain, Snow. The special lower beam filament shield in General Electric *All-Weather* Headlamps blocks uncontrolled upward light, reduces kick-back glare, helps you see better in fog, rain and snow.

Is Accurate Aiming REALLY Important? Yes! Road shock and vibration can cause headlamps to become mis-aimed. Aimed high, headlamps glare

into the eyes of oncoming motorists. Aimed low, beams don't project far enough down the road. (If, at a point 25 feet ahead of your car, your headlamps are aimed only 3" low, you get half the light you *should have* at 300 feet!) But G-E *All-Weather* Headlamps have Aim-right Gizmos, (see arrows at right), that help dealers aim them quickly, accurately . . . even in daylight. So, for safer driving, better seeing in all weather, more accurate aiming, replace present headlamps with a pair of G-E *All-Weather* Headlamps today! General Electric Miniature Lamp Dept., Nela Park, Cleveland 12, Ohio.

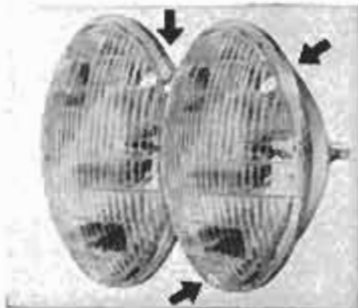

Progress Is Our Most Important Product

GENERAL  ELECTRIC



Smooth Engine Power
calls for Quality Bearings . . .

FEDERAL-MOGUL QUALITY!

Federal-Mogul engine bearings are first choice for replacement in commercial vehicles and industrial engines. They are preferred by men who know their business . . . and their bearings! In your car engine, too, Federal-Mogul bearings restore smooth power, lively pick-up and economical operation. They are *engineered* for dependable performance!

FEDERAL-MOGUL SERVICE

Federal-Mogul-Bower Bearings, Inc.

Ask your Mechanic!

RESEARCH • DESIGN • METALLURGY
PRECISION MANUFACTURING • SERVICE



the *Corse*, a 515-ton aviso built in 1842 and remaining in service until 1890, while the historic *Napoleon*, a 5120-ton, 94-cannon three-mast ship built at Toulon in 1850, was the world's first propeller-driven man-of-war. It had a speed of 13 knots.

The *Napoleon* was designed by a brilliant young naval engineer, Stanislas Dupuy de Lome, who also had the honor of designing the 5618-ton *Gloire*, the first armored ship ever made. Launched in 1859, this famous vessel marked the beginning of modern navies. It was copied by all the great powers and, between 1862 and 1864, France built 11 ships which were almost identical. Models of the *Corse*, *Napoleon* and *Gloire*, as well as scores of other historically important steamships, are exhibited in the museum.

Along with the magnificent models that trace the development of French ship-building are many curiosities. Perhaps the most astonishing of these is the exquisite model of a fully rigged 88-cannon warship which the City of Dieppe presented to Empress Marie Louise when, in 1811 a few weeks after her visit to this port with Napoleon, she gave birth to a son. The allegorical sea horses drawing the ship, as well as every single one of the hundreds of details, including the sails, banners and rigging, are carved out of ivory.

Ebony and Ivory Model

Another exhibit of which the museum is particularly proud is its model (scale $\frac{1}{40}$) of the century-old man-of-war *Valmy*, for this fine ship is built of ebony and ivory, with the metalwork in sterling silver. Six craftsmen worked five years to make it.

Together with the priceless *Louis XV* and beautifully sculptured 17th-century man-of-war *Soleil-Royal*, these two models are possibly the most valuable in the entire collection. But nobody knows what they or the other miniature vessels in the museum are worth—that is, what price they would bring if put up for sale today. None has ever been placed on public sale.

Even in the rare cases where the museum has actually bought models, the price paid has little relation to what they could be sold for today. A striking example of this is the model of the *Muiron* (scale $\frac{1}{72}$), for which the museum paid 310 gold francs, or about \$77 in 1836.

The real *Muiron* was a 44-cannon frigate built at Venice in 1797. It was captured by the French shortly afterward, and in 1799 brought General Bonaparte back from Egypt to France, successfully evading the British fleet. Bonaparte was so delighted with the ship that he ordered the present

(Continued to page 251)

MAGNA
unveils
revolutionary
new line of
power tools

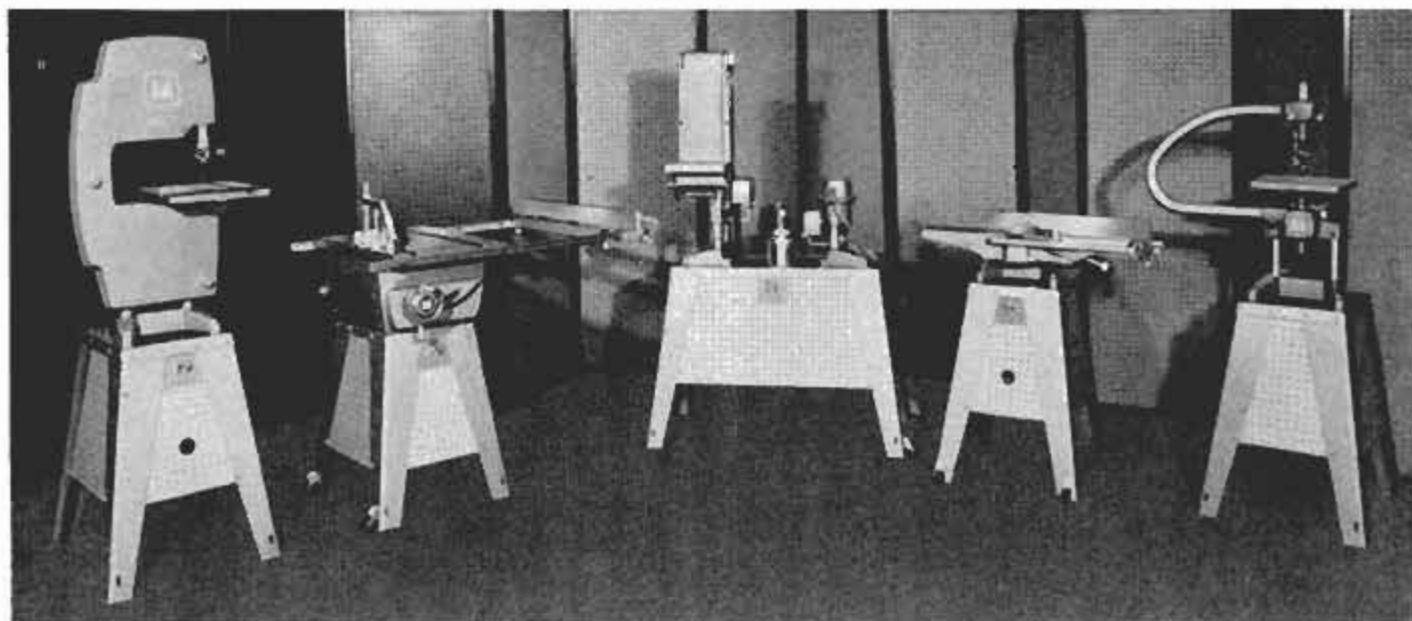

® T. M. REG.

Magna Power Tool Corporation, manufacturer of SHOPSMITH®, the original multi-purpose home workshop in one unit, is now introducing a new line of MAGNA single-purpose power tools.

MAGNA-LINE includes the revolutionary new Magna 9-in. Saw with "The Helping Hand"—a built-in extension which makes the largest effective table on the market;

4-in. Jointer with the longest table, largest fence in its class; 11-in. Bandsaw with automatic blade tracking; 6-in. Belt Sander with automatic belt tensioning; 18-in. Jigsaw with full speed-range; and Compressor-Sprayer with 100-ft. range.

For specifications and full information on the new MAGNA-LINE single purpose power tools, mail the coupon on Page 250.

NEW Magna-Line **NEW** Magna-Line **NEW** Magna-Line

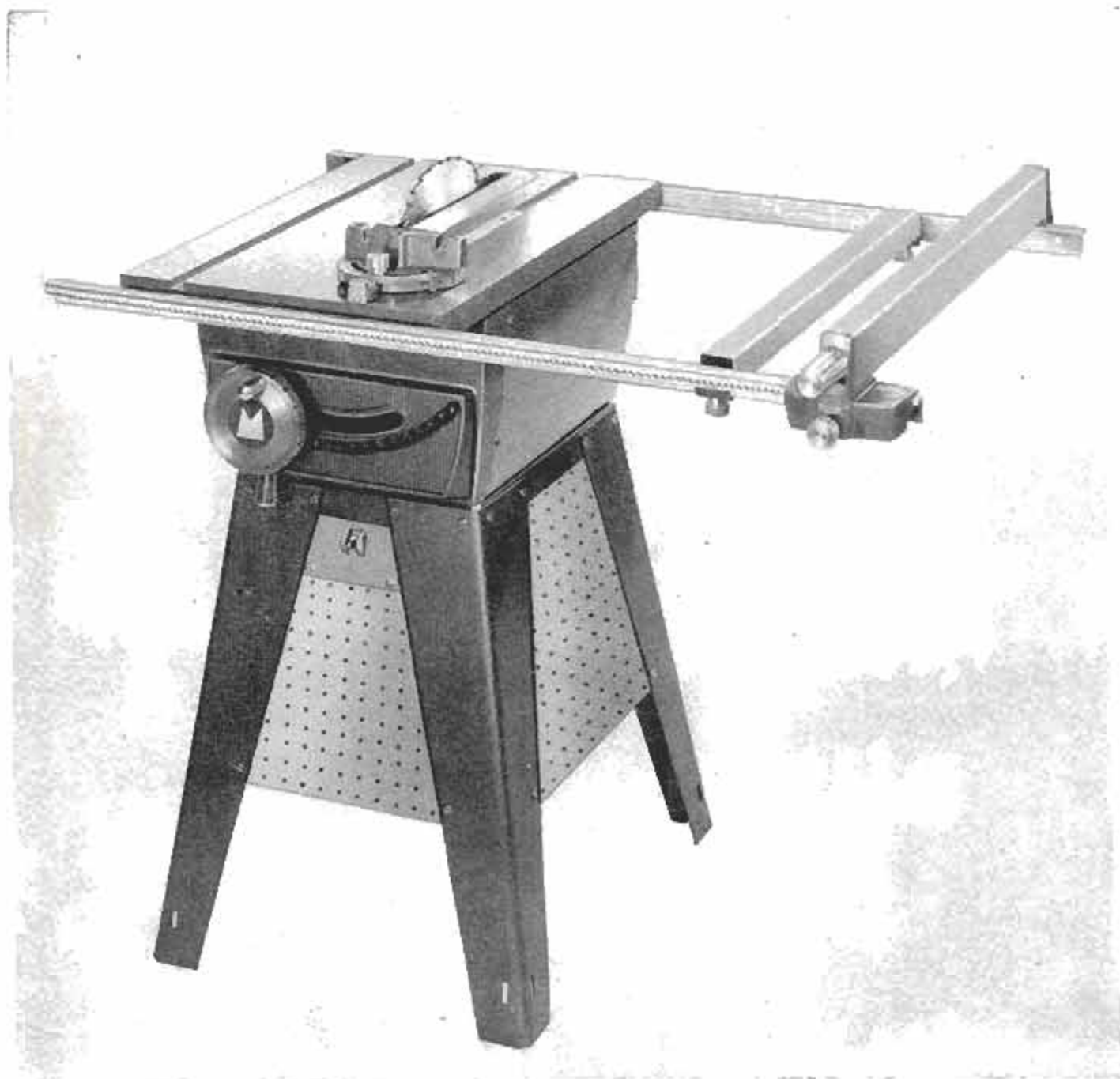

Magna 9-in. Saw with "The Helping Hand"

The new Magna 9-in. Saw is the only tilt arbor saw with "The Helping Hand"—a built-in extension which makes the largest (34" x 24") effective table on the market, allowing bigger rip and cross-cut capacity than any other saw; Epicyclic Speed-gear Control gives you full 45° tilt with only 10 turns of knob, compared with 40 to 60 turns on other saws; Single-Knob Control—push

for projection, pull for tilt adjustment; Self-aligning Fence locks front and back with single knob; colored Safety Zone Table Insert cannot catch work piece; exclusive pressure-cast tub front bolted rigidly to table, coordinates all controls; externally adjustable Tilt Stops; constant tensioning of matched twin belts; 3 Auto-Stops on Miter Gauge.

NEW Magna-Line NEW Magna-Line NEW Magna-Line

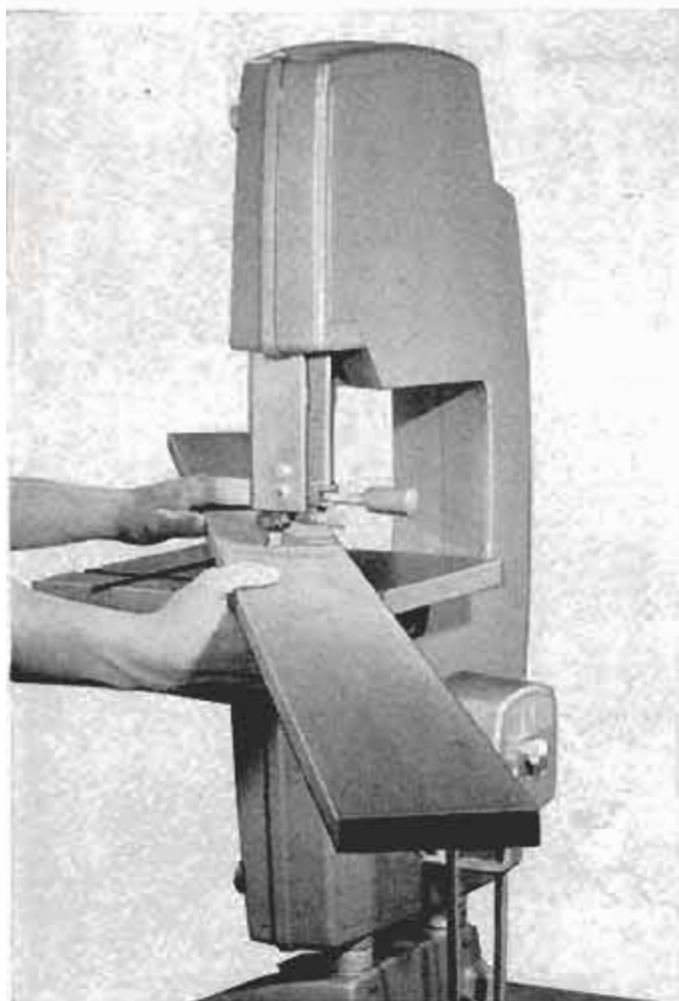

MAGNA 11-IN. BANDSAW WITH AUTOMATIC BLADE TRACKING

A new engineering triumph offering: exclusive Automatic Blade Tracking—greater safety, easy to change blades; Single-knob Blade Guide Control; cross-cuts any length stock (up to 6" width) without throat interference; sealed ball bearings; maximum safety—everything enclosed except essential cutting portion of blade.

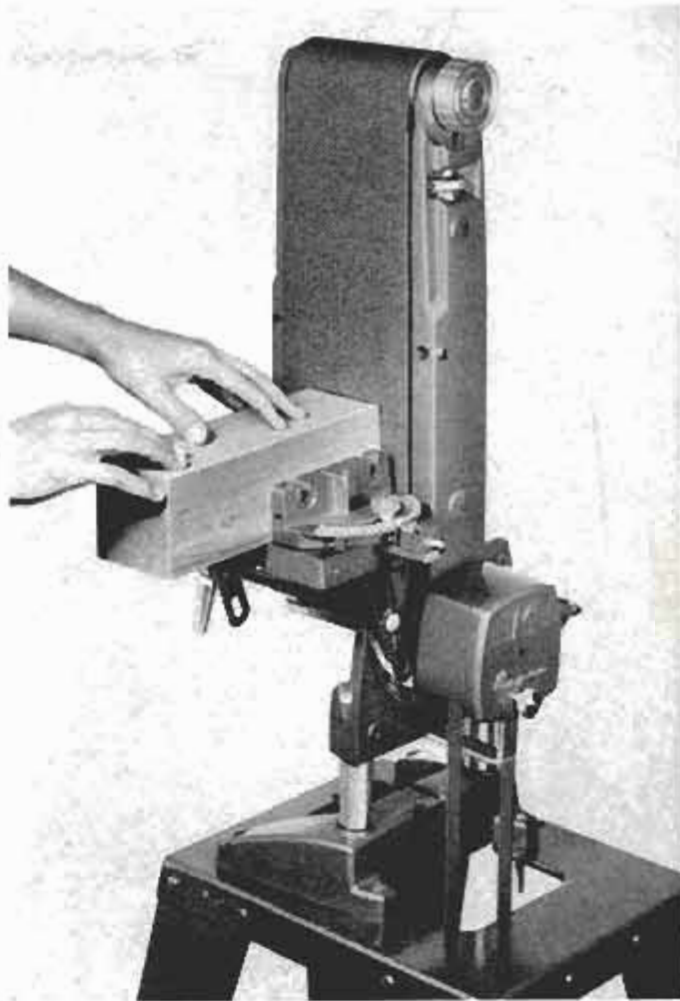

MAGNA 6-IN. BELT SANDER WITH AUTOMATIC BELT TENSIONING

Compare these big features with those of any other belt sander: Single-knob Control gives Automatic Belt Tensioning; instant belt removal; 6-inch by 16½-inch Back-up Plate for large work in horizontal or vertical position; table tilts in either direction, mounts as fence on either side; tilts, locks in any position from horizontal to vertical.

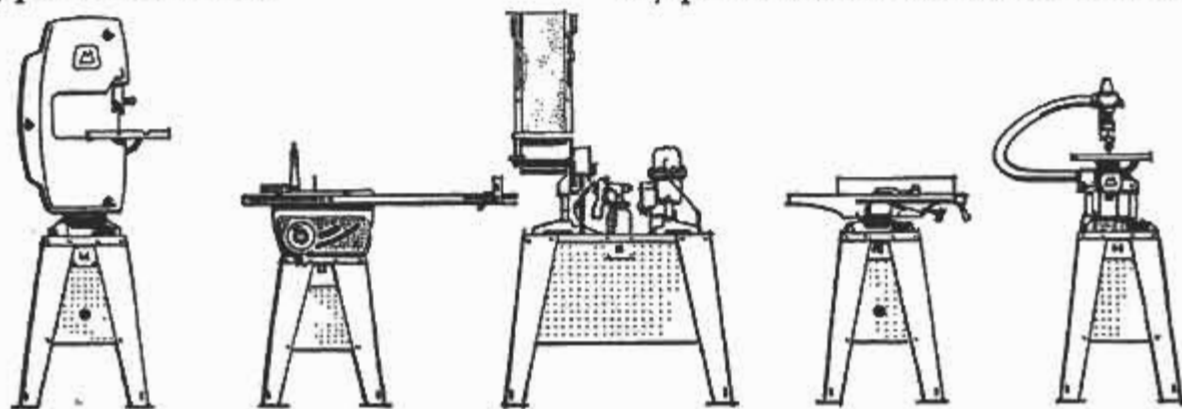

NEW Magna-Line **NEW** Magna-Line **NEW** Magna-Line

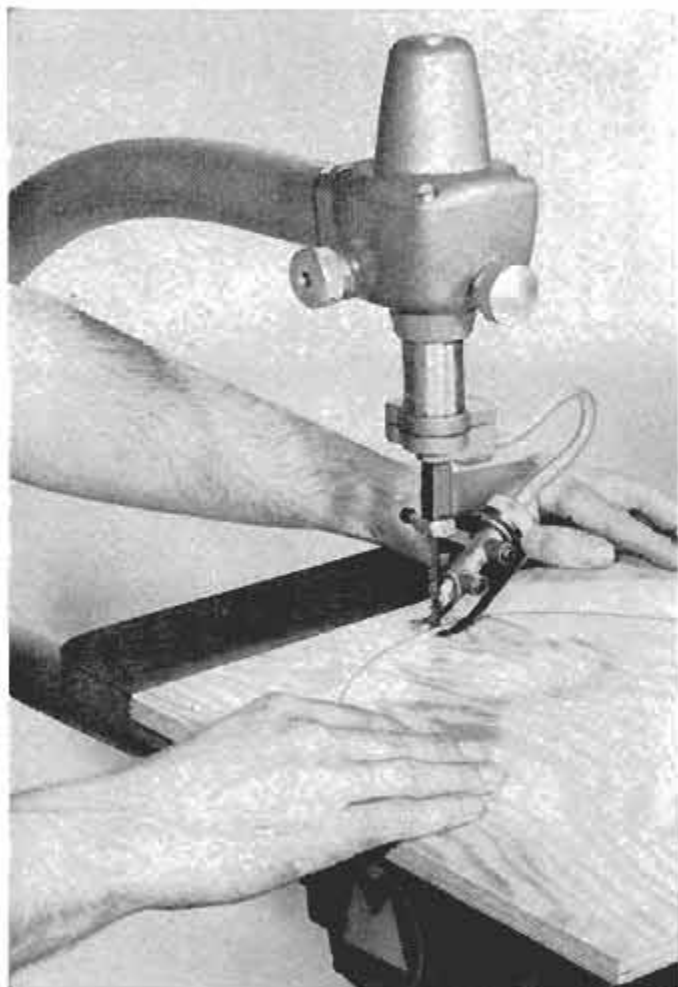

MAGNA 18-IN. JIGSAW WITH FULL SPEED-RANGE

The Magna Jigsaw gives you precision, capacity, ease of adjustment. Exclusive Full Speed-range operates as fast as 2500 rpm! Cuts through 2-inch stock at low speeds, smooth-cuts thinnest wood at high speeds. Use it for metal working, also, or as regular saw for straight cuts with heavy blades. Blower keeps cutting-line sawdust free.

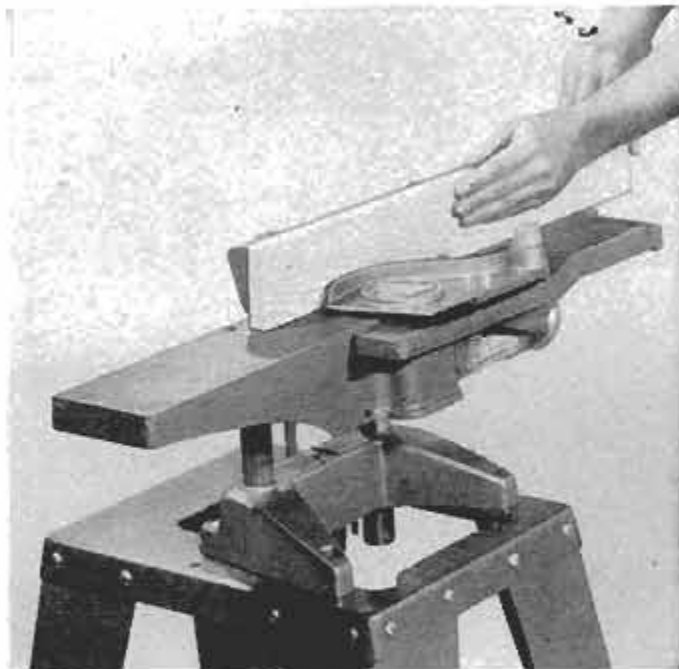

MAGNA 4-IN. JOINTER WITH LONGEST TABLE, LARGEST FENCE

The big, heavy-duty Magna 4-in. Jointer with the longest (28") table, largest (3" x 21 3/4") fence in its class, has adjustable in-feed table, fixed outfeed table; One-knob Fence Lock controls tilting of fence, 3 adjustable autostops; Spring-controlled Safety Guard; extra-rigid One-piece casting Fence; knives individually micro-adjustable, safety-tapered.



MAGNA POWER TOOL CORPORATION
America's Finest Power Tools



MAGNA POWER TOOL CORPORATION

Dept. 800- M, at office nearest you:
Box 2808, Fort Wayne, Ind., or Menlo Park, Calif.

◀ Please send me a free 16-page MAGNA-LINE catalog.

Name _____

Street Address _____

City _____ Zone _____ State _____

model in 1803, and kept it on the desk of his bedchamber right up to his downfall. Obviously the original purchase price of 310 francs furnishes little clue as to what a museum or private collector would be willing to pay for this ship today.

Largest Model

Near the door of the Musee de la Marine stands its largest model, *L'Ocean*, a vessel of 120 cannon, 20 feet long and 16½ feet high. Built for the instruction of sailors, the outsize model somehow came into the possession of a Belgian showman, who exhibited it in country fairs along the Franco-Belgian border. He also used it for another purpose. Every time he brought it into France, its hold was filled with lace and precious stones. The French customs finally caught up to him. *L'Ocean* was seized and eventually given to the museum.

The centerpiece of the vast collection of famous and curious ships, of marine paintings and documents, of figureheads and ship's gear and of all manner of other things that tell the story of man's struggle to conquer the sea is *Le Canot de l'Empereur*. This is not a model but the original, a graceful and beautifully decorated boat more than 57 feet long, which was rowed by a crew of 24 men.

This priceless craft has a curious history. In 1811, when Napoleon announced that he was going to Antwerp to inspect the defenses at the mouth of the Scheldt, it was decided that he must have a boat worthy of him. Plans were hastily drawn up, a sculptor went to work at once on the decorations, and in 21 days and nights of uninterrupted labor the craft was completed. Two days later, Napoleon was taken in it to visit the port. He never used it again.

Stored away in the Brest arsenal, it was only taken out 47 years later, when Napoleon III and Empress Eugenie paid a visit to the naval base. It served a final time in 1903, a half-century later, when President Emile Loubet went to Brest.

After that this fine boat, with the life-size gilt figure of Neptune sitting on its prow and its luxurious cabin filled with dust and memories, lay forgotten at Brest for another 40 years. Then in 1943, at a time when the Germans, confident that they would win the war, were already planning a postwar Paris of their making, it was decided to bring the Emperor's boat to Paris. With the Germans taking charge of everything the craft was loaded on a special car and, since it protruded far over the sides, the track in the opposite direction was cleared during its voyage from Brest.

In Paris, however, manpower could not

(Continued to page 252)



*like this convenient
Wardrobe and Desk*

You can Afford Expensive Ideas with **Fir Plywood**

*... or this roomy
Garden Storage Unit*



Give your home the "custom touch" with fir plywood. Whether you use it for smart, good-looking built-ins... strong, rigid subfloors and sheathing... or distinctive exterior siding—you'll find fir plywood fits your plans and your budget. Created by nature, improved by man, fir plywood is real wood made larger, stronger... better looking and more versatile.



Grademarked for your protection, fir plywood comes in standard grades as well as special textured or overlaid panels. DFPFA industry grademarks attest quality, performance, value.

FREE PLANS for units shown above. Write (USA only) Douglas Fir Plywood Assn., Dept. 9, Tacoma 2, Wash. Order plans by name.

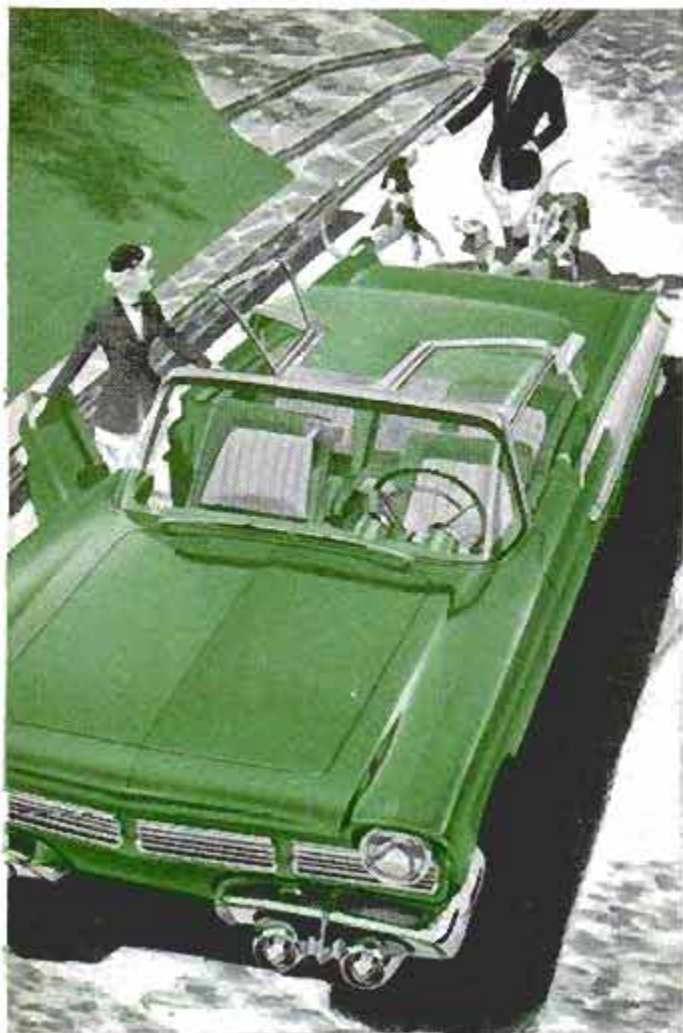

**Top protection...top performance—
yours with years-ahead
Quaker State Motor Oil**



Super-refined from Pure Pennsylvania Grade Crude Oil, world's finest. Famous for performance, protection, economy! Try it!

QUAKER STATE OIL REFINING CORP., OIL CITY, PA.
Member Pennsylvania Grade Crude Oil Association

be spared to get the bulky exhibit into the Palais de Chaillot, and consequently it was left outside in a makeshift shelter until the war's end. A huge hole was then cut in the wall and, on July 28, 1945, 134 years after it was built, the *Canot de l'Empereur* moved into its permanent home. There is also a model of it in the museum.

Beginnings of the Museum

This was one of the final steps in forming France's great ship museum, which had its beginnings 277 years ago, in 1679.

In that year, Jean-Baptiste Colbert, Louis XIV's illustrious minister, took a step of primary importance in the history of shipbuilding. Until then vessels had been constructed almost by improvisation.

Colbert now ordered the superintendents of all navy yards to make a model, on the scale of $\frac{1}{12}$ or $\frac{1}{20}$ of every ship they built, and he further specified that "these models must be made with such precision that they may serve for the measurements and proportions of any ships built in the future."

In the century that followed the orders, magnificent collections grew up in the various arsenals. Members of Royalty and the Court began seeking models to add to their private collections of curios. In this way the arsenal exhibitions were pretty thoroughly ransacked by the influential people of the country.

During the French Revolution many collections of the emigrating nobility were seized and placed on display, but some years passed before these ships, the royal collection and numerous models from the arsenals were united in a single museum. This was opened to the public in 1833 on the top floor of the Louvre.

When the huge old Trocadero was made over into the Palais de Chaillot for the 1937 World's Fair, part of one wing was given to the Musee de la Marine, which by then was run by the Navy. But only toward the end of the war could the museum start moving into its splendid new quarters.

The new museum has been managed from the start by Lt. Comdr. Jacques Vichot.

A well-stocked marine library and documentation service is open to the public for research, and naval experts are available for technical information. Twice a month visitors are conducted through the workrooms where the models are built.

The models that have been accumulated over the last $2\frac{1}{2}$ centuries continue to increase. The storerooms are stuffed with models that can't be placed on exhibition. And, a decade after moving in, the Navy is beginning to grumble that its magnificent quarters are too small for the proper display of its incomparable collections. ★★

New SKIL Orbital Sander gives faster, smoother performance on every job!



Use $\frac{1}{2}$ of standard size sheet. Paper clamps hold up to 6 sheets for fast paper change. No screwdriver needed.

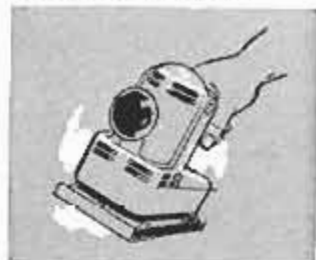

TUF-TEX finish on aluminum housing gives sure grip, light-weight handling ease.

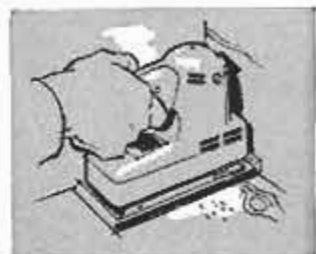

Special design lets you get into corners—sand right up to vertical edges.

Nothing makes tough sanding jobs easier than this new SKIL Model 592! Gives professional results in less time—even on roughest wood, plastic or metal. Always leaves a fine, flawless finish. Smooths the most delicate surfaces without swirls or gouge marks.

Extra front knob and touch-contact switch give easy, sure control. Powerful 5500 r.p.m. motor and $\frac{3}{16}$ " orbital stroke gives faster

stock removal. Extra large sanding pad—over 25 sq. inches! Rugged die-cast aluminum housing and ball-bearing construction mean longer, trouble-free operation. Many other valuable and convenient SKIL features.

Ask for a free demonstration. See the SKIL Model 592 Sander at your hardware, appliance or department store today. **Only \$49.95!**



Made only by SKIL Corporation,
formerly SKILSAW, Inc.
5033 Elston Avenue, Chicago 30, Illinois
3601 Dundas Street West, Toronto 9, Ontario
Factory Branches in ALL Leading Cities

Look for this
SKIL TOOL CENTER
at your local hardware store!

Featuring Model 592 Sander, plus:

- $\frac{1}{4}$ " Drill Kit at \$29.95
- 6" Saw at \$49.95
- $6\frac{1}{2}$ " Saw at \$64.95



**no other plier
does so many jobs
SO WELL**

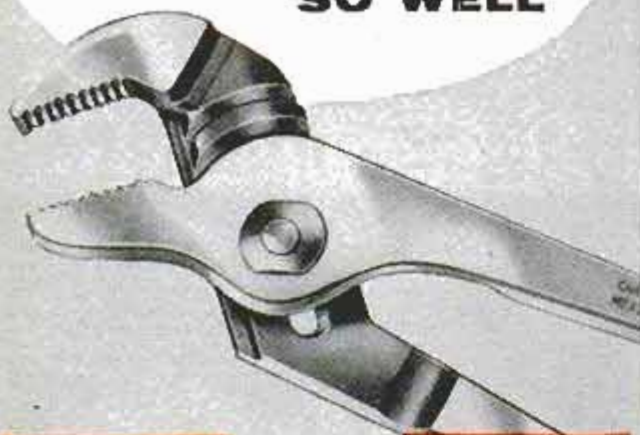

CHAN NEL LOCK

No. 420

GRIPS LIKE A PIPE WRENCH

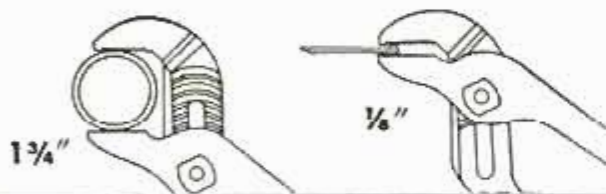

Help yourself to a Channellock No. 420 . . . the handiest plier of them all. With this handy plier, you can grip anything from a cotter pin to a 1 3/4" hex nut. And what gripping power! Just like a pipe wrench. What's more, Channellock is streamlined . . . easy to use in hard-to-get-at places. This all 'round usefulness is the reason why Channellock is the favorite plier of craftsmen everywhere. It'll be your favorite, too . . . for the same reason. Ask your hardware man for a Channellock No. 420.

BE SURE IT'S A GENUINE CHANNELLOCK



CHAMPION DEPARTMENT TOOL Co. MEADVILLE, PA.

Obstacle Course for Trail Riders

(Continued from page 161)

In the training of trail horses the rider and the horse should both be properly educated to recognize when an obstacle is not safe for crossing.

The rider should be aware that the horse can often sense hidden dangers that may not be apparent to the human eye. One device used at a horse show was a huge tractor tire covered with a canvas. The depression in the middle was filled with water.

This was an extremely hazardous obstacle. It was meant to be the type the horse should refuse, and the rider should recognize the horse was right. Several horses approached it, then shied away. But most of them, when the riders insisted, proceeded. Each stepped into the hazard and promptly slipped.

Finally one good rider approached the hazard. The horse refused to go through. Three times this was repeated with the same result. Without forcing the horse through, the man rode on to the next hazard.

The judges awarded the rider first place in the event. He and his horse both had trail know-how. It was brought out in the show arena and it would also be put to work on the open-country trail. ★ ★ ★

Radiation Detector Clipped to Clothes

Plastic beads that acquire an electrostatic charge when shaken are used in a new radiation detector that may be clipped to the clothes or placed on a table. The charged beads repel each other and cling to the sealed glass walls of the dosimeter. When 50 roentgen units of radiation have accumulated, however, the beads lose their

charge and fall out of sight. Fifty roentgens is approximately one eighth the amount of radiation the average person can withstand. The dosimeter is intended for personnel in areas where exposure may occur and for the general public in the event of an atomic attack.



Crystal Cave in Kentucky is the nucleus of a cave system larger than any now known in the world, with 32 miles of passages already surveyed or explored.



Only \$239 delivered, complete with 9" saw blade and $\frac{3}{4}$ hp motor

Only AMF DE WALT makes making things so easy!

With a versatile AMF DeWalt® Home Power Shop, you can make home repairs, build furniture, handle even major projects like a *professional!*

AMF DeWalt is the *first* all-purpose power tool designed on the modern mechanical arm principle that outmodes all other power tools. It's actually 12 professional power tools in 1—a *complete home workshop!*

- **Arm swings and locks at any position** for miter cuts—gives easier, safer *top-side cutting* that eliminates errors . . . you see your mark *and* your cut.
- **Builds into workbench!** Because entire arm *swings clear* of work area, you can cut and assemble on the same work bench! *Save valuable space* and get *extra convenience too!*
- **Powerful $\frac{3}{4}$ hp motor is U.L. Approved**—guaranteed for full year—tilts and turns to any angle.

Motor carriage rolls smoothly on ball bearings in protected trackways. Simply change circular tool on direct-drive motor shaft and you have another power tool—at *no added cost!*

● **Superior safety and accuracy!** Exclusive DeWalt Safety Key Switch prevents unauthorized use. DeWalt's patented design and rugged precision construction provides *safety and unmatched accuracy* that assures years of superior workmanship.

INSIST ON A DEMONSTRATION. See why, *feature by feature*, AMF DeWalt is the finest home power shop you can buy. A small down payment on DeWalt's Easi-Budget Payment Plan* will put an AMF DeWalt in your workshop *now*.

OWNERS! Valuable new *Owner's Manual* just off the press, "Easy Ways to Expert Woodworking," \$4.95 postpaid. Order yours today!

*Does not apply in Arkansas or outside U. S. continental limits

SEND COUPON FOR FREE ILLUSTRATED BOOKLET!

AMF DeWalt Inc., Dept. PM-611, Lancaster, Pa., Subsidiary of AMERICAN MACHINE & FOUNDRY COMPANY



Please send FREE colorful illustrated 20-page Booklet

Name _____

Address _____

City _____ Zone _____ State _____



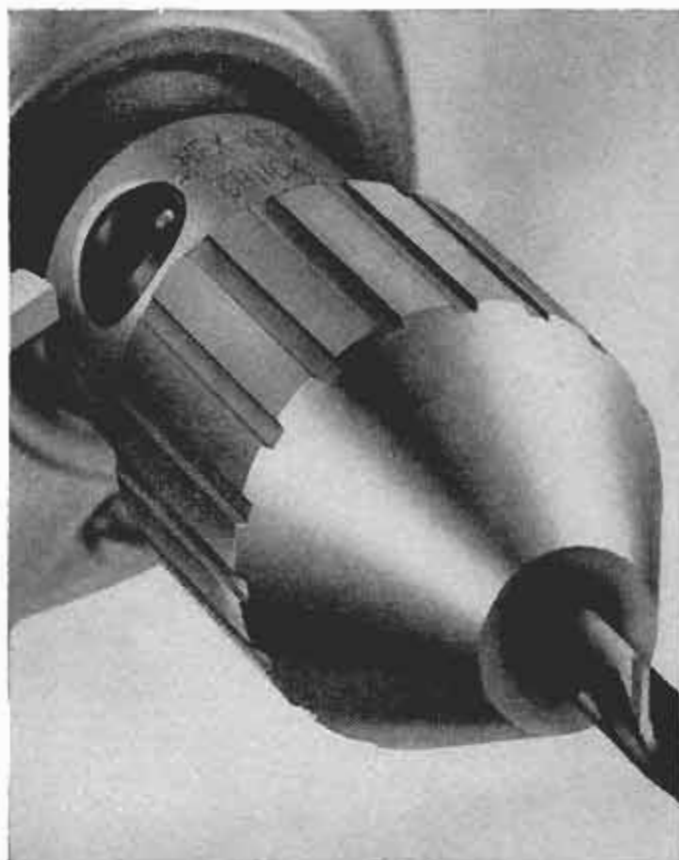

There's power in this end, too!

Electric drill power isn't all in the motor. There's another kind of power — just as important to you — in the business end of a portable electric drill. It's the gripping power that has to be in the chuck, particularly when you are using sanding and screwdriver attachments that must be chucked on the drill.

Take the drill shown here. It is equipped with a Jacobs Model 6141 Rubber-Flex Hex-Key Chuck. You cannot buy a more powerful grip on a portable electric tool. It is compact, light in weight, and easy to operate. Buy the drill and buy the chuck. Jacobs is a name men go buy!

This Jacobs Hex-Key Chuck *looks* different because it *is* different. A quarter turn of a standard Allen key produces tremendous holding power. It actually produces a gripping leverage ratio of 1000 to 1! Another quarter turn easily releases the twist drill.



Reg. U.S. Pat. Off.

The Jacobs Manufacturing Company
West Hartford 10, Connecticut

Their Job Is to Guard Your Health

(Continued from page 145)

these are ailments or hazards that can be controlled with proper precautions. And here is where the Occupational Health Field Center enters the picture. The center, which occupies one floor of a rambling brick building in downtown Cincinnati, is staffed by experts.

Lab Has Four Sections

The laboratory is divided into four sections: Toxicology, medical, engineering, and the program or planning section which investigates problems and plans the laboratory's work. The toxicologists investigate substances to determine whether they may contain enough toxicants to damage workmen. The medical section deals in treatment. The engineering section works with such problems as mine and factory ventilation and soundproofing.

In addition to the staff in Cincinnati the field headquarters maintains a substation which deals in West Coast industrial-health problems from its Salt Lake City base. The 15 people in the Salt Lake City laboratory send their big problems back to Cincinnati where the laboratory is equipped with the latest scientific apparatus.

One challenge they've tackled in recent years is a study of the hazards faced by uranium miners and millers. The people in this youthful industry were increasingly concerned about their health. They wanted to know if they faced hazards from radioactive dusts and what steps to take to prevent trouble.

Their request reached Cincinnati in 1950, and a crew of two doctors, two laboratory technicians and four engineers and chemists tackled the problem from the Salt Lake City headquarters. They surveyed seven mines, collected hundreds of dust samples, and consulted with numerous uranium workers. They found that over a long time these workmen might face a serious hazard by breathing the radioactive dusts unless proper control measures were taken.

Their next step was to determine the amounts of ventilation needed in a uranium mine to reduce the dust to a safe level. They even built an experimental mine-ventilation project for close-up study. Their work brought a new degree of safety and confidence to the uranium worker. The occupational-health technicians in traveling laboratories are still busy in this field.

Workmen Fainted on Job

In another trouble-shooting job a team of men from field headquarters visited a

(Continued to page 258)



Santa Says:

"A WONDERFUL HOBBY
WORKSHOP GIFT"

JUST DIAL
40 DIFFERENT
WIDTHS ON
ANY SAW!

WITH **Warren** DADO
SAWING WASHERS

Cut 40 smooth, accurate, parallel grooves — any angle, with your present saw blade. Dial desired width with Micromatic adjustment. Leave on saw for straight cuts. Sizes to fit your arbor — $\frac{1}{2}$ ", $\frac{3}{8}$ ", $\frac{3}{4}$ ", 1". A perfect gift for woodworkers. See your dealer or write!

ONLY
\$4.95
PER
SET

SEND FOR FREE BOOKLET
WARREN WASHERS COMPANY
DEPT. 31 • BOX 98 • NORTH END STATION • DETROIT, MICH.

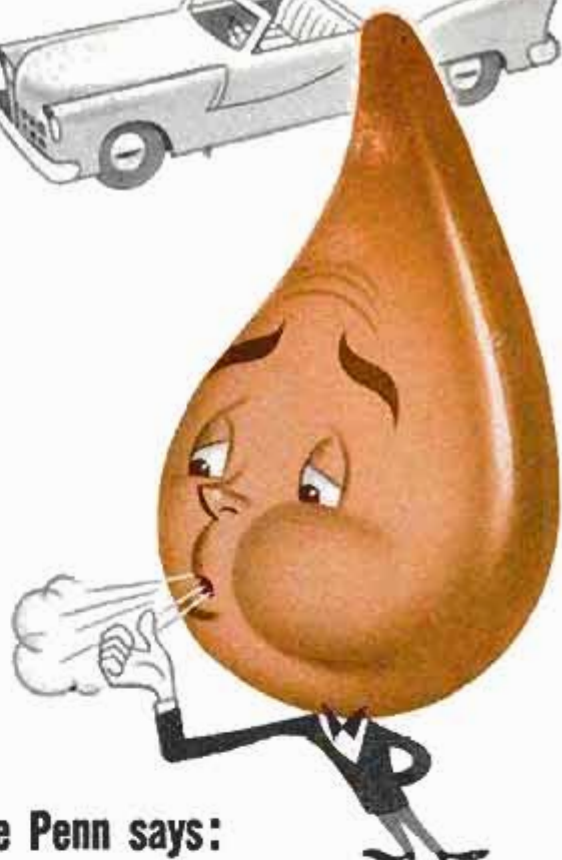

Pete Penn says:

"Pardon me, but..."

"You're looking at the kid Mother Nature endowed with everything the other motor oils *wish* they had."

Nature's *best* crude comes from the oil fields of the Pennsylvania Grade region. That's why today's *best* motor oils are brands of Pennsylvania. They give your engine greatest protection against wear caused by the high speeds in today's close-fitted engine parts.

Take Pete Penn's advice . . . at your next oil change, tell the dealer to put in a brand of Pennsylvania. Carried by good dealers *everywhere*.

Today's BEST Oils

Start with Nature's BEST Crude
...and that means Pennsylvania!

INSIST on
a brand
of



PENNSYLVANIA
Motor Oil

PENNSYLVANIA GRADE CRUDE OIL ASSOCIATION, Oil City, Penna.

Sluggish appliance?

Maybe all it needs is a drop of 3-IN-ONE Oil. Quickly penetrates and lubricates without leaving a gummy deposit as other oils do. Prevents rust, too.



"3-IN-ONE" OIL

Drive with Confidence

DINSMORE Auto Compasses

Shows you the right way—the short cuts. Saves time, money. Write for new compass history folder, "Pants—Knives—Compasses," and name of nearest dealer.

DINSMORE INSTRUMENT CO., 1802-41 Kelso St., Flint 1, Mich.

ONLY COMPASS
APPROVED BY
AUTO MAKERS

Say You Saw It in Popular Mechanics

Protect your home against
power interruptions
with an...

**ONAN Emergency
ELECTRIC PLANT**

Provides dependable stand-by electricity for heating system, pumps, freezer, lights, appliances. Keeps home safe, livable. Automatic start and stop. Find out how little it costs!

Write for Folder!

D. W. ONAN & SONS, INC.
3650 University Ave. S. E. • Minneapolis 14, Minnesota

A SIZE FOR EVERY NEED
500 to 50,000 watts.
Compact, quiet-running.
Gasoline-powered.
Priced from \$255.00

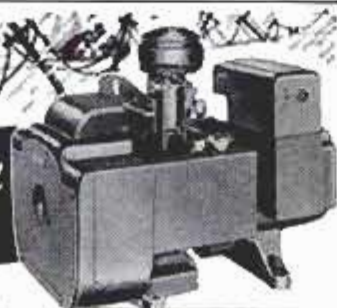

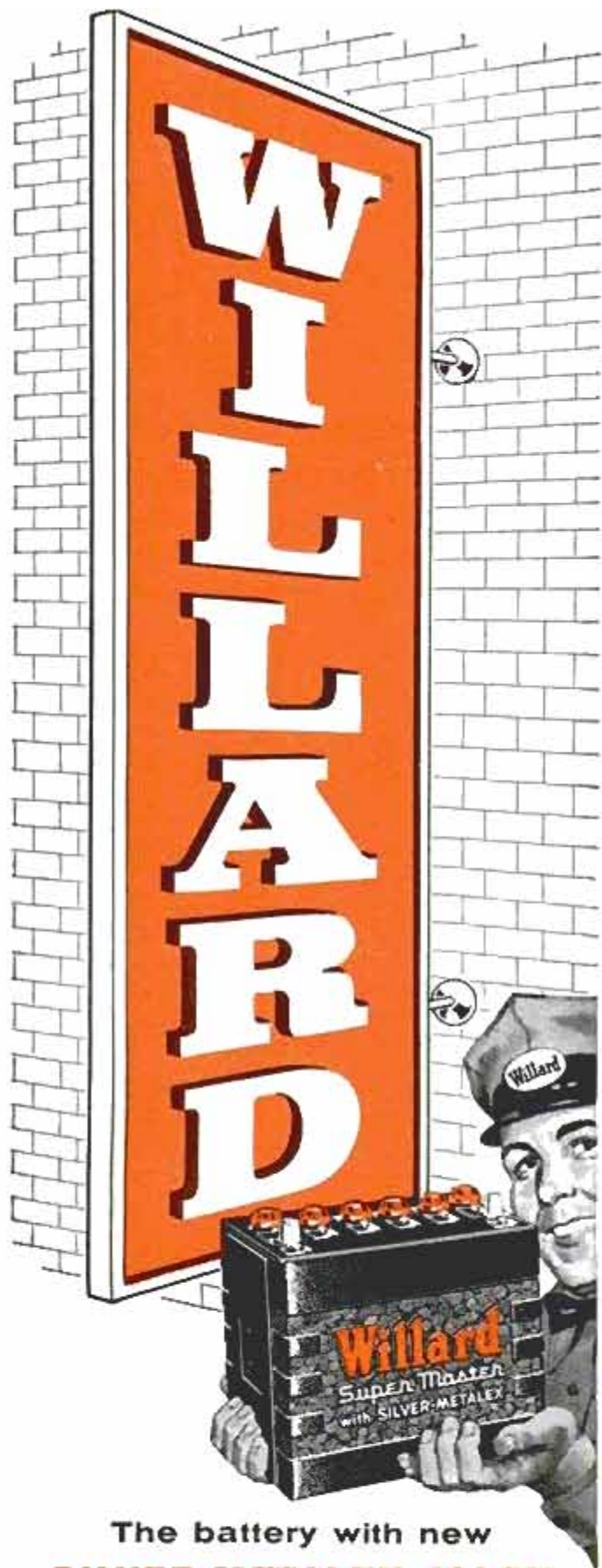

The battery with new
SILVER-METALEX ALLOY
STAYS FACTORY-FRESH
IN YOUR CAR

...sold, serviced and guaranteed by competent dealers in your neighborhood—and wherever you drive.

woodworking shop where the whole community was upset by the fact that shop workmen were fainting on the job. The physician and the industrial hygienist went over the plant with all the thoroughness of good detectives. They showed a special interest in new processes, changes in procedures and new materials being used.

Within 24 hours they found that the workmen were exposed to toxic amounts of lead and phosphate and that these, combined with heat and fast production schedules, were at the root of the fainting.

The investigators left behind a set of simple suggestions which soon corrected the trouble. They suggested that the workmen take more salt tablets to cut heat stress, that new exhaust ventilating equipment be installed in the plant and that the workmen be given more careful and frequent medical checkups.

Dr. W. Clark Cooper, director of the field headquarters, says the biggest single type of industrial ailment is dermatosis. "Occupational skin diseases seldom kill people," he says, "but they cost plenty in lost time and lowered efficiency." Statistics show that about two thirds of all industrial compensation cases are due to skin diseases. One 1951 survey in four states showed that 3100 cases of industrial skin disease cost \$830,800 or \$268 per case. And the industries lost the skill of these workers for the time they were off the job.

One of the simplest cases Dr. Donald J. Birmingham, chief dermatologist, ever tackled was in a rubber factory. Fifteen workers there ran rubber for gaskets through a soap solution eight hours a day. They were suffering serious discomfort from skin troubles. "Wear protective gloves," said Doctor Birmingham, and the trouble was stopped.

Find the Villain

But the solution to the problem is seldom as obvious. Most workmen have their own ideas about the cause of their sickness or injury on the job. And sometimes they're 100 percent wrong. Here's where the industrial-health scientists come in as they did in one Michigan case not long ago. The Public Health Service was asked to check into a serious outbreak of sores on the hands and forearms of workers in a factory making canvas tentage for the Army.

The canvas had been treated and impregnated for a number of things and finally dyed olive drab and these materials stained the workers' arms and clothing. The answer seemed obvious, that the trouble was some place in the materials used on the canvas.

But when the researchers patch-tested ailing workers with bits of material with

(Continued to page 260)

DO IT BETTER . . .

DO IT WITH **DP**



CAULK
GLAZE
SEAL
PATCH

Now's the time to seal all cracks and openings around doors, windows, brick work, foundations, and chimneys. **D-P Caulking Compound** does it . . . so easy! Get it in bulk or in cartridge form. Does not crack . . . withstands expansion and contraction. One of many fine **D-P** products. At all good stores!

Ask your dealer for **D-P** Products.

THE DICKS PONTIUS CO.
5301 Huberville Ave., Dayton 3, Ohio
INSIST ON **D-P** BEST SINCE 1867

BOAT KITS 28 MODELS—8 to 19 ft.
\$39 up—FREE FREIGHT

SAVE 2/3!

Easy-to-build MAHOGANY FRAMES—DECKS

19' CRUISER KIT \$499.50!

SEND 10¢ for

KIT CATALOG!

Includes Hardware

Trailers—Fiberglass



BOAT PLANS—Patterns—Frame Kits

Build over 50 modern boats from large scale plans, available with FULL-SIZE patterns, new PRE-FAB frame kits! All types; prams to cruisers, 6 to 25 ft. Best buy for Amateurs! SEND 10¢ for CATALOG.

Craig Craft
Tonawanda, N. Y.

**CUT RADIO CHASSIS HOLES
IN 1-1/2 MINUTES OR LESS**

Quickly make accurate round, square, key, or "D" openings . . . in metal, bakelite or hard rubber . . . with GREENLEE Radio Chassis Punches. Simply turn with a wrench. Many sizes. Write for details. Greenlee Tool Co., 2111 Columbia Avenue, Rockford, Illinois.



KING MIDGET

Drive it for 75¢ per week. Rider Agents wanted—earn your own car free. Also KING MIDGET JUNIOR chassis, finely engineered, ready to run and priced at a fraction of any similar car. GET THE FACTS. Send 25¢ for 32 page picture book giving special prices and agents proposition on both cars. Or send \$1 (refunded first order) for this plus actual assembly book and service manual.

MIDGET MOTORS CORPORATION, ATHENS 1, OHIO



**GIVE THE
WORLD
YOUR**



40" TALL

CHRISTMAS WELCOME
with these decorations you make
from full-size patterns

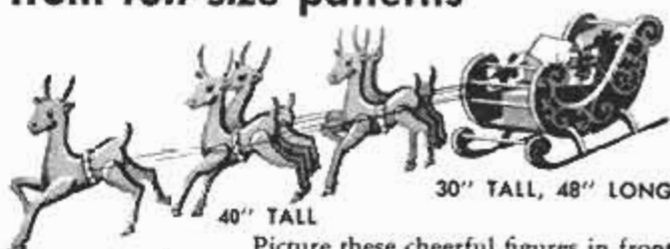

30" TALL, 48" LONG

40" TALL

Picture these cheerful figures in front of your own home . . . brilliantly colored and near life-size. And you are the artist—because you make the figures, or paint them, or arrange them in your own personal way. You do all this and get professional results . . . with the help of Easi-Bild* Patterns and Homasote.

The full-size patterns specify all materials and the right tools, give you complete instructions. From there on, the craftsmanship is all yours, because now you know where to start and where you are going.

The Madonna Outdoor Greeting Card—4' high—gives your home the quiet beauty of a cathedral, with its stained-glass effect. Santa and the Reindeer stand 40" tall, and the 2 1/2'-high Sleigh is a real, three-dimensional sled. The Jolly Snowmen Greeters are a cheerful welcome on your front door. Sound-deadening Trainboards and Christmas Tree Platforms are easily made with Homasote in any shape—and in sizes up to 8' x 14'. 3/8" weatherproof Homasote is free from splinters and long-lasting.

Homasote Insulating-Building Boards and Easi-Bild Patterns are carried by your lumber dealer. If you want the name of your local dealer, or to order the patterns separately, use the coupon below. Your dealer can also furnish you with the figures already cut out and a painting pattern, if you prefer.

Making your own Christmas decorations is real fun for your family, club, or school group. Whether you simply paint the cut-outs, or build the complete figures, it's easy with Easi-Bild and Homasote. Start your project now by mailing in the coupon! *T.M. Reg. Easi-Bild Pattern Company



Christmas
Greetings

48" HIGH

MAKE it at home...with HOMASOTE

HOMASOTE COMPANY, Dept. L-6, Trenton 3, N. J.

I enclose . . . for which send the following patterns:

Santa Claus—35¢ Reindeer—35¢ Choir Boys—50¢

Jolly Snowmen—35¢ Sleigh—50¢ Nativity Scene—\$5.00

Madonna—50¢ Send name of nearest Homasote Dealer

NAME

ADDRESS

CITY ZONE STATE



THIS COUPON brings you the most exciting news in Power Tools!

AT LAST!



Motor Tools

specially designed to bring you today's most wanted features in Power Tools!

...Power Packed Beauties with BUILT-IN-MOTORS

CONVENIENT: Darra-James Motor Tools take the guesswork out of choosing the proper motor. They come equipped complete with Timing Belt, Pulley, and G. E. Motor with Cord, Plug, and Switch. **ABSOLUTELY NOTHING TO BUY.** Everything is built to the most rigid factory specifications.

TIME-SAVING: Since each tool comes equipped complete with motor and accessories, there's nothing to mount — thus, no time lost.

SIMPLE TO OPERATE: Just plug in, flip the switch and operate as easy as running a toaster.

MOVABLE: Each Motor Tool is compact and can be carried quickly and easily from one place to another. . . move the tool to the job. . . NOT the job to the tool!

RUGGED: Entire tool is constructed of heavy-duty cast iron to assure many years of trouble-free service.

CHOICE OF COLORS: Darra-James Motor Tools are available in either popular Slate Gray or new Woodland Green to enhance the beauty of your home workshop.

ECONOMICAL: Darra-James Motor Tools cost less than similar tools and motors purchased separately.

All Darra-James Power Tools can now be purchased for **ONLY 10% DOWN** through our convenient credit plan



4 1/2" JOINTER (Model 845)

Uniquely synchronized to maintain constant distance between table and blades at any depth of cut • Rebbers up to 3/4" planes any board up to 4 1/2" wide • Tables adjust individually for perfect alignment • Ball-bearing construction • U. S. Rubber Power-Grip Timing Belt Drive • 1/2 H. P. continuous duty G. E. motor



8" TILTING ARBOR SAW (Model 825)

A quality tilting arbor saw at a minimum price • Cuts stock 2-9/16" thick • With extensions, rips to center of 33" panel • Motor, guard, and splitter tilt with blade to 45° • Precision-ground cast iron table (18" x 20") stays flat • Lifetime ball-bearing arbor unit • 3/4 H. P. continuous duty G. E. motor



8" TILTING ARBOR SAW (Model 815)

An economy saw that will perform all operations of high-priced models • Cuts stock 2 1/2" thick, rips to center of 18" panel • Blade, guard, and motor tilt to 45° • Table and work stay flat • Precision ball-bearing arbor unit • 3/4 H. P. continuous duty G. E. motor

Ask your dealer about the complete line of Darra-James standard power tools



which they worked, not one of them contracted a new sore from the patch. Then the technicians began to study the materials the workers used to wash their stained hands. Here was the villain. Powerful cleansing agents such as white gasoline, mineral spirits and some hand cleaners were causing the trouble.

Workmen switched to different cleansing techniques and began wearing sleeves and gloves. Within 60 days the trouble was gone.

One of the newer fields the occupational-health experts are tackling with increasing vigor is that of noise in industry. In wood and metal-working shops and on many other jobs noise is sometimes a hazard to the worker. Too much noise may prevent him from hearing a warning of danger, or the excessive noise may lower his working efficiency or even endanger his hearing ability.

Researchers are just beginning their studies in this complicated field. Their work may eventually lead to quieter and more pleasant working conditions.

Even the men who make the money you earn have industrial-health hazards. Fascinating as the task must sometimes seem from the outside, the workers in the United States Mints are often exposed to fumes of lead, zinc, selenium, tellurium and acid mists. The industrial-health watchdogs from Cincinnati have been called to this scene, too.

At their suggestion the mints were equipped with better devices for the control of dusts, excessive noise, better lighting. Now the men who make money go about their task assured of health protection all American workers ask of an increasingly complex industrial age. ★ ★ ★

Thick-Shelled Eggs Coming to Market

Eggs with thicker, more durable shells may soon be coming to market, now that Dr. William H. McGibbon at the University of Wisconsin has shown that shell quality is inherited. The stronger shells are considered more desirable because they hold up better under handling and marketing. Doctor McGibbon has developed strains of hens which lay hard-shelled eggs, and other strains which lay softer-shelled varieties. A thin shell makes up eight percent of the egg's total weight, while the hard shell averages 11 percent of the weight.

New Zealand is exporting green powdered buttermilk to Malaya and Singapore for use as poultry feed, the green coloring being added to distinguish it from powdered milk for human consumption.

Whatever your business...

you save money with stapling

Below you see five of the vast number of businesses which report savings with Bostitch stapling. In shipping, Bostitch provides quick, easy carton closures—on seams, tops and bottoms—that actually strengthen the cartons. In production, everything from paper to sheet metal is fastened with Bostitch equipment—

speeding output, cutting costs. A Bostitch Economy Man will be glad to help with your fastening problems. He's one of 375 trained fastening specialists working out of 123 cities in the U. S. and Canada. Over 800 different models of Bostitch staplers use 200 types of staples, tailored to the job.

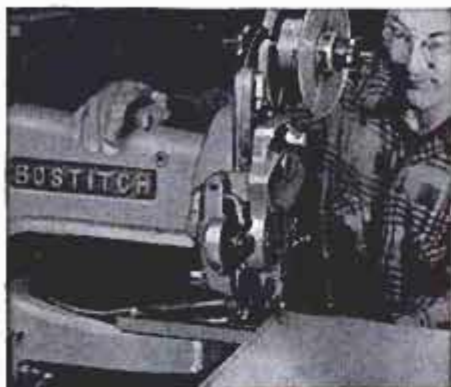

These steel freezer cabinets, once spot-welded, are now wire stitched. "Bostitch method trims fastening costs by 75%."

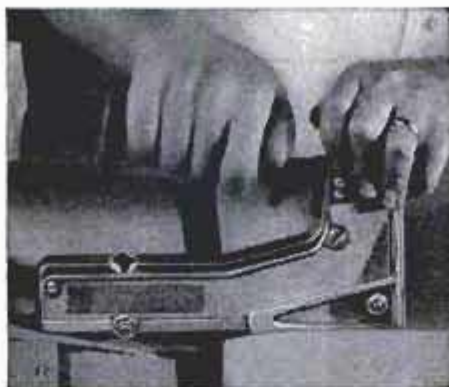

Using Bostitch Autoclench stapler, this man says he seals boxes "five times faster" than he can with glue. Saving "over 50%."



Air freight bills stapled to corrugated containers with new-type tacker "hold better than with tape at 1/10th the cost."



Roofers use heavy-duty Bostitch stapling hammers to lay asphalt shingles on new roofs. "Four times faster than nailing."



"Twice as many boxes can be stapled in an hour, with only two-thirds as much manpower." Staplers take up less floor space.



For greatest savings, use only genuine Bostitch staples in Bostitch machines. They're precision-made to work together!

FIND HOW TO CUT COSTS in your business; attach this coupon to your business letterhead and mail today.

Fasten it better and faster with

BOSTITCH[®]
STAPLERS AND STAPLES

Bostitch, Inc., 551 Mechanic Street, Westerly, R. I.

Name _____ Position _____

Company _____

Address _____

City _____ Zone _____ State _____

Sound your Z...make it

EASY ON OIL FOR KEEPS

because—



Pennzoil with Z-7 keeps engines clean

It's true—you'll use less oil when you use Pennzoil with Z-7! For this different Pennsylvania motor oil has an all-oil lubricating body that stays tough under even the most intense engine heat and pressures. It also prevents formation of carbon, sludge and other oil-wasting deposits. By keeping rings, valves and bearings clean and free, Pennzoil with Z-7 keeps the whole engine smooth-running, safe, and easy on oil—not for just a few miles after an oil change, but for keeps. Get Pennzoil with Z-7, The Tough-Film[®] oil, now, in the exact seasonal grade for your car!



IN EVERY STATE,
AT DEALERS WHO
care FOR YOUR CAR



MEMBER PENN. GRADE CRUDE OIL ASSN.
PERMIT NO. 2, OIL CITY, PA.

Algae For Dinner

(Continued from page 136)

algae were supplying an abundance of oxygen, something that was needed by the bacteria for oxidizing the sewage.

At the start, Professor Gotaas was merely interested in learning whether algae might be useful in sewage treatment. It turned out that the discoveries made by him and his associates were much broader than that.

They found that the oxygen given off by the algae helps the bacteria to efficiently digest the sewage, and that at the same time the carbon dioxide and ammonia given off by the bacteria are greedily consumed by the algae. The sewage meanwhile supplies all the phosphorus, magnesium, potassium and other minerals that the algae require.

After studying the independent work that had been done on chlorella the sanitary engineers realized that they had much more than an efficient process for sewage treatment, they also had an ideal method for growing algae.

For the last several years an outdoor sewage-treatment plant using algae has been in operation at the Richmond engineering station of the university. Typical sewage consisting of domestic and industrial wastes is piped from one of the city's main lines and is circulated to a number of long, shallow concrete tanks. Surprisingly, there are no obnoxious odors from the open vats. Only a faint smell reminiscent of freshly cut grass or hay can be detected.

The plant operates almost without human control except for the algae-harvesting operation. Raw sewage pours in at one end, fairly pure water and algae are removed at the other end.

Sewage treatment and algal growth occur together, at the same time. The speed of the process depends on the amount of sunlight that falls on the tanks. This varies with the season of the year and the geographical location. Depending on these factors, the detention period is from one to six days. It is estimated that a three-day treatment would be adequate in 12-inch-deep ponds as far north as New York City or Salt Lake City during 80 percent of the year. In the summer it would be possible to grow algae as far north as the Arctic Circle.

The University of California research group believes that it has worked out most of the major production problems. Now it is seeking the most efficient way of harvesting the algae. The cheapest method appears to be one in which the algae are precipitated by chemical coagulants.

From the day-to-day operation of the pilot plant some very general conclusions

(Continued to page 264)

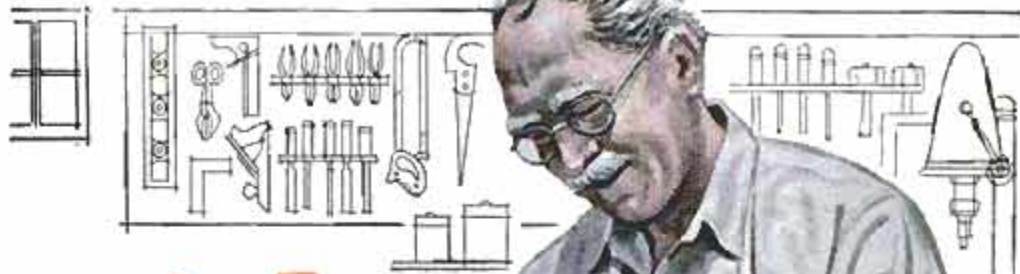

You Sand Like An Expert with a DREMEL Straight-Line Action Sander



Professional experts sand *with-the-grain* of the wood, to get a velvet finish. And that's the way you sand, when you use a Dremel Straight-Line Action Sander.

Sands in a Straight Line

The Dremel duplicates the back-and-forth motion the old-time craftsman always used when he sanded by hand — before he had a Dremel. That's the secret of getting a finish that is smooth as glass.

Other sanding motions sand across-the-grain — leaving scratches and orbital swirls. These become especially noticeable when you stain, varnish, or lacquer and spoil the finished appearance of your wood.

That's why so many experts — and novices, too — insist on a Dremel for sanding woodwork,

furniture, cabinets, boats, wood paneling, and many, many other projects.

You Can Polish, Also

You're not limited to sanding, with a Dremel. You can remove the sandpaper and slip on a polishing pad.

Then you're all set for speedy, effortless polishing of furniture, your automobile, or any other waxed surface.

Dremel Straight-Line Action Sanders are available in three sizes. See your local power-tool dealer and ask for a demonstration. Compare with other makes for price, performance, simplicity of construction, and ease of handling. A close-up comparison will convince you that a Dremel is your best all-around buy.

See the Dremel at your hardware store.

Give a Dremel Sander this Christmas.



Model 53. Heavy-duty unit designed for rough, medium, or fine sanding. Powerful ROTARY MOTOR will not stall or burn out. 24 sq. in. sanding pad. Wgt. 5 1/4 lbs. Easy handling. \$34.85.



Model 2000 Sander-Polisher. Handyman's favorite for all household or hobby projects. Easy to use. Wgt. 5 lbs. 21 sq. in. sanding pad. Includes steel carrying case, 1 polishing pad, 25 assorted abrasives. \$24.50. **Model 2000 Sander only (less case) — \$19.95.**



Model 8. A sander, polisher, and massager all in one. Light with smooth, powerful action. Wgt. 2 1/2 lbs. 13 sq. in. sanding pad. Includes 6 abrasives, polish pad, massage pad. \$14.85.

D-2

Write for FREE Catalog
DREMEL MFG. CO.
Dept. 116L • Racine, Wisconsin

BUY NOW! See your dealer... if he can't supply you, order direct on 5-day trial, money-back guarantee. Remit in full and we'll pay postage. Or, send \$2.00 now, then you pay mailman balance, plus postage and C.O.D. fee.

EVEN THE SMALLEST HANDS can make strong, flexible bonds fast with Pliobond. And they'll last—are resistant to water, oil, chemicals and age—hold fast to virtually any material found around the home.



BUY THE ONE ADHESIVE THAT'S—

SO EASY to use, anyone can make it work—and do a better job faster

SO STRONG it can lift a truck—meet almost any bonding strength requirement

SO VERSATILE it bonds virtually any material or combination of materials—does almost any home or hobby bonding job

Pliobond
BY
GOOD YEAR

"BONDS ANYTHING TO ANYTHING"

AVAILABLE AT chain, hardware and hobby stores everywhere. Ask for it by name—Pliobond. You'll find it the handiest thing on your workshop shelf.

Pliobond—T. M.
The Goodyear Tire & Rubber Company,
Akron, Ohio



have been reached. One is that the organic wastes from a city of 100,000 population can be made to produce 10 tons of dry algae concentrate per day, at the same time making available some 10,000,000 gallons of reclaimed water. These figures don't include the waste from the usual organic industries of a city that size. Such waste could raise the production figures materially.

A rough estimate is that it would cost from \$80 to \$100 per million gallons of sewage to construct and operate an algae plant. The present cost of processing sewage is from \$30 to \$50 or more per million gallons.

The algae plant could be a bargain even though it cost twice as much to operate. Even at a sales price of six cents per pound the dried concentrate would gross \$1200 per day (for a city of 100,000). Thus the sewage-treatment operation would break even or show a slight profit, as against the \$500 per day the same city now spends.

Algae at a Profit

These figures are the basis for the statement that algae can be produced for nothing, or less than nothing. If the algae were sold at a higher price the profit for treating the sewage would be correspondingly higher. Professor Gotaas stresses the fact, however, that the process is still in an experimental stage and that cost estimates are based on pilot-plant operation. Further economic studies are being made.

It is said that the United States throws away sufficient wastes to produce 10,000 tons of algae concentrate every day, more protein than is produced on a million acres of land in a year by conventional means.

Algae may have other uses besides being a source of food. The dried concentrate could be a worthwhile source of power. Its fuel characteristics are similar to those of medium-grade bituminous coal although the heat content is somewhat less.

Produces Methane Gas

Fifteen grams of algae can be made to produce 10 liters of gas, of which more than 60 percent is methane. The same gas also contains carbon dioxide and a trace of hydrogen. Methane is a good fuel. It can be compressed, bottled and transported. By means of a petroleum-refinery process it can even be changed into gasoline.

Algae may become an important source of vitamins. They may be used as organic collectors of certain rare elements such as germanium. Alga appears to have an important future, so important that the Rockefeller Foundation and the U. S. Public Health Service, together with the university, are jointly sponsoring the present studies. ★ ★ ★

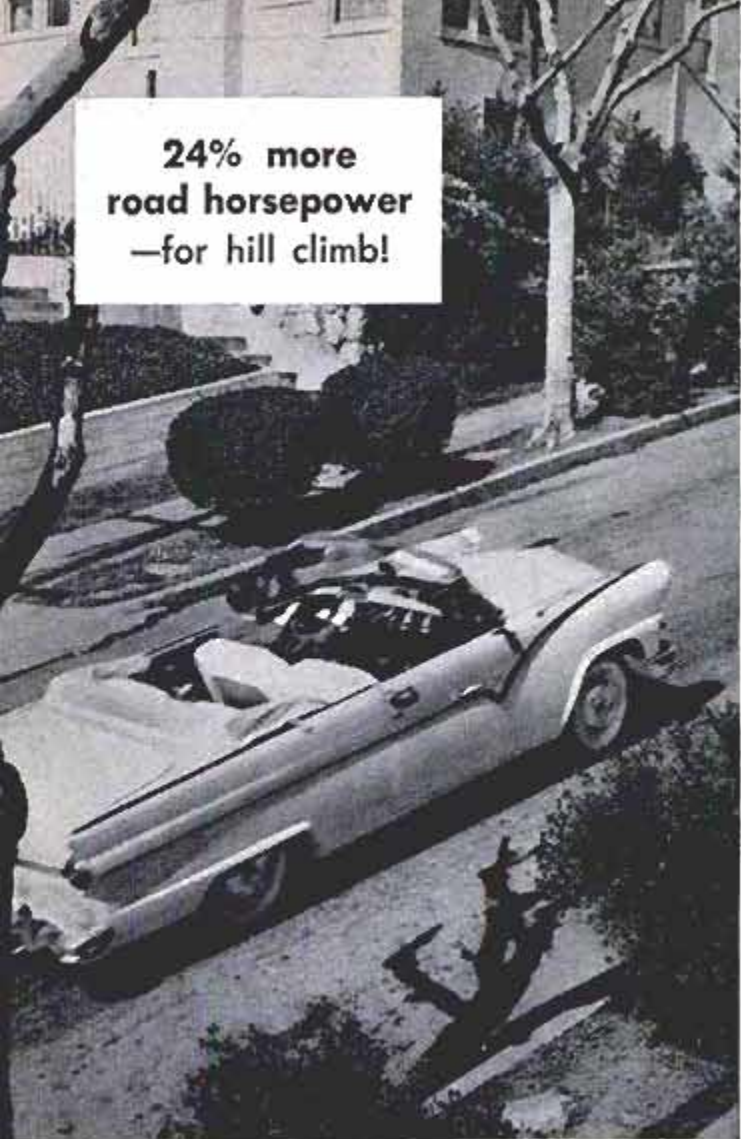

24% more
road horsepower
—for hill climb!

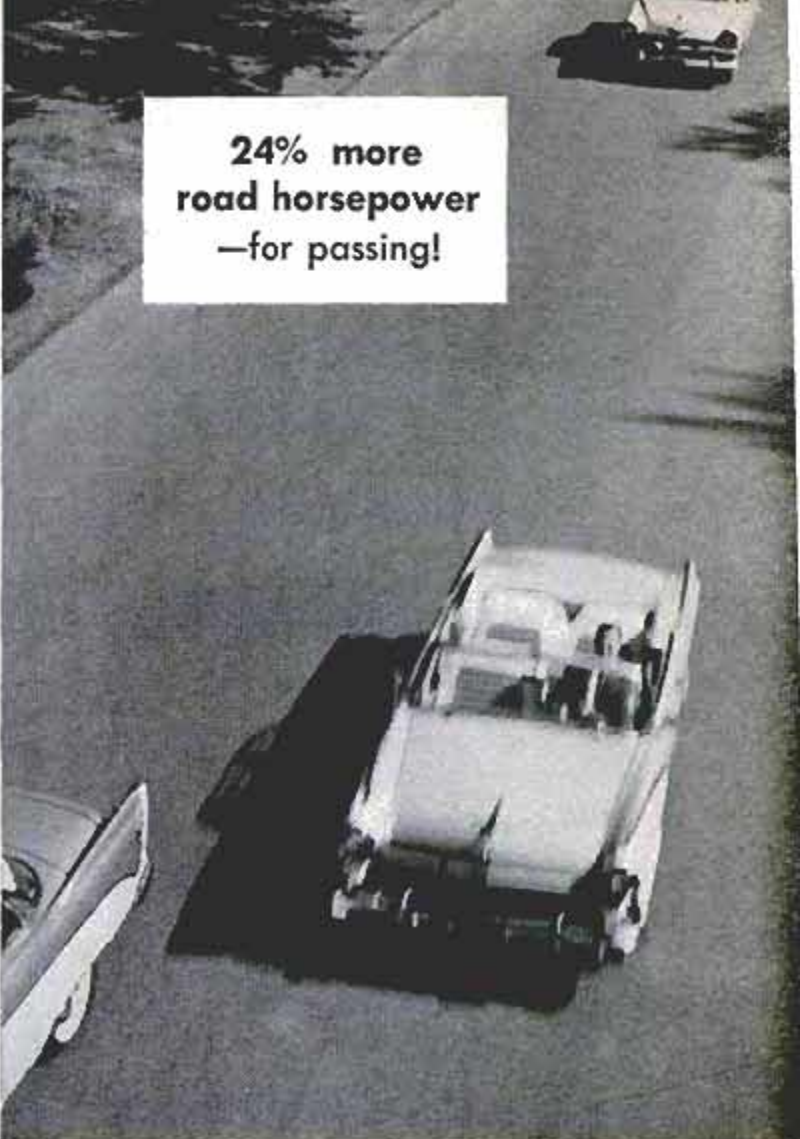

24% more
road horsepower
—for passing!

In cars that have gone about 10,000 miles without a spark plug change—

New Champions can increase road horsepower by 24%!

TESTS with major makes of cars prove it! Independent engineers took cars whose plugs had run 10,000 miles or so and tested them for power — first with their regular plugs, then with 5-rib Champions with the new Powerfire electrodes.

Nothing about these cars was changed except their spark plugs. Yet there was an *immediate* increase in their road horsepower — the real power actually delivered at the rear wheels! *The average road horsepower gain for all cars tested was 24%!*

It comes down to this: There just never has been a spark plug to match these new Champions with their Powerfire electrodes! Replace your old plugs with new 5-rib Champions today — and you'll feel the difference *at once!*

CHAMPION

LOOK FOR THE 5 RIBS





Trademark

Be sure you get the original **ALLEN-A INSULAIRE***

thermal underwear with Navy's arctic wonder-fabric

**Warmth without bulk for all
men and women who work or
play in chilling temperatures**



The Navy needed a wonder-fabric—warm enough for far-below-zero weather, yet unusually absorbent so it could be worn indoors or in mild weather without sweltering. And 100% laundry-foolproof.



Here's the fabric they developed—in well-made shirts and drawers especially designed for active men and women. Now you can shed extra layers of bulky, heavy outer clothing—dress lighter, have more freedom.



Made of down-soft cotton (doesn't itch), knitted in unique 3-dimension pattern. Traps body-heat in thousands of tiny "pockets" for perfect insulation. Rigorously tested for warmth in arctic conditions. Can be machine-washed, tumble-dried. Won't shrink out of size.



If your dealer can't supply you, mail this ad with your name and address for further information to The Allen-A Co., Dept. PM, Piqua, O.



*Trademark

Goal No. 1: The Weed-Free Farm

(Continued from page 168)

are two types of 2,4-D: amine formulations and ester formulations. The ester type is the most active and therefore will have greater effects, but at the same time it is more dangerous to nearby flowers. The label will tell you which is present. The amines are water solutions and make clear sprays; the esters usually are oil solutions and make milky sprays in water. If your problem is mostly dandelions and plantains, use the amine type, as it will easily kill these weeds. On other broadleaved weeds which are more difficult to kill, your best bet is an ester formulation. On these hard-to-kill enemies, apply early in the season, just after they have started growth. Some of these stubborn weeds may require repeated doses.

Eliminating crab grass. 2,4-D does not appreciably affect any of the weedy grasses such as crab grass, quack grass, foxtail and nimble Will. Since your lawn grass and crab grass are both grasses, and closely related, it has been difficult to find a chemical that will kill one without injuring the other. You'll find three materials currently on the market: Phenyl mercuric acetate (PMA), potassium cyanate (PC) and disodium methyl arsenate, introduced last year.

All are marketed under several different trade names, and all are capable of doing an excellent job when conditions are right. However, all three can—and frequently do—burn the lawn grass if applied a bit too strong or when the weather is a little too hot. *Apply them precisely according to the instructions.*

Several new chemicals—one being sold on an experimental basis this year—have given excellent results in killing crab-grass seedlings as they come up. One of these chemicals may well prove as effective an answer to crab grass as 2,4-D is for dandelions. We'll know more next year.

Corn. Many farmers now give corn one spraying and one cultivation, where four cultivations were the rule not so long ago. 2,4-D again is the standard chemical. It can be applied pre-emergence at one to two pounds per acre, but is usually applied post-emergence. Apply it before the corn reaches a height of 10 inches. This catches the weeds in their younger, more susceptible stages. Another reason for early application is that one of the effects of 2,4-D on corn is to make it temporarily brittle, and corn more than a foot high is likely to be broken by a strong wind or the cultivator within 10 days after application. If you feel it absolutely necessary to spray corn more

(Continued to page 270)

ALL WRAPPED UP FOR YOUR CHRISTMAS!
 DISSTON'S World-famous D-23 hand saw—only \$895
 DISSTON-CARLSON 10 ft. Steel Tape Rule—only \$325
 Both together . . . \$1220



Disston tools make fine gifts for the whole family!



DISSTON CARLSON steel tape rules are sturdy, easy to read, famous for high quality. The #3310 has a 10-foot reach; is 1/4" wide; has patented swing tip and 10-second blade change features.



A tip for FATHERS

If your youngster has his eye (and his hands) on your tools, you can make his Christmas merrier with a grown-up gift of a Disston D-23 Hand Saw and a Disston Carlson Rule. He'll get a lifetime of satisfaction from these fine tools. And both you and your son will find you have more family fun when you join forces and "do-it-together."



A hint for SONS

Wondering what to get Dad for Christmas? How about a Disston D-23 Hand Saw and a Disston Carlson Rule? Dad will really appreciate these

fine gifts—and be proud of you for being smart enough to buy Disston. Disston, you know, is the saw carpenters use. If Dad already has a 5 1/2-pt. or 8-pt. Disston, get him a 10-, 11-, or 12-pt. for fine finishing work.



AND a word for MOM!

You can keep *all* the men in your family happy, Mom, with Disston tools for Christmas. (It's a good way to get some work done around the house, too.)

Prices vary slightly in some localities.

SEE . . . TOUCH . . . and TEST
 these and other fine Disston Tools
 at your favorite hardware or tool store.
 Stop in tomorrow . . .

DISSTON-HKP
 Henry DISSTON DIVISION
 H. K. PORTER COMPANY, INC.
 Philadelphia 35, Pa.

»»»»» MERCURY PIONEERS TWO

1. World's first 6 cylinder 60 h. p. outboard!

NEW MARK 75 MARATHON



• Now in production! *Real* outboard power—and safer, smoother, more maneuverable than any engine you've ever handled! Revolutionary 6-cylinder design... a firing impulse every 60 degrees of crankshaft rotation... the smoothness and flexibility of the finest foreign sports cars... single lever control... greatest operational ease of any outboard... *direct* reversing... with no bulky reverse gears! With super hot ignition, these 6 cylinders start instantly, idle smoothly and slowly... give new definition to low speed operation.

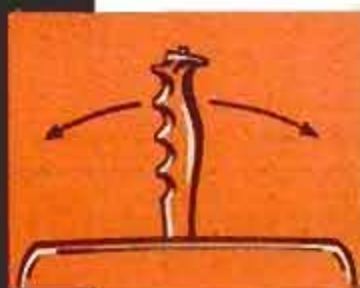

NEW SIMPLIFIED SINGLE LEVER CONTROL. *Throttle, reverse, neutral all on finger-tip remote control.*



16 $\frac{2}{3}$ % LESS PISTON SPEED. *Slow-travelling, short-stroke pistons prolong engine life. Other engines, even at lower rpm, have up to 20% more piston speed than this built-to-last Mercury Mark 75 Marathon!*



EQUAL TO A V-12 IN SMOOTHNESS! *Naturally, a 6-cylinder 2-cycle engine has the same number of firing impulses per revolution as a 12-cylinder 4-cycle V-12! Mercury's famous Full-Jeweled Power* guarantees smooth power longer, too!*

*Anti-friction ball and roller bearings throughout.

MERCURY OUTBOARDS for 1957 »»»»»

REVOLUTIONARY NEW OUTBOARDS!

2. New 10 h.p. Mercury for super-slow trolling!

NEW MARK 10 TROL-TWIN



● The new Mercury Trol-Twin was designed expressly for fishermen! New glide-angle underwater structure slides smoothly over stumps, rocks and through thickest weeds, puts cylinders at their best idling angle for hours of slow trolling. Single lever control . . . throttle, neutral and reverse all on one-hand control. Big displacement for power to plane your boat . . . get fishing fast.

Prop-Jet Exhaust buries exhaust under water and with it the sound. Ask your Mercury dealer about his new easy terms today! You'll be glad you did.



FINGER-TIP TROLLING. Just flick the exclusive Speed-r-Troll Switch! No ordinary throttle can give you idling speeds as low as this . . . or so steady!



ONE-HAND CONTROL! Twist the tiller handle for speed. Twist again for neutral or reverse. One control does everything.



EXHAUSTS THRU PROPELLER HUB! Exclusive Mercury Prop-Jet Exhaust buries exhaust under water . . . leaves it far behind.

Write today for complete color catalog

© KIEKHAEFER CORPORATION 1956

KIEKHAEFER CORPORATION • Fond du Lac, Wisc.

12 NEW MODELS >>> 6 to 60 HORSEPOWER

For Your Windows...

Mortell
Mortite

WEATHERSTRIP

Keeps Heat In—Keeps Cold Out!



WEATHER STRIP WITH YOUR FINGERTIP—Put an end to unhealthy, fuel-wasting drafts—Mortite your windows *now*. Weatherproofs any window *in seconds* at so little cost! Self-adhering—no tacks—no tools—just press in place! Use inside or out—no need to go out in cold to apply. Won't crack, chip or peel...can be used over and over!

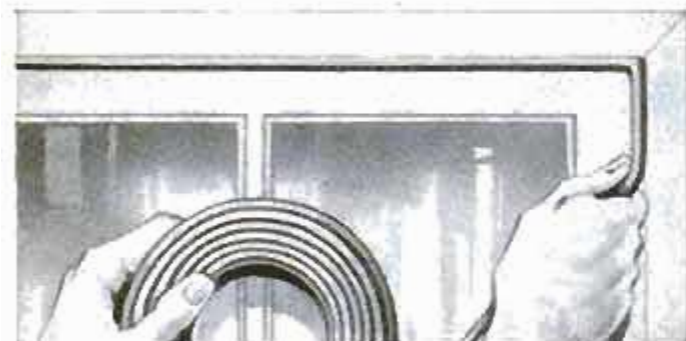

SOFT ROPELIKE STRANDS, EASY TO PRESS IN PLACE—One-quarter-inch diameter Mortite unrolls like ribbon, moulds into place like modeling clay. Ideal as gasket, caulker, even a base for flower stems. Perfect plugger-upper for many home uses all year long!



KEEP **Mortite** HANDY

Available at all leading stores.
Send for Free Folder showing
Mortite uses in, around home!

29¢ • 98¢ • \$1.25

JW Mortell
COMPANY

Serving the Home and Industry Since 1895
522 Burch St. • Kankakee, Illinois

than a foot high, lower the spray nozzle so the drops will fall mostly on the weeds.

Though the ester type is somewhat more hazardous to the corn, it is often used, but in lower doses, throughout the corn belt. The ester type is less affected by rain or dry weather. With plenty of moisture in the soil, rapidly growing corn sprayed in hot weather may be severely injured by either type of 2,4-D at any age.

Weed grasses in corn. It's ironic but inevitable that when we drastically reduce broadleaf weeds in corn, we invite an increase in the weed grasses. Several new products are available as weapons in this new battle. Dinitros, sold under the trade names Premerge and Sinox PE, when applied at a low dosage just as the corn is coming through and the grasses are in seed leaf, will usually wipe out the grasses. Two promising new chemicals in this field, being tested under the trademarks Karmex DL and Randox, may be on the market generally in 1957. TCB is also a new chemical of promise. Karmex DL and TCB may control all weed growth for four to six weeks after application.

Weeds in small grains. Not long ago spring wheat arriving at market averaged more than seven percent weed seeds. This waste not only had to be disposed of, but it probably prevented the production of twice as much wheat. Again, 2,4-D, frequently applied by plane, has worked a revolution. Most of the common small-grain weeds are susceptible, and the gain in crop yield has been almost unbelievable. But again, as in corn, there has been an invasion by weedy annual grasses. Wild oats are now the most serious single weed threat in the spring-wheat area and there is nothing yet on the market to combat them.

Control of brush. Chemicals have reduced the cost of controlling trees and brush by more than half. On most woody plants, 2,4,5-T is more effective than 2,4-D. 2,4,5-T is more expensive than 2,4-D. Mixtures of the two are widely sold as brush killers.

To kill brush, always use low-volatile ester formulations, applied either in water or in oil solutions. Use about four pounds of 2,4-D—2,4,5-T brush killer to 100 gallons of water to kill brush which is in leaf. To prevent resprouting of stumps and brush, or as a basal application to the lower 12 inches of standing trees, apply a solution of 8 to 16 pounds in 100 gallons of fuel oil (not water) liberally to the top and sides of the stumps or tree trunks, so that some runs down onto the root crown. Brush killer or 2,4,5-T is still more effective if

(Continued to page 271)

applied in frills (continuous ax cuts around the trunk). A machine has recently been introduced to do this girdling several times faster. Girdling will kill the tree without chemical application, but the chemical hastens the job and prevents sprouting.

Ammonium sulfamate, sold under the trade name Ammate, is usually deadly to brush in a water solution of $\frac{3}{4}$ to 1 pound per gallon. This same chemical is frequently applied dry or as a strong solution in frills, cups (notches) or on stumps.

Sodium arsenite, known as a tree killer—and a good one—for more than a generation, is not only a deadly poison but actually attracts livestock. Prof. L. C. Swain of the New Hampshire Agricultural Experiment Station has come up with a new technique that eliminates the poison hazard to animals and man and does a better job. He has devised tabs of blotting paper which are saturated with sodium arsenite. The tabs, inserted under the bark every three to five inches around the trunk, will completely kill the tree at very low cost.

Poison ivy. Use any of the brush killers described above, or a new one on the market this year, amino triazole. Ammate or amino triazole is best to use in town, as the drift is less dangerous to other plants.

Canada thistle. This weed draws more cusses than any other in the northern United States and much of Canada. 2,4-D will easily shrivel the tops, but you have to make two applications a year for at least three years to knock out the roots. Amino triazole is the most promising herbicide we've found yet, though it is too early to make definite recommendations.

Quack or couch grass. Another of the most serious weeds in the northern states, quack grass can be controlled in large areas by cultivation. However, where the land is to go into corn or potatoes, try chemical control with a new herbicide called dalapon. The quack grass is permitted to make five to six inches of growth in early spring, then sprayed with 5 to 10 pounds of dalapon in 40 gallons of water per acre. Two to 10 days later the quack grass is plowed. If you want the field for corn you must allow at least 30 days between spraying and planting, since dalapon injures corn.

Soybeans. This crop suffers as much or more than corn from annual weeds. Tests prove three chemicals reasonably satisfactory, dinitro, CIPC, and a product sold under the trade name of Alanap. Alanap does not control smartweed. CIPC does not control ragweed and dinitro is mean to work with. Take your choice, and remember, there is some hazard to the beans with all three products.

(Continued to page 272)

For Your Doors...

Mortell

FOAMFLEX DOORSTRIP

Stops Drafts—Stops Noise!

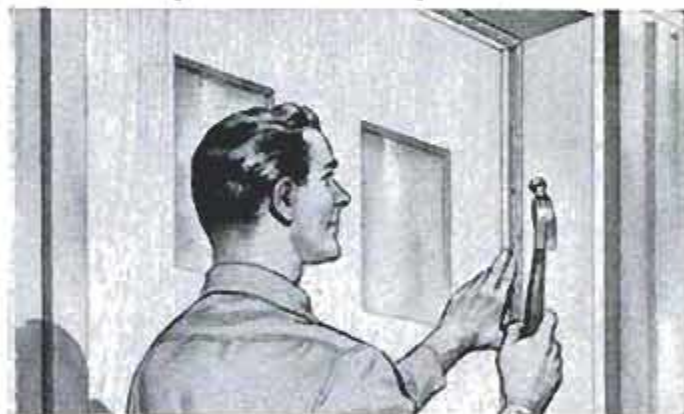

MAKE ANY DOOR AIR TIGHT IN TEN MINUTES— Remarkable new Foamflex snugs up skin-tight—hugs even warped doors—cushions slams and shocks! Use it to replace inefficient weatherstripping. Foamflex nails over present door stop moulding or replaces it entirely. Quick, easy, inexpensive—all you need is a hammer, a saw, a few minutes time—gives a completely draft-free door!



CLEAR WOOD MOULDING AND CLOSED CELL VINYL FOAM— Foamflex consists of water-and-weather proof vinyl foam and $\frac{1}{4}$ " x $\frac{5}{8}$ " wood moulding strips, permanently bonded by an exclusive process. Durable foam edge absorbs shocks, noise, never absorbs moisture! Stays flexible to 50 degrees below zero. Can be painted without hardening!

**ONE SET
\$2.29**



More than enough to weatherstrip the average door—two seven-foot lengths, one three-foot length, package of nails

Your Favorite Hardware or Building Supply Dealer Has It!

**JW Mortell
COMPANY**

Serving the Home and Industry Since 1895
522 Burch St. • Kankakee, Illinois

free

world's most complete
electronic buying guide

ALLIED'S 1957 ELECTRONIC SUPPLY CATALOG

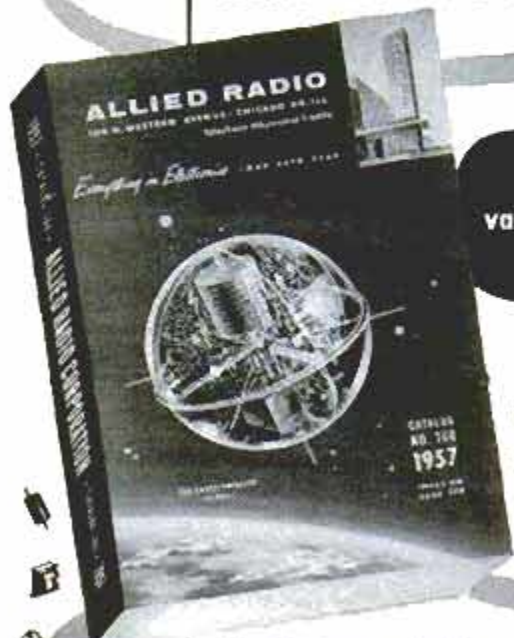

356

value-packed
pages

SAVE on
Everything
in
Electronics

World's Largest Stocks...
Everything For Experimenters,
Builders, Amateurs, Servicemen,
Engineers & Hi-Fi Hobbyists

Send for ALLIED'S value-packed 356-page 1957 Catalog. Save on everything in Electronics: Hi-Fi systems and components; latest builders' kits (see the famous KNIGHT-KIT line); recorders and phono equipment; TV tubes, antennas, accessories; Amateur station equipment; test instruments; industrial electronic equipment; plus the world's largest stocks of parts, tubes, transistors, tools and books. Save on everything in Electronics—send today for your FREE 1957 ALLIED Catalog!

Everything in Electronics
From One Reliable Source

Our
36th year

ALLIED RADIO

ALLIED RADIO CORP., Dept. 5-11-6
100 N. Western Ave., Chicago 80, Ill.

Rush FREE 1957 ALLIED 356-Page Catalog

Name _____

Address _____

City _____ Zone _____ State _____

Sugar beets. Heretofore sugar beets have been a notorious "stoop labor" crop. Chemical control of early weeds in the row has played an important part in the recent complete mechanization of this crop. TCA at five pounds per acre pre-emergence is a standard recommendation for control of annual grasses (except wild oats). Other herbicides are being successfully tried.

Cotton. Cotton, which usually takes the most hand labor for cultivation, has been produced without any hand cultivation by the use of chemicals.

The most generally used pre-emergence herbicide in cotton is CIPC at 6 to 10 pounds per acre. To cut costs, it is usually applied in bands, 14 inches wide or wider, over the rows. With 42-inch rows this reduces the actual amount of chemical to two or three pounds per acre. Use the lower rates on lighter soils. Karmex DL is another pre-emergence herbicide that shows great promise.

After the cotton is up, herbicidal oils may be applied at the rate of five gallons per acre where the cotton is in 40-inch rows. The oil must be directed less than an inch above the soil and may be used not more than three times, at least five days apart. Oil applications must cease as soon as cracks appear in the bark of the cotton.

It is impossible at this stage to make general recommendations on the control of perennial weeds in established cotton. However, Dr. H. E. Rea of Texas has found it possible to control light infestations of Johnson grass by spot-treating them with oils of the Stoddard-solvent type. Obviously this kills the cotton at the point of application as well as the Johnson grass, but so does hoeing, and the oil is both surer and cheaper. Doctor Rea has developed some ingenious solenoid operated sprayers for applying oil from the tractor.

Peanuts. The treatment here is quite similar to that recommended for soybeans. Dinitros and SES used before emergence have given excellent results in controlling annuals, as have most of the other chemicals mentioned for soybeans. So far the control of perennials, such as Bermuda grass, has escaped us, but it seems clear at this stage that complete chemical weed control in peanuts isn't very far off.

Potatoes. 2,4-D is the veteran in this field. It is thoroughly practical as a pre-emergence spray, using the ester type at 1½ pounds per acre in 10 to 20 gallons of water. Spray it one to two days prior to the emergence of potatoes. A warning: Don't use it on sandy soils or in a hot spell.

Strawberries. These have always required costly hand weeding. Preplanting,

(Continued to page 274)

SAVE \$30.30 ON THIS PESCO
HYDRAULIC CONTROL VALVE

ITEM #371V



FOR SAFE POSITIVE CONTROL OF HYDRAULIC CYLINDERS AND MOTORS

—BUILT-IN RELIEF VALVE—(In fact, VALVE—to operate one double acting cylinder) —OPEN CENTER—with valve in neutral, cylinder is locked in position and pump is unloaded. —SPRING RETURN TO NEUTRAL —FULLY BALANCED PLUNGER —EASILY STACKED INTO 2, 3, or 4 valve combinations for multiple cylinder operation. —8 gal. per min. capacity, at 1500 P.S.I. —1/2" pipe ports. —CONNECT PUSH RODS TO HANDLE FOR REMOTE CONTROL —EASY MOUNTING • LIST PRICE—\$46.80. • YOU SAVE \$30.30. —DIMENSIONS—9"x4 1/2"x 2 1/2"—Ship. Wt.—8 lbs. F.O.B. Chicago, **16.50**

BELT DRIVEN A.C. GENERATORS
ITEM #1010



Ideal for powering electric tools, oil burner, refrigerator, lights, or other appliances requiring up to 1000 watts of power. 1000 WATTS. 115 Volts. 60 cycles A.C. 3600 R.P.M. Compact, self-regulating generator with V Belt pulley and double outlet receptacle. Rotation counterclockwise. May be driven by tractor or auxiliary gasoline engine. Requires 2 1/2 HP minimum. Dimensions: 10" long x 8" high x 6" wide. Shipping wt. 27 lbs. F.O.B. Chicago. **79.50**

Model 700 — 750 WATTS (Same as above) F.O.B. Chicago. **59.50**

2000 Watt Generator. **149.50**

BRAND NEW 1 H.P. 12 Volt Electric Motor



• For electric wheel chairs (Pop. Mech. design—Mar.-1953)
• For electric golf carts
• For self-propelled scooters, children's mid-let cars.

ITEM #308
Rated 1 H.P.—100 amps., 5600 R.P.M., 12 volts, D.C.—This double shaft motor of ball-bearing construction may be run on 6 volts for lower horsepower requirements.—Standard 1/2" shafts, flange mountings.—Dimensions: 9"x10"x4 1/2". Ship. wt. 19 lbs. A real F.O.B. value at. **12.50** Chicago

2-H.P.—24 Volts—90 Amps
ELECTRIC MOTOR 4000 RPM
Spline shaft both ends. Style similar to above. Mfgd. by Hobart or Diehl.
ITEM #315
F.O.B. Chgo. **13.00**

GROBAN BARGAINS!
SURPLUS & NEWLY MANUFACTURED
SPECIALS

GROBAN HYDRAULIC SPEED REDUCER



with FINGERTIP CONTROL

USE FOR: • Reamer Drives • Midget Cars • Feed Mills • Canning Machines • Conveyors • Lathes • Milling Machines • Motor Boats • Cream Separators • Garden Tractors • Pumps.

Variable output speeds from 0 to input speed available by moving control handle. Locking handle maintains setting. Use input power of 1/4 to 1 1/2 H.P. Shafts 3/8" diam. Input rotation counter-clockwise facing shaft. Input speed 750 R.P.M. 7 1/2"x1 1/2"x 1 1/2". Output rotation reversible. Gov't. acquisition cost \$428.00. Shpg. wt. 31 lbs. Complete with 2 qts. of oil and full instructions. F.O.B. Chicago. **54.50**

HYDRAULIC LIFT CYLINDERS

• For Fork Lift Trucks
• For Presses • Loading Ramps • Lifts 12500 lbs.
Heavy duty hydraulic cylinders, at big savings.

ITEM #502—4" Bore—36" Stroke—1 3/4" Piston Rod. Wt. 95 lbs. F.O.B. Chicago. **72.00**

ITEM #503—4" Bore—54" Stroke—1 3/4" Piston Rod. Wt. 135 lbs. F.O.B. Chicago. **96.00**

1/4" Metal Stamping Set



STAMP YOUR NAME ON WOOD OR METAL!

Full alphabet A to Z, "&" and period. Precision hand trimmed deep cut, hardened STEEL STAMPS—in fitted Wooden Box—made to rigid U. S. Navy specifications by Young Bros.—Comparable to sets selling for \$27.00. **5.95**

Shipping Wt. 5 lbs. F.O.B. Chicago

HIGGINS BRONZE CENTRIFUGAL PUMP

PUMPS ALMOST ANYTHING

Fine for:— • Irrigation • Sump Pumping • Sewer Drainage
75 gallons per minute @ 2400 R.P.M. Higgins Type PNB, Model R, marine bilge pump. Open Impeller design for handling muddy water. Delivers 75 gallons per minute, 30 foot head with 3/4 H.P. motor. Pump body and impeller are made of solid bronze, with alloy steel 1/2" diameter shaft, 1 3/4" long. Rotation of the pump is clockwise. Inlet has 1 1/2" plain thread. Plain 1 1/2" outlet for hose connection. Shipping weight 23 lbs. F.O.B. Chicago. **23.50**

ORDER DIRECT FROM AD FREE! — NEW CATALOG

SATISFACTION GUARANTEED 1957 EDITION, 56 PAGES, chuck-full of unsurpassed War Surplus and newly manufactured Equipment Bargains for farm, home, factory, workshop. Write letter today.

To place phone orders call Webster 9-3793

GROBAN SUPPLY CO. Dept. PM-11
1139 S. WABASH AVE., CHICAGO 5, ILL.

GENERAL ELECTRIC "MAZDA"
5 1/2" Sealed Beam
110 V. SPOTLIGHTS

THROWS A BEAM TO 1000 FT.
Item #418



Uses conventional 110 Volt current—Fine for lighting up drive-ways, signs, parking lots, displays, garages. Built for use as Flashing Signal for U.S. Navy—to stand heavy surge loads. Shipping Wt. 2 lbs. U. S. Gov't. Cost \$12.68 ea.

Now Each. **2.50** Postpaid

Lots of 3—6.00, Postpaid

HYDRAULIC PRESSURE GAUGE

Also suitable for oil, water, air, steam.

RANGE 0-1000 P.S.I.

ITEM #408



Black cast iron case with 6" diameter rear mounting flange. Bottom connection 1/4" pipe thread. Bushed movement for greater accuracy. Shipping Wt. 3 lbs. Manufactured by H. O. Trerice Co., Detroit, Michigan. Model 41-G-450 —Black numerals on white face. 20 lb. increments within 100 lb. divisions. \$32.60 value—Postpaid. **6.95**

PESCO GEAR TYPE HYDRAULIC PUMP

Compact — Powerful — Reliable

ITEM #160—Especially designed for belt drive from fan belt, power take-off, drive pulley, electric motor or small gas engine. Equally suitable for direct coupling.

Pedestal type mounting with two bolt holes for 3/4" hold-down bolts. Standard 1/2" pipe thread inlet and outlet ports. Delivers 4.5 GPM at 1000 PSI at 2800 RPM with 4 HP. Hardened steel gears turn in dense oilite bronze bearings. Rotation—clockwise facing shaft. Guaranteed trouble-free service. Ship. wt. 6 lbs. F.O.B. Chicago **22.50**

Say You Saw It in Popular Mechanics

IF YOU USE HAND TOOLS—YOU NEED A

HANDI-ROLL \$5.95 POST PAID



HANDI-ROLL makes it easy to carry or store hand tools up to 12" long. 24 spacious pockets keep tools handy, separate. Rolls up for easy carrying by special handle, lock strap. Grommets permit hanging above work bench. (Price does not include tools.) Made of heavy, waterproof duck. Send check or money order to . . .

THE HANDI-ROLL COMPANY, 19934 BILTMORE, DETROIT 25, MICHIGAN

The Modern PLASTIC for lasting Home Repairs

PERMANENTLY mends cracks or holes in wood, tile, stone or plaster. Sticks and stays put—Does not chip, shrink or fall out. Easy to use. Economical. Mold it, chisel it, polish or paint it. The big 4-lb. can is obtainable from your lumber, paint or hardware dealer at \$1.25; or will be shipped direct postpaid (in U. S.) for \$1.50. Complete satisfaction guaranteed or your money refunded.

DONALD DURHAM CO.
Box 804-T Des Moines, Iowa



you know
this means
quality*...



NOW LET'S TALK PRICE!

YOU: Can I get a better 6½" power saw at any price?

US: Not to our knowledge, or to the knowledge of a famous research institute.

YOU: Well, how much do I save?

US: Anywhere from \$10 to \$20! And it has ball bearings for smooth running, a full horsepower motor and the exclusive Automatic Safety Clutch, which increases the work life of the Pet saw up to 15 times.

YOU: How?

US: It eliminates motor burnout, the major cause of saw damage, and kickback, the major cause of accidents. This Pet saw is really the best buy on the market. Only \$49.95. At your hardware dealer's.

* report by a famous research institute proves that this Pet saw equals or excels any other make, regardless of price!

postplanting, and winter herbicides are now available to reduce the cost of growing this crop.

Vegetables. These differ so widely that most crops require different herbicides and different times and rates of application. Therefore, chemicals may do more harm than good to a small plot, and a home gardener should stick to his hoe. Here's a check list for the commercial grower:

Asparagus. Apply the new Karmex DW just after the cutting season at one to three pounds per acre.

Squash, pumpkin and cucumber. Alanap 1, applied as a pre-emergence spray.

Tomatoes. These are extremely sensitive to most weed killers. However, some new compounds show promise for use both in direct-seeded tomatoes or as a preplanting treatment for transplants. Watch for news in this field within a year or two.

Cabbage, cauliflower, turnips, radishes, broccoli and Brussels sprouts. TCA gets the nod here, as it has little effect on the vegetables but brings death to grass weeds and some broadleaved weeds. Some new compounds may kill the most stubborn pests, but we're not sure yet.

Carrots. Here we have the most nearly ideal weed-control chemical, Stoddard solvent or "carrot oil." Just about all growing plants except members of the carrot family are susceptible to this chemical, so one application will knock practically all the weeds out of carrots.

Unfortunately, we don't yet have the equivalent of carrot oil for other crops. If the farmer doesn't make a final clean-up with a hoe or plow, the weeds which are resistant will increase. This brings up a new and irritating situation: Before long he will have as many weeds in the field as ever, but they will be kinds which he cannot control with our present chemicals.

Even if we can achieve the weed-free farm, the farmer still should loosen the soil by at least one cultivation per season. But his work will be easier and his crops won't be fighting a continuous battle for food and sunlight. ★★★

Quieter Airliner Flights

Tests on the Lockheed Super Constellation have shown that the position of the plane's propellers as they spin has a serious effect on the noise level in the cabin. During the tests it was found that the two right engines running together at the same speed made less noise when they were 60 degrees out of phase. Under ideal phasing conditions, the noise level in the cabin can be cut 15.5 decibels, mostly in the low tones which are difficult to muffle.

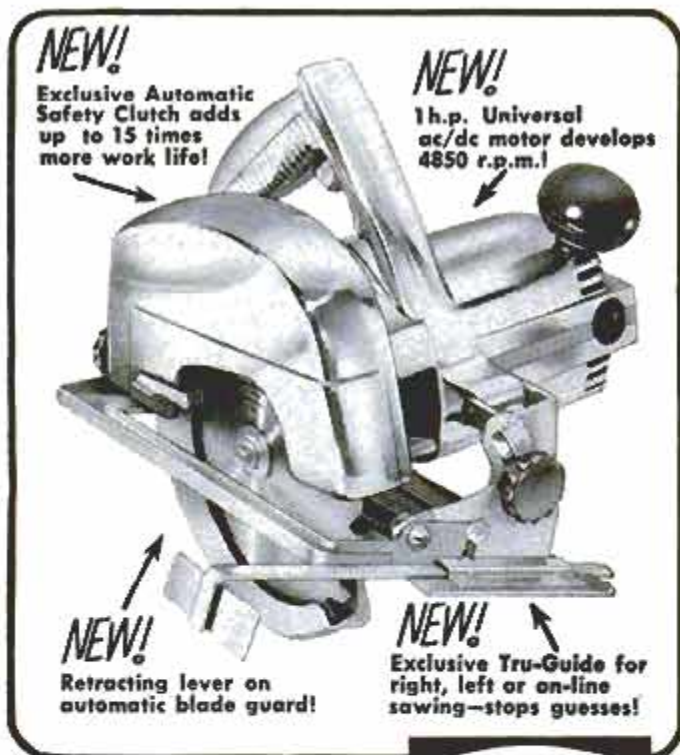

*Those who depend
on their tools depend on*

**JOB
TESTED**

T.M.

PORTABLE ELECTRIC TOOLS, Inc.

Chicago 20, Illinois



HOME HOBBYISTS

check your
work shop H.I.*

before starting
that project...



*HARDWARE INVENTORY

Have you ever had to stop in the middle of a pet project for want of a basic hardware item? No need to lose a valuable evening if you stock up in advance. Practically every one of your projects will require abrasives — sanding papers, sanding discs or grinding wheels. And to keep your tool edges sharp and safe, you'll need sharpening stones. Your nearby Carborundum hardware or building supply dealer has everything to equip your shop — the finest abrasives made to give you more professional results in shorter time.

STOCK UP NOW WITH

CARBORUNDUM

REGISTERED TRADE MARK

FIRST with the **BEST** in everything **ABRASIVE**

● Add these Carborundum time savers to your Hardware Inventory —

● **RED-I-CUT® Sanding Paper** —

Waterproof paper for finishes on lacquer or varnish.



● **GARNET Papers** —

For wood sanding and fine finishing.



● **ALOXITE Papers** —

For wood or metal sanding and finishing.



● **"SAND SCREEN"** —

Open web construction eliminates loading or glazing — lasts up to 15 times longer than regular papers



● **HANDY-SANDY** —

Emery cloth in assorted grits — 4 1/4" x 5" sheets.



● **NO. 109 COMBINATION STONE** —

Dual-grit for sharpening steel blades and chisels



● **NIAGARA® Grinding Wheels** —

General purpose, 3" to 10" diameter.

● **FLEXBAC® Pad** —

For attachment to your electric drill. Gives speedy, smooth disc sanding without swirl marks on both flat and contoured surfaces.



● **HANDY-SANDY DISCS** —

For use with the FLEXBAC® Pad — available in assorted grit sizes.



Start your

DELTA

HOME WORKSHOP

for as little as **\$9.95**



IT'S SO EASY TO OWN THE BEST!

There's no need to put up with second best when you can enjoy real DELTA Quality Power Tools—the fine tools that set the standards for all others—for only 10% down. For instance, as little as \$9.95 is all you need to start a *real* home workshop with the big, brand new DELTA 9" tilt arbor saw. Or for just a few dollars you can take home the new, bigger and better Delta-Shop or the great new DELTA "900" radial saw—or any other DELTA tool.

Your Delta Dealer can help you select the *right* tools for *your* needs because DELTA makes the world's most complete line of both individual and combination tools.

Visit your DELTA Dealer today—he's listed in the Yellow Pages of your phone book. Or see DELTA Homecraft Tools at leading department and hardware stores.

See how *easy* it is to own the *best*!



NEW!

DELTA

9" Tilt Arbor Saw

... starts your shop
for as little as

\$9.95 down

Ideal "first" tool for your workshop because it's the basic tool of all wood-working. Biggest saw value you've ever seen.



NEW!

DELTA

"900" Radial Saw

... yours for as little as

\$23.90 down

World's most powerful, most useful all-purpose 9" radial saw. Rips, drills, cuts, sands, grinds, shapes, cuts mouldings and does many other jobs.



NEW!

Bigger, better

DELTA'SHOP

... complete workshop for
as little as

\$28.95 down

Famous all-in-one workshop now with big, brand new 9" tilting arbor saw, plus jointer, drill press, sander. Does 90% of all woodworking jobs.

Get your free Power Tool Guide



another product by
ROCKWELL



**Delta Power Tool Division,
Rockwell Manufacturing Co.**
502L North Lexington Ave., Pittsburgh 8, Pa.

- Please send me free illustrated Power Tool Guide.
 Please send me names of Delta Dealers near me.

Name _____

Address _____

City _____ County _____ State _____

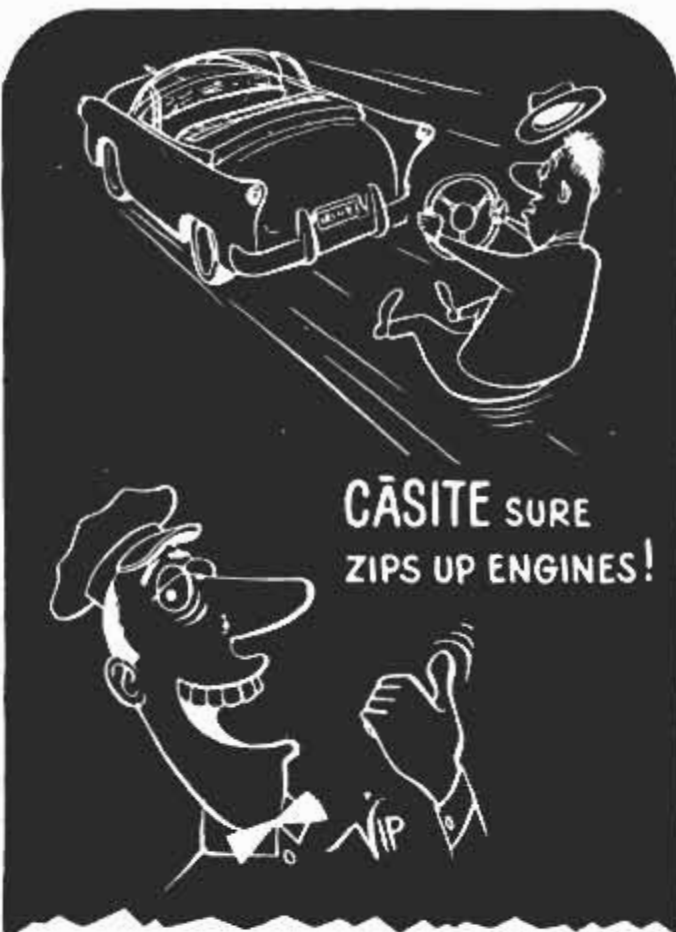

TUNE-UP when you GAS-UP

A pint in the crankcase . . . a pint through the air intake . . . restores pep and performance—frees sticky valves and rings—keeps your engine clean or *Double-Your-Money-Back!*

HASTINGS MANUFACTURING CO., HASTINGS, MICH.

CASITE



Buy these Hastings Products with confidence:
Casite, Wear Reducer, Piston Rings,
Oil Filters, Spark Plugs

How Dangerous Is Fallout?

(Continued from page 100)

Further, the report states that strontium-90, one of the long-lasting fission products, is absorbed by humans, plants and animals. The report concludes by quoting the National Academy of Sciences: "Already some children have accumulated a measurable amount of radioactive strontium in their bodies. The amount, however, is quite small—a thousandth of what is considered a permissible dose."

This seems to bear out the opinion of most experts that the fallout from bomb tests at present is not dangerous, but that man must watch the amount of radioactivity he releases into the atmosphere in the future.

Suppose I were in the danger area, and were subject to fallout from a bomb. What could I do about it?

The Federal Civil Defense Administration hopes and expects that our early-warning network would permit target areas to be evacuated. However, fallout can spread 200 miles or more downwind, so a person unaffected by the bomb itself could still be in great danger. He should take cover, cover as deep as possible. An old-fashioned storm or cyclone cellar would be excellent. Next best would be the basement of a home, with all the windows closed. Any cover would help a great deal. The main idea is to prevent dust from falling on you, and to remain in the shelter until you are told by authorities that radioactivity has fallen to a point where it is safe to leave. Eat no food which has been opened prior to the fallout, and drink no water unless you are sure it has been stored in a sealed container.

Is anything currently being done to protect us from possible fallout?

Yes, indeed. The problem is under continuous study by the Federal Civil Defense Administration. New instruments are being developed to measure this invisible danger. And right now the U.S. Weather Bureau is sending out coded fallout forecasts, regularly twice a day. These forecasts, in the hands of proper officials, would permit them to calculate the fallout pattern from a bomb burst at any point in the country, and warn those in the potential danger area to seek cover. ★ ★ ★

☐ Mexican yams are the source of a chemical from which two powerful new drugs—one for arthritis treatment, the other an anesthetic—have been developed.

BIG
10" x 12"

PROFESSIONAL PLASTIC LAMINATING HYDRAULIC PRESS

DESIGNED FOR HOME USE

- 40-ton Pressure Cast Steel Table Press
- Electrically Heated and Water Cooled
- 3 10" x 12" Laminations at One Time



NEW LARGER PRESS BRINGS BIGGER PROFITS!

The same press used by large laminating firms, now for home use. Steady hydraulic pressure and one heating-cooling operation assure perfect results. Plaques—book covers—signs bring bigger profits in art and commercial fields. Cash in on the demand for large laminations. Increased output will pay for this professional press in no time. Liberal trade-in on smaller presses. Write for details.

FREE Handy scale for computing laminating charges sent to you on request.

WILLSON & GEVERT HYDRAULIC PRESS CO., Inc.
Dept. 112 1369 Lawrence Road, Havertown, Pa.

Find HIDDEN TREASURES

GOLD, SILVER, PRECIOUS METALS with the Famous Model 27 Metal Detector, Lightweight, ultra-sensitive, low cost. None finer. Also GEIGER COUNTERS for uranium and the VIOLITE for tungsten. INFORMATION FREE

THE *Detectron* CORP.
5528 Vineland Ave., No. Hollywood, Calif.



FORD STETHOSCOPE

Brand-New FORD STETHOSCOPE which cost the government many times our low price. For physicians or for industrial purposes. List Price \$8.00. Our Low Price... **\$2.75**
Money Back Guarantee

MATTHEW DAY CO., INC., Dept. 21-M, Dumont, New Jersey

ONE-MAN SAWMILL AS LOW AS \$50.00 DOWN

Take BELSAW Portable Sawmill right to the trees—turn out valuable lumber for home and farm—sell to local yards—make up to \$50 a day custom sawing for neighbors. BELSAW lasts a lifetime. No crew needed. Power with tractor or auto engine. Beginners get excellent results. Send today for **FREE BOOK.**

BELSAW MACHINERY CO.
3457 Field Bldg. Kansas City 11, Missouri

\$40 for 1 1/2 DAY'S SPARE TIME WORK GRINDING LAWMOWERS

Yes, J. H. B. writes, "not bad for a 76 year old young fellow earning \$40 for a day and a half's work" . . . and others are making even bigger money with the Universal Model B Lawnmower Grinder. You, too can make good spare or full time profits in your own business in your garage or basement. We furnish everything you need. Write today. No cost or obligation. Dept. M-116

ROGERS
MANUFACTURING CO.
LINDSEY, OHIO



"Imagine Jim Building This

'Famous Designer' Original for Us!



with Cummins Easy-to-Follow "Famous Designer" plans

and Cummins® Portable Electric Tools



Built of Walnut Weldwood—a product of United States Plywood Corporation.

"The pleasing lines of this Screen-Bar are typical of Edward Wormley's furniture . . . and we're twice as proud of it because Jim built it with plans from our Cummins dealer!"

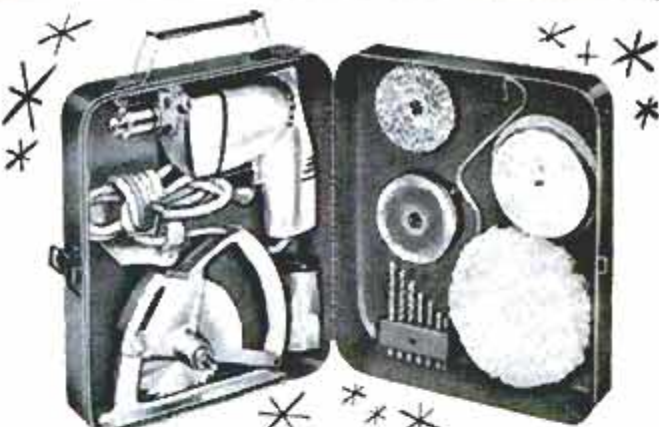

Work faster, easier, more accurately with a Cummins Portable Electric Workshop! Easy-to-use attachments put power on dozens of jobs, drilling, sawing, sanding, polishing and many more! "Organizer" case keeps attachments where you want them! Cummins-built motor means long, dependable service!

Get Screen-Bar plans at your Cummins dealers now (or use coupon below) — see his Cummins tools display!

CUMMINS Model 3052 Drill-Saw Kit Over 35 pieces **\$39.95**
Other Cummins Drill Kits for Christmas gift giving from \$24.95 to \$49.95.
Prices slightly higher in Canada. PM-2

Take this coupon to the dealer displaying this ad, or mail to

Enclosed is 25c in coin. **Cummins Portable Electric Tools**
Send me the Cummins-U. S. Plywood Screen-Bar. "Famous Designer Plan"
Send me information on other plans available.

5055 N. Lydell Ave., Milwaukee 17, Wis.

Name _____
Address _____
City _____ Zone _____ State _____

Made by *John Oster* MANUFACTURING CO.
© 1956 J.O.M.C.



Now! NEW EASE IN SNOW REMOVAL

With Steering Sulky and Self Starter

- Powerful Gravelly Tractor—with *push-button Starter, New Steering Sulky* and *Snowblower*—make snow removal almost child's play!
- You can blow snow—deep or light, wet or dry—wherever you want it, with fingertip maneuverability. 48" Snow Plow also available. 23 year 'round attachments... *All on Easy Pay Plan.*

Write today for FREE 24-page
"Power vs Drudgery" Booklet!

GRAVELLY TRACTORS, INC.
BOX 1163 DUNBAR, W. VA.

FIELD-TESTED SINCE 1922

**TOOL
PROTECTION**

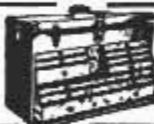

For complete protection to precision tools, house them in a Gerstner Chest. Free Catalog.

GERSTNER TOOL CHESTS
456 Columbia St., Dayton 7, Ohio

**YOU SHOULD EQUIP
YOUR
TRAILER
WITH**

why...



BULL DOG

- AXLE ASSEMBLIES
- JACKS • COUPLERS

BULL DOG straight or drop axles in single or tandem—capacities up to 10,000 lbs. steel axles—any width—and the famous safety-engineered "Torq-Less" axles for all types of trailers.

JACKS—Bull Dog Jacks make hitching and parking a one-man job... easy to install.

COUPLERS—Bull Dog Couplers hitch or unhitch mobile homes in a moment.

Write today for FREE descriptive folder 13-R.

**HAMMER BLOW
TOOL COMPANY**
WAUSAU • WISCONSIN



Chrysler Family Makes Debut

(Continued from page 107)

FireSweep. It shares chassis and sheet-metal parts with Dodge, adding individuality by using De Soto grille, taillights and interiors. Its V8 engine is the single-rocker-arm-shaft design. Wheelbase is 122 inches, same as Dodge's. Over-all length is 215.8 inches, compared to Dodge's 212.2.

The big De Sotos, the FireFlite and the FireDome, have a 126-inch wheelbase and use the double-rocker-arm-shaft engine.

Horsepowers are 295 for the four-barrel FireFlite, 270 for the two-barrel FireDome, 260 for the four-barrel FireSweep and 245 for the two-barrel FireSweep. Displacement of both FireSweep engines is 325 cubic inches, of FireFlite and FireDome engines 341 cubic inches.

De Soto's over-all styling is simple and clean. From the rear, it retains its distinctive vertical row of three lights in each fender. The front grille is essentially a series of unbroken horizontal lines. Four headlights are optional on all except the FireSweep models.

Dodge Has Swept-Wing Styling

Dodge, even more than others in the Chrysler family, has emphasized tailfins.

Wheelbase is two inches longer, but over-all length only a fraction of an inch more. Width is increased by 3.3 inches and height lowered as much as 5 inches.

Wide-set headlights are hooded under forward-thrusting fenders and, being paired with large parking lights, look like dual headlights. This, plus the rugged grille, makes the car appear much wider.

The three-speed automatic transmission, Torque-Flite, is available on Dodge in addition to the two-speed PowerFlight. Retained is the six-cylinder engine for fleet buyers and the few low-power buyers.

The push-button shift is improved by a neutral-start button. The button automatically puts the transmission in neutral when you press it to start the engine.

Displacement is boosted to 325 cubic inches, intake valves enlarged and compression ratio up to 8.5 to 1. Horsepower ratings are: Coronet six, 138 horsepower; the V8s, 245 and 260 horsepower; and the D500, 285 and 310 horsepower.

Plymouth High Styled

With the Corporation putting its big sales effort on the breadwinning low-price field, Plymouth is out to do battle in a body that looks like a dream car.

Aiming for a bigger chunk of the station-wagon market, Plymouth offers some new

(Continued to page 282)

Bench Saw Owners SAVE \$10

SEARS
ROEBUCK AND CO.



1-inch Planer and
Jointer Cutter Bits
shown on head above

SPECIAL PRICE NOW FOR
CRAFTSMAN
REG. TRADE MARK
**Molding
Cutter Set**
Separate
Prices Total **\$9.95**
\$19.95

**SALE
ENDS
Dec. 31,
1956**



You get Molding Cutter Head and
6 Cutter Bits Sets shown. 18 cutter
bit sets available at Sears stores



Cabinet
Door Lip
Cutter Bits



Base Molding
Cutter Bits



Glue Joint
Cutter Bits



1/4 and 1/2-inch
Quarter Round
Cutter Bits



3/8-inch Cove
Cutter Bits

Converts bench saw to a jointer-planer or shaper

We know of no comparable set
selling anywhere near this LOW
SALE PRICE. Planes, joints,
cuts picture frames, molding,
building trim, etc. Number of
designs limited only by your
imagination!

Special analysis steel cutter
head. Positive-grip safety
lock aligns bits. Fits most bench
and radial saws with 1/2, 5/8 or
3/4-in. arbors.

Special heat-treated tool
steel cutter bits; 1 in. wide.
Each bit set contains 3 bits
(shown above at left). In plastic
box, with wrench, spacer washer,
bushings, instructions. See
it at your nearest Sears Retail
Store\$9.95



**CRAFTSMAN Hold-down
Attachment** fits most
bench saws. *Greater
Accuracy* . . . gives constant 4-point pressure.
Greater Safety . . . keeps hands away from blade!
At your Sears larger retail stores and in Sears
mail order catalogs

\$329

CRAFTSMAN Hand and Power Tools by **SEARS, ROEBUCK and CO.**
Famous for fine quality . . . precision performance . . . low price!

ideas in that body style. The rear seat on all eight-passenger wagons now faces rearward, giving the riders an observation-car view as they drive along the highway.

There is also a lockable compartment in the floor at the rear so you can hide your valuables out of sight, something wagons have never had before. To make room for this compartment, the engineers located the spare tire vertically in the left rear fender. When needed, it cranks down out of its protected compartment. The gasoline tank is located in the right rear fender. The rear window cranks up and down for ventilation and is powered on some models.

Wheelbase is now 118 inches, 3 inches more than last year. Over-all height is only 54.8 inches on hardtops. Belt lines (the horizontal line at the base of the windows) is lowered by about 2 inches.

Although these changes make Plymouth look much longer, by measurement it is a fraction of an inch shorter than it was in 1956. Width is greater by 3.6 inches.

Plymouth, like Dodge, retains the six-cylinder engine. It develops 132 horsepower. The 277-cubic-inch Plaza V8 develops 197 horsepower; the 301-cubic-inch Savoy and Belvedere V8s have 215 horsepower; and a power-pack version puts out 235 horsepower. ★ ★ ★

Gunstock for Camera Eliminates "Jitters"

Squeezed against the shoulder, a new gunstock for cameras tends to eliminate photographers' "jitters." The stock will fit any movie or still camera. Used with a still camera, it permits slower shutter speeds. With a movie camera, it helps the photographer follow moving objects accurately as well as with a smooth panning action.



BUILD YOUR OWN *Electro-Voice* HI-FI SPEAKER CABINET!

Assemble a Unique Corner Folded Horn

Electro-Voice KD Kits make it easy to build any of seven single- or multiple-speaker high-fidelity speaker enclosures. Kits contain everything you need, pre-cut, partially assembled pieces, glue, screws, tools. Priced from \$26 (the Baronet kit) to \$118 (the incomparable Patrician Kit).

Illustrated, step-by-step instruction books, 75c to \$1.50. Finishing kits, \$5.

E-V's BUILDING BLOCK PLAN

Here's how to step-up from a single speaker to a multi-speaker high-fidelity system one economical step at a time! Start with an Electro-Voice coaxial speaker, add matched components as your budget permits.

Hear what you can have: See your Electro-Voice Dealer, dial the E-V Systems Selector and listen to the improvement as each component is added to your basic speaker.

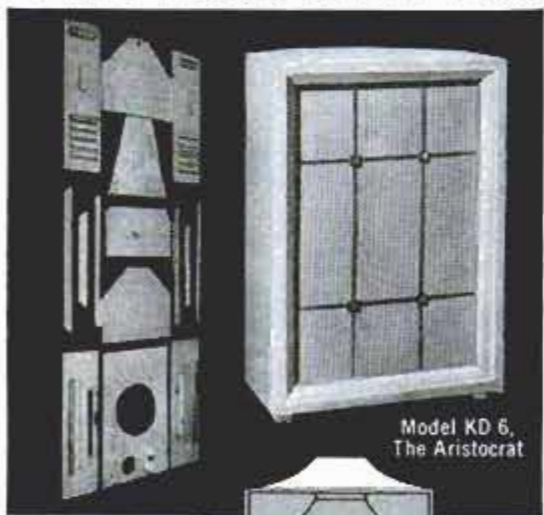

Model KD 6,
The Aristocrat

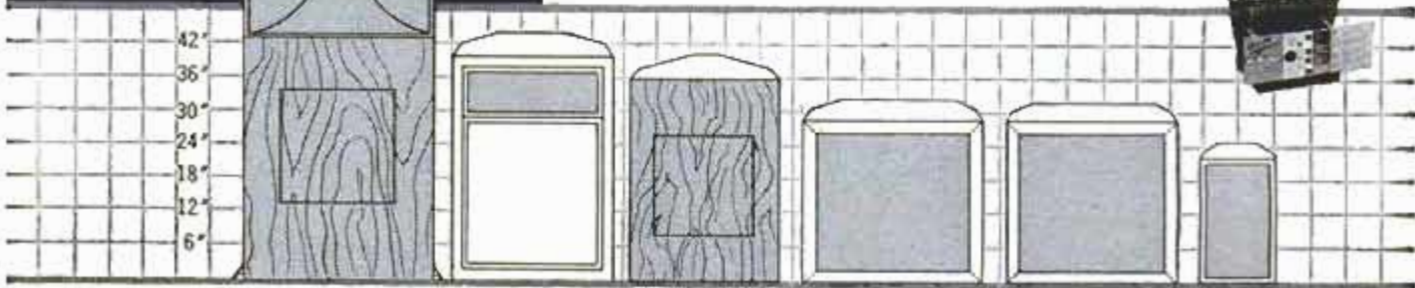

Model KD 1,
The Patrician IV

Model KD 3,
The Centurion

Model KD 2,
The Georgian

Model KD 4,
The Regency

Model KD 5,
The Empire

Model KD 7,
The Baronet

Electro-Voice® ELECTRO-VOICE, INC. BUCHANAN, MICHIGAN
Export: 13 East 40th Street, New York 16, U. S. A. Cables: ARLAB

Write TODAY for
Bulletin PM611.

NEW POWER TOOLS by Shopmaster

New rugged design... exclusive features... professional-like performance. As little as \$10.00 down at your Shopmaster Dealer. Send for FREE Do-It-Yourself Project Plan and Catalog.

24" Radial Arm
DRILL PRESS
positive angle
drilling.

8" Tilting Arbor
CIRCLE SAW...
cast iron table.

6" JOINTER-PLANER
adjustable front
and rear tables.

Shopmaster Inc.

1214 South 3rd Street
Minneapolis 15, Minn.

A Subsidiary of
JONES & LAMSON Machine Company
Springfield, Vermont, U.S.A.

PRECISION-BUILT TO DO THE JOB YOU WANT DONE

FOR BETTER REFINISHING JOBS USE



Klean-Strip
PAINT REMOVER

- Non-inflammable
- Removes any finish
- Fast • Non-messy
- Needs no neutralizing

"Peels
Off
Paint"

New Long Lasting Combination Blade
Roc-Edge 6" SAW **\$1.49**
BLADE ~~7" \$1.59~~ ~~8" \$1.00~~
Fits any power saw. At all Hardware Stores

Holt's HAVE THE ANSWER!

**REPAIR MUFFLER AND
EXHAUST LEAKS in 10 min.**



Simple finger and thumb repair. Guard
against carbon monoxide poisoning. Make
gastight joints when installing new mufflers.
Withstands heat and vibration.

SETS LIKE A WELD—NO TOOLS NEEDED

**Holt's GUN-GUM
MUFFLER SEAL**

\$1.69
Per Can

See Your Neighbourhood Auto Accessory and Parts Replacement Store
TREGLOWN CO. INC., FANWOOD 106, N.J.

TRADE MARK REGD. CANADA: 1366 Greene Ave., Montreal 6 (Price Higher)

Write
for Full
DETAILS

UTICA'S MAGIC BUTTON

makes the
difference



Select-O-Lock*
gives 2 tools in 1

UTICA's brand new SELECT-O-LOCK adjustable wrench gives you two tools in one. Push the magic button—the wrench is locked—just like an open end wrench. Pull the magic button, it's a conventional adjustable wrench.



Push—it's Locked!



Pull—it's Unlocked!

See the new SELECT-O-LOCK, No. 93, adjustable wrenches in 6-8-10 and 12 inch sizes at your hardware dealer.

*PATENTED



THE HALLMARK OF QUALITY



*New! Beautiful!
Life-Like!*

Full
Color

GIANT PASTE-ON, CUT-OUT XMAS LAWN DECORATIONS

New way to say "Merry Christmas" to the entire neighborhood. Bright colorful Christmas figures for beautiful king-size lawn, roof and window decorations. Printed in sparkling full color on heavy paper. All you do is paste pattern on fir plywood and cut out with saw. It's easy. Anyone can do it. Order today!

Jolly 6-Foot Santa
(plus 24" Xmas
Wreath cut-out) **50c** each

Two 4-Foot Angels
(plus 24" Xmas
Candle cut-out) **50c** pair

Three 4-Foot Choir Boys
(plus Xmas Music
Scroll cut-out) **50c** set

Shipped prepaid in heavy cardboard tubes. Offer good USA only. Sorry, no C.O.D.

DOUGLAS FIR PLYWOOD ASSN. Dept. 9, Tacoma 2, Wash.

Kean Kutt says...



**SHARK
BRAND**

SWEDISH CHISELS
MAKE HARD JOBS
EASY because of

SWEDISH CHARCOAL STEEL

The steel used in Shark Brand Chisels contains fewer impurities than steel made with coal or coke and when it is properly annealed and tempered becomes tough but not brittle and therefore they hold their edge much, much longer.



...but there's more to why Shark Brand Chisels outlast and outperform ordinary chisels. Ask for them at your hardware dealer... write for new free booklet Dept. PM

Sandvik STEEL, INC.

Saw & Tool Division
1702 NEVINS RD., FAIR LAWN, N. J.

IN CANADA: P.O. DRAWER 1330, STATION "O," MONTREAL 9



Ford Family is Lower, More Powerful

(Continued from page 112)

rings or doughnuts soften both these actions. They roll and flex just like the big tires on the wheels, softening road vibrations and driving torque.

Newly designed rear-spring bumpers reduce windup during acceleration. An improved shock absorber dampens extreme wheel movement while driving fast over chuck holes or on washboard roads. All body mounts this year are rubber insulated, there being no tire-carcass insulators as in previous years.

A left-hand-operated keyboard is used to shift the automatic transmission. The neutral-start button simplifies things. To start the car you turn the key and depress the neutral-start button. This puts the transmission in neutral and operates the starter simultaneously. An emergency-brake release button (a foot-operated "hand" brake is used this year) is also part of the control keyboard.

Carburetor air is drawn from inside or outside the engine compartment, depending upon temperature. This reduces choke time under freezing conditions by as much as 50 percent, saving gasoline and minimizing crankcase dilution. When the engine is hot, cooler and denser air is drawn in from outside to increase power.

An automatic clutch allows the engine fan to free wheel at speeds over 40 miles per hour, increasing horsepower at the rear wheels slightly (however, even a trained engineer cannot sense the difference without a stopwatch). The real important gain is not the added horsepower, but the noise reduction. At high speed (when a fan is not needed at all) much of the engine noise is air turbulence caused by the fan whirling at as much as 5000 revolutions per minute. Free wheeling eliminates this and, as an obvious bonus, increases power slightly.

Mercury offers two engines: A 312-cubic-inch V8 of 255 horsepower and a 368-cubic-inch V8 of 290 horsepower. Both have a 9.75 to 1 compression ratio.

The body is longer by five inches. Wheelbase is now 122 inches, an increase of three inches. Over-all height is lowered by three inches. Width is greater by three inches where it counts—in the seating area as well as over-all. Despite a lowered roof, headroom is about the same (a fraction greater) in the front seat and two inches greater in the rear.

Mercury is saving its top line, the Turnpike Cruiser, for introduction at the New

(Continued to page 288)

There's Big money in arc welding!

See how it pays with the new low cost Hobart welder. One of these easy to use models can become your key tool, in fact, the very method of putting you in business and more money in your pocket. Double earnings doing construction work. Cash in on the big demand for emergency repair work. Now is the time to get started. Get a HOBART welder. Hobart Brothers Co., Box M-116 Troy, Ohio, Ph. 21223. HOBART TRADE SCHOOL . . . learn arc welding quickly by actual on-the-job experience. Complete or partial courses. G.I. approved. Non profit.

Hobart "One of the world's largest builders of arc welders and arc welding equipment."

HOBART BROTHERS CO., BOX M-116 TROY, OHIO

Without obligation, send complete details on:

- 200 amp. "HUSKY BOY"
 200 amp. "BANTAM CHAMP"
 200 amp. TRANSFORMER
 AC POWER-AC WELDER COMB.

free
 "Vest
 Pocket Guide
 for Welders"

Name _____

Address _____

City _____ State _____

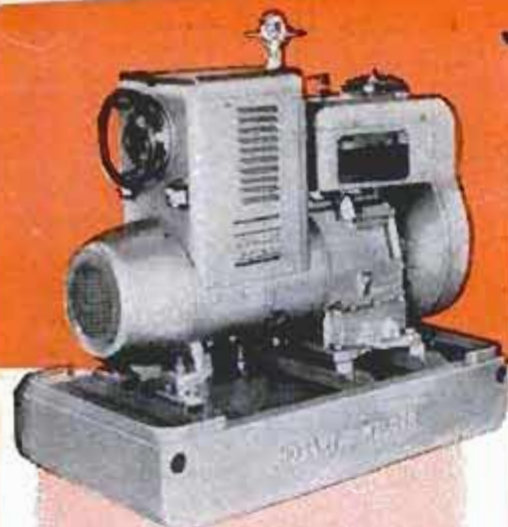

A real PROFIT MAKER

for emergency repair jobs "Husky Boy"

Hobart's 200 amp. air cooled engine driven arc welder welds anywhere!

Investigate these MONEY-MAKERS today!

200 amp. light weight, low cost "BANTAM CHAMP" is specially designed to let you do production and repair work in your own shop.



200 amp. TRANSFORMER AC welder for operating on single phase 220 volt power. Ideal for shops that would like to do production and repair work.



200 amp. AC Power-AC Welder Combination. Four cylinder air cooled engine. Furnishes current for welding-power for running tools, lights, etc. Mounts easily on truck or trailer.



Welding lessons book. 200 pages self-teaching... only \$1.00

Check the COUPON! investigate these money-makers today

DO MORE PLANING JOBS WITH LOW COST BELSAW



Exclusive MONEY-MAKING Features: Full 12 3/4" x 6" capacity • Power feeds at 14' to 34' a minute • Provides for Grinding Knives in the Cutter-head • Attachments for Jointing, Rabbeting, Tongue, Matching, Groove. Convert low cost rough lumber into high priced stock. Easy to make flooring and popular patterns. Send Today for FREE Literature and Prices.

Belsaw Machinery Co., 2057 Field Bldg., K.C. 11, Mo.

LOW DOWN PAYMENT EASY TERMS

LUBRIPLATE
 IN HANDY TUBES
 KEEPS RUST OFF GUNS,
 MAKES REELS RUN SMOOTH



TRY LUBRIPLATE! Not an old-fashioned oil that runs off or gets gummy. LUBRIPLATE is a new, white and clean, semi-fluid lubricant that stays put.

• In handy 25¢, 50¢ and \$1.00 tubes at Sporting Goods, Hardware, Marine and Auto Supply Stores.

• Dealers write to LUBRIPLATE DIVISION, Fiske Bros. Refining Co., Newark 5, N.J.

LUBRIPLATE
 THE MODERN LUBRICANT



NOVEMBER 1956

FOR SKILLED WOOD-WORKERS ONLY!

No. 2500
 \$59.95



SYNCR0
 2500
JIG SAW

At last—a jig saw designed only for the few real homecrafters who demand, use and appreciate the best in tools! This heavy 62 pound ruggedly constructed Syncro "2500" slices thru 2 x 4's or cuts intricate designs with almost unbelievable accuracy and smoothness. The entire arm—not the table—tilts 45° to either side. Powered with Syncro's latest Reciprocating Motor—guaranteed against burn-out during ownership. Sure, 2500 costs you more but it does more than others costing more! This masterpiece—designed for master wood-workers only—is already a favorite of industrial wood pattern-making shops. So new your tool dealer may not have it. Write for Free details.



Table stays level; arm tilts; beveling is easy.



Full 30" Throat

SYNCR0 CORPORATION
 DEPT. 1-86, OXFORD, MICHIGAN, U.S.A.
 WORLD'S LARGEST MAKERS OF RECIPROCATING MOTORS

285

SEALS HEAT IN... SEALS COLD OUT



Bridgport INNER-SEAL
WEATHER **Live Rubber** STRIPPING

Guaranteed by Good Housekeeping

Get a warmer, more comfortable home AND save up to 20% on fuel costs with INNER-SEAL weather stripping on your doors, windows, storm windows!

INNER-SEAL is waterproof, tough, flexible; easy to install; lasts for years. Spring steel wire molded in neoprene-coated sponge rubber assures tight seal. Has Good Housekeeping guarantee.

Buy it in exact-length "do-it-yourself" paks or in bulk at hardware, variety stores, building suppliers. Get free weather stripping booklet "Why Shiver" from dealer or write Dept. PM.

BRIDGEPORT FABRICS, INC.
200 HOLLAND AVE., BRIDGEPORT 9, CONN.

A perfect paint job with half the trouble. Get your money's worth. Paint shaken on a Red Devil Paint Conditioner is ready to use right out of the can. Paint is perfectly mixed factory-fresh—needs no stirring. Ask your dealer to mix your paint on a

Red Devil PAINT CONDITIONER



FREE

How to Prepare Surfaces for Finishing. Illustrated instructions on preparing masonry, wood and metal surfaces for painting.

Red Devil Tools, Dept. 150
2400 Vauxhall Rd., Union, N. J.

Please send FREE copy of "HOW TO PREPARE SURFACES FOR FINISHING."

NAME _____
ADDRESS _____
CITY _____ ZONE _____ STATE _____



AMAZING NEW "ARCO-SAW" CUTS ANY GROOVE!

WHIZZES THRU 2x4's!

Not even a \$100 Portable Saw has a dado cutter! "ARCO-SAW" (fits any 1/4" drill) with new "Dado-Arbor" adjusts easily to cut any size groove up to 1/2" wide x 1" deep in ONE CUT! Graduated Depth-Bevel-Rip Gages adjust for depth of cut up to 1 3/4", angle cuts to 45°. "Dado-Arbor" swivels sawblade to cut large grooves cleanly and accurately and is easily removed to use the saw for straight or angle cuts. Right angle steel gear drive and safety-yoke permit ONE HAND operation. Includes 5" Blade. **\$12.95**

SOLD AT BETTER HDWE. STORES EVERYWHERE. If not available, order direct with handy coupon on our MONEY BACK GUARANTEE.

Arrow Metal Products Co., Dept. PM-11, 140 West Broadway, N.Y. 13, N.Y.

— MAIL THIS COUPON TODAY! —

- Please send on Unconditional 10-Day Money Back Guarantee:
- No. 456 "Arco-Saw" **\$12.95**
 - Extra "Arco-Saw" Blades (Specify Style Below) **\$1.75**
 - Rip Crosscut Combination Safecut
 - No. 550 "Arco Jig-Saw" **\$10.95** } SEE "ARCO JIG-SAW"
 - No. 401 "Arco Stand" **\$2.95** } AD ON OPPOSITE PAGE
 - 6 Extra Jig Saw Blads. **\$1.95**

Name _____
Address _____
City _____ Zone _____ State _____
 Check, M.O. Ship ppd. C.O.D. plus post.
Arrow Metal Products Co., Dept. PM-11, 140 West Broadway, N.Y. 13, N.Y.

MAGNETS

5 Assorted Size Magnets \$1.00. Powerful Pocket Magnet w/ case \$1.00. Hot Pad Magnets—large size \$1.00. Bulletin Board Magnets \$1.00. Slender Magnets—pencil type 2/\$1.00. Retrieving Magnets—extra power, heavy duty—30 lb. pull \$4.00, also 50-75-100 lb. pull. Explore, learn Electricity, Magnetism, Electro magnets, complete kit and instructions with 22 experiments and models. . . . \$7.95
TRANSISTOR RADIO KIT—all parts & instructions—powerful. . . \$7.95
Also—Rods, discs, bars, horseshoes. Send stamp for catalog. Specify your requirements—100% SATISFACTION GUARANTEED.
PARK MAGNETS, 2611, 1557 GREENBAY RD., HIGHLAND PARK, ILL.

Say You Saw It in Popular Mechanics

NOW—THE QUICK-WAY TO SHARPEN ALL CIRCULAR SAWS



Model PG-12 Complete No extras to buy. **\$16.50** Postage Paid

NEW
Model PG-12 sharpens, joints, gums, and retoots all cross cut, rip, combination, miter, and planer blades up to 12" in diameter. Two precision index plates give versatile, accurate sharpening. Guarantees precise spacing of teeth. New safety rest prevents tilting and gouging of blade. Save time and money. Special \$3.00 grinding wheel also included for use on your own power table. Fits regular or radial swing tables.

Order today. Send check, cash, or money order. We pay postage. FREE Booklet—"How To Sharpen Saws."

QUICK-WAY SAW CO.
136 TOMPKINS ST. CORTLAND, N. Y.

"ARCO JIG-SAW"

WITH EXCLUSIVE NEW
CIRCLE-
CUTTER
& RIP
GAGE!



"ARCO JIG-SAW" IS A PORTABLE SAW
AND CAN BE USED AS A TABLE SAW!

(with "Arco Stand" shown at right). Another "ARCO" FIRST! "Arco Jig-Saw" (guaranteed to fit any 1/4" drill) with Adjustable Circle-Cutter & Rip Gage saves hours of work—assures professional-looking results everytime—whether cutting circles, curved patterns, or straight cutting. Cuts perfect circles any size up to 20" diameter; rips accurate widths any size up to 10" wide. Has same capacity and cutting speed as \$55 jig saws. Does work of Jig, Keyhole, Coping, Rip, Cross-cut, Band & Hacksaw! Built-in "Air-Jet" blows away sawdust. Cuts intricate patterns—however large—in plywood, plastics, metals—even cuts 2x4's! Starts inside holes. Includes blade.

\$10⁹⁵

"ARCO STAND" — Casting & Clamp \$2.95
6 Extra Assorted Blades \$1.95

SOLD AT BETTER HOWE. STORES EVERYWHERE. If not available, order direct with handy "ARCO" coupon on opposite page and try both "Arco-Saw" & "Arco Jig-Saw" on our UNCONDITIONAL 10-DAY MONEY BACK GUARANTEE. Send check or M.O. (ppd.). C.O.D.'s—plus post.

ARROW METAL PRODUCTS CO.

Dept. PM-11, 140 WEST BROADWAY, NEW YORK 13, N. Y.

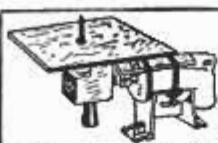

Converts to Table Saw



Ripping with Gage

Give a Wanted Christmas Gift

MAKE HOME AND SHOP
REPAIR JOBS EASY
WITH THIS

Snap-on

HANDY TOOL SET
No. 2022-HB

\$57.45



Here, in one convenient set, are the basic tools the handyman needs for a variety of home and shop repair jobs and hobby work. Makes a wonderful Christmas gift.

Made by Snap-on — first choice of professional mechanics — this set contains hammer, Phillips and standard-tip screwdrivers, screw starter, six open-end wrenches 3/8 to 15/16 in., three types of pliers, two adjustable wrenches, vise-grip wrench, pipe wrench, hack saw, steel rule, file, tin snips and putty knife. Set fits neatly in strong, heavy-gauge steel box.

Snap-on tools are quality-built to outlast and outperform. Order your set now. Send check or \$5 down on c.o.d. orders.

* Snap-on is the trademark of Snap-on Tools Corporation

SNAP-ON TOOLS CORPORATION

8062-K 28th Avenue • Kenosha, Wisconsin

Enclosed is \$57.45 (\$5 on c.o.d.)

Send Set No. 2022-HB to:

Send catalog

Name

Address

City Zone State

SAY YOU SAW IT IN POPULAR MECHANICS

The CHRISTMAS GIFT for a Lifetime Enjoyment

**NOW! HOME CRAFTSMEN CAN OWN
THIS PROFESSIONAL ARC WELDER**

EASY TERMS
ONLY \$98⁵⁰
F. O. B.

Now you can own a Trindl full 125 amp Industrial Welder at a price far less than smaller machines. With a Trindl 125A you can weld metals up to 1/2 inch thick. Operates off either 110 or 220 volt line, properly wired. 16 heat stages from 20 to 125 amps. Make and repair anything of metal around the home, garage, farm or shop, like a professional. No previous experience or training needed. Full "do-it-yourself" instructions with each machine. Complete only \$98.50 f.o.b. factory, or write for details. Trindl manufactures a complete line of heavy duty welding machines. Dealer inquiries invited.

TRINDL PRODUCTS Ltd., Dept. T2-M
1807 So. Clark St., Chicago 16, Ill.



Guaranteed
12 MONTHS
IN
CONTINUOUS
OPERATION



FREE

WRITE FOR
COMPLETE
DETAILS AND
EASY PAY PLAN



WIZARD POWER TOOLS
...built to make it and take it!



WIZARD 6 1/4" PORTABLE SAW: Cuts 2x4 at 45°. Adjustable cut to 2 1/8". Powerful 7 amp. motor. Special slip-clutch prevents motor burn out. With rip guide and safety guard **\$39.95**
Other models \$29.95 to \$52.95

Team up with WIZARD for a faster, easier job. These rugged tools are compact, easy to handle, yet big enough for any home project. Check the complete line of power-packed WIZARDS at your nearby Western Auto Store before you buy *any* tool . . . then

JOIN THE MILLIONS WHO KNOW THAT YOU GET MORE TOOL PER DOLLAR WITH WIZARD THAN WITH ANY OTHER NATIONAL BRAND!

WIZARD 1/4" DRILL:
 Powerful, 2 amp. motor. Geared chuck. Locking trigger. Accessories and kits are available. . . . **\$19.50**
Others \$12.50 to \$49.95



Wizard 
 OVER 400 ITEMS FOR THE WORKSHOP
Sold Nationally by

Western Auto
 STORES AND ASSOCIATE STORES
 NOTE: In some areas of the U. S., Hawaii, Alaska, and Mexico, prices slightly higher. Western Auto Associate Dealers own their stores, set their own prices, terms and conditions.

York Auto Show in December. It is expected to be loaded with exciting innovations although it must necessarily use much if not all of the same sheet metal as these models.

Lincoln for 1957

Principal styling changes in the Lincoln are in the rear fenders and the front headlight arrangement. It is longer by two inches than in 1956 but the added length is in the bumpers.

Rear fenders cant outward in a bold fin shape. Arranged vertically in front are two pairs of headlights (optional in states that permit them).

One all-new body is offered, a four-door hardtop. Continued is the four-door sedan with a slenderized center pillar.

The top two headlights are standard seven-inch units. The lower two are smaller auxiliary driving lights that can be turned on or off independent of the top lights. With all four lights on, there is 50 percent more light on the road. The lower location of the auxiliary lights makes shadows larger so objects on the road become more apparent.

The engine has a redesigned combustion chamber and develops 300 horsepower with its 368 cubic inches. Compression ratio is 10.0 to 1. Four-barrel carburetors and dual exhausts are standard (the tail pipes end below the rear bumpers out of sight where they do not soil the chrome).

Other important changes include a smaller turbine in the torque converter to permit increased engine speed for breakaway acceleration. An extra-cost locking differential minimizes slippage on ice. Adjustable shock absorbers (adjustable by dealer) are also optional.

Another optional feature is an electric door-locking system. By pushing a dashboard button you lock all four doors at once (a light flashes if a door is not fully closed). You still have to lock them individually when you leave the car, however. Power-operated vent windows are another optional feature.

Standard on all Lincolns is a warning light in the fuel gauge that tells the owner when he's down to three gallons of gas. ★ ★ ★

Self-Developing Camera Now Takes Transparencies

Photographers are now able to take black-and-white transparencies with the Polaroid Land camera. The transparencies are made by a new high-speed film (ASA equivalent 800 daylight) and can be made in either 2 1/4 by 2 1/4 or 3 1/4 by 4 inches.

IDEAS FROM WELDWOOD

THIS MONTH'S PROJECT— BUILDING CHILDREN'S FURNITURE FOR CHRISTMAS

This Christmas, you can have a richly rewarding time, and save money on Christmas presents, by giving your children furniture and toys you built yourself. And there are plenty of project ideas in the just completed 144-page book "Children's Furniture You Can Build." (See coupon to get your copy.)

Building any one of these pieces of children's furniture—like those shown on the right—really isn't hard. The well-illustrated book gives careful step-by-step directions. And, to insure your satisfaction, author-designer Bill Baker recommends Weldwood products be used. Weldwood hardwoods—like Samara* and Nakora*—are inexpensive, easy to work and strikingly beautiful. And old-time favorites—like Weldwood fir plywood and Weldwood glues—are used to make even hard-looking jobs easier. You'll find that both amateur and professional woodworkers enjoy using Weldwood products because they can be sure of extra quality.

So, for Christmas gifts your children will enjoy using and you'll enjoy making, send for "Children's Furniture You Can Build."

*Trademark



Old-fashioned cradle is made of Weldwood birch plywood.



"Desk 'n' shelves" solves youngsters' toy storage problems.



Wardrobe-Chest of Drawers will delight any young Miss.



Ride 'em cowboy, on a safe, sturdy Weldwood Rocking Horse.

This Month's Hint

To make a stronger than normal water-mix putty, substitute Weldwood Presto-Set Glue for the water. W. S., Elmira, N. Y.

The Weldwood Question Box

Q. I want to install some Micarta® with Contact Cement, but I'm afraid I won't position the Micarta correctly and—since Contact Cement bonds instantly—I'm afraid I'll ruin the job. Any suggestions?

A. Actually, it's pretty hard to go wrong if you follow these di-

rections carefully. (1) Coat both surfaces with Contact Cement and let dry. (2) When the surfaces are dry, put a sheet of paper covering the surface on which the Micarta is to be placed. (3) When that's in place, position the Micarta carefully . . . slowly pull out the paper, pressing the Micarta in place. The

Micarta will bond instantly and permanently.

However, if your hand wobbles, or if you *do* make a mistake, good lacquer thinner will dissolve the bond temporarily and allow you to remove the Micarta. After a short drying time, the bond may again be made without additional Contact Cement.



Weldwood®

A product of

United States Plywood Corporation
Weldwood—The Best Known Name in Plywood

United States Plywood Corporation
P. O. Box 191, Greenwich, Conn.

PM 11-56

Enclosed find 75¢ for which please send me the Fawcett Book "Children's Furniture You Can Build," by Bill Baker.

NAME.....
ADDRESS.....
CITY.....STATE.....

It's **QUICKER...Works SLICKER** with

WISE-GRIP



Put a "handle" on work when using power tools! Holds tiniest work with ease—and SAFETY!

Does More Jobs Easier Than Any Other Tool Made!



No. 10W, 10" \$2.60

A squeeze of the hand locks jaws onto work with ton-pressure! Quickly adjusts for use as All-Purpose Wrench, Super-Pliers, Clamp, Wire Cutter, 7" and 10" cutter optional. \$1.85 to \$2.60 at your dealer.

Made By PETERSEN MFG. CO., Dept. M-11, DeWitt, Nebr.

Makes EVERY JOB EASIER

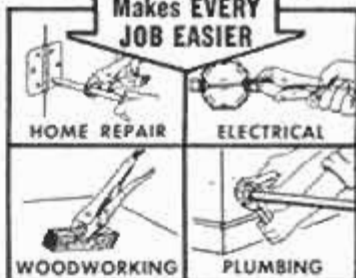

MENDS MOST ANYTHING

"HOLDS LIKE IRON"

Used by fine furniture makers. Ideal for home and office. In 3/4 oz. or 2 1/2 oz. sizes.

NEW 1957 EDITION JUST OUT!



Get This Giant Catalog Of

WOOD & WOODWORKING MATERIALS

TOOLS—PLANS—SUPPLIES

World's Largest Selection of Finest Domestic and Imported Woods ... Mouldings, Hardware Tools—ALL AT LOW MONEY SAVING PRICES!

Your complete wood buying guide and project book. Craftsman is your best, most complete source of finest kiln-dried domestic and rare imported woods, beautiful wood inlays, colorful bandings, matched plywoods, embossed mouldings, carved ornaments, newest woodworking tools, "hard to find" cabinet hardware and fittings ... more than 1,500 items! Packed with newest scroll saw patterns, project ideas and money making plans. Enclose 25c (refunded with first order) to help pay mailing, handling cost. Write

Craftsman Wood Service Co., Dept. A-11
2729 S. Mary Street, Chicago 8, Ill.

132 PAGES

Many in full color

packed with rare, fancy & imported woods ... veneers, plywoods, patterns, tools, ornaments, hardware ... everything for the woodworker.

MAIL COUPON NOW!

CRAFTSMAN SERVICE CO., Dept. A-11

2729 S. Mary Street, Chicago 8, Ill.

Enclosed find 25c. Rush WOODWORKERS' CATALOG.

NAME _____

ADDRESS _____

CITY _____ ZONE _____ STATE _____

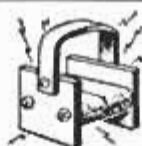

GENUINE ALNICO MAGNETS

AMAZING, PERMANENT, NON-ELECTRIC, HIGHLY PRACTICAL. Conduct interesting experiments. Hundreds of uses. Retrieve valuable steel items such as guns, tanks from fresh or salt water; tools from tanks & drains. **GUARANTEED.** Try any magnet one week. Money back if you are not well-pleased.

No. M-710 Has pull of 225 lbs. on flat steel block \$16.50
No. M-625 Has pull of 125 lbs. on flat steel block \$9.50
No. M-575 Has pull of 75 lbs. on flat steel block \$6.50
No. M-500 Has pull of 50 lbs. on flat steel block \$4.50
No. M-47 Hot Pad Magnets, 10 for \$1.00 \$1.00
No. M-35 Hobbyist assortment of 8 small magnets \$1.50

Send M.O. or check. We pay postage. Sorry no C.O.D.'s.

MIAMI MAGNET COMPANY, 3240 N.W. 27th Ave., Miami 42, Fla.

HEAVY OIL-PH-BALL BEARINGS PUMPS MILLIONS OF GALS.

695 CELLAR & SUMP DRAIN 7500 G.P.H. Pump, Stand, \$14.45
Legs, Coupling, Hardware.

IRRIGATE, SPRAY, DRAIN OR FILL ANYTHING—ANYWHERE! Will not Rust—Clog—or Leak. Patented Seal, Pumps 2800 gph, 420 gph at 75' high or 1800 gph from 25' well. Six blade impeller. Threaded for pipe. 3/4" inlet, 1/2" outlet. Use 1/2 to 3/4 hp motor ... 7500 gph 9.95
Heavier 2800 gph 6.95
Check, MD or COD—Lifetime Trade Guarantee
FREE Literature—Comparison Charts

U. A. T. ENG. & MFG. CO. HICKSVILLE 273, NEW YORK

Works in seconds!

Loosens Rusted Bolts nuts, screws, "frozen" parts!

LIQUID WRENCH

AT HARDWARE STORES, GARAGES SERVICE STATIONS EVERYWHERE

For information write manufacturer
Radiators Specialty Co., Charlotte, N. C.

SAY YOU SAW IT IN POPULAR MECHANICS

ELECTRIC WELDER AC or DC 110 Volts

The "Little Marvel" all-metal welder, 5-year written guarantee. Welds 1/8" metal or money back. Repairs tanks, tools, fenders, machine parts, etc. Complete with everything—rods, unit, eye shield, directions. \$6.95 plus 50c postage. Flame torch accessory for soldering, cutting, brazing \$3.95 complete with carbons, brass rods, flux. \$2.00 Deposit on C.O.D. 75 ampere 1/4 inch Transformer Welder \$21.95 F.O.B.

ESSAY MFG. CO., Dept. 51, Quincy 69, Mass.

\$6.95 Complete

FREE AMAZING NEW BOOK "HOW TO ANSWER ADS"

Never before have you seen anything like this. Tells you in simple language the correct way to answer ads. Gets you quicker replies—better results, and greater satisfaction. Will save you time and money and it's **ABSOLUTELY FREE.** No obligation whatever. Every reader of advertising should have this booklet. Send a postcard for your copy NOW. F. W. JOHNSON, Popular Mechanics Magazine, Room 600-A, 204 East Ontario Street, Chicago 11, Ill.



POPULAR MECHANICS

BUILD YOUR OWN POWER TOOLS-

PLANS
only
1.00
EACH
POSTPAID

With

GIL-BILT PARTS-PLAN

KITS

10" TILT/ARBOR SAW



Sturdy wood, steel, and aluminum construction. NEW DEPARTURE ball bearings. Capacity and performance of floor saws selling for \$150.00 and up. Plans, all metal parts in kit with 10" comb. blade \$25.90, less blade \$22.95. F.O.B. St. Louis. Detail PLANS—PATTERNS only \$1.00 postpaid.

12-IN. BAND SAW

Ball bearing drive, rigid cast aluminum wheels, rubber tires. Handles stock up to 6 inches thick. Cuts to center

of 24" circle. 18 x 18 inch tilt table. Capacity and performance of band saws selling for \$80 and up. Plans and all metal parts in kit with 1/4" blade \$23.95. Detail PLANS—PATTERNS only \$1.00 postpaid.

For shipments up to 600 miles, add 5%; over 600 add 10%. Amount in excess of actual postage will be refunded.

Also Build-it-yourself 18" Band Saw, 6" Bolt Sander, Shaper, 8" Tilt-Table Saw. Simplified plans, build easily with hand tools only. Advertised and sold for 8 years, over 30,000 units in use. Money back Guarantee. FREE CATALOG.



GILLIOM POWER TOOLS DEPT. 80-L, LAMBERT FIELD ST. LOUIS 21, MISSOURI

I CAN SAVE YOU 94%!

REAL LOW PRICES

Send for NEW 1957 Illustrated BOOK of BIG WAR SURPLUS BARGAINS for mechanics, farmers, gadgeteers.

AIRCRAFT STARTERS

Makes excellent winch for lifting, wagon unloaders, pulling stumps, stretching fence or moving heavy objects—1001 uses at home, farm or factory. Operates on 6 to 32 volts or manually. Built-in reduction gear (140 to 1) and clutch. High torque, low speed. Mfg. by Bendix at many times this price.



Make your own conversion

K. ORT, Dept. PM11, York, Pa.

only \$14.89

WAR SURPLUS BARGAIN BOOK 10¢

BUILD FINE GRANDFATHER CLOCK NOW

The simple sensible Red-i-Kut way as thousands have — SAVE HALF, SHOP TESTED PLANS "SPIRIT OF THE CENTURY", "Narrow waist 83" tall or stately straight side "SPIRIT OF AMERICA." EASY-to-FOLLOW photopack PLANS tell all—plus BROCHURE of heavy brass weight Westminster, tube chime, movements, gorgeous bronze-silver dials, 3/4" solid mahogany case kits. Send \$1.00 today—Both plans \$1.50 NOW. Kuempel Chime Clock Works, 28 Kuempel Bldg., Minneapolis 16, Minn.

DIGS 2" TRENCHES to 18" DEEP

New Model B DITCH WITCH digs 2-in. trenches to 18-in. deep. Perfect for lawn sprinkler systems, utility service lines. Digs straight, curved and cornered trenches in all soils, even rocky and frozen. Low Cost! Write for new Bulletin. THE CHARLES MACHINE WORKS 620 B Street Perry, Oklahoma



Say You Saw It in Popular Mechanics

DO IT YOURSELF

It's Easy With ...



Soldering's really a "cinch" ... when you use time-tested, reliable KESTER ... available everywhere.

FREE! "Soldering Simplified" ... 16-page how-to-solder booklet. At your dealer or write direct.

KESTER SOLDER COMPANY
4251 Wrightwood Avenue Chicago 39, Illinois

Made
\$900
IN SPARE TIME

with
FOLEY* automatic SAW FILER

*Trade Mark Reg. U.S. Pat. Off.

"I did very well last year with my Foley equipment, sharpening about 950 saws in my spare time. About \$900 for me."

Leo H. Mix

"I have done 4 or 5 thousand saws in my spare time in the 4 1/2 years since I got the outfit, and they are all coming back with repeat orders."

Len Crego

Make up to \$3 or \$5 an hour in Spare Time

With the high prices of food, clothing and everything else, just think what you could do with extra money every week! With a Foley Automatic Saw Filer you can file hand, band and circular saws better than the most expert hand filer. "The first saw I sharpened with my Foley Filer came out 100%" — writes Clarence E. Parsons. Cash business, no canvassing. No eyestrain — no experience needed.

FREE BOOK Shows How to Start

"MONEY MAKING FACTS" tells just what to do to start your own spare time business in your basement or garage. Just think — with a small investment, no overhead, no stock of goods to carry, you can get right into a cash business. Send coupon today — no salesman will call.



Send for **FREE BOOK**

FOLEY MFG. CO.
1116-6 Foley Bldg., Minneapolis 18, Minn.
Send FREE BOOK — "Money Making Facts"

Name _____

Address _____

NEW IDEAS FOR DECORATING

COFFEE
TABLES
•
PICTURE
FRAMES
•
LAMP
SHADES
•
WASTE
BASKETS
•
ETC., ETC.



Create them yourself
with New Flexible

Weldwood® Wood-Trim*

Add a distinctive, luxury look to scores of familiar household objects—with Weldwood Wood-Trim. It's real wood veneer in easy-to-use rolls! Applies in minutes, with any good wood glue like Weldwood Contact Cement or Presto-Set® Glue. No clamps, nails, hot iron, etc.

Edges plywood tool

Great for covering exposed edges and giving a "pro" finish to plywood tables, desks, cabinets, etc.

8 ft. rolls 1" wide, 89¢ each. Oak, African Mahogany, Walnut, Birch, Korina, Fir.

For perfect wood finishing jobs, use FIRZITE® and SATINLAC®

At hardware, paint and lumber dealers or write for free leaflet. Dept. PM11-5WT



Another
Weldwood
Wizard

Trade Mark UNITED STATES PLYWOOD CORP., BOX 525, N. Y. 46

SAY YOU SAW IT IN POPULAR MECHANICS

FAIRGATE'S NEW Graduated T-SQUARES



(FOR QUICK SQUARING
AND EASIER MARKING)

ALL-METAL • STRONG AS STEEL • NON-RUST • FEATHER-LIGHT • EASY TO HANDLE	24" — \$5.50
	30" — \$6.00
	36" — \$6.75
SEND FOR FREE CIRCULAR	42" — \$8.25

THE FAIRGATE RULE CO.
COLD SPRING, NEW YORK Dept. P.M.



Shotgun Quickly "Ages" Chair For Antique Collector

Amateur antique collector Phil George of Wenatchee, Wash., "ages" furniture for his home with a shotgun. Using a light charge with minute soft lead pellets, he shoulders the shotgun and blasts the piece. The gouging of the pellets into the surface of a table or chair does in seconds what wear and tear of everyday use would do in several hundred years. He also makes worm holes by hammering a bent section of wire into the wood, and produces deep scars by hitting it with a length of chain. Fire is used for special effects.

Fatigue Is Responsible For Many Farm Accidents

The disappearance of the horse from the farm can be blamed for the high level of farm accidents, according to Dr. Franklin H. Top of Iowa City, Iowa. He points out that horses had to be rested periodically, and with this came rest for the farmer. The same horses could not be worked for 10 or 15 hours a day for several days. Mechanization has caused fatigue for the farmer, resulting in many farm accidents. Doctor Top points out that the majority of accidents occur at midmorning and mid-afternoon peaks, and suggests short breaks at those times to prevent fatigue.

Hidden lightning flashes, some of them 100 miles long, which have previously been hidden from view by clouds, have been spotted for the first time on radarscopes.

*Two
Great
New*



PLUMB F-16R
\$3.95

PLUMB F-16
\$3.95

PLUMB

HAMMERS

WITH

**NON-BREAKABLE
Fiber-Glass Handles**

*Stronger than Steel
-with the Hickory
feel*

- ✓ Handle guaranteed non-breakable, in normal use
- ✓ Will not bend out of shape
- ✓ Will not collapse
- ✓ Will not rust, rot or corrode

The Gift that Makes A Hit!

Plumb Deluxe Hammer
F-56 Gift Packaged
for Holiday Giving
As Advertised
\$4.49



FAYETTE R. PLUMB, INC., PHILADELPHIA 37, PA.

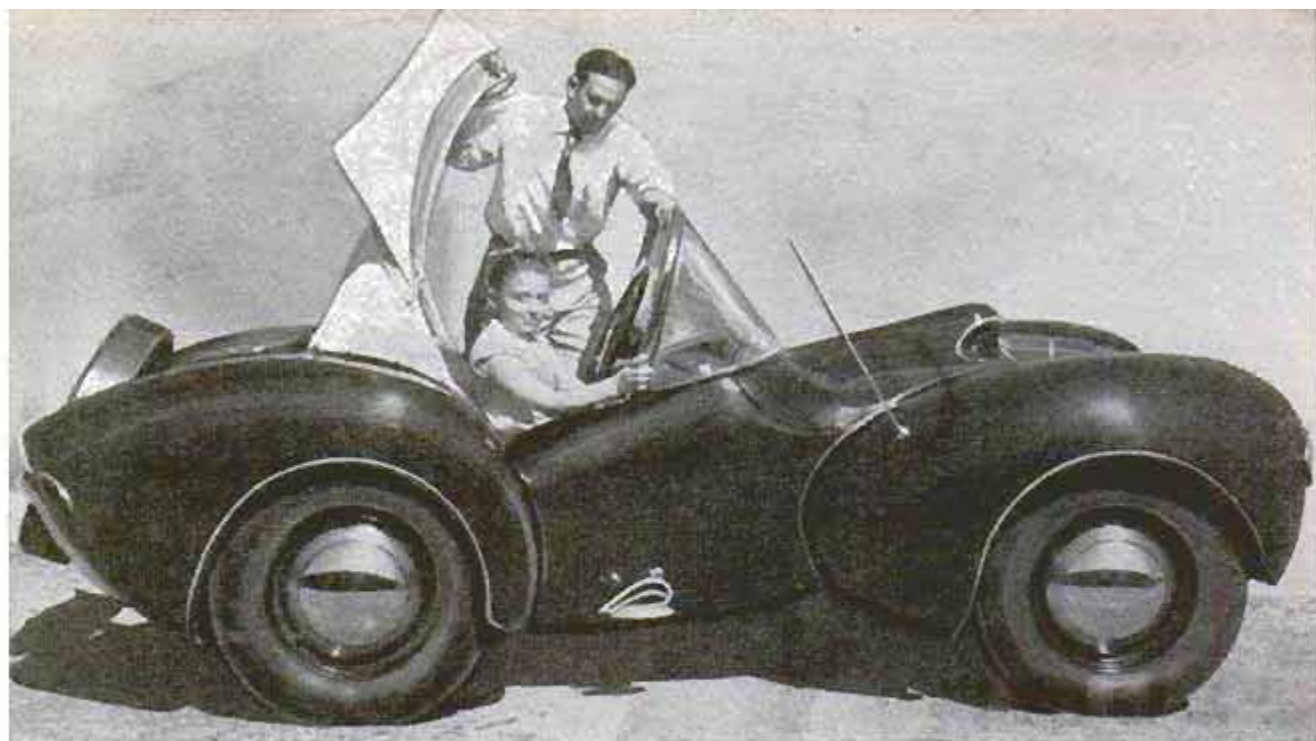

Homemade Auto Is Curvacious

"All curves" is the only way to describe a car built by Leopold Garcia of Bernalillo, N. Mex. Garcia built the car for \$800, mainly from scrap parts. A Ford engine powers the little convertible. A two-seater,

it has an 80-inch wheelbase and weighs 2200 pounds. Instead of headlights it has "eyelights" shaped in chrome and set in "pupils." Curled exhaust pipes do double duty to become rear bumpers.

**THE WINNING TOUCHDOWN!
BOB'S DONE IT AGAIN!**

**NOW... SCORING WITH HER
WOULD BE MY REAL BIG WIN!**

**SMELLS GRAND!
PACKS RIGHT!
SMOKES SWEET!
CAN'T BITE!**

**A PIPE SMOKER, TOO!
MM-M-MMH!
HE'S FOR ME!**

IT'S
SIR WALTER
RALEIGH-
NATURALLY!

SIR WALTER RALEIGH'S BLEND
OF CHOICE KENTUCKY BURLEYS
IS EXTRA AGED TO GUARD
AGAINST TONGUE BITE.

FREE!
24-PAGE BOOKLET ON
PIPE CARE. JUST WRITE
TO: SIR WALTER RALEIGH
DEPT. 122-K
LOUISVILLE, KY.

New Porter-Cable quality saw makes every professional cut! Only \$54⁵⁰

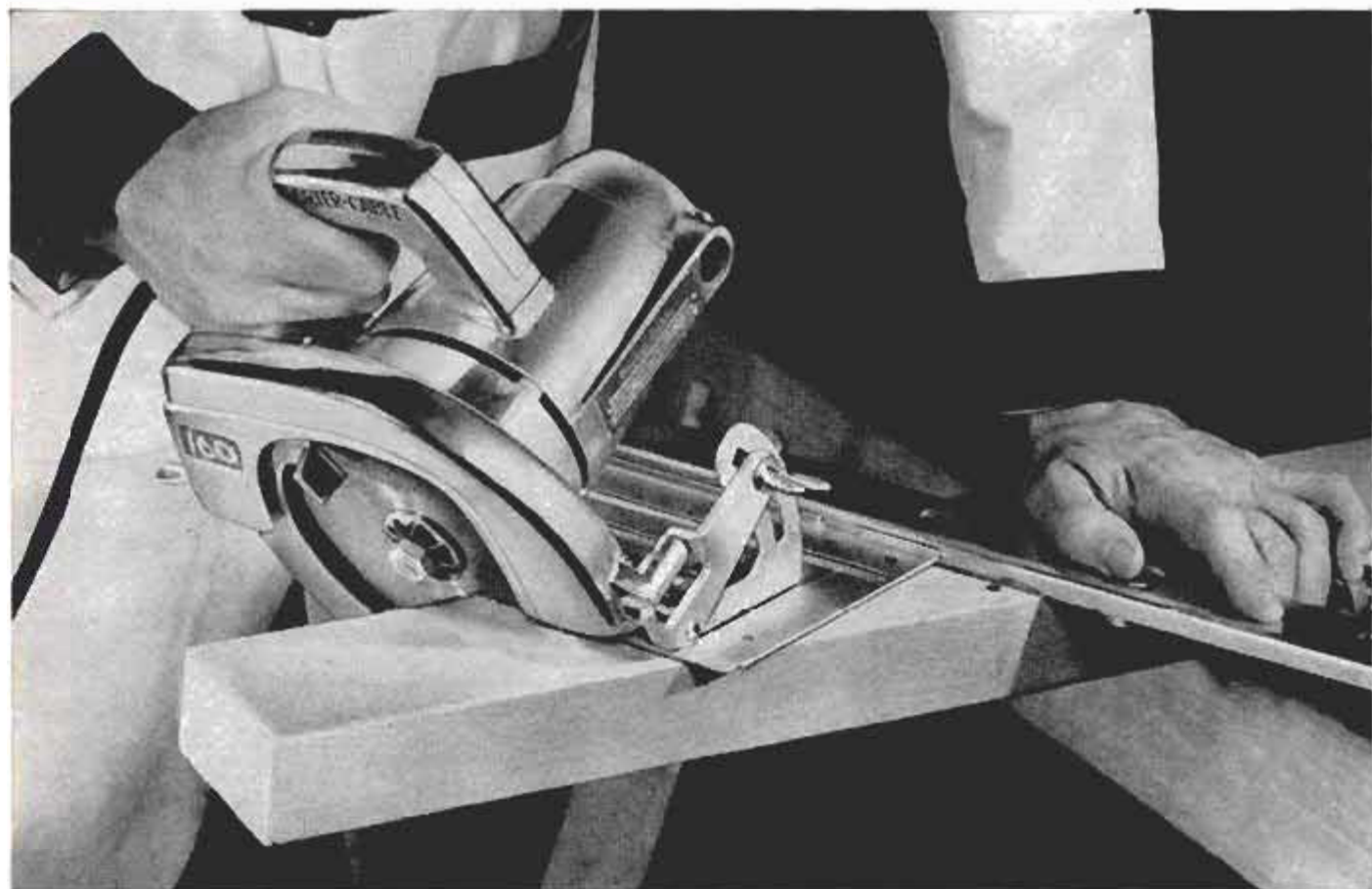

Big saw performance! Porter-Cable's new Model 160 Saw gives you exclusive features found *only* in Porter-Cable quality Saws — at a sensational, new low price!

It makes every professional cut, including compound miters, in full 2" dressed lumber. It provides all the power, speed and cutting capacity you'll need in a saw.

You get the famous Porter-Cable Kick-Proof Clutch, telescoping guard, precision ball bearings and instant depth and bevel adjustments, for accuracy and ease of use.

You can't beat this value anywhere...and the special introductory offer makes it your one *best* saw buy!

SPECIAL INTRODUCTORY OFFER!

Expires January 31, 1957

SAVE \$5.00 when you purchase the sensational new Model 160 Saw in kit form.

\$64.50 Value — Now only \$59.50

Kit Includes:

Model 160 6½" Saw

Rip Guide for fast, accurate ripping all dressed 2" lumber up to 45°

Carrying Case... constructed of strong, welded steel for full protection and durability

SEE YOUR DEALER — OR MAIL COUPON TODAY!

- PORTER-CABLE MACHINE CO.
- 614A N. Salina St., Syracuse 8, N. Y.
- Please send complete information on Model 160
- Saw, and the name of my nearest dealer.

Name _____

Address _____

City _____ Zone _____ State _____

Porter-Cable

Quality Electric Tools

In Canada: write Porter-Cable, Ltd., Box 5019, London, Ont. Canadian prices slightly higher.

GRINDS • CARVES • ENGRAVES
DRILLS • ROUTS • SHARPENS

DREMEL *Electric* MOTO-TOOL

The handiest tool you can own for household jobs, your workshop, or hobby projects. Handles like a pencil. It saves time—makes all jobs easier—gives the finished product a professional look.

The Dremel Moto-Tool has an excellent record as a precision tool in industry. Fastest, most powerful tool of its kind—27,000 rpm. Buy a Moto-Tool—it will pay for itself in no time.



MODEL No. 2 (Wgt. 13 oz.) \$17.85

MODEL No. 1 \$12.85

Moto-Tool Kit No. 2

Includes Model No. 2 Moto-Tool, 23 accessories (high-speed-steel cutters, grinders, polishers, etc.) in a sturdy steel case \$25.95

Kit No. 1 \$21.50

SEE YOUR DEALER. If he cannot supply you, order direct from factory on a 3-day trial, money back guarantee. Send full amount and we pay postage or send \$2.00, and pay postman balance plus C.O.D. charges and fee.

DREMEL MFG. CO., Dept. 116L, Racine, Wisconsin

HELPFUL BOOKS

Send post card asking for FREE catalog

Popular Mechanics Press, 200 E. Ontario, Dept. 601, Chicago 11

BARRON Drill Press TOOLS



ROTARY PLANER

Planes • Rabbits
Tenons • Panels
Routs • Bevels

Only \$8.50

Shipped Prepaid - Complete

FOR WORKSHOP AND INDUSTRIAL USES . . .

● Over 40 precision built woodworking tools and accessories . . . **Hi-Speed Router Bits—Rotary Surface Sanders & Drum Sanders—Safety Shaper Cutters—Dovetail Cutters—Large Auxiliary Metal Tables—Spindle Adapters—Handy Bench Vises.** Many other items indispensable for accurate, useful, versatile workshop use. Every tool sold on complete satisfaction or money back. Write for special folder—"24 Extra Uses for Your Drill Press."

WRITE FOR FREE WORKSHOP GUIDE

BARRON TOOL CO. INC.

300 Architects Bldg., Detroit 1, Mich.

NOW! A marvel of engineering . . .

that brings you **HIGHEST**
Oil Filtering **EFFICIENCY**
IN AUTOMOTIVE HISTORY!



The New Wm. Schwalge Product
Electrically-Heated
RECLAMO

RE-REFINES AND STABILIZES MOTOR OIL!

Reclamo's **GREATER FILTER CAPACITY** (treble that of other models) and water-vaporizing **CONTROLLED HEAT**—results in continuous **RE-REFINING ACTION** that provides super efficient filtration for today's car, truck, tractor engines. **STABILIZES** crankcase oil **AT PEAK OF LUBRICATING QUALITY!**

UNEQUALLED IN PERFORMANCE—REMOVES Solids, PREVENTS excess Water, Acid, Sludge Formation—CHECKS Fuel Dilution—MAINTAINS Stable Viscosity—ENDS NEEDLESS OIL CHANGING!

EXCLUSIVE FEATURES: Electrically heated by surplus generator current, thermostat controlled (for 6-12-24 volts, also for 110-220 volt stationary engines)—Steel body—Hinged mounting bracket—Easy to install or transfer to other equipment.

GUARANTEED! Reclamo is sold with an unconditional six months' no-risk return privilege—**YOU ARE THE JUDGE.**

Descriptive literature free. **DEALERS WANTED.**

WM. SCHWALGE
Author, Inventor,
Pioneer in oil
reclaiming since 1910.



RECLAMO MFG. CO.
6251 Touhy Ave., Dept. M-118,
Chicago 30, Ill.

Manufactured Reclamos now OSBO-LETC accepted (new or used) for trade-in.

Handy Mail Order List

Little Library of Useful INFORMATION

5 for \$1.00
12 for \$2.00
25¢ Each

Here at amazingly low cost is the practical help and information you have always wanted. Articles in previous issues of Popular Mechanics have been classified according to subject and are now available in these handy reprint booklets.

How to Use Measuring Tools—
Micrometers, Calipers, etc. —106.

Power Driven Saws—74.
Drill Presses, Grinders, etc.—79.

Wood, Metal-Turning Lathes—81.

Filing Machine, Hacksaw, Cutoff

Wheel, Shaper—82.

Lathe Tools You Can Make—101.

Workbenches—Tool Cabinets—47.

Spray Painting—94.

From Pattern to Casting—91.

Tool and Saw Sharpening—92.

Sharpening Drills, Wood Bits—

90.

Successful Wood Turning—32.

How to Read Blueprints—71.

Metal Turning Lathe Kinks—99.

Operating a Metal Lathe—100.

Heat Treating, Hardening—102.

Working With Glass—103.

Servicing Electric Motors—75.

Electromagnets & Solenoids—44.

Transformer Construction—41.

The Boy Electrician—43.

Soldering and Brazing—17.

Arc and Spot Welders—5.

Electroplating With Nickel, Chro-

mium, Cadmium, etc.—86.

Plating Leather, Wood, etc.—87.

Lower Your Fuel Costs—31.

Curing Leaky Basements—45.

Fitting Home Game Room—55.

Indoor & Outdoor Fireplaces—88.

Backyard Gardening—39.

Lawn and Garden Novelties—72.

Trellises, Pergolas, Fences—76.

Lawn and Garden Furniture—77.

Playground Equipment—73.

How to Use Your Drill Press—125.

Making Serving Trays—53.

Knots and Ropework—105.

Sanders—80.

House-Wiring—89.

Smoking Stands—56.

Desks—58.

Book Cases—59.

Action Toys—66.

High Flying Kites

—67.

Telescopes—20.

Metal Craft—28.

Small Looms—37.

Working With Plastics—61.

Simple Home Improvements—104.

Ridding Home of Insect Pests—107.

Children's Room Furniture—51.

Jigsawed Novelties—57.

Doll House & Doll Furniture—60.

25 Shelves You Can Make—64.

Novelties Turned on Lathe—62.

Inlay Pictures—Veneering—63.

Wood, Soap Carving—65.

Windmills & Weather-vanes—68.

Lamps from Wood, Metal—69.

Rustic Furniture—18.

Wood Finishing—60.

How to Fix Electrical

Appliances—111.

Painting Your House—117.

Build Your Own Relays—123.

Rowboats, Small Dinghy—83.

Small Sail Boats—84.

Two Outdoor Runabouts—85.

Build Own Canoe, Kayak—30.

Build Class-E Ice Yacht—22.

Auto Kinks, Shortcuts—10.

Lawn and Garden Equip-

ment—124.

Motor-Driven Midget Cars—34.

Stop Auto Electric Troubles—95.

Photo Printers and Dryers—25.

Photo Darkroom Equipment—96.

Trick and Table Top Photos—97.

Home Movie Equipment—118.

Poultry Houses—108.

Guns and Decoys—109.

Re-Silvering Mirrors—70.

Chemical Experiments—93.

Log Cabins, Tourist Houses—14.

Using Basic Tools—120.

Farm and Garden Tractors—8.

Building Extra Attic Rooms—23.

Attractive Basement Rooms—24.

Gem Cutting—42.

Photo Enlargers—1.

Photo Kinks—98.

Cleaning Formulas

—11.

Taxidermy—9.

Photo Lighting—119.

Training Dogs—35.

Small Furnaces—36.

Check Titles Wanted, Clip, Mail with Remittance to

POPULAR MECHANICS PRESS, Dept. 1156, 200 E. Ontario, Chicago 11



SAVE TIME and STEPS with your own PRIVATE DIRECT LINE ARMY FIELD \$0.95
INTER-TELEPHONE SYSTEM • SIMPLE TO INSTALL • ALL METAL TELEPHONES EA.

FOR HOME—RANCH—INDUSTRIAL—Now you can have low cost communication with just released EE-91 U. S. Signal Corps telephones. Anyone can install with only pliers and screwdriver. String wire to each phone, connect batteries—ring and talk up to 20 miles. Complete and ready to operate (less batteries), excellent condition . . . \$9.95 ea. New, with used handsets . . . \$14.95 ea. Telephone wire, indoor or outdoor, new 2-cond. 2¢ ft. Other Army & Navy Field Telephones Available—Write For Free Folder

TELEPHONE WIRE—All weather, all purpose wire on original factory reels. W110B 18 ga. 2-conductor insulated copper-steel conductors.

Now Perfect—Select grade Grade 1, unused like new
1/2 mile reel \$18.95 1/2 mile reel \$13.95
1 mile reel \$32.50 1 mile reel \$22.50
500 ft. reel \$5.95

WD12/TT new Polyethylene Plastic, 2-cond.
1/2 mile reel \$26.40

TERMS: Send check or M.O. D&B-rated firms send P/O. No C.O.D.'s. All prices FOB Sacto. Buyers in Calif. add 4% tax.



**GIGANTIC
SAVE-TO-70%**

MAIL SALE

**WAR SURPLUS
EXCESS INVENTORY
BANKRUPT STOCK**

ARMY POWER PLANTS

Marvelous buys in new condition and brand new genuine Surplus AC and DC Power Plants and Generators. We pay freight to you on most of the units.

- 1000-w, 115-v, 60-c, \$149.50; 2000-w, 115-v, 60-c, \$269.50; 3000-w, 115-v, 60-c, \$299.50; 5000-w, 115-v, 230-v, 60-c, \$497.50 FOB; 25,000-w, 220-v, 60-c, 3-P (cost \$5,000), \$1895 FOB; DC 3000-w, 115-v generator, \$58.75.

AIR COMPRESSORS & PARTS

Save to 70% on air compressors, etc.

- One Cyl. Air Compressor \$19.95
- Two Cyl. Air Compressor \$49.95
- Air Corp Air Tank (10x18) \$8.79
- Auto. Pressure Motor Switch \$4.95
- Pressure Gauges 100, 100, 300 lb. 1.89
- Pressure Regulator & Air Filter \$5.95

HYDRAULIC EQUIPMENT BARGAINS

Typical bargain buys in finest hydraulic valves, cylinders, gauges, etc. All prepaid.



- Special Farm Cylinder Buy, see cut 3" bore, 6 1/2" stroke, 1000-lb. \$11.91
- Multi-Purpose Hyd. Control Valve \$12.95
- Blackhawk Hand Hydraulic System \$23.95
- Motor Driven (12-v DC) 1000 lb. hyd. pump \$43.92
- Pressure Gauge 1000, 1500, 3000 lb. \$3.49

GAS ENGINE BLOWER-HEATER

(Only 31 units, order promptly)



New expensive hi-capacity Govt. blower-heaters. More heat than large home furnaces. Burns ordinary gasoline. Heat output over 100,000 Btu!

Consists of one cyl. gas engine (1.5 h.p.) driving super-charger type enclosed flame heater. Tremendous heat.

Use for temporary heating buildings under construction, plaster drying, corn drying, utilities manhole heater, etc. Do not confuse with used worn out units—these are new, perfect.

Govt. Cost over \$500. Special \$92.70 Ppd.

MULTI-SPEED AC MOTOR

Unique 115-v, 60-c, multi-speed gear reduction motor. 4 separate shafts—8, 32, 320, 4000 rpm. Hundreds interesting applications including baby bassinet rocker.



Cost \$42.50, Sale \$9.42 Ppd.

GEAR REDUCTION AC-DC MOTOR



Expensive geared down ball bearing motor. Gear ratio 54 to 1. Output speed 200 rpm but can be reduced by rheostat to any speed down to 10 rpm. Very hi-torque. Fully reversible. Will run on DC 6 to 24 volts, or on 115-v AC. Dozens uses industry, experimental, window displays, etc. Marvelous unit. Est. Cost \$35, Special \$3.97 Ppd.

Automatic Remote Control Switch



Amazing dial telephone switch. Complete with dial. Dial up any number from 1 to 99.

Fine for remote control, private phone system, amazing demonstration, experimental, etc. Used but good. Instructions furnished. Cost over \$100. Sale \$13.71 Ppd.

ELECTRIC WINCH 6-12 Volt DC

Marvelous 100-to-1 ratio finest all ball bearing gear reduction winch. Runs from car, truck or boat battery. 1000 lb. capacity on 6-v, 2000 lb. on 12-v. Holds 40' cable. Mount in truck to cut labor in half. Quantity limited. Fully reversible. Est Govt Cost over \$250. Sale, \$46.71 F.O.B.



SPECIALS FROM PREVIOUS ADS (Pre-Paid)

- Warm Electric Winch 2000-lb. 115-v, 60-c. \$83.71
- Surveyors-Contractors Level and Rod \$46.50
- Govt. Geiger Tube & Instructions . . . \$1.31
- Desk Phone, make antique lamp . . . \$1.99
- Irrig. Pump 18,500 Gal. per hr. \$46.37
- Dial Handset Extension Phone . . . \$13.61
- G.E. Amplifier-Rectifier (8150) . . . \$6.97
- 1000-Lb. Geared Hand Winch \$9.81
- Golf Car Battery Motor 6 or 12 volt \$19.46
- AC-115-v. Voltmeter \$3.98
- 40,000 B.T.U. Fuel Oil Blower-Heater \$41.90
- Rotary Gas Bbl. Hand Pump \$19.32
- Gas Hand Wobble Pump \$9.75
- Weed Spray 5-row boom outfit . . . \$79.50
- Generator AC-DC type, 115-v., 800-c., 125 amp., AC, and 30-v., 125-amp. DC \$18.25
- Gear Reduction Motor ratio 1500-1. Runs on AC-DC. Many uses \$8.72
- Amazing Gyroscopic Motor 12-24v. . . \$4.81
- Air Corp Spotlight 110-v, Swivel mt. \$8.36
- Fire-Burglar Alarm Kit \$8.95
- Army Tree and Pole Climbers . . . \$1.79
- Clamp-On Direct Reading Outboard Speedometer 0 to 33 mph \$7.81

SPECIAL OF THE MONTH!



Home Laboratory Experimental Kit

(Note: We have approximately 900 kits available—order promptly.)

Wonderful gift for boys, young men, equally fascinating for mature men. Hundreds fascinating experiments. Wire up burglar detector, sensitive eavesdropping unit, appliance tester, Rectifier, geiger counter, fish shocker, vacuum tube excts., black light experiments, code oscillators, dozens other marvelous educational practical experiments and uses.



CONTAINS 115-v. hand driven AC generator (fish shocking type) geiger tube, DC-AC electric bell, relay, vacuum tube, motor, capacitors, resistors, magnet, transmitter, receiver, Weston sensitive milliammeter unit, electro-magnet, thyratron tube, electric eye tube, black light (ultra violet) tube, and over 12 other pieces of useful experimental units. Over 90 pieces. Includes instructions for setting up Home Experimental Laboratory and full experimental instructions. (You pay postman for psig) Est. Govt. cost over \$60. Special \$6.98 FOB

INVALID CHAIR—BOYS AUTO MOTOR

Marvelous ball bearing battery (6 or 12 v.) electric gear reduction motor. Makes wonderful amazing electric drive for boys auto, invalids chair, etc. Also useful for factory electric lifts—trucks, etc.



Gear ratio 40 to 1. Hi-bronze. Finest precision gears. Fully reversible. Buy of the year. Est. Govt. Cost over \$150. Sale, \$14.99 F.O.B.

CONTRACTOR-BUILDER-FARMER LEVEL



Precision quality level by leading mfr. Excellent for setting foundations, grading, farm contouring, surveying, etc. Powerful optically true telescope, finely graduated azimuth scale, sensitive level adjustment, polished oak tripod, 8 1/2 ft. 3-section rod, fine case, instructions, etc. A wonderful buy. Sale \$42.95 Ppd.

ORDER FROM AD or write for big new WINTER CATALOG 1000s of items! Motors, sporting goods, hand-electric tools, watches, etc. We pay freight except where stated "F.O.B."

BURDEN SALES COMPANY
813 "O" St. LINCOLN, NEBRASKA



HAVE A BIGGER—MORE EFFICIENT HOME WORKSHOP

Popular Mechanics PLANNING YOUR HOME WORKSHOP shows you how to make use of every inch of space in your workshop; detailed floor plans, wiring layouts and power tool hookups plus actual photographs of famous home workshops you can use as models. Save money by building your own shop furniture. Special Where-to-Buy-it Guide. 450 Illustrations. Cloth Bound, Working Diagrams. Order \$2.50 your copy today from POPULAR MECHANICS PRESS 200 E. Ontario Street Chicago 11

KARI-MOR SIDE CAR CARRIERS HOOKS ON CAR DOORS

For carrying long material, lumber, pipe, ladders, etc. Strong aluminum arms attach on doors—no holes to drill. Sturdy web straps holds load securely. Suction cups protect car finish. For home owners, contractors, painters, plumbers, electricians. Fits all cars. CHICAGO PRECISION INDUSTRIES, Dept. A 181 East Lake Shore Drive, Chicago 11, Ill.



Only \$4.95 per pair
Money back guarantee—Postage Paid, No C.O.D.'s.

ARROW'S AUTOMATIC NAILING KIT



FAST! SAFE! HOLDS!

One squeeze and you've nailed it! Ideal for ceiling tile, insulation, wire fencing, carpentry, carpeting, padding, etc.

FOR 1001 DO-IT-YOURSELF JOBS!

The perfect gift! Handsome tool chest carry-carton contains:

- Arrow's T-50 Automatic Gun Tacker!
- Supply of 5000 staples in 4 sizes!
- Arrow's handy staple remover!

All for only \$15.50! Available at leading hardware and lumber yard dealers



ARROW FASTENER CO., INC.

ONE JUNIUS STREET
BROOKLYN 12, N.Y.

WAR SURPLUS AND OTHER BARGAINS SAVE UP TO 90%

BUILD YOUR OWN ARC WELDER, LIGHT PLANT OR BATTERY CHARGER

Complete Kit \$39.95

Kit consists of: 1 Famous Navy NEA-5 Generator, New! Combination AC-DC Type, AC voltage—115 V. DC voltage—24 V. 200-300 Amps. 2 complete generators in 1 . . . 2 separate fields & 2 separate armatures on same shaft yet no larger than regular aircraft generator. Ideal for home, farm & shop lighting plants by hooking wires to AC side which will give 1200 watts. DC side can be used for charging batteries, welding & operating war surplus low voltage hobby motors & equipment. Also in kit: 1 Voltage Regulator DC. 1 Voltage Regulator AC. 1 Reverse Current Relay. 1 Ammeter and Shunt. 1 Voltmeter, 0 to 30 Volts. 1 Rheostat. 1 Electrode Holder. 1 Giant Toggle Switch. Welder's Shield. Wiring diagram for hookup as welder. Wt. under 100 lbs. Approx. GOVT. COST \$600. Kit, \$39.95. Navy NEA-5 Generator (only) — same as above . . . if purchased separately: \$27.50.

RT GENERATOR KIT Jack & Heintz or GE. Rated 300 Amps. 24-32 Volts. With same items as above incl. 300 Amp Ammeter. Approx. GOVT. COST for kit \$600. Complete kit only \$39.95. Wt. 60 lbs.

HOMELITE PORTABLE POWER PLANT

Buy power for pennies. Ideal for welding, battery charging, emergency lights for cabins, camps, trailers, aircraft or wherever power needed. Easy rope pull starting. Fully equipped, ready to start. 2000 W. 32 V. 5 HP. Complete, nothing else to buy. Like new, tested. Shock mounted. De Luxe type. Net wt. 115 lbs., gross wt. cased 200 lbs. Approx. GOVT. COST \$700. While they last—\$59.95.



BENDIX AIRCRAFT COMPASS

For boats, trucks, cars. By Pioneer Instrument Co., div. Bendix. Mark VIII. Graduated in increments of 1°; 360°. Major graduations every 5°. Magnetic. Can be lighted with 6, 12 or 24 volt standard bulb. Flush panel mounting. Approx. GOVT. COST \$250. Perfect . . . \$10.95 ppd. (Great Xmas Gift.)



MICROMETERS Chrome plated, precision engineered, carefully tool to give long life. All new 0-1" cap. \$2.25 ea., 1-2" cap. \$3.50.



"HELIOS" ORIGINAL TOOLMAKERS VERNIER CALIPERS

ULTRAPRECISION — Imported. Used by machinists at Lockheed, Douglas, Bendix, GM, RCA, GE. Model 51/2E. Genuine Helios. Hardened lapped precision surfaces. 1/1000" and 1/128" graduations. Handy slide roll and thumb lock. Quick, accurate depth. A \$35 value. De Luxe finish. ALL NEW. Just \$7.95. Leather carrying case, \$1 extra.



WOOD PROPELLER Originally intended for govt radio & target planes.

Now the perfect "prop" for den, trophy room, game room or boy's bedroom. Clock, barometer or photo can be inserted easily into center (complete with mounting holes). Top grade bird's-eye maple; flawless, smooth, highly varnished; 30" tip to tip. Can be used to operate ice sleds, etc. Approx. GOVT COST \$57. New—\$3.95. (Great Xmas gift.)



AERO SAFETY FILM Cut your own. Makes into either 8x10, 4x5, 5x7. Type 1B-Kodak Super XX or Triple Span. Aerial Reconnaissance Base. 9 1/2"x200". Late date. Guaranteed perfect. Vacuum packed. Wt. 11 lbs. Approx. GOVT. COST \$125 per roll. Only \$10.95 per roll.



REVERSIBLE RACHET WRENCH

For diesels, ships, farm machinery, trucks, bridges, oil fields, all heavy equipment. Terrific leverage, 4" Lowell, safety steel, sockets for 2 3/8", 2 9/16" & 3 1/8" hexagon nuts. Navy surplus. Approx. GOVT. COST \$215 a set. Wt. 50 lbs. NEW! Now \$10.95 per set.



BENDIX PUMP & MOTOR

Can be used for pumping fuel, oil or wherever hydraulic pressure is required. Pump has 1" connections, built-in relief valve, adjustable up to 1500 lbs. Max. capacity 6 GPM. 1 1/2 H.P., 24 volt motor, 4000 RPM. Can be used on 12 to 36 volts. Approx. GOVT. COST \$350. NEW — \$10.95.



NEW! BIG CATALOG Largest ever . . . just out . . . new low prices. Send 25c for your copy today. Prices F.O.B. Culver City unless otherwise stated. Check, cash or money order. 50% deposit for C.O.D.

AIRBORNE SALES CO., INC. DEPT. PM1156
8501 Stellar Drive, Culver City, Calif.

PAGE HOME WORKSHOP MACHINES

Page Power Tools help the home handyman every step of the job. Every machine precision-made, with finest parts! **LOW PRICES!**

3" Tit-A-Bow SAW
1 1/2" Drill Press
18" Zig Saw
10" Band Saw

Write for complete catalog and details.

PAGE TOOLS, 1910 M.S. 81st, Milwaukee, Wis.



Standing in the hatchery's trout pond, two men load fish into escalator with dip nets for trip to tank

Trout Go for a Ride On Fish Escalator

Catchable-sized trout at the Darrah Springs State Fish Hatchery in California take a ride on a portable escalator before they are planted in the state's trout streams. The escalator is used to load the trout into the hatchery's trucks and makes it possible to load the trucks in 15 minutes, instead of the several hours previously required. The escalator consists of an endless rubber belt with cleats three inches high. Two men use dip nets to put the fish on the escalator. Each pocket on the belt holds enough water to assure the fish a safe ride into the truck's tank. The fish are counted by measuring the displacement in the truck's tank after loading.

Spout at the top of the escalator is guided by employee of hatchery. Truck holds 5000 trout per load



\$500 FOR YOUR OLD HAND SAW OR POWER SAW!

ANY MAKE OR CONDITION!

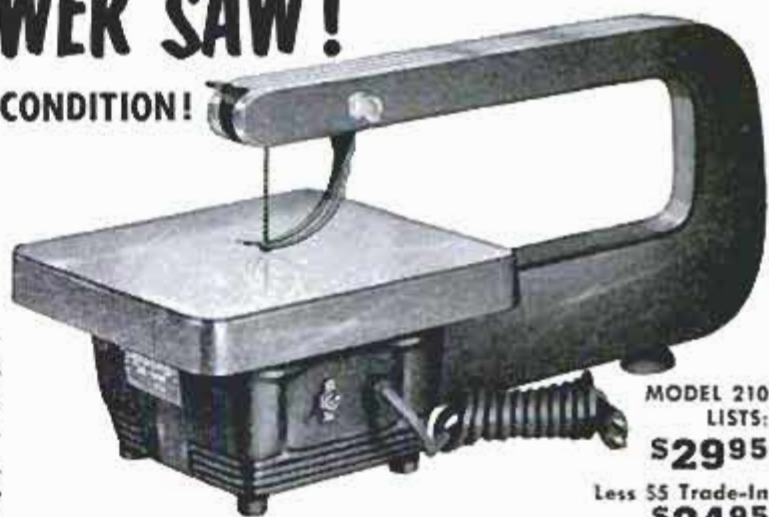

MODEL 210
LISTS:
\$2995

Less \$5 Trade-In
or... **\$2495**

\$ For \$ OUT-CUTS ALL OTHERS

SYNCRO

210 JIG SAW

Your old hand or power saw (any make or condition) is good for a \$5 trade-in allowance towards purchase of the amazing new Syncro "210" True Cut Jig Saw at your tool dealer! This husky, massive, precision-built saw has big 15" throat, 100 sq. in. table — cuts 1 3/4" wood accurately — curved or straight! Powered with famous Syncro Reciprocating Motor—greatest achievement of power research. No belts, cams, gears. No rotating parts to wear out. Motor guaranteed against burn-out during ownership.

See your tool dealer today—trade in your old hand saw and save \$5! Offer ends Dec. 31, 1956.

SYNCRO CORPORATION • DEPT. T-86 • OXFORD, MICHIGAN U. S. A.

WORLD'S LARGEST MANUFACTURER OF RECIPROCATING MOTORS

IDEAL CHRISTMAS GIFT FOR ANY MAN

WELD **BRAZE**
SOLDER **CUT**



4WAY
ONLY
\$14.75
f.o.b. factory

WELDER
Complete with
Twin Carbon Arc
Torch and ac-
cessories... to
handle all metal-
craft work.

Acclaimed by thousands of Homeowners, Mechanics and Hobbyists as the welder of 1001 uses. Easily operated from properly wired 110 volt AC or DC line. The ideal gift with a life-long use....Order today on 10 day money back guarantee.

FOUR-WAY WELDER CO., Dept. F2-M
1810 S. Federal St. • Chicago 16, Ill.

SAY YOU SAW IT IN POPULAR MECHANICS



\$5000
PER DAY
AND MORE

SERRATING AND SHARPENING TABLE KNIVES

SAW-KEEN PORTABLE, ELECTRIC, EASY - TO - OPERATE
Be your own boss, work anywhere, full or part time. Every restaurant, hotel, drive-in, etc., repeat customers. Serrated (saw-edged) table and steak knives in great demand. \$98.50 investment returns first week. Guaranteed. Write today for proven daily profit plan.
CUTTER-CRAFT 58-R SOUTH RAYMOND PASADENA 1, CALIF.

DISCOVER ROD-IT-YOURSELF Machine

SAVES PLUMBING BILLS



Attachable Cutter Blades



FREE BOOKLET TELLS HOW TO DO YOUR OWN RODDING—START YOUR OWN BUSINESS—RENT IT.

CHICAGO—Nov. 1st—Home Owners, Apartments, Contractors, Realtors, Offices, including Factories are constantly having trouble with clogged-up pipes which proves expensive in Costly Plumbing Bills—

But now—here is a NEW RODDING TOOL designed to clean the most stubborn drain and sewer stoppages. Not just an ordinary rod, but a patented unit guaranteed to make every bend in pipe up to 100 ft. A new Discovery in Swedish Music Wire gives the Rod a 100% more Flexibility than any other sewer cable. Yet anyone can operate this rod which is whirled down the drain in a few minutes.

TOILETS, URINALS, SINKS, and FLOOR DRAINS clogged with paper, grease, rags, sand, hair and other debris can be cleared **SAVING THE OWNER THE RODDING TOOL'S PRICE**, the first time it is used. Cutter blades can be attached for removing roots.

This new unit can be used on any 1/2" to 6 inch waste pipe including Bath-tubs, Septic Lines, Sewers, Laundry Tubs, and avoids Flooded Basements. Obstructions give away immediately when struck by this new machine.

This New Rodding Tool is offered on a 30 Day FREE TRIAL. BUT MOST IMPORTANT IS THIS—What is this Tool worth in your own Home, Apartment, or Factory in **COSTLY PLUMBING BILLS SAVED!** Tear this Ad out now and write your Name and Address beside this Ad for **FREE BOOKLET** which lists Hand and Electric Units. For your own good, mail now—**NO AGENT WILL CALL**—or write postcard. (CHICAGO PHONE KILDARE 5-1702).

Obstructions give away immediately when struck by this new machine.

BUILD WELDER OR LIGHT PLANT

General SALVAGE CO. SALE

NEW HYDRAULIC CYLINDERS

Instruc. incl. TYPES AMPS VOLTS PRICE
 DELCO P1 200 24 \$15.50
 J & Heinz R1 300 24 \$25.50
 G-1, 160-250 amps, 30V, new \$19.50 used \$12.95
Flexible Coupling to fit G-1, P-1 or R-1, \$4.95
RHEOSTAT = R-27 or Carbon Pile Voltage Regulator for regulating voltage on all DC Generators. Instructions incl. \$6.95 ea.
115 V A C GENERATOR G. E. #511 A. C. - D. C.
 Generator. Ideal A.C. Light Plant & D.C. Battery Charger or Welder. 1250 Watts A.C., 800 cy., 10.9 Amps., 115V. A.C. & 200 Amps. 30V. D.C. Instructions incl. Good Condition \$17.50. New \$27.50. (5) **SPEED REDUCER** 10:1, 90 degree angle, rated 2 H.P. \$6.95. **GEAR UNIT** 1:1 ratio with One input, 2 output shafts, 10 H.P. \$5.95.
SENSATIONAL SELSYNS for remote control, 110V. A.C. Use two for remote radio or TV tuner, weather vane, Visual paging system, etc. Instructions incl. \$7.95 per pair.
 (1) **VOLTMETER D.C.** 30 Volts, 0-300 Ohms. \$5.95. **TACHOMETER INDICATOR** 0-10,000 R.P.M. New \$8.95. **HYDRAULIC PRESSURE GAUGE**, 0-2000 P.S.I. 1/4" ports. \$4.95. **AMMETER** 0-300 Amps. \$4.95
RIGHT ANGLE DRIVE, 1:1 ratio with two 3/4" shaft extensions. 3"x3"x1 1/2" body. \$3.50

WATER PUMP WITH MOTOR
 Water Pump with Motor, 1/2 H.P. 200 G.P.H. runs on 6-12 & 24V. D.C. Adj. press 1" ports \$12.95, with 400 G.P.H. \$14.95.
 (2) **Makes Ideal Winch Moist.** 1/2 H.P. motor with gear unit 14:1, runs on 12-24V. D.C., reversible, belt or direct drive. Instructions \$7.95.
ANTENNA ROTATOR MOTOR #572. Reversible, 7 R.P.M. 24V. D.C. & applicable for 110V. A.C. Powerful, for TV, Ham, F.M., etc. Instruction incl. \$8.95.
ROMEC HYD. PUMP & MOTOR. Positive displacement, 900 G.P.H., .28 H.P. 2500 R.P.M. for 12-24V. D.C. 3/4" ports. New, \$19.50.
 (5) **ROTARY GEAR PUMP #101** for hydraulic, water, or vacuum, 180 G.P.H. 200 P.S.I., 29" Vacuum \$7.50
 Black & Decker Pump & Motor, 2 G.P.H. 1200 RPM D.C. & Appl. for 110V. A.C. 1/4" ports. New \$8.95
 New Linear Actuator, 5 1/2" travel, rated 800 lbs. thrust, 1150 lbs. static load, with 1/2 H.P. motor 12-24V. D.C. & appl. for 110V. A.C. \$8.95

Air or Oil	Bore	Stroke	Shaft	D. Action	Price
11	1 1/2"	6"	5/8"		\$7.50
500	1 1/2"	7 1/2"	5/8"		\$8.50
711	2 1/2"	11"	1 1/4"		\$12.50
127	4 1/2"	10 3/4"	1-5/16"		\$27.50
511	3 1/2"	21 3/4"	1 1/4"		\$25.50

New Hose & hydraulic list on request.
HYDRAULIC PUMP BARGAINS 1500 P.S.I. MFG. TYPE R.P.M. G.P.H. NEW
 Pesco Gear 1500 198 \$12.95
 Pesco Gear 4300 360 \$14.50
 7 *Pesco Gear .447 cu. in. rev. 270 \$16.50
 *Stratopower .450 cu. in. 3750 400 \$17.50
 *with built in pressure control & reversible Vickers .507 cu. in. rev. \$19.50. 410 cu. in. rev. \$17.50
NEW FOUR WAY OPEN CENTER CONTROL VALVE has built in adj. relief for 1 to 4 D.A. cylinders. 3/4" ports. #10060 \$14.50. #4W11 four way with 1 handle for I.D.A. cyl. \$8.95.
FOUR WAY SOLENOID VALVES. Instruction for 24 V.D.C. & appl. for 110V. A.C. off in neutral. 3/4" #1213, \$12.50. #324 with 1/4" ports, \$9.95. #322 one way normally closed 1/4" ports, \$2.35.
 New Weaver Hydraulic Hand pump. Heavy duty. 2000 P.S.I. including built in Pressure relief. Handle adjustable from 12"-26". Wt. 10 lbs. \$9.95
GENERAL SALVAGE CO. CHECK OR M.O.
 2922 E. 27 St., Dept. 71, Kansas City 27, Mo.

earn BIG PROFITS

Sharpening Hand Saws



The Foley Saw Retoother cuts perfect new teeth right over old ones in less than 1 minute, without removing saw handle. Makes filing easy. Takes all hand saws 4 to 16 points per inch. Relieves eye-strain. No experience needed.

FREE Foley Price Guide of saw sharpening charges. A valuable chart of actual prices. Send coupon today. No salesman will call.

FOLEY MFG. CO. 1170-6 Foley Bldg., Minneapolis 10, Minn.
 Send FREE Price Guide and Foley Retoother circular.

Name _____
 Address _____

Short Cuts with WILHOLD WHITE GLUE



1 1/2" #18 brads hold while glue dries.

MAKE DRAWER ENDS without dowels or dovetails
 You'll like it better. Simplifies woodworking. Sets quick, dries clear, holds permanently. Illustrated, one of many Wilhold shortcuts. **FREE BOOKLET.**
 Paint, Hardware, Lumber, Variety Stores. Or write **WILHOLD PRODUCTS** Los Angeles 31, Calif.; Chicago 44, Ill.

50% MORE PRACTICAL MALL 3/8" DRILL KIT



\$39.95

"POWER PLANNED"—does all usual kit jobs and many more

New 389 kit does hard jobs in cement, steel and stone as well as in wood. Rugged 3/8" drill has geared chuck and key, 650 RPM, 60 cycle, 115 V. AC-DC motor, cord, switch and plug. U. L. approved. Ideal for masonry, for precision polishing and sanding. Bits, pedestal, pads, discs, handle and steel chest included. Get 50% more practical, more efficient MALL 389 drill kit wherever high quality tools are sold.

MALL TOOL COMPANY
 Division of Remington Arms Company, Inc.
 7805 South Chicago Avenue, Chicago 19, Illinois

MEASURES UP!

ONLY \$2.39 (10 FT.)

the *Evans* **KING-SIZE TAPE**

IT STANDS UP STRAIGHT 6-8-10-12 FOOT LENGTHS



Long upright measuring jobs are easy with Evans King Size. Blade is a full 3/4" wide... 33% wider than ordinary tapes. Stands straight up or lays down flat - won't bend or buckle. Easier to read, too. Free belt clip, Tenite utility case. Sliding end hook - for 100% accurate inside-outside measuring.

Exclusive! NO FIGURING!

Work in feet & inches? Read here 
 Work in inches? Read here 

ALSO... get Evans Regular White-Tapes
 • 6 Ft. only 98¢ 50 Ft. only \$4.98
 • FREE Tenite utility case • All Evans quality features • 6-8-10-12-50-100 foot lengths
 Ask your hardware dealer - Today!

Evans RULE CO.
 Elizabeth, N. J. Montreal, Que.

NEW CLAUSING 10" SAW

Way Ahead in Quality Performance and Value

Heavier throughout . . . more powerful . . . greater in production capacity . . . and unmatched for ease of operation and safety, Clausing gives you performance never before achieved in a 10" saw. Engineered to handle power up to 3 HP, the saw alone weighs 385 lbs! Has bigger arbor . . . $\frac{3}{4}$ " diameter. Sealed-for-life, preloaded ball bearings . . . exclusive new, totally enclosed, fan-cooled, continuous-duty motors . . . the result of 3 years saw-motor research, 1, 1½, 2 and 3 HP. Three big table sizes . . . up to 54¾" x 27½"! Double-locking lift-off fence, Big, efficient mitre gauge. Cast-iron base. Clausing is in a class by itself — the saw to consider before buying any circular saw. Get all the details and compare!

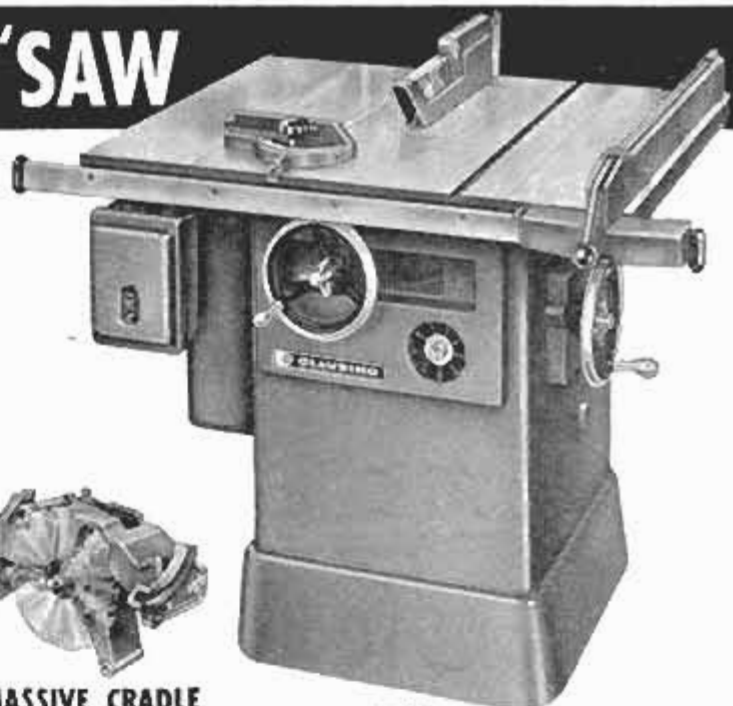

MASSIVE CRADLE AND ARM

Heavy box-shape castings for maximum strength. Inside and out the Clausing is ruggedly built.



BIG ARBOR, BEARINGS

Arbor is $\frac{3}{4}$ " solid bar of precision ground steel. Spins on two large, preloaded, sealed-for-life ball bearings.

WRITE FOR FREE CATALOG TODAY!



CLAUSING

DIVISION, ATLAS PRESS COMPANY

11-135 N. Pitcher Street • Kalamazoo, Michigan



Changeable Headboard Matches Bedspread

Matching an upholstered headboard to bedspread and curtains is easy with a removable panel mounted in an English bed. The material is stretched across the padded insert which is then pressed into the frame and held in place with two clips. It can be quickly taken out for cleaning.



Colored Pencils For Photographs

Pencils which can be sharpened to a fine point and yet produce the texture of photographic oil colors when applied to matte or semimatte photo-prints are now being imported from France. The pencils come in 18 colors, and can be applied after the surface has been lightly coated with a solution which is included in the set. Biggest use for the pencils is in coloring fine details, such as eyebrows or jewelry, on photographic prints.

STOP THAT DRAFT!

Get
DRAFTITE*
WEATHERSTRIP
for your
house
doors



Get
STANSTRIP*
WEATHERSTRIP
for the bottom
of your
garage
door

At your hardware or building supply dealer. If he's out of stock, we'll mail it to you. Send check or money order:

StanStrip — 37c a foot any length.
Draftite — \$2.49 a package.

*TRADEMARK

The Standard Products Co.

BOX 678C LEXINGTON, KY.



Heavy Duty, All Steel
TOOL CHEST
\$25⁹⁰ F.O.B.
ST. PAUL

WHERE ELSE

can you get 4 drawers with built-in locking system, sliding on compound glides—at this price! Baked blue-gray enamel. 26" x 12 1/4" x 12 1/4". Your money back if not satisfied! Write for bulletin, describing this and 12 other models.

HUOT MANUFACTURING CO.

555 No. Wheeler St., St. Paul 4, Minn.



BIG MONEY SAVING BARGAINS

COMPLETE 1/2 H.P. Paint Sprayer \$35.00—TANK Mounted 1/2 H.P. AIR COMPRESSOR, \$75.00—Westinghouse 110V. 60 cy. 1725 rpm 1/4 H.P. Electric Motor \$8.50—1/2 H.P. \$9.50—1/2 H.P. \$13.50 — EXHAUST FANS 110V—60 cy. 12 in. Blade Square Panel Mtd. \$10.50—16 in. Blade Square Panel \$15.00 — 18 in. Blade Round Frame \$20.00 — 24 in. Blade Round Frame \$25.00—1 Cylinder 1/2 H.P. 2.5 cfm AIR COMPRESSOR \$19.00—1 Cylinder 3/4 H.P. 4.5 cfm AIR COMPRESSOR \$27.50 —TWIN CYLINDER 1 H.P. 9 cfm AIR COMPRESSOR \$52.00. All Prices Fob. Chgo.



Money Back Guarantee

C. MARSHALL SALES, 3548 Fullerton Ave., Dept. P-11. CHICAGO 47

Marco KIT BOATS—DO IT YOURSELF—SAVE 50%



MARCO 14 \$189.50 Delivered

WRITE FOR FREE FOLDER

ACCESSORIES • FIBERGLAS
Marine ASSOCIATES
BOX 6188 • LONG BEACH 11, CALIF.

8' to 14' models, factory to you, no dealers, mahogany decks and framework, all brass fastenings, 14' hull kits as low as \$129.50 including freight charges. CATALOG 35c includes Kits, Hardware, Trailers, Fiberglass.

NEW STANLEY Glide-O-Matic

- Positive lock
- Automatic return
- Steel scribes



This rule locks at the measurement you take. Set it, forget it; the rule remembers when you push the lock button.

And when you release the lock the blade glides smoothly home into the gleaming case.

No pencil needed! Glide-O-Matic marks your measurement with hardened steel scribes.

For inside measurements, use the back of the tape. It's graduated in red with the first two inches omitted to compensate for 2" case.

Be precise. Say Stanley. Ask for Stanley Glide-O-Matic at your favorite hardware store. It's a good rule.

3 sizes, each in plastic utility box:
8 ft.—\$1.98 10 ft.—\$2.39 12 ft.—\$2.89

For free booklet on measuring tools and how to use them, write Stanley Tools, Division of The Stanley Works, 62N Elm St., New Britain, Connecticut.

STANLEY

The Tool Box of The World

DRAINS cellars, cisterns, wash tubs; \$7.95 IRRIGATES - CIRCULATES - SPRAYS



Type P Pump has 1,001 uses. Up to 3000 GPH; 450 GPH 80' high; or 1800 GPH from 25' well. Use 1/8 to 3/4 HP motor. Coupling included free. 1" inlet; 3/4" outlet. Stainless shaft. Won't rust or clog! Postpaid if cash with order. Rush your order today.

MONEY BACK GUARANTEE
Centrifugal and Gear Pumps in All Sizes
LABAWCO PUMPS, Belle Meade 7, N. J.

SPARE-TIME MONEYMAKING OPPORTUNITIES

READ OUR CLASSIFIED ADS

HUNDREDS OF BARGAINS

AMAZING OFFERS



KATO A.C. GENERATORS

A WIDE VARIETY FOR ANY ELECTRICAL APPLICATION!

Adaptable to all well-known makes of engines. 350 Watts through 500 KVA and larger. To 600V. Odd frequencies from 15 to 1000 cycles. Also, Rotary Converters, High Frequency Changers, Motor Generator Sets.

FREE FOLDER

KATO Engineering Company
1402 First Ave., Mankato, Minn.

SAW SHARPENING IS EASY

Sensational new Super Filer No. 11 joints and sharpens both hand and circular saws 6" to 10" with all teeth the correct height, depth, pitch and bevel. Easy to use — when file hits hardened steel roller, teeth are finished. Saw runs true and smooth with no side pull. Complete with special 8" file.

\$995
PPD.

"TRU-CIRCLE" saw set automatically sets teeth at 10° or more.

\$295
PPD.

DOWEL CENTERS

Assure positive, quick alignment of major units with ADM Dowel Centers. Insert in drilled holes, press mating piece against points, tap lightly. Centers inscribe exact location for opposite holes. Pairs of 3 popular sizes (6 centers)—for 1/4", 3/8", 1/2" holes \$1.00 ppd.

SUPER SAW FILER NO. 6. Automatically controls Depth, Angle, Pitch, Automatic Depth Control Rollers. Perfect level and angle maintained, and fool-proof depth control for all Rip, Crosscut and Handsaws. Precision made and calibrated for instant setting at desired angle. Can be used in any vise or clamp. Complete with file, only \$6.50 ppd.

MONEY BACK GUARANTEE. SEND FOR FREE CATALOG
A. D. MCBURNEY, 5808 Hollywood Blvd., Dept. A-116, Hollywood 28, Calif.

SMALL! POWERFUL!

ECONOMY TRACTOR



Thousands
In Use

Write for
complete
details.

Engineering Products Co.
915-K-11 Niagara Ct.
Waukesha, Wisconsin

Unequaled value! Low price!

America's finest tractor. Ruggedly built. Easy to operate. 790 lbs. Borg-Warner clutch, trans. and diff 140 to 1 reduction. 40% more drawbar pull than ordinary tractors 8-1/4 H. P. engine. 20 quick change implements. HOOD, FENDERS.

VARIABLE SPEED

HYDRAULIC POWER TRANSMISSION



It has Infinite Speeds 0 to 550. Reverse. Automatic Overload Protection; Adjustable Torque up to 180 inch pounds. 5/8" Input and Output Shafts. It will handle 1/4 to 1 1/2 H.P. Motor. Case measures 7 1/2" long, 7" high, 8 1/2" wide. VALUE OVER \$300. Shipping Wt. 25#. On C.O.D. Orders we require a 10% Deposit.

\$54.50

Feb. Chicago

DIRZIUS MACHINE SHOP "H" 1423-25 So. 52nd Ave., Cicero 50, Ill.

Wholesale! TOOLS! GUNS! CAMERAS!

AGENTS — BUY TOOLS, PHOTO EQUIP., SPORTING GOODS, JEWELRY AND THOUSANDS OTHER NATIONALLY ADVERTISED PRODUCTS AT BIG DISCOUNTS. — IN PROFITS SELLING TO OTHERS.

POSTCARD BRINGS FREE COPY "THE WHOLESALE PLAN" —
AMERICAN BUYERS SERVICE

HERTEL STATION, DEPT. 15, BUFFALO 16, NEW YORK

Get up to
40% off

FURNITURE for YOUR BEDROOM

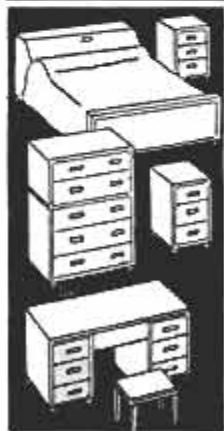

SAVE MONEY, be the envy of your neighbors by making this beautiful bedroom suite yourself! Only a power saw and jointer are needed to turn out this smart suite, featuring bed with storage space, three-piece vanity with cosmetic compartment and makeup mirror, Mr. and Mrs. dresser, and twin night stands with drawers. Letters demanding detailed plans poured in after this furniture was pictured in Popular Mechanics Magazine. Now the 4 plans are ready—easy-to-follow scale drawings—and they're yours for only \$2.00! Send for a complete set today.

POPULAR MECHANICS PRESS
200 EAST ONTARIO STREET, CHICAGO 11, ILL.

LOOK! All New - All Precision - All Deluxe

SUPERSHOP MODEL X

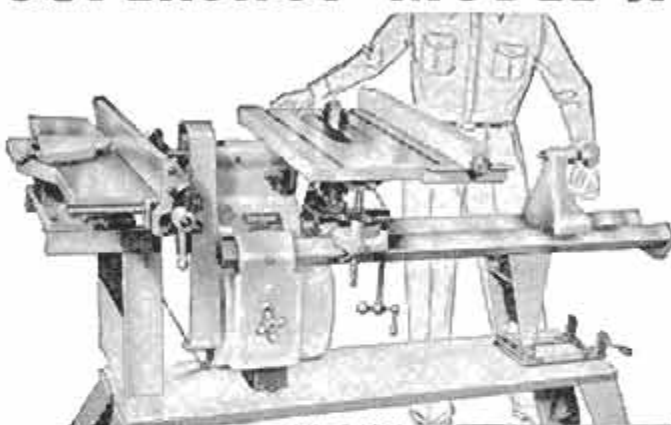

8" SAW

**WE PAY ALL
FREIGHT FOR
YOUR FREE
HOME TRIAL**

**ONLY
\$139.50
EASY
PAY
PLAN**



Vert. Drill Press



Hor. Drill Press



8" Sander

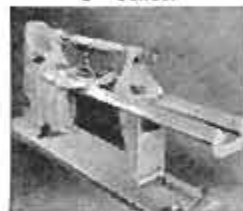

30" Lathe



5" Grinder

Never before have you seen so much deluxe, precision-built power tool workshop at any price! Designed for the man who wants the best. Massive cast and precision-machined headstock, self-centering inverted "V" bedways (like precision metal lathes), exclusive non-friction speed changer, extra-large cast and precision-ground saw table. 100% ball bearing, lifetime-lubricated. You save by ordering direct from factory. You are invited to test Supershop Model X in your home FREE. Mail coupon or postcard for FREE brochures, photos, details, specifications, accessory list — and amazing freight prepaid FREE HOME TRIAL PLAN. All free.

**MAIL COUPON OR
POSTCARD TODAY**

POWER TOOLS, INC. 189 Yates Avenue
Beloit, Wisconsin

NAME _____

ADDRESS _____

CITY _____ STATE _____



2½x - 4x or 6x RIFLESOPES
10 DAY MONEY BACK GUARANTEE



IDEAL GIFT for DAD or SON
10 DAY MONEY-BACK GUARANTEE

YOUR CHOICE! SAME PRICE!

2½x — Overall lgth. 9¼"
28 ft. FIELD OF VIEW AT 100 YDS.
4x — Overall lgth. 9¾"
28 ft. FIELD OF VIEW AT 100 YDS.
6x — Overall lgth. 10¼"
28 ft. FIELD OF VIEW AT 100 YDS.

NEW PAL-MASTER SCOPES
for TARGET - BENCH REST or HUNTING

Choice of 3 different
powers at the same
LOW PRICE!

ONLY 9.95
WITH MOUNT

COMPARE THESE QUALITY SCOPE FEATURES:

- | | |
|--|---|
| 1—ADJUSTMENTS Positive Internal. Direct reading Windage & Elevation Knobs | 4—RETICLE Sharp, Clear Cross-Hair. |
| 2—LENSES Top quality Optical Glass —precision ground, polished, color corrected, no distortion, hard coated glass-to-air surfaces. | 5—FOCUS is Lock-Tight. Won't "shoot off." |
| 3—EYE RELIEF 2½" to 4½". Safe on heavy recoil. | 6—BARREL Rust-proof, Extra Durable Steel. |
| | 7—Guaranteed to perform perfectly on ANY RIFLE. |
| | 8—Made by leading American Optical firm. |

MOUNT INCLUDED with SCOPE

SIDE or TOP MOUNTS available with scope to fit most rifles. When ordering specify type mount, gun model number and brand.



11" BLADE

NEW

SPECIAL PARATROOPER FOLDING MACHETE
WITH LEATHER HOLSTER

A new design and a new blade shape with tapered, beveled edge that's honed to cut quicker and deeper! The blade is finest, blue, nickel-alloy steel. The handle is heavy bakelite with diamond point knurl to assure positive, non-slip grip. Blade folds into handle and special steel guard like a giant pocket-knife giving absolute protection to the user. When open a positive safety lock holds blade rigidly in place. A rawhide wrist thong in handle prevents losing knife. Ideal for chopping, cutting or hacking use. Overall 17". Blade is 11". **GENUINE LEATHER HOLSTER** — for machete above. Has belt-loop and long rawhide thong for leg strap. Beautifully double-stitched throughout. **1.50**

MACHETE
2.89
1.50 VALUE

BUILD-IT-YOURSELF
12 INCH BOAT KIT



with **ELECTRIC MOTOR & SPOTLIGHT**

Here is a genuine electric motor driven speedboat that will make many a young sailor happier this Xmas. The hardwood hull and deck are already completed (excepting paint) and is ready for final assembly. Included in this complete kit is an electric motor, flexible coupling, drive shaft with propeller, adjustable rudder, windshield, electric spotlight and other accessories and hardware. Can be finished and ready for launching in one hour. Motor and spotlight operate on 2 standard flashlight batteries. Order now — Xmas delivery assured to Dec. 15.

ONLY 3.95
WITH MOTOR

18" PREASSEMBLED HYDROPLANE

XMAS GIFT BARGAIN



A sleek, single-step hull made of special hardwood. Hull sections are preformed and shaped making the assembly faster, easier and very attractive. All parts, including metal framed, plastic windshield, are furnished. Hull is designed to take a miniature outboard motor.

ONLY 4.95

ELECTRIC OUTBOARD MOTOR

Designed to drive boats like hydroplane above. Runs on two regular flashlight batteries (mounted in boat). Has clamp-on mount. Will tilt and swivel for steering. 1" dia. prop. For boats up to 18".

2.59

23" WINGSPAN



F-51 MUSTANG U-CONTROL AIRPLANE
½ CLASS ONLY 3.95

The famous Mustang Fighter of World War II. An excellent model for the beginner in control-line flying. Easy to build and fly. Kit has many pre-cut and shaped parts for easy, accurate assembly plus large pictorial instructions. Gas powered.

.009 MODEL GASOLINE ENGINE



Develops .15 HP at 14,000 RPM. Ideal for Mustang above or similar models. Operates with glow-plug ignition and rotary valve carburetion. Easy starting.

4.95

FREE CATALOG— illustrated showing many more models, supplies, accessories, sporting & camping goods, etc. Send for Catalog C-8.

PALLEY'S—SEE OPPOSITE PAGE FOR ADDRESS

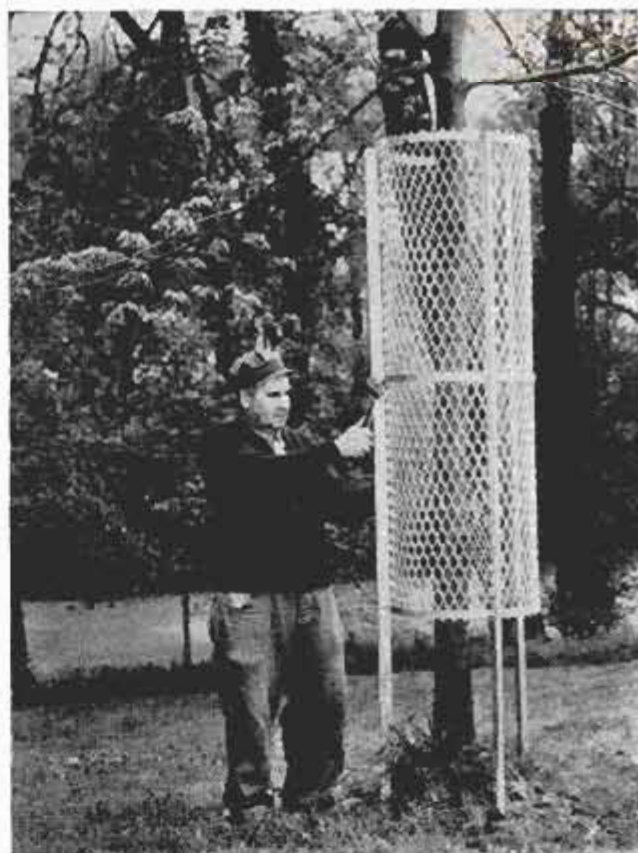

Wheeling Corrugating Co., Wheeling, W. Virginia

Metal Guards Protect Trees

Durable metal tree guards are assembled from a knocked-down package that includes the necessary nuts and bolts. Made of galvanized mesh and sturdy posts that are driven into the ground, the guards are 18 inches in diameter and have a 60-inch mesh height. When the young tree or shrub no longer needs protection, the guard can be disassembled and used elsewhere.

Ball Bearings From the Sky

Microscopic ball bearings are falling out of the sky at the rate of 20 per hour per square yard of earth. That rate of fall, at least, is true in the Southwest where scientists of the New Mexico Institute of Mining and Technology are collecting and studying them. Known as spherules, they apparently originate as dust from interplanetary space that melts and forms into droplets as it enters the atmosphere, or from droplets torn off the molten surfaces of larger meteors.

The micrometeorites are magnetic, perfectly round and average 1/5000 inch in diameter. They are collected by means of glass trays that are filled with ethylene glycol to prevent them from bouncing out or being blown away. The trays are placed in various locations including the top of a 10,300-foot mountain in New Mexico. Later the spherules are removed with a magnet for study under a microscope.



OWN YOUR OWN SATELLITE REPLICA

(COST GOVT APPROX. \$250)

This approximately 15" Lucite plastic ball contains its own electro-vacuum gyro mounted in center, and also many other intricate gadgets and electronic devices. It was used in research and experimental radio controlled drone planes to simulate planetary actions. This unusual piece not only has great breakdown value but in home or office decoration. . . . **795**

AMAZING NEW IMPORT TERRESTRIAL & ASTRONOMIC TELESCOPE

83 POWER
40 POWER
or
23 POWER
PLUS A

VARIABLE 25 and 60 POWER TERRESTRIAL TELESCOPE

Never in our history have we been able to offer a telescope value like this. For our one Low Price you get

- 1-Astronomical LENSES - Three of 23X, 40X and 83X magnification. Achromatic & precision ground.
- 2-Variable Power LENS of 25 & 60X for straight through viewing. Fully corrected for Terrestrial sighting.
- 3-BODY - Steel for a lifetime of use.
- 4-LENGTH - 19-1/2" 22-1/2" extended.

FREE BOOK ON STARS - Tells you all about the stars and the constellations - Where to find them at different times - How to identify them and many other intriguing facts on astronomy.

EXTRA 100X EYEPIECE **750** 125X EYEPIECE **995**

TOP QUALITY IMPORT

83 and 40 POWER ASTRONOMICAL SCOPE

Very similar to the scope described above but has 83X and 40X astronomical eyepieces and the objective lens is 40MM. The variable terrestrial lens is 25X - 30X. All steel body tube is 26" long. Included with the scope is a sun glass, a diagonal prism, an erecting prism, a hardwood tripod and a fitted hardwood case. Ideal for the student, hobbyist, etc. An exceptional Xmas gift!

SPECIAL 4995
EXTRA 100X EYEPIECE - **750**

25 POWER x 30 MM TELESCOPE & TRIPOD

Nowhere but PALLEY'S can you find a buy like this! Here's a scope, complete with a sturdy metal tripod, that you can have a lot of fun with. Use it to spot "hits" on the target, for stargazing, interesting views of the beach, etc. Made of aluminum and chrome plated brass. Field: 62 ft. at 1000 yds. Lens: 1-3/16" dia.

20 POWER x 40mm SPOTTING SCOPE WITH TRIPOD & CASE

Imported directly by Palley's. The finest spotting scope for the money that we have seen. A FULL 20 POWER MAGNIFICATION yet small enough to fit easily in your gun case, knapsack, etc. Has precision ground and polished lenses and prisms throughout. With fully coated objective lens. Eye-piece is fully adjustable. Comes with a sturdy tripod and special leatherette carrying case with zipper enclosure. Weighs only 15 ozs. Overall length 8 1/2".

Optical items in this ad were made by finest, German trained, Japanese Optical Technicians.

NOW 895
2500 VALUE

NEW IMPORT

Objects appear
to be 25 TIMES
CLOSER to you!

2995
VALUE

Only 1995
WITH
CASE

SAVE UP TO 50% ON XMAS OPTICAL BUYS

MAKE THIS A SCIENTIFIC CHRISTMAS
10 DAY FREE TRIAL or MONEY BACK GUARANTEED

AMAZING NEW DESIGN 60 to 600 POWER - 2 EYEPIECE SPECIAL MICROSCOPE

ANOTHER PALLEY SCOOP
HAS 60 - 120 - 200 - 300 - 400 & 600
POWER MAGNIFICATION WITH ILLUMINATED
SUB-STAGE MIRROR and TRIPLE TURRET

Now you can change magnification with a simple shift of the dual eyepiece turret. No loss of focus - No re-adjustments - Your choice of 6X or 20X eyepiece with any of the objective lenses instantly!

INCLUDES THESE ADDED FEATURES:

Has triple revolving turret with 10X, 20X, & 30X precision ground and polished lenses - Dual eyepiece turret with 6X and 20X lenses - New Patented Sub-Stage with a built-in, battery operated light, no external light source needed - A large sub-stage mirror with revolving variable iris - All-metal precision made body, inclines through 90° - Special fitted hardwood case and glass slides. Ideal Xmas Gift!



NEW
IMPORT



XMAS 1695
SPECIAL PRICE 1695

PALLEY 60 to 450 POWER MICROSCOPE

with ILLUMINATED SUB-STAGE
MIRROR and TRIPLE TURRET

Take advantage of our tremendous foreign purchase. Ideal for use by the Amateur, Scientist, Student, in Home Laboratory for study of insects, tissue, minerals, microbes, liquids, etc. ORDER TODAY!!

CHECK THESE FEATURES

Microscope has triple revolving turret with 10X, 20X and 30X, precision ground and polished lenses - Two interchangeable eyepieces of 6X & 15X - New Patented Sub-Stage with built-in light, needs no external light - Large sub-stage mirror for external light - All-metal body, precision made, inclines through 90° - Fitted hardwood case and 3 glass slides. ORDER NOW!!

HAS 60, 120,
150, 180, 300
and 450 POWER
MAGNIFICATION

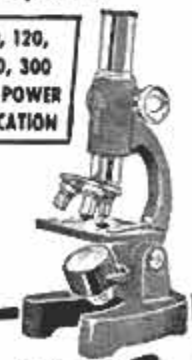

1295
INCLUDING
FREE 8 P.C. DISSECTING SET
Has scalpel, scissors, tweezers, slides, probe, pins & magnifying glass. All in hardwood case.

SAVE PALLEY 100 - 200 - 300X BUY MICROSCOPE NOW

Perfect GIFT for STUDENT - AMATEUR SCIENTIST

A triple revolving, objective lens turret allows selection of 100, 200 or 300 POWER magnification. Has fine, ground and polished lenses and ALL METAL construction. This instrument is NOT A TOY! Right or left hand rack & pinions make smooth, precise adjustments. Body inclines 90°.

WAS 125 NOW 795



SPECIAL MICROSCOPE LIGHT

Specialty designed to provide proper light for specimen slides on microscope or any other close inspection work. Universal-joint body permits setting at any angle. Heavy metal base with bakelite head and chrome fittings. For 110-120 AC-DC. Has 5 watt bulb, cord and plug. Vary handy.



495

NEW
IMPORT

NEW ILLUMINATED MAGNIFIER

Provides 5 POWER magnification with brilliant illumination for precise inspection of any substance, material or specimen. The head contains a 50 MM lens and has internal calibrated scale to show relative size of subject. Body is nickel plated metal and holds 2 flashlight batteries. Head is molded bakelite. Takes a regular flashlight bulb.

NEW 4-6 OR 10 POWER EYE LOUPES

A 4X & a 6X lens are interchangeable for either power or can be combined for 10X in this one handy two-piece unit.

1295
VALUE

ONLY 495

125

Palley's

TERMS: Send Check, Cash or money Order. 20% Deposit with C.O.D.s. Prices F.O.B. Los Angeles, Calif. Warehouse

2263 EAST VERNON AVE. DEPT PM-11-LOS ANGELES 58, CALIF

Schupack's Amazing Tool Bargains! Save up to 100%!

75 Mounted Wheels & Miniature Cutters. Regular \$11.00 value **\$4.50** Post-paid
 For cutting and grinding on wood, metal or plastic. Includes 26 mtd. wheels and points on 3/32" shank; 24 miniature cutters on 3/32" shank; 25 short shank min. cutters. Will fit all electric drills and hand grinders.

FLEXIBLE SHAFT—ONLY \$4.95 Post-paid
 Fits all electric drills & hand power tools. 35 3/4" long. Oilite bearings. Core of specially wound, high carbon steel wire in flexible steel casing. Will accommodate tool shafts up to 1/4" dia. For lathes, electric drills, etc.

2 DRUM SANDERS
 With 12 Bands in Assorted Grits. 1 1/2" dia. x 1" long on 1/4" arbor with 12 bands. **\$1.50** Post-paid
 One drum, 1" dia. x 1" long on 1/4" arbor with 6 extra sleeves **\$1.00** Post-paid

8 Carbon Steel Wood Bits for Braces. Assorted sizes, 3/32" to 1/4", for drilling on wood **\$1.75** P.P. or metal.

15 Assorted Drills. From 1/16" to 1/2" high speed steel and carbon. Only **\$3.95** P.P.

30 Assorted Drills. Hi-speed steel & carbon. Up to 1/4" dia. **\$2.75** P.P.

12 Assorted Drills. High speed and carbon steel from 1/16" to 1/4" dia. **\$3.60** P.P.

ELECTRIC HAND GRINDER
 Fits in the palm of the hand and has an air-cooled motor that runs at 20,000 rpm. AC or DC at 110 volts. Comes complete with both 3/32 and 1/4" collets. **\$9.50** P.P.

SPECIAL—100 PIECES for ELECTRIC GRINDERS
 Grinding Wheels, Cut-off Wheels, Sanding Discs, Mounted Stones, Honing Stones, Rotary Cutting Burs, Mandrels and other items. **\$1** P.P.

20 Abrasive Rolls, cloth, and 1/4" mandrel for grinding, sanding, deburring metal, plastic, wood or rubber. Only **\$1** P.P.

12 MINIATURE CUTTERS
 For cutting wood, plastic or metal. Assorted shapes on 3/32" shank. For die makers, home workshop, etc. **\$1** P.P.
36 Short Shank Miniature Cutters **\$1**

12 MOUNTED WHEELS and points on 1/4" shank **\$2.65**
 For grinding on plastic wood, soft & hard metals. Regular Value \$8.40. **\$1.60** P.P.

18 Mounted points on 3/32" shank **\$2.50**; 12 mtd. wheels on 1/4" shank **\$3.60**

18 Rotary Cutters P.P. **\$5.85**
 Assorted sizes cutter on 1/4" or 3/32" shank. Will fit all hand grinders. Ideal for cutting wood, metal, or plastic. Brand new.

ADAPTER CHUCK
 With 2 interchangeable collets, opening from 3/32" to 1/4". **\$1.50** P.P. mandrel. Price each only **Adapter Chuck. From 60 to 80 on 3/32 in. Mandrel \$1.00**

10 ASSORTED YAPS. Precision ground thread. All popular sizes up to 1/4". Brand new. **\$2.50**

5 H.S. and carbon drills from 6" to 12" in length. Assorted sizes up to 1/4" diam. for drilling in hard to reach places. A reg. \$10.00 val. for only **\$1.95** P.P.

5 H.S. Taper Shank Bridge Reamers from 13/32" to 1-5/32". All brand new and in excellent condition. Reg. \$25 val. for **\$7.95** P.P.

7 Larger Drills. From 1/4" to 1-1/4" High speed steel and carbon. **\$7.50** P.P.

5 Woodworkers Drills. From 1/4" to 5/8" on 1/4" shanks. **\$2.95** P.P.

2 Circular Saws. On 2 Mandrels—all at one low price, 1" diameter saws on 1/2" Mandrels. For cutting wood, plastic or soft metals. Order at once. **\$1.50** P.P.

112 PIECE ASSORTMENT for ELECTRIC GRINDER
 Here's what you get! Mounted Stones on 1/4" shank. Drum Sander. Sanding Sleeves for sander. Rotary Cutters. Wire Scratch Brush. Bristle Brushes. Circular Saw. Buffering Wheel. Grinding Wheel. Rubber Polishing Wheel. Cut-off Wheels. Rubber Cylinder. Mandrels to fit above tool, ass'd. Sanding Discs. Sharpening Stones, etc. **\$3.95** P.P. \$10.00 value—only.

32 H.S. steel drills, threaded shanks from 3/32" to 1/4". Reg. \$8.50 value, only **\$2.00** P.P.

No C.O.D.'s please
 New Illustrated Catalog 10c

SCHUPACK SUPPLY CO. 7311 COTTAGE GROVE AVE. DEPT. PM-12 CHICAGO 19, ILL.

Need an extra \$1,000, \$2,000, or more? Make it with an **IDEAL LAWNMOWER SHARPENER**



There are thousands of lawnmowers in your locality: Average \$1,000 profit per 250 mowers with customer satisfaction and repeat business assured. Provide this essential service with an Ideal® Lawnmower Sharpener, the only machine that grinds the reel to "fit" the bed knife. Compare by any standard. The Ideal, backed by 53 years of experience, costs no more. Write today for complete, free catalog.

THE FATE-ROOT-HEATH COMPANY
 Dept. PM-11 Plymouth, Ohio

GEARS
 In Stock - Immediate Delivery
 Gears, speed reducers, sprockets, thrust bearings, flexible couplings, pulleys, etc. A complete line is carried in our Chicago stock. Can also quote on special-gears of any kind. Send in your blueprints and inquiries.
Send for Complete Catalog No. 10
CHICAGO GEAR WORKS
 440-50 N. Oakley Blvd., CHICAGO 12, ILL.



BIRCH TABLE LEGS—TOPS PLYWOOD—FURNITURE KITS
 Build attractive, modern furniture pieces with highest grade selected birch table legs. Choice of turned, tapered or bent laminated. Smoothly sanded with brackets, ready to attach and finish. Set of 4, only \$3.75 ppd. Also Aluminum Folding Legs, \$9.95 set of 4. Order now. Write for FREE CATALOG of quality furniture kits, legs, tops, plywood.
BIRCHWOOD INDUSTRIES
 DEPT. 12 FITCHBURG, MASS.



No Leak Lamp
TEST Circuits, Fuses, Outlets easily, quickly, safely. Shockproof. Pull fuses 10 to 100 Amp.
STAR TEST-PLIERS
\$2.95
 \$1.65 add'l for 2 ft. leads. At dealers... or order direct from us. Mailed POSTPAID for 25c add'l.
STAR FUSE CO., 233 Canal St., New York 13, N. Y.



POWER HACKSAW \$58.50
 LESS MOTOR
 F.O.B. Benton Harbor
 Rugged cast iron construction. Wt. 56 lbs., bronze bearings. Draw cut. Auto. return lift. Auto. shut-off. Vise swivels 45°. Cap. 4"x4".
 Dept. PM-116
EXCEL MACHINE TOOLS BENTON HARBOR, MICHIGAN



AUTOMATIC RETOOTHER
 MAKES NEW PROFITS
 for HAND SAWS
 Cuts new teeth in 50 seconds—any size 4 to 10 points. Old teeth fall off as chips. Easy to operate. A perfect job.
BURR MFG. CO.
 8933-N VENICE BLVD. LOS ANGELES 34, CALIFORNIA



CRESCENT TOOLS
Give Wings to Work
 ASK YOUR HARDWARE DEALER

SOLVE YOUR STORAGE PROBLEM
 With TURNBUCKLES Perforated Board fixtures you can easily end space-wasting clutter and keep everything neatly in place until needed.
 TURNBUCKLES do-it-yourself fixtures come in a wide variety of shapes and sizes... fit easily into any wall-hung perforated board... and hold everything from clothing and kitchen utensils to hand tools and garden equipment.
TURNBUCKLES, INC.
 BOX 333, MICHIGAN CITY, IND.
 Send for your free copy of space saving suggestions for home, farm and workshop.



PORTABLE LIGHT PLANTS

GIANT 2500 WATT PLANT

110-120 v. 60 cyc. AC. Absolutely the best made—exclusive dynamicaly balanced armature—heavy windings develop up to 5000 watt overload for motor starting. Skid mounted—portable. Powered by an easy starting Briggs or Wisconsin 6 HP engine—complete with all accessories; engine easily disconnected for other uses. Big outlet box, voltmeter, no wiring necessary. Ample current for all purposes. Factory warranty. (Item 31) Wt. 210 lb. Reg. price \$585. Special at..... **\$299.50**

Same plant with electric self starter (Item 31a)..... **\$359.50**

Generator only and control box..... **\$169.50**

DUAL VOLTAGE 110-220 available on any of above models for \$28.00 additional.

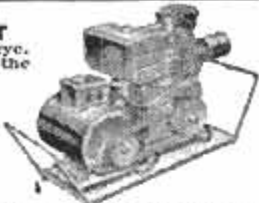

POWER-FLO 3500 WATT

115-230 v. 60 cyc. AC. A rugged power plant for heavy duty use. Duplex power distribution provides both 115 v. and 230 v. output at the same time if desired. Powered by a big 8 HP Wisconsin engine with triple V belt drive. Has built-in overload protection. A dependable plant for either standby or regular service. Equipped with electric self-starter. (Can also be started by rope) and plug-in outlet box. (Item 108) Wt. 310 lbs. Factory price..... **\$439.50**

GENERATOR ONLY belt driven..... **\$239.50**



(Item 198)

Get the best for less at **MASTER MECHANIC'S** bedrock factory prices!

700 WATT PLANT



115 v. 60 cyc. AC Powered by a rugged 2.2 HP. easy starting Briggs engine. No wiring necessary; just plug in and operate. Plenty of current for any oil burner, freezer, brooder, emergency lights, etc. which require up to 700 watts. Ideal for television and radios. Complete with voltmeter and built-in winding to charge 6 v. auto batteries. (Item 24) Wt. 75 lbs. Easily fits in car trunk. Be prepared if storm knocks out power lines. Regular \$275.00 value..... **\$143.50**

1200 Watt Plant (Item 45) same as Item 24 but larger generator and engine with 50% greater output..... **\$199.50**

We make every type and size of light plants—Write, giving us your requirements!

PUSH BUTTON START

LESS THAN WHOLESALE

1500 WATT PLANT

115v. 60 cyc. AC Push Button Start. Powered by a 3 1/2 HP. Clinton engine. Combines big output with easy portability. Provides emergency power for operating any oil burner, sump pump, freezer, television, lights, communications systems, etc. which require up to 1500 watts. (Item 22) Wt. 110 lbs. Reg. \$475 value. Factory price..... **\$239.50**

1750 Watt Plant Powered by 4.5 Briggs engine. Electric starting & battery charging built-in! Factory price..... **\$279.50**

MASTER-LITE 2500 Watt Plant 110/120 v. 60 cyc. AC. A powerful plant, ruggedly constructed and yet designed for easy portability. Can be started by rope or built in 12 v. electric push button starter. Built-in winding to charge battery. Powered by a big 5.10 HP Briggs engine, complete with all accessories. Includes control box, voltmeter, and handy plug-in power receptacle. An ideal plant for permanent or stand-by service. Wt. 225 lb. Reg. price \$645.00 (Item 21) Factory Price..... **\$329.50**

3500 Watt Plant Push Button Start (Item 23) 115 v. 60 cyc. AC. Similar to above, but larger and 33% more capacity. (Item 23) Wt. 270 lbs. Reg. \$760. Factory Price..... **\$379.50**

DUAL VOLTAGE 110/220 for Item 21 or 23—\$30 additional.



\$239.50
\$279.50



(Item 21)

DIESEL LIGHT PLANT

(Item 1660) Diesel Master—11-12 kw. 110/220 v. AC single or 3 phase. 1800 rpm direct connected. Electric Self-starting. Engineered for permanent power where continuous low-cost, heavy duty service is important. Wt. 1350 lb. Reg. list \$3650.00. Factory Price..... **\$1895.00**



(Item 1660)
\$1895.00

HEATING & VENTILATING FAN

(Item 10) Easily installed in furnace pipes. Forces even heat to all rooms. Over range removes kitchen smoke and odors. Powerful, continuous duty motor. 110-120v. AC. Mount in wall or ceiling to ventilate any area. Quiet, super-efficient fan moves huge volume of air. (400 to 600 CFM)

8" Pipe, wt. 5 lb..... **\$6.85**
9" Pipe, wt. 6 lb..... **\$7.85**
10" Pipe, wt. 7 lb..... **\$8.85**
12" Pipe, wt. 8 lb..... **\$9.85**

HEAVY DUTY FAN. Semi-enclosed motor, suitable for spray booths, restaurant exhausts, poultry houses, etc. 10" Fan, wt. 8 lbs. (Item 10E)..... **\$11.95**
12" Fan, wt. 10 lbs. (Item 10D)..... **\$12.95**

HIGH SPEED BARN FAN similar to above, but larger, high speed motor moves huge volume of air.
12" Fan (Item 10F)..... **\$14.95**
14" Fan (Item 10G)..... **\$17.95**



PORTABLE BOOM HOIST



Here is a big 8000 to 10,000 lb. capacity boom hoist at a fraction of the usual cost (it's Gov't surplus) — that can pay for itself on one job! Can be mounted as a stationary crane in yards or on build-up.

As a wrecker or mobile crane. Massive telescoping boom is quickly extended from 10 to 20 ft. with a built-in winch. Ideal for erecting buildings, hoisting materials, loading machinery, unloading RR cars, lifting boats from water, laying in sewer pipe, etc. (Item 801) Wt. 650 lbs. Orig. cost over \$350. Special F.O.B. Shelby, Ohio..... **\$89.50**

GIANT METAL SHEARS

"PEKTO"
A 36 inch cutting blade made of special high carbon alloy steel, perfectly aligned and ground. Easily cuts steel plate up to 12 gauge or 1/2" thick. Overall length 40". Wt. 23 lbs. (Item 156) Regular **\$49.50**, While they last..... **\$14.95**

Double Acting Hydraulic Cylinder



A powerful cylinder mfd. by Massey Harris which develops both a pushing and a pulling action. Will push 8,100 lbs., with a 1000 PSI pump pressure. Cylinder is 3 3/4" O.D. with 6 1/2" stroke—standard heavy duty clevises on both ends. Has standard 1 1/2" pipe thread openings. Can be used for tilting buckets or blades, raising or lowering implements, hydraulic presses, etc. Can also be used as an air cylinder. (Item 802) Wt. 17 lbs. Reg. \$68 value, Special..... **\$14.95**

JET FLOW BLOWER

Tremendous air movement (1800 CFM) and quiet operation make this double inlet 10" turbine blower unbeatable for heating, cooling, drying and air conditioning. Ideal for attic or barn ventilation, converting gravity heating to forced air; spray booth exhausts, etc. Operates with any 1/4, 1/2 or 1 HP motor. Oversized, long life bearings. Includes variable speed motor pulley and belt. Dimensions 19" h x 18" x 16 1/2". Outlet opening 13" x 11 3/4". Wt. 45 lbs. Item Factory Special..... **\$29.50**

HEAVY DUTY 1/4 HP motor for above **\$17.95**.

Send check or M.O. Prices f.o.b. Factory. 10 day Money back guarantee. SEND 10c for..... **MASTER MECHANIC MFG. CO.,** DEPT. 37-P Burlington, Wis.

EXTENSION CORD

Heavy duty and very flexible. Neoprene 14-2 cable. 20 year quality. Wt. 12 lbs. (Item 185) 100 ft. Complete with rubber plug and outlet. A terrific buy at only..... **\$8.95**



NO. 10-2 POWER CABLE. Heavy duty, very flexible, rubber covered, 50 ft. with male and female fittings. Wt. 9 lbs. (Item 502a) **\$10.45**
50 ft. without fittings (Item 502)..... **\$9.45**

NO. 12-2 POWER CABLE. Very flexible rubber covered, special outside shield for grounding power tools, etc. 50 ft. (Item 199) Wt. 8 lbs. **\$6.95**. 100 ft. (Item 200)..... **\$12.95**

NO. 14-8 Conductor Power Cable, heavy duty very flexible, rubber covered, with 8 contact plug & socket. Ideal for tractor-trailer connections (Item 700) 15 ft..... **\$9.95**

52 pc. SOCKET SET

Lightest quality, guaranteed non-breakable sockets made by Husky. Beautifully matched chrome thin wall alloy absolutely the best. Contains a complete set of 28 sockets in 1/2" drive, 3/4" drive and 1 1/4" drive, plus all necessary extensions, handles, speeders, reversible ratchets, etc.; all uncond. guaranteed against breakage. A beautiful set of tools that will handle any job in a big doghouse steel box. Wt. 17 lbs. (Item 205)..... **\$27.95**

List price \$62.90, Factory special.....

SCREW-TYPE PRESS

A tremendously powerful press capable of exerting nine tons of pressure. Pays for itself straightening bent parts, or pushing out bearings and bushings. Ideal for manufacturing and assembly operations because of precise control. Massive 1 1/2" screw permits precise control over vertical travel. Extra heavy ribbed yoke has a throat 21" high; depth capacity for working to the center of an 11" object. Includes 8" x 15 1/2" vise-type table and two nutting arbors. Wt. 150 lbs. (Item 707). Reg. **\$49.50**. \$149.50. Special.....

HYDRAULIC PRESS. Nine ton capacity. See Oct. Pop. Mech's. ad for details—or write, Complete, Wt. 110 lbs. (Item 464)..... **\$69.50**

Variable Speed Selector

Heavy duty, made by B. F. GOODRICH for industrial use. Provides instant speed changes for any drive. For machine tools, dryers, printing, conveyors, production lines, hoists—any operation requiring variable speed. Employs reliable "trouble free" planetary system. No hydraulic power losses. Infinite range, smooth operation, easy installation. 3 sizes: 1/2-1 hp. 30 lbs.; 1-2 hp. wt. 55 lbs.; 2-3 hp. wt. 105 lbs.; Reg. list \$228, \$252 and \$352. Our prices..... **\$79.50, \$89.50 and \$114.50**



MASTER DC ARC WELDERS

Now! a portable rugged, industrial type welder with terrific performance, yet at a price hundreds of dollars less than you'd expect. Senior model made for years of trouble-free, continuous service. High capacity DC welding unit enables you to tackle any job with confidence—easily welds anything up to 2" plate using from 1/16" to 1/4" rods. Built-in stabilizer and cooling system makes arc easy to strike and hold. Dual control rheostat provides low heat soldering, brazing and welding from 30 to 300 amps. Complete with instructions, guarantee and triple V-belt or flat pulley. Easy to hook up and easy to operate. **WELDER ONLY — DUAL CONTROL MODEL.** Same as above, but drive with your tractor, jeep or gas engine of 14 HP or more. (Item **\$119.50**) Wt. 110 lbs. \$450 value.....

WELDER ONLY — INDUSTRIAL MODEL same as above but with ceramic rotary type rheostat providing 74 different heat settings for all types of welding (Item 38b) **\$139.50** \$500.00 value

COMPLETE POWER MASTER (Illustrated above) powered by a 14.6 hp., air cooled Wisconsin engine. Wt. 480 lbs. (Item 280) Compared with welder costing \$1200. **\$449.50** Factory Special.....

WELDING KIT Two 10 ft. leads, welding helmet, electrode holder, ground clamp. Sold only with welder at..... **\$10.50**



(Item 280)

More for Your Money

If there is any one reason why South Bend Lathes are so popular it is because they represent the maximum value per dollar of cost. We invite comparison feature-by-feature with any other make, and are confident you will find South Bend gives you more for your money. Send coupon for catalog.



HARDENED BED WAYS

Hardened and precision ground bed ways can be supplied in lieu of regular at small extra cost—also hardened and ground cross-feed screw.

TIME PAYMENTS

only 3¼% interest

Yes, only 3¼% interest on original unpaid balance. Low down payment and balance in up to 24 equal monthly payments.

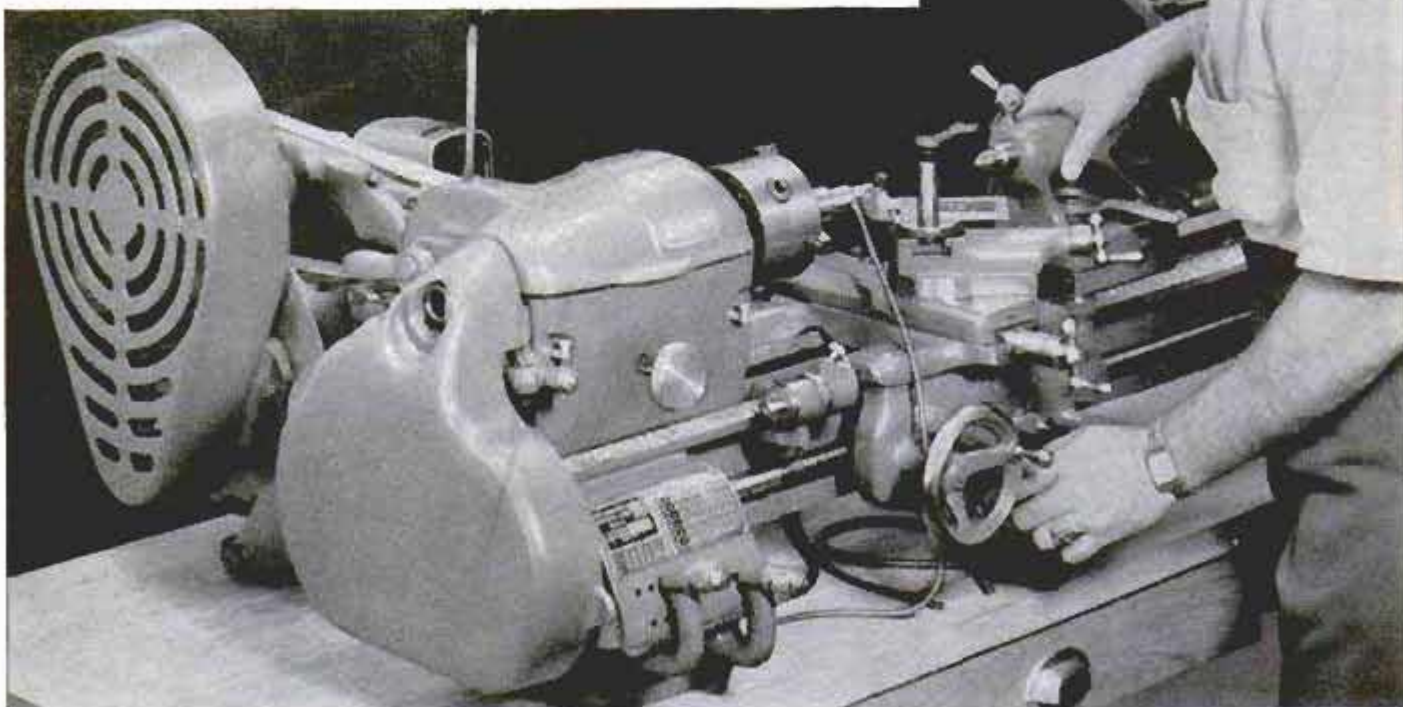

PLEASE SEND INFORMATION CHECKED:



9" and 10" BENCH LATHES



10" to 16-24" FLOOR LATHES



DRILL PRESSES



½" & 1" Collet TURRET LATHES



TOOL GRINDERS



7" BENCH SHAPERS



MILLING MACHINES

Name _____ Street _____

City _____ State _____

Building Better Tools Since 1906 • SOUTH BEND LATHE • South Bend 22, Indiana

Now...the perfect trio of **WELLER TOOLS**
 to **GIVE** or **RECEIVE** for **CHRISTMAS**
SAWING • SANDING • SOLDERING

With one or more of these faultless Weller tools, inexperienced amateurs as well as able handymen and hobbyists can do *hundreds* of homecraft jobs easily, quickly, successfully.



\$19.95



\$14.95



\$7.95

WELLER SABRE SAW

Portable Jig Saw. Seven saws in one. Cuts wood up to 1" thick, do-it-yourself aluminum, composition board, plastic, etc. Makes its own starting hole. Cuts curves, circles (as tight as a coin), intricate shapes. Exclusive strain-relief design eliminates blade breakage. Reciprocal action. Combination knob and handle grip for positive control. Polished aluminum housing. 3 blades and wrench included. Nothing like it at anywhere near its price. Guaranteed. Model 800

WELLER POWER SANDER and POLISHER

Sands down old paint in a jiffy. Puts satin-smooth finish on new wood... but fast. Readies old furniture for refinishing by removing scars, stains and other blemishes. 25 square-inch sanding area—twice that of comparably priced sanders. Straight-line action. Makes 14,400 power strokes a minute. Sands with the grain. Goes all the way into corners. Fits under low places. Guaranteed. Model 700

WELLER COMPLETE SOLDERING KIT

Latest type Weller Gun. Heats in 5 seconds. Triggermatic control. 2 spotlights to light up work. Joins metal parts. Makes electrical connections. Seals leaks and seams. Kit includes Soldering Brush to clean connections, Soldering Aid to twist wires, famous Kester Solder. Another practical do-it-yourself home tool to give or receive this Christmas. Guaranteed. Model 8100K

AVAILABLE FOR CHRISTMAS FROM YOUR HARDWARE DEALER

Weller

ELECTRIC CORP. • EASTON, PA.

Look for this name—it's your guide to quality in small power tools

Trend setting glimpse of tomorrow...the Magnificent

'57 Lark

DREAM STUFF? Call it that. But what a *practical* dream...to pleasure-power your *own* new boat with such commanding drive and speed and stunning modern beauty! *Any smart hull*... forwardly-styled "dream boat" or able cruiser, family runabout or sport fisherman... receives a noble lift when a Lark goes on the transom.

Under the hood purrs a brawny new engine—muscle and tuned for the real jobs of boating—35 *big-load* horsepower! For fast, sure starts there's a new 12-volt system. For cruiser lighting a new heavy-duty generating system is available, with capacity to keep batteries charged at peak. The Lark is *here*—at your Evinrude dealer's *noze*. Look for his name under "Outboard Motors" in your phone book. For full-color catalog of the complete Evinrude line for '57, write **EVINRUDE MOTORS**, 4358 N. 27th St., Milwaukee 16, Wisconsin.

A Division of Outboard Marine Corporation
In Canada: Mfd. by Evinrude Motors, Peterborough

Evinrude

pioneers in quiet outboard motors

