

POPULAR MECHANICS

MAGAZINE

WRITTEN SO YOU CAN

U.S. TRADE MARK, G.P. & B. PRINTED IN U.S.A.

OCTOBER 1956

35 CENTS

Our Big Annual Home Section

- PM small home for the big family
- Wood paneling adds that look of luxury
- Fresh ideas for remodeling
- Plus: Facts about costs, soundproofing, storage walls, scores of new ideas

Page 189

Page 187

PM House
for Big Families
Page 161

Out of the blue



... from
Evinrude
comes news to
set your boating
dreams aglow

THEY'RE HERE... nine glorious new Evinrudes for '57! *Right now*—at top boating dealers straight across America—you can see these new '57 models... ride with them... *run them*... and savor the grand new thrills in your boating future!

TALK ABOUT PERFORMANCE... they're *loaded!* Three superb new "35's." A new Lark magnificently styled to complement the finest boats afloat. New, more powerful, high compression engines

that set an entirely new standard of big-load driving ability. Wonderfully smooth and *whisper quiet!* New 12-volt electric starting. A new high-capacity generating system for cruising folks who want abundant current!

GOOD NEWS, too, in the medium power field! A new Fastwin with a great new engine—power increased full 20% for stand-out performance on family runabouts—flashing take-offs for skiers. A new Fastwin Electric with 12-volt starting.

RIGHT DOWN THE LINE—in every popular power range for family boating or fishing fun—these exciting new '57 models are waiting for you now. See your Evinrude dealer—look for his name under "Outboard Motors" in your phone book. If you own a motor, see him now for the most favorable trade-in deal of the year. For catalog of the '57 Evinrude line, write **EVINRUDE MOTORS**, 4333 N. 27th Street, Milwaukee 16, Wisconsin.

A Division of Outboard Marine Corporation
In Canada: Mfd. by Evinrude Motors, Peterborough



Evinrude

quiet outboard motors

8 reasons why your car needs a **MOPAR** cold-weather checkup now



Cold-weather starting demands more from your battery. A MoPar check NOW will avoid danger of getting stranded with a dead battery.



Cooling systems operate under different conditions these chilly days. MoPar Anti-Freeze now will prevent costly freeze-up damage later on.

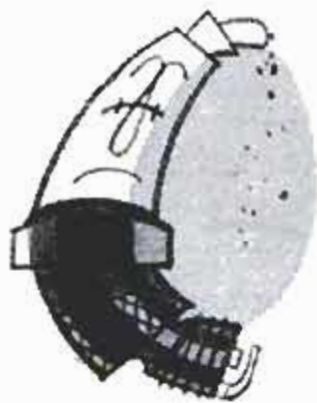

Cleaned, adjusted or, if needed, new MoPar Spark Plugs will give you faster starts, save your battery, and give better gas mileage.

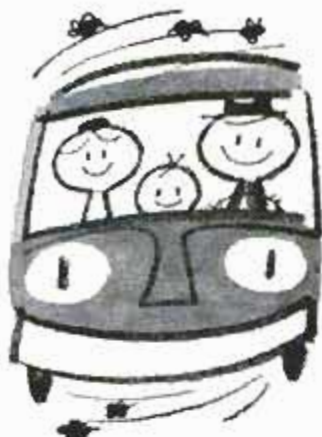

Have the thermostat checked. MoPar Thermostats let your engine and car heater operate at most efficient temperatures during cold weather.



Cold-weather driving loads oil with impurities. Protect your engine with a new MoPar Oil Filter Cartridge when you switch to winter-grade oil.



Leaking mufflers make windows-up driving dangerous. Rust, acids and knocks damage even the best. Give yours a MoPar checkup.

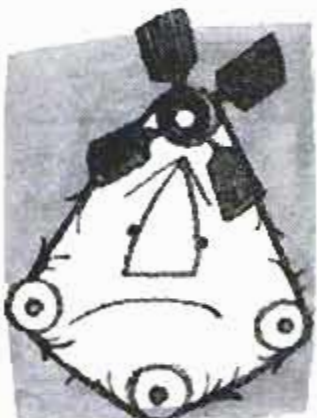

Fan belt turns your generator, keeps battery up. Prepare for winter's heavy demands on your battery by giving fan belt a MoPar checkup.

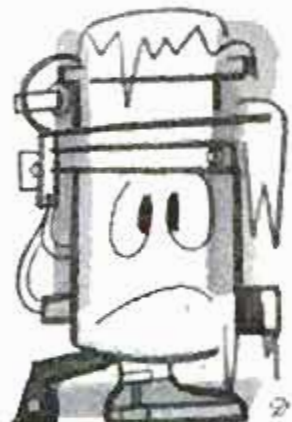

MoPar Gasoline Anti-Freeze saves you trouble by preventing frozen carburetors and fuel lines. Get a can at check-up time.

Fall's the time to have your car checked. An 8-point MoPar checkup now will take care of every cold-weather need. It'll give you peace of mind—and, in case of sudden autumn freezes, it'll save you costly repair bills. MoPar parts and accessories are the only ones engineered especially for Plymouth, Dodge, De Soto, Chrysler and Imperial cars, and Dodge Trucks. They're guaranteed by Chrysler Corporation. Get your MoPar cold-weather checkup at Plymouth, Dodge, De Soto and Chrysler dealers and better repair shops everywhere.

This One



FJLT-JHL-PCJ5

MOPAR

PLYMOUTH · DODGE · DE SOTO · CHRYSLER · IMPERIAL
PARTS & ACCESSORIES

CHRYSLER CORPORATION • PARTS DIVISION

STANLEY STEELMASTER

The Finest Hammer Ever Made

Driving nails is work — no doubt about it. But it's also the kind of clean, thumping exercise a man can enjoy. There's smacking satisfaction in belting a shiny tenpenny into stout 2 x 4 studding. This is the hammer to use . . . for accuracy, authority and pleasure . . . it's the Stanley STEELMASTER, the finest hammer ever made.

TEMPERED RIM MINIMIZES CHIPPING — Exclusive! Rim of striking face is induction tempered to minimize chipping.

LOCKED-ON HEAD — The head is permanently locked to the handle; it will never come loose.

CHROME ALLOY HANDLE — Special chrome alloy steel handle *will not break!* It flexes a little, it absorbs vibration, but it will not break. Chrome plating prevents rust.

ACUSHNET CONTOURED GRIP — Good-to-the-hand neoprene forms a non-slip, cushioned grip. It won't mar either, so the butt end can be used to tap work into place.



FREE "HAMMER HOLSTER"

Introductory extra! Your hardware dealer has free leather holster to keep STEELMASTER within reach when you're working.

Hammers up, men. Pick the finest made — the Stanley STEELMASTER. In 13, 16, and 20 oz. sizes. For useful nail chart send 10¢ to Stanley Tools, 620 Elm St., New Britain, Conn.



STANLEY

THE TOOL BOX OF THE WORLD

Popular Mechanics Magazine

Registered in U. S. Patent Office and Canada

H. H. WINDSOR, Founder

H. H. WINDSOR, JR., Editor and Publisher



Next Month

Coming right at you is one of the first of the 1957-model automobiles. Big changes are in store and you'd hardly recognize the car shown above in silhouette as the young brother of its '56 counterpart. Sorry we can't tell you more about it, but watch the newsstands for your November *PM*. In it we'll bring you the first photographs and all the details of many of the '57 models. Most of them are coming out earlier than usual this year and some are already in production—but under wraps! Among those you'll see in our next issue are the big three—Chevrolet, Ford and Plymouth. All the Chrysler line will also be shown—Chrysler, DeSoto, Dodge, Imperial as well as Plymouth. Ford, Lincoln and Mercury will make their debut; also Nash, Rambler and Hudson. Studebaker will be ready, too, but Packard and the rest of General Motors' line will be a month later.

Sources of further information not listed in the index, starting on page 106, about articles in this issue, frequently are shown in the Where-to-Find-It List prepared for each issue. A copy may be obtained by readers, without charge, from Bureau of Information, *Popular Mechanics*, 200 East Ontario Street, Chicago 11, Ill.

Published monthly by Popular Mechanics Company, 200 E. Ontario St., Chicago 11, Ill. H. H. Windsor, Jr., president; Wm. Harrison Fetridge, exec. vice-pres.; Franklin S. Forsberg, operations vice-pres.; D. F. Windsor, vice-president and secretary-treasurer; H. H. Windsor III, vice-president; W. T. Windsor, vice-president; Joseph R. Buell, Jr., advertising manager; Alan M. Deyoe, circulation manager. Single copy in the United States and Canada, 35 cents; subscription rates in the United States and possessions, Canada, Philippines and countries of the Pan-American Postal Union, 1 year \$3.50; 2 years, \$6.00; 3 years, \$8.00. To all other countries add \$1.00 a year over United States prices for overseas postage. If you plan to move, notify us at least 30 days in advance so you will not miss an issue. Give both your old and new addresses. Entered as Second Class Matter, September 15, 1903, at the Post Office at Chicago, Illinois, under Act of March 3, 1879. Entered as Second Class Matter at Post Office Dept., Canada. Registered as Second Class Matter at the Post Office at Mexico, D. F., Mexico, June 20, 1950. Copyright 1956 by Popular Mechanics Company. Copyright under International Copyright Union. Copyright in France. All rights reserved under Pan-American Copyright Union. Printed in the United States of America.

IMPORTANT NOTICE—It is the intention of this magazine to provide its readers with information regarding the latest developments in the mechanical arts. We take no responsibility as to whether the disclosures contained in our articles are covered by patents and advise readers to investigate this subject before making, using, or selling any of the products, machines, or processes described in order to avoid possible liability for patent infringements.

Volume 106 OCTOBER 1956 Number 4

Address all communications to: 200 E. Ontario St., Chicago 11, Ill.

Managing Editor.....Roderick M. Grant
 Assistant Managing Editor.....Wayne Whittaker
 Shop Notes and Crafts Editor.....James R. Ward
 Radio-Television, Electronics Editor.....Lothar Stern
 Associate Editor.....Clifford B. Hicks
 Associate Editor, Automotive.....Arthur R. Railton
 Associate Editor, Shop Notes and Crafts.....Wayne C. Lecky
 Associate Editor, Shop Notes.....W. Clyde Lamme
 Assistant Editor, Crafts.....Jay W. Hedden
 Assistant Editor, Makeup.....John C. Dalen
 Automotive Correspondent.....Leo Donovan
 Art Director.....Frank Beatty
 Assistant Editors—Leonard F. Hiltz, Emily M. Rice, Earl F. Woback
 Eastern Editor.....Richard F. Dempewolf
 Empire State Bldg., Room 2906, New York City 1
 Western Editor.....Thomas E. Stimson, Jr.
 Suite 1010, 3460 Wilshire Blvd., Los Angeles 5, Calif.
 London Manager.....Douglas W. Wedderspoon
 Eagle House, Jermyn St., London S. W. 1, England
 Director, Bureau of Information.....Allan Carpenter
 200 E. Ontario St., Chicago 11

Advertising Offices
 Chicago: 200 E. Ontario St., Whitehall 4-0100; New York: Empire State Bldg., 350 Fifth Ave., Longacre 5-7580; Detroit: General Motors Bldg., TRinity 5-8711; Cleveland: Hanna Bldg., 1422 Euclid Ave., PRospect 1-0456; Los Angeles: 3460 Wilshire, DUnkirk 2-8458; San Francisco: Russ Bldg., 235 Montgomery St., YUkon 2-0823.

In This Issue...

The Plane for the Do-It-Yourselfer	113
Magic Crystals Grown Here	118
Father and Son Build a Sports Car	125
Surplus Power Pumps Water Uphill	129
Nature Puts Men to the Supreme Test	134
Change for a Quarter, Mister?	144
Magic in Bubbles	148
Owners Report on the Volkswagen	154

SPECIAL HOUSING SECTION—

PM's Big-Family House	161
We Saved \$4225 By Finishing It Ourselves	174
More House for Less Money	181
Parade of Homes	185
Old-Fashioned Closets Are Space Robbers	190
Here's Your House of the Near Future	193
Decorate With Hardwood Plywood	197
Paving Your Patio	202
Home Soundproofing	207

For the Craftsman...

Patter's Wheel Built Into a Kitchen Stool	211
Cord Cocktail Table	218
Dry Your Films in Filtered Air	226
Paper Masks	230
Power Shop in a Closet	239
Speed Torque	245
How Would You Do It?	258
Radio, TV and Electronics	261

See pages 106, 108 and 110

for other items and manufacturers of available products

Give your car **NEW LIFE!**



Get the **FULL** energy of your battery

with

BOWES *Tension-Lock*



TERMINAL

BATTERY CABLES

**Note these
BIG Advantages**

- 1 No trouble making nuts or bolts.
- 2 Guaranteed corrodless.
- 3 Can't slip or work loose.
- 4 Longer battery life.
- 5 Road tested in hundreds of cars over many thousands of miles for more than two years with perfect performance record.

**Fully 50% of Cables
now in use are faulty**

Have your Bowes Dealer check your cables now. If faulty he will assure you greatly improved performance with the full energy providing, trouble free Bowes Tension Lock Terminal Battery Cables.

Old style nut and bolt type battery cable terminals are trouble makers. They will develop energy stealing corrosion, and, in many cases, work loose and rob you of the full energy of your battery.

With the new Bowes Tension-Lock Terminal Battery Cable there are no bolts or nuts. Instead, a heavy duty tempered spring steel clip is die cast into the noncorrosive terminal which is quickly and easily removed or applied with specially designed reverse pliers.

You are thus assured not only of no corrosion... but also constant perfect contact enabling your battery to deliver its full energy.

**Guaranteed for the life of your car and guaranteed
to provide full capacity of your battery at all times**

BOWES "SEAL FAST" CORP., INDIANAPOLIS 7, INDIANA • HAMILTON, ONTARIO, CANADA • LONDON, ENGLAND
BOWES PACIFIC CORPORATION, RIVERSIDE, CALIFORNIA



Do your Christmas hinting early!

When the little woman asks for gift ideas, let her know you'd like Thor SpeedTools, the finest tools ever built for home workshop use. Thor is the largest exclusive manufacturer of portable air and electric tools. Every Thor SpeedTool brings the power and precision, the balance and durability you expect from Thor's quality reputation. SpeedWay Manufacturing Co., a division of Thor Power Tool Co.

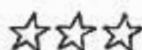

THOR 3-STAR CHRISTMAS SPECIAL

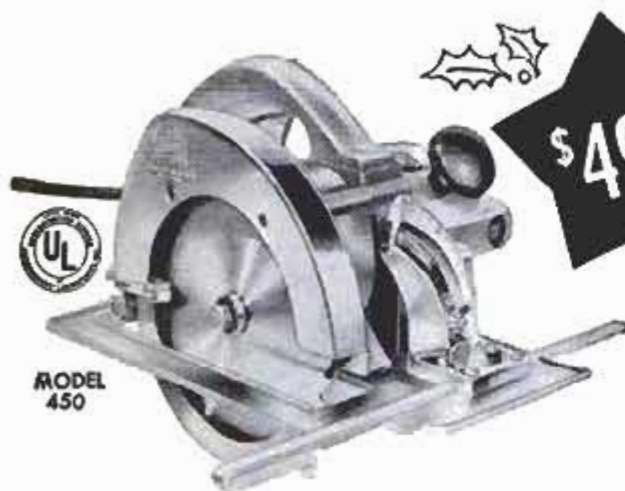

MODEL 450

\$49.95



MODEL 25

\$24.95

This new Thor 6 1/2" SpeedSaw is a must for building furniture, cupboards, closets, built-ins. Its Thor-built stall-proof universal motor takes the blade easily through a 2 x 4 at 45° angle. Other Thor SpeedSaws from \$29.95 to \$64.95—all top values!

Whether you're making 1/4" holes in steel or 1/2" holes in hardwood, this new Thor 1/4" SpeedDrill does it faster and easier, thanks to its extra power. Long grip means easy handling. Other Thor SpeedDrills from \$16.95 to \$65.00, many in kits.



MODEL 15TK

Here's the world's most popular electric sander, in a complete Thor SpeedSander Kit, to help you do a truly professional job refinishing antiques, smoothing unpainted furniture, or polishing to a high gloss. Other SpeedSanders, \$24.95 to \$54.50.

\$34.95
COMPLETE
KIT



THOR POWER TOOL COMPANY, Aurora, Illinois

Branches in all principal cities

World's largest exclusive manufacturer of portable air and electric tools

Free!

ON THIS OFFER

THIS AMAZING NEW

TV "DETECT-O-SCOPE"

SPOTS
BAD
TV
TUBES
Instantly!

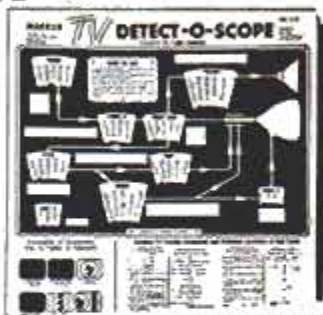

Most TV failures are due to faulty tubes. "Detect-O-Scope" tells at a glance how to spot bad ones. Gives numbers of tubes; shows how to locate, check, and replace them safely. 16 x 21 inches. Sells regularly for \$1.00—but it's

**YOURS FREE WITH FAMOUS
MANUAL SHOWN BELOW**

FIX TV AND RADIO SETS RIGHT AWAY

—even if you never fixed a lamp or doorbell before!

McGraw-Hill's Amazing New Low-Cost Instruction Manual Skips Hard-to-Understand "Theories" and Formulas—Tells HOW-TO-DO-IT in PLAIN ENGLISH

A T LAST—a well-known expert tells you how to fix TV or radio sets! Right from first chapters you start doing simple repairs. Soon you can actually start fixing your own and friends' sets... even start your own profitable business!

Why It's So EASY

The author made this manual easy-to-follow—even for the most "unhandy" beginner. A-B-C directions, 700 clear illustrations show exactly WHAT and HOW to fix, step-by-step. Where and how to buy parts; where to get circuit diagrams; how to test WITHOUT a tube tester; how to use 58 TV controls; simple "cures" for common troubles; how to fix speakers, phono pick-ups, in-

stall and check antennas—and much more.

SEND NO MONEY

Mail coupon NOW! If book doesn't pay for itself in 10 days, don't keep it! McGraw-Hill Book Co., Dept. PM-10, 327 W. 41 St., New York 36, N.Y.



10-DAY FREE TRIAL OFFER

McGraw Hill Book Co., Dept. PM-10
327 West 41st St., New York 36, N. Y.

Please send the TV "Detect-O-Scope" FREE with Markus' Television and Radio Repairing for 10 days' trial. If not delighted, I may return book, pay nothing. Otherwise, I will send only \$1.95 plus few cents shipping; then 3 monthly payments of \$2. ("Detect-O-Scope" is FREE in any case.)

Name _____

Address _____

City _____ Zone _____ State _____

SAVE MONEY. Check here if enclosing \$7.95 as payment in full WITH coupon. Then WE pay shipping costs. Same 10-day return privilege. (Offer good in U.S.A. only.)

ACROSS THE DESK



To the Editor:

We confirm receipt of a clipping of an article (PM, June, page 144) illustrating the first prototype of our "Motor-Waterski-Craft." We send you the first photographs of our second type which speeds to 46 miles



per hour. This type is eight feet long and powered by a 30-horsepower engine. Another type we plan will be for outboard motors. The mass production of our waterski towboat could be attempted without any difficulty. The manufacture is possible in glass fiber, light metal or wood.

Helmut Stieger and
Kurt Schachner,
Sackgasse 2,
Klagenfurt-Annabichl, Austria

To the Editor:

I never throw away the back issues of your wonderful magazine. I have received many fine ideas from your magazine and look forward to it each month.

A football fan offered me a free ticket to a game and he almost fainted when I told him I had just received the new issue of *Popular Mechanics* and I would rather read the magazine than go to any football game.

L. O. Gunn,
Jacksonville, Tex.

To the Editor:

Your article in the August issue of *Popular Mechanics*, "Driverless Tractor 'Stunts' for Safety," was interesting. This test was first made by the University of California, Agricultural Engineering Division, at Davis, Calif.

While this test demonstrates the ease of tipping over a high-wheeled tricycle tractor, it does not demonstrate a condition

(Continued to page 8)

Satisfied with my JOB and PAY? **NOT ME!!**

TODAY, you are probably earning enough to get by—enough to provide your family with life's necessities, and perhaps you are depositing a few extra dollars in the bank.

BUT are you content with just earning a living wage? Do you say "Someday I'll really get a break and go right on to the top." **THAT'S WISHFUL THINKING!**

You know that the "breaks" go to the man or woman who is *prepared* to take advantage of them—to the person who can fill the better job and who is worth more money. He makes the "breaks" instead of waiting for them.

DO YOU QUESTION YOUR OWN ABILITY?

There is a field of business which has never been overcrowded—it's the **ACCOUNTING FIELD**. And the demand for skilled accountants—men and women who really know their business—is increasing. State and Federal legislation requires much more efficient accounting from business. Corporations are in constant need of expert counsel in matters relating to Auditing, Cost Accounting, Business Law, and Income Tax Procedure. Men who prove their qualifications in this important branch of business are promoted to responsible executive positions—given an opportunity to earn real salaries. The range is \$4,000 to \$10,000 a year—even to higher income figures.

WHY BE SATISFIED WITH YOUR PRESENT JOB?

Why accept mediocre pay when right in your own home you can acquire the necessary training to advance rapidly in the profitable, growing profession of Accounting.

Under the LaSalle Problem Method you can acquire a thorough knowledge of Accounting, master its fundamental principles, become

expert in the practical application of those principles—without losing an hour from work or a dollar of pay.

Your training will be under the supervision of organization and management specialists, Attorneys and Certified Public Accountants. Preliminary knowledge of bookkeeping is not necessary. We train you from the ground up—Basic Accounting right through specialized training in Industrial, Commercial, or Public Accounting and C.P.A.

SO RIGHT NOW—TODAY

If you are ambitious—if you want to get into a high-paying profession—investigate the opportunities in this profitable field.

DON'T BE SATISFIED

with just an ordinary job—decide today to send for LaSalle's **FREE** book, "Accountancy, The Profession That Pays." In it you will find complete information on the opportunities which are open to those qualified, and you will learn how you can prepare yourself for a better job and more money. **NO OBLIGATION. MAIL THE COUPON TODAY!**

CHARTER MEMBER OF THE NATIONAL HOME STUDY COUNCIL

**MAIL THE
COUPON
TODAY!**

**OVER 4,200 C.P.A.'S
HAVE BEEN TRAINED
BY THE LA SALLE
PROBLEM METHOD**



-----SEND FOR FREE BOOK-----

LaSalle Extension University

—A Correspondence Institution—
Dept. 1064H, 417 S. Dearborn St., Chicago 5, Ill.

Please send me, free of all cost or obligation, your illustrated book, "Accountancy, The Profession That Pays."

Name.....Age.....

Address.....

City, Zone, State.....

CLEAN YOUR CARBURETOR

Feel the difference!



An important part of your car's Fall checkup . . . a GUMOUT-clean carburetor. GUMOUT removes the gum and varnish from your carburetor that cause trouble—waste gas—reduce power.



- Fall, Winter, Spring, Summer . . . you enjoy greater power, faster starts, use less gas—when you clean your carburetor with GUMOUT.
- GUMOUT cleans carburetors quickly and easily.
- Saves time and money.
- Just add GUMOUT to your gas tank . . . or ask your service man to run it directly through your carburetor.
- Available at service stations and auto supply stores everywhere.

SEND FOR **FREE**

46-page
"CARBURETOR HANDBOOK"

GUMOUT DIVISION
Pennsylvania Refining Company
2671 Lisbon Road
Cleveland 4, Ohio



(Continued from page 6)

where the driver could be spared injury by means of a safety arch.

Over 40 farm people each year lose their lives in California due to tractor turnover



and upsets. Through the co-operation of the University of California at Davis, the Pacific Equipment Company of Richmond and the Industrial Indemnity Company of San Francisco, a safety arch was constructed to protect the driver of these tractors in case of a roll-over or upset, provided the operator was wearing a seat belt.

Such an arch was built and tested by turning over a Ford tricycle high-wheeled tractor at the Davis campus. The device was given a thorough test and studies were made with strain gauges and examination of a dummy driver. After about eight upsets and roll-overs, it was determined that an operator of a tractor protected by the seat belt and safety arch would survive, probably without injury.

Thos. Soule,
Chief Safety Engineer,
Industrial Indemnity Co.,
San Francisco 4, Calif.

To the Editor:

I was reading the letter by Starr Jenkins (Across the Desk, July). Wow! I can see where he worked only temporary in the P.O. I have too, but I didn't get those ideas. I would suggest going to an outfit

(Continued to page 10)

YOUR MOVE, DAD!



The first frantic months of fatherhood are over. You have time now to really enjoy the new baby—and time to really think ahead.

There's plenty to think about. And lots to plan for. What kind of a Dad will you be? What kind of a provider?

One thing's sure: now you've got to earn more money! About \$500 a year more, to start with. *But how?*

Try doing what some five thousand new fathers did last year. Start preparing yourself for a better job—at home, in your spare time. *Enroll with I.C.S.*

Most of these new fathers already have job promotions, fat pay boosts. One writes, "I've

jumped five years in one." Another reports, "I'm making \$125 more a month."

There's no magic in I.C.S. Just sound, practical, step-by-step training. And a *method* that makes it possible to master any subject as rapidly as your time and ability permit.

You have 256 courses to choose from. Business. Technical. Engineering. All job-related. All keyed to everyday problems. Let us send you a *free sample lesson* together with two valuable books—(1) opportunities in your field and (2) "How to Succeed." No obligation—except the new one you have as a father.

The famous I.C.S. coupon is right here. *And it's your move!*

For Real Job Security—Get an I. C. S. Diploma!

I. C. S., Scranton 9, Penna.

Member, National Home Study Council

INTERNATIONAL CORRESPONDENCE SCHOOLS

65TH YEAR

BOX 06626K, SCRANTON 9, PENNA.

Without cost or obligation, send me "HOW TO SUCCEED" and the opportunity booklet about the field

(Partial list of 256 courses)

BEFORE which I have marked X (plus sample lesson):

ARCHITECTURE and BUILDING CONSTRUCTION

- Air Conditioning—Refrig.
- Architecture
- Architectural Interiors
- Building Contractor
- Building Estimator
- Building Maintenance
- Carpentry and Mill Work
- Heating
- Painting Contractor
- Plumbing
- Reading Arch. Blueprints

ART

- Cartooning
- Commercial Art
- Fashion Illustrating
- Magazine Illustrating
- Show Card and Sign Lettering
- Sketching and Painting

AUTOMOTIVE

- Auto Body Rebuilding
- Auto Elec. Technician
- Auto-Engine Tune Up
- Automobile Mechanic

AVIATION

- Aeronautical Engineering Jr.
- Aircraft & Engine Mechanic

BUSINESS

- Advertising
- Bookkeeping and Accounting
- Business Administration
- Business Correspondence
- Public Accounting
- Creative Salesmanship
- Federal Tax
- Letter-writing Improvement
- Office Management
- Professional Secretary
- Retail Business Management
- Sales Management
- Stenographic-Secretarial
- Traffic Management

CHEMISTRY

- Analytical Chemistry
- Chemical Engineering
- Chem. Lab. Technician
- General Chemistry
- Natural Gas Prod. & Trans.
- Petroleum Engineering
- Plastics
- Pulp and Paper Making

CIVIL, STRUCTURAL ENGINEERING

- Civil Engineering
- Construction Engineering
- Highway Engineering
- Reading Struct. Blueprints
- Sanitary Engineering
- Structural Engineering
- Surveying and Mapping

DRAFTING

- Aircraft Drafting
- Architectural Drafting
- Electrical Drafting
- Mechanical Drafting
- Mine Surveying and Mapping
- Plumbing Drawing and Estimating
- Structural Drafting

ELECTRICAL

- Electrical Engineering
- Electrical Maintenance
- Electrician Contracting
- Lineman

HIGH SCHOOL

- Commercial Good English
- High School Subjects
- Mathematics

LEADERSHIP

- Foremanship
- Industrial Supervision
- Leadership and Organization
- Personnel-Labor Relations

MECHANICAL AND SHOP

- Gas—Electric Welding
- Heat Treatment Metallurgy
- Industrial Engineering
- Industrial Instrumentation
- Industrial Supervision
- Internal Combustion Engines
- Machine Design-Drafting
- Machine Shop Inspection
- Machine Shop Practice
- Mechanical Engineering
- Quality Control
- Reading Shop Blueprints
- Refrigeration
- Sheet Metal Worker
- Tool Design Toolmaking

RADIO, TELEVISION

- Industrial Electronics
- Practical Radio TV Eng'ng
- Radio and TV Servicing
- Radio Operating

RAILROAD

- Air Brake Equipment
- Car Inspector
- Diesel Engineer & Fireman
- Section Foreman

STEAM AND DIESEL POWER

- Combustion Engineering
- Diesel—Elec. Diesel Eng's
- Electric Light and Power
- Stationary Fireman
- Stationary Steam Engineering

TEXTILE

- Carding and Spinning
- Cotton, Rayon, Woolen Mfg.
- Finishing and Dyeing
- Loom Fix'g Textile Des'ing
- Textile Eng'g Throwing
- Warping and Weaving

MISCELLANEOUS

- Domestic Refrigeration
- Marine Engineering
- Ocean Navigation
- Professional Engineering
- Short Story Writing
- Telephony

Name _____ Age _____ Home Address _____
 City _____ Zone _____ State _____ Working Hours _____ A.M. to P.M. _____
 Occupation _____

Canadian residents send coupon to International Correspondence Schools, Canadian, Ltd., Montreal, Canada. . . . Special tuition rates to members of the U. S. Armed Forces.

(Continued from page 8)

that installs small tubes in stores and then figure how much it would cost for cross-country tubes, town to town, farm to farm, etc. Then figure which cost is astronomical, the (present) system or the proposed system. Then go to different companies that use meter systems and figure how much cheating, meter jumping, slugs, machines going haywire, etc.

As for code numbers for everyone—a little inquiry to the Army and Navy APO or FPO and service numbers will tell you how confusing it is. As it is now you get your letters pretty quick even with bad addressing. How would you like to get your tax bill, invitations, etc., about a month late?

As for automation of numbers—and people—once that happens you might as well quit writing letters, for everything will be exactly to form, size, length, amount of words, what you do, what time you go to bed, get up, etc. All numbers—if you forget or lose your number you may, as well die, because you won't know what to do without your code number.

A. M. Seppola,
5015 N. Melvina Ave.,
Chicago 30

To the Editor:

Dotted along main roads out of Council Grove, Kans., are farm-direction signs such as this one. Spaced at three or four-mile intervals, they tell the city cousin, or the visitor from the next county, how to reach

(Continued to page 14)



New greaseless way to keep your hair neat all day



Prevents dry, shaggy
"musk-ox hair"

New Vitalis keeps hair in place and prevents dryness with V-7, the *greaseless* grooming discovery.

You never have an overslick, plastered-down look. Try it. You'll like it.



New VITALIS® Hair Tonic with V-7®

ANOTHER FINE PRODUCT
OF BRISTOL-MYERS



I WILL TRAIN YOU AT HOME FOR GOOD PAY JOBS IN RADIO-TELEVISION

J. E. SMITH has trained more men for Radio-Television than any other man. OUR 40th YEAR

America's Fast Growing Industry Offers You Good Pay—Bright Future—Security

I TRAINED THESE MEN

 "Started to repair sets six months after enrolling. Earned \$12 to \$15 a week in spare time."—Adam Kramlik, Jr., Sunnyside, Pennsylvania.

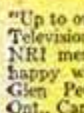
 "Up to our necks in Radio-Television work. Four other NRI men work here. Am happy with my work."—Glen Peterson, Bradford, Ont., Canada.

 "Am doing Radio and Television Servicing full time. Now have my own shop. I owe my success to N.R.I."—Curtis Stath, Ft. Madison, Iowa.

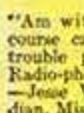
 "Am with WCOC. NRI course can't be beat. No trouble passing 1st class Radio-phone license exam."—Jesse W. Parker, Meridian, Mississippi.

 "By the time I graduated I had paid for my course, a car and testing equipment. Can service toughest jobs."—E. J. Streitenberger, New Boston, Ohio.

AVAILABLE TO
VETERANS
UNDER G. I. BILLS

You Learn by Practicing with Parts I Send

Nothing takes the place of PRACTICAL EXPERIENCE. That's why NRI training is based on LEARNING BY DOING. You use parts I furnish to build many circuits common to Radio and Television. As part of my Communications Course, you build many circuits, including low power transmitter shown at left. You put it "on the air," perform procedures required of broadcast operators. With my Servicing Course you build modern Radio, etc.; use Multitester you build to make money fixing sets in spare time while training. You can stay at home, keep your job, learn Radio-TV in spare time at low cost. Mail coupon for book showing other equipment you build and keep.

The Tested Way To Better Pay!

Training plus opportunity is the PERFECT COMBINATION for job security, good pay, advancement. In good times, the trained man makes the BETTER PAY, GETS PROMOTED. When jobs are scarce, the trained man enjoys GREATER SECURITY. NRI training can help assure you more of the better things of life.

Start Soon to Make \$10, \$15 a Week Extra Fixing Sets

Keep your job while training. I start sending you special booklets the day you enroll, that show you how to fix sets. Multitester built with parts I send helps you make \$10, \$15 a week extra fixing sets while training. Many start their own Radio-Television business with spare time earnings.

My Training Is Up-To-Date
You benefit by my 40 years' experience training men at home. Well illustrated lessons give you basic principles you need. Skillfully developed kits of parts I send (see below) "bring to life" things you learn from lessons.

2 FREE BOOKS SHOW HOW MAIL COUPON



Television Making Good Jobs, Prosperity—Even without Television, Radio is bigger than ever. 115 million home and auto Radios are big market for servicing. 3000 broadcasting stations use operators, technicians. Government, Aviation, Police, Ship, Micro-wave Relay, Two-way Radio Communications for buses, taxis, trucks, R. R. are growing fields. Television is moving ahead fast.



About 300 Television stations are now on the air. Hundreds of others being built. Good TV jobs opening up for Technicians, Operators, etc.

25 million homes now have Television sets. Thousands more are being sold every week. Get a job or have your own business selling, installing, servicing.

Radio-TV Needs Men of Action—Mail Coupon
Without obligating you in any way, I'll send an actual lesson to prove that my training is practical, thorough; 64-page book to show good job opportunities for you in Radio-TV. Terms for NRI training are as low as \$5 a month. Many graduates make more in two weeks than total cost of training. Mail coupon now. J. E. SMITH, President, National Radio Institute, Dept. 6KA, Washington 9, D. C. OUR 40TH YEAR.

Good for Both—FREE

MR. J. E. SMITH, President, Dept. 6KA
National Radio Institute, Washington 9, D. C.
Mail me Sample Lesson and 64-page Book, FREE.
(No salesman will call. Please write plainly.)

Name Age

Address

City Zone State

VETS write in date of discharge



FOR A REAL JOB OR A
BUSINESS OF YOUR OWN



LEARN
**OIL BURNER
SERVICING**

at home—in your spare time!

GET THE FACTS FREE!

Let us send you — without obligation — a Sample Lesson plus all the information you'll need to get you started on the road to success in the automatic oil heating field. Let us prove to you that salaries are higher, opportunities greater, advancement quicker in the fast-growing Oil Burner industry.

5 PROGRAMS IN ONE. We offer you a complete and approved training program — available at no other school — prepared with the co-operation of America's leading heating system manufacturers. Covers Installation, Operation, Maintenance and Service plus Electrical Controls, Firebrick Construction and Sheet Metal Fabrication. Even includes a "Special Business" Plan to help you start your own service shop.

START NOW . . . TODAY! Put your spare time to work. Learn a skilled trade. No previous experience or special education required. Earn while learning, doing part-time jobs in your own area. Low tuition. Tools furnished. Send coupon now. No obligation.

MASS. TRADES "Training Thousands since 1936"

RESIDENT SCHOOL — APPROVED FOR VETS
LICENSED BY MASS. DEPT. OF EDUCATION

Member — Oil Heat
Institute of America



Write NOW for
FREE SAMPLE
lesson and booklet.
No obligation. Use
the coupon below.

MASS. TRADES

161-A High St., Boston 10, Mass.

Please rush **FREE** booklet and Sample Lesson on **OIL BURNER SERVICING**. I understand there is no obligation.

Name Age.....

Address

City Zone..... State.....

TRAINING AVAILABLE IN CANADA

**FREE-A BUSINESS
OF YOUR OWN**

- Start Spare Time
- No Training Period
- No Investment
- No Stock to Buy

**SUBSTANTIAL MONEY-MAKING
OPPORTUNITY**

Your Total Cost
— a 3-cent stamp



All we ask of you is that you like to sell. If you can make a fair living selling anything else, we will show you how to make tremendous profits as a MASTER Work Garment Salesman, and furnish everything you need, free.

MASTER Work Garment salesmen are making thousands of dollars in hundreds of communities all over America. Men who — a year ago — didn't know what a work garment was, are now buying homes and cars with the profits from a MASTER Dealer franchise. Your sales are volume sales, repeat sales, steady-income-to-you sales. Every business in the country is a prospect for uniforms and work clothes with name-and-advertising embroidery. Stores can't compete. MASTER brings you the world's finest, most complete quality lines in new styles and fabrics. We supply everything you need — samples, sales material and guidance. You can start right away in your spare time. Keep present job until you are sure your new business is all we say. Write us today for full details.

GEO. MASTER GARMENT CO.
758 WATER STREET, LIGONIER, INDIANA

SHORTHAND in

**6
WEEKS**

Famous SPEEDWRITING shorthand. 120 words per minute. No symbols; no machines; uses ABC's. Easiest to learn, write and transcribe. Lowest cost. For business and Civil Service. 350,000 graduates. Typing available. 34th year. Write for FREE booklet to: SCHOOL OF

Speedwriting

Dept. 1510-6, 55 W. 42 St., New York 36

SELL LIKE WILD

SEEKING NEW PRODUCTS... Get my outfit of Newest Household Needs. See my 47 money-making specialties. Latest conveniences for your home and car. Newest Inventions! All Fast Sellers! **Make Big Money. Take orders from friends.** Be first to write. Hurry — just a postcard will do. **SEND NO MONEY. Just your name.**

KRISTEE PRODUCTS, Dept. 692, Akron 8, Ohio

SAY YOU SAW IT IN POPULAR MECHANICS



MEN! TRAIN NOW FOR
A BIG PAY FUTURE IN
DIESEL
& SCIENTIFIC MOTOR TUNE-UP

- Diesel Construction
- Diesel Engine Repairman
- Diesel Operator
- Industrial Maintenance
- Auto Engine Rebuilding
- Bus & Truck Maintenance

Go places with **DIESEL!** Farms, factories and power plants, trains, ships, trucks, busses all use **DIESEL POWER...** all need **DIESEL-trained men!** You can start your **DIESEL** training at home, in spare time, with tested, proved U E I training. Course includes practical work on Diesel engines under skilled instructors. You learn the operation, maintenance servicing of all types of Diesel engines. **PLUS Scientific Motor Tune-up.** **ACT NOW!** If you have mechanical ability, diploma not necessary. Write now for Free book "EARNING POWER in DIESEL." Act Today!

UTILITIES ENGINEERING INSTITUTE

2521 Sheffield Ave., Dept. DC-61, Chicago 14, Ill. (Founded 1927)

POPULAR MECHANICS



INVENTORS

Learn how to protect your invention. The U. S. Patent Laws provide that any new and useful art, machine, article of manufacture, or composition of matter, or any new and useful improvement thereof, may be patented if the act of invention is involved. Therefore, every inventor with a valuable invention should take advantage of the Patent Laws and proceed for patent protection in order to safeguard his rights.

A patent gives the inventor the exclusive right to prevent others from making, using, or selling the invention claimed in the patent for a period of seventeen years.

The Patent Laws were enacted for the benefit of the inventor to give him protection for the features of his invention which are patentable. These features must be properly and concisely set forth and claimed in a formal application for patent, in order to comply with the requirements of the Patent Laws. For that reason, unless the inventor is familiar with patent matters, he should engage a competent registered patent attorney or agent to represent him. We are registered to practice before the U. S. Patent Office and are prepared to serve you in the handling of your patent matters.

A specially prepared booklet entitled "Patent Guide for the Inventor", containing detailed information with respect to patent protection and procedure, together with a "Record of Invention" form will be promptly forwarded to you without obligation upon request.

CLARENCE A. O'BRIEN & HARVEY JACOBSON

Registered Patent Attorneys

61-K DISTRICT NATIONAL BUILDING

WASHINGTON 5, D. C.

a given farm once he leaves the main road. The signs at Council Grove, unique in the Plains states, were erected by a 4-H Club as their project. However, any group of residents can do the same thing—particularly if they want their guests to find them easily and simply.

John R. Clawson,
Wichita, Kans.

To the Editor:

I cannot agree that the Empire State Building light source is so very fantastic (1,800,000 candlepower). On the Canadian side of Niagara Falls in 1932 the Canadians built twenty-four 36-in. searchlights operating at 55,000,000 candlepower apiece, to illuminate in color the cataracts at nightfall.

Herluf E. Jorgensen,
Kenosha, Wis.

Thank you, sir; it was our mistake. Three ciphers were omitted in the August report on the Empire State Building searchlights. Total candlepower is 1,800,000,000.

To the Editor:



Adapting old clocks so that blind men may tell time has become a popular form of manual therapy at the Veterans Hospital, Vancouver, Wash.

Old clocks are gathered by service organizations and given to the manual-arts therapy department of the hospital where they are cleaned, oiled and then fitted with a plywood front upon which the dial figures and graduations are marked with roundheaded tacks, easily felt and read by the blind.

Hal Cooley,
Ward 20,
Veterans Hospital,
Vancouver, Wash.

To the Editor:

What's all this "tzimis" about recharging dry cells? When I was a boy we used to reactivate those famous old Red Seal batteries, but good, by making nail holes about an inch apart over the whole skin and then soaking the battery in a rather strong solution of sal ammoniac overnight. Recharge? Why it was the closest approach to perpetual motion ever achieved by man!

Jonas Arnold,
Chicken St.,
Wilton, Conn.



**HURDLE THE LOW-PAY RUNGS
for TOP-PAY CAREER in
AERONAUTICAL
ENGINEERING FIELD**

Lots of fellows can earn a living—but there just aren't enough who are qualified for the top of the ladder.

Good positions with High Pay and Professional Recognition are waiting for you in AVIATION. The field of AERO ENGINEERING DESIGN is wide open!

Save two years! Embry-Riddle's 96-week course prepares you for a top position in this air era. You'll learn airplane and aircraft engine design, aerodynamics, etc. Stripped of non-essentials, E-R training provides maximum education in minimum time—geared to the High School Graduate.

Mail coupon now for pictorial brochure and full information. You'll enjoy study and play in Miami's perfect year-round climate.

• Training Authorized under G.I. Bills •

MAIL THIS COUPON TODAY

DEAN OF ADMISSIONS, Dept. 99
Embry-Riddle School of Aviation
Miami 30, Florida

I am interested in the courses checked. Please send FREE pictorial brochure and full particulars.

- | | |
|--|---|
| <input type="checkbox"/> AERO ENGINEERING DESIGN | <input type="checkbox"/> COMMERCIAL PILOT |
| <input type="checkbox"/> BUSINESS-PILOT | <input type="checkbox"/> A & P COMBINED WITH COMMERCIAL PILOT |
| <input type="checkbox"/> A & P MECHANIC | <input type="checkbox"/> INSTRUMENT RATING |

Name Age
(Please Print or Write Plainly)

Address

City State

I am a (check one) Veteran Non-Veteran

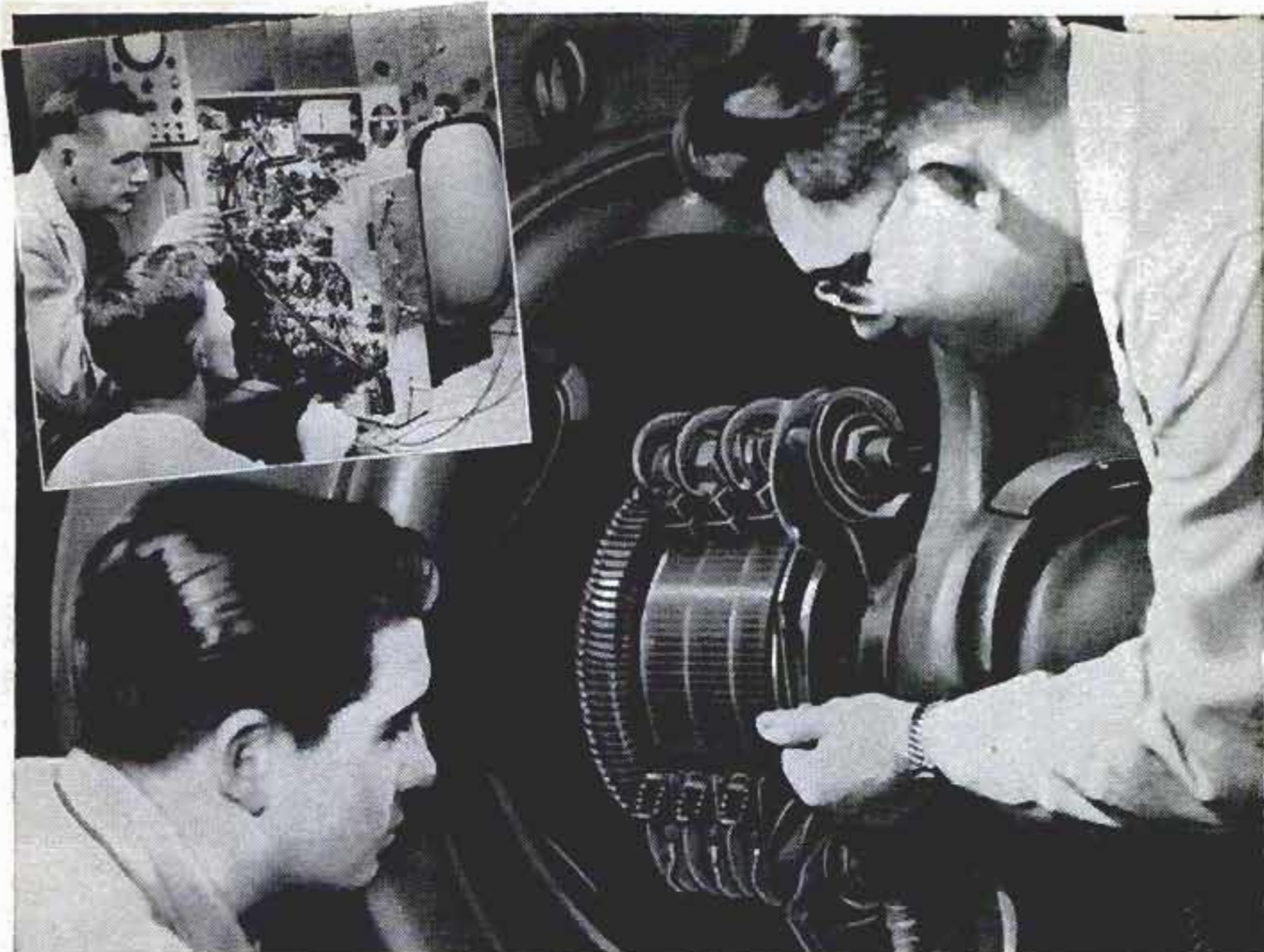

TRAIN FOR A FUTURE IN

Electricity or Television -RADIO-COLOR TV -ELECTRONICS

**IN GREAT SHOPS OF COYNE—
Largest, Oldest, Best Equipped
School Of Its Kind In The U. S.**

Veterans and Non-Veterans

Whether 17 or up to 45 years of age, prepare for your future now. Don't be satisfied with a "No Future" job. Train the Coyne way for a better job in a field that offers a world of opportunities in the years ahead.

WE TRAIN YOU IN CHICAGO

Learn the easier, practical way at Coyne, on real, full size equipment. No advanced education or previous experience needed. Lifetime employment service to graduates.

Train in the shops of Coyne—where thousands of successful men have trained for nearly sixty years—Coyne is the oldest, best equipped school of its kind—established in Chicago in 1899.

FINANCE PLAN Enroll now. You may pay most of tuition later. Part time employment help for students.

CLIP COUPON NOW for big new illustrated Coyne book. No obligation; no salesman will call. Get vital facts now!

**Training in
REFRIGERATION
and
ELECTRICAL
APPLIANCES
can be included**

*Mail Coupon
Today for
BIG FREE
BOOK*



**"Guide to Careers in
ELECTRICITY, ELECTRONICS
and TELEVISION-RADIO"**

B. W. COOKE, President
COYNE ELECTRICAL SCHOOL
500 S. Paulina St., Chicago 12, Ill., Dept. 76-72H

Send BIG FREE book and details of your training offer. This does not obligate me and no salesman will call. I am interested in:

- ELECTRICITY-Electronics
- TELEVISION-Radio-Color TV

Name.....

Address.....

City.....State.....

B. W. COOKE, President

COYNE
ELECTRICAL SCHOOL

FOUNDED 1899

A TECHNICAL TRADE INSTITUTE OPERATED NOT FOR PROFIT
500 S. PAULINA STREET, CHICAGO, Dept. 76-72H
ELECTRICITY * RADIO * TELEVISION * REFRIGERATION * ELECTRONICS



**Want better pay,
steady work and
a way to make
extra money?**

Learn at Home IN YOUR SPARE TIME to Fix Electrical Appliances

To build a better future, get into a field where there's much important work and the security that comes from knowing a good trade. Servicing electrical appliances offers that OPPORTUNITY. Every wired home has an average of 8 electrical appliances. Up to 10 million new appliances are sold every year and owners pay well to keep them in repair. That's making a fast-growing need for trained men.

Start Soon to Earn \$3, \$4, \$5 an Hour Extra in Your Spare Time

Start soon to fix electric toasters, clocks, fans, vacuum cleaners and other appliances for neighbors and friends. Work in your basement, garage or spare room. Pick up \$3 to \$5 an Hour extra that way. It's easy to increase your earning power—to pay for this training many times over with your spare time earnings.

Learn and Earn with Multi-Use Tester Built with Parts We Send

This course includes the parts to build a portable, sturdy Appliance Tester that helps you locate electrical defects quickly and easily. You use it to learn and do actual electrical appliance repair jobs. If you want better pay learn this good

trade. No need to give up your present job. You can train at home in your spare time for only \$2.50 down and \$5.00 a month. A small price to pay for increased earnings, a more secure future. Paste coupon below on a 2c postal or mail in envelope for free book and sample lesson. Address National Radio Institute, Dept. AK6, Washington 9, D. C.

**2c TO MAIL THIS
COUPON MAY START
YOU TO SUCCESS
LESSON AND BOOK
FREE**



**NATIONAL RADIO INSTITUTE
Dept. AK6, Washington 9, D. C.**

Please send me Electric Appliance Training lesson and book free.
(No salesman will call.)

Name _____ Age _____

Address _____

City _____ Zone _____ State _____

APPROVED MEMBER NATIONAL HOME STUDY COUNCIL

INVENTORS

If you believe that you have an invention, you should find out how to protect it. The first step is to have a search made of the prior pertinent U. S. patents. If a report on this search indicates that the invention appears patentable you can apply for a patent, and the specifications and claims should be prepared.

The firm of McMorrow, Berman & Davidson, with offices in Washington, D. C., is qualified to take the necessary steps for you. We can make a preliminary search on your invention, advise you whether we think it can be patented, and prepare your application for patent.

Unless you are fully familiar with the U. S. Patent Laws, we recommend that you engage the services of a Registered Patent Attorney to protect your interests. The patent laws are *your* laws. A patent gives you the right to prevent others from making, using or selling the invention claimed in your patent for a period of 17 years.

Use these patent laws for your protection. Investigate whether your invention can be patented. If you have what you believe to be an invention, we suggest that you have this firm make a search for you.

Send for a copy of our Patent Booklet entitled "How To Protect Your Invention," containing information about patent protection and patent procedure. Along with this we will also send you an "Invention Record" form, for your use in writing down and sketching details of your invention. We will mail them promptly. No obligation. They are yours for the asking.

McMORROW, BERMAN & DAVIDSON

Registered Patent Attorneys

PATENTS • COPYRIGHTS • PATENTS

1352 VICTOR BUILDING, WASHINGTON 1, D. C.



Train AT HOME for a GOOD JOB in

AUTO MECHANICS

A better job with more pay will mean *better living* for you. It can mean a fine home, a new car, nice vacations, and good educations for the kids. If you would like to earn up to \$125 a week and more—and be able to afford better living, *train yourself* in Auto Mechanics. You can do it with CTI showing you how—and you can learn at home in spare time!

GOOD JOBS ARE WAITING EVERYWHERE because there are over 60 million cars and trucks on the road—7 million new ones each year. One-third are in the heavy-repair classification. Skilled mechanics are needed to keep these cars operating. You can be one of them—make big money, enjoy lifetime security—even open a shop!

EARN AS YOU LEARN just as many CTI students do. They make up to \$15 a week and more in spare time. Some start their own shops by graduation time. CTI Shop-Method Home training, based on resident school practice, makes every step easy.

DIESEL MECHANICS OR BODY-FENDER TRAINING is also yours at no extra cost. A wonderful chance to give yourself a well-rounded education. Only CTI gives you this extra choice! Get the facts: Mail coupon.



YOU PRACTICE WITH THIS TUNE-UP KIT

Kit includes a Compression Tester, a Vacuum Gauge and Fuel Pump Tester, an Ignition Timing Light, and a portable steel case. These professional instruments help you locate engine troubles, let you get useful practice. You keep this kit!

MECHANIC'S TOOLS TOO

You'll use these tools to get real experience. They'll increase your interest, stamp you as a "pro." You'll earn spare time cash with them. No extra cost for tools—you keep them.

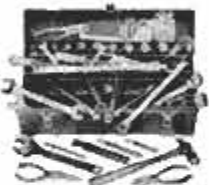

MAIL COUPON TODAY!

MAIL TODAY FOR 2 FREE BOOKS

COMMERCIAL TRADES INSTITUTE
1400 Greenleaf Ave., Chicago 26
Dept. A-366

Send your new Auto Mechanics book and Sample Lesson. BOTH FREE.

Name _____ Age _____

Address _____

City _____ Zone _____ State _____

Member National Home Study Council



Shrinks Hemorrhoids New Way Without Surgery

Science Finds Healing Substance That Relieves Pain—Shrinks Hemorrhoids

For the first time science has found a new healing substance with the astonishing ability to shrink hemorrhoids and to relieve pain—without surgery.

In case after case, while gently relieving pain, actual reduction (shrinkage) took place.

Most amazing of all—results were so thorough that sufferers made astonishing statements like "Piles have ceased to be a problem!"

The secret is a new healing substance (Bio-Dyne*)—discovery of a world-famous research institute.

This substance is now available in suppository or ointment form under the name Preparation H.* Ask for it at all drug counters—money back guarantee. *Reg. U. S. Pat. Off.



Home Craftsmen And Do-It-Yourself Fans—

Make neat, longwearing Big Favorite work and leisure clothes your "uniform" for workshop and do-it-yourself jobs. Many fashionable, practical styles.

25,000 DEALERS,
COAST TO COAST



THE FAVORITE GARMENT CO. Lynchburg, Va. Jackson, Miss.

MONEY in WORMS

Big money made raising fishworms and crickets. Billions used yearly—unlimited market—sell by mail—We teach you how to raise and where to sell. Learn about our new, exclusive 6 to 12 inch African Redworm—in demand everywhere. Free Literature. CARTER WORM RANCH, PLAINS, GEORGIA



SEND FOR THIS **FREE!**

Make money. Know how to break and train horses. Write today for this book FREE, together with special offer of a course in Animal Breeding. If you are interested in Galting and Ridding the saddle horse, check here () Do it today—now.

BEERY SCHOOL OF HORSEMANSHIP
Dept. 11010 Pleasant Hill, Ohio

SEND FOR Free Record

START SPEAKING
FRENCH
OR
SPANISH ALMOST OVERNIGHT!

HERE'S the easiest way to learn FRENCH, SPANISH, Russian, German, Italian, Japanese or Brazilian. Listen to FREE 2-sided non-breakable record. Let your eyes follow words in FREE sample lesson. Almost at once you'll be chatting in a new language with a perfect accent! That's all you hear! No dull, tedious work. Just listen—imitate! It's that easy! Offer may end soon. Rush 25c to help cover cost of special packaging, shipping. State language you want. We'll also send free information on full Cortina course. CORTINA ACADEMY, Dept. 6410, 136 W. 52nd St., New York 19.

Now... In Your Own Home **LEARN**

TELEVISION RADIO-ELECTRONICS

THE AMAZINGLY EFFECTIVE
DTI WAY

**NO PREVIOUS TECHNICAL
EXPERIENCE NEEDED**

**NOW... get
EVERYTHING
YOU NEED**

for real Laboratory-
type training
AT HOME.

-with the aid of BOTH
HOME LAB EQUIPMENT
and HOME MOVIES

What will mailing the coupon below do for YOU? Just this! You'll find out about one of today's most remarkable... practical ways to prepare to get into America's amazing billion dollar opportunity field of TELEVISION-RADIO-ELECTRONICS. You'll see how to get into highly interesting work that pays well... that offers one of America's most promising futures... that enables you to start your own business almost "on a shoe string," if you prefer this to a job opportunity.

And above all, you'll get some GOOD NEWS especially welcomed by men anxious to earn REAL MONEY in this growing field. For you'll see that NOW you can get the kind of practical, laboratory-type training so desirable for making real progress in Television-Radio-Electronics AND WITHOUT LEAVING HOME.

You'll see that DeVRY Technical Institute sends everything needed to set up your own HOME LABORATORY. You get and keep the same type of basic electronic equipment used in our modern Chicago Training Laboratories. You get home training that includes the knowledge and experience gained from training thousands of students first hand in Chicago. And to top it all, you use DTI's amazingly effective and exclusive home training aid—INSTRUCTIVE MOVIES. But why not get the complete story? Mail coupon today for complete facts.

1. Build over 300 fascinating experiments from 16 BIG SHIPMENTS of Electronic-Radio parts which you KEEP.
2. Build valuable commercial-type test equipment—as shown in the set—which you KEEP. This includes a quality 5-INCH oscilloscope and vacuum tube voltmeter—both highly useful for Television work.
3. Build and keep a big 21 INCH TV Set. (DTI offers another home training in Television-Radio-Electronics, but without the TV set.)
4. Use a 16 mm. movie projector and new series of highly instructive movies—a wonderful aid to help you grasp important fundamentals faster... easier... better.
5. Enjoy well-illustrated, easy-to-read lessons with handy FOLD-OUT diagrams.
6. Get an honest-to-goodness EMPLOYMENT SERVICE to help you get a good job after graduating—or assistance in starting your OWN SALES AND SERVICE BUSINESS. Mail coupon today for the complete details.

5 INCH
"SCOPE"

Oscilloscope

Vacuum Tube Voltmeter

21 INCH

Build and keep this BIG DTI
Engineered TV set—easily
converted to U.H.F. (DTI offers
another home training, but
without the TV set.)

Get this
information-
packed
publication
FREE!

**89 WAYS
TO
EARN
MONEY
IN TELEVISION
RADIO
ELECTRONICS**

MODERN
LABORATORIES

If you prefer, get all your preparation in our new Chicago Training Laboratories—one of the finest of its kind. Ample instructors, modern equipment. Write for details!

MILITARY SERVICE!

If you're subject to military service, the information we have for you should prove very helpful. Mail coupon today.

Member of National Home Study Council

DeVRY TECHNICAL INSTITUTE

4141 BELMONT AVE., CHICAGO 41, ILL. Dept. PM-10-M

I would like your valuable information-packed publication showing how I can get started toward a good job or my own business in Television-Radio-Electronics.

Name _____ Age _____

Street _____ Please Print Apt. _____

City _____ Zone _____ State _____

1014A

DTI's Training is available in Canada

"One of America's Foremost
Electronics Training Centers"

DeVRY TECHNICAL INSTITUTE

CHICAGO 41, ILLINOIS

FORMERLY

DeFOREST'S TRAINING, INC.



UTILITY TESTER[®]



AS AN ELECTRICAL TROUBLE SHOOTER

• Measures A.C. and D.C. Voltages, A.C. and D.C. Current, Resistances, Leakage, etc. • Will measure current consumption while the appliance under test is in operation • Incorporates a sensitive direct-reading resistance range which will measure all resistances commonly used in electrical appliances, motors, etc. • Leakage detecting circuit will indicate continuity from zero ohms to 5 megohms (5,000,000 ohms) • Will test Toasters, Irons, Broilers, Heating Pads, Clocks, Fans, Vacuum Cleaners, Refrigerators, Lamps, Fluorescents, Fans, Switches, Thermostats, etc. • Will test all TV tubes for open filaments, inter-element shorts, burned out tubes, etc. (Will not test TV tubes for quality. An emission type tester such as the Model TC-55 described below is required to test tubes for quality).

AS AN AUTOMOTIVE TESTER

• Tests both 6 Volt and 12 Volt Storage Batteries • Generators • Starters • Distributors • Ignition Coils • Regulators • Relays • Circuit Breakers • Cigarette Lighters • Stop Lights • Condensers • Directional Signal Systems • All Lamps and Bulbs • Fuses • Heating Systems • Horns • Also will locate poor grounds, breaks in wiring, poor connections, etc.

Handsome round-cornered molded bakelite case, 3 1/2" x 5 1/2" x 2 1/4". Complete with all test leads. Also included is a 64 page book giving detailed instructions, for testing all electrical appliances, automotive equipment, TV tubes, etc. Only

15⁸⁵

Superior's New Streamlined Model TC-55

TUBE TESTER



QUICKLY AND EFFICIENTLY TESTS RADIO AND TV TUBES INCLUDING: SEVEN PIN MINIATURES; EIGHT PIN SUBMINIATURES, OCTALS AND LOCTALS; NINE PIN NOVALS

YOU CAN'T INSERT A TUBE IN THE WRONG SOCKET. It is impossible to insert the tube in the wrong socket when using the new Model TC-55. Separate sockets are used, one for each type of tube base. If the tube fits in the socket it can be tested. "FREE-POINT" ELEMENT SWITCHING SYSTEM. The Model TC-55 incorporates a newly designed element selector switch system which reduces the possibility of obsolescence to an absolute minimum. Any pin may be used as a filament pin and the voltage applied between that pin and any other pin, or even the

"top-cap." CHECK FOR SHORTS AND LEAKAGES BETWEEN ALL ELEMENTS. The Model TC-55 provides a super sensitive method of checking for shorts and leakages up to 5 Megohms between any and all of the terminals. ELEMENTAL SWITCHES ARE NUMBERED IN STRICT ACCORDANCE WITH R.M.A. SPECIFICATION. One of the most important improvements, we believe, is the fact that the 4 position fast-action snap switches are all numbered in exact accordance with the standard R.M.A. numbering system. Thus, if the element terminating in pin No. 7 of a tube is under test, button No. 7 is used for that test.

The Model TC-55 comes complete with operating instructions and charts. Use it on the bench—use it for field calls. A streamlined carrying case, included at no extra charge, accommodates the tester and back of instructions.

26⁹⁵

SHIPPED ON APPROVAL
NO MONEY WITH ORDER — NO C.O.D.

Try either of the above instruments for 10 days before you buy. If completely satisfied then send down payment and pay balance as indicated on coupon. No Interest or Finance Charge Added! If not completely satisfied, return unit to us, no explanation necessary.

MOSS ELECTRONIC DIST. CO., INC.
Dept. D-290, 3849 Tenth Ave., New York 34, N. Y.

Please rush the unit(s) checked. If satisfactory, I will remit down payment within 10 days, and the balance at the monthly rate indicated below. If not satisfactory, I may return merchandise for cancellation of account.

Model 70... Total Price \$15.85
—\$3.85 within 10 days. Balance \$4.00 monthly for 3 months.

Model TC-55... Total Price \$28.95—\$6.98 within 10 days.
Balance \$5.00 monthly for 4 months.

Name.....

Address.....

City..... Zone..... State.....

All prices net, F.O.B., N.Y.C.



Use my **TESTED SALES PLAN** to make an extra **\$50.00** every week!

Just a few hours each week — evenings, Saturdays — can add \$50 to \$100 to your regular income. Be a factory representative for Charles Chester patented Air-Cushion shoes — bring new comfort to friends, neighbors, co-workers — dress, work, leisure shoes for all the family sold only direct from factory to wearer. No investment is required — you make no deliveries, no collections. Just collect deposit from your customers; we do the rest!

STEADY AUTOMATIC REPEAT BUSINESS

Satisfied customers reorder constantly! CHARLES CHESTER representatives offer more than 140 styles, in a tremendous size range, 1-18, AAA to EEE. No Experience Needed — our tested, proven Sales Plan shows you how! Write today for details and FREE SALES KIT!



CHARLES CHESTER SHOE COMPANY
217 Foundry St., Brockton, Mass.

Learn ACCOUNTING Business Administration

Bookkeeping, secretarial and allied subjects at home in your spare time or attend nationally approved resident school. Write for FREE Success Book giving complete details on courses, plans, rates and employment opportunities. G.I. approved. Write Dept. A.

Hills BUSINESS UNIVERSITY AND EXTENSION SCHOOL
612 W. MAIN ST. OKLAHOMA CITY 2, OKLAHOMA

TASOPE PHOTO-ENGRAVING PLANTS



Material Cost Of This Cut 34¢
Selling Price \$1.00 And Up

Establish your own profitable PHOTO-ENGRAVING business. Make cuts for newspapers, printers, and advertisers. Make etched name plates, plaques etc. Instructions furnished, no experience necessary. Sold direct from factory since 1931. First five hundred cuts sold locally or by mail will pay for plant and pay you well for your time. Write for FREE catalog.

TASOPE, DEPT. PM-10, AURORA, MO.

RUPTURED?

Something different. Light. Cool. No leg straps. No elastic. No pressure on hips or spine. Inexpensive. Worn by Mechanics, Farmers, Doctors, etc., everywhere. Guaranteed. Write

HAND-LOCK PRODUCTS EST. 1893
DEPT. PM, PRESTON, ONT., CAN.

CABINET MAKING

LOW COST HOME TRAINING COURSE FOR BEGINNERS & ADVANCED CRAFTSMEN

Make money. Learn skills and secrets of fine woodworking and tool use. Professionally prepared shop method training tells and shows how. Covers everything. Easy to master.

Write for Free Booklet
INTERSTATE TRAINING SERVICE
DEPT. F3, PORTLAND 13, OREGON

See the Greatest Show on Earth with this GIANT ASTRONOMICAL TELESCOPE

\$1500
FULL PRICE



Delivered ready for use. Has 45X, 75X and 100 power individually mounted eyepieces with brass focusing tube plus sun projector lens for observing sun spots and solar storms. Steel telescope tube 30 in. long. Rigid 6 ft. tripod adjustable to any height. Steel for mounting with closely machined aluminum tripod head assembly assures extra fine adjustments. This professional type instrument provides full power with clear vision at all times. See the moons of Jupiter, our own moon, planets, milky way, double stars, star clusters, etc. All for only \$15.00 FOB Mattituck. Sent express. COD orders require \$5.00 deposit. Satisfaction guaranteed. 200X and 400X eyepieces available at \$2.00 ea.

SUFFOLK SCIENCE SERVICE
Dept. TD-10 MATTITUCK, N. Y.

NATIONAL SCHOOLS

proudly presents

FOR MEN
WHO WANT
TO EARN
MORE MONEY

TELERAMA • ALL 8 BRANCHES OF TELEVISION • ELECTRONICS • RADIO IN ONE DYNAMIC, MODERN SHOP METHOD, HOME TRAINING COURSE

*Registration applied for

Another great advance in **HOME STUDY TRAINING**. Let National Schools, of Los Angeles, a practical Technical Resident Trade School for over 50 years, train you at home by Shop-Method, for today's unlimited opportunities in **ALL 8 BRANCHES** of the Television, Electronics, Radio Industry.

Check all you receive in *One Master Course at One Low Tuition*

1. Television — Including Color TV
2. Radio — FM and AM
3. Industrial Electronics
4. Sound Recording and Hi-Fidelity
5. Preparation for FCC License
6. Automation
7. Radar and Sonar
8. Communications

ALL OF THIS MODERN, NEWEST, PRACTICAL EQUIPMENT IS YOURS TO KEEP!

- Parts to Build a modern TV set, including large screen Picture Tube.
- Parts to build a powerful Superhet Receiver, standard broadcast and short wave.
- Parts to conduct many experiments and build Continuity Checker, RF Oscillator, TV Circuits, Audio Oscillator, TRF Receiver, Signal Generator.
- Professional Multimeter
- These are a MUST for all technicians.

YOU DO MANY PRACTICAL JOBS.

You do servicing, circuit analysis and many other down-to-earth experiments. You build a modern TV set from the ground up... with equipment kits we give you, including a new large screen picture tube and professional Multimeter, at no additional charge.

EARN AS YOU LEARN! Many of our students earn their entire tuition and more in Spare Time jobs we show them how to do while learning. **YOU GET GRADUATE ADVISORY SERVICE, TOO.**

ALL YOURS
TO KEEP

L. J. ROSENKRANZ President of NATIONAL SCHOOLS



This Master-Shop-Method course is completely up-to-date. Here in Los Angeles, the TV and Electronics center of the world, we are able to keep in constant touch with the industries' latest developments. As a student, you will quickly master all phases at home... in your spare time. Your earning power will grow with every lesson. Just as thousands of National Schools graduates do every day, you can handle servicing, manufacturing, repairing, hundreds of other jobs, or make good money in your own business. **SECURE YOUR FUTURE—NOW. SEND COUPON BELOW.**



IN THESE MODERN TV STUDIOS, SHOPS AND LABORATORIES, your Shop Method Home Study Course was developed by experienced instructors and engineers. What an advantage that is to you at home — each lesson is tested, proved, easy to understand. You can master the most up-to-date projects, such as color TV set repair, printed circuits — even prepare for F.C.C. License and industrial electronics without taking a special course. **TAKE YOUR FIRST STEP NOW TO A TOP-PAY JOB IN TV, ELECTRONICS, RADIO. SEND COUPON BELOW TODAY.**

APPROVED FOR
VETERANS
AND
NON-VETERANS

NATIONAL SCHOOLS

4000 S. FIGUEROA ST., LOS ANGELES 37, CALIF.
187 N. LA SALLE ST., CHICAGO 1, ILL.

IN CANADA: 811 W. Hastings St., Vancouver, B. C.

NATIONAL SCHOOLS
TECHNICAL TRADE TRAINING SINCE 1905
Los Angeles, California

GET FAST SERVICE — MAIL NOW TO OFFICE NEAREST YOU!

NATIONAL SCHOOLS, DEPT. RS-106
4000 S. FIGUEROA ST., LOS ANGELES 37, CALIF. OR 187 N. LA SALLE ST., CHICAGO 1, ILL.
Rush free TV-Radio "Opportunity" Book and sample lesson. No salesman will call.

NAME _____ BIRTHDAY _____ 19__

ADDRESS _____

CITY _____ ZONE _____ STATE _____

VETERANS: Give Date of Discharge _____



MEMBER



FREE!

Fully illustrated "CAREER" BOOK in TV, Radio, Electronics. AND actual Sample Lesson—yours at no cost, no obligation SEND COUPON NOW—TODAY!



DRAFTSMEN



**CASH BIG
PAY CHECKS!**

Train Now for
more success,
greater security

**LEARN AT HOME IN SPARE TIME
(or at college in Chicago)**

Check the want ads in any newspaper—SEE the big-pay opportunities open to you as a draftsman. What's more, you can learn this well-paid, prestige profession at home—quickly, easily! No special talent needed. Get complete, step-by-step Chicago Tech lessons in the mail, spend a few pleasant hours studying each week. In a short time you'll be a well-trained draftsman, ready to take your pick of many good jobs. Act now!



Free Information—Mail Coupon Today!

Get **FREE TRIAL LESSON** plus information about C.T.C. practical training. Learn what successful Chicago Tech graduates say about high pay and opportunities in drafting. No charge, or obligation.

CHICAGO TECHNICAL COLLEGE

N-254 Tech Bldg., 2000 So. Michigan Ave.
Chicago 16, Illinois

Mail me **FREE** lesson with facts about big opportunities in **DRAFTING**.

Name _____ Age _____

Address _____

City _____ Zone _____ State _____

Not Satisfied With Your Present Earnings?

Investigate

This NEW 2 in 1 BUSINESS OPPORTUNITY

- Popular, Money-Making **HOT DRINK** and **HOT SOUP** Venders
- Handle Either or Both Types
- We Train You, We Set Up Routes

Eye-catching, easy-to-operate vending machines serve delicious, nationally known Hot Drinks (3) and Piping Hot Soups (5)! Our factory experts set up routes, train you to operate this year-round, big-volume business. **NO SELLING!** A minimum cash investment of \$1290.00 required. Up to 75% of equipment costs can be financed. Operate full or spare time.

How many machines can you handle? 10 units, doing nat'l 1954 average, would pay approx. \$13-\$16,000 yearly!

Write or wire giving age, address and phone. Details **FREE**. No obligation!

SUPERIOR DISTRIBUTING CORP., Dept. CB-10
4555 E. Warren Ave., Denver 22, Colo.



Learn CARBURETOR and IGNITION



Start Training at Home For This Clean, High-Class Type of Position

Get in line for a raise—or for more profits in your own shop. Learn testing and adjusting with latest-type scientific motor tune-up equipment. This enables you to locate the trouble exactly, and fix it fast—handling and getting paid for *more jobs per day*. There's money in this, and it's clean, high-class work which gets the respect and confidence of your customers.

Send for **FREE SAMPLE LESSON** Carburetor and Ignition Specialization offers very superior opportunities for better pay and bigger profits because relatively few mechanics know anything about this time-saving, money-making new test equipment. Now our spare-time home-study method teaches you the principles and shortens your shop training. Ambitious men (age 18-55); Send for full **FACTS AND FREE SAMPLE LESSON** at once. Write today to

UTILITIES ENGINEERING INSTITUTE
2525 Sheffield Ave., Dept. OC-5, Chicago 14



WORLD'S LOWEST PRICED ADDING MACHINE

Counts up to 999,999,999
IDEAL FOR BUSINESS AND PERSONAL USE—GUARANTEED ACCURATE. Not a toy. Operates with only a finger flick. Adds, subtracts, multiplies, divides. Counts up to one billion. Pays for itself over and over. Ideal Gift—for Business, Income Tax and School use. **MONEY BACK GUARANTEE.** Send name and address. Pay postman only \$2.95 plus postage. Beautiful rich-looking Leatherette Case included at no extra cost. Money back in 10 days if not delighted. **AGENTS WANTED.**

CALCULATOR MACHINE COMPANY
P.O. Box 126, Dept. G-56, Huntingdon Valley, Penna.

Vest Pocket Size
FREE TRIAL
\$2.95

only
TOTAL COST SEND NO MONEY

MAKE BIG MONEY AT HOME!

INVISIBLE REWEAVING

Pays up to \$10 in an Hour!

Make moth holes, cigarette burns, tears, rips, disappear from all fabrics. Little-known craft pays extra spare-time profits at home. Write today for exciting details **FREE!**

FABRICON 8342 S. Prairie Avenue
Dept. 3210, Chicago 19, Ill.



MAKE TREMENDOUS PROFITS

Have fun! Earn Big Money! Cast plaster figurines, bookends, piqueas, novelties at home in your spare time with X.L. rubber molds! **NO EXPERIENCE NEEDED!** Models and rubber for 3 molds, only \$1.50 ppd. Send 25c (refunded with order) for 40 page catalog now!

PLASTIC ARTS STUDIO 3403 SO. MADISON, DEPT. PMA
MUNCIE, INDIANA

Say You Saw It in Popular Mechanics

JEEP OWNERS

STA. WAGONS • JEEPSTERS • PICK-UPS!

RE-POWER with Ford 6 or V-8 engines. Our **F-J ADAPTOR-CONVERSION KITS** fit **ALL** Willys Jeeps including 1956. Kit No. 4-K for 1940-56 Ford engines in 1954-56 Pickups & Sta-Wagons priced at \$52.85 incl. Fed. tax. Kits for 1932-56 Ford engines in **ALL** other Willys Jeeps... \$43.25 Tax incl. Write today for free details or send check or M.O. for prepaid shipment. Tell us your engine you will use and whether 2 or 4 Whl-Dr. **ORDER NOW FOR EARLY SHIPMENT.**

HOOSIER MACHINE PRODUCTS CO.
312 S.E. 6th St. Pendleton, Oregon

**SAVE GAS, GEARS,
TIRES ON YOUR
4-WHEEL DRIVE!**



Stop Front End Drag in 2 W. D.

Get maximum use of your vehicle with these famous hubs! They "take out" the front end in 2-wheel drive, give your vehicle "pick-up" economy, pop, speed, power, handling ease; stop front end gear whine, shimmy. 4-wheel drive as usual, when you need it—automatically, as you shift, with Warn Lock-o-matics, manually with Locking hubs. Models for all makes 4 w.d.s. to 1½ tons at truck dealers everywhere, or write:

WARN MFG. CO., Riverton Box 6064-A10, Seattle 88, Wn.



**WARN
HUBS**

LOOKING FOR JOB SECURITY AND SUCCESS?

LET MY STUDENTS AND GRADUATES TELL YOU

ABOUT MY TRAINING —

\$60 A WEEK IN SPARE TIME



I have the skill and know-how to do the work I love best and to enjoy better things in life, thanks to RTTA. I am working at TV servicing and making \$60 a week sparetime.

Harold Gimlen, Flint, Mich. 1/22/54

HAS OWN BUSINESS



I have a shop at home and have been working on radio and TV after working hours of my regular job. I average \$50 a week for this part time work. RTTA training helped me in making extra money and giving me experience in the electronic field.

Richard Hennis, Little Rock, Ark. 1/22/54

L. C. Lane, B.S., M.A.
President, Radio-Television Training Association. Executive Director, Pierce School of Radio & Television.



— ABOUT MY EQUIPMENT

YOU GET ALL THIS EQUIPMENT



"... a money making little gem."

I have completed kit #4 and was amazed at how it works. I showed it to a friend of mine and he asked me to set it up for one of the picnics his social club was having. That sure is a money making little gem.

John Fernandez, Fresno, Calif. 1/27/54

"We get excellent pictures..."

I would like to compliment you on an excellent and complete course. We get excellent pictures on my TV set from WSTR (Syracuse, N.Y.), approximately 110 air miles away. The set is working good and I have had to replace only three tubes since I assembled it two years ago.

Larry N. Stafford, Kingston, Ont., Canada 7/1/54

"... very good reception..."

I have really enjoyed the course and have come a long way in TV servicing. I am getting very good reception on my TV station considering that the nearest VHF station is 120 miles.

J. W. Henson, Jr., Henderson, Texas 7/1/54

AIRCRAFT INSPECTOR

With RTTA training and through repairing radios and televisions for the right people at the right price, I was able to make the right contacts. I am now an Inspector for Douglas Aircraft at about \$125 a week.

Hugh Maddox, Los Angeles, Calif. 1/22/54

ELECTRICAL TESTER

RTTA training has helped me understand TV and many variations of simple circuits. The course covers all subjects very clearly. I am now an Electrical Tester for Western Electric Co. at \$83.42 a week.

Raymond Lapan, Burlington, N. C. 1/22/54

SERVICE MANAGER

I manage two radio and television shops, one here and one in Pompano Beach. RTTA training increased my knowledge of TV circuits and showed me new, quicker methods of repairing. Lessons as presented are very concise and clear.

William Phillips, Fort Lauderdale, Fla. 1/22/54

REPAIRED EVERY SET

RTTA training helped me to understand TV more thoroughly. I have repaired every set that I was called on to repair.

Andrew Busi, Jr., Iselin, Pa. 1/27/54

YOU, TOO, CAN GET A BETTER-PAYING JOB IN THE EVER-EXPANDING RADIO-TELEVISION-ELECTRONICS FIELD

Why limit yourself and your earnings because of your lack of training. Learn **AT HOME** in your **SPARE TIME** to be an electronic technician, television repairman, or studio technician. You don't need any experience whatsoever. Many students earn up to \$25 weekly in spare time while learning.

After you finish my Radio-FM Television Course or FM-Television Course you can have, if you want it, two weeks of laboratory training at my associate resident school in New York City—**AT NO EXTRA COST.**

If you have had previous radio and television experience you can take my practical TV Cameraman and Studio Technician Course to qualify for a good-paying job in a TV studio.

Write to me today and let me show you how you can begin now to put yourself on the road to a better future.

VETERANS!

My school fully approved to train veterans under new Korean G.I. Bill. Don't lose your school benefits by waiting too long. Write discharge date on coupon.

YOU GET THESE FREE



MAIL THIS COUPON TODAY!

Mr. Leonard C. Lane, President
RADIO-TELEVISION TRAINING ASSOCIATION
Dept. M-9C, 52 East 19th Street, New York 3, N. Y.

Dear Mr. Lane: Send me your NEW FREE BOOK, FREE SAMPLE LESSON, and FREE aids that will show me how I can make TOP MONEY IN TELEVISION. I understand I am under no obligation.

(PLEASE PRINT PLAINLY)

Name _____ Age _____

Address _____

City _____ Zone _____ State _____

- I AM INTERESTED IN:
- Radio-FM-TV Technician Course
 - FM-TV Technician Course
 - TV Cameraman & Studio Technician Course

VETERANS!

Write discharge date

Radio-Television Training Association

52 EAST 19th STREET • NEW YORK 3, N. Y.

Licensed by the State of New York • Approved for Veteran Training

OCTOBER 1956

HOW TO FIX ANY PART OF ANY CAR

QUICKLY--EASILY--RIGHT!



FREE 7-DAY TRIAL

WHETHER you're a beginner or an expert mechanic—now you can "breeze through" any "fix-it" job from simple carburetor adjustment to complete overhaul. Just look up job in index of MOTOR'S Brand-New Auto Repair Manual. Follow simple step-by-step directions, clear pictures. Presto—the job is done!

No guesswork! MOTOR'S MANUAL takes you from "scratch"—shows WHERE to start, WHAT tools to use. Covers EVERY job on EVERY car built from 1946 thru 1956!

Everything You Need to Know "Boiled Down" from 160 Official Shop Manuals

BIG NEW, REVISED, ENLARGED, Edition contains the "meat" from over 160 OFFICIAL shop manuals—simplified for YOU. 23,436 essential repair specifications on 737 chassis models. Over 1,000 big pictures. More than 2,900 "this-is-how" pictures, 225,000 service and repair facts. Leads beginners every step of the way. Time-saving factory repair procedures for experts. Instructions and pictures so clear you CAN'T go wrong. Used by U. S. Army and Navy.

Try Book FREE 7 Days

SEND NO MONEY! Pay postman nothing. Make Manual show you what it's got. Unless you agree this is the greatest time and work saver you've ever seen—return book in 7 days and pay nothing. Mail coupon today to MOTOR—Book Dept., Desk 1K, 250 W. 55th St., New York 19, N. Y.

MOTOR'S AUTO REPAIR MANUAL

Covers 737 Models All These Makes

- | | |
|-------------|-------------|
| Buick | Imperial |
| Cadillac | Jeep |
| Chevrolet | Kaiser |
| Chrysler | Lincoln |
| Clipper | Mercury |
| Continental | Nash |
| Crosley | Oldsmobile |
| De Soto | Packard |
| Dodge | Plymouth |
| Ford | Pontiac |
| Frazer | Rambler |
| Henry J | Studebaker |
| Hudson | Thunderbird |
| | Willys |

Same FREE Offer On MOTOR'S New Truck Repair Manual

Covers EVERY job on EVERY popular make gasoline and Diesel truck made from 1946 thru 1956. FREE 7-Day Trial. Check proper box in coupon.



MAIL COUPON NOW FOR 7-DAY FREE TRIAL

MOTOR BOOK DEPT.
Desk 1K, 250 W. 55th St., New York 19, N. Y.
Rush to me at once (check box opposite book you want):

MOTOR'S New AUTO REPAIR MANUAL. If O.K., I will remit \$2 in 7 days, \$2 monthly for 2 months and a final payment of 95c (plus 35c delivery charges) one month after that. Otherwise I will return the book postpaid in 7 days. (Foreign price, remit \$9 cash with order.)

MOTOR'S New TRUCK REPAIR MANUAL. If O.K., I will remit \$2 in 7 days, and \$2 monthly for 3 months, plus 35c delivery charges with final payment. Otherwise I will return book postpaid in 7 days. (Foreign price, remit \$10 cash with order.)

Print Name..... Age.....

Address.....

City..... State.....

Check box and save 35c delivery charge by enclosing WITH coupon entire payment of \$6.95 for Auto Repair Manual (or \$8 for Truck Repair Manual.) Same return-refund privilege.

Bean's Free Fall Catalog

Just Off The Press



Fully illustrated, 108 pages, showing Hunting Footwear, Clothing, and one hundred and twenty other leather and canvas specialties of our own manufacture for campers and hunters.

L. L. Bean, Inc., 141 Main St., Freeport, Maine
Mfrs. Hunting and Camping Specialties

TELEPHONES



Desk Stand Style
Slightly used but in excellent condition
Many Valuable Uses
Inter-House Phones House to Barn, etc.
Loud Speakers Microphones
Educational Purposes, Toys, etc.
Come complete, ready to use with wiring diagrams included. **\$2.75** Postpaid in U.S.A.
Two complete for only **\$5.00**
TELEPHONE LAMP KIT—with illustrated instructions for making Desk Telephone Lamp including all parts (harp, nipples, push switch, cord, plug, etc.)
... **\$6.50** Ppd. (Shade is not included).

MICROPHONE, Dept. X-4302, 1760 W. Lunt Ave., Chicago 26, Ill.

Secrets of VENTRILOQUISM Now Revealed!



Easy to learn in 60 to 90 days with our Home Study Course. **RESULTS GUARANTEED.** Make Money! Be Popular! Have Fun! Big Opportunity! Radio, Television, Stage Appearance! For FREE Information regarding price and terms WRITE. You must state your age. Dummy Catalog 25c.
FRED MAHER SCHOOL OF VENTRILOQUISM
Box 36, Studio PM-10 Kensington Station
Detroit 24, Michigan

LEARN LOCKSMITHING

Learn this fascinating, profitable trade from experts in your spare time at home! Age or physical handicap no disadvantage. Year around, steady income. Full or part time. Practical, illustrated lessons. You can make money even while learning! All materials and special tools supplied without extra charge.
INSTITUTE OF LOCKSMITHING, Dept. P-83
15 PARK AVENUE RUTHERFORD, N. J.
Lic. by N. J. State Board of Education
Approved for Veterans



WE PAY \$16 for 59 Lincoln Pennies

Send \$1 for a Lincoln cent album (to hold your pennies). Fill the spaces with dates shown in album, return **COMPLETE** album and receive \$16 by return air mail PLUS \$1 back for album (total \$17). Save other sets worth hundreds of dollars! All information sent with 1st album. Send \$1 to: **BYMAIL, BOX 67, Dept. C-38** Oakland Gardens Stat., Flushing, N. Y.



Engineer "Scoops" Power Tool Market with

3-D MAGIC BOOM!



THE BOOM RAISES

—or lowers—locks at any height from table top to 20' above table, 34' above shelf, 56' above floor. When horizontal booms slides to and fro.

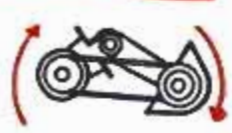

THE BOOM ROTATES

—swings the power head 360° in a complete circle—locks in any position. Work any place on table top or on material at side of table.



THE BOOM TILTS

—locks in position at any angle from vertical to horizontal. Permits operating at any angle or at any compound angle to work.

No more hodge-podge assembly of separate tools in one table. No more lack of precision. No more time lost in "changeover" from one tool to another. No more limits on usefulness. In one brilliant stroke of design a leading automotive engineer stunned the power tool industry with the "MAGIC BOOM"—an invention so amazing it is almost impossible to describe. Here, for the first time, the home craftsman is given a tool that works in THREE DIMENSIONS—a single tool that converts—in seconds—into any one of ELEVEN BASIC TOOLS having 126 different uses.

Sent for FULL 30 DAYS' TRIAL ...to use in your own workshop ENTIRELY AT OUR RISK!

The Three Dimensional flexibility of the "Magic Boom" was made possible by the invention of a PINCH-LOCK, PIVOT-BLOCK Bearing. There are only two controls. The Magic Boom can be released or locked tight with a single hand wrench in two seconds. It is this which permits raising or lowering instantly—sliding to and fro, instantly—rotating...swinging 360° in a full circle—or tilting and locking at any angle to the work—even at compound angles. It is this that permits a speed in changeover that gives the MAGIC BOOM the usefulness of ELEVEN BASIC Single Purpose Tools. And then—it is PORTABLE! Yes, the "Magic Boom"—in three parts—can be put in the

trunk of your car for use at a summer cottage or on a distant job. A perfect tool for the beginner—one you can grow with—and a superior tool for the experienced home craftsman.

Prove these claims at our risk! Anyone can make claims. And—because our claims are so extraordinary—we refuse to sell a single Paramount Tool to anyone until after it has been used for 30 days on trial. So, we put the Paramount Woodworker in your workshop for 30 days' use. We prepay freight to your door. After 30 days' use, we'll even pay the return freight if you decide to return the tool. No obligation to buy whatever. No salesman will call. You will be the sole judge.

SEND NO MONEY...JUST YOUR NAME!

Get the pictures, descriptions, specifications we will gladly mail to you free and postpaid. Compare the prices and terms with any tool you've ever heard of. Then decide if you want to take advantage of our 30 day Trial Offer. No money is needed. There is no charge for this information now or at any other time. Just your name on the coupon brings all the surprising facts. Mail the coupon today. What you receive in the mail will give you one of the most eye-opening experiences of your life.

PARAMOUNT WOODWORKER
1644 W. Lafayette Blvd., Dept. 110, Detroit 16, Mich.
DEALERS: Write for information

PARAMOUNT WOODWORKER
1644 W. Lafayette Blvd., Dept. 110,
Detroit 16, Michigan

FREE! MAIL NOW

Without cost or obligation to me, please send "Paramount Power Tool" Picture Folder and complete details of your 30 DAY TRIAL OFFER. Everything you send me now is FREE and no salesman will call.

Name _____

Address _____

City & Zone _____ State _____

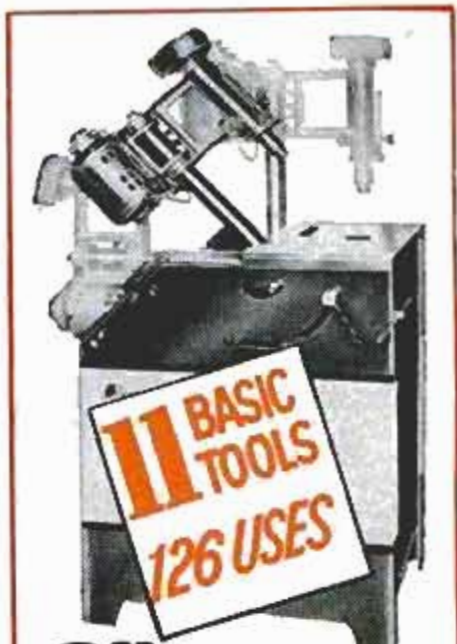

3RD DIMENSION Triples Uses!

The Paramount Woodworker and its available accessories has 126 uses and works with precision on wood, metal, even ceramics. Converts—in seconds—to any of these 11 Basic Tools.

1. **SAW.** Table saw in tilt-table operates at any angle to 45°. Retractable saw for plunge cut.

2. **DRILL PRESS.** Magic Boom permits radial drilling in any position on or off table—angle drilling—round stock drilling—compound angle drilling—and index drilling.

3. **HORIZONTAL DRILL.** Micrometer adjustment assures precision and drilling of any length of work.

4. **LATHE.** Capacity up to 3 1/2' in length. Magic Boom permits straight or angle turning. Face plate fits either end of spindle.

5. **SANDER.** Disc Sander operates at any angle to 45°, also operates as Oscillating Sander. Converts to Drum Sander.

6. **SHAPER.** Quickly adapts to Contour Shaper or Straight Shaper.

7. **ROUTER.** Can be used for straight and contour routing.

8. **MOLDING AND DADO MACHINE.** Dado slot separate from saw slot. Dado and Molding Tool operate on other end of spindle.

9. **INVERTED SURFACE GRINDER.**

10. **METAL CUT-OFF TOOL** replacing saw with abrasive wheel permits cutting metals of any hardness—even ceramics.

11. **GLUE PRESS & SURFACE PLATE.** Both fixed and tilt-table top are heavy cast iron. Blanchard ground to furnish permanent surface plate. Working height 36" above floor. Lathe height 42" above floor, as recommended by school and industry.

CHEMISTRY



THE MOST PROFITABLE BUSINESS ON EARTH!

Be a **CHEMIST!** One of the really **GREAT** professions! We teach you at home with simplified but thorough lessons. No previous training required. Earn while you learn. This is a **GOLDEN AGE** for those with special knowledge! Diploma awarded. **YOU** can be a specialist in a few months! Here are a few of our most popular courses.

1. HOW TO MAKE PRECIOUS SYNTHETIC GEMS!

Make beautiful precious gems! Rubies! Sapphires! Emeralds! etc. Easy-to-build furnace and secret formulas do the trick! Turn out a pocket-full of precious gems every day! Complete Course, **\$15.00***.

2. HOW TO MAKE ALL FIREWORKS!

With home-made equipment! Skyrockets, bombs, torpedoes, pin-wheels, and hundreds of others! Cost of complete course . . . **\$15.00***.

3. HOW TO TURN WATER INTO GAS!

This gadget actually turns water into powerful gas! Can be built from junk parts for less than \$1.00. Complete instructions, only . . . **\$2.00.**

4. HOW TO MAKE PLASTICS & MOULDINGS

The art of converting plastics and compositions into articles of great variety and value! Make anything! A genuine Gold Mine! Thousands of students have turned this course into rich rewards! Complete, **\$25.00***.

5. CHEMICAL PRINTING!

Build three presses for less than \$1.00 that will print 20,000 perfect copies from any original! Not a toy! Complete instructions . . . **\$2.00.**

6. HOW TO MAKE CHEMICAL SPECIALTIES

Manufacture Inks, **\$2.00.** Cosmetics, **\$15.00***. Adhesives, **\$2.00.** Artificial Bait, **\$2.00.** Paint, **\$5.00.** Candy, **\$5.00.** Perfumes, **\$2.00.**

7. MAJOR COURSE IN PRACTICAL CHEMISTRY!

Best course in U.S.A. Earn diploma. Acquire a dignified profession! With complete laboratory, **\$85.00***. Without laboratory, **\$50.00***.

8. OTHER COURSES

Crime Detection, **\$5.00.** Horticulture (Florist), **\$25.00***. Electroplating, **\$5.00.** Taxidermy, **\$5.00.** Radiation, **\$2.00.** Junior Chemistry Course, **\$36.00***. * May be paid **\$5.00** down, balance monthly.

LITERATURE describing the above courses and easy payment plans **FREE** on request. Prices shown above are total costs of complete courses! Want a fascinating introduction to the marvels of Chemistry? Just send **\$1.00** for Chemistry Outfit and we will include **FREE**, one **URANIUM TESTER** and a **CHEMICAL PUZZLE** worth \$2.50, if you can solve it!

NATIONAL SCHOOL OF CHEMISTRY
P.O. BOX 606-A REDWOOD CITY, CALIF.

start a big profit business
with a small investment
**EARN UP TO
\$200 a DAY**

Manufacturing Exciting New RAINBOW ROCK Concrete Slump Brick in your back yard

Earn big building boom profits with Rainbow Rock, the colorful new building brick that's taking the country by storm. Sell all you can make to contractors, builders, building supply houses. **RAINBOW ROCK CUTS LABOR COSTS BY 1/3!** Amazing low cost machine makes modern slump brick 24" long (3 times the length of ordinary brick) in a variety of widths and pastel colors . . . up to 1500 bricks a day! **NEEDS NO SPECIAL SKILL.** Operates indoors or out. Full instructions and valuable mixing formulae supplied. **YOU CAN START EARNING BIG MONEY NOW.** **PAY AS YOU PROFIT!** A limited number of machines available on easy payment terms. **NOW** is the time to start. Write today for free literature and full information.

GENERAL ENGINES CO., INC.
Dept. MR-106—Route 130
Thorofare, N. J. - Tilden 5-5401



STEEL PIER SENSATION
Luxurious **RAINBOW ROCK** fireplace wall in living room of the "Home of the Century" in Atlantic City, N. J.'s Steel Pier . . . acclaimed by over 500,000 Summer, 1953 visitors as the most beautiful they'd ever seen! Endorsed by the Pier's famous architect, William F. B. Koelle.



Makes beautiful, decorative fences, garden walls, garages, outside walls, room separators, etc.

Pyroil "B" add to oil 12 oz. can 79¢ . . . \$1.00 in Canada at your service station



FREE VALVE LIFTERS ADDS PEP AND POWER

Frees sticky hydraulic valve lifters. Prevents dry metal-to-metal starts. Reduces friction, increases horsepower, keeps motor clean. Save . . . buy pints and quarts at all auto supply stores. Write for trial offer, Dept. PM-106.



Pyroil Company Inc., La Crosse, Wis.
Toronto, Canada

Super Lubricants • World Famous Since 1929



GIANT BALLOONS

Biggest & best! Surplus US Govt. (new overage) Neoprene weather target balloons.

FOR FUN—Great in backyard, at parties, picnics, fairs. Young & old enjoy 'em!
FOR ADVERTISING—Attract big crowds to business openings, civic events, trade shows, exhibitions. Paint 'em with a sales message and they'll pay off for you!
FOR PROMS—Makes any high school or college prom more festive. Real cool!
Approx. inflated sizes.

3 ft. dia., 49¢—5 ft. dia., 99¢
10 ft. dia., \$1.59—13 ft. dia., \$1.95

Postage paid on prepaid orders. Cal. res. add sales tax.

VOLUME SALES CO., War Assets Division
3930 Sunset Blvd., Dept. PM1056, Los Angeles 29, Calif.

LAW FREE BOOK THE LAW TRAINED MAN

Write today for a **FREE** copy of illustrated law book, "THE LAW TRAINED MAN," which shows how to earn the professional Bachelor of Laws (LL.B.) degree through home study of the famous Blackstone Law Course. All necessary books and lessons provided. Moderate cost; convenient monthly terms. Write for **FREE** law training book today.

Blackstone School of Law, 225 N. Michigan Ave.
Founded 1890 Dept. 57 Chicago 1, Ill.

REAL ESTATE BE A BROKER

PAYS BIG! SEND FOR FREE, BIG, ILLUSTRATED CATALOG NOW! Graduates report making substantial incomes. Start and run your own business quickly. Men, women of all ages, learn easily. Course covers Sales, Property Management, Appraising, Loans, Mortgages, and related subjects. **STUDY AT HOME** or in classrooms in leading cities. Diploma awarded. Write **TODAY** for free book! No obligation. Approved for World War II and Korean Veterans.
WEAVER SCHOOL OF REAL ESTATE (Est. 1936)
2020R Grand Avenue Kansas City, Mo.



Say You Saw It in Popular Mechanics



EXTRA MONEY Selling EXCLUSIVE PARAGON Cushion Shoes

Even If Now Employed

Enjoy your own lifetime, independent shoe business without investment. Steady repeats. To \$4.00 pair advance commissions. Big bonus. Make \$50 and more a week in full or spare time. Over 153 latest smart styles. Magic cushion. Easy to start. Write for **FREE OUTFIT** today!

PARAGON SHOE COMPANY
79 Sudbury St., Dept. 20, Boston 16, Mass.

No. 574
Lo-Line
2 Eyelet
Crushed
Grain

ATTENTION: MEN 17 to 55



Handling Materials

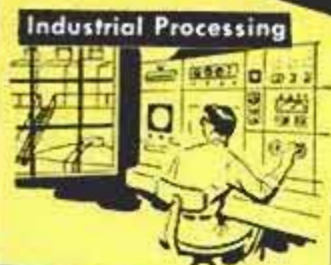

Industrial Processing



Does your present job offer advancement?

PREPARE NOW AT HOME FOR A PROFITABLE CAREER IN

AUTOMATION ELECTRONICS!

PRACTICAL NEW TRAINING METHOD IS THOROUGH, DOWN-TO-EARTH!

In plant after plant, many machines are being designed to run themselves. This is called "Automation." The jobs of some men who used to run these machines are gradually disappearing. Every year sees more changes; more unskilled jobs being replaced. But it's making many new jobs too—good-pay, solid-future jobs in plants, offices and elsewhere—for men who are trained in Automation Electronics.

NOW IS THE TIME TO GET YOUR TRAINING

The design, operation and maintenance of controls that regulate the new "automatic equipment," is a promising field of the future. It's still uncrowded. There's time to get in on the ground floor if you act now.

NO PREVIOUS TECHNICAL TRAINING NEEDED

Many men 17 to 55, regardless of present job, even men without previous technical training or advanced education, can train for good jobs in Automation Electronics. DeVry Technical Institute offers effective training in your own home with movies, plenty of practical equipment and easy-to-read texts. Or get all of your training in DeVry's large well-equipped training laboratories in Chicago... one of the finest of its kind!

WE HELP YOU GET STARTED IN THE FIELD

When you've completed the DTI training, you'll have the know-how—the practical training you need to hold down a good job in Automation. Our effective Employment Service will help you get

started toward many wonderful and exciting opportunities. You have nothing to lose—and much to gain. Send that coupon now so we can tell you about it.

MANY SUCCESSFUL GRADUATES

For 25 years, DTI has been building men for better jobs. Our files contain many letters from men who have won success in electronics and who give much credit to their DTI training.

GET INTERESTING NEW BOOKLET

The interesting story of "Automation and YOU" is yours for the asking. Simply fill in... mail the coupon. See how DeVry's training programs may prepare YOU for a start in this coming new field.

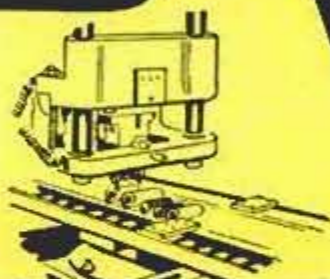

Making Electronic Devices



Recording and Billing



GET THIS BOOKLET FREE

DeVRY TECHNICAL INSTITUTE, Dept. PM-10A-M
4141 Belmont Avenue, Chicago 41, Ill.

I would like further information about the newer Electronic opportunities in AUTOMATION, also facts on how you may help me to prepare.

Name _____ Age _____

Please Print

Street _____ Apt. _____

City _____ Zone _____ State _____

1040 DTI's training is available in Canada

One of America's Foremost Electronics Training Centers

Member of National Home Study Council



DeVRY TECHNICAL INSTITUTE

CHICAGO 41, ILLINOIS

FORMERLY

DiFOREST'S TRAINING, INC.



YOU
can
acquire

LAW NIGHTS AT HOME!
LL. B. DEGREE

LaSalle's famous Law Library—used as reference in many Law libraries and Law offices—has enabled thousands to master Law surprisingly fast, in spare hours at home, for business and professional advancement.

These 14 remarkable volumes, compiled by leading professors and lawyers, cover the whole basic field of Law in condensed, orderly, simplified manner.

You advance rapidly with this great library, plus special lectures furnished. We guide you step-by-step with personalized Problem Method of instruction . . . you learn by doing—handling legal problems—not by memorizing rules.

Send for two FREE booklets, "Law Training for Leadership," and "Evidence," answering questions about Law and its value to you, and telling how LaSalle Law graduates are winning rapid advancement in business and public life. Mail coupon below. No obligation.

LA SALLE EXTENSION UNIVERSITY
A Correspondence Institution

417 S. Dearborn St. Dept. 1064L Chicago 5, Ill.

Send me your two FREE booklets described above, without obligation.

Name.....Age.....

Street.....

City, Zone & State.....

ENGINEERING DEGREE IN 27 MONTHS

B. S. DEGREE IN

Aeronautical, Chemical, Civil, Electrical, Mechanical and Electronic Engineering (inc. Radio and TV)
Big Demand for Graduates

Hundreds of young men are earning B. S. ENGINEERING DEGREES annually in this recognized institution — year around classes optional. New terms start quarterly. Many students earn a major part of their college expenses in this large industrial center.

Low tuition. Competent instruction. Thorough, intense practical program. Modern, well-equipped laboratories including new physics laboratory and modern wind tunnel. Individualized instruction emphasized.

Government approved for G.I.'s. Engineering preparatory courses. Students from 48 states and 21 foreign countries. Enter December, March, June and Sept. Send coupon for free catalog and full information. Enroll now.

INDIANA TECHNICAL COLLEGE

5106 E. Washington Boulevard, Fort Wayne 2, Indiana

Please send me free information on B.S. Engineering Degree in 27 months as checked.

- Aeronautical, Chemical, Civil, Electrical,
 Mechanical, Electronics

Name.....

Address.....

CAVITEX

*Superfine
Masonry*



X-5

Manufacturing Rights Now Available in 427 Territories

Cavitex offers building owners the ultimate in masonry at sensationally low costs. Designed in line with today's architecture. Long and low. Large color range. Modular in all dimensions. Strong—safe—enduring. Suited to all types of wall construction—8' solid, cavity, partition, veneer.

As a local manufacturing opportunity, Cavitex has tremendous potentials. Local materials are processed by local labor for local consumption. Vast economies effected. That's why Cavitex has price-appeal to buyers and profit-appeal to producers. Hundreds of territories are open.

Cavitex manufacturers operate in franchise-protected territories and with exclusive privileges. Extensive sponsor cooperation. Basic machinery available on lease. Write or wire for book "Opportunity, Unlimited" and tentative reservation of territory.

W. E. DUNN MFG. CO.
409 W. 24th St., Holland, Mich.
In Canada
Dunn Masonry Machinery, Ltd.
844 Dundas Highway
Cooksville, Ontario



**CARBURETOR SAVES GAS
VACUMATING OVERRICH MIXTURES**



Car owners who are getting poor gas mileage, and wasting money due to overrich mixtures, will be pleased to learn how to save gas. Easily installed VACU-matic invention is Automatic and operates on the supercharge principle. For cars, trucks, tractors. **SALESMEN WANTED! Big Profits!** FOR FREE PARTICULARS. HOW YOU CAN GET ONE ON YOUR OWN CAR FOR INTRODUCING, just send your name and address on a post card to—**VACU-MATIC CARBURETOR, Dept. 863, Wauwatosa, Wis.**

earn as TAX EXPERT

**\$15
HOUR**

Our students earn as much as \$3,000 in 3 short months preparing income tax returns in spare time. Also operate lucrative year-round Business Tax Service. Dignified home-office business. Experience unnecessary. We train you; help you start. State approved home training program. Write today for free prospectus.

UNION INSTITUTE, 68 Hudson, Hoboken 20N, N. J.

SAVE MONEY!

FREE BARGAIN BOOK

CENTRAL CAMERA CO.
PHOTOGRAPHIC HEADQUARTERS SINCE 1899
Save money on all photographic equipment. Send for Central Camera Co. FREE Photographic Bargain Book today.

CENTRAL CAMERA CO.
Dept. A-10 230 S. Wabash Chicago 4, Ill.

RUPTURED?

Write for New Relief FACTS FREE!

ENJOY NEW FREEDOM

of action, peace of mind and comfort at work or play. Proven, patented MILLER holds your rupture back Day & Night—will bring you lasting relief! Has helped thousands of others! For FREE facts in plain wrapper—

Send Name and Address to **FRED B. MILLER, DEPT. 1M**

Manufacturer, HAGERSTOWN, MARYLAND



ENTIRELY DIFFERENT

ENGINEERS!**INVENTORS!****MECHANICS!****HOME HOBBYISTS!***If you work with machinery of any kind... you need*

THE NEW PRACTICAL PICTORIAL GUIDE TO MECHANISMS & MACHINES

THE ENCYCLOPEDIA WITH 4000 DESIGN DRAWINGS

Newest, most comprehensive one-volume encyclopedia of its kind. An essential to everyone, professional or amateur, interested in machines and mechanical function. Offers many leads and avenues of information to your mechanical problems. Don't search your memory... have the drawings you need right on tap in your workshop. Contents are divided for quick, easy reference: MEASUREMENTS, FLUIDS, MECHANICS, HEAT, LIGHT, SOUND, ELECTRICITY, MISCELLANEOUS MECH-

ANISMS. Material is complete and up-to-the-minute, researched from patent drawings, catalogs, and engineering portfolios. Includes comprehensive glossary of mechanical and technical terms. Gives you an easy-to-follow procedure on obtaining patents for mechanisms or devices. 256 pages, 6x9", cloth bound.

4000 Illustrations and Explanations of Every Kind of Machine and Motion Device

PARTIAL LIST OF CONTENTS:

Generators, Motors, Transformers, Communications, Instruments, Switches, Tubes and Lamps, Industrial Devices, Tools, Conveyors, Lifts, Hoists, Cranes, Trusses, Sloyd Knife, Plunger Stoker, Splined Shaft, Anthropometer, Corkscrew Padlock, Calipers, Mandrels, Tappet Wheel, Spindle Revolution Counter, Wagner-Feunel Tacheometer, Pantograph, Burette, TV with Scent, Helix, Torsion Balance, Weighbridge, Straw Squawker, Clepsydra, Kymograph, Geneva Stop, Optical Gyroscope, Screw Pitch Gauge, Ellipsograph, Hyperbola Scriber, Azimuth, Nephoscope, Maxwell's Dynamical Top, Epicyclic Train, Hygrodeik, Compensating Manometer, Humiguide, Doubletrees, Flutter Wheel, Telephoto System, Pneumatic Trough, Aspirator, Bellows Compressor, Hastie's Hydraulic Engine, Rotary Blower, Wobble Pump, Bombardon, Scotch Boiler, Polarized Relay, Caisson, Duct Elbows, Swing-Check Valve, Toggle Clip Pipe Joint, Scroll Cam, Inertia Governor, Current Motor, Spanish Module, Vacuum Lift Nozzle, Vaporstat, Star Projector, Skew Worm and Wheel Gears, Double Pawl, Tongued Steam Turbine, Cascade Phase Inverter, Lenticular Bearing, Windlass, Opera Glass, Sector Pinion and Double Rack, Chalumeau, Rawhide Mallet, Bridge Truss, Knuckled Joint Tappet, Helmholtz Resonator, Variable Power, Mangonin Shunt, Distance, Area, Volume, Weight, Time, Angles, Static Testers, Wheels, Valves, Mills, Turbines, Siphons, Pumps, Intensifiers, Tanks, Pipes and Fittings, Filters and Stills.

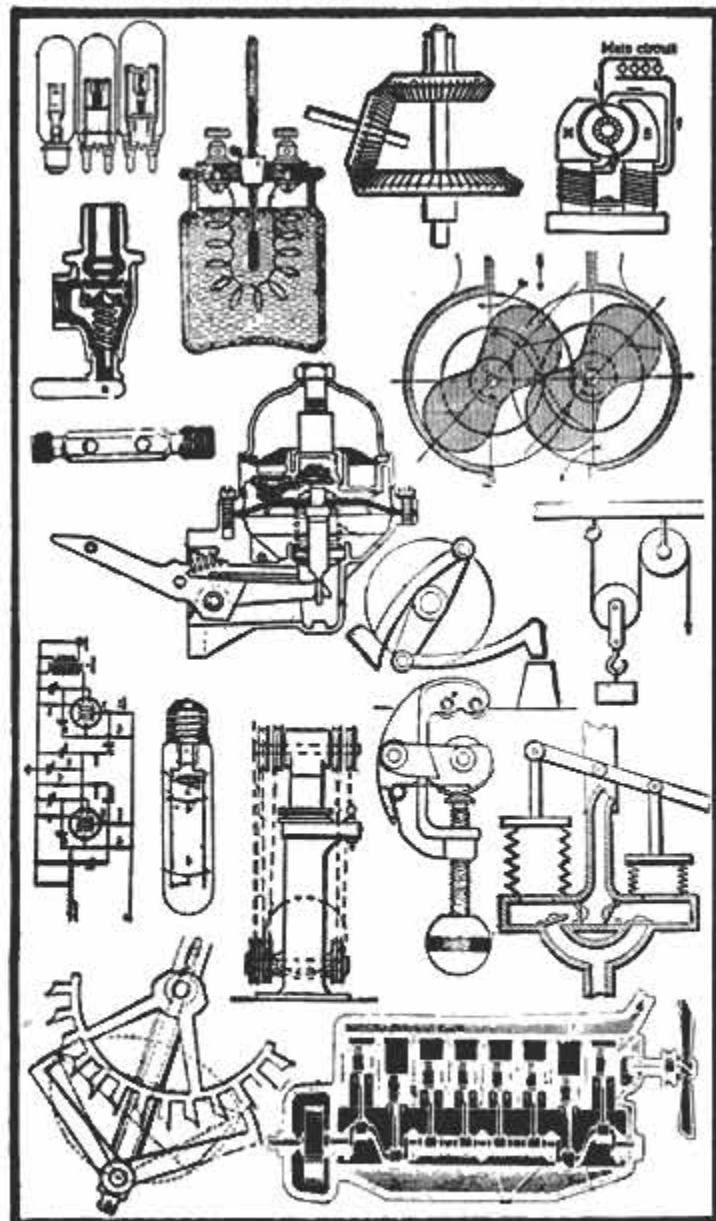

So comprehensive a volume never before offered at so low a price! \$4.00

UNIVERSITY BOOKS, INC., Dept. P. M.
404 Fourth Avenue, New York 16, N. Y.

Please send me _____ copies of PRACTICAL PICTORIAL GUIDE TO MECHANISMS AND MACHINES by Simon Palestrant.

Enclosed \$4. Send book postpaid.

Send book C.O.D. at \$4. I'll pay C.O.D. postage.

NAME _____

ADDRESS _____

CITY & ZONE _____ STATE _____

Inventors

Take these necessary preliminary steps promptly to protect your invention by applying for a United States patent—

Sketch and describe your invention. Sign, date and have this disclosure witnessed by two people who understand your invention. Have us make a preliminary search among U. S. patents already granted for similar types of invention. We then report to you on the probable patentability of your invention and recommend your further course of action.

Write for our instructive booklet, "Patent Protection for Inventors" and our convenient "Evidence of Invention" disclosure form. No obligation.

VICTOR J.
EVANS & Co. *Merlin M. Evans*
REGISTERED PATENT ATTORNEY
230-L MERLIN BUILDING, WASHINGTON 6, D. C.

better work *easier*



Any job is easier in free-action clothes like Anvil Brand. No bothersome binding. Ample muscle room. And for toughness—wear Anvil matching shirts and pants of washable twills in variety of colors. Many styles of Anvil utility and casual garments for men, boys, ladies, girls. In leading stores.

Anvil Brand
SINCE 1877 **ANVIL BRAND** factories
HIGH POINT / NORTH CAROLINA



instead of a job
... train for a Career



Industrial growth . . . automation . . . technical advances create career opportunities for engineers, accountants, management experts. Share rewards awaiting college-trained men. Important firms visit campus regularly to employ Tri-State College graduates. Start any quarter in this world-famed college. Approved for veterans.

Bach. of Science degree in 27 months

In Mechanical, Civil, Electrical, Chemical, Aeronautical, Radio (TV-Electronics) Engineering. In 36 Months a B.S. in Business Administration (General Business, Accounting, Motor Transport Management majors). Capable students may accelerate. 36-weeks course in Drafting. *Intensive program: technical fundamentals stressed: comprehensive courses with more professional class hours. Small classes: personalized instruction.* For earnest, mature students whose time and budget require accelerated courses and modest costs. Preparatory courses. Beautiful campus in friendly college town. Well-equipped, new and modernized buildings and laboratories. Enter Jan., March, June, Sept. Write Jean McCarthy, Director of Admissions, for "Your Career in Engineering and Commerce."



TRI-STATE COLLEGE

4106 College Avenue . . . Angola, Indiana



I Made \$14,839 in 1 Year SERVICING RADIATORS!

Are you earning under \$8,000 a year? Hundreds now making \$10,000 - \$12,000 - \$15,000 a year servicing auto-truck-tractor radiators the Inland way. Easy to learn. Inland, largest radiator servicing equipment mfg., offers the complete package—equipment, merchandising, "Pays-for-itself" financing, and Free training school for customers.

WRITE for FREE Radiator Servicing Folder.

INLAND MFG. COMPANY, Deps. PM-18 1108 Jackson St., Omaha 2, Neb.

What Every Mason Wants



We have important Masonic books and lodge supplies for Blue Lodge, Chapter, Commandery, Scottish Rite, and Shrine.

OUR RITUALS ARE USED THE WORLD OVER

Send for free catalog of books and rituals for Masons, Odd Fellows, Knights of Pythias, Knights of Columbus, etc.

EZRA A. COOK PUBLICATIONS, INC. P.O. Box 796, 22A, Chicago 90, Ill.

FREE! 107 BRITISH COLONY STAMPS

All different from Britain's farflung colonial empire. Catalog value \$2.50.

FREE STAMP MAGAZINE. Approvals.

Send 10c for handling. Act now!

NIAGARA STAMP COMPANY
St. Catharines 77, Ont., Canada



HELPFUL BOOKS

Send post card asking for FREE catalog

Popular Mechanics Press, 200 E. Ontario, Dept. 601, Chicago 11

DRAW

YOUR WAY TO FAME

Ask how to get started with
CARTOONS-OF-THE-MONTH
ROSLYN, NEW YORK

WRITE TODAY!

Learn PHOTOGRAPHY at Home

Splendid opportunities. Prepare in spare time. Practical basic training. Long-established school. Send for free book, "Opportunities in Photography." No obligation. American School of Photography, 835 Diversy Parkway, Dept. 1357, Chicago 14, Ill.

OFFERED FOR A LIMITED TIME ONLY!

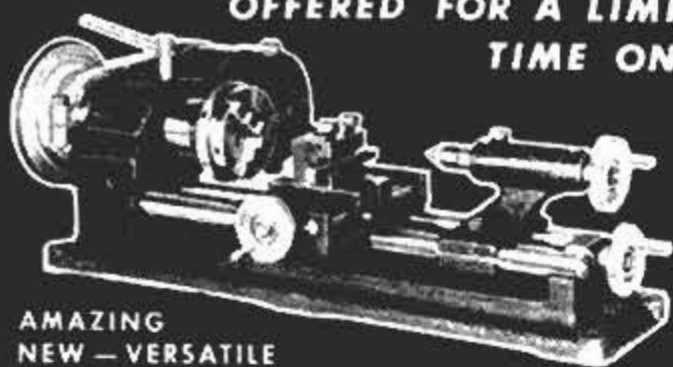

AMAZING NEW — VERSATILE

Save over 50% by ordering now!

AVAILABLE ON EASY INSTALLMENT TERMS

For machining ✓ METALS ✓ PLASTICS ✓ WOODS

PRECISION BUILT... FOR PRECISION RESULTS

UNIMAT

10 IN. COMPLETE HOME POWER WORKSHOP

COMPLETE BASIC UNIT \$199.50 VALUE now \$99.50

YOU CAN MAKE EVERYTHING WITH UNIMAT

Here's your chance to get years of pleasure and practical use while you work with UNIMAT—the unique and multi-purpose machine tool. UNIMAT is a complete miniature home workshop that enables you to make thousands of small articles from metal, wood and plastic! If you're the kind of man who gets real pleasure and satisfaction creating beautiful and useful things, UNIMAT is a must for you! With UNIMAT you can even make your own miniature gas and steam motors—model railroad equipment, fishing tackle, unusual trophies, knick knacks, chess sets, personalized costume jewelry, a man who needs a versatile and practical machine, UNIMAT is the ideal item! Or, if you're the kind of man who's especially handy around the house, various models of your own design and hundreds of other fascinating hobby tool for you too! With UNIMAT you can do hundreds of small repair jobs—fix home and farm implements economically, avoid costly repair bills, repair vacuum cleaners, washing machines, rifles and guns, engine parts, farm equipment, cameras, duplicate unobtainable parts, develop your own inventions and gadgets or even earn money repairing—because UNIMAT is adaptable to so many interesting, practical and useful projects! UNIMAT more than pays for itself in a short time!

PORTABLE AND COMPACT

The UNIMAT is a precision built lathe that quickly converts into a drill press, hand drill, polishing or grinding machine, tool grinding machine, milling machine, jig saw, threading machine, circular saw and indexing-dividing machine. UNIMAT's convenient compact size (all operating positions on just one base) enables it to be set up on any table. You can even use the handy wooden carrying case, included with the basic unit, as a work bench! Takes up a little space as a typewriter, requiring a working space of only 9" x 18". Fully operates on your ordinary 110 volt AC or DC house current. Just plug it in and you're all set to start your projects. It's simple to operate—the easy-to-follow 35 page instruction manual tells you how!

HERE'S WHAT YOU GET WITH THE BASIC UNIT

The UNIMAT Basic Unit includes: 1. Precision lathe and all attachments necessary to set up; 2. Drill Press—3. Hand Drill—4. Polishing and Grinding you also get these 13 accessories Free: AC/DC Power Motor, with reduction Machine—5. Tool Grinding Machine—6. Milling Machine. With the Basic Unit pulleys (11 speeds—375 R.P.M. to 9200 R.P.M.), self-centering universal three-jaw "Cushman" lathe chuck with reversible jaws (bore 2 1/2" Dia.) 1/2" Drill Chuck, Fixturing Tool Holder, Grindstone Holder, Lathe Dog, Face Plate, 2 centers, Allen Wrench. Easy-to-follow instruction manual, all packed in sturdy wood veneer carrying case!

ORDER THESE ATTACHMENTS WITH YOUR BASIC UNIT

7. The Jig Saw complete with 12 blades—8. Threading Attachment with 3/8", 1/2", 3/4" NC Thread patterns and formed tool bit for outward threads—9. Circular Saw complete with 2 blades—10. Indexing and Dividing Attachment complete with table and 3 clamps. All attachments can be ordered individually with the Basic Unit, or at any time in the future! All attachments mount quickly and easily on UNIMAT and increase its versatility even more!

YOU SAVE 50% IF YOU ORDER NOW

UNIMAT previously sold for \$199.50! Now, for this limited time only, you can own a UNIMAT for this extremely low price of only \$99.50! This tremendous savings of \$100.00 is yours because all manufacturer's agents and wholesaler's profits have been eliminated. And you can make this sensational purchase on easy time payments!

EASY CREDIT BUDGET PLAN AT NO EXTRA CHARGE

Yes, for just \$49.50 down, and only \$10 a month or \$2.50 per week, until balance is paid, you can be the proud owner of UNIMAT, the machine tool that can be used in a thousand ways! Don't miss out on this sensational bargain. Take advantage of this unusual value while the offer lasts, choose either the monthly or weekly budget plan to suit your convenience. There's no extra charge for this installment payment service. This 50% savings offer cannot last long and may be withdrawn at any time! So don't delay—be sure to order your UNIMAT today! Send check or money order for immediate delivery. We will pay all shipping charges east of the Mississippi—slight shipping charge west of the Mississippi. If you are not satisfied within 10 days your money will be cheerfully refunded in full. Take advantage of this unusual offer today. Act Now! Send Coupon today!

DEALERS: FEW TERRITORIES STILL AVAILABLE!

AMERICAN EDELSTAAL [AMSTERDAM] INC
UNIMAT DIVISION • 350 BROADWAY • NEW YORK 13 NEW YORK

BASIC UNIT



1—Lather Center height 1.42", distance 0.83". Turns between centers and in vertical position using chuck. Base: 1 1/4" x 3 1/2".

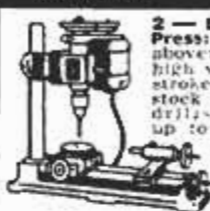

2—Drill Press: Chuck above table 5" high with 1" stroke. Headstock drills holes up to 1" at 60° angle.



3—Hand Drill: Headstock and motor become hand drill with 11 speeds from 375 R.P.M. to 9200 R.P.M.

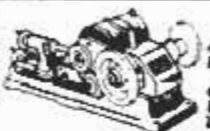

4—Polishing or Grinding: Polishing or grinding wheels on spindle can be pivoted outside of the bed for larger wheels.



5—Tool Grinding: Holds grindstones up to 2.36" Dia. Plytype grinders can be mounted in any position.

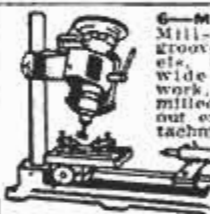

6—Milling: Mills slots, grooves, bevels. Permits wide angle work. Prisms milled without extra attachment.

ATTACHMENTS



7—Jig Saw: Easily attached to base for sawing metal, wood, plastic. Equipped with 12 assorted blades. \$19.00

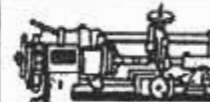

8—Threading: Including Tool bit and 3 patterns for 1/4", 3/8", 1/2" NC threads. Other patterns obtainable. \$31.50



9—Circular Saw: Attaches easily and includes metal and wood saw blades. \$9.50



10—Indexing Dividing: Includes table and 3 clamps for cutting 2, 3, 4, 6, 8, 12 or 24 toothed gears. \$15.50

American Edelstaal (Amsterdam) Inc., Dept. PM-106
350 Broadway, New York City 13, N. Y.

I am enclosing \$_____ for payment as checked below

Items	Full Payment	Down Payment	Monthly for 3 Mos.	Weekly for 20 Wks.
Basic Unit	\$99.50	\$49.50	\$10.00	\$2.50
Jig Saw	19.00	10.00	1.80	.45
Circular Saw	9.50	5.50	.80	.20
Threading	31.50	18.50	3.00	.75
Indexing and Dividing	15.50	7.50	1.60	.40

Please send me FREE literature.

Name _____
Address _____
City _____ Zone _____ State _____
New York City residents add 3% City Sales Tax.



This Sealed Book
LOANED
To You

THOUSANDS EVERYWHERE ACCLAIM THIS New Psychology Of Life!

Have you unrealized hopes? Are the better things of life always just beyond your reach?

Times have changed—but have you? Adopt a new psychology of life and **MASTER YOUR PROBLEMS**. It takes no greater mental effort to *achieve results* when you know how.

Let the Rosicrucians show you how, by the use of simple laws, you can apply the powers of your mind to bring about startling changes in your life. If you are sincere in your desire, write for the free Sealed Book. It will point out how you may obtain this most helpful information. Address: Scribe W.A.W.

The Rosicrucians (AMORC)
SAN JOSE CALIFORNIA

High School at Home

MANY FINISH IN 2 YEARS

No classes. No time wasted going to and from school. Progress as fast as your time and abilities permit. Standard H. S. texts supplied. Thousands enroll each year in this 59-year-old school. Send for FREE descriptive booklet.

AMERICAN SCHOOL, Dept. H745
Drexel at 58th St., Chicago 37, Ill.

Without obligation, please send FREE descriptive booklet.

Name.....

Address.....

Complete Canadian Courses available. Write American School, Dept. H745, 6083 Sherbrooke St. W., Montreal



ONE BUSINESS THAT IS NOT AFFECTED BY STRIKES, DEPRESSIONS OR POLITICS

WITH A POTENTIAL MARKET OF 50,000,000 CUSTOMERS

New shop-method, home-training system gives you electrical know-how that used to take years to learn. Learn at home by building valuable testing kits, repairing your own and neighbors' appliances. It is not unusual for appliance repairmen to charge on the basis of \$5.00-\$6.00 an hour.

FREE ILLUSTRATED BOOK

Shows you how you learn every phase of electrical appliance. How to make money while you learn. Write today for your FREE copy.

CHRISTY TRADES SCHOOL

Dept. D-5903
4804 North Kedzie Ave., Chicago 25

RETRACT-A-PEN RIOT! Prices Slashed to New Low!

REFILLS (49c Value Each)
10 only \$1.00

RETRACTABLE PENS 5 for \$1.00 (100 for \$10)

Choice of Red, Blue, Black or Green Ink! Barrels in ast'd colors. Will not leak, smear or transfer. Send check or M.O. Add 10c for shipping. Money back guarantee. Quantity and imprint prices on request.

Barclay Distributors, Dept. 380, P. O. Box 45, Forest Hills, N.Y.

New Way to Improve YOUR ENGLISH

A command of effective English gives you added advantages and better opportunities. Poor English handicaps you more than you will ever realize. You can improve your English through Sherwin Cody's 100% self-correcting invention. **FREE BOOK.** If you are ever embarrassed by mistakes in grammar, spelling, punctuation, or pronunciation, this new free book "How You Can Master Good English in 15 Minutes a Day" will prove a revelation to you. Send for it now. It is free. No obligation. No salesman will call. Address: **SHERWIN CODY COURSE IN ENGLISH, 5816 Central Drive, Port Washington, N. Y.**

WELDING may aid your SUCCESS

Arc and Acetylene; welding metallurgy; Hellare, etc. This is home, spare-time training for men who appreciate the importance of welding and want to advance in the art, get promotion, enlarge own shop, etc. Send for **FREE BOOK, Utilities Engineering, 2523 Sheffield, Dept. WC-14, Chicago 14**

AGENTS—Now Save Up to 50% on Nationally Advertised Products

Use this big, new **FREE CATALOG** to buy all kinds of big name merchandise at terrific savings. Set yourself up in business—make money in your spare time.

EVERGREEN STUDIOS
Dept. 64, Box 846 Chicago 42, Ill.

Say You Saw It in Popular Mechanics



No investment, no experience needed. Just show magic cushion comfort to friends, neighbors, co-workers. Advance commissions to \$4.00 a pair, plus Cash Bonus, Paid Vacation, \$25.00 Reward Offer, Outstanding values for men, women, children. Money back guarantee. Shoe samples supplied without cost. Write TODAY for **FREE** new 84 page catalog and full details.

TANNERS SHOE CO., 152 BROCKTON, MASS.

Two-Eyelet Hit With Cushioned Comfort

RCA offers you the
 finest training
 at home in
Radio-TV
 electronics,
TV servicing,
Color TV

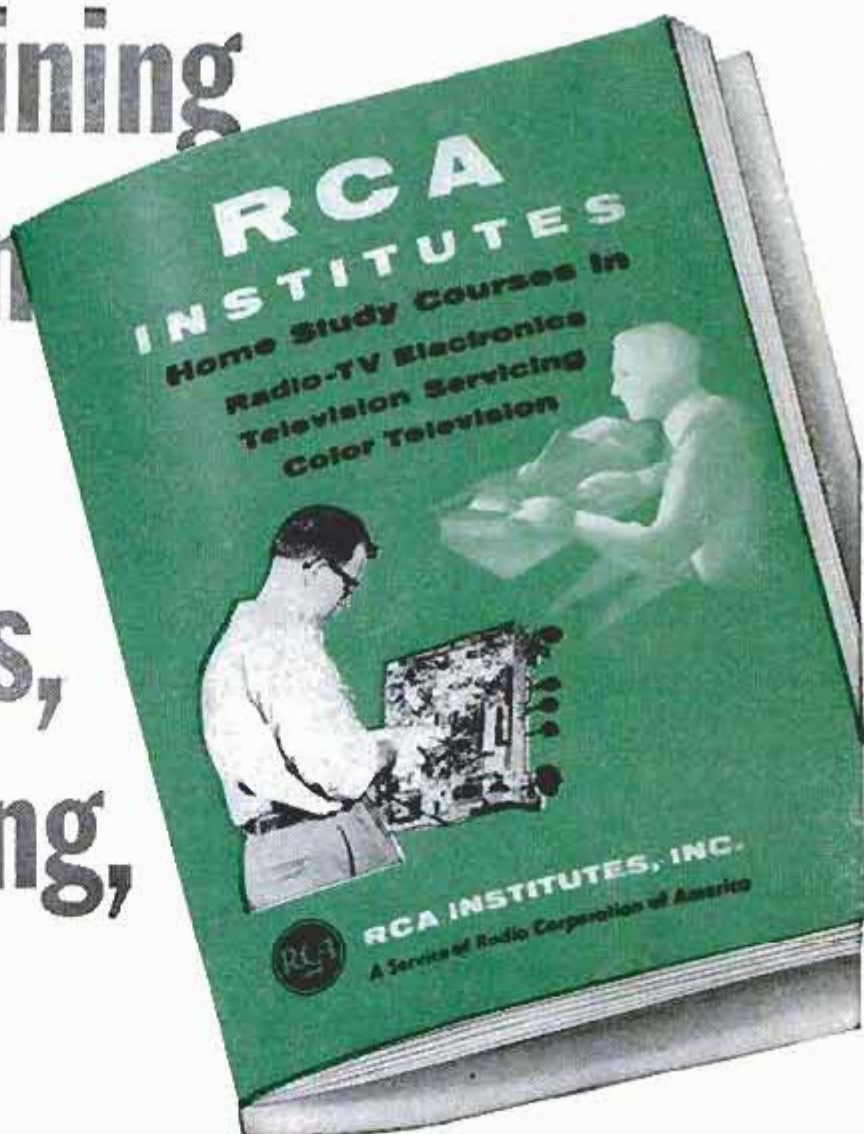

**SEND FOR THIS FREE
 BOOK NOW!**

The instruction you receive and equipment you get (and keep) will start you on your way. Pay-as-you-learn. You pay for only one study group at a time. This 52 page book contains complete information on Home Study Courses for the beginner and the advanced student.



RCA INSTITUTES, INC.
 A SERVICE OF RADIO CORPORATION of AMERICA
 350 WEST FOURTH STREET, NEW YORK 14, N.Y.

RCA Institutes, Inc., Home Study PM106,
 350 West Fourth Street New York 14, N. Y.
 Without obligation, send me FREE CATALOG
 on Home Study Courses in Radio, Television
 and Color TV. No salesman will call.

Name.....
 Please Print
 Address.....
 City..... Zone..... State.....

VETERANS
 KOREAN G. I.
 P. L. 550
 CHECK HERE
 ()

DIESEL MECHANICS IN DEMAND

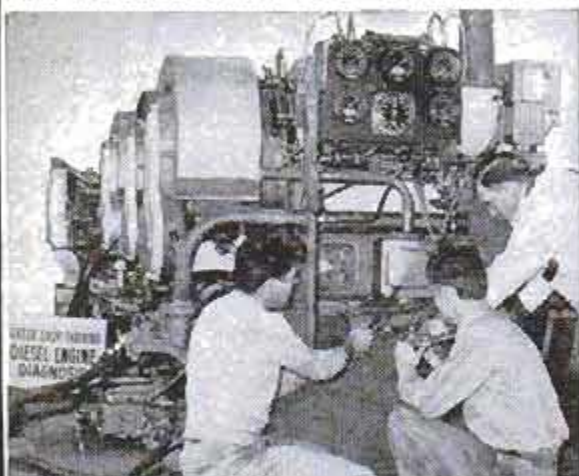

Learn to earn big pay in DIESEL in our large, modern equipped Chicago school and shop. No previous experience or training necessary. We help you find living quarters and part time job while in school. Complete, practical courses taught in the following trades, under the supervision of experienced, expert technicians.

APPROVED FOR CIVILIANS OR GI'S

— CHOOSE YOUR TRADE —

CHECK HERE	WEEKS
<input type="checkbox"/> DIESEL MECHANICS	20
<input type="checkbox"/> AUTO MECHANICS	20
<input type="checkbox"/> BODY & FENDER	16 2/3
<input type="checkbox"/> GAS-ARC WELDING	4-12
<input type="checkbox"/> REFRIGERATION	13 1/2
<input type="checkbox"/> AIR CONDITIONING	8 1/3
<input type="checkbox"/> MACHINIST TRADE	30
<input type="checkbox"/> ADVANCED MACHINIST (includes tool & die)	32 1/2
<input type="checkbox"/> PIANO TUNING & REPAIR	36

CHOOSE YOUR ENGINEERING COURSE

These courses are intended as terminal education for men who wish to enter the Diesel-Automotive and Refrigeration-Air Conditioning fields as technicians. These courses are designed to prepare men for supervisory positions. Students with a high school education, or equivalent, will be accepted.

<input type="checkbox"/> DIESEL AUTOMOTIVE ENGINEERING	2 years
<input type="checkbox"/> REFRIGERATION & AIR COND. ENGINEERING	18 months

FREE EMPLOYMENT HELP

Start your career with Greer by checking your interest above and mail coupon for complete information at no obligation.

NAME _____ AGE _____

STREET _____

TOWN _____ ZONE _____ STATE _____

Established 1902 — Over 50,000 Graduates.

54 years of continuous trade school experience to guide your training.

GREER SHOP TRAINING

Box J, 2236 S. Michigan Ave.
Chicago 16, Illinois

23 YEARS AT THIS ADDRESS
TUBE FREE WITH EVERY PASSENGER TIRE
LOW OVERHEAD—LARGE VOLUME SALES & SMALL PROFITS
BRING YOU THESE "LOWEST PRICES."



INSURED TIRE SERVICE

Our entire stock of very slightly worn EXTRA MILEAGE TOP GRADE Tires, (Written Insurance Guarantee).

EVERYBODY 10% off ON EVERY MAY TAKE TIRE

12 MOS. WRITTEN GUARANTEE. WHITE WALLS \$1.00 EXTRA Selected for Toughest Jobs—Prices Shaved to the Bone	600-16	670-15	710-15	760-15	800-15	820-15	
600-16	\$3.22	475-19	\$5.32	700-15(6)	\$8.72	700-20	\$10.92
600-16(6)	6.42	640-15	4.92	750-16(8)	9.92	750-20(10)	14.92
650-16	5.42	670-15	5.22	700-17	10.92	750-20(8)	10.92
650-16(6)	6.42	710-15	5.32	750-17	12.92	825-20	17.22
700-16	6.22	760-15	5.42	825-15	15.92	900-20	18.22
750-16(6)	7.42	800-15	5.72	600-20	9.62	1000-20	18.02
550-18	4.82	820-15	5.72	650-20	10.72	1100-20	18.02
550-17	4.72	670-16	5.15	32x6(8)	10.32	1000-22	19.02
650-15	5.22	760-16	7.72	32x6(10)	12.32	1100-24	23.72
700-15	5.32	700-16(6)	7.72	750-15	11.92	1100-22	21.02

"EXTRA SPECIAL" Fully guarantee "AAA" Grade, FREE TIRE with 2 or more of these, W.W. \$1.00 Extra. Factory Tested Tube given. GIANT TIRE SALE

600-16 tire & tube	670-15 tire & tube	710-15 tire & tube	760-15 tire & tube	800-15 tire & tube	820-15 tire & tube
\$7.42	\$7.42	\$7.42	\$7.42	\$7.42	\$7.42

SNOW TIRES \$9.42 ORDER ANY 4 PLY PASSENGER SIZE 12 MO. GUAR. BLACK WALL

Thousands of tires shipped all over the U.S.A. All tires shipped F.O.B. Phila. Send Check or M.O. with this ad. Dept. 2. No C.O.D. STANDARD 834 N. Broad St., Philadelphia 30, Pa.

Imported Collection of 315 STAMPS 25c



Includes Grace Kelly-Rainier Royal Wedding stamp; Jean Monaco U.S. President Set showing F.D.R., Washington, Lincoln, Eisenhower; Dutch New Guinea 1st stamp issued and hundreds more! Total of 315 all-different stamps. Catalog value \$6.95—yours for 25c to introduce our Bargain Approvals. Send 25c — ask for LOT FO-24

ZENITH CO., 81 Willoughby St., Brooklyn 1, N.Y.

LEARN LANDSCAPE GARDENING

A thorough, interesting home study course for those who wish to become LANDSCAPERS, GARDENERS, DESIGNERS, etc., for profit or pleasure. Write today for FREE INFORMATION to:

NATIONAL LANDSCAPE INSTITUTE

Dept. M-106 310 S. Robertson Blvd. Los Angeles 48, Calif.

RADIO

Engineering. All phases radio & electronics theory & practice; television; FM; broadcasting; servicing; aviation, marine & police radio. Prepare for good pay; 18-month course. Graduates in demand by major companies. Enter Jan., March, June, Sept. Regular campus life. Write for catalog. VALPARAISO TECHNICAL INSTITUTE, Dept. D, Valparaiso, Ind.

FREE GERMAN HUNTING KNIFE

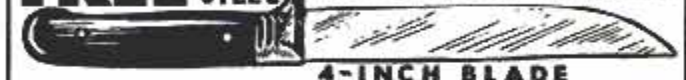

4-INCH BLADE

We give you handiest hunting and fishing knife you've ever had! Has 4-INCH LONG highly tempered steel blade—VERY SHARP! Attractive handle. We send knife FREE to acquaint you with our below-wholesale bargains. Please send 25c for handling. NO LIMIT—but send 25c handling for each knife. Order TODAY! HUNTING KNIFE, Dept. K-102, Box 881, St. Louis, Mo.

Super Powerful All Channel TV RECEPTION IN ALL DIRECTIONS

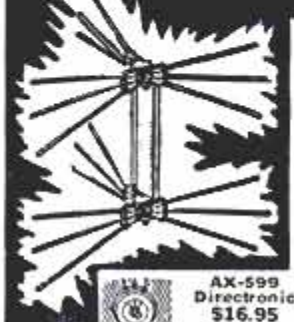

Rocket DIRECTRONIC MOTORLESS TV ANTENNA

- 360° Electronically Switched Beam
- No Motors
- No Roof
- Orientation
- No Electric Power
- No Ghosts
- Flick of Switch Clears Picture Instantly

In the city or in an ultra-fringe area, the Directronic will outperform ordinary antennas. Only the Motorless 360° Directronic TV Antenna offers "around the compass" reception WITHOUT Rotors. Clarity of picture will amaze, it's so bright, so sharply defined. AX-599 "Service-man's Array" contains Hi-Pac molded insulator of extremely high tensile strength, 18 hi-tensile aluminum alloy elements, 1 set of connecting stubs (3), Universal U-Clamps for masts to 1 1/2". Directronic Beam Selector. 75 feet of Tri-X Cable. 25% deposit on C.O.D. orders, please. Money Back Guarantee.

NATIONAL ELECTRONICS OF CLEVELAND
660R Euclid Ave., Dept. P-10 Cleveland 3, Ohio

I call this machine "My Little Money Maker"



It can be put anywhere in the house—in the kitchen, the basement, or the attic and it goes on making money for you whether you're there or not. Three times a day—while you're at work, while you're asleep, or at the movies—it turns out a product that sells for \$6 and the cost of raw materials is only 54c. It will make 6 a day, and the profit on each is more than \$5.00. I'll be glad to tell you how to get one of these little money makers working for you.

What a fellow makes in his regular job today is hardly enough to make ends meet. Higher taxes, higher costs of food and rent and almost everything else raise hob with the savings account. And I say that what a fellow puts away is even more important than what he makes. It would worry me sick if I couldn't save a little against a rainy day.



And that makes it almost necessary to make some extra money. There are lots of ways to do it, too. The magazines and newspapers are full of ads for agents to sell things. But if I had to make a living by selling, from house-to-house, I'm afraid I'd starve to death. I like to make something with my hands and

either sell it by mail or let the stores sell it for me. There are lots of people like me. Another thing: Lots of men—and women, too—don't want to get mixed up with something that might hurt them on their jobs. They want a plan they can operate at home—in spare time—one that they can work at any time they please and one that doesn't need any rented store or hired help. And that's where my little money maker rings the bell.



Let's say you're like me. You want to make some extra money but you don't want to do any selling. All right—take a look at what you can do with this machine. I'll give you some facts that I discovered and your own common sense will tell you they're true. If you're going to make something, it ought to be something that lots of people want—something that lots of people buy. It shouldn't be something that sells at just certain seasons—but all year round. And, it shouldn't be any flash in the pan. It's got to be steady—year after year—something that's not here today and gone tomorrow.

Well, give a thought to this: What's more permanent than babies? Ever since I can remember there's been more and more babies born every year. Last year three and a half million. This year more. Next year, more yet. Then answer this question and tie it in with your thinking: What's stronger than mother's love for her baby? And what is more powerful than love or sentiment in making people buy things. Now you've got the idea.

Every year millions of mothers want their babies' first shoes preserved as mementos. These mothers have the shoes "bronzed" as they call it—by electroplating. Electroplating coats the shoes with copper and preserves them forever. And there's no big company that has a corner on the business of metalizing baby shoes. Almost all of this work is done by little fellows in their kitchens



or basements. Lots of orders come to you by mail when you send out circulars letting mothers know you can do the work. Lots of stores take orders, but they have to turn the work over to you. There are six or seven ways to get orders without making any house-to-house calls. The big job is keeping up with them.

You see, you can clean up six pair shoes in a few minutes. In a few minutes more you can dip them in the hardening solution like you see in the picture. Then you spray them with a conductive coating and hang two pair in the tank on copper wires. Just turn the switch and walk away. The machine does the rest. Eight hours later those shoes are ready to take out of the tank, burnish and mount and ship or deliver. Two pair every eight hours, whether you are asleep, awake or at the movies. The materials cost 54c a pair.

The retail price you get for electroplating is \$6.00—so the profit is more than \$5.00 a pair. Since you can do six pair a day you can see what the profit is, and the beauty of it is that the machine doesn't cost much. Almost anyone can afford the equipment. The book tells how to run the machine and how to get orders without house-to-house selling.

If you'll just put your name and address on the coupon and mail it to me, I'll send you all the information right away by mail. After you have read all this you will know what you want to do. It will be easy to decide whether you would like to have a "Little Money Maker" of your own. Everything I send you now is free. There is no catch to it and nobody will call to try to sell you anything. I'll send everything free and postage paid. All you have to do is mail the coupon, get the facts and then decide. Mail the coupon right away so I can help you get started making money!

ARTHUR B. MASON, 1512 Jarvis Ave., Chicago 12, Ill.

ARTHUR B. MASON
1512 Jarvis Ave., Chicago 26, Ill.

Please tell me about the seven different ways to make money at home in spare time with your "Little Money Maker." It is understood that no salesman will call and it is up to me to decide what I want to do. Everything you send me now is free and will not cost me a penny now or ever.

Name _____

Address _____

City _____ Zone _____ State _____

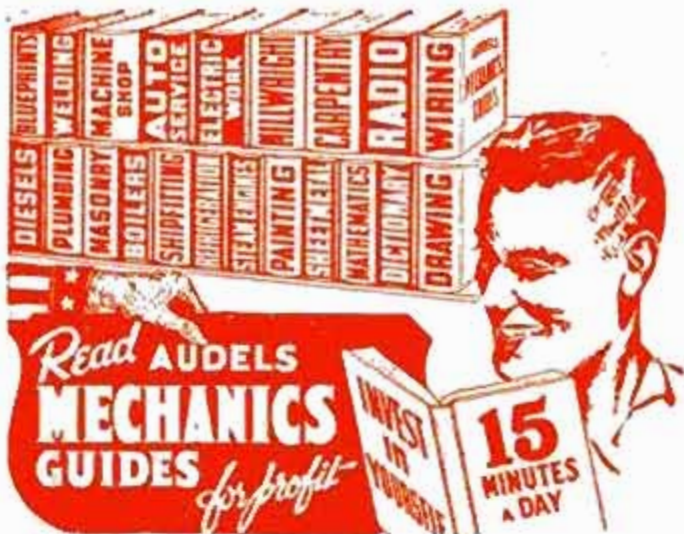

Every Mechanic can Step Up his Skill with AUDELS GUIDES. Containing Practical Inside Information in a Handy Form. Covers facts and figures of your Trade. All illustrated and explained. Books sent to you for 7 DAYS FREE EXAMINATION. Send No Money. Nothing to Pay Postman. Check Books Wanted - Mail Today.

MAIL ORDER

AUDEL, Publishers, 49 W. 23 St., New York 19, N.Y.

Please send me for FREE EXAMINATION books marked (X) below. If I decide to keep them I agree to mail \$1 in 7 days on each book or set ordered and further mail \$1 monthly on each book or set until I have paid price, otherwise I will return them.



Check NOW!

You Can Look Over Any Guide In Your Own Home — Start the Easy Payments If Satisfied

MAIL THIS TODAY



- HOME APPLIANCE SERVICE GUIDE, 800 Pages \$4
- AUTOMOBILE MECHANICS GUIDE, 1664 Pages . . . 4
- TRUCK & TRACTOR GUIDE, 1299 Pages . . . 4
- DIESEL ENGINE MANUAL, 575 Pages . . . 2
- MACHINISTS HANDY BOOK, 1650 Pages . . . 4
- WELDERS GUIDE, 600 Pages . . . 1
- BLUE PRINT READING, 440 Pages . . . 2
- MATHEMATICS & CALCULATIONS, 700 Pages . . . 2
- SHEET METAL PATTERN LAYOUTS, 1100 Pages . . . 4
- SHEET METAL WORKERS HANDY BOOK, 388 Pgs. . . 1
- MECHANICAL DRAWING GUIDE, 160 Pages . . . 1
- MECHANICAL DRAWING & DESIGN, 480 Pages . . . 2
- TELEVISION SERVICE MANUAL, 434 Pages . . . 2
- RADIOMANS GUIDE, 1080 Pages . . . 4
- ELECTRONIC DEVICES, 216 Pages . . . 2
- ELECTRIC MOTOR GUIDE, 1000 Pages . . . 4
- WIRING DIAGRAMS (Light & Power), 272 Pgs. . . 1
- ELECTRICIANS EXAMINATIONS, 250 Pages . . . 1
- ELECTRIC POWER CALCULATIONS, 425 Pages . . . 2
- HANDY BOOK OF ELECTRICITY, 1440 Pages . . . 4
- ELECTRIC DICTIONARY, 9000 Terms . . . 2
- ELECTRIC LIBRARY, 7000 Pages (12 Book Set) 18
- REFRIGERATION & Air Conditioning, 1280 Pgs. . . 4
- MILLWRIGHTS & MECHANICS GUIDE, 1200 Pgs. . . 4
- POWER PLANT ENGINEERS GUIDE, 1500 Pages . . . 4
- ENGINEERS & FIREMANS EXAMS, 525 Pages . . . 1
- PUMPS, Hydraulics & Air Compressors, 1658 Pgs. . . 4
- OPERATING ENGINEERS LIBRARY (3 Books) . . . 9
- CARPENTERS & BUILDERS GUIDES (4 Book Set) 6
- PLUMBERS & Steamfitters Guides (4 Book Set) 6
- MASONS AND BUILDERS GUIDES (4 Book Set) 6
- PAINTERS & DECORATORS MANUAL, 450 Pgs. . . 2
- HOUSE HEATING GUIDE, 1000 Pages . . . 4
- OIL BURNER GUIDE, 384 Pages . . . 1

Name _____
 Address _____
 Occupation _____
 Employed by _____ P-10

FREE—Amazing Book on RHEUMATISM, ARTHRITIS

If you suffer aches, pains and discomforts of Rheumatism, as manifested in ARTHRITIS, NEURITIS, SCIATICA or LUMBAGO, send today for this FREE Book. It reveals important facts about why drugs and medicine give only temporary relief without removing cause. Explains a proven, specialized system of treatment that may save you years of distress. No obligation. Write for this FREE Book today!
BALL CLINIC, DEPT. 756, EXCELSIOR SPRINGS, MO.

INVENTORS

PROTECT YOUR INVENTION BY A U. S. PATENT. SEND FOR FREE "INVENTION RECORD" FORM AND "PATENT INFORMATION EVERY INVENTOR SHOULD HAVE."

CARL MILLER

REGISTERED PATENT ATTORNEY

WOOLWORTH BLDG., 36th FLOOR, 106A NEW YORK CITY

INVENTORS

I shall be pleased to furnish you, upon request, with full information relative to patent procedure—without any obligation on your part.

PATRICK D. BEAVERS

Registered Patent Attorney

934 Columbian Building Washington 1, D. C.

INVENTORS

Whether an invention is patentable can be substantially determined by a search of the U. S. Patent records. Without obligation, write for information explaining the steps you should take to secure a patent.

JOHN N. RANDOLPH

Registered Patent Attorney

201 Columbian Building, Washington 1, D. C.

PATENTS

C.A. SNOW & CO.

REGISTERED PATENT ATTORNEYS
 WRITE FOR INFORMATION TO
 428 SNOW BUILDING, WASHINGTON 1, D. C.

Say You Saw It in Popular Mechanics

INVENTORS

Send for PATENT INFORMATION Book and INVENTOR'S RECORD without obligation

GUSTAVE MILLER
 106-PM WARNER BUILDING WASHINGTON 4, D.C.

REGISTERED PATENT ATTORNEY
 ASSOCIATE EXAMINER
 U.S. PAT. OFF. 1922-1929
 Patent Attorney & Advisor
 U. S. NAVY DEPT. 1930-1947
PATENT LAWYER

Enjoy the Fascinating Story of the Horseless Carriage in It's thrilling, fascinating, informative. From the very first gasoline-propelled buggy to the cars of today and the atomic auto of the future. The first cars—the men who made them—the scrambled start and development of the fabulous auto industry—the story of auto racing. 166 thrilling action pictures—old-time cars—racing cars—early auto advertising — automotive oddities. Listing of 2000 U. S. autos included. Ideal gift book. Cloth bound, only \$3.00 by mail. Money back if not pleased. Paper covered edition \$1.00 at newstands.



POPULAR MECHANICS PRESS, Dept. 1056, 200 E. Ontario St., Chicago 11

Yours FOR JUST \$1.00

This \$4.95 Regular Size Presto Fire Extinguisher
for Letting Us Prove How You Can
**MAKE \$1,000.00 A
UP TO 1,000.00 MONTH**



**Charles Kama of Texas Reported Making Better Than That—
Said, "Haven't Touched Bottom Yet!"**

Mr. Kama had NO sales experience until he took up PRESTO Science's New "Midget Miracle" Fire Extinguisher. He has done so well that he's been featured as "Salesman of the Month" on the front cover of a national sales magazine.

Why do we make this amazing offer? Simply because we're certain that once you hold a PRESTO in the palm of your hand, and actually use it to put out a demonstration fire in a bucket—you will realize why it "sells on sight!"

Can You Use Profits Like These?

Without even demonstrating the amazing PRESTO, an Ohio man made a net profit of \$76.56—THE VERY FIRST DAY! A Florida salesman earned \$600 in one month. Another Ohio man earned \$2,100 in 2 months. A New York salesman earned \$1,500 in one month. A New Hampshire man added the PRESTO as a sideline and picked up an extra \$1,800 in 20 months.

Why Large PRESTO Profits Are So Easy

Everyone is terrified at the very thought of FIRE! Last year alone, over 11,000 people died in fires. Most people who see the tiny PRESTO in action want one or more—ESPECIALLY WHEN THE PRICE IS ONLY \$4.95 EACH! Lightweight PRESTO does the job of bulky extinguishers that cost 4 times as much and are 8 times as heavy. Never corrodes. Guaranteed for 20 years!

The secret of PRESTO'S amazing power is a startling chemical which is 1.5 to 6 times as effective as ordinary chemicals of other extinguishers on an equal weight basis. Makes possible an extinguisher so light, so handy—even a child can use it. Just a twist of the knob . . . and flames disappear! "Sells on sight!" to owners of cars, homes, stores, farms, boats, offices, factories, and to stores for resale. OVER TWO MILLION ALREADY SOLD!

Mail Coupon with \$1.00 for Your Regular-Size PRESTO

Mail coupon with \$1 TODAY—and we'll send you a Regular \$4.95 PRESTO at once. Then you can demonstrate this miracle fire extinguisher to yourself and friends and see for yourself. If not amazed, return PRESTO to us and we'll refund your \$1.00. Or keep it at big saving when you order 6 or more. You can't lose—you risk nothing.

We'll also send you—FREE—a complete Sales Kit to help you get started. Mail coupon now to

**MERLITE INDUSTRIES
(Presto Div.) Dept. X-15M,
114 E. 32nd St.,
New York 16, N. Y.**



- Only Presto Has ALL These Features**
- Ends Fire as Fast as 2 Seconds
 - Chemical Contents 1.5 to 6 times More Effective than Others
 - Weights Less Than 1 Lb.
 - Easily Held in One Hand—Even by a Child
 - Needs No Inspection or Re-Charging—Does Not Corrode or Deteriorate
 - Costs Only \$4.95—Yet Outperforms Bulky Extinguishers Costing Several Times as Much
 - Automatic Pressure—No Pumping
 - Guaranteed for 20 Years—Certificate is Packed With Every Presto

YOU May Make Money Like This!



Averages \$15.20 an Hour
"The 'Natural' of the decade is the PRESTO... because it is handy in size, simple to operate, and in the right price range. For every hour I devoted to PRESTO I have earned an average of \$15.20 an hour."—William F. Wydallis, Ohio.



Made Over \$1000 a Month
"PRESTO is the fastest money-maker ever produced. If a man demonstrates intelligently, sales follow automatically. I have made an excellent living with PRESTO, over \$1000.00 a month."—Stanley Hyman, N. Y.



\$75 to \$80 a Week
"I've sold Presto for over 4 years. My selling time has usually averaged less than a day or two a week. These part time sales have brought me as much as \$75.00 to \$80.00 a week."—Walter Gable, Md.

Best Selling Months Are Here! Don't Delay—Mail Coupon Now!

**MERLITE INDUSTRIES (Presto Div.), Dept. X-15M
114 E. 32nd St., New York 16, N. Y.**

I enclose \$1.00 for which please send me regular-size \$4.95 PRESTO as a demonstrator. I agree to demonstrate it to myself and friends. This sample becomes mine to keep at this low price when I send you order for 6 or more Prestos. If I decide NOT to sell, I will return the PRESTO to you and you will refund my \$1.00.

Also send me absolutely FREE, Complete Sales Kit containing everything I need to get started making good money introducing the PRESTO in my locality.

Name _____

Address _____

City _____ Zone _____ State _____

IN CANADA: Mopa Co., Ltd., 371 Dowd St., Montreal 1, P. Q.

Check the Kind of Body You Want



Charles Atlas

...and I'll Prove How EASILY You Can Have It!

Just tell me, in coupon below, the kind of body you want—and I'll give it to you SO FAST your friends will be amazed! "Dynamic Tension," my easy, 15-minutes-a-day method, will make your chest and shoulders bulge... arms and legs surge with power... your whole body feel "alive!"

FREE BOOK 32 pages on how "Dynamic Tension" changed me from a 97-pound weakling into "World's Most Perfectly Developed Man"—and how I'll prove it can change YOU too. Mail coupon NOW!

CHARLES ATLAS, Dept. 810,
115 East 23rd St., New York 10, N. Y.

Dear Charles Atlas: Here's the Kind of Body I want:
(Check as many as you like)

- More Weight—Solid—in The Right Places
 Broader Chest, Shoulders
 Powerful Arms, Legs, Grip
 Slimmer Waist, Hips
 Better Sleep. More Energy

Send me absolutely FREE a copy of your famous book "Everlasting Health and Strength"—32 pages, crammed with photographs, answers to vital questions, and valuable advice. No obligation.

NAME _____ AGE _____
(please print or write plainly)
ADDRESS _____
CITY _____ STATE _____

LEARN UPHOLSTERY

in your spare time
run your own
business
AT HOME



FREE BOOK
with
sample
lessons

with course

YOU MAKE

SLIPPER

CHAIR

CLUB

CHAIR

OTTOMAN

PLUS

SLIP COVERS

Yours to Keep

or Sell

BE YOUR OWN BOSS

Earn more from the start! Set up your own profitable business, in your own home, enjoy steady income, independence for life—in the booming field of Custom Furniture Upholstery. Right off you start learning with tools, complete frames, fabrics and materials, included FREE with your UTS course. You learn skilled professional custom upholstery, reupholstery, furniture finishing, repairs, how to make beautiful slip covers, window cornices, cushions and draperies. EARN WHILE YOU LEARN, in your spare time... the UTS easy way.

FREE ILLUSTRATED BOOK, WITH SAMPLE LESSONS
Get ready for well-paid job and big profits, from steady work, as your own boss, running your own business. Mail coupon NOW! Training in N. Y. School also available.

APPROVED FOR VETERAN TRAINING

UPHOLSTERY TRADES SCHOOL
Dept. ER-310, 721 B'way, N. Y. 3, N. Y.

Please send me FREE book "Your New Way to a Successful Career," and FREE sample lesson. No obligation—no salesman will call.

Home Study N. Y. School Training

Name _____
Address _____
City _____ Zone _____ State _____
 Check if Korean Veteran

FREE

A NEW HOME INDUSTRY



GEARS
FISHING LURES
OPPORTUNITIES UNLIMITED

JEWELRY GEMS

HANDLES KNIVES - DIALS

STATUES FIGURINES

Let us show you how extremely easy and PROFITABLE it is to make beautiful and useful things out of LIQUID PLASTIC, LIQUID MARBLE, LIQUID IVORY, LIQUID GLASS, CERAMICS, ETC... as easy as pouring water out of a glass! Make novelties, jewelry, gifts, artware, toys, tools, dies, gadgets, ceramics... a million useful things! We supply everything—MATERIALS and INSTRUCTIONS!—Send only 25c for big 64 page catalog of casting materials, molds and accessories and we will include free of extra cost a remarkable book, "THE WONDERS OF LIQUID PLASTICS"... that will open your eyes to wonders you never dreamed off! Send 25c today—this may be the lucky coin that will start the most fascinating and profitable phase of your life!

PLASTICAST COMPANY

6612 N. CLARK ST. DEPT. PC-802 CHICAGO 26, ILLINOIS

NEWER CAR \$100!

Sounds Impossible? Not at all! Some of the nation's leading businessmen do it. You can, too—IF you know the inside facts. YOU can purchase a newer car each year for \$100—OR LESS! "AUTOMOTIVE BUYING REPORT," written by a licensed, bonded automobile dealer tells how. Get authentic facts, figures, information, actual dealers' wholesale prices never before exposed! Stop losing \$500, \$800, \$1000 yearly on car depreciation! If you have ever wanted a later model car and felt you couldn't afford it, or if you've ever lost money trading cars—this is for you. Let others pay high prices for their cars, you don't have to! Send one dollar for "AUTOMOTIVE BUYING REPORT" and be driving a newer car next week. WE GUARANTEE to save you hundreds of times over this small cost—OR YOUR MONEY BACK! Send \$1 for your copy to: KEMP MOTOR CO., Dept. 10M, 2015 N.E. 18th St., Ft. Lauderdale, Florida.

LEARN WHILE ASLEEP!

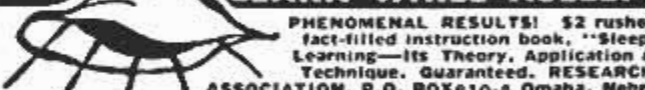

PHENOMENAL RESULTS! \$2 rushes fact-filled instruction book, "Sleep-Learning—Its Theory, Application & Technique. Guaranteed. RESEARCH ASSOCIATION, P.O. BOX 610-A, Omaha, Nebr.

TERMITES

Kill Termites Yourself with ARAB
U-DO-IT TERMITE CONTROL

Costs \$20.00 to protect 5-room house for 5 years. Harmless to flowers and shrubs. FREE FOLDER and prices at Bldg. Supply Dealers or write FEDERAL CHEMICAL CO., INC., 2701 Winthrop Ave., Indianapolis, Dept. PM 106.

STOP PROWLERS with new — LOXEM SAFETY LOCK



Protect your home! World's only INSIDE SAFETY LOCK providing Positive Protection on side, rear and French doors having glass COMPLETE panels. No outside keyhole to pick. Impossible to open door even when glass is broken. Unlocks only with special key. Permanently installed in minutes without removing present lock. Money back guarantee.

At hardware stores, locksmiths or direct from
LOXEM MFG. CO., 481 MAIN ST., NEW ROCHELLE, N. Y.

NEW - - EXCLUSIVE !

SOMETHING NEW AND DIFFERENT FOR THE 160,000,000 AMERICAN PEOPLE

DIRECT FROM THE FACTORY TO YOU
COMBINATION ORDER - - - - EACH \$9.99



Into Your Food

CULTURED MUSHROOM SALT
HI-QUALITY MUSHROOM SALT
NU-STLE MUSHROOM SIZONING

VERY ECONOMICAL, TOO

READY FOR EVERYDAY USE AND GIFTS
IT MAKES A YEAR ROUND SURPRISING GIFT ... A GIFT FOR WEDDINGS, CHRISTMAS, MOTHER'S DAY, FATHER'S DAY, BIRTH-DAYS, ETC. A GIFT FOR ALL PURPOSES—IT IS DIGNIFIED, TASTY, DELICIOUS FOR ALL FOODS.

RECIPE INSTRUCTIONS ON ALL SHAKERS

A new, convenient way for roasts, steaks, chops, chicken, stews, chop suey, ham and eggs, bacon and eggs, omelets, fricasses, wild game, fish, spaghetti, macaroni, meat sauces, noodles, vegetables, macaroni spaghetti, noodle sauces, gravies, soups, meat balls, fowl, etc.—TASTY APPETIZING FOR SANDWICHES TOO.

3 NEW FLAVORS MAKE TASTY DELICIOUS MEALS, TRY IT AND SEE FOR YOURSELF. OH WHAT PEP AND ZEST!

Cultured Mushroom Salt, 1—1 oz. Fancy Shaker; Hi-Quality Mushroom Salt, 1—1 oz. Fancy Shaker; Nu-Stle Mushroom Sizoning, 10—1½ oz. Fancy Shakers. 12 Shakers will FLAVOR 480 to 720 MEALS. Handy—Economical, too

DIRECT FROM THE FACTORY TO YOU
COMBINATION ORDER - - - - EACH \$9.99

MAIL ORDERS ONLY

We Ship in Beautiful Shakers and Beautiful Shipping Boxes
FOR YOUR OWN USE AND TO GIVE FOR GIFTS

SELECT YOUR ORDER FROM THESE CONVENIENT SIZES

PLEASE CHECK ONE {
Send me 12 fancy shakers in 1 combination order \$ 9.99
Send me 24 fancy shakers in 2 combination orders \$19.98
Send me 36 fancy shakers in 3 combination orders \$29.97
Send me 48 fancy shakers in 4 combination orders \$39.96
Send me 60 fancy shakers in 5 combination orders \$49.95
Send me 72 fancy shakers in 6 combination orders \$59.94

WE PAY SHIPPING CHARGES—51c Shipping and Handling Charges are Included in Above Prices

Cut off Here **WASHINGTON MUSHROOM IND. INC., FACTORY** Cut off Here

Dept. 2-B 2954 Admiral Way, Seattle 6, Wash. Date.....

Enclosed \$..... P.M.O. Bank M.O. Express M.O. Certified Personal Check

Send me..... combination order or orders.

Name.....

R.F.D. or Street..... City or Town..... State.....

AVOID THE RUSH—SEND YOUR ORDER TO-DAY—NO C.O.D.'s, PLEASE
All U.S.A. and Foreign Copyrights Herein are Reserved—U.S.A. Copyright 1956

Make \$500 an Hour CASH PROFIT THE DAY YOU START!



START YOUR OWN BUSINESS AT HOME... SHARPEN HOUSEHOLD, GARDEN AND SHOP TOOLS IN SPARE TIME

Now you can turn spare time into Big Cash Profits with new Belsaw Sharp-All. Sharpen knives, scissors, shears, snips, ice skates, mower blades, hedge trimmers, grass whips, axes, chisels, screw drivers, scrapers and saws... just about any household, garden and shop tool. Your own CASH business with no inventory. No calls to make. No experience needed.

Learn how easily you can start your own spare time business. Amazing low cost easy-payment plan. Send postcard for FREE BOOK.

BELSAW SHARP-ALL CO
717 Field Bldg. Kansas City 11, Missouri

FREE BOOK

I'll Send You This Handsome SAMPLE CASE—FREE!



Make up to \$30⁰⁰ in a Day!

Your Own Tailored Suits Without 1¢ Cost

If you want to make more money, spare time or full time, rush the coupon below today for this big, valuable tailoring Sample Case packed with 150 beautiful, big-value suit and overcoat samples. Just show the samples and last-minute styles to friends, fellow-workers, others. Take their orders for fine made-to-measure clothes—and pocket BIG CASH PROFITS in advance. No experience, no tailoring knowledge needed—and no money needed, ever. **WE SUPPLY EVERYTHING FREE...** sample case, sample suitings, equipment, complete instructions. Start making money first day!

Use Spare Evenings... Weekends... Make Money... Get Suits!

It's easy to make money taking orders in just spare time—lunch-time, evenings, weekends. When men see the fine fit, quality and value of our suits—THEY ORDER! So we make it easy for you to get your own personal suits and overcoats without paying even one penny. Don't wait! Rush coupon with your name, address, and age for FREE Sample Case.

J. C. FIELD & SON, Dept. Y-1716
Harrison & Throop Streets, Chicago 7, Ill.

J. C. FIELD & SON, Dept. Y-1716
Harrison & Throop Sts., Chicago 7, Ill.

Please rush **ABSOLUTELY FREE** the valuable Sample Case with suit fabrics and style display. Include instructions, money-making plans and details for getting my own suits without paying one cent.

Name _____ Age _____

Address _____

City _____ State _____

KING MIDGET

Drive it for 75c per week. Rider Agents wanted—earn your own car free. Also KING MIDGET JUNIOR chassis, finely engineered, ready to run and priced at a fraction of any similar car. **GET THE FACTS.** Send 25c for 32 page picture book giving special prices and agents proposition on both cars. Or send \$1 (refunded first order) for this plus actual assembly book and service manual.

MIDGET MOTORS CORPORATION, ATHENS 1, OHIO



\$ OWN A BUSINESS \$ SPARE TIME — FULL TIME

Earn from \$3000 to \$20,000 yearly. We specialize in putting people in business. We train you, guide you and furnish you with everything needed. If any of these businesses interest you be sure to see our offer: Mail Order, Insurance, Photography, Real Estate, Bookkeeping or Collection. One hour each evening is all you need. We take care of the rest. Write today.

\$ NATIONWIDE BUSINESS INSTITUTE \$
DEPT. M-10 618 SAVANNAH COLUMBUS 4, OHIO

PORTABLE CAR COVER Heavy Vinyl Plastic

Protect Against RAIN • SUN • DUST (formerly \$8.95)

Long-lasting plastic, folds compactly, off and on in a liffy, sturdy elastic binding gives extra security. State make, model and year

Send \$6.95 plus 35¢ postage or sent C.O.D. Extra Heavy Plastic Gauge \$8.95 + 45¢ postage. BEA SALES, Dept. B-4, 125 E. 46th St., New York 17



STUDY TO BE A DOCTOR of Psychology or Metaphysics

Obtain a Ps.D., Ms.D., or Ph.D. Be a Teacher, Lecturer or Accredited Practitioner. Teach others how to achieve Health, Happiness and Contentment. Chartered by State. Correspondence Courses only. Write for FREE book telling how.

THE NEOTARIAN FELLOWSHIP
Desk 8, Pickwick Building Kansas City 6, Missouri

RUN YOUR OWN RESTAURANT

I show you how to get started just as I did; where to locate, 7 ways to get capital, money making methods, even how to run a sandwich business right out of your own home with only a few dollars investment. Write for free details.

School of Restaurant Arts, 1100, Fremont, Ohio

PUMP WATER FAST!

Drains Wash Tubs, Cellars, Cisterns. Famous #7 pumps 2800 gph. 420 gph. at 75' high or 1600 gph. from 25' well. Sturdy rustproof alloy metal. Six blade impeller. 3/4" inlet, 1/2" outlet. Standard pipe threaded. Uses any 1/2 to 1/2 H.P. Motor. Will not leak or clog. Iron clad guarantee. Send check, M.O., or sent C.O.D. **\$795** IN U.S.

Irrigate, Fill Tanks, Draw Well Water. Heavy duty #8 pumps 7000 gph. —1000 gph. 75' high 3000 gph. from 25' well. Rustproof alloy metal. 8 blade impeller. 1" inlet, 1" outlet. Standard pipe threaded. Will not leak or clog. Iron clad guarantee. Send check, M.O., or sent C.O.D. **\$1195**

Free Catalogue—Gear Pumps, Large Centrifugal Pumps, Deep and Shallow Well Pumps, Sump Pumps. **IN U.S.**

MOORE MANUFACTURING CO.
SWEDSBORO 1, NEW JERSEY

HOW WOULD YOU LIKE TO BREAK INTO ENGINEERING STARTING NEXT MONTH?

Your start in Engineering could mean higher pay, more interesting work, a real chance for advancement. Here's how to do it—fast!

A career in Engineering may be closer than you think, whatever your age or education or present job.

You know about the tremendous demand for engineers and technicians. But do you know how easy it is to get the training that will qualify you for this vital work, and how quickly you can advance?

First Step Wins Job Consideration

The moment you enroll for a course in Engineering you're in a position to change your job. I.C.S. Engineering Courses, for example, start you off with Basic Mathematics and Drafting. Most employers are quick to accept men who start technical training.

Your Advancement Is Rapid

Your interest, your determination, your willingness to spend free hours improving your-

self all-work in your favor. But your mastery of engineering subjects is what wins you the biggest boosts.

The I. C. S. method makes it possible for you to learn while you earn, to qualify yourself for upgrading step by step—from Draftsman to Detail Designer to Engineering Technician to full-fledged Engineer. It's a plan fitted to your needs, with personalized instruction and guidance, and, if you like, regular progress reports to your employer.

Mail Coupon for Free Books

If you are seriously interested in a fresh start in an opportunity-packed field, then mark and mail the coupon today. We'll send you three free books—(1) the 36-page career guide "How to Succeed," (2) Opportunity outlooks in your field of interest, (3) sample lesson (Math) demonstrating I. C. S. method.

For Real Job Security—Get an I. C. S. Diploma!

I. C. S., Scranton 9, Penna. Member, National Home Study Council

INTERNATIONAL CORRESPONDENCE SCHOOLS

65TH YEAR

BOX 14626K, SCRANTON 9, PENNA.

Without cost or obligation, send me "HOW TO SUCCEED" and the opportunity booklet about the field BEFORE which I have marked X (plus sample lesson):

- | | | | | |
|--|---|--|--|--|
| <p>ARCHITECTURE and BUILDING CONSTRUCTION</p> <ul style="list-style-type: none"> <input type="checkbox"/> Air Conditioning—Refrig. <input type="checkbox"/> Architecture <input type="checkbox"/> Architectural Interiors <input type="checkbox"/> Building Contractor <input type="checkbox"/> Building Estimator <input type="checkbox"/> Building Maintenance <input type="checkbox"/> Carpentry and Mill Work <input type="checkbox"/> Heating <input type="checkbox"/> Painting Contractor <input type="checkbox"/> Plumbing <input type="checkbox"/> Reading Arch. Blueprints <p>ART</p> <ul style="list-style-type: none"> <input type="checkbox"/> Cartooning <input type="checkbox"/> Commercial Art <input type="checkbox"/> Fashion Illustrating <input type="checkbox"/> Magazine Illustrating <input type="checkbox"/> Show Card and Sign Lettering <input type="checkbox"/> Sketching and Painting <p>AUTOMOTIVE</p> <ul style="list-style-type: none"> <input type="checkbox"/> Auto Body Rebuilding <input type="checkbox"/> Auto Elec. Technician <input type="checkbox"/> Auto-Engine Tune Up <input type="checkbox"/> Automobile Mechanic | <p>AVIATION</p> <ul style="list-style-type: none"> <input type="checkbox"/> Aeronautical Engineering Jr. <input type="checkbox"/> Aircraft & Engine Mechanic <p>BUSINESS</p> <ul style="list-style-type: none"> <input type="checkbox"/> Advertising <input type="checkbox"/> Bookkeeping and Accounting <input type="checkbox"/> Business Administration <input type="checkbox"/> Business Correspondence <input type="checkbox"/> Public Accounting <input type="checkbox"/> Creative Salesmanship <input type="checkbox"/> Federal Tax <input type="checkbox"/> Letter-writing Improvement <input type="checkbox"/> Office Management <input type="checkbox"/> Professional Secretary <input type="checkbox"/> Retail Business Management <input type="checkbox"/> Sales Management <input type="checkbox"/> Stenographic-Secretarial <input type="checkbox"/> Traffic Management <p>CHEMISTRY</p> <ul style="list-style-type: none"> <input type="checkbox"/> Analytical Chemistry <input type="checkbox"/> Chemical Engineering <input type="checkbox"/> Chem. Lab. Technician <input type="checkbox"/> General Chemistry <input type="checkbox"/> Natural Gas Prod. & Trans. <input type="checkbox"/> Petroleum Engineering <input type="checkbox"/> Plastics <input type="checkbox"/> Pulp and Paper Making | <p>CIVIL, STRUCTURAL ENGINEERING</p> <ul style="list-style-type: none"> <input type="checkbox"/> Civil Engineering <input type="checkbox"/> Construction Engineering <input type="checkbox"/> Highway Engineering <input type="checkbox"/> Reading Struct. Blueprints <input type="checkbox"/> Sanitary Engineering <input type="checkbox"/> Structural Engineering <input type="checkbox"/> Surveying and Mapping <p>DRAFTING</p> <ul style="list-style-type: none"> <input type="checkbox"/> Aircraft Drafting <input type="checkbox"/> Architectural Drafting <input type="checkbox"/> Electrical Drafting <input type="checkbox"/> Mechanical Drafting <input type="checkbox"/> Mine Surveying and Mapping <input type="checkbox"/> Plumbing Drawing and Estimating <input type="checkbox"/> Structural Drafting <p>ELECTRICAL</p> <ul style="list-style-type: none"> <input type="checkbox"/> Electrical Engineering <input type="checkbox"/> Electrical Maintenance <input type="checkbox"/> Electrician <input type="checkbox"/> Contracting <input type="checkbox"/> Lineman <p>HIGH SCHOOL</p> <ul style="list-style-type: none"> <input type="checkbox"/> Commercial <input type="checkbox"/> Good English <input type="checkbox"/> High School Subjects <input type="checkbox"/> Mathematics | <p>LEADERSHIP</p> <ul style="list-style-type: none"> <input type="checkbox"/> Foremanship <input type="checkbox"/> Industrial Supervision <input type="checkbox"/> Leadership and Organization <input type="checkbox"/> Personnel-Labor Relations <p>MECHANICAL AND SHOP</p> <ul style="list-style-type: none"> <input type="checkbox"/> Gas—Electric Welding <input type="checkbox"/> Heat Treatment <input type="checkbox"/> Metallurgy <input type="checkbox"/> Industrial Engineering <input type="checkbox"/> Industrial Instrumentation <input type="checkbox"/> Industrial Supervision <input type="checkbox"/> Internal Combustion Engines <input type="checkbox"/> Machine Design—Drafting <input type="checkbox"/> Machine Shop Inspection <input type="checkbox"/> Machine Shop Practice <input type="checkbox"/> Mechanical Engineering <input type="checkbox"/> Quality Control <input type="checkbox"/> Reading Shop Blueprints <input type="checkbox"/> Refrigeration <input type="checkbox"/> Sheet Metal Worker <input type="checkbox"/> Tool Design <input type="checkbox"/> Toolmaking <p>RADIO, TELEVISION</p> <ul style="list-style-type: none"> <input type="checkbox"/> Industrial Electronics <input type="checkbox"/> Practical Radio TV Eng'g <input type="checkbox"/> Radio and TV Servicing <input type="checkbox"/> Radio Operating | <ul style="list-style-type: none"> <input type="checkbox"/> Television Technician <p>RAILROAD</p> <ul style="list-style-type: none"> <input type="checkbox"/> Air Brake Equipment <input type="checkbox"/> Car Inspector <input type="checkbox"/> Diesel Engineer & Fireman <input type="checkbox"/> Section Foreman <p>STEAM AND DIESEL POWER</p> <ul style="list-style-type: none"> <input type="checkbox"/> Combustion Engineering <input type="checkbox"/> Diesel—Elec. <input type="checkbox"/> Diesel Eng's <input type="checkbox"/> Electric Light and Power <input type="checkbox"/> Stationary Fireman <input type="checkbox"/> Stationary Steam Engineering <p>TEXTILE</p> <ul style="list-style-type: none"> <input type="checkbox"/> Carding and Spinning <input type="checkbox"/> Cotton, Rayon, Woolen Mfg. <input type="checkbox"/> Finishing and Dyeing <input type="checkbox"/> Loom Fix'g <input type="checkbox"/> Textile Des'ing <input type="checkbox"/> Textile Eng'g <input type="checkbox"/> Throwing <input type="checkbox"/> Warping and Weaving <p>MISCELLANEOUS</p> <ul style="list-style-type: none"> <input type="checkbox"/> Domestic Refrigeration <input type="checkbox"/> Marine Engineering <input type="checkbox"/> Ocean Navigation <input type="checkbox"/> Professional Engineering <input type="checkbox"/> Short Story Writing <input type="checkbox"/> Telephony |
|--|---|--|--|--|

Name _____ Age _____ Home Address _____

City _____ Zone _____ State _____ Working Hours _____ A.M. to P.M. _____

Occupation _____

Canadian residents send coupon to International Correspondence Schools, Canadian, Ltd., Montreal, Canada. . . . Special tuition rates to members of the U. S. Armed Forces.

TRAIN AT HOME FOR BIG PAY IN HOME BUILDING AND CONSTRUCTION

Make big money in a better job or a business of your own! Each year over \$20 billions are spent on home remodeling alone.



BE A CONTRACTOR
Five out of every 10 homes need repairs or modernizing. HBTI trains you at home in every phase of contracting. You learn complete home building and construction. Earn good money as a builder by sub-contracting all the work!

EARN SPARE TIME CASH
Build dormers, porches, stairways, attics. Earn up to \$4 an hour, plus commission on materials. Seven out of every 10 home owners want work done—there's lots of opportunity in your own community. Mail coupon for two valuable free books.



MAIL TODAY • 2 FREE BOOKS

HOME BUILDERS TRAINING INSTITUTE, Dept. HB-112
1400 Greenleaf Ave., Chicago 26, Ill.
Send Success Book and Sample Lesson. Both FREE.

Name _____ Age _____
Address _____
City _____ Zone _____ State _____

SAY YOU SAW IT IN POPULAR MECHANICS

73

Make Money Manufacturing Concrete Drain Tile



Manufacturers of concrete drain tile are in the driver's seat. Why? Because their basic costs are not burdened by freight, distribution and breakage costs—items which the clay tile people have to pass along. Net results: concrete tile can sell for less, yet show a generous profit.

The market is big—and getting bigger. Not only because of increased farm drainage, but also because drain tile are needed in home building, reclamation projects, highway construction, and many other purposes.

Tile made on the Champion are outstanding in quality—dense, strong, uniform and truly round. All sizes up to 12" diameter. Easy to make, because the Champion Machine is simple, compact, and requires no skilled labor. Business is a low-investment opportunity, with equipment available on terms. Write for catalog.



W. E. DUNN MFG. CO.
520 W. 24th Street, Holland, Mich.



IN CANADA: DUNN MASONRY MACHINERY LIMITED
970 Dundas Highway, Cooksville, Ont.

"WE'RE LOOKING FOR PEOPLE WHO LIKE TO DRAW" ... says Norman Rockwell, one of America's 12 Most Famous Artists. If you like to draw, you may have talent to become a successful artist, spare or full time. Find out for sure with our scientific, 8-page Free Art Talent Test. Thousands paid \$1 to take it. Get it FREE. No obligation. Send your name, address, age to: Famous Artists Schools, Dept. 6-L, Westport, Conn.

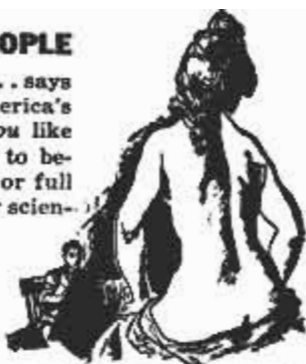

ELECTRIFY YOUR SEWING MACHINE! NEW LOW PRICE!
Buy direct and save! Kit comes fully wired, installed in a jiffy. Fits all machines. ALL-NEW PARTS!
• AC-DC Motor & bracket • Multi-speed foot control • Cord set & block • 115 v 60 c • Full instructions • Steel pulley & belt
BONUS: 10 day free trial, Reg. \$2.95 Sewlite given FREE with kit. Reg. \$7.95 pinking shears only \$1 with order. Send no money. Kit sent C.O.D. or send money order and we'll pay postage. State whether wheel on your machine turns towards or away from you. Shipping wt. 6 lbs.
SENIOR SEWING MACHINE CO., Box 142, Dept. P309, Bklyn 6, N. Y.



MECHANICAL DENTISTRY

To make Crowns, Plates, Bridgework, etc., for Dentists. Easy practical way to learn mechanical dentistry at home in spare time. FULL EQUIPMENT OF TOOLS AND MATERIALS INCLUDED WITH COURSE. Low tuition. Easy terms. Write for FREE BOOK about this money making profession that is not affected by machine age.

McCARRIE SCHOOL OF MECHANICAL DENTISTRY
207 N. Broad St., Dept. 58, Philadelphia 7, Pa.

PRINTS POST CARDS

Learn how both large and small businesses are boosting sales with new advertising machine. Write today for FREE illustrated BOOK of unique advertising plans, money-making ideas for your business. Cardmaster, 1920 Sunnyside, Dept. 1210 Chicago 40, Ill.



SEND ME

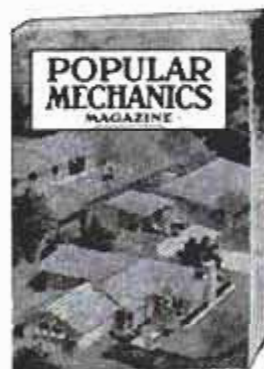

every month so I am sure to see each new issue. Here's

- \$3.50 for 1 year
 \$8.00 for 3 years

name _____

address _____

city _____

zone _____

state _____

Hand this order to your newsdealer or send it to
POPULAR MECHANICS
200 East Ontario St. Chicago 11, Ill.

Tells How You Can Learn to MOUNT BIRDS!



FUN! RECREATION! PROFIT!

FREE BOOK

all kinds of wild-game, and common specimens too. We can positively TEACH YOU. So GRASP this opportunity. RUSH letter or postal for this amazing FREE BOOK. Don't delay. State your AGE. N. W. SCHOOL OF TAXIDERMY, 2510 Elwood Bldg., Omaha 2, Neb.

Learn At Home

Men, Boys, Hunters, Fishermen, mount and save your lovely wild-game trophies. Be a Taxidermist. Mount Birds, Animals, Heads, Fish, Tan skins. YOU learn easily, quickly in spare time. Have a grand home-museum. The finest and the greatest hobby known, for sportsmen. Fun, real profits.

Yes, FREE, Beautiful strange, valuable Book, telling all about Taxidermy. Contains over 100 beautiful game-pictures. And it's yours FREE, if you rush your request. You can mount



SHEET METAL BRAKES

- Forms angles, locks, pans, etc. Quick eccentric clamp. All steel construction.
- 15" — 16 gauge steel..... \$23.50
 - 36" — 22 gauge steel..... 35.50
 - 48" — 24 gauge steel..... 52.00
 - 49" — 16 gauge Bender..... 42.00
 - 12" — 12 gauge Bender..... 16.00
 - 18 ga. Electric Bench Shear..... 48.00
 - 1/4 x 3 Adjustable Bender..... 11.50
 - 16 ga. 7" Bench Shear, 3 adj. ga. 16.50
 - 30" — 20 gauge Curve Former... 9.50

ORDER DIRECT OR SEND FOR FREE CATALOG
VYKE MFG. CO., P-4158 Jason St., Denver 11, Colo.

60 POWER TELESCOPE \$3.98

VARIABLE EYEPIECE 20X-40X-60X — BRASS SOUND NEW! Three telescopes in one. 3 different magnifications. 20 power for ultra-bright images with 40 and 60 power for extra long range. Guaranteed to bring distant objects, people, sports events, ships, moon, stars, etc. 60 times as close.

Postpowerful for anywhere near the moon. ey. 5 sections. Closes to 1 ft. long. Contains 4 ground and polished lenses. Also used as a powerful compound microscope. Directions included. Mass production enables us to offer this instrument at amazing price of \$3.98 complete. Money back guarantee. We pay postage. Get yours now. **CRITERION CO., 331 Church St., Hartford, Conn., Dept. PMB 39**

Exclusive Double-Bearing HEAVY-DUTY PUMPS

IRRIGATE • DRAIN • CIRCULATE • SPRAY
 Up to 7,500 GPH. 3,000 GPH from 25' well. Use 1/4 to 1 HP motor. 1 1/2" inlet; 1" outlet. Stainless shaft. TYPE X-2 oilless bronze bearings. **\$10.95**
 Won't rust.....
 TYPE XB—Ball bearing model..... \$12.95
 Postpaid if cash with order. Rush your order today
MONEY BACK GUARANTEE
 Centrifugal and Gear Pumps in All Sizes
LABAWCO PUMPS, Belle Mead 2, N. J.



OWN CALIFORNIA LAND

STATE GOV'T. LANDS. 500,000 Acres as low as \$2. per acre min. offer 40 to 640 Acre. Ranch and Farm Tracts. Southern and Northern California Locations.
NO HOMESTEADING! NO IMPROVEMENTS! NO SALES TO ATTEND! you select, apply and BUY DIRECT through the mail. Lists & maps now available. **WRITE RESEARCH DIV.**
RANCH DEVELOPMENT CORP. 760 FOOTHILL BLVD. REALTY, CALIFORNIA
LARGEST LAND CORPORATION OF ITS KIND IN THE WORLD

Say You Saw It in Popular Mechanics

RHEUMATISM

NEURITIS • SCIATICA • LUMBAGO
 Why continue to suffer agonizing pains when usual remedies have failed. Learn how thousands have been successfully treated by an amazing new method which is fully explained in our New FREE Book. Don't wait. Write today. No obligation.
EXCELSIOR INSTITUTE, Dept. C9806, Excelsior Spgs., Mo.



IF YOU "EAT, SLEEP AND LIVE" CARS... TURN YOUR HOBBY INTO A CAREER!

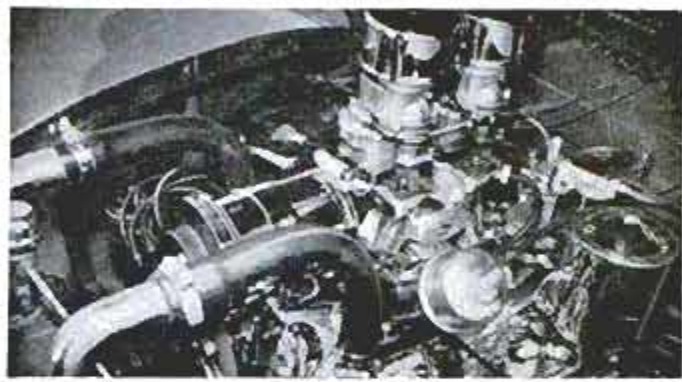

Get America's Big-time, Big-future

AUTO MECHANICS & DIESEL COURSE

at home in your spare time!
 Los Angeles' National Schools, America's automotive Technical Trade School since 1905, now brings its famous resident Shops and Faculty direct to you at home—to prepare you to earn more money, with job security, in today's fast-moving, opportunity-filled Auto Mechanics Industry! Get your home training from the "Car Capital of The World"—America's most auto-minded city, center of Hot Rod and Sports Car activity! Mail coupon right now!

"SHOP-METHOD" HOME TRAINING!

YOU MASTER ALL PHASES, INCLUDING DIESEL. All lessons fully illustrated. We show you how to *earn as you learn*. OK for Vets. Graduate Advisory Service.

NOW! YOU GET AND KEEP ALL OF THIS VALUABLE, PROFESSIONAL EQUIPMENT!

You keep this modern "MOTOR ANALYZING SET." Contains latest Standard Engine Vacuum Fuel Pump, Remote Starter Switch, Modern Timing Light, Standard Compression Tester. Plus... compact, rugged, carrying case and complete instructions.

This set of **LIFE-TIME TOOLS** is yours to keep. You also get this all-metal tool box as part of your course. All tools of the latest design, used by the "pros," built for a lifetime of rugged use.

SEND FOR FREE BOOK AND SAMPLE LESSON

Approved for GI Training.

NATIONAL SCHOOLS

Los Angeles 37, California
 CANADA: 811 W. Hastings St., Vancouver, B. C.

NATIONAL SCHOOLS

TECHNICAL TRADE TRAINING SINCE 1905
 LOS ANGELES 37, CALIFORNIA

NATIONAL SCHOOLS, Dept. DB-106
MAIL NOW TO OFFICE NEAREST YOU

4000 S. FIGUEROA ST. OR 187 N. LA SALLE ST.
 LOS ANGELES 37, CALIF. OR CHICAGO 1, ILL.

Send for FREE Auto-Diesel Opportunity Book and Sample Lesson.

NAME _____ BIRTHDAY _____ 19 _____

ADDRESS _____

CITY _____ ZONE _____ STATE _____

VETERANS: Give Date of Discharge _____

NEVER AT THIS LOW PRICE!
**GENUINE 120-POWER
 ACHROMATIC TELESCOPE**

with Coated Lens and
 3-POWER FINDER attached

ONLY
\$18.95
 PREPAID



EXTRA BONUS GIFTS:

- 108 page book, "Discover The Stars"
- Magic Star Finder Dial
- 220X & 400X Eyepiece lenses

**BRING THE MOON, PLANETS, STARS, PEOPLE
 120 TIMES CLOSER, CLEARER, SHARPER.**

Never before has an ACHROMATIC 120X telescope with range finder and tripod sold for anywhere near this amazing low price! Now you can not only explore the heavens and bring the moon, planets, stars, etc. 120 times closer, but you can also observe all distant objects, people, ships, etc. too, because all pictures are erect, and not upside down as in all astronomical telescopes. The kind of needle-sharp color-free viewing only a genuine achromatic lens can bring you. Ready for immediate use. Its 5 precision lenses bring you viewing at 40X—80X—120X, the tubes extend to 43", made of jet bakelite, finished in camera bellows black (for sharper, clearer images). Trimmed with gleaming brass. The 3 power finder scope mounted on main tube is a feature usually found on more expensive telescopes—brings difficult objects on target before observing with main scope. For extra stability 5 ft. hardwood folding tripod is equipped with heavy cast iron head fitted with Criterion's famous 360 degree all aluminum mount that locks instantly in any position. Obtainable only from Criterion, shipped prepaid. 4-Bonus gifts—108 page book "Discover The Stars," magic star finder dial that aids in locating stars ANYWHERE at ANY TIME of the year, and 220X and 400X eyepiece lenses included free of any cost for experiments. You must be completely satisfied with this super offer or your money back in full. Shipped to you complete, nothing else to buy, at the amazing low price of \$18.95. Without tripod \$14.95.

Send cash, check, or money order today to:

Dept. PMA7, Criterion Co., 331 Church St., Hartford, Conn.

... **TURN CONCRETE
 INTO GOLD!**



**MAKE UP TO \$75 A DAY
 IN YOUR OWN BUSINESS**

If you want to have your own business — to start a business on your own — here's your big opportunity! New high speed, low cost General block machine produces up to 1,000 concrete blocks a day. Sell all you make to builders, supply houses, and others for homes, factories, buildings, garages. Cash in on the building boom! You can make profits of 100% to 150% — up to \$75 a day! General block machine equipped with 1/2 h.p. electric motor — or can be supplied with gasoline engine — works anywhere, in little space, indoors or out. Operates from ordinary house light socket. Simple, foolproof 3 step operation — so easy a child can do it. Makes superior 3 core blocks any size from 4" to 12". Also makes chimney, ash, corner and other types. Blocks meet any building code anywhere in the country. Materials — sand, water, cement, available anywhere. Simple illustrated operating instructions and mixing formulas for cement and cinder blocks supplied with each machine. Write for FREE folder with full information.

**MOTOR
 DRIVEN**

R.L.T. of
 New York City re-
 ports: "MY GENERAL
 BLOCK MACHINE
 PAID FOR ITSELF
 IN FIRST 2 WEEKS!"
 Hundreds now in
 use the world over!
 Write for FREE details today!

EXTRA

Amazing illustrated book gives floor plans for 6 sensational concrete block bungalows. Tells how to lay blocks, lay out building lines, mix concrete, build steps, porch and concrete floors all at great savings. Written by experts. Can save many times the cost of the machine! Get it now! No strings attached. Send \$1.

BOOK SENT FREE IF YOU BUY MACHINE.
 \$1 REFUNDED IF YOU BUY LATER.

GENERAL ENGINES CO.

DEPT. M-106, ROUTE 130, THOROFARE, N. J.



**Nutria... NEWEST
 OPPORTUNITY**

New fur-bearing animal now being bred in U. S. Offers huge profits to breeders. This fur is next to Mink NOW in price and will soon surpass it. 15 to 20 young per year. Most easily and economically raised animal known. 1 1/2c per day to feed. ANY CLIMATE, disease resistant. The Cabana Marrone strain is obtainable ONLY through Cabana Nutria, Inc., and its authorized dealers and distributors. For free booklet and address of Cabana ranch nearest you write:

CABANA NUTRIA, INC.
 636-M West Lemon Ave., Arcadio, Calif.

**IT'S EASY...
 MAKE MONEY IN PHOTOGRAPHY**

If you are over 17—good pay and fascinating work await you in photography! Start making money quickly in sparetime—step into your own studio or exciting career job. LEARN-BY-DOING method trains you at home! Write TODAY for FREE catalog. Also Resident Training, Co-ed. 47th Year. Approved for Veterans.

NEW YORK INSTITUTE OF PHOTOGRAPHY
 Dept. 49, 10 West 33 Street, New York 1, New York
47th YEAR

**LEARN METALCRAFT
 and JEWELRY MAKING**

Low Cost Home Training Now Available

Make money. Learn profitable skills and arts of decorative metal and jewelry crafts. Course is complete. Professionally prepared. Easy to master. Special tools and materials furnished.

Write for **INTERSTATE TRAINING SERVICE**
 Free Booklet DEPT. K-3 PORTLAND 13, OREGON

Grow authentic, LIVE dwarf trees!
 Fascinating hobby! Profitable business!

GROW MINIATURE TREES
 SEND FOR FREE SEED & INFORMATION!

MINIATURE NURSERY CLUB
 Dept. JJ-10, P.O. Box 8794,
 Los Angeles 8, Calif.

BIG MONEY in your own
DRY CLEANING BUSINESS

MEN! WOMEN! Let us show you how to open up your own Dry Cleaning shop. Learn AT HOME, in spare time. You'll be amazed to learn that you can go into this fast-growing business with next to no cash at all. Experience unnecessary. Easy-to-understand lessons. Convenient time-payments. Write for FREE details. **Imperial School of Dry Cleaning, Dept. PM-10, 1700 Touhy, Chicago 26, Ill.**

**Do You Want to Learn to . . .
 REPAIR OUTBOARD MOTORS
 LAWNMOWERS, TRACTOR MOTORS &
 ALL SMALL 2 and 4-CYCLE ENGINES**

Would you like to learn at home or in your shop—following fully illustrated, easy-to-understand lessons—to repair your own outboard motor and other powered equipment or make extra money in this wide-open field? Write today for Free Information.

LINCOLN TECHNICAL INSTITUTE
 Suite 101-E, 472 Market St., Newark 5, N. J.

INSURED TIRE SERVICE
POPULAR BRANDS
FREE INSURANCE POLICY given with each used tire sold. We guarantee the amount of service you pay for.
 NOWHERE CAN SUCH QUALITY BE FOUND AT SUCH LOW PRICE!

SPECIAL!
 Deduct 10% on orders for Two or More used tires

YOU CAN'T LOSE!!

GOODYEAR SUBURBANITE TYPE SNOW TIRES
 New Tire Guarantee—Factory Rebuilt
BEST WINTER TRACTION OF ALL!

670x15 \$9.95 | 710x15 650x15 \$10.90
 600x16 760x15 | 800-820x15

Super Quality — Rugged Performance — 6 Months Insured Service

600x16	\$3.65	670x15	\$3.95	700x16	\$4.45	760x16	\$4.75
650x15	3.85	670x16	4.05	710x15	4.35	820x15	4.95
650x16	4.25	700x15	3.95	760x15	4.45	850x17	4.65

Supreme Quality — Nothing Finer — 12 Months Insured Service

600x16	\$5.25	675x19	\$5.45	700x15(6)	\$10.45	700x20	\$12.50
600x16(6)	6.75	640x15	4.95	750x16(8)	15.95	750x20(8)	15.50
650x16	5.75	670x15	5.35	700x17	11.95	750x20(10)	17.50
650x16(6)	7.25	710x15	5.45	750x17	16.45	825x20	21.50
700x16	6.35	760x15	5.95	750x15	10.95	900x20	19.95
750x16(6)	8.45	800x15	6.35	30x5	11.25	1000x20	20.45
550x15	4.95	620x15	6.35	600x20	10.95	1100x20	21.25
850x17	6.75	850x15	8.35	650x20	11.75	1100x22	21.95
650x15	5.25	670x16	5.15	32x6(8)	11.95	1100x22	22.75
700x15	5.35	700x16(6)	10.25	32x6(10)	12.75	1100x24	25.95

Whitewalls \$1.00 extra.

MIDLAND TIRE SALES
 Speedy shipments on Mail Orders. F.O.B. Chicago. Insurance policy sent with each order. Deduct 10% on orders for 2 or more used tires. Send CHECK or MONEY ORDER.—No COD's.
 3701 S. Normal, Dept. PM-51, Chicago 9, Ill.

TECHNICAL EDUCATION

• Air Conditioning and Refrigeration Technology • Diesel Technology • Drafting Technology • Electrical Technology • Electronic Technology • Excellent faculty, accredited curricula, extensive counseling and guidance, full college activities, job placement service, G.I. approved. Opportunity to continue education and earn a B.A.S. degree. Open to high school graduates or equivalent. Feb., June and Sept. semesters. Write for free brochure.

COLLEGE OF TECHNOLOGY, University of Houston
 DEPT. 1A6, 3801 Cullen Blvd., Houston, Texas

Write Like This Complete OUTLINE FREE!

MIRACULOUS IMPROVEMENT in your Penmanship in six hours practice with Grooved Letters. No failures. Inexpensive. No charges unless you're satisfied after 6 hours practice.

WRITE OZMENT BOX 665
 34-P, ST. LOUIS, MISSOURI

SAY YOU SAW IT IN POPULAR MECHANICS

POW hunting slingshot

- accurate—powerful—silent
- kills small game, pests
- hits like a rifle

Special: 200 extra steel balls \$1

Used by expert marksmen! 7" hardwood stock, 45 lb. pull. Has double rubber for double power. FREE!—target, extra rubber and big supply heaviest steel balls used by experts. Illustrated catalog. Authorized model of Slingshot Assn.

\$1.50 postpaid (no cod's)

I. J. STONE Dept. B10, 1616 Oak St. • Santa Monica, Calif.

MAKE BIG PAY!

in the construction industry as an operator of Bulldozers, Draglines, Back Hoes, Scrapers and Motor Graders. Learn these skills NOW! Contractors need operators of earth-moving machines and pay high wages to our graduates. Don't be satisfied with just a job . . . learn a career!

Write TODAY for FREE School Catalog

National School of Heavy Equipment Operation
 P.O. Box 8243 (D-10) Charlotte, N. C.

1957 ALLIED ELECTRONIC SUPPLY CATALOG

free!

356 value-packed PAGES



WORLD'S LARGEST STOCKS

SAVE ON EVERYTHING IN ELECTRONICS



Everything for Experimenters, Builders, Amateurs, Servicemen, Engineers and Hi-Fi Hobbyists

Save on *everything* in Electronics: Hi-Fi systems and components; latest builders' kits (see the famous KNIGHT-KIT line); recorders and phono equipment; TV tubes, antennas, accessories; Amateur station equipment; P.A. systems; test instruments; industrial electronic supplies—plus *everything* in parts, tubes, transistors, tools and books. Get more for your money—send today for your FREE 1957 ALLIED Catalog!

Our 36th year

Everything in Electronics From One Reliable Source

Send for FREE Catalog

ALLIED RADIO

ALLIED RADIO CORP., Dept. 5-K-6
 100 N. Western Ave., Chicago 80, Ill.

Rush FREE 1957 ALLIED 356-Page Catalog

Name _____

Address _____

City _____ Zone _____ State _____

Some make more, some less: T. THORN reports:

\$690 gross in single
MONTH
IN MY OWN BUSINESS!

Start
YOUR OWN
Business!



• Here's YOUR chance to start a money-making, year-round business of your own and make the success you've dreamed about. R. O. Donnley took in \$40 in seven hours. O. W. Ware landed a \$750 hotel job. R. Traynor grossed over \$450.00 in five days. Homes, hotels, offices, clubs, offer you big profit possibilities. Auto upholstery also.

NO SHOP OR OFFICE NECESSARY. You clean furniture on customers' premises. No hauling. No high rents. Supplies inexpensive; operate from your home. What you take in is mostly profit.

• If you want to be your own boss—free from layoffs, strikes and bosses, we will help you to start and succeed. Don't delay...read the facts, then decide for yourself.

MAIL COUPON TODAY FOR FREE BOOK

VON SCHRADER MFG. CO.
N10 "D" Pl., Racine, Wisconsin

Without obligation rush your **FREE** booklet about how I can start my own permanent, profitable electric Upholstery Cleaning business.

Name _____

Address _____

City _____ Zone _____ State _____

SAY YOU SAW IT IN
POPULAR MECHANICS

Profitable Future Now Open to You in

WATCH REPAIRING

Train at Home in Spare Time for High Pay or Profitable Business Opportunities

Remarkable Sweazey Plan shows you how to repair Swiss or American Watches. No previous experience necessary. Job Guide program starts you making repairs right away. Survey shows part time watchmakers reported hourly rates up to \$8.00 per hour. Includes training to help you get started in business. Get facts today. Send for colorful **FREE BOOKLET** and **FREE SAMPLE LESSON**. Here is professional training from famous, long established institution. Founded 1908. Write today — no obligation.

CHICAGO SCHOOL OF WATCHMAKING
2330 N. Milwaukee, Dept. 1106, Chicago 47, Illinois

FREE CATALOG & SAMPLE LESSON

YOURS FREE!

VUER-PROJECTOR
& Full Color Slide Kit—Authentic \$4.95 Value!

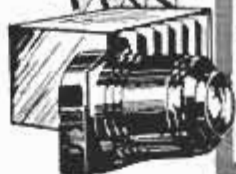

If You're Interested In
BREEDING TROPICAL FISH
For Profit & Pleasure

This handsome, precision-viewing instrument and color slides are yours **FREE**—just for showing your interest in Tropical Fish Breeding! See gorgeous BETTAS, colorful TETRAS, exotic ANGEL FISH, etc., in the vibrant beauty of full color! Convince yourself Tropical Fish Breeding is the profitable, easy-to-start home business for you! Breed them in your living room, spare-room, anywhere. Success is assured because we'll buy every fish you produce! No experience or costly equipment needed. Start spare-time, on a "short string"...build a \$10,000 home business! Investigate!

Write today for **FREE** details on "Profit-Proven" Success Plan & Vuor! (If under 17, ask for plan A.)

TROPICAL FISH BREEDERS OF AMERICA
Dept. 3-10
Los Angeles 61, Calif.

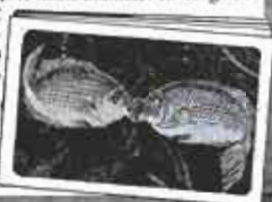

ELECTROPLATE

IT YOURSELF!



NOW using **NEW** plating kit. It's easy to electroplate any object with the same **LUSTER** and **DURABILITY** as done by the most expensive equip. Complete kit and instructions on plating metal and non-metal objects, with Nickel, Chrome, Copper, Gold, etc. **ONLY \$5.95. SEND NO MONEY**—everything sent C.O.D. plus postage. OR send \$5.95 now and receive it postpaid. Money back in 7 days if not satisfied.

M. Z. SALES CO., Dept. G-8, 113 W. 42nd St., New York 36, N. Y.

WHEELS WHEELS WHEELS

- 7" Disc Wheel 3/4" Tire 3/4" sleeve 45c ea.
- 8" Disc Wheel 1 1/4" Tire 1/2" sleeve 70c ea.
- 7" Disc Wheel 1" Tire 1/2" ball bearing 80c ea.
- 8" Disc Wheel 1 1/4" Tire 1/2" ball bearing \$1.00 ea.
- 6" Disc Wheel 1.50 semi-pneum. Tire 1/2" B.B. \$1.35 ea.
- 8" Disc Wheel 2" semi-pneum. T. 1/2" B.B. \$1.50 ea.
- 10" Disc Wheel 1.75 semi-pneum. T. 1/2" B.B. \$1.50 ea.
- 10" Disc Wheel 2.75 semi-pneum. Tire 5/8" B.B. \$3.50 ea.
- 12" Disc Wheel 1.75 semi-pneum. T. 1/2" B.B. \$1.85 ea.

Above wheel prices includes hub cap. Plus Postage, C.O.D.'s accepted. AXLES—Sizes 5/16 in., 3/8 in., 1/2 in.—Cut to size—End holes drilled.

UNITED WHEEL STAMPING CO.
12131 S. PEORIA STREET PM-10 CHICAGO 43, ILLINOIS

FORD STETHOSCOPE

Brand-New **FORD STETHOSCOPE** which cost the government many times our low price. For physicians or for industrial purposes. List Price \$8.00. Our Low Price **\$2.75**

Money Back Guarantee
MATTHEW DAY CO., INC., Dept. 2-M, Dumont, New Jersey

Finish HIGH SCHOOL AT HOME

Complete 4 Yrs. in 12 Months

Learn More! Earn More! Enter professional or technical schools. Advance Socially. Live a Happier, Fuller Life. Individual Courses or complete schedule. **WRITE FOR SCHOOL BULLETIN.**

ACADEMY FOR ADULTS
30 W. Washington, Dept. PM-106, Chicago, Ill.

HIGH BLOOD PRESSURE?



New simplified gauge tests blood pressure at home! This instrument detects internal changes which lead to unexpected strokes, heart and kidney damage, insomnia, headaches, etc. No experience or assistance needed to test pressure accurately. Operating instructions also include information on what to do to prevent or reduce the damaging effects of high blood pressure. These useful instruments are fully guaranteed and actually pay for themselves within a week. Order now for immediate shipment.

THE STANDARD UNIT \$6.50 postpaid Or C.O.D. plus postage. Contains everything that is needed, including functional stethoscope.

THE DELUXE UNIT (photo) \$9.75 postpaid Or C.O.D. plus postage. Same outfit as standard unit, but includes genuine professional stethoscope.

JOY SPECIALTY COMPANY, Scientific Instrument Div.
2320-A W. HUBBARD STREET CHICAGO 12, ILL.



Full Color—Wall Size International

WORLD MAP

It's wall size! 33 inches x 50 inches. Heavy duty durable stock in 8 full colors with clear type to instantly identify any corner of the globe. All in precision detail. Smart as a mural. Educational for children's rooms, den, office, civic, schools, etc. Order Direct today. Send \$1.00 each prepaid or 3 for \$2.75. Same large map of U.S.A. Same price. Guaranteed.

\$1

TERRY ELLIOTT CO., Dept. MP-73
135 East 44th St. New York 17, N. Y.

LEARN NOW for Success in REFRIGERATION & AIR CONDITIONING AUTO MECHANICS HYDRA-MATIC TRANSMISSIONS OIL BURNER SERVICING

Practical, Shop-Type Courses

Day & Evening Classes — Korean Veterans Eligible

Write today for FREE information

LINCOLN TECHNICAL INSTITUTE
Suite 10-E 472 Market St. Newark 5, N. J.

FULL SIZE MODEL KITS!



The original kit.

Just out! Now 9 authentic models for den or game room. Wood with machine work done for you. Process for gun metal finish. Order direct or send 15c for interesting, revised catalog.

\$5.95

For NEW illustrated catalog of 9 models. Send 15c to:

O'BRIEN GUNCRAFT (D) P.O. BOX 657 MADISON, WIS.

ATTENTION HOME WORKERS WE NEED YOUR PRODUCTS

ALL NEW PLAN!! Salesman established in every area to sell Casecraft products manufactured by home workers. Also men wanted for participation in spare-time subcontract plan to help fill huge demand. We supply full instructions, tools, materials, everything—you fill orders for special luggage and all types of portables. No previous experience necessary. Free details.

ABARSI, Dept. AL, 807 W. Sunset Blvd., Los Angeles 12, Calif.

Say You Saw It in Popular Mechanics

GIANT 6-FT. GOVT. SURPLUS

59c



Great Fun for Kids and Adults at Beach, Playground or Water Sports. Inflate to Giant 6 ft., 21 ft. Round, with Air or Gas. Flying Adept. visible for miles. Terrific for attracting crowds at Openings, Fairs, Roadside Stands, Gas Stations, Sport Events. Use as Water Markers and Buoys. Made of genuine Neoprene Rubber for extra durability. Surplus. Never Used. Sold at fraction of cost. Add 10c handling cost per order. 59c ea. 2 for \$1, 5 for \$2, 13 for \$5. Huge 10 ft., \$1 ea. Huge 20 ft., \$2 ea. No C.O.D.s. Dealers Wanted.

NOVEL MFG. 33 2d Ave., Dept. G-1650
New York 3, New York

Regular 49½¢ Plastic STORM WINDOWS

CUT PRICE ONLY

19½¢

10.8 Sq. Ft. Size!

No Nails • No Hooks
No Screws • No Tools



Protect your family all winter for pennies!



INSTALL IN MINUTES!

Just Press On

LIFT FOR AIRING!

No nails, screws, tools. Cut & fit window, press on Adheso border—that's all! So easy! So simple and quick! When winter's over fold away like cloth for next year.

In Use from Coast to Coast

Storm Windows need not cost up to \$14. Now, for pennies per window, you can seal out wintry blasts with **TRANS-KLEER**—the amazing flexible product developed by a multi-million dollar American firm. Imagine it—a standard 10.8 sq. ft. window can be insulated for only 19½¢. This storm window is as transparent as glass, yet can't peel, chip, shatter or rattle! Weighs less than 1/10th of the lightest glass window developed—yet laboratory tests show it has the tensile strength of over a TON per square inch! Crystal clear yet flexible like rubber! Not affected by snow, sleet, rain or dampness—because it's **NONPOROUS**. Won't crack at even 53 degrees **BELOW FREEZING**. Use and re-use **YEAR AFTER YEAR** for winter comfort and protection!

OVER 2,000,000 SOLD FOR 49½¢

TRANS-KLEER plastic storm windows are in use thruout America & Canada by home owners, hospitals, churches, public buildings, etc. Shipped flat in rolls measuring 36"x43"—108 sq. ft.—enough for 10 standard windows. Over 2,000,000 windows sold for 49½¢ each! Now—exactly the same 10 window kit—including special Adheso border is yours for only 1.98 during this sale! 10 glass windows would cost \$79 to \$160. With **TRANS-KLEER** you save a terrific sum! You enjoy amazing fuel savings also! Play safe—order **NOW** on trial. At this low 1.98 price they're sure to sell out fast. The genuine, original **TRANS-KLEER** is sold only by mail—not in stores. Enjoy new comfort, feel the difference—even test with a thermometer. Then, if not convinced your 1.98 comes back quick. **RUSH COUPON TODAY!**

THORESEN'S, Dept. 6-L-74, 352 Fourth Ave., New York 10, N.Y.

THORESEN'S, Dept. 6-L-74

352 FOURTH AVENUE, NEW YORK 10, N.Y.

RUSH—Rolls Trans-Kleer measuring 108 sq. ft. (10 windows averaging 10.8 sq. ft. each) with Adheso border on 7 day trial, money back guarantee.

- Payment enclosed. Send prepaid.
 Send C.O.D. plus postage.

CHECK AMOUNT DESIRED:

- 1 Roll (108 sq. ft.) for 10 windows—1.98
 2 Rolls (216 sq. ft.) for 20 windows—3.50

Name _____

Address _____

City _____

State _____

CANADIANS: Save tariff—order direct from Thoresen Ltd.,
45 St. James St. W. Dept. US-74, Montreal 1, P. Q.

WE PAY \$3.50 LB.

GUARANTEED MARKET

**WANTED
MEN AND WOMEN**

GROW MUSHROOMS

Cellar, shed and outdoors.
Spare or full time year round.

We pay \$3.50 per pound.

WE PAID John Betts

\$9,999.90 He started as an
Amateur

Write for . . .
FREE BOOK

**WASHINGTON MUSHROOM
INDUSTRIES, INC.**

DEPT. 290

2954 ADMIRAL WAY SEATTLE 6, WASHINGTON

BECOME AN EXPERT IN

**TRAFFIC and
TRANSPORTATION**

Today the man trained in TRAFFIC AND TRANSPORTATION is one of the most important and well paid individuals in business and industry. Thousands of firms need experts on rates, tariffs, regulations, etc.

We train you thoroly at home in spare time thru the famous LaSalle Problem Method under the personal guidance of expert traffic authorities.

Splendid opportunities developing rapidly in MOTOR TRUCK and other phases of the Traffic and Transportation field.

Get the facts. Mail coupon today for FREE 48-page book, "Traffic and Transportation—the Fast Growing Profession." Learn about the opportunities and how you can qualify as an expert in the TRAFFIC AND TRANSPORTATION field.

LASALLE EXTENSION UNIVERSITY
A Correspondence Institution

417 S. Dearborn St., Dept. 1064T, Chicago 5, Ill.

Name.....

Address.....

City..... Zone..... State.....

**NATO CONVERSION Allows Release
GUAR. VERY
GOOD COND.**



**BRITISH
ARMY RIFLES**

HUNTERS!

\$29.95

Brit. No 1 MK. III, official issue throughout Brit. Empire today. .303 Cal. All milled parts, long range sights (not wartime model). Fastest bolt action in world. 25" bbl. 10-shot mag. Wt. 8 1/2 lbs. Bore very good. Powerful, used for big game today on every continent. Complete with sling and 20 rds. mil. amm. FREE. (Addit. Mil. amm.: \$7.50 per 100 rds.) SOFTNOSE SPORTING AMMO. made by Rem. & Win., sold everywhere. Bayonet: \$1.95. **TO ORDER:** Send check, cash or M.O. \$10 for C.O.D.

CANADIANS: Order (without red tape) rifles Spd from G. K. Harper, Ltd. 16 Baywater Ottawa.

**GOLDEN STATE ARMS CORP. 236 Armory Bldg.
1165 E. Colorado Street, Pasadena 1, Calif.**

TV Strong man
DAN LURIE
says



Send
for
FREE
Catalog

\$10,000 REWARD

if correct use of my new body building course fails to build you a "HE-MAN" BODY The secret is in my revolutionary, exclusive Body Mould system. Yours FREE with famous

DAN LURIE BARBELLS

Scientific! Fastest, surest method known—beats all other training methods. Results guaranteed. Special low prices.

50 lb. set \$ 8.48 • 100 lb. set \$13.98
150 lb. set \$20.48 • 200 lb. set \$25.98
13c per lb. F.O.B. 50% Deposit required

DAN LURIE BARBELL CO.

52M10 Bristol St., Dept. 659-K, B'klyn, 12, N. Y.

It's Easy to PLAY the GUITAR

Learn at Home with
My Studio Method
on Records

Play the
Very First Day

NOW—Learn by the Method that made top-billed musicians of many of my pupils. Lessons on records with text, music, and, if you ACT NOW, a fine, full-size, steel-strung, professional, Spanish-type Guitar FREE with course. Write **SIO MARGOLIS STUDIOS**, c/o Thunderbird, Dept. ER-703, Valley Stream, N. Y.

**FREE MUSIC
OPPORTUNITY BOOK**

No obligation! Write today!

BRONZE FOUNDRY Schools and Home Workshops

Make your own castings of aluminum, copper, bronze, silver. Foundry sets are available in three sizes including 2400 Deg. F. blast furnaces. See advertisements in March or Apr. issues, free Circular.

KANSAS CITY SPECIALTIES CO.

P.O. Box 6022

Dept. P-10

Marysville, Kan.



**FREE! CALIFORNIA
GARDEN BOOK**

Pictorial round-up of latest, smartest ideas in garden arrangement and structures, by famous California landscape architects. Dramatic new planters, terraces, fences, arbors, shelters.

Write for Garden Book, California Redwood Assn., 572 Sacramento St., San Francisco 11.

WAR SURPLUS BARGAINS

WAR SURPLUS BARGAINS

\$500,000.00 INVENTORY for QUICK LIQUIDATION
Surplus items—hundreds of them for home, shop, factory, farm and outdoor use. New items, used items, reconditioned items—all at tremendous savings—all priced for quick sale.

Page After Page of Values
This big catalog shows page after page of amazing money saving values. Write for your copy today. Send 10c to cover postage, mailing, etc. Write today! SEND TODAY FOR YOUR COPY

10c

STARK'S 212 W. Madison St.
Dept. PM-5610
CHICAGO 6, ILL.

The famous ALLIED School
LEARN-BY-DOING-METHOD
 Will Prepare You for
 Great Opportunities in
AIR CONDITIONING
HEATING & REFRIGERATION



FREE Sample Lesson and Book



BIG KITS

Train at Home in Your Spare Time or at the Allied Institute in Chicago

Here is the finest training for one of the greatest industries of our time. Here is preparation for high pay made possible only because of ALLIED'S extensive resident training facilities—the "know how" that has won the cooperation of industry. You can be sure of the quality of Allied training—resident training on a wide variety of equipment—and home study training that has behind it a great resident school. That is why it means so much more to you when you enroll for Allied Home Study training—or whether you come to the big Allied training shops.

You are Supplied Shop-Work Kits if You Prefer to Train at Home

Right in your own home you do the practical air conditioning and refrigeration work made possible by ALLIED training. You are given actual Work Shop kits, and right at home have the opportunity to build an Air Conditioner, Freezer, or other units of your choice. ALLIED Home Study Work-Shop training right in your own home on actual equipment is made possible only because of ALLIED'S resident facilities. That is why you can progress so much faster, begin to earn so much sooner. Even in your spare time while learning your hourly pay can be really big!

Send for Free Books at Once—Tell How to Get Ready for Good Jobs or Business of Your Own

ALLIED gives you the comprehensive all-around training you need—Air Conditioning, Heating, Refrigeration. Here is your chance to get into a great industry now while so many are growing rapidly with it—and making more and more money. Vast expansion is taking place in home air conditioning, auto air conditioning, increasing uses of industrial air conditioning. The need for trained men in Air Conditioning, Heating and Refrigeration points the way to success for you. Get the facts—find out what makes ALLIED training so superior. Send for free books today—no obligation!

ALLIED SCHOOL of Mechanical Trades
 1338-42 South Michigan Avenue
 Chicago 5, Illinois

ALLIED SCHOOL OF MECHANICAL TRADES

Allied Institute of Technology
 1338-42 South Michigan Ave., Dept. PM-10A, Chicago 5, Ill.

Gentlemen:

Mail me FREE BOOKS explaining ALLIED'S training program in AIR CONDITIONING, HEATING, and REFRIGERATION.

I am interested in resident training home study

Name _____ Age _____

Address _____

City _____ County _____ State _____

Amazing New Auto "Trouble-Shooter"

Spots 2300 Car Troubles —IN A JIFFY!

MOTOR'S ENLARGED Guide Shows You "What's Wrong" Quickly, Easily!

No more guessing or groping for causes of car ailments! Now you can put your finger on every possible cause of car trouble—by turning to check-list in MOTOR'S new "TROUBLE-SHOOTER!" For example, if car is "burning oil," index leads you straight to 11 things that may be causing it. In same way, no matter what is wrong, this guide checks through 2300 possible causes in a jiffy! Section on automatic transmissions alone worth price of book. Saves time, work, headaches. NEW EDITION—GREATLY ENLARGED! 50 photos, diagrams, drawings make everything clear. A "must!" for beginner or veteran mechanic. Spiral binding; stays open while you work.

SEND NO MONEY—MAIL COUPON When postman delivers your "Trouble-Shooter," pay him only \$2.00 plus postage and C.O.D. charges. Use it for a full week. Then, if not delighted, just return it and your money will be refunded. Mail coupon today to: **MOTOR Book Dept., Desk T1K, 250 West 55th St., New York 19, N. Y.**



**NEW ENLARGED EDITION
208 PAGES**

**MOTOR BOOK DEPT., Desk T1K,
250 WEST 55th ST., NEW YORK 19, N. Y.**

Rush me MOTOR'S brand new enlarged, revised TROUBLE-SHOOTER. I will pay postman only \$2 on delivery, plus 46c actual Gov't. postage and C.O.D. charges. If not completely satisfied, I may return book in 7 days for immediate refund.

Name _____
(PLEASE PRINT CLEARLY)

Address _____

City _____ State _____

SAVE CHARGES. Check here if you ENCLOSE \$2.00 as payment in full; you SAVE 46c postage, C.O.D. charges. Same return privilege; full money-back guarantee.

MAIL ORDER SPECIAL



\$9⁵⁰

CAMP STOVE

ORIGINAL COST \$80

Ideally suited for drying plaster or paint in new construction

BRAND NEW U. S. ARMY FIELD RANGE Burner Unit, approx. 50,000 B.T.U. complete w/2 extra generators, unit as pictured. Cook on it, use as cabin heater. Shipping wt. approx. 55 lbs. Size: 21 1/2" lg, 19" w., 17 1/2" h.

SPECIAL! NEW ARMY MACHETTES.....\$1.95

FOLDING FOX-HOLE SHOVELS.....\$1.00

FOX-HOLE PICK-MATTOCK.....\$1.00

All prices FOB Memphis—order now. Supply limited

J. P. DAVIDSON CO.

104 N. Front

Memphis, Tenn.

OWN a Business

\$5 HOURLY Profit . . .

Even If NOW Employed



Alert dealers average \$5 hourly profit on own service plus \$3 on EACH serviceman. You can profitably operate part time while building a full time business. We locally train and assist you.

Clean and Mothproof, Rugs and Upholstery

Duraclean cleans by absorption! No scrubbing, soaking or shrinkage. Dirt, grease and unsightly spots vanish as if by magic . . . matted pile rises . . . colors revive.

Duraproof protects against moths and carpet-beetle damage. Makes materials resistant to both. Backed by an International Money-Back 6-Year Warranty.

No experience needed. Easy to learn. Quickly established. Nationally advertised Services rendered "in the home." You are trained in your own home town. No Shop Needed. We furnish enough materials to return your TOTAL investment. Territories limited. Write today for FREE booklet explaining details and Easy Terms.

Duraclean Co., 6-160 Duraclean Bldg., Deerfield, Ill.

Try my new pipe 30 days



I discovered this pipe by accident. It harnesses four great natural laws to give everything you've ever wanted in a pipe. No "breaking in"—smokes cool and mild from the first puff—down to the last bit of tobacco without a bite. Never has to be rested or cleaned, yet no goo can reach the tongue.

To discover for yourself this simple truth of tobacco enjoyment—smoke my new kind of pipe 30 days AT MY RISK. Send your name today. **FREE.** E. A. Carey, Dept. 1210, 1920 Sunnyside, Chicago 40, Ill.



Easy to make your own BOWS—ARROWS—EQUIPMENT

Illustrated Hand-Book 84 pgs. \$1, tells you how! Large Colored Catalog 5c—Send for it!

Ask your dealer for "Stemmler's Archery" (Oldest Mfr. in U.S.A.)

L. E. STEMLER CO.

Manorville (Box 1) L. I., N. Y.



DRAW The First Day! NO LESSONS! NO TALENT!

New Amazing Invention—"Magic Art Reproducer." You can draw Your Family, Friends, Anything From REAL LIFE—Like An Artist! Even If You CAN'T DRAW A STRAIGHT LINE! Anything you want to draw is automatically seen on any sheet of paper thru the "Magic Art Reproducer." Then easily follow the lines of the "picture image" with a pencil for an original "professional looking" drawing. Also reduces or enlarges. SEND NO MONEY! Free 10 Day Trial! Pay Postman on delivery \$1.98 plus postage. Or send only \$1.98 with order and we pay postage. Money Back Guarantee.

NORTON PRODUCTS, Dept. 5810W, 296 Broadway, N. Y.



MILES-PER-GALLON ALUMINUM CALCULATOR

To make that neighbor lose his bet. You 'gotta' know what miles you get. So its miles per gallon now you seek. Then thru the slot just take a peek. **\$1 PPD.**

MRMCO, 800 S. Ada St., Dept. PM, Chicago 7, Ill.

Say You Saw It in Popular Mechanics

RUPTURED

BE FREE FROM TRUSS SLAVERY

Why put up with wearing a griping, chafing unsanitary truss when there is a new modern **NON-SURGICAL** treatment that permanently corrects rupture. Write today for our New **FREE** Book that gives facts that may save you painful and expensive surgery, and tells how non-surgically you may again work, live, play and love and enjoy life in the manner you desire. There is no obligation.

Excelsior Hernia Clinic, Dept. 8305, Excelsior Springs, Mo.

HOW TO GROW ORCHIDS IN YOUR OWN HOME!

NO GREENHOUSE NEEDED
- ANY CLIMATE - MAINE
TO CALIFORNIA ...
YEAR 'ROUND!

BIG PROFITS SPARE OR FULL TIME

Fill your home with gorgeous Orchids. Huge purple Cattleyas, exquisite Cymbidiums - dozens of others! Many grow without soil, getting food from the air. White Orchids, yellows, greens, every rainbow color. No equipment needed. Start on table or window ledge.

SUCCESSFUL HOME GROWER SHOWS YOU HOW! Complete instructions show you step-by-step how he and his wife started with a few plants and developed a big-profit home-business - grew an Orchid collection now worth a fortune. Learn how orchids multiply, how one plant may become many, each as valuable as the first. No big investment or overhead. Takes but a few minutes a week.

Big-profit orders for plants and flowers come from individuals, florists, hotels, clubs, etc. Year 'round gift. Millions sold by Mail-Order.

COMPLETE INSTRUCTIONS AND BLOOMING-SIZE ORCHID PLANT MAY BE EXAMINED IN YOUR HOME-NO OBLIGATION TO BUY A THING! Secrets of the experts in simple language, jam-packed with "show-how" drawings, magnificent full-color pictures of Orchids. Send No Money. Write NOW for your FREE FACTS that show you how to learn to grow Orchids at home. Airmail is quicker.

Orchids have rewarded me richly - thanks to Tropical Flowerland.
S. V. SMART - Colorado

TROPICAL FLOWERLAND, Dept. 31A
100 S. Vermont, Los Angeles 4, Calif.

15 X 65 MAGNESIUM SALE

Regularly \$69.50
Save \$19.55

Tremendous power. Brings objects 15 times closer! Wide field (65 mm objective lens... almost 3" across)! Easy to hold-focus. 39 oz! 8 1/2" x 9". Exclusive with UNITED. Regularly \$89.50. **\$49.95** Sale Price for This Sale Only. Sale including case, straps! Made in Japan. USE 30 DAYS, if not satisfied return for refund. UNITED BINOCULAR CO., 9043 S. Western, Dept. ARF-808 Chicago 20. DEALERS WANTED



DON'T SWAP SAFETY FOR "DISCOUNTS"

Cheaper PRICED Tires are Cheaper GRADE Tires. Year after year, the Blatt Name in this book, PROVES - IT'S DANGEROUS TO PAY LESS for fine tires worn slightly. We always try to ship your favorite brand (Not Recaps)

GOOD YEAR Goodrich, U. S., Atlas, Lec, General, Firestone & others.

12 MO. GUARANTEE I replace FAST any defective tire, frt. excl.

FREE TUBE with every tire **FREE** This pictured Tire Ash Tray given with 2 or more tires

WHAT A DIFFERENCE IN SAFETY, A FEW CENTS MAKES!			
600-16	\$5.28	670-15	\$5.18
650-16	5.68	710-15	5.38
700-16	5.78	760-15	5.38
640-15	5.18	800-15	5.68
700-15	4.98	820-15	5.68
475-15	5.38	550-17	5.38
WHITEWALLS \$1.00 EXTRA		1100-20	17.28
		700-17	\$9.98
		700-20	8.98
		750-20	9.88
		825-20	16.58
		900-20	15.58
		1000-20	17.28
		750-17	12.98
		600-16 (R)	50.00
		650-16 (R)	6.48
		700-16 (R)	7.08
		700-15 (R)	7.88
		650-20	8.98
		750-16	7.58

GENUINE CO. RELEASE ADJUSTED TIRES any car size **\$7.95** White Walls no exc. tax **\$1 ex.**
Free Replacement, frt. excl., if they fail to give new top grade tire service.

SAVE \$3 to \$33. SUBURBANITE SNOW and other All types, factory Mud-Grip, Retreaded, & slightly used. SPECIAL 12 MONTH WRITTEN **\$6.22** any no exc. car tax **GUARANTEE.**

Send Check or M.O. & this ad for fast shipment. F.O.B. Phila. I personally select your tires - as if my future depended on it. Read that again.

MARVIN BLATT 6th & Spring Garden Sts. Philadelphia Pa. **MILITARY MUD-GRIP TIRES** AA Guar. 6 Mos. **\$9.58** AAA 12 Months **\$13.98** 750-20 **10.58** 750-20 **17.08**

IMPORT PAYS BIG



New World Trade Boom Offers Big Profit Opportunity to Ambitious Men and Women. Learn how to import thousands of products at low foreign prices for buyers in your locality at high U. S. prices - operate a worldwide mail-order Import-Export business from your home. **START WITHOUT CAPITAL** or previous experience. Training includes shipment to you of many sample imports from 'round the world. Opportunity world travel. Save on personal purchases of Clothes, Tools, Gems, Watches, Cameras, etc. **HERE'S PROOF**... an import from overseas **SENT AT OUR COST**. Mail this ad with 25¢ (coin) and we'll rush you this \$2 Melson Automatic cigarette lighter to convince you of tremendous profits. Send for your lighter and full details showing how to learn World Trade secrets to put you on road to your own Profitable Home Business. (No lighter without this ad - only one to a person.) You can get details alone **FREE**, but the lighter is actual proof of import values. Either way, **WRITE TODAY!** **MELLINGER COMPANY, Dept. F25A, 1717 Westwood, Los Angeles 24, Calif.**



Quick, EASY Way to REPRODUCE any Object

You can make exact copies of lamp bases, sculpture, medals, statuettes - any object of wood, metal, clay, plastic or glass - right at home, overnight! Cost - only a few cents! Our PLATEX MOLD method needs no heat-curing; no special skill or tools. Complete kit PM100J, only **\$3.95** postpaid. Brochure PM10 gives step-by-step instructions. Send 10¢ today.

SCULPTURE HOUSE, 304 W. 42nd St., New York 36



LOCKSMITHING

Practical Up-to-Date Course - ONLY \$5.95

53 illustrated self-instruction lessons. Easy to learn. Full price only \$5.95 postpaid - or COD plus postage. Satisfaction guaranteed - or full refund. **NELSON HALL CO., 210 S. Clinton St., Dept. KU-2, Chicago 6, Ill.**



GENUINE INCA CHINCHILLAS

Guaranteed Registered 86 to 92 stock 7A to 12A, \$65.00 a pair, \$100.00 colony. 50% down, 50% COD. Airmail Delivery. Pelt market insures maximum returns on investment. **O. T. McBRIDE, 2203 Burbeck, Richmond, Calif.**



HOW TO BE THE HAPPIEST CREATIVE ENGINEER IN CALIFORNIA

Engineers (E.E., M.E., Mfg., Sales) can have the kinds of jobs that creative men dream about. Top salaries and benefits. Suburban locations in Fullerton, Newport Beach, Richmond, or Palo Alto.

Write Beckman Instruments, Inc., 2999 W. 6th Street Los Angeles 5, California. Ask for Career File #93.

COMPACT PRECISION Sight Level

TAKES PLACE OF COSTLY SURVEYING EQUIPMENT "Finding still more uses every day" say engineers, students, home owners, public works managers and others, about the ever-popular sighting level. Fits palm of the hand - sights like a telescope. Spirit level bubble appears on calibrated scale, enabling user to accurately project level line of sight. For laying out gardens, patios, drains, ditches, fences and land work, etc. A FINE GIFT ITEM. Postpaid in U.S.A. **\$2.50**
Next Top Grain Cowhide Case, \$1.00 (Mail Orders Only)

Air Line Pilots use for spotting cloud levels.
FRANK SOUTH COMPANY
3901 CLAYTON ROAD WEST FORT WORTH 16, TEXAS, Dept. PM.

New! SECRET POCKET RADIO

\$2.98



Listen at work, play, in bed. **INVISIBLE.** Fits shirt pocket. No tubes. No batteries. No electric plug-ins. No expense. Plays day & night forever. New soft-powered diode rectifier replaces tubes. **NO BUILDING.** **READY TO USE.** Tuner covers complete broadcast band. Red plastic case only 3 x 3 1/4 x 1 inches. Lifetime guarantee. Radio (without phone) \$2.98. Hearing Aid Phone (plugs in ear, flesh-colored, almost invisible) \$1.98. Regular phone \$1.25.

JOHNSON SMITH & COMPANY Dept. 367 Detroit 7, Mich.

Catalog of 3100 Novelties 10c

Send 10c for amazing catalog of novelties, live animals, scientific supplies, hobbies, funmakers, planes & boats, looms, magic tricks, joke articles, unusual seeds, gadget time-savers, cameras, optical goods, projectors, movies, lucky jewelry, religious novelties, disguises, musical instruments, stamps, coins, puzzles, fortune tellers, radios, auto & bike accessories, binoculars, magnifiers, compasses, banks, smokers' gadgets, artists' supplies, printing sets, ovens, games, plants, etc. Send 10c (3 for 25c—get for friends!).

JOHNSON SMITH & CO. Dept. 367 Detroit 7, Michigan

MEN WANTED

Earn \$100 Per Week and up
AUTO DIESEL MECHANICS

Master a trade with a future—learn Auto-Diesel mechanics in our shops. You learn with tools on real equipment. Earn while you learn. Many of our graduates earn \$100 per week and up. No previous experience necessary. Day and night courses. Approved for veterans. Write for free bulletin.

NASHVILLE AUTO-DIESEL COLLEGE

226 7th Ave., N., Dept. 75 Nashville 3, Tenn.

A POSTCARD CAN PUT YOU IN A FINE BUSINESS!

Rush Card TODAY for FREE OUTFIT! Get in highly profitable, repeat-order shoe business! Sell amazing line of Air-Cushion Innersole comfort shoes to friends, neighbors, fellow workers. Even, sport, work safety shoes for men, women. Never sold in stores. Just 2 orders a day—in spare time—brings in \$168 EXTRA income a month! No investment. Send card TODAY for FREE SELLING OUTFIT!



MASON SHOE MFG. CO., Dept. 338 Chippewa Falls, Wisconsin

SPARE-TIME MONEYMAKING OPPORTUNITIES READ OUR CLASSIFIED ADS

HUNDREDS OF BARGAINS AMAZING OFFERS

NEW BENJAMIN SUPER CO₂ GAS CARBINE—\$15.95*

HI-LO (2 Stage) Jet Power
Cal. .177 or .22
RIFLED
Shoots Pellets & Darts
Ideal for Target and Small Game. Safe—ECONOMICAL—ACCURATE
CONVENIENT—PRACTICAL—NON TOXIC. EASY TO OPERATE—NO PUMPING—NO FLINCHING.

Get 40 SHOTS from each 10¢ STANDARD SIZE CO₂ (Soda) CARTRIDGE. Up to 3/4" Penetration. Ask your Dealer for Demonstration. **FREE Folder**

BENJAMIN AIR RIFLE CO. 896 MARION ST., ST. LOUIS 4, MO., U.S.A.

FREE! Fabulous Collection from SOUTH of the BORDER



Start TODAY to enjoy an exciting new hobby! Rush Coupon for big, valuable collection of genuine, all-different postage stamps from the exciting land of the mysterious Amazon... scarce airmails, gorgeous commemoratives, giant-sized stamps picturing wild horses, covered wagons, action-packed fights, native war heroes; PLUS sensational train stamp, beautiful "Christ of the Andes"; many others. EXTRA! Bargain Catalog, "Collector's Manual" plus other exciting offers for your inspection. Enclose 10¢ for mailing expenses. . . ACT NOW!

JAMESTOWN STAMP CO. DEPT. N10PM, JAMESTOWN, N.Y.

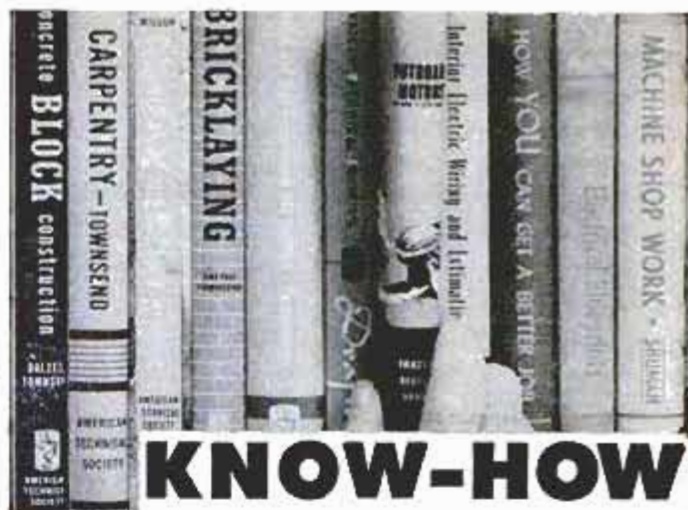

KNOW-HOW

ALWAYS AT YOUR FINGERTIPS!

Always there to show and tell you the things you want to know for use on your job, your own building repair project, or to further your career. Published by the American Technical Society, these beautifully and durably bound books are the best in the field. They cover, Automotive, Building Trades, Electrical, Machine Trades, Mathematics, Engineering, General, and How-To-Do-It subjects.

Publishers since 1898, The American Technical Society makes their books available to everyone, and will permit the readers of this publication to use any books they select for a 10 day trial. This means you can examine them in your own home and prove the value of having "know-how at your fingertips." If you do not find them to be the most valuable investment you have ever made, return them within 10 days and owe nothing.

USE ANY OF THESE BOOKS 10 DAYS FREE

American Technical Society (Publishers Since 1898)
848 East 58th Street, Dept. K 720
Chicago 37, Illinois

Please rush me the books I'm checking below to examine at home. If I'm not convinced that any one or more of these books are the best investment I've ever made, I may return them and owe nothing.

BUILDING AND HOME WORKSHOP

- Concrete Block Construction for Home and Farm Building your own garage, summer home, etc. \$3.25
- Carpentry—beginner or tradesman 504 pages 586 illustrations \$2.50
- Cabinet Making and Millwork \$6.50
- Building Trades Blueprint Reading \$2.75

AUTOMOTIVE AND OUTBOARD MOTORS

- Automotive Brakes and Power Transmission Systems \$6.95
- Outboard Motors—selection, use and repair \$3.95

DRAFTING

- Drafting—for everyone \$3.80
- Freehand Sketching \$1.65

ELECTRICAL

- Interior Electric Wiring—residential and farm \$4.25
- Fundamentals of Electricity 415 pages 325 illustrations \$3.50
- How to Read Electrical Blueprints Home, industrial, motors, controls, etc. \$4.75

MACHINE TRADES

- Machine Shop Work—507 pages—592 illustrations \$4.00

MATHEMATICS

- Practical Mathematics For beginners and those who have forgotten \$3.00

PHOTOGRAPHY

- Photography—thorough coverage of commercial, news, fashion and other profit-making fields. \$5.00

Name _____

Address _____

City and Zone _____ State _____

I prefer

- Ten day no-cost-trial. If I keep books, will remit by check or money order. (3 book limit on free trial)
- Send C.O.D. Same return privilege—money refunded.
- I'm enclosing \$_____ now in full payment to save postage—same return privilege—money refunded.

AIRLINES ARE HIRING!

TRANSPORTATION AGENTS • TICKET AGENTS



Men reaching retirement, shorter working hours and expanding industry has created thousands of openings for ambitious young men who have the necessary training to step into these positions.

TRAIN AT HOME for an essential, exciting career, while you earn on your present job. Very liberal starting salaries; advance to \$8500 a year or more! In transportation work you get a secure future with rapid advancement opportunity, liberal retirement and insurance benefits, vacations with pay and free travel passes.

Travel by air or rail free to training center for final job preparation. If you are 17½ to 35 years, decide now to better yourself and write for detailed information. Specify railroad or airlines.

GALE 3253 HENNEPIN AVENUE
MINNEAPOLIS 8, MINNESOTA
AIRLINE TRAINING CENTER

RAILROADS ARE HIRING!

STATION AGENTS • TELEGRAPHERS



GALE 3253 HENNEPIN AVENUE
MINNEAPOLIS 8, MINNESOTA
RAILROAD TRAINING CENTER



MAKE STRIPES with new PAINT PEN

Straight, curved, single or double
With any color paint, stripe furniture, bikes, autos, model planes, toys, linoleum, wallboard. Clean, crisp decorative lines. Can't clog or smear. Also use with glue, tempera, textile paint or underglaze...on wood, glass, plastic, ceramics, metals, fabrics and paper. Ask your dealer or order direct.

Single 1/16" stripe \$1.25 model
Other single stripe models \$1.75 ea.
1/64", 1/32", 3/64", 5/64", 3/32" & 1/8"
Complete Kit \$5.00 (all 7 tips)
Extra tips 90c ea.
Extra 1/4" tip...\$1.20

DEALERS Master paint striping tool in display carton. Write for discounts.
HOBBY "Professional" results every time. Simple, easy to use. Order now.
MFRS Ask about heavy duty industrial striping tools.
DOUBLE STRIPE MODEL 5 COMBINATIONS \$3.25

WENDELL MFG. CO. 4234 LINCOLN AVE., Dept. 322
CHICAGO 18, ILLINOIS



ASSEMBLE A BIG 100 POWER 3" REFLECTING TELESCOPE

... with this complete 87 piece "Do-It-Yourself" Kit. See the moon, stars close up, or view terrestrially. Kit includes: 3" f/10 aluminized and overcoated. Spherical Mirror—60X Eyepiece and 100X Barlow Lens—Crossline Finder, sturdy 40" Tripod—fork type Equatorial Mount. Complete instructions furnished. Order by Stock No. Send check or M.O. Money back guarantee. Shipping weight 10 lbs. Stock No. 85,025-H. **\$29.50** f.o.b. Barrington, N. J. Ask for FREE catalog M

EDMUND SCIENTIFIC CORP., Barrington, N. J., U.S.A.



Venus di Milo 10¢

Ancient Greece stamps! Venus stamp (illustrated) plus Alexander the Great, bullfight, Olympic victory, Greek gods, etc. Complete, 10c with approvals.

WINTHROP STAMP CO., Dept. PM 10, Groton, Conn.

SAY YOU SAW IT IN POPULAR MECHANICS

CONCRETE BLOCK HOME PLANS

\$1900 DUPLEX



Build your own 24'x36' duplex complete with central heating for \$1900. Easy to follow plans drawn especially for amateurs. No block cutting necessary. Slab floor, rock wool insulated, forced warm air heating—75,000 BTU furnace and prefab duct system available at tremendous saving. Each side contains 11'x17' living room and kitchenette, 10'x11' bedroom, 6'x9' bath, and five closets. Genuine blueprints, scale 1/4"=1'. Instructions, and material cost list, \$2.00 ppd. \$1150 GARAGE APARTMENT, 22'x24', Liv. room, kit., two bedrooms and bath. Double garage below. Plan \$1.00. \$2500 RANCH HOME, 25'x48', Liv. room, kit., bath, two bedrooms, den with fireplace, utility room, garage, central heating. Plans \$2.00. Quality assured by money back guarantee. MEMBER ARKANSAS HOME BUILDERS ASSOC. BAILEY BUILDERS 7608 Harmon Drive Little Rock, Ark.

1', instructions, and material cost list, \$2.00 ppd. \$1150 GARAGE APARTMENT, 22'x24', Liv. room, kit., two bedrooms and bath. Double garage below. Plan \$1.00. \$2500 RANCH HOME, 25'x48', Liv. room, kit., bath, two bedrooms, den with fireplace, utility room, garage, central heating. Plans \$2.00. Quality assured by money back guarantee. MEMBER ARKANSAS HOME BUILDERS ASSOC. BAILEY BUILDERS 7608 Harmon Drive Little Rock, Ark.

HOW TO FIX ANY AIR COOLED ENGINE!



Save time and money on servicing small engines used on power lawn mowers, garden tractors, industrial applications, etc! **SMALL ENGINES SERVICE MANUAL** shows you how to make expert repairs, tune-up, overhaul or troubleshoot on 200 makes and models. Edited by engineers and professional mechanics.



Covers any job on 2 or 4-cycle popular makes of engines. Includes 1, 2 and 4 cylinder models in light weight and heavy duty types—1 to 35 H.P. Eliminates guesswork! Contains 25,000 procedures with easy-to-follow instructions, plus time-saving shortcuts. 6,000 specifications. Over 300 drawings and illustrations to guide you. Complete parts information on 1,700 items. Only manual of its kind! Order NOW at introductory price of \$3.45. Send check or M.O. with order. Money refunded if you're not satisfied. Order today!

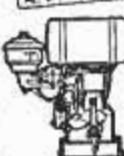

SMALL ENGINES SERVICE MANUAL

400 Graphic Arts Bldg.

Kansas City 5, Mo.

YES! SEND



directly to my door every month

I am enclosing
 \$3.50 for 1 year
 \$8.00 for 3 years

name _____

address _____

city _____

zone _____

state _____

Hand this order to your newsdealer or send it to
POPULAR MECHANICS
200 East Ontario St. Chicago 11, Ill.

Make SURE, SAFE INSULATED ELECTRICAL CONNECTIONS

The New

SUPER *Champ* Hand Tool

The ONE Tool for ALL Wire Sizes used in Home Wiring, Appliances, Automobiles.

DOES ALL THESE THINGS BESIDES

CRIMPS Solderless Terminals and Connectors without solder or tape for safe connections.

CUTS Wire, making clean, sharp cut through Insulation and Conductor.

STRIPS Wire sizes #22-#10. Gauges assure proper length for sure, safe crimp.

SHEARS Bolts and screws without damaging threads — no filing or hack sawing.

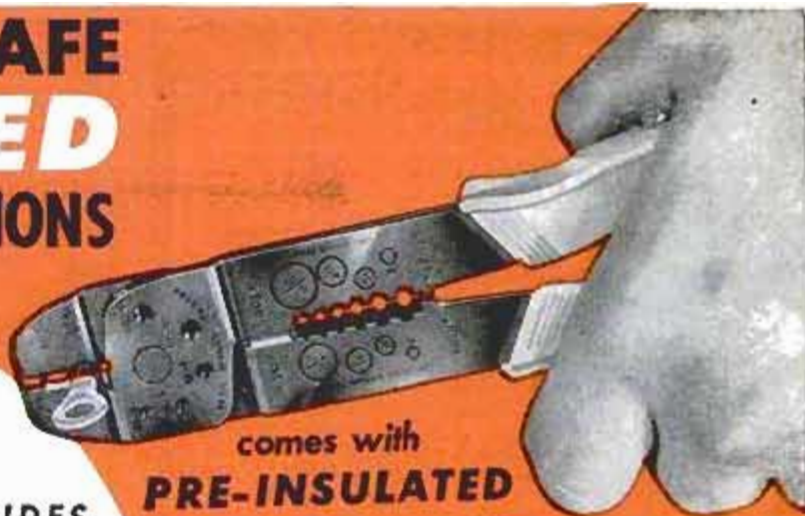

comes with
PRE-INSULATED



FREE with Each TOOL

ORDER DIRECT — USE COUPON

Satisfaction guaranteed or money back. Send check or money order for \$3.95. (Ohio residents add 12c sales tax.)

T. W. Berger, Inc.

National Distributor Consumers and Dealers

AIRCRAFT-MARINE PRODUCTS, Inc.

210 OC Mariemont Center Bldg., Cincinnati 27, Ohio

T. W. Berger, Inc.

National Distributor Champ Tool

210 OC Mariemont Center Bldg., Cincinnati 27, Ohio

Send me post paid the new super Champ Hand Tool. I am enclosing \$3.95. (Ohio residents add 12c sales tax.)

check money order

NAME _____

ADDRESS _____

CITY _____ ZONE _____ STATE _____

Only
\$3.95

Post Paid

Watch Repairing Pays Big Money Learn at home



Watch repairers in great demand. Train step-by-step in 10 easy lessons. We furnish all tools and 15 jewel watch and practice movement. Turn spare time into cash. A licensed school. Low cost. Send for FREE book today.

ILLINOIS SCHOOL OF WATCH REPAIRING

2870 Elston Ave., Dept. PM-106, Chicago 18, Ill.

\$\$ Save \$\$ on US Gov't Surplus \$\$\$

Buy direct from Gov't. These are a sample of saving made. Lifeboat \$12. Grinder \$4.69. Shaper \$15. Truck \$76.77. Tractor \$75. Typewriter \$7.51. Freezer \$50. Sprayer \$15.25. Motor \$4. Hunting, fishing, sporting, camping equip, jeep, power tools, machinery, cameras, radio, photo, printing equip, hundreds others may be purchased at tremendous savings direct from Gov't through our Bulletin "Surplus Sales." Price \$1.00.

The Abacus Press, Box 169DDD, Dept. 6, East Htfd. 8, Conn.

"YOU ARE UNDER ARREST!"



Help Bring Crooks to Justice Through Scientific **CRIME DETECTION!**

We have taught thousands this exciting, profitable, pleasant profession. Let us teach you in your own home. Learn Finger Printing, Firearms Identification, Police Photography, Secret Service Methods thoroughly, quickly, at small cost. Over 800 of all American Bureaus of Identification employ I.A.S. students or graduates. Write stating age, for "Blue Book of Crime."

(A Correspondence School Since 1916)

INSTITUTE OF APPLIED SCIENCE, 1920 Sunnyside Ave., Dept. 1357, Chicago 40, Ill.

FREE AMAZING NEW BOOK "HOW TO ANSWER ADS"

how to answer ads

Never before have you seen anything like this. Tells you in simple language the correct way to answer ads. Gets you quicker replies—better results, and greater satisfaction. Will save you time and money and it's ABSOLUTELY FREE. No obligation whatever. Every reader of advertising should have this booklet. Send a postcard for your copy NOW. F. W. Johnson, Popular Mechanics Magazine, Room 600-A, 204 East Ontario Street, Chicago 11, Illinois.

PREPARE FOR BETTER JOB, BIGGER PAY IN SPARE TIME AT HOME

Today, choose the job you want—and prepare for it in time you might otherwise waste. Or if you are already in the work you like best, start training now for quicker promotion and increased pay. During more than 50 years AMERICAN SCHOOL has helped ambitious people to reach higher goals. Check subject that interests you and mail coupon for full information.

AMERICAN SCHOOL, Dept. 6745, Drexel at 58th, Chicago 37, Ill.

Without obligation, please send FREE and postpaid, full particulars about the subject checked below.

- | | | |
|--|---|---|
| <input type="checkbox"/> Accounting | <input type="checkbox"/> Contracting | <input type="checkbox"/> Mechanical Engineering |
| <input type="checkbox"/> Apprenticeship Courses | <input type="checkbox"/> Diesel Technician | <input type="checkbox"/> Mechanical Technology |
| <input type="checkbox"/> Architecture & Building | <input type="checkbox"/> Drafting—Building Trades | <input type="checkbox"/> Metalworking Courses |
| <input type="checkbox"/> Automotive Technician | <input type="checkbox"/> Drafting—Machine Trades | <input type="checkbox"/> Plumbing—Practical |
| <input type="checkbox"/> Better Foremanship | <input type="checkbox"/> Electrical Engineering | <input type="checkbox"/> Private Secretary |
| <input type="checkbox"/> Blueprint Reading | <input type="checkbox"/> Electricity—Practical | <input type="checkbox"/> Retail Merchandising |
| <input type="checkbox"/> Bookkeeping | <input type="checkbox"/> Electronics—Industrial | <input type="checkbox"/> Salesmanship—Outside |
| <input type="checkbox"/> Business Management | <input type="checkbox"/> HIGH SCHOOL COURSES | <input type="checkbox"/> Sheet Metal Work |
| <input type="checkbox"/> Civil Engineering | <input type="checkbox"/> Machinists | <input type="checkbox"/> Tool Making |

NAME _____ OCCUPATION _____ AGE _____
HOME ADDRESS _____ STATE _____
CITY _____

Canadians: Write American School, Dept. 6745, 6083 Sherbrooke St. W., Montreal

MAIL COUPON NOW

TRAINED MEN NEEDED!

BIG PAY!—GOOD FUTURE!

- DIESEL ELECTRONICS
 AUTO AUTOMATION

NEVER BEFORE has the opportunity been so good for the properly trained mechanic and technician to step into BIG PAY POSITIONS with rapid advancement and future security virtually assured.

YOUR SUCCESS depends on the quality of training you receive... and the reputation of the school you attend.

YOUR GUARANTEE we are giving the best in mechanical and technical training is proved by the fact... we have a waiting list of good pay positions for our graduates, with leading companies throughout the United States.

RESIDENT SHOP TRAINING is easier and costs less than you may think! We provide you with housing and part-time jobs while in school, plus free nation-wide placement service for graduates.

Check subject above in which you are interested and mail for

FREE BOOKLET

Your Future
in
ELECTRONICS
AND
AUTOMATION

BAILEY

Technical Schools

Veteran Approved
1634 S. Grand, St. Louis 4, Mo.

Your Future
in
DIESEL and
AUTO
MECHANICS

Name _____ Age _____
Street _____
Town _____ Zone _____ State _____

AMAZING NEW PERSONAL POCKET RADIO



LISTEN WHILE YOU WALK DOWN THE STREET!

Slims in any pocket—wt. only 7 ozs. Size 2 1/2" x 4 1/4" x 1 1/2". Beautiful Black Gold Plastic Case. NO HOOKUPS—NO WIRES—NO PLUG-INS! Self-contained. 150-hour life flashlight batteries and BUILT-IN ANTENNA. POSITIVELY NO AERIAL HOOKUPS! EVER! GUARANTEED RECEPTION OF RADIO STATIONS TO 50 MILES up to 1500 miles for powerful stations! New patented Super-regenerative Diode tube and transformer audio stage for sharp selectivity and sensitivity! Easy to use top tuner (while walking). Tiny, plastic personal ear plug.

LET YOU ALONE LISTEN WHILE YOU WALK, VISIT, WORK, HIDE OR SLEEP ANYTIME—ANYWHERE. MONEY-BACK GUARANTEE AND ONE YEAR SERVICE GUARANTEE.

SEND ONLY \$5.00 (c.k. mo) and pay postman \$14.95 plus postage on delivery or send \$19.95 for postpaid delivery. GET YOUR TINYTONE REAL POCKET RADIO now and be ready to listen to Civil Defense Alarms, news, music, sports, etc. on a moment's notice without bothering those around you. NOT AN UNWORKABLE, INCOMPLETE KIT OR PLAYTHING. BUT A REAL POCKET RADIO! Shipped complete with batteries—Ready to listen! Available only from: WESTERN RADIO, Dept. APM-10, Kearney, Nebr.

BOAT PLANS-PATTERNS FRAME KITS

A modern up to date series of inboard and outboard designs for the amateur builder. State specific size and type or send 50c for BIG NEW CATALOG.



marine GLEN designs Box 568T Compton, Calif.

Say You Saw It in Popular Mechanics



DEVELOP A HE-MAN VOICE!

Write for FREE book "How to Strengthen Your Voice for Greater Success" by Eugene Feuchtinger. No obligation. Book will be mailed at once in plain wrapper, postpaid. Just send your name and address. State age. PERFECT VOICE INSTITUTE, 210 S. Clinton St., Studio KU-2, Chicago 6, Ill.

Encourage This Fellow!
Give His Natural Talents
a Grand Lift With This
Popular Mechanics
Helpful Book!



Every Boy Should Have It!
The Build-It-Yourself
Book for Boys

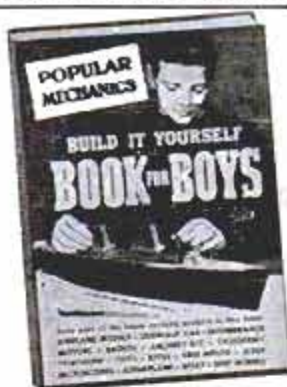

192 Pages
469 Pictures

It's natural for boys to want to make things—to work with tools—to fashion the kind of things kids want. So give boys the Build-It-Yourself Book for Boys. Encourage a youngster to express himself—make him happy—with the sensational new Popular Mechanics book that shows how to make 56 different things every boy dreams about. It covers science, mechanics, electricity, modeling and other fields. 192 pages of easy-to-follow instructions. 469 how-to-do-it pictures.

Try It • Your Money Back If You Want It!
Build-It-Yourself Book for Boys sent postpaid for \$2.50 or COD, charges extra. Money refunded if you are not pleased after 5 days' use. Mail the coupon for quick service.

Use This Coupon for Quick Book Service

POPULAR MECHANICS PRESS, Dept. 1056
200 East Ontario Street, Chicago 11, Illinois

Send "Build-It-Yourself Book for Boys." I understand you will refund full price if I return book in 5 days

I enclose \$2.50 Send COD

Name _____

Address _____

City _____ Zone _____ State _____

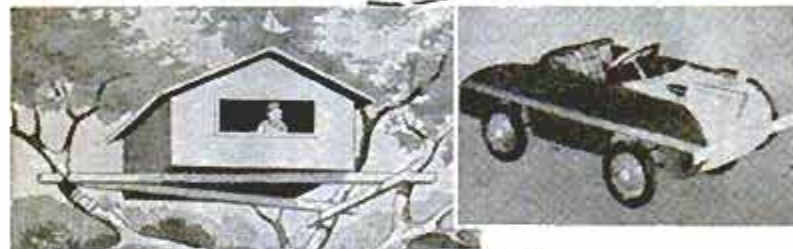

Science and Mechanics
Especially for Boys

Boys can make all of these with the help of this fine Popular Mechanics book—Tree House—Sidewalk Auto—Midget Racer Hydroplane With Engine—Practical Microscope—Fascinating Electrical Dart Game. 51 other things boys want. Airplane Models, Aquaplane, Archery Kit, Bird Houses and Shelter, Boats, Bobsled, Boomer-

56 Toys, Games
Gadgets, Models, Boats,
Electrical Devices, Autos—
That Boys Can Make

angs, Cannon Toy, Electric Motors, Garage Toy, Helicopter Toy, Hunting Knife, Kites, Log Cabins, Marble Game, Printing Press, Radio Sets, Rafts, Railroad Modeling, Scooters, Sprinkler Truck, Squirt Gun, SS United States Model, Surfboard, Tank Toy, Taxidermy, Telegraph Set, Telephone, Water Skis, Weather Instruments, Toboggan, Worktable.

The tragic fact, our doctors tell us, is that every third cancer death is a needless death... twice as many could be saved.

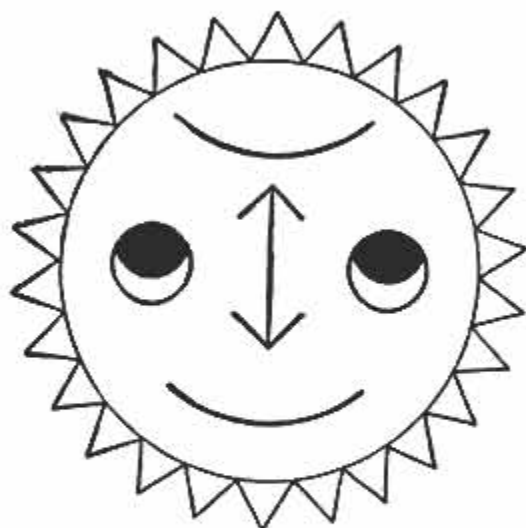

LET'S LOOK AT THE BRIGHTER SIDE

Many thousands of Americans are cured of cancer every year. More and more people are going to their doctors *in time*... To learn how to head off cancer, call the American Cancer Society or write to "Cancer" in care of your local Post Office.

American Cancer Society



695 HEAVY OILPH-BALL BEARINGS PUMPS MILLIONS OF GALS.

CELLAR & SUMP DRAIN 7500 G.P.H. Pump, Stand, Legs, Coupling, Hardware. **\$14.45**

IRRIGATE, SPRAY, DRAIN OR FILL ANYTHING—ANYWHERE! Will not Rust—Clog—or Leak. Patented Seal. Pumps 2800 gph, 420 gph at 75' high or 1000 gph from 25' well. Six blade impeller. Threaded for pipe. 3/4" inlet, 1/2" outlet. Use 1/4 to 3/4 hp motor. **7500 gph 9.95**
Heavier 2800 gph 8.95 **Heavier 11.95**

Check. MO or COD—Lifetime Trade Guarantee
 FREE Literature—Comparison Charts
U. A. T. ENG. & MFG. CO. HICKSVILLE 273, NEW YORK

Learn All About Cars!

**AUTO MECHANICS — AUTOMATIC TRANSMISSIONS
 ACETYLENE AND ARC WELDING
 BODY AND FENDER REPAIR**

Day-Night School 30 Years in the Same Location

WOLVERINE SCHOOL OF TRADES

Approved Under the G.I. Bill of Rights by the State Board of Education

WOLVERINE SCHOOL OF TRADES, Dept. PM
 1400 West Fort St., Detroit 16, Mich.

Name _____
 Address _____
 City _____ State _____

1 I SHOW YOU HOW TO MAKE MONEY AT ONCE

2 START YOUR OWN BUSINESS

IN 2 WEEKS—
 AT HOME
 IN SPARE TIME



**PLATE
 Baby Shoes
 IN
 BRONZE
 AND
 COLORED
 PEARL**

**MILLIONS OF
 NEW PROSPECTS
 EVERY YEAR**



Now is the time to cash in on this big-paying, easy-to-operate, year-round business and you need no experience. **MATERIALS COST YOU ONLY 50c — YOU GET \$6.00!** With many actual "show-how" illustrations and step-by-step instructions, **YOU** can start earning money at once in one week. Working only a few hours you can make more money than many people make working an entire week.

IMMEDIATE RESULTS

- Big Income
- Huge Demand
- Sales Plan
- Future Security
- Your Own Business

We will send you full details absolutely free.

FREE!

**MONEY
 MAKING
 PLAN**

Full Details
 Without
 Obligation

**MAIL COUPON
 TODAY!**

**KIKTAVI COMPANY, Dept. PM-5610
 11029 S. Vermont, Los Angeles 44, Calif.**

KIKTAVI COMPANY, Dept. PM-5610
 11029 S. Vermont, Los Angeles 44, Calif.

Send me **FREE** details of your **MONEY MAKING PLAN**, without obligation.

NAME _____

STREET _____

CITY _____ ZONE _____ STATE _____

POPULAR MECHANICS PRESS, Dept. 1056

200 E. Ontario Street, Chicago 11, Illinois

Gentlemen: Please send copies of book nos.:

1 2 3 4 5 6 7 8 9 10 11 12 13 14
15 16 17 18 19 20 21 22 23 24 25 26
(circle numbers desired)

Remittance enclosed

Send C.O.D. (\$2.00 or more) I enclose \$ _____

Name _____

Address _____

City _____ Zone _____ State _____

**FILL-IN and
MAIL THIS
← COUPON!**

SAVE MONEY *with these* NEW DO-IT-YOURSELF BOOKS



- 1. HOW TO PAINT INSIDE AND OUT:** Step-by-step instructions. Easy to follow illus.
- 2. HOW TO LAY LINOLEUM AND TILE:** How to get the best from your labors. Diagrams.
- 3. HOW TO REMODEL YOUR BASEMENT AND ATTIC:** Planning ideas, hints, instructions. Illus.
- 4. HOW TO TAKE CARE OF YOUR LAWN:** Detailed guide to a perfect lawn and healthy shrubs.
- 5. HOUSE WIRING AND ELECTRICAL REPAIRS:** Ideas and instructions for the homemaker. Diagrams.
- 6. SMALL BOATS YOU CAN BUILD:** Plywood dinghy, 15-ft. sailing knockabout, 8-ft. duckboat, etc.
- 7. PLUMBING REPAIRS MADE SIMPLE:** Fix faucet noises, water hammer, clogged pipes yourself.
- 8. FENCES, GATES, TRELLISES AND WALKS:** Variety of fences, etc., with instructions, diagrams.
- 9. BUILT-IN FURNITURE FOR YOUR HOME:** Wall cabinet, wardrobe, linen closet, crib, etc.
- 10. BUILD YOUR OWN BARBECUE:** Stone and brick fireplaces, grills, barbecue pits, etc.
- 11. LAWN AND GARDEN PROJECTS:** Picnic furniture, folding chairs, garden pool, etc.
- 12. THREE LOW-COST HOMES YOU CAN BUILD YOURSELF:** Build your own home—save half the cost.
- 13. 125 SIMPLE HOME REPAIRS:** Stop faucet leaks, replace sash cords, cut glass, etc.

- 14. SIMPLE TELEVISION REPAIRS:** Only a screwdriver, pliers and soldering iron necessary.
- 15. MODERNIZE YOUR KITCHEN:** Planning for convenience and economy. Ideas, diagrams.
- 16. 30 ONE-EVENING PROJECTS:** Decorative, easy-to-make chairs, lamps, tables, shelves, etc., for the home.
- 17. HOW TO WINTERIZE YOUR HOME:** Prepare for bad weather. Make storm windows, repair roofs, etc.
- 18. HOW TO SET UP YOUR HOME WORKSHOP:** Detailed layout plans for basement conversion. Diagrams.
- 19. LANDSCAPING YOUR HOME AT LOW COST:** How to plan and plant beautiful home surroundings.
- 20. CONCRETE CONSTRUCTION AROUND THE HOME:** How to make steps, walks, driveways, fireplaces, etc.
- 21. REFINISHING FURNITURE, FLOORS AND WOODWORK:** What you need and how to do the job properly.
- 22. HOW TO USE POWER TOOLS IN YOUR HOME WORKSHOP:** Basic and advanced operations, ideas, tips.
- 23. HOW TO CURE YOUR LEAKY BASEMENT:** Causes of, and how to stop, dampness and water seepage.
- 24. MONEY-SAVING HOUSEHOLD FORMULAS:** Safe, efficient polishes, cosmetics, etc., you can make.
- 25. UPHOLSTERING AT HOME:** Using foam rubber, upholster chairs, benches, etc., at a big saving.
- 26. HOW TO GET THE MOST OUT OF YOUR CIRCULAR SAW:** How to build and use this tool for best results.

ONLY 25¢ EACH 6 for \$1.25 ALL 26 for \$4.50

Art Talent Test FREE!

Find out if you have talent enough for a money-making career in art. Take the simple Art Talent Test that has started thousands toward successful careers. Trained artists are needed for advertising, illustrating, cartooning. If you like to draw or sketch, find out whether an art career is for you. Write today for free Talent Test. No obligation.



WRITE FOR YOUR
FREE COPY TODAY!

**ART INSTRUCTION, INC., STUDIO 10136
500 South 4th Street • Minneapolis 15, Minnesota**

Please send me your Talent Test, without cost or obligation.
(PLEASE PRINT)

Name _____ AGE _____ Phone _____
Address _____ City _____ Zone _____
State _____ County _____ Occupation _____

**ENGINEERING
DEGREE IN
27 MONTHS**

INDIANA TECHNICAL COLLEGE

B. S. DEGREE, Aeronautical, Chemical, Civil, Electrical, Mechanical and Electronic Engineering (inc. Radio and TV), Drafting, one-year. Low rate. Earn board. Large industrial center. Students from 48 states, 21 countries. Demand for graduates. G.I. Government approved. Enter December, March, June, Sept. Write today for catalog. 1610 E. Washington Boulevard, Fort Wayne 2, Indiana.

RADIO CONTROL YOUR MODEL PLANES BOATS CARS

"CUSTOM MIDGET" ONLY RADIO \$9.98

LICENSE FREE BAND

OPERATES SAME AS \$50.00 SETS. INCLUDES LONG RANGE TRANSMITTER RADIO, RECEIVER RADIO AND CONTROL ACTUATOR ALL 3 EASY ASSEMBLY WITH OUR PARTS AND PLANS \$9.98. PLANS ALONE \$1.

RADIOMODELS BOX 35 DEPT. PM BALTIMORE 6, MARYLAND

DETAILED INFORMATION & RADIO CATALOGUE 25c

SPECIAL "SUPPLY SOURCE DIRECTORY" & \$7.00 SUPPLY COUPON... \$1.00

BOOK "RADIO CONTROL OF MODEL AIRCRAFT" CONTAINS 14 PLANS \$3.98

RADIO CONTROL GARAGE DOOR DETAILS... \$1.00

LEARN MEAT CUTTING AT NATIONAL Pay After Graduation



The steady dependable trade of Meat Cutting taught easily in 8 short weeks. YOU LEARN BY DOING under actual meat market conditions in big modern school at Toledo.

For beginners or men with experience. Get a profitable store of your own. Remember, PEOPLE MUST EAT! Big pay jobs. Free employment help. Thousands of successful graduates.

Buying, cutting, percentage, pricing, advertising, selling, etc. A complete retail meat education. National School established 33 years. Get National training NOW. Pay your tuition in easy weekly payments

after you graduate. Send coupon for FREE 52 page school catalog — TODAY. G.I. approved.

National School of Meat Cutting, Inc., Dept. 50-J, Toledo 4, Ohio

Send me your FREE school catalog on National Training at Toledo in Meat Cutting, Meat Merchandising and Self Service Meats. No obligation. No salesman will call.

Name _____ Age _____

Address _____

City _____ State _____

Approved for training Korean Veterans

MATHEMATICS

ADVANCED

INDUSTRY TODAY DEMANDS, MORE THAN EVER, THE MAN WITH A GOOD MATHEMATICAL FOUNDATION.

In any branch of engineering, too, mathematics (up to and including calculus) is essential if you want to get ahead in this modern age of technical development. Our reasonably priced home study courses can train you by easy stages to advanced standards—even from an elementary beginning. Examination successes have been won by our students throughout the world. Write today for our handbook listing mathematics and over ninety other courses in all branches of engineering.

Civil	Radio	A.M.I.Mech.E.
Structural	Electronics	A.M.Brit.I.R.E.
Mechanical	Aeronautical	A.F.R.Ae.S.
Electrical	A.M.I.C.E.	B.Sc. (Pure Science)



105 PAGE HANDBOOK FREE

Canadian Institute of Science and Technology Limited
625 Century Bldg., 412, 5th St. N.W. Washington, D.C.
Please forward free of cost or obligation your handbook, "ENGINEERING OPPORTUNITIES".

Name.....
Address.....
.....Course
Interested in.....Age

Canadian Address: Canadian Institute of Science
Garden Building, 263 Adelaide St. W., Toronto, Ont.

ESHELMAN ELECTRIC STARTER GENERATOR

For All Small Engines, Gives Push Button STARTING and CHARGES BATTERY

Combination starter-generator ends pull cord or crank starting. For tractors, pumps, mowers, etc. Powered by 12 volt car battery. Trouble free, V-belt drive. No clutches or chains. Operates lights, radio. Write for free literature. State engine make.

Dept. 56-510, ESHELMAN, 109 Light St., Balto, 2, Md.



Shipping Point: RENO
BALTIMORE - CHICAGO

BIG PAY JOBS for men who qualify in DIESEL



TRAIN NOW FOR A DIESEL FUTURE. Steady, high-pay jobs await men qualified in Diesel, Tractor, and Heavy Equipment. Are you qualified for job and advancement opportunities in this fast-growing field? You can qualify!

COMPLETE DIESEL COURSE NOW AVAILABLE. If you are ambitious and want to get ahead in this big money field, you'll want to know about the complete Diesel home training course now offered by Interstate Training Service. Covers all phases of operation, repair, service. Easy to master in spare time. No interference with present job. Up-to-the-minute. Regularly revised to cover new developments. We invite comparison of material offered. Advisory placement service for our students.

YOU OWE IT TO YOURSELF to investigate Interstate Training Service Diesel Training. Thousands agree it has helped them to better jobs...better pay. It can do the same for you!

WRITE FOR FREE INFORMATION TODAY

INTERSTATE TRAINING SERVICE, Portland 13, Ore.
Please see that I receive FREE 24-page book,
"Getting Ahead in Diesel." (A-3)



NAME.....AGE.....
ADDRESS.....
CITY.....ZONE.....STATE.....



Miniature Scene Built Inside Gallon Jug

Tiny manikins seated at a table inside a glass gallon jug comprise a unique exhibit at a New York hobby show. Builder Nathan Halpern, 78, included such realistic details as a wooden floor, a chandelier, tableware and decorations—even a stuffed turkey. Halpern is one of 2000 persons between the ages of 60 and 98 who exhibited their hobbies.

Mushrooms From Sawdust

Flavorful mushrooms are being produced from sawdust by Dr. S. S. Block and George Tsao of the University of Florida. In two weeks, 500 pounds of fresh "oyster" mushrooms were grown in a ton of ordinary sawdust that was supplemented with 100 pounds of oatmeal. Unlike commercial mushrooms, which require a cool environment, the oyster mushrooms were grown at a temperature of 78 degrees. The scientists point out that the 75 million tons of sawdust wasted each year in the United States alone could profitably be turned into food by this method.

☐ For four years Chicago's Midway airport has been the busiest in the United States, with 381,737 arrivals and departures setting a new record in 1955 for an average of more than 43 per hour. Next four in order were Miami, New York's LaGuardia, Los Angeles and Atlanta.



new **FREE** booklet tells how you can **ADD** almost **2 INCHES TO YOUR HEIGHT** with

you may think you're TALL enough but.....

Lack of height can hurt your chances for success! So why sell yourself short? "ELEVATORS", amazing height-increasing shoes make you almost 2 INCHES TALLER the instant you put them on. Only you know the secret. But everyone immediately notices the improvement in your appearance.



for **FREE** Booklet and dealer's name write to: **STONE-TARLOW CO., INC., DEPT. PM10. BROCKTON 68, MASS.**

Say You Saw It in Popular Mechanics

WHAM-O FENCING SWORDS

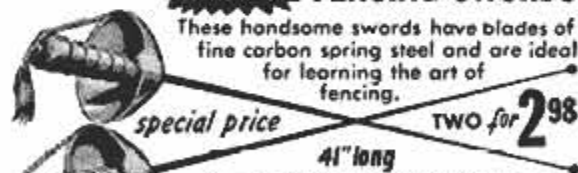

These handsome swords have blades of fine carbon spring steel and are ideal for learning the art of fencing.

special price **TWO for 2.98**
41" long

Can be hung as wall display in den. Polished metal guards with blood red and silver cordons, beautifully set off the solid alder grips. Once used in deadly combat, now an exciting sport. A real bargain, \$2.98 with fencing instructions and safety tips. Fencing masks \$1.50 each. At sports dealers or send:

WAMO MFG. CO., Box 62-T, San Gabriel, Calif.

DO IT YOURSELF BUT DO IT BETTER WITH THE RIGHT MATERIALS!



Get Popular Mechanics **DO-IT-YOURSELF Materials Guide**

The Key to Buying and Using Lumber, Hardware and Other Home Workshop Materials

The right lumber. The right grade. The right fastenings, nails, screws, glue and other hardware. These are all just as important as the right design and the right kind of workmanship. It's true, whether you're fixing up the house, making a fine piece of furniture or knocking out a time-killing gadget. Get Popular Mechanics Materials Guide. Fills a long-felt need of home owners and home workshop fans. Has how-to-do-it information too. Send only \$2.95 for postpaid delivery. Money back if you want it in 5 days.

You Need This

How to select and how to use—Lumber, mill-work, plywood and hard-board—Exterior wall and roof materials—Hardwood floors and floor coverings—Wall and ceiling materials—Doors, windows, screens and weather stripping—Glass, the material of tomorrow—Plumbing pipes and fittings—Electrical equipment—Nails, screws, bolts, etc.—Hinges, locks and other hardware—Paints and miscellaneous products.

192 Fact filled pages. 667 how-to-do-it pictures

POPULAR MECHANICS PRESS, Dept. 1056, 200 E. Ontario St., Chicago 11

BUY DIRECT and SAVE UP TO 1/2 on ITALIAN ACCORDIONS EASY TERMS



Accordions of famous makes and breath-taking beauty now can be yours! Mail coupon for **FREE** Color Catalog and amazing Wholesale Prices.



5 DAYS FREE TRIAL
• **MONEY BACK GUARANTEE**
• **MAIL COUPON NOW**

TRY BEFORE YOU BUY

World's largest selection direct from Importer to you! 30 models to choose from. **SATISFACTION GUARANTEED** or your money back. Trade-ins accepted. Terms as low as \$10 monthly. Write today!

Big Color Catalog FREE!

Send me Free Color Catalog—full details.

Name _____
Address _____
City _____ State _____

ACCORDION MANUFACTURERS & WHOLESALE OUTLET

2003 West Chicago Ave., Dept. R-106, Chicago 22, Ill.

BOAT KITS
12 Models as low as \$39.95 (freight included). Fiberglass boat covering kits, marine supplies, etc. Free folders.

TAFT MARINE WOODCRAFT
DEPT. PM-10 636-39th Ave. N.E., Minneapolis 21, Minn.

ONLY \$495
Freight included
FREE FOLDER

18 FT CRUISER

WORK FOR THE



GOVERNMENT

START AS HIGH AS \$3,850.00 YEAR
Prepare now for next exams. Other positions start high as \$4,525.00.
Men—Women, 18-55
Mail Coupon.

FRANKLIN INSTITUTE, Dept. Y-93, Rochester 4, N. Y.
(Not Government Controlled) Star Rush FREE:
(1) 36-page book with partial list of U.S. Gov't Jobs. (2) Tell me how to prepare for these tests.

Name _____ Age _____
Address _____

TELEPHONES, TELEPHONE PARTS and WIRE & CONSTRUCTION SUPPLIES



MAGNETO TELEPHONES for Rural telephone lines, construction jobs, factories, farms, camps or summer homes, etc.

BATTERY OPERATED TELEPHONES for Inter-House, House to Barn or Office to Shipping Room telephone service. Handset style or Desk Stand style.

MOTEL TELEPHONE SYSTEM—Simple economical telephone service between office and each cabin. Suitable for roadside Drive-In food service, etc.

ANTIQUE TELEPHONE CABINETS—complete with all parts except generator.

Ideal for Home Hobby Shops. Make beautiful Radios, Spice Cabinets, Liquor Chests and Flower Boxes. **TELEPHONE LAMPS.** Make your own. Beautiful. Different. We furnish the parts or a complete Lamp, if you prefer.

WORM HARVESTER—Dan Mac Magneto—gathers fishworms by electricity.

WRITE FOR ILLUSTRATED BULLETIN "AA" which gives full facts on all of the above.

TELEPHONE REPAIR & SUPPLY CO.
Dept. AA-1 1760 Lunt Ave. Chicago 26, Ill.
"America's Largest Independent Telephone Repair Shop"

WANT HIGH PAY and STEADY WORK?

Get into

DIESEL AND HEAVY EQUIPMENT

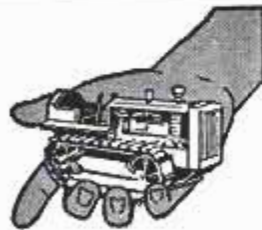

We are now accepting men to train for Diesel and Heavy Equipment. High pay and future security are the benefits of a trained and qualified Diesel man. If you have mechanical aptitude, write to us for free information without obligation as to how you may become a part of this rapidly expanding industry.

MAIL THIS COUPON TODAY!

We will give you complete details about possibilities for you in the Diesel and Heavy Equipment field, without cost or obligation. Fill in the information below, or write at once to:

TRACTOR TRAINING SERVICE, INC., Dept. PM-9

1525 E. 53rd St., Chicago 15, Illinois or
3334A Bloor St., West, Toronto 18, Canada

Gentlemen:
I would like all the facts about opportunities for me in Diesel.

NAME _____ AGE _____

ADDRESS _____

CITY & STATE _____

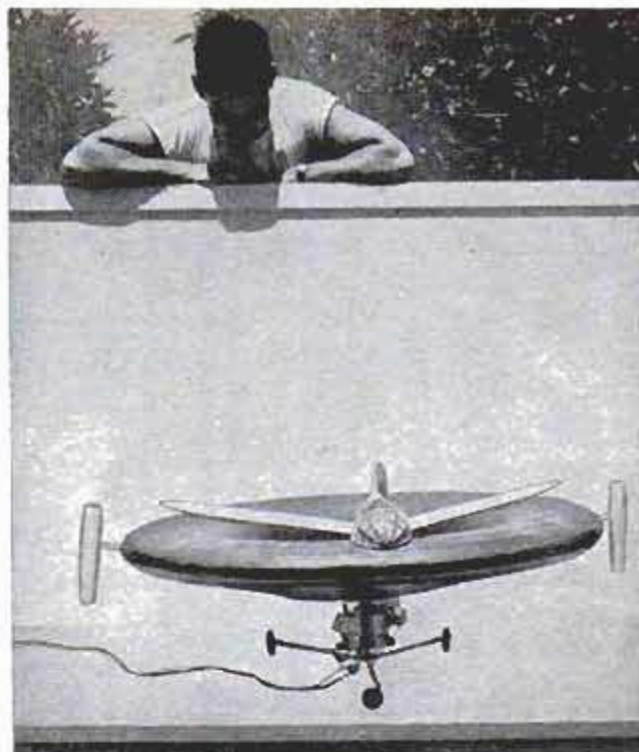

Doctor Builds Model Of Flying Saucer

Employing a venturi in the center of a circular airfoil, a West Coast doctor has built a working model of a flying saucer. The venturi draws air across the airfoil, which creates lift, causing the saucer to rise vertically and hover. The model is 36 inches in diameter with a 12-inch venturi. Power from a three-quarter-horsepower electric motor drives the coaxial propellers in the venturi. The doctor estimates, after testing the model, that an aircraft 18 feet in diameter powered by an 85-horsepower motor, would carry 700 pounds at 150 miles per hour.

First All-Color TV Station Sets Pace for Industry

Television Station WNBQ, in Chicago, recently started telecasting all of its live studio programs in color—the first station in the world to take this step. Ten hours of daily programs in color are planned. Under the compatible-color system, the programs can also be picked up by black-and-white receivers. Conversion of the station to color cost \$1,300,000.

ACTION

STARTS
WITH



HOT TIP
SPARK PLUGS

**The World's Only Pen That Is
GUARANTEED TO WRITE
FOR ONE FULL YEAR**

—or Silver Tip Cartridge Replaced Free!

Exclusive! To introduce sales agents to sensational, immediate profits in their own business. No investment, no inventory for you to stock. Fabulous SILVER-LIFE chrome band and clip Retractable Pens sell themselves—are available only from Academy! Beautiful color combinations, free 2-color imprinting up to 6 lines. We give you everything you need for a secure future in the lucrative advertising specialty field. Send today for FREE starting outfit and details.

3 sample pens—\$1; 1 Doz.—\$3
6 sample refills—\$1; 1 Doz.—\$2

Made to Sell
For \$1 Each!
Satisfaction
Guaranteed
or refund

Academy Ideas, Inc.

Dept. PM-10, 2046 Eastchester Road,
New York 61, N. Y.
In South: Dept. PM-10, 1101 Lincoln Road,
Miami Beach, Florida

NOW NO ONE CAN KEEP A SECRET FROM YOU!

20x-40x-60x TELESCOPE

only \$269

postpaid

Amaze your friends...
See what they're doing—
without being seen!

Special: Order now, get
Free carrying case



3-range all metal
telescope magnifies up
to 60 power. Watch ball
games, look at the moon, stars,
animals, distant buildings... up close.

Rotating eyepiece, bright chrome-like
tube, made for long use. Good on hikes,
camping trips, can use either 20x, 40x, or 60x
power instantly. Opens to 3-times its length. No as-
sembling, ready-to-use, no special instructions required.
Money back guarantee. Send cash, check or money order to:

I. J. STONE, Dept. TB 10, 1616 Oak St. • Santa Monica, Calif.

**HAVE A BIGGER—MORE
EFFICIENT HOME WORKSHOP**

Popular Mechanics PLANNING YOUR
HOME WORKSHOP shows you how to make
use of every inch of space in your work-
shop; detailed floor plans, wiring layouts
and power tool hookups plus actual photo-
graphs of famous home workshops you can
use as models. Save money by building
your own shop furniture. Special Where-
to-Buy-It Guide, 450 Illustrations. Cloth
Bound. Working Diagrams. Order
your copy today from

\$2.50
POPULAR MECHANICS PRESS
200 E. Ontario Street Chicago 11



NSU PRIMA DELUXE II

El. Starter—6.2 HP—Rear Seat
—Bagg. Carrier Spare Wheel—
Speedometer—El. Fuel
Gauge—100 mls. p. gal.—
Baked enamel finish.

Compl. price **\$449.00**



See your nearest NSU
dealer or write for
colorful illus. booklet

BUTLER & SMITH
P.O.B. 45, New York 24, N.Y.



SAY YOU SAW IT IN
POPULAR MECHANICS

FREE! LAFAYETTE CATALOG

- WORLD'S LARGEST HI-FI CENTER
- MORE VALUE—MORE ITEMS
- EVERYTHING IN ELECTRONICS



NAME _____
ADDRESS _____
CITY _____ ZONE _____
STATE _____

Lafayette Radio
165-08 Liberty Ave.
JAMAICA 33; N. Y.
CUT OUT AND MAIL TODAY!

**Make Money
in
ART**

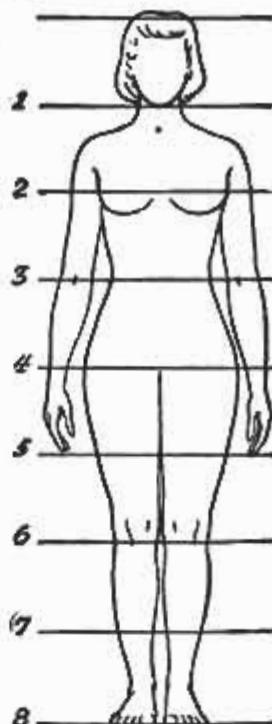

**It's EASIER
Than You Think!**

DRAWING at left shows how
to proportion average hu-
man figure, 8 heads tall. Gen-
eral art instruction has been
simplified same way in our fa-
mous home study course. With
it, you can develop artistic abil-
ity you never dreamed you had
—train for top pay in Illustrat-
ing, Cartooning, Design, Fash-
ion Art, Lettering, Portraits, TV.
Low cost. Individual supervision.

SEND FOR FREE BOOK.

Describes our methods. Lists op-
portunities. Quotes students. No
obligation. No salesman will call.
Mail coupon now. **Washington
School of Art, Studio 1410,
Fort Washington, N. Y.**

WASHINGTON SCHOOL OF ART (Estab. 1914)

STUDIO 1410, FORT WASHINGTON, N. Y.

Send me **—FREE—** illustrated book, "Art for Pleasure and Profit,"
plus free talent test. No obligation. No salesman will call.

Name _____

(Please Print)

Address _____

City _____ State _____



**PLAY
RIGHT AWAY**

ANY INSTRUMENT

**—even if you don't
know a single note now!**

NOW it's EASY to learn ANY instrument. No boring exercises.
Even if you don't know a single note now, we'll have you playing
delightful pieces RIGHT AWAY—right from your FIRST lesson!
And properly BY NOTE. Simple as A-B-C. Make amazing progress.
No special "talent" needed. Learn at home in spare time, without a
teacher. Only a few cents per lesson. Soon you can play any piece you
wish. 900,000 students. (Now in our 58th successful year.)

FREE 36-PAGE ILLUSTRATED BOOK

—Just send this ad, with your name and address filled
in below to: **U. S. School of Music, Studio 3010,
Port Washington, N. Y.** (No obligation, no salesman
will call.)

Name _____

Address _____



"We'll be using them for years..."



...that's why we pick the Brand that's made a Name for itself!"

EVERYTHING that goes into a new house takes a big bite out of the family budget. And it's all too true that you have to live with mistakes you make in buying . . . whether they be appliances, furniture, food, clothing or whatever. So buy brands that have made a name for themselves. You're bound to be satisfied.

FOUR WAYS BRAND NAMES SATISFY YOU MOST

1. BUY WITH TRUST!

Spend *confidently* on known quality. Brand Names wear best, work best, taste best, are best.

2. SHOP WITH EASE!

Spend *efficiently* on proved value. Brand Names save time "puzzling" over labels, models, prices, etc.

3. ENJOY MORE CHOICE!

Spend *shrewdly* among widest selections. Brand Names offer the most in sizes, types, colors, flavors, etc.

4. GET THE "LATEST"!

Spend *smartly* on up-to-date products. Brand Names keep improving, modernizing, introducing new things.



MANUFACTURER



DEALER



CUSTOMER

"I made it!"

"I sold it!"

"I bought it!"

Advertisers in this magazine are good names to know. They're proud of their brands 'cause they satisfy so.

BRAND NAMES FOUNDATION, INC. • 37 Fifth Avenue • New York 16, N. Y.

UNCLAIMED MICROSCOPE SHIPMENT!

Message to Popular Mechanics Readers: We have been fortunate in being able to purchase an unclaimed ocean shipment of student and professional microscopes at about half normal price. We are happy to pass this saving on to you. These instruments make wonderful gifts for adults and boys and girls who have begun to take an interest in nature. Order now. The supply at these prices is limited. All lenses are precision ground optical glass, no plastic lenses.



\$9.99
POSTPAID

MODEL 300 KIT—28 PIECES

INCLUDES TRIPLE TURRET 100X, 200X, 300X MICROSCOPE

and the following pieces of equipment: 1 light with 3 bulbs—6 blank slides—6 covers for slides—1 needle—1 tweezer—1 scalpel—1 eyedropper—4 specimen bottles with cork—2 specimen bottles with cork—1 flask beaker—1 measuring beaker—1 grinder mixer—1 box, approximate size 11"x 16"x 5 1/2"—1 instruction manual.

This model is powerful enough to plainly show microscopic animal life in aquarium and pond water. Thousands are in use in high schools throughout the United States. This complete kit has been nationally advertised at \$22.50.

\$4.99
POSTPAID



MODEL 300 MICROSCOPE

TRIPLE TURRET 100X, 200X, 300X

This is the basic instrument included in the kit shown at left. Purchase price includes a hardwood cabinet and instruction manual. This model is now selling on the American market for \$10.00.

\$28.75
POSTPAID



MD 800 PROFESSIONAL MICROSCOPE

QUAD TURRET—75X, 150X, 300X, 600X

A professional quality instrument for advanced hobbyists, high school and college biology students and pre-med use. Prismatic swivel head, achromatic condenser, six aperture diaphragm, precision rack and pinion focusing. Hardwood carrying case included. A \$50 value.

TO ORDER: Send check or money order. 1/2 deposit for C.O.D. 10-day money back guarantee. Calif. resid. add 4% state tax. All instruments shipped well packed and insured.

the **akron** 4414 SUNSET BLVD., LOS ANGELES 27, CALIF.

MASTER MIND!



Learn Short-Cut Mathematics

Juggle figures, do baffling number tricks. Make people gasp at your marvelous lightning-quick mind. Multiply 4 figures by 4 figures without using old-fashioned multiplication! Big cloth-bound volume; fully illustrated course for self-instruction.

Sharpen up Your Brain Power

Includes worked-out problems, answers, etc. Sensational bargain, only \$3.95 postpaid or COD plus postage. Satisfaction guaranteed or refund. Order this amazing "Short-Cut Mathematics" today!

NELSON-HALL CO., 210 S. Clinton St. Chicago 6, Ill. \$3.95 Complete

Police Auto Alarm

Auto Thefts and Burglaries up 20%

New foolproof invention gives complete 24-hour protection. The instant anyone tampers with your car, a piercing alarm results. Easy to install. 10 year guarantee. Order today! Volume buyers write...

Sample **\$4** Post paid
Retail for \$6.95



GREGORY SALES CO., 2066 East 89th St., Cleveland 6, Ohio

What Every Farmer Should Know About Taking Care of Farm Animals



The Most Popular Veterinary Guide Ever Printed

This practical and helpful VETERINARY GUIDE FOR FARMERS prepares the farmer to perform many routine veterinary tasks—provides quick information that can often save the life of an animal—prevents disease in herds—saves money on the farm in a hundred different ways.

Written in plain understandable language. It covers symptoms, causes of disease and prevention, and treatment of cattle, swine, sheep, horses and poultry and warns when to call in the professional veterinarian. Names, terms and phrases made clear in a separate section. Over 100,000 copies of this book are in use on American farms. 275 pages. Fully illustrated. Only \$3.95. Order today under money-back guarantee.

POPULAR MECHANICS PRESS, Dept. 1056 200 E. Ontario St. Chicago 11, Ill.

BIG MONEY AWAITS MEN TRAINED IN

TELEVISION — RADIO — ELECTRONICS — RADAR

Only CTS offers COMPLETE TRAINING in all phases of Electronics. Why be satisfied with less? You learn by working with actual equipment. Comprehensive Training Program allows you to EARN AS YOU LEARN.

19 TRAINING KITS INCLUDED!

You receive a Multi-Tester, Oscillator, Signal Tracer, Electronic Timer, Regenerative Radio, 24" TV set (optional) and other valuable testing equipment. FREE BOOK and TWO FREE LESSONS sent on request. No obligation.



Send for 3 FREE BOOKS!

CHRISTY TRADES SCHOOL, 4804 N. Kedzie, Dept. T-803, Chicago 25

NEW!



Woodshop Tool Maintenance

Fully Illustrated Coverage of Sharpening and Conditioning Hand and Power Tools!

Features unusual displays and spectacular presentations that show how to keep tools in condition.

CUNNINGHAM & HOLTROP . . .
(#1 in coupon) **\$7.00**

- ART OF TILE SETTING
Carls & Wines . . . (#2 in coupon) **\$3.95**
- ART OF BRICKLAYING
Ray . . . (#3 in coupon) **\$4.50**
- WATCH REPAIR
Kelly . . . (#4 in coupon) **\$4.75**

GUARANTEED MONEY BACK
within 10 days if not satisfied

CHAS. A. BENNETT CO., INC. \$. . . Enclosed
7416 Durac Bldg., Peoria, Ill. Sent C.O.D.
Send book(s) circled: 1 2 3 4

Name _____
Address _____ City _____ State _____

PREPARE FOR THE BEST JOBS

IN INDUSTRY

TRAIN at HOME
IN YOUR SPARE TIME
or at
ALLIED INSTITUTE
in Chicago

- MECH. ENGINEER
- DRAFTSMAN
- TOOL DESIGNER
- TOOL ENGINEER
- TOOL & DIE MAKER
- MASTER MACHINIST

NO RECESSION FOR ALLIED TRAINED MEN

MORE JOBS THAN GRADUATES Shortages of Draftsmen, Designers, Tool Engineers, Machinists, Tool & Die Makers are so widespread that you can pick a highly paid key job and look forward to Achievement and Security.

You can begin your training in Short Courses and continue progressively to a Bachelor Degree in 26 months.

Allied is approved by Industry, Dept. of Education, Office of Public Instruction, State of Illinois, U. S. Veterans Admin., U. S. Dept. of Justice. Accredited: C. S. A.

SEND FOR
FREE
BOOKS

ALLIED SCHOOL of MECHANICAL TRADES
1338-42 South Michigan Ave. Dept. PM-10 Chicago 5, Illinois

SEND ME WITHOUT OBLIGATION INFO. ON YOUR COURSES:

HOME STUDY RESIDENT VETERAN NON VETERAN

NAME _____

ADDRESS _____ AGE _____

CITY _____ COUNTY _____ STATE _____

**"TOOK IN \$217
FIRST 10 DAYS"**

Some make more, some less

We help you to start Your Own All-Year Business

Make Big Money! With our easily operated, highly efficient wall washer, Chas. Stelle took in \$217 gross in first ten days. E. L. Goss took in more than \$10,000 in one year. E. C. Taber wrote, "I made \$400 gross in two weeks." And no wonder—this machine washes walls 6 times faster and better than by hand. **Your Money-making Opportunity.** Enjoy independence—freedom from bosses, layoffs. Customers everywhere—homes, offices, schools, etc. Expenses low, profits high. No shop necessary; operate from home. Can start spare time until your full time is available.

Loss no time. Get all facts without obligation

FREE BOOK! MAIL COUPON TODAY!

- VON SCHRADER MFG. CO.
- N 10 "W" Pl., Racine, Wisconsin
- Send at once (no obligation) your **FREE** booklet containing information about your
- **WALL WASHING MACHINE** and how I can start my own permanent, profitable business.
- Name _____
- Address _____
- City _____ Zone _____ State _____



An Introduction to Wonderful Worlds for Young Americans!

One pound Uranium Equal to 2,000,000 pounds of coal

the Boy Scientist



A Space Platform May Look Something Like This

New Popular Mechanics Book Packed With Thrilling Facts and Fascinating Information

Get this thrilling Popular Mechanics book for every boy you know. In it, your own boy scientist can pore over the world-shaking discoveries in astronomy, physics, chemistry, sound, electricity, atomic theory and relativity. In the same thrilling pages, he can meet the greats of the world of science such as Galileo, Newton, Franklin, Faraday, Einstein and many others. With its help, he can participate in monumental discoveries by performing the many experiments which are suggested in the book and explained in word and picture.

The Spark That Opens Up a New World

Written by John Lewellen, noted writer of a dozen books on science and natural history, Preface by Dr. Wilbur Beauchamp, Professor of Education, University of Chicago, who says "the Boy Scientist may well be the spark that starts some boy on the way to becoming a scientist and the Nation's need for scientists is very great."

Finest Gift for Boys Use "Money Back" Coupon

Is there a boy in your family? Then get him the Boy Scientist. It could be one of the most important books he ever reads. Want to send the supreme gift to some boy you know? Then give him the Boy Scientist too. There is no finer gift for any occasion. Sent postpaid to any address for only \$3.95. Order on Money Back coupon now. If not immensely pleased with the book return in 5 days and the entire purchase price will be refunded.



Meet These Greats . . . Know Their Achievements

- Galileo . . . the first modern scientist
- Newton . . . the law of gravity and famous three laws of motion
- Boyle . . . and how gases behave
- Archimedes } . . . and
- Pascal } liquids
- Bernoulli } . . . and
- Huygens . . . and light
- Benjamin Franklin . . . and electricity
- Bequerel . . . radioactive fog
- Einstein . . . theory of relativity
- Rumford . . . heat
- Mersenne . . . the laws of sound
- Tomorrow . . . will bring new discoveries



Prepared in the famous Popular Mechanics easy-to-read and easy-to-understand style. Adults too, will find this a fascinating book.

Library Cloth Binding
6 3/4 x 10 In.
264 Pages
277 Illustrations

Use This "On Approval" Coupon

POPULAR MECHANICS PRESS

Dept. 1056, 200 E. Ontario Street, Chicago 11

Send at once _____ copies The Boy Scientist, \$3.95 each. I understand I may return books in 5 days and you will refund full purchase price.

- Remittance for \$ _____ enclosed. Send postpaid.
- Send COD. I will pay postman.

Name _____

Address _____

City _____ Zone _____ State _____

STOP

CHANGING OIL! BUYING FILTERS!

New Life-Long Filter Made of Cal-si-loy Gives 20,000 Miles per Oil Change!

Best and most startling development in the automotive industry is a new type permanent oil filter made of a recently perfected alloy which not only possesses super-efficient filtering properties, but also prevents corrosive engine acids from forming.

CAL-SI-LOY—A MAGIC METAL! The discovery of CAL-SI-LOY by the Canadian National Research Council makes possible the most perfect filter yet devised! Millions of silvery spherical metal balls are compressed into a solid but porous wall that provides the most efficient filter known. The Life-Long Filter cannot channel, works perfectly in hot and cold climates.

NO OIL FILTER REPLACEMENT! The Life-Long CAL-SI-LOY Filter will outlast your car with only an occasional cleaning. It cleans your oil of impurities—abrasives, dirt, sludge and corrosive engine acids—keeping it clean and fresh for 20,000 miles more between changes. Unlike the old bronze type filter, the Life-Long CAL-SI-LOY Filter keeps your oil bright and clean.

REPELS MOISTURE—CANNOT ABSORB ADDITIVES By eliminating moisture and engine acids, the Life-Long Filter eliminates sludge. All-metal, it cannot absorb the additives in your oil. The entire CAL-SI-LOY filter wall acts as a catalyst to destroy the damaging acids your engine produces. The Life-Long Permanent All-Metal Filter has the greatest filtering surface of any type of filter.

"DOES NOT WEAR OUT MECHANICALLY" SAYS U.S.

BUREAU OF STANDARDS Test after test has proved that if acids, metal particles and dirt can be kept out of your oil, its lubricating efficiency remains unimpaired for 20,000 miles or more. Life Long Filters screen out infinitesimally small particles—smaller than any other type of filter!

SAVES YOU HUNDREDS OF DOLLARS... GIVES YOU NEW

CAR PERFORMANCE! The Life-Long Filter can make your engine last twice as long without overhaul or expensive repairs. You get more mileage from your gasoline and oil, enjoy new pep and performance from your old car!

ONLY LIFE-LONG GIVES YOU THESE IMPORTANT ADVANTAGES!

Guaranteed to outlast your car
Filters the most minute particles
Cannot channel or blow-up
Gives the valuable detergent
your oil
Acts as a catalyst to prevent
acid formation
Repels moisture and prevents
sludge from forming

- Efficient in hot or cold climates
- Cannot be cut by sharp metal particles
- Nothing to wear out
- Easy to install—easy to clean
- Thoroughly investigated by U.S. Patent Office and issued Pat. No. 2716492

MONEY-BACK GUARANTEE The Life-Long Filter is conditionally guaranteed to completely protect your oil for at least 20,000 miles. Free replacement of the unit during the entire life of your car if any mechanical failure develops your Life-Long Filter!

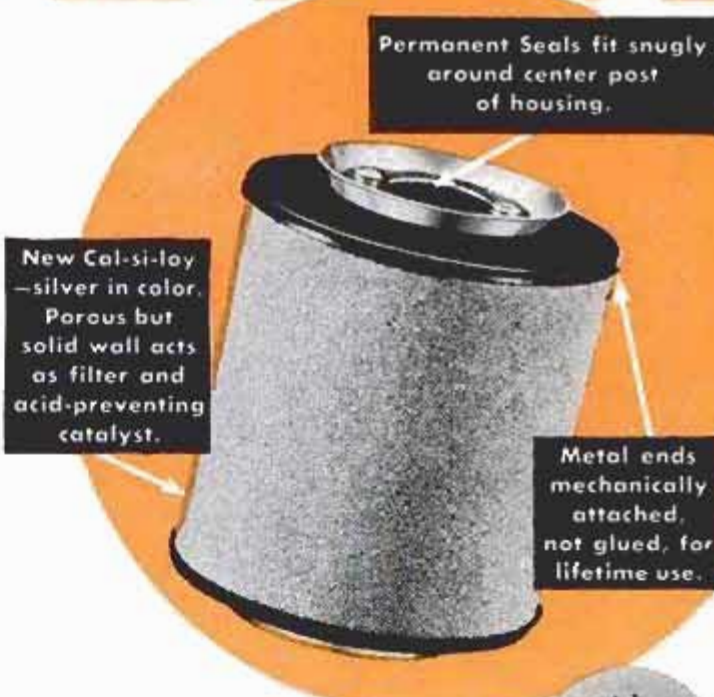

FIFTY MILLION FILTER TRAPS!

Photo A shows the damaging particles present in unfiltered oil after limited use. Photo B shows the particles remaining in oil after filtering through old-style filters after limited service. In Photo C, the harmless, infinitesimal particles remaining after screening through a Life-Long CAL-SI-LOY Filter are not visible even though magnified!

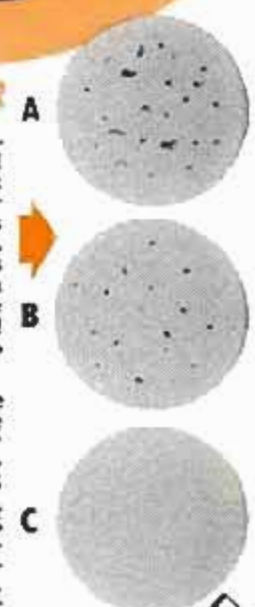

FITS ALL CARS AND LIGHT TRUCKS

You can install the Life-Long Filter yourself in five minutes, and it is easy to clean. Only \$9.95 for all cars using by-pass filters. Full-flow models only \$12.95 (Buick V-8, Olds V-8, Pontiac V-8, '54-'56 Ford V-8 and Mercury, '52-'56 Ford 6 and Lincoln, '46-'56 Chrysler). Housing, only \$9.95. Satisfaction guaranteed or money refunded. Use the coupon below to order direct from the factory!

FREE! CAL-SI-LOY RADIATOR ROD

\$3.95 value! Rids radiators and block of scale, rust and corrosion. Upon receipt of your order for a Life-Long Filter we'll send you a new CAL-SI-LOY Radiator Rod (made of the same miracle metal!) FREE!



LIFE-LONG CORPORATION, Dept. PM-1056
140 Kansas St., El Segundo, California

Please ship me the following at once. Enclosed is \$_____ full price. Factory pays all shipping costs.

- Life-Long By-Pass Permanent Filter @ \$9.95
- Life-Long Full-Flow Permanent Filter @ \$12.95
- Life-Long Filter Housing (needed only where car does not have filter) @ \$9.95

Make, Model & Year Car _____

Filter Cartridge Model & No. now used _____

Name _____

Address _____

City _____ Zone _____ State _____

DISTRIBUTORS WANTED

Exclusive distributor franchises are now available at no cost. Protected territories. Wire, write or phone for full details now.

LIFE-LONG

MANUFACTURING CORPORATION
140 KANSAS STREET, EL SEGUNDO, CALIFORNIA



23
BIG KITS
to build
AIR CONDITIONER
REFRIGERATOR
FREEZER or
MILK COOLER

This CTI Student Is Training at Home in Spare Time for a Big-Pay Job . . .

As a CTI student, you build a complete, heavy-duty, commercial-type refrigeration high-side. You get all parts and tools without extra cost. You do 10 complete troubleshooting and service jobs. You build (and keep) an air conditioner, freezer, refrigerator or milk cooler. Only CTI sends 23 big kits—brings Shop Method training right into your home!

Be a Success — Be Secure in AIR CONDITIONING AND REFRIGERATION

Letters from Students Show Value of Training



"When I came home from the army, there was no work. Thanks to CTI training, I am now employed full time at good wages. I got 3 raises and a bonus. Have my own home."—*Daniel Stevens, Springfield, O.*

"Without the practical and theoretical training I received through CTI, I never could have started a business of my own. I have a small shop. Am financially independent."—*K. Sellman, Guthrie Center, Ia.*

"Am very glad I learned through CTI. I am now an able refrigeration technician. Am earning good wages, find my work interesting. I recommend CTI to any ambitious man."—*A. W. Heindrich, Kewanee, Ill.*



"I find the lessons very interesting and easy. Since my fifth lesson I have been working on refrigerators. I rebuild old ones and sell at a nice profit. Am planning a full time shop."—*W. O. Ward, Mich.*

"Your course proved to be very valuable to me. As a result of your training, my partner and I run our own repair shop. He is also a CTI graduate. We also employ a former CTI student as our outside repair technician."—*J. J. Gieruga, Chicago.*

"My training thru CTI has changed my life. It has changed it from working for bare necessities to my owning a business."—*J. J. Kish, E. Chicago, Ind.*

Do you really want to be a success? Then get into air conditioning and refrigeration! This old, established industry offers security. Because it's growing bigger every day, thousands of new jobs must be filled. Many pay up to \$125 a week and more. Most set the stage for you to open a shop. Find out how you can train at home in spare time. Just fill out and mail coupon for two new books that give the facts. Both are free.



R. C. Anderson
President

Over 150,000,000 Units Need Service and Repair

This is why the air conditioning and refrigeration industry needs trained technicians so badly: Over 150 million units are in use today. Each year, some 3 million refrigerators, 1 million freezers, and 2 million air conditioners are produced. Yet, experts say the surface has hardly been scratched. It takes tens of thousands of trained men to keep commercial and home units in working order.

AUTO AIR CONDITIONERS

It is estimated that this year, over 300,000 new cars will have air conditioners. Tens of thousands of older models also are in the market. Already the auto industry is seeking trained men for this exacting work. Be one!



Earn Cash as You Train

CTI training is so practical that soon after starting, many students do repair work in spare time for profit. It's not unusual for students to have a going business by the time they graduate. Assembling CTI kits, doing real repair jobs, you learn fast. No need to waste years in low-pay apprenticeship.

Training You Can Trust

CTI home training was developed in our own resident shops—thoroughly tested in the field. CTI was the only civilian school to train men in refrigeration for the U.S. Army during WWII. That CTI is way-ahead in home instruction is proved by the practical training kits that we provide. You can't get better or more complete training.

COMMERCIAL TRADES INSTITUTE

1400 Greenleaf Ave. Dept. R-304
Chicago 26, Illinois

Mail me your book *Success In Air Conditioning and Refrigeration*, and *Sample Lesson*. Both FREE.

Name _____ Age _____

Address _____

City _____ Zone _____ State _____

Member National Home Study Council



MAIL COUPON FOR 2 FREE BOOKS

You can have the full story on your opportunities by filling out and mailing coupon. CTI will send you two new books, just off the press. Act today.

• CTI graduates often open shops. You can start a business with a small investment. Start small, grow big!



Get the Facts First—then Decide

**WORLD'S
BEST
WANT-AD
MEDIUM**

CLASSIFIED ADVERTISEMENTS



Advertisements in this section \$1.25 per word, each insertion, minimum 10 words, payable in advance.

To be inserted under proper classification, copy must be in our office the

20th of the second month preceding date of issue

F. W. Johnson, Manager, Classified Advertising

Popular Mechanics Magazine, 200 East Ontario Street, Chicago 11, Illinois

YOU'LL PROFIT

By reading and answering the classified ads in this section. Hundreds of opportunities for you to make and save money

AUTOMOBILES, MIDGET CARS

AUTOMOBILE Design, the complete styling book \$3.00. All other motor books. Free catalog. Automotive Press, 523 Balough, Daytona Beach, Florida.

"MICRO-Midget" sport car. Runs on walk, lawn, street. Boys 9-16, \$99.50. Free literature. Micro-Midget, 940 N. 23rd St., Omaha 2, Nebr.

BUY Surplus jeeps, trucks; direct from government. List \$1.00. Box 1842AY, Hartford 1, Connecticut.

HUNDREDS Of automobile catalogs—American, antique, foreign; dealer books, glossy photographs, shop manuals; free motor magazines—Offered by non-profit club. Write immediately. Get on free mailing list. Auto Maniacs, Stockbridge, Michigan.

OVERDRIVE Performance. More mileage. Less engine wear. Instructions \$1.00. Remmert, Bixby, Oklahoma.

AUTO SUPPLIES AND EQUIPMENT

AUTO Mechanics make extra money introducing Hove-O-Matic amazing invention. Prevents vapor-lock. Stops flooding. Saves gas. Eliminates traffic stalling. Makes motor purr like a kitten. Free catalog. Hove Engineering Co., 529 S. 7th St., Minneapolis 15, Minn.

SAVE Money on jeep and army truck parts. Large inventory. Catalogs for jeep or GMC. American Auto Parts Co., 1830-PM Locust, Kansas City, Mo.

FREE Discount catalog—Speed, power, custom equipment. Almquist Engineering, Milford 7P, Pennsylvania.

AUTO Accessory and parts catalog. 1956 edition—all new! 180 pages. Save up to 50%. Over 75,000 items, including Hollywood accessories, hi-speed equipment, rebuilt engines, all parts and accessories for all cars and trucks! Hard-to-get parts! Send 25¢ (refundable). J. C. Whitney, 1919-PM Archer, Chicago 16, Ill.

LATEST Custom accessories. Items not in stores. New low prices. Continental wire kits, push-button doors, trunks, etc. New illustrated catalog, biggest ever, 25¢. Eastern Auto, 3319-A South Grand, Los Angeles 7, California.

EXHAUST Manifold paint. Won't burn off. \$1.25 pint. New "A" Ford parts catalog, 35¢. Huber, 15 Emerson, Clifton, New Jersey.

BRAND New first quality tires. Tractor, truck, aircraft, passenger. Wholesale prices. Also all size army surplus used tires, at tremendous savings. Duddy's, 152 N. Beacon Street, Boston, Mass.

GOT A mechanical skill? You can get ahead fast as auto claims adjuster. Terrific profit opportunities. Over 40 million auto losses urgently needed claim investigation past year. Free book. Universal Schools, 6801 Hillcrest, PM10, Dallas 5, Texas.

1956 SUPERIGNITIONER: Starting, pep, mileage \$4.50. \$38 barbells \$29.75. EG. Eimsford, N. Y.

GAS Mileage: Three simple ways to improve your cars' fuel economy, \$1.00. Mileage, P.O. Box 781, Minneapolis, Minn.

CRANKSHAFT Grinder, hand operated. Makes bearings fit without taking engine apart, \$3.75. Literature. L. D. McGee, 719 Cascade St., Wenatchee, Wash.

SENSATIONAL (Patented) 100,000 mile motor treatment. "Lachapelle's" renews compression, power. Saves gas, oil, repairs, \$3.00 delivered. Money-back guarantee. You can't lose. Free circular. Write Joe Dillon, Authorized Warehouse, Agents Distributor, Box 32321, Bridgeport, Ohio. Exclusive agencies.

NEW And used parts at savings. Complete guaranteed parts service for all models cars and trucks—1924 and later. Largest in the West. Army parts specialists. No catalog. Submit your needs for quotations. Fast mail order service. Pioneer Auto and Truck Parts Co., 734 W. 13th Ave., Denver, Colorado.

JEEP Owners—V8 power. Read Jeep owners ad, page 22.

MOTORISTS! Eliminate costly repair bills! Amazing scientific discovery economically restores "new car" performance. Any age, condition. Seals worn pistons; increases power, compression; saves gas, oil; lubricates. Easily applied. Results guaranteed, \$2.50 (postpaid or c.o.d.). Free information. Compression Seal, 1781 Orchid Avenue, Hollywood 28, California.

CAR Burning oil? Losing compression? Try Clifford's Compression Seal. Tube, \$2 postpaid. Clifford's Engineering, 452 Claim, Aurora, Illinois.

PISTONS. Olds 4" plus. Chevrolet 3 3/4, deflector top, \$41.00 a set. Dempsey Wilson Camshaft Co., 4667 Rosecrans, Hawthorne, Calif.

THIEVES. Vandals run from automobile equipped with police auto alarm. Sample \$4.00 postpaid. Retail \$6.95. Easy to install, 10-year guarantee. Volume buyers. Write Gregory Sales, 2066 East 89th Street, Cleveland 6, Ohio.

AUTO TRAILERS

EXCEPTIONAL Expanding eight foot trailer. Accommodates family of five. Build yourself. Literature 10¢. Framar Company, Wilmington, Mass.

MOTORCYCLES, BICYCLES, MOTORSCOOTERS AND SUPPLIES

PARTS. Pistons, new, used. Harley, Indian, Henderson, list 10¢. Ballak, 811 N. 9th, St. Louis 1, Missouri.

RECONDITIONED Motorcycles and motors. Chromium accessories. Complete stock Indian parts. Expert rebuilding. Fast service. Indian Motorcycle Sales, Kansas City 27, Missouri.

HARLEY-Davidsons—Used bargains, shipped prepaid. New, used parts, accessories for current and obsolete models. Bulletin, catalog 25¢. Knuth's (factory dealer), 2491 Fond du Lac, Milwaukee, Wis.

BICYCLE Shock absorbers, \$5.95 postpaid. Leaflet. Thomas, Box 1873, Oakland, California.

HEY Kids! Boys, girls. You can have continuous bright head and tail lights on your bicycle. No batteries to buy. New, amazing generator keeps lights bright. Lasts lifetime. Complete generator light kit \$5.00. Free details. Langen, 170 High, Fitchburg, Mass.

BICYCLE Supplies. Substantial savings. Free delivery. Attleboro Cycle, Attleboro, Massachusetts.

SERVICYCLE \$8. Midget motorcycle \$10. Cushman motorscooter \$10, midget car \$25 less engines; Briggs engine \$4; four airplane tires \$3. (Mailorder only). Send 25¢ (35¢ for first class mailing) for directory-catalogue number 73, just out, listing these and hundreds of other bargains, homebuilders parts, plans, etc. Midget Motors Directory, Athens, Ohio.

PARTS For Cushman, Doodle-Bug, Salsbury, etc. Send make, model, 25¢ for price list. Motor Scooter Parts Co., Dept. P10, Box 7211, Indianapolis 1, Indiana.

AVIATION

AVIATION Surplus bargain catalogue. One dime. Box 22PM, Thomasville, Penna.

PROPELLERS. Plans, supplies by world's oldest and largest manufacturer of special design airboat and snowplane propellers. Latest designs. Prompt delivery. Satisfaction guaranteed. 48 page catalog 25¢. Banks-Maxwell, Box 3301E, Ft. Worth 5, Texas.

BUY Surplus aircraft; fuselages; accessories; engines; instruments; electronics—Direct from U. S. government depots. List and procedures \$1.00. Brody, Box 8-PMC, Sunnyside 4, New York.

BATTERIES, GENERATORS

EDISON Nickel storage batteries. Any voltage, any amperage. Unconditionally guaranteed. Power plants, generators, motors. Literature. Hawley Smith Co., Croton Falls 1, N. Y.

ELECTRICAL SUPPLIES

LAMP. Electrical parts, wholesale. Thousands of items for repairing, converting. Catalog 25¢. Brown Lamp, Box 305, Clayton 5, Mo.

CONDUIT Bending data. Plastic, pocket-size, 40¢. Pal-Notes, Underwood, N.D.

LAMP Parts—Wholesale catalog. For repairing, converting, and mounting. Lamp Specialties Co., 322 Washington, Newark 2, New Jersey.

LAMPS—Parts catalog showing wiring instructions, 25¢. Gyro Lamps, 5402P Clark, Chicago 40.

ELECTRIC Pencil: Engraves all metals \$2.00. Beyer Mfg., 10511-H Springfield, Chicago 43.

WELDING, SOLDERING, PLATING

BUY Welding supplies direct from manufacturer. Cable, welding rods, helmets, etc. Portable arc-welders and kits at tremendous savings. Free factory catalog! LeJay, 2907 Emerson Ave. So., Minneapolis, Minnesota.

NEW All-in-one oxyacetylene outfit welds sheet, plate; cuts heavy steel; heats; brazes. Uses interchangeable tips. Portable, easy to operate. Complete with instructions, \$75.50. Gas cylinders on special moneysaving plan. Write for free information: Dept. M, Linde Air Products Company, 30 East 42nd Street, New York 17, New York.

WELDERS, 110 Volts—1/2" metal \$6.95 plus 50¢ postage, 1/4" metal \$21.95 f.o.b. Complete ready to use. Essay Mfg. Co., Dept. B, Quincy 69, Mass.

"BUILD-UR-OWN" a.c. welder and a.c. power plant with a good used engine and low cost Hobart generator. Welds anywhere and supplies 5kw stand-by power for any emergency. Write Hobartweld, Box M-1063, Troy, Ohio.

ACETYLENE Welding outfits new \$54.50; used \$34.50; arcwelders \$56.50. Eagle Welding, Dept. PM, 5085 Broadway, Chicago 40, Ill.

ALUMINUM Soldering, Lam Flux. Solders aluminum like other metals. \$2. No c.o.d. Lampe, Box 371, Lindenhurst, N. Y.

BUILD 300-Ampere welder using aircraft generator. Plans 10¢ including big catalog welder-kits, generators, winches, motors, hydraulics. Dunbar Mfg., 6600 Sylvan, Houston 23, Texas.

A.C. Welders, 4 sizes. Lowest prices. Free literature. Holgeron's Serv., Canton, Kan.

WELDERS, 110/220, \$39.50. Morris, 1070 Inner Drive, Schenectady 3, New York.

ELECTROPLATING Equipment, anodes and solutions for all types of plating. Instructions. Assemble your own plater and save. Free catalog. Ramyr, Dept. E-4, 1624 East First Street, Los Angeles 33, California.

MACHINERY, TOOLS, SUPPLIES

WOODWORKERS—Sensational new tools save you money. Write for free catalogue and homeshop notes. Lee Tools, Box 22PM, Rochester 17, N. Y.

CUSTOM Made blanking dies \$50.00 and up. Custom manufacturing. Southwestern Specialty Co., Box 3506, Sta. A, El Paso, Texas.

BUILD Your own tools. 60 page book of drawings and catalog of castings. \$1.00. Casting Specialties Co., Thiensville 11, Wis.

SAW Sharpening equipment? Buy? Sell? Used. Saw Filers, 316 North 2nd, Maywood, Illinois.

LAWNMOWER Sharpeners: \$59.75 to \$259.50 until Jan. 1. Turner-Cline, 430 Yellowstone, Pocatello, Idaho.

ENGINES, MOTORS, DYNAMOS

A.C. Generators, 750 watt \$42.00. 1500 watt \$67.50; motors, 5 horse \$110, 3 horse \$87.50, 1 horse \$38.50. Butler, 1885 Milwaukee, Chicago.

REWIND Motors yourself. Complete instructions \$1.00. Lewis Mfg., Howell, Michigan.

WINDING Data. 275 motors, single and three phase, \$1.10. Data Company, Box 7631, Kansas City 28, Mo.

SMALL Electric motors. Bargains. Literature free. Kitco, Dept. 5, Box 212, Monroe, Wisconsin.

INJECTOR Used parts wanted. GM71-110. Bares, 7120 Carnegie, Cleveland 3, Ohio.

1/2 **HORSEPOWER** Electric motors, a.c. 110, used, good \$5.00 each, f.o.b. Plant Machinery Corp., Richmond & Norris Sts., Philadelphia 25, Penna.

BOATS, OUTBOARD MOTORS

FIBERGLAS Permanent boat waterproofing. Special 25% summer discount. Complete kits, \$9.45 up. Guaranteed materials. Easy application. Full instructions. Free literature. Ajax Plastics, Dept. PM, P.O. Box 1323, Fort Worth, Texas.

MARINE Conversions for Ford and Jeep engines. Catalog 25c. Lehman Manufacturing Company, 972D Broad Street, Newark 2, New Jersey.

FORDS And Jeeps 100% marine engines with famous Convo-Kits. Deluxe catalogue 25c coin. Oscomotor's, 3627B Lawrence, Philadelphia 40, Penna.

NEW, Used, rebuilt marine motors. Marine conversions, fittings. Free catalog. Stokes Marine Supply, Dept. 24, Coldwater, Michigan.

BOAT Plans—Full size patterns. Frame kits. Modern inboard and outboards for amateur builders. Complete new catalog 50¢ or specify requirements. Glen Designs, Box 568, Compton, Calif.

FIBERGLAS Boat coating. Plexiglas boat windshields—Clear, blue, green tints. Wholesale-retail. Instructive information catalog free! Gem-O'-Lite, 5529 Cahuenga, North Hollywood, California.

"GLASBOTE" Plastic and glass cloth for boat covering. Complete information and material price list free. Buchanan Plastics, 1728 Hamilton Road, Okemos, Michigan.

PLYWOOD Boat plans, 21 for \$1.00. Catalog boat building plans 25¢. The Rudder, 15 Murray Street, New York City 7.

FULL Size, cut-to-shape boat patterns, blueprints, 7 1/2-38 feet. New 1956 illustrated 85 page "Build-A-Boat" catalog of naval architect-designed cruisers, runabouts, sloops, skiffs, outboard boats, sailing, racing, houseboats, 50¢. 1956 "How to Build a Boat" booklet, \$2.50. Cleveland Boat Blueprint Co., Dept. A-66, Box 1651, Cleveland 4, Ohio.

MARINE Conversion, Willys to Cadillac, engines, kits and parts. Catalogue and conversion hints free. Barr Marine, 2706 Castor Avenue, Philadelphia 34, Penna.

FREE Catalog! Boat kits, trailers, fiber-glass, marine hardware. Luger Industries, Dept. M, 3404 Lyndale Ave. So., Minneapolis, Minn.

AIRBOATERS. Make your Continental aircraft engine self-starting with our starter-generator kits. Complete, less cables, batteries, \$49.95. Write—Midwest Airboat Starter Co., Tyler, Minn.

FIBERGLASS Boat coverings wholesale prices. Free literature, samples. Seifert's, Box 31K, DePere, Wisconsin.

PLANS Catalogs: Powerboat 50¢, sailboat 25¢. Marinecraft, Box 161-M, Brighton, Mass.

ATHLETIC EQUIPMENT, BODY BUILDING COURSES

BARBELLS, Dumbbells. Courses. Free catalogue. Good Barbell Co., Reading, Penna.

OUTSTANDING Physical development! New guaranteed system uses only a rope! Strength, health, gain, reduce. Valuable booklet free. Roperdisc, 4834 Art St., Room 205, San Diego 15, California.

DISABLE Any bully, with two fingers. Secrets, Ju-Jitsu, 96 pages, illustrations, \$1.50. Seico, P.O. Box 38, Cooper Station, New York 3, N. Y.

SPORTING GOODS, GUNS, FISHING TACKLE, ARCHERY, TRAPPING

JAP Rifle altering to 30-06, \$6.00. Jap-shells, \$3.75. Catalog 5¢. T. P. Shop, West Branch 11, Mich.

5000 BARGAINS, Firearms, binoculars, war relics. Catalog 50¢. Smith Firearms, Runnemede, N. J.

DIVING Equipment for skin divers and professional divers. Send 25¢ for catalog and decompression chart. Desco, 212 N. Broadway, Milwaukee 2, Wisconsin.

SAMPLE: 25¢ Copy of "The Archers' Magazine." Send 10¢. 1200 Walnut Street, Philadelphia 7, Pennsylvania.

MOLDS For fisherman's sinkers, jigs, squids, casting and spinning lures. Free catalog. Sweet's Molds, Tonawanda 1, New York.

FORTUNE Possible raising crickets and 12 inch African fishworms. Free literature. Carter Ranch, Plains, Georgia.

NYLON Rope, lines, cords. Every description for all household and sportsmen's uses. Finest made. Free catalog and samples. Beebe Cordage Co., Cranford 8, N. J.

BOWLERS Proven strike method. Top scores. Start today. Speedy, accurate. \$1.00 postpaid. 5 day return guarantee. Bowlers Research, 11 East 53 Street, New York 22, N. Y.

CAMPING Equipment, tents. Direct from manufacturer. World's largest selection. Send 15¢ for 120-page 1956 tent and camping equipment catalogue-handbook. Morsan Tents, 10-21R, 50th Ave., Long Island City 1, New York.

FREE Below wholesale fishing catalog. Fishing Tackle Mart, Dept. 510, Box 6737, Chicago, Ill.

\$10,000 YEAR Possible. earthworms. 32-page booklet tells how, 35¢. Missouri Earthworm Research, Box E6851, Kansas City, Missouri.

180 PROFUSELY illustrated pages antique pistols, swords, daggers, armor, etc. 50¢. Robert Abels, M860 Lexington Ave., New York City 21.

GOLFERS: "Six Lessons from Johnny Revolta." Send 10¢ to Golf Digest, Box 550 A, Evanston, Ill.

HOW To catch fish, scent secrets. 10¢. Johnston's, 312 Lake Avenue, Ithaca, New York.

RIFLE Specials! Krags, \$39.50; Jap 6.5, \$29.50; Jap 7.7, \$19.50; Russian 30, \$19.95; Mauser 8mm., \$29.50-\$44.50; Swiss, \$16.50. Super bargain catalog 50¢. Agramonte's, Yonkers 2G, N. Y.

START Your own fishing lure business. Send \$2.00 for 20 beautiful flatface lures (less hooks) returnable. Quaker City Mfg. Co., 3514-24 N. Lawrence St., Philadelphia 40, Penna.

FIELD Duck and geese decoys. None better. Details free. South End Lumber, P.O. Box 434, Brandon, Manitoba, Canada.

FREE Giant handbook! "How to Bow-hunt and Bowfish" 100's revealing secrets! Also tells how to improve shooting accuracy, select best equipment, make your own tackle, etc. Illustrated! Yours free with large bargain catalog. (Save 50% on archery equipment). Send 25¢ to cover mailing expenses refunded on first purchase. Supply limited! Hurry! Malibu Archery, 1036ROR South La Brea, Los Angeles 19, California.

FREE Fishing catalog—132 pages. Over 3000 hard to find fishing specialties. Netcraft Company, Dept. PM10, Toledo 13, Ohio.

CAMPERS, Scouts. Send \$5.95 new all in one camping knife kit. Guaranteed. Stainless steel. Compact utensils. Camper, P.O. 53PM, Glendora, California.

PLAYGROUND Ball repair, \$1.00. All makes. Skin diver suits. All rubber and fabric inflated items. Vulcanizing. You pay postage. Rubber Repair, 4979 University, San Diego, Calif.

JEOP Owners—V8 power. Read Jeep owners ad, page 22.

FREE—Giant 1957 wholesale sporting goods catalog. Lowest wholesale prices. Complete line of cameras, sporting goods, appliances, outdoor items. Write today. Santa Fe Distributing Co., 1321 Main St., Dept. PM, Kansas City, Missouri.

BINOCULARS, TELESCOPES, MICROSCOPES, MAGNIFIERS

MICROSCOPES, Telescopes, binoculars, surveying, everything optical, photographic. Importers prices. 25¢ catalog. Magnification Instrument Co., 2 East 45 St., New York City.

DYNASCOPE—Sensational new reflector telescope. Send for details. Criterion Co., Dept. DP 25, Hartford, Conn.

SALE! United binoculars. Ideal Christmas gifts. \$3.95 to \$250.00. Free 56 page binocular-telescope catalog. United, 9043 S. Western, A-908, Chicago 20. Dealers wanted.

BUILD Your own reflector telescope. Complete kit: Mirrors, eyepieces, tripod, all other accessories. Request free illustrated literature. Criterion Manufacturing, Dept. KPM 22, Hartford, Conn.

FREE Binocular information. Write Sheehan & Company, Dept. A20, 1420 Kipling, Houston 6, Texas.

MICROSCOPES, 100X below import cost. Reg. \$4.95. Now \$1.95 plus 50¢ pp. Rush order, limited quantity. Magnification Instrument Co., 2 East 45 St., New York City.

400X Telescopes easily made. Kit includes focusing tube, erector, five finished lenses and building instructions—\$3.75. Free booklet on completed telescopes, tripods, mirrors, lens kits, etc. Suffolk Science, Mattituck 3, New York.

REFLECTING Telescope, 60X, completely assembled \$29.75. Guaranteed observatory clearness. Free information. SkyScope, 475 Fifth Avenue, New York City 17.

AMAZING Prices, precision binoculars and gunscoops. Free trial. Folder, "Binocular Selecting," catalog free. Prentiss Importers, Mercury Bldg., West Los Angeles 25, Calif.

BINOCULARS, Telescopes, microscopes. Terrific values \$3.98 up. Request free money-saving catalog. Criterion, Dept. P 47, Hartford, Conn.

REFLECTOR Telescope kits \$6.25 (3") to \$175 (12"). Mirrors, cells, focusing mounts, tripods, eye systems. Anything, everything in telescopes. Free catalog. Also ready to use telescopes from \$25. Esco Products, Oakridge, New Jersey. Showroom, 166 Church Street, New York City.

MICROSCOPE Catalog free. Research Scientific Supplies, 60 Wall St., New York City 5.

WAR Surplus bargains: Millions of lenses, instruments, telescopes, binoculars, components and complete line of astronomical telescope items. World's greatest optical market place! Send only \$1.00 for beginner's 10-lens kit and big instruction booklet Stock 2-CH. Write for catalog CH, free! Edmund Scientific Corp., Barrington, New Jersey.

PETS—DOGS, BIRDS, RABBITS, HAMSTERS, ETC.

HUNTERS! Raccoon Mountain and Short Creek kennels now combined. Large number of coonhounds, foxhounds, rabbit-hounds, beaglehounds, bird-dogs, puppies. Free literature and pictures. Trial. Dures Thomas, Owner, Box 464, Boaz, Alabama.

HAMSTERS, Pair \$2.95. Free booklet. Jer-Fre's Hamstery, 2425 Hoyt, Muskegon Heights 13, Mich.

MINK Raising information free. Complete. Lake Superior Mink Farm, Superior, EEl, Wisconsin.

RAISE Rabbits successfully by knowing facts. 48 page illustrated book describing 25 breeds. Housing, feeding, breeding, marketing, etc. Plus bulletin, 25 cents. American Rabbit Association, 36 Arba Building, Pittsburgh, Penna.

STANDARD Rabbit Journal, Milton 3, Penna. Year \$1.00. Sample dime. Beginner's manual 25¢.

RAISE Mink; Free booklet, pen plans, inside secrets, feed, care. Mink are money makers. Investigate today. Lawrence Mould, Brigham City 12, Utah.

MAKE Money raising chinchillas, mink, nutria, rabbits, cavies for us. Free catalog. Keency Brothers, New Freedom 2, Penna.

GROW Mushrooms. Cellar, shed. Spare, full time, year round. We pay \$3.50 lb. We paid John Betts \$7,977.76, he started as amateur. Free book. Mushrooms, Dept. 171, 2954 Admiral Way, Seattle, Wash.

SPORTSMEN: World's largest kennel offers 500 Pointers, Setters, Straight Cooners, Combination Hounds, Rabbit and Squirrel Dogs, Beagles, Fox and Wolf Hounds. Trial. Prices reasonable. Catalogue free. Smokey Mountain Kennels, Cleveland, Tennessee.

PROFITS! Raise Nutria beavers. Herb Miller, 513 Kent, Lubbock, Texas.

HAMSTERS, Golden: young, \$3.00 pair. Fully developed \$4.00 pair. Adirondack Hamstery, Prospect 160, New York.

WHITE German Shepherd puppies. Theatrical dog tricks. Knoff, Nashotah, Wisconsin.

FOR Reptiles, wild animals, birds, pets, curios: Write Ross Allen's, Silver Springs, Florida.

CHINCHILLAS. Registered. Graded. Free cage. Stewart Chinchilla Ranch, Washingtonville, N.Y.

EXTRA Money raising Angora, New Zealand rabbits. Write Martin's Rabbitry, Morganfield, Ky.

HUNTERS. Fine hunting hounds. Reasonable. Trial. Free list, pictures. Okaw River Kennel, Cowden, Illinois.

SAINT Bernards. Registered. Large. Healthy. Poling's Kennels, R. 2, Elida, Ohio.

BREEDING Pairs of violet and 40 other varieties of parakeets shipped anywhere. Breeders of Budgerigars, 64 Kamper St., Buffalo 10, N. Y.

PEDIGREE Police puppies. All colors including white. Ansonia Kennels, Mose, N. Dak.

RAISE Rabbits on \$500 month plan. Plenty markets. Free details. White's Rabbitry, Dept. 120, Mount Pleasant, Michigan.

PLANTS, SEEDS, BULBS, NURSERY AND GARDEN SUPPLIES

WORLD'S Greatest cash crop. Free information. Write Ginseng Gardens, Asheville, N. C.

GINSENG, Goldenseal, Roots bring up to \$12 pound. Full information. F. M. Collins, Viola, Iowa.

RAISE Your shrubs, trees from seed. Free planting guide, price list. Woodlot Seed Co., Norway 9, Michigan.

MERION Blue grass plugs, 100 for \$4.95. Bayer Gardens, Rt. 1, Neenah, Wisconsin.

LIVE Xmas outdoor planter. Spruces, 18-inches, 5 for \$4.95 prepaid. Order before Oct. 25. Bayer Gardens, R. 1, Neenah, Wisconsin.

FARMS, FARM LANDS, REAL ESTATE

HOMESITES \$15 Monthly—California's finest garden section. Morro Bay's scenic shores. Wonderful fishing, boating. Fertile soil, softest water, temperate climate, congenial community. Free literature. Richard Otto, Department M, San Luis Obispo, California.

TAXLESS Homes. Florida's Highlands. Informative literature. Theodore Gau, San Antonio, Florida.

FLORIDA. Nice homesites, \$245 at \$10 monthly. Folder free. Howard Vernor, DeLand, Florida.

500,000 ACRES California state government land low as \$5 acre minimum offer. Send 10¢ (coin) for information on available lists and maps of 40 to 640 acre tracts. Pacific Lands, 7419-F Beverly Blvd., Los Angeles 36, California.

FREE Information. Government land. U.S., Alaska. Sledge Surveys. Macon, Mississippi.

FLORIDA—Beautiful homesites, 80 by 135 feet, only \$250, payable \$10 monthly. Near booming Panama City pleasure resort. Many lakes, streams. Wonderful fishing, hunting. 20-acre winter garden farms, money-making tung groves. Low prices, easy terms. Booklet free. Wendell Wood, Fountain, Florida.

OZARKS! \$8 Acre. Listings, information free. Write: Armstrongs, Shook, Missouri.

TEXAS Resort sites \$149.50, \$5.00 down. \$5.00 month. Send for map, photos, literature. Healthy, scenic ranch. P. M. Matlock, Pipe Creek, Texas.

LOOKING For a ranch? For the best see Bill Thach, Southern Colorado Land & Livestock Co., Walsenburg, Colo.

FLORIDA Bargain homes. Low taxes. Cummins Realty Agency, Box 848, Eustis, Florida.

BIG Strout catalog! Mailed free! Farms, homes, businesses, bargains galore! Accurate, reliable descriptions of over 3000 properties in 36 coast-to-coast states! Livestock, equipment often included, many with low down payments and easy terms! World's largest. Serving you 56 years! Depend on Strout Realty, 7-MF S. Dearborn St., Chicago 3, Ill.

PROFITABLE OCCUPATIONS

HOW To fix watches overnight. Do-it-yourself method. 70 drawings, 65 troubles, wholesalers listed. Manual \$1.00. Guaranteed. Weber Service, Box 2489, Denver 1, Colorado.

WELDING Pays big money. Learn easily at best equipped school in country. Non-profit school with low cost training. O.I. approved. Write Hobart Trade School, Box M-1062, Troy, Ohio.

BUY Wholesale thousands nationally advertised products at big discount. Free "Wholesale Plan." American Buyers', Hertel Station, Buffalo 16-B1, N.Y.

MAKE Money writing short paragraphs! No tedious study. I tell you what to write, where and how to sell; and supply list of editors buying from beginners. Many small checks add up quickly. Write to sell, right away. Send for free facts. Benson Barrett, Dept. CP-27-X, 7464 Clark, Chicago 26.

LUCRATIVE! Plumbing drain cleanout service. Experience unnecessary. Postcard to: Gycc, Palm Beach, Florida.

60% PROFIT Cosmetics. \$25 day up. Hire others. Samples, details. Studio Girl Hollywood, Glendale, Calif., Dept. 12610-H.

VENDING Machines—No selling. Operate a route of coin machines and earn amazing profits. 32-page catalog free. Parkway Machine Corporation, Dept. 25, 715 Ensor Street, Baltimore 2, Maryland.

HOME Mailorder beginner's manual, 25¢. Carnahan Bros., 9610 Acacia, Fontana, Calif.

PHOENIX Help wanted and business opportunities classified section mailed \$1.00. Pearce, 95 E. Weldon, Phoenix, Arizona.

GROW Dwarf fruit trees indoors. Fortune possible. Full secret \$1.00. P. Reinhardt, 3203 So. 22nd St., Saint Joseph, Missouri.

MAGAZINE Subscriptions—Largest commissions bonus. Qualified Agency, 451KA Kingston, Brooklyn 25, N. Y.

RAISE Rabbits on \$500 month plan. Plenty markets. Free details. White's Rabbitry, Dept. 121, Mount Pleasant, Michigan.

EVERYBODY Likes candy. Learn to make professionally home. Our 45th year. Ragsdale Candies, D6, East Orange, New Jersey.

MAILORDER Can be your future! Ten thousand word fact-packed book outlines 30 years successful experience, 25¢. KR, Box 503P, Iowa Falls, Iowa.

TO \$50 For poems—Greeting cards, magazines. Information free. Hobbies, 1603-B Sun Valley, Austin, Minnesota.

WHOLESALE Catalog! 30-80% discounts! Appliances, musical instruments, typewriters, tools, watches, jewelry, cameras, housewares, etc. Consolidated Distributors, 1300-14 Main, Clifton, New Jersey.

YOUR Own wholesale business without investment. Free catalog. Norris, 487-X Broadway, New York City.

BE Your own boss. Start a buying service. Buy wholesale thousands nationally advertised products. Make big profits from over 3,000 suppliers. Free details. Associated Wholesalers, 1016-DD Starr, Burlington, Iowa.

BUY Wholesale! Discounts to 80%! Appliances, cameras, sporting goods, tools, watches, housewares, etc. Free catalogs. Buy-Rite, Box 258-C, Hawthorne, New Jersey.

LEARN Free how to become glamour photographer. Make big profits photographing beautiful models. Opportunities nation-wide. No previous experience or expensive equipment needed. Write for free illustrated Success Plan. Harrison's, 1031-C Magnolia Park Station, Burbank 20, Calif.

GROW Mushrooms. Cellar, shed. Spare, full time, year around. We pay \$3.50 lb. We paid John Betts \$7,977.76, he started as amateur. Free book. Mushrooms, Dept. 99, 2954 Admiral Way, Seattle, Wash.

FOREIGN Jobs—Latin America, Alaska, Canada, up to \$1500 monthly. Up-to-date 1936 foreign service directory gives complete information; hot list of firms hiring for military and civilian construction, aircraft, oil, exporters-importers, mining, \$1.00. How-when-where to apply. 9th successful year! Global Reports, Box 883-S, Hollywood 28, Calif.

FREE Folio "\$5,000-\$45,000; Unlimited Vacations." No merchandise, equipment. Unknown! Work home, sparetime! Haylings, Carlsbad, Calif.

RAISE Pheasants on \$100 week plan. Little capital and space can make you independent. Free details. Great Central System, Columbus 1, Kansas.

MAKE New greaseless doughnuts in kitchen. Sell stores. Free recipes. Michael Ray, 3605 South 15th Ave., Minneapolis 7, Minnesota.

BE The Popular Mechanics representative in your neighborhood and earn big profits in your spare time. Write Popular Mechanics Magazine, Room 408M, 200 E. Ontario St., Chicago, Ill.

FORTUNE Possible raising fishworms and crickets. Free literature. Carter Wormery, Plains, Georgia.

AUCTIONEERING—Home study course. Diploma granted. Auction School, Ft. Smith, Ark.

FREE Book "505 Odd, Successful Businesses." Work home. Pacific, OceanSide, Calif.

MAKE Flexible molds. Cast plaques, figurines. Free sample. Tooker. 630-M Chestnut, Hamilton, Ohio.

LEARN Real estate by listening to records. Lee Institute, Brookline 46, Mass.

MUSHROOMS Now bring bigger, quicker cash. Spawn plus newest manureless growing, marketing methods. \$1.00. Free literature. Luxur, 641 South 19th, Newark 3, N. J.

BOOKS, PERIODICALS, PICTURES, POSTCARDS

SPARETIME Repeat profits taking subscriptions all magazines. Good commissions. Exceptional special offers. Cassell Agency, Boynton Beach, Florida.

BOOKHUNTERS! Scarce, rare, miscellaneous books. Atlantic Book Service, Cedar Street, Charlestown 29, Mass.

JOHN Friend, bookfinder, can get the book you want. Free search service. Box 197PM, Cardiff, Calif.

BRITISH Book bargains—All subjects. Catalog 10¢. Transbooks, Box 22-PME, Brooklyn 36, N. Y.

14 VOLUME Encyclopedia \$16.35 plus postage. Write, C. M. Marrs, North Taze-well, Va.

"SCIENCE Milestones." Records march of science starting 400 years before Christ, right up to date. Amazing facts revealed. 312 pages packed with startling information that will thrill you. A real history of science. \$5.00. Literature free. Popular Mechanics Press, 200-8M East Ontario St., Chicago 11, Ill.

TAINTER'S Book Shop, Temple, N. H. Books on everything. Try our search service.

NATIONAL Geographic Magazines, 1888-1956. Periodical Service, Box 465-PM, Wilmington, Delaware.

BOOK Catalog, 1000 interesting titles. Send 10¢. Books Publishing Co., Amityville 3, N. Y.

OUT-Of-Print books at lowest prices! You name it—we find it! Fast service. No obligation. International Bookfinders, Box 3003-PM, Beverly Hills, Calif.

RARE Magazines, catalog 10¢. Nationwide Magazine Exchange, Box 1375-P, San Antonio 6, Texas.

BOOKFINDERS! All subjects. Send wants! Jaher Book Service, 183 Hazelwood Drive, Westbury, N. Y.

FREE: Exciting catalog packed with books covering most everything. Think of it—From cover to cover you will find described and illustrated hundreds of books telling how to fix and how to build almost anything. How to remodel your home; do your own decorating, plumbing, electrical work. Simplified books covering concrete work, carpentry, painting, furniture making and refinishing. How to build your own boat, home workshop tools. Best books on photography, welding, hobbies, homecraft. How to make a home freezer. Send for your free copy now. Popular Mechanics Press, 200-BC East Ontario St., Chicago 11, Ill.

GAMES, TOYS, NOVELTIES

NUKENO: End all dull parties with the world's greatest card game. America's finest entertainment. Exciting, educational. Postpaid \$1. Hackbarth Enterprises, Fayetteville, New York.

MAGIC TRICKS, PUZZLES, JOKER NOVELTIES

LEARN Ventriloquism, easiest method. Details free. Smith, 2125 No. Bigelow, Peoria, Ill.

BE A magician! Large professional catalog of latest tricks. 35¢. Ireland, C-109 North Dearborn, Chicago 2, Illinois.

MAGIC As a hobby. Book \$1.00. Minge's, 6775 Ash, Derby, Colorado.

3100 NOVELTIES, Jokes, tricks, gadgets, funmakers, hobbies. Big catalog 10¢. Johnson-Smith, D-407, Detroit 7.

VENTRILLO. Professional voice-throwing instrument and catalog 25¢. Box 971-PM, Philadelphia 5.

DOLLAR Magic set free with catalog 25¢. 4462-PM Germantown, Philadelphia.

WORLD'S Finest professional magic, Joker novelties. Giant illustrated catalog 10¢. Top Hat, Evanston 12, Illinois.

500 TRICKS, Douglas famous 120-page catalog, only 10¢. Fastest service to magicians for 30 years. Send 10¢ today. Douglas Magicland, Dept. 1, Dallas, Texas.

SMOKEBOMBS 25¢, 7 For \$1.00. Ter-rific! 4463-PM Greene, Philadelphia 44.

WOODEN Nickels, catalog, trick, 10¢. 1,500,399 tricks, jokes. Magico, Box 1376-P, San Antonio 6, Texas.

FREE Trick and professional catalog of 600 tricks, \$1.00. Terry's Magic Studio, 1921-66th Street, Brooklyn 4, New York.

SENSATIONAL Magician's wand 25¢. Vanishes handkerchief! Catalog included. Box 1352-PM, Philadelphia 5.

PROFESSIONAL Catalog, 175 pages, 25¢. Williams, 900 Plymouth, Ellwood City, Penna.

SVENGALI Trick deck free with catalog 50¢. 1746-PM Market, Philadelphia 3.

COINS, TOKENS, CURRENCY

BRILLIANT Uncirculated complete sets—Jefferson nickels \$19.95; Roosevelt dimes \$14.95; Franklin 1/2 \$27.50. Beautiful foreign sets—Cambodia \$1.00; Camarcons 90¢; Dominican Republic \$2.95; Irish animals \$2.50; Laos 95¢; Saarland \$1.95; Tahiti \$1.00; Viet Nam 95¢; Giant bargain catalogue 50¢. Bebee's, 4514 North 30th, Omaha 11, Nebraska.

FOREIGN Coin bargains. List free. Andrews, Box 677, Sumner, Wash.

101 DIFFERENT Foreign bills, \$1.00 postpaid. Dwight Musser, Dunbar, W. Va.

AMERICAN Coins! Stamps! Extensively! Sullivan, 127-FF East Fourth, St. Paul 1, Minnesota.

CZECHOSLOVAKIA, India, Vatican City, Austria, Finland's coins—All 10¢. Jolie, Roslyn Heights, N. Y.

OLD Money wanted. Will pay fifty dollars for nickel of 1913 with Liberty head (no buffalo). We pay cash premiums for all rare coins. Send \$4 for large coin folder. May mean much profit to you. Numismatic Co., Dept. 20, Fort Worth, Texas.

\$4,000.00 FOR 1913 Liberty head nickel. Dimes 1894-S, 1895-O, 1916-D. Quarters 1827, 1896-S, 1901-S, 1913-S, 1923-S. We pay \$10.00-\$2000.00. Certain dates—Lincoln cents, \$75.00. Indianheads, \$80.00. Large cents, \$500.00. Eagle cents, \$325.00. 2¢ pieces, \$70.00. 3¢ pieces, \$90.00. Half-dimes, \$500.00. Shield nickels, \$120.00. 1875 Canadian quarter, \$50.00. Hundreds of others worth \$10.00-\$1000.00. Wanted—Half dollars, dollars, gold coins, paper money, etc. Know their true value. Our large illustrated guarantee buying-selling catalogue, giving complete all coin information—send \$1.00. Purchase made from catalogue-holders only. Catalogue dollar refunded on \$20.00 sale. Worthycoin Corporation, Leaders Numismatic Quotations, K-240-C, Boston 8, Massachusetts.

BRILLIANT Uncirculated 1953-S mint set \$2.00, 1954-S \$1.75, 1955-S 25¢. Armstrong, South 206 Howard, Spokane 4, Wash.

40 DIFFERENT Selected coins, \$1.00. Oddehon, Box 482, St. Louis, Mo.

1955 PDS Cents 10¢ each. 1955 PDS dimes 25¢ each. 1955D quarter 75¢. Free list for stamp. Wiese, Box 8444, Dallas.

OLD U.S. gold coins and commemorative half dollars bought and sold. Bernice Mangini, 118 Texas Street, San Francisco, California.

OLD Coins, currency bought, sold. Large list 10¢. Thos. J. Settle, Box 1173, Church Street Station, New York 8, N. Y.

LARGEST Coin magazine, 180 pages, 35¢. Scrapbook, 7320-J Milwaukee, Chicago 31.

25 DIFFERENT Indian cents \$2.00, bargain lists free. Sayers, 1000 East Unaka, Johnson City, Tennessee.

100 DIFFERENT Foreign coins \$4; 100 Indianhead cents \$6. Parker, 1254 Market, San Francisco 2, Calif.

36 DIFFERENT Foreign coins \$1.00. Robbins, 1007 Cleaveland, Montgomery 8, Alabama.

GET Profit and pleasure in collecting old coins. Send 10¢ for 56-page illustrated coin catalog. You'll be delighted with it. Send for it now. B. Max Mehl, 370 Mehl Building, Fort Worth, Texas. Largest rare coin establishment in U.S. Established 56 years.

FIVE Foreign coins from Switzerland, Belgian East Africa, etc., plus foreign banknote, only 10¢ with coin approvals. Littleton Coin Company, Littleton R1, New Hampshire.

6-IN-1 Special! Magnifying glass; check list; 25 coin envelopes; giant 60 page bargain catalog; ten different Indian pennies; Mexican ten-peso: All six, \$1.00 postpaid. Ben's Coin Shop, 31 North Clark, Chicago 2, Illinois.

FREE! Foreign coin, banknote and coin collectors illustrated catalog to approval service applicants. Send 3¢ postage. Tatham Coinco, Springfield 30, Mass.

SAN Francisco mint closed! Made only cents and dimes in 1955. In short supply and great demand. One each, brilliant uncirculated, for 25¢. Free coin lists with order. Bryson Stamp & Coin Company, 612 White, Toledo 5, Ohio.

BARGAIN Lists, Indianhead cent, 10¢. Economy Sales, 157 Dean, Mansfield, Mass.

U. S. Large cent, 2¢ piece and bargain list, only \$1. Deimaco, Box 1123, Wilmington, Del.

MORGAN Dollars, 1878-87-90-91-97S \$2.00 ea. New illustrated catalog 25¢. Shultz, Box 746, Salt Lake 10, Utah.

\$20 PAID For 20 Lincoln cents taken from circulation. Send \$1 for list of these cents. This dollar refunded with first purchase. Gasser, Box 34-615, Los Angeles 34, California.

THOUSANDS Foreign coins. Lists 6¢. Benson, 2526 Middle Road, Davenport, Iowa.

18 DIFFERENT Foreign countries! All coins brand new. Kay Coin, Box 407, Bloomfield, N. J.

STAMP COLLECTING

100 DIFFERENT Austria 10¢. Approvals. Aronson, Box F, Newton Centre 59, Mass.

FIFTY Different British colonials. Plus dozen Confederates (facsimiles) dime! Approvals. Gene's, 1707 N. Congress, Austin, Texas.

UNITED States commemorative collection containing 33 different—10¢. Approvals. White, 516-A Avenue L, Brooklyn 30, New York.

100 DIFFERENT Switzerland 25¢. Approvals. Aronson, Box F, Newton Centre 59, Mass.

U. S. Catalog, Olympic set, 1000 hinges 25¢. Approvals. Buckley, 208 Ludlow Bldg., Dayton 2, Ohio.

30 DIFFERENT Commemoratives 1893 up 10¢. U. S. approvals. K&B, Box 70, Brooklyn 23, N. Y.

TRAVEL Through 50 countries! A virtual world cruise! 50 stamps, each from a different country, Abyssinia to Zanzibar. Bargain unsurpassed! To new approval applicants, 5¢. Avalon Stamp Co., Dept. M, Springfield, Mass.

TWO \$5.00 U.S. stamps plus 20 different, 10¢ with U.S. approvals. Irwin, Box 1105, Brooklyn 30, N. Y.

SELL Your surplus good grade stamps. Write, describing fully what you have. Vanroy Shirk, Lebanon, Pennsylvania.

FREE! Catalog! About stamps. Illustrated. Free! The Stampart, Hartford 1, Connecticut.

FREE United States price list. Mark Hanna, 335 Fifth Ave., Pittsburgh 22, Penna.

50 DIFFERENT Argentine 10¢. Approvals. Reuter, 611 W. 40th Pl., Los Angeles 37.

OLD Scarce U.S. seconds on approvals. Slight imperfections, lowest prices. Her-nfield, Clintonhill Sta., Newark 8, N. J.

U. S. Classics. Over 50 yrs old. 15 selected old-timers. Missing in biggest collections. All 15 at less than 1¢ each. 10¢ with approvals. Jaro, Box 246-T, New York City 8.

50 DIFFERENT United States 5¢ with bargain approvals, lists. Bookman, Box 8245-M, Madeira Beach, Fla.

AMAZING Offer! 200 United States stamps—including commemoratives, air-mails, high denominations to \$1.00. Only 10¢ to approval applicants! Illustrated bargain lists free. Mystic Stamp Co., Dept. 80, Camden, New York.

WORLD'S Largest stamp (7 1/2 x 14 inches). A real curiosity! Retailers for 50¢, only 3¢ to approval applicants. Tatham Stamp Co., Springfield 30, Mass.

FREE! 55 British Colonies, 5¢ postage. Kensington Stamps, Buffalo 15, N. Y.

WOW! 135 All different Germany 10¢. Zeppelins, semi-postals, airmails, high values. Big bargain lists and approvals included. Jamestown Stamp, Dept. A10PMC, Jamestown, N. Y.

100 OLD United States between 1861 and 1935, \$1.00. Roush Stamps, 51 Chestnut, Mansfield, Ohio.

225 STAMPS For only 10¢! This mammoth value includes airmails, pictorials; stamps from strange countries cataloging up to 25¢ each! Also approvals. Mystic Stamp Company, Camden 80, New York.

MINT Commemoratives at face! Send 25¢ for surprise packet of all different, mint U.S. commemoratives. Mint U.S. approvals too. Western, Box 1689P, Salinas, California.

UNITED States approvals. Select copies, used—mint. Kingsbury, Fairfax, Vermont.

ICELAND 10 Different beautiful stamps for only 10 cents to applicants for our good old fashioned approvals. Old Colony Stamp Co., Dept. A, Milford, Connecticut.

100 DIFFERENT China 10¢. Approvals. Coast, P.O. 2187H, Santa Ana, California.

100 YEAR Old United States stamps are sent on approval together with all commemoratives, airmails, etc. Also all foreign, Roosevelt, etc. Send 10¢ for 50 different U. S. and approvals. Globus, New York 10, N. Y. Dept. 213.

FREE! Monaco wedding stamps, given applicants for approvals. Exotic, Box 482-MM, Coral Gables 34, Florida.

EXCITING "Strange countries" packet. Free with approvals! Saxon, Orange, Calif.

1-2¢ EACH! Thousands of exciting worldwide stamps. Free examination. Cole, Box 223-A, Buffalo 21, N. Y.

SELL Stamps to our readers. Your ad in this space will be read by thousands of stamp buyers. I'll prove that to you. Write now for Folder "S." F. W. Johnson, Classified Advertising Manager, Popular Mechanics, 200 E. Ontario St., Chicago 11, Ill.

300 DIFF. World wide 25¢, plus surprise packet. Packet list free. Econopackets, Box 168, Riverside 9, Calif.

14,000 DIFFERENT—Yours on our streamlined systematic club plan for only 50¢ weekly. Big shipment every two weeks. Details free. L. G. Ware, Baldwin 75, New York.

PRICE List free. Peter Wetterquist, 1635—13th Avenue, Rockford, Illinois.

FREE Sample! Interesting, illustrated, informative! National Stamp News, Anderson, South Carolina.

FREE United States illustrated catalog. Bailey, 45 Bromfield, Boston, Mass.

FREE! Smallest stamp. Giant, midget triangles. Approvals, Delton Page, Box 201X, East Paterson, New Jersey.

SWITZERLAND Prize package! 50 different, including trains, bridges, castles, commemoratives, bi-colors, pictorials. All for 10¢ with approvals. Molzan, 720 Pomona, El Cerrito 8, California.

AMERICAN Commemoratives; Colonial pictorials; Asian topicals; with surprising approvals. Bristol, Canton Center, Conn.

U.S. Flag, \$5.00 stamps, 25 different collection. Only 10¢. Approvals. Willett Stamps, Box 390-A, Mount Kisco, N. Y.

BARGAIN. 200 Different U. S., 200 different Canadian, for \$5.00. Guaranteed. E. Filon, 8915 Hochelaga, Montreal 5, Canada.

ECONOMICAL, 1/2¢, 1¢, 2¢, Approvals. 22,000 varieties available. Dresel, 230-N Hamilton, Teaneck, New Jersey.

FREE Stamps with our low priced worldwide approvals. Postage paid both ways. Write now. P. Roy (B), 160 St. Johns Place, Brooklyn 17, N. Y.

THIRTY-ONE Different stamps cataloging \$1.50, or twenty different German covers, 25¢. Dicranian, 1066 44th, Brooklyn 19, N. Y.

MONACO. Nudes (3) 5¢. Approvals. Hannay's, 473 Myrtle, Albany 8, N. Y.

ZEPPELIN Stamps, rarest of the popular topicals. Complete Germany set free, with approvals. (6¢ postage, please.) Variety Stamps, 57-Z Circuit, Newton Highlands 61, Mass.

GIANT Approvals, thousands different, 1¢ and 2¢ each. Wahl's Stamp Exchange, 7008P Farragut, Chicago 31, Ill.

MINT Canadian Pakistani at face lists 20¢. King, 330 Alexander, Kamloops B.C., Canada.

FIRST U.N. set. Among world's prettiest. Only 10¢. Approvals. Welles, Box 1246-R, New York City 8.

U.S. Stamps—At discount prices. Giant illustrated catalogue. Only 10¢. Raymax, 37-VZ Maiden Lane, New York City 38.

300 DIFFERENT Given free with approvals. Particulars. Windsor Stamps, 8834 Cornell Ave., Chicago 17.

U.S. Airmails, 15 different plus perforation gauge and illustrated price list only 10¢. D. C. Reukauf, Box 113, Riverdale, Maryland.

INTRODUCING Our better United States approvals, we offer 15 most wanted United States stamps, including Columbian, Pan-Pacific, bi-centennials, Army Navy, famous Americans, airm, other commemoratives; everything 10¢. Ocean Stamps, Box 64-PM, Brooklyn 29, N. Y.

WONDERFUL 200 Different includes Iceland, Israel, British Colonies, bicolors, sets just \$2 postpaid. Fully guaranteed. Exceptional! Eugene Stubenrauch, 19 Quebec Drive, Huntington Station, New York.

75 DIFFERENT U.S., 10¢. Approvals. Edgar, Box 437M, Punxsutawney, Penna.

ZOOLOGICAL. Old United States, Africa, and 50 different others 10¢. Approvals. Gericke, Box 756, Milwaukee 1, Wisconsin.

SEND 200 Different your duplicates and dime. Receive 200 different. Better sent, better received. Gaines Stamp Exchange, Box 824, Oklahoma City.

FREE! Complete, obsolete U.S. occupation set with fine approvals. Airmails, colonials, commemoratives. Riedell, Greensburg, Pennsylvania.

BETTER Grade foreign lot \$1.00. Kistner, Box 11, Ozone Park, N. Y.

FREE! 25 Different mint China. Approvals. Wright, 6435 Edloe, Houston 5, Texas.

1000 WORLDWIDE Plus 100 U.S. \$1.50. Approvals. Casto, Box 357, Dunbar, W. Va.

WONDERFUL Offer, 7 complete mint sets only 10¢ with approvals. Reich (M26), 1033 Lawrence, Chicago 40.

EVA Perons, coronation, locomotive, 100 others to approval applicants. 3 cts. Norman, Box 1323, Southside Sta., Springfield, Missouri.

10 CRAZY Shaped stamps, 3¢ to approval applicants. Knopp, Box 1381, Bristol, Conn.

30 DIFFERENT Formosa, special \$1.00. Universal, Box 6, Kenosha 5, Wisconsin.

STAMPS: Below wholesale, sample, plan, 25 cents. Seevee, Box 174, Center Ossipee, New Hampshire.

FREE Sample stamp newspaper, information on collecting, special lists. Approvals. Littleton Stamp Co., Littleton A1, New Hampshire.

LIQUIDATION Sale. \$25.00 catalog value, all different world wide for \$3.00. Most catalog 4¢ through \$2.00 each. No junk. Satisfaction guaranteed. No approvals follow. Whalen, 1435 1st Ave., Oakland 6, California.

GIANTIC Collection free. Includes triangles, early United States, animals, commemoratives, British Colonies, high value pictorials, etc. Complete collection plus big illustrated magazine all free. Send 5¢ for postage. Gray Stamp Company, Dept. PM, Toronto, Canada.

FREE! Giant catalog offering thousands of bargains. Sent with beautiful approvals. Jamestown Stamp Co., Dept. E10PMC, Jamestown, N. Y.

90,000 STAMPS Disposal sale: Assortment 40 cts. Big lot \$1. Extra special better stamps \$2. Giant assortment \$5. Persil, 436 N.Y. Ave., Brooklyn 25, N. Y.

THOUSAND Mixture, hundreds different, 50¢ to approval customers. Rainy Day, Wellsville, N. Y.

PENNY Approvals that satisfy. Robert Moed, P.O. Box 62, Brooklyn 29, N. Y.

150 ALL Different United States. \$1.00. Thom, 4808 15th Avenue, Minneapolis 17, Minnesota.

MONACO Pipex, elephants, war machines! Madagascar, Morocco, others! 123 all different stamps, 10¢. Approvals. Billingslea's, Gilmer 5, Tex.

AFRICA, Triangles, old U.S. and over 100 different others. Everything 10¢ with approvals. Adams Stamps, 4209 Hubby, Waco, Texas.

FREE With approval. Spanish Zaragoza religious set. William, Diamond, Penna.

SAVE Cash! Buy with your duplicate U.S. commemoratives. Send postage for details. Mason Belcher, 338 West 71st, Chicago, Ill.

40,000 VARIETIES Available on approvals. 1/2¢ upwards, Kelgwin, Box 933B, Daytona, Florida.

100 DIFFERENT, Pipex 4 American presidents, postage set (5) Grace Kelly, \$1.00. Satisfaction guaranteed. Gockler, 3636 Sixteenth Street, NW, Washington, D.C.

70 DIFFERENT U.S., included 35 commemoratives, 25¢. No approvals. Seidenberg, Appleton, Wisconsin.

200 BEAUTIFUL Hungarian pictorials. All different. All beauties. Catalog value over \$10.00. Only \$1.25 with approvals. Mark Stamps, 4628 N. Hollywood Avenue, Milwaukee 11, Wisconsin.

12,000 PENNY Approvals waiting for you. Many from exotic countries, pictorials, airmails, new issues. Tilbury, Box 862, Newark 1, N. J.

U. S. Mint specials! 13 different commemoratives, 25¢; flag set, complete, \$1.00. Free price list. Brooks, 2352P East 23rd Street, Brooklyn 29, New York.

CANADA, Queens, wildlife, commemoratives, 10 var., 10¢. Attractive approvals. Rhéume, 6591 11th Ave., Montreal 36, Canada.

GREECE, 100 Different, only 25¢ with quality approvals. Livingstonville Stamp Co., Middleburg 10, New York.

PRICE List, foreign and U.S. No approvals. Stamps, 5000 Miami, St. Louis 9, Mo.

FREE! Seven short sets! Approvals. Gerrert, 4235-Y Alton, Louisville 7, Ky.

AIRMAILS—25 Different \$1.00. No approvals. Basner, Box 424, Woodridge, N. Y.

U. S. Revenues on approval. El Jay Stamps, Box 286, New York 36, New York.

FREE—Cyprus set with approvals. Ampro, Box 4207, St. Louis 16, Mo.

500 WORLD Mixture 25¢. Better approvals. Whitney, 5800 Division South, Grand Rapids 8, Michigan.

BOLIVIAN U.N. and Paraguay sets 5¢ with approvals. Benzra, 3530 Pauiding Ave., New York 69, N. Y.

PHILATELIC Agencies. Directory listing 100 throughout world. \$1.00. Bedard Publications, Box 637-A, Detroit 31, Mich.

10 PANAMA 10¢. Worldwide 2¢ approvals. Moffat's, 740-A Milton, Rock Hill, South Carolina.

BRITISH Colonies peace issues all mint (90) \$3.00. Marson, Box 5041, Portland 13, Oregon.

BRITISH West Indies. 15 pictorials. 10¢ with approvals. Seminole Stamps, Box 1138-P, Coral Gables 34, Florida.

99 DIFFERENT Latin Americans, just 10¢. Approvals included. Fred Pittsley, South Montgomery, Napa, Calif.

FREE Old U.S. with top approvals for 3¢ postage. Hart, 350 Riviera Isle, Fort Lauderdale, Fla.

55 FOREIGN Free to approval applicants. Collier, Box 142, Chamberlayne, Ga.

FREE, Mint British Colonies from North Borneo, Caymans, Seychelles, Dominica, Papua, New Guinea, Sarawak, Brunel. Free with approvals. Viking, Great Neck 8, N. Y.

FOREIGN Stamps. Bags. 3—\$1.00. Eagle, 4520 Frances, Burnaby 2, B. C., Canada.

100 DIFFERENT U. S.—50¢. Approvals. Utecats, 1143A North Keeler, Chicago 51.

FIFTY Different United States. Obsolete and current. 10¢ with approvals. Keller, Library, Penna.

SOUVENIR Sheet Russia 1937 10¢ with approvals. Kingman, 30 Empire, Yonkers 4, N. Y.

FREE! African death masks! 111 others. Approvals. Imperial, Linton, North Dakota.

PENNY Approvals! Lowest prices! All postage paid. You can't lose! Try them! Riviera, Box 971E, Santa Barbara, Calif.

FINLAND 1944 Red Cross, complete mint set 25¢. Approvals. Ralph Rice, 15 Longlane, West Hartford 7, Connecticut.

WEDDING. Pipex, triangles, animals, free with approvals. Choice, Box 366, Miami Beach 39, Florida.

WEIRD Diamond shape coffee stamps. Lovely flower triangle! First American big commemorative. Greenland, idol dancer, etc. Free with approvals. Capital Stamp Co., Ferrysburg 2, Mich.

FREE! 1956 Olympic set; approvals. H & H Stamp Center, Box 76, Brooklyn 26, N. Y.

STAMP Collecting outfit, includes packet worldwide stamps, package hinges, watermark detector, millimeter gauge. Everything 10¢ with approvals. Lorain Brown, Marion 1, Michigan.

50 **DIFFERENT** Spain 10¢. Approvals. Kopels, 3201 Argyle, Chicago 25, Illinois.

U. S. \$5 Coolidge—35¢! Approvals. Gatewood, Box 346, Winston-Salem, N. C.

OLYMPIC Sport sets, 14 stamps, 10¢ with approvals. Norton, Box 926, San Antonio 6, Texas.

FREE 55 British Colonies, plus surprise, with approvals. Fried, Box 473, North Hollywood 11, Calif.

ALL Different—500, 50¢; 1000, \$1.25; 2000, \$3.00; 5000, \$12.00; 100 Canada 35¢. Approvals. K. S. Holmes, London, Canada.

LUXEMBOURG, 25 Different 5¢. Approvals. Neal, 5950 Tower, Riverside, Calif.

FINE Approvals, fair prices. John King, Box 523, Caribou, Maine.

BEAUTIFUL Set, 10¢ with approvals. Guyton, Box 1275, Monroe, Louisiana.

TEN Free from first book, 500 2¢ approvals. Hadrian, 12 East 31st St., New York City 16.

1957 U. S. Illustrated catalogue free. Stone's, 192 Washington, Boston 8, Mass.

SUEZ Canal—27 different Egypt 10¢ with approvals. Excello Stamp Company, Box 489, Red Bank, New Jersey.

AMAZING U. S. philatelic novelty free with big lively stamp magazine 10¢. Chambers Stamp Journal, 15115 Warwick, Detroit 23B, Michigan.

ANTIQUES, RELICS, INDIAN GOODS, CURIOS

FOUR Arrowheads \$1.00. Spear \$1.00. Tomahawk \$2.00. Palmer, 435 Washington Road, McKeesport, Penna.

SCALPING Knife, spearhead, thunderbird, drill, \$4.00. List free. Arrowhead, Glenwood, Arkansas.

10 ANCIENT Arrowheads \$2.00. Grooved tomahawk \$3.00. List free. Lear's, Glenwood, Arkansas.

SELECTED War arrowhead \$1.00. List 5¢. H. Talburt, Calico Rock, Ark.

PRECIOUS STONES, MINERALS

AGATES, Gems, machines. Free list. Northwest Gems, 2819 North Warner, Tacoma 7, Washington.

CUT Gems, make jewelry—For profit or fun. 100 page magazine tells how: where to get supplies. Sample 25¢ or request free literature. Lapidary Journal, Del Mar 2, Calif.

SAPPHIRE, Topaz, tourmaline, garnet, peridot. Five uncut gem specimens, \$1.00. Ten polished gems, baroque shaped, \$1.00. Free big bargain list jewelry, gems, profitable, easy "do it yourself" projects. O'Brien's, 1116M Wilcox, Hollywood 38, Calif.

GEMSTONE Opalized wood. Beautiful specimens 60,000,000 years old. Display—Cut fine gems. \$1.00 generous sample. Edward Helpenstell, 1429 Sandpiper Dr., Bellaire, Texas.

AGATIZED; Opalized wood. 8 lbs. \$5.00. Texas Gems, Box 185, Taylor, Texas.

EARTH Science, the rockhounds' national magazine. Subscription \$3.00, sample 25¢. Box 1357, Chicago 90.

FIND Uranium, tungsten, mercury, hundreds of other minerals with Mineralight. Free information kit on fun and profit in fluorescent minerals; hobby set. Write Dept. FMS, Ultra-Violet Products, San Gabriel, California.

HOBBIES AND COLLECTIONS

COLLECTORS Matchbook covers. 100 different unused, \$1.00. Catalog 25¢. Album \$3.00. Charles Edelman, 1311-C East 84, Cleveland 3, Ohio.

U.S. Coins valued and illustrated—Hand-book \$1.00; guidebook \$1.75 postpaid. Louis Bell, Masonic Building, Decatur, Alabama.

WANTED—Cigarette, tobacco cards. Write Charles Bray, East Bangor, Penna.

CERAMICS. Fun. Profit. Illustrated catalogue, 25¢. Deductible. Seeley's Ceramics, Elm St., Oneonta, N. Y.

MILITARY Miniatures. Civil War. Custer's Cavalry, American Revolution and U. S. Marines. Illustrated catalog 25¢. Bussler Miniatures, Dept. Z, 40 Howe St., Quincy 69, Mass.

HOBBIES, Craft, hobby kits. Catalog 10¢. Daters, 821 Divisadero Street, San Francisco 17, California.

INVENTING Can be an interesting and profitable hobby. Write for complete particulars. Institute of American Inventors, Dept. 40-E, 635-F St., N.W., Washington 4, D. C.

NAZI Insignia, 12 different \$1.00. Medals, patches, armbands, flags, daggers. Illustrated lists. 10 cents. Medcrafts, Box 532, Victoria, B.C. 2, Canada.

MING Trees—How to make, sell, obtain materials. Interesting, profitable hobby. Complete instructions airmailed \$2.00. Yung, PK45, Vekaleter, Ankara, Turkey.

FREE—"Learn & Earn" leathercraft catalog. Tandy Craft Center, 35 E. 14th, Dept. E, New York, N. Y.

CAMERAS, PHOTO SUPPLIES

BASS Says: Quality cameras since 1910. When in Chicago visit the camera cross roads of the world, or write us for your favorite equipment, new or used. Satisfaction guaranteed. Bass Camera Co., Dept. AG, 179 W. Madison St., Chicago 2, Ill.

OIL Coloring photographs—A fascinating hobby or profitable sideline for those with artistic talent. Learn at home. Easy simplified method. Free booklet. National Photo Coloring School, 835 Diversey Parkway, Dept. 3437, Chicago 14.

20 TO 75% Discount everything photographic gift-ware. Free catalogue. Dart, 3812E Atlantic Avenue, Brooklyn 24, New York.

TRAVELERS. Name the spot—we have the slide! 4000 Kodachrome 2x2 slides and 1200 stereos, sent on approval. Send 25¢ (deductible from first order) for 40-page, illustrated catalog. Ernest K. Wolfe, 1315 Westwood, Los Angeles 24, California.

GIGANTIC Savings! Film, paper, aerial cameras, supplies. Request free 1956 bulletin. Supreme Photo, 11 Broadway, Dept. PM, New York City 4.

FREE! Free! Free! Bargain book. Big savings—Still, movie camera, equipment and supplies. Photographic headquarters since 1899. Central Camera Company, Dept. 10-1, 230 S. Wabash Ave., Chicago 4, Illinois.

PHOTOGRAPHY For pleasure or profit. Learn at home. Practical basic training. Long established school. Free booklet. American School of Photography, 835 Diversey Parkway, Dept. 3441, Chicago 14.

BUY Wholesale nationally advertised cameras, photo supplies, thousands other products at big discount. Free "Wholesale Plan." American Buyers, Hertel Station, Buffalo 16-E1, N. Y.

WANTED 8MM. Camera owners desiring bargain! 1½" fl. 9 ultra sharp Tele plus 7mm. f2.5 wide angle lens. Not an attachment but actual lenses. Coated. Two for the price of one at \$29.95. Specify camera. Sterling Howard, 561-M East Tremont, New York City.

MAKE Better enlargements; BlendOray screens. Any enlarger, no retouching. \$1.00. Nichols Photo, Bristol, Penna.

USED Lenses, cameras, photographic correspondence courses. (Bought and sold). Photographers Market Guide \$2.00. Mike Blizard Company, Dept. 15-OC, Lincolnwood, New Jersey.

AMAZING Price. Government surplus at less than wholesale. Paper, film, cameras, dark room equipment. Send 10¢ for bulletins mailed free for 1 year! Air Photo, Room 409, New York 57, New York.

FANTASTIC! Secret camera built in windproof cigarette lighter! \$9.95 includes case, 80 pictures. Cameralite, 600—16th Street, Oakland, California.

DISCOUNTS To 60% photo equipment, appliances, Lionel-Gilbert trains. Free catalog. Mailers Mart, Box 135-PM, Pelham, New York.

GET Our price before buying cameras, projectors, recorders, typewriters, watches, gifts, etc. Unbelievable savings! 6¢ stamps brings complete wholesale catalog. Imperial Enterprise, Inc., Dept. PS, 34 Park Row, New York 38, N. Y.

BEST Discounts photo supplies and color finishing. Send for free catalogue. Superior Photo, P.O. Box F, Hillside, N. J.

PHOTO FINISHING

10 PHOTO Christmas cards 89¢. Sample 10¢. Try us once! Fast service! Top quality! 8 enlarged dated prints from your roll 25¢; 12-35¢ (trial offer). Reprints 4¢. Kodacolor specialists: Roll developed 90¢; prints 32¢ each. Free mailers. Willard Studios, Box 2553G, Cleveland, Ohio.

WASHINGTON, D. C., Kodachrome color reproductions, Capitol, White House, etc., 15 for \$1.00. Free remailing. Davidson, 3607 Appletree Drive, Alexandria, Virginia.

TRIAL Offer—8 jumbos 25¢, 12-35¢. Thrifty Photo, PM106, Box 275, San Francisco 1, Calif.

TEN 5x7—\$1.00. Send negative. Huffman, 309 Water, Whitesboro, Texas.

PHOTOS, Wallet cards, laminated plastic last lifetime 35¢. Box 711, Denver, Colo.

UNBELIEVABLE Values! Enlargements, finishing, photostats, Reproductions, 417-19 Broadway, Joliet, Illinois.

LIFETIME (Copyright) ultra fine grain prints. Custom developing plus prints on heavy portrait weight paper. Salon quality. 8 exposure 75¢; 12 exposure \$1.10; 35mm.—20 exposure \$1.85, 36 exposure \$3.50. Free mailers and circulars. Lifetime Photo, Post Office Box 96, Chicago 17, Illinois.

PHOTOS Copied. 20 wallet-size deluxe prints \$1.00. Original picture returned. Send any size photo or negative. Federal Wallet-Size Photo Co., Dept. PM-6, P.O. Box 2448, Kansas City 6, Mo. (No c.o.d.'s please).

NO Charge developing rolls. Pay for good prints only. Jumbos 4¢. Contacts 3¢. Failures refunded. Returned same day. Satisfaction guaranteed. Square Deal Photos, Hutchinson, Kansas.

ENLARGEMENTS! Eight 5x7's or five 8x10's. \$1.00. Willard Enlargers, Box 967, Little Rock, Ark.

SPECIAL Gift with first roll developed and 8 dated jumbo prints, or 16 dated contact prints in wallet folder 40¢. 12 exposure 50¢. Owl Photo Co., Dept. 21, Weatherford, Okla.

ENLARGEMENTS, Heavyweight eight 5x7's or five 8x10's, \$1.00. Jack Koons, Huntington Mills, Luzerne County, Pennsylvania.

TWO Beautiful prints from each picture on roll. 8 exposure 40¢; 12 exposure 50¢. Thirty-five years of satisfied customers. Quick service. Lens Photos, Dept. J-4, Janesville, Wis.

12 EXPOSURE Rolls, 39¢, jumbo prints. Guaranteed work, one day service. Lincoln Studios, Dept. K, Box 13, Lincoln, Neb.

TWO Beautiful enlargements from each picture on roll. 8 exposures 55¢. 12 exposures 75¢. Cut Rate Photos, Dept. B-4, Janesville, Wis.

REAL Quality, fast service on your black and white and color film. Free mailers, circulars plus introductory gift. Black and white developing and printing 8 exposure 50¢; 12 exposure 75¢; 35mm—20 exposure \$1.25, 36 exposure \$2.50. Standard color prices. Hailey Photo, Post Office Box 96, Chicago 17, Illinois.

QUALITY Kodak finishing. 8 exposure roll 35¢; 12 exposure 50¢; 16 exposure 60¢. Reprints 4¢. Fast service. Guaranteed quality. 40 years continuous operation. Be a satisfied customer. We do color. Send for mailers. Mail Order Photo Service, Box 297, Watertown, Wisconsin.

TOP Quality. Fast service. 8 jumbos 35¢, 16 contacts 40¢. Reprints—Jumbos 4¢; contacts 3¢. Satisfaction guaranteed. Free mailers, circulars. Fast-X-Photo, Box A, Jersey City, New Jersey.

8-HOUR Service on deluxe jumbo prints. 8-exposure roll—developed and 8 jumbo prints 40¢, 12 exposure 55¢, 16 exposure 70¢; 35mm. 20 exposure 75¢, 36 exposure \$1.25. Jumbo decklegrade reprints 4¢ each. Contact prints made if specified. Bay Photo Service, P.O. Box 210 Oakland, California.

FREE Superpak album with 8 jumbos only 35c. 12-50c. Prompt superior service. Quality guaranteed. Mailers and circulars free. Grand Fotos, GPOB 1410, New York City 1.

MOTION PICTURES AND SOUND EQUIPMENT

WILD Life films. Buy direct from studio at tremendous savings. Kodachrome, b&w 8 and 16mm and 2x2 slides. Free illustrated brochure. Wild Life Films, 5614-A Cahuenga Boulevard, North Hollywood, California.

SOUND 16MM bargains: Lists. Film Enterprises, Box #23, Hagerstown, Maryland.

RECORDERS, Tapes; wholesale. Free catalogue. Carstan, 215 E. 88, New York City 28.

NEW 8MM and 16mm movies direct from distributor at dealer's prices! Special with this ad: New 50 ft. 8mm Hollywood beauty \$1.00-400 ft. 16mm new sound musical \$3.95. Money-back guarantee. Terrific bargains on new and used movie equipment. Send 6¢ stamps for catalog. Imperial Enterprise, Inc., Dept. SE, 34 Park Row, New York 38, N.Y.

16MM. Sound-used projectors and films. Rental, sale, exchange, bargain prices. Free lists. Also 8 mm. Specify film size. National Cinema, 71 Dey Street, New York City.

8-16MM. Films. Free catalogue (with sample film 10¢). Garden, 690 Howard Avenue, Brooklyn, N.Y.

5,000 8-16MM. Movie films. Free catalogues. International, Greenvale, N.Y.

TAPE Recorders, tape. Unusual values. Free catalog. Dressner, 69-02M 174 St., Flushing 65, N.Y.

MOVIE Camera film: 8mm. roll \$1.50, 16mm. 100' \$3.00. Free processing. Better Films, 742 New Lots, Brooklyn, N.Y.

SAVE 50%! Guaranteed-fresh color, b.&w. movie film! 8mm., 16mm. Free catalog! Eso-R, 47th Holly, Kansas City 12, Missouri.

FREE! Blackhawk's big sale catalog new and used 16mm., 8mm. films; 2"x2" color slides; used 16mm. sound projectors. Biggest stock in U.S.A. Blackhawk Films, 1700 Eastin, Davenport, Iowa.

MOVIES; Movies; movies: 8 and 16 mm. B & W and color. Free gift and list sent in well sealed envelope. G & M Films, Box 4161, Glendale, California.

MUSIC AND MUSICAL INSTRUMENTS

1956 ACCORDIONS — Wholesale. Free catalog. American Accordion Center, PM-10, 5329 Belmont, Chicago.

SWISS Musical movements. Best. \$2.50. Spielman, 131 West 42nd, New York City 36.

SONGWRITERS: Learn to arrange music with the "Lightning Arranger" (musical slide rule). Plastic model: \$2.00. John Corley, 805 E. Main, Brenham, Texas.

EARN Money writing words, tunes for TV, records, radio. Details free. Linton School of Songwriting, 20 (N) Denmark Street, London W.C. 2, England.

SONGWRITERS: Recording company wants new songs. Royalty basis. National sales, promotion if selected. Send material. Music Makers, Dept. E-25, Box 2507, Hollywood, Calif.

ACCORDIONS — Direct from importer. Save 50% and more! Free trial. Lifetime guarantee. Trades accepted. Free catalog. Write Accordion Manufacturers, Dept. 106R, 2003 Chicago, Chicago 22, Illinois.

PLAY Piano the first day! Copyrighted secret. Details free. Miracle Method, Box 5203P, Phoenix, Arizona.

SONGWRITERS. Send poems. Free examination. Gregory, 1215 Third Ave., New York City 21.

SACRED Music composed to religious words. Professional copies printed. Regional Belcher, Box 354, Morristown, New Jersey.

SONGWRITERS. Free booklet successful songwriting. Gateway Songs, Box 2470, Hollywood 28, Calif.

POEMS Wanted for new songs. Send poems. Free examination. Immediate consideration. Songcrafters, Arcade Station, Nashville, Tenn.

POEMS. Songs wanted! Free examination. Bengol, 93 Jefferson, Chelsea 50, Massachusetts.

FREE Records of your song. Your words, my melody. Free information Johnny Mack's Melody Mart, 1094 West 39th Street, Dept. A, Los Angeles 37.

ACCORDIONS, Wholesale to everyone. Save up to 60%. All national known brands. Free catalogue. Del Principe, 29 South Cicero, Chicago 44.

POEMS Wanted for new songs. Send poems. Immediate consideration. Crown Music Company, 1476 Broadway, New York City 36.

WRITE Songs. Big money and reputation. Write for information. J. Gordon Pub. Co., 4700 South California Avenue, Chicago.

VIOLINMAKERS. Repairers. Fine tone wood, and all violin supplies. Send for free wholesale price list. International Sales, 414-MPM E. Baltimore St., Baltimore 2, Maryland.

SONGPOEMS And lyrics wanted. Mail to: TinPan Alley, Inc., 1650 Broadway, New York 19, N.Y.

SONGWRITERS: Song poems wanted. \$100 advance royalty paid writer of best song selected each month. Hollywood Tunemasters, Dept. U, 1609 Vista Del Mar, Hollywood 28, Calif.

SWISS Musical movements, \$1.90. Helax, 218 West 72nd Street, New York 23.

WHOLESALE Catalog! 30-80% discounts! Appliances, musical instruments, typewriters, tools, watches, jewelry, cameras, housewares, etc. Consolidated Distributors, 1300-34 Main, Clifton, New Jersey.

SONGWRITERS! Protect your ideas! Hold all poems, songs! Write for safe, correct procedure. Song Service, Dept. P, 333 W. 56th, New York City 19.

DISCOUNTS. Instruments, accessories, national brands. Tempo Music, 37 Cutler, New London, Connecticut.

SONGS Into dollars. Share \$29 million dollars yearly for new songwriters, song-poets. Songs composed, published, promoted by famous firm. Information, appraisal free. Send to Nordyke Publishing, 6000 Sunset, Hollywood 28PM, California.

RADIO, TELEVISION AND ELECTRONICS

CRYSTAL Radio builders. Free information. Hulet, 305 Hope, Lakewood, N.J.

CRYSTAL Radio kit \$1.00, preassembled \$1.25, phone \$1.75; catalogue. Clearco Crystal Company, 2966 North 4th, Milwaukee 12, Wisconsin.

EXPERIMENTERS Radio bread board complete with 2 diodes, 5 crystals, 5 coils, circuits and condenser \$2.00 post paid. With phone \$4.00. Small Radio Lab, 1331 Tyler, Topeka, Kansas.

FREE 356 Page 1957 radio, TV, Hi-Fi, electronics catalog! World's largest stocks, lowest prices. Everything for experimenters, builders, amateurs, servicemen. Latest build-your-own famous Knight-kits, Hi-Fi, phonos, recorders, P.A., TV accessories. Thousands of parts, tubes, test instruments, tools and books. Write for free copy! Allied Radio Corp., 100 N. Western Ave., Dept. 34-K-6, Chicago 80, Illinois.

WHOLESALE! Tape recorders, Phonographs, Radios. Catalogue 10¢. Towers, Box 155, Philadelphia 5.

TRANSISTORIZED P-M radio kit \$9.95. Ekeradio, 646 North Fair Oaks, Pasadena, California.

24 PAGE Handbook "Crystal Set Construction" including experimenter's catalog—30¢. Laboratories, 328-C Fuller, Redwood City, California.

BUSINESS OPPORTUNITIES

FLEXIBLE Rubber molds for plaster and Marble figurines. Sample and large illustrated catalog 25¢, refunded on first order. K-C Novelties, Dept. 26, Southampton, Massachusetts.

\$200 WEEKLY—Fire detection systems for homes, stores, churches. Fairwood Co., Hanover Center, Mass.

NATIONALLY Advertised merchandise at lowest wholesale prices. Your own business; no investment no inventory. Send 25¢ for colorful catalog. Hundreds of items. Name Brand Wholesale Distributors, Box F, River Road, Tonawanda, New York.

BIG Profits. Operate electric motor repair shop at home. Complete instructions. Lincoln School, Box 52, Hempstead, N.Y.

WHOLESALE List! Curtains, orlon pillows, rugs. Johnson Wholesale Company, Box 12702, Dallas 17, Texas.

WANTED: Home producers, to be subcontractors. Cast plastic products for manufacturers in our clearing house service. Thousands of easily-made items required. Cash in at home, without previous experience. Plastic Service Associates, Dept. 10-PM, East Boston 28, Massachusetts.

OPERATE Profitable mail-order business. Wonderful opportunity. Write for details. G. W. Walker, Box 34, Stuyvesant Sta., Brooklyn 33, N.Y.

FREE Name brand catalog! Below wholesale prices, plus shipping allowance! Bard Company, 4138PM Bailey, Cleveland 13, Ohio.

FLORIDA Opportunities! Hundreds of jobs, businesses, farms, groves, homes. Free details! Florida Opportunity Journal, Vero Beach 15, Florida.

ORNAMENTAL Iron railings. Start your own business. Details free. Barry, Box 306, Bound Brook, New Jersey.

HOUSEWIVES Want mirror shiny floors. You show them how without waxing. Big profits for distributors. Exclusive territory. Custom, 6515 Chestnut, Pennsauken, N.J.

EXTRAORDINARY New mail order ideas, opportunities. Specific methods, products, projects, sources. Authentic, reliable. Free information: Business-Fax, Box 1024-C, Galveston, Texas.

ALL New plan! Subcontract casecraft work at home. Also manufacture for salesmen selling your products nationally. We supply complete instructions, tools, supplies everything. Free details. Abarai, 807-BL W. Sunset, Los Angeles 12, Calif.

MAIL Order advertising agency executive reveals sensational no-risk advertising and merchandise methods. Start in office or home; minimum capital; positive profits. Free details: Impact! 2108 Payne, Dept. 11-10, Cleveland 14, Ohio.

AMAZING New wholesale business. Tremendous profits. Valuable folio free. McCann, 1612 Johnson, Amarillo, Texas.

ADVERTISING Book matches—Cash in on big demand; sell union label matches. Cuts for all businesses and political parties. Free powerhouse selling kit, low prices, protection guaranteed on repeat orders. Cash commissions. Superior Match Co., Dept. MX1056, 7530 Greenwood, Chicago.

START A buying service, buy wholesale thousands nationally advertised products. Make big profits selling at sizable discounts. Postcard brings details. American Buyers, Hertel Station, Buffalo 16-C1, New York.

OPERATE Profitable mail order business. Write Walter Service, 4159A East 112th, Cleveland 5, Ohio.

BECOME Tax consultant. Graduates earn \$3,000 every tax season preparing returns evenings. State approved. Union Institute, 68 Hudson, Hoboken, 2N, N.J.

GROW Expensive herbs for us! Big profits home-business of your own. Year around profitability! We supply everything necessary! Send for free rare seeds and revealing plan. National Herb Exchange, Dept. OR, Gardena, Calif.

"HOW To Start a Business" booklet sent free! If you know any trade, go into business for yourself! Learn the 9 easy steps to follow. We've guided 5,000 others to success. Revealing free booklet yours for the asking! Write! National Business Consultants, Office OR, Los Angeles 61, Calif.

MAKE Profitable products. Sell mail-order. Catalogue free. International, 6347 Parnell PM10, Chicago 21, Illinois.

OPERATE Statement mailing service from your home as our representative. Material furnished. American, Mt. Airy, Maryland.

BUY Wholesale! Resell at big profits. Brand name merchandise — Appliances, cookware, housewares, watches, jewelry, dry goods, clothing, sporting goods, toys, gifts, etc. Free 1957 color catalog with confidential cost sheet. Merit Home Products, Dept. PM-10, 107 Manhattan Ave., Brooklyn 6, New York.

OPERATE Restaurant or diner. Free booklet reveals plan. Write Restaurant Arts, BU-110, Fremont, Ohio.

60% PROFIT Cosmetics. \$25 day up. Hire others. Samples, details. Studio Girl Hollywood, Glendale, Calif., Dept. 12610-H.

FREE Toy catalog and wholesale prices. Arro Sales Co., 1261 Brinton Rd., Pittsburgh 21, Penna.

IMPORT Your own fast selling products in small quantities. Also start profitable mail-order business using international drop-shipment method. Capital unnecessary. Free details. Ga. Overseas Trading Co., Dept. W, 715 Persons Bldg., Macon, Ga.

WHOLESALE Buyers service! Buy nationally advertised merchandise wholesale. Sell way below retail. Fabulous profits. Write Wholesale Buyers, Box 22-PK, St. Louis 3, Missouri.

FOR Fun and profit at home, make fascinating "Snowstorm" bowls. We furnish materials. Hanco, Box 97C, Lombard, Ill.

BOOKKEEPERS, Keep books, small firms spare time. Manual latest technique by C.P.A., \$3.00. Modern Business, Box 406, Youngstown 1, Ohio.

BUY Wholesale; go into business for yourself. Tremendous discounts on name brand merchandise. Jewelry, household items, appliances, etc. Free wholesale catalog. Normandy Distributing Corp., Dept. PM, 133 Fifth Ave., New York, N. Y.

BE A meat wholesaler. Large profits, no investment or experience required. Free information. Write Meats for Profit, 5801 Cleveland Ave., Worthington, Ohio.

VENDING Machines—No selling. Operate a route of coin machines and earn amazing profits. 32-page catalog free. Parkway Machine Corporation, Dept. 26, 715 Ensor Street, Baltimore 2, Maryland.

\$1,000,000 BUSINESS Partnership. Sell Christmas buyers first. Nationally advertised merchandise. Air mail \$1.00. Refundable. Colco, Forsyth, Ga.

SELL Business cards by mail. Sales literature supplied. Vosacek Printing, 4444 P Ute, San Diego 17, Calif.

LEARN Sewing machine repairing easy. Neighborhood sparetime gold mine. Supplies! Free brochure. Taylor Service, Box 2126, San Bernardino, Calif.

MAKE Money, address and mail new self-selling catalog. We fill orders for you; big profits; many repeats. Send 25¢ for sample and complete details! Tip Top, Box 259, Indianapolis 6, Ind.

PLATE Baby shoes, jewelry, gifts, bronze and colored pearl. Free booklet. Platex, 11029 South Vermont, Los Angeles 44.

RAISE Rabbits on \$500 month plan. Plenty markets. Free details. White's Rabbitry, Dept. 122, Mount Pleasant, Michigan.

SPARE, Full-time. \$5-\$200 profit per order. Name brand appliances cameras, etc. No inventory. Free details. Happy Homes, Dept. P-10, 366 Hempstead Ave., West Hempstead, N.Y.

FREE Lists, 640,000 items wholesale. P. Cottage Industries, Omaha 12, Nebr.

HOW To make up to \$100.00 a week in spare time—by mail. Tested, money-making plan. Free details. Personal Press, 1412-PM Great Northern Bldg., Chicago 4, Illinois.

WHOLESALE—Beautiful chrome plated retractable pen and pencil set \$1.35 post paid. Distributors inquiries invited, P. Mitchell, 3325 E. Michigan, Fresno, Calif.

FREE Literature describing moneymaking mailorder plans. National Service, Richland, Georgia.

\$6000.00-12000.00 ANNUALLY. Your own business. Operate shoppers guide. Home operation possible. Details free. Roy Keller, 413 Finch, Adrian, Michigan.

GOLD, Silver, platinum; how to refine, test, make alloys, solders, etc. "The Jeweler's Melting Pot." Formerly \$5.00, now \$3.20. No cod's. Frank Herman, 1529 Liberty Street, Los Angeles 26, Calif.

FREE! Complete mailorder business. Terrific profits! No investment! VitaMins, 2908PM Beverly, Los Angeles 57.

\$100 WEEK Spare time. Fast-selling religious jewelry. Free catalogue. Steven's, 304-PM Diamond, Pittsburgh 22, Penna.

\$900.00 A Month mailorder plan free. Send postcard. Globe, Box 40-B, Adelaide Street Station, Toronto, Canada.

WHOLESALE Catalogue! Appliances, watches! Toys. A Régnier, 329 West 101 Street, New York City.

BE Your own boss. You can't get anywhere working for someone else. Learn the best business for you, how to get started, how to be successful. Write today for the amazing free details. McFarling, 1601 N. 3rd, Temple, Texas.

RUBBER—Mold liquid, molds, models, casting, coloring, baby-shoe metal coating, pearl finishing materials. Wholesale price list; samples 25¢ refunded. Homecraft, 6925 N. Greenview, Chicago.

VENDING Machines—Every description. New or used. Lowest prices. Start a route or sell outright. Mack Postel, 2952 Milwaukee, Chicago 18.

MAIL Order opportunity. Tested. We supply everything. Details. Girard's, Azusa, Calif.

SELL Printing by mail! We fill orders at wholesale prices. Free plan, catalog, samples. Sutton Printing, Box 853-M, Waycross, Georgia.

DOLLARS in the mail! Learn fascinating inside secrets of success! KR, Box 503P, Iowa Falls, Iowa.

\$26,500 SALES in two weeks! Amazing radio-mail order method. Free details. Broadcast Service, 1413-PO Great Northern Building, Chicago 4, Illinois.

IMPORT. Mail order opportunities. Mail-order laws and regulations. Complete \$1. Details, stamp. Will Riet Co., 107F Ilford Ave., North Arlington, New Jersey.

GROW Orchids at home—Profitable, fascinating. Year 'round, Maine to California. No greenhouse. Gorgeous cattleyas, cymbidiums, etc. Successful home grower shows you how. Full details free. Flowerland, 100 So. Vermont, Los Angeles 4.

MAIL Order plus know-how equals success plus independence. Get "How to Sell by Mail" at once. 25¢ postpaid. Coin, stamps. Richard P. Hyland, 1014 4th Street, Santa Monica, California.

YOUR Own name brand business. No investment; no inventory. Part time or full time. Sell famous brands of appliances, housewares, silverware, radios, vacuum cleaners, lamps, tools, clocks, watches, jewelry, etc., etc., over 1000 items. Join thousands of successful independent dealers. Send for free catalog and dealer price list. H. B. Davis Corp., Dept. 11, 145 W. 15 St., New York City.

FREE Brochure! Import, export, mail-order. Warner, Box 6, Fort Scott, Kansas.

DIRECT From leading Swiss and other European manufacturers and distributors—Rare articles at big savings. Big profit opportunities. Free catalog. International Associates, Box 1143-A, Chicago 90.

"I Earn \$400.00 a week." I've learned an amazing new method of printing colorful signs, banners, cards, posters, glasswear—anything. No printing press or other expensive equipment is necessary! Big money-making opportunity for anyone. Write for my secret and revealing home-business plan, you'll be amazed! Mr. Anderson, Screen Print Company, Dept. OR, Los Angeles 61, California.

BUY Wholesale! Discounts to 80%! Appliances, cameras, sporting goods, tools, watches, housewares, etc. Free catalogs. Buy-Rite, Box 258A, Hawthorne, New Jersey.

FREE "How to Start Your Own Mail Order Business." Exclusive franchise! Your own catalogs. We ship hundreds of top mail order items for you. Write now! Mail Order Associates, Paramus 1, New Jersey.

COLORGLAZED Concrete pottery made without molds. Patented method. Cemetery products, novelties, tiles. Basement leak-sealing. Money-making projects. Booklet, details free. Men only. National Potteries Company, Grand Rapids, Minnesota.

\$800 CASH, Plus commission, collecting magazine subscriptions. Rare list 25¢. Warner, Box 1085, Bridgeport, Conn.

YOU Can make money for Christmas in spare time taking magazine renewal subscriptions. No capital or experience necessary. All supplies furnished. Write today! McGregor Magazine Agency, Dept. 500B, Mount Morris, Illinois.

IMPORT-Export opportunity, profitable, world-wide, mail-order business from home, without capital; or travel abroad. Established world trader ships instructions for no-risk examination. Experience unnecessary. Free details. Mellinger F701, Los Angeles 24.

GROW Mushrooms. Cellar, shed. Spare, full time, year round. We pay \$3.50 lb. We paid John Betts \$7,977.78, he started as amateur. Free book, Mushrooms, Dept. 172, 2954 Admiral Way, Seattle, Wash.

MAKE Flexible molds. Cast plaques, figurines, free sample. Tooker, 630-B Chestnut, Hamilton, Ohio.

11,000 NEW Prospects daily. Baby record books, shoes, albums. Sell mailorder. Everything furnished. Free literature. No-Co-Ro, Capitola, California.

LIQUID Rubber, make flexible molds. Free sample. Chaney, 1130 E. 16th St., Jacksonville 6, Fla.

WHOLESALE Catalogue! Appliances, cameras, watches! Cam Company, 8806PM 20th Ave., Brooklyn 4, N. Y.

"MAILORDER Laws and Regulations." Discusses federal, state, local licenses, necessary taxes, legal requirements governing mailorder businesses, \$1.00. "Mail-order Rules for Beginners." Additional helpful information, \$1.00. Play safe. Order both. Tasker, 105 East Custis, Alexandria, Virginia.

MONEY In saw and lawnmower sharpening sparetime at home. Free book. Virgil Foley Company, Columbia Heights, Minnesota.

POPCORN And potato chip equipment. Eakins, Box 933-A6, Springfield, Ohio.

FREE Folio "\$5,000-\$45,000, Unlimited Vacations." No merchandise, equipment. Unknown! Work home, sparetime! Haylings, Carlsbad, Calif.

\$250 WEEK Cleaning venetian blinds. Patented machinery. Free literature. Robinson, 7213B, Indianapolis 1, Indiana.

BREED Rare tropical fish at home. Earn big money! Learn secrets! Help fill huge demand. Amazing opportunity! Free plan. Tropical Fish Breeders, Los Angeles 61, Calif.

BE Appointed state notary public now. Write. Stationers, Helotes, Texas.

COPUBLISH Mail Sale Advertiser, leading mail order paper. Details, latest copy, dime. Vanroy Shirk, Lebanon, Penna.

MINK Raising information free. Complete. Lake Superior Mink Farm. Superior, ERI, Wisconsin.

FREE Book "505 Odd, Successful Businesses." Work home. Expect something odd! Pacific, Oceanside, Calif.

NATURAL Molding rubber, extra thick. Free sample. W. Wooley, 115-A Donald, Peoria, Illinois.

MAKE-Sell polishes, cleaners, anything. Formula catalog free. Kemixer, Park Ridge, Ill.

BIG Profits raising fishworms and crickets. Free literature. Carter Farms, Plains, Georgia.

FIX Typewriters. Inexpensive home course teaches factory secrets. Free booklet. Write, Typewriter, Tarentum 1, Penna.

NEWEST Spare, full-time home business. \$5 to \$10 hour possible. Paint with suede—The finish with touch and eye-appeal. Beautifully auto dashboards, signs, radios, toys, figurines, lamps—1001 others. Complete, step-by-step instructions sent for no-risk examination. Free details. Coast, Los Angeles 61.

\$70 WEEKLY—Home, spare time. Simplified mail bookkeeping. Immediate income—easy! Auditax, 34757A, Los Angeles 34.

\$150 WEEK—Easy! Start home Venetian blind laundry. Revealing book free. A. T. Co., 101 S. 44th, Philadelphia 4, Penna.

WANT To make big money at home? \$5 profit in an hour possible with invisible reweaving. Make tears, holes disappear from clothing, fabrics. Steady year-round demand from cleaners, laundries, homes. Details free. Fabricon, 8334 Prairie, Chicago 19, Illinois.

BRUSH Plating outfits for plating articles in the home and shop. No tanks necessary. Good income spare or full time. Free particulars. Gunmetal Co., Ave. H, Decatur, Illinois.

WE Love our mailman—He leaves over \$1000.00 monthly in our rural mailbox. My college professor husband drafted a scientific home mailorder method. We bought a Texas ranch, live as we always wanted. Now we sell the Ranch Mailorder Method. Operates anywhere. Inquire: Eveningshade Ranch, Helotes, Texas.

50% PROFIT Baking new greaseless doughnuts in kitchen. Grocers buy daily. Free recipes. M. Ray, 3605 South 15th, Minneapolis 7, Minnesota.

MAKE 80¢ Profit on every dollar selling merchandise by mail. Everything furnished. Write: Eastern, Box 142-A, Boston 24, Massachusetts.

\$1,000 MONTHLY Possible in collection agency business. Free details. Write Cole Associates, Syracuse 2, N. Y.

\$5,000 YEARLY. Spare time at home. Nothing to buy. No local selling. Dignified. Guaranteed. Home Harvest. Rt. 3, Box 3491-A, Albuquerque, New Mexico.

HOW To make money with carnival games. 144 page book. 35 illustrations. Enormous profits possible full or part time. \$2.00 postpaid. Free details. Theron Fox, 1296 1/2 Yosemite, San Jose 28, California.

TO \$100.00 Weekly. Sparetime, home operated mailorder business. Successful beginner's plan. Everything supplied. Lynn, 10420-W National, Los Angeles 34.

WHOLESALE Buyers! New 1956 "blue book" gives names of over 3000 jobbers, manufacturers who supply anything. Free details. Associated Wholesalers, 1016-D Starr, Burlington, Iowa.

AMAZING Successes through franchises! Become exclusive distributor, agency operator. Nationwide opportunities. Request details. National Franchise Reports, 333 North Michigan, Chicago 1.

WHOLESALE Catalog! 30-80% discounts! Appliances, musical instruments, typewriters, tools, watches, jewelry, cameras, housewares, etc. Consolidated Distributors, 1300-11 Main, Clifton, New Jersey.

REBUILD Batteries; repair dolls; make rubber stamps; "60 Ideas" free. Universal, Box 1076-A, Peoria, Ill.

OPERATE Mailorder folio business! Free details. Ballard's, 425 East Catherine, Louisville 3, Ky.

MAILORDER! Succeed with something new that everyone wants. Free information. MCB, 1221P W. Minnehaha Pkwy., Minneapolis 19, Minn.

GET The real dope on raising needed capital. Write Enterprise Bureau, Syracuse 2, N. Y.

RAISE Nutria—Vegetarian; raise mink, carnivorous. Individually or combined, potential terrific. Voight Farms, Atlanta 2, Texas.

PLASTERCRAFT Molds, liquid rubber, plasters, flocks, candle supplies. Catalog and manual free. Blue Rapids Supply, Blue Rapids, Kansas.

BIG Profits, selling, John Raper line guides. Makes any fishing pole a fly rod. Literature free. John T. Raper Mfg. Co., Fairfield, N. C.

EARN \$10,000 Yearly raising Angora rabbit wool for us. Information 25¢ coin. American Angora Company, Malta 12, Montana.

SPECIALIZED Magazines. 5,166 different publications—All businesses, trades, vocations, professions, sports, hobbies, etc. Free list. Write today. Commercial Engraving Publishing Company 34C North Ritter, Indianapolis 19, Indiana.

CASH From sawdust. Seventy methods. Tin-cans, thirty methods. Newspapers, eighteen methods. Instructions 50¢ each. All three \$1.00. Charles Company, 12-DXV, Norwood, Ohio.

INTERESTED Mailorder? Samples leading publications in field 25¢. Palm, Box 1221, Baton Rouge, La.

\$46 FROM Square foot plywood with yourigsaw. Woodart, Bridgewater, Mass.

TO Survive as a salesman—Know the tricks of sales resistance. Free facts. Countersalesmanship, Dept. D, 120 Boylston Street, Boston 16, Massachusetts.

FREE Booklet, earn money at home schemes. D. Reuter, 120 Boylston Street, Boston 16, Massachusetts.

BIG Profits making candies. Particulars free. Raymond Schenck, Butler, Penna.

FREE Catalogs. Each contains hundreds of businesses, farms and income properties throughout the U.S. Specify type and location desired. Deal direct with owners. U. I. Buyers Digest, 1608 Hillhurst Ave., Dept. PM-2, Los Angeles 27, Calif.

MONEYMAKING OPPORTUNITIES

WEAVE Rugs. Make big profits. Send for our free catalog, sample card, and low prices on carpet warp, rug filler, looms, parts, inexpensive beam counter. If you have loom, give make, weaving width please. Or. Rug Company, Dept. 0678, Lima, Ohio.

FREE Catalog! Nationally advertised watches, jewelry, appliances, gifts. Buy wholesale for personal needs or resale. Louis Perloff, Dept. PM, 733 Walnut Street, Philadelphia, Penna.

START A buying service, buy wholesale thousands nationally advertised products. Make big profits selling at sizable discounts. Postcard brings details. American Buyers, Hertel Station, Buffalo 16-D1, New York.

EASY Work, big profit, seal photographs, cards, etc., in plastic. Home business. Details, complete kit \$1.00. Permafilm, Route 6, Greenville, S.C.

MEN-Women! Start money-making plastic laminating business at home in spare time. Material that costs 11¢ brings back \$2.58. No canvassing or selling but mail orders bring in \$20 a day. Write for full particulars free. Rush name on postcard to Warner, Room 710, 1512 Jarvis, Chicago 26, Ill.

MAKE Money writing short paragraphs! No tedious study. I tell you what to write, where and how to sell; and supply list of editors buying from beginners. Many small checks add up quickly. Write to sell, right away. Send for free facts. Benson Barrett, Dept. C-27-X, 7464 Clark, Chicago 26.

EARN Money at home. "Moneygetters Bulletin" tells how. Sample 25¢. Donovan, 79-PM Greenbelt, Levittown, N.Y.

SELL Titania gems. Far more brilliant than diamonds. Catalog 10¢. Diamonite, 2420-M 77th, Oakland 5, California.

SEAL In plastic birth certificates, social security, photos, etc.; 600% profit, no experience needed. Complete kit seals eight, \$1.00 postpaid. Kaple Sales, 14 Oak, Shelby, Ohio.

BUY Wholesale! Save 66 2/3%! Appliances, furniture, jewelry, toys, sporting goods, tools. Free details. National Buyers Service, Box 3338EB, San Francisco.

\$7.00 RETURNS \$90.00. Information, dollar supply 50¢. Feeteze, 474-PM Sinclair, Atlanta 7.

RAISE Rabbits on \$500 month plan. Plenty markets. Free details. White's Rabbitry, Dept. 123, Mount Pleasant, Michigan.

MIMEOGRAPHING Services pay sensational local profits. Exciting secret plans exposed! Rush name. Mozelle Mimeo Shop, Bonham, Texas.

VENDING Machines—No selling. Operate a route of coin machines and earn amazing profits. 32-page catalog free. Parkway Machine Corporation, Dept. 27, 715 Ensor Street, Baltimore 2, Maryland.

NEED Products? Salesmen? Markets? Details free! Sayer Associates, 1129-C1 Vermont, Washington 5, D.C.

PLASTIC Foam products. Revolutionary brand new line. Box 25, Cudahy, Wis.

PLEASANT Profits—Let us show you how to start your own complete scissors and tool sharpening business. Free details. Serr-Edge Inc., 9729 Lorain, Cleveland 2, Ohio.

MEN And women wanted to start home business in spare time with little table-top rubber stamp machine. Easy to earn up to \$9.80 an hour without previous experience. Full particulars free by mail. Send postcard to Roberts, 1512 Jarvis, Room 710, Chicago 26, Ill.

IMPORT Opportunities, full details 10¢. Value Imports, 1215 East 93 St., Brooklyn 36, N. Y.

FRAUDS To watch out for. Avoid being swindled. 25¢. Barnes, Box 332, Glens Falls, N. Y.

100 JOBS At home. Free details. Good Will, 12 Montplaisir, Cap Madeleine, P.Q., Canada.

"TEN Years in Mail Order" can save you money. \$1.00 or send for details. Modern Enterprises, 517 Beechtree Dr., Cincinnati 37B, Ohio.

MAKE Money with your camera. Keep your job at same time. \$1.00. Gem Publications, Dept. 16-OC, Linwood, N. J.

START Big-pay business at home in spare time. No experience needed to operate little table-top machine for bronzing baby shoes. Make \$5.46 profit on every pair. Full particulars free. Send postcard to Mason, 1512 Jarvis, Room 710, Chicago 26, Ill.

AMATEUR Artists! Turn your talent into cash! Hamilton, Dept. 4-PMJ, Astoria 5, N.Y.

LEARN Technical Metaphysics and insure your future. Easy, inexpensive correspondence course. Simplest method known. Diploma. Write: Premier College of Technical Metaphysics, 2532 McKenzie St., Vancouver 8, B. C., Canada.

60% PROFIT Cosmetics. \$25 day up. Hire others. Samples, details. Studio Girl Hollywood, Glendale, Calif., Dept. 12610-H.

GROW Mushrooms. Cellar, shed. Spare full time, year round. We pay \$3.50 lb. We paid John Betts \$7,977.76, he started as amateur. Free book. Mushrooms, Dept. 173, 2954 Admiral Way, Seattle, Wash.

EARN Money evenings copying and duplicating comic cartoons for advertisers. Adservice, Argyle 1, Wisconsin.

FREE Book "505 Odd, Successful Businesses." Work home. Expect something odd! Pacific, Oceanside, Calif.

READ Progressive Mailtrade, the magazine that tells how to make money by mail. Dime brings sample and special offer. Progressive Mailtrade, Box 357, Sheboygan, Wisconsin.

PRIZE Contests provide fabulous and confidential home income opportunities! Here's how and where to win your share! Send stamp! National Contest Bulletin, Box 2685-F, Miami 16, Florida.

FREE Folio "\$5,000-\$45,000, Unlimited Vacations." No merchandise, equipment. Unknown! Work home, sparetime! Haylings, Carlsbad, Calif.

FORTUNE Possible raising, fishworms and crickets. Free literature. Carter Hatchery, Plains, Georgia.

ATTENTION: Typewriter owners. Make handsome profits. Write today. Groves Company, 682, Hastings 8, Nebraska.

START A profitable subscription business in spare time! We need men and women (young or old) as representatives for all leading national magazines. Liberal commissions on all subscriptions. Supplies free. Send this ad with your name and address to: Agency Bureau, Dept. PM, Hearst Magazines, 250 West 55th St., New York 19, N. Y.

EARN \$50.00 Daily making mats, shoes and mud guards from old tires. S and S Patents Inc., 1307 North Clark St., Chicago 10, Ill.

LOOKING For something informative? Home work, mail order plans, and trade magazine 25¢. Warren Co., P.O. Box 11, Glenview, Ill.

WHOLESALE Catalog! 30-80% discounts! Appliances, musical instruments, typewriters, tools, watches, jewelry, cameras, housewares, etc. Consolidated Distributors, 1300-27 Main, Clifton, New Jersey.

100% PROFIT. No investment. Stamp brings details, samples. Miller, Box 584, Brooklyn 1, New York.

YOU Earn exceptional fees managing money-raising campaigns for churches, hospitals, organizations. Low cost spare time course guaranteed. Backed by 36 years experience. William Arbogast, 229 East Mason Avenue, Alexandria, Virginia.

DOLLARS Every day! Amazing new magic mail plan. Set-up free. Miller, Box 588X, Oshkosh, Wis.

"EARNING Home Profits Preserving Flowers" shows how to make money with this little known hobby method. Inquire: Mountainside, Springwater 1, New York.

TURN Sparetime into extra cash! Write today for free folder, describing interesting, home moneymaking opportunities! Dean Stike, R-2, Chilhowie, Virginia.

PREPARE Income tax returns at home full or spare time. \$5.00-\$10.00 per hour. Practical instructions amazingly simplified. No lessons. Particulars free. Fox Business Publications, Box 1285-A, Peoria, Ill.

GENERAL Contest Bulletin. Lists contests monthly. Sample, 25¢. 1609 1/2 East 5th Duluth, Minn.

FORMULAS. PLANS, ETC.

LIFETIME Business! Manufacture extremely profitable products! Lists free! Thermolab, Peoria 4, Ill.

WATERLESS Hand soap, cleaner. Complete formula and materials to make a quantity. Complete \$1.00. Write Grucza Co., Box 215, Station F, Buffalo, N.Y.

PRODUCT Analysis, manufacturing formulas, processes developed. Moderate fees. Plastics, Box 1574, Boston 4, Mass.

PRACTICAL Formulas. Lists free. Cummings, Chemist, Gordon Ave., Syracuse 4, N. Y.

FORMULAS; All kinds, latest, best. Literature free. Kemixal, Park Ridge, Ill.

LATE, Modern manufacturing formulas. List free. Moon Chemical, Martville, New York.

PLASTICS

LAMINATING Supplies. Free price list. Solomson, 46 Cornhill, Boston 8, Mass.

LEARN Plastics fabrication for spare time income. Low cost home training now available. Write for free booklet. Interstate Training Service, Dept. D-3, Portland 13, Ore.

PLEXIGLAS, Fiberglass, polyester, acetate. Instructive wholesale-retail catalog free! Gem-O-Lite, 5529 Cahuenga, North Hollywood, California.

PLEXIGLAS, Lucite. Square foot cost. 1/16", \$1.18; 1/8", \$1.52; 3/16", \$1.86; 1/4", \$2.21; 3/8", \$3.23; 1/2", \$4.36. Colors add 10%. Send 15¢ for postage. Aristocrat Plastics, 23-25 Sussex Avenue, Newark, N. J.

PLASTIC Sheet, rod, tubing. Catalog 10¢. Coleman Sales, 5926 Cornell, Dearborn, Michigan.

REPAIR Kit welds broken or cracked plastic articles. Restores original finish. Complete kit \$3.00. Free information. Rayther, Box 271, Station B, Toledo, Ohio.

PLEXIGLAS Square foot cost 1/8" \$1.20. 5/32" \$1.35, 3/16" \$1.58, add 15% for postage, write for list. Aircraft Plastics, P.O. Box 7924, Mt. Lebanon 16, Penna.

"U-Mix-It" liquid vinyl experimental kit, 20¢. Technicraft, 1156 Commonwealth, Boston 34.

REINFORCED Plastic. Stronger than steel. Hundreds of uses. Information, six samples and wholesale catalog. 25¢. Seifert's, Box 31M, DePere, Wisconsin.

NEW Liquid casting plastic, clear, colors. Embed real flowers, insects, photos, coins. Saw, drill, carve. Send 25¢ for handbook. "How to Cast with Liquid Plastic," and proved success plan showing how to make money at home. Castolite, Dept. L-101, Woodstock, Ill.

PLEXIGLAS Craftsman's Handbook \$1.75 post paid. Free plexiglas bargain price list. M. A. Schoener, 19 Summit Drive, Pittsburgh 9, Penna.

CHEMISTRY

YOUNG Chemists. Experimenter's newspaper 15¢. Experimenter, 713 Second St., Canonsburg, Penna.

CHEMISTRY-Science magazines. Literature free. Lanxon, Box 5126-C, Lansing 6, Mich.

ILLUSTRATED Catalog: Chemistry, mineralogy, biology 20¢. Tracey Laboratories, Evanston, Illinois.

CHEMICALS And apparatus for industrial, analytical, and private laboratories. Catalog 25¢. Dept. M-50, Biological Supply Co., 1176 Mt. Hope Ave., Rochester 20, N. Y.

CHEMICALS, Glassware, catalog 25¢. Refundable. Laboratory Sales, Box 161-E, Brighton, Mass.

BOOKLETS: 60 pages each! "Beginners Chemistry," "Chemistry," "Einstein's Relativity," "Physics," "Atomic Theory," "Electron Theory," "Scientific Oddities," "Light," "Sound," "Heat," "Electricity," "Radio," "Astronomy," "Useful Tables," "Geometry," "Mathematical Oddities," "Scientific Terms." Order by titles. 10¢ each. Franks, 3121 South Racine, Chicago 8.

AGENTS WANTED

EXCLUSIVE Line of personal initialed buckles, belts, cap badges, 3,000 emblems, etc. Hook-Fast, Dept. PM, Roanoke, Va.

BIG Money-making opportunity. Exclusive line work uniforms. Jackets, pants, shirts, coveralls. Advertising embroidered. Every business prospect. Outfit free. Master Co., 422 Water, Ligonier, Ind.

SELL Perfume wholesale or retail. Details free. Sample \$1.00. L. Zonis, Box 6550, Philadelphia 38, Penna.

BUY Wholesale thousands nationally advertised products at big discount. Free "Wholesale Plan." American Buyers, Hertel Station, Buffalo 16-A1, N.Y.

GOOD Man can make \$3,000.00 next 90 days. Every house in town wants amazing NiLite "cats-eye" lawn sign. Automatic selling plan pays profits everyday. Write today for free details. NiLite, 173 W. Madison, Dept. 301A, Chicago.

NEW Home club plan sensation! Style shows, children's, adults' apparel easily earns \$20.00-\$40.00 evenings. Prizes, gifts, fun! Experience unnecessary. Complete outfit furnished. Beeline Fashions, Bensenville 642, Illinois.

MAKE Money selling ties! Square ends, reversibles, round bottoms, feather, kerchief sets. Money-back guarantee. Postage prepaid. Special offer: 2 sample ties \$1.00. Retail value \$3.00. Free catalog. Phillip's Neckwear, 20 W. 22nd St., Dept. 415, New York City 10.

EXTRA Cash in your spare time. No experience needed. Just show superb Elmira Christmas cards, name imprinted. Samples on approval. Bonus: Free box of cards; also 50% profit on first order. Elmira Greeting Card Co., 293 Clinton, Elmira, N. Y.

START Your own business on credit. Your own boss. 1598 dealers sold \$5,000 to \$32,000 in 1955. We supply stocks, equipment on credit. 200 home necessities. Sales experience unnecessary. Pleasant, profitable business backed by world-wide industry. Write Rawleigh's, Dept. J-U-PPM, Freeport, Ill.

AT Last! Something new and sensational in latest tall Christmas cards. Make extra money fast! Show satins, velours, metallics. Gets easy orders. Pays up to 100% profit. 30 free samples. With name 50 for \$1.50. Big line. Amazing convertible pen-pencil, napkins, gifts, stationery. Several \$1.00 boxes on approval. Puro Greetings, 2801 Locust, Dept. 640-M, St. Louis 12, Mo.

BIGGEST Christmas card profits. Sensational "Super-36" assortment pays \$1.25 profit on every box—\$50.00 on 40 boxes easy. 200 fast sellers double earnings! Tall cards, novelties, stationery, bargain specials. Assortments on approval. Color catalog, personalized album free. Midwest, 1113 Washington, Dept. 494-T, St. Louis 1, Missouri.

100% PROFIT. Sell stainless steel tableware—Details free. Heyer, 38-11 Raven Street, Levittown 7, New York.

FOG-Stop windshield cloth. Instantly removes blurry mist, frost, sleet, snow. Stops windshield fogging. Samples sent on trial. Kristee Co., Dept. 55, Akron 8, Ohio.

START Greeting card, gift shop at home. Show friends new type Christmas, all occasion assortments, gift wrappings, novelties. Profits to \$1.00 per box. Bonus. Write today for feature boxes on approval. 74 free samples personal Christmas cards, stationery, free catalog. New England Art Publishers, North Abington 1033-B, Mass.

60% PROFIT Cosmetics. \$25 day up. Hire others. Samples, details. Studio Girl Hollywood, Glendale, Calif., Dept. 12610-H.

\$1,000.00 A Month for making dramatic 3-second demonstration of amazing lightweight Presto Fire Extinguisher. New chemical used by airforce snuffs out fires instantly. Only \$4.95. Terrific commissions. Millions want it. Free kit. Merlite, 114 E. 32nd, Dept. P-56M, New York 16.

FREE Box of 20 nationally famous Christmas cards included with other fast selling assortments sent on approval. Earn \$50.00 by selling only 50 boxes of our 900 series Christmas card assortment. Can be done in a few hours of your spare time. Sunshine Art Studios, Inc., Dept. PM19, Springfield 1, Mass. Pasadena 1, Calif.

WAXES Floors without "wax." New invention. No more floor wax to buy. Sensational seller. Samples sent on trial. Kristee Co., Dept. 56, Akron 8, Ohio.

SELL Profitable personalized rugs. For information write Bobby's, Dept. M10, Manitou Springs, Colorado.

BUY Wholesale! 100,000 name brand products! Save 66%!! Big profits selling others spare time! Free details! National Buyers Service, Box 3338EE, San Francisco.

OVER 200% Profit. New, ingenious household item. Retail below \$1.00. Excellent seller. For details write: Atlantic Import, 1302 Cadillac Tower, Detroit 23, Mich.

EXCLUSIVE Distributorships. Top quality low cost English chamois. Babrok, Hudson Falls, N. Y.

FINANCE Your own business! Free literature. Advance, Box 1377-BK, Miami 8, Florida.

NEW Invention, \$4.95 fire alarm, paying up to \$1,100 a month. No wiring. Unlimited market. Dramatic demonstration. Free kit. Merlite (Alarm Div.), 114 E. 32nd St., Dept. F-56M, New York 16, N. Y.

YOU Can make money for Christmas in spare time taking magazine renewal subscriptions. No capital or experience necessary. All supplies furnished. Write today! McGregor Magazine Agency, Dept. 500A, Mount Morris, Illinois.

GOLDMINE Of 600 money makers. Copy free. Specialty Salesman Magazine, Desk 5-B, 307 N. Michigan, Chicago 1.

AMAZING New "Touch-Glow" Christmas cards sell swiftly from free samples. \$62.50 profit on 50 boxes easy! Many tall cards, stationery, novelties, album of imprints. Profits to 100% plus gift bonuses. Samples on approval. Creative, 4401 Cermak, Dept. 509-D, Chicago 23.

FREE! Beautiful feather pictures 200% profit! Apartado 9036, Mexico 1, D. F.

YOUR Own business—Used suits \$1.50, overcoats 65¢, mackinaws 35¢, shoes 12½¢, ladies coats 30¢, dresses 15¢. Enormous profits. Catalog free. Nathan Portnoy Associates, 605-AA West 12th Place, Chicago 7.

GOLD Or silver letters, numbers, windows, doors, trucks. 1" to 6". 500% profits. Free samples. Atlas-T, 544 West 79th, Chicago 20.

PRINTING, Advertising salesmen—Excellent moneymaking sideline selling decalcomania name plates, small quantities. Automobile initials, sign letters. Free samples. Raico, XL, Boston 19, Mass.

\$1.00 PROFIT Selling \$2.95 photo enlargement deal. Allen Studio, Riegler Bldg., Little Rock, Ark.

AGENTS — 300% Profit selling genuine gold window letters; stores and offices. Free samples. Metallic Sign Letter Co., 431-D North Clark, Chicago.

USED And new watches \$2 up. Free list. Southern Watches, Gray, Georgia.

YOUR Ad in this space will get some good agents for you. Yes, I'll prove it. Write for Folder "A" right now. F. W. Johnson, Classified Advertising Manager, Popular Mechanics Magazine, 200 E. Ontario St., Chicago 11, Ill.

EASY Handwork makes fast-selling articles. Sample free. Sunmade Company, Brockton 64, Massachusetts.

WANT More business? Here's an amazing opportunity to increase your sales. Talk to thousands of interested readers of "Mechanica Popular." Our Spanish Edition covers the Latin American countries like a blanket. They're real mailorder buyers. Classified rate 75¢ per word. Try an ad in our next issue. Classified Advertising Department, Popular Mechanics Magazine, 200 East Ontario Street, Chicago 11, Ill.

CALIFORNIA Sweet smelling beads. Sensational sellers. Particulars free. Mission, 2328-PM W. Pico, Los Angeles 6, California.

RUN Spare-time greeting card and gift shop at home. Show friends samples of our new 1956 Christmas and all-occasion greeting cards and gifts. Take their orders and earn to 100% profit. No experience necessary. Costs nothing to try. Write today for samples on approval. Regal Greetings, Dept. 89, Ferndale, Mich.

TREMENDOUS Profits! Every man, woman and child a customer. Used suits \$1.50, pants 35¢, dresses 20¢, shoes 20¢. Operate from store, home, car. Free catalog. Superior, 1250-A Jefferson, Chicago 7.

FAST Selling money makers! Metallic ironing board cover; purse-shopping bag; many others including \$1 retailers. Quality Products, Dept. A, Box 748, Passaic, N. J.

REDUCING Machines. Factory agents. 100% profit. Exclusive. Mary-Mac, 1012 Powhattan, Dallas 2, Texas.

WHOLESALE Catalog! 30-80% discounts! Appliances, musical instruments, typewriters, tools, watches, jewelry, cameras, housewares, etc. Consolidated Distributors, 1300-10 Main, Clifton, New Jersey.

COUNTRY Salesmen. Automatic fire extinguisher. Huge profits. Out-O-Matic Co., 1737 E. 31st, Denver, Colorado.

SCHOOL Seniors—Be popular with classmates. Have spending money galore. Details free. Craftcards, Box 235-L, Pittsburgh 19, Pennsylvania.

MEN-Women agents: Sensational new money-makers — Beautifully hand-painted, plastic personalized photo enlargements, compacts, rings, bracelets, lockets, etc. Simply take orders, pocket 40% commission. We deliver and collect. Sales outfit free. Novelco, 3343 North Avenue, Chicago 47.

FANTASTIC New money-making plan. Sell nothing, yet make to \$50 daily! Offer women, personally or by mail, beautiful stainless steel tableware set complete with chest, free for selling just two sets to friends. Exclusive patterns not obtainable elsewhere. Guaranteed 50 years. Can't rust, stain or tarnish. Successor to sterling. Amazing low wholesale cost starting at \$2.70 set. Postcard brings catalog, booklet "How To Make Money in your Own Business," all money-making plans absolutely free. Topval Corp., Lindenhurst 91, N. Y.

NEW Design 7 1/2"x14" signs, Day-Glo Christmas, general, religious, 35¢ to \$2.00 sellers. Samples \$1.00. Free literature. Sho-Card Signs, Prattville, New York.

AMAZING Profits taking orders for nationally-advertised cosmetics, medicines, polishes, soaps, extracts. Advertising giveaways make selling easy. Exclusive territory. Write for free sales aid kit offer! We trust you. Sayman Products (Since 1877), Dept. 304, 2101 Locust, St. Louis, Mo.

BIG Profits selling bargain-priced imported ball pens. Kern Products, 150-07, 77th Ave., Flushing 67, N. Y.

IDEA Catalog 25¢! Makes you the boss in your own money-making independent advertising specialty business. Academy Ideas, Inc., 2046-C Eastchester Road, New York 61, N. Y.

FREE Book for men and women genuinely interested in owning their own business "Where to buy 800,000 articles wholesale!" Free facts. No obligation. Glass Publishing, Ellwood City, Penna.

SELL African wood carvings. Figures, heads, busts, etc. Up to 150% profit. Details free or \$1.00 with sample carving. Kempo, Box 4098, San Diego 4, California.

LIFETIME Repeat business. Agents, salesmen, crew managers, sparetime workers, distribute our discount catalog. Name brands. Receive commission for lifetime. Catalog, instructions \$1.00. Information free. Save yourself up to 80%! Smart Shoppers' Club, 1354 Emory Road, Atlanta 6, Georgia.

BUY Wholesale 750,000 products. Details free. Carter, Box 6011-AW, Chicago 80.

COULD You sell first quality nylon stockings at 39¢? That's all they cost if they run within 3 months because new slashed prices only 79¢ prepaid (including your commission and bonus). If free replacement needed, customer has two pairs for 79¢! Fantastic opportunity for fabulous earnings. Just write orders, spare or full time. We deliver and collect. Postcard brings free sample stocking and outfit. Dept. 23, Kenmart, 108 Lawrence St., Brooklyn 1, N. Y.

AGENTS! Profits unlimited, choice territories available. Sell the industrial trade a new patented machine vise. For full informative circular, Baier and Son, 15820A Pinehurst, Detroit 38, Michigan.

UP To \$10.00 per hour profit. New permanent scent for cards, cloth, wood, etc. Lasts indefinitely. Details and sample. P. Sturling, 5540 Pensacola, Chicago.

AGENTS; 100% Profit. Make \$1000.00 per month selling Dauben sponge mops. Every home, restaurant, beauty parlor a prospect. Send for free information. Dauben Industries, 1784 Pontiac Drive, Pontiac, Michigan.

SELL Negro Christmas cards, exclusive, new styles, full discounts, big profits! Send \$1 for sample kit, applied against first order or refund guaranteed if not satisfied. Colortone Originals, 114 Pearl St., Mount Vernon, N. Y.

BUY IT WHOLESALE

WHOLESALE Catalog! Appliances, cameras, watches. Postcard: Selbyco, Decatur 161, Illinois.

FREE Catalogs by using directory of 500 wholesale sources. \$1.00. K-C Sales, 838 South 12th St., Newark 8, N.J.

NATIONALLY Advertised merchandise at lowest wholesale prices. Catalog 25¢. Name Brand Wholesale Distributors, Box G, Tonawanda, New York.

MEN'S Suits. Nothing like it in America. Year round gabardine. Blue, gray, tan, charcoal, brown sizes 34-44. Regulars, shorts, longs, \$19 each—2 for \$37. Postage prepaid. Money refunded if not satisfactory. Trend Clothing Company, Box 1014, Baltimore 3, Md.

BUY Wholesale! Resell at big profits. Brand name merchandise—Appliances, cookware, housewares, watches, jewelry, dry goods, clothing, sporting goods, toys, gifts, etc. Free 1957 color catalog with confidential cost sheet. Merit Home Products, Dept. FMB, 107 Manhattan Ave., Brooklyn 6, New York.

WHOLESALE Catalog! Appliances, cameras, watches. Distributors, Box 106A, Hudson, New York.

\$1.00 BRINGS Wholesale catalog and \$1.00 merchandise certificate. Radaker, 510 Park Ave., Anderson, Ind.

QUANTITY Buyers: Nationally advertised \$54.75 watch \$14.75; \$49.95 automatic skillet \$10.20. Etc. Colico Distributors, Forsyth, Ga.

BUY Wholesale nationally advertised appliances, radios, watches, etc. Catalog \$1.00 (refundable). D'Auria, Box 355-PM, Jackson, Michigan.

WHOLESALE Catalog! Jewelry; appliances; housewares! Postcard! Midwest, M-156-M, Pontiac, Ill.

VITAMINS: Save 50%. Free catalogue lists all formulas. Mention product now using for free samples. Vitamin Specialties, Philadelphia 40, Penna.

YOUR Cost as little as 30¢ on dollar! Household items needed in every home. Sell direct, by mail or to agents. Postcard brings booklet "How To Make Money in Your Own Business," catalog and money-making plans absolutely free. Topval Corp., Lindenhurst 724, N. Y.

FREE Wholesale catalog. Name brand appliances, furniture, cameras, watches, luggage, tools, toys, sporting goods. Make Christmas savings-profits! Housewares, 924-P West 79th Street, Chicago 20.

BUY Wholesale! Discounts to 80%! Appliances, cameras, sporting goods, tools, watches, housewares, etc. Free catalogs. Buy-Rite, Box 258 D, Hawthorne, New Jersey.

FREE! Illustrated wholesale catalog. Save and earn money on over 1000 most popular, brand-name housewares and appliances. Tremendous discounts. Write: Shop Smart Ltd., Dept. 110, Box 687, Newark 1, N. J.

WHOLESALE Catalog! 30-80% discounts! Appliances, musical instruments, typewriters, tools, watches, jewelry, cameras, housewares, etc. Consolidated Distributors, 1300-20 Main, Clifton, New Jersey.

FREE Gift catalog. Wholesale catalogs, name brands. Edith's, Deep River, Conn.

USED And new watches \$2 up. Free list. Southern Watches, Gray, Georgia.

ELECTRIC Guitars, amplifiers, wholesale. Free catalog. Carvin, PM287, Covina, Calif.

SALESMEN—DISTRIBUTORS

AD Matches! Sell amazing designs—10, 20, 30, 40 and 240-light book matches. Bigger spot cash commissions; every business a prospect. Low prices for high quality. Repeats. Start without experience; men, women; full, part time. Buy nothing! Sales kit furnished. Match Corp., Dept. PM-82, Chicago 32, Illinois.

CHESTLITE And instant light. No competition. Buyers everywhere. Write for particulars. Substantial profits. Emergency Lights Inc., 620 W. Anaheim St., Long Beach 13, California.

GOOD Man can make \$3,000.00 next 90 days. Every house in town wants amazing NiLite "cats-eye" lawn sign. Automatic selling plan pays profits everyday. Write today for free details. NiLite, 173 W. Madison, Dept. 301B, Chicago.

AUTOMATIC Bed warming sheet, you sleep on, not under. Beats electric blankets 10 ways, costs half as much. Generous profits. Information free. Electro-Warmth, Danville, Ohio.

TAPE Recording! Exceptionally profitable opportunity in your area. Free information. Baron's, Lynden, Washington.

\$1,000.00 A Month for making dramatic 3-second demonstration of amazing lightweight Presto fire extinguisher. New chemical used by airforce snuffs out fires instantly. Only \$4.95. Terrific commissions. Millions want it. Free kit. Merlite, 114 E. 32nd, Dept. F-56M, New York City 16.

ANYONE Can sell famous Hoover uniforms for beauty shops, waitresses, nurses, doctors, others. All popular miracle fabrics—Nylon, dacron, orlon. Exclusive styles, top quality. Big cash income now, real future. Equipment free. Hoover, Dept. K-100, New York 11, N. Y.

\$6.73 PROFIT On every sale of Lightning portable adding machines. Retail \$14.95. Free details. Lightning Adding Machine Sales Co., 2306B W. Slauzon Ave., Los Angeles 43, Calif.

MONEY-Making opportunity! Take big profit orders for world famous patented varieties fruit trees. Also flowering shrubs, roses, vines. Big sales outfit free. Stark Bro's, Desk 30107, Louisiana, Missouri.

GET New shirt outfit free: Make \$90.00 weekly on 5 average orders a day. Famous quality made-to-measure dress and sport shirts at \$3.95 up sell fast to all men. No experience needed. Full or part time. Write: Packard Shirt Co., Dept. 321, Terre Haute, Ind.

ADVERTISING Book matches—Cash in on big demand; sell union label matches. Cuts for all businesses and political parties. Free powerhouse selling kit, low prices, protection guaranteed on repeat orders. Cash commissions. Superior Match Co., Dept. M-1056, 7530 Greenwood, Chicago.

NEW Insulated jackets, shoes sell fast! Be first to take orders for amazing insulated leather shoes, jackets. Keep body heat in, cold, dampness out. We furnish complete sales outfit free. Big monthly earnings on just 2 daily sales. 190 other money makers. Send postcard today. Mason Shoe, C35, Chippewa Falls, Wis.

ICE-Melter pellets melt ice and snow. One order daily pays you up to \$175 per week. 30 times better than salt. Factories, stores, homes are sure prospects. No investment. Revere Chemical Corporation, University Center Station, Cleveland 6, Ohio.

SALESMEN And agents wanted. Sell our beautiful line of dolls. Real money making opportunity. Prospects everywhere. Send for catalog. Glazer Mfg. Co., 93 19th Street, Brooklyn 32, N. Y.

STOCK Signs—Attractive, fast selling, various colored backgrounds, large profits. Fifteen samples one dollar. Details free. F. I. Adams, 158 Roberta Road, Ormond Beach, Fla.

NEW Invention. \$4.95 fire alarm, paying up to \$1,100 a month. No wiring. Unlimited market. Dramatic demonstration. Free kit. Merlite (Alarm Div.), 114 E. 32nd St., Dept. F-56M, New York 16, N. Y.

BRAND New product. 250% profit. Vita-Cell Corporation, 929 Sheridan, Saginaw, Michigan.

WILL You wear new suits and topcoats without one penny cost and agree to show them to friends? You can make up to \$30.00 in a day even in spare time, without canvassing. Pioneer Tailoring Co., Congress & Throop Sts., Dept. A-1226, Chicago 7, Illinois.

SLASHED Prices create fantastic money-making opportunity! Sell first quality sheer women's nylon stockings, guaranteed against runs-snags for only 79¢ prepaid! Actually includes your commission and bonus. Also socks guaranteed one year. Make to \$5 hour writing orders, spare or full time. Experience unnecessary. We deliver and collect. Postcard brings free sample stocking and money-making outfit. Dept. 213, Kenmart, 108 Lawrence St., Brooklyn 1, N. Y.

WHOLESALE—Get the big merchandise—Furniture, appliances, T.V.'s, clothing, tools, auto accessories; most anything. Save half. Literature free. Associated Wholesalers, 1016-DY Starr, Burlington, Iowa.

FRESH Flower fragrance gold baskets. Proven successful money-makers everywhere. Send \$1.00 for demonstrator. Evans, 5930 Comey, Los Angeles 34, Calif.

SALESMEN—Making big money is as easy as falling off a log! There is no selling involved in placing Novo humorous greeting card displays with all types of stores. 25 years of tremendous success. Nationally advertised, non-competitive. Christmas, Valentine, everyday cards. Each store can make you up to \$250.00 annually. Just stop and think what 100 store accounts will do for your income! Write Novo, 1166 Milwaukee, Dept. PM-1, Chicago 22, Ill.

300% SALES Increase guaranteed. Give vacations, other valuable prizes. Your cost 25¢ sent. Salesbooster, 3000 Booker, Fort Worth 11, Texas.

USED And new watches \$2 up. Free list. Southern Watches, Gray, Georgia.

NEW Jobs open in selling! Send name, address for five free issues of Opportunity Magazine's money-making guide, listing hundreds of companies who'll pay you well, full or part-time. No experience needed. Opportunity, 850 N. Dearborn, Dept. 17, Chicago 40, Ill.

ONE Monument sale weekly earns \$200 or more. Jones Monumental Works, St. Cloud, Minn.

WHOLESALE Catalog! 30-80% discounts! Appliances, musical instruments, typewriters, tools, watches, jewelry, cameras, housewares, etc. Consolidated Distributors, 1300-12 Main, Clifton, New Jersey.

MAKE \$10.00 An hour or more, spare time, with tested free trial sales plan for fastest-selling new home appliance. Defrosts refrigerators automatically. Sell 8 homes in 10. Free details, guaranteed profit offer. Write Defrostomatic, 173 W. Madison, Dept. D-102, Chicago.

FREE Catalog ladies' handtooled handbags. Garza, Apartado 82, Tampico, Mexico.

BUILD Sales by recruiting productive distributors selling direct or to retail outlets. Secure most concentrated circulation through classified columns of Salesman's Opportunity. Write for facts. Gilbert, Salesman's Opportunity, Room 1700, 850 N. Dearborn, Chicago 10.

BIG Money daily: Two minute demonstration makes easy sale. Demonstrate and sell Campbell's Gro-Green with Dietene fertilizer and nitrogen solutions. Only company manufacturing all formulas for all fertilizer needs. Est. 1928. Free sample and demonstrating kit free. Full or part time. Campbell Company, Rochelle 228, Illinois.

EMPLOYMENT INFORMATION

CLASSIFIED Sections. San Francisco, Oakland, Sacramento, Stockton, \$1.98. Central Forwarding, Box 1392, Stockton, California.

FOREIGN, Alaskan, U.S.A., job opportunities! To \$1500.00 monthly! Million Americans employed overseas. Copyrighted reports. Who to contact for highest paying jobs. Laborers, trades, truck drivers, office, engineers, many others. 52 countries—St. Lawrence project, Spain, Latin America, northern projects, Europe. Year registration-advisory service. Application forms. Unconditional money-back guarantee! \$2.00 (airmailed \$2.25) c.o.d.'s accepted. International Reporter, St. Louis 1-PL, Missouri.

COPYRIGHTED Reports on best paying jobs with travel, adventure, promotions. Construction, aviation, shipping, laborers, clerical, trades, supervisory, factory, unusual opportunities. Many types of work. Skilled and unskilled. Foreign and state-side openings for men and women. Only \$2.00 (\$2.25 airmail), including registration-advisory service. Satisfaction guaranteed. Included absolutely free: Special reports on Alaska, Spanish airbase construction, South American opportunities and husband-wife foreign jobs. Research Services, Suite 207-PMI, Brown Building, St. Louis 5, Missouri.

FABULOUS Houston. Want-ads airmailed \$1.00. Other business information, contacts. Bill Delaney, 4017 Drake, Houston 5, Texas.

ALASKAN Jobs! Gigantic construction projects. Names, addresses companies hiring. Thousands skilled, unskilled needed. High wages. Salary information. Alaskan map, sample application included. Home-stead, mining, fishing, lumbering, aviation, railroad job information. \$2.00 complete. Alaskan Opportunities (PM) Box 362, Kenmore, Wash.

OVERSEAS Jobs—40 employers' addresses. \$1.00. Applications guaranteed. Clement's Distributors, Box 512, Fayetteville, Tenn.

JOB Information. High pay. South America, the Islands, U.S.A., foreign countries. All trades. Clerical, labor, engineers, drivers, others. Women also. Companies pay overseas fare if hired. Write Section 92F, National Employment Information, 1020 Broad, Newark, N. J.

JOBS Plentiful in Southern California. Classified listings, \$1. Box 73, Hawthorne, California.

EDUCATIONAL AND INSTRUCTION

WELDING Training pays at Hobart Welding School, Box M-1061, Troy, Ohio. VA contract. Best equipment. Catalog free.

FREE Trial—Complete language course for home study by Linguaphone, the world's standard conversational method. At home, easily, quickly learn to speak French, Spanish, German, Japanese, Modern Greek—Your choice of 34 languages. It's like living in another country. Send for free book and details of free trial. No obligation. Try, don't buy! Linguaphone Institute, T-83-106 Rockefeller Plaza, New York City 20.

BLUEPRINT Reading—Train at home. Learn to read blueprints with confidence in 10 easy lessons. Write today Belton School, 1059-A North Lawndale, Chicago 51.

SPEAK. Sing with power, personality. Home self-training method on records. Amazing details free. Canfield, 2018-A 5th Ave. South, Minneapolis 4, Minn.

COMPLETE Your high school at home in spare time with 59-year-old school. Texts furnished. No classes. Diploma. Information booklet free. American School, Dept. X745, Drexel at 58th, Chicago 37, Illinois.

PIANO Tuning pays. Big money in spare time. Learn at home in 30 days. No musical knowledge necessary. Phonograph, records, tools and instructions furnished. Personal instructions available. Free catalog. Capital Tuning School, 16 Southwest Second, Fort Lauderdale, Fla.

EARN Money writing words, tunes for TV, records, radio. Details free. Linton School of Songwriting, 20 (M) Denmark Street, London W.C.2., England.

U.S. Civil Service tests! Training until appointed. Men-women, 18-55. Start high as \$87.00 week. Experience often unnecessary. Get free 36-page book showing jobs, salaries, requirements, sample tests, benefits. Write: Franklin Institute, Dept. Y-24, Rochester, N.Y.

DRAFTING. Design, blueprint reading. Good paying. Easy to learn at home. Minimum age 17. Write Utilities Engineering Institute, Dept. TC-2, 2525 Sheffield, Chicago 14.

FINISH High school at home, spare time. No classes. Diploma awarded. Write for free catalog. Wayne School, Catalog HP-68, 2527 Sheffield, Chicago 14.

"TRIGSIE" Trigonometer gives direct, practical answers to solve right triangle problems—No formulas, no computations. Quality instrument. Write for free literature. Vanora Products, Dept. P-9, P. O. Box 8485, Kansas City, Mo.

SCIENCE Of memory simplified. Volume one of Memorology free. Memorology Studio, 2016 Sunnyside Ave., Chicago 25, Ill.

HAND Engraving; learn at home. Write Box 116, Mishawaka, Ind.

DRAFTING—Design, Architectural, Mechanical, Electrical, Structural, Aircraft mathematics, Physics, Estimating, Surveying. Veteran approved. Mondell Institute, 230 West 41 St., New York City.

HELP Yourself to abundant living. Our courses have aided students to richer fuller lives. Learn secret of contentment, happiness. Earn degrees Ps.D., Ms.D. Write for free book. College of Universal Truth Correspondence School, 23-C E. Jackson, Chicago.

ENGINEERING. Home study. Midwest Engineering School, 10923 Hillcrest, Hickman Mills, Missouri.

STUDY For Doctor's degree of psychology, metaphysics and divinity. Correspondence courses only. College of Divine Metaphysics, Dept. P-M, 2811 North Illinois, Indianapolis 8, Indiana.

LEARN Mineralogy at home. Diploma course. Fortunes now being made in uranium and other minerals. Free catalog. Mineral Science Institute, Desk 2, 159 East Ontario, Chicago 11.

HIGH School diploma at home. Licensed teachers—Approved materials. Southern States Academy, Box 144-MX, Station E, Atlanta, Georgia.

I want to send you proof of the wonderful pulling power of Popular Mechanics classified pages. What's your proposition? Write me today. Include literature if possible. F. W. Johnson, Manager Classified Advertising, Popular Mechanics Magazine, 200 E. Ontario St., Chicago 11, Ill.

BE A real estate broker. Study at home. Write for free book today. GI approved. Weaver School of Real Estate, 2018P Grand, Kansas City, Missouri.

EARN While you learn. Auto and diesel mechanics master this top paying trade. Many graduates earn \$100 a week and up. Approved for Korean veterans. For free information write Dept. No. 256, Nashville Auto-Diesel College, Nashville 3, Tenn.

BOOKKEEPERS! Increase your earnings! Operate your own simplified "Dollar-A-Week" bookkeeping and tax service. Full or spare time. Details free. No obligation. Ellis, Box 200, Cedar Grove, North Carolina.

WANT A diesel job? New opportunities to increase income. Higher pay. More money. We can help you qualify. Tools. Shop method home training. Write today! Diesel, Tractor, Heavy Equipment Division, Interstate Training Service, Dept. B-3, Portland 13, Oregon.

INVESTIGATOR Training. Phillips Secret Service System, 1917-B North Kenneth, Chicago 39.

USED Correspondence courses and educational books bought, sold, rented. Free catalog. Educational Exchange, Menlo, Georgia.

STARTLING Discovery! Amazing new, unworked profession. Know yourself, others; how they think, act. Big money, recognition, returns for those who qualify. Learn at home, spare time. Send only \$1.00 for secrets (regular price \$1.50). \$3.00 credit coupon given. Give age, occupation, your handwriting for surprise worth \$1.00. Estes, 2307-PM National Station, Springfield, Missouri.

SWEDISH Massage. We train you at home. Earn big profits from your own private practice or work with hospitals and doctors. Free catalogue. National Institute, Desk 4, 159 E. Ontario, Chicago, Ill.

BOOKS. Free 1956 catalog, 100 pages Text, vocational, educational, instructional subjects. Millions of volumes, new and used. Bargain prices. Books bought, Est. 1902. Long's College Book Co., Dept. PM, Columbus 1, Ohio.

BOOKS; Hundreds of subjects. Big catalog free. Popular Mechanics Press, 200-BC East Ontario St., Chicago 11.

GROW Mushrooms. Cellar, shed. Spare, full time, year round. We pay \$3.50 lb. We paid John Betts \$7,977.76, he started as amateur. Free book, Mushrooms, Dept. 174, 2954 Admiral Way, Seattle, Wash.

USED Correspondence courses and books sold and rented. Money back guarantee. Catalog free. (Courses bought.) Lee Mountain, Pisgah, Alabama.

MIDLAND Linotype School. Charles City, Iowa. Civilian and veteran courses. Free placement. Established 1909.

WELDING. Arc or torch. Learn at home. Free details. Marnel, Box 7642, Denver 15, Colorado.

BARGAIN. Exciting Little Library booklets. 25¢ each. Tool making, painting, welding, home improvement, games, models, plastics, lamp making, glass blowing, boats, photographs. Free catalog. Popular Mechanics Press, 200-LB East Ontario St., Chicago 11.

PIANO Tuning pays. Learned easily at home. GI approved. 59th year. Free booklet. Niles Bryant School, Dept. P, 3731 Stockton, Sacramento 20, Calif.

WANT Strong, masculine voice? Send for free booklet. Perfect Voice Institute, 210 South Clinton, Studio 2KU-2, Chicago 6.

FREE Listings used correspondence courses and books. Bought and sold. Photographers Market Guide \$1. Money-making Guide \$1. Gem Publications, Dept. 5-O, Linwood, N. J.

ELECTRIC Wiring—Home study. Master Electrician Institute, Box 244, Fitchburg, Massachusetts.

ENGINEERING Degrees earned by home study. (Residential courses also available). American College of Engineering, Box 27724-B, Hollywood 27, California.

EARN Degree. Free bulletin. Homestudy only. Midwestern Bible School, 1060 Broadripple, Indianapolis.

CONVERSATIONAL Spanish, daily phrases, pronunciation in English. Practical help for students, teachers, travelers. Copyrighted, 35¢. Box 1792, El Paso, Tex.

USED Correspondence courses and books, bought, sold, rented. Money-back guarantee. Free catalog. Bayles, 211 Essex, Hackensack, New Jersey.

LEARN Public speaking. The world's best easiest way to success, in one easy lesson or money back. \$2.00. Boland's, Box 26, Garden Grove, Calif.

SECRET Investigation. Experience unnecessary. Investigators particulars free. George Wagner, M125 West 86th, New York 24.

DEGREES, Residence, correspondence. Golden State University, 4415 Santa Monica Boulevard, Hollywood 29, California.

PLAYS, STORIES, MANUSCRIPTS

ALL The world loves an author. If you write, we appraise/sell. Write/phone. Daniel S. Mead, Literary Agt., 419 Fourth Ave., New York City 16; OR 9-1150.

WANT Your book published? Learn how we publish, advertise, promote, distribute. Many successes. Free booklet PM. Vantage, 120 West 31, New York City.

WANTED: Book manuscripts, all subjects considered. Greenwich Book Pub., Attn. Mr. Zealand, 489 Fifth Ave., New York City.

SPECIAL SERVICES

INFORMATION On anything. Ferguson Research Specialists, 116-14 141 St., South Ozone Park 36, N. Y.

ANSWERS To questions on sports, mathematics, history, law or any fact subject. Send \$1.00 and your question to: Answer, Box 3070, Hollywood 28, California.

ARTISTS' SUPPLIES

IF Interested in artist frames, canvas, canvas boards, Red Sable brushes, etc., be sure to get our money saving price lists before buying. International Sales Co., 414-APM E. Baltimore St., Baltimore 2, Md.

CARTOONING, COMMERCIAL ART, SHOWCARD & SIGN PAINTING, TATTOOING

"HOW To Make Money With Simple Cartoons." A book everyone who likes to draw should have. It is free; no obligation. Simply address Cartoonists' Exchange, Dept. 910, Pleasant Hill, Ohio.

LETTER Patterns give signs professional touch. Catalogue, samples dime. Patterns, 2240-M, Fillmore, Chicago 12.

LEARN Sign painting at home. Particulars free. Bolger, 148 Concord, River Edge, New Jersey.

REDWOOD Raised letters for stores. Cut any size, any pattern. Retail at wholesale. Commercial Signs, 11056 San Leandro Blvd., Oakland 3, California.

ARTISTIC Back-dated art magazines. Eight \$1.00. Other courses. Free catalog. Art Book Shop, Arnold, Mo.

YOU Can entertain with chalk talks: Catalog 10¢. Balda The Cartoonist, Oshkosh, Wis.

TATTOOING Supplies, licensed course, illustrated brochures 25¢. Zeiss, 728 Lesley, Rockford, Illinois.

PAINT Signs—Master die cut, outline letter patterns. Complete assortment 1½" to 12" high, prepaid \$2.00. Everly, 583, Newton, Iowa.

LEARN Sign painting at home. Free talent test. Ben Kerns, Box 812-PM, Greenville, S.C.

BASIC Art training at home. Write for free talent test. Students' Art Club, Kennebunkport, Maine.

ADVERTISING AGENCIES. LETTER WRITERS, FOR ADVERTISERS

ADVERTISING, Result-getting ads prepared, placed newspapers, magazines, radio, anywhere! Lowest rates. Catalogue free. Baker Advertising Agency, 189 W. Madison, Chicago 2.

MAILING Lists most any classification \$5.00 1000. Your circulars mailed with ours \$4.00 1000. Write for our literature. Dixie Mailers, King, N. C.

ADVERTISE: 24 Words, 100 Canadian newspapers \$5.50. Lists free. Advertising Bureau, 10511-C Springfield, Chicago 43.

CANADIAN Business opportunity seekers guaranteed. List on gummed labels. \$9—1000. Massow, 166 Kenilworth South, Hamilton, Ontario.

FREE! 1956 Advertisers Rate and Data Directory. 52 pages! E. H. Brown Advertising Agency, 20 N. Wacker, Chicago 6.

BEFORE Advertising—Get instructive Ad-Guide and newspaper-magazine rate-book, free. Chicago Advertising Agency, Chicago 4.

GUMMED Addresses. Army officers. \$10.00, 1000. Capt. P. E. Chamberlain, 45th FA Bn, APO 178, New York.

RUBBER STAMPS AND OFFICE SUPPLIES

FREE Style list stock stamps. Criterion, Box 2326, Denver 25, Colo.

THREE Lines \$1.00 postpaid. Free stamp pad. Barber, Marengo, Ohio.

3 LINES, 1.00. Fast service. Catalogue. Johnson, 443 MacDonough, Brooklyn 33, N. Y.

3-LINE Pocket rubber stamp and pad postpaid \$1.00 with order. Asher's, 2030 Haring St., Brooklyn 29, N.Y.

GREATEST Invention since ball point pens. Personalized stamps with emblem. Write James Snyder, 619-2C, Princeton, Indiana.

FINEST! To 3 lines, \$1.00. Pocket or regular. Salesmen wanted. Nabor's, 90 Nance, Nashville 10, Tenn.

3 LINES, \$1.00. Cushioned—Indexed. Satisfaction guaranteed! Campfield, 14 Beaufort Circle, Springfield 4, Mass.

AIR Mail 25¢. Special stamps for making Christmas cards. Ravis, 5905-A Ellsworth, Dallas 6, Texas.

4-LINES \$1.50. Script \$2.50. Metal pocket stamps \$1.75. Top professionals. Roughsedge's, 2 Lionel, Clark 1, N. J.

ENGRAVED Sign for your desk \$2.25. Beauty Marker, 605 Lafayette St., Aurora, Ill.

TYPEWRITERS, DUPLICATORS, OFFICE DEVICES

EXECUTIVE Checkwriter protects your checks, \$9.95 postpaid. Write for printed sample. Jinny Products, Box 422, Meriden, Conn.

RECONDITIONED Typewriters, all makes, \$15.00 up. Details free. Typewriter Mart, 5139 N. Clark, Chicago 40.

RECONDITIONED Typewriters, duplicating, printing devices, \$25.00 up. Supplies. Appliances. DixieGraph, King, N. C.

PORTABLE Mimeograph! Uses no stencil, no ink. The newest, cleanest, smallest, lightest and cheapest. Weight 15 pounds. DuPont Distributors, P.O. Box 695, Dept. A, New York 1, N. Y.

PRINTING, MULTIGRAPHING, MIMEOGRAPHING, GUMMED LABELS

RAISED Letter business cards. Free literature. Scull's Printing, Wildwood, New Jersey.

TYPEWRITING, Mimeograph work wanted. Toole's, 2209 East Franklin, Evansville, Indiana.

100 8½x11 WATERMARKED Letterheads and 100 envelopes postpaid \$2.10. H. Hudson, Centredale, R.I.

ILLUSTRATED Catalog: Printing, mimeographing. Letterhead folio. Carol, 1863 Edgewood, Norfolk 3, Virginia.

RICHARDSON'S Press. Complete business printing. Reasonable, prompt. Samples. 615 Broadway, Benton Harbor, Mich.

250 LETTERHEADS. Envelopes, cards \$7.25. Samples. E. T. Printing, Route 20, Pottstown, Penna.

BOOKLET, Publication, catalog printers, lowest cost. Catalog free. Adams Printery, 30 West Washington, Chicago 2, Illinois.

BUSINESS Cards of distinction. James Williams, 584 W. Preston Street, Baltimore 1, Maryland.

100 LETTERHEADS 8½x11 And 100 envelopes 6¼, \$2.50 postpaid. Same 3 line setup. Econoprint, Box 625, Whittier, California.

1,000 RAISED Letters business cards \$3.50. Samples. Pioneer, 195-J, Quebec, Island Park, N. Y.

125 LETTERHEADS, 8½x11, One color, \$1.00. 2 colors, \$2.00. Academy Press, Enterprise, Kansas.

COMPLETE Mail advertising service: Mimeographing, printing, offset, copy, art. Catalog free! Jay Edwards, 164-77th, Brooklyn 9, New York.

FREE Catalog, samples. Dealers wanted. Sutton Printing, Box 853-P, Waycross, Georgia.

100 BUSINESS Cards \$1.00. Printers, 1418 Broadway, Rockford, Illinois.

BUSINESS Printing. Fast service. Free estimates, catalog. Cramer, 1010 Morgan, Martinsville, Indiana.

CIRCULARS, Booklets, letterheads, statements, estimates, anything! Lonelm Printers, Paulding, Ohio.

OFFSET Printing \$6.50—1000, 8½x11, 16 lb. National Letter, 251 W. 42 St., New York City 36.

MIMEOGRAPHING—Letters, pricelists, formulas, instructions. Lowest prices. Lem's Letter Shop, 5710 Stanton, Detroit 8.

ADS Running under this heading sell printing. Ask me for proof. I'll gladly send you amazing facts. Ask for Folder "P." F. W. Johnson, 200 E. Ontario St., Chicago 11, Ill.

FREE Catalog business, personal printing. D. M. Press, Sebastopol, California.

BUSINESS Printing. Reasonable. Catalog free. Howprint, 723-G Eunice, Webster Groves 19, Missouri.

SALES Books, order books, bill books, printed business forms. Eddirose, Bronx 72, N. Y. Free catalog.

100 LETTERHEADS (8½x11) Printed carefully, \$1.00, postpaid. Envelopes same. Race Printers, Hudson, New York.

FAST Service! 100 8½x11 letterheads \$2.00, postpaid. Bass Press, Knox, Indiana.

PRINTING. Catalog free. Wellar Press, Box 262, Dover, N. J.

BUSINESS Cards—Wholesale. Agents wanted. Decco Service, Box 3315-M, St. Louis 3, Mo.

100 LETTERHEADS 5½x8½ And 100 envelopes, both printed, 3-lines, \$1.75 cash, no c.o.d.'s. Sheldon, 115 Ninth, Philadelphia, Penna.

QUALITY Printing at wholesale prices. Catalog, samples, free. Bryan & Allen, 503 Williams Ave., Panama City, Fla.

BUSINESS Printing, offset, mimeographing. Samples. D'Yarnett, 285 Cypress, Columbus 23, Ohio.

QUALITY Printing at small town prices. Send copy for quotations. Mercury Press, Box 69M, Marengo, Iowa.

PRINTING OUTFITS AND SUPPLIES

RUBBER Stamp making presses, hydraulic operated, electrically heated. 3 sizes 5"x8", 8"x12", 10"x15". Complete starting outfits. All kinds supplies. Custom Manufacturing, 601 N. Jefferson, Springfield, Missouri.

MAKE Your own self-molding rubber stamps and printing cuts. Plexirubber, Argyle 1, Wisconsin.

DO Your own printing. Save money. Simple rules. We supply everything. Print for others; good profit. Raised printing like engraving too. Have home shop. Details free. Kelsey Presses, V-11, Meriden, Connecticut.

PRESSES, Type cabinets, supplies. List for stamp. Lincoln Press Company, 220-K Hartwell, Fall River, Mass.

PATENT ATTORNEYS

INVENTORS: When you are satisfied that you have invented something of value write me, without obligation, for information as to what steps you should take to secure a patent. Write Patrick D. Beavers, Registered Patent Attorney, 936 Columbian Bldg., Washington 1, D. C.

PATENTS. "Proof of Invention" free. E. E. Vrooman, Registered Patent Attorney, 507 McKim Building, Washington 5, D. C.

"INVENTOR'S Guide" and "Record of Invention" free on request. Frank P. Ledermann, Registered Patent Attorney, 154 Nassau Street, New York City.

INVENTORS—If you believe you have an invention, you should find out how to protect it. The firm of McMorow, Berman & Davidson with offices in Washington, D.C., is qualified to take the necessary steps for you. Send for copy of our patent booklet "How to Protect Your Invention." We will also send you an "Invention Record" form. No obligation. They are yours for the asking. McMorow, Berman & Davidson, Registered Patent Attorneys, 134-B Victor Building, Washington 1, D.C.

PATENTS — Irving L. McCathran, 315 McLachlen Bldg., Washington 1, D. C. Registered Patent Attorney.

INVENTION Record form free and "Patent Information Every Inventor Should Have." Carl Miller, Registered Patent Attorney, Woolworth Building, New York.

REGISTERED Patent attorney offers services. Sanders, 6430 Evans, Chicago 37, Illinois.

C. A. Snow & Co.—M427, Snow Building, Washington 1, D. C. Registered Patent Attorneys. Write for information.

INVENTORS: Without obligation, write for information explaining the steps you should take to secure a patent. John Randolph, Registered Patent Attorney, 303 Columbian Bldg., Washington 1, D. C.

INVENTORS — Take these preliminary steps toward patent protection. Sketch and describe your invention. Sign, date and have this disclosure witnessed by two people who understand your invention. Have us make a preliminary search among U.S. patents already granted for similar types of invention. We report on the probable patentability of your invention and recommend your further course of action. Write for our instructive booklet, "Patent Protection for Inventors" and convenient "Evidence of Invention" disclosure form. Victor J. Evans & Co., 231-L Meriin Building, Washington 6, D. C.

INVENTORS: Learn how to protect your invention. Unless the inventor is familiar with patent matters, he should engage a competent registered patent attorney or agent to represent him. We are registered to practice before the U.S. patent office and prepared to serve you in handling your patent matters. "Patent Guide for the Inventor" containing detailed information concerning patent protection and procedure with "Record of Invention" form will be forwarded to you upon request—without obligation. Clarence A. O'Brien & Harvey Jacobson, Registered Patent Attorneys, 61B-K District National Building, Washington, D.C.

FOR INVENTORS

IDEAS Developed for products and your profit with effective patent protection at low definite cost. Foreign patents: Canadian patents filed \$100.00. 30 yrs. in business. Joseph O'Brien, Patent-Development Engineer, 132 Nassau St., New York 38, N. Y.

SEARCHES—Put your patent searches in the hands of a registered patent attorney or agent, as he qualifies to give a worthwhile patentability report. Record of invention form upon request and information on patent protection. Patrick D. Beavers, Registered Patent Attorney, 936 Columbian Bldg., Washington 1, D. C.

INVENTORS: Information on patent procedure furnished on request, without obligation. John Randolph, Registered Patent Attorney, 303 Columbian Building, Washington 1, D. C.

"INVENTOR'S Guide" and "Record of Invention" free on request. Frank P. Ledermann, 154 Nassau Street, New York 38, N. Y.

INVENTORS—This firm is registered to practice before the United States Patent Office and available to assist you in the preparation and prosecution of your patent application. "Patent Protection for Inventors" booklet containing detailed information and steps to take toward patent protection sent promptly upon request. No obligation. Victor J. Evans & Co., 232-L Meriin Building, Washington 6, D. C.

INVENTORS: Learn how to protect your invention. Unless the inventor is familiar with patent matters, he should engage a competent registered patent attorney or agent to represent him. We are registered to practice before the U.S. patent office and prepared to serve you in handling your patent matters. "Patent Guide for the Inventor" containing detailed information concerning patent protection and procedure with "Record of Invention" form will be forwarded to you upon request—without obligation. Clarence A. O'Brien & Harvey Jacobson, Registered Patent Attorneys, 61A-K District National Building, Washington, D.C.

PATENT Searches \$5.00. 48-hour service. Free invention protection forms. Write Raymond L. Smith, Patent Searcher, 620 Sheraton Building, Washington 5, D. C.

MANUFACTURERS Names; any classification; 25-\$5.00. Russell Tupper, Sandwich, Mass.

INVENTORS! Have your good patentable idea? Write Mr. Metzler, 11 West 42nd, New York City.

INVENTORS—If you believe you have an invention, you should find out how to protect it. The firm of McMorow, Berman & Davidson with offices in Washington, D.C., is qualified to take the necessary steps for you. Send for copy of our patent booklet "How to Protect Your Invention." We will also send you an "Invention Record" form. No obligation. They are yours for the asking. McMorow, Berman & Davidson, Registered Patent Attorneys, 134-A Victor Building, Washington 1, D.C.

PATENT Searches \$5.00. 48-hour airmail service. Invention protection forms free. Write Patent Engineering Service, 711 14th Street N. W., Washington 5, D. C.

INVENTION Record form free and "Patent Information Every Inventor Should Have." Carl Miller, Registered Patent Attorney, Woolworth Building, New York.

PATENT Searches, including copies of nearest patents, \$6.00. Reports airmailed within 48 hours. More than 100 registered patent attorneys use my service. For free invention protection forms, write Miss Ann Hastings, P.O. Box 176, Washington 4, D. C.

PATENT Decisions without lawyers. Complete university patent course condensed to 100 easy reading pages. \$4.95. George Heitman, B.S.M.E., M.S., Meeker Ave., Allendale, N. J.

COMPREHENSIVE List of buyers, manufacturers specifically selected for your own invention. Send details of invention use and \$3.00. Winsor, Dept. A, Box 171, Albuquerque, New Mexico.

INVENTORS: Test the commercial value of your patented or unpatented inventions, quickly and inexpensively. Write for free information. Institute of American Inventors, Dept. 40-B, 635-F St., N.W., Washington 4, D. C.

INVENTORS—Send for free patent information book and inventor's record. Registered Patent Attorney, Associate Examiner, Patent Office 1922-29, Patent Attorney & Advisor, Navy Department 1930-47. Gustave Miller, 106A Warner Building, Washington 4, D. C.

PATENT Searches \$4.00. Accurate, reliable airmail reports. Free protection forms. Write us first! Patent Service Institute, Albee Building, Washington 5, D. C.

IDEAS For inventions: 100 needed products are described. Items listed have large market potential. Satisfaction guaranteed. Send \$1. Research Surveys, Box 3891, Columbus 13, Ohio.

SEND Dollar for your copy "People, Patents, and Profits" and official registration. Dollar applies toward services. National Institute of Design & Invention, Box 127-M, San Mateo, California.

INVENTIONS WANTED

INVENTIONS Wanted. Patented; unpatented. Tremendous manufacturers lists. Global Marketing Service, 2420 77th, Oakland 5, California.

INVENTORS. Give us the opportunity to explain our selling plan for your invention, gadget or device, patented or unpatented; free particulars available upon request. Demarest and Demarest, Box 95, Battle Creek, Michigan.

INVENTORS. Don't sell your invention patented or unpatented until you receive our offer. Write Cowgill, Box 298, Marion, Ohio.

INVENTIONS Wanted. Patented or patent pending. 25 years experience promoting inventions. National Service Bureau, 3120 Meramec, St. Louis 18, Mo.

SUPERIOR Promotions. Patented; unpatented inventions. Free, informative booklet, guidance. Superior, 338-344 North Rodeo, Beverly Hills, Calif.

WILL Finance and manufacture your invention or formula if it appeals to us. National Research & Development Corp., 11 W. 42 St., New York 17, N. Y.

ATTENTION Inventors! To sell your invention advertise in Gadgets, Patents, Invention Magazine. Inventors' Service Bureau, 107 W. Van Buren, Chicago 5, Ill.

INVENTIONS Promoted. Guaranteed plan. Write for free booklet "Your Invention." Kessler Corporation, 5101W, Fremont, Ohio.

AMERICAN Congress of Inventors. Quick response. Free Thomas Edison's formulas for success. Inventors, Box 1481, Milwaukee 1, Wisconsin.

INVENTIONS Promoted. A-1 service for years. Adam Fisher Co., 5418 Idaho, St. Louis, Mo.

INVENTORS: Hundreds of manufacturers have requested our assistance in locating marketable new products. Complete information free. Institute of American Inventors, Dept. 40-D, 635-F St. N.W., Washington 4, D. C.

FREE Details available. Exhibit your invention in America's largest invention exhibition. Viewed by thousands of manufacturers. Act at once. California Inventors Association, 681 Market Street, San Francisco 5, California.

MR. Inventor! Mr. Manufacturer! If you have an item that requires capital, development and top notch national sales coverage, contact us immediately. We have the organization, financing and know-how. Principals only. Confidential. Reply to Advertiser, c/o Hayes-Endler-Brown, 555 Madison Avenue, New York 22, N. Y.

PATENTS FOR SALE

INVENTIONS For sale. Queries from manufacturers solicited. Kessler, Patent Broker, Fremont, Ohio.

MANUFACTURING

MODELS — Small lot manufacturing. Metals, plastics, etc. Milburn, Burlington, Kentucky.

MODELS, MODEL SUPPLIES

12 GEARS. Common pitch, both spurs and bevels, various sizes, cut to AGMA specifications. \$3.00 postpaid cash or money order. Mass Gear, Woburn, Mass.

TRUCKS. Superbly detailed plastic scale models. 20 ton van, 5000 gallon milk or gasoline trailer, your choice \$1.00 each postpaid. Satisfaction guaranteed. Free cement with \$2.00 order. Plastic kits, ships, cars, planes, trains, guns, tanks. Inquiries answered. Bronx Hobby, 1359-A Jerome Avenue, Bronx 52, New York.

WANTED—Viking metal model liners, warships. (Scale 1:1250). Models, Box 91, Blue Island, Ill.

BUILD A live steam locomotive! Plans, instructions \$8.50. Details free. David Bair, 725 Walden, Winnetka, Illinois.

POWER Models. Unusual steam gasoline and traction engines, fittings, metals. Comprehensive catalog \$1.00. Chas. Cole, Ventura, Calif.

CATALOGS: Ship models 50¢; foreign woods, and veneers 50¢; garden circus lists 35¢. Jig saw blade list free. Wild's, 510 East 11th Street, New York City 9.

SHIP Model kits and fittings including clippers, trawler, fishermen, frigates, privateer, radio control tug, etc. Send 25¢ for 1956 catalog. Model Shipways, Box 85, Bogota, N. J.

BUILD Miniature passenger hauling live steam locomotive with file and drillpress. We do machine work, you bolt it together. Catalog 50¢. Little Engines, Lomita, Calif.

SHIP And yacht model fittings; blueprints. Send 35¢ for illustrated catalog listing hundreds of items. A. J. Fisher, 1002-1 Etowah Ave., Royal Oak, Mich.

SHIP Models. Most complete line in New England. Kits, fittings, plans, books, tools, engines, motors. Illustrated catalog 30¢. James Bliss & Co., Inc., Dept. SM, 342 Atlantic Ave., Boston 10, Mass.

BALSA Wood and model aircraft. 40-page catalog 25¢. Sig Co., Montezuma, Iowa.

LIONEL, American Flyer trains sold, repaired. Big discounts. Bulletin free. Catalog 25¢. Mack Bros., 2043-P Chicago Ave., Chicago 22.

HOME CRAFTSMEN

AROMATIC Red cedar lumber. Small lots shipped anywhere. 1/2" and 3/4". Red Cedar Products, Robertsville, Mo.

LAMP Size cypress knee with nipple installed \$2.00. Cy Products, Dept. 2-Y, Lafayette, La.

VIOLINMAKERS. Good seasoned European wood, tools, instructions. Catalogue 10¢. Premier Violin Supplies, 309 West Fourth St., Los Angeles 13, Calif.

LEATHERCRAFT. Send 10¢ for new 76-page catalog of tools, supplies, kits, including metalcrafts, enameling, ceramics, all other crafts. Complete stock. Reasonable. Since 1910. Sax Bros., Dept. PM1, 1111 N. 3rd, Milwaukee, Wis.

BUY Wholesale nationally advertised power, hand tools, thousands other products at big discounts. Free "Wholesale Plan." American Buyers', Hertel Station, Buffalo 16-Fl, N. Y.

101 FULL Size patterns. Smart, new, gifts, novelties, lawn figures, shelves, action windmills, alphabets. Plus "Make Money Jig Sawing." Only \$1.00. Mastercraft 105M, 7041 Olcott, Chicago 31, Ill.

METALCRAFT. Big illustrated catalog free. Aluminum, copper, and enameling supplies. J. C. Larson Co., 820 S. Tripp, Dept. 6127-M, Chicago 24.

LEATHERCRAFT. Copper enameling, mosaic tile, shellcraft, metal tooling, beadcraft, many more crafts. Free big catalog. Kit Kraft, Dept. 2310, Studio City 1, Calif.

RHINESTONE Jewelry is simple to make yet looks professional. Stunning brooch and earring kit, plus catalogue, for only \$1.00. Jewelcraft Co., Dept. P., Framingham, Mass.

FREE. Complete illustrated catalog. Leathercraft kits, supplies. J. C. Larson Co., 820 S. Tripp, Dept. 6527-L, Chicago 24.

FINISHING Wood, genuine wood finished panels, available 32 colors. Free information. Gaston Finishes Company, Bloomington, Indiana.

MONEYMAKING Projects for woodcraft shops. Northland Products, Route 1282, Rockland, Maine.

GRANDFATHER Clock movements, plans, kits. Wholesale catalog 25¢. Mason-Sullivan, Noroton, Conn.

JIGSAW Patterns for boys! Large variety, gifts, novelties, usefuls, pinups, lawn ornaments. \$1.00. Pauls Plans, 4633 North 18th, Milwaukee 9, Wisconsin.

CHILDREN'S Knockdown platform rocker. Springs, duran, lumber, etc. 100% parts. Make this for Christmas. \$6.75 each. Matching ottoman \$1.00 each p.p. For further information write Carpenter Furniture Co., P.O. Box 3173, Birmingham, Ala.

OVER 900 Woodworking projects. Books and patterns. Free catalog. Craftsman, 115-C Worth St., New York City 13.

KNOCKDOWN Cedar chests. Lumber and veneers. Free price list. Giles & Kendall Company, Huntsville, Ala.

TABLE Legs—Beautiful sturdy birch—Turned, tapered, or bent laminated, set of 4 only \$3.75 postpaid. Brackets to attach included. Makes hundreds professional designs. Write for free catalog quality furniture kits, legs, tops, plywood. Birchwood Industries, Dept. 1, Fitchburg, Mass.

FREE! Craftsmen's—Craftswomen's reference books, gifts, patterns, samples, plans. Send only \$1.00 for this sensational free-items-directory. Craftsmen's Service, 412 Portland, Rochester 5, New York.

STYLICRAFT Sure fire hits. "Pre-traced" leather kits. Handbags, billfolds, filigree belts, over fifty other projects. Patterns on leather. Why trace? Just carve, assemble and lace. Large assortment "precarved" kits also available. Send 25¢ for catalog, free folder. Refunded first order. Apache Leather Company, 2804 E. Washington St., Phoenix, Arizona.

KNOCKDOWN Cedar chests and lumber. Free price list. Bedford Lumber Company, Shelbyville, Tennessee.

18 FULL-Size patterns. Save money with easy-to-use, professionally designed full-size patterns. Make money selling beautiful, useful furniture. Make modern step and cocktail tables; metal lamps; cupola; 12-foot outdoor. All patterns test-built; sold with money-back guarantee. Get your free list of these convenient, economical patterns today. Popular Mechanics Press, 300-HH E. Ontario Street, Chicago 11, Illinois.

ALL Crafts, supplies. Large free catalog. National Handicraft, 199 William Street, New York City 38.

FREE Catalog. 1560 patterns and designs. Craftplans, 1321-A South Michigan, Chicago 5.

WOODWORKING And cabinetmaking course for beginning and advanced home craftsmen. Only complete low-cost home training program available. Write for free booklet. Interstate Training Service, Dept. G-3, Portland 13, Ore.

I want to send you proof of the wonderful pulling power of Popular Mechanics classified pages. What's your proposition? Write me today. Include literature if possible. F. W. Johnson, Manager Classified Advertising, Popular Mechanics Magazine, 200 E. Ontario St., Chicago 11, Ill.

129 NEW Full-size jigsaw patterns. Artist-drawn. \$1. Craftplans, 1321-A South Michigan, Chicago 5.

LAZY Susan bookcase lamp. Beautiful, practical, profitable. Free details. Key Supply, 5764B N. Lacey Ave., Chicago 30, Illinois.

LEARN Art metalcraft and jewelry making. Complete, inexpensive, home training course now available. Special tools and materials furnished. Write for free booklet. Interstate Training Service, Dept. L-3, Portland 13, Oregon.

FREE "Do-it-yourself" leathercraft catalog. Tandy Leather Company, Box 791-Q17, Fort Worth, Texas.

DO IT YOURSELF

BEAUTIFUL Moulded plastic, letters, signs. Colors, P.O. Box 106, Spencer, Ind.

BUILD A loom. Weave rugs, drapes, cloth. Complete instructions with 8 drawings \$1.00. Or. Rug Company, Dept. 0679, Lima, Ohio.

8'x7' OVERHEAD Type garage doors, with complete hardware. 4 sections high. 6 panels across \$60.00. Other sizes. County Doors, 493 Gregory St., Bridgeport, Conn.

WATER Purification. No tanks. Complete plans \$1. Norman, Box 61023, Los Angeles, Calif.

BUILDING Or remodeling? Save 50 percent or more of your cost by installing your own heating and/or air conditioned system with our complete "do-it-yourself" packaged automatic controlled hot water or warm air heating and air conditioning systems. We supply you the complete pre-cut system composed of nationally known units and material custom designed from your plan or sketch plus complete set of drawings and instructions so easy to understand that you can readily install it yourself. Hundreds of satisfied customers have proved the practicability of our method. You will be proud of the professional results you obtain. Write for free folder describing method and procedure—no obligation. Convector Corporation, 52 Canal Street, S.W., Washington, D. C.

BUILD Inexpensive concrete blockmaker—Motor, hand. Write. C. Lee, Mountain View, Oklahoma.

CLOCK Movements—Gorgeous dials, plans, kits. See ad page 317.

PATIO 5 Hole golf game. Easily built. Have fun galore. Illustrated plans \$1.00. Moneyback guarantee. Free gift included. Brownie's, 5835 Fairmount, San Diego 20, Calif.

BUILD The patented Little Mint Paper Baler. Slickest baler for homes, offices, stores, etc. Plans and license \$1.00. L. M. Baler Co., Box 125-A, Wausau, Wisconsin.

NOVELTY Jewelry, parts and findings assorted \$1.50 pound. Imported stones 1000 assorted \$3.00. Beads imported assorted \$1.00 pound. Pearls assorted \$1.00 pound. Add 25¢ for postage. Merchandise, 19-E 16th Street, New York 3, N. Y.

WATCHES, OLD GOLD, JEWELRY

DIAMONDS, Jewelry. Free catalog. Direct factory savings. Hedges, Amityville 187, N. Y.

RHINESTONES. Send \$2.25 for five gross, value \$6.00, free bargain list, catalog. Ebert, Box P183, East Orange, New Jersey.

WHOLESALE Quality jewelry findings, chains, etc. Fraternal, religious emblems. Catalog 10¢. First order discount 10%. Caraday, Dept. PM8-6, Box 71, Ryder Station, Brooklyn 34, N. Y.

WATCH And clock repairing books. Free information. North American, Dept. 16K, 2320 N. Milwaukee, Chicago 47, Illinois.

RHINESTONES, Jewelry settings, copper enameling, hobby kits. Illustrated catalog 10¢. J & M Novelties, Dept. CL-3, Griffith, Indiana.

10 WATCHES \$18.00. Minor repairs. Catalog 20¢. Berkwit, 1150 Castle Hill, New York City 62.

WATCHMAKERS'—Jewelers' supplies, instructions. Catalog 20¢. Bengale Company, Culver City, California.

COSTUME Jewelry supplies. Catalog and samples. 35¢. Largest line in America. Milady-Fair Co., G.P.O. Box 1328, New York City 1.

USED And new watches \$2 up. Free list. Southern Watches, Gray, Georgia.

HIGHEST Cash for old gold, broken jewelry, gold teeth, watches, diamonds, silverware, spectacles, platinum, mercury. Free information. Satisfaction guaranteed. Rose Refiners, Heyworth Bldg., Chicago 2.

TOBACCO, SMOKERS' SUPPLIES

DRI-Well pipes. Pipe making instructions. Walter Miller, Germantown, Ohio.

RAZORS, BLADES, SHARPENING

100 FINEST Quality, double edge blades. If you don't trust the quality, send \$1.00 after you receive blades. Kalnmais, 1934 N. Hoyne, Chicago 47, Illinois.

100 BEST Blades \$2.50 postpaid. Chester, 319 1/2 N. Forence, Monterey Park, Calif.

GET Perfect shaves for days with each double-edge blade. Complete instructions \$1.00. Nothing further to buy. Dept. G, Box 322, Chula Vista, Calif.

TRAVALONG Famous stainless steel safety razor. Used by U.S.A.F. in survival kits. Uses any double-edge blades. Carries blades inside. Fits in watch pocket. Perfect gift, premium. Sample \$1.50. No c.o.d. Money back guarantee. Profitable territory open. The Pak Co., Cleveland 12-P, Ohio.

FOR THE HOME

FOAM Rubber furniture cushions. Factory seconds. 50% discount. Free catalog. Perma-Foam, 236C Rhode Island Ave., East Orange, New Jersey.

SAVE On even your income. Revolutionary system tells how; helps. Year, \$2, Box 1992, Tulsa, Okla.

BE Your own plumber. You can. Few inexpensive tools and our instructive book, "Home Plumbing Guide," shows and tells you how. Hundreds of photographs and diagrams. Easy to follow. 160 pages. \$3.50. Catalog free. Popular Mechanics Press, 200PG East Ontario St., Chicago 11, Ill.

OF INTEREST TO WOMEN

DRESSES 24¢; Shoes 39¢; men's suits \$4.95; trousers \$1.20. Better used clothing. Free catalog. Transworld, 164-S Christopher, Brooklyn 12, N. Y.

GROW Mushrooms. Cellar, shed. Spare, full time, year round. We pay \$3.50 lb. We paid John Betts \$7,977.76, he started as amateur. Free book. Mushrooms, Dept. 176, 2954 Admiral Way, Seattle, Wash.

WANT To make big money at home? \$5 profit in an hour possible with invisible reweaving. Make tears, holes disappear from clothing, fabrics. Steady year-round demand from cleaners, laundries, homes. Details free. Fabricon, 8332 Prairie, Chicago 19, Illinois.

SELL Fine fabrics. Get yours wholesale. Box 863, Norwalk, Conn.

BOOKS: Hundreds of subjects. Big catalog free. Popular Mechanics Press, 200-BC East Ontario St., Chicago 11.

FREE—Big new wholesale catalog! Up to 50% saving for you, family, friends on nationally-known gifts, jewelry, toys, appliances, Christmas cards, etc. Also make money selling part time! Write: Evergreen Studios, Box 846-D, Chicago 42, Ill.

PROFITABLE Home business. Make fast-seller chenille monkey trees, dolls, flowers. Terrific holiday demand. Information free. Velva, Bohemia 16, N. Y.

LEARN Professional cake decorating. Details free. Deco-Secrets, Venice 3, Calif.

UNION Looms for profitable weaving. Weave rugs at home for neighbors on \$69.50 Union loom. Thousands doing it. Booklet free. Caricraft Co., Polk St., Boonville, N.Y.

"8 MISTAKES Parents Make." Every parent should have this new book about child training. It is free; no obligation. Simply address Parents Association, Dept. 6710, Pleasant Hill, Ohio.

CASH Paid for box tops! Some. 25¢: Inquire: Boxtops-3, Cedar Hill, Texas.

\$200 MONTHLY Possible sewing baby-wear! No house selling! Rush stamped addressed envelope, Babygay, Warsaw 43, Indiana.

WANTED—MISCELLANEOUS

WANTED. Exclusive distributorship. Fast selling items. Almar Sales, 188 West Randolph, Chicago 1.

CASH For antique northwest coast totems, masks, carvings. Send photos. Robert Stolper, 8852 Cynthia, Los Angeles, California.

SCRAP Mercury (quicksilver) containers supplied — Tantalum, tungsten, silver, platinum. Metallurgical Products Company, Established 1909, 35th & Moore Sts., Philadelphia 45, Penna.

QUICKSILVER, Sterling, silver solders, precious metals. Wholesale Terminal, Norwood, Massachusetts.

BOOKS: Hundreds of subjects. Big catalog free. Popular Mechanics Press, 200-BC East Ontario St., Chicago 11.

PERSONAL

BORROWING By mail. Loans \$100 to \$600 to employed men and women. Easy, quick. Completely confidential. No endorsers. Repay in convenient monthly payments. Details free in plain envelope. Give occupation. State Finance Co., 323 Securities Bldg., Dept. D-227, Omaha 2, Nebraska.

MIKE Alvanos, tour conductor. Travels in the Congo and East Africa. Address: P.O. Box 893, Tel. 2190, Stanleyville, Belgian Congo.

"HOW Can I find out?" You can! Information confidentially developed. Any matter, person, problem. Worldwide. Officially licensed. Established 1922. William Herman, 170 Broadway, New York City.

BOOKS: Hundreds of subjects. Big catalog free. Popular Mechanics Press, 200-BC East Ontario St., Chicago 11.

REMAILING SERVICE

LETTER Remailing, receiving-forwarding address for rent. McLaughlin, 800 Stewart, Columbus 6, Ohio.

MONTREAL. Letter remailed 25¢, etc. R. Cote, 1567 East Laurier Street, Montreal, Que., Canada.

NEW York City. Remailing 25¢, also forwarding and shopping. Betty, 510 East 11th Street, New York City 9.

HONOLULU Remailing 25¢. Receiving-forwarding available! Write: Fobel, 3132-E George Street, Honolulu.

HOLLYWOOD—Long-Beach remail 25¢. Mailing address \$2.00 month. Lenormand, 722 Magnolia, Long-Beach, California.

MAIL Received-forwarded. \$3 month. Hedgpath, Box 830, Alhambra 23, Calif.

COLUMBUS, Ohio. Remails 25¢, etc. John Volan, 1437 N. High St., Columbus 1, Ohio.

DAYTONA Beach remailing 25¢. Receiving, forwarding. Box 830, Daytona Beach, Florida.

REMAILS—Santa's Village \$1.00. Niagara Falls, Toronto 25¢. Box 66, Sta. D. Toronto, Canada.

TREASURE FINDERS

FIND Buried treasure, gold and silver, with Goldak's sensational 3 1/2 lb. "find-it" locator, only \$49.50. Write for free literature on complete line of mineral, metal locators; Geiger and scintillation counters. Goldak, 1541 W. Glenoaks Blvd., Glendale, Calif.

FREE. 16-Page manual from world's largest mfr. of prospecting equipment. Delectron Corp., 5528 Vineland, North Hollywood, Calif.

GOLD And silver indicators. Price \$30. Box 51, Plant City, Fla.

FOR Treasure locators, geiger, scintillation counters, mineralights, M-Scope. Fisher Research Laboratory. See advertisement page 344.

URANIUM, Gold, silver treasure. New power-packed highly sensitive metal detectors, Geiger counters and mineralights. Kits and assembled models from \$12.50. Lightest weight, guaranteed, free literature. Electronic Applications, Dept. M, Box 8, Arlington 10, Virginia.

JEOP Owners—V8 power. Read Jeep owners ad, page 22.

FOR SALE—MISCELLANEOUS

SPORT. Dress jackets. Wholesale. Free booklet. Allied, Box 183M, Everett, Mass.

SAVE Up to 50% on new Lionel trains. Send 10¢ for illustrated catalog. Gammerman's, Dept. A, 3808 Eastern Avenue, Baltimore 24, Maryland.

WAR Surplus bargains! New government releases arrive constantly. Save up to 80%. Blankets, boots, coats, tents, wearing apparel. Send for free war surplus catalog. Sioux Falls Surplus Store, Sioux Falls, South Dakota.

AMAZING Automatic razor blade sharpener. Blade lasts for months. Sample \$1.25. Universal Products, 3915 W. School Street, Chicago 18, Illinois.

HEARING Aid batteries, wholesale. Free list. Habs, Box 51, York, Penna.

BOOKS: Hundreds of subjects. Big catalog free. Popular Mechanics Press, 200-BC East Ontario St., Chicago 11.

TYPICAL Leather bags, skirt lengths. Free catalog. Mapiilon, Box 268, Guatemala, C. A.

MISCELLANEOUS

TOKYO! Get your gifts from Japan for Christmas. Last day shipment Nov. 25. Kimonos, jewels, model engines, etc. Information \$1.00. Clarence Yamagata, 202 Naka 7 Bldg., Marunouchi, Tokyo.

BRILLIANTIZE: Amazing new cleaner. Works like magic. Cleans copper, silver, other metals instantly. Safe for delicate items. Tremendous profits. Details free. Stephenson's, Box 435, Ames, Iowa.

BACKYARD Bonanzas raising earthworms! Get \$10 orders, keep \$8! Raising, marketing instructions, 10¢. Oakhaven-M, Cedar Hill, Texas.

RECEIVE Samples, magazines, catalogs, opportunities, 10¢. American Directory, Leming, Texas.

1 JOHN 5; 1 & 4. Whitcomb, 308 Sycamore, Newport News, Va.

VITAMINS At savings—Fine products. Feel better, younger! Free literature. Vitamin-Center, Drawer 2318P, Detroit 31.

DWARF Trees, plants, shrubbery grown on your living-room table. Profitable hobby. Complete instructions and seeds. Only \$2.00. Miniature Nursery, 3252 West 84th St., Cleveland 2, Ohio.

FABULOUS Los Angeles area! High pay jobs, opportunities galore. Bargains, real estate, travel arrangements, personal situations, fun, glamor, the works. World's largest classified section, L.A. Times (Sunday, approx. 50 pages), mailed Saturday, \$1.00 in U.S., Canada, Mexico. Airmail, \$2.00. Kinetic, Box 211, Van Nuys, Calif.

WHOLESALE Catalog! 30-80% discounts! Appliances, musical instruments, typewriters, lools, watches, jewelry, cameras, housewares, etc. Consolidated Distributors, 1200-13 Main, Clifton, New Jersey.

LEATHER Jackets renovated, expertly. Free circular 8. Berlew Mfg. Co., Freeport, New York.

YOU'LL Never fall asleep playing Country Auction. Fast-moving, action-packed board game. \$2.95 postpaid. Details free. Everett, 1900 N. Keeler Ave., Chicago 39, Illinois.

RECEIVE Magazine samples, mails, catalogues, offers from everywhere. Get listed 25¢. Rorick, Cincinnati 26, Ohio.

GROW Mushrooms. Cellar, shed. Spare, full time, year round. We pay \$3.50 lb. We paid John Betts \$7,977.76, he started as amateur. Free book. Mushrooms, Dept. 175, 2954 Admiral Way, Seattle, Wash.

STUPENDOUS Mental power. Adults. Details 3¢. Delmar Wisdom, 846 Sunny-side, Chicago 40.

CIGARETTES—Make 20 for 9¢. Facts free. Moberly, Box 810, Owensboro, Ky.

YOUR Name wanted. We'll send 1000 publishers, mailers, wholesalers your name, on our list one year 25¢. Dixie Mailers, King, N. C.

DO It yourself. What? Repair TV, build furniture, make barbecue, plumbing repairs, build boats, do house wiring, remodel home, lay tile, modernize kitchen, repair home, and scores of other things you can do yourself. Books covering each subject, only 25¢. Send for descriptive list. It's free. Popular Mechanics Press, 200-LB East Ontario St., Chicago 11, Ill.

CESSPOOLS, Septic tanks, outhouses, clogged drains, cleaned, deodorized without digging, pumping. Sursolvent reduces contents. Reclaims leachability. Old systems work like new. Free details. Electric Sewer Cleaning, Allston 34, Mass.

70 BIBLE Lessons, 25¢. Bulletin, Box 87, Cathedral Station, New York City 25.

CYPRESS Knees, \$5.00 dozen, up. Details. Gipple's Giftwares, DeLeon Springs 2, Florida.

POWERFUL New drafting underlay (American Mathematical Monthly, Nov. 1955). Draw accurate spherical space figures. Solve spherical trigonometry, axonometry. With treatise. \$2.95. Sphere Grid, 3829 Davis Place, N.W., Washington 7, D. C.

MIRACLE Cross with Lord's Prayer. Gold plated. Simulated diamond encrusted. Wonderful Xmas gift. \$1.95 p.p. Saltzburg, 1154 Monroe, Rochester, N.Y.

BOOK Listing thousands of valuable free items available from government and industry \$1. Money-back guarantee. Free Offers, Box 102-C, Brooklyn 19, N.Y.

LEFT Handed? Send for free list of articles made special for left hand use. Make ideal gifts. Left Hand Products, Box 402, Warren, Ohio.

"HOME Improvement Guide." New, amazing 192 page volume. Packed with ideas, plans for remodeling, decorating, landscaping, built-in projects. \$2.50 prepaid. Popular Mechanics Press, 200-HG East Ontario St., Chicago 11.

IMPORTED Baby carriages, sliding windows, beautiful colors. Will ship by Christmas. Free details. Pidanza, 27830 White Rd., Wickliffe, Ohio.

EXCLUSIVE 35MM color slides of Swedish ship Stockholm showing collision damage. 60¢ or 2-\$1.00. Pride Service, P.O. Box 3837, Cleveland 10, Ohio.

STOP Defrosting your refrigerator by hand. Defroster, automatic, simple to attach, guaranteed. Send for free literature. Leonard, 8113 E. 5th St., Downey, Calif.

CATHOLIC Gift supreme—Most beautiful Catholic Bible ever published, with Cardinal Spellman's imprimatur. Bonus, genuine mother-of-pearl rosary from Holy Land. Write International Associates, Box 1143-B, Chicago 90.

LOVEMATE Cuff-links or earrings. Genuine gemstone. Aventurine or tiger-eye. \$1.00 pr. Turquoise earrings \$1.00. Edward Helpenstell, 1429 Sandpiper Dr., Belaire, Texas.

BUY Wholesale! Discounts to 80%! Appliances, cameras, sporting goods, tools, watches, housewares, etc. Free catalogs. Buy-Rite, Box 258-B, Hawthorne, New Jersey.

INTELLIGENCE Test. Exact I.Q. Score fit yourself! \$2.00. Testing Service, 4912 Reid Way, Sacramento 19, California.

Get into... PLASTIC LAMINATING AT HOME!



THIS MAN...
... is taking out of the machine a Plastic Sealing Job — ordered by mail — only 11¢ in material cost brings back \$2.58 in cash by mail. Capacity of machine: \$25.00 profit per hour of operation.

Get **ORDERS** and **CASH** from your mailman—do work in **SPARE TIME** at home—or expand into **FULL TIME** business. Send coupon for Free facts about the newest and most fascinating of all home operated businesses. For the first time a simplified machine brings the fabulous profits of Plastic Sealing and Plastic Laminating within the reach of the small operator. Anyone can learn to operate the machine with a few minutes practice—then with our Magic Mail Plan can get mail orders pouring in daily with cash in every envelope. **No canvassing—no selling.** We even

Make \$20 to \$30 a Day by..
MAGIC MAIL PLAN!

supply the circulars you mail to bring back cash and orders. Don't waste a minute. Rush your name. We'll send you **FREE** and postpaid, pictures, prices, details, and all the facts you need to start. Mail coupon or send name on postcard. **No charge.** Warner Electric Co., 1512 Jarvis Av., Dept. L-1010, Chicago 26, Ill.

Make Thousands of Beautiful Art Creations

**COSTUME JEWELRY • CIGARETTE BOXES
TRAYS • CANDLESTICKS • COASTERS
LAMP BASES • BOOK ENDS...ALL IN
SPARKLING COLORED PLASTIC**



WARNER ELECTRIC CO., 1512 Jarvis Av.

Dept. L-1010, Chicago 26, Ill.

At no cost to me, please rush complete details postage prepaid. I am under no obligation.

Name _____

Address _____

City _____ Zone _____ State _____

SAY YOU SAW IT IN POPULAR MECHANICS

FIND HIDDEN RICHES!

NOW—find buried treasure, gold, silver, and metal objects, with sensational 3 1/2-lb. locator—**GOLDAK'S "FIND-IT"**... only \$49.50 complete with earphones, batteries, instructions.



Manufacturers of metal detection devices since 1933.

Write for **FREE** literature full line metal, mineral locators, geiger and scintillation counters.

GOLDAK CO., 1542-10 W. Glenoaks Blvd., Glendale, Calif.

PLEASE SEND ME



for the time checked.
I am enclosing . . .

- 1 year \$3.50
 2 years \$6.00

name _____

address _____

city _____ zone _____ state _____

Hand this order to your newsdealer or send it to
POPULAR MECHANICS
200 East Ontario St. Chicago 11, Ill.

PEE WEE BATTERYLESS "LIFETIME" RADIO



REALLY WORKS — FOR LIFE!

Works WITHOUT TUBES, BATTERIES OR ELECTRICAL PLUGS. Will never run down or burn out! World's smallest, SMALLER THAN A PACK OF CIGARETTES! GUARANTEED TO RECEIVE LOCAL RADIO STATIONS ANYTIME—ANYWHERE YOU GO! Sensational new Ferrite Selective Tuner — Perma-Crystal diode, super SPEAKERPHONE, durable black and gold plastic case.

SEND ONLY \$2.00 (will ok. mo) and pay postman \$4.99 COD postage on arrival or send \$6.99 for postpaid delivery. **SENT COMPLETE READY TO LISTEN WITH LIFETIME GUARANTEE.** Nothing extra to buy—ever. Available only from: **MIDWAY COMPANY Dept. WPM-10 KEARNEY, NEBRASKA**

NOW — A Real "Do-It-Yourself" OPEN FIREPLACE and CHIMNEY



Without Mortar or Masonry



For old or new homes, cottages, cabins, shelters.

SAVE MORE THAN HALF!

Eliminate masonry materials and save labor costs with this complete, full-sized, full-service wood-burning fireplace and chimney!

FIRE-SAFETY CLEARANCES BUILT IN!

Butts right against wood flooring, walls, studs, joists and beams with complete safety. Labeled by Underwriters' Laboratories, Inc.

EASY ONE-MAN INSTALLATION!

No mortaring! Flue is of strong, permanent, stainless steel. Realistic brick-finish aluminum chimney top.

Scientifically proportioned—**WON'T SMOKE!**

Write today for free details!



Majestic
THULMAN FIREPLACE

THE MAJESTIC CO., INC., 456 ERIE ST., HUNTINGTON, IND.

I'll Send You This Famous TRAVIS BIKE MOTOR AT TREMENDOUS 30% SAVING



IF YOU'LL AGREE TO DEMONSTRATE TO YOUR BIKE-RIDING FRIENDS

AMAZING NEW RIDER-DEMONSTRATOR PLAN CAN PAY FOR YOUR MOTOR... AND BRING YOU EXTRA CASH, TOO!



If you'll agree to demonstrate to friends, we'll sell you a rugged, powerful 1 1/2 H.P. world-famous Travis Motor for your own bike at amazing low Demonstrator Price of 30% off! Just ride around town and see how everyone wants a Bike Motor like yours. Only 3 orders and your own Travis is paid for—costs you nothing. Then you keep on making wonderful profits in your spare time!

World's Lowest-Priced Bike Motor . . . Unequaled Features!

SAFE . . . mounts on front fork away from rider, always under control of bike brakes. **POWERFUL** . . . climbs hills, carries heavy loads. **SMOOTH-RIDING** . . . 2-cycle airplane-type multi-finned air cooled engine, ball bearing construction, direct drive to front wheel (no belts or pulleys to break). **LIGHT-WEIGHT** . . . only 17 lbs., perfectly balanced. **MOUNT IN LESS THAN 30 MINUTES** . . . anybody can do it with just pliers and screwdriver. **FITS ALL BIKES** . . . boys' or girls', balloon or lightweight. Motorcycle-type control. Unconditionally guaranteed . . . carries unique LIFE-TIME Factory Rebuilding Policy.

FREE! Rush name, address NOW for complete details of amazing Rider-Demonstrator Plan that saves you 30% and shows you how Travis pays for itself, makes EXTRA MONEY for you. Everything FREE. No obligation. Write:



TRAVIS PRODUCTS CO. 224 W. HURON, DEPT. K-3 CHICAGO 10, ILL.

SAY YOU SAW IT IN POPULAR MECHANICS

• A LIFETIME REGISTERED

KEEPER OF THE KEYS

DON'T RISK LOSS of Valuable KEYS...

A very useful and beautiful leather Key Holder of top grain cowhide—your personal Registration Number permanently imprinted. When lost, finder drops in any U.S. Mail box (no postage or wrapping needed) and your keys are returned to our Recording Office where name and address of owner is recorded in our files. We return them to owner Postpaid. Give yourself a really useful gift — or order several as gifts for friends. Order your Rivera Registered Key Case today—sent Postpaid for only \$1 (6 for \$5) Price includes Federal Excise Tax. Be sure and print plainly owners' names and addresses to be registered.

RIVERA LEATHER, Dept. PM10, 9603 Shade Lane, Rivera, Calif.

Quantity discount to Business Firms—Write for details.

Install this superior HYDRAULIC EQUIPMENT Yourself!

Smooth-acting directional control valves — excellent feathering characteristics — minimal restrictions — performance comparable to the best . . . High performance hydraulic motor which may be used as pump — 16 gal. capacity at 1000 RPM and 1000 psi — May be used in combination to provide a fluid power transmission with a 10 HP capacity. Valve, \$16.95. Motor-Pump, \$56.50. Hydraulic Oil Reservoir with dual half-plate, three 3/4" SPT female ports. 5-10-15-25 gal. capacities. Price, 5-gal. \$9.95. Shpg. Wt. 15 lbs. For each add 1 1/2-gal. capacity, add \$4.50 and 8 lbs. wt. Set up your own hydraulic systems for post-hole diggers, loaders, unloaders, stackers, dumping equipment, automatic lathe feeds, home shop presses. Sold by units or package, including tanks.



OIL POWER CO., BOX 172, WAUKESHA, WIS.

House of Hazards Has Many Fires But No Alarms Are Sent

Fires are always breaking out in one house in Milwaukee, Wis., but alarms are never sent in, because the house is only

a miniature and the fires are started on purpose. The tiny house, called the House of Hazards, belongs to the Milwaukee Fire

Department and is electrically wired so when buttons are pushed, fires are started at 19 different points in the house. Used as a part of the department's fire-prevention campaign, the house demonstrates fire hazards around the home. Before a demonstration, the house is fitted with tissue paper drapes, bedding, upholstery and other items. Only the tissue paper burns during the demonstrations, since the house is completely lined with asbestos.



Tomato plants grow best at a night temperature of 64.6 degrees Fahrenheit, according to research at the California Institute of Technology.

BUY A "DIAL-A-SHARP SAW" FROM THIS AD NOW!

REQUIRES ONLY 1/5 HP OTHERWISE USED—SAWS NAILS IN WOOD, DULLING ONLY PART OF SAW STAYS SHARP UP TO TEN TIMES LONGER—DIAL FRESH, SHARP SECTION FOR FINE CUTTING



This device uses a STANDARD ROUND SAW BLADE and is to be attached to the conventional saw. The difference in length of the teeth is created only by its off-center positioning on the Dial-A-Sharp Saw Collar. The saw blade is positioned off-center so as to dull only 50% of the teeth at one time thus resharpening the teeth in the other sections for later use.

The section which cuts sharp longer than when using all of the teeth of the same time because it GENERATES LESS HEAT and leaves the uncut portion of the blade an area to which heat can travel and be dissipated. The result is the uncutted BLADE NOT BURNING and softens and dulls at the cutting edges as soon as it would if all teeth were cutting.

To dial to a sharp section of the saw, simply loosen arbor nut and move saw blade until a new number appears in the center of the Counterweight Collar window. The etched numbers on the saw blade are located to dial to the opposite side of blade.

Any round circular saw blade of appropriate diameter and arbor hole size may be used on the Dial-A-Sharp Saw Counterweight Collar by first adjusting the balance of the complete assembly or our balancing cone as follows:

20. Place balancing cone on the point of a nail which extends 1/4 to 2 inches through a block of wood. Nail must have a sharp unsharpened point for accurate balance.

21. Place flanged dialing or balancing cone to provide a support area greater than the saw blade hole. Be sure to replace the balancing cone down on the balancing side to be used to OPERATE SAW ROUND for jointing and avoid interference with the eccentric positioning of saw blade during balancing.

22. Place saw blade and Counterweight on balancing cone. Be certain that the saw hole is lined into the colored bushing and is thus held in the eccentric position at which it will be operated.

23. Place laminated type Counterweight or stamped type Counterweights in a position on flanged dialing or balancing cone to balance exactly level or 5" heavy toward the cutting section. Counterweights should always be on their leading pins in a hole of the same length as the opposite Counterweight. With laminated type Counterweights always add or remove weights to balance exactly level.

24. Place spring clips into grooved positions on pins which hold the Counterweight Collar together when handling.

To install saw blade and Counterweight Collar on your sawing machine for operation, simply remove them from the balancing cone after balancing level and first, place the saw blade against your machine's feed table on the arbor. Second, place Counterweight Collar on arbor and tighten saw blade hole over eccentric bushing. Dial saw to desired position and tighten arbor nut. The saw blade and Dial-A-Sharp Saw Collar are now ready for use and the blade may be dialed to any position or turned over and will operate WITHOUT ADJUSTMENT. If any abnormal vibration is noted in operation, re-read balancing instructions and re-balance saw and Counterweight Collar.

In all cases with the Dial-A-Sharp Saw you should use the same saw tooth design and number of teeth as you would use for round operation for a given material, in other words use metal cut-off saw for non-ferrous metals and plastics, use cut-off saw for cross grain sawing in wood, use rip saw, with no less than 35 teeth, for ripping, use combination or hollow ground saws wherever they would be applicable normally. Flanged bushing is to be used to operate saw blade round on your machine for jointing for sawing cross grain in wood where splinters are unacceptable and where you are willing to dull all the teeth at the same time with enough force.

SPECIAL INSTRUCTIONS TO SAW USER—The saw blades used on the Dial-A-Sharp Saw Collar should be sharpened and set in the conventional manner. The teeth must always have some hook or be pitched to the arbor hole. The faces of the teeth should never be leaning backward. Sharpen predominantly on the faces to obtain maximum service between sharpenings.

COUPON ORDER BLANK — CIRCLE DESIRED ITEMS — FILL SPECIFICATION SPACES
Prices F.O.B. Hayward, California. 10-DAY MONEY BACK GUARANTEE less Shipping and Handling Costs. DISTRIBUTOR INQUIRIES WELCOMED. Send Check or Money Order 100% Deposit on C.O.D. Order!

SAW ENGINEERING INC., P. O. Box 301, Hayward, California

SAW BLADE PRICES WITH DIAL NUMBERS		Prices of Counterweight Collar Sets Without Saw Blade	
Flat Dia.	Saw H.S. Mixture Ground For Price.	#1 for 6" to 8" diam Saws, 1/2 or 3/4" arbor	\$ 5.95
Cut-off	Non-Ferrous	#2 for 8" to 12" diam Saws, 1/2, 3/4, 1 or 1 1/4" arbor	7.95
Combination	Ground Metals	#4 for 12" to 20" diam Saws, 1 or 1 1/4" arbor	16.95
6"	2.50 1.50	Your Saw Diameter	Your Machine Arbor Size
7"	2.75 1.50	Operating R.P.M.	Type of Machine
8"	2.90 1.75 10.25	Manufacturer of Machine	
9"	3.40 1.45	Material Being Sawn	
10"	3.90 12.95 23.90	Use of Material Being Sawn	
12"	5.10 14.55 27.95	Type of Blade Desired	
14"	15.97 24.50 33.20	Name	
16"	19.60 29.60 41.00	Address	
		City	State

HOW TO BUILD Your Own GARAGE

Save Up to 50% of Usual Cost!

Get Popular Mechanics' brand new book **How to Build Your Own Garage** by Wayne Leckey, Assistant Shop Notes Editor, and find out how you can build your own garage at savings of 50% of usual cost. Leckey tells in clear step-by-step instructions and shows in big, clear photos, drawings and diagrams how to perform every building operation from laying the concrete to installing the final trim. There are 25 designs. Brick, frame, and concrete block fully covered. Send \$3.50 for your copy. 7-day money back guarantee.

POPULAR MECHANICS PRESS, 200 E. Ontario, Chicago 11, Ill.

Say You Saw It in Popular Mechanics

BUILD 16 RADIO
CIRCUITS AT HOME WITH THE NEW IMPROVED 1957 PROGRESSIVE RADIO "EDU-KIT"

A PRACTICAL HOME RADIO COURSE only \$19.95

All parts, tools, instructions, punched metal chassis, printed circuit materials, electric soldering iron, Tester included. Unconditional Money-Back Guarantee.

PROGRESSIVE "EDU-KITS" INC.
Rm. 550-B, 497 Union Ave., Brooklyn 11, N.Y.

ORDER FROM AD—RECEIVE BONUS RESISTOR KIT WORTH \$5
Please Rush me Free Descriptive Literature concerning "EDU-KIT."
Also send me Free Radio, TV, Hi-Fi Servicing Literature. No obligation.

NAME _____
ADDRESS _____

Do-It-Yourself... Better... Easier... With the Right Materials!



Better Home Workshop Job Skills

160 Pages
667 Pictures

For Better Home Repairs and Improvements

What materials to use—how to use them. More than 50 pages of vital home shop information.

New ceilings over old. From walls and ceilings section with 21 pages and 91 pictures. One of 12 big, fat sections in the book.

Contains All This Helpful Information

- Improvements around the house
- How to select and how to use lumber, millwork, plywood and hardboard
- Exterior wall and roof materials
- Hardwood floors and floor coverings
- Wall and ceiling materials
- Doors, windows, screens and weather stripping
- Glass, the material of tomorrow
- Plumbing, pipes and fittings
- Electrical equipment
- Nails, screws, bolts, etc.
- Hinges, locks and other hardware
- Paints and miscellaneous products
- Index

You Need the New Popular Mechanics DO-IT-YOURSELF Materials Guide

The Key to Buying and Using Lumber, Hardware and Other Home and Home Workshop Materials

The right lumber. The right grade. The right fastenings, nails, screws, glue and other hardware. These are all just as important as the right design and the right kind of workmanship. It's true, whether you are fixing up the house, making a fine piece of furniture or just knocking out a time-killing gadget. Get Popular Mechanics Materials Guide. Fills a long-felt need of home owners and home workshop fans, who frequently are stumped over what is the best or most suitable material. You get expert information quick in this book. You get too, the best information on how to use the materials recommended.

Order on 5 Days' Trial Mail Coupon

Send only \$2.95 for postpaid delivery. Sent COD if you prefer Money back if you are not pleased and you return book within 5 days. Mail coupon today.



Use This Coupon for Quick Book Service

POPULAR MECHANICS PRESS Dept. 1056
200 East Ontario Street, Chicago 11, Illinois

Send me the Do-It-Yourself Materials Guide. If I return the book in 5 days you will refund the full purchase price.

I enclose \$2.95 Send COD

Name _____
Address _____
City _____ Zone _____ State _____

Now—from EVANS

A NEW TWO-WAY TOOL

- It's a **Chalk Line**
 - It's a true **Plumb Line**
- It's a real Professional Tool...

**Priced Right
For You!**

50 ft. - \$1.49
100 ft. - \$1.69

First time ever — this real mechanic's tool, at a low, low price! Engineered and Designed for Accuracy. It's Easy to Handle, Built for Long, Dependable Service!

Here's what you get:

Positive S-L-I-D-E action brake... separate from rewind wheel. Automatically released on rewind.

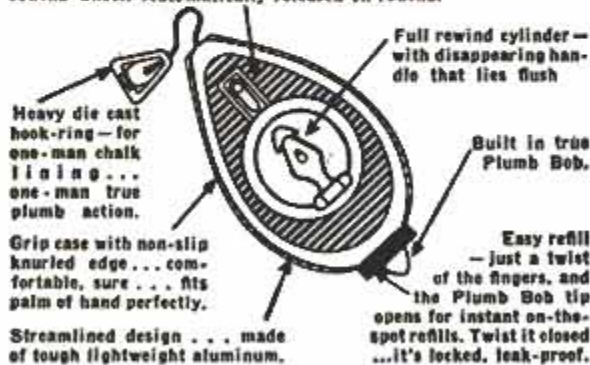

Unconditionally Guaranteed

See it—try it—Buy it at your dealer's today!

Evans RULE CO.
Elizabeth, N.J.

3594

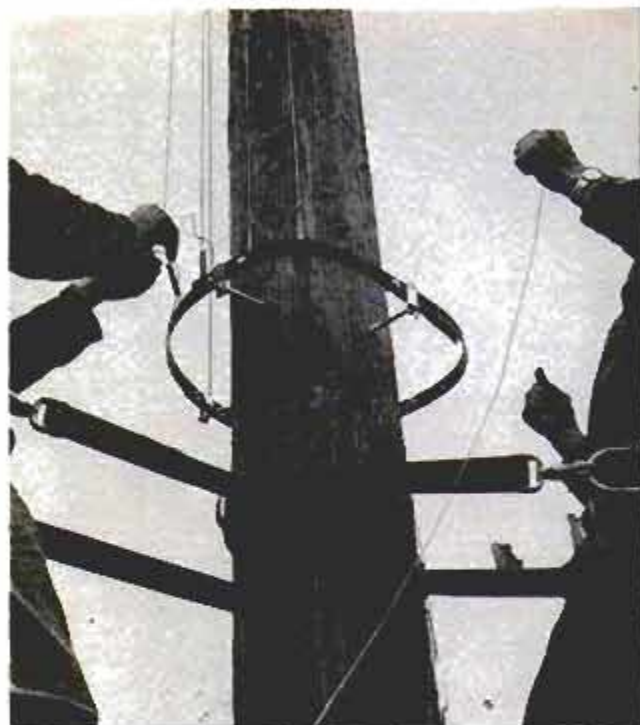

**Glass-Fiber Wires on Poles
Keep Woodpeckers Away**

Power companies, paying huge bills for replacement of wooden power poles that have been attacked by the pileated woodpecker, are testing a new idea for stopping the bird. Developed by a Minnesota farmer, a shield for the poles is made of tensioned glass-fiber wires. When the bird attempts to get at the pole, he is bounced back by the wires. Pole replacement costs from \$200 to \$1000 per pole, and one company spends \$15,000 a year over a 2400-mile system, paying for the woodpecker's damage. No one has been able to stop him yet.



POPULAR MECHANICS

JEEPS

and 4 Wheel Drives NEED FREE-LOCK HUBS

<p>FRONT DRIVE WITH FREE-LOCK</p> <p>LOW OPERATING COSTS</p> <p>ONLY WHEELS MOVE ALL PARTS STOP</p> <p>IN 2-WHEEL DRIVE NO PARTS MOVING!</p>	<p>FRONT DRIVE WITHOUT FREE-LOCK</p> <p>HIGH OPERATING COSTS</p> <p>WHEELS MOVE ALL THESE PARTS MOVE</p> <p>IN 2-WHEEL DRIVE OVER 100 PARTS MOVING—WEARING!</p>
--	---

EASILY INSTALLED ON EACH FRONT WHEEL

and by a quick easy finger tip turn of the lock-control engage or disengage the front wheels from the front drive axles. Results in free wheeling the front wheels in 2-wheel drive, or fast engaging for 4-wheel drive. When front wheels are free wheeling, front drive is idle... STOPS FRONT-DRIVE WEAR, INCREASES VEHICLE POWER, and gives MORE MILES PER GALLON OF FUEL.

**Buy from your Dealer
WRITE FOR FREE FOLDER**

FREE-LOCK CORPORATION
5801 N. Federal Blvd., Denver 11, Colo.
EASTERN OFFICE: 360 Willoughby, Brooklyn 5, N.Y.

IT'S EASY TO HAVE BEAUTIFUL WALLS

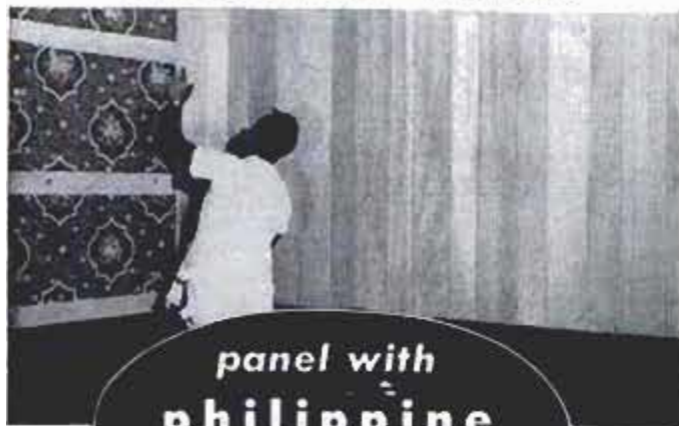

panel with
**philippine
mahogany**

*Easy to install—Easy to finish
Long life—Minimum care
Available in solid lumber
or plywood*

**PHILIPPINE MAHOGANY
ASSOCIATION, INC.**

Dept. PM, 1017 S. Fair Oaks Ave.,
South Pasadena, California

send for
your free
IDEA BOOK

NEED CONCRETE...USE SAKRETE

● It's Easy To Fix With a
SAKRETE MIX. Do it in '56!

Patch It - Build It - Repair It



● For the SAKRETE 48-
page booklet with photos,
diagrams and instructions
for "Do it yourself" cement
jobs, see your building sup-
ply dealer, lumber dealer or
hardware store or send 25
cents to —

SAKRETE, Inc.
P. O. Box 11, Dept. A
Cincinnati 17, Ohio

Gravel Mix —
Sand Mix —
Mortar Mix —

SAKRETE



Tractor operator does not have to twist around when using seat, which turns to the side when required

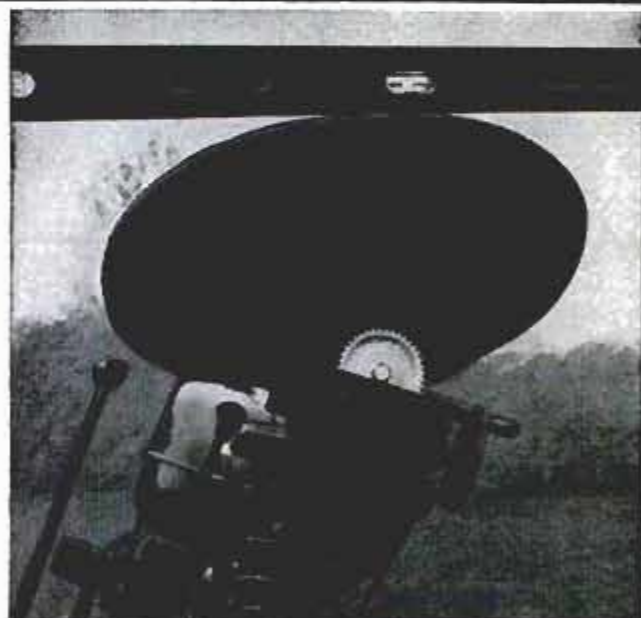

Slight turn of the crank levels seat when tractor is tilted, as during plowing of a hillside or bank

Driver on the Level With Adjustable Seat

Full of sympathy for farmers who sit with twisted backs, on tractors, James F. Steinle, of Greenville, Ohio, has invented a tractor-seat mount which will permit them to ride level at all times. The leveling device mounts under the seat of any make

of tractor, and by a slight turn of a crank, the seat can be leveled, permitting the operator to work in comfort and reducing fatigue. Steinle believes, too, that it is more difficult for a tractor operator to be thrown from his seat than from the usual type.



**do it
faster -
better**

save up to **50%**

with
**UPSON
BOARDS**

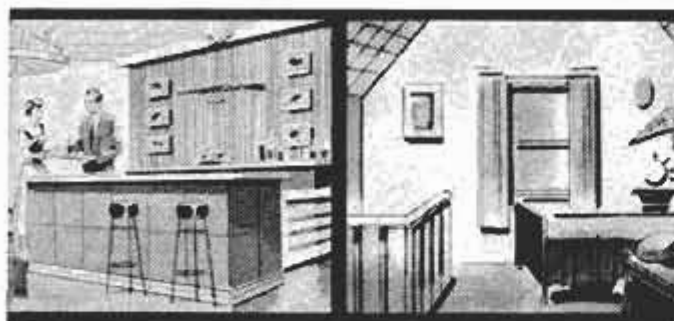

Making a fun room is easy and inexpensive with Upson Boards.

From unfinished attic to beautiful extra room with crackproof $\frac{1}{4}$ " or $\frac{3}{8}$ " Upson Boards.

There is no end to the fine, beautiful jobs you can do with Upson Wall Board. Here are just a few:

- Add-A-Room • Attics • Basement Walls and Ceilings • Built-ins • Cabinets • Chests • Closets • Cut-out Toys • Doll House • Door Panels • Drawer Bottoms • Garage Walls and Ceilings • Model Train Tables • Play-Store • Recreation Room • Storage Walls • Toy Chest • Wardrobes**

Light and strong, Upson saws cleanly. Sands smoothly. Paints beautifully. Assures you of a quality finished job for less money. You'll be amazed with the results. Ask your lumber dealer about Upson Board's large variety of thicknesses and sizes. Won't split, splinter or crack. From $\frac{1}{10}$ " $\frac{3}{16}$ ", $\frac{1}{4}$ ", $\frac{3}{8}$ " to waterproofed, super-strong $\frac{3}{8}$ " for outside use. Pebbled, smooth and striated surfaces. Sizes from 4' x 6' to huge 8' x 20'. Saves up to 50%. Costs 50% less than plywood of same thickness. To be sure of best results, always ask your lumber dealer for Upson Board by name.

Order Now — Special price



3 for \$2.00

**DISPOSABLE
Sanding Discs**

Fits any 8" power saw. Faced with Aluminum Oxide Abrasive. One side coarse grit. Other side fine. Use on wood or metal. Order now. Upson Co., 4410 Upson Point, Lockport N. Y. Sent postpaid.



**Precision Altimeter
Accurate to 18 Inches**

Accurate enough to sense a change in static pressure even when raised only a foot and a half at ground level, a sensitive barometric altimeter has now been introduced. Even in the rarefied air at 60,000 feet, the altimeter records changes of 20 feet, a comparatively minute variation. Its biggest advantage over present altimeters is its speed, since it will record altitude changes in less than one-quarter of a second. Because of this speed, it can also be used as a rate-of-descent meter, and when connected to the automatic pilot can control a plane as it descends.

Hot Rod for Ice Fishermen

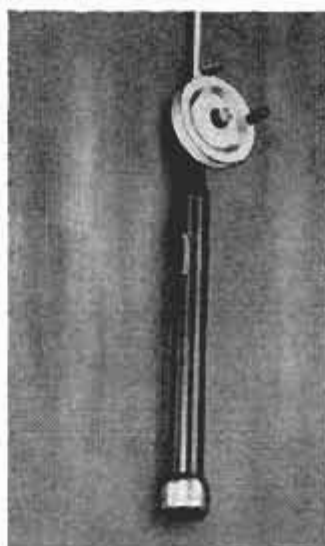

Cold hands, the traditional affliction of ice fishermen, can be cured by a fishing rod with a heated handle. Heat is supplied by a wick which burns a special fuel inside of the handle. The amount of heat delivered can be controlled and the length of time the handle will stay warm varies from three to seven

hours, depending on how much heat the user requires. Three different lengths of glass-fiber tips are available to fit into the handle, which is $8\frac{1}{4}$ inches long.



Amazing Portable Power Tapper Drives Taps . . . IN SECONDS!

Here's the ingenious Supreme push-pull tapper . . . a low cost instant reversing, speed reducing attachment for all portable and regular power drills. When in place on a power drill, the Tapper reduces the drill 7:1 on the forward motion and a gentle pull instantly REVERSES the spin down to a 6:1 ratio. As the Tapper reduces speed it increases torque a like amount. Drives taps up to 5/16" . . . in seconds!

Handymen, mechanics, and craftsmen of every kind will find the gear reduction Tapper an indispensable attachment. The reversing feature enables operator to remove the tap by power, to work tap in and out when tapping tough materials, or when chip accumulations hinder operation.

The Push-Pull Tapper is a quality precision tool that will give years of service. Complete with wrench pin, 5 collets from 0 to 5/16", 1/2" x 20 to 3/4" x 24 spindle adapter, chuck adapter and bushing wrench.

\$29.95 PPD.

CHANGE YOUR PORTABLE DRILL TO A HIGH POWER TOOL WITH SUPREME VERSAMATIC REVERSES!

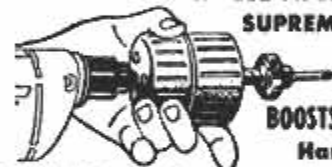

BOOSTS POWER • REDUCES SPEED
Hand Clutch Type Controls

With this amazing new attachment on your quarter inch electric drill, you've got a versatile tool for all kinds of heavy jobs. Its 7 to 1 speed reduction steps up power in proportion . . . plenty of drive for big diameter drilling and tapping, and at the lowest speeds needed for such work. It's a power wrench, for running nuts on or off, it's a whiz of a power screwdriver for handling even the largest screws in any number. The VERSAMATIC is easy to use, reverses with a flick of the wrist. Rugged planetary gear cuts speed from 7 to 1 forward, 6 to 1 reverse. Comes in complete kit containing slotted screwdriver Phillips bit, adapter for 1/4 inch socket sets (square drive), wrench pin and 12 page instruction book. Adapter 1/2 inch chuck available at \$7.50 extra. **ONLY** Complete ppd.

\$14.95



7 Power ILLUMINATED LOUPE A must for every handyman, hobbyist, student

Imagine, a precision-built 7 power magnifier with built-in light so every detail stands out clear and sharp regardless of outside illumination. Coated lens. Battery model. An opening in the housing permits use with other instruments. Lens diameter 1-3/16". Supplied with linen tester plate for thread counting, which fits into the bottom of the housing. An absolutely amazing value . . . worth \$9.95 . . . (batteries not included)

\$4.95 PPD.

Send check, cash or M.O. COD fee extra. **MONEY BACK GUARANTEE**

SCOTT MITCHELL HOUSE, INC., Dept. M-249, 611 Broadway, New York 12, N.Y.

Bigger Drills at LOW, LOW PRICES! 4 Pc. HIGH CHROME SPEED SET!



REG. \$42.50
NOW \$9.95

plus 50c pp., hdg.

Another of Scott Mitchell's famous tool bargains! The original \$42.50 price is right on the package, but you pay only \$9.95! A wonderful buy for advanced hobbyists, carpenters, construction workers, factories, machine shops! Made of high quality, specially hardened steel, with turned down shanks to fit all 1/2" electric drills. Zip through hardwoods, aluminum, iron, plastics, even the toughest steel! Sizes 3/4", 3/4", 7/8", 1". Come in numbered pocket, snap closure tool roll.

SENSATIONAL BUY! Tool Steel 20-Pc. National Coarse TAP & DIE SET!



REG. \$32.50
NOW \$12.95

plus 50c pp., hdg.

Compact, complete set of professional toolmaker quality. Made of high-quality tool steel throughout with hardened, tempered cutting edges. Pipe, machine screw, coarse threads all supplied up to 1/2". Set includes 1 tap and die in each of these sizes: 6-32, 8-32, 10-24, 12-24, 1/4-20, 5/16-18, 3/8-16, 7/16-14, 1/2-13, die stock, adjustable wrench. Metal Case. A wonderful buy! Act now to make sure you don't miss out!

Also available: National Fine 20-pc. Tap & Die set. Contains 1 tap and die in these sizes: 6-40, 8-36, 10-32, 12-28, 1/4-28, 5/16-24, 3/8-24, 7/16-20, 1/2-20, die stock, adjustable wrench. Metal Case. **\$12.95** plus 50c pp., hdg.

Save on all PLUMBING JOBS

When You Build · When Making Improvements · Repairs · Maintenance

Get POPULAR MECHANICS Home Plumbing Guide



How to plan plumbing installations, select materials and fixtures.

How to save money on all plumbing jobs using approved methods.

Easy to Do Professional-Like Jobs and Save Over One-Half

Get the Popular Mechanics HOME PLUMBING GUIDE. It shows how you can do every kind of plumbing job yourself and save from a few to hundreds of dollars. Covers plans, layouts, installation, maintenance and repair. Shows what materials to get and use, where to get them and how to do a proper job with approved methods. Few, other than the simplest tools are required and some of these can be rented. Don't pay high prices for work you can do yourself. Get the HOME PLUMBING GUIDE for only \$3.50. You will be amazed how jobs you thought difficult are simplified.

Clip This Ad and Mail. Money Back if Not Pleased

Invest only \$3.50. Use the book for 7 days. Then if you are not satisfied return it for full refund of your money. Sent C.O.D. (U.S.A. only) if you prefer.



- 15 Ways to Save Money
- All about modern home plumbing
- How to use plumbing tools
- Getting acquainted with pipe
- Planning home plumbing systems
- Installing and maintaining home drainage systems
- Private sewage disposal systems
- Causes and cures of drainage troubles
- Installing home water lines
- Private water supply systems
- Water Heaters
- Water Conditioning
- Water system troubles and cures
- Installing and caring for fixtures
- What to do with valves and faucets

Over 500 How-to-do-it Pictures Guide You

POPULAR MECHANICS PRESS, Dept. 1056, 200 E. Ontario St., Chicago 11

The Chief Steel 5-Shelf Unit

75 Inches High
36" Wide—12" Deep

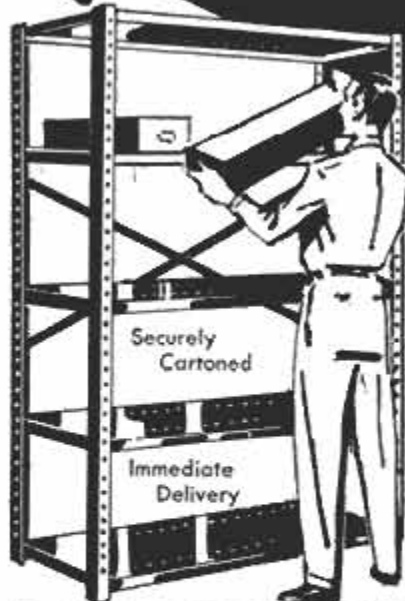

- Hundreds of Uses
- Offices • Churches
 - Schools • Garages
 - Stores • Homes
 - Shops • Greenhouses
 - Hobby Shops

Adjustable shelves, back braced . . . green metallic finish . . . Shipped K. D.

888
F.O.B. Detroit

15" depth 9.88
18" depth 10.88

Extra Shelves
12" deep 1.50, 15" deep 1.75
18" deep 2.00

MOHAWK LUMBER & SUPPLY COMPANY

M 14525 W. Chicago Blvd., Detroit 28 Mich.
Ship _____ Shelf Units as follows: _____ 12" deep _____ 15" deep _____ 18" deep
and extra shelves _____ 12" _____ 15" _____ 18" . . . F.O.B. Detroit.
\$3 deposit Enclosed Check M.O. for \$ _____
with C.O.D.
orders NAME _____
Ship via ADDRESS _____
 FREIGHT EXPRESS CITY _____ STATE _____

HOLD your work!

with "Jorgensen" and "Pony"

CLAMPS—used by industry—sold thru
—tool dealers everywhere!



"PONY" clamp fixtures make ideal bar clamps on black pipe.



"JORGENSEN" and "PONY" "C" clamps are available in many styles and sizes.



"JORGENSEN" hinged clamps—Something NEW! Mount on any bench or saw horse—out of the way when not in use—swing up into clamping position. Slide in steel track for "sideways adjustment."



Genuine "JORGENSEN" handscrews—the favorite in shops for over 50 years!



"PONY" spring clamps—extra hands for the busy craftsman.

These and many other designs described in literature sent FREE upon request. For big, 32-page "HOW-TO-CLAMP-IT" catalog, send 25c.

ADJUSTABLE CLAMP COMPANY

"The Clamp Folks"

421 NO. ASHLAND AVE.

CHICAGO 22, ILL.



Automatic Inflator

Life jackets are automatically inflated when immersed in water by a triggering unit that can save the life of an unconscious wearer. The five-ounce unit, which is fastened to the jacket's carbon-dioxide inflation cartridge, does not interfere with normal manual operation. Heart of the unit is an effervescent pellet that dissolves into



gas upon contact with water. The gas created forces a piston to release a spring-loaded plunger that yanks the handle of the inflation cartridge. The unit inflates the jacket 15 seconds after it hits water.

INSULATE NOW

for as **\$67.60**
low as **67.60**

cost for average attic

Do it Yourself in One Afternoon!



ZONOLITE®

VERMICULITE INSULATION

Easiest of all insulations to install... save as much as \$100 installation costs. Cuts fuel bills up to 40%. Fireproof, rotproof, permanent.

LIFETIME GUARANTEE!

Zonolite is guaranteed to last the lifetime of the building in which it is installed. No further maintenance is ever required.

Write for
FREE

How to Insulate
BOOKLET

Zonolite Company, Dept. J-M-106
135 So. LaSalle St., Chicago 3, Ill.

Please rush your FREE Booklet, NJ-47 with details on How to Insulate.

Name.....
Address.....
City..... Zone..... State.....

AT LUMBER OR BUILDING MATERIAL DEALERS

SAVE 50% - Sturdy Steel Shelving

Buy Direct from the Factory

Home • Office • Industry
Adjustable • Will Hold 2,000 Lbs.

Strong, practical, fireproof, portable
75" high, 36" wide, 12" deep—com-
plete with 4 uprights, 5 shelves,
brackets, bolts—ready to assemble
yourself, in minutes. Money-back
guarantee. Shipping weight 30 lbs.

LAST
CARRY
ARE
Twice
AS LONG
AS DURABLE

Cost 1/2 as much as wood

\$9.88
In. com.
FOB Fact.

18" Shelf Units, \$12.88

RELIABLE Manufacturing Dist. - Dept. PM-18 - 8028 E. Wash St. - Indianapolis 18, Ind.

Make your own conversion

AIRCRAFT STARTERS

Makes an excellent winch for loading
hay, wagon unloaders, pulling
stumps, stretching fence or moving
heavy objects - 1001 uses at home,
farm or factory. Operates on 6 to 32
volts or manually. Has built-in
reduction gear (140:1) and clutch.
High torque, low speed. Made by
Bendix at many times this price.
P.O.B. York
weight 42 lbs.

\$14.89

KARL ORT, Dept. PM10, York, Pa.



BUY NOW PRICES ARE LOW!

IMPORTED HIGH SPEED DRILLS

13 Pc. Set contains 1/16 5/16 3/32 7/64 1/8
9/64 5/32 1/64 3/16 13/64 7/32 15/64 1/4

WITH PLASTIC CASE 85¢ Per Set Postpaid

JAMES "A" McCOY P.O. BOX 74
WORLD TRADING CASPER, WYOMING
CO.



don't say glue . . . say "Yoo-Hoo"

UHU®

GLUES EVERYTHING BETTER!

At variety, hardware, magazine & newspaper stores

POPULAR MECHANICS

BIG-FAMILY HOUSE



Now—at moderate size—a completely livable modern home for the 3-, 4- and 5-children family. Beautifully planned throughout: eliminates crowding by a unique balance of adult and child living areas in just 1350 sq. ft. Features 4 bedrooms, 2 bathrooms, a feeling of space and convenience missing in many larger conventional houses. Can be built with partial basement—or on full concrete-slab foundation.

Easy, Inexpensive to Build

All necessary materials are standard and obtainable in any lumberyard. This design saves on materials, materials cost, lot cost and labor—gives you a truly outstanding home for comfortable big-family living.

Low in Cost... High in Privacy

A split-living home so well designed each family member can have privacy and space for himself!

POPULAR MECHANICS PRESS, Dept. 1056
200 E. Ontario Street, Chicago 11, Illinois

Send at once Plans for the Big-Family House.

Complete Set of 7 Blueprints . . . **\$12.50**

Remittance enclosed Send COD (postage extra)*

Name _____

Address _____

City _____ Zone _____ State _____

* No COD's outside U.S.A.

The mower that **DRIVES** like a CAR!

NEW!

SHAW

RM 24 MOWER WITH AMAZING MAGIC DRIVE



Three Speeds
forward
neutral & reverse

Wide range of speeds, and reverse lets you handle any terrain, any type mowing easily, fast. 1½ to 6 M.P.H. at normal engine speed. Throttles down to 65 ft. per min. or up to 550 ft. per min. In neutral, you need not use foot pedal to stop machine. Mows average lawns in high. Then for heavy cutting a flick of finger shifts to lower gear without stopping. Simple durable construction, patents applied for. Low cost!

Riding Tractors — 2½ to 14 H.P. Pull 8, 10, 12, 14" plows. ¾ to 7 M.P.H.
Walking Tractors 2½ to 5 H.P.

See your Shaw dealer or write for free literature and name of nearest dealer. Dealer inquiries invited! New low prices.

SHAW
DU-ALL

Manufacturing Company
4510 Front Street, Galesburg, Kansas
668-G N. 4th Street, Columbus, Ohio

CERAMIC TILE • 28¢ Sq. Ft. Up

DO IT YOURSELF — SAVE 50%

EASY MASTIC METHOD — FACTORY OUTLET

TILE YOUR BATH \$25.00 up

Tile — Trim — Grout — Mastic. All materials to tile 3 walls over tub 4 ft. high.

TILE TOOLS FOR SALE OR RENT

Send \$1.00 for 28 Ceramic Tile Samples and Setting Instructions. Your \$1.00 will be refunded with any \$25.00 purchase.

Mosaic and Quarry Tile, Venetian Glass and Supplies

Showroom and Warehouse Open

SATURDAYS 7:30 to 4:00
WEEKDAYS 7:30 to 5:00
SUNDAYS 9:00 to 2:00

WE SHIP TILE EVERY PLACE

TERRY TILE OF CALIFORNIA
5200 W. WASHINGTON BLVD.
LOS ANGELES 16, CALIF. WE 1-1863

MEND METAL AT HOME with DEVCON



AS EASY
TO USE AS
MODELING
CLAY

The Plastic Steel

80% STEEL—20% PLASTIC

DEVCON and a putty knife . . . tools for 1001 home repairs. DEVCON bonds steel to itself or to aluminum, bronze, brass, iron, wood, porcelain, glass, concrete and other surfaces. For home . . . farm . . . garage . . . or marine use, DEVCON fixes radiators, washing machines, cracked engine blocks . . . just about anything! Easy to use, DEVCON saves dollars!



HARDENS IN 2 HOURS
EVEN UNDER WATER



\$1.98 per kit enough for several projects
Also—1 lb. packages for big jobs—\$3.95
At leading hardware and hobby stores—write for free literature

DEVCON CORPORATION

175 Endicott St., Danvers, Mass.

DO IT BETTER



SAWS

FLAT SANDER

and MUCH FASTER

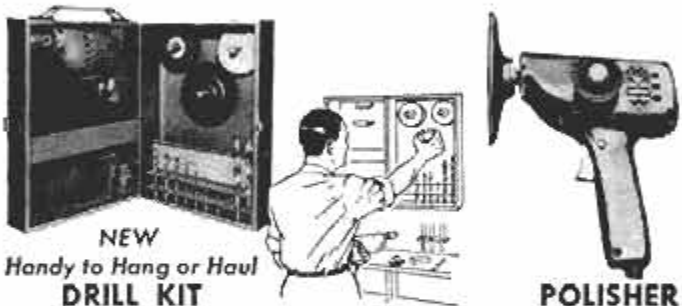

NEW
Handy to Hang or Haul
DRILL KIT

POLISHER

with SIOUX TOOLS

The Tools the Professionals Use!



ALBERTSON & CO., INC., SIOUX CITY, IOWA, U.S.A.



Live-Action Decoy Looks Like Feeding Duck

Activated by dry ice, a duck decoy for hunters bobs his head into the water like a feeding bird from two to four times a minute. One charge of dry ice will cause the decoy to "feed" for three hours. The decoy is made of plastic and comes painted in either mallard or pintail designs. The life-like action of the decoy is said to fool even the wariest of wild waterfowl.

Replacement Antenna For Car Radios

Broken automobile-radio antennas can be replaced by the owner in 60 seconds without replacing the wiring or the old base. The replacement staff has a base which fits over the original antenna base and is made secure by tightening a setscrew with a wrench provided. The new staff sits 22 inches high when collapsed and its three sections extend to a height of 56 inches.





80 TIMES AROUND THE WORLD — AND NOT A SINGLE BATTERY FAILURE !

Test Proves Auto-Lite Sta-ful Finest Battery Money Can Buy

A dramatic test of battery endurance, conducted by Auto-Lite battery engineers, has proved to motorists that battery worries can be avoided!

This rugged and demanding test covered two million miles of actual daily driving by 100 car owners in every section of the United States and Canada. The batteries used were Auto-Lite Sta-ful Batteries which have three times the liquid reserve of ordinary batteries.

FINAL RESULT: Not one single battery failed! After 2 years' continual use, 95% gave better cold weather starting than required of new batteries.

The test also proved that Auto-Lite Sta-ful needs water only 3 times a year in normal car use. You can get an Auto-Lite Sta-ful for just a few cents a month more than you'd pay for an ordinary battery.

Dry Charged...
Fresh
when you buy!

Available for 6- and
12-Volt Electrical Systems.

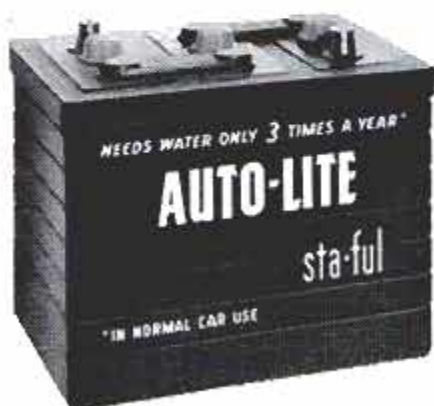

AUTO-LITE

sta-ful

Needs water only 3 times a year*

*In normal car use

Auto-Lite manufactures over 400 products, including Spark Plugs, Batteries, Wire and Cable and Automotive Electrical Systems . . . sold throughout the United States and Canada

Use 'em together



No. 10
only \$1.89

the **STAR** Hack Saw Blade
& the **STAR** "Lever-Lock" Frame ...

Get Better Metal Cutting Results
Change Blades Faster



Exclusive!
One-piece solid Heat-Treated Back



Exclusive!
"Lever-Lock"...change Blades Instantly.



Exclusive!
Tenite handle molded around steel back for greatest strength...perfect balance!

AT ALL LEADING HARDWARE STORES



It's Yours!

...Info-packed booklet on metal cutting.
Send 10¢ in coin.

Clemson Bros., Inc., Middletown, N. Y., U. S. A.

SAVE HUNDREDS OF DOLLARS
with **HOME-A-MINUTE "KIT"**

This is not something to fool around with.

A Hard Hitting System
of Saving Big Money

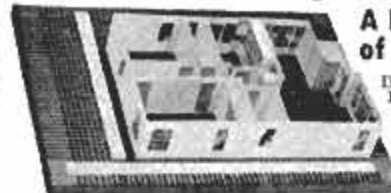

Design and build your New Home, Attic Flat, Extra Bedrooms or Remodeling—IN MINUTES—with dozens of fiber partitions, Doors, Windows, Kitchen Cabinets, made to 1/4 inch scale same as blueprint. THEN, BELIEVE IT OR NOT, YOU, THE LAYMAN, who knows nothing about building, can estimate your own costs—IN MINUTES—after you adjust charts to local prices.

Don't build anything until you get this "KIT" if you want to save money. Handbook tells you how. This information should not pass you by. Complete "KIT" \$2.95 p.p.d., if COD plus postage and \$1 deposit required. Handbook without "KIT" \$1.95 or free literature. Money back guarantee, Return in 10 days.

SPECIAL NOTICE!—As a builder, controlling over 3 million dollars worth of home construction, we will ATTEMPT, but not promise, to obtain a special discount to you for your building materials on your new project, thru your favorite, local, Lumber Dealer. Details with "KIT."
R. A. HALL & CO. 2825 N. 69th St. MILWAUKEE 10, WIS.

SAY YOU SAW IT IN POPULAR MECHANICS

Children's KNOCKDOWN PLATFORM ROCKERS

Springs, Duran, Lumber, etc. 100% parts. Make this for Christmas. Matching ottoman \$1.00 each, both p.p. Send check or money order to



\$6.75
Each

CARPENTER FURNITURE CO.,
P.O. BOX 3173 BIRMINGHAM, ALABAMA

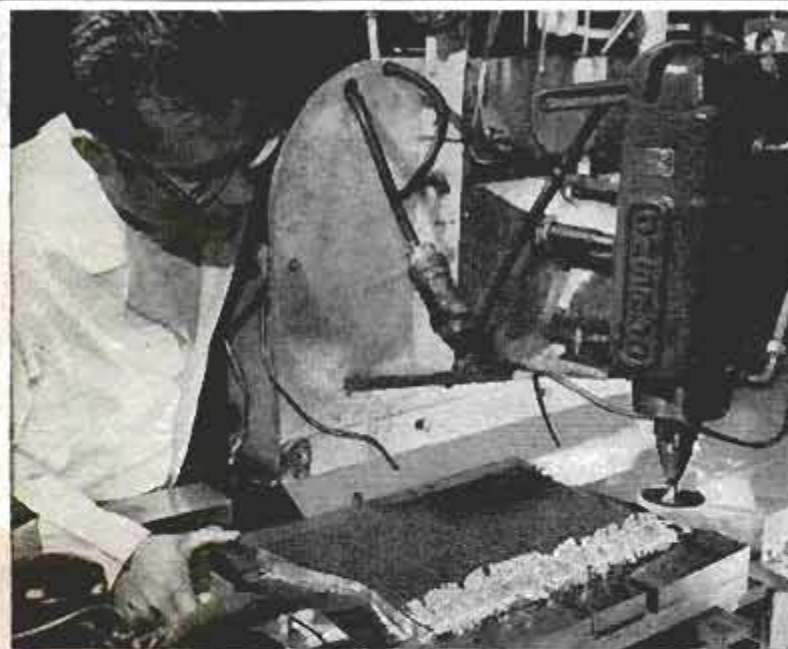

New Quick-Freeze Method Helps Machining

Tissue-thin metal honeycombs, used in guided missiles, are machined rapidly and economically without crushing after freezing them "stiff as a board." A refrigeration unit has been coupled to a standard milling machine at the Northrop Aircraft plant. Water is poured into the cells of the honeycomb material and the material placed in

the refrigerator. In a few minutes the honeycomb, normally fragile and easily crushed, becomes hard and stiff, making it easy to machine by a rotating tool which shears the frozen honeycomb smoothly as it passes over the part. Bevel cuts, slots, and concave or convex shapes may be machined by the quick-freeze method.

Save that PAINT BRUSH

— now more valuable than ever

Perfect
for
NYLON BRUSHES

BEFORE



AFTER

10c
25c

KEEP
BRUSHES
LIKE
NEW
WITH
DIC-A-DOO

At Paint,
Hardware, Dept.,
and 5 & 10¢ Stores



Patent Cereals Co.

Geneva, New York

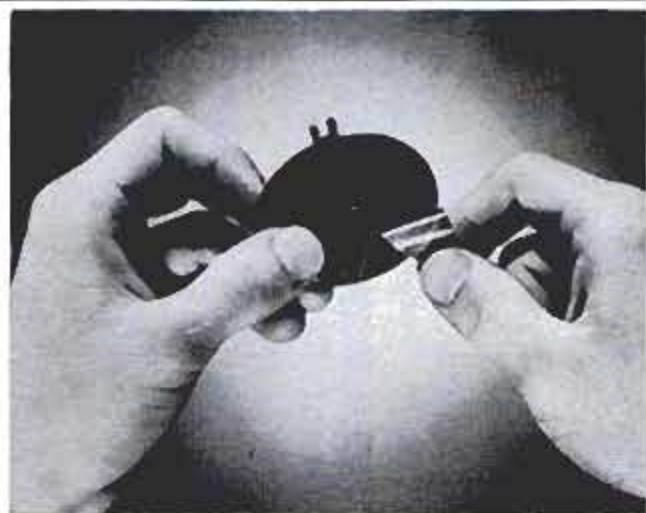

Valve Replacement for Tubes Is Easy to Apply

Applied hot or cold, replacement valves for tire tubes are as easy to use as a simple puncture patch. No vulcanizer is needed. The tube is prepared with a layer of cement and the base of the replacement valve placed in position and rolled down firmly to insure adhesion.

☐ Averaging 40 miles of flight per day, a Monarch butterfly marked and released in Toronto was discovered in Maryland 15 days and 560 miles later.

"We brought the charm
of
'Famous
Design'
into our
home



with **Cummins**
portable power tools!"

Built of Weldwood Plywood — a product
of United States Plywood Corporation



"We built this
good-looking
Serving Table-
Cart ourselves —
and it's an
original Russel
Wright design
you can't buy
anywhere!
Your Cummins
dealer has the
simple plans —
and the Cummins
power tools to
do the job right,
the easy way!"

Make every cut
required for this
Serving Table-
Cart with
Cummins
MAXAW . . .
quickly, easily,
accurately!
Exclusive True
Course Guide
assures straight
cuts so you can't
saw off the line!
Slip MAXAW into
sturdy, oversize, all-
steel MAXAW 777
Saw Table — make
precision bevel, miter,
crosscut or rip cuts.
Get Serving
Table-Cart plans
at your Cummins
dealer now.

Other Cummins MAXAWS
priced to \$79.95.

Prices slightly higher in Canada.

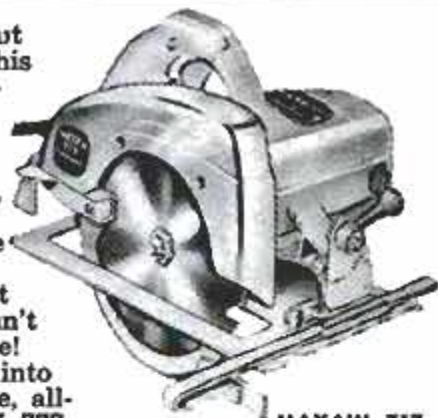

MAXAW 717
6 1/2" blade cuts
1 7/8" at 45°
angle . . . \$49.95



MAXAW 777
SAW TABLE
Converts MAXAW
into tilt arbor
table saw in
seconds! Equals
cutting capacity
of 8" table saw
. . . weighs 46
pounds without
saw . . . \$39.95

Take this coupon to the dealer displaying this ad, or mail to:

Cummins Portable Electric Tools PM-1
5055 N. Lydell Ave., Milwaukee 17, Wis.

() Enclosed is 25c in coin. Please send me the Cummins-
U. S. Plywood "Famous Designer Plan" for Russel Wright's
Serving Table-Cart.

() Please send me information on the other plans available
in your "Famous Designer" series.

NAME _____

ADDRESS _____

CITY _____ ZONE _____ STATE _____

Made by *John Oster* MANUFACTURING CO. © 1956 J.O.M.C.



Inflad-Air Pneumatic Products Co., Pleasantville, N.J.

Poleless Tent

Requiring no poles, ropes or stakes, an inflatable tent provides complete protection against weather and insects. It also has its own built-in air mattress. The entire tent inflates with a hand pump and is self-supporting. A zippered door and window provide ventilation. The floor contains an air mattress that inflates to a depth of 4½ inches. Because the tent requires no staking down, it can be put up anywhere. The only requirement is level ground.



German Table Organ

Small enough to be carried around like a portable typewriter, a reed organ manufactured in Germany is powered by an electric blower. A sliding control modulates the volume. Weight of the instrument is about nine pounds. The keyboard covers slightly more than two octaves.

☞ The highest gust of wind ever measured on earth was recorded at 231 miles an hour atop Mount Washington, N. H., in April 1934.

For more comfortable winter driving



- with faster motor warm-up
- quick heat from your heater
- and better defrosting

replace your motor thermostat

with a HIGH-TEMPERATURE BRIDGEPORT THERMOSTAT



Enjoy more heat from your car heater and faster motor warm-up all winter. Ask your Service Dealer to replace your motor thermostat when he puts in anti-freeze. This simple, low-cost changeover will also give you greater gasoline mileage.



Robertshaw-Fulton
CONTROLS COMPANY

BRIDGEPORT THERMOSTAT DIVISION • MILFORD, CONN.

POPULAR MECHANICS



THE WIZARD OF OOZE

helps you calk cracks and joints inside and outside your home

LIKE MAGIC!

Check flow of calk where you want to ... with **DOUBLE-CHEK**

NO MUSS **NO WASTE**

AN EXCLUSIVE FEATURE OF

Handi-calk

DOUBLE-CHEK

CALK CARTRIDGE AND GUN



Convertible Fishing Reel For Spinning and Bait Casting

You can use a new fishing reel for both spinning and bait casting. The reel is designed for old-time bait casters who don't want to throw away all their tackle and invest in new spinning equipment. The new closed-face reel can be used on both bait casting and spinning rods. The angler can use a bait-casting technique and still have the advantages of a spinning reel, including the elimination of backlash. A brake permits the line to be controlled by a thumb lever when a large fish is hooked.

BIG Money-Saver

Atlas

6" JOINTER-PLANER

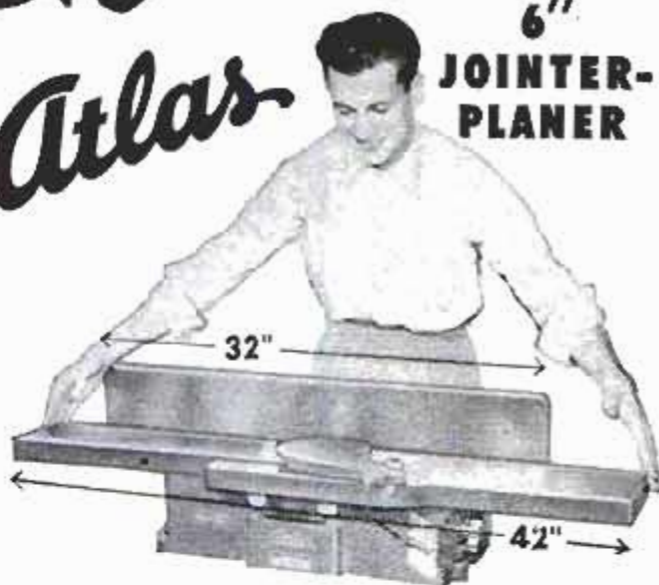

For Furniture, Remodeling, Construction

Whatever you want to do—"finish out" a house or a room, remodel, make kitchen cabinets or furniture—this Atlas 6" jointer-



Rear table is wide to support big boards.



New type fence mount assures fast set up—greater rigidity and accuracy.



Cutter head removes for sharpening blades without disturbing their setting.

planer is the tool to own.

You can plane mirror-smooth surfaces in seconds with the Atlas—rabbet, chamfer, taper, edge.

Table and fence are both big for big board work . . . precision-ground for smoothness and accuracy. Fence is rigid—triplly supported, easily positioned, has width-of-rabbet scale.

Atlas has no equal in value for the home shop, contractor, or commercial shop. See it at your dealer's, or send post card or coupon for catalog.



NEW MODERN FURNITURE PROJECT BOOK

16 complete, easy-to-follow plans for beautiful modern furniture . . . chairs, lamps, tables, etc. Build your own! Have fun! Save! — Only \$.50 postpaid, \$.65 outside U.S.A.

ATLAS PRESS CO.

1024 N. Pitcher St., Kalamazoo, Mich.

Please send catalog showing jointer-planer.
Inclosed is _____ for _____ plan book.

Name _____

Address _____

City, State _____

WOLVERINE

Vinyl Plastic Plated
PIGSKIN WORK GLOVES

**MUST BE BEST
OR YOUR
MONEY
BACK!**



For the toughest, longest wearing hand protection yet ... Wolverine suede pigskin coated with flexible vinyl plastic! They're immune to hot corrosive, caustic or acid solutions...defy abrasive wear that literally eats up ordinary work gloves.

WEAR A PAIR 7 DAYS

... your money back in full if you don't agree they're the best work gloves you ever wore.

Write for free catalog and name of dealer, to
WOLVERINE, Box PM-108, Rockford, Mich.

NEW Easy-to-Use SOLDER*



**Solders in ONE
operation... just apply
Swif® and heat**

SWIF is a real 50/50 tin-lead solder in paste form with flux combined. Just apply Swif and heat. All extra preparatory steps are eliminated by its one-step cleaning, tinning and soldering action. It makes perfect soldered connections with the heat of a match, torch, or soldering iron. Tube holds enough Swif for hundreds of jobs. Swif has been used by professional plumbers for years. At hardware, hobby, plumbing and auto stores. 59¢ per tube. Slightly Higher in Canada. Send For Free Literature.

HERCULES CHEMICAL CO., Inc.
416 B'way., New York 13, N. Y.



Small Range Finder

Golfers and others can measure distances with a little range finder accurate between 13 and 250 yards. Sighting on a distant point, the user sees two images until he turns a dial to make them coincide. The pointer on the dial then tells the distance. An optional telescope eyepiece gives an enlarged image. Possessing a much greater range than camera range finders, the instrument is valuable to photographers using telescopic lenses. It also suits the needs of farmers, surveyors, realtors and others who sometimes need to estimate distances.

Preoiler Ends Dry Starts

Dry starting, a major cause of engine wear, is virtually eliminated by a pressure-retaining device that starts oil flowing the instant the ignition key is turned on. The oil is trapped in the pressure container when the engine is stopped and is held there under pressure until the ignition is turned on again. At that moment the pressurized lubricant is discharged through the lubrication system forcing itself onto all bearing surfaces and, at the first turn of the crankshaft, to cylinder walls. The unit mounts on the fire wall of the car.

Protective coatings of chromium plate are being applied to the inside of Navy's 3 to 16-inch guns when they are "moth balled."

DRAWERS STICKING?

Roll-eez

Trade Mark
SET "A"

INSTALL

ROLLER BEARINGS FOR WOODEN DRAWERS

— the Sensational **NYLON** ROLLER BEARINGS that ELIMINATE the CAUSE of STUCK DRAWER TROUBLES!

Do-It-Yourself

Works Wonders on Furniture, Built-ins

49¢

Quick, easy to install. Roll-eez produce smooth drawer action because they eliminate friction of wood-against-wood and keep drawers in alignment — prevent sticking and binding even in hot, humid weather! Used in cabinet-shops. Noiseless NYLON rollers give lasting service. Each drawer set includes simple instructions and nails. Anyone can attach.

At Hardware, Building Supply Dealers. If Not Available, Remit Direct to Factory.

Building? Remodeling? Have cabinets equipped with Roll-eez. Low Cost, convenient.

Junior-Pro Prod. Co. Dept. M 118 E. Marceau, St. Louis 11, Mo.

Performance Compares with High Priced Slides.

Roll-eez "N" on rail at drawer opening. If drawer has center guide, nail third Roll-eez "N" on top of back in the middle, and Roll-eez "M" on bottom of back, straddling the guide.

Set for 1 drawer
Nail 2 Roll-eez "N" on rail at drawer opening. If drawer has center guide, nail third Roll-eez "N" on top of back in the middle, and Roll-eez "M" on bottom of back, straddling the guide.

ONE Power TOOL for DOZENS of JOBS!

FOREDOM FLEXIBLE SHAFT MACHINES

SAVE MONEY...

provide unending fun. Used since 1922. Pencil-size handpiece promotes skill. USES: Grind, polish, drill, mill, saw, cut, clean, carve, rout, sand, etch, engrave, etc. Model FSLR \$25.50 (also sold less motor for use with your own electric drill or motor).

FOREDOM ELECTRIC CO. • Dept. H34K27 Park Place • New York 7, N. Y.

FREE CATALOG

JOBBERS DEALERS WRITE

YOU CAN BUILD A VIOLIN FOR PLEASURE OR PROFIT

Now you can build a rich toned mellow violin modeled after a famous "Strad." YOU CAN MAKE A STRADIVARIUS VIOLIN contains 8 full scale plans plus complete instructions. You work directly from the plans with no confusing scale of dimensions to translate. Detailed instructions for each step including varnishing and stringing—even shows how to build your own tools. Cloth bound. Order today from

POPULAR MECHANICS PRESS \$3.50
Dept. 956, 200 East Ontario Street, Chicago 11, Illinois

STAR TEST-PLIERS

TEST Circuits, Fuses, Outlets easily, quickly, safely. Shockproof. Pull fuses 10 to 100 Amp.

Test 110-600 Volts

\$2.95
\$1.95 add'l for 2 ft. leads. At dealers . . . or order direct from us. Mailed POSTPAID for 25c add'l.

STAR FUSE CO., 233 Canal St., New York 13, N. Y.

No Leak Lamp

NOW—THE QUICK-WAY TO SHARPEN ALL CIRCULAR SAWS

NEW

Model PG-12 sharpens joints, gums, and retweets all cross cut, rip, combination, miter, and planer blades up to 12" in diameter. Two precision index plates give versatile, accurate sharpening. Guarantees precise spacing of teeth. New safety rest prevents tilting and gouging of blade. Save time and money. Special \$3.00 grinding wheel also included for use on your own power table. Fits regular or radial swing tables.

Model PG-12 Complete No extras to buy. \$16.50 Postage Paid

Order today. Send check, cash, or money order. We pay postage. FREE Booklet—"How To Sharpen Saws."

QUICK-WAY SAW CO.
136 TOMPKINS ST. CORTLAND, N. Y.

Mammoth 1956 Wholesale Tool Catalog

TOOL CATALOG

YOUR NAME

puts You In Business

The opportunity now awaits you to own and operate your own business on a part time or full time basis in the lucrative field of HARDWARE, HAND TOOLS, FANS, POWER TOOLS, MOTORS, PAINTS, etc., or BUY TOOLS FOR YOUR INDUSTRIAL OR INSTITUTIONAL USES.

Buy Nationally Advertised Tools for Resale or Industrial or Institutional Use

NO INVESTMENT REQUIRED, BUY AS YOU NEED IT. A MILLION DOLLAR INVENTORY AT YOUR FINGER TIPS.

Discount UP TO 50%

Every one needs tools. Meet the demands of the growing "Do-it Yourself" markets. Sell direct from the jumbo buying guide—your cost is known only to you.

ENCLOSE \$1.00 FOR DEALER'S 1956 MAMMOTH TOOL CATALOG.

JUST FILL OUT COUPON

\$1.00 refund on first purchase or refund if you are not 100% satisfied.

EVERY ONE NEEDS TOOLS. MEET THE DEMANDS OF THE GROWING "DO-IT YOURSELF" MARKETS. SELL DIRECT FROM THE JUMBO BUYING GUIDE—YOUR COST IS KNOWN ONLY TO YOU.

ENCLOSE \$1.00 FOR DEALER'S 1956 MAMMOTH TOOL CATALOG.

JUST FILL OUT COUPON

SILVO HARDWARE COMPANY
Dept. PM-10, 108 Market St., Philadelphia 6, Pa.

I am enclosing \$1.00. Rush me your dealer's mammoth Catalog Today. If I am not completely satisfied with your plan, I understand that I can return the Dealer's Catalog for refund, and if I decide to order, my \$1.00 will be deductible from my first order.

NAME

ADDRESS

CITY ZONE STATE



LOOSENING, TIGHTENING or SPINNING...

*YOU do it faster
and easier with*



BOX & OPEN END WRENCHES!

Smooth, long handles give extra leverage and firm, comfortable grip. Extra strong, thin-walled openings allow work in tight spots. Special analysis steel, beautifully finished.

Buy P&C's popular 6-piece set in durable, blue plastic kit with transparent pockets.

BUY YOUR TOOLS FROM THESE COLORFUL P&C MERCHANDISERS. Sold by more than 12,000 stores. Send 10c for tool catalog.

...the best tools money can buy

P & C TOOL CO.

Dept. H3, Box 5926, Portland 22,
Oregon, and Schiller Park Illinois



Collapsible Steering Column

Traffic accidents will result in fewer deaths if a collapsible steering column is built into the car, says Jarsley Dvorak, a mechanic in Melvin, Iowa. Dvorak has designed such a column and incorporated into it a disconnect switch so the entire electrical system is shut off by the collapsing column to prevent a short circuit from starting a fire. The driver can adjust the steering-column length to suit his driving position.



Ⓢ Gas provides 26 percent of this country's energy production.

What a Saving! New...

This Pump

PROVIDES YOU WITH
ALL THE WATER YOU WANT
Now—and in the Future

The Amazing
PEERLESS

CONVERTIBLE jet

It converts easily from shallow to deep well operation. Widest range of capacities, tank sizes and piping arrangements. Economical to install and operate. Made by Peerless, America's leading vertical turbine pump maker, so you know it's the best!



Shallow
well unit
with 4-gal.
Tank; neat,
compact

LOADED with features!

Self-Priming Shallow
Well Unit
Pumps Up to 1000 GPH
Deep Well Unit
Pumps Up to 840 GPH
1/3, 1/2, and 3/4 hp units
Installs Over Well or Offset
All Bronze Impeller
and Jet
Pressures Up to 40 lbs.
or more
Regulator Valve Built-In

FREE



BULLETIN

Profusely
illustrated.
Shows all
models.

PEERLESS PUMP DIVISION
Food Machinery and Chemical Corp.
2005 Northwestern Ave.
Indianapolis 8, Indiana

Please send Convertible Jet Bulletin B-2423

Name _____

Address _____

Town _____ State _____

200 Amph. WELDER



General Electric 200 Amph. 28 volt D.C. ball bearing, forced air cooled H.D. Generator direct connected to Clinton 9+ H.P. 4 cycle air cooled Engine with enclosed automatic governor plus manual control. Built in reactance coil, welding heat control with variable field rheostat. Mounted on rigid channel steel base with carrying handles. A portable highly engineered compact welder that can be transported in the back of most any automobile. Complete in new fully tested

operating condition with 2-15 ft. welding leads, electrode holder, ground clamp and helmet. A \$500.00 value for.. **\$298.00** cash. FOB.

HUNT MECHANICAL ENGINEERING SERVICE
BOX 207PM, OLDSMAR, FLORIDA

Aluminum SANDING PLATE
Value **\$1.50**
\$2.80
Fits 1/2" & 3/4" arb. 6" disc. Distic 50¢
6 Sanding Discs 25¢



HEATING ELEMENT
1320 W. - 110 V. 10"
x 9 1/2" - make your own heater for Bath or Poultry House.
\$10 Value **\$1.50**

FREE 100 PAGE CATALOG

PENNA. WHOLESALE DISTRIBUTORS
104 N 6th ST. PHILA. PA.

GET THE HABIT OF READING
OUR CLASSIFIED ADS.

Wonderful Opportunities Amazing Bargains

MAGNETS

5 Assorted Size Magnets \$1.00. Powerful Pocket Magnet W/case \$1.00. Hot Pad Magnets—large size 8/\$1.00. Bulletin Board Magnets 8/\$1.00. Slender Magnets—pencil type 2/\$1.00. Retrieving Magnets—extra power, heavy duty—30 lb. pull \$4.00, also 50-75-100 lb. pull. Explore, learn Electricity, Magnetism, Electro magnets, complete kit and instructions with 22 experiments and models... \$3.98. **TRANSISTOR RADIO KIT**—all parts & instructions—powerful... \$7.95. Also—Rods, discs, bars, horseshoes. Send stamp for catalog—Specify your requirements—100% SATISFACTION GUARANTEED. **PARK MAGNETS, 2610, 1557 GREENBAY RD., HIGHLAND PARK, ILL.**

PAGE WORKSHOP MACHINES
Page Power Tools help the home handyman every step of the job. Every machine precision-made, with finest parts! **LOW PRICES!**

A FAMOUS NAME FOR THIRTY YEARS

8" Tin-Arbor SAW
14" Drill Press
18" Jig Saw
10" Band Saw

Write for complete catalog and details.

PAGE TOOLS, 1910 M.S. 81st, Milwaukee, Wis.

Build a Boat for Fun or Profit

Popular Mechanics

23 BOATS
You Can Build



Complete Patterns and Working Drawings

Build the boat you have always wanted. Build it for fun or to sell at a profit. Get Popular Mechanics 23 BOATS YOU CAN BUILD—row boats, canoes, sail boats, power boats and other craft including a 25 ft. cabin cruiser that sleeps four; 11 1/2 ft. car-top row boat; 8 ft. duck boat; 15 ft. sailing knockabout—in all, 23 of the most popular boats. Book includes more than 500 photos, plans, diagrams and working drawings, plus step by step instruction that anyone can follow. Only simple tools needed. Material list of lumber, hardware, fittings, etc. included. Order today, under money-back guarantee. Only 82.75 postpaid.

Row Boats, Canoes
Sail Boats, Power
Boats and Others



POPULAR MECHANICS PRESS, Dept. 1056, 200 E. Ontario St., Chicago 11

From attic gloom to extra room!



NOW YOU CAN TURN that waste space into a cozy extra room with Gold Bond Insulation Plank and Ceiling Tiles. Use them in your attic, basement, house extension, or anywhere. They'll keep you warmer in winter, cooler in summer, too!

COSTS LITTLE. Gold Bond Insulation Planks come ready to install... no painting or papering needed. Just nail or staple them in place. Special edges hide the fastenings. You can choose ivory or a blend of four harmonizing colors. The cost? Far less than you'd think possible!

FOR THE CEILING use Gold Bond Insulation Tiles. They absorb sound just like the Insulation Planks... perfect for a bedroom, add restful quiet to a den or game room.

YOUR GOLD BOND DEALER has all the material and know-how you'll need... he'll even help you with easy terms.

NATIONAL GYPSUM COMPANY

Buffalo, N. Y.



Mail the coupon today for Gold Bond "How-to-Do-It" Plan #14... complete illustrated instructions that show how you can build a room just as attractive as this.



MAIL THIS COUPON TODAY!

National Gypsum Co., Dept. PM106, Buffalo 13, N. Y.
Please send me Gold Bond "How-to-Do-It" Plan #14, giving complete instructions on how to apply Gold Bond Insulation Planks and Tiles.

Name _____

Address _____

City _____ Zone _____

County _____ State _____

THE SURE
WAY TO
KNOW

YOU ARE
BUYING A FINE
POWER DRILL

For top performance, choose the power drill equipped with a Supreme Chuck. The finest in quality and precision. Or replace your old style chuck with a Supreme. See your hardware dealer.

Supreme Chucks
BRAND



SUPREME PRODUCTS, INC., 2222 S. CALUMET, CHICAGO 16

You can't "louse" it up

...if you use



deft
WOOD
FINISH

SEALS, PRIMES, FINISHES
Dries in 30 min.

Don't be afraid to tackle natural interior wood finishing. Use semi-gloss Deft. *It's so easy to use that ANYONE can get professional results.* DEFT seals, primes, finishes...dries in 30 min. No thinning, nothing else to use. Will not darken. Apply two coats for a beautiful finish, three coats for BAR TOP. Final coat may be steel-wooled to a mirror-smooth fine-furniture finish. Use on walls, floors, cabinets, turniture. *If your dealer does not have DEFT, write:*

DESMOND BROS.
1826 West 54th Street
Los Angeles 62, California
Please send me Free Booklet.

Name _____

Address _____

City _____ State _____

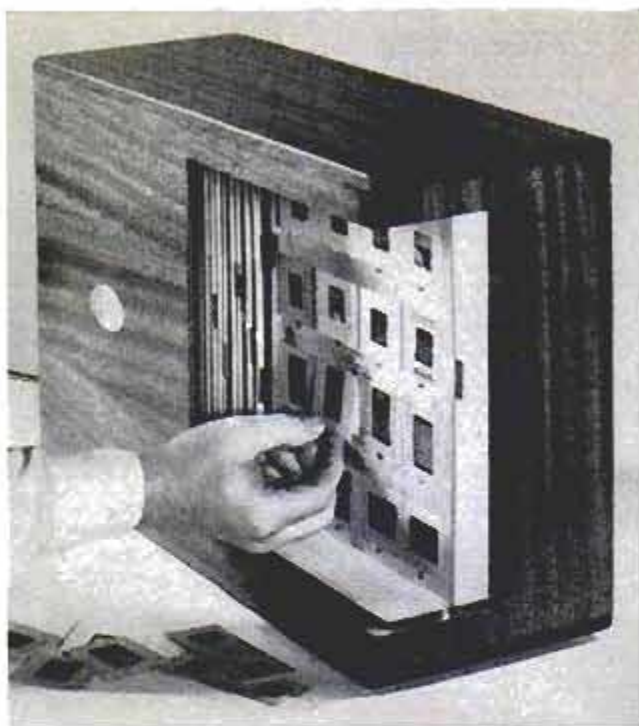

Color-Slide Frustration Ended By Previewer and Storage Unit

Developed by a missionary who had collected a great number of slides and had to find some means of sorting them for lectures, a color-slide previewer permits him to look over his whole collection at the rate of 1000 slides in five minutes. The slides are stored 16 to the page in cardboard pages which fit into a leather-bound volume. When the volume is fitted into the viewer, the pages are pulled out and viewed against a ground-glass background. A quick selection of slides can be made after a glance at the page. Each volume can store 192 slides of 35 millimeter.

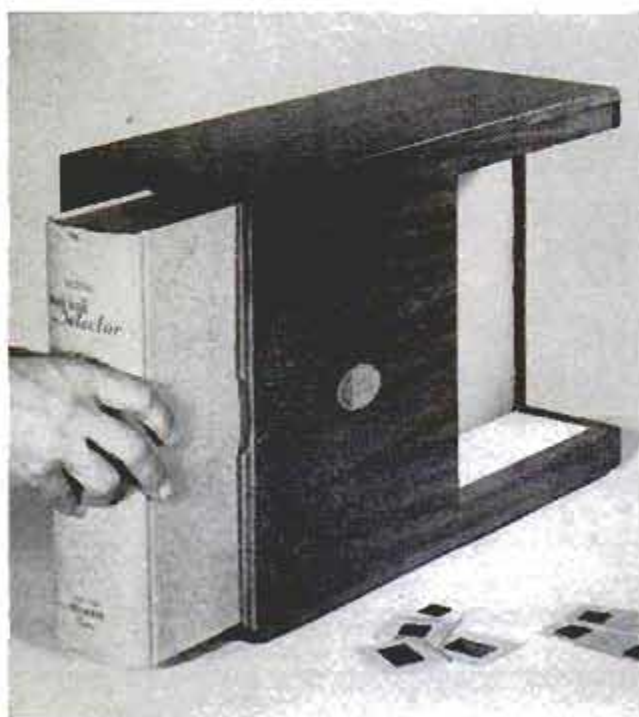

POPULAR MECHANICS

FULL-X-TEND

Pat. No. 2733972 Trade Mark Reg.

Drawer will not drop when fully extended. Large NYLON rollers assure true alignment, long life and easy quiet operation. Wherever new drawers are needed, either LIP or FLUSH front, there is a FULL-X-TEND slide available up to 24" (load limit 30 pounds).

Only 7/16" clearance required on each side of drawer. Packed one set to carton complete with screws and instructions.

At your Bldg. Matl. Dealer, or if he does not have them we will ship direct upon receipt of payment, all delivery charges prepaid (Calif. add 4% sales tax). Write for full descriptive literature.

DRAWER SLIDES

SUPPORT THE DRAWER FULLY EXTENDED

9"	\$3.00
10"	SET
14"	\$3.20
16"	SET
18"	\$3.40
19"	SET
20"	SET
21"	SET
22"	\$3.60
24"	SET

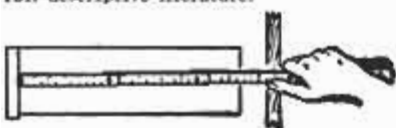
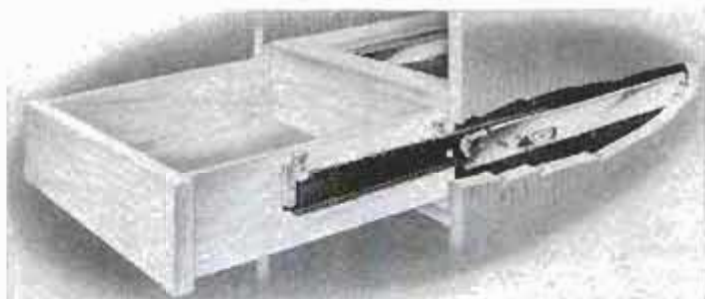

Order the longest size, not to exceed the distance from the rear of the DRAWER FRONT to the rear (inside) of the cabinet. See sketch at left.

A. GEO. DIACK

1427 SANTEE St., Los Angeles 15, Calif.

Works in seconds

Loosens Rusted Bolts nuts, screws, "frozen" parts!

LIQUID WRENCH

AT HARDWARE STORES, GARAGES SERVICE STATIONS EVERYWHERE

For information write manufacturer
Radiator Specialty Co., Charlotte, N. C.

CLOSE OUT! HEAVY DUTY 6-VOLT MOTOR

ALL BRAND NEW! ORIGINAL PRICE \$16.50. Only

Just 1200 Left - Hurry! **\$1.49**

A terrific buy! Oilite bearings. 1/2 inch shaft. High starting torque. Enclosed body. Perfect for car heater & defroster or any 6 volt battery operated mechanism. Send \$2. (\$1.49 plus 51c) and we'll ship postpaid on 10 day money back offer.

ILLINOIS MERCHANDISE MART, Dept. M-8, 1227 Loyola, Chicago 26, Ill.

SIMPLIFY PREVENTIVE MAINTENANCE WITH MACHINE TOOL RECONDITIONING & THE ART OF HAND SCRAPING (2nd printing)

SEND FOR FREE FOLDER DESCRIBING ILLUSTRATED BOOK

MACHINE TOOL PUBLICATIONS, 382 Holly Ave., St. Paul 2, Minn.

make your own Gems 32.50 F.O.B.

The Gem Maker comes complete with all necessary equipment, including a super-charged diamond blade for sawing, and all wheels for grinding, shaping and polishing; also complete instructions. The complete equipment as shown, less motor and belt, for only \$32.50, f.o.b., Burlington, Wisconsin. Write today for information and literature.

B & I MANUFACTURING CO.
Dept. P, Burlington, Wis.

Grips the screw!

Drives it too!

Quick-Wedge SCREW-HOLDING SCREWDRIVER

2" to 14" blades, 4 bit sizes Available with shockproof plastic covered tubing Unconditionally guaranteed

ASK FOR IT AT YOUR DEALER
Kedman Co., 233 So. 5th W., Salt Lake City

MONEY MEN ALL DATA FREE

THE PLASTEX Industry needs manufacturers on small scale and for big production of Lamps and Clock Stands, Art Goods and Novelties in Plaster and Marble imitation. Experience unnecessary. The material makes regular 10c store sellers. Rubber moulds furnished for speed production. Small investment brings good returns. We are now placing big Chain Store Orders with manufacturers. Ambitious men have chance for real prosperity. Our Free booklet will interest and benefit you.

PLASTEX INDUSTRIES, Dept. A
3400 Third Ave. New York 56, N. Y.

SAY YOU SAW IT IN POPULAR MECHANICS

WHAT DO YOU KNOW ABOUT HAND SAWS?

TAPER GRINDING

Two-directional taper grinding means that the blade is thinner at the back than at the tooth line—and tapers from handle to tip. Proper taper grinding gives the blade better clearance in the cut reducing friction and ensures perfect balance and flexibility. SANDVIK Swedish steel hand saws all feature taper grinding over the entire blade... a feature found only in top quality saws.

IF YOU SHOULD KNOW

Write today for free booklet "Things You Should Know About Hand Saws". Write Dept. PM

Sandvik STEEL, INC.

Saw & Tool Division
1702 NEVINS ROAD, FAIR LAWN, N.J.
IN CANADA: P.O. Drawer 1330 Station "O" Montreal 9

**MAKE YOUR OWN
BOLTS, BRACES,
HANGERS!**



now available
GALVANIZED!

**REDI-BOLT®
THREADED STEEL RODS**

Save repair and construction time. Just cut to length; heat and bend; add std. nuts. Seven sizes: 1/4", 5/16", 3/8", 7/16", 1/2", 5/8", and 3/4". Handy lengths of 24" and 36". Available in galvanized or blue rust-resistant finish.

Sold in Leading Hardware Stores

REDI-BOLT, Inc.

5330 Indianapolis Blvd., East Chicago, Indiana

**SPARE-TIME MONEYMAKING OPPORTUNITIES
READ OUR CLASSIFIED ADS**

HUNDREDS OF BARGAINS

AMAZING OFFERS

1/2-HP Motor SPEED REDUCER

Reduces Speed at a 20-1 Ratio

Brand New! Guaranteed! Gov. Cost \$86

Only \$1650



Mfr'd. for Army radar equipment, this reducer is a masterpiece of design and precision workmanship. For experimental and laboratory uses . . . for building special equipment that saves valuable man hours. Ratio of 20-1 gives approximately 90-RPM with 1750 motor, direct drive . . . or can be belt driven to give ANY DESIRED SPEED! Use with any size motor up to 1/2-HP. Case is cast of aluminum alloy (not die cast) and has BALL BEARINGS throughout. Heavy duty, double reduction, spur gear drive built for continuous duty. Smooth, quiet running. Base to shaft is 4 3/4" high. Comes complete with couplings. Operates: conveyors, timing devices, revolving window displays and signs, tumbling equipment and machine tool drives . . . 1,001 uses!
Order From Ad! We Pay Shipping!
ROBERTS ELECTRIC CO., Dept. PM-497, 849 W. Grand, Chicago 22, Ill.



**SEE
YOU
AT THE
POLLS!**

WHERE-TO-BUY-IT INDEX

Source of supply appears after items commercially available

AUTOMOTIVE

Replacement antenna for car radios (Snyder Mfg. Co., 2218 W. Ontario, Philadelphia, Pa.)..... 94
Valve replacement for tubes is easy to apply (Bridgeport Brass Co., Bridgeport 2, Pa.)..... 97
Preoiler ends dry starts (Pre-Matic Mfg. Co., 4605 N.E. 118th Ave., Portland, Ore.).....100
Collapsible steering column.....102
Six jets atop auto aid test work.....147
Propeller drive powers car.....147
Chain brake keeps car on jack (Kriewaldt Specialty Mfg. Co., 502 Park Ave., Oconto, Wis.).....264
Trailer-car brakes synchronized (Warner Electric Brake and Clutch Co., Beloit, Wis.).....336

AVIATION

Precision altimeter accurate to 18 inches (The Garrett Corp., AirResearch Mfg. Div., Los Angeles, Calif.)..... 3
Automatic inflator (North American Aviation, Inc., International Airport, Los Angeles 45, Calif.)..... 92
New quick-freeze method helps machining (Northrop Aircraft, Inc., 1001 E. Broadway, Hawthorne, Calif.)..... 96
United Air Lines puts DC-6A air freighters into service.....117
"Sky screen" speeds relay of radar-tracking information (Northrop Aircraft Inc., Hawthorne, Calif.).....128
Supersonic parachute tailored for shock.....151
Pilots see in dark with "cat eye" electronic light amplifier...152
Flying tanker refuels three at a time.....160
Airport visitors hear control tower.....322

BOATS AND SPORTS

Hot rod for ice fishermen (Vapor Chemical Co., 3930 Rives-Eaton Rd., Rives Junction, Mich.)..... 90
Live-action decoy looks like feeding duck (Ducking Ducks, Inc., 2201 N.W. Thurman, Portland, Ore.)..... 94
Convertible fishing reel for spinning and bait casting (Alrex Corp., 411 Fourth Ave., New York City)..... 99
Small range finder (Federal Instrument Corp., 12-10 Broadway, Long Island City 6, N. Y.).....100
Rectangular sail moves boat faster.....122

SPECIAL HOUSING SECTION

Ceramic tile now applied with adhesive.....167
This old house is young again.....169
Remodeling tips from the nation's top remodeler.....170
Shutters are back again.....178
Year-round check list for house and yard.....184

MISCELLANEOUS

Miniature scene built inside gallon jug..... 60
Doctor builds model of flying saucer..... 62
First all-color TV station sets pace for industry..... 62
House of hazards has many fires but no alarms are sent..... 86
Glass-fiber wires on poles keep woodpeckers away..... 88
Driver on the level with adjustable seat..... 89
Sand skiers flash down manmade mountain.....116
Here it is: "Picture-Phone" lets you see caller.....122
Feather River dam would feed 600-mile system.....124
Ballast-reclaiming machine saves railroad \$140 per hour (Athey Products Corp., 5631 W. 56th St., Chicago).....128
Propaganda phonograph takes parachute drop.....132
Wheelless cultivator moves on endless steel track (O. W. Shelor, 601 Front Ave., Salem, Va.).....132
Back-yard airplane "flies" on ground.....139
LSM converted for deep-sea oil drilling.....139
Rake on casters levels lawns (Wilson Distributors, 111 Stephen Place, Box 93, North Syracuse, N. Y.).....142
Standard bus rides the rails.....143

(Continued to page 108)

GUARANTEED PROTECTION AGAINST WATER LEAKAGE!

ROX MASONRY PAINT

RECLAIM YOUR BASEMENT

Rox guarantees to protect your basement against water leakage. Convert it to a usable recreation room or workshop where tools are safe from moisture with Rox.



SEALS SURFACES, GUARANTEED NOT TO BLISTER OR PEEL

Masonry or brick stucco walls absorb tons of water. This water, if not kept out, can deteriorate masonry. Rox becomes part of the masonry surface itself as it seals the surface and protects against water even in gale-driven rains.

Available in 5 colors
and white at
authorized Rox dealers
in U. S. and Canada.

Send For This Booklet Today!

18 pages of helpful hints to glamorize recreation areas, both indoors and out. Packed with diagrams and colorful pictures. Send 15c for handling.

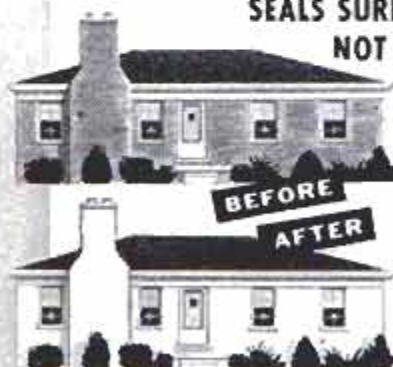

INSIST ON GENUINE ROX
"Hasn't Leaked Yet"

ROX PRODUCTS CO.

DEPT. M10 • DETROIT 27 • MICHIGAN

© ROX PRODUCTS CO.

PUMP FASTER with a "HY-JET"!

Made of aircraft grade aluminum alloy, this rugged #10 centrifugal pumps up to 4500 G.P.H. Ideal for irrigating—draining—filling—spraying. Uses 1/8 to 3/4 H.P. motor. Rust-proof 1/2" shaft, oilless bearing, 3/4" suction, 1/2" discharge, std. pipe threads, adaptable to garden hose. \$8.95
Heavy-Duty HY-JET #20 fills and empties pools, ponds, etc. Extra powerful—up to 8000 G.P.H. Use 3/4 to 3 H.P. motor. Rugged, rust-proof 1/2" shaft, oilless bearing, 1 1/4" suction, 1" discharge, std. threads. \$11.95
Prepaid if cash with order. Send Check or M.O. \$2 deposit if COD. Money-back guarantee.



MACK EQUIPMENT & MACHINE CO., Dept. K-10
329 No. Indiana Ave. Atlantic City, N. J.

SAY YOU SAW IT IN POPULAR MECHANICS

THE ORIGINAL PACKAGED BOAT KITS

Made ONLY by Custom-Craft



World's largest line! Over 200 Boats: Kits, Formed-Hulls, Semi & Custom-Finished! All types: Prams-Cruisers! Easy to build! Flying stern, Tredonic bottom, Bulkhead construction!
Send 25¢ for KIT CATALOG
52 pages; Includes Victory Series, hardware, paint accessories, Fiberglass! Send \$1.00 for Catalog Plus "Boating Handbook". DEALERS-AGENTS INQUIRE

BOAT PLANS & PATTERNS Frame-Pac Kits

World's largest selection; over 200 plans, full-size patterns, frame-pac kits! Designed strictly for amateurs! All types: prams, kayaks, racers, runabouts, catamarans, houseboats, cruisers - inboard-outboard 6-40' wood-plywood-steel!
Send 25¢ for PLAN CATALOG
Catalog PLUS "Boatbuilding Handbook" \$1.00
DEPT. PM CUSTOM-CRAFT - BUFFALO 7, N. Y.



Super-honed wheel and special axle, perfect design and workmanship guaranteed. Long life and perfect, easy cuts. Factory-sealed packaging for your protection.

Red Devil GLASS CUTTERS



FREE How To Cut Glass. Illustrated instructions on tools and methods of cutting glass.

Red Devil Tools. Dept. 149
2400 Vauxhall Rd., Union, N. J.
Please send FREE copy of "HOW TO CUT GLASS."

NAME _____
ADDRESS _____
CITY _____ ZONE _____ STATE _____

1662

FROM ALL OVER THE WORLD...

news you want to hear with a

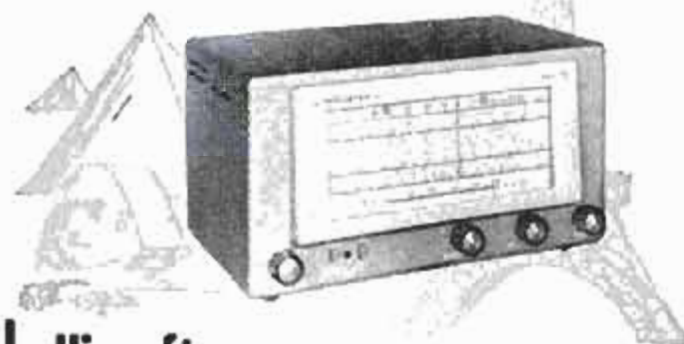

hallicrafters Model S-38D—Only \$49.95

It's a fascinating, exciting hobby to listen in on the whole wide world by short wave with Hallicrafters S-38D radio. With this exceptional receiver you enjoy not only standard broadcasts . . . but can choose from the 3 international short wave bands. You, too, will praise the performance of Hallicrafters S-38D radio . . . the choice of countless governments as well as radio experts the world over. Hear the S-38D at your nearest Electronic Parts Distributor today—\$49.95 . . . or write

hallicrafters

CHICAGO 24, ILLINOIS

GOTTA COMMON CAR COMPLAINT?

- Hard starting
- Engine dies
- Rough idle
- Jerky acceleration
- Low gas mileage



FUEL PRESSURE REGULATOR

\$6.95

You need a MILESMASTER®

Milesmaster cures engine troubles

It regulates fuel pressure. Keeps raw gas from flooding engine and washing lubrication off cylinders and pistons. Reduces so-called vapor lock. Prevents crankcase dilution which forms harmful gums. Eliminates ignition fouling. Saves wear and tear on carburetor float and needle.

New motoring thrills

If you want a new thrill from smooth, step and go, economical engine operation, have your dealer install a Milesmaster. Save its cost in first few thousand miles.

MILESMASTER, INC.

Factory and Sales, Box 46, Exeland, Wis., U.S.A.
Executive Office: Suite 703
6 N. Michigan Ave., Chicago 2, Ill.

What MILESMASTER does for your car

- Saves gas
- Reduces wear
- Prevents dilution
- Provides smooth idle
- Eliminates flooding, percolation, vapor lock
- Filters the fuel
- Traps steel and rust particles

Money Back Guarantee
Have your dealer install MILESMASTER on your car. Drive it for two weeks. If not completely satisfied, your money will be refunded in full.
MILESMASTER, INC.

(Continued from page 106)

Truck hoist built from kit features light weight and simplicity (Hydraulics Unlimited Mfg. Co., P.O. Box 207, Eaton, Colo.)	142
Pocket instrument compares surfaces (Bausch & Lomb Optical Co., 635 St. Paul St., Rochester, N. Y.)	147
Guide for hair clipper assures even cut (Home Trimmer Co., 20 W. Jackson Blvd., Chicago 4)	151
Mobile drill platform rests on stilts (R. G. Le Tourneau, Inc., Longview, Tex.)	151
Police call box	284
Mesquite becomes cattle feed	318
Hospital call system	330
Car drives generator (Kato Engineering Co., Mankato, Minn.)	332
Hearing aid for dogs (Malco Co., 23 N. Third St., Minneapolis, Minn.)	336
Paper cutter has safety roller (The Crusader Co., Dept. 149, P. O. Box 368, Woodland Hills, Calif.)	338

PHOTOGRAPHY

Color-slide frustration ended by previewer and storage unit (Westphal's Handviewer, Box 133, Angwin, Calif.)	104
Camera mounts on helmet	132
Hobbyists can print photographs on metal (Grover Photo Products, 341 Arden Ave., Glendale 3, Calif.)	270

SCIENCE

Mushrooms from sawdust	60
Battle TV	117
Fully automatic communications center	133
Missiles travel 7000 miles per hour	143
Electronic oven uses microwaves to bake cake in six minutes (Tappan Stove Co., Mansfield, Ohio)	152
Low temperature traps energy	152
Remote control for television set employs ultrasonic commands	153
Tiny transducer locates heart defects (Dr. Samuel Bellet, 2021 Spruce St., Philadelphia 3, Pa.)	270
Peat-taconite partnership	282
Rocket fuel becomes rust inhibitor	302

Radio-Television, Electronics

Why buy an oscilloscope?	261
--------------------------	-----

Craftsman and Shop Notes Index

CONSTRUCTION

Shingle platform is self-supporting on double-course walls	216
Reduce crawl-space humidity with adequate ventilation	216
Dam prevents gully erosion	260

HOUSE AND HOME

Covering window helps increase wall space	210
"Air washed" roof keeps porch cool	210
Metal flashing under fascia board prevents water damage to dormer	210
Hamper partitioned to aid in sorting clothes	224
Corner box stores blankets for twin beds	225
Improvised steam-pipe deflectors direct heat into basement	228
Footstool-chest	229
Chain permits proper seating of toilet flush ball	248
Quarter-round prefinished to simplify painting	248
Metal "stirrup" in concrete base extends life of rotted post	250
How to restore piano finish checked by hairline cracks	251

HOUSEHOLD HINTS

Solving Home Problems—	
Bar of soap can be used to lubricate needle	214
Handy spool rack	214
Sandwiches are slipped easily into bags	214
Releasing fountain-pen cap that has become stuck	214
Plastic bottle caps that are difficult to unscrew	214
Serviceable one-pot "greenhouse"	215
Clean silverware with toothpaste	215
Size and style number of shoes kept legible	215
Storing shoes that are not often worn	215
Fishbowl cover that is easily removed	215
Care and use of rubber gloves	222
Handy utility tray keeps house-cleaning materials together	222
Magnet holds cover on automatic washer open	224

(Continued to page 110)

101 FREE TIPS

For the Handyman
who works with wood

SEND
for this informative booklet

ON
WOODLIFE
The Original
Water Repellent
Preservative



Anything made of wood — and this folder illustrates 101 items — should have the water repellency, resistance against warping, swelling and shrinking — and immunity against termites and decay — made possible with Woodlife.

Woodlife is the original water repellent wood preservative containing PENTACHLOROPHENOL that should be on every handyman's work shelf — along with this folder which shows how to apply Woodlife to 101 household wood-working projects.

Woodlife is made by the makers of P.A.R., the water repellent, glossless finish that protects and restores the natural beauty of Redwood and Red Cedar.

Send for the "101 TIPS" Booklet, TODAY!

Protection Products MANUFACTURING COMPANY

Dept. J Kalamazoo, Michigan

When you repair, remodel or build, always ask for
Woodlife-treated lumber!

Find HIDDEN TREASURES

GOLD, SILVER, PRECIOUS METALS with the Famous Model 27 Metal Detector. Lightweight, ultra-sensitive, low cost. Nano finer. Also GEIGER COUNTERS for uranium and the VIOLITE for tungsten. INFORMATION FREE

THE *Detection* CORP.
5528 Vineland Ave., No. Hollywood, Calif.



14' Model Pictured

42 TOP PERFORMING
MODELS, 8' thru 18'
... from \$39.25 incl. frt.

Runabouts, Cruisers, Convertibles, Fishing, etc. for every purpose with modern styling, advanced design. No experience necessary, amateurs can easily assemble. Save 1/3 to 1/2 "factory-built" prices!

FIBERGLAS, TRAILERS, ACCESSORIES

YATES-AMERICAN INDUSTRIES, INC. DEPT. R-10 3404 Lyndale S.
Minneapolis 8, Minn.

FREE!
BOAT
KIT
CATALOG

Need an extra \$1,000, \$2,000, or more? Make it with an
**IDEAL LAWNMOWER
SHARPENER**



There are thousands of lawnmowers in your locality: Average \$1,000 profit per 250 mowers with customer satisfaction and repeat business assured. Provide this essential service with an Ideal[®] Lawnmower Sharpener, the only machine that grinds the reel to "fit" the bed knife. Compare by any standard. The Ideal, backed by 53 years of experience, costs no more. Write today for complete, free catalog.

THE FATE-ROOT-HEATH COMPANY
Dept. PM-10 Plymouth, Ohio



\$159.50

(for 8" saw, less motor, guard, and extensions)
As your budget grows, add 4" jointer (\$59.00), 10" sander (\$16.00).
Prices will vary in some areas.

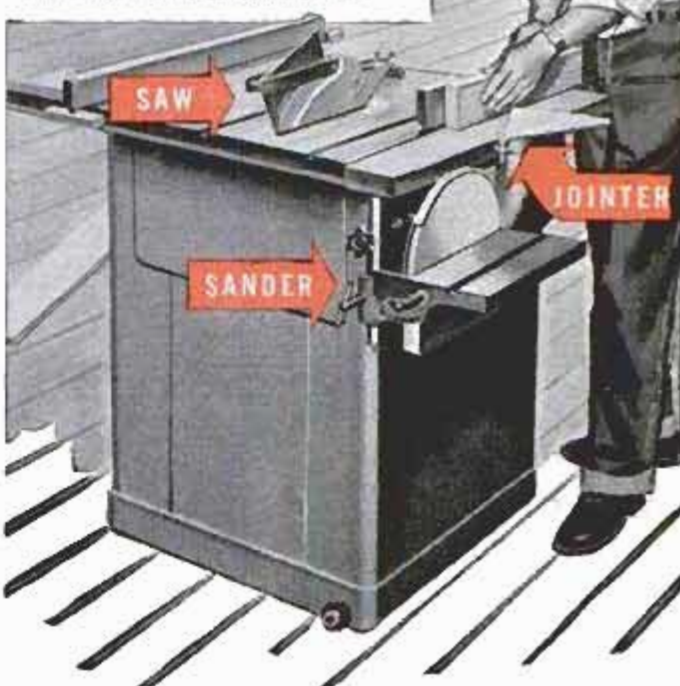

**The mobile workshop
preferred by professionals**

New **YATES-AMERICAN**

1 Quickest change-over from saw to jointer to sander.

2 Compactness with capacity.

3 Quality features—patented feather-touch rip fence.

Take a cue from the craftsmen. See your Yates-American dealer today, or write for colorful catalog.



Yates-American

BELOIT, WISCONSIN
Department K, 783 N. Fourth Street

NAME YOUR BONDING PROBLEM and Pliobond will answer it—quickly and permanently. Pliobond will join almost anything found in the home with strong, flexible bonds that resist water, oil, household chemicals and aging.



TRY THE ONE ADHESIVE THAT'S—

SO VERSATILE it bonds virtually any material or combination of materials—does almost every home or hobby bonding job

SO EASY to use, anyone can make it work—and do a better job faster

SO STRONG it can lift a truck—meet any bonding strength requirement

Pliobond
BY

GOOD YEAR

"BONDS ANYTHING TO ANYTHING"

AVAILABLE AT chain, hardware and hobby stores everywhere. Ask for it by name—Pliobond. You'll find it a worth-while addition to your workshop.

Pliobond—T. M.

The Goodyear Tire & Rubber Company,
Akron, Ohio



(Continued from page 108)

Rubber-headed tacks keep breadboard from skidding.....	228
Liquid-soap dispenser	235
Tape protects bottle labels.....	236
Clothespin holds milk order.....	238
Ironing-board cover fastened with safety pins and cord.....	238

MISCELLANEOUS

Sandbox contents stored in milk cartons for winter.....	213
Card-dealing error corrected.....	224
Looped cord on wand "impossible" to remove from buttonhole.....	224
Lawn furniture easily stored between joists of garage ceiling.....	228
Mysterious jumping-match trick.....	228
Film-spool wheels for toys.....	232
Acoustical tile and wooden pegs provide hours of fun.....	234
Invisible writing on paper.....	234
Cork on hard masonry wall receives bulletin thumbtacks.....	244
Compass on tractor saves steps.....	260
Pressure tunnel for hay drier made from compacted bales.....	260
Trailer-mounted fence reel.....	260
Underground location of well found with two pieces of string.....	260

PHOTOGRAPHY

Midget flashbulb case.....	217
Low-voltage light aids in setting photo-enlarger f-stop.....	222
Hinged darkroom paper cutter.....	225
Photoflood clamp "slipproofed" with coat of rosin.....	236
Darkroom timer set without light.....	238

TOOLS

File tang is handy drift for removing drill bits.....	244
Long-nose pliers shaped to remove sanding disks.....	244
Rotary file used as reamer.....	244
Portable vise mounted in concrete.....	248
Two clevises form universal joint.....	250
Shopping for Tools—	
Direct-reading force gauge.....	253
Hold-downs for use on machine tables.....	253
Compact one-motor workshop.....	253
Builder's framing rule.....	254
Router kit.....	254
Ornamental-iron porch columns.....	254
Portable metal shear.....	255
Weld positioner.....	255
Glass cutter.....	255
Precision tapping tool.....	255
Testing device for auto cooling systems.....	255

WORKSHOP HINTS

Drain hole punched in can.....	216
Tightening loose setscrew.....	216
Snap fasteners tightened with locking pliers.....	222
Toolbox drill holder.....	225
Nail driven into saw kerf relieves saw binding.....	228
Hose is round-work sanding block.....	229
Waxed folding rule protected from dust and wear.....	229
Friction clamp holds T-square in position on board.....	232
Glue sizing for wood joints.....	232
Improvised lock washer.....	232
Panel of wood or plate glass carried in rope sling.....	232
Tape skidproofs drill point.....	234
Vacuum cups on tape dispenser permit one-hand operation.....	234
Luminous paint "lights" dead fuse.....	235
Melting stick shellac.....	235
Special force cup clears obstruction from floor drains.....	235
Flowerpot lamp on tripod is novel planter.....	236
Nine uses for eyebolts.....	237
Drawer pulls protect open toggle switch from damage.....	243
Pitted gasket seat smoothed.....	243
Vacuum collects belt-sander dust.....	243
Rack for small parts made from coffee cans.....	244
Keyhole saw more easily filed in conventional vise.....	248
Adjustable lathe center for supporting small work.....	250
Screwdriver blades hardened by heating and quenching.....	250
Threading taps kept sharp.....	250
Bend plastic the easy way.....	251
Felt hat provides disks for buffing wheel.....	252
Fractured plasterboard can be severed with handsaw back.....	252
Increasing vise-jaw capacity.....	252
Petroleum jelly on fiber washers keeps battery-cable nut free.....	252
Setting engine valves.....	252
Aligning circular-saw blades.....	256
Drill-press trays hold stock and finished parts.....	256
Retriever for small parts.....	256
Safe brad and pin driving.....	256
Diameter of cylindrical object measured with two squares.....	257
Sleeve holds square stock in 3-jaw chuck.....	257



TRAINING IN THE U.S. AIR FORCE CAN PAY YOU BIG DIVIDENDS

As a man with mechanical ability, you have the opportunity to advance your skill in the U.S. Air Force. As an Airman you will train in the latest techniques of electronics, rocket propulsion, photography, or any one of over 40 career fields—and you earn while you learn! You'll see new places, too, make new friends, and work with men who share your interests. For now and for your future, find out about the dividends the U.S. Air Force can offer you. Mail the coupon now, or see your local Air Force Recruiter.

Go places
faster on the
All-Volunteer Team
—the **U.S.**
AIR FORCE

M-57-PM

PASTE COUPON ON POSTCARD and mail to
Airman Recruiting Information Branch
Box 2202, Wright-Patterson AFB, Ohio

Please send more information on my opportunities
for enlisting in the U.S. Air Force. I am between
the ages of 17-34 and reside in U.S.A. or possessions.

Name _____

Address _____ Age _____

City _____ Zone _____ State _____



More road horsepower for hill climb! Bob Unser sets a new record in 1956 Pikes Peak Hill-Climb Race in car powered with Jaguar engine and Champion spark plugs. Champions give him more power in his family car, too!

New Champion spark plugs can increase road horsepower by 24%!

Tests show new Champions can give you an immediate boost in road horsepower if you have driven about 10,000 miles without a spark plug change

Whatever make of car you drive, you'll be amazed at the difference in performance a set of new 5-rib Champions can give you.

That difference has been proved conclusively in tests by independent engineers. When they put new Champions in cars whose plugs had gone 10,000 miles or so, there was an *immediate* increase in road horsepower—the real power actually

delivered at the rear wheels! *The average gain for all cars tested was 24%!*

There just never has been a spark plug to match these new 5-rib Champions! Replace your old plugs with new Champions today. You'll feel the difference *at once!*



LOOK FOR THE 5 RIBS



New Powerfire electrode stands up better in today's engines. Photo shows how ordinary electrode (left) burns away. Champion's Powerfire electrode (right), after identical use, is still good for miles of powerful, full-firing performance.

THE PLANE FOR THE DO-IT-YOURSELFER

By Bob Gray

BOB NESMITH OF HOUSTON, Tex., hopes his "Cougar I" will do for flying what Henry Ford's Model-T did for driving—put an airplane in reach of all who want one.

All, that is, who want one enough to build it themselves. Unlike Mr. Ford's early creation, this high-speed, low-cost craft won't be sold commercially.

"Any reasonably good mechanic," says Nesmith, "can build this plane in his own garage workshop for \$1400 or less—even if he's never flown before."

That's what ex-Air Force ferry pilot Nesmith, 42, has been doing himself for the past year.

Convinced that sports flying shouldn't be limited to those who can plunk down \$15,000 for a swanky cabin job, he put the Cougar together with a maximum of safety, a minimum of cost.

And the Cougar is a current wonder of Texas aviation circles. In a field where 150 miles per hour is considered fast for even expensive light planes, the Cougar romps along at nearly 200 miles per hour, with only a 105-horsepower Lycoming in the nose. Wingspread is 20 feet; body length, 18 feet. Cruising speed is about 180.

Not only does this little ship have speed, but it also handles easily and has good stability. It is so stable in a power-on stall,

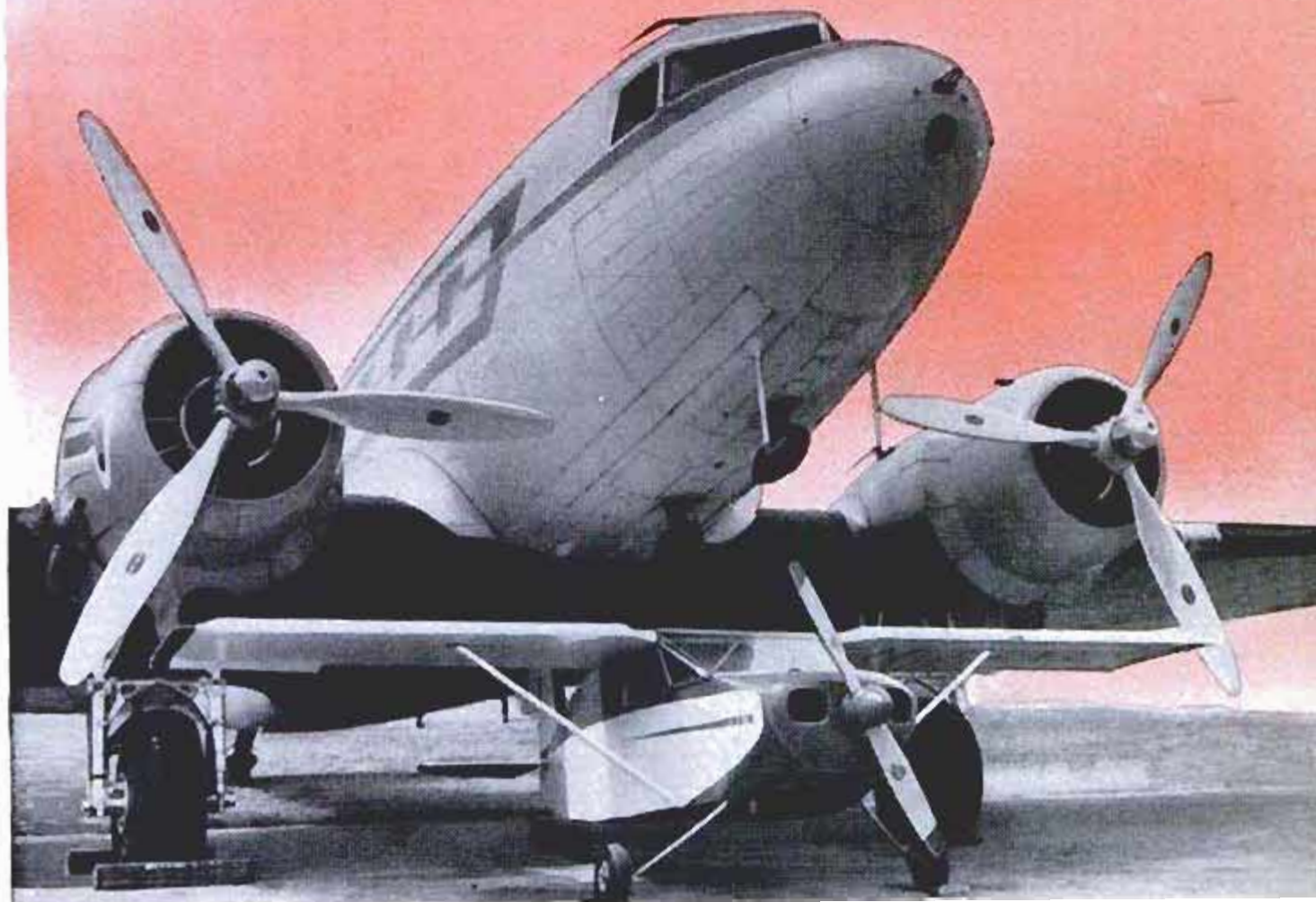



Graceful in flight, and not at all homemade looking, the little Cougar cruises at 180 miles per hour

in fact, that it will not fall off to either side in a spin. Instead, it simply hangs on its nose and moves forward at about 75 miles per hour. And, to complete the picture, the plane is economical to run, since its gas-consumption rate is low considering its speed.

Construction reflects Nesmith's determination for simplicity and low cost. Engine, wheels and instruments are stock items. An 85-horsepower Continental—costing \$200 less than the Lycoming—is adequate power, says Nesmith.

The fuselage is steel tubing with ordinary fabric covering. Wings are of built-up spruce ribs with $\frac{1}{16}$ -inch mahogany-plywood covering. Light sheet metal covers the cabin, while the one-piece windshield is Plexiglas that Nesmith molded over a wooden frame by pouring hot water on it.

Bob Nesmith, the builder, says final plans show two inches more headroom in cabin for taller pilots

Empty, the Cougar weighs 600 pounds; fully loaded, 1200. It lands at 50 miles per hour without use of its flaps, takes off at 60 within 250 feet of runway.

Nesmith, who's been building and flying planes since he was 13, knew at the outset that most home mechanics aren't aircraft engineers. Neither, technically, is he. That's where the CAA comes in.

What makes building your own plane practical, he says, is readiness of the Civil Aeronautics Administration to provide free advice, supervision and inspection as you go along.

To insure "airworthiness," CAA Safety Agents in Houston checked the Cougar at each stage of construction. They looked over original plans, the materials, power plant, Nesmith's welding, controls and landing gear. That help and supervision is not only gratis, it's necessary before the CAA will give its blessing to the finished homemade plane.

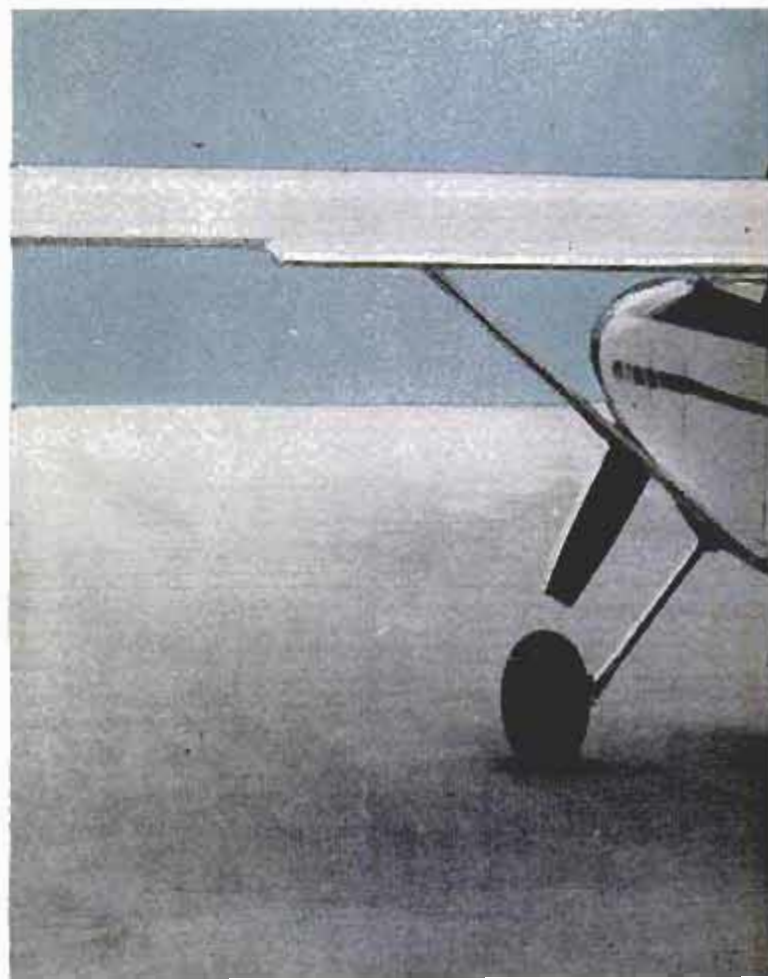

The Cougar's cost, Nesmith says, is related to the builder's ingenuity. It cost him \$1600, but he had little time to look for second-hand parts. "Around most airports," he says, "you can get about 80 per cent of this airplane for nothing."

Junked aircraft will furnish spars, fittings, all sorts of tubing. A bent propeller can be cut down to the Cougar's 64-inch requirements for about \$25. A new one might cost \$150.

In plans he's now preparing, Nesmith says he'll give detailed instructions on materials, their procurement, plus building techniques. And as far as he's concerned, everyone is welcome to the plans.

He'll turn them over to a Houston blue-printing firm where the public can get them for only the cost of the blueprints.

Why the generosity?

Nesmith says he's "made his pile." He runs the Houston firm of Robert E. Nesmith, Inc., a multimillion-dollar contracting firm.

Now that he flies only for a hobby, he says, he'd like to see more people of modest means doing the same thing.

The Cougar implements that desire by stressing safety and economy. It will carry two people and 96 pounds of luggage about 1000 miles without refueling. It got the CAA Certificate of Airworthiness on Dec. 27, 1955.

Those who build it, by CAA rules, will have to fly it within a 25-mile radius of their "home" field and carry no passengers



Professional look is carried into the cabin and instrument panel. Windshield is made of curved plastic

until after the craft has logged 50 hours. Then the horizon and your pocketbook are the limits.

The home craftsman who tackles the job, Nesmith says, should be prepared to spend up to 600 man-hours of work. That's what it took him.

"But that's an asset, too," Nesmith adds. "You can build the plane a little at a time, and buy your materials as you get the money." ★ ★ ★

Cougar maneuvers easily on the ground because of its light weight, requires only one man to hangar it





Sand-skiing match drew 8000 cars and 25,000 spectators. International champions participated in the meet

Sand Skiers Flash Down Manmade Mountain

ONE OF THE biggest sand piles in the world is a 200-foot manmade mountain at Fort Meade, Fla. Its top is 330 feet above sea level, making it the highest point in Florida. The pile, which consists of tailings from a Swift & Co. phosphate mine, grew

during a five-year period to cover 18 acres and contain 3,000,000 tons. Now it serves as a waterless beach for inland Floridians who sunbathe on its slopes. It has even been the site of a sand-skiing match that drew 25,000 spectators.

Sand when dry makes for smooth, fast skiing. Winner of meet made it down 356-foot course in 11 seconds





Army scouts will soon be using an eight-pound TV camera and a 47-pound backpack transmitter to send on-the-spot battle-picture reports to command posts. Pictures up to a mile distant can be picked up by the camera and sent to a receiver another half mile away. The camera has four interchangeable lenses, including a wide-angle lens for viewing a broad sector and a telephoto lens for subjects at a great distance.

A tripod replaces the pistol grip for unattended operation in radioactive, exposed or remote positions. The back-pack transmitter can operate continuously for two hours on a five-cell rechargeable silver-zinc battery that can be replaced in two minutes. Push-button controls at a Jeep console permit Army troop leaders to monitor pictures taken by five cameramen and to relay them to higher headquarters.

United Air Lines Puts DC-6A Air Freighters Into Service

Five new DC-6A Cargoliners, capable of carrying payloads of over 30,000 pounds per flight, are going into operation on United Air Lines' coast-to-coast schedule. The planes will carry no passengers, and will nearly double the line's total freight-carrying capacity. With a range of 2400 miles when fully loaded, the DC-6A has

many advances over earlier air freighters. Powerful floodlights have been installed on board to illuminate ramps for night operations. Nets divide the cabin into compartments for destination allocations and fast loading and unloading. Schedules call for overnight flights from Newark to Los Angeles and San Francisco via Chicago.

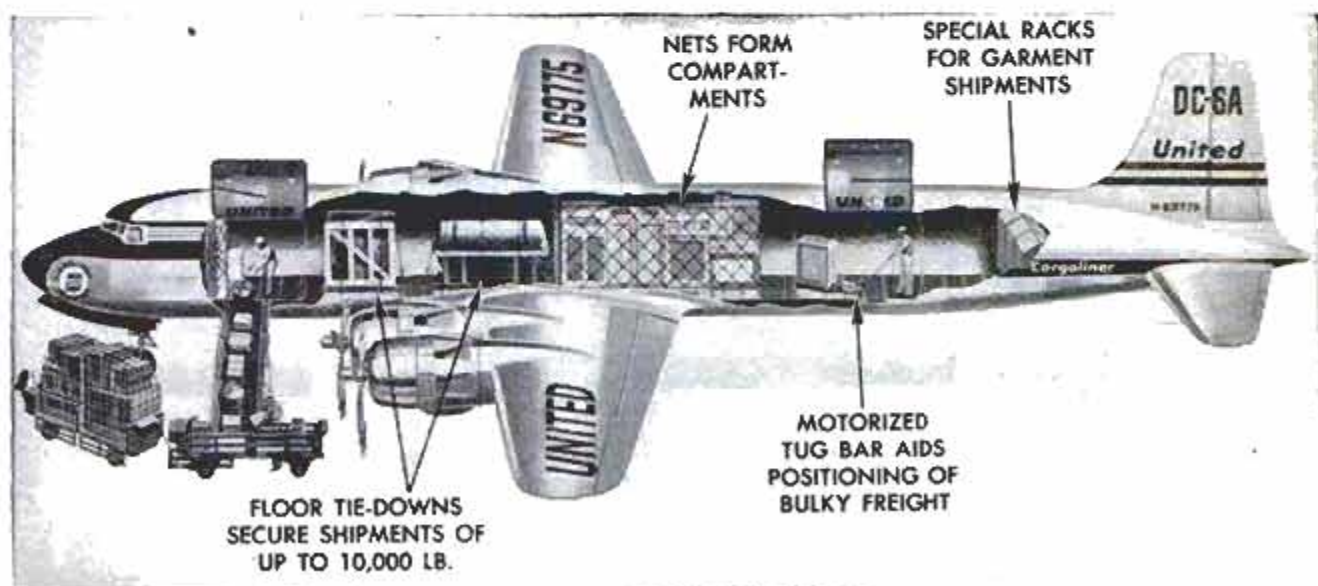



MAGIC CRYSTALS GROWN HERE

Above, typical prism, lens and window blanks in foreground of picture were cut from synthetic optical crystal ingots like those in background

Large crystal of sodium chloride, below at left. In this form, crystal is called an ingot, and takes its shape from crucible in which it is grown

Platinum crucible shown below at right, worth a small fortune, is reshaped on steel mandrel after having been used in growing a chemical crystal

By
Walter E. Burton

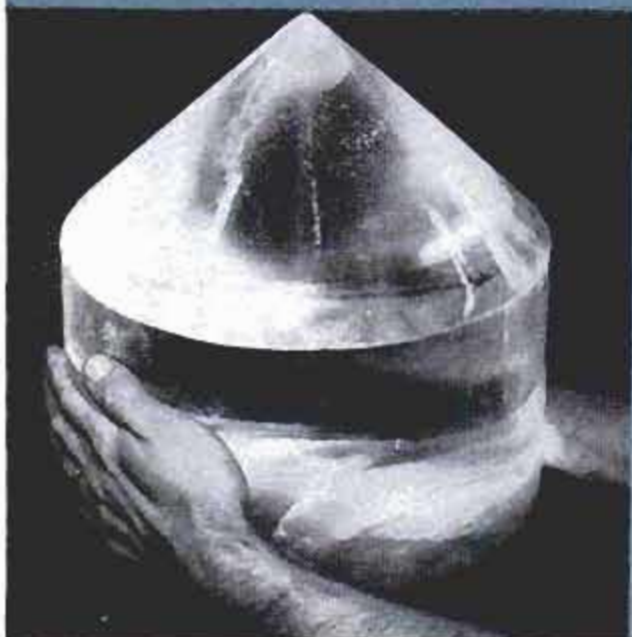

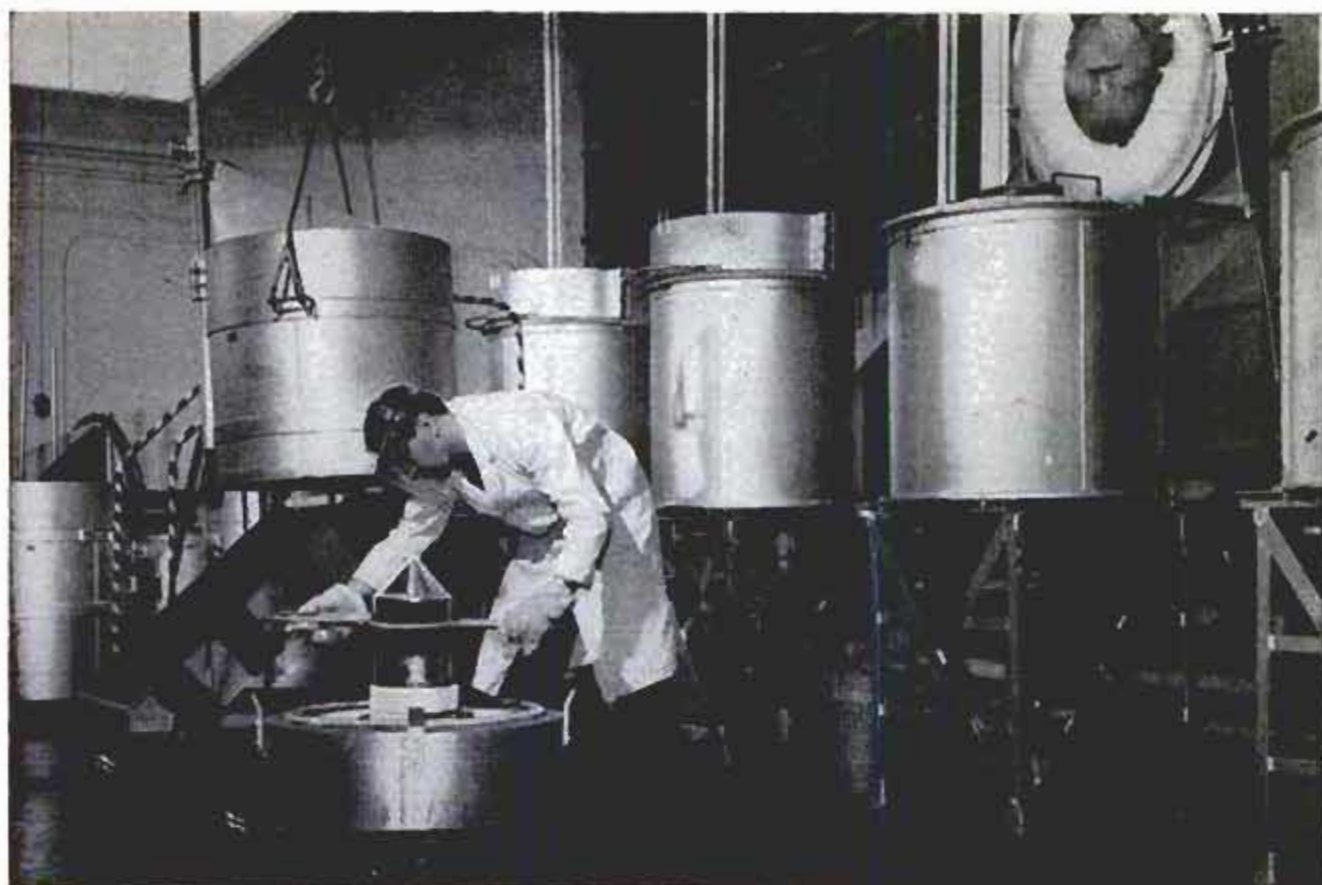

An inverted platinum crucible is removed from a crystal after a quick heating to liquefy the crystal surface

CHEMICAL CRYSTALS that remember things, "smell out" uranium at long range, help identify unknown substances, make infrared and ultraviolet light do tricks; crystals that can be rolled into thin films as if they were so much plastic, and others so hard they must be cut with diamond saws or so dense that they are in a class with lead and gold—these are some of the strange products of a Cleveland, Ohio, laboratory whose technicians often wish they had a fortune teller's crystal ball to guide them in their pioneering work.

This crystal center is at the main laboratory of the Harshaw Chemical Company. Unlike automobiles, the crystals seldom lend themselves to mass-production methods, and the demand for a particular kind often is limited.

MIT Process

About 18 years ago, the need for new sources of large infrared-transmitting crystals became great. Up to that time, crystals capable of passing long-wave radiation (beyond the red end of the visible spectrum) without absorbing some of it had come principally from the Ural Mountain region in Russia. At the Massachusetts Institute of Technology, methods of making infrared-transmitting crystals of substances like potassium bromide and calcium and lithium fluoride were developed, and the Harshaw Chemical Company was asked to produce them under the MIT process. Since

then, the crystal work at the Cleveland laboratory has led into strange byways and involved many chemical substances.

A chemical crystal is composed of a salt or combination of salts and often is soluble in water. Perhaps the most familiar example is sodium chloride, ordinary table salt. In the Harshaw laboratory, table-salt crystals have been grown weighing nearly 100 pounds. Such crystals—in fact, practically all of those made at the Cleveland laboratory—are produced by first melting the chemical and then cooling it under controlled conditions.

Three Groups of Crystals

Crystals produced at the laboratory are nearly all of inorganic salts and fall into three main groups: 1. Infrared and ultraviolet-transmitting types; 2. Crystals for scintillation counting, as in uranium detectors; 3. Those suitable for use in electronic memory devices such as computers and automatic telephone equipment.

Ever hear of a string saw? It is one of the special devices developed at the Harshaw laboratory in connection with the crystal work. Although it takes various forms, a typical string saw resembles a bandsaw; but instead of a conventional toothed blade, it uses an endless cotton string that runs through a pan of water. The wet string, rubbing against a crystal made of a water-soluble chemical, gradually dissolves its way along. The crystal is fed to the string

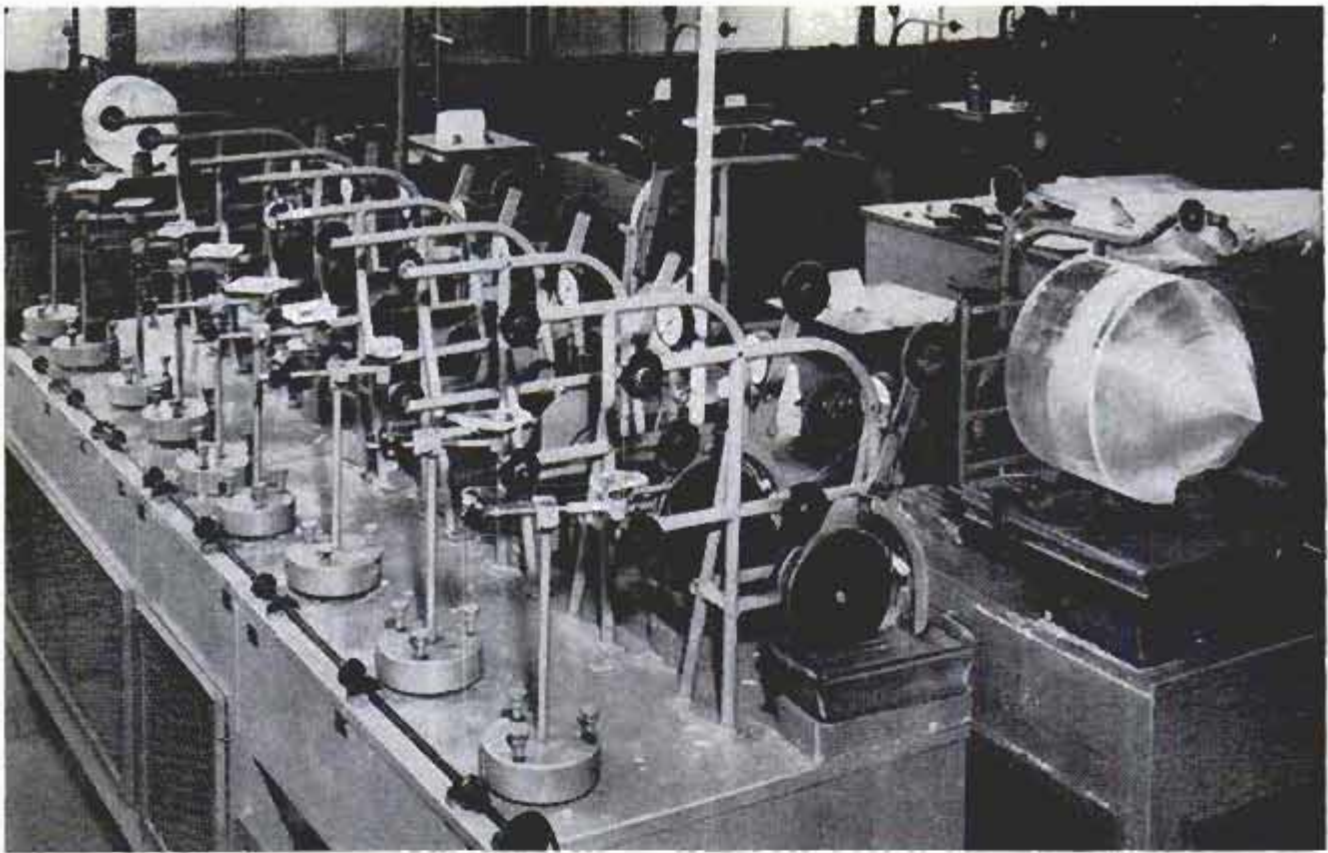

String saws in foreground cut crystals into various shapes. At right, a large ingot is being cut by a saw

Some of the manmade crystals are so hard that they have to be cut with a diamond-charged circular saw

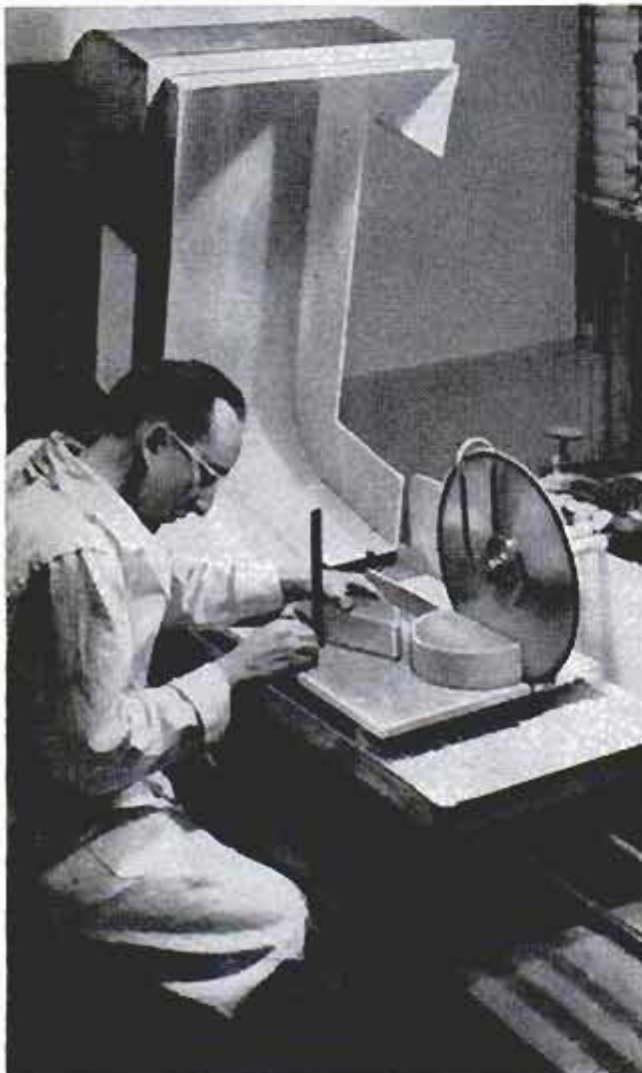

to produce slabs, cylinders, prisms or other forms. The cut surface is composed of a series of small ridges.

Purifying Is Important

In many ways, the process of manufacturing crystals is just as fascinating as the uses to which they eventually are put. Because the presence of even a minute trace of impurities may affect the optical or other performance of a crystal, the first step is the purification of the salt. This can be costly. In the case of cesium iodide, the cost of the raw material may run more than \$200 a pound; then the work of purifying it in preparation for crystal-making may double that cost.

After the chemical has been purified, it may have to be kept at boiling-water temperature in an oven for a week to drive out all traces of moisture. Next it is placed in a platinum crucible—which in itself may represent an investment of \$4000 for a size no bigger than a gallon bucket. A typical crucible of this size is shaped somewhat like a big-gun projectile—cylindrical with the bottom conical. The crucible and its chemical charge are heated in an electric resistance furnace.

After the charge, which is positioned near the top of the furnace chamber, has melted, the crucible is lowered at about $\frac{1}{8}$ inch per hour to the cooler portion of the chamber, so that, starting at the crucible bottom, the charge is gradually cooled below its melting point, and the entire mass becomes

crystallized. The crucible, still perhaps at 1200 degrees Fahrenheit, is transferred to another furnace and inverted, and the temperature raised rapidly. This causes a "skin" of the chemical next to the platinum walls to melt, and the crystal slides out of its costly jacket. Next it is placed in an annealing furnace where it may spend a week cooling to room temperature.

Crystals Can Be Machined

After that, almost anything may happen to the crystal—depending on the job it is to do. It may be mounted in a lathe and machined to precise shape and size, an operation done mostly by lathe bits that scrape rather than cut, and whose "chips" are whisked away by a suction hose. Frequently the crystal is cut with a string saw, ordinary bandsaw or a circular diamond saw, the tool depending on the hardness and other properties. Another way is to split the crystal along natural cleavage planes, much as an expert cuts a diamond. A piece of crystal of the scintillating type may be made into a cylinder and bored to receive a test tube; a radioactive material placed in the tube then will be almost completely surrounded by the crystal whose job is to catch radiation.

Mortality Rate High

The mortality of crystals between the furnace and the final product may be high. It is not uncommon for a giant crystal the size of a loaf of bread to shatter as the result of a sudden mechanical or thermal shock, and wind up as a bucketful of little crystals. A lot of other things can go wrong. Going back to that cesium iodide whose purified form may represent a cost of hundreds of dollars per pound—a very low yield from the growth process may mean that the final, usable crystals are worth as much as some precious or semi-precious stones of comparable size. John Harshaw, an electrical engineer-chemist turned crystal specialist, who is manager of the crystal division, exhibited a large crystal that was being machined in a lathe to a form required by its future job in a laboratory. Finished and specially shock-mounted, the crystal, the only one of its kind in existence, would be worth the price of a couple of the better automobiles. "Where it is going, it will be handled by remote-control equipment," he said. "If it were not shock-mounted, and someone manipulating the controls should let it drop suddenly, the crystal might shatter into hundreds of pieces."

An outstanding Harshaw development is the making of synthetic optical crystals used chiefly in chemical analysis and other

(Continued to page 320)



Laboratory worker splits a rock-salt crystal along natural cleavage planes, using hammer and chisel

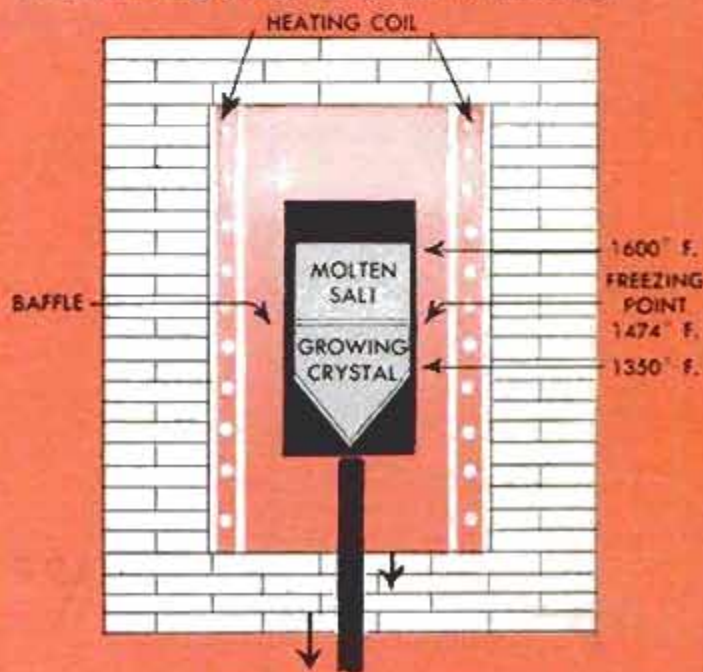

Above, diagram of typical resistance furnace in which chemical crystals are grown. Crucible is moved slowly into cooler part of furnace. Below, crystalline silver chloride is rolled thin and flat

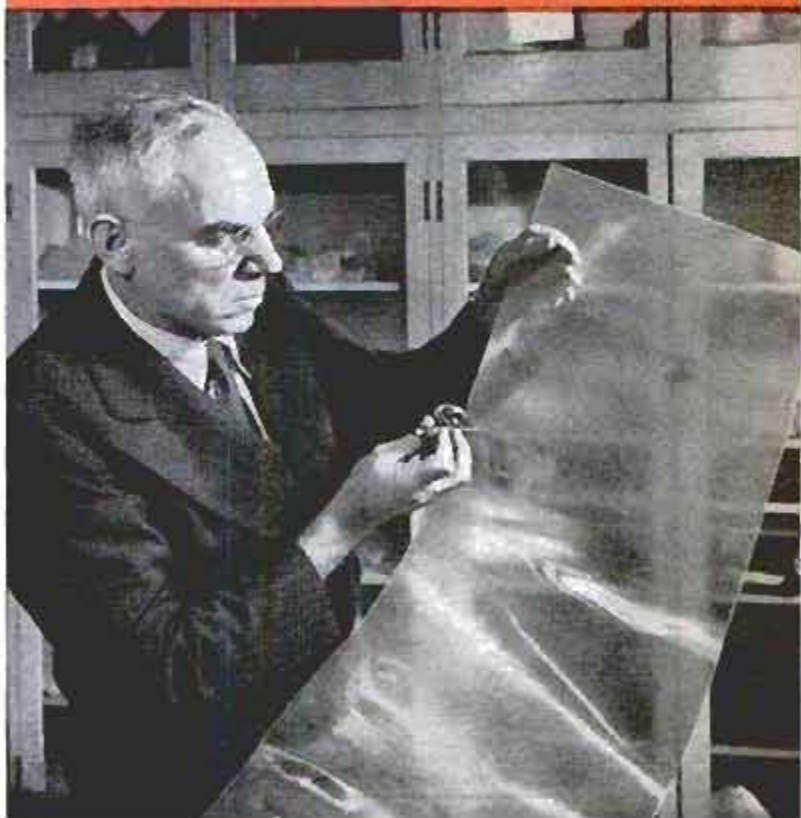



Experimental model at left has camera and screen in same unit. "Desk model" at right has a separate camera

Here It Is: "Picture-Phone" Lets You See Caller

Soon you may be able to see the person you are talking to on the telephone. Bell Laboratories has developed an experimental "Picture-Phone" system which has transmitted pictures over short and long distances, even from New York to Los Angeles. The experimental equipment has pictures varying in size from 1 by 1½ inches to 2 by 3 inches. The system, while somewhat similar to television, differs in several respects. In TV, 30 pictures are transmitted per second; the phone system sends out only one picture every two seconds, and the picture has less detail. It shows promise of being commercially feasible because the picture can be transmitted over a pair of ordinary telephone wires instead of expen-

sive coaxial cables or microwave relays. One new line, consisting of a pair of wires like the regular telephone line, would be installed at your home to carry the picture. With the experimental equipment you can dial the pictures into existence providing a switch is open at both ends of the line. If either switch is closed, the telephone call goes through without the pictures. Thus it would be impossible for a person to be seen by a caller unless he flipped on the switch, and he can flip it off again at will. The "Picture-Phone" requires only natural daylight or moderate artificial light. One model has the miniature camera mounted on a desk. Another incorporates the camera into the same unit as the screen.

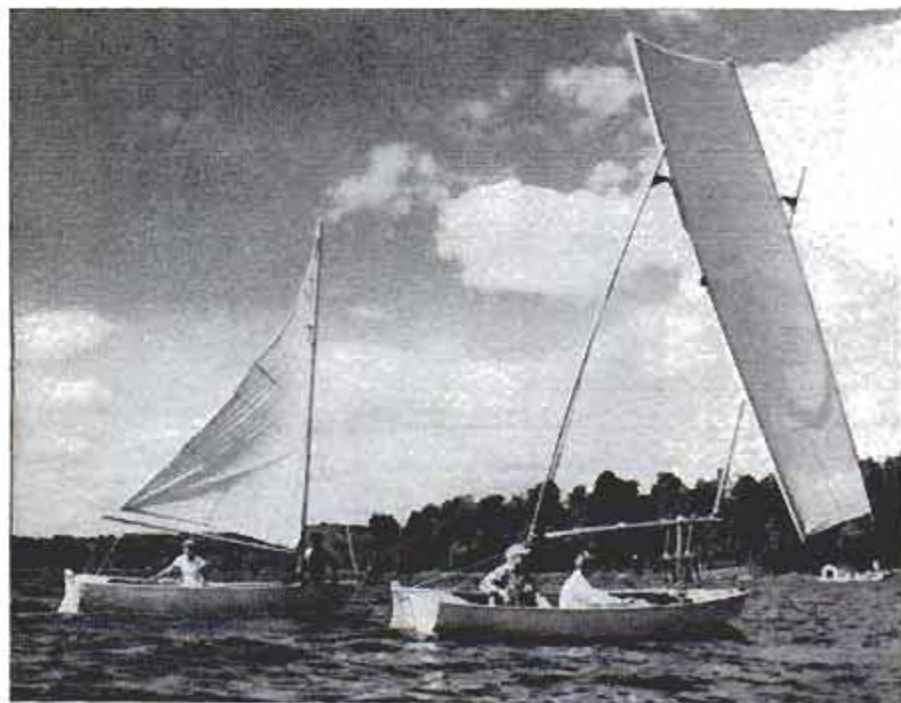

Rectangular Sail Moves Boat Faster

One of man's oldest methods of getting from here to there has been revised. Burnice D. Bedford, a General Electric engineer, has come up with a rectangular sail for boats that is outperforming conventional sails. The canvas is stretched across a frame and suspended between two "masts." It swings upward in a breeze, lifting the boat instead of leaning it with the wind. It is said to be safer and faster than a triangular sail, reducing the tendency of a boat to overturn.

NOT REVOLUTIONARY? Months ago, Harlow H. Curtice, GM president, said the 1957 cars would not be revolutionary. You'll see soon.

If they're not revolutionary, they come mighty close to it. To be sure, there will be no rear engines, no gas turbines, no atom power plants—not even fuel injection or air suspension till the Eldorado Brougham.

But there will be revolutionary changes in chassis design to lower the cars from three to five inches.

Your still-new-smelling 1956 car will probably look as tall as a panel truck when you park it alongside your neighbor's 1957 model. And he'll have just as much headroom in his—in fact, some 1957 cars have more. How was the "miracle" accomplished? By a combination of factors: Sunk-en floors, especially in rear; flatter but wider frames; smaller wheels; lower seats; thinner upholstery; flatter roof design; lower driveshafts.

All these (and perhaps other) factors have subtracted enough to make the 1957 car so low that the man of normal height can wash the roof without getting on tip-toes. Each has subtracted only a fraction of an inch, but together the total is great.

Is it good to go so low? Certainly there are advantages. It lowers the center of gravity and improves road holding. It improves appearance, making the car look longer without being any longer (although some are six inches longer as well).

However, it does require that you stoop to enter. But you'll get used to it and you'll love the long, low look. Wait and see.

Tailfins and Headlights

This is the year of tailfins and headlights. Twin-headlight styling is spreading like the wrap-around windshield did a few years back. A battle rages between those who want the double lights to be vertical (like Nash and Lincoln) and those who want them to be horizontal (like Imperial and Mercury). The obvious compromise is to make them diagonal—and don't laugh! Already at least one company admits it is playing with the idea of oblique dual headlights (our first prediction for 1959!).

Such headlights would carry out the motif of the diagonal tailfin that is spreading like crab grass in the suburbs. When the Chrysler family came out well-finned in 1956, some critics thought this was too much. Why make a car like an airplane, they asked? But by this time next year, you'll think fins are as necessary to an automobile as they are to a sailfish.

Hudson and Nash will get minor facelifts for 1957. American Motors had hoped to bring out a pair of all-new cars this year, but by the time the decision was made, it

Detroit Listening Post



By Leo Donovan

was too late to get the tooling schedules set up. If hopes materialize, the 1958 Hudson and Nash will be out real early in 1957 and they will be plenty fancy. But in this business, it's a long time between introductions and anything can happen.

Is It a "Packabaker"?

We've seen the end of the Packard as a prestige car, it's sad to report. The decision to build the 1957 Packard in South Bend means, according to insiders, that it will be a Studebaker with Packard name plate.

There just isn't time to move production tools from Detroit to South Bend. There isn't time to set up a new assembly line. The cars will come down the Studebaker line and trim will be added to provide a Packard look. But Packard as a separate, fine car competing with Cadillac, Lincoln and Imperial is gone. It will probably take a crash program to get even the "Packabaker" ready for January as announced.

It is now certain that all except Buick, Cadillac, Lincoln and Studebaker will have 14-inch wheels. And these exceptions will wear a special tire with a narrower white wall to make the wheel look smaller than it actually is.

Because of the possibility (remote though it is) of legislation to tax cars by horsepower in an attempt to reduce traffic deaths, the industry is expected to slow down or at least to play down horsepower increases. Nobody ever says a word about horsepower until introduction day so anything can happen. If one manufacturer ups his power drastically, you can bet that his competition will follow along. Horsepower is the easiest part of a car to redesign! It can be done with the stroke of a pen (within limits).

There will be no Motorama this year and that may mean there will be no futuristic show cars. Chrysler had one on the way from Italy, but it went down with the ill-fated *Andrea Doria*. Photographs of it seem, to some insiders at least, to suggest that Chrysler was lucky—the dream car's styling already looked a bit out of date. That's how fast the industry obsolesces itself!

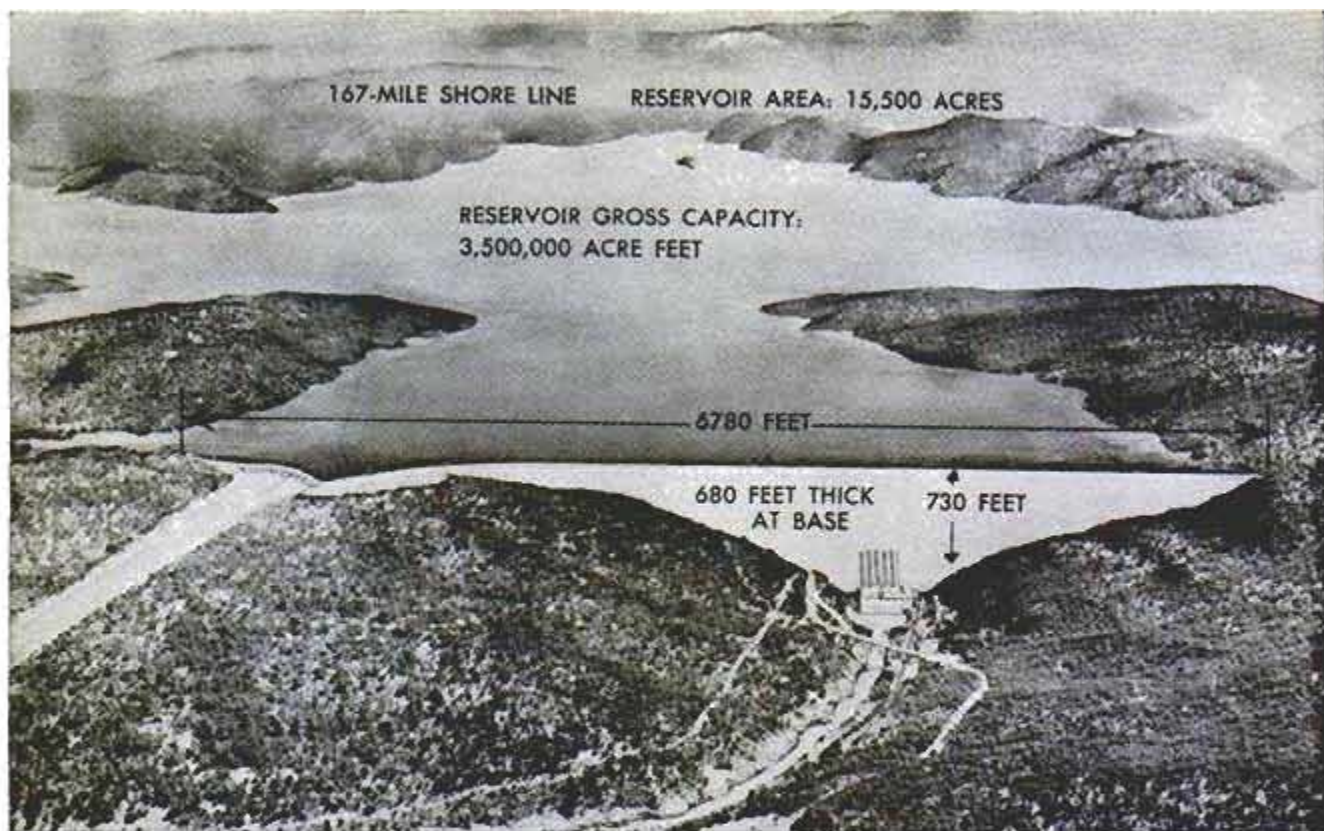

Feather River Dam at Oroville would create huge reservoir and allow water to be rationed out as needed



Feather River Dam Would Feed 600-Mile System

CALIFORNIA proposes to transport water almost 600 miles to irrigate rain-deficient areas in the central and southern parts of the state. First step in the project would be construction of a dam across the Feather River. Taller than Hoover Dam and containing more concrete than Grand Coulee Dam, it would release Feather River water into the Sacramento River to compensate for water diverted from the Sacramento by the proposed aqueduct. The dam also would provide flood control to prevent such disasters as last winter's flooding of Yuba City.

As much as four million acre feet of water per year would be carried by the aqueduct down the length of the San Joaquin Valley, under the Tehachapi Mountains, along the desert east of Los Angeles, and finally to reservoirs near San Diego. Various water-deficient areas along the right-of-way would be served. Total pumping lifts would be close to 4000 feet.

It is estimated that the project will cost \$1,500,000,000 over the next 20 years. It is part of California's over-all plan for making full use of its water resources. The plan calls for 260 new dams to provide water for 40 million persons and to triple the present irrigated acreage.

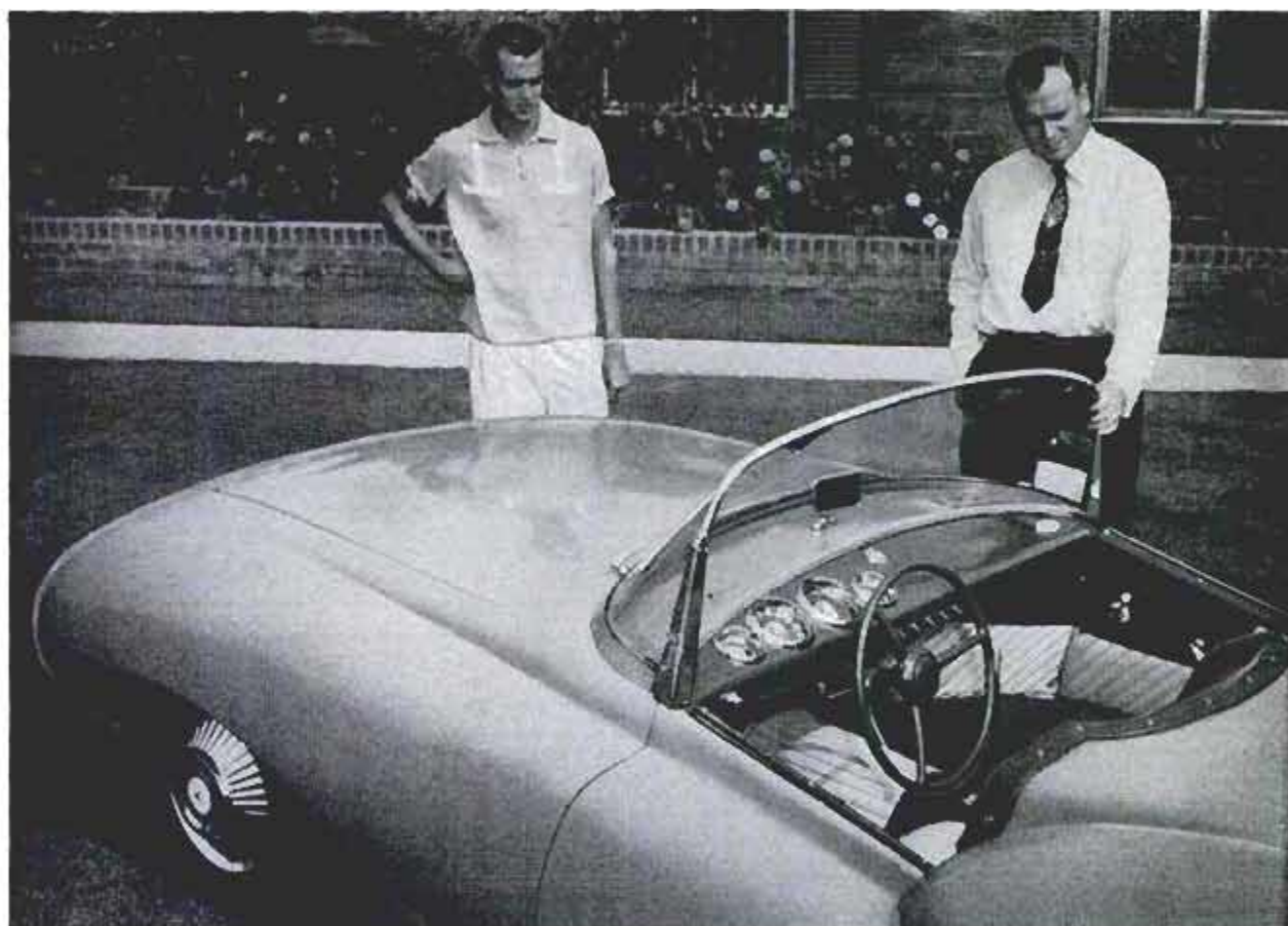

Admiring the fine installation job they did on the windshield frame are the author, right, and his son Bill

Father and Son Build a Sports Car

By Robert W. Berry

WHEN MY SON and I decided to build ourselves a sports car of our own design we didn't know what we were in for. It is probably just as well, because an awareness of the many, many late nights and long week ends in the garage might

have discouraged us from what has been a most rewarding experience.

Bill, my 16-year-old son, and I had some experience building hot-rod cars, but to design and build a complete car was something new and challenging.

Completely designed and built by the father-son team, the Falcon is a sleek, handsome sports car with a plastic body



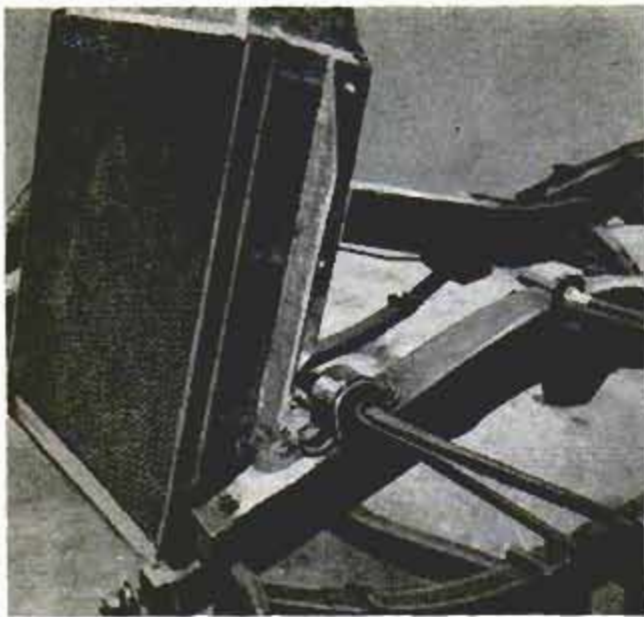

In order to provide the low hood line wanted by the builders, the radiator had to be slanted backward

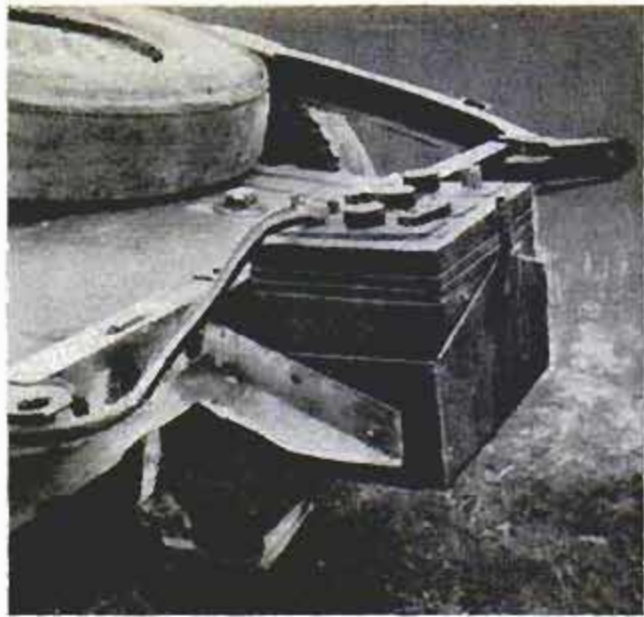

Weight distribution is improved by putting the battery at extreme rear of frame, behind the gas tank



Wood templates covered with screen were assembled like this to form a frame for the plaster mockup



Plaster is then applied by hand to form the master over which the glass-fiber female mold is created

The car was built from the wheels up in our two-car garage. We used an old frame as raw material for the chassis. Side rails were tailor-made by cutting and splicing them to the 100-inch wheelbase. We boxed the rails by welding an additional channel and used tubing and boxed channel for cross members. We used tubular axles, leaf springs, airplane-type shocks and a fast steering ratio to insure the sports-car feel. Three and a half turns from lock to lock give a turn circle with a diameter of 32 feet. Drive is Hotchkiss and rear-axle ratio is 3.9 to 1.

The engine is a Buick V8 of 322 cubic inches, slightly modified to produce about 250 horsepower. Compression ratio is 9.2 to 1 and a two-inch dual-exhaust system is used.

To obtain fore-and-aft balance, the 12-

volt battery is installed at the rear of the frame. The radiator is slanted to provide the required low hood line. The wheels are 15-inchers. Tires are 5.90 in front and 7.60 in rear to provide easy steering plus good traction. The spare is a compromise of 7.10 for emergency use only.

Styling is our own and expresses a desire to be different without offending. It has a teardrop nose and a relatively high but flat rear deck to move the low-pressure area behind the car instead of above it. Cut-down doors give a sports-car look to the car and the single tailfin adds a little flash. These are individual opinions which you may not agree with but, after all, the real reason for building a car yourself is to create something that you like. You are not trying to appeal to everybody, just to yourself.

The whole project took us 18 months of our spare time. The rest of the family helped at times and, on occasions, some of our friends pitched in.

The biggest part of the project was the construction of the tooling and molds for the plastic body. Standard methods were used. First, we built a full-size master plaster mockup and then made glass-fiber female molds from it.

Originally, of course, we made detailed scale drawings on which we worked out the dimensions. From this drawing, loft lines were laid out to full size on paper and wood templates made from the lofted lines. These were assembled into a frame to form the skeleton for the master plaster mockup. Screening was attached to the templates to support the plaster.

Commercial casting plaster was applied in two coats. We applied it by hand, but worked it with steel scrapers. This is the most difficult operation for a novice and the one we found the hardest to do. The surface of the master must be perfect because it is transferred exactly to the inside of the female mold and then back to the finished part. Successful work depends upon a well-finished master surface. To perfect the surface we did much sanding and polishing. Several months were spent on this operation alone.

In the next step we molded the glass-fiber female mold over the master plaster. This was made in one large layup and it required fast work by two or three men. The entire master was covered with glass-fiber mat and cloth, impregnated with polyester resin. All air bubbles must be worked out as you go along.

The female mold is flexible and requires support. A wooden framework is built to the contours of the master and attached to the outside of the female mold.

With the body tooling complete, we used the hand layup cold-set method to make the plastic body panels and sections. The

parts are about 1/8 inch thick, lightweight and very strong. Within 24 hours, parts could be removed from the molds and the rough edges trimmed with a saw.

The body consists of nine major plastic sections. These parts are carefully trimmed and fitted before being bonded together.

Surfacing of the body prepared it for painting. Careful sanding and filling with body putty were necessary.

The windshield (from a 1955 Pontiac) is held in place by a steel frame which is chrome plated. We sawed, filed and formed it by hand. It is fastened to the steel frame which reinforces the cockpit. We made the instrument panel of steel sheeting and it holds the chrome-circled dials at an angle looking up at the driver. The instruments include a tachometer.

Seats are the bucket type and the driver's seat adjusts fore and aft. We made the frames by cutting down a set of old two-door-sedan seats. Nothing we could buy would fit the troughs in our floor so we had to build the seats. The only job we contracted out was the upholstery.

Dry weight of the car is 2500 pounds and this gives an excellent power-weight ratio of 10 pounds per horsepower. Weight distribution of the unloaded car is exactly 50-50, front and rear. Center of gravity is low. Acceleration is excellent because of the fine traction. The ride is firm, but softer than on some foreign sports cars. Cornering is flat and breakaway speed is high.

The engine is very smooth running and, unlike some sports cars, is very quiet. Being coupled to the Dynaflow transmission, it is a pleasure to drive. Originally, we were devoted to the old stick-shift gearbox, but after driving the torque converter in our family sedans for many miles decided the automatic transmission is here to stay. Under the light weight of our plastic car, the Dynaflow just loafs along. Acceleration in Drive range produces faster acceleration than any stock car we have driven. ★ ★ ★

Extremely dignified yet with a flashy feeling is the front end of the Falcon. Note how headlights are inside grille





Scrapers on endless track shovel rock onto conveyor. After screening, cleaned rock is dumped into boxcar

Ballast-Reclaiming Machine Saves Railroad \$140 Per Hour

Ballast for railroad beds can be profitably reclaimed with a mobile unit. Reclaiming 140 tons of ballast per hour, the machine saves more than \$1 per ton over the cost of new ballast. Adjustable for cutting depth, the machine travels along railroad tracks and picks up ballast and

deposits it on a shaker screen. Dirt and other fine particles shake out and fall to the road bed. The cleaned ballast is then fed to a conveyor belt that dumps the ballast into railroad cars. Hydraulic controls, operated from the driver's seat, raise or lower conveyor for loading cars.

"Sky Screen" Speeds Relay of Radar-Tracking Information

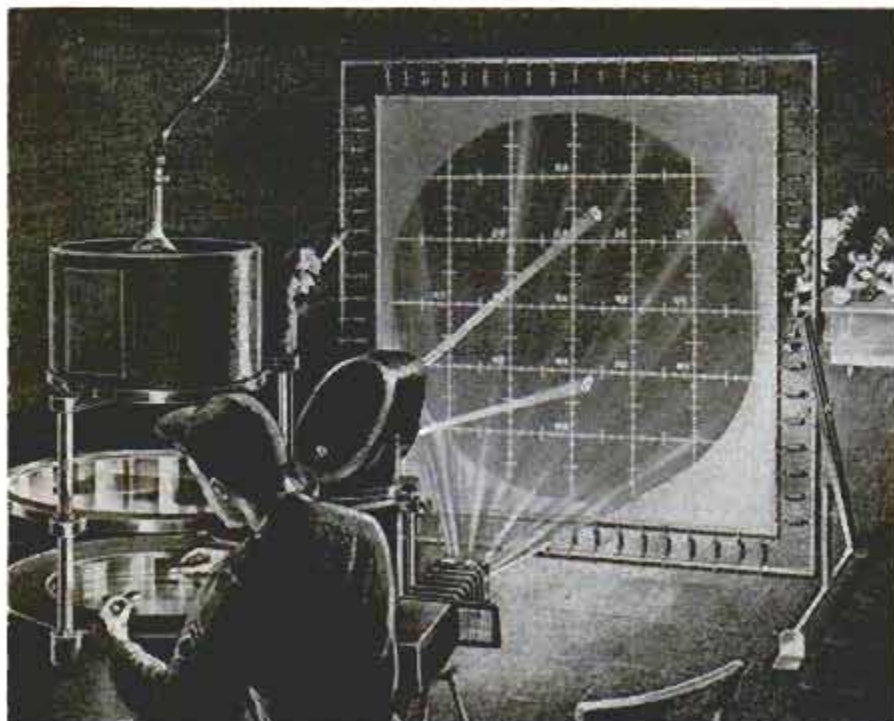

Tracking of aircraft at air-defense filter centers will be speeded up as the new "Sky Screen" takes over. The Sky Screen is an optical projection device capable of faster and more accurate transmission of radar data on a viewing screen for aircraft control and identification. It is a unique arrangement of mirrors and lenses, and eliminates nearly all human factors in the relay procedure. The Sky Screen has an important potential use for airport-traffic control, harbor control of shipping and aircraft spotting from mobile units.

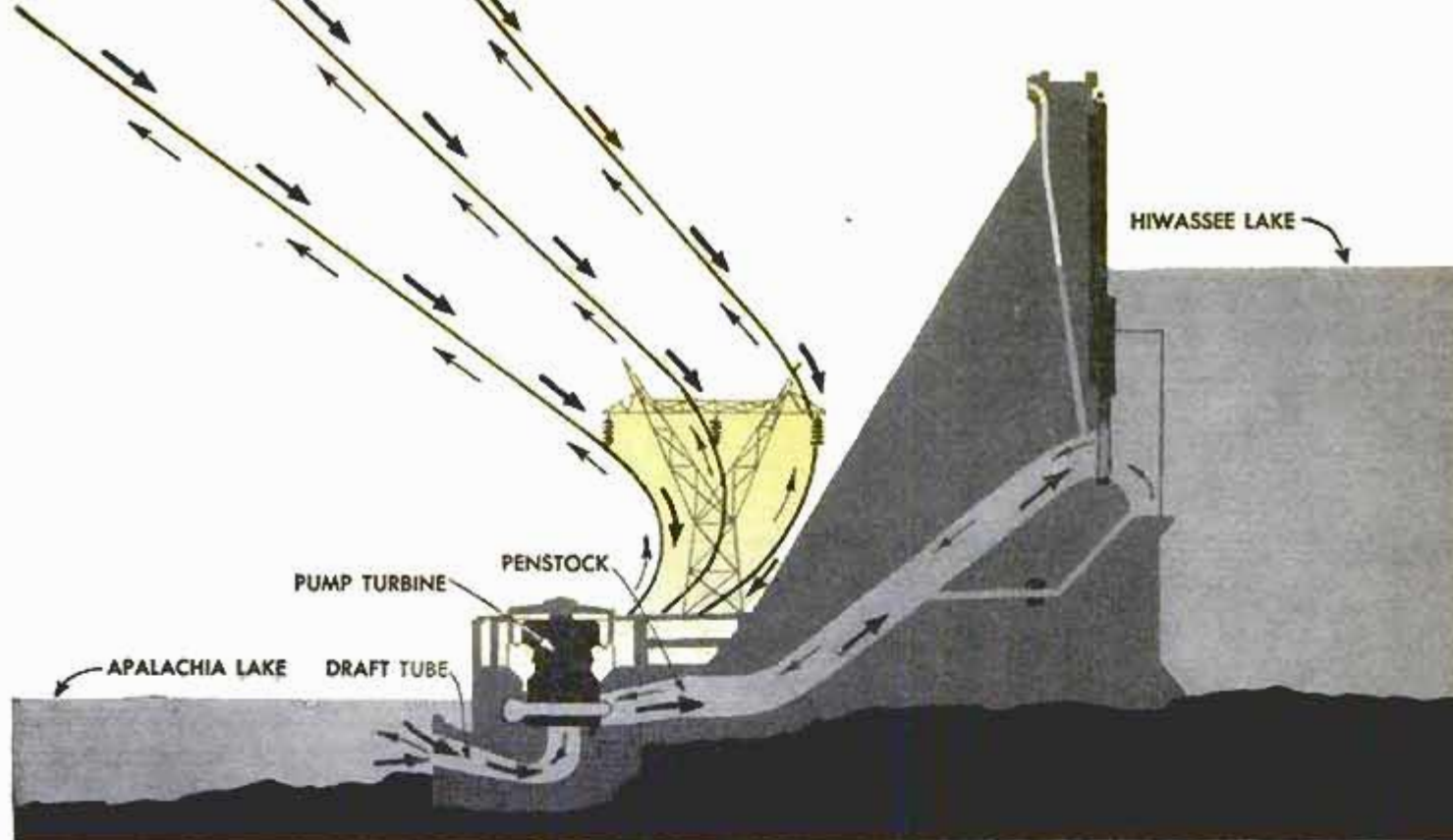

Arrows show how electricity flow is reversed to pump water uphill for storage in hours of low power demand

Surplus Power Pumps Water Uphill To Store Energy for Peak Loads

By Frank C. Osterland

WANT TO SEE a 102,000-horsepower motor—largest in the world? A pump so huge it can lift three times as much water as New York City uses? They're both part of a remarkable machine recently installed at TVA's Hiwassee Dam.

It's something brand new in the power business, a hydroelectric giant that's helping power engineers answer a problem of growing concern to electric power companies like the one that sells you electricity.

The trouble is, people don't use electricity at a constant rate throughout the day. At night, when homes and factories are quiet, very little is used. During daytime hours more than twice as much is needed. Power companies keep track of this daily rise and fall in our use of electricity.

Generators must be kept ready to take care of everyone's needs, even when the use of electricity is at its peak. And

More massive than a locomotive, and too large for rail shipment, world's largest motor had to be assembled in powerhouse at Hiwassee Dam. Motor develops 70,000 kva as a generator

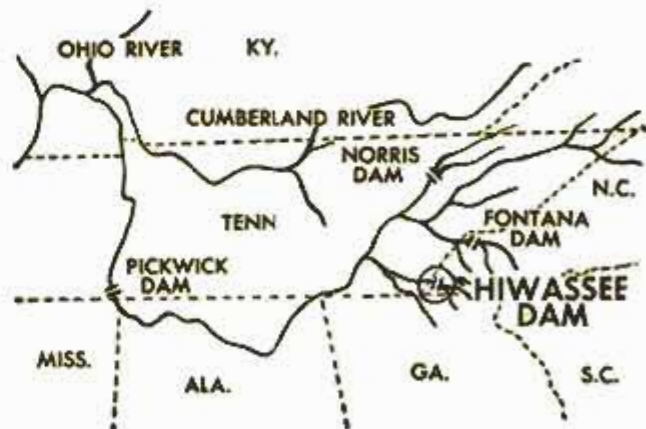

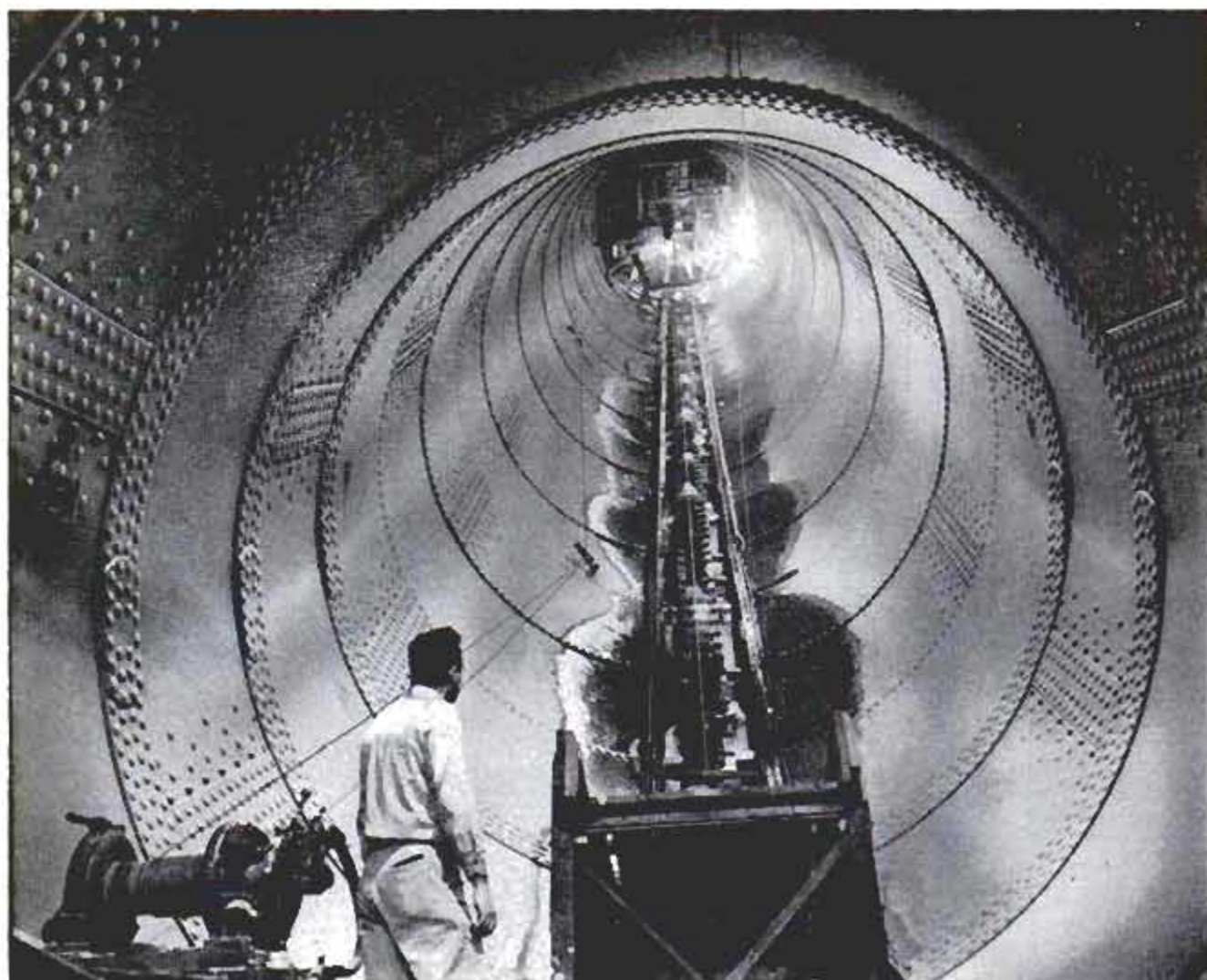

Water is pumped higher than 15-story building through 18-foot pipe. Released, it rushes down to turn turbine

some generators in use when demand is high must be shut down when less power is used.

To complicate this problem even more, modern steam-turbine generators operate most economically 'round the clock, 24 hours a day. If they can't operate efficiently, our electric bills go up.

Power producers want to reduce the difference between high and low points on

their daily load curves. They need some means of using enough electricity to keep steam-powered generators in operation when normal demands are low. Otherwise, some generators will have to operate only part time, and the cost of electricity will be greater.

If American power planners are right, the answer to this problem lies in a scheme called pumped storage, in which water can

Chart indicates how use of electricity varies. Center line shows how power use is leveled with pump unit

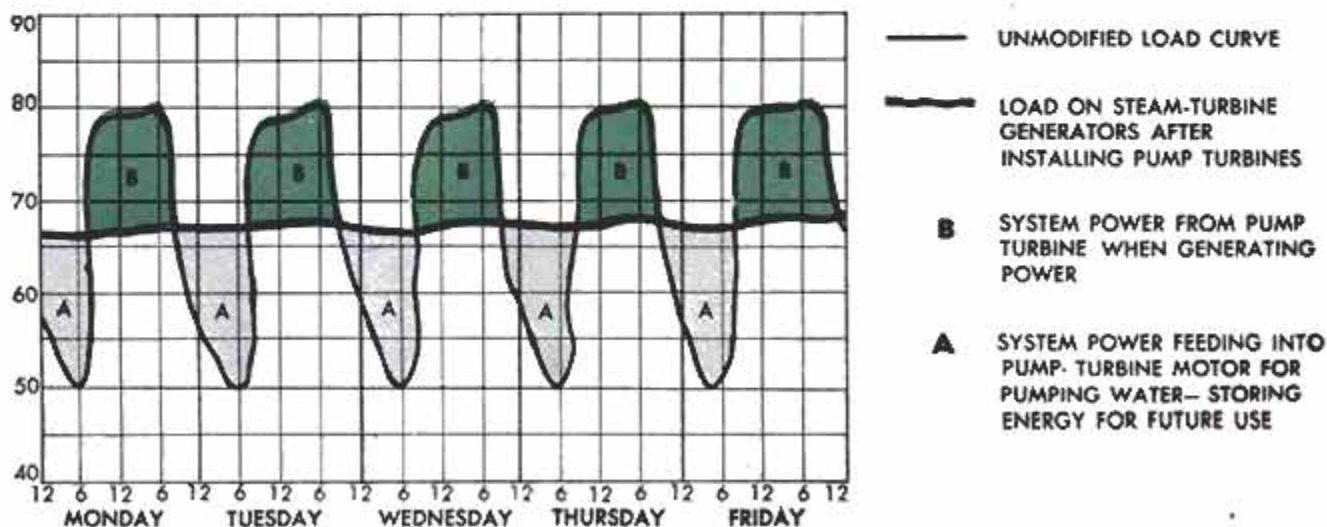

be used over and over again for power production. And the new machine, called a reversible pump-turbine unit, fits right into this picture. It's a dual-purpose machine, built by Allis-Chalmers, which combines an electric motor and generator with a hydraulic pump and turbine.

In pumped-storage installations, this reversible machine puts surplus off-peak generating capacity to work and pumps billions of gallons of water from a low-level reservoir into a higher storage reservoir. Then, when more electricity is needed, this stored water power is released through the same machine and converted again to usable electric energy. Pumped storage is like a hydroelectric storage battery for millions of kilowatts.

No, this is not perpetual motion. As much as one-third more surplus power may be needed for pumping than is produced again by water-power generation.

The accompanying chart shows how pumped storage with pump-turbine units operates to level off the peaks and valleys of a power-systems load. The Hiwassee unit is the first in the United States for this purpose, and others are being built.

Mississippi River water will supply a pumped-storage project being planned for the St. Louis area in Missouri. Stored in a series of reservoirs formed by dams to be built along a small creek bed, this water will provide as much power as the entire area now produces in conventional generating stations.

Proposals have been made for another pumped-storage scheme in western New York. Water from Lake Erie would be pumped some 4½ miles to fill a storage basin covering almost 11 square miles. Studies have been made for a power plant of 400,000-kilowatt generating capacity below this basin. ★ ★ ★

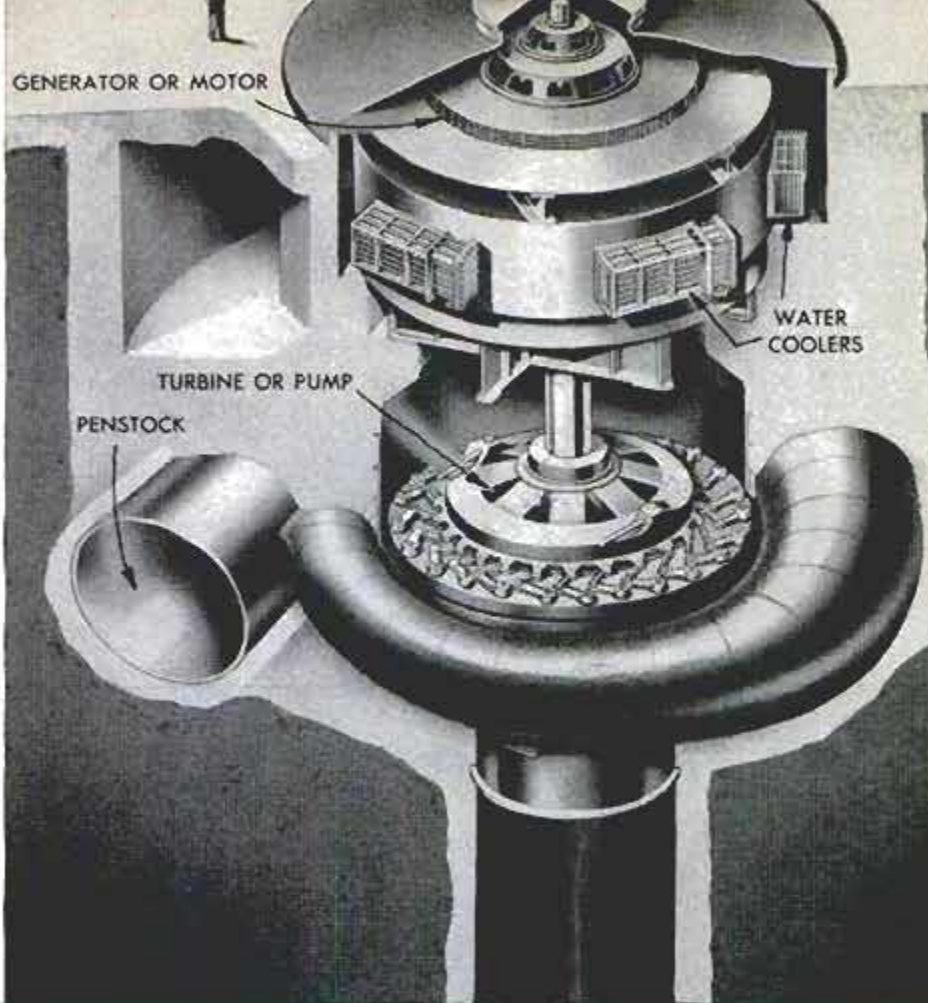

Artist's drawing of the electric motor and reversible pump at Hiwassee. Rated at 102,000 horsepower as a pump, 80,000 as a turbine

Diagram shows pumping and generating cycles. Current from system operates motor which spins pump, pushing water into reservoir. Returning water turns turbine which drives generator to produce electricity

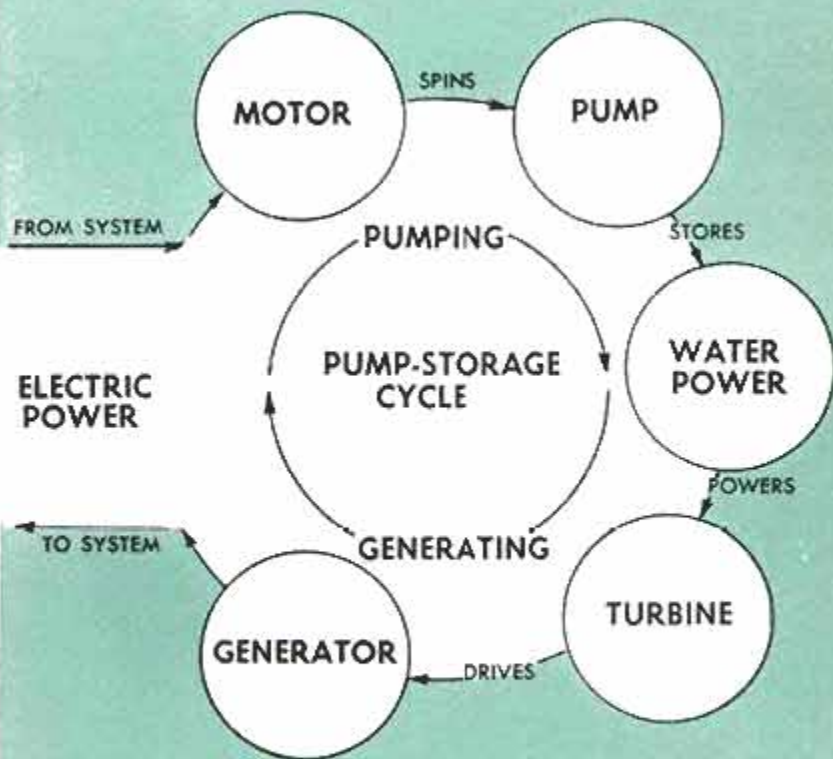



Camera Mounts on Helmet

Handling a movie camera while flying a jet is risky business, so test pilot Gerald Huelsbeck mounted the electrically operated camera on his crash helmet. Now he doesn't have to remove his hands from the controls of the plane while taking pictures. A piece of lead on the other side compensates for the weight of the camera.

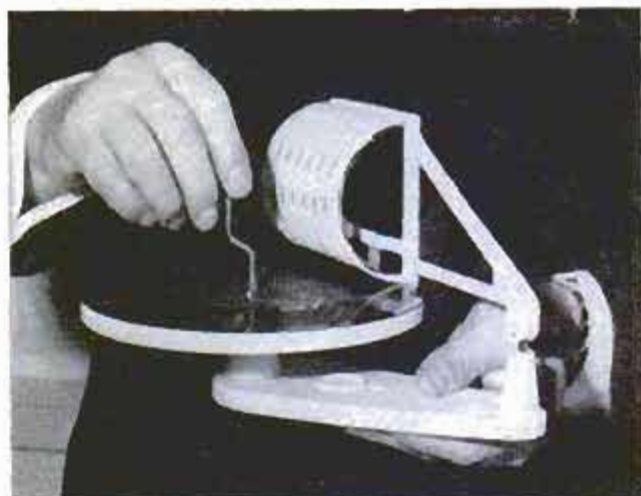

Propaganda Phonograph Takes Parachute Drop

Recordings to combat communist propaganda and a tiny, plastic hand-operated phonograph, rugged enough to be parachuted behind the iron curtain, are offered by Brig. Gen. David Sarnoff, chairman of the board of the Radio Corporation of America. Developed in the RCA laboratories, the little phonograph could be made for 50 cents, with records costing only a nickel apiece. A plastic "radiator" serves as a speaker. The set is designed to reproduce sound frequencies between 500 and 4000 cycles per second, the normal voice range.

Wheelless Cultivator Moves on Endless Steel Track

Home gardeners can cultivate to a depth of 18 inches with a miniature tractor that has a Caterpillar-type tread. The tractor moves on one endless steel-cleated track powered by a 1½-horsepower gasoline engine. The track cultivates the surface with a chopping action that mulches grass and

weeds. Plow blades are attached behind the tractor for deep cultivation. The tractor cultivates right up to fence lines and can be turned in a six-inch circle because of its wheelless design. It can be adjusted so it merely scratches the surface or subsoils the lawn or garden.





Above, Davis Communications Center from the air. Below, array of automatic teletypewriters at the center

Fully Automatic Communications Center

RISING OUT of the level fields between Davis and Winters, Calif., is a forest of branchless trees—the antenna towers of the Army's new automatic communications center. And in three buildings clustered beside this denuded forest is some of the most complex communications equipment in the world. The station is a relay point for messages from Army bases all over the Pacific, tying these installations with Alaska, Seattle, Los Angeles, Chicago and the Pentagon. A message is received automatically on a punched tape, which is then scanned by a machine that reroutes the message to a transmitter for relay to its destination. All messages are automatically sent on teletypewriter machines at 100 words per minute. Sixteen such circuits are in operation and eventually the station will have a capacity of 7000 words per minute. In older systems messages would be delayed hours at the relay station while operators routed and sent them by hand.

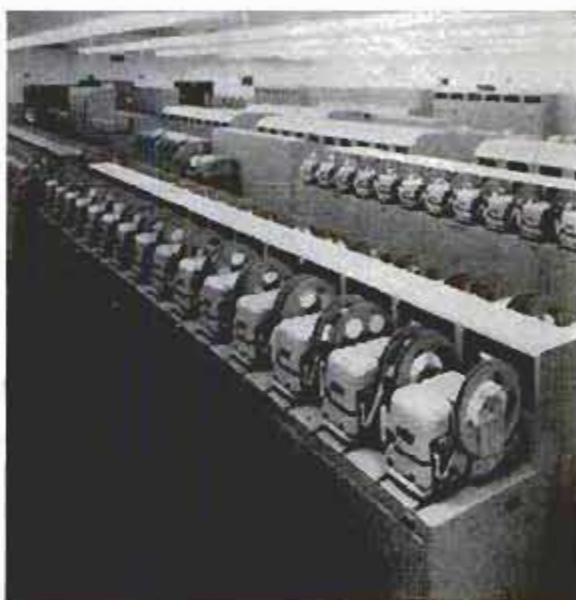

Below, transmitters which send messages from tape. Entire relay process is done automatically





During simulated rescue operation, wounded survivor is lashed into snow boat, which will be towed to base

Survive . . . or perish. Our pioneering men are learning the tough lessons of survival on the bleak, sterile ice of Antarctica, where

NATURE PUTS MEN TO THE SUPREME TEST

By Richard F. Dempewolff

Typical crevasse formation has overhanging walls that make it impossible for a man to climb out without help





Author and Dr. Oliver Austin, USAF, follow trail flags during 10-mile hike in blizzard. Trail is obscured

OUR AERIAL explorers are heading for the South Pole again, but through this Antarctic summer they won't go unprotected as they did a year ago. Last fall the trail blazers of Operation Deepfreeze flew pioneering missions for thousands of uncharted miles over the earth's southern ice-cap with only radio contact to guard their return to base.

Now a rescue and recovery squad with parachuting dog-sled teams is ready in the event of trouble, and practice sessions in emergency procedures have sharpened them into rescue experts. The pioneers weren't so well chaperoned a year ago and sometimes the going was grim.

For two days last February most of us aboard ships of Operation Deepfreeze's Task Force 43, listened glumly to weak SOS signals crackling in from a hand-cranked "Gibson Girl" transmitter. Then—silence. Somewhere out on Antarctica's lifeless waste, seven men returning by plane from a trail-blazing sledge trip into Marie Byrd Land had crashed and were fighting for

survival. Missing were pilot Bob Streich, copilot Glen Lathrop, plane captain John Floyd, a photographer named Chet Stevens and three Seabees—George Moss, Alvah Edwards and Dick Levesque.

Search planes combed the 4000-foot crags that jut from the high snow desert east of Little America. For seven days, while the world waited, they found nothing. Then, Lt. John Sullivan, pilot of a deHavilland Otter search plane skimming jagged peaks of the North Alexandra range, spotted some fluorescent orange wing tips.

"It's surrounded by signs of survival techniques just like in the movies," he radioed excitedly. "But no signs of life." Sullivan circled a camp neatly rigged and braced against the gales. Snow-block houses and walls sheltered material salvaged from the wreck. Parachutes had been used to make additional shelters. A thin line of sled and boot tracks snaked away through the desolate peaks.

An hour later, a helicopter out of Little America homed in on the scene. Hovering



Inside center section of survival tent, Ensign Tuck sets up single-burner stove to cook and heat tent



Steel talons called "crampons" are lashed to boots when crossing smooth glare ice of glaciers and bays



Hot-can rations cook themselves without flame. Drops of water are trickled into chemical which becomes hot

a few feet above the terrain, it followed tracks of men and sleds for 35 miles through the mountains. Twenty-five miles from Okuma Bay on Antarctica's coast, the 'copter crept up on the column of plodding men. They were walking home!

Seven-Day Nightmare

Later, aboard the USS *Glacier* on the day of their rescue, the survivors told us the details of a seven-day nightmare in blizzard-swept mountains, after their plane had crashed into a jagged peak during a storm.

"We cleared the plane of everything—in case of fire," said Lathrop. "We dug a snow cave under the wing tip, walled it with snow blocks and draped a parachute canopy over the outside. We rescued the Gibson Girl transmitter, a primus stove which we fueled with gas from the plane, a theodolite, compass, seven sleeping bags and enough survival rations for two weeks. On half rations, we could go a month."



New polar clothing, developed for testing on Operation Deepfreeze, substitutes sleeve muffs for mittens

A sample of their meals would never make the menu at the Waldorf. The first day each man got two ounces of pemmican, half a honey biscuit, a tiny cube of margarine and a candy bar. Next day, each had an ounce of oatmeal, half a biscuit and one prune. "We alternated that diet for variety," Lathrop recalled sourly.

For four days, a blizzard pinned the men to their camp while temperatures skidded to minus five degrees. But they managed to string an aerial up the hillside and crank out SOS signals on the Gibson Girl.

Numbered Jokes

Finally the sky cleared, and the survivors were able to pinpoint their position by shooting the sun. "We discovered we were only 110 miles from Little America," said Lathrop. "Okuma Bay was 80 miles. There, we could find seals and penguins to supplement our rations, boost morale and give us a closer intermediate goal. We packed 300

Single tent sleeps three men. To enter, zipper canopy is rolled back, exposing fabric tunnel entrance which is closed with drawstring and pulled inside tent. Assembled on A-frames, tents can be joined end to end for larger quarters



Full rescue rig, using 11 dogs in tandem hitch, can draw 1400 pounds. Each dog pulls twice his own weight. Bicycle wheel on back of sledge is the sledgometer for measuring the number of miles traveled as navigation help



pounds of gear on a lightweight plastic sled that Moss and Edwards man-hauled over the mountains. Those men worked like horses, making one mile per hour through hip-deep snow. During blizzards we steered each other by voice because no one could see 10 feet through the blinding drift. We kept up morale by telling jokes until they ran out. Then we numbered them. Someone would shout 'nine,' and everyone would laugh. Someone else would yell '42,' and if nobody laughed he'd pull the old saw about some people being able to tell that one better—which brought down the party."

When the helicopter finally pulled up behind the group on the seventh day, only the last two men in line saw it coming. They waved their arms, too overwhelmed to shout the news to the rest. The whirring blades finally brought the other heads around. "Then," said Lathrop, "we all bawled. There wasn't one dry eye in fourteen."

No More Colds

These men were lucky. They crashed within helicopter range of home base, and close enough to walk out if necessary. In the

Snow crevasses such as this under Little America had to be filled





Four de Havilland Otters were a part of Deepfreeze's air fleet. This one was a victim of bad polar weather



Two polar tents zipped together are raised as a unit on a simulated rescue mission, 20 miles from base



Carcass of sheep left at Captain Scott's cabin in 1902 is still preserved by frigid Antarctic weather

north country, one can find edible lichens, mosses, fish and wildlife when he knows where to look and how to rig snares. But except for a spattering of birds and seals along the costal ice, Antarctica is a dead world—vast, glittering white, punctuated by lunar landscapes of barren, windswept mountains. Not a tree, stick or weed exists to build a fire if you had a match. Even bacteria are inactivated by shuddering cold. Men with sniffles on Deepfreeze ships became well after a day or two on the ice and will not have another cold until they come home. Disease and decomposition are virtually unknown. We saw

the remains of a meal, left by a 1917 British expedition on a table in an old abandoned camp. Bread, cheese, potatoes and biscuits are remarkably preserved after 39 years. So is the carcass of a sheep that lies on the porch of Capt. Robert Scott's 1902 cabin at Hut Point.

Except for Navy air search and rescue techniques, a plane crash 1000 miles out on that desolation probably would mean the end, even for well-provisioned survivors in good physical condition. Every long flight in Antarctica carries rations and survival gear for 30 days. But everyone

(Continued to page 290)

Safest way to travel off marked trails is on skis or snowshoes, with two or more men tied together





Surplus LSM has been converted for use in deep-sea drilling operations to explore for tidelands oil

LSM Converted for Deep-Sea Oil Drilling

Old Navy men would hardly recognize a surplus LSM now sailing the coastal waters off Ventura, Calif., for it has been converted for use in deep-sea drilling operations to explore for oil in the booming California tidelands. The 600-ton craft, now called the *M. V. Rincon*, was converted to a driller at a cost of about \$500,000. Two major changes were made. Both screws were removed, making the vessel a barge, and

a 10-foot-wide scupper was cut through the middle of the hull to permit drilling operations. A 65-foot folding mast—the sea-going counterpart of an Oklahoma oil rig—towers over the deck. Four winch anchors, with each anchor weighing 7000 pounds, are used to keep the ship from pitching. And a device, similar to the gimbal used to keep a ship's compass level, has been installed to minimize roll.

Back-Yard Airplane "Flies" on Ground

Playing pilot is the standard game for boys in one Phoenix, Ariz., neighborhood, now that Elmer Orgill has built a plane in his back yard for his son. The plane is 10 feet long and is mounted on a universal joint embedded in concrete, which makes it possible for the pilot to climb, dive, bank and turn the craft. A half-horsepower motor drives the 40-inch wooden propeller. The instrument panel features real aircraft instruments and a buzzing device adds realistic flight sounds. Movable controls give children the feeling of flying the plane.



Child's plane is mounted on universal joint that is bedded in concrete

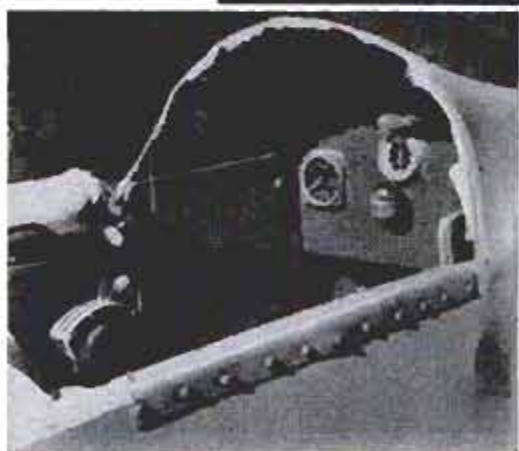

Controls and instrument panel have components taken from real plane

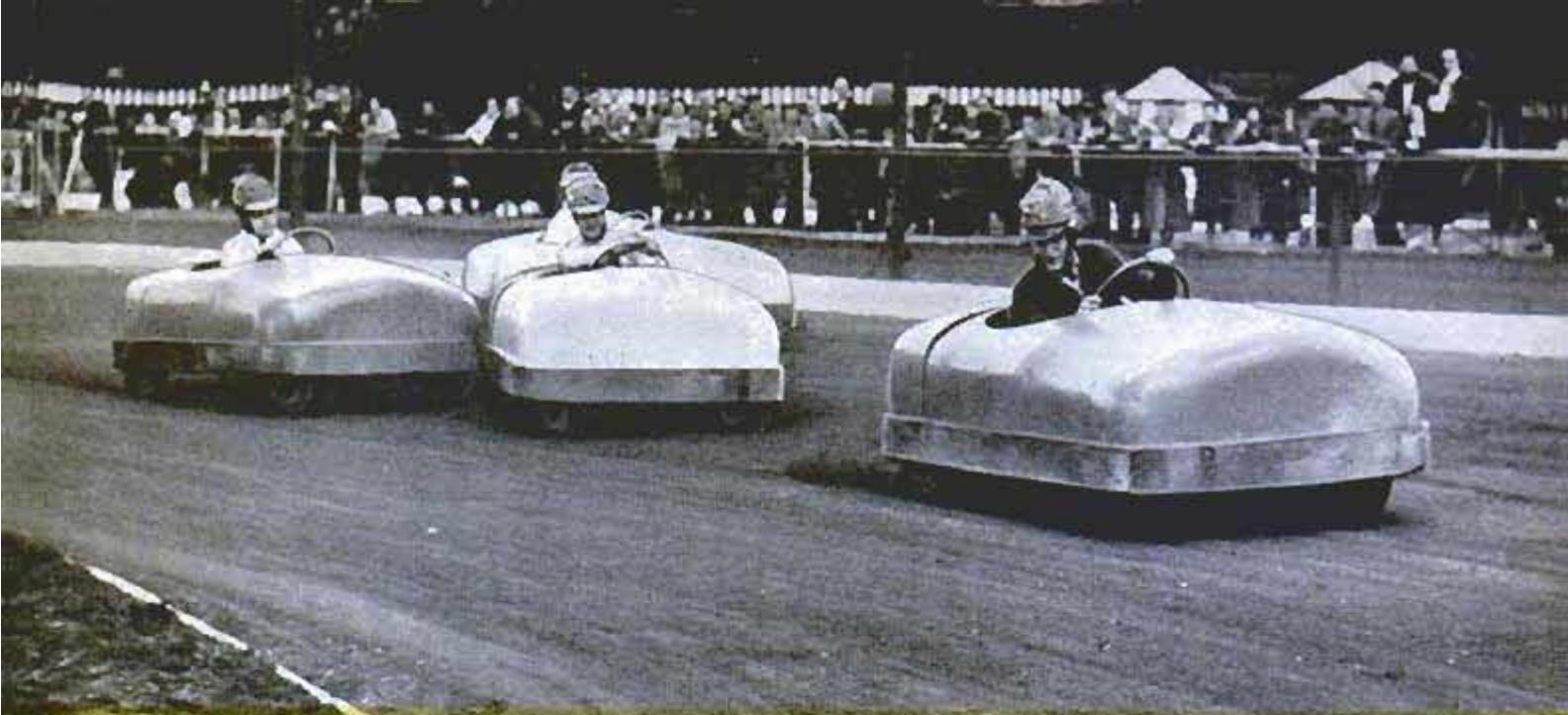

Four feet wide, the cars fill up the corners and drivers have to jostle their way into the straightaway

FLYING SOAPBOXES

JUST ABOUT anybody can be a race driver in Southampton, England. In fact, in some races spectators are invited to become contestants. Driving the tiny, seven-foot-long cars looks like so much fun that over 800 persons wanted to drive the first time the invitation was extended.

The cars look like huge soapboxes with a hole in the top for the driver to sit in. The flush sides extend almost to the ground, making the small wheels virtually invisible as the cars scoot around the oval.

Powered by a 190-cubic-centimeter rear engine, the racers have started a craze in

Spins are frequent, but the cars are very stable. This fellow seems to be making a U-turn in traffic!

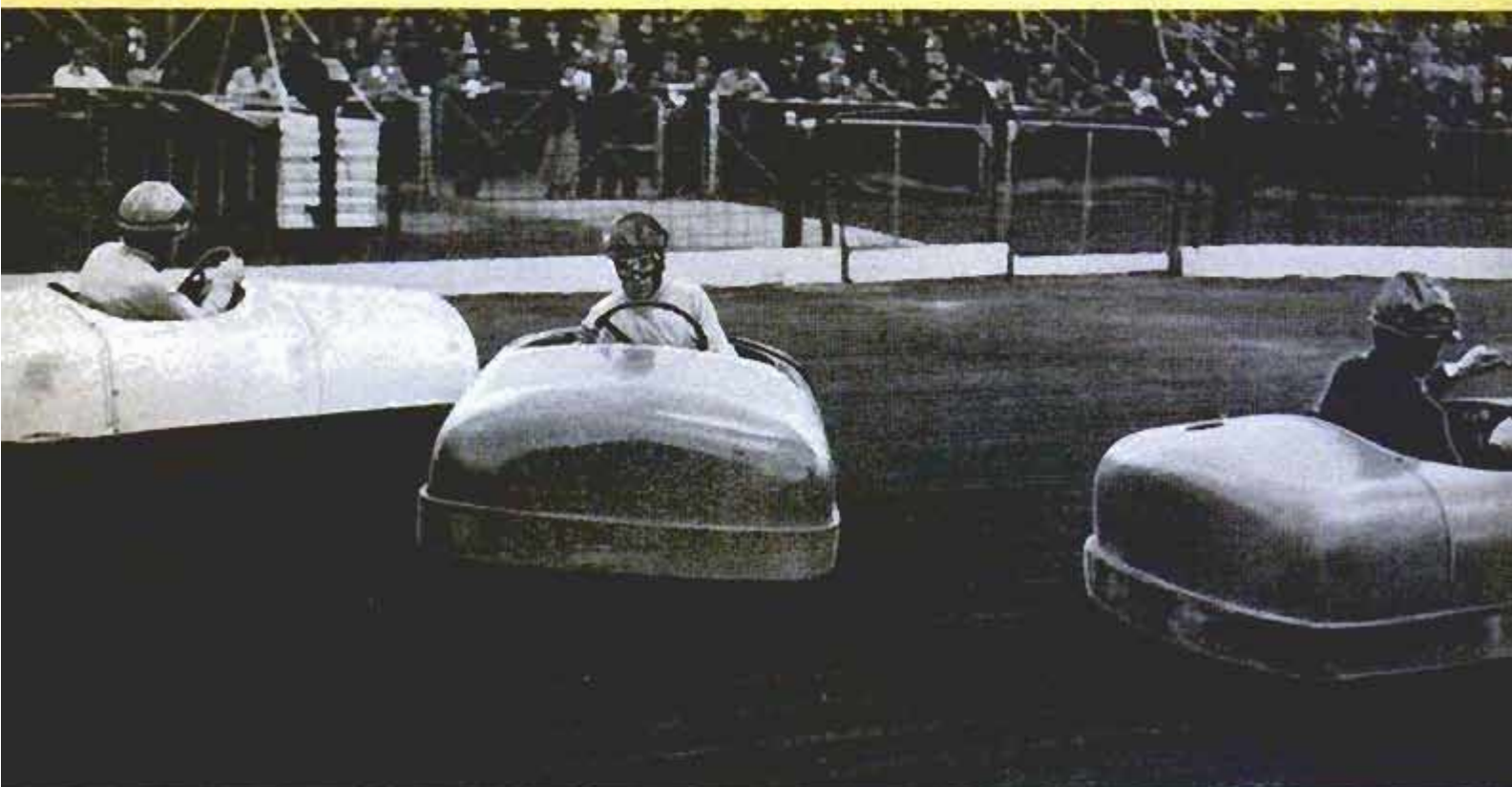



Sometimes the cars tip over, but not often. This is a lady driver—a novice making like a professional

the British Isles. Officially known as Bantam Speedcars, they are better known to the public as buzz-boxes or soapboxes.

The three-speed transmission gives a top speed of about 45 miles per hour. All four wheels are powered to provide excellent traction and safety as the cars spin dizzily around a small and often slick raceway.

Steel Frame Protects Drivers

A strong steel framework backs up the all-metal body which is protected by a rubber bumper encircling the car. Despite this, however, the bodies are frequently dented as two or more of the little speedsters come together at odd angles.

A regular event at the track is Ladies' Day when aspiring female drivers (novices to racing, usually) try their skill at bumping and boring their way around. ★ ★ ★



Mounted over the rear axle is the 190-c.c. engine

Dents do result when cars carom off each other (see car at right), but drivers are well protected by the body

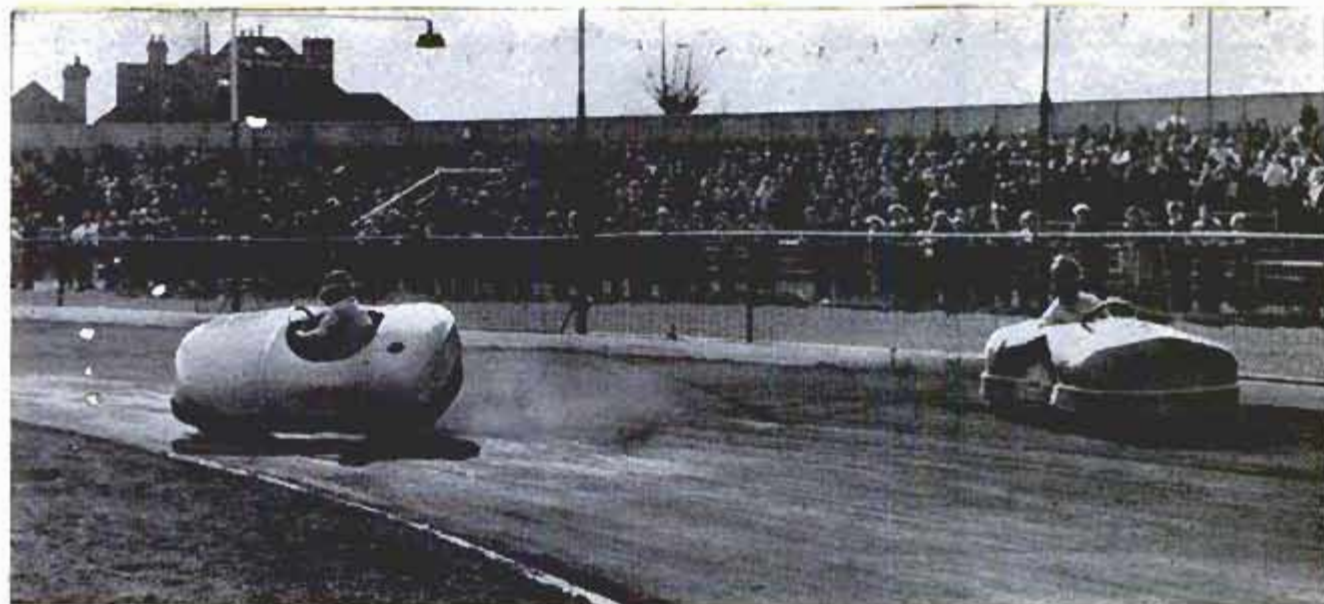



Standard Bus Rides the Rails

Carrying passengers on the Island of Sylt, West Germany, is a bus that is unusual in one respect: It rides the rails instead of the roads. No alterations have been made except to replace the wheels with rail wheels. A turntable at one end of the line and a triangular track at the other end permit the vehicle to be turned around for another trip.

Rake on Casters Levels Lawns

Contractors and landscapers can do a fast job of leveling the topsoil around a new home with a tractor-drawn rake. The rake's teeth are mounted on an adjustable bar, permitting windrowing of unwanted stones, weeds, branches and other trash on either side. Regardless of the angle of the bar, the teeth are always in correct alignment with the ground. Adjustable caster wheels regulate the penetration of the teeth.



Truck Hoist Built from Kit Features Light Weight and Simplicity

Amateur mechanics can install a hydraulic hoist on their trucks, using a kit that includes all materials. Hoists are made in

32 different models, for both end and side unloading, and for large and small trucks. The two main units of the hoist consist of the hydraulic pump and the telescoping arms which raise the truck bed to dumping position. The pump unit is simple in design and comes in electric, piston, four-piston and gear models. The arms come in three sizes or expandable lengths. The average weight of the entire hoist is only about 273 pounds, compared to 1800 pounds for some standard hoists.



Telescoping arms tilt truck bed to side. Other models dump from end

Ⓞ Radar for the first time is being used to spot cloud-hidden lightning strokes—some of them 100 miles long.

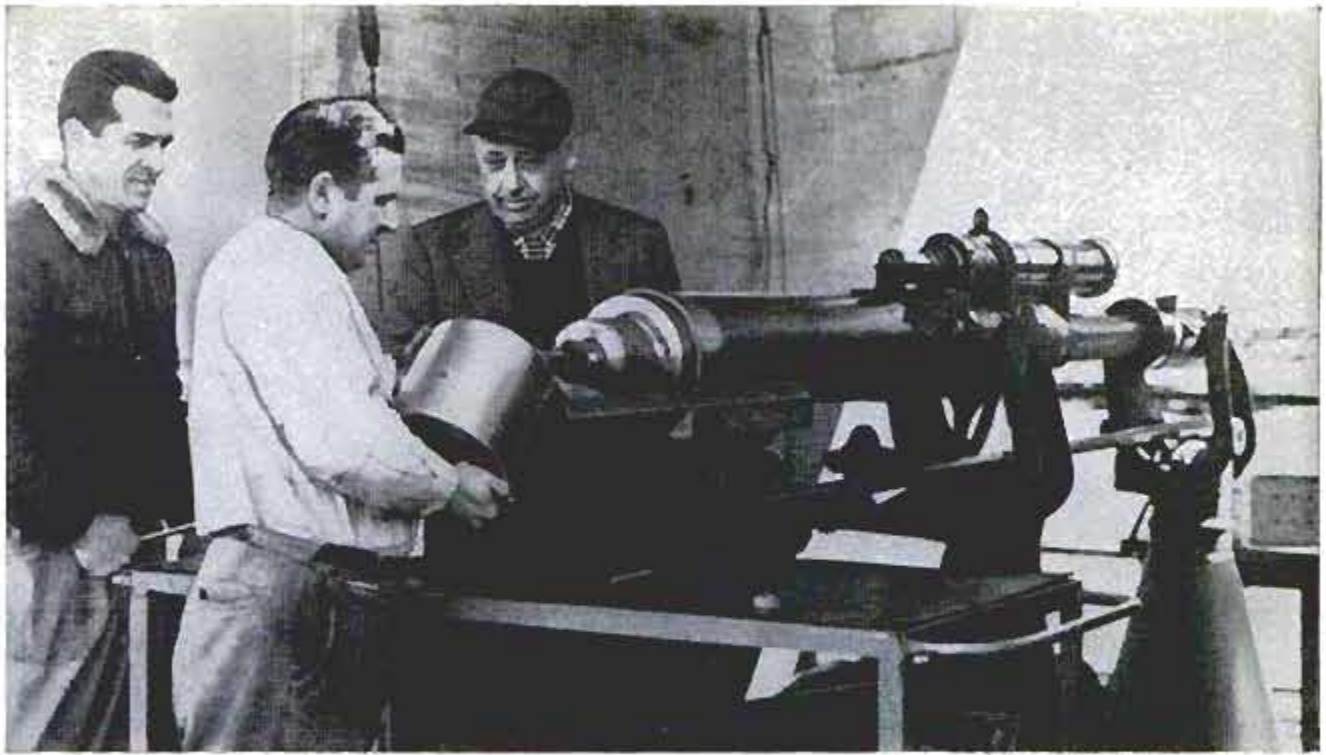

Official United States Navy photos

Breech nut is screwed on over breech plug, last step before firing. At right, nylon sphere fired at 17 times speed of sound creates shock wave (thin curved line) and ionizes the gas in front of it

Missiles Travel 7000 Miles Per Hour

MISSILES the size of golf balls are fired at a record 7000 miles per hour by a Naval Ordnance gun powered by compressed helium. Photos and instrument readings taken during tests of model missiles and planes may help reveal ways to overcome the tremendous heating by air friction of high-speed missiles.

Below, hydrogen and oxygen combine to heat helium, which fills gun chamber. When gun is fired, disk in holder ruptures and the projectile shoots out to hit velocity screens, register speed

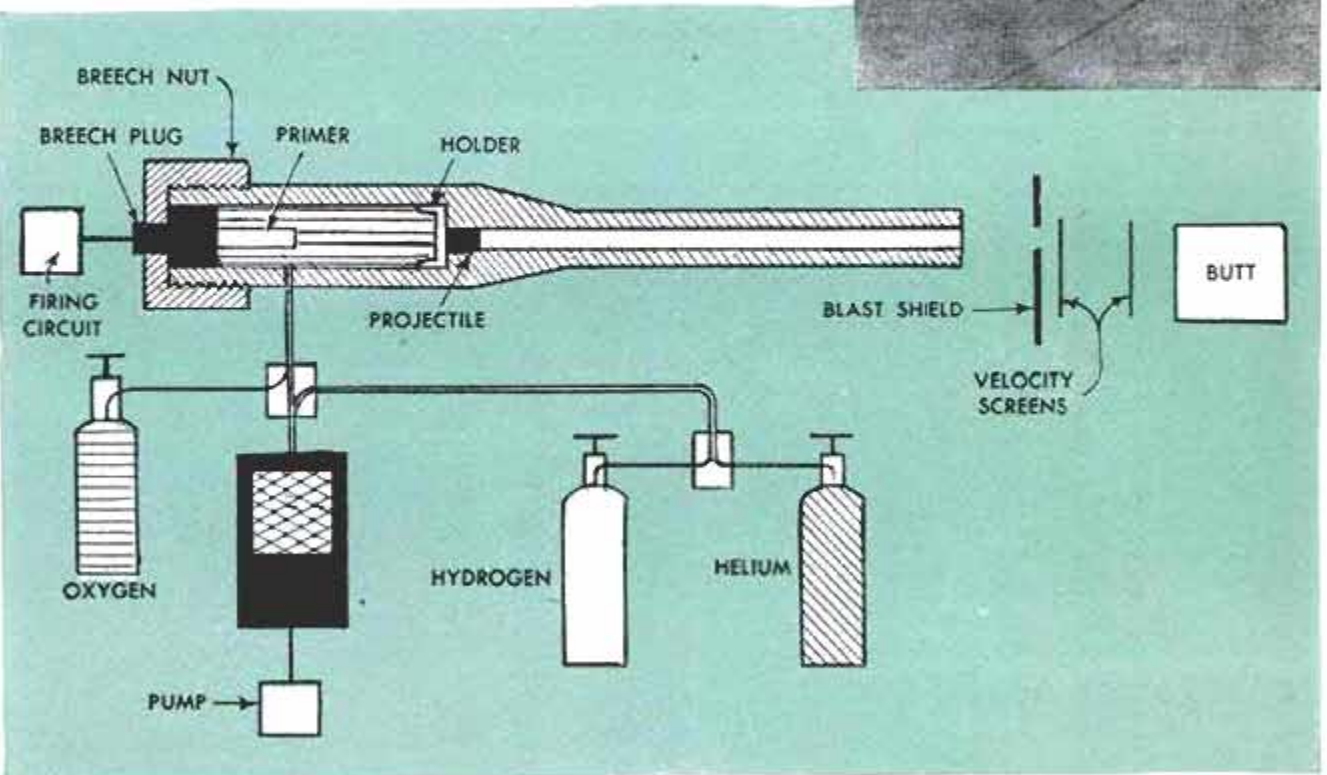
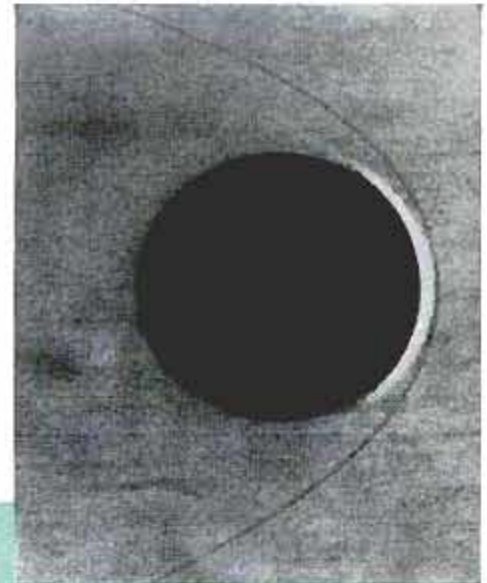

Change for a Quarter, Mister?

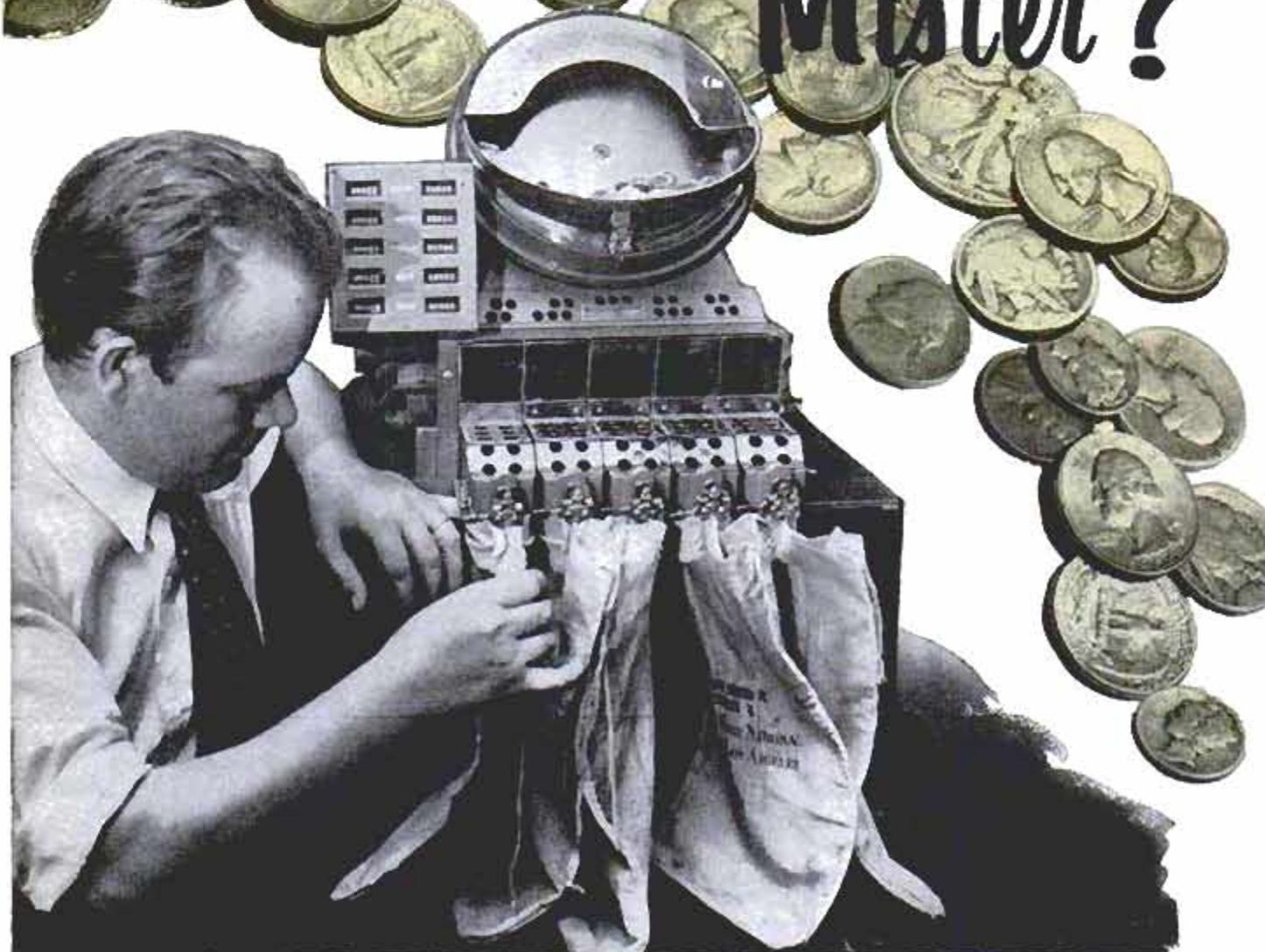

High-speed sorter separates and counts coins from pennies to half dollars, rejects slugs and foreign coins
Semiautomatic machine wraps and counts rolls. Armed guard places bags on conveyor for delivery to surface



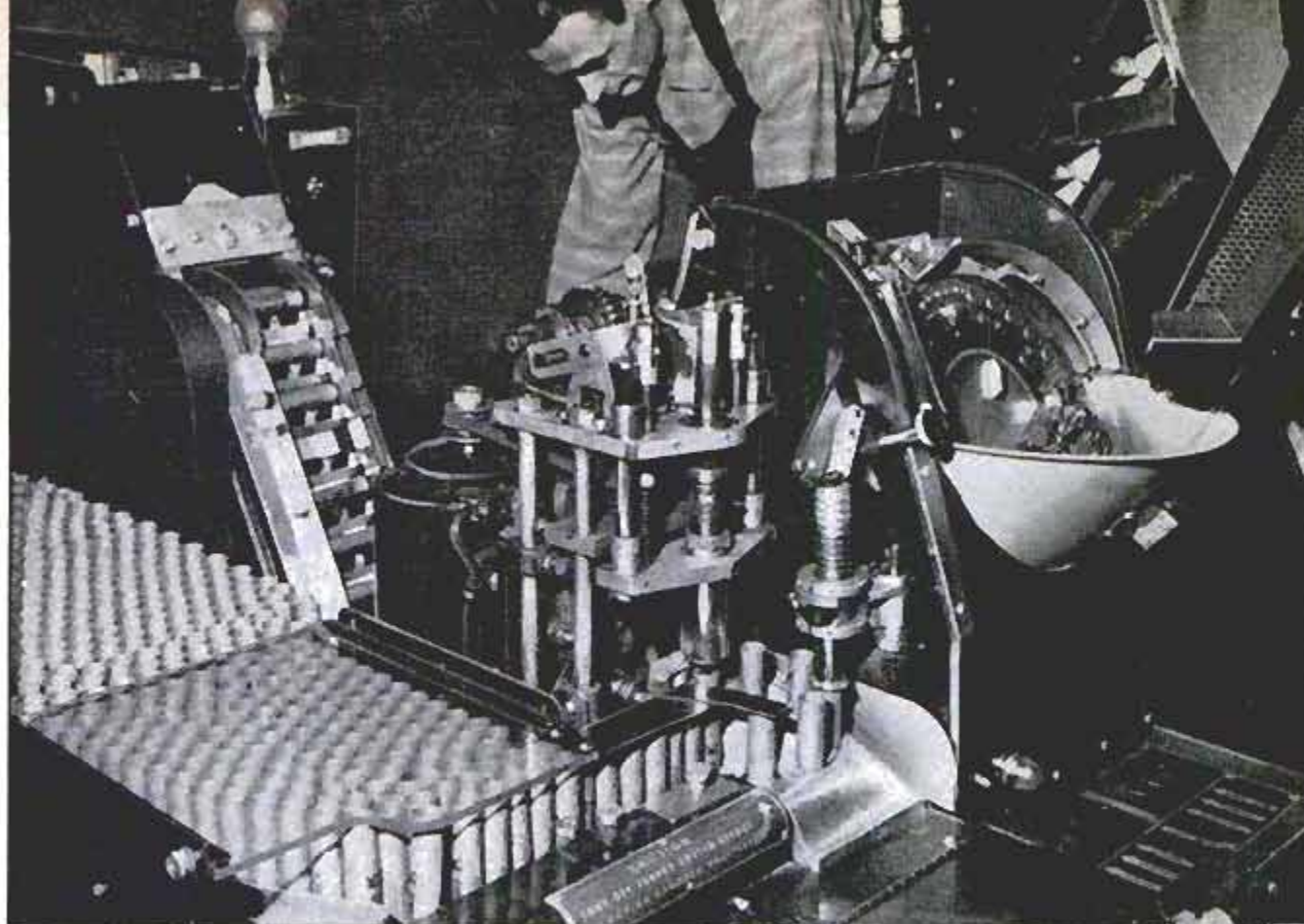

Machine picks up each coin individually and counts it. Coins then go into prerolled wrappers. Mechanism crimps ends of the wrappers and counts the rolls



By Jack B. Kemmerer



Tremendous increase in vending machines in offices and factories has boosted demand for small coins

EVER WONDER what happens to the millions of pennies, nickels, dimes, and slugs dropped each week into the multitude of vending machines?

Last year we, the people of this country, put \$1,800,000,000 in coins into vending machines, not counting telephones, parking meters and service machines such as coin-operated TV receivers. For these coins we received items ranging from hot coffee, cold drinks, hot soup, cigarettes and fresh fruit to pocket combs, toothbrushes, handkerchiefs, music and hot meals.

There are more coins in use today in the United States than ever before, and the

amount is still on the upswing. The action of private companies and state or local governments has a marked effect on the need for coins in circulation. For example, when the New York subway fare was raised from a nickel to a dime there was a great shortage of dimes in the city. When telephone companies throughout the nation raised the cost of a phone call from a nickel to a dime, many areas were again pinched for dimes. When the state of



Handling pennies through quarters, this machine counts and wraps coins, delivers 1000 rolls per hour

California passed a sales tax several years ago there was an extreme shortage of pennies. The San Francisco mint had only 1.5 million pennies on hand, not nearly enough to meet the need. So great was this need that the mint had to coin a million pennies a day until the shortage was overcome.

One surprising thing about coin usage is the manner in which it varies from area to area. Even local neighborhoods within

Pennies are dumped into a hopper. Covered belt in the background will carry them to counting head



a city vary greatly in the amount of coins used. The need for coins also varies greatly according to the time of year, with Christmas being the heaviest season and requiring the most coins.

Banks Work Overtime

The tremendous population growth in southern California has the banks working overtime to meet the greatly increased demand for pennies, nickels, dimes, quarters and half dollars. Today Los Angeles handles more coins than any other city in the world. To keep ahead of this need, local banks have installed highly mechanized equipment for all phases of the work. One such installation, Security-First National Bank of Los Angeles, is the largest in the world and currently sorts, counts and wraps more than 30 tons of coins in a five-day week. This adds up to approximately one half million rolls of coins per month, varying anywhere from \$300,000 to \$600,000 per week.

Money coming into the vault arrives in armored trucks. An armed guard in a bulletproof, glass-enclosed cupola overlooking the truck delivery area flashes a coded signal to another guard in the vault.

The second guard presses a button and a heavy steel door is raised electrically. The raised door exposes a conveyor belt which carries the money sacks to the underground level.

Downstairs, the heavy sacks are unloaded onto hand trucks. Guards then push the trucks through several more steel doors into the vault for sorting, counting and wrapping. ★ ★ ★

Counter releases any number of rolls desired into sacks. Now coins are ready to leave counting house

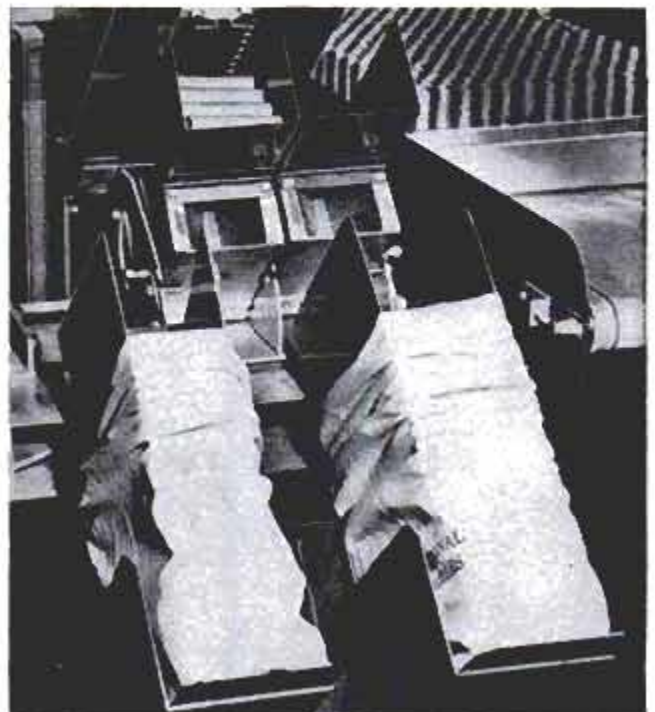

Propeller Drive Powers Car

Although he had never built a car before, that didn't stop Clifford J. Robins, a grocer in Somerset, England. In about a year, he put together a three-wheeled car that is powered by a pusher propeller. The propeller drive means that no transmission, clutch or differential is needed. The engine is a Ford V8. Top speed is 70 miles per hour. It cost less than \$600 to build.

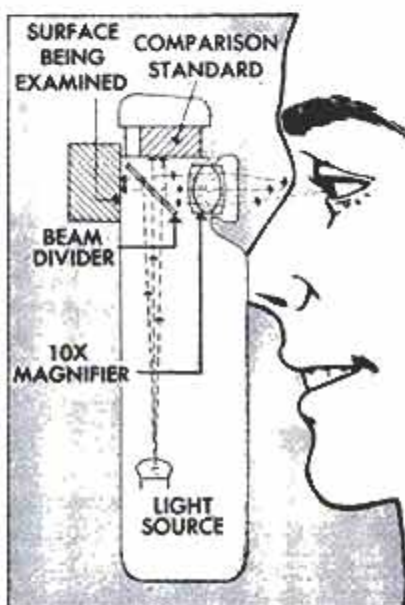

Pocket Instrument Compares Surfaces

Pocket-sized, held in the hand and inexpensive, a new comparator for judging the smoothness of the surface on machined metal against a selected standard will speed up the work of production and quality-control men. Using a new type of optical system, the comparator illuminates both the known standard and the work under study, and magnifies them 10 times for close study.

Six Jets Atop Auto Aid Test Work

John Shelburne, of Hannibal, Mo., has bolted six jet engines to the top of a 1937 Chevrolet automobile to make what is probably the world's fastest stock car. Shelburne built the jet car in order to do preliminary research on such things as heat exchangers, afterburners, power-booster nozzles and other jet accessories. No performance figures are available as yet.

Stockholm's first motel, opened recently, is one of a chain of Swedish motels that will extend well into Lapland.



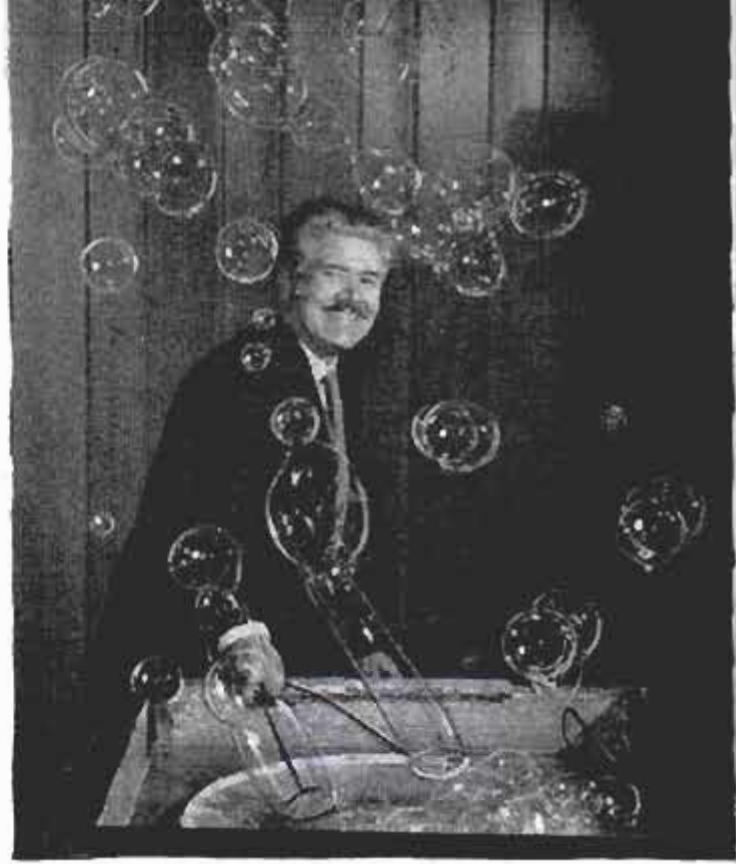

MAGIC IN BUBBLES

By Marshall Lincoln

I'M FOREVER Blowing Bubbles" is an appropriate theme song for Eiffel Plasterer of Huntington, Ind. A retired high-school science teacher, he has transformed an interest in surface-tension effects with soap bubbles into a fascinating entertainment feature called "Bubbles Concerto."

"The Bubble Man," as he bills himself, started working with soap bubbles years ago while teaching physics and chemistry at Huntington High School. He was seeking a soap solution that would produce bubbles durable enough to withstand the heat of a projector lamp. His object was to bombard a bubble with sound waves, then project its image to show his pupils "what sound looked like."

Long-Lived Bubbles

After finding a soap solution that would help give this effect, he began using it to make long-lived bubbles and bubbles that were elastic enough to do tricks with.

His first shows were informal affairs for other teachers at the school. Later he developed an evening show for general audiences, and after a few years this show took so much of his time that he quit teaching. Now he divides his time between touring with Bubbles Concerto and operat-

ing his farm a few miles south of Huntington. Not a man to slip into a humdrum existence, Plasterer also collects steam threshing engines.

Science is lively and entertaining—that's the theme of his bubble program.

"These bubbles are liquid—not plastic or rubber bubbles, which are solids," Plasterer emphasizes at the start of his show.

Bubbles Are Easily Broken

"Since they are liquid, they are very delicate and easily broken." With this knowledge, his audience is more able to appreciate the feats Plasterer and his son Bill perform.

Dust and wind are his worst enemies, Plasterer says, for small amounts of either can easily break the fragile bubbles. He uses a solution of soap, water and glycerin, which he sometimes warms on an electric hot plate for greater strength.

"I always save a few bubbles for my next performance just in case I should run short," he tells his audience, producing a jar holding a bubble or two blown at a previous performance.

He once had a bubble that lasted more than 200 days. During his travels, it aged and shrank, until it was barely visible. One day, finally, it shrank out of existence.

"It didn't break, it just passed on," he recalls with a trace of regret in his voice.



On opposite page the "Bubble Man" encases a Boy Scout in a bubble and fills the stage with shower of bubbles. Here he blows a huge bubble with his own "pipe," balances one bubble on three others, makes a bubble "walk uphill," blows a chain of bubbles and plays a tune on a trumpet while he blows a huge bubble



A bubble "balloon," filled with hydrogen, carries aloft tiny flag suspended from a wire loop

Below, Plasterer shows even a newspaper can be used as a bubble pipe when rolled into a cone



For huge bubbles, Plasterer uses a metal "horn" about six inches across. Attached to it is a flexible metal tube about two inches in diameter. This strange-looking device is the pipe with which he can blow a bubble about two feet in diameter.

He also shows his spellbound audience how to blow a bubble from the horn of a trumpet, while playing the trumpet. Of course, "I'm Forever Blowing Bubbles" is the tune.

Many spectators don't realize it unless they are told, but this feat, besides being entertaining, proves that sound waves can pass through the fragile soap film, without either the film or the sound being altered noticeably.

Bubble Cage

Probably his most spectacular bit of "bubble magic" is encasing a person in a huge bubble.

After explaining that the theoretical limit for a closed bubble is about 27 inches in diameter, he explains that unclosed bubbles may be much larger.

For encasing a person, Plasterer uses a large pan, about three feet square, filled an inch or so deep with his soap solution.

While the person, either a child or an adult, stands on a small platform in the pan, Plasterer quickly raises a large metal hoop from the solution up over the person's head. The hoop pulls with it the strong soap solution into a shimmering cylindrical form which surrounds the startled assistant.

Decorating a Christmas Tree

By attaching tiny wire loops to the branches of a Christmas tree, Plasterer can decorate the entire tree with bubbles which, under good conditions, will last through his show.

A chain of bubbles several feet long can be fabricated by the scientific showman, and a bubble may be balanced on three others placed upon small stands on his table.

Tricks like the chain and the placing of one bubble upon others are more difficult than they look, Plasterer says, because it is a natural tendency of two soap bubbles in contact to join into a single larger bubble.

Plasterer makes a balloon by inflating a bubble with hydrogen and attaching to it a tiny wire loop. Attached to the loop is a long thread which in turn is attached to a tiny silk flag or paper star.

The flag or star is carried slowly upward by the hydrogen "balloon" until it touches the ceiling, where it remains unless the contact with the ceiling breaks the bubble.

As a finale, Plasterer sometimes uses several small wire loops which he immerses in a pan of soap solution, then waves quickly through the air to produce several bubbles almost simultaneously. By repeating this process rapidly, he fills the stage area with a shower of bubbles that envelops himself, his assistant and his equipment. ★ ★ ★

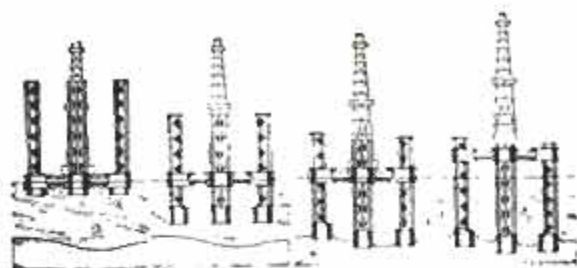

Mobile Drill Platform Rests on Stilts

Costing about \$2,000,000, a "portable island" can be towed from one offshore drilling spot to another. Under way, three legs which are 140 feet long, tower above the platform. At the new drilling site, a switch is turned and the legs move down through the platform until they strike the ocean floor. The platform then moves right up the legs until it is well above the water level. An oil-drilling tower will be mounted on the half-acre platform,



which also will have offices and living quarters for 42 men. Powering the stilts are 63 huge electric motors. Electricity is supplied by diesel-driven generators.

Supersonic Parachute Tailored for Shock

Bailouts at high altitudes and transsonic speeds, a growing problem as today's planes fly higher and faster, may be possible with the "Skysail." This is a parachute made up of concentric cloth rings assembled from specially shaped panel sections which utilize a new type of harness that spreads the area of opening shock on the wearer. The pack is designed to be secure against inadvertent opening by the slipstream at speeds above 450 miles per hour. And to increase comfort and safety, each Skysail is custom fitted to the wearer. The Skysail is now undergoing tests by the Navy.

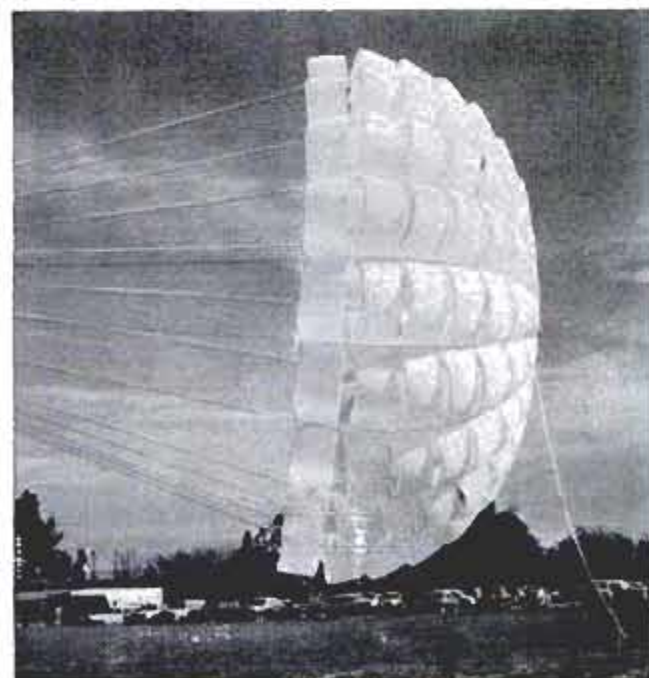

Guide for Hair Clipper Assures Even Cut

Part of a home hair-cutting kit, a new guide for an electric clipper assures an even tapered hair cut—without danger of taking off too much hair. The guide is placed over the head and the clipper placed in it. When the clipper is run up the guide, it stays just the right distance from the head to make the proper cut. Then the guide is moved on the head and another cut is made. The kit not only includes the guide and an electric clipper, but also regular barber's shears and comb, a crew-cut attachment and easy-to-follow instructions—everything for cutting hair at home.



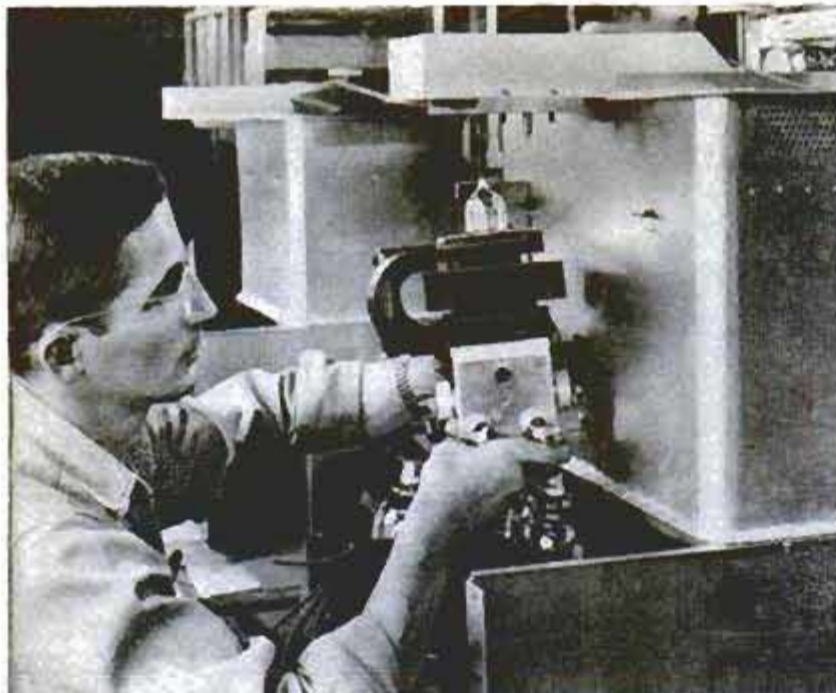

Magnetron generates microwaves that cook food. Bacon is cooked on napkin and paper plate which remain cool

Electronic Oven Uses Microwaves to Bake Cake in Six Minutes

You can bake a cake in six minutes and a five-pound beef roast in 30 minutes with an electronic oven now available. A magnetron tube heats the food with microwaves. The meat plate and the oven walls

remain cool during cooking; food is cooked in serving dishes and bacon is broiled on a paper napkin. The range has only two cooking speeds. A conventional electric element is used for browning foods.

Pilots See in Dark With "Cat Eye" Electronic Light Amplifier

Over a thousand times more sensitive than a standard television camera, the Air Force's new "Cat Eye" system will enable pilots to see in the dark with daylight clarity. Now undergoing further develop-

ment, the tube, during tests, made it possible for observers in a plane to see the ground clearly on a moonless, winter night. Cat Eye senses and amplifies light which is always present but unseen by the human eye, and at the same time it increases the contrast between light and dark. Present work on Cat Eye is toward black-and-white picture presentation, but scientists say it can also be used for color.



Low Temperature Traps Energy

Large amounts of energy may someday be trapped in solids at extremely low temperatures, then released at will. According to Dr. C. M. Herzfeld of the National Bureau of Standards, recent studies show that atoms can be imprisoned in solids at temperatures within 10 degrees of absolute zero. Molecules of certain gases consist of two atoms held together by electric forces. Some molecules break apart into two atoms under an electric discharge. Then these separated atoms are trapped in a solid. The atoms cannot recombine because of the cold. When the solid warms up, energy is produced.

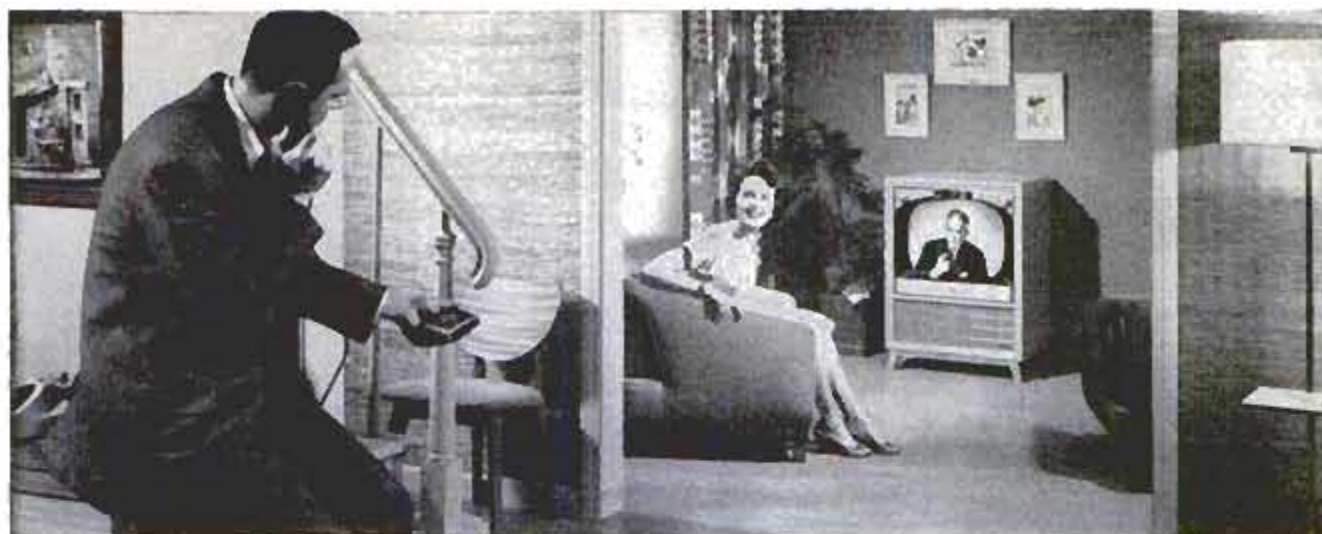

No wires or connections of any kind are required by ultrasonic control box

Remote Control for Television Set Employs Ultrasonic Commands

PREDICTIONS that the wonders of ultrasonics would some day be available in the home are beginning to come true as the Zenith Radio Corporation announces a remote-control device employing ultrasonic waves for its new television sets. Produced by a small four-button box which weighs but eight ounces, the waves are at too high a frequency to be heard or felt. But they are picked up by an ultrasonic microphone built into the television set. With the control, the set can be turned on and off, channels can be changed or the sound can be lowered.

The inaudible signals are effective up to 40 feet from the set. Other ultrasonic waves will not affect the controls, since they will react only to a tone at exactly the right frequency that lasts for an electronically measured period of time. Inside of the control box are four aluminum-alloy rods of slightly different lengths, adjusted to vibrate at the proper frequency. When a control button is pushed, a tiny spring-loaded hammer strikes the end of a rod, producing the signal which actuates the control unit on the set.

Right, front and back views of the control mechanism. Spring-loaded hammers hit aluminum-alloy rods to create ultrasonic waves when buttons are pushed

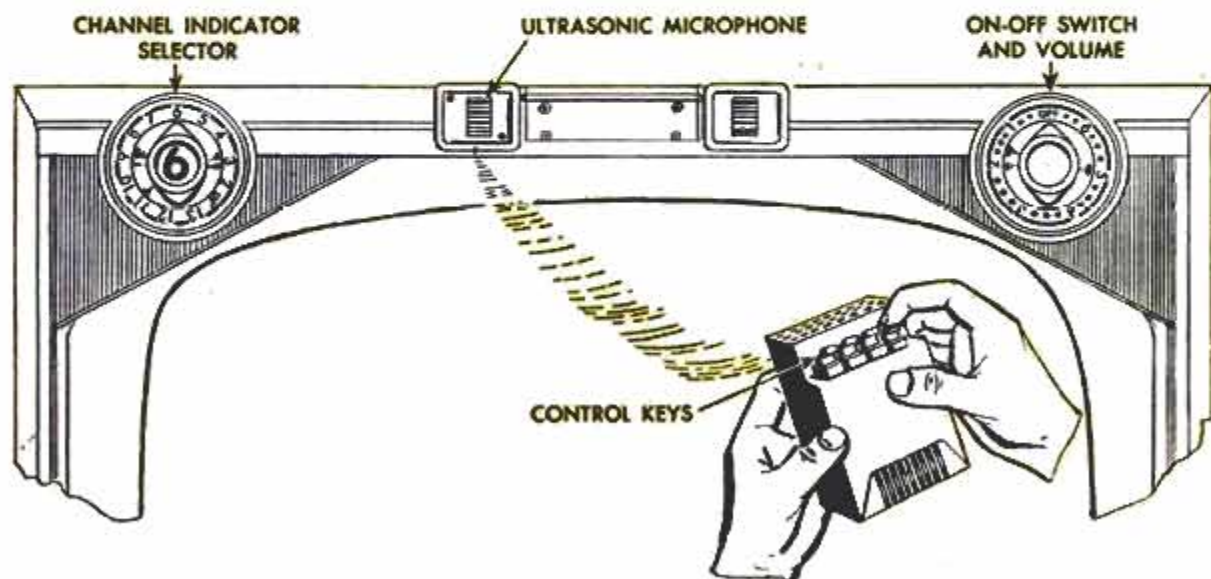

OWNERS REPORT on the VW

Owning a VW Is Like Being in Love!

"This is the first major love affair of my life."

FLORIDA BUSINESS WOMAN

"Haven't talked to a VW owner yet who wasn't crazy about the little car. Some are madly in love with it. Me too!"

IOWA TOOL AND DIEMAKER

"The VW is to my wife and me what watermelon is to a farm boy -- the only thing that would make it better is more of the same. There's something magnetic about this wonderful little car."

KENTUCKY TEACHER

"Have never been so happy or so completely satisfied with a car. My only real complaint is that I have to fight with my wife to get to drive it."

CALIFORNIA AIRCRAFT INSPECTOR

"Words can hardly describe my elation over having come in contact with the VW. It's the most wonderful thing that has happened to me since I've been driving automobiles."

OKLAHOMA AIR FORCE TECHNICIAN

CLYMER DRIVES the VOLKSWAGEN

By Floyd Clymer

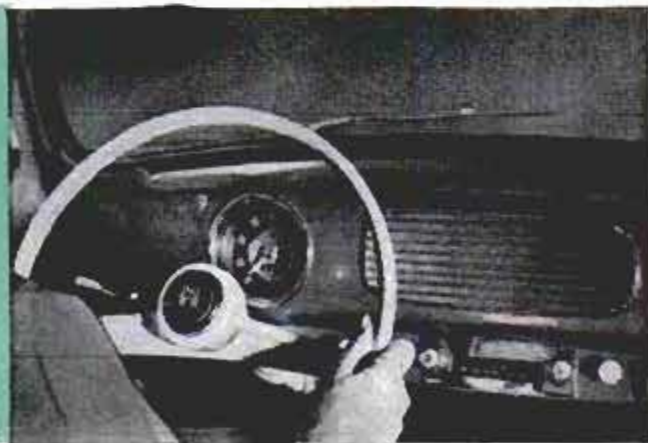

THE VOLKSWAGEN test was from Los Angeles to San Diego, across the border to Mexicali, Mexico, and return through the back mountain and desert country for a total of 629 miles, which included some testing in the desert and over winding mountain trails.

Because the car is small and short, with a wheelbase of only 94½ inches, the handling characteristics, stability and roadability may astound the average American driver. This German car has amazing performance and roadability. For over 100 miles I encountered head and quartering side winds and the car was remarkably

stable, although when a large truck or bus passed there was noticeable, but not alarming, side sway for an instant. Roadability is helped by the fact that the floorboard is about three inches below the top of the frame and two inches below the running board.

The horizontally opposed, four-cylinder, air-cooled engine has a displacement of only 72.74 cubic inches (about the size of some of our high-powered motorcycles).

It cruises easily at 70 miles per hour. Even at this speed the roadability was so good that I removed both hands from the

(Continued to page 314)

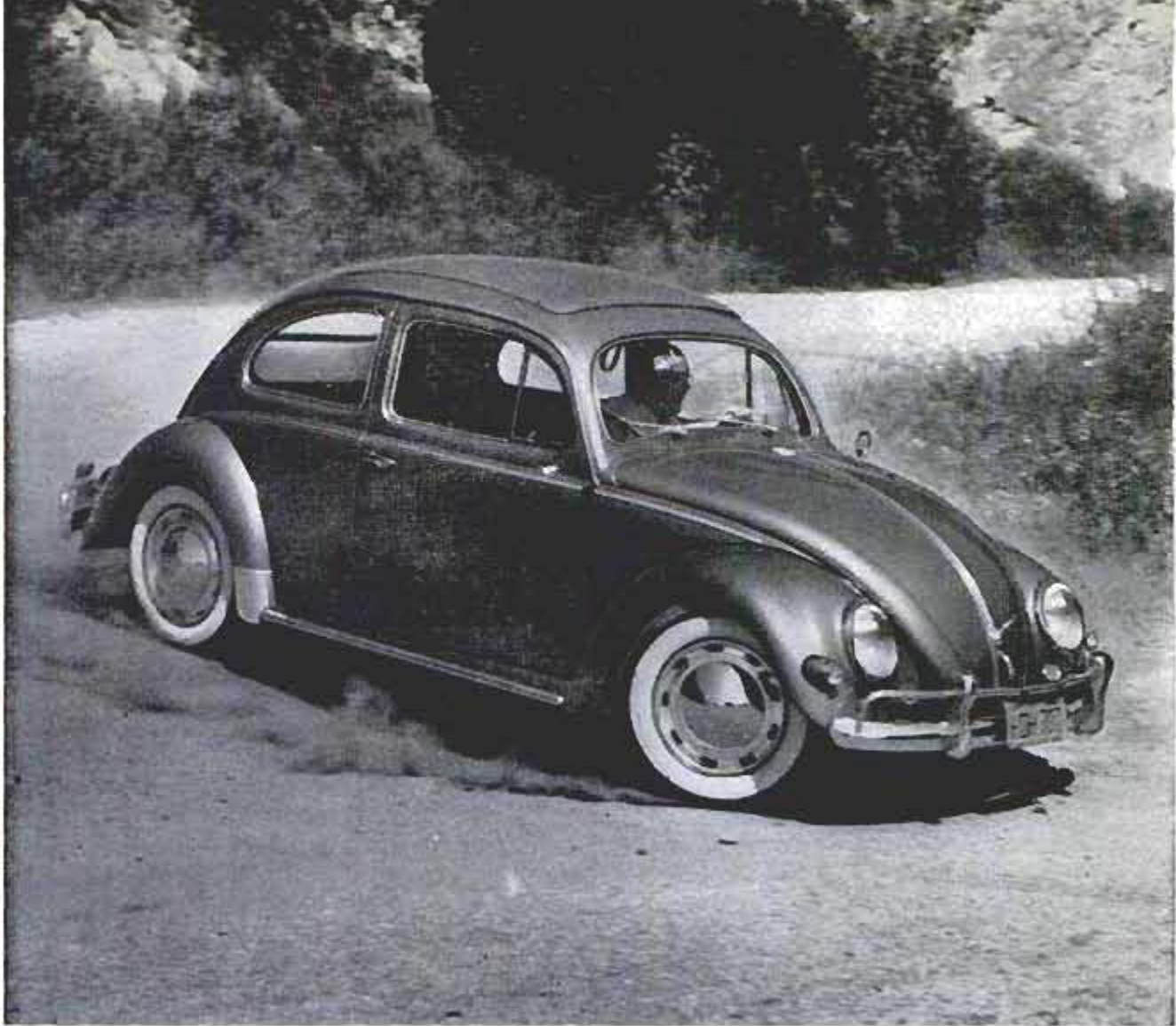

Although not a sports car—neither the VW nor its owners admit it—it behaves like one on the corners

VOLKSWAGEN MAY NOT BE A BIG CAR, BUT IT'S A FINE ONE, SAY OWNERS

By Volkswagen Owners

WHAT'S VOLKSWAGEN'S secret? What is there about this small, ugly, low-powered import that excites people all over the world and makes every owner talk like a salesman?

To find out, we asked hundreds of VW owners. Their replies are unbelievable. These owners actually have fallen in love with a car. Not a single owner in the survey rates the VW as "poor." An amazing 95.8 percent say it's "excellent"—many adding a plus sign! And all this on a car that sells for about \$1600.

One owner, an engineer in Texas (an amazingly high percentage of VW owners are engineers and technicians; see table on page 157) sums it up just about as well as it can be done:

"The VW is an engineering masterpiece. It was designed to fit a purpose and a price.

The purpose is to provide reliable transportation for a few (4) persons at a reasonable price. It was not designed to outdrag D-type Jags or haul seven persons at the same time. On several occasions I have spent 10 or 12 hours behind the wheel and arrived in better shape than when I drove a Detroit car—and I had a much better time driving. When the occasion presents itself you can take to the side roads, buzz around corners, shift gears like crazy—in short, have a barrel of fun and still not leave a widow and three orphans. I can afford a bigger car, but I think I shall buy another VW. I would rather have two VWs than one big car. In general, I love it because of what it is—a VW."

That high praise sums up what hundreds of owners report. Obviously, there is more

(Continued to page 157)

An Engineer Analyzes The Volkswagen

By Dale Kelly, SAE

Model tested: Two-door sedan. Rear-axle ratio: 4.4 to 1. (Highest gear in transmission is an over-drive with a ratio of .82, making over-all ratio 3.61 to 1.) Wheelbase: (measured) 95 inches. Tires: 5.60 x 15. Curb weight: 1580 pounds with gas tank

half full (41 percent of weight on front wheels, 59 percent on rear wheels). Barometer: 28.8 inches. Temperature: 92 degrees. Payload: 400 pounds for acceleration tests and 200 pounds for the economy tests.



ACCELERATION TIME IN SECONDS

	0 to 20	0 to 40	0 to 60	1/4 mile
Ignition timed for regular gasoline				
Shifting at 2000 r.p.m.	5.7	20.0	47.5	29.1
Shifting at 2500 r.p.m.	4.7	17.7	42.5	27.4
Shifting at 3000 r.p.m.	5.2	15.3	42.5	26.8
Shifting at 3500 r.p.m.	5.7	15.6	41.0	27.7

TOP SPEED: 65 miles per hour



FUEL ECONOMY IN MILES PER GALLON

	Steady 30 m.p.h.	Steady 50 m.p.h.	Steady 60 m.p.h.	Traffic Route
In third gear	35 m.p.g.	34 m.p.g.	28 m.p.g.	28 m.p.g.
In fourth gear	44 m.p.g.	34 m.p.g.	28 m.p.g.	28 m.p.g.

In the traffic test, the car makes 10 full stops per mile and is driven fast enough to average 15 miles per hour. First, second and third gears only were used. In all tests ignition was timed for regular gasoline.

ESTIMATED ANNUAL GASOLINE BILL: \$83 for 10,000 miles.



SPEEDOMETER ERROR (MILES PER HOUR)

Indicated speed	20	30	40	50	60	70
True speed						
Car No. 1	25.0	32.5	40.0	47.0	56.0	65.0
Car No. 2	21.0	29.5	38.0	47.0	57.0	67.0

(Test was conducted with two different Volkswagens.)

ODOMETER ERROR

The odometer indicated two percent more than the actual distance traveled (102 miles for a true 100 miles).



DRIVER'S VISION

Some portion of the road could be seen 8 feet in front of the car (A in sketch) by an average driver (5 feet 9 inches tall); full width of the road could be seen 12 feet in front of the car (B in sketch).



GROUND CLEARANCE

The bottom corner of the rear overhang would touch the ground if the car were driven through a dip whose profile had a radius of curvature of less than 21 feet (solid line in sketch). The center of the car would drag if the car were driven over a hump with a radius of less than 10 feet (dotted line in sketch). The engine would drag if the car were driven in ruts deeper than 8 inches. The doors would open over a 13-inch curb.

MISCELLANEOUS

OCTANE REQUIREMENT

The best acceleration from 35 to 55 miles per hour in fourth gear was obtained with timing set at 7 degrees before top center. At this setting the engine did not knock on typical regular gasoline. Therefore, it would be impossible to improve performance by using premium gasoline.

STEERING:

From straight ahead, the steering wheel had to be turned only .43 revolution to complete a circle with an outside radius of 50 feet. The steering wheel turned 2.5 turns from lock to lock. Diameter of the turn circle: 37 feet. Diameter of the walled circle in which the car could turn was 38 feet. Steering-wheel diameter: 16 inches.

LUGGAGE CAPACITY:

In addition to the spare tire and the tire-changing tools, the luggage compartment at the front of the car could accommodate one cardboard carton of the size used for 48 tall cans of evaporated milk; two more could be stored behind the back seat.

WATER RESISTANCE:

The body was well sealed against water leaks. In ten trips through the splash pan at 20 miles per hour a few drops of water entered the front luggage compartment, but none got into the body. Ignition and brakes were not affected.

CENTER OF GRAVITY:

The center of gravity of the unloaded car was 21.5 inches above the ground.

Percentages, below, summarize what VW owners from 41 states (in color on map) think about their cars



The Owners Analyze the Volkswagen

Over-All Rating of the Volkswagen

EXCELLENT	AVERAGE	POOR
95.8%	4.2%	0.0%

Had trouble with engine?

No trouble	90.2%
Some trouble	9.3%
Considerable trouble	0.5%

What was engine trouble?

Oil leak	1.4%
Clutch	1.4%
Main bearing	1.0%

Would like faster acceleration?

Yes, would	45.5%
No, would not	54.5%

Would like more top speed?

Yes, would	10.6%
No, would not	89.4%

Would like more room inside?

Yes, would	26.8%
No, would not	73.2%

Would like four doors?

Yes, would	22.3%
No, would not	77.7%

Even if car had to be bigger?

Yes, even if bigger	11.2%
No, not if bigger	11.1%

Rides better than U.S. cars?

Yes, rides better	43.6%
Rides about same	36.1%
No, does not ride better	20.3%

Have taken long trip (over 500 miles)?

Yes	45.6%
No	54.4%

How was the long trip?

Comfortable, pleasant	72.2%
Somewhat tiring	13.4%
Undecided, no answer	14.4%

How was car delivered?

Excellent condition	85.8%
Average condition	12.3%
Poor condition	1.9%

How is dealer service?

Excellent	65.8%
Average	26.7%
Poor	7.5%

Have owned VW before?

Yes, have	7.5%
No, have not	92.5%

Would buy VW again?

Yes, would	93.6%
Might	5.5%
No, would not	0.9%

What was traded on VW?

No trade	51.4%
Traded a Volkswagen	2.8%
Traded another foreign	6.1%
Traded GM make	12.6%
Traded Chrysler make	10.3%
Traded Ford make	8.8%
Traded other U.S. make	8.0%

Who are the VW owners?

Technicians, craftsmen	17.5%
Engineers	10.4%
Businessmen, executives	8.8%
Doctors, dentists, lawyers	7.4%
Salesmen	6.6%
Teachers	5.7%
Scientists	2.6%
Others	41.0%

Best-Liked Features

Cheap to operate	68.9%
Easy to handle	47.6%
Easy to park	32.1%
Comfortable ride	20.8%
Excellent workmanship	16.0%

Small size	13.7%
Roadability	9.0%
Advanced engineering	9.0%

Most-Frequent Complaints

No complaints at all	25.9%
Limited rear vision	10.4%
Engine, transmission noise	10.4%
Cross wind bothers at speed	9.0%
Hard to shift into reverse, low	7.5%
Wipers too slow	7.1%
Needs more power	6.6%
Heater inadequate	5.2%
Bumpers too soft	4.7%

What Should Be Changed?

Nothing at all	25.9%
Increase power slightly	12.3%
Make engine quieter	11.3%
Improve rear vision	9.4%
Increase heater output	9.0%

IS IT THE SECOND CAR?

Is VW second car in family?

Yes, it is	43.7%
No, it is only car	56.3%

What is the other car?

Low-price make	42.4%
Medium-price make	46.7%
High-price make	10.9%

Which car is used most?

VW is used most	73.1%
Other car is used most	10.8%
Both used about same	16.1%

Who drives the VW in family?

Husband drives VW	70.2%
Wife drives the VW	17.0%
Both drive about same	12.8%

to this car than is apparent as it scoots past you in traffic. There is more to it than dollar-saving economy of operation, although this is the most frequently mentioned best-liked feature with 68.9 percent of the owners listing it.

"We fill the car with gas every Friday. It used to cost me \$3.50 to \$4.00 to fill my V8 each week. It costs me from 90 cents to \$1.10 to fill the VW each week despite the fact that the price of gas is up three cents a gallon."—New Jersey retired owner.

"I drive 56 miles a day on a rural news route in the Santa Cruz Mountains. I average 28 miles per gallon in this stop-and-go

driving (60 stops in 56 miles)."—California news carrier.

"On a 3300-mile trip to Florida, the VW used 1/2 cup of oil, averaged 36.5 miles per gallon."—Michigan teacher.

"We traveled from California to Illinois and back, going 4996 miles including side trips. Our entire cost was \$51 for gas, two grease jobs, two oil changes and a wash job."—California cashier.

"We went 612 miles on \$4.79 worth of gas in 11 1/2 hours. Whenever a car passes me (which is seldom), I chuckle because it's costing him at least four times as much to drive his car as it's costing me."—Missouri teacher.



Above, the VW has no gas gauge. If you must know how much gas you have, use a yardstick! Below, some owners dislike the roller accelerator pedal (arrow)



But It's Noisy!

Volkswagen owners may be fanatical in their praise, but they aren't blind to its faults. Only 25.9 percent say they have no complaints at all—a relatively small percentage when compared with previous reports on American cars.

Two complaints are tied for top mention: (1) engine and gear noises; and (2) limited rear and front-quarter vision. Each was mentioned by 10.4 percent of the owners.

"Better noise insulation would help. My 1956 seems noisier than the 1954 model, but a little glass-fiber matting does wonders."—Louisiana Air Force instructor.

"It's noisy, but becoming quieter or am I getting used to it?"—California steno.

"Excessively noisy, especially with the windows open on a windy day. Unable to hear radio then."—California aircraft worker.

"Needs a larger rear window. There are some blind spots at the sides in back."—Massachusetts student.

"Get rid of the blind spot beside the windshield."—California truck driver.

Handling Praised

Second to economy on the best-liked list is ease of handling with 47.6 percent of the owners mentioning it.

"I like the way it handles in traffic. And after a one-day drive of 500 miles with three adults and two children in the car we were actually less fatigued than in our

Below and opposite, some owners say the VW floats across deep puddles! We tried it. Despite a 185-pound driver and a full gas tank, it did float, but water leaked in through the bottom of the doors



previous United States car."—California business man.

"I could write pages about the VW. I'm scared to death to drive our full-size car, but I'll try anything in the 'bug'! It lets me feel I'm the boss when I'm behind the wheel and not as though I'm driving by remote control. When I turn the wheels I know exactly what angle I'm getting. As long as VW is made I'll never drive anything else."

—Ohio housewife.

Today's congestion makes parking a headache, but VW owners don't mind. Ease of parking is the third best-liked feature with 32.1 percent mentioning it.

"Parking in a very small space, I nosed her in and my friend and I picked up the rear end and moved it into the curb, to the amusement of passers-by."—New York carpenter.

"The answer to the second-car problem. Small, easily parked, it is ideal for shopping."—California salesman.

More Complaints

Here are more owners' complaints, listed in order of frequency of mention:

"Car tends to sway at speeds above 55 miles per hour in strong winds when only one or two passengers are in it. Otherwise very well satisfied with the car."—California Air Force sergeant.

"I have no complaints, but my wife doesn't like pushing down on the gearshift lever to get into reverse. It is difficult for her to do."—Arizona contractor.

"Windshield wipers are too slow."—Florida aircraft mechanic.

(Continued to page 304)



Above, air-cooled rear engine has only one fault, say owners: It's a bit noisy. Below, the four cases fit inside car without infringing on seating space. One goes under hood, others pack behind rear seat

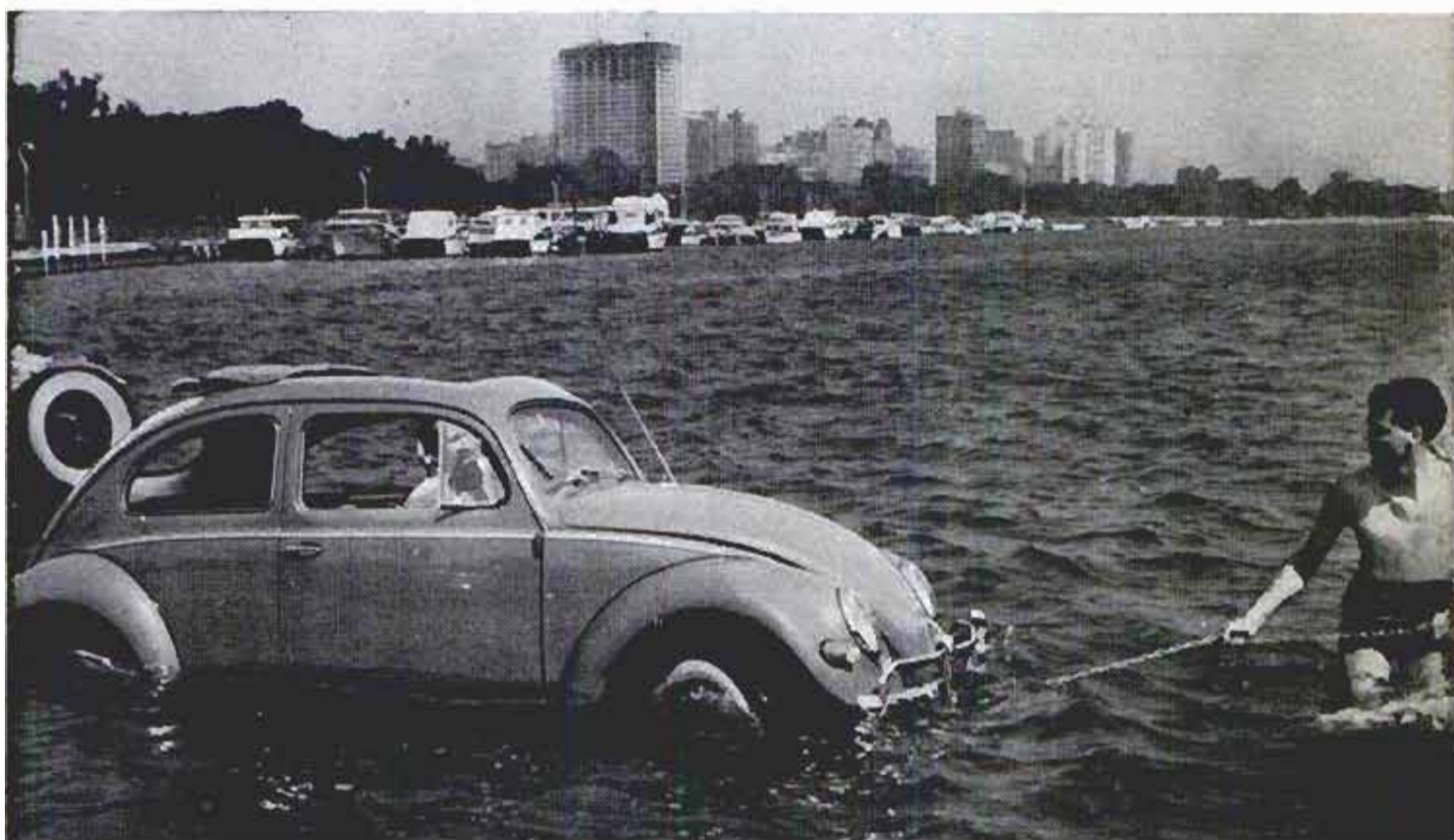
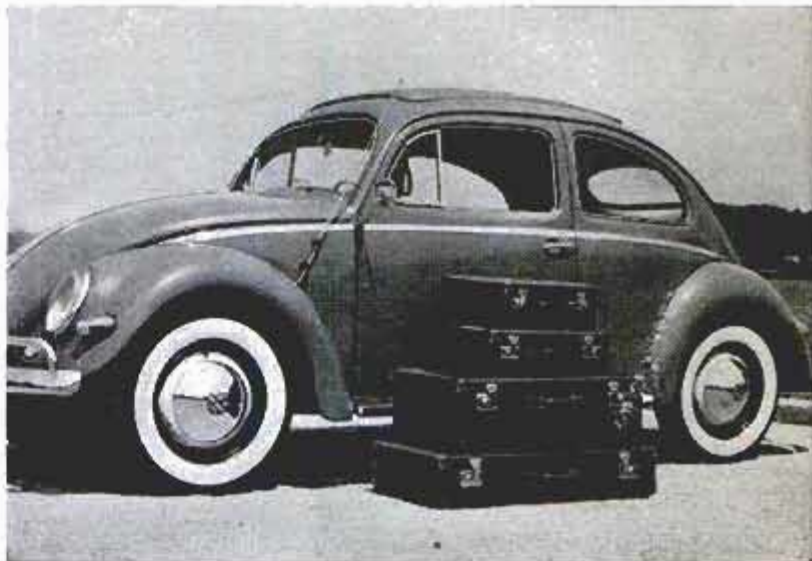



Flying Tanker Refuels Three at a Time

Three F-100 Super Sabers can be refueled at one time in mid-air as the result of further developmental work on the KB-50 Flying Tanker. The KB-50 is a modifi-

cation of the famous Superfortress of World War II. The Air Force has been giving the new fueling system operational testing at Eglin Air Force Base, Fla.

On the Next 50 Pages We Present

Popular Mechanics Annual

HOME SECTION

It is our belief that a magazine home section should present above all else an answer to a national housing need. The biggest problem today is finding a home of medium cost to accommodate larger families. Our solution is the carefully planned house pictured on the following six pages. Other articles and illustrations offer new and exciting ideas from a coast-to-coast study by our staff of the best in modern housing.

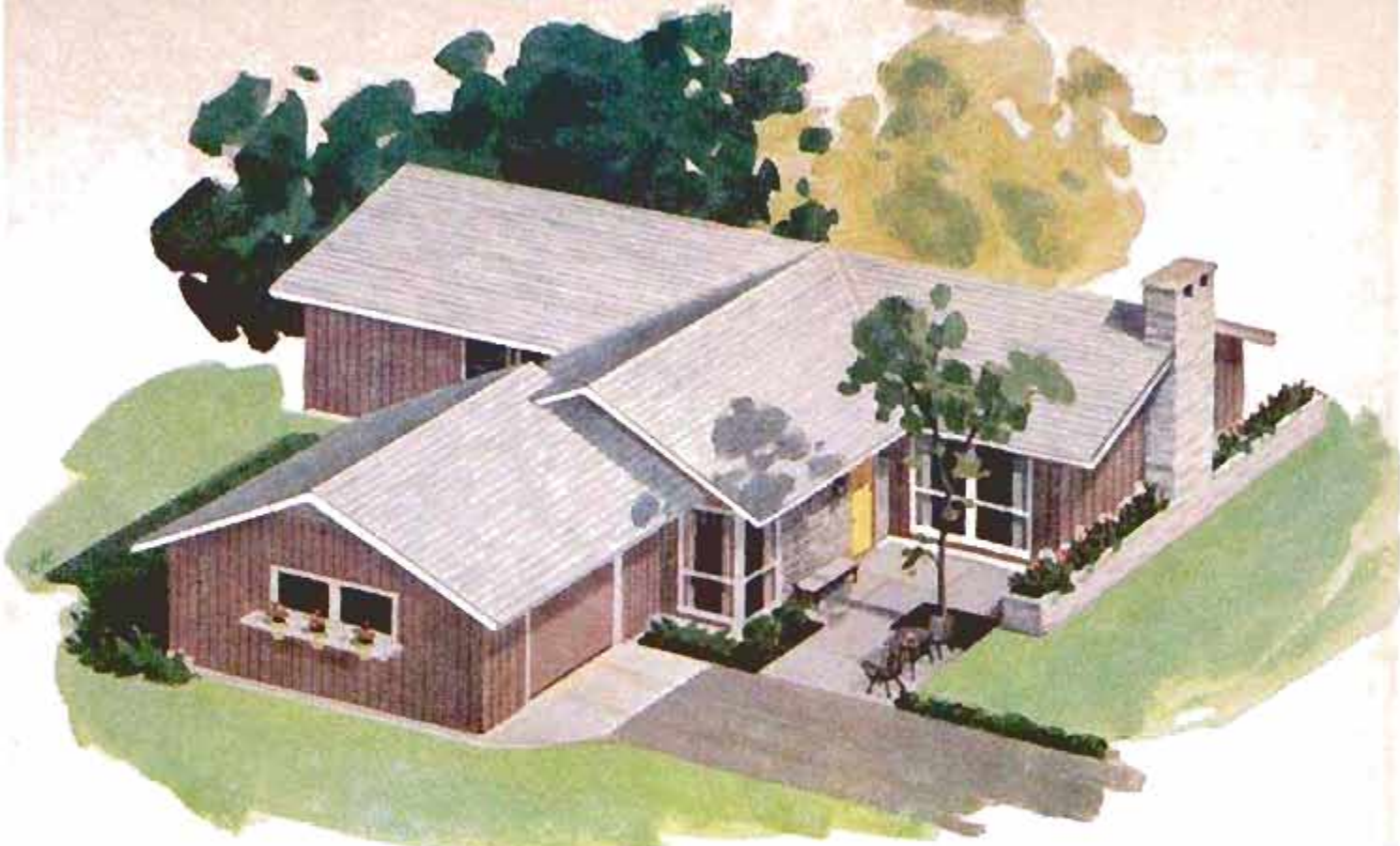

This attractive medium-sized home features four bedrooms and two baths with definite child and adult areas

Introducing The *PM* Big-Family House

By Wayne Whittaker

WHEN THE *PM* HOUSE for 1956 was being planned there were two things uppermost in the minds of the designer and editors who created it:

Rule No. 1—This home should not be “just another ranch-type house.”

Rule No. 2—The house should offer a solution to some national housing need.

The “need” was easy to put a finger on, as any builder or real-estate operator across the country will testify. For the family that can afford only a house of medium size, the vital question of the day is: “Where, oh where, are we going to put the kids?”

Families of three, four and five children (and there are lots of them these days) have been desperately seeking this answer. Meanwhile, they have been buying or building conventional three-bedroom houses apparently designed to drive parents into padded cells. There has been a great need for a home of moderate size planned with a nice balance of adult and child living areas, for eating and sleeping, for play and entertaining, for outdoor as well

as indoor living, a place where the traffic patterns of children are not always underfoot of the adults. You will find all of these features in the beautiful four-bedroom, two-bath home shown on these pages. The actual living area, not including the garage or the partial basement, is only 1350 square feet.

The first big problem for the editors was to find the best architect in the United States for this particular job. He is William H. Weist, a young designer and professional engineer of South Bend, Ind., who is well known for the clean design of his contemporary homes. Weist has won numerous national awards for his houses. A family man himself, Weist was able to tackle the problems of a comparatively small big-family house with some practical first-hand experience. He also had an ear trained toward Washington, D. C., earlier this year during the Women's Congress on Housing. That was a group of housewives

summoned from all over the country by the Housing and Home Finance Agency to air their views on what's wrong with

Blueprints for the *PM* Big-Family House are available for \$12.50. Write: Plans Dept., *Popular Mechanics Magazine*, 200 E. Ontario St., Chicago 11.

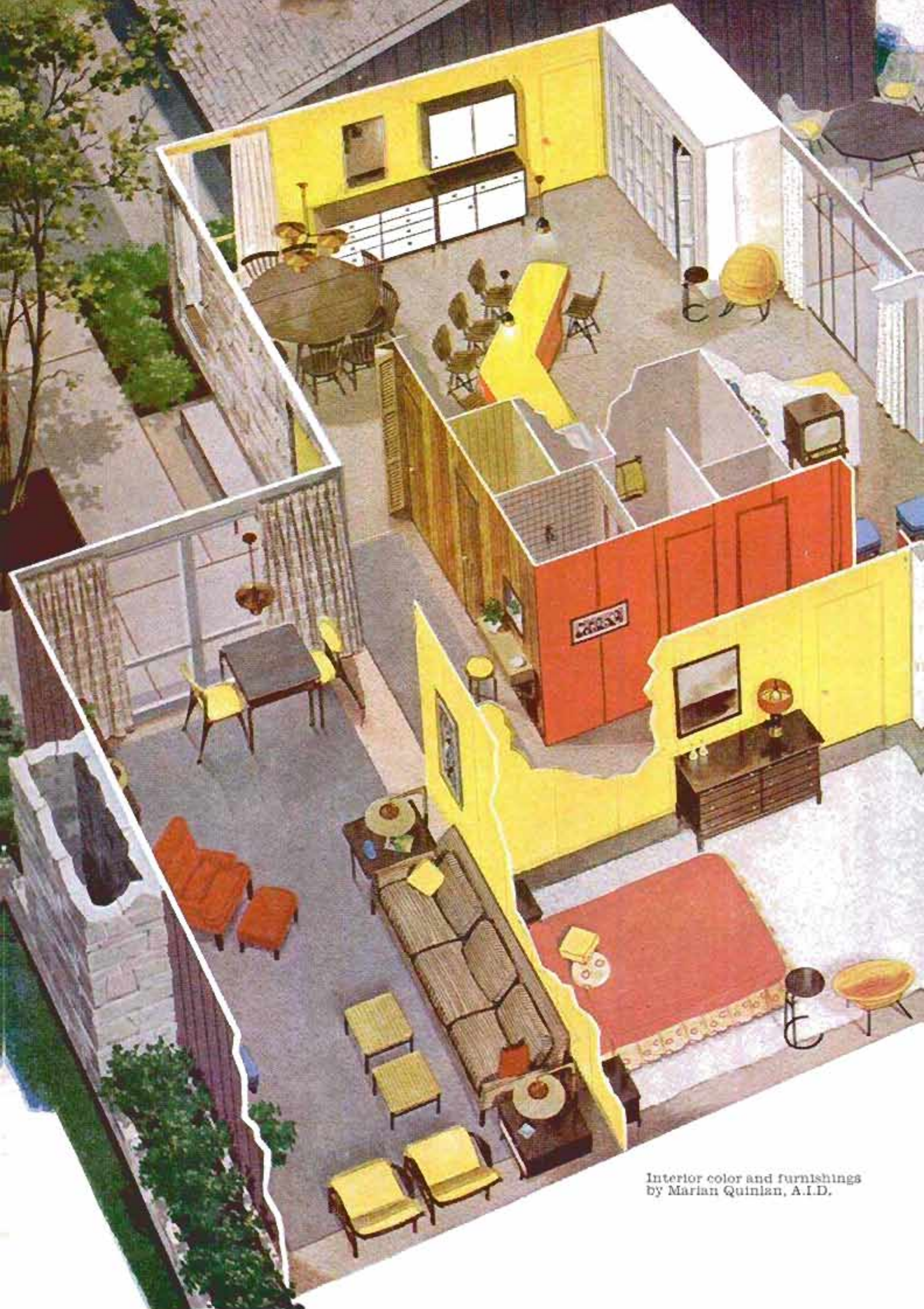

Interior color and furnishings
by Marian Quinlan, A.I.D.

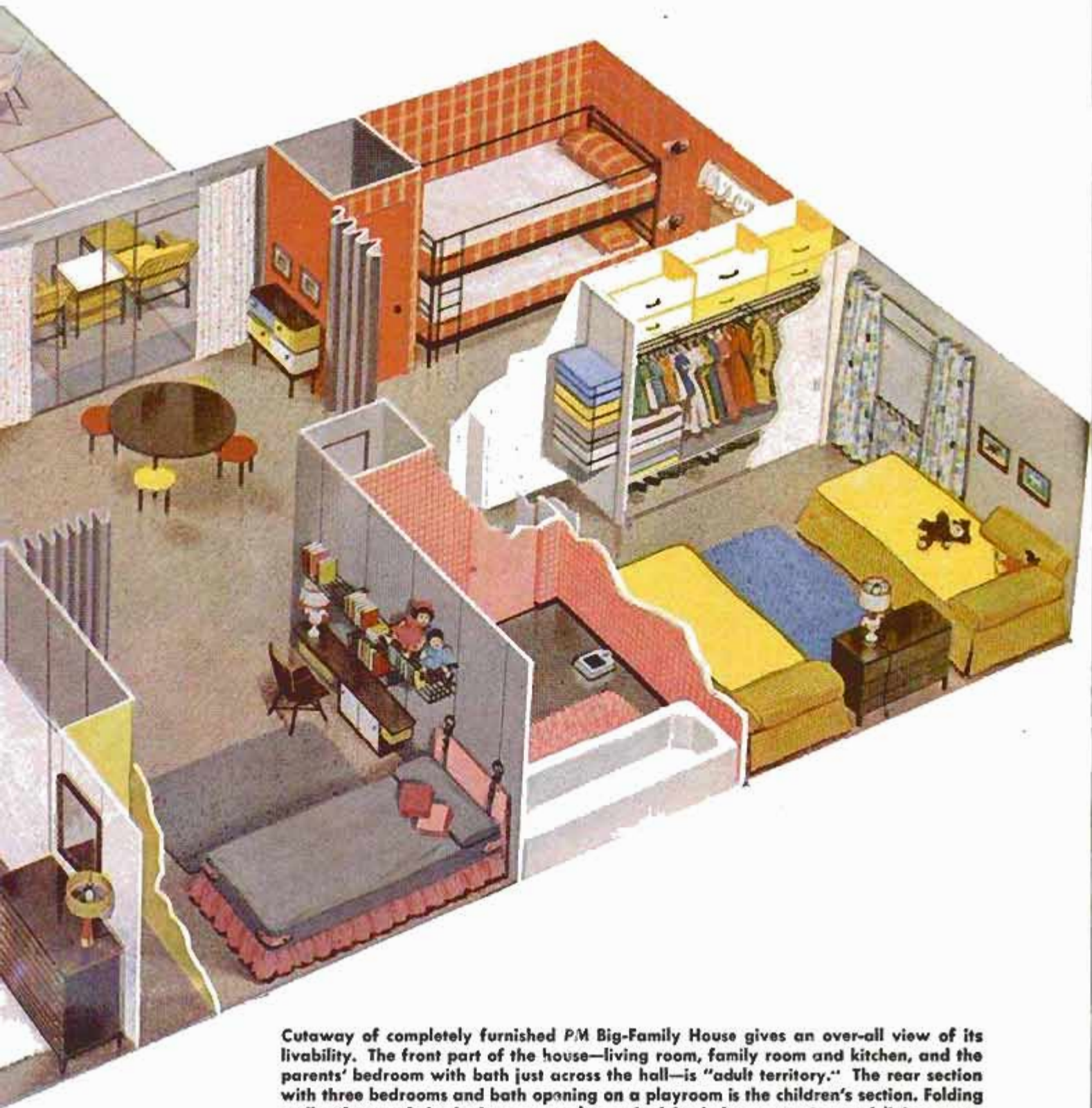

Cutaway of completely furnished P/M Big-Family House gives an over-all view of its livability. The front part of the house—living room, family room and kitchen, and the parents' bedroom with bath just across the hall—is "adult territory." The rear section with three bedrooms and bath opening on a playroom is the children's section. Folding walls of two of the bedrooms can be pushed back for more play and living space during the day. The rear patio is accessible both from kitchen and playroom. There are five possible dining areas: Round table in the all-purpose room, kitchen counter, playroom, rear patio and end of living room. The shuttered doors at end of kitchen hide laundry equipment and provide extra storage space. Walls of boys' bunk bedroom are covered with fabric. Corner bedroom closet makes good use of splines in interior wall panels for attachment of plastic storage drawers. Pleasant informal living is the keynote of this colorful home. (For detailed information as to furnishings in home, write Bureau of Information, *Popular Mechanics Magazine*, 200 E. Ontario Street, Chicago 11.)

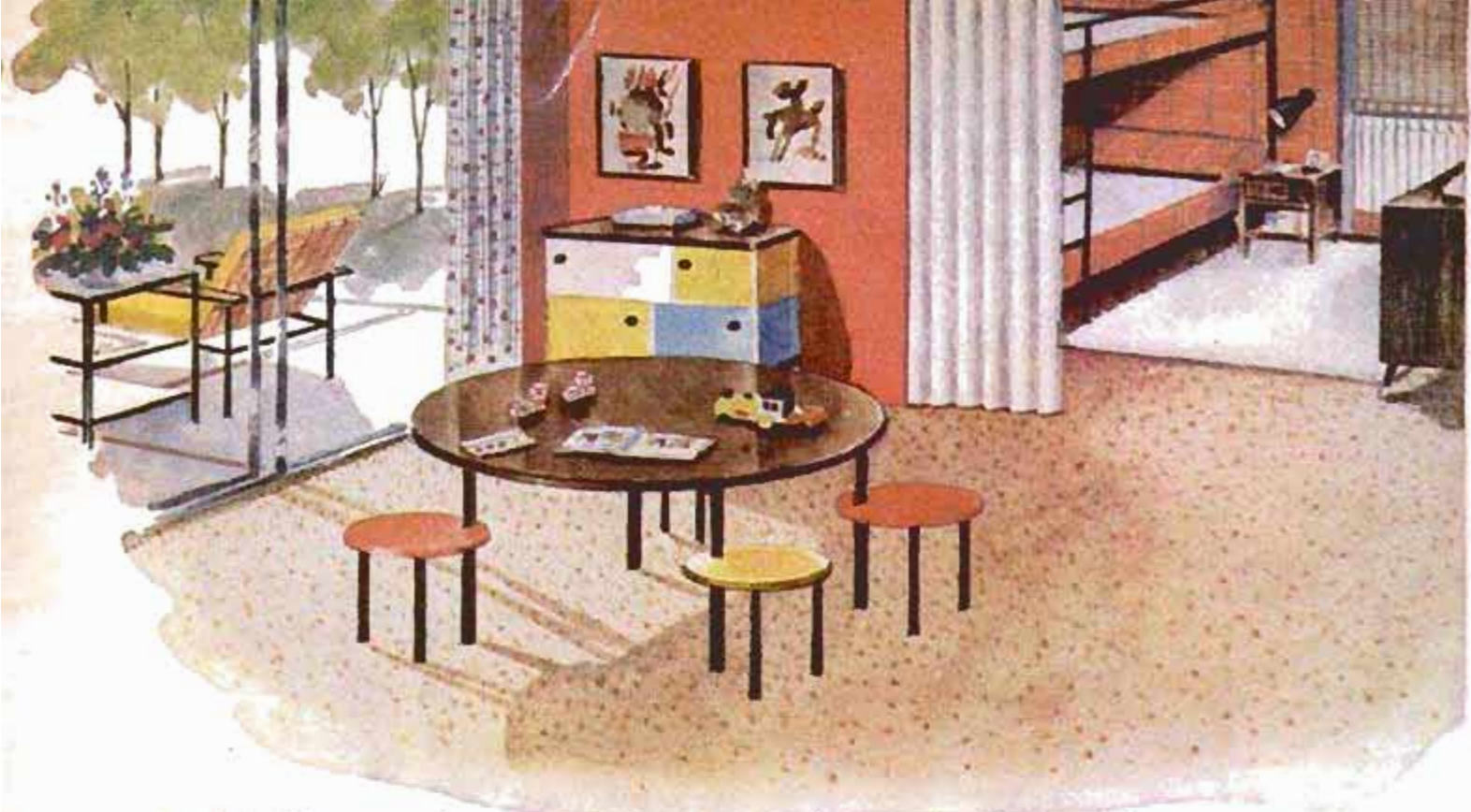

Detail of children's area shows corner of playroom and a glimpse into bunk bedroom. Glass doors lead to patio

today's houses. They had many suggestions.

The biggest problem in the new PM house was to devise some means of arranging the children's sleeping area (three bedrooms) so that they would not end up as tiny cubicles. This was accomplished by the use of folding doors and grouping the

bedrooms and children's bathroom around a play area which is 14½ feet long by 10 feet wide. By day, the doors fold back and give a spacious feeling to this section of the house. This feeling of space is increased by the sliding glass doors on one side of the playroom that open out onto the rear patio.

Sheltered rear patio affords easy access from children's area or kitchen. Area could be roofed and screened

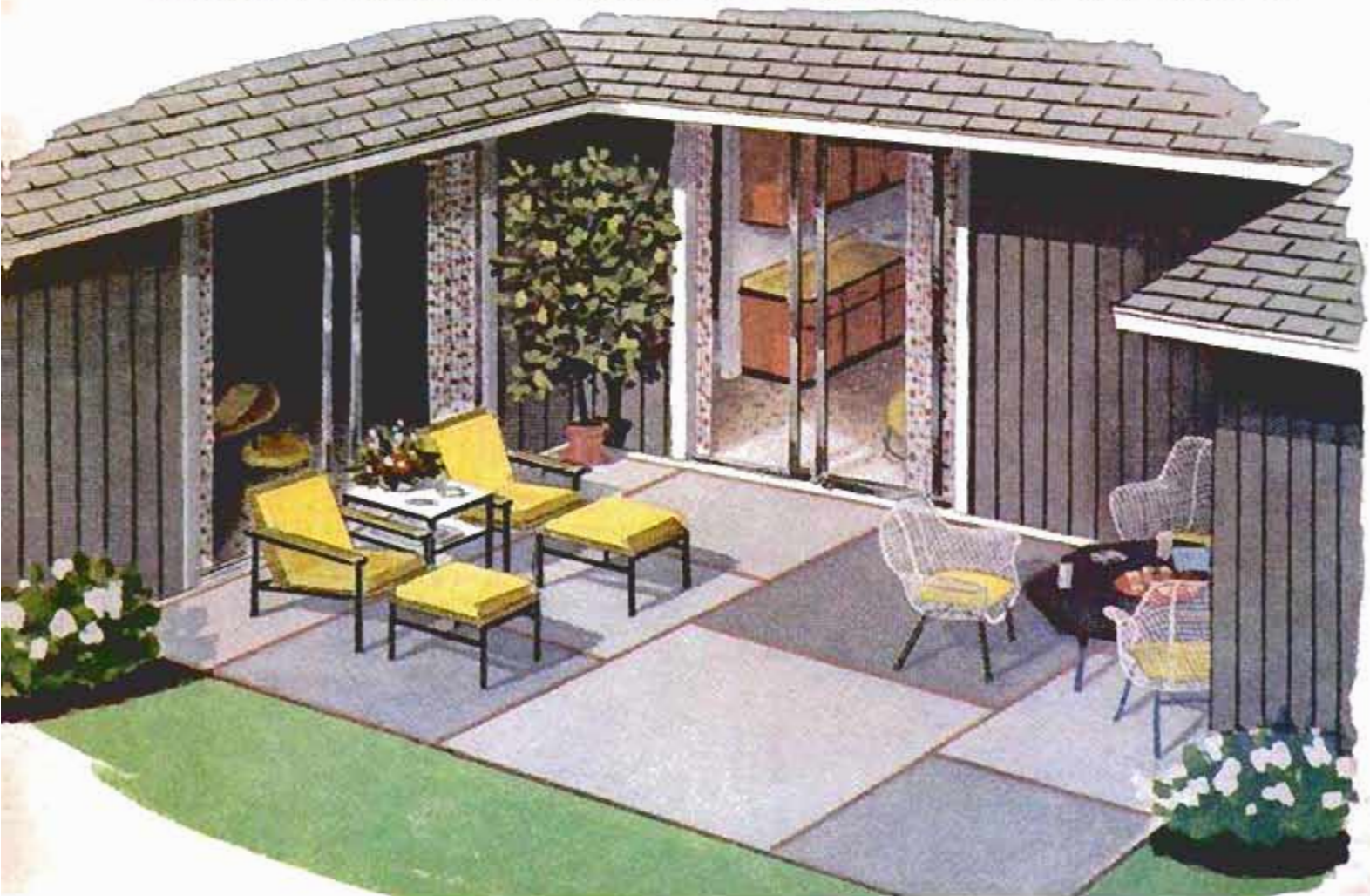

This floor plan with stairs in garage is designed for basement under the kitchen and all-purpose area. Laundry as shown or in basement is optional. Furnace and hot-water heater may also be located in the basement. The parents' bath across hall from largest bedroom also serves as powder room for guests. Children's area is remote from living room, and traffic by the children need not pass through any adult territory of house

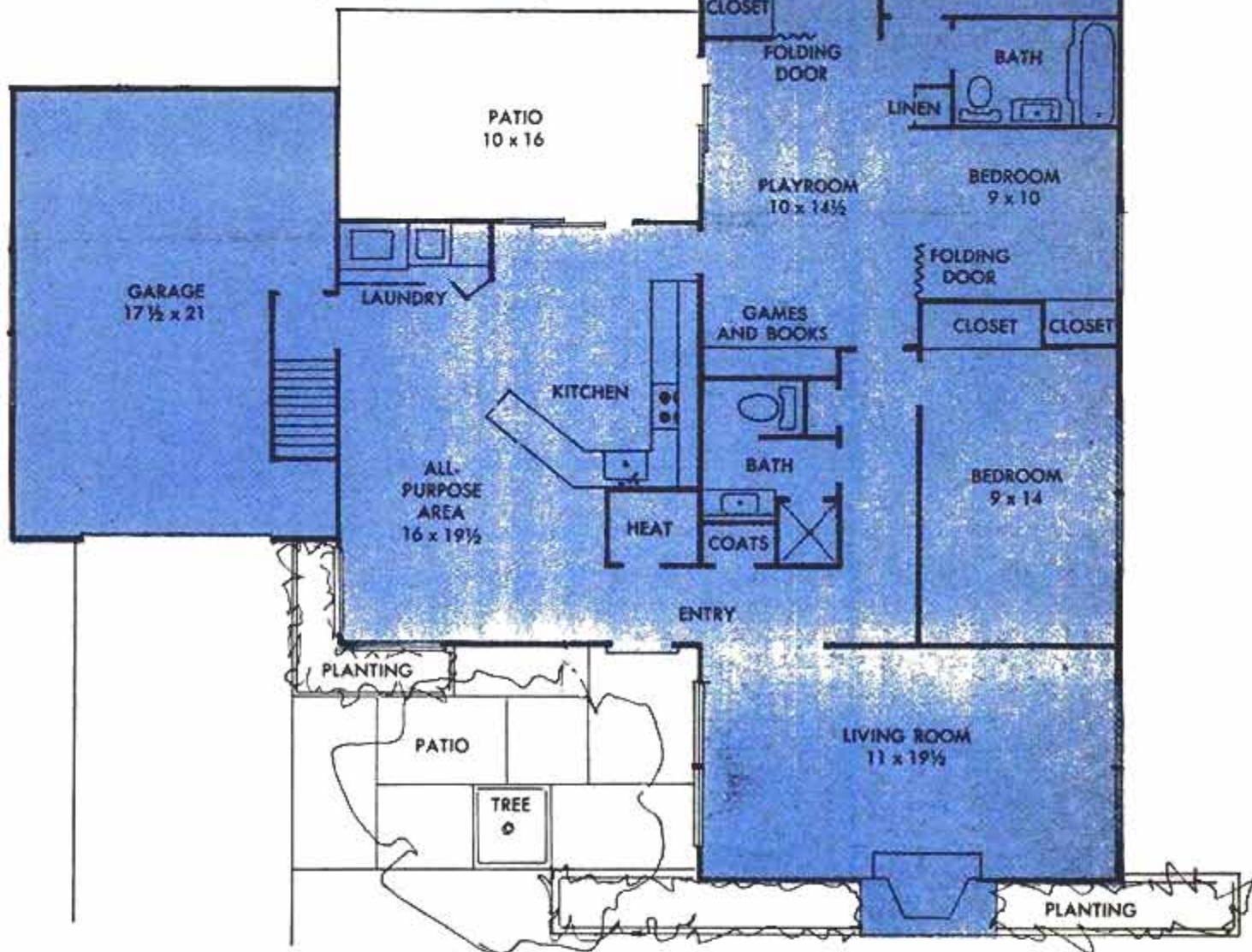

Another excellent feature of this section of the house is that the children can come and go by the patio entrance without disturbing the rest of the house. A door leads from the kitchen into the playroom, allowing for convenient supervision of the smaller children. If desired, children's meals can also be served with ease on a table in the playroom. One end of the playroom has a storage wall for games and books. This room is also a good place for the TV set.

A study of the two-page cutaway painting of the house (pages 162-163) reveals how carefully the designer planned for adult as well as children's areas. The kitchen and all-purpose section, which is 19 1/2 feet by 16 feet, is designed as adult territory except for dining. The living room

Interior walls are formed of Adjust-a-bilt panels which are two feet wide and joined by steel pieces as shown in diagram. Shelves or cabinets can be easily attached to slots in openings between panels

L. A. Darling Co., Bronson, Mich.

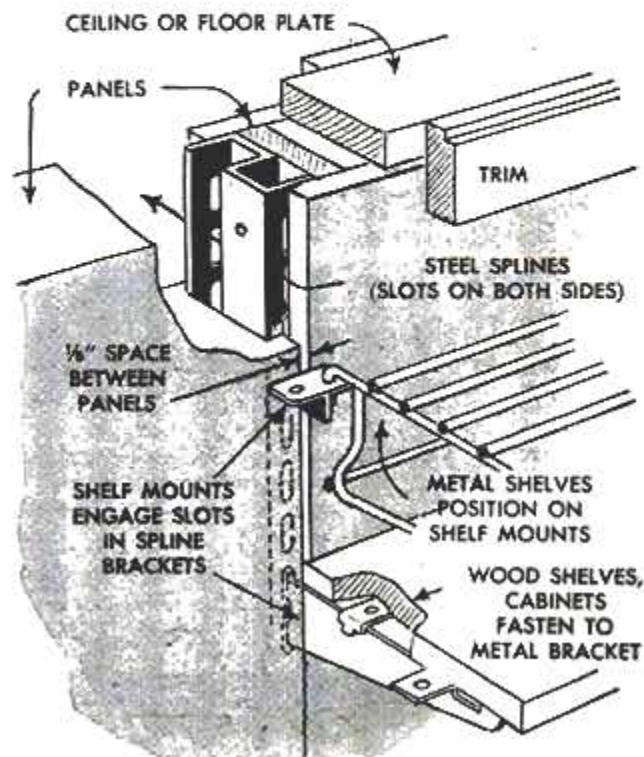



Angled counter gives smart touch to kitchen area. Laundry equipment is concealed behind shuttered doors.

is remote from the children's area with the parents' bedroom, a bathroom and closets forming a natural sound barrier.

The kitchen was carefully planned for convenience and accessibility. Here food can be served handily on the snack counter, to the dining table at one end of the all-purpose room, through sliding glass doors to the rear patio or to the playroom. Laundry and additional storage facilities can be located in one corner of this room behind shuttered doors. Space for the hot-water heater and furnace is provided along the cabinet wall. However, the laundry, furnace and water heater may be installed in the basement beneath this room if the builder prefers. The house can be built

either with a partial basement or on a full concrete-slab foundation. Without a basement, the only place available for a workshop is in the garage.

The living room, 19½ by 11 feet, is convenient to the entrance and guest closet. It has windows at either end and a fireplace on the long wall. The size of this room is in balance with the rest of the house, just as is the parents' bedroom which is 9 by 14 feet. Weist refrains from calling this room a master bedroom because the parents' bath is across the hall and also doubles as a powder room for guests. He believes that every part of a small home should be in perfect "balance."

(Continued to page 274)

Variation of the house plan has canted roof with fireplace at end of living room. This view is from the garage side of house. The vertical siding lends height.



Ceramic Tile Now Applied With Adhesive

By Jay W. Hedden

ONCE CONSIDERED a luxury feature to be found only in expensive homes, ceramic tile now has joined other modern materials to be included in houses in the medium-price range. Recently marketed, mastic-type adhesives that permit the tile to be applied to almost any surface, including plasterboard, have brought its installation costs much closer to those of other types of floor and wall coverings.

All three types of ceramic tile — glazed wall tile, unglazed floor tile known as ceramic mosaics, and quarry tile, the latter generally used for terraces and heavy-duty areas—can be applied with adhesives. Although elimination of the cement used in conventional tile application reduces the weight of a tiled wall or floor considerably, structural strength and alignment still are

Special grout is wiped over tiles and forced into joints, then excess is squeegeed off as shown below



Wall tiles are forced against the adhesive with a twisting motion. Projections cast on the tiles space them correctly

important. Only selected studs should be used in a wall to be tiled, and they should be cross-braced midway in height with 2 x 4 bridging. When the walls of a bathroom are to be tiled, the tub should rest on metal hangers fastened solidly to the studs so it will not be affected appreciably if the floor settles. When plasterboard is used as a base for ceramic tile, it should be installed horizontally on studs set on 16-in. centers, using cement-coated nails spaced 4 in. apart. The sealed edges of the plasterboard should be primed and placed next to the tub, allowing a space of $\frac{3}{16}$ in. There are

Damp sponge is used to clean tiles and smooth joints. Dry cloth is used for final dusting and polishing

Photos courtesy Tile Council of America, Inc.





After sheets of tile are aligned they are forced into adhesive and leveled with tile-setter's beating block



Minimum amount of water is used on paper, since moisture on adhesive greatly increases setting time

special primers made for application of ceramic tile with adhesives, but tile adhesive thinned with solvent may be used. The adhesive also is used for calking around pipes and between wall and tub. All joints in a plasterboard wall should be taped and cemented in the usual manner, then painted with primer. One coat of primer is enough for walls enclosing tubs, while shower areas require two coats brushed on at right angles to each other. It is recommended that flashing of 1-in. aluminum angle be installed in corners under the tile to minimize cracking and moisture penetration.

For application of the tile, the adhesive is spread thinly and uniformly on the sur-

Floor tiles do not require soaking with water before application of grout to joints as their absorbency is almost nil



face with a toothed trowel, after which the tiles are forced against it with a slight twisting motion. After all the tiles have been applied to the wall, the adhesive is allowed to dry for about 12 hr. The joints then should be soaked with water if the tiles were not soaked prior to installation. Next, grout is forced into the joints by hand, or with a sponge or squeegee. Grout used for wall tiles is a special kind chosen for its whiteness, low shrinkage and resistance to moisture. After the grout has stiffened somewhat, a damp sponge is used to smooth the joints, then the tiles are cleaned with a damp cloth and finally polished with a dry one to remove the fine cement dust. A final polishing may be done after the grout is dry.

Floor tile is installed in the same manner as wall tile, but with a different adhesive. To provide a firm, true surface for floor tile it is recommended that $\frac{5}{8}$ -in. exterior plywood be nailed every 6 in. directly to joists spaced 16 in. on centers. Even better construction is to nail $\frac{1}{2}$ -in. plywood over 1 x 6 subflooring nailed diagonally to the joists.

Mosaic floor tiles come pasted to 1 x 2-ft. sheets of paper to permit faster installation. The sheets of tile are pressed into the spread adhesive, then the paper is peeled off after being moistened with water. Floor-tile adhesives also require 12 hr. to set. Grout for floor tile is a mixture of waterproof portland cement, one part, and finely screened sand, one part, with enough water to make a workable consistency. ★ ★ ★



THIS OLD HOUSE IS YOUNG AGAIN

NEW HARDBOARD SIDING, modern windows, a cantilevered porch and entrance stoop, in addition to a complete remodeling job inside, have given an old home in Oak Park, Ill., a new lease on life.

When the owner bought it, the house was covered with asbestos shingles over the original narrow beveled-wood siding. It was located on a lot condemned for a new school addition and had to be moved three blocks to the present site. It was placed sideways on the lot and the old-fashioned front porch torn off.

The exterior walls were stripped down to the wood sheathing. Attractive awning-type windows were put in and a screened porch extended cantilever-style from a small concrete foundation. A sun-shield overhang ties in with the porch roof and is supported by wood beams extending across the living-room and entrance-hall ceilings. Adding to the modern effect is a semiattached garage at the rear with a wide overhanging flat roof.

The architect, W. Lockwood Martling,



From the inviting sun deck over the cantilevered screen porch to the modern entrance stoop on the side, remodeled home (top) creates an air of youth. Dormers on the roof are all that give secret away

Jr., renowned in the Chicago area for making new homes out of relics, went all out on the inside. A wall was removed between the old living and dining rooms, making one large room across the front of the house. Sliding glass doors at the dining end of this room lead to the porch. The original large kitchen was torn apart to make room for a powder room and breakfast area. A big entrance hall was provided with space for a closet. Partitions were ripped out on the second floor to make a master bedroom across the front. The remodeling also included all new plumbing. Exterior colors of soft blue siding, coral trim and yellow accents are continued on the inside. The architect even used modern landscaping for a "young" effect.

Peter Turchon of Homes, Inc., in Boston, buys and remodels 500 old houses a year. We asked him and his assistant, Charles Norton, to pass along a few pointers to our readers.

Remodeling Tips From the ROOFS

Roofs seldom need replacing, but nearly all need repairs. Leaks should be stopped, and rotted or worn shingles replaced in patches wherever needed. Any redecorating inside will be ruined if water gets into the house afterward. Flat roofs can be made watertight with an inexpensive coating of tar and gravel; asphalt shingles are best for slopes.

EXTERIOR REPAIRS

Never cover wood siding with any new surface. It's wasteful. Besides, a coat of paint looks better anyway. Masonry should be pointed up and rotten wood replaced. Occasionally, an ancient portico or porch can be torn off economically if sagging, or if the looks of the house will be substantially improved. Any exterior work should be regarded with caution as any major outside building changes are expensive. Do not put in more than you can get out.

STRUCTURAL CHANGES

Go easy here, but keep a careful eye on the essentials. Rotten wood in sills or studs should be replaced. The cause (usually poor outside drainage) should be removed. Masonry foundations should be repaired where necessary. To put a sway-backed house back on an even keel at low cost, set jack-columns on a firm base under the sagging beams and take up only a turn or two each day. If you try to do it all at once you will crack plaster. Disconnect all steam and water pipes so movement of the house won't snap old joints. Homes, Inc., straightened one house that had no firm basement floor for columns. Nine hydraulic jacks were used with nine men working them simultaneously. Two new 12 by 12 beams were placed under the house with the ends seated in prepared niches in the foundation wall. Then the house was lowered into place.

INTERIOR WALLS

Many old houses have crooked walls and plaster that is rough and uneven. Wall surface replacement is expensive. Wallpaper can cover a multitude of flaws. Cracks can be patched and papered over. Where walls are crooked, the effect can be dispelled by intelligent use of wallpaper patterns. Striped paper run horizontally around a warped corner will hide the tilt. Large patterns are best. Where plaster is rough, use a heavy pebble-textured paper.

CEILINGS

When ceilings are bad, a slick new ceiling of dry panels can be fastened to furring strips nailed through the old plaster. If old ceilings are too high they can be lowered a foot or two with a dry panel at reasonable cost. In kitchens or baths, ceilings can be dressed up even more simply and very effectively with one-foot-square dry panels that are simply stapled directly to the old ceiling without any furring. Materials for new ceilings are varied and good.

Nation's Top Remodeler

FLOORS

If floors are made of hardwood they can be sanded. However, floors in most old houses are soft wood and should be cleaned and repainted or covered with linoleum if they are pitted or splintered. Baths and kitchens should almost always get new floor coverings of asphalt tile or linoleum which are not expensive.

KITCHENS

Top priority should be given kitchens when it comes to redecoration. Old stoves should be torn out, also iron sinks and wooden drainboards. These can be replaced with low-cost modern units, many of which are available from mail-order houses. Some modern sink units can be purchased in kit form and are easily assembled. Metal wall-cabinet units (in banks to fit the kitchen layout) can be bought for little. Unpainted wood cabinets of the do-it-yourself variety may also be used. Walls may be covered part way up with plastic or metal tile if the wall surface is even. If not, wavy walls can be furred out and panel-type tileboard used. A simple coat of enamel paint can be used on good walls with excellent effect and for a tenth the cost. You can put a picture window over the sink for \$80 to \$120. Whatever you do make use of what the house has to offer.

BATHROOMS

Plumbing is the most expensive part of any modernization and should not be changed if it works well. If the old bathtub works try to think of some way to dress it up. Remember a new \$75 tub may require \$300 of plumbing revision. With new asphalt tile on the floor, ceiling tile stapled to the overhead, and with paint, paper or tileboard on the walls, even an old-fashioned bath can be made to look pretty good for a little money. Careful window treatment and good use of colors in the accessories are also important factors in the new-old bath.

WIRING

New fixtures can be installed in most old houses at slight expenditure and go a long way to minimize the shabby appearance of an old house. All old wiring should be checked carefully for safety and replaced where necessary. Extra outlets should be installed generously to accommodate modern appliances.

HEATING

Most old houses in the northern part of the country have adequate heating. If not, a hot-air floor furnace or oil-burning unit with hot-air outlet into the living room will do a passable job at reasonable cost. As far as the mortgage goes, this will satisfy most banks and insurance companies. Cold floors or walls may be corrected with insulation.



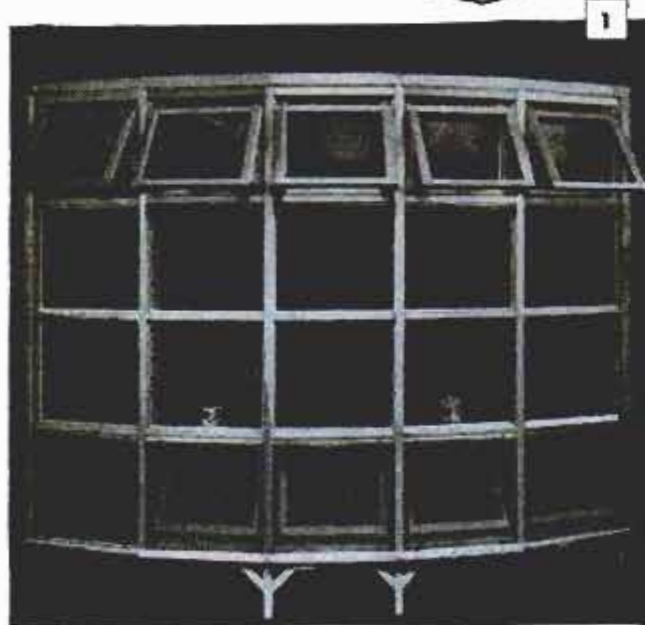
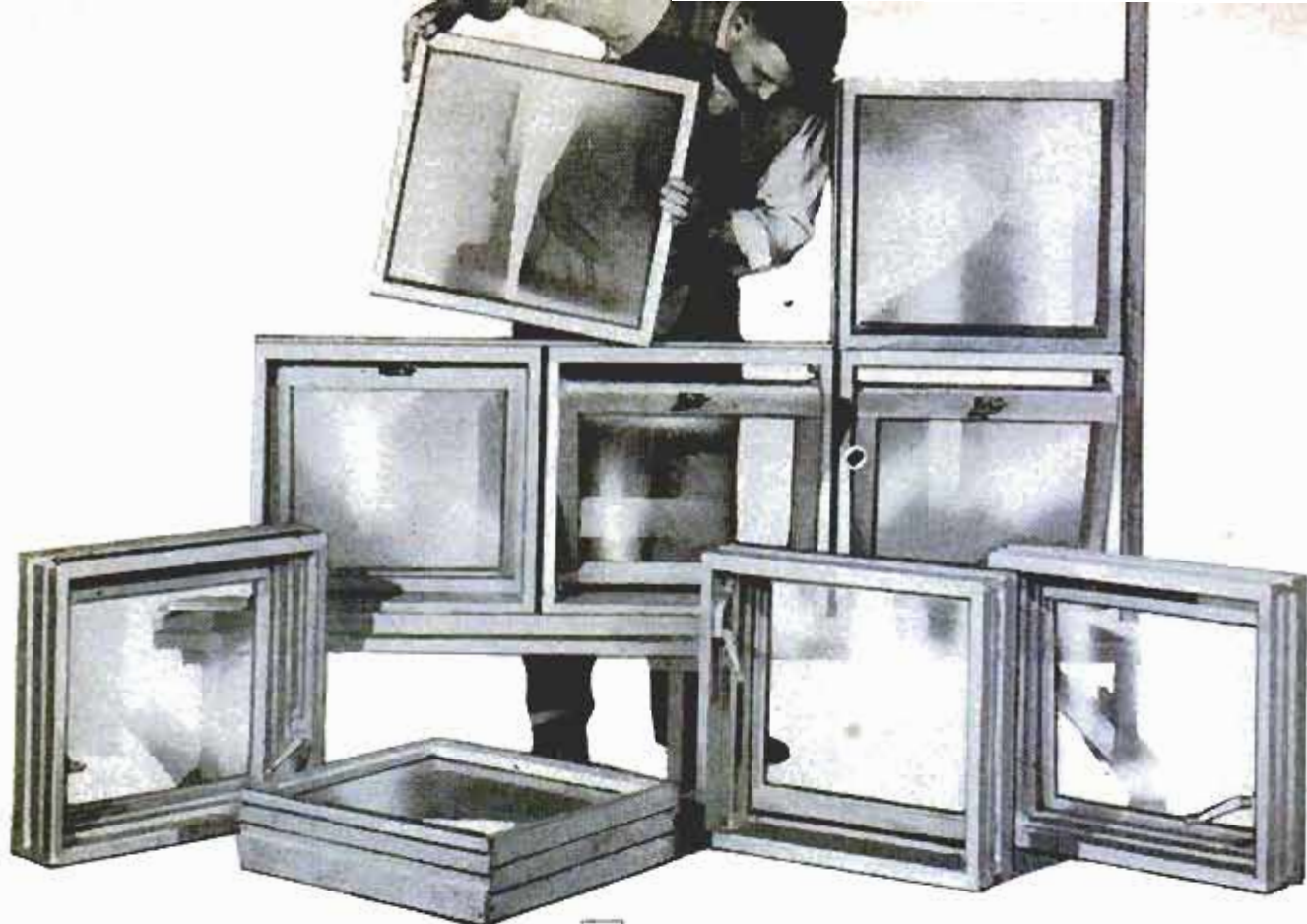

NEW IDEAS

1. SECTIONAL WINDOW UNITS can be set up to suit the builder's taste. The jambs on all sides "nest" into adjacent units. They are supplied in 24 shapes and sizes, awning, hopper or stationary

Woodco Corp., North Bergen, N. J.

2. SCALE-MODEL KIT gives home planners a three-dimensional preview. Kit contains 175 parts scaled $\frac{1}{4}$ inch to the foot—the same scale used for blueprints. The parts interlock and require no tools

National Plan Service, Inc., 1700 West Hubbard St., Chicago 22.

3. "WASHBOARD" WINDOW made of Plexiglas is designed in louver style for control of heat and glare. Each section has a transparent and opaque surface to diffuse the light. It does not open

Luria-Cournand, Inc., Havre de Grace, Md.

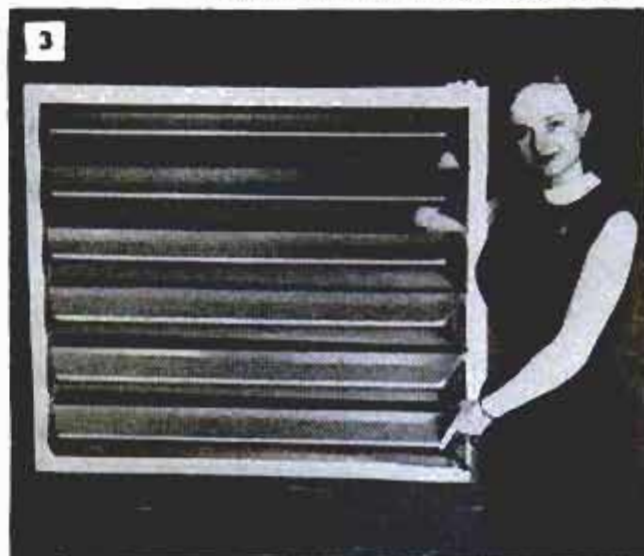
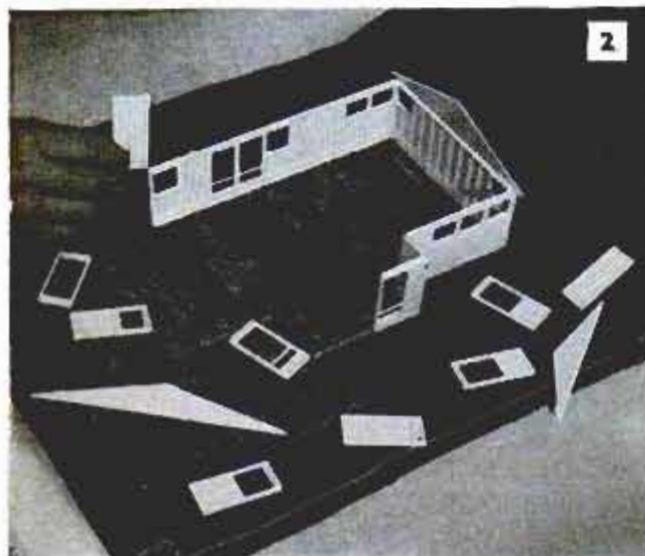



4. ELECTRICAL OUTLET COVER prevents children from sticking metallic objects into openings which may result in serious shocks. It also prevents pulling out plugs. Plastic cover is easily installed in about two minutes without tools or any rewiring.

Robert Brody Co., 3 Coenties Slip, New York City 4.

6. PLASTIC PANES prevent passage of ultraviolet light that is harmful to materials in homes or show windows. The panes permit passage of 50 percent of visible light and are almost unbreakable. They are available in a variety of light-fast colors.

Firestone Tire & Rubber Co., Akron, Ohio.



OCTOBER 1956

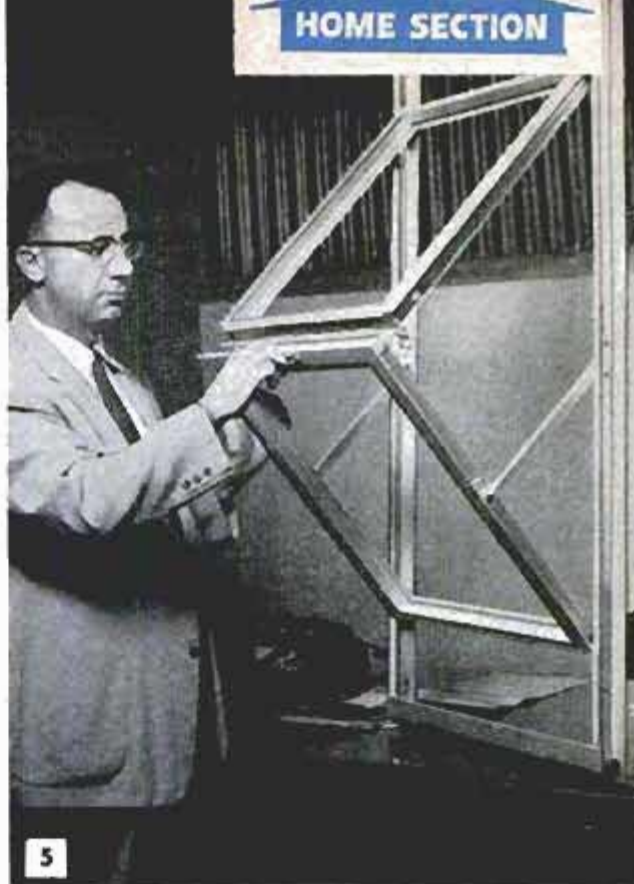

5. JACKKNIFING WINDOW projects into the room when open, making it easy to clean both sides of the panes. When closed, window seals tight and is locked with a key. It was designed for air-conditioned buildings and can be installed horizontally.

Marmet Corp., Wausau, Wis.

7. WOODEN BRICKS can be made of short pieces of 2 by 4 and 2 by 6 lumber for building walls or room dividers. They can be locked together with dowels or glued like regular bricks for non-load-bearing partitions. Bricks can be homemade.

Timber Engineering Co., Washington, D. C.

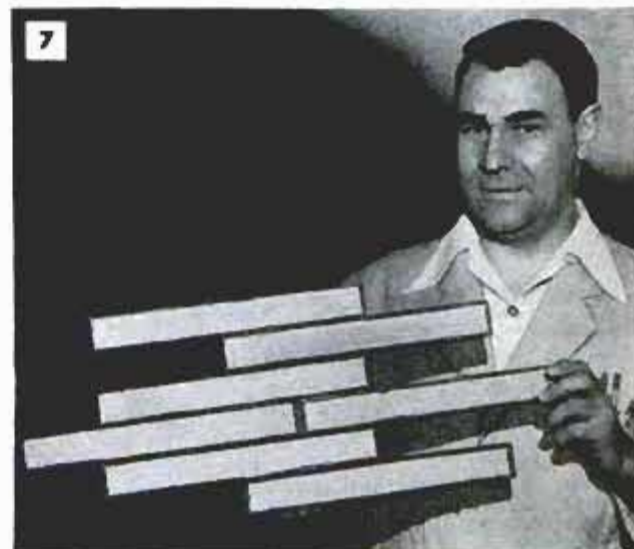

173



The Murphys at work on their new home—Frank attaches light fixture and Evelyn is busy fitting shutters

WE ARE SAVING \$4225 BY

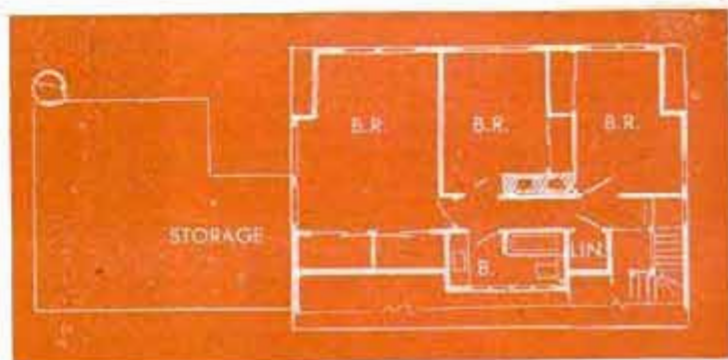

Not including garage or storage above it, the house plan provides 1985 square feet of living area. The Murphys designed the house themselves and hired an architect to make the working drawings. It has a full basement. Left, Frank at work stapling insulation between studs in the two unfinished bedrooms

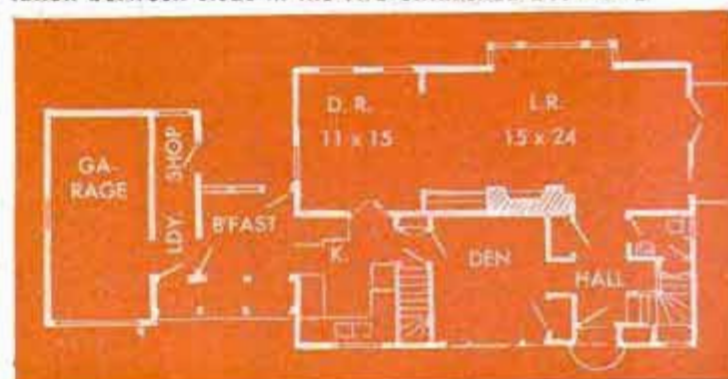



Small Julie takes it easy while her busy parents fit shutters to windows under narrow decorative porch

FINISHING THE HOUSE OURSELVES

By Frank and Evelyn Murphy

LIKE EVERYONE ELSE who wants a new home, we talked and planned for several years. Somehow, all of our talks about the house ended at the same dead end: Our needs and plans called for more house than we could afford.

Then we would start cutting back. Out would go the fireplace, the extra den-bedroom, the breakfast room and so on. This would result in the gloomy conclusion that we would be as well off in the old house. So we waited. Eventually we bought a lot in the wooded section of our suburb, Glen Ellyn, which is 25 miles west of downtown Chicago.

"We'll have the money to build the kind of a house we want someday," Frank would say.

And Evelyn would reply: "Yes, but we want it now while the children are growing up—not after they're gone."

Our children are Tommy, age 8, and Julie, 3. We are in our middle thirties with no prospects of getting any younger.

One night Frank, who is a commercial artist, was turning the pages of *Popular Mechanics* when he looked up with a gleam in his eye.

"It says here that 60 percent of the

builders of new homes plan to do part of the work themselves," Frank said. "Do you suppose we could swing our house financially if we can get a contractor to let us do several thousand dollars' worth of finishing on the job?"

"Like what?" Evelyn wanted to know.

"Like painting, staining woodwork, papering, maybe putting on the insulation, finishing the upstairs rooms, bathroom tiling and certainly all the landscaping."

We grew more enthusiastic as we talked far into the night and for the first time our gray-shingled dream house with white trim took on a tinge of reality.

Two nights later we nervously presented our beautiful plans to Harvey Mickelsen, a top-notch contractor who has built many fine homes in our area. Our house was to be colonial, or Cape Cod, in style with modern touches such as a living room to the rear with big windows looking out at the woods in back. The first floor also included dining room, kitchen, breakfast room, a den-guest room and lavatory. We eliminated the central hall of traditional design because of the wasted space. Our staircase goes up under the eaves to three bedrooms and a bath on the second floor. Extra space and light for the second floor are provided by big dormers, both front



Half the battle in hanging wallpaper is having the right tools, Frank reports. His helpers declined to comment. Below, first coat of paint goes on plastered dining-room wall. All woodwork has natural stain



and back. Floor area of the house totals 1985 square feet which, of course, does not include an attached 1½-car garage adjoining the breakfast room. Eventually, the garage will be partitioned for a workshop and laundry.

Mr. Mickelsen liked the plans but reminded us that building costs in the Chicago area are about the highest in the United States. This we knew, and we told him that our only hope of getting a permanent home that would supply all our future needs was to be permitted to do some of the finishing work ourselves. He explained that we were tackling a big job that might take a couple of years out of our lives. Would we be willing to give up all our free time to the task—nights, week ends, vacations? We would. Then, while our hearts leaped with joy, he agreed to let us handle the painting "contract," the application of all insulation, staining of all the natural birch woodwork throughout the house and the kitchen cabinets, finishing of three bedrooms and bath on the second floor and the landscaping. His bid would include full basement and a slab for the screened porch that will someday adjoin the living room.

Blueprints Cost \$250

We got two local architects, Gerald Perkins and Michael Mulloy, to make the blueprints and working drawings from our sketches. This cost \$250. Before Mr. Mickelsen bid on the plans we learned that our loan company demanded that one bedroom and bath be finished on the second floor by the contractor. We were to be allowed to do the floor and wall tiling in the bathroom. Mr. Mickelsen then gave us job estimates on our do-it-yourself projects:

Painting and decorating (including window sash, all outside trim, staining and varnishing woodwork and cabinets, paper hanging).....	\$2000.00
Insulation (labor)	100.00
Tiling bath (floor and tub wall) ..	150.00
Finishing two upstairs bedrooms (including dry walls, woodwork, closets, flooring, decorating).....	975.00
Landscaping	1000.00
Total \$4225.00	

Mr. Mickelsen warned us that there would be extra costs and possibly unforeseen expenses. This was too true, especially in the case of 150 feet of special sewer line we had to put in, not to mention the driveway we had completely overlooked. We also decided to go all out on the fireplace wall, a built-in bookcase, hardwood, multipane windows, a custom-built colonial staircase, and other refinements.

We broke ground on July 11, 1955, and moved in on New Year's Day, 1956. This



After shellac and varnish came the rubbing. "I rested by thinking of the money saved," says Evelyn

was good timing for our do-it-yourself chores because we got the outside painting and insulation work done in good weather. We painted the window frames as soon as they were delivered to the job to prevent warping. In our enthusiasm we painted them inside and out, forgetting that we were having natural woodwork within. This entailed a later tedious job of paint removal. As soon as the trim went on, one or both of us was there with a paintbrush. The contractor loaned us a hammer-type stapler for the insulation and this job took a couple of months of Frank's spare time.

We have congratulated ourselves from the beginning on our selection of stained shingles for siding. They saved painting.

After the house was closed in and the heat on we tackled the woodwork. This meant staining, a coat of shellac, two coats of varnish and then rubbing. Nail holes were filled after the staining. We learned the hard way that you can't use the same stain on the filler, but must use dry pigment to get the correct shade. We acquired a wallpapering kit which we think is easily worth its weight in gold.

Moving into an unfinished house with your children can be whatever you want to make it—a harrowing experience or an adventure. Two of our upstairs bedrooms have walls of studs and bare insulation. You have to step across the conduit on the unfinished floors. When we first moved in the shingle siding was not yet on and small birds could easily slip through the knotholes

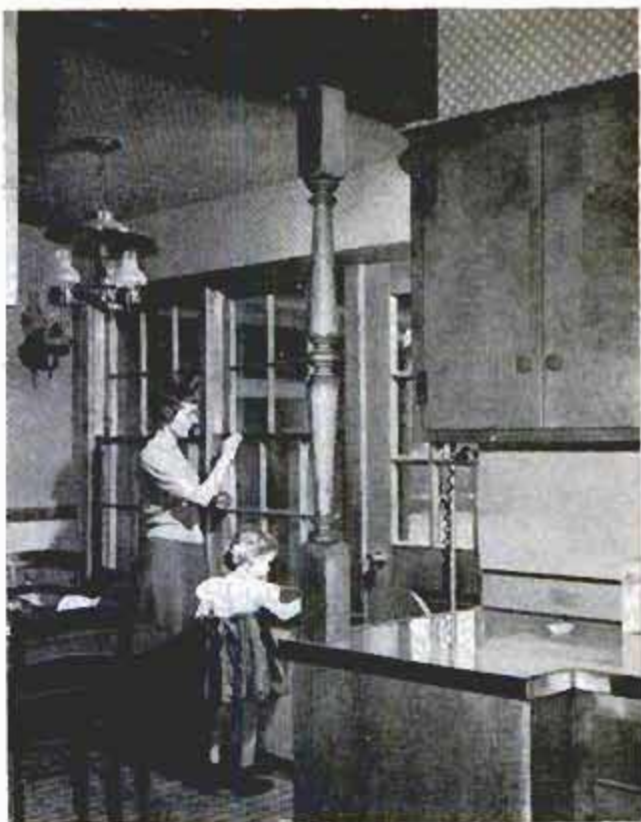

Filling nail holes with putty was a long and tedious job. Dry pigment was used to stain the putty

into the bedrooms. The children loved it.

Sometimes we feel like a couple of mountain climbers trying to scale a peak. We are much too far up the mountain to turn back if we wanted to and from time to time we get a view of that shimmering peak—our finished permanent home. ★ ★ ★

Young Tommy demonstrates how slick sliding doors work on his bedroom closet. All woodwork is birch

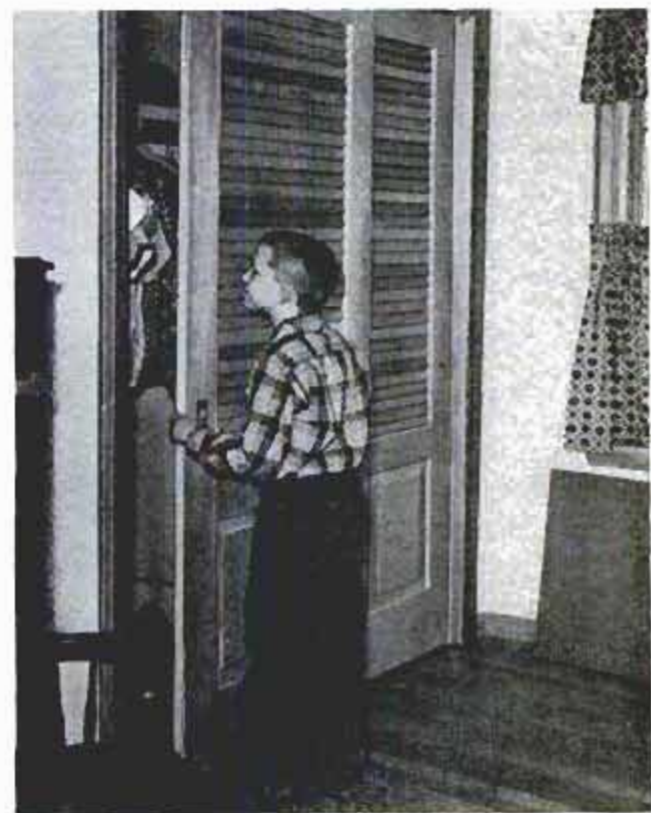

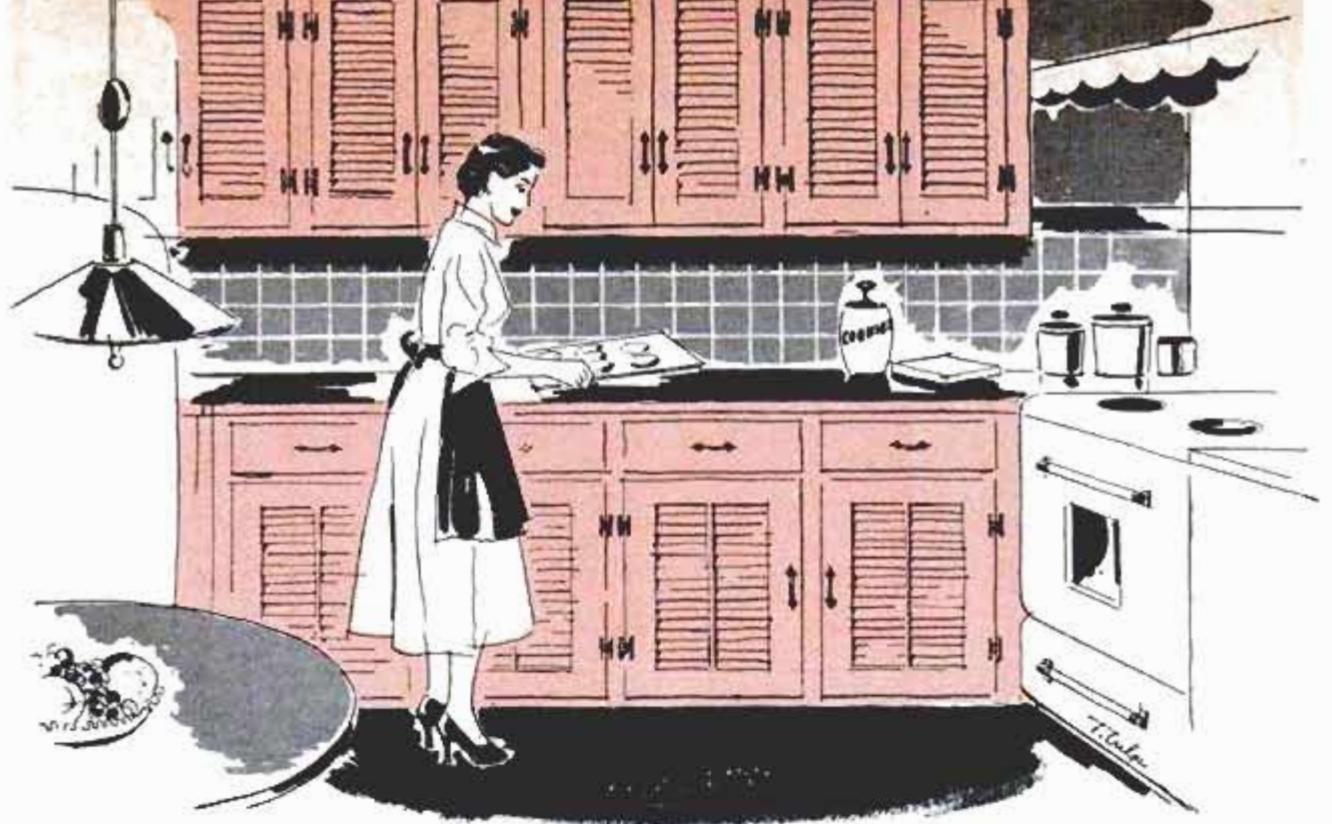

When planning a new kitchen keep in mind the decorative value and practical utility of shutter doors. They are always in character, add a touch of the seasoned provincial to modern kitchen decoration

SHUTTERS ARE BACK AGAIN

By W. Clyde Lamme

AN INTERESTING TREND in present-day interior decoration is the use of shutters to attain a pleasing and livable harmony of old and new. In modern homes the warmth and distinction of interior shutters have been rediscovered by decorators and homeowners alike. New applications have been worked out for today's larger windows and closet doors, also in multi-

If you have an expanse-of-wall problem or a wide, plain doorway that seems to have no solution decorative, think of tall, folding shutters with medallions

purpose rooms where doorway and window treatments assume new importance. On kitchen cabinets, shutter doors serve a threefold purpose. They are attractive without any out-of-character feeling, conceal contents of cabinets and provide ventilation. Closed, shutters give solid-wall privacy to window walls, make the perfect background for indoor greenery. ★ ★ ★

Shuttered windows recall the old, combine it with modern decoration. Shutters can cover only window or run from floor to ceiling for a feeling of height

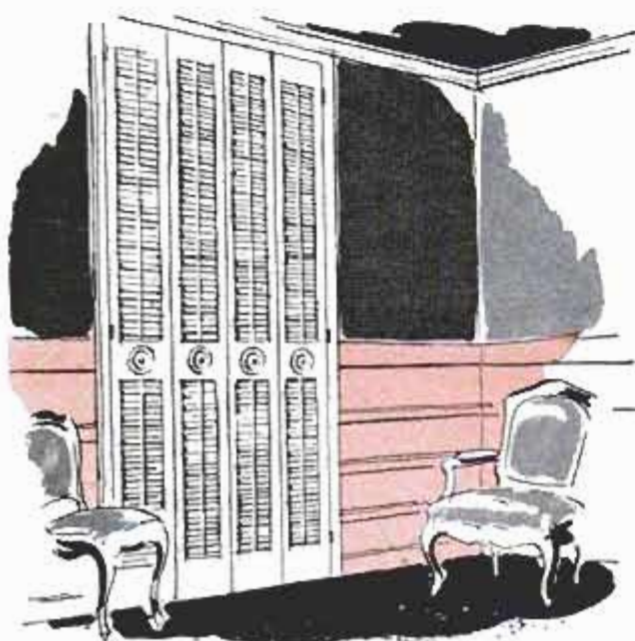

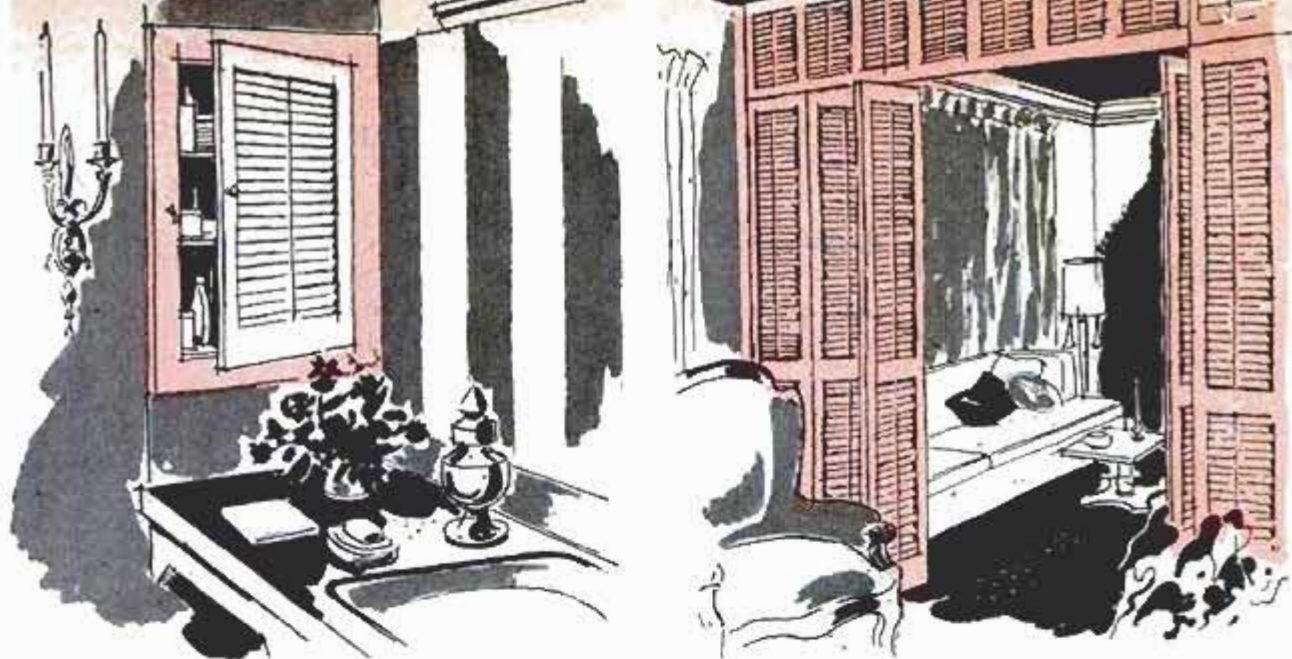

Shutter door solves the problem of what to do with unsightly built-in shelves you often find in older homes. The door makes an attractive closure and contents of shelves need not be selected for appearance

Remember the combinations possible with shutters and you have a solution ready when the problem of room dividers comes up. In this application shutters in upper row are fixed. Those below fold accordion-style

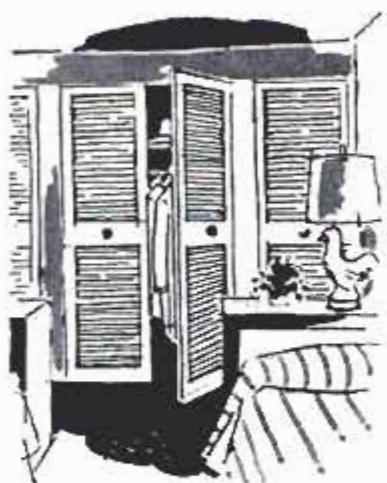

Full-length shutter doors do two things for a clothes closet, hide contents from view and provide adequate air circulation

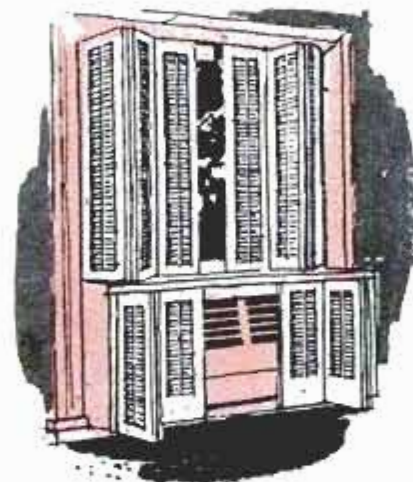

If the radiator under a window baffles you, try this solution. As you can see, it really works. Both sets of shutters fold flat

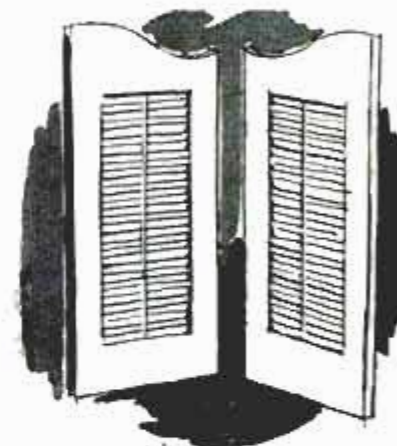

Can you think of anything better to open way to basement recreation room than old-fashioned swinging "saloon" doors?

Reshape a corner effectively with a folding screen of shutters made with movable slats above, solid panels in the lower half



In older homes the classic room divider with its square or round columns and ponderous woodwork is well replaced with shutters and companion planters for real or artificial greenery. The middle shutters can be arranged either to slide on rails or swing out



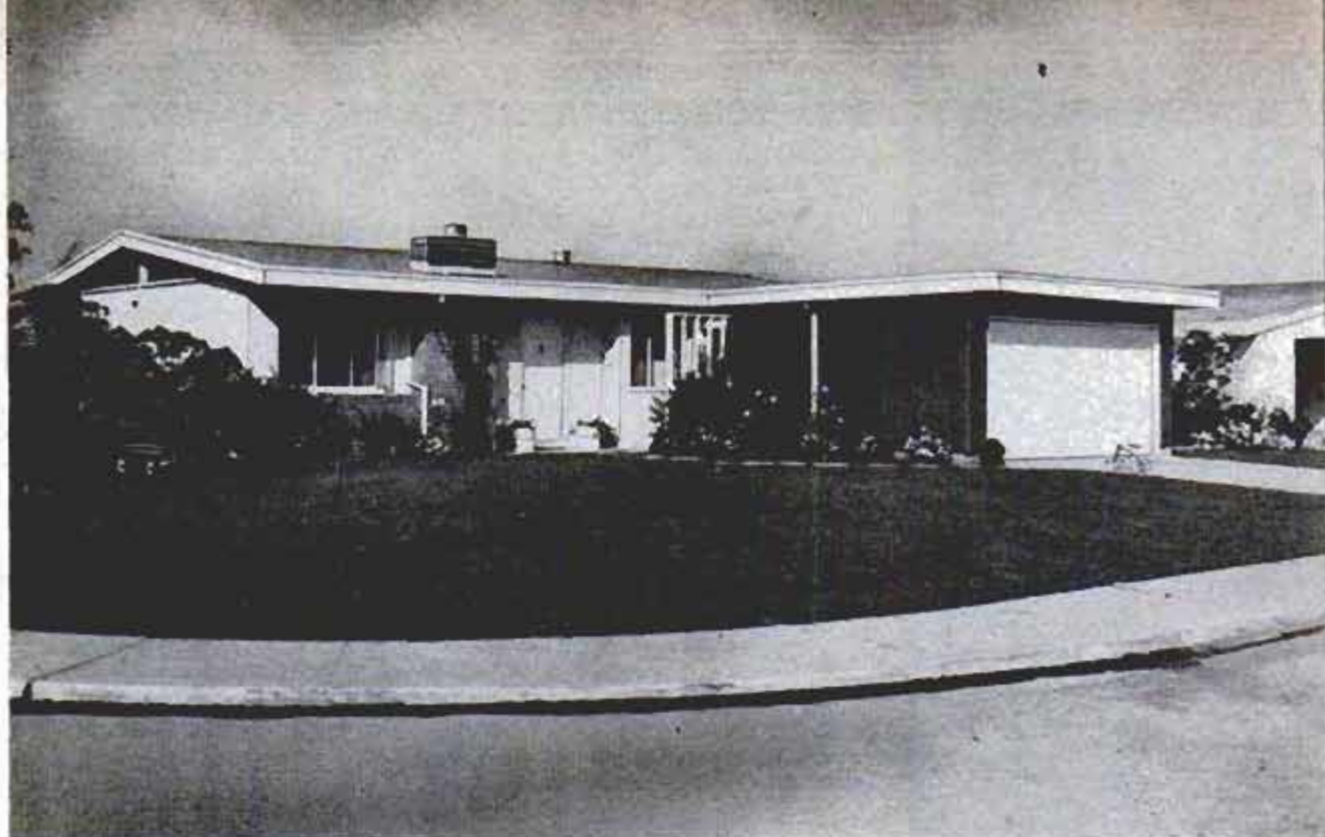

This is one of the attractive low-cost McKellar homes now being constructed in San Francisco and Sacramento

*A three-bedroom, two-bath house for \$12,500—
here's how one West Coast builder offers*

More House for Less Money

By Tom Riley

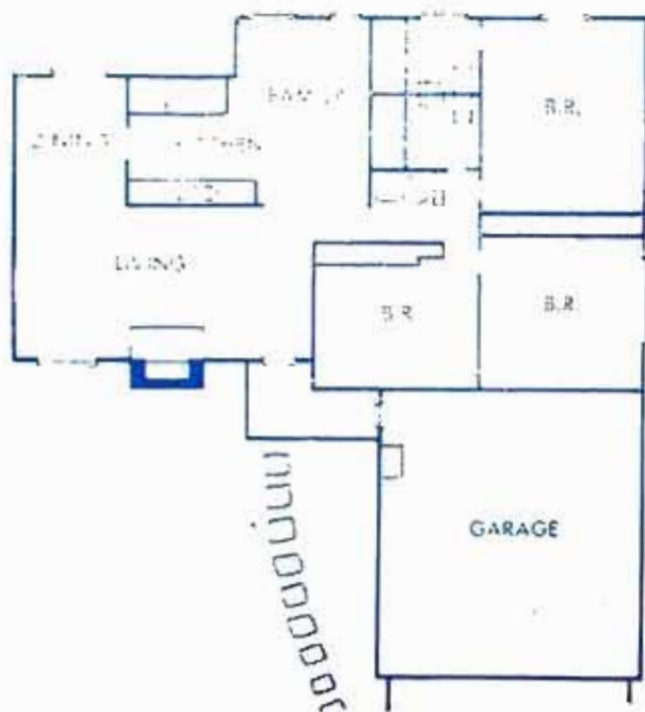

THIS IS THE INSIDE STORY of how one large contractor is building houses today. The contractor is McKellar and Associates of Menlo Park, Calif. In these times of high prices, the story is of genuine interest to any homeowner, as well as to professional builders. Why? Because McKellar has been able to produce large numbers of well-built homes around San Francisco, Sacramento, and Las Vegas—three-bedroom, two-bath, double-garage homes with 1200 square feet in the house plus 456 in the garage at \$12,500 to \$13,500.

What really flabbergasts the visitor is that these homes are in neat subdivisions with paved streets and sidewalks, with the sewers in, front lawns and a paved patio in each back yard. Each house is equipped with the latest in dishwasher, disposal unit, range, automatic washer and clothes drier. Everything is included at the price.

How does this contractor do it? These

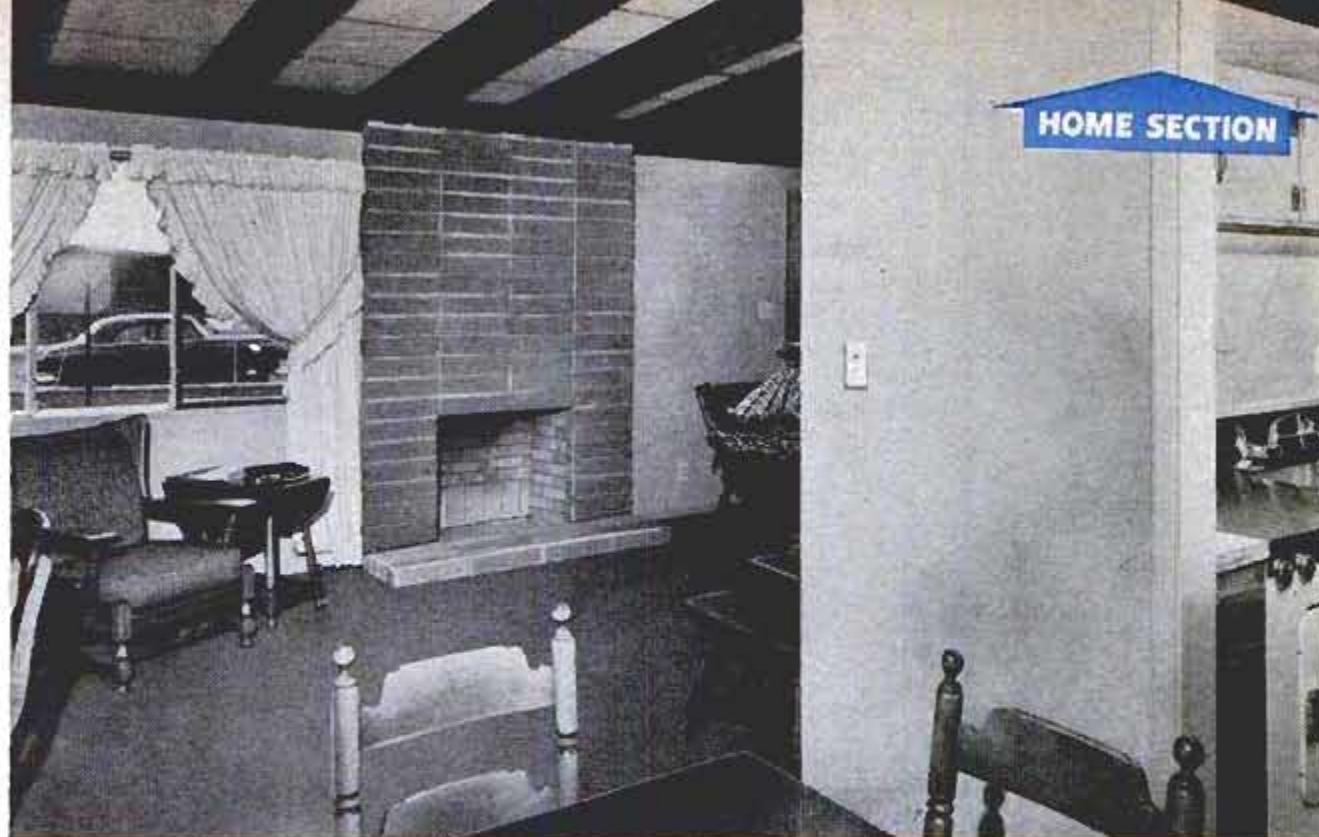

View of the living room from the dining area shows the fireplace, beamed ceiling and glimpse of kitchen

houses are not just thrown together. They follow standard construction methods and fully pass FHA specifications. In fact, each McKellar house is sold with a full guarantee by the builder against any structural defects for an entire year, even to a sticking door or crack in the ceiling.

One answer is that the firm builds these homes in large tracts of 200 to 500 houses. But that is only a small part of the story. The general manager, Ralph Calcaterra, is a genial but alert man who spends little of his time supervising. He leaves that to able assistants and spends his time on his tracts and elsewhere searching for less costly and better ways to build houses. As a result, he has found a bagfull of proved tricks and simplifications. Many of these can be used by anyone building a house anywhere in this nation.

Cost-Saving Tricks

"You may need to make some modifications for houses in different regions," says Calcaterra. "For instance, steeper roofs in areas of heavy snows, but such things will be in your local codes. What you will not need is special or hard-to-get material."

The how-they-do-it starts right with the foundation. Most of these houses are being built with concrete slab floors. A dozer levels the ground—to the same level for the house and the garage, which is quick and easy to do. Then a rough ditch is dug around the perimeter of house and garage to the depth of the foundation walls needed. Two men quickly set up reusable plank forms with iron stakes and iron braces

around the outside of the house and garage. On the inner side of the house foundation walls, they use steel reinforcing rod for stakes and Steeltex, a wire-mesh reinforcing with a building-paper backing, for the form itself. That form will remain there. While the forms are going in, a small plumbing crew is placing all the waste sewage lines of the house. Sometime in the afternoon, a ready-mix concrete truck roars up. But, instead of concrete splashing from its trough, coarse gravel for the base of the slab rattles out.

Gravel Poured, Too

Calcaterra had noted that the concrete trucks usually are idle in the afternoons (no one wants concrete delivered late) and so he thought of asking the cement companies to deliver gravel in their ready-mix trucks. The trucks spread the gravel out evenly over the house floor with their troughs, saving many man-hours of shoveling gravel from dumped piles. This has proved a boon to the cement companies—carrying the gravel cleans out the ready-mix drums, eliminating periodic chipping of dried cement from the inside.

Another saving enters here. The gravel is laid thick for the slab of the house, thin or not at all for the floor of the garage. Calcaterra finds it less expensive and better construction to place reinforcing wire mesh in the garage-floor slab, rather than to place gravel below an unreinforced slab. And this way the garage floor will be the 4 inches below the house floor that is required by most building codes, without

grading to two levels and without having complicated forms.

Precut Lumber Used

While the concrete is curing, a lumber truck backs into the space between two houses and drops the framing for the walls of both houses in two huge banded bundles. This lumber is fully pre-cut to exact lengths at a lumberyard. Each piece is numbered and stacked so the first piece needed will be at the top of the pile. Practically all a carpenter needs to bring to the job is a hammer, and four carpenters can erect the pre-cut stud walls of a house in one day flat. That isn't just the outside walls, but also the interior partitions and door and window openings throughout. The lumber truck makes a second trip and drops two more bundles, pre-cut roof lumber this time for the two houses. Mainly, this is 4 by 6 ceiling beams that the carpenters simply drop in place in pre-cut notched beams and nail down. The carpenters completely frame the house, roof and everything, in 56 man-hours. A lone painter now appears on the scene with a stepladder and he starts painting the 4 by 6 ceiling beams as they hang there exposed to the sky. He primes and finishes them, brushing on the final color or stain desired in that particular house.

Roof Is Put On

Meanwhile, the carpenters are installing the finished doorframes and metal windows. The window frames arrive at the site complete with metal sills and with the glass already installed. A mason crew has

also appeared and now is erecting a fireplace by the standard method. When the paint on the ceiling beams is dry, a roofing crew bounces onto the lot in a truck with a lifter bed that hoists large 2 by 8-foot sheets of Simpsonboard or Firtex to the roof. This is the roof sheathing, a heavy 2-inch-thick panel of laminated softboard that looks like giant ceiling tiles and has a heavy tongue-and-groove joint around the edges. The roofing crew lays this sheathing in place, saws and fits it around all roof openings with a portable electric saw, and nails it down—all in two hours. The new softboard sheathing is the same as the comparatively weak ceiling tiles we all know, but on the brick laminated layer the roofing crew walks with less care than usual. The material is stronger than ordinary $\frac{3}{4}$ -inch wood sheathing, according to the manufacturer. Over the sheathing, the roofing crew lays a standard three-layer mopped roof, finishing it off with granite screenings, dolomite or colored rock for a top-grade gravel roof.

Odd-Looking Houses

At this point, the McKellar houses have a definitely unusual appearance. The windows are fully completed, seemingly ready for draperies and curtains. The fireplace and doorframes are also finished. But the walls elsewhere are just bare studs. You can step through a wall, almost anywhere, and find to your surprise that the ceilings throughout the house are completed! These are open-beam ceilings in the modern manner. The beams are already painted. Since

(Continued to page 285)





1. Here are some of money-saving features used in construction of these houses. Gravel is poured from ready-mix trucks, saving many man-hours of shoveling

2. Every piece of framing is precut and numbered at mill. Picture shows packages containing lumber for side walls of two houses dropped between two sites

3. Giant ceiling tiles of softboard are roof sheathing and also insulation. Tiles are two inches thick, can be laid in place quickly to cut costs

4. First layer of the three-layer roofing is laid directly over sheathing. Roofs in the background are completed, topped with light-colored rock

5. House is strange looking with windows installed, and ceilings all painted but no walls. Opening at left is for fireplace, which masons will put in shortly

6. Exterior is finished in stucco, applied through a hose by Gunitite process. Two coats are applied by hose. Trowel men follow behind to smooth finish

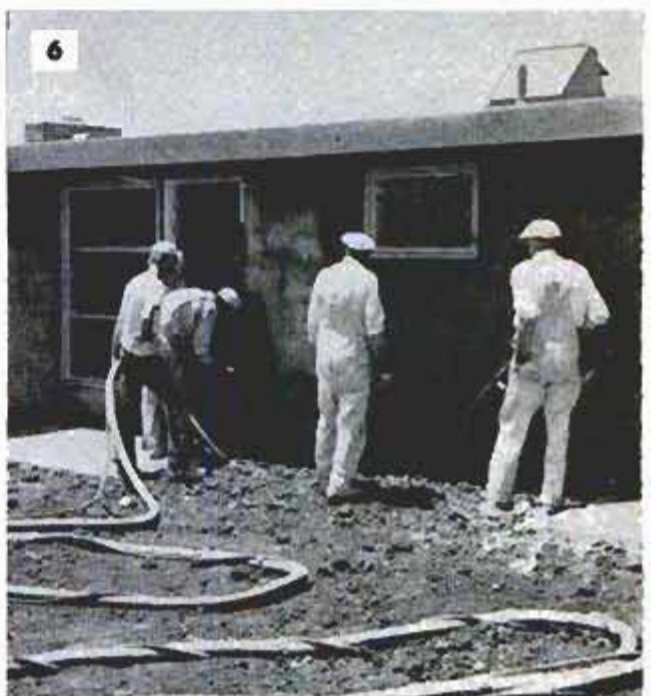
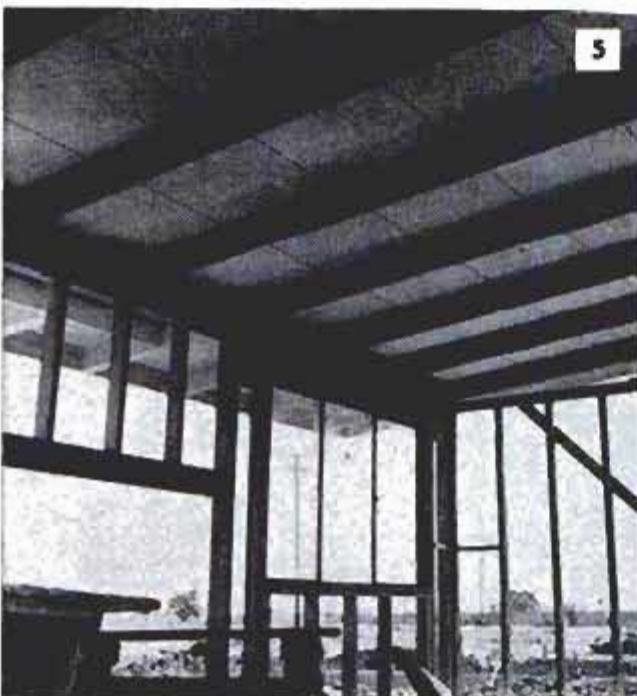
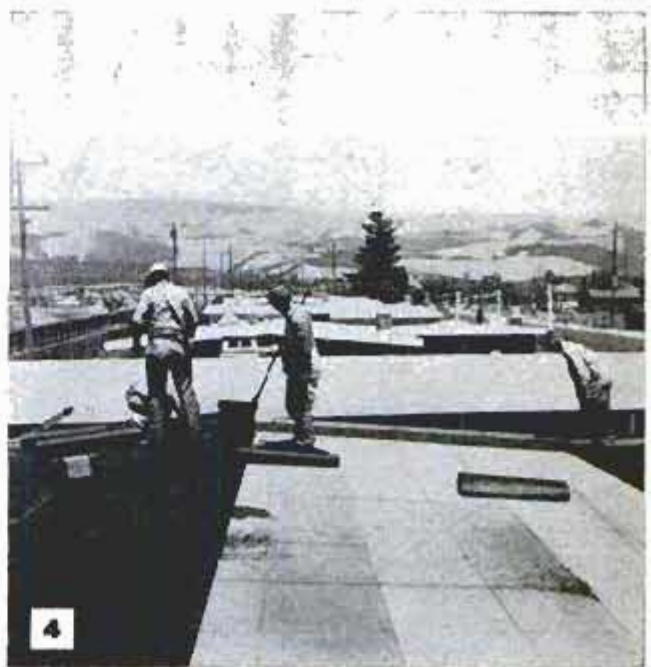
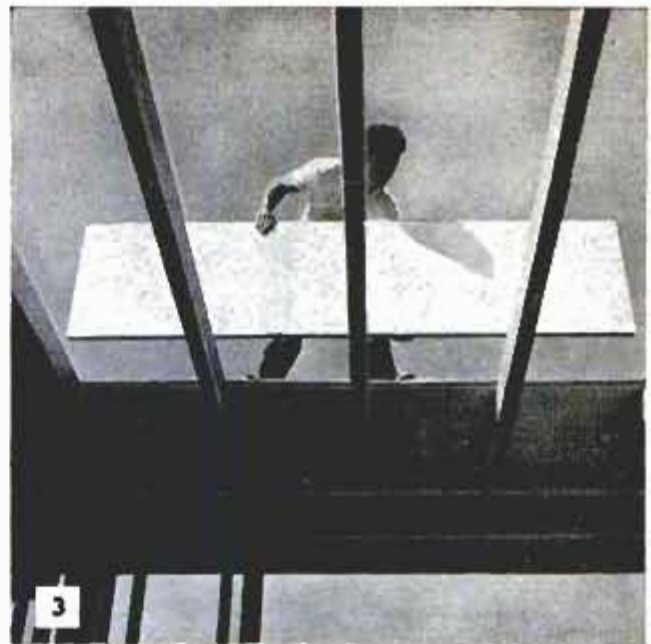

YEAR-ROUND CHECK LIST

FOR HOUSE AND YARD

JANUARY



Repair furniture.
Fix faucet leaks.
Change furnace filters.
Prune fruit trees.
Inspect plant mulching.
Feed the birds

JULY

Paint trim.
Check flashing.
Tuck-point brick.
Clean chimney.
Fertilize lawn again.
Spray evergreens.
Check extinguishers.
Check basement humidity



FEBRUARY

Build yard furniture.
Repair awnings.
Start plants in flats.
Make root cuttings.
Prepare hotbed.
Prune trees, grapevines.
Fertilize lawn.
Plan garden, flowers.
Order garden seeds



AUGUST



Clean and check furnace (Change filter, oil motor and fan, follow factory instructions).
Finish outside painting.
Water lawn on schedule.
Stock up on fuel.
Fertilize garden

MARCH



Repair screens.
Check yard tools.
Buy grass seed.
Check garden hose.
Repair trellises.
Check electric cords.
Paint and paper

SEPTEMBER

Have TV and radio sets checked (antennas, grounding wires, etc.).
Oil and clean kitchen ventilating fan.
Reseed spots in lawn.
Store electric fans in dustproof bags.
Repair storm windows



APRIL

Check roof for leaks.
Sharpen mower.
Plant trees and shrubs.
Seed, top-dress lawn.
Clean attic, garage.
Hang birdhouses.
Clean planting borders.
Check electric fans.
Paint lawn furniture.
Repair fences



OCTOBER



Turn off and drain outside faucets.
Store garden hose.
Water evergreens.
Prepare shrubs for winter

MAY



Clean fireplace (put wood ashes on garden).
Edge sidewalks and flower borders.
Set out transplants.
Have air conditioner serviced.
Oil all appliances

NOVEMBER

Test weather stripping.
Screen shrubs and young trees from rabbits.
Clean rain gutters



JUNE

Clean yard incinerator.
Spray shrubs.
Treat lawn with weed killer.
Check locks and the operation of windows



DECEMBER



Prepare for Christmas:
Make outside decorations.
Finish workshop projects early.
Check tree lights, stand, outside lights.
Fireproof tree or have extinguishers handy.
Recheck extinguishers

PARADE OF HOMES

Livability.. Design.. Price

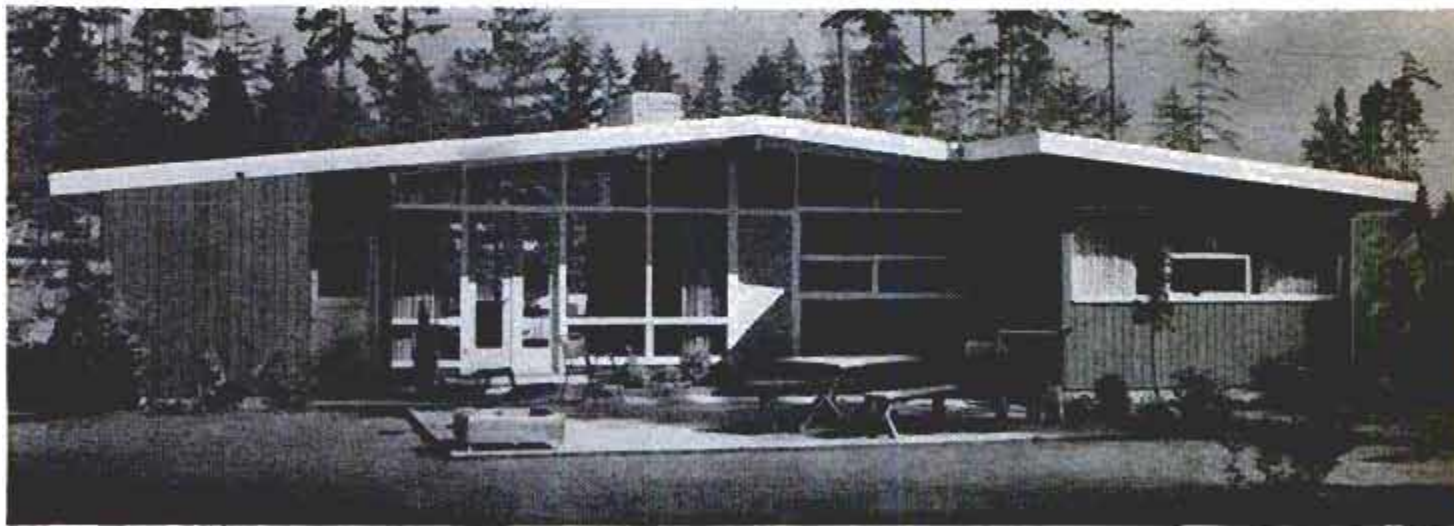

Big windows at rear of this Seattle house face open patio; garage is at left, bedroom wing at the right

WASHINGTON

Three bedrooms, one bath
 Floor area—1067 square feet
 Price—\$13,250 (including lot)

This compact, attractive and livable small home was built by Albert Balch, leading Northwest builder, in a wooded section of his home town—Seattle. The architect is John Ridley. The house stands on a lot 60 by 135 feet. Foundation is concrete slab; exterior walls are vertical cedar siding; interior-wall finish is USG Drywall; insulation is Rock Wool; floors are oak; the framing is post and beam. The living area has a beamed studio ceiling and French doors lead to the patio for indoor-outdoor living. Fireplace is Arizona sandstone

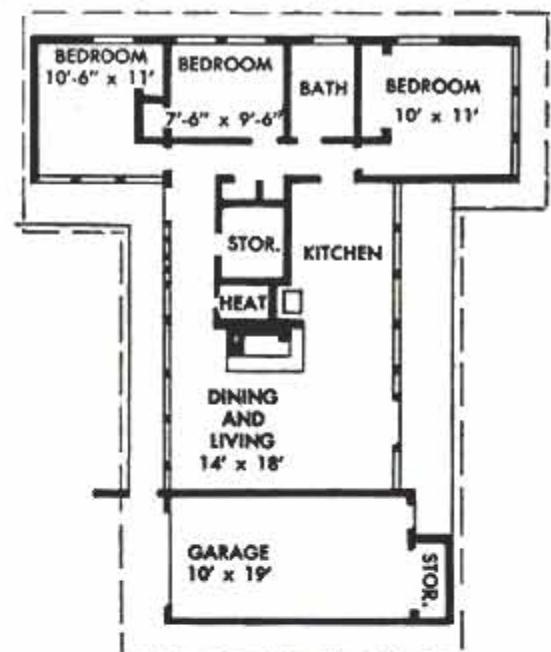

Front of house designed by John Ridley features an interesting window treatment in clean, simple design



TEXAS

Three bedrooms, two baths
Floor area—1438 square feet
Price—\$21,500 (including lot)

The price of this house (also featured on cover) includes not only the lot but an all-weather air-conditioning system, a fully equipped kitchen and the rugs and draperies. It was built by Lawrence O'Donnell of Suburban Homes Lumber and Realty in Houston. The architect is Ursula Oberdieck. Open-plan interior is enhanced by sliding glass doors connecting three rooms with rear porch. Entry under covered front porch leads to bedrooms, living area or kitchen. The house is built on a slab foundation and the low exterior walls are of Holiday Hillstone



NEW YORK

Three bedrooms, two baths
Floor area—1600 square feet
Price—\$30,500 (including one-acre lot)

This house provides 600 additional square feet of unfinished space on the second floor for two more bedrooms and a bath. It was built at Huntington, N.Y., by N. A. Piccione. Architect, Herman H. York. Large living-dining area and den open on spacious terrace at rear. Exterior combines brick veneer, redwood paneling and cedar shingles. Foundation is poured concrete with a full basement. All exterior walls and ceilings are fully insulated and the wood-sash windows are double-hung. Extras include a built-in oven, table-top range, dishwasher, refrigerator, freezer and a wall clock. Floors are oak and the flush doors are mahogany stained. An oil furnace supplies heat through baseboard-radiation system



CALIFORNIA

Three bedrooms, two baths
Floor area—1300 square feet
Price—\$16,750 (including lot)

Built on a lot only 53 by 100 feet in a suburb of San Francisco, this informal open-plan house provides three outdoor-living areas. It was built for John C. Mackay & Associates, Menlo Park, by the Palo Alto Development Co. The architects are Anshen and Allen of San Francisco. Foundation has concrete perimeter wall; garage is slab; framing is post and beam with exposed rafters; roof is built up; exterior is redwood siding and cement plaster; the interior is dry wall. Extras include complete G-E kitchen with wall-hung refrigerator, washer-drier, landscaping

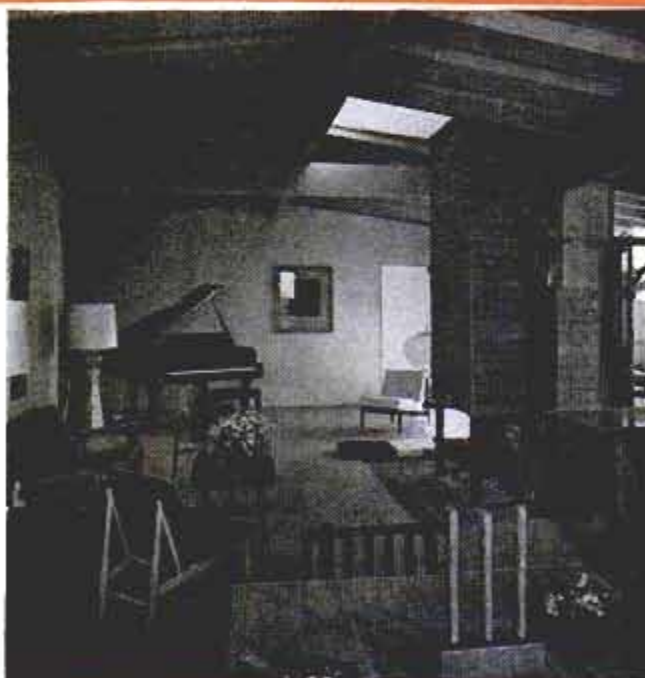

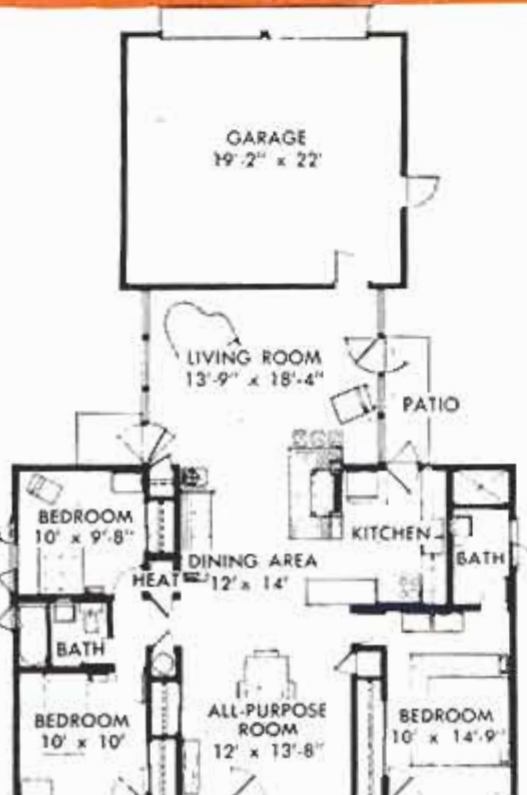

COLORADO

Three bedrooms, 1½ baths
 Floor area—1450 square feet
 Price—\$16,646 (including lot)

Unusual in design, this house was built in Colorado Springs by the Gamble Building Co., Denver. Architect is Joseph Marlow. Foundation is slab; roof, low-pitched rafters; siding, redwood. Extras: Gas-fired incinerator, oven, range, all-copper plumbing, built-in TV antenna with three plug-in jacks



ILLINOIS

Four bedrooms, 1 bath
 Floor area—1100 square feet
 Price—\$14,900 (including ½ acre)

Fold-back partition makes the den of this Chicago house into a fourth bedroom. It was built by J. E. Merrion & Co. and the architect is Emil J. Minx. Foundation is concrete slab; exterior, hardboard; roof, rafters and asphalt shingles; fully insulated; dry-wall interior partitions; cabinets are of birch



TENNESSEE

Three bedrooms, 1 bath
 Floor area—1247 square feet
 Price—\$16,250 (including lot)

Features of this house are the rear living room and large family room off the kitchen. It was built by Martin L. Bartling, Jr., in Knoxville. Architect is William A. Sloan, Jr. Exterior walls are an adaptation of the Lu Re Co. panel system and roof has the new nailed-and-glued trusses. Extras include a G-E Kitchen Center (range, oven, dishwasher, disposal unit, washer-drier). Floors are concrete with wood in living room and family room, others vinyl asbestos. Interior partitions are Adjust-a-Bilt (see page 165). Ceilings have radiant heat by electric Ceil Heat

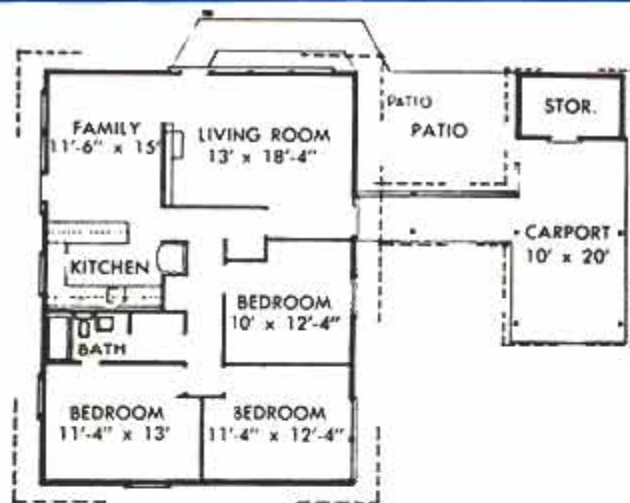

TEXAS

Three bedrooms, 1 bath
 Floor area—1128 square feet
 Price—\$11,500 (including lot)

Even competitive builders in Dallas admit this is "a lot of house for the money." Built by Tom Lively of Centex Corp. (world's biggest builder), the house features a large kitchen, attached brick garage and living room opening onto patio (see cover). House is brick veneer on slab foundation. Many extras offered



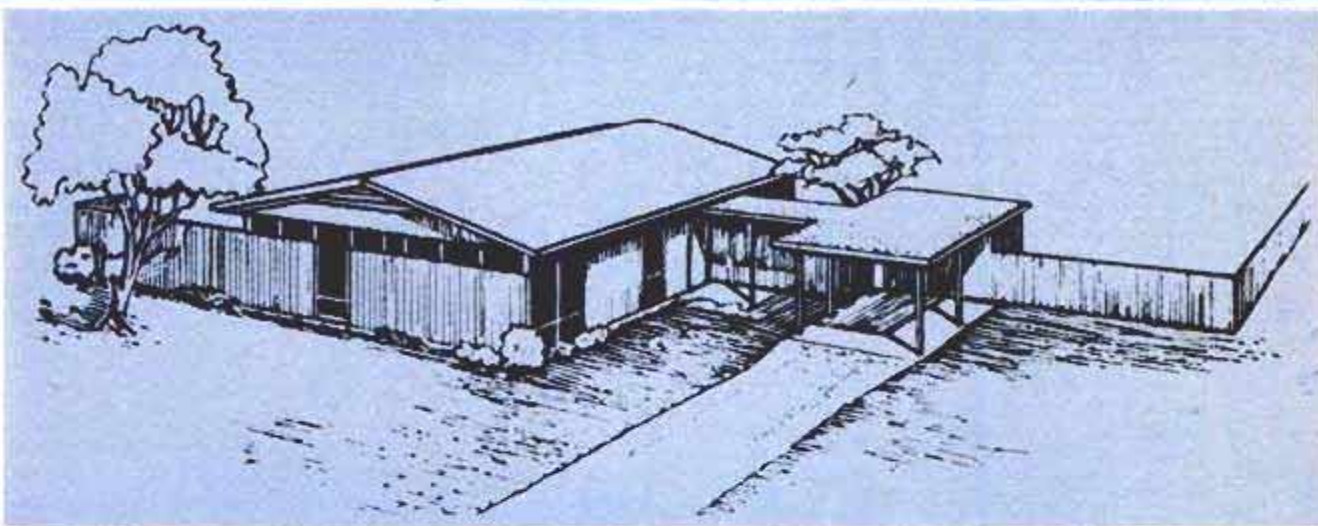
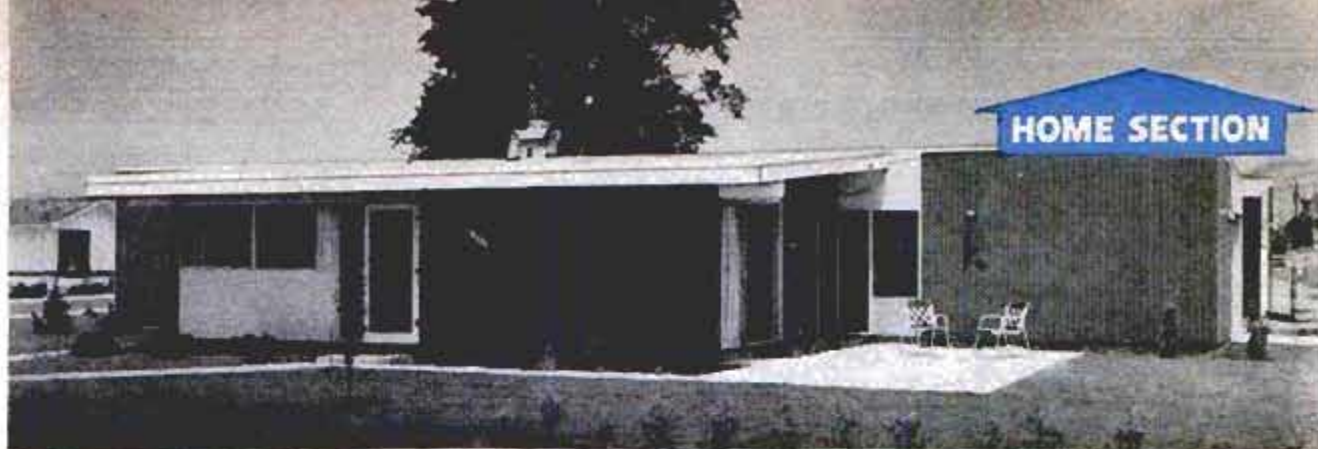

OLD-FASHIONED WALK-IN CLOSETS

ARE SPACE ROBBERS

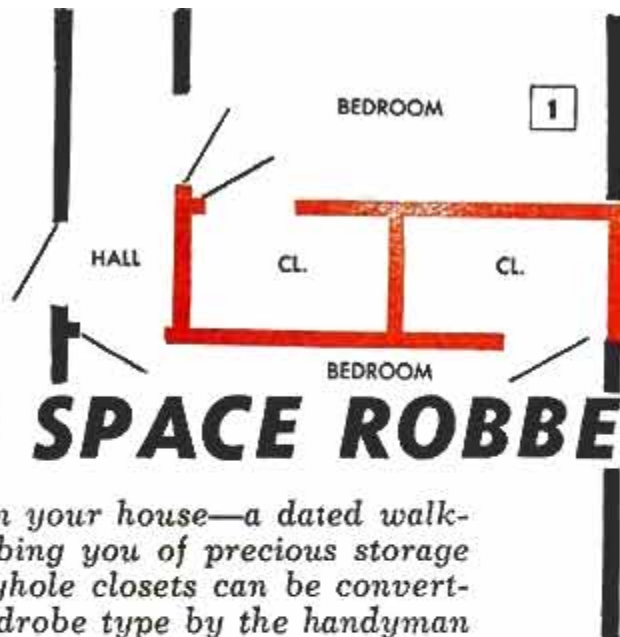

Are you harboring a thief in your house—a dated walk-in clothes closet that is robbing you of precious storage space? Many of these cubbyhole closets can be converted to the more efficient wardrobe type by the handyman

By Wayne C. Leckey

ONE THING most homes have in common is the lack of closet space. In the compact modern home the space simply isn't there; in older homes the space is there but it is wasted.

Cubbyhole closets were the thing back in the days when home designers seemed to think it was necessary to walk into a closet to use it. Every home had them but they were anything but efficient. Half of

the area was taken up by floor and they soon became catch-alls where everything could be chucked out of sight. Common arrangement to be found was two closets located end to end, each one fitted with a swinging door and serving an adjacent bedroom as you see in Fig. 1. A short clothes rod, a few hooks and a shelf are all they offered. For the amount of space these closets occupied they hardly earned their keep compared with the modern wardrobe storage-type walls which provide the maximum in usable closet space.

Can Be Converted

Many of these dated closets lend themselves to remodeling and it's something the handy homeowner can do himself. If you have an arrangement similar to

Hinged in pairs to fold to each side this four-section door unit of welded steel comes in baked-on enamel in colors and wood grains

American Welding & Mfg. Co., photos



the one shown in Fig. 1, which is typical in older homes, you can make it into the popular wardrobe type without too much expense and gain 50 per cent more usable storage space. Essentially, it means widening the present small door openings, knocking out the cross wall and erecting a dividing wall lengthwise from floor to ceiling as in Fig. 2. This involves knocking off the plaster from part of the present walls after first removing the old trim. In the event you plan to reuse some of the old trim, take care in removing the baseboard and door casings. One of the best ways to do this to avoid splitting or otherwise marring the wood is to remove the nails with a pin punch. It looks something like a nail-set but differs in that it has a straight shank. First locate the nailheads by scraping away the paint or varnish if necessary and then drive the nails all the way through the trim with the pin punch. The trim will lift off without a mar.

Reframing Is No Problem

The typical framing drawing given in Fig. 2 shows what is required in the way of new framing. After you have the plaster off the walls to be removed, rip out the old studs along with the wood lath nailed to them. You'll find these are spiked to 2 x 4 plates at top and bottom and it will be necessary to either withdraw the nails at the bottom or saw off the studs just above the nails to let you wrench the studs free from the top plate. The plates across the floor are pulled up but the top ones are left intact. Most of the material in the old walls can be reused in the new framing. In erecting the

Right, these bypassing-type rolling doors come with hangers attached and consist of hard-board panels in metal frames

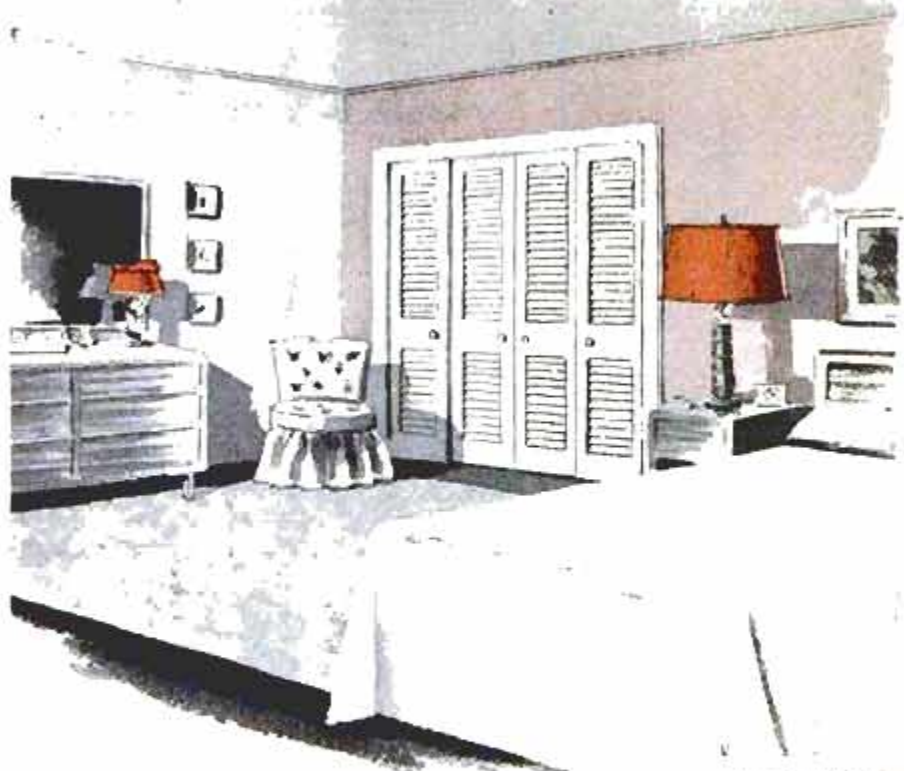

Kennatrack Corp.

Bypassing louvered doors have advantage over others since they allow air to circulate inside the closet

center dividing wall, cut two 2 x 4s the same length for the top and bottom plates and nail the bottom one to the floor. The top one is nailed to the ends of 2 x 4 studs which should be cut long enough to wedge in place between the ceiling and the bottom plate. Space the studs 16 in. on centers and toenail the lower ends to the

Woodall Industries, Inc. photo





Curtliff Corp. photo

Raised closet floor permits wall-to-wall carpeting and provides "kickboard" for accordion-folding doors. Same doors can be installed from floor to ceiling

bottom plate. A few nails into the ceiling joists will anchor the top of the wall. Framing each outside wall of the closet is done as in Fig. 2. Actual size of the open-

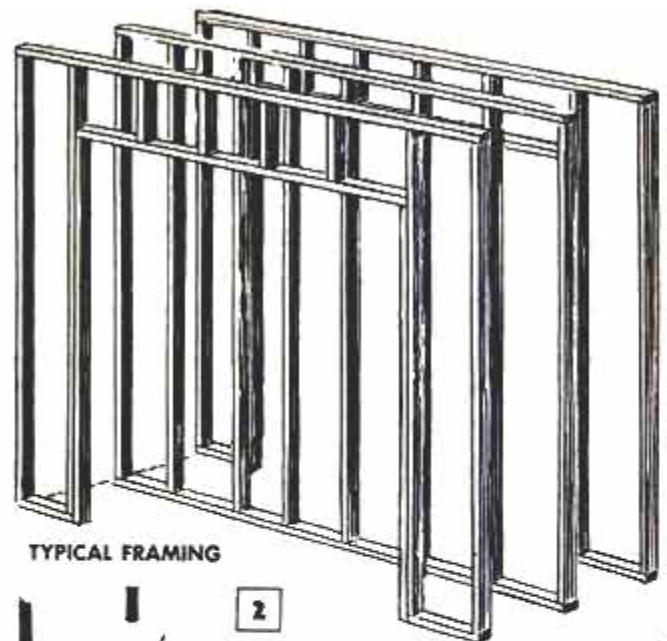

TYPICAL FRAMING

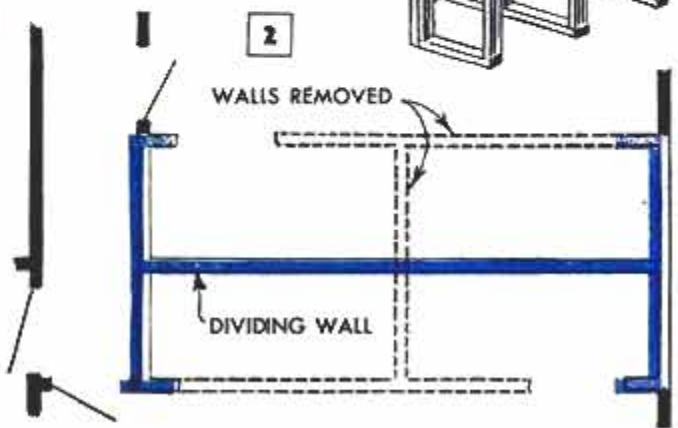

The Stanley Works photo

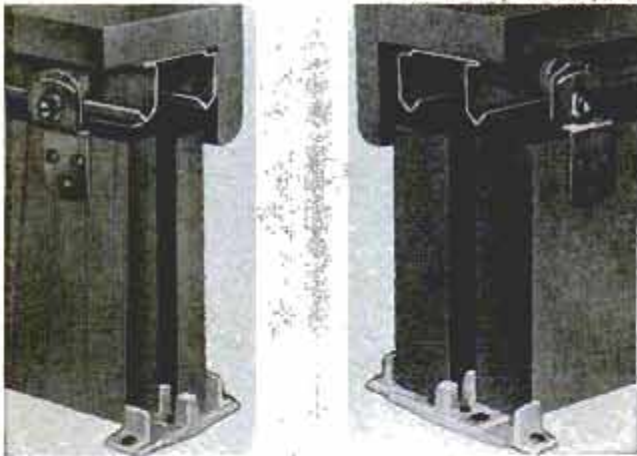

Typical door hardware available. Track below includes plaster ground which can be treated four ways

ing, of course, is determined by the type of doors you select. Plasterboard or wallboard may be used to cover the framework. You may prefer to have at least the face of the walls plastered.

Types of Doors and Track

You have a wide choice of doors and door hardware. There is the bypassing, rolling type that can be had in hardboard or wood, solid or louvered. Another is the four-section-type all-metal doors that fold in pairs to each side. Still another is the so called accordion-type door. Then there are the plain plywood doors that you provide yourself for which you can buy track-and-hanger sets of numerous types, all of which are easily installed by anyone. ★ ★ ★

Washington Steel Products, Inc. photos

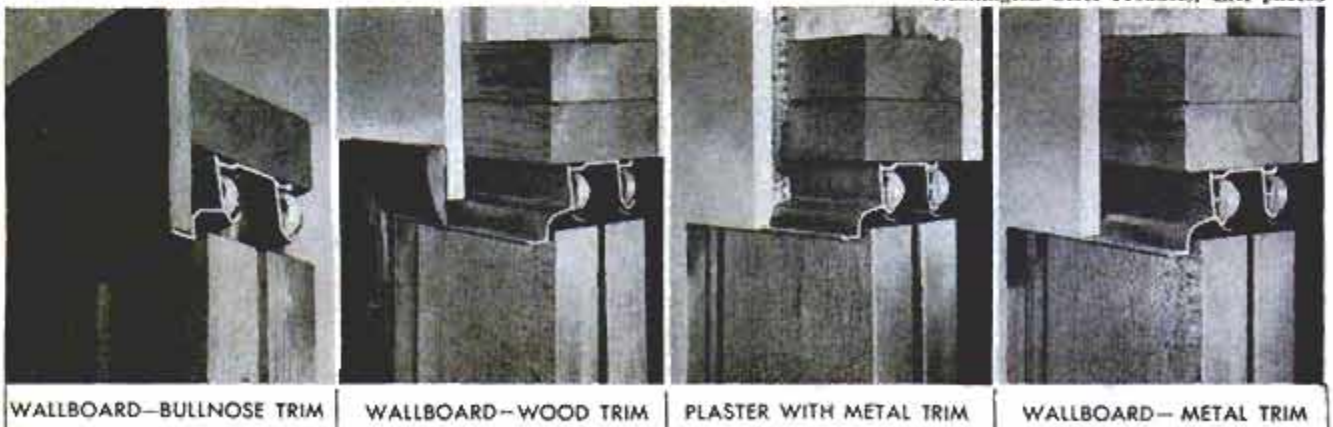

WALLBOARD—BULLNOSE TRIM

WALLBOARD—WOOD TRIM

PLASTER WITH METAL TRIM

WALLBOARD—METAL TRIM

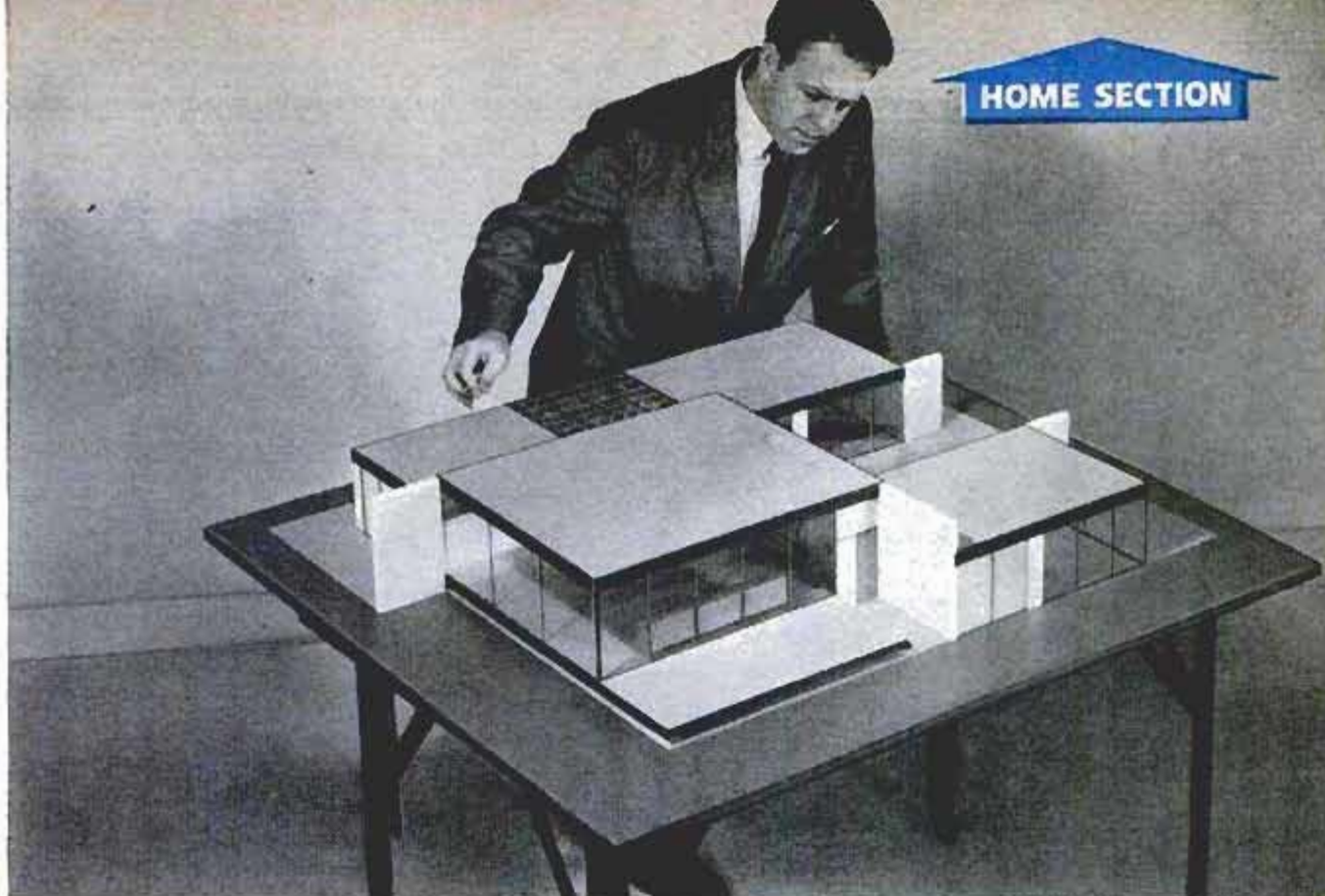

Model by Raymond J. Wisluga

Author-Designer Doblin takes a close look at the home he designed around service "cores" which he says will revolutionize building in the near future. Big living room is in foreground, bedrooms at the right

HERE'S YOUR HOUSE OF THE NEAR FUTURE

By Jay Doblin

(Director, Illinois Institute of Technology's
Institute of Design)

WHEN I SPEAK of the house of the near future I mean 10 or 15 years from now—not 25 or 30. And I refer not just to what is loosely termed contemporary modern architecture, but to the mechanical centers or "cores" around which every house is built. These are the cores of a home which include the food or kitchen core, power core, bath cores, entertainment core and communications core.

At present most of these mechanical parts are laboriously and expensively assembled at the site. These cores should and will be available as complete units which can be installed easily at reasonable cost. In fact, I have seen some of these cores which have been developed in the research departments of some of the nation's largest appliance manufacturers. These units are not the figments of anyone's imagination. The parts of which they are composed are

Service cores which would be installed as complete units are shown in color. Power core is in ground



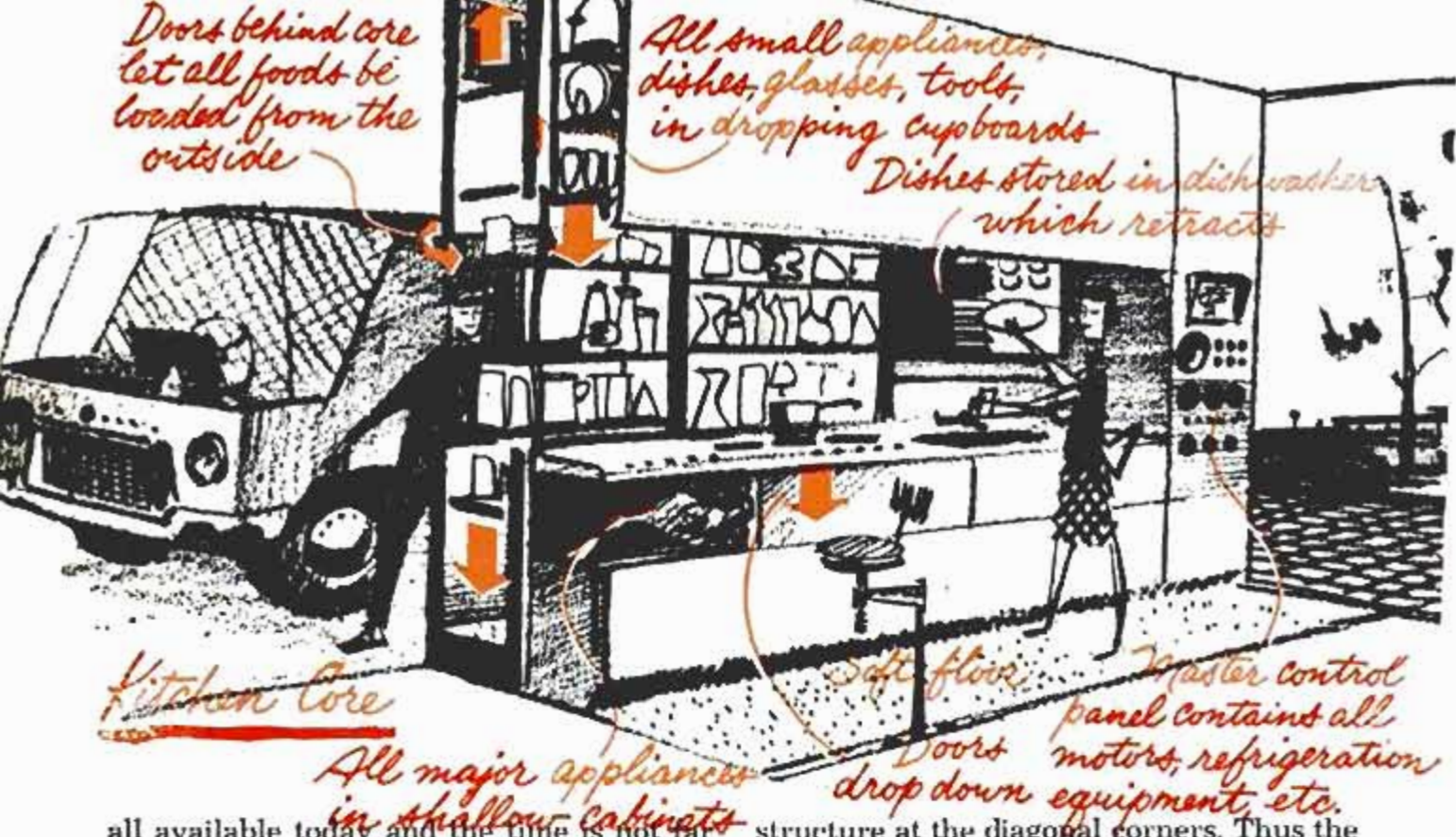

all available today and the time is not far off when these units will make their debut to builders and consumers.

These cores present a new concept of home building and I have designed the house featured on these pages to illustrate their use. This house has 2800 square feet of living space, a 30 by 30-foot living room and a 20 by 20 kitchen. Although it is shown with only two bedrooms, other bedroom units could be added with ease.

The structural design of the house employs the new aesthetic appeal in which windows and doors are not punched through the walls as in most conventional houses today. A simplified design is achieved by the use of a diagonal steel beam across each room, supporting the roof

structure at the diagonal corners. Thus the roof is not supported by exterior or interior walls or columns. This gives an unusual floating quality to the house and the window mullions are combination tension-compression members which balance the roof rather than support it.

This house would have all ducts, conduit, plumbing and the like in a trough around the perimeter. The cores which carry all mechanical equipment would be plugged into them, making an extremely simple mechanical setup.

The purpose of disconnecting the house structure from the electrical, plumbing and conditioning systems is to permit the appliance manufacturer to produce the most efficient arrangement of components. This

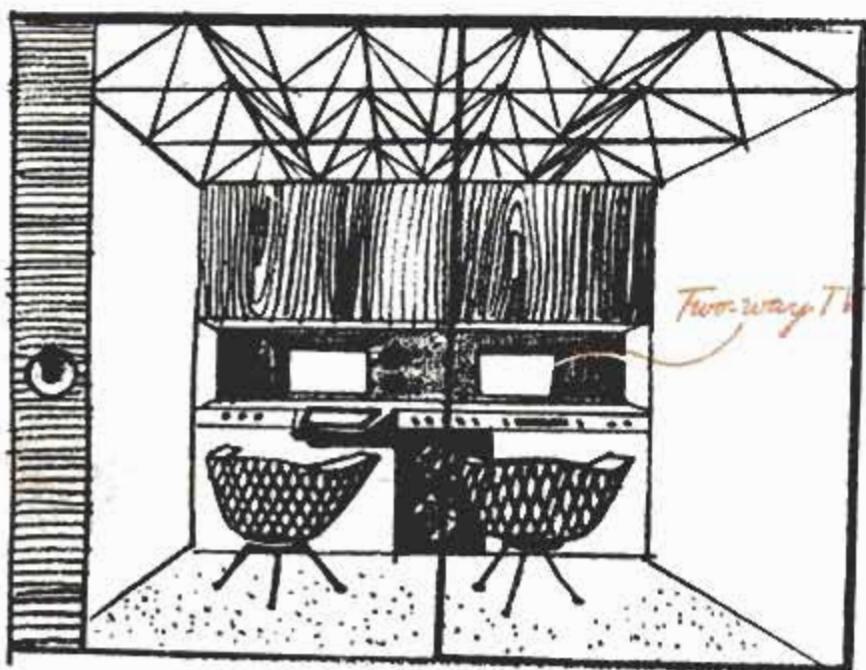

Sketches From
The Author's Notebook

Communications Core

Soundproof room for mail, books and magazines (on film), recordings, files, music, reading



will actually save the consumer money even though the total expense of the core is high. The same equipment bought individually and installed piecemeal would cost more. These cores, as an integral part of the house would, of course, be included in the mortgage. Also, the house structure could be expanded or contracted without affecting the equipment as the house is designed modularly to accommodate the cores.

Every effort has been made to make the house as livable as possible. The bedrooms have been isolated from the living quarters by walls and by the corridor, but the house

can still be opened up so that the entire interior can be seen from most areas. The circulation corridor down the center permits entrance into both ends of the house and access to all rooms without going through any other room. Each bedroom contains its own bath core and could contain two cores with a different arrangement. Now let's take a close look at the various cores:

Bath Core

This unit, which is 12 feet long, 8 feet high and 5 feet deep, contains all the necessary equipment. A small area is devoted

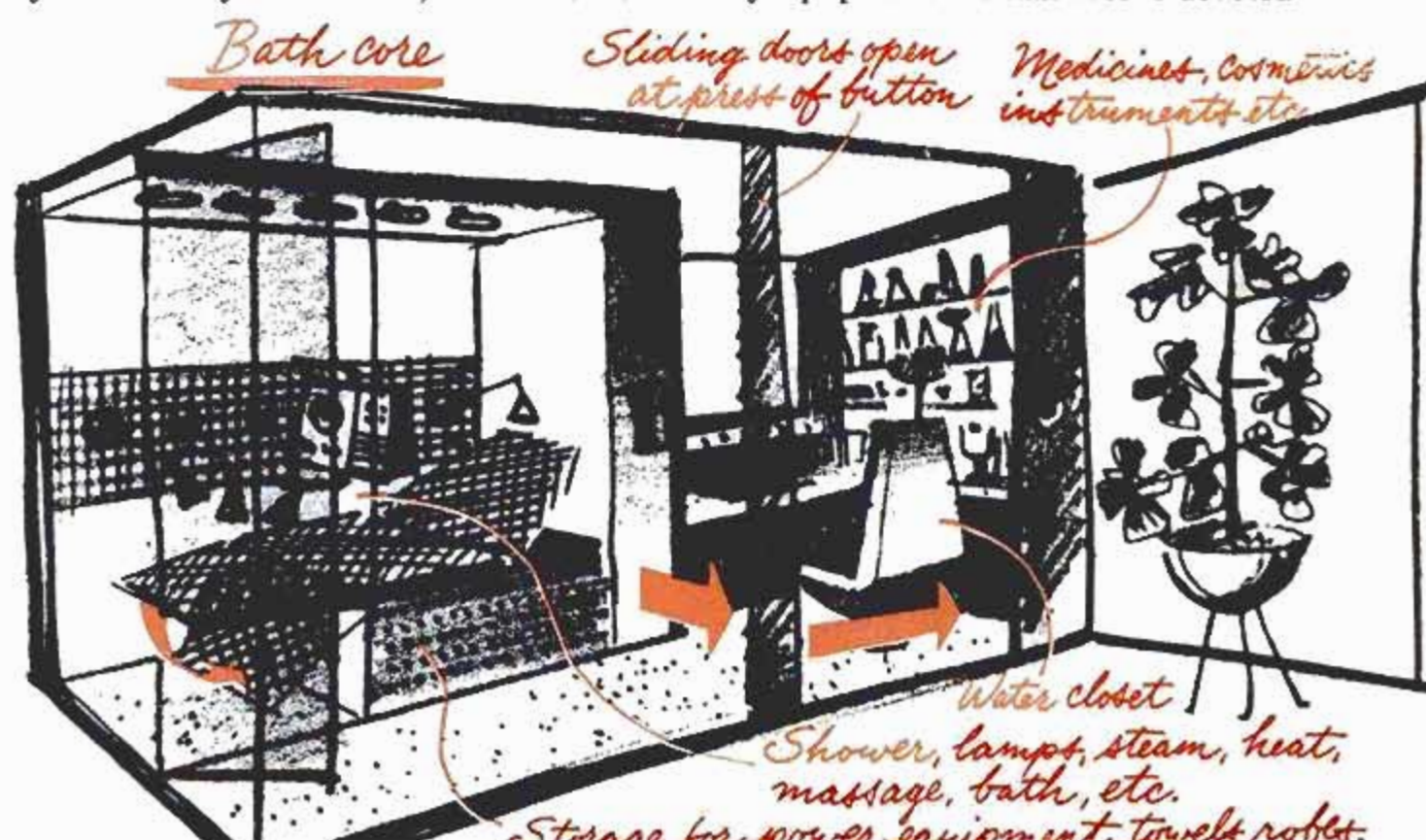

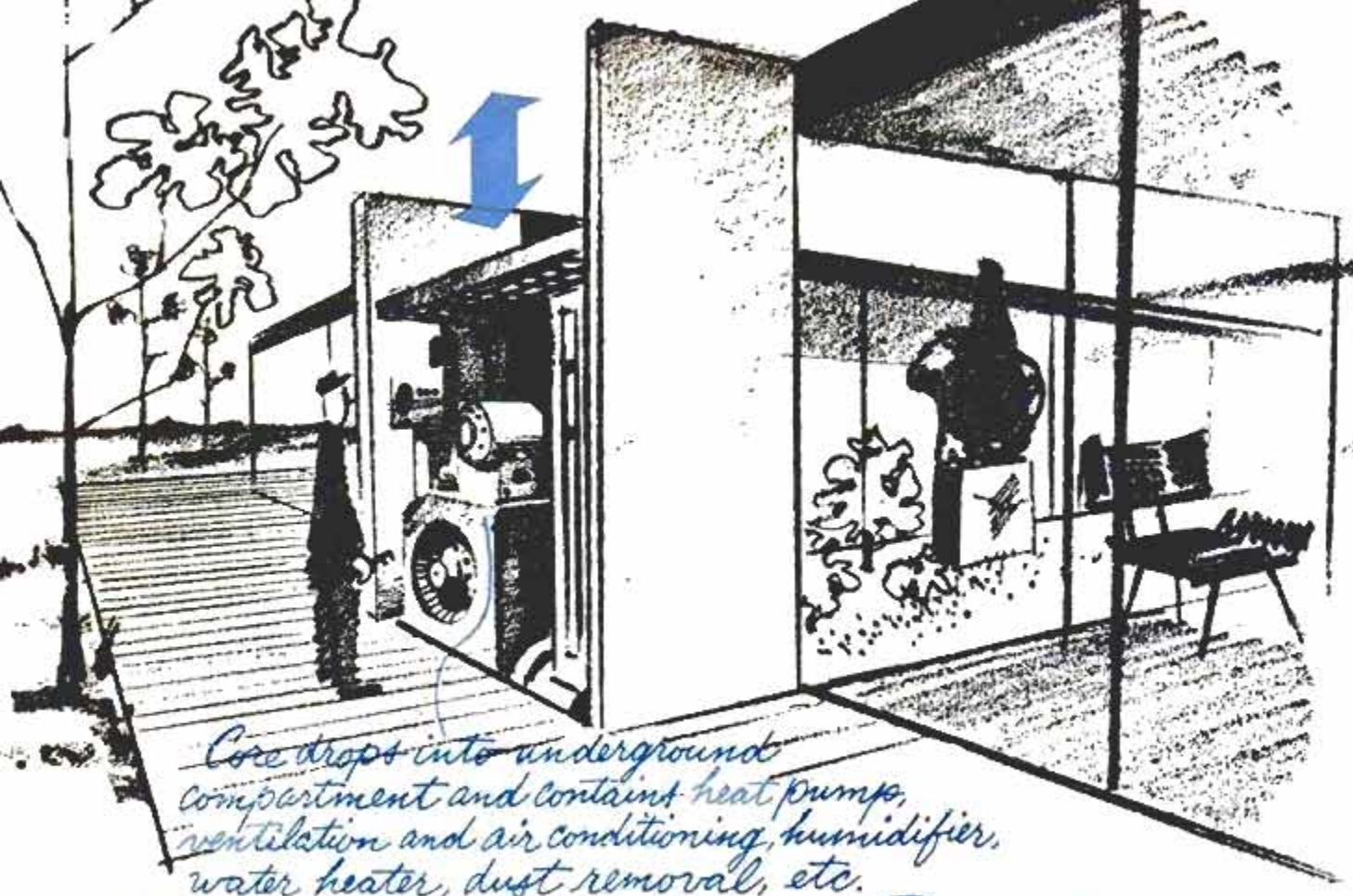

Core drops into underground compartment and contains heat pumps, ventilation and air conditioning, humidifier, water heater, dust removal, etc.

Power core

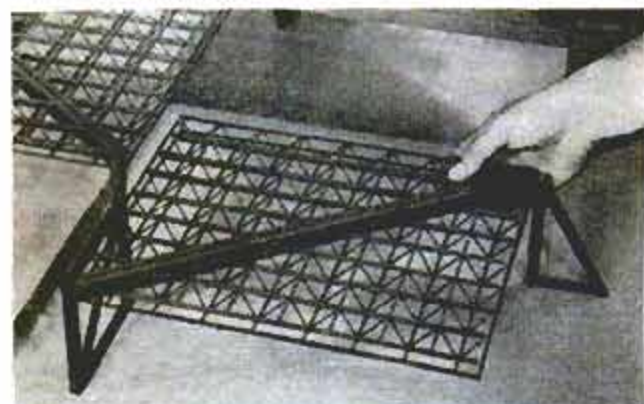

Close-up of structural section shows double steel beam and steel triangles which carry roof weight

to a sink and water closet and the storage of personal items and cosmetics. The largest section is the bathing and health center. This unit would be put into place with only one electrical and one water connection required. The bath core eliminates the necessity of assembling on the site individual pieces of plumbing equipment and connecting them up and would consequently render more service for less cost.

The bathing and health section is entered

(Continued to page 281)

Doblin adjusts roof structure which is cantilevered from diagonal beam supported by protruding piers





Paneling two walls of living room, A, changes its appearance drastically as shown by the color photo below

Decorate with **HARDWOOD PLYWOOD**

PART I

ALL THE SOFT richness and beauty of walls paneled in hardwoods are well within the means of any homeowner, even owners of the lowest-cost homes. The many beautifully grained woods available in the form of large panels of hardwood plywood offer a wide choice, such as mahogany, walnut, oak, birch, cherry, and bring installation well within the ability of the average homeowner.

The advantages of wood paneling are many. It lasts indefinitely, withstands scuffing and is easy to maintain, requiring in most cases only an occasional dusting and an annual waxing. Also, it works well into wall built-ins, the number and kind being limited only by good design and the desires of the owner.

To prove that any homeowner can install hardwood paneling, *Popular Mechanics*, in collaboration with the Hardwood Plywood Institute, commissioned an inexperienced homeowner to panel



Above, sample of Honduras mahogany used in living room and kitchen. It may be finished natural, or it can be given a special finish to produce almost any color desired





Girl's room, B, was paneled in birch and given a gray tone

his home. The results are shown on these pages. Referring to the exploded view on pages 198 and 199, the home was a medium-low-cost trilevel comprising a living room, A; kitchen, F; and two bedrooms, D and E, with an unfinished attic. During the paneling operation, the attic was finished to provide two additional bedrooms, B and C, bedroom E being converted to a den.

In the living room and in the dining area of the kitchen, Honduras mahogany was used, applying it to one wall on which a plate rack was installed and a door faced with plywood. In the living room, two walls and an open stairwell were paneled, plus a built-in planter-divider island at the front entrance. The original wooden rail on the stairwell gave way to a built-in cabinet with indirect lighting.

The two rooms created in the attic, one for a boy, was paneled in walnut, and one for a girl, was paneled in birch. The converted room that became a den was paneled in oak,

Typically male in furnishings, the boy's room, C, was paneled in walnut

Copyright 1959, Walt Disney Productions

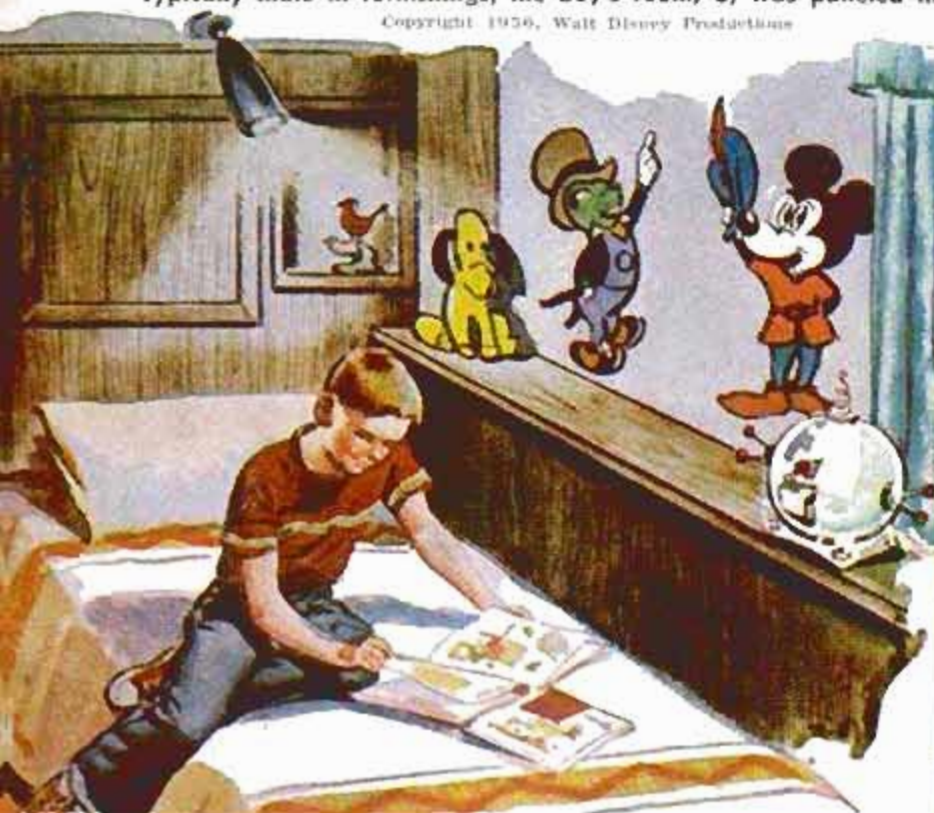

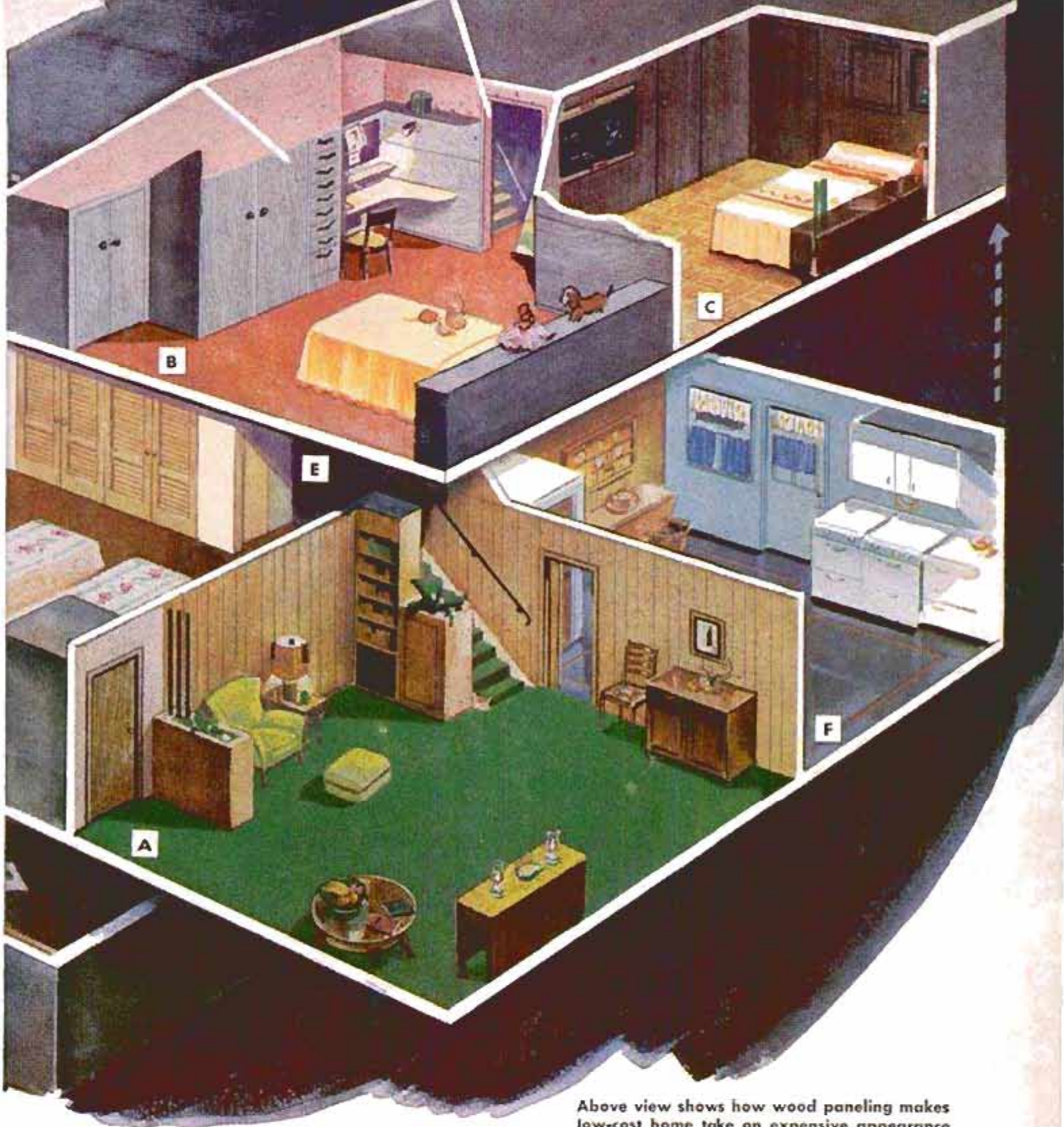

Above view shows how wood paneling makes low-cost home take on expensive appearance

and the master bedroom was done in quilted maple. To complete the house, a "family room" in the basement will be paneled in ash.

The plywood may be used as plain panels or it may be grooved. Grooving serves a three-fold purpose: It relieves the unbroken expanse of wall, simulates random-width planking and, more important, allows unobtrusive joints between sheets.

Grooving is best done with a hand router by placing the plywood face up on a flat

surface. With a pencil mark the locations of the grooves at each end of the sheet. Bear in mind that grooves always run with the grain, never against it.

Then, using a straightedge (an 8-foot length of 1 x 4 will do), align corresponding pencil marks, allowing for the distance between the point of the bit and the outside edge of the router plate. Secure the straightedge and run the groove.

The actual grooves should be about $\frac{1}{20}$ in. deep. This depth will penetrate the



The warmth of maple paneling plus well-designed built-ins give room C an irresistible feminine appeal

veneer to the next layer of wood, but the finishing process will subdue the difference in coloring to the point where the grooves will be properly emphasized.

Grooving Process Simple

While the grooving operation is not difficult, be careful that the straightedge does not lift from the plywood and allow the router to slide under it. Also, when putting a half-groove, or bevel, on the edges of each plywood sheet for joining to the next one, use a special bit or, as was done here, use a plane.

The actual widths for the random-width effect are not critical, but it is best to observe a minimum of 3 in., 4 in. being preferred. If you use the accepted spacing of

the grooves (6-4-6-10-6-8-8) you will find that a groove will cover a stud for nailing if the studs are 16-in. on center. However, in the method of application used here it was not necessary to consider the studs.

Two Ways of Applying

There are two major methods of application—nailing directly through to the studding, or using one of the new adhesives now available and applying the paneling directly to the plastered walls. For this job Rolltite mastic was used. There are two ways of spreading the adhesive, either by “butterballing,” as shown on page 201, or with a notched trowel furnished with the mastic. Either method is satisfactory. However, care must be taken to provide a firm

Strictly masculine, den E is done in oak and provided with built-ins to suit the desires of almost any man

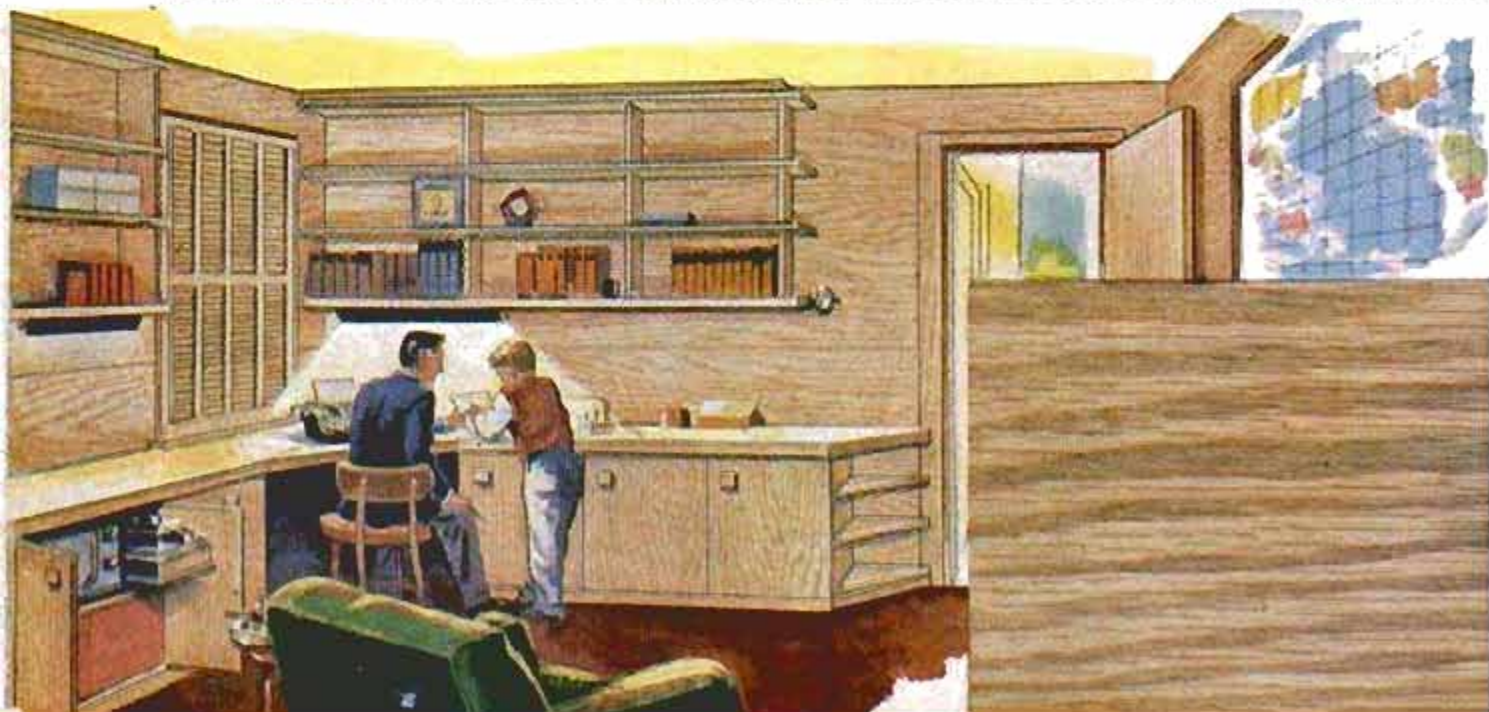

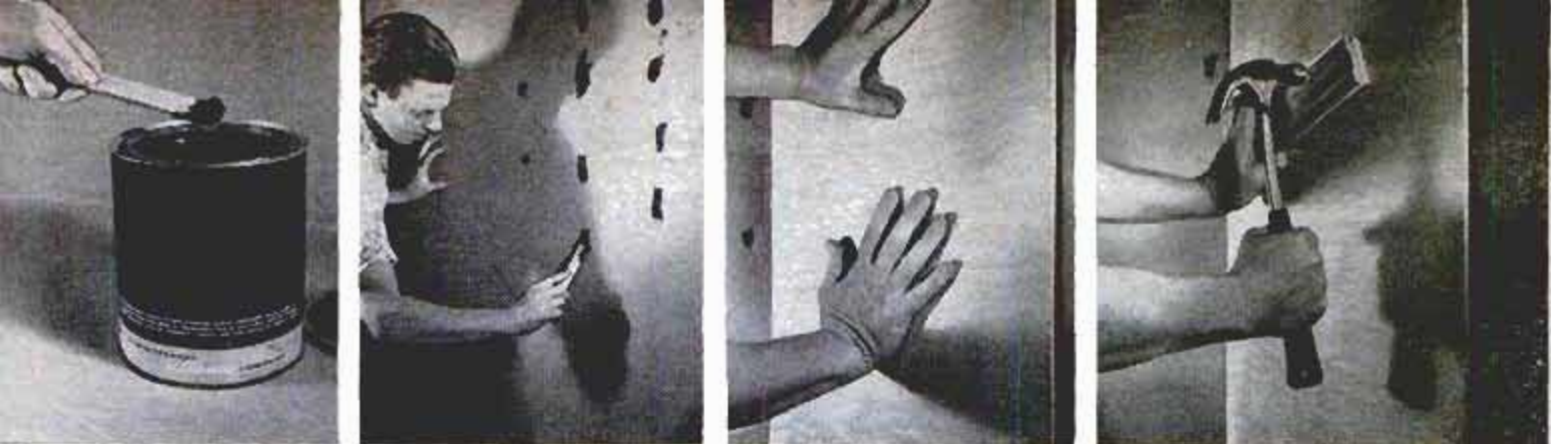

Plywood applied with adhesive which is put on wall and panel pressed against it and snugged with hammer

bond between the back of the paneling and the adhesive long enough for it to set.

Shore Up When Possible

Setting time can be found on the label and, where not in the way of family activities, it is wise to shore up pressure against the paneling with 2x4s. The method shown, tapping with a hammer and piece of scrap lumber, will be found adequate in most instances.

Fit Panels to Walls First

Fit your panels first, accurately cut, before you spread the mastic. While this type of adhesive allows the home craftsman much more latitude than does the contact type, it still is advisable to press the panels into place as soon after applying the adhesive as possible.

If you install built-ins, such as the planter island and the book shelves shown, plan the wiring and other features, such as the copper planting box. Then, as you build up the unit, these features will fall into the plan easily. Indirect lighting makes a dramatic showing of your plantings, illuminates the shelves below as well as the poles and also serves as a night light.

Use Millwork to Match

The usual pine molding should be replaced with molding to match the type of wood in the paneling. In paneling the walls of a stairwell, a problem may arise in that it is not easy to replace the portion of the stair stringer. The illustration at the bottom of this page shows one treatment of this problem.

Also, in paneling stairwells, you will find that the standard 4x8 sheet of plywood will not be long enough. As shown in the center illustration on this page, turn the grain for this treatment.

While any of the fine-grain hardwood plywoods makes a vast improvement in any room, there are other touches that emphasize the paneling and also have a very utilitarian purpose. One of these touches is the wrought-iron handrail avail-

able from Tennessee Fabricating Company. It not only steadies footsteps on a stairway, it serves to keep hand marks off the walls.

In next month's installment, learn how to build the planter island and other built-in features. ★ ★ ★

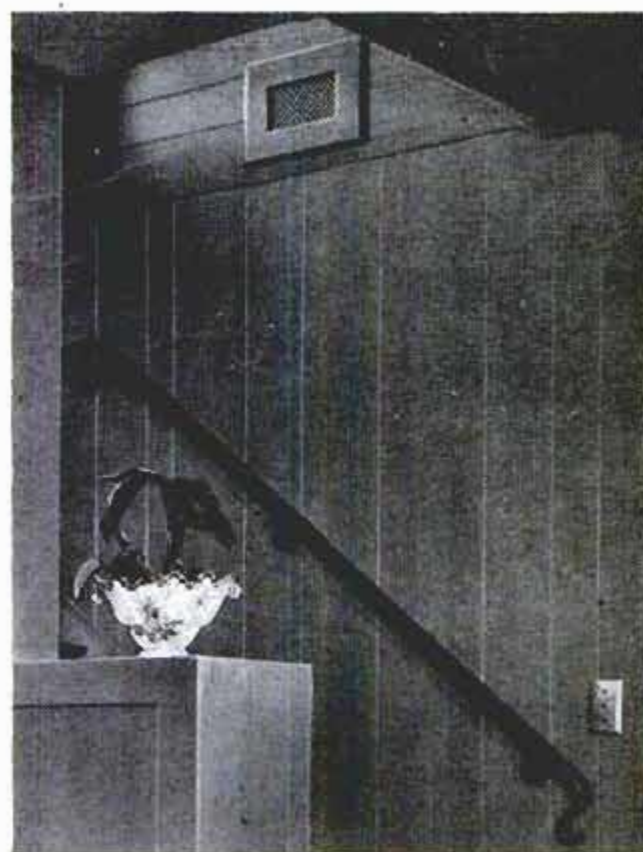

Above, hand rail adds safety factor, plus decor, to stairwell paneling. Grain direction is changed from vertical to horizontal to make use of standard size sheets of plywood. Below, treatment of mahogany molding around painted stringer and wall



PAVING PATIOS FOR YOUR PATIO

By Hi Sibley

HERE ARE SEVERAL WAYS to pave your patio. And by doing the "spade work" yourself the total cost can be kept to a minimum. For small jobs, like stepping stones or precast squares, the concrete can be mixed in a steel wheelbarrow; for larger areas a wooden platform, Fig. 9, is useful. On extensive construction, a power mixer saves time and a lot of hard work. In the latter case, most homeowners will find it more economical to rent the mixer when needed because the comparatively high initial cost, storage problem and infrequent use would not justify owning it.

Concrete Paving

A 1:2:3 mixture (cement, 1 part; sand, 2 parts; gravel, 3 parts) is recommended for patio paving. The proportions can be easily and accurately measured in a bottomless box of 1-cu.-ft. capacity, Fig. 9. First, the ground should be prepared. For large concrete slabs, excavate to a depth of 6 in., moisten the soil and tamp it thoroughly. Next, spread 2 in. of sand or cinders at the bottom of the excavation.

When mixing the concrete, place the measuring box on the wooden platform and fill with sand twice. Follow with three measures of gravel and crushed rock not

1. Above, flagstone is close-laid in random pattern on concrete with concrete-mortar joints. Straight edges of stones form border of small decorative pool



2. For novel treatment of concrete terrace above, expose gravel aggregate by brushing concrete away from small stones immediately after it has set

3. Below, tile or brick borders add touch of color to patio laid with concrete or wooden squares. Wooden borders for concrete squares are treated 2 x 4s

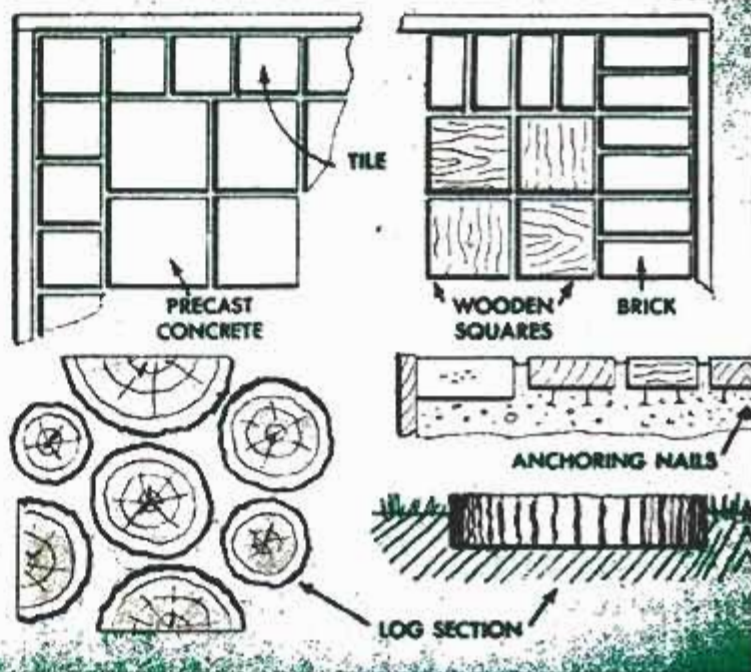
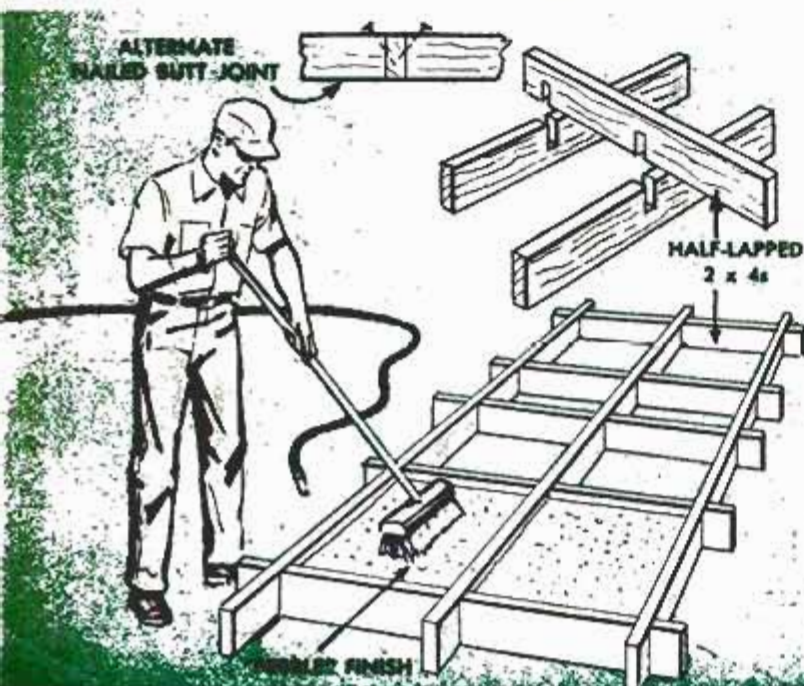



4. Natural flagstone in background is laid on concrete and in foreground directly on soil in informal pattern

larger than walnut size. Mix the mass thoroughly and then add one sack of portland cement. These ingredients should be mixed until a uniform gray color is obtained. Now make a depression in the mound and mix water in it a little at a time, Fig. 12. For dry aggregates (sand and gravel or crushed rock) add 5½ gal. of water, less for moist or wet material. A good

mixture should appear plastic, not "runny."

An entire slab of concrete should be poured in one operation and spaded against the sides of the form. Then with a strike board it is leveled even with the top edge of the form which is sloped ¼ in. to the foot to provide the necessary grade for good drainage.

For precast-concrete squares, make a

5. Bricks laid in herringbone pattern are attractive but require cutting at 45-deg. angle at border

6. Formal treatment of patio overlooking valley is this glazed-tile surface laid on concrete slab

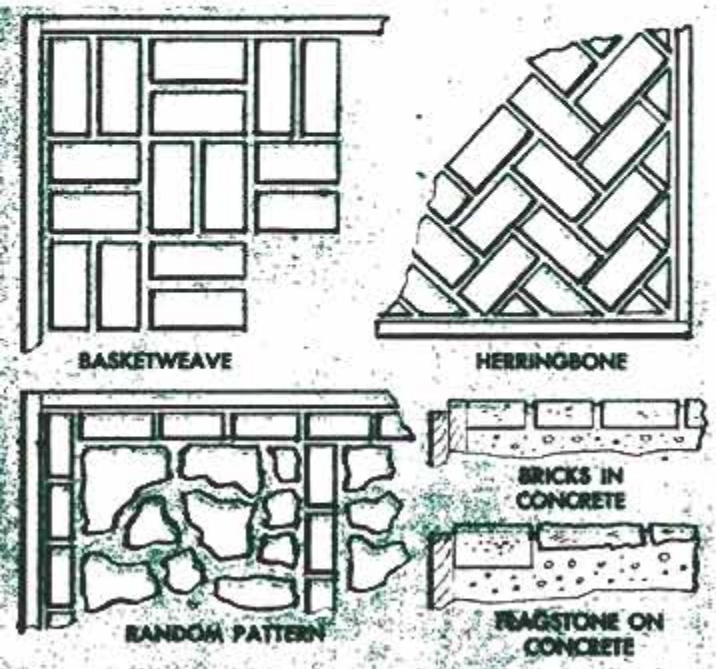



7. Above, precast-concrete squares laid on soil, spaced 1½ in. apart with dichondra planted between



8. Redwood-log sections set flush in ground shown above are creosoted on bottom, stained or left natural on top. Use assorted sizes to avoid monotony

form that will produce several sizes and shapes that can be assembled into a random pattern, Fig. 11. The members of the form should be tapered as shown in the end view for easy removal of castings.

Improve Appearance of Concrete

The advantages of paving with concrete are its permanence and low cost. The disadvantages are its harshness of surface, glare and commercial appearance. The latter can be avoided or at least improved upon by staining, adding borders and trim, and modifying the surface.

One way of changing the surface is to expose the aggregate. To do this the mix must be slightly drier than normal. As soon as the cement is poured, level it with a board. Then break the surface by sweeping it with an ordinary push broom to roughen and prevent it from setting, Fig. 3. When the concrete is hard enough to walk on, use a steel brush to expose the larger pebbles. (It will take from 4 to 12 hours to harden sufficiently, depending upon the weather.) During this operation keep water running over the concrete to wash away the loosened particles. When the concrete takes on a "pebbly" finish the job is done.

Concrete exposed to the sun and wind should be kept moist for at least 48 hours after it is laid. Stepping stones cast directly in the ground will not collect water on top when given a slight crown as shown in Fig. 11.

Bricks, laid in basket-weave and nu-

9. Measuring material for small amount of concrete is easy and accurate when 1-cu.-ft. bottomless box shown below is used and mixing done on platform

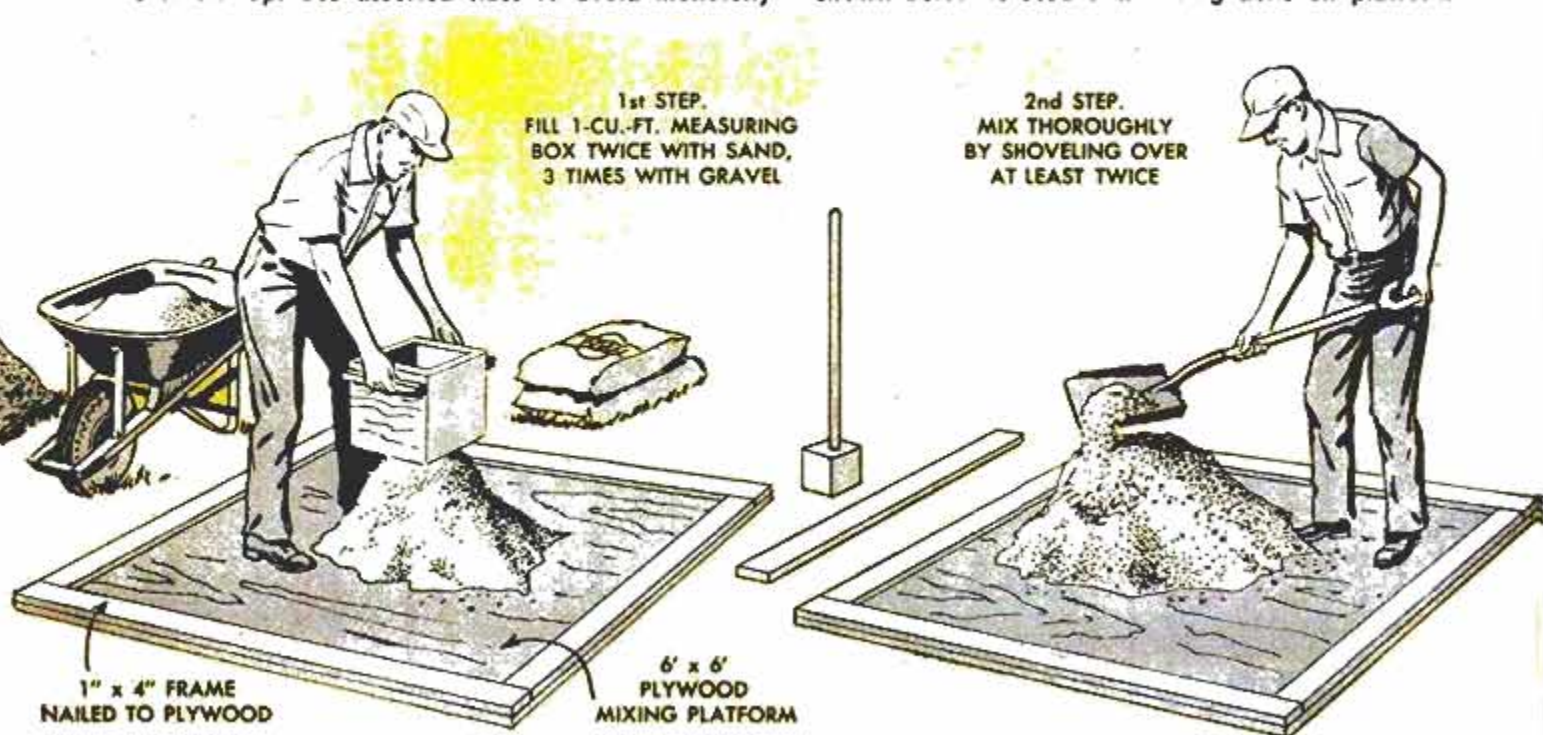

merous other interesting patterns, Figs. 5, 10, 11, are one of the most popular materials used for paving patios. Bricks may be laid on tamped soil, cinders or on concrete with or without cemented joints. On soil, the bricks can be laid close together, or spaced $\frac{1}{2}$ in. apart if you wish grass to grow between them. The herringbone pattern is interesting but requires cutting the border bricks at 45-deg. angles as shown in Fig. 5.

Miscellaneous Patio Surfaces

When available, 3-in.-thick sections cut from redwood logs make a unique arrangement of stepping blocks, Figs. 3 and 8. These should be creosoted on the bottom, and in a damp climate laid on sand. A novel arrangement is to lay wooden squares between brick borders, using protruding nailheads on the underside to anchor the blocks in the concrete, Fig. 3. The monotony of large areas of flagstone can be broken by adding borders or partitions of rectangular stone or brick.

For an unusual effect, pave your patio with concrete blocks set on edge on a concrete slab and with 3-in. asphalt borders around sections containing 24 or more blocks each. After the blocks are laid, fill the border spaces with $2\frac{1}{2}$ in. of crushed rock. Then fill the remaining space flush with cold-mix asphalt. Do not sprinkle cement powder on the asphalt since the black is needed for contrast with the gray blocks. ★ ★ ★

11. Forms used for making concrete castings are beveled as shown at right for easy removal of castings

12. Below, mix cement evenly with sand and gravel, then with water until mass is plastic but not "runny"



10. Above, brick laid in basket-weave pattern without use of mortar makes interesting walk around patio

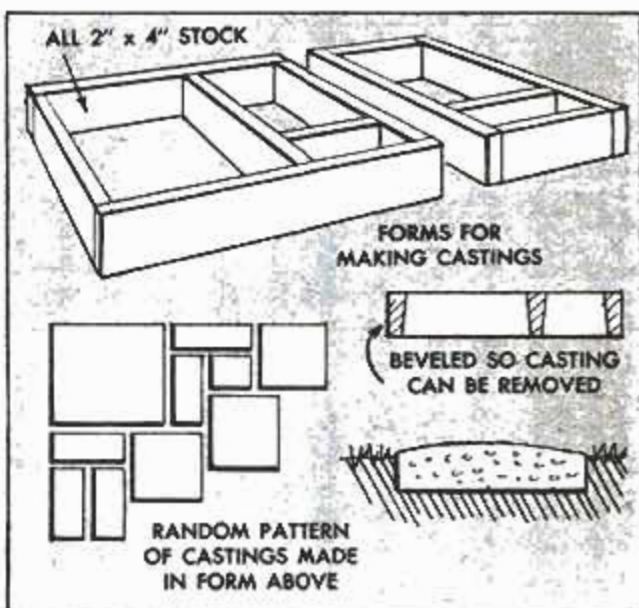

3rd STEP.
ADD 1 SACK OF
CEMENT AND MIX
DRY BY SHOVELING

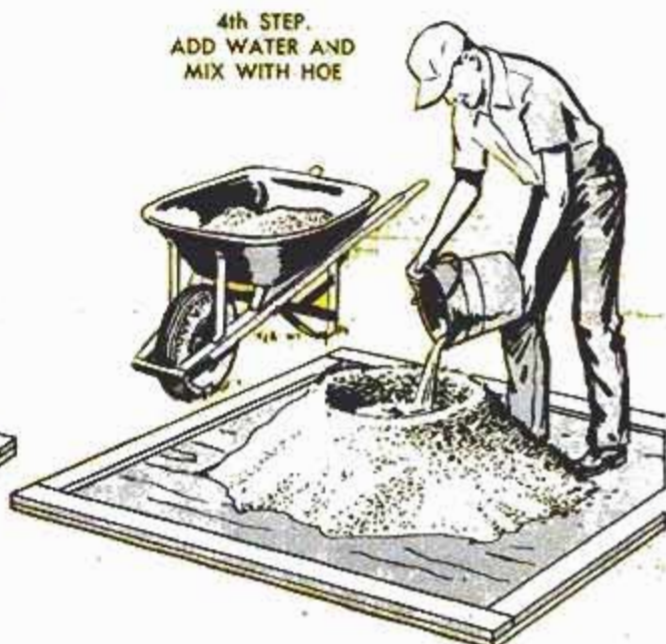

4th STEP.
ADD WATER AND
MIX WITH HOE



Johns Manville photo

Game rooms are soundproofed with acoustical wallboard and tiles stapled to furring strips on joists

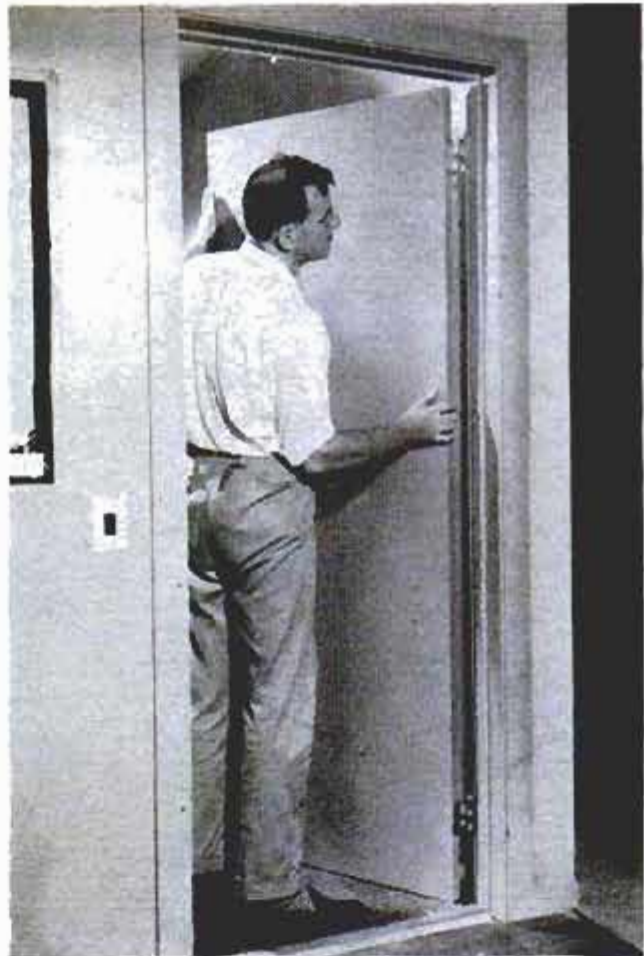

Replacing hollow-core doors with solid-core type materially reduces sound transmission between rooms

BUILDING QUIET INTO YOUR HOME

By Stanley Schuler

MODERN LIFE has many advantages not available 25 years ago, but it also has some disadvantages, one of which is noise. We produce it inside our homes, outside our homes, in the air and even underground. Electronic devices and modern home appliances do the job inside, while modern transportation and industry set up a din outside, to say nothing of the noise we humans produce ourselves. All this noise adds up to an almost unbearable situation at times, which makes insulation against noise equally as important as insulation against heat and cold. In new construction, soundproofing should be considered with other modern improvements. In existing homes, soundproofing is a little more difficult, but not impossible.

Eliminating Sound

The first step in soundproofing an existing home is to determine what sounds actually can be eliminated or materially reduced in volume. Check the blowers and motors on the heating plant for worn bear-

ings, noisy mountings and loose fan blades and hubs. Test rubber mountings. If worn or damaged they may be transmitting vibration noises all through the house via the ductwork.

Central air conditioners should be completely insulated from the ductwork by means of flexible sleeves which prevent the transmission of noise and vibration through the ducts.

Automatic washers sometimes are connected to the water supply with rigid piping. Installing short lengths of rubber hose between the washer and pipe will eliminate sounds transmitted throughout the house in this manner.

Vacuum cleaners, food mixers and other small appliances generally can be quieted by cleaning their motors and mechanisms, then oiling or packing with grease as required. Noise emanating from circulating fans usually is a result of one or more blades being bent out of alignment. Improvise a gauge from a block of wood, hold it inside the guard of the fan and then

An excellent method of soundproofing in new construction is to build interior walls so that alternate studs touch only one surface. A blanket of soundproofing material then is woven between the studs as indicated and the alternate sets of studs are covered with $\frac{1}{2}$ -in. insulating lath, which permits using wallpaper, paint or other decorating materials without affecting the acoustical characteristics of the wall

Another method of soundproofing walls in new construction, where space is a major factor, is to use special resilient clips to support the insulating lath. Plaster then is applied to the lath. This type wall actually has slightly better soundproofing characteristics than the one described above

To effectively soundproof an existing wall, first cover it with $\frac{1}{2}$ -in. insulating board, then build an auxiliary wall of 2 x 2 studs against it. The insulating board is to be left loose, so use only enough nails to keep it in position until the studding is fitted against it, then remove the nails. Cover the auxiliary wall with $\frac{1}{2}$ -in. insulating lath and plaster it to provide a finished wall. When required, both sides of an existing wall can be soundproofed in this manner

Basement game rooms are areas that produce a great deal of noise that can become objectionable to persons on the first floor of the house. The solution to such a situation is to soundproof the basement ceiling by covering it with sheets of $\frac{1}{2}$ -in. insulating board. Furring strips then are nailed over the board, being located along the floor joists as indicated. Insulating lath next is nailed to the furring strips and the final step is to apply plaster to the insulating lath

For maximum soundproofing between floors of a house being constructed, the method shown at the right should be employed. The subflooring first is covered with $\frac{1}{2}$ -in. insulating lath, then furring strips are nailed over it along the floor joists and the finished floor is nailed to the furring strips. The ceiling below is made of 2 x 4s running parallel to the ceiling joists, but having no connection with them. Insulating lath then is nailed to the 2 x 4s and is covered with plaster

Another method of soundproofing a ceiling in an existing structure is to first nail $\frac{1}{2}$ -in. insulating lath to the old ceiling, then nail furring strips over the lath. A second layer of insulating lath is nailed to the furring strips, as indicated, and this latter layer is covered with plaster. When a very complete soundproofing is desired, both in the rooms upstairs and those down, acoustical plaster can be applied in place of the usual type that does not soundproof

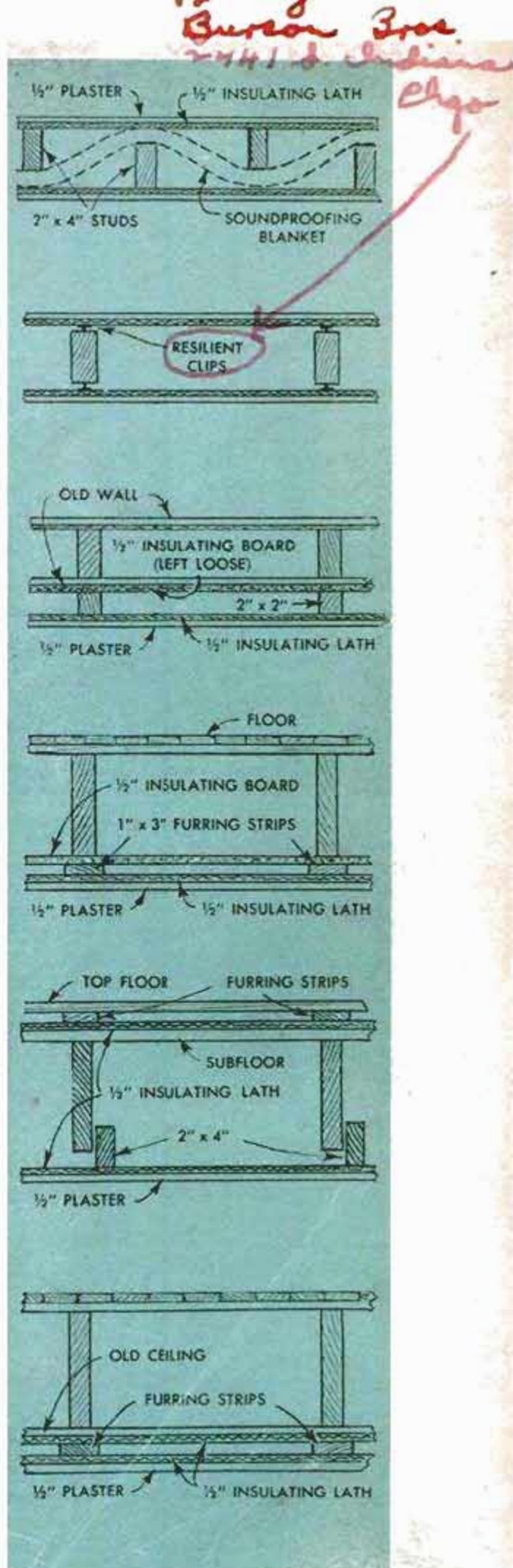



Draperies are an ideal method of soundproofing a room and will also muffle sounds coming through a window

bend each blade so the tip just touches it.

When all the noisy appliances have been quieted, begin a check of such items as door latches, locks and hinges. Although these sounds are commonplace and generally disregarded, they add to the general din. A few drops of oil usually will quiet a squeaking hinge. Latches and locks that do not catch properly unless a door is slammed sometimes require refitting. Powdered graphite forced into a lock with an applicator often will free the mechanism so it works easily. If a door is slammed often, install a door closer to prevent the noise and assure that the door is closed properly.

Soundproofing a Home

After all unnecessary noise has been eliminated or reduced to a minimum, structural soundproofing is required to further quiet a house. Generally, exterior walls are sufficiently dense to absorb outside sounds and prevent them from entering the house. Single-paned windows are not, and when they are facing toward a busy street or other source of noise should be double glazed with the two panes about 1½ in. apart. Since this will present a problem of cleaning the inside surfaces of the panes of glass, a better method is to

keep storm windows on the year 'round. Adjustable brackets should be fitted on the storm windows so they can be opened if desired. Combination storm windows also are effective in reducing sound transmission. The simplest way of soundproofing a window is to install draperies.

Inside a house there also is a problem of airborne sound passing from one room to another. Radios and television sets sometimes can be heard in another room even though the door between rooms is closed. Lightweight, hollow-core doors offer little resistance to the passage of sound and must be replaced with heavier, solid-core doors when soundproofing between rooms is necessary. Sound-absorbing materials in the room from which the sounds originate also will reduce the volume of sound transmitted through the air. A rug over a pad will absorb sound that ordinarily would be reflected back from the floor, and upholstered furniture will absorb still more sound.

If you have a laundry or utility room that has masonry walls, it is a simple matter to install acoustical tiles with mastic-type adhesives. The tile will absorb much of the noise resulting from the operation of appliances and make the room a more com-

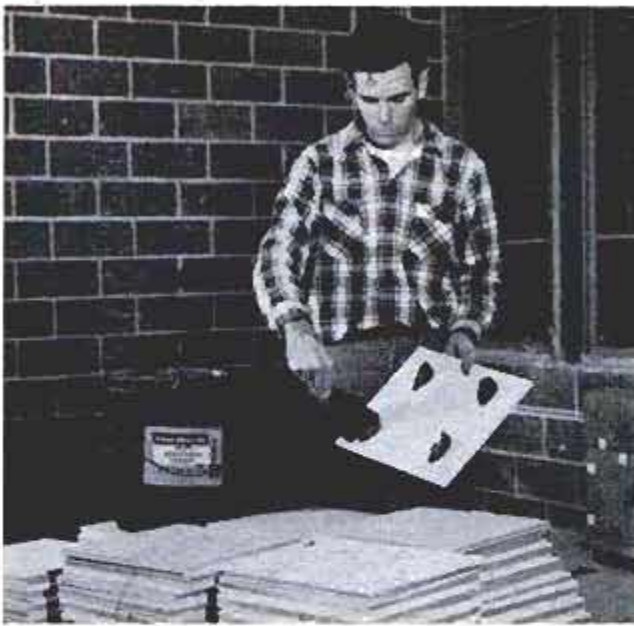

Acoustical tiles can be applied to masonry with adhesives so that no mechanical fasteners are required



Acoustical tile on ceiling only often is sufficient to reduce noise levels to an acceptable minimum

comfortable place in which to work. Acoustical tile also can be applied to plastered walls with adhesive. In the case of a basement room, rough concrete walls may require the installation of furring strips to which the tiles are nailed or attached with clips.

Very often, applying tile only to the ceiling of a noisy room is enough to reduce noise to a comfortable level. It also is possible to install too much soundproofing, so that a room has a "dead" feeling, where voice tones are immediately absorbed and even the sound of a radio seems muffled.

Basement game rooms very often are a source of noise that will penetrate through the first floor. The simplest way to soundproof the floor in this case is to nail furring strips to the floor joists and install a ceiling of acoustical tiles. Where a situation might be extreme—a basement workshop in

which power tools are used would be an example—it would be necessary to use one of the methods shown on page 207 to soundproof the floor. If a game room or workshop is included in the plans of a new home, soundproofing between the first floor and basement ceiling should be specified to assure maximum living comfort in the finished home. For the same reason, in a two-story home where bedrooms are on the second floor, the ceiling between the upper and lower floors should be soundproofed.

In single-story, ranch-type homes it is the walls that are most important in soundproofing. Walls between sleeping and living areas should be soundproofed, and solid-core doors installed so that sleepers are not disturbed by other members of the family who stay up late. ★ ★ ★

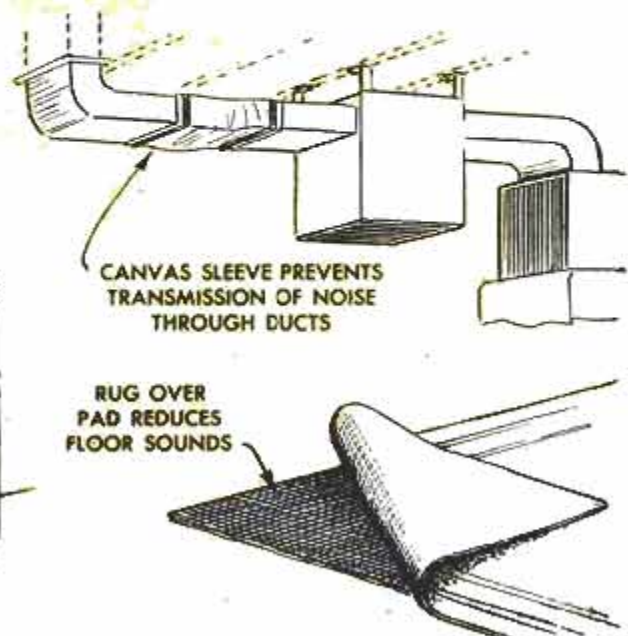
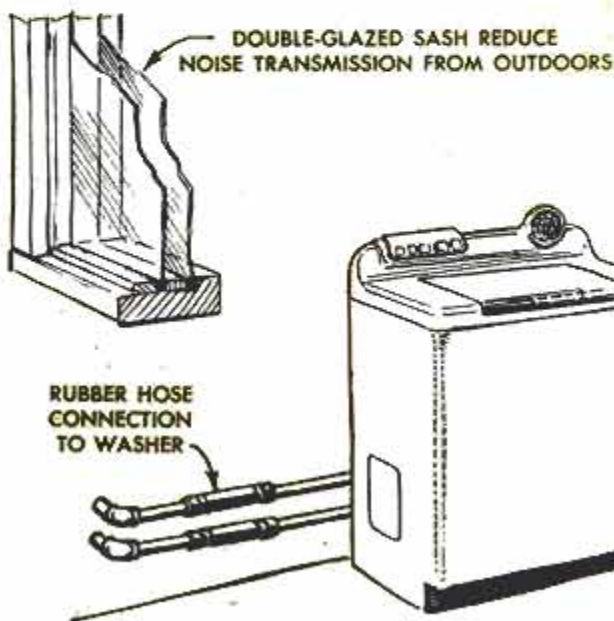

Covering Window Helps Increase Wall Space

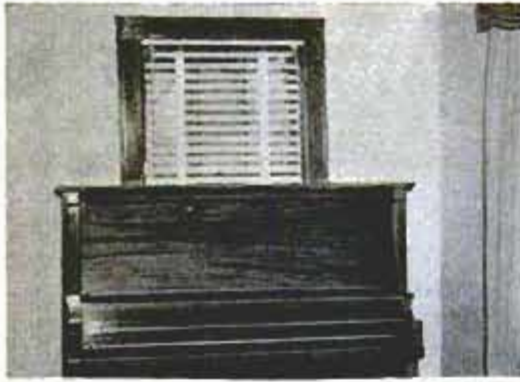

If a window limits the placing of large pieces of furniture such as a piano, the window can be concealed temporarily by covering it with a panel decorated to blend with the adjoining wall. To make the panel, first construct a 3-sided frame of 1-in. stock which will fit around the edge of the window casing. Brace the framework at the corners with right-angle brackets. Then drive two finishing nails into the edge of the top piece of casing and drill matching holes into the top member of the framework. Nail a sheet of hardboard to the framework and slip it over the window.

"Air Washed" Roof Keeps Porch Cool

Space between the ceiling and roof of a shed-type porch stores up considerable heat on a hot sunny day, and this heat radiating downward often makes the porch unbearably hot. One effective method of removing heat is to install screened openings in the ceiling at the lower end of the roof for entrance of air, and louvered openings at the top of the end walls, as exits. As shown in the illustration, the fresh air comes in at the lower edge of the roof and is exhausted out of the louvered openings.

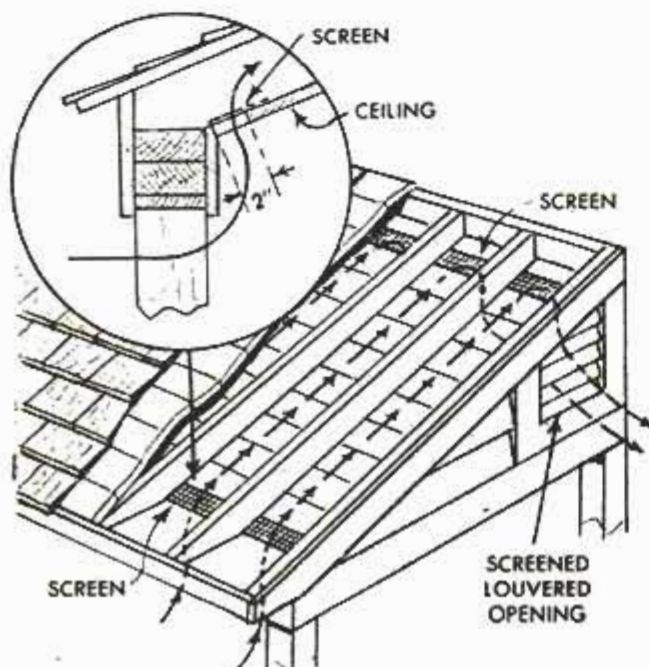

Metal Flashing Under Fascia Board Prevents Water Damage to Dormer

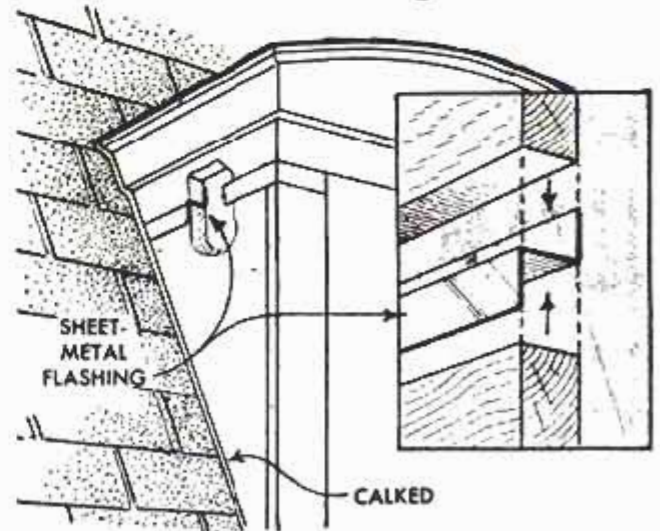

In some types of dormer construction the siding material is butted against the fascia board resulting in a joint which eventually may open and allow water to enter. To avoid this problem, install a metal flashing, bent as indicated, in the joint. Another source of leaks is the corner where the dormer joins the roof. Calk this joint, even though flashing may have been installed under the roofing.

☛ Luminous paint applied to the outer edge of each step on basement stairs will help to eliminate one source of accidents in the home. A coat of white shellac over the paint will protect it from wear.

POTTER'S WHEEL

Built Into a Kitchen Stool

By Ross E. Williams

ALTHOUGH the traditional kick wheel is as old as the art of pottery throwing, modern beginners and advanced artists in clay appreciate the smooth action, and especially the uniform speeds possible with a motor-driven wheel. Power drive enables the pottery worker to give full attention to the throwing processes, makes painstaking jobs less tiring, and eliminates the necessity of making compensations for any irregularities caused by vibration or variations in the speed of the wheel.

Using an ordinary steel kitchen stool, an 8-in. aluminum sanding disk, a 9-to-1 right-angle speed reducer, a rubber-mounted 1/4-hp. motor (with resilient base) and a few other accessory parts, you can build a variable-speed potter's wheel on which you can turn out work of professional quality. The illustration at the right pictures the completed unit, the left-hand photo below shows the reduction drive as-



sembled while the right-hand photo pictures the drive unit being mounted vertically between the seat and lower frame of the stool.

As the first step in construction, remove backrest from the stool. If you purchase

Speed-reducing drive assembled ready for installation in stool. Turntable is on 8-in. aluminum sanding disk

Drive assembly being installed in stool. Stepped V-pulleys gives 4 speeds from motor to reducer

Photos by John Boynton

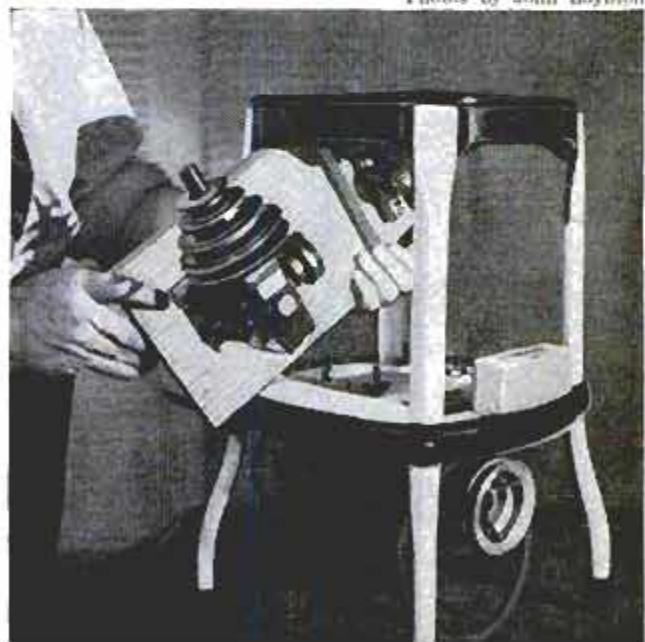

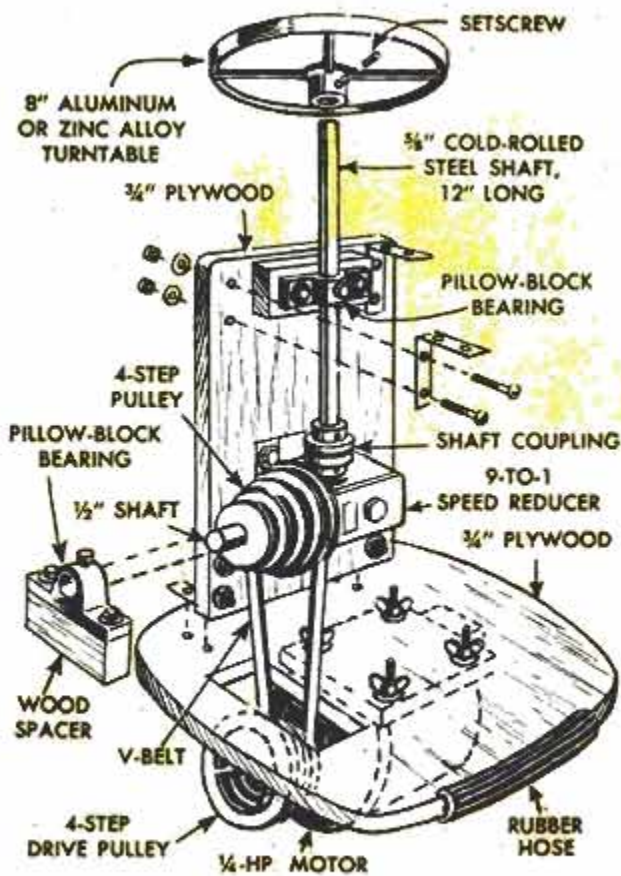

To make bat of right size pour plaster of paris into an aluminum pie plate. Permit bat to harden fully before removal from form



Plaster-of-paris bat is "glued" to turntable with a thin layer of moist clay. Bat provides base on which potter's clay is centered ready for the first steps in throwing

a stool, buy one without the retractable steps, as neither these nor the backrest is needed. Then remove the lower frame and place it on a piece of $\frac{3}{4}$ -in. plywood as in the left-hand photo below. Hold it securely in position and run a pencil line on the plywood, the pencil point bearing against the inner edge of the frame. Then run a line around the outer edge. Lay the frame aside and mark a pencil line halfway between these two lines. Cut out on the bandsaw or jigsaw (or with a coping saw), the blade cutting just outside the middle line. This should give you a piece of plywood shaped to fit inside the frame with the edges bearing on the lower flange.

Laying out plywood shelf, using lower stool frame as template. This shelf serves as base for motor



Further cutting will be necessary to obtain a true fit of the plywood shelf around the legs of the stool when assembling. For extreme quietness of operation, the shelf should be rubber-mounted by fitting a length of rubber hose (or rubber tubing) over each of the four curved edges at the time of assembly. A length of hose is shown in position in the detail above at the left.

No locating dimensions are given for the belt opening in the plywood shelf. The location and size of the opening must be determined by trial fitting of the various parts. The vertical shaft carrying the turntable (sanding disk) passes through a hole drilled in the steel top of the stool and through a hole punched in the plastic bowl (a flexible plastic dishpan is just the right size). The bowl is attached to the stool top with four brass bolts so that it can be removed for cleaning. The lower end of the turntable shaft is carried in a flexible coupling, one flanged half of which is fitted to the output shaft on the speed reducer. The vertical shaft is carried in a pillow-block

After marking around inner and outer edges of frame, mark a third line halfway between. Saw outside line



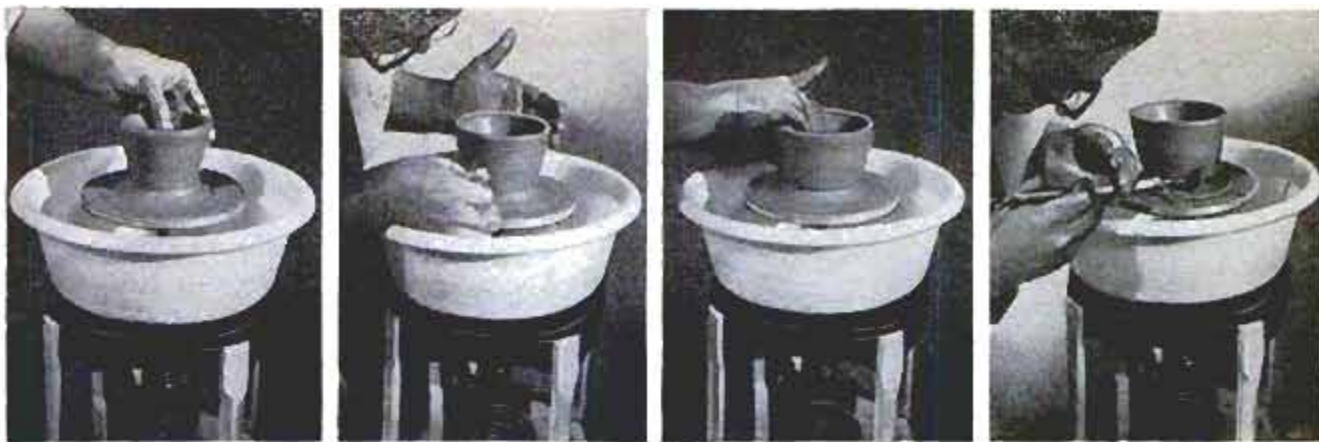

Photos above picture four important steps in the throwing process. Also, they show the purpose of the bowl, adapted from a flexible plastic dishpan, in preventing the wet clay from being thrown on floor

bearing which is mounted on a spacer block to bring it in line with the output shaft on the reducer. A 1/2-in. rigid coupling is fitted onto the end of the input shaft on the reducer. This takes a short length of 1/2-in. shaft on which the 4-step driven pulley is mounted. The outboard end of this shaft extension is carried in a 1/2-in. pillow block as shown. The 4-step driving pulley on the motor gives the drive a selection of 4 speeds. The vertical plywood base carrying the reducer and turntable shaft should be cut to a snug fit between the plywood shelf and the metal stool top. The ends are held in place with steel angle brackets and stove bolts.

One thing to remember before final assembly: If you are right-handed the turn-

table should rotate in a counterclockwise direction. If you are naturally left-handed the turntable should rotate clockwise. If necessary, reverse the motor by interchanging the leads to the starting winding. Wire a 2-pole toggle switch in the power cord to control the motor.

Before throwing on the wheel (turntable) you cast plaster-of-paris disks with tapered edges on which the clay is centered for throwing. These are called bats and are cast in aluminum pie plates as in the upper right-hand details on the opposite page. The individual bat is "glued" to the turntable with a small quantity of wet clay. The four photos above show important steps in throwing work on the wheel. They are, of course, only representative. * * *

Sandbox Contents Stored in Milk Cartons for Winter

Empty milk cartons provide a handy method of storing the sand removed from a sandbox that is dismantled and stored for the winter months. The flat-topped, 1/2-gal.-size cartons stack compactly and are easier to handle than are large boxes or bags that sometimes are used. Also, the waxed material of which the cartons are made is resistant to moisture which may be in the sand. Before pouring the sand into the cartons, sift it through a screen to remove foreign matter. Other uses for the milk cartons are to store various mixtures of potting soil, and as containers for fertilizers or other materials spilled from a broken bag.



SOLVING Home Problems

BAR OF SOAP can be used to lubricate needle when sewing heavy materials such as canvas. The soap lubrication is especially effective for large needles that have rusted and become roughened. Simply force the needle into the soap frequently during the sewing. The small amount of soap that is deposited will be removed first time the material is washed

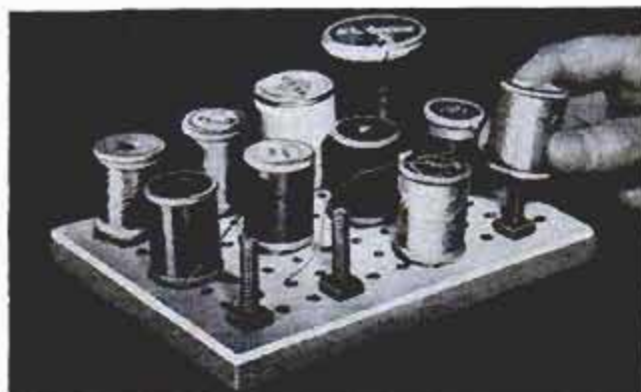

SANDWICHES ARE SLIPPED INTO BAGS easily without being crushed or forced apart when a pancake turner is used as a "shoehorn" to slide them into bags as shown in photograph below. Idea is especially useful for sandwiches that have very soft fillings

FOUNTAIN-PEN CAP that becomes stuck on barrel can be released by wrapping adhesive tape around both the barrel and the cap as shown in the lower photograph below so that a good grip is provided on the smooth surfaces of the pen. The cap then can be unscrewed from the barrel with comparative ease

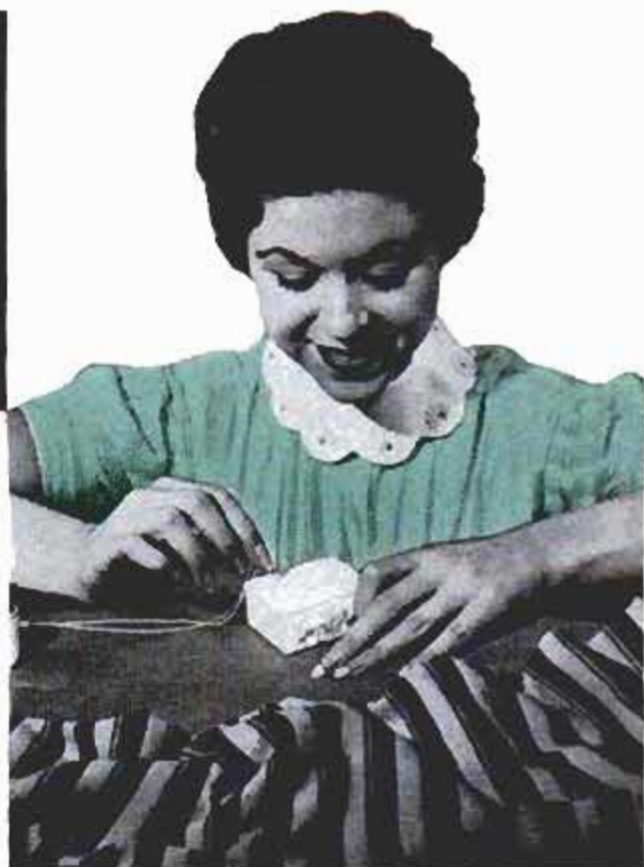

HANDY SPOOL RACK is made in a few minutes from a piece of perforated acoustical tile or perforated hardboard. Cut the tile or hardboard to the desired shape and size, then fit a small stove bolt into every fourth hole. Turn a nut snugly against the tile on each bolt and rack is finished and ready for the spools

PLASTIC BOTTLE CAPS that frequently are difficult to unscrew because the contents have coated the bottle threads with an adhesive substance, can be kept loosened by using wax as a "dry lubricant." Clean the threads on the bottle, then rub them with wax paper as indicated in the photograph below





SERVICEABLE ONE-POT "GREENHOUSE" can be made by slipping a plastic bag over flowerpot and plant. Another use for a plastic bag is as a moisture retainer when a plant must be left untended over a week end



SHOES THAT ARE NOT OFTEN WORN can be stored in the bottom of a garment bag in which are hung clothes that do not reach to the bottom. The shoes are protected and out of the way, yet do not require racks that would occupy valuable closet space

FISHBOWL COVER that is easily removed and replaced is made by stretching a hairnet over a pair of embroidery hoops of a size required to fit the bowl opening. The net prevents the fish from jumping out and also discourages the family cat from fishing



OCTOBER 1956



WHEN SILVERWARE NEEDS CLEANING and there is no polish in the house to do the job, toothpaste can be used as a satisfactory substitute. Apply the paste to the silver with a soft cloth and rub briskly so the mild abrasive in the paste removes the tarnish. Finally, rinse and wipe dry

SIZE AND STYLE NUMBER OF A PAIR OF SHOES you find especially comfortable can be kept legible until they are ready to be discarded in exchange for a similar pair if the numbers are covered with a strip of cellulose tape. The thin, smooth tape will not be felt when the shoes are worn



215

Shingle Platform is Self-Supporting on Double-Course Wall

Utilizing the 1/2-in. overhang of the top course of shingles on a double-course wall, this platform holds a supply of shingles

within reach of the workman and is completely portable and self-supporting. As shown in the detail, the platform is made of scrap wood and a trimmed shingle. The projecting nails are forced into the lower course of shingles by the weight on the platform and the trimmed shingle is held by the projecting shingles of the upper course. To move the platform, simply lift up on the shelf to disengage the nails, then lower it so the trimmed shingle clears the overhang of the course.

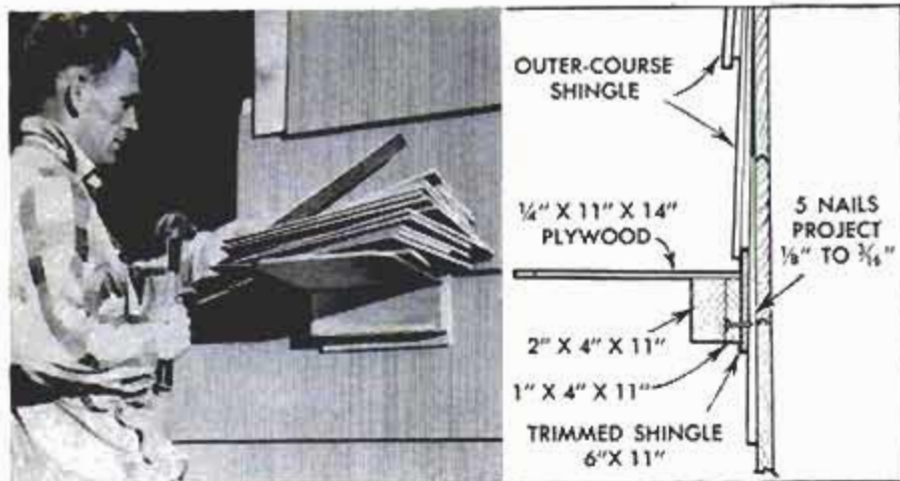

Red Cedar Shingle Bureau

Reduce Crawl-Space Humidity With Adequate Ventilation

Where no other effective means of condensation control is provided, crawl-space humidity under house floors may be reduced by adequate ventilation. There should be at least one vent opening in each wall of a structure, and preferably located near a corner. Total unobstructed venting area of all openings combined should equal approximately 2 sq. ft. for each 100 lineal ft. of crawl-space perimeter.

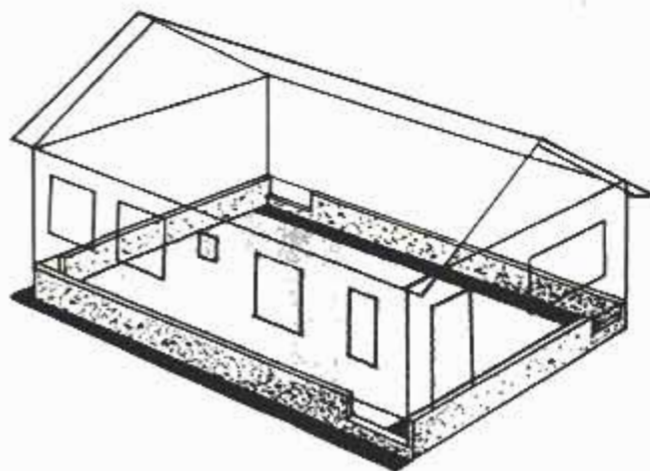

Allowances must be made for wire mesh or louver obstructions, placed in the vents to keep out pets and wildlife, quite often requiring twice as much opening. Vents should be placed as high as possible in the wall for greatest effectiveness. Closing the vents over winter eliminates their usefulness, but if they are left open, the floor above the crawl space must be insulated. Crawl space used as a plenum for warm-air heating should not be ventilated. Instead, humidity must be controlled by a suitable ground barrier and good drainage.

Tightening Loose Setscrew

A worn, loose-fitting setscrew on a door-knob, machine or appliance can be made to fit tightly by flattening the threads slightly. Place the screw on a steel block and tap it with a hammer until the threads are burred. This will permit a better grip until the screw can be replaced.

Drain Hole Punched in Can

To get the last drop of solvent, thinner, or other liquid from a can of the type shown, punch a pouring hole in one corner on the top as close to the edge as possible. If the can is to be used later as a container, the hole is easily closed with a drop of liquid solder.



WTM 58
 &
 PhotoKinks 58

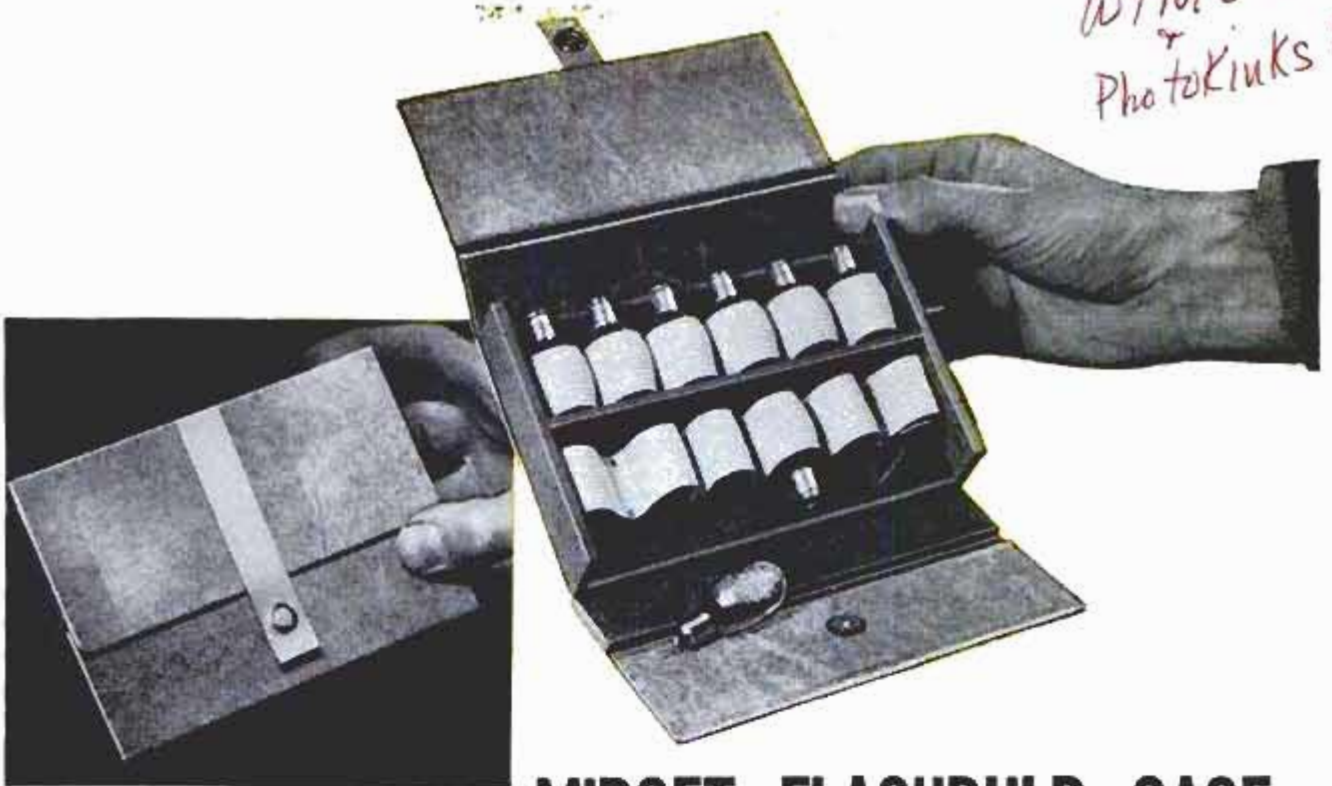

MIDGET FLASHBULB CASE

A DOZEN midget M-2 flashbulbs may be carried in this easily made case which fits conveniently in a coat pocket or gadget bag. The case is lined with felt on the bottom and on both sides of the partition to protect the bulbs. Each bulb fits in a separate pocket formed by strips of elastic webbing which are tacked to the bottom, nail points being clinched over on the opposite side. Covering the case is a 9 x 12-in. sheet of cloth-backed plastic which is glued to the bottom so that it extends equally beyond the ends, $3\frac{3}{8}$ in. beyond one side and $4\frac{3}{8}$ in. beyond the other side. Dimensions given are for a case to carry midget, type M-2, flashbulbs, but a similar case can be constructed to carry bulbs of other sizes.

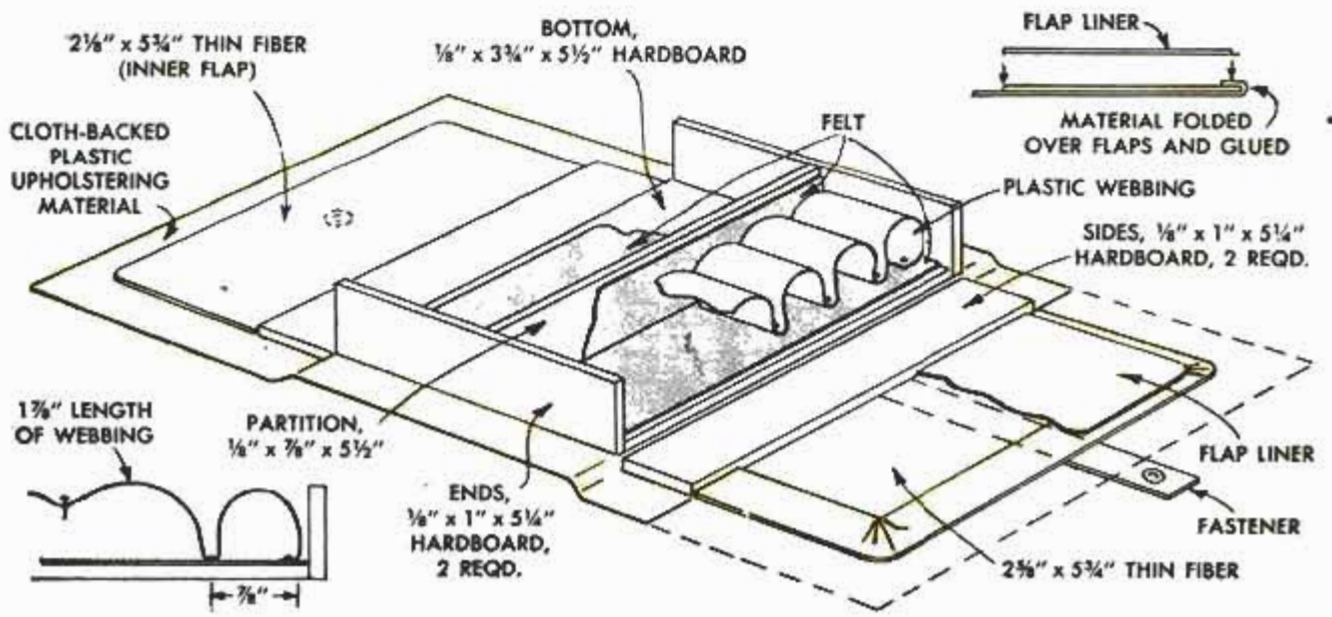
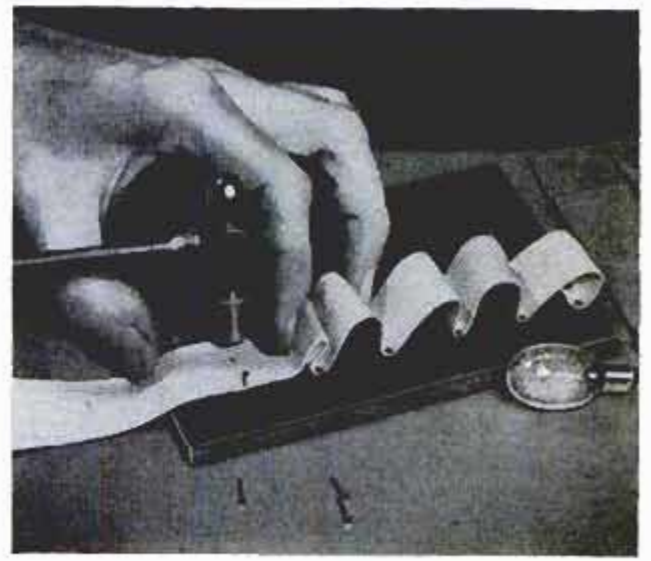

Cord Cocktail Table

Designed and built
by Darrell Huff
and Paul Corey



A unique feature of this cocktail table is the tray in the center which can be used for serving snacks

Considerable table space is available with the tray in place, and the magazines are concealed as well

HERE'S A COCKTAIL TABLE that will not seem out of place in a large living room of a modern ranch house. Its massive top (30 x 48 in.) includes a 15 $\frac{3}{4}$ x 29-in. serving tray which, when removed, reveals a cord rack for storing more than two dozen magazines. Whether it's used for coffee or cocktails you'll appreciate the abundance of table space and the convenience of a serving tray which becomes a part of the table. Even the tray is large enough to carry the cups or glasses, food and drinks you must bring in from the kitchen. No need for extra trips back and forth to the living room, and transferring of items from the tray to the table. It's all done in one trip.

Constructing the top is the first step in making the table. Framing members are all cut from 1 $\frac{1}{4}$ x 1 $\frac{3}{4}$ -in. stock. The four outside pieces are rabbeted $\frac{1}{2}$ in. down from the top edge and $\frac{3}{4}$ in. in from the

inner side to accommodate the double thickness of $\frac{1}{4}$ -in. plywood which comprises the top surface. Cut a rabbet $\frac{3}{8}$ in. wide by $\frac{1}{2}$ in. deep in both top corners of the two cord stringers as indicated in the detail on page 221. Clamp the stringers together on edge and drill $\frac{1}{4}$ -in. holes through both of them at the same time, for the cord which will be installed later. Drill the holes at 1-in. intervals along a line 1 in. from the bottom of the stock starting 2 in. in from the end. Then cut mortises in the side frame members for the ends of the stringers, centering the slots 18 $\frac{5}{8}$ in. from one end of the table and 13 $\frac{1}{8}$ in. from the other end. Assemble the framework as indicated in the detail on the facing page. Mitered joints at the corners are glued and reinforced with corrugated fasteners which are driven in from the bottom.

Now cut pieces of $\frac{1}{4}$ -in. fir plywood to

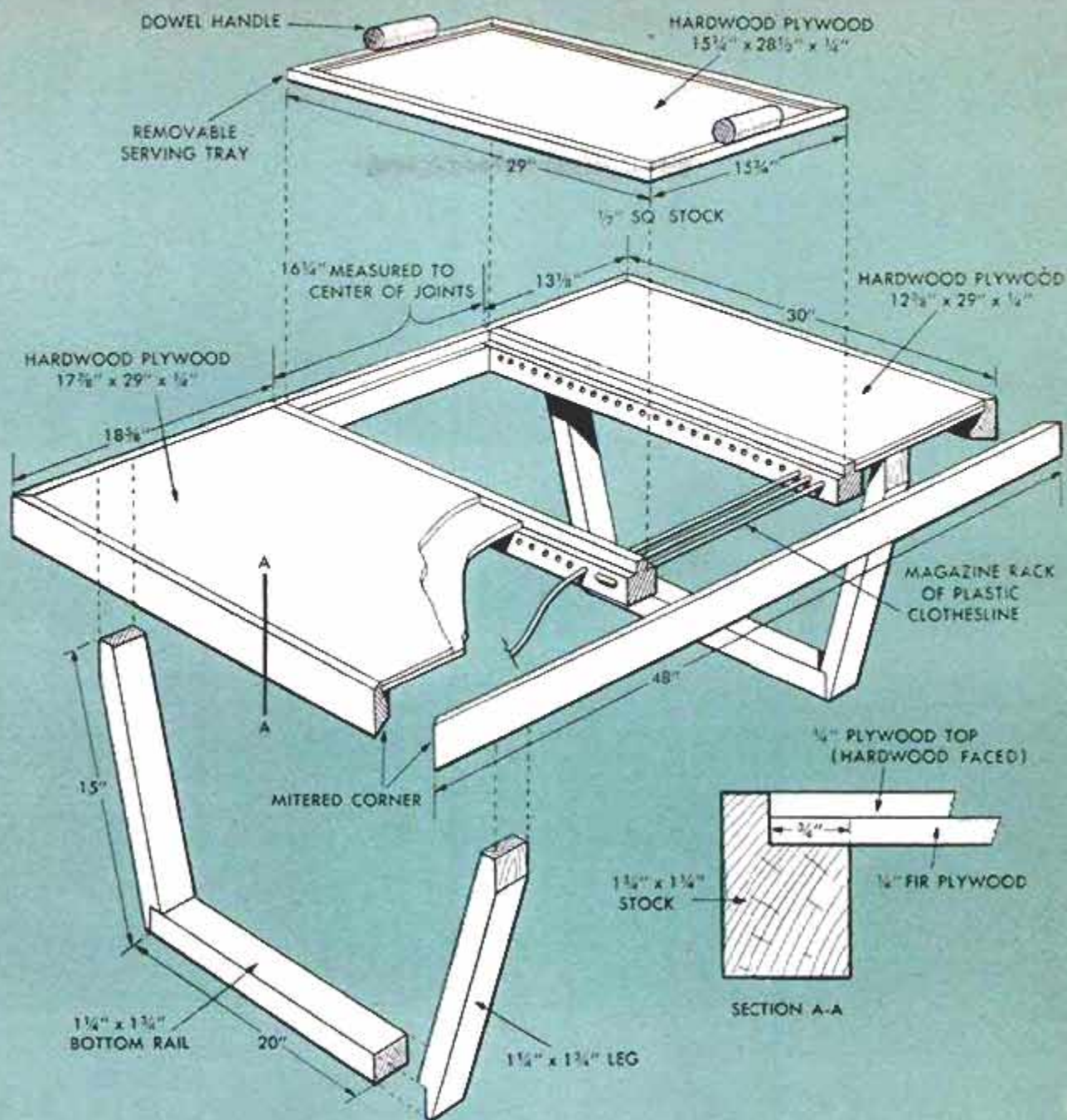

Framing members for the top are mitered together. Joints are glued and then reinforced with corrugated fasteners which are driven in from the bottom side

Holes may be drilled in both stringers at the same time if they are clamped together on edge as shown. Drill holes 1 in. apart starting 2 in. from one end

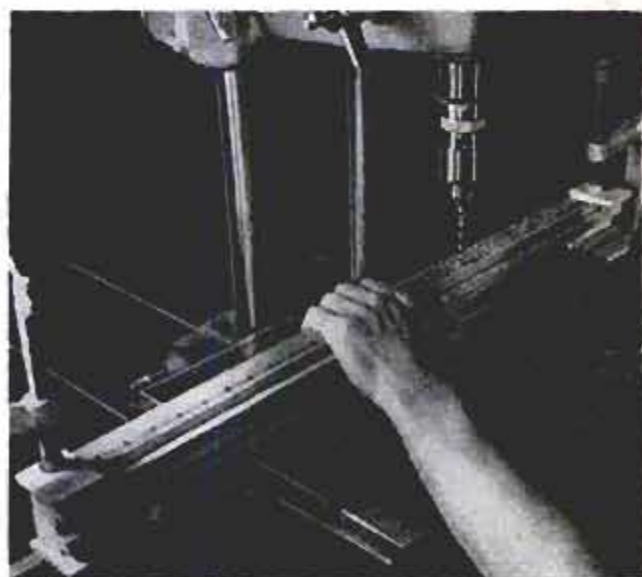

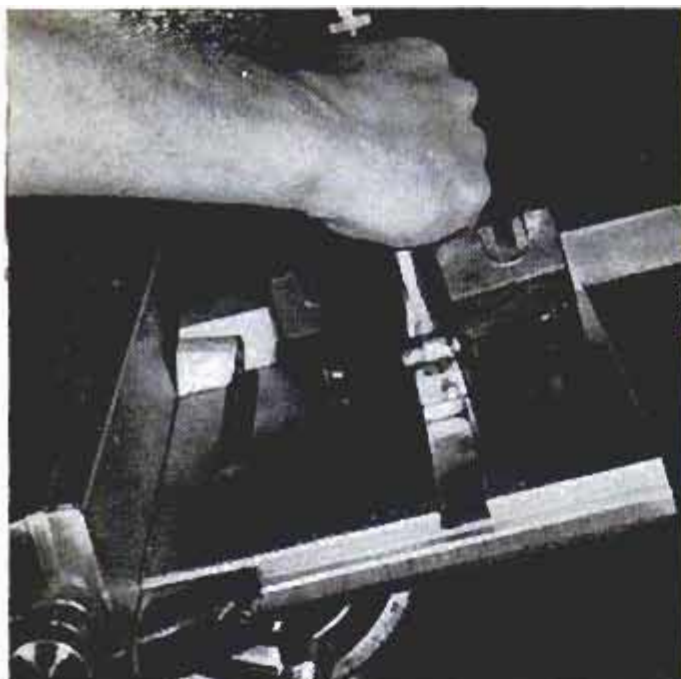

Each leg is undercut for the bottom rail. Vertical cut is at right angles to end and crosscut as shown

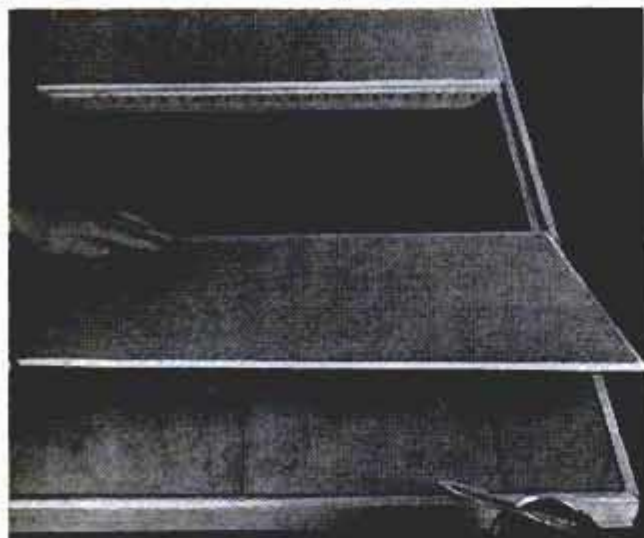
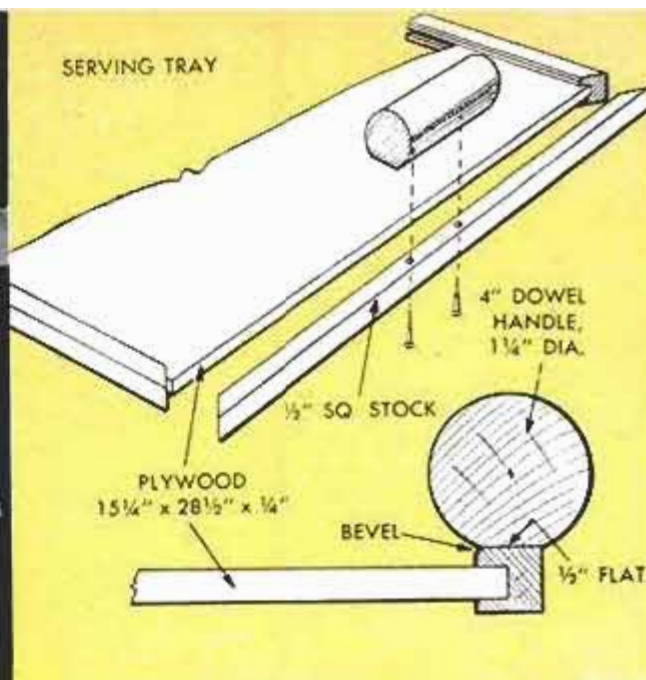
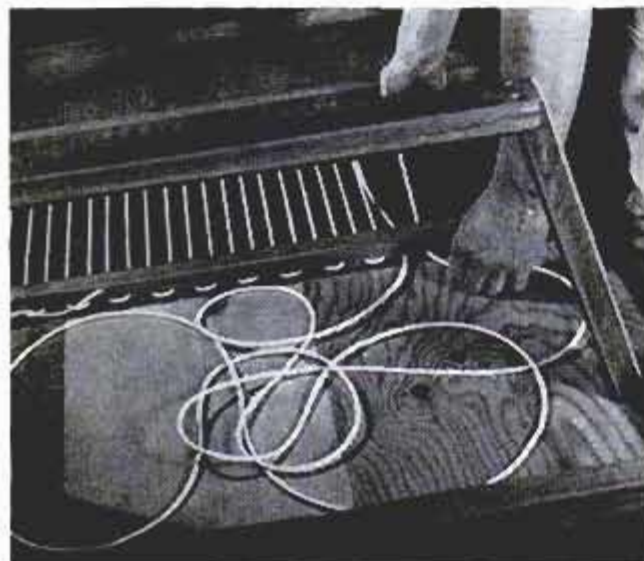

Table top is hardwood plywood glued to sheets of fir plywood. Both panels are recessed in the framing

One hand is used to lace the cord between the two stringers while the other is used to pull it tight



fit in the two end rectangles of the frame. Fasten them in place with glue and brads. Then cut two similar panels of hardwood plywood and laminate them to the fir panels already in place. An alternate method is to use $\frac{1}{2}$ -in. plywood with a finished hardwood surface on one side.

Next in line of construction is the serving tray. Start by cutting a $\frac{1}{4}$ -in. plywood panel $15\frac{1}{4}$ in. wide by $28\frac{1}{2}$ in. long. Frame the panel with $\frac{1}{2}$ -in.-sq. stock which has a $\frac{1}{4} \times \frac{1}{4}$ -in. rabbet in the center of one side. Miter the frame together at the corners and glue the plywood in the rabbet. Install a 4-in.-long handle cut from $1\frac{1}{4}$ -in. round stock on the frame at each end of the tray. Cut a $\frac{1}{2}$ -in. flat surface the full length on each handle before screwing it in place on the tray. This will keep them from working loose. The completed tray should fit into center opening of table.

The end of the cord is fastened by weaving through return loops on the outside of one of the stringers



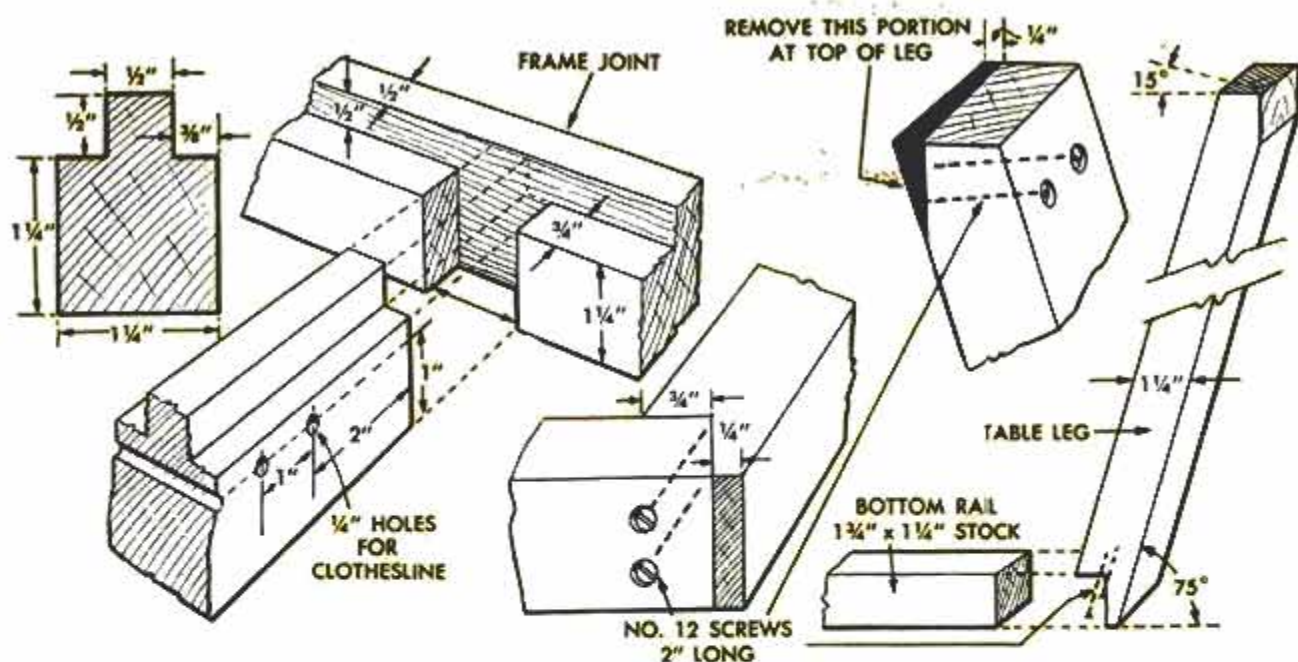

Plastic clothesline is used to support the magazines. Begin weaving the cord at the center of the stringers running it straight across. Tighten it by working the slack out to the sides, and then secure the ends by slipping the cord through a couple of the return loops on the outside of the stringers.

Legs for the table are cut from $1\frac{1}{4} \times 1\frac{3}{4}$ -in. stock. By making each crosscut at 15 deg. the legs, when installed, will lean out at the top as shown in the detail on page

219. Cut off a $\frac{1}{4}$ -in. wedge from the top outside corner of the legs so they will fit flat against the inside of the table-top framing. Undercut the bottom of each leg to receive the end of one of the two bottom rails which are fastened to the legs with wood screws driven up from underneath. Each rail is $1\frac{1}{4} \times 1\frac{3}{4} \times 20$ in. and is used to steady the legs and to prevent marring of the floor surface. This feature also permits skidding the table across a rug without having to lift it. ★ ★ ★

Nontoxic Ink for Children

Food-coloring fluid diluted with an equal quantity of water makes an excellent nontoxic ink for use by children. It's washable, too. If accidentally spilled on hands or clothing, it rinses away immediately with plain water. Various colors can also be used in a child's paint box, mixing them together for other shades.



Clipped Brads Are Dowel Centers

When making doweled joints, brads driven into place and clipped short will mark the centers for the holes in the absence of conventional dowel centers. To assure correct positioning, marking should be done with the members laid out on a flat surface, or with a flat surface held against them. The clipped brads are easily removed with a pair of pliers after marking is completed.

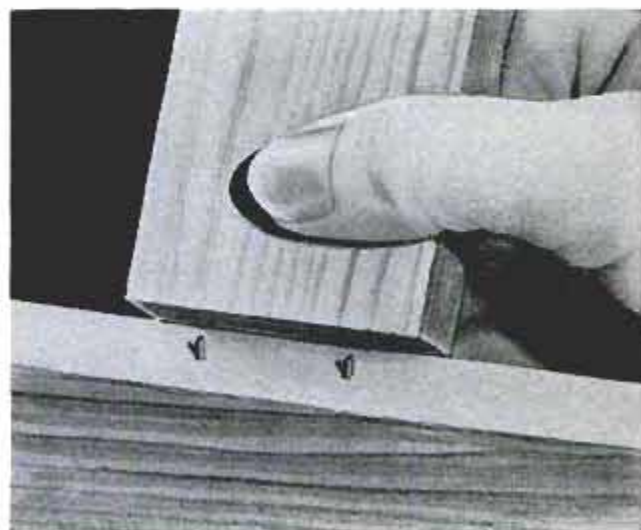

Handy Utility Tray Keeps House-Cleaning Materials Together

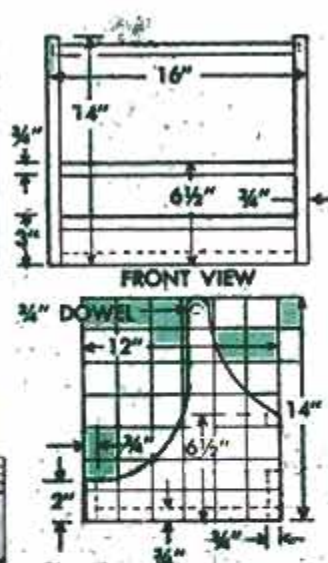

Many steps will be saved by the busy housewife if she has a tray like this one for all her cleaning materials. To build it, temporarily nail together the two pieces for the sides, trace the pattern on one of them, and cut both out at the same time. Pull apart, drill a mortise on the inside of each piece for the dowel handle. Fit the bottom between the front and rear pieces and nail the $\frac{3}{4}$ -in.-sq. cleat in place.
T. M. Fenn, Chicago.

Care and Use of Rubber Gloves

Rubber gloves will give longer, better service if certain proven procedures for their care and use are followed. To aid in donning the gloves, sprinkle talcum powder on the hands. Talcum sprinkled on inside and outside will protect the gloves against rotting and tackiness. To remove rubber gloves, turn them back from the wrists until completely inside out. Then to reverse them, tuck the fingers inside the wrist band and blow out to the original position. Repair cuts and punctures with tire patches applied on the inside. Never leave rubber gloves partly inverted or folded together in pairs. Always dry them thoroughly inside and out before storing.

Robert L. Hay, St. Petersburg, Fla.

Snap Fasteners Tightened With Locking Pliers

Loose-fitting snap fasteners can be tightened easily by squeezing the male piece slightly with locking pliers. Adjust the jaw opening so that it spreads the round head on the fastener slightly when the jaws are closed. Locking pliers permit the correct amount of pressure to be applied to the fasteners, which is not possible when using conventional pliers.



Locking pliers permit the correct amount of pressure to be applied to the fasteners, which is not possible when using conventional pliers.

Ken Murray, Colon, Mich.

Low-Voltage Light Aids in Setting Photo-Enlarger F-Stop

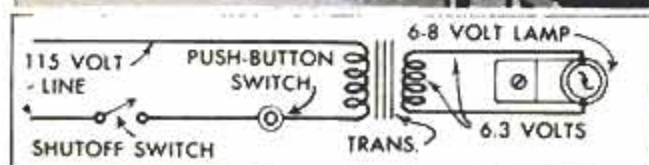
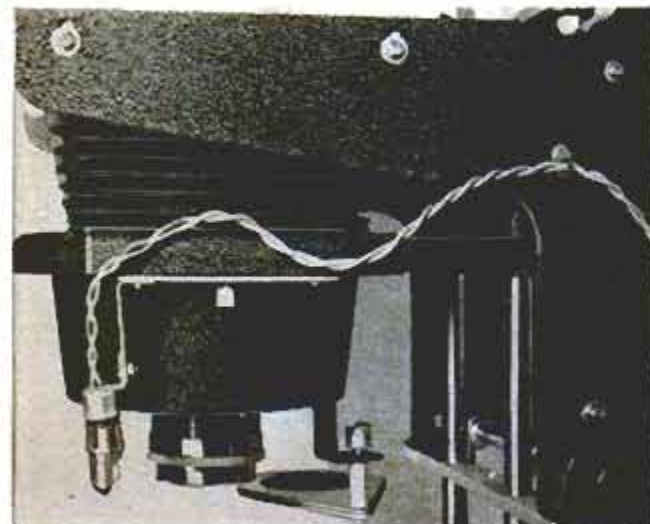

Photographers who may have an enlarger not equipped with a lens that locks into each f-stop position, and those more fortunate who occasionally find it necessary to set the lens diaphragm at an intermediate position will find that illuminating the lens markings will aid in proper setting. Current for the lamp is derived from a small transformer that steps down house current to 6 or 8 volts. The transformer can be mounted in a galvanized electrical outlet box which has a toggle switch and a momentary contact button attached to the cover plate. Following the wiring detail, the toggle switch opens and closes the line voltage supply while the push button lights the lamp. The lamp should have a metal shield with a small opening in it to direct the light on the markings without illuminating the work.

Edward J. Rzeppa, West Chicago, Ill.

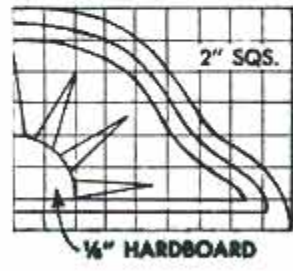
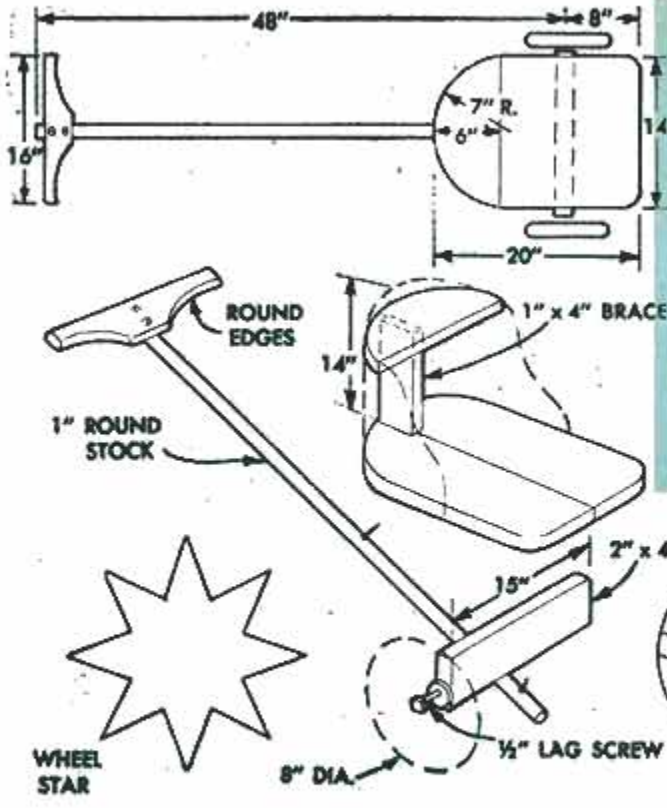

Here Comes the Circus Parade!

THIS CHARIOT and circus wagon will help authenticate the sidewalk parade in which all children love to participate. Two wagon wheels, a sheet of hardboard and some scrap lumber are all you need for the "Roman chariot." Cut the platform, handle and pole from 1-in. lumber, the cross piece for the lag-screw axles from a 2 x 4, and assemble the parts with wood screws and stove bolts. Paint the dashboard before bending it.

2-in. pine for the framing and wider boards for top and bottom. The ends are 3/8-in. plywood with the rear gate hinged at the top and latched at the bottom with a slide bolt. Drill 1/16-in. holes in the framing for the dowel bars, being sure the top and bottom holes are in alignment. The decorative pieces can be cut from plywood or hardboard and painted bright colors. Change the dimensions where necessary to fit the wagon on which the cage is to be used.

The "wild animal" cage is made of 3/4 x

Hi Sibley, Nuevo, Calif.

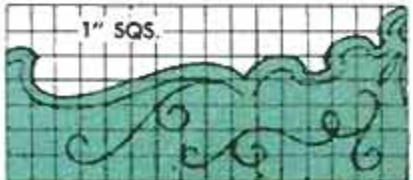
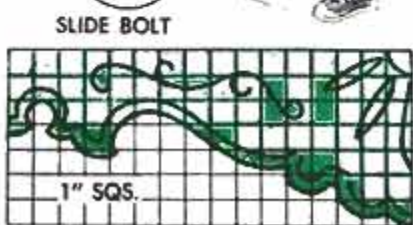
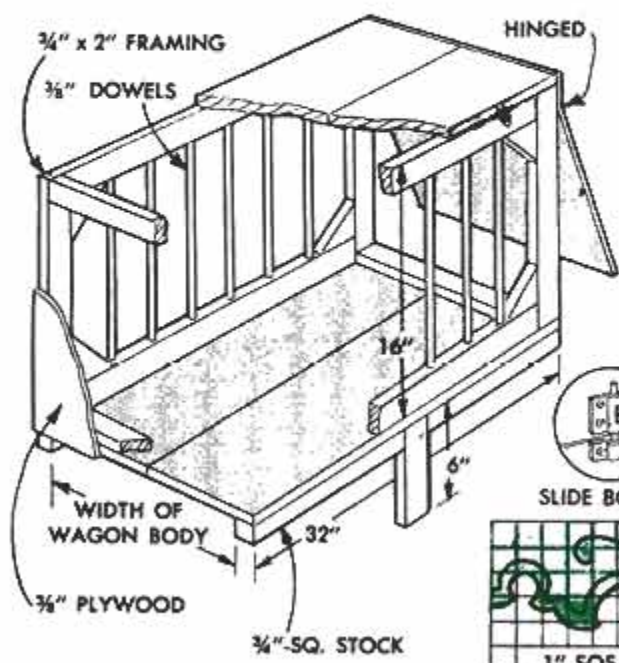

Looped Cord on Wand "Impossible" to Remove From Buttonhole

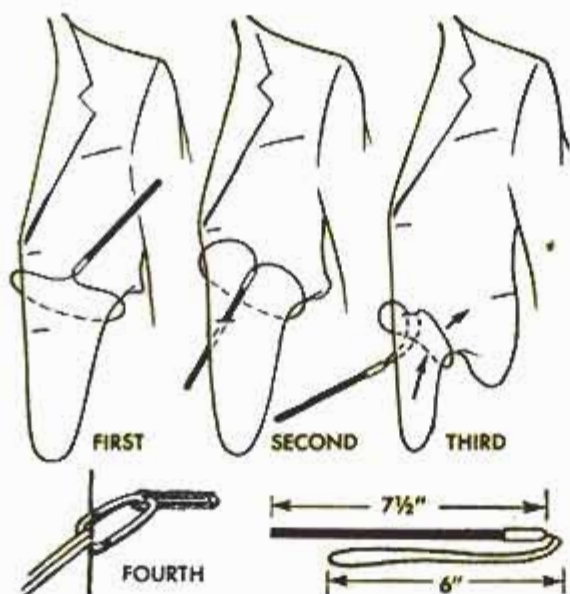

Dad can baffle the youngsters at their next party with this "magic wand and cord" stunt. Once the cord is looped through a suitcoat buttonhole, its removal becomes doubly mystifying when the discovery is made that the loop of cord is too small to permit the wand to pass through it. To loop the cord through the buttonhole, first roll the corner of the coat and pull it down through the loop until the wand is above the buttonhole. Second, pass the wand down through the button-

hole. Third, pull the rolled corner of the suitcoat back through the loop. The result is shown in the fourth detail. Reverse the procedure to remove the cord. The wand is a 1/4-in. dowel 7 1/2 in. long. The knotted ends of the cord are hidden in a metal or plastic pencil cap cemented to the end of the dowel.

Hamper Partitioned to Aid In Sorting Clothes

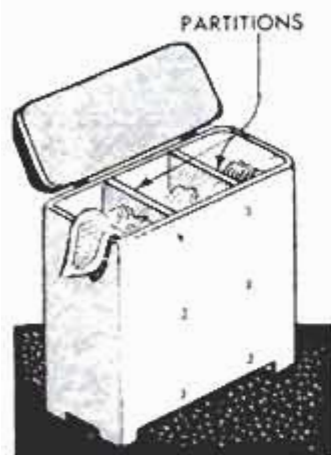

Partitioning the clothes hamper will enable the entire family to help segregate the weekly wash, lessening the task of clothes sorting on washday. Plywood paneling is cut to fit inside the hamper, dividing it into two or more sections. Wooden blocks are glued

to the panels flush with the vertical edges, and then the entire assembly glued inside the hamper. If screws are used to reinforce the blocks, countersink them and cover them with wood putty so they cannot rust and discolor the clothing. Label each section on the cover.—Doris Fenn, Chicago.

Card-Dealing Error Corrected

When the dealer in a friendly card game, where all the cards are distributed, forgets where the next card is to be dealt he may complete the deal satisfactorily without having to count the individual hands. Just resume dealing, starting with the first player originally dealt, and deal until the number of cards remaining is less than the number of players. Then starting with your own hand, deal the remainder counterclockwise, including the "kitty" if it is lacking. This method is especially useful when using several decks at the same time.

Jack T. Tomlinson, Berkeley, Calif.

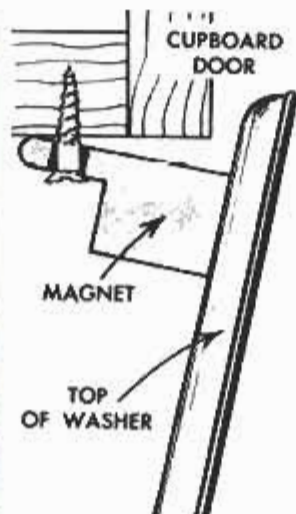

Magnet Holds Cover on Automatic Washer Open

When an automatic washer must be placed under a wall cabinet where the cover cannot be opened fully, a magnet mounted on the bottom front edge of the cabinet will hold the cover open while loading or unloading the machine. A cheap bar magnet with holes provided for screws will do the job nicely. Leave the mounting screws a little loose so a flat side of the magnet can engage the cover.—Rex Eidson, Portland, Ore.

Corner Box Stores Blankets for Twin Beds

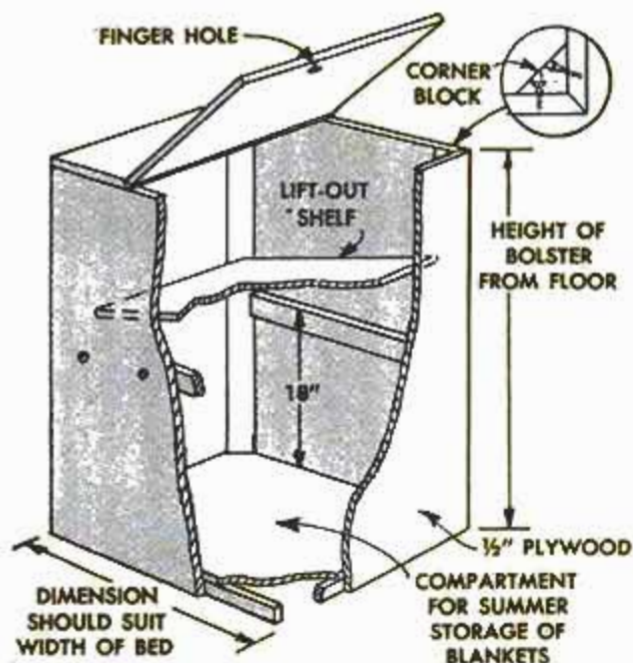

A square box built to fit in a corner formed by twin beds placed at right angles along adjacent walls can be used for summer storage of blankets. Height of the box should be equal to the distance from the floor to the top of the bolsters or pillows on the beds. Width of the beds determines the horizontal dimensions.

First assemble the four sides, which are cut from $\frac{1}{2}$ -in. plywood. Miter them together, reinforcing the corners with trian-

gular cleats, which are glued and screwed in place. Then nail strips to the inside along one edge to support the bottom panel. A second framework of strips is nailed to the inside 18 or more inches up from the bottom to support a removable shelf. This shelf is a snug fit inside the box and is removed by means of a finger hole. Make the top of the box in two pieces, with a wide panel hinged to a narrow strip which is nailed to the edge of the sides.

Toolbox Drill Holder

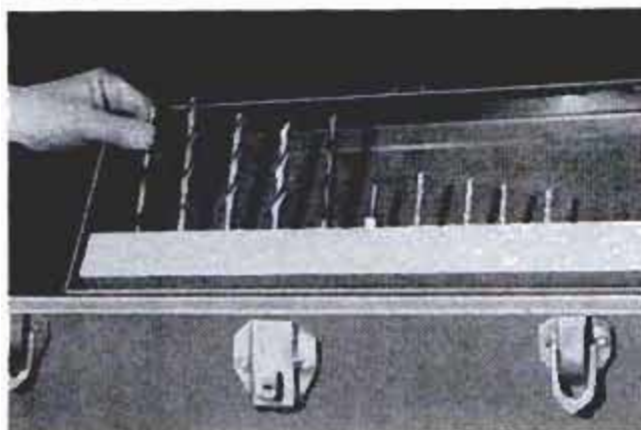

Drill bits scattered at random on the bottom of a toolbox waste time when making a selection of the desired size. To prevent this, fit all the drills in a length of wood fitted to the underside of the toolbox lid. The wood should be $1\frac{1}{4}$ x $1\frac{1}{4}$ in. with enough holes of the right sizes to accommodate the most frequently used drill bits. Make sure the drill holder is positioned properly so that the lid can be closed without any difficulty.

Glen F. Stillwell, Manhattan Beach, Calif.

Hinged Darkroom Paper Cutter

If more usable counter space is needed in a darkroom, hinge the paper cutter so it can be swung up against the wall. It will be necessary to screw a stepped block to the edge of the cutter board, as shown, to provide clearance for the pivot mechanism of the cutter knife. The hinges then are screwed to the block and to the counter top.

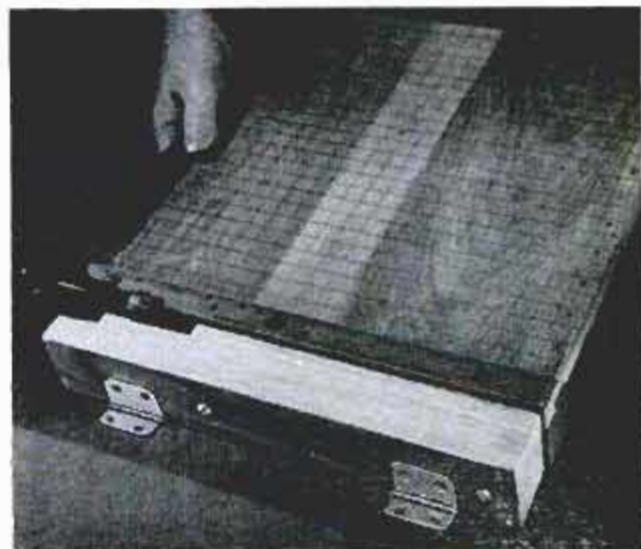

WIM 58 + PhotoKinks

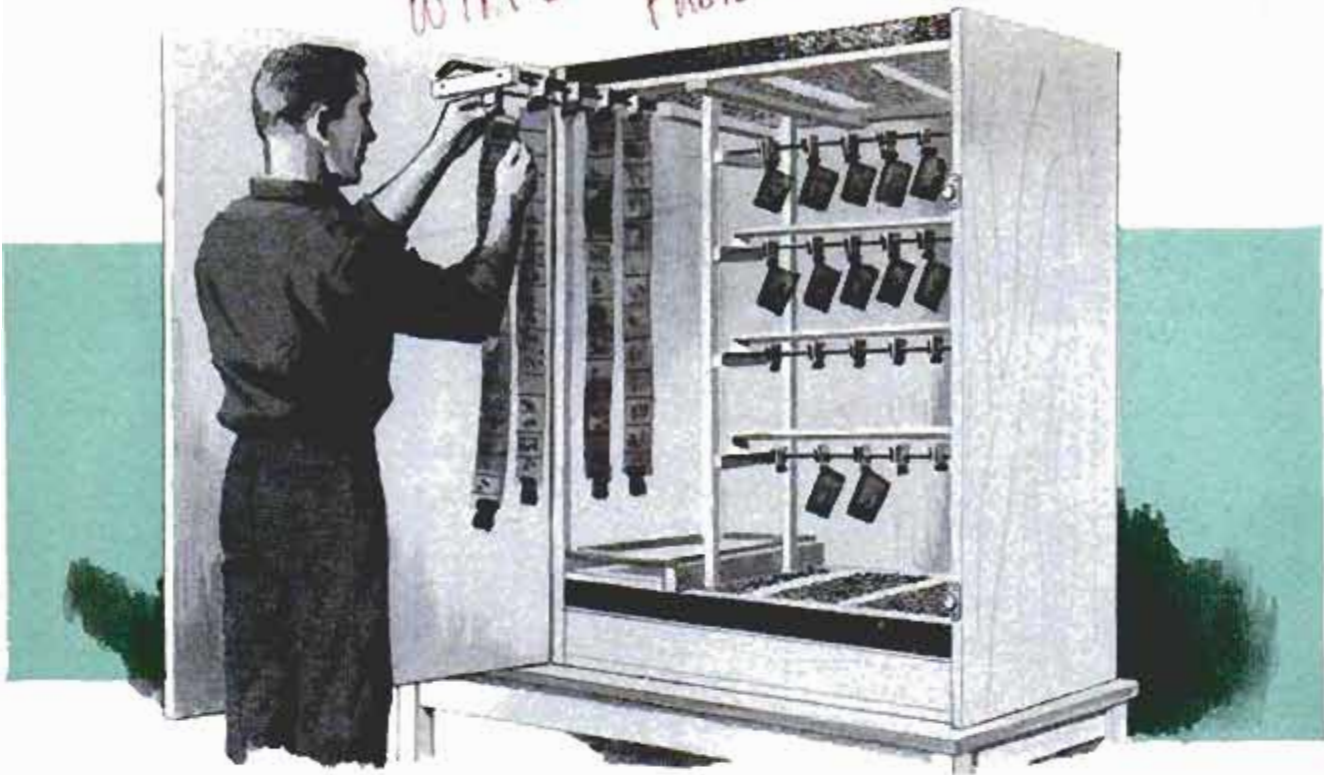

Dry Your Films in Filtered Air

By Hartwell J. Kennard

Cut film is hung from dowels by means of film clips which are spaced apart and held with rubber bands

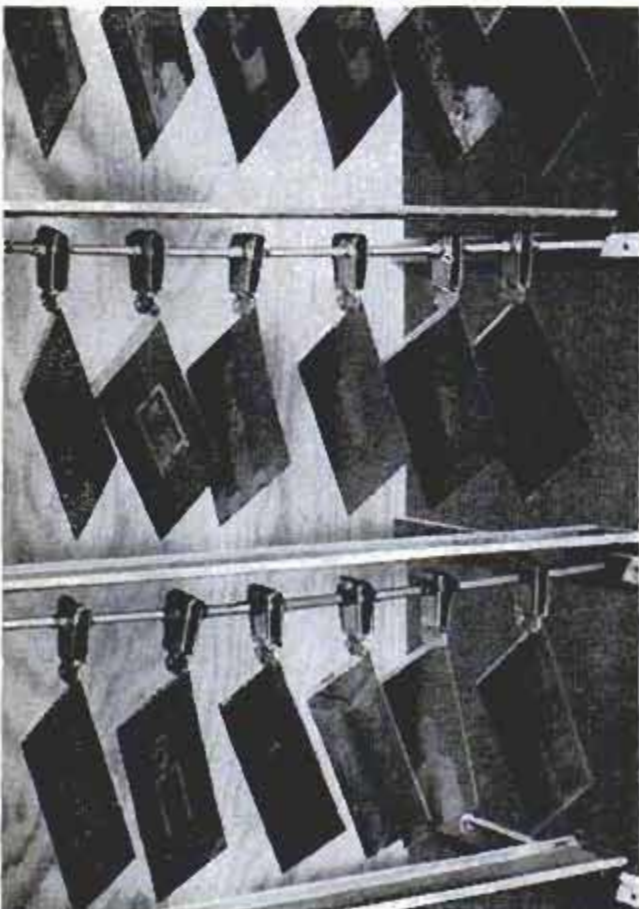

RAPID, UNIFORM DRYING of roll and cut film is possible with this cabinet through which warm air is forced by a fan enclosed in a sheet-metal housing at the base of the cabinet. Air passes over an electric heating element mounted in the fan housing, then through an opening in the side of the cabinet. Inside the cabinet, the air is filtered and moves to the top, drying the film as it rises. The air then escapes through another filter covering the top which is installed to keep dust from settling back into the cabinet. Using filtered air prevents dust from being drawn in through openings or leaks in the cabinet. Too-rapid air current should be avoided as it may pick up loose dust inside the cabinet and deposit it on the film. Periodic wiping of the interior with a damp cloth will minimize this problem.

Dimensions of the cabinet are based on the sizes and quantity of film to be dried. Those given in the illustration on the opposite page are for a cabinet which will accommodate 8 rolls of 120 or 620 film and 64 sheets of 4 x 5-in. cut film at the same time. Height is determined by the length of roll film to be dried while depth and width are based upon intended film capacity and adjusted to a specific size of air filter. Filters used are of the type designed for heating or air-conditioning installations. Insert filters correctly.

Start construction by making a box of $\frac{3}{4}$ -in. plywood to the over-all dimensions of the proposed cabinet. The top is left

AIR FILTER, 15" x 30 1/2", 2 REQD.

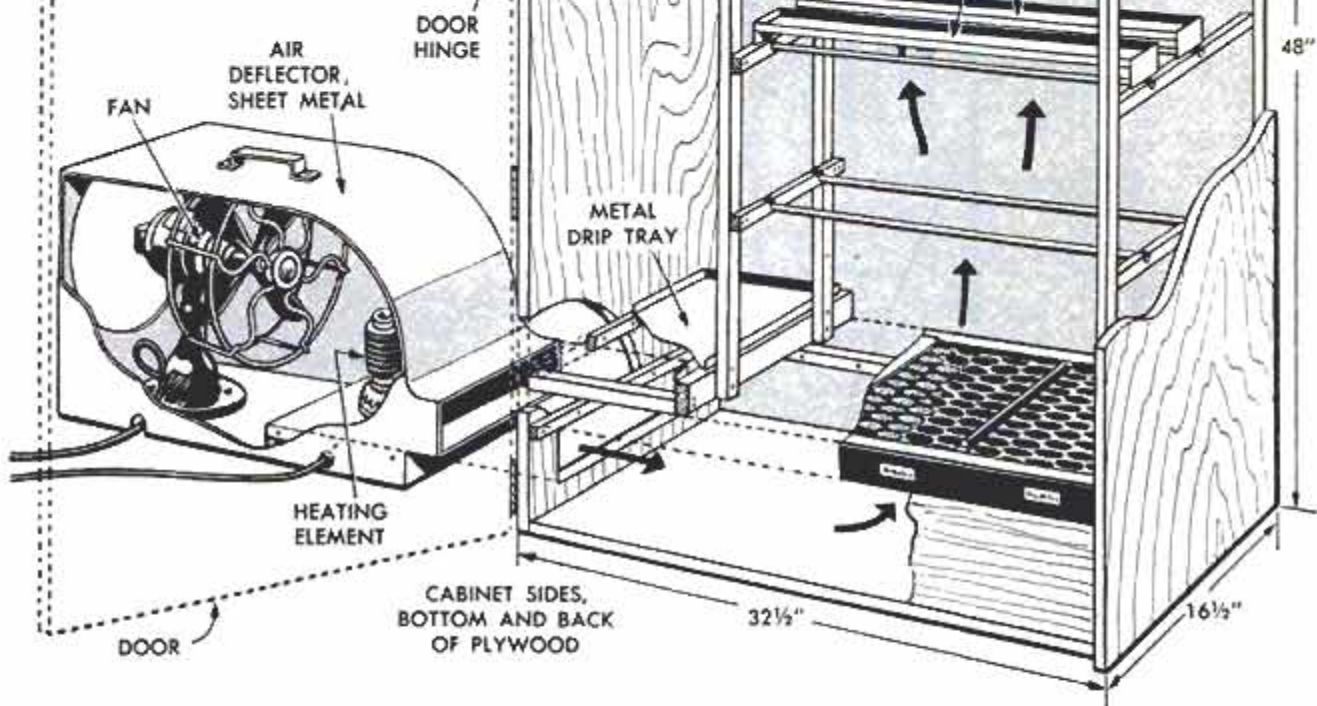
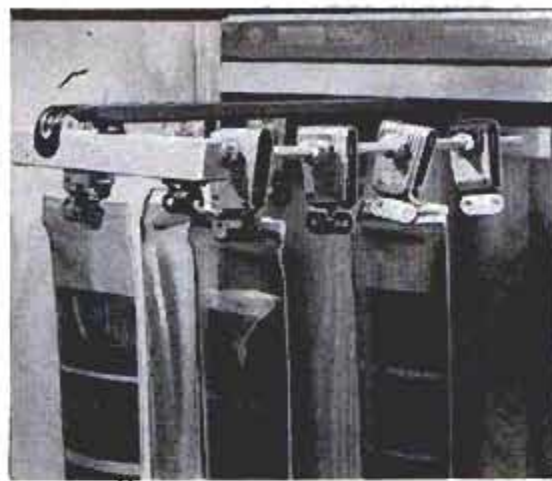

open for the exhaust filter, and the door on the front is not installed until the interior is completed. Nail a piece of 3/4-in. plywood about 5 in. wide between the sides at the bottom of the door opening to form a warm-air chamber. Then nail 3/4-in. square cleats to the sides and back panel, at the same height, on which to rest the lower filter. Cut a slot for warm-air intake in one side of the cabinet just below the cleat. Construct the sheet-metal housing which can be slipped down over a conventional circulating fan to direct the air from it into the slot in the cabinet. Mount one or two heating elements inside the housing in front of the fan to warm the air. A round hole of the same diameter as the fan blade is cut in the back of the housing through which air may be drawn by the fan.

Returning to the cabinet, nail a framework of cleats inside a few inches down from the top to support the exhaust filter. Fasten a cross piece between the front and rear cleats and suspend the vertical sup-

ports for the cut-film racks and drip trays as illustrated. Each rack is a length of dowel rod fitted with film clips spaced equally apart by means of rubber bands which are doubled around the rods on both sides of the clips. This system permits changing of the spacing for different sizes of cut film. Cut notches in the horizontal supports at each end of the racks to space the racks properly front to back. Drip trays are made from galvanized sheet metal and placed on the supports below each rack. Cut the ends of the trays extra long so that when they are soldered on they will extend down to form legs. Then the trays will not interfere with the removal of the racks. Since individual racks can be removed for loading, the cabinet door is only open for short periods of time allowing less dust to enter.

A pot-and-pan rack which pulls out for loading is used to hold roll film. Pot hooks are replaced with dowel rods which are fitted with film clips. ★ ★ ★

Lawn Furniture Easily Stored Between Joists of Garage Ceiling



Lawn furniture can be stored between the joists of the garage ceiling. Nail 2 x 4s edgewise to the underside of the joists and then nail a wood or panel ceiling up against these. The resulting space is deep enough to accommodate the furniture which is bulky in size but light in weight. Similar pockets can be formed by nailing boards to the roof rafters.

Improved Steam-Pipe Deflectors Direct Heat Into Basement



Lengths of aluminum ridge roll placed over hot water or steam pipes direct heat from the pipes into the basement shop or recreation room. The insulation is first re-

moved from the heating pipes in the area to be heated, and the deflectors are then placed over the pipes as indicated. When the heating season is over, the deflectors may be removed and stored.

O. H. Hampsch, Oak Park, Ill.

Nail Driven Into Saw Kerf Relieves Saw Binding

If a saw binds when cutting heavy stock, or wet or green lumber, push a nail into the saw kerf to relieve the binding. As the cut progresses, either drive in more nails closer to the saw, or drive a larger-size nail into the end of the cut.

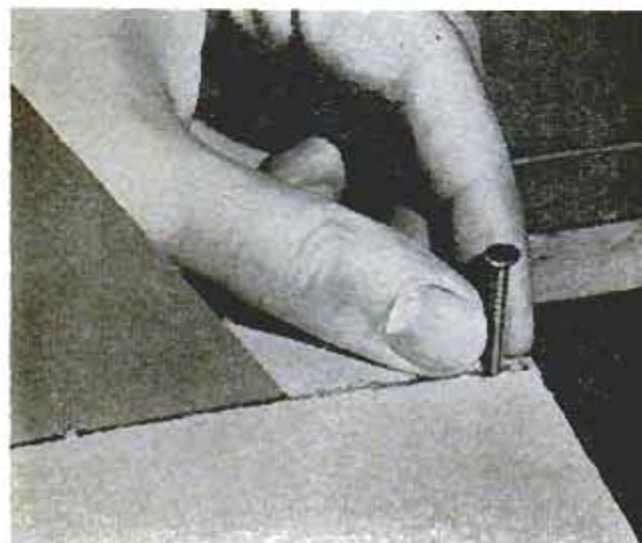

Rubber-Headed Tacks Keep Breadboard From Skidding

Drive a rubber-headed tack under each corner of a breadboard to keep it from skidding when rolling out dough. The rubber also helps cushion the noise created by the rolling pin. — Victor H. Lamoy, Upper Jay, N. Y.

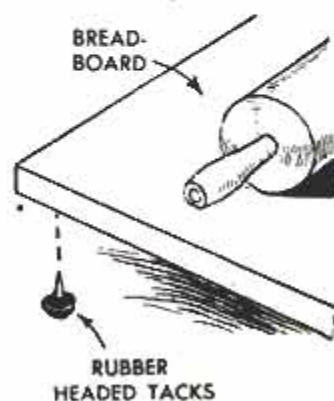

Mysterious Jumping-Match Trick

Amaze your audience of friends with the startling and puzzling behavior of a jumping match explained as a mystery of static electricity. Accompany your demonstration with "small talk," explaining that a charge of static electricity can be built up in the match head by rubbing a wooden matchstick through your hair, or against your clothing. Place a second match on a table so that it projects over the edge, and move the "charged" match up to it slowly, with your palm away from the viewers. As the two heads nearly touch, flick the lower end of the match with your "trigger" finger (third finger) so the match rises slightly and flicks the one on the table. Practice it well before demonstrating so that you can cause the reaction with the least amount of motion.

Leonard W. Mitchell, Marion, Ky.

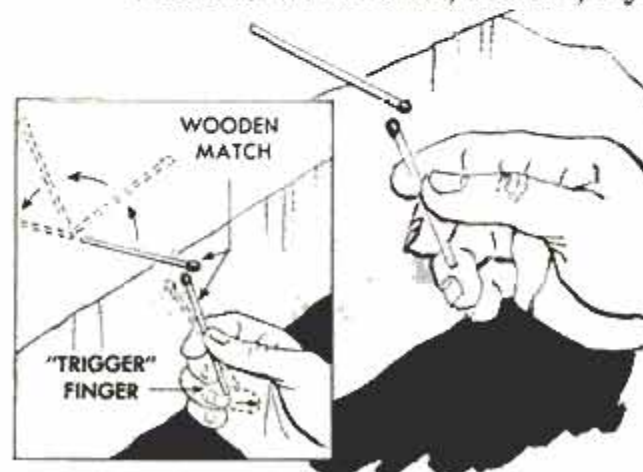

Footstool-Chest

In two or three evenings you can make this comfortable footstool with a compartment for storage of pipes, tobacco and a book or two. The ends and side rails are cut from birch plywood. Plastic fabric, stretched over a thick layer of cotton stuffing and tacked along the edges of the fir-plywood top panel as shown, affords a soft and durable surface on which to rest tired feet. A second fir-plywood panel screwed to the underside of the top panel covers the exposed edges of the plastic. After sanding, apply the desired finish.—Dick Hutchinson, San Gabriel, Calif.

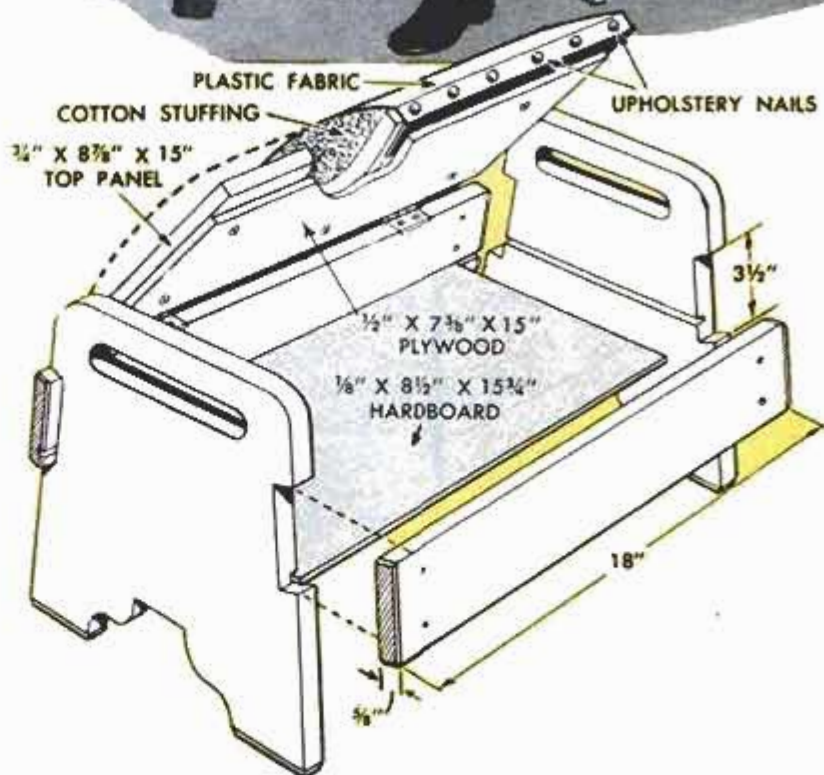
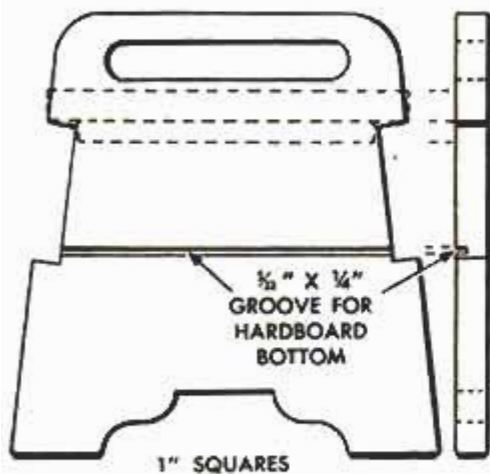

Waxed Folding Rule Protected From Dust and Wear

A wooden folding rule will last longer and be easier to read if it is given a coat of paste wax and then polished. The wax lubricates the joints and provides a slick surface on the rule, which rejects dust and grime. Apply the wax with a clean cloth and be sure that it is worked well into the joints.

Hose Is Round-Work Sanding Block

To sand small-diameter round work, slit a short length of garden hose lengthwise and fit a piece of sandpaper inside the hose with the abrasive side in towards the center. For larger-diameter round work, line a short piece of a stiff cardboard mailing tube. Cut the sandpaper large enough so that the edges extend out through the slot to prevent it from snagging on the work.

P. Casperson, El Cajon, Calif.



WTM 55

The Paper-Bag Mask

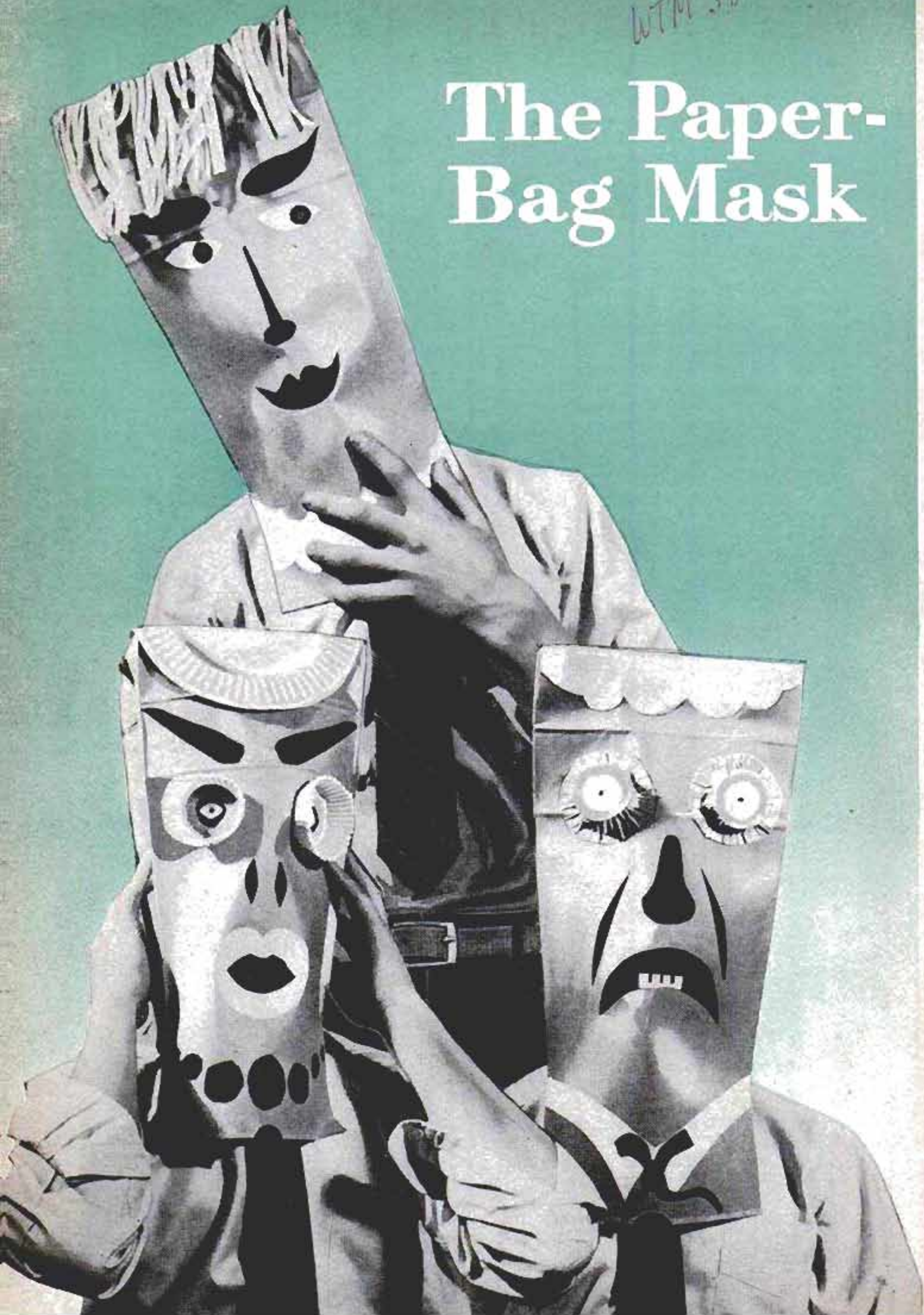



Exaggerated features, such as these eyes, are most effective on paper-bag masks. Hair is strip of paper cut or notched to complement face on mask

MASKS FOR HALLOWEEN or children's parties and other occasions are inexpensive and fun to make when paper bags are decorated similarly to the ones shown on these pages and given to the guests. With only paper bags of an appropriate size, some colored paper, a pair of scissors and a little glue, you can exercise your inventiveness and make masks that will be a source of a lot of laughs. Also, water colors and crayons can be used very effectively on the masks for a variety of grotesque facial features and humorous expressions. Remember to leave holes for the eyes and a hole or two in the top for ventilation. The rest is up to you. Cut and paste as your imagination dictates. ★ ★ ★

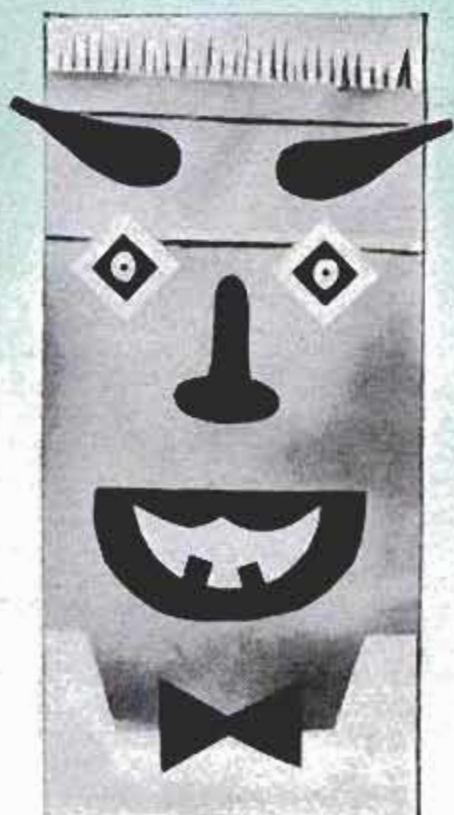

Above, standard grocery bag large enough to slip over head is folded flat and, below, eyes, mouth and nose cut from colored paper are glued in place

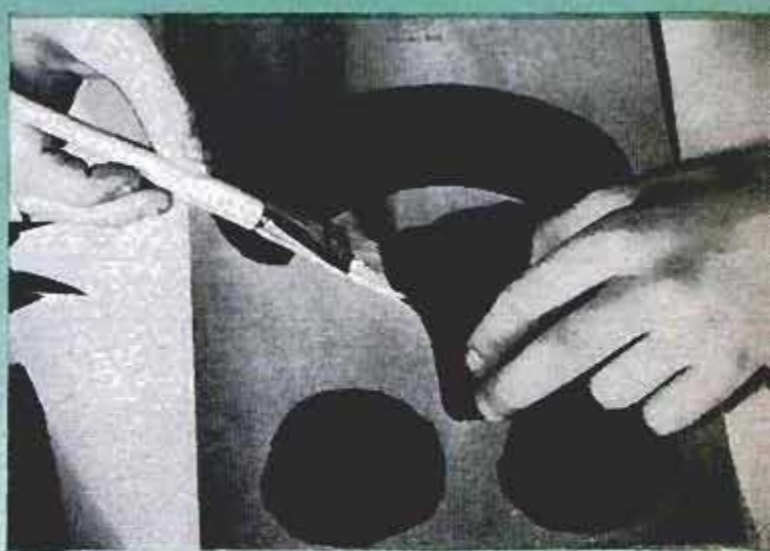

Below, after whites of eyes are glued in position, cut small hole in each at eye level. Left, large eyebrows, peculiar eyes, other abnormal facial features lend individualistic appearance to mask



Panel of Wood or Plate Glass Carried in Rope Sling



A large sheet of plywood or glass can be carried easily with the aid of a rope sling looped around the lower corners as shown. When a fairly heavy sheet of glass is to be carried, slip pieces of cloth in between the rope and the edges of the glass to keep it from cutting the rope. Be sure both ends of the rope are knotted together securely before using it as a sling.

Improvised Lock Washer

When a regular lock washer is not available, an ordinary flat metal washer can be substituted if it first is bent slightly across the middle. When the washer is drawn up tight, the arc provides tension that holds the nut in place and prevents it from turning.



Film-Spool Wheels for Toys

When wooden blocks are employed to construct toy trains, attachment of wheels and axles can be simplified by using film spools fitted into slots cut in the bottom of the blocks. The slots must be wide and deep enough to permit free turning of the axles. Staples driven across the slots after installation of the axles will hold them in place. Sharp edges on the flanges of the spools should be filed smooth.

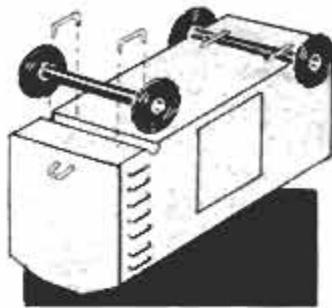

Friction Clamp Holds T-Square In Position on Board

Accidental slipping of a T-square, when ruling spaced lines, can be prevented by slitting a piece of sponge rubber and slipping it over the blade of the square and against the edge of the drawing board. The friction provided will steady the T-square and yet permit easy movement when necessary. A bath sponge or a section cut from a sponge-rubber kneeling pad will do the trick.

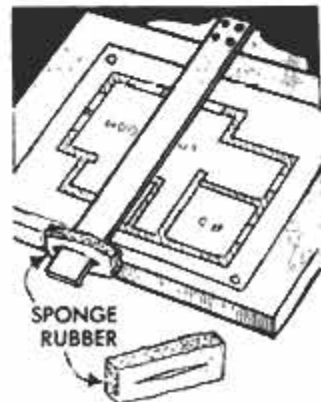

Glue Sizing for Wood Joints

Furniture and picture-frame joints can be made more secure with an application of glue sizing on the surfaces to be joined before actually gluing them together. This practice is especially useful for joints where considerable end grain appears, as the sizing seals the pores against penetration by the glue used in joining the members. The sizing is made from the same glue used in fastening the pieces together but is diluted to a thin solution. Any excess remaining on the surfaces should be removed to permit an open joint.

Glue sizing may also prove useful in treating end-grain paneling, especially plywood. Applied to the bare wood, it limits penetration by the finishing material, creating less contrast between end-grain and cross-grain surfaces. Some finishes, however, will not adhere to glue sizing.

Walter E. Burton, Akron, Ohio.

use your camera AS A TELESCOPE

By Walter E. Burton

MAKE YOUR PRESS-TYPE CAMERA double as a telescope simply by replacing the ground glass with an eyepiece assembly mounted on a square of hardboard or plywood of the same dimensions. The lens in the camera serves as an objective lens and a double concave lens (eye lens) is used for the eyepiece lens which magnifies the image of an object produced at the focal plane, like a Galilean-type telescope.

In addition to giving clear, magnified images of distant objects, the telescope can be used to observe insect and small-animal life without distracting them.

To make the conversion, first remove the ground glass at the back of the camera and use it as a pattern to cut the panel on which the eyepiece is mounted. The eyepiece lens shown is a double concave lens with a -37 -mm. focal length and 13-mm. dia. and was used with a 9 x 12-cm. Linhof camera. All parts for the eyepiece are cut from an aluminum film-cartridge can, assembled with glue, and mounted on the panel as shown. Blacken the exposed side of the fiber washer before cementing it on the lens to reduce reflection. This arrangement is designed for use with a camera lens of 203-mm. (8-in.) focal length. Mount the eyepiece in alignment with the axis of the camera's lens.

The most satisfactory magnification obtainable with this telescope is between 3 and 4 power. Always keep the aperture setting at maximum opening when using the camera for this purpose. The diameter of the field of view depends upon the diameter of the camera's lens; and it becomes less at higher magnifications. The camera-focusing knob is used to focus the telescope.

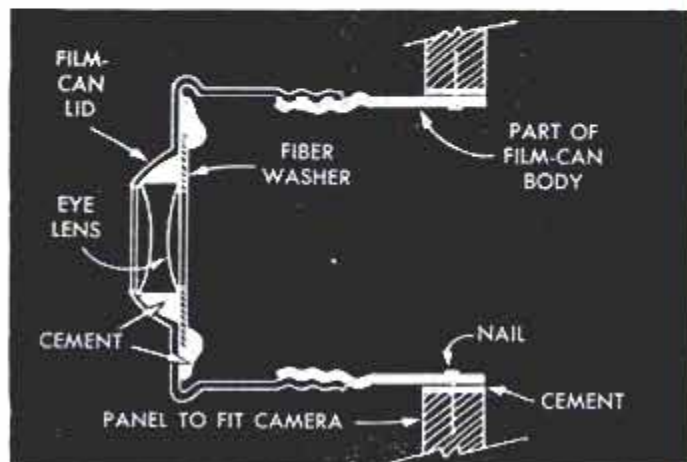

Acoustical Tile and Wooden Pegs Provide Hours of Fun



An inexpensive perforated acoustical tile plus a handful of wooden pegs will keep a youngster occupied for a long period of time. The tile is one of a type applied to ceilings for soundproofing, and the pegs are cut from dowel rods and painted. Golf tees may also be used as pegs. Various patterns and games can be devised for placing the pegs in the holes of the tile.

Victor H. Lamoy, Upper Jay, N. Y.

Invisible Writing on Paper

An invisible message can be written on a sheet of white paper by first soaking it in water and placing it on a sheet of glass. Cover the wet paper with a piece of dry paper and write a message on the latter, pressing firmly enough so that the impressions go through onto the wet sheet. When the writing is completed, remove the dry sheet. All traces of writing will disappear when the wet sheet has dried, but will reappear when the sheet again is soaked in water.

Tape Skidproofs Drill Point

When drilling a polished wood or metal surface the drill point will sometimes skid out of the punch mark and scrape or mar the finish. This can be prevented from happening by placing a piece of masking tape (right) at the desired point and making the punch mark on it.

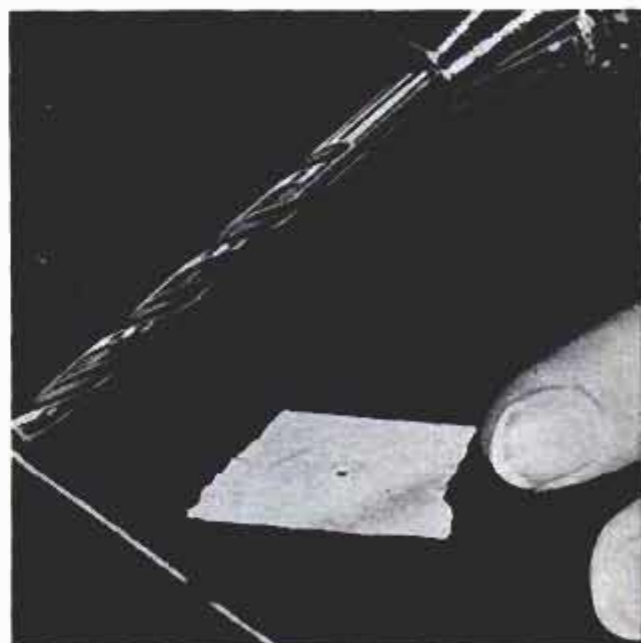

Keeping Electric Plug in Receptacle

When the contacts of a much-used wall receptacle become worn and will not hold a plug firmly, insert a short piece of wire solder in the hole in each prong of the plug. Crush these with a pair of pliers to form small lead rivets. The extra thickness supplied by the rivets will permit the receptacle contacts to grip the plug prongs firmly.

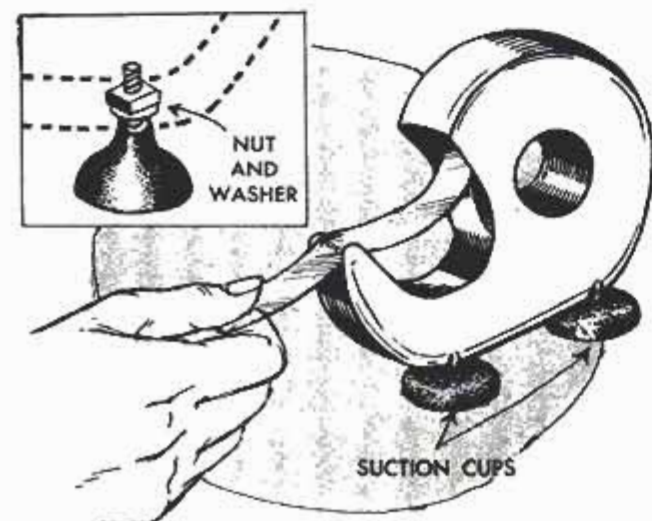

Vacuum Cups on Tape Dispenser Permit One-Hand Operation

Attach two rubber suction cups to the bottom of a plastic, pocket-size cellulose-tape dispenser and it becomes a stationary unit that can be used with one hand. Drill or burn two holes in the bottom of one half of the dispenser and attach the suction cups with nuts and washers as shown. Cut the threaded shafts flush with the top of the nuts so they do not interfere with the tape. Lightweight and portable, compared to cast-iron types, the modified dispenser will adhere to any smooth surface, whether vertical or horizontal.

Andrew Vena, Philadelphia, Pa.

Special Force Cup Clears Obstructions From Floor Drains

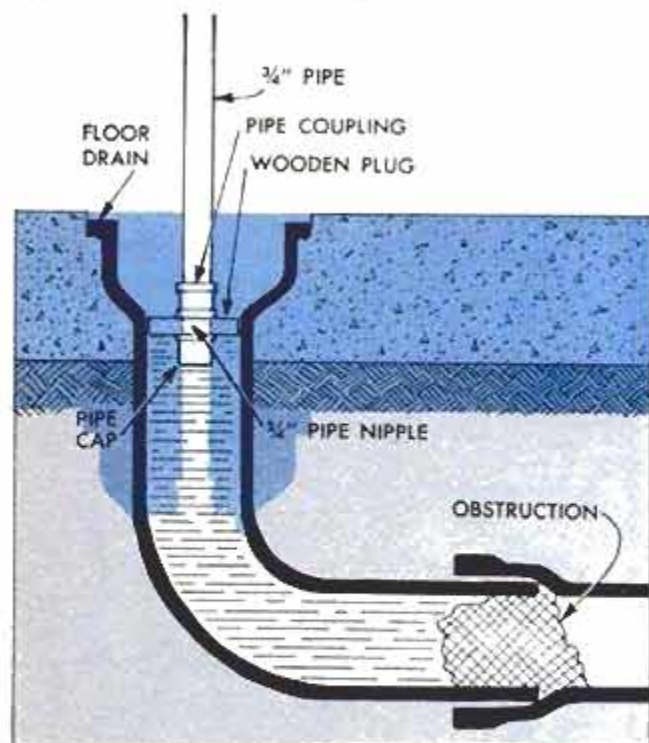

Surface drains in floors, driveways and sidewalk areaways can be quickly cleared of obstructions with this homemade plumber's "force cup." It consists of a 3 or 4-ft. length of 3/4-in. pipe and a wooden disk which is held to the lower end of the pipe by means of a pipe coupling, short nipple and cap. The wooden disk is a sliding fit inside the drain. Rounding the edges of the disk will help insert it. A length of beaded

weather stripping, or a piece of inner tube, tacked around the bottom edge of the disk acts as a seal for more efficient use of the tool. To clear a drain, first be sure it is full of water, then insert the tool, forcing it quickly down as far as it will go. Repeated up and down motion will force the water in the drain down against the obstruction to push it free. Be careful that the wooden "piston" doesn't become jammed in the drain.

Liquid-Soap Dispenser



Flexible plastic dispensers used commercially for condiments are ideal as home dispensers for liquid soaps, shampoos and other fluids. They can be purchased empty from hardware stores and may be mounted over sinks with steel strapping.

Melting Stick Shellac

By using a heated putty knife, stick shellac used as a wood filler can be cut more readily. After applying it to the work direct a narrow flame from a torch against the back of the putty knife to indirectly heat the shellac so it can be spread smoothly. Fill the depression slightly above the surface of the work to allow for shrinkage.

Arthur G. Patterson, Minneapolis, Minn.

Luminous Paint "Lights" Dead Fuse

Luminous paint applied to the edge of the mica or glass window of electric fuses will make it possible to find a blown fuse instantly, even in total darkness. The short burst of light from inside the fuse, when it "blows," is sufficient to activate the paint and make it glow so the defective fuse can be seen at a glance.



Flowerpot Lamp on Tripod Is Novel Planter

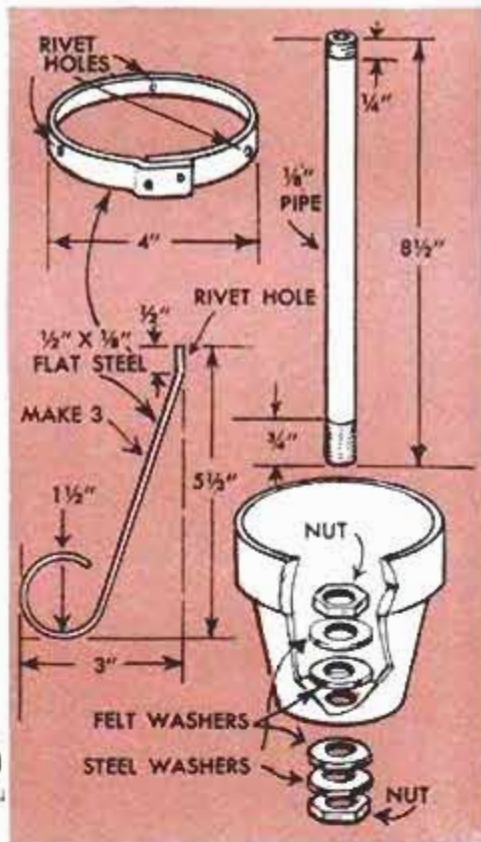

An interesting planter lamp can be made easily by mounting a pull-chain socket on a length of pipe fastened through the drain hole of a flowerpot set on a flat-steel tripod. Form the tripod legs by bending equal lengths of flat steel around a large iron shaft. Then rivet them to a steel ring that is dimensioned to fit under the rim of the flowerpot. Fasten a length of 1/8-in. pipe, threaded at both ends, in the drain hole of the pot and screw a pull-chain socket on the other end of the pipe. Wire the socket by running the cord up through the pipe. Add a plant and clip a shade over the bulb. Herbert Y. Moon, Orient, N. Y.

Tape Protects Bottle Labels

Transparent cellulose tape is ideal for protecting bottle labels and is less messy to apply than liquid protectors. For wide labels that cannot be covered with a single strip of tape, several strips are applied, each one slightly overlapping the preceding one as pictured below.



More Power to You

If you own a prewar home, chances are its wiring system doesn't have the power and circuits it should to safely operate modern-day appliances. A two-part story next month explains how your new or old home should be wired for more power

Photoflood Clamp "Slipproofed" With Coat of Rosin

The rubber covering on the jaws of a photoflood clamp will become glazed in time and allow the clamp to slip. This will not happen if the clamp jaws are coated with a mixture of a little rosin dissolved in turpentine. The liquid will dry quickly, leaving a nonslipping rosin coating.



NINE USES FOR EYEBOLTS

By Russell J. Love

OFTEN CONSIDERED only as fixtures to receive screen-door hooks or for stringing clotheslines, eyebolts actually have many other practical uses. The nine uses shown below very likely will suggest further ap-

plications. One might be to use eyebolts to replace screw eyes or screw hooks that have pulled loose in a wooden surface and cannot be retightened because the holes have become oversized.

Eyebolts used as thumbscrews permit using rod in eye to provide greater leverage for tightening such things as adjustable units on power tools

Make crank for turning shaft by fitting eyebolt in tapped hole in collar so it forms both setscrew and crank arm

Two eyebolts can be used to provide a strong padlock hasp. One eyebolt is fitted through door or gate, the other through doorjamb or gatepost

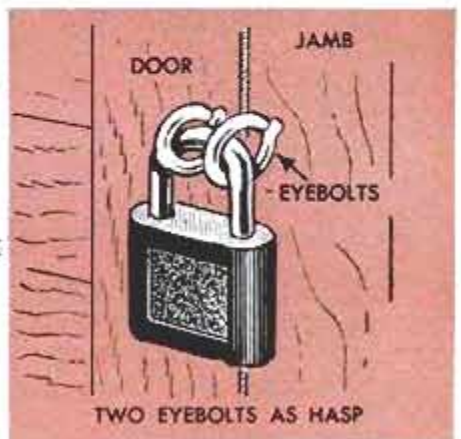
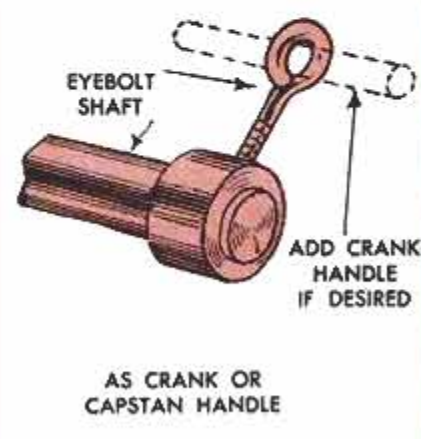
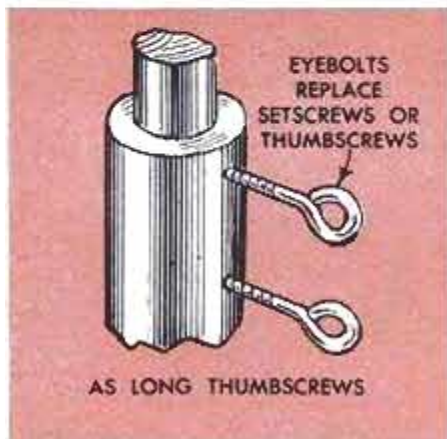

Inexpensive substitutes for pin-and-strap hinges are made with eyebolts as shown. Bolts or rivets can be used as hinge pins

Adjustable tie rod for controlling tension of guy wire or brace consists of eyebolt at one or both ends of length of flat steel or chain

Safe suspension of a youngster's swing is assured by fitting ropes with thimbles and pivoting them in eyebolts in cross piece

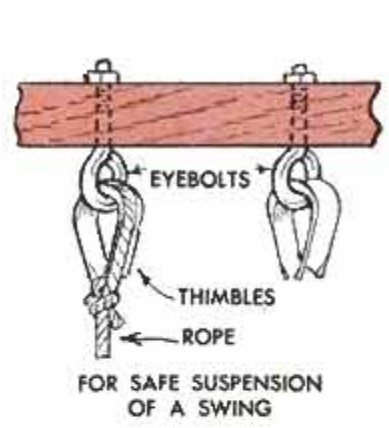
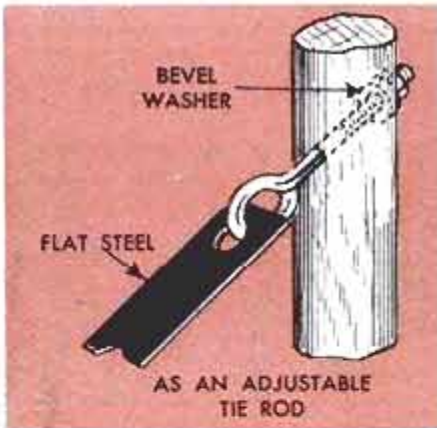
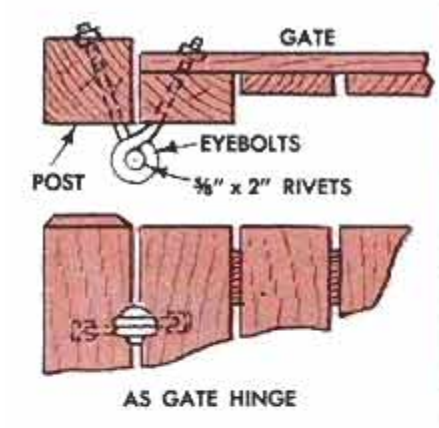

Shouldered eyebolt is ideal ready-made drawbar pin. Nut can be turned tightly on threads to prevent pin from bouncing out of hole in drawbar

Nuts embedded in mortar hold eyebolts to provide crane pivots and also permit removing eyebolts if desired

Eyebolt is safer support for hoist or pulley than screw eye which may pull out. Eye of bolt is opened to receive hoist, then closed again

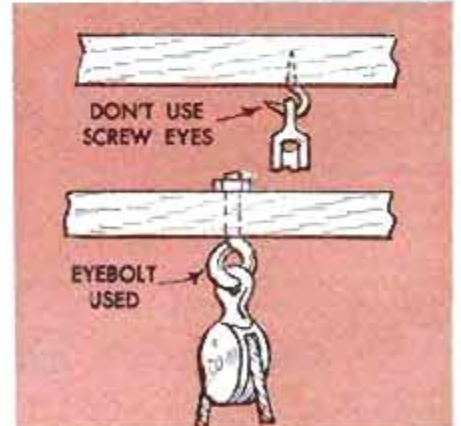
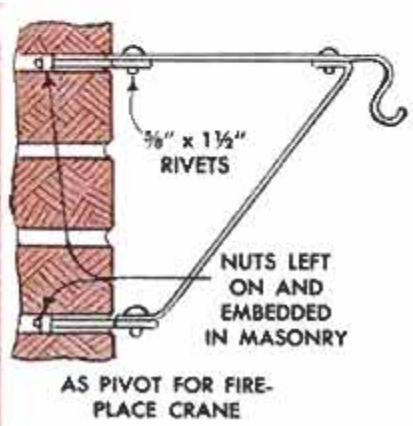
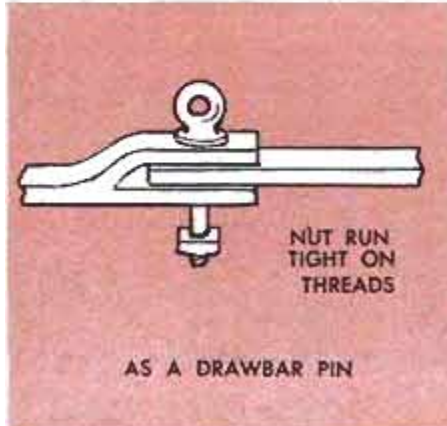

Darkroom Timer Set Without Light



Clipped to the adjusting knob of a darkroom timer clock, a spring-type clothespin permits a photographer to set the clock while working in total darkness. With the clock stopped, the clothespin is clipped on the knob so that it points to 12 o'clock. The photographer then knows that moving the clothespin right until it is horizontal will set the clock for 2½ min., straight down will give 5 min., and so on.

Clothespin Holds Milk Order

Using a card or folded strip of stiff paper, you can display a special order for your dairyman which will not be overlooked or blown away. Simply clip the note in a spring-type clothespin and insert the pin in the mouth of a bottle.

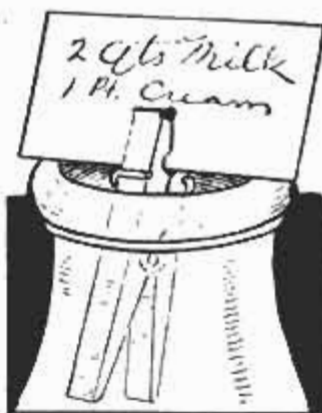

Ironing-Board Cover Fastened With Safety Pins and Cord

An ironing-board cover can be kept smooth and in place by using safety pins and a length of strong cord. Attach the pins to the edge of the cover and lace the cord through them similar to the method used in lacing shoes.



Popular Mechanics Bookshop

NEW FULL-SIZE PATTERNS

Simply trace patterns on wood and saw to the traced lines. Authentic designs by professional designer. Every step made easy for building at home. Complete material list and step-by-step instructions included.

Crusette, Utility Outboard, No. 101. Length 12 feet, beam 4½ feet. Ideal for fishing, picnics. 4 patterns in set. \$2.00
Trundle Beds, No. 102. Safer beds for children. One tucks away under the other. 3 patterns in set. \$1.50
Modern Cocktail Table, No. 103. Plank top, metal grille insets in sides. 1 pattern. 50c
Modern Step Table, No. 104. Modern and stylish. 24 inches high. 1 pattern. 50c
Toys for the Children, No. 105. Giraffe drawing board and Bucking Bronco. 1 pattern. 50c
Juvenile Chest Robe, No. 106. Two drawers, shelf, hanging storage. 2 patterns. \$1.00
Cúpola and Weathervane, No. 107. Can be made of metal or tempered hardboard. 1 pattern. 50c
Personal Work Bench, No. 108. Drawer and sliding doors. Storage space. 2 patterns. \$1.00
Valances and Trims, No. 109. Adjustable. Decorative. 12 designs on 1 pattern. 50c

Decorative Wall Shelves, No. 110. Modern or traditional styling. 2 in 1. 50c
TV Chair, No. 111. Foam-rubber upholstery. 2 patterns. \$1.00
Modern Tub Chair, No. 112. Real all-out lounging chair. 2 patterns. \$1.00
Sofa Bed, No. 113. Sagless-type wire springs built-in. 2 patterns. \$1.00
Love Seat, No. 114. 48 inches between arms. 2 patterns. \$1.00
Corner Table, No. 115. Simple to make. Attractive and fashionable. 50c
Palette Coffee Table, No. 116. A modern and beautiful piece of furniture for your home. Takes very few hours of work. 50c
Traditional Magazine Rack, No. 117. Holds several magazines on both sides. Easy to make. 50c
Lamps and Planter, No. 118. "Jeweled" lamp is from old Mexico. Plans also include planter coach lamp, good for porch post to light stairs. \$1.00

Twin-Bed Headboard, No. 119. Want to give that twin-bed a new look? Here's the perfect answer, an attractive up-to-date headboard. 50c
Night Stand, No. 120. Build this night stand for your bedroom. Use drawer for storing extra linen or sheets. Designed to hold several books plus a lamp. 50c
Santa, No. 121. Stands 42 inches high. Fun to make. Perfect to place in the window or on your lawn for holidays. 50c
Sleigh and Reindeer, No. 122. Entire family will enjoy making Santa's sleigh and his reindeer. Complete plans. \$1.00
Dinette Set, No. 123. A 2-piece set. Ideal for the playroom. Stands 21 inches high. Complete set of plans includes chair and table. 50c
Shoeshine Box, No. 124. A pattern popular with men. Enough room inside box to hold polishes, cloths and brushes. 50c

All patterns are available from

POPULAR MECHANICS BOOK DEPT. 208 E. Ontario St. Chicago 11, Illinois

SU
58

POWER SHOP IN A CLOSET

With these folding tool cabinets you can operate your table-top power shop in a minimum of space

LACK OF SPACE in which to arrange individual machines for safe and efficient operation is a major problem in setting up a home shop, especially in basementless homes and apartments. If, for example, you begin with only three basic machines such as a small circular saw, jointer and drill press, there must always be a clear area in front of each machine sufficient to permit the operator freedom of movement in handling stock from 3 to 6 ft. in length. If you add these three separate areas you have a considerable total-space requirement. Later on, if you acquire a lathe, shaper and bandsaw or jigsaw, the requirement is practically doubled. As a rule, such shop plans can be carried out only in a full-size basement, the attic or an addition to the garage. Aside from the basic space requirements the cost of such a shop plan may be prohibitive.

In apartments and some small homes shop space may reduce to closet size and the available work area in front of the closet to little more than the space required for swinging the door fully open. However, there are combination machines, such as the unit made by Cummins of John Oster, which can be fully utilized in a restricted space. These one-motor units are portable, will work on any ordinary table top, and provide circular saw, lathe, vertical and horizontal drill, and with accessories can be converted into a grinder, disk sander, drum sander and shaper.

The photo above and those on the following two pages picture a storage cabinet that fits on the back of a closet door. When lowered, the unit provides a hinged table top in which the power shop is placed for use. When combined with the individual cabinet, which is fitted with a large drawer, you have a separate bench. When not in use, hand tools, accessories and the power shop are stored in the closet. The fold-away cabinet is detailed at the right. It consists of a perforated-hardboard panel, two side pieces, a shelf, top piece and two cleats for attaching to the closet door. A tool rack for miscellaneous hand tools and accessories is



X506

Photos by Cummins of John Oster

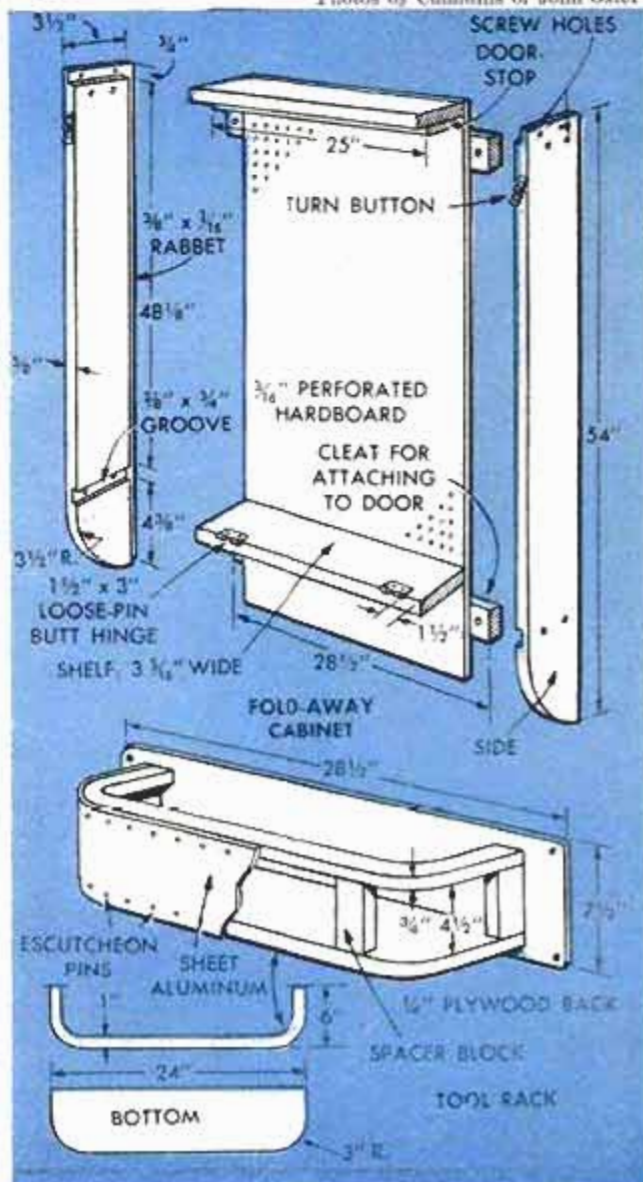



Photos by Cummins of John Oster

View above pictures the folding table in the down position with power shop in place. At left, table on separate cabinet forming a portable workbench

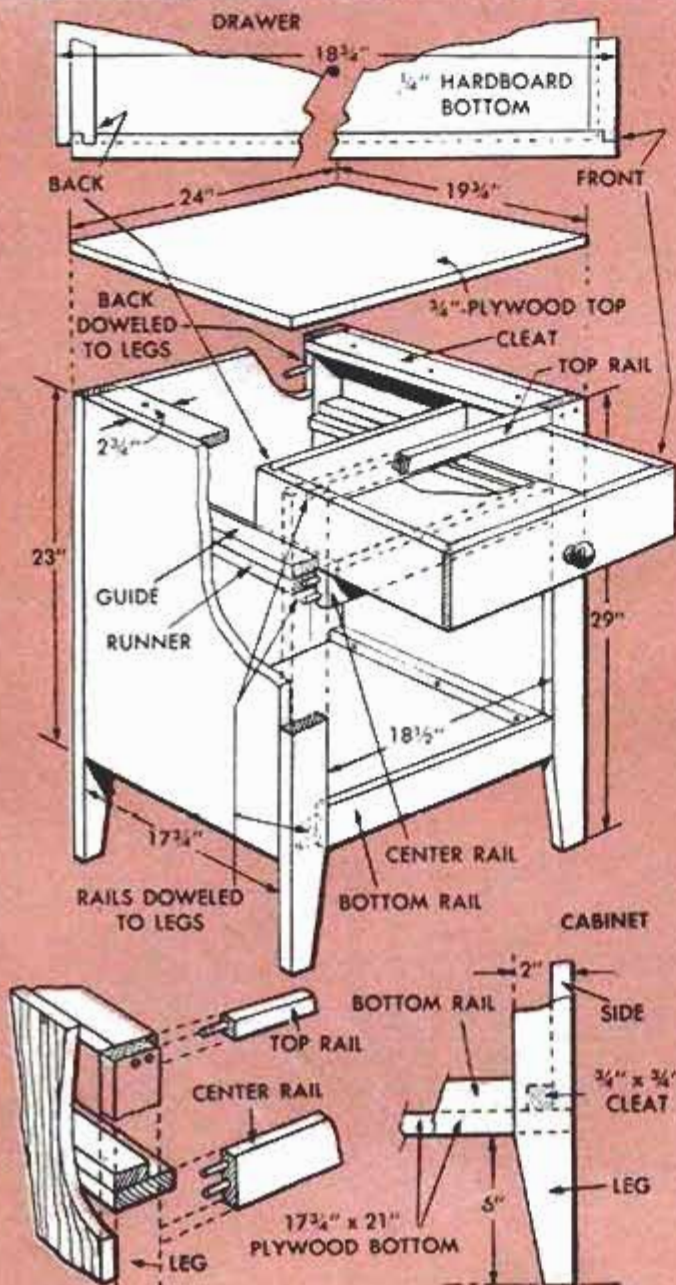

an optional feature. It is made with rounded corners and is attached to the closet door under the fold-away cabinet. Hand tools most used are arranged on hangers and racks which are especially made for use with perforated-hardboard tool panels.

As detailed, the fold-away cabinet fits a 30-in. door with plenty of room for clearance all around. If fitted to doors of other widths it will be necessary to alter the dimensions of the unit. Usually it's best to begin by building the fold-away, or hanging, cabinet first and attaching it to the door. Then make and fit the hinged table top and you have a place to set up the power shop for use in building the separate cabinet. Note in the detail of the hanging cabinet that a strip is attached to the underside of the top piece. This strip serves as a stop for the folding table when in the raised position. It should be located only after the table top is hinged in place. Note also that the thickness of the side pieces is given as $\frac{3}{8}$ in. This thickness is suitable only if you use hardwood. If pine or other softwood is used the side pieces should be cut from $\frac{3}{4}$ -in. stock. The total height of the table is about $29\frac{3}{4}$ in. Some operators will prefer a table top somewhat higher, especially when using the power shop as a lathe. These changes should be made as the unit is built.

If you desire a higher table top, one way of hinging so that it will close into the

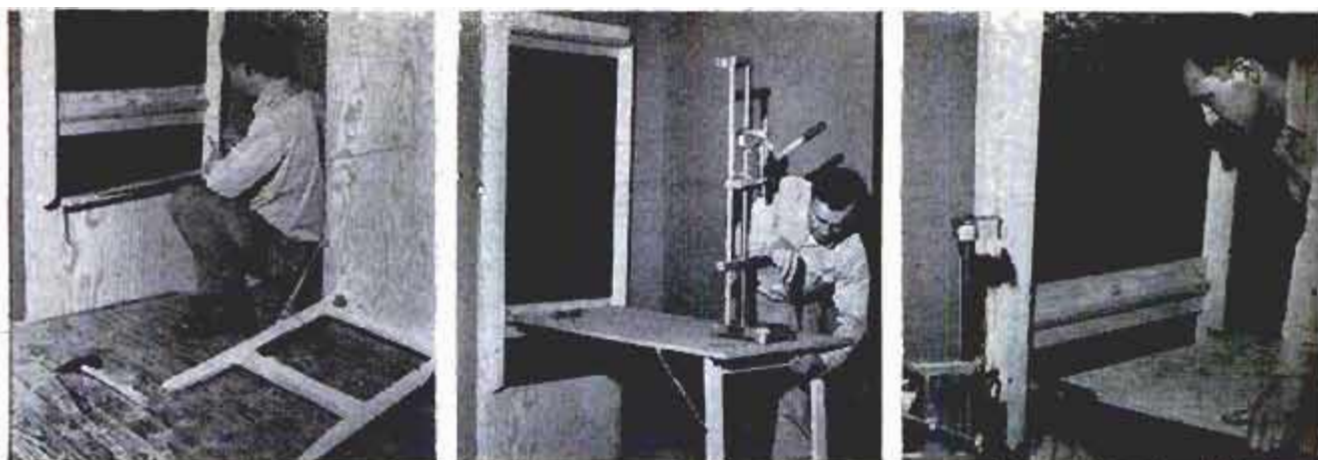

Photos by Cummins of John Oster

In some cases it is necessary to hinge the table top permanently. Photo at left shows fold-away cabinet with narrow shelf to which inner end of table is hinged with flat-iron links as in right-hand photo

same space is pictured in the three upper photos on this page. Here the lower shelf of the fold-away cabinet is replaced by a strip about 1½ to 2 in. wide, photo at the left. The hinges are simply ⅛ by ¾-in. flat-iron links, 4 to 6 in. long and drilled near each end for No. 8 screws. One end of each link is attached to the side pieces of the cabinet with a screw and a washer between the metal and wood. The other ends of the links are attached to the ends of a strip of hardwood screwed to the underside of the table top as in the right-hand photo. When the table top is lowered the inner end is raised and swung back on the links until it rests on the narrow shelf. If the links have been correctly located the table will lock in position and provide a rigid support for the power shop. To fold the top up, it is first lifted and swung outward, then raised to the vertical position. Of course, this method of hinging does not permit easy removal of the top as does the use of butt hinges with loose pins.

In the construction details of the cabinet, opposite page, the back and sides are of ¾-in. plywood. Legs are solid stock of the same thickness, preferably of hardwood. Rails are doweled to the front legs and both front and back legs are screwed to the side panels. The back panel is doweled to the back legs. However, it is possible to simplify and speed up construction somewhat by using a ¼-in. plywood back panel and attaching it to the back face of the legs with screws.

A tool cabinet should be given a good, durable finish for two reasons. A well-finished cabinet is a pleasure to work with because it is more attractive. It also is easier to keep clean. Fine dust from sanding and grinding operations will not stick to a properly finished surface. Before applying any finishing

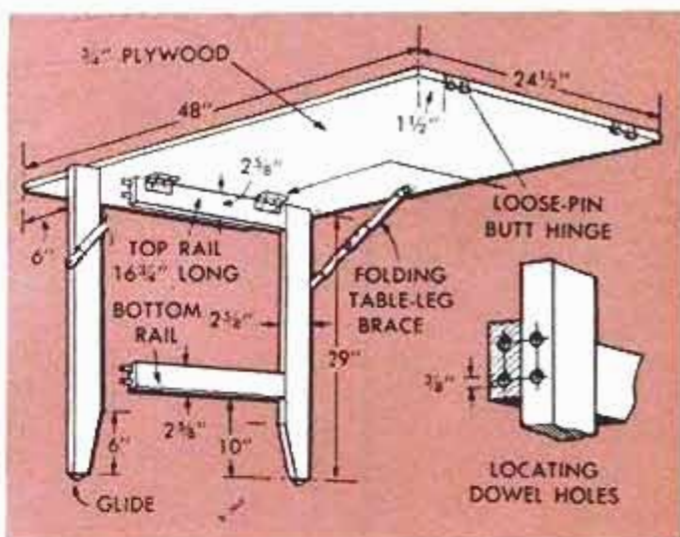

Outer end of table top is supported in the down position on folding legs held rigidly by leg braces. Table top also can be detached and one end supported on the portable cabinet to form a sturdy workbench

While not necessary, it often is desirable to fasten the power shop to the table top. By drilling holes in the table top slightly oversize for 1/4 or 5/16-in. bolts with wing nuts, the shop is easily removed or replaced

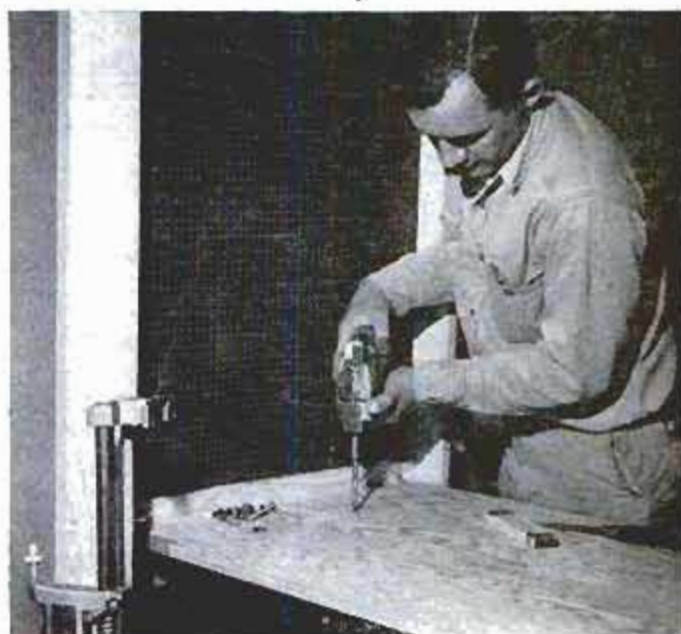

ALTERNATE DESIGN FITS DOOR OR WALL

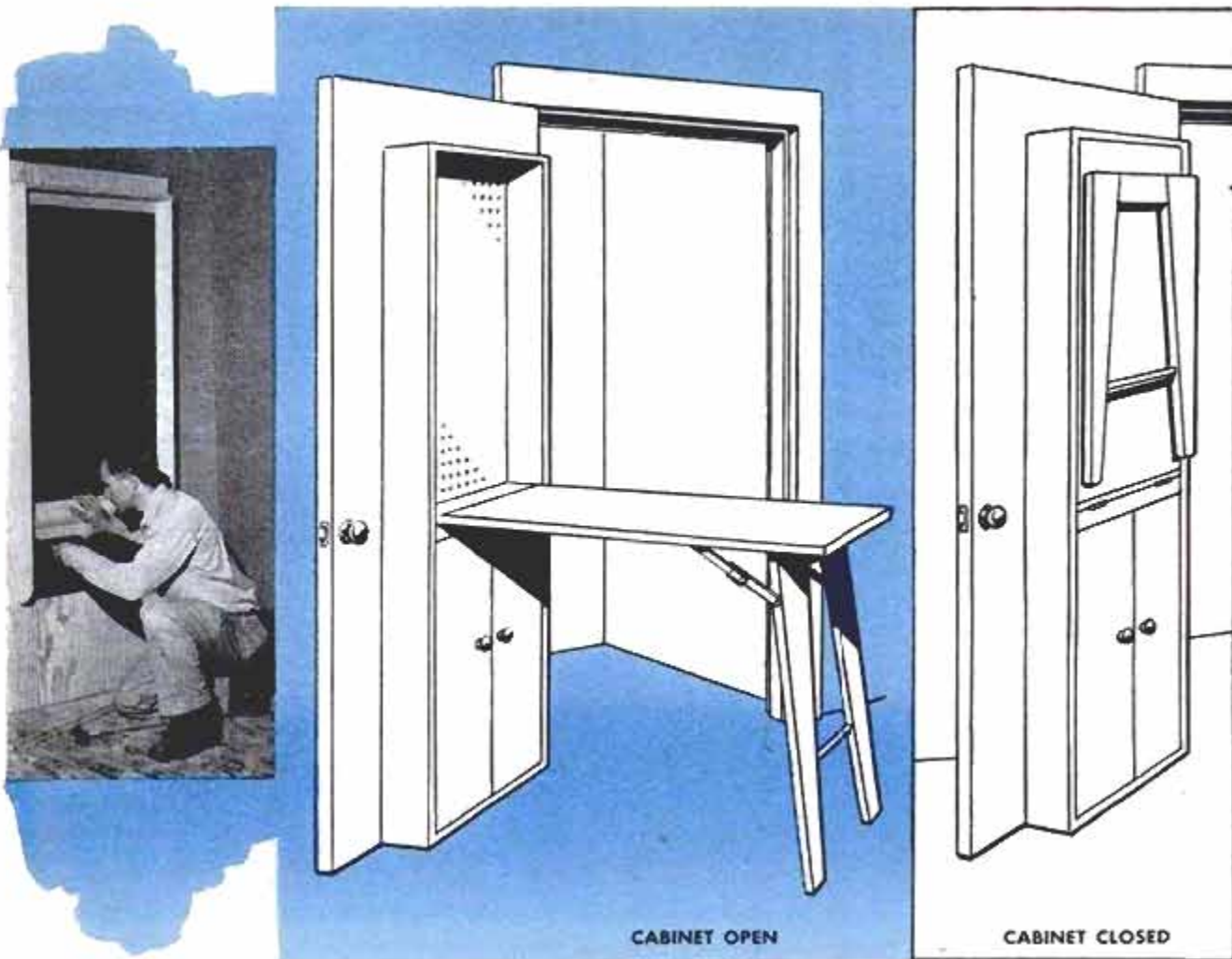

This type cabinet for power shop is designed to be attached to door or wall either in the house or garage

material sand all exposed surfaces, using several grades of sandpaper from coarse to fine. Then, if fir plywood has been used for the table top and other plywood parts, apply a sealer especially made for this wood. For a natural finish, apply one or two coats of clear lacquer of the type made for brush application. If two coats are required, sand the first coat lightly with fine sandpaper. Rub down the second coat with fine steel wool. If you use paint or enamel, it's a good idea to apply an undercoater.

The details above suggest an alternate cabinet with a folding table which can be fastened to a door or to the wall. It is similar in general construction to that already described, except that the lower compartment is fitted with flush plywood doors. The sides extend from the lower edge of the door to a point about 6 in. below the top of the door. The back panel of the upper compartment is cut from perforated hardboard. The lower back panel is $\frac{1}{4}$ -in. plywood. ★ ★ ★

Number of Bit Revolutions Indicates Depth of Bore

You can judge the depth of a hole bored in wood fairly closely if you count the revolutions made by the brace. Chalk a vertical line on the chuck of the tool to use as a gauge, and start counting after the screw point of the bit has entered the work. An average bit takes about 16 revolutions to bore 1 in., but due to the variation of different size bits a table of turns-per-inch for each one should be drawn up.

Ken Murray, Colon, Mich.



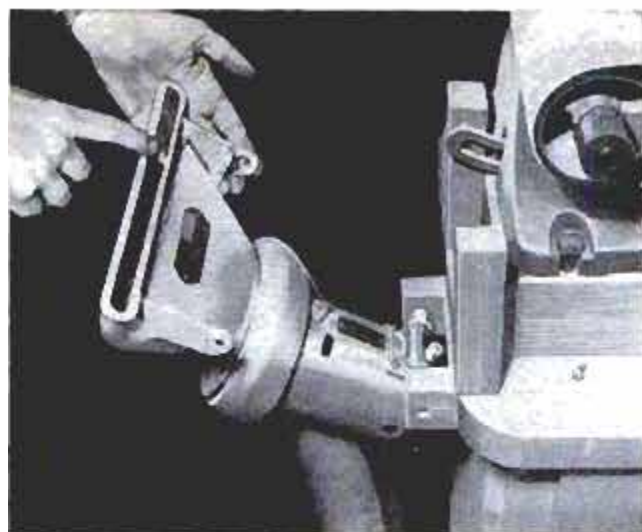

Pivoting on its rear axle, the vacuum is held in the operating position by a pin inserted through one front-wheel bracket. A wooden plug reduces the nozzle opening to the width of the sanding belt



With an attachment hose mounted in the usual manner the vacuum is used for cleaning the shop and power tools. On the model shown it was necessary to cover the wide nozzle to produce maximum suction in hose

Vacuum Collects Belt-Sander Dust

By M. C. Anderson

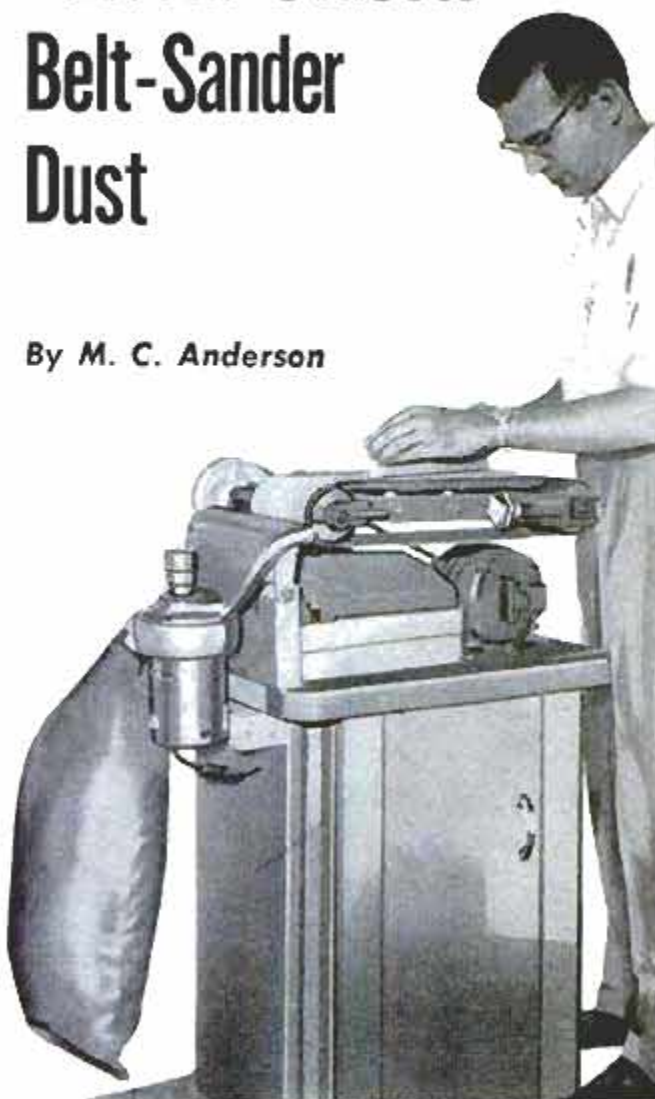

This home-shop belt sander was equipped with a dust collector made from an old upright vacuum cleaner with the handle and wheels removed. A ball-bearing motor was found best suited for vertical mounting

Drawer Pulls Protect Open Toggle Switch From Damage

A pair of drawer pulls, installed one on either side of a toggle switch, will allow it to be operated as usual but will prevent inadvertent throwing of the switch. The protective hood will also shield the switch from accidental damage.

Pitted Gasket Seat Smoothed

Sometimes a compression leak will develop between a spark-plug gasket and the machined gasket seat in an engine cylinder head because the seat is rusted or pitted. To smooth the seat, one mechanic uses a modified spark plug as a tool to "grind" the seat face so the gasket will seat properly. The threads are ground off the plug and an oil-soluble grinding compound is wiped on the gasket face of the plug, which then is rotated in the spark-plug hole.

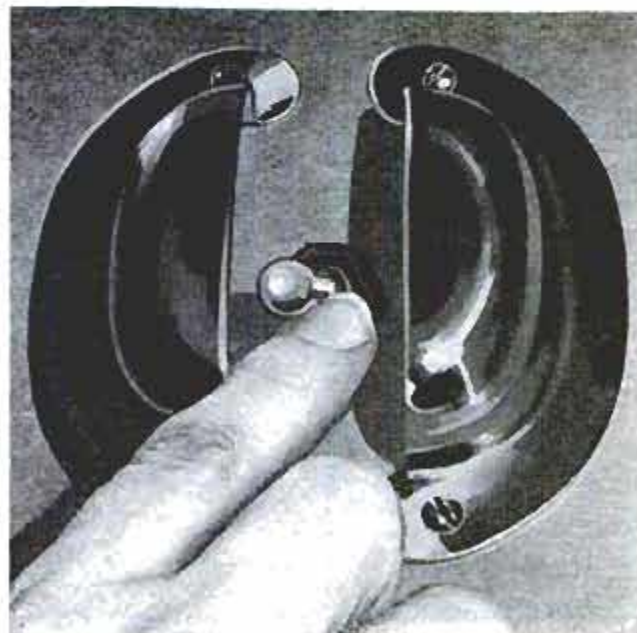

Rack for Small Parts Made From Coffee Cans



This handy storage rack with swingout bins for small parts was made by one home craftsman from several empty coffee cans, two $\frac{1}{4}$ -in. steel rods threaded on both ends and two boards. A pair of hinges—narrow strips of metal cut from heavy tin or galvanized iron—are riveted to each can. Then, the cans are assembled on the rods with a washer inserted between the cans to permit them to swing free. One board is fastened on the rods at the bottom for the base of the rack and one is fastened at the top to complete the framework and provide a cover for the two top cans.

D. C. Marshall, Manhattan, Kans.

Cork on Hard Masonry Wall Receives Bulletin Thumbtacks

When it is necessary to attach bulletins to a cement or brick wall and no special bulletin board has been mounted for the purpose, the job may be done by cementing sections cut from large corks to the wall. The cork slices, approximately $\frac{1}{4}$ in. thick, provide surfaces easily penetrated by the thumbtacks.

Long-Nose Pliers Shaped To Remove Sanding Disks



Long-nose pliers can be used to remove sanding disks if the jaws are ground to fit the lug holding the disk on the sanding tool. The pliers eliminate the need for a pin type spanner wrench which can be easily lost or mislaid.—Harvey Muller, Danboro, Pa.

File Tang Is Handy Drift For Removing Drill Bits

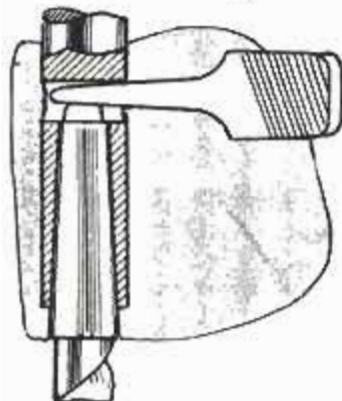

When you mislay or lose the regular drift, the tang of a large file inserted in the slot of the tapered drill spindle will remove the bit without damage. If the bit is "frozen" in the spindle taper a light tap on the end of the file with

a soft hammer usually will loosen it. Protect the end of the bit with a block of wood.

Frank LaSaracina, New York City.

Rotary File Used as Reamer

Emergency substitution of a rotary file for a reamer to enlarge the hole through a gear proved very successful to one lathe operator. Mount the gear in the lathe chuck and slip the shaft of the rotary file into the tailstock chuck. The original hole in the gear serves as a pilot hole for the file and permits accurate enlarging. The file will not last as long as a bit of the same size, but it is cheaper to use when only a few holes have to be enlarged.

John Tavian, Mentone, Calif.

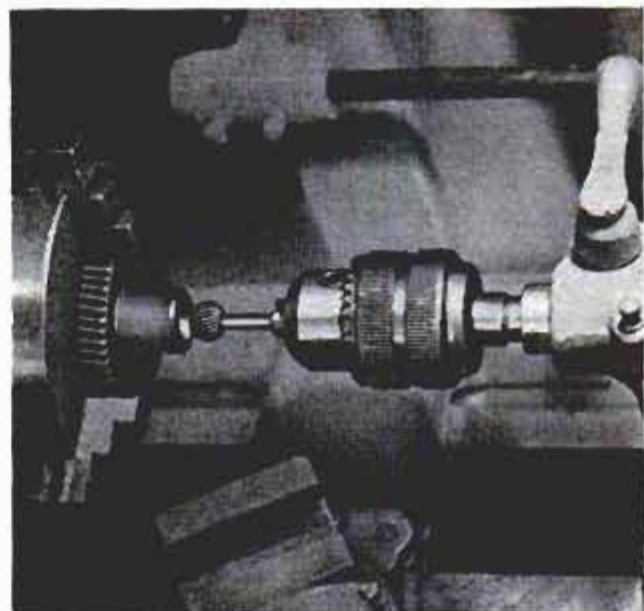

SPEED TORQUE SN 58

By J. B. Mullen



WHEN SETTING UP power-driven machines to do a given job it often is necessary to make quick and reasonably accurate calculations of the power required, speed reductions and other problems having to do with mechanical drives through belts or gears from motor to driven machine. As examples, it may be necessary to determine how much "pull" a motor has and what load it can lift when speed is reduced. If a speed-reducing drive is used between the motor and such equipment as a conveyor belt, it may be important to know how many feet per minute the belt will move. It may be necessary to determine the size of the motor required to drive a machine through an intermediate speed reduction. Usually these problems can be solved by using an alignment chart.

Although the horsepower of a motor is a measure of how much work it can do in a given time, torque is more accurately employed when calculating its output and is more directly applicable to the operation of the machine. Torque is the product of a weight or force acting around a shaft multiplied by the distance from the center of the shaft, as shown diagrammatically in details at the right. Torque usually is expressed in ft.-lb., which is the product of the length of the arm in feet times weight or force in pounds. Torque also may be stated in other units, the conversion table on page 247 showing conversions of torque units to ft.-lb. By reducing speed as shown by the geared windlass at the right, the torque is increased proportionately. In the example, the torque exerted on the crank, 150 ft.-lb.,

APPROX. EFFICIENCIES FOR VARIOUS DRIVES

TYPE OF SPEED REDUCTION	EFFICIENCY
Single reduction:	
V-belt	97 Percent
Flat-leather belt	90 Percent
Spur gear	95 Percent
Worm gear	80 Percent
Multiple reduction:	Find efficiency separately for each stage and multiply them together.

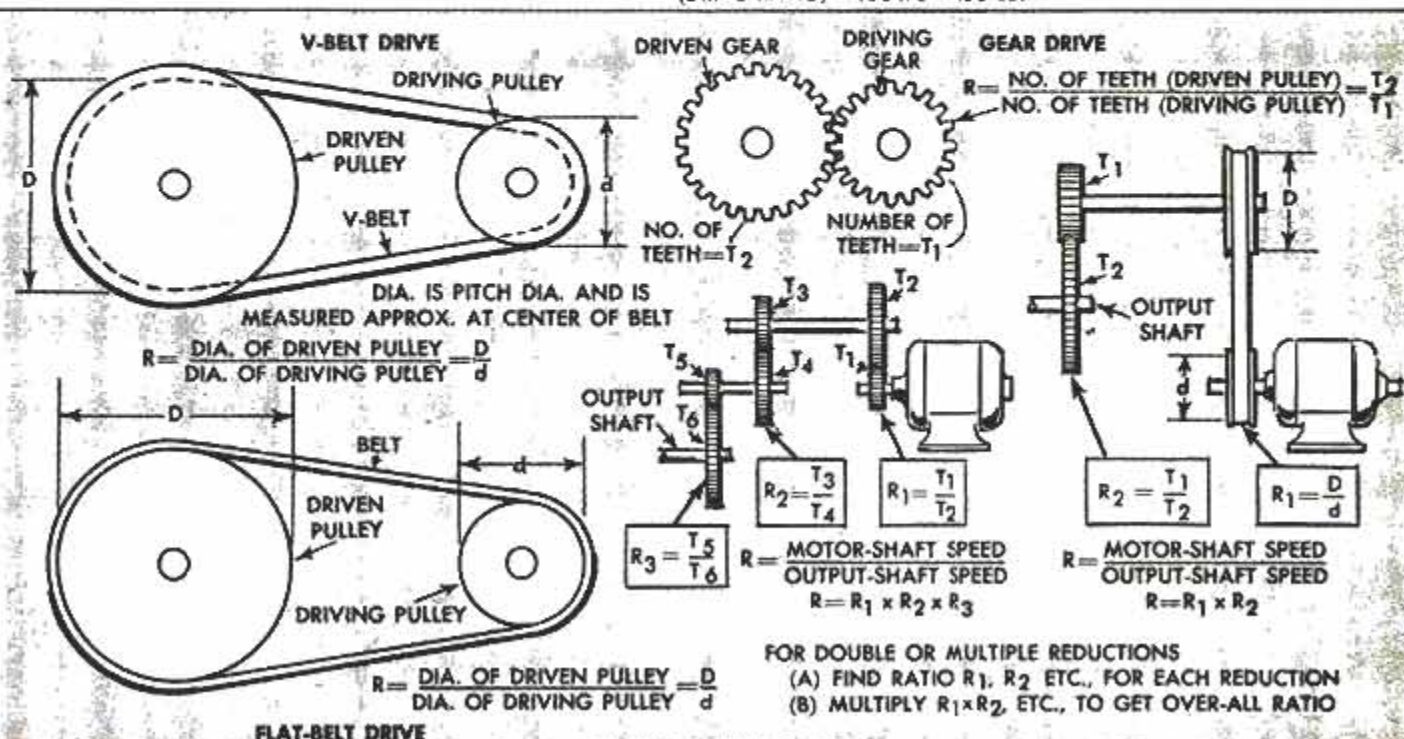
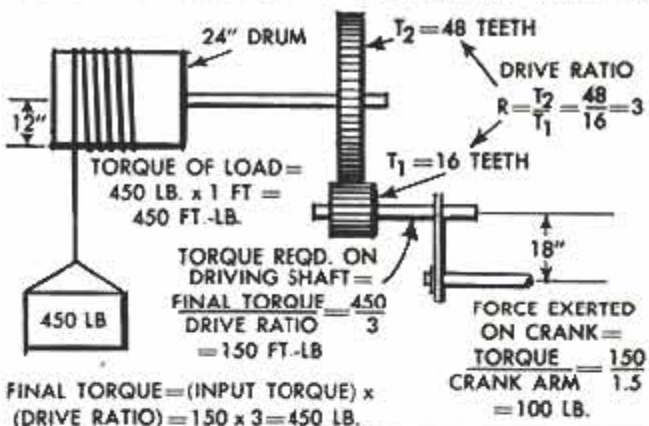
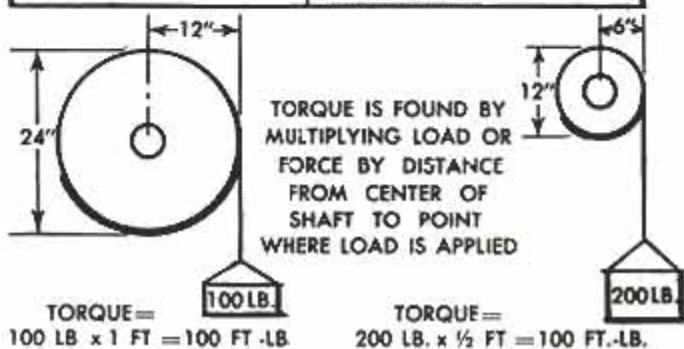



is increased to 450 ft.-lb. applied to the hoisting drum. If distance to the center of rotation is changed, the torque exerted by the weight also is changed. Thus, if the weight is being hoisted on a drum 4 ft. in diameter, it would exert a torque of 900 ft.-lb., and the 3-to-1 reduction gear would require that a torque of 300 lb. be put on the crank arm.

When it is necessary to determine what horsepower is required for a given load at a given speed reduction, the problem usually can be solved with the alignment chart as shown by the dotted lines. Assuming, as an example, a 100-lb. load is to be lifted on a 24-in. drum with a 100-to-1 speed reduction. The torque required on the drum is 100×1 , or 100 ft.-lb. This value is located on the T_1 -scale and the drive ratio, which is the motor-shaft speed divided by output-shaft speed (in this case, 100), is found on the R-scale and a straightedge is

laid on the two points. The answer found on the T-scale, 1 ft.-lb., is the torque that the motor must deliver. From this value, and the motor speed located on the S-scale (1725 r.p.m.) the motor horsepower can be found on the H-scale, in this case, $\frac{1}{3}$ hp.

For comparison, if no speed reduction were used, the motor would have to deliver 100 ft.-lb. directly. A straightedge laid from this point on the T-scale to 1725 r.p.m. on the S-scale will strike far beyond the range of the H-scale. Actually a 35-hp. motor would be required to drive the load without speed reduction.

Alignment-chart scales can be used to solve a number of problems pertaining to mechanical drives, several of which are shown by dotted lines on the charts, the chart on page 247 being a duplicate of that on page 246. As an example, it is required to find the drive ratio to deliver desired output torque from a motor of known speed and power, the desired output torque, 180 ft.-lb., the motor power, $\frac{3}{4}$ hp., and the motor speed, 1725 r.p.m., being the known values. First, lay the straightedge from 1725 on the S-scale to $\frac{3}{4}$ on the H-scale. The first answer, on the T-scale is motor torque, 2.25 ft.-lb. Next, lay the straightedge from this point to 180 on the T_1 -scale. The second answer, on the R-scale will be the required drive ratio, R equals 80, or

ALIGNMENT CHART FOR SPEED AND TORQUE

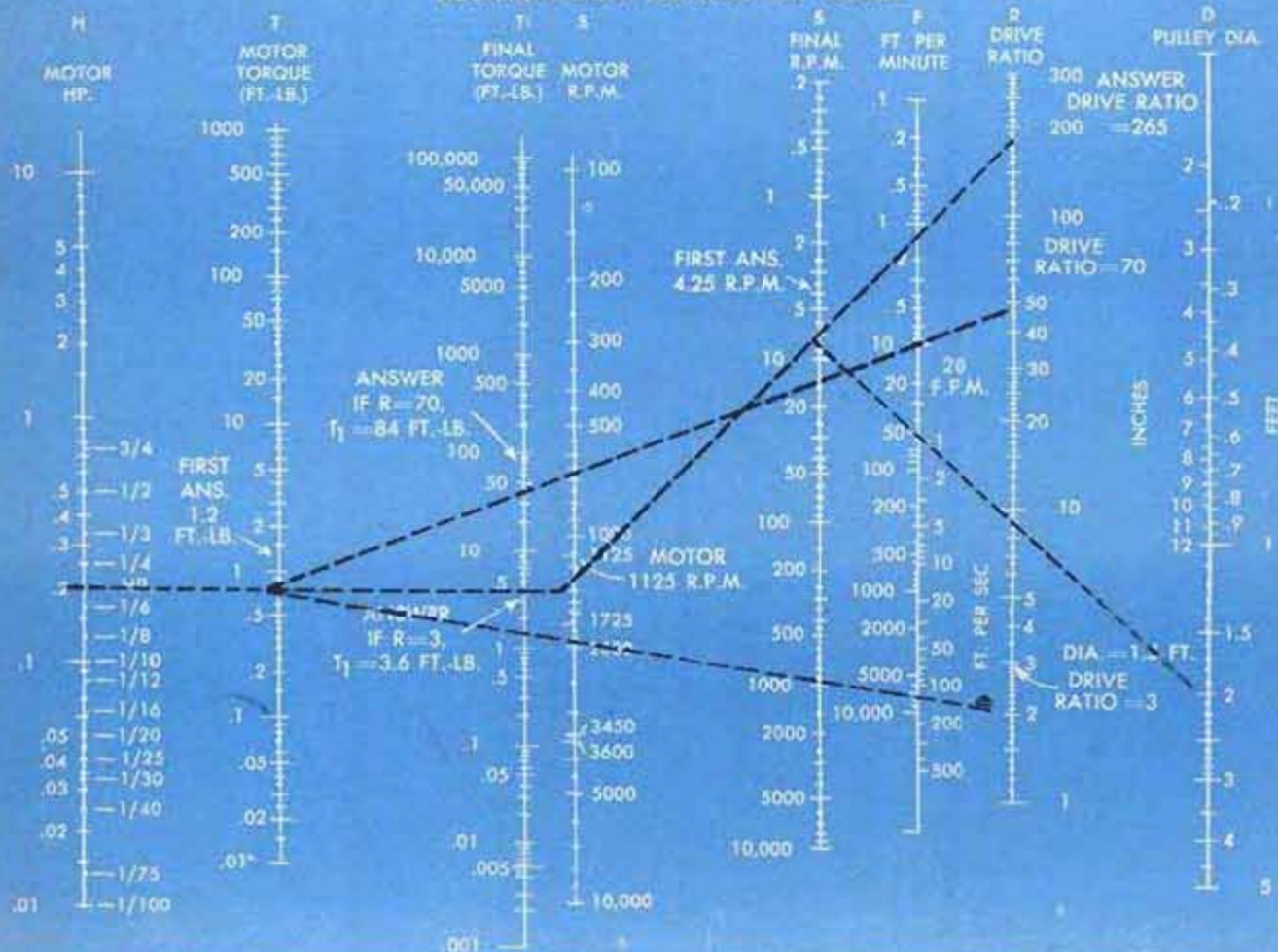

80 to 1. This example is typical procedure.

In another example it is required to find speed of output in r.p.m. and f.p.m. (feet per minute), with the drive ratio, the motor speed and the diameter of the hoist drum being known. Lay the straightedge from 1725 on the S-scale to 100 on the R-scale. The first answer on the S-scale (final r.p.m.) is the output speed, or 17.25 r.p.m. Now lay the straightedge from this point to 2 on the D-scale. The answer, read on the F-scale, will be 108 f.p.m. (feet per minute). It should be noted that the dotted lines on the charts are included merely for illustrative purposes and do not necessarily represent the more precise calculations possible when a straightedge is used.

In general the procedure is simply to locate known values on two of the scales. Lay the straightedge on these points. Then find an answer where the straightedge crosses the appropriate scale. This answer can then be used with another known value for further calculations. The chart does not make allowances for friction or other losses in the drive. If these values enter the calculations, they usually are compensated for by using a slightly larger motor, or a slightly higher drive ratio than calculated. Efficiency figures given in the table on page 245 for various types of drives also may be used in this connection. The values given in this table are only close approximations. ★ ★ ★

TORQUE UNITS

WEIGHT	LENGTH OF ARM	TORQUE	CONVERSION FACTOR
OZ.	IN.	IN.-OZ.	.0052
OZ.	FT.	FT.-OZ.	.625
LB.	IN.	IN.-LB.	.083
LB.	FT.	FT.-LB.	1

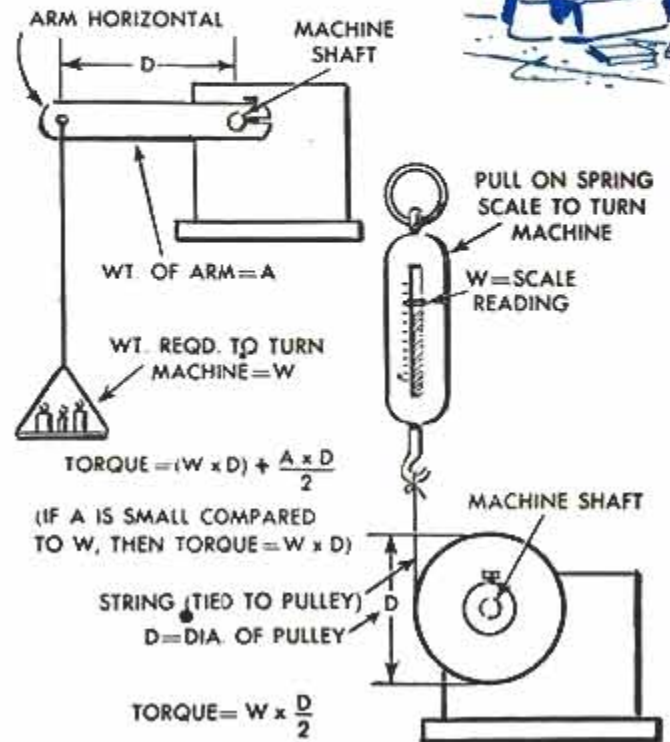

ALIGNMENT CHART FOR SPEED AND TORQUE

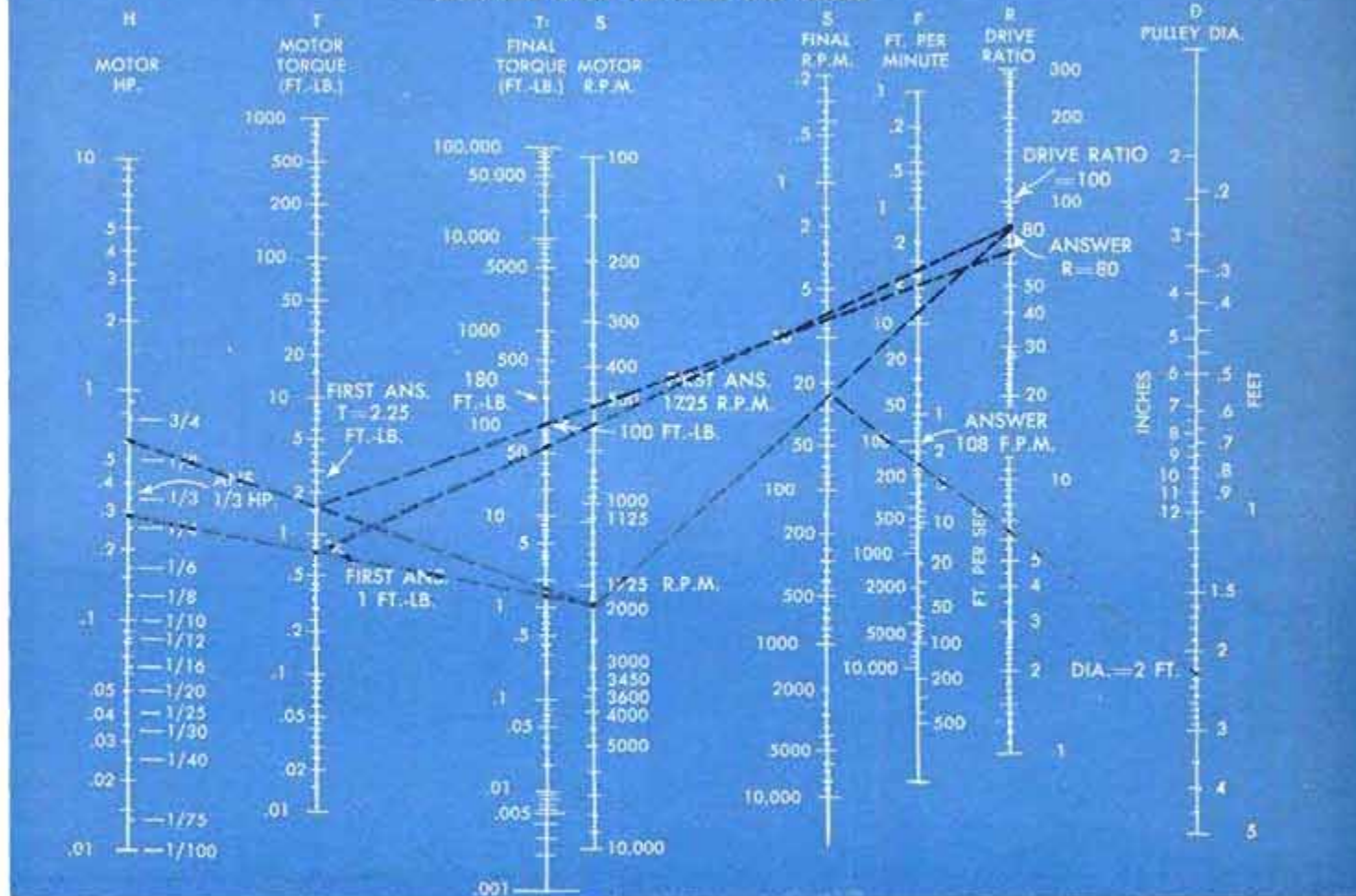

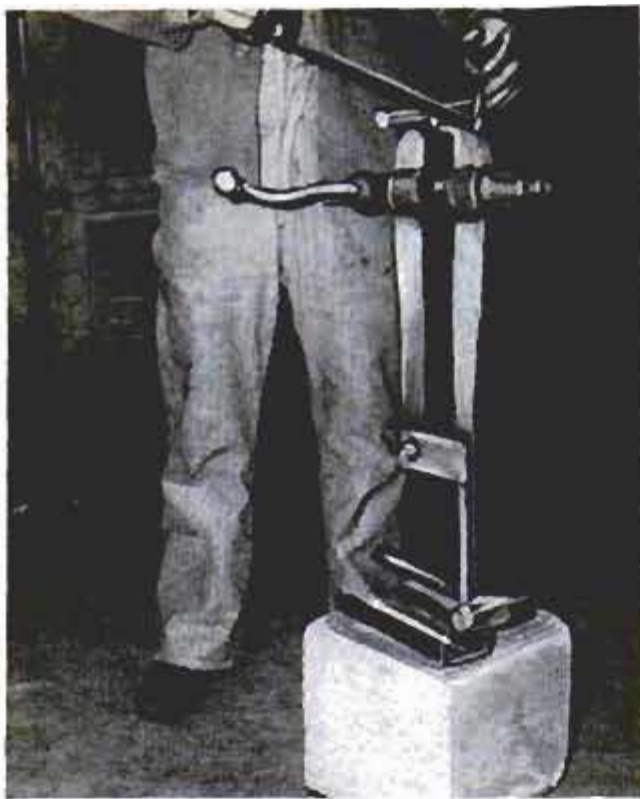

Portable Vise Mounted in Concrete

A vise of the type shown, mounted on a block of concrete, is sufficiently portable to be carried to the job away from the shop and yet rigid enough for heavy-duty usage. The base was made by filling a wooden crate with concrete and embedding bolts in the top of the block on which to fasten the vise.—C. F. Marley, Nokomis, Ill.

Keyhole Saw More Easily Filed In Conventional Vise

When a keyhole saw is hand-filed, the job can be done easier in a bench vise than a saw vise. Teeth at the narrow end of the tapered blade require the most filing and the end of the saw can be held more conveniently in the deeper jaws of a conventional vise.—Michael Logocki, Gary, Ind.

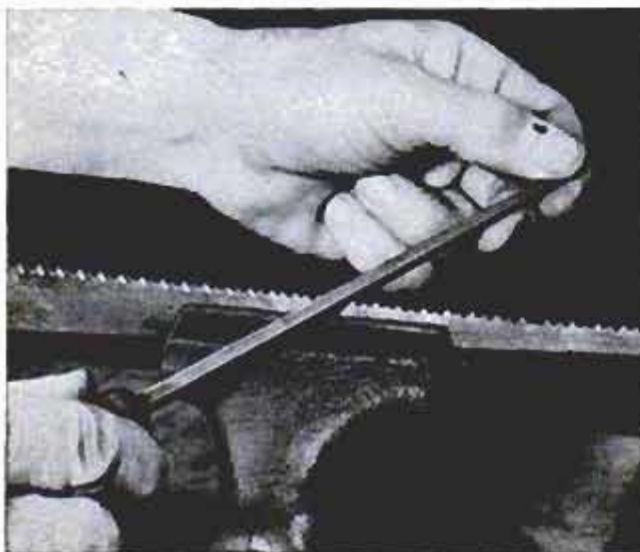

Quarter-Round Prefinished To Simplify Painting

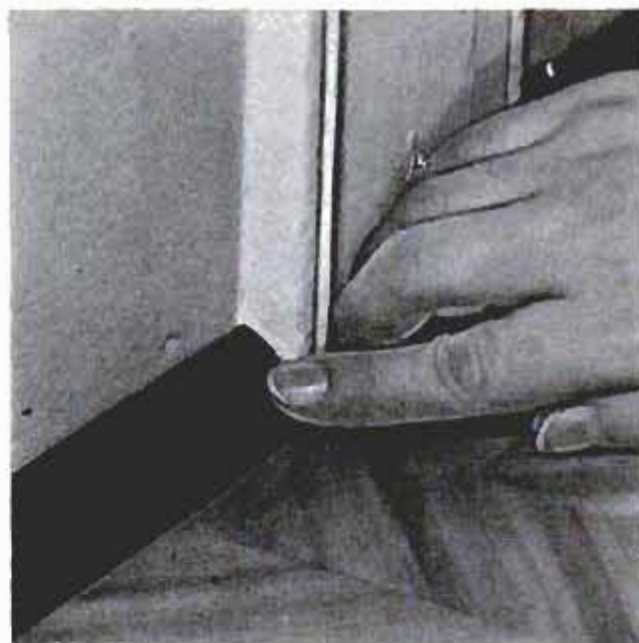

Save time and temper, and protect newly finished floors from paint spatters and runs by painting quarter-round molding before installing it. Installing the prefinished molding requires only driving and counter-sinking a few nails, covering them with putty and touching up with a small paintbrush. The awkward job of crawling along on hands and knees to paint the molding thus is avoided.

Chain Permits Proper Seating Of Toilet Flush Ball

A toilet flush tank that leaks due to an improperly seated flush ball can be repaired by replacing the upper lift wire with a small copper or brass chain. The flexible chain will permit the flush ball to drop squarely into the flush-valve seat without the binding that frequently occurs when a standard lift wire is used. To install the chain cut it to the right length, attach one end to the trip lever and the other end to the lift wire. There should be a slight sag in the chain when the valve is in "closed" position.—Norm Jacky, Fond du Lac, Wis.

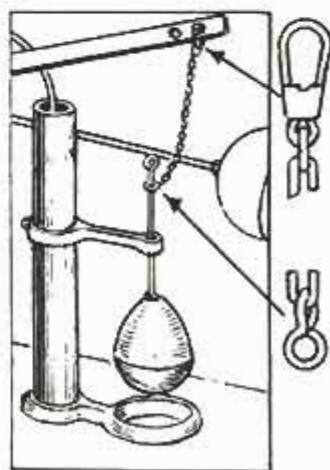

Before discarding an old tackle or tool box consider the possibility of salvaging the trays for use in bench drawers to hold small parts.

JIG FOR TOOL-POST GRINDER

By Carleton A. Phillips

IT IS EASY to adapt a 1/4-in. electric drill for use as a tool-post grinder with this simple jig consisting of a base, two V-blocks, a band and holder for securing the grinder in cutting position on a lathe, and an arbor for the grinding wheel.

From 1 x 1-in. steel stock make the holder 3 1/4 in. long and remove 3/16 in. of the metal from two opposite sides for a distance of 2 1/2 in. Either a mill or bandsaw can be used for this operation. The unmilled end remaining is then squared off and the end drilled and tapped to take a 1/4-20 machine screw.

The V-block and base assembly is made from 1/4-in. mild steel. First, two 10-24 holes are drilled and tapped about 3/8 in. in from the edges of the base as shown in the end view of the V-block and base assembly. Each V-block is fastened to the base with two 5/8-in. 8-32 roundheaded screws.

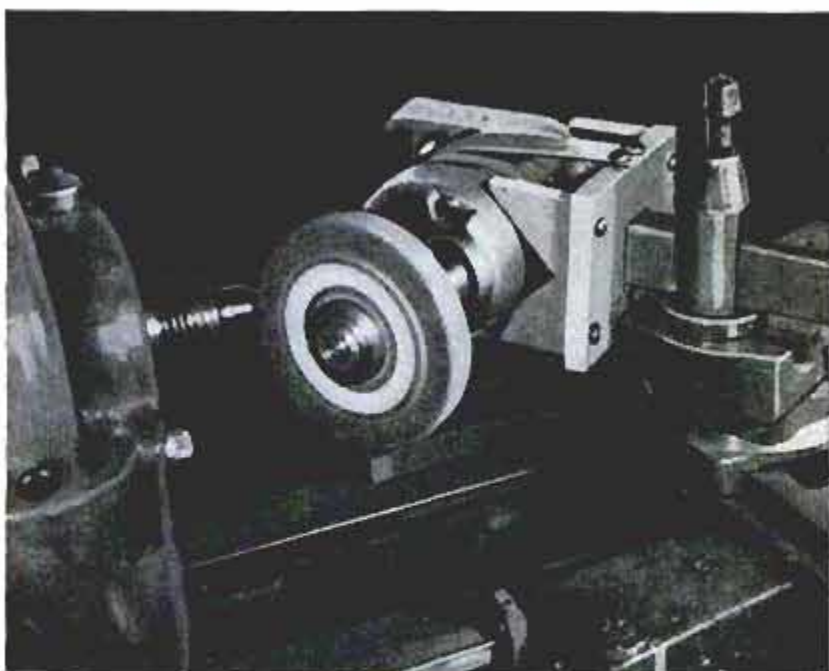

The band is cut from thin sheet metal and screwed to the base as shown. For a tight fit, drill and fasten one end of the band first, and then, with the electric drill in position on the V-blocks, pull the band tight around it and drill a 1/4-in. hole in the band at the point of contact with the base. Notice that this end of the band is fitted with a metal block.

The arbor is turned from 1/2-in.-dia. stock as shown in the detail at the upper left corner of the drawing and the collars are turned from 1 1/4-in.-dia. stock. If the diameter of the hole in the grinding wheel is larger than 3/8 in., turn a bushing to make it fit.

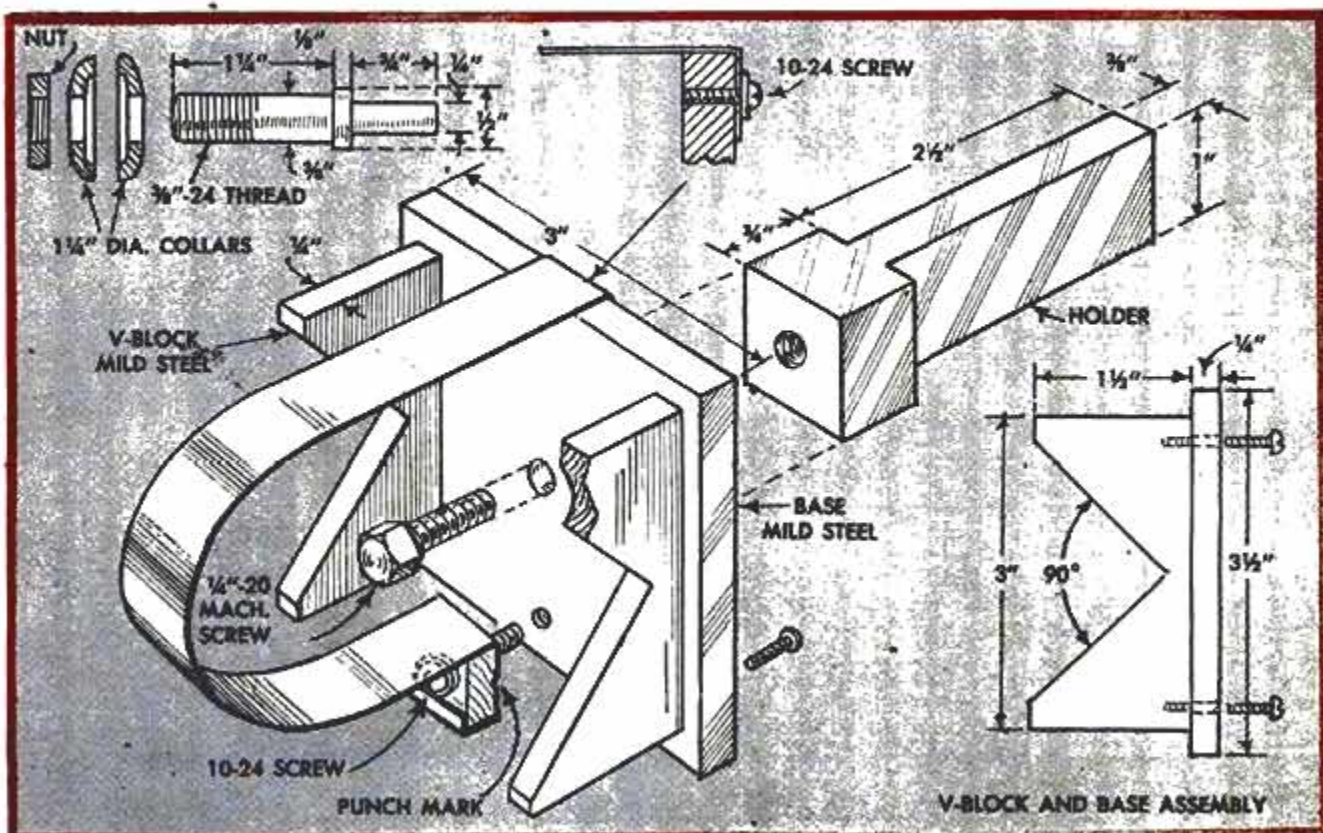

Metal "Stirrup" in Concrete Base Extends Life of Rotted Post

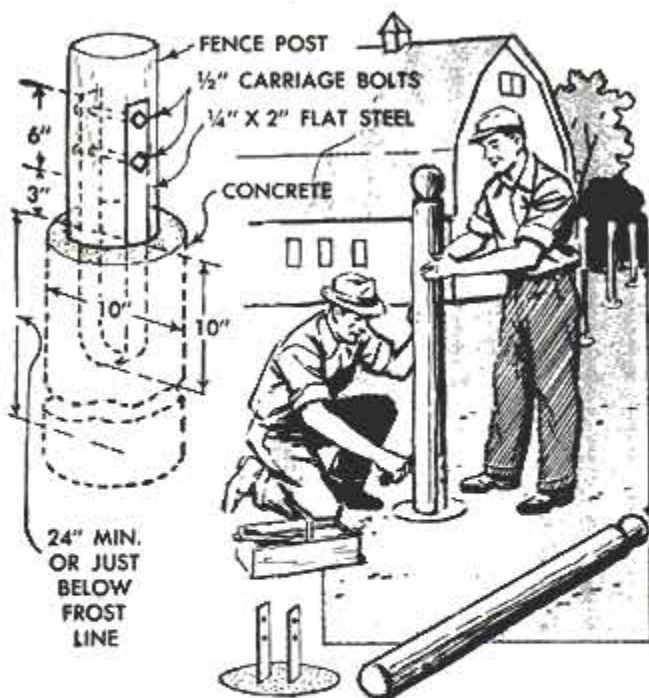

Fence posts that have rotted below ground level but are sound above can be given a new lease on life by replacing the rotted ends with a metal "stirrup" embedded in concrete. Simply saw off the rotted ends making the posts uniform in length. Next, cut and drill the stirrups using two pieces of $\frac{1}{4}$ x 2-in. flat steel 18 in. long, or a single 40-in. length bent to a U-shape. Fill the postholes with concrete and embed the stirrups as shown in the detail, being sure that the top of the concrete slopes away from them. To assure correct width between the projecting ends of flat steel, temporarily bolt a block of wood between them, the same size as the fence posts. The stirrups should be set vertically erect and aligned with the fence line. After the concrete has hardened, the posts are bolted on and all metal parts given a protective coat of red-lead paint.

Screwdriver Blades Hardened By Heating and Quenching

Steel blades of inexpensive screwdrivers can be hardened by heating until red hot and then quenching them quickly in warm water. If not tempered, the blades often prove too soft for the job and tend to bend or chip at the tip.



Adjustable Lathe Center For Supporting Small Work

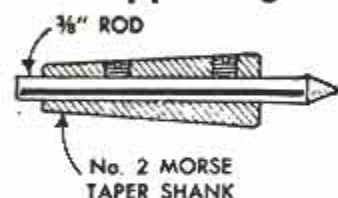

An adjustable lathe center for supporting delicate work can be made from the tapered shank of a discarded twist drill and a short length of drill rod. The tapered shank is drilled lengthwise and reamed to accommodate the drill rod. Two holes are then drilled and tapped for the setscrews that hold the drill rod in place. The assembly is mounted in the headstock spindle and a 60-deg. point turned on the end of the rod. As the point becomes dull it can be moved forward and resharpened so that the point is always at the same distance from the headstock when the taper shank is seated in the spindle.

Threading Taps Kept Sharp

Sharpen taps with a dowel-shaped oilstone, rubbing it back and forth along the cutting edges. When tapping holes use a lubricant of cutting oil and white lead for cleaner threads.

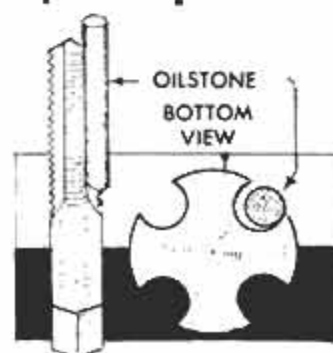

Two Clevises Form Universal Joint

Flexible universals for light-duty motor shafting or wrench drives can be improvised from two clevises joined together as shown in the illustration. The connecting link is an oblong block of wood, metal or plastic with two holes drilled across at right angles to each other. Small bolts are placed through the clevis and link, and capped with a locknut. Back off the nuts just enough to permit free movement.



BEND PLASTIC the EASY WAY

Find it difficult to bend thick plastic into right angles without cracking, scorching or leaving bubbles in the material? Then try using the element from a discarded 220-v. hot-water heater to soften the plastic for bending, instead of the usual electric oven or torch which does not heat the plastic evenly along the line of bend. First, reshape the element so it will be about $\frac{1}{2}$ in. away from the plastic when in heating position. Scribe a line across the plastic where the bend is desired, place it in a vise as shown, and hold the heating element over the plastic until it becomes pliable. Make the bend and clamp a hardwood board over it until the plastic cools. Wyatt M. Wayne, Miami, Fla.



Above, 110-v. current passing through 220-v. hot-water heating element produces right amount of heat to soften plastic for bending without scorching

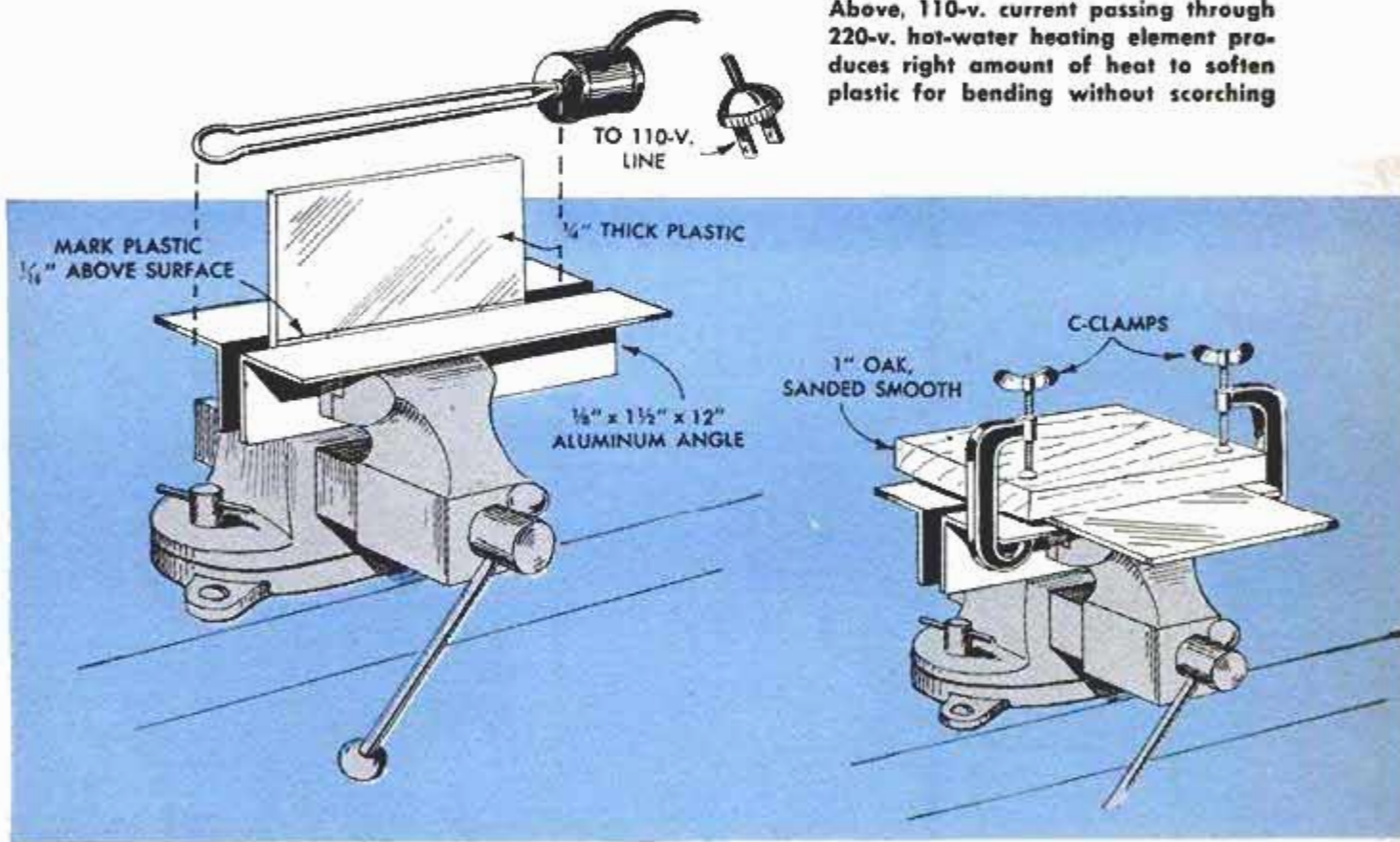

How to Restore Piano Finish Checked by Hairline Cracks

If the finish on your piano has become checked from age it can be restored with a treatment of amalgamate thus eliminating the need for refinishing. First wipe the surface clean of dust and wax, using a cloth saturated in denatured alcohol. Then brush on the amalgamate, applying it sparingly to prevent "sag." Similar results can be had by using denatured alcohol to soften and smooth the varnish, but it has

a greater tendency to "sag" or run. Removable panels should be worked on a table, or other flat surface, to minimize the sagging effect. When dry, sand the surface with waterproof sandpaper, grit 450, dipped in water. A coat of satin varnish will then cover any apparent unevenness. For a softer effect, rub the surface with fine steel wool dipped in linseed or rubbing oil.

Lillian S. Graham, Minneapolis, Minn.

Fractured Plasterboard Can Be Severed With Handsaw Back



After scoring and fracturing a piece of plasterboard, use the back of a handsaw to cut the remaining layer of cardboard. Fold the plasterboard double, as indicated, then slide the saw along between the panel sections, employing it in the manner of a large knife to slice the cardboard.

Increasing Vise-Jaw Capacity

Narrow pieces of steel bolted on top of the jaws of a vise, but spaced farther apart, will increase the capacity of the vise for holding larger lightweight work. Clamp the steel strips to the vise in the desired positions. Then drill and tap two holes through each strip into the vise jaws below.

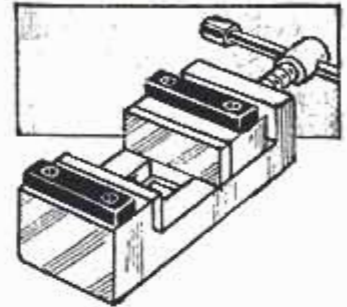

C. W. Woodson, Chicago.

Setting Engine Valves

When it is necessary to adjust gasoline-engine valves, the piston in the cylinder on which the valves are being adjusted should be on top dead center of the compression stroke. To be sure of this for each cylinder, begin with No. 1, cranking the engine in the normal direction of rotation until the exhaust valve is just closing, while the intake is beginning to open. This obtains top dead center of the exhaust stroke. Then, turn the crankshaft exactly one revolution for the correct positioning of the compression stroke and make the valve adjustment on No. 1. Now, proceed with the valve adjustment through the engine according to its firing order. Or, to bring the next piston to the correct position for setting the valve in its cylinder, turn the crank exactly 180 deg. in a 4-cylinder engine, 120 deg. in a 6-cylinder, and 90 deg. in an 8-cylinder engine.

Felt Hat Provides Disks For Buffing Wheel

An old felt hat, a $\frac{1}{4}$ -in. bolt and two washers are the only materials needed to make a buffing wheel for use with a $\frac{1}{4}$ -in. drill motor. Cut a number of disks from the hat, using a water tumbler or other round shape as a pattern. Punch a hole in the center of each disk and slip them onto bolt, using a washer on each side of the assembly. Use a lock washer or locknut to insure that the assembly stays tight when rotating at high speed.

Gilbert C. Close, Hawthorne, Calif.



Petroleum Jelly on Fiber Washers Keeps Battery-Cable Nut Free

Corrosion on a battery-cable terminal which often causes the nut to "freeze," can be prevented if two fiber washers are used between the nut and the terminal. Coat the washers with petroleum jelly before installing them.

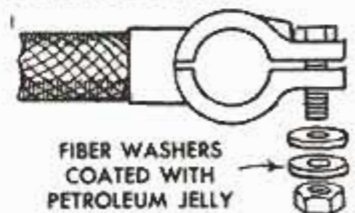

John Krill, North Lima, Ohio.

SHOPPING FOR TOOLS

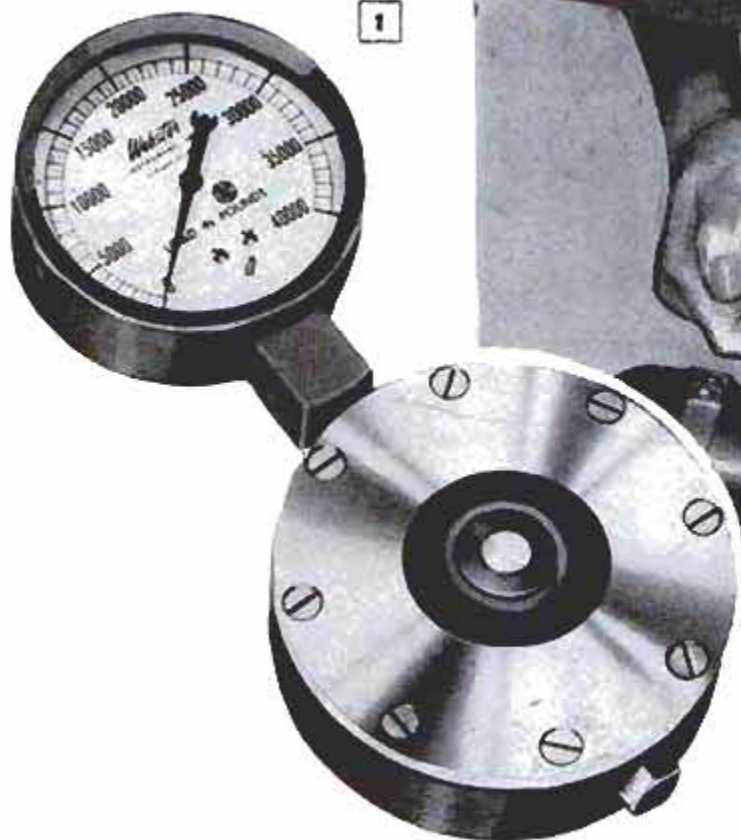

1

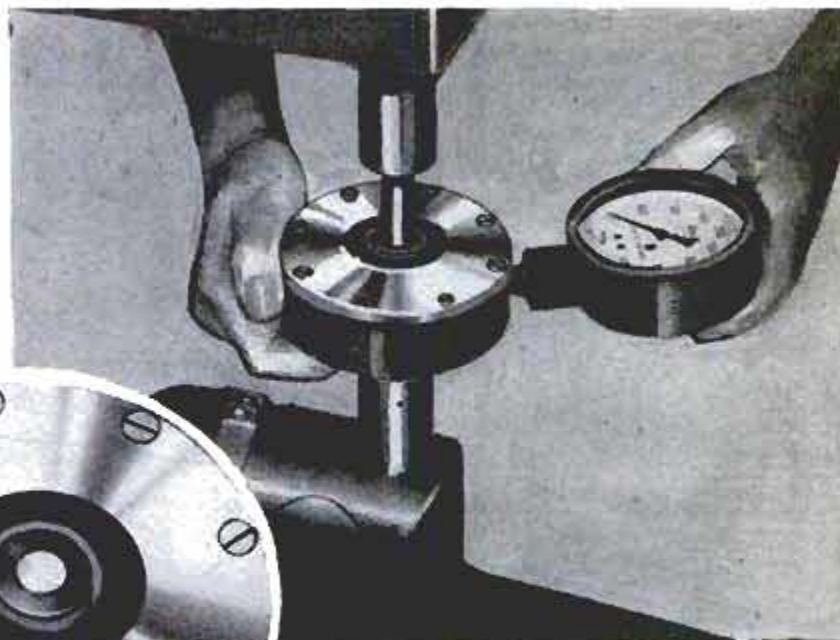

1. DIRECT-READING FORCE GAUGE operates hydraulically and is designed to measure force exerted between electrodes on spot-welding units and between rolls on roll-welding equipment. Insulated contact surfaces prevent damage from accidental firing of welding unit being checked. Registers from 1000 to 40,000 lb.

Webster Instrument Co., 11856 Mississippi Ave.,
Los Angeles 25, Calif.

2. HOLD-DOWNS for use on machine tables do not require blocking or shimming. Adjust quickly to varying heights of work having steps, ledges and offsets, making it difficult to hold with conventional clamping equipment. Each one-piece curved unit is slotted to permit positioning of the clamping bolt at any point along the full length of the slot. Concave washers, supplied with each clamp, distribute the pressure uniformly

Bausch Products, 18411 W. McNichols,
Detroit 19, Mich.

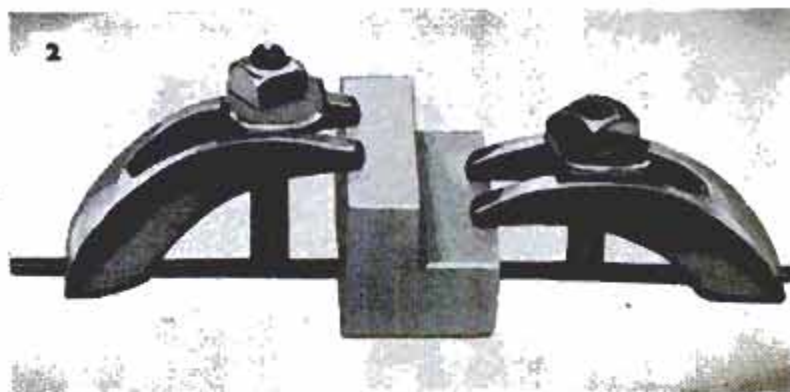

2

3. COMPACT ONE-MOTOR WORKSHOP for home, farm or school shop combines six machines in one unit only 40 in. long; circular saw with 8-in. blade, lathe, vertical drill press, disk sander, grinder and horizontal drill. Lathe takes 30 in. between centers with spindle speeds variable from 875 to 3500 r.p.m. Any standard 1/4 or 1/2-hp., 1750-r.p.m. motor can be used. Machine is supplied with drill chuck, lathe centers and sanding disk

Michael Mfg. Co., 303 Hamilton St.,
Racine, Wis.

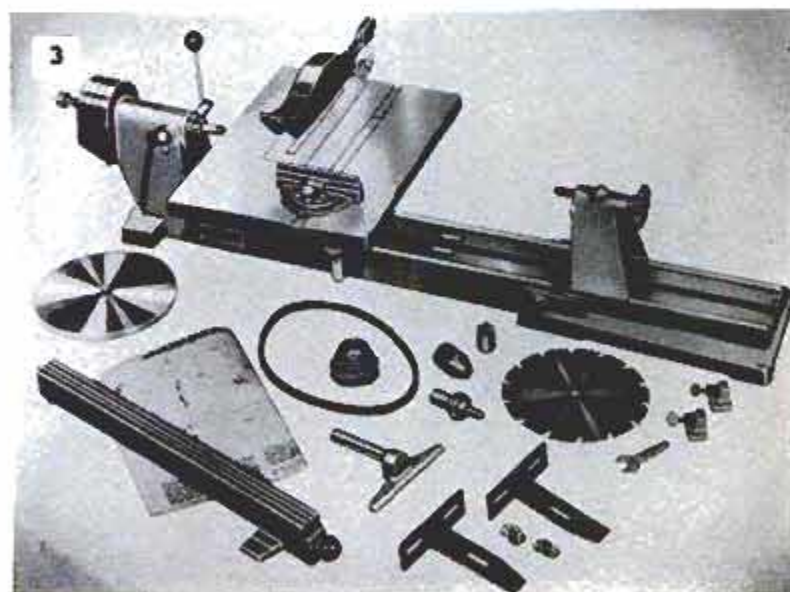

3

SHOPPING FOR TOOLS

(Continued from preceding page)

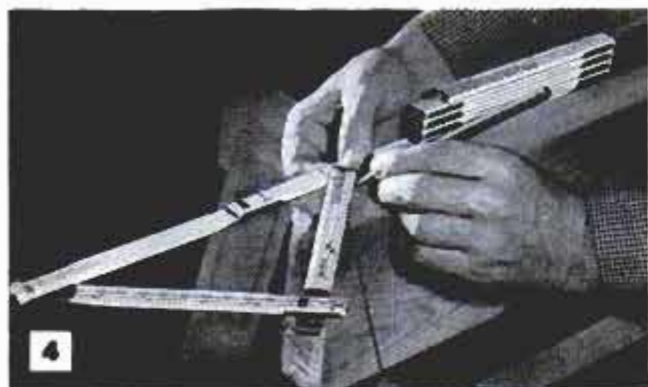
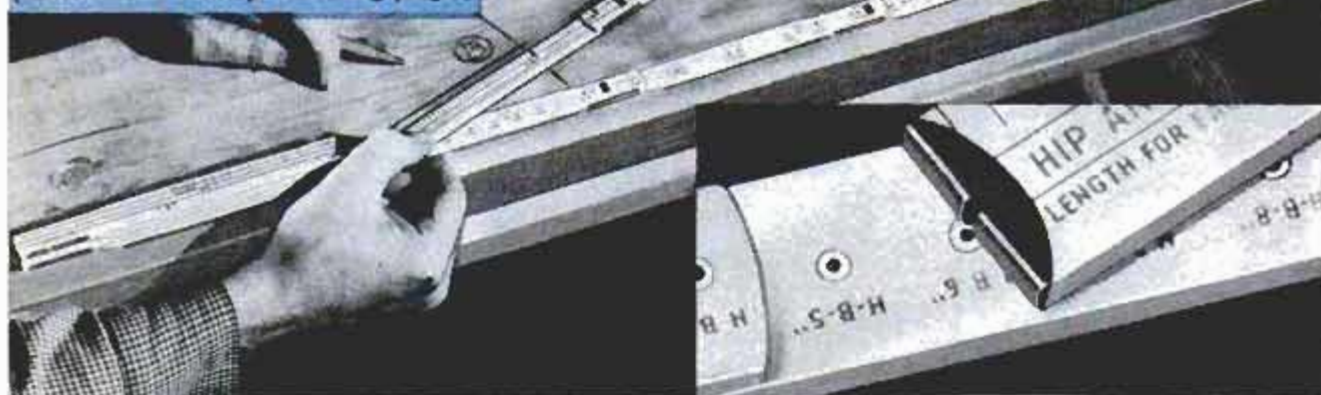

4. BUILDER'S FRAMING RULE has all the features of the conventional 6-ft. folding rule and in addition comes with special markings on the reverse side which enable the user to lay out common, hip, valley or jack-rafter cuts without the use of a steel

5. ROUTER KIT consists of carbide bit and guide for trimming veneers and laminates. Bit, shown in photo, is designed for either flush or bevel trimming of hard-plastic surfacing materials. Detail shows panel bit which also is available as a special accessory

Stanley Electric Tools, Div. of Stanley Works, New Britain, Conn.

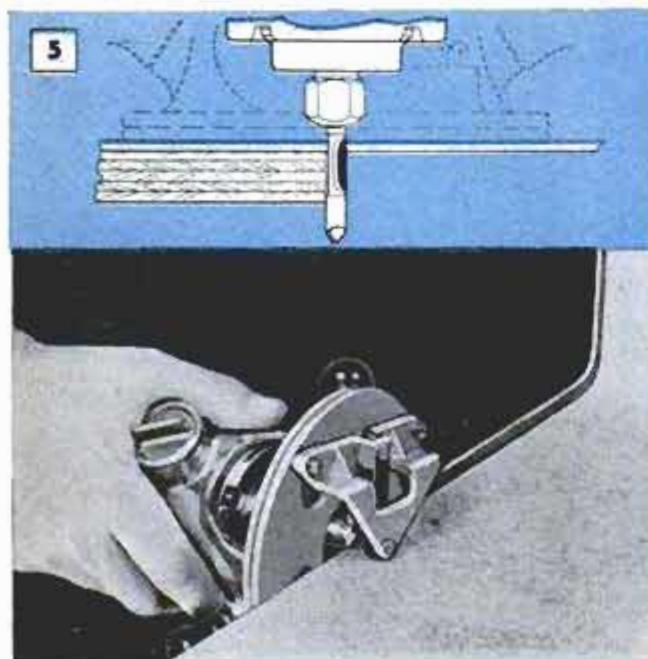

square. Also is used by carpenters for finding the pitch, or rise, of an existing roof. Upper photo shows how rule is folded to make layout for bottom plate cut on low-pitch hip and valley rafters. Left, marking top side cut and right, the top plumb cut

Master Rule Mfg. Co., 40 Mulberry St., Middletown, N. Y.

6. ORNAMENTAL IRON PORCH COLUMNS are set quickly without drilling holes in concrete on either old or new work with this special adjustable lug which fits into the lower end of the square column. Sharp point on lug enters concrete and anchors column

Tennessee Fabricating Co., 1490 Grimes St., Memphis, Tenn.

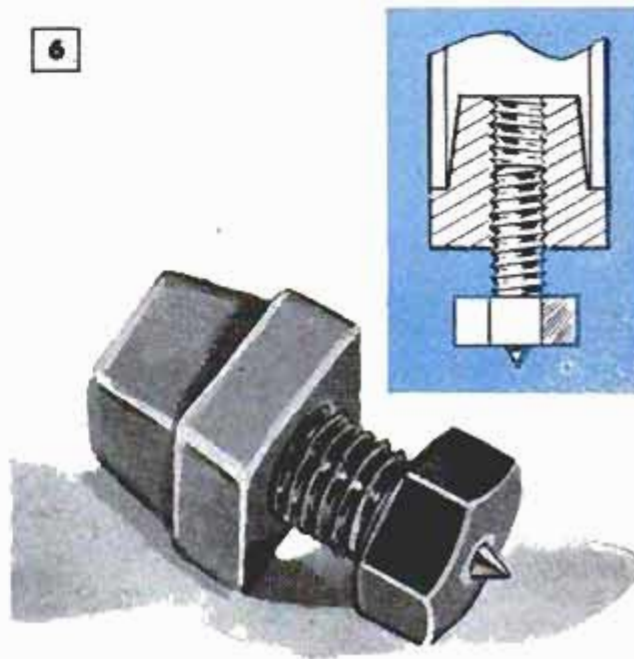



7. PORTABLE METAL SHEAR is mounted on a rigid tripod that folds for transport or moving from place to place on the job. Weighs only 20½ lb. with a handle length of 22 in. and a cutting capacity of 2½ in. Cuts sheet metal up to 10 ga., notches, trims and makes bevel cuts. Especially handy in auto body shops and also for mass-producing duplicate sheet-metal parts or parts cut from extruded metals. Will also cut hardwood and plastic. Inset pictures compound leverage that gives smooth cut to end of blades

Airborne Sales Co., Metal King Div., 8501 Stellar Drive, Culver City, Calif.

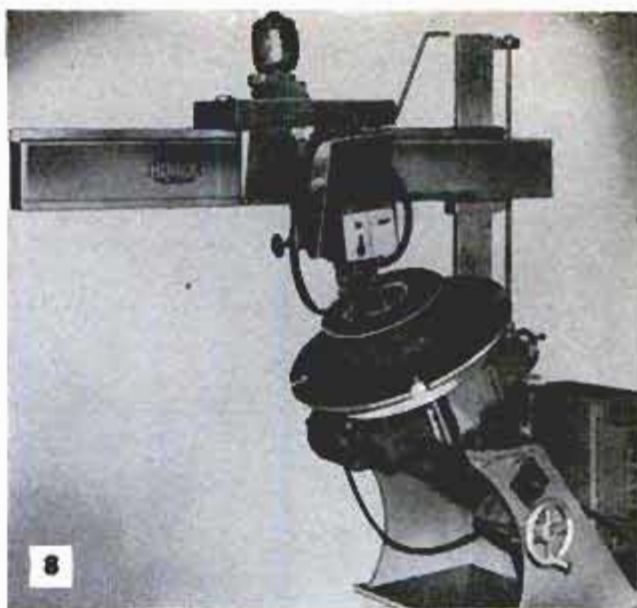

9. GLASS CUTTER has a cutting wheel of carbide precision-mounted on a special bearing which provides exceptionally smooth operation. Carbide cutter requires a minimum of pressure to make a sharp score and a clean break on window glass of any standard thickness. Also cuts ordinary plate glass

Millers Falls Co., Greenfield, Mass.

8. WELD POSITIONER has been designed to simplify the problems of metal-fabricating shops planning setups to handle automatic welding. Adjustments permit positioning both weldment and automatic welding head. This is accomplished by rotating both the column and ram after the work is mounted. Lateral travel of the ram is power-actuated, the carriage travel being 36 in. Over-all height of machine is 6'-6" and the size pictured is rated at 500-lb. capacity. Other sizes are available on special order

C. B. Horrick Mfg. Corp., 2000 Center St., Cleveland, Ohio.

10. PRECISION TAPPING TOOL for use in drill press or lathe enables the user to cut a true, clean thread and reduces tap breakage to the minimum. Tool is held in drill chuck in either the drill press or lathe and the tap lined up with the hole in which the thread is to be cut. Tap is run in by hand

F. & G. Engineering Co., 6004 Grace St., Chicago 34

11. TESTING DEVICE for checking auto cooling systems can detect gasket leaks and other defects in pressurized systems. Prevents loss of expensive anti-freeze solution. Dial indicates correct pressure readings for 4, 7 and 14-lb. systems. Adapter with 2-way rubber bushing fits all radiator-neck openings

E. Edelmann & Co., Chicago

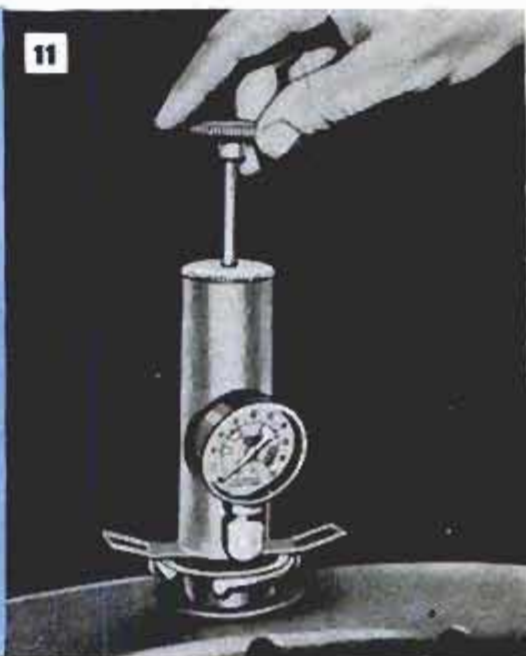
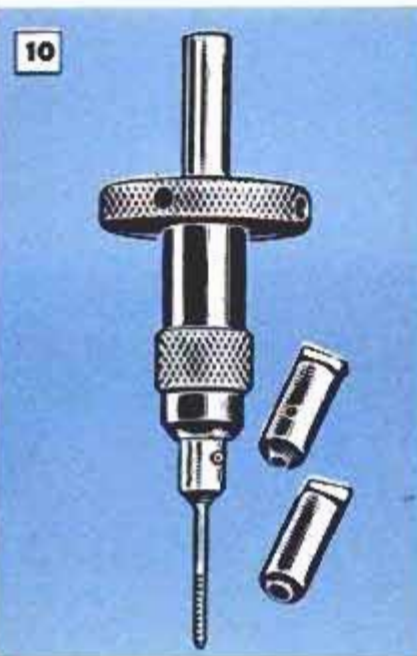

Drill-Press Trays Hold Stock and Finished Parts

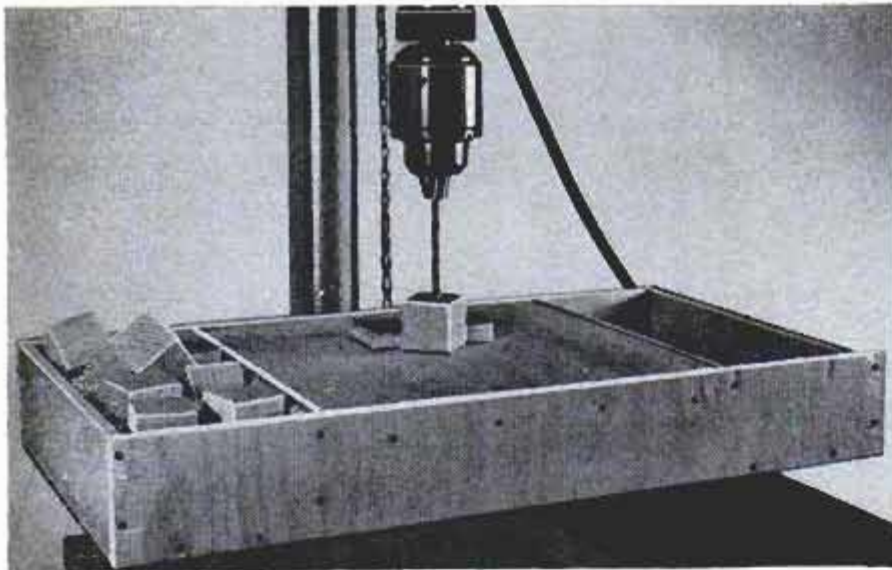

When drilling a large quantity of small parts, two boxes, one on each side of the shop drill-press table, are convenient for holding stock and finished parts. Undrilled parts are then taken from one box and deposited in the other after drilling. Make the boxes equal in length to the depth of the drill-press table. Then join them together front and rear with long, narrow pieces of wood, making the assembly a tight fit around the edge of the table. To protect the table top cut a wood panel to fit over it. The top panel is fastened to the boxes at either side.—Bertram Brownold, Cedarhurst, N. Y.

Safe Brad and Pin Driving

Driving small brads and pins for model making, picture framing and other uses can be done safely with the aid of a short piece of small-bore tubing. The driving rod is a finishing nail with the point removed and the end flattened, and may be magnetized to hold the brad while positioning it for driving. The rod should have a friction fit inside the tubing so a pin or brad will not become wedged between it and tubing.

Carl S. Bates, Chicago.



Retriever for Small Parts

Tools and small parts are easily retrieved from blind holes with this tool made from two pieces of stiff wire. Bend one end of each wire to form a jaw, and tape or solder the wires together, allowing space above the jaws for spring action. Then tape the jaws to provide a nonslip grip.—

James P. Marshall, Barrington, R. I.

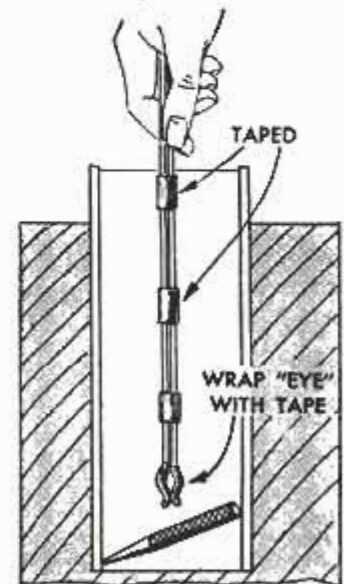

Aligning Circular-Saw Blades

To align the blade on a circular saw, fasten a bolt to the blade, with the shank between two of the teeth, and measure the gap from the bolt to the rip fence.

Check the gap with the bolt resting on the table, then rotate the blade until the bolt again strikes the table and make a similar check. Adjust the saw blade accordingly.

E. P. Graff, Ridgewood, N. J.

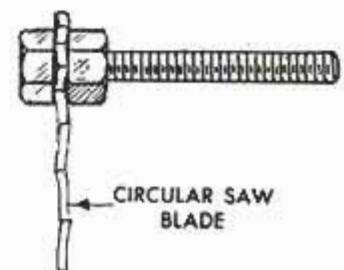

Sleeve Holds Square Stock in 3-Jaw Chuck

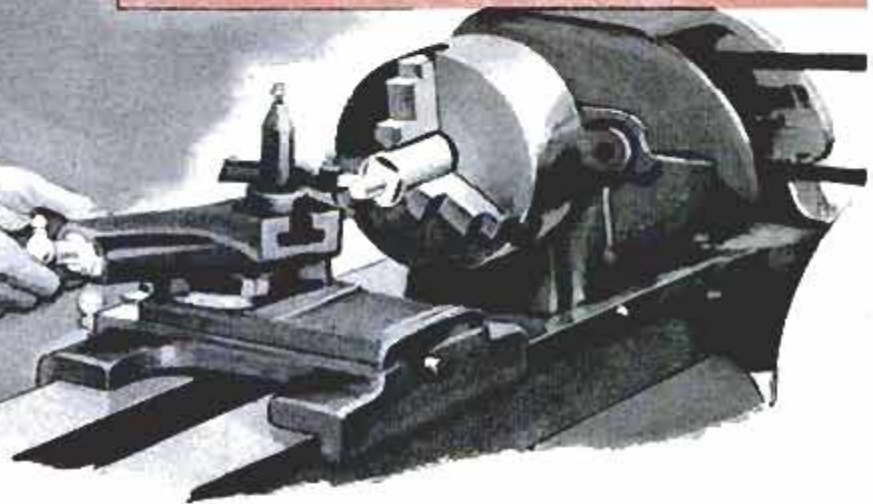
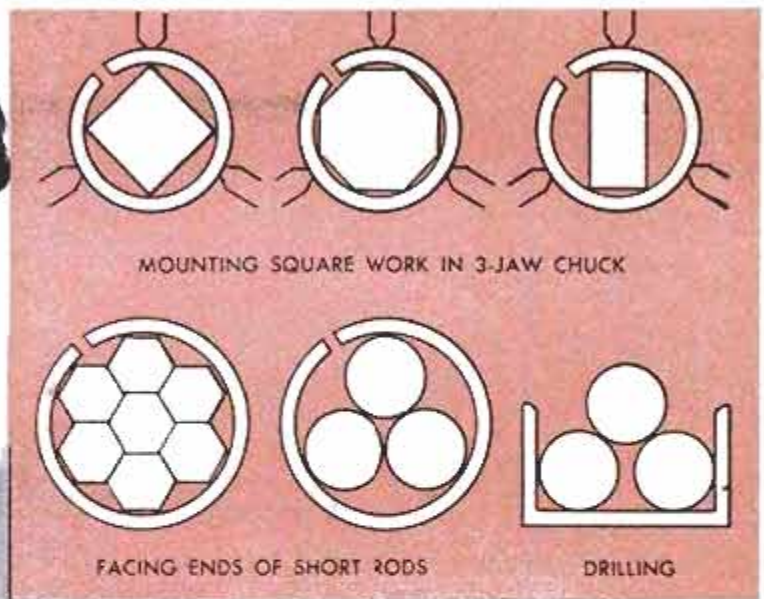

When a 4-jaw lathe chuck is not available, square, rectangular and octagonal bar stock can be held in a 3-jaw chuck if it first is inserted in a sleeve, consisting of a split length of pipe or tubing as shown in the upper details. A similar sleeve can be used to hold a number of pieces of

round or hexagonal stock that are to be faced (two lower left-hand details). Several lengths of round stock can be held in a 4-jaw chuck for facing, lower right-hand detail. The same length of channel will provide a "vise" for holding the round stock for cross-drilling in a drill press.

Diameter of Cylindrical Object Measured With Two Squares

With the aid of two squares straddling the object as shown, the diameter of a cylinder can be measured. It is essential, for accuracy, that the legs of the squares that overlap each other be in perfect alignment. If a try square is used in conjunction with a carpenter's square, the handle of the try square is held against the edge of the other square.

When installing spark plugs in recessed holes common to V-8 engines use a short length of garden hose, which fits snugly over the end of the plug, to start the threads. Tighten the plugs with the conventional wrench.

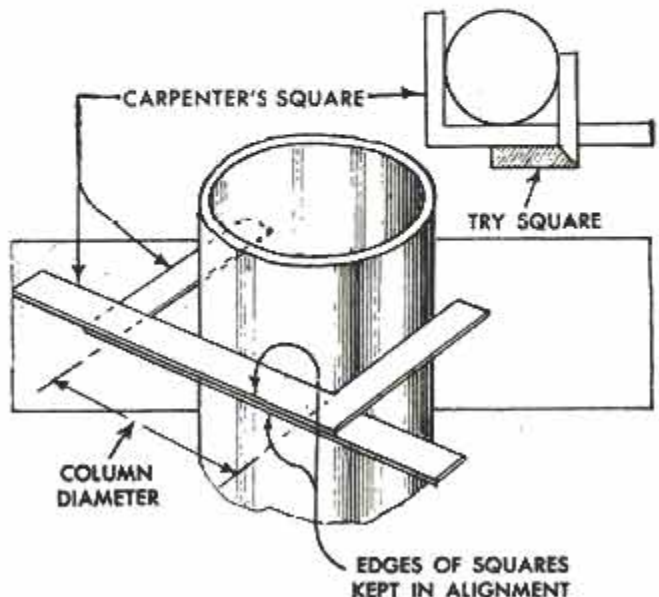

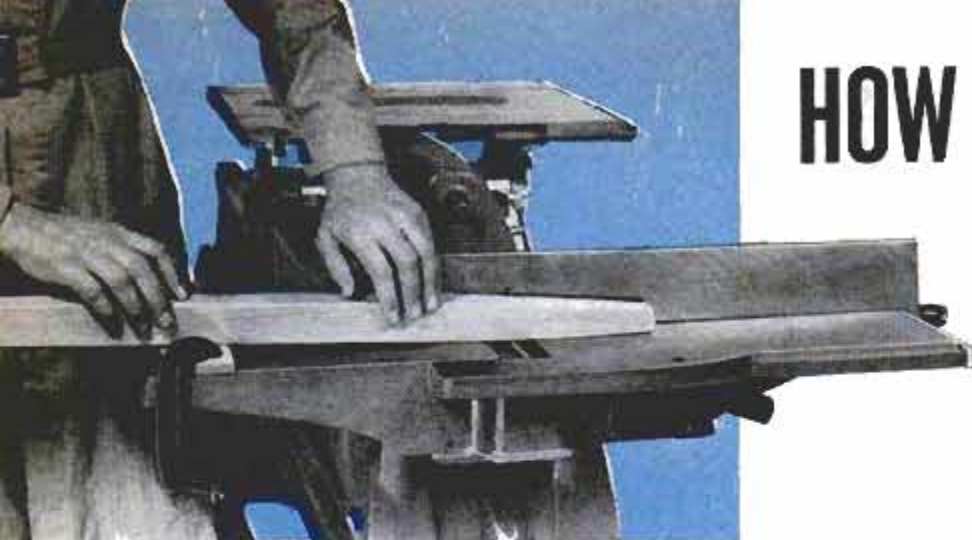

5050

HOW WOULD YOU DO IT?

By Chris Nelson

Q—In what manner can a jointer be used to make a gradual taper near the end of a piece of stock that will be used as a table or desk leg?

A—Fasten a block of wood to the outfeed table with a C-clamp, place one end of the stock on the block and pull it over the jointer head. The farther the block is from the jointer head, the more gradual will be the taper, since, in effect, a curve with a very large radius is being cut on the leg. If a perfectly flat, or true, taper is required, fasten the block to the piece of stock. The angle between the stock and the jointer table then will remain constant

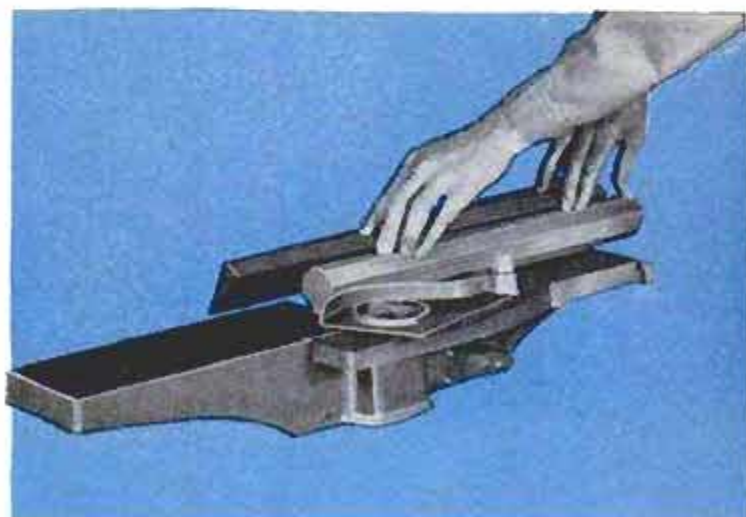

Q—How can you cut a piece of stock lumber, such as a 2 x 4, on a jointer so that it will have an octagonal cross section?

A—Set the jointer fence at a 45-deg. angle and remove each of the original corners as shown above. If it is desired to have a cross section that is a regular octagon, first rip the stock so that it has a square cross section, then remove the corners until all eight faces are the same width

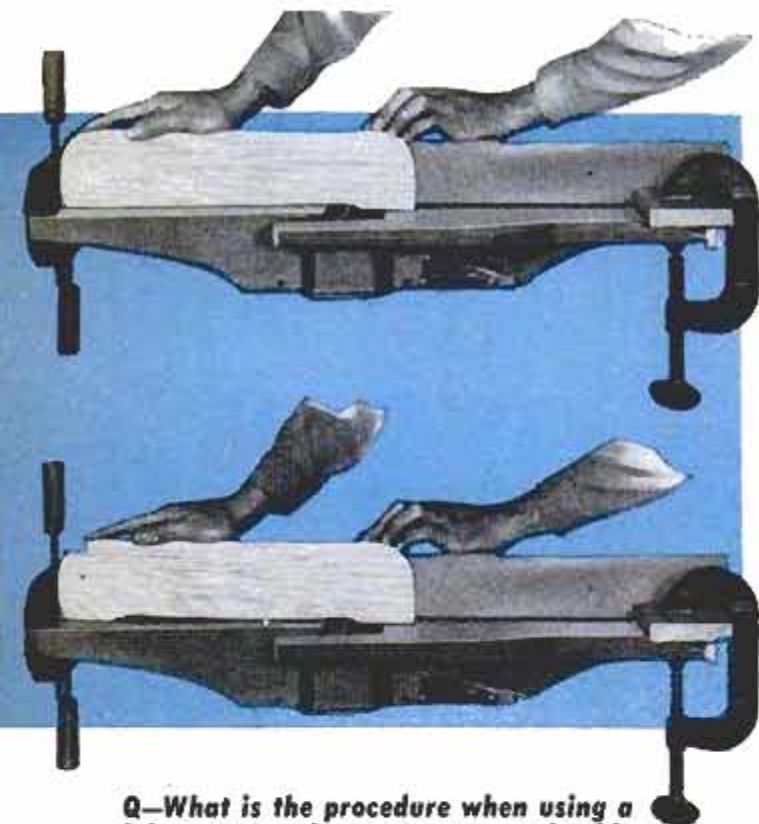

Q—What is the procedure when using a jointer to produce recess-tapered table legs having four sides tapering to a squared end section?

A—First, cut a gradual taper on all four sides of each of the legs, as described in the first item on this page. Next, place a stop block at each end of the jointer table, as shown in the photo at the right, to gauge the beginning and end of a recessing cut that is made on each side of each leg to form the end sections desired. As indicated, a push stick must be used for this operation, as your left hand will be over the jointer head at the end of the cut

Q—What is a recessing cut, and how can it be made on your jointer?

A—Place a stop block or clamp near each end of the jointer as shown in the upper photo at left. Position them so recess will start and stop at the proper distance from the ends of the work. Now, make two cuts, one from each end, so that you will have the result shown in the lower photo. Make a third cut if a straight edge is required on the recess

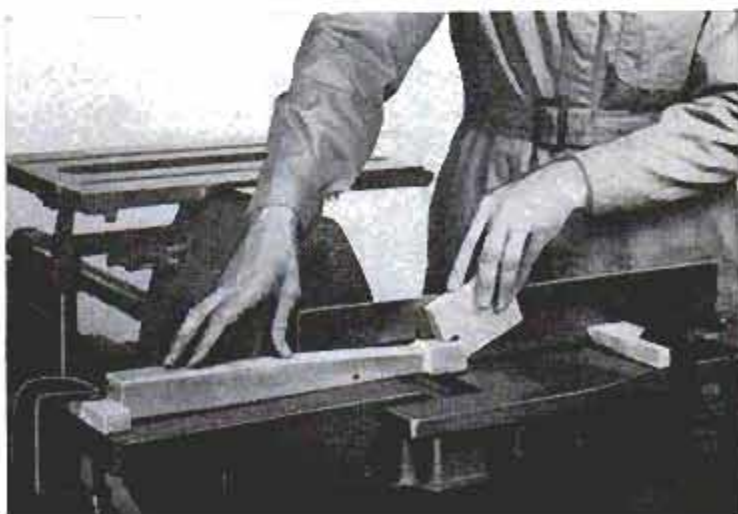



Q—How do you use a jointer to cut an accurate rabbet across the grain, and what hand tool is needed to aid in making the cut?

A—To cut the rabbet, make the pass as shown in the photograph above. The hand tool is a pusher-hold-down, which must be used, not only to protect fingers, but to keep the stock flat on the table throughout the cut. Assemble the pusher-hold-down from a few blocks of wood. To assure a uniform width of the rabbet, hold the end of the stock firmly against the jointer fence



Q—When a board is warped across its width so that one edge is bowed and the other dished, what procedure should be used to straighten it on a jointer?

A—Start as shown in the photo above by jointing the dished edge. The first pass will produce good bearing surfaces that permit making successive passes until the edge is straight. Hold the straightened edge against the fence of a table saw and rip the board to a uniform width



Q—Bevels can be made on a jointer by tilting the fence either forward or backward. How do you determine which method should be used?

A—It is necessary to use the open angle—fence tilted backward—when beveling large pieces as shown in the photograph at the left. When the size of the stock permits, use the closed angle—fence tilted forward toward the table—as it is the safer of the two methods

Q—A long taper—specifically 10 in. long and 1/4 in. deep—is required on all four sides of four table legs. Where should the stop block be located on a jointer and how should the stock be placed?

A—Clamp the stop block to the infeed table, as shown in the photograph at the right, so that the 10-in. mark on the stock is directly above the jointer head. Set the depth adjustment to 1/4 in. and lower the work with one end butted against the stop block. As soon as the work contacts the outfeed table, advance it to make the cut



Compass on Tractor Saves Steps



Farmers laying out fields for plowing can be assured of straight lines by using an auto compass mounted on the tractor. With a plow attached to the tractor, start on one side of the field and drive across keeping the compass reading constant. This will result in a straight furrow from which to start working the field. The method is especially helpful where terrain demands diagonal planting of fields.

Max Stickelman, Rossburg, Ohio.

Dam Prevents Gully Erosion



To prevent further erosion in a gully through which water ran during every heavy rain, a field dam and draitile inlet were built across its upper end. Concrete wings were poured to retain the banks on each side of the gully and a slab was poured on the uphill side of the draitile. An earthen dam was built on the downhill side. A grating made from steel angles welded to cross braces prevents debris from clogging the tile.



Trailer-Mounted Fence Reel

Unwinding woven-wire fence is no problem when using this trailer-mounted reel. It consists of two 2 x 4s bolted to the trailer bed to support a pipe axle. The axle rests in slots formed between the ends of wooden blocks spiked to the top surface of each 2 x 4. Boards nailed over the ends of the slots keep the axle positioned endwise. Rolls of barbed wire also may be unwound by this method. To unwind more than one roll at a time place a wood or metal disk on the axle between the rolls.

G. E. McVicker, Bethesda, Md.

Pressure Tunnel for Hay Drier Made From Compacted Bales

Tightly compacted hay bales instead of expensive wood were used by one farmer to construct a pressure tunnel for directing air from a drying fan through loose hay stored in a haymow. The tunnel sides are three bales high and the tunnel top is formed by placing bales at right angles to the walls, with the ends of the bales resting on the walls. The drying fan has a 36-in. blade that is driven by a 5-hp. electric motor running on 220 volts.

A. E. Holden, Angola, Ind.

Underground Location of Well Found With Two Pieces of String

Keeping a rough sketch, with dimensions, of the exact location of a dry well or septic tank in its relation to two permanent objects will enable you to find it easily when repairs or improvements are necessary. To find the well, cut two pieces of string corresponding to the two specified measurements as shown in the illustration.

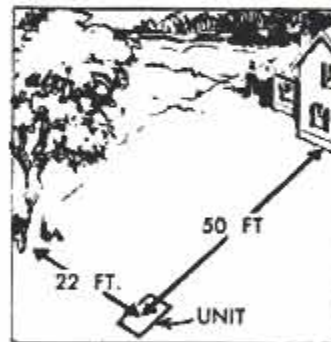

Attach them to the respective objects and draw them taut at their fullest extent. Where the ends meet should be the location of the well.—Art Kaser, Niles, Mich.

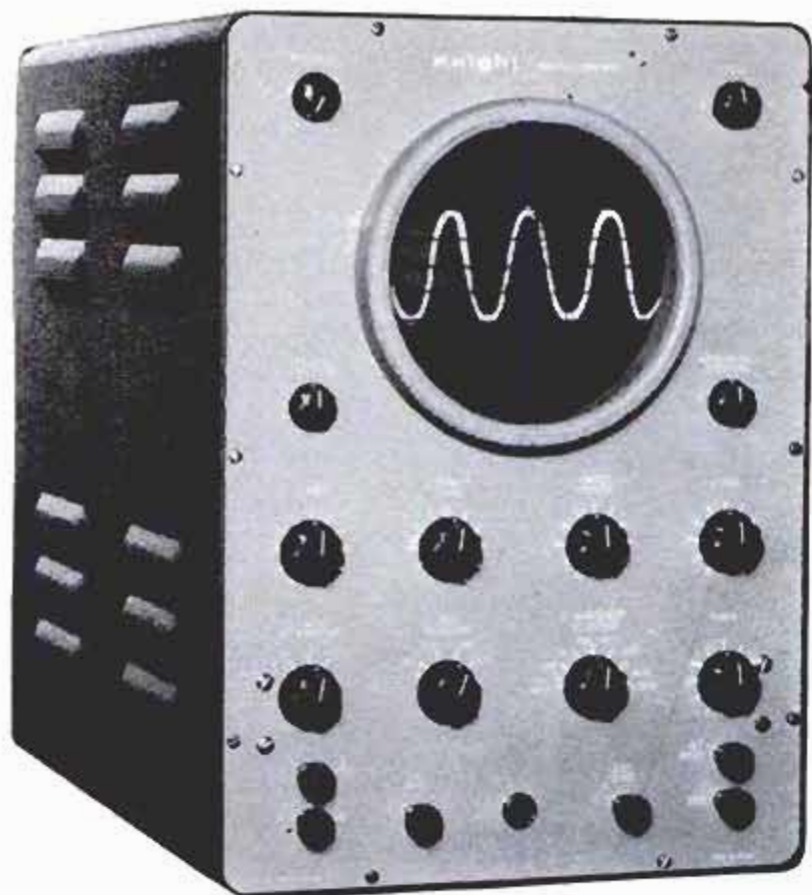

Why Buy an OSCILLOSCOPE?

SERVICING of modern electronic equipment is big business. Big—and complicated. Gone are the days when almost anyone could repair a radio with little more than a screwdriver and a soldering iron. Today, with television and high fidelity, not to mention the unlimited field of industrial electronics, the technician must be skilled in the use of many test instruments, one of which is the oscilloscope.

To the experienced serviceman, the oscilloscope needs no introduction. But to the thousands of newcomers who, each year, enter the electronics field as students or experimenters, it is still an object of mystery, to be purchased only after a thorough knowledge of electronics has been acquired. It is seldom realized that the scope is an excellent aid in the study of electronics, as well as being indispensable for more advanced work.

The greatest value of the oscilloscope

By
Otto
Fried

lies in its ability to show an actual picture of the signal at any point in an electronic circuit. This picture, properly interpreted, indicates flaws and defects which are virtually undetectable by any other testing method. In the study of electronics, the observation of the signal wave forms as they actually appear, as well as the effects caused by defective components, is often far more effective than the reading of lengthy texts in demonstrating fundamental theory.

The heart of the oscilloscope is the cathode-ray tube, a unit similar to the picture

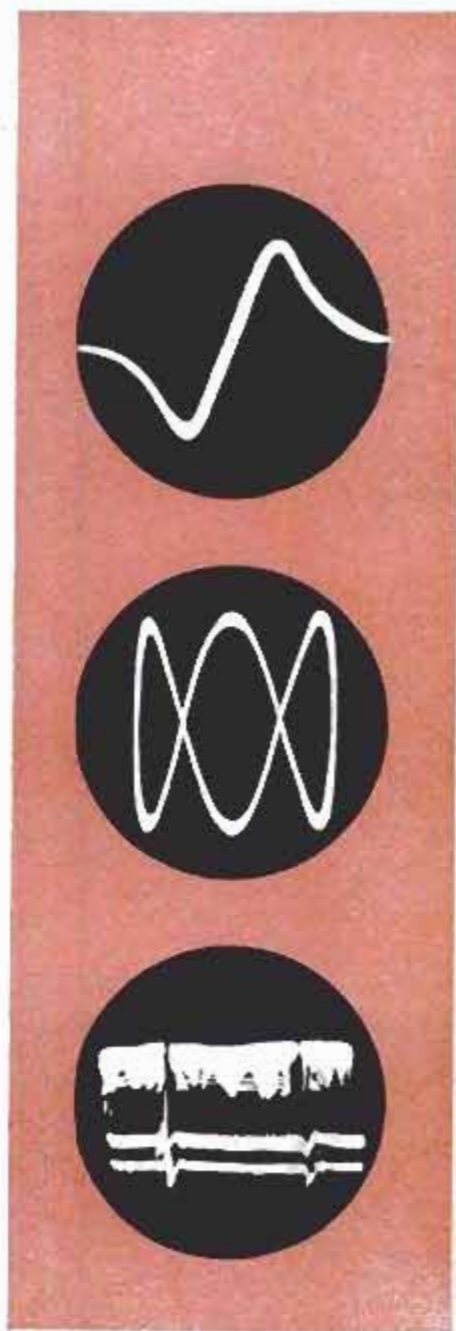

tube of a television receiver. The principle of this tube is shown in Fig. 1. The electron gun, mounted in the neck of the tube, creates a stream of electrons, called the electron beam, which is "shot" towards the screen. If the proper voltages are applied to the various elements of the gun, the beam will be focused so that all the electrons strike the screen in a very small area, causing a tiny circle of light to appear in the center of the screen.

In traveling from the gun to the screen, the beam must pass between two sets of deflection plates. These are so arranged that the horizontal plates are to the left and right of the beam, while the vertical plates are above and below. If a voltage is applied to the horizontal plates so that the one on the right is positive with respect to the left one, the beam, in passing, is attracted toward the positive plate. The forward momentum of the beam quickly carries it past the plate, but not before it has been deflected. As a result, the beam will no longer strike the screen in the center, but at some point at the right. The greater the voltage on the plate, the more the beam will be deflected before leaving the field of influence of the plate. Similarly if one of the vertical plates is made positive with respect to the other, the beam will be deflected up or down, depending on which

plate has received the positive voltage.

Now, let's see what happens when a "saw tooth" wave of voltage is applied between the two horizontal plates. This wave causes the voltage on the right plate to vary gradually, at a linear rate, from some negative value to a positive value. At the end of the cycle, this voltage will drop very rapidly back to its original negative value. As a result, the beam will first strike the screen at the left edge, travel slowly to the right, and at the end of the cycle, return quickly to its starting position. If this saw-tooth wave is applied at a rate of more than 15 or 20 times per second, the eye cannot follow the rapid movement of the beam, so that a single horizontal line, or trace, will appear on the screen.

If a sine wave of voltage is applied to the vertical plates, the beam will be deflected up and down. But, if a sine wave is applied to the vertical plates at the same time that a saw-tooth wave of the same

HOW ELECTRON GUN WORKS

Filament (1) heats cathode (2) which emits electrons (3). Voltage between cathode and grid (4), as determined by setting of intensity control (5), controls the number of electrons in the beam. Voltage on first anode (6) propels electrons towards screen (8). Correct voltage between first and second anode (7) causes beam to be focused at the screen.

Fig. 1. Phosphor-coated screen converts energy in electron beam into visible light

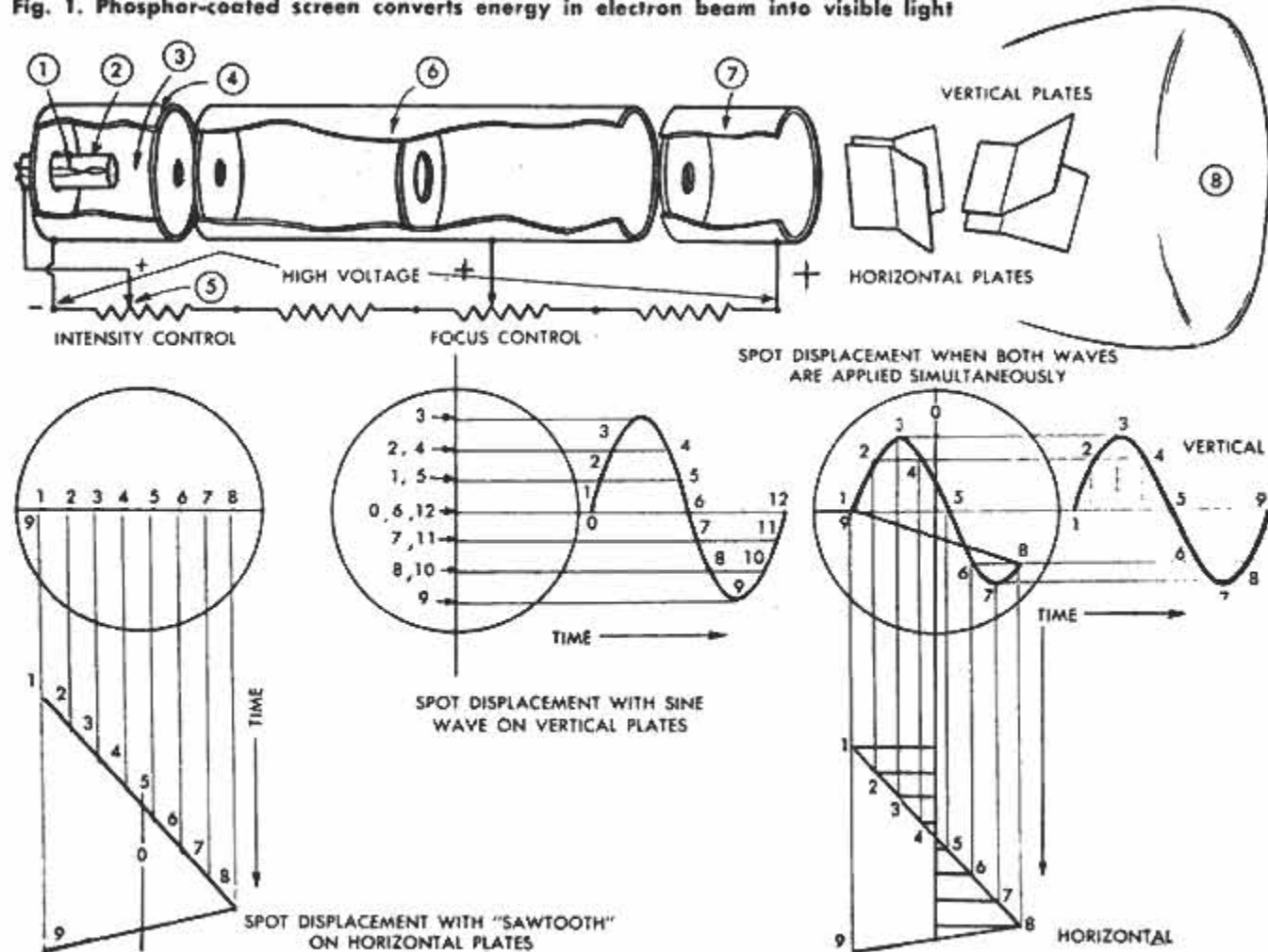

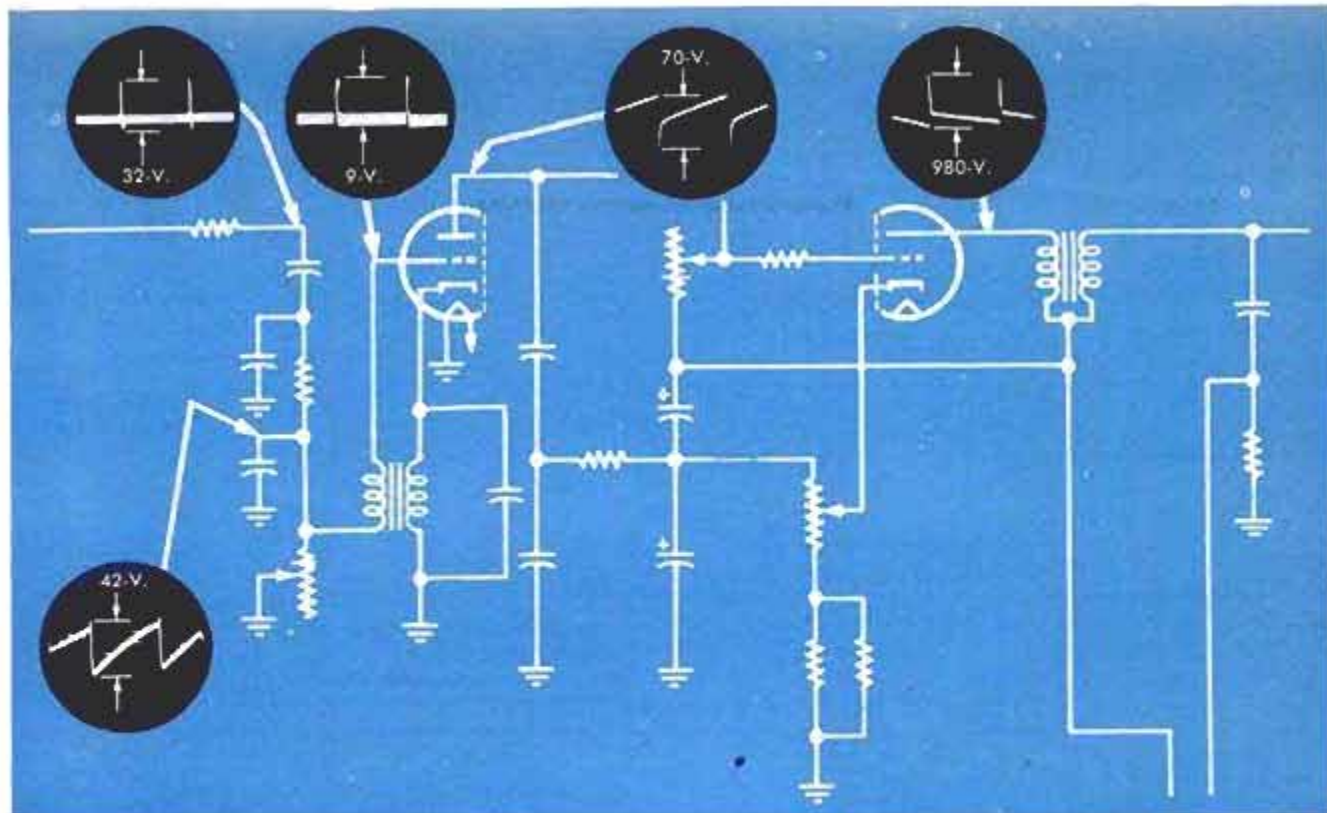

Fig. 2. Information in typical television-service manual simplifies trouble shooting by wave-form comparison

frequency is applied to the horizontal plates, the beam will move in both directions simultaneously. As a result, a replica of the sine wave will appear on the screen.

In the same manner, the trace will faithfully follow any wave applied to the vertical plates, *regardless of its complexity.*

Every oscilloscope contains a saw-tooth "sweep" generator whose output is applied to the horizontal plates. What's more, the frequency of this generator can be varied, so that we can see a part of a cycle, a full cycle, or a number of cycles of any wave applied to the vertical plates.

Oscilloscope Applications

No other single instrument has as many

applications as the oscilloscope. In fact, its uses are so numerous that only a few of the more important ones can be described here.

Wave-Form Analysis: One of the most-important service applications of the oscilloscope is for signal tracing and wave-form analysis in television receivers. So important is this method of trouble shooting that service manuals include the correct wave forms at various test points in schematic diagrams. By comparing the wave form actually appearing on the oscilloscope screen with the one shown on the schematic, you can tell at a glance if the receiver is operating properly at that point.

Fig. 2 shows information given on a

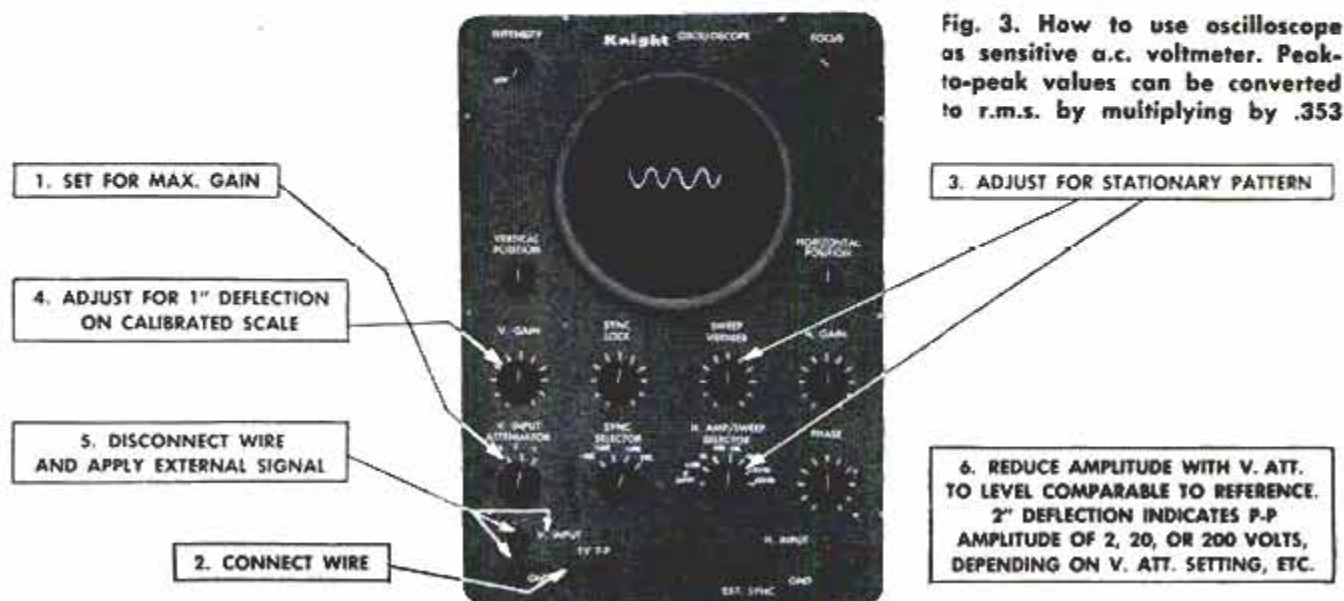

Fig. 3. How to use oscilloscope as sensitive a.c. voltmeter. Peak-to-peak values can be converted to r.m.s. by multiplying by .353

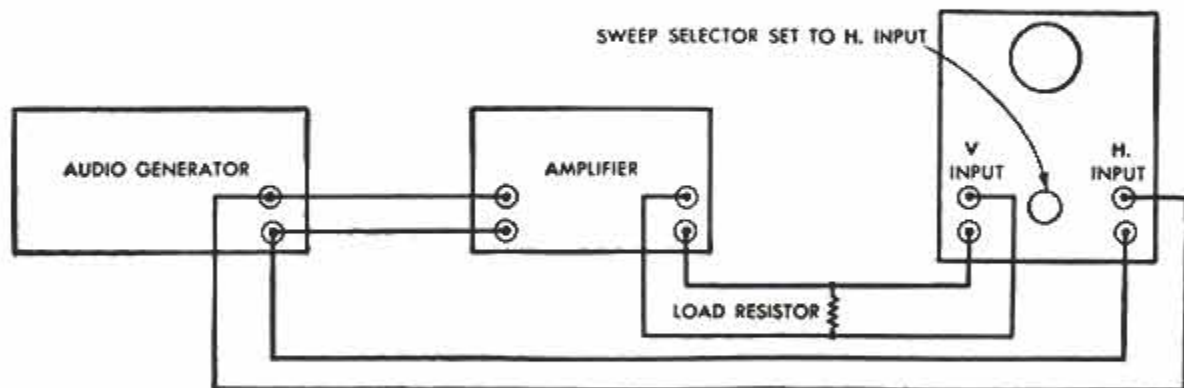

Fig. 4. Oscilloscope shows amplifier distortion. Top, with "saw tooth" sweep. Bottom, with sine-wave sweep

schematic of a typical television set. This information includes not only the correct wave form but also the peak-to-peak voltage of the wave. Normally, voltage readings are taken with a voltmeter, but since such a meter gives no indications of the actual wave shape, its use is severely limited. The oscilloscope itself can provide accurate voltage data.

A.C. Voltage Measurements: The amount of beam deflection is directly proportional to the amplitude of the voltage applied to the deflection plates. Therefore, if a voltage of known amplitude is applied to the vertical plates, to serve as a reference, the amplitude of an unknown voltage can readily be determined by direct comparison. For example, if the reference voltage causes a 1-in. deflection, any voltage causing a 3-in. deflection will have three times the amplitude of the reference. Proper use of the scope controls (see Fig. 3) permits rapid voltage measurements from a fraction of a volt to several hundred volts.

Many modern oscilloscopes have a built-in calibrating voltage source. For those not so equipped, any known voltage can be applied externally to serve as a reference.

Distortion and Phase Shift: Distortion in electronic equipment may be difficult to

detect by ear, but it is readily apparent on the oscilloscope screen.

Distortion is particularly disturbing in high-fidelity amplifiers and similar audio equipment. To detect its presence, merely feed a signal from a good audio generator to the input of the amplifier, and view the amplifier output on the scope screen. Some of the patterns which may be encountered are illustrated at the top of Fig. 4.

Every oscilloscope has provisions for disconnecting the internal saw-tooth sweep so that a sine wave from an external source can be used for the horizontal sweep. This results in a variety of patterns, called Lissajous' figures, on the scope screen which, when properly interpreted, will provide even more information about the performance of an amplifier. The test setup and some typical patterns which may appear are also shown in Fig. 4. Even a slight departure from the normal straight-line pattern indicates some amplifier non-linearity or peak-clipping, while an elliptical or circular pattern shows phase shift in the unit under test.

Frequency Measurements: By means of Lissajous' figures, the frequency of an unknown signal can be measured with a great

(Continued to page 272)

For Your Home—add new beauty—new convenience with Exquisite **HARDWOOD PLYWOOD**



American Elm paneling, Oak built-ins and bar, and floor blocks • • • all Hardwood Plywood

Whether you're remodeling, adding a spare room, or building—no other material gives your home the sheer beauty and delightful individuality of Genuine Hardwood Plywood. And, unlike paper thin wall coverings, Hardwood Plywood paneling is an investment that will last the life of your home. Your first cost is your last cost—an occasional waxing replaces costly periodic painting or papering.

Easy-to-apply panels come in a wide variety of sizes and styles. The unending variations in grain and color from such prized woods as Birch, Cherry, Gum, Mahogany, Maple, Oak, Walnut, Elm and other species available, add a life-long look of luxurious quality wherever they're used. See the HPI Species Chart at your lumber dealer. You'll be delighted with the modest cost of a genuine Hardwood Plywood paneled wall.



Your assurance of highest standards

The HPI trade mark on Hardwood Plywood identifies American mills operating under a rigid 5-point quality control program.

HARDWOOD PLYWOOD INSTITUTE 600 S. Michigan Avenue, Chicago 5, Illinois, Dept. 11-H.

- Enclosed is 15c for descriptive folder "How to Make a Small Home Larger," as illustrated.
- Enclosed is 25c for copy of "A Treasury of Hardwood Plywood," a guide to selection and use.

NAME _____

ADDRESS _____

CITY _____

ZONE _____

STATE _____



*Masters of
Re-Carburetion*

assure top performance of

CARTER
CARBURETERS



These factory-trained specialists, found in a network of automotive repair shops, stand ready to serve you, the motoring public.

Look for your Carter dealer behind the sign shown here—or under **CARBURETER** in your classified directory.



CARTER CARBURETOR
DIVISION OF **OCF INDUSTRIES**
INCORPORATED
ST. LOUIS 7, MISSOURI

Clinic for Homemakers



As a service to our readers in solving the hundreds of problems pertaining to a home—inside or out—the editors of *Popular Mechanics* invite you to present your problems to The Clinic Editor for help and advice. Address your questions to The Clinic Editor, *Popular Mechanics Magazine*, 200 East Ontario Street, Chicago 11, Ill.



Door Shrinkage

Q—The front door of my home has six solid-wood panels with beveled edges that fit in grooves cut in the sides and cross members. The door was painted before hanging about a year ago. Now I notice unpainted wood at the edges of the panels and there are slight ridges at the extreme edges of the painted areas. The areas of bare wood are about $\frac{1}{8}$ to $\frac{1}{4}$ in. wide.

—K. L., Mo.

A—Shrinkage of the door panels is the cause of the exposed bare wood. Probably the wood has lost its excess moisture and has now stabilized to the point where no further shrinkage will occur under normal conditions. If we can assume that this is so, then the wood should be repainted to prevent absorption of moisture through the exposed edges of the panels. The slight ridges you refer to are caused by an accumulation, or fillet, of paint at the points where the panels join the stiles and rails. The ridges should be leveled by sanding before repainting. Apply two coats of outside paint in the color desired. Be sure to paint the top, bottom and both vertical edges of the door, thinning the paint somewhat for the first coat so that it will penetrate and give added protection against absorption of moisture. Before painting the edges, it might be well to check the fit of the door as it often happens that the addition of two coats of paint to the total width will cause a door to fit too tightly. If necessary plane the stiles lightly to assure correct fit.



Unstable Floor

Q—My living room is 14 ft. wide and when one walks across the floor the furniture moves perceptibly and the floor boards squeak. Joists are spaced 16 in. on centers and seem to be in good condition, as the basement is quite dry. It has been suggested that I double alternate joists, bolting the new ones to the old. Also I've thought of putting in an extra beam. Which is better?

—L. G., Wis.

(Continued to page 268)



**NO MORE
STALLING!**

**NO MORE
BURNT BLADES!**

Only **SHOPSMITH** with Power Shift
gives you a clean cut every time!

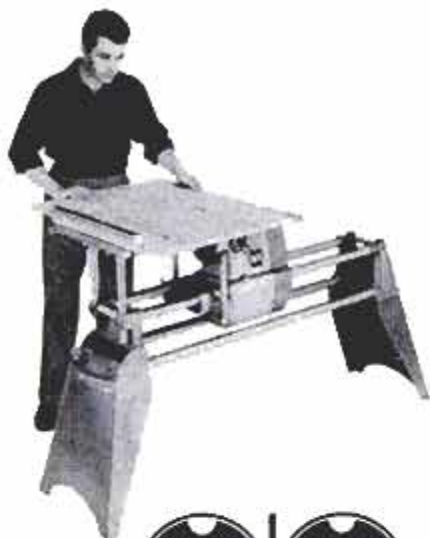

MAGNA POWER TOOL CORPORATION
America's Finest Power Tools

©T. M. Reg.



EXCLUSIVE
SPEED-DIAL

When you saw through $\frac{3}{4}$ -inch plywood or green lumber, you need rugged power for a clean, true cut. Only SHOPSMITH's exclusive Speed-Dial Power Shift can give it to you! SHOPSMITH's Speed-Dial gives you correct work speeds (from 700 rpm to 5200 rpm!) and the power to do any kind of sawing job easily and accurately.

In addition, SHOPSMITH® is *all* the five major power tools you need to complete any project: 9" Saw, 12" Disc Sander, 16 $\frac{1}{2}$ " Vertical Drill, 34" Lathe, and unlimited-capacity Horizontal Drill—all in one compact unit! The built-in $\frac{3}{4}$ hp motor, all belts and pulleys, are enclosed for safety. See SHOPSMITH demonstrated at leading hardware and department stores, or at any Montgomery Ward store.

Own **Shopsmith** for as little as \$3 a week

Mail Coupon for 3 free books

- 1 "Project Digest," 36 pages of modern woodwork projects.
- 2 The valuable home-shop guide: "What to Look for When you Buy Power Tools."
- 3 Illustrated 20-page SHOPSMITH catalog.

MAGNA POWER TOOL CORPORATION

Dept. 500-M, Box 2808, Ft. Wayne, Indiana, or Menlo Park, Calif.

Name _____

Address _____

City _____ Zone _____ State _____

If you own SHOPSMITH check whether model Mark 5 _____ or 10ER _____

ONLY SHOPSMITH LETS YOU COMPLETE THE JOB!

Which *finishing* Wizard can help you today?



It's a good idea to keep them all handy. You never know what finishing problem may develop in working with wood. As products of the world's largest plywood organization, these "wizards" are designed to give you expert results in many finishing tasks.

For protecting and bringing out the natural beauty of any wood—use **SATINLAC**®

Makes the most practical, beautiful and durable natural finish for hard or soft wood! So quick-drying you can apply 3 coats a day. SATINLAC is so easy to maintain!



For blond woodsy effects without a "painty" look—use

WHITE FIRZITE®

Versatile! A two-fold boon:
(1) As an undercoater for soft wood or plywood paint jobs, seals pores to help prevent grain raise and checking.
(2) As a finish, produces a blond woodsy finish with no "painty" look. Great for pickled and wiped effects too!



For making fir plywood look like costlier woods—use **CLEAR FIRZITE**®

Magic action for plywood stain jobs! Tame wild grain with a starting coat of Clear Firzite—add colors in oil to achieve the rich look of oak, walnut, mahogany. Clear Firzite also helps prevent grain raise and face checking.



Ask your hardware, paint, or lumber dealer about these Weldwood Finishing Wizards... or mail coupon for FREE leaflets.

UNITED STATES PLYWOOD CORPORATION
Box 525—New York 46, N. Y. PM 10-68

Send me leaflets on:

Satinlac White Firzite Clear Firzite

NAME _____

ADDRESS _____

CITY _____ ZONE _____ STATE _____

(Continued from page 266)

A—The span is rather long, even for 2 x 10 joists spaced 16 in. If the extra posts are no inconvenience in the basement, perhaps the installation of an extra beam is worthwhile. If posts are objectionable, then doubling the joists as you suggest might prove practical. However, before attempting either step, we would try tightening up the original bridging, or perhaps installing two new runs of bridging, spaced equidistantly. To do this properly, it will be necessary to raise the floor with jackscrews just sufficiently to relieve the existing joists of the load. Then either cut new bridging strips, or re nail the original ones, making sure that the mitered ends fit snugly. Replace any that do not fit true. This should stiffen the floor, but for greater rigidity it may be necessary to add two additional lines of bridging. Flooring squeaks usually can be eliminated by drilling a row of holes between the joists and driving screws through the subfloor into the top floor boards.



Heat Loss

Q—What, if any, is the insulating value of ordinary window glass? I have been told that its insulating properties are quite high and that there is a marked difference between single and double-strength glass, the latter having much the greater value so far as insulating properties go. I find this difficult to accept, as my windows seem to admit a lot of cold during the winter months—R. F., N. Y.

A—Glass is not generally regarded as an insulating material, due to its sectional density. The resistance of an ordinary pane of glass to the flow, or passage, of heat is due not so much to the glass itself as to the air films on both sides. There is little difference between single and double-strength glass in the matter of resistance to passage of heat, or heat transmission. Tests made by glass manufacturers have shown that with as much as 100-deg. variation in the temperature, on one side of the pane of glass as compared with the other, there was approximately 2 deg. difference in the actual temperature of the two surfaces of the pane. It also was shown that more than 95 percent of the resistance to passage of heat, or heat transfer, was in the air films. In relatively still air these are quite effective.

Fire Mark

Q—Mine is not a problem having to do with home repairs but rather that of identifying something I found in an old home I recently purchased. It's a metal plate, apparently cast of lead or pewter, oval in shape and about 3 in. long. It was attached to the wall over an upstairs window and had been covered with many layers of wallpaper. In the center of the oval is what appears to be a crude tree. No one I've asked seems to know what it is. Could it be a family coat of arms?—T. P., Vt.

A—No. If we can judge correctly from your description it's what was known as a fire mark and is a rather unusual find. In the American Colonies, beginning about the middle of the 18th century, a fire mark attached to a building was evidence that the structure was insured against loss by fire. Fire marks were of many different designs but the oval shape was common. In some cases the pattern, usually in raised relief, had some special significance. Many marks were painted in bright colors. It is rather unusual to find a fire mark in the location you describe. Generally it was attached to a porch column, a door casing, or in some other prominent location on the exterior of the structure. It could be, of course, that the mark was moved from its original position by some more recent owner of the property, perhaps with the thought of preserving it.

Solve this Free Puzzle

—and your

Gluing problems, too!

Test your skill — Let us send you the free puzzle that the Weldwood Wizard holds in his hand. It's lots of fun, and — it will help you choose the Weldwood adhesives best suited to each job. There are 4 Weldwood adhesives now, you know — read about 'em, then mail coupon for *your* free puzzle.

For wood-to-wood joints that never come loose—use

WELDWOOD Plastic Resin GLUE

Imagine—joints glued with this Wizard are stronger than the wood itself! And they grow even stronger with age! That's why it's America's most popular wood glue. Highly water-resistant, stain- and rot-proof. Easy-to-mix powder. 15c, 35c, 65c and larger sizes.



For weatherproof boat repairs—use

WELDWOOD WATERPROOF RESORCINOL GLUE

100% Waterproof! A "must" for any wood gluing exposed to climate, boiling or salt water, cold weather, mold, fungus, mild acids, alkalis, etc. Terrific for sporting goods, woodwork in damp basements, lawn furniture. ¼ pints, pints, quarts, gallons.



For in-a-hurry gluing of wood, paper, cloth, fabric—use

WELDWOOD PRESTO-SET® GLUE

Ready to use. Sets fast! Glues like magic! Presto-Set is the Weldwood-perfected white glue that bonds wood to wood, wood to cloth, cloth to paper, upholstery fabrics to wood, leather to leather, etc. Clean to work with — no sticky hands. 19c, 29c, 49c tubes; pint and quart jars.



For putting up plywood panels without nails—use

WELDWOOD® CONTACT CEMENT

Revolutionary! Speedier, easier, new way to install plywood panels. No nails, no holes to fill and finish. Bonds instantly, permanently on contact. No clamps and presses — ideal for applying plastic laminates like Micarta to table tops, kitchen counters, etc. 1001 other uses for home, hobby, garage. 29c, 40c, 70c and larger sizes.



Mail this Coupon
for **free puzzle**

UNITED STATES PLYWOOD CORPORATION

Box 525 — New York 46, N. Y.

PM 10-66

Please send me puzzle without charge. Also leaflets on:

- Weldwood Plastic Resin Glue
- Weldwood Waterproof Resorcinol Glue
- Weldwood Presto-Set Glue
- Weldwood Contact Cement

NAME _____

ADDRESS _____

CITY _____ ZONE _____ STATE _____

YOU USE CASITE, TOO?



TUNE-UP when you GAS-UP

A pint in the crankcase . . . a pint through the air intake . . . restores pep and performance—frees sticky valves and rings—keeps your engine clean or *Double-Your-Money-Back!*

HASTINGS MANUFACTURING CO., HASTINGS, MICH.

CASITE



Buy these Hastings Products with confidence:
Casite, Wear Reducer, Piston Rings,
Oil Filters, Spark Plugs



Hobbyists Can Print Photographs on Metal

Amateur photographers can print pictures on aluminum sheets, using ordinary photo negatives and equipment. The metal sheets are photo-sensitized and can be used for either contact prints or enlargements. Processing requires 45 minutes and includes one extra step—anodizing, to make the image part of the metal surface so it cannot easily be damaged. The photographs may be finished in various colors or made to fluoresce, if desired. The process is said to be excellent for reproducing metal name plates, instrument faces or instruction cards to be attached to machinery.

Tiny Transducer Locates Heart Defects

Defects in the human heart can be located better when doctors can listen to the heart from within rather than through the chest. In order to get inside the heart, a tiny transducer, measuring only $\frac{60}{1000}$ inch in diameter, has been developed. This is inserted in the heart on the tip of a heart catheter, and "broadcasts" the sound of the heart through the catheter to a tape recorder. When played from the tape, the heart sounds are amplified so that heart specialists can hear them easily.

☐ America's biggest radio telescope, a 140-foot "dish," will be located in a valley about 35 miles south of Elkins, W. Va.

You'll read this level faster,
easier, more accurately than
any level you've ever used . . .

EMPIRE

*Magnified
Crystal
Vision*

LEVELS

You get 300% GREATER VISIBILITY with new MAGNIFIED CRYSTAL VISION SIGHTS. Vials are mounted in new "snap-in" holders, between stereoptic *magnifying* lenses, for improved end-to-end viewing. This means more light, more ease and accuracy in reading, with NO SHADOWS, NO REFLECTIONS . . . nothing to obstruct your vision! You can read level or plumb from greater distances and wider angles, even in dim light. And there's no cement or adhesive to shatter loose or dry out.

CHECK THESE FEATURES:

1. 300% MORE VISIBILITY
2. "SNAP-IN" VIAL HOLDERS (PATENT PENDING)
3. VIALS EXPOSED END TO END
4. STEREOPTIC MAGNIFYING LENSES
5. SHOCK-PROOF — SHATTER-PROOF MOUNTING
6. NO SHADOWS — NO REFLECTIONS
7. LUMINOSITY FACTOR VIAL FLUID
8. PRECISION REPLACEMENT UNITS
9. UNMOVABLE ADJUSTMENT

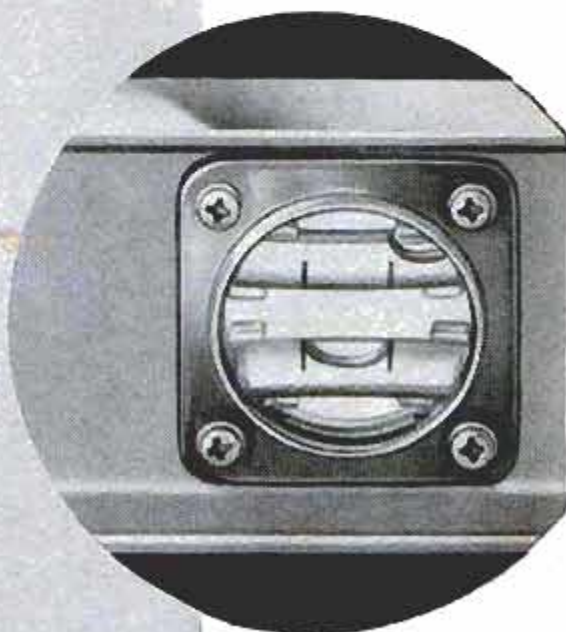

**"MAGNIFIED
CRYSTAL VISION"**

The enlarged photo above shows the unique method of mounting the new Empire vials in crystal-clear *Magnified* shatter-proof lenses. Notice that vial ends are free for easy reading. "Snap-in" holders provide easy replacement of vials, if necessary, by removing four screws.

**TREAT YOURSELF to New
Level Accuracy NOW . . .
with EMPIRE Magnified
Crystal Vision LEVEL!**

Magnesium

Model 152M, 24"\$ 8.00
Model 152M, 28" 9.00
Model 152M, 48" 14.50
Model 152M, 78" 24.00

Aluminum

Model 152A, 24"\$ 8.00
Model 152A, 28" 9.00
Model 152A, 48" 14.50

See your dealer
or mail this coupon:

EMPIRE LEVEL MFG. CO.
10930 W. Potter Road
Milwaukee 13, Wis.

Please send full-color catalog
sheet featuring the new
Empire Levels.

.....
Name

.....
Address

.....
City, State

.....
Name of nearest dealer

EMPIRE LEVEL MFG. CO.

Tools for the Nation's Craftsmen

10930 W. POTTER ROAD • MILWAUKEE 13, WIS.



Why Buy an Oscilloscope?

(Continued from page 264)

degree of accuracy. The test setup is similar to the one shown above, except that the known frequency signal from a generator (either audio or r.f.) is applied to the horizontal input, while the unknown signal is applied to the vertical input. The frequency of the generator is then varied until a pattern like one of those illustrated in Fig. 5 appears. The unknown frequency is then determined by this simple formula:

$$\text{Unknown frequency} = \frac{\text{number of loops touching H. axis}}{\text{number of loops touching V. axis}} \times \text{frequency of known signal}$$

Other Applications: In conjunction with a separate sweep-frequency generator, the oscilloscope represents the quickest, most accurate means of aligning FM and television receivers. Procedures for doing this are included in all service manuals.

The radio amateur will find the scope indispensable for checking transmitter modulation percentages and testing the performance of home-built equipment.

Industrially, it is widely used for armature testing, pressure measurements, resistance welding, motor tune-up and testing photographic shutters, and numerous other applications.

Modern oscilloscopes are available in kit form at prices ranging from about \$30 to \$100. The instructions provided with these kits are so explicit that, if you have done any previous wiring, you should have little difficulty in assembling one of these. ★ ★ ★

Fig. 5. Oscilloscope test setup and patterns for frequency measurements. Calibrated generator is needed

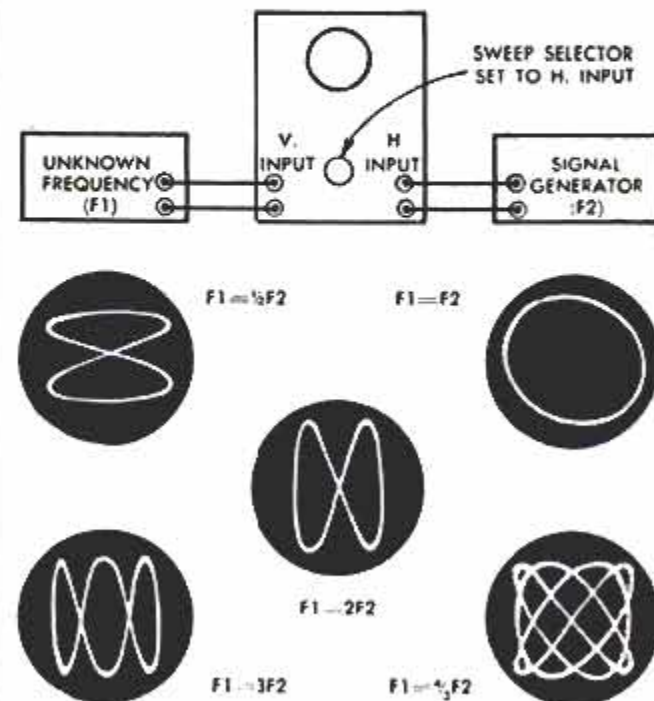

"How do you pick a durable paintbrush that'll do an easy, streak-free job?"

LEO B. SMITH, *Smith Decorating Co., Hammond, Ind.*

"When customers ask my help in choosing paintbrushes, I point out that you judge a brush by its bristles," says Mr. Smith.

"I show my customers that really fine brushes have bristles with long, tapered tips and 'flagged' or split ends. Furthermore, the bristles are of different lengths and are formed to a full head. To demonstrate, I show them a well-made brush with Du Pont TYNEX nylon bristles.

"Brushes with TYNEX nylon bristles come in all sizes, including the handy, narrow widths. What's more, your brush is easy to clean, when it's made with TYNEX, which means you'll be able to use it and re-use it and always get top results.

"When you see the trademark TYNEX on the handle," I tell my customers, "you're sure you're getting the best."

FREE! 8-page booklet full of helpful painting tips. Write Du Pont Company, Polychemicals Dept. PM10, Wilmington 98, Del.

TYNEX is the registered trademark for Du Pont nylon bristles



1. PICK UP MORE PAINT! Actual photo shows how tapered TYNEX nylon bristles are tipped and flagged for better paint pickup—unsurpassed by any other bristles.

2. FLOW IT ON SMOOTH AND EVEN! You can do streak-free work with any paint, varnish or lacquer . . . on any

surface. And TYNEX bristles last 3 to 5 times longer than natural bristles.

3. CLEAN IN ANY SOLVENT! When you're finished, just dip the brush in cleaner recommended by the paint manufacturer. Paint loosens readily, can be thoroughly rinsed out.



BETTER THINGS FOR BETTER LIVING
...THROUGH CHEMISTRY

TORO



\$169⁵⁰*...*the best you can buy*

Extra-heavy steel castings . . . mirror-polished working surfaces . . . years-ahead design features (like the single out-in-front control that either tilts—accurate to 1/10 degree—or raises the blade) . . . all these are yours in the Toro 10-inch Deluxe Tilt-arbor Saw—the *best* table saw you can buy.

Other professional-quality machines in the Toro home power tool line include: an 8-inch Deluxe and an 8-inch Standard Tilt-arbor saw,

a 12-inch drill press, 10-inch band saw, 18-inch jig saw, 4-inch belt sander, 4 and 6-inch jointer-planers.

You can see them all and get all the specifications in the latest full-color Toro Power Tool Catalog. For your free copy write Toro, 3016 Snelling Ave., Minneapolis 6, Minnesota.

**Table extensions and stand extra. Prices higher in the West and Canada; subject to change.*

TORO



TORO MANUFACTURING CORPORATION • MINNEAPOLIS 6, MINNESOTA

Looking for Something?

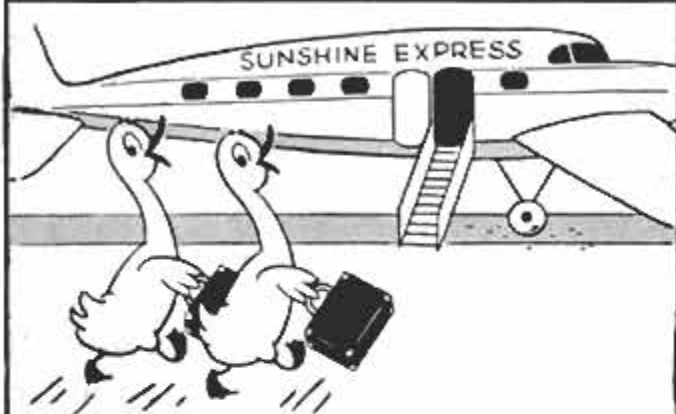

**FROM AIRLINES TO
TRAVEL BUREAUS
WHATEVER YOU NEED**



Ads with this emblem make your shopping easier

The PM Big-Family House

(Continued from page 166)

"Balance is a key factor in designing a house of medium size," says Weist. "One thing we have avoided in this house is the look of a Ford with Cadillac fenders."

All interior partitions of the house are formed of dry-wall panels two feet wide and joined by steel splines. An opening of $\frac{1}{8}$ inch between the panels permits a variety of metal or wood shelves, cabinets or other accessories to be suspended from them. The spline panels are especially useful in the closets. The panels can be painted or papered and are also available in wood veneer.

The roof of the house is supported by conventional 20-foot trusses so none of the interior walls is load bearing. Thus, it is possible, as the family grows up, to change the room arrangements with the least bother. The play area can be eliminated and bedrooms enlarged. Also, an addition can be added easily to the children's area.

All materials in the PM Big-Family House are standard and readily obtainable in any lumberyard. The siding is vertical redwood rough boards; the stone can be Indiana limestone, Wisconsin Lannon stone or something similar; windows are made of redwood vertical-grained sash and frames can be double-glazed or not as the builder prefers; aluminum screens fit on the inside for easy maintenance; sliding glass doors to the rear patio have aluminum frames and sash.

The walls of the house are conventionally framed, studs on 16-inch centers with insulation and plywood sheeting between the inside dry wall and the exterior redwood. The attic is fully insulated. Shingles are conventional asphalt.

The big question about any new house is: How much does it cost? Building costs vary by thousands of dollars for various parts of the country. We had this house estimated in South Bend for \$20,000 including the lot. The house can be built for considerably less by omitting the fireplace and partial basement and using a carport instead of the garage. As the house is shown, it will fit on a 65-foot lot.

A variation of the plan is available with the fireplace at the end of the living room (Page 166) and with a canted roof that lends a distinctly modern effect.

The editors of this magazine believe that the PM Big-Family House will rank high among the successful houses we have presented to our readers in the past. We think it is one of the most livable houses we have seen anywhere. Of one thing we are sure: It's not just another house! ★ ★ ★

GLIDDEN GUIDE

to Every Kind of Painting



HOW TO

Protect the beauty, life and value of your home with modern, easy-to-use Glidden paints



Paints are no longer just lead and oil. Glidden paints...easier and more economical to use...are the result of chemical formulations developed to give the best possible results at lowest cost.

You add value and beauty to your home with the right paints, the right colors. The next 6

pages contain up-to-date information on just about every job you'll want to do around the house, with helpful tips on technique. Use this valuable guide, and the expertly made paints recommended, to protect the beauty, life and value of *your* investment.

HOW MUCH PAINT WILL YOU NEED?

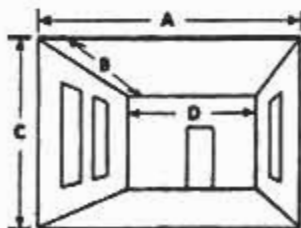

INSIDE

Multiply length (A) by width (B) for ceiling area. Multiply height (C) by length (D) for each wall. Add results for total area, allowing for windows, doors, etc. Divide total square feet by 500 (average sq. ft. coverage per gallon) for total amount of paint needed.

OUTSIDE

Multiply height (E) by length (F) for each side. For gables, multiply (G) by (H) and divide by 2. Add results, making allowances for doors, windows, etc., and divide total by 500 (average sq. ft. coverage per gallon). Allow 20% more paint for very rough surfaces. 50% more for first coat on concrete block.

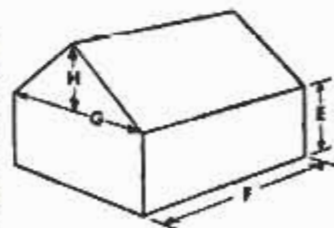

GLIDDEN GUIDE to every kind of Painting

CUT PAINTING WORK 46% WITH SPRED SATIN

As the photos show, SPRED SATIN, the 100% latex wonder wall paint, goes on twice as fast as ordinary paints with either brush or roller—and with only about half the effort.

Other SPRED SATIN features help you do a better job faster and easier: fast drying, easy touch-up, no streaks, sags or brush marks, no unpleasant odor.



Trace-motion photos show professional painter using 2 different paints. With ordinary paint (left) painter had to do almost twice as much brushing. SPRED SATIN (right) flows on smoothly, quickly, covering same size area, same surface, with 46% less work.



Never paint from full can. To take advantage of SPRED SATIN no-drip feature, dip brush only 1" into paint, slap bristles against inside of can. Surface tension binds paint to brush until applied.

How to do it EASIER, FASTER with SPRED SATIN



CLEAN SURFACE. Fix all nicks and cracks with SPRED PATCH.

Sand, spot prime patched areas. Dull glossy surfaces by sanding, or with SURFACENE.



WITH ROLLER... cut in edges with brush. Overlap each roller stroke 50%, or, use clean 4" brush, apply generously with short strokes. SPRED SATIN leaves no brush, lap, sag marks.



EASY TOUCH UP... by stippling lightly with tip of brush. Touch up anytime with SPRED SATIN, without leaving a mark!



EASY CLEAN-UP... wash roller, pan, brush with warm soapy water. Rinse. That's all there is to it!



Start with ceiling. Arrange platform or ladder for safety and comfort, paint a strip as wide as you can comfortably reach. SPRED SATIN no-drip feature makes ceiling painting much easier.

PAINT AND TEXTURE WALLS IN ONE EASY OPERATION WITH

SPRED STIPPLE-TEXTURE

Here's the newest, easiest way to get beautiful textured effects on exterior or interior walls. New SPRED STIPPLE-TEXTURE gives you all the application advantages of SPRED SATIN, and a durable, washable finish that will stay new-looking for years.



FOR LATEST SOFT LUSTRE EFFECTS ON WOODWORK USE EASY, SMOOTH-FLOWING SPEED-WALL

in colors matching
SPRED SATIN



Use SPEED-WALL on woodwork, cabinets or furniture where a washable, soft lustre enamel finish is desired. SPEED-WALL may be used for both interior and exterior painting.

Good decorating has become more and more important in the home painting field. You can obtain the latest soft lustre decorating effects on woodwork with Glidden SPEED-WALL semi-gloss Alkyd enamel. Colors match or harmonize with SPRED SATIN. Easy to apply, fast drying, durable and washable.



THE GLIDDEN DRAMATONE SYSTEM *Solves all your color problems*

Use color with confidence! The Glidden Dramatone system is the safest, surest way to success with color. Back of each big, 4" chip tells exactly how to mix special colors. Chips are designed for you to take home to see how colors will look in your home . . . contain complete color harmony and decorating information.



You can have brilliant, tile-like beauty in kitchens, bathrooms, on furniture, with **JAPALAC ENAMEL**



JAPALAC looks, wears and washes like baked enamel. Excellent for interior or exterior surfaces, flows on smoothly, dries quickly without brush or lap marks.

JAPALAC colors stay brilliant, making it excellent for furniture and other surfaces that get hard wear. Apply with tip of brush. Does most jobs in one coat.

NOW!
**JAPALAC IN
SPRAY CANS**



Perfect for painting porch furniture, bicycles, etc. An easy touch-up method, too!

The same JAPALAC colors that match those you now get in regular cans.



GLIDDEN GUIDE

to every kind of Painting

SOLVE PEELING, STAINING, FADING PROBLEMS ON STUCCO, MASONRY, ASPHALT AND ASBESTOS SHINGLES WITH SPRED GLIDE-ON!



PAINT A ONE-STORY HOUSE OVER THE WEEK END!

SPRED GLIDE-ON goes on so fast and easy, with brush, roller or spray, that you can paint the average one-story masonry ranch-type home in a single week end. This revolutionary vinyl paint for exterior masonry surfaces dries in minutes to a beautiful suede-like finish.



GLIDE-ON ADDS YEARS TO ROOF LIFE, COOLS YOUR HOME TOO!



PREMATURE PAINT FAILURE? SPRED GLIDE-ON resists the premature paint failure common to other masonry paints because its tough vinyl film resists cracking, peeling, blistering, staining, acid and alkali action.



PAINTING CONCRETE BLOCK? Fill small holes and pores with SPRED STIPPLE-TEXTURE, the ideal filler for interior and exterior masonry block—provides complete water-repellent surface.



SPRED GLIDE-ON resists the most extreme weather conditions. Keeps moisture out, yet surface "breathes" to let vapor escape from inside, prevents blistering.



CLEAN UP IN SECONDS! Just rinse brush or roller and other equipment in warm soapy water, and rinse.



Proven by test to be amazingly effective on tile, asbestos and asphalt shingle roofs! Cools by reflecting instead of absorbing heat . . . protects by sealing surface against dirt and weather.

Unretouched photo shows how heat from 375-watt infra-red bulb "boils" unpainted asphalt shingle surface. Area protected by GLIDE-ON is undamaged because intense heat is reflected.

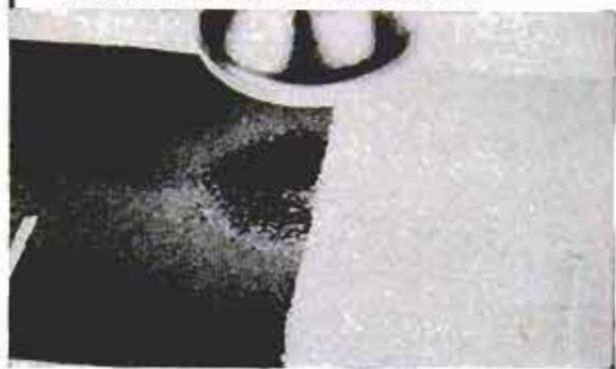



GET MAXIMUM EXTERIOR BEAUTY AND COMPLETE PROTECTION WITH GLIDDEN HOUSE PAINTS



Surface must be clean, smooth and dry. Sand rough spots, dust clean.



Caulk all joints next to windows, etc. Putty all nail heads.



Clean metal surfaces with wire brush. Spot-prime bare spots on old metal.

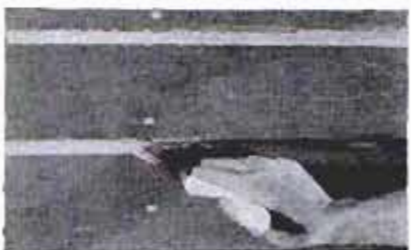

Cut in bottom edge of each board before painting face.



Apply paint liberally. Brush well into surface. Level with sweeping finishing strokes.

ONE-COAT WHITE SAVES TIME, MONEY!

If you want to do a 2-coat job in one coat, save half the time, nearly half the cost of painting a white house with Glidden ENDURANCE IMPERIAL. Only one coat of this premium quality paint will beautify and protect your home for years! Alkyd fortified and precision balanced for a long life.



SOLVE SHINGLE AND SHAKE PROBLEMS

ENDURANCE Resists Rot, Decay, Warping



ENDURANCE Shingle and Shake Stain preserves and protects shingles, shakes and rough-surfaced lumber. Prevents rot, decay, moisture and insects. Penetrates deeply to retard warping, curling, splitting. Wide selection of attractive colors.

ADD DISTINCTIVE BEAUTY WITH ENDURANCE

If you're looking for "picture book" colors, durability and quality in a house paint—you'll find the ideal combination in Glidden ENDURANCE. Easy to apply, retains color and beauty for years! Ideal for painting shutters and other trim, too!



GLIDDEN GUIDE

to every kind of Painting

FOR FAST, EASY, PROFESSIONAL RESULTS USE GLID-TONE—COMPLETE WOOD FINISHING SYSTEM

GLID-TONE

Complete Line of
Wood Finishing Products

- **GLID-TONE WOOD STAIN**
Furniture, paneling, all exterior and interior wood surfaces.
- **GLID-TONE SATIN-SHEEN VARNISH**
Creates hand-rubbed effects.
- **GLID-TONE GLOSS VARNISH**
For floors, trim, bar and table tops, furniture—the all-purpose interior varnish.
- **GLID-TONE CRYSTALACQ**
Water-clear brushing lacquer.
- **GLID-TONE NATURAL WOOD FILLER**
Fills pores in open-grain woods.
- **GLID-TONE SPAR VARNISH**
The superior spar varnish for all exterior surfaces including boats.
- **GLID-STRIP**
Non-flammable paint, varnish remover.

There isn't a wood finishing job around the house or in your hobby shop that you can't handle like a craftsman with GLID-TONE products. Use on any type of wood, plywood or veneer. Wide range of staining colors, for exterior or interior use.



New wood must be dry, smooth. For light modern finishes, bleach, stain with GLID-TONE Platinum or Blonde—protect with GLID-TONE Varnish.

Clean old wood to bare surface with GLID-STRIP. Sand smooth, then finish as new wood. Restore and refinish antiques the GLID-TONE way!

HOW TO PROTECT EXTERIOR AND INTERIOR FLOORS OF CONCRETE, WOOD OR LINOLEUM

FOR CONCRETE: PLI-NAMEL

Indoors and out, patios, porches, basement floors look better, get more protection when painted with Glidden PLI-NAMEL, synthetic rubber base high-gloss enamel.

FOR WOOD AND LINOLEUM: FLORENAMEL

Porch floors, sun decks, steps—any surface that gets lots of wear will look better, last longer with FLORENAMEL. Dries overnight.

SCUFFING is no problem on floors painted with PLI-NAMEL. Sticks where others fail.

EXTRA WEAR FROM OLD LINOLEUM . . . and a modern stippled finish can be obtained with a sponge and FLORENAMEL.



Glidden *Pacemaker in Paints*

The Glidden Company, Cleveland 2, Ohio. In Canada: The Glidden Company, Ltd., Toronto, Ontario. SPRED products also sold by dealers for the following points: HEATH & MILLIGAN • CLIMATIC • ROYAL • T. L. BLOOD



Here's Your House of the Near Future

(Continued from page 196)

by a watertight sliding glass door. Inside is a reclining chair instead of a tub or vacant shower space. This section can be partially filled with water for a bath or used as a sit-down shower. In the ceiling are various health lamps and oil sprays.

Kitchen Core

For several years I have been taunting the kitchen-appliance manufacturers with the fact that they are continuing to make a kitchen for an obsolete method of preparing food. Preprocessed foods are not only here but are gaining such a tremendous acceptance that soon there will be little else on the market. This eliminates the need for mixing, peeling, blending and other devices used in the preparation of raw foods. The core I have designed takes full advantage of this fact and is, I suppose, a revolutionary unit.

All food, housewares and appliances are contained in the core. This unit would be loaded from the rear outside the house. All power equipment (needed to raise and lower the shelves) would be available from the outside at the end of the core, as well as on the inside. The housewife would do all her work in a narrow band from 25 inches to 66 inches high. This would relieve kitchen fatigue and add to the speed and enjoyment of food preparation.

Refrigerated, frozen, sterilized, dried and canned foods would be contained in a rear elevator, bringing them within easy reach across an 18-inch-deep work area. Glasses, dishes and tools would be stored in the food elevator section since continuous access is not a factor. Soiled implements would be returned to their regular place and would be cleaned at the press of a button. The counter would contain all preparation equipment and cleaning areas for it.

In addition to the food core, the large kitchen affords plenty of space for dining and a laundry area.

Power Core

This would contain all heavy equipment such as ventilating, heating and air conditioning. It is disconnected from the house proper to prevent any transmission of noise or vibration. This prepackaged unit would require only water supply and electricity to keep the house in whatever atmosphere is desired by the family. It would contain a heat pump, ventilating equipment, air purifier, odor and germicidal control. The

(Continued to page 282)

help yourself
to the
handiest
plier
ever
designed

CHAN NEL LOCK

No. 420

GRIPS LIKE
A PIPE
WRENCH

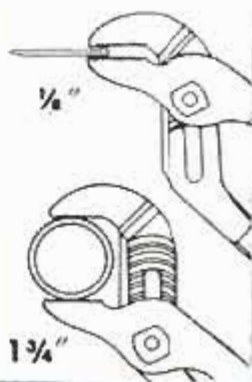

No other plier does so many jobs so well as a Channellock No. 420. Grips anything from a small cotter pin to a 1 3/4" hex nut. And what a grip! Just like a pipe wrench. What's more, Channellocks are streamlined . . . easy to use in hard-to-get-at places. Ask your hardware man for a Channellock plier. You'll soon agree with thousands of other craftsmen . . . Channellock is the handiest plier of them all.

BE SURE IT'S A GENUINE CHANNELLOCK



CHAMPION DEPARTMENT TOOL CO. MEADVILLE, PA.



Show the world
your

CHRISTMAS SPIRIT...



with these prize-winning,
worthwhile decorations

Colorful, almost life-size — these cheerful figures are completely in the Christmas spirit. Your guests and neighbors admire Santa, the quiet beauty of the Madonna, the Nativity Scene, or any of the other bright outdoor decorations.

You add your personal touch by making your own arrangement. Simply buy the patterns with the coupon below, or the unpainted figures from your lumber dealer. All figures are built with full-size Easi-Bild* Patterns—which specify each material, including 3/8" Homasote Insulating-Building Board.

Your dealer will furnish you with the Homasote Board in the size specified by the pattern. Or you can buy the figure already cut out with the painting pattern attached. To cut out the figure yourself, all you need is a key-hole saw.

Each figure has unique possibilities... a Madonna Greeting Card beside the walk, the Jolly Snowmen Greeters on the front door, or Santa and his five reindeer and sleigh on the front lawn. Your family, club or school group can enjoy a satisfying, creative project. Users of Easi-Bild Patterns tell us every year about the community Christmas competitions and prizes, and the many compliments they receive.

Get your cut-out figures, with Easi-Bild painting pattern and complete instructions attached—or the plain Homasote and pattern—from your local Homasote Dealer. It's real fun making your own Christmas decorations—easy, too—and you always get a professional job. To order patterns alone, or to find the name of your Homasote Dealer, mail us the coupon.

*T.M. Reg. Easi-Bild Pattern Company

MAKE it at home...with HOMASOTE

HOMASOTE COMPANY, Dept. K-7, Trenton 3, N. J.

I enclose..... for which send the following patterns:
 Santa Claus—35¢ Reindeer—35¢ Choir Boys—50¢
 Jolly Snowmen—35¢ Sleigh—50¢ Nativity Scene—\$5.00
 Madonna—50¢ Send name of nearest Homasote Dealer

NAME.....
 ADDRESS.....
 CITY.....ZONE.....STATE.....

power core is located at the end of the garden court below ground level. It can be elevated for servicing.

Entertainment Core

This core, stationed at one end of the living room, would integrate all equipment which has to do with group amusement or education. Home movies, television, radio, recorded music, color slides and so on will be immediately available. Some of this entertainment will be obtained by remote pickup and some would be contained in the unit on film, tape or recordings. The core could afford facilities for audio-visual home education which is becoming increasingly popular, particularly in the languages and arts.

Communications Core

This device would be enclosed in a soundproof area and would be a combination office-at-home and library. It would contain the telephone, of course, and possibly a closed-circuit television to your place of business. Here the mail could be handled. Any business or personal records would be stored here—on film. An entire library could also be stored on film in small space with a convenient viewer for reading or research. Here all types of communications could be received or sent out in complete privacy. For a large family of diverse interests, additional communications cores could be placed back to back. A small core of this type might be located in a bedroom.

Actually, this house could be built today just as it is designed. There are no materials or equipment required which are not on the market. The design of the house has a slight Japanese flavor because certain areas can be opened and closed to suit one's fancy. A basic simplicity of design is the keynote. ★ ★ ★

Peat-Taconite Partnership

Peat—one of Minnesota's most-abundant resources, yet one that is little used—may team up with taconite in the production of iron ore. Taconite is a low-grade ore containing only about 25 percent iron. It is crushed to a fine powder and the magnetic iron removed, yielding a concentrate of about 62 percent iron. The powder, however, is too fine for blast furnaces and must be formed into small balls or pellets. The University of Minnesota has been experimenting with peat as a binder for these balls. Clay, shipped in from outside the state, now is used as a binder, and the new system promises to be lower in cost.

This Coupon

brings you
the most
exciting news
in Power Tools



TOOLKRAFT CORPORATION
400 Plainfield St., Springfield, Mass.

Please send me the following:

Free folder on complete line of Darra-James power tools.

Free folder on Darra-James MotorTools

Name of my nearest dealer.

Power Tool Handbook. I enclose 10c to cover handling and postage.

NAME _____

STREET _____

CITY _____ ZONE _____ STATE _____



At Last!



MoterTools

specially designed to bring you
today's most wanted features in Power Tools!

CONVENIENT: Darra-James *MoterTools* take the guesswork out of choosing the proper motor. They come equipped complete with Timing Belt, Pulley, G.E. Motor with Cord, Plug, and Switch. **ABSOLUTELY NOTHING TO BUY.** Everything is built to the most rigid factory specifications.

TIME-SAVING: Since each tool comes equipped complete with motor and accessories, there's nothing to mount—thus, no time lost.

SIMPLE TO OPERATE: Just plug in, flip the switch and operate . . . as easy as running a toaster.

MOVABLE: Each *MoterTool* is compact and can be carried quickly and easily from one place to another . . . Move the tool to the job—NOT the job to the tool!

RUGGED: Entire tool is constructed of heavy-duty cast iron to assure many years of trouble-free service.

CHOICE OF COLORS: Darra-James *MoterTools* are available in either Woodland Green or Slate Gray to enhance the beauty of your home workshop.

ECONOMICAL: Darra-James *MoterTools* cost less than similar tools and motors purchased separately.

...Power Packed Beauties
with **BUILT--IN--MOTORS**



(Model 825)
8" TILTING ARBOR SAW

A quality tilting arbor saw at a minimum price • Cuts stock 2-9/16" thick • With extensions, rips to center of 33" panel • Motor, guard, and splitter tilt with blade to 45° • Precision-ground cast iron table (16" x 20") stays flat • Lifetime ball-bearing arbor unit • 3/4 H.P. continuous duty G. E. motor

\$114.95
without extensions or guard



All Darra-James Power Tools can now be purchased
for **ONLY 10% DOWN** through
our convenient credit plan



(Model 645)
4 1/2" JOINTER

Uniquely synchronized to maintain constant distance between table and blades at any depth of cut • Rabbits up to 3/8", planes any board up to 4 1/2" wide • Tables adjust individually for perfect alignment • Ball-bearing construction • U. S. Rubber Power-Grip Timing Belt Drive • 1/2 H. P. continuous duty G. E. motor



(Model 815)
8" TILTING ARBOR SAW

An economy saw that will perform all operations of high-priced models • Cuts stock 2 1/2" thick, rips to center of 18" panel • Blade, guard, and motor tilt to 45° • Table and work stay flat • Precision ball-bearing arbor unit • 3/4 H. P. continuous duty G. E. motor

\$89.95
without extensions or guard



ASK YOUR DEALER
ABOUT THE COMPLETE LINE
OF DARRA-JAMES
NON-MOTORIZED POWER TOOLS!



YOU'LL BE AS BUSY AS A BEAVER WITH DARRA-JAMES POWER TOOLS!

SMOOTH!



Finish rooms fast
with smooth,
strong walls of

SHEETROCK

T. M. Reg. U. S. Pat. Off.

The Fireproof Gypsum Wallboard

Walls and ceilings go up *fast* when you use tapered edge SHEETROCK. Joints are easily finished smooth and level with the wall surface. Room-height, 4' x 8' panels are simple to cut, fit and erect. Just nail them to wood framing or over old walls and ceilings. SHEETROCK walls and ceilings are strong, crack-resistant; take any decoration.



PERF-A-TAPE* JOINT SYSTEM —the secret to smoothness

Special perforated tape applied in combination with PERF-A-TAPE cement assures perfectly smooth joints. Use PERF-A-BEAD* metal corner protection to reinforce outside corner angles. For further information and FREE instruction folder, write Dept. PM-63, 300 West Adams Street, Chicago 6, Ill.



UNITED STATES GYPSUM

The Greatest Name in Building



Police Call Box

Citizens of Dusseldorf, Germany, can summon police help in a hurry from a new call box. One of many being installed at strategic spots in the city, it is connected by telephone line to police headquarters. Just press a button and announce your location into the grill and police will come to your rescue.

Chain Brake Keeps Car on Jack

With one wheel locked by a bumper brake, a car cannot roll off a jack during a tire change. The brake consists of a chain that hooks around the bumper and a plate on which the wheel rests. With the wheel in position, the chain pulls tight, locking the wheel from additional movement. It takes only a moment to "set" the brake and it assures stability even when the car is jacked high as with a bumper jack, says the manufacturer.

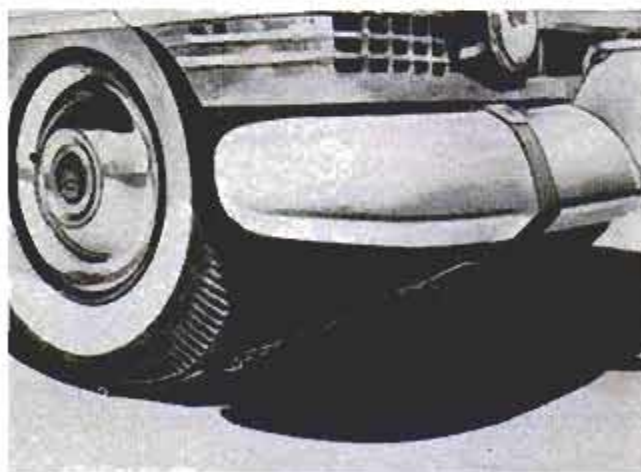

More House for Less Money

(Continued from page 182)

the underside of the softboard roof sheathing comes prefinished from the factory, the ceilings are completely done. "And you gain free," remarks Calcaterra, "two inches of good insulation overhead." The firm's experience has been that the softboard insulation is the very best, giving no condensation or shrinkage problems, no mice or insect problems and no fire hazard after a period of years.

The seemingly forgotten exterior walls now are enclosed. Part of the exterior is wood siding. Just recently, the firm has changed from using redwood board and batten and redwood lapped siding to using Rusticwood, grooved exterior panels of 5/8-inch redwood plywood that comes wire-brushed on the outer surface. Calcaterra has found that these panels go up faster, are stronger and give less paint and shrinkage problems. The other part of each house exterior is of stucco, applied by standard three-layer practice. When possible, the firm subcontracts to have the scratch and brown coats, the first two layers, applied by the Gunit process. The finish coat is troweled on and the finish color is mixed in the finish coat, eliminating a paint job afterwards and giving a thick permanent finish that does not deteriorate.

Prebuilt Closets Moved In

Now, huge prebuilt closets are slid inside the house. Calcaterra has found he can buy closets ready-made to his specifications by cabinet shops, better closets and at less cost than building them on the job. Of 3/4-inch plywood, these are the hall and bedroom closets. When in place, they form several of the house's interior partitions, as shown by the shaded areas of the floor plan. These closets are standard height, door height, and thus will slide in through the doorways and can be moved about inside the house. The extra space between their tops and the ceiling is closed off with a panel of 3/4-inch plywood, giving an extra storage shelf above.

Most of the other interior walls are finished off with standard 1/2-inch gypsum board. Care is taken in the designing to have as few odd joints to tape as possible. The ceiling beams directly above the gypsum panels are grooved at the lumber mill so the panels can simply slide up into the grooves to finish off their top edges. In this living room, one wall is wood-paneled. The Shadowood plywood is used in most of the houses today, because of its attractiveness and because its "toasted" grooves hide

(Continued to page 286)



BASEMENT LIKE A DUNGEON?

make it brighter and drier with

DURA-DRI CEMENT COATING

Do it yourself! Just apply this heavy-bodied protective coating with a brush right over any porous masonry. **TEXOLITE*** DURA-DRI controls water penetration; decorates in any one of four beautiful colors.

DURA-STOP Compound fills holes and cracks through which water flows under pressure. Use this quick-setting hydraulic cement when necessary before applying DURA-DRI—for a complete water control system. For further information see your U.S.G. dealer, or write Dept. PM-64, 300 W. Adams St., Chicago 6. *T.M. Reg. U.S. Pat. Off.



UNITED STATES GYPSUM
The Greatest Name in Building



Sound your Z...enjoy

GAS ECONOMY FOR KEEPS

because—

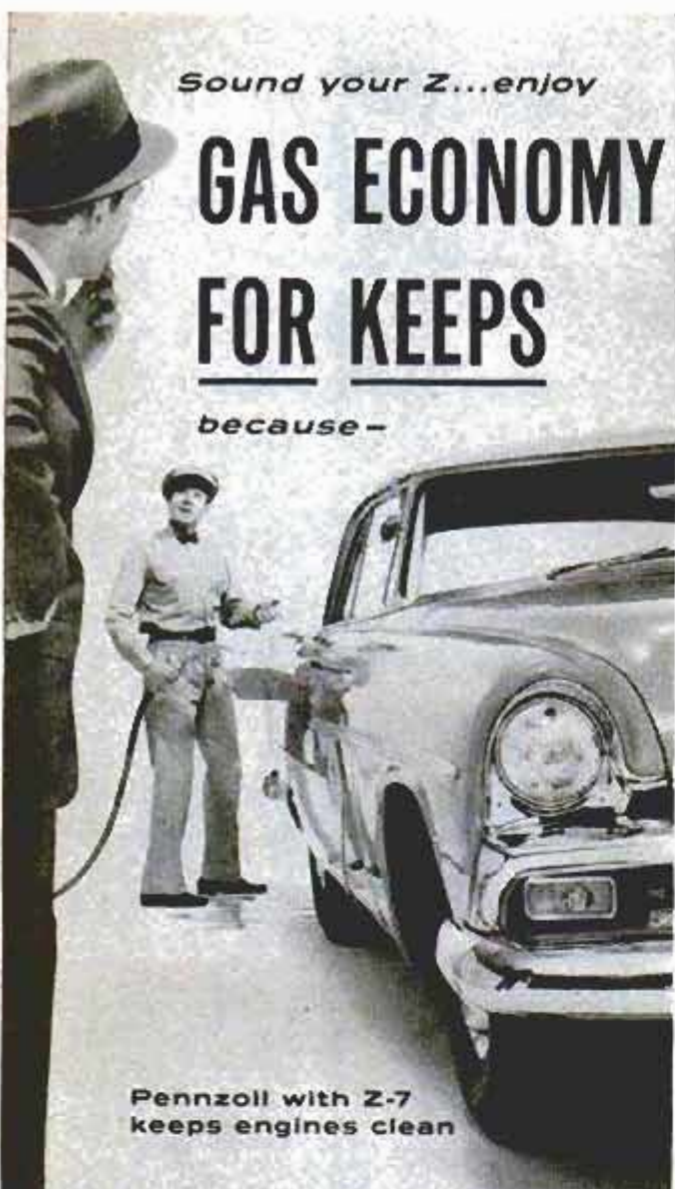

Pennzoil with Z-7
keeps engines clean

Can motor oil really increase gasoline mileage? Yes! Pennzoil with Z-7 prevents deposits from forming in combustion chambers. This eliminates power-stealing knock and ping. By keeping engines clean, this different Pennsylvania motor oil with an all-oil body makes every drop of fuel work harder, unlocks full horsepower—not for just a few miles after an oil change, but for keeps. To make the gasoline you use take you farther on every tankful, get Pennzoil with Z-7, The Tough Film® oil, in the exact seasonal grade for your car!



IN EVERY STATE,
AT DEALERS WHO
care FOR YOUR CAR



MEMBER PENN. GRADE CRUDE OIL ASSN., PERMIT NO. 2, OIL CITY, PA.

finish nails without any problems. Kitchen cabinets are of ash, finished natural. These also are prebuilt in a cabinet shop and brought in complete. The G-E Kitchen Center is installed in these houses, complete with sink, drainboard, disposal unit, built-in range, oven, dishwasher, washer and drier. Far from cheap, Calcaterra, nevertheless, has found that it costs less to use this kitchen center than to install separate appliances and build cabinets for them.

More Cost-Cutting Tips

"There are some other things to think of, too," he says. "One is to keep your plumbing in a straight line." By this, he means to eliminate as many branch lines of piping as possible, to have bathrooms back to back and to have the bathrooms and the kitchen on either a straight line or an easy angle toward the sewer.

"Another thing we like," he explains, "is to use Novoply for all sliding closet doors. Before we used that nonwarping panel for sliding doors, we thought nothing of replacing 100 to 200 doors in a tract. Of 700 Novoply doors installed recently, we haven't had one to replace. Still another saving is to continue the brick of the fireplace full width on up to the ceiling. Yes, that costs us a little more, about \$70 more than an ordinary mantel fireplace. But it saves a bit of paneling above the fireplace, probably \$20 worth, and the important thing is that the expanse of brick adds tremendously to the appearance of the room."

McKellar and Associates spend at least a full year developing any new house plan they use. This, of course, is of little help to the individual builder. The firm decides on a certain plan, then everyone concerned spends weeks trying to find fault with it. Then a pilot house is built and, as it being constructed, each piece of lumber is counted and measured and compiled into a cutting list for precutting the lumber.

Scene is Quiet

Most anyone would picture an explosion of activity when this firm starts erecting a tract of 500 houses. No such thing happens. Actually, the McKellar developments move along more leisurely than the construction of an individual home. Only small crews are around. Only a few lots are being graded, a few roofs being finished, a few interiors being painted each day. There is no beehive of activity with men rushing here and there. Each man has a certain job to do on each house and soon he becomes a specialist at it, doing his part easily as well as right. And each day a few more houses are fully completed. ★ ★ ★



Easy desk and cabinets for kitchen corner

These are a snap to build with Western Pine woods.

A pleasure to work with, the low-cost Western Pines cut cleanly with either hand or machine tools, take all finishes easily.

See these carefully selected, straight-grained, well-seasoned woods at your local lumber dealer's.



FREE! New booklet of bright ideas!

"FRIENDLY HOME IDEAS IN WESTERN PINE"—85 photographs, many in color, feature traditional and contemporary ideas for building, decorating and remodeling using cheerful Western Pines. Also new modern finishes. Write for your FREE copy to WESTERN PINE ASSOCIATION, Dept. 524-N, Yeon Bldg., Portland 4, Oregon.

The Western Pines

Idaho White Pine

Ponderosa Pine

Sugar Pine

and these woods from the Western Pine mills

WHITE FIR • INCENSE CEDAR

RED CEDAR • DOUGLAS FIR

ENGELMANN SPRUCE

LOGSPOLE PINE • LARCH

are manufactured to high standards of seasoning, grading, measurement

TODAY'S WESTERN PINE TREE FARMING GUARANTEES LUMBER TOMORROW

BUILD IT

FIX IT

with

AMBROID

IT STAYS STUCK

Excellent for model building, home crafts, projects, furniture making, jewelry, toys, etc. Bonds many materials ordinary adhesives fail to hold.

MENDS wood, leather, canvas, upholstery, china, glass, pottery, etc.

Try Ambroid in your Business, too. Unsurpassed for Radio, TV and Electronics. Makes ideal protective coating on wiring, coils, etc. Suited for quick assembling.

SPORTSMEN! Take Ambroid on your trips—first aid for sports equipment. Perfect for Archery, too.

If your hardware or hobby dealer cannot supply you, send 30c for large tube, postpaid. Money back guarantee.

AMBROID WEYMOUTH 88, MASS.

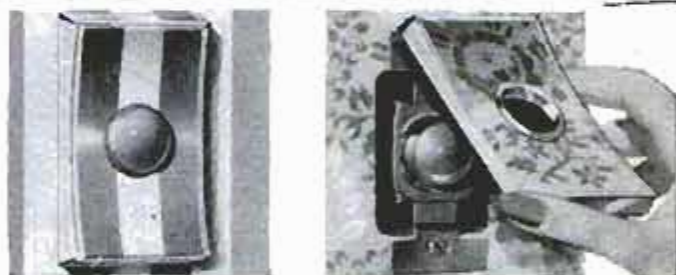

\$1.95 complete—at leading hardware, electric and department stores.

Ever See A Light Switch Like This?

New decorator light switch easiest yet to install! Honeywell Tap-Lite is a new kind of wall switch. Transparent plate snaps off for decorating; just add your own wallpaper, drapery material, or one of the colored inserts provided. It's simple to replace old switches; Tap-Lite has screwless terminals. Quiet and easy to operate. Tap—it's on! Tap—it's off!

Tap-Lite by

HONEYWELL



NOW— 6 great new power tools in 1

Porter-Cable's revolutionary

ROUTO-JIG!



1 ROUTER! Routo-Jig converts to a high-speed, efficient portable router in *seconds!* Special bits available for fast, easy work in wood, plastics, compositions. 24,000 R.P.M. speed for clean, smooth, *finished* cuts in every application.
Model 140-R Router....\$42.50



2 JIG SAW! Routo-Jig is a new kind of portable jig saw with *rotary* action—for intricate contours or straight cut-off work in wood up to 1" thick. Sturdy cutting bit reduces blade breakage to a minimum.
Model 140
Jig Saw-Router.....\$49.95

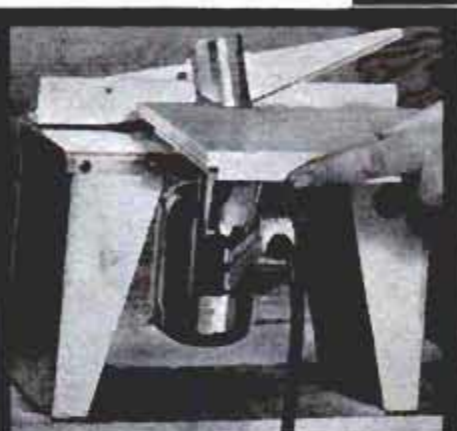

3 SHAPER! Husky accessory Shaper Table makes Routo-Jig a precision Shaper and Joiner. Quick, accurate, professional results on difficult rabbet cuts, moulding cuts, joiner work. Adjustable fence, built-in safety guard.
Shaper Table.....\$12.00

Never before—a single tool so *versatile!* The amazing new Routo-Jig converts in a jiffy to any one of *six* top-quality portable power tools—lets you equip your workshop at a fraction of former costs!

Use the Routo-Jig as a *router*, for mortising, grooving, rabbetting... as a *jig-saw*, for cutting intricate contours and freehand shapes... as a high-speed *finishing sander*, with orbital motion that can't gouge or mar.

With its own accessory table, the Routo-Jig is a precision *shaper*—for moulding, beading, joining. It's a smooth-cutting *power-plane*—lightning-fast on the toughest planing jobs. And the Routo-Jig even goes to work in the garden—as a light, handy lawn trimmer for the places that mowers miss!

It's a shop in itself! And, like every Porter-Cable tool, the Routo-Jig is *quality built throughout*—for years of dependable, trouble-free service. See it—try it—at your Porter-Cable dealer's today! Or write for free literature.



4 POWER PLANE! Routo-Jig converts quickly into a precision power plane. 24,000 cuts per minute for velvet-smooth surfacing—instant bevel and depth adjustments. Special design prevents digging in or gouging. Plane Attachment.....\$12.50

5 SANDER! Precision-built sander attachment makes Routo-Jig a fast, efficient finishing sander. Orbital motion sands with, against, or across the grain — high speed and generous sanding surface make finishing quick and easy. Sander Attachment.....\$19.95

6 GRASS TRIMMER! With accessory trimmer unit and long, stand-up handle, Routo-Jig takes the work out of grass trimming—around sidewalks, driveways, flower beds, fences! Light, handy — even youngsters use it! Grass Trimmer Attachment.....\$9.95

FREE! \$20.00 SAVINGS CERTIFICATE with your 6-in-1 Routo-Jig! Saves you \$7.00 on Shaper...\$3.00 on Sander...\$3.00 on Plane...\$3.00 on Grass Trimmer...\$4.00 on Dovetail Templet. You save on *every* attachment, whether you choose one or all five! See your dealer or write for complete details. Offer expires January 31, 1957.

PORTER-CABLE MACHINE CO.
6140 N. Salina St., Syracuse 8, N. Y.

Yes, send me complete information on the Model 140 Routo-Jig, and the name of my nearest dealer.

Name _____

Address _____

City _____ Zone _____ State _____

Porter-Cable

Quality Electric Tools

Your Nicholson files are fine tools. Proper care will keep them in tiptop cutting condition

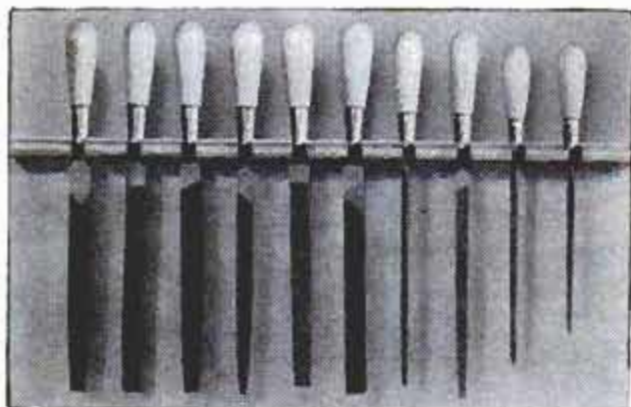

Simply constructed file rack is fabricated of strips of wood nailed to a plywood backboard. Ferruled handles make files easier to work, easier to store.

Aside from storing your files separately to prevent dulling, you should keep them free of filings or chips that often collect between the teeth during use. After every few strokes, tap the end of the file on your bench to loosen chips. And always use a file card or file brush before putting the file away.



File card, top, is for more general use. File brush, bottom, combining brush and card, is used especially on finer cut files. Overall length: 10 inches.

Prefinished Nicholson metal ferruled file handles of seasoned hardwood and Nicholson file cards and brushes are available at your hardware dealer's. And if you need a new file... for any shaping or sharpening job... ask for a Nicholson or Black Diamond file.

Free 49-page book, "FILE PHILOSOPHY," is yours for the asking. It's loaded with information on proper selection, care and use of files and rasps.



NICHOLSON FILE COMPANY
Providence, R.I.



(In Canada: Nicholson File Company of Canada Ltd., Port Hope, Ontario)

NICHOLSON FILES
A FILE FOR EVERY PURPOSE

Nature Puts Men to the Supreme Test

(Continued from page 138)

who's been on the south polar plateau knows this would never guarantee a safe walk home. Yawning crevasses impose endless detours. Formidable blizzards delay progress. A polar blizzard isn't necessarily accompanied by a fall of snow. Howling wind sweeps across the icecap lifting a blinding curtain of snow granules from the ground. Any wind over 20 knots will raise the hissing, stinging barrage of drift high enough to obscure buildings. Men can't see 10 feet, and could walk right off the barrier edge without knowing it. Particles encrust goggles, and the wind has a "knife" in it.

Captain Scott and his party of four returning from the pole in 1912, figured supplies too closely. They'd have made it except for a six-day blizzard that pinned them down only 11 miles from a supply cache they'd left near the Beardmore Glacier. They were found on the icecap nearly a year later, frozen to death in their sleeping bags.

Flying Rescue Teams

So, when Deepfreeze planes head over the polar icecap this month, crews will be protected by a special dog-sled rescue and recovery squad. This outfit will be based in a forward camp at the foot of the Beardmore Glacier, halfway to the pole. The entire unit—dogs and all—is equipped to fly out over a disaster scene and parachute to the rescue.

"The dogs," explains Lt. (jg) John Tuck, one of the officers in charge of the squad, "have 28-foot chutes that accommodate two of them at once. Dogs enjoy parachuting, land easily and sit calmly, waiting to be unhitched, with a 'you got me into this, now get me out' expression. They rarely tangle lines or get excited. If a plane crashes, we're alerted by radio. If the crack-up is inaccessible to snow vehicles or ground units, off we go in our rescue Otter. The team, fresh and well provisioned, will easily bring survivors back across 1000 miles of ice in less than 30 days."

Besides Tuck, Lt. (jg) Dave Baker, Sgt. Henrik "Dutch" Dolleman, Sgt. Tom McEvoy and Seaman Jim Brown comprise the two-legged members of the team. Thirty other members, with names like Petya, Ooloo, Kageluk and Towha, are blue-eyed Huskies and Malamutes. They ran through rehearsals at McMurdo Sound base this year, simulating rescues in blizzards and

(Continued to page 292)

DO IT BETTER . . .

DO IT WITH DP



**CAULK
GLAZE
SEAL
PATCH**

Prevent drafts, moisture, damage and deterioration the easy way. Use D-P Caulking Compound . . . in cans or handy cartridges for gun use. Always stays in condition for immediate use. Fill cracks in brick, stone, wood. D-P stays in place permanently. Get D-P glazing, sealing and caulking compounds or putties at all good stores!

Ask your dealer for D-P Products.

THE DICKS PONTIUS CO.
5301 Huberville Ave., Dayton 3, Ohio
INSIST ON D-P BEST SINCE 1867

DO EVERY FASTENING JOB 10 TIMES FASTER!

Amazing one-hand operation, 10 times faster than hammer & nails. Can't jam.



ARROW
DO-IT-YOURSELF
TACKER, No. T-50

for ceiling tile, insulation, wire fence & every home job

At your local hardware dealer or lumber yard

Arrow Fastener Co., Inc., 1 Junius St., Brooklyn, N. Y.

NEW! **GLASS!** **AUTOMOTIVE CATALOG**

1956 Edition! Everything for car, truck, custom-style! car, hot rod . . . at **LOWEST PRICES!**

SAVE UP TO 50% on all parts, accessories! Only complete automotive buying guide . . . 75,000 items . . . 196 pages! Thousands of **hard-to-find parts**; equipment, parts for 1920 to 1956 models; **Hollywood accessories** never before offered; **hi-speed parts**. Send your name and address and 25c (refundable with first \$5.00 order) to:

J. C. Whitney & Co. 1917 Archer, Dept. P-10, Chicago 16, Ill.



SEND FOR FREE CATALOG

Money-Making Tools!

It's easy to own the same "pay-off" tools used and endorsed by America's top-earning mechanics! You can start building your own kit with basic Snap-on sets—add others any time. Never sold in stores—direct to users only. Send today for free catalog!

Snap-on Tools Corporation
8062-J 28th Ave., Kenosha, Wis.



Snap-on Tools
THE CHOICE OF BETTER MECHANICS

FREE PLANS



IDEAS FOR YOUR HOME FROM NBC-TV HOME

Smart new designs by leading architects show scores of worthwhile home-improvements you can make with fir plywood.



Ideas for Built-Ins

Complete, fully-illustrated booklet contains plans for Sectional Storage Units, Built-in Range and Oven, Under Eaves Wardrobe and Desk.

Ideas for Furniture and Decorations

Detailed plans and step-by-step instructions for easy-to-make Platform Sofa, Chestend Tables plus remodeling ideas.



Ideas for Outdoor Living

Plans and ideas for Garden Storage Cabinets, attractive Sun Sleds, Patio Wind Screens and Landscape Fencing.

... and remember, whether you build, remodel or do-it-yourself

You can Afford Expensive Ideas with **Fir Plywood**

Your lumber dealer has sizes and grades for every job. Look for the DFPA quality grademark on every panel.

MAIL COUPON FOR FREE PLANS

DOUGLAS FIR PLYWOOD ASSOCIATION
Dept. 9-S, Tacoma 2, Wash. (USA Only)

Please send free plans booklets checked:

Built-Ins Furniture Outdoor Living

Name

Address

City Zone State



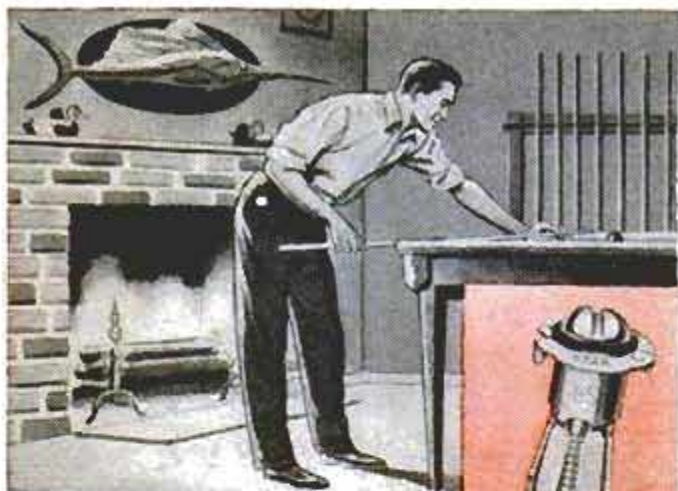

A fastener that grips fixtures to walls quickly, securely...



★STAR WALLGRIPS

REPLACEMENT OR REFUND OF MONEY
 Guaranteed by
 Good Housekeeping
 IF NOT AS ADVERTISED THEREIN

makes any fixture-hanging job a simple task. Fixtures can be quickly removed or replaced when redecorating without disturbing the WALLGRIP. Send for new booklet "The Hang of Things", showing how to fasten all kinds of fixtures to any type of wall.

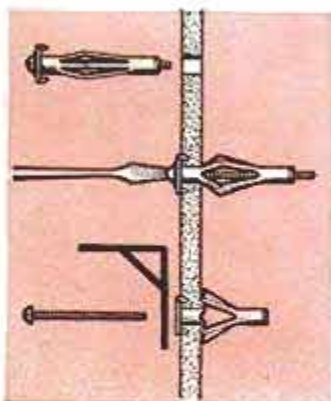

How WALLGRIPS work in hollow walls:

1. Insert in Hole. Wings spread as bolt is tightened.
2. Positive Stop tells WALLGRIP is set.
3. Remove bolt and replace through fixture and tighten.

★STAR EXPANSION

Fasteners for Home and Industry

Dept. PM10, 142 Liberty Street
 New York 6, N. Y.

Please send me a FREE copy of the book "The Hang of Things".

Name _____

Address _____

City _____ Zone _____ State _____

snowstorms, and trailing a sledgehammer (a "fifth wheel" to measure mileage) behind them over the drifts.

"A working team," explains Tuck, "consists of three men and 11 dogs hauling two loaded sledges. The lead dog is out front, followed by five pairs on opposite sides of a gang line. Over rough ice, we use a fan hitch, with the dogs spread out in front so they can pick their own way. On sharp ice they'll wear boots to protect their pads."

Simulated Rescue Missions

I went with the team on a simulated mission across McMurdo's bay ice one snowy day. Two men rode with the sleds, shouting verbal commands to the animals. The third man, on skis, worked out ahead probing with a pole for hidden snow-bridged cracks.

Half a ton of survival rations and gear made the sledges bulge, but the dogs moved at a four-mile-per-hour clip. "Each dog pulls about twice his weight," Tuck shouted at me over the wind. "They average 65 pounds, so a team can draw about 1400 pounds."

On those sleds were two boxes of medical supplies, a stove, 10 gallons of fuel, two tents, harness repair kits, bundles of trail flags and a 20-pound plastic sled for man-hauling supplies if the dogs gave out. There was a sea bag of polar clothing, one sleeping bag per man, one "Angry 9" radio and a hand-crank transmitter.

"The compass is carried in the trailing sledge," Tuck pointed out. "All the metal is in the lead sledge where it won't have any magnetic influence."

One crate held fancy day-and-night distress gear—cans that belch smoke if ignited at one end, or flare if the other end is lighted. There were signal panels and lamp-black for marking messages on the snow. Rope, ice axes and steel-toothed crampons that fasten to boot bottoms for climbing glacial ice walls were insurance that survivors of a mountain crash could be reached without delay. The rest of the load was food. "Thirty days' worth of survival rations, and pemmican for the dogs," said Tuck. "And if we run out, more can be dropped by air."

Twenty miles down the ice, camp was set up. While snow swirled around us, tricky polar "A frame" tents were hauled from the load. In 10 minutes their double-walled sides of Egyptian cotton, supported by a simple inverted V-frame at each end, were hauled erect by guy lines and staked down. Each has a tunnel entrance that can be tied shut with a drawstring. The tents can be zippered together—end to end—to make a single unit with three weather-tight compartments sleeping six to nine men. Inside,

(Continued to page 294)

GRAVELY with Starter makes



Snow Removal A SNAP

● Save your heart! . . . Powerful Gravelly Tractor with push-button starter, 48-inch Snowplow attachment takes all the work from snow removal!

23 DIFFERENT TOOLS

● 23 attachments to save your time and work all year long. *Easy Pay Plan* . . . only 20% down, 18 months on balance. Write today for FREE 24-page "Power vs Drudgery" Booklet.



GRAVELY TRACTORS, INC.
BOX 1063 DUNBAR, W. VA.

FIELD-TESTED FOR 34 YEARS



GENUINE ALNICO MAGNETS

AMAZING, PERMANENT, NON-ELECTRIC, HIGHLY PRACTICAL. Conduct interesting experiments. Hundreds of uses. Retrieve valuable steel items such as nuts, tackle from fresh or salt water; tools from tanks & drains. **GUARANTEED.** Try any magnet one week. Money back if you are not well-pleased.

No. M-710 Has pull of 225 lbs. on flat steel block. . . . \$16.50
No. M-625 Has pull of 125 lbs. on flat steel block. . . . \$9.50
No. M-575 Has pull of 75 lbs. on flat steel block. . . . \$6.50
No. M-500 Has pull of 50 lbs. on flat steel block. . . . \$4.50
No. M-47 Hot Pad Magnets. 10 for \$1.00 50 for \$4.87
No. M-35 Hobbyist assortment of 8 small magnets. . . . \$1.50

Send M.O. or check. We pay postage. Sorry no C.O.D.'s.

MIAMI MAGNET COMPANY, 3240 N.W. 27th Ave., Miami 42, Fla.

FOR COLOR SLIDE FANS—new Kodak Ektachrome Processing Outfit, 35mm. Use it anywhere—no darkroom needed! Outfit includes Kodak Day-Load Tank. Comes complete with everything needed to develop, mount color slides. Order from your dealer. Only \$24.75

Eastman Kodak Company, Rochester 4, N. Y.

SAY YOU SAW IT IN POPULAR MECHANICS

SAVE MONEY ON YOUR COMPRESSED AIR

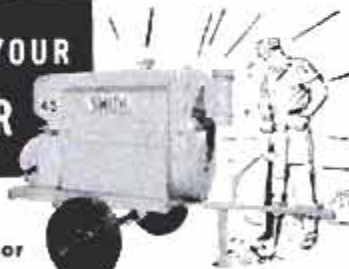

buy this complete
SMITH 45-P air compressor

Right for spray painters, plumbers, contractors, monument shops, tire changing trucks, maintenance shops, quarries, utilities, many other users. Delivers 45 plus cu. ft. per minute; pressure up to 150 P.S.I. Powered by Wisconsin 4-cyl. air-cooled engine; uses less than 1 gal. gasoline an hour! Most compact, biggest-value compressor for its capacity anywhere! Other models to 230 cfm.

write for
FREE
brochure

GORDON SMITH & COMPANY, Inc.
411 College Street, Bowling Green, Ky.



GREENLEE HANDY CALCULATOR

WALK BITS AND CAR BITS
EXPRESSOR BITS
MACHINE BITS
MATERIAL TOOLS
AUTOMATIC PUSH DRILLS
PIPE, COUPLER AND
FLANGING SERVICES

WOOD CHISEL AND BIT
SPECIAL TOOLS
SAWBLADES
SPECIAL SCREW DRIVERS
NAILING SPECIAL PURPOSES
TOOLS FOR ELECTRICIANS
AND PLUMBERS
SPECIAL HANDS AND SET
IN YOUR STORE.

GREENLEE

solves woodworking problems in seconds!

Speed your jobs, get answers to countless building and woodworking questions immediately! Improved GREENLEE Woodworking Calculator converts linear to board feet, gives nail specifications, tool sharpening tips. Compares woods, gives bit sizes for screws, concrete mixes, painting information, etc. Convenient . . . simple to read. 6" diameter . . . heavily varnished cardboard. Special offer by the makers of famous GREENLEE tools . . . **Only 25c**

(no stamps please)



The GREENLEE line of fine tools includes auger bits, electric drill bits, chisels, gouges, spiral screw drivers, drawknives, and many more. At leading hardware and building supply dealers.

GREENLEE TOOL CO.,
2109 Columbia Ave., Rockford, Ill.

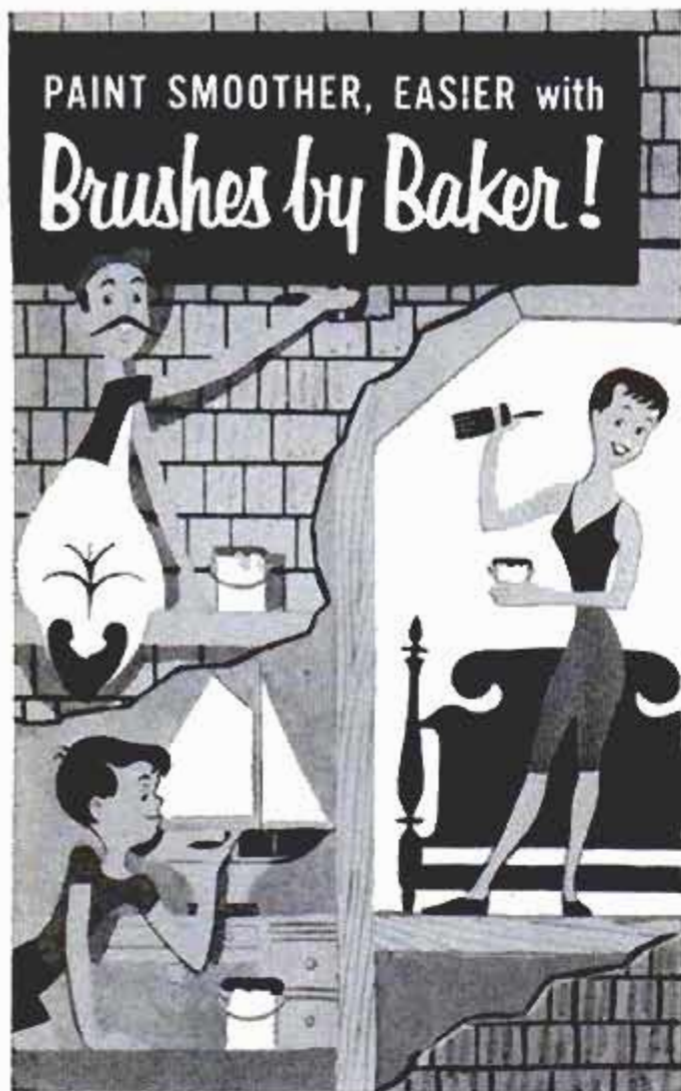

Use Baker Brushes and paint easier, faster, better! Enjoy smoother painting, use fewer strokes, get more coverage. Next time you paint choose the right Baker Brush size most practical for the job.



learn to paint like an expert . . .

Free booklet tells "HOW TO DO A GOOD PAINT JOB." Today, send card to Baker Brush Co., Inc., 83 Grand Street, New York 13.



BRUSHES BY BAKER
AMERICA'S FINEST PAINTING TOOLS

a single-burner camp stove will keep temperature above freezing though sub-zero gales blow outside.

Dogs Like Flying

How will air delivery of rescue teams work? Great, according to Dutch Dolleman. A veteran of both Greenland and Antarctica, the sergeant is a firm believer in dogs for polar work. "They like flying," he says. "On the ground they move fast and are light enough to cross most snow-bridged crevasses without breaking through."

Dutch should know. In 1942 he was driving dog teams on Greenland's west coast when a B-17 went down on the eastern side of the icecap. "It was a heavily crevassed pressure area," he recalls. "Eastern teams tried to go in overland, ran short of food and tentage and gave up. One motor sledge went down a crevasse. Another went out to rescue it and lost a man in a crevasse. A Grumman that went in cracked up on the take-off. Finally, they turned the job over to us. Col. Bernt Balchen showed up in a PBV. We loaded two 9-dog teams and all our gear, flew over the cap to within 15 miles of the wreck and Colonel Balchen landed the flying boat on its keel in the snow. Next day we went in with the dogs and were trapped by storms that kept us pinned in snow tunnels for 21 days. But we sledged those survivors out through hundreds of crevasses to where a plane could land and pick them up. They flew home. We rode home by dog sled—six days to make 60 miles."

Dogs Disappear

Running dogs through crevassed terrain is touchy unless you know what you're doing. "We probe suspicious spots with a ski pole," Dutch reveals. "If it doesn't poke through, then we ski across using lines. If the bridge doesn't sag, dogs and empty sledges are brought across. The load is pulled across with lines, piece by piece, and re-rigged."

"I was watching a biologist at Little America drive a team over virgin territory when suddenly the whole rig disappeared," says Dutch. "He was lucky. They all landed on a second snow bridge 15 feet below, and we hauled them out." Another time, some of Dolleman's own dogs broke away and fell through a snow bridge while cavorting. "I snagged them out with a meathook on a long pole," he recalls.

Half the battle of being rescued in polar territory is staying alive until help comes. "Your first goof may be your last in Antarctica," warned Maj. Murray Wiener, Air Force advisor on emergency survival

(Continued to page 296)

E Z KLEEN

AIR FILTER

it's aluminum!
it's washable!
it saves you money!



Popular Sizes \$ **1.75**
From



FOR A CLEANER, MORE COMFORTABLE HOME—Clean filters in your forced air furnace or air conditioner mean better air circulation, lower fuel and power costs, greater comfort. Simply wash E Z Kleens with water . re-coat with convenient Hand-Koter (or Super Hand-Koter for odor-removal, too)... they're good as new . last for years. Insist on E Z Kleens for comfort, cleanliness, convenience. RESEARCH PRODUCTS CORP., Dept. 227, Madison 10, Wis.

At Your Dealer, or Consult Your Classified Telephone Directory

IN CANADA Hicks-Baker, Ltd., 234 Madison St., Winnipeg — Durable Oil Equipment Ltd., 80 Semit Ave., Toronto



New "PULL-GEAR" SPEED-REDUCING PULLEY



Provides Correct Speed and Power to Drill Up to 1 3/8" with 1/2 H.P. Motor

Amazing new internally geared speed reducer doubles drill press capacity. Greater power, greater efficiency, greater productivity.

Provides the correct speed and power for larger drilling, reaming, tapping and boring on light presses. Easily installed in five minutes. Adaptable to all type machines. Spindle speed range approx. 45 to 3000 RPM. Made in 3 motor shaft sizes: 1/2"—5/8"—3/4". Write for literature.

WRITE FOR LITERATURE

THE PULL-GEAR CO.

25427 Mound Road
Center Line, Mich.

Jet King POCKET-SIZE

BUTANE BLOW TORCH

**SOLDERS!
BRAZES!
FIXES LEAKS!**



ONLY \$ **1.95**
WITH CHARGER

Every do-it-yourself and hobby fan needs this Kidde JET KING butane Blow Torch. Just the tool you've been looking for to do dozens of jobs in home or hobby...TV, appliance, lamp, radio or plumbing repairs...precision soldering, brazing or metal craft. Useful, too, for starting charcoal fires. A tiny, clean, safe charger does the job.

Each charger gives 30 minutes of intense 3500° pinpoint flame; turns on and off. Extra chargers, 39¢ per box of 2. Money back guarantee. At leading hardware and hobby stores... or send check or money order, we pay postage.

Kidde

KIDDE MANUFACTURING CO., INC.
Dept. T-1
42 Farrand Street, Bloomfield, N. J.

Please send me _____ JET KING BLOW TORCHES plus:
_____ boxes extra chargers (limit 2 boxes per torch).
My check , money order for \$ _____ is enclosed.
Name _____
Street _____
City _____ State _____

For better finishes use ADALOX sandpaper



BELTS



CUT SHEETS



DISCS



ROLLS

Bring-up smooth finishes every time with fast-cutting Behr-Manning ADALOX sandpapers. Available in a wide selection of grits and backings to boost both your hand and machine sanding operations. Keep a supply handy in your home or shop. Ask for ADALOX at local Hardware and Paint Stores.

Here's HELPFUL FINISHING DATA

32 illustrated pages on the how-to of finishing wood and metal. At your Hardware or Paint Store, or send 25¢ to Behr-Manning Co., Troy, N. Y., Dept. PM-10



C-7



BEHR-MANNING PRODUCTS: Coated Abrasives • Sharpening Stones • Behr-cat Tapes
NORTON PRODUCTS: Abrasives • Grinding Wheels • Grinding Machines • Refractories

procedures. Wiener's job was to brief pilots and ground personnel who would be going out over the ice. He emphasized the dangers of frostbite, snow blindness, and the importance of staying dry. "Antarctica is as safe or dangerous as you make it," he told them. "The water under the bay ice here is 28 degrees, and your life in it is good for about eight minutes. If you should fall in, get out fast and roll in the snow to blot out moisture. Jump around, brush off the snow and roll some more. Shiver all you want. Shivering is the body's way of creating energy and warmth by drumming up circulation. But get home as fast as you can—and don't take off your boots, or your feet may freeze solid."

Orange Immersion Suits

For helicopter pilots flying over water, Deepfreeze sported bright-orange experimental immersion suits this year. The easily spotted insulated "froggy suits" were tested in 29-degree sea water at Cape Evans by three swimmers, who dog-paddled around for 35 minutes in what they claimed was "solid comfort."

Men were shown how to make cardboard masks with slits, to avoid snow blindness if sunglasses were lost. "You don't need a sunny day to go snow-blind," Wiener informed us. "Some of the worst cases occur under overcast." He drove home the point with a personal experience during a Greenland trek in 1937—without glasses. "In three days I was blind," he said. "The pain was as bad as though hot poker speared my eyeballs. I lay groaning in a dark hut for four days before I could stand daylight again."

Crews were briefed on antarctic phenomena so that by the time they hit the ice they knew what to expect. Mirages, produced by density differential in the air, like desert phenomena, are a common sight on the flat, endless barrier. Odd little fogs created by encampments and people are a polar curiosity. You can spot a group of men below the horizon 10 miles away, by the tiny cloud of condensation their body heat creates above them. Usually it is composed of frost flakes.

The major stressed the wisdom of holing in during blizzards or whiteouts. Whiteout occurs when light bounces between overcast sky and snow, wiping out shadows and horizon. A man can fall off a 10-foot embankment without seeing it. The effect of whiteout on open barrier is like being suspended in space. Pilots were warned to stay on the ground during such conditions.

One of the wildest examples of what can happen to pilots who won't stay put in

(Continued to page 298)

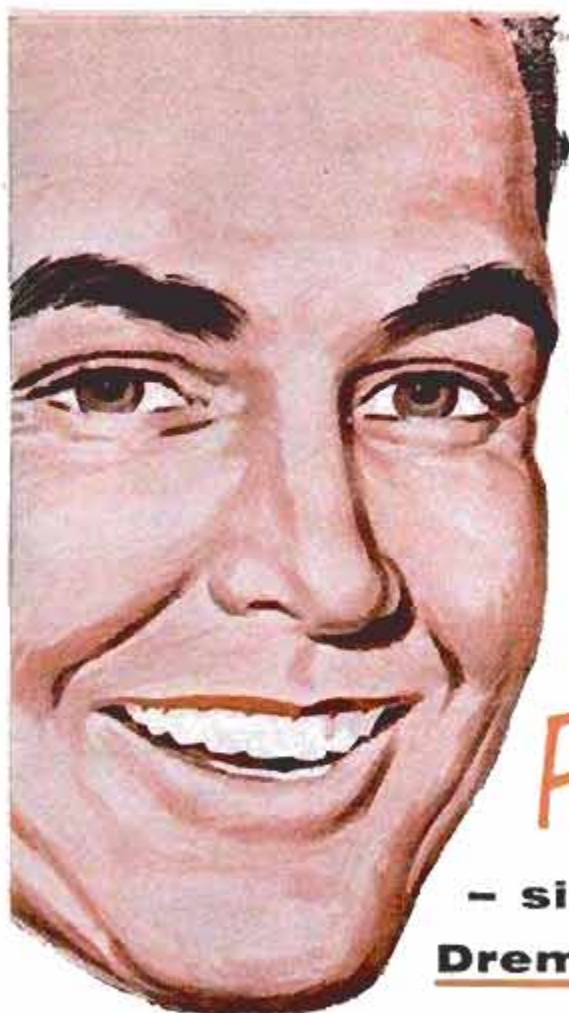

So light, a card table can be your workbench.



Fun is a Family Affair!

— since we got our **Dremel Moto-Jig Saw**

Woodworking is a happy family hobby, when you have a Dremel Moto-Jig Saw.

You don't need special skills. You don't need a special workshop. You don't need a lot of money—the low, low price of a Dremel Moto-Jig Saw includes a powerful rotary motor—not a vibrator.

A PROFESSIONAL-QUALITY TOOL!

Not a toy—New **ROCKER-ACTION** principle actually out-performs heavier, more expensive jig saws—practically eliminates the age-old blade-breakage problem. Rubber suction cups eliminate need for bolting permanently to workbench. Cuts 1 3/4" wood.

IT'S SUPER-SAFE!

Even Junior can use your Dremel Moto-Jig Saw without your worrying. A specially designed blade guard makes it safe for young, inexperienced operators. This safety feature has popularized its use in Cub Scouting, elementary schools, 4-H Club work, etc.

PROVE IT YOURSELF!

Don't take our word for all this. Inspect the Dremel Moto-Jig Saw up close at your hardware or hobby-craft store. See if you don't agree then that you just can't make a better investment for wholesome family fun.

Send coupon for free catalog.



New, Exciting Pattern Packet

Contains full-size patterns for 16 fascinating projects, carbon tracing paper, and complete instructions. Projects include a tie rack, ring-throwing game,

house-number sign, sewing-accessory stand, earring holder, and other useful home projects you can make for fun, gifts, or profit. Order by coupon—75¢.

MODEL 15

Weights 12 lbs.
15" throat—cuts to center of 30" circle

\$29.95

MODEL 8

Weights 10 lbs.
8" throat—cuts to center of 16" circle

\$23.50

Prices include ROTARY MOTOR

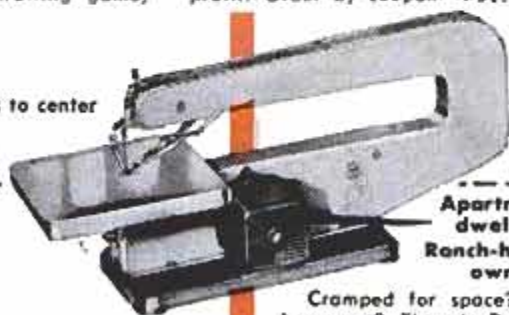

Apartment dwellers!
Ranch-home owners!

Cramped for space? No basement? Then the Dremel is for you. Set up shop on the kitchen table—store in a closet when not in use.



SEE YOUR DEALER. If he can't supply you, order direct on 5-DAY trial, money-back GUARANTEE! We ship post paid.

DREMEL MFG. CO., Dept. 116K, Racine, Wisconsin

Enclosed is check money order for \$..... in full payment for one Model..... Dremel Moto-Jig Saw. If not satisfied, I can return it in 5 days and get my money back.

Enclosed is.....¢ for packet of 16 jig-saw patterns
 Send me free power-tool catalog.

Name.....

Address.....

City..... Zone..... State.....

Why is Jim* the only guy in the plant who always has money?



He rides
to work
on a

**new 100-mile-per-gallon
HARLEY-DAVIDSON
HUMMER**

*Here's why Jim always has money

Depreciation on a Hummer is less than \$10 per month. Car averages \$50.

Fuel for a week's riding (130 miles) on a Hummer costs 40¢—car, about \$2.50.

After minimum down payment, monthly installments (18) on a Hummer are as low as \$17 including fire, theft and collision insurance; local taxes, freight and carrying charges. Similar monthly car payments would exceed \$100.00.

Yessir, wheeling to work on a new 1957 Harley-Davidson Hummer is more than fun! It's the quickest, most practical and economical transportation you can own. Now, 5" brakes — front and rear — provide even greater safety. New colors in amazing new enamel . . . last longer . . . need no waxing.

Why not stop in at your Harley-Davidson dealer. See for yourself how the new Hummer will save you money, time and trouble . . . make riding to and from work a thrilling invigorating pleasure.

Other models available to meet every purpose, any purse. See your dealer.

HARLEY-DAVIDSON
MOTOR COMPANY
DEPARTMENT P • MILWAUKEE 1, WISCONSIN

whiteout occurred in Greenland, when a PBY pilot heading home over the icecap during such a phenomenon, suddenly felt a bump. Nothing seemed wrong outside, but his air speed was dropping. He applied power, but nothing happened. Then he tried to drop the nose. It wouldn't go down. The pilot was "flying" on the ground without even knowing it. So, he and his crew spent 16 days living on tight rations and huddling to keep warm until rescue parties could reach them.

Deepfreeze personnel learned that Antarctica's wildlife is not all friendly, despite the sociable habits of most. Among the lazy seals, sprawling near tidal cracks sunning themselves, are sea leopards that resemble seals. "Poke one with a ski pole and you'll see the difference," Wiener warned. "An ugly reptilian head will open a yawning jaw studded with sharp teeth. He'll lash out in attack and promptly kill you."

Killer Whales

The 35-foot killer whales coasting along the ice edge in schools also have antisocial habits. Diving under the ledge, they heave up in unison to crack the ice and toss tender morsels like seals and people into the sea, where they are quickly torn apart and eaten. "Even the comical Emperor Penguin will fight back if teased," the major revealed. "And he can break a man's leg with his powerful flippers if he's excited. He probably doesn't mean it, but the leg is broken."

"You can listen to lectures forever," Wiener finally concluded. "But it's being on an expedition that teaches you. You'll learn fast on the ice."

We did. Within 24 hours, one correspondent had fallen through a crack in McMurdo's ice and come home dripping icicles. Several cases of snow blindness screamed the darkness away in the depths of the ships, reminding everyone not to forget sunglasses.

Men learned to build snow caves and houses of snow blocks cut with snow knives. The entrance is built lower than living area, so heat generated by human bodies is trapped inside. Three or four men can raise a good igloo's temperature to well above freezing when it's sub-zero outside. Even a single candle can produce surprising warmth. Simplest shelter is a hole in the snow, with peaked or arched roof of snow blocks over the top. More elaborate is the snow house, made of snow-block walls roofed with a parachute canopy.

"Hang on to your parachute," was a point hammered at airmen continually. You get

(Continued to page 300)

NOW You Can Have the Right Screw and Save Time and Money, too!



From prized reproductions to modern furniture — your workshop projects deserve the components that assure Quality and Permanence... Southern Fasteners — made of finest materials available — are headed, threaded and tested for quick starting and permanent grip.

You get Double Economy, too, when you buy Southern Screws by the box! Save up to 50% on the cost of your fasteners — save hours of time in trips to the hardware store to buy expensive pre-packaged screws by the half-dozen.

Specify Southern—and to be sure of the size of Southern Screws you need, mail the coupon below for our new FREE Technical Chart No. 4, for measuring length and diameter of Wood and Sheet Metal Screws, list of head styles available, pilot hole and drill bit sizes. Send for your copy today.



wood screws
machine screws
A&B tapping screws
dowel screws
wood & type U
drive screws
roll thread
carriage bolts
stove bolts
hanger bolts

SOUTHERN SCREW COMPANY

Box 1360 — PM-10
Statesville, North Carolina

Please send me my FREE COPY of TC-4.

Name _____

Address _____

City _____ Zone _____ State _____



Warehouses: NEW YORK • CHICAGO • LOS ANGELES • DALLAS • Sold Through Leading Wholesale Distributors

OCTOBER 1956

For those
who buy the best!

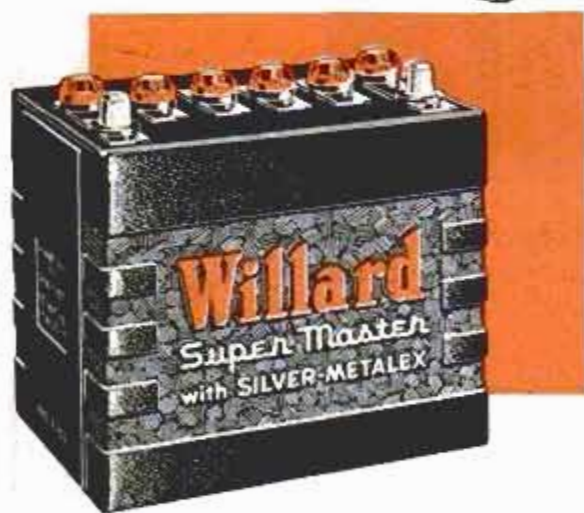

The battery with new Silver-Metalex Grid Alloy for life-long fresh power!

Now, a battery that maintains a full reserve of factory-fresh power . . . gives years of lightning-quick, dependable starts, regardless of how much—or how little—you drive. It's the all-new . . .

→ *Super Master*

Warranted by competent dealers
everywhere — and wherever you drive!

Import
299

the idea when you realize the things that its shrouds, webbing, canopy and metal parts can provide in emergency: lean-tos, bedrolls, blankets, slingshots, fishlines and hooks, nets, mukluks, eye shields against snow blindness, scarves, leggings, bandages, splints, packs, sails, snowshoes and signal panels.

It was an abandoned parachute, carelessly tossed in a rescue weasel after a plane crash, that made a tepee for five Deepfreeze Seabees when their vehicle plunged into a crack 20 miles back on McMurdo's ice. Without it, they'd never have survived the two-day blizzard that kept them pinned down.

Wind Makes it Colder

Cold and wind are two primary hazards in Antarctica. "Every knot of wind in sub-zero temperature is equal to an extra degree of cold," according to several old-timers. Antarctica has plenty of both. It freezes skin. Tears turn to icicles. Moisture from breath coats glasses and hoods with white rime. Eyelashes freeze and nostril hairs fuse into a frigid lump of ice.

Frostbite is painless in early stages, so Wiener advised the men to use the "buddy system" on the ice. Each man could watch the other for the telltale yellowish-white blotches. Gentle massage with warm, bare fingers is the antidote, they discovered. The old remedy of rubbing with snow can cause irreparable damage to the injured tissue. This year, the Air Force tried new sleeve muffs, into which hands can be drawn when not needed. Stitched to the outside of each muff is a patch of mouton for rubbing frostbitten noses or cheeks and restoring circulation.

There's another advantage to the buddy system. If one man falls in a crack or crevasse, the other can pull him out. Deepfreeze men soon learned to snowshoe or ski across virgin snow single file, roped together like mountain climbers. More than one man plunged through a snow-roofed crevasse, and hung dangling at the end of a line attached to the waist of his dug-in buddy until he could be hauled out. But there were no casualties from this source.

Out in the open, most Deepfreeze personnel wore Thermosuits and Thermoboots. These garments were developed for production by Salvatore Gianola and Dominic Maglio, two ex-Navy Brooklynites now heading the Techno Efficiency Council. The clothes are based on the refrigerator principle of moisture barrier insulation. Suits have half an inch of nylon fleece sandwiched between two layers of impervious neoprene-coated fabric. Boots are

(Continued to page 302)



SKIL

6 1/2" SAW

ZIPS through the toughest cuts!

This quiet-running SKIL 6 1/2" Saw zips through dressed 2 x 4's—even at 45° bevel. Weighs only 11 pounds for easy one-hand operation. Has high-speed blade (6100 r.p.m.), heavy-duty motor with die-cast housing, telescopic safety guard, quick-setting depth and bevel adjustments. A real professional builder's saw, priced for the homeowner at only \$64.95!

Ask for a free demonstration today! See the SKIL 6 1/2" Saw at your hardware, appliance, or department store. Other SKIL Saws from 4 1/4" at \$34.95 to 8 1/4" at \$89.95.



Look for this
SKIL TOOL CENTER
 at your local hardware store!

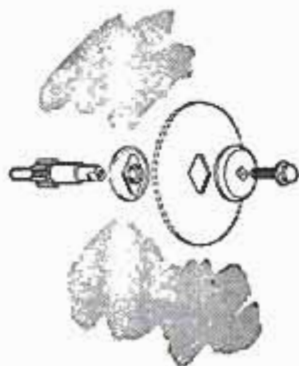

EXCLUSIVE! New SKIL Vari-torque Clutch now available on larger SKIL Builders Saws. Protects user against kickback . . . saves wear and tear on gears, bearings and motor. On every job . . . through the toughest cuts . . . it's smooth, fast going with a SKIL Builders Saw. Over a million now in use by carpenters and craftsmen!



Made only by SKIL Corporation, formerly SKILSAW, Inc.
 5033 Elston Avenue, Chicago 30, Illinois • 3601 Dundas Street West, Toronto 9, Ontario
 Factory Branches in ALL Leading Cities

"CRESTOGRIP"

The New Utility Plier

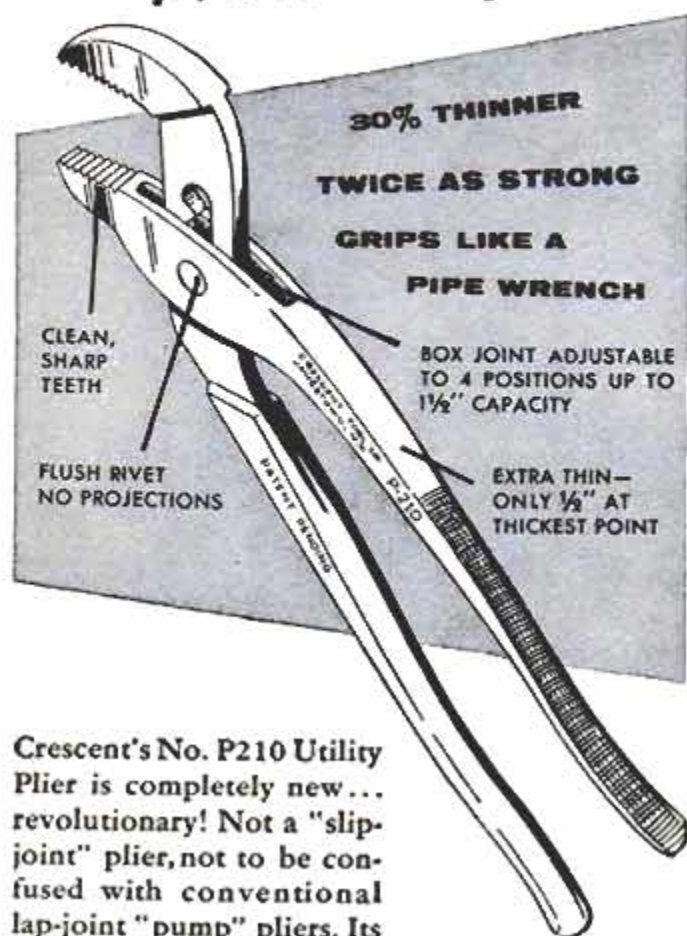

Crescent's No. P210 Utility Plier is completely new... revolutionary! Not a "slip-joint" plier, not to be confused with conventional lap-joint "pump" pliers. Its double-strong box joint design is absolutely unique. It will grip flat, square, hex or round objects with powerful leverage. Handsomely finished in rust-resistant zinc plate.



QUICK, POSITIVE ADJUSTMENT

This cut-away view shows joint construction with its extra generous bearing surface at the arrow point.

\$3.00

Sold by hardware stores everywhere.

CRESCENT TOOLS

Give Wings to Work

*Sign of the Artisan
Symbol of Excellence*



Crescent is our trade-mark, registered in the United States and abroad, for wrenches and other tools. Sold by leading distributors and retailers everywhere and made only by

CRESCENT TOOL COMPANY, JAMESTOWN, N. Y.

similarly insulated, with rubber skin outside and in. Wearing this outfit is like being in a Thermos jug. Keep moving and it's good to 60 below zero.

Warned About Perspiration

Ordinarily, perspiration is one of the first things the polar greenhorn is warned about. Body moisture fills air spaces of fabric, freezes and, instead of having clothing to insulate you, a suit of ice conducts the cold right to tender flesh. It's an old polar custom for shirt, pants, mittens and socks to go to bed with a man so his body heat will dry them out. In Thermoclothes, you swim in perspiration because there's no place for it to go. But, since the insulation is sealed and dry, you stay insulated.

To demonstrate these clothes before I went on Deepfreeze, Sal Gianola dressed me in a bright-red civilian outfit, designed for hunters and skiers. He shoved me under a cold shower until I was as wet inside as out. Then he stood me in a cold room where the temperature was minus 50 degrees. A 40-knot synthetic wind whistled around my ears. I stayed there 20 minutes with icicles hanging from my sleeves. When I came out, the water inside was still there, but I had warmed it to body temperature.

Insulated or not, the experienced polar traveler wears just enough to keep him warm without perspiring, shedding as the work grows harder, and buttoning up at the halt.

Probably the most violently controversial subject in polar survival is whether a beard is a help or hindrance. In a blizzard it's a menace. Snow particles cling to it and breath makes icicles in it. A man can wind up not only looking like an ice sculpture for a winter carnival, but can easily sustain severe frostbite. Under Antarctica's dazzling summer sun, however, a beard is a great burn preventive. Besides, shaving with melted snow water each morning leaves something to be desired. Major Wiener refused to discuss the subject. "Anyone can see where I stand," he told us as he stroked three inches of carefully cultivated foliage. ★ ★ ★

Rocket Fuel

Becomes Rust Inhibitor

Hydrazine, a chemical that was used as a rocket fuel in World War II, now has become a weapon in the war against rust. The chemical is a highly effective agent for the removal of dissolved oxygen from water, a chief cause of rust. A nonflammable form of hydrazine has been developed for use in steam boilers.

IDEAS FROM WELDWOOD

THIS MONTH'S PROJECT—DRESSING UP A FIREPLACE WALL

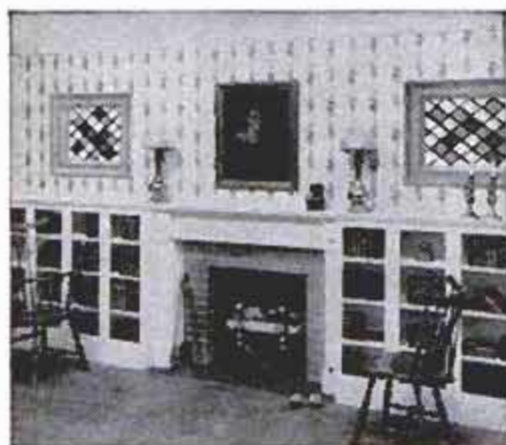

The Weldwood Question Box

Q. I have a sort of "free form" curved bar in my cellar, and I would like to wood panel it. Is there any way I could bend wood paneling to fit curves?

A. Yes. If the curves are not "too curvy," you can use ordinary Weldwood hardwood plywood paneling. Use $\frac{1}{8}$ " thick paneling—(available in a wide range of woods)—and nail it on or attach with Weldwood Contact Cement. Paneling $\frac{1}{8}$ " thick has enough "give" to bend to some degree. If, on the other hand, the curves are too acute, the only other method is to groove the back of the panels to allow them to bend.

Look what Weldwood paneling and a dash of imagination did for this 1926 living room! Weldwood paneling really makes a remodeling or modernization job a snap. In this room, Cherry V-Plank* paneling was used. The big 4' x 8' panels go up quickly and easily, are grooved to give that random-plank effect. And the grooves are spaced to fall on 16" centers and hide nail holes. (Paneling may be installed *without* nails by using Weldwood Contact Cement.)

Weldwood paneling, you know, ends forever the need of painting or redecorating. It's a one-time investment—and not a very high one, at that. For example, in this room, all that Cherry V-Plank—including that used as facing for radio-phonograph compartment (left) and desk-bookcase unit (right)—costs only \$107. That's the first and the final cost!

Remodeling this room is the featured project in the latest issue of Delta Power Tool's "Deltagram." To get your copy—which even includes step-by-step directions for making all the built-ins—just send coupon.

*Trade Mark

This Month's Hints

1. Your breadbox will do double-duty if you follow this suggestion. A piece of Weldwood plywood attached inside the door of a front-opening breadbox serves as a bread cutting board whenever the door is opened. Attach plywood to door with Contact Cement,

or drill and use nuts and bolts. R. W., Union, N. J.
2. $\frac{1}{4}$ " and $\frac{3}{8}$ " scraps of Weldwood Plywood can be cut into triangular shapes and used as gussets to strengthen the corners of window screens, shipping crates, doors, etc. L. M., Lincoln, Indiana.

This method is tricky and we would recommend it only to experienced woodworkers.

HAVE A QUESTION?

Send it to "The Weldwood Question Box," 55 West 44th Street, New York 36, N. Y.

\$10 for your ideas
for "This Month's Hints," if accepted for publication. (Hints must apply to some Weldwood product.) Send them to "Weldwood Hint Editor," 55 West 44th St., New York 36, N. Y.



Weldwood®

A product of

United States Plywood Corporation

Weldwood—The Best Known Name in Plywood

United States Plywood Corporation
55 West 44th St., New York 36, N. Y.

Enclosed find 10¢ for remodeling issue of the "Deltagram." PM10-56

NAME.....

ADDRESS.....

CITY.....STATE.....

HOW TO ADD AN EXTRA ROOM TO YOUR HOUSE



The Fiberglas Do-It-Yourself Bug makes it easy to do . . . with this FREE book!

It's a simple job to finish your attic, add an extra room, enclose a porch or build a screened patio, when you use this 16-page book as a guide. Complete step-by-step instructions take you from start to finish in easy stages and with lots of pictures.

The book even shows how fuel savings *alone* can pay for all the insulation . . . if you install the necessary amount of Fiberglas* Insulation. You'll find out why you need *fully* adequate insulation—not just minimum amounts—to enjoy low-cost comfort *all year 'round*. So for the *easy* way to add a room or finish an attic, and the *right* way to fully insulate for a warmer house in winter at lower fuel cost, and a cooler house in summer, rush this coupon for your **FREE BOOKLET** today!



OWENS-CORNING
FIBERGLAS

VT.M. Reg. Owens-Corning Fiberglas Corporation

Owens-Corning Fiberglas Corporation,
Dept. 178-J, Toledo 1, Ohio

Please rush me a **FREE** copy of the Fiberglas "How To Do-It-Yourself" book.



Name.....

Address.....

City.....Zone.....State.....

Volkswagen May Not Be Big, But It's Fine

(Continued from page 159)

"Maybe it's just my car, but it takes two hands to shift into reverse."—Connecticut schoolteacher.

"The car is dangerously in need of more torque at moderate speeds for passing."—Pennsylvania anthropologist.

"Underpowered when passing, especially with four passengers."—Ohio body-shop owner.

"Heater could give more heat at city speeds."—Wisconsin TV technician.

"Should have provision for defrost without heat or at least without heat to the lower duct outlets."—Ohio engineer.

"Back bumper is too easily pushed in by American cars. I often find I cannot open the back end of the car to get at the engine after someone has dented the bumper."—California secretary.

Fabulous VW Stories

Every VW owner seems to have an anecdote about his automobile that is worth repeating.

"I climbed a bunch-grass hillside lined with deep cow trails that has even stumped four-wheel-drive vehicles. I had two men in the rear seat. I also ran into a deep puddle of water (about 14 inches deep and 150 feet long) at 40 miles per hour. The car weathered the water and actually floated across the deepest part."—Washington wheat farmer.

"During unusually heavy rains the little Volks negotiated flooded fords and pools that made less hardy breeds hesitate. In one instance, it ran for quite a distance with both exhaust pipes underwater. The interior remained high, dry and comfortable."—California electronic technician.

"The spirit of friendship between VW owners is something not found when driving a domestic car. Recently while on a week-end outing, we stopped to take some pictures. A passing VW from out of state stopped to inquire if we were having any trouble and if he could help."—Illinois machine designer.

"Can go almost any place. Once we could not make it between some trees so we lifted the car around inch by inch to continue on a footpath. We emerged among some hikers who were shocked to see a car come out of the woods at that point."—North Dakota student.

"I use my VW for exploring river-valley country where there are no roads. I get through mud holes and willow thickets fully loaded. I've climbed earth dams

(Continued to page 306)

NEW!

ROCKWELL-BUILT

DELTA 9"

tilting arbor saw

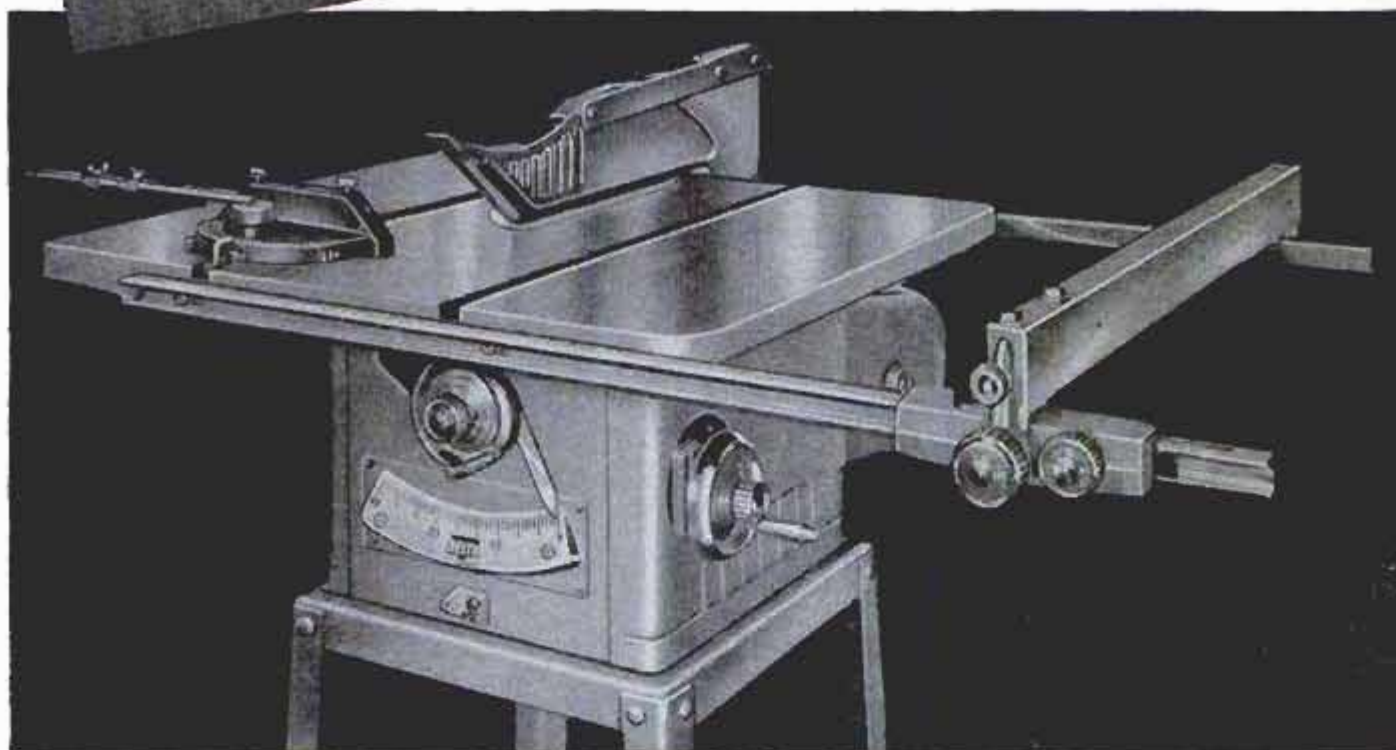

... biggest saw value you've ever seen!

Finest 9" saw ever built for home workshops—bigger, better, safer—and its really low price will amaze you! But you have to see it and try it to appreciate these outstanding Delta Quality features:

NEW SAFETY, CONVENIENCE: Protected switch prevents accidental starting—up-front controls conveniently grouped for safer, easier operation—raised tilt angle scale that's easy to see, easy to read.

BIG SAW CAPACITY AND PRECISION: Full 9" capacity! Cuts 2 $\frac{3}{4}$ " deep, rips to center of 48" panel.

PLUS all the famous Delta Quality features that give you years of accurate, trouble-free operation.

Get all the facts about Delta's big new 9" Tilting Arbor Saw—compare and make up your own mind! And get the facts about easy Delta Budget Plan terms—as little as 10% down, as long as 24 months! Your Delta Dealer is listed under "TOOLS" in the Yellow Pages of the phone book.



Send for
FREE catalog!



Delta Power Tool Div., Rockwell Manufacturing Co.
502K N. Lexington Ave., Pittsburgh 8, Pa.

- Please send complete information on new Delta 9" Tilting Arbor Saw.
- Please send name of my nearest Delta Dealer.

Name _____

Address _____

City _____ County _____ State _____



another product by
ROCKWELL



where only 'Cats' and bulldozers have been before."—Missouri writer.

"I had my car washed in a three-minute car wash. I jokingly suggested that I should get it washed at half price. So it was!"—Washington insurance inspector.

"Some of my friends, during my absence, put the 'bug' on top of a low stone wall. They later lifted it down with me in it."—Kentucky treasurer.

"When we got the new VW home and in the garage for the first time our dog barked furiously at the car and would not go near it. She ran in circles around the car, barking all the while."—New Jersey owner.

"About once every two weeks people come up to my house, ring the doorbell and ask what is that thing parked in front. They say it's real cute. They ask the price, how I like it, and walk away saying 'You know, we should have a car like that.'—Pennsylvania technician.

"I hit a 10-inch pool of water at 40 miles per hour and scooted across as if on water skis."—California switchman.

"I want to beam every time I look at the VW and have noticed the same expression on most VW owners when they wave or toot their horn as we pass each other."—California homemaker.

"My husband would trade me in before he would his VW."—Louisiana housewife.

"My only real complaint is that I have to fight with my wife to get to drive."—California flight inspector.

And More Complaints

Perhaps after reading the preceding you understand better the VW owner's infatuation with his car.

He still permits himself to complain a bit, however, and here are some more things he would like changed:

"Gas gauge should be standard equipment."—California information director.

"Should use a dash light to warn of low fuel supply instead of floor lever. At 60 miles per hour on a crowded highway or at low speeds in heavy traffic, the VW will cough, sputter and cease to perform for a frightening 5 to 10 seconds while driver thrashes at the floor lever switching to auxiliary tank. My system now is to buy gas every 300 miles."—Ohio designer.

"My only real complaint is the fact that when windows are open (I have tried every possible combination) a drumming noise is created that seems likely to burst an eardrum."—California conductor.

"Back windows should open. Door should close easier when windows are shut."—New York lawyer.

(Continued to page 308)

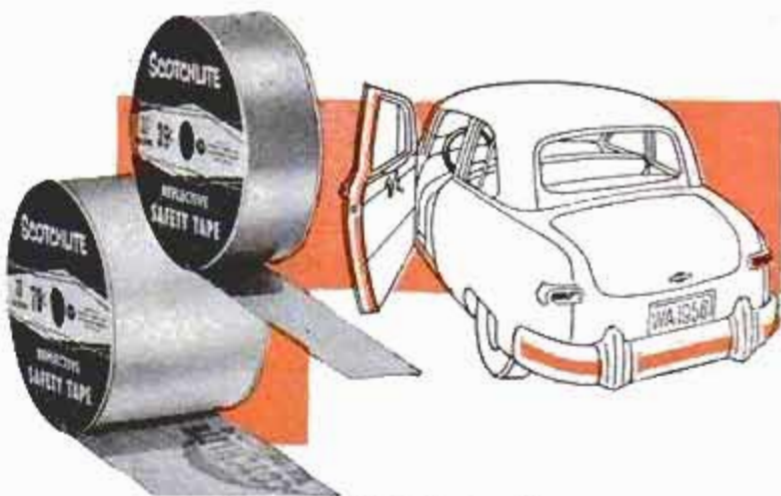

"Scotchlite" Reflector Tape

More complete night safety. Reflects up to 200 times more light than other parts of car.

Red, 1'x30" (C2599)	394
Red, 2'x30" (C2594)	784
Silver, 1'x30" (C2593)	394
Silver, 2'x30" (C2595)	784

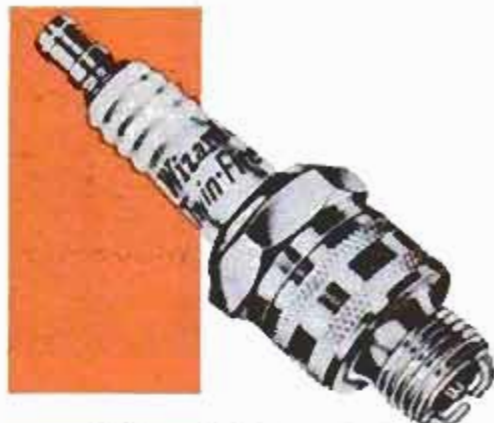

Wizard "Twin-Fire"® Spark Plugs . . . guaranteed 18,000 miles! Give top performance twice as long as single electrode plugs. (Alternate firing twin electrodes stay accurately gapped up to twice as long.) Sets of 4 or more, ea. (11070-95) **75c**



Entirely new kind of wax! Vista, made by Simoniz, is a new turbo-whipped cream wax that cleans and waxes in one easy application . . . yet gives cars the lustre and all-weather durability of a paste-wax job! 10 oz. can (3P722) **\$2.00**



Like a "tune-up"! For better engine performance the year around, add Casite to your motor oil with every oil change. Keeps engine clean. Gives you easier, faster starting... quiet, smooth power. Ideal for new cars. Pint, only (A1329)..... **\$1.00**



Repair your brakes, quickly, easily — with Wizard Master and Wheel Cylinder Kits. Includes live rubber cups, boots, pistons, springs, etc. For most cars, trucks. Master Cyl. Kits, with piston (55750-85)..... from **98c**
Wheel Cyl. Kits (52805-41)..... from **37c**

Non-slip, non-stretch, cool running! Top quality Wizard Fan Belts are guaranteed to fit. Inner core of endless rubber impregnated rayon cords. Tough rubber cushion assures efficient, peak performance. Carry a spare! (79105)..... **\$1.19**

"New-Condition" Your Car Now

Choose from over 4,000 guaranteed top quality parts and accessories at

Western Auto

Stores and Associate Stores



Wizard Tune-Up Kit makes it easy to "tune" ignition system. Complete kit with heavy duty points, condenser, rotor. Saves gas, makes car start easier, run smoother, perform better. Easy instructions. All popular cars. (14815-32) ... From **\$1.10**



Car Top Carriers. Reddi-Rak, all steel—completely assembled. Adjustable. Heavy web straps anchor to rain gutter... vacuum cups support and cushion any load.
Strong steel 45" (65229) Pr. **\$8.55**
Hardwood 48" (65279) Pr. **\$6.50**



Protect floor of your car and help keep trade-in value high with these twin Floor Mats. Cover entire front area, flat and slope. Designed to stay in place. Fit all cars. All new rubber. Black, red, blue, green, yellow, white. (201130-5) Pair **\$4.59**

NOTE: In some areas of the U. S., Hawaii, Alaska, and Mexico, prices slightly higher. Western Auto Associate Dealers own their stores, set their own prices, terms and conditions. (PM106)



WIZARD POWER TOOLS
...built to make it and take it!



WIZARD 6 1/4" PORTABLE SAW: Cuts 2x4 at 45°. Adjustable cut to 2 1/8". Powerful 7 amp. motor. Special slip-clutch prevents motor burn out.

With rip guide and safety guard **\$39.95**

Other models \$29.95 to \$52.95

Team up with WIZARD for a faster, easier job. These rugged tools are compact, easy to handle, yet big enough for any home project. Check the complete line of power-packed WIZARDS at your nearby Western Auto Store before you buy *any* tool . . . then

JOIN THE MILLIONS WHO KNOW THAT YOU GET MORE TOOL PER DOLLAR WITH WIZARD THAN WITH ANY OTHER NATIONAL BRAND!

WIZARD 1/4" DRILL:

Powerful, 2 amp. motor. Gearing chuck. Locking trigger. Accessories and kits are available. **\$19.50**

Others \$12.50 to \$49.95



Wizard



OVER 400 ITEMS FOR THE WORKSHOP

Sold Nationally by

Western Auto

STORES AND ASSOCIATE STORES

NOTE: In some areas of the U. S., Hawaii, Alaska, and Mexico, prices slightly higher. Western Auto Associate Dealers own their stores, set their own prices, terms and conditions.

"Turn circle too large for such a small automobile."—Florida doctor.

"Car must be shifted frequently in city driving."—New Jersey engineer.

"Accelerator pedal is too high from the floor. Makes it hard driving in high heels, besides it wears out the back of my shoe."—Texas secretary.

"Wife doesn't like the roller accelerator pedal."—California underwriter.

"Gas fumes noticeable just after taking on gas."—New Jersey nurse.

"Space behind rear seat difficult to load."—Virginia travel manager.

"Too little legroom in back. In fact, I must sell it for that reason and hate to."—Virginia real-estate saleswoman.

"Battery in inconvenient place."—Oklahoma student.

"Brake and clutch pedal too close together."—New York mechanic.

"No place for left foot while driving, except on top of dimmer."—Maryland engineer.

"Not enough luggage space for such items as golf clubs and carts."—California writer.

Good on Long Trips

Prospective owners may consider the VW fine for around town, but not so good for long vacation trips. Most of the owners disagree with this opinion.

"The thing that amazed our friends is that on our trip to Florida we drove 650 miles on Saturday and the remaining 550 miles the next day. We cleaned up and were sightseeing by 4:30 p.m. that same day. Coming back we drove 1000 miles straight through from Georgia in 24 hours."—Ohio stockbroker.

"Two adults and two children went over 3000 miles on our vacation trip. We drove over 70 miles per hour. Better than 500 miles a day, averaging 35 1/2 miles per gallon."—Florida painting contractor.

"Drove 2000 miles in 37 hours. Had no trouble. 35 miles per gallon. Total trip of 4000 miles cost about \$33. Comfortable."—California switchman.

"Just returned from a 1525-mile trip. Used \$15.27 worth of gas. Highway speed was 72 miles per hour. On the trip were my wife and I who rode in the roomy, adjustable, reclining front seats. In the nose or trunk I had two cots, my camp stove and two pillows. In the back-seat area we had our tent, icebox, food and utensil box, six quilts, two small suitcases, minnow bucket, three fishing rods and some odds and ends."—Oklahoma Air Force inspector.

"Well impressed after a 1400-mile trip in two days. No discomfort, stiffness or soreness."—Oklahoma insurance salesman.

(Continued to page 313)

QUICK SANDPAPER SOLUTIONS

to common household
problems
by
CARBORUNDUM

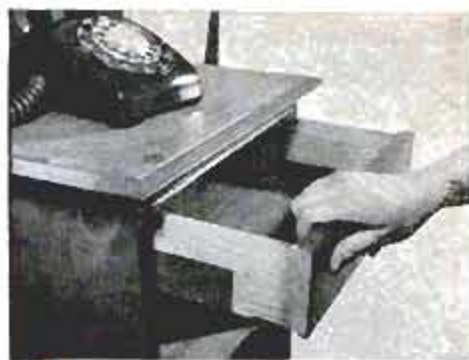

● **Repair Binding Drawers**—Cement a small piece of Fine Garnet Paper by CARBORUNDUM, sand side out, to shiny spot where drawer binds. Work drawer in and out till it's free, and remove paper.



● **Open Stubborn Jar Covers**—SAND SCREEN by CARBORUNDUM is a magic jar opener. Gives you a firm grip to loosen covers quickly without damaging them.

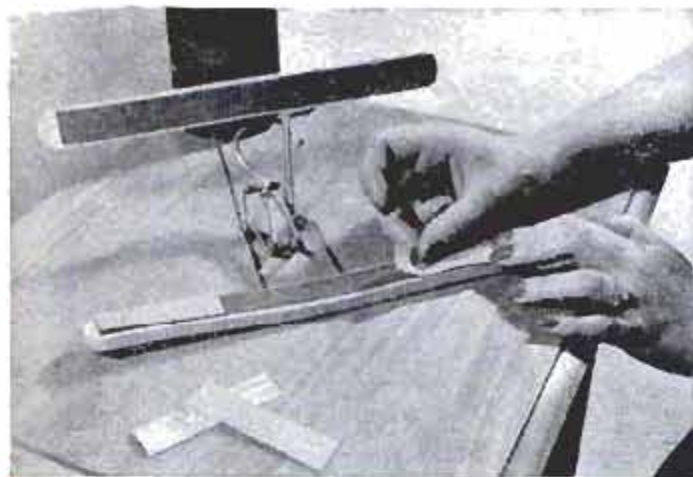

● **Make Non-Slip Hangers**—Glue small strips of Medium Emery Cloth by CARBORUNDUM to the jaws of the hanger—makes a tight non-slip grip for trousers or skirts.

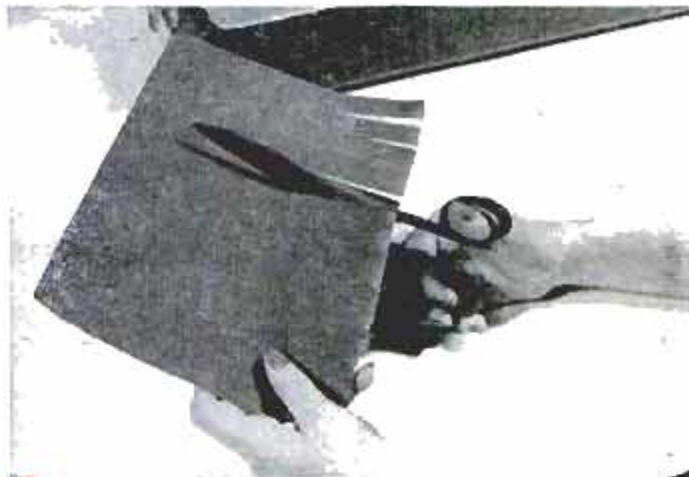

● **Sharpen Scissors**—Scissors can be sharpened quickly and as good as new by taking several cuts through a piece of CARBORUNDUM's Medium Emery Cloth.



● **Fix Sticky Doors**—No need to remove hinges. Just slip a sheet of Medium Garnet Paper by CARBORUNDUM under door. Open and close door till action is free.



● **A good workshop idea**—Glue small strips of emery cloth to your bench. Use to quickly sharpen knives, tools and drawing pencil.

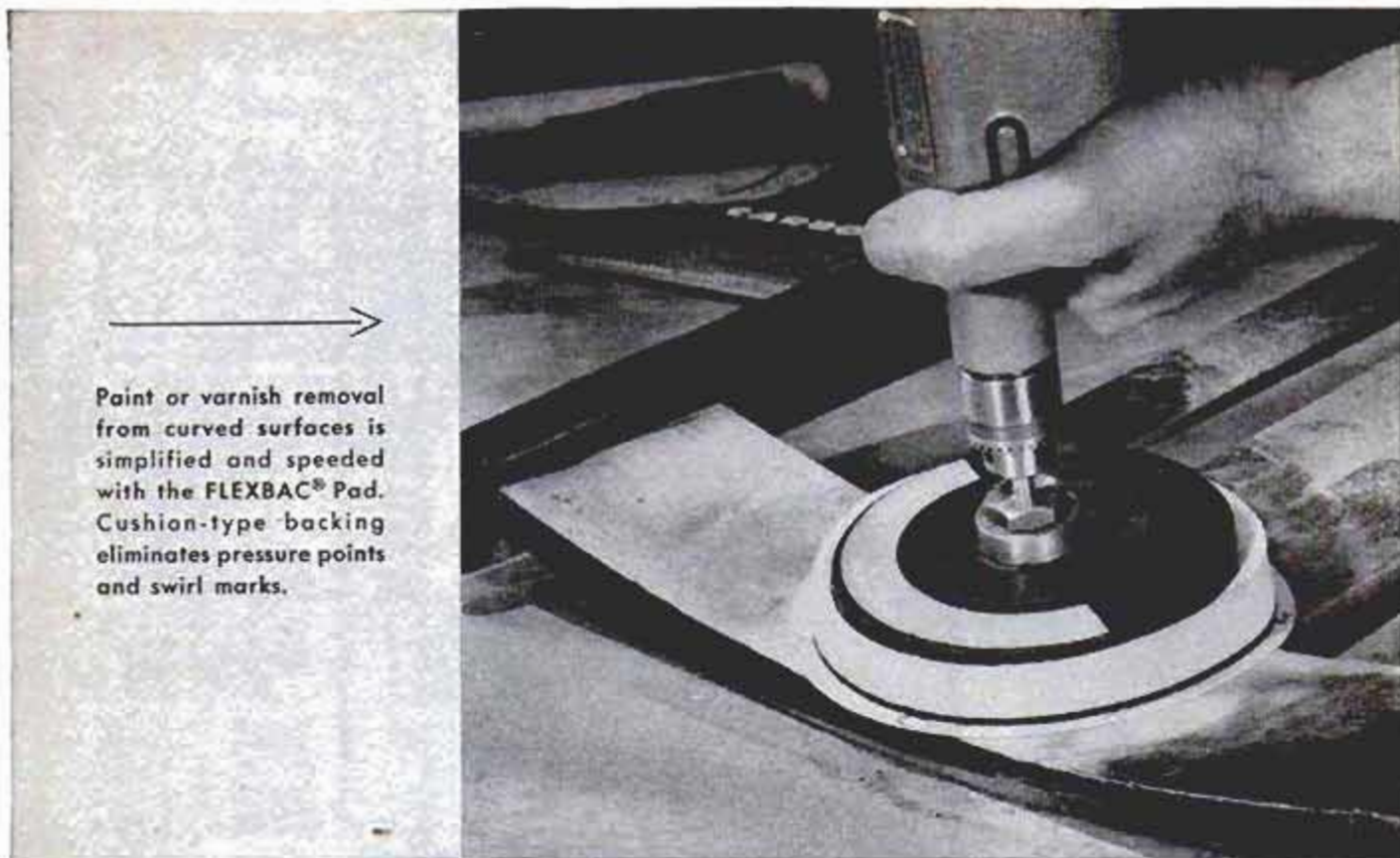

→
 Paint or varnish removal from curved surfaces is simplified and speeded with the FLEXBAC® Pad. Cushion-type backing eliminates pressure points and swirl marks.

How to get **EXTRA WORK** *out of your electric drill*

- **It's easy to Disc-Sand**
 —professionally with
 this **NEW... versatile**
FLEXBAC® Pad

Now you can tackle sanding jobs with your electric drill that used to involve long hours of plain elbow grease. CARBORUNDUM's new FLEXBAC® Pad makes power sanding easy, even for the amateur, because it does away with swirl marks you get with ordinary disc sanding. This cushion-type pad is completely pliable from center to outer edge permitting the sander disc to follow contours and curves smoothly and evenly on either wood, metal or plastic. A natural for contour work on furniture or boats, the FLEXBAC® Pad is also a real time saver on flat surface jobs such as preparing interior or exterior walls for painting.



Easy to install adapter spindle to fit all portable electric drills is provided with each FLEXBAC® Kit.



Adhesive surface of pad is protected with special cover when FLEXBAC® is not in use.



Heat from a light bulb will quickly restore adhesive to normal tackiness, if lost after long periods of storage.

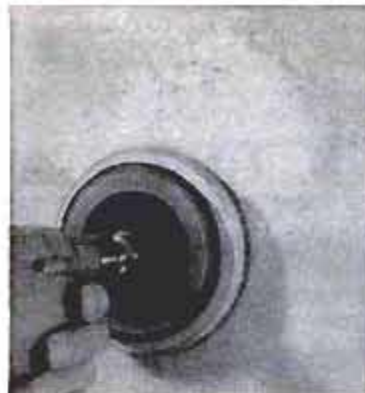

← You can patch plaster professionally even without a steady trowel. Your electric drill and a FLEXBAC® Pad will blend the patched area perfectly, ready for paint.

→ Wallboard joints become invisible in a hurry with FLEXBAC®. The disc rides on a cushion-type pad and you can whisk it lightly over the dry joint cement without leaving a mark.

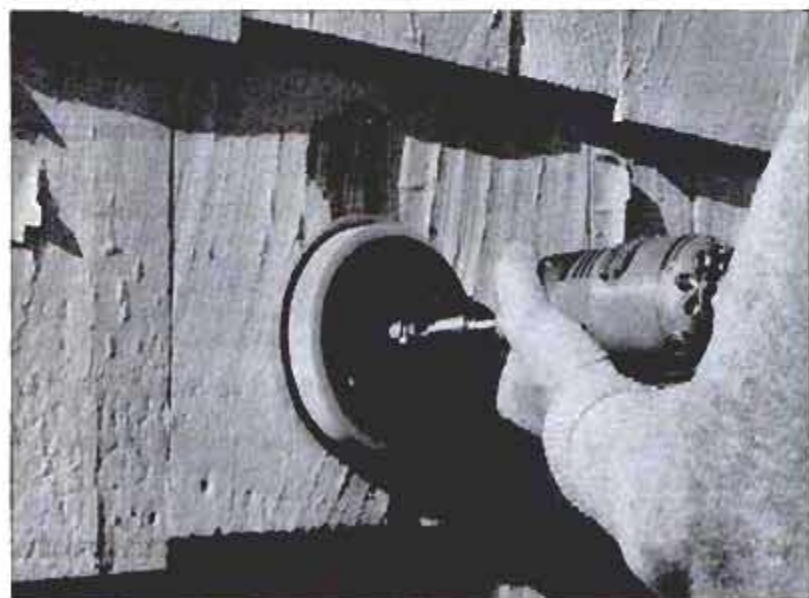

FLEXBAC® is fast and smooth on flat surfaces too. Excellent for removing old scaly paint before repainting.



Spades, hoes and other garden tools can be easily polished with a FLEXBAC® Disc Sander. Cleans off even crusted cement, leaving metal sparkling new.

The pad is pre-coated with a pressure-sensitive adhesive which holds the sander disc in place. Discs can be changed in a second by merely "peeling" the old one from the pad and pressing on a new one in its place. The adhesive quality is maintained with an adhesive restorer which can be quickly brushed on the pad occasionally as needed. The FLEXBAC® Pad Kit is available at CARBORUNDUM's hardware and building supply dealers everywhere. HANDY-SANDY Discs by CARBORUNDUM can be bought for the FLEXBAC® Pad in five different grit sizes or in packs of assorted grits.



Merely press on a HANDY-SANDY Disc by CARBORUNDUM on face of pad. To change discs, simply peel off old disc and press on a new one.

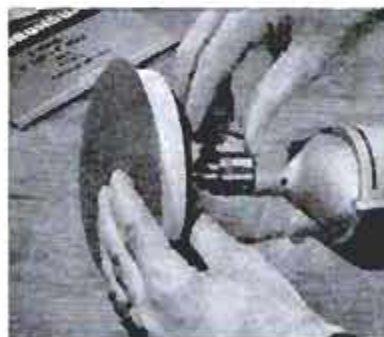

Adapter spindle is tightened in drill chuck. Recommended speed of drill for FLEXBAC® is up to 3000 r. p. m.



Periodically, depending on rate of use and type of operation, adhesive on FLEXBAC® Pad should be renewed with adhesive reactivator.

SHARPENING TIPS from CARBORUNDUM

Sharp cutting tools are not only more efficient and faster than dull tools, they're safer. Sharp edges cut as you expect them to—dull edges slip and are most often the cause of cuts and bruised knuckles.

Abrasive stones are inexpensive and there's one designed by CARBORUNDUM for every sharpening purpose. You'll get keener edges and longer tool life by always using the *right* sharpening stone.

PLANE BLADES and CHISELS

Use a CARBORUNDUM Brand Silicon Carbide Combination Stone. Hold the blade against coarse side, take even smooth strokes until a wire edge is produced. On the other side of stone (fine grid) place chisel flat and take a few light strokes. To produce a perfect cutting edge, draw the edge through a piece of wood.



MOWER BLADES

Without removing from machine, a nicked mower blade can be sharpened with a few strokes of a No. 46 Home and Garden Stone by CARBORUNDUM. The shape of this stone permits it to reach every part from bed knife to blades.

FARM TOOLS

The No. 57 File by CARBORUNDUM is excellent for putting keen edges on spades, hoes and other farm implements. It gives better and longer service than metal files.

ABRASIVES TO USE WHEN REFINISHING FURNITURE

REFINISHING STEPS		ABRASIVE MATERIAL BY CARBORUNDUM®	GRIT SIZE	REMARKS
REMOVING OLD FINISH	Roughing off	Flint Paper	Coarse	Until surface of wood is slightly exposed.
PREPARING SURFACE	High spots, scars, etc.	Garnet Cabinet Paper	80—1/0 (Coarse)	Dents can be raised with moist cloth and electric iron.
	Final Wood Finish	Garnet Finishing Paper	120—3/0 (Medium)	Until completely smooth.
	After staining	Garnet Finishing Paper	220—6/0 (Ex. Fine)	Lightly.
FINAL FINISH COATS Penetrating Wood Finish:	After 1st Coat	Garnet Cabinet Paper	220—6/0 (Ex. Fine)	Lightly.
	After 2nd Coat	RED-1-CUT® Waterproof Paper	320 (Fine)	Use dry.
	After 3rd Coat	RED-1-CUT® Waterproof Paper	400 (Ex. Fine)	Use lukewarm mild soap solution to lubricate.
VARNISH	After applying Sealer	Garnet Finishing Paper	220—6/0 (Ex. Fine)	Use filler and sealer first if required.
	After 1st, 2nd Varnish Coats	RED-1-CUT® Waterproof Paper	320 (Fine)	Use dry.
	After final Varnish Coat	RED-1-CUT® Waterproof Paper	400 (Ex. Fine)	Use with soap solution.
SHELLAC	After 1st Coat	Garnet Finishing Paper	220—6/0 (Ex. Fine)	Use filler and sealer if required.
	After 2nd Coat	RED-1-CUT® Waterproof Paper	320 (Fine)	Use dry.
	After Final Coat	RED-1-CUT® Waterproof Paper	400 (Ex. Fine)	Use with soap solution.
ENAMEL	After Primer	Garnet Finishing Paper	220—6/0 (Ex. Fine)	Lightly.
	After 1st Enamel Coat	RED-1-CUT® Waterproof Paper	320 (Fine)	Lightly—do not sand final enamel coat.

In grit-size numbering system, 1/0 is equivalent to 80 grit; 6/0 is 220; 9/0 is 320 and 10/0 is 400.

CARBORUNDUM

REGISTERED TRADE MARK

...**FIRST** with the **BEST** in everything **ABRASIVE**

CARBORUNDUM®, FLEXBAC®, RED-1-CUT®, and SAND SCREEN are trade marks which indicate manufacture by The Carborundum Company.

Here, in order of frequency of mention, are more of the features liked best by the Volkswagen owners:

"Everything about this car is top notch. Those Germans are real craftsmen."—Pennsylvania realtor.

"I like the way it holds the road at 70 miles per hour."—Michigan diemaker.

"I like the peace of mind I have knowing I am driving the finest engineered automobile in the world."—California engineering supervisor.

"I now own two VWs. I discovered the trade-in value of the 1955 VW was \$1700 so I decided to keep it for my son and daughter. Now we have two and I plan to trade one each year. The trade-in value of the two-year-old will be about \$1500."—Delaware underwriter.

"A delightful car. Fun to drive. A car with its own personality."—Florida student.

"Needs no repairs. I drive a motor route for a newspaper seven days a week, making 600 stops in three hours and about 40 miles. The car has held up for 9000 miles and still haven't taken the brakes up. This is the first car on the route that uses no oil. It averages between 21 and 25 miles per gallon on the route."—Nebraska route man.

"Excellent winter car. Did not use chains or snow tires once and passed many cars stuck on hills or in snowbanks."—Massachusetts bank clerk.

"Storage space behind rear seat ideal for pups, cats, birds or small active boys."—California aircraft inspector.

"Less trouble to wash and wax as it has about half the surface of conventional car. My wife likes the absence of engine heat on her feet."—Florida minister.

"Sold on its tight body construction. Bought it for city driving only, but since then the other car just sits and we do all or most all of our driving in the VW."—Nebraska packing-house worker.

"My wife threatened divorce if I bought a VW. But I bought it anyway. Now she wants one."—Washington, D. C., broker.

"The jack is wonderfully simple and efficient. I have changed a flat in my dress suit, it's so simple."—California teacher.

"Toughest little car I've ever been in. You get every ounce of power, gas and speed it has got and never feel sorry for it. If I need more than one car, I'll have two VWs."—Ohio modelmaker.

There it is—the story of the most enthusiastic collection of owners ever to have taken part in a *Popular Mechanics* Owners Report. For the dispassionate view of an analytical engineer turn to Dale Kelly's report on page 156. For the veteran's view of the VW, read what Floyd Clymer writes beginning on page 154. ★ ★ ★



Even
without
this
famous
guarantee

Genuine
RIDGID
would still be
**the World's Most
Popular Pipe Wrench**



Millions of
users know it
out-performs,
out-lasts all others!

It's the "RIDGID" name that guarantees you everything you want in a pipe wrench—instant bite on the pipe or conduit, instant let-go—it can't lock because of patented hookjaw suspension . . . handy pipe scale, easy-spin adjusting nut, comfort-grip I-beam handle and every one factory-tested before shipment! For your work, for your home, it's most for your money—buy it at your Hardware Store!



The Ridge Tool Company, Elyria, Ohio, U.S.A.

Useful, Dependable, High Quality
Starrett tools

for HOME IMPROVEMENT
HOME WORKSHOP
DO-IT-YOURSELF
CARPENTRY & WOODWORKING

No. 132 Precision Bench Level
4", 6", 9", 12", 18", 24" sizes



No. 9 Combination Set with square head, center head and non-reversible protractor head. 12", 18", 24" sizes

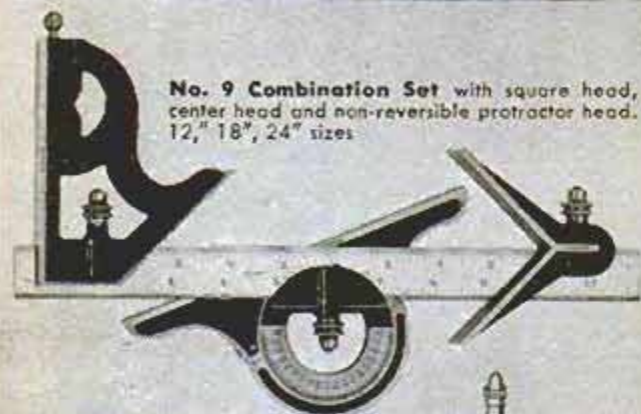

No. 800 Square Head Nail Sets. Five point sizes — 1/32" to 1/2"



Starrett Tool and Instrument Oil has countless uses around the house.

- No. 604-R Steel Rules, 1" to 72" lengths, 8ths, 16ths, Quick Reading 32nds, 64ths
- No. 439 24" Combination Tool—seven useful tools in one
- No. 47 6" Universal Bevel
- No. 92 Dividers 6" to 9"
- No. 85 Improved Extension Dividers, 7" to 12"
- No. 50 Improved Trammels
- No. 59 Precision Trammels and Attachments
- No. 108 Aluminum Line Level
- No. 116 Bevel End Nail Sets
- No. 176A Extra Heavy Nail Sets
- No. 111 Stair Gage Fixtures
- No. 470 Hexagonal Stair Gage Fixtures

- No. 87 Mercury Plumb Bob
- No. 99 Popular Priced Transit
- No. 101C Leveling Instrument
- No. 999 Leveling Rod and Plastic Target
- No. 554 "Eyeglass" Screw Driver
- No. 425 Pocket Slide Caliper
- No. 548 Architect's Pocket Tape
- No. 530 Easy-Read, No-Glare Steel Tape
- No. 129 Bench Block
- No. 819 Lightweight Automatic Centering Punch
- No. BS1214 Bluestripe High Speed Hacksaw Blades
- SAFE-FLEX High Speed Hole Saws

FREE Starrett Catalog displaying all these and many more Starrett precision tools, tapes, hacksaws, band saws and band knives. Write Dept. AP.



THE L. S. STARRETT COMPANY
Athol, Massachusetts, U. S. A.

Clymer Drives the Volkswagen

(Continued from page 154)

wheel for as long as 10 seconds before directional control was necessary.

Compression ratio is 6.6 to 1, low by our standards, and regular gas is satisfactory. Repair work on the engine can be done easily and, if necessary, the entire engine and transmission can be removed in about 30 minutes. The engine is precisely built and the instruction manual states "no break-in period is necessary and your car may be operated right from the beginning at the full speeds recommended for the gears."

The four-speed transmission shifts easily and silently. Top gear (fourth) should be used for speeds above 35 and for cruising. For moderate inclines and heavy traffic, third is most desirable. My top speed in third gear was 60, although not higher than 45 is recommended. Reverse is engaged by pressing down on the lever and moving it to the left and back.

Because of the suspension system, which uses torsion bars front and rear and independently sprung rear axles, the driver can corner very fast with practically no roll or sway.

The steering ratio is very fast, requiring only 2.4 turns of the wheel from lock to lock. It feels as though you aim the car rather than steer it. The car is especially easy to park or turn around. Despite the lowness of the car, road clearance is 6.8 inches, almost as much as the average American car.

Gasoline mileage was extremely high, even while driving at quite high speeds. Oil consumption was nil. Crankcase oil capacity is only 5.3 pints. One delightful thing about driving a Volkswagen is that the gas tank, while holding only 10.6 gallons, still enables the operator to drive a long distance without refueling. A reserve gas supply of 1.3 gallons (opened by a lever at the base of the fire wall) is an excellent feature, and is good for 40 additional miles after the main-tank supply is exhausted.

The air-cooling system for the engine works perfectly. I drove the car in 106-degree heat on the Mojave Desert for 10 miles in low gear without overheating. Of course having no water to boil was a real joy.

Brakes are excellent and there was no evidence of fading even while braking at high speed or descending steep grades. The clutch and brake pedals are located too close together—at least, for a man with big feet. Travel between the throttle and the brake pedal should be a little less. Either

(Continued to page 316)

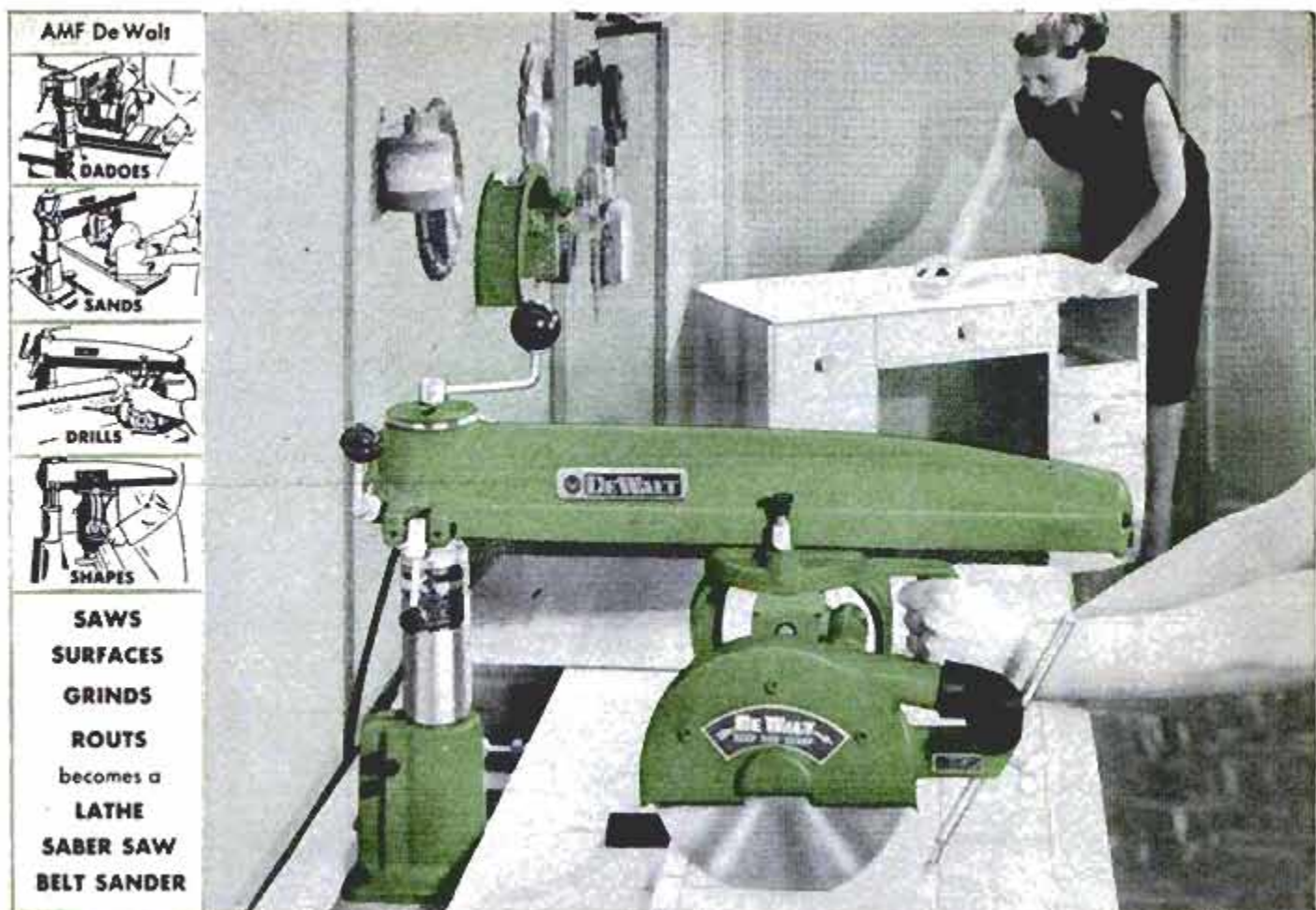

Only \$239 delivered, complete with 9" saw blade and $\frac{3}{4}$ hp motor

Only AMF DE WALT makes making things so easy!

With a versatile AMF DeWalt® Home Power Shop, you can make home repairs, build furniture, handle even major projects like a *professional!*

AMF DeWalt is the *first* all-purpose power tool designed on the modern mechanical arm principle that outmodes all other power tools. It's actually 12 professional power tools in 1—a *complete home workshop!*

- **Arm swings and locks at any position** for miter cuts—gives easier, safer *top-side cutting* that eliminates errors . . . you see your mark *and* your cut.
- **Builds into workbench!** Because entire arm *swings clear* of work area, you can cut and assemble on the same work bench! *Save valuable space* and get *extra convenience too!*
- **Powerful $\frac{3}{4}$ hp motor is U. I. Approved**—guaranteed for full year—tilts and turns to any angle.

Motor carriage rolls smoothly on ball bearings in protected trackways. Simply change circular tool on direct-drive motor shaft and you have another power tool—at *no added cost!*

— **Superior safety and accuracy!** Exclusive DeWalt Safety Key Switch prevents unauthorized use. DeWalt's patented design and rugged precision construction provides safety *and* unmatched accuracy that assures years of superior workmanship.

INSIST ON A DEMONSTRATION. See why, *feature by feature*, AMF DeWalt is the finest home power shop you can buy. A small down payment on DeWalt's Easi-Budget Payment Plan* will put an AMF DeWalt in your workshop *now*.

OWNERS! Valuable new Owner's Manual just off the press, "Easy Ways to Expert Woodworking," \$4.95 postpaid. Order yours today!

*Does not apply in Arkansas or outside U. S. continental limits

SEND COUPON FOR FREE ILLUSTRATED BOOKLET!

AMF DeWalt Inc., Dept. PM-610, Lancaster, Pa., Subsidiary of AMERICAN MACHINE & FOUNDRY COMPANY



Please send FREE colorful illustrated 20-page Booklet

Name _____

Address _____

City _____ Zone _____ State _____



the throttle lever should be higher or the brake pedal lower. The hand-brake lever is located between the two front seats and operates by an upward pull of the right hand—it is very efficient, easily applied and released.

There is surprising leg and head room in the car. Unlike foreign-built sports cars, entry and exit are easy. The doors are wide, light and easy to open and close. Despite lowness of the car, the doors have more curb clearance than some American cars. The driving position is comfortable. Each front seat can be independently adjusted to suit the driver and passenger. A thumb lever allows selection of three different angles of incline for the seat back.

The interior is beautifully finished and the instrument panel is very plain but functional. High-grade imitation-leather upholstery is used. Gasoline tank and spare tire are under the front hood. This hood is locked from inside and released by a pull knob on the dash. There is also luggage space under the hood in addition to the luggage space behind the rear seat. A small pocket in the left door is for maps, gloves or other small articles. All in all, there is quite a lot of luggage space for the size of the car. There are a small glove compartment and an ash tray in front of the passenger.

There is no fuel gauge. The reserve gas supply provides ample warning time when fuel is needed. There is a direction indicator, a green warning light for oil pressure, and a red warning light for generator and cooling system.

The clutch and brake pedals require moderate operating pressure. There is a roller on top of the accelerator pedal. A good feature is the fact that the throttle lever has long movement, which eliminates any sensitive quick-action operation.

The heating arrangement is satisfactory. Hot air from the engine flows into the body through ducts controlled by a knob at the base of the shift lever. The defroster is also satisfactory.

The body has a solid feel, undoubtedly due to the fact that the frame and body are built as a single welded unit. No squeaks or rattles developed. Three turns of the rather small cranks are required to open the windows. This action should be faster.

Front vision is excellent due to stubby, sloping hood. Side vision is satisfactory. Rear vision would be improved by a larger rear window.

Volkswagen has no automatic transmission available.

In mud, snow or sand the engine weight

(Continued to page 318)

**THE PRIZE IS YOURS!
MAN... YOU'RE IN!**

**NOW, THERE'S A PRIZE
I'D LOVE TO WIN!**

**SMELLS GRAND!
PACKS RIGHT!
SMOKES SWEET!
CAN'T BITE!**

**A PIPE SMOKER,
TOO? mmmm!
YOU'RE FOR
ME**

**IT'S
SIR WALTER
RALEIGH-
NATURALLY!**

**SIR WALTER RALEIGH'S BLEND OF CHOICE
KENTUCKY BURLEYS IS EXTRA-AGED
TO GUARD AGAINST TONGUE BITE.**

FREE!

**24-PAGE BOOKLET ON
PIPE CARE. JUST WRITE
TO: SIR WALTER RALEIGH
DEPT. 121-J
LOUISVILLE, KY.**

ELECTRIC MOTORS—POWER KITS for HOBBY-RESEARCH-INDUSTRY



The Wilson's line offers complete motorizing service—1½ to 12 volt motors—powerful low speed and variable speed gear trains—parts for all types of drives—complete kits—for driving toys, models, research projects and industrial devices. This list may help solve a gift or technical problem for you.

- No. 8-100 Hi-Drive Motor, 3-6V. \$2.50
- No. 9-100 Same for 12V. \$3.00
- No. 3-100 Tiny Atom Motor, 1½-3V. \$2.00
- For higher voltages. \$2.50
- No. 3113N Tiny Atom motor assembly kit with many acc. \$3.50
- No. 1300N Small accessories kit \$1.00
- No. 3700 Large accessories kit \$3.00
- No. 4000 De-Luxe accessories kit with motor. \$5.00
- No. 700 Super-Power kit with motor, speed reducer, all accessories. \$10.00
- No. 88 Kit of 8 pulleys—2 belts \$2.00
- No. 3000 Vari-speed gear unit. \$4.00
- No. 1049 Gear train with Hi-Drive motor No. 8-100. \$5.95
- Same with No. 9-100 Motor. \$6.45
- Item illustrated. Ask for FREE Cat.

All Wilson's motors have Permanent Alnico Magnets.

Remit with order and we pay postage in U.S.A. No. C.G.D. Add 3% Sales Tax for delivery in Ohio. Write Dept. PM.

For quick delivery see your local dealer — or order direct

WILSON'S OF CLEVELAND

425 Lakeside Ave., N.W. • Cleveland 13, Ohio



"We put TWINSULATION in our attic... and are we glad!"

"Our house stays warm all winter—fuel bills have dropped 25%."



"Upstairs rooms stay comfortably cool all summer."



"We did it all in one afternoon, and even I put up part of it."



Two insulations in one, TWINSULATION® combines rock wool (to block heat), aluminum (to reflect heat). Gold Bond wraps an aluminum covering all around thick blankets of rock wool. That's why TWINSULATION cuts winter fuel bills up to 25%, keeps your home up to 15° cooler in summer. Easy to handle, easy to put up. See your nearest Gold Bond® dealer. He's listed in your October 1st issue of Life magazine. Look him up... soon!

SEND FOR ILLUSTRATED BOOKLET

Gold Bond

BUILDING PRODUCTS



National Gypsum Company, Dept. PM106
Buffalo 2, New York

I enclose 10¢ for "Home Insulation" booklet.

Name _____

Street _____

City _____ State _____

BUILD FINE GRANDFATHER CLOCK NOW
The simple sensible Red-Kut way as thousands have—**SAVE HALF. SHOP TESTED PLANS "SPIRIT OF THE CENTURY"** Narrow waist 83" tall or stately straight side **"SPIRIT OF AMERICA."** **EASY-TO-FOLLOW** plans tell all—plus **BROCHURE** of heavy brass weight Westminster, tube chime, movements, gorgeous bronze-silver dials, 3/4" solid mahogany case kits. **Send \$1.00 today—Both plans \$1.50 NOW.**
Kuempel Chime Clock Works, 28 Kuempel Bldg., Minneapolis 16, Minn.

ONE-MAN SAWMILL LOW AS \$50.00 DOWN
Take BELSAW Portable Sawmill right to the trees—turn out valuable lumber for home and farm—sell to local yards—make up to \$50 a day custom sawing for neighbors. BELSAW lasts a lifetime. No crew needed. Power with tractor or auto engine. Beginners get excellent results. Send today for **FREE BOOK.**
BELSAW MACHINERY CO.
Full 3457 Field Bldg. Kansas City 11, Missouri

SAY YOU SAW IT IN POPULAR MECHANICS

Protect your home against power interruptions with an...
ONAN Emergency ELECTRIC PLANT
Provides dependable stand-by electricity for heating system, pumps, freezer, lights, appliances. Keeps home safe, livable. Automatic start and stop. Find out how little it costs!
Write for Folder!
D. W. ONAN & SONS, INC.
3648 University Ave. S. E. • Minneapolis 14, Minnesota

A SIZE FOR EVERY NEED
500 to 50,000 watts.
Compact, quiet-running.
Gasoline-powered.
Priced from \$255.00



Make this decorative Santa Sleigh with

ELMER'S® Waterproof Glue

Brighten your home during the holidays with this outdoor Christmas decoration. And be sure you build with Elmer's Waterproof Glue to insure bonds stronger than the wood itself. Resistant to acids, alkalis, fungus, rot, weather, it's the glue used by boatbuilding experts.



Santa Claus Sleigh. Full size EAST-BILD® Pattern #434. Just trace, saw, assemble. Only 50¢. Send cash or money order to Elmer's Pattern Dept. PM-106, P.O. Box 215, Pleasantville, N. Y. *T.M. Reg. East-Bild Pattern Co., Inc.

Repair as strong as new with

ELMER'S® GLUE-ALL



Helps repair or build furniture neatly, easily. Elmer's modern, plastic glue is strong, dries quickly. Ideal for wood, paper, cloth. Handy squeeze bottle speeds job.

Bond plastic laminates to plywood with

ELMER'S® CONTACT CEMENT

Does professional job quickly, without clamps, nails, presses. Highly resistant to heat, water. Outperforms other contact cements in stress tests.



At hardware, lumber, paint, marine supply dealers. The Borden Company, Chemical Division



IF IT'S **Borden's** IT'S GOT TO BE GOOD

in rear helps make for good traction. While descending my favorite 32-percent test hill I could stop the VW at the steepest point and then back it up to the top—something that 75 percent of the American cars will not do. The car also topped the 600-yard hill at 15 miles per hour in low gear, which is faster than about half our American cars will do. Noise and fumes are at the rear, although the engine, like most air-cooled engines, is rather noisy.

There is a tendency to over-steer until one becomes accustomed to the car because of the light front end. One disadvantage is that on icy roads or on loose gravel, when cornering at high speeds, there is a tendency for the rear end to break loose and skid. But this need not concern the average conservative driver.

The excellent mechanical jack fits into a socket in the underside of either running board, thus the entire side of the car is quickly raised for tire changes.

I abused the Volkswagen in every way I could think of and punishment seems to have little effect upon the operation or handling of the car. If you drive a VW 100 miles or more, you lose the feeling that you are in a small car. There is no feeling of danger in the car. I do feel, however, that the Volkswagen driver must be more careful when signaling and when turning in traffic than the driver of a larger car.

In my judgment, the Volkswagen is a thoroughly practical, dependable, economical and worthwhile car for anyone interested in low-cost transportation. Nearly every Volkswagen owner is an unpaid salesman. He likes to talk about his car and most owners sing its praises from morning until night. The man who knocks the VW and says he wouldn't have one as a gift is usually the one who has never driven or ridden in one.

Service facilities are usually good, especially in the larger cities. Spare parts are readily available and, fortunately, few models and infrequent changes make it easier than usual for even a small dealer to carry a complete parts stock. ★ ★ ★

Mesquite Becomes Cattle Feed

Mesquite, long a plague of the West, may soon aid drought-stricken cattlemen as a livestock feed. The Southwest Foundation for Research and Education has been using mesquite in livestock feed successfully for three years. Only the woody, stem part of the bush is used. It is chipped, then ground into fibers. The fibers are combined with molasses and cottonseed meal. One half or more of the total feed is mesquite fibers.

\$500 FOR YOUR OLD HAND SAW OR POWER SAW!



ANY MAKE OR CONDITION!



MODEL 210
LISTS:

\$2995

Less \$5 Trade-In

or... **\$2495**

Your old hand or power saw (any make or condition) is good for a \$5 trade-in allowance towards purchase of the amazing new Syncro "210" True Cut Jig Saw at your tool dealer! This husky, massive, precision-built saw has big 15" throat, 100 sq. in. table — cuts 1 3/4" wood accurately — curved or straight! Powered with famous Syncro Reciprocating Motor—greatest achievement of power research. No belts, cams, gears. No rotating parts to wear out. Motor guaranteed against burn-out during ownership.

See your tool dealer today—trade in your old hand saw and save \$5! Offer ends Dec. 31, 1956.

\$ For \$ OUT-CUTS ALL OTHERS

SYNCRO

210 JIG SAW

SYNCRO CORPORATION • DEPT. 1-76 • OXFORD, MICHIGAN U. S. A.
WORLD'S LARGEST MANUFACTURER OF RECIPROCATING MOTORS

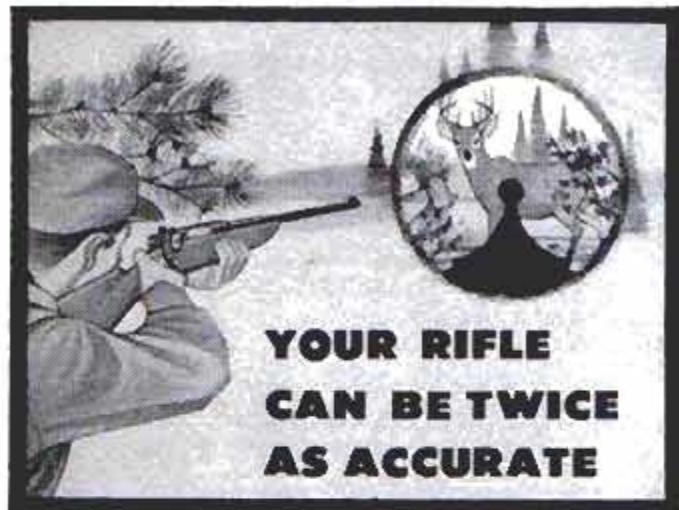

**YOUR RIFLE
CAN BE TWICE
AS ACCURATE**

Open rear sights cut the accuracy of modern guns and ammunition in half. Lyman precision receiver sights deliver all the accuracy built into your rifle.

SPECIFY LYMAN SIGHTS With a receiver and front sight combination for all popular rifles, you can have Lyman Sights for your gun for as little as \$6.50. You can't buy more accuracy at any price!

FREE CATALOG Discover how you can double your shooting accuracy. Send for free, full-color 24-page catalog. Describes all Lyman Products for Shooters.

THE LYMAN GUN SIGHT CORP.
MIDDLEFIELD • CONNECTICUT

STOP SAGGING REARS!



with
LOW-COST

AIR LIFT PNEUMATIC SPRING BOOSTERS

Car got that "middle age spread" look? Even new cars need help for overloads of luggage, equipment or extra passengers. AIR LIFTS fit between leaf springs and frame — inflate with air to support overloads up to 1000 lbs! Perfect for vacation trips, and so easy to install. See your dealer or write for his name.



FREE . . . tip-packed literature on Air Lift remedies for sagging rears. Write Dept. 410.



AIR LIFT COMPANY,
LANSING, MICHIGAN

SAVE MONEY ON EVERYTHING IN HI-FI

FREE

ALLIED'S 356-PAGE 1957 CATALOG



FEATURING THE WORLD'S
LARGEST STOCKS OF
HI-FI COMPONENTS
AND SYSTEMS



Save on Everything in Hi-Fi

Here's your complete money-saving guide to Hi-Fi. Shows you how to select a custom Hi-Fi music system for your home at no more than the cost of an ordinary phonograph. If you prefer to assemble your own system, tells you what to look for and how to save money on each unit. Offers you the world's largest selection of complete Hi-Fi systems as well as individual amplifiers, tuners, changers, speakers, enclosures and accessories from which to make your money-saving choice. Want to build-your-own?—see the famous Hi-Fi KNIGHT-KITS. For everything in Hi-Fi—for everything in Electronics, get the FREE 1957 ALLIED Catalog. Write for your copy today!

America's Hi-Fi Center • Our 36th Year

ALLIED RADIO

ALLIED RADIO CORP., Dept. A-106
100 N. Western Ave., Chicago 80, Illinois

Send FREE 1957 ALLIED 356-Page Catalog

Name _____

Address _____

City _____ Zone _____ State _____

Send
for FREE
Catalog

Magic Crystals Grown Here

(Continued from page 121)



A scintillation crystal of sodium iodide is sealed in an aluminum housing to protect it from moisture

work involving infrared and ultraviolet light. Perfect single crystals weighing, in most cases, as much as 35 pounds are produced from molten sodium chloride (table salt, or rock salt), lithium fluoride, potassium bromide, potassium chloride, potassium iodide, thallium bromide iodide, calcium fluoride, barium fluoride, cesium iodide, cesium bromide and optical silver chloride. The crystal ingot, after it emerges from the annealing furnace, is cut into prisms, lenses and windows. Such crystalline lens elements are used in making all sorts of lenses, including achromatic and apochromatic types—microscope objectives, camera lenses, telescope lenses and others. These are principally for infrared and ultraviolet work, but some are used with visible light. A crystal lens may be combined with lenses of other material such as quartz. The windows and prisms are used in such instruments as spectrometers for work with infrared and ultraviolet radiation.

Besides the routine melting of salt in a crucible, other techniques of making crystalline forms sometimes are used. The crystals can be grown in their natural forms by planting tiny crystal seeds in saturated solutions. Sometimes a crystal is formed by a process similar to powder metallurgy. The powdered salt is compressed in a vacuum chamber until it fuses into a uniform mass. This method is used for making potassium bromide pills for the identification of unknown substances. The purified bromide is combined with a quantity of the unknown chemical. When infrared radiation is passed through the pill, none is absorbed by the potassium bromide, and so the precise amount of infrared absorbed by the unknown can be determined. By comparing this absorption with that of known

(Continued to page 322)

Last year's profit \$3,000!

with a FOLEY AUTOMATIC SAW FILER



"Last year's profit amounted to \$3,000. Not so bad for a one-man outfit"—from Chas. C. Hough. James B. Williams wrote us—"I made \$765 last year filing saws, and it sure comes in handy. I do this work in my spare time." Men in communities of all sizes make up to \$3 or \$5 an hour with the Foley Saw Filer working full time or part time.

It's no trick to take care of the saw filing for your neighborhood hardware or lumber dealer — plus looking after the saws for farmers, townspeople, manual training departments and factories. The Foley files all hand saws, also band and cross-cut circular saws. It's a repeat cash business, no canvassing, no eyestrain and no experience needed.

Send Coupon for **FREE BOOK**
SHOWS HOW TO START

"MONEY MAKING FACTS" shows just how you can start at home in your spare time working in your basement or garage. It's an immediate cash business that can develop into a full-time repair shop. Send coupon today—no salesman will call.

FOLEY MFG. COMPANY
1016-G Foley Building, Minneapolis 18, Minnesota
Send me free book "MONEY MAKING FACTS"



Name _____

Address _____

Soldering is Easy

with
INSTANT STARTING



Lenk

LIQUEFIED **LP** PETROLEUM
Torch

only **\$2.95**

THE ONLY THROW-AWAY FUEL-CONTAINER WITH SELF-SEALING SAFETY VALVE.

Here's what you can do

- regular soldering, sweat fittings,
- silver soldering, refinish furniture,
- remove paint and putty

Available at Hardware Counters Everywhere.

Write for **FREE**
Soldering Instructions.

THE **Lenk** MFG CO.
BOSTON 15, MASS.

Speedy Sprayer

mobile paint sprayer

Choice of craftsmen for 35 years! Saves time, paint and money. Quickly gives flawless finish to walls, furniture, screens, fences and handiwork. Sprays all materials; ¼ H.P. motor. Diaphragm principle assures clean, oil-free air. Never needs lubrication. With gun, less motor.
No. 890 Speedy Sprayer . . . \$38.50

Add wheels with Wheel Kit No. 909. Includes 6" wheels, handle, fittings. **\$6.95**

FREE!

Write for
"How to Spray"
Booklet and
Literature.



At dealers everywhere

W. R. BROWN CORPORATION
2635 N. NORMANDY AVE., CHICAGO 35, ILLINOIS

Peels off Paint!



KLEAN-STRIP Remover makes any refinishing job easier

- Breaks bond between any finish and surface
- One application removes many coats
- Fast-acting, non-messy, easy to use
- Leaves surface smooth, dry, ready to refinish
- Needs no neutralizing or afterwash
- Buy Klean-Strip where you buy paint

NON-INFLAMMABLE
KLEAN-STRIP
PAINT REMOVER

The Klean-Strip Co., Inc.
2340 S. Lauderdale, Memphis 6, Tenn.



50% MORE PRACTICAL MALL 3/8" DRILL KIT



**"POWER PLANNED"—does all
usual kit jobs and many more**

New 389 kit does hard jobs in cement, steel and stone as well as in wood. Rugged 3/8" drill has geared chuck and key, 650 RPM, 60 cycle, 115 V. AC-DC motor, cord, switch and plug. U. L. approved. Ideal for masonry, for precision polishing and sanding. Bits, pedestal, pads, discs, handle and steel chest included. Get 50% more practical, more efficient MALL 389 drill kit wherever high quality tools are sold.

\$39⁹⁵

MALL TOOL COMPANY

Division of Remington Arms Company, Inc.
7805 South Chicago Avenue, Chicago 19, Illinois

substances, identity often can be established. The pill can be filed away for future use.

Crystals in Sheet Form

One of the infrared-transmitting materials frequently used for crystals is silver chloride. It happens that this salt is plastic at room temperature and so can be rolled into thin sheets and films. It can be cut into any form desired. Silver chloride has to be coated with silver sulphide (the stuff on tarnished silver) to protect it from ultraviolet radiation; otherwise the silver in it would precipitate out and render it opaque.

In the 1940s, about the end of the war, interest in crystals got a boost from the demand for scintillation devices. Scintillation crystals have the property of transforming short-wave electromagnetic radiation such as gamma rays into visible light. Small light flashes produced when the rays strike the crystal are picked up by a photoelectric tube, amplified and made to serve a useful purpose such as the production of audible clicks in an instrument designed for detecting uranium. Organic crystals such as those of naphthalene, stilbene and anthracene are used. Inorganic crystals suitable for scintillation counters include cesium, sodium and potassium iodides, and cesium bromide, to which small quantities of thallium iodide are added as an activator. Inorganic scintillation crystals are made into devices that are used for measuring energy of radiation.

Used in Locating Oil

Such scintillation crystals have a variety of uses other than the bloodhounding of uranium. They are valuable in physics and medicine. They are used in gauges for continuously checking the thickness of sheet materials such as plastic film emerging from a machine. They serve as X-ray detectors. One of their important uses is in the logging of oil wells by detecting radiation which may indicate the location of oil.

Scintillation crystals, John Harshaw explained, are being employed in blood studies. In one such application, living animal or human blood is made to circulate in a tube running through the crystal of a scintillation counter. A radioactive material injected into the blood stream passes through the tube and is detected by the crystal. The dilution of the injected material by the blood can thus be determined and the blood volume calculated. The scintillation crystal can also determine the aortal output. Another use for crystals that can "see" gamma rays is in the comparing of blood circulation through the feet or

(Continued to page 326)

NEW... *Estwing* Cushion Grip Hammer

UNMATCHED VALUE!

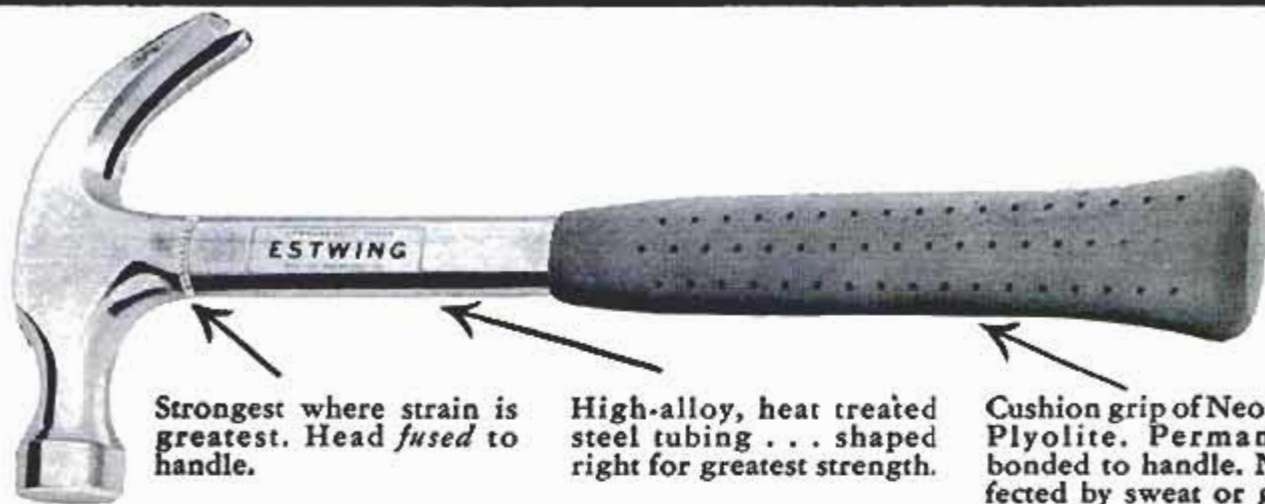

Strongest where strain is greatest. Head fused to handle.

High-alloy, heat treated steel tubing . . . shaped right for greatest strength.

Cushion grip of Neoprene-Plyolite. Permanently bonded to handle. Not affected by sweat or grease.

16 oz. Professional Tool

Completely Mirror Polished

See the Complete Estwing Line at Leading Hardware Stores



Write Dept. PM-10 for Free Catalog

\$4²⁵

Estwing Mfg. Co., Rockford, Ill.

FREE AMAZING NEW BOOK "HOW TO ANSWER ADS"



Never before have you seen anything like this. Tells you in simple language the correct way to answer ads. Gets you quicker replies—better results, and greater satisfaction. Will save you time and money and it's ABSOLUTELY FREE. No obligation whatever. Every reader of advertising should have this booklet. Send a postcard for your copy NOW. F. W. JOHNSON, Popular Mechanics Magazine, Room 600-A, 204 East Ontario Street, Chicago 11, Ill.

SAW SHARPENING IS EASY



Sensational new Super Filer No. 11 joints and sharpens both hand and circular saws 6" to 10" with all teeth the correct height, depth, pitch and bevel. Easy to use—when file hits hardened steel roller, teeth are finished. Saw runs true and smooth with no side pull. Complete with special 8" file..... **\$995 PPD.**

"TRU-CIRCLE" saw set automatically sets teeth at 10° or more... **\$295 PPD.**



SUPER DRILL GRINDER

Sharpens round shank drills from 3/32" to 1/2" in diameter, up to 6" long. Grinds old drills like new in 4 different point angles, using hand or power grinding wheels... **\$295**



DOWEL CENTERS

Assure positive, quick alignment of mating units with ADM Dowel Centers. Insert in drilled holes, press mating piece against points, tap lightly. Centers inscribe exact location for opposite holes. Pairs of 3 popular sizes (6 centers)—for 1/4", 3/8", 1/2" holes... **\$100 PPD.**

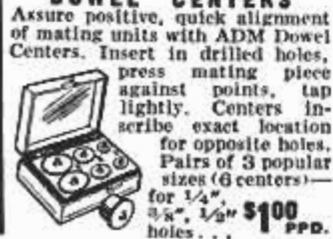

MONEY BACK GUARANTEE

SEND FOR FREE CATALOG

A. D. MCBURNEY, 5908 Hollywood Blvd., Dept. A-106, Hollywood 28, Calif.



Pella
WOOD FOLDING DOORS

Beautiful • Functional • Economical

Modernize with "folding walls" . . . use as room dividers, as closures for closets, bedrooms and kitchens. PELLA DOORS fold like an accordion . . . save floor and wall space. Door panels constructed of solid wood cores with beautiful veneers of birch, pine, oak and Philippine mahogany. Anyone can install . . . factory assembled and complete with all hardware. Easy instructions. Order unfinished and save. Free folder.

---CLIP AND MAIL TODAY!---

ROLSCREEN COMPANY, Dept. H-101, Pella, Iowa
Please send free 6-page folder on PELLA WOOD FOLDING DOORS.

NAME _____

ADDRESS _____

CITY _____ ZONE _____ STATE _____



BEFORE-DARK PHOTO OF FOOTBALL FIELD—where the after-dark Headlamp Comparison Test photos,

Now...twice the light for

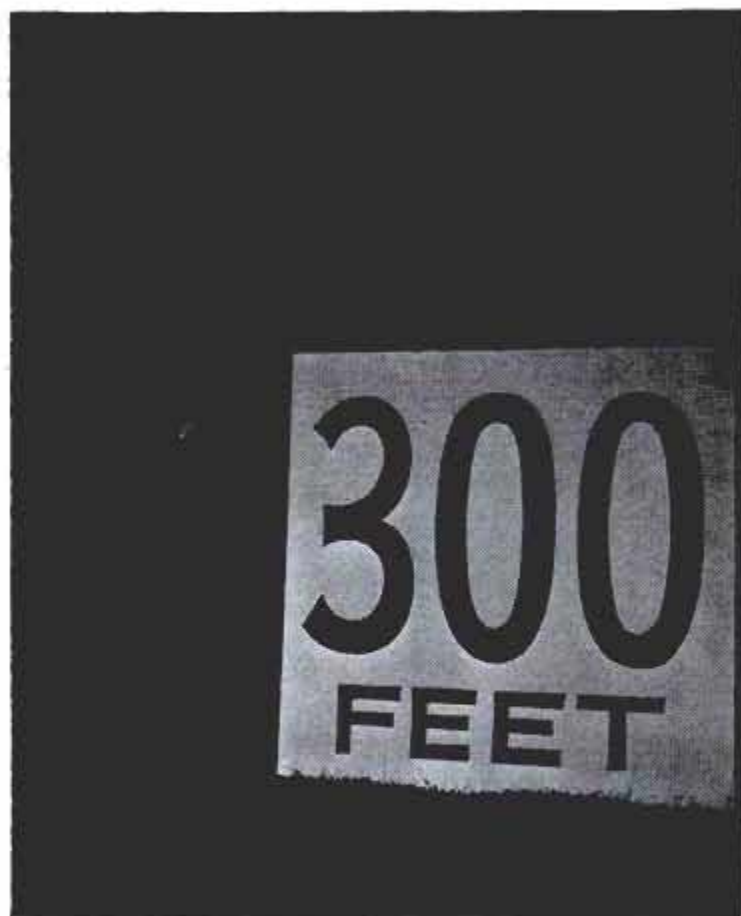

OLDER TYPE SEALED BEAM HEADLAMPS—
Student barely visible at 300 feet.

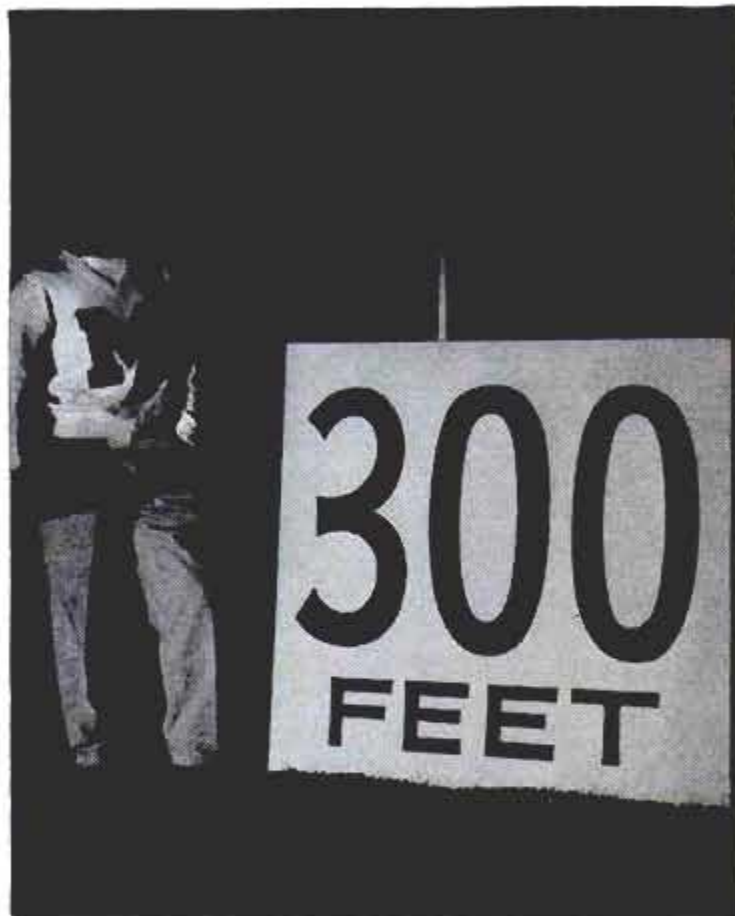

NEW GENERAL ELECTRIC *All-Weather* HEADLAMPS—
Twice as much light at 300 feet and beyond!

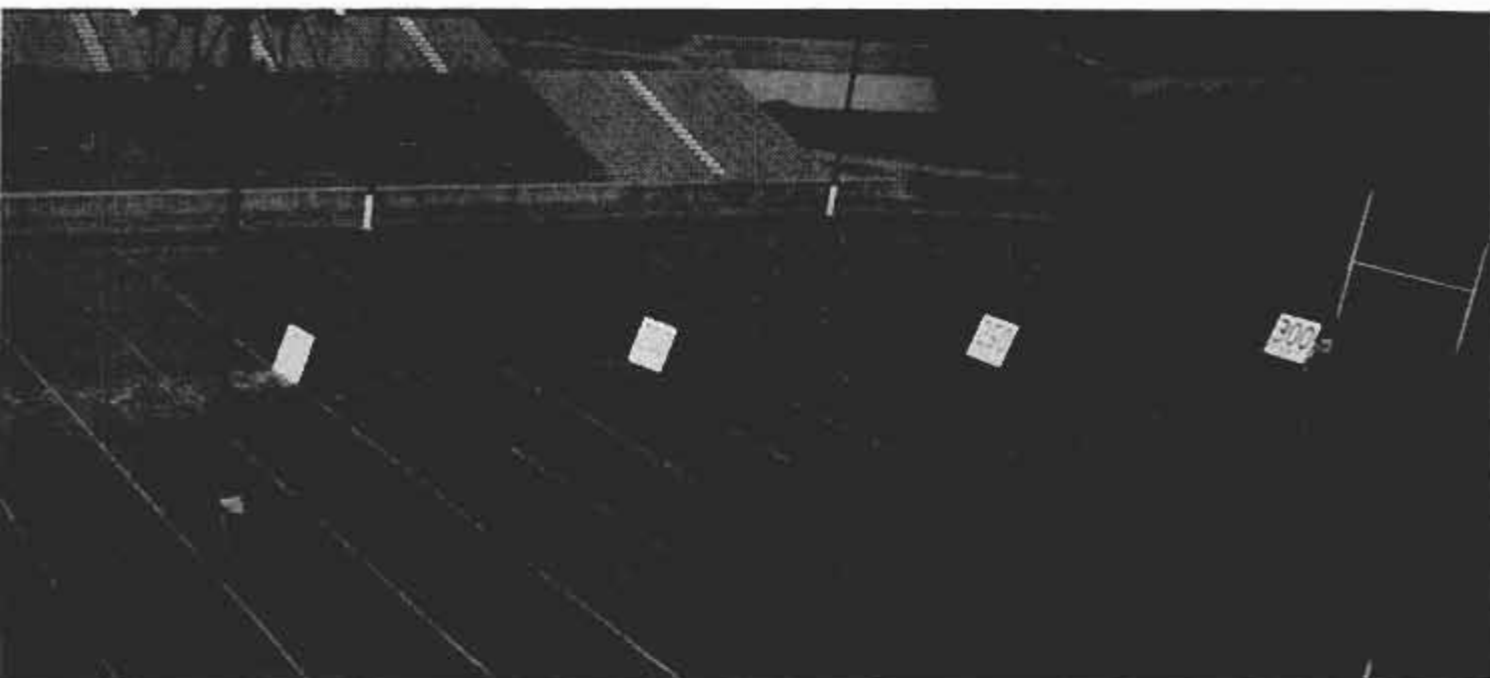

below, were made. Student-model stands at the marker, a full 300 feet from the car headlamps.

safer driving at night!

LOWER BEAM OF NEW G-E *All-Weather* HEADLAMPS GIVES TWICE THE LIGHT 300 FEET AHEAD ON YOUR SIDE OF THE ROAD!

Why 300 feet? Because at 300 feet, and at normal speeds, you should see objects *clearly*. Good visibility at that distance is easy with *upper* beams—yet, traffic conditions force you to rely most on the *lower* beam. That's why G. E. redesigned its headlamp lens, upped the wattage, redistributed light in the lower beam. The "Headlamp Comparison Test", pictured at left, shows that you see better at this critical seeing point with G-E *All-Weather* Headlamps — *photographic proof that you can get twice the light for safer driving at night!*

See Better In Fog, Rain, Snow. The special lower beam filament shield in General Electric *All-Weather* Headlamps blocks uncontrolled upward light, reduces kick-back glare, helps you see better in fog, rain and snow.

Is Accurate Aiming REALLY Important? Yes! Road shock and vibration can cause headlamps to become mis-aimed. Aimed high, headlamps glare

into the eyes of oncoming motorists. Aimed low, beams don't project far enough down the road. (If, at a point 25 feet ahead of your car, your headlamps are aimed only 3" low, you get half the light you *should have* at 300 feet!) But G-E *All-Weather* Headlamps have Aim-right Gizmos, (see arrows at right), that help dealers aim them quickly, accurately . . . even in daylight. So, for safer driving, better seeing in all weather, more accurate aiming, replace present headlamps with a pair of G-E *All-Weather* Headlamps today! General Electric Miniature Lamp Dept., Nela Park, Cleveland 12, Ohio.

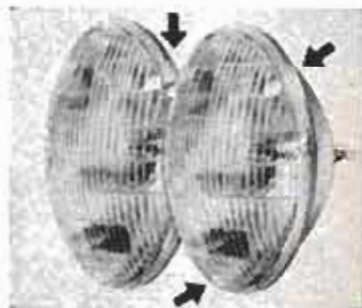

Progress Is Our Most Important Product

GENERAL  ELECTRIC

OLD PAINT PEELS OFF IN MINUTES



DOW METHYLENE CHLORIDE does the job faster, safer and with much less effort

Paint removers containing Dow Methylene Chloride get down under paint and lift it right off the surface. Just brush on, wait ten minutes, then wash or wipe loose paint off. Beats hard work a mile! Safer, too, because it's nonflammable. Available in wash-off or scrape-off types at hardware and paint stores. Look for paint removers labeled "nonflammable" or "contains Methylene Chloride".

For more information, write to THE DOW CHEMICAL COMPANY, Dept. S-945E-1, Midland, Michigan.

you can depend on **DOW CHEMICALS** 

NEW 1957 EDITION JUST OUT!



Get This Giant Catalog Of

WOOD

& WOODWORKING MATERIALS

TOOLS—PLANS—SUPPLIES

World's Largest Selection of Finest Domestic and Imported Woods ... Mouldings, Hardware Tools—ALL AT LOW MONEY SAVING PRICES!

Your complete wood buying guide and project book. Craftsman is your best, most complete source of finest kiln-dried domestic and rare imported woods, beautiful wood inlays, colorful bandings, matched plywoods, embossed mouldings, carved ornaments, newest woodworking tools, "hard to find" cabinet hardware and fittings ... more than 1,500 items! Packed with newest scroll saw patterns, project ideas and money making plans. Enclose 25c (refunded with first order) to help pay mailing, handling cost. Write

Craftsman Wood Service Co., Dept. A-10
2729 S. Mary Street, Chicago 8, Ill.

132 PAGES

Many in full color

packed with rare, fancy & imported woods ... veneers, plywoods, patterns, tools, ornaments, hardware ... everything for the woodworker.

MAIL COUPON NOW!

CRAFTSMAN SERVICE CO., Dept. A-10

2729 S. Mary Street, Chicago 8, Ill.

Enclosed find 25c. Rush WOODWORKERS' CATALOG.

NAME _____

ADDRESS _____

CITY _____

ZONE _____

STATE _____

hands. A crystal forming part of a scintillation counter is placed against each foot or hand to pick up the radiation from injected material. In thyroid studies, a scintillation crystal can be used to trace the size and shape of a thyroid gland containing radioactive iodine.

Scintillation Counter

Perhaps the most familiar job for scintillation crystals is in detection of uranium deposits. The scintillation counter of which the crystal is a part may be used at ground level or from the air while surveying for radioactive materials. Such counters are being sold even in department stores.

Harshaw scientists have been experimenting with crystals of cadmium sulphide, which can convert the sun's energy into electricity, and some day may be important in solar batteries.

The company makes a crystal form of barium titanate that has a memory. Its use in automatic telephone equipment is being studied, and it has potential applications in computers and other memory devices. A typical barium titanate crystal having a one-track mind is .125 inch or so square and .0025 inch thick. On opposite surfaces, two lines of conducting material a few thousandths inch wide are deposited in a vapor chamber. The lines run at right angles to each other, and the area between their crossed portions determines the current-conducting path through the crystal. The memory characteristic of barium titanate depends on the fact that it can be polarized by passing a current, at low voltage, through it. That is, particles in the crystal are arranged so their positive or negative ends all point in one direction. After the voltage is removed, these particles remain lined up in this direction so they remember what happened to them last. Later it is possible to "read" this information by again applying a voltage to the crystal. If this "reading" voltage is in the same direction, the current will be small because the particles are already lined up in this direction. If the previous voltage was in the opposite direction, the reading voltage will reverse alignment of the particles. Because this represents work, the current flow will be much larger. It is possible to produce, on a single crystal, a hundred or more memory points by depositing a grid of crossed lines on the crystal surface, and each point can operate independently of its neighbors.

The crystal-makers at Cleveland regard their work more as an art than an industry. In the growing and using of crystals, problems of technique and purity can be great. In some cases, getting rid of impurities is

(Continued to page 328)

A. C. ELECTRIC GENERATOR

ITEM #G-75-D 7½ K.W. (7500 single phase) WATTS: 110/220 volt output. 3 wire system. 2 bearing construction. 5 groove 6" V belt pulley included. Self-excited. Foot mounted. Drive generator from tractor or stand by engine. Ample power for 6 room house. Dimensions: 34" x 11½". Shipping Wt. 420 lbs. F.O.B. Chicago. . . . **295.00**

Complete control box for these generators includes A.C. rheostat, automatic voltage regulator, field rheostat, and voltmeter, already wired and ready to connect to generator. List price \$167.00. Our Price **56.45**

300 AMP. D. C. GENERATORS IDEAL FOR WELDING GENERATORS

Type R-1, ITEM #91, rated 300 amps. - 30 volts. Mfg. by Jack & Heintz. Government Acquisition Cost \$380.00. Shpg. wt. 55 lbs. Dimensions: 16" x 10" x 7". Complete with instructions to connect as welder. F.O.B. Chicago. . . . **35.00**

ITEM #90 - When connected as a welder, this unit will deliver 200 amps for a sustained period and 250 amps for intermittent service. This generator is widely used for shop-built portable welders. Rated 200 amps, 28 volts, 2500 R.P.M., using 10 H.P. Dimensions: 15" L. x 6" W. x 8¼" H. Splined drive shaft. Gov't. Acq. cost \$300.00. Shpg. Wt.: **22.50** 51 lbs. F.O.B. Chicago. . . .

ITEM #99 - 12 V. - 50 Amps. - Leeco-Neville generator for autos, trucks, road machinery, boats and battery charges. Precision aircraft quality construction, with life-time grease sealed ball bearings and heavy insulated windings. Standard 4-bolt square mounting flange, spline shaft. Dimensions: 16" L. X 8½" Dia. Wt. 23 lbs. Gov't. Acq. cost - \$92.00. Now. . . . **16.50** F.O.B. Chicago

BERRY - HEAVY DUTY HYDRAULIC PUMP or MOTOR

ITEM #166 - Use on road machinery, vibrators, paper mills, wire reels, hydraulic presses, speed control units. Ball bearing construction, balanced cam design assures high efficiency performance. When used as a pump, delivers 8 G.P.M. at 1000 P.S.I., 8 H.P. At 1200 R.P.M. as a HYDRAULIC MOTOR: Rated up to 12 H.P., up to 2400 R.P.M. Standard ¾" pipe thread ports, ½" shaft with keyway. Dimensions: 14½" x 8" x 7". Weight 63 lbs. Regularly \$212.00. OUR SPECIAL PRICE. . . . **59.50** F.O.B. Chicago

GROBAN BARGAINS!

SURPLUS & NEWLY MANUFACTURED

SPECIALS

FACTORY-TO-YOU-VALUE PORTABLE ELECTRIC LIGHT PLANTS



BRAND NEW 1956

ITEM #1008

POWER TO OPERATE:
 • Electric Saw, Electric Drills, Pipe Bender.
 • Refrigerator, Deep Freezer, Incubator.
 • Water Pump, Radio, Lights, Air-conditioner.

COMPACT - FITS IN THE TRUNK OF YOUR CAR

1000 WATTS OUTPUT, continuous duty. 115 Volts A.C. 60 cycles, 9 amps. Powered by husky, easy starting Clinton engine. Engine and generator operate at 3600 R.P.M. for maximum efficiency at minimum weight. Both units are mounted on steel base, with heavy sheet metal belt guard. Generator is self regulating, and is equipped with outlet box containing fuse and 2 A.C. convenience receptacles. Cost only 5c an hour to operate. Dimensions: Length 20½", Width 12", Height 16". Shipping wt. 100 lbs. F.O.B. Chicago. . . . **149.50**

700 WATT-GENERATOR SET—same as above, slightly smaller—with Briggs-Stratton Engine—Model 708—F.O.B. Chicago. . . . **129.50**

ITEM #2008—2000 WATTS—115 V. A. C. generator set, powered by husky, fast starting Briggs-Stratton engine. Mounted on portable steel carrying base for easy handling. — Just right for small cottage and cabins needing inexpensive 2000 Watts of electricity. Ship. Wt. 190 lbs. F.O.B. Chicago. . . . **295.00**

U.S. NAVY ALL BRONZE CENTRIFUGAL PUMP



ITEM #384

These all bronze Centrifugal Pumps are ideal for use as marine bilge pumps, circulating pumps, fire protection or irrigation, car-washing, dewatering, basement sump pumping, lawn sprinkling. Will pump water, oil, brine, gasoline, DDT and sulphur compounds. Equipped with 6" adjustable 'V' pulley, 2" dia. inlet and outlet, 180 GPM capacity. Inlet and outlet take hose with 2¼" inside diameter. Dimensions: 11" x 8" x 11".

Total head-feet	Speed	H.P.	GPM
25	3600 RPM	3	180
35	3000 RPM	1¼	90
20	2400 RPM	1½	75

Back plate may be rotated for most convenient inlet position. Gov't acquisition cost \$96.00. Shipping weight 31 lbs. F.O.B. Chicago. . . . **29.50**

HYDRAULIC LIFT CYLINDERS

• For Fork Lift Trucks • For Presses • Loading Ramps • Lifts 12500 lbs. Heavy duty hydraulic cylinders, at big savings.

ITEM #502—4" Bore—30" Stroke—1¾" Piston Rod. Wt. 95 lbs. F.O.B. Chicago. . . . **72.00**

ITEM #503—4" Bore—54" Stroke—1¾" Piston Rod. Wt. 135 lbs. F.O.B. Chicago. . . . **96.00**

GROBAN FOUR-WAY OPEN CENTER HYDRAULIC CONTROL VALVE

ITEM #126—Four-way open center control valve, with built-in adjustable relief valve factory set at 1000 P.S.I. Spring loaded neutral position. For use with one double acting cylinder. In neutral position cylinder is locked and pump unloaded. Can be used as single unit or mounted in series. Has ¾" pipe thread inlet and outlet. ½" pipe thread cylinder ports. Finger grip handle. Ship. wt. 10½ lbs. AN OUTSTANDING BUY! F.O.B. Chicago. . . . **21.50**

BRAND NEW! JUST RELEASED! Blackhawk Hand-Hydraulic Pump

ITEM #82. Perfect for Hydraulic Presses, Snow Plows, Farm Wagons, Jacks and Farm Plows. A few easy strokes of the 20" handle and you can lift 5000 lbs., using a 2½" bore Hydraulic Cylinder. Blackhawk Model P-151—complete with built-in oil tank and release valve. Rated 1200-8400 lbs. per square inch. Dim.: 9"x7"x6". Ship. wt. 35 lbs. Worth much more. F.O.B. Chicago. . . . **22.50**

ITEM #2784. 1-6 Ft. length double wire braid rubber covered hydraulic hose—tested to 20,000 lbs. . . . **3.95**



GROBAN SUPPLY CO. Dept. PM-10
 1139 S. WABASH AVE., CHICAGO 5, ILL.

HOBART 2 H.P. 12-24 VOLT ELECTRIC MOTOR

ITEM #315—Rated 24 volts D.C. 90 amps, 4000 R.P.M. Has ½" spline shaft on both ends of motor, ball bearing construction, as specified for use with electric wheelchair design Popular Mechanics March issue, 1953. Convertible for use on 6 to 12 volts. Shipping Wt. 21 lbs. Dimensions: 11" x 5" x 6½". F.O.B. Chicago. . . . **13.00**



ORDER DIRECT FROM AD SATISFACTION GUARANTEED
 Send Payment Or Purchase Order Today
 For Phone Orders call WEBSTER 9-3793

FREE! - NEW CATALOG
 1956-'57 EDITION. 56 PAGES. chock-full of unsurpassed War Surplus Equipment Bargains for farm, home, factory, workshop. Write letter today.

NOW You Can DRILL, SAW, REAM, CUT . . . ALL WITH ONE BIT!

Beaver's new improved Hi-Speed side cutting drill bit can be used on any electric drill, drill press, lathe, etc. Made from the finest American hi-speed steel. 3¼" long, 2" side cutting section, ¼" diameter. Designed to cut steel, wood, plastic, aluminum, etc. MONEY back guaranteed. Specify types desired. All Purpose, Wood and Heavy Metal. BUY From Your Dealer or send check or money order today. Dealer inquiries invited. Ideal Xmas Gift. BEAVER DRILL & TOOL CO., 30088 McGee Trafficway, Kansas City, Mo.



BEAVER Hi-Speed-Saw DRILL BITS
 ONLY \$245 each 3 for \$7.00

Now you can spray

New 3-in-one Oil-Spra lubricates and forms a barrier against rust! No more messy rags—oily fingers! Sprays oil at touch of button!



"3-IN-ONE" OIL

Turn your basement into a FUN-AND-HOBBY ROOM for only \$16⁰⁰ a month!*



It's easy to do with Gold Bond Building Products



Build a room like this in your basement—or in *any* waste space. It's a cinch with Gold Bond Building Products... made to *work together*.

Strong, sturdy walls are Gold Bond Gypsum Wallboard. Big, lightweight panels are easy to apply. Simply saw like lumber, or score with a knife and snap off. Conceal joints with Gold Bond Tape Joint Treatment.



On the ceilings use Gold Bond Insulation Tiles. Quickly applied; interlocking edges hide nails or staples.

Finish with Gold Bond Velvet—world's finest latex paint. Goes on with brush or roller, dries in minutes, washable. Clean equipment with water.

See your local Gold Bond® Dealer for all building, remodeling materials.

*BASED ON COST OF MATERIALS SPREAD OVER 36 MONTHS.
PRICES VARY SLIGHTLY IN SOME LOCALITIES.

SEND FOR
ILLUSTRATED
BOOKLET

Gold Bond

BUILDING PRODUCTS



National Gypsum Company, Dept. PM106
Buffalo 2, New York

Please send me Gold Bond "How-to-Do-It" Plan #18, showing me how to build a basement fun-and-hobby room. Enclosed is 10¢ to cover mailing.

Name _____

Street _____

City _____ Zone _____ State _____

the biggest job, and working methods have to be very clean. The act of growing large crystals requires a highly specialized technique. For instance, the process of getting heat into a large mass of chemical and then getting it out again, at a carefully controlled rate, requires skillful control.

Many of the finished crystals are surprisingly rugged; others, such as some scintillation crystals, are protected by hermetically sealed containers. Because the crystal materials often are soluble in water, humidity may have to be controlled. Instruments in which crystals are mounted are often heated so the crystal temperature remains above the condensation point of atmospheric vapor.

Strange Requests

Almost daily, the Harshaw laboratory receives some strange request involving crystals. A university once sent a few grams of a special chemical isotope and asked that a crystal be made from it. Nobody knew how to do this, but a method was worked out without wasting too much of the precious stuff.

So far, no one has asked the Harshaw scientists to make a workable magic crystal ball; but if this project ever is carried out, one of the first tests will be to see what future it predicts for other wonder crystals.

★ ★ ★

Rewind Starter for Power Mowers

Now you can install on your power mower a rewind starter similar to the snap-back reels on outboard motors. The old starting pulley is removed and replaced with the starting unit, which is secured to the engine shaft. If necessary, new holes may be punched or drilled to mount the unit.

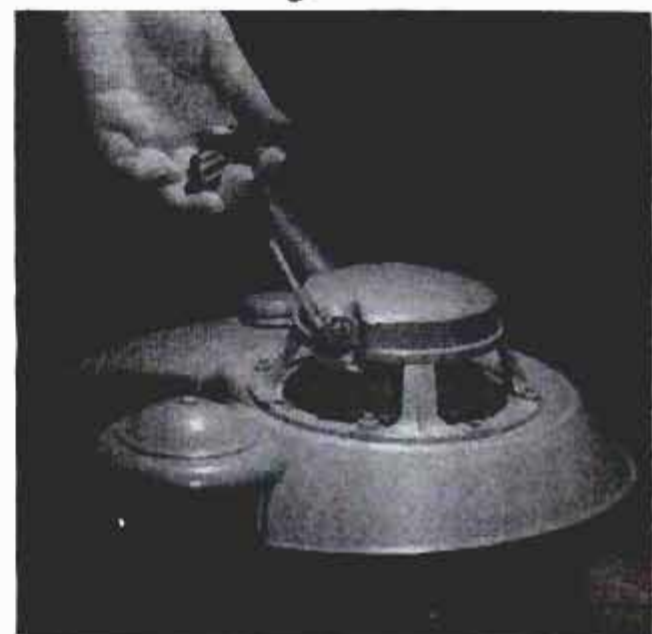

Now! Ready for your Ford—THE DRY-CHARGE BATTERY WITH THE LONGEST LIFE



"See the difference?" says Donald Droste, Ford's Chief Battery Engineer. "You get more life-building fluid in a Ford Battery and that means a longer life. And it holds more fluid because its walls are made of such strong materials they can be made slimmer—yet give you the same strength as the thicker walls of ordinary batteries."



"They're factory fresh, too, for an even longer life. The life-building fluid of the new Genuine Ford dry charge battery is packaged separately and added when you buy it. That means there's no power loss in storage . . . and many extra amp-hours of battery life for your Ford."

All Genuine Ford Parts are made right to last longer in your Ford!

Genuine Ford Batteries, like all Genuine Ford Parts, are made to the exact specifications set by the men who first built your Ford.

In addition, all Genuine Ford Parts have to pass grueling Ford "torture" tests before being approved for manufacture.

That's why it pays to insist on "Genuine Ford Parts." They're made right to fit right to last longer in your Ford!

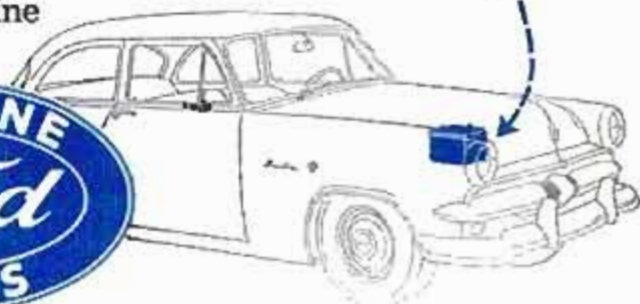

Keep your Ford all Ford

24 Drilling Combinations with Parker No. 4 Wood Screw COUNTERSINK BIT SET

Parker COUNTERSINK BITS
No. 4 for WOOD SCREWS
For all electric drills, call presses and hand drills

Drills and Countersinks
3 depths for flush or recessed screws
— in 1 operation —
4 drills for the 8 most popular
screw sizes

Automatic stop
adjusts to 3 depths

TO ADJUST
STOP

Slide spring lock (1) to the right to set on the desired position on the left hand stop-lock automatically.

PARKER MANUFACTURING CO.
WORCESTER 1, MASS., U.S.A.

Drills and countersinks to flush, putty or plug depths for 8 most popular screw sizes. Depth-a-dapter adjusts easily on all 4 bits.

At your Dealer's Only **\$1.70** per set
PARKER MANUFACTURING CO.
WORCESTER 1, MASS., U.S.A.

**SAY YOU SAW IT IN
POPULAR MECHANICS**



MENDS MOST ANYTHING

"HOLDS LIKE IRON"

Used by fine furniture makers. Ideal for home and office. In ¼ oz. or 2½ oz. sizes.



Hospital Call System

Hospital patients can call for a specific item, such as a glass of water, by pressing the right button of a bedside panel. A corresponding panel lights up at a central location, thus eliminating an extra trip to the patient's room to find out what is needed. The six-volt unit plugs into a wall outlet and is easily moved. The system, not yet in production, can help solve the nurse shortage, since many calls can be answered by someone other than a nurse.



Longer lasting, smoother running... B&D Tools!

Powerful Sander and Jig Saw make "homework" a pleasure!



Zips through wood or metal fast... powerful B&D motor... chosen by professionals.

Only \$54.50

Including blades (coarse tooth, fine tooth, 2 metal cutting, knife blade).



Makes intricate cuts in floor covering, plastics, compositions. Cutting line always visible... makes pocket cuts without lead hole.

Only \$52.50

Includes sand paper.

Jig Saw does work of a jig saw, sabre saw, keyhole saw, plus most band saw operations. Pays for itself on first home project. Complete with 5 different blades to cut almost any material in your workshop.

No. 44 Sander does ten hours sanding in an hour! Sands with, across or against the grain. No chance to ruin the job... even if you're a beginner. Gives satin-smooth finish on wood or metal.

Both of these famous tools are built to last, by Black & Decker. For more information see your B&D dealer or write to; THE BLACK & DECKER MFG. Co., Dept. M-106, Towson 4, Md.

Look in the Yellow Pages under "Tools-Electric" for Nearest Dealer



King size bottom plate extends beyond housing for close quarter work. Exclusive paper holder stays open while changing paper.



Expert results every time. Perfect for refinishing furniture... even valuable antiques.



Black & Decker®

World's largest maker of portable electric tools

CUT PERFECT GROOVES WITH *Warren* WASHERS ON YOUR SAW BLADE!

You Just DIAL the Cut Wanted

over 250,000 sets in use!



NOT ONE—NOT TWELVE—BUT 40 DIFFERENT CUTS!

Warren Washers—engineered to cut clean, accurate, parallel grooves with your present power saw. 40 micromatic adjustments—just dial the desired width. Actually strengthens blade, eliminates vibration—leave on saw for straight cuts. No burning or chipping. Over 250,000 satisfied users in 48 States and many foreign lands. Be sure to get genuine Warren Washers... they're guaranteed!

FREE! Send for free descriptive booklet. Arbor sizes 1/2", 3/4", 1". See your dealer or write direct.

WARREN WASHERS CO.

Dept. 30, Box 98, North End Station, Detroit, Mich.

ONLY \$4.95 SET

It's easy to hang a door

with the NEW **McKINNEY NON-MORTISE HINGE**



Simple • Easy • No Chiseling

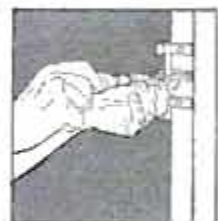

- No Mortising
- Self-Aligning
- E-Z-Out Pin
- Heavy Gauge
- No Special Tools

3 Finishes: Dull Brass, Nickel or Bonderized Prime Coat
Send for Free Folder and Installation Instructions on McKinney Non-Mortise Hinges.

McKINNEY MANUFACTURING COMPANY
1715 Liverpool Street, Pittsburgh 33, Pa.

Name _____

Address _____

City _____ Zone _____ State _____

WAR SURPLUS AND OTHER **BARGAINS** SAVE UP TO **90%**

PIONEER MAGNETIC COMPASS

For boats, trucks, cars. By Pioneer Instrument Co., Div. of Bendix, No. 1829-2A. Contains screw-type heeling compensator, removable drawer-type compensator, screw-type horizontal compensator and spider-type compensator. All devices for elimination of errors caused by effects of magnetism. Has constant deviation corrector and course setter. Rotable dial engraved with compass card graduations. Complete with book of instructions, light and mounting screws and shock mounts. Shpg. Wt. 10 lbs. Approx. GOVT cost \$400. NEW, \$13.95. (Great Xmas gift.)



ARC WELDER KIT \$27.95 — build your own

Complete make-up package consisting of 1 Aircraft DC Generator, Electric Auto-Lite 160-240 Amps, 24 Volt, RPM from 2600 up, 1 Rheostat, 1 Giant Toggle Switch, 1 Ammeter, 1 Shunt, 0 to 240 Amps, 1 Voltmeter, 0 to 30 Volts, 1 Electrode Holder, 1 Welder's Shield, 1 Voltage Regulator. Wiring diagram chart showing conversion of Aircraft Generator to Arc Welder. Shpg. Wt. under 100 lbs. Approx. GOVT. COST \$475. Like new, perfect. \$27.95.



DC Generator (only)—same as above... if purchased separately: \$12.50.

HEAVY-DUTY RHEOSTAT

Designed for heavy-duty use with Air Force heated suits. Ideal for regulating voltage on electric welders, model trains, lights, generators, electric blankets; controls soldering irons, photo flood lamps, etc. Rated 5.75 ohms, 100 watts with double windings & dual female 25 amp, 125 volt receptacles. Size: 7" H x 5 1/4" W x 1 3/4" D. Shpg. Wt. 2 1/2 lbs. Approx. GOVT COST \$25. Brand new, only \$1.65



NEW PUMP AND MOTOR

Pump has 1" connections, built-in relief valve, adjustable up to 1500 lbs. Max capacity 6 GPM. 1 1/2 H.P., 24-volt motor, 4000 RPM. Can be used on 12 or 36 volts. Govt. cost approx. \$350 — our price — NEW — \$9.95.



WOOD PROPELLER

Originally intended for govt radio & target planes. Now the perfect "prop" for den, trophy room, game room or boy's bedroom. Clock, barometer or photo can be inserted easily into center (complete with mounting holes). Top grade bird's-eye maple; flawless, smooth, highly varnished; 30" tip to tip. Can be used to operate ice sleds, etc. Approx. GOVT COST \$57. New—\$3.95. (Great Xmas gift.)



MICROMETERS Chrome plated, precision engineered, carefully tooled to give long life. All new 0-1" cap. \$2.25 ea., 1-2" cap. \$3.50.



REVERSIBLE RATCHET WRENCH

For dionels, ships, farm machinery, trucks, bridges, oil fields, all heavy equipment. Torque leverage, 4" Lowell, safety steel, sockets for 2 3/8", 2 9/16" & 3 1/8" hexagon nuts. Navy surplus. Approx. GOVT. COST \$215 a set, Wt. 50 lbs. NEW! Now \$10.95 per set.



NEW! BIG CATALOG Largest ever... just out... new low prices. Send 25c for your copy today. Prices F.O.B. Culver City unless otherwise stated. Check, cash or money order. 50% deposit for C.O.D.

AIRBORNE SALES CO., INC. DEPT. PM 1056
8501 Stellar Drive, Culver City, Calif.

PRECISION BUILT



Cabinet-making at its finest gives you a chest to be proud of. Free Catalog.
GERSTNER TOOL CHESTS
456 Columbia St., Dayton 7, Ohio

SAY YOU SAW IT IN POPULAR MECHANICS

\$5000

PER DAY

AND MORE

SAW-KEEN

SERRATING AND SHARPENING TABLE KNIVES

PORTABLE, ELECTRIC, EASY - TO - OPERATE

Be your own boss, work anywhere, full or part time. Every restaurant, hotel, drive-in, etc., repeat customers. Serrated (saw-edged) table and steak knives in great demand. \$98.50 investment returns first week. Guaranteed. Write today for proven daily profit plan.

CUTTER-CRAFT 58-P SOUTH RAYMOND PASADENA 1, CALIF.



Airport Visitors Hear Control Tower

Newly installed coin-operated "listening posts" at the Oakland, Calif., International Airport enable air travelers and visitors to hear the radio conversations between pilots and the traffic-control tower. The machines are mounted on the railing of the observation deck.

Car Drives Generator To Provide Electric Power

You can use the spinning rear wheels of a car or tractor to generate electric power for a 30-horsepower 110/220-volt motor. The vehicle's rear wheels rest on two parallel rollers that drive the electric generator through V-belts. A short approach ramp is used to back the car or tractor onto the rollers. The unit, which can be equipped with generators of various sizes, acts as an emergency electricity source during power failures or can be used in construction work as a portable power supply. Without the generator, the unit can be used to drive pumps, circle saws and almost any type of small machinery through a direct drive to a belt pulley.

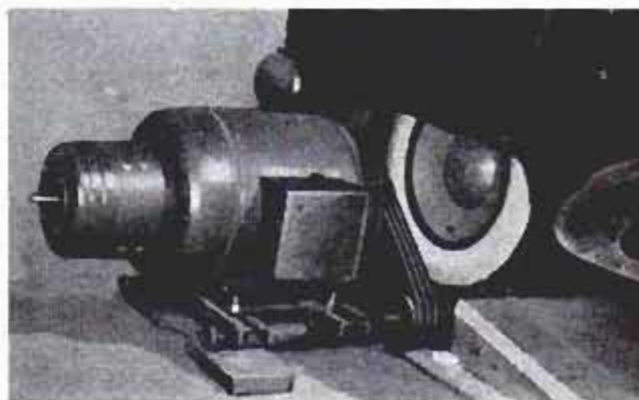

it's NEW! it's ALL IN ONE LEVEL · SQUARE · TAPE

IT'S A LEVEL!
Built-in, accurate unbreakable Level.

IT'S A TAPE!
10 ft., replaceable WYTEFACE® Tape.

IT'S A SQUARE!
Accurate Square. Easy to use.

ADD 2 INCHES

Only \$1.98
at your hardware store



KEUFFEL & ESSER CO.
Hoboken, N. J.

SENSATIONAL NEW HIGH SPEED DRILL MASTER

NOW turns the ordinary shop drill into HIGH SPEED DRILL. PRESS at a big saving. When DRILLMASTER is used on a 5,000 rpm drill press its top speed will be 20,000 rpm. Does the work of expensive high speed drill presses on brass, aluminum, plastics and cast iron where high speed drilling is necessary. Available for work of any size runs. Fits any 1/2" chuck, holding drills from 5/32 to 2/80. Shafts are heat treated and ground. Ball bearings and oil impregnated bearings and gear train are housed in cast aluminum. Precision made throughout. **\$62.50** Fob. Wt. MAIL ORDER TODAY only. **ON C.O.D. ORDERS WE REQUIRE A 10% DEPOSIT.** 2% DIRZIUS MACHINE SHOP "E", 1423-25 So. 52nd Ave., Cicero 50, Ill.



FINISH CONCRETE OR MASONRY WALLS WITH WALLBOARD OR WOOD PANELS-

Do It Yourself
this easy,
low-cost way!

Just attach Gemco Anchor Nails (16" apart) to walls with waterproof Tuff-Bond Adhesive. These will hold furring strips securely in place. Then nail wallboard or wood panels to furring strips... and the job is done. It's that simple! All you need is the Gemco Anchor Nail Kit... at better dealers everywhere. If your dealer cannot supply you, write...

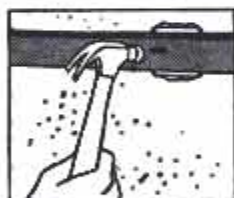
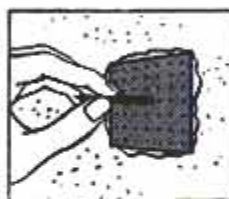

Goodloe E. Moore, Incorporated, Danville 2, Ill.

OCTOBER 1956

YOU SAVE \$10 to \$20...

(smaller saws cost that much more!)

NEW! 6 1/2" POWER SAW

with exclusive
**Automatic
SAFETY CLUTCH**
increases work life
up to 15 times!

says Fred Wiborg,
Master Carpenter
of Chicago



only \$49.95

This new Pet saw is packed with power... a husky 1 horsepower. And Pet's exclusive Automatic Safety Clutch eliminates dangerous kick-back, motor burn-outs from overloads. Increases saw life up to 15 times!

And what a price! This all-new Pet 6 1/2" saw costs \$10 to \$20 less than other top 6 1/4" saws!

Fred Wiborg (above) says, "I job-tested this Pet saw on the roughest, toughest work I could find... and it came through like a thoroughbred. Cuts a 2 x 4 at 45° in one cut! And you should see the report on it by a famous research institute. Proves that this Pet saw equals or excels any other make, regardless of price!"

Automation is the secret of its amazing low price—JOB-TESTING is the secret of its heavy duty performance. See it tomorrow for sure!

- 1 h.p. Universal ac/dc motor develops 4850 r.p.m.!
- Exclusive Tru-Guide for right, left or on-line sawing — stops guesses!
- Exclusive Automatic Safety Clutch adds up to 15 times more work life!
- Comfort-engineered Handi-Grip for easiest working angle!
- Retracting lever on automatic blade guard!
- Easy grip knobs adjust all saw positions instantly, effortlessly!

NEW!

Those who depend
on their tools depend on

**JOB
TESTED**



PORTABLE ELECTRIC TOOLS, INC.

Chicago 20, Illinois

Build it Yourself! Furniture • Furnishings • Work Benches • Children's Toys • Shelves • Boat • Cupola • Weathervane • With

**Popular
Mechanics
NEW**

FULL SIZE PATTERNS

**Authentic Designs by Professional Designer
Trace Patterns on Wood and Follow Simple Guides
Every Step Made Easy for Building at Home**

Now, save money and turn out professional-looking jobs in your own home. Everything you need to know for building handsome furniture, a 12-foot outboard, toys for the children and many other items is contained in these patterns. Trace the patterns on the lumber, saw, smooth the edges and assemble—it's as easy as that. Every nail, screw, dowel and bolt is clearly located for you on the pattern. You can't make a mistake.



Modern Step Table

No. 104. Designed to be a companion piece for No. 103, described in the listing below, this table is 28 x 18 inches, upper step 24 inches high. Complete in one pattern. **50 cents**



Personal Work Bench

No. 108. This compact, sturdy work bench has sliding doors and a drawer. Top is 44 x 20 inches, 35 inches high. Lots of work space in small area. Two patterns in set. . . . **\$1.00**



CRUSETTE

12 Foot Utility Outboard

No. 101. Build this runabout at amazing savings with ordinary hand tools. Length 12 feet, beam 4½ feet. Complete material list and instructions included. Four patterns. . . . **\$2.00**



Trundle Beds

No. 102. These space-saving beds are safer for young people, 90 x 45½ inches. Top bed 40 inches, lower bed 23 inches high. Three patterns in set. . . . **\$1.50**

11 OTHER PATTERNS AVAILABLE

In addition to the 4 full-size patterns illustrated, there are 11 others in stock. If you've been looking for some good projects for your shop, you'll want more than one of them. These patterns have become so popular that the supply may soon be exhausted. It is not surprising that Popular Mechanics readers have responded enthusiastically to the original announcement of these patterns—just think of it, you can't go wrong! Every pattern has been proven for design and correct fit of parts—is guaranteed to please you! So act now, while all patterns are still available.

No. 103. **Modern Cocktail Table.** Matches No. 104 above. 40 x 19 inches, 15½ inches high. Plank top and metal grill inserts in sides. One pattern. . . . **50 cents**
No. 105. **Toys for the Children.** "Giraffe Drawing Board" and "Bucking Bronco" riding toy. Pattern includes painting suggestions. One pattern. . . . **50 cents**
No. 106. **Juvenile Chest Robe.** Has hanging storage space, two drawers and shelf. 30 inches wide, 16 inches deep, 39 inches high. Two patterns in set. . . . **\$1.00**
No. 107. **Cupola and Weathervane.** 24 x 24 inches, 34 inches high, plus height of vane, which is made of metal or tempered hardboard. One pattern. . . . **50 cents**
No. 109. **Valances and Trims.** Twelve designs included. Merely trace patterns on the wood, saw and assemble. Finishing suggestions given. One pattern. . . . **50 cents**
No. 115. **Corner Table.** A new pattern to be used with the cocktail and step tables (Nos. 103 and 104) or alone. 29½ x 29½ inches, 18 inches high, plus an 8 inch diagonal step. One pattern. . . . **50 cents**

No. 110. **Decorative Wall Shelves.** Modern shelf with metal trim is 28 x 16 x 8 inches. Traditional shelf is 29½ x 16 x 8 inches. One pattern. . . . **50 cents**
No. 111. **TV Chair.** Seat 22 inches deep, 24 inches wide. Overall, 27½ x 32½ inches, 26½ inches high. Sagless springs and foam rubber. Two patterns in set. **\$1.00**
No. 112. **Modern Tub Chair.** Seat 22 inches deep, 24 inches wide. Overall, 28 x 27 x 27 inches. Sagless type springs and foam rubber. Two patterns in set. . . . **\$1.00**
No. 113. **Sofa Bed.** 78¾ x 29¾ inches, 33 inches high, with removable bolster. Uses 4½ inch standard foam rubber or other mattress. Two patterns in set. **\$1.00**
No. 114. **Love Seat.** Uses sagless type springs with foam rubber padding. 48 inches between arms, 21 inches deep. Overall, 55½ x 29 inches. Two patterns in set. . . . **\$1.00**

Order Blank for Popular Mechanics Patterns

Popular Mechanics Press • 200 E. Ontario St. • Chicago 11

Send postpaid Popular Mechanics Full Size Patterns as indicated below. Remittance for \$_____ enclosed. I understand that any pattern which does not please me may be returned within 7 days for full refund. Dept. 856

Gentlemen: Please send me Full Size Patterns numbers:
101 102 103 104 105 106 107 108 109 110 111 112 113 114 115
(circle numbers desired)

Name _____
Address _____
City _____ State _____

GIGANTIC
SAVE-TO-70%

MAIL SALE

WAR SURPLUS
EXCESS INVENTORY
BANKRUPT STOCK

ARMY POWER PLANTS

Marvelous buys in new condition and brand new genuine surplus AC and DC Power Plants and Generators. We pay freight to you on most of the units.
 • 1000-w, 115-v, 60-c. \$149.50; 2000-w, 115-v, 60-c. \$269.50; 3000-w, 115-v, 60-c. \$299.50; 5000-w, 115-v, 230-v, 60-c. \$497.50 FOB;
 25,000-w, 220-v, 60-c. 3-P (cost \$5,000). \$1895 FOB;
 DC 3000-w, 115-v generator. \$58.75.

AIR COMPRESSORS & PARTS

Save to 70% on air compressors, etc.
 • One Cyl. Air Compressor. \$19.95
 • Two Cyl. Air Compressor. \$49.95
 • Air Corp Air Tank (10x18). \$8.79
 • Auto. Pressure Motor Switch. \$4.95
 • Pressure Gauges 100, 160, 300 lb. 1.89
 • Pressure Regulator & Air Filter. \$5.95

HYDRAULIC EQUIPMENT BARGAINS

• Agricultural Cylinder (6 1/2" stroke) \$11.91
 • Control Valve for DA Cyls. \$12.95
 • Pump, 1000 lb. 12 gpm 400 rpm. \$45.50
 • Cylinder, 3" bore, 24" stroke, 7000 lb. lift. \$39.95
 • Pressure Gauges 1000, 1500 or 3000 lb. \$3.49

BLACKHAWK HAND HYDRAULIC SYSTEM . . . \$23.95 PPD.

Build your own press, wagon unloader, etc. Consists of complete hand pump, reservoir, valve, etc. Pressure to 8000 lbs. Cost Gov't over \$100.



MOTOR DRIVEN HYDRAULIC SYSTEM . . . \$41.92 FOB.

12-v. DC motor drives 2000 lb. hydraulic pump. Built-in reservoir. Operates from tractor storage battery. Reduced speed works on 6-v. LI-I \$104.50.



INDUSTRIAL DIAL THERMOMETER

Highest quality 4 1/2" dial thermometer. Beautiful unit. Range 20 to 220° F. Complete with 5' copper capillary tubing with 1" I.P. union on bulb end. Many industrial and home uses. Leading make. Original cost \$29.50. . . . Sale \$8.37 Ppd.

1 1/2 HP, 115-V, 60-CYCLE MOTOR

Brand new General Electric, single phase 1 1/2 HP, 3450 rpm, 115-v, 60-c motors. Fine units for work shops, pumps, etc. A real buy! Gov't cost \$89.50. . . . Sale \$41.39 F.O.B.

TWIN BLOWER UNIT

Powerful, quiet, twin squirrel-cage blower unit. Powered by 1/2 HP capacitor 115-v, 60-c AC motor.
 • Excellent for improving efficiency hot air furnaces, air conditioning, exhausting fumes, etc.
 Gov't Cost \$79.50. . . . Sale \$36.91 F.O.B.

MISCELLANEOUS SPECIALS (PRE-PAID)

- Gear reduction unit, 85 to 1, (866). \$8.91
- Auto. stop-by-step switch. \$13.71
- Auto-pulse fuel pump (6-v). \$6.95
- Surveyors-Contractors level. \$46.50
- Gov't Geiger tubes & instructions. \$1.31
- 16,500 gal. 2 1/2" irrigation pumps \$44.37
- 1000 lb. geared hand winch. \$8.95
- Giant Fresnel advertising floodlight (F.O.B.). \$47.71
- Desk telephone (make antique lamps) \$1.99
- Campers power plant (110-v, DC). \$79.50
- Robot control hyd. cylinders. \$3.89
- Invalid & child's car (6-v geared motor). \$13.71
- Extension hand set phones & cradle. \$5.06
- Dial handset telephones (\$26.50). \$13.61
- Farmers 5-row crop sprayer (#175) \$97.50
- G.E. 0-300 amp. DC ammeter. \$6.89
- Navy centrifugal 1 1/2" bronze pump \$24.61
- Portable Gov't 40,000 BTU heaters \$36.91
- \$45 Selsyn 115-v, 60-c. AC motors \$6.49
- G.E. amplifier-rectifiers (#150). \$6.97

SPECIAL OF THE MONTH! GOV'T WEATHER INSTRUMENT

4-star buy! Beautiful satin finish chrome etched dial unit to mount in den or living rm. Small oval windows light up to indicate wind direction. Sturdy attractive transmitter unit mounts on roof, transmits wind direction to indicator. Unit has equipment which indicates wind velocity on living room dial.
 • Instrument has built-in transformer (plugs into any 110-v source), also includes all indicating bulbs, lenses, velocity buzzer, etc. (Note: Unit does not include the flat metal vane but does include shaft, winder, etc. Roof-top velocity anemometer is not furnished but easily contrived.) Gov't cost, mechanism furnished, over \$100. Sale. . . . \$18.71 PPD.



PERSONNEL CARRIER MOTOR

Amazing buy! Use for golf cars, factory personnel carriers, boys auto, and 100x other uses.
 • Powerful expensive ball-bearing gear reduction motor runs on any 6-v or 12-v storage battery. Powerful high torque. Shaft speed 150-300 rpm. Full instr. Easily reversible. Wt. 34 lbs. Gov't cost over \$200. . . . Sale \$19.46 F.O.B.



6-VOLT ELECTRIC WINCH

Rugged 100 to 1 ratio, built-in gear DC ball-bearing motor. (Runs on either 6 or 12 volts). Ideal for trucks, boat trailers, industry, farms. Will handle 1000 lbs. on 6-v. or 2000 lbs. on 12-v. 54 lbs. Holds 40' cable. (Over \$250) . . . Sale \$46.71 F.O.B.

ORDER FROM AD or write for big new WINTER CATALOG 1000s of items! Motors, sporting goods, hand-electric tools, watches, etc. We pay freight except where stated "F.O.B."

BURDEN SALES COMPANY
812 "O" ST. LINCOLN, NEBRASKA



10" TILT/ARBOR SAW BUILD-IT-YOURSELF from GIL-BILT KITS-PLANS

Sturdy wood, steel, and aluminum construction. NEW DEPARTURE ball bearings. Capacity and performance of floor saws selling for \$150.00 and up. Plans, all metal parts in kit with 10" comb. blade \$25.90, less blade \$22.95. F.O.B. St. Louis. Detail PLANS-PATTERNS only \$1.00 postpaid.

Build-it-yourself 12" and 18" Bandsaws, 6" Belt Sander, Shaper. Simplified plans, build easily with hand tools only. Advertised and sold for 8 years, over 30,000 units in use. Money back guarantee. FREE CATALOG.

GILLIOM POWER TOOLS, Dept. 80-K, Lambert Field, St. Louis 21, Mo.

HELPFUL BOOKS

Send post card asking for FREE catalog
 Popular Mechanics Press, 200 E. Ontario, Dept. 601, Chicago 11

Do a Real Professional-Like Job
 Yourself and SAVE

HOW to PAINT With Brush and Spray

Covers All Painting Methods and Materials

You can do professional-like painting and finishing jobs yourself and save about two-thirds of the cost. Sam Brown, noted craft authority, makes it so easy for you in his book, HOW TO PAINT WITH BRUSH AND SPRAY. Order your copy now and enjoy this tremendous saving. It covers exterior painting, wall and interior decorating, furniture finishing, concrete painting — every type of painting with brush, spray gun, roller and other methods. Tells what finish is best; what materials to use, etc. No previous experience needed. Fully illustrated. Order by mail. Only \$2.50. Money back if not pleased.

POPULAR MECHANICS PRESS, Dept. PM1056
 200 E. ONTARIO ST., CHICAGO 11, ILL.



Bore 35 standard holes
 with just one tool

New IRWIN Expansive Bit

lets you dial your size

Just turn the dial and you're set to go with this new Irwin Expansive bit. No hunting for the size you need. Fits all hand bit braces. Clean, fast, accurate boring action from 7/8" to 3" — 35 standard hole sizes in all!

And what a really fine precision tool to own. It's drop-forged from special bit steel, heat treated full length, machined for accuracy and sharpness, highly polished, too. Two cutters supplied with each bit. Model No. 21 with 3/8" to 1 3/4" boring range also available. Ideal for home handyman, professional woodworker, or farm. See your independent hardware dealer soon.



No. 22
 Micro
 Dial
 only
 \$3.45
 7/8" to 3"
 boring
 range

IRWIN

Wilmington, Ohio

the original solid
 center auger bit
 •
 screw drivers
 screw driver bits

STOP THAT DRAFT!

Get
DRAFTITE*
WEATHERSTRIP
for your
house
doors



Get
STANSTRIP*
WEATHERSTRIP
for the bottom
of your
garage
door

At your hardware or building supply dealer. If he's out of stock, we'll mail it to you. Send check or money order:

StanStrip — 37c a foot any length.
DraftTite — \$2.49 a package.

*TRADEMARK

The Standard Products Co.

BOX 678C LEXINGTON, KY.

DIGS 2" TRENCHES to 18" DEEP

New Model B DITCH WITCH digs 2-in. trenches to 18-in. deep. Perfect for lawn sprinkler systems, utility service lines. Digs straight, curved and cornered trenches in all soils, even rocky and frozen. Low Cost! Write for new Bulletin. **THE CHARLES MACHINE WORKS**
620 B Street Perry, Oklahoma



VOLUME BLOWERS FOR HEATING, VENTILATING, EXHAUSTING

Air Condition Your Car, Make Car Heaters, Ventilate Furnace and Heat from Boat Bilges and Gallies, Make Heat Boosters, Exhausters, Coolers, Dryers and dust collectors with this BARGAIN-190 cu. ft. per minute Blower. Blower overall 9"x8"x8". Heavy sheet metal construction. Made by large manufacturer to sell at lower prices our price.
B-6D Blower complete-100 CFM, with 4 volt, direct current motor. Postpaid \$12.50
B-10A Blower, complete with 110 volt, 60 cy., AC Motor. Postpaid \$13.50
C. MARSHALL SALES, 3546 Fullerton Ave., Dept. P-10, Chicago 47



100 BEST Woodworking Projects

The "Must" for All Home Workshops

Selected by Popular Mechanics Editors

Enjoy the fun of making things. Revel in the pride of the craftsman when neighbors and friends admire your handiwork. Get 100 BEST WOODWORKING PROJECTS, complete with simplified instruction, plans, diagrams and more than 400 how-to-do-it pictures. Make all kinds of furniture — chairs, tables, desks, bed room furniture. Make baby carriages, clock cases, lamps, book shelves, fireplaces, attic ladder, folding screen, kitchen accessories, games, swings, storage bins, garden sets, etc., at little or no cost. Send only \$2.00 with name and address today. Money back if not pleased.

POPULAR MECHANICS PRESS, Dept. PM1056
200 E. ONTARIO STREET CHICAGO 11, ILL.



Trailer-Car Brakes Synchronized

Trailer and car are brought to a synchronized stop without danger of jackknifing by a control device that is operated by the car's brake pedal. Stopping the car in the normal manner also operates the trailer brakes. The unit mounts on the steering column. A separate control permits the operation of the trailer brakes alone, if desired.



Hearing Aid for Dogs

Silkie once was a good watchdog, but the years crept up on him and he lost his hearing. His owner searched until he found a hearing-aid company which would design a special hearing device, dog-type, and now Silkie, though advanced in years, is a good watchdog once again. The custom-designed bone conductor is strapped over his left ear and a microphone is then clipped to his harness.

REPAIR MUFFLER AND EXHAUST LEAKS in 10 minutes!



A simple finger and thumb repair. Guard against carbon monoxide poisoning. The plastic gas-tight seal sets hard and seals all joints, withstands heat and vibration, prevents harmful fumes. No dismantling required. Use it for installing new mufflers. No tools needed.

*Holt's GUN-GUM MUFFLER SEAL

\$1.69 Per Can

Write for Full DETAILS

See Your Neighborhood Auto Accessory and Parts Replacement Store

*Trade Mark Regd.

TREGLOWN CO. INC., FANWOOD 103, N.J.
CANADA: 1366 GREENE AVE., MONTREAL 8 (Prices higher)



64" FLEXIBLE SHAFT WOVEN WIRE CORE

USE AS ELECTRIC DRILL

\$5.95

REAL BARGAIN — cannot be duplicated for \$15.00. Coupling fits 1/2" or 3/4" motor shaft (state which); other end fits standard chuck. Durable, heavy. Use it for grinding, polishing, buffing, drilling, etc. Heavier constr. Chuck for same only \$1.25. Send check or money order and we will ship P.P. prepaid or C.O.D. Plus Postage. Money refunded if not satisfied.

72" SIZE \$6.95

L. C. DOWNEY CO. — Dept. M
8004 TRAYMORE AVE., PHILA. 18, PA.

SPARE-TIME MONEYMAKING OPPORTUNITIES READ OUR CLASSIFIED ADS

HUNDREDS OF BARGAINS AMAZING OFFERS

DRAINS cellars, cisterns, wash tubs; IRRIGATES - CIRCULATES - SPRAYS \$7.95

Type P Pump has 1,001 uses. Up to 3000 GPH: 450 GPH 80" high; or 1800 GPH from 25" well. Use 1/6 to 1/4 HP motor. Couplings included free. 1" inlet; 3/4" outlet. Stainless shaft. Won't rust or clog! Postpaid if cash with order. Rush your order today.

MONEY BACK GUARANTEE
Centrifugal and Gear Pumps in All Sizes
LABAWCO PUMPS, Belle Meade 7. N. J.

PREVENT APPLIANCE PLUG LOCK AVOID PULL OUT PLUGS

Safeguard food freezers, refrigerators, sump pumps, clocks, etc., against accidental removal of plug.

40c p.p. (No C.O.D.'s)
General Manufacturing Co.
Box 206, Mentor, Ohio

There's a Katolight ELECTRIC PLANT for every portable or standby power need.



• COMMERCIAL • FARM
• HOSPITAL • HOME
Katolight Portable Power Plants give you electric power anywhere . . . anytime. Standby Plants permit uninterrupted operation of all electrical equipment despite power failure. Extra high overload capacity. Long life, dependability. Full line from 350 Watts to 75 KW and larger.

WRITE FOR NEW FOLDER KATOLIGHT CORPORATION, Box 891-22 Mankato, Minn.

Scroll-Sawing Simplified with a DREMEL Electric MOTO-SAW

HANDY FOR THE HOBBYIST OR CRAFTSMAN



Cuts scrolls like magic
Safe as a handsaw
7200 strokes per minute

Only \$6.85 with 3 blades



You do a professional job on any hobby or household project when you use a Dremel Moto-Saw. You just guide it—it does the work. High-speed reciprocating motor—easily cuts asphalt and rubber tile, masonite, formica, wood up to 3/4". Blade holder faces four ways—saw sideways, backwards, or forward. Cuts smooth, no sanding required. Only two moving parts—never needs oiling. Uses 110-120 V. A.C. Buy a Dremel Moto-Saw today—the handiest tool you'll ever own.

New, exciting Pattern Packet contains full-size patterns for 16 fascinating projects, carbon tracing paper, and complete instructions. Projects include tie-rack, house number sign, earring holder, ring-throwing game, sewing-accessory stand, and other useful projects you can make for fun, gifts or profit. Order today—send 75c.

SEE YOUR HARDWARE OR HOBBYCRAFT DEALER. If he cannot supply you order direct from the factory on a 5-day trial, money-back guarantee. Send \$6.85 now, we pay the postage; or send \$2.00 now and pay your postman the balance plus postage and C.O.D. fees. Order today!

DREMEL MANUFACTURING CO. Dept. 116K
Racine, Wisconsin

WELD BRAZE

SOLDER CUT

4WAY

ONLY \$14.75
f.o.b. factory

WELDER

Acclaimed by thousands of Homeowners, Mechanics and Hobbyists as the welder of 1001 uses. Easily operated from properly wired 110 volt AC or DC line. The ideal gift with a life-long use....Order today on 10 day money back guarantee.

FOUR-WAY WELDER CO., Dept. F2-K
1810 S. Federal St. • Chicago 16, Ill.

Complete with Twin Carbon Arc Torch and accessories . . . to handle all metal-craft work.

\$40 for 1 1/2 DAY'S SPARE TIME WORK GRINDING LAWMOWERS

Yes, J. H. B. writes, "not bad for a 76 year old young fellow earning \$40 for a day and a half's work" . . . and others are making even bigger money with the Universal Model B Lawnmower Grinder. You, too can make good spare or full time profits in your own business in your garage or basement. We furnish everything you need. Write today. No cost or obligation. Dept. M-106

ROGERS MANUFACTURING CO.
LINDSEY, OHIO



KNIFE THREAD INSERT®

for STEEL THREADS in WOOD

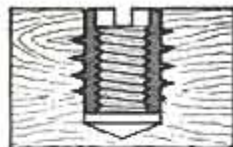

Blade-sharp threads cut cleanly into drilled hole. Quickly installed with screwdriver. Insert provides permanent steel threads in hard or soft wood and other materials.



NOW BEING USED EXTENSIVELY BY...

- The U. S. Government
- House Trailer and Truck Van Mfrs.
- Woodworking Firms
- Furniture Plants
- Cabinet Makers
- Carpenters
- Homecrafters



METAL TO WOOD



TABLE & CHAIR LEGS

ROSAN INC.

2901 W. COAST HIGHWAY • NEWPORT BEACH, CALIFORNIA

Write Direct to:



MARCO 14 \$189.50 Delivered

MARCO KIT BOATS-DO IT YOURSELF-SAVE 50%

8' to 14' models, factory to you, no dealers, mahogany decks and framework, all brass fastenings. 14' hull kits as low as \$129.50 including freight charges. CATALOG 35c includes Kits, Hardware, Trailers, Fiberglass.

WRITE FOR FREE FOLDER

Marine ASSOCIATES
BOX 4186 • LONG BEACH 11, CALIF.

POWER HACKSAW \$58.50

LESS MOTOR
F.O.B. Benton Harbor

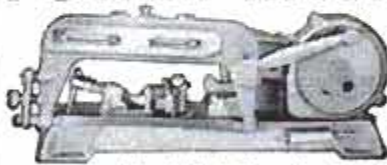

Send for full details and name of nearest dealer.

• Rugged cast iron construction. Wt. 56 lbs., bronze bearings. Draw cut. Auto. return lift. Auto. shut-off. Vise swivels 45°. Cap. 4"x4".

Dept. PM-106

EXCEL MACHINE TOOLS BENTON HARBOR, MICHIGAN

The Chief... for a Man with a Hobby Shop

TOOL CHEST

Perforated Hardboard, 32" x 32" x 6" Shipped KD

31 Piece Tool Hanger Kit \$1.39

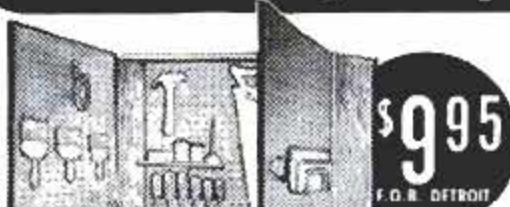

\$9.95
F.O.B. DETROIT

Keeps all tools neat and handy

Built to Last a Lifetime:

\$21.95
F.O.B. DETROIT

WORK BENCH

with Bottom Shelf and 18" Sq Drawer. 2" x 6" Solid Plank Grooved and Dovetailed Top and 1" x 8" Back Rail, Shellacked to a Smooth, Satiny Finish Shipped with Bolts, Nuts, Screws, with ABC Chart for Quick and Simple Assembly.

6 ft long
34" high
26" deep

MOHAWK LUMBER & SUPPLY CO.

14525 W. Chicago Blvd., Detroit 28, Mich. (M)

Enclosed Check Money Order for \$_____

Ship _____ CHIEF WORK BENCHES @ 21.95 each

_____ TOOL CHESTS @ 9.95 _____ HANGER KITS @ 1.39.

\$5 deposit with C.O.D. orders
 FREIGHT
 EXPRESS
Name _____
Address _____
City _____ State _____

Use this to order

Also Eshelman TRACTORS, Riding ROTARY MOWERS, ROTARY TILLERS at amazing savings. Write for Free Literature

ESHELMAN GOLF CAR

GASOLINE ENGINE

36 HOLES PER GAL. GAS UP TO 20 MILES PER HR.

Costs a fraction of most other cars. Ideal for golfers. Also Child's 2 pass. Cars. Write for free Literature & Rider Agent Plan.

ESHELMAN, Dept. MC-510, 109 Light St., Balto., Md.



Shipping Points: BALTIMORE • CHICAGO • RENO • PATENTED



Paper Cutter Has Safety Roller

Designed to eliminate the hazards of guillotine-type paper cutters, one that uses a cutter wheel mounted on a small I-beam has been put on the market. The manufacturers say that it combines safety and accuracy, and can be used to cut anything from tissue to illustration. The cutting blade is mounted in an aluminum housing and is self-sharpening. The baseboard on which the cutter is mounted is ruled in one-half-inch grid lines to help in accurate cutting.

MARLITE - IT - YOURSELF



**a few days ago,
this was a dingy basement!**

... but economical Marlite Plank and Block made the beautiful difference. This easy-to-handle paneling makes week-end projects out of week-long jobs. The exclusive tongue and groove joint simplifies installation; conceals all fastening. And Marlite's melamine plastic finish never needs painting. Dirt wipes off with a damp cloth.

Your building materials dealer will show you Marlite in "Companion Colors," distinctive wood and marble patterns. Ask him for free remodeling folder, or write Marsh Wall Products, Inc., Dept. 1042, Dover, Ohio.

Marlite®

plastic-finished
WALL and CEILING PANELING

A product of Masonite® research

**FOR
SKILLED WOOD-WORKERS
ONLY!**

No. 2500
\$59.95



SYNCR0

2500
JIG SAW

At last—a jig saw designed only for the few real homecrafters who demand, use and appreciate the best in tools! This heavy 62 pound ruggedly constructed Syncro "2500" slices thru 2 x 4's or cuts intricate designs with almost unbelievable accuracy and smoothness. The entire arm—not the table—tilts 45° to either side. Powered with Synerco's latest Reciprocating Motor—guaranteed against burn-out during ownership. Sure, 2500 costs you more but it does more than others costing more! This masterpiece—designed for master wood-workers only—is already a favorite of industrial wood pattern-making shops. So new your tool dealer may not have it. Write for Free details.



Table stays level; arm tilts; bevelling is easy.



Full 30" Throat

SYNCR0 CORPORATION
DEPT. 1-76, OXFORD, MICHIGAN, U.S.A.
WORLD'S LARGEST MAKERS OF RECIPROCATING MOTORS

hobart

arc welding pays BIG MONEY!



200 amp. Air Cooled "Husky Boy" with 2 cylinder engine

200 or 300 amp. AC POWER-AC WELDER

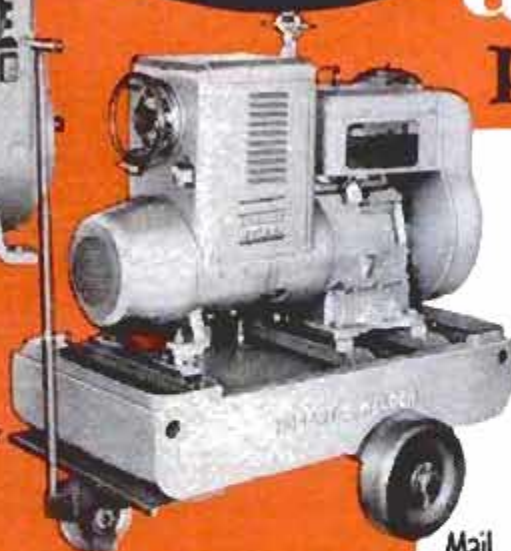

Modern Welding Lessons. 200 pages, fully illustrated. \$1.00

Mail Coupon Today!



free! Welder's Vest Pocket Guide

check here for "Vest Pocket Guide"

250 amp. "BIG BROTHER" "BUILD YOUR OWN" TRANSFORMERS

Hobart Successful Manufacturers Since 1893

WELD ANYWHERE. Double your earnings doing construction work. Cash in on the big demand for emergency repair work. Any one of these low cost Hobart Welders puts you in business.

All of these Hobart models open up new welding opportunities—let you get the "BIG PAY" jobs. Besides outstanding performance, they give you built-in convenience features at no extra cost that help you turn out topnotch work. Write for complete details to: HOBART BROTHERS CO., BOX M-106, Troy, Ohio. "One of the world's largest builders of arc welding equipment." Phone 21223

HOBART BROTHERS CO., Box M-106, Troy, Ohio

Without obligation, send me details on:

- AC Power-AC Welder 200 amp. "Husky Boy"
 250 amp. "Big Brother" 300 amp. "Build Your Own"
 180 to 500 amp. Transformers

NAME _____

ADDRESS _____

CITY _____ STATE _____

FIXIT TIPS...

WITH "SCOTCH" 33
PLASTIC ELECTRICAL TAPE



WRAP FRAYED APPLIANCE CORDS with this tough, waterproof plastic tape. Insulates, resists wear and corrosion. UL approved.



SEAL CRACKS in distributor caps, mend other plastic products. Thin, stretchy tape sticks tight. Get "SCOTCH" 33 Plastic Electrical Tape, 39¢ at stores everywhere.

© 1956, Minnesota Mining & Mfg. Co., St. Paul 6, Minn.

PRODUCT OF
3M
RESEARCH

SAY YOU SAW IT IN
POPULAR MECHANICS

SAVE MONEY on LUMBER with the LOW-COST BELSAW PLANER

Convert Rough and Random Size Lumber Into Cabinet Finished Stock

Now anyone can make perfect cabinet finished stock from low-cost rough lumber... any size up to 12 1/4 inches wide and 6 inches thick. Turn out high grade finished material at a fraction of the cost you pay lumber yards. Big 42-inch-long bed makes it easy to plane heavy, wide and long pieces... BELSAW self-feeds at 14 to 34 feet per minute.

USE THIS ONE LOW-COST MACHINE for Planing, Jointing, Sawing, Milling, Tongue and Groove.

You can easily make flooring, siding and many other popular patterns with your Belsaw. Your Belsaw quickly pays for itself with savings on raw materials and profits on finished stock... a highly profitable machine for custom work. Compare Belsaw with any 12-inch planer on the market... Belsaw gives you more essential features—yet costs you \$50 to \$125 less than others.

Send Today for Free Literature on the
Belsaw Multi-Duty Planer.

BELSAW MACHINERY CO 2057 Field Bldg. Kansas City 11, Mo.



Aim HIGH-Aim LOW!

You don't need a third hand with a Delta Reddy-lite. Hang it up. Set it down. Aim the 800-ft. beam anywhere! Uses 6-volt battery. See your dealer. Yours, less battery, for **\$3.75** only.....

Delta ELECTRIC CO.
Marion, Ind.

REDDYLITE

360° Swivel
ELECTRIC
LANTERN

IF YOU USE
HAND TOOLS-YOU NEED A

HANDI-ROLL

\$5.95
POST PAID

HANDI-ROLL makes it easy to carry or store hand tools up to 12" long. 24 spacious pockets keep tools handy, separate. Rolls up for easy carrying by special handle, lock strap. Grommets permit hanging above work bench. (Price does not include tools.)
Made of heavy, waterproof duck.
Send check or money order to...

THE HANDI-ROLL COMPANY, 1903A BILTMORE, DETROIT 35, MICHIGAN

ELECTRIC WELDER

AC or DC
110 Volts

The "Little Marvel" all-metal welder, 5-year written guarantee. Welds 1/8" metal or money back. Repairs tanks, tools, fenders, machine parts, etc. Complete with everything—rods, unit, eye shield, directions. \$6.95 plus 50¢ postage. Flame torch accessory for soldering, cutting, brazing \$3.95 complete with carbons, brass rods, flux. \$2.00 Deposit on C.O.D. 75 ampere 1/4 inch Transformer Welder \$21.95 F.O.B.

\$6.95
Complete

ESSAY MFG. CO., Dept. 51, Quincy 69, Mass.

Wholesale!

TOOLS! GUNS!
CAMERAS!

AGENTS - BUY TOOLS, PHOTO EQUIP., SPORTING GOODS, JEWELRY AND THOUSANDS OTHER NATIONALLY ADVERTISED PRODUCTS AT BIG DISCOUNTS. BIG PROFITS SELLING TO OTHERS.

POSTCARD BRINGS FREE COPY "THE WHOLESALE PLAN"

AMERICAN BUYERS SERVICE

Get up to
40% off

HERTEL STATION, DEPT. 15, BUFFALO 16, NEW YORK

HARGRAVE CLAMPS

A Complete Line for All Purposes

Hargrave Industrial Type Clamps are ideal for the home workshop. Economical—sturdy to give you a life-time of service. Made in openings from 3/4" to 12" and depths from 1/2" to 16".

WRITE FOR FREE CATALOG No. 116
Showing Clamps, Chisels, Punches, Masonry Drills for hand and power hammers, Carbide Drills, Washer Cutters, etc.

On sale at all leading Hardware Stores

THE CINCINNATI TOOL CO.
1987 Waverly Ave., Cincinnati 12, Ohio

NOW! A marvel of engineering ...

that brings you **HIGHEST**
Oil Filtering **EFFICIENCY**
IN AUTOMOTIVE HISTORY!



The New Wm. Schwalge Product

Electrically-Heated
RECLAMO

RE-REFINES AND STABILIZES MOTOR OIL!

Reclamo's **GREATER FILTER CAPACITY** (treble that of other models) and water-vaporizing **CONTROLLED HEAT**—results in continuous **RE-REFINING ACTION** that provides super-efficient filtration for today's car, truck, tractor engines. **STABILIZES** crankcase oil **AT PEAK OF LUBRICATING QUALITY!**

UNEQUALLED IN PERFORMANCE—REMOVES Solids, PREVENTS excess Water, Acid, Sludge Formation—CHECKS Fuel Dilution—MAINTAINS Stable Viscosity—ENDS NEEDLESS OIL CHANGING!

EXCLUSIVE FEATURES: Electrically heated by surplus generator current, thermostat controlled (for 6-12-24 volts; also for 110-220 volt stationary engines)—Steel body—Hinged mounting bracket—Easy to install or transfer to other equipment.

GUARANTEED! Reclamo is sold with an unconditional six months' no-risk return privilege—**YOU ARE THE JUDGE.**

Descriptive literature free. **DEALERS WANTED.**

WM. SCHWALGE
Author, Inventor.
Pioneer in oil
reclaiming since 1910.



RECLAMO MFG. CO.
6251 Touhy Ave., Dept. M-106,
Chicago 30, Ill.

Manifold-heated Reclamos now OHSO-
LITE, accepted (new or used) for trade-in.

Print Your Own



Cards, Stationery, Advertising, Circulars, labels, photo and movie titles, church work, tags, etc. Save money. Sold direct from factory only. Raised printing like engraving, too.

Own a Printing Business

Print for Others, Good Profit. Have home shop. Junior press \$15; Senior \$29 up. We supply everything. Easy rules. Pays for self in short time. Write for free catalog of outfits and all details. **KELSEY PRESSES, C-37 Meriden, Conn.**

New Long Lasting Combination Blade
Roc-Edge 6" SAW \$1.49
BLADE ~~7" \$1.99~~ ~~8" \$2.00~~
Fits any power saw. At all Hardware Stores

Also Eshelman
2 Passenger
SPORT & GOLF Cars
Costs small fraction of most other cars.
4 times more gas mileage
Write for **FREE** Literature
Dept. R-510, **ESHELMAN**, 109 Light St., Balto. 2, Md.

ESHELMAN TRACTORS LOW AS \$99
Shipping Points: BALTIMORE • CHICAGO • RENO

Plow • Cultivator • Saws
Dozer • Harrows
• Snow-Plow • Rolls
• Mower • Mow • Tills
Eshelman Tractors, Tillers, Riding Rotary Mowers for Better Lawns and Gardens. Advertisers in GOOD HOUSEKEEPING, Thousands of Satisfied Users.

2 to 8 HP

"DO IT YOURSELF"
IT'S EASY WITH
KESTER SOLDER



Soldering's really a "cinch"... when you use time-tested, reliable **KESTER**... available everywhere.

FREE! "Soldering Simplified"... 16-page how-to-solder booklet. At your dealer or write direct.

KESTER SOLDER COMPANY
4251 Wrightwood Avenue Chicago 39, Illinois

LOOK! All New - All Precision - All Deluxe SUPERSHOP MODEL X

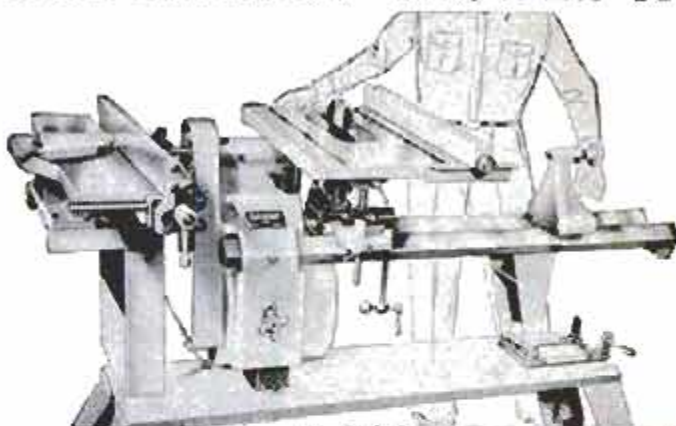

8" SAW

WE PAY ALL FREIGHT FOR YOUR FREE HOME TRIAL

ONLY \$139.50 EASY PAY PLAN



Vert. Drill Press



Hor. Drill Press



8" Sander



30" Lathe



5" Grinder

Never before have you seen so much deluxe, precision-built power tool workshop at any price! Designed for the man who wants the best. Massive cast and precision-machined headstock, self-centering inverted "V" bedways (like precision metal lathes), exclusive non-friction speed changer, extra-large cast and precision-ground saw table. 100% ball bearing, lifetime-lubricated. You save by ordering direct from factory. You are invited to test Supershop Model X in your home **FREE**. Mail coupon or postcard for **FREE** brochures, photos, details, specifications, accessory list—and amazing freight prepaid **FREE HOME TRIAL PLAN**. All free.

MAIL COUPON OR POSTCARD TODAY

POWER TOOLS, INC. 188 Yates Avenue
Beloit, Wisconsin

NAME _____
ADDRESS _____
CITY _____ STATE _____

It's QUICKER... Works SLICKER with

WISE-GRIP



As a speed wrench! A squeeze of the hand locks jaws onto nut. Then give it a whirl!

Does More Jobs Easier Than Any Other Tool Made!



No. 10W, 10" \$2.60

A squeeze of the hand locks jaws onto work with ton-pressure! Quickly adjusts for use as All-Purpose Wrench, Super-Pliers, Clamp, Wire Cutter, 7" and 10" cutter optional. \$1.85 to \$2.60 at your dealer.

Made By PETERSEN MFG. CO., Dept. M.10 DeWitt, Nebr.

Makes EVERY JOB EASIER



BARRON Drill Press TOOLS



ROTARY PLANER
Planes • Rabbits
Tenons • Panels
Routs • Bevels
Only \$8.50
Shipped Prepaid - Complete

FOR WORKSHOP AND INDUSTRIAL USES...

Over 40 precision built woodworking tools and accessories... Hi-Speed Router Bits—Rotary Surface Sanders & Drum Sanders—Safety Shaper Cutters—Dovetail Cutters—Large Auxiliary Metal Tables—Spindle Adapters—Handy Bench Vises. Many other items indispensable for accurate, useful, versatile workshop use. Every tool sold on complete satisfaction or money back. Write for special folder—"24 Extra Uses for Your Drill Press."

WRITE FOR FREE WORKSHOP GUIDE

BARRON TOOL CO. INC.

300 Architects Bldg., Detroit 1, Mich.

MAKE YOUR KITCHEN COOL AND ATTRACTIVE



WITH THE **Salem**

VENTILATING HOOD BY TRADE-WIND

Easily installed in a wood or metal cabinet over your stove. Choose one of the three powerful Trade-Wind Ventilators to exhaust all heat, cooking odors and grease. Hood is made of genuine copper laminated to steel. Rich antique finish. 30", 36", 39", 42", 48" lengths available. Ask your electric dealer or mail coupon today.

Trade-Wind Motorfans, Inc.
7755 Paramount Blvd., Dept. PM, Rivera, Calif.
Please send information and prices on the Salem Ventilating Hood.

Name _____
Address _____



OVERLOAD SPRINGS

\$9.95 Per Pair Postpaid
2,000 lb. Size \$11.95

For cars and trucks. Front or rear. Gives 2,000 lbs. extra capacity for all 1/2, 3/4, and 1 ton trucks, 500 or 1,000 lbs. extra for all cars. Easily installed. Guaranteed. State make, model, and year.

BRINKMAN MFG. CO.
2315 CLAY, DEPT. 15-0, TOPEKA, KAN.

DOES YOUR WATER SYSTEM LOSE ITS PRIME?



See Why **BURKS PUMPS**

ARE SELF-PRIMING

DECATUR PUMP CO., 61-C ELK ST., DECATUR, ILL.

WHY TAKE LESS THAN THE BEST?

INSIST ON **EAGLE FOLDING RULES**

COIL SPRING JOINTS

GUARANTEED AGAINST JOINT FAILURE FOREVER

EAGLE RULE MFG. CORP. N.Y. 59, N.Y.

HELPFUL BOOKS

Send post card asking for FREE catalog
Popular Mechanics Press, 200 E. Ontario, Dept. 601, Chicago 11

Automatic Saw Set...

MAKE EXTRA PROFITS!

Set 400 teeth per minute on hand or band saws, 4 to 16 point, with the BeMaCo Automatic Saw Set. Fast, accurate, true hammer-anvil action sets teeth uniformly, eliminates tooth breakage. Used profitably by saw shops and manufacturers everywhere. Every machine positively guaranteed! Write for details—today!



Saw Machine Division 24-C

BEAVER MFG. CO.
800 ISIS AVENUE • INGLEWOOD, CALIF.

SAVE 50%

GENUINE SELECT PHILIPPINE MAHOGANY PLYWOOD DIRECT FROM IMPORTER

For Fine CABINET WORK, FURNITURE, Paneling DENS, OFFICES, HOTELS, etc.

Our prices are LESS THAN DOMESTIC PLYWOOD at WHOLE SALE. This selected LUAN MAHOGANY meets the most rigid specifications. It is WEATHER and WATER RESISTANT. You'll be amazed at the beauty of this fine wood. Its rich golden elegance will thrill you. Rotary cut for beauty of grain. Both sides sanded and ready to use. Bonded with finest resin adhesive. Face side unjointed.

FREE SAMPLE ON REQUEST

Available in three thicknesses - 3mm (approx. 1/8"), 4mm and 1/4". ALL orders shipped by special Truck for lowest rates. No order accepted for less than 100 lbs. - equal to (A) 1/4" sheets, (B) 4mm sheets or (C) 3mm.

3MM (1/8") x 3FT. x 6 FT. \$5.00 VALUE PER SHEET

1/4" x 4 FT. x 8 FT. 9.50 VAL. MIN. ORDER 4 SHEETS \$49 PER SHEET

SAVE 50% ON TRANSLUCENT FIBERGLAS PANELS

Use it for patio covers, interior decor, walls, partitions and many other uses. Ideal for the home, office, shop, indoor or outdoor installations. Finest quality. Available in many widths and lengths. Excellent color selection. Write for a FREE Sample and Booklet.

Only 49¢ SQ. FT.



SAVE 40% ON BRASS TIP-WOOD LEGS

Beautifully turned and sanded, fully seasoned. Complete with genuine brushed brass tips and sturdy steel mounting plates. Available finished or unfinished. Finishes are Blonde, Silver Fox, Mahogany or Charcoal Black. Please specify finish. Prices per set of 4

SIZE	FINISHED	UNFINISHED	SIZE	FINISHED	UNFINISHED
4"	\$2.65	\$2.15	12"	\$3.95	\$3.55
6"	\$3.00	\$2.65	14"	\$4.40	\$3.95
8"	\$3.55	\$3.00	18"	\$5.35	\$4.75

NEW NYLON ROPE

Very finest quality. Lustrous white color.

SIZE	Strength	PRICE
1/8" Nylon	300 lbs.	5¢ run ft.
1/4" Nylon	1100 lbs.	9¢ run ft.
3/8" Nylon	2700 lbs.	17¢ run ft.
1/2" NYLON	5000 lbs.	27¢ run ft.
11/16" Nylon	13500 lbs.	39¢ run ft.
15/16" Nylon	17500 lbs.	57¢ run ft.
1" Nylon	18000 lbs.	62¢ run ft.

STAINLESS STEEL CABLE

Finest quality preformed cable. Extra flexible. Rust and corrosion resistant. Aircraft quality. 7 x 19 strand. Breaking strength in chart below.

Dia.	Test lbs.	Price/ft.	Dia.	Test lbs.	Price/ft.
1/16"	480 lbs.	7¢	7/32"	5000 lbs.	29¢
3/32"	1000 lbs.	14¢	1/4"	6600 lbs.	38¢
5/32"	2000 lbs.	21¢	5/16"	9600 lbs.	47¢
3/16"	2900 lbs.	23¢			

3/64" - 1 x 7 strand. Stainless Steel with wire core. 280 lbs. breaking strength - Price/ft. - 5¢

AIR PRESSURE TANKS

G-1 Type. Stainless steel. Shatter-proof and rustless. Has reinforcing ribs and is built to withstand pressures up to 200 PSI. High safety factor. 1/4" pipe ports. Ideal for use in Air Storage in painting, spraying, etc. Can also be used for water storage, as a bunny, etc. Size: 12 1/2" diam. by 24" in length.

NEW & UNUSED 14.95 USED 11.95

SAVE ON UNIVERSAL JOINT

90° to 180° Universal joints. Has a heavy duty, solid cast bronze body. Rotates from 90° to 180° as desired. Has 29/32" dia. steel shafts with a ball & socket joint. In excellent condition, ready for use.

Write TODAY for complete list of many other types of universal joints, hoists, hydraulics, etc.

SAVE ON METAL WORKING CARBON STEEL TWIST DRILLS

Made by Cleveland, Morse, etc. All are unused and in excellent condition. 3/16" Aircraft. Threaded shank. . . . 9¢ ea. 11/16" with Taper Shank. . . . 89¢ ea. 63/64" with Taper Shank. . . . 99¢ ea. 2" diameter with Taper Shank. . . \$2.29 ea.

SAVE on Surplus Drills. Hundreds more in stock. Write for complete list of other sizes and prices.

133 PC. POWER TOOL KIT

Can be used with any electric drill or grinder. Set includes grind, polish, cut-off & buffing wheels, sand discs, cutters, mandrels, burnisher, stones, rubber wheels, etc. 133 pcs. in all. Save 50%.

JUST ARRIVED - SURPLUS

2000 WATT POWER GENERATOR

IDEAL FOR USE ON FARM, IN CAMP, CABIN, MINE AS STANDBY POWER. Delivers 28 V. DC or 70 amps. Rated capacity - 2000 Watts. Driven by a single cylinder, air-cooled, 2 cycle, gasoline engine. Turns 3600 R.P.M. Comes complete with voltage regulator and

voltmeter. Available in rope start or push-button start by battery. Size: 21 1/2" x 18 1/2" x 18 1/2".

89.00

KNIFE BARGAIN FOR SPORTSMEN

AMAZING FOLDING MACHETE WITH LEATHER HOLSTER

2500 COYT VALUE **4.95**

The latest design in battle machetes. A new blade shape that cuts quicker and deeper. Blade is finest, blued steel with ground and honed edge. Folds into the heavy bakelite handle like a giant pocket knife. When open a special safety lock holds blade rigidly in place. Ideal for all chopping, cutting or hacking uses. Complete with Whitstone and rugged, hvy. duty leather belt holster. Overall lgth. 17" open. Blade 8".

NEW NAVY FIGHTING KNIFE

KNIFE 298 LEATHER HOLSTER 1.99

Dagger design with 6-1/2" steel blade and genuine laminated leather handle. Blade is hollow ground on cutting edge and is double-edged 3-1/2" at the point. An excellent knife for the camper, hunter, rancher, woodsman, etc. Comes in leather belt sheath. Overall length 11 inches.

MACHETE NEW 1.98

22" Vanadium steel blade with a 5" curved, hardwood handle. Brand new stock. Comes with a rugged belt sheath. A BUY!

15" BOLO KNIFE 1.98

Top quality Steel blade. 15 inches long. Ideal for chopping, clearing brush, etc. Comes with belt sheath.



3400 RPM - 1/2 HP POWER SAW

RIPS - CROSSCUTS CUTS A FINISHED 2x4 LIKE A KNIFE THROUGH BUTTER

COMPARES TO SAWS SELLING UP TO \$49.50 **19.98** Complete with 5-1/2" Blade

A rugged, professional type, adjustable saw. Will cut any angle from 0 to 45°. Has an adjustable (0 to 6") rip fence. Safety trigger switch on handle. Full 1/2 HP Universal AC-DC, 110-120 Volt, 60 cycle motor. Weighs only 6 1/2 lbs. Thousands already sold. Your satisfaction guaranteed.

EXTRA SAW BLADES - Available in Rip, Crosscut or Combination. Please Specify **2.95 ea.**

NEW POWER SAW BENCH TABLE

This sturdy, precision made bench-saw table converts our famous power saw (above) to a handy bench saw. Permits angle and bevel cuts, rip, crosscut & cones with rip fence and mitre guide. 14" x 16" table, 8" high.

NEW ONLY 9.95

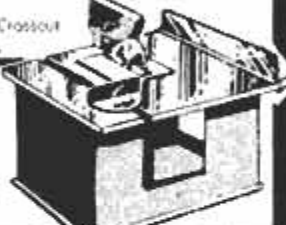

SAVE 40% ON BRASS TIP-WOOD LEGS

Beautifully turned and sanded, fully seasoned. Complete with genuine brushed brass tips and sturdy steel mounting plates. Available finished or unfinished. Finishes are Blonde, Silver Fox, Mahogany or Charcoal Black. Please specify finish. Prices per set of 4

SIZE	FINISHED	UNFINISHED	SIZE	FINISHED	UNFINISHED
4"	\$2.65	\$2.15	12"	\$3.95	\$3.55
6"	\$3.00	\$2.65	14"	\$4.40	\$3.95
8"	\$3.55	\$3.00	18"	\$5.35	\$4.75

NEW IMPORT 25 POWER 30MM TELESCOPE & TRIP OD

ONLY 8.95 2500 VAL.

Objects appear to be 25 TIMES CLOSER to you!

Ideal for spotting "hits" on the target range, stargazing or for fun at the beach, etc. Made of aluminum and chrome plated brass. Field of view: 62 ft. at 1000 yds. Object lens: 1-3/16" dia. Imported.

CONVERTED NYLON PARACHUTE CAR COVERS

Protects your car from all kinds of weather. Converted to give a snug fit and go on easily.

For Dodge, Buick, Chrysler, Cad and other large makes **8.95** For Ford, Chevy, Plymouth, Nash Rambler, etc. **7.95**

UNCONVERTED PARACHUTES

Full 35 foot diameter. Makes an excellent outdoor cover, shade, etc. **22.95**

PALLEY 100 - 200 - 300X MICROSCOPE

IDEAL FOR STUDENTS, AMATEURS, SCHOOLS, ETC.

Has fine, ground and polished lenses. Precision, all-metal construction - NOT A TOY!! Triple-revolving objective lens allows selection of 100, 200 or 300X magnification. Right or left hand rack & pinion adjustment. Body inclines 90°. Plano, substage mirror. Comes in sturdy hardwood case. **WAS 12.95 NOW 7.95**

12" ELECTRIC BOAT KIT

Has pre-formed wood hull & deck. Just install elect. motor & spotlight - add windshield, rudder, propeller and paint hull and it's ready to go. **3.95 WITH MOTOR**



Order From This Ad. Pay by M.O. or check. P.O.'s except. from D&B firms. 1% deposit with C.O.D.'s. All prices FOB Los Angeles area's.

Palley's 2263 E. VERNON AVE. DEPT. PM-10 LOS ANGELES 58, CALIF

FREE CATALOG

Of other model boats, plates, Sports equip., microscopes, etc. Write for Cat. No. M-6.

"ARCO JIG-SAW"

WITH EXCLUSIVE NEW
CIRCLE-
CUTTER
& RIP
GAGE!



"ARCO JIG-SAW" IS A PORTABLE SAW
AND CAN BE USED AS A TABLE SAW!

(with "Arco Stand" shown at right).
"Arco Jig-Saw" guaranteed to fit any
3/4" drill with Adjustable Circle-Cutter
& Rip Gage saves hours of work—
assures professional results. Cuts perfect
circles up to 20" diam., rips accurately
up to 10" wide. Cuts intricate pat-
terns—however large—in plywood,
plastics, metals—even rips thru 2x4's!
Has same capacity & cutting
speed as \$55 jig saws. "Air-Jet"
blows away saw-dust. Includes blade.

\$10⁹⁵

"ARCO STAND" — Casting &
Clamp \$2.95
6 Extra Assorted Blades \$1.95
At Your Dealer or try it on our 10-day
Unconditional Money Back Guarantee.
Send check, M.O. (add. P.O.D. & post.)

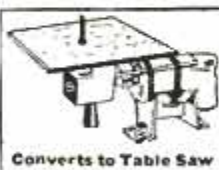

Converts to Table Saw



Ripping with Gage

ARROW METAL PRODUCTS CO.

Dept. PM-10, 140 WEST BROADWAY, NEW YORK 13, N.Y.

SAY YOU SAW IT IN POPULAR MECHANICS

**YIPPEE-EE
A SAWHORSE
IN A JIFFY**

NO
NAILS
NO
BOLTS
NO
SCREWS



WITH **Jiffy** SAWHORSE
BRACKETS

ALL WELDED construction. Use any
2x4's for legs and cross bar.

SET UP OR knocked down instantly.
Easy to move from job to job, and
easy to store.

FOR SALE BY most hardware and lum-
ber stores. If your dealer cannot supply
you, write us direct.



At Work



At Home



GRAND HAVEN STAMPED PRODUCTS CO.
GRAND HAVEN, MICH.

MORE \$ \$ \$ PER HOUR WITH MODERN IMPROVED LAWNMOWER SHARPENER



Write for
free
booklet
10A

Grinds All Reel
Type Mowers
Hollow Grinds or
Flat Grinds Bed Knives

Engine, oil, or gasoline
are not removed from
power mowers. Wheels,
handle and roller re-
main in place.

Moderns precision
grinding assures re-
peat business.
100% Steel Construction

Compare
Before You Buy

Faster—Easier to
operate

NO CHANGE IN PRICE FOR OVER 10 YRS

\$263.00 Complete with 1/2 H.P. Motor

f.o.b. Pasadena, Calif.

MODERN MFG. CO.

160 N. FAIR OAKS, PASADENA, CALIF.

ONE-BAG MIXER THAT TRANSPORTS



Universal Transmix® transports, mixes and
dumps cement, silage, dirt, etc. P. T. O. driven—
no gears or chains. Can be installed or removed
in 15 minutes. Fits Ford, Ferguson, AC-WD,
IHC Super C, H&M, Case VAC, J. D.-40,
Oliver 55, and other 2- and 3-plow tractors.
Unconditionally guaranteed. See your dealer or
write, giving tractor model, to

UNIVERSAL PULLEYS COMPANY
342 NORTH MOSLEY • WICHITA, KANSAS



EXPLORE FOR TREASURE!

Find gold, silver, coins, jewelry, battle
relics! Treasure-Metal-Mineral Detec-
tors. M-SCOPE. Used worldwide for
Treasure Hunting, Mineralights, Geiger,
Scintillation Counters. Prices from
\$14.75. Fully GUARANTEED. Time
Payment Plan. FREE Treasure and
Uranium booklets. New outfitting cat-
alog. **FISHER RESEARCH LAB., INC.**
Dept. PM-1, Palo Alto, Calif.

most amazing blade you ever saw!

Tyler
SPYRAL BLADE

SAWS METAL, WOOD, PLASTIC, ETC.
up or down, right or left, even in circles!



Does what no other Blade can Do. Fits Standard Coping
Saw or Hacksaw Frames. NO special adapters needed!
World's safest saw blade.

You'll find hundreds of uses for Tyler Spyral Blades.
There's nothing like them! The first important improve-
ment in blades since the invention of the saw. Fun to
use... cuts so fast and easy; no chipping or tearing—
leaves clean smooth edge.

AT YOUR HARDWARE DEALER, OR SEND **\$1.00** FOR...
12 Spyral Coping Saw blades—OR—3 Spyral Hacksaw blades

TYLER MANUFACTURING CO. 1005 W. Arbor Vitae Ave., Inglewood, Calif.

PORTABLE LIGHT PLANTS

1500 WATT PLANT

115v. 60 cyc. AC Push Button Start. Powered by a 3 1/2 HP. Clinton engine. Combines big output with easy portability. Provides emergency power for operating any oil burner, sump pump, freezer, television, lights, communications systems, etc. which require up to 1500 watts. (Item 22) Wt. 110 lbs. Reg. price \$417.50. Factory price... **\$239.50**



\$239.50

1750 Watt Plant

Powered by 4.5 Briggs engine. Electric starting & battery charging built-in. Factory price... **\$279.50**

\$279.50

MASTER-LITE 2500 Watt Plant

110/120 v. 60 cyc. AC. A powerful plant, ruggedly constructed and yet designed for easy portability. Can be started by rope or built-in 12 v. electric push button starter. Built-in winding to charge battery. Powered by a big 5.16 HP Briggs engine, complete with all accessories. Includes control box, voltmeter, and handy plug-in power receptacles. An ideal plant for permanent or stand-by service. Wt. 225 lbs. Reg. price \$645.00 (Item 21) Factory Price... **\$329.50**



\$329.50

3500 Watt Plant Push Button Start (Item 23) 115 v. 60 cyc. AC. Similar to above, but larger and 33% more capacity. Wt. 270 lbs. Reg. \$750. Factory Price... **\$379.50**

9 TON HYDRAULIC PRESS

A tremendously powerful hydraulic press, capable of exerting 18,000 lbs. pressure. Pays for itself many times over—straightening bent connecting rods, king pins, crankshafts, axles, link pins and bars—or pushing out frozen bearings and bushings. Developed pressure under precise control and visible at all times on accurate gauge. Complete with both large and small anvil and fits to straighten any kind of curve or bend. (Item 404) Wt. 110 lb. Actual list price \$305. Our special close-out price... **\$69.50**



SCREW TYPE PRESS Nine ton capacity. See Sept. Pop. Mech's. ad for details—or write. Complete. Wt. 150 lbs. (Item 797)... **\$49.50**

EXTENSION CORD

Heavy duty and very flexible. Neoprene 14-2 cable. 20 year quality. Wt. 12 lbs. (Item 185) 100 ft. Complete with rubber plug and outlet. A terrific buy at only **\$8.95**



No. 10-2 POWER CABLE. Heavy duty, very flexible, rubber covered, 50 ft. with male and female fittings. Wt. 9 lbs. (Item 592a) **\$10.45**
50 ft. without fittings (Item 592b) **\$9.45**
NO. 12-2 POWER CABLE. Very flexible rubber covered, special outside shield for grounding power tools, etc. 50 ft. (Item 190) Wt. 8 lbs. **\$6.95**. 100 ft. (Item 200)... **\$12.95**
No. 14-8 Conductor Power Cable, heavy duty very flexible, rubber covered, with 8 contact plug & socket. Ideal for tractor-trailer connections (Item 796) 15 ft.... **\$9.95**

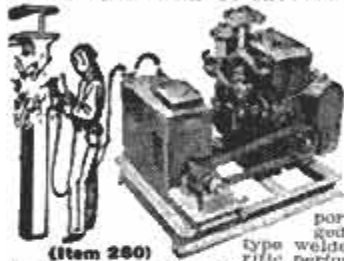

MASTER DC ARC WELDERS

Now! a portable rugged, industrial type welder with terrific performance, yet at a price hundreds of dollars less than you'd expect. Senior model made for years of trouble-free, continuous service. High capacity DC welding unit enables you to tackle any job with confidence—easily welds anything up to 2" plate using from 1/16" to 1/4" rods. Built-in stabilizer and cooling system makes arc easy to strike and hold. Dual control rheostat provides low heat soldering, brazing and welding from 30 to 300 amps. Complete with instructions, guarantee and triple V-belt or flat pulley. Easy to hook up and easy to operate. **WELDER ONLY — DUAL CONTROL MODEL.** Same as above, but drive with your tractor, jeep or gas engine of 14 HP or more. (Item 38a.) Wt. 110 lbs. **\$119.50**
WELDER ONLY—INDUSTRIAL MODEL same as above but with ceramic rotary type rheostat providing 74 different heat settings for all types of welding (Item 38b) **\$139.50**

COMPLETE POWER MASTER (Illustrated above) powered by a 14-hp. air cooled Wisconsin engine. Wt. 480 lbs. (Item 283) Compare with welder costing \$1200. Factory Special... **\$449.50**

WELDING KIT Two 10 ft. leads, welding helmet, electrode holder, ground clamp. Sold only with welder at... **\$10.50**

BUY at **FACTORY PRICES** direct from **MASTER MECHANIC**



700 WATTS PUSH BUTTON START
115 v. 60 cyc. AC. Powered by a rugged 2.2 HP easy starting Briggs engine. No wiring necessary; just plug in and operate. Plenty of current for any oil burner, freezer, brooder, emergency lights, etc. which require up to 700 watts. Ideal for television and radios. Complete with Voltmeter and built-in winding to charge 6 v. auto batteries. (Item 24) Wt. 75 lbs. Easily fits in car trunk. He prepared if storm knocks out power lines. Reg. \$275 value... **\$143.50**
1200 Watt Plant (Item 45) same as Item 24 but larger generator and engine with 50% greater output... **\$199.50**
We make every type and size of light plants—Write, giving us your requirements!

PORTABLE BOOM HOIST

Here is a big 3000 to 10,000 lb. capacity boom hoist at a fraction of the usual cost (it's Gov'L. surplus)—that can pay for itself on one job! Can be mounted as a stationary crane in yards or on buildings; or as a mobile crane on trucks and tractors. Designed for easy mounting in front or rear of trucks for use as a wrecker or mobile crane. Massive telescoping boom is quickly extended from 10 to 20 ft. with a built-in winch. Ideal for erecting buildings, hoisting materials, loading machinery, unloading RR cars, lifting boats from water, laying in sewer pipe, etc. (Item 801) Wt. 450 lbs. Orig. cost over \$350. Special F.O.B. Shelby, O.)... **\$89.50**



Double Acting Hydraulic Cylinder

A powerful cylinder mfr'd. by Massey Harris which develops both a pushing and a pulling action. Will push 8,100 lbs., with a 1000 PSI pump pressure. Cylinder in 3 5/8" O.D. with 3 1/2" stroke—standard heavy duty clevises on both ends. Has standard 1/2" pipe thread openings. Can be used for tilting buckets or blades, raising or lowering implements, hydraulic presses, etc. Can also be used as an air cylinder. (Item 802) Wt. 17 lbs. Reg. \$68 value, Special... **\$14.95**



GIANT METAL SHEARS

Nine inch cutting blade made of special high carbon alloy steel, perfectly aligned and ground. Easily cuts steel plate up to 12 gauge or 1/4" thick. Overall length 40". Wt. 23 lbs. (Item 156) Reg. \$49.50. While they last... **\$14.95**



JET FLOW BLOWER

Tremendous air movement (1800 CFM) and quiet operation make this double inlet 10" turbine blower unbeatable for heating, cooling, drying and air conditioning. Ideal for attic or barn ventilation, converting gravity heating to forced air; spray booth exhausts, etc. Operates with any 1/2, 1 1/2 or 3 HP motor. Oversized, long life bearings. Includes variable speed motor pulley and belt. Dimensions 19" hi x 18" x 16 1/2". Outlet opening 13" x 11 3/4". Wt. 45 lbs. (Item 245). Reg. \$54.50. Factory Special... **\$29.50**
HEAVY DUTY 1/4 HP motor for above **\$17.95**.

LESS THAN WHOLESALE

GIANT 2500 WATT PLANT

110-120 v. 60 cyc. AC. absolutely the best made—exclusive dynamically balanced armature; heavy windings; develops up to 5000 watt overload for motor starting. Skid mounted—portable. Powered by an easy starting Briggs or Wisconsin 6 HP engine—complete with all accessories; engine easily disconnected for other uses. Big outlet box, voltmeter, no wiring necessary. Ample current for all purposes. Factory warranty. (Item 31) Wt. 210 lb. Reg. price \$585. Special at... **\$299.50**
Same plant with electric self starter (Item 31a)... **\$359.50**
Generator only and control box... **\$169.50**
DUAL VOLTAGE 110/220 available on any of above models for \$28.00 additional.

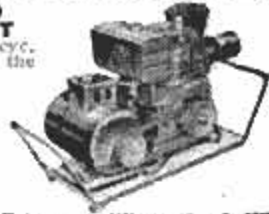

HI-LINE 6000 WATT PLANT

Push Button Start 115-230 v. 60 cyc. A.C. A brute of a power plant with a rugged 14.6 hp. Wisconsin engine. Plenty of electricity for ranges, water heaters, freezers, pumps, machinery, etc. Affords both 110 and 220 volts. Ideal where heavy current is needed. Wt. 590 lbs. Easily worth \$905. With crank start. Factory price... **\$585.50**
Same plant, but with self-starter, **\$645.00**



JET STEAM MASTER

Now, a super efficient portable steam generator that produces live steam at 100 lbs. pressure in 60 seconds from a cold start! Produces large volume of high pressure steam on 2 pints of fuel oil. Instantly cleans sticky grease, dirt, rust, old paint, etc. oil implements and road machinery. Pays for itself in a few weeks. Sterilizes soil. Sterilizes as it cleans—bulk equipment, etc. Fully automatic—oil fired with new, built-in lifetime bronze water circulating pump. Draws water from faucet or bucket. Simple and safe—anyone can use it; built-in safety valve. Complete with 12 ft. of hi-pressure steam hose and new triple efficiency steam gun that automatically mixes in soap solution if desired. Wt. 250 lbs. (Item 403). Special factory price... **\$349.50**



HEATING & VENTILATING FAN

(Item 10) Easily installed in furnace pipes. Forces even heat to all rooms. Over range removes kitchen smoke and odors. Powerful, continuous duty motor, 110-120v. AC. Mount in wall or ceiling to ventilate any area. Quiet, super-efficient fan moves one volume of air. (400 to 600 CFM).
8" Pipe, wt. 5 lb. **\$6.85**
9" Pipe, wt. 6 lb. **\$7.85**
10" Pipe, wt. 7 lb. **\$8.85**
12" Pipe, wt. 8 lb. **\$9.85**
HEAVY DUTY FAN. Semi-enclosed motor, suitable for spray booths, restaurant exhausts, poultry houses, etc. 10" Fan, wt. 8 lbs. (Item 10E).... **\$11.95**
12" Fan, wt. 10 lbs. (Item 10D).... **\$12.95**
HIGH SPEED BARN FAN similar to above, but larger, high speed motor moves huge volume of air.
10" Fan (Item 10F).... **\$14.95**
14" Fan (Item 10G).... **\$17.95**



Rugged, ball bearing WINCH

Sturdy ball bearing winch—sturdy tough aluminum alloy construction. Powered by an easy starting 2 1/2 HP Briggs gas engine thru gear reduction drive—it exerts up to 3000 lbs. of terrific force for hoisting materials or pulling. Combination gear and pulley reduction results in tremendous multiplication of engine power. Idler pulley clutch arrangement and built-in drum brake (with ratchet hand lever) enables operator to ease loads down gently and lock at any point desired. Drum handles 400 ft. of 3/4" cable or 600 ft. of 1/2" cable. Ideal for contractors, farm implement haulers and unlimited other uses. (Item 795) Wt. 125 lbs. Only... **\$149.50**
HAND WINCH—Same winch with large crank handle for extra leverage and 2 speed drive. (Item 794) Wt. 60 lbs. **\$59.50**



Send check or M.O. Prices f.o.b. Factory. 10 day Money back guarantee. SEND 10c for... **BIG 1956 Catalog**
MASTER MECHANIC MFG. CO., DEPT. 16-P Burlington, Wis.

SOUTH BEND 10"-1" COLLET LATHE

Top Value
for those
who want
the best!

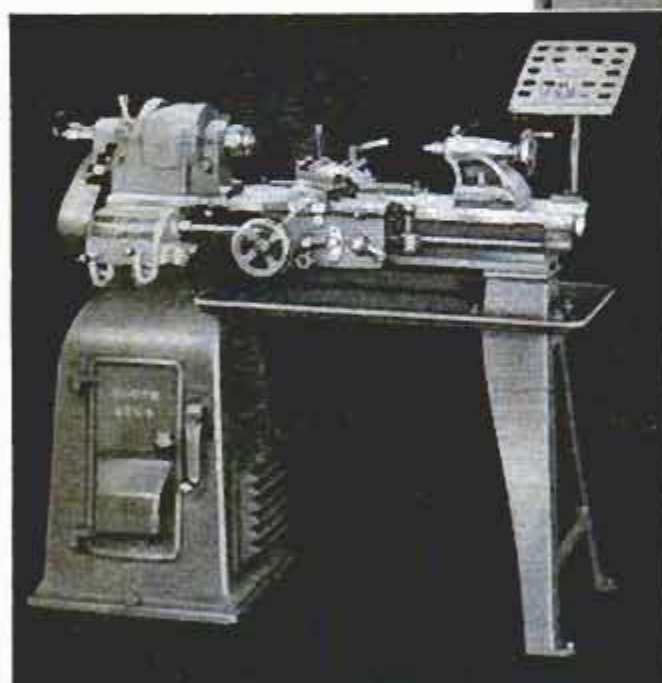
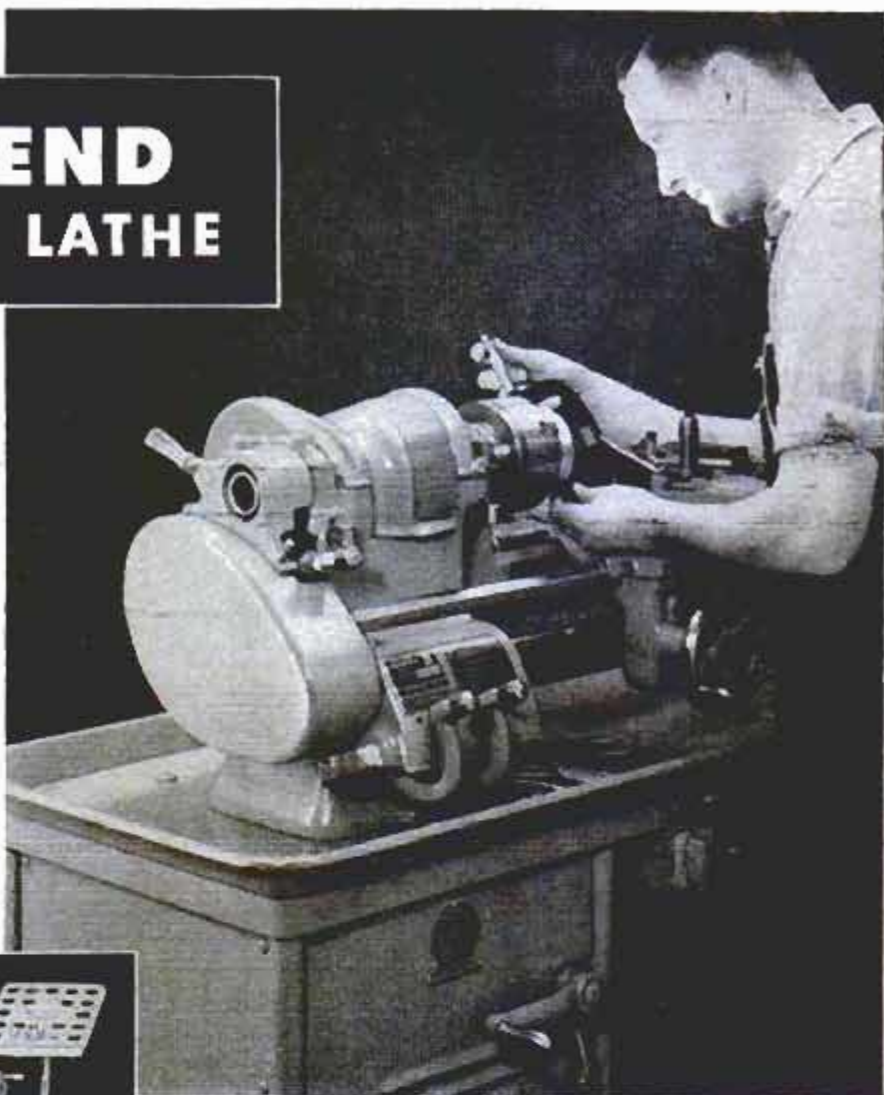

Built for exacting industrial work, the South Bend 10"-1" collet lathe satisfies the demands of any craftsman. Its accuracy simplifies precision jobs and permits work of the highest professional quality. This is the perfect tool for shop owners who want accuracy and versatility. Write for literature on the 10"-1" collet lathe and its many attachments. Time payment terms available. Only 3¼% interest on original unpaid balance due.



PLEASE SEND INFORMATION CHECKED:

- | | | | | | | |
|---|---|---|--|---|---|---|
|  |  |  |  |  |  |  |
| <input type="checkbox"/> 9" and 10" BENCH LATHES | <input type="checkbox"/> 10" to 16-24" FLOOR LATHES | <input type="checkbox"/> DRILL PRESSES | <input type="checkbox"/> ½" & 1" Collet TURRET LATHES | <input type="checkbox"/> TOOL GRINDERS | <input type="checkbox"/> 7" BENCH SHAPERS | <input type="checkbox"/> MILLING MACHINES |

Name _____ Street _____
City _____ State _____

Building Better Tools Since 1906 • SOUTH BEND LATHE • South Bend 22, Indiana

PUT FORMICA® TO WORK
to Finish an Attic



This family made room for a second bath by applying plywood over open studding and put the new gray Milano Formica on the walls and sloping ceiling. The Vanity[®] unit is pink Milano on top and Formica Brachen Maple in front.

FREE! Easy step-by-step picture instructions show you how you can apply colorful Formica to nearly any vertical or horizontal surface. Write today to:

FORMICA CORPORATION *Subsidiary of* 
4596 Spring Grove Ave., Cincinnati 32, Ohio

In Canada: Arnold Bonfeld & Co., Ltd., Oakville, Ontario.

Customers buy Formica because it is a brand name they know and trust.

DEMAND THIS CERTIFICATION

We protect this faith in our product by certifying every sheet with a wash-off Formica marking. It is for your protection and guarantee that you are getting genuine Beauty Bonded Formica.

This mark certifies genuine

808 001 WITH 1014 DE 100 5001 01 4 2007 11010



Beauty Bonded
FORMICA
Laminated Plastic

Proven in Performance

Seeing is believing. If this wash off identification is not on the surface, it's not FORMICA.

MAKES EVERY KIND OF CUT

*in
many
kinds
of
materials*



Weller **SABRE SAW** *portable jig saw*

Here's 7 saws in 1 in a handsome, streamlined polished aluminum housing. Truly portable, use it anywhere... never needs lubrication.

The Weller Sabre Saw offers power and performance found only in saws costing much more. And it has many exclusive

features; such as its strain-relief design that eliminates blade breakage.

Smooth, steady cutting is provided by reciprocating motor... no gears to wear or parts to replace. Supplied with 3 special blades for fine work, rough cutting and metal, and blade adjustment wrench. Guaranteed for one year.

Weller

*Other Weller Tool Values Include Weller Power Sander
And Soldering Gun Kits. See Them At Your Dealer Or
Write For Bulletin.*

ELECTRIC CORP., Easton, Pa.