

POPULAR MECHANICS

MAGAZINE

WRITTEN SO YOU CAN UNDERSTAND

REG. U.S. PAT. & TM. OFF. TRADE MARK, GREAT BRITAIN, No. 40426

REG. U.S. PAT. & TM. OFF.

**Our Newest
JET BOMBER...**
an artist's conception
of the delta B-58
—See page 89



What's it like to own a \$10,000 car?
Read the OWNERS REPORT on the
CONTINENTAL MARK II

ANTARCTIC ALBUM

Eight pages of color photographs
from the bottom of the world

How to take pictures indoors
without flash

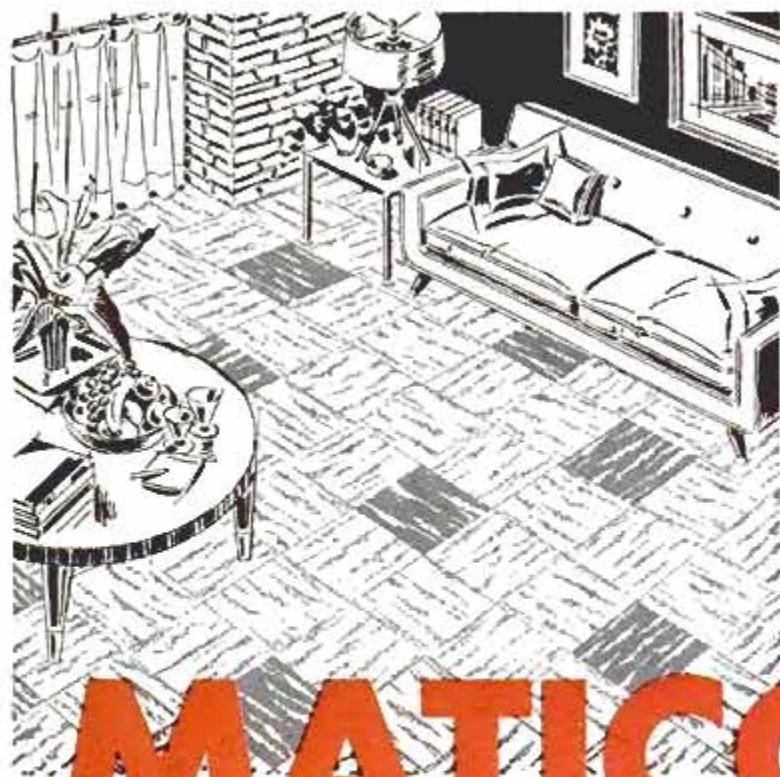

*Replace your
worn-out
floors with*
**BEAUTIFUL,
ECONOMICAL**

MATICO TILE FLOORING

DO-IT-YOURSELF IN JUST A FEW HOURS

Yes, you can install your own smart, easy-to-clean MATICO Tile Floor . . . free your wife from floor drudgery . . . in just a few hours. It's easy with MATICO's big, new illustrated instruction book to show you how. And you couldn't choose a more economical, durable, colorful flooring. MATICO comes in popular marbleized colors, Confetti dots-of-color patterns and smart wood tones in asphalt and vinyl-asbestos tile.

CUT COSTS TOO

Save money? You bet. You save plenty by installing your own floor . . . and MATICO saves on upkeep, too, because it requires less care, lasts for years. Ask your MATICO dealer for full details today. He's listed under "floors" in the classified telephone directory. Or mail coupon for your free instruction book.



Mastic Tile Corp. of America
Dept. M2-9, Newburgh, N. Y.

Please send me full details on MATICO Tile Flooring and FREE install-it-yourself instruction book.

NAME _____

ADDRESS _____

CITY _____ ZONE _____ STATE _____

GC 347

**MASTIC TILE CORPORATION
OF AMERICA**

Houston, Tex. • Joliet, Ill.

Long Beach, Calif. • Newburgh, N. Y.

Rubber • Vinyl • Asphalt Tile • Confetti • Aristoflex
Parquetry • Maticork • Cork Tile • Plastic Wall Tile





THERMO-MAGIC!

AC HOT TIP

**HEATS FAST TO PREVENT FOULING!
COOLS FAST TO CONTROL PRE-IGNITION!**

The unique AC Hot Tip Spark Plug insulator is deeply recessed to meet the demands of today's varying driving conditions: stop-and-go city traffic and high-speed highway cruising!

The AC Hot Tip heats fast to burn away oil, carbon and other deposits as soon as they form. These fouling deposits are the cause of misfiring, loss of power and poor performance in high-compression engines. The AC Hot Tip cools fast to control the pre-ignition of high-octane gasolines. Knocking, pinging and rough engine performance are the results of harmful pre-ignition.

Ask your AC dealer to check your spark plugs today. If he recommends new ones, you'll find that AC Hot Tip Spark Plugs are best for today's high-compression engines and high-octane gasolines!



This One



LYG5-59H-Q1T1



Watch **BIG TOWN** on NBC-TV

AC SPARK PLUG  THE ELECTRONICS DIVISION OF GENERAL MOTORS



WARREN A. MARRISON. Tompion Gold Medal, Worshipful Company of Clockmakers of the City of London, for pioneer work on development of quartz crystal oscillators as precision standards of time.



AXEL G. JENSEN. David Sarnoff Gold Medal, Society of Motion Picture and Television Engineers, for Television Research; G. A. Hagemann Gold Medal for Industrial Research, Royal Technical College, Copenhagen.



H. T. FRIIS. Medal of Honor, Institute of Radio Engineers, and Valdemar Poulsen Gold Medal, Danish Academy of Technical Sciences; important work in application of short and ultra-short radio waves.



CLAUDE E. SHANNON. Stuart Ballantine Medal, Franklin Institute of the State of Pennsylvania, for contributions to a comprehensive theory of communication.



W. G. PFANN. Mathewson Gold Medal, American Institute of Mining and Metallurgical Engineers, for discovery of and pioneering research in zone melting.



H. F. DODGE. Shewhart Medal, American Society for Quality Control, for original contributions to the art of statistical quality control.



R. KOMPFNER. Duddell Medal, Physical Society of England, for his original work on the traveling wave tube.

These are some of our recent medal winners at Bell Laboratories. The awards they have won symbolize recognition for outstanding achievement in the many sciences that bear on telephony. Bell Labs is extremely proud of them—and of the thousands of scientists and engineers who work with them to keep the American telephone system the greatest in the world.



WALTER H. BRATTAIN. Co-winner with Dr. John Bardeen of John Scott Medals, City of Philadelphia, for invention of the transistor.

BELL TELEPHONE LABORATORIES



WORLD CENTER OF COMMUNICATIONS RESEARCH AND DEVELOPMENT

Popular Mechanics Magazine

Registered in U. S. Patent Office and Canada

H. H. WINDSOR, Founder

H. H. WINDSOR, JR., Editor and Publisher



Next Month

When Cecil York got tired of answering the gag question "how do you wind it?" he installed a big key on the back of his Volkswagen for a trip from San Fernando, Calif., to Missouri. For a key to the success of this little German car, you can read next month what the American owners of Volkswagens have to say about it. Our report on questionnaires sent to the Volkswagen owners will appear in the October issue

Sources of further information not listed in the index, starting on page 74, about articles in this issue, frequently are shown in the Where-to-Find-It List prepared for each issue. A copy may be obtained by readers, without charge, from Bureau of Information, Popular Mechanics, 200 East Ontario Street, Chicago 11, Ill.

Published monthly by Popular Mechanics Company, 200 E. Ontario St., Chicago 11, Ill. H. H. Windsor, Jr., president; Wm. Harrison Petridge, exec. vice-pres.; Franklin S. Forsberg, operations vice-pres.; D. F. Windsor, vice-president and secretary-treasurer; H. H. Windsor III, vice-president; W. T. Windsor, vice-president; Joseph R. Buell, Jr., advertising manager; Alan M. Deyoe, circulation manager. Single copy in the United States and Canada, 35 cents; subscription rates in the United States and possessions, Canada, Philippines and countries of the Pan-American Postal Union, 1 year \$3.50; 2 years, \$6.00; 3 years, \$8.00. To all other countries add \$1.00 a year over United States prices for overseas postage. If you plan to move, notify us at least 30 days in advance so you will not miss an issue. Give both your old and new addresses. Entered as Second Class Matter, September 15, 1903, at the Post Office at Chicago, Illinois, under Act of March 3, 1879. Entered as Second Class Matter at Post Office Dept., Canada. Registered as Second Class Matter at the Post Office at Mexico, D. F., Mexico, June 20, 1950. Copyright 1956 by Popular Mechanics Company. Copyright under International Copyright Union. Copyright in France. All rights reserved under Pan-American Copyright Union. Printed in the United States of America.

IMPORTANT NOTICE—It is the intention of this magazine to provide its readers with information regarding the latest developments in the mechanical arts. We take no responsibility as to whether the disclosures contained in our articles are covered by patents and advise readers to investigate this subject before making, using, or selling any of the products, machines, or processes described in order to avoid possible liability for patent infringements.

Volume 106

SEPTEMBER 1956

Number 3

Address all communications to: 200 E. Ontario St., Chicago 11, Ill.

Managing Editor.....	Roderick M. Grant
Assistant Managing Editor.....	Wayne Whittaker
Shop Notes and Crafts Editor.....	James R. Ward
Radio-Television, Electronics Editor.....	Lothar Stern
Associate Editor.....	Clifford B. Hicks
Associate Editor, Automotive.....	Arthur R. Railton
Associate Editor, Shop Notes and Crafts.....	Wayne C. Leckey
Associate Editor, Shop Notes.....	W. Clyde Lammey
Assistant Editor, Crafts.....	Jay W. Hedden
Assistant Editor, Makeup.....	John C. Dalen
Automotive Correspondent.....	Leo Donovan
Art Director.....	Frank Beatty
Assistant Editors—Leonard F. Hilts, Emily M. Rice, Earl F. Wabeck	
Eastern Editor.....	Richard F. Dempewolf
Western Editor.....	Thomas E. Stimson, Jr.
London Manager.....	Douglas W. Wedderspoon
Director, Bureau of Information.....	Allan Carpenter

Chicago: 200 E. Ontario St., Whitehall 4-0100; New York: Empire State Bldg., 350 Fifth Ave., LOngacre 5-7580; Detroit: General Motors Bldg., TRinity 5-8711; Cleveland: Hanna Bldg., 1422 Euclid Ave., PRospect 1-0456; Los Angeles: 3460 Wilshire, DUmkirk 2-8458; San Francisco: Russ Bldg., 235 Montgomery St., YUkon 2-0823.

In This Issue...

Electrons Join the College Faculty	81
Era of the Flying Triangles	89
Detroit Listening Post	97
Gettysburg in Miniature	102
Don't Stop Fishing at the First Frost	109
Antarctic Album	113
Keeping 2000 Ghost Ships Alive	121
Indoor Pictures Without Flash	132
What's New for Your Home	144
Owners Report on the Continental Mark II	146
There's Atomic Energy in Granite	154
Keeping Up With the Atom	159
Radio, TV and Electronics	165

For the Craftsman...

Matching Lamp and Folding Screen	169
Knock Out That Spot	172
"Rolling Dinette" Has Drop Leaves	178
Solving Home Problems	186
The Causes and Cures of Tire "Thump"	194
Electric Sparks Cut Hard Metals	209
How Would You Do It?	218
Shopping for Tools	222
Clinic for Homemakers	226

See pages 74, 76 and 78 for other items and manufacturers of available products

Engineer's Report:
1956 CHEVROLET

HERE'S WHY IT'S EASY TO "POINT" A CHEVROLET

By **ED COLE**, *Chevrolet Chief Engineer*

After you've driven a new Chevrolet for a while you'll find that one of the most satisfying things about it is its steering. You "point" it where you want it to go and it goes there—with superlative ease and precision.

The secret is **Ball-Race steering**, in which 54 micro-polished steel balls provide *rolling* friction instead of the usual

sliding friction. The "drag" of friction is reduced to the lowest point we can get it. And, in addition, the *weight* on the front wheels is lightened by moving the center of balance farther back.

The result is exceptionally light-handed steering—manual steering that comes awfully close to the ease of power steering. Better still, the improved weight distribution gives Chevrolet better rear wheel traction and better roadability.

Our ideal at Chevrolet is to produce the best *road* car the world has ever seen—and Ball-Race steering is a big factor. Your Chevrolet dealer will be glad to arrange a demonstration so you can sample it for yourself—a preview of the additional pleasure Chevrolet can give you during every mile you drive. . . . Chevrolet Division of General Motors, Detroit 2, Michigan.



Texaco Tips On Car Care

How to test your brakes

Be sure that all tires have equal and correct pressure, then drive to a hard-surfaced road where there is no traffic. Then, at twenty miles per hour speed, hit the brakes fast and hard. If your car doesn't stop within twenty feet, or it pulls to one side, or only one tire makes a scuff mark, your brakes need expert attention. If you have to pump the brake pedal, probably the hydraulic fluid level is low, or air is in the system. For safety's sake, don't delay any brake work found necessary.

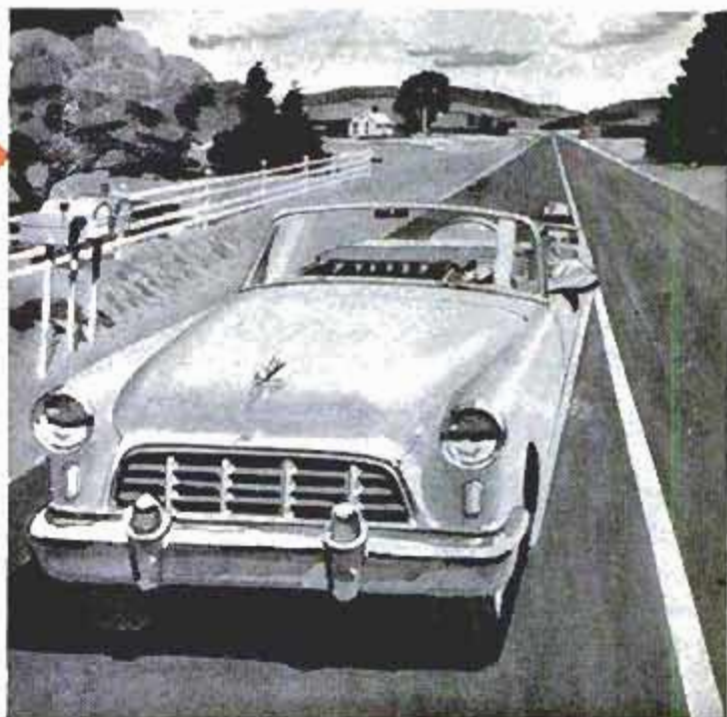

How to enjoy "cushiony" motoring



Treat yourself—and your car—to *Marfak* chassis lubrication. Tiger-tough *Marfak* protects vital chassis points of wear and friction . . . won't jar out, shake out or splash out . . . keeps giving you that *cushiony* feeling for 1,000 miles or more. Today, drive in for longer lasting *Marfak* chassis lubrication. Available from your Texaco Dealer, the best friend your car has ever had.

TEXACO DEALERS IN ALL 48 STATES

Texaco Products are also distributed in Canada and in Latin America



THE
TEXAS
COMPANY

**New Tools for Your Needs
Further Expand PROTO's
Huge Professional-
Quality Line**

Joining the thousands of other proven standard and special tools are hundreds of *new* tools, developed to meet the exacting requirements of your job. With this extensive line you can build a complete matched set of guaranteed tools, getting time-saving designs, long service and highest quality at the right price. Make your PROTO dealer your Tool Headquarters. Send 10c for catalog of entire line to

PROTO TOOLS

2235 Santa Fe Ave., Los Angeles 54, Calif.
Eastern Factory, Jamestown, N. Y., Canadian Factory, London, Ont.

Forging Ahead
Through
Leadership,
Quality,
Service and
Understanding



ACROSS THE DESK



To the Editor:

On behalf of the officers and men of the Civil Engineer Corps and Seabees, I want to compliment you and Mr. Richard E. Dempewolff on the excellent articles in your April and May issues, "Seabees Build a Town Under Antarctic Ice."

These articles are the most thorough and complete that we have seen of our participation in Operation Deepfreeze, and we are proud of your excellent and very interesting coverage and pictures.

We have publicized these articles to our people. However, it is such a fine presentation that we would like very much to have permission to reprint it, or portions, in our official monthly publication for our Reserve Officers, the "CEC Bulletin." We would appreciate very much having your permission to do so.

Again, our sincere congratulations to you and to Mr. Dempewolff.

R. H. Meade,
Rear Admiral, CEC, USN,
Chief of Bureau of Yards and Docks,
Washington, D. C.

To the Editor:

I have just finished reading "Look What Happens When the Atom Strikes a Valley" by Clifford B. Hicks, in your May 1956 issue. I am wondering if I could obtain permission to use the material in this article in making certain off-the-cuff speeches in my home state.

I frequently have invitations to speak unexpectedly in communities which have expressed a desire for the establishment of a gigantic atomic-energy project. The article expresses the possibilities, both good and bad, in such a way that I find it entirely adequate to my purpose.

I would, of course, give *Popular Mechanics* Magazine credit for gathering this information.

Clinton P. Anderson

New Mexico's Senator Anderson is chairman of the Joint Committee on Atomic Energy of the United States Congress.

Editor's Note

Commenting on the "tripont sloop" pictures on our July cover, Comdr. Victor

(Continued to page 8)

GOOD SALARY

FINE CAR

To the man who wants to enjoy
CAREER

To the man who wants to enjoy
an ACCOUNTANT'S

A NICE HOME

BANK ACCOUNT

FREE SAMPLE LESSON

IF you're that man, here's something that will interest you.

Not a magic formula—not a get-rich-quick scheme—but something more substantial, more practical.

Of course, you need something more than just the desire to be an accountant. You've got to pay the price—be willing to study earnestly, thoroughly.

Still, wouldn't it be worth your while to sacrifice some of your leisure in favor of interesting home study—over a comparatively brief period? Always provided that the rewards were good—a salary of \$4,000 to \$10,000 and up?

An accountant's duties are interesting, varied and of real worth to his employers. He has *standing!*

Do you feel that such things aren't for you? Well, don't be too sure. Very possibly they *can* be!

Why not, like so many before you, investigate LaSalle's modern Problem Method of training for an Accounting position?

Just suppose you were permitted to work in an accounting firm under the personal supervision of an expert accountant. Suppose, with his aid, you studied accounting principles and solved problems day by day—easy ones at first—then more difficult ones. If you could do this—and could turn to him for advice as the problems became complex—soon you'd master them all.

That's the training you follow in principle under the LaSalle Problem Method.

You cover accounting from Basic Accounting right through Accounting Systems and Income Tax Procedure. As you go along, you absorb the principles of General Accounting, Auditing and Basic Cost Accounting. Then you may choose Commercial Accounting, Industrial Accounting or Public Accounting and prepare for the C. P. A. examinations.

Your progress is as speedy as you care to make it—depending on your own eagerness to learn and the time you spend in study.

Will recognition come? The only answer, as you know, is that success *does* come to the man who is really *trained*. It's possible your employers will notice your improvement in a very few weeks or months. Indeed, many LaSalle graduates have paid for their training—with increased earnings—before they have completed it! For accountants, who are trained in organization and management, are the executives of the future.

Get Free Sample Lesson—Also

"Accountancy, The Profession That Pays"

For your own good get all the facts about this completely new and modern accounting training. Write for Free Sample Lesson—also latest book "Accountancy, The Profession That Pays." They will prove that Accounting offers brilliant futures to those who aren't afraid of serious home study, and will show the wide range of opportunities that exist today. No cost or obligation. If you want a position of higher income, greater prestige and professional standing... MAIL THE COUPON NOW!

Over 4,200 Certified
Public Accountants among
LaSalle alumni

Member, National Home Study Council

LASALLE EXTENSION UNIVERSITY
A CORRESPONDENCE INSTITUTION

417 S. Dearborn St. Dept. 964H Chicago 5, Ill.

I want to be an accountant. Send me without obligation, Free Sample Lesson—also "Accountancy, The Profession that Pays."

Name.....Age.....
Address.....
City, Zone & State.....



OWN THIS
Prize-Winning
COMBINATION

FOR AS LITTLE AS \$26.82 PER MONTH



PACEMAKER 4x5 SPEED GRAPHIC[®]
AND STROBOFLASH[®] IV

You can do more things better with the Pacemaker Graphic than with any other camera. Most of the nation's press photographers are a testimonial to its ruggedness, dependability, and all-round performance. Portraiture, sports, action, copying, close-ups, and photo-micrography are within its scope. Exclusive Graflok Back permits using Graphic film attachments for sheet film, film packs, glass plates, 120 size roll film, Graphic Polaroid Back and the Grafmatic sheet film magazine. The Graphic Rangefinder can be accurately matched in seconds to wide angle, normal or telephoto lenses by means of interchangeable cams. A focusing Rangelite is coupled to Rangefinder mechanism for night use.

LOW COST FLASH PICTURES

Economical Strobflash IV portable electronic flash unit reduces flash illumination to as little as two cents per shot... permits the instant choice of 50, 100, 150 or 200 watt-seconds energy storage for maximum lighting flexibility.

10% DOWN With Graflex' new Easy Payment Plan, you pay only 10% down and take up to 20 months to pay the balance. As little as \$26.82 per month for combination mentioned above. Make a one-stop visit to your local Graflex dealer listed in the yellow pages of your telephone directory. Find out how easy it is to own this versatile, economical, dependable combination.

Prices include federal tax where applicable and are subject to change without notice. Prices are slightly higher in Canada.

Write Dept. PM-96 for further information.



GRAFLEX[®]

Prize-Winning Camera

GRAFLEX, INC., ROCHESTER 8, N. Y.

(Continued from page 6)

Tchetchet of the International Multihull Boat Racing Association tells us he has been experimenting with trihulled boats since 1938. The commodore's first trimaran was launched in 1945 and raced in the 1946 Marblehead Race Week, was destroyed in a storm in 1950 and he then built another which won trophies in several regattas. A 20-foot trimaran designed by Commodore Tchetchet was the subject of a how-to-build article in *PM's* Craftsman section for July 1951.

To the Editor:

Many thanks for "How Would You Do It?" by Chris Nelson, in the July issue. This has helped me a lot in my shop work. Not only is the photography good, but you are to be commended on your safety features. I look forward to your continuing this as a feature of your subsequent issues.

Dr. Robert C. Bailie,
Waynesboro, Ga.

To the Editor:

In the newspapers lately there have been stories about runaway trucks down hills and mountains because of no brakes. I have an idea that may not seem too silly in this auto-minded world of today. Here it is:

You are starting down a mountainside and when you put your foot on the brake pedal, it goes to the floor. No brakes! You're moving too fast to use the emergency brake for fear the trailer truck will jackknife. You pull a lever that has a cable running under the truck to the rear of the trailer to a metal box 12 inches deep and 3 by 3 feet square. The cable pulls a latch out and two doors swing open like bomb bays on an airplane. After doors are open, a huge parachute falls behind and opens. The truck slows down rapidly. Then you use the emergency brake to bring the truck under control. From the time you discover you have no brakes till the time the chute opens it would take less than 30 seconds.

They use parachutes to slow down huge airplanes that come in for fast landings and they weigh much more than a loaded trailer truck. Parachute, box, cable, etc., would amount to about \$100. Consider a trailer truck hauling a pay load of \$5000 to \$10,000 over mountains two or three times a week, it would be worth the extra safety device.

C. L. Blundell, Jr.,
1709 S. Taylor St.,
Arlington, Va.

(Continued to page 10)

PICK YOUR OWN SUCCESS STORY FROM THIS PAGE

These are the true stories of people who seemed trapped in routine, low-pay shaky jobs. Handicapped by lack of proper training, they couldn't get the things they wanted out of life—more money, a job they liked, security and happiness.

They are a small sample of the thousands of men and women—young and old—who turn to I. C. S. for help. Their will-to-learn plus I. C. S. training have changed the course of their lives.

Are you discouraged with your job and pay and feel you can't improve yourself because of lack of specialized education? Well, these men and women were in the same boat. With I. C. S. training, one of these success stories could be about you.

I. C. S. is the oldest and largest correspondence school. 256 courses. Business, industrial, engineering, academic, high school. One for you. Direct, job-related. Bedrock facts and theory plus practical application. Complete lesson and answer service. No skimping. Diploma to graduates.

For Real Job Security—Get an I. C. S. Diploma!

I. C. S., Scranton 9, Penna. Member, National Home Study Council



Wins \$3000 contest—"After my I. C. S. courses I secured a new position," says Mr. Cecil Rhodes. "My income has more than doubled and I recently won a \$3000 sales contest."



From clerk to Assistant Estimator, thanks to I.C.S. "Any way you look at it," writes Mrs. Edna James, "the time and money one spends for I. C. S. Courses will be repaid a thousandfold."



"As a college graduate, I found I.C.S. very valuable." Robert Lee took the I. C. S. Course in Advertising, is now Promotion Manager for a large corporation. "I. C. S. got me started on the way up," he says.



From \$152 to \$395 a month—"I.C.S. made my engineering work more interesting," Frank Bachtik tells us. "I was a Jr. Draftsman making \$152 a month. My present income is \$395.25 a month."

3 FREE BOOKS—a 36-page pocket-size guide to advancement, a gold mine of tips on "How to Succeed." Also a big catalog outlining opportunities in your field of interest and a sample I.C.S. lesson (Math.).

INTERNATIONAL CORRESPONDENCE SCHOOLS

65TH YEAR

BOX 92626J, SCRANTON 9, PENNA.

Without cost or obligation, send me "HOW TO SUCCEED" and the opportunity booklet about the field BEFORE which I have marked X (plus sample lesson):

- | | | | | |
|--|---|--|---|--|
| <p>ARCHITECTURE and BUILDING CONSTRUCTION</p> <ul style="list-style-type: none"> <input type="checkbox"/> Air Conditioning—Refr. <input type="checkbox"/> Architecture <input type="checkbox"/> Architectural Interiors <input type="checkbox"/> Building Contractor <input type="checkbox"/> Building Estimator <input type="checkbox"/> Building Maintenance <input type="checkbox"/> Carpentry and Mill Work <input type="checkbox"/> Heating <input type="checkbox"/> Painting Contractor <input type="checkbox"/> Plumbing <input type="checkbox"/> Reading Arch. Blueprints <p>ART</p> <ul style="list-style-type: none"> <input type="checkbox"/> Cartooning <input type="checkbox"/> Commercial Art <input type="checkbox"/> Fashion Illustrating <input type="checkbox"/> Magazine Illustrating <input type="checkbox"/> Show Card and Sign Lettering <input type="checkbox"/> Sketching and Painting <p>AUTOMOTIVE</p> <ul style="list-style-type: none"> <input type="checkbox"/> Auto Body Rebuilding <input type="checkbox"/> Auto Elec. Technician <input type="checkbox"/> Auto-Engine Tune Up <input type="checkbox"/> Automobile Mechanic | <p>AVIATION</p> <ul style="list-style-type: none"> <input type="checkbox"/> Aeronautical Engineering Jr. <input type="checkbox"/> Aircraft & Engine Mechanic <p>BUSINESS</p> <ul style="list-style-type: none"> <input type="checkbox"/> Advertising <input type="checkbox"/> Bookkeeping and Accounting <input type="checkbox"/> Business Administration <input type="checkbox"/> Business Correspondence <input type="checkbox"/> Public Accounting <input type="checkbox"/> Creative Salesmanship <input type="checkbox"/> Federal Tax <input type="checkbox"/> Letter-writing Improvement <input type="checkbox"/> Office Management <input type="checkbox"/> Professional Secretary <input type="checkbox"/> Retail Business Management <input type="checkbox"/> Sales Management <input type="checkbox"/> Stenographic-Secretarial <input type="checkbox"/> Traffic Management <p>CHEMISTRY</p> <ul style="list-style-type: none"> <input type="checkbox"/> Analytical Chemistry <input type="checkbox"/> Chemical Engineering <input type="checkbox"/> Chem. Lab. Technician <input type="checkbox"/> General Chemistry <input type="checkbox"/> Natural Gas Prod. & Trans. <input type="checkbox"/> Petroleum Engineering <input type="checkbox"/> Plastics <input type="checkbox"/> Pulp and Paper Making | <p>CIVIL, STRUCTURAL ENGINEERING</p> <ul style="list-style-type: none"> <input type="checkbox"/> Civil Engineering <input type="checkbox"/> Construction Engineering <input type="checkbox"/> Highway Engineering <input type="checkbox"/> Reading Struct. Blueprints <input type="checkbox"/> Sanitary Engineering <input type="checkbox"/> Structural Engineering <input type="checkbox"/> Surveying and Mapping <p>DRAFTING</p> <ul style="list-style-type: none"> <input type="checkbox"/> Aircraft Drafting <input type="checkbox"/> Architectural Drafting <input type="checkbox"/> Electrical Drafting <input type="checkbox"/> Mechanical Drafting <input type="checkbox"/> Mine Surveying and Mapping <input type="checkbox"/> Plumbing Drawing and Estimating <input type="checkbox"/> Structural Drafting <p>ELECTRICAL</p> <ul style="list-style-type: none"> <input type="checkbox"/> Electrical Engineering <input type="checkbox"/> Electrical Maintenance <input type="checkbox"/> Electrician <input type="checkbox"/> Contracting <input type="checkbox"/> Lineman <p>HIGH SCHOOL</p> <ul style="list-style-type: none"> <input type="checkbox"/> Commercial <input type="checkbox"/> Good English <input type="checkbox"/> High School Subjects <input type="checkbox"/> Mathematics | <p>LEADERSHIP</p> <ul style="list-style-type: none"> <input type="checkbox"/> Foremanship <input type="checkbox"/> Industrial Supervision <input type="checkbox"/> Leadership and Organization <input type="checkbox"/> Personnel-Labor Relations <p>MECHANICAL AND SHOP</p> <ul style="list-style-type: none"> <input type="checkbox"/> Gas—Electric Welding <input type="checkbox"/> Heat Treatment <input type="checkbox"/> Metallurgy <input type="checkbox"/> Industrial Engineering <input type="checkbox"/> Industrial Instrumentation <input type="checkbox"/> Industrial Supervision <input type="checkbox"/> Internal Combustion Engines <input type="checkbox"/> Machine Design-Drafting <input type="checkbox"/> Machine Shop Inspection <input type="checkbox"/> Machine Shop Practice <input type="checkbox"/> Mechanical Engineering <input type="checkbox"/> Quality Control <input type="checkbox"/> Reading Shop Blueprints <input type="checkbox"/> Refrigeration <input type="checkbox"/> Sheet Metal Worker <input type="checkbox"/> Tool Design <input type="checkbox"/> Toolmaking <p>RADIO, TELEVISION</p> <ul style="list-style-type: none"> <input type="checkbox"/> Industrial Electronics <input type="checkbox"/> Practical Radio TV Eng'ng <input type="checkbox"/> Radio and TV Servicing <input type="checkbox"/> Radio Operating | <ul style="list-style-type: none"> <input type="checkbox"/> Television Technician <p>RAILROAD</p> <ul style="list-style-type: none"> <input type="checkbox"/> Air Brake Equipment <input type="checkbox"/> Car Inspector <input type="checkbox"/> Diesel Engineer & Fireman <input type="checkbox"/> Section Foreman <p>STEAM AND DIESEL POWER</p> <ul style="list-style-type: none"> <input type="checkbox"/> Combustion Engineering <input type="checkbox"/> Diesel—Elec. <input type="checkbox"/> Diesel Eng's <input type="checkbox"/> Electric Light and Power <input type="checkbox"/> Stationary Fireman <input type="checkbox"/> Stationary Steam Engineering <p>TEXTILE</p> <ul style="list-style-type: none"> <input type="checkbox"/> Carding and Spinning <input type="checkbox"/> Cotton, Rayon, Woolen Mfg. <input type="checkbox"/> Finishing and Dyeing <input type="checkbox"/> Loom Fix'g <input type="checkbox"/> Textile Des'g <input type="checkbox"/> Textile Eng'g <input type="checkbox"/> Throwing <input type="checkbox"/> Warping and Weaving <p>MISCELLANEOUS</p> <ul style="list-style-type: none"> <input type="checkbox"/> Domestic Refrigeration <input type="checkbox"/> Marine Engineering <input type="checkbox"/> Ocean Navigation <input type="checkbox"/> Professional Engineering <input type="checkbox"/> Short Story Writing <input type="checkbox"/> Telephony |
|--|---|--|---|--|

Name _____ Age _____ Home Address _____
 City _____ Zone _____ State _____ Working Hours _____ A.M. to P.M. _____
 Occupation _____

Canadian residents send coupon to International Correspondence Schools, Canadian, Ltd., Montreal, Canada. . . . Special tuition rates to members of the U. S. Armed Forces.

FOR A REAL JOB OR A
BUSINESS OF YOUR OWN

LEARN
OIL BURNER
SERVICING

at home—in your spare time!



GET THE FACTS FREE!

Let us send you — without obligation — a Sample Lesson plus all the information you'll need to get you started on the road to success in the automatic oil heating field. Let us prove to you that salaries are higher, opportunities greater, advancement quicker in the fast-growing Oil Burner industry.

5 PROGRAMS IN ONE. We offer you a complete and approved training program — available at no other school — prepared with the co-operation of America's leading heating system manufacturers. Covers Installation, Operation, Maintenance and Service plus Electrical Controls, Firebrick Construction and Sheet Metal Fabrication. Even includes a "Special Business" Plan to help you start your own service shop.

START NOW . . . TODAY! Put your spare time to work. Learn a skilled trade. No previous experience or special education required. Earn while learning, doing part-time jobs in your own area. Low tuition. Tools furnished. Send coupon now. No obligation.

MASS. TRADES "Training Thousands since 1936"

RESIDENT SCHOOL — APPROVED FOR VETS
LICENSED BY MASS. DEPT. OF EDUCATION

Member — Oil Heat
Institute of America



Write **NOW** for
FREE SAMPLE

lesson and booklet.
No obligation. Use
the coupon below.

MASS. TRADES
161-A High St., Boston 10, Mass.
Please rush **FREE** booklet and Sample Lesson on **OIL BURNER SERVICING**. I understand there is no obligation.
Name Age.....
Address
City Zone..... State.....

TRAINING AVAILABLE IN CANADA

To the Editor:

I am a reader of your magazine. It is very excellent and wonderful, especially the articles for the craftsman.

I am very interested in modeling small planes and machines. Now I want to make a jet engine for my bicycle, so I would be very thankful if you would send me some details for this.

Farouk Ismail,
Saddar Bazar,
Hyderabad, West Pakistan

☆☆☆

Back in December 1947, PM reported the construction by William Tenney and Charles Marks at Dayton, Ohio, of what



was acclaimed the world's first jet-propelled bicycle (above), powered by three tiny jet engines developed for model planes. Our Automotive Editor, Art Railton, didn't recall this, however, and thought the idea was impractical. He took the letter home and showed it to his sons.

"Don't be silly, dad," replied Steve, aged seven. "I'll show you how to build one." Here is Steve's solution of the problem:



put gas tank on
cross bar put a
pipe down to
rocket

Radio-Television Can Give You a Job with a Future

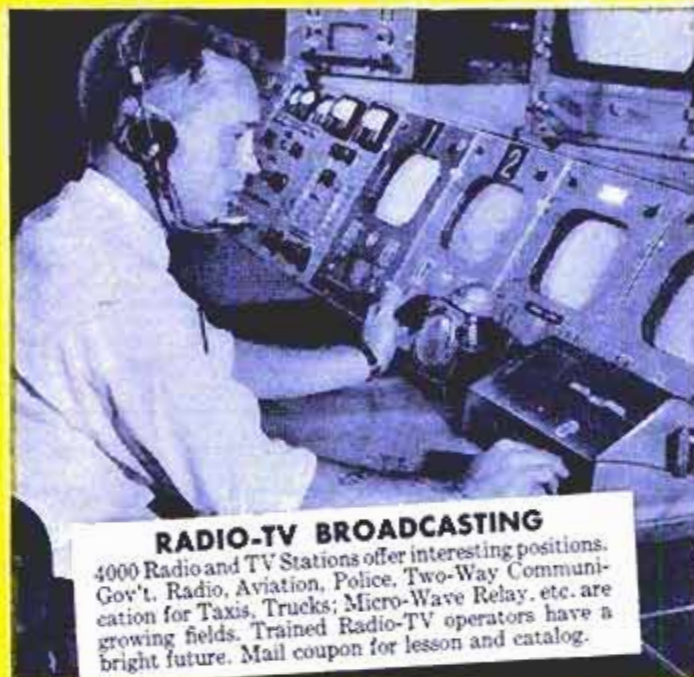

RADIO-TV BROADCASTING

4000 Radio and TV Stations offer interesting positions. Gov't. Radio, Aviation, Police, Two-Way Communication for Taxis, Trucks; Micro-Wave Relay, etc. are growing fields. Trained Radio-TV operators have a bright future. Mail coupon for lesson and catalog.



RADIO-TV SERVICING

125 million home Radios, 30 million auto Radios PLUS 40 million Television sets; millions more sold each year. COLOR TV and Hi-Fi are making new demands for trained technicians. Good opportunities for spare time earnings, or a business of your own.

Read What N.R.I. Graduates Say About RESULTS of Training

Good Spare Time Earnings

"Before enrolling I was a laborer in a factory. Now I have good Radio-TV service job PLUS profitable spare time business."

E. M. DUDEK, Chicago, Ill.

Started His Own Business

"Decided to quit my job and do Television work full time. Doing all right financially. Not punching a time clock."

W. F. KLINE, Cincinnati, Ohio

Now TV Studio Supervisor

"I have progressed very rapidly. My present position is Studio Supervisor with KEDD Television, Wichita." — ELMER FREWALDT, Wichita, Kansas



J. L. Smith
founder

N.R.I. Trains You at Home in Spare Time

Fast Growing Industry Offers You Better Pay and Bright Future
Training PLUS opportunity is the ideal combination for success. You know the rich opportunities in Radio-TV. And NRI can supply the training to prepare you quickly. Keep your job while training. Learn at home in spare time.

many students earn \$10, \$15 a week extra in spare time fixing sets. Vacuum Tube Voltmeter you build helps locate and correct set troubles. Easy to understand lessons supply the basic principles. And you LEARN-BY-DOING with kits of equipment which "bring to life" what you read in NRI lessons.

"There is no future for me here. What can I do without specialized training? What chance have I got. I can't go away to school?" If thoughts like these worry you—if you question your chances for advancement and security—find out what NRI offers you. For over 40 years NRI has been helping ambitious men train for and cash in on the opportunities and security to men who know Radio-Television.

Oldest and Largest Home Study Radio-TV School

NRI has grown with Radio-TV. Skilled instructors, specialists, technicians, etc. devote full time to providing effective, easy-to-understand courses. You are backed by the record and reputation of the OLDEST and LARGEST home study Radio-TV school. NRI training is low cost, Easy terms. Many students pay for training with spare time earnings. Some make enough to start their own business when they get the NRI Diploma. Find out more. Mail coupon. NRI, Dept 6JA, Washington 9, D. C.

Added Income Soon — \$10, \$15 a Week in Spare Time

As proof that NRI training is result-getting, practical—soon after enrolling.

FREE LESSON AND CATALOG

Mail Coupon. Paste on post-card or mail in envelope. NRI will send SAMPLE LESSON and 64 Page Catalog. Shows job opportunities, what graduates are doing, how you learn, equipment you get.

VETERANS

Available Under G.I. Bills

MAIL COUPON NOW

National Radio Institute

Dept. 6JA, Washington 9, D. C.

Mail me Sample Lesson and 64-Page Catalog FREE. (No salesman will call. Please write plainly.)

Name _____ Age _____

Address _____

City _____ Zone _____ State _____

Approved Member National Home Study Council

You Learn by Practicing with Kits N.R.I. Sends



Nothing takes the place of practical experience. That's why a feature of NRI training is LEARNING-BY-DOING. You build this low-power Radio-Transmitter, other equipment, as part of Communications Course. You build Vacuum Tube Voltmeter, other equipment, as part of Servicing Course.

SAVE! 40 to 70% BUY DIRECT FROM THE IMPORTER!

HI-SPEED HOME & CAR WASHER with 2 washing heads

REGULAR **4 98**



1 79

- Wash cars
- Windows
- Screens
- Floors

Now in one simple operation you can scrub, suds, rinse! Attach Hi-Speed washer to garden hose... wash cars, windows, porches, floors, screens, outside home in HALF time. No splashing! New improved model has 2 wash heads. Change over in seconds. Automatic Hydraulic Sudser built in! Save labor, time, money. Wash outside walls—save re-painting. No back or arm strain. Wash car, tiles, awnings, storm windows, floors, in minutes without getting messy. New 3 section handle—extends from 1 to 3 ft.

2 Heads are Better Than 1



Use **BRUSH** head for washing dirt; circular **SQUEEGEE** head for smooth surfaces, windows, etc. **WIPES** as it washes. Order now on 7 day home trial. **Special:** Generous size detergent pellets especially made for use with this washer—only 19c extra when purchased with the Hi-Speed washer. Complete kit: washer with 2 heads & pellets, only 1.98. Order by No. 44.

No Splash!

(Copyright 1956—M.M. Co.)

3-COLOR POLICE FLASHLITE



Changes **99c**
Colors Like Magic

Presto! . . . at your fingertips . . . automatic switch gives you powerful white, red or green beam visible miles away. Spotlite and floodlite combined. So dependable for home, farm, office, factory. Lifesaving friend in highway emergencies. Thousands in use by police in all states. Over 100,000 sold for 1.98 to 2.98. For a limited time only.

No. 75—Special99c

Black Eagle GERMAN BINOCULARS NOW 1 98



Now only 1.98 for this quality German binocular. Why pay more? Has many features found in expensive glasses: Hi Fidelity Viewing up to 25 miles—clear as a bell—synchronized centre focusing—very sturdy, yet only 8 oz. Ideal for all sports, nature study, trips, birdwatching, etc. Mail only 1.98 for prompt shipment. Order by No. 78.

10 in one! SWISS ARMY TYPE KNIFE \$1.98



OVER 50,000 SOLD AT \$3.95

10 TOOLS IN ONE—the Swiss Army type knife is recognized as the most compact multi-purpose tool ever devised. This new Korium version is the lowest price ever asked for the Swiss knife! Finest Solingen steel. Has scissors, saw, icepick, jackknife, screwdriver, awl, can opener, bottle opener, corkscrew & penknife. Solid Vidal handle; best attachment. Length, 3 1/2". Wonderful for all outdoorsmen, motorists, people who travel. This type knife carried all year 'round by Swiss Army officers. It can be a life-saver! When you see its fine construction and you have it in your hands, you'll agree it's a \$3.95 value. Order by No. 88. New, deluxe model now yours for only \$1.98.

NEW 1956 MODEL SPECTOSCOPES



99c

Reg. 1.98

Over a half million people paid \$1.98 for these famous Spectoscopes. They're the binoculars you wear like eyeglasses. Use all day without fatigue. Wonderful for watching sports, theatre, TV, racing, public events. Sharp individual focusing for each eye. Gives magnified close-up viewing. Powerful, clear, sharp images. No blur or distortion. Made in Western Germany to precision standards. Order by No. 90.

Helen of Troy HUNT KNIFE NOW 1 98 REG. 3.95



The most unique knife of the year—made by the renowned craftsmen of Solingen, Germany. Blends utility and art with a master's touch. Artistically cast and finished in a rich golden hue. To see it is to want it . . . Six inch blade of heavy-duty Solingen steel, 10" over-all. Tough—rugged—sharp! A collector's item: one that graces rec or den wall as well as a superb hunting knife. Metal-tipped leather sheath included at no extra cost. No. 84 . . . only 1.98

SPECIAL DISCOUNT COUPON

THORESEN'S, Dept. 6-K, 585 Water Street, New York 2, N. Y.

RUSH the items checked below on 7-Day free home trial . . . money back guarantee. If not delighted with the merchandise I will return it in 7 days for full refund.

- Payment enclosed. Send postage & tax paid.
- Send C.O.D. I'll pay charges.
- No. 44—Hi-Speed Home & Car Washer (1.79 plus 19c for Pellets)
- No. 78—Black Eagle Binoculars (1.98)
- No. 75—3-color Police Flashlite (99c)
- No. 88—Swiss Army Type Knife (1.98)
- No. 90—Spectoscopes (99c)
- No. 84—Helen of Troy Hunting Knife (1.98)

Name _____
Address _____
City _____ Zone _____ State _____
CANADIANS: Order direct from Thoresen Ltd., Dept. 6-K, 45 St. James St., West, Montreal 1, P.Q. Same money back guarantee. No extra for tariff.

INVENTORS

Learn how to protect your invention. The U. S. Patent Laws provide that any new and useful art, machine, article of manufacture, or composition of matter, or any new and useful improvement thereof, may be patented if the act of invention is involved. Therefore, every inventor with a valuable invention should take advantage of the Patent Laws and proceed for patent protection in order to safeguard his rights.

A patent gives the inventor the exclusive right to prevent others from making, using, or selling the invention claimed in the patent for a period of seventeen years.

The Patent Laws were enacted for the benefit of the inventor to give him protection for the features of his invention which are patentable. These features must be properly and concisely set forth and claimed in a formal application for patent, in order to comply with the requirements of the Patent Laws. For that reason, unless the inventor is familiar with patent matters, he should engage a competent registered patent attorney or agent to represent him. We are registered to practice before the U. S. Patent Office and are prepared to serve you in the handling of your patent matters.

A specially prepared booklet entitled "Patent Guide for the Inventor", containing detailed information with respect to patent protection and procedure, together with a "Record of Invention" form will be promptly forwarded to you without obligation upon request.

CLARENCE A. O'BRIEN & HARVEY JACOBSON

Registered Patent Attorneys

61-J DISTRICT NATIONAL BUILDING

WASHINGTON 5, D. C.

WHAT SECRET POWER DID THIS MAN POSSESS?



BENJAMIN FRANKLIN
(A Rosicrucian)

WHY was this man great? How does anyone—man or woman—achieve greatness? Is it not by mastery of the powers within ourselves? Know the mysterious world within you! At-tune yourself to the wisdom of the ages! Grasp the inner power of your mind! Learn the secrets of a full and peaceful life!

Benjamin Franklin—like many other learned and great men and women—was a Rosicrucian. The Rosicrucians (NOT a religious organization) first came to America in 1694. Today, headquarters of the Rosicrucians send over seven million pieces of mail annually to all parts of the world. Write for YOUR FREE COPY of "The Mastery of Life"—TODAY. No obligation. No salesmen. A non-profit organization. Address: Scribe V.P.C.

**THIS BOOK
FREE!**



The ROSICRUCIANS

SAN JOSE • (AMORC) • CALIFORNIA

—SEND THIS COUPON—

Scribe V.P.C.
The ROSICRUCIANS (AMORC)
San Jose, California
Please send me the free book, *The Mastery of Life*, which explains how I may learn to use my faculties and powers of mind.

Name _____
Address _____
City _____

Not Satisfied With Your Present Earnings?

Investigate

This NEW 2in1 BUSINESS OPPORTUNITY

- Popular, Money-Making HOT DRINK and HOT SOUP Venders
- Handle Either or Both Types
- We Train You, We Set Up Routes

Eye-catching, easy-to-operate vending machines serve delicious, nationally known Hot Drinks (3) and Piping Hot Soups (5)! Our factory experts set up routes, train you to operate this year-round, big-volume business. NO SELLING! A minimum cash investment of \$1290.00 required. Up to 75% of equipment costs can be financed. Operate full or spare time.

How many machines can you handle?
10 units, doing nat'l 1954 average,
would pay approx. \$13-\$16,000 yearly!

Write or wire giving age, address and phone.
Details FREE. No obligation!

SUPERIOR DISTRIBUTING CORP., Dept. CB,
4555 E. Warren Ave., Denver 22, Colo.



FOR BIG MEN ONLY!



SEND
FOR
FREE
CATALOG

SIZES 10 to 16 WIDTHS AAA to EEE

We SPECIALIZE in large sizes only—sizes 10 to 16; widths AAA to EEE. Casuals; Wing Tips; Hand-Sewn Moccasins; Cordovans; Dress Oxfords; Work Shoes; Sox; Slippers; Rubbers. Enjoy the finest in fit, comfort, style at amazingly low cost. Mail only. Write TODAY for FREE Style Book!

KING-SIZE, INC.
891 Brockton, Mass.



WORLD'S LOWEST PRICED ADDING MACHINE

Counts up to 999,999,999
IDEAL FOR BUSINESS AND PERSONAL USE—GUARANTEED ACCURATE. Not a toy. Operates with only a finger flick. Adds, subtracts, multiplies, divides. Counts up to one billion. Pays for itself over and over. Ideal Gift—for Business, Income Tax and School use. MONEY BACK GUARANTEE. Send name and address. Pay postman only \$2.95 plus postage. Beautiful rich-looking Leatherette Case included at no extra cost. Money back in 10 days if not delighted. AGENTS WANTED.

CALCULATOR MACHINE CO., (Mfrs.)
Box 84 Dept. S-58 Glenview, Illinois

Super Powerful All Channel TV RECEPTION IN ALL DIRECTIONS

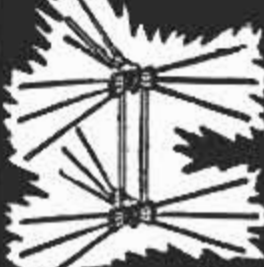

Rocket DIRECTRONIC MOTORLESS TV ANTENNA
360° Electronically Switched Beam
• No Motors • No Ghosts
• No Roof • Flick of
• Orientation Switch Clears
• No Electric Picture In-
stantly

In the city or in an ultra-fringe area, the Directronic will outperform ordinary antennas. Only the Motorless 360° Directronic TV Antenna offers "around the compass" reception WITHOUT Rotors. Clarity of picture will amaze, it's so bright, so sharply defined. AX-599 "Serviceman's Array" contains Hi-Pac molded insulator of extremely high tensile strength, 18 hi-tensile aluminum alloy elements, 1 set of connecting stubs (3), Universal U-Clamps for masts to 1 1/2". Directronic Beam Selector, 75 feet of Tri-X Cable. 25% deposit on C.O.D. orders, please. Money Back Guarantee.

NATIONAL ELECTRONICS OF CLEVELAND
6808 Euclid Ave., Dept. P-9 Cleveland 3, Ohio

FREE WORLD FACES
ENGINEERING SHORTAGE

35,000 ENGINEERING
POSTS STILL UNFILLED

REDS LEAD FREE WORLD
IN ENGINEERING RACE

INDUSTRY'S DOOR IS
WIDE OPEN TO
NEW ENGINEERS

HERE'S NEW OPPORTUNITY FOR YOU IN THE BIG RACE FOR ENGINEERS!



Read between the news headlines. You'll see a whole new field of opportunity opening up in the race for Engineers. Here's your one big chance to help the Free World and win a professional rating.

As an Engineer you'll do interesting, rewarding work. You'll have a real chance for advancement. Half our industrial leaders have come up through Engineering. You'll enjoy high professional standing; economic, cultural and social prestige. You'll get true job security. And soon after you start your course you'll be ready for a job in an engineering department as an aide.

I. C. S. can help YOU!

Almost every phase of Engineering is represented in the 256 I. C. S. courses. You study in your spare time, at your own pace. No interference with job or social life. Instruction is personalized, direct, job-related. Bedrock facts and theory plus practical application. Low cost. Easy-pay plan. Diploma to graduates.

Coupon brings 3 free books!

(1) "How to Succeed"—36-page guide to advancement. (2) Career Catalog of opportunities in field of your choice. (3) Sample I. C. S. lesson in basic mathematics. Just mark and mail the coupon below.

"I obtained a professional rating one year short of the time required to complete a college engineering course," reports A. P. A., Wyomissing, Pa.

This statement helps demonstrate the thoroughness of I. C. S. instruction. Take the Engineering courses, for example. You go step-by-step from simple Arithmetic to advanced subjects: Thermodynamics, Drafting, Hydrostatics, Strength of Materials, Report Writing, Commercial Law, etc. There's no scrimping. You cover as many as 176 subjects in all—as rapidly as your time and ability permit.

For Real Job Security—Get an I. C. S. Diploma! I. C. S., Scranton 9, Penna. Member, National Home Study Council

INTERNATIONAL CORRESPONDENCE SCHOOLS

65TH
YEAR

BOX 35626J, SCRANTON 9, PENNA.

(Partial list of 256 courses)

Without cost or obligation, send me "HOW to SUCCEED" and the opportunity booklet about the field BEFORE which I have marked X (plus sample lesson):

<p>ARCHITECTURE and BUILDING CONSTRUCTION</p> <p><input type="checkbox"/> Air Conditioning—Refrig.</p> <p><input type="checkbox"/> Architecture</p> <p><input type="checkbox"/> Architectural Interiors</p> <p><input type="checkbox"/> Building Contractor</p> <p><input type="checkbox"/> Building Estimator</p> <p><input type="checkbox"/> Building Maintenance</p> <p><input type="checkbox"/> Carpentry and Mill Work</p> <p><input type="checkbox"/> Heating</p> <p><input type="checkbox"/> Painting Contractor</p> <p><input type="checkbox"/> Plumbing</p> <p><input type="checkbox"/> Reading Arch. Blueprints</p> <p>ART</p> <p><input type="checkbox"/> Cartooning</p> <p><input type="checkbox"/> Commercial Art</p> <p><input type="checkbox"/> Fashion Illustrating</p> <p><input type="checkbox"/> Magazine Illustrating</p> <p><input type="checkbox"/> Show Card and Sign Lettering</p> <p><input type="checkbox"/> Sketching and Painting</p> <p>AUTOMOTIVE</p> <p><input type="checkbox"/> Auto Body Rebuilding</p> <p><input type="checkbox"/> Auto Elec. Technician</p> <p><input type="checkbox"/> Auto-Engine Tune Up</p> <p><input type="checkbox"/> Automobile Mechanic</p>	<p>AVIATION</p> <p><input type="checkbox"/> Aeronautical Engineering Jr.</p> <p><input type="checkbox"/> Aircraft & Engine Mechanic</p> <p>BUSINESS</p> <p><input type="checkbox"/> Advertising</p> <p><input type="checkbox"/> Bookkeeping and Accounting</p> <p><input type="checkbox"/> Business Administration</p> <p><input type="checkbox"/> Business Correspondence</p> <p><input type="checkbox"/> Public Accounting</p> <p><input type="checkbox"/> Creative Salesmanship</p> <p><input type="checkbox"/> Federal Tax</p> <p><input type="checkbox"/> Letter-writing Improvement</p> <p><input type="checkbox"/> Office Management</p> <p><input type="checkbox"/> Professional Secretary</p> <p><input type="checkbox"/> Retail Business Management</p> <p><input type="checkbox"/> Sales Management</p> <p><input type="checkbox"/> Stenographic-Secretarial</p> <p><input type="checkbox"/> Traffic Management</p> <p>CHEMISTRY</p> <p><input type="checkbox"/> Analytical Chemistry</p> <p><input type="checkbox"/> Chemical Engineering</p> <p><input type="checkbox"/> Chem. Lab. Technician</p> <p><input type="checkbox"/> General Chemistry</p> <p><input type="checkbox"/> Natural Gas Prod. & Trans.</p> <p><input type="checkbox"/> Petroleum Engineering</p> <p><input type="checkbox"/> Plastics</p> <p><input type="checkbox"/> Pulp and Paper Making</p>	<p>CIVIL, STRUCTURAL ENGINEERING</p> <p><input type="checkbox"/> Civil Engineering</p> <p><input type="checkbox"/> Construction Engineering</p> <p><input type="checkbox"/> Highway Engineering</p> <p><input type="checkbox"/> Reading Struct. Blueprints</p> <p><input type="checkbox"/> Sanitary Engineering</p> <p><input type="checkbox"/> Structural Engineering</p> <p><input type="checkbox"/> Surveying and Mapping</p> <p>DRAFTING</p> <p><input type="checkbox"/> Aircraft Drafting</p> <p><input type="checkbox"/> Architectural Drafting</p> <p><input type="checkbox"/> Electrical Drafting</p> <p><input type="checkbox"/> Mechanical Drafting</p> <p><input type="checkbox"/> Mine Surveying and Mapping</p> <p><input type="checkbox"/> Plumbing Drawing and Estimating</p> <p><input type="checkbox"/> Structural Drafting</p> <p>ELECTRICAL</p> <p><input type="checkbox"/> Electrical Engineering</p> <p><input type="checkbox"/> Electrical Maintenance</p> <p><input type="checkbox"/> Electrician <input type="checkbox"/> Contracting</p> <p><input type="checkbox"/> Lineman</p> <p>HIGH SCHOOL</p> <p><input type="checkbox"/> Commercial <input type="checkbox"/> Good English</p> <p><input type="checkbox"/> High School Subjects</p> <p><input type="checkbox"/> Mathematics</p>	<p>LEADERSHIP</p> <p><input type="checkbox"/> Foremanship</p> <p><input type="checkbox"/> Industrial Supervision</p> <p><input type="checkbox"/> Leadership and Organization</p> <p><input type="checkbox"/> Personnel-Labor Relations</p> <p>MECHANICAL AND SHOP</p> <p><input type="checkbox"/> Gas—Electric Welding</p> <p><input type="checkbox"/> Heat Treatment <input type="checkbox"/> Metallurgy</p> <p><input type="checkbox"/> Industrial Engineering</p> <p><input type="checkbox"/> Industrial Instrumentation</p> <p><input type="checkbox"/> Industrial Supervision</p> <p><input type="checkbox"/> Internal Combustion Engines</p> <p><input type="checkbox"/> Machine Design-Drafting</p> <p><input type="checkbox"/> Machine Shop Inspection</p> <p><input type="checkbox"/> Machine Shop Practice</p> <p><input type="checkbox"/> Mechanical Engineering</p> <p><input type="checkbox"/> Quality Control</p> <p><input type="checkbox"/> Reading Shop Blueprints</p> <p><input type="checkbox"/> Refrigeration</p> <p><input type="checkbox"/> Sheet Metal Worker</p> <p><input type="checkbox"/> Tool Design <input type="checkbox"/> Toolmaking</p> <p>RADIO, TELEVISION</p> <p><input type="checkbox"/> Industrial Electronics</p> <p><input type="checkbox"/> Practical Radio TV Eng'ng</p> <p><input type="checkbox"/> Radio and TV Servicing</p> <p><input type="checkbox"/> Radio Operating</p>	<p><input type="checkbox"/> Television Technician</p> <p>RAILROAD</p> <p><input type="checkbox"/> Air Brake Equipment</p> <p><input type="checkbox"/> Car Inspector</p> <p><input type="checkbox"/> Diesel Engineer & Fireman</p> <p><input type="checkbox"/> Section Foreman</p> <p>STEAM AND DIESEL POWER</p> <p><input type="checkbox"/> Combustion Engineering</p> <p><input type="checkbox"/> Diesel—Elec. <input type="checkbox"/> Diesel Eng's</p> <p><input type="checkbox"/> Electric Light and Power</p> <p><input type="checkbox"/> Stationary Fireman</p> <p><input type="checkbox"/> Stationary Steam Engineering</p> <p>TEXTILE</p> <p><input type="checkbox"/> Carding and Spinning</p> <p><input type="checkbox"/> Cotton, Rayon, Woolen Mfg.</p> <p><input type="checkbox"/> Finishing and Dyeing</p> <p><input type="checkbox"/> Loom Fix'g <input type="checkbox"/> Textile Des'g</p> <p><input type="checkbox"/> Textile Eng'g <input type="checkbox"/> Throwing</p> <p><input type="checkbox"/> Warping and Weaving</p> <p>MISCELLANEOUS</p> <p><input type="checkbox"/> Domestic Refrigeration</p> <p><input type="checkbox"/> Marine Engineering</p> <p><input type="checkbox"/> Ocean Navigation</p> <p><input type="checkbox"/> Professional Engineering</p> <p><input type="checkbox"/> Short Story Writing</p> <p><input type="checkbox"/> Telephony</p>
---	--	--	--	---

Name _____ Age _____ Home Address _____

City _____ Zone _____ State _____ Working Hours _____ A.M. to P.M. _____

Occupation _____

Canadian residents send coupon to International Correspondence Schools, Canadian, Ltd., Montreal, Canada. . . . Special tuition rates to members of the U. S. Armed Forces.

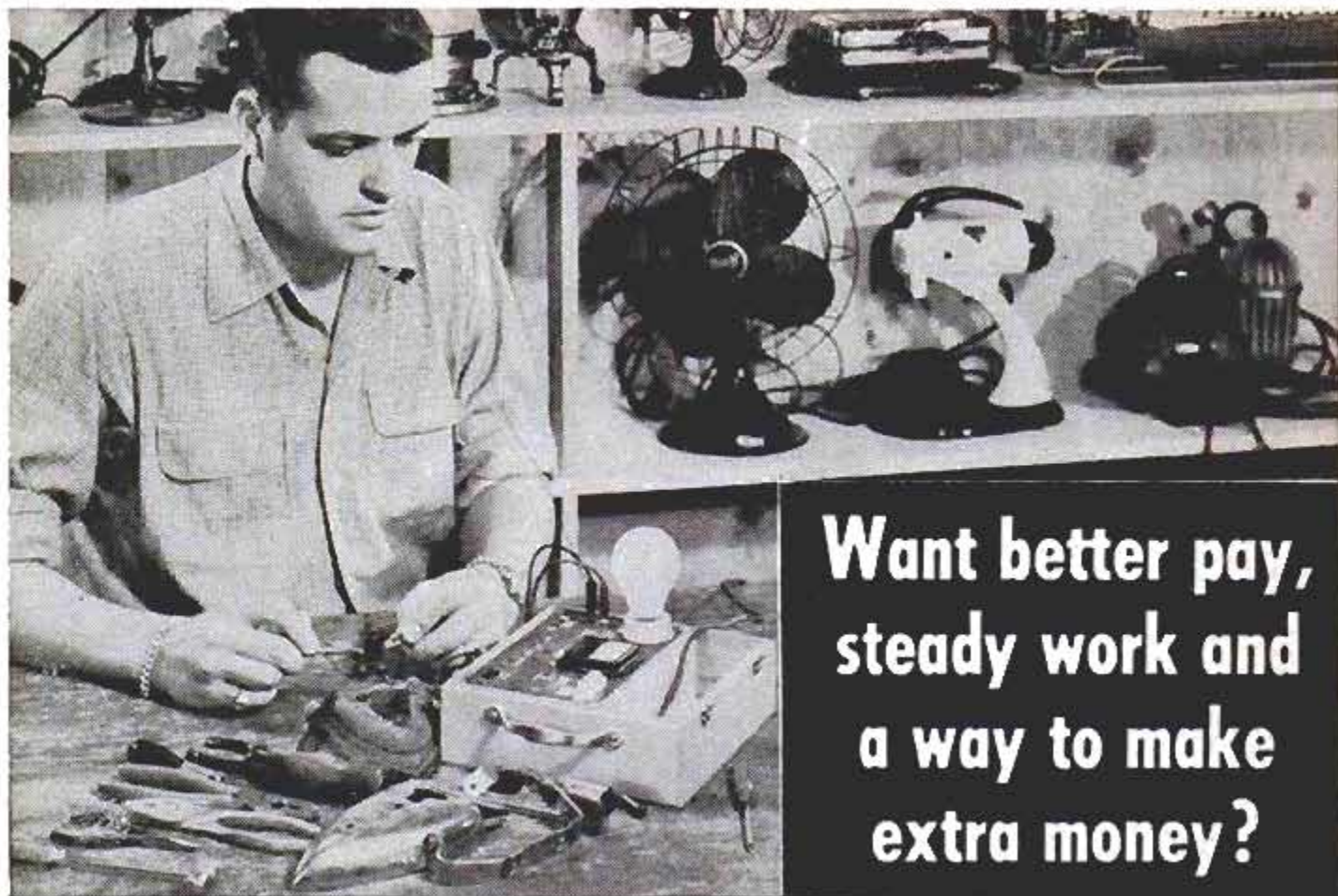

**Want better pay,
steady work and
a way to make
extra money?**

Learn at Home IN YOUR SPARE TIME to Fix Electrical Appliances

To build a better future, get into a field where there's much important work and the security that comes from knowing a good trade. Servicing electrical appliances offers that OPPORTUNITY. Every wired home has an average of 8 electrical appliances. Up to 10 million new appliances are sold every year and owners pay well to keep them in repair. That's making a fast-growing need for trained men.

Start Soon to Earn \$3, \$4, \$5 an Hour Extra in Your Spare Time

Start soon to fix electric toasters, clocks, fans, vacuum cleaners and other appliances for neighbors and friends. Work in your basement, garage or spare room. Pick up \$3 to \$5 an Hour *extra that way*. It's easy to increase your earning power—to pay for this training many times over with your spare time earnings.

Learn and Earn with Multi-Use Tester Built with Parts We Send

This course includes the parts to build a portable, sturdy Appliance Tester that helps you locate electrical defects quickly and easily. You use it to learn and do actual electrical appliance repair jobs. If you want better pay learn this good

trade. No need to give up your present job. You can train at home in your spare time for only \$2.50 down and \$5.00 a month. A small price to pay for increased earnings, a more secure future. Paste coupon below on a 2c postal or mail in envelope for free book and sample lesson. Address National Radio Institute, Dept. AJ6, Washington 9, D. C.

**2c TO MAIL THIS
COUPON MAY START
YOU TO SUCCESS
LESSON AND BOOK
FREE**



**NATIONAL RADIO INSTITUTE
Dept. AJ6, Washington 9, D. C.**

Please send me Electric Appliance Training lesson and book free. (No salesman will call.)

Name _____ Age _____

Address _____

City _____ Zone _____ State _____

APPROVED MEMBER NATIONAL HOME STUDY COUNCIL

INVENTORS

If you believe that you have an invention, you should find out how to protect it. The first step is to have a search made of the prior pertinent U. S. patents. If a report on this search indicates that the invention appears patentable you can apply for a patent, and the specifications and claims should be prepared.

The firm of McMorrow, Berman & Davidson, with offices in Washington, D. C., is qualified to take the necessary steps for you. We can make a preliminary search on your invention, advise you whether we think it can be patented, and prepare your application for patent.

Unless you are fully familiar with the U. S. Patent Laws, we recommend that you engage the services of a Registered Patent Attorney to protect your interests. The patent laws are *your* laws. A patent gives you the right to prevent others from making, using or selling the invention claimed in your patent for a period of 17 years.

Use these patent laws for your protection. Investigate whether your invention can be patented. If you have what you believe to be an invention, we suggest that you have this firm make a search for you:

Send for a copy of our Patent Booklet entitled "How To Protect Your Invention," containing information about patent protection and patent procedure. Along with this we will also send you an "Invention Record" form, for your use in writing down and sketching details of your invention. We will mail them promptly. No obligation. They are yours for the asking.

McMORROW, BERMAN & DAVIDSON

Registered Patent Attorneys

PATENTS • COPYRIGHTS • PATENTS

1351 VICTOR BUILDING, WASHINGTON 1, D. C.



IF YOU "EAT, SLEEP
AND LIVE" CARS...

TURN YOUR HOBBY INTO A CAREER!



Get America's Big-time, Big-future

AUTO MECHANICS & DIESEL COURSE

at home in your spare time!

Los Angeles' National Schools, America's automotive Technical Trade School since 1905, now brings its famous resident Shops and Faculty direct to you at home—to prepare you to earn more money, with job security, in today's fast-moving, opportunity-filled Auto Mechanics Industry! Get your home training from the "Car Capital of the World"—America's most auto-minded city, center of Hot Rod and Sports Car activity! Mail coupon right now!

"SHOP-METHOD" HOME TRAINING!

YOU MASTER ALL PHASES, INCLUDING DIESEL. All lessons fully illustrated. We show you how to *earn as you learn*. OK for Vets. Graduate Advisory Service.

NOW! YOU GET AND KEEP ALL OF THIS VALUABLE, PROFESSIONAL EQUIPMENT!

You keep this modern "MOTOR ANALYZING SET." Contains latest Standard Engine Vacuum Fuel Pump, Remote Starter Switch, Modern Timing Light, Standard Compression Tester. Plus... compact, rugged, carrying case and complete instructions.



This set of LIFE-TIME TOOLS is yours to keep. You also get this all-metal tool box as part of your course. All tools of the latest design, used by the "pros," built for a lifetime of rugged use.

SEND FOR FREE BOOK AND SAMPLE LESSON

Approved for GI Training.

NATIONAL SCHOOLS

Los Angeles 37, California

CANADA: 811 W. Hastings St., Vancouver, B. C.

NATIONAL SCHOOLS

TECHNICAL TRADE TRAINING SINCE 1903
LOS ANGELES 37, CALIFORNIA

NATIONAL SCHOOLS, Dept. DB96

MAIL NOW TO OFFICE NEAREST YOU

4000 S. FIGUEROA ST. OR 187 N. LA SALLE ST.
LOS ANGELES 37, CALIF. CHICAGO 1, ILL.

Send for FREE Auto-Diesel Opportunity Book and Sample Lesson.

NAME _____ BIRTHDAY _____ 19 _____

ADDRESS _____

CITY _____ ZONE _____ STATE _____

VETERANS: Give Date of Discharge _____

Shrinks Hemorrhoids New Way Without Surgery

Science Finds Healing Substance That Relieves Pain—Shrinks Hemorrhoids

For the first time science has found a new healing substance with the astonishing ability to shrink hemorrhoids and to relieve pain—without surgery.

In case after case, while gently relieving pain, actual reduction (shrinkage) took place.

Most amazing of all—results were so thorough that sufferers made astonishing statements like "Piles have ceased to be a problem!"

The secret is a new healing substance (Bio-Dyne*)—discovery of a world-famous research institute.

This substance is now available in suppository or ointment form under the name Preparation H.* Ask for it at all drug counters—money back guarantee. *Reg. U. S. Pat. Off.



Sold by
25,000 stores

Home Craftsmen And Do-It-Yourself Fans—

You're dressed for the job—and neatly, too—when you wear N&W work and leisure clothes. Full line for men and women.



N&W INDUSTRIES, Inc. Lynchburg, Virginia
Jackson, Mississippi

Say You Saw It in Popular Mechanics

TELEPHONES



Desk Stand Style

Slightly used but in excellent condition

Many Valuable Uses
Inter-House Phones House to Barn, etc.
Loud Speakers Microphones
Educational Purposes, Toys, etc.

Come complete, ready to use with wiring diagrams included. Two complete for only \$3.00

TELEPHONE LAMP KIT— with illustrated instructions for making Desk Telephone Lamp including all parts (harp, nipples, push switch, cord, plug, etc.) \$6.50 Ppd. (Shade is not included).

MICROPHONE, Dept. X-4202, 1760 W. Lunt Ave., Chicago 26, Ill.

Subscribe to TRAILER TOPICS MAGAZINE

6-Month Trial
Subscription \$1



Discover how you can enjoy every modern convenience in your own home for just pennies a day. Read the true-life stories of those who live in mobilehomes and love it.

Only \$3.00 for 2 years.

TRAILER TOPICS MAGAZINE

Room 1572, 28 East Jackson Blvd., Chicago 4, Illinois

Train in Big
COYNE
Shops

GREAT OPPORTUNITY FIELDS!

TELEVISION OR ELECTRICITY
RADIO-COLOR TV ELECTRONICS



Instructor helping students check the wiring and trace the circuits of television receivers.

Instructor explaining operation and testing of a large Motor Generator.

This big fire-proof building is occupied entirely by Coyne.

YOUNG MEN AND OLDER MEN— PREPARE FOR A CAREER WITH A FUTURE!

Conditions are changing. Many "one operation" jobs will not last. Don't be satisfied with a "no future" job. Whether 17 or up to 45 years of age, train the Coyne way for a better job and a real future in Electricity-Electronics or Television-Radio, fields that offer a world of opportunities.

TELEVISION-RADIO-COLOR TV

Here at COYNE you're trained for Testing, Trouble-Shooting and Servicing on AM and FM Radio Units, Auto Radio, Television, etc. Thousands of Coyne trained men in good jobs or own well paying TV-Radio businesses of their own.

ELECTRICITY ELECTRONICS

Big opportunities everywhere—city, town and country, in Power Plant Work, Motors, Industrial Electronics, Armature Winding, Home and Factory Wiring, Appliances, Refrigeration, Maintenance, Illumination, etc.

WE TRAIN YOU IN CHICAGO

Our famous Practical-Technical method gives you practical experience on a massive outlay of equipment plus necessary technical training right here in the great Coyne shops.

Training in Refrigeration and Electric Appliances can be included.

Training offered to VETERANS and NON-VETS alike

START NOW—PAY LATER
Enroll now, pay most of tuition later. Part time employment help for students. Lifetime employment service to Graduates.

B. W. COOKE, President

COYNE
ELECTRICAL SCHOOL

FOUNDED 1899

A TECHNICAL TRADE INSTITUTE OPERATED NOT FOR PROFIT

500 S. PAULINA STREET, CHICAGO, Dept. 66-72H

ELECTRICITY ★ RADIO ★ TELEVISION ★ REFRIGERATION ★ ELECTRONICS

OLDEST AND BEST EQUIPPED SCHOOL OF ITS KIND IN THE U.S.

Mail Coupon for Big FREE Book!

Whether you prefer Television-Radio or Electricity-Electronics, mail coupon TODAY and we'll mail you a Big, fully Illustrated Book "Guide to Careers in Electricity-Electronics and Television-Radio" which describes all the training we offer. No salesman will call.



B. W. Cooke, President
COYNE ELECTRICAL SCHOOL, Dept. 66-72H
500 S. Paulina St., Chicago 12, Ill.

Send me your Big Free book. I am interested in field checked below. This does not obligate me.

- TELEVISION-RADIO
 ELECTRICITY-ELECTRONICS

Name _____

Address _____

City _____ State _____

WHAT DO YOU WANT?

- Your Own Business?
- A Useful Homecraft?
- A Steady Job?
- Substantial Sparetime Earnings?
- A Better Future?

They're All Waiting for YOU in

CUSTOM FURNITURE UPHOLSTERY

You can do what Leonard Schroeder and hundreds of other UTS graduates have done. Be your own boss, make good money working at home, in your own shop or in a well-paid job. Best of all you can earn while you learn! Now the practical N. Y. State-approved UTS course is available to you AT HOME. You learn professional custom furniture upholstery, reupholstery, slip covers, furniture finishing, repairs — window cornice, cushion, and drapery making. Course includes FREE — ALL tools, complete frames and materials you use to make beautiful furniture and slip covers — yours to keep or sell. Many UTS students earn enough in spare time to get STARTING CAPITAL for their own shops. What they have done, YOU CAN DO!



LEONARD SCHROEDER, former low-paid accountant increases earnings 110%. Now operating own successful upholstery business.

Big FREE Book—FREE SAMPLE LESSON
Our FREE book "Your New Way to a Successful Career," with Sample Lesson tells how you can prepare at home for this fascinating, well-paid trade. WRITE TODAY! Training in N. Y. School also available. Upholstery Trades School, Dept. EO-304, 721 Broadway, New York 3, N. Y.

MATERIALS FREE WITH COURSE YOU MAKE

- SLIPPER CHAIR
- CLUB CHAIR
- OTTOMAN
- PLUS SLIP COVERS

Yours to keep or sell

APPROVED FOR VETERANS

UPHOLSTERY TRADES SCHOOL, Dept. EO-304
721 Broadway, New York 3, N. Y.

Send me FREE book with FREE Sample Lesson. No obligation. No salesman will call.
 Home Study In N.Y. School Training

Name _____
Address _____
City _____ Zone _____ State _____
 Check if Korean Veteran

M. R. Stanley, California, Reports—

\$26⁵² PROFIT

IN 3 HOURS... FIRST DAY!

MAKE GOOD MONEY Right from the Start with New Life-Saving

MERLITE FIRE ALARM

Mr. Stanley says: "Received my first order of Merlites about noon. Worked from 1:30 to 4:30, three hours, and made \$26.52 profit. The Merlite Fire Alarm is a terrific seller."

Amazing new super-sensitive Fire Alarm HOWLS tremendous irritating continuous blast, audible up to 1/5 mile away, when fire first strikes, before lives and property are destroyed. Entirely self-contained, needs no installation, no hookup to electric circuits. Sell for only \$4.95 less batteries, make up to \$2.70 profit on each one!

Simple Sensational 10-Second "Lighted Match" Demonstration Hands You up to \$1,000 a Month!

Prove instantly that Merlite Fire Alarm is super-sensitive to any fire. Show how tiny flame from a match triggers Merlite's 1/5-mile HOWL, and take big orders. Homeowners eagerly buy Merlites for every room. Sell 6 to 12 and more to stores, offices, factories, hotels, bakeries, farms, etc. Sell only 20 Merlites every weekday, pocket up to \$1,000 profit in a month!

FREE! ILLUSTRATED SALES KIT AND BIG MONEY-MAKING SALES PLANS

Some areas of country still open to good man, ready to take easy, fast orders full time or spare time. Send name, address today for big Illustrated Sales Kit, everything you need to start making good money first day. Write NOW! MERLITE INDUSTRIES, Dept. F-15L, Fire Alarm Div., 114 East 32nd St., New York 16, N. Y.
In Canada: Mopa Co., Ltd., 371 Dowd St., Montreal 1, P. Q.

"Building Beautifiers" Can Earn High Incomes

Colorcrete, a cementitious plastic, gives lifetime beauty and protection to drab, dirty masonry — concrete, stucco, etc. — on all kinds of buildings. Tough, tenacious, enduring. Easily cleaned. Helps to daylight dark interiors. Choice of gleaming white or 30 colors. Applied under pneumatic pressure to form an inseparable bond.



More Colorcretors are needed to supply the ever-increasing demand. Low investment appeals to men of limited capital. Work is easy, fascinating, highly profitable. Broad opportunity to develop a lifetime business. No special ability or experience needed because we supply full instructions and sales cooperation. Colorcrete machine is simple to operate, easy to move around. Write today for Opportunity Book.

Colorcrete Industries, Inc. **COLORCRETE**
570 Ottawa Av., Holland, Mich.
IN CANADA: DUNN MASONRY MACHINERY LIMITED
1020 Dundas Highway, Cooksville, Ont.

LAW...

STUDY AT HOME Legally trained men win higher positions and bigger success in business and public life. Greater opportunities now than ever before. We guide you **More Ability: More Prestige: More Money** step by step. You can train at home during spare time. Degree of LL.B. We furnish all text material, including 14-volume Law Library. Low cost, easy terms. Get our valuable "Law Training for Leadership" and "Evidence" books FREE. Send NOW.

LASALLE EXTENSION UNIVERSITY, 417 South Dearborn Street
A Correspondence Institution Dept. 964L Chicago 5, Ill.

POW hunting slingshot

- accurate — powerful — silent
- kills small game, pests
- hits like a rifle

Special: 200 extra steel balls \$1

Used by expert marksmen! 7" hardwood stock, 45 lb. pull. Has double rubber for double power. FREE! — target, extra rubber and big supply heaviest steel balls used by experts. Illustrated catalog. Authorized model of Slingshot Assn.

\$150 postpaid (no cod's)

I. J. STONE Dept. B-9, 1616 Oak St. • Santa Monica, Calif.

SAY YOU SAW IT IN POPULAR MECHANICS

INSURED TIRE SERVICE

POPULAR BRANDS

FREE INSURANCE POLICY given with each used tire sold. We guarantee the amount of service you pay for.

NOWHERE CAN SUCH QUALITY BE FOUND AT SUCH LOW PRICE!

SPECIAL! Deduct 10% on orders for two or more used tires

YOU CAN'T LOSE!!

Super Quality — Rugged Performance — 6 Months Insured Service			
600x16	\$3.65	670x15	\$3.95
650x15	3.85	670x16	4.05
650x16	4.25	700x15	3.95
670x16	4.45	700x16	4.45

Supreme Quality — Nothing Finer — 12 Months Insured Service			
600x16	\$5.25	670x15	\$5.45
600x16(6)	6.75	640x15	4.95
650x16	5.75	670x15	5.35
650x16(6)	7.25	710x15	5.45
700x16	6.35	760x16	5.95
750x16(6)	8.45	800x15	6.35
850x16	4.95	820x15	6.35
850x17	4.75	850x15	5.35
850x15	5.25	670x16	5.15
700x15	3.35	700x16(6)	10.25

whitewalls \$2.00 extra.

Speedy shipments on Mail Orders. F.O.B. — Chicago. Insurance policy sent with each order. Deduct 10% on orders for 2 or more used tires. Send CHECK or MONEY ORDER. — No COD's.

MIDLAND TIRE SALES 3701 S. Normal, Dept. PM-50, Chicago 9, Ill.

Prepare Now... in spare time at Home... for a New,

PROFITABLE, INTERESTING FUTURE
 in **AUTOMATION**
 ELECTRONICS
TELEVISION
 RADIO-ELECTRONICS



RADIO CHIEF OF ILE DE FRANCE
 FRENCH LUXURY LINER PRAISES D T I

Radio Chief—Jean Desmas Says:

"Your Training Organization in Chicago is known not only throughout Europe, but also in many parts of the world as one of America's finest Television, Radio and Electronics training centers."



JACK DEMPSEY

Former World's Heavyweight Champion
 TELLS WHY HE'S PROUD

TO BE WITH **D T I**

- I have been greatly impressed with D T I's wonderful spirit of friendliness and sincere determination to help its students make good in Television-Radio-Electronics.
- I admire its remarkable 25 year record of helping men build brighter futures.
- I also admire the business policy of its management and the thoroughness of its large faculty of instructors.
- Never have I heard young men praise a school as enthusiastically as do the students and graduates of D T I. They are its best boosters.

Prepare At Home Or In Our Chicago Laboratory!

See for yourself how readily you may prepare at home, or in our modern Chicago laboratories, for a good job or business of your own in one of America's most promising, fast-growing fields—TELEVISION-RADIO-ELECTRONICS.

If you train at home you get (1) the use of a 16-mm. movie projector and 16 reels of animated movies to help you learn important points faster... easier, (2) modern, well illustrated lessons and (3) sixteen shipments of electronic parts enabling you to get valuable practical experience from over 300 projects—including building and keeping the electronic equipment shown below. And upon completing training, you have the optional privilege of building and keeping a big 21 INCH TV Set. (D T I offers another home training in Television-Radio-Electronics, but without the TV set.) Get the full story. Mail coupon today!

LAUD D T I'S HOME MOVIES IN CONGRESS

D T I's remarkable home training benefit of visual training MOVIES has been praised from the floor of the House of Representatives in Washington, D.C. and recorded in the Congressional Record.



"HOME MOVIES"



VACUUM TUBE VOLTMETER



OSCILLOSCOPE



21 INCH

Build and keep the BIG D T I Engineered TV set—easily converted to U. S. F. (D T I offers another home training, but without the TV set.)

89 WAYS TO EARN MONEY IN TELEVISION RADIO ELECTRONICS

MEMBER OF NATIONAL HOME STUDY COUNCIL
MAIL COUPON TODAY!

DeVRY TECHNICAL INSTITUTE
 4141 BELMONT AVE., CHICAGO 41, ILL.

Dept. PM-9-M

I would like your valuable information-packed publication showing how I may get started toward a good job or my own business in Television-Radio-Electronics.

Name _____ Age _____
 Street _____ Apt. _____
 City _____ Zone _____ State _____
 1005 D T I's Training is Available in Canada

If subject to military service, the information we have for you should prove very helpful. Mail coupon today.

"One of America's Foremost Electronics Training Centers"



DeVRY TECHNICAL INSTITUTE
 CHICAGO 41, ILLINOIS
 FORMERLY
DeFOREST'S TRAINING, INC.



DRAFTSMEN



**CASH BIG
PAY CHECKS!**

Train Now for
more success,
greater security

**LEARN AT HOME IN SPARE TIME
(or at college in Chicago)**

Check the want ads in any newspaper—SEE the big-pay opportunities open to you as a draftsman. What's more, you can learn this well-paid, prestige profession at home—quickly, easily! No special talent needed. Get complete, step-by-step Chicago Tech lessons in the mail, spend a few pleasant hours studying each week. In a short time you'll be a well-trained draftsman, ready to take your pick of many good jobs. Act now!



Free Information—Mail Coupon Today!

Get **FREE TRIAL LESSON** plus information about C.T.C. practical training. Learn what successful Chicago Tech graduates say about high pay and opportunities in drafting. No charge, or obligation.

CHICAGO TECHNICAL COLLEGE

M-254 Tech Bldg., 2000 So. Michigan Ave.
Chicago 16, Illinois

Mail me **FREE** lesson with facts about big opportunities in **DRAFTING**.

Name _____ Age _____

Address _____

City _____ Zone _____ State _____

SAY YOU SAW IT IN POPULAR MECHANICS

**SAVE 75%
ON**



WORK CLOTHES!

SURPLUS STOCK FROM MIDWEST SUPPLY FIRM!
Terrific values you've got to see to believe!

SHIRTS 79c
Made to sell for 2.99! Now only 4 for \$2.99

What a buy! 4 for the price of one! These shirts, though used, are washed, sterilized and ready for long, tough wear. In blue, tan or green. Send neck size, 1st and 2nd color choice.

PANTS to match Unbelievable 99c
Bargains! Sold for 3.95. Now only 4 for \$3.75
Send waist measure and inside leg length.

COVERALLS... wear 'em used and save \$2.29
plenty! Originally 6.95. Now only 3 for \$6.75
Send chest measurement.

SHOP COATS... fully reconditioned. \$1.79
Take advantage of this rock-bottom price. Send chest measurement. Now only 3 for \$5.00

SATISFACTION GUARANTEED! Your money back if you can beat these bargains anywhere! You can't lose so order **TODAY** for immediate delivery! Send \$1.00 deposit on C.O.D. orders. Add 25¢ postage and handling on prepaid orders.

GALCO SALES CO. Dept. 139
7120 Harvard Ave. • Cleveland 5, Ohio

23 YEARS AT THIS ADDRESS
TUBE FREE WITH EVERY PASSENGER TIRE
LOW OVERHEAD—LARGE VOLUME SALES & SMALL PROFITS
BRING YOU THESE "LOWEST PRICES."



Guarantees are as reliable as the company giving them. Our Guarantee accepted by the Public with satisfaction for 23 years.

"The Most Protection for the Least Money,"
Guaranteed Sent With Order
White Walls \$1.00 Ex. 50 Years of Combined family experience in High Quality Tires.
PARTIALLY USED—SEND AD

TAKE THE 10% DISCOUNT WE OFFER & PUT MONEY IN YOUR POCKET!
EVERYBODY 10% off ON EVERY TIRE
MAY TAKE

12 MOS. WRITTEN GUARANTEE
WE SPECIALIZE IN TRUCK TIRES
Matched Tires Shipped all over USA and Foreign Countries. **IMMEDIATE SHIPMENTS MADE.** Depend on **STANDARD for SERVICE.**
Selected for Toughest Jobs
Prices Shaved to the Bone

600-16	\$5.22	475-18	\$5.32	700-15 (H)	\$8.72	700-20	\$11.92
600-16 (G)	6.42	640-18	4.92	750-16 (B)	9.82	750-20 (I)	14.72
650-16	5.42	670-15	5.22	700-17	10.92	750-20 (R)	10.92
650-16 (G)	6.42	710-15	5.32	750-17	12.92	825-20	18.52
700-16	6.22	760-15	5.42	825-15	15.92	900-20	18.72
750-16 (G)	7.42	800-15	5.72	800-20	9.62	1000-20	19.72
850-16	4.82	820-15	5.72	850-20	10.72	1100-20	19.72
850-17	4.72	870-18	5.15	32x6 (H)	10.32	1000-22	20.92
850-18	5.22	760-18	7.72	32x8 (I)	12.32	1100-24	25.72
700-15	5.32	700-16 (G)	7.72	750-15	11.82	1110-22	20.02

"EXTRA SPECIAL" Fully guarantee all size 4-ply pass. **FREE TIRE** with 2 or more of these. **W.W. \$1.00 Extra.**
Factory Tested Tube given. **GIANT TIRE SALE \$7.42 EA.**

SNOW TIRES \$8.92 ORDER ANY 4 PLY PASSENGER SIZE
12 MO. GUAR. BLACK WALL

Thousands of tires shipped all over the U.S.A. All tires shipped F.O.B. Phila. Send Check or M.O. with this ad. Dept. 2. No C.O.D.
STANDARD 834 N. Broad St., Philadelphia 30, Pa.

See the Greatest Show on Earth with this
GIANT ASTRONOMICAL TELESCOPE

\$15.00
FULL PRICE



Delivered ready for use. Has 45X, 75X and 100 power individually mounted eyepieces with brass focusing tube plus sun spot projector lens for observing sun spots and solar storms. Steel telescope tube 50 in. long. Rigid 6 ft. tripod adjustable to any height. Steel forked mounting with closely machined aluminum tripod head assembly assures extra fine adjustments. This professional type instrument provides full power with clear vision at all times. See the moons of Jupiter, our own moon, planets, milky way, double stars, star clusters, etc. All for only \$15.00 FOB Mattituck. Sent express. COD orders require \$5.00 deposit. Satisfaction guaranteed. 200X and 400X eyepieces available at \$2.00 ea.

SUFFOLK SCIENCE SERVICE
Dept. TD-9 MATTITUCK, N. Y.

DRAINS cellars, cisterns, wash tubs; **\$7.95**
IRRIGATES - CIRCULATES - SPRAYS



Type P Pump has 1,001 uses. Up to 3000 GPH; 450 GPH 8 1/2' high or 1800 GPH from 25' well. Use 1/8 to 3/4 HP motor. Coupling included free. 1" inlet, 3/4" outlet. Stainless shaft. Won't rust or clog! Postpaid if cash with order. Rush your order today.

MONEY BACK GUARANTEE
Centrifugal and Gear Pumps in All Sizes
LABAWCO PUMPS, Belle Meade 7, N. J.



Grow authentic, **LIVE** dwarf trees!
Fascinating hobby! Profitable business!

GROW MINIATURE TREES
SEND FOR FREE SEED & INFORMATION!

MINIATURE NURSERY CLUB
Dept. JJ-9, P.O. Box 8794,
Los Angeles 8, Calif.

FALSE TEETH
KLUTCH holds them tighter

KLUTCH forms a comfort cushion; holds dental plates so much firmer and snugger that one can eat and talk with greater comfort and security; in many cases almost as well as with natural teeth. Klutch lessens the constant fear of a dropping, rocking, chafing plate. 35c and 60c at druggists... If your druggist hasn't it, don't waste money on substitutes, but send us 10c and we will mail you a generous trial box.

KLUTCH CO. Box 693-I ELMIRA, N. Y.

CLUTCH

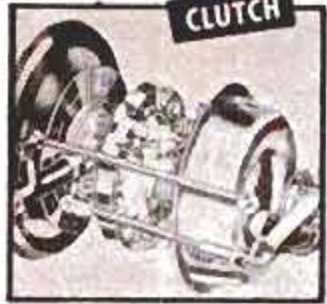

IGNITION



CARBURETORS



AUTOMATIC TRANSMISSIONS

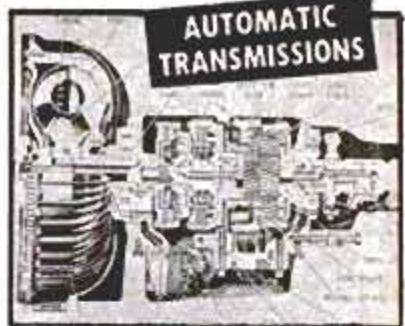

2900 photos and diagrams, plus crystal-clear directions, make every operation easy as A-B-C.

Diagrams, tables and text take the "mystery" out of all ignition systems.

You get illustrated adjustment procedures for all types of carburetors.

ALL AUTOMATIC TRANSMISSIONS are fully covered in special big section. (NOTE: All pictures shown here are greatly reduced in size. Actually, this giant book is almost a foot high!)

Here's the EASY Step-by-Step Way to FIX ANY PART OF ANY CAR

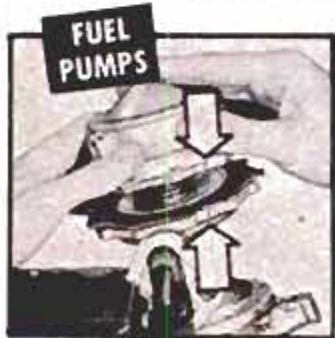

Fuel pumps can cause trouble. Pictures show exactly how to take them apart, fix them.

Now—Whether You're a Beginner or Expert Mechanic—You Can "Lick" Any Auto Repair Job On Any Car Built from 1946 Through 1956!

in a jiffy!

NOW you can tackle any repair job, and do it quickly, easily, right—the first time! MOTOR'S BRAND-NEW AUTO REPAIR MANUAL shows you how—with crystal-clear pictures and step-by-step directions you can easily follow.

No guesswork. This giant guide tells you where to start; what tools to use. Leads you easily and quickly through the entire operation. Covers everything from a simple carburetor adjustment to a complete overhaul.

Everything You Need to Know

BIG, NEW REVISED Edition has MORE REPAIR INFORMATION THAN EVER! OVER 1,000 giant pages, 2,900 "This-Is-How" pictures—clear drawings, diagrams, cutaway photos—make every step EASY. 291 "Quick Check" charts—23,436 essential repair specifications, 225,000 service and repair facts, instructions and pictures so complete, so clear—you CAN'T go wrong!

section that enables you to spot any car trouble in a jiffy.

Factory Specifications and Adjustment Tables. Tune-up Charts, Tables of Measurements and Clearances. Overhauling, Replacement Facts—AND MUCH MORE.

Used by Armed Forces, hundreds of thousands of auto service men! Now try it on this GUARANTEE:

Try Book for a Week FREE SEND NO MONEY

Pay nothing to postman. Test book in your own garage or shop. It's GUARANTEED to pay for itself in 7 days. If it doesn't just return the book, and owe nothing. Rush coupon for your free-trial copy of this great money-saving Manual. MOTOR Book Dept., Desk 1J, 250 West 55th St., New York 19, N. Y.

Even a green beginner can do a good job. And top mechanics will be amazed at the time-saving procedures.

The "Meat" of Over 160 Official Shop Manuals

The editors have put together the "Know-How" from over 160 Official Shop Manuals; "boiled it down" into one handy indexed book.

Includes ALL Automatic Transmissions. Covers new Carburetors, Engines, Fuel Pumps, 12-Volt Ignition System, Starting Motors, Generators, Distributors, Voltage Regulators, Axles, Brakes, Power Steering, etc. PLUS new Trouble-Shooter

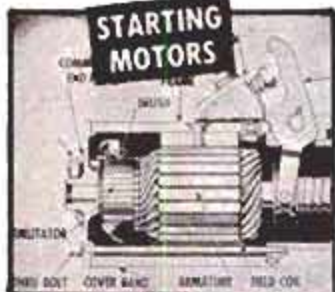

No guesswork. Clear pictures show how to fix starting motor, generator, brakes, etc.

Just 2 of the Many Letters of Praise
Does Every Job. "My MOTOR Manual is a wonderful help. It has a position to do every job."—S. L. Sharpless, Los Angeles, Calif.
Amazed Self and Friends. "I amazed myself and my friends, too. Now do jobs that stumped me before."—Michael Duticaky, Newark, N. J.

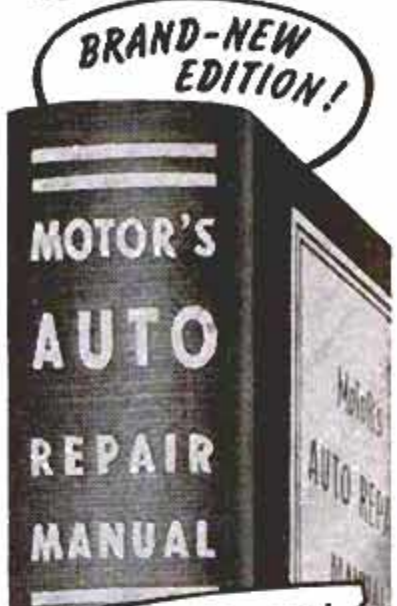

SEND NO MONEY! TRY BOOK FREE!

USED BY U.S. ARMY NAVY MARINES

MAIL COUPON NOW FOR 7-DAY FREE TRIAL

MOTOR Book Dept., Desk 1J, 250 West 55th Street, New York 19, N. Y.

Rush to me at once (check box opposite book you want).
 MOTOR'S New AUTO REPAIR MANUAL. If okay, I'll remit just \$2.00 in seven days, then \$2.00 monthly for two months and a final payment of 95c (plus 35c delivery charges) one month after that. Otherwise, I'll return the book postpaid in seven days. (Foreign price: Remit \$9.00 cash with order.)
 MOTOR'S New TRUCK REPAIR MANUAL. (Described at left.) If okay I will remit \$2.00 in seven days, and \$2.00 monthly for three months, plus 35c delivery charge with final payment. Otherwise I will return book promptly. (Foreign price: Remit \$10.00 cash with order.)

Print Name.....Age.....

Print Address.....

City & Zone No.....State.....

SAVE 35c delivery charge by enclosing WITH COUPON check or money order for full payment of \$6.95 for Auto Repair Manual (or \$8.00 for Truck Manual). Same 7-day return-for-refund privilege applies.

Same FREE 7-Day Offer on MOTOR'S Brand-New TRUCK REPAIR MANUAL

Covers EVERY job on EVERY gasoline-powered truck made from 1946 thru 1956—including GM Cummins Diesels—Over 2,000 facts, Check proper box in coupon for free trial.

COVERS 737 MODELS— ALL THESE MAKES

Buick	Ford	Nash
Cadillac	Frazier	Oldsmobile
Chevrolet	Henry J	Packard
Chrysler	Hudson	Plymouth
Clipper	Imperial	Pontiac
Continental	Jeep	Rambler
Crosley	Kaiser	Studebaker
De Soto	Lincoln	Thunderbird
Dodge	Mercury	Willis

2,000,000 COPIES SOLD!

SALESMEN GETTING UNBELIEVABLE SENSATIONAL NEW LIGHTING DISCOVERY



Stuart G. Nelson, President
SUNRAY PRODUCTS CORP.

If you can throw a switch, a revolutionary new kind of Fluorescent Lamp can lead you to earnings of \$200 to \$400 a week, and more—and create a "retirement" income on your repeats!

The bare facts about this invention are so fantastic that they sound like wild exaggerations. Yet every statement is true—as you will see when you read my letter.

Preliminary sales work shows fortunes will be made by the salesmen who have the vision to see the tremendous possibilities in the swelling National surge toward "better seeing." Read with care. It may be another decade before you have another opportunity as important as this.

To enable you to understand this opportunity I will have to tell you the difference between "lighting" and "illumination." Lighting is the source of light—illumination is the useful result of lighting. You install lighting to provide illumination. Different human activities require different kinds of illumination. And the illumination varies in two ways: (1) The *amount* of light delivered, and (2) The *color* or *character* of the light delivered.

Until recently all of man's inventive genius was aimed at producing *more light* from a given amount of electricity.

The search for more light culminated in the development of the Fluorescent lamp. Per watt of current used it gave a higher level of light than any incandescent lamp—about two-and-a-half times as much. It gave a whiter, stronger, more brilliant light. The nation's storekeepers, offices, and manufacturing plants switched to Fluorescent with breathtaking speed. But then came a shock.

A backlash

Fluorescent lamps are affecting the eyes of the people who work under them. Eye strain has risen to an all time high level. Nervous disorders are on the increase. The efficiency of employees is showing a serious drop-off due to tensions caused by eye strain.

The cause? GLARE! Glare is reflected light entering the eye at an angle different from the angle at which the eye is focused. Fixture manufacturers

have adopted scores of louvers for their fixtures in an attempt to cut down glare. But these louvers cut down the amount of light delivered to the working area—particularly as they become crusted with dust.

And, in spite of partial reduction, glare continued.

until—

Sometimes—more often than not—inventors and engineers who know the subject best, get so complicated in their thinking that they overlook the simple things. And most great inventions are simple.

A simple invention

The new SUNRAY lamp is such an invention. It is so simple that when you see it, you will wonder why the engineers hadn't thought of it years ago. Yet it is so radically different that patents have been granted on the methods for making it.

The claims made are so fantastic that no amount of talk by the most convincing salesman could make a prospect believe. Yet one simple Three-Minute Demonstration — with Four Lighted Tubes give such dramatic proof to the prospect's own eyes that he knows every claim is true — he knows that he **MUST** have SUNRAY LAMPS for his store, office or factory.

Throw the switches— write the orders!

In our demonstration case there are four Fluores-

WEEKLY CHECKS DEMONSTRATING FOR FACTORIES, STORES AND OFFICES

cent lamps and four switches. Snap the first switch and you have the light from a standard fluorescent lamp shining down on a printed sheet of paper. The eye is repelled by glare. You snap the second switch. The SUNRAY lamp lights up. The contrast is almost as night from day. From one paper the glare still slams into the eye. From the other side, no glare. Just a soft, restful, but adequate illumination.

The effect on the prospect is as instantaneous as the demonstration. He needs no "selling" for he has seen what ten thousand words would not have made him believe. The order is ready to write.

But wait. One more surprise!

SUNRAY made a second discovery. It relates to COLOR. Lights of different colors create startling differences in the way different things appear to the eye. Under standard fluorescent lamps food, faces, clothing, furniture and painted surfaces look unnatural. The colors are not true. Color distortion is often so great that the merchandise displayed looks uninviting.

There is no one fluorescent lamp that will make all colors appear as they do in daylight—not even the lamp that is called a Daylight lamp. But SUNRAY engineers found the secret of COMBINING lamps of different tints to give the exact illumination that is best for each type of business. In different combinations, they can be made to improve the appearance of any product—whether it be a steak, a head of lettuce, a fine cabinet, a suit, pair of shoes, a woman's hat or dress, or an automobile.

An instant success

And the next two SUNRAY lamps in your demonstration case permit you to show this difference so dramatically that the prospect starts selling you.

This is not guesswork on my part. I'm not talking about what I hope will be the case. For the last four years we made selling tests in scattered territories.

We were optimistic. We had great hopes. But the actual sales records made our wildest hopes seem pale. One of our men in a Mid-West state has made an average of more than \$200.00 a week from the first week, he started three years ago. He has made as much as \$480.00 in one week. And, right now, he is getting repeat orders from 75% of his original customers—three out of four. His repeat-order business alone would keep him living like a king the rest of his life.

The story is the same with thirty other men. Stead-

ily adding customers. Increasingly easy to sell. The demonstration does it. Some of the biggest names in industry are already permanent users.

Experimenting is done—

We are ready now for our greatest expansion. We have three plants in which we can turn out twenty million dollars worth of lamps a year.

There is an opportunity for you, if—. What's the "if"? Not experience with lamps. Not knowledge of electricity or lighting. All this we can give you in simplified form—selling instructions you can master in 30 minutes. No, the thing we want is sincerity. If you are mature enough to know that no success is gained without work; if you are willing to put in the hours to get yourself established; if you can recognize the value of a connection of permanence and stability, I'd like to give you all the exciting information about your future with SUNRAY.

If you can qualify— send your name

The information is free, naturally. It is complete—so complete that after reading my letter you will either say this is one of the greatest opportunities you have ever had, or you'll say, "It's not for me." If selling is your profession, then you will not want to take a chance on missing the SUNRAY opportunity—at least not for the cost of a three-cent stamp. Send your name and address. I'll mail a complete, down-to-earth presentation which discloses every angle of this great business. Then you can decide whether this is the opening you've longed to find.

Stuart G. Nelson, Pres., SUNRAY PRODUCTS CORP., 1617 Lexington Ave., Warren, Pa.

Stuart G. Nelson, Pres.; SUNRAY PRODUCTS CORP.,
1617 Lexington Ave., Warren, Pa.

Dear Sir: I will be glad to read the information you send me about the opportunities in the sales of SUNRAY Products. The information is free and there is no obligation on my part.

Send to _____

Address _____

City _____

Zone _____ State _____

My NEW Easy Method Trains You At Home

for a Good-Pay Job and Security IN AIR CONDITIONING AND REFRIGERATION



R. C. Anderson, President of Commercial Trades Institute, has devoted his entire adult life to training thousands of men for success in the technical world.

**MAIL COUPON
FOR 2 NEW
FREE BOOKS**



YOUR OPPORTUNITIES FOR SUCCESS ARE BEST IN AMERICA'S FAST-GROWING INDUSTRY

Over 150 million air conditioning and refrigeration units are in use today—and millions more are in production. *The industry is growing so fast that there's a big shortage of trained mechanics who can make installations and repairs.* Air conditioning and refrigeration men are well paid, they work steady, and their futures are secure. *You can break into this big, uncrowded field.* You can do it by learning air conditioning and refrigeration at home in spare time. To find out how easy it is, just mail coupon below. I'll send you two books which give astounding job and training facts.

You Get Shop Practice with 23 Big Kits I Send

Only CTI sends you 23 big kits of air conditioning and refrigeration equipment. You get practical service and repair experience at home, the kind of experience that trains and qualifies you for the big-paying field jobs. In the photo above, you see a student assembling a condensing unit with kits I send. The final result is a complete, heavy duty, commercial type, 1/4 hp air conditioning and refrigeration high side. CTI kits help you run many tests. You will overhaul, repair and assemble motor and twin-cylinder compressor. With this unit you do 10 complete service and trouble-shooting jobs. During your training, you build and keep an air conditioner, refrigerator, freezer or milk cooler. Here is a proven, exciting way to get solid experience with your training. You start at the top, not near the bottom, when you graduate. Mail coupon below for full description of kits.

Earn Money Spare Time As You Train

My training will help you begin earning extra money in spare time soon after you enroll. Many students earn from \$10 to \$20 a week repairing refrigerators and air conditioners in their communities. Many have gone right into business upon graduating because of the satisfied customers they gained while doing spare time work. The "On-the-Job" Training that you get with CTI kits gives you practical experience which makes it easy for you to do outside service work.

Mail Coupon for Facts on Your Future

Make up your mind right now to get the better things out of life. Mail coupon below, which will bring you my brand new book, "Success in Air Conditioning and Refrigeration," and also, a free sample lesson. Learn how I train you . . . how big your opportunities are . . . and what my graduates are earning. — R. C. ANDERSON, PRESIDENT, COMMERCIAL TRADES INSTITUTE, CHICAGO 26, ILL.

CTI Trains You for Hundreds of Jobs in this Big-Pay Field . . .

I TRAIN MEN TO MAKE GOOD IN LIFE



"When I came home from the army, there was no work. Thanks to CTI training, I am now employed full time at good wages. I got 3 raises and a bonus. Have my own home." — DANIEL SZEWEENS, SPRINGFIELD, O.

"Without the practical and theoretical training I received through CTI, I never could have started a business of my own. I have a small shop. Am financially independent." — K. SELLMAN, GUTHRIE CENTER, IA.

"Am very glad I learned through CTI. I am now an able refrigeration technician. Am earning good wages, find my work interesting. I recommend CTI to any ambitious man." — A. W. HEINDRICH, KEWANEE, ILL.

"I find the lessons very interesting and easy. Since my fifth lesson I have been working on refrigerators. I rebuild old ones and sell at a nice profit. Am planning a full time shop." — W. O. WARD, MICH.

"Your course proved to be very valuable to me. As a result of your training, my partner and I run our own repair shop. He is also a CTI graduate. We also employ a former CTI student as our outside repair technician." — J. J. GIERTUGA, CHICAGO.

"My training thru CTI has changed my life. It has changed it from working for bare necessities to my owning a business." — J. J. KISH, E. CHICAGO, IND.



Last year, 2 million air conditioners were installed in homes. Experts say that 6 million will be sold in 3 years more. Plenty of job opportunities in the home field! And many new jobs are opening in the institutional, industrial and transportation fields, too! Office buildings, factories, hospitals, motels and stores are installing units by the thousands. Experts say that 4 million cars will have air conditioning within three years. You can see, there's opportunity for high pay and advancement everywhere, often right in your own back yard. Let CTI help you get set for success.

REFRIGERATION MAKES JOBS

Over 42 million refrigerators in American homes! Over 3 million sold last year — 4 million per year in the future! Over 1 million food freezers are sold annually, too. All this adds up to job opportunities. When you consider the millions of groceries, meat markets, truck lines, transport systems and beverage industries that depend heavily on refrigeration, you get some idea of the big need for skilled technicians who must install, repair and service. Yes, refrigeration is big, uncrowded!



IT'S EASY TO START IN BUSINESS—BE YOUR OWN BOSS

Want to be independent? You, too, can start your own business with a small investment — and grow big, as so many CTI men have done.

MAIL TODAY



Your success is as near as the corner mail box

BOTH BOOKS FREE!

Mr. R. C. Anderson, President
Commercial Trades Institute
1400 Greenleaf Ave.
Chicago 26, Ill. Dept. R-299

Mail me Sample Lesson and 32-page book, "Success in Air Conditioning and Refrigeration." Both FREE.

Name _____ Age _____

Address _____

City _____ Zone _____ State _____

Member: National Home Study Council



RCA offers you the
 finest training
 at home in
Radio-TV
 electronics,
TV servicing,
Color TV

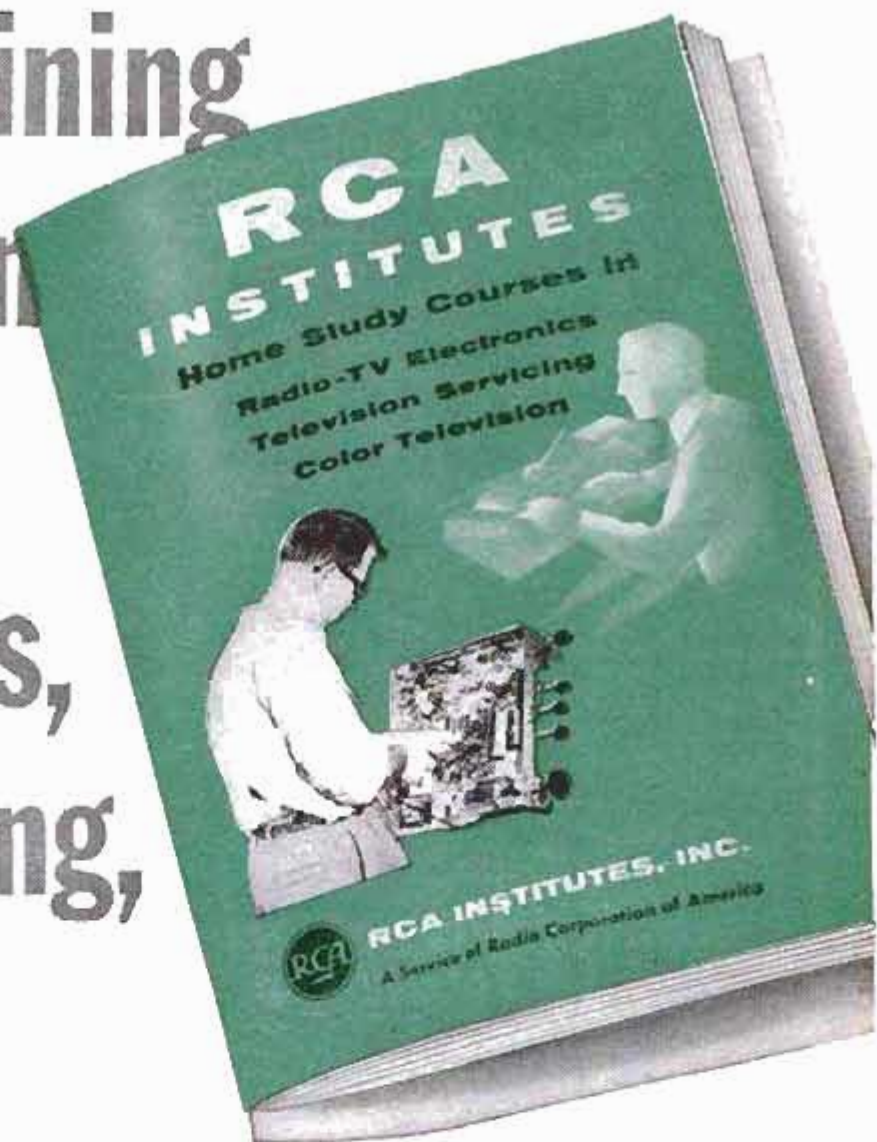

**SEND FOR THIS FREE
 BOOK NOW!**

The instruction you receive and equipment you get (and keep) will start you on your way. Pay-as-you-learn. You pay for only one study group at a time. This 52 page book contains complete information on Home Study Courses for the beginner and the advanced student.



RCA INSTITUTES, INC.
 A SERVICE OF RADIO CORPORATION OF AMERICA
 350 WEST FOURTH STREET, NEW YORK 14, N.Y.

RCA Institutes, Inc., Home Study PM96,
 350 West Fourth Street New York 14, N. Y.
 Without obligation, send me FREE CATALOG
 on Home Study Courses in Radio, Television
 and Color TV. No salesman will call.

Name Please Print
 Address
 City Zone State

VETERANS
 KOREAN G. I.
 P. L. 550
 CHECK HERE
 ()



"Put Your Finger" ON Any Car Trouble IN A JIFFY!

Brand-New, Greatly Enlarged Edition of MOTOR'S "Trouble-Shooter" Helps You Find "What's Wrong" Quickly and Easily!

NOW SPOTS OVER 2300 CAUSES OF CAR TROUBLES!

Save time and work on any auto repair job! Amazing TROUBLE-SHOOTER lists 2300 specific causes of car troubles; helps you find the one you're after FAST. BIG NEW EDITION! Over 50 diagrams, photos; explains operating principles of engine parts, ignition, etc.

If car is "burning oil," index leads you to 11 things that can be causing trouble. In the same way, you can track down any trouble. Covers engines, clutches, brakes, ignition, all automatic transmissions, power steering, power brakes, etc. Spiral binding; book stays open while you work. Quick help to beginners as well as experienced repair men!

SEND NO MONEY

Simply mail coupon. Pay postman \$2.00 plus postage, C.O.D. charges on delivery. Try MOTOR'S Trouble-Shooter for 7 days. If not delighted, just return it for refund. Mail coupon NOW to: MOTOR-Book Dept., Desk T1J, 250 West 55th Street, New York 19, N. Y.



Just Out! Includes all newest automatic transmissions.

HOW TO SPOT: 57 points to check in starting a stalled engine. 61 causes of overheating. 46 synchromesh transmission troubles. 316 different automatic transmission troubles. 24 checks for poor high speed performance and lack of power. 56 causes of engine "misses." 74 causes of engine noises. 59 checks for clutch troubles. 38 rear axle troubles. 44 causes of hydraulic brake troubles. 19 power brake troubles. 80 causes of power steering troubles. 23 overdrive troubles. . . . and MUCH, MUCH MORE!

MAIL NO-RISK COUPON NOW!

MOTOR BOOK DEPT., Desk T1J
250 WEST 55th ST., NEW YORK 19, N.Y.

Rush me MOTOR'S brand new enlarged, revised TROUBLE-SHOOTER. I will pay postman only \$2 on delivery, plus 46c actual Gov't. postage and C.O.D. charges. If not completely satisfied, I may return book in 7 days for immediate refund.

Name _____ (PLEASE PRINT CLEARLY)

Address _____

City _____ State _____

SAVE CHARGES! Check here if you ENCLOSE \$2.00 as payment in full; you SAVE 46c postage, C.O.D. charges. Same return privilege; full money-back guarantee.



instead of a job . . . train for a Career



Industrial growth . . . automation . . . technical advances create career opportunities for engineers, accountants, management experts. Share rewards awaiting college-trained men. Important firms visit campus regularly to employ Tri-State College graduates. Start any quarter in this world-famed college. Approved for veterans.

Bach. of Science degree in 27 months

In Mechanical, Civil, Electrical, Chemical, Aeronautical, Radio (TV-Electronics) Engineering. In 36 Months a B.S. in Business Administration (General Business, Accounting, Motor Transport Management majors). Capable students may accelerate, 36-weeks course in Drafting. Intensive program: technical fundamentals stressed; comprehensive courses with more professional class hours. Small classes; personalized instruction. For earnest, mature students whose time and budget require accelerated courses and modest costs. Preparatory courses. Beautiful campus in friendly college town. Well-equipped, new and modernized buildings and laboratories. Enter Sept., Jan., March, June. Write Jean McCarthy, Director of Admissions, for "Your Career in Engineering and Commerce."



TRI-STATE COLLEGE

496 College Avenue . . . Angola, Indiana



GIANT BALLOONS

Biggest & best! Surplus US Govt. (new overage) Neoprene weather target balloons. We've sold for years, buy in confidence.

FOR FUN—Great in backyard, at parties, picnics, fairs, Young & old enjoy 'em!
FOR ADVERTISING—Attract big crowds to business openings, civic events, trade shows, exhibitions. Paint 'em with a sales message and they'll pay off for you!
FOR PROMS—Makes any high school or college prom more festive. Real cool!
Approx. inflated sizes.

3 ft. dia., 49c—5 ft. dia., 99c
10 ft. dia., \$1.59—13 ft. dia., \$1.95

Cal. res. add sales tax. Postage paid on prepaid orders.

VOLUME SALES CO., War Assets Division
3930 Sunset Blvd., Dept. PM956, Los Angeles 29, Calif.

LEARN LANDSCAPE GARDENING

A thorough, interesting home study course for those who wish to become LANDSCAPERS, GARDENERS, DESIGNERS, etc., for profit or pleasure. Write today for FREE INFORMATION to:

NATIONAL LANDSCAPE INSTITUTE

Dept. M-96 310 S. Robertson Blvd. Los Angeles 48, Calif.



Learn To MOUNT BIRDS

Here's Best Hobby for Fun & Profit

TAN SKINS, MAKE UP FURS
Be a Taxidermist. We teach you at Home. Mount Birds, Animals, Pets, common specimens. Save your hunting trophies, decorate home and den. Make genuine KROME LEATHER, tan and make up furs for spacetime profit. INVESTIGATE TODAY
FREE BOOK 45 pages-tells all about it. Hunters, get your copy. It's Now Free. Send post card. State your AGE.
IN. W. SCHOOL OF TAXIDERMV. DEPT. 2509, Omaha, Nebr.



SAY YOU SAW IT IN POPULAR MECHANICS

SELL TO UNCLE SAM!



That's how I made \$20,000 a year—selling junk jewelry to the U. S. Government. Send me your name and I'll show you how I did it.

LEARN AT HOME IN ONE EVENING

This is the most fantastic way of making money you ever heard of. That's because you do all your "selling" BY MAIL to one customer—the U. S. Government! Uncle Sam will buy all the old junk jewelry you send in at \$35.00 AN OUNCE for the gold it contains. Just follow my Plan and you can pick up gold on any street in your town. I show you where to find it, what to pay, how to test and how to mail to Uncle Sam for cash. I'll teach you the secrets by which I made \$20,000 a year. No charge for facts. No salesman will call. Send no money—just your name, address on postcard. **Leslie Patton, 335 W. Madison St., Dept. 99, Chicago 6, Ill.**

ENCYCLOPAEDIA BRITANNICA



Brand New Edition Now Available *Direct From The Publisher On Easy...* **Book a Month Payment Plan**

All 24 Volumes Delivered Immediately— You Pay Later on Easy-to-Own Purchase Plan

Yes, the latest edition of Britannica—the greatest treasure of knowledge ever published—is now being offered on a remarkable plan that puts this world-renowned reference library within reach of every family. All 24 volumes will be placed in your home...NOW...you pay for it as you enjoy it...*as easy as buying a book a month!*

Thousands of Subjects of Practical Value to Your Whole Family



In the brand-new edition of Britannica you will find thousands of subjects that you and your family will refer to in the course of your normal day-to-day affairs. For example, you'll find special articles on household budgets...interior decorating...medicine and health...home remodeling...child care...adolescent problems...rules and regulations for all sports...every kind of hobby...plus a treasure house of knowledge on *all* subjects. Useable information that can save you many dollars.

New Edition Profusely Illustrated

The new Britannica almost "televises" the information to you by means of 23,225 pictures, plus charts, maps and drawings. But it does not merely show "attractive" pictures—it is the work of 5,258 of the world's best minds. The final authority on factual knowledge; a constant inspiration that will enrich the lives of yourself and your family.

In today's world...Factual Knowledge Opens the Way to Financial and Social Success

Self-confidence—and the confidence of others—are two rewards you can expect from Britannica's world of facts. For instance, did you know...

- Britannica provides instant and authentic information on every conceivable subject or thought.



- Britannica will enable parents to work more closely with their children at home...helping them build a more solid foundation in today's highly competitive society.

- It will build self-confidence...by helping all members of your family to understand...and talk intelligently on every subject that enters into the lives of successful men and women.

Preview Booklet Offered FREE!

Simply fill in and mail the coupon today, and we will send you...*without cost or obligation*...a copy of our beautiful, new booklet which contains an exciting preview of the latest edition of Encyclopaedia Britannica. Send no money—not even for postage. It's yours, *absolutely free!*

Just as soon as we receive your coupon, we will send your illustrated, free booklet, so that you can read and enjoy it at your leisure, in the privacy of your home. There is no obligation, of course. However, since this offer is necessarily limited, please mail the coupon *today* before it slips your mind.

Mail Coupon
 NOW for
**FREE
 BOOKLET!**



ENCYCLOPAEDIA BRITANNICA, Dept. 15-F

425 N. Michigan Avenue, Chicago 11, Ill.

Please send me, free and without obligation, your colorful Preview Booklet which pictures and describes the latest edition of ENCYCLOPAEDIA BRITANNICA in exciting full detail. Also include complete information on how I may obtain this magnificent set, direct from the publisher, on the Book a Month Payment Plan.

Name _____
 (Please Print)

Address _____

City _____ Zone _____ State _____

In Canada, write E. B. Ltd., Terminal Bldg., Toronto, Ontario

DIESEL MECHANICS IN DEMAND

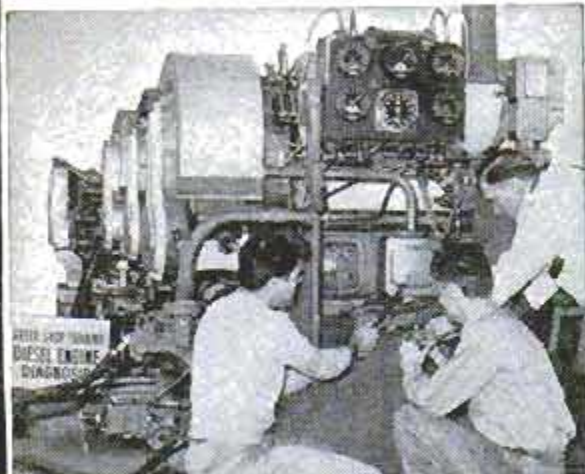

Learn to earn big pay in DIESEL in our large, modern equipped Chicago school and shop. No previous experience or training necessary. We help you find living quarters and part time job while in school. Complete, practical courses taught in the following trades, under the supervision of experienced, expert technicians.

APPROVED FOR CIVILIANS OR GI'S

— CHOOSE YOUR TRADE —

CHECK HERE	WEEKS
<input type="checkbox"/> DIESEL MECHANICS	20
<input type="checkbox"/> AUTO MECHANICS	20
<input type="checkbox"/> BODY & FENDER	16 2/3
<input type="checkbox"/> GAS-ARC WELDING	4-12
<input type="checkbox"/> REFRIGERATION	13 1/2
<input type="checkbox"/> AIR CONDITIONING	8 1/3
<input type="checkbox"/> MACHINIST TRADE	30
<input type="checkbox"/> ADVANCED MACHINIST (includes tool & die)	32 1/2
<input type="checkbox"/> PIANO TUNING & REPAIR	36

CHOOSE YOUR ENGINEERING COURSE

These courses are intended as terminal education for men who wish to enter the Diesel-Automotive and Refrigeration-Air Conditioning fields as technicians. These courses are designed to prepare men for supervisory positions. Students with a high school education, or equivalent, will be accepted.

<input type="checkbox"/> DIESEL AUTOMOTIVE ENGINEERING	2 years
<input type="checkbox"/> REFRIGERATION & AIR COND. ENGINEERING	18 months

FREE EMPLOYMENT HELP

Start your career with Greer by checking your interest above and mail coupon for complete information at no obligation.

NAME _____ AGE _____

STREET _____

TOWN _____ ZONE _____ STATE _____

Established 1902 — Over 50,000 Graduates.
54 years of continuous trade school experience to guide your training.

GREER SHOP TRAINING

Box 1, 2236 S. Michigan Ave.
Chicago 16, Illinois

Would YOU Like to Make \$1,000 A MONTH?

That's what Stanley Hyman made selling the amazing new PRESTO Fire Extinguisher!



Amazing new kind of fire extinguisher. Tiny "Presto" does job of bulky extinguishers that cost 4 times as much, are 8 times as heavy. Ends fires fast as 2 seconds. Fits in palm of hand. Never corrodes. Guaranteed for 20 years! Sells for only \$4.95! Over Two Million Sold!



Show it to civil defense workers, owners of homes, cars, boats, farms, etc. and to stores for resale—make good income. H. J. Kerr reported \$20 a day. C. Kama, \$1,000 a month. Write for FREE Sales Kit. No obligation. **MERLITE INDUSTRIES, Dept. P-151**
114 East 32nd Street, New York 16, New York
IN CANADA: Mopa Co., Ltd., 371 Dowd Street, Montreal 1, P. Q.

SHINE WITHOUT 'POLISH'



Cars Glean Like Mirror

MEN! WOMEN! So easy a child can do it! Amazing "Dry" Polish puts mirror-like shine on car WITHOUT 'POLISH'. No messy pastes, liquids, sprays. Simply glide over car. PRESTO! Leaves hard, lustrous, long-lasting protective Wax Coating. Take orders! Earn money!

SAMPLES FOR TRIAL

Sample offer sent immediately to all who send name at once. Just a postcard will do. SEND NO MONEY—just your name. **KRISTEE CO., Dept. 691 Akron 8, Ohio**

LEARN METALCRAFT and JEWELRY MAKING



Low Cost Home Training Now Available

Make money. Learn profitable skills and arts of decorative metal and jewelry crafts. Course is complete. Professionally prepared. Easy to master. Special tools and materials furnished.

Write for Free Booklet **INTERSTATE TRAINING SERVICE**
DEPT. K-3 PORTLAND 13, OREGON

MONEY in WORMS

Big money made raising fishworms and crickets. Billions used yearly—unlimited market—Sell by mail—We teach you how to raise and where to sell. Learn about our new, exclusive 6 to 12 inch African Redworm—in demand everywhere. Free Literature, **CARTER WORM RANCH, PLAINS, GEORGIA**

JEEP OWNERS

STA. WAGONS • JEEPERS • PICK-UPS!

RE-POWER with Ford 6 or V-8 engines. Our F-J ADAPTOR-CONVERSION KITS fit—All—Willys Jeeps including 1956. Kit No. 4-K for 1949-56 Ford engines in 1954-56 Pickups & Sta-Wagons priced at \$52.85 incl. Fed. tax. Kits for 1932-56 Ford engines in ALL other Willys Jeeps . . . \$43.25 Tax incl. Write today for free details or send check or M.O. for prepaid shipment. Tell us year engine you will use and whether 2 or 4 Whi-Dr. **ORDER NOW FOR EARLY SHIPMENT.**

HOOSIER MACHINE PRODUCTS CO.
312 S.E. 6th St. Pendleton, Oregon

SAVE GAS, GEARS,
TIRES ON YOUR
4-WHEEL DRIVE!



Stop Front End Drag in 2 W. D.

Get maximum use of your vehicle with these famous hubs! They "take out" the front end in 2-wheel drive, give your vehicle "pick-up" economy, pep, speed, power, handling ease; stop front end gear whine, shimmy. 4-wheel drive as usual, when you need it—automatically, as you shift, with Warn Lock-o-matics, manually with Locking hubs. Models for all makes 4 w.d.s. to 11 1/2 tons at truck dealers everywhere. or write:

WARN MFG. CO., Riverton Box 6064-A9, Seattle 88, Wn.



WARN HUBS

GET IN ON THE TV

BOOM!

I. C. Lane, B.S., M.A.
President, Radio-Television Training Association
Executive Director, Pierce School of Radio & Television

TRAIN FOR A TOP-PAY JOB AS A TELEVISION TECHNICIAN NO PREVIOUS EXPERIENCE NEEDED — study AT HOME in your SPARE TIME

Next to the atom and hydrogen bombs, the biggest noise being made today is by the booming radio-television-electronics industry.

Now, while the boom is on in full force, is the time for you to think about how you can share in the high pay and good job security that this ever-expanding field offers to trained technicians.

Just figure it out for yourself. There are more than 400 television broadcasting stations operating right now

and hundreds more to be built; more than 34 million sets in the country and sales increasing daily. Soon moderately priced color television sets will be on the market and the color stampede will be on.

All these facts mean that good jobs will be looking for good men. You can be one of those men if you take advantage of my training now — the same training that has already prepared hundreds of men for successful careers in the radio-television-electronics field.

No experience necessary! You learn by practicing with professional equipment I send you. Many of my graduates who now hold down good paying technician jobs started with only grammar school training.

If you have previous Armed Forces or civilian radio experience you can finish your training several months earlier by taking my FM-TV Technician Course. Train at home with kits of parts, plus equipment to build YOUR OWN TV RECEIVER. ALL FURNISHED AT NO EXTRA COST!

After you finish your home study training in the Radio-FM-TV Technician Course or the FM-TV Technician Course you get two weeks, 50 hours, of intensive Laboratory work on modern electronic equipment at our associate school in New York City, Pierce School of Radio & Television. THIS EXTRA TRAINING IS YOURS AT NO EXTRA COST WHATSOEVER. My courses are complete without this extra training, however. It is just an added opportunity for review and practice.

**RADIO-FM-TV
TECHNICIAN
TRAINING**

**FM-TV
TECHNICIAN
TRAINING**

**EXTRA
LABORATORY
TRAINING IN
NEW YORK
CITY
AT NO EXTRA
COST!**

VETERANS!

My School fully approved to train Veterans under new Korean G. I. Bill. Don't lose your school benefits by waiting too long. Write discharge date on coupon.

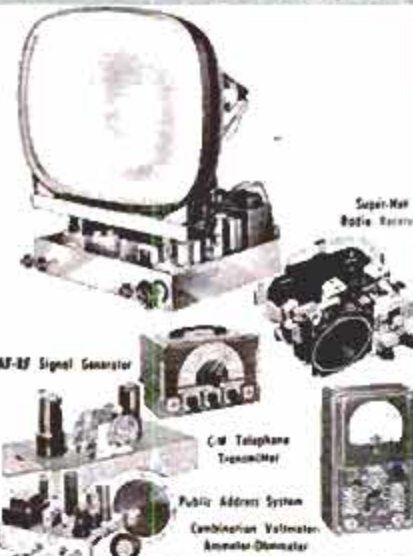

LEARN BY DOING

As part of your training I give you the equipment you need to set up your own home laboratory and prepare for a BETTER-PAY TV JOB. You build and keep an Electromagnetic TV RECEIVER designed and engineered to take any size picture tube up to 21-inch, (10-inch tube furnished. Slight extra cost for larger sizes.) . . . also a Super-Het Radio Receiver, AF-RF Signal Generator, Combination Voltmeter-Ammeter-Ohmmeter, C-W Telephone Transmitter, Public Address System, AC-DC Power supply. Everything supplied, including all tubes.

EARN WHILE YOU LEARN Almost from the very start you can earn extra money while learning by repairing radio-TV sets for friends and neighbors. Many of my students earn up to \$25 a week . . . pay for their entire training from spare time earnings . . . start their own profitable service business.

FCC COACHING COURSE Qualifies you for Higher Pay! Given to all my students AT NO EXTRA COST. Helps you qualify for the TOP JOBS in Radio-TV that demand an FCC license! Full training and preparation at home for your FCC license.

YOU GET
THESE
free!



MAIL THIS COUPON TODAY!

Mr. Leonard C. Lane, President
RADIO-TELEVISION TRAINING ASSOCIATION
Dept. M-9C, 52 East 19th Street, New York 3, N. Y.

Dear Mr. Lane, Send me your NEW FREE BOOK, FREE SAMPLE LESSON, and FREE aids that will show me how I can make TOP MONEY IN TELEVISION. I understand I am under no obligation.

(PLEASE PRINT PLAINLY)

Name _____ Age _____

Address _____

City _____ Zone _____ State _____

I AM INTERESTED IN:

- Radio-FM-TV Technician Course
 FM-TV Technician Course
 TV Camera & Studio Technician Course

VETERANS!
Write discharge date

Radio-Television Training Association

52 EAST 19th STREET • NEW YORK 3, N. Y.

Licensed by the State of New York • Approved for Veteran Training

Inventors

Take these necessary preliminary steps promptly to protect your invention by applying for a United States patent—

Sketch and describe your invention. Sign, date and have this disclosure witnessed by two people who understand your invention. Have us make a preliminary search among U. S. patents already granted for similar types of invention. We then report to you on the probable patentability of your invention and recommend your further course of action.

Write for our instructive booklet, "Patent Protection for Inventors" and our convenient "Evidence of Invention" disclosure form. No obligation.

VICTOR J. EVANS & Co. *Merlin M. Evans*
REGISTERED PATENT ATTORNEY

230-K MERLIN BUILDING, WASHINGTON 6, D. C.

... TURN CONCRETE INTO GOLD!



MAKE UP TO \$75 A DAY IN YOUR OWN BUSINESS

If you want to have your own business — to start a business on your own — here's your big opportunity! New high speed, low cost General block machine produces up to 1,000 concrete blocks a day. Sell all you make to builders, supply houses, and others for homes, factories, buildings, garages. Cash in on the building boom! You can make profits of 100% to 150% — up to \$75. a day! General block machine equipped with 1/2 h.p. electric motor — or can be supplied with gasoline engine — works anywhere, in little space, indoors or out. Operates from ordinary house light socket. Simple, foolproof 3 step operation — so easy a child can do it. Makes superior 3 core blocks any size from 4" to 12". Also makes chimney, sash, corner and other types. Blocks meet any building code anywhere in the country. Materials — sand, water, cement, available anywhere. Simple illustrated operating instructions and mixing formulas for cement and cinder blocks supplied with each machine. Write for FREE folder with full information.

MOTOR DRIVEN

R. L. T. of New York City reports: "MY GENERAL BLOCK MACHINE PAID FOR ITSELF IN FIRST 2 WEEKS!" Hundreds now in use the world over! Write for FREE details today!

EXTRA

Amazing illustrated book gives floor plans for 6 sensational concrete block bungalows. Tells how to lay blocks, lay out building lines, mix concrete, build steps, porch and concrete floors all at great savings. Written by experts. Can save many times the cost of the machine! Get it now! No strings attached. Send \$1.

BOOK SENT FREE IF YOU BUY MACHINE.
\$1 REFUNDED IF YOU BUY LATER.

GENERAL ENGINES CO.

DEPT. M-96, ROUTE 130, THOROFARE, N. J.

HOW TO BUILD YOUR OWN CONCRETE BLOCK HOME
Only \$1 Prepaid

AMMUNITION

for a fraction of regular cost



Reload a whole carton for the cost of a few rounds of factory ammunition. Shotgun shells, rifle and pistol cartridges can be reloaded safely and easily with an inexpensive set of famous IDEAL Reloading Tools. 164 page IDEAL Reloaders Handbook ... \$1.00, post-paid. Free folder on request.

THE LYMAN GUN SIGHT CORP.
MIDDLEFIELD, CONN.

Better Than Your Own

SHOE STORE AT HOME



Two-Eyelet Hit With Cushioned Comfort

No investment, no experience needed. Just show magic cushion comfort to friends, neighbors, co-workers. Advance commissions to \$4.00 a pair, plus Cash Bonus, Paid Vacation, \$25.00 Reward Offer. Outstanding values for men, women, children. Money back guarantee. Shoe samples supplied without cost. Write TODAY for FREE new 84 page catalog and full details.

TANNERS SHOE CO., 123 BROCKTON, MASS.

\$2.95 OR 2 FOR \$5.00!



TESTED AND GUARANTEED

Write for free list on all types of telephones. Shipments F.O.B. TELEPHONE ENGINEERING CO., Dept. 896, Simpson, Pa.



GIANT FREE CATALOG of OPTICAL BARGAINS

ASTRONOMICAL TELESCOPE HEADQUARTERS Complete Line of Astronomical Telescope Parts and Assembled Telescopes. Also huge selection of lenses, prisms, war surplus optical instruments, parts and accessories, Telescopes, microscopes, binoculars, etc. Fresnel Lenses for making Solar Furnace. SEND ONLY \$1.00 for beginner's 10-lens kit and big instruction booklet Stock 2-H. Ask for FREE catalog H. EDMUND SCIENTIFIC CORP., Barrington, N. J., U.S.A.



LEFAX TECHNICAL DATA BOOKS
POCKET SIZE • LOOSE LEAF

Printed on loose leaf, 6 hole, 6 3/4" x 3 3/4" bond paper, each book contains about 140 pages of technical data, condensed, accurate, essential, for engineer, technical worker, student, business man

Architecture	Surveying	Mech'l Drawing	Metallurgy
Home Heating	Surveying Tables	Machine Design	Hydraulics
Illumination	Highway Eng'g.	Machinist's Data	Radio
Electrician's Data	General Math	Mech. of Materials	Television & FM
Builder's Data	Math Tables	Pwr. Trans. Mach.	Electricity, AC
Lumber Data	Physics	Thermo. Tbla. &	Electricity, DC
Air Conditioning	Trig-Log Tables	Charts	AC Motors &
Building Constr.	Geo'l Chemistry	Phys. & Thermo.	Gen'lrs.
Reinf. Concrete	Chemical Tables	Data	Transformers,
Piping Data	Analytic Chem.	Metals	Relays & Meters

Write for FREE catalogs (2000 listings). See how helpful Lefax can be to you. Send \$1.25 book, or \$6 for any five books to

LEFAX PUBLISHERS, Dept. PM-3, PHILADELPHIA 7, PA.

NATIONAL SCHOOLS

proudly presents

FOR MEN WHO WANT TO EARN MORE MONEY

TELERAMA • ALL 8 BRANCHES OF TELEVISION • ELECTRONICS • RADIO IN ONE DYNAMIC, MODERN SHOP METHOD, HOME TRAINING COURSE

*Registration applied for

Another great advance in **HOME STUDY TRAINING**. Let National Schools, of Los Angeles, a practical Technical Resident Trade School for over 50 years, train you at home by Shop-Method, for today's unlimited opportunities in **ALL 8 BRANCHES** of the Television, Electronics, Radio Industry.

Check all you receive in *One Master Course* at One Low Tuition

1. Television — Including Color TV
2. Radio — FM and AM
3. Industrial Electronics
4. Sound Recording and Hi-Fidelity
5. Preparation for FCC License
6. Automation
7. Radar and Sonar
8. Communications

ALL OF THIS MODERN, NEWEST, PRACTICAL EQUIPMENT IS YOURS TO KEEP!

- Parts to Build a modern TV set, including large screen Picture Tube.
- Parts to build a powerful Superhet Receiver, standard broadcast and short wave.
- Parts to conduct many experiments and build Continuity Checker, RF Oscillator, TV Circuits, Audio Oscillator, TRF Receiver, Signal Generator.
- Professional Multimeter
- These are a MUST for all technicians.

YOU DO MANY PRACTICAL JOBS. You do servicing, circuit analysis and many other down-to-earth experiments. You build a modern TV set from the ground up... with equipment kits we give you, including a new large screen picture tube and professional Multimeter, at no additional charge.

EARN AS YOU LEARN! Many of our students earn their entire tuition and more in Spare Time jobs we show them how to do while learning. **YOU GET GRADUATE ADVISORY SERVICE, TOO.**



L. J. ROSENKRANZ
President of NATIONAL SCHOOLS



This Master-Shop-Method course is completely up-to-date. Here in Los Angeles, the TV and Electronics center of the world, we are able to keep in constant touch with the industries' latest developments. As a student, you will quickly master all phases at home... in your spare time. Your earning power will grow with every lesson. Just as thousands of National Schools graduates do every day, you can handle servicing, manufacturing, repairing, hundreds of other jobs, or make good money in your own business. **SECURE YOUR FUTURE—NOW. SEND COUPON BELOW.**



IN THESE MODERN TV STUDIOS, SHOPS AND LABORATORIES, your Shop Method Home Study Course was developed by experienced instructors and engineers. What an advantage that is to you at home — each lesson is tested, proved, easy to understand. You can master the most up-to-date projects, such as color TV set repair, printed circuits — even prepare for F.C.C. License and industrial electronics without taking a special course. **TAKE YOUR FIRST STEP NOW TO A TOP-PAY JOB IN TV, ELECTRONICS, RADIO. SEND COUPON BELOW TODAY.**

APPROVED FOR VETERANS AND NON-VETERANS

NATIONAL SCHOOLS

4000 S. FIGUEROA ST., LOS ANGELES 37, CALIF
187 N. LA SALLE ST., CHICAGO 1, ILL.

IN CANADA: 811 W. Hastings St., Vancouver, B. C.

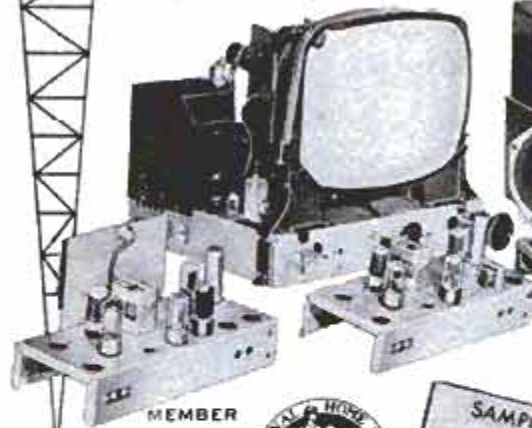

FREE!
Fully illustrated "CAREER" BOOK in TV, Radio, Electronics. AND actual Sample Lesson—yours at no cost, no obligation **SEND COUPON NOW—TODAY!**



NATIONAL SCHOOLS
TECHNICAL TRADE TRAINING SINCE 1905
Los Angeles, California

GET FAST SERVICE—MAIL NOW TO OFFICE NEAREST YOU!

NATIONAL SCHOOLS, DEPT. RB 96
4000 S. FIGUEROA ST. OR 187 N. LA SALLE ST.
LOS ANGELES 37, CALIF. OR CHICAGO 1, ILL.

Rush free TV-Radio "Opportunity" Book and sample lesson. No salesman will call.

NAME _____ BIRTHDAY _____ 19 _____

ADDRESS _____

CITY _____ ZONE _____ STATE _____

VETERANS Give Date of Discharge _____

CHEMISTRY



THE MOST PROFITABLE BUSINESS ON EARTH!

Be a CHEMIST! One of the really GREAT professionals! We teach you at home with simplified but thorough lessons. No previous training required. Earn while you learn. This is a GOLDEN AGE for those with special knowledge! Diploma awarded. YOU can be a specialist in a few months! Here are a few of our most popular courses.

1. HOW TO MAKE PRECIOUS SYNTHETIC GEMS!

Make beautiful precious gems! Rubies! Sapphires! Emeralds! etc. Easy-to-build furnace and secret formulas do the trick! Turn out a pocket-full of precious gems every day! Complete Course, \$15.00*.

2. HOW TO MAKE ALL FIREWORKS!

With home-made equipment! Skyrockets, bombs, torpedoes, pin-wheels, and hundreds of others! Cost of complete course . . . \$15.00*.

3. HOW TO TURN WATER INTO GAS!

This gadget actually turns water into powerful gas! Can be built from junk parts for less than \$1.00. Complete instructions, only . . . \$2.00.

4. HOW TO MAKE PLASTICS & MOULDINGS

The art of converting plastics and compositions into articles of great variety and value! Make anything! A genuine Gold Mine! Thousands of students have turned this course into rich rewards! Complete, \$25.00*.

5. CHEMICAL PRINTING!

Build three presses for less than \$1.00 that will print 20,000 perfect copies from any original! Not a toy! Complete instructions . . . \$2.00.

6. HOW TO MAKE CHEMICAL SPECIALTIES

Manufacture Inks, \$2.00. Cosmetics, \$15.00*. Adhesives, \$2.00. Artificial Hair, \$2.00. Paint, \$5.00. Candy, \$5.00. Perfumes, \$2.00.

7. MAJOR COURSE IN PRACTICAL CHEMISTRY!

Best course in U.S.A. Earn diploma. Acquire a dignified profession! With complete laboratory, \$85.00*. Without laboratory, \$50.00*.

8. OTHER COURSES

Crime Detection, \$5.00. Horticulture (Florist), \$25.00*. Electroplating, \$5.00. Taxidermy, \$5.00. Radiation, \$2.00. Junior Chemistry Course, \$38.00*. *May be paid \$3.00 down, balance monthly.

LITERATURE describing the above courses and easy payment plans FREE on request. Prices shown above are total costs of complete courses!

FREE Want a fascinating introduction to the marvels of Chemistry? Just send \$1.00 for Chemistry Outfit and we will include FREE one URANIUM TESTER and a CHEMICAL PUZZLE worth \$2.50, if you can solve it!

NATIONAL SCHOOL OF CHEMISTRY

P.O. BOX 608-A REDWOOD CITY, CALIF.

You Can Be a Local
Manufacturer of
CAVITEX

**SUPERFINE
MASONRY**

Local production explains why Cavitex can offer so much in quality for so little money, yet is so generous in profit potentials. It's a case of streamlined manufacturing—processing local materials for local building—cutting out the high costs of freight and distribution.

Cavitex creates new standards of beauty—in size, proportion and color. "Puts emphasis on the horizontal." Cored-out design for lighter weight and greater insulation values. Available in 8-inch and 4-inch.

Hundreds of territories are available to men looking for a local manufacturing enterprise. Franchise privileges. Responsible operators can obtain basic equipment on attractive rental terms. The Cavitex industry is sponsored by a million-dollar company backed up by fifty years of experience and reputation. Write or wire at once for "Opportunity, Unlimited" and tentative reservation of territory.



W. E. DUNN MFG. CO.
409 W. 24 St., Holland, Mich.
In Canada
Dunn Masonry Machinery, Ltd.
844 Dundas Highway
Cooksville, Ont.

X-4



Make \$5.00 an Hour
**CASH
PROFIT**
The Day You Start!

Start Your Own Business
at Home . . . Sharpen
Household, Garden and
Shop Tools in Spare Time

Turn your spare time into Big Cash Profits with the new Belsaw Sharp-All. No experience needed to sharpen knives, scissors, shears, ice skates, mower blades, hedge trimmers, axes, chisels and circular saws . . . just about any household, garden and shop tool. Your own CASH business. No inventory . . . no calls to make.

Learn how easily you can start your own spare time business. Amazing low cost easy-payment plan. Send postcard for

FREE BOOK

BELSAW SHARP-ALL CO., 717 Field Bldg., Kansas City 11, Mo.

GIANT STAMP ZOO FREE!

Snakes, Leopards, Rhinoceros, Zabu, Koalabear and other fierce jungle beasts. Approvals. Send 10c for handling. **FREE STAMP MAGAZINE.**

LINCOLN STAMP COMPANY,
St. Catharines 57, Ont., Canada



**SAVE
MONEY!**

FREE BARGAIN BOOK

CENTRAL CAMERA CO.

PHOTOGRAPHIC HEADQUARTERS SINCE 1899

Save money on all photographic equipment. Send for Central Camera Co. **FREE Photographic Bargain Book today.**

CENTRAL CAMERA CO.

Dept. A-D 230 S. Wabash Chicago 4, Ill.

STUDY TO BE A DOCTOR of Psychology or Metaphysics

Obtain a Ph.D., M.A., or Ph.D. Be a Teacher, Lecturer or Accredited Practitioner. Teach others how to achieve Health, Happiness and Contentment. Chartered by State. Correspondence Courses only. Write for **FREE** book telling how.

THE NEOTARIAN FELLOWSHIP

Desk 8, Pickwick Building Kansas City 6, Missouri

TERMITES

**Kill Termites Yourself with ARAB
U-DO-IT TERMITE CONTROL**

Costs \$20.00 to protect 5-room house for 5 years. Harmless to flowers and shrubs. **FREE FOLDER** and prices at Bldg. Supply Dealers or write **FEDERAL CHEMICAL CO., INC., 2701 Winthrop Ave., Indianapolis, Dept. PM 956.**

LEARN AT HOME

Key to Success

LOCKSMITHING

Learn this profitable business from experts in your spare time. Locksmiths have no "slow" seasons or layoffs; they are always in demand. Age or minor physical handicap can't stop you. America's only recognized locksmithing school can teach you easily and quickly. Simple, illustrated lessons plus materials and tools supplied. Make money while learning. Get into this uncrowded field now!

Send for **FREE BOOKLET**

INSTITUTE OF LOCKSMITHING
Dept. P-22, 23 Park Avenue, Rutherford, N. J.
Lic. by N. J. State Board of Education
Approved for Veterans

PAINTING IS EASY! WITH THE FAMOUS BURGESS *electric* SPRAYER

*Just plug in
and Spray*

SPRAYS:

PAINT • VARNISH •
ENAMEL • SELLAC •
MOTHPROOFERS • GARDEN
SPRAYS • WATER • INSECTICIDES
1,000 USES IN EVERY HOME!

For the fastest, smoothest painting or spraying job you ever saw, try the Burgess Sprayer. Completely self-contained... just plug into regular household outlet, pull the trigger, and paint furniture, floors, walls, screens, cabinets, fences. Pipe for mothproofing and garden spraying, too. New sapphire nozzle, handy spray-adjuster. 25-oz. graduated jar. Easier to clean than a brush. Get your Burgess Sprayer today!

only
\$12.95 AT YOUR
FAVORITE
DEALER

If not available locally, send \$12.95 for post-paid delivery. Money-back guarantee.



SEND FOR FREE BOOKLET
"HOW TO PAINT THE EASY WAY"
BURGESS VIBROCRRAFTERS, INC.
DEPT. A-42 • GRAYSLAKE, ILLINOIS

A POSTCARD CAN PUT YOU IN A FINE BUSINESS!

Rush Card Today for FREE Selling Outfit!

Get into a profitable business without spending 1¢! Rush postcard for powerful FREE Sales Outfit that makes it easy to take orders for Mason's fast-selling line, including warm insulated Jackets, Boots, featuring Air-Cushion inner-soles—over 190 dress, sport and work styles for men, women! Friends, people where you work, buy fast—pay you big profits. Just 2 combination shoe-jacket sales a day pay you up to \$660 monthly EXTRA CASH! Folks must buy from you—Mason products never sold by stores! Start now! Rush postcard for FREE Outfit!

MASON Shoe Mfg. Co., Dept. 337
Chippewa Falls, Wis.



RUPTURED

BE FREE FROM TRUSS SLAVERY

NOW there is a new modern Non-Surgical treatment that permanently corrects rupture. These Non-Surgical treatments are so certain, that a Lifetime Certificate of Assurance is given. Write today for our New FREE Book that gives facts that may save you painful and expensive surgery, and tells how non-surgically you may again work, live, play and love and enjoy life in the manner you desire. There is no obligation. Excelsior Hernia Clinic Dept. 8305 Excelsior Springs, Mo.

CAN YOU QUALIFY?

REPRESENTATIVES WANTED NOW IN EVERY AREA OF THE U.S.

Work Full Time or Spare Time right in your own home. Big Profit Opportunity with

NEW MIRACLE PRINTING PRESS

Screen Printing is a revolutionary new way of printing WITH-OUT A PRINTING PRESS. Anyone, knowing the secrets can print MULTI-COLORED POSTERS, SIGNS, CARDS - anything Print on GLASS, WOOD, PAPER, LEATHER - anything - Print on FLAT or CURVED surfaces - Lets you print sample quantities for LESS than it would cost on a \$5,000 printing press. AMAZING, but True! Mr. Anderson earns \$400 a week Screen-Printing in a small city.

NO SELLING—WE SUPPLY EVERYTHING!

You print in your own HOME, GARAGE or SPARE ROOM WITHOUT DOING ANY ART WORK! Rush name & address for COMPLETE FREE DETAILS & COLORFUL SAMPLES, etc. Write: Screen-Print Co., Dept. 29, Los Angeles 61, Calif.

**I EARN CASH
DOING REPAIR JOBS
WHILE I TRAIN!**



CTI training in Auto Mechanics is so practical that many students do repairing in spare time, earn up to \$15 a week and more. CTI training pays its own way!

AUTO MECHANICS

**EARN GOOD PAY
ENJOY SECURITY**

A Trade You Can Learn at Home

Now hear this: if you want to earn up to \$125 a week or more, or open a shop of your own! The auto industry is America's greatest. No wonder! There are over 60 million cars and trucks on the road, and a third are in the "heavy repair" classification. Each year, over 7 million new vehicles are produced. As a result, there's a severe shortage of skilled mechanics—and too few are training to fill the vacancies. What an opportunity for you! Yes, you can have one of those high-pay, steady, life-long jobs. How? *By training at home in spare time!*

The CTI Shop-Method Home Training Plan gets you ready for success in months—not years. You get easy-to-understand picture lessons, as well as valuable tools and a tune-up kit (see below). You learn to repair engines, transmissions, brakes, and the various systems—cooling, lubricating and electric. And that isn't all: *If you want additional training in Diesel Mechanics or Body-Fender Rebuilding, you get it (without extra cost).* Why not get all the facts? You can, by just filling out and mailing the coupon. We'll send two FREE BOOKS that show how you can fit into America's No. 1 industry.

You Practice with Tune-Up Kit and Tools



Only CTI sends this professional Tune-Up Kit. It includes a Compression Tester, a Vacuum Gauge and Fuel Pump Tester, an Ignition Timing Light, and a portable steel case. Instruments locate engine troubles quickly, help you get valuable practice.

You get this top quality set of mechanic's tools. You'll need tools to practice and for experience, and to earn money spare time. Tools increase your interest, stamp you as a "pro." *You get both the Tune-Up Kit and the set of tools as part of your training—no extra cost.*

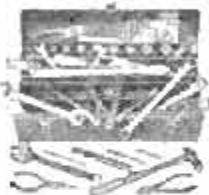

MAIL COUPON TODAY!

COMMERCIAL TRADES INSTITUTE

1400 Greenleaf Ave. Dept. A-352
Chicago 26, Ill.

Send your Auto Mechanics book and Sample Lesson. Both FREE.

Name _____ Age _____

Address _____

City _____ Zone _____ State _____

Member National Home Study Council



Learn ELECTRIC APPLIANCE REPAIR IN YOUR SPARE TIME AT HOME



START YOUR OWN BUSINESS

ONE BUSINESS THAT IS NOT AFFECTED BY STRIKES, DEPRESSIONS OR POLITICS

WITH A POTENTIAL MARKET OF 50,000,000 CUSTOMERS

New shop-method, home-training system gives you electrical know-how that used to take years to learn. Learn at home by building valuable testing kits, repairing your own and neighbors' appliances. It is not unusual for appliance repairmen to charge on the basis of \$5.00-\$6.00 an hour.

FREE ILLUSTRATED BOOK

Shows you how you learn every phase of electrical appliance. How to make money while you learn. Write today for your FREE copy.

CHRISTY TRADES SCHOOL
Dept. D-5803
4804 North Kedzie Ave., Chicago 25

NEVER AT THIS LOW PRICE!

GENUINE 120-POWER ACHROMATIC TELESCOPE

with Coated Lens and 3-POWER FINDER attached

ONLY \$18.95 PREPAID

EXTRA BONUS GIFTS:

- 108 page book, "Discover The Stars"
- Magic Star Finder Dial
- 220X & 400X Eyepiece lenses



BRING THE MOON, PLANETS, STARS, PEOPLE 120 TIMES CLOSER, CLEARER, SHARPER.

Never before has an ACHROMATIC 120X telescope with range finder and tripod sold for anywhere near this amazing low price! Now you can not only explore the heavens and bring the moon, planets, stars, etc. 120 times closer, but you can also observe all distant objects, people, ships, etc. too, because all pictures are erect, and not upside down as in all astronomical telescopes. The kind of needle-sharp color-free viewing only a genuine achromatic lens can bring you. Ready for immediate use. Its 5 precision lenses bring you viewing at 40X—80X—120X, the tubes extend to 43", made of jet bakelite, finished in camera bellows black (for sharper, clearer images). Trimmed with gleaming brass. The 3 power finder scope mounted on main tube is a feature usually found on more expensive telescopes—brings difficult objects on target before observing with main scope. For extra stability 5 ft. hardwood folding tripod is equipped with heavy cast iron head fitted with Criterion's famous 360 degree all aluminum mount that locks instantly in any position. Obtainable only from Criterion, shipped prepaid. 4-Bonus gifts—108 page book "Discover The Stars," magic star finder dial that aids in locating stars ANYWHERE at ANY TIME of the year, and 220X and 400X eyepiece lenses included free of any cost for experiments. You must be completely satisfied with this super offer or your money back in full. Shipped to you complete, nothing else to buy, at the amazing low price of \$18.95. Without tripod \$14.95.

Send cash, check, or money order today to:
Dept. PMA6, Criterion Co., 331 Church St., Hartford, Conn.

INVENTORS

PROTECT YOUR INVENTION BY A U. S. PATENT. SEND FOR FREE "INVENTION RECORD" FORM AND "PATENT INFORMATION EVERY INVENTOR SHOULD HAVE."

CARL MILLER
REGISTERED PATENT ATTORNEY

WOOLWORTH BLDG., 35th FLOOR, 96A
NEW YORK CITY

PATENTS

C. A. SNOW & CO.

REGISTERED PATENT ATTORNEYS

WRITE FOR INFORMATION TO
428 SNOW BUILDING, WASHINGTON 1, D. C.

INVENTORS

Whether an invention is patentable can be substantially determined by a search of the U. S. Patent records. Without obligation, write for information explaining the steps you should take to secure a patent.

JOHN N. RANDOLPH
Registered Patent Attorney
201 Columbian Building, Washington 1, D. C.

INVENTORS

Send for PATENT INFORMATION Book and INVENTOR'S RECORD without obligation

GUSTAVE MILLER
96-PM WARNER BUILDING WASHINGTON 4, D. C.

REGISTERED PATENT ATTORNEY
ASSOCIATE EXAMINER
U. S. PAT. OFF. 1922-1929
Patent Attorney & Advisor
U. S. NAVY DEPT. 1930-1947
PATENT LAWYER

Say You Saw It in
POPULAR MECHANICS

INVENTIONS WANTED

If you want to market, or sell, your invention for cash or royalties, write for our Free Booklet. Send no drawings. We also welcome hearing from firms, or private capital, wishing to review inventions in any field. We will be glad to send notice of our clients' inventions.

GLOBAL MARKETING SERVICE
2420 77th Ave. Dept. PD Oakland 5, Calif.

INVENTORS

I shall be pleased to furnish you, upon request, with full information relative to patent procedure—without any obligation on your part.

PATRICK D. BEAVERS
Registered Patent Attorney
984 Columbian Building Washington 1, D. C.

SCIENTIFIC CRIME DETECTION



There's a Thrill in Bringing a Crook to Justice.

A Steady Pay Profession Good Times or Bad.

We have taught thousands this exciting, profitable, pleasant profession. Let us teach you, too, in your own home. Learn Finger Printing, Firearms Identification, Police Photography and Criminal Investigation thoroughly, quickly and at small cost.

Over 800 of All U. S. Bureaus

of Identification employ students or graduates of I. A. S. You, too, can fit yourself to fill a responsible crime detection job with good pay and steady employment. But don't delay—get the details now. Let us show you how easily and completely I can prepare you for this fascinating work, during spare time, in your own home. You may pay as you learn. Write today, stating age. No salesman will call.

(A Correspondence School Since 1916)

INSTITUTE OF APPLIED SCIENCE
1920 Sunnyside Ave., Dept. 1356, Chicago 40, Ill.

Be A
**FINGER
PRINT
Expert**

FREE!!!
Send for Thrilling
"BLUE BOOK
OF CRIME"

"We're looking for people who like to draw..."



says Norman Rockwell, one of America's 12 Most Famous Artists. If you like to draw, you may have talent to become a successful artist, spare or full time. Find out with our remarkable 8-page Free Art Talent Test. Thousands paid \$1 to take it. Get it FREE. No obligation. Send your name, address, age to: Famous Artists Schools, Dept. 0-K, Westport, Conn.

Learn ACCOUNTING
Business Administration

Bookkeeping, secretarial and allied subjects at home in your spare time or attend nationally approved resident school. Write for FREE Success Book giving complete details on courses, plans, rates and employment opportunities. G.I. approved. Write Dept. A.

Hills BUSINESS UNIVERSITY AND EXTENSION SCHOOL
629 W. MAIN ST., OKLAHOMA CITY 2, OKLAHOMA

RADIO Engineering. All phases radio & electronics theory & practice; television; FM; broadcasting; servicing; aviation; marine & police radio. Prepare for good pay; 18-month course. Graduates in demand by major companies. Enter Jan., March, June, Sept. Regular campus life. Write for catalog.

VALPARAISO TECHNICAL INSTITUTE, Dept. D, Valparaiso, Ind.

REAL ESTATE
BE A BROKER

PAYS BIG! SEND FOR FREE, BIG, ILLUSTRATED CATALOG NOW! Graduates report making substantial incomes. Start and run your own business quickly. Men, women of all ages learn easily. Course covers Sales, Property Management, Appraising, Loans, Mortgages, and related subjects. **STUDY AT HOME** or in classrooms in leading cities. Diploma awarded. Write TODAY for free book! No obligation. Approved for World War II and Korean Veterans.

WEAVER SCHOOL OF REAL ESTATE (Est. 1936)
2020R Grand Avenue Kansas City, Mo.

PUMP WATER FAST!

Drains Wash Tubs, Cellars, Cisterns. Famous #7 pumps 2800 gph. 420 gph. at 75' high or 1600 gph. from 25' well. Sturdy rustproof alloy metal. Six blade impeller. 3/4" inlet, 1/2" outlet. Standard pipe threaded. Uses any 1/2 to 1 1/2 H.P. Motor. Will not leak or clog. Iron clad guarantee. Send check, M.O., or sent C.O.D. **\$795** IN U.S.

Irrigate, Fill Tanks, Draw Well Water. Heavy duty #8 pumps 7000 gph. —1000 gph. 75' high 3000 gph. from 25' well. Rustproof alloy metal. 8 blade impeller. 1" inlet, 1" outlet. Standard pipe threaded. Will not leak or clog. Iron clad guarantee. Send check, M.O., or sent C.O.D. **\$1195**

Free Catalogue—Gear Pumps, Large Centrifugal Pumps, Deep and Shallow Well Pumps, Sump Pumps.

MOORE MANUFACTURING CO.
SWEDESBORO 1, NEW JERSEY

Read **AUDELS MECHANICS GUIDES** for profit

15 MINUTES A DAY

Every Mechanic can Step Up his Skill with AUDELS GUIDES. Containing Practical Inside Information in a Handy Form. Covers facts and figures of your Trade. All illustrated and explained. Books sent to you for 7 DAYS FREE EXAMINATION. Send No Money Nothing to Pay Postman. Check Books Wanted — Mail Today.

MAIL ORDER
AUDEL, Publishers, 49 W. 23 St., New York 10, N.Y.

Please send me for FREE EXAMINATION books marked (X) below. If I decide to keep them I agree to mail \$1 in 7 Days on each book or set ordered and further mail \$1 monthly on each book or set until I have paid price, otherwise I will return them.

- HOME APPLIANCE SERVICE GUIDE, 800 Pages \$4
- AUTOMOBILE MECHANICS GUIDE, 1664 Pages. 4
- TRUCK & TRACTOR GUIDE, 1299 Pages . . . 4
- DIESEL ENGINE MANUAL, 575 Pages . . . 2
- MACHINISTS HANDY BOOK, 1650 Pages . . . 4
- WELDERS GUIDE, 600 Pages . . . 1
- BLUE PRINT READING, 440 Pages . . . 2
- MATHEMATICS & CALCULATIONS, 700 Pages. 2
- SHEET METAL PATTERN LAYOUTS, 1100 Pages 4
- SHEET METAL WORKERS HANDY BOOK, 388 Pgs. 1
- MECHANICAL DRAWING GUIDE, 160 Pages . . 1
- MECHANICAL DRAWING & DESIGN, 480 Pages 2
- TELEVISION SERVICE MANUAL, 434 Pages . . 2
- RADIOMANS GUIDE, 1080 Pages . . . 4
- ELECTRONIC DEVICES, 216 Pages . . . 2
- ELECTRIC MOTOR GUIDE, 1000 Pages . . . 4
- WIRING DIAGRAMS (Light & Power), 272 Pgs. 1
- ELECTRICIANS EXAMINATIONS, 250 Pages. . 1
- ELECTRIC POWER CALCULATIONS, 425 Pages. 2
- HANDY BOOK OF ELECTRICITY, 1440 Pages. . 4
- ELECTRIC DICTIONARY, 9000 Terms . . . 2
- ELECTRIC LIBRARY, 7000 Pages (12 Book Set) 18
- REFRIGERATION & Air Conditioning, 1280 Pgs. 4
- MILLWRIGHTS & MECHANICS GUIDE, 1200 Pgs. 4
- POWER PLANT ENGINEERS GUIDE, 1500 Pages 4
- ENGINEERS & FIREMANS EXAMS, 525 Pages . 1
- PUMPS, Hydraulics & Air Compressors, 1658 Pgs. 4
- OPERATING ENGINEERS LIBRARY (3 Books) . 9
- CARPENTERS & BUILDERS GUIDES (4 Book Set) 6
- PLUMBERS & Steamfitters Guides (4 Book Set) 6
- MASONS AND BUILDERS GUIDES (4 Book Set) 6
- PAINTERS & DECORATORS MANUAL, 450 Pgs. 2
- HOUSE HEATING GUIDE, 1000 Pages . . . 4
- OIL BURNER GUIDE, 384 Pages . . . 1

Name _____

Address _____

Occupation _____

Employed by _____

Say You Saw It in Popular Mechanics

NEW BENJAMIN SUPER CO₂ GAS CARBINE—\$15.95*

HI-LO (2 Stage) Jet Power
Cal. .177 or .22

RIFLED
Shoots Pellets & Darts

Illustrated—Owens Model Benjamin Super CO₂ Carbine Gas Rifle with Custom Stock—\$15.95

IDEAL FOR TARGET AND SMALL GAME, SAFE—ECONOMICAL—ACCURATE

CONVENIENT—PRACTICAL—NON TOXIC, EASY TO OPERATE—NO PUMPING—NO FLINCHING.

Get 40 SHOTS from each 10¢ STANDARD SIZE CO₂ (Soda) CARTRIDGE. Up to 3/4" Penetration. Ask your Dealer for Demonstration.

FREE Folder

New Benjamin .177 or .22 CO₂ ROCKET Gas Pistol with HI-LO JET POWER.....\$15.00

BENJAMIN AIR RIFLE CO. 896 MARION ST., ST. LOUIS 4, MO., U.S.A.



**study
nuclear
engineering
at home**

NOW YOU can prepare yourself for the limitless opportunities offered by the nation's fastest growing industry—*atomic energy!*

Get complete, basic nuclear energy training quickly, easily—the ISS home study way. You are taught by a group of educators and scientists now active in atomic research and development. *Higher mathematics avoided—a high school education qualifies you for study.*

YOU WILL NEED A WORKING KNOWLEDGE OF NUCLEAR SCIENCE SOON IF YOU ARE . . .

- A practicing engineer • A technician
- A supervisor • An engineering assistant
- A member of a management group

Low Cost 39 lesson course. Pay-as-you-learn installment plan available.

PERFECT FOR COMPANY TRAINING PROGRAMS—discounts for groups of six or more.

ISS SEND TODAY FOR FREE DETAILED INFORMATION

INSTITUTE OF SCIENTIFIC STUDIES

Dept. M-9, 248 Arlington Ave., Elmhurst, Ill.

NAME _____

ADDRESS _____

CITY _____ STATE _____

Send information on ISS Group Study Plan

PRINTS POST CARDS

Learn how both large and small businesses are boosting sales with new advertising machine. Write today for FREE illustrated BOOK of unique advertising plans, money-making ideas for your business. **Cardmaster, 1920 Sunnyside, Dept. 129, Chicago 40, Ill.**



Now—You Can Own and Play a

Famous Make Italian **ACCORDION**

Save UP TO 50%

Choose from famous quality makes at lowest WHOLESALE prices . . .

Get the facts about owning and playing the accordion . . . it's easy and loads of fun!

You order on NO RISK PLAN . . . 5 DAYS FREE TRIAL! Save up to 50% off regular price. Easy, convenient terms. You choose from the finest and most famous Italian accordion makes for which we are authorized direct factory distributors. FREE home study course included. Find out about the fun and profit in store for the accordion owner. Rush coupon for big Color Catalog and low Wholesale Prices . . . yours FREE. No obligation. Write TODAY! **Accordion Manufacturers & Wholesalers Outlet 2003 W. Chicago Av., Dept. R-96, Chicago 22, Ill.**

**5 DAY
FREE
TRIAL
Easy Terms**

Accordion Manufacturers & Wholesalers Outlet • MAIL COUPON!
2003 W. Chicago Av., Dept. R-96, Chicago 22, Ill.

Send big FREE Color Catalog, best terms, lowest wholesale prices.

NAME _____

ADDRESS _____

CITY _____ ZONE _____ STATE _____



NEW KIT \$2

Laminates Photos, Cards, Clippings in Clear Plastic

Do-it-yourself quicker, easier with new PLAIN-VU process. Save 1/2 cost! Permanent, clear plastic protection. Applies like "tape." No machines to buy. No tools, no heat, no mess. 100% transparent Vinyl, clearer than glass. Processed with new PLAIN-VU laminant. Won't discolor, harden or deteriorate. Flexible, durable. A profitable hobby. Introductory Kit: 10 sheets (3" x 4") processed, ready to use, only \$2, postpaid. **Money-back guarantee.** Send check, cash or m.o. to

PLAIN-VU, Box 83, Mentor, Ohio



OWN a Business

If employed, start part time. Alert dealers can gross \$5 hourly profit on own service plus \$3 on EACH serviceman. Clean, revive, moth-proof rugs & upholstery on location. No shop needed. Services nationally advertised. Repeat customers. Easy to learn. We locally train and assist you. Quickly established. Easy terms. Send today for FREE booklet. No obligation.

DURACLEAN CO., 6-169 Duraclean Bldg., Deerfield, Ill.

Finish HIGH SCHOOL AT HOME

Complete 4 Yrs. in 12 Months

Learn More! Earn More! Enter professional or technical schools. Advance Socially. Live a Happier, Fuller Life. Individual Courses or complete schedule. **WRITE FOR SCHOOL BULLETIN.**

ACADEMY FOR ADULTS

30 W. Washington, Dept. PM-96, Chicago, Ill.



Easy to make your own BOWS—ARROWS—EQUIPMENT

Illustrated Hand-Book 84 pgs. \$1, tells you how! Large Colored Catalog 5c—Send for it!

Ask your dealer for "Stemmler's Archery" (Oldest Mfr. in U.S.A.)

L. E. STEMMLER CO.

Manorville (Box 1) L. I., N. Y.

CAFE RUN YOUR OWN DINER

I show you how to get started just as I did; where to locate, 7 ways to get capital, money making methods, even how to run a sandwich business right out of your own home with only a few dollars investment. Write for free details.

School of Restaurant Arts, 19D, Fremont, Ohio

NEW, NATURAL LIGHTWEIGHT DENTAL PLATE



MADE FROM YOUR OLD ONE—New Professional Method gives you natural-looking, perfect-fitting plastic plate—upper, lower or partial—from your old cracked or loose plate without an impression. **CLINICAL** method means fast service, huge savings. Try new plate full 30 days at our risk. New plates sent you Air Mail same day.

Now Priced Low As **\$15.95**

SEND NO MONEY—just your name and address for full particulars FREE. No cost. No obligation. Act now. **CLINICAL DENTAL LAB., 335 W. Madison St., Dept. C20K, Chicago 6, Ill.**

Learn PHOTOGRAPHY at Home

Splendid opportunities. Prepare in spare time. Practical basic training. Long-established school. Send for free book, "Opportunities in Photography." No obligation. **American School of Photography, 835 Diversay Parkway, Dept. 1358, Chicago 14, Ill.**

POPULAR MECHANICS

SEND FOR Free Record

START SPEAKING
FRENCH
OR
SPANISH ALMOST OVERNIGHT!

HERE'S the easiest way to learn FRENCH, SPANISH, Russian, German, Italian, Japanese or Brazilian. Listen to FREE 2-sided non-breakable record. Let your eyes follow words in FREE sample lesson. Almost at once you'll be chatting in a new language with a perfect accent! That's all you hear! No dull, tedious work. Just listen—imitate! It's that easy! Offer may end soon. Rush 25c to help cover cost of special packaging, shipping. State language you want. We'll also send free information on full Cortina course. **CORTINA ACADEMY, Dept. 649, 136 W. 52nd St., New York 19.**

Free! 153 GERMANY

Giant and midget-sized STAMPS; hated Hitler heads; blood-red swastikas; inflation issues with pre-war face of millions of dollars; Allied and Russian Occupation issues; birds, animals, air-mail stamps—168 all-different, guaranteed worth \$2.46 at Catalog prices. **EXTRA!** Free booklet, bargain lists, and other fascinating offers for your free consideration. Send 10c for mailing expenses. **Jamestown Stamp Co., Dept. ASPM, Jamestown, N.Y.**



250 POWER



Complete Telescope Lens Kit **only \$3.49** postpaid

Conquer Space. Explore the Universe, Planets, Moon Craters, New Stars, etc. Complete Lens Kit consists of 80 inch focal length ground and polished objective lens, eyepiece lenses for 50 POWER, 100 POWER, 150 POWER, 200 POWER, 250 POWER, and all necessary lens fittings. Easy to make from simple step by step instructions. (Tripod and mount not included.) Money-back guarantee.

BUSSE SALES CO., Hartford 1, Conn., Dept. PM 49



DEVELOP A HE-MAN VOICE!

Write for FREE book "How to Strengthen Your Voice for Greater Success" by Eugene Feuchtinger. No obligation. Book will be mailed at once in plain wrapper, postpaid. Just send your name and address. State age. **PREFECT VOICE INSTITUTE, 210 S. Clinton St., Studio JU-2, Chicago 6, Ill.**

SAY YOU SAW IT IN
POPULAR MECHANICS

earn as \$15 HOUR as TAX EXPERT

Our students earn as much as \$3,000 in 3 short months preparing income tax returns in spare time. Also operate lucrative year-round Business Tax Service. Dignified home-office business. Experience unnecessary. We train you; help you start. State approved home training program. Write today for free prospectus. **UNION INSTITUTE, 68 Hudson, Hoboken 20M, N. J.**

AN EXCITING NEW WAY TO START THE REWARDING HOBBY OF ORCHIDS AT HOME

Just \$4.88 postpaid brings you a golden cascade from Mexico—the exotic **ONCIDIUM SPLENDIDUM** orchid specially imported to grow and bloom right in your own room! Develops tall spray of 10 to 25 spectacular blossoms...yellow with stripes of mahogany brown.

SHIPPED COMPLETE . . .

Sturdy plant...potting materials (Wonderbark) stake and tie...full instructions for potting and care! Sent approx. 4 mo. in advance of blooming period. Guaranteed to grow!

LIMITED QUANTITY
AVAILABLE • ORDER TODAY!

Rod McLellan Co.

1450 EL CAMINO REAL
SOUTH SAN FRANCISCO 14, CALIF.

AT
A COST
NEVER
BEFORE
POSSIBLE!

1957 ALLIED ELECTRONIC SUPPLY CATALOG

free!

356
value-packed
PAGES

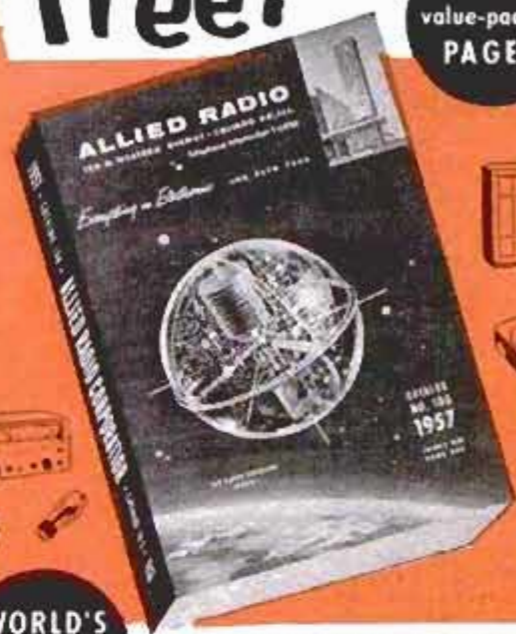

WORLD'S
LARGEST
STOCKS

SAVE ON EVERYTHING
IN ELECTRONICS

Everything for Experimenters, Builders, Amateurs, Servicemen, Engineers and Hi-Fi Hobbyists

Save on *everything* in Electronics: Hi-Fi systems and components; latest builders' kits (see the famous KNIGHT-KIT line); recorders and phono equipment; TV tubes, antennas, accessories; Amateur station equipment; P.A. systems; test instruments; industrial electronic supplies—plus *everything* in parts, tubes, transistors, tools and books. Get more for your money—send today for your FREE 1957 ALLIED Catalog!

Everything in Electronics
From One Reliable Source

Send
for FREE
Catalog

ALLIED RADIO

ALLIED RADIO CORP., Dept. 5-J-6
100 N. Western Ave., Chicago 80, Ill.

Rush FREE 1957 ALLIED 356-Page Catalog

Name _____

Address _____

City _____ Zone _____ State _____

Here's the Kind of MEN I Build!



CHARLES ATLAS

Will You Let Me
PROVE I Can Make
YOU a New Man?

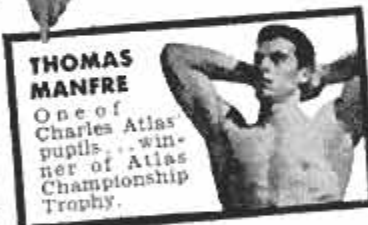

THOMAS
MANFRE

One of
Charles Atlas
pupils...win-
ner of Atlas
Championship
Trophy.

I don't care how old or young you are, or how ashamed of your present physical condition you may be. Just give me 15 minutes a day, and I'll start giving you RESULTS that you can SEE, FEEL, and MEASURE with a tape! I can broaden your shoulders, strengthen your back, develop your whole muscular system INSIDE and OUTSIDE! I can add inches to your chest... give you a vise-like grip... make your legs powerful... help you ram your body so full of strength, red-blooded vitality your friends will be amazed!

WRITE FOR FREE BOOK. 32 pages about how "Dynamic Tension" changed me from 97-lb. weakling into "World's Most Perfectly Developed Man"—and what I'll prove it can do for YOU. CHARLES ATLAS, Dept. 89, 115 E. 23rd Street, New York 10, N.Y.

CHARLES ATLAS, Dept. 89
115 East 23rd St., New York 10, N. Y.

Send me—absolutely FREE—a copy of your famous book, "Everlasting Health and Strength"—32 pages, crammed with photos and valuable advice.

Name _____ Age _____
Address _____
City _____ State _____

MAKE TREMENDOUS PROFITS

...earn Big Money! Cast plaster figurines, bookends, plaques, novelties at home in your spare time with X.L. rubber molds! NO EXPERIENCE NEEDED! Molds and rubber for 3 molds, only \$1.50 ppd. Send 25c (refunded with order) for 40 page catalog now!

PLASTIC ARTS STUDIO 3403 SO. MADISON, DEPT. PM2
MUNCIE, INDIANA

start a big profit business
with a small investment
EARN UP TO
\$200 a DAY

Manufacturing Exciting New RAINBOW ROCK

Concrete Slump Brick
in your back yard

Earn big building boom profits with Rainbow Rock, the colorful new building brick that's taking the country by storm. Sell all you can make to contractors, builders, building supply houses. RAINBOW ROCK CUTS LABOR COSTS BY 1/3! Amazing low cost machine makes modern slump brick 24" long (3 times the length of ordinary brick) in a variety of widths and pastel colors... up to 1500 bricks a day! NEEDS NO SPECIAL SKILL. Operates indoors or out. Full instructions and valuable mixing formulas supplied. YOU CAN START EARNING BIG MONEY NOW. PAY AS YOU PROFIT! A limited number of machines available on easy payment terms. NOW is the time to start. Write today for free literature and full information.

GENERAL ENGINES CO., INC.
Dept. MR-96—Route 130
Thorofare, N. J. - Tilden 5-5401



STEEL PIER SENSATION
Luxurious RAINBOW ROCK fire-
place wall in living room of the
"Home of the Century" in Atlantic
City, N. J.'s Steel Pier... acclaimed
by over 500,000 Summer, 1953 visi-
tors as the most beautiful they'd ever
seen! Endorsed by the Pier's famous
architect, William F. B. Kaulle.



Makes beautiful, decorative fences,
garden walls, garages, outside
walls, room separators, etc.

DO IT YOURSELF MAKE BIG PROFITS

Become a manufacturer. Sell direct. Assemble your own retractable ball pens with gilt cap. They are unconditionally guaranteed. We supply all parts. No machinery necessary.

The complete pen costs you only 12 1/2c which is actually a dollar value.

Minimum order 100 pens. Send check or money order. No COD's.

Sell to stores bankers offices institutions and make TERRIFIC PROFITS

\$12.50 puts you in the finest and most profitable business.

PERMARITE CORP., Dept. 10A

154 West 27th St. New York 1. N. Y.



I Made \$14,839 in 1 Year SERVICING RADIATORS!

Are you earning under \$8,000 a year? Hundreds now making \$10,000 - \$12,000 - \$15,000 a year servicing auto-truck-tractor radiators the Inland way. Easy to learn. Inland, largest radiator servicing equipment mfr., offers the complete package—equipment, merchandising, "Pay-for-itself" financing, and Free training school for customers.

WRITE for FREE Radiator Servicing Folder.

INLAND MFG. COMPANY, Dept. PM-9, 1108 Jackson St., Omaha 2, Nebr.

HELPFUL BOOKS

Send post card asking for FREE catalog

Popular Mechanics Press, 200 E. Ontario, Dept. 601, Chicago 11



STOP Radio and TV Noises with NEW, IMPROVED FILTER PLUG

BALANCED CIRCUIT eliminates power line interference from household appliances, fluorescent lights, motors, oil burners, autos, etc. Simple to use. Don't despair if you've tried other filters without success. THIS ONE WORKS. 10 day trial period. Money back guarantee. We pay postage.

\$150 DELUXE MODEL

SCOPE MFG. CO. Dept. PM-5, Box 23
Knickerbocker Sta., NYC 2, N.Y.

Secrets of VENTRILOQUISM Now Revealed!



Easy to learn in 60 to 90 days with our Home Study Course. RESULTS GUARANTEED. Make Money! Be Popular! Have Fun! Big Opportunities! Radio, Television, Stage Appearances! For FREE information regarding price and terms WRITE. You must state your age. Dummy Catalog 25c. FRED MAHER SCHOOL OF VENTRILOQUISM Box 38, Studio PM-9 Kensington Station Detroit 24, Michigan

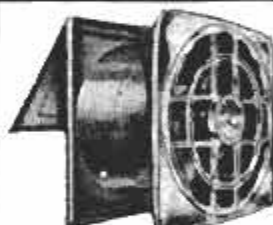

ATTENTION HOME OWNERS!

NO EXCUSE NOW FOR NOT HAVING A KITCHEN FAN! Complete unit. Polished grill. Automatic fan goes on when door opens! \$15.95 Postpaid

Don't let price fool you, this is the latest new model!

Pennsylvania Wholesale Distributors
104 N. 6th Street, Philadelphia 6

FREE BOOK-FREE SERVICE

2,000 BUSINESSES, FARMS, INCOME PROPERTIES FOR SALE THROUGHOUT U.S.

State what you want—where you want to locate. We'll advise owners FREE. No commission or fee to pay us. No salesman will call. Write today. U.S. BUYERS' REPORT, 5410A Wilshire Boulevard, Los Angeles 36, Calif.

SHORTHAND IN 6 WEEKS

Write 120 words per minute
Age no obstacle—LOWEST COST

Famous SPEEDWRITING shorthand. No symbols; no machines; uses ABC's. Easiest to learn and use. Fast preparation for a better position. Nationally used in leading offices and Civil Service. 120 words per minute—50% FASTER than Civil Service requirements. Over 350,000 taught by mail or through classroom instruction. The very low cost will surprise you. Typing available. 33rd Year. Schools in over 400 cities in U.S., Canada, Cuba, and Hawaii.

Write For Free Booklet To: School of

Speedwriting

Dept. 1509-6, 55 W. 42 St., N. Y. 36

LAW

Men and women STUDY AT HOME for Business Success and LARGER PERSONAL EARNINGS, 44 years expert instruction—over 114,000 students enrolled. LL.B. Degree awarded. All text material furnished. Easy payment plan. Send for FREE BOOK—"Law and Executive Guidance"—NOW!

AMERICAN EXTENSION SCHOOL OF LAW

Dept. H-15, 201 N. Wells St., Chicago 6, Illinois

IT'S EASY...

MAKE MONEY IN PHOTOGRAPHY

If you are over 17—good pay and fascinating work await you in photography! Start making money quickly in sparetime—step into your own studio or exciting career job. LEARN-BY-DOING method trains you at home! Write TODAY for FREE catalog. Also Resident Training. Co-ed. 47th Year. Approved for Veterans.

NEW YORK INSTITUTE OF PHOTOGRAPHY

Dept. 49, 10 West 33 Street, New York 1, New York

47th YEAR

SAY YOU SAW IT IN POPULAR MECHANICS

\$\$\$ Save \$\$\$ on US Gov't Surplus \$\$\$

Buy direct from Gov't. These are a sample of saving made. Lifeboat \$12. Grinder \$4.69. Shaper \$15. Truck \$76.77. Tractor \$75. Typewriter \$7.51. Freezer \$50. Sprayer \$15.25. Motor \$4. Hunting, fishing, sporting, camping equip, jeep, power tools, machinery, cameras, radio, photo, printing equip, hundreds others may be purchased at tremendous savings direct from Gov't through our Bulletin "Surplus Sales." Price \$1.00.

The Abacus Press, Box 169DDD, Dept. 6, East Hdfd. 8, Conn.

★ WORK FOR UNCLE SAM ★

U. S. GOV'T. JOBS! AS HIGH AS \$4,525.00 YEAR TO START. Men, women, 18-55. Experience often unnecessary. Write immediately for FREE 36-PAGE BOOK with list of many positions, salaries, sample tests, and full particulars telling how to qualify for them. (Not Gov't. Controlled)

Franklin Institute, Dept. X-93, Rochester 4, N. Y.

How To Hold

FALSE TEETH

More Firmly in Place

Do your false teeth annoy and embarrass by slipping, dropping or wobbling when you eat, laugh or talk? Just sprinkle a little FASTEETH on your plates. This alkaline (non-acid) powder holds false teeth more firmly and more comfortably. No gummy, gooey, pasty taste or feeling. Does not sour. Checks "plate odor" (denture breath). Get FASTEETH today, at any drug counter.

5 Engineering Technicians
needed for each engineer



Become an

ENGINEERING TECHNICIAN

at MSOE

in Milwaukee

Industries need five technicians for every engineer—and there is a critical shortage of both. Top jobs are waiting for well-trained men. Join the engineering team!

MSOE's unique educational program of technical institute and collegiate engineering courses offers you step-by-step advancement. You can become a qualified engineering technician in 12 to 18 months, ready to begin your career in industry. Or you may continue your studies, without loss of time or credit, to earn a Bachelor of Science degree in engineering in 36 to 42 months. Prepare yourself for the opportunities ahead in one of these MSOE courses:

ENGINEERING TECHNICIAN
COURSES

MECHANICAL: Air Conditioning — Industrial Technology

ELECTRICAL: Radio — Television — Electronics—Electrical Power Technology

BACHELOR OF SCIENCE
DEGREE COURSES

MECHANICAL ENGINEERING:
Refrigeration, Air Conditioning and Plant Engineering option, or Metals Fabrication and Industrial option

ELECTRICAL ENGINEERING:
Electronics major or Power major

MSOE's complete, modern facilities include specialized technical laboratories and equipment, visual aid theater, and reference library. Fully accredited technical institute courses approved for veterans; 50,000 former students; excellent placement record for graduates.



4 TERM OPENINGS YEARLY
SEPTEMBER, JANUARY, APRIL, JULY

Clip and Mail Today!

MILWAUKEE

SCHOOL OF ENGINEERING

Dept. PM-956, 1025 N. Milwaukee St.
Milwaukee 1, Wisconsin

MS-41

Please send me free career booklets on:

- Mechanical Engineering and Technology
 Electrical Engineering and Technology
 Radio-Television

I am interested in
(name of course)

Name..... (Age).....

Address.....

City and State.....

If veteran, give discharge date.....

FREE

A NEW HOME INDUSTRY



Let us show you how extremely easy and PROFITABLE it is to make beautiful and useful things out of LIQUID PLASTIC, LIQUID MARBLE, LIQUID IVORY, LIQUID GLASS, CERAMICS, ETC. . . as easy as pouring water out of a glass! Make novelties, jewelry, gifts, artware, toys, tools, dies, gadgets, ceramics . . . a million useful things! We supply everything—MATERIALS and INSTRUCTIONS!—Send only 25c for big 64 page catalog of casting materials, molds and accessories and we will include free of extra cost a remarkable book, "THE WONDERS OF LIQUID PLASTICS" . . . that will open your eyes to wonders you never dreamed of! Send 25c today—this may be the lucky coin that will start the most fascinating and profitable phase of your life!

PLASTICAST COMPANY

6612 N. CLARK ST. DEPT. PC-702 CHICAGO 26, ILLINOIS



Become A . . . BUILDING CONTRACTOR!

MAIL COUPON for FULL DETAILS

Simplified home study training program. Learn every phase of building, estimating, contracting. Fortunes are made in this line of work every year. Use spare hours—no interference with present work. Diploma awarded. Low tuition rates.

AMERICAN TECHNICAL SOCIETY

Dept. MP-96, 850 E. 58th Street, Chicago 37, Ill.

Please send me full details of your building, estimating and contracting training program.

Name _____

Address _____

City _____

State _____

SAY YOU SAW IT IN
POPULAR MECHANICS

BECOME AN EXPERT IN TRAFFIC and TRANSPORTATION

Today the man trained in TRAFFIC AND TRANSPORTATION is one of the most important and well paid individuals in business and industry. Thousands of firms need experts on rates, tariffs, regulations, etc.

We train you thoroly at home in spare time thru the famous LaSalle Problem Method under the personal guidance of expert traffic authorities.

Splendid opportunities developing rapidly in MOTOR TRUCK and other phases of the Traffic and Transportation field.

Get the facts. Mail coupon today for FREE 48-page book, "Traffic and Transportation—the Fast Growing Profession." Learn about the opportunities and how you can qualify as an expert in the TRAFFIC AND TRANSPORTATION field.

LASALLE EXTENSION UNIVERSITY

A Correspondence Institution

417 S. Dearborn St., Dept. 964T, Chicago 5, Ill.

Name.....

Address.....

City..... Zone..... State.....

AMAZING NEW PERSONAL POCKET RADIO



LISTEN WHILE YOU WALK DOWN THE STREET!

Slips in any pocket—wt. only 7 ozs. Size 2 3/4" x 4 1/4" x 1 1/4". Beautiful Black Gold Plastic Case, NO HOOKUPS—NO WIRES—NO PLUG-INS! Self-contained, 100-hour life flashlight batteries and BUILT-IN ANTENNA. POSITIVELY NO AERIAL HOOK-UPS EVER! GUARANTEED RECEPTION OF RADIO STATIONS TO 50 MILES up to 1500 miles for powerful stations! New patented Super-regenerative Diode tube and transformer audio stage for sharp selectivity and sensitivity! Easy to use top tuner (while walking). Tiny, plastic personal ear plug.

LET'S YOU ALONE LISTEN WHILE YOU WALK, VISIT, WORK, RIDE OR SLEEP ANYTIME—ANYWHERE. MONEY-BACK GUARANTEE AND ONE YEAR SERVICE GUARANTEE.

SEND ONLY \$5.00 (ck, mo) and pay postman \$14.95 plus postage on delivery or send \$19.95 for postpaid delivery. GET YOUR TINYTONE REAL POCKET RADIO now and be ready to listen to Civil Defense Alarms, news, music, sports, etc. on a moment's notice without bothering those around you. NOT AN UNWORKABLE, INCOMPLETE KIT OR PLAYTHING, BUT A REAL POCKET RADIO! Shipped complete with batteries—Ready to listen! Available only from: WESTERN RADIO, Dept. APM-9, Kearney, Nebr.



DRAW The First Day! NO LESSONS! NO TALENT!

New Amazing Invention—"Magic Art Reproducer." You can draw Your Family, Friends, Anything From REAL LIFE—Like An Artist! Even if You CAN'T DRAW A Straight Line! Anything you want to draw is automatically seen on any sheet of paper thru the "Magic Art Reproducer." Then easily follow the lines of the "picture image" with a pencil for an original "professional looking" drawing. Also reduces or enlarges. SEND NO MONEY! Free Trial! Pay Postman on delivery \$1.98 plus postage. Or send only \$1.98 with order and we pay postage. Money Back Guarantee.

NORTON PRODUCTS, Dept. 5809W, 296 Broadway, N. Y.

YOU BUILD 'EM — WE SELL 'EM EARN UP TO \$50.00 A DAY AT HOME

Participate in our national sales and sub-contract plan—spare time—full time. You assemble special luggage and cases for photographers, musicians, salesmen, and all types of portables. We supply complete instructions—materials—tools—everything. No previous experience necessary. Free details. Abarsi Cascraft, Dept. AK, 807 W. Sunset Blvd., Los Angeles 12, Calif.

PLEASE SEND ME



for the
time checked.

I am enclosing . . .

1 year \$3.50

2 years \$6.00

name _____

address _____

city _____

zone _____

state _____

Hand this order to your newsdealer or send it to
POPULAR MECHANICS
200 East Ontario St. Chicago 11, Ill.

LEARN MEAT CUTTING AT NATIONAL

Pay After Graduation



The steady dependable trade of Meat Cutting taught easily in 8 short weeks. YOU LEARN BY DOING under actual meat market conditions in big modern school at Toledo.

For beginners or men with experience. Get a profitable store of your own. Remember, PEOPLE MUST EAT! Big pay jobs. Free employment help. Thousands of successful graduates.

Buying, cutting, percentage, pricing, advertising, selling, etc. A complete retail meat education. National School established 33 years. Get National training NOW. Pay your tuition in easy weekly payments

Fastest, surest method known to develop a HE-MAN BODY

New revolutionary Dan Lurie Body-moulding courses are the secret FREE with any purchase of famous Dan Lurie Barbells. Special low prices. Send for FREE catalog.

50 lb. set \$ 8.48 • 100 lb. set \$13.98
150 lb. set \$20.48 • 200 lb. set \$25.98
Add'l wts. 13c per lb. Prices FOB plant

DAN LURIE BARBELL CO.
52MA Bristol Street, Dept. 669-JA, Bklyn 12, N.Y.

Tillholster
America's most
Muscular man.

LOW DIRECT PRICE

Write Like This Complete OUTLINE FREE!

MIRACULOUS IMPROVEMENT in your Penmanship in six hours practice with Grooved Letters. No failures. Inexpensive. No charges unless you're satisfied after 6 hours practice.

WRITE OZMENT BOX 665
34-P, ST. LOUIS, MISSOURI

ARTHRITIS—RHEUMATISM VITAL FACTS EXPLAINED

FREE DESCRIPTIVE BOOK

How crippling deformities may be avoided. This amazing FREE BOOK explains why ordinary methods give only temporary relief—if that. Describes a drugless method of treatment successfully applied in thousands of cases. Write for this 36-page FREE BOOK today. No obligation.

BALL CLINIC, DEPT. 756, EXCELSIOR SPRINGS, MO.

WAR SURPLUS BARGAINS

WAR SURPLUS BARGAINS

\$500,000.00 INVENTORY for QUICK LIQUIDATION

Surplus items—hundreds of them for home, shop, factory, farm and outdoor use. New items, used items, reconditioned items—all at tremendous savings—all priced for quick sale.

Page After Page of Values

This big catalog shows page after page of amazing money saving values. Write for your copy today. Send 10c to cover postage, mailing, etc. Write today! SEND TODAY FOR YOUR COPY

10c

STARK'S 212 W. Madison St.
Dept. PM-569
CHICAGO 6, ILL.

after you graduate. Send coupon for FREE 52 page school catalog — TODAY. G.I. approved.

National School of Meat Cutting, Inc., Dept. 50-H, Toledo 4, Ohio

Send me your FREE school catalog on National Training at Toledo in Meat Cutting, Meat Merchandising and Self Service Meats. No obligation. No salesman will call.

Name _____ Age _____

Address _____

City _____ State _____

Approved for training Korean Veterans

Big MONEY IN TELEVISION

RADIO — RADAR — ELECTRONICS

CHRISTY TRAINING is complete training. Why settle for less? Let's you EARN AS YOU LEARN while working on actual equipment. 19 TRAINING KITS INCLUDED! Send today for FREE BOOK and TWO FREE LESSONS. No obligation.

CHRISTY TRADES SCHOOL, 4804 N. Kedzie, Dept. T-703, Chicago 25.

3 Free BOOKS!

Easy as A-B-C

"DO-IT-YOURSELF" MUSIC LESSONS

PLAY ANY INSTRUMENT

LEARN AT HOME THIS QUICK MONEY-SAVING WAY

SIMPLE as A-B-C. Your lessons consist of real selections, instead of tiresome exercises. You read real notes—no "numbers" or trick music. Some of our 900,000 students are band LEADERS. Everything is in print and pictures. First you are told what to do. Then a picture shows you how. Then you play it yourself and hear how it sounds. Soon you are playing your favorite music.

STOP CHEATING YOURSELF OF THESE JOYS!

Popularity! New friends. Gay parties. Good times. Career. Extra Money. Understand, appreciate and converse about music. Learn lives and compositions of classic and modern musical masters. Relax! Banish worries and frustrations. Satisfy self-expression, creative urge. Gain self-confidence.

Mail coupon for Free 36-page illustrated book. Mention your favorite instrument, U. S. SCHOOL OF MUSIC, Studio 309, Port Washington, New York.

FREE BOOKLET

U. S. SCHOOL OF MUSIC, Studio 309, Port Washington, N. Y.

Please send me your FREE 36-page illustrated book. No obligation. No salesman will call upon me. I would like to play (Name Instrument).

Instrument _____ Have you Instrument? _____

Name _____ (Please Print)

Address _____

TRAINED MEN NEEDED!

BIG PAY!—GOOD FUTURE!

- DIESEL ELECTRONICS
 AUTO AUTOMATION

NEVER BEFORE has the opportunity been so good for the properly trained mechanic and technician to step into BIG PAY POSITIONS with rapid advancement and future security virtually assured.

YOUR SUCCESS depends on the quality of training you receive... and the reputation of the school you attend.

YOUR GUARANTEE we are giving the best in mechanical and technical training is proved by the fact... we have a waiting list of good pay positions for our graduates, with leading companies throughout the United States.

RESIDENT SHOP TRAINING is easier and costs less than you may think! We provide you with housing and part-time jobs while in school, plus free nation-wide placement service for graduates.

Check subject above in which you are interested and mail for

FREE BOOKLET

Your Future in ELECTRONICS AND AUTOMATION

BAILEY

Technical Schools

Veteran Approved

1634 S. Grand, St. Louis 4, Mo.

Your Future in DIESEL and AUTO MECHANICS

Name _____ Age _____
Street _____
Town _____ Zone _____ State _____



Let me show you

HOW TO SPEAK AND WRITE LIKE A COLLEGE GRADUATE

I have helped thousands of men and women who have not had college training in English to become effective speakers, writers, and conversationalists. With my new C. I. METHOD, you can stop making mistakes, build up your vocabulary, speed up your reading, develop writing skill, learn the "secrets" of conversation. You don't have to go back to school. Takes only 15 minutes a day at home. Costs little. 32-page booklet mailed FREE upon request. Send me a card or letter TODAY!

Don Bolander, Career Institute
Dept. 1059 25 East Jackson Chicago 4, Illinois
Please mail me your FREE 32-page booklet on English.

Name _____
Address _____
City _____ Zone _____ State _____

-CHECK AND SEND NOW- McKNIGHT'S up-to-date, easy-to-read, authentic HOW TO DO IT BOOKS

World's most popular "How to" books. Approved by vocational instructors, schools & colleges. Complete step by step details. Jam-packed with illustrations.

- Send for
FREE
colorful folders
describing books

Woodworking
 Metalworking
 Welding
 Home Mechanics
 Electricity
 Crafts

McKNIGHT & McKNIGHT
Publishing Company
Dept. 444, Bloomington, Ill.

NAME _____
ADDRESS _____
CITY _____ STATE _____

PEE WEE BATTERYLESS "LIFETIME" RADIO



REALLY WORKS — FOR LIFE!
WORKS WITHOUT TUBES, BATTERIES OR ELECTRICAL PLUGS. Will never run down or burn out! World's smallest, SMALLER THAN A PACK OF CIGARETTES! GUARANTEED TO RECEIVE LOCAL RADIO STATIONS ANYTIME—ANYWHERE YOU GO! Sensational new Ferrite Selective Tuner — Perma-Crystal diode, Super SPEAKER-PHONE, durable black and gold plastic case.

SEND ONLY \$2.00 (will ck. mo) and pay postman \$4.99 COD postage on arrival or send \$6.99 for postpaid delivery. SENT COMPLETE READY TO LISTEN WITH LIFETIME GUARANTEE. Nothing extra to buy — ever. Available only from: MIDWAY COMPANY Dept. WPM-9 KEARNEY, NEBRASKA

Enjoy the Fascinating Story of the Horseless Carriage in

It's thrilling, fascinating, informative. From the very first gasoline-propelled buggy to the cars of today and the atomic auto of the future. The first cars—the men who made them—the scrambled start and development of the fabulous auto industry—the story of auto racing. 168 thrilling action pictures—old-time cars—racing cars—early auto advertising — automotive oddities. Listing of 2000 U. S. autos included. Ideal gift book. Cloth bound, only \$3.00 by mail. Money back if not pleased. Paper covered edition \$1.00 at newsstands.



POPULAR MECHANICS PRESS, Dept. PM956, 200 E. Ontario St., Chicago 11

BOAT KITS

ONLY \$495
Freight included
FREE FOLDER

28 FT CRUISER

12 Models as low as \$39.95 (freight included). Fiberglass boat covering kits, marine supplies, etc. Free folders.

TAFT MARINE WOODCRAFT
DEPT. PM-9 636-39th Ave. N.E., Minneapolis 27, Minn.

Say You Saw It in Popular Mechanics

Save on all PLUMBING JOBS

When You Build · When Making Improvements · Repairs · Maintenance

Get POPULAR MECHANICS Home Plumbing Guide



How to plan plumbing installations, select materials and fixtures.

How to save money on all plumbing jobs using approved methods.

Easy to Do Professional-Like Jobs and Save Over One-Half

Get the Popular Mechanics HOME PLUMBING GUIDE. It shows how you can do every kind of plumbing job yourself and save from a few to hundreds of dollars. Covers plans, layouts, installation, maintenance and repair. Shows what materials to get and use, where to get them and how to do a proper job with approved methods. Few, other than the simplest tools are required and some of these can be rented. Don't pay high prices for work you can do yourself. Get the HOME PLUMBING GUIDE for only \$3.50. You will be amazed how jobs you thought difficult are simplified.

Clip This Ad and Mail. Money Back if Not Pleased

Invest only \$3.50. Use the book for 7 days. Then if you are not satisfied return it for full refund of your money. Sent C.O.D. (U.S.A. only) if you prefer.

Over 500 How-to-do-it Pictures Guide You



POPULAR MECHANICS PRESS, Dept. 956, 200 E. Ontario St., Chicago 11

ATTENTION MASONS!

ACCIDENT — HEALTH —
HOSPITALIZATION INSURANCE
AT COST



• Non Cancellable • Benefits Not Prorated
• No Medical Examination • No Paid Agents
• Coverage On or Off the Job

FIRST 3 MONTHS PROTECTION FOR MEMBERSHIP FEE \$2.00
FOR MASONS ONLY under 56 yrs. of age
WRITE AT ONCE

THE MASONIC CASUALTY COMPANY
80 BOYLSTON STREET, Dept. P-9, BOSTON 16, MASS.
NO AGENT WILL CALL

WHEELS WHEELS WHEELS

7" Disc Wheel 3/4" Tire 3/8" sleeve	45c ea.
8" Disc Wheel 1 1/8" Tire 1/2" sleeve	70c ea.
7" Disc Wheel 1" Tire 1/2" ball bearing	1.00 ea.
8" Disc Wheel 1 1/8" Tire 1/2" ball bearing	1.35 ea.
6" Disc Wheel 1.50 semi-pneum. Tire 1/2" B.S.	1.50 ea.
8" Disc Wheel 2" semi-pneum. Tire 1/2" B.S.	1.50 ea.
10" Disc Wheel 1.75 semi-pneum. Tire 3/4" B.S.	3.50 ea.
12" Disc Wheel 1.75 semi-pneum. Tire 1/2" B.S.	1.85 ea.

Above wheel prices includes hub cap. Plus Postage, C.O.D.'s accepted.
AXLES—Sizes 5/16 in., 3/8 in., 1/2 in.—Cut to size—End holes drilled.

UNITED WHEEL STAMPING CO.
12131 S. PEORIA STREET PM-9 CHICAGO 43, ILLINOIS

FIX home & car APPLIANCES YOURSELF

NEW! EICO® REDI-TESTER
KIT \$12.95 Factory-wired \$15.95

All-in-one MULTI-RANGE ac/dc voltmeter, ammeter, ohmmeter, wattmeter, leakage checker. Locates defects in irons, fans, refrigerators, mixers, air-conditioning, TV & radio tubes and parts, batteries, generators, etc. Easy instruction Book has introduction to electricity & procedures for common repair jobs. Examining EICO's complete line of 50 professional instruments & kits - Write for FREE Catalog - "M-9"

Electronic Instrument Co., Inc., 84 Withers St., Bklyn 11, N. Y.

HOW TO BREAK and TRAIN HORSES

SEND FOR THIS FREE!

Make money. Know how to break and train horses. Write today for this book FREE, together with special offer of a course in Animal Breeding. If you are interested in Gaiting and Riding the saddle horse, check here () Do it today—now.

BEERY SCHOOL OF HORSEMANSHIP
Dept. 1109 Pleasant Hill, Ohio

STUDY INDUSTRIAL DESIGN

You can train at Art Center School in California with practicing-professionals for upper-level jobs in INDUSTRIAL DESIGN. Recent graduates have been added to the staff at General Motors, Chrysler, Raymond Loewy, Henry Dreyfuss, etc. Majors in transportation, general product design, structures, community development, packaging, display, 4-year degree courses. Learn to combine imaginative design with technical proficiency, coordinate utility and beauty. Stimulating environment. Field trips. Advantages of mild Southern California climate and nearby holiday spots. Accredited. Coed. Placement service. Established 25 years. New terms February, June, September. Catalog.

ART CENTER SCHOOL, Edward M. Adams, Director
5353 WEST THIRD STREET, LOS ANGELES 5, CALIFORNIA

Success Requires Training! **LEARN**
AIR CONDITIONING
and **REFRIGERATION**

This great, modern industry is alive with opportunities for trained men. Installation, maintenance and servicing of home and industrial equipment is a well-established, paying trade and business. Now mechanically inclined men can get practical instruction in spare time at home, plus quick shop practice at U.E.I. (founded 1927).

IMPORTANT FACTS FREE — Write today
Find out all about these interesting opportunities without obligation. Send a postcard or short note right now.

UTILITIES ENGINEERING INSTITUTE, Dept. C-16
2525 SHEFFIELD AVENUE CHICAGO 14, ILLINOIS

IMPORT PAYS BIG!



B. L. MELLINGER
Exporter-Importer

NEW WORLD TRADE BOOM OFFERS BIG PROFIT OPPORTUNITY to ambitious Men and Women everywhere. I'll show you how you may Import Thousands of desirable products at low foreign prices for buyers in your locality at high U.S. Prices — how you can operate a world-wide mail-order Import-Export business from home whether you live in a big city, or small town.

B. L. Mellinger

HERE'S PROOF!

As startling first-hand proof I will send you an actual import from overseas. **AT MY COST** — something to see and use. Just mail me 25c in coin and I will rush you this Imported Melson Automatic cigarette lighter — made to retail in the U.S. at \$2. This magnificent Import will convince you of the tremendous profits being made in World Trade.



START AT ONCE WITHOUT CAPITAL or previous experience. Fantastic profits are possible. My training also includes shipment to you of many sample imports from 'round the world.

GRASP THIS OPPORTUNITY TODAY! Send for your Melson Automatic cigarette lighter now and I will include full details that show you how to learn my Big Profit secrets of Import-Export—complete instructions that will put you on the road to a Profitable business of your own. Opportunity to travel abroad for profit and pleasure. I'll also show you how you can save many dollars on your own purchases of Clothes, Tools, Gems, Antiques, Watches, Cameras, China, Silks, Toys, etc. You can have the complete details FREE without ordering the lighter if you wish, but I would like to send you the Melson lighter as an actual demonstration of Import Values. Either way, mail coupon now. Airmail reaches me overnight.

The Mellinger Co., Dept. F259, 1717 Westwood, Los Angeles 24, Calif.

HERE'S MORE PROOF!

"We operate a profitable World Trade Business from our home... Thanks to MELLINGER."

Don and Muriel Bowman, Calif.

MAIL COUPON NOW!

The Mellinger Co., Dept. F259
1717 Westwood, Los Angeles 24, Calif.

Mr. Mellinger: Show me the big profits to be made through World Trade. I enclose 25c in coin. Send me one Melson Cigarette Lighter and your plan that shows me how to learn the secrets of World Trade. (No lighter without a coupon. Only one to a person.)
 Just send your FREE World Trade Plan.

Name _____ Age _____
Street _____
Town _____ Zone _____ State _____

not everyone does as well, but E. O. Lockin, who started a business of his own, reports...

for 12 months I've averaged
\$800 PER MONTH INCOME —
 most of it clear profit for me!

Many men have discovered how to be independent, to be free of bosses and layoffs. L. A. Eagles grossed more than \$200 his first week. Others report gross up to \$12,000 per year. How much you make depends largely on you. You need no special skill, no large investment.

No shop necessary. Our **ELECTRIC RUG WASHER** cleans rugs, carpets right on floor... helps to show their natural color, beauty. So efficient and safe, used by largest hotels and railroads.

You take no risk. Machines fully guaranteed. Write for full information including how to make big profits in **YOUR OWN BUSINESS.**



MAIL COUPON TODAY FOR FREE BOOK

VON SCHRADER MFG. CO., 910 "R" PL, Racine, Wis.

Without obligation, send your **FREE** booklet containing information about your **ELECTRIC RUG WASHER** and how I can start *my own* permanent, profitable business.

Name _____

Address _____

City _____ Zone _____ State _____

**FREE
 1957
 CATALOG!**

Over 15,000 bargains in the fields of Hi-Fi, Radio, Television and Electronics!

Send for Your Copy Today!

E-Z TERMS!

Only 10% Down
 Top Trade-Ins
 Up to 50% Savings on More Than 800 Guaranteed Reconditioned Eqpt. Items!



WORLD RADIO LABORATORIES
 The World's Largest Distributor of Amateur Radio Eqpt.
 3415 W. Broadway — Council Bluffs, Iowa
 Leo I. Meyerson PERSONALIZED SERVICE

MAIL HANDY COUPON

WORLD RADIO LABORATORIES, INC. PM-9
 3415 W. Broadway — Council Bluffs, Iowa

PLEASE RUSH ME: Free Catalog Hi-Fi Booklet
 Info on Kits Recond. Eqpt. List

NAME _____

ADDRESS _____

CITY _____ STATE _____

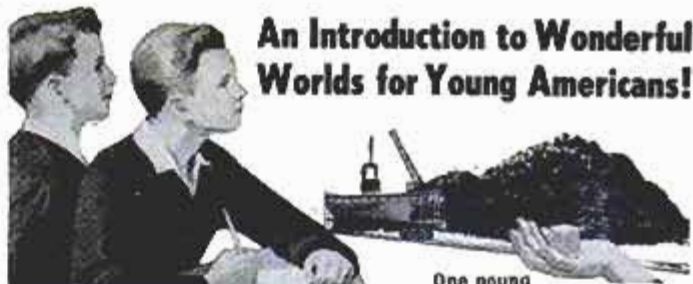

An Introduction to Wonderful Worlds for Young Americans!

One pound Uranium Equal to 2,600,000 pounds of coal

—the **Boy Scientist**

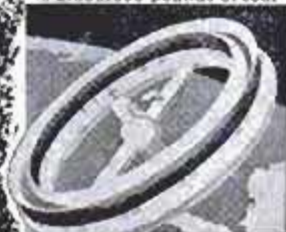

A Space Platform May Look Something Like This

New Popular Mechanics Book Packed With Thrilling Facts and Fascinating Information

Get this thrilling Popular Mechanics book for every boy you know. In it, your own boy scientist can pore over the world-shaking discoveries in astronomy, physics, chemistry, sound, electricity, atomic theory and relativity. In the same thrilling pages, he can meet the greats of the world of science such as Galileo, Newton, Franklin, Faraday, Einstein and many others. With its help, he can participate in monumental discoveries by performing the many experiments which are suggested in the book and explained in word and picture.

The Spark That Opens Up a New World

Written by John Leuellen, noted writer of a dozen books in science and natural history. Preface by Dr. Wilbur Beachamp, Professor of Education, University of Chicago, who says "the Boy Scientist may well be the spark that starts some boy on the way to becoming a scientist and the Nation's need for scientists is very great."

Finest Gift for Boys Use "Money Back" Coupon

Is there a boy in your family? Then get him the Boy Scientist. It could be one of the most important books he ever reads. Want to send the supreme gift to some boy you know? Then give him the Boy Scientist too. There is no finer gift for any occasion. Sent postpaid to any address for only \$3.95. Order on Money Back coupon now. If not immensely pleased with the book return in 5 days and the entire purchase price will be refunded.

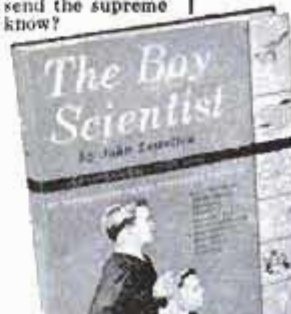

Meet These Greats . . . Know Their Achievements

- Galileo . . . the first modern scientist
- Newton . . . the law of gravity and famous three laws of motion
- Boyle . . . and how gases behave
- Archimedes } . . . and
- Pascal } liquids
- Bernoulli } . . . and light
- Muygens . . . and electricity
- Benjamin Franklin . . . and electricity
- Bequerel . . . radioactive fog
- Einstein . . . theory of relativity
- Rumford . . . heat
- Mersenne . . . the laws of sound
- Tomorrow . . . will bring new discoveries



Prepared in the famous Popular Mechanics easy-to-read and easy-to-understand style. Adults too, will find this a fascinating book.

Library Cloth Binding
 6 3/4 x 10 In.
 264 Pages
 277 Illustrations

Use This "On Approval" Coupon

POPULAR MECHANICS PRESS

Dept. 956, 200 E. Ontario Street, Chicago 11

Send at once _____ copies The Boy Scientist, \$3.95 each. I understand I may return books in 5 days and you will refund full purchase price.

- Remittance for \$_____ enclosed. Send postpaid.
- Send COD. I will pay postman.

Name _____

Address _____

City _____ Zone _____ State _____

SEWS LEATHER

AND TOUGH TEXTILES LIKE A MACHINE

With SPEEDY STITCHER Automatic Sewing Awl, anyone can quickly and skillfully sew or repair anything made of LEATHER, CANVAS, NYLON, PLASTIC, or other heavy materials. Sew firm, even lock-stitches like a machine. Gets into hard-to-reach places. Specially made for heavy duty sewing on BAGGAGE, FOOTWEAR, RUBS, AWNINGS, SAILS, UDDLERY, UPHOLSTERY, OVERALLS, AUTO-TOPS, SPORTS GEAR, and other tough sewing jobs. Here's the handiest tool you'll ever own. Will save you any times its small cost. Comes ready for instant use... complete with bobbin of waxed thread and 3 different types of diamond-pointed needles. Easy-to-follow directions will make you an expert in minutes. Extra needles and waxed-thread always available. Have money, send \$1.98 for postpaid delivery. If C.O.D., \$1.98 plus stage. MONEY BACK GUARANTEE.



ONLY **1.98**

SPORTSMAN'S POST
36 Madison Ave., Dept. A-347, New York 17

Stamp Collectors

SENSATIONAL MONACO WEDDING



Have You Seen Grace! Grace Kelly-Prince Rainier Wedding Issued Complete Set of postage is yours. Included in Monaco Collection with Giant Historical Set portraying Washington, Lincoln, Roosevelt & Eisenhower including Diamonds, Triangles, Saints, Helicopter, etc. Altogether with a 48 Page Stamp Dictionary for only 25c to introduce our bargain approvals. **STAMPEX CO., Box 47-AM, White Plains, N. Y.**

Complete set & more Only **25c**

MAKE BIG MONEY AT HOME!

INVISIBLE REWEAVING

Pays up to \$10 in an Hour!

Make moth holes, cigarette burns, tears, rips, disappear from all fabrics. Little-known craft pays extra spare-time profits at home. Write today for exciting details FREE!

ABRICON 8342 S. Prairie Avenue
Dept. 329. Chicago 19, Ill.



MECHANICAL DENTISTRY

A profession offering unlimited opportunities. Most modern and complete course embracing every branch from Plate to Porcelain Work, which prepares you to work for Dentists or start your own business. Individual instruction—practical training in day or night school. No books—no classes. Catalog upon request. **McCARRIE SCHOOL OF MECHANICAL DENTISTRY**
17 N. Broad Street Dept. 57 Philadelphia 7, Penna.

SAY YOU SAW IT IN POPULAR MECHANICS

LEARN PLASTICS

COMPLETE LOW COST SHOP METHOD HOME TRAINING NOW AVAILABLE

Get in on Big Money opportunities in Plastic molding, casting, forming, carving, etc. Earn as you learn with Interstate's professionally prepared course. All plastic materials furnished.

INTERSTATE TRAINING SERVICE
DEPT. C-3, PORTLAND 13, OREGON

RUPTURED?

Write for New Relief FACTS FREE!

ENJOY NEW FREEDOM of action, peace of mind and comfort at work or play. Proven, patented MILLER holds your rupture back Day & Night—will bring you lasting relief! Has helped thousands of others! For FREE facts in plain wrapper—
Send Name and Address to **FRED B. MILLER, DEPT. 1K**
Manufacturer, HAGERSTOWN, MARYLAND



ENTIRELY DIFFERENT



Do You Like art?

DRAW FOR MONEY!

Our Simple Method Proves You Can Learn to Draw at Home in Spare Time

YOU can learn Commercial Art, Designing, Illustrating, Cartooning, etc. . . . right at home, in spare time. No previous art training necessary. Soon be your own boss — work at home, pick your own working hours. Or earn big money as staff artist for advertising agency, newspaper, magazine, dept. store, etc. Or make Art a profitable hobby. Earn while you learn. 22-piece art outfit given with your first lesson AT NO EXTRA CHARGE. (School est. 1914.)

FREE BOOK, "ART FOR PLEASURE AND PROFIT." Describes our methods.

Lists opportunities. Tells what our students say. No obligation. So mail coupon at once. Free Talent Test.



FREE BOOK

Washington School of Art
Studio 149, Port Washington, N. Y.
Send me—FREE—your valuable Illustrated Book, "Art for Pleasure and Profit." No obligation. No salesman will call.
Name..... Age.....
(PLEASE PRINT PLAINLY)
Street.....
City..... Zone..... State.....

PREPARE FOR BETTER JOB, BIGGER PAY IN SPARE TIME AT HOME

Today, choose the job you want—and prepare for it in time you might otherwise waste. Or if you are already in the work you like best, start training now for quicker promotion and increased pay. During more than 50 years AMERICAN SCHOOL has helped ambitious people to reach higher goals. Check subject that interests you and mail coupon for full information.

AMERICAN SCHOOL, Dept. G645, Drexel at 58th, Chicago 37, Ill.
Without obligation, please send FREE and postpaid, full particulars about the subject checked below.

- | | | |
|-------------------------|--------------------------|------------------------|
| Accounting | Contracting | Mechanical Engineering |
| Apprenticeship Courses | Diesel Technician | Mechanical Technology |
| Architecture & Building | Drafting—Building Trades | Metalworking Courses |
| Automotive Technician | Drafting—Machine Trades | Plumbing—Practical |
| Better Foremanship | Electrical Engineering | Private Secretary |
| Blueprint Reading | Electricity—Practical | Retail Merchandising |
| Bookkeeping | Electronics—Industrial | Salesmanship—Outside |
| Business Management | HIGH SCHOOL COURSES | Sheet Metal Work |
| Civil Engineering | Machinists | Tool Making |

NAME.....
HOME ADDRESS.....
CITY.....
STATE.....
OCCUPATION.....
AGE.....

Canadians: Write American School, Dept. G645, 6083 Sherbrooke St. W, Montreal

MAIL COUPON NOW

HOW TO GROW ORCHIDS IN YOUR OWN HOME!

NO GREENHOUSE NEEDED
- ANY CLIMATE - MAINE TO CALIFORNIA ...
YEAR 'ROUND!

BIG PROFITS SPARE OR FULL TIME



Most successful hobby / home. People know the value of an orchid. It flowers 4 1/2 months.

THOMAS HUIEY - Author

Fill your home with gorgeous Orchids. Huge purple Cattleyas, exquisite Cymbidiums - dozens of others! Many grow without soil, getting food from the air. White Orchids, yellows, greens, every rainbow color. No equipment needed. Start on table or window ledge.

SUCCESSFUL HOME GROWER SHOWS YOU HOW! Complete instructions show you step-by-step how he and his wife started with a few plants and developed a big-profit home-business-grew an orchid collection now worth a fortune. Learn how orchids multiply, how one plant may become many, each as valuable as the first. No big investment or overhead. Takes but a few minutes a week.

Big-profit orders for plants and flowers come from individuals, florists, hotels, clubs, etc. Year 'round gift. Millions sold by Mail-Order.

COMPLETE INSTRUCTIONS AND-BLOOMING-SIZE ORCHID PLANT SENT FOR YOU TO EXAMINE AT HOME WITHOUT RISK. Secrets of the experts in simple language, jam-packed with "show-how" drawings, magnificent full-color pictures of Orchids. Send No Money! Write NOW for your FREE FACTS that show you how to learn to grow Orchids at home. Airmail is quicker.

TROPICAL FLOWERLAND, Dept. 319
4622 Wilshire Blvd., Los Angeles 5, Calif.



Orchids have rewarded me richly - thanks to Tropical Flowerland.
S. V. SMART - Colorado

LEARN WHILE ASLEEP!

PHENOMENAL RESULTS! \$2 rushes fact-filled instruction book, "Sleep-Learning—Its Theory, Application & Technique. Guaranteed. RESEARCH ASSOCIATION, P.O. BOX 610, Omaha, Nebr.

SAY YOU SAW IT IN POPULAR MECHANICS

New! SECRET POCKET RADIO

\$2.98

Listen at work, play, in bed. **INVISIBLE.** Fits shirt pocket. No tubes. No batteries. No electric plug-ins. No expense. Plays day & night forever. New self-powered diode rectifier replaces tubes. **NO BUILDING. READY TO USE.** Tuner covers complete broadcast band. Red plastic case only 3 x 3 1/4 x 1 inches. Lifetime guarantee. Radio (without phone) \$2.98. Hearing Aid Phone (plugs in ear, flesh-colored, almost invisible) \$1.98. Regular phone \$1.25.

JOHNSON SMITH & COMPANY Dept. 363 Detroit 7, Mich.

Catalog of 3100 Novelties 10c

Send 10c for amazing catalog of novelties, live animals, scientific supplies, hobbies, funmakers, planes & boats, looms, magic tricks, joke articles, unusual seeds, gadget timesavers, cameras, optical goods, projectors, movies, lucky jewelry, religious novelties, disguises, musical instruments, stamps, coins, puzzles, fortune tellers, radios, auto & bike accessories, telescopes, magnifiers, compasses, banks, smokers' gadgets, artists' supplies, printing sets, engines, motors, shockers, knives, billfolds, guns, rifles, sports, books, games, plants, etc. Send 10c (3 for 25c—get for friends!).

JOHNSON SMITH & COMPANY Dept. 363 Detroit 7, Mich.

POWERFUL ELECTRIC GENERATOR

Cost Over \$20.00 New! While They Last, \$3.95

Generates Up to 75 Volts. Use to generate electricity, to ring bells, light up lights, as a medical battery, deliver terrific electric shock as joke, many electrical experiments, classroom uses, etc. Cost over \$20 new. Used but excellent operating condition. Hand crank or gear wheel drive. Made by leading electrical companies. Each has 3 or 4 five-inch 1-lb. bar magnets (alone worth more than total cost), generating armature, wire leads, gear crank, ready for use. Originally used in crank phones. Complete unit weighs over 5 lb. Postpaid \$3.95.

JOHNSON SMITH COMPANY, Dept. 363, Detroit 7, Mich.



Learn To MOUNT BIRDS

Here's Best Hobby for Fun & Profit

TAN SKINS, MAKE UP FURS

Be a Taxidermist. We teach you at Home. Mount Birds, Animals, Pets, common specimens. Save your hunting trophies, decorate home and den. Make genuine **KROME LEATHER**, tan and make up furs for sparetime profit. **INVESTIGATE TODAY**

FREE BOOK 48 pages—tells all about it. If interested, get your copy. It's Now Free. Send post card. State your AGE.

IN. W. SCHOOL OF TAXIDERMISTRY, DEPT. 2509, Omaha, Nebr.



It's Easy to PLAY the GUITAR

Learn at Home with My Studio Method on Records

Play the Very First Day

or IT DOESN'T COST YOU ONE CENT

I teach you on records. Your course includes RECORDS, TEXT, MUSIC, and a Professional GUITAR. **FREE!** Learn how you get course with guitar on **FREE TRIAL!** No obligation. Write **SID MARGOLIS STUDIOS, c/o THUNDERBIRD, Dept. TE0-702 Valley Stream, N. Y.**

FREE MUSIC OPPORTUNITY BOOK
No obligation! Write today!

TASOPE PHOTO-ENGRAVING PLANTS



Establish your own profitable **PHOTO-ENGRAVING** business. Make cuts for newspapers, printers, and advertisers. Make etched name plates, plaques etc. Instructions furnished, no experience necessary. Sold direct from factory since 1931. First five hundred cuts sold locally or by mail will pay for plant and pay you well for your time. Write for **FREE** catalog.

TASOPE, DEPT. PM-9, AURORA, MO.

LAW FREE BOOK

THE LAW TRAINED MAN

Write today for a **FREE** copy of illustrated law book, "THE LAW-TRAINED MAN," which shows how to earn the professional Bachelor of Laws (LL.B.) degree through home study of the famous Blackstone Law Course. All necessary books and lessons provided. Moderate cost; convenient monthly terms. Write for **FREE** law training book today.

Blackstone School of Law, 225 N. Michigan Ave.
Founded 1890 Dept. 56 Chicago 1, Ill.

SEND ME



every month so I am sure to see each new issue. Here's

\$3.50 for 1 year
 \$8.00 for 3 years

name _____

address _____

city _____ zone _____ state _____

Hand this order to your newsdealer or send it to

POPULAR MECHANICS
200 East Ontario St. Chicago 11, Ill.

DON'T SELL YOURSELF SHORT!

Why let the fact that you're short handicap you? Simply step into "ELEVATORS" amazing height-increasing shoes... you're almost 2 INCHES TALLER instantly. Only you know how you gained the added stature, but everyone notices the difference! Step UP in the world in "ELEVATORS"

For FREE Booklet and dealer's name write to:

STONE-TARLOW CO., INC., DEPT. PM9, BROCKTON 68, MASS.

LEARN TO BECOME A GAME WARDEN

or GOVT. HUNTER. Join FORESTRY, FISHERY, or WILDLIFE Services. Excellent opportunities! Good pay (\$2500 to \$10,800 a year). Pleasant Work. Prestige, Real Security, Healthful Working Conditions, and Retirement Income can all be yours. Help fill the demand in your area. Make your love of the outdoors become your business. Learn at home in spare time—it's Easy! Fun! Fascinating!

FREE! (if over 17 years old.) Complete, illustrated booklet that gives you complete facts. SUPPLY LIMITED—send your name and address now—TODAY!

HOME STUDY EDUCATORS, Dept. R-9, 1036 S. La Brea, Los Angeles 19, Calif.

60 POWER TELESCOPE \$3.98

VARIABLE EYEPIECE 20X-40X-60X — BRASS BOUND NEW! Three telescopes in one. 3 different magnifications. 20 power for ultra-bright images with 40 and 60 power for extra long range. Guaranteed to bring distant objects, people, sports events, ships, moon, stars, etc. 60 times as close. Most powerful for any where near the moon. 5 sections. Closes to 1 ft. long. Contains 4 ground and polished lenses. Also used as a powerful compound microscope. Directions included. Mass production enables us to offer this instrument at amazing price of \$3.98 complete. Money back guarantee. We pay postage. Get yours now. **CRITERION CO., 331 Church St., Hartford, Conn., Dept. PMB 38**

SAY YOU SAW IT IN POPULAR MECHANICS

AGENTS—Now Save Up to 50% on Nationally Advertised Products

Use this big, new FREE CATALOG to buy all kinds of big name merchandise at terrific savings. Set yourself up in business—make money in your spare time.

EVERGREEN STUDIOS
Dept. 64, Box 846 Chicago 42, Ill.

Auto Service Men . . . STEP UP YOUR PAY!



New Sun School Makes it Easy!

Be an EXPERT in Scientific Engine Tune-Up and Service!

Sun-trained experts in the use of electronic engine test equipment are in demand now! They make MORE MONEY because they know how to use the "tools" which can quickly and profitably keep today's complex engines tuned up to their full power and economy levels!

You Can Provide This Service and Increase Your Earnings—it's easy the Sun way!
Sun Electric Corporation, Chicago—world's largest

Costs are LOW . . . plan NOW to increase your skill and position in the industry! Send for complete information . . . FREE Brochure!

Go after the BIG MONEY in ELECTRICAL Repair and Maintenance

Keeping industrial and domestic electrical machinery "going"—that's a big-pay job for thousands of men—big today—and ever-growing. In this electrical age! Get into this promising line—grow with it into bigger opportunities and get really worthwhile pay. Let this big, practical, Electrical Maintenance and Repair Library show you how—as it has hundreds of other men.



5 volumes 2112 pages 1801 illustrations
Starts at beginning, and takes you step-by-step through every phase of connecting, altering, testing, repairing all types of equipment. How to install motors, generators, rewind motors; inspect, repair starters; locate trouble, test induction motors, and MUCH MORE! One entire volume crammed with troubleshooting charts. Simple diagrams make everything crystal-clear. Gives best on-the-job practice of experts. Will help to put you in big-pay class and rate you an EXPERT electrical worker.

FREE 10-DAY TRIAL
Send no money. Just mail coupon. Easy payments.

McGraw-Hill Book Co., Dept. PM-9, 327 West 41st St., New York 18, N. Y.

Send me for FREE 10-Days' Examination the Electrical Maintenance and Repair Library. If not satisfied I will return books. Otherwise, I will send \$5.00, plus delivery costs, then and \$4.00 a month for 5 months, until total of \$25.00 is paid.

Name _____
Home Address _____
City & State _____ PM-9
WE PAY DELIVERY cost if you enclose \$5.00 first payment WITH coupon. Same return privilege for full refund.

Profitable Future Now Open to You in WATCH REPAIRING

Train at Home in Spare Time for High Pay or Profitable Business Opportunities

Remarkable Sweazey Plan shows you how to repair Swiss or American Watches. No previous experience necessary. Job Guide program starts you making repairs right away. Survey shows part time watchmakers reported hourly rates up to \$6.00 per hour. Includes training to help you get started in business. Get facts today. Send for colorful FREE BOOKLET and FREE SAMPLE LESSON. Here is professional training from famous, long established institution. Founded 1908. Write today — no obligation.

CHICAGO SCHOOL OF WATCHMAKING
2330 N. Milwaukee, Dept. 196, Chicago 47, Illinois

manufacturer of automotive test equipment—Now offers a completely new service training program. Train with specialists in the fully-equipped Sun Technical Training School, at Sun's Chicago headquarters. Learn the latest on any or all of these subjects:

- Test Equipment Operation . . . on Modern engines! You use every piece of Sun equipment!
 - Automotive Electricity . . . full coverage with accent on generators and regulators!
 - Modern Tune-Up Procedures . . . Carburetion—how to do it fast, accurately, prevent comebacks!
 - Service Merchandising . . . how to sell all work needed by customer!
- G. I. Bill Approved!

Sun Electric Corp., Dept. PM-7
Harlem & Avondale Ave., Chicago 31, Ill.
NAME _____
COMPANY _____
ADDRESS _____
CITY _____ ZONE _____ STATE _____

work in cushioned comfort!



Rests your feet while you work... perfect for mechanics, filling station men, anyone who works around oil! Soft, resilient full-cushion insoles absorb shock of pounding steps, give snug comfort all day long. Built-in steel shanks. Handsome soft leather uppers... looks like a dress shoe, but is solidly built for rugged service and extra wear. Get a pair today!



STAR BRAND

Cush-N-Bilt WORK SHOES
"Star Brand Shoes are Better!"

For nearest dealer, write:

ROBERTS, JOHNSON & RAND, Division of International Shoe Co., St. Louis 3, Mo.



ALL PARTS & TOOLS INCLUDED

BUILD 16 RADIO

CIRCUITS AT HOME WITH THE NEW IMPROVED 1957 PROGRESSIVE RADIO "EDU-KIT"

A PRACTICAL HOME RADIO COURSE only \$19.95

All parts, tools, instructions, punched metal chassis, printed circuit materials, electric Soldering Iron, Tester included. Unconditional Money-Back Guarantee.

PROGRESSIVE "EDU-KITS" INC., Rm. 549B, 497 Union Ave., Brooklyn 11, N. Y.

ORDER FROM AD—RECEIVE BONUS RESISTOR KIT WORTH \$5

Please Rush me Free Descriptive Literature concerning "EDU-KIT."

Also send me Free Radio, TV, Hi-Fi Servicing Literature. No obligation.

NAME _____

ADDRESS _____

SAVE HUNDREDS OF DOLLARS with HOME-A-MINUTE "KIT"

This is not something to fool around with.



A Hard Hitting System of Saving Big Money

Design and build your New Home, Attic Flat, Extra Bedrooms or Remodeling—IN MINUTES—with dozens of fiber partitions, Doors, Windows, Kitchen Cabinets, made to 1/4 inch scale same as blueprint. THEN, BELIEVE IT OR NOT, YOU, THE LAYMAN, who knows nothing about building, can estimate your own costs—IN MINUTES—after you adjust charts to local prices.

Don't build anything until you get this "KIT" if you want to save money. Handbook tells you how. This information should not pass you by. Complete "KIT" \$2.95 ppd., if COD plus postage and \$1 deposit required. Handbook without "KIT" \$1.95 or free literature. Money back guarantee. Return in 10 days.

SPECIAL NOTICE!—As a builder, controlling over 3 million dollars worth of home construction, we will ATTEMPT, but not promise, to obtain a special discount to you for your building materials on your new project, thru your favorite, local, Lumber Dealer. Details with "KIT."

R. J. HALL & CO. 2825 N. 69th St. MILWAUKEE 10, WIS.

Now You Can Upholster Any Piece of Furniture!

Upholster—Restyle Any Piece of Furniture Yourself

John Bergen, custom furniture designer, tells and shows you how to transform old out-of-date furniture into brand new smart-looking comfortable furniture in his new book **ALL ABOUT UPHOLSTERING**.

No Experience Needed

Bergen tells you every step to follow in amazingly clear easy-to-understand step-by-step instructions and then shows you how in hundreds of big, clear drawings and photos. You read and see how to strip the old frame, install new webbing and springs, apply burlap, install stuffing and padding, fit the muslin cover and the final fabric and install trim.

Use New Materials—Methods

Now you can have furniture upholstered with foam rubber, sagless springs and other new materials that add so much to comfort and durability and are so costly when included in new furniture.

Save 50% of Usual Cost

Don't pay a small fortune for new furniture when you can make your old furniture better than new! Why pay high prices to have someone else upholster and restyle your old furniture when you can do it yourself for cost of materials alone? It's easy and it's fun.

Special Chapter on Slipcovers

Learn how to make custom-made slipcovers with professional look and fit. Find out how you can realize tremendous savings by investing a few spare-time hours and the cost of a few yards of fabrics.

7-Day Money Back Guarantee

Send for your copy of **ALL ABOUT UPHOLSTERING** today. Read and use it for 7 days. If it isn't entirely satisfactory return it for a full refund.

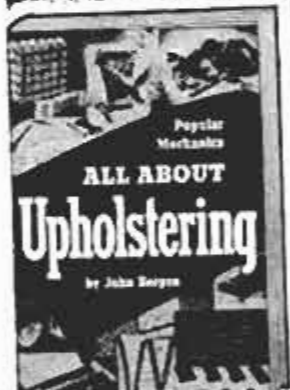

USE THIS HANDY ORDER COUPON

POPULAR MECHANICS PRESS, Dept. 956
200 E. Ontario St., Chicago 11, Illinois

Gentlemen:

Please send my copy of **ALL ABOUT UPHOLSTERING**. Enclosed is my remittance of \$3.50. If I am not completely satisfied with the book I will return it for a full refund after 7 days.

Name _____

Address _____

City _____ Zone _____ State _____

BRITAINS No. 1 RIFLE

ACCURATE, POWERFUL

SMLE No. 1 MARK III

NATO CONVERSION ALLOWS RELEASE

HUNTERS \$29.95

Pride of British troops throughout Empire today. Big Game hunters from Canadian wilderness to African Congo claim the powerful .303 caliber SMLE is best for all big game. Fastest bolt action in world. All milled parts. Long range sights. 10-shot mag. 25" Bbl, cal. .303. **GUARANTEED EXCELLENT CONDITION** complete with sling and 20 rds. mil. ammo. **FREE.** Addit. Mil. ammo. \$7.50 per 100 rds. **SOFTNOSE SPORTING AMMO.** made by Rem. & Win., sold everywhere. Bayonet \$1.95. **TO ORDER:** Send check, cash or M.O. \$10 for C.O.D. Calif. resid. add 4% state tax.

CANADIANS: Order (without red tape) rifles Spd. from G. K. Harper, Ltd., 16 Bayswater, Ottawa.

GOLDEN STATE ARMS CORP. 218 Armory Bldg., 1165 E. Colorado St., Pasadena 1, Calif.

MEN! TRAIN NOW FOR A BIG PAY FUTURE IN**DIESEL****& SCIENTIFIC MOTOR TUNE-UP**

GO PLACES WITH DIESEL! Farms, factories and power plants, trains, ships, trucks, busses all use **DIESEL POWER** . . . all need **DIESEL-trained men!** You can start your **DIESEL** training at home, in spare time, with tested, proved U E I training. Course includes practical work on Diesel engines under skilled instructors. You learn the operation, maintenance, servicing of all types of Diesel engines, **PLUS Scientific Motor Tune-up.**

ACT NOW! If you have mechanical ability, **YOU'LL LIKE DIESEL!** High School diploma not necessary. Write now for **FREE** book, "EARNING POWER IN DIESEL."

UTILITIES ENGINEERING INSTITUTE, Dept. DC-60
2521 SHEFFIELD AVENUE, CHICAGO 14, ILL.

- Diesel Construction
- Diesel Engine Repairman
- Diesel Operator



Titleholder
America's most
Muscular man.



LOW
DIRECT
PRICE

**BUILD YOURSELF A
"HE-MAN" BODY**
In Only 6 Weeks or Money Back!

Fastest, surest method known . . . with famous **DAN LURIE Barbell's**. Special low prices . . .
50 lb. set \$ 8.48 • 100 lb. set \$13.00
150 lb. set \$20.48 • 200 lb. set \$25.98
FREE! If you act fast. Complete Course, 68 photos. **SEND FOR FREE CATALOG.**
Add'l wts. 13c per lb.
All prices **FOB plant**

DAN LURIE BARBELL CO.
52M9 Bristol St., Dept. 669-J, Bklyn 12, N. Y.

LOCKSMITHING

Practical Up-to-Date Course — **ONLY \$5.95**

53 Illustrated self-instruction lessons. Easy to learn. Full price only \$5.95 postpaid—or **COD** plus postage. Satisfaction guaranteed or full refund! **NELSON HALL CO., 210 S. Clinton St., Dept. JU-2, Chicago 6, Ill.**

FREE AMAZING NEW BOOK "HOW TO ANSWER ADS"

how to
answer
ads

Never before have you seen anything like this. Tells you in simple language the correct way to answer ads. Gets you quicker replies—better results, and greater satisfaction. Will save you time and money and it's **ABSOLUTELY FREE.** No obligation whatever. Every reader of advertising should have this booklet. Send a postcard for your copy **NOW.** **F. W. JOHNSON, Popular Mechanics Magazine, Room 600-A, 204 East Ontario Street, Chicago 11, Ill.**

YOU CAN BUILD A VIOLIN FOR PLEASURE OR PROFIT

Now you can build a rich toned mellow violin modeled after a famous "Strad." **YOU CAN MAKE A STRADIVARIUS VIOLIN** contains 8 full scale plans plus complete instructions. You work directly from the plans with no confusing scale of dimensions to translate. Detailed instructions for each step including varnishing and stringing—even shows how to build your own tools. Cloth bound. **Order today from**

POPULAR MECHANICS PRESS \$3.50
Dept. 956, 200 East Ontario Street, Chicago 11, Illinois

BUY IT WHOLESALE!

GET UP TO 40% OFF
Agents—Start Buying Service at Home. Get big-name merchandise for clients up to 40% off. Sales easy as you can give sizeable discounts. still make fat commissions. Postcard brings **FREE COPY "The Wholesale Plan."**

FREE!
"THE WHOLESALE PLAN"

American Buyers Service

HERTEL STATION, DEPT. R, BUFFALO 16, N. Y.

Paint STRIPES with New "PAINT PEN"!**Straight, Curved or Parallel Lines**

Use like a fountain pen with any color paint to stripe furniture, bikes, autos, model planes, toys, linoleum, wall board. Beautiful clean, crisp results every time. Can't clog or smear. Also use with glue, tempera, textile paint or ceramic under glaze. Paints on wood, glass, plastic, metals, fabrics and paper. Tool complete with tip for 1/16" stripe only \$1.25 postpaid. Other complete tools with following tips. 1/64", 1/32", 3/64", 5/64", 3/32", 1/4"—\$1.75 each. Extra tips 90c each. Entire kit with tool and 7 tips—\$5. A 1/4" tip only \$1.20 each. C.O.D.'s postage collect.

New! "DOUBLE-STRIP" 5 Way Combination Model only \$3.25

Double Stripes—one wide and one narrow or two wide or two narrow at the same time.

FREE Send postcard for complete information—**or ORDER TODAY.**



\$1.25

DEALERS: Master Paint Stripping Tool in display cartons of 1 doz. **FAST, PROFITABLE SALES.** Write for new discounts.

HOME CRAFTSMEN! New Paint Stripping Tool gives "professional" results every time, simple, easy to use. Send \$1.25 now.

MANUFACTURERS: Write today for information about industrial models and production stripping tools.

WENDELL MFG. CO., Rt. 321
4234 Lincoln Ave., Chicago 18, Ill.

SAY YOU SAW IT IN POPULAR MECHANICS**PREPARE FOR THE BEST JOBS IN INDUSTRY**

TRAIN at HOME
IN YOUR SPARE TIME
or at
ALLIED INSTITUTE
in Chicago

- MECH. ENGINEER
- DRAFTSMAN
- TOOL DESIGNER
- TOOL ENGINEER
- TOOL & DIE MAKER
- MASTER MACHINIST

NO RECESSION FOR ALLIED TRAINED MEN

MORE JOBS THAN GRADUATES Shortages of Draftsmen, Designers, Tool Engineers, Machinists, Tool & Die Makers are so widespread that you can pick a highly paid key job and look forward to Achievement and Security.

You can begin your training in Short Courses and continue progressively to a Bachelor Degree in 26 months.

Allied is approved by Industry, Dept. of Education, Office of Public Instruction, State of Illinois, U.S. Veterans Admin., U. S. Dept. of Justice, Accredited, C. S. A.

SEND FOR FREE BOOKS

ALLIED SCHOOL of MECHANICAL TRADES
1338-42 South Michigan Ave. Dept. PM-9 Chicago 5, Illinois

SEND ME WITHOUT OBLIGATION INFO. ON YOUR COURSES:

HOME STUDY RESIDENT VETERAN NON VETERAN

NAME _____

ADDRESS _____

AGE _____

CITY _____

COUNTY _____

STATE _____

MAKE BIG PAY OR START IN BUSINESS

GET INTO HOME BUILDING AND CONSTRUCTION

Over 300,000 new jobs open each year. You can earn up to \$4 an hour by remodeling or building homes.

TRAIN AT HOME IN SPARE TIME

Over \$20 billions will be spent this year in home remodeling alone. Five out of every ten homes need repairs or modernization. *Make big money in a better job or a business of your own.* HBTI trains you at home in your spare time. Our new, *Job-Applied method* makes every step easy. Learn every phase from doing the actual work to full-scale contracting.

EASY TO EARN AS YOU TRAIN

Get valuable experience and earn extra cash in your spare time building dormers, stairways, attics, etc. Find out how to earn as you train. *Just mail coupon below. Act today!*

MAIL TODAY • 2 FREE BOOKS

HOME BUILDERS TRAINING INSTITUTE, Dept. HB-107
1400 Greenleaf Ave., Chicago 26, Ill.
Send free Success Book and Sample Lesson. No cost or obligation.

Name _____ Age _____
Address _____
City _____ Zone _____ State _____

Learn All About Cars!
AUTO MECHANICS — AUTOMATIC TRANSMISSIONS
ACETYLENE AND ARC WELDING
BODY AND FENDER REPAIR

Day-Night School 30 Years in the Same Location
WOLVERINE SCHOOL OF TRADES
Approved Under the G.I. Bill of Rights by the State Board of Education

WOLVERINE SCHOOL OF TRADES, Dept. PM
1400 West Fort St., Detroit 16, Mich.

Name _____
Address _____
City _____ State _____

High School at Home

MANY FINISH IN 2 YEARS

No classes. No time wasted going to and from school. Progress as fast as your time and abilities permit. Standard H. S. texts supplied. Thousands enroll each year in this 59-year-old school. Send for FREE descriptive booklet.

AMERICAN SCHOOL, Dept. M645
Drexel at 58th St., Chicago 37, Ill.
Without obligation, please send FREE descriptive booklet.

Name _____
Address _____

Complete Canadian Courses available. Write American School, Dept. H645, 6083 Sherbrooke St. W., Montreal

51 YEARS 1 generation of the **BLATT** family famous in **TIRES**

FREE This pictured tire ash tray given with 2 or more tires!

GOOD YEAR Goodrich, U. S. Atlas, General, Lee & others.

FIRESTONE Fine Hi-Grade Family-Safe Tires Worn Slightly

ADVERTISED ELSEWHERE AT \$7.25 to \$6 Each
12 MONTHS WRITTEN GUAR. BOND WITH EVERY TIRE & TUBE FREE
SPECIAL—TAKE 20% OFF EVERY TIRE IN THIS AD
A TIRE FREE with every 2 or More 4-Ply Black Car Tires

600-16	\$6.48	670-15	\$6.66	600-16(6)	\$6.35	650-20	\$11.20
650-16	6.48	710-15	6.66	650-16(6)	6.40	700-20	12.60
700-16	6.66	760-15	6.76	700-16(6)	7.63	750-20	15.45
640-15	6.66	820-15	6.98	700-15(6)	8.60	825-20	19.45
700-15	6.66	820-15	6.98	750-16	7.40	900-20	20.00
650-15	6.66	475-19	6.86	700-17	10.80	1000-20	20.00
WHITEWALLS \$1 Extra				750-17	12.80	1100-20	20.00

SPECIAL GENUINE ADJUSTMENT TIRES Released by "Co." Adjusters
(Don't forget to take off your 20% discount)
Guaranteed to Give NEW TIRE SERVICE & TUBE FREE
FREE TIRE with every 2 or more Black 4-Ply Car Tires

600-16	\$9.40	670-15	\$9.50	600-16(6)	\$11.25	650-20	\$15.50
650-16	9.45	710-15	9.60	650-16(6)	12.51	700-20	20.75
700-16	9.50	760-15	9.90	700-16(6)	12.52	750-20	26.20
640-15	9.50	800-15	9.95	700-15(6)	12.53	825-20	28.10
700-15	9.60	820-15	9.95	750-16	12.54	900-20	30.40
650-15	9.60	475-19	9.50	700-17	17.25	1000-20	34.20
WHITEWALLS \$1 EXTRA				750-17	19.55	1100-20	35.60

MY GOLDEN RULE GUARANTEE I will replace at once, absolutely FREE, (frt. excl.) any defective tire regardless of mileage or months.

WARVIN BLATT 6th & Spring Garden Sts. Philadelphia Pa. 900-16 Military Mud-Grip \$16.09
Send Ck. or M.O. for fast shipment. I personally select your tires, as if my future depended on it. FOB Phila.

MECHANICAL ADDRESSER COMPLETE
30 DAY TRIAL OFFER \$10⁹⁵



Addresses anything available—easily, quickly, professionally. Thousands in use. Complete with supplies for 250 names. Money-back guarantee. Send check or money order or write for additional information to:
JACOBI ADVTG. 53 W. JACKSON CHICAGO 4

SAY YOU SAW IT IN POPULAR MECHANICS

SALESMEN WANTED

Earnings \$5000 to \$8000 per year, calling on hardware stores and lumber yards, selling and installing Popular Mechanics show windows. No window trimming experience necessary (we train you) but selling experience essential. Must have automobile. Average territory consists of about 5 counties. Salesmen have exclusive territory. Home every night.

Not a get rich quick scheme but steady dignified work by which a skilled, industrious salesman can earn a good living. This company, in cooperation with Popular Mechanics and the leading manufacturers of tools, equipment and materials, offers retailers traffic-stopping window displays to retail hardware stores and lumber yards at a nominal cost. All equipment furnished. Endorsed by many retailers, jobbers and manufacturers. Much repeat business. Extras offer additional earning opportunity. Desirable but not necessary to have knowledge of hardware and lumber lines. Personal training given.

For details write, giving all the facts about yourself. If your letter indicates that you might qualify, an appointment will be made for an interview.

WINDOW DISPLAYS, INC.
1580 SHERMAN AVENUE EVANSTON, ILLINOIS



ANNOUNCING!

THE Cadmium Battery

**a genuine cadmium battery
GUARANTEED
TO OUTLAST YOUR CAR!**



WELD-TYPE CONSTRUCTION

NOT DAMAGED BY OVERCHARGE

IMPROVED TERMINAL DESIGN

SHOCK-RESISTANT CASE

SINTERED CADALLOY PLATES

GREATER ELECTROLYTE CAPACITY

TURNS ENGINE OVER 25% FASTER IN 8 P.M. TEST

MAKES LIGHTS 30% BRIGHTER

RECOVERS POWER IMMEDIATELY AFTER COMPLETE, RAPID DISCHARGE

GOOD FOR MORE THAN 300,000 MILES

WILL NOT FREEZE - STARTS ENGINES INSTANTLY AT ARCTIC AND DESERT TEMPERATURES

You—and the public—have been hearing and reading for years about European-type Cadmium batteries that last longer than automobiles. But so far you haven't been able to buy such batteries.

Truth is, the European-type batteries simply aren't practical for ordinary motoring use—too big and too expensive. Now, after testing more than 400 different combinations of materials and many construction designs, an American manufacturer has at last developed

a Cadmium Battery practical for general motoring use.

This revolutionary new type battery is different from any other American or European battery ever made. *It is superior to European-type Cadmium batteries, yet is no larger nor costlier than ordinary batteries!*

As a result of more than a year of continuous laboratory and road tests, The Cadmium Battery is unconditionally guaranteed by the factory to outlast your car.

COMPARE WITH CONVENTIONAL LEAD-ACID BATTERIES!

ORDINARY LEAD-ACID BATTERY					
THE CADMIUM BATTERY					

The key to the remarkable capacity and long service life of The Cadmium Battery was the discovery of a method of sintering the grids with a newly-developed cadmium alloy. Both the composition of the Cadalloy (derived from cadmium), as well as the method of sintering, or forming, the grids are original and carefully guarded secrets which are highly important to the performance, characteristics and life of the unique Cadmium Battery.

The Cadmium Battery is the finest battery made in America. It gives "temperature-proof" faster starting, brighter lights, better operation of all the car's electrical equipment. Completely modern in every respect, it is designed for today's automotive electrical systems and is ideal for cars with full electrical equipment.

One price for all 6- and 12-volt passenger cars and light trucks: Only \$39.95. Never before offered for less than \$100.

COMPLETE LINE OF INDUSTRIAL, COMMERCIAL, MARINE, MOTORCYCLE AND AIRCRAFT BATTERIES



THE Cadmium Battery Corporation

140 KANSAS STREET EL SEGUNDO, CALIFORNIA

THE CADMIUM BATTERY CORP., Dept. PM
140 Kansas St., El Segundo, Calif.
Please ship Cadmium Battery guaranteed to outlast my car.
@ \$39.95

6-volt automotive 12-volt automotive

Year of Car _____ Model of Car _____

Make of Car _____ No. of Cylinders _____

Name _____

Address _____

City _____ Zone _____ State _____

EXCLUSIVE DISTRIBUTORS NOW BEING APPOINTED

The Cadmium Battery Corporation operates its own completely modern, 65,000 sq. ft. factory and is a financially responsible organization. If you are interested in acquiring a valuable distributor franchise (no charge for franchise) with a protected territory guaranteed in writing, contact us at once by telephone, wire or letter. Address John Galahad, Sales Manager, Cadmium Battery Corporation, 140 Kansas St., El Segundo, California Phone: EAStgate 2-0367, El Segundo Cable address: CADMIUM, Los Angeles.

Get into... PLASTIC LAMINATING AT HOME!



Sensational New
**"ONE MAN
BUSINESS"**
...pays \$10 to \$20 profit
for each dollar of cost.

Make \$20 to \$30 a day by our
**MAGIC MAIL PLAN... get
orders and cash from your mailman!**

Here's the newest and most fascinating of all home-operated businesses. For the first time, a simplified machine brings the fabulous profits of Plastic Sealing and Plastic Laminating within the reach of the small operator. Can be

operated in a corner of the kitchen, basement, or garage. And any man or woman, regardless of age, education, or experience—can learn this interesting work in a few minutes of reading—can turn out professional jobs after one hour's practice.

TWO EXCITING FIELDS FOR BIG PROFITS!

No house-to-house canvassing. No face-to-face selling. We not only supply the equipment you need for the work, but also show you exactly how to cash in big daily profits from two big demand fields.

A FORTUNE IN PLASTIC SEALING

Millions of people want to protect valuable cards, photographs, documents and papers against wear, soil, and damage. By our MAGIC MAIL Plan you get this business through the mails. Open envelopes and take out money and orders. Details of this plan will amaze you. It will be sent free. Just mail coupon.

ENORMOUS PROFITS IN LAMINATING

A creative, artistic business. Gift shops sell your entire output. Just a few of thousands of giftwares illustrated on this page. Beautiful colors. Endless designs. Exclusive "one of a kind" appeal brings sales at ten to twenty times the cost of materials. Beautiful illustrations and instructions for making these artistic novelties sent free.

**NO MONEY—
Just Send Name!**



RUSH COUPON

Never before has such an opportunity been offered the small, home-operator—an opportunity to gain complete personal independence in a big money business of your own. Don't lose a minute. Get the facts at once. All information, fully illustrated with pictures, is free. Send the coupon—or send your name and address on a postcard. There is no charge now, or at any other time. Send for the information on this exciting opportunity today.



\$5-\$10-and \$20 BILLS COMETO YOU IN THE MAIL

By our MAGIC MAIL Plan you sit at home, send out mail, and get back money and orders. Additional profits in supplying lifetime protection for SNAPSHOTS—IDENTIFICATION CARDS—DISCHARGE PAPERS—DRIVERS' LICENSES—SOCIAL SECURITY CARDS—VOTERS REG. CARDS—MENUS—BIRTH CERTIFICATES—CREDIT CARDS—BIRTH AND WEDDING ANNOUNCEMENTS—PASSES—DOCUMENTS.

Lifetime protection. See how laminating prevents soiling, wear, and moisture damage with flexible plastic covers.



WARNER ELECTRIC CO., Dept. L109
1512 Jarvis Avenue, Chicago 26, Illinois

Please mail, postage prepaid, complete information with illustrations showing the things I can make and the money possibilities in Plastic Laminating. All this is free. No Salesman is to call. Also, tell me how I get orders and money from my Postman by the MAGIC MAIL Plan.

NAME _____
ADDRESS _____
CITY _____ ZONE _____ STATE _____

Thousands of Beautiful ART CREATIONS

Made by Laminating as explained in our Free information. Send coupon for list and pictures of COSTUME JEWELRY—JEWELS—CIGARETTE BOXES—CUFF LINKS—NOVELTY BUTTONS—TRAYS—CANDLESTICKS—COASTERS—CLOCK CASES—LAMP BASES—PICTURE FRAMES—BOOK ENDS—CHARMS—ADVERTISING SIGNS—NAME PLATES—BELT BUCKLES—CHECKERS—PAPER KNIVES—CHESSMEN—BOOKMARKS—TIE RACKS—KEEPSAKES OF ALL KINDS.

WORLD'S
BEST
WANT-AD
MEDIUM

CLASSIFIED ADVERTISEMENTS



Advertisements in this section \$1.25 per word, each insertion, minimum 10 words, payable in advance.

To be inserted under proper classification, copy must be in our office the 20th of the second month preceding date of issue

F. W. Johnson, Manager, Classified Advertising
Popular Mechanics Magazine, 200 East Ontario Street, Chicago 11, Illinois

YOU'LL PROFIT

By reading and answering the classified ads in this section. Hundreds of opportunities for you to make and save money

AUTOMOBILES, MIDGET CARS

CROSLEY Special. Build for under \$200.00. Instructions \$2.00. Sports Car, Box 711-G, Columbus 7, Ohio.

MAGAZINE About antique automobiles. Send for free sample copy. Franson's Motor News, Box 254, Eugene, Oregon.

JEEP Tops, American-Foreign convertible tops. Free catalogue. Mor-Nan, 307 Cambridge, Boston 14, Mass.

ANTIQUE Automobile color slides. 2x2. Illustrated catalog free. Universal, Box 779A, Beverly Hills, Calif.

HUNDREDS Of automobile catalogs—American, antique, foreign; dealer books, glossy photographs, shop manuals; free motor magazines—Offered by non-profit club. Write immediately. Get on free mailing list. Auto Maniacs, Stockbridge, Michigan.

CUSTOM Books; all motor books. Catalog 25¢ refundable. Automotive Press, 523 Ballough, Daytona Beach 4, Florida.

AUTO SUPPLIES AND EQUIPMENT

NEW Ford parts 1928-1932. Richard Huber, 15 Emerson, Clifton, N. J.

RADIOS Custom for 1952 through 1956 Fords \$38.90. Free literature. Nordic Radio, Box 582, Evanston, Illinois.

ATTENTION Auto mechanics. Beautiful cast aluminum plate emblem. Send \$1.00. Trade Emblems, 271 Pierce Ave., Norwood, R. I.

BUY Wholesale nationally advertised auto supply, thousands other products at big discount. Free "Wholesale Plan." American Buyers, Hertel Station, Buffalo 16-G, N. Y.

FORD T and A parts? Try best source old car parts anywhere. Wisneski, Milwaukee 7, Wis.

SAVE Money on jeep and army truck parts. Large inventory. Catalogs for jeep or GMC. American Auto Parts Co., 1830-PM Locust, Kansas City, Mo.

AUTOMATIC Headlight dimmer. Transistorized. Kit or ready to install. Nagos, Littleton, Massachusetts.

FREE Discount catalog—Speed, power, custom equipment. Alquist Engineering, Milford 7P, Pennsylvania.

UP To \$50.00 each for new or used GM-110 diesel fuel injectors. Parts also purchased. Bruce W. Mayer, 2090 East 19th Street, Cleveland 15, Ohio.

AUTO Accessory and parts catalog, 1956 edition—all new! 180 pages. Save up to 50%. Over 75,000 items, including Hollywood accessories, hi-speed equipment, rebuilt engines, all parts and accessories for all cars and trucks! Hard-to-get parts! Send 25¢ (refundable). J. C. Whitney, 1919-PM Archer, Chicago 16, Ill.

NEW And used parts at savings. Complete guaranteed parts service for all models cars and trucks, 1924 and later. Largest in the West. Army parts specialists. No catalog, write for quotations. Fast mail order service. Pioneer Auto and Truck Parts Co., 734 W. 13th Avenue, Denver, Colorado.

LATEST Custom accessories. Items not in stores. New low prices. Continental tire kits, push-button doors, trunks, etc. New illustrated catalog, biggest ever, 25¢. Eastern Auto, 3319-A South Grand, Los Angeles 7, California.

GM71-110 Discarded injector parts wanted. Bonus on HV. Bares, 7120 Carnegie, Cleveland 3, Ohio.

JEEP Owners—V8 power. Read Jeep owners ad, page 30.

YOU Can paint your car for only \$6.95. Thousands satisfied customers. Details free! Adams Industries, P.O. Box 243, Waco, Texas.

CRANKSHAFT Grinder, hand operated. Makes bearings fit without taking engine apart. \$3.75. Literature. L. D. McGee, 719 Cascade St., Wenatchee, Wash.

AUTO TRAILERS

EXCEPTIONAL Expanding eight foot trailer. Accommodates family of five. Build yourself. Literature 10¢. Framar Company, Wilmington, Mass.

TRAILER Building manual \$1.00. Booklet 30¢. Kamcraft, Box 1153, Milwaukee 1, Wis.

MOTORCYCLES, BICYCLES, MOTORSCOOTERS AND SUPPLIES

RECONDITIONED Motorcycles and motors. Chromium accessories. Complete stock Indian parts. Expert rebuilding. Fast service. Indian Motorcycle Sales, Kansas City 27, Missouri.

HARLEY-Davidsons—Used bargains, shipped prepaid. New, used parts, accessories for current and obsolete models. Bulletin, catalog 25¢. Knuth's (factory dealer), 2491 Fond du Lac, Milwaukee, Wis.

HEY Kids! Boys, girls. You can have continuous bright head and tail lights on your bicycle. No batteries to buy. New, amazing generator keeps lights bright. Lasts lifetime. Complete generator light kit \$5.00. Free details. Langen, 170 High, Fitchburg, Mass.

NSU And BMW motorcycles, 2 to 35 h.p., singles and twins, chaindrive and shaft-drive. Butler & Smith, P.O.B. 45, New York 24, N. Y.

SERVICYCLE \$8, Midget motorcycle \$10. Cushman motorscooter \$10, midget car \$25 less engine; Briggs engine \$4; four airplane tires \$3. (Mailorder only). Send 25¢ (35¢ for first class mailing) for directory-catalogue number 73, just out, listing these and hundreds of other bargains, homebuilders parts, plans, etc. Midget Motors Directory, Athens, Ohio.

BICYCLE Shock absorbers, \$5.95 post-paid. Leaflet. Thomas, Box 1873, Oakland, California.

BICYCLE Supplies. Substantial savings. Free delivery. Attleboro Cycle, Attleboro, Massachusetts.

PARTS For Cushman, Doodle-Bug, Salisbury, etc. Send make, model, 25¢ for price list. Motor Scooter Parts Co., Dept. P9, Box 7211 Indianapolis 1, Indiana.

SERVICYCLE \$20.00; Whizzer motorbike \$25.00; Cushman motorscooter \$25.00; midget auto \$25.00. Rush 25¢ (35¢ first class mail) for new catalog—959 listing many other amazing bargains in motors, midget cars, motorscooters, motorbikes, construction plans. Associated, Box 534, Toledo, Ohio.

AVIATION

AIRCOOLED Engine, Franklin 0-425-9, 245hp., six cylinders (three each side); 44% standard aircraft, with dual magnetos, ignition harness, carburetor. Low time! P.O.B. c.w.o., 98% off AAF cost, now only \$99.50. O. K. Williams, Box 6067, San Antonio, Texas.

AVIATION Surplus bargain catalogue. One dime. Box 22PM, Thomasville, Penna.

HELICOPTERS—1 And 3 man. Aviation marvels. Construct own. Plans, \$4.00, \$6.00 respectively. General Aviation, Box 384 Windsor, Ontario, Canada.

AVIATION Surplus materials; new, huge bargain catalog, listing over 1000 items; hydraulics, electrical, electronics, air, engines, airboat parts, etc. Send 25¢. Aero Parts Supply, 8102 Lockheed, Houston, Texas.

PROPELLERS. Plans, supplies by world's oldest and largest manufacturer of special design airboat and snowplane propellers. Latest designs. Prompt delivery. Satisfaction guaranteed. 48 page catalog 25¢. Banks-Maxwell, Box 3301E, Ft. Worth 5, Texas.

LIGHTPLANE Manual blueprints. Circulars illustrated 30¢. Kamcraft, Box 1153, Milwaukee 1, Wis.

ELECTRICAL SUPPLIES

LAMPS. Parts catalog containing wiring instructions 25¢. Gyro Lamps, 5402P Clark, Chicago 40.

ELECTRIC Pencil; Engraves all metals \$2.00. Beyer Mfg., 10511-H Springfield, Chicago 43.

ELIMINATE Middleman, buy direct from factory, utility light 25' yellow thermo plastic cord, side-outlet, swing-open case \$2.85. A. DeMambro, Mayville, New York.

LAMP. Electrical parts, wholesale. Thousands of items for repairing, converting. Catalog 25¢. Brown Lamp, P.O. Box 305, Clayton 5, Mo.

WELDING, SOLDERING, PLATING

A.C. Welders, 4 sizes. Lowest prices. Free literature. Holgerson's Serv., Canton, Kan.

WELDERS, 110/220, \$39.50. Morris, 1070 Inner Drive, Schenectady 3, New York.

ACETYLENE Welding outfits, new \$49.00; used \$29.00; arcwelders \$56.50. Eagle Welding, Dept. PM, 5085 Broadway, Chicago 40, Ill.

ELECTROPLATING Equipment, anodes and solutions for all types of plating. Instructions. Assemble your own plater and save. Free catalog. Ramyr, Dept. E-4, 1624 East First Street, Los Angeles 33, California.

BUY Welding supplies direct from manufacturer. Cable, welding rods, helmets, etc. Portable arc-welders and kits at tremendous savings. Free factory catalog! LeJay 47, Minneapolis, Minnesota.

"BUILD-UR-OWN" a.c. welder and a.c. power plant with a good used engine and low cost Hobart generator. Welds anywhere and supplies 5kw stand-by power for any emergency. Write Hobartweld, Box M-963, Troy, Ohio.

MACHINERY, TOOLS, SUPPLIES

AMAZING New power tool for all craftsmen. Low priced. Unusual. Write for free details. Expect something different. Douglas Scott Development Corp., 3931 W. 150, Cleveland 11, Ohio.

LAWNMOWER Sharpeners: \$59.75 to \$259.50 until Jan. 1. All new. Past. Turner-Cline, 430 Yellowstone, Pocatello, Idaho.

HARD-To-get tools for toolmakers and machinists. Transfer punches, parallels, angle plates, edge finders, and many other wanted tools. Send for free catalog. Ponto Tools, Box B, Leucadia, Calif.

CUSTOM Made blanking dies \$50.00 and up. Custom manufacturing. Southwestern Specialty Co., Box 3506, Sta. A, El Paso, Texas.

ACCURATE Lathe, English model makers. Science Now Company, Catskill, New York.

BUILD Your own tools, 60 page book of drawings and catalog of castings, \$1.00. Casting Specialties Co., Theinsville 11, Wis.

ENGINES, MOTORS, DYNAMOS

1/2 HORSEPOWER Motors, used, good, \$5.00 each, f.o.b. Plant Machinery Corp., Richmond & Norris Sts., Philadelphia 25, Penna.

REWIND Motors yourself. Complete instructions \$1.00. Lewis Mfg., Howell, Michigan.

WINDING Data, 275 motors, single and three phase, \$1.10. Data Company, Box 7631, Kansas City 28, Mo.

GAS Engines: "Continental" 1 1/2 h.p.; "Briggs Stratton" 1 h.p.; \$29.95 ea. f.o.b. Boston: All new, horizontal shaft, 4 cycle; details, money back guarantee, free. Northern, 172-M Merrimac Street, Boston, Mass.

SMALL Electric motors, Bargains. Literature free. Kitco, Dept. 4, Box 212, Monroe, Wisconsin.

A.C. Generators, 750 watt \$42.00, 1500 watt \$67.50; motors, 5 horse \$110, 3 horse \$87.50, 1 horse \$38.50. Butler, 1885 Milwaukee, Chicago.

BOATS, OUTBOARD MOTORS

FIBERGLASS. Free catalog. Sealite Fiberglass Process, 22259 Goddard, Dearborn, Michigan.

MARINE Conversions for Ford and Jeep engines. Catalog 25c. Lehman Manufacturing Company, 972D Broad Street, Newark 2, New Jersey.

FIBERGLAS Permanent boat waterproofing. Special 25% summer discount. Complete kits, \$9.45 up. Guaranteed materials. Easy application. Full instructions. Free literature. Ajax Plastics, Dept. PM, P.O. Box 1323, Fort Worth, Texas.

FORDS And Jeeps 100% marine engines with famous Convo-Kits. Deluxe catalogue 25c coin. Oscomotors, 3827B Lawrence, Philadelphia 40, Penna.

BOATS. Big savings. Free information. Boats, Box P-9, Henrietta, N. Y.

FREE Catalog! Boat kits, trailers, fiberglass, marine hardware. Luger Industries, Dept. M, 4452 Nicollet, Minneapolis, Minn.

NEW, Used, rebuilt marine motors. Marine conversions, fittings. Free catalog. Stokes Marine Supply, Dept. 24, Coldwater, Michigan.

BOAT Plans—Full size patterns. Frame kits. Modern inboard and outboards for amateur builders. Complete new catalog 50¢ or specify requirements. Glen Designs, Box 568, Compton, Calif.

BOAT Coverings, fiberglass, wholesale prices. Free literature, samples. Seifert's, Box 31M, DePere, Wisconsin.

BUY Wholesale nationally advertised outboards, thousands other products at big discount. Free "Wholesale Plan." American Buyers', Hertel Station, Buffalo 16-H, N. Y.

FIBERGLAS Boat coating. Plexiglas boat windshields—Clear, blue, green tints. Wholesale-retail. Instructive information catalog free! Gem-O-Lite, 5529 Cahuenga, North Hollywood, California.

PLYWOOD Boat plans, 21 for \$1.00. Catalog boat building plans 25¢. The Rudder, 15 Murray Street, New York City 7.

PLANS Catalogs; sailboat 35¢, powerboat 50¢. kits. Marinecraft, Box 161-M, Brighton, Mass.

PORTABLE Toilet. Four pounds. Folding aluminum legs. Standard seat. Disposable plastic bags. \$11.95 ppd. The Mail Mart, Box 175, Richmond, Indiana.

FULL Size, cut-to-shape boat patterns, blueprints, 7 1/2-38 feet. New 1956 illustrated 85 page "Build-A-Boat" catalog of naval architect-designed cruisers, runabouts, sloops, skiffs, outboard boats, sailing, racing, houseboats, 50¢. 1956 "How to Build a Boat" booklet, \$2.50. Cleveland Boat Blueprint Co., Dept. A-66, Box 1651, Cleveland 4, Ohio.

ATHLETIC EQUIPMENT, BODY BUILDING COURSES

4 MUSCLE Courses 25¢. Fully guaranteed. Sids System, Southgate, California.

BARBELLS Dumbbells. Courses. Free catalogue. Good Barbell Co., Reading, Penna.

OUTSTANDING Physical development! New guaranteed system uses only a rope! Strength, health, gain, reduce. Valuable booklet free. Ropercise, 4834 Art St., Room 205, San Diego 15, California.

BE Taller! Coach's "Inch-At-A-Time" system, \$2 complete. Marty Snyder, Box 195-HY, Union City, New Jersey.

SPORTING GOODS, GUNS, FISHING TACKLE, ARCHERY, TRAPPING

FREE—Below wholesale fishing catalog. Fishing Tackle Mart, Dept. 59, Box 6737, Chicago, Ill.

GUNS! We buy, sell, trade! Free! Send for latest list of used and new gun bargains, plus gun trading dope sheet. Describe your gun fully! Dept. CM-9, Klein's, 227 West Washington, Chicago 6, Ill.

FREE Fishing catalog—132 pages. Over 3000 hard to find fishing specialties. Netcraft Company, Dept. PM9, Toledo 13, Ohio.

CATCH Fish with smell. Old timer's secret recipes, formulas, processes, 10¢. Johnson's, 312-F Lake Avenue, Ithaca, New York.

JAP Rifle altering to 30-06, \$6.00. Japshells, \$3.75. Catalog 5¢. T. P. Shop, West Branch 11, Mich.

5000 BARGAINS, Firearms, binoculars, war relics. Catalog 50¢. Smith Firearms, Runnemed, N. J.

FREE Giant handbook! "How to Bow-hunt and Bowfish" 100's revealing secrets! Also tells how to improve shooting accuracy, select best equipment, make your own tackle, etc. Illustrated! Yours free with large bargain catalog. (Save 50% on archery equipment). Send 25¢ to cover mailing expenses refunded on first purchase. Supply limited! Hurry! Malibu Archery, 1036RSR South La Brea, Los Angeles 19, California.

BUY Wholesale nationally advertised sporting goods, thousands other products at big discount. Free "Wholesale Plan." American Buyers', Hertel Station, Buffalo 16-I, N. Y.

JEEP Owners—V8 power. Read Jeep owners ad, page 30.

180 PROFUSELY Illustrated pages antique pistols, swords, daggers, armor, etc. 50¢. Robert Abels, M880 Lexington Ave., New York 21.

DIVING Equipment for skin divers and professional divers. Send 25c for catalog and decompression chart. Desco, 212 N. Broadway, Milwaukee 2, Wisconsin.

SAMPLE: 25c Copy of "The Archers' Magazine." Send 10¢. 1200 Walnut Street, Philadelphia 7, Pennsylvania.

MOLDS For fisherman's sinkers, jigs, squids, casting and spinning lures. Free catalog. Sweet's Molds, Tonawanda 1, New York.

SKIN Divers, 3000 lbs. certified air compressing stations, 110v, \$200.00. Garrett, 3471 Weldner, Oceanside, N. Y.

FORTUNE Possible raising crickets and 12 inch African fishworms. Free literature. Carter Ranch, Plains, Georgia.

NYLON Rope, lines, cords. Every description for all household and sportsmen's uses. Finest made. Free catalog and samples. Beebe Cordage Co., Cranford 8, N. J.

CAMPING Equipment, tents. Direct from manufacturer. World's largest selection. Send 15¢ for 120-page 1956 tent and camping equipment catalogue-handbook. Morsan Tents, 10-21R, 50th Ave., Long Island City 1, New York.

FISHWORMS. Breeders, 100, \$1.00. Manual 50¢. Literature free. Three Oaks Ranch, Dresden, Tenn.

COLT 38 Frontiers, new \$125; excellent .25 automatics \$24.50; Kentuckles \$39.50; Lugers \$39.50; P38's \$34.50; Springfield \$24.50. Catalog 50¢. Agramonte's, Yonkers 2G, N. Y.

BOWLERS Proven strike method. Top scores. Start today. Speedy, accurate. \$1.00 postpaid. 5 day return guarantee. Bowlers Research, 11 East 53 Street, New York 23, N. Y.

BINOCULARS, TELESCOPES, MICROSCOPES, MAGNIFIERS

DYNASCOPE—Sensational new reflector telescope. Send for details. Criterion Co., Dept. DP 24, Hartford, Conn.

WAR Surplus bargains: Millions of lenses, instruments, telescopes, binoculars, components and complete line of astronomical telescope items. World's greatest optical market place! Send only \$1.00 for beginner's 10-lens kit and big instruction booklet Stock 2-CH. Write for catalog CH, free! Edmund Scientific Corp., Barrington, New Jersey.

REFLECTOR Telescope kits \$6.25 (3") to \$175 (12"). Mirrors, cells, focusing mounts, tripods, eye systems. Anything, everything in telescopes. Free catalog. Also ready to use telescopes from \$25. Esco Products, Oakridge, New Jersey. Showroom, 166 Church Street, New York City.

BUILD Your own reflector telescope. Complete kit: mirrors, eyepieces, tripod, all other accessories. Request free illustrated literature. Criterion Manufacturing, Dept. KPM21, Hartford, Conn.

AMAZING Prices, precision binoculars and gunsopes. Free trial. Folder, "Binocular Selecting," catalog free. Prentiss Importers, Mercury Bldg., West Los Angeles 25, Calif.

REFLECTING Telescope, 60X, completely assembled \$29.75. Guaranteed observatory clearness. Free information. Skyscope, 475 Fifth Avenue, New York City 17.

SAVE 35% \$150,000.00 Binocular stock! Pocket sizes to 20X. \$3.95 to \$250.00. Also telescopes, riflescopes. Free 56-page 3-color catalog. United, 9043 S. Western, A-408, Chicago 26, Dealers wanted.

400X Telescopes easily made. Kit includes focusing tube, erector, five finished lenses and building instructions—\$3.75. Free booklet on completed telescopes, tripods, mirrors, lens kits, etc. Suffolk Science, Mattituck 3, New York.

EXTRAORDINARY Binocular presentation. Write Sheehan & Company, Dept. A19, 1420 Kipling, Houston 6, Texas.

150X Telescopes. Revere Inst. Co., 5880 Hollywood Boulevard, Hollywood 28, Calif.

REFLECTING Telescopes, mirrors, kits. Lowest prices anywhere. Free catalogue. Aurora Telescope Company, 266 Avenue C, Bayonne, N. J.

BINOCULARS, Telescopes, microscopes, terrific values \$3.98 up. Request free money saving catalog. Criterion, Dept. P46, Hartford, Conn.

PETS—DOGS, BIRDS, RABBITS, HAMSTERS, ETC.

MONTHLY Bird magazine (budgies, canaries, finches, etc.). One year \$3.00. American Cage-Bird Magazine, 3449 N. Western Avenue, Dept. P.M., Chicago 18, Illinois.

PROFITS! Raise Nutria beavers. Herb Miller, 513 Kent, Lubbock, Texas.

HAMSTERS, Golden: young, \$3.00 pair. Fully developed \$4.00 pair. Adirondack Hamstery, Prospect 160, New York.

RAISE Rabbits on \$500 month plan. Free details. White's Rabbitry, Jackson, Mich.

UNUSUAL Pets: Baby monkeys, ocelots, kinkajous, skunks, etc. Send 10¢ for complete price list. Nature at Home, 4001 W. Pico, Los Angeles, California.

WHITE German Shepherd puppies. Theatrical dog tricks. Knoff, Nashotah, Wisconsin.

RINGTAIL Monkeys \$37.50. Scentless skunks \$15.00. Raccoon cubs \$10.00. Armadillos \$6.00. Fox squirrels \$15.00. Flying squirrels \$4.00. Turtles, snakes, frogs. Catalog 10¢. Ray Singleton, Rattlesnake, Fla.

RAISE Mink: Free booklet, pen plans, inside secrets, feed, care. Mink are money makers. Investigate today. Lawrence Molder, Brigham City 12, Utah.

CHINCHILLAS—17, Equipment. Highest bid. Sealy, 20191 Charleston, Detroit 3, Mich.

MAKE Money raising chinchillas, mink, nutria, rabbits, cavies for us. Free catalog. Keeney Brothers, New Freedom 2, Penna.

GROW Mushrooms. Cellar, shed. Spare, full time, year round. We pay \$3.50 lb. We paid John Betts \$7,977.76, he started as amateur. Free book. Mushrooms, Dept. 171, 2954 Admiral Way, Seattle, Wash.

SPORTSMEN: World's largest kennel offers 500 Pointers, Setters, Straight Cooners, Combination Hounds, Rabbit and Squirrel Dogs, Beagles, Fox and Wolf Hounds, Trial. Prices reasonable. Catalogue free. Smokey Mountain Kennels, Cleveland, Tennessee.

BEAUTIFUL Pure white pedigreed police puppies. Ansonia Kennels, Mose, N. Dak.

HUNTERS! Raccoon Mountain and Short Creek kennels now combined. Large number of coonhounds, foxhounds, rabbit-hounds, beaglehounds, bird-dogs, puppies. Free literature and pictures. Trial. Dures Thomas, Owner, Box 464, Boaz, Alabama.

HAMSTERS, Pair \$2.95. Free booklet. Jer-Fre's Hamstery, 2425 Hoyt, Muskegon Heights 13, Mich.

MINK Raising information free. Complete. Lake Superior Mink Farm, Superior, Eel, Wisconsin.

RAISE Rabbits successfully by knowing facts. 48 page illustrated book describing 25 breeds. Housing, feeding, breeding, marketing, etc. Plus bulletin. 25 cents. American Rabbit Association, 36 Arba Building, Pittsburgh, Penna.

STANDARD Rabbit Journal, Milton 3, Penna. Year \$1.00. Sample dime. Beginners manual 25¢.

PLANTS, SEEDS, BULBS, NURSERY AND GARDEN SUPPLIES

GINSENG, Goldenseal. Roots bring up to \$12 pound. Full information. F. M. Collins, Viola, Iowa.

RAISE Your shrubs, trees from seed. Free planting guide, price list. Woodlot Seed Co., Norway 9, Michigan.

WORLD'S Greatest cash crop. Free information. Write Ginseng Gardens, Asheville, N. C.

FARMS, FARM LANDS, REAL ESTATE

OZARKS! \$7 Acre. Diversified listings free. Write: Armstrongs, Shook, Missouri.

HOMESITES \$15 Monthly—California's finest garden section. Morro Bay's scenic shores. Wonderful fishing, boating. Fertile soil, softest water, temperate climate, congenial community. Free literature. Richard Otto, Department M, San Luis Obispo, California.

NEW Strout fall catalog. Just out! Mailed free! Over 3000 bargains. 36 states, coast-to-coast. Farms, homes, businesses. World's largest! 56 years service. Strout Realty, (MF), 7 So. Dearborn St., Chicago 3, Ill.

TAXLESS Homes. Florida's Highlands. Informative literature. Theodore Gau, San Antonio, Florida.

FLORIDA, Nice homesites, \$245 at \$10 monthly. Folder free. Howard Vernor, DeLand, Florida.

FLORIDA—Beautifully shaded homesites, acreages. Central Florida. ¼ mile to excellent fishing. Boat rights, \$295. \$10.00 monthly. Free brochure. Haines Creek Heights, P.O. Box 1597, Eustis, Fla.

FREE Information. Government land. U.S., Alaska. Sledge Surveys, Macon, Mississippi.

FLORIDA: Waterfront acreage. 20 acre tracts on west coast. Deep water. Wonderful fishing. From \$995, \$95 down, balance \$15 monthly. No interest. Harry Boehme, 309 Biscayne Bldg., Miami, Fla.

FARM in Florida—\$12,000 per acre possible. Lease 50¢ per acre per year. Free seed. No clearing or draining. Complete details: \$10.00. Creekmore, Apalachicola, Florida.

500,000 ACRES California state government land low as \$5 acre minimum offer. Send 10¢ (coin) for information on available lists and maps of 40 to 640 acre tracts. Pacific Lands, 6441-43 N. Figueroa St., Los Angeles 42, California.

PROFITABLE OCCUPATIONS

WELDING Pays big money. Learn easily at best equipped school in country. Non-profit school with low cost training. G.I. approved. Write Hobart Trade School, Box M-962, Troy, Ohio.

MAKE Money writing short paragraphs! No tedious study. I tell you what to write, where and how to sell; and supply list of editors buying from beginners. Many small checks add up quickly. Write to sell, right away. Send for free facts. Benson Barrett, Dept. CP-27-W, 7464 Clark, Chicago 26.

WHOLESALE Catalog! 30-80% discounts! Appliances, musical instruments, typewriters, tools, watches, jewelry, cameras, housewares, etc. Consolidated Distributors, 1300-14 Main, Clifton, New Jersey.

MUSHROOMS Grown boxes. Manureless process. Spawn \$1.00. Gordons, 553 William, Winnipeg, Manitoba.

SUCCESS 1000 Plans. Free. Higher income, independence, fun. Success Systems, 162 Colin, Toronto 7, Canada.

YOUR Own wholesale business without investment. Free catalog. Norris, 487-X Broadway, New York City.

BUY Wholesale thousands nationally advertised products at big discount. Free "Wholesale Plan" American Buyers', Hertel Station, Buffalo 16-B, N. Y.

LEARN Free how to become glamour photographer. Make big profits photographing beautiful models. Opportunities nation-wide. No previous experience or expensive equipment needed. Write for free illustrated Success Plan. Harrison's, 1031-C Magnolia Park Station, Burbank 20, Calif.

GROW Mushrooms. Cellar, shed. Spare, full time, year around. We pay \$3.50 lb. We paid John Betts \$7,977.76, he started as amateur. Free book. Mushrooms, Dept. 99, 2954 Admiral Way, Seattle, Wash.

FOREIGN Jobs—Latin America, Alaska, Canada, up to \$1500 monthly. Up-to-date 1956 foreign service directory gives complete information; hot list of firms hiring for military and civilian construction, aircraft, oil, exporters-importers, mining, \$1.00. How-when-where to apply. 9th successful year! Global Reports, Box 883-S, Hollywood 28, Calif.

FREE Folio "\$5,000-\$45,000; Unlimited Vacations." No merchandise, equipment. Unknown! Work home, sparetime! Haylins, Carlsbad, Calif.

RAISE Pheasants on \$100 week plan. Little capital and space can make you independent. Free details. Great Central System, Columbus 1, Kansas.

MAKE New greaseless doughnuts in kitchen. Sell stores. Free recipes. Michael Ray, 3605 South 15th Ave., Minneapolis 7, Minnesota.

BE The Popular Mechanics representative in your neighborhood and earn big profits in your spare time. Write Popular Mechanics Magazine, Room 408M, 200 E. Ontario St., Chicago, Ill.

FORTUNE Possible raising fishworms and crickets. Free literature. Carter Wormery, Plains, Georgia.

AUCTIONEERING—Home study course. Diploma granted. Auction School, Ft. Smith, Ark.

FREE Book "505 Odd, Successful Businesses." Work home. Pacific, Oceanside, Calif.

MAKE Flexible molds. Cast plaques, figurines. Free sample. Tooker, 630-M Chestnut, Hamilton, Ohio.

LEARN Real estate by listening to records. Lee Institute, Brookline 46, Mass.

WANT Share in booming \$6 billion business? 40,000,000 auto accidents; 365,000 home fires; \$100 million railroad losses need claim adjusting. Train home for terrific full or spare time opportunities. Free book. Universal Schools, 6801 Hillcrest, PM9, Dallas 5, Texas.

HOME Mailorder beginner's manual, sources, methods, opportunities, 25c. Carnahan Bros., 9610 Acacia, Fontana, Calif.

MAGAZINE Subscriptions—Highest commissions, bonus. Qualified Agency, 451JA Kingston, Brooklyn 25, N. Y.

60% PROFIT Cosmetics. \$25 day up. Hire others. Samples, details. Studio Girl Hollywood, Glendale, Calif., Dept. 1269-H.

MUSHROOMS Now bring bigger, quicker cash. Spawn plus newest manureless growing, marketing methods. \$1.00. Free literature. Luxur, 641 South 19th, Newark 3, N. J.

BUY Wholesale 750,000 products. Details free. Carter, Box 6011-D, Chicago 80.

BOOKS, PERIODICALS, PICTURES, POSTCARDS

BRITISH Book bargains—All subjects. Catalog 10¢. Transbooks, Box 22-PM, Brooklyn 26, N. Y.

CLAN Moffat Bulletin, \$1.00 copy. 11303 75 Avenue, Edmonton, Canada.

NATIONAL Geographic Magazines, 1888-1956. Periodical Service, Box 465-PM, Wilmington, Delaware.

BOOK Catalog, 1000 interesting titles. Send 10¢. Books Publishing Co., Amityville 3, N. Y.

OUT-Of-Print books at lowest prices! You name it—we find it! Fast service. No obligation. International Bookfinders, Box 3003-PM, Beverly Hills, Calif.

RARE Magazines, catalog 10¢. National Magazine Exchange, Box 1375-P, San Antonio 6, Texas.

HORSE Books—Breaking, training, care. Carson, 1304 W. Kiowa, Colorado Springs, Colorado.

BOOKFINDERS! All subjects. Send wants! Jaher Book Service, 183 Hazelwood Drive, Westbury, N. Y.

"SCIENCE Milestones." Records march of science starting 400 years before Christ, right up to date. Amazing facts revealed. 312 pages packed with startling information that will thrill you. A real history of science. \$5.00. Literature free. Popular Mechanics Press, 200-SM East Ontario St., Chicago 11, Ill.

JOHN Friend, bookbinder, can get the book you want. Free search service. Box 197PM, Cardiff, Calif.

BOOKHUNTERS! All subjects. Send wants! College Book Service, 52 W. Kingsbridge Rd., New York 68, N. Y.

FLYING Saucer books, rented, sold. New Era, BM-18 Melrose Building, Houston 7, Texas.

FREE: Exciting catalog packed with books covering most everything. Think of it—From cover to cover you will find described and illustrated hundreds of books telling how to fix and how to build almost anything. How to remodel your home; do your own decorating, plumbing, electrical work. Simplified books covering concrete work, carpentry, painting, furniture making and refinishing. How to build your own boat, home workshop tools. Best books on photography, welding, hobbies, homecraft. How to make a home freezer. Send for your free copy now. Popular Mechanics Press, 200-BC East Ontario St., Chicago 11, Ill.

GAMES, TOYS, NOVELTIES

PLAY "Big-League" baseball! 50 stars, diamond, rules, dice, score sheets \$2.98. Pennant Race, Box 61, Syracuse 10, N. Y.

MAGIC TRICKS, PUZZLES, JOKER NOVELTIES

WORLD'S Finest professional magic, Joker novelties. Giant illustrated catalog 10¢. Top Hat, Evanston 12, Illinois.

3100 NOVELTIES, Jokes, tricks, gadgets, funmakers, hobbies. Big catalog 10¢. Johnson-Smith, D-202, Detroit 7.

DOLLAR Magic set free with catalog 25¢. 4462-PM Germantown, Philadelphia.

500 TRICKS, Douglas famous 120-page catalog, only 10¢. Fastest service to magicians for 30 years. Send 10¢ today. Douglas Magicland, Dept. 1, Dallas, Texas.

SMOKEBOMBS 25¢. 7 For \$1.00. Terrific! 4463-PM Greene, Philadelphia 44.

WOODEN Nickels, catalog, trick, 10¢. 1,500,399 tricks, jokes, Magic, Box 1375-P, San Antonio 6, Texas.

FREE Trick and professional catalog of 600 tricks, \$1.00. Terry's Magic Studio, 1921-66th Street, Brooklyn 4, New York.

SENSATIONAL Magician's wand 25¢. Vanishes handkerchief! Catalog included. Box 1352-PM, Philadelphia 5.

PROFESSIONAL Catalog, 175 pages, 25¢. Williams, 900 Plymouth, Ellwood City, Penna.

SVENGALI Trick deck free with catalog 50¢. 1746-PM Market, Philadelphia 3.

BE A magician! Large professional catalog of latest tricks. 35¢. Ireland, C-109 North Dearborn, Chicago 2, Illinois.

VENTRILLO, Professional voice-throwing instrument and catalog 25¢. Box 971-PM, Philadelphia 5.

COINS, TOKENS, CURRENCY

LARGEST Coin magazine, 180 pages, 35¢. Scrapbook, 7320-J Milwaukee, Chicago 31.

25 DIFFERENT Indian cents \$2.00, bargain lists free. Sayers, 1000 East Unaka, Johnson City, Tennessee.

100 DIFFERENT Foreign coins \$4; 100 Indianhead cents \$6. Parker, 1254 Market, San Francisco 2, Calif.

TREMENDOUS Investment! In 1955 thousands made 50% return holding U.S. government proof coin sets six months. Information \$1.00. Brian Beck, 11th Avenue, West Bend, Wisconsin.

ILLUSTRATED Catalog, U.S. paper money, \$1.00 postpaid. Quaker, 2218 O. St., Washington 7, D. C.

BRILLIANT Proof set \$3.95. Large \$1.00 bill \$2.95; new \$4.95. Giant bargain catalogue 35¢. Bebee's, 4514 North 30th, Omaha 11, Nebraska.

36 DIFFERENT Foreign coins \$1.00. Robbins, 1007 Cleaveland, Montgomery 8, Alabama.

FIVE Foreign coins from Switzerland, Belgian East Africa, etc., plus foreign banknote, only 10¢ with coin approvals. Littleton Coin Company, Littleton R1, New Hampshire.

GET Profit and pleasure in collecting old coins. Send 10¢ for 56-page illustrated coin catalog. You'll be delighted with it. Send for it now. B. Max Mehl, 370 Mehl Building, Fort Worth, Texas. Largest rare coin establishment in U.S. Established 56 years.

6-IN-1 Special! Magnifying glass; check list; 25 coin envelopes; giant 60 page bargain catalog; ten different Indian pennies; Mexican ten-peso; All six, \$1.00 postpaid. Ben's Coin Shop, 31 North Clark, Chicago 2, Illinois.

FREE! Foreign coin, banknote and coin collectors illustrated catalog to approval service applicants. Send 3¢ postage. Tatham Coinco, Springfield 30, Mass.

SAN Francisco mint closed! Made only cents and dimes in 1955. In short supply and great demand. One each, brilliant uncirculated, for 25¢. Free coin lists with order. Bryson Stamp & Coin Company, 612 White, Toledo 5, Ohio.

BARGAIN Lists, Indianhead cent, 10¢. Economy Sales, 157 Dean, Mansfield, Mass.

U. S. Large cent, 2¢ piece and bargain list, only \$1. Delmaco, Box 1123, Wilmington, Del.

MORGAN Dollars, 1878-87-90-91-97S \$2.00 ea. New illustrated catalog 25¢. Shultz, Box 746, Salt Lake 10, Utah.

100 COINS and bills, \$1.00. Oddehon, Box #82, St. Louis, Mo.

55S CENT 10¢, 55D quarter 30¢, 55D dime 25¢. Coin list free with order. W.esc. Box 8444, Dallas.

\$20 PAID For 20 Lincoln cents taken from circulation. Send \$1 for list of these cents. This dollar refunded with first purchase. Gasser, Box 34-615, Los Angeles 34, California.

THOUSANDS Foreign coins. Lists 6¢. Benson, 2525 Middle Road, Davenport, Iowa.

OLD Money wanted. Will pay \$100.00 for 1894 dime, S. mint, \$50.00 for 1913 Liberty Head nickel (not buffalo). Big premiums paid for all rare coins. Send 4¢ for large coin folder. May mean much profit to you. Numismatic Co., Dept. 20, Fort Worth, Texas.

BRILLIANT Uncirculated 1954-S mint set \$1.75, 1955-S 25¢. Armstrong, South 206 Howard, Spokane 4, Wash.

STAMP COLLECTING

16 "FIRST Issues" from 16 countries, 25¢! Extraordinary collection (all Scott #1, including Singapore, United Nations, Vietnam, etc.). Rare value! Approvals. Variety Stamps, 57-F Circuit, Newton Highlands 61, Mass.

FREE! Giant catalog offering thousands of bargains. Sent with beautiful approvals. Jamestown Stamp Co., Dept. E9PMC, Jamestown, N. Y.

ROOSEVELT, Flower triangles, 26 others, 3¢. Approvals. Marylandco, Arlington, Baltimore 15, Maryland.

100 DIFFERENT Austria 10¢. Approvals. Aronson, Box F, Newton Centre 59, Mass.

WEDDING, Pipex, triangles, animals, free with approvals. Choice, Box 366, Miami Beach 39, Florida.

FIFTY Different British colonials. Plus dozen Confederates (facsimiles) dime! Approvals. Gene's, 1707 N. Congress, Austin, Texas.

MONACO Nudes, mint 10¢. Approvals. Barricks, 1734 Seward, Detroit 6, Mich.

DEALERS. Wholesale list. Postage 3¢. Frank, 5031 Queensberry, Baltimore 15, Maryland.

MINT Stamp grab boxes. \$2.00 each. Elroy Foley, Northwood, Iowa.

OPPORTUNITY Knocks! Receive monthly stamp-news journal free as you receive approvals. Write: Greg's, 2369 Benrus Blvd., San Antonio, Texas.

1000 DIFFERENT Worldwide, only \$1.50. Universal, Box 6, Kenosha 5, Wisconsin.

UNITED States commemorative collection containing 33 different—10¢. Approvals. White, 516-A Avenue L, Brooklyn 30, New York.

100 DIFFERENT Switzerland 25¢. Approvals. Aronson, Box F, Newton Centre 59, Mass.

CYPRUS—Free set (4 stamps) to approval applicants. Ampco, Box 4207, St. Louis 16, Mo.

513 DIFFERENT Worldwide from Cunha, Sudan, Libya, etc., cataloging over \$10 only 35¢. Approvals. Littleton Stamp Co., Littleton, Q1, N. H.

CANADA—Newfoundland collection including early issues, commemoratives, pictorials and high values. Plus set of fascinating triangle stamps. Plus set of unused British Colonies. Plus large stamp book. All four offers free. Send 10¢ to cover postage. Empire Stamp Corp., Dept. PM, Toronto, Canada.

AMERICAN Stamps! Coins! Extensively! Sullivan, 127-F East 4th, St. Paul 1, Minn.

U. S. Catalog, Olympic set, 1000 hinges 25¢. Approvals. Buckey, 208 Ludlow Bldg., Dayton 2, Ohio.

WOW! 135 All different Germany 10¢. Zeppelins, semi-postals, airmails, high values. Big bargain lists and approvals included Jamestown Stamp, Dept. A9PMC, Jamestown, N. Y.

90,000 STAMPS Disposal sale! Big lot \$1. Extra special better stamps \$2. Giant assortment \$5. Persil, 436 New York Ave., Brooklyn 25, N. Y.

30 DIFFERENT Commemoratives 1893 up 10¢. U. S. approvals. K&B, Box 70, Brooklyn 23, N. Y.

TRAVEL Through 50 countries! A virtual world cruise! 50 stamps, each from a different country, Abyssinia to Zanzibar. Bargain unsurpassed! To new approval applicants, 5¢. Avalon Stamp Co., Dept. M, Springfield, Mass.

TWO \$3.00 U.S. stamps plus 20 different, 10¢ with U.S. approvals. Irwin, Box 1105, Brooklyn 30, N. Y.

SELL Your surplus good grade stamps. Write, describing fully what you have. Vanroy Shirk, Lebanon, Pennsylvania.

FREE! Catalog! About stamps, illustrated. Free! The Stampmart, Hartford 1, Connecticut.

FREE United States price list. Mark Hanna, 335 Fifth Ave., Pittsburgh 22, Penna.

50 DIFFERENT Argentine 10¢. Approvals. Reuter, 611 W. 40th Pl., Los Angeles 37.

OLD Scarce U.S. seconds on approvals. Slight imperfections, lowest prices. Herfeld, Clintonhill Sta., Newark 8, N. J.

U. S. Classics. Over 50 yrs. old. 15 selected old-timers. Missing in biggest collections. All 15 at less than 1¢ each. 10¢ with approvals. Jaro, Box 246-T, New York City 8.

50 DIFFERENT United States 5c with bargain approvals, lists. Bookman, Box 8245-M, Madeira Beach, Fla.

AMAZING Offer! 200 United States stamps—including commemoratives, airmails, high denominations to \$1.00. Only 10¢ to approval applicants! Illustrated bargain lists free. Mystic Stamp Co., Dept. 80, Camden, New York.

WORLD'S Largest stamp (7½ x 14 inches). A real curiosity! Retail for 50¢, only 3¢ to approval applicants. Tatham Stamp Co., Springfield 30, Mass.

100 OLD United States between 1861 and 1935, \$1.00. Roush Stamps, 51 Chestnut, Mansfield, Ohio.

225 STAMPS For only 10¢! This mammoth value includes airmails, pictorials; stamps from strange countries cataloging up to 25¢ each! Also approvals. Mystic Stamp Company, Camden 80, New York.

FAMOUS Men, jungle scenes, zoo, United States commemoratives, 100 others. Ten cents with request for thrifty approvals. Casner Stamps, 247-A Riverside, El Paso, Texas.

MINT Commemoratives at face! Send 25¢ for surprise packet of all different, mint U.S. commemoratives. Mint U.S. approvals too. Western, Box 1689P, Salinas, California.

UNITED States approvals. Select copies, used—mint. Kingsbury, Fairfax, Vermont.

ICELAND 10 Different beautiful stamps for only 10 cents to applicants for our good old fashioned approvals. Old Colony Stamp Co., Dept. A, Milford, Connecticut.

100 DIFFERENT China 10¢. Approvals. Coast, P.O. 2187H, Santa Ana, California.

100 YEAR Old United States stamps are sent on approval together with all commemoratives, airmails, etc. Also all foreign, Roosevelts, etc. Send 10¢ for 50 different U. S. and approvals. Globus, New York 10, N. Y. Dept. 213.

FREE! 55 British Colonies, 5¢ postage. Kensington Stamps, Buffalo 15, N. Y.

FREE! Monaco wedding stamps, given applicants for approvals. Exotic, Box 482-MM, Coral Gables 34, Florida.

U. S. Stamps—At discount prices. Giant illustrated catalog. Only 10¢. Raymax, 37-VZ Maiden Lane, New York City 38.

EXCITING "Strange countries" packet. Free with approvals! Saxon, Orange, Calif.

1-2¢ EACH! Thousands of exciting worldwide stamps. Free examination. Cole, Box 223-A, Buffalo 21, N. Y.

BULGARIA Pictorials: 50 diff. 15 cents. approvals. Boger, Box 152, North Wales, Pennsylvania.

AMERICA'S Finest U. S. catalogue free. Stone's, 192 Washington, Boston 8, Mass.

FREE With approvals, Spanish Zaragoza religious set. William, Diamond, Penna.

UNITED States. Fine mint airmails. #C7, #C8, #C9, #C10. Only \$1.00. Approvals accompany. Whiton Paine, Westport 11, Connecticut.

DOMINICAN Republic. 10 pictorials. 10¢ with approvals. Seminole Stamps, Box 1138-P, Coral Gables 34, Florida.

SELL Stamps to our readers. Your ad in this space will be read by thousands of stamp buyers. I'll prove that to you. Write now for Folder "S." F. W. Johnson, Classified Advertising Manager, Popular Mechanics, 200 E. Ontario St., Chicago 11, Ill.

300 DIFF. World wide 25¢. plus surprise packet. Packet list free. Econopackets, Box 168, Riverside 9, Calif.

14,000 DIFFERENT — Yours on our streamlined systematic club plan for only 50¢ weekly. Big shipment every 4 weeks. Details free. L. G. Ware, Baldwin 75, New York.

GIANT Approvals, thousands different, 1¢ and 2¢ each. Wahl's Stamp Exchange, 7008P Farragut, Chicago 31, Ill.

FINER United States? Get my illustrated pricelist 25¢. Refunded first order. M. Souza, Jr., 323 Hersom, New Bedford, Massachusetts.

PRICE List free. Peter Wetterquist, 1635—13th Avenue, Rockford, Illinois.

FIVE Scott international collections for sale cheap. Others also. List free. Alateio, Maynard, Massachusetts.

25 OLD U.S. 10¢, 1/2¢ approvals. Richard Carson, Council Grove, Kansas.

100 DIFFERENT U. S. stamps, one dollar. Includes several 19th century. Feuer, 108 S. Twyckenham, South Bend, Ind.

30,000 STAMP Grabbags, 25¢ each. Billingslea's, Gilmer 5, Tex.

40% SCOTT Or less. Hummer, 1523 N. Valley, Burbank 1, Calif.

500 WORLDWIDE Mixture. Big variety. 25¢. Monjar, Fairmount, Cincinnati 14, Ohio.

FREE Gift with three years subscription. The Stamp World \$1.00. Robert Ward, 7117 Kleber, Cleveland 31, Ohio.

MONACO Wedding set (5). "Philatelic Reader," 10¢. Approvals. Philately, 800C Kildonan, Winnipeg 5, Canada.

FREE Sample! Interesting. Illustrated. Informative! National Stamp News, Anderson, South Carolina.

FREE United States illustrated catalog. Bailey, 45 Bromfield, Boston, Mass.

66 BRITISH Colonies 6¢, approvals. Casto, Box 357, Dunbar, W. Va.

ALBANIA-Roosevelt set free. Approvals. W. B. Stamps, Wilkes-Barre, Penna.

55 FOREIGN Free to approval applicants. Collier, Box 142, Chamblee, Ga.

FREE! Smallest stamp. Giant, midget triangles. Approvals. Delton Page, Box 201X, East Paterson, New Jersey.

PHILATELIC Agencies—Directory listing 100 throughout world, \$1.00. Bedard Publications, Box 637A, Detroit 31, Mich.

ECONOMICAL, 1/2¢, 1¢, 2¢. Approvals. 22,000 varieties available. Dresel, 230-N Hamilton, Teaneck, New Jersey.

25 DIFFERENT From 25 countries, 25¢ with approvals. Marquette, 3706 W. 69th Place, Chicago 29.

MOZAMBIQUE Company set free. Approvals. Weitz, Box 83F, Orange, N. J.

BARGAIN. 200 Different U. S., 200 different Canadian, for \$5.00. Guaranteed. E. Pilon, 8915 Hochelaga, Montreal 5, Canada.

100 FOREIGN, 20 U.S. commemoratives, 10¢. Approvals. Weckerling, 3210A Hancock, Austin 3, Texas.

LISTS 3¢, U.S., Canada, worldwide items. As Penniston, Norborne, Mo.

FREE! Seven short sets! Approvals. Gernert, 4235-X Alton, Louisville 7, Ky.

U.S. Flag, \$5.00 stamps, 25 different collection. Only 10¢. Approvals. Willett Stamps, Box 390-A, Mount Kisco, N. Y.

1000 WORLDWIDE \$2.00, 6000 \$10.00. Commemoratives accepted. Boettger, 488A. Kitimat, B. C., Canada.

100 STAMPS 10¢ With approvals. Guyton, Box 1275, Monroe, Louisiana.

AMERICAN Commemoratives; Colonial pictorials; Asian topicals; with surprising approvals. Bristol, Canton Center, Conn.

5000 DIFFERENT, Free details, sample 25¢. Flint, Box 66M, Fall River, Mass.

77 DIFFERENT U.S. — 25¢ approvals. Utechs, 1143D North Keeler, Chicago 51.

SURPRISE Set and fifty all different free with approvals that satisfy. Stamp Imports, Peterborough, Ontario, Canada.

50 DIFFERENT Australia, 10¢ approvals. Valley Stamps, Box 414, Spring Valley, California.

ILLUSTRATED Catalog, 101 different stamps only 25 cents. Golden Bear, 6818 Gladys, El Cerrito, Calif.

SWITZERLAND Prize package! 50 different, including trains, bridges, castles, commemoratives, bi-colors, pictorials. All for 10¢ with approvals. Molzan, 720 Pomona, El Cerrito 8, California.

10 BEAUTIFUL Triangles, 10¢. With approvals. Lowell Otis, San Andreas, Calif.

EXTRA! Special offer this month, 3 rare old used U.S., \$2.50 catalogue value, only 50¢ with approvals. Metropolitan Stamps, Box 312Z, Jackson Heights, N. Y.

ANTIQUES, RELICS, INDIAN GOODS, CURIOS

10 ANCIENT Arrowheads \$2.00. Grooved tomahawk \$3.00. List free. Lear's, Glenwood, Arkansas.

SPECIAL 3 Bird arrowheads \$1.00. Smith, 841 N. Tacoma, Indianapolis, Ind.

SELECTED War arrowhead \$1.00. List 5¢. H. Talburt, Calico Rock, Ark.

SCALPING Knife, spearhead, thunderbird, drill, \$4.00. List free. Arrowhead, Box 1249, Hot Springs, Arkansas.

ANTIQUE Brass phones \$5.00. Free list. Tontz's, Elsinore 5, Calif.

PRECIOUS STONES, MINERALS

TEN New Mexico minerals \$1.50, six fluorescents \$1.00; five crystalized minerals \$1.00, fools gold 25¢. Hartson, Winston 6, New Mexico.

400,000,000 YEAR Ordovician fossils. Five classified \$1.00. Don MacKenzie, Northfield, Minn.

AGATES, Gems, machines. Free list. Northwest Gems, 2819 North Warner, Tacoma 7, Washington.

CUT Gems, make jewelry—For profit or fun, 100 page magazine tells how: where to get supplies. Sample 25¢ or request free literature. Lapidary Journal, Del Mar 2, Calif.

SAPPHIRE Topaz, tourmaline, garnet, peridot. Five uncut gem specimens, \$1.00. Ten polished gems, baroque shaped, \$1.00. Free big bargain list jewelry, gems, profitable, easy "do it yourself" projects. O'Brien's, 1116M Wilcox, Hollywood 38, Calif.

GEM Material, 20 pieces \$2. Swigert's, 2218 Louella, Venice, Calif.

OPALS, Amethysts, 10 ring size polished stones \$5.00. Kendall Sanmiguel Allende, Guanajuato, Mexico.

2 GENUINE Little Falls diamonds in natural stone setting, \$2. Rock City Traders, Box 611, Little Falls, N. Y.

HOBBIES AND COLLECTIONS

NAZI Insignia, 12 different \$1.00. Medals, patches, armbands, flags, daggers. Illustrated lists, 10 cents. Medcrafts, 2004 35th St. S.W., Calgary, Canada.

MILITARY Miniatures. Civil War. Custer's Cavalry, American Revolution and U. S. Marines. Illustrated catalog 35¢. Bussler Miniatures, Dept. Z, 40 Howe St., Quincy 69, Mass.

INVENTING Can be an interesting and profitable hobby. Write for complete particulars. Institute of American Inventors, Dept. 40-E 631-E St., N.W. Washington 4, D. C.

COLLECTORS Matchbook covers, 100 different unused, \$1.00. Catalog 25¢. Album \$3.00. Charles Edelman, 1311-C East 84, Cleveland 3, Ohio.

U.S. Coins valued and illustrated—Handbook \$1.00; guidebook \$1.75 postpaid. Louis Bell, Masonic Building, Decatur, Alabama.

100 NEW Military ribbons, patches including purple heart, \$2.00 postpaid. Victory, 8211 South Alameda Street, Los Angeles, California.

CRAFT Sets and model kits. Catalog 10¢. Daters, 821 Divisadero Street, San Francisco 17, California.

CAMERAS, PHOTO SUPPLIES

FRANCHISED Camera repair shops needed! Start profitable business with NCRS training. Write National Camera Repair School, Dept. E-9, Englewood, Colo.

FREE! Free! Free! Bargain book. Big savings—Still, movie camera, equipment and supplies. Photographic headquarters since 1899. Central Camera Company, Dept. 9-1, 230 S. Wabash Ave., Chicago 4, Illinois.

MAKE Better enlargements. Blend-O-Ray diffusing screens. Complete set, \$1.00. Nichols Photo, Bristol, Penna.

TITLE Kit colorful plastic \$39.95. Mackalls, 271 Ely, Palo Alto, Calif.

PHOTOGRAPHY For pleasure or profit. Learn at home. Practical basic training. Long established school. Free booklet. American School of Photography, 835 Diversey Parkway, Dept. 3441, Chicago 14.

BUY Wholesale nationally advertised cameras, photo supplies, thousands other products at big discount. Free "Wholesale Plan." American Buyers, Hertel Station, Buffalo 16-E, N. Y.

20 TO 75% Discount everything photographic, gift-ware. Free catalogue. Dart, 3812E Atlantic Avenue, Brooklyn 24, New York.

OIL Coloring photographs—A fascinating hobby or profitable sideline for those with artistic talent. Learn at home. Easy simplified method. Free booklet. National Photo Coloring School, 835 Diversey Parkway, Dept. 3436, Chicago 14.

BASS Says: Quality cameras since 1910. When in Chicago visit the camera cross roads of the world, or write us for your favorite equipment, new or used. Satisfaction guaranteed. Bass Camera Co., Dept. AG, 179 W. Madison St., Chicago 2, Ill.

REAL Wholesale sources. Thousands nationally advertised products. Details free. Martex, 132-A Nassau St., New York 7, N. Y.

TRAVELERS. Name the spot—we have the slide! 4000 Kodachrome 2x2 slides and 1200 stereos, sent on approval. Send 25¢ (deductible from first order) for 40-page, illustrated catalog. Ernest K. Wolfe, 1315 Westwood, Los Angeles 24, California.

AMAZING Prices. Government surplus at less than wholesale. Paper, film, cameras, dark room equipment. Send 10¢ for bulletins mailed free for one year! Air Photo, Room 409, New York 57, New York.

DISCOUNTS To 60%. Photo equipment, appliances, tape recorders. Free catalog. Mailers Mart, Box 135-PM, New Rochelle, New York.

GIGANTIC Savings! Film, paper, aerial cameras, supplies. Request free 1956 bulletin. Supreme Photo, 11 Broadway, Dept. PM, New York City 4.

WANTED 8MM camera owners desiring bargain! 1 1/2" f. 9 ultra sharp Tele; plus 7mm. f2.5 wide angle lens. Not an attachment but actual lenses. Coated. Two for the price of one at \$29.95 (specify camera). Sterling Howard, 561-M East Tremont, New York City.

PHOTO FINISHING

TRIAL Offer—8 jumbos 25¢, 12-35¢. Thrifty Photo, PM96, Box 279, San Francisco 1, Calif.

4x5 ENLARGEMENTS 10¢, 8x10's 30¢. Overnight service. Reproductions, 417-19 Broadway, Joliet, Illinois.

LIFE Pictures. 35¢ for 12 jumbos from roll or negatives. Life Pictures, Hutchinson, Kansas.

NO Charge developing rolls. Pay for good prints only. Jumbos 4¢. Contacts 3¢. Failures refunded. Returned same day. Satisfaction guaranteed. Square Deal Photos, Hutchinson, Kansas.

ENLARGEMENTS! Eight 5x7's or five 8x10's, \$1.00. Wilart Enlargers, Box 967, Little Rock, Ark.

SPECIAL Gift with first roll developed and 8 dated jumbo prints, or 16 dated contact prints in wallet folder 40¢. 12 exposure 50¢. Owl Photo Co., Dept. 21, Weatherford, Okla.

ENLARGEMENTS, Heavyweight eight 5x7's or five 8x10's, \$1.00. Jack Koons, Huntington Mills, Luzerne County, Pennsylvania.

FIRST Class return—First class quality. Your films expertly processed, rushed to you by fast mail. Sparkling, enlarged prints: 8 exposure roll 50¢, 12-70¢, reprints 6¢. Unconditionally guaranteed. Photo Masters, Box 26-M, Philadelphia, Penna.

TWO Beautiful prints from each picture on roll. 8 exposure 40¢; 12 exposure 50¢. Thirty-five years of satisfied customers. Quick service. Lens Photos, Dept. J-4, Janesville, Wis.

12 EXPOSURE Rolls, 39¢, jumbo prints. Guaranteed work, one day service. Lincoln Studies, Dept. K, Box 13, Lincoln, Neb.

TWO Beautiful enlargements from each picture on roll. 8 exposures 55¢, 12 exposures 75¢. Cut Rate Photos, Dept. B-4, Janesville, Wis.

QUALITY Kodak finishing. 8 exposure roll 35¢; 12 exposure 50¢; 16 exposure 60¢. Reprints 4¢. Fast service. Guaranteed quality. 40 years continuous operation. Be a satisfied customer. We do color. Send for mailers. Mail Order Photo Service, Box 297, Watertown, Wisconsin.

TOP Quality. Fast service. 8 jumbos 35¢. 16 contacts 40¢. Reprints—Jumbos 4¢; contacts 3¢. Satisfaction guaranteed. Free mailers, circulars, Fast-X-Photo. Box A, Jersey City, New Jersey.

8-HOUR Service on deluxe jumbo prints. 8-exposure roll developed and 8 jumbo prints 40¢. 12 exposure 55¢. 16 exposure 70¢; 35mm. 20 exposure 75¢. 36 exposure \$1.25. Jumbo deckle reprints 4¢ each. Contact prints made if specified. Bay Photo Service, P.O. Box 219, Oakland, California.

FREE Superpak album with 8 jumbos only 35¢. 12—50¢. Prompt superior service. Quality guaranteed. Mailers and circulars free. Grand Fotos, GPOB 1410, New York City 1.

NOW. Your favorite photograph permanently sealed in metal. Send any size picture and we will make into a beautiful 7x5 metal print. Clear sharp photo necessary. Money back guarantee. Cash, \$5.95 prepaid. C.O.D. accepted. Free literature. Miller-Holles Studios, 437 E. Market, Alliance, Ohio.

TRY Us once! Fast service! Top quality! 8 enlarged dated prints from your roll 25¢; 12—35¢. (Trial offer). Reprints 4¢. Kodacolor specialists: Roll developed 90¢; prints 32¢ each. Free mailers. Willard Studios, Box 2553G, Cleveland, Ohio.

PLASTIC: Social Security, identification cards or wallet size photos sealed in lifetime plastic. Same day service. Any three for only \$1.00. Permanent Pictures Inc., P.O. Box 2438, Miami 30, Florida.

PHOTO Statuette from your negative. \$1.00. E. Brown, 205 Jones Ave., Crawfordsville, Ind.

PHOTOS, Etc., permanently sealed in plastic. Wallet size 50¢, 4x5 \$1.00. Inquiries invited. Perma Plastics, Box 90-A, Brooklyn 35, N. Y.

PHOTO Lampshades made from your pictures. Woods, Wyoming 2, Penna.

SUPERIOR Quality jumbo prints. Over 30 years fast, dependable service. 8 exp. roll 35¢, 12 exp. 50¢, 20 exp. \$1.00. Jumbo reprints 4¢. Picture Memories, Box 28, McMinnville, Oregon. Mailers on request.

MOTION PICTURES AND SOUND EQUIPMENT

16MM. Sound-used projectors and films. Rental, sale, exchange, bargain prices. Free lists. Also 8 mm. Specify film size. National Cinema, 71 Dey Street, New York City.

8-16MM. Films. Free catalogue (with sample film 10¢). Garden, 690 Howard Avenue, Brooklyn, N. Y.

ALL Kinds 16mm. sound films. Sale. Cheap. Roshon, 335 Fifth, Pittsburgh 22, Penna.

5,000 8-16MM. Movie films. Free catalogues. International, Greenvale, N. Y.

TAPE Recorders. tape. Unusual values. Free catalog. Dressner, 69-02M 174 St., Flushing 65, N. Y.

MOVIE Camera film: 8mm. roll \$1.50. 16mm. 100' \$3.00. Free processing. Better Films, 742 New Lots, Brooklyn, N. Y.

SAVE 50%! Guaranteed-fresh color, h.&w. movie film! 8mm., 16mm. Free catalog! Eso-R, 47th Holly, Kansas City 12, Missouri.

"ENTIRE Life of Christ" 8 mm. silent, 16 mm. narrated with sacred music. Hemenway Film, 424 Little Bldg., Boston 16, Mass.

FREE! Blackhawk's big sale catalog new and used 16mm., 8mm. films; 2"x2" color slides; used 16mm. sound projectors. Biggest stock in U.S.A. Blackhawk Films, 1700 Eastin, Davenport, Iowa.

MOVIES: Movies; movies: 8 and 16 mm. B & W and color. Free gift and list sent in well sealed envelope. G & M Films, Box 4161, Glendale, California.

BEST 16 MM. movies. prices. service. Try us. Free listings. Specify. Gaines, Box 114-PM, Skokie, Ill.

MUSIC AND MUSICAL INSTRUMENTS

SONGWRITERS. Free booklet successful songwriting. Gateway Songs, Box 2470, Hollywood 28, Calif.

POEMS Wanted for new songs. Send poems. Free examination. Immediate consideration. Songcrafters, Arcade Station, Nashville, Tenn.

POEMS, Songs wanted! Free examination. Bengol, 93 Jefferson, Chelsea 50, Massachusetts.

FREE Records of your song. Your words, my melody. Free information. Johnny Mack's Melody Mart, 1094 West 39th Street, Dept. A, Los Angeles 37.

ACCORDIONS, Wholesale to everyone. Save up to 60%. All national known brands. Free catalogue. Del Principe, 29 South Cicero, Chicago 44.

POEMS Wanted for new songs. Send poems. Immediate consideration. Crown Music Company, 1476 Broadway, New York City 36.

WRITE Songs. Big money and reputation. Write for information. J. Gordon Pub. Co., 4700 South California Avenue, Chicago.

VIOLINMAKERS, Repairers. Fine tone wood, and all violin supplies. Send for free wholesale price list. International Sales, 414-MPM E. Baltimore St., Baltimore 2, Maryland.

SONGPOEMS And lyrics wanted. Mail to: TinPan Alley, Inc., 1650 Broadway, New York 19, N. Y.

SONGWRITERS: Song poems wanted. \$100 advance royalty paid writer of best song selected each month. Hollywood Tunemiths, Dept. U, 1609 Vista Del Mar, Hollywood 28, Calif.

SWISS Musical movements, \$1.90. Heiax, 218 West 72nd Street, New York 23.

SACRED Music composed to religious words. Reginald Belcher, Box 354, Morris-town, New Jersey.

1956 ACCORDIONS—Wholesale. Free catalog. American Accordion Center, PM-9, 5329 Belmont, Chicago.

SONGS And poems wanted. Records made. Five Star Music Masters, 630 Beacon Bldg., Boston.

WHOLESALE Catalog! 30-80% discounts! Appliances, musical instruments, typewriters, tools, watches, jewelry, cameras, housewares, etc. Consolidated Distributors, 1300-34 Main, Chilton, New Jersey.

SONGWRITERS! Protect your ideas! Hold all poems, songs! Write for safe, correct procedure. Song Service, Dept. P, 333 W. 56th, New York City 19.

PHONOGRAPH Records cheap. Catalogue. Paramount, MD-313 East Market, Wilkes-Barre, Penna.

ACCORDIONS—Direct from importer. Save 50% and more! Free trial. Lifetime guarantee. Trades accepted. Free catalog. Write Accordion Manufacturers, Dept. 96R, 2003 Chicago, Chicago 22, Illinois.

DISCOUNTS. Instruments, accessories, national brands. Tempo Music, 37 Cutler, New London, Connecticut.

SONGS Into dollars. Share \$29 million dollars yearly for new songwriters, song-poets. Songs composed, published, promoted by famous firm. Information, appraisal free. Send to Nordyke Publishing, 6000 Sunset, Hollywood 28PM, California.

SONGWRITERS: Amazingly new offer. Robert Hensley, Rt. 1, Box 131, Mars Hill, North Carolina.

RADIO, TELEVISION AND ELECTRONICS

FREE 356 Page 1957 radio, TV, Hi-Fi, electronics catalog! World's largest stocks, lowest prices. Everything for experimenters, builders, amateurs, servicemen. Latest build-your-own famous Knight-kits, Hi-Fi, phonos, recorders, P.A., TV accessories. Thousands of parts, tubes, test instruments, tools and books. Write for free copy! Allied Radio Corp., 100 N. Western Ave., Dept. 34-J-5, Chicago 80, Illinois.

BUILD 16 Radio circuits at home, only \$19.95 complete. Free dynamic radio and electronics tester, set of tools, soldering iron, plus many other free extras. No additional parts, tools or experience required. A practical home radio and electronics course. Unconditional money-back guarantee. Send for descriptive literature: free valuable radio, TV and Hi-Fi manuals on request. Order direct from this ad, and receive bonus resistor kit worth \$5. Progressive Edu-Kits Inc., 497 Union Ave., Room 49B, Brooklyn 11, N. Y.

TRANSISTOR Radio kit. Complete. Powerful. \$7.95. Park Magnets, Highland Park, Illinois.

CRYSTAL Radio builders. Free information. Hulet, 305 Hope, Lakewood, N. J.

TRANSISTOR Radio, 12,000 mile range. Kit \$7.95. Ekeradio, Pasadena, California.

CRYSTAL Radio kit \$1.00, preassembled \$1.25, phone \$1.75; catalogue. Clearco Crystal Company, 2966 North 4th, Milwaukee 12, Wisconsin.

EXPERIMENTERS Radio bread board complete with 2 diodes, 5 crystals, 5 coils, circuits and condenser \$2.00 post paid. With phone \$4.00. Small Radio Lab, 1331 Tyler, Topeka, Kansas.

OPERATE Two TV sets from one antenna. Details 10¢. Lackner Products, 2029M Bradley, Chicago 18.

BUSINESS OPPORTUNITIES

MAKE Money with perfumes! Your opportunity is now. Be your own boss. We have 32 highly guarded formulas. The materials used in making these perfumes are obtainable in almost any drugstore, at a tremendous profit to you! Start your own business today. Why wait? All 32 formulas complete, now only \$3.00. 100% guaranteed or money back. Jack P. Hodges, P.O. Box 44, Ahwahnee, Madera Co., Calif.

ADVERTISING Book matches—Cash in on big demand; sell union label matches. Cuts for all businesses and political parties. Free powerhouse selling kit, low prices, protection guaranteed on repeat orders. Cash commissions. Superior Match Co., Dept. MX956, 7530 Greenwood, Chicago.

YOU Can make money for Christmas in spare time taking magazine renewal subscriptions. No capital or experience necessary. All supplies furnished. Write today! McGregor Magazine Agency, Dept. 500B, Mount Morris, Illinois.

BUY Wholesale! Resell at big profits. Brand name merchandise—Appliances, cookware, housewares, watches, jewelry, dry goods, clothing, sporting goods, toys, gifts, etc. Free illustrated color catalog listing over 1001 items with confidential cost sheet. Merit Home Products, Dept. PM-9, 107 Manhattan Ave., Brooklyn 6, N. Y.

IMPORT-Export opportunity. profitable, world-wide, mail-order business from home, without capital; or travel abroad. Established world trader ships instructions for no-risk examination. Experience unnecessary. Free details. Mellinger F701, Los Angeles 24.

PROFITS Stamping social security plates. Catalog free. General Products, 188-PM State, Albany 10, N. Y.

GROW Mushrooms. Cellar, shed. Spare, full time, year round. We pay \$3.50 lb. We paid John Betts \$7,977.76, he started as amateur. Free book. Mushrooms, Dept. 173, 2954 Admiral Way, Seattle, Wash.

START Your own fishing lure business. Send \$2.00 for 20 beautiful flatface lures (less hooks) returnable. Quaker City Mfg. Co., 3514-24 N. Lawrence St., Philadelphia 40, Penna.

MAKE Flexible molds. Cast plaques, figurines, free sample. Tooker, 630-R Chestnut, Hamilton, Ohio.

11,000 NEW Prospects daily. Baby record books, shoes, albums. Sell mailorder. Everything furnished. Free literature. No-Co-Ro, Capitola, California.

WORK At home—Sensational new plans for beginners. Free details. Shields, Box 164A, Miami 38, Florida.

LIQUID Rubber, make flexible molds. Free sample. Chaney, 1130 E. 16th St., Jacksonville 6, Fla.

WHOLESALE Catalog! Appliances, cameras, watches! Cam Company, 6806PM 20th Ave., Brooklyn 4, N. Y.

"MAILORDER Laws and Regulations." Discusses federal, state, local licenses, necessary taxes, legal requirements governing mailorder businesses, \$1.00. "Mail-order Rules for Beginners." Additional helpful information, \$1.00. Play safe. Order both. Tasker, 105 East Custis, Alexandria, Virginia.

MONEY In saw and lawnmower sharpening sparetime at home. Free book. Virgil Foley Company, Columbia Heights, Minnesota.

POPCORN And potato chip equipment. Eakins, Box 933-A6, Springfield, Ohio.

FREE Folio "\$5,000-\$45,000. Unlimited Vacations." No merchandise equipment. Unknown! Work home, sparetime! Haylings, Carlsbad, Calif.

\$250 WEEK Cleaning venetian blinds. Patented machinery. Free literature. Robinson, 7213B, Indianapolis 1, Indiana.

BREED Rare tropical fish at home. Earn big money! Learn secrets! Help fill huge demand. Amazing opportunity! Free plan. Tropical Fish Breeders, Los Angeles 61, Calif.

BE Appointed state notary public now. Write. Stationers, Helotes, Texas.

COPUBLISH Mail Sale Advertiser, leading mail order paper. Details, latest copy, dime. Vanroy Shirk, Lebanon, Penna.

MINK Raising information free. Complete. Lake Superior Mink Farm. Superior, EEL, Wisconsin.

FREE Book "505 Odd, Successful Businesses." Work home. Expect something odd! Pacific, Oceanside, Calif.

NATURAL Molding rubber, extra thick. Free sample. W. Wooley, 115-A Donald, Peoria, Illinois.

MAKE-Sell polishes, cleaners, anything. Formula catalog free. Kemixer, Park Ridge, Ill.

YOUR Own name brand business. No investment; no inventory. Part time or full time. Sell famous brands of appliances, housewares, silverware, radios, vacuum cleaners, lamps, tools, clocks, watches, jewelry, etc., etc., over 1000 items. Join thousands of successful independent dealers. Send for free catalog and dealer price list. H. B. Davis Corp., Dept. W, 145 W. 15 St., New York City.

BIG Profits raising fishworms and crickets. Free literature. Carter Farms, Plains, Georgia.

GROW Orchids at home — Profitable, fascinating. Year 'round, Maine to California. No greenhouse. Gorgeous cactleyas, cymbidiums, etc. Successful home grower shows you how. Full details free. Flowerland, 4622 Wilshire, Los Angeles 5.

WE Love our mailman—He leaves over \$1000.00 monthly in our rural mailbox. My college professor husband drafted a scientific home mailorder method. We bought a Texas ranch, live as we always wanted. Now we sell the Ranch Mailorder Method. Operates anywhere. Inquire: Eveningshade Ranch, Helotes, Texas.

FIX Typewriters. Inexpensive home course teaches factory secrets. Free booklet. Write. Typewriter, Tarentum 1, Penna.

NEWEST Spare, full-time home business. \$5 to \$10 hour possible. Paint with suede—The finish with touch and eye-appeal. Beautify auto dashboards, signs, radios, toys, figurines, lamps—1001 others. Complete, step-by-step instructions sent for no-risk examination. Free details. Coast, Los Angeles 61.

\$70 WEEKLY—Home, spare time. Simplified mail bookkeeping. Immediate income—easy! Auditax, 3475A, Los Angeles 34.

\$150 WEEK—Easy! Start home Venetian blind laundry. Revealing book free. A. T. Co., 101 S. 44th, Philadelphia 4, Penna.

WANT To make big money at home? \$5 profit in an hour possible with invisible reweaving. Make tears, holes disappear from clothing, fabrics. Steady year-'round demand from cleaners, laundries, homes. Details free. Fabricon, 8334 Prairie, Chicago 19, Illinois.

BRUSH Plating outfits for plating articles in the home and shop. No tanks necessary. Good income spare or full time. Free particulars. Gunmetal Co., Ave. H, Decatur, Illinois.

HIGHEST Commissions all magazines. Free catalogue, supplies, prizes, exclusive extras. Subscription Service Co., Box 2070, Birmingham, Alabama.

LEARN Sewing machine big money repair, sales, service. Machines, "everything" wholesale. Taylor Service, Box 2126, San Bernardino, Calif.

INTERNATIONAL Mailorder business. Complete setup service—Not just instructions. Hermes, 152 West 42, New York City 36.

50% PROFIT Baking new greaseless doughnuts in kitchen. Grocers buy daily. Free recipes. M. Ray, 3605 South 15th, Minneapolis 7, Minnesota.

MAKE 80¢ Profit on every dollar selling merchandise by mail. Everything furnished. Write: Eastern, Box 142-A, Boston 24, Massachusetts.

\$1,000 MONTHLY Possible in collection agency business. Free details. Write Cole Associates, Syracuse 2, N. Y.

\$5,000 YEARLY, Spare time at home. Nothing to buy. No local selling. Dignified. Guaranteed. Home Harvest, Rt. 3, Box 3491-A, Albuquerque, New Mexico.

HOW To make money with carnival games. 144 page book, 35 illustrations. Enormous profits possible full or part time. \$2.00 postpaid. Free details. Theron Fox, 1296 1/2 Yosemite, San Jose 28, California.

TO \$100.00 Weekly. Sparetime, home operated mailorder business. Successful beginner's plan. Everything supplied. Lynn, 10420-M National, Los Angeles 34.

WHOLESALE Buyers! New 1956 "blue book" gives names of over 3000 jobbers, manufacturers who supply anything. Free details. Associated Wholesalers, 1016-D Starr, Burlington, Iowa.

SHARPEN Saws and lawn-mowers spare time or full time; very profitable; complete power equipment; easy to operate; no experience necessary; thousands of satisfied users. Free literature. Max Mfg. Co. 138 Stockton Ave., San Jose 26, California.

MODERN Formulas for easily making fastest selling big profit products. Valuable literature free! Miller, Chemist, 1517-K, Tampa, Florida.

AMAZING Successes through franchises! Become exclusive distributor, agency operator. Nationwide opportunities. Request details. National Franchise Reports, 333 North Michigan, Chicago 1.

DRAFTSMEN, Make structural steel shop drawings at home. You can earn \$3.50 or more per hour. Send \$2.00 for select list of companies. Pride Service, P.O. Box 3837, Cleveland 10, Ohio.

STAY Home. Make money. Thousands do. Amazing opportunity. Home Business Digest, 254, 290 Fairview, Canfield, Ohio.

LIQUID Rubber \$3.00 quart. Truair, 2875 N. Elston Ave., Chicago 18, Illinois.

MAIL Order Opportunity Magazine. Information. Ideas galore. Sample 25¢. 115 Hyde Park Ave., Tampa 6, Fla.

OPERATE Restaurant or diner. Free booklet reveals plan. Write Restaurant Arts, BU-19, Fremont, Ohio.

BECOME Tax consultant. Graduates earn \$3,000 every tax season preparing returns evenings. State approved. Union Institute, 68 Hudson, Hoboken, 2M, N. J.

"HOW To Start a Business" booklet sent free! If you know any trade, go into business for yourself! Learn the 9 easy steps to follow. We've guided 5,000 others to success. Revealing free booklet yours for the asking! Write! National Business Consultants, Office SR, Los Angeles 61, Calif.

WHOLESALE Catalog! 30-80% discounts! Appliances, musical instruments, typewriters, tools, watches, jewelry, cameras, housewares, etc. Consolidated Distributors, 1300-11 Main, Clifton, New Jersey.

START A buying service, buy wholesale thousands nationally advertised products. Make big profits selling at sizable discounts. Postcard brings details. American Buyers, Hertel Station, Buffalo 16-C, New York.

AMAZING Profits made from an old-sawdust-pile. This is new. Unlimited opportunities for the person who sends \$2.00 for the formula that makes a product that is in demand all over the country. McClain's, 12069 Greenlawn, Detroit 4, Mich.

WANTED! Home workers to assemble luggage and cases for ready market. Instructions, materials, tools, everything supplied. Free details. Abarsi, 807-BK Sunset, Los Angeles 12.

REBUILD Batteries; repair dolls; make rubber stamps; "60 Ideas" free. Universal, Box 1076-A, Peoria, Ill.

OPERATE Mailorder folio business! Free details. Ballard's, 425 East Catherine, Louisville 3, Ky.

MAILORDER! Succeed with something new that everyone wants. Free information. MCB, 1221P W. Minnehaha Pkwy., Minneapolis 19, Minn.

GET The real dope on raising needed capital. Write Enterprise Bureau, Syracuse 2, N. Y.

WANTED: Home producers, to be subcontractors. Cast plastic products for manufacturers in our clearing house service. Thousands of easily-made items required. Cash in at home, without previous experience. Plastic Service Associates, Dept. 9-PM, East Boston 28, Massachusetts.

MAKE Profitable products. Sell mail-order. Catalogue free. International, 6347 Parnell PM9, Chicago 21, Illinois.

GROW Expensive herbs for us! Big profits home-business of your own. Year around profitability! We supply everything necessary! Send for free rare seeds and revealing plan. National Herb Exchange, Dept. SR, Gardena, Calif.

IMPORT Your own products in small lots. Also, start profitable mail-order business using international drop shipment method. Capital unnecessary. Free details. Georgia Overseas Trading Company, Dept. W, 715 Persons Bldg., Macon, Ga.

GOLD, Silver, platinum; how to refine, test, make alloys, solders, etc. The Jewellers Melting Pot, publication, now \$3.20, no c.o.d. Frank Herman, 1529 Liberty Street, Los Angeles 26, Calif.

RAISE Nutria—Vegetarian; raise mink, carnivorous. Individually or combined, potential terrific. Voight Farms, Atlanta 2, Texas.

PLASTERCRAFT Molds, liquid rubber, plasters, flocks, candle supplies. Catalog and manual free. Blue Rapids Supply, Blue Rapids, Kansas.

EXCLUSIVE Distributor for fast moving products in booming maintenance products field. Earn \$150 weekly while building big repeat business. Modest inventory. Complete merchandising program. Custom, Pennsauken 8, N. J.

REPRESENTATIVES Wanted everywhere. Part-time. Experience unnecessary. Credit and collection work. This is a money maker. Send 50¢ today (deposit but refundable) for instructions and supplies. Watts National Credit Service, 3837 Chestnut, Kansas City 28, Missouri.

OPPORTUNITY! Start collection agency. Very profitable. Valuable franchise ready. Write: Edmondson, Box 4865-P, Atlanta 2, Georgia.

BIG Profits, selling, John Raper line guides. Makes any fishing pole a fly rod. Literature free. John T. Raper Mfg. Co., Fairfield, N. C.

EARN \$10,000 Yearly raising Angora rabbit wool for us. Information 25¢ coin. American Angora Company, Malta 12, Montana.

SPECIALIZED Magazines. 5,166 different publications—All businesses, trades, vocations, professions, sports, hobbies, etc. Free list. Write today. Commercial Engraving Publishing Company 34C North Ritter, Indianapolis 19, Indiana.

MAKE Extra buck. Sell nationally advertised merchandise. Free wholesale catalog. Harry Cohen & Sons, Inc., 1069-PM9 Utica Ave., Brooklyn 3, N. Y.

MAKE Money. Address and mail new self-selling catalog. We fill orders for you; big profits; many repeats. Send 25¢ for sample and complete details! Tip Top, Box 259, Indianapolis, Ind.

CASH From sawdust. Seventy methods. Tin-cans, thirty methods. Newspapers, eighteen methods. Instructions 50¢ each. All three \$1.00. Charles Company, 12-DXV, Norwood, Ohio.

OPERATE Wholesale gift business. Mail order or local. Rudd, Box 445, Sylacauga, Alabama.

INTERESTED Mailorder? Samples leading publications in field 25¢. Palm, Box 1221, Baton Rouge, La.

SELL Nationally advertised items. Write: Regnier, 329 West 101 Street, New York City.

RECEIVE Big big mail 10¢. Greener, Box 306-M, Burley, Idaho.

FINANCE Your own business! Free literature. Advance, Box 1377-BJ, Miami 8, Florida.

"I Earn \$400.00 a week." I've learned an amazing new method of printing colorful signs, banners, cards, posters, glasswear—anything. No printing press or other expensive equipment is necessary! Big money-making opportunity for anyone. Write for my secret and revealing home-business plan, you'll be amazed! Mr. Anderson, Screen Print Company, Dept. PM-9, Los Angeles 61, California.

TAX Experts earn good income. Learn at home. Tax Service, Box 11564, Dallas 18, Texas.

60% PROFIT Cosmetics. \$25 day up. Hire others. Samples, details. Studio Girl Hollywood, Glendale, Calif., Dept. 1269-H.

PRESERVE Flowers permanently. Free details. Spera, Box 596, Toronto, Canada.

WASTE Materials everywhere are easily turned into valuable building materials without formulas. Free trial. Bays Laboratory, Oklahoma City 9.

NEED Mailorder business advice? Consult experienced counselor. \$2.00 per letter. Tasker, 105 East Custis, Alexandria, Virginia.

SAW Filing? Get facts! H. A. Saw Fliers, Maywood, Illinois. Questions? Fee \$1. Not connected with manufacturers.

MAIL Order advertising agency executive reveals sensational no-risk advertising and merchandise methods. Start in office or home; minimum capital; positive profits. Free details: Impact! 2108 Payne, Dept. 11-9, Cleveland 14, Ohio.

MAIL Order plus know-how equals success plus independence. Get "How to Sell by Mail," at once. 25¢ postpaid. Coin or stamps. Richard Hyland, 1014-4th Street, Santa Monica 1, California.

46 FROM Square foot plywood with your jigsaw. Woodart, Bridgewater, Mass.

HAVE Profitable home mailorder business selling quilt pieces, remnants—Full, sparetime! Over 20,000,000 "repeat" prospects! Rush name for details of this amazing moneymaking business today! Coleman, Box 821-A, Newark 1, N. J.

MAIL Catalogs featuring real merchandise. Charles, Box 32-P, New York 63, N. Y.

AGENTS, Salesmen, others. 100% sales increase in 30 days. Your total cost a self-addressed #10 manila envelope or 10¢ sent to Sales Booster, 3000 Booker, Fort Worth 11, Texas.

\$26,500 SALES In two weeks! Amazing radio-mail order method. Free details. Broadcast Service, 1412-SP Great Northern Building, Chicago 4, Illinois.

\$200 WEEKLY Applying Sun-Shield miracle tint. Small investment. Free details. Trans-World, Department PM, 1707 North Alexandria, Los Angeles 27, Calif.

TO Survive as a salesman—Know the tricks of sales resistance. Free facts. Countersalesmanship, Dept. D. 120 Boylston Street, Boston 16, Massachusetts.

SELL New nationally advertised 17 jeweled watches. Your cost \$8.95. Watch sets \$5.95. Result Sales, Dept. M, 580 Fifth Ave., New York City.

BIG Profit low cost English chamois. Readers 100%. Babrok, Hudson Falls, N. Y.

FREE Booklet, earn money at home schemes. D. Reuter, 120 Boylston Street, Boston 16, Massachusetts.

TO \$100 Weekly operating home mail-order business. Write: National Service, Richland, Georgia.

WHOLESALE Buyers service! Buy nationally advertised merchandise wholesale. Sell way below retail. Fabulous profits. Write Wholesale Buyers, Box 22-PH, St. Louis 3, Missouri.

BIG Profits making candies. Particulars free. Raymond Schenck, Butler, Penna.

AMBITIOUS? We establish you in your own business, supply catalogs, circulars, etc., ship orders under your label, show you exactly what to do. Experience unnecessary. No stock to carry. Sell direct, through agents, by mail. Postcard brings catalog, booklet "How To Make Money in Your Own Business," and money-making plans absolutely free. Topval Corp., Lindenhurst 918, N. Y.

MONEYMAKING OPPORTUNITIES

GROW Mushrooms. Cellar, shed. Spare, full time, year round. We pay \$3.50 lb. We paid John Betts \$7,977.76, he started as amateur. Free book. Mushrooms, Dept. 173, 2954 Admiral Way, Seattle, Wash.

EARN Money immediately repairing electric clocks without experience. \$3.00 investment. Details free. Puthuff, Box 1504, Santa Rosa, Calif.

LEARN Technical Metaphysics and insure your future. Easy, inexpensive correspondence course. Simplest method known. Diploma. Write: Premier College of Technical Metaphysics, 2532 McKenzie St., Vancouver 8, B. C., Canada.

EARN Money evenings copying and duplicating comic cartoons for advertisers. Adservice, Argyle 1, Wisconsin.

FREE Book "505 Odd, Successful Businesses." Work home. Expect something odd! Pacific, Oceanside, Calif.

READ Progressive Mailtrade, the magazine that tells how to make money by mail. Dime brings sample and special offer. Progressive Mailtrade, Box 357, Sheboygan, Wisconsin.

SELL Titania gems; far more brilliant than diamonds. Catalog free. Diamonite, 2420-M 77th, Oakland 5, California.

PRIZE Contests provide fabulous and confidential home income opportunities! Here's how and where to win your share! Send stamp! National Contest Bulletin, Box 2685-P, Miami 16, Florida.

FREE Folio "\$5,000-\$45,000, Unlimited Vacations." No merchandise, equipment. Unknown! Work home, sparetime! Haylings, Carlsbad, Calif.

FORTUNE Possible raising, fishworms and crickets. Free literature. Carter Hatchery, Plains, Georgia.

ATTENTION: Typewriter owners. Make handsome profits. Write today. Groves Company, 882, Hastings 8, Nebraska.

START A profitable subscription business in spare time! We need men and women (young or old) as representatives for all leading national magazines. Liberal commissions on all subscriptions. Supplies free. Send this ad with your name and address to: Agency Bureau, Dept. PM, Hearst Magazines, 250 West 55th St., New York 19, N. Y.

EARN \$50.00 Daily making mats, shoes and mud guards from old tires. S and S Patents Inc., 1307 North Clark St., Chicago 10, Ill.

LOOKING For something informative? Home work, mail order plans, and trade magazine 25¢. Warren Co., P.O. Box 11, Glenview, Ill.

PHOTO Christmas greetings bring big profits in your spare time. Show Whitehall's fast selling Christmas greetings, everyday cards, personalized stationery, napkins, gifts. Samples on approval; 1/2 price feature offer. Make big money fast. Whitehall Studios, 396 Cleveland, Elmira, N. Y.

MEN And women wanted to start home business in spare time with little table-top rubber stamp machine. Easy to earn up to \$9.80 an hour without previous experience. Full particulars free by mail. Send postcard to Roberts, 1512 Jarvis, Room 79, Chicago 26, Ill.

MAKE Money writing short paragraphs! No tedious study. I tell you what to write, where and how to sell; and supply list of editors buying from beginners. Many small checks add up quickly. Write to sell, right away. Send for free facts. Benson Barrett, Dept. C-27-W, 7464 Clark, Chicago 26.

NEW General, religious, comedy 7"x11" signs—cost 7¢, sell 50¢. Sample free! Lowy, 812 Broadway, Dept. 941, New York City 3.

WHOLESALE Catalog! 30-80% discounts! Appliances, musical instruments, typewriters, tools, watches, jewelry, cameras, housewares, etc. Consolidated Distributors, 1300-27 Main, Clifton, New Jersey.

MAKE \$5,000 Yearly sparetime raising mink, chinchillas, nutria, etc. Free booklet reveals proved plans. Write: Furs, 588 Mt. Pleasant Road, Toronto 1, Canada.

100% PROFIT. No investment. Stamp brings details, samples. Miller, Box 584, Brooklyn 1, New York.

START Big-pay business at home in spare time. No experience needed to operate little table-top machine for bronzing baby shoes. Make \$5.48 profit on every pair. Full particulars free. Send postcard to Mason, 1512 Jarvis, Room 79, Chicago 26, Ill.

START A buying service, buy wholesale thousands nationally advertised products. Make big profits selling at sizable discounts. Postcard brings details. American Buyers, Hertel Station, Buffalo 16-D, New York.

MEN — Women! Start money-making plastic laminating business at home in spare time. Material that costs 11¢ brings back \$2.58. No canvassing or selling but mail orders bring in \$20 a day. Write for full particulars free. Rush name on postcard to Warner, Room 79, 1512 Jarvis, Chicago 26, Ill.

YOU Earn exceptional fees managing money-raising campaigns for churches, hospitals, organizations. Low cost spare time course guaranteed. Backed by 36 years experience. William Arbogast, 229 East Mason Avenue, Alexandria, Virginia.

START Identification tag business. Clearview Co., 172 Stanton St., New York City.

INCREASE Your income. Free literature. Bercher, Box 500, Shreveport, Louisiana.

NEED Products? Salesmen? Markets? Details free! Sayper Associates, 1129-C Vermont, Washington 5, D. C.

BOX Tops, wrappers, labels, etc. Sell for cash. Only 25¢ brings buying list. Lauback, P.O. Box 129, Syracuse 4, New York.

60% PROFIT Cosmetics. \$25 day up. Hire others. Samples, details. Studio Girl Hollywood, Glendale, Calif., Dept. 1269-H.

ELECTRICAL Cord repairing made easy. Amazing pocket instructions \$1.00. Free details. Marnel, Box 7642, Denver 15, Colorado.

DOLLARS Every day! Amazing new magic mail plan. Set-up free. Miller, Box 588X, Oshkosh, Wis.

NOW'S The time for getting into your own profitable weatherstrip business. E-Z-On-11, 1009 Harvard, Evanston, Ill.

"EARNING Home Profits Preserving Flowers" shows how to make money with this little known hobby method. Inquire: Mountainside, Springwater 1, New York.

TURN Sparetime into extra cash! Write today for free folder, describing interesting, home moneymaking opportunities! Dean Stike, R-2, Chilhowie, Virginia.

PREPARE Income tax returns at home full or spare time. \$5.00-\$10.00 per hour. Practical instructions amazingly simplified. No lessons. Particulars free. Fox Business Publications, Box 1265-A, Peoria, Ill.

GENERAL Contest Bulletin. Lists contests monthly. Sample, 25¢. 1609 1/2 East 5th, Duluth, Minn.

MAKE Money from trash. Details \$1.50. Binna, 29 North Hancock, Madison, Wis.

GUARANTEED New mailorder business. Complete information \$2.00. Royal, Box 140, Richmond 1, Virginia.

UNUSUAL Opportunity in fabulous mail-order. Delta, 2139-R Logan, Youngstown 4, Ohio.

EXPORT — IMPORT

LIMITED Number of copies Japan Trade Guide, 1956 English edition, still available. Act now! 700 pages. Published under supervision of Japanese government. Includes import-export regulations, customs, shipping, patents, etc., and 110-page directory listing 2,000 manufacturers and trading firms. Price \$10.75 postpaid—or write for brochure. Japan Trade Guide, Box 3452 Terminal Annex, Los Angeles 54, California.

IMPORT. Export mailorder opportunities. Details. Warner, Box 756, Shafter, California.

FORMULAS, PLANS, ETC.

PRODUCT Analysis, manufacturing formulas, processes developed. Moderate fees. Plastics, Box 1574, Boston 4, Mass.

NEW Window cleaner formula, \$1.00. Weko, 2024 Delaware, New Philadelphia, Ohio.

"FORTUNES In Formulas." 900 page book, over 10,000 formulas, plus catalog of chemicals mentioned, only \$4.75, postpaid anywhere. Details free. Fabian Chemical Co., 3760 St. Catherine Rd., Montreal 26, Can.

PRACTICAL Formulas. Lists free. Cummings, Chemist, Gordon Ave., Syracuse 4, N. Y.

FORMULAS; All kinds, latest, best. Literature free. Kemixal, Park Ridge, Ill.

LATE. Modern manufacturing formulas. List free. Moon Chemical, Martville, New York.

MODERN Formulas for today's fastest selling big profit products. Valuable literature free! Miller, Chemist, 1517-J, Tampa, Florida.

PLASTICS

NEW Liquid casting plastic, clear, colors. Embed real flowers, insects, photos, coins. Saw, drill, carve. Send 25¢ for handbook, "How to Cast with Liquid Plastic," and proved success plan showing how to make money at home. Castolite, Dept. K-101, Woodstock, Ill.

LAMINATING Supplies. Free price list. Solomon, 46 Cornhill, Boston 8, Mass.

PLEXIGLAS. Cut to size. Clear. Any thickness. Colors. Rods, Tubing. McClarin Plastics, P.O. Box 168H, Hanover, Penna.

LEARN Plastics fabrication for spare time income. Low cost home training now available. Write for free booklet. Interstate Training Service, Dept. D-3, Portland 13, Ore.

PLASTIC Repair kit welds breaks and cracks. Restores original finish. Complete kit \$3.00. No c.o.d. Free information. Rayther, Box 271, Station B, Toledo, Ohio.

PLASTIC Foam products. Revolutionary brand, new line. Box 25, Cudahy, Wis.

PLEXIGLAS, Fiberglass, polyester, acetate. Instructive wholesale-retail catalog free! Gem-O-Lite, 5529 Cahuenga, North Hollywood, California.

REINFORCED Plastic. Stronger than steel. Hundreds of uses. Information, six samples and wholesale catalog. 25¢. Seifert's, Box 31M, Deperre, Wis.

PLEXIGLAS, Lucite. Square foot cost. 1/16", \$1.18; 1/8", \$1.52; 3/16", \$1.86; 1/4", \$2.21; 3/8", \$3.23; 1/2", \$4.36. Colors add 10%. Send 15¢ for postage. Aristocrat Plastics, 23-25 Sussex Avenue, Newark, N. J.

NEW Liquid casting plastic, clear, colors. Embed real flowers, insects, photos, coins. Saw, drill, carve. Send 25¢ for handbook, "How to Cast with Liquid Plastic," and proved success plan showing how to make money at home. Castolite, Dept. K-101, Woodstock, Ill.

CHEMISTRY

ILLUSTRATED Catalog: Chemistry, mineralogy, biology 20¢. Tracey Laboratories, Evanston, Illinois.

CHEMICALS And apparatus for industrial, analytical, and private laboratories. Catalog 25¢. Dept. M-50, Biological Supply Co., 1176 Mt. Hope Ave., Rochester 20, N. Y.

SPECTROSCOPE For quick analysis \$3.00. Kutting, 26278 Arastradero, Los Altos, Calif.

AMAZING New Book of Science. Experiments, formulas and catalogue of laboratory supplies. Only 25¢. National Scientific Co., Dept. PM-9, 500 W. Road, Lombard, Illinois.

CHEMICALS, Glassware, catalog 25¢. Refundable. Laboratory Sales, Box 161-E, Brighton, Mass.

AGENTS WANTED

SPARE Time selling—Quick cash! Cash in on the huge demand for gifts, greeting cards, gadgets, toys, and stationery in your area. Sell world famous brands like Westinghouse through us! No experience needed. Excellent money profits from spare time sales. Send for free money making plan and big free colorful catalog now! Greetings Unlimited, 336 Park Square, St. Paul, Minn.

YOU Can make money for Christmas in spare time taking magazine renewal subscriptions. No capital or experience necessary. All supplies furnished. Write today! McGregor Magazine Agency, Dept. 500A, Mount Morris, Illinois.

GET Your share of the big profits from amazing, fast-selling Shumit. Millions will be sold. Everyone who wears shoes is your prospect. Rush your name and address for free sample offer. Anchor Sales, 11 E. Huron, Chicago 11, Ill.

ATTENTION Club chairman! Here's way to increase funds. Discover this new easy way to raise money. No risky investments 30-day credit, fast service. Sell dependable, well known name brands from America's largest assortment of greeting cards, gifts, gadgets, jewelry, toys, and personalized stationery! Send for free details and catalog. North Star, Dept. 736, St. Paul, Minn.

GOLDMINE Of 600 money makers. Copy free. Specialty Salesman Magazine, Desk 5-B, 307 N. Michigan, Chicago 1.

START Your own business on credit. Your own boss. 1598 dealers sold \$5,000 to \$32,000 in 1955. We supply stocks, equipment on credit. 200 home necessities. Sales experience unnecessary. Pleasant, profitable business backed by world-wide industry. Write Rawleigh's, Dept. I-U-PPM, Freeport, Ill.

SEEKING New products? Get my outfit 47 money-making specialties. Latest conveniences for home, car. Send no money. Just your name. Kristee Co., Dept. 53, Akron 8, Ohio.

SELL Newest tall Christmas cards—Make 75¢ on sensational \$1.25 assortment. 250 hottest gifts, cards, stationery. 50 exclusive personalized designs, super-roll gift wraps, 30 for \$1 box. Samples on approval, surprise offers, prompt action gift. Cardinal, 1400 State, Dept. K-79, Cincinnati 14.

CHRISTMAS Cards—144 exceptionally distinctive greetings, all with customer's name. To attract big-volume sales, line includes many cards specially designed for business firms and professional people. All popular subjects, wide price range. Unequaled in lavish treatment, unusual illustration, high-quality stock. Up to \$5 to \$100 commission on each sale. Full or part time. Experience unnecessary. Old, established firm. For complete sample kit, write Process Corp., 1950 S. Troy, Dept. MS-9, Chicago 23, Ill.

FREE Box of 21 nationally famous Christmas cards included with other fast selling assortments sent on approval. Earn \$50.00 by selling only 50 boxes of our 900 series Christmas card assortment. Can be done in a few hours of your spare time. Sunshine Art Studios, Inc., Dept. PM-9, Springfield 1, Mass.; Pasadena 1, Calif.

AMAZING New "Touch-Glow" Christmas cards sell swiftly from free samples. \$62.50 profit on 50 boxes easy! Many tall cards, stationery, novelties, album of imprints. Profits to 100% plus gift bonuses. Samples on approval. Creative, 4401 Cermak, Dept. 509-D, Chicago 23.

FREE! Beautiful feather pictures 200% profit! Apartado 9036, Mexico 1, D. F.

YOUR Own business—Used suits \$1.50, overcoats 65¢, mackinaws 35¢, shoes 12½¢, ladies coats 30¢, dresses 15¢. Enormous profits. Catalog free. Nathan Portnoy Associates, 605-AA West 12th Place, Chicago 7.

GOLD Or silver letters, numbers. Windows, doors, trucks. 1" to 6". 500% profits. Free samples. Atlas-T, 544 West 79th, Chicago 20.

PRINTING. Advertising salesmen—Excellent moneymaking sideline selling decalcomania name plates, small quantities. Automobile initials, sign letters. Free samples. Ralco, XL, Boston 19, Mass.

\$1.00 PROFIT Selling \$2.95 photo enlargement deal. Allen Studio, Riegler Bldg., Little Rock, Ark.

AGENTS—300% Profit selling genuine gold window letters; stores and offices. Free samples. Metallic Sign Letter Co., 431-D North Clark, Chicago.

USED And new watches \$2 up. Free list. Southern Watches, Gray, Georgia.

YOUR Ad in this space will get some good agents for you. Yes, I'll prove it. Write for Folder "A" right now. F. W. Johnson, Classified Advertising Manager, Popular Mechanics Magazine, 200 E. Ontario St., Chicago 11, Ill.

EASY Handwork makes fast-selling articles. Sample free. Sunmade Company, Brockton 64, Massachusetts.

WANT More business? Here's an amazing opportunity to increase your sales. Talk to thousands of interested readers of "Mechanica Popular." Our Spanish Edition covers the Latin American countries like a blanket. They're real mallorder buyers. Classified rate 75¢ per word. Try an ad in our next issue. Classified Advertising Department, Popular Mechanics Magazine, 200 East Ontario Street, Chicago 11, Ill.

CALIFORNIA Sweet smelling beads. Sensational sellers. Particulars free. Mission, 2328-PM W. Pico, Los Angeles 6, California.

RUN Spare-time greeting card and gift shop at home. Show friends samples of our new 1956 Christmas and all-occasion greeting cards and gifts. Take their orders and earn to 100% profit. No experience necessary. Costs nothing to try. Write today for samples on approval. Regal Greetings, Dept. 89, Ferndale, Mich.

TREMENDOUS Profits! Every man, woman and child a customer. Used suits \$1.50, pants 35¢, dresses 20¢, shoes 20¢. Operate from store, home, car. Free catalog. Superior, 1250-A Jefferson, Chicago 7.

FAST Selling money makers! Metallic ironing board cover; purse-shopping bag; many others including \$1 retailers. Quality Products, Dept. A, Box 748, Passaic, N. J.

REDUCING Machines. Factory agents. 100% profit. Exclusive. Mary-Mac, 1012 Powhattan, Dallas 2, Texas.

AT Last! Something new and sensational in latest tall Christmas cards. Make extra money fast! Show satins, velours, metallics. Gets easy orders. Pays up to 100% profit. 30 free samples. With name 50 for \$1.50. Big line. Amazing convertible pen-pencil, napkins, gifts, stationery. Several \$1.00 boxes on approval. Puro Greetings, 2801 Locust, Dept. 640-L, St. Louis 12, Mo.

WHOLESALE Catalog! 30-80% discounts! Appliances, musical instruments, typewriters, tools, watches, jewelry, cameras, housewares, etc. Consolidated Distributors, 1300-10 Main, Clifton, New Jersey.

NEW Invention, \$4.95 fire alarm, paying up to \$1,100 a month. No wiring. Unlimited market. Dramatic demonstration. Free kit. Merlite (Alarm Div.), 114 E. 32nd St., Dept. F-53L, New York 16, N. Y.

BIGGEST Christmas card profits. Sensational "Super-36" assortment pays \$1.25 profit on every box—\$50.00 on 40 boxes easy. 200 fast sellers double earnings! Tall cards, novelties, stationery, bargain specials. Assortments on approval. Color catalog. Personalized album free. Midwest, 1113 Washington, Dept. 494-S, St. Louis 1, Mo.

MAKE \$100 Weekly selling stainless kitchenware. Details free. Write, Conklin, Box 12, Ontario, Calif.

IF You want to earn money fast, I'll send you free sample stocking of newest stretch DuPont nylons to sell at only \$1 a pair. American Mills, Dept. 497, Indianapolis 7, Ind.

BUY Wholesale thousands nationally advertised products at big discount. Free "Wholesale Plan." American Buyers, Hertel Station, Buffalo 16-A, N. Y.

ENJOY Sparetime profits servicing new and renewal magazine subscriptions for friends, neighbors, organizations. No experience. No investment. Free catalog, supplies. Complete information. National Publications Company, Dept. P1, 4055 Wilshire Blvd., Los Angeles, Calif.

LET Us send you for free trial everything needed to make extra money. Show friends amazing value Christmas, all occasion greeting card assortments. Profits to 100%. Bonus. Write for feature boxes on approval, 74 free samples personal Christmas cards, stationery. New England Art Publishers, North Abington 933-D, Mass.

MAKE Extra money—With newest Christmas card assortments, 21-card \$1.00, \$1.25, \$1.50 "tall-slim" Christmas, all occasion, religious assortments, gift wrappings, gifts, novelties, imprinted Christmas cards. Experience unnecessary. Profits to 100% plus cash bonus. Write for samples on approval, free \$1.00 gift offer, catalog, selling plan. Hedenkamp, 361 Broadway, Dept. PM-44, New York City.

NEW Home club plan sensation! Style shows, children's, adults' apparel easily earns \$20.00-\$40.00 evenings. Prizes, gifts, fun! Experience unnecessary. Complete outfit furnished. Beehive Fashions, Bensenville 613, Illinois.

EXTRA Cash in your spare time. No experience needed. Just show superb Elmira Christmas cards, name imprinted. Samples on approval. Bonus: Free box of cards; also 50% profit on first order. Elmira Greeting Card Co., 291 Clinton, Elmira, N. Y.

\$1,000.00 A Month for making dramatic 3-second demonstration of amazing lightweight Presto fire extinguisher. New chemical used by airforce snuffs out fires instantly. Only \$4.95. Terrific commissions. Millions want it. Free kit. Merlite, 114 E. 32nd, Dept. P-53L, New York City 16.

EASIEST \$65 You'll ever make! Show amazing "Magic-Lustre" Christmas cards. 65 boxes pay \$65. Personalized cards 25 for \$1. Assortments on approval, free sample book. "Southern Belle" doll free for promptness. Southern, 478 N. Hollywood, Dept. M-63, Memphis 12, Tenn.

DRYCLEANS Clothing for only 10¢ per garment. Lightning seller. Saves dry-cleaning bills. Samples sent on trial. Kristee Co., Dept. 54, Akron 8, Ohio.

BIG Money-making opportunity. Exclusive line work uniforms. Jackets, pants, shirts, coveralls. Advertising embroidered. Every business prospect. Outfit free. Master Co., 421 Water, Ligonier, Ind.

OVER 100% Profit. Ingenious imported needle threading machine. Sells on sight. Send 50¢ for sample and money making details. Atlantic Import, 1302 Cadillac Tower, Detroit 26, Mich.

"BABY Sitter." Amazing new invention. Works through radio. No wires. No installation. Simple demonstration. Make fast sales. Pays wonderful profit. Exclusive territory to livewires. Write, Accurate Communications Equipment Corp., 520 Fifth Ave., New York 36, New York.

MEN. Money! Miracle Glasstint tints windshield. Gives marvelous glare-proof protection, plus 1956 look. Sprays on in jiffy. Reduces glare from sun, headlights. Lasts for years. Auto, truck owners buy on sight. Profits 100% up. Rush postcard for free details. Glasstint, 220 S. State, Dept. PM-9, Chicago.

MEN-Women agents: Sensational new money-makers — Beautifully hand-painted, plastic personalized photo enlargements, compacts, rings, bracelets, lockets, etc. Simply take orders, pocket 40% commission. We deliver and collect. Sales outfit free. Novelco, 3343 North Avenue, Chicago 47.

COUNTRY Salesmen. Automatic fire extinguisher. Huge profits. Out-O-Matic Co., 1737 E. 31st, Denver, Colorado.

MEN, Women, make money spare time plus new car as bonus for encouragement. Amazing hosiery guaranteed to wear without holes, snags, and runs, or replaced free. For example, lovely 60 gauge nylons guaranteed for as long as 1 1/4 years, or replaced free. Write Wilknit, 1769 Wash., Greenfield, Ohio.

GOLF Balls. Complete line. Easy to sell. Repeat business. Good profit. Golfer's Ruff, Lynbrook, N. Y.

MEXICAN Feather pictures. Big profits. Sample 15¢ stamps. Juansosa, Soledad 45-13, Mexico City.

SPONGERASER Whisks bugs off windshield. Cleans car, windows. Gas stations buy quantities. Sample 50¢, Babcock, Box 551-P, Scottsdale, Arizona.

NEW Design 7 1/4"x14" signs, stores, taverns, gas stations, comedy and Christmas—35¢ to \$2.00 sellers. \$1.00 samples. Free literature. Full or spare time. Sho-Card Signs, Prattville, New York.

TREMENDOUS Profits! Amazing new Magica — Removes rust stains instantly from fabric, porcelain, chrome, metal. Rush 50¢ for sample tube, demonstrator cloth and money-making details. Fred Pedersen, 156 Grove, Berrien Springs 12, Michigan.

NEED Money? \$50 yours. Sell only 100 boxes new Christmas cards. Other amazing offers. Free samples imprinted cards. Feature box assortments on approval; free catalog. 100 profitable items. Work with a national leader. Write today. Pen-N-Brush, Dept. PM-9, 139 Duane Street, New York City 13.

60% PROFIT Cosmetics. \$25 day up. Hire others. Samples, details. Studio Girl Hollywood, Glendale, Calif., Dept. 1269-H.

FOAM-O-Cell sponge, new miracle household item; cleans rugs, carpets, upholstery like new! Tremendous market, fast \$1.00 seller, big profits. Free details. M & M, Dept. 4-PM, 842 Third Avenue, New York City 22.

NAMEPLATES. Desk signs. Free samples. Biggest profits. Whitney Signs, West Springfield, Massachusetts.

SELL Profitable personalized rugs. For information write Bobby's, Department 18, Manitou Springs, Colorado.

SCHOOL Seniors—Be popular with classmates. Have spending money galore. Details free. Craftcards, Box 235-L, Pittsburgh 19, Pennsylvania.

FANTASTIC New money-making plan. Sell nothing, yet make to \$50 daily! Offer women, personally or by mail, beautiful stainless steel tableware set complete with chest, free for selling just two sets to friends. Exclusive patterns not obtainable elsewhere. Guaranteed 50 years. Can't rust, stain or tarnish. Successor to sterling. Amazing low wholesale cost starting at \$2.70 set. Postcard brings catalog, booklet "How To Make Money in your Own Business," all money-making plans absolutely free. Topval Corp., Lindenhurst 81, N. Y.

BIG Profits! Sell amazing Seal-Tite puncture-proofing compound to car owners, cab and truck fleets, service stations, etc. Terrific appeal, fast \$1.98 seller! Free details. M & M, Dept. 2-PM, 842 Third Avenue, New York City 22.

SELL Wholesale to hardwares, groceries, plumbers. Retail to consumer. New Septic-clean for septic tanks. Large profits. Septicclean, 2870 Coolidge, Berkeley, Mich.

BIG Profits! Easy to sell beautiful hand painted portraits, made from any snapshot or negative. Details. H. Shultz Co., Box 44-747, Sta. H, Los Angeles, Calif.

BUY IT WHOLESALE

WHOLESALE Catalog! 30-80% discounts! Appliances, musical instruments, typewriters, tools, watches, jewelry, cameras, housewares, etc. Consolidated Distributors, 1300-20 Main, Clifton, New Jersey.

FREE Gift catalog. Wholesale catalogs, name brands. Edith's, Deep River, Conn.

WHOLESALE Catalog. 100 pages, \$1.00 refundable. Conklin, Box 12, Ontario, California.

USED And new watches \$2 up. Free list. Southern Watches, Gray, Georgia.

BUY Wholesale! Nationally known brands. Catalog \$1.00. D'Auria, Box 355-PM, Jackson, Michigan.

BARGAINS, Joblots, closeouts. 2000 items. Tremendous savings, clothing, toys, gifts, jewelry, television, etc. 25¢ brings wholesale catalog. \$1.00 merchandise certificate included free. Reliable Jobbing, 311-B North Desplaines, Chicago.

WHOLESALE Catalog 75¢ jewelry, watches, appliances. Riddy Sale Co., 15218 Shiloh Rd., Cleveland 10, Ohio.

ELECTRIC Guitars, amplifiers, wholesale. Free catalog. Carvin, PM287, Covina, Calif.

WHOLESALE Catalog! Jewelry; houseware; appliances! Postcard! Midwest, B-156-M, Pontiac, Ill.

FREE! Illustrated wholesale catalog. Save and earn money on over 1000 most popular, brand-name housewares and appliances. Tremendous discounts. Write: Shop Smart Ltd., Dept. 19, Box 687, Newark 1, N. J.

WHOLESALE Catalog! Appliances, cameras, watches. Postcard. Selbyco, Decatur 160, Illinois.

YOUR Cost as little as 30¢ on dollar! Household items needed in every home. Sell direct, by mail or to agents. Postcard brings booklet "How To Make Money in Your Own Business," catalog and money-making plans absolutely free. Topval Corp., Lindenhurst 624, N. Y.

SALESMEN—DISTRIBUTORS

SALESMEN: For fast selling imported merchandise, 40% commission. Write for free information. Box 4082, Corpus Christi, Texas.

USED And new watches \$2 up. Free list. Southern Watches, Gray, Georgia.

NEW Jobs open in selling! Send name, address for five free issues of Opportunity Magazine's money-making guide, listing hundreds of companies who'll pay you well, full or part-time. No experience needed. Opportunity, 850 N. Dearborn, Dept. 17, Chicago 40, Ill.

BUILD Sales by recruiting productive distributors selling direct or to retail outlets. Secure most concentrated circulation through classified columns of Salesman's Opportunity. Write for facts. Gilbert, Salesman's Opportunity, Room 1700, 850 N. Dearborn, Chicago 10.

GOOD Man can make \$3,000.00 next 90 days. Every house in town wants amazing NILite "cats-eye" lawn sign. Automatic selling plan pays profits everyday. Write today for free details. NILite, 173 W. Madison, Dept. 301, Chicago.

ADD \$20.00 To \$200.00 per week to your income with Miracle Bowls! Sell door to door and store to store. Just add water and watch them grow. Write for free literature now. Miracle Bowls, Dept. 3, Littleton, Colorado.

INTRODUCING Fast selling patented close quarter saw, factory to you. Retail \$1.00. Diesel Power Inc., Greenville, Penna.

SALESMEN Wanted. Make money in oil. Complete line lubricants including nationally acclaimed motor conditioner that increases gasoline mileage 33%. Free sample kit. Revere, Box 1886, Cleveland 6, Ohio.

BUSINESS Kit free! Postcard puts you in business! Complete line. 190 shoe styles, also jackets. New discoveries pay big commissions. No investment. Send for free kit. Mason Shoe, C34, Chippewa Falls, Wisc.

GET New shirt outfit free: Make \$90.00 weekly on 5 average orders a day. Famous quality made-to-measure dress and sport shirts at \$3.95 up sell fast to all men. No experience needed. Full or part time. Write: Packard Shirt Co., Dept. 307, Terre Haute, Ind.

ONE Monument sale weekly earns \$200 or more. Jones Monumental Works, St. Cloud, Minn.

ADVERTISING Book matches—Cash in on big demand; sell union label matches. Cuts for all businesses and political parties. Free powerhouse selling kit, low prices, protection guaranteed on repeat orders. Cash commissions. Superior Match Co., Dept. M-956, 7530 Greenwood, Chicago.

\$1,000.00 A Month for making dramatic 3-second demonstration of amazing lightweight Presto fire extinguisher. New chemical used by airforce snuffs out fires instantly. Only \$4.95. Terrific commissions. Millions want it. Free kit. Merlite, 114 E. 32nd, Dept. P-53L, New York City 16.

NEW Invention, \$4.95 fire alarm, paying up to \$1,100 a month. No wiring. Unlimited market. Dramatic demonstration. Free kit. Merlite, Alarm Div., 114 E. 32nd St., Dept. P-53L, New York 16, N. Y.

CALENDARS, Advertising novelties, matches. All styles, including religious, varnished. 12 sheet, girls. Hundreds of advertising novelties, book matches, etc. Fleming Calendar Co., Sales Division, 6539 Cottage Grove, Chicago 37, Ill.

WHOLESALE Catalog! 30-80% discounts! Appliances, musical instruments, typewriters, tools, watches, jewelry, cameras, housewares, etc. Consolidated Distributors, 1300-12 Main, Clifton, New Jersey.

AD Matches! Sell amazing designs—10, 20, 30, 40 and 240-light book matches. Bigger spot cash commissions; every business a prospect. Low prices for high quality. Repeats. Start without experience; men, women; full, part time. Buy nothing! Sales kit furnished. Match Corp., Dept. PM-81, Chicago 32, Illinois.

SELL Calendars. You make big money daily. Giant line. Every business buys. Also business printing, book matches, advertising specialties. Big sales outfit free. Write, Arrow Press, 515J Fourth Ave. So., Minneapolis, Minn.

BUY Wholesale thousands nationally advertised products at big discount. Free "Wholesale Plan." American Buyers, Hertel Station, Buffalo 16-J, N. Y.

ANYONE Can sell famous Hoover uniforms for beauty shops, waitresses, nurses, doctors, others. All popular miracle fabrics—Nylon, dacron, orlon. Exclusive styles, top quality. Big cash income now, real future. Equipment free. Hoover, Dept. MJ-100, New York 11, N. Y.

BIG Profits selling service stations, garages. Motor additive, oil substitute. Sample \$1.00. Penfield Petroleum, 136-30 38th Ave., Flushing, N. Y.

NEW Tubular ornamental iron: Completely standardized. Tremendous opportunity in home improvement field. Distributors or dealers wanted. Write Eng-hauser Manufacturing Company, Lebanon 3, Ohio, for particulars.

YOUR Next job. Here's an opening for a man in your area to take over thousands of contacts for factories, offices, stores, etc. Earnings in advance; bonus benefits. We figure this man is worth up to \$16,000.00 in a year. Write or wire B. L. Slocum, Vice President, Littleton, Colo.

MONEY-Making opportunity! Take big profit orders for world famous patented varieties fruit trees. Also flowering shrubs, roses, vines. Big sales outfit free. Stark Bro's, Desk 30197, Louisiana, Missouri.

IF You want increased sales write: Woods, Wyoming 2, Penna.

AMAZING Whitewall tire cleaner sells for half regular price, earns 100%. Demonstrator set and \$2.98 salable merchandise \$1.00. Details 3-way profit plan free. Kem-Oil, 2610 Ashland, Houston, Texas.

MAKE \$10.00 An hour or more, spare time, with tested free trial sales plan for fastest-selling new home appliance. Defrosts refrigerators automatically. Sell 8 homes in 10. Free details, guaranteed profit offer. Write Defrostomatic, 173 W. Madison, Dept. D-102, Chicago.

FREE Catalog ladies' handtooled handbags. Garza, Apartado 82, Tampico, Mexico.

MASTICOTE "Alcoa aluminum" pigmented liquid roofing brings big orders. Our top salesmen average over \$10,000 a year—commission. Madison Paint Co., Mfrs. Dept. PM569, Cleveland 2, Ohio.

70¢ PROFIT On each dollar! Exclusive patterns, luxurious stainless steel tableware, guaranteed 50 years. Can't rust, stain or tarnish. Looks like silver. All popular size sets complete with chests. Have agents, others, sell for you. Offer women set free for every two sets they sell friends. Use catalogs with only your name. We ship under your label. Postcard brings catalog, booklet "How To Make Money in Your Own Business," all money-making plans absolutely free. Topval Corp., Lindenhurst 125, N. Y.

EMPLOYMENT INFORMATION

JOB Information. High pay. South America, the Islands, U.S.A., foreign countries. All trades. Clerical, labor, engineers, drivers, others. Women also. Companies pay overseas fare if hired. Write Section 92F, National Employment Information, 1020 Broad, Newark, N. J.

COPYRIGHTED Reports on best paying jobs with travel, adventure, promotions. Construction, aviation, shipping, laborers, clerical, trades, supervisory, factory, unusual opportunities. Many types of work. Skilled and unskilled. Foreign and state-side openings for men and women. Only \$2.00 (\$2.25 airmail), including registration-advisory service. Satisfaction guaranteed. Included absolutely free: Special reports on Alaska. Spanish airbase construction. South American opportunities and husband-wife foreign jobs. Research Services, Suite 207-PMH, Brown Building, St. Louis 5, Missouri.

JOBS Plentiful in Southern California, classified listings, \$1. Box 73, Hawthorne, California.

LIVE in Southern California! Thousands high pay jobs available. Current list, all types. State sex. Send \$1.00 to "Opportunities," P. O. Box 3562, Long Beach 3, Calif.

FOREIGN, Alaskan, U.S.A., job opportunities! To \$1500.00 monthly! Million Americans employed overseas. Copyrighted reports. Who to contact for highest paying jobs. Laborers, trades, truck drivers, office, engineers, many others. 52 countries—St. Lawrence project, Spain, Latin America, northern projects, Europe. Year registration-advisory service. Application forms. Unconditional money-back guarantee! \$2.00 (airmailed \$2.25) c.o.d.'s accepted. International Reporter, St. Louis 1-PK, Missouri.

FORTUNE In import from France. Plan \$1.00. Lenormand, 722 Magnolia, Long Beach, California.

EDUCATIONAL AND INSTRUCTION

PAINT Oil portrait, first lesson. "Miracle Method" home-study portrait course. Raydee Studios, Studio C, Box 3202, Reading, Pennsylvania.

COMPLETE Your high school at home in spare time with 59-year-old school. Texts furnished. No classes. Diploma. Information booklet free. American School, Dept. X645, Drexel at 58th, Chicago 37, Illinois.

"TRIGONISIE" Trigonometry gives direct, practical answers to solve right triangle problems—No formulas, no computations. Quality instrument. Write for free literature. Vanora Products, Dept. P-9, P. O. Box 8485, Kansas City, Mo.

SCIENCE Of memory simplified. Volume one of Memorology free. Memorology Studio, 2016 Sunnyside Ave., Chicago 25, Ill.

PHOTOGRAPHY For pleasure or profit. Learn at home. Practical basic training. Long established school. Free booklet. American School of Photography, 835 Diversey Parkway, Dept. 344-B, Chicago 14.

HANDWRITING Character analysis self-taught. Free brochure. Lucas, 2419 Sunset Boulevard, Los Angeles 26, California.

WELDING Training pays at Hobart Welding School, Box M-961, Troy, Ohio. VA contract. Best equipment. Catalog free.

FINISH High school at home, spare time. No classes. Diploma awarded. Write for free catalog. Wayne School, Catalog HP-67, 2527 Sheffield, Chicago 14.

HAND Engraving; learn at home. Write Box 116, Mishawaka, Ind.

BLUEPRINT Reading—Train at home. Learn to read blueprints with confidence in 10 easy lessons. Write today Belton School, 1059-Y North Lawndale, Chicago 51.

ENGINEERING, Home study. Midwest Engineering School, 10923 Hillcrest, Hickman Mills, Missouri.

DRAFTING-Design, Architectural, Mechanical, Electrical, Structural, Aircraft mathematics. Physics, Estimating, Surveying, Veteran approved. Mondell Institute, 230 West 41 St., New York City.

HELP Yourself to abundant living. Our courses have aided students to richer fuller lives. Learn secret of contentment, happiness. Earn degrees Ps.D., Ms.D. Write for free book. College of Universal Truth Correspondence School, 23-C E. Jackson, Chicago.

STUDY For Doctor's degree of psychology, metaphysics and divinity. Correspondence courses only. College of Divine Metaphysics, Dept. P-M, 2811 North Illinois, Indianapolis 8, Indiana.

LEARN Mineralogy at home. Diploma course. Fortunes now being made in uranium and other minerals. Free catalog. Mineral Science Institute, Desk 2, 159 East Ontario, Chicago 11.

HIGH School diploma at home. Licensed teachers—Approved materials. Southern States Academy, Box 144-MX, Station E, Atlanta, Georgia.

I want to send you proof of the wonderful pulling power of Popular Mechanics classified pages. What's your proposition? Write me today. Include literature if possible. F. W. Johnson, Manager Classified Advertising, Popular Mechanics Magazine, 200 E. Ontario St., Chicago 11, Ill.

BE A real estate broker. Study at home. Write for free book today. GI approved. Weaver School of Real Estate, 2018P Grand, Kansas City, Missouri.

EARN While you learn. Auto and diesel mechanics master this top paying trade. Many graduates earn \$100 a week and up. Approved for Korean veterans. For free information write Dept. No. 256, Nashville Auto-Diesel College, Nashville 3, Tenn.

BOOKKEEPERS! Increase your earnings! Operate your own simplified "Dollar-A-Week" bookkeeping and tax service. Full or spare time. Details free. No obligation. Ellis, Box 200, Cedar Grove, North Carolina.

WANT A diesel job? New opportunities to increase income. Higher pay. More money. We can help you qualify. Tools. Shop method home training. Write today! Diesel, Tractor, Heavy Equipment Division, Interstate Training Service, Dept. B-3, Portland 13, Oregon.

INVESTIGATOR Training. Phillips Secret Service System, 1917-B North Kenneth, Chicago 39.

USED Correspondence courses and educational books bought, sold, rented. Free catalog. Educational Exchange, Menlo, Georgia.

STARTLING Discovery! Amazing new, uncrowded profession. Know yourself, others; how they think, act. Big money, recognition, returns for those who qualify. Learn at home, spare time. Send only \$1.00 for secrets (regular price \$1.50). \$3.00 credit coupon given. Give age, occupation, your handwriting for surprise worth \$1.00. Estes, 2307-PM National Station, Springfield, Missouri.

SWEDISH Massage. We train you at home. Earn big profits from your own private practice or work with hospitals and doctors. Free catalogue. National Institute, Desk 4, 159 E. Ontario, Chicago, Ill.

BOOKS: Hundreds of subjects. Big catalog free. Popular Mechanics Press, 200-BC East Ontario St., Chicago 11.

BOOKS. Free 1956 catalog, 100 pages Text, vocational, educational, instructional subjects. Millions of volumes, new and used. Bargain prices. Books bought. Est. 1902. Long's College Book Co., Dept. PM, Columbus 1, Ohio.

ENGINEERING Degrees earned by home study. American College of Engineering (University of the West), Box 27724-B, Hollywood 27, California.

GROW Mushrooms. Cellar, shed. Spare, full time, year round. We pay \$3.50 lb. We paid John Betts \$7,977.76, he started as amateur. Free book. Mushrooms, Dept. 174, 2954 Admiral Way, Seattle, Wash.

USED Correspondence courses and books sold and rented. Money back guarantee. Catalog free. (Courses bought.) Lee Mountain, Pisgah, Alabama.

MIDLAND Linotype School. Charles City, Iowa. Civilian and veteran courses. Free placement. Established 1909.

FINGERPRINT Training. Alabama School of Fingerprinting, Box 185-A, Fairfield, Alabama.

LEARN To fit hearing aids, or scientific massage. Diplomas, Write Box 3611; Oklahoma City 6.

DRAFTING, Design, blueprint reading. Good paying. Easy to learn at home. Minimum age 17. Write Utilities Engineering Institute, Dept. TC-1, 2525 Sheffield, Chicago 14.

TRANSFORM Yourself via subconscious. Free brochure. Box 847, H-9, Ocean Park, Calif.

LEARN Advertising. America's highest paid profession. Botts Advertising, 1211 Laura MP, Wichita, Kans.

WELDING, Arc or torch. Learn at home. Free details. Marnel, Box 7642, Denver 15, Colorado.

WANT Strong, masculine voice? Send for free booklet. Perfect Voice Institute, 210 South Clinton, Studio 2JU-2, Chicago 6.

DIPLOMA, Degree correspondence courses, nursing, psychology, science. Aureas, Central Valley, New York.

USED Correspondence courses, books bought, sold, rented. Catalog free. Myrtle Vernon, 624 Mohawk Street, Rossville, Ga.

UNIVERSITY Degrees by residence, correspondence. Golden State University, 4415-23 Santa Monica Boulevard, Hollywood 28, California.

BARGAIN, Exciting Little Library booklets, 25¢ each. Tool making, painting, welding, home improvement, games, models, plastics, lamp making, glass blowing, boats, photographs. Free catalog. Popular Mechanics Press, 200-LB East Ontario St., Chicago 11.

PLAYS, STORIES, MANUSCRIPTS

MAKE Money writing features. Amazing book tells how. Free literature. Ben Arid Hermosa Beach, Calif.

ALL The world loves an author. If you write, we appraise/sell. Write/phone. Daniel S. Mead, Literary Agt., 419 Fourth Ave., New York City 16; OR 9-1150.

WANT Your book published? Learn how we publish, advertise, promote, distribute. Many successes. Free booklet PM, Vantage, 120 West 31, New York City.

WANTED: Book manuscripts, all subjects considered. Greenwich Book Pub., Attn. Mr. Zealand, 489 Fifth Ave., New York City.

SPECIAL SERVICES

VETERANS—Papers scattered? Free folder! Records Holder Co., Charles Town, W. Va.

THE Drafting and Designing Service, 4024 So. Maplewood, Chicago 32, Illinois.

INFORMATION On anything. Ferguson Research Specialists, 116-14 141 St., South Ozone Park 36, N. Y.

ARTISTS' SUPPLIES

IF Interested in artist frames, canvas, canvas boards, Red Sable brushes, etc., be sure to get our money saving price lists before buying. International Sales Co., 414-APM E. Baltimore St., Baltimore 2, Md.

CARTOONING, COMMERCIAL ART, SHOWCARD & SIGN PAINTING, TATTOOING

TATTOOING Supplies, licensed course, illustrated brochures 25¢. Zeiss, 728 Lesley, Rockford, Illinois.

PAINT Signs—Master die cut, outline letter patterns. Complete assortment 1½" to 12" high, prepaid \$2.00. Everly, 583, Newton, Iowa.

DRAW Your way to fame. Free information. Cartoons-of-the-Month, Roslyn, N.Y.

LEARN Sign painting at home. Free talent test. Ben Kerns, Box 812-PM, Greenville, S.C.

BASIC Art training at home. Write for free talent test. Students' Art Club, Kennebunkport, Maine.

"HOW To Make Money With Simple Cartoons." A book everyone who likes to draw should have. It is free; no obligation. Simply address Cartoonists' Exchange, Dept. 99, Pleasant Hill, Ohio.

ADVERTISING AGENCIES, LETTER WRITERS, FOR ADVERTISERS

ADVERTISING Ratebook leading newspapers, magazines, free. Chicago Advertising Agency, Chicago 4.

NEW Mothers—1,000 names \$6.00. World Trading Co., Aguila, Arizona.

FREE! 1956 Advertisers Rate and Data Directory. 52 pages! E. H. Brown Advertising Agency, 20 N. Wacker, Chicago 6.

ADVERTISING, Result-getting ads prepared, placed newspapers, magazines, radio, anywhere! Lowest rates. Catalogue free. Baker Advertising Agency, 189 W. Madison, Chicago 2.

MAILING Lists most any classification \$5.00 1000. Your circulars mailed with ours \$4.00 1000. Write for our literature. Dixie Mailers, King, N. C.

WOMEN Mail buyers names, \$5.00 thousand. Du-Rite, 624 East 17th, Indianapolis 2, Indiana.

25 WORDS Display \$2.50, extra words 10¢. Mail Gazette covers 30,000 cash mail order buyers, U.S., Canada. Linco, Box 3215, Tulsa 8, Okla.

ADVERTISE: 24 Words, 100 Canadian newspapers \$5.50. Lists free. Advertising Bureau, 10511-C Springfield, Chicago 43.

RUBBER STAMPS AND OFFICE SUPPLIES

YOUR Name, address, and choice of emblem. \$2.00 postpaid. Free information. James Snyder, 619-1C, Princeton, Indiana.

3 LINES \$1.00. 4 Lines \$1.35. Free pad. Postpaid. Ascot, Mandarin, Florida.

FREE Style list stock stamps. Criterion, Box 2326, Denver 25, Colo.

THREE Lines \$1.00 postpaid. Free stamp pad. Barber, Marengo, Ohio.

3 LINES, 1.00. Fast service. Catalogue. Johnson, 443 MacDonough, Brooklyn 33, N. Y.

12 IN 1 Phrase stamp with key. Airmail, fragile, etc. A must in home, office, industry. \$1.95 ppd. Milbon Sales Co., 2651 Bascher, Chicago 26, Ill.

TYPEWRITERS, DUPLICATORS, OFFICE DEVICES

RECONDITIONED Typewriters, duplicating, printing devices. \$25.00 up. Supplies. Appliances. DixieGraph, King, N. C.

PORTABLE Mimeograph! Uses no stencil, no ink. The newest, cleanest, smallest, lightest and cheapest. Weight 15 pounds. DuPont Distributors, P.O. Box 695, Dept. A, New York 1, N. Y.

PRINTING, MULTIGRAPHING, MIMEOGRAPHING, GUMMED LABELS

OFFSET Printing \$6.50—1000. 8½x11, 16 lb. National Letter. 251 W. 42 St., New York City 36.

MIMEOGRAPHING—Letters, pricelists, formulas, instructions. Lowest prices. Lem's Letter Shop, 5710 Stanton, Detroit 8.

ADS Running under this heading sell printing. Ask me for proof. I'll gladly send you amazing facts. Ask for Folder "P." F. W. Johnson, 200 E. Ontario St., Chicago 11, Ill.

FREE Catalog business, personal printing. D. M. Press, Sebastopol, California.

MIMEOGRAPHING. Beautiful art work. Send 25¢ for samples. Barr's, Box 934, Hutchinson, Kansas.

BUSINESS Printing. Reasonable. Catalog free. Howprint, 723-G Eunice, Webster Groves 19, Missouri.

SALES Books, order books, bill books, printed business forms. Edidrose, Bronx 72, N. Y. Free catalog.

100 LETTERHEADS (8½x11) Printed carefully, \$1.00, postpaid. Envelopes same. Race Printers, Hudson, New York.

FAST Service! 100 8½x11 letterheads \$2.00, postpaid. Bass Press, Knox, Indiana.

PRINTING. Catalog free. Wellar Press, Box 262, Dover, N. J.

BUSINESS Cards—Wholesale. Agents wanted. Deco Service, Box 3315-M, St. Louis 3, Mo.

ILLUSTRATED Catalog: Printing, offsetting, colored mimeographing. Letterhead folio included. Carol, 1863 Edgewood, Norfolk 3, Virginia.

100 LETTERHEADS And 100 envelopes \$2.50 postpaid. Three lines, same setup. Econoprint, Box 625, Whittier, California.

OFFSET Printing, \$2.50, 100: \$6.50, 1000 postpaid 8½x11, 16 lb. Letters, pricelists, booklets, instructions. Tech, Box 748, Freeport, New York.

1,000 RAISED Letters business cards \$2.95. Samples. Pioneer, 195-I Quebec, Island Park, N. Y.

100 LETTERHEADS 5½x8½ And 100 envelopes, both printed, 3-lines, \$1.75 cash, no c.o.d.'s. Sheldon, 115 Ninth, Phillipsburg, Penna.

QUALITY Printing at wholesale prices. Catalog, samples, free. Bryan & Allen, 503 Williams Ave., Panama City, Fla.

REASONABLE Prices. Quality printing. 100 or million. Send us your copy. Lind Printing, 1121 East Colorado, Glendale 5, California.

FINE Printing for every purpose. Samples. Treaster Printing, Milroy, Penna.

BUSINESS Printing, offset, mimeographing. Samples. D'Yarmett, 285 Cypress, Columbus 23, Ohio.

QUALITY Printing at small town prices. Send copy for quotations. Mercury Press, Box 69M, Marengo, Iowa.

CIRCULARS. Booklets, imitation letters. Estimates free! Lonelm Printers, Paulding, Ohio.

GUMMED Labels in rolls. Name and address in three lines. ½x1¼. 500 \$1.00. Business cards, \$3.95. Guaranteed. Mailed same day. Samples. Alexander, Box 474, Pomona, California.

COMPLETE Mail advertising service: Mimeographing, printing, offset, copy, art. Catalog free! Edwards, 164—77th, Brooklyn 9, New York.

PRINTING OUTFITS AND SUPPLIES

RUBBER Stamp making presses, hydraulic operated, electrically heated. Also supplies. Custom, Box 211-M, Springfield, Missouri.

MAKE Your own self-molding rubber stamps and printing cuts. Plexirubber, Argyle 1, Wisconsin.

DO Your own printing. Save money. Simple rules. We supply everything. Print for others; good profit. Raised printing like engraving too. Have home shop. Details free. Kelsey Presses, V-11, Meriden, Connecticut.

PRESSES. Type cabinets, supplies. List for stamp. Lincoln Press Company, 220-J Hartwell, Fall River, Mass.

PRINTERS New type fonts, 85 cents each. Eschinger, 7211 N. Second St., Philadelphia 33, Penna.

PATENT ATTORNEYS

PATENTS—Irving L. McCathran, 315 McLachlen Bldg., Washington 1, D. C. Registered Patent Attorney.

INVENTION Record form free and "Patent Information Every Inventor Should Have." Carl Miller, Registered Patent Attorney, Woolworth Building, New York.

REGISTERED Patent attorney offers services. Sanders, 6430 Evans, Chicago 37, Illinois.

C. A. Snow & Co.—M427, Snow Building, Washington 1, D. C. Registered Patent Attorneys. Write for information.

INVENTORS: Without obligation, write for information explaining the steps you should take to secure a patent. John Randolph, Registered Patent Attorney, 203 Columbian Bldg., Washington 1, D. C.

INVENTORS: Learn how to protect your invention. Unless the inventor is familiar with patent matters, he should engage a competent registered patent attorney or agent to represent him. We are registered to practice before the U. S. patent office and prepared to serve you in handling your patent matters. "Patent Guide for the Inventor" containing detailed information concerning patent protection and procedure with "Record of Invention" form will be forwarded to you upon request—without obligation. Clarence A. O'Brien & Harvey Jacobson, Registered Patent Attorneys, 61B-G District National Building, Washington, D. C.

INVENTORS: When you are satisfied that you have invented something of value write me, without obligation, for information as to what steps you should take to secure a patent. Write Patrick D. Beavers, Registered Patent Atty., 935 Columbian Bldg., Washington 1, D. C.

PATENTS. "Proof of Invention" free. E. E. Vrooman, Registered Patent Attorney, 507 McKim Building, Washington 5, D. C.

"INVENTOR'S Guide" and "Record of Invention" free on request. Frank P. Ledermann, Registered Patent Attorney, 154 Nassau Street, New York City.

INVENTORS. If you believe you have an invention, you should find out how to protect it. The firm of McMorrow, Berman & Davidson with offices in Washington, D. C., is qualified to take the necessary steps for you. Send for copy of our patent booklet "How to Protect Your Invention." We will also send you an "Invention Record" form. No obligation. They are yours for the asking. McMorrow, Berman & Davidson, Registered Patent Attorneys, 1349 Victor Building, Washington 1, D. C.

INVENTORS—Take these preliminary steps toward patent protection. Sketch and describe your invention. Sign, date and have this disclosure witnessed by two people who understand your invention. Have us make a preliminary search among U.S. patents already granted for similar types of invention. We report on the probable patentability of your invention and recommend your further course of action. Write for our instructive booklet, "Patent Protection for Inventors" and convenient "Evidence of Invention" disclosure form. Victor J. Evans & Co., 231-K Merlyn Building, Washington 6, D. C.

FOR INVENTORS

INVENTORS—This firm is registered to practice before the United States Patent Office and available to assist you in the preparation and prosecution of your patent application. "Patent Protection for Inventors" booklet containing detailed information and steps to take toward patent protection sent promptly upon request. No obligation. Victor J. Evans & Co., 232-K Merlyn Building, Washington 6, D. C.

INVENTORS. If you believe you have an invention, you should find out how to protect it. The firm of McMorrow, Berman & Davidson with offices in Washington, D. C., is qualified to take the necessary steps for you. Send for copy of our patent booklet "How to Protect Your Invention." We will also send you an "Invention Record" form. No obligation. They are yours for the asking. McMorrow, Berman & Davidson, Registered Patent Attorneys, 1348 Victor Building, Washington 1, D. C.

MANUFACTURERS Names. Any line. 25—\$5.00. Russell Tupper, Sandwich, Mass.

IDEAS Developed for products and your profit with effective patent protection at low definite cost. Foreign patents: Canadian patents filed \$100.00. 30 yrs. in business. Joseph O'Brien, Patent-Development Engineer, 132 Nassau St., New York 38, N. Y.

SEARCHES—Put your patent searches in the hands of a registered patent attorney or agent, as he qualifies to give a worthwhile patentability report. Record of invention form upon request and information on patent protection. Patrick D. Beavers, Registered Patent Attorney, 936 Columbian Bldg., Washington 1, D. C.

INVENTORS: Information on patent procedure furnished on request, without obligation. John Randolph, Registered Patent Attorney, 202 Columbian Building, Washington 1, D. C.

"INVENTOR'S Guide" and "Record of Invention" free on request. Frank P. Ledermann, 154 Nassau Street, New York 38, N. Y.

INVENTORS: Learn how you can protect your invention. A specially prepared booklet "Patent Guide for the Inventor" containing detailed information concerning patent protection and procedure together with "Record of Invention" form will be promptly forwarded to you upon request—without obligation. We are registered to practice before the United States patent office and are prepared to serve you in the handling of your patent matters. Clarence A. O'Brien & Harvey Jacobson, Registered Patent Attorneys, 61A-G District National Building, Washington, D. C.

PATENT Searches \$5.00. 48-hour service. Free invention protection forms. Write Raymond L. Smith, Patent Searcher, 620 Sheraton Building, Washington 5, D. C.

INVENTIONS: Wanted. Patent pending only. Write Stark Company, Cedarburg, Wisconsin.

PATENT Searches \$5.00. 48-hour air-mail service. Invention protection forms free. Write Patent Engineering Service, 711 14th Street N. W., Washington 5, D. C.

INVENTION Record form free and "Patent Information Every Inventor Should Have." Carl Miller, Registered Patent Attorney, Woolworth Building, New York.

PATENT Searches, including copies of nearest patents, \$6.00. Reports airmailed within 48 hours. More than 100 registered patent attorneys use my service. For free invention protection forms, write Miss Ann Hastings, P.O. Box 176, Washington 4, D. C.

INVENTORS: If you have an invention for sale, patented or unpatented, write Institute of American Inventors, Dept. 40A, 631-E St. N.W., Washington 4, D. C.

INVENTORS—Send for free patent information book and inventor's record. Registered Patent Attorney, Associate Examiner, Patent Office 1922-29, Patent Attorney & Advisor, Navy Department 1930-47, Gustave Miller, 96A Warner Building, Washington 4, D. C.

PATENT Decisions without lawyers. Complete university patent course condensed to 100 easy reading pages. \$4.95. George Heitman, B.S.M.E., M.S., Meeker Ave., Allendale, N. J.

COMPREHENSIVE List of buyers, manufacturers specifically selected for your own invention. Send details of invention use and \$3.00. Winsor, Box 171-A, Albuquerque, New Mexico.

INVENTIONS WANTED

TOY Or game ideas wanted by large, well-rated manufacturer. For prompt action, best offer, write M. J. Lee Co., 2222 So. Michigan Ave., Chicago 16, Ill.

ADULT, Children's games suitable for patented toy scoring device. \$1.00 brings information. N. Saunders, 662 West Hill, Ontario, Canada.

INVENTIONS Promoted. Guaranteed plan. Write for free booklet "Your Invention." Kessler Corporation, 591W, Fremont, Ohio.

AMERICAN Congress of Inventors, quick response. Free "Thomas Edison's Formulas for Success." Inventors, Box 1481, Milwaukee 1, Wisconsin.

INVENTIONS Wanted. Patented; unpatented. Tremendous manufacturers lists. Global Marketing Service, 2420 77th, Oakland 5, California.

INVENTORS. Give us the opportunity to explain our selling plan for your invention, gadget or device, patented or unpatented; free particulars available upon request. Demarest and Demarest, Box 95, Battle Creek, Michigan.

ESTABLISHED Manufacturer, with facilities to fabricate lightweight metal products, wants patented or unpatented items to manufacture. Write Tom Lee, Magnesium Products of Milwaukee, 742 W. Virginia St., Milwaukee 4, Wisconsin. Write for form to use when submitting your idea.

INVENTORS: Hundreds of manufacturers have requested our assistance in locating marketable new products. Complete information free. Institute of American Inventors, Dept. 40-D, 631-E St. N.W., Washington 4, D. C.

INVENTORS, Don't sell your invention patented or unpatented until you receive our offer. Write Cowgill, Box 298, Marion, Ohio.

INVENTIONS Wanted. Patented or patent pending. 25 years experience promoting inventions. National Service Bureau, 3120 Meramec, St. Louis 18, Mo.

SUPERIOR Promotions. Patented; unpatented inventions. Free, informative booklet, guidance. Superior, 338-344 North Rodeo, Beverly Hills, Calif.

WILL Finance and manufacture your invention or formula if it appeals to us. National Research & Development Corp., 11 W. 42 St., New York 17, N. Y.

FREE Details available. Exhibit your invention. America's largest invention exhibition. Viewed by thousands of manufacturers, distributors. Entry deadline October 16. California Inventors Association, 681 Market Street, San Francisco 5, California.

ATTENTION Inventors! To sell your invention advertise in Gadgets, Patents, Invention Magazine, Inventors' Service Bureau, 107 W. Van Buren, Chicago 5, Ill.

PATENTS FOR SALE

TALKIE-Movie toy. Recreational, educational. D'Algodt, 628 W. 114th, New York City 25.

FOR Sale or lease. U. S. patent on gold recovery machine. W. S. Temple, 101 N. 22 Ave., Hattiesburg, Miss.

INVENTORS: Test the commercial value of your patented or unpatented inventions, quickly and inexpensively. Write for free information. Institute of American Inventors, Dept. 40-B, 631-E St., N.W., Washington 4, D. C.

MANUFACTURING

WOOD, Composite products. Small lot manufacturing. Lee, 719 Moore St., Bristol, Va.

PAINT Mfg. equipt. Finest formulas. Positive retirement security. Box 205, Worthington, Ind.

MODELS—Small lot manufacturing. Metals, plastics, etc. Milburn, Burlington, Kentucky.

MODELS, MODEL SUPPLIES

POWER Models. Unusual steam gasoline and traction engines, fittings, metals. Comprehensive catalog \$1.00. Chas. Cole, Ventura, Calif.

CATALOGS: Ship models 50¢; foreign woods, and veneers 50¢; garden circus lists 35¢. Jig saw blade list free. Wild's, 510 East 11th Street, New York City 9.

STEAM Locomotive castings, plans, instructions. Details 25¢. B&B, 10 High, Morristown, N. J.

SHIP Model kits and fittings including clippers, trawler, fishermen, frigates, privateer, radio control tug, etc. Send 25¢ for 1956 catalog. Model Shipways, Box 85, Bogota, N. J.

BUILD Miniature passenger hauling live steam locomotive with file and drillpress. We do machine work, you bolt it together. Catalog 50¢. Little Engines, Lomita, Calif.

SHIP And yacht model fittings; blueprints. Send 35¢ for illustrated catalog listing hundreds of items. A. J. Fisher, 1002-1 Etowah Ave., Royal Oak, Mich.

SHIP Models. Most complete line in New England. Kits, fittings, plans, books, tools, engines, motors. Illustrated catalog 30¢. James Bliss & Co., Inc., Dept. SM, 342 Atlantic Ave., Boston 10, Mass.

BALSA Wood and model aircraft. 40-page catalog 25¢. Sig Co., Montezuma, Iowa.

ANVIL—Hobby builder's—2" high, 4 1/2" long. 6 assorted tools. \$2.00 postpaid. U.S.A. Bob Hodgson, Dept. 1, R.D. 2, Dover, Pennsylvania.

LIONEL American Flyer trains sold, repaired. Big discounts. Bulletin free. Catalog 25¢. Mack Bros., 2043-P Chicago Ave., Chicago 22.

HOME CRAFTSMEN

KNOCKDOWN Cedar chests. Lumber and veneers. Free price list. Giles & Kendall Company, Huntsville, Ala.

STYLECRAFT Sure fire hits. "Pre-traced" leather kits. Handbags, billfolds, filigree belts, over fifty other projects. Patterns on leather. Why trace? Just carve, assemble and lace. Large assortment "precarved" kits also available. Send 25¢ for catalog, free folder. Refunded first order. Apache Leather Company, 2804 E. Washington St., Phoenix, Arizona.

KNOCKDOWN Cedar chests and lumber. Free price list. Bedford Lumber Company, Shelbyville, Tennessee.

18 FULL-Size patterns. Save money with easy-to-use, professionally designed full-size patterns. Make money selling beautiful, useful furniture. Make modern step and cocktail tables; metal lamps; cupola; 12-foot outboard. All patterns test-built; sold with money-back guarantee. Get your free list of these convenient, economical patterns today. Popular Mechanics Press, 200-HH E. Ontario Street, Chicago 11, Illinois.

ALL Crafts, supplies. Large free catalog. National Handicraft, 199 William Street, New York City 38.

LEATHERCRAFT. Send 10c for new 60-page catalog of tools, supplies, kits, including metalcrafts, enameling, ceramics, all other crafts. Complete stock. Reasonable. Since 1910. Sax Bros., Dept. FM1, 1111 N. 3rd, Milwaukee, Wis.

FREE Catalog. 1560 patterns and designs. Craftplans, 1321-A South Michigan, Chicago 5.

WOODWORKING And cabinetmaking course for beginning and advanced home craftsmen. Only complete low-cost home training program available. Write for free booklet. Interstate Training Service, Dept. G-3, Portland 13, Ore.

I Want to send you proof of the wonderful pulling power of Popular Mechanics classified pages. What's your proposition? Write me today. Include literature if possible. F. W. Johnson, Manager Classified Advertising, Popular Mechanics Magazine, 200 E. Ontario St., Chicago 11, Ill.

BENCH Vise, wedge type. Merely push stock in place. Made of aluminum alloy. \$2.45 postpaid. Flash Bridge Co., Holland, Michigan.

METALCRAFT. Big illustrated catalog free. Aluminum, copper, and enameling supplies. J. C. Larson Co., 820 S. Tripp, Dept. 6027M, Chicago 24.

BUY Wholesale nationally advertised power, hand tools, thousands other products at big discounts. Free "Wholesale Plan." American Buyers', Hertel Station, Buffalo 16-P, N. Y.

101 FULL Size patterns. Smart, new, gifts, novelties, lawn figures, shelves, action windmills, alphabets. Plus "Make Money Jig Sawing." Only \$1.00. Mastercraft 95M, 7041 Olcott, Chicago 31, Illinois.

129 NEW Full-size jigsaw patterns. Artist-drawn. \$1. Craftplans, 1321-A South Michigan, Chicago 5.

WALNUT, What-not shelves, table kits. Glued up panels. Turning squares and blocks. Free catalogue. Ozark Woods Mfg., Home Craft Div., Dept. 12, Ozark, Missouri.

LAZY Susan bookcase lamp. Beautiful, practical, profitable. Free details. Key Supply, 5764B N. Lacey Ave., Chicago 30, Illinois.

MAKE Your own furniture using wrought iron legs. Plans, literature 25¢. Hibbard's, 624 Celey, Hampton, Va.

LEARN Art metalcraft and jewelry making. Complete, inexpensive, home training course now available. Special tools and materials furnished. Write for free booklet. Interstate Training Service, Dept. L-3, Portland 13, Oregon.

FREE. Complete illustrated catalog, leathercraft kits, supplies. J. C. Larson Co., 820 S. Tripp, Dept. 6427-L, Chicago 24.

LEATHERCRAFT. Copper enameling, mosaic tile, shellcraft, metal tooling, beadcraft, many more crafts. Free big catalog. Kit Kraft, Dept. 239, Studio City 1, Calif.

GOURDS, Indian corn, strawflowers, mixed celosia. Thirty-five pieces, \$3.50 postpaid. Bayer Gardens, Route 1, Neenah, Wisconsin.

FREE "Do-it-yourself" leathercraft catalog. Tandy Leather Company, Box 791-Q17, Fort Worth, Texas.

OVER 900 Woodworking projects. Books and patterns. Free catalog. Craftsman, 115-C Worth Street, New York City 13.

LAMP Size cypress knee with nipple installed \$2.00. Cy Products, Dept. 2-X, Lafayette, La.

DO IT YOURSELF

BUILD The patented Little Mint Paper Baler. Slickest baler for homes, offices, stores, etc. Plans and license \$1.00. L. M. Baler Co., Box 125-A, Wausau, Wisconsin.

CONVERT Any heating main into a radiator. Write for details. Bildvactor Co., Inc., P.O. Box 233, Wallingford, Conn.

NOVELTY Jewelry, parts and findings assorted \$1.50 pound. Imported stones 1000 assorted \$1.00. Beads imported assorted \$1.00 pound. Pearls assorted \$1.00 pound. Add 25¢ for postage. Merchandise, 19-E 16th Street, New York 3, N. Y.

WATER Purification kit, filter, softener, chlorinator. Free brochure. Plans \$3.00. Norman, 1302 S. Figueroa, Los Angeles 15.

PREFABRICATED Upholstered chair and footstool kit. Plans and samples, 25¢. Fall-Art, 16 Brewster Terrace, Methuen, Mass.

ORNAMENTAL Iron designs. Book of 1500 beautiful, practical designs for railings, columns, etc. Free literature. Cunningham, 3881 South 3200 West, Salt Lake City, Utah.

REPAIR Your own fountain pens. Complete kit with instructions. 60 cents. Pens, 231 Fulton, Hempstead, N. Y.

NEW Auto-opening, self-closing drive or farm gates. Convenient, practical, inexpensive, easily built. Plans for dollar bill. John H. Pratt, Box 626, Boron, California.

IDENTIFY Your belongings with your own triple stencil. Your name in one inch and quarter inch letters. Your initials in quarter inch. Limit fifteen letters and spaces. Print name and address plainly. Send \$1.00 to Wm. V. Davis, 1610 Lincoln Blvd., Beatrice, Nebraska.

WATER Softener tanks, zolite, parts to make your own unit. McCarthy Company, 2930 W. Burlingame, Milwaukee 10, Wis.

NEW "Handbook" on all types of gun cabinets, tells you, shows you, how you can build your own deluxe gun cabinet. Rush \$1.00 for yours. Coladonato Bros., Dept. 14, Hazleton, Penna.

CLOCK Movements—Gorgeous dials, plans, kits. See ad page 247.

MAKE Your own, Jeweler's or Mannheim or Pinchblack gold. All three formulas, very old, \$1.00. Superweld of USA, DeKalb, Texas.

CHARTS: Mechanics, hobbyist, and craftsmen, send 25¢ each for your hang-up chart on screw thread, or decimal equivalents sizes. Becko's Enterprises, Prattsville, New York.

SEND \$1.00 For illustrated complete plans, for game. Satisfaction guaranteed. Brownie's, 5835 Fairmount, San Diego 11, Calif.

WATCHES. OLD GOLD. JEWELRY

WATCHMAKERS'—Jewelers' supplies, instructions. Catalog 20c. Bengale Company, Culver City, California.

COSTUME Jewelry supplies. Catalog and samples, 35c. Largest line in America. Milady-Pair Co., G.P.O. Box 1328, New York City 1.

USED And new watches \$2 up. Free list. Southern Watches, Gray, Georgia.

HIGHEST Cash for old gold, broken jewelry, gold teeth, watches, diamonds, silverware, spectacles, platinum, mercury. Free information. Satisfaction guaranteed. Rose Refiners, Heyworth Bldg., Chicago 2.

WATCH And clock repairing books. Free information. North American, Dept. 16J, 3320 N. Milwaukee, Chicago 47, Illinois.

10 SWISS Watches \$18.00. Catalog 20¢. Berkowitz, 1150 Castlehill, New York City 62.

RHINESTONES. Jewelry settings, copper enameling, hobby kits. Illustrated catalog 10¢. J & M Novelties, Dept. CK-3, Griffith, Indiana.

WATCHMAKER'S Tools, materials, supplies, watches. Catalog. Gales, Box 1000, Chicago 90, Illinois.

TOBACCO, SMOKERS' SUPPLIES

DRI-Well pipes. Pipe making instructions. Walter Miller, Germantown, Ohio.

CIGARETTE. Pipe or natural leaf tobaccos. Jolley Farms, Dresden, Tenn.

FOR THE HOME

WEATHERVANES, house signs, reflecting letters. Aluminum. Free literature. Lehigh, 1932 Newcastle Avenue, Westchester, Illinois.

PRESTIGE! Painting. Honoring your family. Free illustrations. Potraits. Ojai, Calif.

BE Your own plumber. You can. Few inexpensive tools and our instructive book, "Home Plumbing Guide," shows and tells you how. Hundreds of photographs and diagrams. Easy to follow. 160 pages. \$3.50. Catalog free. Popular Mechanics Press, 200PG East Ontario St., Chicago 11, Ill.

FOAM Rubber furniture cushions. Factory seconds. 50% discount. Free catalog. Perma-Foam, 236C Rhode Island Ave., East Orange, New Jersey.

BABY Rocks self to sleep with Rock-a-Crib springs. Fits all cribs. \$3.95. C.O.D. \$4.95. Home Fair, Box 301, Staten Island 1, New York.

SAVE On even your income. Revolutionary system tells how; helps. Year, \$2. Box 1992, Tulsa, Okla.

OF INTEREST TO WOMEN

MONEY For your spare time! No hard work. No regular hours. No experience necessary, just a wide acquaintanceship. Ambitious people have a chance for real prosperity by showing our hundreds of exclusive new designs of imported and domestic fabrics for suits and dresses. Few hours a day gives additional income up to \$40 a week and more. Our easy to show complete new sample book brings fast profitable sales. It will interest and benefit you. Write for it today! English Shop, Ltd., Pelham, New York.

EMBROIDER Stamped linens. Buy direct from manufacturer and save. Send for free catalog. Dept. 186, Merrilee, 16 West 19th Street, New York 11, N. Y.

LEARN To decorate cakes, beautifully and artistically, in your own home. For complete details write: Marie's School of Artistic Cake Decorating, P.O. Box 448, Denver 1, Colo.

NEED Funds? Make big profits easily selling useful kitchen necessities, gifts, cards. Complete credit to organizations! Free catalog. Approval samples sent if requested. Bob Moneymakers, PM-10, Oneonta, New York.

"8 MISTAKES Parents Make." Every parent should have this new book about child training. It is free; no obligation. Simply address Parents Association, Dept. 679, Pleasant Hill, Ohio.

DRESSES 24¢; Shoes 39¢; men's suits \$4.95; trousers \$1.20. Better used clothing. Free catalog. Transworld, 164-S Christopher, Brooklyn 12, N. Y.

GOOD Money in weaving. Weave rugs at home for neighbors on \$69.50 Union Loom. Thousands doing it. Booklet free. Union Looms, 153 Post St., Boonville, N. Y.

SELL Fine fabrics. Get yours wholesale. Box 863, Norwalk, Conn.

WANT To make big money at home? \$5 profit in an hour possible with invisible reweaving. Make tears, holes disappear from clothing, fabrics. Steady year-round demand from cleaners, laundries, homes. Details free. Fabricon, 8333 Prairie, Chicago 19, Illinois.

\$2.00 HOURLY Possible doing light assembly work at home. Experience unnecessary. Crown Industries, 8507-D West Third, Los Angeles 48, California.

GOOD Money in weaving. Weave rugs at home for neighbors on \$69.50 Union loom. Thousands doing it. Booklet free. Carcraft Co., Polk St., Boonville, N. Y.

BOOKS; Hundreds of subjects. Big catalog free. Popular Mechanics Press, 200-BC East Ontario St., Chicago 11.

GROW Mushrooms. Cellar, shed. Spare, full time, year round. We pay \$3.50 lb. We paid John Belts \$7,977.76. He started as amateur. Free book. Mushrooms, Dept. 176, 2954 Admiral Way, Seattle, Wash.

FREE—Big new wholesale catalog! Up to 50¢ saving for you, family, friends on nationally-known gifts, jewelry, toys, appliances, Christmas cards, etc. Also make money selling part time! Write: Evergreen Studios, Box 846-D, Chicago 42, Ill.

PROFITABLE Home business. Make fast-seller chenille monkey trees, dolls, flowers. Terrific holiday demand. Information free. Velva, Bohemia 16, N. Y.

KOOL Hand tongs. Lift sterilized nursing bottles, instruments, fruit jars, baked potatoes, sweet corn, wieners, hot pans and many other items. Price 50¢ postpaid. Diesel Power, Inc., Greenville, Penna.

\$5.00 HOUR Possible plating baby shoes, gifts, ceramics in beautiful colored pearl. Equipment unnecessary. Free booklet. Armstrong, 321—24 Street, Hermosa Beach, California.

PERFUME Your combs with Permascent. Free sample. Delight, Inc., 4554 Broadway, Chicago 40.

\$200 MONTHLY Possible. sewing baby-wear! No house selling! Send stamped, addressed envelope. Babywear, Warsaw 43, Indiana.

NEW Perfume like lip stick. Airmailed direct from Paris. Clayton Sales, 633-B Clayton, Wichita 12, Kansas.

START Home sewing shop. Increase your income. 100% profit. We have material. Details 10¢. Bunny Shoe, Box 6171-P, Columbus 23, Ohio.

WANTED—MISCELLANEOUS

SCRAP Mercury (quicksilver) containers supplied—Tantalum, tungsten, silver, platinum. Metallurgical Products Company, Established 1909, 35th & Moore Sts., Philadelphia 45, Penna.

QUICKSILVER, Sterling, silver solders, precious metals. Wholesale Terminal, Norwood, Massachusetts.

BOOKS; Hundreds of subjects. Big catalog free. Popular Mechanics Press, 200-BC East Ontario St., Chicago 11.

WANTED: Fast selling mailorder items. Almar Sales, 188 W. Randolph St., Chicago 1.

PERSONAL

"HOW Can I find out?" You can! Information confidentially developed. Any matter, person, problem. Worldwide. Officially licensed. Established 1922. William Herman, 170 Broadway, New York City.

BOOKS; Hundreds of subjects. Big catalog free. Popular Mechanics Press, 200-BC East Ontario St., Chicago 11.

BORROWING By mail. Loans \$100 to \$600 to employed men and women. Easy, quick. Completely confidential. No endorser. Repay in convenient monthly payments. Details free in plain envelope. Give occupation. State Finance Co., 323 Securities Bldg., Dept. C-227, Omaha 2, Nebraska.

BUY Vitamins direct. Amazing savings. Catalog free. Matoska, White Bear, Minn.

"KNOW Yourself!" Grapho-analysis, scientific analysis of handwriting accepted by psychiatric world, reveals unbiased truth about your character. \$2.00. D. Ballard, 363 Maint., Shawfield, S. C.

LEGAL Forms, wills, leases, partnerships. Marriage, birth certificates. \$1.00 each. Form, Elizabethton 4, Tenn.

VITAMINS. Save 40%. Free catalogue lists all formulas and brands. Mention product now using for free sample. Vitamin Specialties, Philadelphia 40, Penna.

REMAILING SERVICE

CHICAGO Remailing 35¢. Receiving, forwarding, Errands, information, etc. Suite 631, 127 N. Dearborn, Chicago 2, Ill.

LETTER Remailing, receiving-forwarding address for rent. McLaughlin, 800 Stewart, Columbus 6, Ohio.

CHANGE The post mark. Remails 25¢. Unico, 216 Polk, Charleston, Illinois.

SOUTH Bend remailing 25¢, forwarding rates. Schaut, 619 Kamms, Mishawaka, Indiana.

SECRET Mail address. \$3 month. Hedg-peth, Box 830, Alhambra 23, California.

NEW York City—Remails 25¢. S. H. Brown, 178-39 Leslie Rd., St. Albans, L. I., 34, N. Y.

MONTREAL. Letter remailed 25¢, etc. R. Cote, 1567 East Laurier Street, Montreal, Que., Canada.

NEW York City. Remailing 25¢, also forwarding and shopping. Betty, 510 East 11th Street, New York City 9.

TREASURE FINDERS

TREASURE, Metal, mineral detectors. M-Scope. Used worldwide for treasure hunting. Mineralights, Geiger, scintillation counters. Prices from \$14.75. Fully guaranteed. Use our time payment plan. Free booklets on treasure hunting, uranium prospecting. Free catalog. Fisher Research Lab., Inc., Dept. PM-C1, Palo Alto, Calif.

GOLD, Silver, metal detectors. Geiger counters for uranium. Violites. Sensational new fully guaranteed models. None finer. Information free. Detectron Corp., 5528 Vineland Ave., North Hollywood, California.

FIND Buried treasure, gold and silver, with Goldak's sensational 3 1/2 lb. "find-it" locator, only \$49.50. Write for free literature on complete line of mineral, metal locators; Geiger and scintillation counters. Goldak, 1541 W. Glenoaks Blvd., Glendale, Calif.

JEEP Owners — V8 power. Read Jeep owners ad, page 30.

URANIUM, Gold, silver treasure. New power-packed highly sensitive metal detectors, Geiger counters and mineralights. Kits and assembled models from \$12.50. Lightest weight, guaranteed, free literature. Electronic Applications, Box 8, Arlington 10, Virginia.

YOU Test your ore for 20 metals. Simple. \$7.50. Free information. Mineralogist, Box 731, Centralia, Washington.

FOR SALE—MISCELLANEOUS

WAR Surplus bargains! New government releases arrive constantly. Save up to 80%. Blankets, boots, coats, tents, wearing apparel. Send for free war surplus catalog. Sioux Falls Surplus Store, Sioux Falls, South Dakota.

AMAZING Automatic razor blade sharpener. Blade lasts for months. Sample \$1.25. Universal Products, 3915 W. School Street, Chicago 18, Illinois.

FRESHLY Shelled pecans \$1.25 per pound. National, Box 185, Orangeburg, S. C.

HEARING Aid batteries, wholesale. Free list. Habs, Box 51, York, Penna.

BOOKS: Hundreds of subjects. Big catalog free. Popular Mechanics Press, 200-HG East Ontario St., Chicago 11.

TYPICAL Leather bags, skirt lengths. Free catalog. Mapilon, Box 268, Guatemala, C. A.

MISCELLANEOUS

BUY Wholesale thousands nationally advertised products at big discount. Free "Wholesale Plan." American Buyers, Hertel Station, Buffalo 16-K, N. Y.

ROMANS 14; 17 and 18. Whitcomb, 308 Sycamore, Newport News, Va.

ROOT Clogged drains chemically cleaned. Free details. Chemical Drain Cleaning Co., Allston 34, Mass.

WHOLESALE Catalog! 30-80% discounts! Appliances, musical instruments, typewriters, tools, watches, jewelry, cameras, housewares, etc. Consolidated Distributors, 1300-13 Main, Clifton, New Jersey.

LEATHER Jackets renovated, expertly. Free circular 8. Berlew Mfg. Co., Freeport, New York.

YOU'LL Never fall asleep playing Country Auction. Fast-moving, action-packed board game. \$2.95 postpaid. Details free. Everett, 1900 N. Keeler Ave., Chicago 39, Illinois.

RECEIVE Magazine samples, mails, catalogues, offers from everywhere. Get listed 25¢. Rorick, Cincinnati 26, Ohio.

GROW Mushrooms. Cellar, shed, spare, full time, year round. We pay \$3.50 lb. We paid John Betts \$7,977.76, he started as amateur. Free book. Mushrooms, Dept. 175, 2954 Admiral Way, Seattle, Wash.

EARTHWORMS Urgently needed! We shipped \$3,175.75 worth, first year, spare-time, backyard! Why can't you? Raising, marketing instructions, 10¢. Oakhaven-M, Cedar Hill, Texas.

STUPENDOUS Mental power. Adults. Details 3¢. Delmar Wisdom, 846 Sunnyside, Chicago 40.

CIGARETTES—Make 20 for 9¢. Facts free. Moberly, Box 810, Owensboro, Ky.

YOUR Name wanted. We'll send 1000 publishers, mailers, wholesalers your name, on our list one year 25¢. Dixie Mailers, King, N. C.

DO It yourself. What? Repair TV, build furniture, make barbecue, plumbing repairs, build boats, do house wiring, remodel home, lay tile, modernize kitchen, repair home, and scores of other things you can do yourself. Books covering each subject, only 25¢. Send for descriptive list. It's free. Popular Mechanics Press, 200-LB East Ontario St., Chicago 11, Ill.

CESSPOOLS, cesspools, outhouses, clogged drains, cleaned, acidized without digging, pumping. Solvent reduces contents. Reclaims leachability. Old systems work like new. Free details. Electric Sewer Cleaning, Allston 34, Mass.

"HOME Improvement Guide." New, amazing 192 page volume. Packed with ideas, plans for remodeling, decorating, landscaping, built-in projects. \$2.50 pre-paid. Popular Mechanics Press, 200-HG East Ontario St., Chicago 11.

BRILLIANTIZE: Cleans copper, silver, other metals instantly. Amazing. Safe for proof coins. Postpaid \$1.00, \$2.00, \$5.00. Dealers wanted. Stephenson's, Box 435, Ames, Iowa.

SELL! Buy! Trade! Anything. Write: "Trading Post Magazine," 525 Dewey, Jackson 40, Michigan.

70 BIBLE Lessons, 25¢. Bulletin, Box 87, Cathedral Station, New York City 25.

TRADE Your used cameras and electric trains for brand new, nationally-advertised tools, appliances, jewelry, guns, etc. Send us a list of what you have to trade and what you want. Liberal allowances. Dept. PMO, Ray's Hardware Co., 120 Flatbush Ave., Brooklyn 17, N. Y.

JOIN Horton's wholesale buyers club. Lowest prices of all. Free details. Horton's, Suite 602, 20 West Jackson, Chicago 4.

CYPRESS Knees, \$5.00 dozen, up. Details. Gipple's Giftwares, DeLeon Springs 2, Florida.

BIG Mails, four months listing, 25¢. Wright Publications, 2270 Hubbard, Memphis 8, Tenn.

TV Cookie. Millions plus millions of repeat customers. Sta. B, Box 1315, Cleveland 3.

POWERFUL New drafting underlay (American Mathematical Monthly, Nov., 1955). Draw accurate spherical space figures. Solve spherical trigonometry, axonometry. With treatise, \$2.95. Sphere Grid, 3829 Davis Place, N.W., Washington 7, D. C.

CABINET MAKING



LOW COST HOME TRAINING COURSE FOR BEGINNERS & ADVANCED CRAFTSMEN

Make money. Learn skills and secrets of fine woodworking and tool use. Professionally prepared shop method training tells and shows how. Covers everything. Easy to master.

Write for Free Booklet **INTERSTATE TRAINING SERVICE** DEPT. F3, PORTLAND 13, OREGON

PORTABLE CAR COVER Heavy Vinyl Plastic (formerly \$8.95)

Protect Against RAIN • SUN • DUST

Long-lasting plastic, folds compactly, off and on in a jiffy, sturdy elastic binding gives extra security. State make, model and year



Send \$6.95 plus 35¢ postage or sent C.O.D. Extra Heavy Plastic Gauge \$8.95 + 45¢ postage. **BEA SALES**, Dept. B-3, 125 E. 46th St., New York 17

HOW TO

TURN Concrete INTO Gold



A MUST FOR EVERYONE CONCERNED!

This MANUAL Tells You How To Make Handsome Profits From Concrete Items YOU CAN MAKE

All you need is a mold or two and a little determination. This Manual contains large, clear pictures, gives prices and description of more than 300 different molds you can buy direct from the manufacturer, AND... priceless trade secrets that make production a snap. Take the first step Today!!!

SEND ONLY \$2.00 FOR YOUR COPY (Placed to you by First Class Mail)

CONCRETE MACHINERY COMPANY, INC. Dept. PM Hickory, N. C.

PERFECT LETTERING
Quick-Easy-Inexpensive with **STENSO** Lettering Guides

MAKE THE SIGNS YOU NEED



Easy as writing your name, with **STENSO** Lettering Guides of sturdy treated stencil board. Use over and over for perfect lettering. Money-Back Guarantee



- GOTHIC** No. 210... 1/2-3/4-1-1 1/4- and 1 1/2 inch letters and numbers **\$1.50**
- ROMAN** No. 211 . . . 1/2-3/4-1-1 1/4- and 2 inch letters and numbers **\$1.50**
- Old English** No. 212 . . . 1-1 1/4 and 2 1/2 inch letters and numbers **\$1.50**

At stores selling school supplies, stationery, art materials, hobbies, or order below from...

STENSO LETTERING CO. Dept. 210 1101 E. 25th St., Baltimore 18, Md.

- Please send me:
- Set #210-\$1.50 Set #211-\$1.50 Set #212-\$1.50
 - LARGE SIZE STENSO LETTERING GUIDES**
 - #93-3 inch letters, numbers, \$1.00 #96-6 inch letters, numbers, \$3.25
 - #94-4 inch letters, numbers, \$1.75 #98-8 inch letters only, \$4.00
 - #95-5 inch letters, numbers, \$2.50 #112-12 inch letters only, \$7.50

Name _____
Address _____
City _____ Zone _____ State _____

NO C. O. D.'S PLEASE!

**GOOD MEN NEEDED TO MAKE
\$3,000 IN NEXT 90 DAYS!**

NILITE "Cat's-Eye" LAWN SIGNS

New Money-Maker! Handsome new lawn sign sells to every home-owner in town. We give you tested sales plans, show you how to get volume through clubs, organizations. Tremendous demand in new housing projects. Ideal for fund-raising.

Ed Franklin of Indiana sold over 800 Nilite signs in a few days of spare time. Weymouth of Texas sold 25 the first afternoon out. Barry of Illinois sold 188 in one suburban neighborhood.

WRITE TODAY for full information and price schedule showing generous discounts for distributors. Sent **FREE** . . . no obligation. Rush your name and address to

NILITE, 173 W. Madison St., Dept. D #80 Chicago 2, Ill.



**"How to Go into
Business for
YOURSELF"**

If you know a trade or occupation—why not go into business for yourself? Why not make the profits others are now making?

IT'S EASY TO START A NEW BUSINESS. It's easier than you think—once you learn the 9 easy steps of building a new business of your own. National Business Consultants has shown over 5000 others how to be successful—let us show YOU too. We guide you every step of the way with sound, proved simple business practices. **EXPAND YOUR OWN BUSINESS.** Learn our tested, profit-making methods for business success. If you already own a business, let N.B.C. guide you too. You'll be amazed. **SEND FOR FREE BOOKLET TODAY!** "How to Start a Business" is jam-packed with revealing information. In easy-to-understand language it explains how to start and make any kind of business profitable. Free for the asking! Sent to you in confidential plain envelope. *Just write:*
NATIONAL BUSINESS CONSULTANTS, Office P-9, Los Angeles 61, Calif.



BOTH FREE!

Rush Name on Postcard Today!

HOME CRAFTSMEN! HOBBYISTS! INVENTORS!

SAVE \$100 ORDER DIRECT

Easily converts from
1-LATHE into **6-Milling**
2-Drill Press **7-Jig Saw**
3-Hand Drill **8-Threading**
4-Polishing or **9-Circular Saw**
Grinding **10-Indexing and**
5-Tool Grinding **Dividing**

Save by eliminating all middleman profits! Send for **FREE** illustrated literature and reduced price list. These terrific savings are offered for a limited time only—**Act now!** Write for complete information to Dept. PM-9, American Edistaal (Amsterdam) Inc., 350 Broadway, N. Y. 13, N. Y.

ENGINEERING DEGREE IN 27 MONTHS

B. S. DEGREE IN Aeronautical, Chemical, Civil, Electrical, Mechanical and Electronic Engineering (inc. Radio and TV) Big Demand for Graduates

Hundreds of young men are earning B. S. ENGINEERING DEGREES annually in this recognized institution — year around classes optional. New terms start quarterly. Many students earn a major part of their college expenses in this large industrial center. Low tuition. Competent instruction. Thorough, intense practical program. Modern, well-equipped laboratories including new physics laboratory and modern wind tunnel. Individualized instruction emphasized. Government approved for G.I.'s. Engineering preparatory courses. Students from 48 states and 21 foreign countries. Enter September, December, March and June. Send coupon for free catalog and full information. Enroll now.

INDIANA TECHNICAL COLLEGE

596 E. Washington Boulevard, Fort Wayne 2, Indiana
 Please send me free information on B.S. Engineering Degree in 27 months as checked.
 Aeronautical, Chemical, Civil, Electrical,
 Mechanical, Electronics

Name _____
 Address _____



Suction Cup Holds Revolving Light on Car

Plugged into the cigarette-lighter socket, a motor-driven revolving red beacon is held in place by a rubber suction cup on its base. Visible for more than 300 yards, the beacon protects you while you change a tire or work on a stalled engine in the dark. It is also furnished with a clear lens so it can be used as a flashlight when not needed for warning purposes.

Mailbox With Overhead Door

Rural mail boxes can be fitted with a new door that swings up and out of the way instead of hinging from the bottom. This permits a car to get almost a foot closer to the mailbox, giving easier access to the box and removing the car that much farther from the traffic lane. Once closed, the door can't fall open accidentally. When the mail carrier opens the door, the signal flag drops automatically.



MEN WANTED

Earn \$100 Per
Week and up
**AUTO DIESEL
MECHANICS**

Master a trade with a future—learn Auto-Diesel mechanics in our shops. You learn with tools on real equipment. Earn while you learn. Many of our graduates earn \$100 per week and up. No previous experience necessary. Day and night courses. Approved for veterans. Write for free bulletin.

NASHVILLE AUTO-DIESEL COLLEGE

226 7th Ave., N., Dept. 75

Nashville 3, Tenn.

ONE BRUISED CASE IN LOT CUT PRICE TO \$19.65 PPD!

BINOCULARS guaranteed NEW PERFECT in every respect, optically & mechanically. Wide field, full size, calibrated for individual focus and interpupillary adjustment, Japan import. Coated objective & ocular lenses. With genuine pigskin case and straps, well packed \$19.65 ppd. plus 10% Fed. Tax. Send check, M.O., 85 deposit for C.O.D. 10-day money-back guarantee! **SEAPORT TRADERS, INC.**, Dept. Y, 409 E. 12th St., Los Angeles 15



Do a Real Professional-Like Job
Yourself and SAVE

HOW to PAINT With Brush and Spray

Covers All Painting Methods and
Materials

You can do professional-like painting and finishing jobs yourself and save about two-thirds of the cost. Sam Brown, noted craft authority, makes it so easy for you in his book, **HOW TO PAINT WITH BRUSH AND SPRAY**. Order your copy now and enjoy this tremendous saving. It covers exterior painting, wall and interior decorating, furniture finishing, concrete painting—every type of painting with brush, spray gun, roller and other methods. Tells what finish is best; what materials to use, etc. No previous experience needed. Fully illustrated. Order by mail. Only \$2.50. Money back if not pleased.



POPULAR MECHANICS PRESS, Dept. PM956
200 E. ONTARIO ST., CHICAGO 11, ILL.

Now . . . New Fun . . . Profit Too . . . for the
Hobbyist . . . Experimenter . . . Home Shop Fan!

Electronics *Made Easy*

New Popular Mechanics Book • Instructions for Beginners
Advanced Projects • Construction Data

Want a Hi-Fi sound outfit—a transistor radio, no bigger than your hand? Want to enjoy the advantages of the big, fascinating electronic field as a career or as a hobby—for pleasure or profit? Then you need the new unusually practical Popular Mechanics book—**ELECTRONICS MADE EASY**. It shows you how you can make many of the newest and "hottest" electronic devices at low cost, even tho you have no previous experience. The book shows too, how electronic tubes work, how to do radio servicing, how to use test instruments and make your own and how to convert old radios into inter-com systems and other devices. Get **ELECTRONICS MADE EASY** today. Let it introduce to you the most fascinating field of these times.

192 Pages of Vital Information • Hundreds of Pictures

High-Fidelity. What it is—Specifications of components—What to look for in equipment—How to build low-power amplifier and speaker systems—10 watt amplifier—25 watt basic amplifier.

Transistor Radio. Six simplified transistor laboratory experiments—Three transistor radios (two with one transistor)—Four-transistor pocket radio—Six-transistor portable radio.

Converting. How to make an inter-com system from an old radio—Mobile Public Address system from an auto radio—Wiring radios and TV for private listening.

Radio, Etc. How it works—How to test and service—How to make four different receivers—Wireless broadcaster—Children's phonograph—Amplifiers—Electronic Relays—How to do radio servicing—Test-Work with tools—many other subjects.

5 Days Trial • Money Back If Not Pleased

The Popular Mechanics Radio Editor wants you to see this timely and practical book and you can have it for 5 days free trial. Just mail the coupon with remittance for \$2.95, or we will send COD. Full purchase price refunded if you are not pleased with the book.

HELP PREVENT CRIPPLING!



*Polio victims
still need treatment!
Help provide
Rehabilitation*

**Sister Elizabeth
KENNY
Foundation**

National Headquarters • Minneapolis, Minn.



Hi-Fidelity Systems
Transistor Radios
Converting Radios
Inter-Com Systems



Order Today Under Money-Back Offer!

POPULAR MECHANICS PRESS
Dept. 956, 200 E. Ontario St., Chicago 11, Ill.

Send *Electronics Made Easy*. If I decide not to keep the book I will return it within 5 days for full refund of purchase price.

Remittance for \$2.95 enclosed. Send COD

Name _____

Address _____

City _____ Zone _____ State _____



"I just thought it would make you feel better to know that I'm satisfied with what I bought."

The products that satisfy most are the brands that have made a name for themselves. That's why advertisers in this magazine are good names to know. They're proud of their brands 'cause they satisfy so.

FOUR WAYS BRANDS SATISFY

1. **BUY WITH TRUST!** Spend *confidently* on known quality. Brand Names wear best, work best, taste best, are best.
2. **SHOP WITH EASE!** Spend *efficiently* on proved value. Brand Names save time "puzzling" over labels, models, prices, etc.
3. **ENJOY MORE CHOICE!** Spend *shrewdly* among widest selections. Brand Names offer the most in sizes, types, colors, flavors, etc.
4. **GET THE "LATEST"!** Spend *smartly* on up-to-date products. Brand Names keep improving, modernizing, introducing new things.

BRAND NAMES FOUNDATION, INC.

437 FIFTH AVENUE, NEW YORK 16, N. Y.

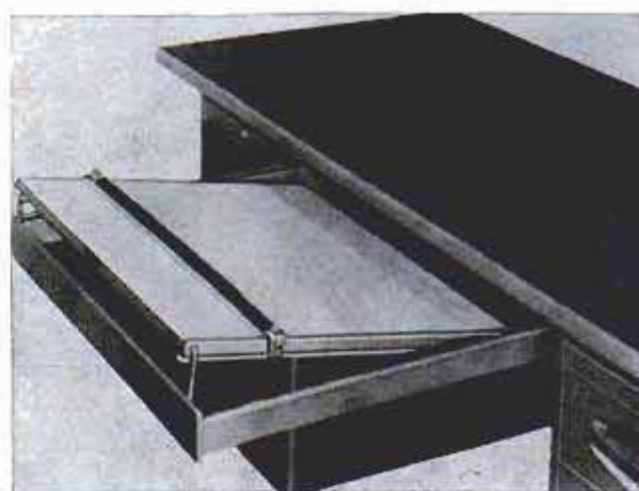

Pop-Out Drawing Board

You can equip your desk with a fold-out drawing board that is set up at a minute's notice. The drawing board is concealed in the desk drawer most of the time. When it is needed, the drawer is opened and the board, equipped with a parallel rule, is placed on top of the desk. Its rear legs are bolted to the drawer bottom. The top of the board is supported on the desk top by a pair of metal legs.

Heat Pump Uses Two-Stage Cycle

Development of a heat pump that operates efficiently using below-freezing outside air has been announced by York. When the outside temperature drops below a certain level, the heat pump switches to a two-stage cycle that involves preheating. It is claimed that this increases efficiency by 67 percent when the outside temperature is 20 degrees below zero. Commercial-size units are being manufactured and home-size heat pumps for year-round heating and cooling are due for production in 1957.

Handy Mail Order List

Little Library of Useful INFORMATION

Here at amazingly low cost is the practical help and information you have always wanted. Articles in previous issues of Popular Mechanics have been classified according to subject and are now available in these handy reprint booklets.

How to Use Measuring Tools—Micrometers, Calipers, etc.—106.

Power Driven Saws—74.

Drill Presses, Grinders, etc.—79.

Wood, Metal-Turning Lathes—81.

Filing Machine, Hacksaw, Cutoff

Wheel, Shaper—82.

Lathe Tools You Can Make—101.

Workbenches—Tool Cabinets—47.

Spray Painting—94.

From Pattern to Casting—91.

Tool and Saw Sharpening—92.

Sharpening Drills, Wood Bits—90.

Successful Wood Turning—32.

How to Read Blueprints—71.

Metal Turning Lathe Kinks—99.

Operating a Metal Lathe—100.

Heat Treating, Hardening—102.

Working With Glass—103.

Servicing Electric Motors—75.

Electromagnets & Solenoids—44.

Transformer Construction—41.

The Boy Electrician—43.

Soldering and Brazing—17.

Arc and Spot Welders—5.

Electroplating With Nickel, Chromium, Cadmium, etc.—86.

Plating Leather, Wood, etc.—87.

Lower Your Fuel Costs—31.

Curing Leaky Easements—45.

Fitting Home Game Rooms—55.

Indoor & Outdoor Fireplaces—88.

Backyard Gardening—39.

Lawn and Garden Novelties—72.

Trellises, Pergolas, Fences—76.

Lawn and Garden Furniture—77.

Playground Equipment—73.

How to Use Your Drill Press—125.

Making Serving Trays—53.

Knots and Rope-work—105.

Sanders—80.

House-Wiring—89.

Hanging Wallpaper—38.

Built-in Fixtures—78.

Bird Houses—7.

Magazine Racks—49.

Clock Cases—50.

Book Ends—52.

Small Tables—54.

Smoking Stands—56.

Desks—58.

Book Cases—59.

Action Toys—66.

High Flying Kites—67.

Telescopes—20.

Metal Craft—28.

Small Looms—37.

Working With Plastics—61.

Simple Home Improvements—104.

Ridding Home of Insect Pests—107.

Children's Room Furniture—51.

Jigsawed Novelties—57.

Doll House & Doll Furniture—60.

25 Shelves You Can Make—64.

Novelties Turned on Lathe—62.

Inlay Pictures—Veneering—63.

Wood, Soap Carving—69.

Windmills & Weather-vanes—68.

Lamps from Wood, Metal—69.

Rustic Furniture—18.

Wood Finishing—40.

How to Fix Electrical Appliances—111.

Painting Your House—117.

Build Your Own Relays—123.

Rowboats, Small Dinghy—83.

Small Sail Boats—84.

Two Outboard Runabouts—85.

Build Down Canoe, Kayak—30.

Build Class-E Ice Yacht—22.

Auto Kinks, Shortcuts—10.

Lawn and Garden Equipment—124.

Motor-Driven Midget Cars—34.

Stop Auto Electric Troubles—95.

Photo Printers and Dryers—25.

Photo Darkroom Equipment—96.

Trick and Table Top Photos—97.

Home Movie Equipment—118.

Poultry Houses—108.

Guns and Decoys—109.

Re-Silvering Mirrors—70.

Chemical Experiments—93.

Log Cabins, Tourist Houses—14.

Using Basic Tools—120.

Farm and Garden Tractors—8.

Building Extra Attic Rooms—23.

Attractive Basement Rooms—24.

Gem Cutting—42.

Photo Enlargers—1.

Photo Kinks—98.

Cleaning Formulas—11.

Taxidermy—9.

Photo Lighting—119.

Training Dogs—35.

Small Furnaces—36.

5 for \$1.00
12 for \$2.00
25¢ Each

Check Titles Wanted, Clip, Mail with Remittance to

POPULAR MECHANICS PRESS, Dept. 956, 200 E. Ontario, Chicago 11

YES! SEND



directly
to my door
every month

I am enclosing

\$3.50 for 1 year

\$8.00 for 3 years

name _____

address _____

city _____ zone _____ state _____

Hand this order to your newsdealer or send it to

POPULAR MECHANICS
200 East Ontario St. Chicago 11, Ill.

NEW Govt. Release!

Original
Cost
\$444.00



HOMELITE "Carryable"
GENERATING PLANT

60 CYCLE,
1500 WATT

\$189.00

Single Phase, 115 Vt., A.C.

Carrying handles for
easy portability. Fits
easily in car trunk

Fully
Guaranteed

Save Hundreds of \$ \$ \$

PAYS FOR ITSELF! Saves time, labor and money. Provides on-the-spot power for CONSTRUCTION, etc. where none is available or expensive to run in. LARGE ENOUGH for Floodlights; Saws; Pumps; and many more labor-saving, heavy-duty machines. Ideal as a stand-by emergency power plant to duplicate house current. Plenty of power for lights, refrigerator, deep freeze, oil burner, radio, etc. Specifications below CAN'T BE MATCHED anywhere at this price!

GENERATOR 1500-1700 Watts, 115 Volts, 60 cycle, single phase, AC. Overload capacity well above its rated output. Excellent automatic voltage regulation plus Field Rheostat for even closer adjustment. Built-in Volt Meter. Oversize brushes.

ENGINE Famous Homelite single cylinder engine. Air cooled; two cycle. Easy rope start. Dust and rain-proof ignition system. Built-in automatic governor. Foolproof pressure vapor lubrication system. Adjustable jet-type carburetor.

This Precision power plant has ball and needle bearings throughout and costs only 5¢ an hour to operate. Satisfaction Guaranteed.

SUPPLY LIMITED! IMMEDIATE DELIVERY! ORDER FROM AD

FREE Catalog of Compressors, Motors and Welders

ROBERTS ELECTRIC CO., Dept. PM-488, 849 W. Grand, Chicago 22, Ill.

SALE

12 X 50 REGULARLY \$67.50
SAVE \$40.55!

High powered, whisper-weight (27 oz.) color corrected, Achromatic binoculars. 7" high! EZ to hold, EZ to focus. CENTER FOCUS for instant finger-tip adjustment. **SALE PRICE FOR THIS SALE ONLY** including case and straps! Made in Japan. **USE 30 DAYS.** If not satisfied return for refund. Add for UNITED BINOCULAR CO., 8043 S. Western, AIF-708, Chicago 20. **DEALERS WANTED**



DO A BETTER JOB
with **DREMEL**

Straight-Line-Action
SANDERS!

Send for FREE
Power Tool Catalog

DREMEL MFG. CO.
RACINE, WIS.



KEEP CESSPOOL TROUBLE
AWAY



WITH

NORTHEL

Suburban & Country Dwellers

NORTHEL Reactivator keeps septic tank and cesspool clean. A bacteria concentrate breaks up solids and grease—prevents overflow, back-up, odors. Regular use saves costly pumping or digging. Simply mix dry powder in water, flush down toilet. Non-poisonous, non-caustic. Guaranteed to reactivate septic tank, cesspool. Six months supply (23 ozs) only \$2.95 ppd. Northel Distributors, PM-9, P. O. Box 1103, Minneapolis 1, Minn.

MEND METAL AT HOME with DEVCON

The Plastic Steel

80% STEEL—20% PLASTIC

DEVCON and a putty knife . . . tools for 1001 home repairs. DEVCON bonds steel to itself or to aluminum, bronze, brass, iron, wood, porcelain, glass, concrete and other surfaces. For home . . . farm . . . garage . . . or marine use, DEVCON fixes radiators, washing machines, cracked engine blocks . . . just about anything! Easy to use, DEVCON saves dollars!



HARDENS IN 2 HOURS EVEN UNDER WATER



\$1.98 per kit enough for several projects
Also—1 lb. packages for big jobs—\$3.95
At leading hardware and hobby stores—write for free literature

DEVCON CORPORATION
175 Endicott St., Danvers, Mass.

Superior's New Model 70 UTILITY TESTER® FOR REPAIRING ALL ELECTRICAL APPLIANCES MOTORS • AUTOMOBILES • TV TUBES

As an electrical trouble shooter the Model 70:



- Measures A.C. and D.C. Voltages, A.C. and D.C. Current, Resistances, Leakage, etc.
- Will measure current consumption while the appliance under test is in operation.
- Incorporates a sensitive direct-reading resistance range which will measure all resistances commonly used in electrical appliances, motors, etc.
- Leakage detecting circuit will indicate continuity from zero ohms to 5 megohms (5,000,000 ohms).
- Will test toasters, Irons, Broilers, Heating Pads, Clocks, Fans, Vacuum Cleaners, Refrigerators, Lamps, Fluorescents, Fans, Switches, Thermostats, etc.
- Will test off TV tubes for open filaments, inter-ament shorts, burned out tubes, etc.

As an Automotive Tester the Model 70 will test:

- Both 6 Volt and 12 Volt Storage Batteries • Generators • Starters • Distributors • Ignition Coils • Regulators • Relays • Circuit Breakers • Cigarette Lighters • Stop Lights • Condensers • Directional Signal Systems • All Lamps and Bulbs • Fuses • Heating Systems • Horns • Also will locate poor grounds, breaks in wiring, poor connections, etc.

Handsome round-crowned molded bakelite case, 3 1/2" x 3 7/8" x 2 1/4". Complete with all test leads. Also included is a 24 page book giving detailed instructions for testing all electrical appliances, automotive equipment, TV tubes, etc. Only \$15.95

SHIPPED ON APPROVAL NO MONEY WITH ORDER—NO C.O.D.

Try it for 10 days before you buy. If completely satisfied then send \$3.85 and pay balance at rate of \$4.00 per month for 3 months—No Interest or Finance Charges Added! If not completely satisfied, return to us, no explanation necessary.

MOSS ELECTRONIC DIST. CO., Inc.
Dept. D-276, 3849 Tenth Ave., N.Y. 34, N.Y.

Please rush me one Model 70. If satisfactory I agree to pay \$3.85 within 10 days and balance at rate of \$4 per month until total price of \$15.95 plus postage is paid. If not satisfactory, I may return for cancellation of account.

Name: _____
Address: _____
City: _____ State: _____

WHERE-TO-BUY-IT INDEX

Source of supply appears after items commercially available

AUTOMOTIVE

- Fan clutch increases mileage..... 98
- Truck-tire remover uses hydraulic jack to spring bead from rim (Vulcan Mfg. Co., Vulcan, Mich.).....105
- "Rallvans" have dual wheels for travel on roads or rails.....131
- Cloth reflects car lights for pedestrian safety (Minnesota Mining and Mfg. Co., 900 Fauquier Ave., St. Paul 6, Minn.).....161

AVIATION

- B-52 becomes flying convertible (Boeing Airplane Co., Seattle 24, Wash.)..... 98
- High-altitude laboratory for aircraft engines.....101
- Vinyl-foam weather strip is bonded to molding (J. L. Mortell Co., Kankakee, Ill.).....112
- Next aviation hazard—the disintegration barrier (Dr. Gottfried K. Wehner, General Mills Electron Physics Laboratory, Minneapolis, Minn.).....129
- Nylon "doughnuts" float helicopter in emergency landing on water (Walter Kilde and Co., 260 Madison Ave., New York City 16).....143
- Tiny helicopter carries one man (Bensen Aircraft Corp., Raleigh-Durham Airport, P. O. Box 2725, Raleigh, N. C.).....143
- Six tiny diesels power model B-36.....164
- Dummy aircraft fool observers.....248

BOATS

- Aluminum catamaran sails Hawaiian waters.....130
- Folding dinghy made of canvas (Lymington Shipway, Inc., Pleasant St., Wickford, R. I.).....137
- Sculling blade moves boat silently to avoid disturbing fish (Florida Sneaker Blade, Commonwealth & Benbow, Jacksonville, Fla.).....152

MISCELLANEOUS

- Connecting link repairs chain (Page Engineering Co., Clearing P. O., Chicago 38)..... 86
- Folding drawing easel locks into hundreds of positions (Draw-Eze Co., 1007 N. Clark St., Los Angeles 46, Calif.)..... 86
- Put-together igloo for small Eskimos (Steward Products, Inc., 9145 Seward Rd., Hamilton, Ohio)..... 90
- Needle point checks plugs (H. C. Sweet Co., 12345 Telegraph Rd., Detroit 39, Mich.)..... 87
- Power digger (Sherman Products, Inc., Fourteen Mile at Coolidge, Royal Oak, Mich.)..... 87
- Model steam engine puffs and separator threshes grain..... 88
- Pulverizer chops up vines..... 88
- Control tower speeds traffic..... 95
- Detroit police wear armor to fight rioters and gunmen..... 95
- "Curtain of air" is invisible draft and temperature barrier (American Air Curtain Corp., 10408 Manchester, St. Louis 22, Mo.)..... 96
- Rome parades anti-riot cars..... 96
- Portable shell reloader (Twidwell Reloading Press, 1940 Lana Ave., Salem, Ore.)..... 99
- Tractor fitted with crawler treads takes skiers up mountain..... 99
- Tent without ropes resists high winds (Porta Co., Inc., 32 Neponset St., Canton, Mass.)..... 100
- Washington glaciers grow..... 100
- Lunch-vending machine serves hot food and soups (F. L. Jacobs Co., 1043 Spruce, Detroit, Mich.)..... 101
- Antique wall phone is rebuilt into doorbell and radio..... 101
- Propose Swedish TV..... 101
- Globe inflated like balloon weighs only two pounds with frame (C. S. Hammond & Co., Inc., Maplewood, N. J.)..... 108
- Skijoring called most dangerous of winter sports..... 108
- Dial selects light or heavy load in shotgun (Remington Arms Co., Inc., Bridgeport 2, Conn.)..... 112
- Underwater sea horse..... 112
- Snow chutes load trucks..... 128
- Rail-measuring car..... 129
- Bug whipper mounts on lamp (Mottershead Associates, 933 E. 49th St., Chicago 15)..... 137
- Spinning reel can be thumbed (Honocks-Ibbotson Co., Utica 2, N. Y.)..... 137
- Caracas cable car..... 140
- Portable storage room erected in six hours (General Products Co., Fredericksburg, Va.)..... 142
- Clamp on bumper holds bicycle (Pope Mfg. Co., Prairie View, Ill.)..... 143
- Volkswagen car ferry..... 153
- Shrimp ranch harvests bait..... 158
- "Crow's nest" gives television cameraman bird's-eye view..... 160

(Continued to page 76)



Every Boy Should Have This Build-It-Yourself Book for Boys!

It's natural for boys to want to make things—to fuss with tools—to fashion the kind of things "kids"

want. So give boys the Build-It-Yourself Book for Boys. Encourage a youngster to express himself through the sensational new Popular Mechanics book that shows how to make 56 different things every boy dreams about. It covers science, mechanics, electricity, modeling and other fields. 192 pages of easy-to-follow instruction and 469 how-to-do-it pictures.

56 Toys, Games, Gadgets, Models, Boats, Electrical Devices, Cars and Other Things Boys Can Make at Home

How to make—Airplane Models, Aquaplane, Archery Kit, Bird Houses and Shelter, Boats, Bobsleds, Boomerangs, Cannon Toy, Electric game, Electric Motors, Garage Toy, Helicopter Toy, Hunting Knife, Hydroplane Model, Kites, Log Cabins, Marble Game, Microscope, Printing Press, Radio Sets, Rafts, Railroad Modeling, Shooter, Scooter, Sidewalk Cars, Sprinkler

Truck, Squirt Gun, SS United States Model, Surfboard, Tank Toy, Taxidermy, Telegraph Set, Telephone, Tree House, Water Skis, Weather Instruments, Toboggan, Worktable.

Build-It-Yourself for Boys sent postpaid for \$2.50 or COD, charges additional. Money refunded if you are not pleased after 5 days' use. Mail order to address below.

Toy motors

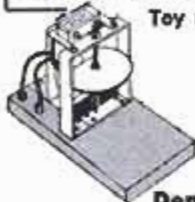

Boomerangs



"Ju-be"—the punt.

POPULAR MECHANICS PRESS
Dept. 956, 200 E. Ontario St., Chicago 11

What Every Farmer Should Know About Taking Care of Farm Animals



The Most Popular Veterinary Guide Ever Printed

This practical and helpful VETERINARY GUIDE FOR FARMERS prepares the farmer to perform many routine veterinary tasks—provides quick information that can often save the life of an animal—prevents disease in herds—saves money on the farm in a hundred different ways.

Written in plain understandable language. It covers symptoms, causes of disease and prevention, and treatment of cattle, swine, sheep, horses and poultry and warns when to call in the professional veterinarian. Names, terms and phrases made clear in a separate section. Over 100,000 copies of this book are in use on American farms. 275 pages. Fully illustrated. Only \$3.95. Order today under money-back guarantee.

POPULAR MECHANICS PRESS, Dept. 956
200 E. Ontario St. Chicago 11, Ill.

Jet King POCKET-SIZE BUTANE BLOW TORCH

ONLY
\$1.95
WITH CHARGERS

**SOLDERS!
BRAZES!
FIXES LEAKS!**



Every do-it-yourself and hobby fan needs this Kidde JET KING butane Blow Torch. No dangerous containers of inflammable liquids to store... a tiny, clean, safe charger does the job. Just the tool you've been looking for to do dozens of jobs in home or hobby... TV, appliance, lamp, radio or plumbing repairs... precision soldering, brazing or metal craft. Useful, too, for starting charcoal fires. Each charger gives 30 minutes of intense 3500° pinpoint flame. Extra chargers, 2 for 39¢. Money back guarantee. At leading hardware and hobby stores... or send check or money order, we pay postage.

Kidde

KIDDE MANUFACTURING CO., INC.

Dept. PM-9

42 Ferrand Street, Bloomfield, N. J.

Please send me _____ JET KING BLOW TORCHES plus: _____ boxes extra chargers (limit 2 boxes per torch). My check , money order for \$_____ is enclosed.

Name _____

Street _____

City _____

State _____

RADIO CONTROL YOUR MODEL

PLANES
BOATS
CARS

"CUSTOM MIDGET" RADIO \$9.98



DETAILED INFORMATION AND RADIO CATALOGUE 25¢

SPECIAL "SUPPLY SOURCE DIRECTORY" & \$7.00 SUPPLY COUPON... \$1.00

BOOK "RADIO CONTROL OF MODEL AIRCRAFT" CONTAINS 14 PLANS \$3.98

RADIO CONTROL GARAGE DOOR DETAILS... \$1.00

LICENSE FREE BAND

OPERATES SAME AS \$30.00 SETS. INCLUDES LONG RANGE

TRANSMITTER RADIO, RECEIVER RADIO AND CONTROL ACTUATOR ALL 3

EASY ASSEMBLY WITH OUR PARTS AND PLANS \$9.98. PLANS ALONE \$1.

RADIOMODELS BOX 36 DEPT. PM. BALTIMORE 6, MARYLAND

ENGINEERING DEGREE IN 27 MONTHS

B. S. DEGREE, Aeronautical, Chemical, Civil, Electrical, Mechanical and Electronic Engineering (inc. Radio and TV), Drafting, One-year, Low rate. Earn board. Large industrial center. Students from 48 states, 21 countries. Demand for graduates. G.I. Government approved. Enter September, December, March, June. Write today for catalog. 1696 E. Washington Boulevard, Fort Wayne 2, Indiana.

INDIANA TECHNICAL COLLEGE

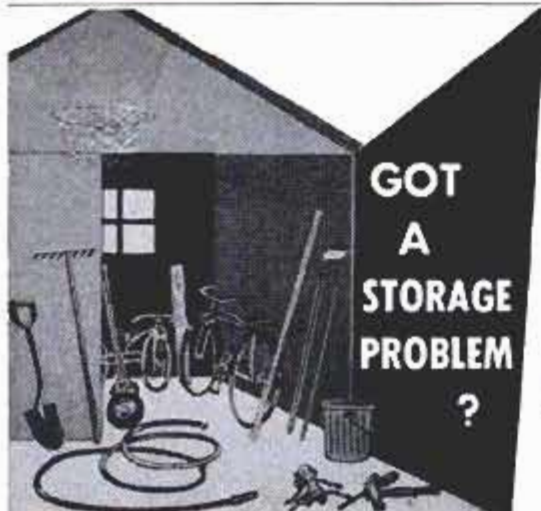

GOT A STORAGE PROBLEM?



Then you need TURNBUCKLES Perforated Board fixtures to end space-wasting clutter and to keep everything neatly in place until needed.

TURNBUCKLES do-it-yourself fixtures come in a wide variety of shapes and sizes... fit easily into any wall-hung perforated board... and hold everything from clothing and kitchen utensils to hand tools and garden equipment.

Send for your free copy of space-saving suggestions for home, farm and workshop.



TURNBUCKLES, Inc.

BOX 333, MICHIGAN CITY, INDIANA

NAME _____

ADDRESS _____

CITY _____

STATE _____

FIXIT TIPS...

WITH "SCOTCH" BRAND
COLORED PLASTIC TAPE

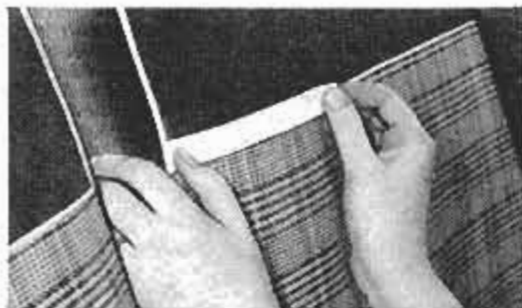

MEND AUTO SEAT COVERS with this stretchy tape that hugs curves, sticks like skin. Choose from seven colors to harmonize or contrast.



REINFORCE BOOK BINDINGS and edges with this long-wearing "SCOTCH" Brand tape. Tough all-plastic backing bends without cracking. $\frac{3}{4}$ " width 25¢, $1\frac{1}{2}$ " width 50¢ at stores everywhere.

© 1956, MINNESOTA MINING & MFG. CO., ST. PAUL & MINN.



TECHNICAL EDUCATION

• Air Conditioning and Refrigeration Technology • Diesel Technology • Drafting Technology • Electrical Technology • Electronic Technology • Excellent faculty, accredited curricula, extensive counseling and guidance, full college activities, job placement service, G.I. approved. Opportunity to continue education and earn a B.A.S. degree. Open to high school graduates or equivalent. Sept., Feb., and June semesters. Write for free brochure.

COLLEGE OF TECHNOLOGY, University of Houston
DEPT. 196, 3801 Cullen Blvd., Houston, Texas

Say You Saw It in
POPULAR MECHANICS

AUTOMATIC

MAKES NEW PROFITS

RETOOTHER

for HAND SAWS

Cuts new teeth in 50 seconds - any size 4 to 16 points. Old teeth fall off as chips. Easy to operate. A perfect job.



BURR MFG. CO.

8933-S VENICE BLVD. LOS ANGELES 34, CALIFORNIA

(Continued from page 74)

Miniature lathe teaches woodworking (Winkle Mfg. Co., 3751 Montgomery Rd., Cincinnati 12, Ohio).....	160
Gasoline-driven lawn mower powers emergency pump (Sears, Roebuck and Co., 925 S. Homan Ave., Chicago 7).....	161
Motorcycle hoist eases repair job (Carlyle Hall, 1161 Bay Laurel Dr., Menlo Park, Calif.).....	164

PHOTOGRAPHY

"Speed tripod" tilts camera 180 degrees (Graflex, Inc., 154 Clarissa St., Rochester 8, N. Y.).....	99
Correct flash exposures automatically computed (Sears, Roebuck and Co., 925 S. Homan Ave., Chicago 7).....	129
Chain pulled taut serves as camera tripod (Haines Mfg. Co., Box 371, Troy, Ohio).....	142

SCIENCE

"Brain" turns plan into finished parts.....	87
Morse-code typewriter.....	88
Voice of America system handles programs in 39 languages.....	105
Fences drop from air on New Zealand farms.....	128
Relief map shows 9000 square miles around San Diego.....	130
"Geiger" tank checks entire body.....	141
Antidote for nerve gases.....	142
World's waterpower barely tapped.....	160
Battery aids leg growth.....	161
Denver oil-shale plant.....	272

WHAT'S NEW FOR YOUR HOME

Push-button spice rack.....	144
Log cart hauls wood for fireplace.....	144
Self-feeding toothbrush carries liquid dentifrice.....	144
Flushing gun blasts drains clear.....	144
Pop-up oven.....	145
Combination unit powers several electrical appliances.....	145
Electric smoker burns hickory chips.....	145
Deep-fat thermometer.....	145
Childproof medicine cabinet.....	145

Radio-Television, Electronics

Pick up short waves on your radio with this multiband converter.....	165
Recording-level meter.....	168

Craftsman and Shop Notes Index

HOUSE AND HOME

Toilet-tank sweating prevented with tepid-water supply.....	171
Bolts through ends of bed slats keep rails from spreading.....	176
Gatepost light simulates old locomotive headlamp.....	177
Old chest of drawers converted to desk for young child or family.....	184
Hand-rotated television antenna operated from inside house.....	188
Presetting of freezer control guards against power failure.....	188
Four-poster magazine rack.....	189
Shoeshine box.....	193
Baby swing with tray.....	200
Mildew and how to combat it in the house.....	201
Nail hardwood floor over old softwood floor.....	206
Door veneer cut with knife prevents saw damage.....	216

HOUSEHOLD HINTS

Partitions separate contents of night-stand drawer.....	171
Appliance cords stored in mailing tubes.....	176
Felt pads under furniture legs prevent damage to tile floors.....	184
Solving Home Problems—	
Roller for painting screens.....	186
Blackboard on panel of kitchen-cabinet door.....	186
Muffin tins used to mold aluminum-foil nut cups.....	186
Paper egg cartons can be reused for storage.....	186
Metal bracket holds decorative tray edgewise.....	186
Small piece of cloth in thread spool holds needles.....	187
Roundheaded upholstery tacks space clothes hangers.....	187
Remove hardened paint spots in fabrics.....	187
Spring-loaded steel balls make rollers for sliding doors.....	187

MISCELLANEOUS

Spring-wound alarm clock operates pull-chain socket.....	171
Rubber band holds handbills for single-copy distribution.....	171

(Continued to page 78)

unknown -



Typewriter Foot Controls

You can type with both hands and feet when your typewriter is equipped with a set of foot controls developed in Germany. A push with the left toe takes care of the back space, a push with the left heel moves the shift. The right toe handles the carriage and margin while the right heel serves the tabulator. The low-cost attachment fits any typewriter.



Ten times as sensitive as previous instruments, a small portable water-vapor analyzer can measure a concentration of one part in a million in a flowing sample.

THEY'RE **NEW!**



FASTEST-CUTTING JIG SAW MADE! This powerful new Millers Falls tool is a jig saw, hack saw, coping saw, rip saw, crosscut and keyhole saw all in one. Makes curved, straight or irregular cuts in wood, metal, all kinds of material—in places often inaccessible to other saws! Exclusive design features and special blades result in far greater cutting speed than any similar saw.

No. 480 Dyno-Mite Electric Jig Saw — \$49.50

THEY'RE **DYNO-MITE**



FOR THAT PROFESSIONAL FINISH! This new Millers Falls Orbital Sander finish-sands furniture, cabinets, interior trim . . . removes paint, varnish or surface imperfections . . . all without tracking, scoring or burning surface. High-speed orbital action permits sanding with or across the grain. Light weight makes it easy to use on overhead and vertical as well as horizontal surfaces.

No. 580 Dyno-Mite Orbital Sander — \$49.50

THEY'RE

Millers Falls

*Finest Power
Tools Made*



FREE AT YOUR HARDWARE DEALER'S
Ask for these folders on the whole power-packed line of Millers Falls Dyno-Mite electric tools including the remarkable new Dyno-Mite Power Workshop, or write direct.

MILLERS FALLS CO. • Dept. PM-15 • Greenfield, Mass.

LITTLE GIANT

RAZOR BLADE PLANES



Adjusts Instantly for Desired Depth of Cut



FLAT PLANE

98c



3-WAY CURVE PLANE

PRECISION TOOLS

Satisfaction Guaranteed!

98c



FOR JOBS OTHER PLANES CAN'T DO

This Side For Long Curves and Flat Surfaces

This Side For Short Curves and Shaping

The blade moves back and forth to adjust the depth of cut for the side being used.

It's a real pleasure to use a tool that is razor sharp!

SEE THE "LITTLE GIANT" PLANES AT YOUR HARDWARE DEALER

MR. DEALER: If you are not yet stocking the "Little Giant" Planes, see your jobber salesman.

MFG. BY WILSON BROS

P. O. BOX 917 COMM. STA. SPRINGFIELD, MO

The Chief Steel 5-Shelf Unit
75 Inches High
36" Wide—12" Deep

Hundreds of Uses
• Offices • Churches
• Schools • Garages
• Stores • Homes
• Shops • Greenhouses
• Hobby Shops

Adjustable shelves, back braced... green metallic finish... Shipped K. D.

888

F.O.B. Detroit

15" depth 9.88
18" depth 10.88

Extra Shelves
12" deep 1.50, 15" deep 1.75
18" deep 2.00

Securely Cartoned
Immediate Delivery

MOHAWK LUMBER & SUPPLY COMPANY

M 14525 W. Chicago Blvd., Detroit 28 Mich.

Ship Shelf Units as follows: 12" deep _____ 15" deep _____ 18" deep _____
and extra shelves: 12" _____ 15" _____ 18" _____ F.O.B. Detroit.

\$3 deposit with C.O.D. orders Enclosed Check M.O. for \$ _____

NAME _____

Ship via _____ ADDRESS _____

FREIGHT EXPRESS CITY _____ STATE _____

(Continued from page 76)

Mileage record on ground-glass strip glued to speedometer.....	181
Folding seat permits more movie enjoyment for small tots.....	181
Index notches in reference books cut with wood gouge.....	184
"Doctored" portrait has eyes that move realistically.....	185
Safety ropes on swing prevent sudden falls.....	185
Vacation address book.....	185
Water-filled mucilage bottle moistens envelope flaps.....	188
Old refrigerator-shell cover locks soft-drink cooler.....	192
Finish flooring installed over concrete without subfloor.....	197
Home-grown fruits and vegetables washed on window screen.....	197
Finger ring size marked on cork to aid in purchasing gift ring.....	197
Wetting agent improves rubber-stamp imprint.....	197
Broom clips hold rolling pin.....	201
Farm-built swing features "constant level" seats.....	201
Balsa wood indented for bending.....	202
Drawing pen easily cleaned on mohair furniture glide.....	202
Knob aids in holding scrub brush.....	202
Tiled-top table has ball-bat legs.....	203
Clothespin fitted on bucket ball provides comfortable handgrip.....	206
Old trunk converted into kennel.....	206
Weathered pump hides lawn hydrant.....	207
Cotter pins held between bricks prevent sag in mason's line.....	216
Lugged rims on tractor wheels give traction on wet ground.....	217
Hydraulic jack with pipe extension used to repair building.....	220
Angled cutoff tool for tubing.....	221

PHOTOGRAPHY

Aligned marks identify loaded developing tank.....	202
Black tape on flash reflector reduces light intensity.....	206
Camera vibration dampener.....	208

SHOPPING FOR TOOLS

Socket driver combines a spinner and ratchet wrench.....	222
Clutch for V-belt drive stops and starts unit automatically.....	222
Rotary wire-stripper attachment.....	222
Double-edged hand hacksaw blade.....	222
Universal collet chuck.....	223
Adhesive dispenser.....	223
Magnetic knife setter.....	223
Chromium-plated steel rules.....	223
Aluminum threshold has three replaceable weatherproof seals.....	224
Micrometers have interchangeable anvils.....	224
Pocket reamer.....	224
Nail anchor.....	224

WORKSHOP HINTS

Salt shaker dispenses pumice.....	176
Swaged joints for copper tubing.....	176
Thread spool aids in driving bullet-type latch.....	176
Heavy soap-water application reveals gas-line leaks.....	181
Notched section of auto tire supports mower against wall.....	181
Reshaping worn paintbrush.....	181
Paper clamp on T-square to rule parallel angular lines.....	184
Castor oil and graphite mixture lubricates rubber casters.....	185
Straight crosscutting of hose.....	188
Tweezers equipped with pen light.....	188
Clearance for leg assemblies to pivot set without washers.....	192
Foot-operated stop holds door when fitting or repairing lock.....	192
Handy utility pail made from gallon paint can.....	192
Banana oil cleans stiff brush.....	201
Comb clears brush of loose bristles.....	202
Dowels "lock" dado joint.....	202
Rolling of flashlight restricted.....	206
Reinforced sandpaper strips substitute for emery cloth.....	208
Backstop permits disks to be quickly trued up in lathe chuck.....	213
"Pleated" paper keeps grit out of metal-cutting lathe.....	213
Wedge-shaped pie plates are handy workshop sorting trays.....	213
Power brush cleans blind holes.....	216
V-block guides bushing into jig-plate hole.....	216
Notched oil-can spout lifts cap.....	217
Sleeve weight hits punch in place of hammer.....	217
Broom clips hold hand grinder.....	220
Centering irregular work in 3-jaw chuck.....	220
Collet plate improves accuracy of duplicate machining.....	220
Locating round stock for transverse drilling.....	221
Pipe cleaners protect taps.....	221

most amazing blade you ever saw!

Tyler SPYRAL BLADE

SAWS METAL, WOOD, PLASTIC, ETC.
up or down, right or left, even in circles!

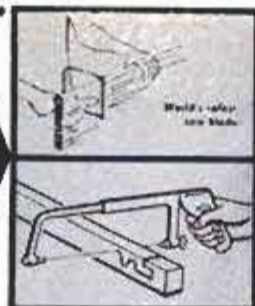

Does what no other Blade can Do. Fits Standard Coping Saw or Hacksaw Frames. NO special adapters needed! World's safest saw blade.

You'll find hundreds of uses for Tyler Spyral Blades. There's nothing like them! The first important improvement in blades since the invention of the saw. Fun to use... cuts so fast and easy; no chipping or tearing—leaves clean smooth edge.

AT YOUR HARDWARE DEALER, OR SEND \$1.00 FOR...
12 Spyral Coping Saw blades—OR—3 Spyral Hacksaw blades

TYLER MANUFACTURING CO. 1005 W. Arbor Vitae Ave., Inglewood, Calif.

695

HEAVY OILIPH-BALL BEARINGS PUMPS MILLIONS OF GALS.



CELLAR & SUMP DRAIN. 7500 G.P.H. Pump, Stand, Legs, Coupling, Hardware. \$14.45

IRRIGATE, SPRAY, DRAIN OR FILL ANYTHING—ANYWHERE! Will not Rust—Clog—or Leak. Patented Seal. Pumps 2800 gph, 420 gph at 75' high or 1600 gph from 25' well. Six blade impeller. Threaded for pipe. 3/4" inlet, 1/2" outlet. Use 1/2 to 3/4 hp motor... 7500 gph 9.95
Heavier 2800 gph 8.95 Heavier 11.95

Check, MO or COD—Money Back Guarantee
FREE Literature—Comparison Charts
U. A. T. ENG. & MFG. CO. HICKSVILLE 273, NEW YORK

CRESCENT TOOLS

Give Wings to Work

ASK YOUR
HARDWARE
DEALER

SAY YOU SAW IT IN
POPULAR MECHANICS

PORTABLE HEATERS



100,000 BTU. Stewart Warner, portable, self powered & contained! Use it anywhere! Powered by small gasoline engine, with supercharger-full blast blowers. 6" flexible ducts furnished to convey blast heat some distance. For heating buildings, starting frozen trucks, equipment, removing ice, snow from doors, metal roofs, wires, for drying, citrus groves, contractors, etc. Just start, automatic blast heat is immediately available. Burns gasoline.

Crated, app. 300¢ gross, f.o.b. Good surplus AAP \$79.50
condition. Now, at fraction orig. cost. Only...
AERO PARTS SUPPLY, 8102 Lockheed St., Houston 17, Texas

Pyroil "A" add to gas... 3 oz. can 25¢... 30¢ in Canada
at your service station



FREES STICKY VALVES ADDS PEP AND POWER

Removes carbon & lead deposits, reduces friction, increases compression 15%. Prevents ping, lubricates upper engine. Save... buy pints and quarts at all auto supply stores. Write for trial offer today. Dept. PM-96,



Pyroil Company Inc., La Crosse, Wis.
Toronto, Canada

Super Lubricants • World Famous Since 1929

5,000-POUND TRUCK is suspended in mid-air through coupling made of two 4" steel discs bonded together with Pliobond.

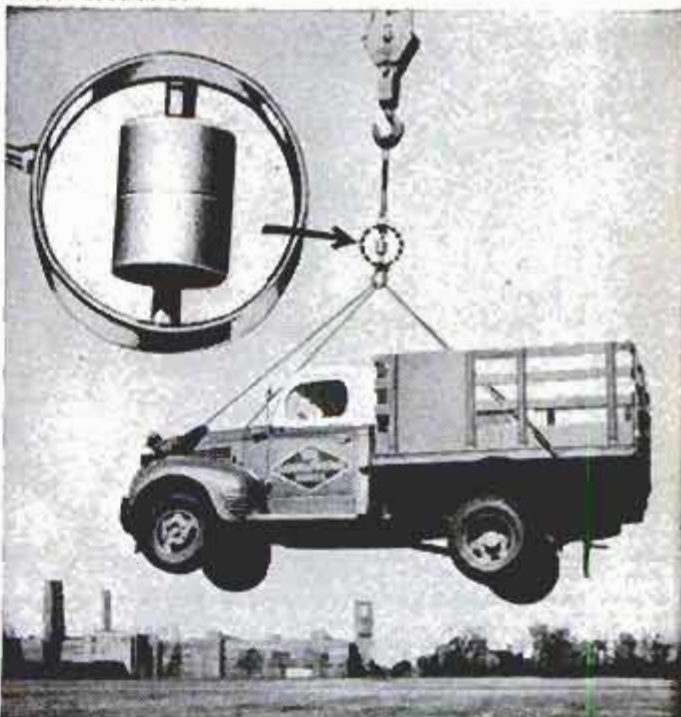

ALWAYS USE THE ADHESIVE THAT'S—
SO STRONG it can lift a truck—meet any bonding strength requirement

SO VERSATILE it bonds virtually any material or combination of materials—does almost every home or hobby bonding job

SO EASY to use, anyone can make it work—and do a better job faster

Pliobond

BY

GOOD YEAR

"BONDS ANYTHING TO ANYTHING"

AVAILABLE AT chain, hardware and hobby stores everywhere. Ask for it by name—PLIOBOND. You'll find it a fast friend.

Pliobond—T. M.

The Goodyear Tire & Rubber Company,
Akron, Ohio



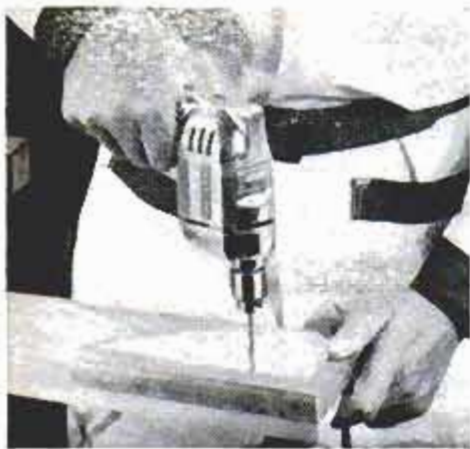

Model 137 1/4" Drill. Compact and handy, yet extra-powerful. Precision-ground gear chuck, trigger switch with locking button. Only \$26.95.



Model 136 Sander. Precision-built 3" belt sander handles every sanding job. Powerful universal motor, trigger switch, instant belt tracking control. Only \$69.50.

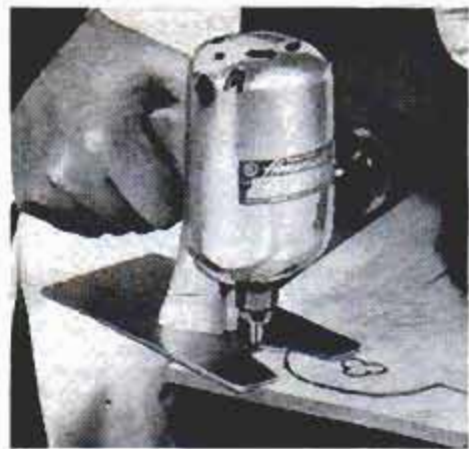

Model 140 Roto-Jig. Versatile 3-in-1 tool that's a high-speed router and rotary jig saw—accessory table makes it a precision shaper, too. Only \$49.95.

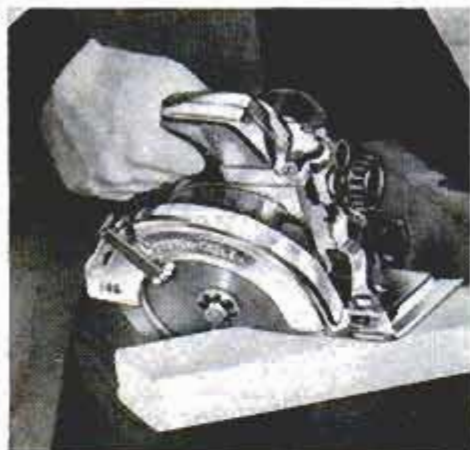

Model 146 Saw. Rugged 6 1/2" professional-capacity saw cuts 2" dressed lumber at 45°—makes every cut it takes to build a house. Only \$69.50.

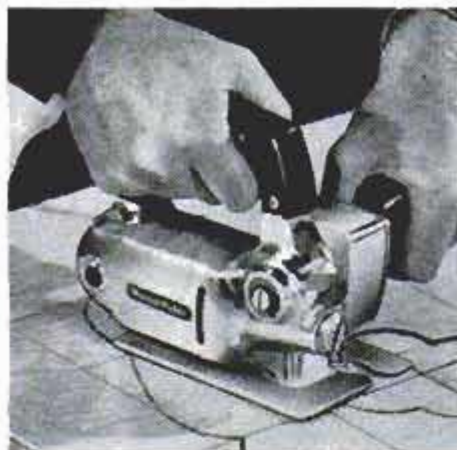

Model 148 Bayonet Saw. Exclusive orbital action cuts up to 4 times faster. Full 2" capacity in wood, 3/4" in aluminum, 1/4" in steel. Only \$99.50.



Model 145 Sander. High-speed orbital motion sands with, against or across the grain—powerful universal motor gives long, trouble-free service. Only \$34.50.

To help you do the job better...

*the world's most complete line of
portable electric woodworking tools*

Planning to "do-it-yourself"? You'll do it *better*, in far less time, with Porter-Cable *quality* electric tools. For fifty years, Porter-Cable has been the choice of *professional* craftsmen—the men who know what *really* counts in picking power tools.

"*Feel*," for example — perfect balance that's sweet and easy in your grip. *Performance* that comes from power and speed to spare. *Safety* that comes from advance features in tool design. *Construction* that's rugged and honest, for years of troublefree service.

You'll find them all in every Porter-Cable tool. *And you'll find value that no other tools can match — for, often as not, Porter-Cable quality costs no more!*



PORTER-CABLE MACHINE COMPANY, 6149 N. Salina St., Syracuse 8, N.Y.

POPULAR SEPTEMBER 1956 MECHANICS

WRITTEN SO YOU CAN UNDERSTAND IT
VOL. 106 NO. 3

TO PARENTS, electronics may mean their television set or maybe some of those Wall Street stocks they want for nest eggs. To college kids, it now means plug-in aids to make learning easier, as well as automation that flunks them if they can't make the grade.

The trend is especially noticeable at highly electrified Cornell University which even has an electronic warehouse full of parts for "do it yourself" professors who want to rig up their own peculiar contraptions. But it's appearing on most large campuses to guide students in their play and spark up their work with push-button pedagogy. Nor is it only for science courses.

For example, Cornell was first to switch over on a big scale to electronic help in making those foreign languages easier to take. Native speakers—tape-recorded—do a big share of the teaching.

This means a student can play the tape back, over and over, for full flavor of the new tongue. He can tape-record himself, then, with oscilloscope, check on his own accent in Spanish, or maybe Vietnamese. Its wavy speech-frequency lines, far more reliable than listening or watching your lips in a mirror, allow you to "see" exactly what you say.

For those who get past Cornell's calculating machines with passing records, even commencement isn't the same any more, though still held in Drill Hall, a building so large that it's only one third filled by a basketball crowd of 9000. The most important personality at graduation exercises used to be Prof. C. L. ("Bull") Durham, with a slight physique but remarkably booming voice that made him the only man fit to master the ceremonies.

Today, it's a much more showy ceremony although run by a man nobody sees—quiet-voiced Arthur Stallman hidden by

By William Gilman

Electrons Join the College Faculty



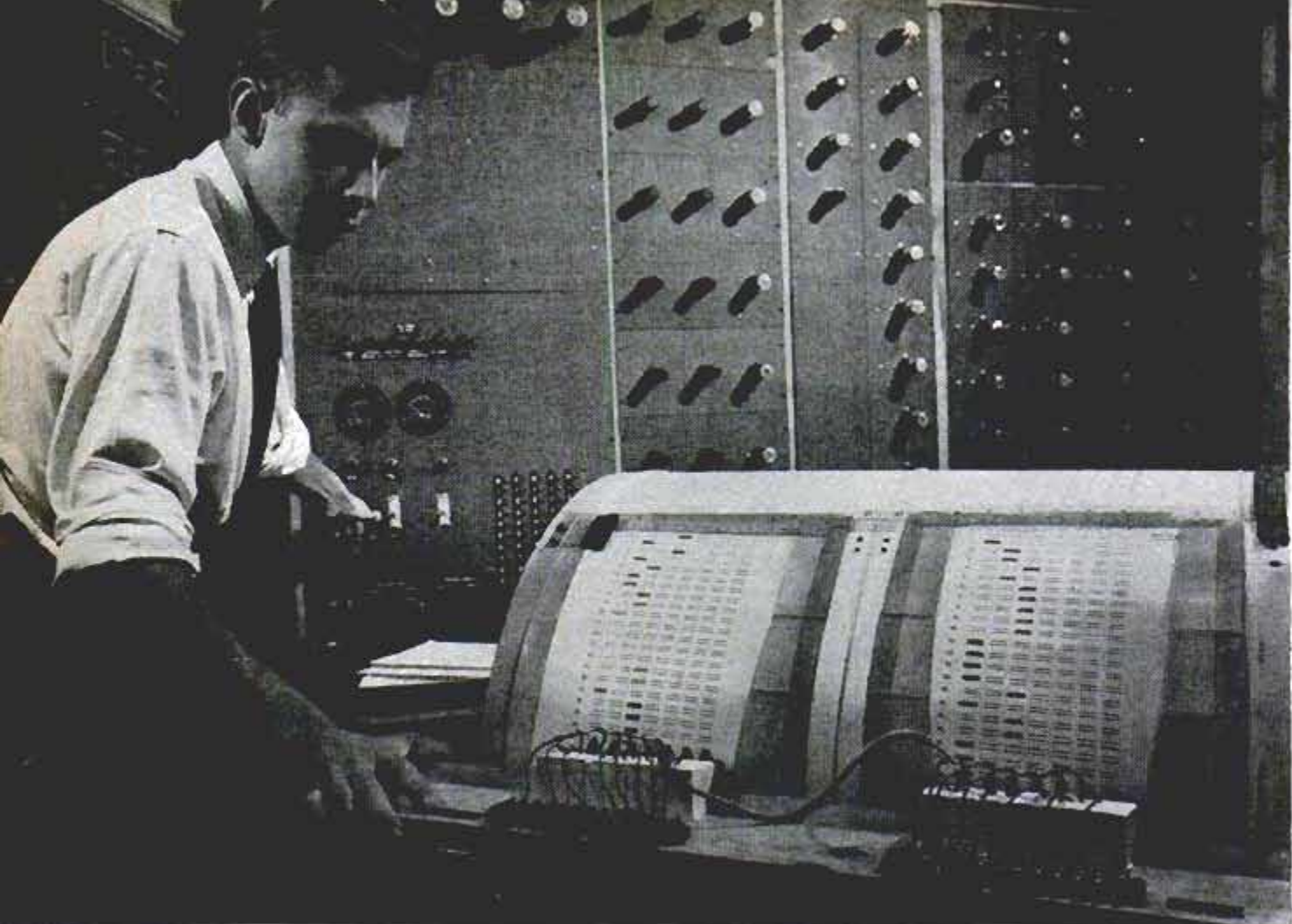

Electronic profile analyzing computer (EPAC) solves complicated problem and shows answer in neon lights

Student in Electron Microscope Laboratory uses new instrument to see things 50 times smaller than under light microscope

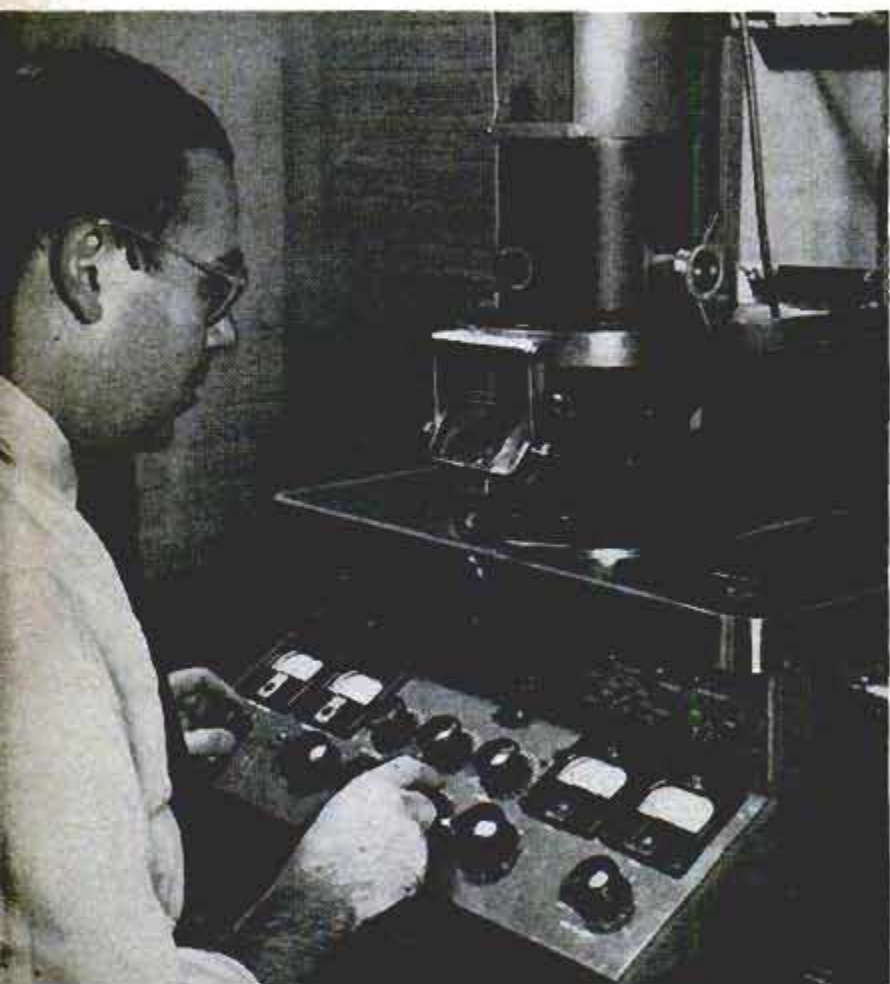

banks of flowers below the stage. With an intricate system of pickups and amplifiers feeding into the little black box before him, he puts on a program frankly designed to give parents and their graduating offspring tears in the eyes.

Stallman's push buttons send the cues that weave a program of taped binaural organ music with live glee club and concert band, that limit the main speaker's oratory to 11 minutes, and march 1700 candidates for diplomas past in an hour.

But biggest change is in day-to-day activities. All over the campus—not just among budding physicists like those using an electron microscope to see how molecules line up—are pedagogic devices that make learning more accurate as well as easier.

For example, the tape recorder can be as helpful in teaching the classics of literature as in music, or in being the "hearing aid" with which young biologists learn the songs of birds or bellows of crocodiles.

Take something as domestic as home economics. Just when is lemon meringue too runny? Even the same

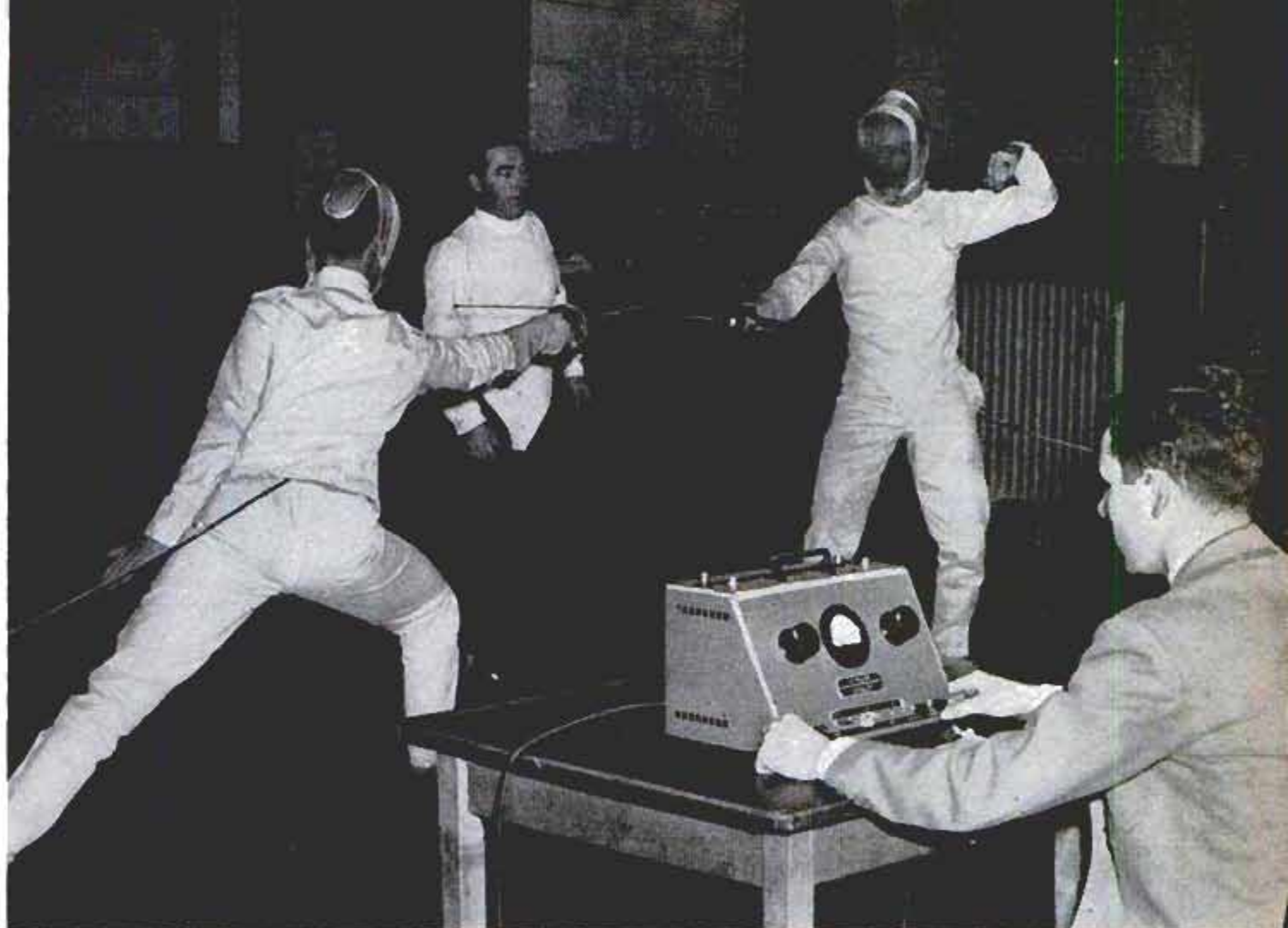

Fencers wield electrified epees. A hit by either registers by light and buzzer on the electric recorder

cook might not agree with herself from day to day. For showing meringue how-to, Mrs. Shirley Felt's "pie tilter" was homemade with parts from the electronics supply. It's motorized so it will tilt to an angle of 90 degrees in one minute, and an arrow pointer records where the meringue starts slipping off the pie's filling.

A Fad-Ometer shows color changes in textiles; it contains a "sun" of its own which in a few hours produces as much fading as weeks of ordinary sunlight. With a "moisture meter" reporting on ripeness of something like sweet corn, there's no need to punch the corn's kernels with your thumbnail. Another electronic gadget called color-meter has dials telling when the sweet potato is a correct yellow or when potato chips are the right shade and thus properly done.

Most science courses are well suited to electronics' teaching aids. How to perform a Caesarean operation on a ewe, in veterinary medicine? Watch the professor over closed-circuit TV. When, in

Colorful commencement program at Cornell is run from this flower-hidden pit. Controller Arthur Stallman electronically builds program of band music, speakers, glee club, tape-recorded organ

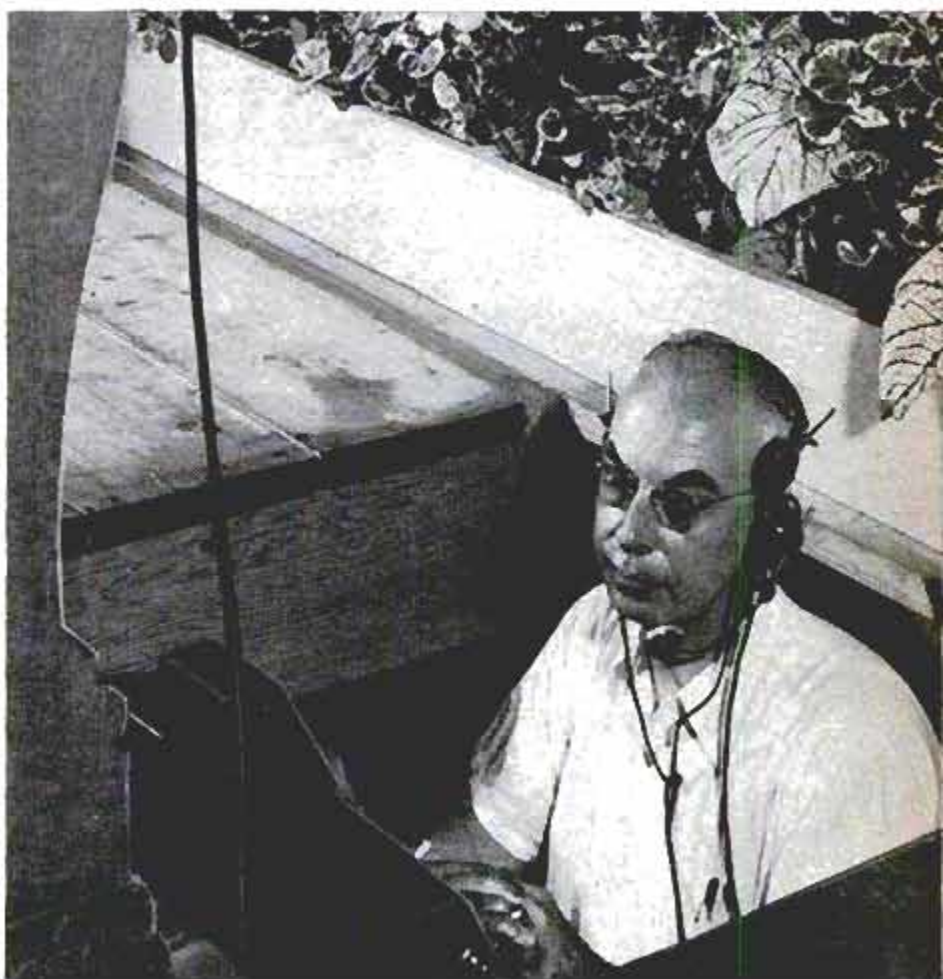



Above, manager Tito Capogrossi of the Cornell Electronics Stores, a warehouse crammed with equipment, pushes remote-control switch to operate samples on display panel. Below, in the home Economics Department, shade of potato chip is tested on electronic color meter



agriculture, is a hog too fat? With the "lean meter," there's no more need to poke the creature's ribs hit-or-miss. Four flashlight batteries power an electrode needle which shows fat and lean areas with simple accuracy—fat is a poor conductor of current.

In physics, what's the "Brownian movement" and how can this microscopic badminton game be seen by a few dozen students simultaneously?

"It used to be I'd set up the experiment with a microscope," says Prof. Guy E. Grantham. "Then I'd ask the students to please stop by, just for a minute in their free time, and take a look."

Now Grantham has captured his audience with two 21-inch TV sets in a closed circuit showing confined to the classroom. While Grantham is explaining, he's focusing the TV camera down the microscope barrel.

It was higher education which explored electronics in the first place—for industrial and war uses. Now it's figuring out meters and blinking lights for college courses—and for the extra-curricular "fun" departments of a modern campus.

At big athletic events, the public-address system is now as standard as the school band, and electrons work in smaller sports, too. Last year, the coxswain of the varsity crew was given an electronic megaphone so bellowing at the crew would be easier on his throat.

The once-dying sport of fencing has bounced back with new life thanks to electronic refereeing. You can still challenge the umpire in baseball, but not in fencing.

With foils, for example, it's foul if you hit above the opponent's shoulders or below a groin line. So a fencer now wears metallic cloth over the target area. Colleges have adopted the foil invented by Coach Bela De Tuscon of Wayne University. It's hollow steel, like a casting rod, but with wires inside, and the fencer wears a battery in his pocket. When he scores a hit, a bulb atop his mask lights up.



In the mechanical engineering school, with electronic help students study motion used on assembly line

Another version has a yellow light for foul, red for fair.

With the epee—the famed “dueling sword”—the entire body is fair target, and first hit is the main thing. But who scores first in the split seconds of an exchange?

The epee’s safety tip has three small prongs. Judges used to look for the blade to bend at a hit. Then a red fluid was used to leave its telltale mark. But judges might take five minutes looking for a red spot on the fencing jacket. All this became so tedious that when the epee events came on at a fencing meet, spectators started drifting home.

That’s all changed. Like its opponents, Cornell coach Georges Coite’s team used electrified epees last year in winning the national intercollegiate team championship.

Here, the epee has a tiny button at its tip. The slightest pressure closes a circuit between two fine wires running down inside one of the weapon’s grooves. There’s a plug-in at the sword’s hand guard (with a grounding connection in case you hit the other’s hand guard). From your hand guard, a cable runs up your sleeve to another plug at the back of your belt. Here, the main cable is connected. It runs off a

(Continued to page 266)

Mrs. Shirley Felt tests lemon meringue pie on electric pie tilter, to see that meringue isn’t runny



Guy E. Grantham, professor of physics, delivers lecture to his class over closed-circuit television





Connecting Link Repairs Chain

Requiring only a hammer for installation, a rugged but simple connecting link has been designed for repairing broken chains. Its manufacturers say one man can make the repair in five minutes right on the job. The connecting link consists of two interlocking halves, held together by two oval pins, which are in turn held by a U-shaped key pin.

Repair on a broken chain can be made in five minutes with simple connecting link. Only tool required is a hammer to drive in oval and key pins

Put-Together Igloo For Small Eskimos

Little Eskimos can plan an imaginary polar-bear hunt in an igloo they construct themselves. Interlocking parts for the igloo are made of heavy-duty corrugated board. The structure stands 40 inches high and is 6 feet in diameter. It can be taken apart and stored in a small box when not in use.

Parts, made of heavy-duty corrugated board, have locking tabs. The igloo is 40 inches high—just right for small Eskimos



Folding Drawing Easel Locks Into Hundreds of Positions

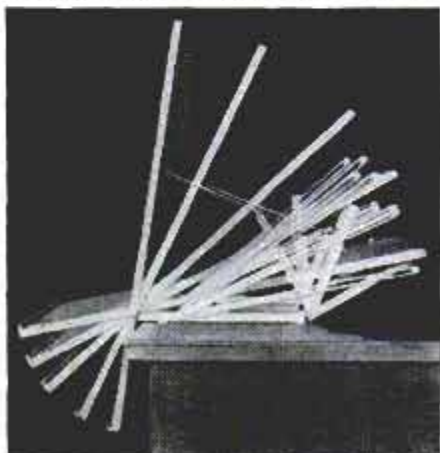

You can lock a new folding drawing easel into hundreds of positions. Quickly adjusted from the horizontal to the vertical or any position in between, it is designed for drafting, general drawing, painting and sketching. Used on a desk or drawing table, it has a wide base to counterbalance the tilting top and prevent its toppling over.

"Brain" Turns Plan Into Finished Part

With a new automatic machine, blueprints are turned into finished parts without human manual labor. The machine, developed by Bendix Aviation Research Laboratories, will accomplish in from two to four hours a technical operation which previously required 400 man-hours. Information from the blueprint is punched onto a plastic tape. The tape then is fed through an electronic control unit which directs servomechanisms to make the proper cuts with a machine tool.

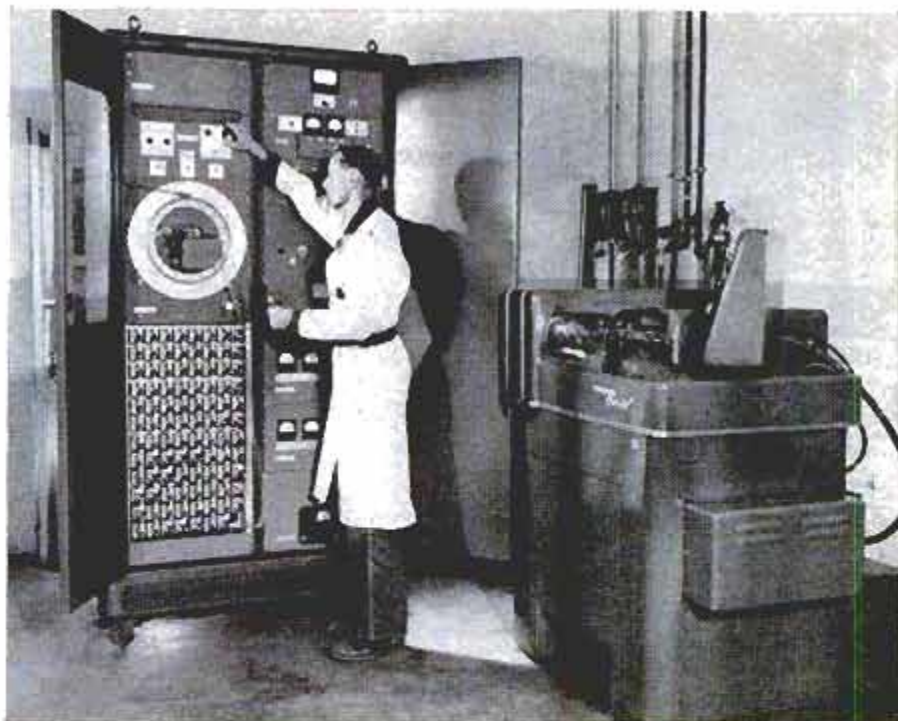

Power Digger

Much of the hand digging once needed for small excavations is now done by portable powered diggers attached to tractors and trucks. With one of these, one man can do the work of 12. The machine can travel from job to job and digs to a depth of 10 feet below grade. One operator reports that he can dig 130 feet of ditch, 2 feet deep and 20 inches wide, in 30 minutes.

Needle Point Checks Plugs

Mechanics are able to check hard-to-reach spark plugs and ignition wiring more quickly with a needle-pointed test device. The needle is attached to an insulated handle on one end of a length of high-tension wire. On the other end is a positive ground clip. The test device eliminates fumbling around hot engines to disconnect wiring and remove the protective covers common on today's engines. The needle itself is about an inch long and the test wire is about 30 inches long.

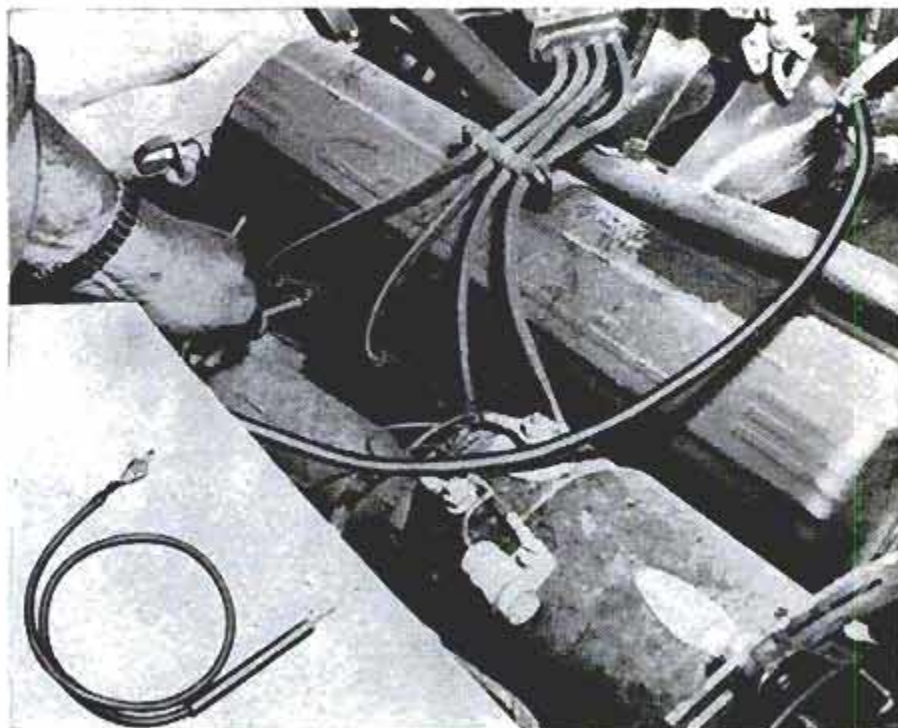



Pulverizer Chops up Vines

Potato vines are no problem on the farm of William Gehring of Rensselaer, Ind. A pulverizer built on the farm moves across the field ahead of the digger. It is set just deep enough to catch the vines, which then pass up through the pulverizer and are ejected through one of two spouts, depending upon the direction of the wind.

Implement precedes digger, can be set just deep enough to catch the vines

Model Steam Engine Puffs and Separator Threshes Grain

Nine years ago, Lawrence D. Graham of Camrose, Alberta, started to build a model of an old-time steam engine. Today he has finished not only the engine, but a model grain separator as well. Both models are amazingly realistic, yet the engine was constructed from memory and the separator from only a newspaper photograph. The grain separator, which will actually thresh grain and blow straw and chaff through a blower, stands 17 inches high and is 4½ feet long. The steam engine is two feet long and really works, though for display purposes it usually is operated on compressed air.

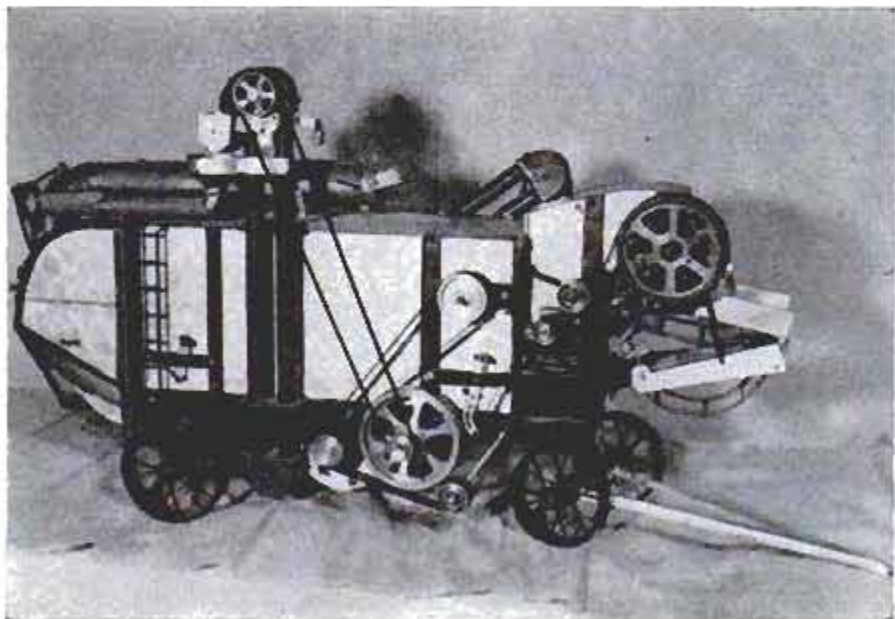
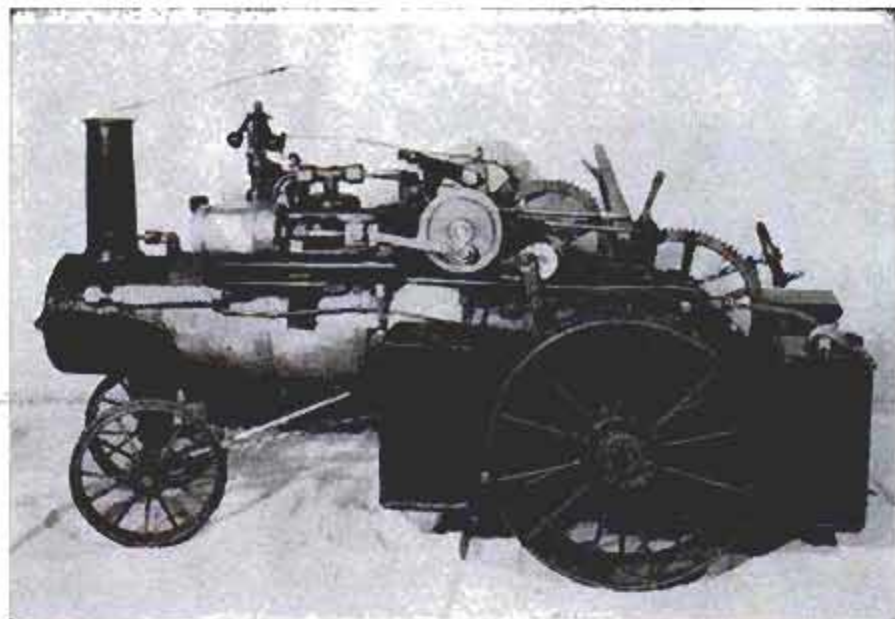

Morse-Code Typewriter

Wireless operators can typewrite Morse code to other stations on the keyboard of a sender invented by Leif Evensen of Larvik, Norway. When a key on the unit is hit, the impulse is converted to Morse code and transmitted by radio at the rate of 240 units per minute.

Soon to emerge from secrecy in a Texas aircraft plant is the first of the delta-winged bombers, shown on this month's cover. From the interceptor to the B-58 and the atom bomber, this is the

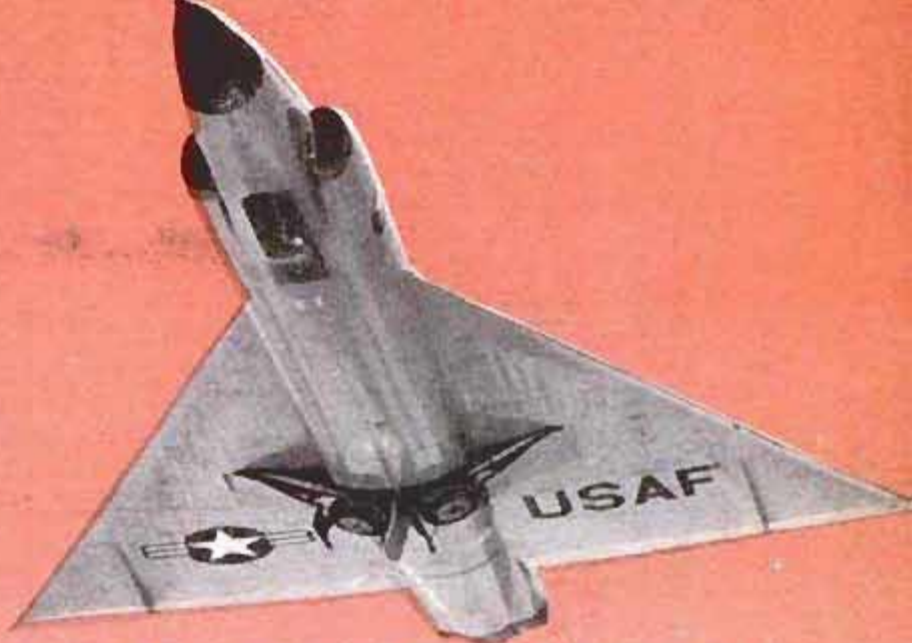

ERA OF THE FLYING TRIANGLES

THE DELTA CHASE PLANE was just getting off the ground at Palmdale almost 150 miles away when Bob Myrann climbed into the new F-102A at San Diego, Calif., and started his cockpit check.

All the instruments checked out and Myrann got his engine started. By then the chase plane was calling him.

"787, this is Rex Warden in 995. I'm just passing Santa Anita race track. You all ready to roll? Over."

"Okay, okay, 995, let's go!" Myrann responded. He taxied out to the far end of the runway, got his take-off clearance and ran the turbine up to full military power. Then he released the brakes and cut in the afterburner. The plane howled down the runway, flared off the concrete, and Myrann pulled it up in a steep climb that would have stalled a piston-engine fighter.

Meanwhile Warden was getting into position. He had flashed across Orange County, started letting down over Escondido, Calif., and had made a big sweep of San Diego. By the time Myrann was airborne, Warden was right on his tail.

Sending a delta chase plane to accompany another delta isn't done every day, but the incident makes a graphic

By
Thomas E. Stimson, Jr.

Hottest of present operational fighters is the delta-winged F-102A, pictured above as its landing gear is retracted after take-off. Below, tail view of the F-102A shows extended speed brakes just above jet outlet. A drag chute is also used to slow plane for landing

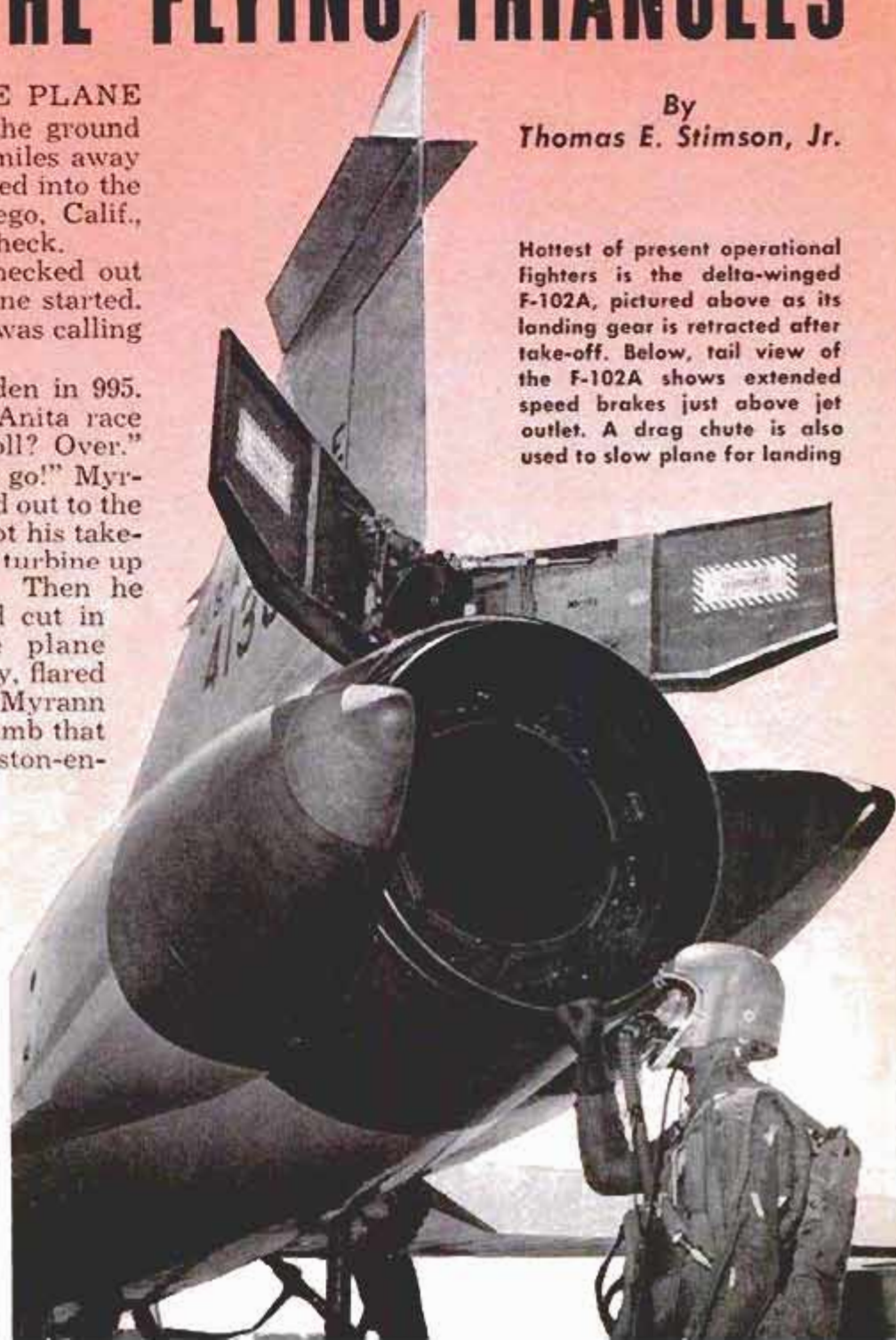

demonstration of how fast the new supersonic interceptors can fly. Warden had taken off from Palmdale and reached San Diego in the same time Myrann needed for a cockpit check and a normal take-off.

The deltas are a new family of aircraft. They get their name from the fourth letter of the Greek alphabet, an equilateral triangle, that the new shape somewhat resembles. The delta has been called the wing of the future for aircraft that fly faster than sound. It isn't very efficient at slow speeds, but it goes through Mach 1 with hardly a tremor—then it's hard to catch. Many designers believe that its margin of superiority widens rapidly as the speed goes up. It is said to be more stable and maneuverable than other designs at high altitudes.

"The delta wing gives an interceptor pilot a tremendous advantage at altitudes of around 50,000 feet," says Warden, chief test pilot at Convair's Palmdale, Calif., facility. "A delta can overtake any bomber that has been built so far. If the bomber pilot tries a tight turn in the thin air he loses speed and goes into a stall. He needs maybe 25 miles of space to turn around. The delta can turn much more sharply. If the bomber pilot tries to dive away, his speed goes up and he gets into compressibility. He loses control. Escape is almost impossible."

These days the F-102A doesn't even need to get close to its target to make a kill. The big six-foot Falcon homing missiles that it carries can be fired from miles away. Interception is automatic and is performed by the new Hughes "seek-find-kill" electronic system that guides the interceptor to the target. If air-to-air aimed rockets are to be fired instead of the guided missiles, the electrical brain "locks on" the target and gives steering directions to the pilot so that he flies a lead collision course. Then the system opens the missile doors under the fuselage and launches the armament at the exact instant when a kill is assured.

The delta configuration has so many advantages that England, Sweden, France and Russia, among others, are building delta aircraft. In the United States, Douglas is using a deltalike shape for its F4D Skyray and again for its A4D Skyhawk. Ryan Aeronautical selected the delta wing for its new X-13 Vertijet aircraft that takes off straight up. Other deltas are on the way.

The real exponent of the aircraft that is shaped like an arrowhead, however, is Convair, builder of the F-102A. Convair used the wing for its Sea Dart seaplane and also for its XFY-1, the turboprop fighter that takes off and lands on its tail. The Convair designers in San Diego regard it as the logical shape for tomorrow's planes

Popular Mechanics' drawing made from designs by Lee A. Ohlinger of Northrop Aviation, Inc.

Giant delta-winged, atom-powered jet transport of the future will be refueled by lead-shielded tank-like vehicles. Operators inside vehicles see through TV iconoscope cameras and do work with robot arms. Trailer under plane contains shielded coffin to receive spent but still radioactive slugs of plutonium which will be replaced with fresh fuel



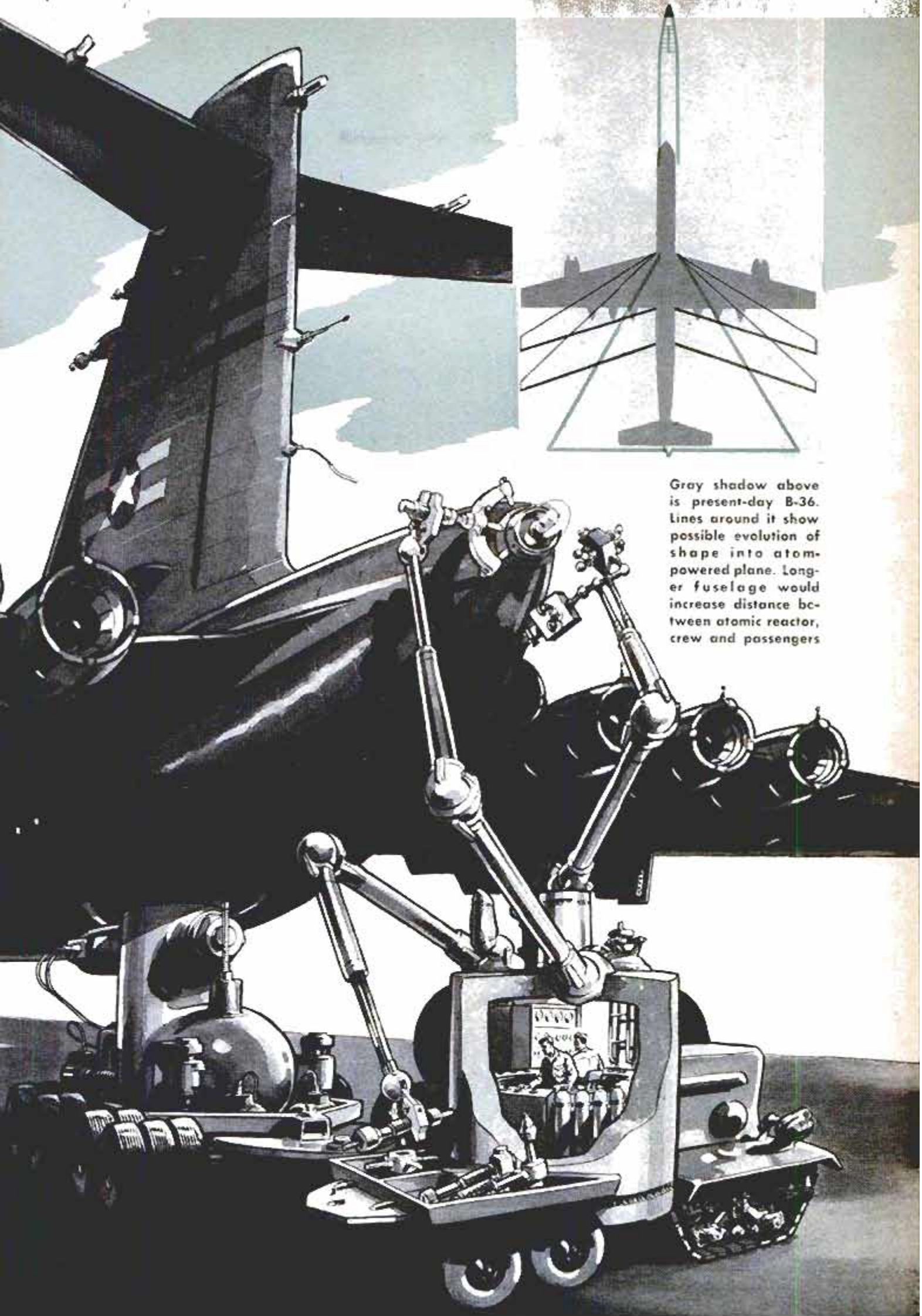

Gray shadow above is present-day B-36. Lines around it show possible evolution of shape into atom-powered plane. Longer fuselage would increase distance between atomic reactor, crew and passengers

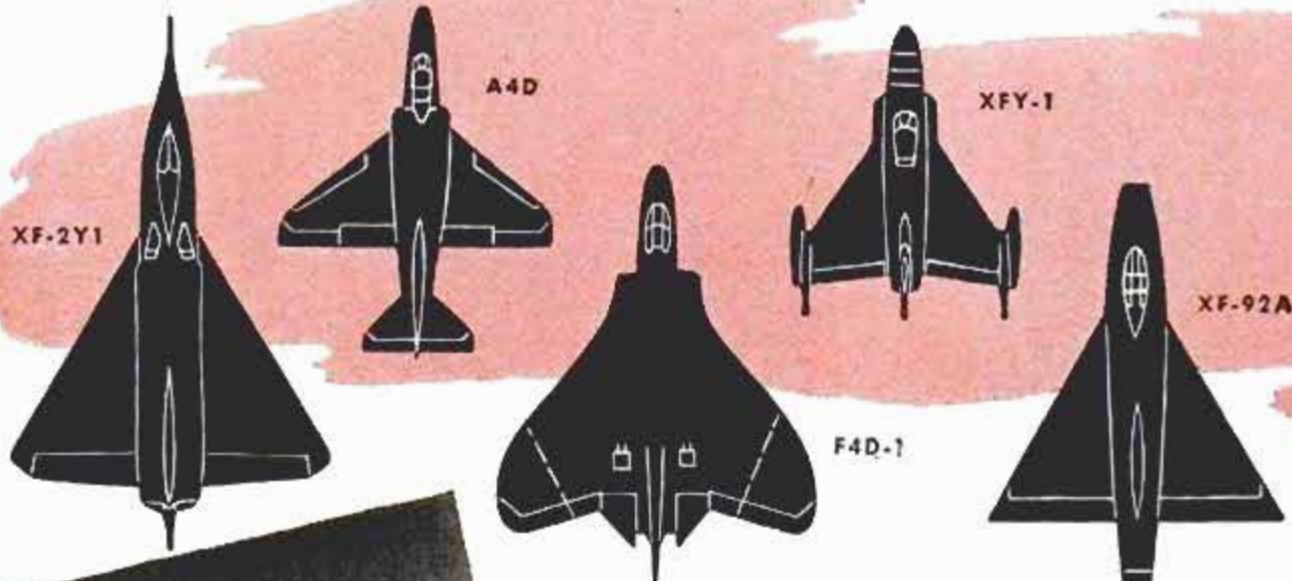

Above, plan views of planes using the delta-wing configuration or variations of it. Left, this month's cover with artist's conception of B-58 accompanied by an F-102A, to which it bears a resemblance in all but size



that are intended to fly at 1500 miles per hour or more.

It's believed that the nuclear-powered aircraft of the not-distant future will have a delta wing. The delta seems to have special advantages where atomic power plants are used.

It's a good guess, too, that the world's first supersonic bomber, the B-58 Hustler that Convair is building at Fort Worth, Tex., has the delta configuration. Our cover painting is an artist's conception of the B-58.

B-58 Will Be Big

The plane likely will be similar to the F-102A interceptor which also appears on the cover. The B-58 will be big and heavy in spite of the fact that it's designed to travel faster than a revolver bullet. Its bomb bay is said to be large enough to pack an H-bomb.

The four jet pods that the artists placed below the wing may carry one or two engines each, depending on the size of the power plants. The pods are placed outboard instead of being buried in the wing because American designers consistently favor this safer location.

Honeycombed Hustler

Among other innovations in the Hustler is the considerable use of aluminum or stainless-steel honeycomb in the basic structure. Honeycomb has a desirable strength-to-weight ratio and also retains

Air turbine on F-102A is an emergency device that pressurizes hydraulic system and other controls in event of engine failure. It is extended when needed



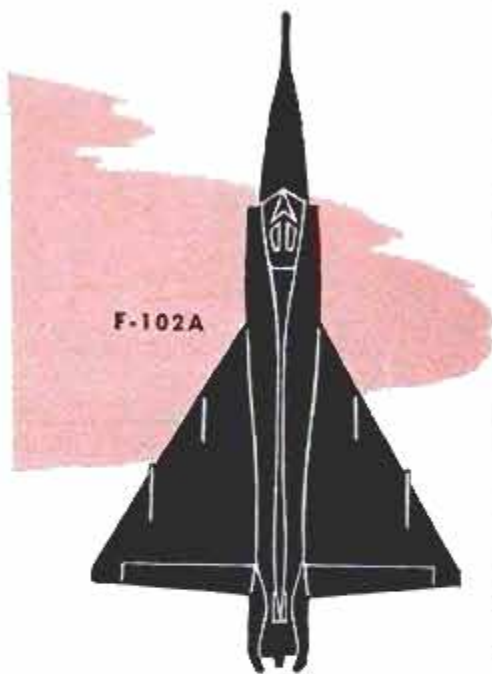

Convair Sea Dart, billed as world's fastest seaplane, uses a delta wing. An early model is pictured. Later ones have a single hydro-ski instead of two

much of its strength at relatively high temperatures. Presumably the B-58 will operate at speeds at which aerodynamic heating will be a problem.

Special radar equipment has been perfected to allow the B-58 bombardier to release his armament with acceptable accuracy even while traveling at possibly 1000 miles per hour some 10 miles above the earth. It has been said, too, that some of the first production B-58s will carry electronic countermeasure devices. These might be improvements in the foil strips that bombers discharged during the last war to create a poor picture on enemy radarscopes, or they could be some entirely new system that would prevent enemy fighters or guided missiles from homing on the bomber.

Wing Is Thick at Fuselage

One virtue of the delta wing is that it can be fairly thick where it joins the fuselage and still have the low thickness ratio that is favored for high speed. This is possible because the wing itself is so deep, from leading edge to trailing edge. This thickness gives enough room for designing a very stiff wing, preferred for high load factors. It also provides room for considerable fuel storage.

Any delta wing has a large area, so wing loading is low. This provides the stability at high altitudes for which the design is noted. It also provides very desirable gliding characteristics. The F-102A, for instance, can deadstick to a landing strip more than 50 miles away from an altitude of 40,000 feet.

One of the reasons why the F-102A goes

through the speed of sound so easily is that it doesn't have a conventional tail group that tends to upset stability. The rudder makes up part of its large fin. Elevators and ailerons are combined in the long "elevons" on the wing's trailing edge. When the control stick is moved forward or aft the elevons operate as elevators; when the control stick is moved to one side the elevons move differentially and serve as ailerons.

Delta Is Logical Shape

The delta configuration seems to be the logical shape for the large atomic-powered aircraft that may be flying soon. Already, Convair is testing an atomic reactor in a big straight-wing B-36, though not for propulsion purposes. The preliminary research is being confined to studies of the radiation and shielding problems. Boeing and Lockheed among others also have study contracts on atomic aircraft.

At Northrop, Lee A. Ohlinger thinks that large military aircraft and possibly commercial airliners using atomic power are only 10 years away.

"From what we know today," he says, "we can expect an atomic airliner to be some 200 feet long, with a delta wing and a long fuselage. It will weigh 150 to 250 tons and will cruise at 60,000 feet at a speed of 1500 miles per hour or more."

The size and shape of an atomic aircraft is dictated by the fact that the power reactor requires some 35 to 50 tons of shielding, he explains. The aircraft has to be large to be able to lift such a dead weight.

To avoid destructive neutrons the crew and passengers must be placed as far as



An F-102A shown in an approach to a landing, with its various parts and outstanding features identified

practical from the reactor itself, hence the pressure cabin would be located in the nose of a long fuselage. For the same reason the reactor should be as far aft as possible. The center of lift of a delta wing is farther aft than in a straight or swept-wing, so the delta is the logical choice aside from its other advantages. The first few nuclear aircraft may not use the delta, but Ohlinger expects that in the long run it will be found to be the most practicable.

The weight of the shielding would be even greater except for several tricks that engineers have devised. One of these is the so-called "shadow shielding" by which the heaviest shielding is placed on the side of the reactor that faces the pressure cabin. Passengers and crew would remain in the shadow of this shielding and thus escape harm.

Atomic Power in a Plane?

How can atomic power propel an aircraft? Various ways have been suggested. The most practical solution seems to be to use ordinary jet engines in which the air normally is heated to 1600 degrees (critical temperature of the turbine blades) by the combustion of a liquid fuel. In the nuclear aircraft no liquid fuel would be used. Instead, the compressor air would be circulated through the hot reactor where it would be heated to the desired temperature. The jet thrust would be just the same as if an ordinary fuel was being burned. Actually, to avoid spewing contaminated air behind the plane, the reactor heat probably would be transferred to the engine air by a heat exchanger.

One reactor would furnish enough heat to operate as many jet engines as would be needed for propulsion. To avoid heat losses from long duct runs it is probable that the jets would be grouped closely at the center line of the plane.

From the power standpoint there's no reason why an atomic aircraft can't be designed to fly at a speed of, say Mach 5, or about 3500 miles per hour. Aerodynamic heating would be offset by refrigeration.

It's quite possible that the ultimate atomic airliners will be able to cruise around and around the earth, staying aloft for weeks or months at a time. Passengers would arrive and depart over various cities by means of shuttle planes that would nose into a retractable air lock under the fuselage. Crews would be changed and supplies brought aboard by the same means. Only when the atomic reactor itself needed servicing would the big transport need to land.

Servicing a Problem

In servicing the plane, no one without protection would dare approach the area where the reactor is located. In fact, after a number of landings the service area of the airport itself could very easily become contaminated.

To service the reactor, a vehicle something like an armored tank with the mechanics sitting inside a shielded turret probably would be needed. They would use periscopes and TV screens to watch their work, which they would perform by operating big mechanical arms.

In such a vehicle they could move up to the rear of the aircraft, unscrew the cover plates and unload the fuel elements that needed to be replaced. These fuel cans would be dropped into a portable "coffin" located on a trailer towed by the service vehicle. Using the same robot arms, the mechanics then could load new elements into the power plant. The reactor would be designed so that any kind of servicing could be performed by the remotely controlled robot arms, including replacement of the entire reactor. ★ ★ ★

Control Tower Speeds Traffic

Before traffic jams start, they are cleared from a control tower that overlooks five intersections near the Miami, Fla., International Airport. It used to take 18 minutes for a car to get through the congested area during rush hours. Now it takes 2½ minutes. Five policemen once manned the intersections. Now one Dade County police officer stands before the control board in the tower, watches the traffic, and presses buttons to regulate the traffic lights. Five series of red, amber and green lights on the control board represent the traffic lights. If the control officer wishes, he can control the lights individually or collectively. The building and control equipment cost only \$8000.



Five series of red, green and amber lights on control board represent traffic lights at intersections. Operator can switch the lights as needed

Tower overlooks five intersections near Miami airport. Building and equipment, designed by the county traffic engineer, cost only \$8000



Detroit Police Wear Armor to Fight Rioters and Gunmen

Armored equipment to protect officers when combating riot crowds and barricaded gunmen is being added to the arsenal of the Detroit, Mich., police. One unit is an armored coat weighing 65 pounds, which has a powerful spotlight mounted on top of it. Worn with this coat are armored leg-

gings. Another unit is an armored, hand-pushed version of an ancient Roman chariot. Officers can crouch behind it, shoot through gunports while advancing and be protected from return fire. As the equipment is manufactured, each precinct in Detroit will be equipped with it.

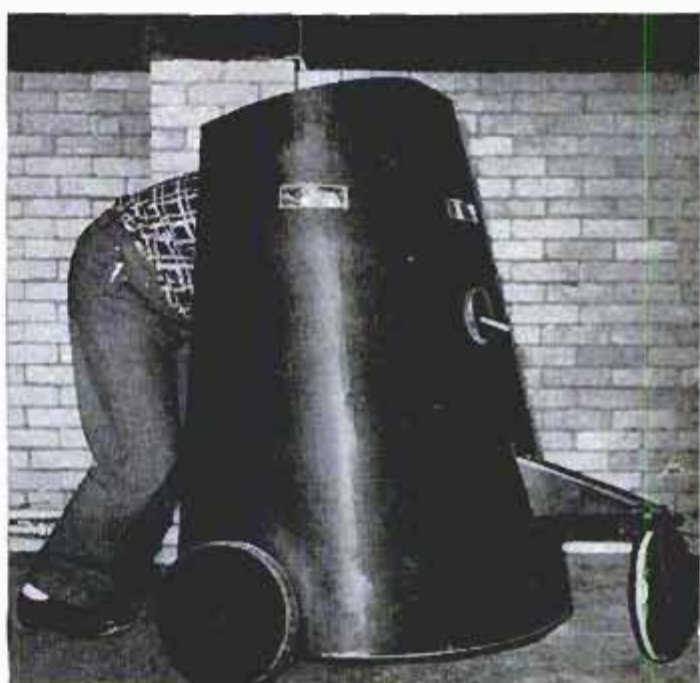



"Curtain of Air" Is Invisible Draft and Temperature Barrier

There's no door in a revolutionary doorway for stores. Instead, a curtain of downward-rushing air acts as a temperature and draft barrier to protect the interior. Rows of overhead nozzles direct filtered, warmed, (or air-conditioned) air downward to a floor grille. There the air is picked up and

recirculated. Periodic water sprays are introduced to guard against the fire danger of lighted cigarettes. The air velocity is a gentle breeze that won't disturb women's hair but is said to keep out dogs and cats. At night, a conventional door protects the opening.

Rome Parades Antiriot Cars

Rome, Italy, is prepared for trouble—lots of it. A new fleet of antiriot cars rolled through the streets during the city's annual police parade. The twin turrets on each car spray red-dyed water instead of bullets into a rioting crowd. Strong wire mesh protects the turrets and drivers' cabs.

☐ Two cups of heavily roasted coffee or 10 cups of standard coffee have one person's daily requirement of the vitamin niacin, according to Dr. L. J. Tepley of the Wisconsin Alumni Research Foundation.



IT'S TIME to look at the calendar. The new beauties for 1957 are about to debut and you'd like to know when.

First of the new cars to hit the streets will be the Continental. Still the Mark II, still outwardly the same (and for the most part inwardly) it will be announced in mid-September. Principal reason for the announcement is to give Continental a chance to mention the many running changes that have been made during production thus far this year. There is no "1957" Continental. The company continues its policy of no annual style changes.

October Busy Month

During October, Automobile Row will be ablaze with celebrations as the following cars bring out their 1957 models: Lincoln, Ford, Dodge, Plymouth, Chevrolet, Studebaker, Hudson, Nash, Rambler. Possibly Mercury, too, but more likely later.

November, too, will be busy—at least the first two weeks of it. During that time will appear the 1957 models of Chrysler, DeSoto, Imperial, Oldsmobile, Buick, Cadillac, Packard, Clipper and Mercury, if the "Big M" isn't in October.

Well before Thanksgiving Day all the new cars will be on the street except such specials as the Chrysler 300 (due to come out early next year) and the long-awaited Eldorado Brougham (now expected to arrive in February).

The birth of the Brougham keeps being delayed as Cadillac takes plenty of time to make sure its lushest car is faultless. With such innovations as fuel injection and air suspension there could be plenty of trouble if engineering of production models isn't done with great care. And there is nothing that will make enemies like a \$10,000 car with trouble-making propensities.

Chevy's Transmission

Chevrolet's new transmission continues to excite insiders. It is said to be the closest approach to the infinitely variable gear-change yet developed. Informers report it will be a "triple turbine" design and will make frequent gear changes imperceptible to the passengers. Now that Ed Cole, former chief engineer, has been made General Manager of the Chevrolet division, you can expect increased emphasis on engineering in this family car that once was as ordinary and unexciting as Monday night at the YWCA.

At least a half dozen 1957 models will have aluminum grilles, replacing the chrome and stainless steel. Some 1956 cars (Plymouth, DeSoto and Cadillac, for instance) used aluminum in their grilles.

Grilles have been (and will continue to be) the trade mark of cars since designers

Detroit Listening Post

By Leo Donovan



covered up the radiator years ago. But recently more and more identity characteristics are being incorporated in the rear end. An outstanding example, of course, is the circular Ford taillight that has been continued for several years, varying only in size (it is continued for 1957, too).

Mercury has had trouble getting something that will "hit it off" as a rear-end recognition device and for 1957 it has what may do the job: The biggest, most dramatic, boldest bumpers you ever saw. There'll be no doubt it's a Mercury when you see the rear bumpers.

Lincoln's rear fenders will serve the same purpose. They stick outward and upward giving an instantly recognizable character to the rear end of the car.

Actually, of course, Cadillac started all this with its tailfins right after the war. Almost dropped as a result of pressure from above, the tailfins became the most successful, best-recognized feature since the Pierce-Arrow headlights.

National Auto Show

Detroit informants believe that the revival of the National Auto Show in New York City in December may mark the end of the so-called dream cars. These high-styled creations have been banned from the show. Only legitimate "for sale" production cars will be shown.

But the industry is not too concerned. It has just about decided that the dream cars are making the public dissatisfied with the production cars that are on sale.

Quietly, without any great fanfare, the Volkswagen continues to sell more and more cars over here. Now the Renault seems to be catching fire, especially the new Dauphine model.

By the way, the VW will bring out a "new" model for 1957. Only the expert will recognize the difference. It will have a heavier crankshaft, larger valves and more horsepower. The heavier crank will appeal to those VW owners who insist on supercharging the little horizontal four.



B-52 Becomes Flying Convertible

Long-range B-52 bombers convert into photo-reconnaissance planes with the addition of a manned capsule that is hoisted and clamped into the bomb bay. The pressurized, air-conditioned capsule can also be used on electronic missions. Equipped with stations for a two-man crew, it has provisions for four aerial cameras, interchangeable electronics equipment and an-

tennas. Two production models of the eight-jet, 200-ton Stratofortress, the B-52B and the B-52C, are being equipped with fittings to hold the two-purpose capsule. Heretofore, a different specialized plane was needed to handle each task. The 650-mile-per-hour B-52B and B-52C operate at altitudes over 50,000 feet and have longer ranges than other American jets.

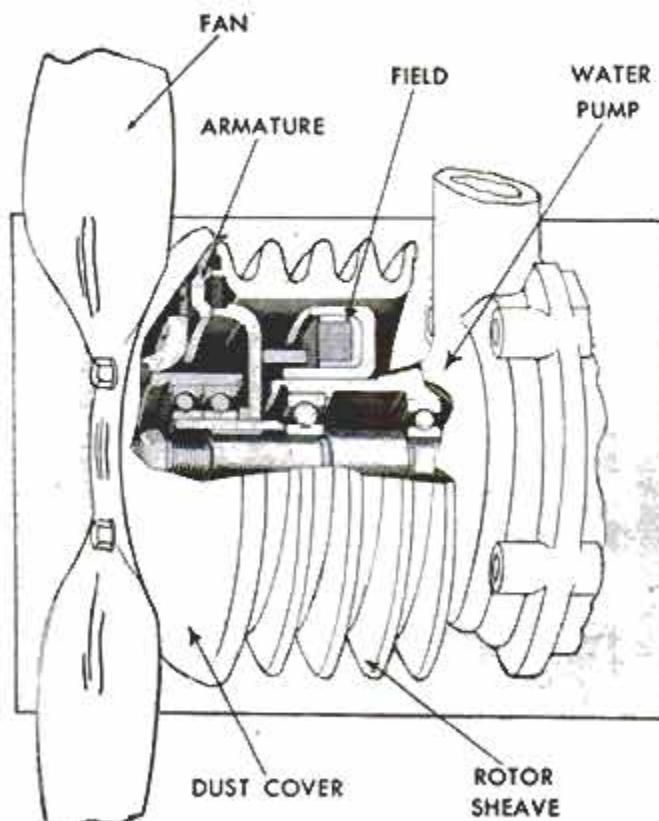

Fan Clutch Increases Mileage

By disconnecting the engine fan when it is not needed and engaging it again when cooling is required, a new fan clutch for trucks and automobiles saves horsepower and increases gas mileage. Tests made with a light truck showed a seven-percent saving of gasoline at an average speed of 50 miles per hour. The fan clutch consists of three principal parts: Stationary magnetic field, rotor and an armature. When water temperature in the cooling system rises to 180 degrees, a thermostatic-type switch sends electric power to the clutch field. Magnetic flux (lines of force) passes through the rotor (driven by the crankshaft) and attracts the armature-fan assembly to the rotor. This locks the fan to the drive pulley and drives it until water temperature is cooled below the control point, at which time a switch turns off the clutch.

☞ There are 138 species of mosquitoes in North America, and one of them does not bite people. It prefers frogs.



Tractor Fitted With Crawler Treads Takes Skiers up Mountain

Crawler tracks mounted on the wheels of a converted Ferguson tractor enable it to pull skiers up a mountain slope in Norway. An extra pair of wheels mounted between front and rear wheels keeps all

wheels turning together. The trailer holds up to 12 people, while three seated on the front of the tractor provide additional weight to improve traction. Detachable skids uphold the trailer wheels in soft snow.

"Speed Tripod" Tilts Camera 180 Degrees

Fast mounting is a feature of a "speed tripod" for cameras. A metal shoe on the camera base slips into a slot on the tripod head, and a screw is turned to lock the camera in place. The tripod, which fits almost any camera, allows normal panning and tilting operations, plus a 180-degree side tilt to facilitate the sighting of reflex cameras. The positive-locking pan head holds the camera rigidly at any angle. A quick twist of a lock screw frees the legs for rapid adjustment, and a double-extension center post gives the 4½-pound tripod a maximum height of 67 inches.



Portable Shell Reloader

In one quick, simple operation, an ammunition reloader removes the old primer cap from a spent shell, resizes the expanded casing neck and seats the new primer. Standing 14 inches high and weighing less than 20 pounds, the reloader is portable. Standard reloading dies are used.

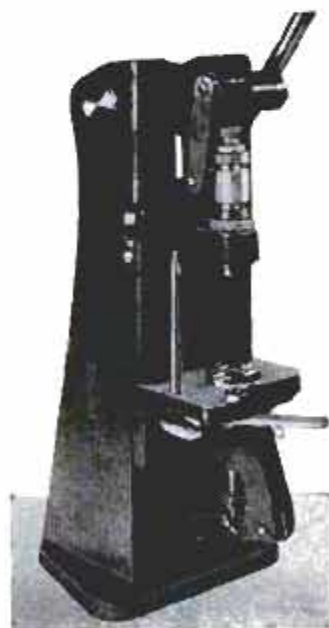

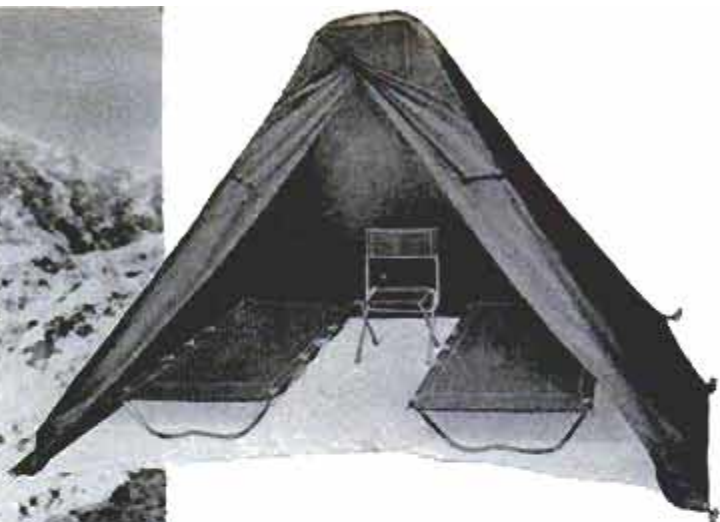

Tent Without Ropes Resists High Winds

Sixty-mile-per-hour winds are resisted by a canvas tent that has no ropes, only nine pegs, and can be set up in five minutes. The tent weighs only $10\frac{3}{8}$ pounds while its poles weigh $4\frac{3}{16}$ pounds. It covers a square area $8\frac{1}{2}$ feet on a side and sleeps four people on the ground or two on cots. Its height is $6\frac{1}{4}$ feet. An overlapping door snaps shut, eliminating tying and untying when entering or leaving.

Boy Builds His Own Tractor From Automobile Parts

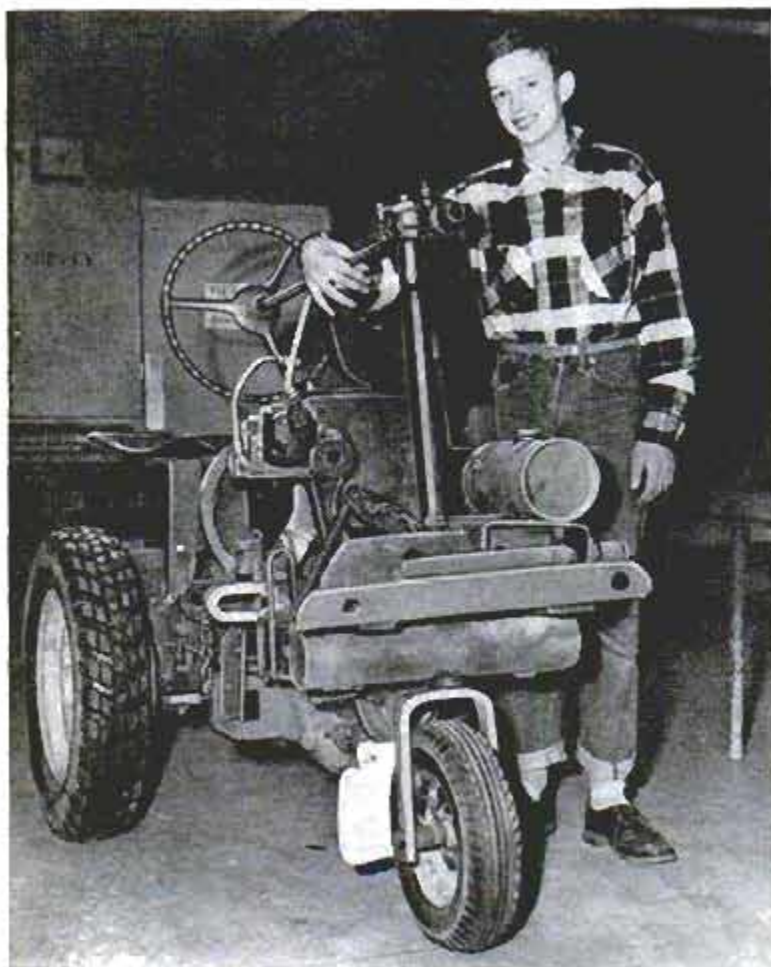

Ronald L. Swartzendruber, 14, of New Carlisle, Ohio, wanted a tractor, but instead of buying one, he built his own. The tractor's parts include the differential from one auto, the transmission of a second and the motor of a third. Ronald says the tractor really works, and he's proved it by towing a wagon loaded with 27 bales of hay—in high gear at a speed of $6\frac{1}{2}$ miles per hour.

Washington Glaciers Grow

Glaciers in the Cascade and Olympic Mountains are growing, according to Dr. Richard C. Hubley of the University of Washington. Of 73 glaciers measured, 50 have been advancing during the last 12 years and the remaining 23 have been increasing in thickness. This marks a sharp reversal of the previous 20 years' shrinkage. During the last 10 years, Hubley says, the mean annual temperature in western Washington has decreased $1\frac{1}{2}$ degrees and mean annual precipitation has increased 15 inches.



Antique Wall Phone Is Rebuilt Into Doorbell and Radio

O. O. Oxford of Dallas, Tex., has remodeled an old crank-type wall telephone into a combination doorbell and radio. After removing the original insides of the telephone, Oxford put an old sewing-machine motor in the top to drive the bell clapper when someone pushes the doorbell. The radio, an entirely separate unit, is housed in the bottom of the telephone case and is regulated with a knob on the side.



Lunch-Vending Machine Serves Hot Food and Soups

You can get hot food at the drop of a coin from a new vending machine. The food is packed in 8½-ounce (portion-size) tin cans heated to 150 degrees by the machine. Each vendor carries six varieties of hot foods selected from the total of 14 solid foods and 13 heavy soups available. A plastic spoon is supplied with each can, which is wrapped in paper so that it can be grasped safely and opened.

High-Altitude Laboratory For Aircraft Engines

Two giant stainless-steel chambers have been built as a part of the Navy's new aviation test laboratory at West Trenton, N. J. The lab was designed to put Navy aircraft engines through performance tests duplicating actual flight conditions from sea level to 65,000 feet at both subsonic and supersonic speeds. An intricate control system logs the hundreds of measurements taken by instruments during the tests.

Propose Swedish TV

Semicommercial television is being proposed for Sweden, which has no regular TV broadcasts. Part of the cost would be borne by annual fees paid by set owners. The rest would come from the sale of short commercials at the beginning and end of programs.

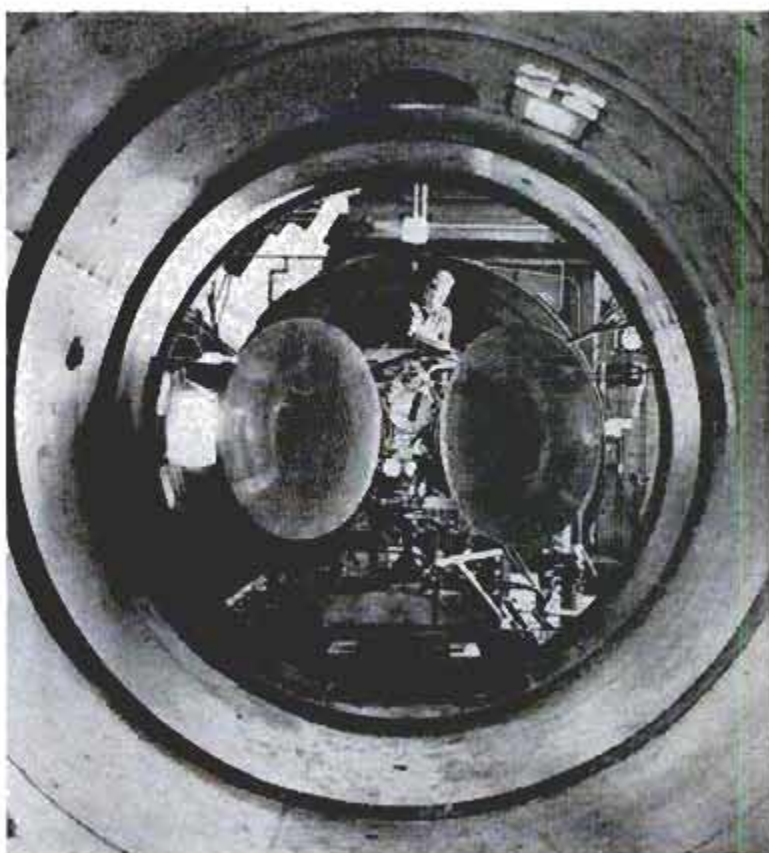



Long shot of battle scene being sighted, as part of animation test with 16-millimeter camera, before final shooting. Reg Massie supervises



By John Franchey

IT IS THE early morning of July 1, 1863. The small town of Gettysburg, Pa., lies sleeping as the rising sun burns off the night mists. And while the vapors rise, delivery boys for baker and dairy pause in their busy rounds to watch Buford's troops move out along the pike and head north, a trim blue line.

Buford's men are exactly two inches in height, and built to scale, as are the plywood-and-matchbox homes which they will pass. The roads they march are paved with corn meal and glue topped with granulated sugar rolled out to a fine level by large rollers made of empty typewriter-ribbon cans. For the road surface must catch the highlights which will be cast

upon it by the photographers' lamps when the shooting starts.

The shooting will be done with a 35-millimeter camera by Reg Massie, art director for a New York publication and an alumnus of Hollywood's famous Disney Studios. The miniature soldiers and other figures numbering in the thousands have been created by his wife, Nancy, and several other artists—all Disney grads and all residents of talent-rich Westport, Conn.

For this is a miniature setting for the three-day Battle of Gettysburg—the bloody Civil War conflict from which the South never recovered. It will be shot in full color and completely animated. Red cannon fire and yellow rifle flashes will send

up clouds of dark smoke. There will be attacks, counterattacks and probing actions—and all the rest of the standard movements of war.

Massie and his wife got the idea for the present production while both were attached to the Signal Corps during World War II. Their job was to re-create the battles of the Pacific with animated maps and figures so that the War College

Artists Don Noonan and Tom Armstrong, right, check town of Gettysburg before ordering Buford's column to march through it. Below, union artillery lumbers into position

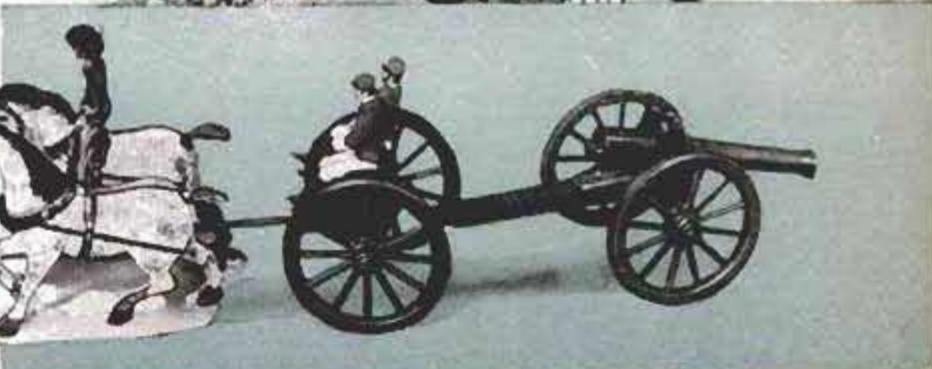

could study them. From this came the original inspiration that led to the Gettysburg production.

"As soon as we got back to Westport," said Mr. Massie, "we began rounding up materials. To make sure every item would be authentic we ransacked old map shops and book stores down on Fourth Avenue in Manhattan. Today we've got a superb collection of Gettysburg material which even includes some of the famous Warren maps of the campaign, as well as Brady photographs and issues of *Harper's Weekly* covering the period."

Although the three days at Gettysburg were among the most terrible in the history of organized warfare, Massie and his associates aren't concentrating on this aspect of the struggle.

"What we're after," he said, "is a kind of stylized effect—something like you get in the Currier & Ives prints. After all, even the bloodiest war can be viewed with a little nostalgia almost 100 years later."

Complete accuracy of detail is the keynote of the Gettysburg scene, painstakingly re-created on a plywood platform in Mr. Massie's studio. Realistic railroad tracks wind through fields where the ripening corn stands higher than a man's head (speaking in scale, of course). This is the backdrop for



Above is the view the camera shown in the first picture has of the battle. Below, Nancy Massie examines shelves of figures





Above, action scene at the field hospital on the third and final day of action. Left, a close-up of one of the "actors," showing the careful attention to detail

Below, top Union brass pose for photographer Matthew Brady before breaking camp at Aquia Creek to depart for Gettysburg. General Hooker, seated, was replaced by General Meade before battle fought three days later



the morning of the first day of the battle.

Mr. Massie says: "This would never hold up as a diorama since it was made to be photographed. The important thing is that things look right to the camera.

"Take that railroad station at Wrightsville — the farthest north the Confederate troops ever penetrated. It shows a train of the Baltimore and Susquehanna Railroad pulled up at the depot with a scattering of civilians, a few military personnel and a number of animals milling about. They are all Northerners. Looks pretty genuine, doesn't it?

"See those stone walls bisecting that field?" he went on. "They play a big role in the battle of the first day. They're on Cemetery Ridge where Howard's 11th Corps made good defensive use of them for the Union. We created those walls of rice and Puffed Wheat.

"We all learned to be pretty ingenious out in Hollywood with Disney. The wheat fields, for instance, came from the yellow whiskers on kids' Halloween masks. The houses, barns and other structures are largely of plywood and balsa, though some farther back are of ready-made plastic or tin from the five-and-ten; those far in the background are merely small matchboxes, properly painted or stained.

If produced commercially, the project would run to a good \$150,000 or more. However, with the participating artists pitching in on a cooperative basis the actual cost will amount to \$25,000 or so. As a result the film will be available to interested parties and groups for a modest fee. ★ ★ ★



Model of the Baltimore and Susquehanna Railroad station at Wrightsville, at the northernmost point reached by Confederate troops during war. Northerners on roof are watching for approaching Confederates

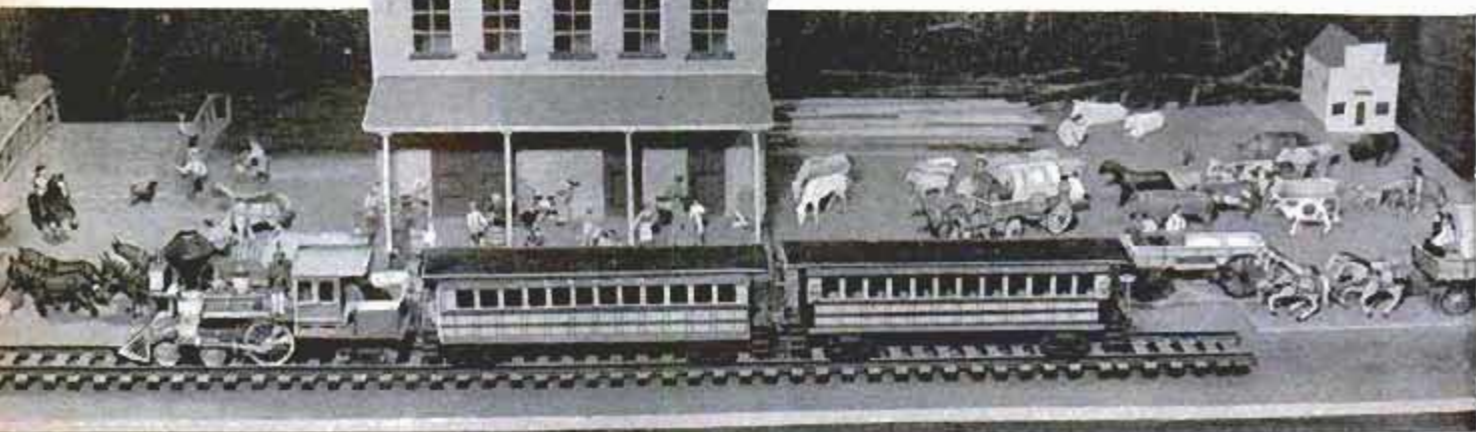

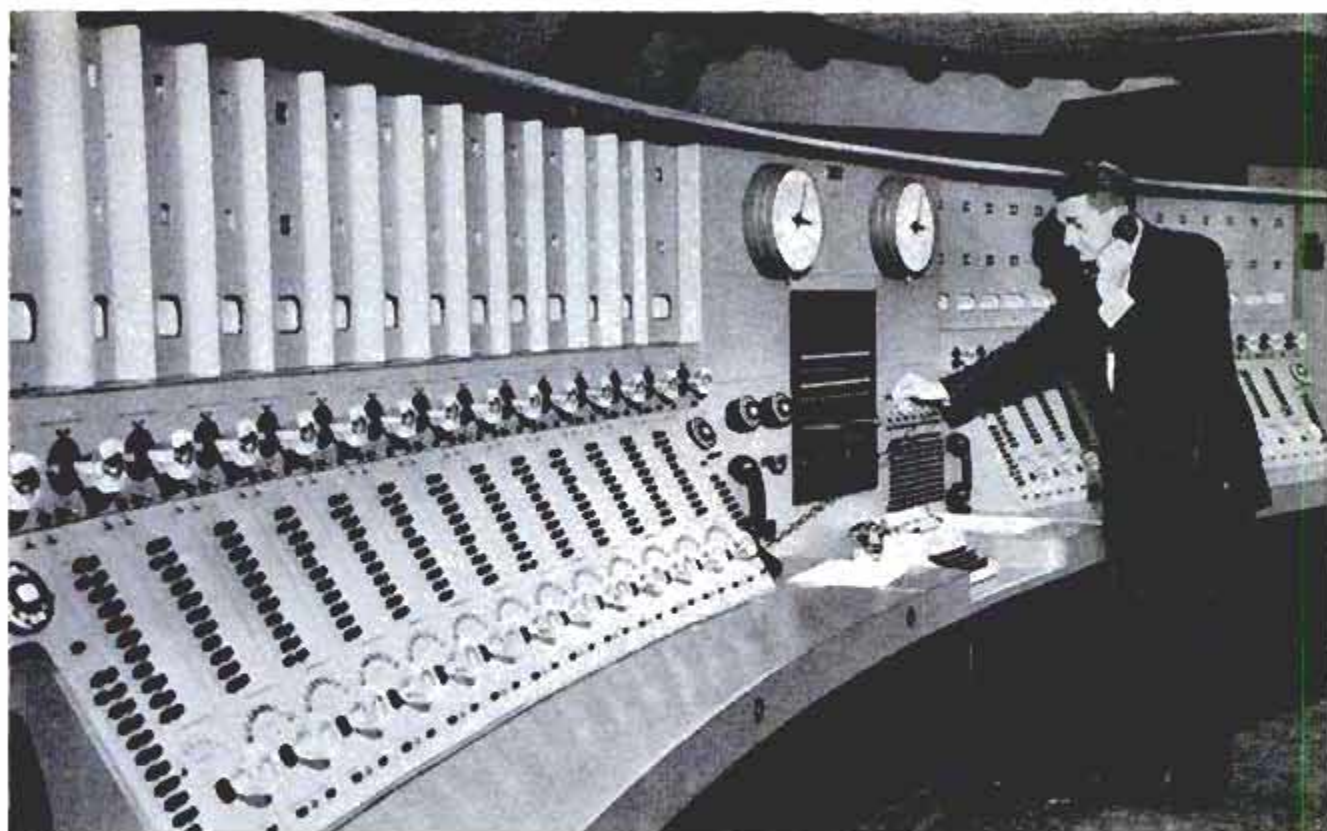

Voice of America System Handles Programs in 39 Languages

In Washington, D. C., the Voice of America has put into operation its master control equipment, believed to be the largest and most flexible in the world. Work on

the new radio facilities in Washington is now completed. The equipment was specially designed and constructed to handle the agency's 39-language programs daily.

Truck-Tire Remover Uses Hydraulic Jack to Spring Bead From Rim

Truck tires are removed in a hurry with a portable, heavy-duty unit that employs a hydraulic jack. The truck wheel is placed on a base and a circular press goes on top of the tire. Extending inward around the circle of the press are metal fingers with built-in rollers that prevent jamming and

damage to the bead. On the press is placed a V-frame with a pull rod that is fastened on the bottom to the base and on the top to a hydraulic jack. Turning a crank on top of the jack takes up the slack before a lever is pushed to activate the jack and spring the tire free of the rim.

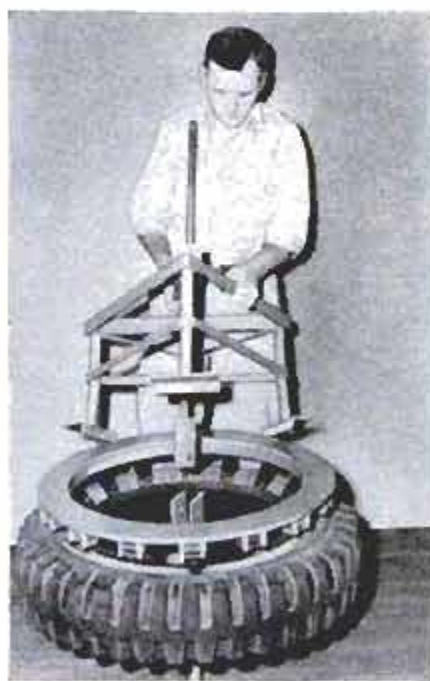



Pumping stations lift water from three rivers into Billings Reservoir, named for an American engineer

BRAZILIAN POWER GOES

By Newton Brown

THE CITY OF SAO PAULO, say many Americans who come to Brazil, is the "Chicago of South America"; a city of modern skyscrapers and humming factories that is as fast-moving and as hard-working as its North American counterpart. But few people who compare these two cities realize that the power that made this industry possible comes from one of the world's most unusual hydroelectric plants.

Sao Paulo, a city of 2,500,000 people, is only 33 miles from the Atlantic, but it is 2300 feet above sea level, more than twice as high as the Empire State Building. It lies on the Brazilian highland plateau that slopes gently away from the sea toward the interior. Thirty years ago, rain falling only 10 miles from the Atlantic flowed 2000 miles inland before returning to the ocean near Buenos Aires.

Back in the 1920s Sao Paulo was in search of a hydroelectric site. And it was A. W. Billings, an American engineer, who conceived the idea of using an "electric syphon" to make the rivers near Sao Paulo flow backward in order to take advantage of the 2350-foot drop from the edge of the plateau down to Cubatao, which is almost at sea level.

By constructing the Pedreira Dam just

south of Sao Paulo, the Billings Reservoir was created which backed water up to the edge of the plateau. A series of pumping plants then lifted water from three rivers—the Tiete, the Guaraparainga and the Pinheiros—into this reservoir. The electric power required to lift this water was multiplied 42 times by the generators in the hydroelectric plant constructed at Cubatao.

This plant was built entirely above ground. Water from the reservoir entered a valve house and from there dropped in a manmade waterfall through steel penstocks to eight generators capable of turning out a total of 484,000 kilowatts.

Just completed is a new underground plant that has almost doubled the electric-generating capacity. This new plant has four 65,000-kilowatt generators and provision for two more, making a total capacity of new and old plants of 874,000 kilowatts, nearly that of Boulder Dam.

More than 1000 Brazilians working under the supervision of 14 American tunnel veterans excavated 460,000 cubic yards of rock and earth, blasting out 8582 feet of tunnels and shafts, traveling sometimes only 14 feet a day.

The longest of these tunnels, a penstock 11 feet in diameter, carries water 4950 feet from the reservoir down to a valve cham-

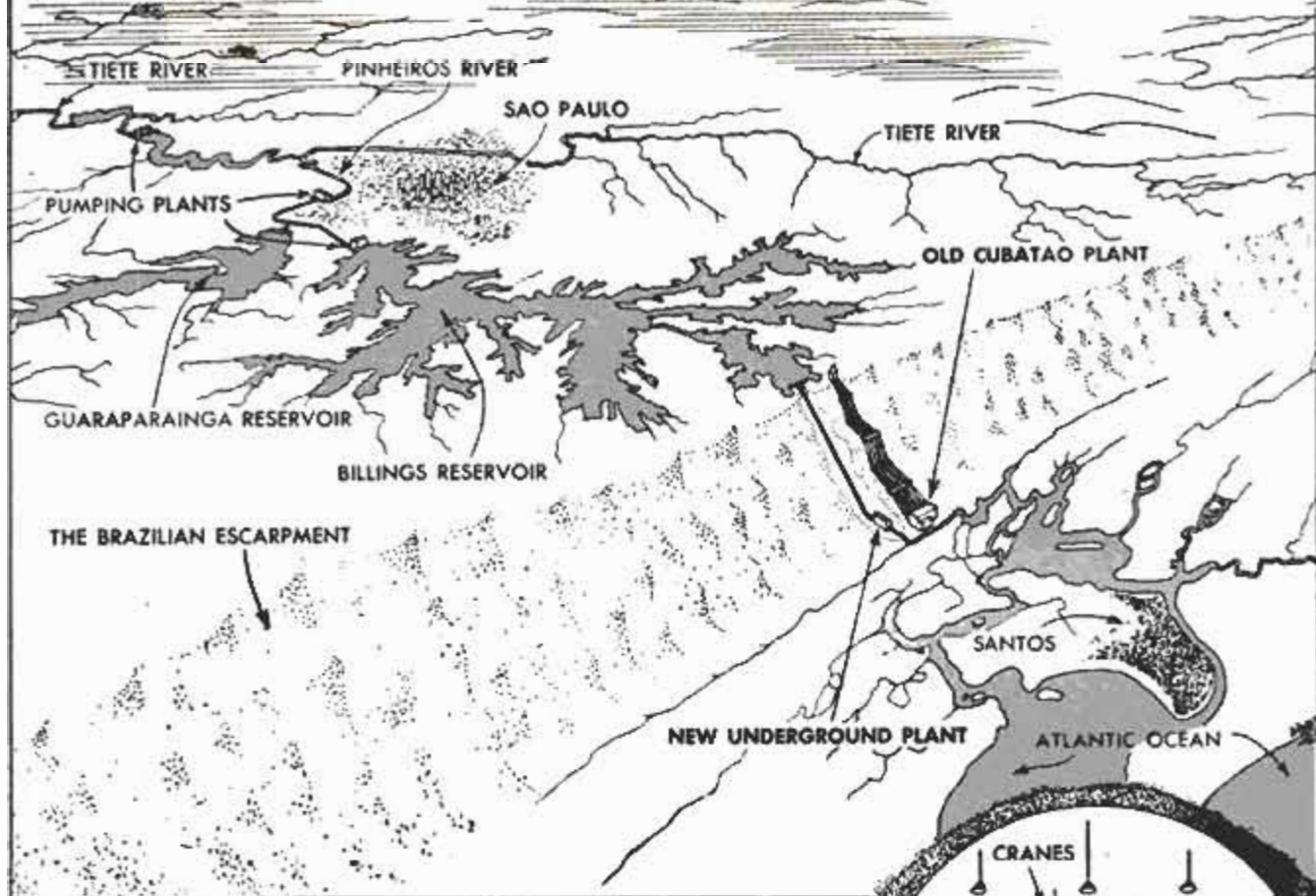

Water falls from reservoir on the high plateau almost to sea level

UNDERGROUND

New underground plant, built in a huge manmade cavern, has doubled the electric-generating capacity. Longest tunnel to the cavern carries the water 4950 feet

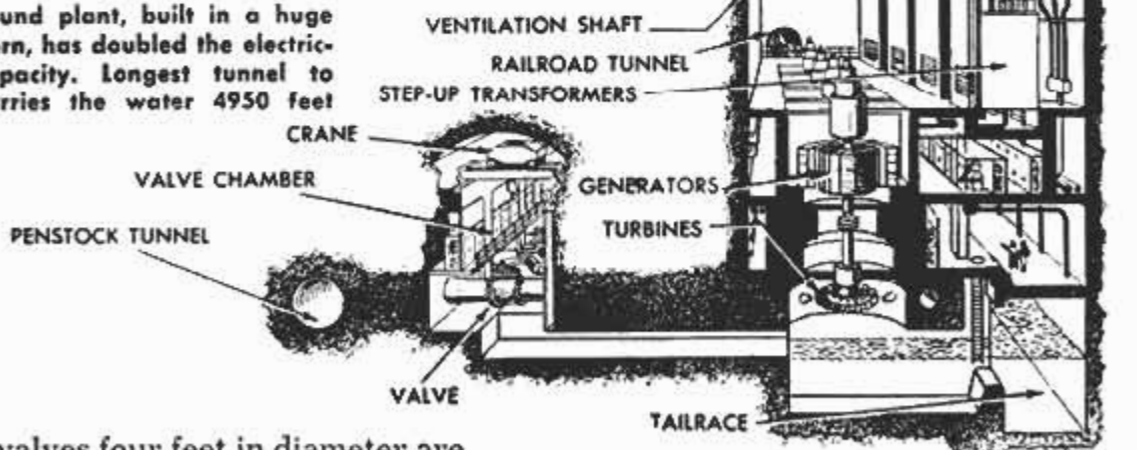

ber. There, valves four feet in diameter are hydraulically operated by water from the penstock.

From the valves water flows to the 88,000-horsepower, vertical shaft, four-jet turbines. And the flow in the jets is automatically balanced by a "nervous system" in which one jet acts as a "master" and the other three follow as "slaves." Turbines operate at 450 revolutions per minute under a pressure of 970 pounds per square inch.

Above the turbines are mounted generators whose rotors hang from combination guide-and-thrust bearings, each taking a total thrust of 337,000 pounds. For each generator there is a transformer which steps up the voltage from 13,800 to 230,000 volts.

Generators, turbines and step-up trans-

formers are all housed in a subterranean cavern which is big enough to hold a 13-story 400-family apartment building. There are four tunnels serving the power cavern: One is the tailrace from which water leaves the turbines, another is the ventilating tunnel and a third is the 1500-foot cable through which power from the transformer is conveyed to a switchyard outside. The last is the access tunnel which is 738 feet long and has a siding so that heavy equipment can be brought directly into the cavern by rail.

In May of this year all four of the new generators were on the line, boosting by a third the electric power for Sao Paulo's industrial boom. ★ ★ ★



In skijoring, man on skis is towed over flat course by low-flying plane

Skijoring Called Most Dangerous of Winter Sports

Present world's speed record for skijoring is 109 miles per hour for skier



Skijoring is the latest sport to become popular at European winter resorts, in spite of the fact that it is probably the most difficult and dangerous of winter activities. In it, a man on skis is towed over a flat course by a low-flying plane. The pilot of the plane must maintain an altitude of just a few feet while he simultaneously watches his instrument panel and the skier behind him. The present world's speed record for the sport, set near St. Moritz, Switzerland, is 109 miles per hour for the skier over a five-kilometer course.

Globe Inflated Like Balloon Weighs Only Two Pounds With Frame

Lung power easily inflates a balloonlike world globe that spins on its axis in a lightweight metal frame. Frame and globe together weigh only two pounds. The 18-inch globe is printed in bright colors and sharp type and is equipped with a time dial to compare times in different parts of the world. The surface is protected by transparent plastic, so that temporary markings and routes can be drawn with a crayon.





When the water is crystal clear in the fall, it pays to go to extremes to keep hidden. You can see the trout better at this time, but he can see you, too. And the sight of a moving figure makes him wary

By
Russell Tinsley

This happy angler displays five-pound trout he has just pulled in from the waters below El Vado Lake, N. Mex.

Don't Stop Fishing at First Frost

You have to change tactics to outsmart those wary old trout in the fall

TOO MANY ANGLERS pack their fishing gear away after Labor Day and regretfully bid farewell to the trout-fishing season. In some states law compels them to do this; with others it merely is a habit. Over one third of the states have trout seasons which extend past Labor Day, this being especially true in the West.

Some mighty decent trout fishing still beckons after the first frost. When tree leaves begin to change color and the air gets nippy, I change strategy and enjoy a form of trout fishing I never could have on opening day.

It takes an entirely different form of trout savvy to succeed during the fall. On opening day the snow-fed streams are murky and straining at their banks; in late fall the water is low and clear as a pane of window glass. The trout are wary, only the hardy surviving the horde of early-season enthusiasts, and they'll be lying in spots you'd never dream of finding them in the spring.

Perhaps a stream is a mass of swirls and eddies during the spring when runoff waters are breaking around



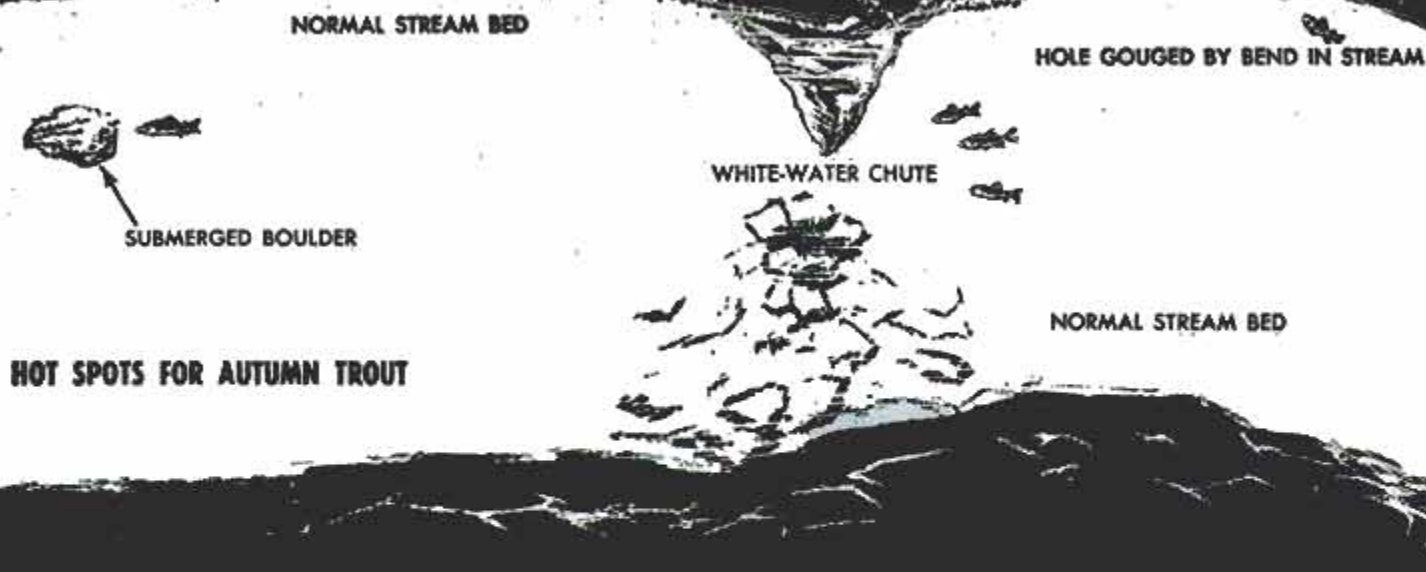

HOT SPOTS FOR AUTUMN TROUT

Learning to "read" a stream is important to trout fishing at any time, and doubly important for autumn fishing



Above, he's got one! And judging from the bend in his rod, that trout is putting up a scrap. Below, note the big flies for autumn and the smaller spring lures

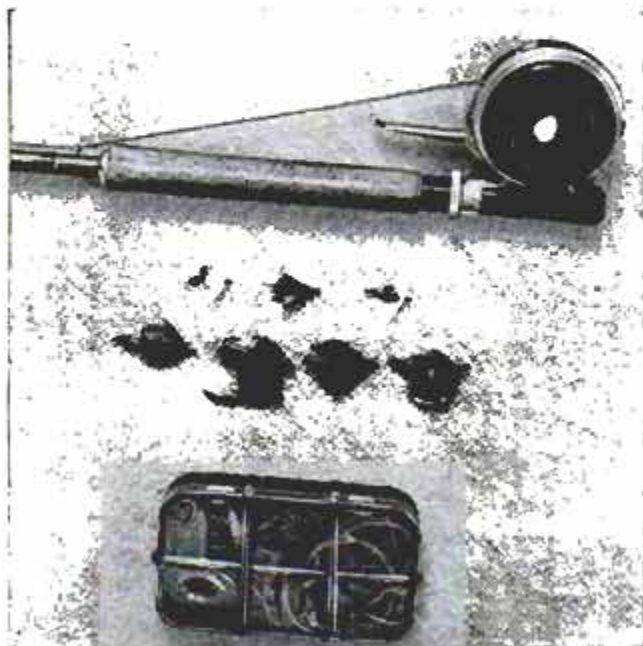

rocks and through narrow channels. During the fall this same spot may be only one main channel, void of bordering eddies and with boulders protruding in spots you had no idea existed earlier in the year. Trout may be feeding in water that is only half as deep as it was opening day, and you're going to find it necessary to alter retrieve and bait to catch fish. But you'll gain a satisfaction from catching an autumn trout that will never come from creeling one a couple of months earlier. This late-fall trout fishing requires skill, and the pay-offs can be extremely gratifying.

The closest trout fishing to my Texas bailiwick is found in New Mexico, over 600 miles away. On opening morning a few years back I was on the Rio Ruidosa, a small spring-fed stream that spills through the Sacramento Mountains in the south-central portion of the state. As I fished, I jotted down pertinent facts about certain holes so I would know the choice spots to hit whenever I returned. After those initial two days, it was late fall during the hunting season before I returned to New Mexico and could break out my tackle.

I tried that identical stretch of the Ruidosa again, expecting some superb fishing. But now the river had changed! In one particular spot, where I had a large eddy crudely drawn on my map, there was nothing but a sluggish current deep in the river bed. Another spot indicated deep, fast rapids, a place where I had taken two nice trout on opening day, but during fall the swift water was so shallow it barely covered fist-size pebbles. I had to seek entirely different spots for my autumn fishing, for the topography of the stream had altered with the water level. Yet I caught a trio of chunky rainbows.

Unless the stream is exceedingly large,

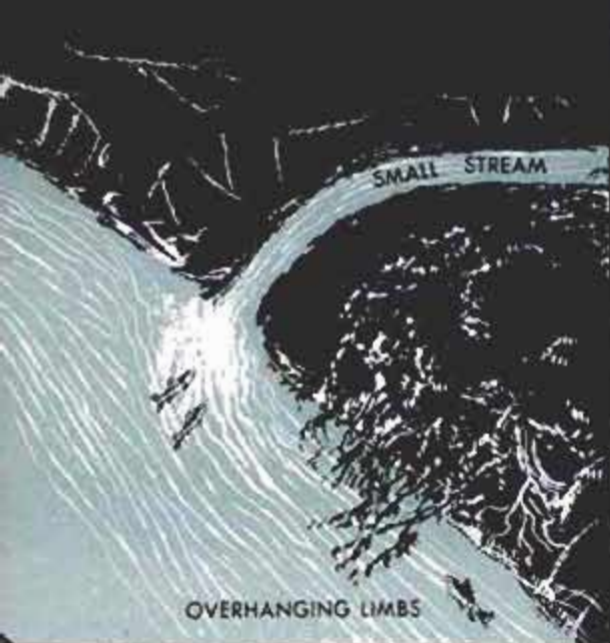

you may as well leave your waders at home during the fall. The clear water gives both parties an advantage; you can spot the trout, but also they can spy you. Wading, you are conspicuous; but by sneaking silently along the bank, you can catch many trout unaware.

Advance on a hole cautiously. Sometimes it pays to crawl, and frequently you must cast from a sitting position. Keeping out of sight and presenting the bait naturally are the prerequisites for successful autumn trout angling.

Under such conditions, I prefer a light 7½ or 8-foot fly rod. Streams in the fall are, on the whole, narrow, and you don't have to worry about distance as you did when the river was high and murky. Accuracy is much more important. And I've found you can control your fly much better if your tackle isn't bulky.

There's also another strong argument for delicate tackle. When the stream is high and currents powerful, a small trout can battle long and hard in the fast-moving water. It is only trout against tackle when water is low, so you'll find much more sport by utilizing a dainty rod.

Wet flies have paid off most consistently for me in the fall. Occasionally you can find some good dry-fly angling if conditions are right. Big gawdy flies will bring the most strikes, and there are several good reasons for this.

Thanks to an old-timer I met on a New Mexico trout stream a few years back, I learned of this

(Continued to page 274)

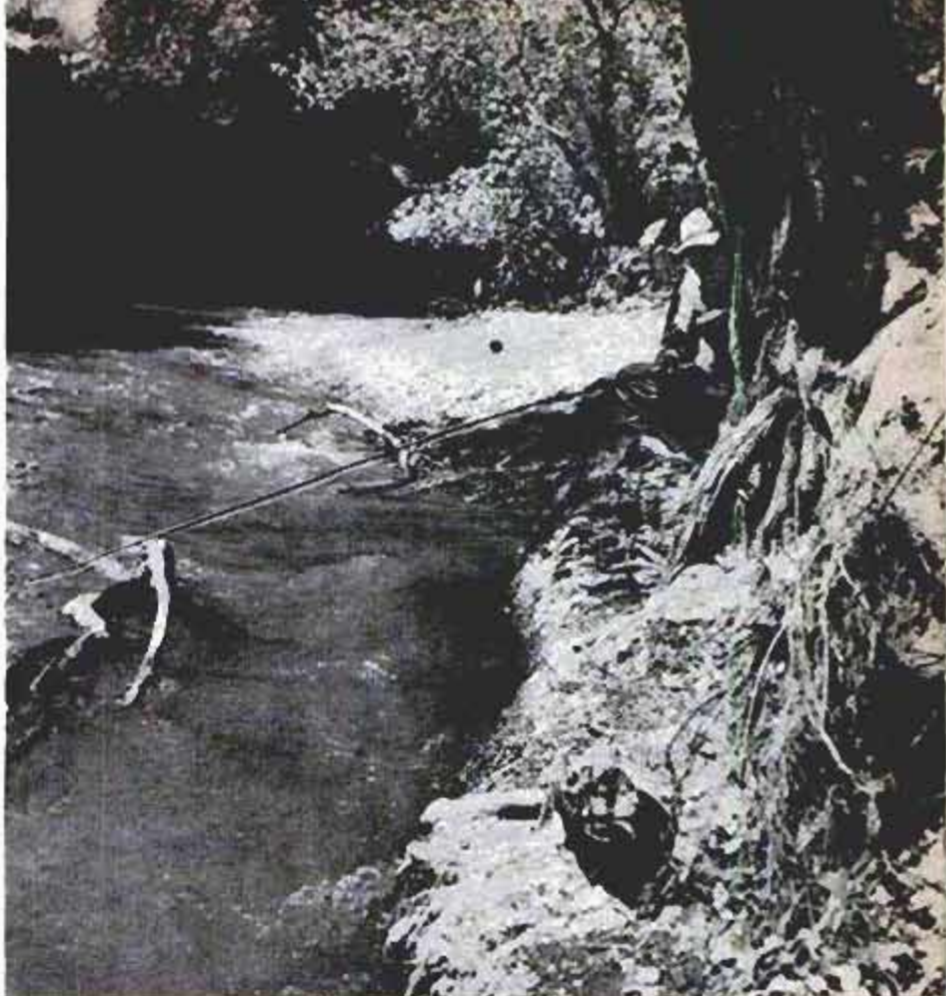

During the autumn months, when only the big, wary fellows are left in the water, stealth is as important as the right lure

Advice from the experts is: When trout fishing, stay back from the bank of a clear stream. This may mean some unusual casting

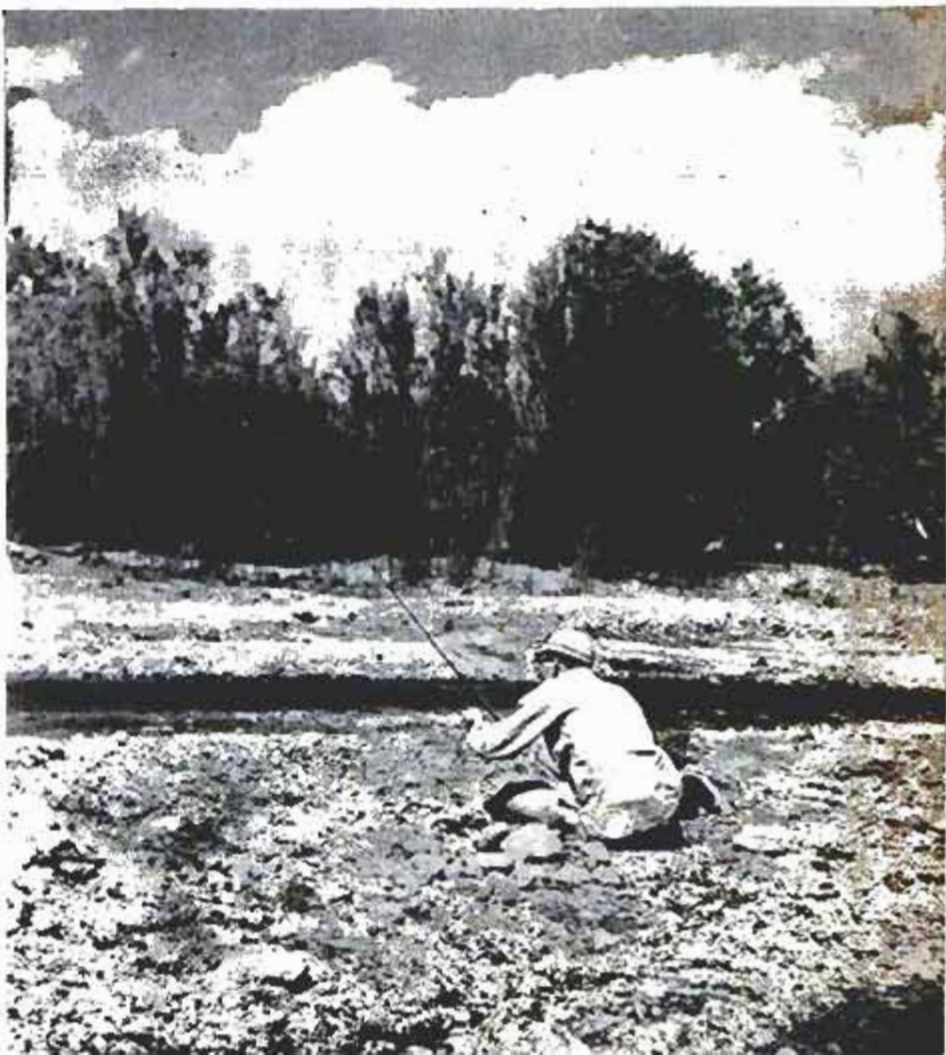



Underwater Sea Horse

Pegasus, an underwater sea horse for skin divers invented by French engineer Dimitri Rebikoff, gives its operator mobility beneath the waves. Ridden like a bike and steered with handle bars, it is equipped



with a two-horsepower motor and a depth governor. It has two headlights and mounts an underwater camera, also an invention of Rebikoff's, for taking color pictures of marine life.

Dial Selects Light or Heavy Load in Shotgun

You can dial a light or heavy load to soften the recoil on the new Remington Sportsman-58 shotgun. A knurled knob on the fore-end is rotated to one of three positions, venting the piston mechanism according to the load selected. This assures proper operation of the gun when firing light or heavy loads up to the standard-length magnum. Models are available in 12, 16 or 20 gauge.

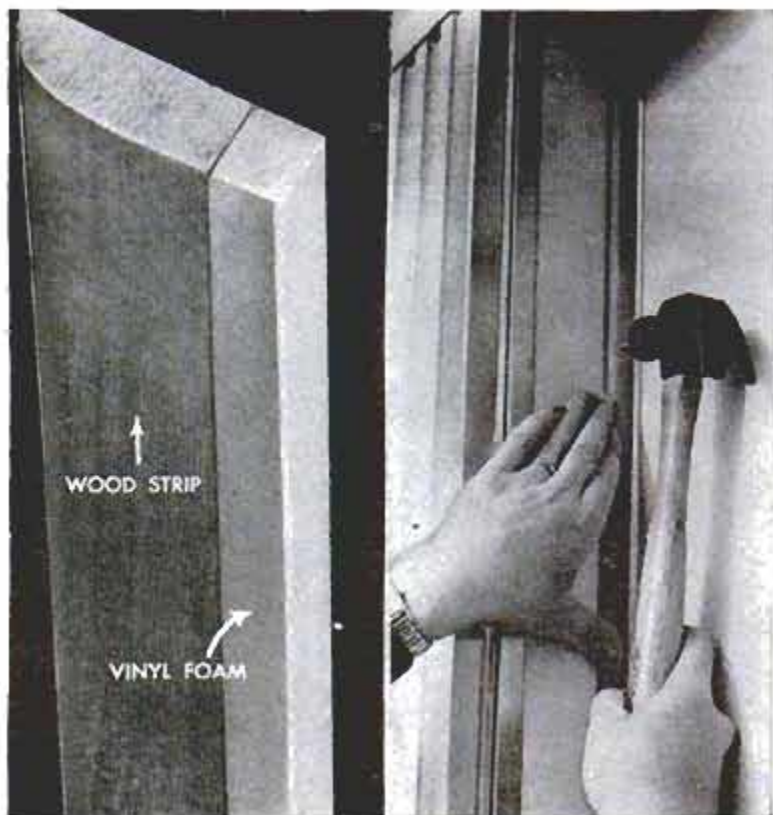
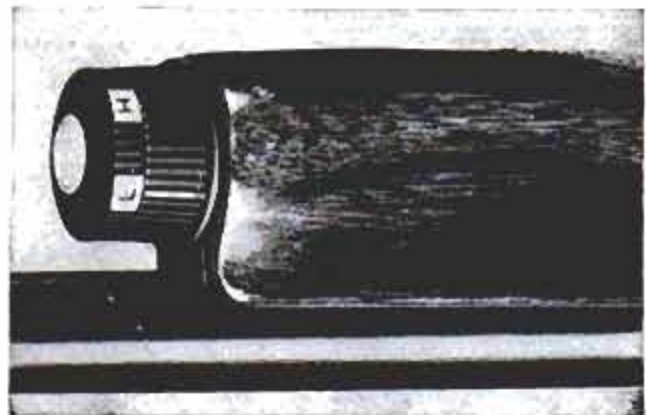

Vinyl-Foam Weather Strip Is Bonded to Molding

Edged with vinyl foam, a beveled molding becomes a permanent part of any doorframe and at the same time serves as a weather-tight door seal. The molding is $\frac{1}{4}$ inch by $\frac{5}{8}$ inch and is available in sets of seven and three-foot lengths. Strips can be nailed over existing doorstops or in place of the old stops. An entire door can be weather-stripped in less than 10 minutes. In addition to providing an airtight seal, the strips assure silent closing of doors.

☐ On July 10, 1955, rain fell at one point in central Iowa at a rate of .69 inch per minute, setting a new record for the United States and possibly for the world. Rain falling at this rate for one hour would total nearly four feet of water.



The Glacier carves a dock in the bay ice of McMurdo Sound. With her 21,000-horsepower engines she crushes a form-fitting berth in 12-foot ice

Reprinted "PM Highlights"

Antarctic Album

Nobody thinks of polar areas as colorful, but I found a good many vivid hues when I visited Antarctica with Operation Deepfreeze. Here are some typical color scenes from the bottom of the world

By Richard F. Dempewolff, PM Editor With Task Force 43

Blue grottoes

in crevasses of the Antarctic are beautiful, but are booby traps for vehicles. We explored this one to a depth of 100 feet

Your grizzled correspondent

wore a beard to avoid painful shaving with snow. The Thermosuit is red for easy spotting

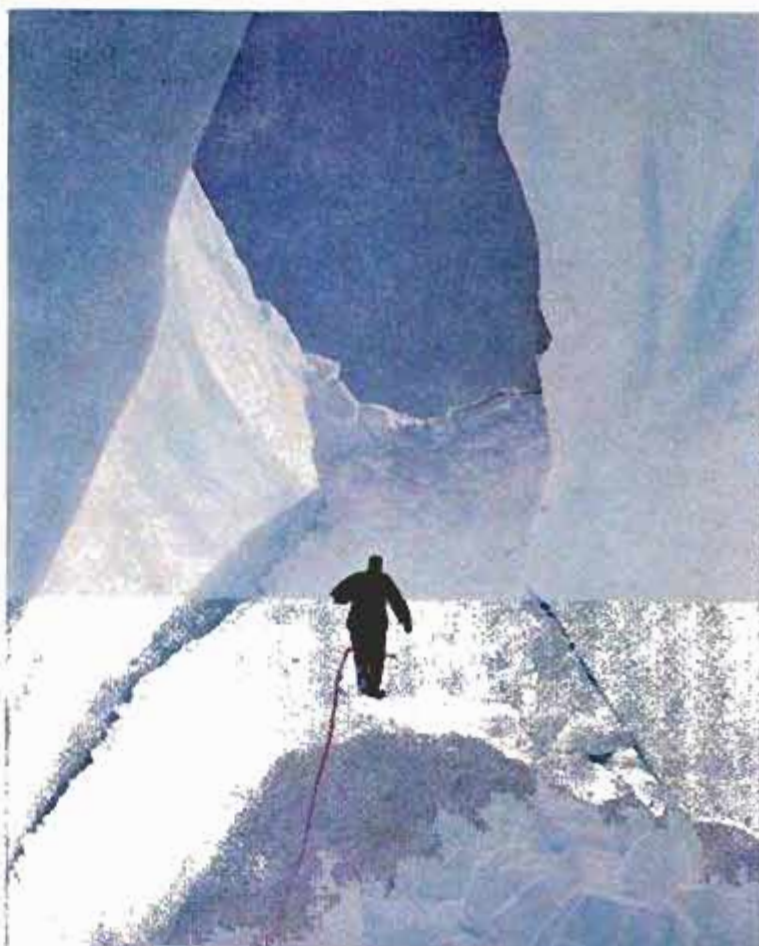



Seventy-five-foot radio towers

still stood at Little America I, but only eight feet remained uncovered when we visited the 1928 site with Admiral Byrd this year. Wearing a reindeer-skin suit, Byrd flew to the site to pay tribute to his first camp

Antarctic sunbathing

is the popular recreation of seals that emerge from the cracks during the subfreezing summer. Some varieties weigh 500 pounds. They ignore humans but "moo" when patted





South Pole housing - antique and modern

sit side by side at Hut Point. In the background are prefabricated homes of the air-facility camp for the expedition. In the foreground is the prefabricated house erected by Scott in 1902, now filled with snow

"I'm the mayor of this place"

Admiral Byrd told us as he stepped from the *Glacier's* helicopter at the ice-prairie site of Little America I. Cameramen recorded his visit. Last year a 220-mile chunk of his desolate domain broke off and went to sea





Lonely cross

erected by the British still stands on a peak at Hut Point, commemorating the heroic journey of Scott and four of his men. They died returning from the Pole in 1912. Our surveyors used the hill for a map station

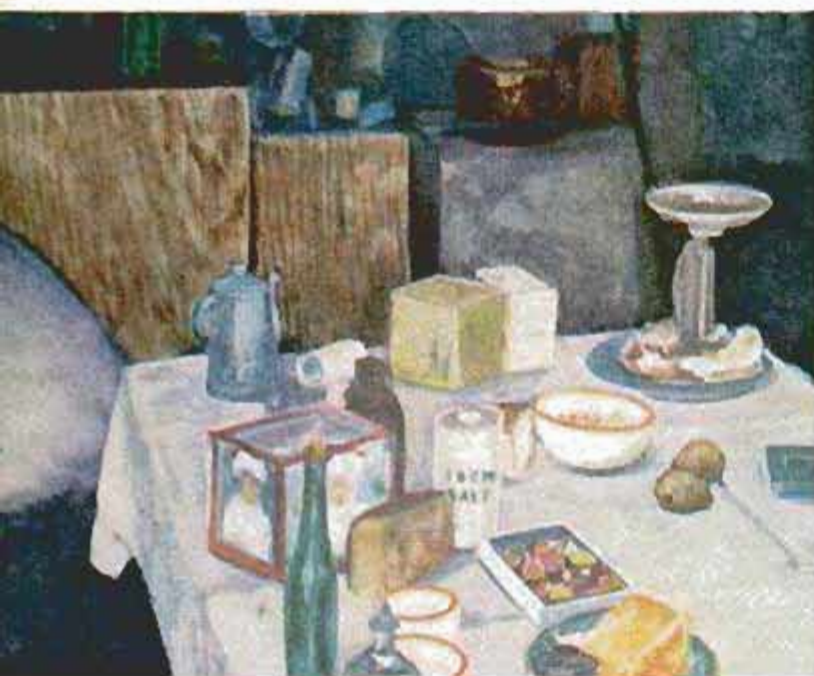

Antarctica's ghost story

In a hut we found meal left by Shackleton party in 1917. Preserved by polar frost and still edible are: 1. Coffee; 2, 3, 4. Biscuits; 5. Scale and cake; 6. Potatoes; 7. Candy; 8. Bread; 9. Cheese; 10. Photo chemical; 11. Wine; 12. Camera back

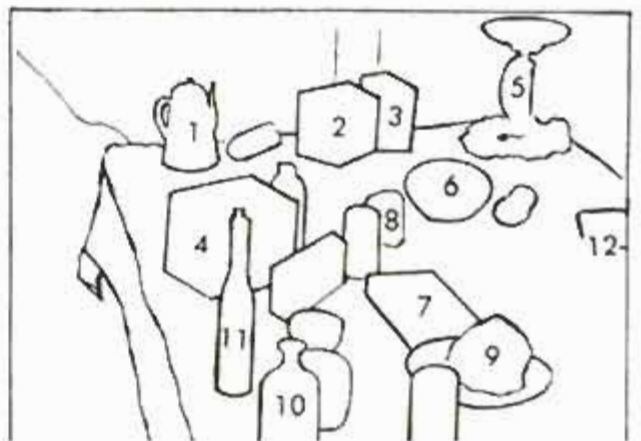



Boy meets girl



Boy gets girl



Plus a dividend



And family responsibility

On a volcanic ridge in Antarctica we found 35,000 Adeliie penguins busily enjoying family life. One old-timer waddled out to greet us each day. Extremely sociable, they seem to think people are just big penguins

Workhorse vehicles for snowfields

are the tracked Weasels, left, and the newer Sno-Cats, right, with four steerable tracks set on the chassis like outriggers. These two, painted orange for quick spotting from ice or air, are loaded for the trail





Swimming is fatal

in the 28-degree polar sea, though these experimental immersion suits may stretch life expectancy to 35 minutes. In normal clothing, man can live only eight minutes at the most, may succumb quicker than that



How strong is the floor?

South-polar-bay ice melts from beneath instead of above, so drill crews test it regularly. Despite such checks, one big tractor crashed through the ice

Light trail party

of Sno-Cat sled trains heads out across 600 miles of storm-swept ice to find a site for observation camp for scientists during International Geophysical Year





Deepfreeze paratroopers

have four legs. The expedition's dog teams, used only for rescue and survival when a plane goes down on the icecap, are flown over the crash scene and dropped by parachute, along with sleds and provisions

Relic of antarctic history

is this hut erected by Shackleton at Cape Royde in 1908. Tons of food cached around the building are well preserved. We drank cocoa and ate jam and cheese that had lain in this open freezer for nearly 50 years





Probing electronic hand

on the front of this Weasel is a crevasse detector under test. It is used over unexplored ice. When it passes over a snow-bridged chasm, the detector starts flashing a warning light inside the vehicle's cab



Home sweet home

to these dog drivers was a bleak tent. The temperature stayed below freezing from the knees down, but sometimes was a cozy 40 degrees at head height

Farewell to Antarctica

was marked by an emergency visit to Little America V to unload a search plane to find survivors of a crash. The ice had broken out of Kainan Bay and ship moored at barrier cliffs, only 25 feet high here





An average of 187 ships of the Reserve Fleet is usually parked in the Hudson, 30 miles above New York City

Keeping 2000 Ghost Ships Alive

By Creighton Peet

THE SIGN by the side of the road reads "Hudson River Reserve Fleet," and you walk up a gangplank into a nightmare world. As far as the eye can see is a forest

Diesel for ship's electric generator is sprayed with machine oil. Engines are periodically turned over

of masts, funnels, derrick booms and deck-houses. But there are no signs of life anywhere among these ships without lights, heat or throbbing engines.

By means of wooden gangways you pass quickly from one ship to another, walking

Walkways connect all ships in a row, but rows can only be reached by small boat and shipside ladder



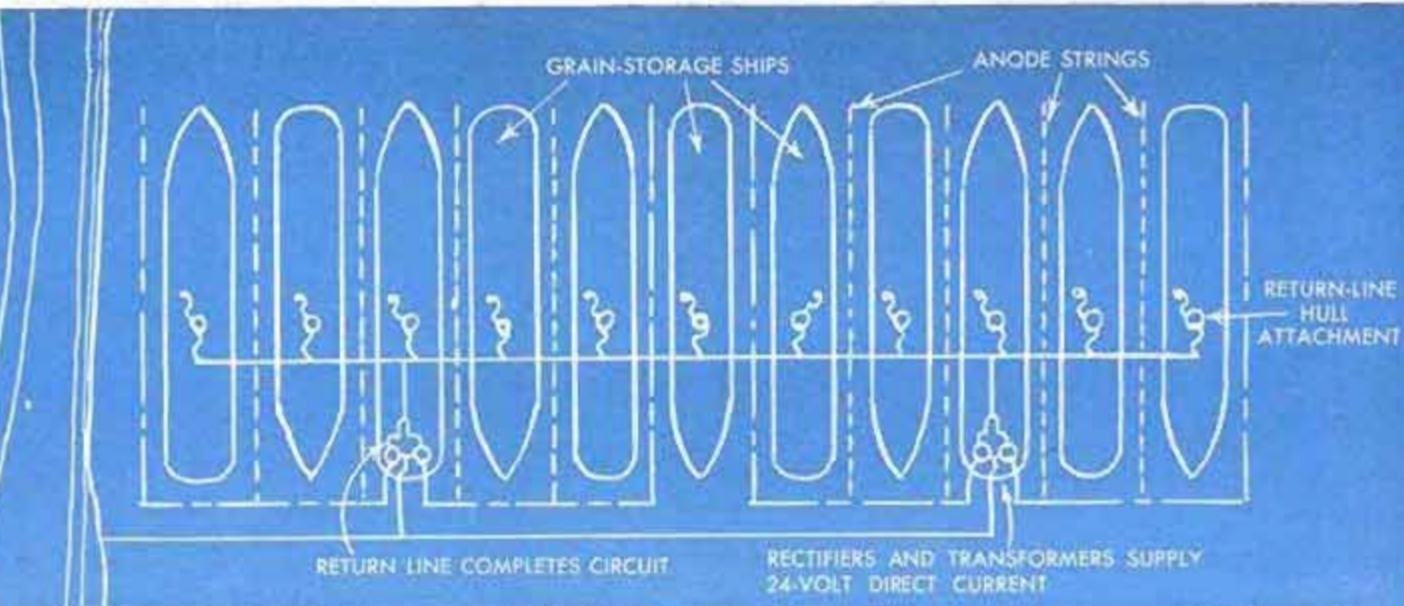
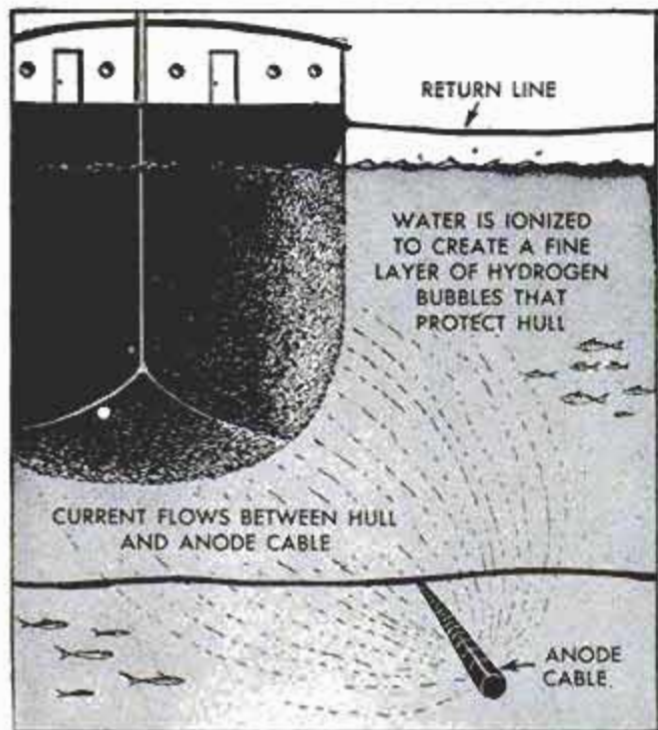

Diagram shows line of ships hooked up for cathodic protection. Power line from mainland supplies rectifiers and transformers with 440-volt alternating current. Arrow points to test rods beside ship. One is hooked up to cathodic protection system, the other is not. Close-up view shows difference in corrosion between rods

Diagram shows principle of cathodic protection system. Hydrogen bubbles on hull guard it from corrosion



right through the crew's quarters at mid-ships. All doors and some ports are wide open. In the bobbing light from the miner's lamp on the hard hat they have given you, you see bunks, galleys, coils of three-inch hawser, piles of furniture and glass-covered bulletin boards that sometimes bear notices from World War II or Korea fighting days. All these ships—Liberties and Victories, mostly—saw service carrying food and arms in the Atlantic or Pacific. On the bottom panels of the doors are notices in big block letters, "Kick Panel Out" recalling the Nazi submarine war. When a torpedo hit, a jammed latch or lock could be fatal.

This Hudson River Reserve Fleet is one of eight such groups of war-built freighters, of which the government still has some 2110. Here in the Hudson there are, on an average, 187 vessels, lashed together with anchor chain, in rows of 15 to 30 each, with square timber fenders hung between them to keep the ships from damaging each other.

You keep passing from one ship to another until the subdued whoosh of a

dozen big electric blowers catches your ear, and through a hatch you see a hold filled with government-owned wheat. Stored in these ships is grain worth some \$45,000,000. For 16 hours a day during cold weather, fans connected to big pipes sunk deep in the grain keep cold air circulating through it until its temperature is lowered to around 35 degrees. With hatches closed in summer, this natural air conditioning lasts through most of the hot weather. Even when it is 95 outside, the wheat seldom is above 60 degrees. Low temperatures discourage insect infestation.

These Reserve Fleets are far from being rusty junk yards, and the Maritime Administration has recently changed the color of the preservative paint on the above-water structures to convince the public of this. Impressions of rust came from a reddish paint and oil covering, which is now being changed to gray.

The most important new development in caring for these billions of dollars worth of ships has to do with the cathodic protection of the underwater portion of their hulls.

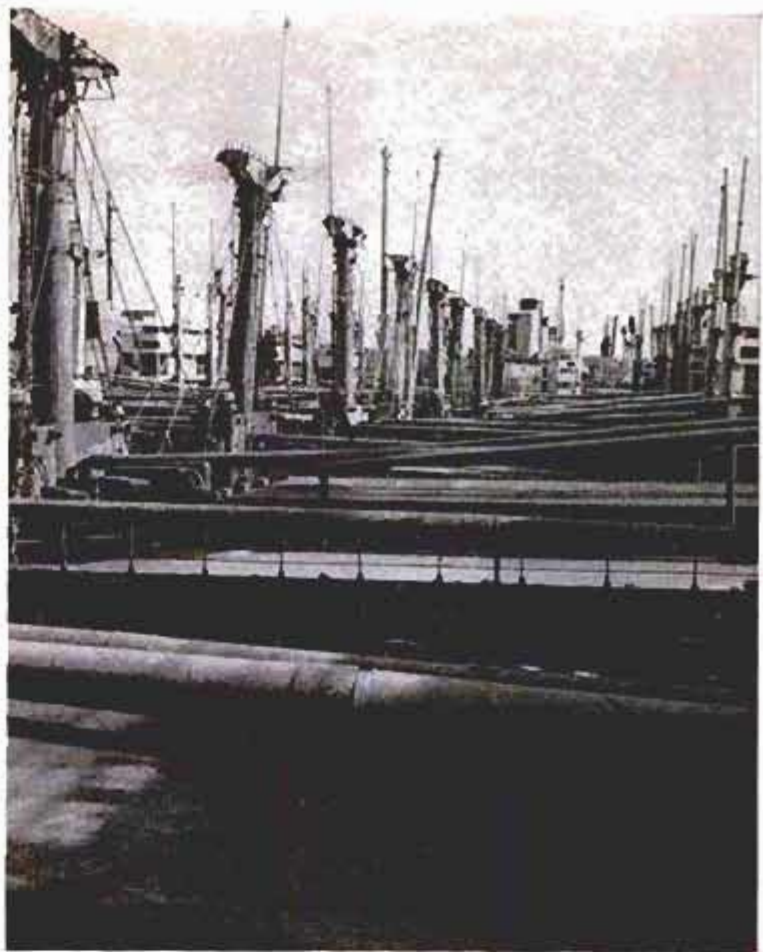

Ships are lashed together with anchor chain in rows, 15 to 30 vessels in a row. Square timbers between ships act as fenders

If ships see action again, they may need to be reconstructed for faster speeds. Here, new prow is fitted

Bethlehem Steel photo

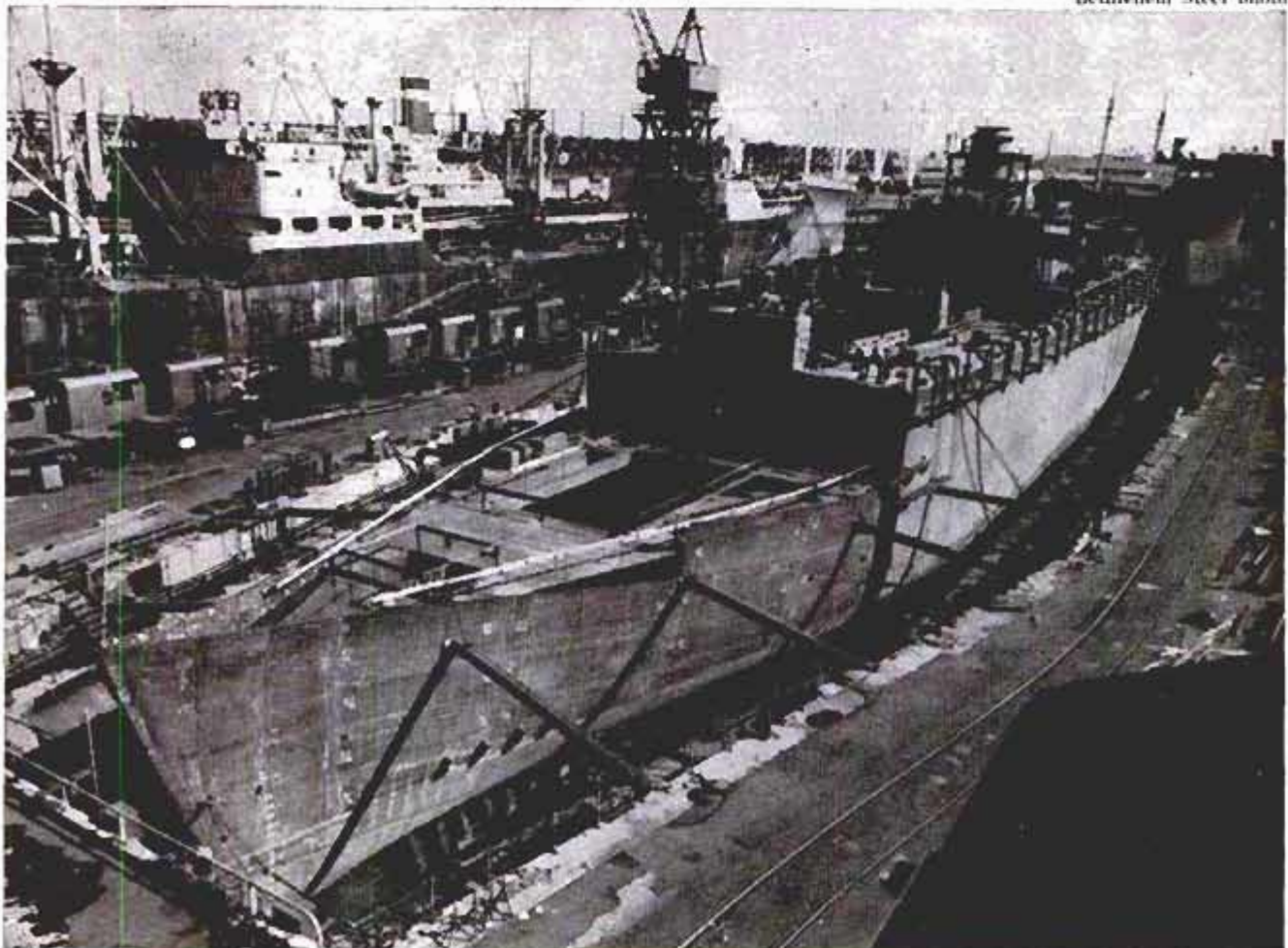

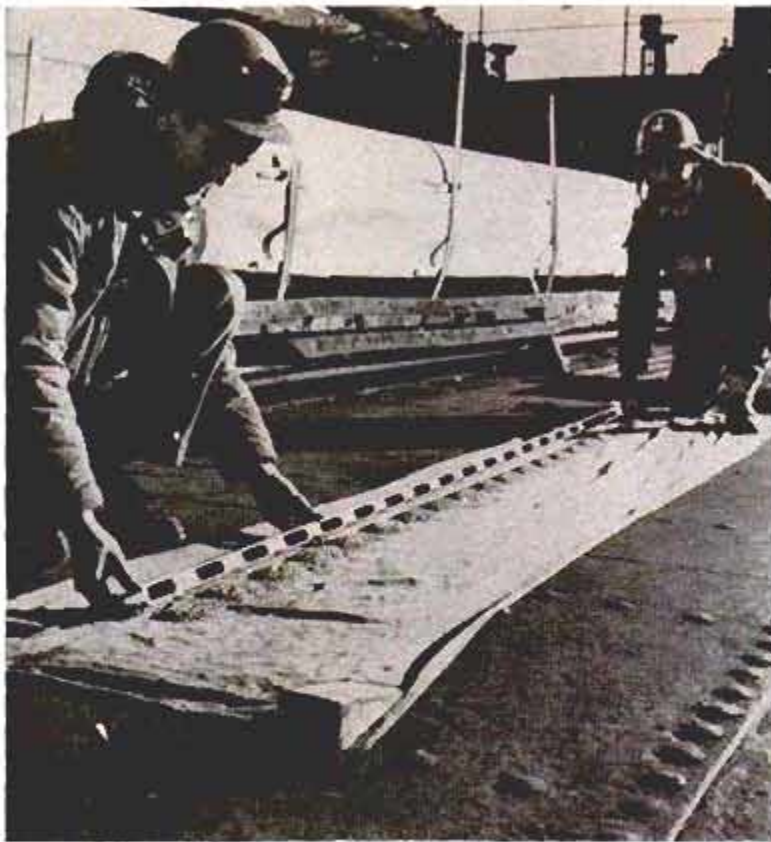

Probe contains pockets along its entire length that catch wheat samples at different levels. Pockets close when knob at top is twisted. Below, 15-foot probe is sunk into grain in ship's hold



This calls for strings of graphite anodes in the river mud between the pairs of ships, and establishing a difference in potential between these anodes and the ships' hulls. Current flows between hulls and anodes.

Electric current is brought in from a nearby utility line at 440 volts alternating current. Through transformers and rectifiers, this is changed to 24 volts, 140 amperes direct current. The positive side of the line goes to anodes through waterproof cables, while the return line is welded to deck plates of each ship. The difference in potential produces a covering of fine hydrogen bubbles on the hulls, preventing any pitting or rusting.

Taxpayers' Delight

The saving to taxpayers from this cathodic protection is spectacular. Not only are the hulls kept free from corrosion, but the trips to dry dock for scraping and painting have been eliminated.

Electricity for this protection costs around \$22,000 a month for the 187 ships in the Hudson, or about \$264,000 per year, plus the cost of replacing the anodes about every seven years. On the other hand, dry-docking all of these ships at proper intervals would cost well over \$1,000,000 a year. Above the water line, hulls are covered with rust-resistant paint.

Only the Ships Are Idle

About 160 men work all year 'round keeping this Hudson River Fleet in shape. Engine, deck and electrical-maintenance departments have regular schedules.

Once a year, all the machinery on each ship gets a thorough going-over. A barge carrying a diesel engine which operates an electric generator and a compressed-air pump is floated alongside a row of ships. Lines and hose are hauled up over the side and the engine-room crew gets to work. The electric power line is hooked into the ship's electric system to provide illumination and operate pumps, compressors and the like. If the main engines are diesel, they are turned over a few times by electric motors. If they are steam reciprocating units, they are operated by compressed air. In most cases all moving parts are sprayed with oil.

Electrical crews check wiring and tag defective lines.

The actual work of making a ship ready to go to sea again is done in shipyards. The record for this renovation is seven days, but the usual time is three weeks. Over 200 Reserve Fleet ships were withdrawn to carry supplies to Korea, and another 500 were used to carry food, coal and other materials for foreign-aid programs.

The grain stored in these ships is under the supervision of Department of Agriculture technicians, who watch its temperature carefully with thermometers on long probes thrust deep into the grain. Other probes bring up samples of wheat, from varying levels, which are inspected for signs of insect infestation.

No "Mothball" Fleet

Reserve Fleet officials in the Maritime Administration of the Department of Commerce have a very different concept of ship preservation from that of the Navy. Whereas the Navy seals up much of its equipment and vital areas with airtight coverings, Reserve Fleet merchant ships are ventilated as much as possible.

But it is now realized that merely preserving the ships is not sufficient. If they should be called back into wartime emergency service, their present top speed of 10 knots would have to be boosted to 15 or 16 knots for convoy duty in waters that may be infested with fast enemy submarines.

Accordingly, the Liberty Ship and Engine Conversion Program is testing four of these ships that have been converted for faster speeds. New and longer prows were installed. Two of the Liberties are powered by improved diesels, one by a steam turbine and one by a gas turbine.

Meanwhile, in the eight Reserve Fleets located in the Hudson River above New York; the James River, Wilmington, N. C.; Beaumont, Tex.; Mobile, Ala.; Suisun Bay, Calif.; Astoria, Ore.; and Olympia, Wash., men are working the year 'round to keep these ships in condition. ★ ★ ★

Ships at Wilmington, N. C. were knocked out of line by Hurricane Hazel in 1954

Norfolk U.S. Naval Air Station photo

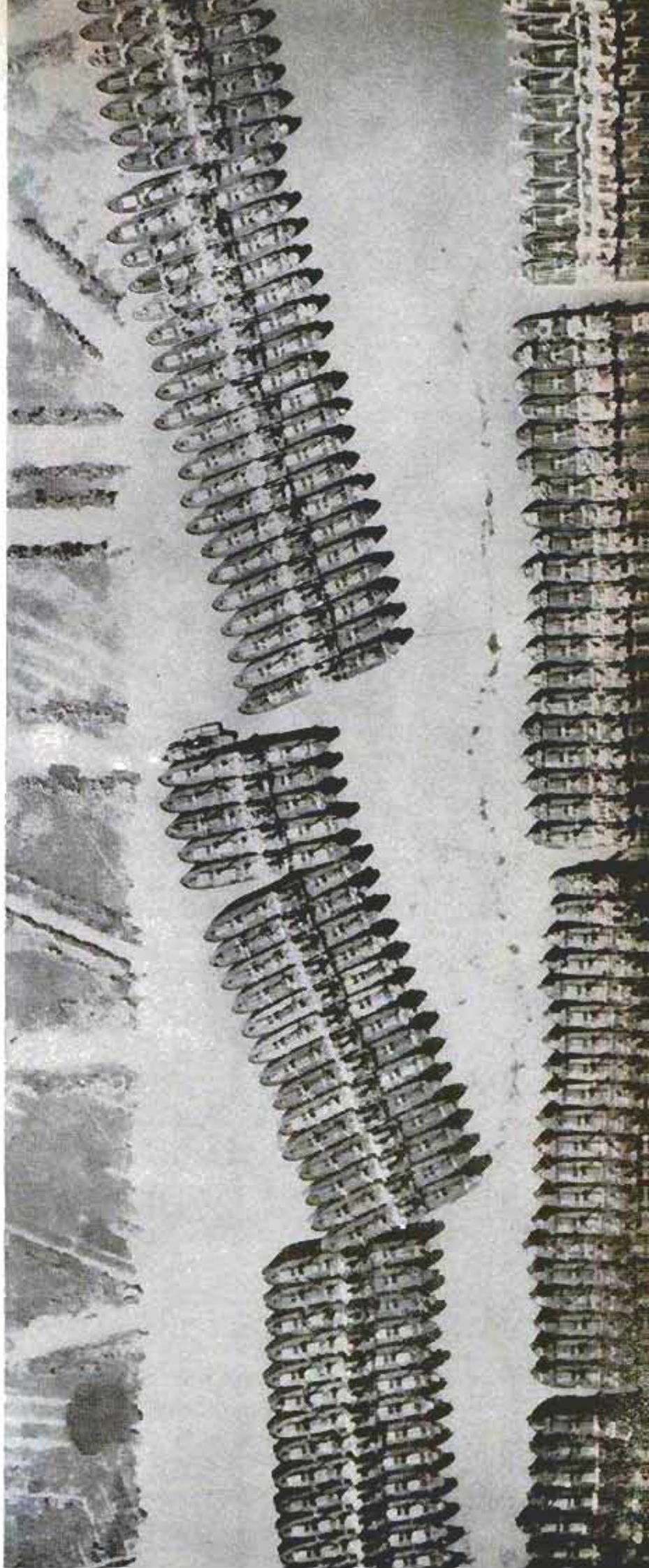



Acid waters of Lake Alma are "sweetened" with hydrated lime. Lime is mixed with water, sprayed from boat



Two men with electrodes and two with nets stun fish in Little Miami River. "Trash" fish are taken from water
Portable weed cutter installed on a rowboat can restore about eight acres of overgrown fishing water per day





Biologists tag three-foot muskie in Rocky Fork Lake. Recovery of tag later reveals growth and travel habits

Better Fishing Ahead!

By Erwin A. Bauer

IN RECENT YEARS, Ohio fishermen have become accustomed to seeing uniformed men engaged in strange activities along local waterways. These men are aquatic biologists of the Division of Wildlife whose business is to provide better fishing—no simple matter in a highly developed state that boasts more than a million anglers, only limited available water and, in places, a bad pollution problem.

To do the job, they've had to devise many curious but effective means and mechanisms. But slowly the effects of their work are being felt in the creels of the state's grateful fishermen.

In many lakes across the state there are actually too many fish—usually panfish stunted by overcrowding and such undesirable species as gizzard, shad, carp and the like. Every conceivable means has been used to remove these unwanted specimens.

Whole Lake Poisoned

One lake—Guilford—was completely poisoned. The fish were removed, ground up and returned to fertilize the water. When the water was pure again, the lake was restocked with game fish like bass and bluegills. Last year fishing there was excel-

lent. Elsewhere only the spawning beds of panfish have been poisoned, to cut production and to prevent stunting before it could happen.

Acid wastes from abandoned coal mines completely sterilized another lake—Alma, in southern Ohio. After most of the mine openings were sealed, biologists "sweetened" the lake with applications of hydrated lime until it could be stocked again.

(Continued to page 250)

Muskie eggs are cared for during hatching by gentle agitation with a feather. Clean water runs through jar





Coils of fence wire weighing 50 pounds each are placed on bomb racks under plane wings and fuselage



Plane flies low over fence line in New Zealand's hill country, dropping the bundles at intervals

Fences Drop From Air On New Zealand Farms

New Zealand is an agricultural country that farms from the air, but so much seed and fertilizer have been sown by plane since the war that a new problem has arisen. Farmers can't cope with the new land coming into production and their biggest headache has been fencing. So now airlift tactics are used to speed up fencing.

Chief Soil Conservator Douglas A. Campbell has invented a method that saves time and money—delivering the fence by air in prepacked bundles, dropped right along the line of the new fence. Galvanized steel posts are bound together in bundles that burst on impact with the ground to prevent damage. Coils of wire are wrapped on wooden cores or old drums and loosely roped to prevent uncoiling. Bundles are attached to bomb rack under plane's wing.

When fence is erected, special tool is used to pull wire tight against battens to prevent "chatter"



Snow Chutes Load Trucks

Relieving flat roofs of the cumulative weight of winter snows is accomplished in Austin, Nev., with the aid of chutes projecting from the front of a building. Trucks are parked directly under the slides and snow shoveled into the top of the slides goes directly into the trucks. During torrential desert rains the slides serve to divert excess water that cannot be handled by the conventional drain spouts.

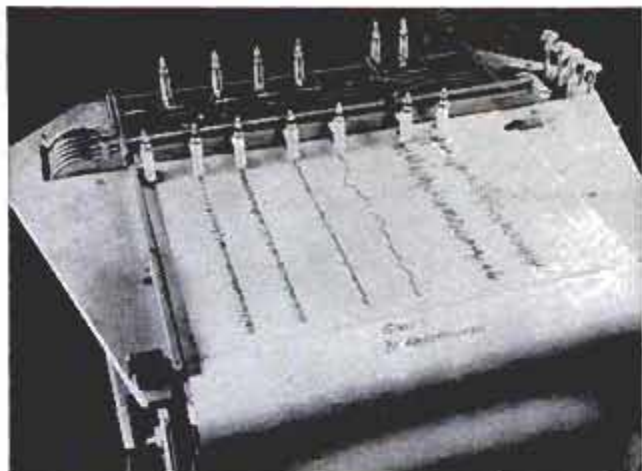

Riding comfort and safety on the German Federal Railway are checked by an inspection car that determines how true the tracks are. Measuring units that ride the rails before and behind transmit information to a graph-making instrument inside

Rail-Measuring Car

the car. The graph reveals any irregularities in distance between the rails, straightness of the track, height of rails and degrees of a curved track. The diesel car has a road speed of 37 miles per hour, but runs at 12 miles per hour while on the job.

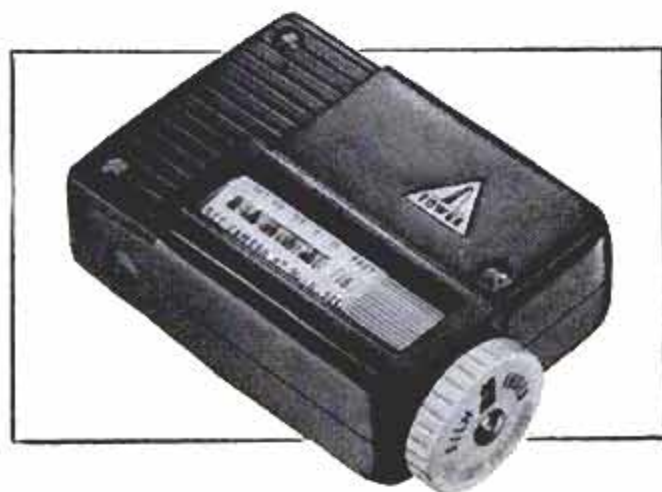

Correct Flash Exposures Automatically Computed

Called "Flashometer," a unique device assists amateur photographers in rapidly computing correct flash exposures. The photographer sets an index number determined by the type of film and size of bulb, then sights through the instrument for alignment on the subject. He then refers to a scale which automatically gives him both the correct exposure setting and the distance to the subject. A single dial and an easily read scale make for simple operation.

Next Aviation Hazard—The Disintegration Barrier

With aircraft through the sonic barrier and on the threshold of the thermal barrier, scientists are tackling the third—the disintegration barrier. Early research indicates that known metals "sputter away" or disintegrate when bombarded by ionized particles moving at 20,000 miles per hour. Testing is done in a futuristic test chamber known as the Electron Physics laboratory which reproduces conditions anticipated at 80 to 300 miles above the earth. Metal is placed in the chamber, and inside pressure is pumped down to the near-vacuum of the outer atmosphere. Ionized atoms are then fired at the material, creating a condition similar to that of a spaceship traveling at 20,000 miles per hour. Atoms colliding with the material being tested knock atoms from the material's surface. The number of atoms dislodged determines the "sputtering rate" of the material.





Relief Map Shows 9000 Square Miles Around San Diego

Nine thousand square miles of area around San Diego, Calif., is portrayed by a relief map that weighs 1500 pounds and covers elevations between minus 4000 feet and 8735 feet above the sea. Made in eight sections, it measures 8 by 17 feet. The relief map begins 23 miles offshore from San Diego and climbs steeply to the crest of Mount Toro, about 90 miles northeast of San Diego. Elevations are represented by one inch to 800 feet. Horizontal distances

are on a scale of 1 to 42,000. The map is colored by sand and crushed rock worked into the Spackle used for the map's surface finish. The Pacific Ocean and the Salton Sea are depicted by sinks covered with blue-tinted glass. Small light bulbs, each activated by a marked push button, designate each town. The map, located in the office of a San Diego newspaper, is expected to prove valuable in studies of population growth, water and transportation problems.



Aluminum Catamaran Sails Hawaiian Waters

Aluminum, not plywood, forms a seaworthy catamaran built by industrialist Henry Kaiser for pleasant cruising in Hawaiian waters. Because of its weight, the metal craft has projections on each side of the ship which serve as outriggers to keep the boat from turning over in heavy seas. The projections make excellent catwalks and observation platforms for guests. From the crawl spaces inside the ship, one can get out on deck through portholes. Watertight bulkheads prevent flooding in case of a break in the hull.

"Railvans" Have Dual Wheels For Travel on Roads or Rails

Trailer is loaded at shipper's dock, then hauled by truck to the rail siding. "Railvan" combines flexibility of truck transport with "long haul" economy of shipment by rail

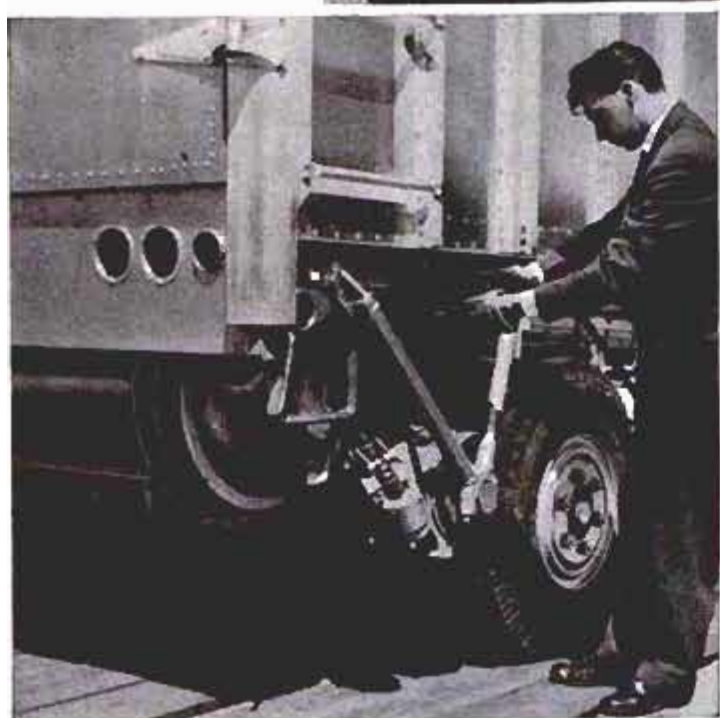

HIGHWAY TRUCKS and freight cars are combined in the Chesapeake and Ohio's new "Railvans." A truck tractor hauls the semitrailer unit to a rail siding, where standard rail wheels are lowered to the tracks. The rubber-tired wheels retract for the ride behind a locomotive to the destination city.

When one set of wheels is in position, the other is retracted. Below, the lead Railvan of the train rests on a set of adapter wheels which couple it to the locomotive

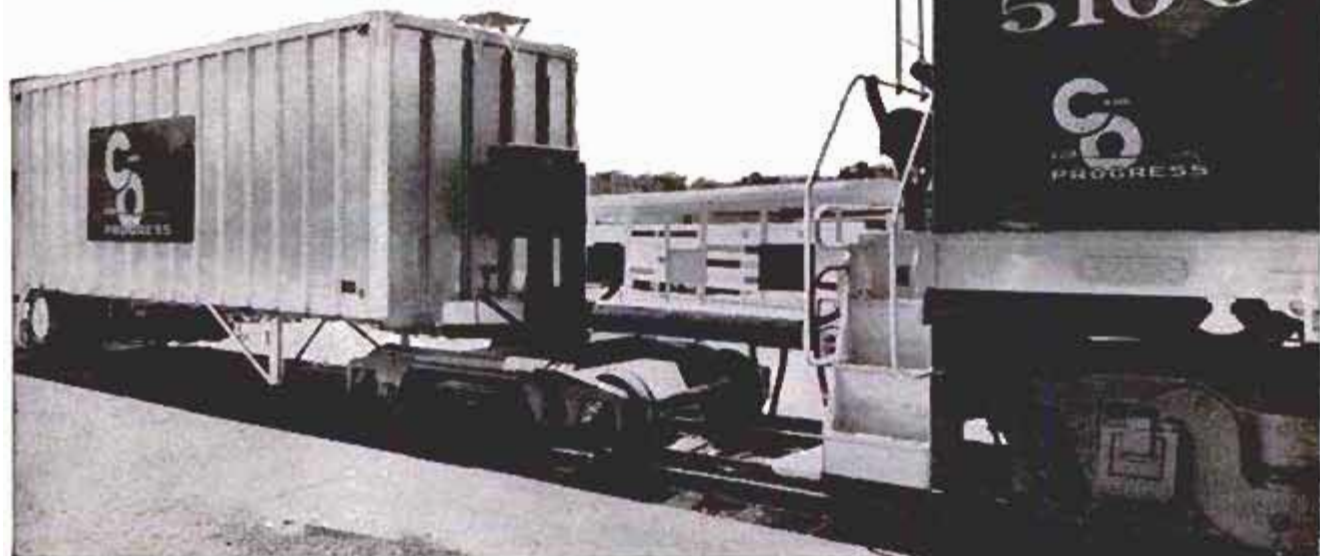



Normal living-room lighting was supplemented by one RFL No. 2 lamp bounced from corner. Shot at $f:4$, $1/50$

Superfast films are revolutionizing photography for the amateur. Now you can take

INDOOR PICTURES WITHOUT FLASH

Photographs by Bob Schwalberg

Pennsylvania Station, New York City, at night, made at $f:2.8$ and $1/50$, developed in Microphen for 26 minutes



THERE'S BEEN a revolution in photography in the past year—a noiseless, nonviolent upheaval that has rewritten all of the old rules on how to get good pictures. The cause of all this tumult was the introduction of the amazing new “superfast” films, such as Kodak Tri-X, just over a year ago.

The results of this revolution are evident all over the country. Pictures are now being taken indoors without flash—using only available light. Owners of cameras with moderately fast f:3.5 and f:4.5 lenses are taking the very same pictures that once needed very expensive f:1.5 and f:2 lenses for shooting. Such brightly lighted indoor spots as airline terminals, banks and supermarkets are now fair game for a photographer looking for unusual pictures. Even owners of the ubiquitous box camera are getting into the act, shooting pictures on cloudy and dark days or indoors with available light that were impossible before. The superfast film, however, is not recommended for outdoor work with box cameras in bright sunlight; pictures under such conditions are likely to be badly overexposed.

What is this Tri-X, that it can do so much for a camera? It's a highly sensitive, medium-fine grain, fully panchromatic black-and-white film, with an ASA speed rating of 200 daylight and 160 for tungsten lamps. Its predecessor, Super XX, was only half as fast, yet Tri-X has equal or less graininess—which means that Tri-X's extra speed is achieved without any sacrifice of pictorial quality.

Commercial photographers say that Tri-X comes close to being an

Action in basketball game at Madison Square Garden, New York City, caught on Tri-X film. Exposure was 1/500 at f:4 with a 50 millimeter lens. Only available light was used. Developed in Promicrol for 16 minutes

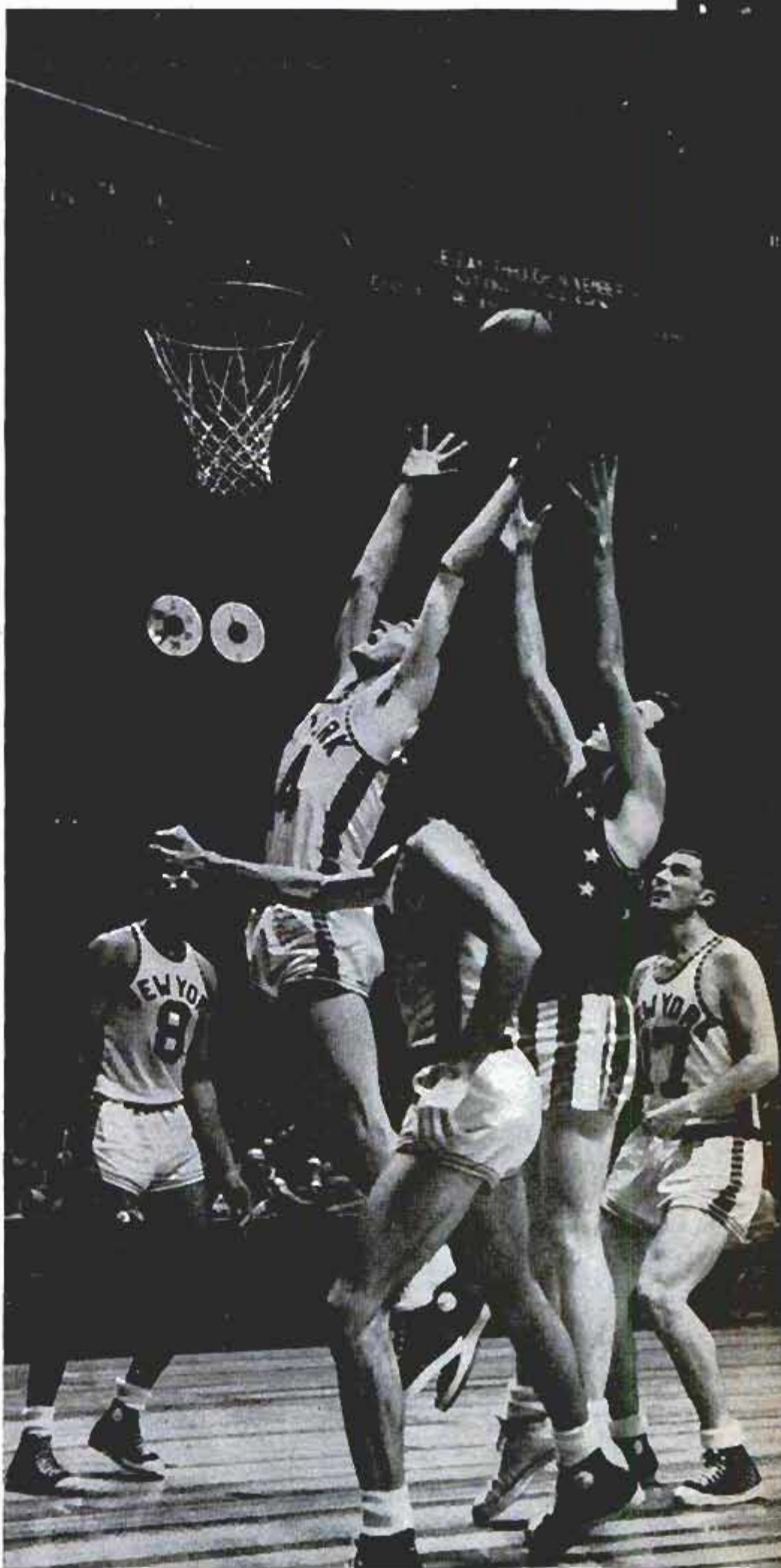



At left, circus shot through a 200-millimeter lens with 35-millimeter camera. Exposure 1/100, f:6.3. Above, bouncing boy caught at f:2.8, 1/500. One photoflood was used

all-purpose film, with a flexibility that is amazing. For example, pictures of indoor sporting events, with older types of film and available light, had to be shot with a relatively wide lens opening and slow shutter speed—and often even a flash was little help. At a basketball game, the flash would merely light the foreground and leave the rest of the picture area dark. But now the superfast film permits a smaller lens opening for the light available—which gives greater depth of field—and allows shutter speeds fast enough to stop the action on the court. The photographer can get a dramatic picture in available light with uniform lighting all over the picture.

The new film has industrial applications, too. For example, an automotive manufacturer who takes frequent pictures of his assembly line can get his pictures quickly and conveniently in available light without distracting the workers by using the new film—where formerly 40 to 200 flash bulbs had to be



Picture on Times Square, New York City, made at $f:4$ and $1/50$, shows ability of Tri-X to penetrate dark areas

synchronized to make satisfactory exposures.

And at home the new film has important plus factors. The father of a new baby can now take appealing snapshots of his offspring without using artificial lighting aids. No time need be lost in elaborate lighting preparations, and the pictures will be softer and more natural than those shot with

flash or photofloods. Cute, unposed pictures are easier to get, and the infant doesn't have to be startled by the sudden brilliant flash of lights.

While the new film often eliminates the need for flash, there are times when the two can be combined most effectively. At a prize fight, for example, with the new film and flash a photographer can freeze

Character study shot in very bad light using $f:2$ and $1/25$ second. Developed for 12 minutes in D-76





Another circus shot with a 200-millimeter lens. Exposure was 1/100 at f:6.3. Developed in D-76 for 13 minutes

the fastest action in the ring. Since he can stop down his lens, he may have enough depth of field to catch the action whether it is right over him or on the far side of the ring. Some very dramatic knockout-punch pictures have been caught using this combination.

And because of the flexibility of the film, he can capitalize on all the picture opportunities around him. Light conditions can vary sharply, yet he can still get his picture. And with the good depth of field permitted by superfast film, focusing is less critical.

Professional photographers say that good as a Tri-X negative made in bright sunlight is, it will never be as good as one shot on a medium-speed, general-purpose

film such as Kodak Verichrome Pan. A high-speed film such as Tri-X should be used to do the job for which it was designed—to take good pictures under poor lighting conditions. Shooting with Tri-X in bright sunlight is like hunting for jack rabbits with a howitzer. But when a soldier needs a howitzer, it's mighty effective—and so is Tri-X.

For best results with Tri-X, use a light meter before shooting and develop according to recommendations. If you haven't a light meter, the chart on this page gives average lens openings and shutter speeds to guide you.

Set the light meter for a film speed of 200 for outdoors or 160 under tungsten

(Continued to page 244)

Charts below are intended as guides for beginner using Tri-X film. Experience will soon teach best methods

GENERAL INDOOR ILLUMINATION EXPOSURE CHART FOR USE WITH TRI-X

Shutter Speed	Average dim indoor locations with sufficient light to read newsprint easily.	Average bright indoor locations in homes and offices with fairly light-colored walls and ceilings.	Very bright indoor locations such as fluorescent-lighted supermarkets, theater marquees, etc.
1/5 sec.	f:5.6 to f:7	f:8 to f:10	f:11 to f:16
1/10 sec.	f:4.5 to f:5.6	f:5.6 to f:7	f:8 to f:11
1/25 sec.	f:2.8 to f:4	f:4.5 to f:5.6	f:5.6 to f:8
1/50 sec.	f:2 to f:2.5	f:2.8 to f:4	f:4 to f:5.6

GENERAL EXPOSURE AND DEVELOPMENT CHART FOR TRI-X FILMS

ASA-Calibrated exposure meter set at	Kodak Formula D-23	Kodak Developer D-76	May & Baker Promicrol Developer	Ilford Microphen Developer
400 to 500	12-13 min.	8-10 min.	7-9 min.	not recommended
650 to 800	not recommended	11-13 min.	10-13 min.	12-15 min.

All developer temperatures should be 68-70 degrees Fahrenheit. Film should be agitated for about 5 seconds after each minute of elapsed time. Tri-X should be given 10 to 20 percent more hypo time than manufacturer of fixer recommends.

Folding Dinghy Made of Canvas

When not in use, this British-made dinghy folds so compactly that it can be carried easily under the arm. The boat, made of canvas and leather, is held open by wooden seats that fit into slanting grooves. Available in three lengths—6, 7½ and 8½ feet—it will accommodate two or three adults. The largest model is rugged enough to take a five-horsepower out-board motor.

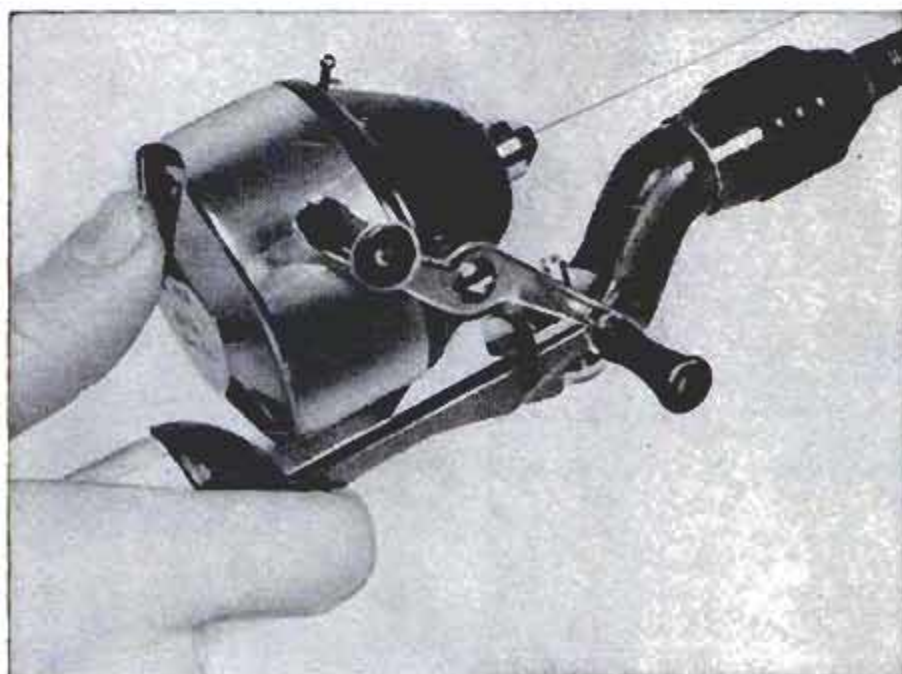

Spinning Reel Can Be Thumbed

Advantages of both spinning and bait casting are combined in a new fishing reel. The spool of the spinning-type reel is at the back. The housing for the spool has a thumb hole which permits thumbing of the line in much the same way that a bait-casting reel is controlled. The line is released by removing the thumb, and the cast is stopped by thumbing the line itself, giving the angler manual control over the cast.

Bug Whipper Mounts on Lamp

Insects attracted to the circular fluorescent tube of an antibug device are struck and killed by a whirling metal wand. The wand is mounted on the shaft of an electric motor that hangs from the reflector of the lamp. Its humming helps attract mosquitoes and other harmful night-flying insects.

☐ Scheduled airlines operated about 20,000 trans-Atlantic flights during 1955, carrying some 692,000 passengers.

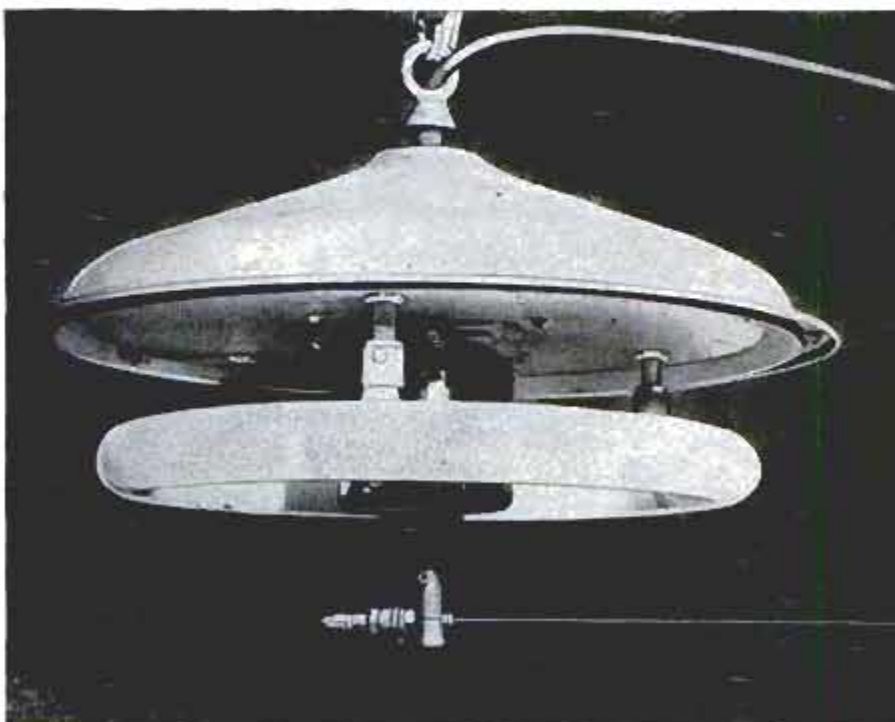



Rested and rarin' to go, this dog leaps from his two-compartment all-steel trailer. Springs make riding easy and mesh provides ventilation

Photos by George Laycock

"Pullmans" for Hunting Dogs

SPORTING DOGS are usually traveling dogs and they ride in an endless variety of "Pullmans" going to and from bench and field trials and hunting areas. Owners are always on the lookout for better dog-hauling vehicles or crates because a dog's comfort en route has a lot to do with his performance in the field. A dog must have room enough to turn around and lie down comfortably. He needs a bed, usually straw, and plenty of fresh air. Some owners use special ventilators. Dogs need protection from rain and snow and if they are used to separate compartments at home it is a good plan to haul them in privacy on the road. Some owners have elaborate trailers that are actually portable kennels. ★ ★ ★

Aluminum dog crates fit easily in the back of this station wagon. Crates are lightweight but sturdy



Single-wheel trailer is easy to handle and the open sides afford lots of fresh air on long journeys

Proud owner's golden retrievers ride in this custom-made crate that fits in the rear of station wagon



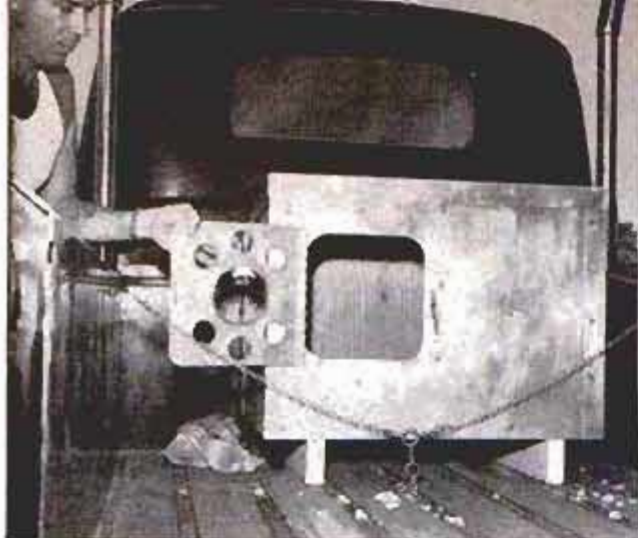

Homemade aluminum box serves as a crate for travel and a kennel at home. When traveling, doors are put on houses. Exhaust extensions protect dogs en route



Plywood box converts the trunk of this car into a hauling crate. The wire is one by two-inch turkey wire. Crate accommodates two or three large dogs



Simple canvas-covered framework converts this pickup truck into a dog "Pullman." Dogs have straw bed



Wire mesh partition in station wagon has a frame of half-inch pipe. Entire rear section becomes a crate

Lucky golden retriever at field trial leaps into a portable kennel that has all the comforts of home including a "kitchen" and "bathroom" (tub) in rear



Caracas Cable Car

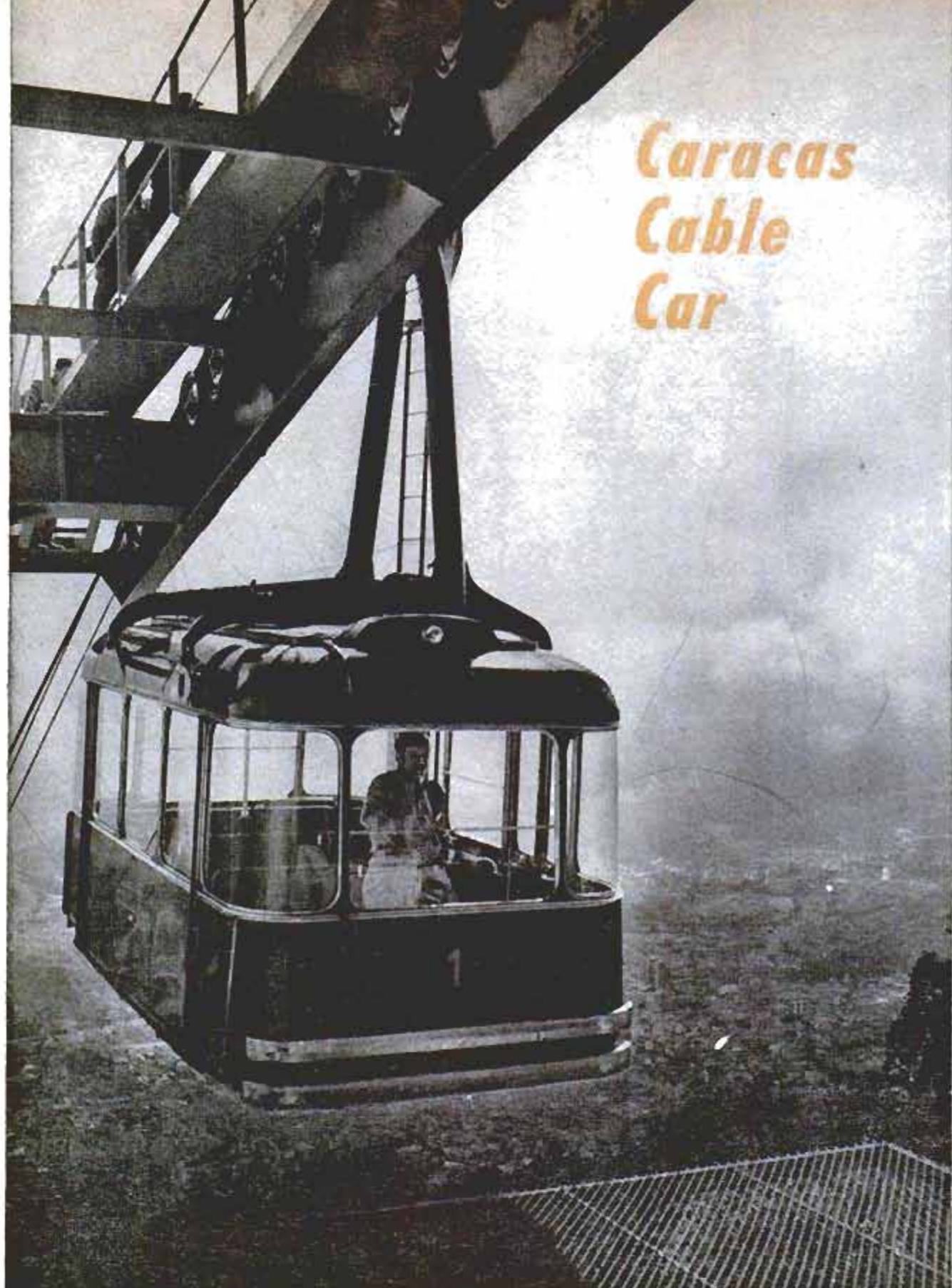

SIGHT-SEERS can now travel in ultra-modern cable cars from Caracas, Venezuela, to the top of 7000-foot Mount Avila. There they can enjoy an unsurpassed view of the city on one side and the blue Caribbean on the other. When the \$15,000,000 project is completed, the cableway will extend up the side of Mount Avila, from Mount Avila to two adjoining mountain

peaks and from Mount Avila down the other side of the mountain to the Caribbean. This, it is said, will make it the world's second longest cable-car system. A mountaintop 14-story circular hotel and an ice-skating arena are also included in the project, which is expected to attract visitors from all over the world. Tours on the run started in February.



Garden Tractor Serves as Truck



Many kinds of work are performed by a garden tractor that can serve as the power unit for a small field truck. In this application, the basic unit is mounted on an axle fitted with two driving wheels and acts as

a tractor to which the car is attached. It can carry loads of up to 880 pounds. The unit also serves as a two-wheel mower, plant-hole driller, plow and can be used to pull trailers or other equipment.

"Geiger" Tank Checks Entire Body

With an elaborate tank-like instrument, scientists at Los Alamos Scientific Laboratory can measure the total radiation present in a human body. The subject, lying in a trough, is pulled inside the tank. Sealed in the hollow walls of the tank are 140 gallons of a liquid which emits tiny flashes of light when gamma rays pass through it. These flashes are detected and amplified by 108 photomultiplier tubes in the outer shell of the tank. Thus the instrument measures all the radioactivity present in any part of the subject's body. The study of natural body radioactivity became necessary when scientists sought to determine precisely how much exposure is possible in a human without damage.

Ⓛ Clogged sink drains and overflowing septic tanks are cleared by introducing a fluid containing enzymes that break up greases and reduce them to harmless amino acids.

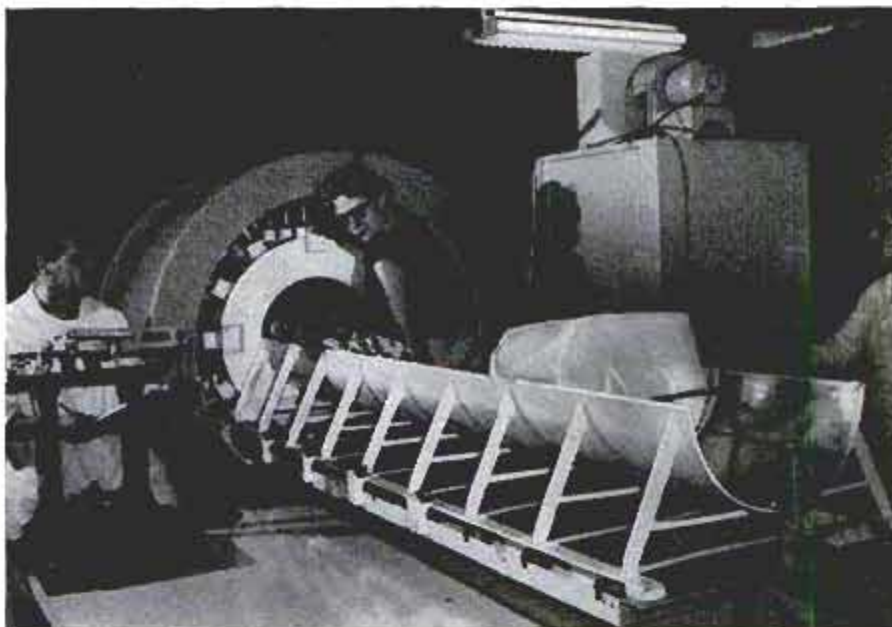

Los Alamos Scientific Laboratory photo

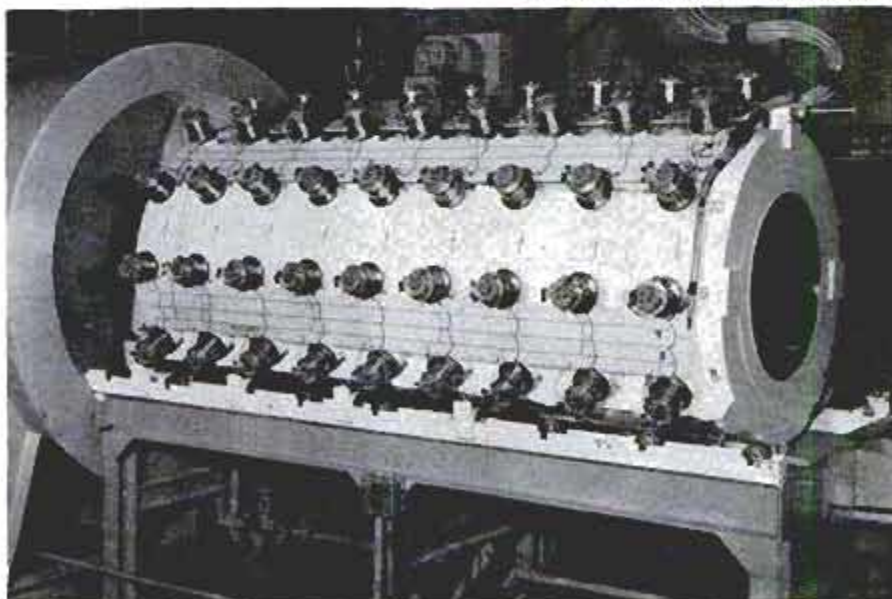



Parts of storage room are cut, shaped and drilled, all ready for assembly with pliers and screwdriver



Side of room is made up of three sheets of aluminum. The roof rafters are preassembled to minimize work



Portable Storage Room Erected in Six Hours

One man can erect a new build-it-yourself storage room in his backyard in four to six hours, using only a pliers and screwdriver. Made of aluminum, the room provides extra storage space, or can be used as a tool shed, a work shop or a playhouse. Size of the completed house is eight by ten feet, six feet high at the rafters. The only thing not provided in the package is a four-inch concrete slab to serve as flooring. Windows can be incorporated in the room at a slight extra cost.

Chain Pulled Taut Serves as Camera Tripod

Unlikely as it may seem at first, a length of lightweight chain is now being marketed as a camera tripod. A fitting on the top of the chain screws into the tripod receptacle on the camera. The photographer then steps on the lower end of the chain and pulls the camera upward until the chain is taut. The manufacturer claims that as long as the chain is kept taut, the camera will be steady. When used with a movie camera to make pan shots, the body is swung at the waist as the camera is moved from side to side.

Antidote for Nerve Gases

Development of an effective antidote against deadly nerve gases has been announced by a team of Columbia University biochemists. Called PAM, an abbreviation of its complicated chemical formula, the antidote has worked on 100 percent of the animals used in tests, where they were exposed to doses of gas which would normally have killed them in five minutes.



Tiny Helicopter Carries One Man

Service-station operators will have to watch not only for cars but also for helicopters pulling up at the pumps when a one-place helicopter nicknamed the Sky Scooter goes into production. Cruising at 60 miles per hour, the little ship carries fuel for two hours of flight in its portable tank. It is equipped with a 40-horsepower air-cooled engine which drives small propellers mounted on each rotor blade.

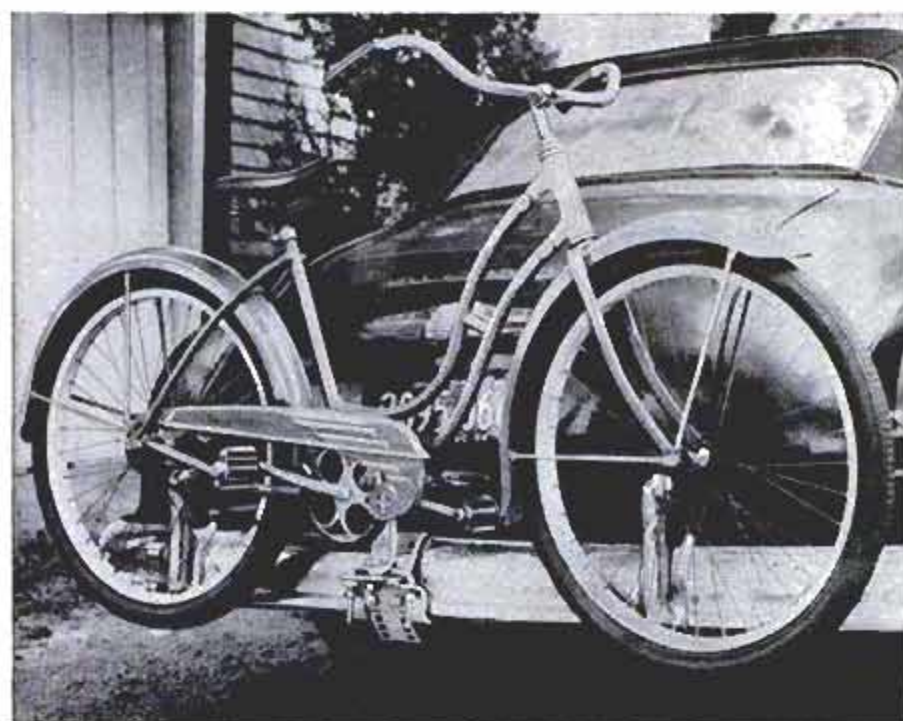

Clamp on Bumper Holds Bicycle

For interesting side trips, take your bicycle along on your next automobile trip. It's easy, now that a special clamp that fits on a car bumper to hold the bike is available. Once the clamp is fastened to the bumper and an inconspicuous pindle is attached to the bicycle, it takes only seconds to mount the bicycle on the bumper. The carrier holds any size of bicycle.

An inconspicuous pindle that is permanently attached to the bicycle fits over clamp on bumper

Nylon "Doughnuts" Float Helicopter in Emergency Landing on Water

Finding himself faced with an emergency landing over water, a helicopter pilot whose whirly-bird is equipped with flotation gear just pushes a button. This releases compressed air, and within five seconds a large doughnut-shaped float inflates over each wheel. The four floats can support a 7200-pound Sikorsky S-55 helicopter with 100-percent reserve buoyancy. The flotation gear is approved by the Civil Aeronautics Authority.



WHAT'S NEW FOR

TOWN HOME



2

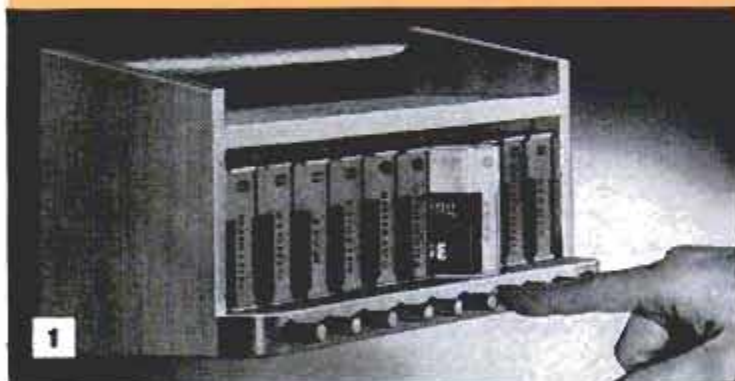

1. **PUSH-BUTTON SPICE RACK** holds 10 standard-size spice cans with edges to front. Push one of the 10 buttons and can above it pops out. Shelf above holds knickknacks

George S. Thompson Corp., 509 Mission St., South Pasadena, Calif.

2. **LOG CART** used to haul wood for the fireplace also serves as an attractive holder for logs once they are inside. The cart has six-inch wheels to make it easy to pull up and down steps as well as on horizontal surfaces. Curved tray that holds the logs is solid brass and 18 inches wide

Leavenworth Steel Inc., First and Walker, Kansas City, Kans.

3. **SELF-FEEDING TOOTHBRUSH** carries a liquid dentifrice in its handle, which is replaced when empty. Shaking the handle forces a few drops of the concentrated liquid dentifrice into the base of the bristles

Amity Sales Co., 711 S. Orange Ave., Newark 6, N.J.

4. **FLUSHING GUN** blasts drains clear. Pumping the handle builds up air pressure until trigger is pulled to shoot air blast down the lavatory, toilet or floor drain.

Miller Sewer Rod Co., 4642 N. Central Ave., Chicago 30

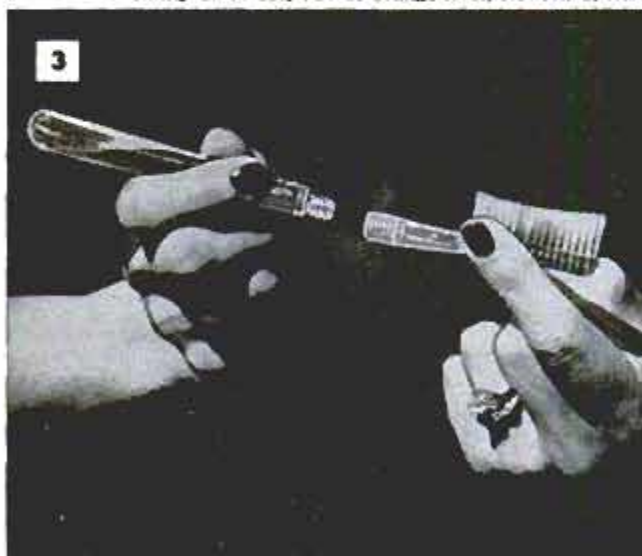

3

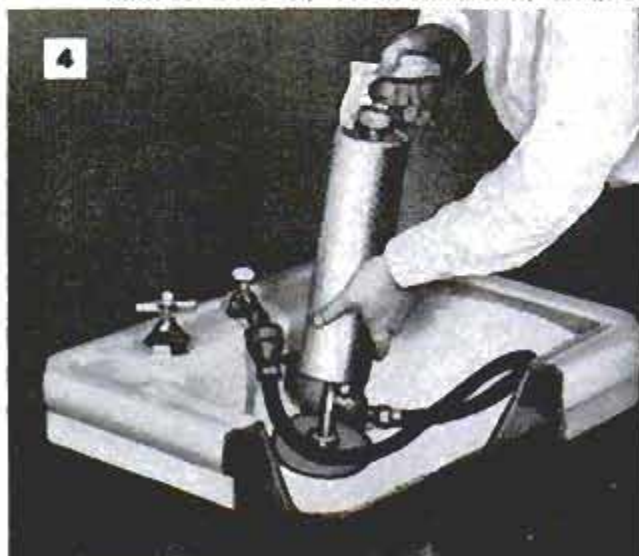

4



5. POP-UP OVEN elevates at push of a button to ease handling of food. Lowered, it serves as a work surface that can be adjusted to any convenient height. Oven, with wall controls, is a self-contained unit

Phileo Corp., Philadelphia, Pa.

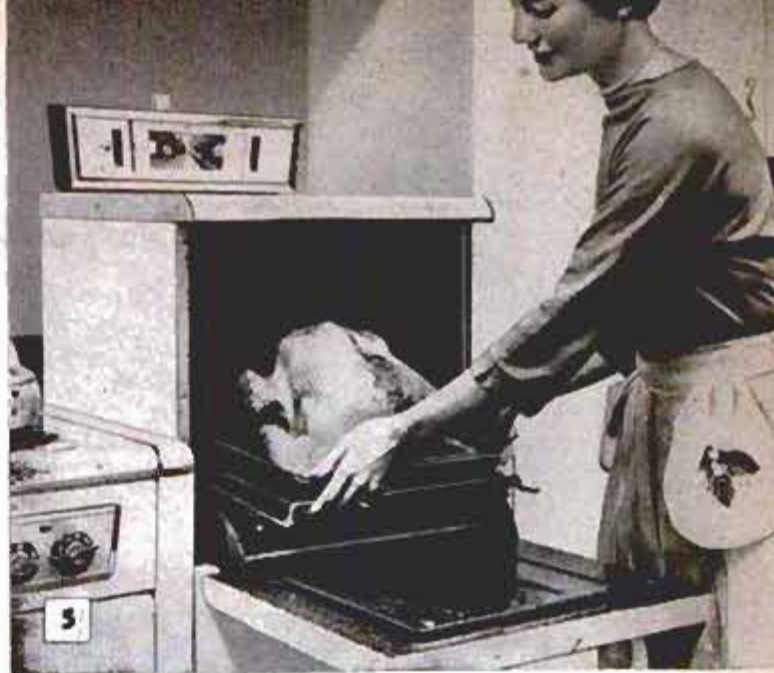

6. COMBINATION UNIT employs one 300-watt motor built into counter top to power food mixer, blender, juicer and knife sharpener. Motor adapts to six different speeds. Unit reduces kitchen clutter

NuTone, Inc., Madison and Red Bank Rds., Cincinnati 27, Ohio

7. ELECTRIC SMOKER burns hickory chips placed on heating element at a low, even temperature that prevents flare-ups and scorching. The portable unit has removable shelves and a sliding, smoke-tight door

Bel Echo Metal Products, Quincy, Ill.

8. DEEP-FAT THERMOMETER, clipped to side of frying basket or cooking pot, assures crisply fried foods. A danger zone on the end of the 200 to 400-degree scale warns the user to lower flame

Cooper Thermometer Co., Pequotuck, Conn.

9. CHILDPROOF MEDICINE CABINET has a three-dial combination lock to prevent small children from reaching poisons and strong medicine stored in it. White-enamelled chest is easily hung from screws

Tot-Safe Co., Durham, Conn.

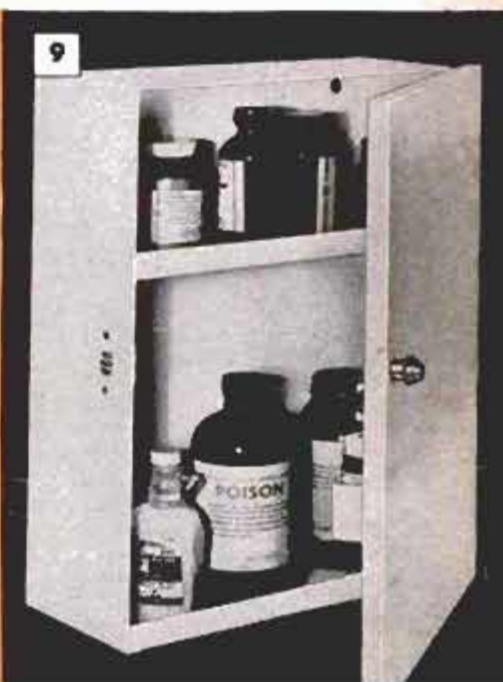

**OWNERS
REPORT:**

**CONTINENTAL
MARK II**



WHAT IS IT LIKE TO OWN A \$10,000 CAR?

So outstanding it's annoying

"So outstanding that everyone stares. People are constantly trying to catch up and pass to get a look. That is sometimes annoying."

NEW YORK SALESMAN

Thrill like very first car

"I feel like I never had a car before. It's the same thrill I got from my very first car and I've been driving since 1930."

CALIFORNIA HOUSEWIFE

Always stylish

"I like the undated aspect. It's a car that will always be in style because of good basic design."

NEW JERSEY FUNERAL DIRECTOR

Think it's foreign

"Fabulous beyond words. Many people do not know what make it is. Most think it is foreign made. We just love it."

MONTANA RESTAURANT OWNER

Requires agility

"A man has to be old to be able to buy one and young to be able to get in and out of it."

FLORIDA RETIRED OWNER

Everything average but price

"Hardly think anyone would buy this car except for prestige. It's hard to get into. Uncomfortable in the back seat. No particular speed. Everything very average except price."

ARKANSAS EXECUTIVE



By Owners of the Mark II

RATHER THAN having the feeling of riding, you experience a floating sensation. It is absolutely the dream car of today." That's what a Texas oil operator says about his Continental Mark II.

And his lyrical description of the ride is similar to that of other owners. Riding comfort is, in fact, the top-ranking best-liked feature, with 40.6 percent of the Continental owners who filled in our questionnaires listing it. The questionnaires were sent to 750 owners—about half of all Continental owners when the survey was made.

"Quiet. Just floats down the highway."
—Indiana investor.

"Feeling of gliding instead of rolling."
—New York artist.

"I have just returned from a seven-day 3000-mile trip through New Mexico and Colorado, a trip I have made many times in other high-price cars. This trip in my Mark II was the most comfortable I have ever made."
—Texas furniture manufacturer.

Mark II owners do like their cars. But, you may be saying, they should! After all,

(Continued to page 148)



CLYMER DRIVES THE MARK II

By Floyd Clymer

MY TEST of the Mark II was from Los Angeles to Fresno, across the mountain range to Salinas, down the Pacific Coast Highway through Santa Barbara, a few speed miles on a dry lake bed and some

back-road tests in the Mojave Desert, totaling 817 miles.

The handling qualities of the Continental are a combination of those found in sports, foreign and American cars. It has the road "feel" of the semisports car and handles

(Continued to page 236)

AN ENGINEER

Analyzes the

MARK II

By Dale Kelly, SAE

Model tested: 2-door hardtop with power steering, brakes, seats and windows, and optional air conditioning. Rear-axle ratio: 3.07 to 1. Wheelbase: 126 inches. Tires: 8.20x15, four ply. Curb weight: 5200 pounds with gas tank half full (54 percent of weight on front wheels, 46 percent on rear). Barometer: 28.82 inches; temperature: 90 degrees F. Payload: 400 pounds for acceleration tests, 200 pounds for fuel economy.



ACCELERATION TIME IN SECONDS

	0 to 20	0 to 40	0 to 60	0 to 80	1/4 mile
Ignition timed for regular gasoline	3.3	7.6	14.4	23.7	20.3
Ignition timed for premium gasoline	3.3	7.3	14	22.9	20.1

(The watch was started at the instant the accelerator was floored. The engine was not run up against the brakes before the start. All tests were in Drive range.)



FUEL ECONOMY MILES PER GALLON

	Steady 50 m.p.h.	Steady 70 m.p.h.
Ignition timed for regular gasoline	14.7	11.5
Ignition timed for premium gasoline	15.4	11.5



SPEEDOMETER ERROR (MILES PER HOUR)

Indicated speed	20	30	40	50	60	70	80
True speed	19	29	39	50	60	70	81

ODOMETER ERROR

The odometer was correct within 1/2 of 1 percent.



DRIVER'S VISION

Some portion of the road could be seen 15 feet in front of the car (A in sketch) by an average driver (5 feet 9 inches tall); full width of the road could be seen 23 feet in front of the car (B in sketch).



GROUND CLEARANCE

The bottom corner of the rear overhang would touch the ground if the car were driven through a dip whose profile had a radius of curvature of less than 27 feet (solid line in sketch). The center of the car would drag if the car were driven over a hump with a radius of less than 23 feet (dotted line in sketch). The frame would drag if the car were driven in ruts deeper than 6.5 inches. The doors would open over a 13-inch curb.

MISCELLANEOUS

OCTANE REQUIREMENT

On an 85-percent-octane blend of octane and heptane, equivalent to typical regular gasoline (octane 82 Motor, 88 Research), the engine ran without knocking at a basic ignition timing of 9 degrees before top center; on a 90-percent-octane blend it ran without knocking at 12 degrees. The acceleration and fuel economy listed above for regular and premium gasolines were obtained at these settings. Ignition timing more than 12 degrees before top center did not produce any further improvement in performance.

At the time of the test the car had a 12,000-mile accumulation of carbon. Another car of the same make and model could easily have an octane requirement several points higher or lower.

STEERING

The steering wheel turned 3.75 turns from lock to lock. The steering-wheel diameter is 17 inches.

the car does cost \$10,000 and for that money it should be good. The owners agree.

"It's a lot of automobile, but it's a lot of dough. Even with hand assembly, a lot of minor annoying adjustments are necessary."—Illinois engineer.

"An outstanding car, but there is a question whether it is worth \$10,000 if performance and reliability are to be the criterions. Entirely too much time in the shop having small things fixed."—Colorado publisher.

But such complaints are infrequent. In

TRUNK CAPACITY

In addition to the spare tire and the tire-changing tools, the trunk could accommodate seven cardboard cartons of the size used for 48 tall cans of evaporated milk.

HEIGHT OF CENTER OF GRAVITY

The center of gravity of the unloaded car was 22.5 inches above the ground.

VENTILATION

The ventilating air inlet was low at the front of the car, where it would be likely, in heavy traffic, to take in exhaust gas from the car ahead.

NOTE: Certain data were not obtained in this test of the Continental because of circumstances beyond the control of the tester. The test car was obtained through the courtesy of Mrs. Willie Zimmermann of San Marcos, Tex., who kindly consented to let her personal car be used. Thanks are also extended to Maddox Motors, New Braunfels, Tex.

the survey, the Continental comes out very well indeed. Here are some quotations that describe how owners feel about their \$10,000 cars:

"There's the luxurious feeling of driving a beautifully engineered and designed automobile."—Illinois salesman.

"I have always wanted the best car I could find. A Rolls-Royce with a little more style, a little more zip, a little less stodgy. I am just satisfying a 40-year desire for the best."—New York retired owner.

Continental owners in 40 states (in color) tell you what they think of their cars in this Owners Report

THE OWNERS ANALYZE THE CONTINENTAL MARK II



EXCELLENT	AVERAGE	POOR
74.7%	19.2%	6.1%
(When its price is considered)		

Had trouble with engine?
 No trouble.....81.6%
 Some trouble.....15.5%
 Considerable trouble.....2.9%

What was engine trouble?
 Oil consumption.....3.9%
 Carburetor.....2.9%
 Hard to start.....2.4%
 Ignition.....1.9%

Had trouble with body?
 No trouble.....60.4%
 Some trouble.....27.0%
 Considerable trouble.....2.9%
 No answer.....9.7%

What was body trouble?
 Body noises.....9.7%
 Water leaks.....9.2%
 Electric windows.....8.2%
 Door operation.....3.9%

Would like faster acceleration?
 Yes.....18.4%
 No.....78.7%
 No answer.....2.9%

Would like more top speed?
 Yes.....5.3%
 No.....78.8%
 No answer.....15.9%

Would like more maneuverability?
 Yes.....8.2%
 No.....83.6%
 No answer.....8.2%

Is it the most comfortable car?
 Yes, it is.....87.4%
 No, it is not.....12.6%

What influenced your purchase?
 Exterior styling.....88.9%
 Prestige value.....60.4%
 Mechanical features.....58.9%

Best-liked exterior feature?
 Plainness, absence of chrome.....45.7%
 Lowness.....14.7%
 Long hood.....9.4%

Least-liked exterior feature?
 Spare-tire bump.....9.4%
 Extra-wide doors.....2.4%
 Short trunk.....2.0%

Best-liked interior feature?
 Leather upholstery.....38.0%
 Dignified dashboard.....11.4%
 Steering-wheel position.....3.3%

Least-liked interior feature?
 Location of driver's ash tray.....7.8%
 Hard center portion of seats.....4.5%
 Hump in center of floor.....3.3%

Who are Mark II owners?
 Have own business.....23.2%
 Executives.....21.0%
 Retired.....10.5%
 Surgeons, physicians.....9.4%
 Bankers, financiers.....7.9%
 Salesmen.....2.6%
 Ranchers, farmers.....2.6%
 Attorneys.....1.5%
 Unspecified.....16.4%
 All others.....4.9%

What did they trade?
 Cadillac.....27.3%
 Lincoln.....26.2%
 Other Ford product.....8.2%
 Other GM product.....5.0%
 Chrysler Corp. product.....4.1%
 Others, no answer.....4.9%
 No trade at all.....24.3%

How was it delivered?
 In excellent condition.....65.2%
 In above average condition.....13.7%
 Average condition.....12.3%
 Below average condition.....8.8%

How is dealer service?
 Excellent.....70.1%
 Average.....20.3%
 Poor.....9.6%

Would buy from him again?
 Yes, would.....79.7%
 No, would not.....8.7%
 No answer.....11.6%

Would buy Continental again?
 Yes, would.....83.6%
 Might.....11.6%
 No, would not.....4.8%

Did own the earlier Continental?
 Yes, did.....21.1%
 No, did not.....79.9%

Best-Liked Features

Smooth, comfortable ride.....40.6%
 Exterior styling.....38.1%
 Ease of handling.....33.2%
 Power, performance.....23.4%
 Roadability.....16.8%
 Quiet operation.....14.8%
 Fine workmanship.....14.8%

Most-Frequent Complaints

No complaints at all.....36.5%
 Hard to get in and out.....19.3%
 Inadequate trunk space.....8.2%
 Service not good enough.....7.8%
 Water leaks.....7.4%
 Rear-seat room inadequate.....4.9%
 Window-lift trouble.....4.5%
 Brakes inadequate.....4.1%

What Should Be Changed?

Nothing at all.....32.0%
 Make it a four-door.....10.2%
 Enlarge trunk.....7.8%
 Make easier to get in, out.....6.1%
 Move spare tire.....4.5%

"I do not care how much I pay for a car. I demand exclusiveness, appearance, riding quality, roadability, quiet, smooth performance and economy. My two Continentals are the closest I have come to satisfying these demands."—Michigan surgeon.

For \$10,000, Complaints

The \$10,000 price tag notwithstanding, there are complaints. Those of us who drive \$2000 cars should feel better now.

By a wide margin, the most-frequent complaint (made by 19.3 percent of the owners) is the awkwardness of getting in and out of the Mark II. Many of the complainers add that this is only a minor point and one that must be put up with if the car is to be made low.

"One does have to learn to get in and out

gracefully, especially from the back seat."—Florida owner.

"A little tight for a fat man to get in and out."—Oklahoma physician.

"Too difficult to get in and out even with the door wide open. When parked, the door width is so great it not only hits other cars but the angle of opening is small. It's a car for youngsters."—Illinois executive.

"A man has to be old to be able to buy one and young to be able to get in and out."—Florida retired owner.

Second on the complaint list (8.2 percent) is the small trunk space resulting from the position of the spare tire. Those who have air-conditioned models have even less trunk space as the evaporator occupies added room.

"Trunk space is limited. I have had to

WHAT MAKES A CAR WORTH \$10,000?



Dials...knobs.on the dashboard look and feel elegant



Leather is soft, supple and tailored in good taste



Convenient fuse box has its circuits labeled in lid



Hub caps cost \$26 apiece, are assembled of 40 vanes. Below, seat backs are biscuited. Note the grab strap



YOU DON'T have to be an engineer to know that the Mark II is outstanding. It shouts quality in a quiet, gentle way.

You don't have to start the engine to sense it. Slide into the seat and feel the softness of the leather. Turn the knobs and you get the same satisfaction that comes when you handle a fine camera or a micrometer. Look at the instruments. Quietly dignified, their delicate needles look confident and trustworthy.

Drive it and you become certain this is a fine car. It is quiet—unbelievably quiet at normal road speeds. Turn the wheel and it responds as you would expect a fine car to. Its long hood and the jewelrylike ornament far in front reinforces your opinion.

On this page are a few of the reasons why the Mark II sells for \$10,000. For those who can insist on finest quality at any cost, it is a small price to pay for the luxury of knowing that they ride in elegance. For others, less fortunate perhaps, to whom a car is utility, neither it nor any car is worth that much.

Not shown here (because of the limitations of the camera) is the invisible element of prestige that must influence anyone who buys the Mark II.

Deep-pile carpet adds living-room feel to the car. Nameplate (center) has owner's name engraved on it



ship luggage. However, a larger trunk would spoil the body lines."—Georgia executive.

"Trunk space was inadequate until I installed puncture-seal tires and removed the spare tire as unnecessary."—Florida used-car dealer.

Continental owners do have a luggage problem, especially if four persons are riding in the car. After all, a Mark II would not look right with a luggage rack on the roof or pulling a trailer loaded with luggage!

Next on the complaint list is dealer service with 7.8 percent mentioning it.

"Dealer has difficulty getting parts. Car delivered with faulty gas gauge, one window not working. Parts not yet received after two months."—California retired owner.

"A car of that price should include the best service possible. I don't feel the company has impressed the dealers with this notion."—Texas surgeon.

Styling Is Praised

Second on the best-liked list is exterior styling with 38.1 percent mentioning it.

"Styling has elegance without bombast."—Missouri insurance executive.

"Distinguished lines. Conservative yet commanding admiration."—Wisconsin executive.

"Undated aspect. A car . . . of good basic design that will always be in style."—New Jersey funeral director.

Ease of handling, despite the bigness of the Mark II, is third on the list of best-liked

(Continued to page 230)

Big complaint is difficulty of getting in and out due to the low roof, wide door and step-down floor



Spare tire cuts luggage space in trunk drastically



Seat back can hit dashboard, scarring the leather



Owners don't like the big hump in rear floor (above) or the hard-to-get-at ash tray in front door (below)





Sculling Blade Moves Boat Silently to Avoid Disturbing Fish

One of the oldest methods of boat propulsion—sculling—has been brought up-to-date. A new blade which fastens to the transom or gunwale takes the art out of sculling. The fisherman or duck hunter merely moves the handle back and forth, and the variable-pitch blade, operated by springs, wiggles like a fish's tail to move

the boat. The sculling blade permits silent movement through the water, enabling the fisherman to move through his favorite spots without disturbing the fish. He can operate the blade with one hand while he casts with the other. The blade folds out of the water when not in use, and can be clamped beside an outboard motor.

Mixing Pump Delivers Any of Five Different Gasolines

By setting the control valve, the attendant selects any of five octane ratings to match the car's requirements. Highest rating is in excess of 100 octane. Mixer pump is being tested in Florida by the Sun Oil Company

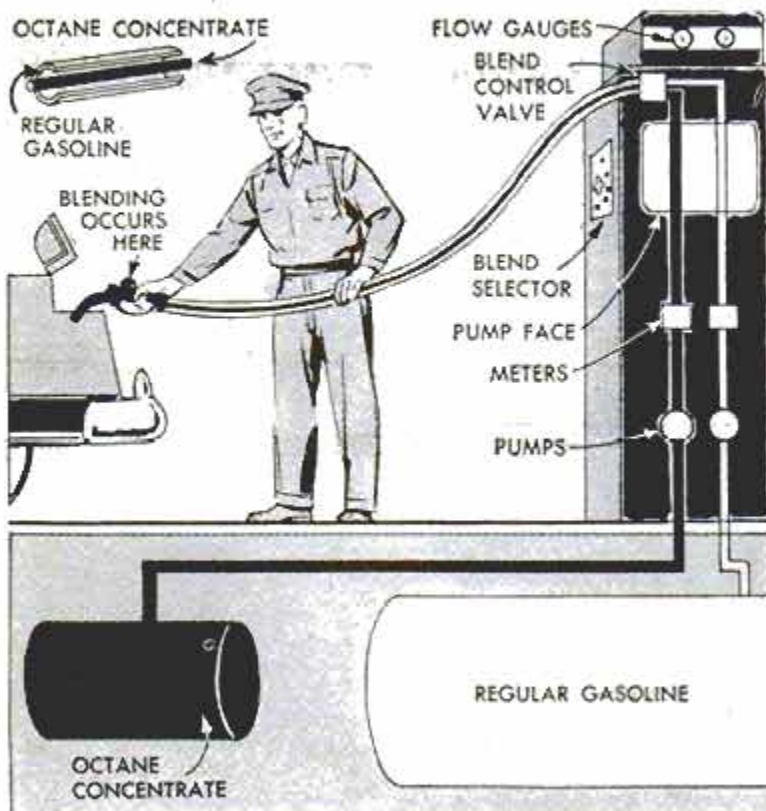



All cars are carried under cover on three decks. A VW is pushed onto the elevator from bottom deck here



Operator raises elevator until it's level with door in side of ship (below) through which the VW is then rolled onto dock. No gas is in cars during voyage

Volkswagen Car Ferry

WHEN VOLKSWAGEN SALES in the United States began to climb (1956 estimate: 60,000), transportation became the problem. With typical thoroughness, the VW engineers designed a fleet of ships just to haul the little "bugs." Today the fleet plies between Germany and the United States with ferrylike regularity. Two sizes of ships are used: A large size (capacity 900 VWs) for ocean ports like New York and small size (290 VWs) for the inland ports like Chicago.

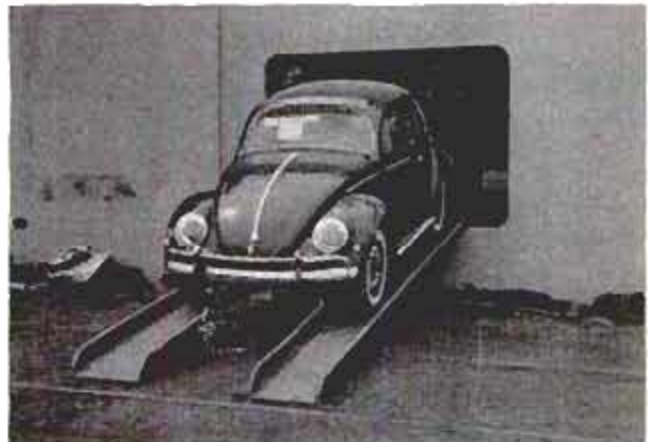

Unloading at Chicago. Ship has Italian name (*Rigoletto*), Swedish captain, and hauls German cars to America!





There's Atomic Energy in Granite: Can We Unlock It?

By Dr. Harrison Brown
*Professor of Geochemistry,
 California Institute of Technology*

As Told to
 Thomas E. Stimson, Jr.

Prospector searching for radioactive ore with a scintillometer gets a high count when testing granite, indicating presence of uranium

COMMON, ORDINARY igneous rock contains all the energy that civilization can use. The energy in a single ton of granite is equal to 50 tons of coal.

The same rock holds immense quantities of valuable metals.

Consider this: 100 tons of granite, a chunk somewhat larger than an automobile, contains eight tons of aluminum and five tons of iron.

Other ingredients include two tons of magnesium, 180 pounds of manganese, 70 pounds of chromium, 40 pounds of nickel,

30 pounds of vanadium, 20 pounds of copper, 10 pounds of tungsten and four pounds of lead.

In 100 tons of average granite there are 14 ounces of uranium and about two pounds of thorium. These radioactive elements are equal in energy to the power obtained from 5000 tons of coal.

Is it possible to unlock this energy from the rock?

It is surprisingly easy. The two elements are concentrated in accessory minerals that make up less than one percent of the

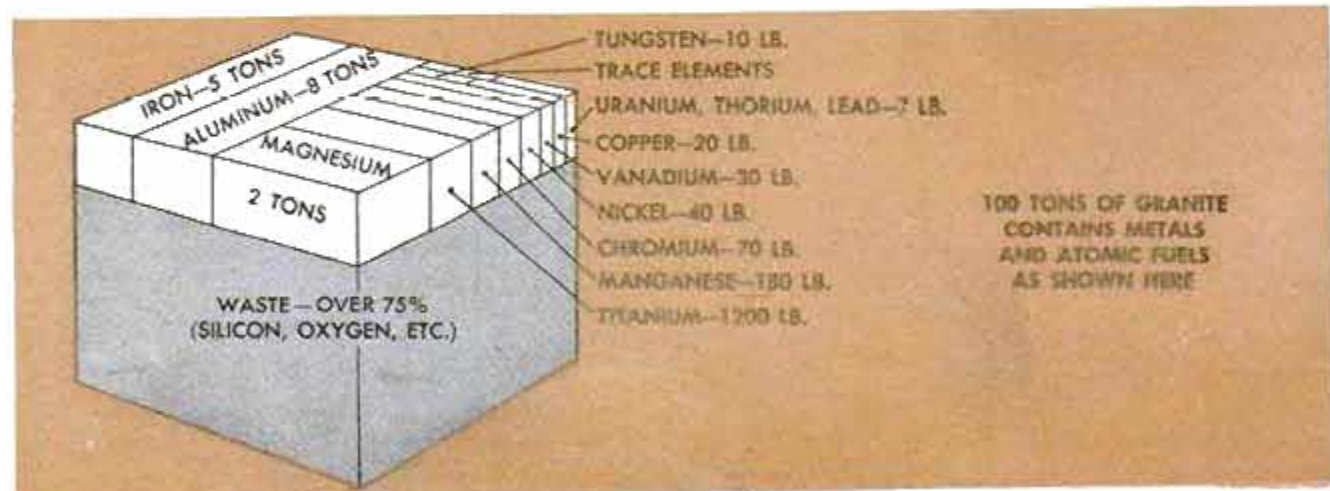

Blvd., Montebello, Calif.



New portable coring tool replaces heavier, more expensive equipment, samples rock to depth of 50 feet

weight of the granite. The rock merely needs to be crushed to grain size and leached for a short time in dilute hydrochloric acid. The acid dissolves and retains important percentages of the uranium and thorium. These may then be separated from the acid by a series of straightforward chemical steps.

This simple process extracts only 25 percent of the radioactive materials but even on this basis, 100 tons of granite yields nuclear fuels that can produce the same energy as is obtained from burning more than 1000 tons of coal.

From the standpoint of energetics it "costs" less than three tons of coal to mine 100 tons of granite and extract its radioactive ingredients. This cost includes the power devoted to quarrying the rock, crushing it, disposal of wastes, transportation, acids, water pumping, shop facilities and other considerations. Thus, by burning three tons of coal one gets a profit, in energy, amounting to 997 or more tons of coal.

In dollars and cents the picture is not as bright. The price of producing uranium from average

granite is estimated at around \$340 per pound. Uranium can be extracted from richer ores much more cheaply than this.

However, some large bodies of igneous rock contain higher-than-average amounts of uranium and thorium. The price of uranium doesn't need to climb much above present levels before these bodies can be mined at a profit.

More study needs to be given to recovery methods that would extract possibly 80 percent of the radioactive materials in

Chemical apparatus in the laboratory of the California Institute of Technology is used to separate some metals from granite





Glauber salt is precipitated out of brine by a spraying process at Searles Dry Lake, Calif. Methods similar to this may eventually be used to extract many products from ordinary igneous rocks such as granite



Above, mineral cores taken from crystal body under Searles Dry Lake, consisting of numerous chemicals locked together. Below, container housing core of sodium-graphite reactor in Santa Susana Mountains, near Los Angeles, is lowered into place

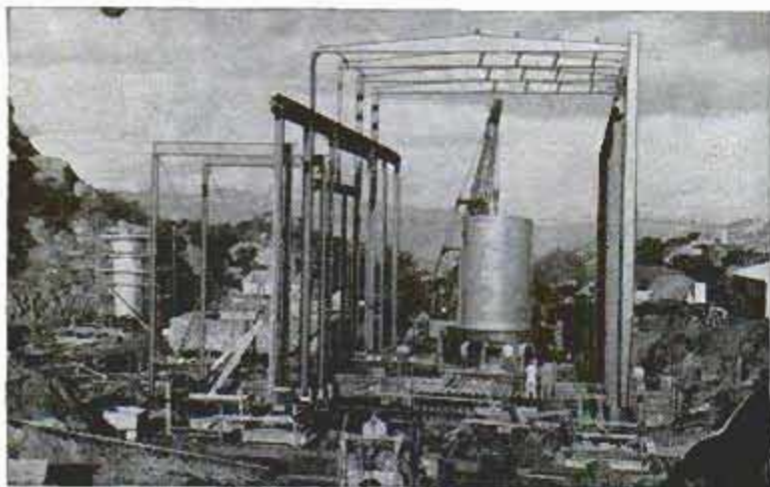

granite. Too, it may pay to investigate the recovery of uranium and thorium as by-products in ordinary hard-rock mining and milling operations. Some mine dumps, also, might pay a profit if their pulverized materials were reworked for their radioactive contents.

In any event, there is ample uranium and thorium in the igneous rocks of the earth's crust to power a highly industrialized civilization for an extremely long time, certainly for thousands of centuries. No nation need be a have-not in atomic energy, for the raw materials are available everywhere.

The role of thorium as a source of atomic energy is relatively new and is still experimental. Thorium is three times as abundant as uranium. In its refined state it is a gray metal resembling platinum in hardness and ductility. It can be extracted from more than 100 different minerals. One source of thorium is the colored glassy monazite particles in granite.

The radioactivity of granite, as a matter of fact, has led to much confusion on the part of week-end prospectors. Prowling the hills with a geiger counter, an amateur prospector is apt to be elated when

(Continued to page 252)

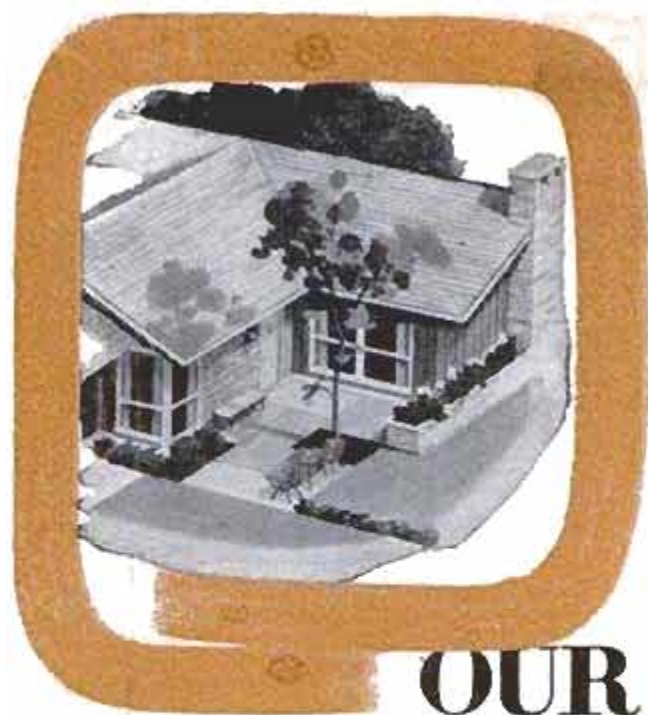

Coming Next
Month

**OUR BIG ANNUAL
SPECIAL SECTION
ON
HOMIES**

Featuring:

An exciting new *PM* home for families with three to five children—a house with a unique children's area that we predict will be the home sensation of the year. It was planned by a noted designer especially for *PM* readers.

Also

- Pointers From the King of Remodelers
- An Album of New Homes
- How to Get More House for the Money
- Space Savers—Storage Walls
- Home Soundproofing
- Shutters Are Back Again
- Your House of the Near Future
- Miracle With Hardwood Panels
- Save \$\$\$ By Finishing It Yourself
- Paving That Patio
- New Materials and Ideas

Look for the 50-Page home section in October



Catching rig is pushed ahead of boat. It is equipped with skids that ride along the bottom of the lagoon

Shrimp Ranch Harvests Bait

AN ESTIMATED 13,000,000 head of marketable shrimp roam the watery range of what may be the world's only shrimp ranch. Located in a lagoon of Bird Key, just off Maximo Point near St. Petersburg, Fla., the ranch confounds experts who said shrimp couldn't be raised in captivity.

A concrete retaining wall several city blocks long keeps shrimp in the lagoon and assures a minimum water depth of 18 inches. The wall above the 18-inch level is inset with 98 gates of nylon screening that permit tidal flow but keep fish out.

Live shrimp, potent fish bait, sell to anglers for \$15 per thousand. A single

female produces 500,000 eggs at each spawning. These facts helped line up backers of the Bird Key Shrimp Company.

Chief problem has been to harvest the shrimp without destroying their breeding grounds. Now, a weird rig of nylon netting promises to lick the difficulty. Pushed by a small, powered boat, the scoop sweeps the lagoon in a set pattern in the dark of night. A searchlight "freezes" the shrimp long enough for them to be caught. Equipped with skids like a sled, the featherweight harvester minimizes damage to the shallow lagoon bottom while floating along at the proper height.

Caught shrimp are dipped from storage pen. Seven-foot nylon gates allow water to pass through concrete dam



KEEPING UP WITH THE ATOM

ONE OF THE MOST important scientific papers of recent years is the report of the National Academy of Sciences on the long-term effects of radiation. The report is not so much concerned with the danger of a large dose of radiation to an individual as with the gradual effects on the human race over a period of centuries.

The dangers, of course, are genetic. Natural radioactivity has always had an effect on evolution. Cosmic rays and other natural radiations can alter an individual's genes, so that his children are departures from his own type. Such altered or mutated genes are inevitably passed along from generation to generation. It's a one-way street, as the altered gene never reverts back to its original type. In this way mutations gradually affect the course of evolution.

The scientists who wrote the report are concerned about the tremendous boost in radiation that may occur as more and more reactors are built. Such a boost could cause a big increase in the number of mutated genes. The scientists are not predicting a race of freaks or monsters. What they see is the possibility of a slow deterioration of the human race over many centuries. Poorer resistance to disease, higher death rates, lower birth rates and an increase in hereditary factors that are detrimental—these may be hallmarks of the atomic age. From a purely selfish standpoint, you don't have to worry about such things. But they may be big worries to your descendants.

The scientists recommend that medical X rays be held to an absolute minimum. This is particularly important up to age 40, as nine tenths of the babies of this country are born to parents younger than 40. They also suggest that a system be set up for keeping track of each individual's radiation exposure, to make sure X rays and the background radiation do not add up to overexposure which might alter his genes.

☆☆☆

Trees, grass and growing plants extract radioactive particles from the air, according to scientists of the Naval Research Laboratory. Whether this natural filtering action is helpful or harmful to man is not yet known.

Experiments show that the radioactive particles strike the small fibers of plants and stick there.

The process puts scientists face to face with a paradox. It is believed that any elim-

ination of radioactivity from the atmosphere, no matter how slight, is beneficial to man. On the other hand, edible plants may snatch radioactivity out of the air, absorb it and carry it over to the dinner table.

☆☆☆

The Los Alamos Scientific Laboratory recently announced a discovery of major importance. Scientists there have detected the neutrino, an atomic particle predicted more than 20 years ago but never identified until now.

Neutrinos are so penetrating that they will pass through billions of miles of solid matter. Scientists hope the discovery of the neutrino will aid in an understanding of the "glue" which holds nuclei together.

☆☆☆

In 1955 the United States had 29 research and power reactors, compared to 16 for the rest of the world. By 1960 this country should have 91 reactors compared to 81 for the rest of the world.

☆☆☆

The man below is holding in his hands the equivalent of 400 tons of coal. The object is a \$4000 fuel element containing 145 grams of U-235. It will be placed in the Ford Nuclear Reactor at the University of Michigan this fall. The reactor will be used for research on the peaceful uses of atomic energy.



Miniature Lathe Teaches Woodworking



Designed as a toy, a miniature lathe for children will actually do a lot of the turning jobs that the big lathes in the shop will do. It is safe for children because its shaft can be stopped by the fingers, but in spite of this safety feature it has enough power to turn out items from wood, plastic and even aluminum. The over-all length is 27 inches and the weight is only 16 pounds, making the machine easy to move from place to place. Power is provided by a $\frac{1}{35}$ -horsepower motor, and there are no belts or gears to damage fingers of young operators.

"Crow's Nest" Gives Television Cameramen Bird's-Eye View

British TV cameramen get a bird's-eye view of sports events from a "crow's nest" on the top of a tall hinged column. Mounted on a truck, the column lowers to the ground to pick up or unload the camera operator. The equipment, used first at a race track, enabled the cameras to sweep the whole course. It is operated by a London firm that covers events for the new commercial television system.

Platform raises TV camera and operator for unobstructed view



World's Waterpower Barely Tapped

While atomic energy may supply most of the horsepower of the future, energy from falling water will continue to be a major and growing power source in years to come. At present, according to a United States Geological Survey, energy developed from waterpower throughout the world has reached a total of 130 million horsepower. But this is only a fraction of the possible three billion horsepower the survey says could be developed from all of the world's rivers and streams.

☐ There is a total of 47 different antivenom preparations available for treatment of snake bite, scorpion sting and spider bite.



Cloth Reflects Car Lights For Pedestrian Safety

Clothing which gives a brilliant reflection of light at night is designed to increase pedestrian safety. Yarn woven into the garments is coated with microscopically small glass lenses. The yarn looks and feels like untreated yarn in daylight. At night it reflects light back only to the source of the light, so the garment looks like any other except to the motorist, who is sitting behind one of the headlights.

Powered Lawn Roller

Metal cans filled with concrete form the wheels of a motorized lawn roller built by Thomas Pitts of Knox, Ind. The motor came from a garden tiller. The front axle is an iron pipe embedded at each end in the concrete of the rollers.

Battery Aids Leg Growth

Miniature electric batteries are being built into children's legs to stimulate bone growth when the legs are of unequal length. So far the technique has been used on 18 cases at Children's Memorial Hospital, Chicago, with encouraging results. Typical case was that of one child whose shortened right leg grew about $\frac{3}{4}$ inch in nine months after a battery was installed. Technique will work only during growing years.



Pulley mounted on electric water pump permits it to be operated by gasoline engine during emergencies

Gasoline-Driven Lawn Mower Powers Emergency Pump

When storms or floods cause a power failure, farmers and other homeowners who depend on electricity to operate their water pumps can now switch to a gasoline-driven lawn mower as a power supply. One manufacturer of water systems has installed an emergency pulley on his equipment which permits any small gasoline engine to supply power to the pump by means of a belt attachment.



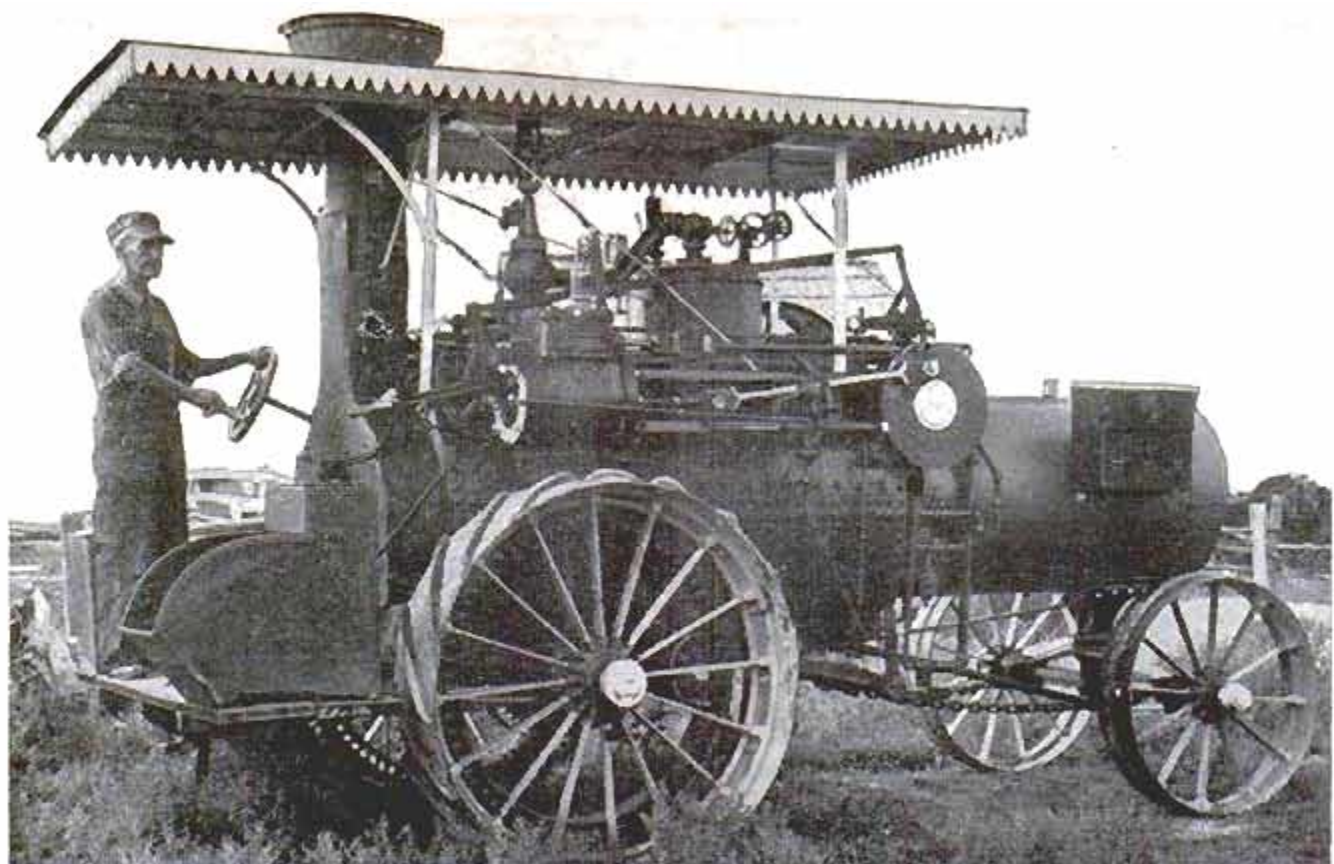

Built around 1890, the Kitten delivered 25 horsepower under the belt of the flywheel and 16 at the drawbar

"Thrashin' Machine" Revival

By Louis Martin Reitz

WHEN ROY ALEXANDER of Bourbon, Mo., was a small boy in the early 1900s he saw his first traction engine and with one whiff of steam and hot oil he got the fever and has never quite recovered. Unfortunately the nearest he ever got to one was when he hauled wood to fire up.

That is, until a few years ago when he found one standing in an old machine shed

where the hens were using it for a roost. Alexander bought it and set to work with a will and a scraper. He soon discovered that the layers of hardened-oil and grease had formed a good protective coating over the machinery and, as these engines burned mostly wood, boiler and flues were good.

After working it over with a bucket of coal oil and a stiff brush and replacing a few flues, he went over the entire engine taking up or pouring new bearings; replacing fittings and tightening up in general. Then with several cans of bright enamel he restored the paint job which in the old days was quite gaudy.

The boiler was usually black with gold trim; the running gear and wheels red or yellow and the steam engine would be red or maroon with gold.

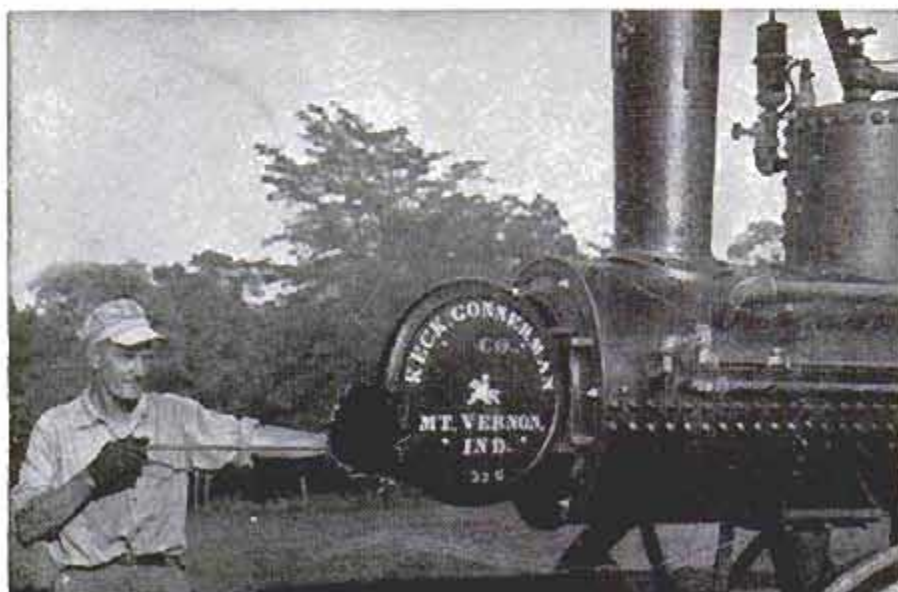

Door was provided for cleaning soot from flues. Keck-Gonnerman engine gave 50/18 horsepower

trim. The water tanks and fuel boxes might be green with yellow or gold curlicues.

This first engine was called a Jumbo and was a sight to see that morning in the sunlight with its new canopy of modern aluminum. Roy put in a fire and watched the needle go over. He then pushed the cutoff lever over to full stroke and, with a few toots of the chime whistle, "Old Jumbo" lumbered off across the fields.

Since then, Alexander has acquired several more engines and restored them. The Kitten engine is his favorite and its design follows closely that of the early Western river steamboat engines and boilers. The stack is to the rear and the engine is also mounted "rear end to." The flames pass from the firebox under the boiler and then return through the flues and up the stack. The cylinders are to the rear and the flywheel and cranks are in front just as they were on the old river boats.

The engines were geared way down and had loads of power at the drawbar at a speed of about four miles per hour. There was a clutch in the flywheel and the belt ran directly off the flywheel and powered the separator or sawmill or any other machinery around the farm. ★ ★ ★

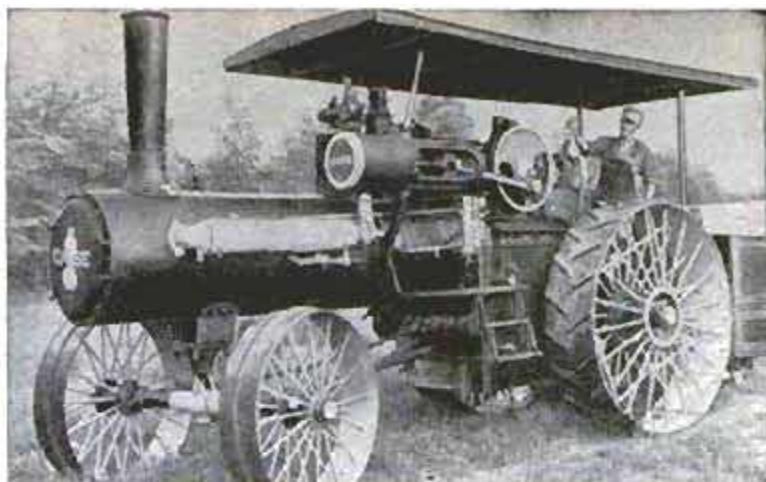

The Case, above, was bigger than most engines, having 65/25 horsepower. Below, Keck-Gonnerman gets an application of oil



Below, the Jumbo, Alexander's first traction engine, as it appeared after he finished the refurbishing. The Jumbo gave 45 horsepower at the belt and 16 at the drawbar

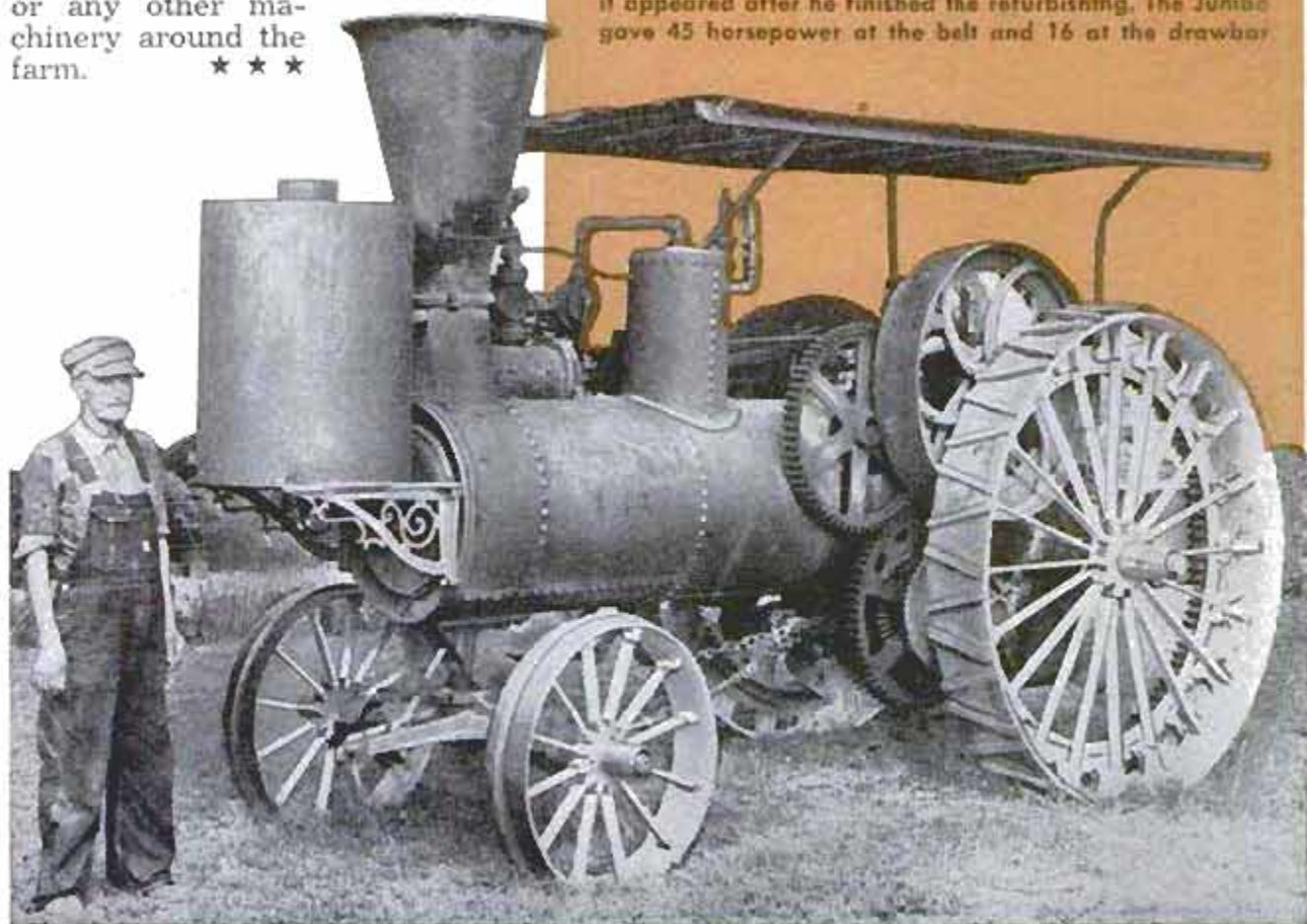

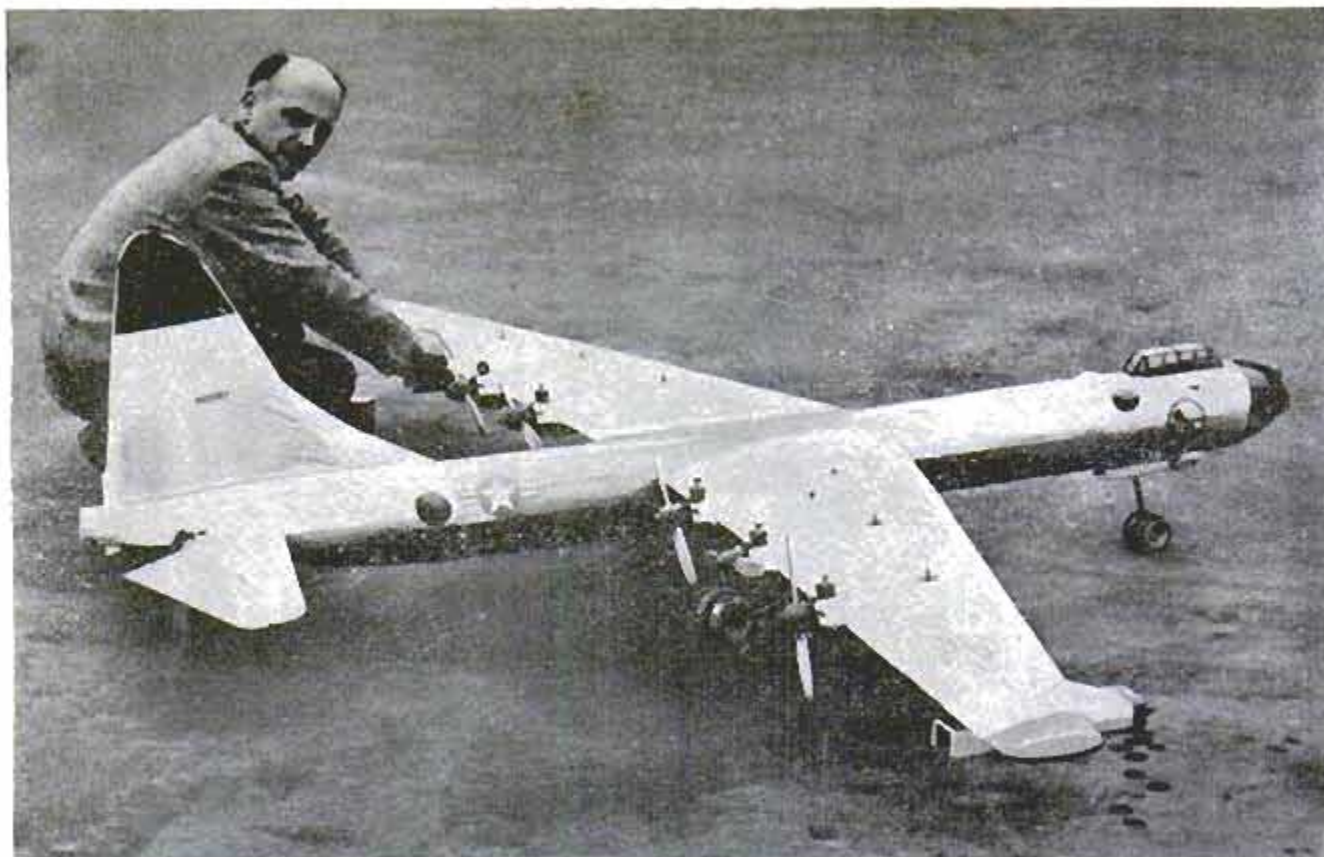

Six Tiny Diesels Power Model B-36

After 200 hours of painstaking labor, Helmut Appelt, of Stuttgart, Germany, has completed and flown a scale model of the global B-36 bomber. The model has a wingspan of 9 feet, 9 inches and weighs 16

pounds. Power is supplied by six tiny diesel engines, plus two rockets which give the plane an extra push on take-off. The plane will fly for six minutes at 30 miles per hour while attached to a 75-foot cable.

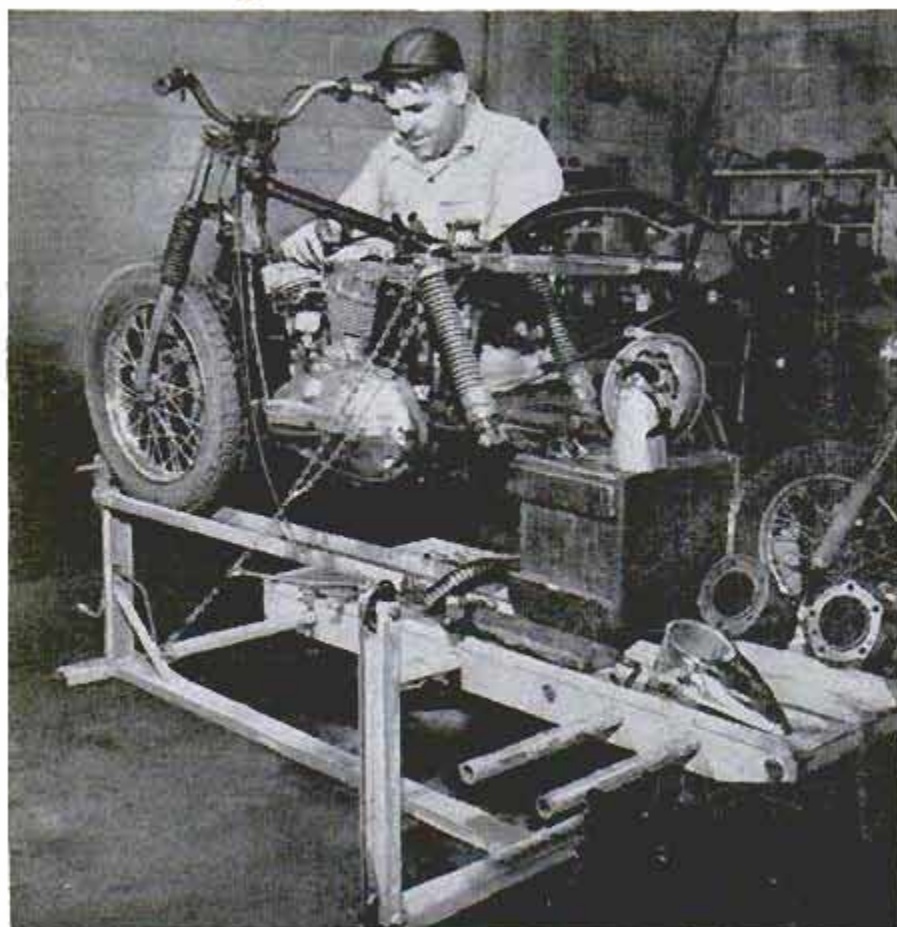

Motorcycle Hoist Eases Repair Job

Motorcycles mounted on a portable hoist are held at a convenient working level for the mechanic, who can sit or stand. One end of the hoist is raised and lowered by a hand crank. A hand winch mounted at the stationary end pulls the vehicle up into position for raising. The back half of the work platform is wide enough to hold tools and parts, and contains holes for pipes which hold the rear wheels of three-wheeled cycles and garden tractors. The motorcycle wheels rest in a grooved center rail. Easily moved by two men, the repair jig can be carried in a small truck or trailer and taken to races or hill climbs.

Pick up Short Waves on Your Radio With This

MULTIBAND CONVERTER

BUILDING A band-switching communications receiver is a project only for a real expert, armed with a lot of expensive test equipment and a considerable amount of know-how. However, a simple converter — with plug-in coils — is a job which even a careful beginner can tackle. And a good converter, used ahead of even a passable a.c.-d.c. radio, will give a \$100 receiver a run for its money.

The converter described here uses the latest in "low noise" circuitry. It is simple to build and will do an excellent job of pulling in short-wave stations from all over the world. Thanks to a simplified tuning arrangement, there are no alignment problems, and the unit can be put into operation with no test equipment at all.

How It Works

The converter uses a pair of 6J6 tubes, and a 6BD6, in a unique circuit popularized by a New Zealand radio amateur, ZL4GP (see schematic diagram in Fig. 2). One of these 6J6 tubes is used as a two-stage oscillator, while the other serves as an r.f. amplifier and mixer. The signal from the antenna is applied to one of the grids of the mixer, while the oscillator signal is fed to the other grid through capacitor C6. The two plates of the mixer are tied together so that the intermediate frequency (the difference between the oscillator and incoming-signal frequencies) appears in the output. This intermediate frequency (i.f.) is then amplified in the following stage and applied to the output jack.



By Jay Stanley

A built-in power supply furnishes the various voltages required by the tubes. To eliminate the possibility of a "hot" chassis, a power transformer is employed. This isolates the circuitry from the a.c. line, and provides filament voltages for the tubes.

The i.f. of the converter falls in the upper portion of the standard broadcast band (between 1400 and 1600 kc.). As a result, any signals picked up by the converter are reduced to a specific frequency within this range and actually rebroadcast to an ordinary radio. In doing this, all of the amplification of the radio, as well as that of the converter, is being used to increase the strength of the short-wave signals. An ordinary 5-tube receiver thus becomes an 8-tube unit for short-wave reception.

Construction

In building the set, the first step is to lay out the chassis. A rear view of the converter, showing the location of all chassis-mounted parts, is illustrated in Fig. 1. The exact location of these is not critical, but your layout should closely follow that of the model, so that the corresponding pictorial diagram, Fig. 3, can be used for the actual wiring. Three holes must be drilled

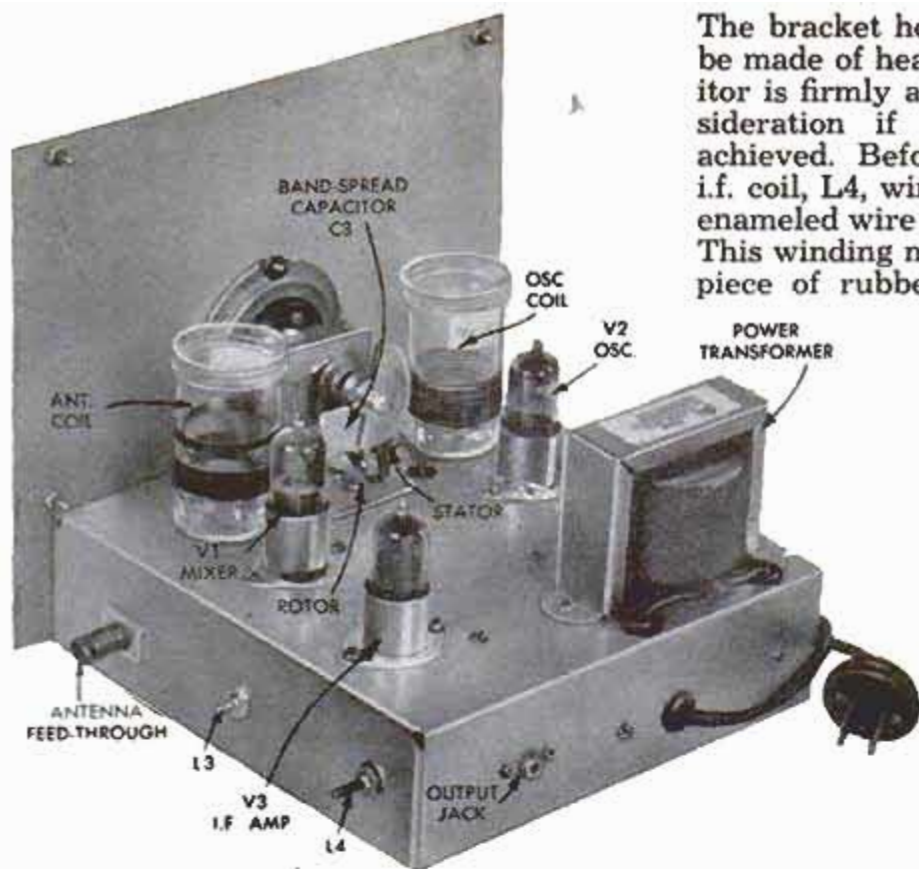

Fig. 1. Rear view of converter shows parts location on 7 x 7 x 2-in. chassis

in the front lip of the chassis to accommodate the band-set capacitor, the on-off switch and the mixer-peaking capacitor. The chassis can then be used as a template for drilling the corresponding holes in the front panel. The holes in the center of the panel, for mounting the bandspread capacitor, C3, may be drilled later, after the capacitor has been mounted on the chassis.

The bracket holding this capacitor should be made of heavy metal so that the capacitor is firmly anchored, an important consideration if smooth tuning is to be achieved. Before mounting the output i.f. coil, L4, wind about 25 turns of No. 30 enameled wire around the end of the form. This winding may be secured with a small piece of rubber tape so that it will not unravel as the coil is mounted.

Be sure to observe polarity when mounting the selenium rectifier between the two terminal strips. Failure to do this will result in damage to the rectifier, the filter capacitors, or both, when the set is turned on.

Wiring of the set is straightforward with the usual precautions of short, well-soldered leads and careful checking and rechecking to avoid wiring errors.

Care should be taken in winding the various plug-in coils to make sure that the correct number of turns is used to cover the individual bands. All antenna coils have two windings while the oscillator coils have only one. The six coils for the lower-frequency bands are wound on 1 1/4-in.-dia. coil forms. For the highest band, commercially available Miniductor coil windings are used. These are wired to standard four-

Fig. 2. Schematic diagram of multiband short-wave converter. Two plug-in coils are used for each band

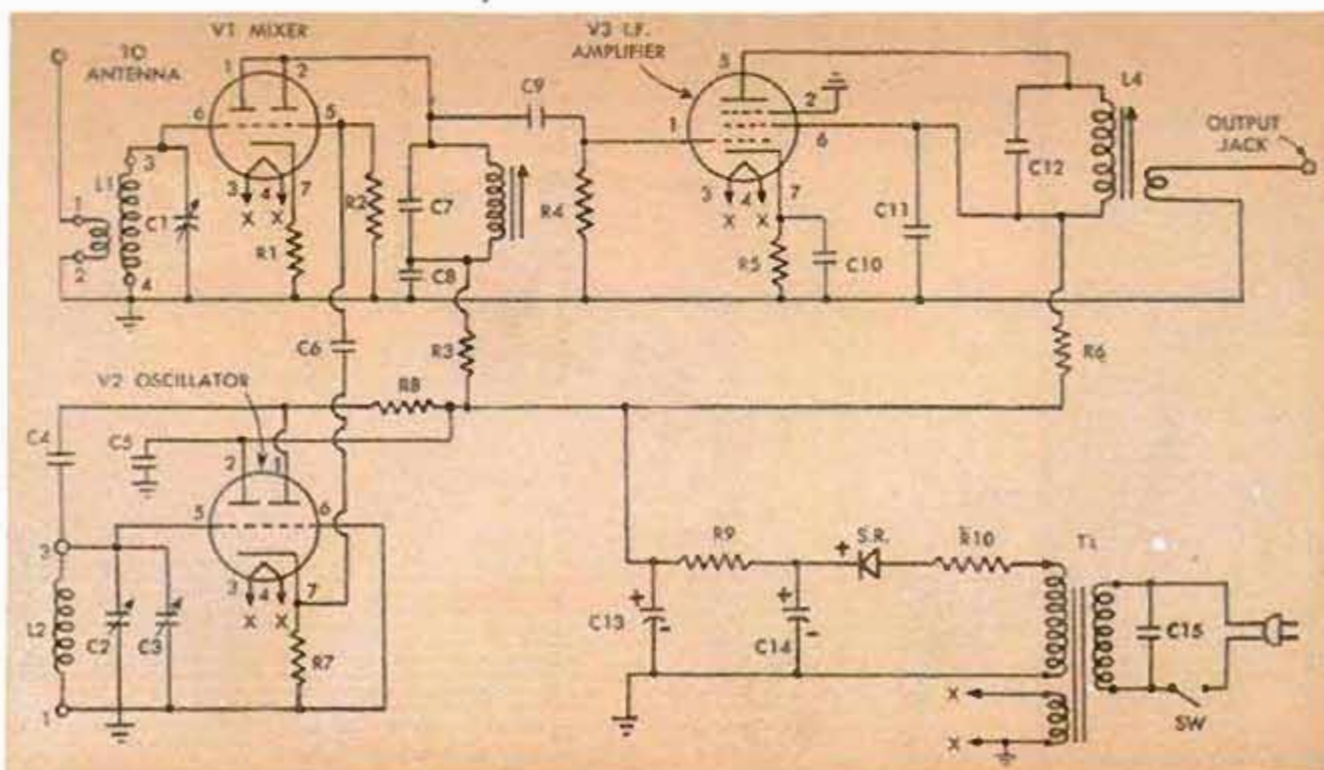

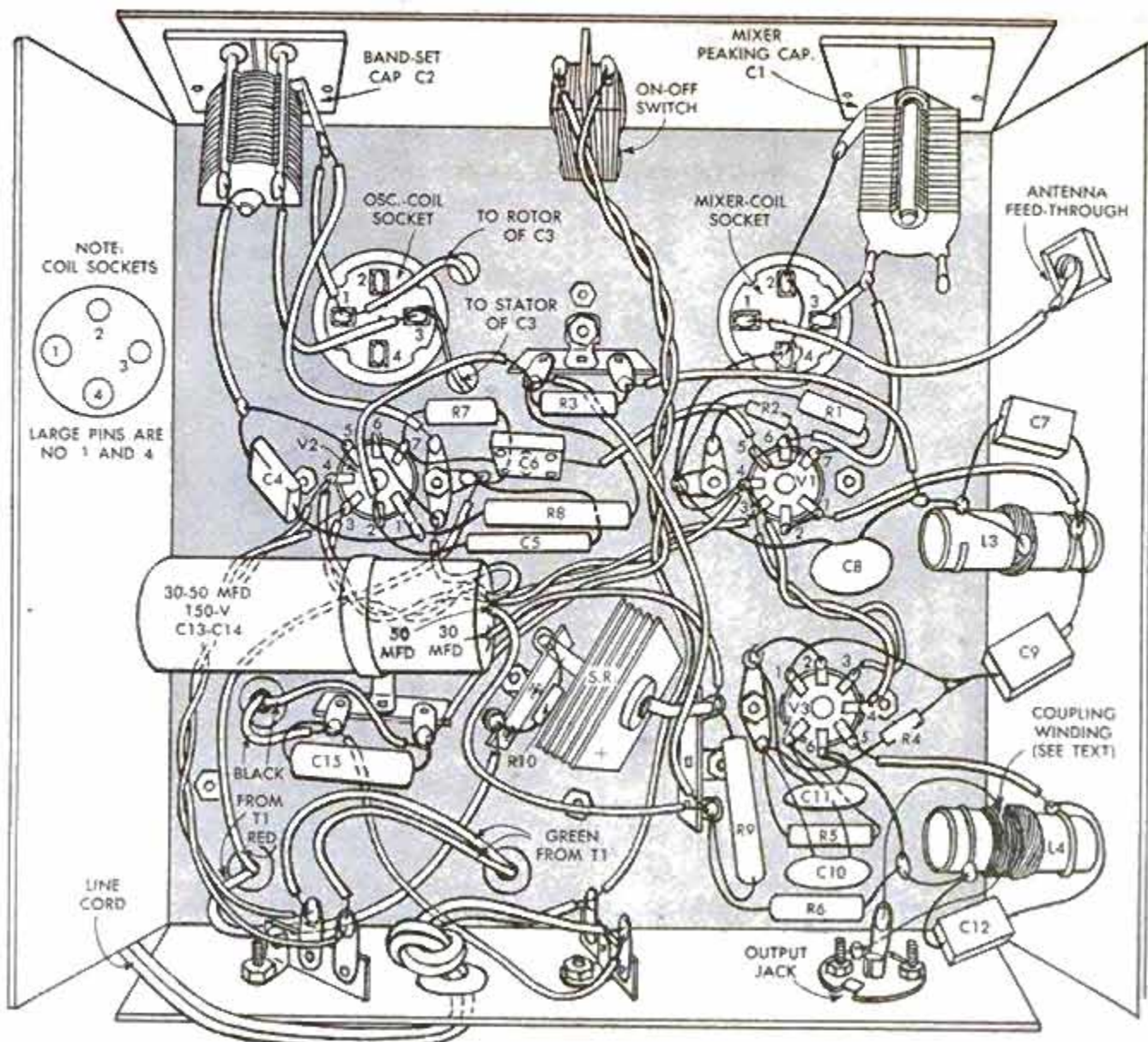

Fig. 3. Bottom view, pictorial wiring diagram. Keep all connecting wires and leads as short as possible

LIST OF MATERIALS

RESISTORS

(K=1000 ohms. M=1,000,000 ohms)

R1=3K, $\frac{1}{2}$ w. R6=1.5K, 1 w.
 R2=27K, $\frac{1}{2}$ w. R8=20K, 1 w.
 R3=4.7K, 1 w. R9=1K, 1 w.
 R4=1M, $\frac{1}{2}$ w. R10=27 ohms, 1 w.
 R5, R7=470 ohms, 1 w.

CAPACITORS

C1, C2=100 mmfd. variable, Hammarlund type HF-100
 C3=15 mmfd. variable, Bud type 1850
 C4, C7, C12=10 mmfd. silver mica
 C5=.003 mfd. ceramic
 C6=100 mmfd. mica
 C8, C10, C11=.01 mfd. ceramic
 C9=50 mmfd. mica
 C15=.005 mfd. 600 v. tubular
 C13, C14=30-50 mfd./150 v. electrolytic

MISCELLANEOUS

L1, L2=Hand-wound coils (see coil table)
 L3, L4=1 mc. slug-tuned coils, CTC type LS-3
 (L4 is modified as per text)

T1=Power transformer, sec. 120 v.-50 ma. and 6.3 v.-2a. Merit type P-3045 or equivalent
 S.W.=S.p.s.t. toggle switch
 S.R.=Selenium rectifier, 65 ma.
 V1, V2=6J6 tubes
 V3=6DB6 tube

Quan. Description

2 4-prong sockets (for coils), ceramic
 6 4-prong coil forms, $1\frac{1}{4}$ " dia., $2\frac{1}{4}$ " high, ICA type 1108B
 1 B & W Miniductor, type 3014
 2 4-prong plugs (see text)
 3 7-prong miniature sockets (use ceramic sockets for oscillator and mixer tubes)
 1 Vernier dial, National type ACN
 1 Dial plate, 180° graduations, for band-set capacitor
 1 Chassis, 7" x 7" x 2"
 1 Panel, 7" x 8 $\frac{1}{4}$ "
 1 Through-panel insulator
 2 Pointer knobs

Line cord with plug, rubber grommets for $\frac{3}{8}$ " hole (4), pin jack, 2-point terminal strips (6), 1 pkg. 6-32 x $\frac{1}{4}$ " machine screws, hex nuts, solder lugs, hookup wire, rosin-core solder.

prong plugs or to coil-form bases from which the tops have been cut off. Fig. 4 shows the two types of coils, together with coil-winding information for the bands.

Special care should be used in drilling the panel holes for mounting the dial. Remember that the shaft coupler of the dial must line up perfectly with the capacitor shaft, and act accordingly.

To avoid hand-capacity effect, with its associated tuning difficulties, the panel must be securely fastened to the chassis. Any paint on the back of the panel, where the panel will contact the chassis, should be scraped away, and the two units should be fastened together with machine screws and nuts at the chassis ends.

(Continued to page 258)

Recording-Level Meter

By Dr. Richard C. Hitchcock

IN LAST MONTH'S ISSUE, we described the construction of a multichannel mixer-preamplifier for increasing the versatility of a recorder or converting an ordinary amplifier into a PA system. Here, then, is a recording-level meter designed as a perfect companion for the mixer.

Most present-day recorders incorporate some sort of recording-level indicator. Usually, this takes the form of a simple neon bulb which lights up on the peaks of the input signal, to indicate that the recorder is being overdriven. Only the most expensive professional recorders actually include a meter which gives a continual indication of the signal strength. Yet, for quality recordings, such a meter is almost indispensable. Not only does it show the point of overloading, but it also indicates when the signal is too weak for proper recording. Observation of the meter, therefore, permits you to turn down the level control for loud passages *before* the overload point is reached, and to turn it up during the soft passages, so that these, too, will be audible in the final reproduction.

In use, the meter is plugged into the monitor jack of the mixer. At this point, the output voltage is high enough to drive the meter pointer off scale when the signal at the mixer output jack has reached a level which will overdrive the recorder. The audio signal is then rectified by an instrument-type rectifier and applied to a

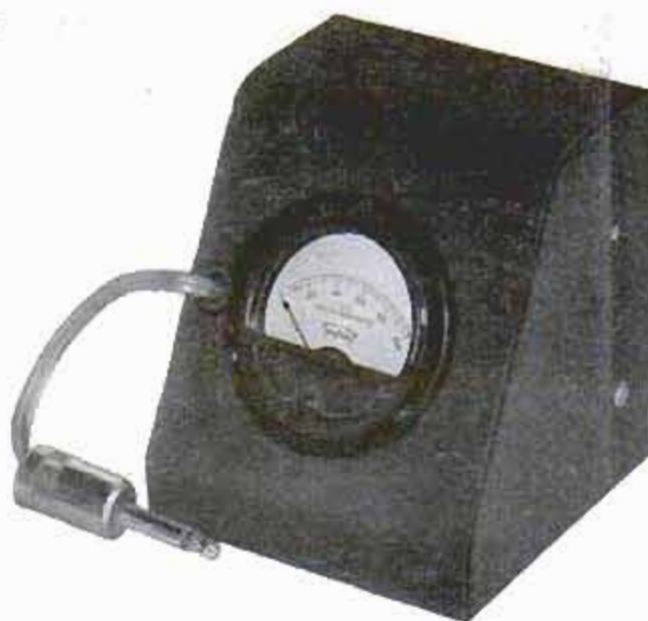

sensitive d.c. meter through a 1000-ohm limiting resistor. A 100-mfd. capacitor in parallel with the meter and limiting resistor slows down the action of the meter so that it will tend to indicate the average level, rather than the instantaneous peaks, of the recorded program. By careful monitoring of the meter, both extremes, the dangerously loud and the abnormally soft passages can be adjusted to the proper recording level.

The simplicity of the circuit is shown in the pictorial and schematic diagrams. The entire unit is built into a sloping-panel steel cabinet which matches that of the mixer. The rectifier is mounted on the side of the cabinet and its leads are soldered to a terminal strip. These leads should not be

(Continued to page 262)

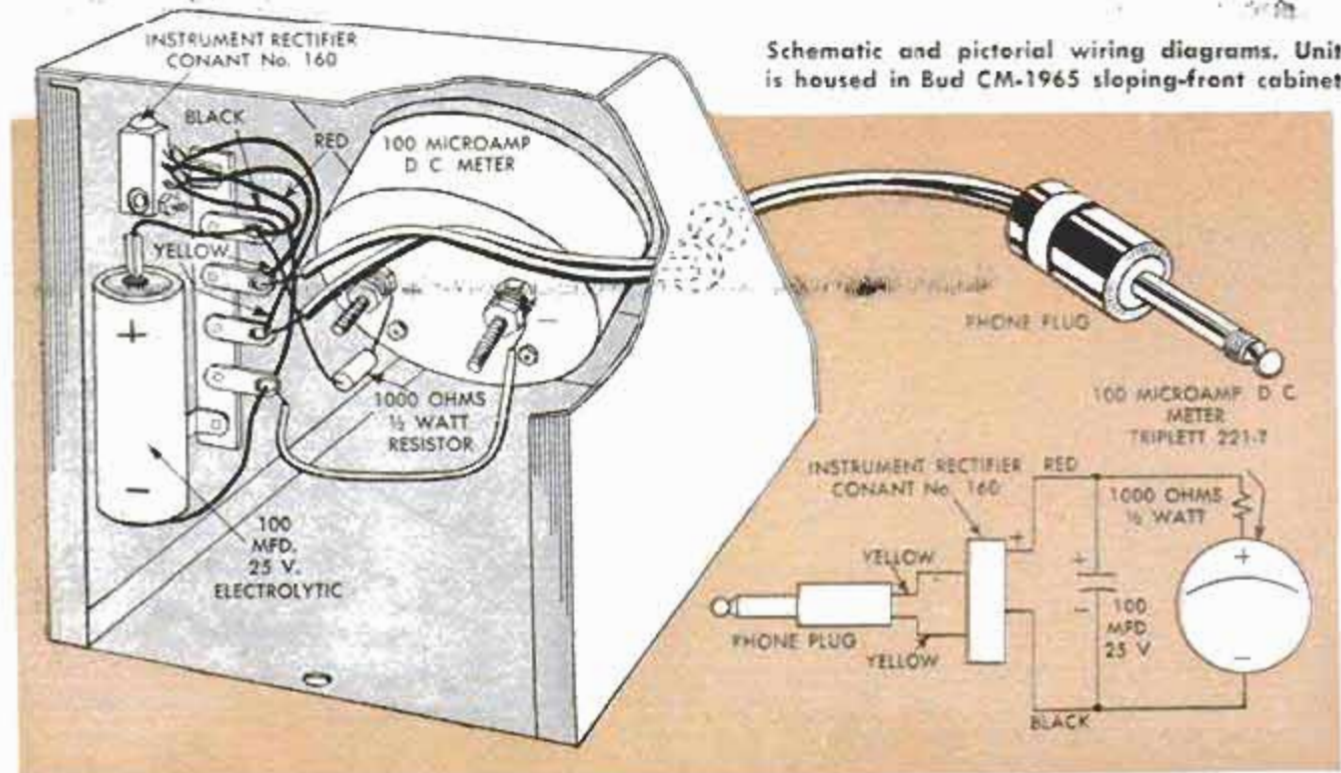

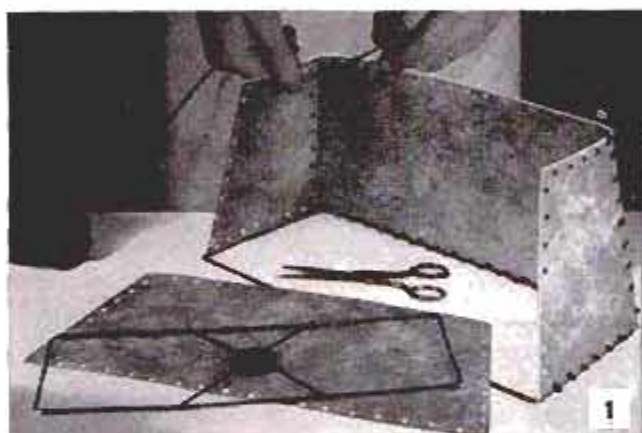

MATCHING LAMP and FOLDING SCREEN

By Bertram Brownold

NOW AVAILABLE in many craft and hobby shops is thin, rigid plastic sheeting, called Panlam, that is featured in a variety of colors and patterns. Because it is translucent, the plastic is ideal for such items as lamp shades, folding screens and room dividers. Although only a lamp shade and folding screen are described in this article, their construction will suggest many other uses for this versatile plastic material that can be cut with ordinary scissors.

The lamp shade requires two wire frames as detailed in Fig. 2. Joints in the wire can be soldered or the wire may be hammered flat and drilled to permit using small rivets. No vertical members are required in the lamp-shade frame, since the plastic is rigid enough to support itself. Drill holes along the edges of the plastic pieces that are used for the shade to permit lacing them to the frame and to each other. Holes are centered $\frac{1}{4}$ in. from the edges and $\frac{3}{4}$ in. apart.

Embossed sheet aluminum, another modern material, is used to make the lamp for which the shade is designed. The lamp consists of a wooden form, Figs. 2 and 3, over

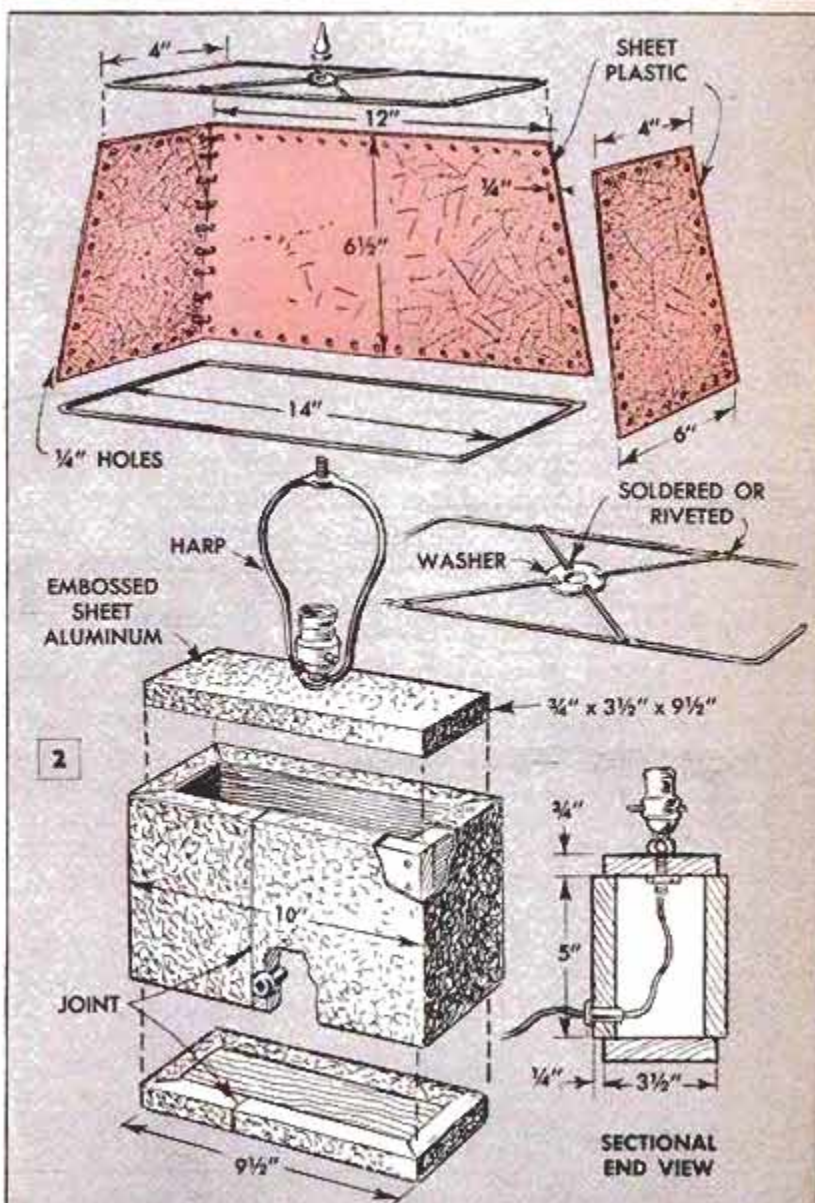



Above, lamp and screen provide interesting ensemble in living room. Below, cutting Panlam with scissors



which the aluminum is folded. A regular lamp harp is used, and is held on the lamp by an assembly consisting of a short $\frac{1}{8}$ -in. pipe nipple screwed into a lamp socket and fitted with a locknut as shown in the sectional end view in Fig. 2. When the sheet aluminum is folded around the wooden lamp form, a seam will result, Fig. 3. Keep the seam at the back of the lamp where it is not readily noticed. To emphasize the embossed pattern of the aluminum, paint it a color to match the plastic shade. Then wipe off the wet paint with a soft cloth so the high spots of the embossing are accentuated. The resulting highlighted pattern is compatible with the design in the plastic.

Frames for the panels of the folding screen are cut from $\frac{3}{4} \times 1\frac{5}{8}$ -in. stock and a $\frac{3}{8} \times \frac{3}{8}$ -in. rabbet is cut along the inner edge of each member to receive the plastic sheet. Joints are half-lapped as shown in Fig. 5. The center cross pieces of the screen frame each require two pieces of $\frac{1}{4} \times 1\frac{3}{4}$ -in. stock. One of the pieces is the full

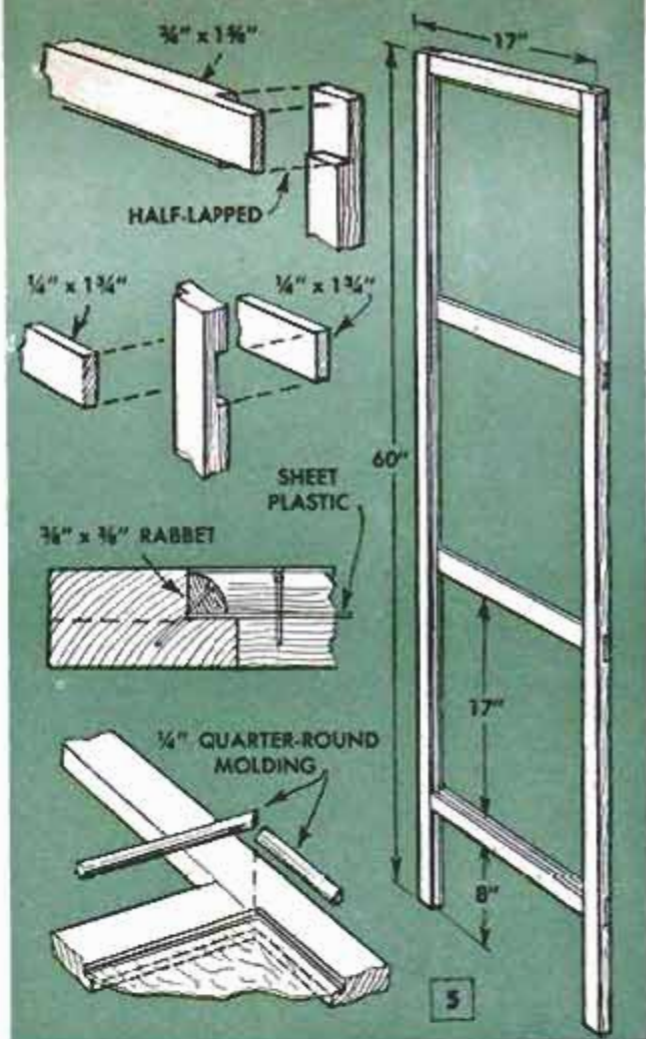

width of the screen and is set in notches cut in the vertical members. The other piece is shorter by the width of the two vertical members and is nailed over the first piece so the plastic, which is fitted the full length of the frames as shown in Fig. 6, is sandwiched between them. To hold the plastic in the rabbets of the frame, $\frac{1}{4}$ -in. quarter round is nailed over it as indicated in the detail in Fig. 5.

Also shown in Fig. 5 is an alternate method of assembling the screen frames, in which three small sheets of plastic are used instead of one larger piece. The cross pieces are made of the same size stock as the end pieces and rabbeted on both edges. Quarter round then is nailed into the rabbet over the plastic on all four inner edges of each section of the screen panels as indicated in the lower left-hand detail in Fig. 5. Two-way hinges, of the type specially made for folding screens, are used to hinge the screen panels together. Fig. 4 shows the completed ensemble in use in the home. ★ ★ ★

☐ Proper location for a piano is against an inside wall away from extremes in temperature such as excessive heat from radiators, or cold drafts, which affect both tone and finish. Non oily polish should be used to protect the keys; other types tend to darken the finish.

Partitions Separate Contents of Night-Stand Drawer

Installing partitions in the drawer of your bedside night stand will enable you to keep its contents in order and make it easier to locate items when they are needed. Scrap pieces of wood, $\frac{1}{4}$ in. thick, may be used for the partitions, which are fastened together with glue and brads. If you prefer to leave the partition assembly loose in the drawer to facilitate cleaning, wooden braces should be added to prevent it from sliding or twisting out of place. An unused cutlery box provides an even easier method of partitioning the drawer, since it is already divided into sections. The most economical means, however, is to join a number of shallow cardboard boxes together and place them in the drawer for use.

Empty the carpet sweeper or vacuum-cleaner bag on a dampened piece of paper to prevent the dust from flying excessively.



Rubber Band Holds Handbills For Single-Copy Distribution

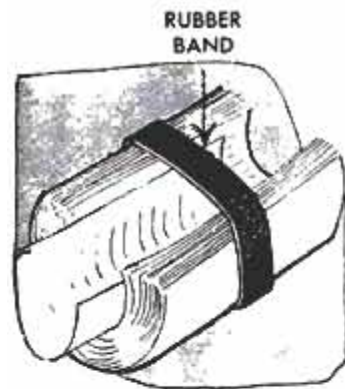

To hold handbills conveniently and securely for easy distribution one at a time, snap a rubber band around them as shown. A sturdy rubber band for this purpose can be cut from a discarded inner tube. Handbills held in

this manner may then be removed, one at a time, from inside the packet without disrupting the remainder.

Toilet-Tank Sweating Prevented With Tepid-Water Supply

Condensation on a toilet flush tank was prevented by one homeowner, who installed an old hot-water tank in the basement, near the furnace, to feed warm water to the toilet. The tank was hung up under the ceiling, a water supply hooked to the intake, and a line run from the outlet to the toilet. Air temperature in the basement warmed the water in the tank, so that approximately 15 flushes in succession can be handled by the water supply.

W. H. Blair, Trail, B. C., Can.

Spring-Wound Alarm Clock Operates Pull-Chain Socket

A time switch that will turn a lamp, radio, or other electrical device on or off automatically can be made with a spring-wound alarm clock and a pull-chain socket, as shown in the illustration. An extension is added to the alarm-winding key to provide space for the string which is attached to the chain on the socket. A hole drilled across the extension permits tying the string so it cannot slip on the shaft. Screw a receptacle plug into the socket to accommodate the appliance cord.

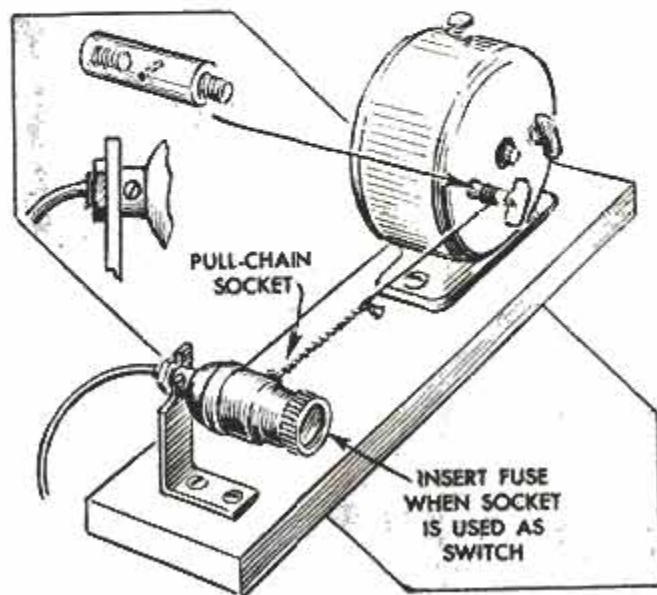

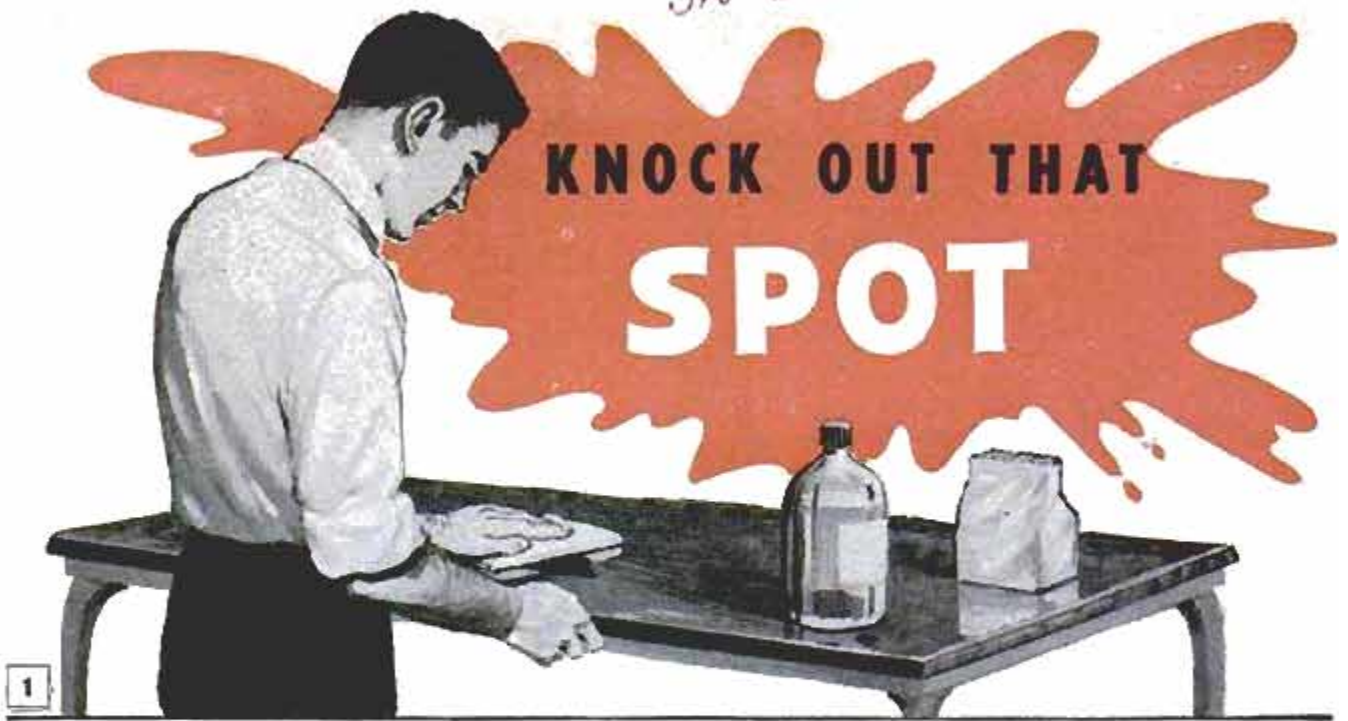

By J. B. Mullen

ALTHOUGH THERE ARE many different staining materials that can cause spots or stains on natural and synthetic fabrics, painted surfaces, masonry and marble, most of these readily classify into types and for each one there is an effective solvent. The solvent can be any liquid used to remove a stain by dissolving it, washing it away by detergent action, or destroying it by chemical action. Table I lists common types of stains and suggests the types of solvents to use on washable and non-washable materials. Table II lists certain other stains that do not classify with major types, while Tables III and IV list types of

solvents and specific applications and show how to make up a handy household spotting kit, also pictured in Fig. 3. The tables are included merely for reference. They are not all-inclusive.

In removing stains from fabrics and certain other materials, there are two points to keep in mind. The first is that the spot may be caused by the combined action of several staining materials. Machine oil, for example, might include metal particles as well as carbon and perhaps acids. The second point to be remembered is that solvents which are harmless to one material may damage another. Because of this the choice



TABLE I—TYPES OF STAINS				
Type of stain	Examples	Use solvent		Do not use
		On washable material	On nonwashable material	
Protein	Egg, meat, blood, milk, cream	Cold water, detergent	Cold water,* inert solvent, detergent	Hot water, heat in any form
Water-soluble	Sugar, syrup, candy	Water, detergent	Cold water*, inert solvent, detergent	
Greasy	Fats and oils, petroleum jelly, motor oil, tar	Grease solvent, detergent	Grease solvent	
Dye-type	Fruit stains, grass, dyes	Hot water, oxidizing	Warm water, oxidizing (mild)	Soap or alkaline substances
Starchy	Flour, starch	Hot water, detergent	Inert solvent, detergent, warm water*	
Solid soil	Mud, metal particles	Brush off, detergent, inert solvent	Brush off, detergent, inert solvent	
Iron (rust)	Rust	Acid	Acid*	

* Sometimes usable by sponging; test before using.

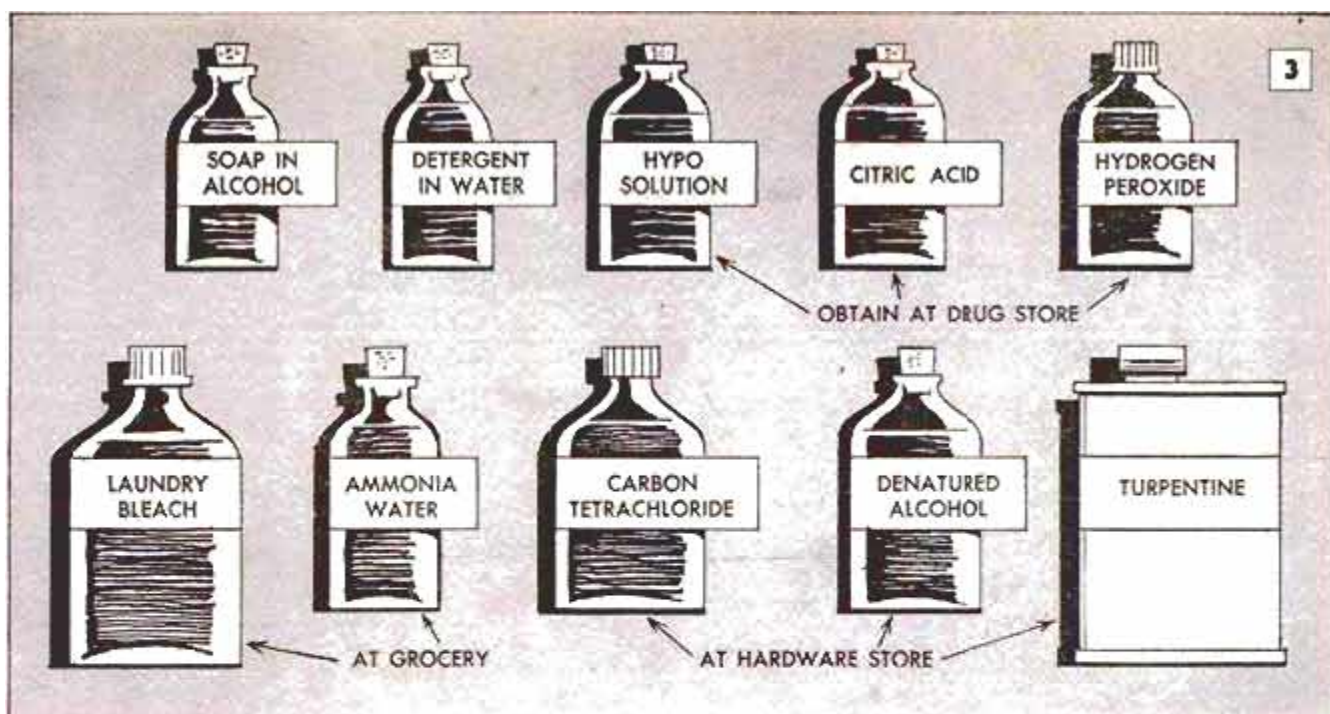

of a solvent is determined both by the stain and the fabric. As a rule, water or solutions in water can be used on washable fabrics, but are not effective on nonwashable fabrics except perhaps by light sponging. Carbon tetrachloride and other non-water-containing solvents are usable on both types of materials and are especially helpful on nonwashables.

Another important classification of fabrics is that between white and colored, or dyed. The inert solvents, water, detergent in water, alcohol, carbon tet and benzol generally can be used on white or colored fabrics, but active solvents such as alkali (ammonia or borax), citric and tartaric acids, laundry bleach and hydrogen per-

oxide usually will change the color of dyes. Avoid the use of these on dyed fabrics. In general, all common solvents can be used on cotton or linen fabrics without damaging the fibers. However, do not use the acid solvents. Alkalis and oxidizing solvents should not be used on silk or wool. Carbon tet is perhaps the only solvent in the spotting kit, Fig. 3, that can be considered safe on fabrics made from synthetic fibers. When any other solvent is used it should first be tested on a scrap of the material. Table III lists a number of solvents for use on different textiles.

There are four methods of applying solvent to fabrics to remove stains. These are the application of pressure, soaking,

Stain	How to remove it
Oil paint—fresh	Remove oil with turpentine or benzol, then launder or (on non-washables) use carbon tetrachloride
— old	Soak in ammonia or borax, launder. Or: soak in benzol
Water paint—fresh	Use water, detergent solution, ammonia
— old	Soak in ammonia
Iodine	Use hot water, or alcohol; on starched material, use hypo
Silver stains	Use hypo (usually requires soaking)
Lipstick	Rub with lard or petroleum jelly, use grease solvent or detergent
Coffee, tea	Hot water; if spot remains, use oxidizing solvent
Wax (paraffin, candles)	Chill if necessary, and scrape off as much as possible. Remove the rest with carbon tetrachloride
Gum	Scrape off as much as possible; then use carbon tetrachloride
Perspiration	Use detergent, then laundry bleach; or sponge alternately with vinegar and ammonia
Scorch	Use mild oxidizing agent, or moisten and place in sun (permanent on silk and wool)
Mildew	Detergent; then use laundry bleach, or hydrogen peroxide
Ink	Apply citric acid or oxalic acid; or apply these alternately with laundry bleach. Many colored inks can be removed with water or alcohol.

Note: Before using the solvents, be sure that they are safe on the material (See Table III)



WHEN REMOVING SMALL SPOTS HOLD MATERIAL OVER CUP OR TUMBLER AND SPONGE



and front and back-sponging. The first refers to the use of water as a solvent. Hold the spotted portion of the cloth under the faucet and turn on the cold water. Often it will help to use embroidery hoops to hold the stained portion of the fabric taut, Fig. 2. In some cases moderately hot water is more effective. Of course, this method is only usable on washable materials and where water can be used as a solvent. Soaking generally means placing the stained portion of the fabric in a small bowl, Fig. 6, and immersing the spot to give the solvent a longer time to work. Often this procedure will need to be followed by sponging to remove rings. It also is effective when using the acid solvents and oxidizing solvents such as hydrogen peroxide, which often require time to act fully.

Sponging is the common method of rubbing the stained fabric lightly with another cloth saturated with a solvent. Many non-washable materials can be sponged in this manner without damage and the grease solvents, such as carbon tet, are most often applied by front-sponging; that is, the solvent is applied to the face of the fabric, Fig. 5. In back-sponging, the solvent is sponged onto the reverse side of the fabric. If the spot is small and covers only a small area, it often helps in either front or back-sponging to stretch the material over the top of a cup or tumbler as in Fig. 4. A more effective method in removing large spots is detailed in Fig. 7, A to D inclusive. Here the material to be sponged is inverted over a pad of clean cloth or blotting paper and back-sponged with a saturated pad. This method has the advantage, especially when treating large spots, of carrying the staining material out of the fabric and into the absorptive pad on the face side without forming rings difficult to remove from the

thicker fabrics. As a rule it is necessary to change the absorptive pad at least once and often two or more times to assure complete removal of large spots containing a considerable amount of staining material. Some users of this method prefer a cotton pad rather than a folded cloth pad for applying the solvent. In using the cotton pad, a somewhat greater amount of solvent can be concentrated in a small area. Fold the cotton pad in a square of lintless cloth.

Rings, formed by the solvent carrying a portion of the stain away from the center of the spot, can be prevented by sponging away from the center of the affected area, working in one direction only and not rubbing back and forth, Fig. 8. On lighter fabrics the rings often are made more conspicuous simply by the contrast of the cleaned area with the rest of the garment.

Many types of stains on materials other than fabrics can be removed simply by washing with a mild detergent. Where oily substances have penetrated and stained painted wood and concrete floors, a "poultice" consisting of an oil solvent mixed with an absorbent material, such as corn meal or whiting, is quite effective. Stains on the marble tops of old tables often can be removed by this method. Sometimes it is best to dust an absorptive material on marble and then apply a pad saturated with a solvent, Fig. 1. The pad tends to retard evaporation of volatile solvents. Although highly flammable, naphtha is perhaps the best for the purpose on most surfaces treated in this manner as it does not soften common finishing materials and it will not damage ordinary marble. Use naphtha outdoors. Ordinary stains that have penetrated brick and stone masonry generally can be removed by poulticing. In some cases simply scrubbing with a detergent solution will prove effective. ★★

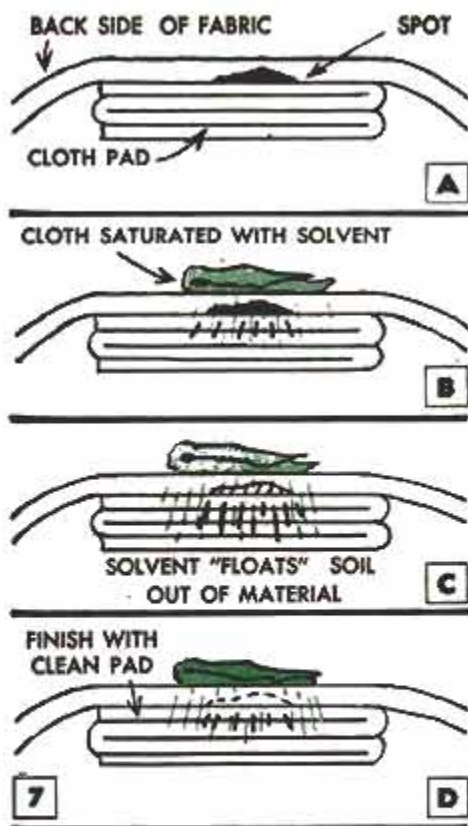

Back-sponging with absorptive pad placed against face side of material is a good method of removing stains on most fabrics, especially those stains covering a fairly large area

Trick in rubbing out stains by the pressure method, using a pad, is to make straight, one-way strokes away from center of stained area. Method prevents formation of rings

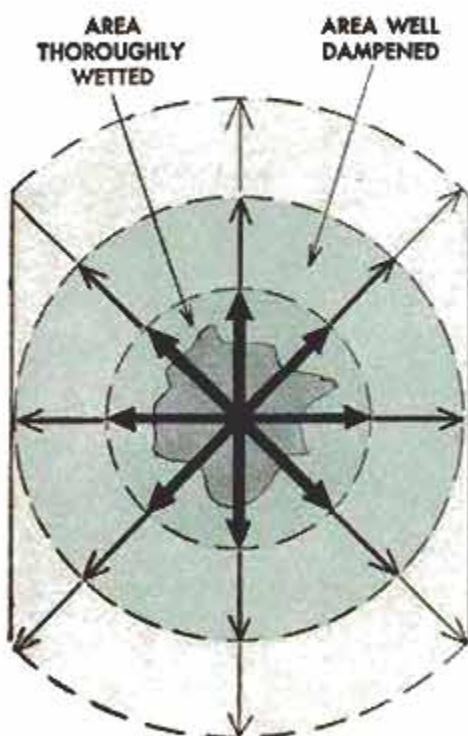

ARROWS INDICATE DIRECTION OF RUBBING. WEIGHT OF ARROWS SHOWS DEG. OF SATURATION

SEPTEMBER 1956

TABLE III—SOLVENTS AND THEIR APPLICATIONS

Solvent class	Name of solvent	Type of stain	Safety of use on textiles					
			Cotton	Linon	Colored Cotton	Silk	Wool	Synthetics
Cold water		Protein-type	A	A	B	B/C	B/C	B/C
Hot water		Fruit, etc.	A	A	B	B/C	B/C	B/C
Inert solvents	Carbon tetrachloride*	Greasy type	A	A	A	A	A	A
	Benzol	Greasy, paint	A	A	B	A	A	B/C
	Turpentine	Paint	A	A	A	A	A	B/C
	Alcohol (or methanol)	Grease; also other stains	A	A	B	A	A	B/C
Oxidizing solvents	Laundry bleach	Fruit, dye-type, etc.	B	B	N	N	N	C/N
	Hydrogen peroxide*		A	A	C/N	C	C	C/N
Detergents	Detergent solution	Greasy type solid soil, etc.	A	A	B	B	B	B
	Soap in alcohol*		A	A	A	A	A	A/B
Acids	Citric acid, oxalic acid, tartaric acid, acetic (vinegar)	Iron, rust alkaline stains	B	B	C	B	B	C/N
Alkali	Ammonia water	Acid stains, perspiration	A	A	C	C	C	C/N
	Borax solution		A	A	C	C	C	C/N
Reducing solvents	Hypo solution	Silver stains, iodine	A	A	C	B	B	B/C
Lacquer solvents	Acetone	Lacquer, nail polish	A	A	B	B	B	C/N
	Lacquer thinner		A	A	B	B	B	C/N

A — Nearly always usable

B — Usually usable, at least by sponging

C — Sometimes usable; try cautiously, by sponging

N — Not safe

* Mildest solvent of its class; best choice for delicate materials

TABLE IV — "SPOTTING KIT" SOLVENTS, AND HOW TO PREPARE THEM

Solvent	Class	Obtain from	How to prepare	Substitute solvents
Carbon tetrachloride	Inert solvent (grease)	Hardware or drug store	Use as purchased	Benzol, naphtha
Turpentine	Inert solvent (paint)	Hardware store	Use as purchased	Mineral spirits, V.M. & P. naphtha
Hydrogen peroxide (3%)	Oxidizing	Drug store	Add a drop of ammonia to a portion just before using	
Laundry bleach (Sodium hypochlorite)	Oxidizing	Grocery	Use 2 to 4 tbsp. in a pint of water	
Detergent solution	Detergent		Dissolve 1 tsp. of mild detergent in ½ pint water	Liquid shampoo
Soap in alcohol	Detergent		Dissolve 1 tsp. of mild soap flakes in ½ pint alcohol	Tincture of green soap
Citric acid	Acid (esp. for iron)	Drug store	Dissolve 1 tbsp. of crystals in ½ cup (4 oz.) of water	Oxalic acid, tartaric acid; or acetic acid, 5% (white vinegar)
Ammonia water	Alkali	Grocery	Use as purchased	Borax solution (2 tbsp. in a pint of water)
Hypo (sodium thiosulphate)	Reducing	Drug store	Dissolve 4 tbsp. in a cup (8 oz.) water	
Alcohol (denatured)	Inert solvent	Hardware store	Use as purchased	Methanol (wood alcohol)

Bolts Through Ends of Bed Slats Keep Rails From Spreading



Bed rails may be held together by inserting stop pins, made from bolts, in holes drilled at the ends of the slats and partly through the rail cleats. With the bolts in place, the bed is easily moved without dropping the spring and mattress.

Victor H. Lamoy, Upper Jay, N. Y.

Thread Spool Aids in Driving Bullet-Type Latch

When driving a bullet-type cabinet latch, the sleeve will not be crushed if one end of a wooden thread spool is held on the flange. To insure trouble-free operation, depress the ball and apply a drop of oil.



Appliance Cords Stored In Mailing Tubes



Cords from a toaster, iron and other small appliances won't get snarled together in the storage drawer if each cord is folded and a piece of cardboard tube is slipped over it. A coat of shellac will strengthen the cardboard.

Swedged Joints for Copper Tubing

When joints in copper tubing occur in locations where it is impossible to join the two ends in the regular way with a coupling or union, swedged joints can be used. Swedging consists of enlarging the end of one tubing so it will slide snugly over the end of another tubing as shown. To do this quickly and accurately, clamp the tubing in a flaring block mounted in a vise and tap a swedging punch into it until the diameter is large enough to accommodate the other pipe. Clean both inside and outside contacting surfaces of the tubing and carefully sweat-solder the joint to make it leakproof.

Salt Shaker Dispenses Pumice

The next time you use powdered pumice stone or other powdered abrasive for rubbing down furniture surfaces to a smooth satiny finish, try a salt shaker as a dispenser. Besides being convenient, the shaker assures uniform distribution, which counts in getting superior results.

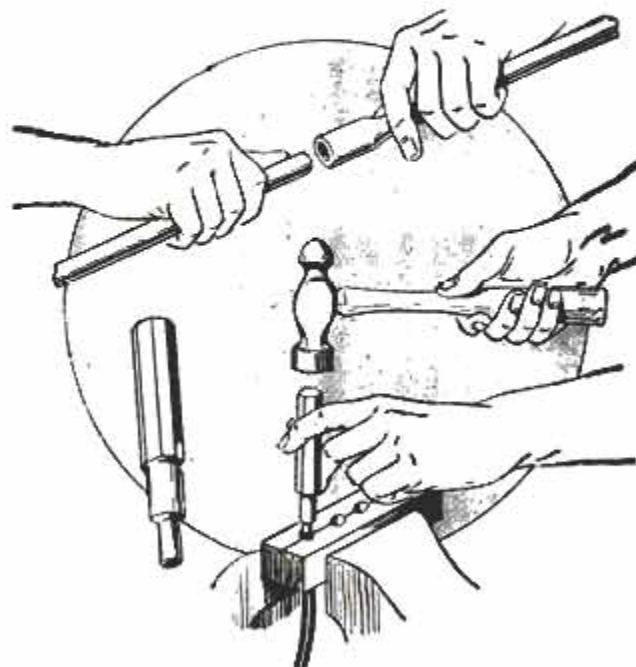

Gatepost Light Simulates Old Locomotive Headlamp

WTM 50

RESEMBLING the headlamp from an old wood-burning locomotive, this gatepost light was made by a model-railroad enthusiast to illuminate his house number. Smaller in size than the original lamp, the major construction change was substitution of electrical light for the kerosene lantern.

All metal parts are galvanized sheet metal which can be readily soldered. The base is assembled first from the three pieces marked A, B and C. Overlapping tabs are soldered to the adjoining piece. The light chamber is framed with $\frac{3}{4}$ -in. galvanized angle and a faceplate of sheet metal in which a 5-in.-dia. hole has been cut. Fitted into the hole is a 2-in. length of stovepipe with $\frac{1}{2}$ -in. tabs cut along the inside edge. An aluminum reflector is hinged to the opposite side of the light chamber to provide access for changing the bulb. A spring catch locks it shut. Individual metal tabs, soldered to the frame, hold the front lens and side windows in place.

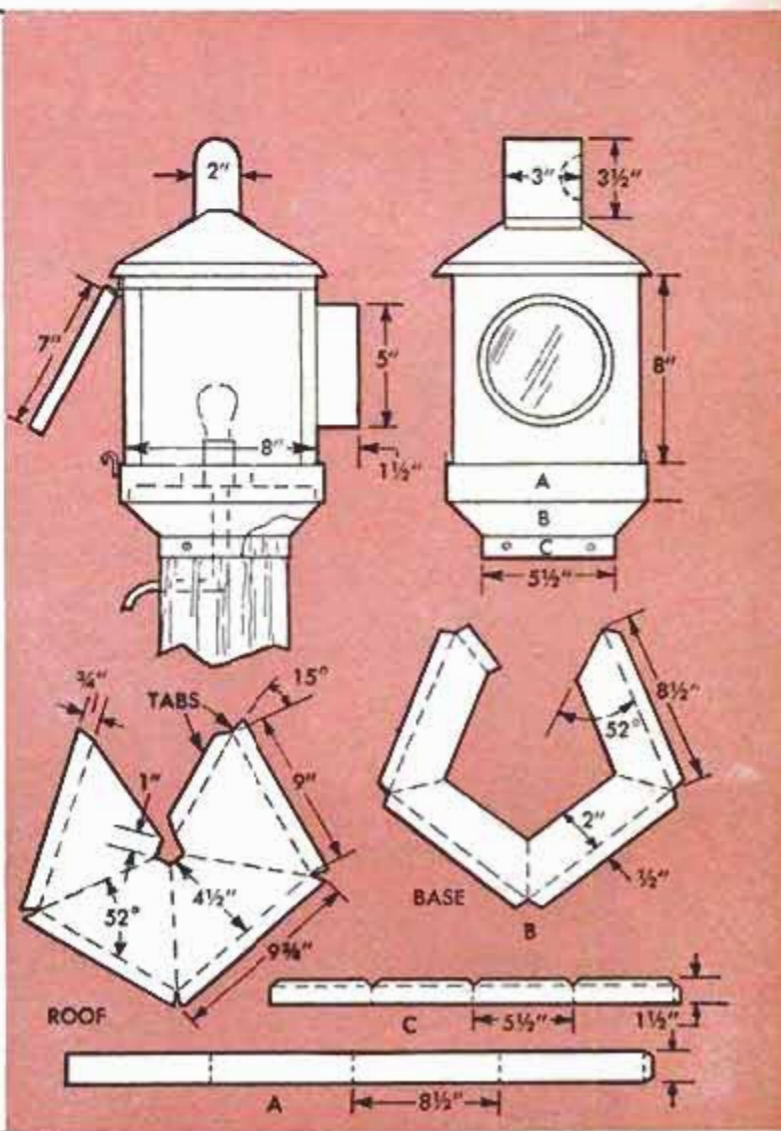
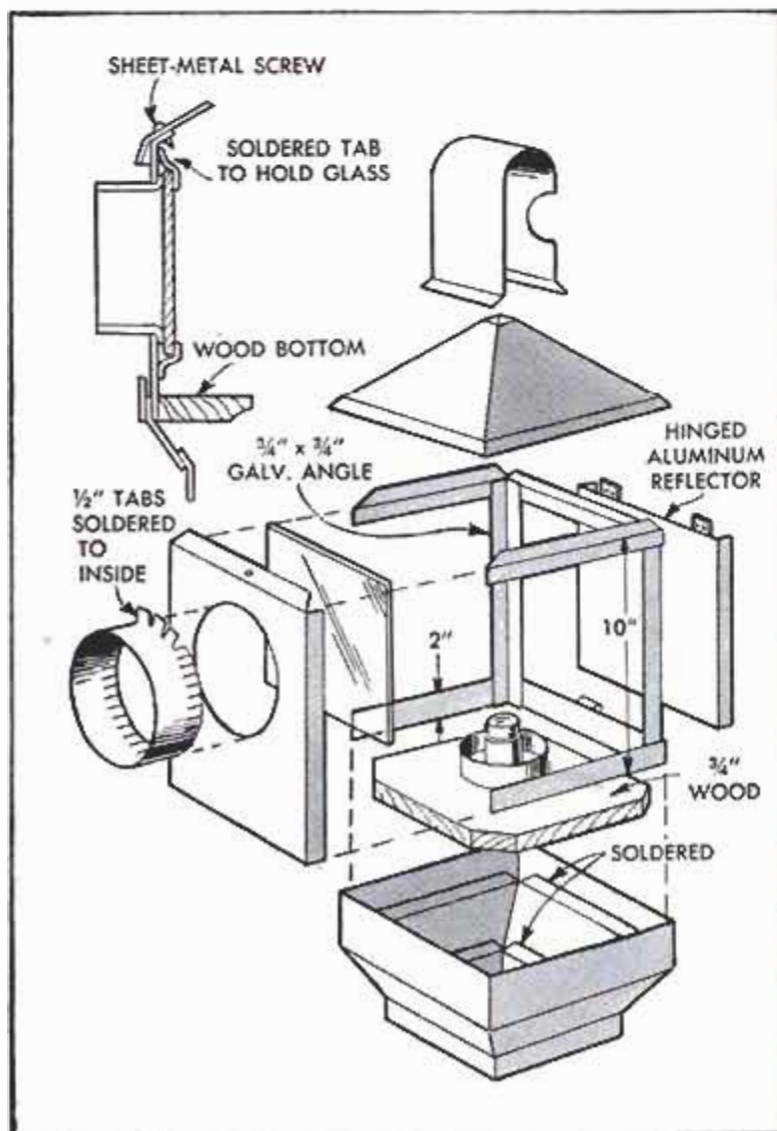

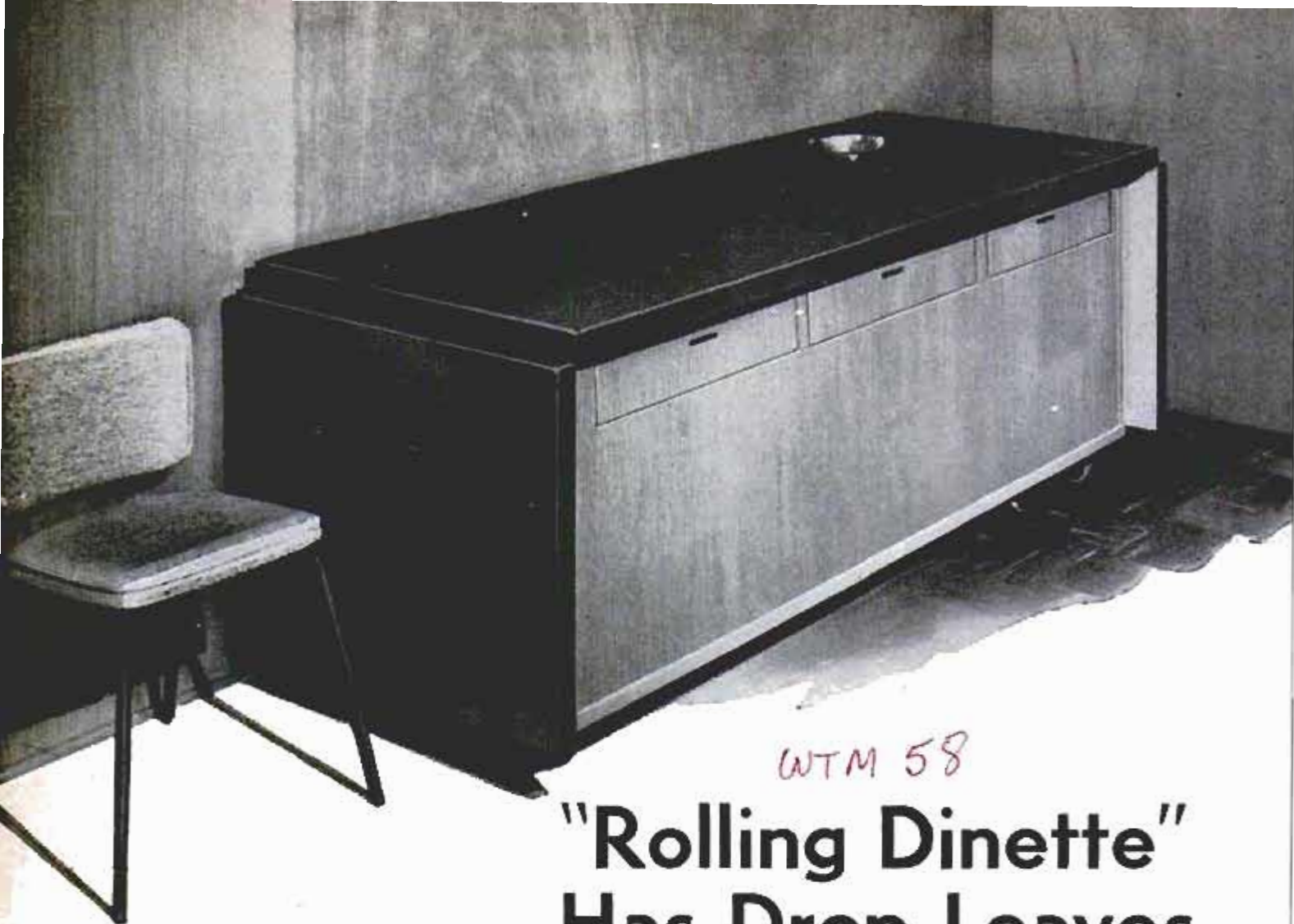

WTM 58

"Rolling Dinette" Has Drop Leaves

By Hi Sibley

IN THE HOME or apartment where dining space is limited, this narrow drop-leaf table on casters provides a means for serving guests on special occasions yet occupies a minimum of space when not in use. An eye-catcher with its natural finish base contrasting with the plastic-laminate top, the table is used to conceal three extra chairs when placed against the wall. Silverware and linen may be kept conveniently in the three matching drawers.



To make the table, first assemble the front and back frames using corrugated fasteners on the inside to secure the butt joints. If equipment is available, a more sturdy construction is possible with half-lap or mortised joints. Next, glue on the plywood paneling after first cutting out the openings for the drawers. Cut out each piece accurately so it can be used on the front of the corresponding drawer, resulting in a continuous grain effect. On the opposite page dimensions are given for both vertical and horizontal application of the paneling. Plywood glued to the back frame should extend down the corner members to the bottom.

Join the front and back sections together with the built-up end frames and then install the four drawer guides. The guides are nailed to the drawer rails which are cut to fit around the short vertical braces at the back. The drawer rails rest on $\frac{3}{4}$ x $\frac{3}{4}$ -in. cleats nailed to the front framing, and on the horizontal rail running just above the kneehole opening at the back. To prevent the drawers from tipping down when pulled out, slides are nailed between

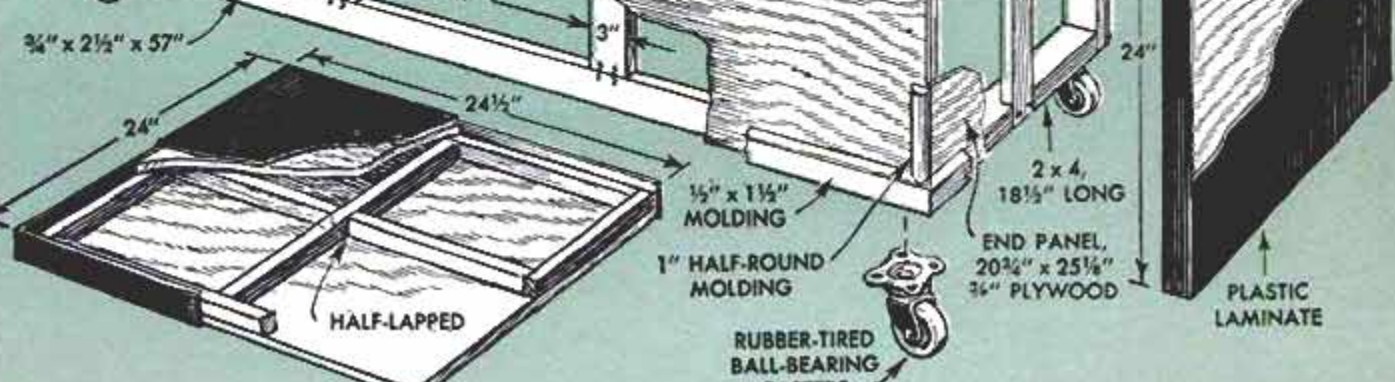
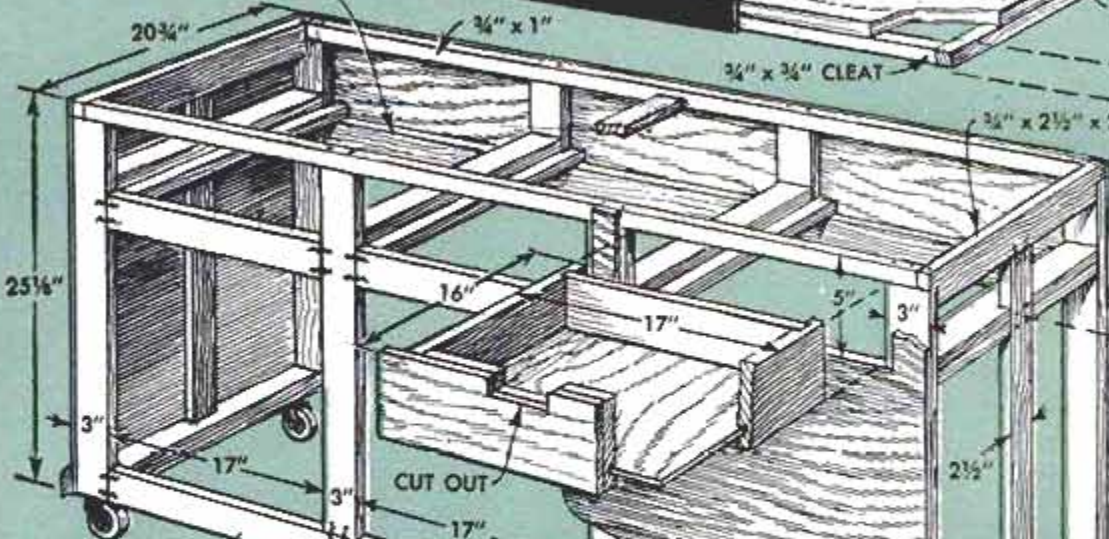
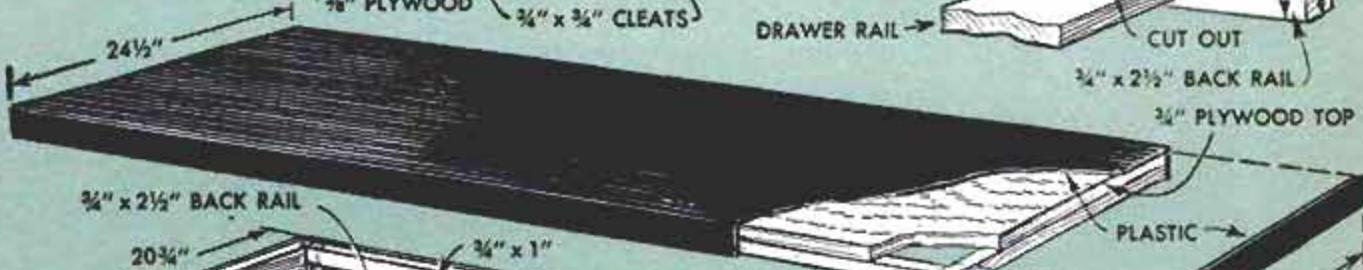
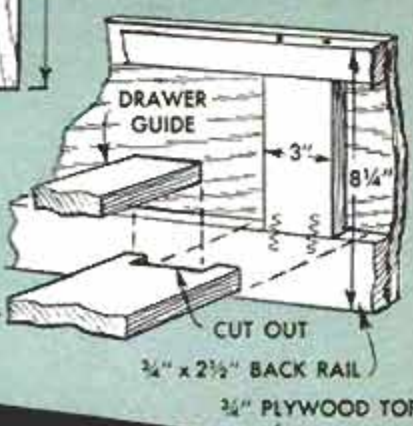
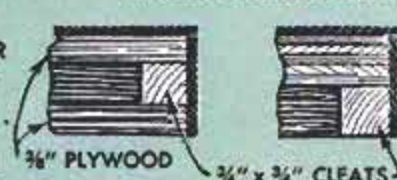
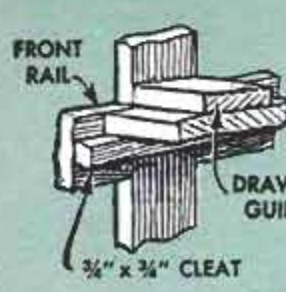
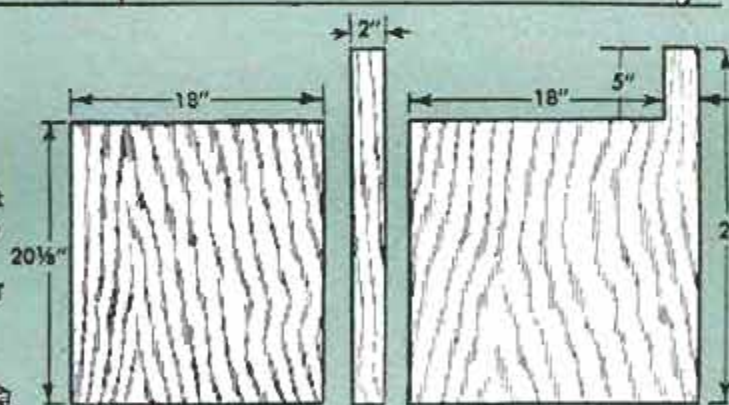
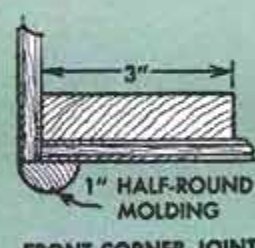
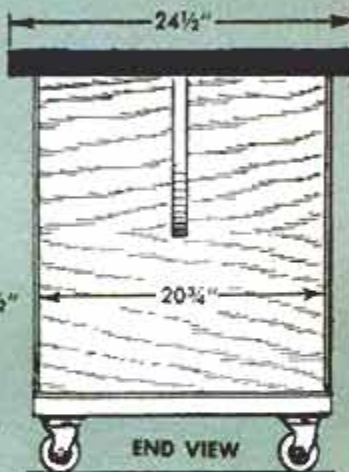
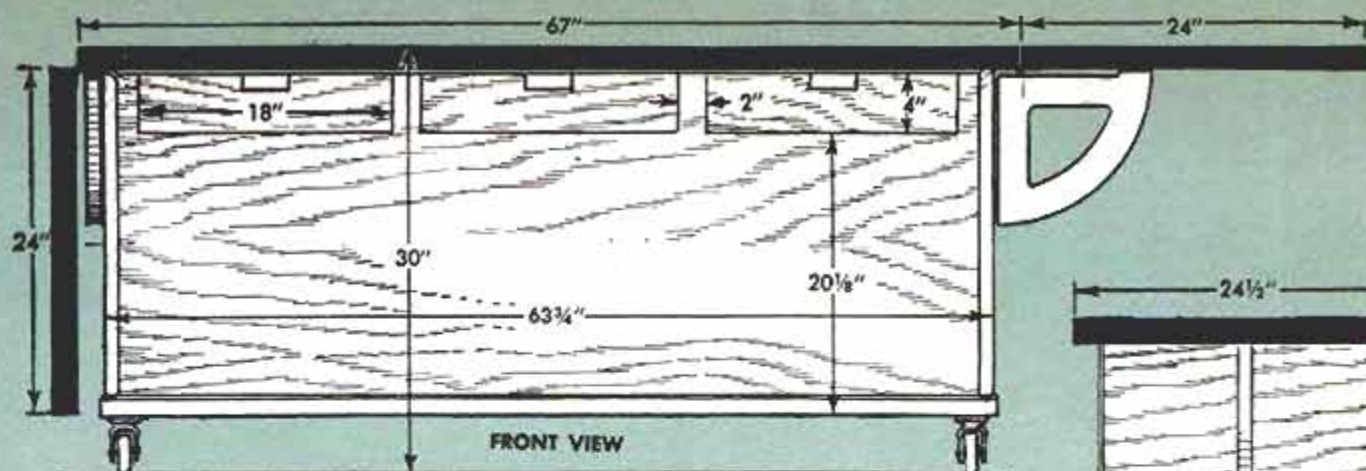

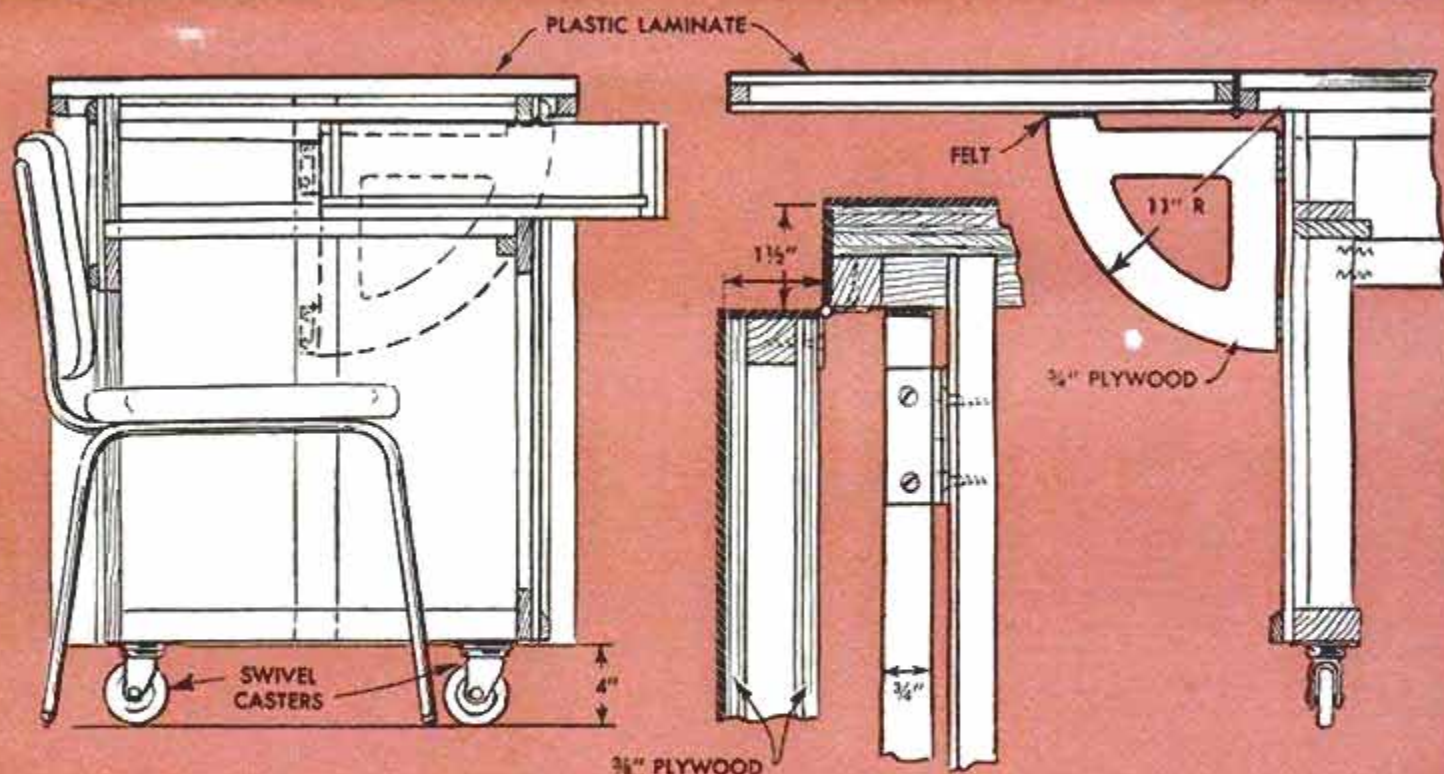

the front and back frames at the top. Drawers are then constructed to fit the openings and faced with the plywood pieces saved for that purpose. Instead of the handhole pictured at the top front edge, a small inconspicuous knob may be attached to the front of each drawer. The end panels, cut to overlap front and back, are then glued in place. Doorstop molding is used to trim the bottom edge of the table, and a half-round molding run above the drawers and down the corners covering the edge of the plywood ends. Now turn the table upside down and attach the casters.

Fir plywood, good one side, is used for the top and each drop leaf. The sheet for the top is $\frac{3}{4}$ in. thick. Cleats, $\frac{3}{4} \times \frac{3}{4}$ in., are nailed along the edge. Fabricate each drop leaf by nailing a piece of $\frac{3}{8}$ -in. plywood to each side of a frame made from $\frac{3}{4} \times \frac{3}{4}$ -in.

stock. The plastic laminate is attached to the top surfaces and to all of the edges with a contact adhesive. Attach the edging strips first, mitering at the corners. The top is then fastened in place with screws from inside the counter. Butt-hinge a leaf to the underside of the top at each end. Leaf supports cut from 1 x 12-in. stock are hinged to the end panels slightly off center to keep them from projecting beyond the front of the table when the leaves are down. A piece of felt glued to the support rest prevents it from scratching the underside of the leaf.

For family meals the table may be turned around so that the drawers face the wall giving plenty of legroom. When guests arrive, it's a simple matter to wheel the table out into the center of the room and expand it to full length. ★ ★ ★

Paint Scraper Easier to Use When Fitted With Knob

Reduce hand cramp and provide better control of a paint scraper by adding a knob to the top as shown. Both hands then can be used, which permits applying extra pressure on the scraper when necessary. The knob is a large drawer pull. Replace the short screw holding the scraper plate to the handle with a longer one, and screw the knob onto the projecting end.

☞ To extend the life of a candle, give it a coat of white varnish and allow it to dry for several days. Not only will the candle last longer, but it will drip less.

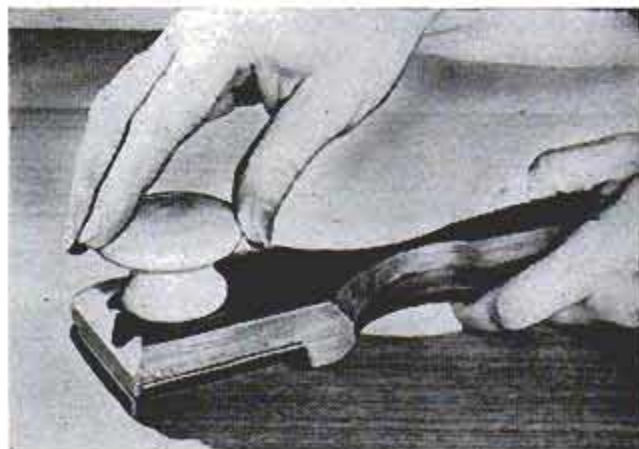

Folding Seat Permits More Movie Enjoyment for Small Tots

Why not provide more comfort and enjoyment for your youngster when he is viewing a movie in the neighborhood theater by raising him up on this folding canvas seat that hooks over the armrests of a regular seat? A piece of canvas, 8 x 18 in., is hemmed to accommodate two $\frac{3}{16}$ -in. metal rods, the ends of which are bent to form hooks that fit snugly over the armrests. Be sure to slip the rods through the hem before bending the ends. Cover them with rubber tubing.

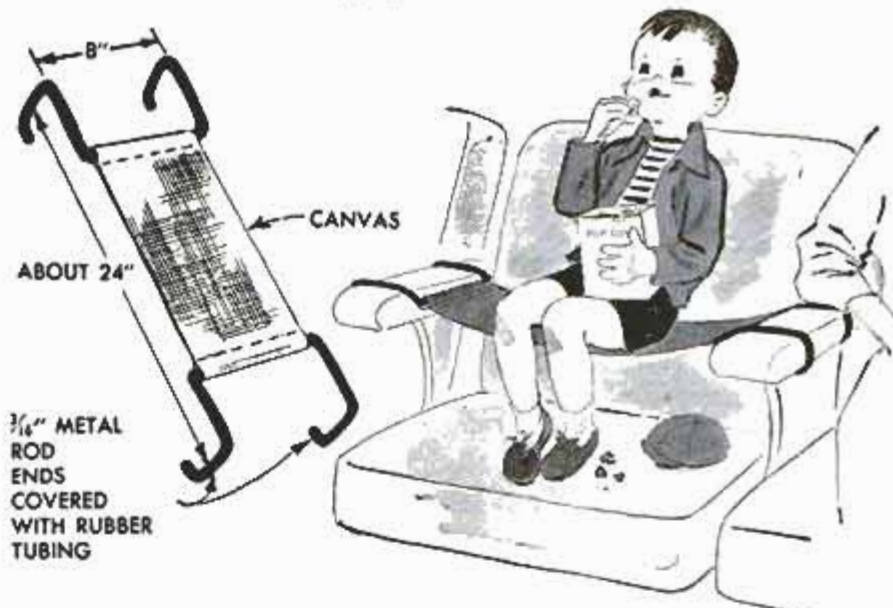

Notched Section of Auto Tire Supports Mower Against Wall

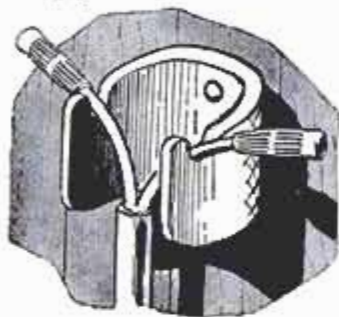

A lawn mower that has a fork-type handle can be kept against the wall of a garage or tool shed by a holder cut from a section of auto tire. After the tire section is cut to the shape shown, it is

nailed to a wall stud at a height that holds the lawn-mower handle in the desired position. Bending the flexible holder permits easy removal of the handle.

Mileage Record on Ground-Glass Strip Glued to Speedometer

Provide a handy place to jot down the mileage when changing oil in your car by gluing a small strip of ground glass to the face of the speedometer with transparent cement. Due to its translucent characteristic, the ground glass will be backlit at night and reflective-lighted by day. Place the frosted side out, to permit writing with a soft, lead pencil. Be sure not to cover indicators for bright lights or turn signals. The strip can also be used to record trip mileage and gasoline input relative to mileage. Markings no longer needed can be easily erased.

Ken Hadenfeldt, Storm Lake, Iowa.

Reshaping Worn Paintbrush

A worn or misshapen paintbrush can be restored to usefulness by trimming it back to shape. You can do a neat job of trimming by holding a razor blade against a pocket comb, illustrated at right, and gently drawing the comb through the bristles. Stray bristles can also be removed by this method.—Ken Murray, Colon, Mich.

Heavy Soap-Water Application Reveals Gas-Line Leaks

Gas leakage from pipes and fittings can be detected by brushing a film of heavy soap water over the suspected area. A leak, even a small one, will cause a bubble to form in the enveloping soap film. Though ammonia is frequently used for this purpose, because the fumes turn white when gas is present, soap water is a satisfactory substitute. Do not attempt to repair leaks while gas is present in the line.

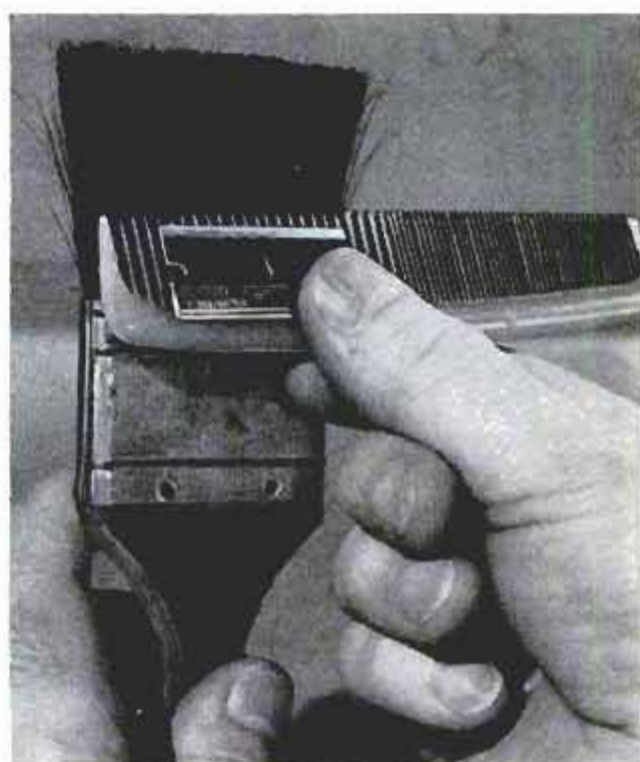

FRESH VEGETABLES

ALL YEAR 'ROUND

By William Gilman

HOW WOULD YOU like to have fresh vegetables from the garden every month of the year, without the expense of storing them in a freezer? With proper storage methods, much the same as produce companies use, radishes, celery, cabbage and other vegetables can be picked at the end of the growing season, packed in boxes in dry leaves or moss and stored.

The majority of winter keepers—rooty vegetables like carrots and beets, or leafy ones, such as cabbage and celery—need a cool, humid atmosphere to keep them fresh. One caution about celery: The flavor of celery is affected by turnips and cabbage when stored next to them.

Storage Bins

First, make several storage bins of the type shown at the bottom of the next page. The bins can be made of rough lumber with large screen panels at the sides and top to provide ventilation and keep pests out. Casters installed on the bottom of each bin permit them to be moved around on concrete floors when cleaning.

Crisp oak or maple leaves are excellent storage medium when 1-in. layers of them are used to separate vegetables. The leaves provide sufficient air space for ventilation, yet retard dehydration



Above, thin coating of wax on severed ends of root vegetables prevents rapid loss of moisture. Below, cabbage packed between layers of peat moss in vegetable bin remains solid and fresh throughout winter



The vegetables should be packed between 1-in.-thick layers of fresh oak or maple leaves or peat moss to provide sufficient ventilation, yet prevent excessive evaporation. A cool corner in the basement, where the temperature remains about 50 deg. F., is an ideal place to keep the bins.

Seal Cut Ends of Beets

Thick-skinned root vegetables, such as beets or rutabagas, will last through the winter without turning spongy or rotting, if the tops and root ends are cut off and the ends dipped in melted wax. When the wax cools a protective seal is left over the severed ends so that the vegetables will keep until spring without becoming dry or wilted.

Tomatoes that are still green just before the first frost arrives can be picked, individually wrapped in newspaper and placed in shallow wooden cartons. Stored in a dark corner of the basement, they will be a source of fresh tomatoes for several weeks.

Another way to "beat the frost" at harvest time is to pull the entire tomato plant from the ground and hang it in the basement. The same thing can be done with peppers. Fruits that are full-grown will continue to ripen much the same as they would under normal growing conditions.

When harvesting squash and pumpkins, pile them in a sunny spot near the house so they can be easily covered on frosty nights. After the squash and pumpkins have "cured" in the sun for a week or two, store them indoors in a dry, frostproof place. ★ ★ ★



Entire tomato and pepper plants with unripe fruit attached are hung in dark corner of basement. Full-grown fruit ripen much the same as under normal growing conditions for fresh post-season supply

Vegetable storage bins are made of rough lumber with screen panels for ventilation and to keep pests out. Two handles on one side and three casters on bottom facilitate moving them when necessary

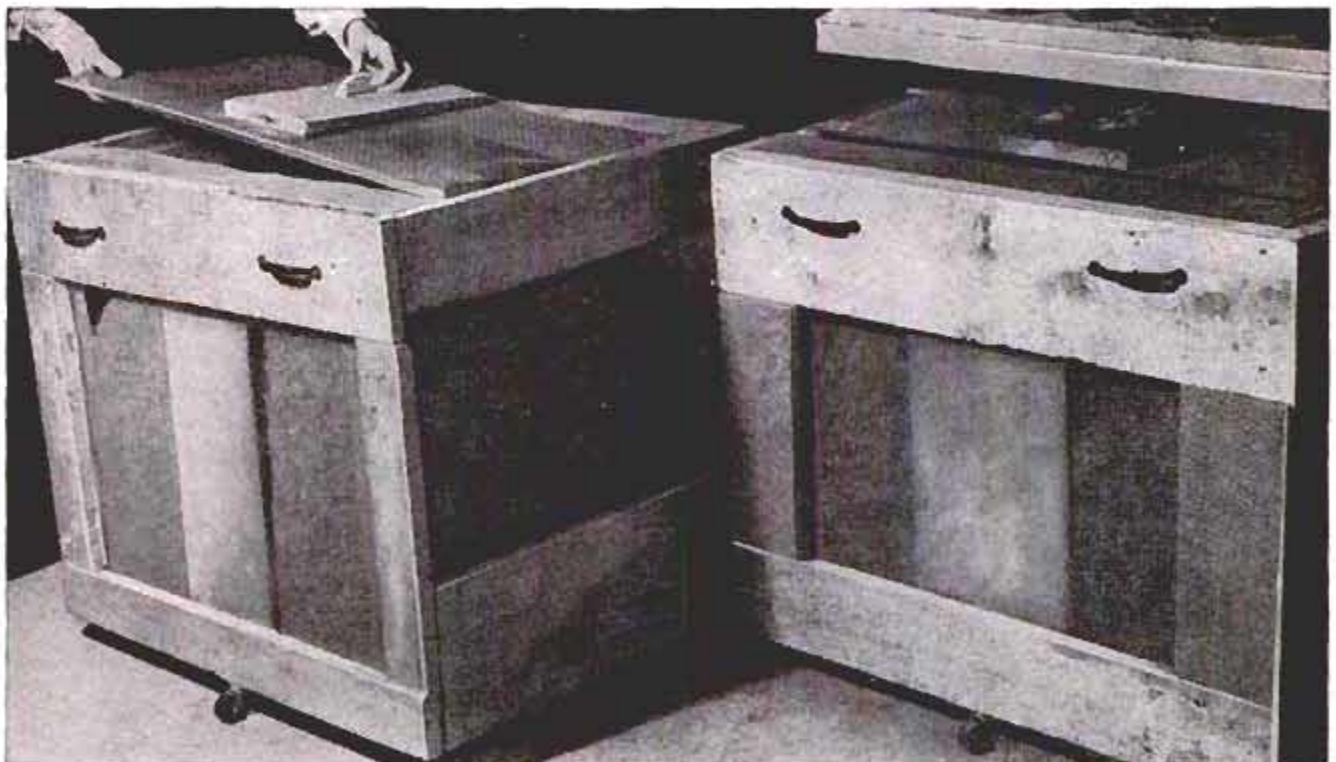

Paper Clamp on T-Square to Rule Parallel Angular Lines

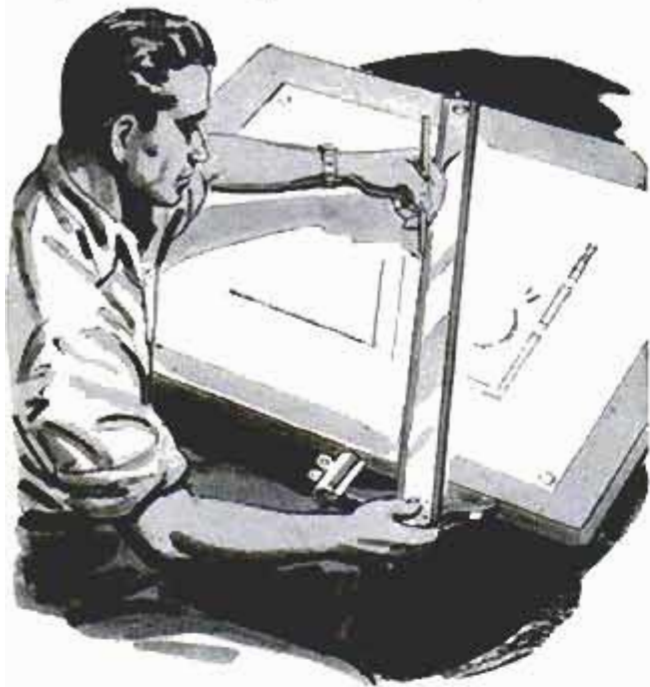

By fitting a paper clamp on the head of a T-square as shown and butting it against the edge of the drawing board you will be able to draw parallel angular lines more rapidly than with the aid of a triangle. The clamp may be adjusted for ruling lines at any desired angle. To assure parallel ruling, always butt the end of the clamp against the edge of the drawing board.

Felt Pads Under Furniture Legs Prevent Damage to Tile Floors

Furniture to be placed on a tile floor, and particularly on rubber tile, should be equipped with felt pads under the legs to prevent damaging the floor. Before gluing the felt in place remove glider buttons, if any, that are attached to the legs. Gliders dent the tile and may also scratch the surface.—Alexander Owen, Schenectady, N. Y.

Index Notches in Reference Books Cut With Wood Gouge

If you have frequent occasion to refer to a book that is divided alphabetically or according to subjects, and yet do not want index tabs projecting from the pages, cut thumb notches in the edge of the book and print reference marks in them. Cut the notches with a wood gouge having a radius of about $\frac{1}{2}$ in. Use a piece of $\frac{1}{8}$ -in. hardboard or plywood as a stop for the gouge, placing it on the sheet that is to bear the reference mark. Drive the gouge in at a slight angle towards the book binding.



Old Chest of Drawers Converted to Desk for Young Child or Family

An old chest of drawers is a good basis for a desk for a child's room, and may even be converted to a writing desk for the entire family. The first step is to remove the lower drawers, including the rails and sup-

ports inside the chest, but leaving the top drawer intact. Side and back panels are left intact, but the legs should be cut down so that the top is at a comfortable level for writing—about 24 in. for children and 30

in. for adults. Replace the bar or pendant type handles on the top drawer with round wood or metal knobs, but before installing them take off the old enamel or varnish with paint remover. Fill handle holes in drawer, and other indentations left by removal of bottom drawers, with a wood filler and sand the surface smooth. Finish with two coats of varnish or paint to match other furnishings in the room.—E. A. Brinton, Salt Lake City, Utah.

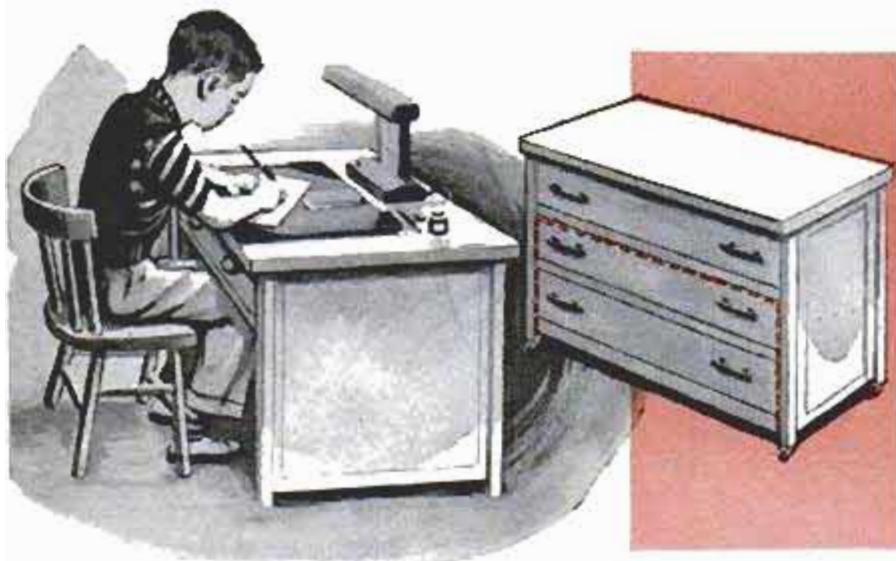

"Doctored" Portrait Has Eyes That Move Realistically

Surprise your friends by showing them a portrait that appears normal but suddenly has unsuspected lifelike movement of the eyes. You will need two duplicate prints of a full-face portrait. Cut a horizontal strip including the eyes from one print. Then using a sharp knife cut out the eyes on the other print. Glue a cardboard backing to this second print that has a slot cut slightly longer than the strip removed from the other print. Glue a piece of sandpaper to the back of the eye strip and place it in the slot. Next cut a narrower slot in another piece of cardboard and glue it over the strip as shown. The exposed sandpaper permits manipulation of the eyes.

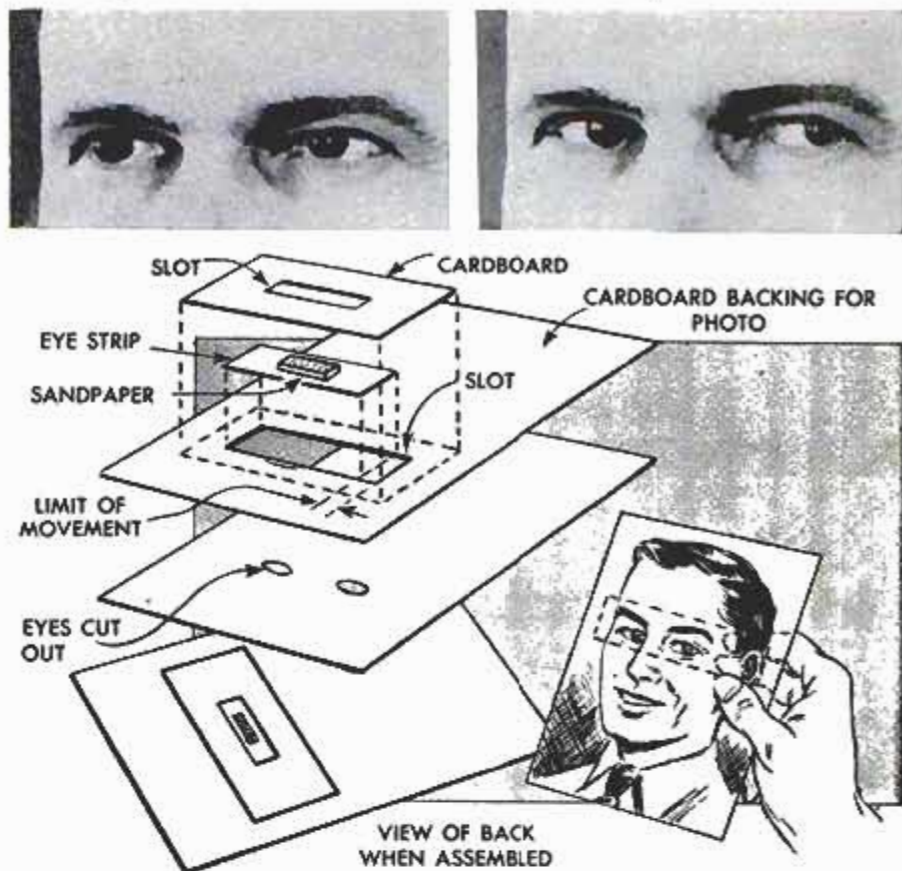

Vacation Address Book

Next time you go on a vacation trip, there will be no problem of remembering the addresses of friends to whom cards and souvenirs are to be sent, if a local telephone directory is taken along for a reference. Also, it is quicker to look up a home-town phone number in your personal copy than to have to hunt through mutilated out-of-town directory in a phone booth.

Walter E. Burton, Akron, Ohio.

Safety Ropes on Swing Prevent Sudden Falls

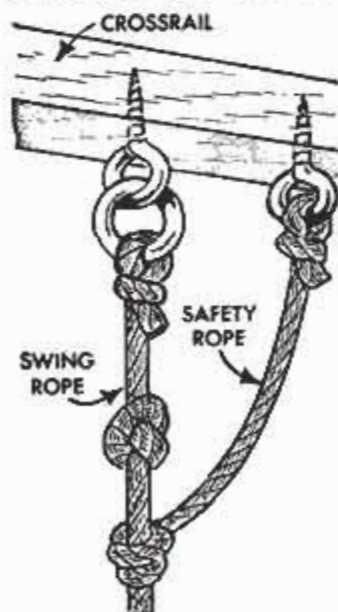

Sudden falls from swings caused by breakage of the rope or a hanger can be avoided by installing auxiliary safety ropes as illustrated. Be sure to tie a knot in each swing rope immediately above the point where the safety rope is attached. Leave a little slack in the safety ropes to permit movement of the swing ropes.

Castor Oil and Graphite Mixture Lubricates Rubber Casters

Castor oil to which some colloidal graphite has been added can be used to lubricate casters having rubber wheels. This non-mineral oil is considered more satisfactory in such applications than are conventional lubricants, which have a softening effect on rubber compounds. If the caster can be taken apart, the special mixture may be applied directly to the bearing surfaces as shown. If not, an oil can or wire applicator is used.

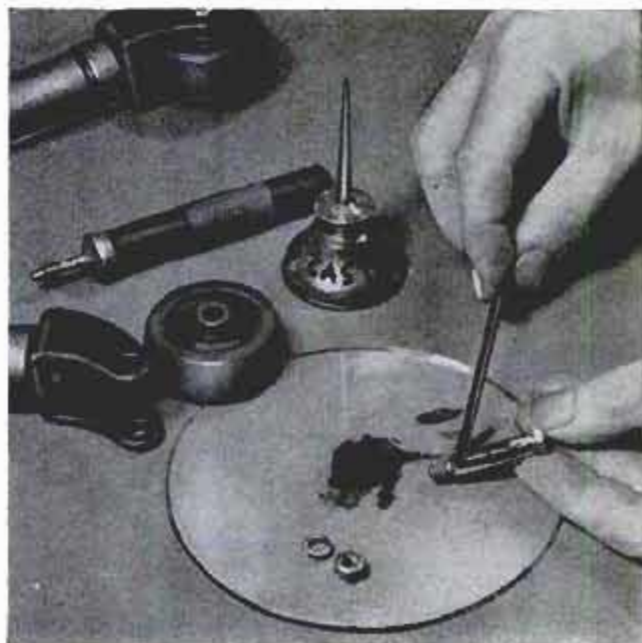

SOLVING Home Problems



ROLLER FOR PAINTING SCREENS is improvised from 4-in. length of 1-in. dowel covered with old pile carpet. Length of heavy wire and dowel serve as a handle

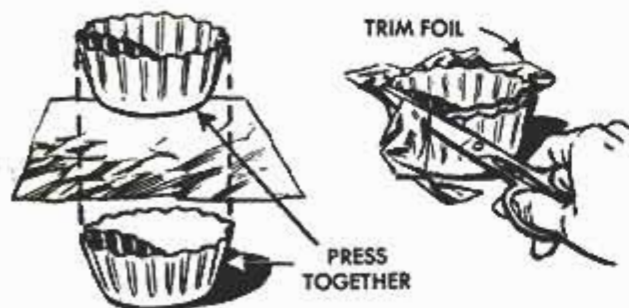

PAPER EGG CARTONS can be reused again and again for storage if coated with water glass. Before coating, reinforce hinge with cloth, using water glass as glue



BLACKBOARD on panel of kitchen-cabinet door is handy for jotting down reminders, grocery lists. Use a blackboard point that dries with "toothed" surface

MUFFIN TINS can be used to mold nut cups from aluminum foil. Place foil over one of the tins. Press second tin into first tin to form foil. Trim edge

METAL BRACKET bent to S-shape holds a decorative tray edgewise on bookcase or mantel. When bending bracket, be sure there are no sharp edges to mar finish

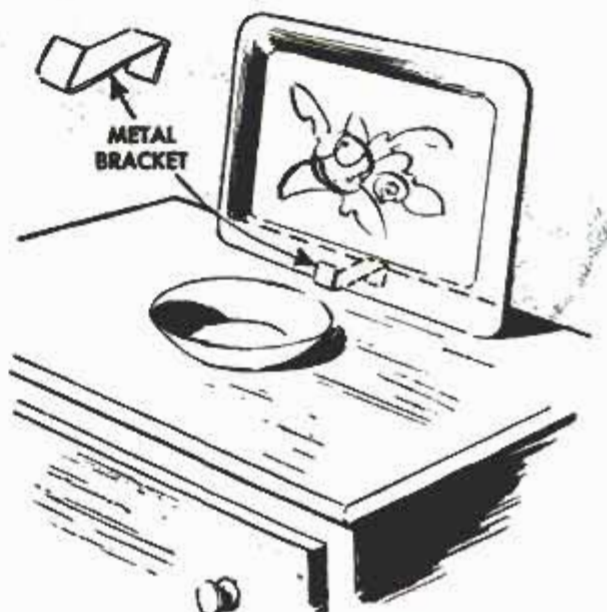

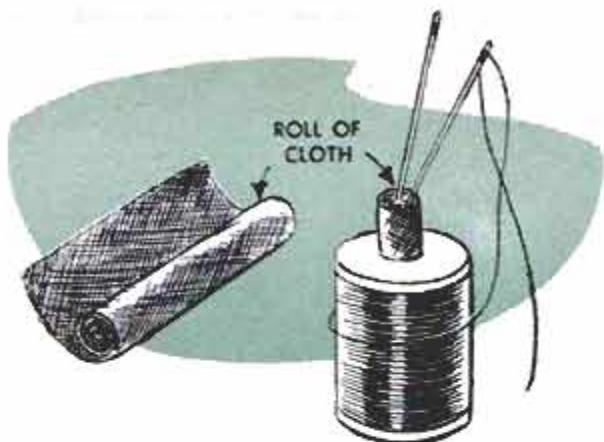

SMALL PIECE OF CLOTH rolled tightly and inserted in hole in a thread spool keeps needles safe, always at hand when needed. Needles can be kept threaded



HARDENED PAINT SPOTS in fabrics can be removed by first breaking paint film with putty knife. Then apply solvent such as turpentine or lacquer thinner

ROUNDHEADED UPHOLSTERY TACKS driven into top side of a wooden clothes rod space clothes hangers equidistantly, making it easy to locate the garments

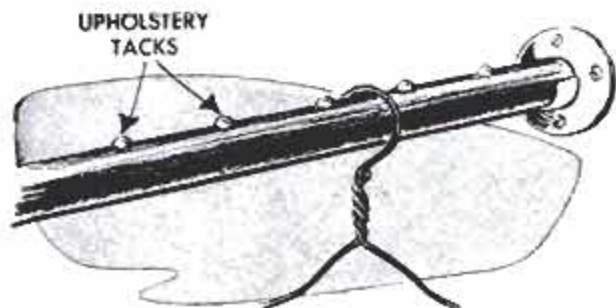

SCISSORS are made safe and at the same time protected from damage in drawers by slipping rubber tubing over the closed points. Also protects pencils

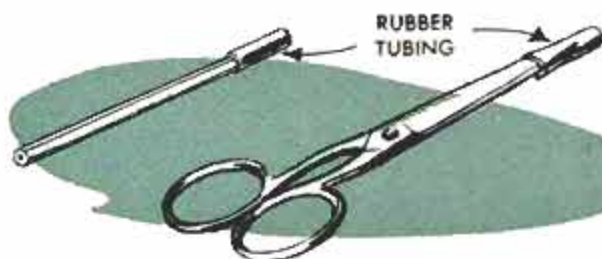

SPRING-LOADED STEEL BALLS make excellent rollers for sliding doors and window sash. Drill holes in sash or door rail and insert coil spring and ball as indicated. Then slide the door or sash back into place

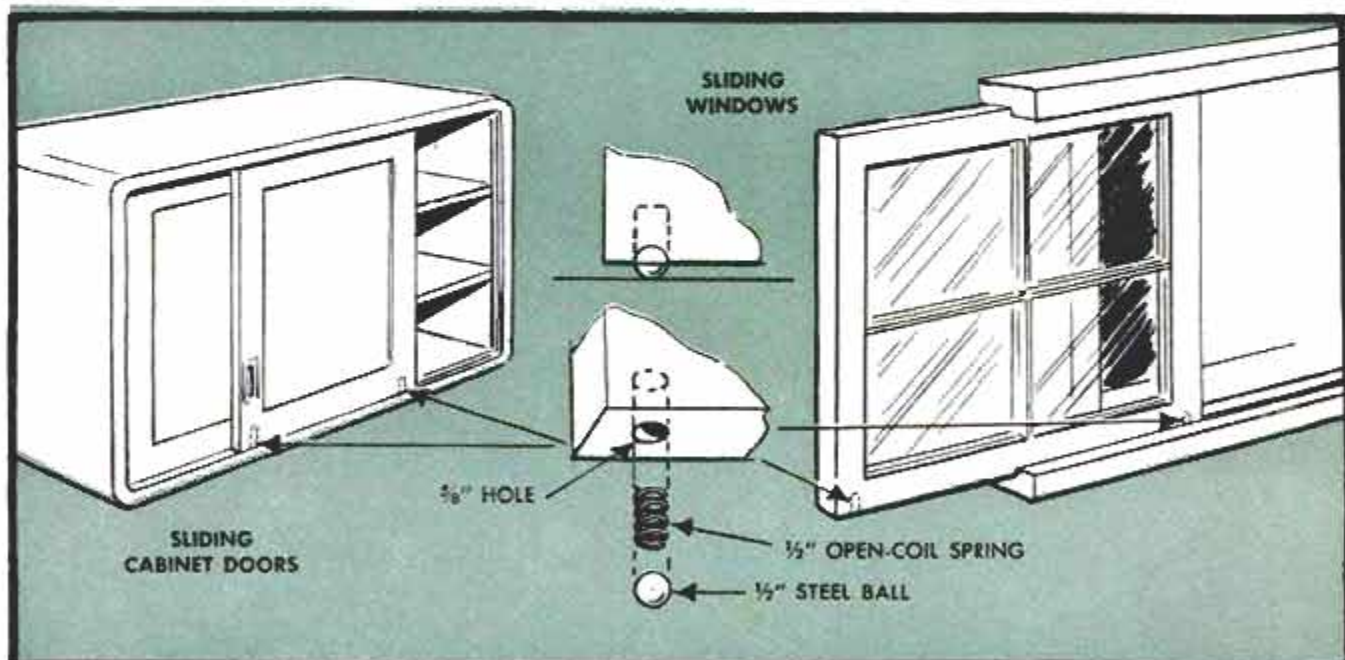

Hand-Rotated Television Antenna Operated From Inside House

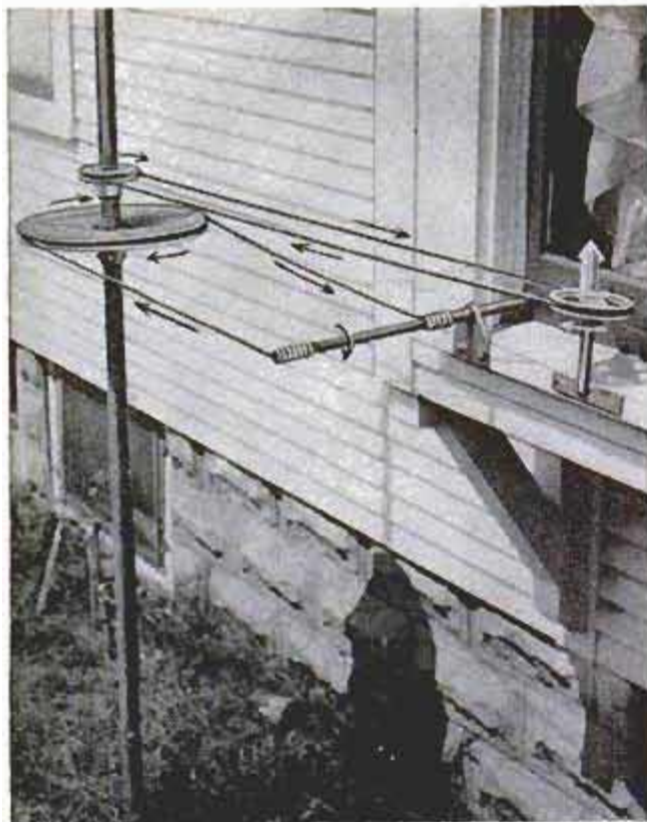

A hand crank inside the window rotates this TV antenna for better reception. The crank rests on upright supports and the window sash is slotted to fit over it. A large pulley is fitted to the antenna-mast level with the extending rod of the crank, and a small pulley fitted just above it. Another pulley, the same diameter as the small one on the mast, is mounted on a vertical shaft attached to the edge of the window sill. Plastic-covered clothesline is brought around the large pulley on the mast and the ends wound in opposite directions and tied to the crank. Another piece of clothesline is tied in a continuous loop around the two smaller pulleys. Install an arrow on the circumference of the window-sill pulley as a visible means of orienting the antenna from inside the house.

A. M. Wettach, Mt. Pleasant, Iowa.

Presetting of Freezer Control Guards Against Power Failure

One food-freezer owner living in the country where electrical power failures occur frequently has devised a procedure for preserving the contents of the freezer when it is temporarily inoperative. He listens for storm warnings over the radio, or TV, and when one is announced turns the temperature control on the unit to the coldest position, leaving it there until the storm has passed. If electrical service is interrupted, the colder air helps to keep the food frozen until power is restored.

John Krill, North Lima, Ohio.

Straight Crosscutting of Hose



Clean crosscutting of rubber hose for washers or when installing fittings can be done easier by plugging the hose with a snug-fitting wooden dowel. The firm support will keep the soft rubber from

sagging out of line from the pressure of the cutting tool. A single-edge razor blade is well suited for this type of cutting job, but must be handled carefully.

Frank A. Javor, North Bergen, N. J.

Water-Filled Mucilage Bottle Moistens Envelope Flaps

The job of moistening a number of envelope flaps is easier with the use of an old mucilage bottle filled with water. Invert the bottle, press it down on the flap and an even amount of water just the right width will be released. When not in use the applicator seals itself preventing the bottle from leaking if tipped over.

Eleanor Smith, Gainesville, Fla.

Tweezers Equipped With Pen Light

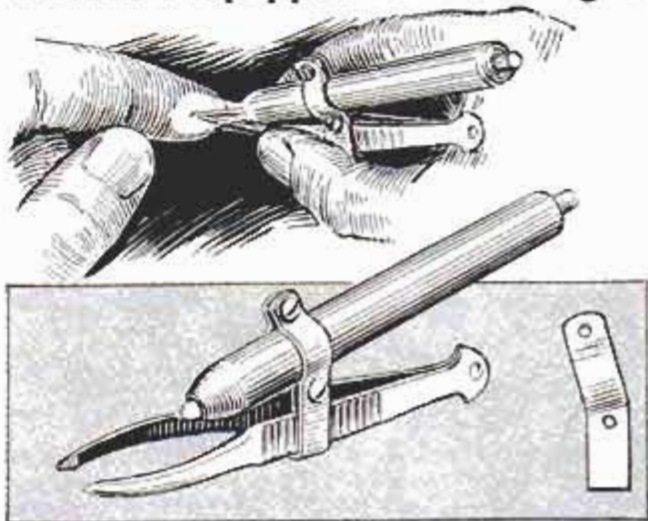

Fine work can be easily illuminated with a single-cell pen light attached to one side of a pair of tweezers by means of a metal bracket. Form and drill the bracket as shown in the illustration so that it fits snugly over one leg of the tweezers and around the flashlight, fastening it in place with small machine screws. Even when not using the tweezers, it can be placed beside the work to provide light.

Four-Poster MAGAZINE RACK

By Hi Sibley

THIS MINIATURE four-poster makes an unusual magazine rack which will fit in well with colonial furnishings. The four posts and two end stretchers present an excellent opportunity for the owner of a wood-turning lathe to practice turning identical work. Rough stock should be $1\frac{1}{2}$ in. sq. and a few inches longer than the length of the finished piece to allow for a shoulder at each end when turning. Following the half patterns below, begin turning the posts, starting at the square section and working towards each end. After turning, reduce the square section of each post to the finished dimension on a jointer. Round tenons are then turned on the ends of the stretchers to fit into holes centered 5 in. down from the tops of the posts. Flat tenons also are formed on the ends of the side rails. Before assembling, attach $\frac{3}{4}$ -in.-sq. cleats to the inside of the framing members, flush with the lower edge, to support the plywood bottom which is nailed in place. Glue the rack together and finish it with a clear, dull-gloss varnish.



flat tenons to fit the mortises in the posts. Flat tenons also are formed on the ends of the side rails. Before assembling, attach $\frac{3}{4}$ -in.-sq. cleats to the inside of the framing members, flush with the lower edge, to support the plywood bottom which is nailed in place. Glue the rack together and finish it with a clear, dull-gloss varnish.

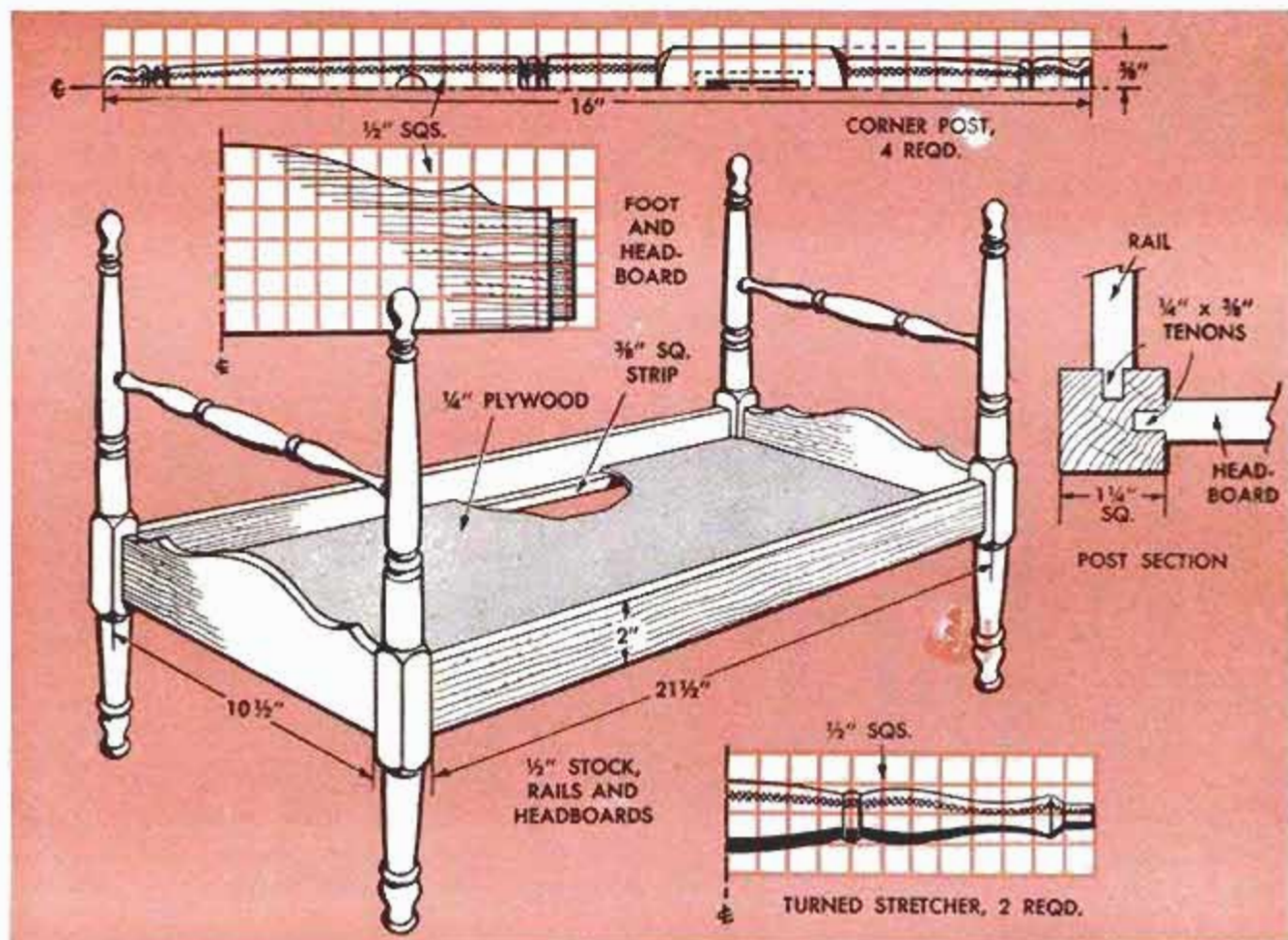



SHORT CUTS *at Your Desk*

If you have a number of letters to mail, make a handy stamp moistener from an emptied air-deodorizer bottle of the type that has a wick. When the bottle is filled with water, stamps simply are pressed against the saturated wick



Improvise a letter scale from a 12-in. ruler balanced on a pencil. If a letter centered on the 10-in. mark outweighs two half dollars placed on the 2-in. mark, the letter weighs more than an ounce and will require additional postage

You can extend the life of a worn typewriter ribbon by soaking it in hot water. Drop it into a jar of water, seal it and let it stand a few days. Then remove the ribbon and permit it to drain dry before reinstalling it in a typewriter

Prevent ink-stained fingers by attaching a pen wiper directly to the bottle so it always is handy when filling a pen. A piece of soft leather is ideal for this when attached with a rubber band so it can be replaced easily when soiled





If you sometimes feel you need a "third hand" when tying a fancy bow on a specially wrapped gift box, try using a pushpin. As shown above, the pin replaces the usual finger while the bow is being tied

When your desk sometimes is used as a package-wrapping table, install a convenient holder for a ball of twine by nailing a plastic measuring cup to the wall. Run the twine through a hole in the cup handle

Instead of "dog earing" the corners of the pages of a book to mark your place, use bookmarks made by cutting the corners from envelopes. The envelope markers fit neatly over the page corners for quick reference

To assure slipfree knots when tying a package to mail, pull the string through a dampened cellulose sponge to wet it thoroughly. When the saturated string dries it will expand slightly, tightening the knots

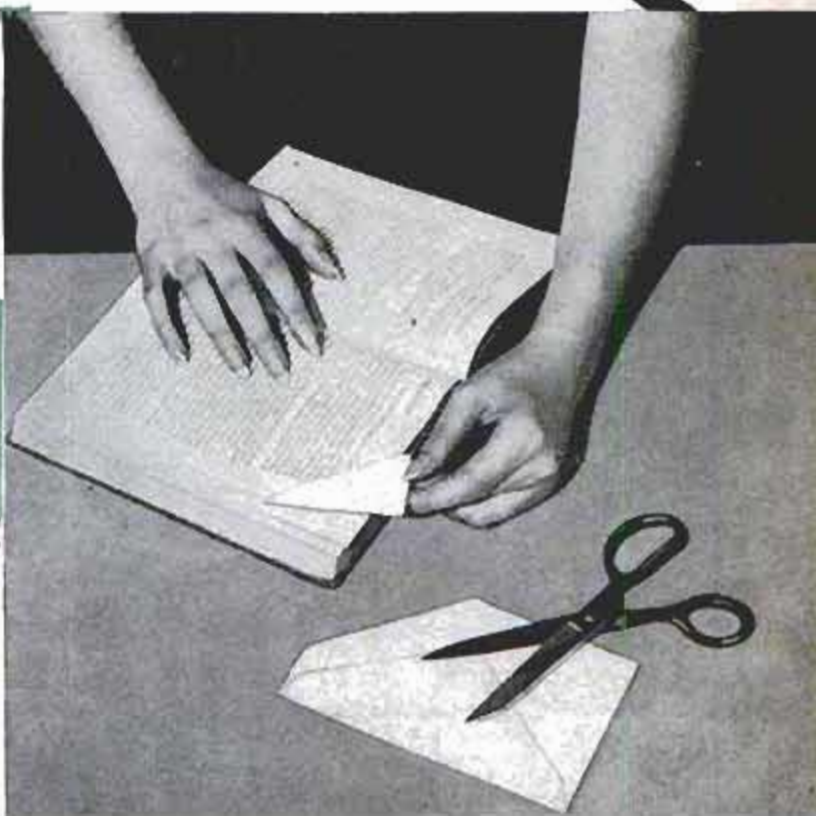

Old Refrigerator-Shell Cover Locks Soft-Drink Cooler



One filling-station operator made a cover for his soft-drink cooler from an old refrigerator shell. It eliminates the need to move the cooler inside at night and yet effectively keeps out prowlers. The cover is slipped over the top and long bolts are pushed through flanges at the bottom and through the wall so that nuts can be attached on the inside.—E. V. Reyner, Townsend, Mont.

Clearance for Leg Assemblies To Pivot Set Without Washers

Where folding legs are assembled in pairs with a cross piece between them, pivoting on bolts is possible without the use of spacers. Run bolts in from the sides of the table through each leg and draw the nuts up on the bolts so that the clearance

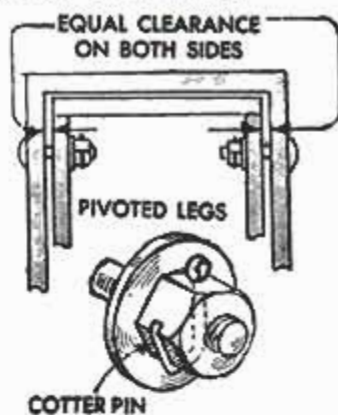

space for each leg is equal. Then drill holes through the nuts and bolts and install cotter pins as shown. Be sure to use washers between the legs and nuts.

Handy Utility Pail Made From Gallon Paint Can

Removing the sealing rim at the top of a clean 1-gal. paint can will provide a handy utility pail that can be used for mixing solutions, drawing liquids from larger containers or as a giant pail. Trimming off the sealing rim with a regular can opener leaves a rounded edge which permits easier cleaning, and prevents hand cuts caused if the entire top flange is removed. If the paint can has no bail, bend one from coat-hanger wire and fit it in holes punched near the top of the pail.



Foot-Operated Stop Holds Door When Fitting or Repairing Lock

If you have no helper to hold a door while fitting a lock, use a foot-operated "door-stop." The stop consists of a flat file with a round clothespin fitted over its mid-point to provide a fulcrum. The tang of the file is slipped under the door at the outer edge.

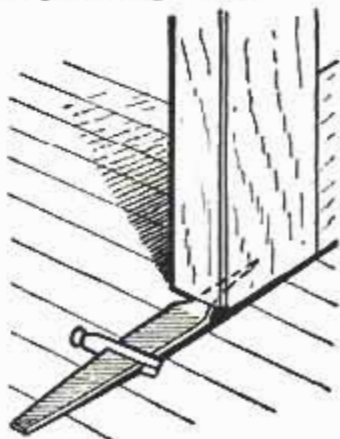

Stepping on the opposite end of the file forces the tang up against the bottom of the door, holding it until foot pressure is released. To apply greater leverage against the door bottom, slide the clothespin toward the tang.

☞ To remove candle wax from a cement floor, first scrape off the excess drippings, and then place a clean blotter over the spot and apply a hot iron to it. The heat will melt the remaining wax which will be drawn up into the blotter.

Shoeshine Box

By John Bergen

DOES YOUR HOME have a place for storing shoeshining equipment? If not, you'll want to build this shoeshine box which, when open, has a convenient footrest on top for that quick shine.

Start by making a paper pattern of the end of the box and trace it onto two pieces of $\frac{3}{4}$ -in. stock which are then cut out. To cut the handholds drill 1-in. holes at each end of the proposed openings and saw out the sections between them with a coping saw. Next, cut out the bottom piece beveling the side edges in at the top slightly. Both sides of the box are identical being beveled at the top outside edge and bottom inside edge. Glue the box together, using finishing nails or wood screws for reinforcement. Set the sides in about $\frac{1}{8}$ in. from the edges of the end pieces and fit the bottom flush with the top of the opening between the feet as indicated.

Small butt hinges fasten the lid to a narrow top piece which is attached to the box so that it overhangs the ends and side. A footrest is fastened to the inside surface of the lid flush with the hinged joint. Cut the footrest from a piece of 2 x 4, tapering it down to a thickness of 1 in. at one end. A slot $\frac{3}{8}$ in. wide by $\frac{1}{4}$ in. deep is cut across the tapered surface $2\frac{1}{2}$ in. from the high end to receive a wooden cleat against which the heel of the shoe rests. Paint your shoeshine box inside and out or finish with stain and varnish.

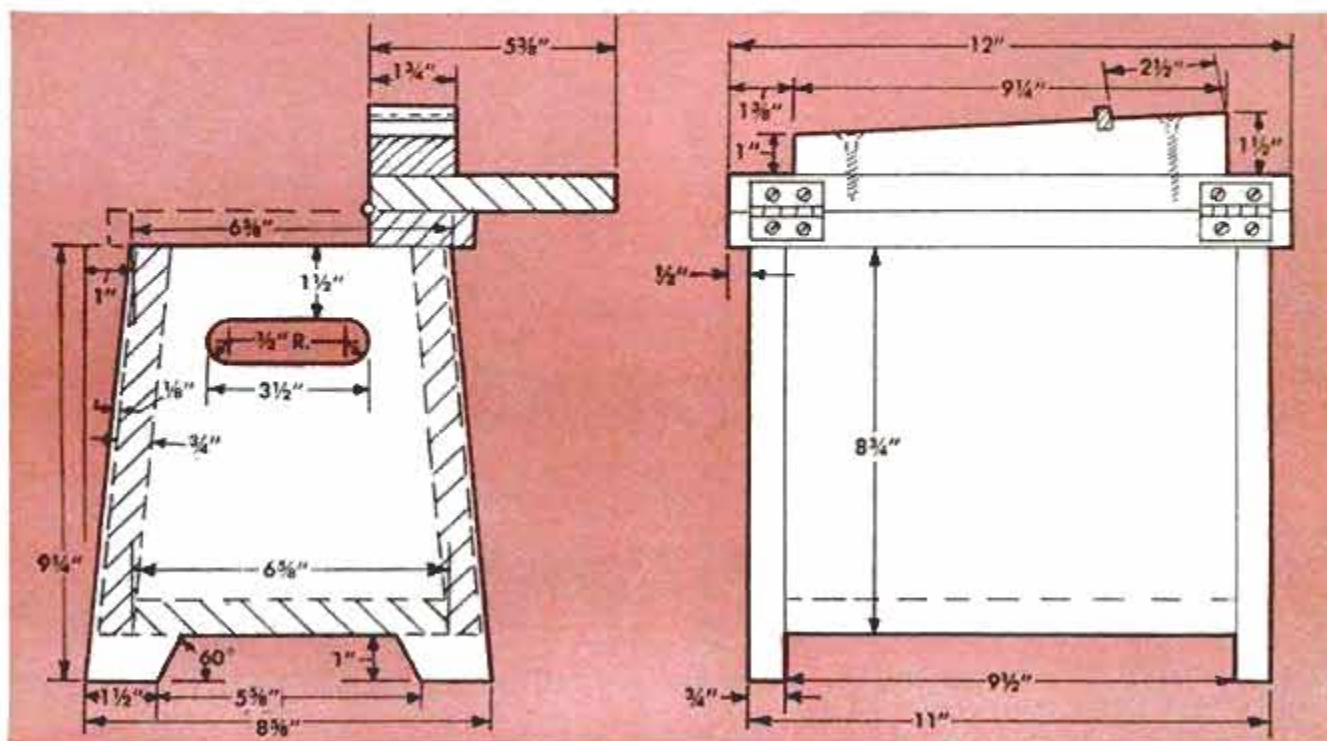
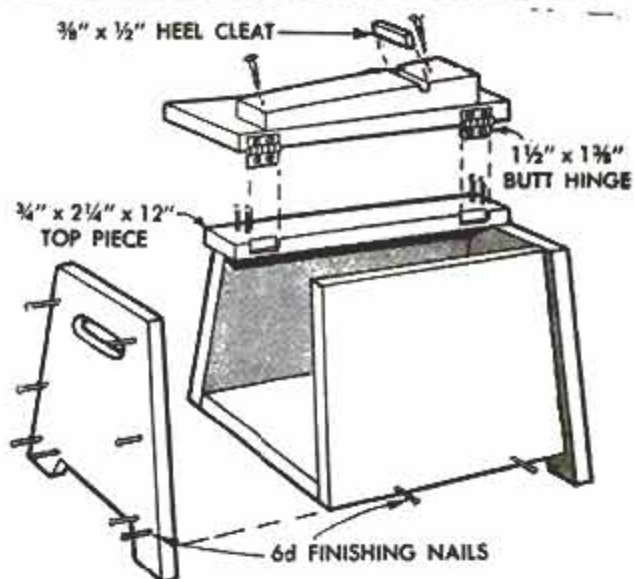

157 auto repair

51:58

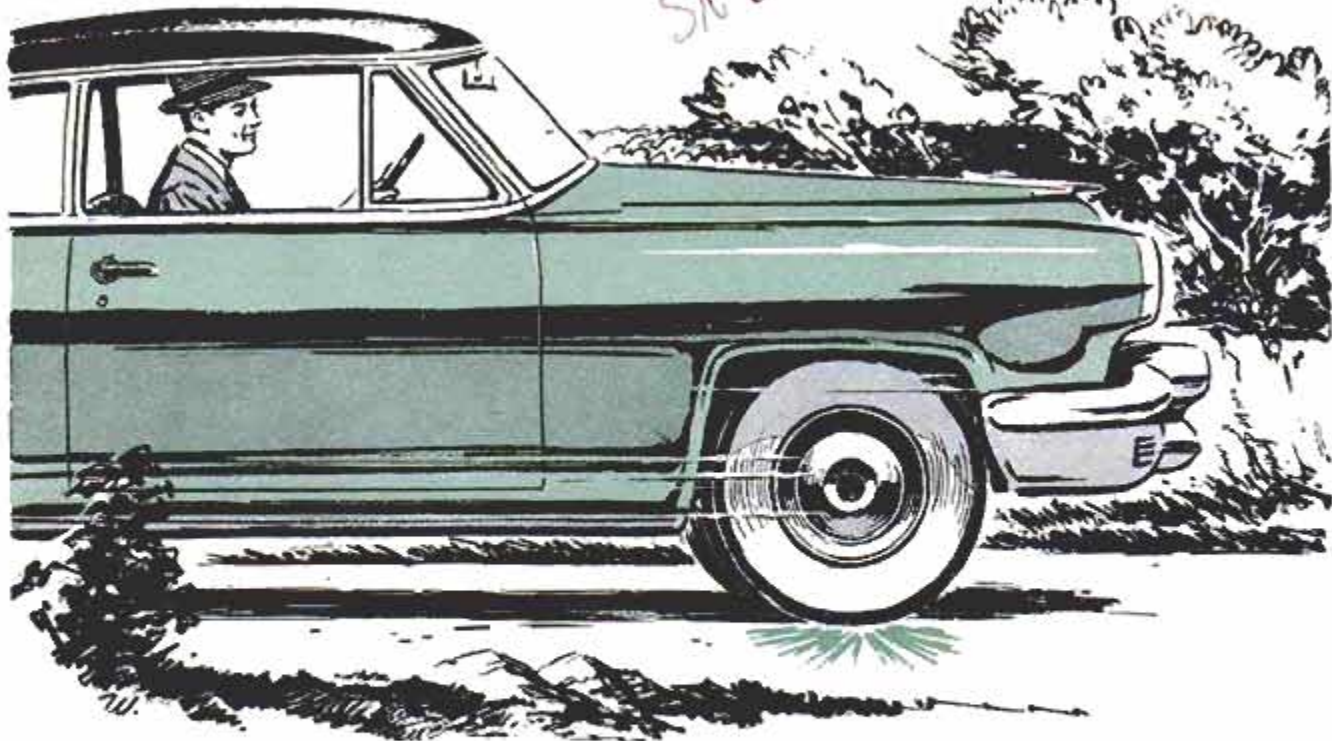

The Causes and Cures of TIRE "THUMP"

By Ed Packer

BECAUSE MODERN CARS run so smoothly and silently, minor sounds and vibrations that went unnoticed in older-model cars are quickly apparent to a motorist today. Generally an unbalanced or out-of-round tire is the first thing blamed for an unusual sound or feeling in a car, although other components of the body, chassis and running gear can produce effects that are identical to tire "thump."

A fairly accurate test that will determine whether the thump is in a tire or some other unit is to inflate all four tires to 50

lb., then choose a smooth stretch of highway and drive at your usual speed. If the thump disappears, it is quite certain that it is caused by a tire. Next, deflate one tire to normal pressure and drive again. If a thump is not apparent, reinflate that tire to 50 lb. and deflate one of the others. Repeat this operation until a tire causes a definite thump at normal pressure. That will be the one causing the trouble. In some cases, when using the "50-lb. test," no thump will be noticed, and when the tires are deflated to normal pressure the

Tires are balanced on cars by this machine that rotates wheel by means of electric-powered roller

Tire out-of-roundness should not exceed .080 in. and no more than .050 in. in 10-in. length of tread

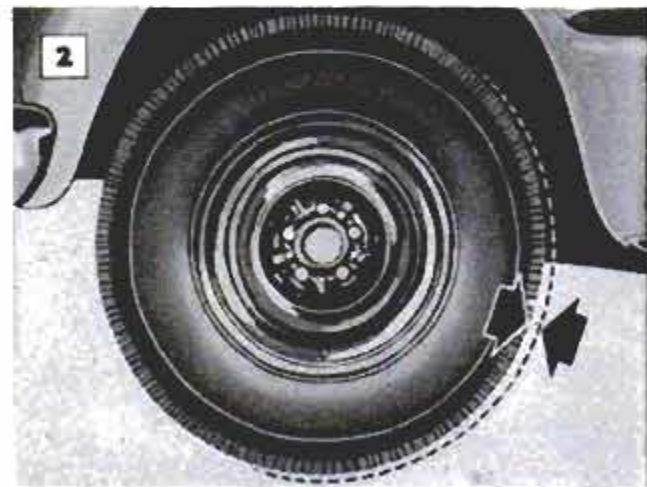
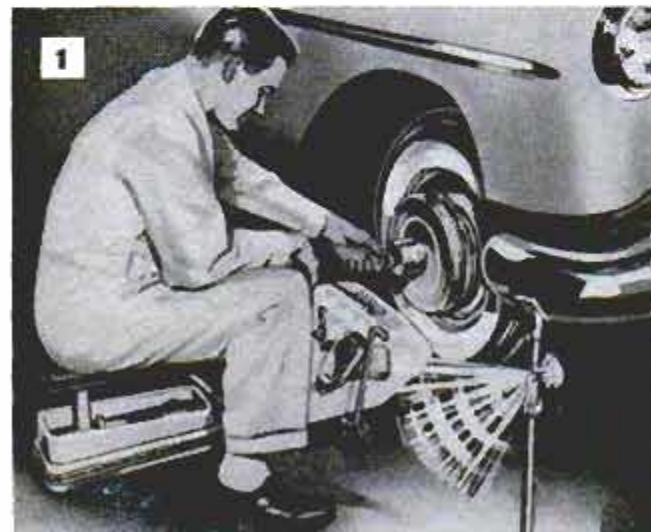

original thump will have disappeared. This phenomenon occurs because overinflation forces the beads of the tires to seat properly on the flanges of the wheel rim, Fig. 8, and the tires then run true.

If a tire is not too badly out of balance it sometimes can be balanced while on the car by a special machine that rotates the wheel by means of a roller driven by an electric motor, Fig. 1. A pointer clamped to the bumper will oscillate in direct proportion to the degree of unbalance as the car is vibrated by the rotating wheel. Lead balance weights are added to the wheel rim until the pointer oscillations are within acceptable limits.

In cases where a thump is extremely severe, a mechanic will check tire out-of-roundness and lateral runout with a dial indicator as shown in Figs. 5 and 6. A soap-and-water solution is painted on the rubber to permit the indicator to slide freely. No tire should be out-of-round more than .080 in., and no more than .050-in. distortion should occur in any 10-in. length of tread. Lateral runout or "wobble" should not exceed .0625 or about $\frac{1}{16}$ in. If runout is .080 in. or more, Fig. 2, remove the tire and check the wheel. Should the wheel also be out-of-round a similar amount, mount the tire with the high side opposite the high side of the rim. However, if the wheel is true, then the tire will have to be buffed to roundness on a machine that removes rubber from the high spot on the tread. Although some tread is removed, the life of the tire is extended since it will not bounce and scuff as it did before. In either of the last two cases, final balancing of the tire-and-wheel assembly is done on a machine of the type shown in Fig. 4.

Should a tire show extreme lateral runout, it is quite possible that the wheel has been bent. Since the tire is flexible, it will follow the distortion of the rim and also

Accurate measurement of tire out-of-roundness is made by using dial indicator bearing against tread



Wheels can be straightened without removing tire by using this machine employing hydraulic pressure



Above, familiar wheel-balancing machine balances wheel-and-tire assembly when removed from car. Below, lateral runout is checked by using dial indicator contacting sidewall lubricated with soap and water

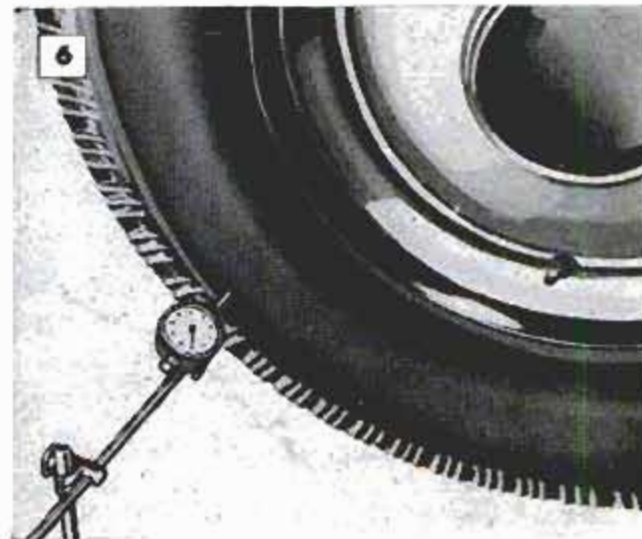
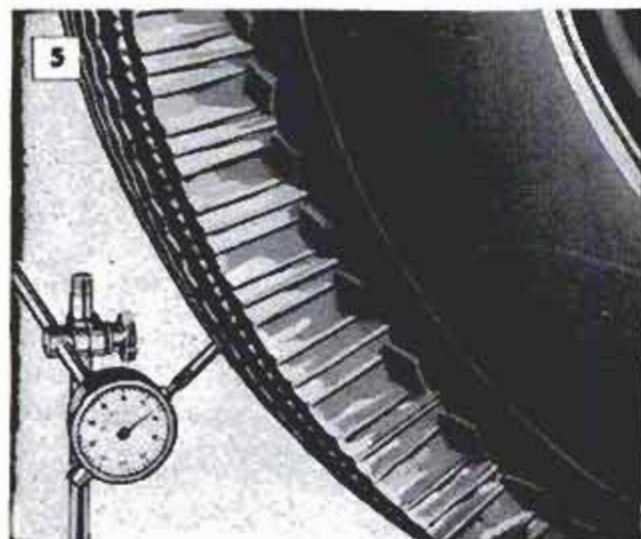



7

One cause of thump is "cupping" of the front tires, which usually is a result of wheel misalignment

appear to be out of alignment. Wheels can be straightened without removing the tires, by using a machine of the type shown in Fig. 3. If a rim has dents, the tire should be removed and the dents hammered out before the rim is straightened, since a damaged rim will not permit a tire to seat properly. The latter is especially true when tubeless tires are used.

A preventive measure against thumping is a visual inspection of the tires on your car. If the front treads show small areas of "cupping" as in Fig. 7, rotate the tires as indicated in Fig. 10. The front tires then will be used at the rear where the strain of acceleration will smooth off the cupped areas. Cupping of the front tires generally indicates misalignment in the front suspension system. Camber, caster and toe-in should be set on a wheel-alignment machine.

When a thumping sound or feeling persists in a car, even when all the tires have been inflated to 50-lb. pressure, some mechanical component is at fault. A thorough grease job sometimes is all that is required to eliminate a thump. "Frozen" kingpins or bushings in the front-wheel suspension will produce a feeling, and sometimes a sound, similar to tire thumping. Because the steering is connected to the front wheels through linkage, unusual sounds originating in the front suspension are felt directly through the steering wheel.

Front-wheel shimmy and tire thump are often traceable to shock absorbers that are inoperative, out of adjustment, or require fluid. Bad shock absorbers allow rear wheels to bounce over small bumps and spin while in the air, causing the rubber to scuff off the tire treads when they again contact the ground. ★ ★ ★

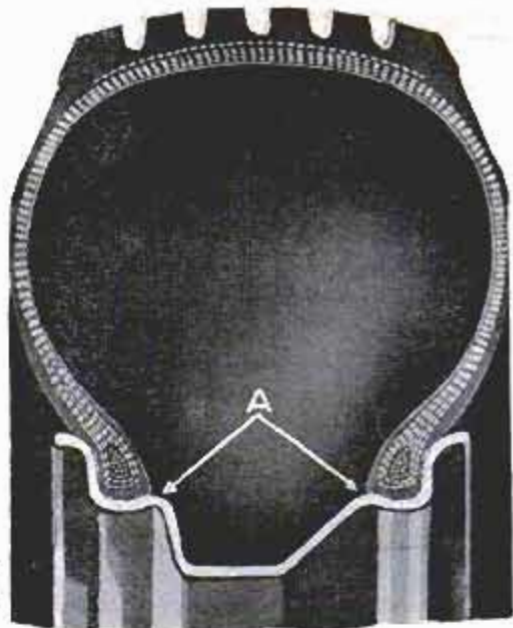

8

Above, overinflating will force bead to seat properly on wheel rim. Tire then is deflated to normal

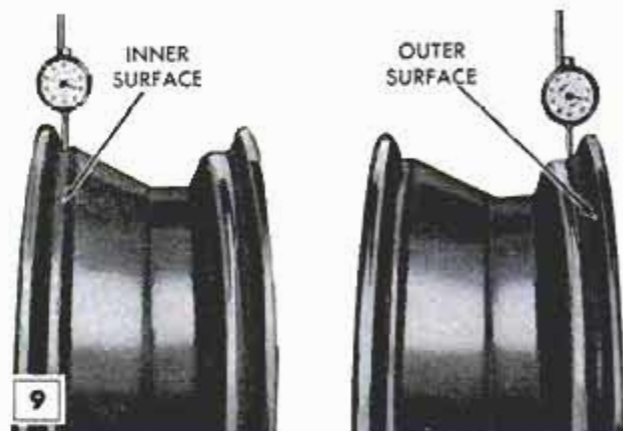

9

Above, since wheels as well as tires can be out of round, they also should be checked with dial indicator when severe thumping is noticed. Below, switching tires as indicated promotes longer wear, helps to avoid wearing conditions that lead to thumping

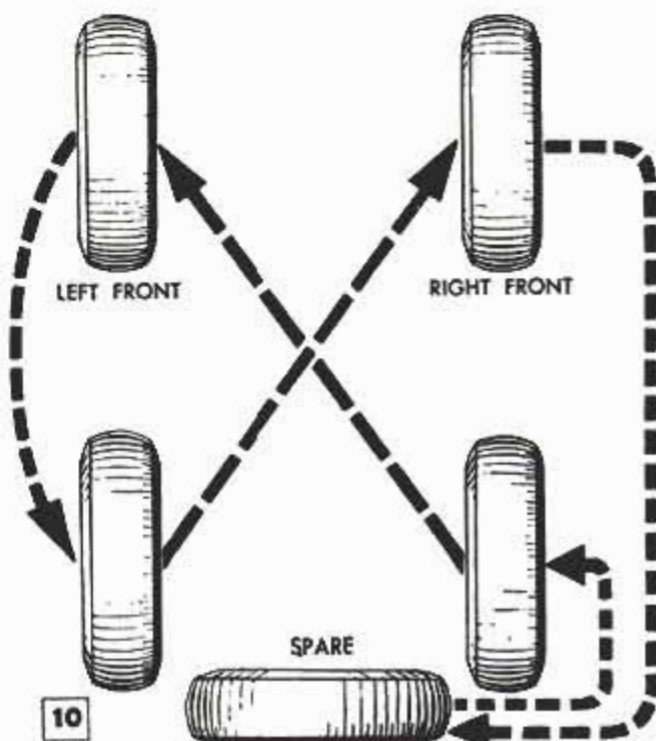

10

Home-Grown Fruits and Vegetables Washed on Window Screen

After gathering fresh fruits and vegetables from your garden, spread them out on a window screen and wash them with a hose. The screen should be propped up slightly on one side so the produce will not rest in the mud that is washed off. Before bringing the produce into the house let the water drain off.—Mrs. Michael Fey, New York City.

Worn spots on a waxed floor should be patched with liquid wax to prolong the life of the overall wax application. The liquid preparation cleans as it waxes so preliminary washing is not necessary.



Wetting Agent Improves Rubber-Stamp Imprint



Rubber stamps will produce more legible imprints if the letters and numerals are first cleaned with a photographic-wetting agent. The treatment prepares the smooth

rubber surfaces so that ink is readily accepted. A heavy solution of washing detergent produces similar results.

Ken Murray, Colon, Mich.

Finger Ring Size Marked on Cork To Aid in Purchasing Gift Ring

Next time you wish to make a surprise gift of a ring, ask to see one that the individual wears and slip it over a tapered cork. Insert a pin, or impress the cork with your fingernail, at the point where the ring binds. As soon as possible, accent the mark by drawing around the cork with a pen or pencil.



Finished Flooring Installed Over Concrete Without Subfloor

By nailing to short pieces of 2 x 4s called screeds, finished flooring may be laid over a concrete floor thus eliminating the need to first install a subfloor. Screeds from 18 to 30 in. are specified in FHA requirements, and should be arranged in staggered parallel rows 12 in. center-to-center with an overlap of not less than 4 in. Treat the screeds with an odorless wood preservative that will not bleed through the flooring before placing them on the concrete. An asphalt mastic applied hot to one side of the screeds is used to fasten them to the concrete. Spread the mastic with a notched trowel of the type used for linoleum cement to prevent too heavy an application. A space of at least 1 in. should be left between the screeds and the base plate of the walls to permit expansion.

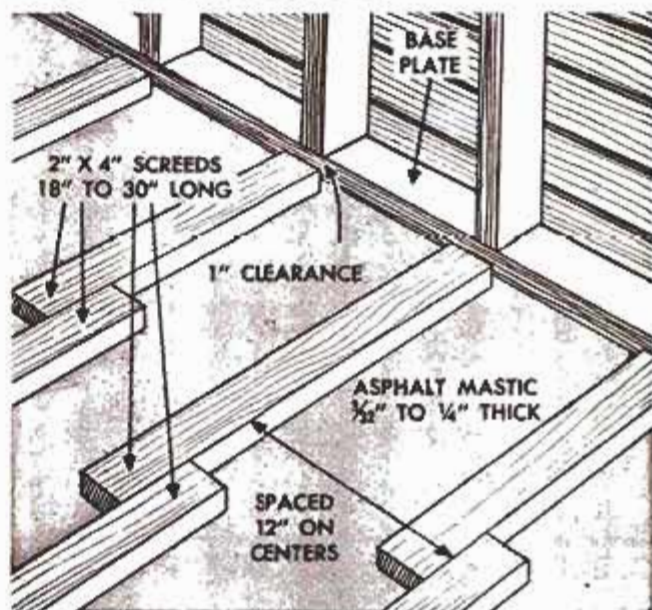

STAPLE SAVVY



When packing lunches in paper bags, you can make sure there will be no accidental spilling of the contents by folding over the top of the bag and stapling it shut. A double fold of the bag top is stronger

Staples can aid lady in distress and save her from embarrassing situation. Staple repair will hold securely until broken strap can be mended or replaced



Handy home file can be made by stapling several business envelopes together at lower edges. Use envelope flaps as index markers by cutting each one slightly shorter than the one behind it, as indicated below



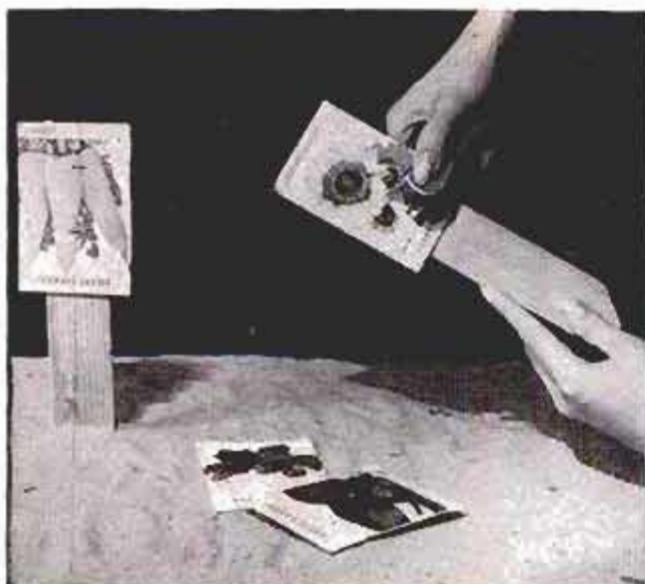

Seed packets used to identify garden plantings will not blow away if slipped over the stakes used to locate the rows and stapled in place. Reinforce the packet with cellulose tape where it is stapled

Installing shelf paper and edging is a lot simpler and quicker when staples are used to hold them in place. Paper liners for drawers also are more quickly fitted when staples are used to fasten them down



SEPTEMBER 1956



Staples are ideal for fastening felt weather stripping to door and window frames, as they are small enough so that they do not interfere with the sealing action of felt, yet hold it securely in place

For repairing screens, replacing screen wire in an old frame, or attaching new screen wire to a frame you have built yourself, staples will help you do the job more neatly and in considerably less time



199

WTM 50

Baby Swing With Tray



Removable tray on swing is convenient play surface, or baby's food can be served on it at mealtime

LIGHTWEIGHT, yet sturdy and practically tipproof because of its wide base, this baby swing can be carried from one room to another and will stand abuse from even the most lively infant. At mealtime the swing is held stationary by a locking bar, and the tray which ordinarily keeps baby safely in the bucket seat becomes a table. Material for the swing can be $\frac{3}{4}$ -in. solid stock or plywood. The swing uprights are 36 in. high and 6 in. wide at the bottom, tapering to 2½ in. at the top. Swing supports are about 26 in. long and 2 in. wide. Height of the seat above the floor is determined by the size of the baby. A rod 20 in. long provides a pivot for the swing. It is fixed solidly in the uprights of the swing stand and runs through brass bushings in the swing supports. Pipe spacers 2½ in. long keep the swing supports centered between the uprights. All joints are screwed and glued for maximum strength. Short lengths of dowel project from the sides of the seat and are located to hold the arms of the tray which are notched as indicated to hook over the dowels. For added safety, fit two removable dowels in blind holes under the arms of the tray.

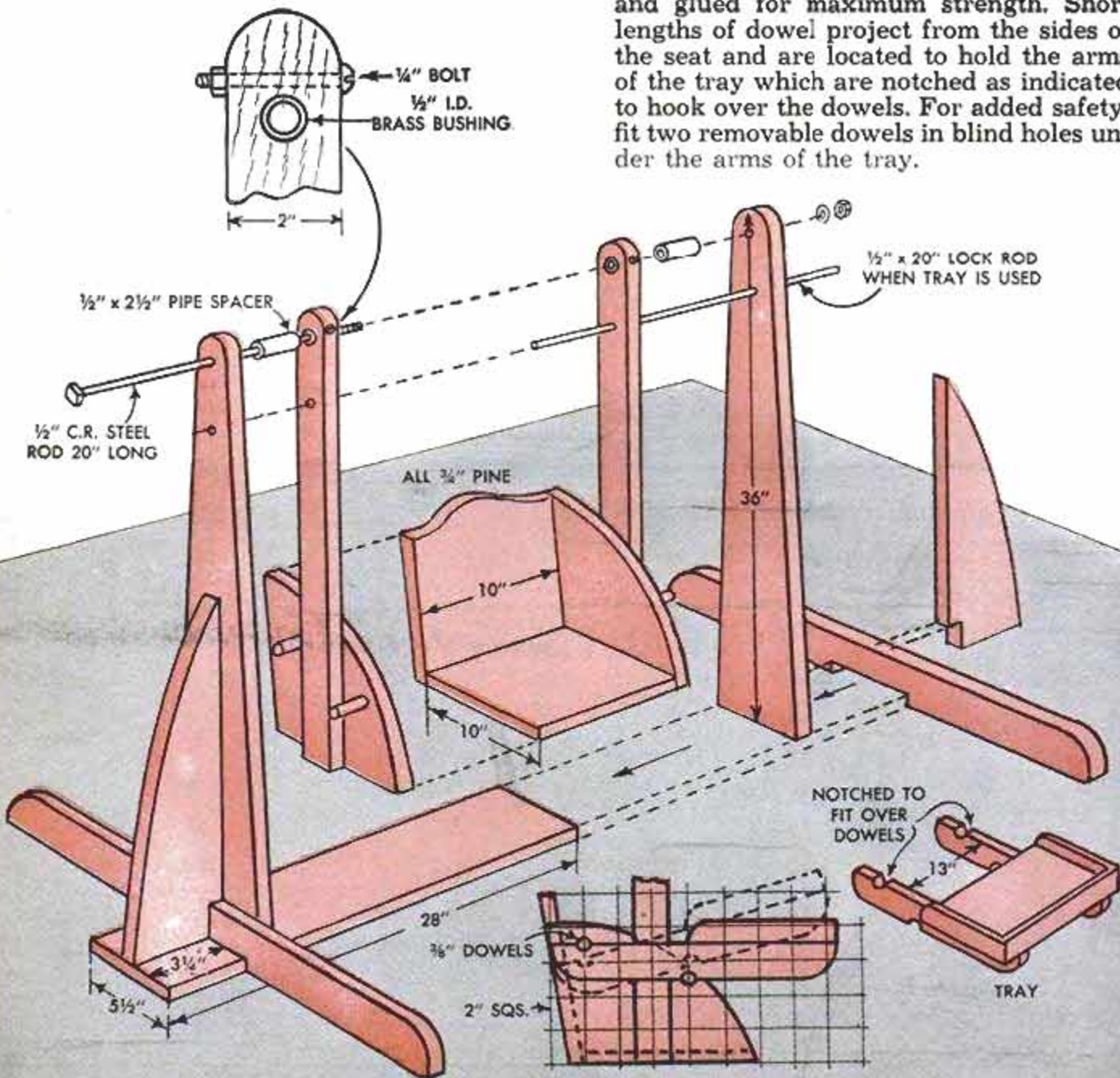

Farm Swing Features "Constant Level" Seats

Lengths of pipe and two seats salvaged from discarded implements were used by one farmer to make this unusual swing for his youngsters. The vertical pipes pass through slots cut in the horizontal one which supports the seats. Bolts fitted through this horizontal pipe provide pivots for the vertical pipes, which are pivoted in a similar manner to an overhead length of pipe in the swing frame. This type of assembly permits the seats and lower horizontal bar to remain level throughout the full arc of the swing travel.

C. F. Marley, Nokomis, Ill.

☐ Surface scratches on pewter can be "erased" or made less noticeable by rubbing the area lightly with No. 0 steel wool.



Broom Clips Hold Rolling Pin



A rolling pin can be stored on perforated hardboard, together with the other small kitchen utensils, by snapping it into a pair of broom clips screwed to the board. Drive the screws into scraps of wood on the back side.

Banana Oil Cleans Stiff Brush

Salvage paint-hardened brushes by soaking them in banana oil and rinsing with turpentine. The banana oil loosens the paint, and the turpentine cleans out both the oil and the paint. As

with all solvents, work only out-of-doors or in a well-ventilated room away from heat and flames.



Mildew and How to Combat It in the Home

If you are troubled with mildew in and around your home, the following information will aid in combating this problem. Mildew is a fungus-type growth that germinates from small microscopic spores which grow readily on food, furniture, clothing and other material that has become damp. It thrives on insulation in electronic equipment and clouds lenses in cameras and telescopes. The most harmful effects of mildew are its ability to stain and

rot cloth, decay wood and spoil food. Mildew requires organic food to exist, its appetite running in a wide range from paints to persimmons. Preferring moisture and warmth, mildew grows most rapidly during summer but actually lives all year long. Since it is impractical to wipe or spray every item subjected to mildew with a fungicide chemical, porous bags of dry chemicals which vaporize to protect against mildew can now be purchased for use around the home. If used according to directions, the chemicals are not dangerous. Rooms that smell musty from mildew should be aired out and all furnishings taken outside for airing and drying. Precautionary procedure to prevent mildew contamination of clothing requires frequent washing and dry cleaning.

Information courtesy of John Clarke & Co., New York City.

Tired of Paint, Wallpaper?

Decorate your walls with beautiful hardwood plywood. It adds warmth and charm like nothing else can. A three-part feature beginning next month shows in full color what a lift wood paneling will give to every room of your house

Aligned Marks Identify Loaded Developing Tank



As a precaution against opening a loaded developing tank by mistake, scribe or paint a continuous line on the cover and container when the tank is closed. Then, when the two marks are in alignment they will indicate that the tank is loaded with film

Knob Aids in Holding Scrub Brush



A drawer knob fastened to the back of a scrub brush will keep it from slipping out of your hand when wet with soap and water. Drill a hole

through the center of the knob and run a wood screw down into the back of the brush.—Mrs. Harvey Muller, Danboro, Pa.

Drawing Pen Easily Cleaned On Mohair Furniture Glide

This large mohair furniture glide is a better means of keeping a drawing pen free of lint than a cloth. It is also used to start the flow of ink in the pen

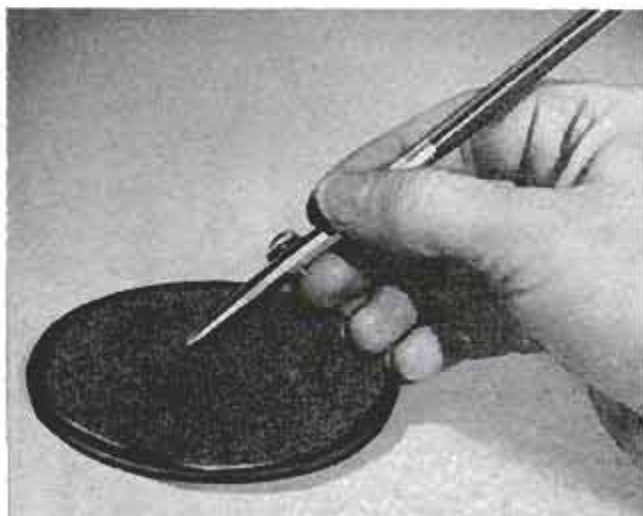

Comb Clears Brush of Loose Bristles

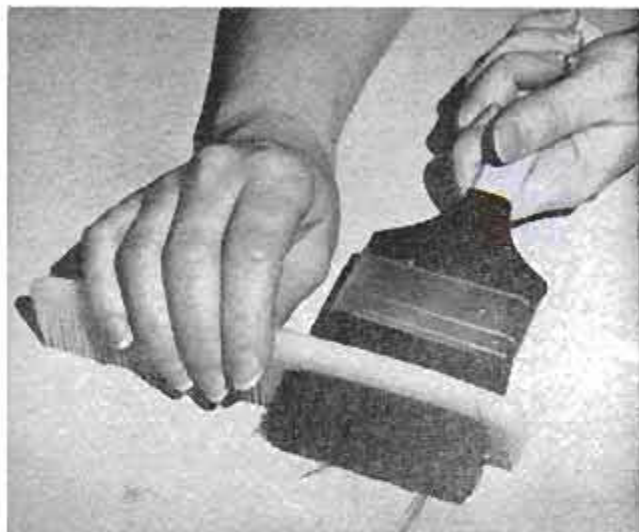

Even the best new paintbrushes have some loose bristles which should be removed before using the brush to avoid ruining a paint job. A good way to do this is to gently run a comb through the bristles

Balsa Wood Indented for Bending

Smooth bending of balsa wood around a specified radius, often required in model building, is accomplished by first indenting the wood on the side having the smallest radius. Indentations

are formed by placing a triangular file under the wood and tapping with a mallet as shown in the illustration. Uniform spacing of the indentations is essential for smooth bending. Distance between the indentations is governed by the radius in that a smaller radius requires closer spacing than a larger one.

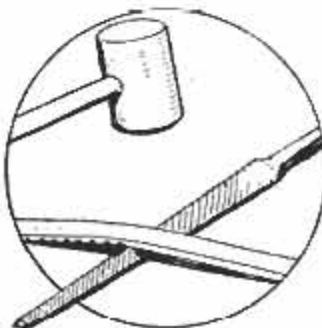

Dowels "Lock" Dado Joint

To "lock" shelf ends into dados cut in the side members of a cabinet, drive dowels into holes drilled in the joint as indicated. The holes are centered on the line between the upper and lower surfaces of the shelf and the sides of the dado. It is impossible for the shelf to pull out of the dado until the dowels have been removed.

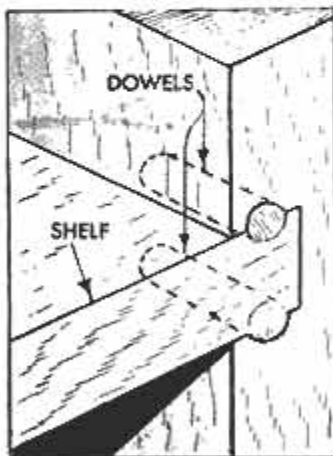

L. H. Weber, Havana, Ill.



TILED-TOP TABLE HAS BALL-BAT LEGS

GRACEFUL LEGS for this table are purchased ready-made as junior-size baseball bats, and ceramic tile is applied to the top with mastic-type adhesive. Size of the original table top was $12\frac{1}{2} \times 18\frac{1}{2}$ in., but the dimensions will vary, depending on the tile pattern. The bat legs are about 21 in. long. The top is cut from $\frac{3}{4}$ -in. plywood and is $\frac{1}{8}$ in. larger all around than the size of the tiles used. Rabbet the lower edges of the top $\frac{3}{8} \times \frac{5}{8}$ in. to accommodate lengths of $\frac{3}{4} \times \frac{3}{4}$ -in. steel angle which are screwed to the underside as shown in the upper right-hand photo. The apron, cut from strips of $\frac{5}{8} \times 2$ -in. hardwood, is beveled along the top edges at an angle of about 85 deg. so that when the legs are attached to it they will have a spread of about 5 deg. from vertical.

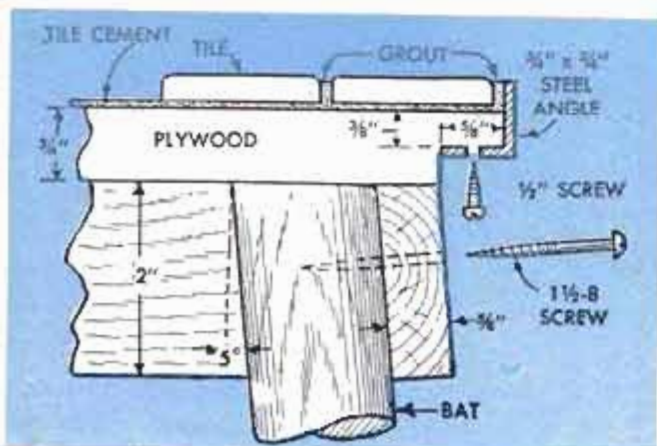

SEPTEMBER 1956



Above, steel angles that protect edges of ceramic tile are screwed to rabbet on underside of table top

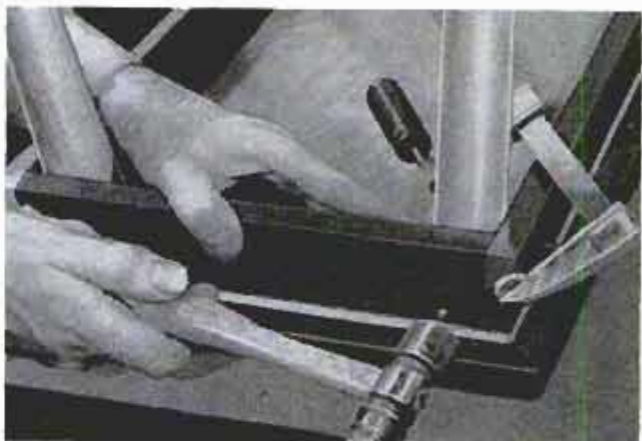

Above, bat legs are installed with trademark inside. Below, tile adhesive is spread with tooth-edged trowel



Below, after adhesive has dried for 12 hours, grout is wiped into joints and between tiles and angles





How to Build a Better Clothesline

By William B. Eagen

ANY HOUSEWIFE would appreciate a clothesline of this type on which to hang her wash. Turnbuckles at the ends of each line permit easy adjustment when necessary, while the sturdy, well-anchored posts prevent the lines from sagging. When strung with galvanized steel or aluminum wire, clothesline props and the hard work of fastening and removing a cotton line each washday are a thing of the past.

Location Is Important

First, choose a location where the clothesline will be exposed to sunlight at least during the morning hours and, if possible, away from bare ground or other sources of wind-blown dirt. Also, it should be behind the house or other building, out of view from the front of the house. When it is not possible to conceal the clothesline in this way, its appearance can be improved by adding latticework to the end posts or planting shrubs on the side exposed to the street. In addition, the location should have good drainage so that the ground remains firm during the wet months.

Next, determine the amount of line space needed for your average size of wash and stake out positions for the posts. A clothesline that is 25 ft. long requires only one post at each end, while one that is 50 ft. or more should have a center post for additional support. No more than 4 lines should

be strung between single posts. If more lines are needed, use two posts at each end, or erect a second clothesline.

For posts, use cedar, redwood or locust 4 x 4s or larger in 8½-ft. lengths and 4 x 4s of the same material for crossarms. The latter should not exceed 5 ft. in length for single-post installations, 10 ft. when two posts are used at each end of the clothesline. Bolt the crossarm in a ¾-in. dado on the side of the post away from the lines so that the crossarm is pulled against the post.

For a completely metal clothesline, use 1½ to 2-in. galvanized-steel pipe for posts and crossarms. The crossarm is welded directly to the top of the post, or slipped on a tee that has been turned on the top of the post. In the latter case it is necessary to drill a hole through the tee and the crossarm and through the tee and post to prevent them from turning or slipping. Or, the tee can be welded to the crossarm and post as shown in the drawing. Pipe caps are turned on open ends of the crossarm for safety and to prevent rain from entering the pipe and rusting it.

Posts Anchored in Concrete

Holes for the posts are dug not less than 2 ft. deep and 8 to 10 in. in dia. The sides at the bottom of each hole are undercut as shown in the drawing, to allow concrete to form an anchor around the post.

Before placing the posts in the ground, whether wood or steel, drill holes in the crossarms for the eyebolts needed to fasten the turnbuckles and lines. Space the holes at least 18 in. apart to allow ample clearance between lines. Also, drill two holes in the underground section of each post for the anchor rods or pipes as shown in the drawing. Then, place the posts in the holes and pour enough concrete in each so that the top can be rounded off about 2 in. above the ground. The underground part of wooden posts must be soaked in creosote or other preservative to prevent rot before they are set in the concrete. When the concrete has hardened, seal the joint between it and the post with tar and paint the above-ground part of the post with a good outdoor paint.

To prevent the posts from being drawn toward each other at the top, guy wires are fastened on the end posts as shown in the drawing. When metal lines are used with wooden posts, a ground wire should be run from each line to a rod in the ground for protection against lightning. ★ ★ ★

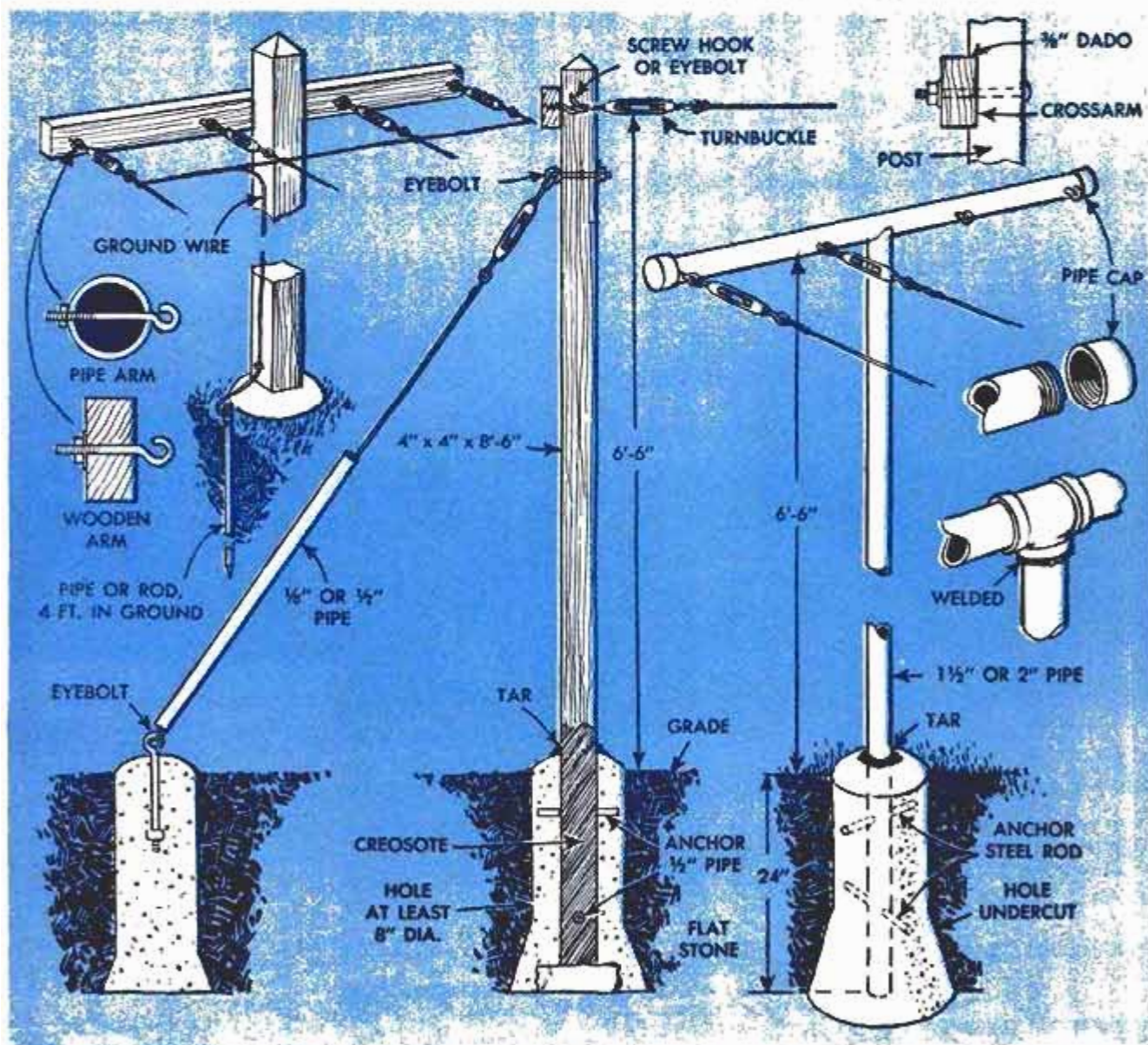

Black Tape on Flash Reflector Reduces Light Intensity

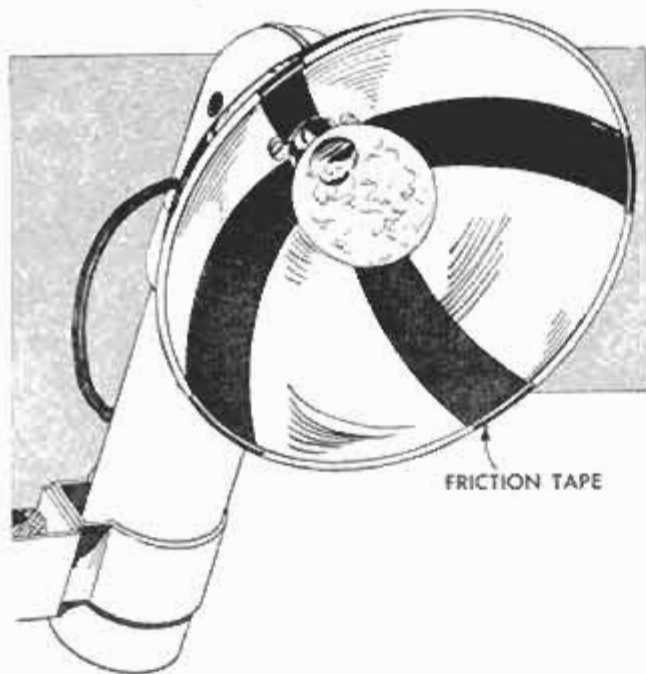

To prevent overexposure when using a photoflash for close-ups, reduce the reflector area with strips of black friction tape. It is best to take several test shots, using different quantities of tape, to determine the resulting flash qualities. When full intensity of flash is required, store the tape on the case for later use.

Eugene Lee Burner, Morgantown, W. Va.

Rolling of Flashlight Restricted

A flashlight or other cylindrical object can be prevented from rolling off a surface which is not perfectly level by taping a matchstick to the side as shown. If a matchstick is not available, a paper clip may be used. To keep a pencil or other small-diameter item from rolling wrap a strip of tape around it with the ends joined together to form a projecting ear.

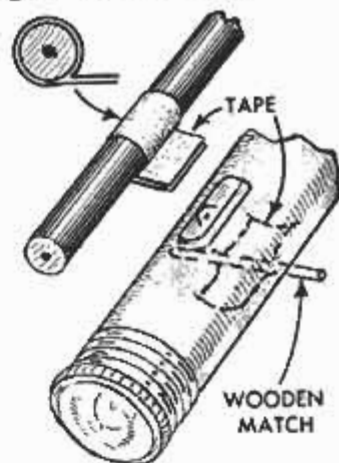

Old Trunk Converted Into Kennel

An excellent portable kennel can be made from an old steamer trunk as shown in the photo. First cut an opening on one side and fold strips of tin over the exposed edges, nailing them in place. If the exterior surface of the trunk is steel, drill holes through it and use sheet-metal screws instead of nails. The door is cut from $\frac{3}{8}$ -in. plywood, and fitted with a knob at the outside leading edge. Rails and stop strip are made by channeling square stock with a rabbet plane. These pieces can also be fabricated by nailing a $\frac{1}{2}$ -in. strip on the outside of a narrower cleat. Vents $1\frac{1}{2}$ in. wide are cut crosswise in the lid and may be also cut on the sides. For added warmth, cover the interior with $\frac{3}{4}$ -in. insulation board.—Laurence M. Bourne, Vancouver, B. C., Can.



Nail Hardwood Floor Over Old Softwood Floor

New hardwood flooring can be nailed on top of an old softwood floor if the latter is nailed tight to the subflooring and badly worn areas are replaced preparatory to installing the new floor. The new material should be laid at right angles to the boards in the old flooring to minimize uneven areas. Use shims where necessary.

Clothespin Fitted on Bucket Bail Provides Comfortable Handgrip

To avoid the discomfort of carrying a heavy pail or other container by means of a wire bail, slip a clothespin over the bail as indicated. Keep a clothespin handy in your car or pocket for this purpose when shopping. Store clerks also will appreciate the comfortable grip so provided when they must get heavy containers from a stockroom.



WEATHERED PUMP

Hides Lawn Hydrant

ADD RUSTIC APPEAL to your yard with this weathered pump that actually supplies water through a pipeline concealed inside. To add to the realism, the pump handle can be made to operate a shut-off valve of the type indicated in the detail. An alternate method of controlling the water is shown in the upper left-hand corner of the detail. Here a standard globe valve is located in the pump spout so that the handle projects through the top. The pump is mounted on a poured-concrete base about 18 in. square which is poured around the water line. A heavy steel angle is embedded in the concrete alongside the pipe to support it and one side of the pump. Steel flats are embedded in the concrete to which the other sides of the pump are bolted. The pump spout can be a length of 3-in. pipe or a split wood turning clamped with sheet-metal bands. Do not stain or paint the pump, simply let the wood weather.

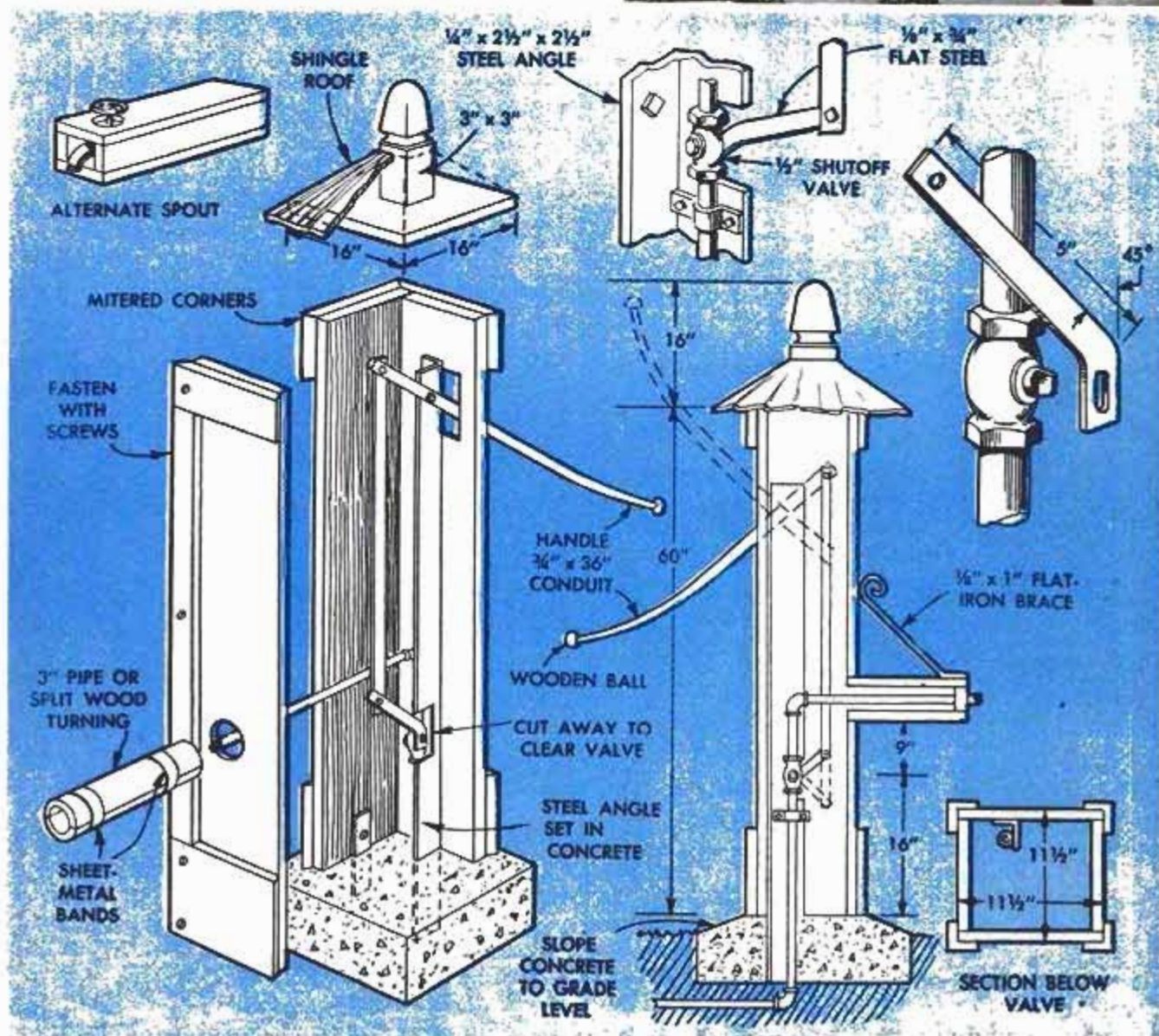



Camera Vibration Dampener

To prevent blurred photos, caused by jarring the camera when tripping the shutter, wire a small weight to the front edge of the camera bed as shown. The jarring especially affects photos taken at slow shutter speeds with a camera racked out for close-ups. A 1 or 2-oz. darkroom-scale weight usually is heavy enough.

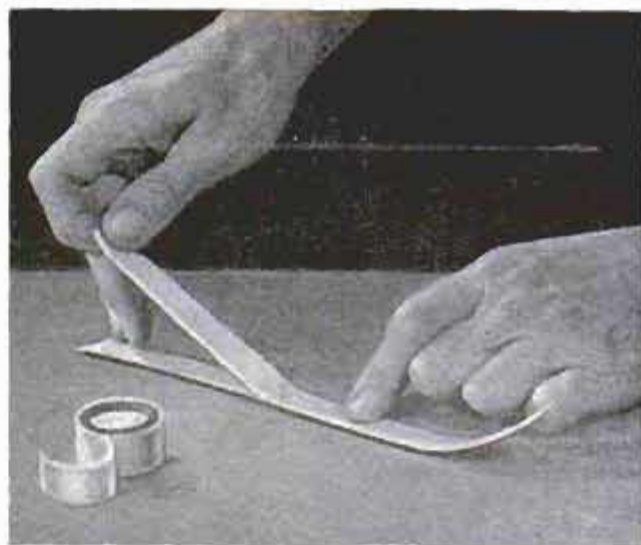

Reinforced Sandpaper Strips Substituted for Emery Cloth

Where abrasive strips must be pulled back and forth to smooth round work or scrollsawed edges, and emery cloth is not at hand, sandpaper cut in strips may be used. Reinforcing the backs of the strips with masking tape prevents the sandpaper from tearing easily and adds extra strength. When thus reinforced, sandpaper can withstand considerably more flexing than normally possible.

FIX-IT-YOURSELF TELEVISION MANUAL

For less than the cost of most new parts, you can learn how to maintain your TV set — and make many repairs yourself!

INCLUDES LATEST DATA ON COLOR AND ULTRA-HIGH-FREQUENCY TELEVISION

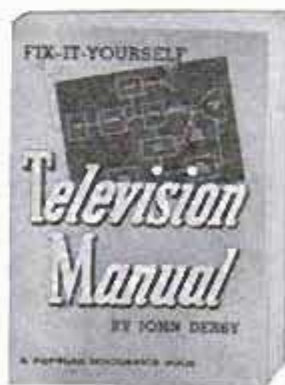

Complete, Reliable, Authoritative

John Derby, famous electronics engineer, has written another fact-filled, money-saving book. ALL ABOUT TELEVISION was bought by 200,000 savings-minded people, and the demand for it is larger than ever. But, with so many new developments in the field, Mr. Derby and Popular Mechanics Press realized a completely new book should be published. One aimed directly at the man who wants to make his own repairs.

Covers the Entire Subject

TELEVISION MANUAL will tell you, with no technical doubletalk, *everything* about television transmission and reception. It will expand your knowledge and enable you to handle 3 out of 4 TV repairs. Never again will you not understand what you're doing with a TV set. You'll know whether to call a professional or do the job yourself.

All the Latest Information

Now you can learn how color TV works, how to care for, and how to enjoy most fully that color set when you get it. TELEVISION MANUAL will show you how to take advantage of the new UHF networks and how to convert your present set to ultra-high-frequency. It will answer almost any question you may have about television.

MONEY-BACK GUARANTEE

TELEVISION MANUAL is guaranteed to satisfy you, to save you money—if not, you can return it within ten days for a full refund of the purchase price. So send your order, with a remittance of only \$3.00, today!

Popular Mechanics Bookshop

208 East Ontario Street
Chicago 11, Illinois

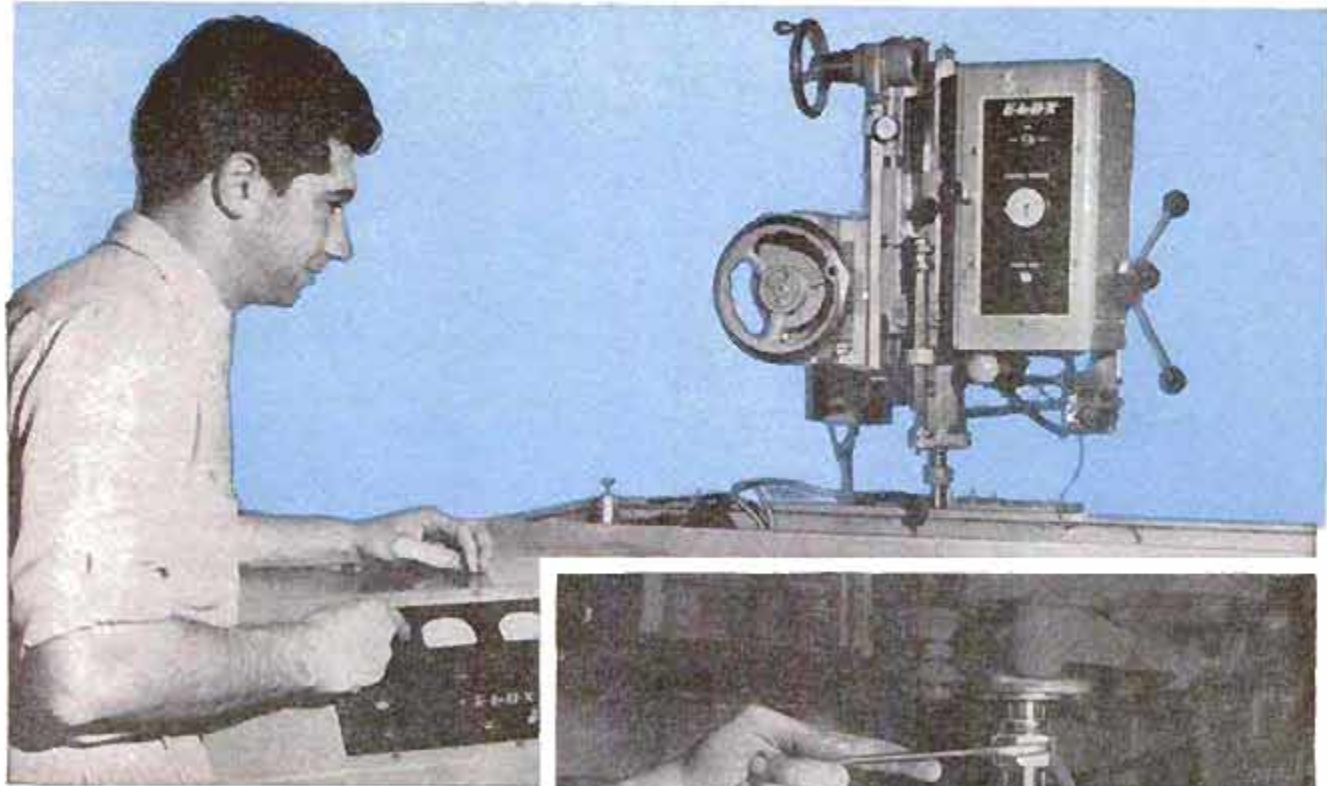

ELECTRIC SPARKS CUT HARD METALS

By Chas. G. Griffith

ELECTRIC SPARKS are the cutting edges of new tools used to machine hard metals. In electrical-discharge machining, or spark machining, as the process is sometimes called, metal is removed by controlled electrical discharges across a dielectric gap. The process is used for regular shop jobs such as drilling, reaming, broaching, diesinking and grinding, and also certain other types of work in exceptionally hard alloys which are impractical to carry out with conventional equipment.

A typical setup is shown diagrammatically on the following pages, the cutting tool being the negative electrode and the work forming the positive electrode. A typical machine of the type commonly used is pictured above and in the photos at the right. The



Above, in appearance the spark-machining unit is very similar to a small vertical milling machine. In the inset a fairly large electrode (cutting tool) is being attached to the spindle

Typical unit has both manual and automatic feeds, the latter electrically controlled to maintain a constant gap between the tool (electrode) and the work. Note separate control unit

Photos courtesy Allied Pacific Mfg. Co.

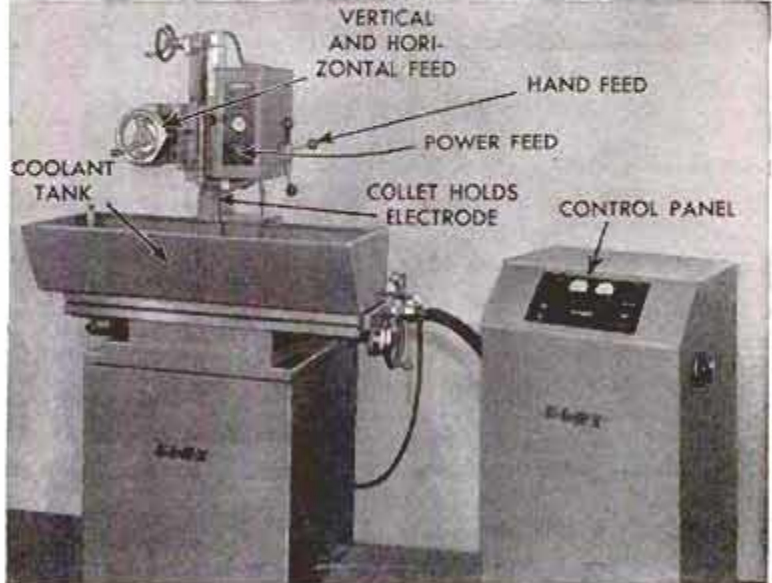

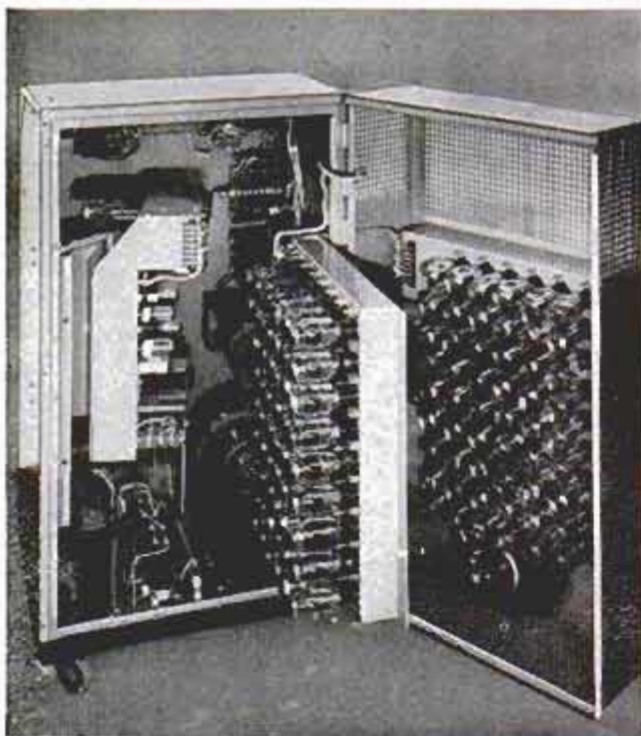

Photos by Elox Corp.

Control unit open to show banks of power tubes and condensers which build up electrical discharges

discharges occur in a dielectric coolant which is forced through the tubular cutting tool under pressure. As sparks do the actual cutting the use of a tool is simply to establish an area of the required size in which the sparks will be discharged. Although heat of the arc at the instant of discharge can reach 20,000 deg. F., or even more, the metal being cut is not heated. For this reason the process does not affect



Here is a machine of a different type especially designed for precision machining of jet-engine parts

either heat-treated or work-hardened metals. No heat is generated in the tool itself.

Constant Boring Rate

The rate of metal removal is constant for any one metal if the power supplied to the tool is held constant. Where holes are to be bored through, a tubular electrode (tool) is used instead of a solid rod. The tube cores the hole through much faster than solid-rod boring, due to the lesser amount of metal that has to be removed. When recessing, diesinking or drilling shallow holes, a solid tool usually is used. In common practice the work is placed in a specially made tank or tray containing the dielectric coolant. Various coolants are used, such as mineral oils, carbon tetrachloride and petroleum jelly. As a rule, clamps are unnecessary as there is

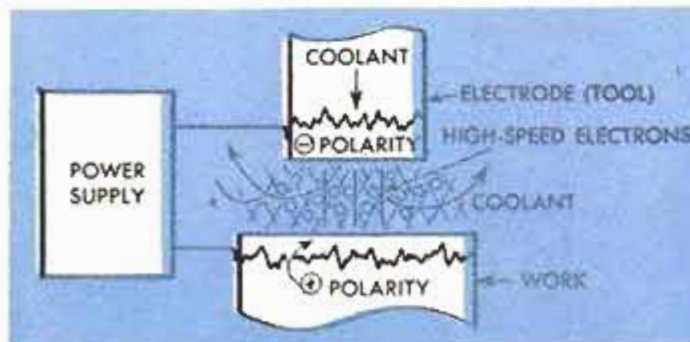

A typical spark-machining setup shown diagrammatically above and at right using hollow electrode through which a dielectric coolant is forced under pressure. The hollow electrode removes metal at a much faster rate than does a solid electrode. Note core formed inside tool

Drawing by Elox Corp.

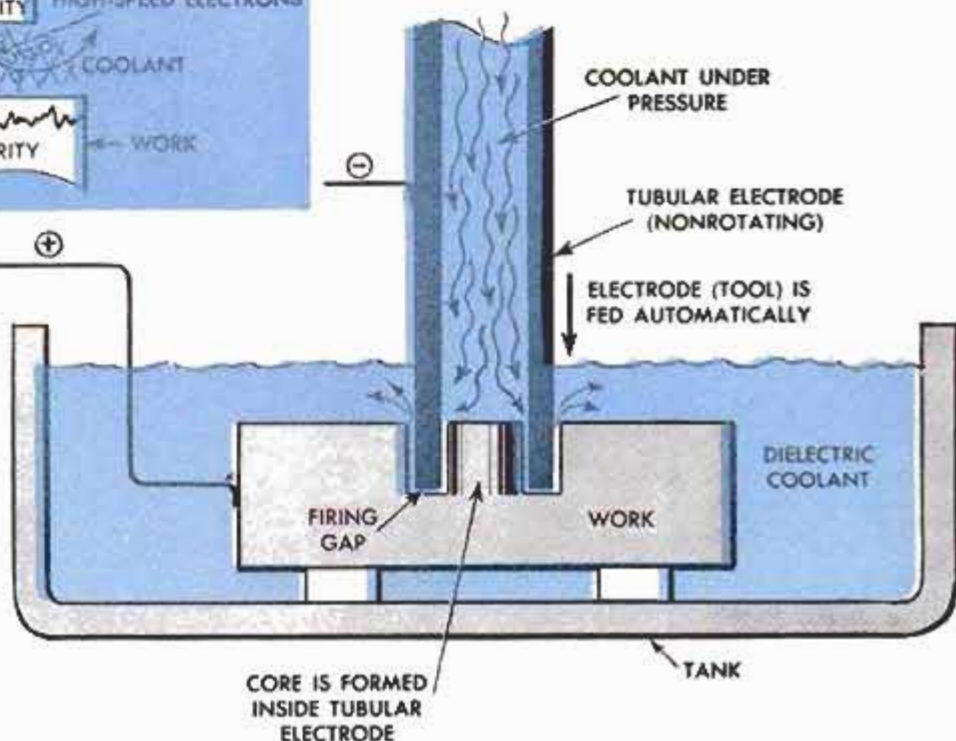

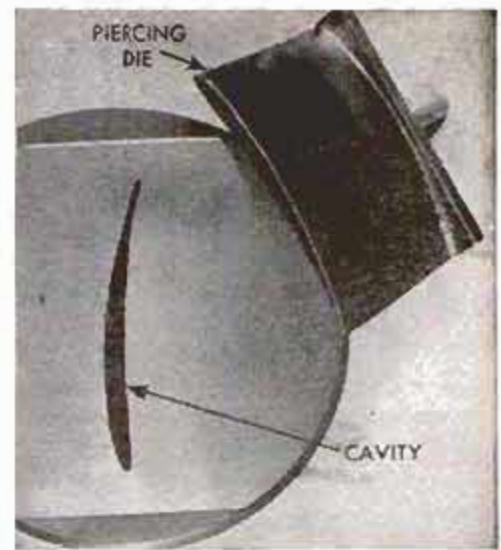
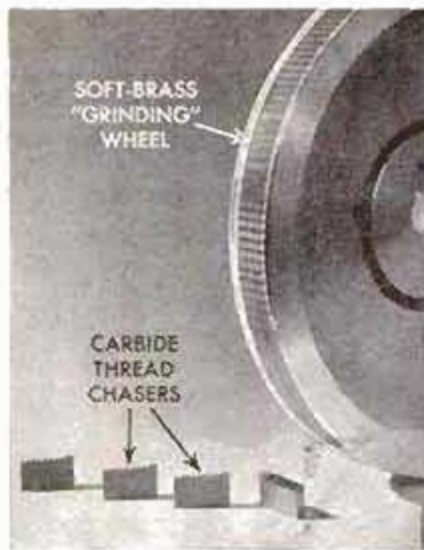
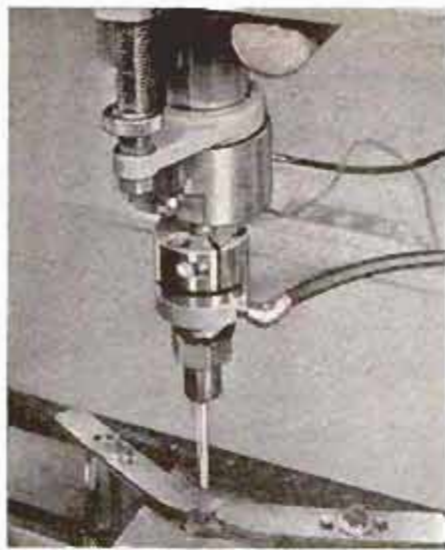

Photos by Elox Corp.

Photo at left pictures a tapping operation, using a special electrode, or "tap." Center view shows a brass grinding wheel used to cut carbide. Right, a piercing tool, or die, cuts cavity of same shape

no contact between the tool and the work while the unit is in operation, but work of an irregular shape may require blocking and clamping to prevent it from tilting out of proper alignment.

Operation of Machine

Although both rotating and vibrating electrodes (tools) are in use, machines of the type pictured have nonrotating electrodes electrically controlled to maintain a preset gap between the tool and work and at the same time to compensate for tool erosion. Once the setup is made and the machine placed in operation it is fully automatic, and requires no adjustment or other attention. Some machines have four working speeds: Roughing, semifinish, finish and microfinish. With adjustments it is possible to attain a 10-microfinish and hold tolerances of .0005. Where pre-

cision is essential the work usually should be done in three stages: Roughing, semi-finishing and finishing steps. By this procedure it is possible to correct any slight errors that may develop in the first two operations. Also, on precision work it's a fairly common practice to run tests on pieces of the same metal as the work piece. This is done to determine the required size of the tool, especially where the electrode (tool) is of a more complicated shape or pattern.

Cutting Tool Construction

In operation, the tool is worn (eroded) away as well as the work, although at a

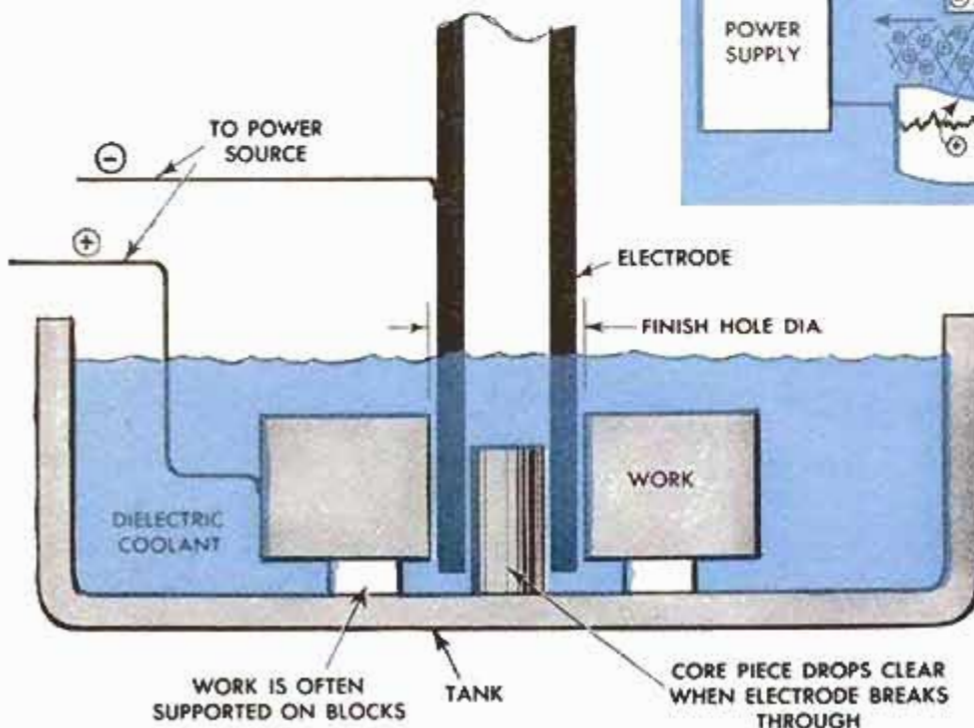
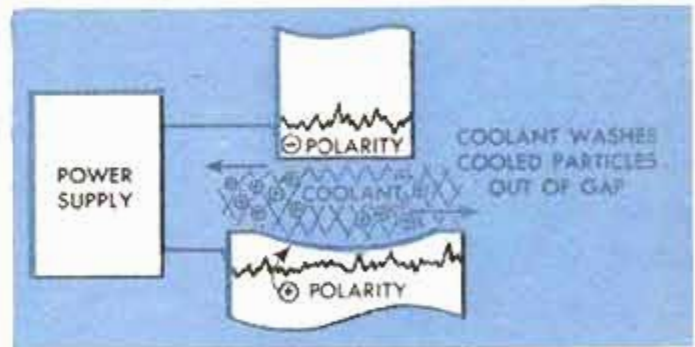

Note in the diagram at the left that finished diameter of hole is larger than the electrode. This is due to necessary spark gap which must be maintained throughout operation. In all diagrams the relative width of spark gap is greatly exaggerated for purposes of clarity

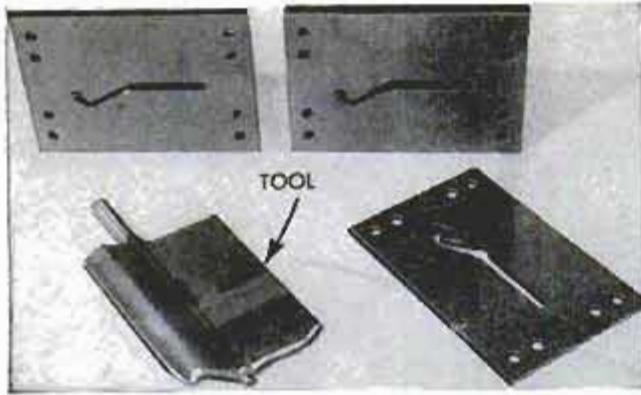

Left and center, examples of work done by spark machining with tools (electrodes) of various shapes, or patterns. Work can be pierced or recessed as shown

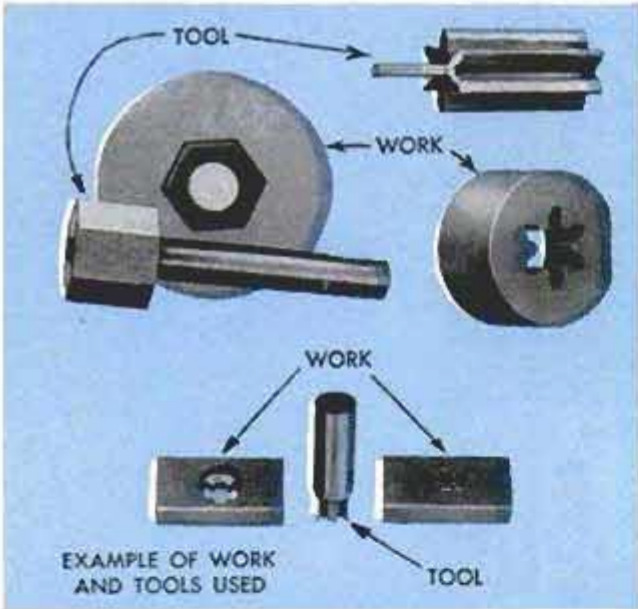

much slower rate. This is due to the heat generated in the immediate vicinity of the arc and also to the friction of metal particles in the coolant fluid. In many types of work, tools made from brass containing about 40 percent zinc appear to give the best average results. However, tools made from brass may not always combine the highest productivity with maximum wear resistance. The wear rate of the tool can be controlled to a certain extent by lowering the power input or selecting a more wear-resistant tool material. One factor that sometimes controls the selection of tool material is the cost of shaping the tool to the desired form. Easily worked materials such as brass are often selected on this basis alone and in some cases metals that can be pressed or cast, such as aluminum and iron, are often preferable.

Tools used for spark machining generally are of two major types, those having a sectional profile and those having complete profiles. The sectional, or partial-profile, tools generally are used for large holes, recesses, or other types of work for which a solid tool would be prohibitive in first cost. Where high precision and fine finish are required, complete, or full-profile, tools are commonly used. In some instances where highest productivity is the main objective, composite tools and multiple-circuit wiring are resorted to, each electrode of the composite tool being wired to a separate condenser. Various common examples of work done by spark machining are pictured on this and the preceding pages. ★ ★ ★

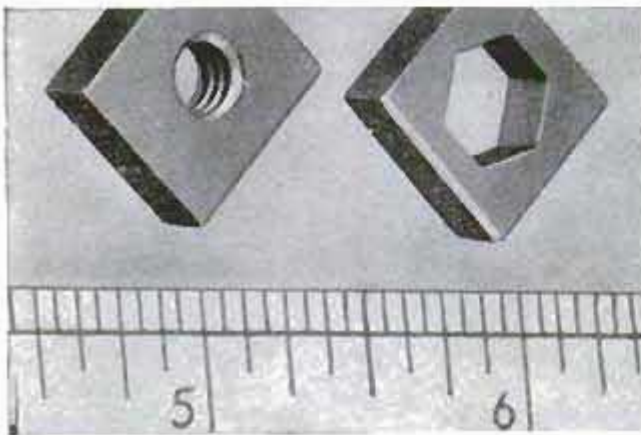

Left, an example of work on small parts. Note relative size and accuracy of the tapped and hex holes. Below, a forging die recessed by spark machining

Photos by Elox Corp.

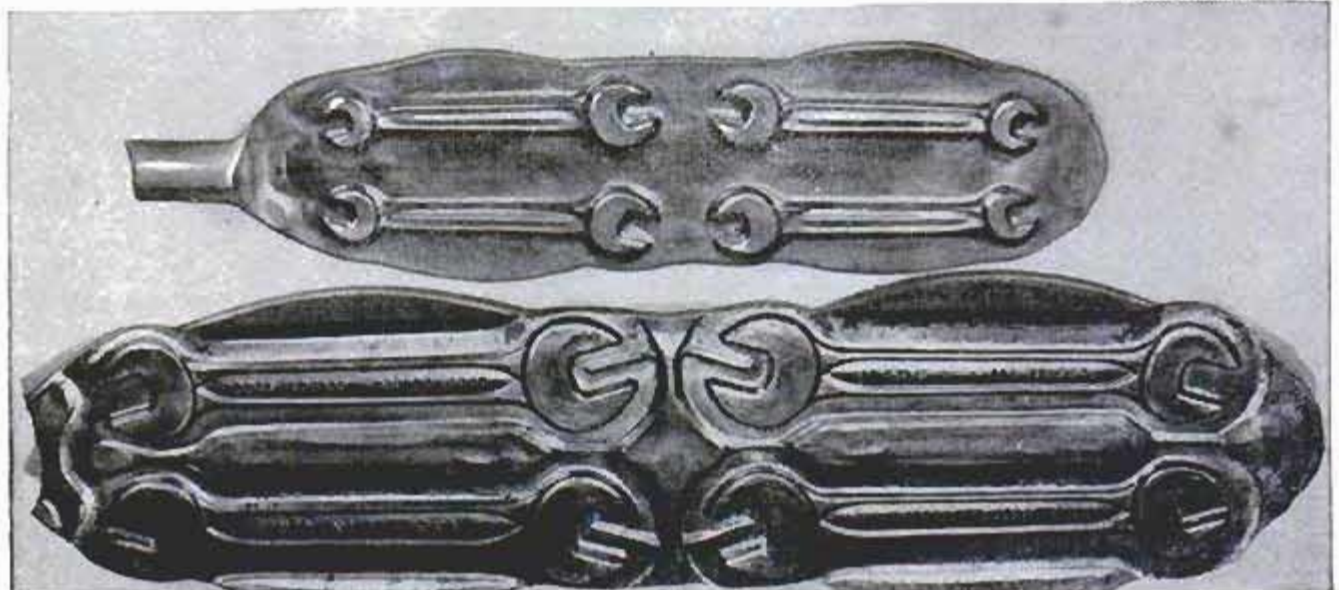

Wedge-Shaped Pie Plates Are Handy Workshop Sorting Trays

Pie plates having a wedge-shaped design to hold individual servings can be utilized in the home workshop as sorting trays. Lay them out in a circle on the bench or place them in a compact row along a shelf by alternating the points. When empty they can be stacked one on top of another. As you prepare for a project place a quantity of each type of screw or nail to be used in a separate tray where they will be convenient to your work. When finished, pour the remainders back into their respective containers using the point of the tray as a funnel. Mixed nails and screws can be poured out on a tray to find a specific one and then funneled back.



"Pleated" Paper Keeps Grit Out Of Metal-Cutting Lathe

When using a tool-post grinder sparks sometimes ignite the cloth ordinarily used to keep abrasive particles off the lathe bed. A simple solution for this is a piece of heavy paper folded accordion style and placed on the bed between the headstock and the carriage. The paper expands and compresses as the carriage is moved along, keeping the bed covered at all times. Sparks strike the folds at a glance and cool off before reaching the bottom of the folds.

John Imbery, Regina, Sask., Can.

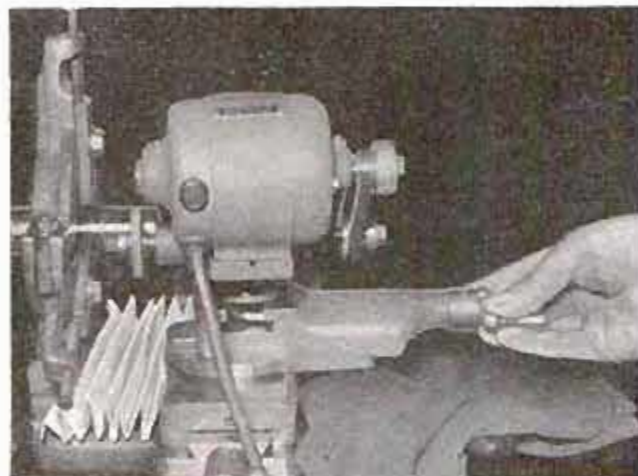

Backstop Permits Disks To Be Quickly Trued Up in Lathe Chuck

A backstop fitted to a No. 2 Morse taper-shank, as indicated, will eliminate much of the time and work in truing disks and other thin work. The length of the shank is determined by the thickness of the chuck, as shown in the detail. The backstop itself is drilled and bored to a press fit on the shank. After the stop is driven onto the shank, the assembly is mounted in the chuck and faced off so the disk is $\frac{1}{16}$ in. short of being flush with the face of the chuck jaws, which permits work to be trued to within a fraction of an inch of that dimension.—C. W. Woodson, Chicago.

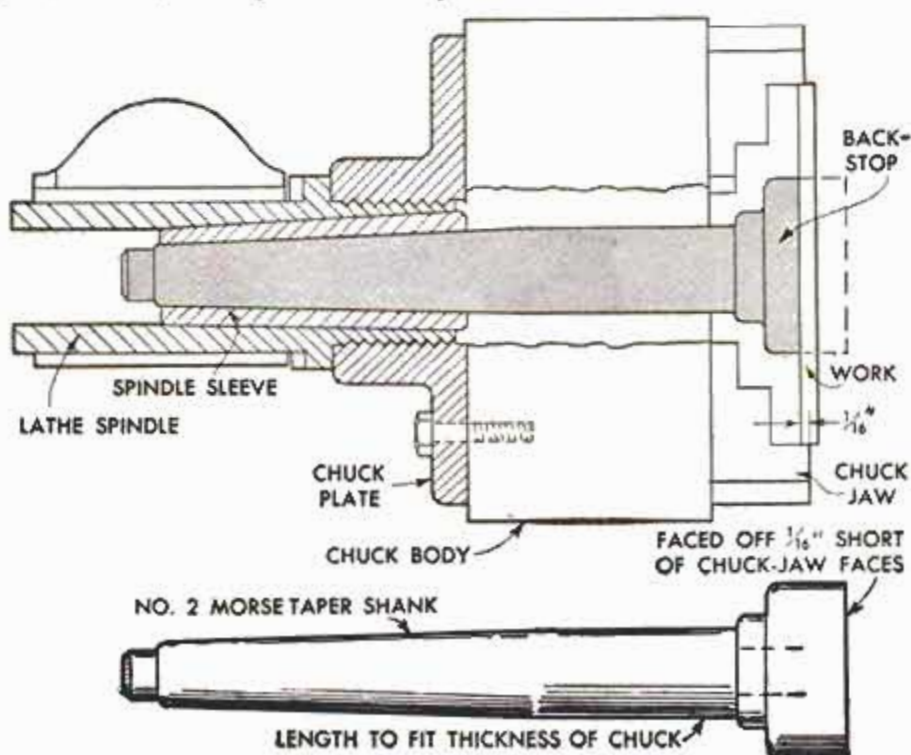

SN 54

LATHE HINTS



Accessories you can make on your own lathe, also setups that simplify and speed up unusual jobs

By C. W. Woodson

Deep Boring

When running deep bores in work of varying diameters, it's an advantage to have the boring bar mounted on an eccentric sleeve for quick adjustment of overhang and position of tool bit in relation to lathe axis. Eccentric mounting of bar also is an advantage for internal threading.

Steady-Rest Setup

When the job calls for running two shoulder cuts from a central point, or when working long stock which is beyond the capacity of the lathe, the setup pictured often proves helpful. By locating a collar to bear against the jaws of the steady rest it is possible to drive the work with a dog rather than mounting in a 3-jaw chuck. This type of setup often prevents chatter marks on long work of small diameter when other setups fail. Mounting on the live center and driving by a dog also prevents any tendency of the stock to whip due to slight misalignment with steady rest.

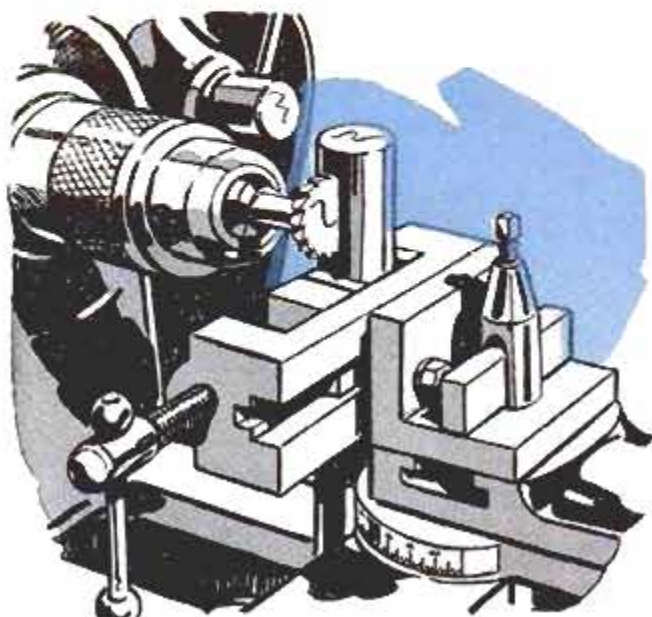
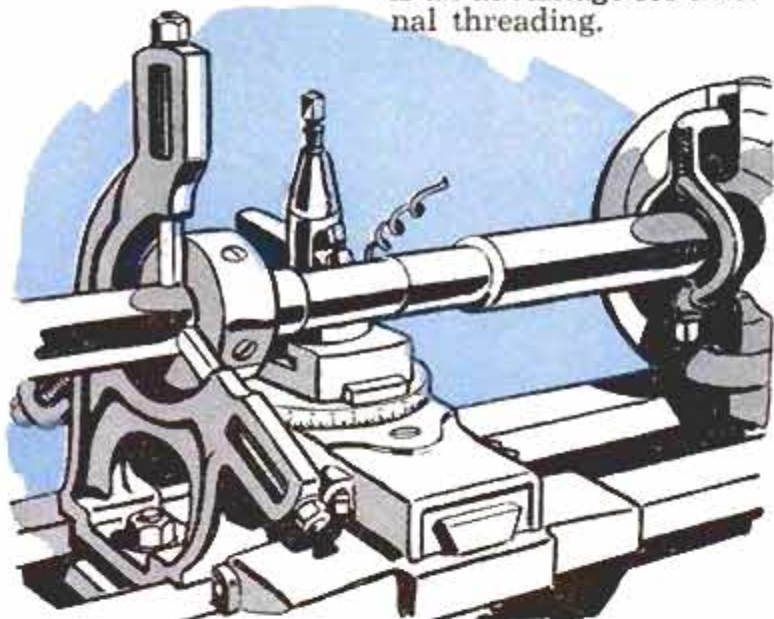

Cutting Keyways

Woodruff keyways are easily cut in the lathe, the work being held vertically in a drill-press vise mounted on a small angle plate. One web of the angle plate is drilled to fit over the tool post and a short length of bar stock is inserted in place of the tool-holder. When the tool-post screw is tightened, the angle plate is held securely in position. The vise is bolted to the vertical web of the plate and care must be taken to locate the jaws perpendicular to the lathe ways. The keyway cutter can be driven by means of a collet chuck or a geared chuck of the type that screws onto the spindle nose. The work is hand-fed to the cutter by means of a cross-feed screw.

Fillet Cutter

Perfectly formed fillets on a shoulder cut are possible with this special tool you can make in your own shop. For cutting mild steel and the softer metals, the cutter can be made from ordinary drill rod, the diameter of the drill rod depending on the radius of the fillet. The holder is made from a length of bar stock, one end being beveled and drilled to take the shouldered end of the cutting tool in a drive fit. A cutting edge is formed on the tool by grinding the end at an angle. An angle of about 60 deg. will be suitable for average work. For brass the angle should be somewhat greater. When using this tool take very light cuts as otherwise it may leave fine chatter marks on the fillet.

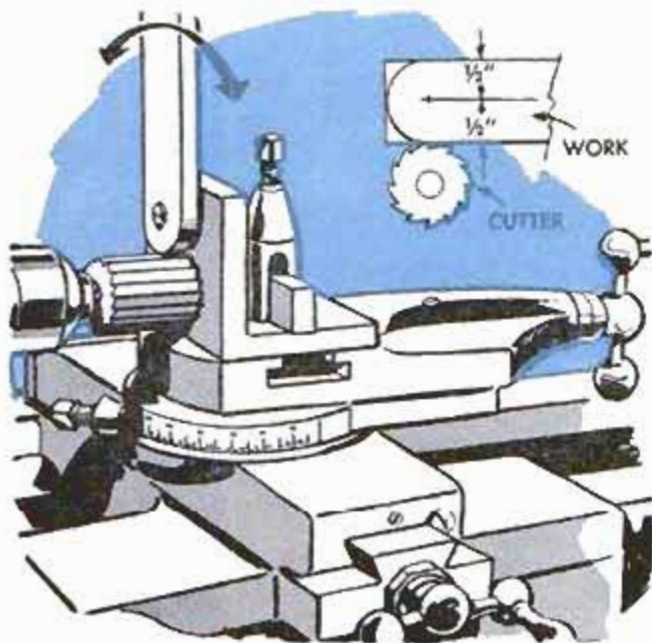
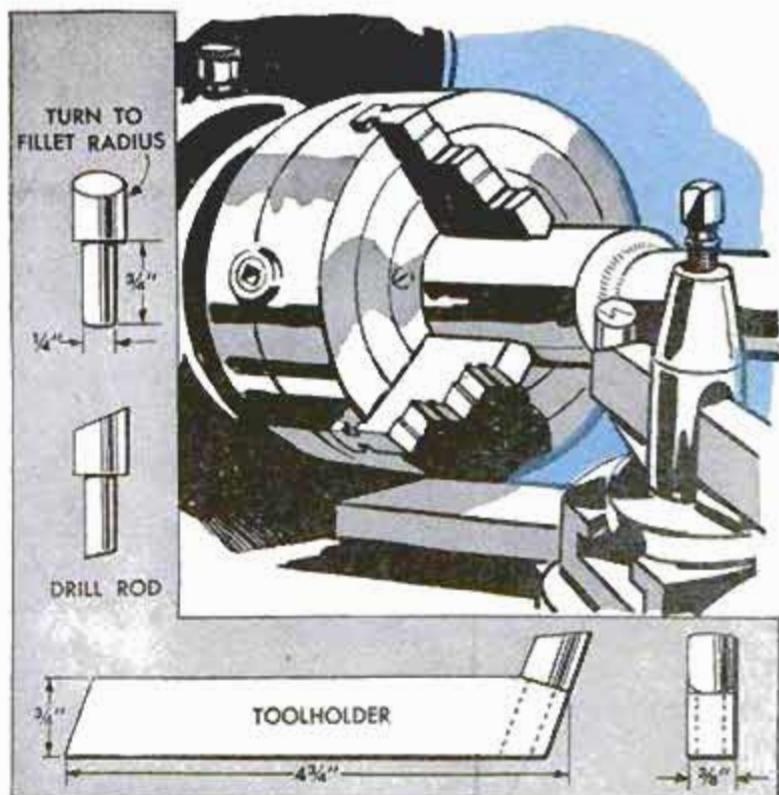

Milling Radius

One machinist made the setup pictured to mill a true radius on the ends of a number of identical pieces of flat stock 1 in. wide. To mill the end the stock is moved through a 180-deg. arc, either forward or backward depending on the direction of rotation of the cutter. As a rule it is best to reverse the lathe.

Boring-Tool Holder

Details below at the left show how to make an eccentric boring-bar holder for deep boring and internal threading. It consists of a base of mild steel and an eccentric bored $\frac{1}{4}$ in. off-center to take a round-bar toolholder. This type of holder is exceptionally steady in deep bores.

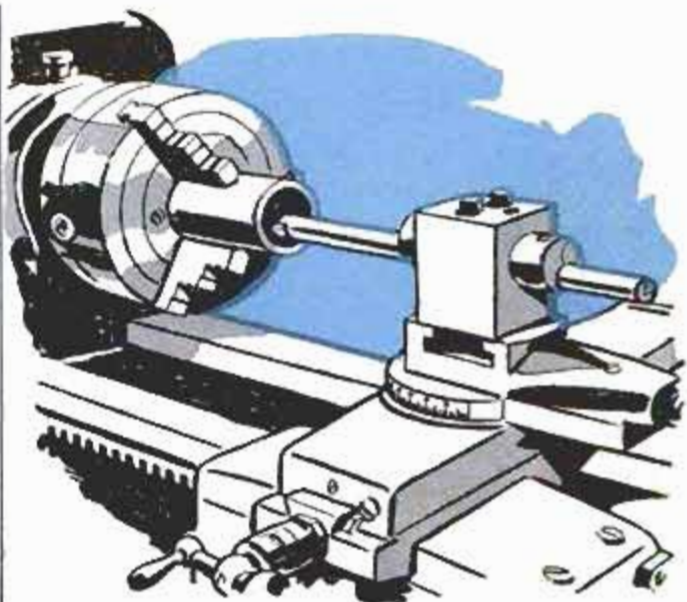
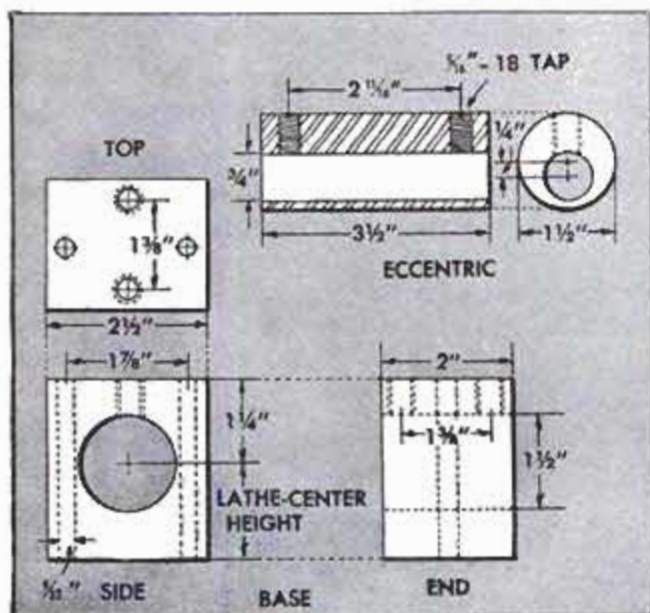



Cotter Pins Held Between Bricks Prevent Sag in Mason's Line

A mason's line that is used on a long wall can be prevented from sagging when one or more cotter pins are slipped on the line and anchored between bricks at regular intervals as shown. It may be necessary to arrange some bricks on the wall temporarily to provide suitable support for the cotter pins at the desired intervals. The pins can be left on the line when it is not in use.

Power Brush Cleans Blind Holes

Blind holes drilled in wood or metal are cleaned easily with a small, round brush fitted in an electric drill. A small bottle or test-tube brush having most of the long wire handle cut off before mounting it in the drill chuck will do.

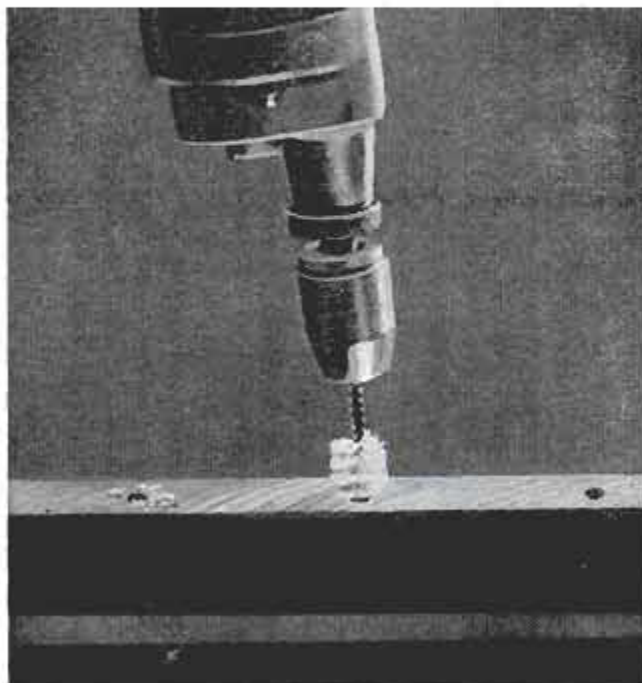

Door Veneer Cut With Knife Prevents Saw Damage

When a door in your home has to be shortened, it can be sawed without splintering the veneer if a cut first is made through the veneer with a linoleum knife. First, measure the door carefully, mark the saw line on both sides and cut through the veneer with the knife as shown. To be sure that the saw stays in the knife cuts, hold the door vertically when sawing through the core, so the blade can be watched on both sides of the door.

Stuart Foster, Columbus, Ohio.

V-Block Guides Bushing Into Jig-Plate Hole

Pressing a round bushing straight into a drill-jig hole can be done easily with the aid of a V-block and a machinist's clamp. Set the bushing in line on top of the hole, place a V-block against it and screw the block clamp, finger tight, against the bushing. Clamp the block and jig plate together with the machinist's clamp as shown in the illustration, being sure that the bushing is still in line. Drive the bushing partially into the hole with a brass rod of similar outside diameter. Complete the seating of the bushing in a vise or arbor press.

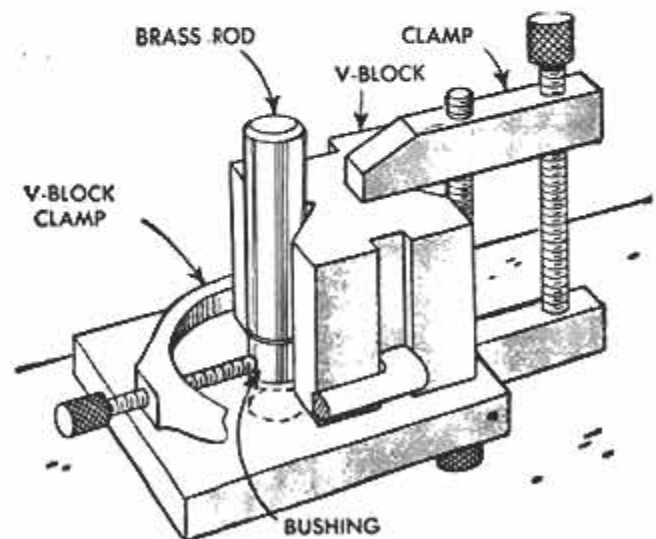

Sleeve Weight Hits Punch in Place of Hammer

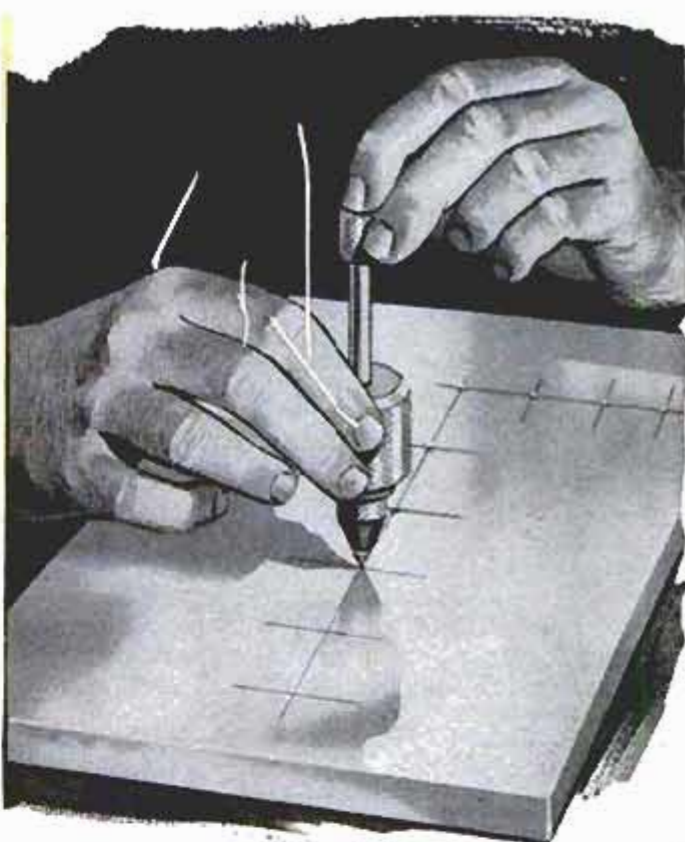
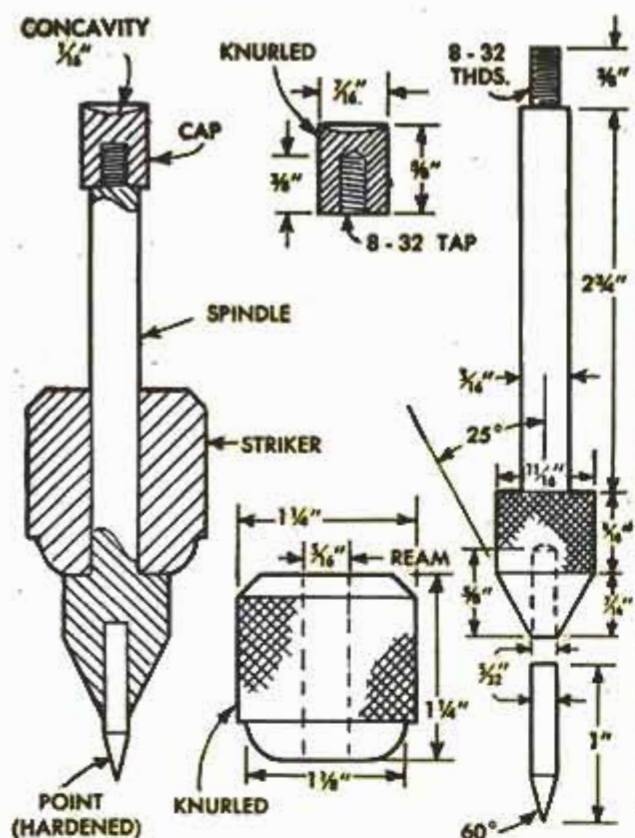

Layouts can be marked more rapidly with the center punch shown in the illustration above as a hammer is not needed to drive it into the work. Instead, a sleeve weight fitted on the spindle is raised and dropped delivering a blow of sufficient force to make an impression in the work.

The spindle and replaceable point are made from tool steel while the striker and the finger grip on the end of spindle are of mild cold-rolled steel. Cut a fine knurl

on the base of the spindle and place an 8-32 thread on the opposite end. Then center-drill the base to receive a short length of rod which is driven into the hole and ground to a 60-deg. point with the tool-post grinder on the lathe.

The sliding striker is turned from bar stock, knurled on the outside, center-drilled and reamed for a sliding fit over the spindle. A finger cap tapped to fit the 8-32 thread on the spindle locks the striker in place.

Lugged Rims on Tractor Wheels Give Traction on Wet Ground

Tractors equipped with an extra set of steel lugs on the outside of the rear wheels are driven easier and faster in wet fields, when working the ground or when hauling feed and water to fowl and livestock. The lugs bite into the ground preventing the rubber tires from slipping, since they are bolted together at the rim and revolve simultaneously.

Notched Oil-Can Spout Lifts Cap

An oil filler cap that is located in a difficult place to reach can be opened and an oil-can spout inserted if a small notch is sawed in the spout. The notch should be about $\frac{3}{16}$ in. from the end of the spout and at a 45-deg. angle. Hold the spout at a 45-deg. angle when filling with oil to avoid spilling it.—Bruce D. Stewart, Winder, Ga.

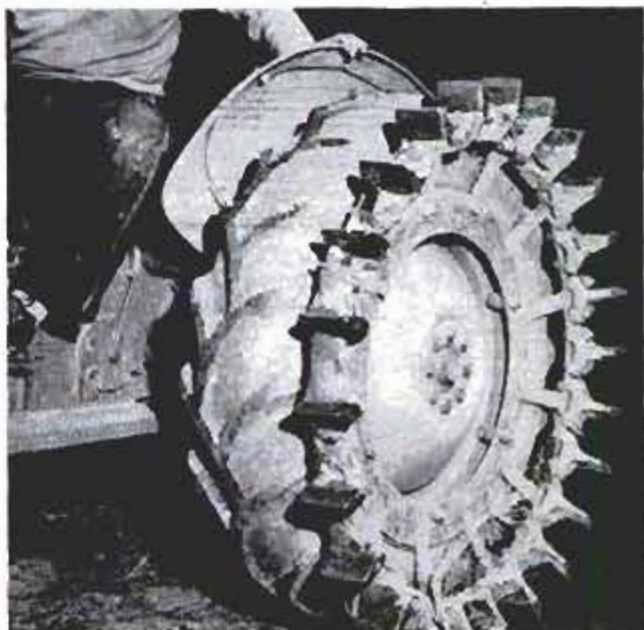

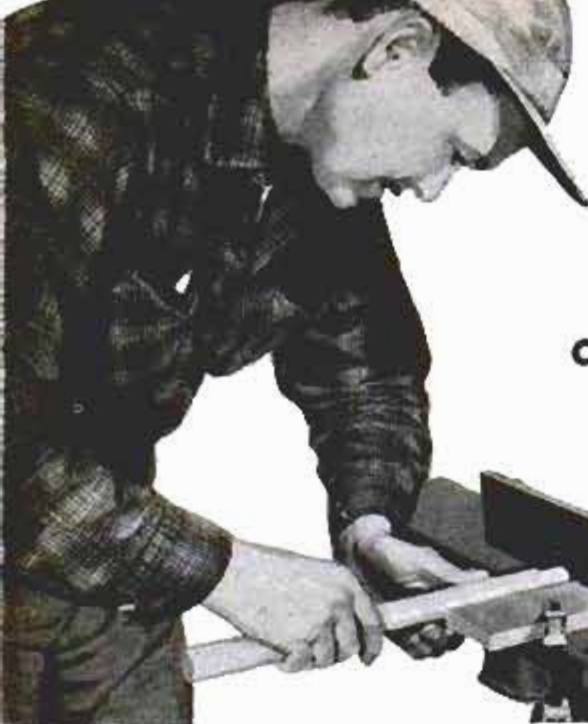

HOW WOULD

By
Chris Nelson

Q—I have to cut round, concentric tenons on a number of 1-in. dowels. I do not have a lathe. How do you do this job accurately?

A—YOU CAN DO IT ON A JOINTER. Set fence across table, measuring distance from outer end of knife to face of fence. This distance should equal length of tenon desired. Lower front table about $\frac{1}{8}$ in. and clamp a block to rabbeting arm so that it clears cutting circle. Run test cut on waste dowel. If size is over that required, move block nearer cutting circle and run a second test cut to give the correct size. Always rotate the stock in same direction jointer head is rotating

Q—How do you adjust a jointer so that the stock does not strike the edge of the rear table? And how do you set the knives in the head correctly?

A—STOCK STRIKING EDGE OF REAR TABLE indicates that surface of table is slightly above cutting circle of knives. Lay a hardwood straightedge on rear table. Lower table until each knife engages straightedge and moves it forward about $\frac{1}{4}$ in. as head is rotated by hand. Check both ends of each knife in this manner. If one knife is low (does not engage straightedge) adjust to correct height. After adjusting, be sure knives are locked in head before starting machine



Q—When depth gauge on a jointer does not give the correct depth setting, how is it adjusted to give the proper reading?

A—LEVEL THE TABLES, first making sure rear table is correctly set in relation to cutting circle of knives. Use steel square or other straightedge long enough to reach very nearly full length of tables. Set pointer at "0." Then lower front table $\frac{1}{8}$ in. and run test cut about 1 in. long on piece of waste stock. Measure the depth of the cut. If it is slightly off, raise or lower table as indicated by depth of cut and run test cuts, adjusting table after each cut, until depth is $\frac{1}{8}$ in. Then reset the scale

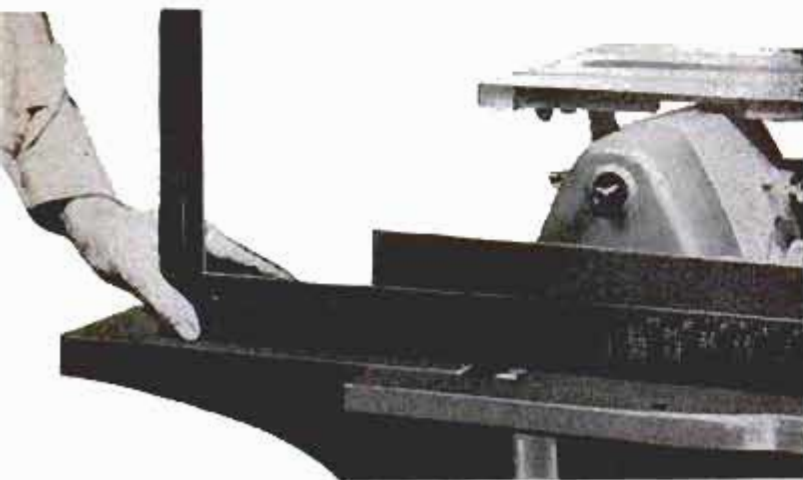

Q—How do you set the jointer fence perpendicular to the surface of the tables when the angle scale does not give a precisely correct reading?

A—PLACE A COMBINATION SQUARE on the table as pictured and tilt the fence right or left until no light can be seen between the edge of the blade and the vertical surface of the fence. Lock the fence in position. Then adjust the pointer to give a "0" reading on the scale. If necessary bend the pointer slightly to bring the point closer to the surface of the scale. This will make it easier to read the depth of cut accurately. Plane one face of a strip of stock true and run a test cut. Check with the square



YOU DO IT?

Q—How do you joint a wide board on a small jointer, especially when the width of the board is more than twice the height of the fence?

A—MAKE AN AUXILIARY FENCE of plywood about 8 in. high and slightly longer than the jointer fence. Joint the edges true and attach the auxiliary fence to the jointer fence with screws. Unless you are certain of the jointer-fence setting, check with a combination square (as pictured on the opposite page) and then see that the angle scale gives the correct reading. Set the machine to take a 1/16-in. cut. If more than 1/16 in. of stock must be removed, make the cut in two or more passes

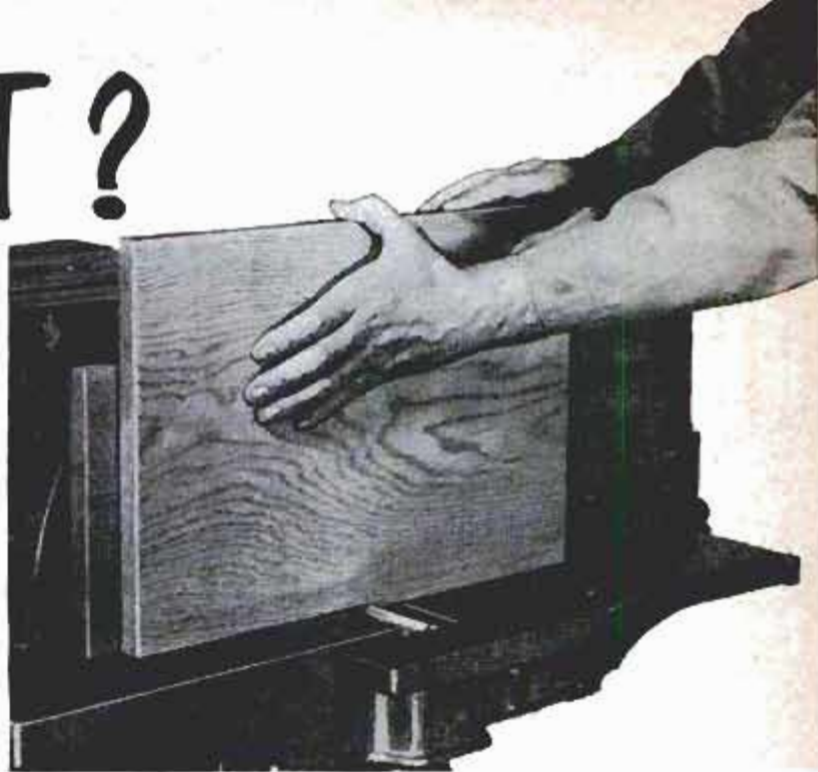

Q—How do you joint the end of a board to prevent splintering of the wood as the corner of the stock clears the cutterhead?

A—MAKE THE CUT IN TWO PASSES by first running in from one edge a distance of about 1 in. as in the inset photo. Then reverse the stock and finish the cut from the opposite edge. If the stock to be end-jointed is more than 1 ft. long, it's a good idea to use an auxiliary fence as in the photo above. This gives a wider bearing surface and assures greater accuracy by preventing the stock from tipping

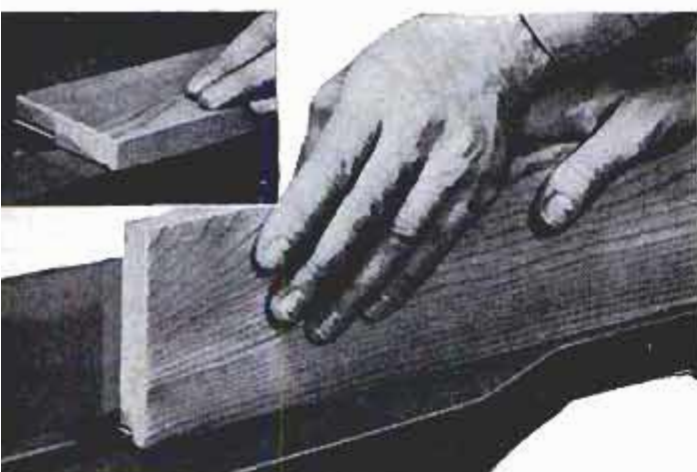

Q—How do you guard against injury to the fingers when planing short pieces? Also, how do you plane thin stock?

A—USE THE GUARD AND A HOLD-DOWN. Jointers come equipped with a swinging guard which covers the exposed portion of the head. In all photos on this and the opposite page guard has been removed purposely. Use guard on all operations except rabbeting. Plane thin stock with a hold-down made as in the photo. It should have a pusher handle and an offset to carry the stock forward as the cut is made. It is not safe to work stock shorter than 6 in. long on small jointer

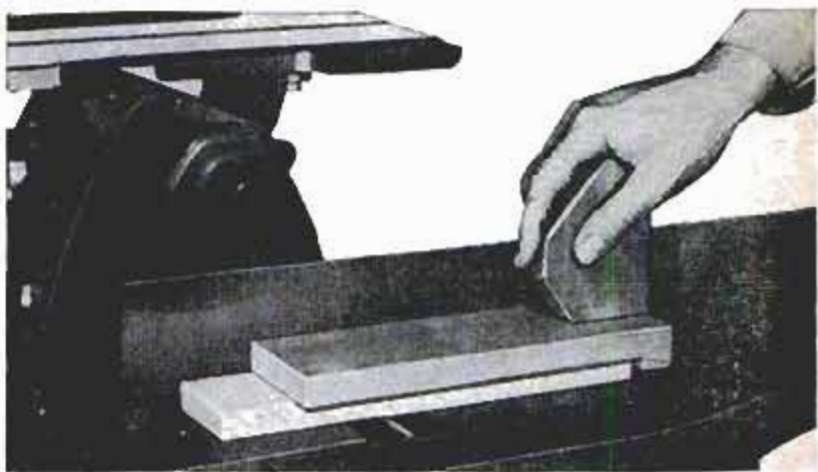

Q—How do you cut rabbets on the jointer? Suppose you need to rabbet the edge or the flat surface. How are these cuts made?

A—NEARLY ALL JOINTERS are fitted with a rabbeting arm designed to support the overhang when making this type of cut. Ends of the jointer knives are ground to a cutting edge and it is important that ends are lined up when knives are replaced in head after grinding. To cut rabbet on edge of stock, move fence across table and measure distance from end of knife to fence. Lower front table to give depth of rabbet as required. Run cut with stock on edge as pictured. Use same setup for face-rabbeting

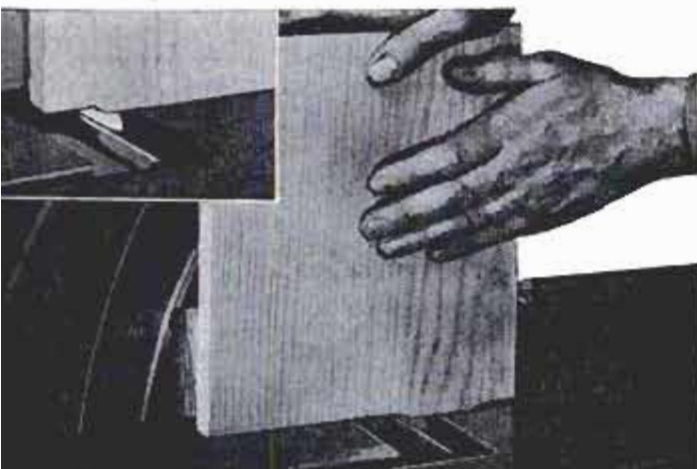

Hydraulic Jack With Pipe Extension Used to Repair Building



Fitted with a pipe extension, a hydraulic jack can be used to brace a small building or to raise a sagging floor or ceiling. The extension is screwed into a coupling which is welded to the end of a 1-ft. length of 1 1/4-in. pipe that has a welded and riveted plug half way up in it against which the pad of the jackscrew bears. A hole is cross drilled in the pipe coupling for the jack handle so that only one wrench is needed to screw on pipe of the required length. With the jackscrew raised a few inches, the short piece of pipe is placed down over it and the longer extension screwed into the coupling.

Collet Plate Improves Accuracy Of Duplicate Machining

Rather than depend on the accuracy of the collet as a stop, one machinist turned a special recessed plate which enabled him to hold the final facing operation on shouldered parts to extremely close limits. In the setup, the rim of the plate bears against the face of the collet closer, with the shouldered end of the work passing through a clearance hole center-drilled through the plate. In operation the plate serves as a positive locator for positioning duplicate work relative to the transverse travel of the cutting tool.—Hans Bonheim, Fair Lawn, N. J.

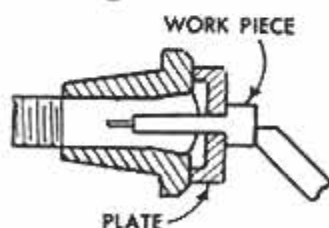

Centering Irregular Work In 3-Jaw Lathe Chuck

Out-of-round or irregularly shaped work with one flat side can be clamped in a 3-jaw lathe chuck by inserting a small metal wedge under the loose jaw. Careful adjustment of the wedge as the chuck jaws are closed will permit accurate centering of the work. If the irregularity in the work is only slight, shim stock can be used instead of a wedge. Wedges and shims also are useful for centering cylindrical work in a 3-jaw chuck when one of the jaws has been damaged and does not close accurately in comparison to the other two.

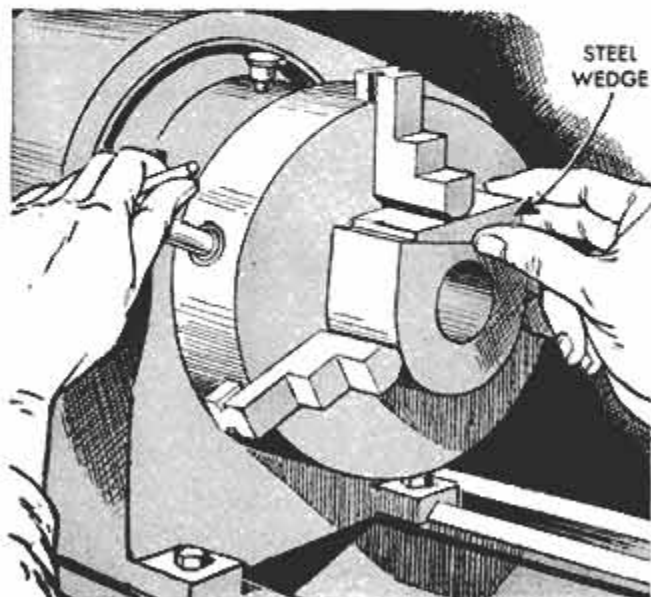

Broom Clips Hold Hand Grinder

Broom-handle clips of the type shown hold a hand grinder in a horizontal position when they are mounted on a wooden base and adjusted to grip the grinder securely. This arrangement is desirable when it is more convenient to hold small parts to be ground than it is to hold the grinder. Also, the grinder can be used as a midget lathe with this method of mounting.

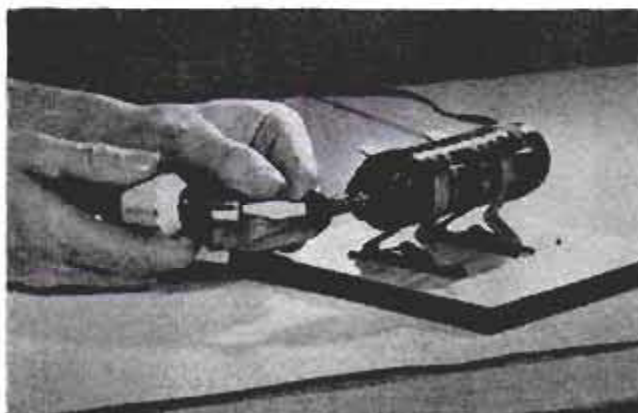

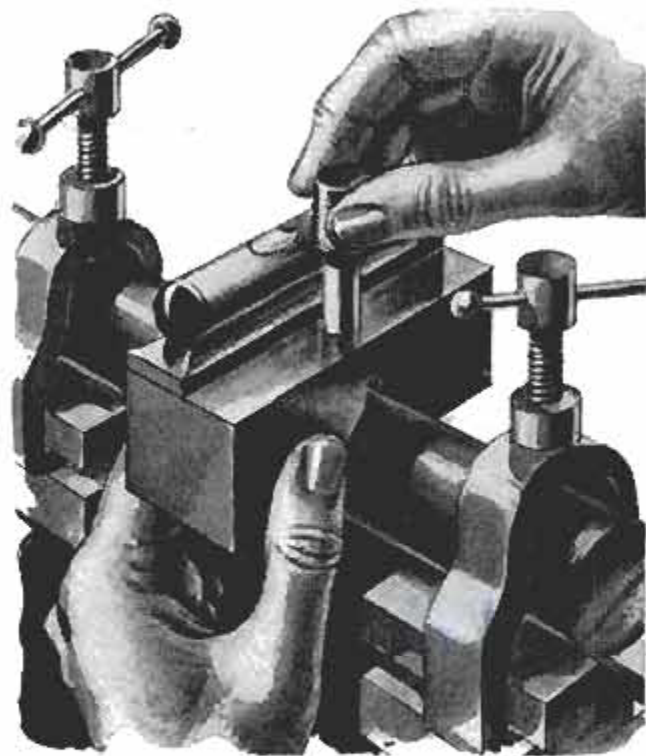
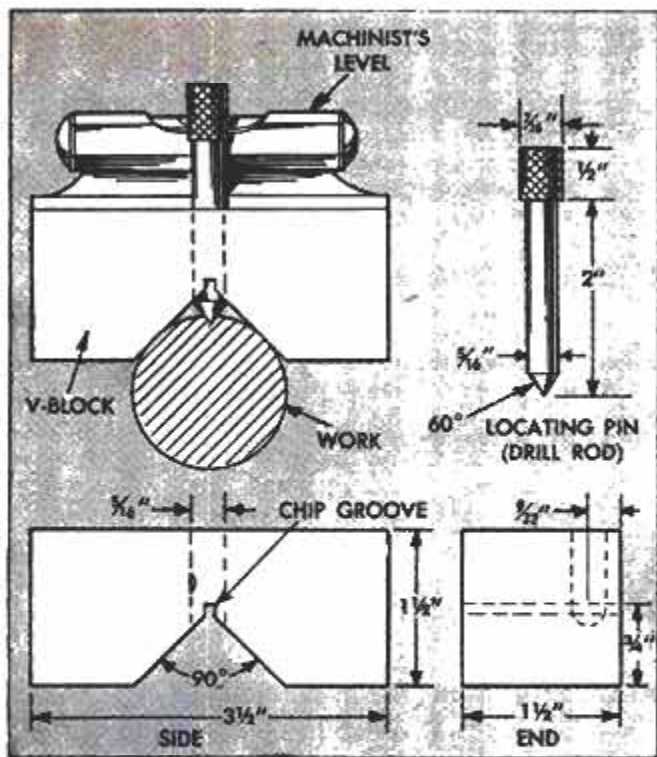

Locating Round Stock for Transverse Drilling

Confronted with the problem of drilling transverse holes through round stock on a small job-shop run, one machinist devised the setup pictured for locating the holes accurately. As the first step, a single V-block is milled from C. R. steel and drilled to take a $\frac{1}{16}$ -in. locating pin, the end of the pin being ground to a 60-deg. point. Then the work is center-punched and mounted in a set of V-blocks and clamps. The clamps are tightened just sufficiently to hold the work in place. After leveling

the drill-press table with a machinist's bench level, the work setup is moved to the drill-press table and the single V-block with the locating pin in place is inverted and placed over it. The bench level is placed on top of the single V-block and the block is moved until the locating pin engages the punch mark on the work. Turning the work and V-block to the level position centers the punch mark. Then the clamps are tightened.

C. W. Woodson, Chicago.

Angled Cutoff Tool for Tubing

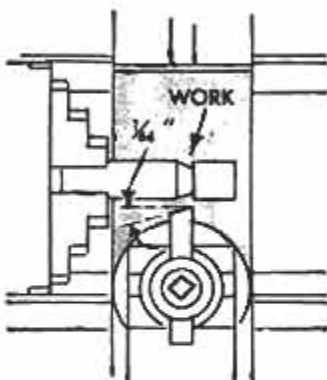

When cutting off lengths of brass tubing in a lathe for use as bushings or spacers, a cutoff tool with a special point ground $\frac{1}{64}$ in. from the square minimizes the tendency for burrs to form on the piece that is cut off. The special

tool is simply an ordinary square lathe bit ground as in the detail, except that the angle of the cutting edge shown is exaggerated for purposes of illustration. The angle helps to prevent chatter marks.

Charles E. Cohn, Chicago.

Several moth balls in each drawer of your toolbox will help prevent the metal parts of tools from rusting.

Pipe Cleaners Protect Taps

Thread-cutting taps can be protected when not in use by wrapping them with pipe cleaners, which will cover the sharp cutting edges. A drop of oil applied to each tap when it is wrapped will prevent it from rusting. Following this practice is of special importance when taps must be stored loose in a box with other tools.



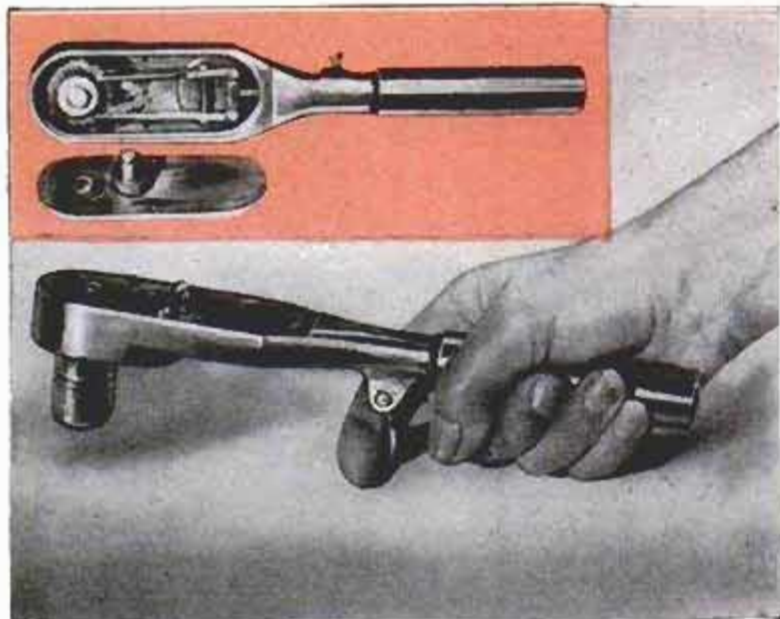

SOCKET DRIVER combines a spinner and ratchet wrench in one handy tool. Using spinner, nuts or capscrews are run on or off by trigger action which turns driving stud right or left throughout free-running range of thread. As nut seats, mechanism is shifted from spinner to ratchet and nut is tightened by ratchet action. In removing nut, procedure is reversed. Short radius of driving head permits work in close quarters. Cover plate prevents entrance of dust. Short movement of one lever reverses both spinner and ratchet, one being disengaged while the other is in operation

Edwin R. Sage, 2429 California St.,
Huntington Pk., Calif.

CLUTCH FOR V-BELT DRIVES on lawn mowers, pumps and other mechanisms of similar power requirements, stops and starts the unit automatically when the speed is changed. It consists of the several parts shown disassembled and assembled at the right. At idle speed halves of split sheave open. This releases tension on the V-belt and stops the driven machine. As speed is increased the spring-loaded governor weights force the halves of the sheave together, increasing tension on V-belt and starting driven machine

V-Plex Clutch Division, Hagerstown, Ind.

ROTARY WIRE-STRIPPER ATTACHMENT removes glass-fiber insulation from 12 different sizes of wire. The dial mechanism is coupled directly to the rotary blades which are power driven. This arrangement reduces the area between the cutting edges to a minimum. Strips the various sizes of wire clean to the bare metal without scoring. Reduces stripping time by 50 percent or more where large quantities of wire of various sizes are used. Accuracy and uniformity of the work hold material losses to the minimum

Public Relations, Northrop Aircraft, Inc., Hawthorne, Calif.

SHOPPING

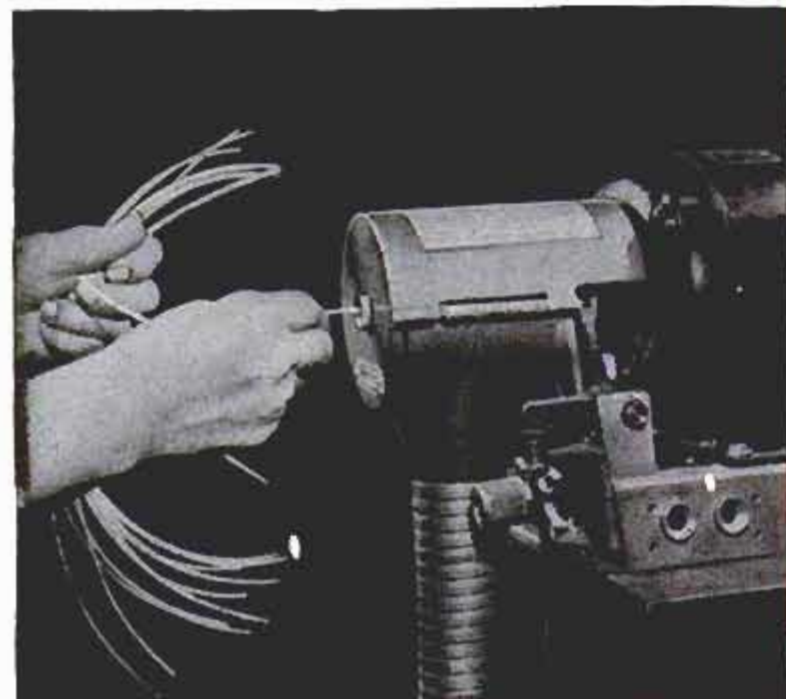
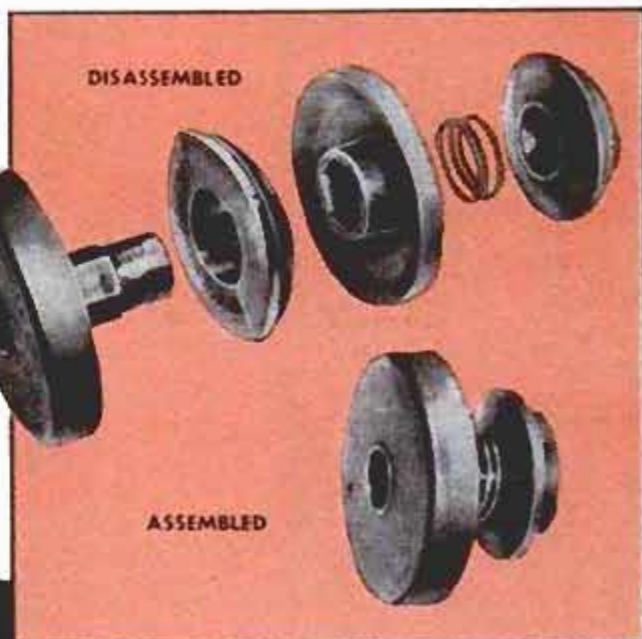

DOUBLE-EDGED HAND HACKSAW BLADE has two cutting edges, one for heavy cutting, the other for light work requiring fine teeth. Use coarse-toothed edge for hacksawing bolts, steel rod, standard pipe and steel angles. Simply turn blade over when cutting thin sections such as sheet metals, thin-wall tubing and conduit and light steel angle. Coarse side has 18 teeth to the inch, the fine side, 24

G. W. Griffin Co., Franklin, N. H.



UNIVERSAL COLLET CHUCK combines the features and advantages of the conventional collet closer into one production lathe tool which is operable positively and quickly with the spindle stopped or rotating. Collets are closed radially, eliminating any tendency of the work to creep. Comes with soft jaws. The chuck will repeat on piece location within .0005. When used as an o.d. chuck the symmetric soft jaws can be machined to suit the job requirements and, since the jaws are reversible, each set can be used for several different types of precision jobs

The Johnal Co., 18561 Parthenia St., Northridge, Calif.

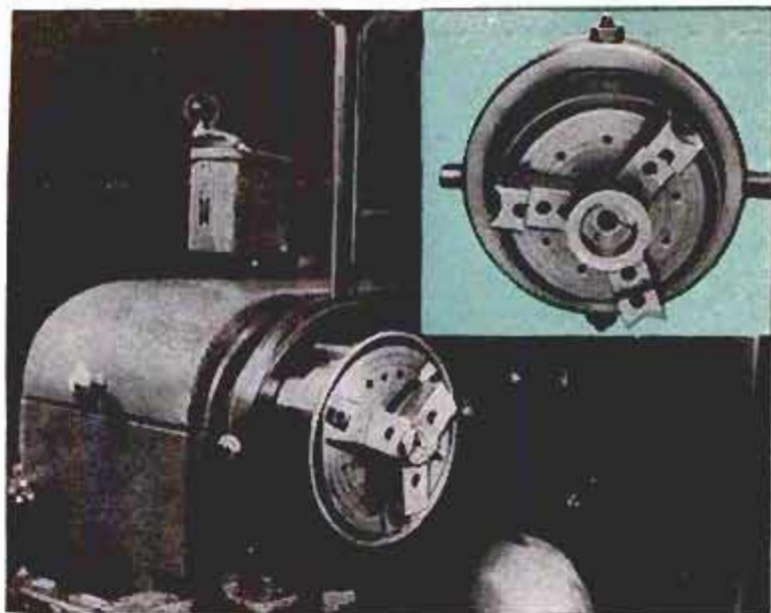

FOR TOOLS



ADHESIVE DISPENSER, OR APPLICATOR, is fountain-pen size, ejects a small drop of adhesive just where you want it when mounting photos or making layouts and pasteups. Artists and draftsmen especially can appreciate its convenience and simplicity. Various adhesives are available in throw-away plastic refill containers. It comes equipped with a cap so it can be carried in the pocket without danger of leakage of the adhesive. Special tip positively prevents clogging

Poppet Corp., 8707 Hudson Blvd., North Bergen, N. J.

MAGNETIC KNIFE SETTER locates all three (or four) knives in a jointer head on precisely the same cutting circle and equalizes the load on each one. Accurate setting gives longer operating periods between sharpenings, smoother work and less wear on the bearings. Unit consists of a permanent magnet and adjustable holder as pictured below at the right. Magnet holds the knife while it is positioned in the head. Adjustable arms bear on inner ends of machine tables

Magna-Set Co., 632 New Haven Ave., Milford, Conn.

CHROMIUM-PLATED STEEL RULES come in 6-in. lengths with both tempered and flexible blades. Decimal graduations in tenths (.10) and fiftieths (.02) make it possible to transfer measurements in decimal parts of an inch without computation

Brown & Sharpe Mfg. Co., Providence, U. S. A.

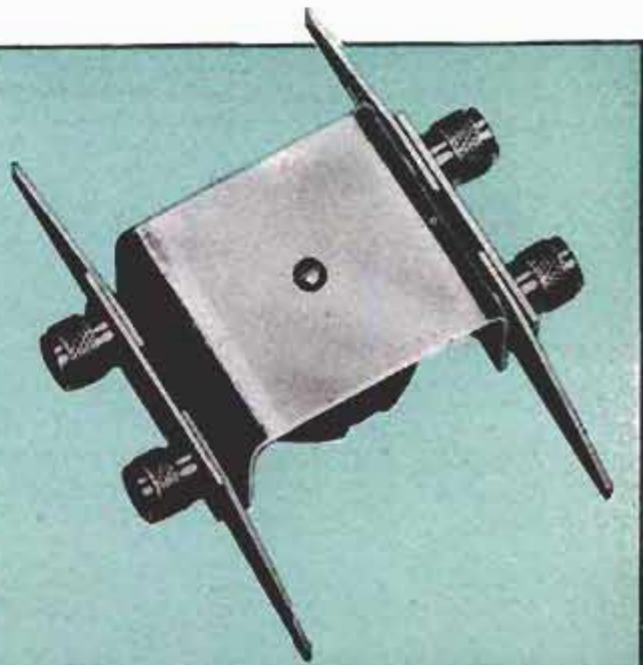

SHOPPING FOR TOOLS

Continued from preceding page

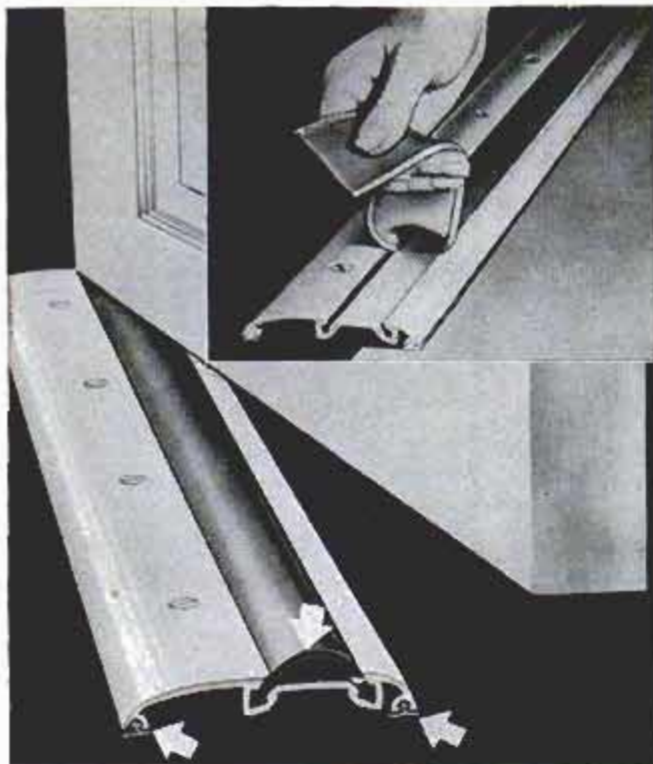

ALUMINUM THRESHOLD has three weatherproof seals (indicated by arrows) of flexible plastic which are replaceable when worn. Plastic inserts form a positive seal at the door bottom and at the floor level. There are no parts attached to the door. Convex surface of the door seal sheds water. Seals at edges of threshold prevent entrance of water. There are no grooves to catch dirt. Attaches directly to floor with screws

Duraflex Co., 3500 N.W. 52nd St., Miami, Fla.

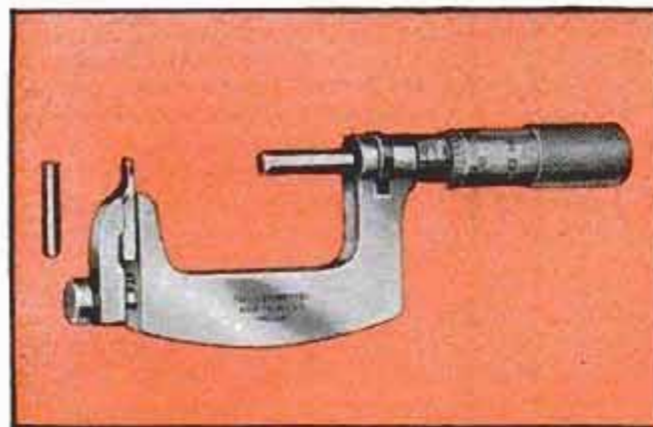

MICROMETERS have interchangeable anvils to handle a wide variety of measurements not possible to obtain with mikes having fixed anvils. Comes in two sizes with a range of 0 to 1 in. and 1 to 2 in. Two anvils are furnished as regular equipment with each mike, a rod anvil .120 dia. and a flat anvil .125 thick at one end and .060 thick at opposite end. Additional anvils can be made in the shop for special purposes

The L. S. Starrett Co., Athol, Mass.

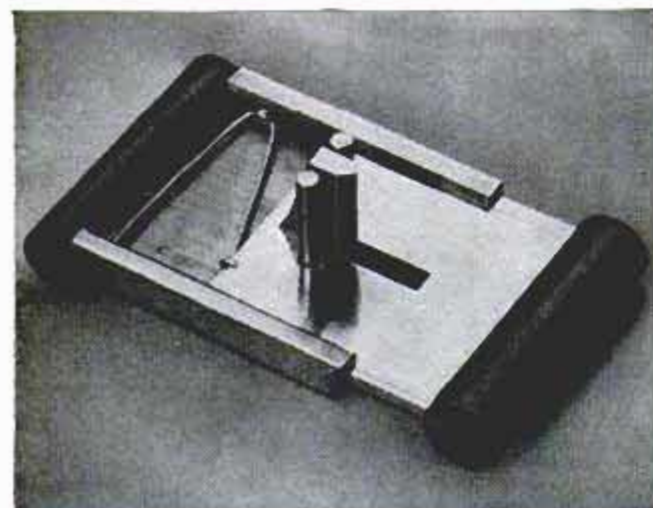

POCKET REAMER for cleaning $\frac{1}{2}$ and $\frac{3}{4}$ -in. solder fittings reams and sizes inside surface and squares end of fitting. Reamer consists of a holder, two guide pins and a blade. Fitting is slipped over guide pins and turned by hand, applying light pressure to handles of reamer to bring cutting edge in contact with inside surface of fitting. Takes only a few turns to clean the fitting ready for resoldering

Leystra Mfg. Co., 15-22 George St., Fair Lawn, N. J.

NAIL ANCHOR, pictured below, is die-cast in one piece from a special alloy that will not rust. Designed to give the greatest holding power with steel spiral nails in any type of masonry in which anchors can be used. Hole is drilled in masonry the same diameter as the anchor being used, then anchor is inserted through a fixture and nail driven. Anchors come in 13 sizes from $\frac{3}{16}$ x $\frac{7}{8}$ in. to $\frac{1}{2}$ x $3\text{-}1\frac{1}{2}$

Arro Expansion Bolt Co., Marion, Ohio.

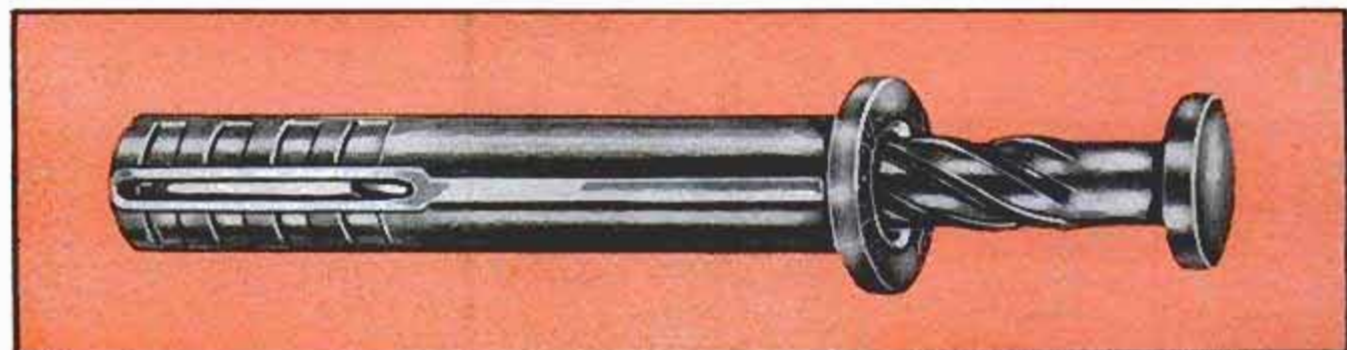

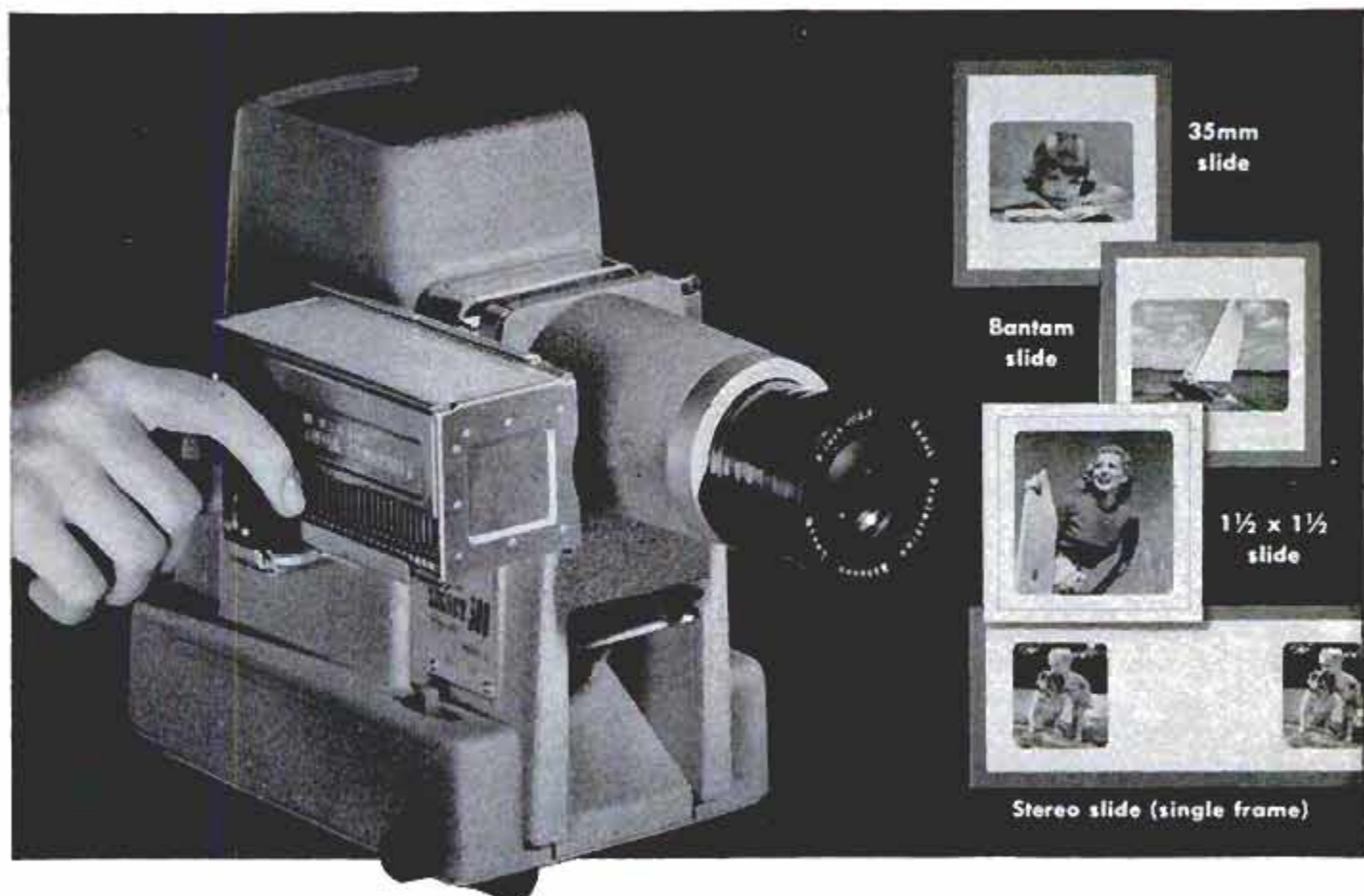

Now! Shoot the size of color slides you like best... **Kodaslide Signet Projector handles them all!**

You probably already know why Kodaslide Signet Projectors are the toast of discriminating color slide fans. Their thrilling "big-screen" performance and handling ease have made them famous.

You probably know, too, that there's a wide selection of Signets to choose from—one with exactly the features you want at the price you want to pay.

But did you know this? . . . *No matter which model you choose, your Signet will project all 4 popular sizes of color slides!*

Think of the satisfaction of being able to project 35mm slides, Bantam slides, *big* transparencies from size 620 or 120 color film—or even single frames of stereo slides. With a Signet, you can project your friends' slides—no matter which size they take!

Your Kodak dealer will gladly show you the Signet 300 (shown above) that comes complete with an automatic slide changer and carrying case for only \$79.45. Other superb Signets from \$59.50 to \$105.50. Most Kodak dealers will arrange convenient terms.

Kodaslide Dial-Lite Viewer—Plugs into any house circuit. Brightness knob dims or brightens light to suit subject being viewed. Accepts *all 4* popular sizes of color slides (described above). Complete with desk tray for slides and viewer, **\$12.95.**

Prices are list, include Federal Tax, and are subject to change without notice.

Eastman Kodak Company
 Rochester 4, N. Y.



3 Weldwood® Wizards for the perfect finishing touch!



Whether you prefer the light blond finish, deep mahogany or a painted job, insure the effect you want with a Weldwood finishing Wizard specialized for the job. Developed by United States Plywood, each meets a variety of finishing needs. Keep all three "wizards" on hand.

Pre-seal fir plywood paint jobs with **WHITE FIRZITE®**

A must for painting fir plywood! As an undercoater, White Firzite is a sealer and primer in one — it seals the pores to help avoid grain raise and checking. And if you want a woodsy blond, pickled, or wiped effect, start with White Firzite to get a real "pro" job without that painty look. (For pastel tones, add colors-in-oil.)



Pre-seal fir plywood stain jobs with **CLEAR FIRZITE**



Tames wild grain on fir plywood, to rival the subdued beauty of more expensive woods. Helps to prevent grain raise and checking. And for oak, walnut, or mahogany effects, simply add colors-in-oil — it's easy to get the effect you want.

Get that modern natural finish with **SATINLAC®**

Satinlac emphasizes and protects the natural grain of any wood—hard or soft, plywood or solid lumber. Fast-dry for fast finishing...dries out of dust in 3 to 4 hours. Long lasting and a cinch to maintain.



Ask your hardware, paint, or lumber dealer about these Finishing Wizards...or mail coupon for FREE leaflets.

UNITED STATES PLYWOOD CORPORATION
Box 525 — New York 46, N. Y. PM9-6S

Send me leaflets on:

White Firzite Clear Firzite Satinlac

NAME _____

ADDRESS _____

CITY _____ ZONE _____ STATE _____

Clinic for Homemakers



As a service to our readers in solving the hundreds of problems pertaining to a home—inside or out—the editors of *Popular Mechanics* invite you to present your problems to The Clinic Editor for help and advice. Address your questions to The Clinic Editor, *Popular Mechanics Magazine*, 200 East Ontario Street, Chicago 11, Ill.



Brick Veneer

Q—I would like to veneer my frame house with brick. There is no basement. Foundation is poured concrete. A builder tells me he can excavate and pour a brick ledge along the existing wall from the top down to the footing, sloping it outward from the top down to a point flush with the lower edge of the footing. Is this permissible?—T. M., N. Y.

A—We assume the builder intends to anchor the brick ledge to the original wall by some practical means such as drilling spaced holes along the length, inserting anchor sleeves and turning in lag screws. Also we are assuming that the top of the new brick ledge will be only slightly above grade level. Otherwise we think the procedure you have outlined is permissible, although it must be understood that it is not orthodox construction practice. Also, you should make sure before proceeding that the addition of a brick ledge in the manner in question is in accordance with your local building code. All other practices common in building brick-veneer walls should be carried out. You do not say, but we assume the house is one-story. We do not think this procedure would be recommended for walls more than one story in height.



Fence Posts

Q—I live outside the city limits and I want to fence my property (about 1½ acres) with a rustic fence, plain but substantial. I've asked the opinion of several neighbors on what wooden posts to use; that is, those that will last the longest. They do not agree and I have about decided to use posts of red cedar. Do you have any other suggestion?—Y. E., Ohio.

A—You couldn't go wrong in choosing red-cedar fence posts. They last many years, weather to an attractive rusticity, take nails, bolts or screws easily and come to you reasonably straight and of a fairly uniform size. These features lighten the job of setting the posts and attaching the boards or rails in any pattern or design you desire. However

(Continued to page 228)

NOW

-there's a Weldwood® Wizard for every gluing job!



Now there's a whole family of Weldwood Glues — four different types of adhesives — each designed to give you the easiest, quickest, surest answer to a particular gluing job. Be prepared by keeping all four of these "wizards" at your workbench.

Bond instantly, permanently on contact with **WELDWOOD CONTACT CEMENT**

Great new way to put up plywood panels — without nails — or nail holes to finish. Perfect for applying Micarta and other plastic surfacing materials. 1001 uses for home, hobby, garage — Weldwood Contact Cement holds fast to any combination of wood, rubber, canvas or any other porous surface. 29¢, 40¢, 70¢ and larger.



Make wood-to-wood joints stronger than wood with **WELDWOOD Plastic Resin GLUE**

Pros and hobbyists alike rate it America's most popular wood glue. Weldwood Plastic Resin Glue makes joints that are actually stronger than the wood itself, and keep growing stronger. Economical, easy-to-mix powder. Highly water-resistant, stain and rot-proof. 15¢, 35¢, 65¢ and larger.



For all outdoor gluing—use **WELDWOOD WATERPROOF RESORCINOL GLUE**

So waterproof it exceeds government specifications for marine use! 100% reliable for boatwork; fixing sports equipment such as fishing rods; repairs in basements; making or mending outdoor furniture. Unaffected by climate, weather, water (even boiling, freezing and salt water!), mold, fungus, mild acids, alkalis, etc. ¼ pts., \$1.00. Also available in pts., qts., gals.



Weldwood perfects a ready-to-use white glue— **WELDWOOD PRESTO-SET® GLUE**

Ready to use — sets fast — bonds like magic. So clean and easy to work with for scores of everyday household and hobby purposes. Use this Weldwood-perfected white glue to bond wood, cloth, paper, fabrics, etc., in any combination. Now in easy-to-use plastic dispensers. 19¢, 29¢, 49¢ and larger.



Remember—

*There's a special Weldwood
Wizard for every gluing job.
Ask your lumber, paint or
hardware dealer... or mail
coupon for FREE leaflets.*

UNITED STATES PLYWOOD CORPORATION

Box 525 — New York 46, N. Y.

PM9-66

Send me leaflets on:

- Weldwood Contact Cement
- Weldwood Plastic Resin Glue
- Weldwood Presto-Set Glue
- Weldwood Waterproof Resorcinol Glue

NAME _____

ADDRESS _____

CITY _____ ZONE _____ STATE _____

Care and Feeding of Engines



BY
S. P. CORP.

BREAKING IN AN ENGINE

Correct engine loading and good lubrication are important in breaking in a new or reconditioned engine. Low-speed idling may cause scuffing of rings. Idle speed of 25 to 30 miles per hour insures lubrication of rings, cylinder wall, pistons, and valve parts.

Short periods of loading are desirable. When engine is warmed up, drive at 25 m.p.h., then push down on accelerator until car speed is 50 m.p.h. Now release accelerator, letting car coast back to 25 m.p.h. Repeat several times. Consult your car manual for break-in schedule recommended by the manufacturer. Caution: Never accelerate a new or reconditioned engine from low (5 to 10 m.p.h.) speed with a wide-open throttle. This would cause overload without proper lubrication.

Drive for the first 200 miles at normal speeds up to 50 m.p.h. Avoid sustained high speeds. If traffic forces you to drive under 25, shift into low gear to maintain engine speed.

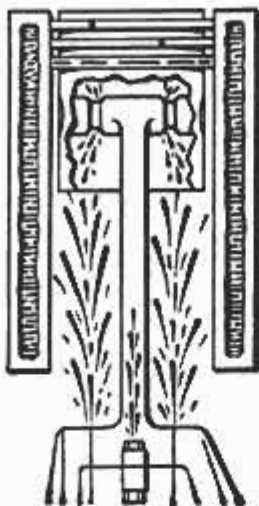

12-VOLT BATTERY CAUTION

In the familiar 6-volt battery, the anti-freeze value of the electrolyte will protect the battery even when there is not enough power to start the engine. In a 12-volt

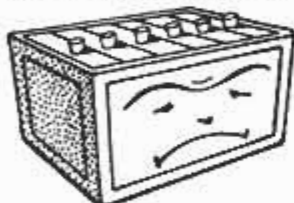

system, with its higher voltage and lower amperage, the battery will not stop cranking the engine until it is completely run down. In this condition the specific gravity will be so near to pure water that it will freeze just below 32° F.

Never allow a 12-volt battery to stand in a discharged condition in cold weather. Freezing will cause irreparable damage.

ASK FOR FREE HANDBOOK

"Care and Feeding of Engines" is an illustrated manual of engine care prepared to help you save money on car repairs. Your copy will be mailed on request. When you re-ring, be sure to use SEALED POWER KromeX Ring Sets for quick seating, immediate oil control, and long, long wear. Your dealer has them or can get them for you. Sealed Power, Dept. G-9, Muskegon, Mich.



Sealed Power

PISTON RINGS

(Continued from page 226)

you imply in your letter that you wish to use the longest lasting posts. Ordinarily this would mean that you should use posts cut either from black locust or Osage orange. One or the other is generally selected when the longest lasting wooden posts are desired. They are, however, rather difficult to obtain in some localities, especially the Osage orange, and both are rather expensive. The wood is very hard and does not take nails readily. When properly seasoned, posts cut from Osage orange are said to last from 20 to 35 years, their total life depending to some extent on local conditions. Black-locust posts should give you 20 years of service.

Wet Basement

Q—My home was built a little over a year ago in a new subdivision. There was difficulty keeping water out at the time the basement walls and floor were poured. Now water comes in along the walls where the floor joins. Also there are areas in my lawn that are continually wet even in dry weather. Lot is graded about 1½ ft. above the surrounding area. Both my builder and I are puzzled. What could be the cause?

—F. D., Ill.



A—You say you are in a new subdivision and for this reason we would suspect right away that the water is coming from a natural spring, a flowing well, or an old farm tile which somehow was plugged at the time the basement excavation was made. Any one of these could be the cause of the trouble you are experiencing. As a rule the remedy is not so simple. Sometimes it is possible to divert the flow of a well or spring into a drain tile where a suitable outlet is no problem. Of course, such a procedure is likely to be expensive, even though it is possible to reach an outlet within a comparatively short distance. If an old flowing well is the cause, it may be possible to locate it and pull the pipe. This may cause dispersal of the water at a lower level and end the trouble. If an old tile line has been broken and plugged by the basement excavation, it may be practical to locate the tile and reconnect it by carrying a new line around the basement wall. If this can be done, it is quite likely to effect a cure in solving your problem of water entering along the walls where the floor joins.

Lawn Clippings

Q—I have been told that late in the season lawn clippings should always be removed, that if left on the lawn after mowing clippings will tend to smother the grass the same as leaves and other trash. I have never quite understood why this should be so. Is there a good reason for removing the clippings each time the lawn is mowed?

—B. E., Kans.

A—If for some reason a heavy turf is left to grow to a height of 4 to 6 in. before mowing there may be some justification for removing the clippings, especially if mowing is done during warm, rainy weather when there is comparatively little sun and wind to "cure" the clippings quickly. Even then clippings should be saved and returned to the lawn, either by scattering uniformly as a mulch, or by composting with other materials and returning in the form of a top dressing. They should never be destroyed entirely, as clippings should always be a part of the lawn-fertilization program. If the newer rotary lawn mower is used, the clippings are chopped, or "recut," and mulching and distribution are carried out more or less automatically. Always keep the blades of a lawn mower sharp (this applies to both reel-type and rotary-type mowers) as otherwise the individual blades of grass will not be severed cleanly and actual damage to the lawn may result over a period of time if a dull mower is used.



ANNOUNCING

TRUE TEMPER'S NEW

JET ROCKET

HEAD WON'T LOOSEN

HANDLE WON'T BEND OR BREAK

Now, at the amazing low price of only \$3.95, you can get this wonderful new JET ROCKET hammer by True Temper. JET ROCKET is built like the famous ROCKET that continues to bring unsolicited letters of praise from craftsmen and do-it-yourselfers alike.

Handle is tubular steel made of a boron alloy especially developed by The Timken Roller Bearing Co. Won't bend or break. Permanently attached to streamlined head, carefully forged and heat-treated for strength. Head is highlighted with a distinctive jet-black finish. Comfortable grip soaks up shock. Won't slip wet or dry, or in gloved hand.

Try the JET ROCKET yourself. Swing it a few times. Notice its perfect balance and feel. Look for it at your favorite tool counter displayed with the famous original ROCKETS—the finest hammer made. True Temper Corporation, 1623 Euclid Avenue, Cleveland 15, Ohio.

TRUE TEMPER®



Finest quality in Hammers, axes, hatchets
Shears • Shovels • Garden, lawn and farm
tools • Fishing tackle • Golf-club shafts

SEPTEMBER 1956



"Imagine...

A GUY WITH A WRENCH CALLS MY PITCH!"

... says Johnny Podres, Brooklyn Dodger
Pitching Sensation

"When my regular serviceman, who really knows the score when it comes to automobiles, started pitching me the reasons why he put in new oil seals when I had the front wheels checked and repacked, I couldn't get a word in edgewise.

"Johnny, you don't risk a close decision when you can play it right and come in safe!" he says. "It's safer to inspect and repack the front wheels every 5,000 miles and it's more economical to replace the oil seals instead of re-using them. Of course, I used C/R oil seals—manufactured to the same rigid specifications as the oil seals installed at the factory."

"Hold it, hold it," I hollered, "I know all these things and I wanted C/R oil seals all the time."

"So why don't you take the signal from both of us ... have your mechanic put in new C/R oil seals after every wheel bearing, brake or engine repair job. It's always cheaper to replace oil seals than to re-use. Have him check front wheel bearings and oil seals every 5,000 miles. It's a sure way to avoid possible danger and expensive tube leaks."

GET THIS FREE TIP...

Write today for this important folder that tells why inspecting and repacking the wheel bearings every 5,000 miles provides economy and safety.



CHICAGO RAWHIDE MANUFACTURING COMPANY
REPLACEMENT DIVISION ELGIN, ILLINOIS



World's Largest
Manufacturer of Oil Seals
for original equipment...

**CHICAGO
RAWHIDE**

Tune-in MONITOR...
NBC's weekend radio
sensation... hear the
C/R oil seal story.

Owners Report on Continental Mark II

(Continued from page 151)

features with 33.2 percent including it. "It requires less wear and tear to drive than any car I have ever owned. Most comfortable and soundproof automobile."—Kansas businessman.

"Handles like a small car in traffic and still is a big car on the open road."—Illinois farmer.

"We drove 763 miles in one 12-hour day and were less tired than on a 500-mile trip in previous cars."—California broker.

What Should Be Changed?

Although 32 percent of the owners say that nothing should be changed in the Mark II, there are others who have some suggestions for modifications:

"Make a short-coupled four-door model."—New York banker.

"Trunk should be eight inches longer."—Wisconsin businessman.

"It isn't easy for elderly persons to get in and out. Should have model designed for middle-aged executives and town use. Too expensive for anyone really young enough to enjoy it."—Alabama rancher.

"Rear seat is too crowded."—Michigan executive.

"Take the spare tire out of the trunk. There isn't enough room for it."—Missouri executive.

"Would prefer a convertible."—Florida housewife.

"Needs more brakes. Can't read small instruments quickly."—California retired owner.

"Should have electric windshield wipers."—Colorado retired owner.

More Best-Liked Features

The following quotations describe other best-liked features in order of frequency of mention. For information on the exact percentages of owners mentioning each turn to page 149.

"Smooth power. Same rate of acceleration from 60 to 80 as from 30 to 50."—Illinois insurance executive.

"I am a fast driver and have averaged better than 90 miles per hour on trips. Even at high speeds my family is comfortable."—Kansas investor.

"No sway on curves. Takes rough roads easily. Steering finest ever."—New York manufacturer.

"For a big car, road holding, cornering and steering are extraordinary. I want to emphasize that I have export springs on my car. I do think this makes a substantial

(Continued to page 232)

DISSTON

D-23 Lightweight, Straight-back

HAND SAW

CUTS CLEANLY!

CUTS SMOOTHLY!

ONLY
\$895

CUTS FOR A
LIFETIME!

10- to 12-pt. Disstons recommended for smoothest cuts in plywood and other well-seasoned woods

When you're cutting plywood and want a beautifully smooth finished edge, you've got to use a saw that's made for finished work.

That's a 10-, 11-, or 12-point Disston. These fine-toothed saws often make the difference between fine workmanship and an ordinary job. They are specifically designed to be used for finishing.

So if you've been trying to cut plywood or other well-seasoned woods with an 8-point saw, ask at your hardware or tool store for a Disston D-23 in 10-, 11-, or 12-point. You'll get a saw of fine tool steel, with perfectly tempered and double taper ground blade . . . a saw you'll use and treasure for a lifetime.

CARLSON STEEL TAPE RULES AND TAPES



WHITE CHIEF
(6 ft.) \$1.80

BIG CHIEF
(12 ft.) \$3.50

STAR CHIEF
(50 ft.) \$5.00

Finest quality long tapes and pocket-size rules for every purpose. From 6 feet to 100 feet. Accurate, easy-to-read. Double graduations, feet and inches. Stiff, rigid, easily-changed blades. Easy-action swing tips.

FREE ILLUSTRATED BOOKLET! 64-page Disston Saw, Tool & File Manual. Tells how to choose and use tools; how to care for them. Helpful hints on wood working, metal working and selection of materials. Write today for your free copy.

DISSTON DE LUXE CIRCULAR SAWS AND DADOS

from \$2.25 to \$22.80

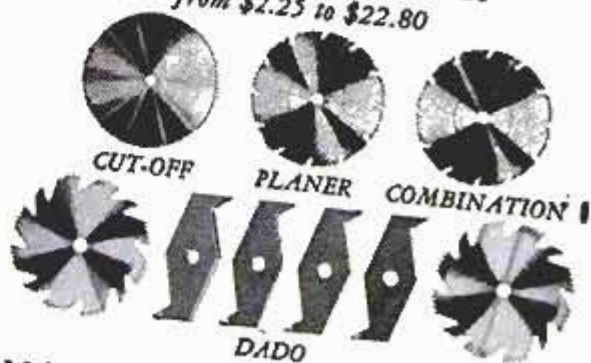

Make cutting easy and accurate. Made of famous Disston steel. High finish; keen teeth; accurate fitting. Special styles to fit all makes of bench and portable electric hand saws.

ASK YOUR HARDWAREMAN
TO SHOW YOU THESE FINE DISSTON TOOLS

DISSTON

Henry DISSTON DIVISION • H. K. PORTER COMPANY, INC.
911 Tacony, Philadelphia 35, Pa.



WILLARD

BATTERIES



LAST LONGER
BECAUSE THEY'RE
BUILT BETTER!

Sold, serviced and
guaranteed by competent
battery dealers in your
neighborhood.

improvement in its handling qualities over standard springs. It's the first quality American car since the Crane Simplex."—Massachusetts investment advisor.

"Silent, noiseless operation. With all windows closed, fresh air through air intakes and air conditioner keeps car exceptionally clean and quiet."—California designer.

"Fine workmanship throughout."—New Hampshire plant manager.

"Interior dignity. Dashboard is simple, like a good clock."—Pennsylvania artist.

"Absence of 'boudoir effect' present in all other cars."—Florida businessman.

"Low center of gravity gives feeling of safety."—New York retired owner.

"To be honest, I like the attraction it has for others. Also the prestige."—Ohio contractor.

"I like it because it is a car apart from them all. Something very few persons have."—Michigan sales manager.

"Long hood is restful on the eyes on long drives. The modern stump hood tires the eyes with the 'on rush' of the too-close view of the road."—California architect.

And More Complaints

Here are quotations describing other complaints of owners, in order of frequency of mention:

"Water leaks at top of door glass."—Minnesota owner.

"If I carried back-seat passengers any distance, there wouldn't be enough room for comfort."—California administrator.

"Not enough headroom in back seat. Head strikes top at slightest bump."—California retired owner.

"Window lifts went out of order."—Indiana industrialist.

"Frankly disappointed with small details: Inoperative window lifts, ash-tray location, door rattles, interior gasoline odor. But to love this automobile is easy. Take it out on the highway and these minor aches are cured."—California manufacturer.

"Biggest complaint is that advertisements lead one to believe extreme care would be taken in manufacturing the car. Car was delivered with many body noises which were difficult to fix. Seat padding was poorly done. Had leaks in doors and trouble with the electric windows."—New York businessman.

"Advertising is grossly exaggerated. Obviously the car does not go through the many checks the factory would lead you to believe, or those performing these checks are not very capable personnel."—California dentist.

"Inadequate brakes for power and weight."—Illinois designer.

(Continued to page 234)

MEN WITH MECHANICAL SKILLS:



CAN YOU MEET THIS CHALLENGE?



Mechanics Creed

Upon my honor I swear that I shall hold in sacred trust the rights and privileges conferred upon me as a certified mechanic. Knowing full well that the safety and lives of others are dependent upon my skill and judgment, I shall never knowingly subject others to risks which I would not be willing to assume for myself, or for those dear to me.

In discharging this trust, I pledge myself never to undertake work or approve work which I believe to be beyond the limits of my knowledge; nor shall I allow any superior to persuade me to approve aircraft or equipment as airworthy against my better judgment; nor shall I permit my judgment to be influenced by money or other personal gain; nor shall I pass as airworthy aircraft or equipment about which I am in doubt, either as a result of direct inspection or uncertainty regarding the ability of others who have worked on it to accomplish their work satisfactorily.

I realize the grave responsibility which is mine as a certified mechanic to exercise my judgment on the airworthiness of aircraft and equipment. I, therefore, pledge unyielding adherence to these precepts for the advancement of aviation and for the dignity of my vocation.

If you are a man who takes real pride in a job well done, the Air Force offers you a challenging and rewarding career. The safety of our country, and the lives of its defenders, depend on your accuracy and devotion to duty. Act today and put your skills to work tomorrow—in the U. S. Air Force.

GO PLACES FASTER ON
THE ALL VOLUNTEER
TEAM

THE U.S. AIR FORCE

PASTE COUPON ON POSTCARD

And Mail To

M-40-PM3

Airman Recruiting Information Branch
Box 2202
Wright-Patterson AFB, Ohio

Please send more information on my opportunities for enlisting in the U. S. Air Force. I am between the ages of 17-34 and reside in U.S.A. or possessions.

Name _____

Address _____ Age _____

City _____ Zone _____ State _____

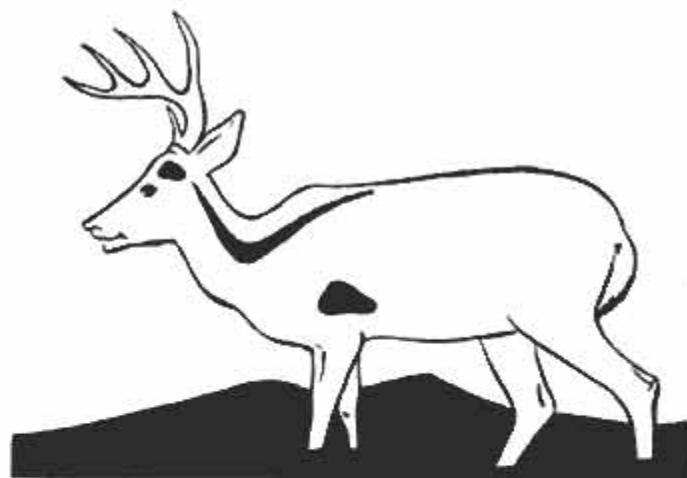

FOR CLEAN KILLS— MICRO-GROOVE ACCURACY

Now all Marlin high-powers have Micro-Groove Rifling*, to give you a 20-25% advantage in accuracy. Vital spots are often no bigger than your hand—so this extreme accuracy pays off every time!

With Micro-Groove Rifling heading Marlin's list of exclusive, game-getting features, the famous, fast-firing 336 is this year's most talked-about, most popular deer rifle!

See this modern rifle at your dealer's. In 30/30 or .35 Rem. calibers, its sharp-shooting accuracy will bring you more game with fewer second shots!

Here are 3 other reasons why the 336 is the outstanding choice for '56:

- 1 **New Type Round Breech Bolt.** The strongest and smoothest of lever actions!
- 2 **Jam-Proof Feeding—Positive Extraction.** The round breech bolt offers unmatched dependability!
- 3 **Lowest 'Scope Mounting.** Side ejection allows lowest mounting of all, for easiest, surest aiming!

Model 336-30/30 Regular Carbine.
\$72.95** without 'scope.

*Patent applied for. **Slightly higher west of the Rockies. Subject to change without notice.

THE NAME FOR GAME

Marlin

FINE GUNS SINCE 1870

MARLIN FIREARMS COMPANY, New Haven, Conn., Dept. PM-96

Please send me your catalog with photo-illustrations and complete descriptions of all Marlin Guns. Also send me a pack of (check preference) () single- or () double-edge Marlin Razor Blades. I enclose 10¢ for handling.

Name.....

Street.....

City.....Zone.....State.....

"Ash tray for driver hard to use because steering wheel too close to door."—Mississippi physician.

"Brakes grab unevenly when hot and fade."—New Jersey industrialist.

"Doors too massive."—Iowa store owner.

"Paint is beautiful (mine is black) but requires much care and can be washed only by trained people."—Oklahoma housewife.

"Car is chauffeur-driven and washed. Paint is soft and difficult to wash without streaking."—Ohio housewife.

"Paint job was so poor the dealer repainted it."—Nevada club owner.

"Tires are not top quality one would expect on this price car."—Wisconsin retired owner.

"Lack of springing in center of seats makes a third passenger, front or rear, uncomfortable. Strictly a four-passenger (or less) car."—California physician.

"Carpet too thick. Difficult to keep clean."—Louisiana oil operator.

"Back of right front seat hits dash when seat is forward."—California physician.

"Don't like imitation spoke wheel disks instead of actual spoke wheels. Very cheap for a \$10,000 car."—Maryland inventor.

"Turn-signal indicator lights on dash should be larger."—California lumberman.

"Our only disappointment is a feeling that as Continental owners we have not received personal attention or contact from the manufacturer. Such personal interest would give us an even greater pride of possession."—California entertainer.

"My chief worry is that newer models of the Mark II may have such mechanical innovations as fuel injection or air suspension. Mechanically, it is a very ordinary car."—Arizona executive.

"I ordered the car air conditioned. When delivered, there was no air conditioning on it. I was told by the dealer (I am sure he did not know any better) that air conditioning would be added later. I have since learned (and so has the dealer) that cars that were not delivered with air conditioning could not be air conditioned under factory specifications. There are differences in the body for air-conditioned models."—Tennessee executive.

"My answers to questions are on the second of two Mark IIs I have had. The first, being a complete 'lemon' in all respects was replaced by the dealer, which I consider an outstanding and unusual service."—Virginia financier.

And finally here are the finest testimonials any car can get:

"I like this car so well, I bought another two months later. Driving this car spoils you for any other make."—Illinois inventor.

(Continued to page 236)

These tests proved **POWER TIP** best for today's overhead-valve V-8 engines

Five years of laboratory and road testing research preceded the announcement of the Auto-Lite Resistor Spark Plug with Power Tip. Here's actual proof showing how this new development in ignition-engineering fires up your engine for top performance and economy at all speeds.

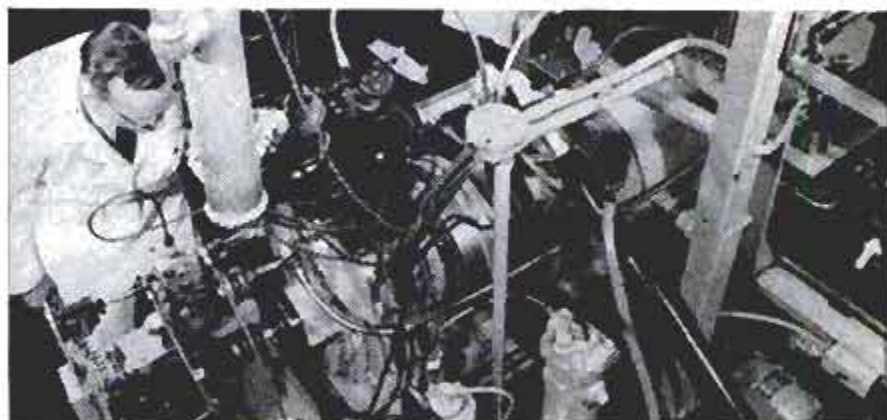

THIS TEST ENGINE, standard testing device used throughout industry, can subject spark plugs to worse conditions than they'll ever meet in your car. In pre-ignition test above, engine power output is increased until spark plug insulator tip becomes hot enough to ignite fuel mixture (pre-ignition). Test proved Power Tip has greater safety factor against pre-ignition than conventional spark plug with shorter insulator tip.



POWER TEST. Late model V-8 engine is operated at wide-open throttle with conventional spark plugs, then with Auto-Lite Resistor Spark Plugs with Power Tip. Standard carburetion and ignition components were used with manufacturer's recommended timing. New Power Tip actually showed better power output and performance than other new conventional plugs at *all speeds*.

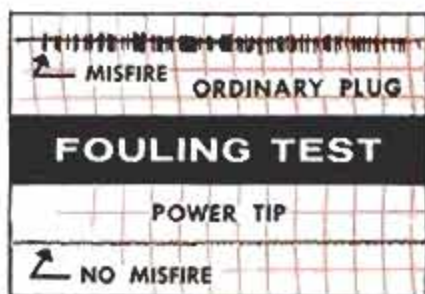

FOULING TEST. Above are recordings taken from test equipment set up to show how spark plug fouling causes misfiring. Both conventional spark plugs and Power Tip were run through same fouling test. Upper chart shows serious *misfiring* recorded during test with ordinary plug. In identical test, lower chart shows new Power Tip continued to operate perfectly with *no misfiring*.



ROAD TEST. The "acid" test of any automotive part. The Auto-Lite Resistor Spark Plug with Power Tip was tested in 17 makes of new cars in cross-country runs with cars traveling thousands of miles—under both city and highway driving conditions. In these test cars, new Power Tip completely confirmed every laboratory test! No doubt about it—only new Power Tip "fires up" engines at *all speeds*.

POWER TIP FITS and has been tested in all these makes of cars with overhead-valve V-8 engines using 14 mm spark plugs: Chevrolet • Chrysler Buick • Cadillac • DeSoto • Dodge • Plymouth • Ford • Hudson • Imperial Lincoln • Mercury • Nash • Oldsmobile • Packard • Pontiac • Studebaker

AUTO-LITE RESISTOR SPARK PLUG WITH **POWER TIP**



Auto-Lite manufactures over 400 products, including Spark Plugs, Batteries, Wire and Cable and Automotive Electrical Systems . . . sold throughout the United States and Canada.

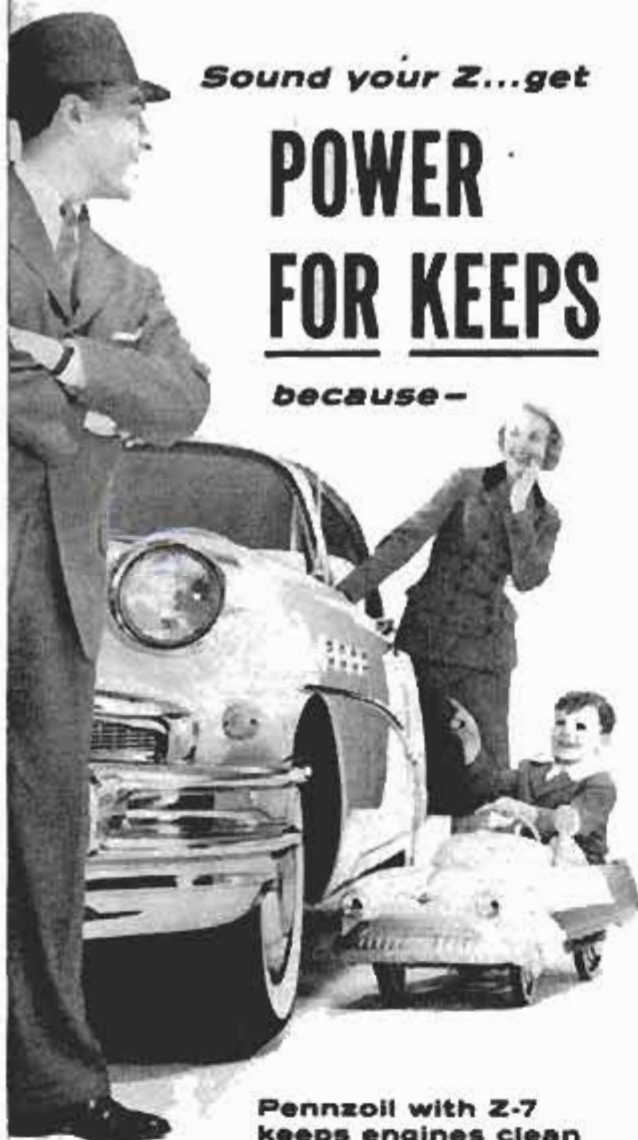

Sound your Z...get

POWER FOR KEEPS

because—

**Pennzoil with Z-7
keeps engines clean**

Pennzoil with Z-7 is The Tough-Film® oil with an all-oil lubricating body. It stays tough under engine heat and pressures, prevents build-up of power-stealing deposits. By keeping engines clean, this different Pennsylvania motor oil controls carbon completely. There's no knock, no ping. Horsepower stays unlocked—not for just a few miles after an oil change, but for keeps. To enjoy all the smooth power you bought, get Pennzoil with Z-7 now in the exact seasonal grade for your car!

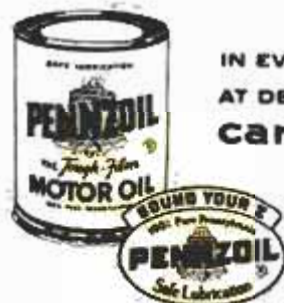

IN EVERY STATE,
AT DEALERS WHO
CARE FOR YOUR CAR

MEMBER PENN. GRADE CRUDE OIL ASSN., PERMIT NO. 2, OIL CITY, PA.

"I like everything about it. I have induced my sister and two brothers each to buy a Continental. I am about to purchase an additional Mark II for my wife."—New Jersey financier.

Most of us will never own a Continental Mark II, but now we know what it's like to own one. These owners tell the whole story, the good and the bad.

For a veteran driver's impressions of the car turn to Floyd Clymer's story on page 147. An engineer, Dale Kelly, gives his findings on page 148. ★ ★ ★

Clymer Drives the Mark II

(Continued from page 147)

not unlike the Thunderbird, although it has much softer front springing. It has the solid feel of a heavy car and drives somewhat like the heavy quality cars of the twenties. The comparatively short wheelbase (126 inches) for a car of its weight contributes to its excellent cornering ability and handling over winding roads. There is only slight roll on corners and the body remains quite flat. Roadability is excellent. Ride is comfortable and luxurious.

It is the heaviest of American cars, its shipping weight being 5190 pounds with air conditioning. Due to the low roof (56 inches from the ground) the car appears wider than its 77.5 inches. Actually, there are five or six wider cars on the market this year.

Top speed at Rosamond Dry Lake by speedometer was 118 miles per hour, proving the Mark II is far from a slow car. At 60 miles per hour I found the speedometer fast by only 4 percent which is more nearly accurate than most speedometers. The Continental is in no sense a hot rod. It is not the fastest American car. Obviously a Continental buyer is not the hot-rod type and few purchasers will want to drive the car wide open for a very long distance. Acceleration is satisfactory, but not sensational.

Considerable pressure is required on the steering wheel. It doesn't steer as easily as many power-steered cars. The wheel is small (17 inches) and the over-all ratio is 20.9 to 1. Steering should be slightly faster. Turning diameter, curb to curb, is 45.3 feet.

Only light brake-pedal pressure is needed for application of the power brakes which are smooth and effective, although at extreme high speeds when slowing for sharp corners there was some fade—not unusual for such a heavy car.

The horsepower has never been listed by the makers and, when officials were asked, they said, "It is more than adequate for top performance." Perhaps this is their way of gracefully getting out of the horsepower

(Continued to page 238)

STANLEY STEELMASTER

The Finest Hammer Ever Made

Driving nails is work — no doubt about it. But it's also the kind of clean, thumping exercise a man can enjoy. There's smacking satisfaction in belting a shiny tenpenny into stout 2 x 4 studding. This is the hammer to use . . . for accuracy, authority and pleasure . . . it's the Stanley STEELMASTER, the finest hammer ever made.

TEMPERED RIM MINIMIZES CHIPPING — Exclusive! Rim of striking face is induction tempered to minimize chipping.

LOCKED-ON HEAD — The head is permanently locked to the handle; it will never come loose.

CHROME ALLOY HANDLE — Special chrome alloy steel handle *will not break!* It flexes a little, it absorbs vibration, but it will not break. Chrome plating prevents rust.

ACUSHNET CONTOURED GRIP — Good-to-the-hand neoprene forms a non-slip, cushioned grip. It won't mar either, so the butt end can be used to tap work into place.



FREE "HAMMER HOLSTER"

Introductory extra! Your hardware dealer has free leather holster to keep STEELMASTER within reach when you're working.

Hammers up, men. Pick the finest made — the Stanley STEELMASTER. In 13, 16, and 20 oz. sizes. For useful nail chart send 10¢ to Stanley Tools, 629 Elm St., New Britain, Conn.



STANLEY

THE TOOL BOX OF THE WORLD

Coleman "OUTING PALS"

Add Hours of Fun
to Every Outing!

You'll have more fun, enjoy new comfort outdoors with Coleman Outing Pals. See them at your dealers.

New Coleman Portable Cooler

Keeps foods, beverages freezer fresh. Low "K-factor" (heat-transfer) holds the cold longer. Lid catch lifts easily, locks automatically. Inside corners rounded, stay clean, odor-free.



Coleman Folding Camp Stove



Lights instantly. Hot, homelike meals anywhere... in a jiffy! Burns low-cost Coleman Fuel or unleaded gasoline. Folds up, carries like small suitcase.

Coleman Carrying Case-Camp Table

Roomy, all-steel carrying case holds 4 folding stools, cooking utensils, food, hunting and fishing gear. Unfolds into strong, rigid picnic table, 28-in. square. Keeps food away from damp ground, insects, litter!



Coleman Floodlight Lantern



Brilliantly floodlights 100-ft. area. Safe, stormproof. Lights instantly. Gives 8 to 10 hours service on single filling. Burns inexpensive Coleman Fuel or unleaded gasoline. Coleman REFLECTOR converts it to a powerful spotlight.

Try new Coleman FUEL. Specially blended, clean burning. Has rust inhibitor. Won't gum up.

FREE New Outdoor Book. Many useful tips for your hunting, fishing and vacation trips.



FILL OUT COUPON!

THE COLEMAN COMPANY, INC.
Dept. 11-PM3, Wichita 1, Kansas

Please send me free copy of the new Coleman Book "More Fun on Every Outing."

Name.....

Address.....

City..... State.....

race controversy, and maybe it is just as well, as power is ample.

At extreme high speeds I found very little wind noise or body rumble. Only on rough roads at quite high speeds was there any noticeable hood flutter, in spite of the fact that the hood is very long (70 inches from windshield bottom to front). The long hood gives a massive appearance from behind the wheel.

The automatic transmission is the best and smoothest I have ever found in any car. It is a torque converter with three gears. The gear changes take place smoothly at various speeds, depending on throttle opening. If the throttle is pushed to the floorboard, the first upshift takes place at 50 miles per hour, or between 30 and 40 miles per hour with partial throttle opening. The second upshift takes place from 40 to 50 miles per hour, on partial-open throttle. If the throttle is held wide open, top upshift takes place at 75 to 78 miles per hour. Downshift at any speed up to 75 miles per hour can be made by floorboarding the throttle and I consider this an excellent feature. Downshift on most cars built today takes place only at speeds below 60 or 65 and many times downshifting is desirable above these speeds.

Interior design and appointments are excellent. The deep-grained leathers immediately catch the eye as being rich in quality. The deep-pile carpets are easily removed for cleaning. Straps on the back of the front seats serve as robe rails or handholds for rear-seat passengers. The Mark II is a fully equipped car. Only air conditioning is optional equipment.

The driver's control panel, located in the armrest of the left door, provides control of every window (even the window vents are power-operated), and of the adjustment of the front seat.

The seating position is excellent. Foam-rubber cushions give lounge-chair comfort. The upholstery is of the highest quality with good springing. The full-length armrests, with their foam-rubber cushions, contribute greatly to passenger comfort. A center armrest may be pulled down from the back of the rear seat into position between its occupants.

The wide, pendulum-type foot brake is better located in relation to the throttle than on any car I have driven, as both pedals are at about equal distance from the floorboard.

The speedometer is directly in front of the driver, with no upper half of the horn ring to obstruct vision. I like the trip-mileage indicator, which can be easily reset by a knob. Instruments are well shrouded to

(Continued to page 240)

DELTA HOME WORKSHOP

Special!

GET THIS FAMOUS DELTA
QUALITY SAW-JOINTER
now...

... AND RECEIVE THIS
\$16.95 DELTA SABER SAW
ATTACHMENT

absolutely
free
of extra charge!



Save Real Money On Genuine DELTA Quality!

PAY AS LITTLE AS \$7.10 a month for your DELTA Quality Saw-Jointer—most basic, most popular of all workshop tools. Genuine DELTA 8" Tilting Arbor Saw and 4" Jointer are mounted on one stand to *save you space*, powered by one motor to *save you money*.

PAY NOTHING EXTRA FOR DELTA Saber Saw attachment! In just seconds it converts your DELTA 8" Tilting Arbor Saw into a versatile machine for curve cutting, sanding, filing. And

it's absolutely **FREE** of extra charge if you buy your DELTA Saw-Jointer *now!*

TAKE UP TO 24 MONTHS TO PAY on terms to suit you! Get your Delta Saw-Jointer and **FREE** Saber Saw attachment *now* and enjoy years of fun and profit! Visit your Delta Dealer (listed under "TOOLS" in the Yellow Pages of your telephone book), or leading hardware and department stores—*today!*



Get Free Catalog, Name of Nearest Delta Dealer



another product by
ROCKWELL



Delta Power Tool Div., Rockwell Manufacturing Co.
502J N. Lexington Ave., Pittsburgh 8, Pa.

- Please send name of my nearest Delta Dealer.
 Please send Delta Homecraft Catalog.



Name _____

Address _____

City _____ County _____ State _____

choose your ride



SOFT

MEDIUM

FIRM

This is the only genuine adjustable shock absorber. A twist of the wrist gives the ride you want—for your make of car, your kind of driving. Only Gabriel has it... Adjustomatic!

Gabriel

AJUSTOMATIC

SHOCK ABSORBERS

The Gabriel Company • Cleveland, O.

kill sun glare or reflection in night driving. I approve of the needle gauges for oil pressure and amperes. These are small and neatly housed under a circular dial which also includes temperature and fuel gauges. There is an excellent, electric clock with a sweep second hand. A tachometer (calibrated to 5000 revolutions per minute) indicates engine speed in terms of revolutions per minute. It is fascinating to drive by "tach," which is usually found only in sports and racing cars. In checking the tachometer we found true speeds as follows: At 40—1500 r.p.m.; at 50—1900 r.p.m.; at 60—2250 r.p.m.

The radio is the best I have found in any car. Signal-seeking, two-bar controls for town or country tuning are standard.

The glove compartment is quite large and is the "drop down" type, which ordinarily I don't like, but Continental has boxed in the sides to prevent articles from falling out when the door drops.

There are foot "wells" front and rear, which make a step-down feature. A larger-than-usual center hump covers the transmission and driveshaft.

Directly in the center above the floorboard hump are levers controlling fresh air, heater, and air conditioning. The ventilating system is perfect. There are four independent outlets, with one master control, each regulating the flow of hot or cold air along either side of the passenger compartment. Two other openings are on each side of the body, with a flow of air directed to the feet of the front-seat occupants. The air for the rear-seat passengers flows through ducts in the base of the doors.

During an extremely hot day (106 degrees) in the San Joaquin Valley near Fresno I found the air conditioning unit to be of high quality in every respect. Even on low blower, the cold, fresh and filtered air was ample. One lever controls the entry of the cool air—certainly the most simple of all air conditioners to operate. There are four circular air outlets in the roof of the car, located somewhat like the overhead outlets in airplanes.

The hand brake is on the left side and its operation would be smoother if a pivoted bracket for the handle shaft were used. The handle, in off position, is too far forward for the average driver.

Front and side vision is good. However, Continental's styling does not allow as large a rear window as in conventional cars. The three-quarter rear vision therefore is not as great as in other cars, in view of the rather wide upper portion of the body between the side and rear windows. I found the body to be tight and, in rather

(Continued to page 242)



The Modern PLASTIC
for lasting Home Repairs

PERMANENTLY mends cracks or holes in wood, tile, stone or plaster. Sticks and stays put—Does not chip, shrink or fall out. Easy to use. Economical. Mold it, chisel it, polish or paint it. The big 4-lb. can is obtainable from your lumber, paint or hardware dealer at \$1.25; or will be shipped direct postpaid (in U. S.) for \$1.50. Complete satisfaction guaranteed or your money refunded.

DONALD DURHAM CO.
Box 804-T Des Moines, Iowa



ELECTRIC WELDER AC or DC
110 Volts

The "Little Marvel" all-metal welder, 5-year written guarantee. Welds 1/8" metal or money back. Repairs tanks, tools, fenders, machine parts, etc. Complete with everything—rods, unit, eye shield, directions. \$6.95 plus 50c postage. Flame torch accessory for soldering, cutting, brazing \$3.95 complete with carbons, brass rods, flux. \$2.00 Deposit on C.O.D. 75 ampere 1/4 inch Transformer Welder \$21.95 F.O.B.

\$6.95
Complete

ESSAY MFG. CO., Dept. 51, Quincy 69, Mass.

Wholesale! TOOLS! GUNS! CAMERAS!
AGENTS — BUY TOOLS, PHOTO EQUIP., SPORTING GOODS, JEWELRY AND THOUSANDS OTHER NATIONALLY ADVERTISED PRODUCTS AT BIG DISCOUNTS. BIG PROFITS SELLING TO OTHERS.
POSTCARD BRINGS FREE COPY "THE WHOLESALE PLAN"
AMERICAN BUYERS SERVICE
HERTEL STATION, DEPT. 15, BUFFALO 16, NEW YORK

Get up to **40% off**



ROTARY MOWER—LEAF MULCHER

- Mulches 30" width! . . . Twice the power of ordinary mulchers . . . gets rid of leaves fast! . . . 5-HP.
- New Steering Sulky, New Optional Starter, New Rotary Cultivator — 23 attachments for year-round work. Snowblower, Snow Plow, Chain and Circular Saws for Fall and Winter jobs . . . Finance Plan available!

Write today for FREE 24-page "Power vs Drudgery" Booklet!

GRAVELY TRACTORS, INC.
BOX 963, DUNBAR, W. VA.

FIELD-TESTED SINCE 1922

new
Fir Plywood**
8 BOAT PLANS
only **25¢** each

PERFORMANCE TESTED
Fir Plywood
Fleet
ARCHITECT DESIGNED

See your lumber dealer or use coupon below.

Large, easy-to-follow plans contain illustrated step-by-step instructions and complete bill of materials.



No. 30. 7' 9" Pram Dinghy



No. 35. 11' 3" Outboard



No. 40. 13' 4" Outboard



No. 45. 13' 9" Punt



No. 50. 15' Outboard



No. 55. 15' 11" Runabout



No. 60. 18' Day Cruiser



No. 65. 20' Cabin Cruiser

*Use Only Exterior Fir Plywood
For All Marine Construction

(EXT-DFPA® Means 100% Waterproof Glue!)

Douglas Fir Plywood Association, Dept. 9, Tacoma, 2, Wash.

Please send plans checked below. I enclose 25c for each. (Good in U.S.A. only)

No. 30 No. 35 No. 40 No. 45 No. 50 No. 55 No. 60 No. 65

Name _____

Address _____

City _____ Zone _____ State _____



For a smooth-driving future
—use years-ahead
Quaker State Motor Oil!



Super-refined from Pure Pennsylvania Grade Crude Oil, world's finest. Famous for performance, protection, economy! Try it!

QUAKER STATE OIL REFINING CORP., OIL CITY, PA.
Member Pennsylvania Grade Crude Oil Association

severe tests, no dust or water leaked inside the body.

The doors are large and heavy, which adds to the solid "feel" of the body, even though they are a little hard to swing open because of their weight. Fortunately, there is a door "stop" when the door is opened fully, or half way—highly desirable with such heavy doors.

The front bumper is narrower than on most cars, and slightly V-shaped, protruding some in front center. Parking lights mounted within the front bumper ends are well protected.

Dual exhaust outlets are mounted within the rear bumper, which now seems to be common—although the dirt which usually accumulates on both sides of the rear bumper as a result is a bit of a hazard to one's clothing when walking around the rear of the car.

The gas-tank filler cap is neatly covered in the left rear taillight assembly. The taillight slides sideways to uncover the cap. This arrangement is a good one even though its operation puzzled most service-station attendants. Few knew how to locate the filler cap. One of the finest features is the 25-gallon-capacity gas tank. I have long advocated the use of larger gas tanks for high-powered cars. Continental's tank capacity is the answer to the prayer of the long-distance driver. After my trip from Los Angeles to Fresno (218 miles) the fuel tank registered nearly half full, which was a pleasant surprise. In spite of this large-capacity tank, there is a warning arrow which lights up on the dash when the fuel supply drops to three gallons.

I have never driven an American car that attracts more attention than the Continental. Most people accept it as high quality and seem to know that it is America's highest-priced car. Undoubtedly every Mark II owner has a certain pride of ownership in this quality car, with a minimum of chrome and a simple styling. I found no squeaks or rattles. The factory manual states that no break-in period is necessary, and that the owner may drive the car as he pleases from the beginning (a procedure I've long advocated in breaking in any modern American car).

I have heard very few complaints with the Continental Mark II and, quite frankly, it is a much better car than I expected. In every detail, large or small, quality sticks out all over, even to the excellent instruction manual and the personalized Continental nameplate attached to the floor-board center. In my opinion, it is the finest and most carefully made motorcar manufactured in this country—and well it should be, at its price. ★ ★ ★

E Z KLEEN

Popular Sizes \$1.75
From

AIR FILTER

it's aluminum!
it's washable!
it saves you money!



FOR A CLEANER, MORE COMFORTABLE HOME—Clean filters in your forced air furnace or air conditioner mean better air circulation, lower fuel and power costs, greater comfort. Simply wash E Z Kleens with water... re-coat with convenient Handi-Koter (or Super Handi-Koter for odor-removal, too)... they're good as new... last for years. Insist on E Z Kleens for comfort, cleanliness, convenience. RESEARCH PRODUCTS CORP., Dept. 227, Madison 10, Wis.

At Your Dealer, or Consult Your Classified Telephone Directory

IN CANADA Hicks-Baker, Ltd., 234 Madison St., Winnipeg — Durable Oil Equipment Ltd., 80 Summit Ave., Toronto



HELPFUL BOOKS

Send post card asking for FREE catalog

Popular Mechanics Press, 200 E. Ontario, Dept. 601, Chicago 11



NEW, IMPROVED CALCULATOR FOR WOODWORKERS only 25c

Instantly gives information on lumber, nails, concrete mixes, painting materials, etc. Convenient, simple to read. Just set dial for nail specifications, to convert linear to board feet, find bit sizes for screws, compare characteristics of woods. 6" diameter heavily varnished cardboard. Send 25c, no stamps, please to Greenlee Tool Co., 2109 Columbia Avenue, Rockford, Illinois.

SAY YOU SAW IT IN POPULAR MECHANICS

Professional Mechanics' TOOL CHEST FOR YOUR HOME WORKSHOP



This may be the lowest cost full-sized chest in America! 4 sliding drawers in blue-gray rugged steel cabinet. 28" x 12 1/2" x 12 1/4". Keep your valuable tools safe, clean and always at your fingertips.

\$24.75

F.O.B. ST. PAUL

FREE BULLETIN



HUOT MFG. CO.

555 No. Wheeler St., St. Paul 4, Minn.

SPRAY PAINT the EASY WAY!



Unique BECKER CO. SPRAY GUN Goes to the Job . . .

Without Attachments!

No Hoses, Wires, Compressors! At last—a completely portable spray gun you can carry to the job as easily as a water pistol. Powered by CO₂ cartridges . . . provides up to 1,000 lbs. pressure. Container holds 21 oz. of liquid, reloads in a flash. Nozzle adjusts from stream to finest spray. At your dealer's or order direct. Remit in full for post-paid shipment. Or send \$2 now, pay postman balance plus COD fee.



ONLY \$19.95

with 10 cartridges

SULLIVAN-BECKER CO.

Dept. 116-J, KENOSHA, WIS.

Smooths out automatic transmissions

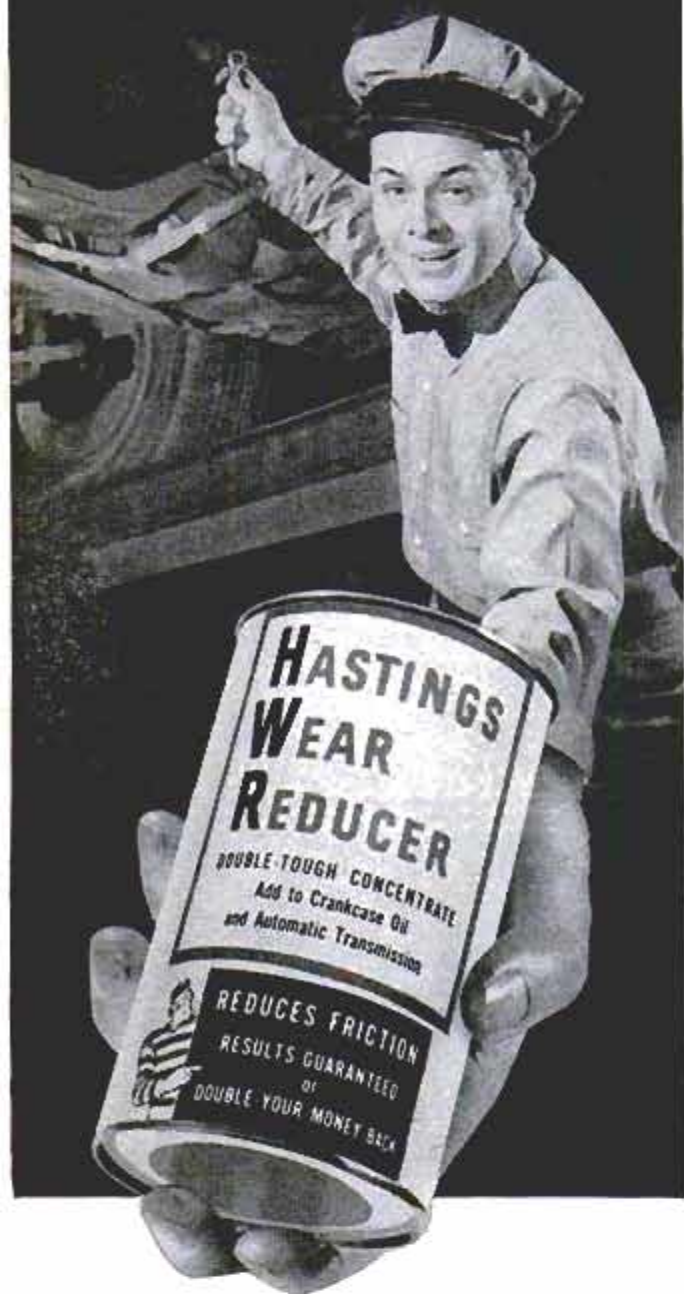

H-W-R rids your automatic transmission of jar and jerk . . . keeps your engine clean, quiet and smooth . . . restores power and stops hydraulic valve lifter noise. Results guaranteed or *Double-Your-Money-Back!*

HASTINGS MANUFACTURING COMPANY, HASTINGS, MICHIGAN

HASTINGS

Buy these Hastings Products with confidence:
Wear Reducer, Casite, Piston Rings,
Oil Filters, Spark Plugs



Taken in a special summer school for children of migrant workers, this was shot at f:2.8 and 1/50

Indoor Pictures Without Flash

(Continued from page 136)

lamps and you'll get good results. However, most professional photographers, who do their own developing, consider such ratings to be very much on the conservative side, with a safety factor of at least 2½ times, and will often use ratings of from 320 to 800.

This large safety factor is designed to cover such variables as performance of equipment or errors in judgment. Experi-

(Continued to page 246)

Boxing picture in available light. Exposure was 1/250, f:3.5. Developed in Promicrol for 14 minutes



DO IT BETTER...
DO IT WITH DP



**GLAZE
CAULK
SEAL
PATCH**

Don't fritter away time and energy on temporary jobs. Use D-P Glazing Compound for ALL windows... wood or metal... for filling nail holes or cracks. Always ready, won't dry or harden in can. Fast, smooth, easy to apply. Just one of many fine D-P products. At all good stores... don't take substitutes!

Ask your dealer for D-P Products.

THE DICKS **PONTIUS CO.**
5301 Huberville Ave., Dayton 3, Ohio
INSIST ON D-P BEST SINCE 1867

Find **HIDDEN TREASURES**

GOLD, SILVER, PRECIOUS METALS with the Famous Model 27 Metal Detector. Lightweight, ultra-sensitive, low cost. None finer. Also GEIGER COUNTERS for uranium and the VIOLITE for tungsten. INFORMATION FREE

THE *Detectron* CORP.
5528 Vineland Ave., No. Hollywood, Calif.



NOW-SHOPSMITH®
for as little as **\$3 per week**

Start enjoying SHOPSMITH now for only \$29 down, \$3 weekly. Start saving now! Savings on projects and home repairs can more than equal weekly payments. See your hardware dealer or Montgomery Ward store. Write for 2 big, free, illustrated books. SHOPSMITH, Dept. 325-B, Menlo Park, Cal., or Box 2800, Ft. Wayne, Ind.

Drive with Confidence

DINSMORE Auto Compasses

Shows you the right way—the short cuts. Saves time, money. Write for new compass history folder, "Pants—Knives—Compasses," and name of nearest dealer.

DINSMORE INSTRUMENT CO., 1802-37 Kelso St., Flint 1, Mich.



ONLY COMPASS
APPROVED BY
AUTO MAKERS

SAY YOU SAW IT IN POPULAR MECHANICS

GENUINE ALNICO
MAGNETS

AMAZING, PERMANENT, NON-ELECTRIC, HIGHLY PRACTICAL. Conduct interesting experiments. Hundreds of uses. Retrieve valuable steel items such as guns, tackle from fresh or salt water; tools from tanks & drains. **GUARANTEED**. Try any magnet one week. Money back if you are not well-pleased.

No. M-710 Has pull of 225 lbs. on flat steel block..... \$16.50
No. M-625 Has pull of 125 lbs. on flat steel block..... \$9.50
No. M-575 Has pull of 75 lbs. on flat steel block..... \$6.50
No. M-500 Has pull of 50 lbs. on flat steel block..... \$4.50
No. M-47 Hot Pad Magnets, 10 for \$1.00..... 50 for \$4.87
No. M-35 Hobbyist assortment of 8 small magnets..... \$1.50

Send M.O. or check. We pay postage. Sorry no C.O.D.'s.

MIAMI MAGNET COMPANY, 3240 N.W. 27th Ave., Miami 42, Fla.

grips like a pipe wrench

**a cinch
to handle**



CHAN NEL LOCK

No. 420

Terrific gripping power on any shape 1/8" to 1 3/4" size. Long and streamlined... easy to use in hard-to-get-at places! Some of the reasons why Channellock is the favorite plier of craftsmen everywhere. And Channellock will be your favorite, too... for the same reasons. No other plier does so many jobs so well. Ask your hardware man for a Channellock No. 420.

BE SURE IT'S A GENUINE CHANNELLOCK



CHAMPION DEPARTMENT TOOL Co. MEADVILLE, PA.

Fast, Safe
No Wash
Non-inflammable

Peels Off Paint

How you can get perfect paint jobs every time!

Klean-Strip is totally unlike ordinary paint removers that dissolve the finish and are so messy to use. Klean-Strip actually breaks the bond between finish and surface . . . removes many coats with one application. It's clean, fast-acting and easy to use . . . leaves the surface smooth and dry, ready to paint without neutralizing or afterwash.

Use Klean-Strip on furniture, woodwork, walls, metal. Klean-Strip peels off any finish. Buy it when and where you buy paint.



KLEAN-STRIP
Paint Remover

THE KLEAN-STRIP CO., INC.
2340 S. Lauderdale, Memphis 6, Tenn.

Speedy Sprayer

mobile paint sprayer

Choice of craftsmen for 35 years! Saves time, paint and money. Quickly gives flawless finish to walls, furniture, screens, fences and handiwork. Sprays all materials; 1/4 H.P. motor. Diaphragm principle assures clean, oil-free air. Never needs lubrication. With gun, less motor.

No. 890 Speedy Sprayer . . . \$38.50

Add wheels with Wheel Kit No. 909. Includes 6" wheels, handle, fittings. **\$6.95**

FREE!
Write for "How to Spray" Booklet and Literature.



At dealers everywhere

W. R. BROWN CORPORATION
2635 N. NORMANDY AVE., CHICAGO 35, ILLINOIS

enced photographers can eliminate the necessity for the safety factor by controlling conditions. The exact speed index used depends on such things as the developer used, shutter accuracy, the photographer's personal opinion about negative quality, the type of enlarger to be used and the lighting conditions.

(Note: All emulsion-speed values referred to here are ASA exposure indexes. Users of Weston-index meters can translate effective ASA speeds into Weston numbers by remembering that any Weston index is approximately four-fifths of an ASA index. For example, a Weston reading of 160 is about the same as an ASA reading of 200.)

Experiment With Tri-X

The photographer just beginning to use Tri-X would best start with the recommended index of 200 set in his meter. A few experimental shots will show him how he can utilize Tri-X's wide latitude and high sensitivity for his own use. A good general rule to follow is that the new films give best results when exposure is just adequate to give detail in the darkest area of the picture.

When the high-exposure indexes are used, developing is an important factor, and each photographer is well advised to do his own film processing. Modern mass-production processing is adjusted to give the widest range of printable negatives—considering that every film on the market from persons who make every conceivable error in exposure must be processed.

Develop It Yourself

But film development is easy to learn, and kits containing everything needed are available at photo-supply stores. As a guide for handling Tri-X in the darkroom, the chart on page 136 is included. This indicates time of development of the film in four different developers to obtain a negative which will make a reasonably grain-free enlargement on normal No. 2 contrast paper. The chart is not intended as an infallible guide, but should be used as a basis for the first trials with Tri-X, until experience takes over.

Each of the developers listed is good, and each has its advantages and disadvantages. D-23 gives a medium-fine grain pattern, and is extremely popular because of its tolerance toward overexposed highlight areas, which it will seldom blacken to the point where they become unprintable. D-76 produces a homogeneous medium-fine grain pattern, within the range of indicated development times, but probably should

(Continued to page 248)

TENSE NERVOUS HEADACHES

call for

STRONGER Yet SAFER

ANACIN

Won't Upset The Stomach

Anacin® not only gives stronger, faster relief from pain of headache, but is also safer. Won't upset the stomach and has no bad effects. You see, Anacin is like a doctor's prescription. That is, Anacin contains not just one but a combination of medically proven, active ingredients. Scientific research has proved no single drug can give such strong yet such safe relief as Anacin. Buy Anacin Tablets today!

For
lawn mowers

New 3-in-one Oil-Spra lubricates all over — forms a barrier against rust! Press button for penetrating oil spray!



"3-IN-ONE" OIL

BUILD FINE GRANDFATHER CLOCK NOW
The simple sensible Red-i-Kut way as thousands have — **SAVE HALF. SHOP TESTED PLANS "SPIRIT OF THE CENTURY"** Narrow waist 83" tall or stately straight side "SPIRIT OF AMERICA." **EASY-TO-FOLLOW** photopack plans tell all—plus **BROCHURE** of heavy brass weight Westminster, tube chime, movements, gorgeous bronze-silver dials, 3/4" solid mahogany case kits, \$ and \$1.00 today—Both plans \$1.50 NOW. Kuempel Chime Clock Works, 28 Kuempel Bldg., Minneapolis 16, Minn.

DITCH-WITCH TRENCHER



Portable DITCH-WITCH digs 4 1/2" or 6" deep, even ditches to 36" depth in all types of soil. Four rugged models. Complete unit — self-propelled. **OUTDIGS 8 MEN**
Write for illustrated literature

The CHARLES MACHINE WORKS
620 B Street Perry, Okla.

HOLD-E-ZEE SCREWDRIVERS

The Original
AUTOMATIC GRIP

Top Quality—Plus!

Finest materials and workmanship plus exclusive, much-wanted features

—YET COST NO MORE THAN ORDINARY SCREWDRIVERS!

At Leading Dealers Everywhere

UPSON BROS., INC., ROCHESTER 14, N. Y.

For better finishes use ADALOX sandpaper



BELTS



CUT SHEETS



DISCS



ROLLS

Bring-up smooth finishes every time with fast-cutting Behr-Manning ADALOX sandpapers. Available in a wide selection of grits and backings to boost both your hand and machine sanding operations. Keep a supply handy in your home or shop. Ask for ADALOX at local Hardware and Paint Stores.

Here's HELPFUL FINISHING DATA

32 illustrated pages on the how-to of finishing wood and metal. At your Hardware or Paint Store, or send 25¢ to Behr-Manning Co., Troy, N. Y., Dept. PM-9



C-7

BEHR-MANNING Co.
A DIVISION OF **NORTON** ABRASIVES

BEHR-MANNING PRODUCTS: Coated Abrasives - Sharpening Stones - Behr-cat Tapes
NORTON PRODUCTS: Abrasives - Grinding Wheels - Grinding Machines - Refractories

KLEINS



AID TO YOUR CRAFTSMANSHIP

These three pliers—a Klein Side Cutting Plier, Long Nose Plier and Oblique Cutting Plier—belong in every workman's kit.

They put the exclamation point after your good workmanship! For a century Klein has stood for the finest in pliers and Kleins are still the standard of comparison by which other pliers are judged.

There is a type and size of Klein Plier for every job—all famous for Klein quality "since 1857."



Your hardware store has Kleins in stock or can get them for you quickly. Look for this new display board. It shows the most popular items in the Klein line.

Mathias **KLEIN** & Sons
Established 1857 Chicago, Ill., U.S.A.
7200 McCORMICK ROAD • CHICAGO 45, ILLINOIS

not be used for more than 15 or 16 minutes on Tri-X, since after this the grain rapidly becomes excessive. D-76 yields the sharpest image of any developer.

Promicrol is much like D-76, except that it is somewhat finer grained and has less tendency to block up highlight areas. Microphen yields a mottled, indistinct grain pattern similar to, but finer than, that of D-23. Microphen should never be used for less than 10 minutes, as it requires this much immersion time to achieve good contrast with Tri-X. Microphen has the least tendency to block up highlight areas of all four developers mentioned.

One interesting technique used by press photographers when they have had to shoot without flash in courtrooms, hospitals and other poorly lighted areas is to develop the Tri-X in Dektol developer for three to five minutes with constant agitation. These negatives will show grain, so it is best to restrict this last-ditch approach to roll-film and film-pack sizes where enlargements of no great size will be required. Shoot an experimental roll to find out whether or not you can use this method in a given situation.

The total effect of this revolution in photography we've been talking about can be summed up like this: The two-to-one difference in speed between the new films and their fastest predecessors has made a gigantic difference between what photographers could do before and what they can do now. ★ ★ ★

Dummy Aircraft Fool Observers

Air Force camouflage experts have developed dummy aircraft, inflated like balloons, to fool enemy observers flying over airfields on which they are placed. The decoy planes would serve to divert enemy bombs and gunfire and deceive the enemy as to Air Force strength and disposition. In tests with mock F-86F and F-84F jet fighters, aerial observers were unable to detect the difference between the accurate models and real planes, and all but two of 14 interpreters who examined 5000-foot aerial reconnaissance photos were unable to spot the decoys. The prefabricated, partially pneumatic F-86F decoy has a fuselage of two-ply rubberized balloon cloth and wings and tail of rigid ribbed sections covered with one-ply rubberized fabric. The F-84F is entirely pneumatic except for the tail. Decoys of other planes will be constructed.

☐ The United States has approximately 312,000 registered civil pilots and 99,000 registered civil aircraft.



Once a dreary attic... now a cheerful room!



With a few household tools and Gold Bond Insulation Planks and Tiles, you can build a room just as attractive as this in your attic or basement.

Walls of Gold Bond Insulation Planks go up fast. The Planks are lightweight, easy to handle. Arrange them vertically, horizontally or diagonally over furring strips and nail or staple. Interlocking edges hide the fasteners. The Planks come with a flame-resistant finish of ivory or a random assortment of

four harmonizing colors... take paint perfectly, too. They are sound-absorbent for restful quiet. And they insulate the room, keep you cooler in summer, cut fuel bills in winter.

Next, nail or staple the ceiling of Gold Bond® Insulation Tiles in place. Interlocking edges hide fasteners, assure accurate positioning. The Tiles sponge up noise, make the room ideal as a bedroom, den, game room.

See your Gold Bond dealer for materials and helpful advice. And ask about easy terms.

MAIL THIS COUPON NOW!



National Gypsum Company, Dept. PM96
Buffalo 2, New York



Please send me Gold Bond's free "How-to-Do-It" Plan #14... giving complete instructions on how to use Insulation Planks and Tiles.

Name _____
Address _____
City _____ Zone _____
County _____ State _____

Gold Bond

BUILDING PRODUCTS

NATIONAL GYPSUM COMPANY

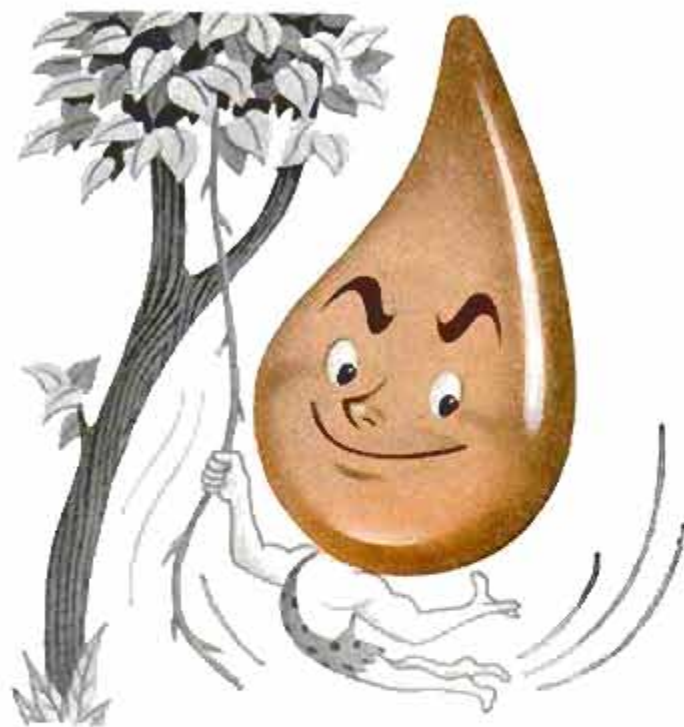

Pete Penn...

Nature's Boy

Native of the country where nature's finest crude oil is found, Pete Penn stands for the *best and most durable* of modern motor oils . . . brands of Pennsylvania.

With close-fitting engine parts and today's high speeds, your car deserves to be protected by *the best oil you can buy*.

A Pennsylvania motor oil will *last longer, increase fuel economy and lower maintenance costs*.

At your next oil change, tell the man to put in a brand of Pennsylvania . . . carried by good dealers everywhere.

Today's BEST Oils

**Start with Nature's BEST Crude
...and that means Pennsylvania!**

INSIST on
a brand
of



© 1966

**PENNSYLVANIA
Motor Oil**

PENNSYLVANIA GRADE CRUDE OIL ASSOCIATION • Oil City, Pa.

Better Fishing Ahead!

(Continued from page 127)

At a lake not far from Alma, the mine-acid problem arose again and was solved by the installation of a limestone-rock filter at the source of the trouble.

By midsummer in many of the more fertile, shallow lakes, aquatic vegetation becomes so thick and lush that fishing is impossible and it is even difficult to get a boat through it. A solution came from Wildlifer Frank Allen, who invented a number of underwater weed cutters.

Working with scrap materials and using cutter bars from old farm mowers, Allen produced one model, still in use, that is jet-propelled and can cut twenty acres of thick weeds per day. Most recent of his inventions is a portable model weighing less than 100 pounds which will fit almost any rowboat—and which can open more than 1000 acres of choice fishing water to the anglers each season.

Ohio's biologists are always looking for new species of fish that can be introduced into state waters—or even hybrids of native fishes that now exist in limited areas and can do well in other lakes in the state.

Muskie Planting Successful

The biologists have enjoyed amazing results with muskies in their planting program. In giant Rocky Fork Lake, inch-long muskies from stock seined in another part of the state grew to three feet and eight pounds in just two years.

Encouraged by this success, biologists are now planning to stock them in other places—to provide a new, exciting game fish and in the hopes that, with their voracious appetites, the muskies will keep the panfish under control and eliminate the need for poisoning.

Biologists and anglers everywhere have always wondered how many fish were in the water all around them. Now, with an electric shocking device, the fish population in all the streams of the state can be inventoried easily. A three or four-man crew can stun all the fish in one section of a creek and count them as they rise to the surface. The stunned fish are netted and the undesirables are removed. The game fish are then counted, sometimes tagged, and returned to the water alive and unharmed.

Tagging fish (on the lower jaw or on the gill cover) with metal tags is an especially useful activity of biologists. Tags that are returned or retrieved in future inventories, reveal how far fish travel and how fast they grow. This information is vital to the men working for better fishing in Ohio—and everywhere. ★ ★ ★

**guess who forgot
the sandpaper?**

**TIMELY TIP TO
WEEKEND HANDYMEN:**

You can't buy sandpaper in your living room. So when you're stocking up on paints, thinners, brushes and tools, make sure you haven't forgotten sandpaper. It's mighty important to a good job.

**CHOOSE THE BEST
SANDPAPER**

Always ask for **CARBORUNDUM®** Brand sandpaper by name, and look for the trademark "CARBORUNDUM" on the back. Available in sheets, rolls, and discs for every type of portable sanding machine.

*See these handy
work-savers at
your dealer:*

● **FLEXBAC® PAD**

For attachment to your electric drill. Soft, cushion-type pad gives speedy, smooth sanding on both flat and contoured surfaces—without swirl marks. Discs cling to adhesive surface of pad—can be changed in seconds.

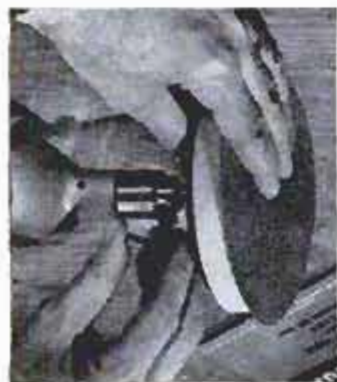

● **"SAND SCREEN"**

Revolutionary new open-mesh abrasive cloth. Use both sides. It never "loads up"...lasts up to 15 times longer than ordinary sandpapers.



● **ABRASIVE FILE**

No. 57 File out-cuts and outlasts metal files. Perfect for sharpening axes, hoes, spades and other tools.



● **KNIFE SHARPENERS**

Put keenest edges on kitchen and carving knives. Long-lasting, fast cutting. Colorful wooden handles.

Always ask for **CARBORUNDUM**

REGISTERED TRADE MARK

FIRST with the **BEST** in everything **ABRASIVE**

NOTHING TO WEAR OUT but the sand paper!



No. 900 HEAVY DUTY SANDER

Outsands, outlasts others. Exclusive "no jump" Multi-Motion action. Get this modern "King of Portables."

\$39.95

That's because both sanders are super-powered with the famous Syncro Reciprocating Motor—today's greatest research triumph! This unique, direct-drive motor has no belt, cam, gears; no rotating parts to wear out. It is guaranteed against burn-out during ownership. Syncros are so easy to use, so powerful, durable! Why push and "fight" old-fashioned portable sanders when Syncro Multi-Motion sanding—with genuine Syncro Reciprocating Motor—is yours so economically? See at tool dealers—write for Catalog, Reciprocating Motor data!



Model 900 sands edges without splintering wood.

No fan to cause "sanding-dust" cloud.

Ideal for heavy duty dry wall jobs.



No. 504 FINISH SANDER

Sand the latest way! Feather-light. Powerful. Easiest for vertical use. Exclusive Multi-Motion action. So economical!

\$19.95
with Genuine Reciprocating Motors

SYNCR

SANDERS

SYNCR CORPORATION

Dept. 1-66, Oxford, Michigan U. S. A.

WORLD'S LARGEST RECIPROCATING MOTOR MAKERS

There's Atomic Energy in Granite: Can We Unlock It?

(Continued from page 156)

he gets a high count from a body of granite or decomposed granite. He's sure he has made a rich strike. Sometimes it is hard to convince him that granite is virtually worthless at present, even though it is a storehouse that we will tap in the future.

Monazite, the chief commercial source of thorium today, is mined as a beach sand on the coasts of India and Brazil. It is also found as a beach sand in Russia and Australia. Smaller quantities of monazite sand occur on the coasts of Florida and Oregon. Other sources of thorium are in the rare earth deposits of Idaho, South Carolina and California.

In the past thorium was used chiefly in the manufacture of mantles for gas lamps of the Welsbach type. Today the Atomic Energy Commission is buying small amounts, paying about \$4 per pound for a product containing at least 50 percent thorium oxide. After reducing this to a metal, the AEC offers it for use in experimental reactors at a price of around \$19 per pound. Until recently the thorium was refined into metal by an expensive batch process that required costly reagents. Now a semicontinuous process, much less expensive, has been worked out.

Thorium is not readily fissionable. It does not maintain a chain reaction as do U-235 and plutonium. It is a raw material for atomic energy, rather than being an atomic fuel in itself.

When bombarded by neutrons, thorium changes into uranium 233, and U-233 can maintain a chain reaction. This explains the importance of thorium.

Thorium is to be used in experimental "breeder" reactors that are intended to produce power and at the same time to create as much nuclear fuel as they consume. In theory, a breeder can produce as much as 115 percent of the fuel it burns up, though this may not prove true in practice. Even if a breeder reactor produces almost as much fuel as it consumes, instead of more fuel, it still represents a big step in the development of energy.

Such a breeder would have a central core in which U-235 or some other atomic fuel is burned. The thorium will be placed like a blanket around the core so that it captures some of the neutrons that the core emits. The U-233 that is thus created from the thorium in turn will emit more neutrons, transmuting additional thorium. The theory is that a breeder reactor will

(Continued on page 254)

For your Ford - always specify the oil filter with the
MICROSCOPIC "STRAINER"

"Dust so small it can't hurt your eye, *can* hurt your engine," says Robert Pocock, Ford's Filter Research Engineer. "That's why it pays to ask for Genuine Ford Oil Filters. They are manufactured to the world's *highest* oil filter specifications. Their filter element must be able to strain microscopic particles *1/100* the size of the dot (•) shown here!"



Genuine Ford Oil Filters, like all Genuine Ford Parts, are designed to rigid Ford specifications!

When a replacement will add to your Ford's performance (whether it's an oil filter, shock absorber, or anything else) it pays to say, "*Genuine Ford, please!*"

That way you know you're getting the part that's been made right to work right in your Ford. And, all Ford Parts must pass special endurance tests before being approved for manufacture.

Do right by your Ford with Genuine Ford Parts . . . *made right to fit right to last longer!*

Keep your Ford all Ford

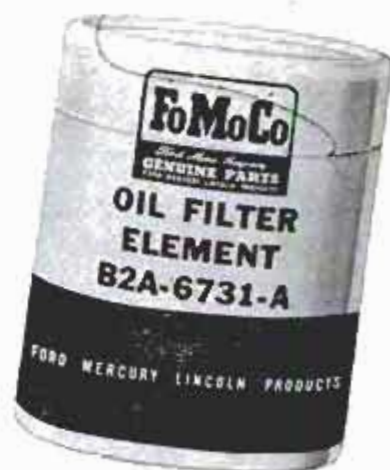
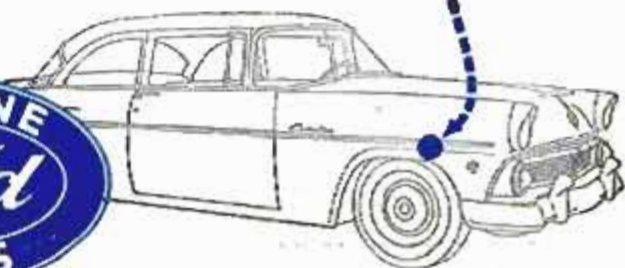

REPLACE YOUR

OLD WOOD CELLAR DOOR



WITH A
MODERN
ALL-STEEL
BILCO
DOOR

DO IT YOURSELF

IN JUST 3 TO 4 HOURS

Think of it! Only a few hours of pleasant work to replace your unsightly, troublesome wood hatchway with a lifetime, weathertight BILCO . . . the door installed on tens of thousands of new homes.

PAYS FOR ITSELF! Cost so little, yet never needs repair or replacement. Operates at a touch. Smooth, trim appearance adds amazing new beauty to your home.

Rush coupon TODAY for free folder and "Do It Yourself" pamphlet showing step by step replacement of wood hatchway.

Bilco®

AMERICA'S FINEST
BASEMENT DOOR

THE BILCO CO.
DEPT. 363C
NEW HAVEN, CONN.

Gentlemen: Please send me "Do It Yourself Pamphlet" along with other literature showing sizes.

Name _____

Street _____

City _____ State _____

maintain itself as long as new supplies of thorium are fed to it.

It may be that thorium reactors can operate at higher temperatures than are permissible with other kinds. The resulting increase in efficiency would produce more steam.

This summer a sodium-graphite reactor using enriched U-238 was being completed near Los Angeles by Atomics International, a division of North American Aviation. Heat from the reactor will create steam that will drive a turboelectric generator which in turn will furnish 7500 kilowatts of power to local lines of the Southern California Edison Company.

The thermal efficiency of the reactor is rated at 30 percent, but if it were of the thorium type its efficiency would be around 33 percent. This seemingly slight increase in efficiency would boost steam temperature from the present 825 degrees to as much as 950 degrees, with an appreciable increase in electrical output.

Important experiments concerned with "thorium breeding" will be conducted in the sodium-graphite reactor at the same time that it is producing commercial power.

Eventually, thorium may become the favored raw material for fueling all large central atomic-power stations. This may not happen for some time, especially in the United States where rather large quantities of the uranium isotope 238 are on hand.

For every pound of fissionable U-235 that is refined, more than 200 pounds of U-238 are automatically obtained. This isotope can be converted into plutonium by bombardment, and plutonium can be used as a nuclear fuel. Too, U-238 that is enriched with U-235 is an acceptable atomic fuel.

Neither of these fuels possesses the breeding characteristics of thorium but from an economic standpoint it may be cheapest to use them. When the AEC released 88,000 pounds of U-235 for power development purposes here and abroad this past spring, it immediately became apparent that we have a vast surplus of useful U-238 on hand. A stockpile of more than 6000 tons of U-238 was obtained when the 88,000 pounds of U-235 were refined.

Another reason why we may be slow in building numerous thorium reactors is that we don't possess rich deposits of thorium. On the other hand, India is greatly interested in using thorium for power because of the deposits of thorium it possesses.

The usual tendency in any mining operation is to work the richest deposit first. Another tendency is to extract only one or two of the most valuable ingredients from an ore and literally to throw all the rest

(Continued to page 256)

IDEAS FROM WELDWOOD

THIS MONTH'S PROJECT—DESK-SEWING TABLE



Here is one of the most versatile, easy-to-build pieces of furniture you can have in your home. First, it's a desk—durable and steady for tots' or teens' homework. Then, it's a sewing table too—with a hinged top that swings out to form a generous 4' x 6' work area for cutting out patterns. (When not used for sewing, it can be wheeled back against the wall.) And the drawers and doors make it a spacious storage cabinet. For Easi-Bild* Plan, see coupon.

This Month's Hints

Installing curtain or drapery rods?

You can avoid drilling into plaster or masonry by following this method. First, make sure your plaster is perfectly sound. Next, take two pieces of plywood—about 2" square and 3/4" thick—drill or nail curtain rod braces and holders to the pieces of plywood. Coat one side of each with Weldwood Contact Cement. Next apply Contact Cement to wall at top corners of the window. Press the blocks to the cemented wall areas and they will be in place permanently. E. W.—Arlington, Virginia.

\$10 for your ideas

for "This Month's Hints," if accepted for publication. (Hints must apply to some Weldwood product.) Send them to Weldwood Hint Editor, 55 West 44th Street, New York 36, N. Y.

HAVE A QUESTION? Send it to "The Weldwood Question Box," 55 West 44th St., New York 36, N. Y.

Constructing this desk-sewing table is really easy. For it is made of Novoply® panels framed with angle irons. Novoply is Weldwood's 3-ply all wood panel made of resin-impregnated wood chips and flakes fused under tremendous heat and pressure. Because of this exacting construction, Novoply panels are extremely stable and virtually warp-free! You'll find Novoply easy to work—resists splitting from nails or screws.

Novoply has a textured, mosaic-like appearance that's handsome and distinctive. So you can either finish it natural—paint it—or cover it with durable Micarta® for scuff-proof, scratch-resistant service. Send for plans today, and see if your kids don't *almost* enjoy doing homework this year.

©T.M. Reg. Easi-Bild Pattern Co.

THE WELDWOOD QUESTION BOX

Q. I've got an old, scratched, and banged upright piano that still has a good tone. Is there any easy way to refinish it or "dress it up" so it will look as good as it sounds?

A. Of course you could scrape the finish off down to the bare wood, but that takes a lot of elbow grease. Why not try this: bond 1/4" thick Weldwood hardwood plywood to the exposed parts of the piano with Contact Cement (one quart should do the job). With the big

4' x 8' panels you can cover the piano quickly and handsomely. You can choose from a great variety of woods, too. Birch, for example, will give a nice modern appearance, while mahogany will blend in well with traditional furnishings. Remove ornamentation such as carved moldings, and roughen the polished surfaces with sandpaper to assure good bonding. Take the piano case apart and cover each part separately to make the job easier.



Weldwood®

A product of

United States Plywood Corporation

Weldwood—The Best Known Name in Plywood

United States Plywood Corporation, Pattern Dept.
P. O. Box 215, Pleasantville, New York

Enclosed find 50c for which please send me Pattern #543—
Desk-Sewing Table. PM 9-56

NAME.....

ADDRESS.....

CITY.....STATE.....

LUBRIPLATE

THE MODERN LUBRICANT



LUBRIPLATE H.D.S. Motor Oil—A heavy duty superior oil with high film strength. Fully detergent, keeps your engine clean, gives your car more power, faster starts, better fuel economy. *The oil that requires no additives.*

LUBRIPLATE CAR LUBRICATION

LUBRIPLATE Car Lubrication is different . . . it's better. LUBRIPLATE Lubricants make your car run better, last longer. Protect your car investment, cut your repair bills and parts replacements to an absolute minimum. If you want the very best for your car insist on LUBRIPLATE Lubrication.

LOOK FOR THIS SIGN!

It's Your Guarantee of the Finest in Car Lubrication. Consult your car dealer.



LUBRIPLATE IN TUBES

Packed in handy tubes for convenient lubrication of car door hinges, locks, hoods, fishing reels, guns, outboard motors, and everything in and around the house. Available at sporting goods and hardware stores, marine dealers and all automotive outlets.

Best for Outboards



Best for Guns and Reels



Best for Lawnmowers



LUBRIPLATE DIVISION, Fiske Brothers Refining Company, Newark 5, N. J., Toledo 5, Ohio

of the minerals on the dump. Eventually, as our richest mineral resources are used up, it will become standard practice to extract as many as 20 or 30 products from any one mining and milling operation.

In a few unique cases this is being done today. American Potash & Chemical Corporation extracts more than 20 chemicals from the brine that it pumps from alkaline deposits lying under Searles Dry Lake in California. Among other products taken from the brine are table salt, salt cake that is used in detergents, potassium chloride that is used in fertilizers, soda ash for glass and washing compounds, borax, sodium phosphate, sodium bromide and lithium chloride.

These and other chemicals are removed from the brine in a series of distillation and precipitation steps. Some of these steps are complicated, some are extremely simple. One worth mentioning is the way that Glauber salt is extracted from the brine. This substance precipitates out of solution at 55 degrees or less. At Searles, brine is simply sprayed into the air above the lake bed when the temperature is below 55 degrees. The Glauber salt collects in big piles under the spray heads. The sprays are automatically turned off when the temperature rises above the critical point; otherwise the precipitated material would go back into solution and drain away.

The Searles operation is exceptional because all its minerals are in solution, a situation entirely different than when handling a rocky ore. But it points the way to the metallurgical and chemical tricks that will be devised for extracting numerous ingredients from many kinds of ore.

We know now that even "barren" granite contains a rich variety of metals. And we know that the rock also holds more than enough atomic energy to perform the work of extracting the metals, with energy left over. The time when we will be mining granite may be a long way off, yet it is interesting to speculate on what our resources will be when that time does come.

Suppose that a few centuries from now the United States becomes much more industrialized than it is at present. Suppose, too, that industry in all other parts of the world rises to the same high level. By then, the world population may well have grown to 30 billion persons.

Such a population might consume rock for its metals and atomic fuels at the rate of 1500 billion tons per year.

Would we soon run out of rock? Hardly. Assuming that all the land areas were available for such processing, man would "eat" his way downward at the rate of less than one tenth inch per year! ★ ★ ★

NEW POWER TOOLS by Shopmaster

New rugged design... exclusive features... professional-like performance. As little as \$10.00 down at your Shopmaster Dealer. Send for FREE Do-It-Yourself Project Plan and Catalog.

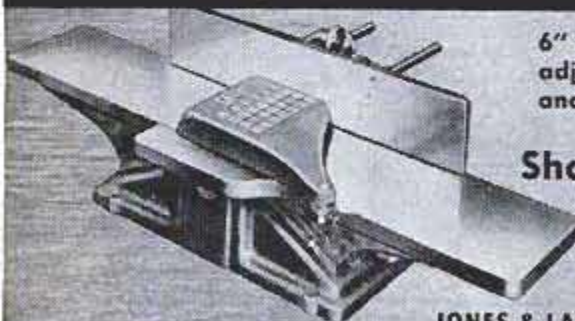

6" JOINTER-PLANER adjustable front and rear tables.



24" Radial Arm DRILL PRESS positive angle drilling.

8" Tilting Arbor CIRCLE SAW... cast iron table.

Shopmaster Inc.

1214 South 3rd Street
Minneapolis 15, Minn.

A Subsidiary of

JONES & LAMSON Machine Company
Springfield, Vermont, U. S. A.

PRECISION-BUILT TO DO THE JOB YOU WANT DONE



- MODERN BEAUTY
- MODERN USEFULNESS
- MODERN IMPROVEMENTS

IN A BRAND NEW MODEL OF A FAMOUS QUALITY INSTRUMENT

HULL AUTO COMPASS

Beaconlite ILLUMINATED \$6.30
Streamline NON-ILLUMINATED \$4.99

As your dealer write for literature
HULL MANUFACTURING CO.
P. O. Box 246-D9 • Warren, Ohio



Exclusive Double-Bearing HEAVY-DUTY PUMPS

IRRIGATE • DRAIN • CIRCULATE • SPRAY
Up to 7,500 GPH, 3,000 GPH from 25' well. Use 1/4 to 1 HP motor. 1 1/4" inlet; 1" outlet. Stainless shaft.
TYPE X—2 oilless bronze bearings. **\$10.95**
Won't rust.....
TYPE XB—Ball bearing model..... \$12.95

Postpaid if cash with order. Rush your order today
MONEY BACK GUARANTEE
Centrifugal and Gear Pumps in All Sizes
LABAWCO PUMPS, Belle Mead 2, N. J.



KING MIDGET

Drive it for 75c per week. Rider Agents wanted—earn your own car free. Also KING MIDGET JUNIOR chassis, finely engineered, ready to run and priced at a fraction of any similar car. **GET THE FACTS.** Send 25c for 32 page picture book giving special prices and agents proposition on both cars. Or send \$1 (refunded first order) for this plus actual assembly book and service manual.

MIDGET MOTORS CORPORATION, ATHENS 1, OHIO





(Pattern No. 586—
50¢ Colonial
Cobbler's Bench)

COLONIAL COBBLER'S BENCH

... is so easy to build yourself with Easi-Bild® Patterns. No skill or experience is needed.

All you do is trace simplified pattern on wood; saw, and assemble. Patterns list materials and outline each construction step.

Complete catalog of over 250 Easi-Bild Patterns is yours for only 35¢. Send to EASI-BILD, Pleasantville, N. Y.

*T.M. Reg. Easi-Bild Co.

EASI-BILD PATTERNS



Easi-Bild Patterns specify **PLASTIC WOOD** for a real professional job. Handles like putty—hardens into wood.

"PLASTIC WOOD"

Multiband Converter

(Continued from page 167)

Coupling

Coupling the converter to your radio can be done in a number of ways, depending upon the type of antenna included in your set. Most sets have one of three types; a built-in antenna loop, the newer type of ferrite-core antenna, or an outside terminal for the connection of an external antenna.

Coupling to the first type (the built-in loop) is simple. Merely construct the "coupling loop" shown in Fig. 5 and plug it into the output jack of the converter. Secure this loop to the back of the radio, in the vicinity of the radio's loop antenna. In

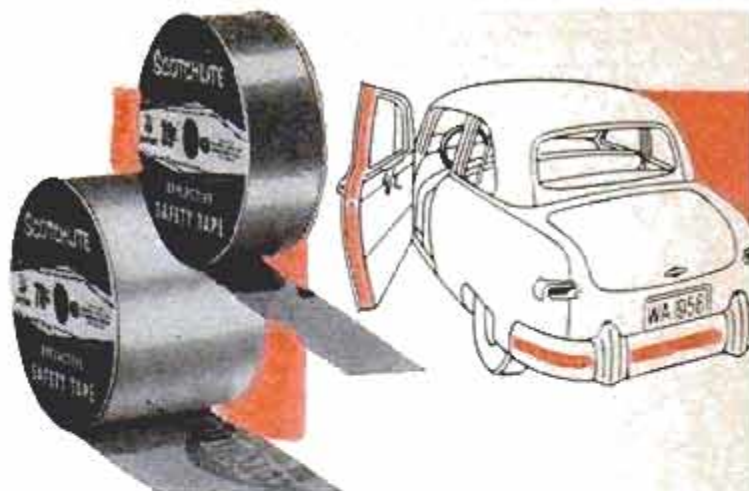

"Scotchlite" Reflector Tape

More complete night safety. Reflects up to 200 times more light than other parts of car. Red, 1"x30" (C2591) 39¢
Red, 2"x30" (C2594) 78¢
Silver, 1"x30" (C2593) 39¢
Silver, 2"x30" (C2596) 78¢

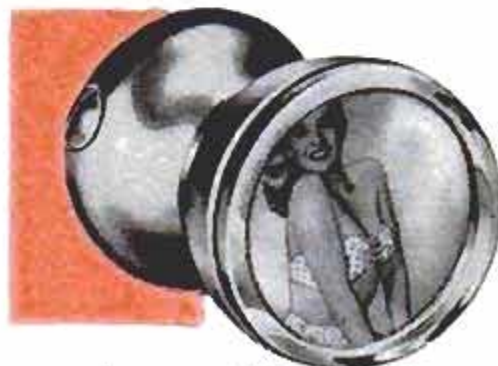

Steering Wheel Spinners

with carved roses, colored photos of Hollywood bathing beauties, colored stars or plain designs under lucite top. Base, cup, chrome. Make parking, turning easier. Also use on boats, trucks. (C1142) \$1.20



Wescote Whitewall Paint.

Makes dress whitewalls out of regular black tires. Renews discolored whitewall tires. Adds life by preventing cracks, preserving rubber. Weatherproofs. White, 1/2 pint (C14876) 42¢
Black, 1/2 pint (C14885) 38¢

COIL-WINDING DATA

BAND	WINDING	L1 ANTENNA COIL	L2 OSCILLATOR COIL
80 Meter (2.6-6.4 mc.)	A	30 1/4 turns, close-wound No. 26 Enam. wire	18 turns, close-wound No. 22 Enam. wire
	B	11 3/4 turns, close-wound No. 26 Enam. wire	
40 Meter (5.3-14 mc.)	A	14 1/2 turns, close-wound No. 22 Enam. wire	10 1/2 turns, spaced to occupy 5/8-in. No. 22 Enam. wire
	B	4 3/4 turns, close-wound No. 22 Enam. wire	
20 Meter (10-27 mc.)	A	8 turns, spaced to occupy 3/4-in. No. 22 Enam. wire	4 1/2 turns, spaced to occupy 1/2-in. No. 22 Enam. wire
	B	4 3/4 turns, close-wound No. 22 Enam. wire	
10-15 Meter (20-45 mc.)	A	4 turns of B&W Miniductor Type 3014	3 turns of B&W Miniductor Type 3014
	B	2 turns insulated hookup wire, wound over winding A	

Fig. 4. Construction of plug-in antenna coils. Form at left is used for all but the highest frequency band. Oscillator coils have only a single winding

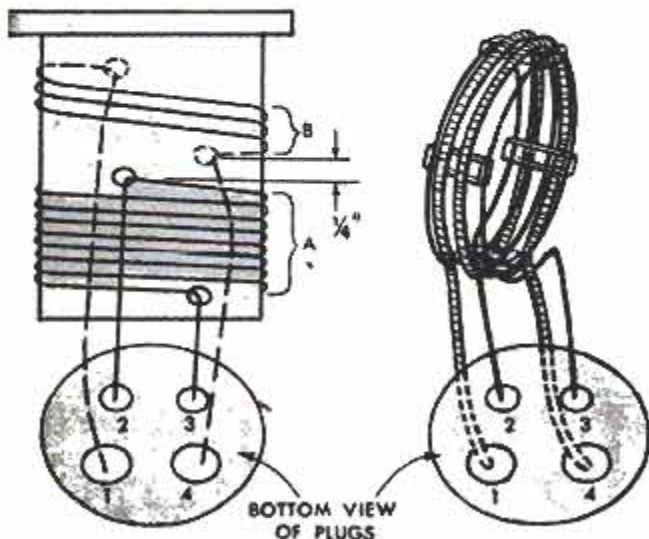

(Continued to page 260)



Like a "tune-up"! For better engine performance the year around, add Casite to your motor oil with every oil change. Keeps engine clean. Gives you easier, faster starting... quiet, smooth power. Ideal for new cars. Pint, only (A1229) **\$1.00**



Portable Spotlight plugs in lighter socket... perfect for night car repairs, finding house numbers, etc. On-off switch in handle. Chrome. Powerful 4 1/2" sealed beam. 10-ft. cord. 6 volt (2L6116) **\$5.85**
12-volt (2LW6120) **\$5.75**

ALDOR
BRAIN-LIKE
THERMOSTATIC
REACTOR
DISK



Guaranteed to fire in oil! Thermostatic control automatically adjusts spark gap for peak efficiency and performance at any heat range. Ideal for modern high compression engines and premium higher octane fuels. (L1280-B) **99¢ ea.**

"New-Condition" Your Car Now

Choose from over 4,000 guaranteed top quality parts and accessories at

Western Auto

Stores and Associate Stores



Wizard De-Sludge-Er Oil Filter Cartridge has new 100% cellulose filter agent. Has these advantages: absorbs moisture better, keeps oil cleaner longer. Won't clog, channel or by-pass. Easy to remove. For most cars, trucks, tractors. (W5812-7) **\$1.29**



Guaranteed leakproof, blowout-proof. Wizard Muffler protects against carbon monoxide gas fumes... gives "new car" silence. Original equipment specifications. Heavy, long-lasting steel. All popular cars. (T1148-1500) From **\$4.95**



Protect floor of your car and help keep trade-in value high with these twin Floor Mats. Cover entire front area, flat and slope. Designed to stay in place. Fit all cars. All new rubber. Black, red, blue, green, yellow, white. (2N1130-5) Pair **\$4.59**

NOTE: In some areas of the U.S., Hawaii, Alaska, and Mexico, prices slightly higher. Western Auto Associate Dealers own their stores, set their own prices, terms and conditions. (PM96)



WIZARD POWER TOOLS
...built to make it and take it!



WIZARD 6 1/4" PORTABLE SAW: Cuts 2x4 at 45°. Adjustable cut to 2 1/8". Powerful 7 amp. motor. Special slip-clutch prevents motor burn out. With rip guide and safety guard **\$39.95**
 Other models \$29.95 to \$52.95

Team up with WIZARD for a faster, easier job. These rugged tools are compact, easy to handle, yet big enough for any home project. Check the complete line of power-packed WIZARDS at your nearby Western Auto Store before you buy *any* tool . . . then

JOIN THE MILLIONS WHO KNOW THAT YOU GET MORE TOOL PER DOLLAR WITH WIZARD THAN WITH ANY OTHER NATIONAL BRAND!

WIZARD 1/4" DRILL:
 Powerful, 2 amp. motor. Geared chuck. Locking trigger. Accessories and kits are available. . . . **\$19.50**
 Others \$12.50 to \$49.95



Wizard 
 OVER 400 ITEMS FOR THE WORKSHOP

Sold Nationally by
Western Auto
 STORES AND ASSOCIATE STORES

NOTE: In some areas of the U. S., Hawaii, Alaska, and Mexico, prices slightly higher. Western Auto Associate Dealers own their stores, set their own prices, terms and conditions.

most cases, the two loops will "couple up" even if they are an inch or two apart, providing they are properly oriented. You may have to try various positions of the converter loop to obtain best results.

Coupling to type two (with the ferrite-core antenna) is just as simple. Wind about 10 turns of insulated wire directly over the ferrite loop coil. Attach a pin plug to the other end of this wire and plug it into the converter output jack.

For type three, where the radio has an external antenna connector, connect a single piece of hookup wire to this connector. The other end of the wire is plugged into the converter output jack.

Adjustment

Proper adjustment of the converter is simplified by the broad-band design of its i.f. stage. Having coupled the unit to your radio, attach an antenna to the converter and set the i.f. tuning slugs protruding through the side of the chassis approximately halfway in. Now, turn on the radio and set its tuning indicator to some frequency between 1400 kc. and 1600 kc. *where no broadcast station is normally heard.*

Plug the two 40-meter coils into the proper converter sockets and set the band-set capacitor, C2, and the mixer-peaking capacitor, C1, to the half-open position. Now, turn on the converter and, after allowing the tubes to warm up, slowly rotate the bandspread capacitor, C3. You should be able to tune in some of the stronger short-wave stations immediately. With a station tuned in (one of the high-speed code stations which emit a kind of raspy buzz is ideal for this purpose), readjust the i.f. tuning slugs for the strongest signal, and retune the mixer-peaking capacitor for maximum volume.

When this is done, you have accomplished

Fig. 5. Construction of loop used for coupling from converter to radios with built-in loop antennas

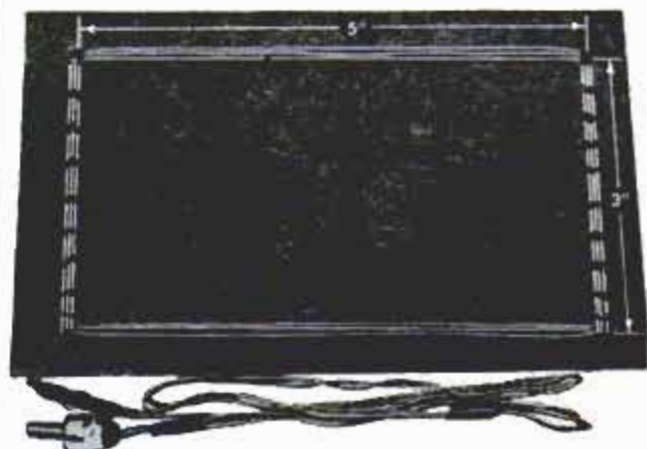

(Continued to page 262)

why... YOU SHOULD EQUIP YOUR TRAILER WITH



BULL DOG

- AXLE ASSEMBLIES
- JACKS • COUPLERS

BULL DOG straight or drop axles in single or tandem—capacities up to 10,000 lbs. steel axles—any width—and the famous safety-engineered "Torq-Less" axles for all types of trailers.

JACKS—Bull Dog Jacks make hitching and parking a one-man job . . . easy to install.

COUPLERS—Bull Dog Couplers hitch or unhitch mobile homes in a moment.

Write today for FREE descriptive folder 13-M.



HAMMER BLOW TOOL COMPANY
WAUSAU • WISCONSIN

free world's most complete electronic buying guide

ALLIED'S 1957 ELECTRONIC SUPPLY CATALOG

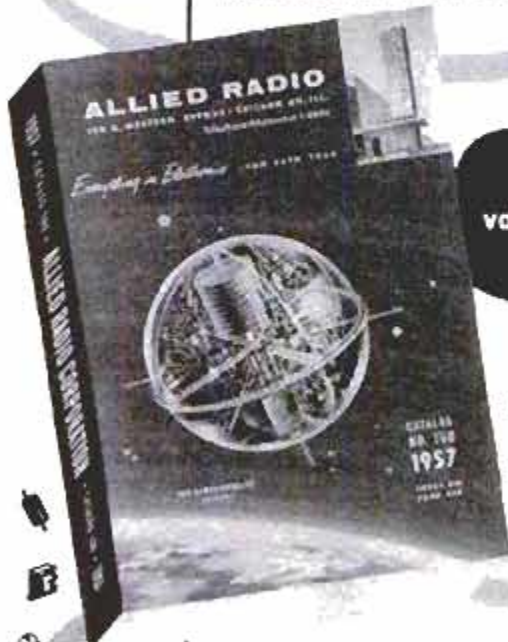

356 value-packed pages

SAVE on Everything in Electronics



World's Largest Stocks . . . Everything For Experimenters, Builders, Amateurs, Servicemen, Engineers & Hi-Fi Hobbyists

Send for ALLIED's value-packed 356-page 1957 Catalog. Save on everything in Electronics: Hi-Fi systems and components; latest builders' kits (see the famous KNIGHT-KIT line); recorders and phono equipment; TV tubes, antennas, accessories; Amateur station equipment; test instruments; industrial electronic equipment; plus the world's largest stocks of parts, tubes, transistors, tools and books. Save on everything in Electronics—send today for your FREE 1957 ALLIED Catalog!

Everything in Electronics From One Reliable Source

Our 36th year

ALLIED RADIO

ALLIED RADIO CORP., Dept. 5-JJ-6
100 N. Western Ave., Chicago 80, Ill.

Rush FREE 1957 ALLIED 356-Page Catalog

Name _____

Address _____

City _____ Zone _____ State _____

BOAT KITS 28 MODELS—8 to 19 ft. \$39 up—FREE FREIGHT

SAVE 2/3! Easy-to-build MAHOGANY DECKS & FRAMES

SEND 10¢ for CATALOG

Boat Plans—Patterns—Frame Kits

Build over 50 modern boats from large scale plans, available with FULL-SIZE patterns, new PRE-FAB frame kits! All types; prams to cruisers, 6 to 25 ft. Best buy for Amateurs! SEND 10¢ for CATALOG.



Craig Craft
Tanawanda, N. Y.

MAGNETS

5 Assorted Size Magnets \$1.00. Powerful Pocket Magnet W/case \$1.00. Hot Pad Magnets—large size 8/\$1.00. Bulletin Board Magnets 8/\$1.00. Slender Magnets—pencil type 2/\$1.00. Retrieving Magnets—extra power, heavy duty—30 lb. pull \$4.00, also 50-75-100 lb. pull. Explore, learn Electricity, Magnetism, Electro magnets, complete kit and instructions with 22 experiments and models . . . \$3.98. TRANSISTOR RADIO KIT—all parts & instructions—powerful . . . \$7.95. Also—Rods, discs, bars, horseshoes. Send stamp for catalog—Specify your requirements—100% SATISFACTION GUARANTEED. PARK MAGNETS, 269, 1557 GREENBAY RD., HIGHLAND PARK, ILL.

SAY YOU SAW IT IN POPULAR MECHANICS

Need an extra \$1,000, \$2,000, or more? Make it with an **IDEAL LAWNMOWER SHARPENER**



There are thousands of lawnmowers in your locality: Average \$1,000 profit per 250 mowers with customer satisfaction and repeat business assured. Provide this essential service with an Ideal Lawnmower Sharpener, the only machine that grinds the reel to "fit" the bed knife. Compare by any standard. The Ideal, backed by 53 years of experience, costs no more. Write today for complete, free catalog.

THE FATE-ROOT-HEATH COMPANY
Dept. PM-9 Plymouth, Ohio

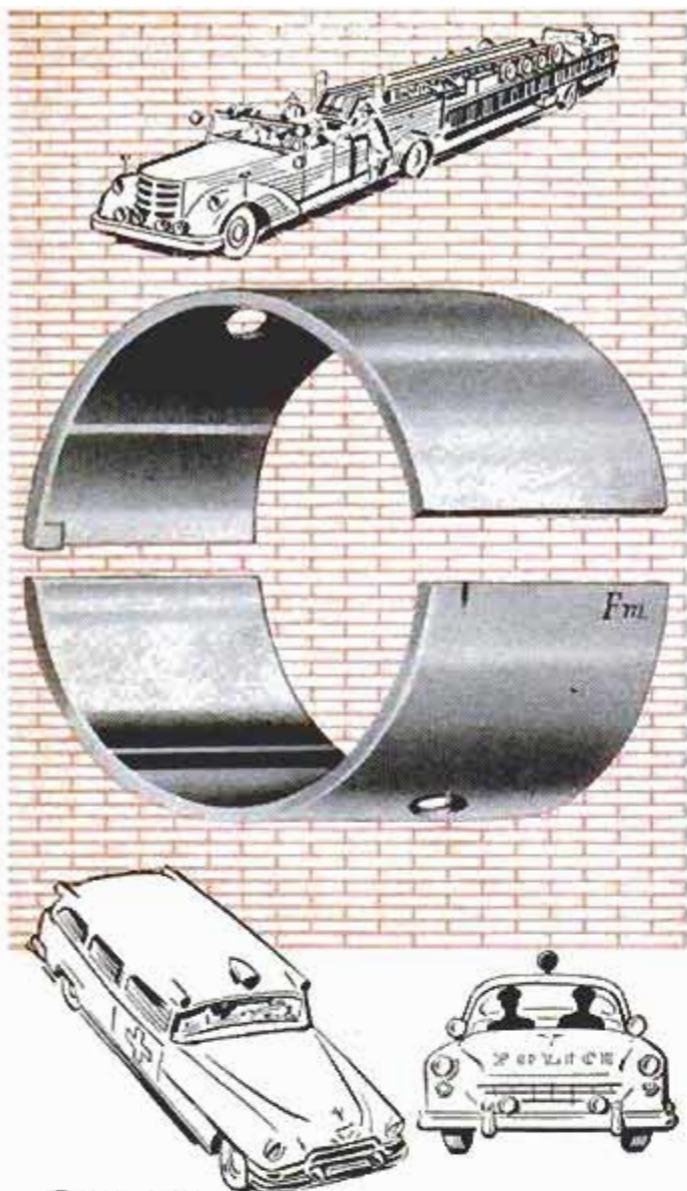

Smooth
Engine Power
calls for Quality Bearings . . .
**FEDERAL-MOGUL
QUALITY!**

You, too, can have the same lively, dependable power vital for emergency vehicles, when you replace worn engine bearings with Federal-Mogul QUALITY bearings. They are *engineered* to stand up under heavy explosive impact loads and to restore snappy power, pick-up and economy!

FEDERAL-MOGUL SERVICE

Federal-Mogul-Bower Bearings, Inc.

Ask your Mechanic!

RESEARCH • DESIGN • METALLURGY
PRECISION MANUFACTURING • SERVICE



the following: 1. The converter i.f. stage is properly aligned and will need no further adjustment, and 2. the mixer is properly tuned to give satisfactory performance over the complete range covered by the bandspread capacitor. Other stations within the band can then be tuned in merely by rotating the bandspread capacitor.

Each set of coils is designed to cover a number of short-wave bands. To tune in a different band with the same set of coils, reset C2 to a different point and adjust C1 to have about the same degree of plate opening (if one is $\frac{1}{2}$ closed, the other should also be approximately $\frac{1}{2}$ closed). Again, tune in a station with the bandspread, and peak C1 for maximum volume. This mixer setting need not be changed unless the band-set capacitor is once more readjusted.

All this is more difficult to describe than to do. After getting the "feel" of the converter, you will have little trouble in tuning to the stations you wish to hear.

One caution: On the high-frequency bands, 20-meter and 15-meter coils, there may be two settings of C1 which will produce the strongest signal. Actually, only the *lower*, the one at which the mixer capacitor is more nearly closed, is the correct one.

What can you pick up with the converter? That depends on the sensitivity of the radio with which it is used and the length of the antenna. Assuming an average a.c.-d.c. set (with its own i.f. stage) and a 60-ft. or longer antenna, foreign stations and amateurs from all over the world will come pounding in. In one test conducted by the author, New Zealand amateurs, in the 15-meter band, were hammering through on a Sunday afternoon in *broad daylight*. ★★ ★

Recording-Level Meter

(Continued from page 168)

shortened, to prevent damage to the rectifier due to overheating. The electrolytic capacitor should be wired into the circuit with the indicated polarity.

Although the meter scale is calibrated in microamperes, the actual calibration is unimportant. All you need is a relative indication of the signal level. Since every recorder is different, the absolute meter readings which will indicate too strong or too weak a signal must be determined by experimentation. To do this, first adjust the volume control of the recorder so that this instrument will provide "quiet" recordings when no signal is applied. This is done by recording a few feet of tape (if a tape

(Continued to page 264)



Home Improvement of the year!

STORM WINDOWS you make yourself of REYNOLDS *Do-It-Yourself* ALUMINUM



Won't rust, rot or warp — ever!

You save from the beginning — and through the years—with Do-It-Yourself Aluminum Storm Windows. They keep their shape, effectively shut out winter's fuel-eating winds. They never need paint. And cost so little in the first place. Completing one in an hour is a leisurely job.

And you can make interchangeable panels of perfectly matching Do-It-Yourself Aluminum screens.



Hardware and Lumber dealers have complete materials and Free instruction sheets. Call Western Union Operator 25 for the name of the dealer nearest you.



Press-together construction with corner locks

REYNOLDS METALS COMPANY
2494 South Third Street
Louisville 1, Kentucky



- CHROME CLAD FINISH
- DECIMAL GRADUATIONS

A New Complete Line of **LUFKIN** machine divided STEEL RULES

You'll find exactly the steel rule you need in the complete Lufkin line. All models from narrow to heavy spring tempered, including shrink rules and combination square blades in either regular or Chrome Clad finish from which to choose.

Lufkin's exclusive Chrome Clad finish resists rust and is also stain and tarnish proof. It wipes clean and is easy to read. Decimal graduations in lengths up to 72 inches in accordance with "American Standards". Graduated in 10ths and 50ths on one side, or on both. See Lufkin's new complete line.

BUY **LUFKIN** TAPES • RULES
PRECISION TOOLS
FROM YOUR HARDWARE OR TOOL STORE

BETTER MEASURE WITH LUFKIN

THE LUFKIN RULE CO., SAGINAW, MICH.

WRITE FOR
FREE NEW
TOOLS
BOOKLET
431

OLD PAINT PEELS OFF IN MINUTES



DOW METHYLENE CHLORIDE does the job
faster, safer and with much less effort

Paint removers containing Dow Methylene Chloride get down under paint and lift it right off the surface. Just brush on, wait ten minutes, then wash or wipe loose paint off. Beats hard work a mile! Safer, too, because it's nonflammable. Available in wash-off or scrape-off types at hardware and paint stores. Look for paint removers labeled "nonflammable" or "contains Methylene Chloride".

For more information, write to THE DOW CHEMICAL COMPANY, Dept. S-945E, Midland, Michigan.

you can depend on **DOW CHEMICALS**



NEW!

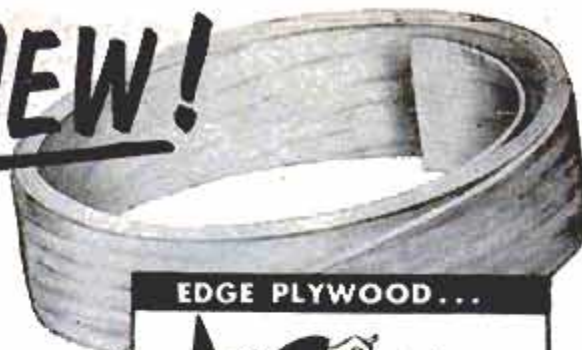

EDGE PLYWOOD...



DECORATE THINGS...



with new Flexible **Weldwood®** **Wood-Trim***

No more exposed edges when you make things of plywood—things like tables, desks, cabinets or other projects. Wood-Trim covers the edge with real wood veneer... gives a real "pro" finish. Apply it in minutes—without clamping, ironing, sawing, nailing, using Weldwood Contact Cement or Weldwood Presto-Set® Glue.

Countless decorative uses too; trim lamp shades and picture frames, decorate coffee tables, clocks, waste baskets, etc.

At hardware, paint and lumber dealers or write for free leaflet. Dept. PM9-6WT
For perfect wood finishing jobs, use Firzite® and Satinlac®. *TRADEMARK

Box 525, UNITED STATES PLYWOOD CORP., N.Y. 46

8 Ft. rolls
1" wide,
89¢ each.
Oak,
African
Mahogany,
Walnut,
Birch or Fir.



Another
Weldwood
Wizard

UNMATCHED



Gerstner Chests are unequalled in quality and performance. Free Catalog.

GERSTNER TOOL CHESTS

456 Columbia St., Dayton 7, Ohio

FUN-WORK YARD TRACTOR

WHEEL-HORSE RIDE-AWAY



Turn work into FUN! Do a dozen back-breaking jobs in a jiffy. Yard-size tractor with 5 forward speeds and 1 reverse. 3½ hp (or 2½ hp) engine. Heavy channel steel chassis. Mow 5-foot swath at 5 mph. Plow snow, cultivate, haul compost, pull any of 22 attaching tools for yard and garden. Write for details, and name of dealer.

SENSATIONALLY \$29950
PRICED AT F.O.B. Factory

WHEEL-HORSE PRODUCTS COMPANY

2664-A Dixieway North

South Bend, Indiana

recorder is used) with no signal source connected to the recorder input jack, and volume control turned up about halfway. Then listen to your recording of "nothing." If excessive hiss or noise is present, repeat the procedure with a lower volume-control setting, until quiet reproduction is obtained. Then, interconnect the mixer, level indicator and recorder, and record a few minutes of a radio program. Adjust the volume of the radio so that the meter pointer deflects about half-scale on the peaks of the program. Play back the recording to determine if the peaks are distorted. If so, try it again for a lower setting of the radio volume control. The highest peak meter reading which gives undistorted recordings is the maximum usable recording level. A line can be drawn on the meter glass, with a wax pencil, to indicate this level.

To determine the lowest usable level, make a short recording from radio with the volume turned down so that it barely deflects the meter pointer. If this level is too low to record satisfactorily, as determined in the playback, try it again at a slightly higher volume, until the meter reading which indicates the lowest usable signal has been determined. Again, draw a line on the meter glass to represent this level. When the meter is calibrated in this manner you are assured of good recordings at all times merely by adjusting the gain controls of the mixer-preamplifier to keep the meter pointer within the two indicated limits.

While designed specifically for use with the mixer-preamplifier described last month, this recording-level indicator could be used directly with any tape recorder having a monitor jack. However, some modifications may be required. The circuit is designed to deflect the meter pointer full scale with an applied audio voltage of about 0.4 volts, rms. The output voltage at the monitor jack of most recorders is considerably higher than this, and the value of the 1000-ohm limiting resistor must be increased so that the current through the meter is reduced to a safe level. To determine the correct resistance value, temporarily replace the 1000-ohm resistor with a 100,000-ohm rheostat. Set this control for maximum resistance, and make a recording from radio, with the recording-level meter plugged into the monitor jack. While recording, vary the resistance of the rheostat until the meter pointer just goes off scale on the signal peaks, as determined by the built-in neon bulb. Then, measure this resistance with an ohmmeter and replace the rheostat with a fixed resistor of a slightly higher value. ★ ★ ★

**BRAND NEW 1 H.P.
12 Volt Electric Motor**



For electric wheel chairs (Pop-Mech. Design—Mar.—1963)
For electric golf carts
For self-propelled scooters, children's mid-gate cars.

ITEM #308
Rated 1 H.P.—100 amps., 5600 R.P.M., 12 volts, D.C.—This double shaft motor of ball-bearing construction may be run on 6 volts for lower horsepower requirements—Standard 3/8" shaft, flange mounting—Dimensions: 9"x4 1/2"x4 1/2". Ship. wt. 19 lbs. A real **12.50** F.O.B. Chicago.

GROBAN HYDRAULIC SPEED REDUCER with FINGERTIP CONTROL

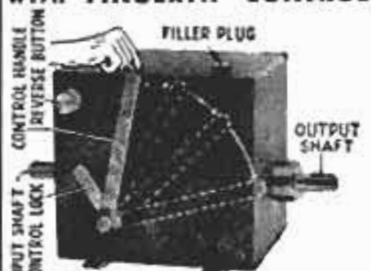

ITEM #115
FOR: Reamer Drives • Midget Cars • Feed Mills • Canning Machines • Conveyors • Lathes • Milling Machines • Motor Boats • Cream Separators • Garden Tractors • Pumps.
Variable output speeds from 0 to input speed available by moving control handle. Locking handle maintains setting. Use input power of 1/4 to 1 1/2 H.P. Shafts 3/8" diam. Input rotation counter-clockwise facing shaft. Input speed 750 R.P.M. 7 1/2" x 7 1/2" x 1 1/2". Output rotation reversible. Ship. wt. 31 lbs. Complete with 2 qts. of oil and full instructions. **54.50** F.O.B. Chicago.

MULTI-PURPOSE HYDRAULIC PUMP OR MOTOR



ITEM #255 Silent, high efficiency, Medical Gear Type Ball Bearing Hydraulic Pump or Motor. Rated 8 Gal. Per Min. At 1500 R.P.M.—Delivers 1000 P.S.I. Using 6 H.P.—Reversible Rotation—3/4" Pipe Thread Inlet and Outlet Ports—1/2" Drain Port—3/4" shaft with keyway and flat for either direct or pulley drive. Dimensions—5 3/8" high, 7 1/2" long, 3 1/2" wide. Shipping weight 18 lbs. **45.50** F.O.B. Chicago.

SHOP BY MAIL and SAVE at GROBAN'S

MASTER & SLAVE HYDRAULIC REMOTE CONTROL SET



ITEM #415—Designed for remote operation of controls on engines, boats, special machinery, etc. Eliminates complicated mechanical linkages, cables, pulleys, etc. The master unit connects to the slave unit with a single 1/4" tube. When master control lever is moved, slave lever follows exactly. Light, compact, aluminum alloy construction. Dim. of both units: 5 1/4" W. 9" H. 1 3/4" D. (exclusive of handle) Ship. Wt. 8 lbs. **27.50** per pair F.O.B. Chicago. (Note—tubing not supplied)

HIGGINS BRONZE CENTRIFUGAL PUMP

PUMPS ALMOST ANYTHING ITEM #414
Fine for: Irrigation • Sump Pumping • Sewer Drainage
75 gallons per minute @ 2400 R.P.M. Higgins Type PNB, Model R, marine bilge pump. Open impeller design for handling muddy water. Delivers 75 gallons per minute, 30 foot head with 3/4 H.P. motor. Pump body and impeller are made of solid bronze, with alloy steel 1/2" diameter shaft, 1 3/4" long. Rotation of the pump is clockwise. Inlet has 1 1/2" pipe thread. Plain 1 1/2" outlet for hose connection. Shipping weight 23 lbs. F.O.B. Chicago. **23.50**

DOUBLE ACTION HYDRAULIC CYLINDERS

ITEM #31C—3 1/2" bore, 11" stroke. Alloy steel cylinder wall, Micro-Honed and all steel 1 1/2" diameter piston rod. 10 1/2" overall length in closed. Clevis mounting at base and shaft. Will lift 9625 lbs. with 1000 PSI Pump Pressure. Uses 3/8" tubing fittings. (Fittings to pipe thread: two 3/8" MPT @ 35c, A 8102.00 value. Shipping weight 11 lbs. F.O.B. Chicago. **25.00**
ITEM #16-C—1 1/2" bore, 26" stroke. Will lift 1760 lbs. with 1000 lbs. pump pressure. Great for hay loaders, etc. 1" stainless steel piston rod. Postpaid. **16.95**
ITEM No. 33C—1 1/2" bore, 4 1/2" stroke, alloy steel barrel, aluminum alloy ends, clevis mounting at both ends, lifting capacity 1760 lbs. in approximately 1/2 second using 1000 P.S.I., overall length closed 15 1/2", has 2-1/2" pipe thread ports. Postpaid. **4.95**

1/4" Metal Stamping Set

STAMP YOUR NAME ON WOOD OR METAL!
Full alphabet A to Z, "&" and period. Precision hand trimmed deep cut, hardened STEEL STAMPS—In fitted Wooden Box—made to rigid U. S. Navy specifications by Young Bros.—Comparable to sets selling for \$27.00. **5.95** Shipping Wt. 5 lbs. F.O.B. Chicago

**GROBAN SUPPLY CO. Dept. PM-9
1139 S. WABASH AVE., CHICAGO 5, ILL.**

BELT DRIVEN A. C. GENERATORS

ITEM #1010
Ideal for powering electric tools, oil burner, refrigerator, lights, or other appliances requiring up to 1000 watts of power. 1000 WATTS, 115 Volts, 60 cycles A.C. 3600 R.P.M. Compact, self-regulating generator with V Belt pulley and double outlet receptacle. Rotation counterclockwise. May be driven by tractor or auxiliary gasoline engine. Requires 2 1/2 HP minimum. Dimensions: 10" long x 8" high x 6" wide. Shipping wt. 27 lbs. **79.50** F.O.B. Chicago.

Model 700—700 WATTS (Same as above) **59.50** F.O.B. Chicago.
2000 Watt Generator **149.50**

SAVE \$30.30 ON THIS PESCO HYDRAULIC CONTROL VALVE

ITEM #371V
FOR SAFE POSITIVE CONTROL OF HYDRAULIC CYLINDERS AND MOTORS—BUILT IN RELIEF VALVE—(4-WAY VALVE—to operate one double acting cylinder • OPEN CENTER—with valve in neutral, cylinder is locked in position and pump is unloaded. • SPRING RETURN TO NEUTRAL. • FULLY BALANCED PLUNGER. • EASILY STACKED INTO 2, 3, or 4 valve combinations for multiple cylinder operation. • 8 gal. per min. capacity, at 1500 P.S.I.—3/4" pipe ports • CONNECT PUSH RODS TO HANDLE FOR REMOTE CONTROL. • EASY MOUNTING • LIST PRICE—\$46.80. • YOU SAVE \$30.30. • DIMENSIONS—9" x 4 1/2" x 2 1/2"—Ship. Wt.—8 lbs. **16.50** F.O.B. Chicago.

Order Direct From Ad
SATISFACTION GUARANTEED. Send Payment Or Purchase Order Today. To place phone orders call WEBSTER 9-3793.

FREE!—NEW CATALOG 1956-'57 EDITION

chuck-full of unsurpassed War Surplus and newly manufactured Equipment Bargains for farm, home, factory, Workshop. Write letter today.

14' Model Featured
42 TOP PERFORMING MODELS, 5' thru 18'
...from \$39.25 incl. frt.
Runabouts, Cruisers, Convertibles, Fishing, etc. for every purpose with modern styling, advanced design. No experience necessary, amateurs can easily assemble. Save 1/3 to 1/2 "factory-built" prices!
FIBERGLAS, TRAILERS, ACCESSORIES
LUGER INDUSTRIES, INC. DEPT. B-9 3404 Lyndale S. Minneapolis 8, Minn.

SIMPLIFY PREVENTIVE MAINTENANCE WITH MACHINE TOOL RECONDITIONING & THE ART OF HAND SCRAPING (2nd printing)
SEND FOR FREE FOLDER DESCRIBING ILLUSTRATED BOOK
MACHINE TOOL PUBLICATIONS, 382 Holly Ave., St. Paul 2, Minn.

WHOLESALE TOOL CATALOG
MAKE EXTRA MONEY
Start Your Own Business
Sell tools part time, full time. Save money for your industrial and institutional use. A MILLION DOLLAR INVENTORY AT YOUR FINGERTIPS.
Buy NATIONALLY ADVERTISED hand tools, hardware, fans, motors, power tools, paints, etc., NO INVESTMENT REQUIRED. Buy as you need it. Up to 50% DEALERS DISCOUNT.
Send \$1 Deposit for mammoth wholesale dealers catalog. \$1 refunded on first purchase or returned if you are not 100% satisfied.
SILVO HARDWARE CO., Dept. PM-9, 108 Market St., Phila. 6, Pa.

MENDS MOST ANYTHING
"HOLDS LIKE IRON"
Used by fine furniture makers. Ideal for home and office. In 1/4 oz. or 2 1/2 oz. sizes.
McCORMICK IRON GLUE
MENDS MOST ANYTHING

MARLITE - IT - YOURSELF



REPLACEMENT OF A HUNDRED OF HOURS
 Guaranteed by
 Good Housekeeping
 IN ACCORDANCE WITH THE ADVERTISED CLAIMS

**a few days ago,
 this was a dingy basement!**

... but economical Marlite Plank and Block made the beautiful difference. This easy-to-handle paneling makes week-end projects out of week-long jobs. The exclusive tongue and groove joint simplifies installation; conceals all fastening. And Marlite's melamine plastic finish never needs painting. Dirt wipes off with a damp cloth.

Your building materials dealer will show you Marlite in "Companion Colors," distinctive wood and marble patterns. Ask him for free remodeling folder, or write Marsh Wall Products, Inc., Dept. 942, Dover, Ohio.



Surgery performed on a dog is demonstrated in the veterinary college using color-television close-ups

Electrons Join the College Faculty

(Continued from page 85)

reel so the fencer can move freely—like a fish the angler is playing. Each fencer's reel is connected to the judge's electronic recording panel.

The first hit sounds a buzzer and lights a bulb. Even if the opponent's hit is only $\frac{1}{25}$ second later, the recorder blocks it out. With such refereeing, there's no crowd boredom and no argument.

With our other great universities, Cornell opened new vistas of knowledge with its atom smashers, radio telescopes and other electronic tools of "pure science" research.

Like others, its knowledge hunters have gone strange places to do odd things. Below Lake Cayuga's waters, 2250 feet down in a vault of America's deepest salt mine, they've run a battery of 48 geiger counters measuring cosmic-ray power. In jungles and atop mountains, Prof. P. P. Kellogg has tape-recorded rare birds. With stroboscopic photography, and electronic hook-ups inside close quarters with 3000 volts only three feet from his face, Prof. Donald B. Griffin discovered the "radar" method by which bats utter supersonic cries to guide their flight even when they are "blind as bats."

Thus, universities now find wide usage

(Continued to page 268)

Marlite®

plastic-finished
 WALL and CEILING PANELING

A product of Masonite® research

NEW Easy-to-Use SOLDER



**Solders in ONE
 operation... just apply
 Swif® and heat**

SWIF is a real 50/50 tin-lead solder in paste form with flux combined. Just apply Swif and heat. All extra preparatory steps are eliminated by its one-step cleaning, tinning and soldering action. It makes perfect soldered connections with the heat of a match, torch, or soldering iron. Tube holds enough Swif for hundreds of jobs. Swif has been used by professional plumbers for years. At hardware, hobby, plumbing and auto stores. 59c per tube. Slightly Higher in Canada. Send For Free Literature.

HERCULES CHEMICAL CO., Inc.
 416 B'way., New York 13, N. Y.





The POWER TO STOP can save your life!

Once you've tried Bendix* Power Brakes—and marveled at the difference they make in stopping ease—you'll demand them for your present car, whatever its make. Ask for a test ride today. Car dealers, better garages, service stations and brake shops across the country have cars equipped with Bendix Power Brake Demonstrator Units. When you've seen the difference, *felt* the difference, you'll know they're the finest automotive buy on the market. And get this: Average price—about \$60 (including installation)!

*REG. U.S. PAT. OFF.

Bendix POWER BRAKES

Bendix Products Division, Bendix Aviation Corp., South Bend, Ind.

RETAIL PRICE \$125.00

FACTORY TO YOU \$79.95

SUPERSHOP includes precision-built 8" tilting table saw, vertical and horizontal drill press, 30" lathe, sander, grinder. 100% BALL BEARING. Write for FREE catalog, full details, trial plan. Easy Pay Plan.

POWER TOOLS, INC.

187 YATES AVENUE
BELLOIT, WIS.



CAMELS HAIR BRUSHES!
SURPLUS! — 20 for \$1.00

Imagine! Never used Camel Hair Brushes that cost many many times this low price. You actually buy these brushes at less than the cost to manufacture. For use in the home, office, shop or store. For touch-up, pasting, drawing, lens cleaner, typewriter cleaner, cleaning precision instruments, guns, tools, sporting equipment and hundreds of other uses. Assorted sizes. Money back if not satisfied, 20 brushes, \$1.00, 42 brushes \$2.00. Add 10c P.P.

MATTHEW DAY CO., INC.

12 E. Madison Ave., Dept. 9-BR
Dumont, New Jersey

Protect your home against
power interruptions
with an ...

**ONAN Emergency
ELECTRIC PLANT**

Provides dependable stand-by electricity for heating system, pumps, freezer, lights, appliances. Keeps home safe, livable. Automatic start and stop. Find out how little it costs!

Write for Folder!

D. W. ONAN & SONS, INC.
3646 University Ave. S. E.



A SIZE FOR EVERY NEED
500 to 50,000 watts.
Compact, quiet-running.
Gasoline-powered.
Priced from \$255.00

Minneapolis 14, Minnesota

**NOW CUT
HOLES & DISCS
PERFECTLY, EXPERTLY
IN SECONDS!**



"ARCO HOLE-SAW"

with New Automatic "SLUG-EJECTOR"
Fits any Electric Drill, Lathe, Drill Press, Motor

Exclusive "Slug-Ejector" pops out discs immediately—therefore works 3-times faster than other hole saws selling for twice as much. 7 shatterproof blades easily exchanged to cut 1", 1 1/4", 1 1/2", 1 3/4", 2", 2 1/4" & 2 1/2" holes thru any 3/4" stock. Safety-lock screw prevents blades from "jumping out." Incl. 1/4" drill bit..... **\$6.50**

No. 600 "ARCO HOLE-SAW"—as above, but with 4 blades to cut 1", 1 1/2", 2" & 2 1/2" holes..... **\$4.95**

At your dealer or order direct on our 10-day Money Back Guarantee. Send check, M.O. (ppd.). C.O.D. plus post.

ARROW METAL PRODUCTS CO.

Dept. PM-9, 140 WEST BROADWAY, NEW YORK 13, N. Y.

FAST-DRYING LUMINALL

concrete FLOOR PAINT

Decorates and preserves interior and exterior concrete floors, patios, primed wood porches and decks. Dries dust-proof in 40 minutes, walk-proof in an hour, traffic-proof overnight! Fast, easy application with brush, roller, floor brush. No special washes or etching needed. Nonflammable! Eight popular colors that wear like iron, last for years!

- COMMERCIAL GARAGES • PATIOS • GARAGES
- SHIPPING AREAS • BASEMENTS • FACTORIES

FREE 62-CHIP COLOR CHART

Features Luminall Concrete Floor Paint, Satin Luminall and Ready-to-Use Luminall for walls, ceilings, trim; Outside Luminall for exterior masonry, asbestos shingles and siding. Write today for your free copy.



LUMINALL PAINTS Dept. 102A
3617 South May Street • Chicago 9, Illinois
Newark 5 • Los Angeles 1 • Dallas 7

UTICA'S MAGIC BUTTON

makes the difference



UTICA's brand new SELECT-O-LOCK adjustable wrench gives you two tools in one. Push the magic button—the wrench is locked—just like an open end wrench. Pull the magic button, it's a conventional adjustable wrench.



See the new SELECT-O-LOCK, No. 93, adjustable wrenches in 6-8-10 and 12 inch sizes at your hardware dealer.

*PATENTED



THE HALLMARK OF QUALITY



Professors check recorded lecture from library which includes talks on anything from gardening to moon

for the electronic gadgets that their research produced. For example, Prof. C. W. Gartlein has been studying the role played by the hydrogen of outer spaces in causing the aurora borealis. Sitting up all night would be one way to take recordings. But he and his students can do it while they sleep. A photoelectric cell records intensity of the northern lights, and a spectrograph chart identifies the hydrogen.

There can be college rivalry in science, too. Cornell has built closed-circuit color TV into its new veterinary-medicine building. It wanted to be first to use such television to show future dog, cat and cow doctors how to do their work.

But the University of Pennsylvania also wanted to claim first. With Cornell's initial show scheduled for last January 6, Penn arranged one for the day ahead. However, January 5 was the day Philadelphia had a power failure. Penn's show couldn't go on, and Cornell University's show "breezed home" the winner.

Part of Cornell's pioneering in offering courses in such things as transistors and use of the electron microscope is due to having strong engineering and science departments which date back to founder Ezra Cornell himself. This versatile genius was first to hang wires from poles to make a long-distance telegraph line. After building the line used by Samuel Morse in his

(Continued to page 270)



Spare time income — or full-time business

CASH FILING SAWS

make up to \$3-5 an hour in home workshop
with FOLEY SAW FILER

Here is a steady CASH business you can start at home in your basement or garage, while you are working at your regular job. No experience is necessary to turn out perfect cutting saws—"the first saw I sharpened came out 100%. I think the Foley Saw Filer is a marvel of perfection," writes Clarence E. Parsons. Every saw you sharpen will bring you new customers. You will find you can make up to \$3 or \$5 an hour—\$20 to \$30 a week in your spare time as a starter.

With a Foley Saw Filer you can file all hand saws, also band and cross-cut circular saws. It is easy to operate—simple adjustments—no eye-strain. Patented jointing principle evens up all irregular teeth and makes an old saw cut just like new.



This Free Book Shows How To Start Your Own Cash Business

"MONEY MAKING FACTS" shows you how to get plenty of saws to file without canvassing, and how you can develop into a general repair shop that will be your own business. This is a helpful, practical book that tells just what to do—send for your free copy today. No salesman will call.

FOLEY MFG. CO., 916-6 Foley Bldg.
Minneapolis 18, Minn.

Send me free book "MONEY MAKING FACTS."

Name.....

Address.....

City..... State.....

WELD **BRAZE**
SOLDER **CUT**

4WAY
ONLY
\$14.75
I.o.b. factory

WELDER
Complete with
Twin Carbon Arc
Torch and ac-
cessories... to
handle all metal-
craft work.

Acclaimed by thousands of Homeowners, Mechanics and Hobbyists as the welder of 1001 uses. Easily operated from properly wired 110 volt AC or DC line. The ideal gift with a life-long use.... Order today on 10 day money back guarantee.

FOUR-WAY WELDER CO., Dept. F2-J
1810 S. Federal St. • Chicago 16, Ill.

P-1 GENERATORS
Aircraft Type 200-250 Amps. 24 Volt D.C. 4500 RPM. Makes a dandy arc welder. Cost GOV'T. \$400. SPECIAL \$14.89. Like NEW! Diagram Included Free. F.O.B. York. NEW '57 catalogue with 1000's of other big bargains—10c.

KARL ORT, DEPT. PM9, York, Pa.

LOCATE ALL TYPES of METAL
with... **HEDDEN**
METAL
DETECTOR

\$395.00 for model shown
Other models on application

Prospectors have found Hedden very efficient in locating gold, silver and other precious metals. It's a real treasure finder. The logging and live stock industries use it to detect and locate tramp metals. Police Departments find hidden weapons. Historical societies use it for locating metallic treasures. Write today for details of this sensational, electronically-developed unit.

Manufactured Exclusively by
ROWE INDUSTRIES • 1702 Wayne St. • TOLEDO, O.

50% MORE PRACTICAL
MALL 3/8" DRILL KIT

Mall

\$37.95

"POWER PLANNED"—does all usual kit jobs and many more

New 389 kit does hard jobs in cement, steel and stone as well as in wood. Rugged 3/8" drill has geared chuck and key, 650 RPM, 60 cycle, 115 V. AC-DC motor, cord, switch and plug. U. L. approved. Ideal for masonry, for precision polishing and sanding. Bits, pedestal, pads, discs, handle and steel chest included. Get 50% more practical, more efficient MALL 389 drill kit wherever high quality tools are sold.

MALL TOOL COMPANY
Portable Power Tools: Gasoline • Electric • Air
7805 South Chicago Avenue, Chicago 19, Illinois

Make **BIG MONEY** with this combination a.c. welder- a.c. power

Welds or runs
tools, lights,
motors, etc.

**A REAL
PROFIT
MAKER**
for
emergency
repair
jobs

**TWO
machines
in ONE**

200 Amp. AC Welder-AC Power Combination, four cylinder air-cooled engine. Furnishes 200 amperes of welding current and 5,000 watts of AC power alternately. Easily mounted on your truck or trailer for quickly getting to where it's needed on a moment's notice.

"Husky Boy" 200 amp. welder driven by a 2 cylinder air-cooled engine. Perfect for outside or around the shop welding. Handles the big pay jobs.

AC Power or AC Welder. An excellent dual purpose combination available in 200 and 300 amp. welding sizes. Can be belted or coupled direct to your own gas engine.

Transformer Type AC Welder 250 amp. A real welder for production and repair work in shops that have only single phase power available.

"Bantam Champ" 250 amp. electric motor driven welder for general shop use. Ideal where compactness and low investment are prime considerations.

Investigate
these
**BIG MONEY
MAKERS**
today



Hobart School of Arc Welding

Learn arc welding quickly by actual on the job experience at the non-profit Hobart Trade School. Complete or partial courses.

Modern Arc Welding Lessons
200 pages. Fully illustrated. Learn practical arc welding in your spare time. Only \$1.00.



**HOBART BROTHERS CO., BOX M-96,
Troy, Ohio, Phone 21223**

"One of the world's largest builders of arc welding equipment."

HOBART BROTHERS CO., BOX M-96, TROY, OHIO

Please send additional data on items checked:

- "Husky Boy" AC Power-AC Welding
 AC Transformer "Bantam Champ"
 Hobart Welding School Welding Lessons, \$1.00

free!

Welder's
Vest Pocket
Guide

NAME _____
ADDRESS _____
CITY _____ STATE _____

famous demonstration between Washington and Baltimore, Cornell went on to be cofounder of Western Union.

But the university also takes pride in its special shopping center called Electronic Stores. This warehouse is a sort of paradise for professors and students seeking parts of all kinds, and does around \$80,000 business a year out of stock or 25 drawers full of catalogs that can get it for you wholesale, or surplus.

Researchers from the Advanced Electronics Center which General Electric has established at Cornell drop in for tube testers and transformers needed in a hurry; and so do the "Home Ec" girls who want "pretty wires" they can use in making designs.

Veterinary teachers shopped here and built a heart-stimulating machine, with two spoon-shaped handles that squeeze helpfully around the animal's heart during an operation, and psychology got parts for the "lie detecting" apparatus proving that neurotics complain more but live just as long as normal folks do.

Parts for the pie tilter came from here. Another time, an aggie student had an assignment to count the flies in an ordinary barn. He brought his problem to Tito Capogrossi, the store manager, and ended up with a gridwork of charged wires spaced just right so that the flies flew between them and shorted circuit with their wings. The rest was just counting dead flies.

Capogrossi uses electronics in selling electronics. On a display panel, for example, he has 50 gadgets ranging from a constant-temperature oven to the device that reels in the antenna of a bomber. He demonstrates these by means of remote-control switches.

It's a store operated by Cornell for the needs of its own departments, but will help out other universities—like the P-4 gun computer off a B-29 which cost Uncle Sam \$23,000 new, and which Cornell sold for \$20 to the University of Arkansas where it was torn apart for its servomechanisms.

The only item Capogrossi will sell to just anybody is his "white elephant"—an Air Force navigation trainer completely equipped with dummy instruments. Originally worth several thousand dollars, Cornell has spent \$250 advertising this unpopular surplus item and will unload it, at latest quotation, for \$10.

To make the work of its professors more efficient, the university now has a tape-recording center. It stores lectures by leading authorities on anything from care of a home garden to making radar contact with the moon.

(Continued to page 272)

REPAIR MUFFLER AND EXHAUST LEAKS in 10 min.

The plastic gas-tight seal sets hard, withstands heat and vibration. Prevents carbon monoxide gas poisoning.



SETS LIKE A WELD — NO TOOLS NEEDED

\$1.69 per can

Holt's GUN-GUM

MUFFLER SEAL PLASTIC SEAL

Write for Full Details

See Your Neighborhood Auto Accessory and Parts Replacement Store
TREGLOWN CO. INC. FANWOOD 96, N.J.
 * TRADE MARK REGD. CANADA: 1368 GREENE AVE, MONTREAL 6 (Prices Higher)



Holt's HAVE THE ANSWER!

WORN ENGINE BURNING OIL!

Increases miles per gallon!
 Restores compression!
 Reduces oil bills!



\$4.95 Tube for most cars

Forms self-lubricating seal at piston top. Inserted through spark plug holes. Used by millions of motorists. Tested and approved by motoring experts.

PISTON SEAL

Also Eshelman TRACTORS. Riding ROTARY MOWERS. ROTARY TILLERS

ESHELMAN TWO PASS CHILD'S AUTO MODEL 2 NP

4 TIMES MORE GAS MILEAGE UP TO 15 MILES PER HR. STURDY, SAFE "Commended by Parents' Mag." Also 2 Pass. Adult Sport and Golf Cars at a small fraction of most other cars. Write for free literature and Rider Agent Plan. Dept. MC-59, ESHELMAN CO., 109 Light Street, Baltimore 2, Md.



Shipping Points: BALTIMORE - CHICAGO - MINN.



Loosens Rusted Bolts nuts, screws, "frozen" parts!

LIQUID WRENCH

AT HARDWARE STORES, GARAGES SERVICE STATIONS EVERYWHERE

For information write manufacturer Radiator Specialty Co., Charlotte, N. C.

GET THE HABIT OF READING OUR CLASSIFIED ADS.

Wonderful Opportunities Amazing Bargains

MONEY for MEN ALL DATA FREE

THE PLASTEX Industry needs manufacturers on small scale and for big production of Lamp and Clock Stands, Art Goods and Novelties in Plastex and Marble imitation. Experience unnecessary. The material makes regular 10¢ store sellers. Rubber moulds furnished for speed production. Small investment brings good returns. We are now placing big Chain Store Orders with manufacturers. Ambitious men have chance for real prosperity. Our Free booklet will interest and benefit you.

PLASTEX INDUSTRIES, Dept. A
 3400 Third Ave. New York 56, N. Y.

Install this superior HYDRAULIC EQUIPMENT Yourself!

Smooth-acting directional control valves — excellent feathering characteristics — minimal restrictions — performance comparable to the best... High performance hydraulic motor which may be used as pump — 16 gal. capacity at 1000 RPM and 1000 psi — May be used in combination to provide a fluid power transmission with a 10 HP capacity. Valve, \$16.95. Motor-Pump, \$56.50. Hydraulic Oil Reservoir with dual half-plate, three 3/4" SPT female ports, 5-10-15-25 gal. capacities. Price, 5-gal. \$9.95. Sbg. Wt. 15 lbs. For each add'l 5-gal. capacity, add \$4.50 and 8 lbs. wt. Set up your own hydraulic systems for post-hole diggers, loaders, unloaders, stackers, dumping equipment, automatic lathe feeds, home shop presses. Sold by units or package, including tanks.



OIL POWER CO., BOX 172, WAUKESHA, WIS.
 SEPTEMBER 1956

\$40 for 1 1/2 DAY'S SPARE TIME WORK GRINDING LAWNMOWERS

Yes, J. H. B. writes, "not bad for a 76 year old young fellow earning \$40 for a day and a half's work" . . . and others are making even bigger money with the Universal Model B Lawnmower Grinder. You, too can make good spare or full time profits in your own business in your garage or basement. We furnish everything you need. Write today. No cost or obligation. Dept. M-96.



ROGERS MANUFACTURING CO. LINDSEY, OHIO

SUPREME Versamatic

REVERSIBLE SCREW DRIVER AND SPEED REDUCER



fits all power drills

First time ever! It REVERSES!



Drive and remove screws with Supreme Versamatic. Versamatic reduces speed 7 to 1, increases power 7-fold. Reverses with one twist. Handles even the largest screws with ease. Also for nut running (adapter furnished); tapping; and all heavy duty drilling where speed reduction is needed. Fingertip control means safe, fast work. Complete set \$14.95.

(1/2" chuck extra). At better hardware stores.

SUPREME PRODUCTS, Inc., 2222 S. Calumet, Chicago 16

FOR SKILLED WOOD-WORKERS ONLY!

No. 2500
\$59.95



SYNCR0 2500 JIG SAW

At last—a jig saw designed only for the few real homecrafters who demand, use and appreciate the best in tools! This heavy 62 pound ruggedly constructed Syncro "2500" slices thru 2 x 4's or cuts intricate designs with almost unbelievable accuracy and smoothness. The entire arm—not the table—tilts 45° to either side. Powered with Syncro's latest Reciprocating Motor—guaranteed against burn-out during ownership. Sure, 2500 costs you more but it does more than others costing more! This masterpiece—designed for master wood-workers only—is already a favorite of industrial wood pattern-making shops. So new your tool dealer may not have it. Write for Free details.



Table stays level; arm tilts; beveling is easy.



Full 30" Throat

SYNCR0 CORPORATION
DEPT. 1-66, OXFORD, MICHIGAN, U.S.A.
WORLD'S LARGEST MAKERS OF RECIPROCATING MOTORS

INSULATE NOW

for as **\$67.60**
low as **cost for average attic**

Do it Yourself in One Afternoon!



ZONOLITE®

VERMICULITE INSULATION
Easiest of all insulations to install . . . save as much as \$100 installation costs. Cuts fuel bills up to 40%. Fireproof, rotproof, permanent.

LIFETIME GUARANTEE!
Zonolite is guaranteed to last the lifetime of the building in which it is installed. No further maintenance is ever required.

Write for
FREE
How to Insulate
BOOKLET

Zonolite Company, Dept. PM-96
135 So. LaSalle St., Chicago 3, Ill.
Please rush your FREE Booklet, HI-47 with details on How to Insulate.
Name.....
Address.....
City..... Zone..... State.....

AT LUMBER OR BUILDING MATERIAL DEALERS

In addition, "thinking machines" of various sorts have been added, in specialized courses, to such aids as the electronic microscope. For example, psychology now has an electronic profile-analyzing computer (EPAC) which solves complicated data and gives the answer in a bank of neon lights on the control panel.

Similarly, electrical engineering has an a.c. power network calculator—a roomful of electronics—as well as a homemade pipeline network analyzer that shows how to operate the water and gas lines of a large city.

The mathematics department has its own computing center organized around a card-programmed electronic calculator (CPC) which is not only used for training its own students but figures out at \$25 per hour rent for any other department that wants to use its brainy automation. But research students get its work done free.

Besides teaching youth with plug-in techniques, Cornell also drops the flunking ones with equal efficiency. This is done by setting exams up in true-or-false fashion, with electronic computers in the testing center rattling off the score.

Even in standard exams, the professor works with a stack of prepunched score cards. He "mark senses" each with a special pencil. If the student earned a 76, the pencil circles a 7 and a 6. Suppose he played hooky? Then a line is drawn through the score called "absent from final."

The cards are turned in to the university's central machine records division. Here's where 10,000 students are "stored" in cabinets. Each becomes an IBM card the day he applies for admission. It tells who he is, what course he is taking, and so on.

From all over the campus, the progress of each student comes to this office's accounting machines, sorters, collators and calculators. From one semester to another, he is punch-carded along the path to the day when the electronic bookkeeper scans his master card and clicks him off as eligible for a sheepskin. ★ ★ ★

Denver Oil-Shale Plant

One ton of oil shale per hour will be processed to produce oil and gas in an experimental unit being constructed for Denver University. The Swedish Aspeco process will be used. The raw shale is heated to a temperature of 1000 Fahrenheit, causing it to release burnable gases and also vapors which condense into oil. The spent shale, containing residual carbon, is burned in a retort to heat circulating steel balls which in turn heat the primary oven.

GIGANTIC
SAVE-TO-70%

MAIL SALE

WAR SURPLUS
EXCESS INVENTORY
BANKRUPT STOCK

Gigantic End-of-Summer Sale

To reduce our immense stocks of the finest war surplus items, we offer hundreds of amazing buys—SEND FOR LARGE FREE CATALOG. All items shown here sent prepaid except when stated "F.O.B."

- TYPICAL SURPLUS BARGAINS**
- Golf Car Battery (6-12v) motors (FOB) \$19.46
 - Hydraulic Pump, 12-v, 1000 lb. FOB \$41.90
 - Air Compressor, sing. cyl. 150 lb. \$19.95
 - Irrigation Pump, 280 g.p.m. 2 1/2" \$44.37
 - Irrigation Pump, 140 g.p.m. 1 1/2" \$24.61
 - Army Power Plant, 3000 watt, 115-v \$349.50
 - Army Power Plant, 2000 watt, 115-v \$269.95
 - Army DC Generator, 115-v, 3000-w \$58.75
 - Gear Head DC Motor, 0 or 12v \$8.72
 - Weed Spray Outfit, 5-row (\$175) \$79.50
 - Hydraulic Cylinder 2"x10", 3000-lb. lift \$17.50
 - Hand Winch, Red. gear type 1000-lb. lift \$8.95
 - Surveyors Level and Tripod, leading make \$42.95
 - Campers Power Plant, 500-w, 115-v DC \$79.50
 - AC-DC Power Rectifier, 110-v to 300-v FOB \$15.61
 - Farm Telephone, Magneto (cost \$25) \$9.95

- Govt. Prismatic Periscopes (cost \$20) \$2.99
- Engineer's Stop Watch, precision \$9.97
- Portable Air Supply, Spraying Tank Unit \$13.49
- Air Powered Tree Trimmer (\$69.50) \$15.37
- Hydraulic Cylinder 1 1/2"x4" (\$75) \$3.49
- Hydraulic Tractor Pump 1000-lb. 12-gpm \$45.50
- Giant Fresnel Advertising Light (\$280) \$49.50
- Govt. Wind Direction Remote Indicating Units (\$121) \$18.71
- Govt. First Aid Kits for Trucks \$6.95
- Window or Attic Fan Kit (24") \$12.95
- Diving Unit (mask, harness & 50' hose) \$12.91
- Blackhawk Hand Hyd. Pump & Reservr. FOB \$19.21
- Finest Paint Spray Gun (1-qt.) \$9.95
- Edwards Alarm Bell 110-v AC (\$3.95) .69c
- Spectacular Revolving Beacon Searchlight (\$1000) FOB \$191.79
- Electric Auto-Pulse Fuel Pump 6-v \$6.95
- G.E. Amplifier-Rectifier 110-v 8(150) \$6.97
- Govt. Fire-Burglar Alarm Unit \$5.87
- Desk Telephones (make antique lamp) \$1.99
- G.E. 0-300 amp DC Ammeter \$6.89

SPECIAL OF THE MONTH

BOAT & TRUCK ELECTRIC WINCH

Operates from 6 or 12-v battery over 1000-lb. capacity
● Powerful expensive Govt. ball bearing motor with built-in 100-to-1 ratio precision reduction gear. Gives smooth powerful pull on winch cable.
● Hundreds of applications. Mount on boat trailers, boat docks, raising anchors, etc.
● Ideal for trucks, farm equipment trailers, industrial uses. Cuts labor loading costs 90%.
Wt. 54 lbs. 17"x12"x8". Drum holds 40' 1/4", or 75' 3/16" cable. Orig. Govt. Cost over \$200.
F.O.B. Lincoln \$46.71



ORDER FROM AD or write for big new **WINTER CATALOG** 1000s of items! Motors, sporting goods, hand-electric tools, watches, etc. We pay freight except where stated "F.O.B."

BURDEN SALES COMPANY
811 "O" St., LINCOLN, NEBRASKA



10" TILT/ARBOR SAW BUILD-IT-YOURSELF from GIL-BILT KITS-PLANS

Sturdy wood, steel, and aluminum construction, NEW DEPARTURE ball bearings. Capacity and performance of floor saws selling for \$150.00 and up. Plans, all metal parts in kit with 10" comb. blade \$25.90, less blade \$22.95. F.O.B. St. Louis. Detail PLANS-PATTERNS only \$1.00 postpaid.

Build-it-yourself 12" and 18" Bandsaws, 6" Belt Sander, Shaper. Simplified plans, build easily with hand tools only. Advertised and sold for 8 years, over 30,000 units in use. Money back guarantee. FREE CATALOG.

GILLIOM POWER TOOLS, Dept. 80-J, Lambert Field, St. Louis 21, Mo.

Schupack's Amazing Tool Bargains! Save up to 100%!

75 Mounted Wheels & Miniature Cutters. Regular \$11.00 value \$4.50
For cutting and grinding on paid wood, metal or plastic. Includes 26 mt. wheels and points on 3/32" shanks; 24 miniature cutters on 3/32" shanks; 26 short shank min. cutters. Will fit all electric drills and hand grinders. No C.O.D.'s.

12 MOUNTED WHEELS and points on 1/2" Shank \$2.95
For grinding on plastic wood, soft & hard metals. Regular Value \$8.40.
18 Mounted points on 3/32" shank \$2.50; 12 mt. wheels on 1/2" shank \$3.60 Catalog 10c.

SCHUPACK SUPPLY CO. 1331 COTTAGE GROVE AVE. DEPT. PM-11 CHICAGO 19, ILL.

WILLIAMS
LOCKING ADJUSTABLES
original PUSH-BUTTON action
6, 8, 10, 12 inch sizes
See Your Hardware Dealer
J. H. WILLIAMS & CO.,
400 Vulcan St., Buffalo 7, N. Y.

MORE \$ \$ \$ PER HOUR WITH MODERN IMPROVED LAWNMOWER SHARPENER



Grinds All Reel Type Mowers
Hollow Grinds or Flat Grinds Bed Knives
Engine, oil, or gasoline are not removed from power mowers. Wheels, handle and roller remain in place. Moderns precision grinding assures repeat business. 100% Steel Construction

Write for free booklet 10A
Compare Before You Buy
Faster—Easier to operate
NO CHANGE IN PRICE FOR OVER 10 YRS.
\$263.00 Complete with 1/2 H.P. Motor
f.o.b. Pasadena, Calif.

MODERN MFG. CO.
160 N. FAIR OAKS, PASADENA, CALIF.



128 PAGES
Many in full color
packed with rare, fancy & imported woods... veneers, plywoods, patterns, tools, ornaments, hardware... everything for the woodworker.

Get This NEW Catalog of WOOD & WOODWORKING EQUIPMENT

WORLD'S LARGEST SELECTION OF FINEST DOMESTIC AND IMPORTED WOODS... MOULDINGS, HARDWARE, TOOLS,—ALL AT LOW MONEY SAVING PRICES!
Your complete wood buying guide and project book. Craftsman is your best, most complete source of finest kiln-dried domestic and rare imported woods, beautiful wood inlays, colorful bandings, matched plywoods, embossed mouldings, carved ornaments, newest woodworking tools, "hard to find" cabinet hardware and fittings... more than 1,500 items! Packed with newest scroll saw patterns, project ideas & money making plans. Enclose 25c (refunded with first order) to help paymailing, handling cost. Write now! Craftsman Wood Service Co., Dept. A-9 2729 S. Mary Street • Chicago 8, Ill.

Red Devil FP33 HOME FLOOR CONDITIONER

The world's most popular style floor conditioner

Counter-rotating brushes mean perfect floor conditioning with a finger-tip touch. Eliminates all drudgery from scrubbing, waxing, polishing, buffing. Will steel wool dirt and grime from wood and all floor surfaces.



How to Maintain Wood Floors. Illustrated instructions on polishing, cleaning, varnishing, waxing and sanding wood floors.

Red Devil Tools. Dept. 148
2400 Vauxhall Rd. Union, N. J.
Please send FREE copy of "HOW TO MAINTAIN WOOD FLOORS."
NAME _____
ADDRESS _____
CITY _____ ZONE _____ STATE _____
1664

WAR SURPLUS AND OTHER BARGAINS **SAVE UP TO 90%**



ARC WELDER KIT \$27.95 — build your own Complete make-up package consisting of 1 Aircraft DC Generator, Electric Auto-Lite 200-250 Amps, 24 Volt, RPM from 2600 up, 1 Rheostat, 1 Giant Toggle Switch, 1 Ammeter, 1 Shunt, 0 to 240 Amps, 1 Voltmeter, 0 to 30 Volts, 1 Electrode Holder, 1 Welder's Shield, 1 Voltage Regulator, Wiring diagram chart showing conversion of Aircraft Generator to Arc Welder. Shpg. Wt. under 100 lbs. Approx. GOVT. COST \$475. Like new, perfect. \$27.95.

DC Generator (only)—same as above... if purchased separately: \$12.50.



HEAVY-DUTY RHEOSTAT Designed for heavy-duty use with Air Force heated suits. Ideal for regulating voltage on electric welders, model trains, lights, generators, electric blankets; controls soldering irons, photofood lamps, etc. Rated 3.75 ohms, 100 watts with double windings & dual female 25 amp, 125 volt receptacles. Size: 7" H x 5 1/4" W x 1 3/4" D. Shpg. Wt. 2 1/2 lbs. Approx. GOVT COST \$25. Brand new, only \$1.95



MICROMETERS Chrome plated, precision engineered, carefully tooled to give long life. All new 0-1" cap. \$2.25 ea., 1-2" cap. \$3.50.



"HELIOS" ORIGINAL TOOLMAKERS VERNIER CALIPERS

ULTRAPRECISION — Imported. Used by machinists at Lockheed, Douglas, Bendix, GM, RCA, GE. Model 51/2E. Genuine Helios. Hardened lapped precision surfaces. 1/1000" and 1/128" graduations. Handy slide roll and thumb lock. Quick, accurate depth. A \$35 value. De Luxe Anial. ALL NEW. Just \$7.95. Leather carrying case, \$1 extra.

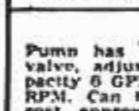

NEW PUMP AND MOTOR

Pump has 1" connections, built-in relief valve, adjustable up to 1500 lbs. Max capacity 6 GPM. 1 1/2 H.P., 24-volt motor, 4000 RPM. Can be used on 12 or 36 volts. Govt. cost approx. \$250 — our price — NEW — \$2.95.

NEW! BIG CATALOG Largest ever... just out... new low prices. Send 25c for your copy today. Prices F.O.B. Culver City unless otherwise stated. Check, cash or money order. 50% deposit for C.O.D.

AIRBORNE SALES CO., INC. DEPT. PM 956
8501 Stellar Drive, Culver City, Calif.

Don't Stop Fishing at First Frost

(Continued from page 111)

time-honored secret. I drove myself nearly mad, crawling and sneaking along this small stream and flipping a small frail fly in spots where big trout lay, fanning their broad tails. It was very exasperating. The trout would ignore the fly even though I thought it was presented perfectly. By noon I had coaxed but a single strike and hadn't landed a fish.

I was resting under a dense-crowned tree and enjoying lunch when I sighted this stooped old man creeping up on the very hole I'd just fished in vain. His rod cocked back and line uncoiled across the water. The bait had no sooner touched water than there was a splash and the rod arched over and bucked in his hand. Dropping my lunch, I streaked down to where he was standing. I could see the long trout slicing through the water. It was a beauty.

Presently, the old man brought the large rainbow to net. He held the 19-inch fish up for me to admire, but I wasn't interested in the trout. What caught my eye was the monstrosity of a fly cradled in the fish's mouth.

"What's that big fly you're using," I asked, flabbergasted.

"It is an oversized version of the Silver Doctor," the old man confessed. "You've got to use large baits this time of year if you want results."

Feeding for Winter

He went on to explain why. During late fall, trout are beginning to feast in preparation for the lean days ahead. They want the biggest mouthful of food they can possibly find, and that's why No. 8 flies often produce better than 12s or 14s. Also, the first freeze kills off all insects except the larger, tougher variety. Next time you're on your favorite trout stream in the fall, study the insect life closely. You'll find this to be true.

I only regret I was unable to get this old man's name before he got away. He made a great contribution to my fishing career, and now I enjoy supreme trout fishing when there are fewer anglers competing and, although the fishing is more baffling, I catch larger trout than I ever would on opening day.

I'll readily admit there's an advantage to being on a trout stream at dawn during the first few weeks of the season. But along into the fall, trout do most of their feeding during midday. As the day progresses, the sun warms the water surface slightly and trout may start feeding. Even a few degrees

(Continued to page 276)

36" FLEXIBLE SHAFT

For Precision Working
—Hard to Get at Places!
Reg. \$9.95 **NOW \$5.95**

plus 35c pp. & hdg.
This handy flexible shaft with complete handle increases the utility of your electric drill, electric motor, grinder or drill press where 1/4" shank can be attached. Easily attached to do grinding, carving, drilling, sanding, polishing, buffing, slotting, engraving, etching, etc., on wood, metal, glass and plastics. The Flexible Shaft is tamper proof, sealed and designed for lifetime service. Can be operated at speeds up to 6000 RPM.

12 Pc. Needle & Warding

FILE SET ONLY
\$2.49 plus 25c hdg. & pstg.

Made from best quality tool steel, fits exacting requirements of mechanics, watch, jewelry craftsmen, hobbyists. Kit contains the following 5 1/2" long needle and warding files with high test cutting qualities: round, flat, knife, square, triangular. In all textures: fine, medium fine, medium, medium coarse, coarse. Comes with polished wood handle and new type steel grip check.

Send Check or M.O. C.O.D. fee extra. **MONEY BACK GUARANTEE**

SCOTT-MITCHELL HOUSE, INC. DEPT. M-237, 611 BROADWAY NEW YORK 12, N. Y.

SAVE \$25 on this unused

Gov't Surplus
STAINLESS STEEL CHISEL & GOUGE SET!

Regularly \$30
— NOW complete \$5.00
4 piece set only. ppd.
singly per chisel \$1.50
or gouge..... ppd.

This is a rare tool bargain! This 4 piece surgical steel chisel and gouge set, never used, still in its original packing—only \$5! Less than the price you'd pay for ordinary chisels! And these are the finest quality tools you can buy for cutting, carving and whittling wood! If they weren't gov't. surplus, you'd expect to pay \$30 a set—\$7.50 each tool! Originally made for surgical use from the finest heavy chromed surgical steel, they'll last a lifetime!
If you could hold these gleaming solid stainless chrome steel tools in your hand, feel their balance, their strength, you'd know this is a truly fabulous tool bargain! The complete set makes a magnificent gift for any hobbyist! But order now! Our supplies at this low price are limited!

Automatic Siphon Pump

SENSATIONAL LOW PRICE
Now — siphon any liquid automatically, safely WITH-OUT peeing tube to mouth! Squeeze bulb of this all new type siphon, liquid starts to flow immediately! Transparent valves let you see liquid flowing! Siphons, pumps gasoline, water, any liquid. Even acids, corrosives! For cars, boats, power mowers, cameras, plumbers, doctors, chemists, factories! Acid resistant. Over 7 ft. long overall!

\$1.98 ppd.

Send Check or M.O. C.O.D. fee extra. **MONEY BACK GUARANTEE**

SCOTT-MITCHELL HOUSE, INC. DEPT. M-237, 611 BROADWAY NEW YORK 12, N. Y.

SPECIAL FACTORY SALE 10" TILT ARBOR POWER SAW

NOW \$10.00
ONLY DOWN



TOTAL FACTORY-TO-YOU
PRICE NOW ONLY
\$49.88

MODEL #2400

Buy direct from manufacturer at less than price of an 8 inch saw of equal quality. Lifetime cast iron and steel construction — shipping weight 76 lbs. Uses any standard 1/4 to 1/3 H.P. motor. Complete as shown — less guard and blade now only \$49.88 for limited special lot. Send check, M.O., or sent C.O.D. Or use easy payment plan. Send \$10.00 down — pay \$10.00 per month (last month only \$9.88). NO EXTRA CHARGES of ANY KIND on easy payment plan.

**FAMOUS AMERICAN
IRONCLAD GUARANTEE** . . .
Try any American power tool for 10 days. If you are dissatisfied, return for full and complete refund — no questions asked. Guarantee offered on more than 3 1/2 million power tools, and never violated.

LOOK AT ALL THESE SPECIAL FEATURES.

GROUND CAST IRON TABLE 15" x 19 1/4"
All cast iron and steel construction • Patented saw tilt mechanism • Patented rip fence • Locks front, rear and against table surface • Depth of cut control • 5/8" Diameter Precision Ground Saw Arbor • Spindle guaranteed for maximum run out of .001 • Massive Cast Iron Mitre Gauge, accurately etched, adjustable stop • Deep mitre gauge slots • Single control tilts blade and locks • Saw insert removable for dado heads, etc. • Motor rides on patented ball bearing motor drive • Depth of cut 3-3/16" • Designed for 10 inch blade, but takes smaller blades of smaller diameter equally well.
FREE CATALOG—Write for big bargains in home power tools.

All power tools sent express collect

AMERICAN MACHINE & TOOL CO.
ROYERSFORD 22, PA.

Overwhelming choice
of winning NASCAR
drivers for every
make of car

5-RIB

CHAMPION

SPARK PLUGS

WITH NEW POWERFIRE ELECTRODE

KEEP ALL SAWS SHARP

SUPER SAW FILER NO. 6

IT'S NEW! with Automatic DEPTH CONTROL ROLLERS

Automatically controls DEPTH—ANGLE—PITCH

Perfect bevel and angle maintained, and fool-proof depth control for all Rip, Cross-cut, and Handsaws. Precision made and calibrated for instant setting at desired angle. Can be used in any vise or clamp. Complete with file, only . . . \$6.50 ppd.

SAVE TIME AND \$\$\$

JOINT & SHARPEN CIRCULAR SAWS

Sensational New Super Filer No. 11 joints and sharpens both hand and circular saws 6" to 10" with all teeth the correct height, depth, pitch and bevel. Easy to use—when file hits hardened steel roller, teeth are finished. Saw runs true and smooth with no side pull. Complete with special 8" file \$9.95 ppd. "TRU-CIRCLE" saw set automatically sets teeth at 10° or more \$2.95.

SEND FOR FREE CATALOG

Guaranteed
A. D. McBURNEY, 5908 Hollywood Blvd., Hollywood 28, Cal., Dept. A-96

SEPTEMBER 1956

Building?
Repairing?
Indoors?
Outdoors?



Build this Kitchen Base
and these Wall Cabinets with

ELMER'S® GLUE-ALL

EASI-BILD® Pattern #201.
Just trace, saw, assemble.
Send \$1.00 in cash or money
order to Elmer's Pattern Dept.,
P. O. Box 26, Pleasantville,
N. Y. *T. M. Reg. Easi-Bild
Pattern Co., Inc.



Give your kitchen a modern look! Use ELMER'S fast-drying glue to make joints strong as wood itself. Won't stain. Easy to apply. Ideal for wood, paper, cloth.



Build or repair boats, outdoor furniture with

**ELMER'S®
Waterproof Glue**

It's the glue that boating experts use. Resistant to acids, alkalis, fungus, rot. Super bond is stronger than wood itself.



Bond plastic laminates to plywood with

**ELMER'S®
CONTACT CEMENT**

Does professional job quickly without clamps, nails, presses.

Highly resistant to heat, water. Outperforms other contact cements in stress tests.



At hardware, lumber, paint, marine supply dealers. The Borden Company, Chemical Division

IF IT'S **Borden's** IT'S GOT TO BE GOOD

Kean Kutt says...



**SHARK
BRAND**
SWEDISH CHISELS
MAKE HARD JOBS
EASY because of...

A MORE DURABLE EDGE

Shark Brand Chisels undergo a special super hardening process which is applied not only to the cutting edge, but is carried two-thirds of the way up the blade. This means longer life for the chisel because it can be sharpened over and over again without losing its edge holding qualities.

... but there's more to why Shark Brand Chisels outlast and outperform ordinary chisels... Ask for them at your hardware dealer now!



Sandvik STEEL, INC.

Saw & Tool Division
1702 NEVINS RD., FAIR LAWN, N. J.

IN CANADA: P.O. Drawer 1330, Station "O," Montreal 9.



... Supplement warning lights with universal-mounting

Accessory Gauges

BY STEWART-WARNER

You need more than warning lights for safe, efficient operation of your car's engine. A generator warning light only indicates that the generator is working, and an oil-pressure warning light tells you when the oil pressure is dangerously low. But with quality Stewart-Warner Gauges you always know your exact oil pressure — your exact amperage reading.

Stewart-Warner offers a complete line of gauges for every purpose — for cars, trucks, buses, tractors, boats and stationary engines.

See your dealer or write:

STEWART-WARNER

Instrument Division

Dept. N-96, 1840 Diversey Parkway, Chicago 14, Illinois

drop in temperature decreases metabolism of trout and reduces their appetites.

Insects also begin to stir later in the day during fall, with the greatest activity coming during midday.

If there are signs of surface feeding, you might do well to give dry flies a whirl. Drab creations will do better than bright multicolored flies, I've discovered, and the best sizes seem to be about No. 10s or 12s. When fishing in this manner, pay particular attention to staying hidden and let no shadow betray your presence, not even from line or leader.

Trout Moving Upstream

Spawning still is another point to consider when trout fishing in the fall. Brookies and browns are moving upstream to find clean gravel bars or such to lay their eggs. If you're not having any luck in your regular trout holes, try locations where small creeks empty into the stream or other such spots where there might be a spreading fan of clean gravel in running water.

Swirls behind small boulders are good spots for brookies to hang out. Also where a white-water chute spreads out into a long slick hole, even though the water may be only ankle deep. Pitching a fly into the head of the current and letting the water carry it naturally into the slick part will many times bring a wallop strike.

A complete reversal of the early-season upstream-fishing procedure is called for in the fall. If you try to toss a fly upstream, the fish can see the shadow of the line on water and will scurry for cover. Feeding the line into the current and letting it ride unhindered downstream will do much better, but watch drag and don't let your line or leader betray the fly's naturalness.

Artificials Pay Off

Artificials have paid off much more consistently than natural bait for me during fall. I've tried minnows and worms with various degrees of success on autumn trout, but the larger fish I've taken on artificials. A big minnow hooked through the lips and drifted with the current often will take a lunker trout, and worms are a handy standby that pay off when all other methods fail.

You can catch trout — big ones, too — throughout the fall season. You're going to have to adapt your presentation and approach to weather conditions, though, and this autumn trout angling requires an uncanny skill uncalled for earlier in the year.

If your state has legalized trout fishing during the fall, or such a place is within a short drive, you're certainly missing something by not giving these autumn trout a fling. Try it sometime. ★ ★ ★

BUILD WELDER OR LIGHT PLANT

Instruc. incl. TYPES AMPS VOLTS PRICE
DELCO FI 200 24 \$15.50
 J & Heins RI 300 24 \$25.50
 G-7, 160-250 amps, 30V, new \$19.50 used \$12.95
 Flexible Coupling to fit G-1, F-1 or H-1, \$4.95
RHEOSTAT R-27 for regulating voltage & pulsation for D.C. generators. Heavy Duty. Instructions incl. New \$5.95.

115 V A.C. GENERATOR G. E. #511 A.C. D.C. Generator, Ideal A.C. Light Plant & D.C. Battery Charger or Welder, 1250 Watts A.C., 800 cy., 10.9 Amps., 115V. A.C. & 200 Amps. 30V. D.C. Instructions incl. Good Condition \$17.50. New \$27.50. (6) **SPEED REDUCER** 10:1, 90 degree angle, rated 2 H.P. \$6.95. **GEAR UNIT** 1:1 ratio with One Input, 2 output shafts, 10 H.P. \$5.95. (5) **HYDRAULIC SOLENOID**, Control Valves, Bendix #81560 for remote control & hydraulic cylinders for 24V. D.C. & Appl. for 110V. A.C. Cap. 1500 P.S.I. Instructions, \$3.95 ea. \$7.50 per pair. (7) **Powerful Antenna Rotator Motor** #101 for TV, Ham, FM, Barbecue rotator, etc., reversible 2 RPM for D.C. or 110V. A.C. Instructions incl. \$9.95. **Tachometer indicator** 0-10,000 R.P.M. New \$8.95. (8) **CUMM OIL FILTER** for autos, filters without cartridge replacements, 3/4" ports \$4.95, **PUROLATOR** #255 for trucks & tractors, 1" ports \$4.95 postpaid.

General SALE

WATER PUMP with MOTOR
 Water Pump with Motor, 1/2 H.P., 200 G.P.H. runs on 0-12 & 24V. D.C. Adj. press 1" ports \$12.95, with 400 G.P.H. \$14.95, with 700 G.P.H. \$16.95.

(2) **Makes Ideal Winch Hoist**, 1/2 H.P. motor with gear unit 14:1, runs on 12-24V. D.C., reversible, belt or direct drive. Instructions \$7.95.

(3) **174 CFM BLOWER & MOTOR**, 1/2 H.P., 20 amp., 11,000 R.P.M. runs on 6-12 or 24V. D.C., 12"x7"x8", O.C. \$50.00. New \$12.95.

(4) **Chandler Evans Large Volume Water Pump**, for oil, insecticides, etc. 400 G.P.H., 1" ports \$8.95. 700 G.P.H. \$10.95.

(5) **ROTARY GEAR PUMP** #101 for hydraulic, water, or vacuum, 180 G.P.H. 200 P.S.I., 29" Vacuum \$7.50.

(6) **AMMUNITION HOIST**, Lifts 250 lbs., has 15 ft. 5/32" Steel Cable. Ratchet Brake holds load in any position \$8.95.

(7) **New Linear Actuator**, 5" travel, 800 lbs. thrust including 1/2 H.P. 12-24V. D.C. motor, & appl. for A.C. \$8.95.

NEW HYDRAULIC CYLINDERS

Air or Oil	Bore	Stroke	Stroke	M. HEIGHT	PRICE
#11	1 1/2"	6"	3 1/2"		\$7.50
#500	1 1/2"	7 1/2"	3 1/2"		\$8.50
#711	2 1/2"	11"	3 1/2"		\$12.50
#127	4 1/2"	10 3/4"	1-5/16"		\$29.50
#511	3 1/2"	21 1/2"	1 1/2"		\$27.95
#111	3"	24"	1-3/16"		\$32.50

(7) **HYDRAULIC PUMP BARGAINS** 1500 P.S.I.
 MFG. TYPE R.P.M. G.P.H. NEW
 Pecco Gear 1500 108 \$12.95
 Pecco Gear 4300 160 \$15.50
 Pecco Gear 447 cu. in. 270 \$17.50
 Stratopower (P. Disp.) 450 cu. in. 400 \$19.50
 (has built in relief, is reversible)
 Vickers 507 cu. in. 3750 \$22.50 410 cu. in. \$17.50
NEW FOUR WAY OPEN CENTER CONTROL VALVE has built in adj. relief for 1 to 4 D.A. cylinders, 3/8" ports. #10060 \$14.50. #4W11 four way with 1 handle for 1 D.A. cyl. \$8.95.

(7) **FOUR WAY SOLENOID VALVES**, Instruction for 24 V D.C. & appl. for 110V. A.C. off in neutral. 3/4" #1213, \$12.50. #324 with 1/4" ports, \$9.95. #322 one way normally closed 1/4" ports, \$2.35.

ROMEK HYD. PUMP & MOTOR, Positive displacement, 900 G.P.H., 28 H.P., 2500 R.P.M. for 12-24V. D.C. 3/4" ports, New, \$19.50.

GENERAL SALVAGE CO. CHECK OR M.O.
 2922 E. 27 St., Dept. 78, Kansas City 27, Mo.

Erect it yourself and SAVE!

GARAGES \$299 up

- Pre-Fab Steel Frame
- Aluminum Siding & Roofing
- Overhead Door ● Shipped anywhere
- Utility Bldgs. for all purposes \$171 up

Write for Folder
JOHN COOPER CO. • 306 2nd St., Hackensack, N. J.



NEW! Giant AUTOMOTIVE CATALOG
 1956 Edition! Everything for car, truck, custom-styled car, hot rod . . . at **LOWEST PRICES!**

SAVE UP TO 50% on all parts, accessories! Only complete automotive buying guide . . . 75,000 items . . . 196 pages! Thousands of hard-to-find parts; equipment, parts for 1920 to 1956 models; Hollywood accessories never before offered; hi-speed parts. Send your name and address and 25c (refundable with first \$5.00 order) to:
J. C. Whitney & Co. 1917 Archer, Dept. P-9, Chicago 16, Ill.



BOAT PLANS-PATTERNS FRAME KITS

A modern up to date series of inboard and outboard designs for the amateur builder. State specific size and type or send 50c for **BIG NEW CATALOG.**

marine  designs **Box 568T Compton, Calif.**



ESHELMAN TRACTORS **LOW AS \$99**

Plows • Cultivates • Saws
 Dozers • Harrows
 Snow-Plows • Rolls
 Mowers • Mows • Tills

Eshelman Tractors, Tillers, Riding Rotary Mowers for Better Lawns and Gardens. Advertisers in **GOOD HOUSEKEEPING**. Thousands of Satisfied Users.

Dept. R-59, **ESHELMAN, 109 Light St., Balto. 2, Md.**



Say You Saw It in Popular Mechanics

QUICK SET DADO
Cuts any width 1/4" to 13/16"

Dial any width dado without removing tool from arbor! High-speed tool steel blades cut smooth dados without vibration, chatter, chewing or burning, and they stay sharp 4 times longer than ordinary dado blades. (NOT a "wobble saw.") 6" diameter. Fits 1/2", 5/8" or 3/4" arbors, right or left rotation. . . . only \$24.75

Woodworkers, dealers, send for free literature

Consolidated Machinery & Supply Co. Dept. PM 2033 Santa Fe Avenue, Los Angeles 21, Calif.



What can I make with HOBBY TOOLS?

"HOBBY TOOLS & HOW TO USE THEM," the new 96-pg. X-acto manual, gives the answers — interestingly and authoritatively. Shows in easy steps what to make and how to make it — projects in whittling, scale modeling, leathercraft, metalwork, block printing, etc.

only **75c**

x-acto

At hobby stores or write direct.
48-45 Van Dom St., L. I. City 1, N. Y.



now get **BLONDE WOOD EFFECTS** on **DARK** woodwork and furniture without removing old paint or stain!

- goes right over old paint or finish!
- three easy steps!
- four colors

Bring old, dark woodwork, furniture and cabinetry up to date—get popular Blonde Wood effects—with O'Brien's Lite-Chrome. This amazing new product goes right over old finishes. No messy removing! No tedious sanding! Three simple steps. Apply Base Coat over old finish . . . a thin coat of Color Grain . . . Clear Coat that dries to a rich, satiny finish. Four colors—Satinwood, White Elm, Silver Birch, Honey Maple. Send only \$2.00 for enough Lite-Chrome for average chest.

O'BRIEN'S lite-chrome FINISHES COLOR GRAIN Silver Birch

NEW

The O'Brien Corp., Dept. PM-9, South Bend, Ind.
 Enclosed is \$2.00 (cash, check or money order—no C.O.D.'s.) for 1/2 pt. of Lite-Chrome Base Coat, 1/4 pt. of Color Grain and 1/4 pt. of Finish Coat. Specify desired color.

Name _____
 Address _____

WOLVERINE PIGSKIN WORK GLOVES

Must Be
BEST
OR YOUR
MONEY
BACK!



Only Wolverine uses choicest domestic pigskin triple-tanned kid-soft to give you comfort unequalled in any other work gloves. Soft? You bet...even dry out soft but man how they do wear...actually save you money!

WEAR A PAIR 7 DAYS

...your money back in full if you don't agree they're the best work gloves you ever wore.

Write for free catalog and name of dealer, to
WOLVERINE, Box PM-97, Rockford, Mich.

\$5000 PER DAY AND MORE

SERRATING AND SHARPENING TABLE KNIVES

SAW-KEEN PORTABLE, ELECTRIC, EASY - TO - OPERATE

Be your own boss, work anywhere, full or part time. Every restaurant, hotel, drive-in, etc., repeat customers. Serrated (saw-edged) table and steak knives in great demand. \$98.50 investment returns first week. Guaranteed. Write today for proven daily profit plan.

CUTTER-CRAFT 58-M SOUTH RAYMOND PASADENA 1, CALIF.

send for
FREE
tool catalog

SNAP-ON TOOLS CORPORATION
8062-1 28th Avenue, Kenosha, Wis.

Send me free catalog.

OCCUPATION

NAME

ADDRESS

CITY ZONE STATE



A big, fact-packed catalog full of pictures and tool information... yours for the asking.

- Snap-on tools help you handle repair jobs faster, easier, better.
- Snap-on tools LAST... pay for themselves over and over.
- Used and endorsed by America's top-earning mechanics in all fields.
- Start building your Snap-on set with basic units... add other tools any time.

Snap-on Tools
THE CHOICE OF BETTER MECHANICS

DO IT YOURSELF

It's Easy With...



Soldering's really a "cinch" ... when you use time-tested, reliable KESTER... available everywhere.

FREE! "Soldering Simplified" ... 16-page how-to-solder booklet. At your dealer or write direct.

KESTER SOLDER COMPANY
4251 Wrightwood Avenue Chicago 39, Illinois

VOLUME BLOWERS FOR HEATING, VENTILATING, EXHAUSTING

Air Condition Your Car, Make Car Heaters, Ventilate fumes and heat from boat bilges and galleys, Make Heat Boosters, Exhausters, Coolers, Dryers and dust collectors with this BARGAIN-190 cu. ft. per minute Blower. Blower overall 9"x8"x8". Heavy sheet metal construction. Made by large manufacturer to sell at three times our price.

B-6D Blower complete-190 CFM, with 6 volt, direct current motor, ... Postpaid \$12.50

B-10A Blower, complete with 110 volt, 10 cv., AC Motor, ... Postpaid \$13.50

C. MARSHALL SALES, 3546 Fullerton Ave., Dept. P-9, Chicago 47



"SPEEDY" DRILL GRINDING GUIDE

One piece cast Aluminum drill holding jig, use with grinding wheel or disc sander to resharpen dull and broken twist drills up to 1/2" diameter. Simple. Anyone can use it. Money back guarantee. Order to-day direct from factory. 11" ppd.



BRASS CASTING CO. BOX 3056, MEMPHIS 9, TENN. \$1.00

FIND HIDDEN RICHES!

NOW—find buried treasure, gold, silver, and metal objects, with sensational 3 1/2-lb. locator—GOLDAK'S "FIND-IT" ... only \$49.50 complete with earphones, batteries, instructions.



Manufacturers of metal detection devices since 1933

Write for FREE literature full line metal, mineral locators; geiger and scintillation counters.

GOLDAK CO. 1542-9 W. Glenoaks Blvd., Glendale, Calif.

SAY YOU SAW IT IN POPULAR MECHANICS

VARIABLE SPEED HYDRAULIC POWER TRANSMISSION



It has Infinite Speeds 0 to 550, Reverse, Automatic Overload Protection; Adjustable Torque up to 180 inch pounds. 5/8" Input and Output Shafts. It will handle 1/4 to 1 1/2 H.P. Motor. Case measures 7 1/2" long, 7" high, 6 1/2" wide. VALUE OVER \$300. Shipping Wt. 25 lb. On C.O.D. Orders we require a 10% Deposit.

\$54.50
only Fab. Chicago

DIRZIUS MACHINE SHOP "F" 1423-25 So. 52nd Ave., Cicero 50, Ill.

CAMPING ACCESSORIES

NEW ARMY CANTEEN & REISSUE CUP AND BELT

A one quart canteen and aluminum cup fit into the insulated canvas cover. Choice of web type pistol belt or cartridge belt with pockets. The canteen is new Korean War Surplus. **259**

PORTABLE, FOLDING SHOVEL - With a 20 inch hardwood handle. Blade will fold to form a pick. Ideal for gardening or use in an emergency. **190**

MACHETE 22" Vanadium Steel Blade with a 5" hardwood handle. Comes with rugged belt sheath. **198**

FREE CAMPING FOLDER

Many amazing Bargains in New Products and Gov's Surplus. Includes Tents, Sleeping Bags, Rucksacks, Knives, Microscopes, Safety Belts, etc. Write Today for No. 28 Camping Folder and SAVE up to 85%.

NEW NYLON ROPE

Very finest quality. Lustrous white color.

SIZE	Strength	PRICE
1/4" Nylon	1100 lbs.	9¢ run ft.
3/8" Nylon	2700 lbs.	17¢ run ft.
1/2" NYLON	5000 lbs.	27¢ run ft.
11/16" Nylon	13500 lbs.	39¢ run ft.
15/16" Nylon	17500 lbs.	57¢ run ft.
1" Nylon	18000 lbs.	62¢ run ft.

STAINLESS STEEL CABLE

Finest quality pre-formed cable. Extra flexible - rust and corrosion resistant. Aircraft quality. 7 x 19 strand.

Diameter	Breaking Strength	Price per ft.
1/16"	480 lbs.	7¢
3/32"	1000 lbs.	14¢
5/32"	2600 lbs.	21¢
3/16"	3900 lbs.	23¢
7/32"	5000 lbs.	29¢
1/4"	6600 lbs.	38¢
5/16"	9600 lbs.	47¢

3/64" = 1 x 7 strand. Stainless Steel with wire core. 280 lbs strength 5¢ per ft.

SAVE ON METAL WORKING CARBON STEEL TWIST DRILLS

Top Quality. Made by famous Morse, Cleveland, etc. Unused - Excellent. See the examples below.
No. 10 Wire Gauge - Straight Shank, Short Flute . . . Only 15¢ each
11/16" - No. 2 Taper 89¢ ea.
63/64" - No. 3 Taper 99¢ ea.
2" diam - No. 3 Taper \$2.29 ea.
Write for complete list of many other sizes.

180° OFFSET DRIVE

For use where tremendous power at low take-off RPM is desired. 6 gears rotate on self-lubricating, hi-speed roller bearings. 85 to 1 gear ratio. Shafts are 1 1/2" & 3/8" dia. USED. **595**
NEW in excellent condition . . . **895**

Palley's
2203 EAST VERNON AVE., DEPT. PM 9 - LOS ANGELES 58, CALIF.



GENUINE SELECT PHILIPPINE MAHOGANY PLYWOOD DIRECT FROM IMPORTER

For Fine CABINET WORK, FURNITURE, Paneling DENS, OFFICES, HOTELS, etc.

Our prices are LESS THAN DOMESTIC PLYWOOD at WHOLESALE. This selected LUAN MAHOGANY meets the most rigid specifications. It is WEATHER and WATER RESISTANT. You'll be amazed at the beauty of this fine wood. Its rich golden elegance will thrill you. Rotary cut for beauty of grain. Both sides sanded and ready to use. Bonded with finest resin adhesive. Face side unjointed.

FREE SAMPLE ON REQUEST

Available in three thicknesses - 3mm (approx. 1/8"), 4mm and 1/4". ALL orders shipped by special Truck for lowest rates. No order accepted for less than 100 lbs. - equal to (4) 1/4" sheets, (6) 4mm sheets or (8) 3mm.

3MM (1/8") x 3 FT. x 6 FT. \$500 VALUE PER SHEET MINIMUM ORDER 6 SHEETS 179

1/4" x 4 FT. x 8 FT. \$950 VALUE MIN. ORDER 4 SHEETS 449 PER SHEET

SAVE 50% ON TRANSLUCENT FIBERGLAS PANELS

Use it for patio covers, interior decor, walls, partitions and many other uses. Ideal for the home, office, shop, indoor or outdoor installations. Finest quality. Available in many widths and lengths. Excellent color selection. Write for a FREE Sample and Booklet. **Only 49¢ PER 50 FT.**

3400 RPM, 1/2 HP POWER SAW
COMPARES TO SAWS SELLING UP TO \$49.50 WITH A 5 1/2" BLADE **ONLY 19.98**
RIPS - CROSSCUTS CUTS A FINISHED 2x4 LIKE A KNIFE THROUGH BUTTER
A rugged, professional type, adjustable saw. Will cut any angle from 0 to 45°. Has an adjustable 10 to 6" rip fence. Safety-trigger switch on handle. Full 1/2 HP Universal AC-DC, 110-120 Volt, 60 cycle motor. Weights only 6 1/2 lbs.
EXTRA SAW BLADES - Available in Rip, Crosscut or Combination. Please Specify **235 each**

NEW POWER SAW BENCH TABLE
A sturdy, precision made bench-saw table to convert our famous power saw (above) to a handy home bench saw. Permits angle & bevel cuts, rip, crosscut and comes with a rip fence and mitre guide. Size: 14" x 16" table, 6" high. **995**

1/4" ELECTRIC DRILL
A tremendous value. Has heat treated, high speed gears - self-lubricating bronze bearings and a genuine Jacobs type Chuck. Fully air cooled. Has a Safety-trigger switch. A tool of many uses - drilling, grinding, sawing, polishing, as a drill-press, etc. Order while stocks complete. **995**

NEW VERTICAL DRILL STAND
CONVERTS THE ABOVE DRILL TO A DRILL PRESS
Makes the above drill even more versatile. Sturdily built with an adjustable drill bracket mounted on a steel column. Gives a 4 to 1 leverage with the handle. Feed travel is 2-1/4". Centre-line of the stand column is 4-1/2". Base can be bolted to your workbench. A \$14.95 Value for **ONLY 995**

GIVE THE KIDS A THRILL



CRYSTAL RADIO **395 NEW**
A GENUINE CRYSTAL RADIO SET. Picks up standard broadcast stations without using batteries or electricity. Just plug-in headset, antenna and ground wires, then tune-in your favorite program. You'll be amazed at the STRONG, CLEAR SIGNAL. Has a 100 KC tuning range. Comes complete with Receiver, Antenna and Ground Wire PLUS a 2000 Ohm Headset. Order Today.

SOUND POWER PHONES

Originally used by the Navy for gun control. Ideal for emergency communications because each set is "sound powered". Will operate up to 1/2 mile distance. Set includes 2 phones on chest plate, 2 headsets, approx., 25 feet of wire. **995 PER SET**

2 PC. 4-6-10 POWER EYE LOUPE

Provides three separate powers of magnification in one handy 2-piece unit. A 4 power and a 6 power lens is interchangeable or they may be combined for 10 power. **135**

AIR CORPS RUBBER BOATS

Ideal for Fishing or Hunting. Made to Gov's specs. Reconditioned and ready-to-use. Supply Limited.

1 MAN 2295 6-7 MAN 6950
HAND AIR PUMP 395
COLLAPSIBLE OARS 1295
NAVY WADING SUITS
Ideal for Surf or Deep Stream fishing. Also whenever necessary to protect body or clothes from mud, moisture, etc. Made of heavy duty rubberized canvas with vulcanized seams, built-in boots & gloves. Sizes: Med. Lg. **895**

NEW HVY. DUTY CHAIN SAW

WITH 18" CHAIN
A gas engine powered, portable chain saw that makes a cut up to 18". Has a two-cycle air cooled engine with dual accelerator controls and grip-right handles. Develops a high cutting speed for straight or right angle cuts. Built for rugged, heavy duty work. Complete with solid aluminum chain guard. \$249 val. **15995**

Order from This Ad. Pay by M.O. or check 15 deposit with C.O.D.'s. All Prices FOB Los Angeles Warehouse

BRONZE FOUNDRY Schools and Home Workshops

Make your own castings of aluminum, copper, bronze, silver. Foundry sets are available in three sizes including 2400 Deg. F. blast furnace. See advertisements in March or Apr. Issues, free Circular.

KANSAS CITY SPECIALTIES CO.
P.O. Box 6022 Dept. P-9 Marysville, Kan.

COMPLETE SOLDERING KIT only \$7.95

Includes: Weller Soldering Gun, over 100 watts; supply of famous Kester Solder; Weller Soldering Aid; and Wire Brush. For hobbies and homecraft. Write for catalog.

WELLER ELECTRIC CORPORATION
601 Stone's Crossing Road Easton, Penna.

Say You Saw It in Popular Mechanics

KATO A.C. GENERATORS

A WIDE VARIETY FOR ANY ELECTRICAL APPLICATION!
Adaptable to all well-known makes of engines. 350 Watts through 500 KVA and larger. To 800V. Odd frequencies from 15 to 1000 cycles. Also, Rotary Converters, High Frequency Changers, Motor Generator Sets.

KATO Engineering Company
1402 First Ave., Mankato, Minn.

FREE FOLDER

STOP THAT DRAFT!

Get

DRAFTITE*
WEATHERSTRIP

for your
house
doors



At your hardware or building supply dealer. If he's out of stock, we'll mail it to you. Send check or money order:

StanStrip — 37c a foot any length.

DraftTite — \$2.49 a package.

*TRADEMARK

Get

STANSTRIP*
WEATHERSTRIP

for the bottom
of your
garage
door

The Standard Products Co.

BOX 678C LEXINGTON, KY.

Build a MOLDED PLYWOOD RUNABOUT

With This Complete Kit...

by America's largest maker
of molded plywood hulls

Save 75% construction time. Molded plywood hull has strength of steel of same weight... assured precision fit... no complex forms to erect... no framing... no planking. Pre-cut all mahogany parts mean factory built appearance inside and out.

Cruiser semi-kits also available.

See your dealer or write
for information to

U. S. MOLDED SHAPES, INC.

651 Market St. S.W.

Grand Rapids 2, Michigan

it's NEW! it's ALL IN ONE LEVEL · SQUARE · TAPE

IT'S A LEVEL!
Built-in, accurate unbreakable Level.



IT'S A TAPE!
10 ft., replaceable WYTEFACE® Tape.

IT'S A SQUARE!
Accurate Square.
Easy to use.

Only \$1.98

at your hardware store



KEUFFEL & ESSER CO.
Hoboken, N. J.

GLUE INJECTOR



Make loose furniture joints good as new with this \$200 pocket-size, all metal glue injector. Complete with fine tool-steel drill. Directions included. Repairs tables, chairs, toys, etc. without disassembly. Dozens of uses. **\$200** ppd. Money-back guarantee

DRUMCLIFF CO., DEPT. L-78, TOWSON 4, Md.

NEW! **RECLAIMO**
ELECTRICALLY HEATED
Oil RE-REFINING Filter
A Wm. Schwelge Product
Super-Efficient Filtration
for TODAY'S Car-Truck-Tractor Engines
Folder with full details FREE
RECLAIMO MFG. CO. 6251 Touhy Avenue
Dept. M-96, Chicago 30, Ill.

Print Your Own
Cards, stationery, circulars, etc. Save money. Print for Others, Good Profit; easy rules sent. Raised Printing like engraving, too. Junior press \$15; Senior \$29 up. Sold direct from factory only. We furnish everything. Write for free details.
KELSEY PRESSES, Y-37 Meriden, Connecticut

make your own Gems 32.50
The Gem Maker comes complete with all necessary equipment, including a super-charged diamond blade for sawing, and all wheels for grinding, shaping and polishing; also complete instructions. The complete equipment as shown, less motor and belt, for only \$32.50, f.o.b., Burlington, Wisconsin. Write today for information and literature.
B & I MANUFACTURING CO.
Dept. P, Burlington, Wis.

STOP HITTING THE END of your GARAGE!
install MITEY-MITE CAR STOPS for GARAGES and CAR PORTS
Protect screens, storm windows, bicycles and yard tools with superstrength malleable iron brackets fastened firmly to floor with mastic cement. All you furnish is a 2 x 4 which fits into brackets. Brackets, mastic and instructions in compact kit. Easy to install, no holes to drill. Send check or money order—prompt shipment. ORDER YOURS NOW!
ONLY \$4.95
Postage Paid
SUPERIOR STEEL & MALLEABLE CASTINGS CO.
Dept. M9 BENTON HARBOR, MICHIGAN, U.S.A.

PORTABLE LIGHT PLANTS

GIANT 2000-2500 WATT PLANT

110-120 v. 60 cyc. AC. Absolutely the best made — exclusive dynamically balanced armature; heavy windings develop up to 5000 watt overload for motor starting, skid mounted — portable. Powered by an easy starting Briggs or Wisconsin 6 HP engine—complete with all accessories; engine easily disconnected for other uses. Big outlet box, voltmeter, no wiring necessary. Ample current for all purposes. Factory warranty. (Item 31) Wt. 210 lbs. Reg. price \$585. Special at..... \$299.50



Same plant with electric self starter (Item 31a)..... \$359.50
Generator only and control box..... \$169.50
DUAL VOLTAGE 110-220 available on any of above models for \$28.00 additional.
POWER-FLO 3000-3500 WATT
115-230 v. 60 cyc. AC. A rugged power plant for heavy duty use. Duplex power distribution provides both 115 v. and 230 v. output at the same time if desired. Powered by a big 8 HP Wisconsin engine with triple V belt drive. Has built-in overload protection. A dependable plant for either standby or regular service. Equipped with electric self-starter. Can also be started by rope and plug-in outlet box. (Item 198) Wt. 310 lbs. Factory price..... \$439.50
GENERATOR ONLY belt driven..... \$239.50

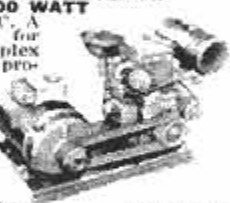

(Item 198)

BUY at FACTORY PRICES direct from MASTER MECHANIC



600-700 WATT PLANT

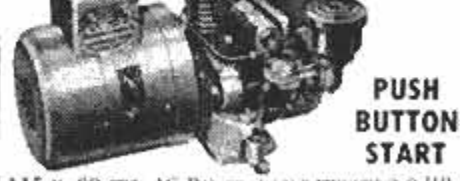

115 v. 60 cyc. AC. Powered by a rugged 2-2 HP easy starting Briggs engine. No wiring necessary; just plug in and operate. Plenty of current for any oil burner, freezer, brooder, emergency lights, etc. which require up to 700 watts. Ideal for television and radios. Complete with voltmeter and built-in winding to charge 6 v. auto batteries. (Item 24) Wt. 75 lbs. Easily fits in car trunk. Be prepared if storm knocks out power lines. **\$143.50**
Regular \$275.00 value.
1000-1200 Watt Plant (Item 45) same as Item 24 but larger generator and engine with 50% greater output..... **\$199.50**
We make every type and size of light plants — Write, giving us your requirements!

LESS THAN WHOLESALE

1300-1500 WATT PLANT

115v. 60 cyc. AC. Push Button Start. Powered by a 3 1/2 HP. Clinton engine. Combines big output with easy portability. Provides emergency power for operating any oil burner, sump pump, freezer, television, lights, communications systems, etc. which require up to 1500 watts. (Item 22) Wt. 110 lbs. Reg. \$475 value. Factory price..... **\$239.50**



1750 Watt Plant Powered by 4.5 Briggs engine. Electric starting & battery charging built-in! Factory price..... **\$279.50**

MASTER-LITE 2500 Watt Plant

110/120 v. 60 cyc. AC. A powerful plant, ruggedly constructed and yet designed for easy portability. Can be started by rope or built-in 12 v. electric push button starter. Built-in winding to charge battery. Powered by a big 5.10 HP Briggs engine; complete with all accessories. Includes control box, voltmeter, and handy plug-in power receptacle. An ideal plant for permanent or stand-by service. Wt. 225 lbs. Reg. price \$645.00. (Item 21) Factory Price..... **\$329.50**



3500 Watt Plant Push Button Start (Item 23) 115 v. 60 cyc. AC. Similar to above, but larger and 31% more capacity. Wt. 270 lbs. Reg. \$740. Factory Price..... **\$379.50**
DUAL VOLTAGE 110/220 for Item 21 or 23 —\$30 additional.

EXTENSION CORD

Heavy duty and very flexible. Neoprene 14-2 cable, 20 year quality. Wt. 12 lbs. (Item 185) 100 ft. Complete with rubber plug and outlet. A terrific buy at only **\$8.95**

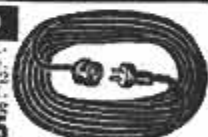

No. 10-2 POWER CABLE. Heavy duty, very flexible, rubber covered, 50 ft. with male and female fittings. Wt. 9 lbs. (Item 592a) **\$10.45**
50 ft. without fittings (Item 592)..... **\$9.45**

No. 12-2 POWER CABLE. Very flexible rubber covered, special outside shield for grounding power tools, etc. 50 ft. (Item 199) Wt. 8 lbs. **\$6.95**. 100 ft. (Item 200)..... **\$12.95**

No. 14-8 Conductor Power Cable. Heavy duty very flexible, rubber covered, with 8 contact plug & socket. Ideal for tractor-trailer connections (Item 796) 15 ft. **\$9.95**

SCREW-TYPE PRESS

A tremendously powerful press capable of exerting nine tons of pressure. Pays for itself straightening bent parts, or pushing out bearings and bushings. Ideal for manufacturing and assembly operations because of precise control. Massive 1 1/2" screw permits precise control over vertical travel. Extra heavy ribbed yoke has a throat 21" high; depth capacity for working to the center of an 11" object. Includes 8" x 13 1/2" vise-type table and four crushing arbors. Wt. 150 lbs. (Item 797). Reg. \$149.50. Special..... **\$49.50**

HYDRAULIC PRESS. Nine ton capacity. See Aug. Pop. Mech's. ad for details—or write. Complete, Wt. 110 lbs. (Item 464)..... **\$69.50**

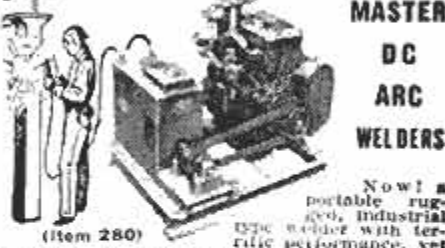

MASTER DC ARC WELDERS

Now! a portable rugged industrial type welder with terrific performance, yet at a price hundreds of dollars less than you'd expect. Senior model made for years of trouble-free, continuous service. High capacity DC welding unit enables you to tackle any job with confidence—easily welds anything up to 2" plate using from 1/16" to 3/4" rods. Built-in stabilizer and cooling system makes arc easy to strike and hold. Dual control rheostat provides low heat soldering, brazing and welding from 30 to 300 amps. Complete with instructions, guarantee and triple V-belt or flat pulley. Easy to hook up and easy to operate.

WELDER ONLY — DUAL CONTROL MODEL. Same as above, but drive with your tractor, jeep or gas engine at 14 HP or more. (Item 388) Wt. 110 lbs. \$450 value..... **\$119.50**

WELDER ONLY — INDUSTRIAL MODEL same as above but with ceramic rotary type rheostat providing 74 different heat settings for all types of welding (Item 388) \$500.00 value..... **\$139.50**

COMPLETE POWER MASTER Illustrated above powered by a 14.6 hp., air cooled Wisconsin engine. Wt. 480 lbs. (Item 280) Complete with welder costing \$1200. Factory Special..... **\$449.50**

HEATING & VENTILATING FAN

(Item 10) Easily installed in furnace pipes. Forces even heat to all rooms. Over range removes kitchen smoke and odors. Powerful, continuous duty motor, 110-120v. AC. Mount in wall or ceiling to ventilate any area. Quiet, super-efficient fan moves huge volume of air. (100 to 600 CFM).
8" Pipe, wt. 5 lb. **\$6.85**
9" Pipe, wt. 6 lb. **\$7.85**
10" Pipe, wt. 7 lb. **\$8.85**
12" Pipe, wt. 8 lb. **\$9.85**

HEAVY DUTY FAN. Semi-enclosed motor, suitable for spray booths, restaurant exhausts, poultry houses, etc. 10" Fan, wt. 8 lbs. (Item 10E)..... **\$11.95**
12" Fan, wt. 10 lbs. (Item 10D)..... **\$12.95**

HIGH SPEED BARN FAN similar to above, but larger, high speed motor moves huge volume of air.
12" Fan (Item 10B)..... **\$14.95**
14" Fan (Item 10C)..... **\$17.95**



Rugged, ball bearing WINCH

Sturdy ball bearing winch—super tough aluminum alloy construction. Powered by an easy starting 2 1/2 HP Briggs gas engine thru gear reduction drive—it exerts up to 3000 lbs. of terrific force for hoisting materials or pulling up.

Combination gear and pulley reduction results in tremendous multiplication of engine power. Idler (pulley clutch arrangement and built-in drum brake (with ratchet hand lever) enables operator to ease loads down gently and lock at any point desired. Drum handles 400 ft. of 3/8" cable or 600 ft. of 1/2" cable. Ideal for contractors, farm implement trailers and unutilized other uses! (Item 795) Wt. 125 lbs. Only..... **\$149.50**

HAND WINCH—Same winch with large crank handle for extra leverage and 2 speed drive. (Item 794) Wt. 80 lbs. **\$59.50**



JET STEAM MASTER

Now, a super efficient portable steam generator that produces live steam at 100 lbs. pressure in 60 seconds from a cold start! Produces large volume of high pressure steam on 2 pints of fuel oil. Instantly cleans sticky grease, dirt, rust, old paint, etc. off implements and road machinery. Pays for itself in a few weeks. Sterilizes soil. Sterilizes as it cleans. Milk equipment, etc. Fully automatic—oil fired with new, built-in lifetime bronze water circulating pump. Draws water from faucet or bucket. Simple and safe—anyone can use it; built-in safety valve. Complete with 12 ft. of hi-pressure steam hose and new triple efficiency steam gun that automatically mixes in soap solution if desired. Wt. 250 lbs. (Item 463). **\$329.50**



JET FLOW BLOWER

Tremendous air movement (1300 CFM) and quiet operation make this double inlet 10" turbine blower unbeatable for heating, cooling, drying and air conditioning. Ideal for attic or barn ventilation, converting gravity heating to forced air; spray booth exhausts, etc. Operates with any 1/4, 1/2 or 3/4 HP motor. Over-sized, long life bearings. Includes variable speed motor pulley and belt. Dimensions 16" H x 18" x 16 1/2". Outlet opening 13" x 11 3/8". Wt. 45 lbs. (Item 245). Reg. \$54.50. **\$29.50**
Factory Special..... **\$29.50**
HEAVY DUTY 1/2 HP motor for above \$17.95.



RUBBER HOSE

Genuine Neoprene Hose—outlasts ordinary rubber 3 to 1. Reinforced with super tough cotton cord plies—yet completely flexible. Equipped with standard thread male and female fittings. Pump water for irrigation, stock tanks, home, barn, fire fighting, etc.—or pump gas and fuel oil. Volume factory prices—save more than 60%!



Length	Price	
10 ft.	5.95	
10 ft.	8.95	
25 ft.	13.95	
50 ft.	24.75	
100 ft.	49.95	
10 ft.	10.95	
25 ft.	14.75	
10 ft.	16.50	
10 ft.	9.50	
2" (suction)	14 ft.	21.50
2 1/2" (discharge)	10 ft.	21.75
3"	10 ft.	25.50

1 1/2" I.D. HIGH PRESSURE STEAM HOSE per ft. **\$1.00**
AIR HOSE Heavy duty, 1 1/4" I.D., 2 braided (150 lb. pressure) with standard couplings, 20 ft. lengths, ea. **\$2.95**
PAINT SPRAY MATERIAL HOSE 3/4" I.D. Synthetic thickol inerture and neoprene cover—finest model 25 ft. lengths with standard couplings. (Item 62) each..... **\$7.50**

TERRIFIC VALUES!

Send check or M.O. Prices f.o.b. Factory. 10 day Money back guarantee. SEND 10c for... **MASTER MECHANIC MFG. CO., DEPT. 99-M Burlington, Wis.** **BIG 1956 Catalog**

New

SOUTH BEND PRECISION VERTICAL MILLING MACHINE

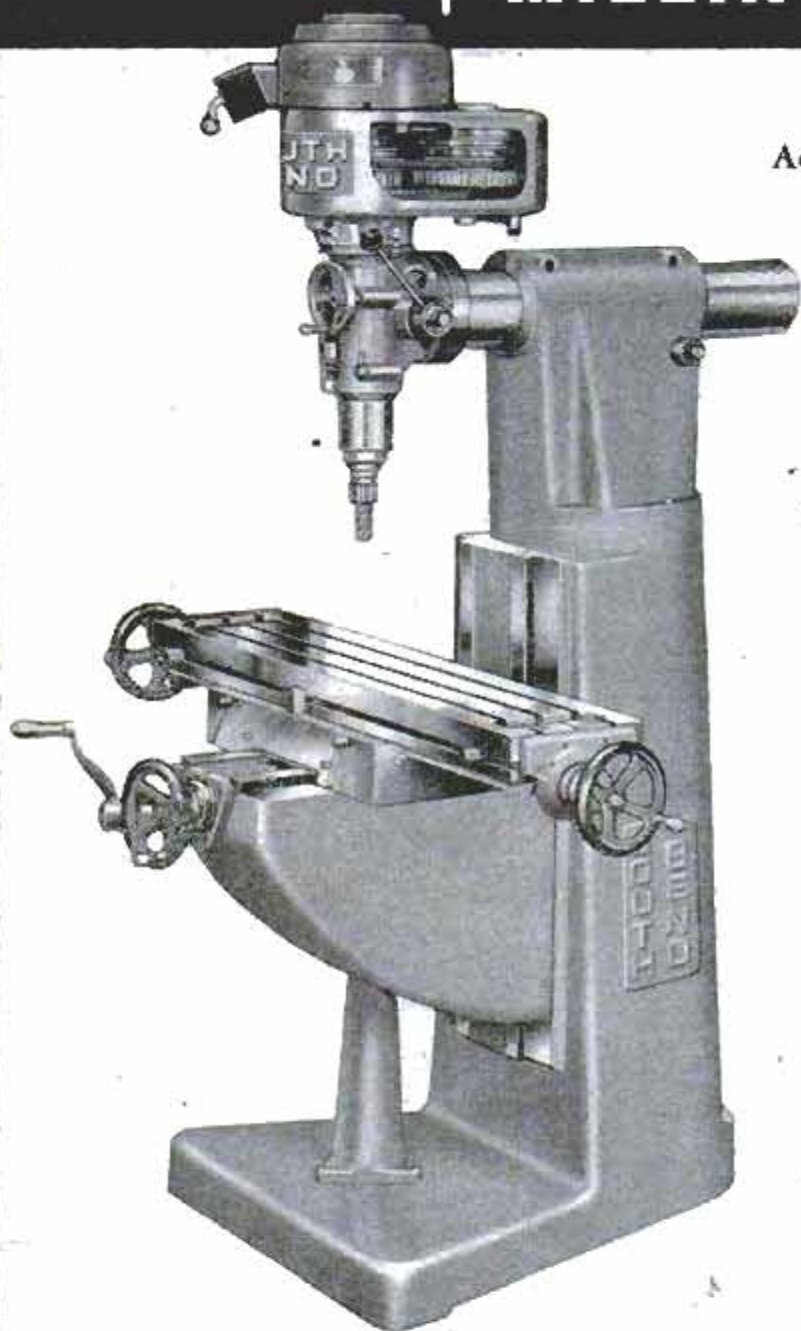

Adequate capacity, accuracy and speed give this new milling machine the ability to keep machining costs low on a wide variety of work. Its simplicity of design provides ease of accessibility and set-up. Reduces operation and job change-over time to a minimum. Ideal for toolroom, production and maintenance work. *Write for information.*

LO-LOSS spindle drive. Precision ground and fitted quill.

Positive action controls with large, adjustable, graduated collars.

Power longitudinal table feed and automatic quill feed optional.



SPECIFICATIONS

Table travel.....	20 or 30"
Cross feed.....	9 1/2"
Spindle to table (max.).....	20"
Spindle to column (max.).....	20"
Ram travel.....	15"
Spindle speeds.....	8
Head rotation.....	360°



SOUTH BEND LATHE South Bend 22, Indiana
Builders of lathes, milling machines, shapers, drill presses, pedestal grinders

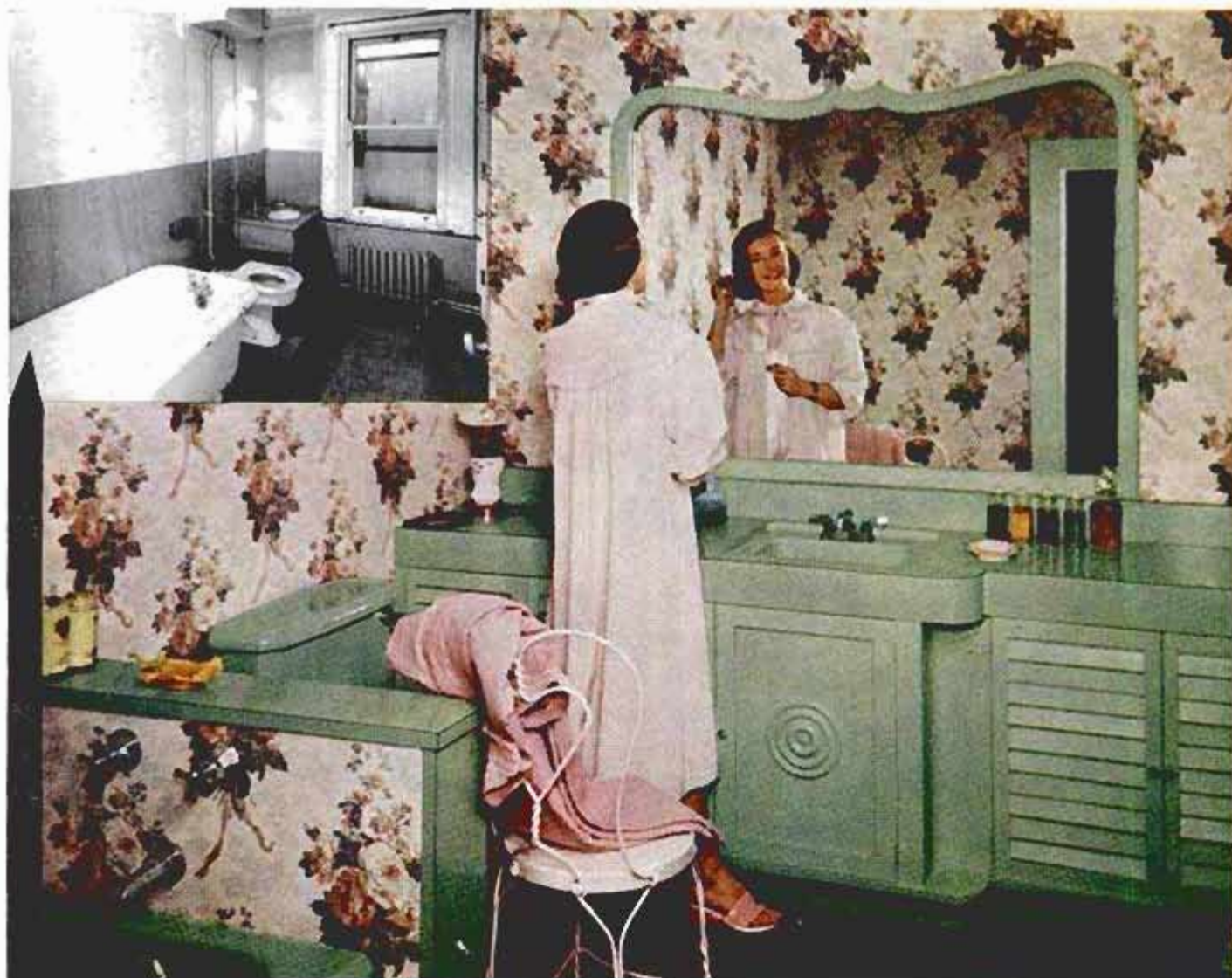

No Bathroom
too hopeless...
No Husband
too helpless...

for **FORMICA**

Customers buy Formica because it is a brand name they know and trust.

DEMAND THIS CERTIFICATION

We protect this faith in our product by certifying every sheet with a wash-off Formica marking. It is for your protection and guarantee that you are getting genuine Beauty Banded Formica.

There may be remodeling jobs beyond the skills of the average husband – but applying Formica is not one of them. The really dramatic focal point of any modern bathroom is the Formica Vanity.® And this is the part that is easy enough for anyone who can saw a straight line. You'll find color blending choices in endless combination when you see the 14 brand new colors in the Sunrise Line of more than 70. Cut your Formica to shape with an ordinary carpenter's saw, apply Formica Contact Bond Cement to both surfaces, let it dry for 40 minutes and roll it down with a rolling pin.

Complete picture instructions and kitchen and bathroom idea literature. Write . . .

Free!

FORMICA Subsidiary of American Cyanamid
4596 Spring Grove Ave., Cincinnati 32, Ohio
In Canada: Arnold Banfield & Co., Ltd., Oakville, Ontario

This mark certifies genuine



Seeing is believing. If this wash-off identification is not on the surface, it's not FORMICA.

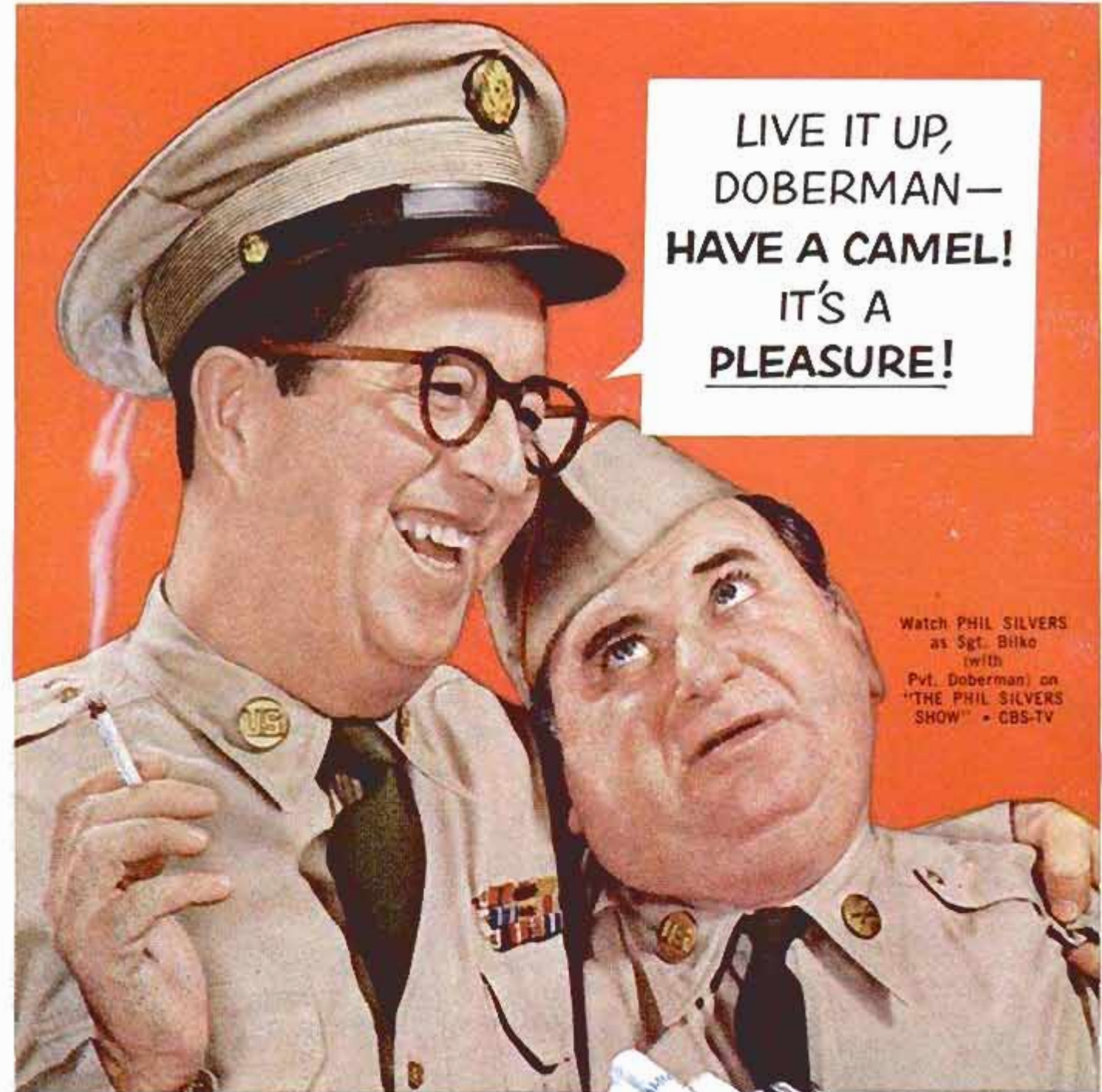

LIVE IT UP,
DOBERMAN—
HAVE A CAMEL!
IT'S A
PLEASURE!

Watch PHIL SILVERS
as Sgt. Bilko
(with
Pvt. Doberman) on
"THE PHIL SILVERS
SHOW" • CBS-TV

R. J. Reynolds Tobacco Co.,
Winston-Salem, N. C.

No two ways about it —
Camel's got what it takes! Camel's
exclusive blend of quality tobaccos
brings you the finest taste in
smoking. *Try* Camels — by far the
best-liked cigarette in America today!



Only Camels
taste so rich, yet smoke so mild!