

AUGUST 1956

35 CENTS

# POPULAR MECHANICS

## MAGAZINE

WRITTEN SO YOU CAN UNDERSTAND IT

REG. TRADE MARK, GREAT BRITAIN, U.S. PAT. OFF.

REG. U.S. PAT. OFF.



What Owners Say About the '56

# CHEVROLET

SCIENCE PROBES THE SECRETS OF THE VIRUS

*For the Craftsman*

How to Take Care of Your Boat

DESERT TORTURE for  
TOMORROW'S TIRES

—See page 76



# Increase the value of your home

install a new

## MATICO TILE FLOOR

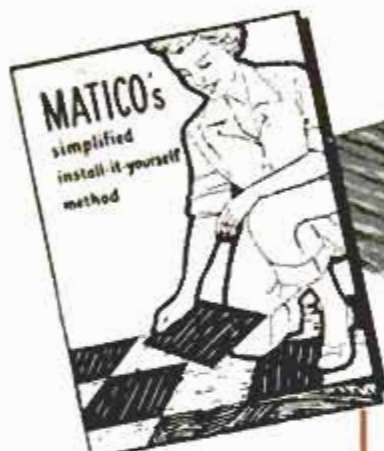

### FREE INSTRUCTION BOOK SHOWS YOU HOW!

Installation is made easy by following the step-by-step instructions. Contains fully illustrated details on installing MATICO from start to finish. Mail coupon for your copy!

### SMART, DURABLE, LOW-COST . . .

### IT'S THE MODERN FLOOR FOR MODERN HOMES

Your home is your most valuable investment! Protect it and increase its value . . . install beautiful, durable MATICO TILE floors in every room. Do it yourself and SAVE! MATICO TILE floors cost so little, and you can finish an entire room in a few hours. You'll be proud of the smart, exclusive patterns you create from the full line of colors. And you'll be amazed at MATICO's rugged, long-lasting wear. MATICO looks like new for years . . . resists scratches, scuff marks, stains . . . is easy to clean. The colors can't wear off because they go right through the tile.

Yes, for all-around utility, nothing compares with MATICO TILE.

60 344



QUALITY CONTROLLED

MATICO  
PRODUCTS



See your local  
MATICO dealer  
as soon as possible.  
He's listed  
in your classified  
telephone directory.

### MASTIC TILE CORPORATION OF AMERICA

Houston, Tex. • Joliet, Ill. • Long Beach, Calif. • Newburgh, N. Y.

Aristoflex • Confetti • Parquetry • Maticork • Asphalt Tile  
Rubber Tile • Vinyl Tile • Cork Tile • Plastic Wall Tile

Mastic Tile Corp. of America  
Dept. M2-8, P. O. Box 986, Newburgh, N. Y.

Please send me FREE install-it-yourself instruction  
book and color charts on Matico Tile Flooring.

Name \_\_\_\_\_

Address \_\_\_\_\_

City \_\_\_\_\_ Zone \_\_\_\_\_ State \_\_\_\_\_





## Build this "game room-guest room"! Free plan from Masonite shows how!

Right now, it's a fun-packed game room for all the family to enjoy. But within minutes it can be transformed into a cozy guest room where overnight guests can sleep in comfort.

Day or night, it reveals a lot of really workable ideas—ideas for efficient use of space, for making the room look more attractive, for adding luxury to your living.

It's fun to build. The room you see is

planned for a 12-ft. by 15-ft. area, but our free plan shows how to use your available space to best advantage with Masonite Panel products. Right now these strong, grainless, easy-to-finish panels are offered in several new surface designs that add so much to the "atmosphere" of your room. See them all at your lumber dealer's. Or send the coupon—now!



Fix it up  
inside and out  
with Masonite  
Products!



MASONITE® CORPORATION  
Dept. PM-8, Box 777, Chicago 90, Ill.  
In Canada: Masonite Corporation, Gatineau, Que.

Please send me \_\_\_\_\_

1 This One



2 5Y5X-HY5-UA2Z

# TRANSISTORS—first family of electronics

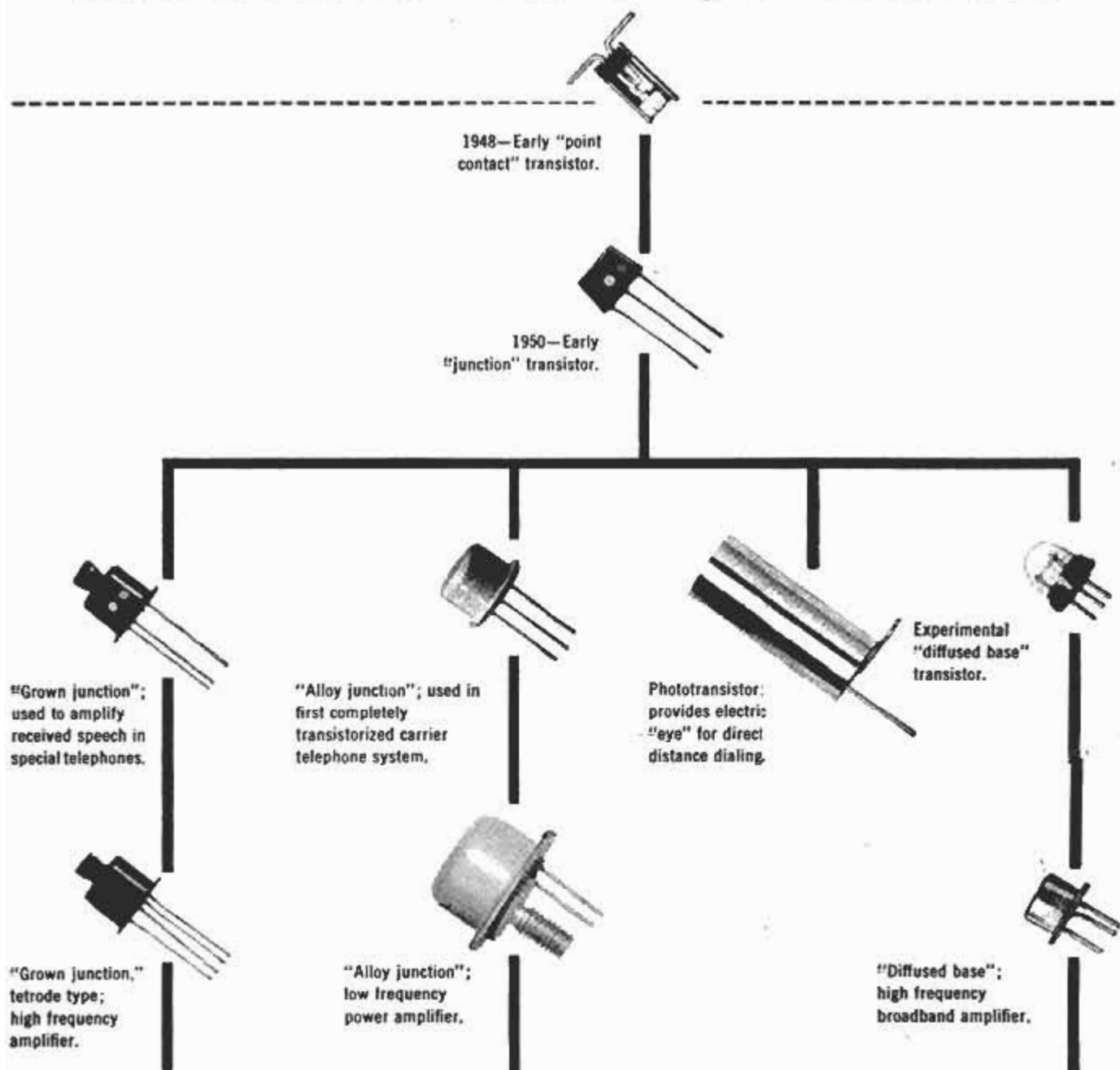

In 1948 Bell scientists announced their invention of the transistor—a tiny device able to amplify signals a hundred thousand times using a small fraction of the power of an electron tube. From this original "point contact" transistor has grown a distinguished family of immense usefulness to electronics. Some of its leading members are shown here, in approximate actual size, with their type names.

For telephony the transistor has opened the way for notable advances in instruments, transmission and switching. Elsewhere it has opened the way to advances in hearing aids,

television, computers, portable radios and numerous military applications.

Bell's transistor family is typical of the Bell Laboratories research that helps keep your telephone service the world's best—and at the same time contributes importantly to other fields of technology.

**BELL TELEPHONE  
LABORATORIES**



World center of communications research and development

POPULAR MECHANICS



# Popular Mechanics Magazine

Registered in U. S. Patent Office and Canada

H. H. WINDSOR, Founder

H. H. WINDSOR, JR., Editor and Publisher



## Next Month

HOW MANY TIMES have you wanted to take good indoor snapshots of the family without an elaborate system of flash or flood lighting? Well, you now can get photos as appealing as the one above, and you can do it in ordinary room light or with the help of just one small bulb. Furthermore you can snap top-notch sports pictures and candid shots without professional equipment. Even the old-time box camera can yield sparkling prints on cloudy days. A feature next month, "Indoor Pictures Without Flash," will tell you how to use the remarkable new "superfast" films

Sources of further information not listed in the index, starting on page 58, about articles in this issue, frequently are shown in the Where-to-Find-It List prepared for each issue. A copy may be obtained by readers, without charge, from Bureau of Information, *Popular Mechanics*, 200 East Ontario Street, Chicago 11, Ill.

Published monthly by Popular Mechanics Company, 200 E. Ontario St., Chicago 11, Ill. H. H. Windsor, Jr., president; Wm. Harrison Fairidge, exec. vice-pres.; Franklin S. Worsberg, operations vice-pres.; D. F. Windsor, vice-president and secretary-treasurer; H. H. Windsor III, vice-president; W. T. Windsor, vice-president; Clover L. Perkins, advertising manager; Alan M. Deyoe, circulation manager. Single copy in the United States and Canada, 35 cents; subscription rates in the United States and possessions, Canada, Philippines and countries of the Pan-American Postal Union, 1 year \$3.50; 2 years, \$6.00; 3 years, \$8.00. To all other countries add \$1.00 a year over United States prices for overseas postage. If you plan to move, notify us at least 30 days in advance so you will not miss an issue. Give both your old and new addresses. Entered as Second Class Matter, September 15, 1903, at the Post Office at Chicago, Illinois, under Act of March 3, 1879. Entered as Second Class Matter at Post Office Dept., Canada. Registered as Second Class Matter at the Post Office at Mexico, D. F., Mexico, June 20, 1950. Copyright 1956 by Popular Mechanics Company. Copyright under International Copyright Union. Copyright in France. All rights reserved under Pan-American Copyright Union. Printed in the United States of America.

**IMPORTANT NOTICE**—It is the intention of this magazine to provide its readers with information regarding the latest developments in the mechanical arts. We take no responsibility as to whether the disclosures contained in our articles are covered by patents and advise readers to investigate this subject before making, using, or selling any of the products, machines, or processes described in order to avoid possible liability for patent infringements.

Volume 106 AUGUST 1956 Number 2

Address all communications to: 200 E. Ontario St., Chicago 11, Ill.

Managing Editor.....Roderick M. Grant  
 Assistant Managing Editor.....Wayne Whittaker  
 Shop Notes and Crafts Editor.....James R. Ward  
 Radio-Television, Electronics Editor.....Lothar Stern  
 Associate Editor.....Clifford B. Hicks  
 Associate Editor, Automotive.....Arthur R. Railton  
 Associate Editor, Shop Notes and Crafts.....Wayne C. Lecky  
 Associate Editor, Shop Notes.....W. Clyde Lammy  
 Assistant Editor, Crafts.....Jay W. Hedden  
 Assistant Editor, Makeup.....John C. Dalen  
 Automotive Correspondent.....Leo Donovan  
 Art Director.....Frank Beatty  
 Assistant Editors—Leonard F. Hilts, Elliott H. McCleary, Emily M. Rice, Earl F. Wobeck, John C. Sorensen  
 Eastern Editor.....Richard F. Dempewolf  
 Empire State Bldg., Room 2906, New York City 1  
 Western Editor.....Thomas E. Stimson, Jr.  
 Suite 1010, 3460 Wilshire Blvd., Los Angeles 5, Calif.  
 London Manager.....Douglas W. Wedderspoon  
 Eagle House, Jermyn St., London S. W. 1, England  
 Director, Bureau of Information.....Allan Carpenter  
 200 E. Ontario St., Chicago 11

Advertising Offices  
 Chicago: 200 E. Ontario St., Whitehall 4-0100; New York: Empire State Bldg., 350 Fifth Ave., Longacre 5-7580; Detroit: General Motors Bldg., Trinity 5-8711; Cleveland: Hanna Bldg., 1422 Euclid Ave., Prospect 1-0456; Los Angeles: 3460 Wilshire, DUnkirk 2-8458; San Francisco: Russ Bldg., 235 Montgomery St., YUKon 2-0823.

## In This Issue . . .

Around the World in 80 Days	65
Detroit Listening Post	74
Tiremakers Race Against Turnpike Speeds	76
Right Behind the Firemen Come the Salvage Squads	82
The Latest From Paris—An All-Plastic House	88
Science Probes the Secrets of the Virus	92
Air Conditioning for the Chicken House	97
What's New for Your Home	106
Privates and Generals Study the A-Bomb	111
Playground With an Imagination	114
The Owners Report on the '56 Chevrolet	122
Keeping Up With the Atom	133
"I Just Built It Because I Needed It"	136
Radio, TV and Electronics	141

## For the Craftsman . . .

Decorate With Paper Transparencies	145
Use Less Soap and Save Money	153
Launch Your Boat the Easy Way	158
Solving Home Problems	162
These Pieces Complete Your Patio Furniture	170
Make Your Rope Last Longer	184
Installing or Replacing Small Water Systems	191
How Would You Do It?	198
Shopping for Tools	202
On the Market for the Do-It-Yourselfer	204
Clinic for Homemakers	206

See pages 58, 60 and 62

for other items and manufacturers of available products





**MECHANICAL  
SKILLS  
CAN GET  
YOU  
AHEAD  
IN THE  
U. S.  
AIR FORCE**

**Here's why —**

If you're interested in mechanics, join the U. S. Air Force. As an Airman you may develop your technical ability and learn a skill that will pay well...and win you extra stripes. Such interesting career fields as Aircraft and Engine Maintenance, Rocket Propulsion and Intricate Equipment Maintenance are open to you, if you qualify. Don't delay—see your local Air Force Recruiter or mail the coupon.



**YOU GO  
PLACES  
FASTER  
IN THE  
U. S. AIR FORCE**

**PASTE COUPON ON POSTCARD** M-19-PM4  
and mail to

AIRMAN RECRUITING INFORMATION BRANCH  
BOX 2202, WRIGHT-PATTERSON AFB, OHIO

Please send more information on my opportunities for enlisting in the U. S. Air Force. I am between the ages of 17-34 and reside in U. S. A. or possessions.

NAME \_\_\_\_\_

ADDRESS \_\_\_\_\_ AGE \_\_\_\_\_

CITY \_\_\_\_\_ ZONE \_\_\_\_\_ STATE \_\_\_\_\_





**24% more road horsepower — for passing!**



**24% more road horsepower — for hill climb!**

**In cars that have gone about 10,000 miles without a spark plug change —**

## **New Champions can increase road horsepower by 24%!**

Hard to believe . . . but true! Tests with major makes of cars prove it. Independent engineers took cars whose plugs had gone roughly 10,000 miles and tested them for power—first with their regular plugs, then with 5-rib Champions with the new Powerfire electrode.

*Nothing about these cars was changed except their spark plugs. Yet there was an immediate increase in their road horsepower—the real power actually delivered at the rear wheels.*

Replace your old plugs with the great new 5-rib Champions with Powerfire electrode today—and you'll feel the difference at once!

**CHAMPION**

LOOK FOR THE 5 RIBS



ORDINARY  
ELECTRODE

POWERFIRE  
ELECTRODE



**New Powerfire electrode** stands up better in today's high-power engines. Photo shows how ordinary electrode (left) burns away. Champion's Powerfire electrode (right), after identical use, is still good for many more miles of powerful performance!



## ACROSS THE DESK



When Charles F. Kettering talks, it pays to listen. Retired — but still busy — vice-president of General Motors Corporation, he played a large part in the development of the self-starter, tetraethyl lead for high-octane gasoline, the electric cash register, ignition and lighting systems for automobiles and a host of other inventions. We thought PM readers would be interested in these excerpts from Mr. Kettering's remarks at the opening of General Motors' new technical center at Warren, Mich.:



"To me a technical center is a place where people can think and develop ideas . . . if we took all the people out of it, we know that nothing would come of it. . . . Ideas are developed in the mind.

"We have roughly 60,000,000 cars,

trucks and so forth in the United States. If we allocated five seats to a vehicle; that gives us 300,000,000 seats. We have only 160,000,000 people, so we can take all of the people of England, France, Italy, Spain and Portugal along as guests, and I am sure some think we do that every Sunday.

"The great difference between an inventor and a scientist is the fact that the inventor, when he fails, counts it as a practice shot, and it doesn't make any difference how many times he makes it. . . . The inventor fails 9999 times and if he succeeds once, he is in. Here in this institution we have the place where scientists can make many practice shots, and the only time we don't want to fail is the last time we try it.

"The thing we need to do is to have in our minds the idea that the future is infinite. You can't avoid it. What are you going to do with it, then? It should be compulsory to use it in the best way that we can.

"Anything you can think of today can be done, but it takes time. How long from the concept of an idea is it before we have the product in the hands of the customer? It is 50 or 60 years sometimes before an idea develops, but if we recognize that there is a definite time in which an idea can become a product, provided the customers are available for it, the future is the greatest

(Continued to page 8)

## New greaseless way to keep your hair neat all day

Billy Pierce took a shower . . . then he used Vitalis



White Sox lefthander Billy Pierce rarely goes to the shower before the game ends.

### New VITALIS® Hair Tonic with V-7®

ANOTHER FINE PRODUCT OF BRISTOL-MYERS



Want the pitch on a greaseless hair tonic?

New Vitalis keeps hair in place and prevents dryness with V-7, the greaseless grooming discovery. You never have an over-slick, plastered-down look. Try it. You'll like it.





If...

YOU WANT TO ENJOY AN

# ACCOUNTANT'S CAREER

## INVESTIGATE THIS OPPORTUNITY TODAY!

**IF** you're that person, here's something that will interest you.

Not a magic formula—not a get-rich-quick scheme—but something more substantial, more practical.

Of course, you need something more than just the desire to be an accountant. You've got to pay the price—be willing to study earnestly, thoroughly.

Still, wouldn't it be worth your while to sacrifice some of your leisure in favor of interesting home study—over a comparatively brief period? Always provided that the rewards were good—a salary of \$4,000 to \$10,000 and up!

An accountant's duties are interesting, varied and of real worth to his employers. He has *standing!*

Do you feel that such things aren't for you? Well, don't be too sure. Very possibly they can be!

Why not, like so many before you, investigate LaSalle's Problem Method of training for an accounting position?

Just suppose you were permitted to work in an accounting firm under the personal supervision of an expert accountant. Suppose, with his aid, you studied accounting principles and solved problems day by day—easy ones at first—then more difficult ones. If you could do this—and could turn to him for advice as the problems became complex—soon you'd master them all.

That's the training you follow in principle under the LaSalle Problem Method. You cover accounting from Bookkeeping and Basic Accounting right through Accounting Systems and Income Tax Procedure. As you go along, you absorb the principles of General Accounting, Auditing and Basic Cost Accounting. Then you may choose Commercial Accounting, Industrial Accounting or Public Accounting and prepare for the CPA examinations.

Your progress is as speedy as you care to make it—depending on your own eagerness to learn and the time you spend in study.

Will recognition come? The only answer, as you know, is that success *does* come to the man who is really *trained*. It's possible your employers will notice your improvement in a very few weeks or months. Indeed, many LaSalle graduates have paid for their training—with increased earnings—before they have completed it! For accountants, who are trained in organization and management, are the executives of the future.

### Send today for Free Book "Accountancy, The Profession That Pays"

For your own good get all the facts about this completely new and modern accounting training. Write for free book "Accountancy, The Profession That Pays," which will prove that accounting offers brilliant futures to those who aren't afraid of serious home study, and will show the wide range of opportunities that exist today. No cost or obligation. If you want a position of higher income, greater prestige, **MAIL THE COUPON NOW!**

Over 4,200 Certified Public Accountants  
among LaSalle alumni

Member, National Home Study Council

**LASALLE EXTENSION UNIVERSITY**  
A CORRESPONDENCE INSTITUTION

417 S. Dearborn St. Dept. 864H Chicago 5, Ill.

I want to be an accountant. Send me without obligation,  
Free Book, "Accountancy, The Profession That Pays."

Name.....Age.....

Address.....

City, Zone & State.....

# CLEAN YOUR CARBURETOR

## Feel the difference!



- ✓ Smoother idling
- ✓ Faster pick-up
- ✓ No stalling



- Don't let a dirty, gummed up carburetor rob your car of power when it's so easy and inexpensive to clean it with GUMOUT
- GUMOUT cleans carburetors fast . . . without fuss
- Just add GUMOUT to your gas tank . . . or ask your serviceman to run it directly through your carburetor
- GUMOUT is great for POWER MOWERS and OUTBOARDS, too! A clean carburetor gives you quicker starts, smoother power
- Sold by service stations, auto supply stores & hardware stores



SEND FOR **FREE**  
46-page  
"CARBURETOR HANDBOOK"  
GUMOUT DIVISION  
Pennsylvania Refining Co.  
2671 Lisbon Road  
Cleveland 4, Ohio

(Continued from page 6)

natural asset we have. You make its value, depending upon how you think."

Popular Mechanics editors present birthday greetings and good wishes to Mr. Kettering, an extraordinary man to whom America and the world owe much. He will be 80 years old on August 29.



Vacation ruined by rain? Next time get it insured. You can't stop the rain, but an insurance company now issues a policy which enables the vacation traveler to collect up to a maximum of \$300 a week for trips spoiled by excessive rain.



When Tom Stimson, our Western editor at Los Angeles, was prowling around the set of the new Todd-AO movie *Around the World in 80 Days*, he discovered a man with an interesting profession. Alex Sinel (at left in photo, facing Stimson) builds trees. The tree shown here is one of the synthetic



evergreens Mr. Sinel was fashioning for a forest background in one of the movie scenes (see Mr. Stimson's story beginning on page 65); it's a desert yucca stalk drilled to receive branches of juniper, then realistically painted. In chatting with Mr. Sinel amid his make-believe forest, Tom discovered he is a regular reader of *Popular Mechanics*, says his subscription is paid up to 1960!

(Continued to page 10)



# Can you profit by their mistakes?

## "Not getting enough education"

You needn't make that mistake. You can get that better job, those big promotions, the regular raises that so many I. C. S. students report. And you can do it without

"going to school," without interfering with your present job or your social life.

**YOU can study with I. C. S. at home, in your spare time!**



## "Wrong choice of career"

When you study with I. C. S. you have 256 courses to choose from. And part of our job here at I. C. S. is not only giving you instruction

but making sure you pick the course that's right for you!

**YOU get expert guidance FREE from I. C. S.!**



## "Failed to seize opportunities"

Your opportunity is right here on this page. Don't pass it by. Don't put it off. Mail the coupon now and let us send you our 3-book career kit.

**YOU get 3 FREE books if you mail the coupon today!**

1. 36-page gold mine of information, "How to Succeed."
2. Career Catalog outlining opportunities in your field.
3. Sample I. C. S. lesson (Math.).



For Real Job Security—Get an I. C. S. Diploma!

I. C. S., Scranton 9, Penna.

Member, National Home Study Council

## INTERNATIONAL CORRESPONDENCE SCHOOLS

65<sup>TH</sup> YEAR

BOX 70626H, SCRANTON 9, PENNA.

(Partial list of 256 courses)

Without cost or obligation, send me "HOW TO SUCCEED" and the opportunity booklet about the field BEFORE which I have marked X (plus sample lesson):

<p><b>ARCHITECTURE and BUILDING CONSTRUCTION</b></p> <p><input type="checkbox"/> Air Conditioning—Refrig.</p> <p><input type="checkbox"/> Architecture</p> <p><input type="checkbox"/> Architectural Interiors</p> <p><input type="checkbox"/> Building Contractor</p> <p><input type="checkbox"/> Building Estimator</p> <p><input type="checkbox"/> Building Maintenance</p> <p><input type="checkbox"/> Carpentry and Mill Work</p> <p><input type="checkbox"/> Heating</p> <p><input type="checkbox"/> Painting Contractor</p> <p><input type="checkbox"/> Plumbing</p> <p><input type="checkbox"/> Reading Arch. Blueprints</p> <p><b>ART</b></p> <p><input type="checkbox"/> Cartooning</p> <p><input type="checkbox"/> Commercial Art</p> <p><input type="checkbox"/> Fashion Illustrating</p> <p><input type="checkbox"/> Magazine Illustrating</p> <p><input type="checkbox"/> Show Card and Sign Lettering</p> <p><input type="checkbox"/> Sketching and Painting</p> <p><b>AUTOMOTIVE</b></p> <p><input type="checkbox"/> Auto Body Rebuilding</p> <p><input type="checkbox"/> Auto Elec. Technician</p> <p><input type="checkbox"/> Auto-Engine Tune Up</p> <p><input type="checkbox"/> Automobile Mechanic</p>	<p><b>AVIATION</b></p> <p><input type="checkbox"/> Aeronautical Engineering Jr.</p> <p><input type="checkbox"/> Aircraft &amp; Engine Mechanic</p> <p><b>BUSINESS</b></p> <p><input type="checkbox"/> Advertising</p> <p><input type="checkbox"/> Bookkeeping and Accounting</p> <p><input type="checkbox"/> Business Administration</p> <p><input type="checkbox"/> Business Correspondence</p> <p><input type="checkbox"/> Public Accounting</p> <p><input type="checkbox"/> Creative Salesmanship</p> <p><input type="checkbox"/> Federal Tax</p> <p><input type="checkbox"/> Letter-writing Improvement</p> <p><input type="checkbox"/> Office Management</p> <p><input type="checkbox"/> Professional Secretary</p> <p><input type="checkbox"/> Retail Business Management</p> <p><input type="checkbox"/> Sales Management</p> <p><input type="checkbox"/> Stenographic-Secretarial</p> <p><input type="checkbox"/> Traffic Management</p> <p><b>CHEMISTRY</b></p> <p><input type="checkbox"/> Analytical Chemistry</p> <p><input type="checkbox"/> Chemical Engineering</p> <p><input type="checkbox"/> Chem. Lab. Technician</p> <p><input type="checkbox"/> General Chemistry</p> <p><input type="checkbox"/> Natural Gas Prod. &amp; Trans.</p> <p><input type="checkbox"/> Petroleum Engineering</p> <p><input type="checkbox"/> Plastics</p> <p><input type="checkbox"/> Pulp and Paper Making</p>	<p><b>CIVIL, STRUCTURAL ENGINEERING</b></p> <p><input type="checkbox"/> Civil Engineering</p> <p><input type="checkbox"/> Construction Engineering</p> <p><input type="checkbox"/> Highway Engineering</p> <p><input type="checkbox"/> Reading Struct. Blueprints</p> <p><input type="checkbox"/> Sanitary Engineering</p> <p><input type="checkbox"/> Structural Engineering</p> <p><input type="checkbox"/> Surveying and Mapping</p> <p><b>DRAFTING</b></p> <p><input type="checkbox"/> Aircraft Drafting</p> <p><input type="checkbox"/> Architectural Drafting</p> <p><input type="checkbox"/> Electrical Drafting</p> <p><input type="checkbox"/> Mechanical Drafting</p> <p><input type="checkbox"/> Mine Surveying and Mapping</p> <p><input type="checkbox"/> Plumbing Drawing and Estimating</p> <p><input type="checkbox"/> Structural Drafting</p> <p><b>ELECTRICAL</b></p> <p><input type="checkbox"/> Electrical Engineering</p> <p><input type="checkbox"/> Electrical Maintenance</p> <p><input type="checkbox"/> Electrician <input type="checkbox"/> Contracting</p> <p><input type="checkbox"/> Lineman</p> <p><b>HIGH SCHOOL</b></p> <p><input type="checkbox"/> Commercial <input type="checkbox"/> Good English</p> <p><input type="checkbox"/> High School Subjects</p> <p><input type="checkbox"/> Mathematics</p>	<p><b>LEADERSHIP</b></p> <p><input type="checkbox"/> Foremanship</p> <p><input type="checkbox"/> Industrial Supervision</p> <p><input type="checkbox"/> Leadership and Organization</p> <p><input type="checkbox"/> Personnel-Labor Relations</p> <p><b>MECHANICAL AND SHOP</b></p> <p><input type="checkbox"/> Gas—Electric Welding</p> <p><input type="checkbox"/> Heat Treatment <input type="checkbox"/> Metallurgy</p> <p><input type="checkbox"/> Industrial Engineering</p> <p><input type="checkbox"/> Industrial Instrumentation</p> <p><input type="checkbox"/> Industrial Supervision</p> <p><input type="checkbox"/> Internal Combustion Engines</p> <p><input type="checkbox"/> Machine Design-Drafting</p> <p><input type="checkbox"/> Machine Shop Inspection</p> <p><input type="checkbox"/> Machine Shop Practice</p> <p><input type="checkbox"/> Mechanical Engineering</p> <p><input type="checkbox"/> Quality Control</p> <p><input type="checkbox"/> Reading Shop Blueprints</p> <p><input type="checkbox"/> Refrigeration</p> <p><input type="checkbox"/> Sheet Metal Worker</p> <p><input type="checkbox"/> Tool Design <input type="checkbox"/> Toolmaking</p> <p><b>RADIO, TELEVISION</b></p> <p><input type="checkbox"/> Industrial Electronics</p> <p><input type="checkbox"/> Practical Radio TV Eng'ng</p> <p><input type="checkbox"/> Radio and TV Servicing</p> <p><input type="checkbox"/> Radio Operating</p>	<p><input type="checkbox"/> Television Technician</p> <p><b>RAILROAD</b></p> <p><input type="checkbox"/> Air Brake Equipment</p> <p><input type="checkbox"/> Car Inspector</p> <p><input type="checkbox"/> Diesel Engineer &amp; Fireman</p> <p><input type="checkbox"/> Section Foreman</p> <p><b>STEAM AND DIESEL POWER</b></p> <p><input type="checkbox"/> Combustion Engineering</p> <p><input type="checkbox"/> Diesel—Elec. <input type="checkbox"/> Diesel Eng's</p> <p><input type="checkbox"/> Electric Light and Power</p> <p><input type="checkbox"/> Stationary Fireman</p> <p><input type="checkbox"/> Stationary Steam Engineering</p> <p><b>TEXTILE</b></p> <p><input type="checkbox"/> Carding and Spinning</p> <p><input type="checkbox"/> Cotton, Rayon, Woolen Mfg.</p> <p><input type="checkbox"/> Finishing and Dyeing</p> <p><input type="checkbox"/> Loom Fix'g <input type="checkbox"/> Textile Des'ing</p> <p><input type="checkbox"/> Textile Eng'g <input type="checkbox"/> Throwing</p> <p><input type="checkbox"/> Warping and Weaving</p> <p><b>MISCELLANEOUS</b></p> <p><input type="checkbox"/> Domestic Refrigeration</p> <p><input type="checkbox"/> Marine Engineering</p> <p><input type="checkbox"/> Ocean Navigation</p> <p><input type="checkbox"/> Professional Engineering</p> <p><input type="checkbox"/> Short Story Writing</p> <p><input type="checkbox"/> Telephony</p>
---	--	--	--	---

Name \_\_\_\_\_ Age \_\_\_\_\_ Home Address \_\_\_\_\_

City \_\_\_\_\_ Zone \_\_\_\_\_ State \_\_\_\_\_ Working Hours \_\_\_\_\_ A.M. to P.M. \_\_\_\_\_

Occupation \_\_\_\_\_

Canadian residents send coupon to International Correspondence Schools, Canadian, Ltd., Montreal, Canada. . . . Special tuition rates to members of the U. S. Armed Forces.



# FREE 30 DAYS SUPPLY Safe High-Potency Nutritional Formula VITAMINS

MINERALS and  
AMINO ACID



25 proven ingredients - 11 vitamins (including blood-building B-12 and folic acid), 11 minerals, choline, inositol and methionine

EACH DAILY C. F. CAPSULE CONTAINS	
Vitamin A	12,500 USP Units
Vitamin D	1,000 USP Units
Vitamin C	75 mg.
Vitamin B-1	5 mg.
Vitamin B-2	2.5 mg.
Vitamin B-6	0.5 mg.
Vitamin B-12	1 mcg.
Niacin Amide	40 mg.
Calcium Pantothenate	4 mg.
Vitamin E	2 I.U.
Folic Acid	0.5 mg.
Plus 11 minerals, choline, inositol and methionine.	

Yes, we want to send you FREE a 30-day supply of high-potency *Vitasafe C.F. Capsules* (a \$5.00 value) so you can discover for yourself how much healthier, happier and peppier you may feel after a few days' trial! Each capsule supplies your body with well over the minimum adult daily needs of the 11 important vitamins, plus 11 minerals, choline, inositol and amino acid.

#### Potency and Purity Guaranteed

You can use these Capsules confidently because strict U. S. Government regulations demand that you get exactly what the label states - pure ingredients whose beneficial effects have been proven time and time again!

#### Amazing New Plan Slashes Vitamin Prices in Half

With your free vitamins, we will send you complete details of an amazing new plan that provides you with a 30-day supply of vitamins every month for just \$2.00 - 60% less than the usual retail price. But remember - you're not obligated to buy from us now or ever! The supply of free capsules is limited - so mail coupon today!

#### VITASAFE CORPORATION

43 West 61st St., New York 23, N. Y.

VITASAFE CORP., Dept. 977  
43 West 61st Street, New York 23, N. Y.

Please send free 30-day supply of proven VITASAFE C.F. Capsules, and full information about the VITASAFE PLAN. I am under no obligation to buy any additional vitamins, and after trying the free sample supply, I will be given the opportunity to accept or reject the benefits offered by the VITASAFE PLAN.

I ENCLOSE 25¢ for packing and postage

Name.....

Address.....

City.....Zone.....State.....

Only one trial supply per family.



Fill Out  
No-Risk  
Coupon  
Today

(Continued from page 8)

### Indian Craftsman

At Wisconsin Dells, famed beauty spot of the Midwest, the people call Roger (Chief Little Eagle) Tallmadge "the man of many jobs and many faces." He is a schoolteacher, boat pilot, expert craftsman (see page 72), museum operator, biologist, actor, civic worker and Indian chief of the Sioux tribe.



In the schoolroom, Chief Little Eagle has the face of a kindly young professor (which he is). When he dons his jaunty pilot's cap, he is the happy-go-lucky boatman of inland waters exchanging banter with gay tourists. But when he puts on his feathered head-dress and full regalia he is all Indian. Born on a reservation in Minnesota, Little Eagle has come a long way and has the college degree of bachelor of science. He likes to think that some of the things he has accomplished may be an inspiration to the youth of his race.

#### To the Editor:

I was glad to receive the cutting headed "Watery Coal Mine" describing our under-sea boring in the Firth of Forth (page 132, PM, April 1956). May I point out that it is a 500, not a 5000-ton tower?

Henry Donaldson,  
Press officer,  
National Coal Board,  
London, England

#### To the Editor:

I was interested in the letter from Newt Stairs in the April issue. I can go him one better. I have a March 1906 issue of PM and have nearly all issues since then.

Lowry Sexton,  
The Dalles, Ore.



## You Practice **SERVICING** with Kits I Send You

Nothing takes the place of PRACTICAL EXPERIENCE. That's why NRI training is based on LEARNING BY DOING. You use parts I send to build many circuits common to Radio and Television. With my Servicing Course you build the modern Radio shown at left. You build a Multitester and use it to help make \$10, \$15 a week fixing sets in spare time while training. All equipment is yours to keep. Coupon below will bring book of important facts. It shows other equipment you build.

## You Practice **BROADCASTING** with Kits I Send You

As part of my Communications Course I send you parts to build low-power Broadcasting Transmitter at left. Use it to get practical experience. You put this station "on the air" . . . perform procedures demanded of broadcasting station operators. An FCC Commercial Operator's License can be your ticket to a bright future. My Communications Course trains you to get your license. Mail coupon. Book shows other equipment you build for practical experience.

# I Will Train You at Home in Spare Time to be a **RADIO-TELEVISION** Technician

## TELEVISION

### Making Jobs, Prosperity

25 million homes have Television sets now. Thousands more sold every week. Trained men needed to make, install, service TV sets. About 200 television stations on the air. Hundreds more being built. Good job opportunities here for qualified technicians, operators, etc.



J. E. SMITH, President  
National Radio Institute  
Washington, D. C.  
Our 40th Year

## America's Fast Growing Industry Offers You Good Pay, Success

Training PLUS opportunity is the PERFECT COMBINATION for job security, advancement. When times are good, the trained man makes the BETTER PAY, gets PROMOTED. When jobs are scarce, the trained man enjoys GREATER SECURITY. NRI training can help assure you and your family more of the better things of life. Radio is bigger than ever with over 3,000 broadcasting stations and more than 115 MILLION sets in use, and Television is moving ahead fast.

## N.R.I. Training Leads to Good Jobs Like These

### I TRAINED THESE MEN

"I have progressed very rapidly. My present position is Studio Supervisor with KEDD Television, Wichita."—Elmer Frewaldt, 3026 Stadium, Wichita, Kans.

"Fix sets part time in my shop. Made about \$500 first three months of the year. Could have more but this is about all I can handle."—Frank Borer, Lorain, Ohio.

"I've come a long way in Radio and Television since graduating. Have my own business on Main Street."—Joe Travers, Asbury Park, New Jersey.

"I didn't know a thing about Radio. Now have a good job as Studio Engineer at KMMJ."—Bill Deltzell, Central City, Nebraska.



**BROADCASTING:** Chief Technician, Chief Operator, Power Monitor, Recording Operator, Remote Control Operator. **SERVICING:** Home and Auto Radios, Television Receivers, FM Radios, P.A. Systems. **IN RADIO PLANTS:** Design Assistant, Technician, Tester, Serviceman, Service Manager. **SHIP AND HARBOR RADIO:** Chief Operator, Radio-Telephone Operator. **GOVERNMENT RADIO:** Operator in Army, Navy, Marine Corps, Forestry Service Dispatcher, Airways Radio Operator. **AVIATION RADIO:** Transmitter Technician, Receiver Technician, Airport Transmitter Operator. **TELEVISION:** Pick-up Operator, Television Technician, Remote Control Operator.



## Start Soon to Make \$10, \$15 a Week Extra Fixing Sets

My training is practical, complete; is backed by 40 years of success training men at home. My well-illustrated lessons give you basic principles you need and my skillfully developed kits of parts "bring to life" things you learn from the lessons. I start sending you special booklets the day you enroll, that show you how to fix sets. Multitester you build with my parts helps you discover and correct set troubles, helps you make money fixing neighbors' sets in spare time while training. Many make \$10, \$15 a week extra this way.

## Mail Coupon — Find Out What Radio-Television Offer You

Act now to get more of the good things of life. I send actual lesson to prove NRI home training is practical, thorough. My 64-page book "How to be a Success in Radio-Television" shows what my graduates are doing and earning. It gives important facts about your opportunities in Radio-Television. Take NRI training for as little as \$5 a month. Many graduates make more than the total cost of my training in two weeks. Mail coupon now to: J. E. SMITH, President, Dept. GHA, National Radio Institute, Washington 9, D. C. Our 40th year.

**AVAILABLE to all qualified VETERANS UNDER G.I. BILLS**

## Good for Both—FREE

MR. J. E. SMITH, President, Dept. GHA  
National Radio Institute, Washington 9, D. C.  
Mail me Sample Lesson and 64-page Book, FREE.  
(No salesman will call. Please write plainly.)

Name ..... Age .....

Address .....

City ..... Zone ..... State .....

**VETS** write in date of discharge



## Mail Today—Tested Way to Better Pay



It's here . . . It's new . . . It's different and 66% more powerful!  
**5 X 50 POWERHOUSE "GIANT"**

Now magnifies area  
 . . . 25 TIMES . . .

From this →  to this → 

These two dramatic photos of the Washington Monument prove beyond words the terrific power of this amazing binocular. The tiny photo is as the naked eye sees it miles from the nation's capital. The big picture is what the POWERHOUSE gives you — 225 times the area!

Precision  
 made in  
 Germany

*Special*  
 now **4.98**

Whatever your eye  
 can see brought  
 5 times closer . . .

**Reg. 12.95 value!**

Just arrived from Germany—the new POWERHOUSE "GIANT". This model is new and completely different. It's 66% more powerful than the original POWERHOUSE. The finest ever developed by the famous 101 year old German factory. Gives you greater range, greater clarity, sharper images and much more magnification. Bigger and better than ever before. German know-how and superb workmanship are reflected in the many quality features usually found in \$25 binoculars.

**Now 7 Ways Better**

1. High structural strength without tiring weight. It's only 12 ounces. 2. Aluminum draw tubes for smoother, faster focusing. 3. Folds to your eye width. 4. Precision Ground Lenses—**NOT PLASTIC!** That's why it doesn't give cloudy, blurred images. 5. Objective lenses interior coated with magnesium fluoride. Just like expensive cameras and \$25 binoculars. 6. Extra large 50mm objective lenses gives you viewing even in moonlight! 7. New 5x50 power system gives you 66% more power than original model. You get better viewing whether it's one or 50 miles away.

**Buy direct from world's largest Importer of German Binoculars**

Thoresen has sold over 1,000,000 German binoculars in recent years. Because we are the world's largest importer of these glasses, we can buy for less and sell for less. That's why we can NOW offer you this 12.95 binocular for only 4.98.

**SEEING IS BELIEVING!**

Try the Powerhouse Giant at our risk! ONE look thru this new POWERHOUSE "GIANT" will convince you! Because words and pictures alone cannot adequately describe it, we want to send one to you on 7 days home trial. Use it on hunting and fishing trips, the races, bird watching, boating and for vacation fun. Always have a "ringside" seat at sports events. Then, if you don't think this is the year's biggest binocular value, just return it for immediate refund of your 4.98. Order at once! This offer may be withdrawn due to production limitations in Germany. Send 4.98 check, m.o. or cash. In any case, you don't risk a cent. So rush coupon today.

**THORESEN'S, Dept. 6-H-66**  
 352 Fourth Ave., New York 10, N.Y.

**from 1 to 50 miles away!**

**RUSH COUPON FOR FREE TRIAL!**

**THORESEN'S, Dept. 6-H-66**  
 352 Fourth Avenue, New York 10, N. Y.

RUSH \_\_\_\_\_ new model POWERHOUSE "GIANT" Binoculars at 4.98 each. I will enjoy it on full week's trial. I will test it for power, appearance, sharp viewing. If I am not thrilled in every way, I am under no obligation to keep it. I'll return it for quick refund of my 4.98. Include **AT NO EXTRA COST** Supple Grain Case & Straps.

Payment enclosed. RUSH prepaid.  
 Send C.O.D. I'll pay charges.

NAME \_\_\_\_\_

ADDRESS \_\_\_\_\_

TOWN \_\_\_\_\_ ZONE \_\_\_\_\_ STATE \_\_\_\_\_

**CANADIAN:** Order direct from Thoresen Ltd., 45 St. James St. West, Dept. US-66, Montreal 1, P.Q. Same price, same guarantee. No extra for tariff.





# INVENTORS

**L**earn how to protect your invention. The U. S. Patent Laws provide that any new and useful art, machine, article of manufacture, or composition of matter, or any new and useful improvement thereof, may be patented if the act of invention is involved. Therefore, every inventor with a valuable invention should take advantage of the Patent Laws and proceed for patent protection in order to safeguard his rights.

A patent gives the inventor the exclusive right to prevent others from making, using, or selling the invention claimed in the patent for a period of seventeen years.

The Patent Laws were enacted for the benefit of the inventor to give him protection for the features of his invention which are patentable. These features must be properly and concisely set forth and claimed in a formal application for patent, in order to comply with the requirements of the Patent Laws. For that reason, unless the inventor is familiar with patent matters, he should engage a competent, registered patent attorney or agent to represent him. We are registered to practice before the U. S. Patent Office and are prepared to serve you in the handling of your patent matters.

A specially prepared booklet entitled "Patent Guide for the Inventor", containing detailed information with respect to patent protection and procedure, together with a "Record of Invention" form will be promptly forwarded to you without obligation upon request.

**CLARENCE A. O'BRIEN & HARVEY JACOBSON**

*Registered Patent Attorneys*

**61-H DISTRICT NATIONAL BUILDING**

**WASHINGTON 5, D. C.**







# THESE MEN ARE GETTING PRACTICAL TRAINING IN **ELECTRICITY**

—**ELECTRONICS**

*On Real:*

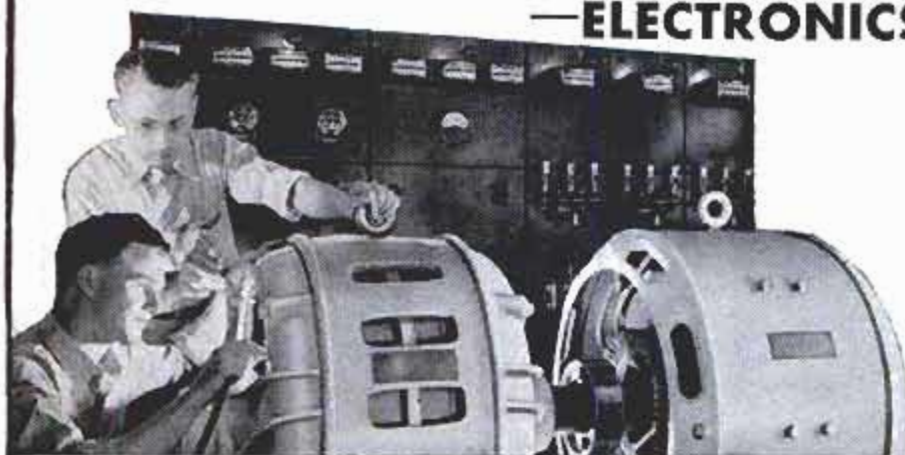

**A.C. and D.C. MOTORS  
GENERATORS  
SWITCHBOARDS  
CONTROLLERS  
WIRING JOBS  
APPLIANCES  
ELECTRONIC UNITS**

*(Shown at left—Instructor explaining operation and testing of a large Motor Generator in our A.C. Department.)*

# AND **TELEVISION-RADIO**

*On Real:*

**TELEVISION  
RECEIVING SETS  
Including Color TV  
AM and FM RADIO  
RECEIVERS including  
AUTO RADIOS  
TELEVISION TEST  
EQUIPMENT**

*(Right — Instructor helping students check the wiring and trace circuits of television receivers.)*

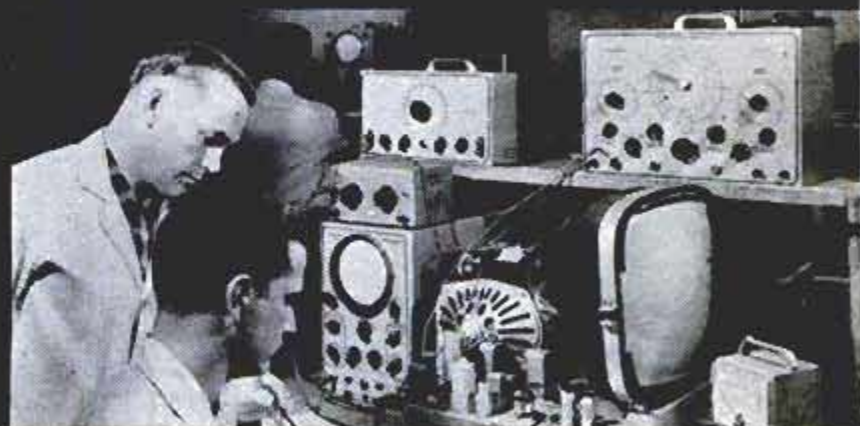

## Train in the great **SHOPS** of **COYNE**

**Largest, Oldest, Best Equipped School Of Its Kind In The U. S.**

Whether 17 or up to 45 years of age, prepare for your future now. Don't be satisfied with a "No Future" job. Train the Coyne way for a better job in a field that offers a world of opportunities in the years ahead.

**FINANCE PLAN** Enroll now, pay most of tuition later. Part-time employment help for students. **WE TRAIN YOU IN CHICAGO** on real equipment. Trained instructors show you how, then you do practical jobs yourself. No previous experience or advanced education needed.

**CLIP COUPON NOW** for big new illustrated Coyne book "Guide to Careers in ELECTRICITY and TELEVISION-RADIO". No obligation; no salesman will call. Get vital facts now! *Training in Refrigeration and Electric Appliances can be Included.*



*Mail Coupon for  
Big Free Book*

**Training Offered  
to VETERANS  
and  
NON-VETERANS  
Alike**

**B. W. COOKE, President  
COYNE ELECTRICAL SCHOOL**

500 S. Paulina St., Chicago 12, Ill. Dept. C6-72H  
Send FREE book and details of all the training you offer. This does not obligate me and no salesman will call. I am especially interested in:

- ELECTRICITY-ELECTRONICS  
 TELEVISION-RADIO

NAME.....

ADDRESS.....

CITY.....STATE.....

B. W. COOKE, Pres. **COYNE** FOUNDED 1899

**ELECTRICAL SCHOOL**

A TECHNICAL TRADE INSTITUTE OPERATED NOT FOR PROFIT  
500 S. PAULINA STREET, CHICAGO, Dept. C6-72H

**ELECTRICITY ★ RADIO ★ TELEVISION ★ REFRIGERATION ★ ELECTRONICS**

AUGUST 1956

15



## WHAT SECRET POWER DID THIS MAN POSSESS?

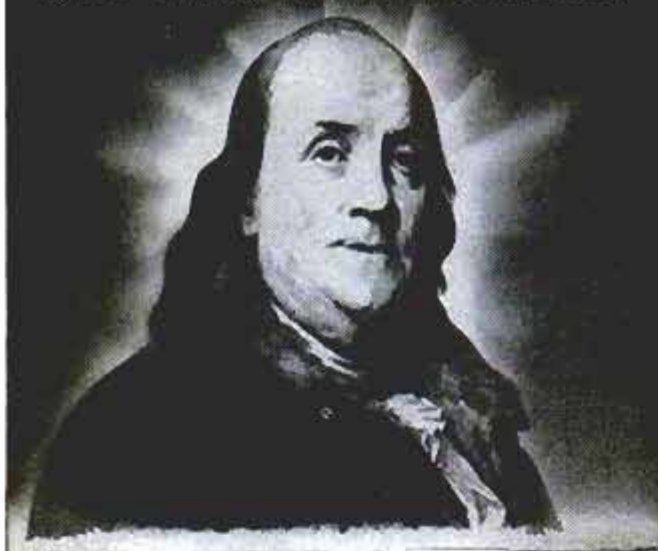

**BENJAMIN FRANKLIN**  
(A Rosicrucian)

**WHY** was this man great? How does anyone—man or woman—achieve greatness? Is it not by mastery of the powers within ourselves?

Know the mysterious world within you! At-tune yourself to the wisdom of the ages! Grasp the inner power of your mind! Learn the secrets of a full and peaceful life!

Benjamin Franklin—like many other learned and great men and women—was a Rosicrucian. The Rosicrucians (NOT a religious organization) first came to America in 1694. Today, headquarters of the Rosicrucians send over seven million pieces of mail annually to all parts of the world. Write for YOUR **FREE COPY** of "The Mastery of Life"—**TODAY**. No obligation. No salesmen. A non-profit organization. Address: Scribe V.M.M.

**THIS BOOK FREE!**



## The ROSICRUCIANS

SAN JOSE • (AMORC) • CALIFORNIA

—SEND THIS COUPON—

Scribe V.M.M.  
The ROSICRUCIANS (AMORC)  
San Jose, California

Please send me the free book, *The Mastery of Life*, which explains how I may learn to use my faculties and powers of mind.

Name \_\_\_\_\_

Address \_\_\_\_\_

City \_\_\_\_\_

## Learn CARBURETOR and IGNITION



**Start Training at Home For This Clean, High-Class Type of Position**

Get in line for a raise—or for more profits in your own shop. Learn testing and adjusting with latest-type scientific motor tune-up equipment. This enables you to locate the trouble exactly, and fix it fast—handling and getting paid for *more jobs per day*. There's money in this, and it's clean, high-class work which gets the respect and confidence of your customers.

**Send for FREE SAMPLE LESSON**

Carburetor and Ignition Specialization offers very superior opportunities for better pay and bigger profits because relatively few mechanics know anything about this time-saving, money-making new test equipment. Now our spare-time home-study method teaches you the principles and shortens your shop training. Ambitious men (age 18-55): Send for full **FACTS AND FREE SAMPLE LESSON** at once. Write today to

**UTILITIES ENGINEERING INSTITUTE**  
2525 Sheffield Ave., Dept. OC-4, Chicago 14

## TELEPHONES



**Desk Stand Style**  
*Slightly used but in excellent condition*

**Many Valuable Uses**  
Inter-Office Phones House to Barn, etc.  
Loud Speakers Microphones  
Educational Purposes, Toys, etc.

Come complete, ready to use with wiring diagrams included. **\$2.75** Postpaid in U.S.A.

Two complete for only **\$5.00**  
**TELEPHONE LAMP KIT**—with illustrated instructions for making Desk Telephone Lamp including all parts (lamp, nipples, push switch, cord, plug, etc.)  
... \$6.50 Ppd. (Shade is not included).

**MICROPHONE**, Dept. X-4102, 1760 W. Lunt Ave., Chicago 26, Ill.



## OWN a Business

If employed, start part time. Alert dealers can gross \$5 hourly profit on own service plus \$3 on EACH serviceman. Clean, revive, moth-proof rugs & upholstery on location. No shop needed. Services nationally advertised. Repeat customers. Easy to learn. We locally train and assist you. Quickly established. Easy terms. Send today for FREE booklet. No obligation.

**DURACLEAN CO.**, 6-168 Duraclean Bldg., Deerfield, Ill.

## RADIO

Engineering. All phases radio & electronics theory & practice; television; FM; broadcasting; servicing; aviation, marine & police radio. Prepare for good pay; 18-month course. Graduates in demand by major companies. Enter Jan., March, June, Sept. Regular campus life. Write for catalog. **VALPARAISO TECHNICAL INSTITUTE**, Dept. D, Valparaiso, Ind.

## MAKE TREMENDOUS PROFITS

have fun! Earn Big Money! Cast plaster figurines, bookends, plaques, novelties at home in your spare time with X.I. rubber molds! **NO EXPERIENCE NEEDED!** Models and rubber for 3 molds, only \$1.50 ppd. Send 25c (refunded with order) for 40 page catalog now!  
**PLASTIC ARTS STUDIO** 3403 SO. MADISON, DEPT. PM2  
MUNCIE, INDIANA

## REAL ESTATE

BE A BROKER

**PAYS BIG! SEND FOR FREE, BIG, ILLUSTRATED CATALOG NOW!** Graduates report making substantial incomes. Start and run your own business quickly. Men, women of all ages, learn easily. Course covers Sales, Property Management, Appraising, Loans, Mortgages, and related subjects. **STUDY AT HOME** or in classrooms in leading cities. Diploma awarded. Write **TODAY** for free book! No obligation.

Approved for World War II and Korean Veterans  
**WEAVER SCHOOL OF REAL ESTATE (Est. 1936)**  
2020R Grand Avenue Kansas City, Mo.



## RUPTURED

BE FREE FROM TRUSS SLAVERY

**NOW** there is a new modern Non-Surgical treatment that permanently corrects rupture. These Non-Surgical treatments are so certain, that a Lifetime Certificate of Assurance is given. Write today for our **NEW FREE Book** that gives facts that may save you painful and expensive surgery, and tells how **non-surgically** you may again work, live, play and love and enjoy life in the manner you desire. There is no obligation.  
**Excelsior Hernia Clinic Dept. 8305 Excelsior Springs, Mo.**



# INVENTORS

If you believe that you have an invention, you should find out how to protect it. The first step is to have a search made of the prior pertinent U. S. patents. If a report on this search indicates that the invention appears patentable you can apply for a patent, and the specifications and claims should be prepared.

The firm of McMorrow, Berman & Davidson, with offices in Washington, D. C., is qualified to take the necessary steps for you. We can make a preliminary search on your invention, advise you whether we think it can be patented, and prepare your application for patent.

Unless you are fully familiar with the U. S. Patent Laws, we recommend that you engage the services of a Registered Patent Attorney to protect your interests. The patent laws are *your* laws. A patent gives you the right to prevent others from making, using or selling the invention claimed in your patent for a period of 17 years.

Use these patent laws for your protection. Investigate whether your invention can be patented. If you have what you believe to be an invention, we suggest that you have this firm make a search for you.

*Send for a copy of our Patent Booklet entitled "How To Protect Your Invention," containing information about patent protection and patent procedure. Along with this we will also send you an "Invention Record" form, for your use in writing down and sketching details of your invention. We will mail them promptly. No obligation. They are yours for the asking.*

**McMORROW, BERMAN & DAVIDSON**

*Registered Patent Attorneys*

**PATENTS • COPYRIGHTS • PATENTS**

**135-Z VICTOR BUILDING, WASHINGTON 1, D. C.**



# Learn at Home

*in your spare time*

# to Fix Electric Appliances



## Better Pay—More Opportunities

Get into a field where there is important work and opportunity for the trained man. Millions of electric appliances are sold every year. Every wired home now has an average of 8. Many of them need service and repair. Owners pay well to have them fixed quickly, properly. This is your opportunity for a better job, your own part time or full time business. NRI can give you the training you need, at home, in your spare time.

## A Way to Extra Money

Soon after starting you will be able to earn extra cash fixing toasters, clocks, fans, vacuum cleaners, etc., for neighbors and friends. Keep your job while learning and earning. Put spare time to work for you. Work in your basement, garage, spare room. You'll be amazed how easily, quickly you, too, can start earning many extra dollars. NRI shows you how. Even before you finish training your spare time earnings may pay for the course and equipment.

## NRI Sends Tester to Learn and Earn

You need proper equipment to service today's automatic appliances. With *this* course you get parts to build professional type, multi-use Appliance Tester. You learn to use it. Takes guess work out of servicing. Mail coupon for FREE book and Sample Lesson. See how easy it is to learn. Find out about NRI—a school that for more than 40 years has been training men, through home study, for success, good pay jobs. Our reputation, record, experience back up this course. Write now to: Electric Appliance Training, NRI, Dept. AH6, Washington 9, D. C.



**FREE Lesson and Book**  
Mail this NOW!

**NATIONAL RADIO INSTITUTE**

Dept. AH6, Washington 9, D. C.  
Send me Lesson and Book Free. No Salesman will call.

Name.....Age.....

Address.....

City.....Zone.....State.....

APPROVED MEMBER NATIONAL HOME STUDY COUNCIL

## Shrinks Hemorrhoids

### New Way Without Surgery

Science Finds Healing Substance That Relieves Pain—Shrinks Hemorrhoids

For the first time science has found a new healing substance with the astonishing ability to shrink hemorrhoids and to relieve pain—without surgery.

In case after case, while gently relieving pain, actual reduction (shrinkage) took place.

Most amazing of all—results were so thorough that sufferers made astonishing statements like "Piles have ceased to be a problem!"

The secret is a new healing substance (Bio-Dyne\*)—discovery of a world-famous research institute.

This substance is now available in suppository or ointment form under the name Preparation H.\* Ask for it at all drug counters—money back guarantee. \*Reg. U. S. Pat. Off.

**SAVE GAS, GEARS,  
TIRES ON YOUR  
4-WHEEL DRIVE!**



**Stop Front End Drag in 2 W. D.**

Get maximum use of your vehicle with these famous hubs! They "take out" the front end in 2-wheel drive, give your vehicle "pick-up" economy, pep, speed, power, handling ease; stop front end gear whine, shimmy. 4-wheel drive as usual, when you need it—automatically, as you shift, with Warn Lock-o-matics, manually with Locking hubs. Models for all makes 4 w.d.s. to 1½ tons at truck dealers everywhere, or write:

WARN MFG. CO., Riverton Box 6064-A8, Seattle 88, Wn.



**WARN  
HUBS**

## JEEP OWNERS

STA. WAGONS • JEEPSTERS • PICK-UPS!

RE-POWER with Ford 6 or V-8 engines. Our F-J ADAPTOR-CONVERSION KITS fit ALL Willys Jeeps including 1956. Kit No. 4-K for 1949-56 Ford engines in 1954-56 Pickups & Sta-Wagons priced at \$52.85 incl. Fed. tax. Kits for 1932-56 Ford engines in ALL other Willys Jeeps . . . \$43.25 Tax incl. Write today for free details or send check or M.O. for prepaid shipment. Tell us your engine you will use and whether 2 or 4 Whl-Dr. ORDER NOW FOR EARLY SHIPMENT.

HOOSIER MACHINE PRODUCTS CO. Pendleton, Oregon  
312 S.E. 8th St.

## LEARN METALCRAFT

and JEWELRY MAKING

Low Cost Home Training Now Available

Make money. Learn profitable skills and arts of decorative metal and jewelry crafts. Course is complete. Professionally prepared. Easy to master. Special tools and materials furnished.

Write for **INTERSTATE TRAINING SERVICE**  
Free Booklet DEPT. K-3 PORTLAND 13, OREGON

## BUY IT WHOLESALE!

GET UP TO 40% OFF

★ Agents-Start Buying Service at Home. Get big-name merchandise for clients up to 40% off. Sales easy as you can give sizeable discounts, still make fat commissions. Postcard brings FREE COPY "The Wholesale Plan."

FREE! THE WHOLESALE PLAN!

**American Buyers Service**

HERTEL STATION, DEPT. R, BUFFALO 16, N. Y.

## Learn BAKING At Home

Baking is one of America's high industries in wages. Nearly DEPRESSION-PROOF. Thorough basic home course lays sound foundation. If you have aptitude, write for FREE Booklet. "Opportunities in Commercial Baking."

NATIONAL BAKING SCHOOL  
835 Diversey Ave. Dept. 135C Chicago 14, Illinois





**NO  
PREVIOUS  
TECHNICAL  
EXPERIENCE  
OR ADVANCED  
EDUCATION  
REQUIRED**

**MEN  
17 to 55  
YEARS OLD  
PREFERRED**

**DeVRY TECH PUTS 25 YEARS OF SUCCESSFUL  
KNOW-HOW BEHIND YOU AS YOU**



Prepare for a Profitable Future in  
**TELEVISION  
AUTOMATION**  
ELECTRONICS

**2 Exclusive DTI Features**

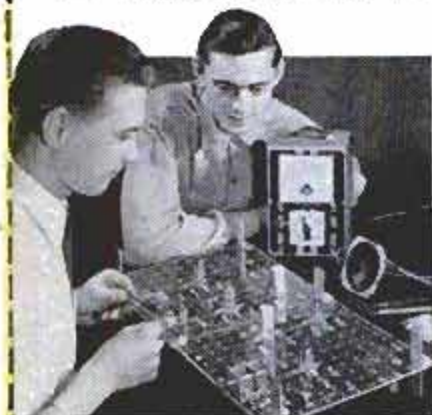

**THE DTI ELECTRO-LAB\***

The men above are learning principles of Television-Radio-Electronics at home the practical DTI way, using the styrene Electro-Lab, Vacuum Tube Voltmeter and speaker—furnished by DTI. It is fun to learn when using this equipment!

\*Trademark



**HOME MOVIES**

It is much easier to understand an electronic principle by movies at home, than by reading about it. Using a special movie projector and instructive films, you "see" what happens in tubes, etc. Yes, the DTI movie way of home training is fun! Let us tell you about it.

**RADIO • ELECTRONICS**

What a wonderful future ahead in Television-Radio-Automation Electronics! Television is booming! Communications is also offering fine opportunities. And now that Electronics is being used more to speed production, Automation Electronics is calling for skilled men.

What's also important: Today's opportunities for starting your own profitable part time or full time servicing business are great.

See how YOU may prepare to fit into this vast field by sending the coupon below. Find out how DeVry's 25 years of experience may start you toward a REAL FUTURE. Prepare at home in spare time, or come to Chicago and get the KNOW-HOW you need in our well equipped training center. Details are yours for the asking.

**EMPLOYMENT SERVICE**

When you complete the training, you get the benefit of effective starting help toward a good job or your own business from DeVry's Employment Service. This is one of the most valuable . . . most effective . . . parts of DeVry's program.

**MILITARY SERVICE**

If you are subject to military service, we have some very valuable information for you.

**YOU BUILD YOUR OWN EQUIPMENT**

Yes, you learn by doing! With 16 shipments of parts furnished by DTI, you work over 300 projects which include building your own test equipment. You build a 5-inch Oscilloscope and a multi-range Vacuum Tube Voltmeter, yours to work with during training—to keep and continue to use after graduation.

"One of America's Foremost Electronics Training Centers"



**89 WAYS TO  
EARN  
MONEY  
IN TELEVISION  
RADIO  
ELECTRONICS**

**REGARDLESS OF YOUR  
PRESENT JOB, FILL  
IN COUPON BELOW!**

Get this interesting publication FREE!

**DeVRY TECHNICAL INSTITUTE**

4141 Belmont Ave., Chicago 41, Ill., Dept. PM-8-M

I would like to know facts about the many opportunities in Television-Radio-Electronics, and how DTI can prepare me for my start in this billion dollar field.

Name \_\_\_\_\_ Age \_\_\_\_\_  
(PLEASE PRINT)

Street \_\_\_\_\_ Apt. \_\_\_\_\_

City \_\_\_\_\_ Zone \_\_\_\_\_ State \_\_\_\_\_

1028 DTI's training is available in Canada

**DeVRY TECHNICAL INSTITUTE**

CHICAGO 41, ILLINOIS

FORMERLY

DeFOREST'S TRAINING, INC.

Member of National Home Study Council







FROM THOUSANDS OF ACTUAL LETTERS IN OUR FILES...

# Amazing Proof That Anyone Can Play Music!



**No Teacher or Special "Talent" Needed — We Show You How to Sit Right Down and START PLAYING REAL MUSIC at Once**

IT'S not what we say about our wonderful easy way to learn music that really counts. It's what our 900,000 STUDENTS say. And THEY send us thousands of enthusiastic comments like those reprinted here — saying it's what they've always dreamed of! A quick, easy way of learning to play any musical instrument. WITHOUT suffering through dull "theories" first. WITHOUT practicing boring scales and exercises. WITHOUT spending time and money on a private teacher.

You just sit right down with the piano, guitar, accordion—or any instrument you're interested in—and actually begin to play. Simple songs at first. Then more advanced compositions. Soon you'll amaze your friends by playing almost anything they request!

**Even Children "Catch on" At Once**

No "trick" methods. You play real sheet music. Big, clear pictures and simple directions make every step simple as A-B-C. So

**12-Year-Old Surprises Her Friends**

"I am twelve years old. Thanks to your Course, I was able to play for the department in our church. All my friends were certainly surprised when they discovered I could play!" — *Patsy Jeffrey, Sweetwater, Texas.*

**"Opened Door to Popularity"**

"I was able to play pieces in a short time. Family and friends certainly surprised. Course opened door to popularity." — *Peter H. Kozyra, P. O. Brokenhead, Manitoba.* (Picture on other side of page)

**Now Invited Out Lots**

"It's been fun. Hasn't cost anywhere near as much as private teacher. Now invited to affairs, dances. Auditioned for 'Barn Dance Jamboree.'" — *Howard Hopkins, E. Syracuse, N. Y.* (Picture on other side of page)

clear, even children "catch on" right away. Whole family can learn for price of one. Costs only a few cents a lesson, including sheet music.

**MAIL COUPON FOR FREE BOOK**

The whole fascinating story of this revolutionary new way to learn music is told in a 36-page illustrated book. You may have a copy FREE simply by mailing coupon. No obligation; no salesman will call on you. U. S. SCHOOL OF MUSIC, Studio 308, Port Washington, N. Y. (Special Reduced Prices on instruments to our students.) Now in Our 53th Successful Year.



Our Former Student  
**LAWRENCE WELK**

Now Has Regular Full Hour TV Show Weekly — with his Own Orchestral

Telecasts his famous "Champagne Music" from Hollywood Over ABC-TV Every Saturday Night

MR. WELK says: "I got my start in music with a U. S. School of Music course. How easy it is to learn to read notes and play an instrument this 'teach yourself' way! In fact this school did so much for me that I've enrolled my two daughters. I highly recommend your school. My best wishes for your continued success."

Lawrence Welk,  
Hollywood, Calif.



Howard Hopkins



Peter Kozyra

900,000 STUDENTS 50 Successful Years

U. S. SCHOOL OF MUSIC, Studio 308, Port Washington, N. Y.

I am interested in learning to play, particularly the instrument checked below. Please send me your free illustrated book. NO SALESMAN IS TO CALL ON ME.

- |  |   |   |
|--|---|---|
| <input type="checkbox"/> Piano           | <input type="checkbox"/> Pipe, Hammond. | <input type="checkbox"/> Piccolo                  |
| <input type="checkbox"/> Guitar          | <input type="checkbox"/> Reed Organ     | <input type="checkbox"/> Modern                   |
| <input type="checkbox"/> Steel Guitar    | <input type="checkbox"/> Tenor Banjo    | <input type="checkbox"/> Elementary               |
| <input type="checkbox"/> Violin          | <input type="checkbox"/> Ukulele        | <input type="checkbox"/> Harmony                  |
| <input type="checkbox"/> Piano Accordion | <input type="checkbox"/> Clarinet       | <input type="checkbox"/> Mandolin                 |
| <input type="checkbox"/> Saxophone       | <input type="checkbox"/> Trombone       | <input type="checkbox"/> Practical Finger Control |
| <input type="checkbox"/> Trumpet, Cornet | <input type="checkbox"/> Flute          |   |

Do you have the instrument? \_\_\_\_\_

Mr. \_\_\_\_\_

Mrs. \_\_\_\_\_

Miss \_\_\_\_\_ (Please Print Carefully)

Address \_\_\_\_\_

City \_\_\_\_\_ State \_\_\_\_\_

(Insert Zone Number, if Any)

NOTE: If you are under 18 years of age parent must sign coupon.





**YOU**  
can  
acquire

## LAW NIGHTS AT HOME! LL. B. DEGREE

LaSalle's famous Law Library—used as reference in many Law libraries and Law offices—has enabled thousands to master Law surprisingly fast, in spare hours at home, for business and professional advancement.

These 14 remarkable volumes, compiled by leading professors and lawyers, cover the whole basic field of Law in condensed, orderly, simplified manner.

You advance rapidly with this great library, plus special lectures furnished. We guide you step-by-step with personalized Problem Method of instruction . . . you learn by doing—handling legal problems—not by memorizing rules.

Send for two FREE booklets, "Law Training for Leadership," and "Evidence," answering questions about Law and its value to you, and telling how LaSalle Law graduates are winning rapid advancement in business and public life. Mail coupon below. No obligation.

### LA SALLE EXTENSION UNIVERSITY A Correspondence Institution

417 S. Dearborn St. Dept. 864L Chicago 5, Ill.

Send me your two FREE booklets described above, without obligation.

Name..... Age.....

Street.....

City, Zone & State.....

## ENGINEERING DEGREE IN 27 MONTHS

### B. S. DEGREE IN

**Aeronautical, Chemical, Civil, Electrical, Mechanical and Electronic Engineering (inc. Radio and TV)**  
Big Demand for Graduates

Hundreds of young men are earning B. S. ENGINEERING DEGREES annually in this recognized institution—year around classes optional. New terms start quarterly. Many students earn a major part of their college expenses in this large industrial center.

Low tuition. Competent instruction. Thorough, intense practical program. Modern, well-equipped laboratories including new physics laboratory and modern wind tunnel. Individualized instruction emphasized.

Government approved for G.I.'s. Engineering preparatory courses. Students from 48 states and 21 foreign countries. Enter September, December, March and June. Send coupon for free catalog and full information. Enroll now.

## INDIANA TECHNICAL COLLEGE

586 E. Washington Boulevard, Fort Wayne 2, Indiana

Please send me free information on B.S. Engineering Degree in 27 months as checked.

Aeronautical,  Chemical,  Civil,  Electrical,  
 Mechanical,  Electronics

Name.....

Address.....

## THE Big Favorite SANTORIZED WORK CLOTHES

25,000 DEALERS,  
COAST TO COAST



THE FAVORITE GARMENT CO. Lynchburg, Va.  
Jackson, Miss.

## Do You Make These Mistakes in English?

MANY persons say "between you and I" — use "who" for "whom" — don't know whether to use one or two "e's" or "m's" or "r's." Every time you speak or write you show what you are. A command of effective English brings you added advantages, better opportunities.

You can improve your English through Sherwin Cody's 100% self-correcting invention. If you are ever embarrassed by mistakes in grammar, spelling, punctuation, or pronunciation, write for FREE book "How You Can Master Good English in 15 Minutes a Day." No obligation. SHERWIN CODY COURSE IN ENGLISH, 588 Central Drive, Port Washington, N. Y.

## IT'S EASY... MAKE MONEY IN PHOTOGRAPHY

If you are over 17—good pay and fascinating work await you in photography! Start making money quickly in spare time—step into your own studio or exciting career job. LEARN-BY-DOING method trains you at home! Write TODAY for FREE catalog. Also Resident Training. Co-ed. 46th Year. Approved for Veterans.

NEW YORK INSTITUTE OF PHOTOGRAPHY  
Dept. 49, 10 West 33 Street, New York 1, New York  
46th YEAR

## MONEY in WORMS

Big money made raising fishworms and crickets. Billions used yearly—unlimited market—Sell by mail—We teach you how to raise and where to sell. Learn about our new, exclusive 6 to 12 inch African Redworm—in demand everywhere. Free Literature. CARTER WORM RANCH, PLAINS, GEORGIA

## earn as \$15 an HOUR as TAX EXPERT

Our students earn as much as \$3,000 in 3 short months preparing income tax returns in spare time. Also operate lucrative year-round Business Tax Service. Dignified home-office business. Experience unnecessary. We train you; help you start. State approved home training program. Write today for free prospectus. UNION INSTITUTE, 68 Hudson, Hoboken 20L, N. J.

## SHINE WITHOUT 'POLISH'

**New Invention! • Sells Like Wild**  
Replaces messy pastes, liquids. Simply glide over shoes—and presto! — you have a lustrous, long-lasting shine. No mess, no fuss. Shoes gleam like mirrors. For Men's, Women's, Children's Shoes. Take orders! Earn money!

**SAMPLES FOR TRIAL**  
Sample offer sent to all who send name at once. Postcard will do. SEND NO MONEY—just your name. KRISTEE CO., Dept. 688, AKRON 8, OHIO

## SAY YOU SAW IT IN POPULAR MECHANICS

## NEW CHEAP MANIAC ALARM SWEEPING THE COUNTRY

**SALESMEN BIG MONEY**  
Protect — Homes — Loved Ones — Business Places From Burglars — Kidnappers — Maniacs With Devil Dog. Doors and Windows may be left open. Amazing one-minute demonstration. Unlimited money-maker. America wants this protection now. Cash in on tremendous demand everywhere. Demonstrator sample all you need. We ship direct to your customers. Wholesale sample offer sent immediately to all who send name at once. Be first — send name on postcard or in letter today.  
NORTHWEST ELECTRIC CO.  
775-K MAIN MITCHELL S. DAK.



don't envy  
TALL men  
...be one!



Stop having to look UP to tall men. Be almost 2 INCHES TALLER yourself, instantly — in "ELEVATORS" amazing height-increasing shoes. Handsome as other shoes, they are fashioned so

only you know you're wearing them. Everyone notices the improvement.

THE ORIGINAL AND GENUINE  
**"ELEVATORS"**  
HEIGHT-INCREASING SHOES  
"YOUR PERSONAL PERSEAL"  
A TRADE MARK OF STONE-TARLOW CO., INC.

For FREE Booklet and Dealer's name write to:  
STONE-TARLOW CO., INC., DEPT. PM8, BROCKTON 68, MASS.

LEARN AT HOME



Send for  
FREE BOOKLET

Learn this profitable business from experts in your spare time. Locksmiths have no "slow" seasons or layoffs; they are always in demand. Age or minor physical handicap can't stop you. America's only recognized locksmithing school can teach you easily and quickly. Simple, illustrated lessons plus materials and tools supplied. Make money while learning. Get into this uncrowded field now!

INSTITUTE OF LOCKSMITHING  
Dept. P-81, 15 Park Avenue, Rutherford, N. J.  
Lit. by N. J. State Board of Education  
Approved for Veterans

**Print Your Own**

Cards, Stationery, Advertising, Circulars, labels, photo and movie titles, church work, tags, etc. Save money. Sold direct from factory only. Raised printing like engraving, too.

**Own a Printing Business**

Print for Others, Good Profit. Have home shop. Junior press \$15; Senior \$29 up. We supply everything. Easy rules. Pays for self in short time. Write for free catalog of outfits and all details.

**KELSEY PRESSES, C-37 Meriden, Conn.**

**STAMMER?**

Get your copy of the 18th edition of my book, "Stammering, Its Cause and Correction," which describes the Bogue Unit Method for scientific correction of stammering and stuttering. Ask, also, for free SPEECH CHART! 55th year. Benjamin N. Bogue, Dept. 563, Circle Tower, Indianapolis 4, Indiana.

GET THIS  
FREE  
BOOK!

**PORTABLE CAR COVER** Heavy Vinyl Plastic (formerly \$8.95)

Protect Against RAIN • SUN • DUST

Long-lasting plastic, folds compactly, off and on in a liffy, sturdy elastic binding gives extra security. State make, model and year

Send \$6.95 plus 35¢ postage or sent C.O.D. Extra Heavy Plastic Gauge \$8.95 + 45¢ postage.

**BEA SALES, Dept. B-2, 125 E. 46th St., New York 17**

**RUPTURED?** Write for New Relief Facts FREE!

ENJOY NEW FREEDOM

of action, peace of mind and comfort at work or play. Proven, patented MILLER holds your rupture back Day & Night—will bring you lasting relief! Has helped thousands of others! For FREE facts in plain wrapper—

Send Name and Address to  
**FRED B. MILLER, DEPT. 1H**  
Manufacturer, HAGERSTOWN, MARYLAND



ENTIRELY DIFFERENT

**YOU'RE HIRED**  
WHEN PROPERLY TRAINED  
AS AN  
**ALL-AROUND MECHANIC**



NOW YOU GET BOTH  
**AUTO MECHANICS**  
(AT HOME,  
**AND DIESEL IN SPARE TIME**)  
IN ONE LOW TUITION COURSE

Train right. Don't be a "one engine mechanic" Learn all engines, including diesel. The qualified, all-around mechanic can pick and choose, specialize anywhere, repair anything, from foreign cars to diesel jobs — he's always in demand where pay is tops

**COURSE COVERS:**

- all engines
- fuel injection
- automatic transmissions
- overhauling
- rebuilding
- customizing
- servicing, maintenance

National Schools of Los Angeles, a leader since 1905, brings its famous training shops to your home — to give you everything you need to make good in today's opportunity-filled Auto Mechanics & Diesel industry

Earn as you learn. We show you how. Free technical consultation service with qualified staff. Job Placement Service.



THIS SET OF LIFETIME TOOLS AND ALL-METAL TOOL BOX ARE YOURS TO KEEP, AS PART OF YOUR COURSE.

**NATIONAL SCHOOLS**

4000 S. FIGUEROA ST., LOS ANGELES 37, CALIF  
187 N. LA SALLE ST., CHICAGO 1, ILL  
IN CANADA: 811 W. Hastings St., Vancouver, B. C.

**NATIONAL SCHOOLS**

TECHNICAL TRADE TRAINING SINCE 1905  
Los Angeles, California

GET FAST SERVICE — MAIL NOW TO OFFICE NEAREST YOU!

NATIONAL SCHOOLS, DEPT. DB-86  
4000 S. FIGUEROA ST. OR 187 N. LA SALLE ST  
LOS ANGELES 37, CALIF OR CHICAGO 1, ILL

Send FREE Auto-Mechanics Book and Sample Lesson  
No obligation, no salesman will call.

NAME \_\_\_\_\_ BIRTHDAY \_\_\_\_\_ 19 \_\_\_\_\_

ADDRESS \_\_\_\_\_

CITY \_\_\_\_\_ ZONE \_\_\_\_\_ STATE \_\_\_\_\_

VETERANS: Give Date of Discharge \_\_\_\_\_



# DRAFTSMEN



**CASH BIG  
PAY CHECKS!**

**Train Now for  
more success,  
greater security**

**LEARN AT HOME IN SPARE TIME  
(or at college in Chicago)**

Check the want ads in any newspaper—SEE the big-pay opportunities open to you as a draftsman. What's more, you can learn this well-paid, prestige profession at home—quickly, easily! No special talent needed. Get complete, step-by-step Chicago Tech lessons in the mail, spend a few pleasant hours studying each week. In a short time you'll be a well-trained draftsman, ready to take your pick of many good jobs. Act now!



**Free Information—Mail Coupon Today!**

Get FREE TRIAL LESSON plus information about C.T.C. practical training. Learn what successful Chicago Tech graduates say about high pay and opportunities in drafting. No charge, or obligation.

## CHICAGO TECHNICAL COLLEGE

K-254 Tech Bldg., 2000 So. Michigan Ave.  
Chicago 16, Illinois

Mail me FREE lesson with facts about big opportunities in DRAFTING.

Name \_\_\_\_\_ Age \_\_\_\_\_

Address \_\_\_\_\_

City \_\_\_\_\_ Zone \_\_\_\_\_ State \_\_\_\_\_

*The finest of Gifts...*

## ENCYCLOPAEDIA BRITANNICA

**Paint STRIPES with  
New "PAINT PEN"!**

**Straight, Curved or Parallel Lines**

Use like a fountain pen with any color paint to stripe furniture, bikes, autos, model planes, toys, linoleum, wall board. Beautiful clean, crisp results every time. Can't clog or smear. Also use with glue, tempera, textile paint or ceramic under glaze. Paints on wood, glass, plastic, metals, fabrics and paper. Tool complete with tip for 1/16" stripe only \$1.25 post-paid. Other complete tools with following tips, 1/64", 1/32", 3/64", 5/64", 3/32", 1/4" — \$1.75 each. Extra tips 90c each. Entire kit with tool and 7 tips — \$5. A 1/4" tip only \$1.20 each. C.O.D.'s postage collect.

**New! "DOUBLE-STRIPES" 5 Way  
Combination Model only \$3.25**

Double Stripes — one wide and one narrow or two wide or two narrow at the same time.

**FREE** Send postcard for complete information—or ORDER TODAY.



**DEALERS:** Master Paint Stripping Tool in display cartons of 1 doz.

**FAST, PROFITABLE SALES.**

Write for new discounts.

**HOME CRAFTSMEN!** New Paint Stripping Tool gives "professional" results every time, simple, easy to use. Send \$1.25 now.

**MANUFACTURERS:** Write today for information about industrial models and production stripping tools.

**WENDELL MFG. CO., Dept. 320  
4234 Lincoln Ave., Chicago 18, Ill.**



## GIANT BALLOONS

Biggest & best! Surplus US Govt. (new coverage) Neoprene weather target balloons. We've sold for years, buy in confidence.

**FOR FUN**—Great in backyard, at parties, picnics, fairs. Young & old enjoy 'em!  
**FOR ADVERTISING**—Attract big crowds to business openings, civic events, trade shows, exhibitions. Paint 'em with a sales message and they'll pay off for you!  
**FOR PROMS**—Makes any high school or college prom more festive. Real cool!

Approx. inflated sizes.

3 ft. dia., 49c—5 ft. dia., 99c

10 ft. dia., \$1.59—13 ft. dia., \$1.95

Cal. res. add sales tax.

Postage paid on prepaid orders.

**VOLUME SALES CO., War Assets Division**  
3930 Sunset Blvd., Dept. PM856, Los Angeles 29, Calif.

## CABINET MAKING



**LOW COST HOME TRAINING COURSE  
FOR BEGINNERS & ADVANCED CRAFTSMEN**

Make money. Learn skills and secrets of fine woodworking and tool use. Professionally prepared shop method training tells and shows how. Covers everything. Easy to master.

Write for **Free Booklet**  
**INTERSTATE TRAINING SERVICE**  
DEPT. F3, PORTLAND 13, OREGON

## MOTORIZE YOUR BARBECUE!

Easily rigged up by anyone. Handles whole ham or 4 small chickens. Commercial-quality thrust—2 r.p.m. gear-head motor (110V-AC)—spring-tension bronze bearing permits spit removal—

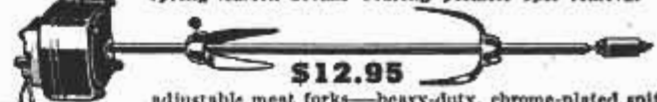

**\$12.95**

adjustable meat forks—heavy-duty, chrome-plated spit. Limited time, introductory offer. Postpaid. (\$13.95 Denver and West).

**B & R SALES CO. — Dept. PM856 — Muncie, Indiana**

## STUDY TO BE A DOCTOR

*of Psychology or Metaphysics*

Obtain a Ps.D., Ms.D., or Ph.D. Be a Teacher, Lecturer or Accredited Practitioner. Teach others how to achieve Health, Happiness and Contentment. Chartered by State. Correspondence Courses only. Write for FREE book telling how.

**THE NOTARIAN FELLOWSHIP**  
Desk B, Pickwick Building Kansas City 6, Missouri

**LAW** Men and women **STUDY AT HOME** for Business Success and **LARGER PERSONAL EARNINGS**, 44 years expert instruction—over 114,000 students enrolled. LL.B. Degree awarded. All text material furnished. Easy payment plan. Send for **FREE BOOK**—"Law and Executive Guidance"—**NOW!**

**AMERICAN EXTENSION SCHOOL OF LAW**  
Dept. H-14, 201 N. Wells St., Chicago 6, Illinois

## BUILD YOUR OWN AIR CONDITIONERS

From Junked Refrigerators for a Few Dollars

**INSTRUCTION BOOKS SHOW YOU HOW... 75c EACH**

"HOW TO BUILD a Low Cost Air Conditioner"

"HOW TO BUILD an Automobile Air Conditioner"

"HOW TO BUILD a Low Cost Home Freezer"

"HOW TO BUILD an Electrostatic Precipitator"

"HOW TO BUILD a Low Cost Dehumidifier"

Complete "Install-It-Yourself" Air Conditioner kits for home and automobile, 2 Ton capacity, Brand New Parts—\$124.40 and up.

**KOOL ENGINEERING CO., Dept. W-8, 3716 Belmont, Chicago 18, Ill.**

**SPECIAL OFFER**

2 Books—\$1.00

3 Books—\$1.50

or all 5 for \$2.00

**FREE!**

Instructions and Literature on kits.

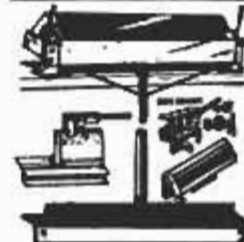

## SHEET METAL BRAKES

Forms angles, locks, pans, etc. Quick eccentric clamp. All steel construction.

15"—16 gauge steel... \$23.50

36"—22 gauge steel... 35.50

48"—24 gauge steel... 52.00

49"—16 gauge Bender... 42.00

12"—12 gauge Bender... 16.00

18 ga. Electric Bench Shear... 48.00

1/4 x 3 Adjustable Bender... 11.50

16 ga. 7" Bench Shear, 3 adj. ga. 16.50

30"—20 gauge Curve Former... 9.50

**ORDER DIRECT OR SEND FOR FREE CATALOG**  
**VYKE MFG. CO., 4158-P Jason St., Denver 11, Colo.**



# Make SURE, SAFE INSULATED ELECTRICAL CONNECTIONS



comes with  
**PRE-INSULATED**



**FREE with Each TOOL**

The New

## SUPER ~~CHAMP~~ Hand Tool

The ONE Tool for ALL Wire Sizes used in Home Wiring, Appliances, Automobiles.

DOES ALL THESE THINGS BESIDES

**CRIMPS** Solderless Terminals and Connectors without solder or tape for safe connections.

**CUTS** Wire, making clean, sharp cut through insulation and Conductor.

**STRIPS** Wire sizes #22-#10. Gauges assure proper length for sure, safe crimp.

**SHEARS** Bolts and screws without damaging threads — no filing or hack sawing.

**ORDER DIRECT — USE COUPON**

Only  
**\$3.95**  
Post Paid

Satisfaction guaranteed or money back. Send check or money order for \$3.95. (Ohio residents add 12c sales tax.)

T. W. Berger, Inc.  
National Distributor Consumers and Dealers  
**AIRCRAFT-MARINE PRODUCTS, Inc.**  
210 AU Mariemont Center Bldg., Cincinnati 27, Ohio

T. W. Berger, Inc.  
National Distributor Champ Tool  
210 AU Mariemont Center Bldg., Cincinnati 27, Ohio  
Send me post paid the new super Champ Hand Tool. I am enclosing \$3.95. (Ohio residents add 12c sales tax.)  
 check  money order

NAME \_\_\_\_\_  
ADDRESS \_\_\_\_\_  
CITY \_\_\_\_\_ ZONE \_\_\_\_\_ STATE \_\_\_\_\_



## MECHANICAL DENTISTRY

To make Crowns, Plates, Bridgework, etc., for Dentists. Easy practical way to learn mechanical dentistry at home in spare time. FULL EQUIPMENT OF TOOLS AND MATERIALS INCLUDED WITH COURSE. Low tuition. Easy terms. Write for FREE BOOK about this money making profession that is not affected by machine age.

McCARRIE SCHOOL OF MECHANICAL DENTISTRY  
207 N. Broad St., Dept. 56, Philadelphia 7, Pa.



## BIG PROFIT making Concrete Drain Tile

Millions of dollars' worth of drain tile are used every year for farm drainage, building construction, reclamation projects, highways, and other purposes. And the big swing is to concrete tile because it's better and costs less. Sales potentials are BIG.

Concrete drain tile is locally manufactured of local materials, for direct selling to local users or contractors. Useless costs—freight, distribution, breakage—are eliminated. While worth more than clay tile, concrete tile can sell for less and still earn a handsome profit.

Tile made on the Champion Machine are strong and uniform. Truly round. All sizes up to 12" diameter. Easy to make because the Champion is simple to operate.

### Get The Champion Facts

Write for the Champion book. Tells about concrete drain tile as an outstanding manufacturing opportunity. Describes the machine and outlines liberal payment terms.

W. E. DUNN MFG. CO.  
522 W. 24th Street, Holland, Mich.



IN CANADA: DUNN MASONRY MACHINERY LIMITED  
970 Dundas Highway, Cooksville, Ont.

## Easier Clothes...

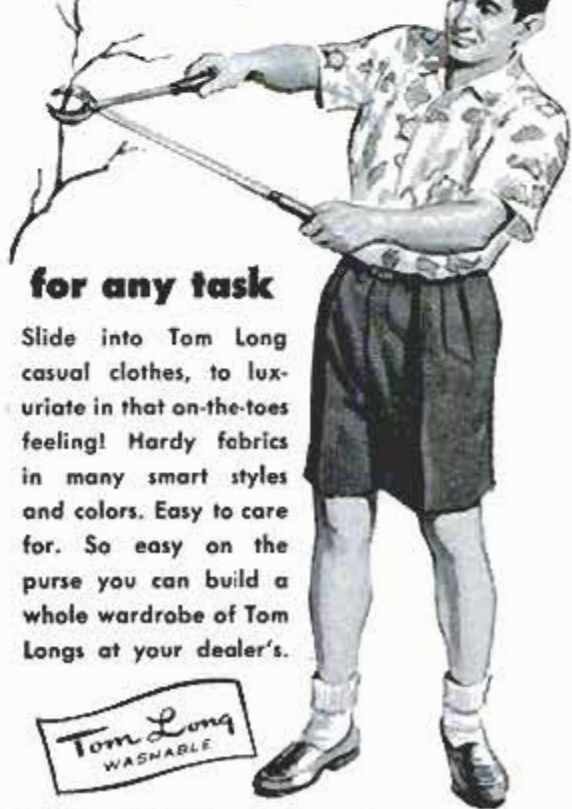

### for any task

Slide into Tom Long casual clothes, to luxurious in that on-the-toes feeling! Hardy fabrics in many smart styles and colors. Easy to care for. So easy on the purse you can build a whole wardrobe of Tom Longs at your dealer's.



**ANVIL BRAND** factories  
HIGH POINT / NORTH CAROLINA  
SINCE 1897



# Inventors

Take these necessary preliminary steps promptly to protect your invention by applying for a United States patent—

Sketch and describe your invention. Sign, date and have this disclosure witnessed by two people who understand your invention. Have us make a preliminary search among U. S. patents already granted for similar types of invention. We then report to you on the probable patentability of your invention and recommend your further course of action.

Write for our instructive booklet, "Patent Protection for Inventors" and our convenient "Evidence of Invention" disclosure form. No obligation.

**VICTOR J. EVANS & Co.** *Merlin M. Evans*  
REGISTERED PATENT ATTORNEY

230-J MERLIN BUILDING, WASHINGTON 6, D. C.



**MEN! TRAIN NOW FOR  
A BIG PAY FUTURE IN  
DIESEL  
& SCIENTIFIC MOTOR TUNE-UP**

- Diesel Construction
- Diesel Engine Repairman
- Diesel Operator
- Industrial Maintenance
- Auto Engine Rebuilding
- Bus & Truck Maintenance

## Be a Trained Diesel Man

Go places with DIESEL! Farms, factories and power plants, trains, ships, trucks, buses all use DIESEL POWER... all need DIESEL-trained men! You can start your DIESEL training at home, in spare time, with tested, proved U E I training. Course includes practical work on Diesel engines under skilled instructors. You learn the operation, maintenance, servicing of all types of Diesel engines, PLUS Scientific Motor Tune-up.

**ACT NOW!** If you have mechanical ability, you'll like Diesel! High School diploma not necessary. Write now for FREE book, "EARNING POWER IN DIESEL." Act Today!



**MAIL NOW FOR FREE BOOK!**

UTILITIES ENGINEERING INSTITUTE, Dept. DC-59  
2521 Sheffield Ave., Chicago 14, Ill. (Founded 1927)  
O. K. I. Rush, without obligation, FREE Book on DIESEL.

NAME \_\_\_\_\_  
ADDRESS \_\_\_\_\_  
CITY \_\_\_\_\_ ZONE \_\_\_\_\_ STATE \_\_\_\_\_  
 Check here for information if under 17.

## FULLY GUARANTEED TIRES COST LESS!

**SPECIAL! DEDUCT 10% ON 4 OR MORE TIRES!**  
Nationally famous FIRESTONE, GOODRICH, U. S. ROYAL, GOODYEAR, and other makes. Every tire selected and inspected for your safety.

**BUY WITH CONFIDENCE FROM PYRAMID TIRE** **WHITE WALL TIRES \$1 EXTRA**

**HIGH GRADE TIRES GUARANTEED 12 MONTHS**

600x16	4.14	700x16	5.14	32x6.8	8.84	825x20	14.24
650x16	4.54	670x15	4.74	32x6.10	10.84	800x20	13.24
650x15	4.34	650x20	7.84	750x20.8	8.54	1000x20	14.14
700x15	4.64	700x20.8	8.94	750x20.10	9.94	1100x20	16.14

**AAA PREMIUM GRADE GUARANTEED 12 MONTHS**

550x15	5.48	700x15	5.98	760x15	5.58	750x20(10)	14.98
600x16	5.28	700x16	6.78	550x17	5.48	825x20	18.68
600x16(6)	6.58	700x16(6)	7.98	600x20	9.78	900x20	18.98
640x15	5.68	750x16(11)	8.98	650x20	10.88	1000x20	19.98
650x16	5.78	800x15	6.88	700x20	12.88	1000x22	21.98
650x16(6)	6.98	820x15	7.48	32x6.8	10.48	1100x20	20.98
670x15	5.98	710x15	6.09	32x6.10	12.48	1000x22	21.98
670x16	6.18	550x18	5.98	750x20(B)	12.98	1100x24	23.98

**MILITARY SPECIAL AA Guaranteed 12 Months—**

900x16	10.99	1000x20	19.98
750x20	10.98	1100x20	21.98

**NEW THREAD GUAR. 12 MOS.**

800x16	8.98
600x16(6)	9.98
700x15(6)	15.95
750x20(8)	24.98

Largest stock of used tires in the East. Thousands of satisfied customers. Write for Free Catalogue.  
**MONEY ORDER OR CHECK WITH ORDER.** **NO C.O.D.'s**

**PYRAMID TIRE CO.**  
1333-35 North 5th St.  
Dept. M., Phila. 22, Pa.

## GIANT FREE CATALOG of OPTICAL BARGAINS

**ASTRONOMICAL TELESCOPE HEADQUARTERS**  
Complete Line of Astronomical Telescopes Paris and Assembled Telescopes. Also huge selection of lenses, prisms, war surplus optical instruments, parts and accessories. Telescopes, microscopes, binoculars, etc. Fresnel Lenses for making Solar Furnace. **SEND ONLY \$1.00** for beginner's 10-lens kit and big instruction booklet Stock 2-B. Ask for FREE catalog H.  
**EDMUND SCIENTIFIC CORP., Barrington, N. J., U.S.A.**

## Free Book on Arthritis And Rheumatism

**HOW TO AVOID CRIPPLING DEFORMITIES**  
Explains why drugs and medicine give only temporary relief and fail to remove the causes; tells all about a specialized non-surgical, non-medical treatment which has proven successful since 1919. Write for this 36-page FREE BOOK today.  
**BALL CLINIC Dept. 756 Excelsior Springs, Mo.**

## Easy to make your own BOWS—ARROWS—EQUIPMENT

Illustrated Hand-Book 84 pgs. \$1, tells you how! Large Colored Catalog \$c—Send for it!  
Ask your dealer for "Stemmler's Archery" (Oldest Mfr. in U.S.A.)  
**L. E. STEMMLER CO.**  
Manorville (Box 1) L. I., N. Y.



## FREE! BOAT KIT CATALOG

14' Model Pictured  
**42 TOP PERFORMING MODELS, 8' thru 18'**  
...from \$39.25 incl. frt.  
Runabouts, Cruisers, Convertibles, Fishing, etc. for every purpose with modern styling, advanced design. No experience necessary, amateurs can easily assemble. Save 1/3 to 1/2 "factory-bull" price!  
**FIBERGLAS, TRAILERS, ACCESSORIES**  
**LUIGER INDUSTRIES, INC. DEPT. 8-B 3404 Lyndale 5 Minneapolis 8, Minn.**



## HAVE A BIGGER—MORE EFFICIENT HOME WORKSHOP

Popular Mechanics **PLANNING YOUR HOME WORKSHOP** shows you how to make use of every inch of space in your work shop; detailed floor plans, wiring layouts and power tool hookups plus actual photographs of famous home workshops you can use as models. Save money by building your own shop furniture. Special Where-to-Buy-It Guide. 450 Illustrations. Cloth Bound. Working Diagrams. Order **\$2.50** your copy today from **POPULAR MECHANICS PRESS 200 E. Ontario Street Chicago 11**





# Like to be an Artist?

Take free Art Talent Test! Find out if you have talent worth training. Demand for artists is increasing— for advertising, cartooning, illustrating. Earnings range up to \$500 a week. Thousands got started by taking this simple Art Talent Test. You take it at home in spare time. Test was developed by professional artists to uncover new talent. Offered free. No obligation. Mail coupon today for your copy!

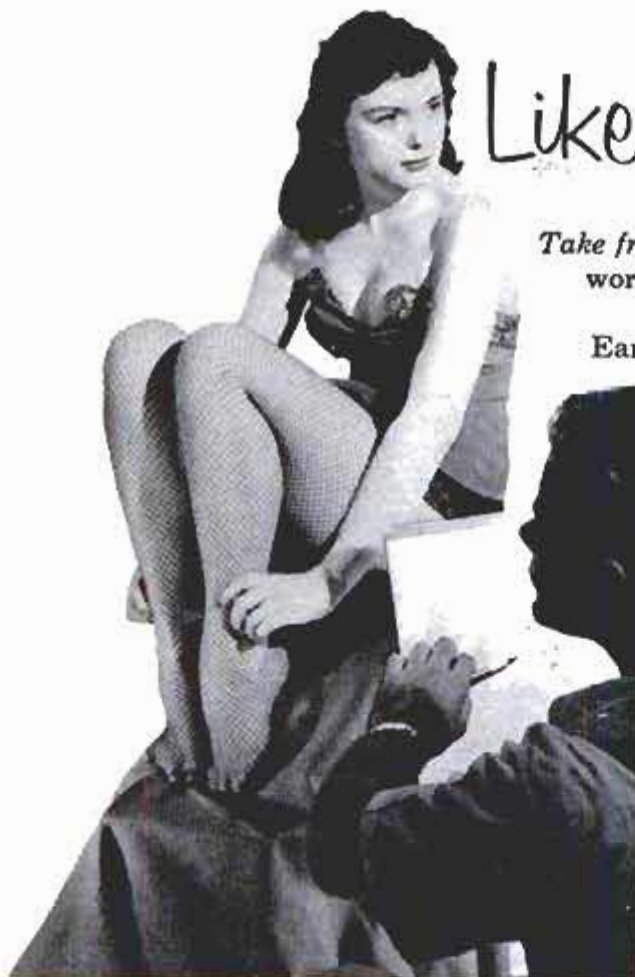

ART INSTRUCTION, INC. • STUDIO 8136  
500 South 4th Street, Minneapolis 15, Minnesota  
Send me your Talent Test, without cost or obligation.  
(PLEASE PRINT)

Name \_\_\_\_\_ AGE \_\_\_\_\_  
Address \_\_\_\_\_ Phone \_\_\_\_\_  
City \_\_\_\_\_ Zone \_\_\_\_\_ State \_\_\_\_\_  
County \_\_\_\_\_ Occupation \_\_\_\_\_

## ... TURN CONCRETE INTO GOLD!



**MAKE UP TO \$75 A DAY  
IN YOUR OWN BUSINESS**

If you want to have your own business — to start a business on your own — here's your big opportunity! New high speed, low cost General block machine produces up to 1,000 concrete blocks a day. Sell all you make to builders, supply houses, and others for homes, factories, buildings, garages. Cash in on the building boom! You can make profits of 100% to 150% — up to \$75. a day! General block machine equipped with 1/2 h.p. electric motor — or can be supplied with gasoline engine — works anywhere, in little space, indoors or out. Operates from ordinary house light socket. Simple, foolproof 3 step operation — so easy a child can do it. Makes superior 3 core blocks any size from 4" to 12". Also makes chimney, sash, corner and other types. Blocks meet any building code anywhere in the country. Materials — sand, water, cement, available anywhere. Simple illustrated operating instructions and mixing formulae for cement and cinder blocks supplied with each machine. Write for FREE folder with full information.

Amazing illustrated

book gives floor plans for 6 sensational concrete block bungalows. Tells how to lay blocks, lay out building lines, mix concrete, build steps, porch and concrete floors all at great savings. Written by experts. Can save many times the cost of the machine! Get it now! No strings attached. Send \$1.

BOOK SENT FREE IF YOU BUY MACHINE.  
\$1 REFUNDED IF YOU BUY LATER.

**GENERAL ENGINES CO.**

DEPT. M-86, ROUTE 130, THOROFARE, N. J.

**MOTOR  
DRIVEN**

R. L. T. of  
New York City re-  
ports: "MY GENERAL  
BLOCK MACHINE  
PAID FOR ITSELF  
IN FIRST 2 WEEKS!"

Hundreds now in  
use the world over!  
Write for FREE details today!

**EXTRA**

**HOW TO  
BUILD  
YOUR OWN  
CONCRETE  
BLOCK  
HOME**  
Only \$1 Prepaid

## Free! SCARCE "TRIANGLE" COLLECTION



Start TODAY to enjoy an exciting new hobby! Get this big, valuable collection of gorgeous, multi-colored triangle shaped postage stamps . . . brought to you from strange and mysterious lands in the wilds of Africa, enchanting Europe, exotic Latin America, etc. All genuine, all-different—picturing man-eating reptiles, jungle birds, action-packed sports, ancient clipper ships; PLUS scarce airmails, fabulous commemoratives, giant and midget-sized stamps. EXTRA! Bargain Catalog, "Collector's Manual" plus other exciting offers for your inspection. Enclose 10c for mailing costs Supplies limited. ACT NOW!

JAMESTOWN STAMP CO. Dept. H8PM JAMESTOWN, N. Y.

RUSH my Free "Triangle" Collection and other offers. I enclose 10c for mailing costs.

Name \_\_\_\_\_

Street \_\_\_\_\_

City \_\_\_\_\_ State \_\_\_\_\_



# Check the Kind of Body You Want



Charles Atlas

...and I'll Prove How EASILY You Can Have It!

Just tell me, in coupon below, the kind of body you want—and I'll give it to you SO FAST your friends will be amazed! "Dynamic Tension," my easy, 15-minutes-a-day method, will make your chest and shoulders bulge... arms and legs surge with power... your whole body feel "alive!"

**FREE BOOK** 32 pages on how "Dynamic Tension" changed me from a 97-pound weakling into "World's Most Perfectly Developed Man"—and how I'll prove it can change YOU too. Mail coupon NOW!

**CHARLES ATLAS, Dept. 88,  
115 East 23rd St., New York 10, N. Y.**

Dear Charles Atlas: Here's the Kind of Body I want:

(Check as many as you like)

- |  |  |
|--|--|
| <input type="checkbox"/> More Weight—Solid—in The Right Places | <input type="checkbox"/> Powerful Arms, Legs, Grip |
| <input type="checkbox"/> Broader Chest, Shoulders              | <input type="checkbox"/> Slimmer Waist, Hips       |
|  | <input type="checkbox"/> Better Sleep. More Energy |

Send me absolutely FREE a copy of your famous book "Everlasting Health and Strength"—32 pages, crammed with photographs, answers to vital questions, and valuable advice. No obligation.

NAME \_\_\_\_\_ AGE \_\_\_\_\_

(please print or write plainly)

ADDRESS \_\_\_\_\_

CITY \_\_\_\_\_ STATE \_\_\_\_\_

## NOW The Short Cut to Learning You've Been Waiting for



### Learn Anything

### FASTER...more easily

with the amazing

### Dormiphonic Memory Trainer

The Scientific Discovery That Works for You... Awake or Asleep

Now, at last, science shows you how to learn "by ear." With Dormiphonic Memory Trainer, you start learning when awake... continue while asleep... save time, effort... learn 20% to 35% faster. So simple a child can operate it—so easy and practical it is used by educators, psychologists, people of all ages and occupations.

Break Down Barriers to Learning

Find out HOW the Dormiphonic Memory Trainer works FOR YOU—how it can help you learn anything in less time, without intensive self-application.

Write for FREE Book, "A New Dimension in Learning," or call for FREE DEMONSTRATION—Get the Scientific Evidence Today.

**MODERNOPHONE, INC.** Circle 7-0830  
236-086 ROCK, PLAZA, NEW YORK 20, N. Y.

Gentlemen: Please send me your FREE Booklet. I am interested in learning more about the DORMIPHONIC Memory Trainer and what it can do for me. No obligation—no salesman will call.

If under 18, check here for Special Booklet A

NAME \_\_\_\_\_

ADDRESS \_\_\_\_\_

CITY \_\_\_\_\_ ZONE \_\_\_\_\_ STATE \_\_\_\_\_

- |   |  |   |
|---|--|---|
| <input type="checkbox"/> My main interest in Dormiphonics is for: | <input type="checkbox"/> Learning a Language | <input type="checkbox"/> Speech Improvement |
| <input type="checkbox"/> Memorization                             | <input type="checkbox"/> Sleep Inducement    | <input type="checkbox"/> School Work        |
| <input type="checkbox"/> Habit Correction                         |  |   |



## CONTRACTORS NEED MEN!

trained to operate Bulldozers, Draglines, Back Hoes, Scrapers and Motor Graders and pay high wages to skilled operators! YOU can make big pay in the construction industry if you learn these skills NOW!

Contractors WANT our graduates.

Write TODAY for FREE School Catalog to

**NATIONAL SCHOOL OF HEAVY EQUIPMENT OPERATION**  
P. O. Box 8243, Dept. D-13 Charlotte, N. C.

## YOU BUILD 'EM — WE SELL 'EM EARN UP TO \$50.00 A DAY AT HOME

Participate in our national sales and sub-contract plan—spare time—full time. You assemble special luggage and cases for photographers, musicians, salesmen, and all types of portables. We supply complete instructions—materials—tools—everything. No previous experience necessary. Free details. Abarsi Casecraft, Dept. AJ, 807 W. Sunset Blvd., Los Angeles 12, Calif.

## WHEELS WHEELS WHEELS

7" Disc Wheel 3/4" Tire 1/2" sleeve	45c ea.
8" Disc Wheel 1 1/8" Tire 1/2" sleeve	70c ea.
7" Disc Wheel 1" Tire 1/2" ball bearing	80c ea.
5" Disc Wheel 1 1/4" Tire 1/2" ball bearing	\$1.00 ea.
6" Disc Wheel 1.50 semi-pneum. Tire 1/2" B.B.	\$1.35 ea.
8" Disc Wheel 2" semi-pneum. T. 1/2" B.B.	\$1.50 ea.
10" Disc Wheel 1.75 semi-pneum. T. 1/2" B.B.	\$1.50 ea.
10" Disc Wheel 2.75 semi-pneum. Tire 3/4" B.B.	\$3.50 ea.
12" Disc Wheel 1.75 semi-pneum. T. 1/2" B.B.	\$1.85 ea.

Above wheel prices includes hub cap. Plus Postage. C.O.D.'s accepted.  
AXLES—Sizes 5/16 in., 3/8 in., 1/2 in.—Cut to size—End holes drilled.

**UNITED WHEEL STAMPING CO.**

12131 S. PEORIA STREET PM-8 CHICAGO 43, ILLINOIS

## ACCORDIONS

Finest Italian makes! Buy direct at Amazing Savings! 5 DAY TRIAL. Low down payment, easy terms. FREE color catalog, lowest wholesale prices. Write today to Accordion Manufacturers & Wholesalers Outlet 2003 West Chicago Avenue, Dept. R-88, Chicago 22, Illinois

Save 1/2

## ROLLER RULE "PENCIL WITH A BRAIN"

Precision made, accurate, handy. Roll it over any surface. Measures curves and straight lines, any shape, any distance. Excellent pencil too.



\$1.49

POST

PAID

A must for architects, engineers, carpenters, plumbers, painters, students, pilots, navigators, etc. Available in inch or nautical measurements. Specify choice. "Your name imprinted in gold—15c extra."

**ROLLER RULE MFG. CO.**

Long Beach 13, Calif.

## Build a Boat for Fun or Profit

Popular Mechanics

# 23 BOATS

You Can Build



### Complete Patterns and Working Drawings

Build the boat you have always wanted. Build it for fun or to sell at a profit. Get Popular Mechanics 23 BOATS YOU CAN BUILD—row boats, canoes, sail boats, power boats and other craft including a 25 ft. cabin cruiser that steps four; 11 1/2 ft. car-top row boat; 8 ft. duck boat; 15 ft. sailing knockabout—in all, 23 of the most popular boats. Book includes more than 500 photos, plans, diagrams and working drawings, plus step by step instruction that anyone can follow. Only simple tools needed. Material list of lumber, hardware, fittings, etc. included. Order today, under money-back guarantee. Only \$2.75 postpaid.

Row Boats, Canoes  
Sail Boats, Power  
Boats and Others



**POPULAR MECHANICS PRESS, Dept. 856, 200 E. Ontario St., Chicago 11**



23 YEARS AT THIS ADDRESS  
TUBE FREE WITH EVERY PASSENGER TIRE  
LOW OVERHEAD—LARGE VOLUME SALES & SMALL PROFITS  
BRING YOU THESE "LOWEST PRICES."

WHAT GOOD IS A TIRE WITHOUT A TUBE?



Guarantees are as reliable as the company giving them. Our Guarantee accepted by the Public with satisfaction for 23 years.

"The Most Protection for the Least Money."

Guarantee Sent With Order

WE WELCOME COMPETITION. NO

ONE CAN TOUCH OUR QUALITY & PRICE!

White Walls \$1.00 Ex. 50 Years of Combined family experience in High Quality tires.

PARTIALLY USED—SEND AD

TAKE THE 10% DISCOUNT WE OFFER & PUT MONEY IN YOUR POCKET!

EVERYBODY 10% off ON EVERY TIRE

12 MOS. WRITTEN GUARANTEE

WE SPECIALIZE IN TRUCK TIRES

Matched Tires Shipped all over

USA and Foreign Countries. IMMEDIATE SHIPMENTS MADE. Depend on STANDARD for SERVICE.

Selected for Toughest Jobs — Prices Shaved to the Bone

600-16	\$5.22	475-19	\$5.32	700-15(H)	\$8.72	700-20	\$11.92
600-16(G)	6.42	640-15	4.92	750-16(H)	9.92	750-20, 10	14.72
650-16	5.42	670-15	5.22	700-17	10.92	750-20(B)	10.92
650-16(G)	6.42	710-15	5.32	750-17	12.92	825-20	18.52
700-16	6.22	760-15	5.42	825-15	15.92	900-20	18.72
750-16(G)	7.42	800-15	5.72	800-20	9.62	1000-20	19.72
850-18	4.82	820-15	5.72	650-20	10.72	1100-20	19.72
850-17	4.72	670-16	5.15	32x6(R)	10.32	1000-22	20.92
850-15	5.22	760-16	7.72	32x6(10)	12.32	1100-24	23.72
700-15	5.32	700-16(G)	7.72	750-15	11.92	1110-22	20.02

"EXTRA SPECIAL" Fully guarantee all size 4-ply pass. FREE TIRE with 2 or more of these. W.W. \$1.00 Extra. \$7.42 EA. Factory Tested Tube given. GIANT TIRE SALE

Thousands of tires shipped all over the U.S.A. All tires shipped F.O.B. Phila. Send Check or M.O. with this ad. Dept. 2. No C.O.D. STANDARD 834 N. Broad St., Philadelphia 30, Pa.

# SHORTHAND in 6 WEEKS

Famous SPEEDWRITING shorthand. 120 words per minute. No symbols; no machines; uses ABC's. Easiest to learn, write and transcribe. Lowest cost. 350,000 graduates. For business and Civil Service. Typing available. 33rd year. Write for FREE booklet to: SCHOOL OF

## Speedwriting

Dept. 1508-6, 55 W. 42 St., New York 36

# LOCKSMITHING

Practical Up-to-Date Course — ONLY \$4.95

53 illustrated self-instruction lessons. Easy to learn. Full price only \$4.95 postpaid—or COD plus postage. Satisfaction guaranteed or full refund! Mail your order today. WELSON HALL CO., 210 S. Clinton St., Dept. HU-2, Chicago 6, Ill.

## POW hunting slingshot

- accurate—powerful—silent
- kills small game, pests
- hits like a rifle

Special: 200 extra steel balls \$1

Used by expert marksmen! 7" hardwood stock, 45 lb. pull. Has double rubber for double power. FREE!—target, extra rubber and big supply heaviest steel balls used by experts. Illustrated catalog. Authorized model of Slingshot Assn.

**\$1.50** postpaid (no cod's)

I. J. STONE Dept. B-8, 1616 Oak St. • Santa Monica, Calif.

# WAR SURPLUS BARGAINS

\$500,000.00 INVENTORY for QUICK LIQUIDATION

Surplus items—hundreds of them for home, shop, factory, farm and outdoor use. New items, used items, reconditioned items—all at tremendous savings—all priced for quick sale.

Page After Page of Values

This big catalog shows page after page of amazing money saving values. Write for your copy today. Send 10c to cover postage, mailing, etc. Write today! SEND TODAY FOR YOUR COPY

**10c**

STARK'S 212 W. Madison St. Dept. PM-568 CHICAGO 6, ILL.

# NATIONAL SCHOOLS

proudly presents

## TELERAMA • ALL 8 BRANCHES OF TELEVISION • ELECTRONICS • RADIO • IN ONE DYNAMIC, MODERN SHOP METHOD, HOME TRAINING COURSE



You get and keep ALL this modern, newest, practical equipment!

\*Registration applied for

YOU COVER ALL 8 BRANCHES IN ONE MASTER COURSE, ONE LOW TUITION

1. Television—including color TV
2. Radio — FM & AM
3. Industrial electronics
4. Sound recording and Hi-Fidelity
5. Preparation for FCC License
6. Automation
7. Radar & Sonar
8. Communications

- Parts to build a modern TV set, including large screen Picture Tube.
- Parts to build a powerful Superhet Receiver, standard broadcast and short wave.
- Parts to conduct many experiments and build — • Continuity Checker • RF Oscillator • TV Circuits • Audio Oscillator • TRF Receiver • Signal Generator
- Professional Multitester
- A MUST for all technicians

FOR MEN WHO WANT TO EARN MORE MONEY! Another great advance in Home Study Training. Let National Schools, of Los Angeles, a practical Technical Resident Trade School for over 50 years, train you at home by Shop-Method, for today's unlimited opportunities in ALL 8 BRANCHES of the Television, Electronics, Radio industry.

YOU DO MANY PRACTICAL JOBS — including servicing, circuit analysis. Build a modern TV set from ground up, with equipment kits we send you, including a new large-screen picture tube and professional Multitester, at no additional charge. You receive an experiment lesson with each kit.

EARN AS YOU LEARN. Many of our students earn their entire tuition and more in Spare Time jobs we show them how to do while learning. YOU GET GRADUATE ADVISORY SERVICE, TOO.

SEND FOR FREE FACT-BOOK AND FREE SAMPLE LESSON! Mail coupon now to office nearest you.

NATIONAL SCHOOLS  
4000 S. FIGUEROA ST., LOS ANGELES 37, CALIF.  
187 N. LA SALLE ST., CHICAGO 1, ILL.  
IN CANADA: 811 W. Hastings St., Vancouver, B. C.

# NATIONAL SCHOOLS

TECHNICAL TRADE TRAINING SINCE 1905  
Los Angeles, California

GET FAST SERVICE — MAIL NOW TO OFFICE NEAREST YOU!

NATIONAL SCHOOLS, DEPT. RR-86  
4000 S. FIGUEROA ST., LOS ANGELES 37, CALIF. OR 187 N. LA SALLE ST., CHICAGO 1, ILL.

Rush free TV-Radio "Opportunity" Book and sample lesson. No salesman will call.

NAME \_\_\_\_\_ BIRTHDAY \_\_\_\_\_ 19 \_\_\_\_\_

ADDRESS \_\_\_\_\_

CITY \_\_\_\_\_ ZONE \_\_\_\_\_ STATE \_\_\_\_\_

VETERANS: Give Date of Discharge \_\_\_\_\_



# BIG VALUES IN ALLIED'S

## LATEST TV-RADIO SUPPLEMENT

**FREE** Send for it



**Bargains for Experimenters, Builders, Amateurs, Servicemen, Hi-Fi Fans**

Send for our latest Supplement packed with big values and new releases in builders' kits, High Fidelity systems and components, P.A. systems, recorders, test instruments, TV accessories, electronic parts, tubes and tools. Make your selections from the world's largest stocks at money-saving prices!

### ALLIED RADIO

100 N. Western Ave., Dept. 5-H-6  
Chicago 80, Illinois

Send for **FREE** supplement

**ALLIED RADIO**



For **CRAFTSMANSHIP AND TOP VALUE**

*Look*  
for these

### "DEE-CEE" FEATURES

- Finest quality fabrics
  - Cut-for-comfort-styling
  - Handsome colors
  - Trim, 6-button fronts
- "Dee-Cee" quality costs no more. Insist on "the brand that covers the land."



WASHINGTON MANUFACTURING CO.  
NASHVILLE, TENNESSEE

Our Garments made in U.S.A. by Americans

## Try your hand as an artist



If you like to draw — you may have talent worth training for a fascinating, money-making art career — spare or full time. Send for 8-page talent test. Men and women who show talent on test are eligible for remarkable home-study art training created by America's 12 Most Famous Artists (Norman Rockwell, Jon Whitecomb, Al Dorne, etc.). Thousands paid \$1 for test. Now it's FREE. No obligation. Send name, address, age to: Famous Artists Schools, Studio 6-H, Westport, Conn.

### FULL SIZE MODEL KITS!



**\$5.95**

The original kit. Just out! Now 9 authentic models for den or game room. Wood with machine work done for you. Process for gun metal finish. Order direct or send 15c for interesting, revised catalog.

For NEW illustrated catalog of 9 models...Send 15c to:  
O'BRIEN GUNCRAFT (D), P.O. BOX 657 MADISON, WIS.

### Finish HIGH SCHOOL AT HOME

Complete 4 Yrs. in 12 Months

Learn More! Earn More! Enter professional or technical schools. Advance Socially. Live a Happier, Fuller Life. Individual Courses or complete schedule. **WRITE FOR SCHOOL BULLETIN.**

### ACADEMY FOR ADULTS

30 W. Washington, Dept. PM-86, Chicago, Ill.



### DEVELOP A HE-MAN VOICE!

Write for FREE book "How to Strengthen Your Voice for Greater Success" by Eugene Feuchtinger. No obligation. Book will be mailed at once in plain wrapper, postpaid. Just send your name and address. State age. **PERFECT VOICE INSTITUTE, 210 S. Clinton St., Studio NU-2, Chicago 6, Ill.**

## YES! SEND



directly  
to my door  
every month

I am enclosing

- \$3.50 for 1 year  
 \$8.00 for 3 years

name \_\_\_\_\_

address \_\_\_\_\_

city \_\_\_\_\_

zone \_\_\_\_\_

state \_\_\_\_\_

A-86

Hand this order to your newsdealer or send it to

**POPULAR MECHANICS**  
200 East Ontario St. Chicago 11, Ill.



# FREE! GRACE KELLY STAMPS!



*Sensational Get-Acquainted Offer!* FREE—from fabulous Monaco . . . you get this unique set of beautiful genuine postage stamps picturing famous Hollywood film star *Grace Kelly*, the glamorous new Princess . . . AND a generous collection of valuable, all-different

Monaco postage stamps—giant commemoratives, dazzling pictorials, multi-color triangle shapes. Spectacular stamps picturing the fascinating dream inventions of Jules Verne; racing trains, boats, mammoth helicopters, wild animals, many others. **EXTRA!** Other exciting offers: 64-page Collectors Guide, Big Bargain Catalog of all U. S. Postage Issues. Send 10c to help cover mailing expenses. Act Now! **HARRIS, 2780 TRANSIT BLDG., BOSTON 17, MASS.**

## It's Easy to PLAY the GUITAR

Learn at Home with  
My Studio Method  
on Records

Play the  
Very First Day

**NOW**—learn by the method that made top-billed musicians of many of my pupils. Lessons on records with text, music, and a fine steel strung, professional guitar FREE with course. Write to me, **SID MARGOLIS** (formerly with CBS, NBC, name bands, etc.) c/o **THUNDERBIRD STUDIOS**, Dept. EM-701, Valley Stream, N. Y.

**FREE MUSIC OPPORTUNITY BOOK**

No obligation! Write today!

## Learn ACCOUNTING Business Administration

Bookkeeping, secretarial and allied subjects at home in your spare time or attend nationally approved resident school. Write for **FREE Success Book** giving complete details on courses, plans, rates and employment opportunities. G.I. approved. Write Dept. A.



Hills

**BUSINESS UNIVERSITY AND EXTENSION SCHOOL**

619 W. MAIN ST. OKLAHOMA CITY 2, OKLAHOMA

## TELEVISION NEEDS TRAINED MEN

Train AT HOME for a top-pay job or your own business. No experience needed. "Learn by doing" with 15 big radio-TV kits, including TV receiver. Licensed by N.Y. State; Approved for Veterans. Write for **FREE BOOK & SAMPLE LESSON, RADIO-TELEVISION TRAINING ASSOCIATION**, Dept. MB-C, 52 E. 19th St., N. Y. 3, N. Y.

## It Pays to be TALLER

You can be impressively taller, increase your business & social potential. Staturaid shoes help you win new heights in life. Choose elevation you desire, in 35 smart styles. Free Catalog P-2. **BURGER CO.**, 433 E. 148 ST., NEW YORK 55, N. Y.

## ★ WORK FOR UNCLE SAM ★

U. S. GOV'T. JOBS! AS HIGH AS \$4,525.00 YEAR TO START. Men, women, 18-55. Experience often unnecessary. Write immediately for **FREE 36-PAGE BOOK** with list of many positions, salaries, sample tests, and full particulars telling how to qualify for them. (Not Gov't. Controlled)

Franklin Institute, Dept. W-93, Rochester 4, N. Y.

## Say You Saw It in POPULAR MECHANICS

250 POWER . . . .



Complete Telescope Lens Kit only \$3.49 postpaid

Conquer Space, Explore the Universe, Planets, Moon Craters, New Stars, etc. Complete Lens Kit consists of 80 inch focal length ground and polished objective lens, eyepiece lenses for 50 POWER, 100 POWER, 150 POWER, 200 POWER, 250 POWER, and all necessary lens fittings. Easy to make from simple step by step instructions. (Tripod and mount not included.) Money back guarantee.

**BUSSE SALES CO., Hartford 1, Conn., Dept. PM 48**

# DIESEL MECHANICS IN DEMAND



Learn to earn big pay in **DIESEL** in our large, modern equipped Chicago school and shop. No previous experience or training necessary. We help you find living quarters and part time job while in school. Complete, practical courses taught in the following trades, under the supervision of experienced, expert technicians.

APPROVED FOR CIVILIANS  OR GI'S

### — CHOOSE YOUR TRADE —

CHECK HERE	WEEKS
<input type="checkbox"/> DIESEL MECHANICS	20
<input type="checkbox"/> AUTO MECHANICS	20
<input type="checkbox"/> BODY & FENDER	16 $\frac{2}{3}$
<input type="checkbox"/> GAS-ARC WELDING	4 - 12
<input type="checkbox"/> REFRIGERATION	13 $\frac{1}{2}$
<input type="checkbox"/> AIR CONDITIONING	8 $\frac{1}{3}$
<input type="checkbox"/> MACHINIST TRADE	30
<input type="checkbox"/> ADVANCED MACHINIST (includes tool & die)	32 $\frac{1}{2}$
<input type="checkbox"/> PIANO TUNING & REPAIR	36

### CHOOSE YOUR ENGINEERING COURSE

These courses are intended as terminal education for men who wish to enter the Diesel-Automotive and Refrigeration-Air Conditioning fields as technicians. These courses are designed to prepare men for supervisory positions. Students with a high school education, or equivalent, will be accepted.

<input type="checkbox"/> DIESEL AUTOMOTIVE ENGINEERING	2 years
<input type="checkbox"/> REFRIGERATION & AIR COND. ENGINEERING	18 months

### FREE EMPLOYMENT HELP

Start your career with Greer by checking your interest above and mail coupon for complete information at no obligation.

NAME \_\_\_\_\_ AGE \_\_\_\_\_

STREET \_\_\_\_\_

TOWN \_\_\_\_\_ ZONE \_\_\_\_\_ STATE \_\_\_\_\_

Established 1902 — Over 50,000 Graduates.  
54 years of continuous trade school experience to guide your training.

## GREER SHOP TRAINING

Box H, 2236 S. Michigan Ave.  
Chicago 16, Illinois



# Make \$500 an Hour CASH PROFIT THE DAY YOU START!



## START YOUR OWN BUSINESS AT HOME... SHARPEN HOUSEHOLD, GARDEN AND SHOP TOOLS IN SPARE TIME

Now you can turn spare time into Big Cash Profits with new Belsaw Sharp-All. Sharpen knives, scissors, shears, snips, ice skates, mower blades, hedge trimmers, grass whips, axes, chisels, screw drivers, scrapers and saws... just about any household, garden and shop tool. Your own CASH business with no inventory. No calls to make. No experience needed.

Learn how easily you can start your own spare time business. Amazing low cost easy-payment plan. Send postcard for FREE BOOK.

### BELSAW SHARP-ALL CO

717 Field Bldg. Kansas City 11, Missouri



## THE MASONIC CASUALTY COMPANY

OFFERS

ACCIDENT—HEALTH—HOSPITALIZATION  
INSURANCE AT COST



- Non Cancellable
- Benefits Not Prorated
- No Medical Examination
- No Paid Agents
- Coverage On or Off the Job

FIRST 3 MONTHS PROTECTION FOR MEMBERSHIP FEE \$2.00

FOR MASONS ONLY under 56 yrs. of age

WRITE AT ONCE

THE MASONIC CASUALTY COMPANY

80 BOYLSTON STREET, Dept. P-8, BOSTON 16, MASS.  
NO AGENT WILL CALL

## TASOPE PHOTO-ENGRAVING PLANTS



Material Cost  
Of This Cut 3/4c  
Selling Price  
\$1.00 And Up

Establish your own profitable PHOTO-ENGRAVING business. Make cuts for newspapers, printers, and advertisers. Make etched name plates, plaques etc. Instructions furnished, no experience necessary. Sold direct from factory since 1931. First five hundred cuts sold locally or by mail will pay for plant and pay you well for your time. Write for FREE catalog.

TASOPE, DEPT. PM-8, AURORA, MO.

## MEN WANTED

Earn \$100 Per  
Week and up

AUTO DIESEL  
MECHANICS

Master a trade with a future—learn Auto-Diesel mechanics in our shops. You learn with tools on real equipment. Earn while you learn. Many of our graduates earn \$100 per week and up. No previous experience necessary. Day and night courses. Approved for veterans. Write for free bulletin.

NASHVILLE AUTO-DIESEL COLLEGE

226 7th Ave., N., Dept. 75

Nashville 2, Tenn.



"Use My TESTED SALES  
PLAN to make an extra  
\$50.00 every week!"

Says CHARLES CHESTER EATON, JR., President  
Charles Chester Shoe Company

JUST A FEW HOURS EACH WEEK — evenings, weekends, — can add \$50 to \$100 to your regular income. Be a factory representative for CHARLES CHESTER exclusive patented air-cushion shoes — bring wonderful new comfort to friends, neighbors, co-workers! A full line of dress, work, leisure shoes for all the family sold only direct from factory to wearer at low factory prices.

### YOUR OWN BUSINESS WITH NO INVESTMENT!

No deliveries, no collections — we supply everything you need. You collect advance cash deposit from your customers — we do the rest — and you earn extra profit-sharing cash bonus monthly!



AIR  
CUSHION  
SHOES

### STEADY AUTOMATIC REPEAT BUSINESS!

Satisfied customers reorder regularly! CHARLES CHESTER representatives offer more than 160 styles, in a tremendous size range: 1 to 18, AAA to EEE. No experience needed — our tested, proven Sales Plan shows you how! Write today for details and FREE SALES KIT!

CHARLES CHESTER SHOE COMPANY  
20. Foundry St., Brockton, Mass.



## Every Boy Should Have This Build-It-Yourself Book for Boys!

It's natural for boys to want to make things—to fuss with tools—to fashion the kind of things "kids" want. So give boys the Build-It-Yourself Book for Boys. Encourage a youngster to express himself through the sensational new Popular Mechanics book that shows how to make 56 different things every boy dreams about. It covers science, mechanics, electricity, modeling and other fields. 192 pages of easy-to-follow instruction and 469 how-to-do-it pictures.

### 56 Toys, Games, Gadgets, Models, Boats, Electrical Devices, Cars and Other Things Boys Can Make at Home

How to make—Airplane Models, Truck, Squirrel Gun, SS United States Model, Surfboard, Tank Houses and Shelter, Boats, Bob-sleds, Boomerangs, Cannon Toy, Electric game, Electric Motors, Garage Toy, Helicopter Toy, Hunting Knife, Hydroplane Model, Kites, Log Cabins, Marble Game, Microscope, Printing Press, Radio Sets, Rafts, Railroad Modeling, Shooter, Scooter, Sidewalk Cars, Sprinkler

Toy, Taxidermy, Telegraph Set, Telephone, Tree House, Water Skis, Weather Instruments, Toboggan, Worktable. Build-It-Yourself for Boys sent postpaid for \$2.50 or COD, charges additional. Money refunded if you are not pleased after 5 days' use. Mail order to address below.

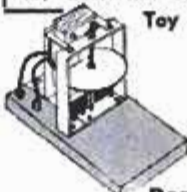

Toy motors



Boomerangs



"Ju-be"—the punt.

POPULAR MECHANICS PRESS  
Dept. 856, 200 E. Ontario St., Chicago 11

POPULAR MECHANICS



**41 YEARS** 1 generation of the **BLATT** family famous in **TIRES**

**Foolish to Pay More — Dangerous to Pay Less!**  
If only you were here in Phila. to SEE our FAMILY-SAFE tires, worn very slightly. YES, a guarantee IS only as good as the Company, that's why **BLATT** offers a **FAST, FREE REPLACEMENT** guarantee within **12 MONTHS** on any defective tire, frt. excl. An **HONEST** written guarantee. Choose your favorite brand, we'll always try to ship your selection. Not recaps or retreads.

**GOOD YEAR** **Firestone**

U.S. Goodrich, General, Atlas, Lee & others.

**FREE** This pictured tire ash tray given with 2 or more tires!

**12 MONTHS TIRE GUAR. & FREE TUBE WITH EACH TIRE**

**SPECIAL TAKE 15% OFF THESE PRICES.**

ANY 16" \$4.98	800-15 \$4.98	750-20 \$9.62	700-17 \$10.12
640-15 4.88	820-15 4.98	750-20 (10) 15.12	750-17 10.32
670-15 4.88	Specialist in 825-20 17.52	600-16 (6) 5.42	
710-15 4.88	N.D. Truck Tires 900-20 18.52	650-16 (6) 6.22	
700-15 4.88	600-20 \$9.62	1000-20 18.22	700-16 (6) 8.02
760-15 4.88	550-20 9.82	1100-20 18.22	700-15 (6) 8.02
Whites \$1. Extra	700-20 8.72	1000-22 19.22	750-16 10.12

**SPECIAL OFFER FREE Tube!** Our entire stock of very slight-order today! **EXTRA MILEAGE \$7.52**

**TOP GRADE Tires** (Written Insurance Guarantee). Buy 2 or more tires, get an extra tire FREE. Not recaps or retreads. \$1. extra for W.W. All Popular Brands.

**MILITARY MUD-GRIP TIRES**  
AA Guar. 6 Mos. AAA 12 Months  
900-16 \$9.59 900-18 \$13.99  
750-20 10.59 750-20 17.99

**MARVIN & Spring Garden Sts.**  
**BLATT 6th Philadelphia Pa.**

**ENGINEERING DEGREE IN 27 MONTHS**

**INDIANA TECHNICAL COLLEGE**

B. S. DEGREE, Aero-nautical, Chemical, Civil, Electrical, Mechanical and Electronic Engineering (inc. Radio and TV). Drafting, One-year. Low rate. Earn board. Large industrial center. Students from 48 states, 21 countries. Demand for graduates. G.I. Government approved. Enter September, December, March, June. Write today for catalog. 1686 E. Washington Boulevard, Fort Wayne 2, Indiana.

**REPAIR ANY WATCH**

**... Swiss or American**

Unique Swoozy System starts you making repairs right away. Develops your skill step-by-step. Teaches modern methods... professional short cuts. Learn by personal attendance or spare time home study. Approved for veterans. Free Sample Lesson. No obligation. Write today!

**CHICAGO SCHOOL OF WATCHMAKING**  
2330 Milwaukee, Dept. 186, Chicago 47, Ill.

**SALE—MAGNESIUM 15 X 65** Regularly \$69.50 Save \$19.55

Tremendous power. Brings objects 15 times closer! Wide field (61mm objective lens... almost 3" across! Easy to hold—focus, 39 oz. 1 8 1/2 "x 9". Exclusive with UNITED.

Regularly \$69.50. **SALE \$49.95**

**PRICE FOR THIS SALE ONLY \$49.95** including case, straps! Made in Japan. USE 30 DAYS. If not satisfied return for refund.

**UNITED BINOCULAR CO., 8043 S. Western, Dept. ARF-608, Chicago 20. DEALERS WANTED.**

**CENTER FOCUS**

**I'LL PAY YOU \$30 PER HOUR TO ASSEMBLE THIS 2 1/2 H. P. OUTBOARD**

"Assemble this first quality full 2 1/2 horsepower outboard motor yourself in two hours and save \$60 off its regular \$119.95 value. All you need is a screwdriver and crescent wrench and you'll have a sleek, smooth-running powerhouse that will let you cruise or troll any 10, 12 or 15 ft. fishing or pleasure craft, and your cost will be less than half any other 2 1/2 H.P. outboard on the American market or your money back! Absolutely all precision parts including gaskets and spark plug. All you do is add fuel. Complete step-by-step plans. Instructions. **PLATINUM:** Air cooled, 2 1/2 hr. cruising, 1 to 8 M.P.H. speed. Full pivot, forward and reverse, double transom clamps. Weight: 22 lbs. All parts warranted. It's brand new and a fine product. Try it and let me know how you like it."

Frank E. Williams, Pres.

**CONTINENTAL SPEED KIT (complete).....\$59.95**

\$20 dep. for C.O.D. Shipped F.O.B. Culver City, Calif. resid. add 4% state tax.

**CONTINENTAL MANUFACTURING CORP.**  
Washington Blvd. at Motor Avenue, Culver City 3, Calif.

**Read AUDELS MECHANICS GUIDES for profit**

**15 MINUTES A DAY**

DISELS BLUEPRINTS PLUMBING WELDING MASONRY MACHINE SHOP BOILERS SHIPBUILDING REFRIGERATION STEAM ENGINES PAINTING SHEET METAL CARPENTRY MATHEMATICS RADIO DRAWING

Every Mechanic can Step Up his Skill with AUDELS GUIDES. Containing Practical Inside Information in a Handy Form. Covers facts and figures of your Trade. All illustrated and explained. Books sent to you for 7 DAYS FREE EXAMINATION. Send No Money Nothing to Pay Postman. Check Books Wanted — Mail Today.

**MAIL ORDER**  
**AUDEL, Publishers, 49 W. 23 St., New York 10, N.Y.**

Please send me for FREE EXAMINATION books marked (x) below. If I decide to keep them I agree to mail \$1 in 7 Days on each book or set ordered and further mail \$1 monthly on each book or set until I have paid price, otherwise I will return them.

- HOME APPLIANCE SERVICE GUIDE, 800 Pages \$4
- AUTOMOBILE MECHANICS GUIDE, 1664 Pages . 4
- TRUCK & TRACTOR GUIDE, 1299 Pages . 4
- DIESEL ENGINE MANUAL, 575 Pages . . . 2
- MACHINISTS HANDY BOOK, 1650 Pages . . . 4
- WELDERS GUIDE, 600 Pages . . . . . 1
- BLUE PRINT READING, 440 Pages . . . . . 2
- MATHEMATICS & CALCULATIONS, 700 Pages . 2
- SHEET METAL PATTERN LAYOUTS, 1100 Pages 4
- SHEET METAL WORKERS HANDY BOOK, 388 Pgs. 1
- MECHANICAL DRAWING GUIDE, 160 Pages . . 1
- MECHANICAL DRAWING & DESIGN, 480 Pages . 2
- TELEVISION SERVICE MANUAL, 434 Pages . . 2
- RADIOMANS GUIDE, 1080 Pages . . . . . 4
- ELECTRONIC DEVICES, 216 Pages . . . . . 2
- ELECTRIC MOTOR GUIDE, 1000 Pages . . . . . 4
- WIRING DIAGRAMS (Light & Power), 272 Pgs. 1
- ELECTRICIANS EXAMINATIONS, 250 Pages . . 1
- ELECTRIC POWER CALCULATIONS, 425 Pages . 2
- HANDY BOOK OF ELECTRICITY, 1440 Pages . . 4
- ELECTRIC DICTIONARY, 9000 Terms . . . . . 2
- ELECTRIC LIBRARY, 7000 Pages (12 Book Set) 18
- REFRIGERATION & Air Conditioning, 1280 Pgs. 4
- MILLWRIGHTS & MECHANICS GUIDE, 1200 Pgs. 4
- POWER PLANT ENGINEERS GUIDE, 1500 Pages 4
- ENGINEERS & FIREMANS EXAMS, 525 Pages . 1
- PUMPS, Hydraulics & Air Compressors, 1658 Pgs. 4
- OPERATING ENGINEERS LIBRARY (3 Books) . . 9
- CARPENTERS & BUILDERS GUIDES (4 Book Set) 6
- PLUMBERS & Steamfitters Guides (4 Book Set) 6
- MASONS AND BUILDERS GUIDES (4 Book Set) 6
- PAINTERS & DECORATORS MANUAL, 450 Pgs. 2
- HOUSE HEATING GUIDE, 1000 Pages . . . . . 4
- OIL BURNER GUIDE, 384 Pages . . . . . 1

**Check NOW!**

You Can Look Over Any Guide In Your Own Home

Start the Easy Payments If Satisfied

**MAIL THIS TODAY**

Name \_\_\_\_\_

Address \_\_\_\_\_

Occupation \_\_\_\_\_

Employed by \_\_\_\_\_

**PEE WEE BATTERYLESS "LIFETIME" RADIO**

**REALLY WORKS — FOR LIFE!**

Works WITHOUT TUBES, BATTERIES, OR ELECTRICAL PLUGGING! World's smallest, SMALLER THAN A PAIR OF CIGARETTES! GUARANTEED TO RECEIVE LOCAL RADIO STATIONS ANYTIME—ANYWHERE YOU GO! Sensational new Ferrite Selective Tuner — Perma-Crystal diode, Super SPEAKERPHONE, turnable black and gold plastic case.

**SEND ONLY \$2.00** (bill ck. mo) and pay postman \$4.99 COD postage on arrival or send \$6.99 for postpaid delivery. SENT COMPLETE, READY TO LISTEN WITH LIFETIME GUARANTEE. Nothing extra to buy — ever. Available only from: MIDWAY COMPANY Dept. WPM-R KEARNEY, NEBRASKA



# WANT HIGH PAY and STEADY WORK?

Get into

## DIESEL

### AND HEAVY EQUIPMENT

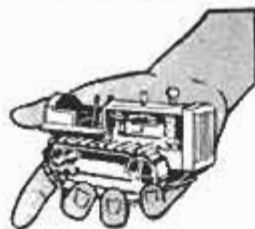

Right now—TODAY—men are needed for training in the Diesel and Heavy Equipment field, and demands are growing! If you are mechanically inclined . . . earning less than \$125.00 per week, find out how you can qualify in:

- DIESEL MECHANICS
- DIESEL PARTS
- DIESEL OPERATION
- DIESEL SALES

Remember, Diesel is high pay . . . is steady work . . . is specialized . . . is growing! You owe it to yourself and your family to get all the facts!

MAIL THIS COUPON TODAY!

We will give you complete details about possibilities for you in the Diesel and Heavy Equipment field, without cost or obligation. Fill in the information below, or write at once to:

**TRACTOR TRAINING SERVICE, INC., Dept. PM-4**

1525 E. 53rd St., Chicago 15, Illinois or  
3334A Bloor St., West, Toronto 18, Canada

Gentlemen: I would like all the facts about opportunities for me in Diesel.

NAME \_\_\_\_\_ AGE \_\_\_\_\_

ADDRESS \_\_\_\_\_

CITY & STATE \_\_\_\_\_

# LEARN UPHOLSTERY

in your spare time  
run your own  
business  
AT HOME



**FREE  
BOOK**  
with  
sample  
lessons

with course



YOU MAKE  
SLIPPER  
CHAIR



CLUB  
CHAIR



OTTOMAN

PLUS  
SLIP COVERS  
Yours to Keep  
or Sell

### BE YOUR OWN BOSS

Earn more from the start! Set up your own profitable business. In your own home, enjoy steady income, independence for life—in the booming field of Custom Furniture Upholstery. Right off you start learning with tools, complete frames, fabrics and materials, included FREE with your UTS course. You learn skilled professional custom upholstery, reupholstery, furniture finishing, repairs, how to make beautiful slip covers, window cornices, cushions and draperies. **EARN WHILE YOU LEARN**, in your spare time . . . the UTS easy way.

**FREE illustrated book, with sample lessons** Get ready for well-paid job and big profits, from steady work, as your own boss, running your own business. Mail coupon NOW! Training in N. Y. School also available.

APPROVED FOR VETERAN TRAINING

UPHOLSTERY TRADES SCHOOL  
Dept. EM-310, 721 B'way, N. Y. 3, N. Y.

Send me **FREE** book "Your New Way to a Successful Career," and **FREE** sample lesson. No obligation—no salesman will call.

Home Study  N. Y. School Training

Name \_\_\_\_\_ Please Print Plainly

Address \_\_\_\_\_

City \_\_\_\_\_ Zone \_\_\_\_\_ State \_\_\_\_\_

Check if Korean Veteran

## FILMS DEVELOPED ½ PRICE

ONLY 40¢ A ROLL FOR 8 EXPOSURES, 12 EXPOSURES . . . 55¢. STOCK UP WITH 3 ROLLS NAME BRAND FILM . . . 99¢. COLOR AT EQUALLY LOW PRICES. FILM DEVELOPED AND RETURNED SAME DAY RECEIVED. MONEY-BACK GUARANTEE + NEW ROLL OF FILM IF NOT SATISFIED.

Please find \$ \_\_\_\_\_ for:  
 developing \_\_\_\_\_ rolls of film  
Please send \_\_\_\_\_ rolls of name brand film  
 127  620  120  116  616  
 Please send free mailing envelope & price list  
PHOTO WHIZ • Hillside Manor 10, L. I., N. Y.

## LEARN PLASTICS



### COMPLETE LOW COST SHOP METHOD HOME TRAINING NOW AVAILABLE

Get in on Big Money opportunities in Plastic molding, casting, forming, carving, etc. Earn as you learn with Interstate's professionally prepared course. All plastic materials furnished.

WRITE FOR FREE BOOKLET **INTERSTATE TRAINING SERVICE**  
DEPT. C-3, PORTLAND 13, OREGON



## DOLLARS for 18¢?

Yes, buy U. S. \$1.00 values for 18¢ abroad. Get new, big profit mail order plan proved by 100,000 cash orders shipped from overseas. You carry no stock. Full or part time—even from home. Export and travel abroad opportunities too. Details with bargain import examples **FREE**. Write MELLINGER CO. Dept. F258 1717 Westwood, Los Angeles 24, Calif.



## GROW ORCHIDS AT HOME

**BIG PROFITS**  
SPARE OR  
FULL TIME

World's most thrilling hobby—profitable home business. Single Orchid plant may multiply into many—each as valuable as the first. Successful home grower shows you how! Raise gorgeous Cattleyas, Cymbidiums, Epidendrums, on living-room table. Big-profit orders come from friends, neighbors, florists, etc.—also Mail Orders. Illustrated secrets of the experts in simple "show-how" language AND blooming-size Orchid plants sent at **NO RISK**. Everything you need to start—for pleasure or profit. **FREE**—full details—**SEND NO MONEY**. Write today. TROPICAL FLOWERLAND, Dept. 318, 4622 Wilshire, Los Angeles 5, Calif.

## "YOU ARE UNDER ARREST!"



### Help Bring Crooks to Justice Through Scientific CRIME DETECTION!

We have taught thousands this exciting, profitable, pleasant profession. Let us teach you in your own home. Learn Fingerprinting, Firearms Identification, Police Photography, Secret Service Methods thoroughly, quickly, at small cost. Over 800 of all American Bureaus of Identification employ I. A. S. students or graduates. Write stating age, for "Blue Book of Crime."

(A Correspondence School Since 1916)

INSTITUTE OF APPLIED SCIENCE, 1920 Sunnyside Ave., Dept. 135C, Chicago 40, Ill.

SAY YOU SAW IT IN  
POPULAR MECHANICS

## 100 BEST Woodworking Projects



### SELECTED FOR YOU BY POPULAR MECHANICS EDITORS

Enjoy the fun—the pride—of making things. Get 100 BEST WOODWORKING PROJECTS, complete with simplified instruction, plans, diagrams and more than 400 how-to-do-it pictures. Make all kinds of furniture, baby carriages, clocks, lamps, book shelves, fireplaces and other useful articles at little or no cost. Send only \$2.00 with name and address. Money back if not pleased.

POPULAR MECHANICS PRESS, Dept. 856, 200 E. Ontario St., Chicago 11

POPULAR MECHANICS



**Free! NORTH AMERICA PLUS  
87 FOREIGN FLAG STAMPS!**



**SENSATIONAL GET-ACQUAINTED OFFER**  
For stamp collectors and EVERYONE seeking an exciting new hobby. Get this big valuable collection of genuine, all-different postage stamps from Greenland (North Pole!), St. Pierre, Newfoundland, Alaska, Confederate States commemorative Sensational Canada picturing walrus, rare whooping crane, Eskimos, Indians, scarce 1851 train stamp. United States: ancient 19th century; spectacular commemoratives—first Holy Bible, bucking broncos, wild west, etc. **PLUS 87 gorgeous flag stamps of 87 different foreign countries!** **EXTRA!** Searce U. S. Telegraph **PLUS** other exciting offers, Bargain Catalog, valuable manual "How to Recognize Rare Stamps". *Enclose 10c for mailing costs.* Supplies are limited . . . **SEND TODAY!**

**KENMORE, MILFORD EF-728, NEW HAMP.**

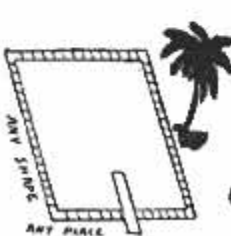

**BUILD A SWIMMING POOL**  
THESE SIMPLE PLANS MAKE IT POSSIBLE FOR YOU TO BUILD A BEAUTIFUL POOL AS LARGE OR SMALL AS YOU WISH FROM INEXPENSIVE MATERIALS AVAILABLE ANYWHERE. THESE EASILY CONSTRUCTED POOLS WILL LAST A LIFETIME REGARDLESS OF CLIMATE OR SOIL.

**COMPLETE GUARANTEED PLANS \$1**  
NORMAN ELLIS Box 1471  
ST. PETERSBURG FLORIDA

**STUDY INDUSTRIAL DESIGN**

You can train at Art Center School in California with practicing professionals for upper-level jobs in **INDUSTRIAL DESIGN**. Recent graduates have been added to the staff at General Motors, Chrysler, Raymond Loewy, Henry Dreyfus, etc. Majors in transportation, general product design, structures, community development, packaging, display. 4-year degree courses. Learn to combine imaginative design with technical proficiency, coordinate utility and beauty. Stimulating environment. Field trips. Advantages of mild Southern California climate and nearby holiday spots. Accredited. Coed. Placement service. Established 25 years. New terms February, June, September. Catalog.

**ART CENTER SCHOOL, Edward M. Adams, Director**  
5353 WEST THIRD STREET. LOS ANGELES 5, CALIFORNIA

**Say You Saw It in Popular Mechanics**



**"I Made \$14,839 in 1 Year  
SERVICING RADIATORS!"**

Are you earning under \$8,000 a year? Hundreds now making \$10,000 - \$12,000 - \$15,000 a year servicing auto-truck-tractor radiators the inland way. Easy to learn. Inland, largest radiator servicing equipment mfr., offers the complete package—equipment, merchandising, "Pays-for-itself" financing, and Free training school for customers.

**WRITE for FREE Radiator Servicing Folder.**

**INLAND MFG. COMPANY, Dept. PM-8, 1108 Jackson St., Omaha 2, Nebr.**

**MAKE UP TO \$20 A DAY WITH**



**EASISHARP**

Big profits in your spare time sharpening scissors. We show you how to start making money immediately. This is your chance now to have your own business and a steady income. Sharpen a pair of scissors in less than two minutes. A child can operate it. Weighs only 10 lbs. Every home, barber, tailor, dressmaker—everybody uses scissors and all need sharpening two to four times a year. Don't let some one else beat you to this opportunity. Write immediately to

**SERR-EDGE MACHINE CO., 9731 Lorain Ave., Cleveland, Ohio**

**RCA offers you the finest training**

**at home in**

**Radio-TV**

**electronics**

**TV servicing**

**Color TV**

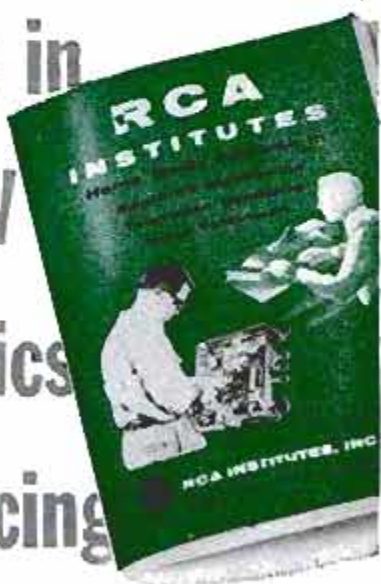

**SEND FOR THIS FREE BOOK NOW!**

The instruction you receive and equipment you get (and keep) will start you on your way. Pay-as-you-learn. You pay for only one study group at a time. This 52 page book contains complete information on Home Study Courses for the beginner and the advanced student.



**RCA INSTITUTES, INC.**

A SERVICE OF RADIO CORPORATION OF AMERICA  
350 WEST FOURTH STREET, NEW YORK 14, N. Y.

RCA Institutes, Inc., Home Study PM-86  
350 West Fourth St., New York 14, N. Y.

Without obligation, send me FREE CATALOG on Home Study Courses in Radio, Television and Color TV. No salesman will call.

Name ..... Please Print .....

Address .....

City ..... Zone .... State .....



# INVENTORS

PROTECT YOUR INVENTION BY A U. S. PATENT. SEND FOR FREE "INVENTION RECORD" FORM AND "PATENT INFORMATION EVERY INVENTOR SHOULD HAVE."

**CARL MILLER**

REGISTERED PATENT ATTORNEY

WOOLWORTH BLDG., 35th FLOOR, 86A  
NEW YORK CITY

# INVENTORS

I shall be pleased to furnish you, upon request, with full information relative to patent procedure—without any obligation on your part.

**PATRICK D. BEAVERS**

Registered Patent Attorney

934 Columbian Building Washington 1, D. C.

## PATENTS

### C. A. SNOW & CO.

REGISTERED PATENT ATTORNEYS  
WRITE FOR INFORMATION TO  
428 SNOW BUILDING, WASHINGTON 1, D. C.

## NEW BENJAMIN SUPER CO<sub>2</sub> GAS CARBINE — \$16.50

HI-LO (2 Stage) Jet Power  
Cal. .177 or .22

RIFLED  
Shoots  
Pellets  
& Darts



IDEAL FOR

TARGET & SMALL GAME

SAFE — ECONOMICAL — ACCURATE

CONVENIENT — PRACTICAL — NON TOXIC

EASY TO OPERATE—NO PUMPING—NO FLINCHING.  
Get 40 SHOTS from each 10¢ STANDARD SIZE CO<sub>2</sub>  
(Soda) CARTRIDGE. Up to 34" penetration.  
Ask your DEALER for DEMONSTRATION.

New Benjamin .177 or  
.22 CO<sub>2</sub> ROCKET Gas  
Pistol with HI-LO JET  
POWER. \$15.00

**BENJAMIN AIR RIFLE CO.**  
896 MARION ST., ST. LOUIS 8, MO., U.S.A.

FREE  
Folder

## BECOME AN EXPERT IN

# TRAFFIC and TRANSPORTATION

Today the man trained in TRAFFIC AND TRANSPORTATION is one of the most important and well paid individuals in business and industry. Thousands of firms need experts on rates, tariffs, regulations, etc.

We train you thoroly at home in spare time thru the famous LaSalle Problem Method under the personal guidance of expert traffic authorities.

Splendid opportunities developing rapidly in MOTOR TRUCK and other phases of the Traffic and Transportation field.

Get the facts. Mail coupon today for FREE 48-page book, "Traffic and Transportation—the Fast Growing Profession." Learn about the opportunities and how you can qualify as an expert in the TRAFFIC AND TRANSPORTATION field.

**LASALLE EXTENSION UNIVERSITY**  
*A Correspondence Institution*

417 S. Dearborn St., Dept. 8647, Chicago 5, Ill.

Name.....

Address.....

City..... Zone..... State.....

# INVENTORS

Send for  
**PATENT INFORMATION**  
Book and  
**INVENTOR'S RECORD**  
without obligation

**REGISTERED PATENT ATTORNEY**

ASSOCIATE EXAMINER  
U.S. PAT. OFF. 1922-1929

**GUSTAVE MILLER**

Patent Attorney & Advisor  
U. S. NAVY DEPT. 1930-1947

86-PM WARNER BUILDING  
WASHINGTON 4, D.C.

**PATENT LAWYER**

# INVENTORS

Whether an invention is patentable can be substantially determined by a search of the U. S. Patent records. Without obligation, write for information explaining the steps you should take to secure a patent.

**JOHN N. RANDOLPH**

Registered Patent Attorney

201 Columbian Building, Washington 1, D. C.



**DRAW The First Day!**  
NO LESSONS! NO TALENT!

New Amazing Invention—"Magic Art Reproducer." You can draw Your Family, Friends, Anything From REAL LIFE—Like An Artist Even If You CAN'T DRAW A Straight Line! Anything you want to draw is automatically seen on any sheet of paper thru the "Magic Art Reproducer." Then easily follow the lines of the "picture image" with a pencil for an original "professional looking" drawing. Also reduces or enlarges. SEND NO MONEY! Free 10 Day Trial! Pay Postman on delivery \$1.98 plus postage. Or send only \$1.98 with order and we pay postage. Money Back Guarantee.

**NORTON PRODUCTS, Dept. 5808W, 296 Broadway, N. Y.**

HOME CRAFTSMEN! HOBBYISTS! INVENTORS!

## SAVE \$100 ORDER DIRECT

Easily converts from

**UNIMAT 10 in 1 COMPLETE HOME POWER WORKSHOP**

Save by eliminating all middleman profits! Send for FREE illustrated literature and reduced price list. These terrific savings are offered for a limited time only—Act now! Write for complete information to Dept. PM-8, American Edelstahl (Amsterdam) Inc., 350 Broadway, N. Y. 13, N. Y.

1—LATHE into	6—MILLING
2—Drill Press	7—Jig Saw
3—Hand Drill	8—Threading
4—Polishing or Grinding	9—Circular Saw
5—Tool Grinding	10—Indexing and Dividing

## FREE AMAZING NEW BOOK "HOW TO ANSWER ADS"



Never before have you seen anything like this. Tells you in simple language the correct way to answer ads. Gets you quicker replies—better results, and greater satisfaction. Will save you time and money and it's ABSOLUTELY FREE. No obligation whatever. Every reader of advertising should have this booklet. Send a postcard for your copy NOW. **F. W. JOHNSON**, Popular Mechanics Magazine, Room 600-A, 204 East Ontario Street, Chicago 11, Ill.

**BOWHUNTERS' OUTFITS**

Save by mail! Sets include custom-grade laminated bows, matched arrows, top-brand quivers, etc. Also complete line glass bows, archery equipment. Terrific values! Amazing FREE TRIAL plant investigate!

\$16.00

FREE!

How to Hunt with Bow—How to Choose a Bow Booklets and Catalog

**SAVE 50%**

**HOW TO**

**MALIBU ARCHERY CO., Dept. R-8, 1036 S. La Brea, L. A. 19, Calif.**

## NEWER CAR \$100!

Sounds impossible? Not at all! Some of the nation's leading businessmen do it. You can, too—IF you know the inside facts. YOU can purchase a newer car each year for \$100—OR LESS! "AUTOMOTIVE BUYING REPORT," written by a licensed, bonded automobile dealer tells how. Get authentic facts, figures, information, actual dealers' wholesale prices never before exposed! Stop losing \$500, \$800, \$1000 yearly on car depreciation! If you have ever wanted a later model car and felt you couldn't afford it, or if you've ever lost money trading cars—this is for you. Let others pay high prices for their cars, you don't have to! Send two dollars for "AUTOMOTIVE BUYING REPORT" and be driving a newer car next week. We GUARANTEE to save you hundreds of times over this small cost—OR YOUR MONEY BACK! Send \$2 for your copy to: **KEMP MOTOR CO., Dept. 8M, 2015 N.E. 18th St., Ft. Lauderdale, Florida.**



## FREE-A BUSINESS OF YOUR OWN

• Start Spare Time • No Training Period  
• No Investment • No Stock to Buy

**SUBSTANTIAL MONEY-MAKING OPPORTUNITY**

Your Total Cost  
—a 3-cent stamp

All we ask of you is that you like to sell. If you can make a fair living selling anything else, we will show you how to make tremendous profits as a MASTER Work Garment Salesman, and furnish everything you need, free.

MASTER Work Garment salesmen are making thousands of dollars in hundreds of communities all over America. Men who—a year ago—didn't know what a work garment was, are now buying homes and cars with the profits from a MASTER Dealer franchise. Your sales are volume sales, repeat sales, steady-income-to-you sales. Every business in the country is a prospect for uniforms and work clothes with name-and-advertising embroidery. Stores can't compete. MASTER brings you the world's finest, most complete quality lines in new styles and fabrics. We supply everything you need—samples, sales material and guidance. You can start right away in your spare time. Keep present job until you are sure your new business is all we say. Write us today for full details.

**GEO. MASTER GARMENT CO.**  
757 WATER STREET, LIGONIER, INDIANA



# AUTO MECHANICS

Make Big Pay and Be a Success in

## CTI TRAINS YOU AT HOME

Think of it: Over 60 million cars and trucks are on the road—over 7 million new ones each year! One-third need heavy repairs. *Mechanics are desperately needed everywhere.* Train for one of these good-pay jobs at home in spare time. CTI Shop-Method training is so practical you can make money in spare time fixing cars. Mail coupon for 2 FREE BOOKS.



**YOU PRACTICE WITH THIS TUNE-UP KIT**  
Only CTI sends you a Compression Tester, Vacuum Gauge and Fuel Pump Tester, and Ignition Timing light, in portable steel case. No extra cost.

**YOU GET TOOLS ALSO**  
This fine-quality set of mechanic's tools are also yours at no extra cost. Using tools and Tune-Up Kit, you get practice and experience. They'll come in handy when you do spare time repair work for profit.



## MAIL TODAY FOR 2 FREE BOOKS

COMMERCIAL TRADES INSTITUTE  
1400 Greenleaf Ave., Chicago 26

Dept. A-341

Send Auto Mechanics Success Book and Sample Lesson.

Name \_\_\_\_\_ Age \_\_\_\_\_

Address \_\_\_\_\_

City \_\_\_\_\_ Zone \_\_\_\_\_ State \_\_\_\_\_

## SAY YOU SAW IT IN POPULAR MECHANICS

*Write Like This*

MIRACULOUS IMPROVEMENT in your Penmanship in six hours practice with Grooved Letters. No failures. Inexpensive. No charges unless you're satisfied after 6 hours practice.

WRITE OZMENT, BOX 665  
34-P, ST. LOUIS, MISSOURI

Complete OUTLINE FREE!

**BOAT KITS**

12 Models as low as \$39.95 (freight included). Fiberglass boat covering kits, marine supplies, etc. Free folders.

ONLY \$495  
Freight included  
FREE FOLDER

16 FT CRUISER

**TAFT MARINE WOODCRAFT**  
DEPT. PM-8 636-39th Ave. N.E., Minneapolis 21, Minn.

# LEARN MEAT CUTTING AT NATIONAL

Pay After Graduation



The steady dependable trade of Meat Cutting taught easily in 8 short weeks. YOU LEARN BY DOING under actual meat market conditions in big modern school at Toledo.

For beginners or men with experience. Get a profitable store of your own. Remember, PEOPLE MUST EAT! Big pay jobs. Free employment help. Thousands of successful graduates.

Buying, cutting, percentage, pricing, advertising, selling, etc. A complete retail meat education. National School established 33 years. Get National training NOW. Pay your tuition in easy weekly payments

after you graduate. Send coupon for FREE 52 page school catalog — TODAY. G.I. approved.

National School of Meat Cutting, Inc., Dept. 50-6, Toledo 4, Ohio

Send me your FREE school catalog on National Training at Toledo in Meat Cutting, Meat Merchandising and Self Service Meats. No obligation. No salesman will call.

Name \_\_\_\_\_ Age \_\_\_\_\_

Address \_\_\_\_\_

City \_\_\_\_\_ State \_\_\_\_\_

Approved for training Korean Veterans



# HUNTERS! CONFISCATED RUSSIAN RIFLES \$14.95

6-SHOT  
BOLT ACTION



## RUSSIAN RIFLE AMMUNITION FREE

20 rounds full jacketed ammo included with each rifle purchase. Additional cartridges: \$7.50 per 100 rds. This ammo is for the Russian Moisin 7.62 MM, and also for the Moisin Nagant. We also now have 7.62 MM softnose hunting ammo, 150 gr. for deer, bear and No. Amer. big game, 20 rds. \$2.95.

**GOLDEN STATE ARMS CORPORATION**  
206 ARMORY BLDG., 1165 E. Colorado St., Pasadena, Calif.

This is the late Russian Model 7.62 MM Moisin Rifle, appr. 30" barrel. Mechanically perfect. Outside: good. Bore: four. Ballistics: 2820 FPS with 150 grain bullet. Ammunition available everywhere in U.S., an excellent hunting cartridge. Minged floor plate. Russian ordnance marks on receiver. The Russians won the International Meet in Venezuela (1954) with this model rifle. These guns were confiscated from Communist revolutionaries and placed on the free world market. They are of the type used by Red Chinese in Korea. The sale of these guns in no way aids any country behind the iron curtain. A Once-in-A-Lifetime collector's item. This is the lowest price we have ever seen which would allow a man to equip himself for big game hunting. For C.O.D. send \$5 deposit. Calif. residents add 4% state tax.

## TECHNICAL EDUCATION

• Air Conditioning and Refrigeration Technology • Diesel Technology • Drafting Technology • Electrical Technology • Electronic Technology • Excellent faculty, accredited curricula, extensive counseling and guidance, full college activities, job placement service. G.I. approved. Opportunity to continue education and earn a B.A.S. degree. Open to high school graduates or equivalent. Sept., Feb., and June semesters. Write for free brochure.

**COLLEGE OF TECHNOLOGY, University of Houston**  
DEPT. 186, 3801 Cullen Blvd., Houston, Texas



## BUILD 16 RADIO

CIRCUITS AT HOME WITH THE NEW IMPROVED  
PROGRESSIVE RADIO "EDU-KIT"

A PRACTICAL HOME RADIO COURSE only **\$19.95**

All parts, tools, instructions, punched metal chassis, printed circuit materials, electric Soldering Iron, Tester included. Unconditional Money-back Guarantee.

**PROGRESSIVE "EDU-KITS" INC.**  
Rm. 548B, 497 Union Ave., Brooklyn 11, N.Y.

ORDER FROM AD—RECEIVE BONUS RESISTOR KIT WORTH \$5

Please Rush me Free Descriptive Literature concerning "EDU-KIT."

Also send me Free Radio, TV, Hi-Fi Servicing Literature. No obligation.

NAME \_\_\_\_\_

ADDRESS \_\_\_\_\_

## Learn All About Cars!

AUTO MECHANICS — AUTOMATIC TRANSMISSIONS  
ACETYLENE AND ARC WELDING  
BODY AND FENDER REPAIR

Day-Night School 30 Years in the Same Location

### WOLVERINE SCHOOL OF TRADES

Approved Under the G.I. Bill of Rights by the State Board of Education

**WOLVERINE SCHOOL OF TRADES, Dept. PM**  
1400 West Fort St., Detroit 16, Mich.

Name \_\_\_\_\_

Address \_\_\_\_\_

City \_\_\_\_\_ State \_\_\_\_\_

## High School at Home

### MANY FINISH IN 2 YEARS

No classes. No time wasted going to and from school. Progress as fast as your time and abilities permit. Standard H. S. texts supplied. Thousands enroll each year in this 59-year-old school. Send for FREE descriptive booklet.

**AMERICAN SCHOOL, Dept. MC45**  
Drexel at 58th St., Chicago 37, Ill.

Without obligation, please send FREE descriptive booklet.

Name \_\_\_\_\_

Address \_\_\_\_\_

Complete Canadian Courses available. Write American School, Dept. MC45, 2007 St. Louis St., W. Montreal

## What Every Farmer Should Know About Taking Care of Farm Animals



### The Most Popular Veterinary Guide Ever Printed

This practical and helpful VETERINARY GUIDE FOR FARMERS prepares the farmer to perform many routine veterinary tasks—provides quick information that can often save the life of an animal—prevents disease in herds—saves money on the farm in a hundred different ways.

Written in plain understandable language. It covers symptoms, causes of disease and prevention, and treatment of cattle, swine, sheep, horses and poultry and warns when to call in the professional veterinarian. Names, terms and phrases made clear in a separate section. Over 100,000 copies of this book are in use on American farms, 275 pages. Fully illustrated. Only \$3.95. Order today under money-back guarantee.

**POPULAR MECHANICS PRESS, Dept. PM856**  
200 E. Ontario St. Chicago 11, Ill.

SAY YOU SAW IT IN  
POPULAR MECHANICS

## SALESMEN WANTED

Prefer men over 50. Earnings \$5000 to \$8000 per year, calling on hardware stores and lumber yards, selling and installing Popular Mechanics show windows. No window trimming experience necessary (we train you) but selling experience essential. Must have automobile. Average territory consists of about 5 counties. Salesmen have exclusive territory. Home every night.

Not a get rich quick scheme but steady dignified work by which a skilled, industrious salesman can earn a good living. This company, in cooperation with Popular Mechanics and the leading manufacturers of tools, equipment and materials, offers retailers traffic-stopping window displays to retail hardware stores and lumber yards at a nominal cost. All equipment furnished. Endorsed by many retailers, jobbers and manufacturers. Much repeat business. Extras offer additional earning opportunity. Desirable but not necessary to have knowledge of hardware and lumber lines. Personal training given.

For details write, giving all the facts about yourself. If your letter indicates that you might qualify, an appointment will be made for an interview.

### WINDOW DISPLAYS, INC.

1580 SHERMAN AVENUE EVANSTON, ILLINOIS



# Get info. PLASTIC LAMINATING AT HOME!



Get **ORDERS** and **CASH** from your mailman—do work in **SPARE TIME** at home—or expand into **FULL TIME** business. Send coupon for Free facts about the newest and most fascinating of all home operated businesses. For the first time a simplified machine brings the fabulous profits of **Plastic Sealing and Plastic Laminating** within the reach of the small operator. Anyone can learn to operate the machine with a few minutes practice—then with our **Magic Mail Plan** can get mail orders pouring in daily with cash in every envelope. **No canvassing—no selling.** We even

**Make \$20 to \$30 a Day by..**  
**MAGIC MAIL PLAN!**

supply the circulars you mail to bring back cash and orders. Don't waste a minute. Rush your name. We'll send you **FREE** and postpaid, pictures, prices, details, and all the facts you need to start. Mail coupon or send name on postcard. No charge. **Warner Electric Co., 1512 Jarvis Av., Dept. L-108, Chicago 26, Ill.**

## Make Thousands of Beautiful Art Creations

**COSTUME JEWELRY • CIGARETTE BOXES TRAYS • CANDLESTICKS • COASTERS LAMP BASES • BOOK ENDS...ALL IN SPARKLING COLORED PLASTIC**



**THIS MAN . . .**  
... is taking out of the machine a Plastic Sealing Job—ordered by mail—only 11c in material cost brings back \$2.58 in cash by mail. Capacity of machine: **\$25.00 profit per hour of operation.**

**WARNER ELECTRIC CO., 1512 Jarvis Av. Dept. L-108, Chicago 26, Ill.**  
At no cost to me, please rush complete details postage prepaid. I am under no obligation.

Name \_\_\_\_\_  
Address \_\_\_\_\_  
City \_\_\_\_\_ Zone \_\_\_\_\_ State \_\_\_\_\_

## 695 FREE WIN A TRACTOR FREE

**HEAVY OIL-PUMP BALL BEARINGS PUMPS MILLIONS OF GALS.**  
IRRIGATE, SPRAY, DRAIN OR FILL ANYTHING—ANYWHERE! Will not Rust—Clog—or Leak. Patented Seal. Pumps 2800 gph, 420 gph at 75' high or 1600 gph from 25' well. Six blade impeller. Threaded for pipe. 3/4" inlet, 1/2" outlet. Use 1/2 to 3/4 hp motor. . . . 7500 gph \$9.95  
Heavier 2800 gph \$8.95 . . . Heavier 11.95  
Check. **NO** or **COD**—Money Back Guarantee  
**FREE** Literature—Comparison Charts  
**U. A. T. ENG. & MFG. CO. NICKSVILLE 273, NEW YORK**

## BUILD YOURSELF A "HE-MAN" BODY

**In Only 6 Weeks or Money Back!**  
Fastest, surest method known . . . with famous **DAN LURIE BarBells**. Special low prices . . .  
50 lb. set \$ 8.48 • 100 lb. set \$13.98  
150 lb. set \$20.48 • 200 lb. set \$25.98  
**FREE!** If you act fast. Complete Course, 68 photos. **SEND FOR FREE CATALOG.**  
**DAN LURIE BARBELL CO.**  
528R Bristol St. Dept. 669-M, Bklyn 12, N.Y.  
**AMERICA'S FAMOUS TV STRONG MAN**

## YOU CAN BUILD A VIOLIN FOR PLEASURE OR PROFIT

Now you can build a rich toned mellow violin modeled after a famous "Strad." **YOU CAN MAKE A STRADIVARIUS VIOLIN** contains 8 full scale plans plus complete instructions. You work directly from the plans with no confusing scale of dimensions to translate. Detailed instructions for each step including varnishing and stringing—even shows how to build your own tools. Cloth bound. **Order today from**  
**POPULAR MECHANICS PRESS . . . \$3.50**  
200 EAST ONTARIO STREET, CHICAGO 11, ILLINOIS

## Get Yourself FIXED FOR LIFE in the Big Pay Shoe Business!

It's easy to make big money—**FULL OR SPARE TIME**—with America's most comfortable shoes! Amazing new "Spring-Step" cushion design proves it by actual demonstration. Only **ORTHO-VENT** has it! There is no other shoe in the world like it. Repeat orders are sure, steady. One try and a customer is sold for life. Profits are **BIG**. Orders are sure and easy with the most amazing 3-minute demonstration in the history of the shoe business. No experience needed. No investment to make. Everything, including actual cut-a-ways, furnished free! Be the big-pay **ORTHO-VENT** man in your territory. Write **TODAY!** E. C. Brand, Sales Manager.



**I'LL PUT UP THE MONEY TO GIVE YOU A FLYING START!**

**I GIVE PRODUCERS THEIR OWN SHOES AS A BONUS!**

**ORTHO-VENT SHOE COMPANY**  
1168 College Ave. Salem, Virginia

## SAY YOU SAW IT IN POPULAR MECHANICS

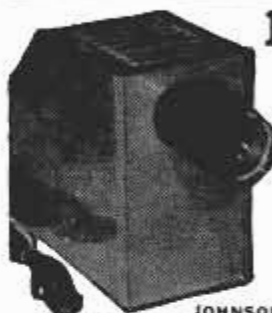

## 100X Area Magnifying Projector

— Enlarges Pictures, Printing, & Objects! — Full Color!

**NEW!** Electric Magna-Vue Optical Instrument projects & enlarges clippings, pictures, sketches, objects in full natural color, correctly & readable. Project on wall, screen or table. **MAGNIFIES 100 AREAS.** Enlarges any material up to 3 1/2"x4-in. to 32"x40 in. For home, school, class, business, shop use. Also make signs, sketches easy from any copy. Enamelled steel, 10x7 1/2-in. high. Quality 2" focusing lens. Operates on standard 110 volt current. Money back . . . . . **\$4.98** guarantee. **Price Postpaid.** . . . . .  
**JOHNSON SMITH CO., Dept. 341, Detroit 7, Mich.**

## 12-Foot BULL WHIP



**HARD HITTING! LOUD CRACKING!** Exports knock ashes off cigarettes, Yank people off feet. Used by trainers, ranchmen. Loud cracker like shot-gun blast. 4-ply hand plaited all leather. With loop handle.

6-ft. \$1.98. 8-ft. \$2.69. 10-ft. \$3.29. 12-ft. \$5.45.  
**Johnson Smith Company, Dept. 341, Detroit 7, Mich.**

## Catalog of 3100 Novelties 10c

Send 10c for amazing catalog of novelties, live animals, scientific supplies, hobbies, funmakers, planes & boats, looms, magic tricks, joke articles, unusual seeds, gadget timesavers, cameras, optical goods, projectors, movies, lucky jewelry, religious novelties, dice, musical instruments, stamps, coins, puzzles, fortune tellers, radios, auto & bike accessories, telescopes, magnifiers, compasses, banks, smokers' gadgets, artists' supplies, printing sets, engines, motors, shockers, knives, billfolds, guns, rifles, sports, books, games, plants, etc. Send 10c (3 for 25c—get for friends!).  
**JOHNSON SMITH & CO. Dept. 341 Detroit 7, Michigan**



## 256X AREA MAGNIFYING Telescope \$2.98

**POWERFUL!** Close-up view blocks or miles away! See without being seen. Examine craters of moon, sports, action, etc. **Magnifies 256 times area.** Precision ground 5-lens optical system, brass fittings, comfortable rubber moulded eyepiece, imitation black leather finish. 1 1/2-in. closed; 19 1/2-in. open; 1 1/4-in. diameter.  
**\$2.98**  
With black carrying case, **ONLY** . . . . .  
**JOHNSON SMITH COMPANY Dept. 341 DETROIT 7, MICHIGAN**

## New! SECRET POCKET RADIO

**\$2.98**  
Listen at work, play, in bed. **INVISIBLE.** Fits shirt pocket. No tubes. No batteries. No electric plug-ins. No expense. Plays day & night forever. New self-powered diode rectifier replaces tubes. **NO BUILDING. READY TO USE.** Tuner covers complete broadcast band. Red plastic case only 3 x 3 1/4 x 1 inches. Lifetime guarantee. Radio (without phone) **\$2.98.** Hearing Aid Phone (plus in ear, flesh-colored, almost invisible) **\$1.98.** Regular phone **\$1.25.**  
**JOHNSON SMITH & COMPANY Dept. 341 Detroit 7, Mich.**





**23**  
BIG KITS  
to build  
AIR CONDITIONER  
REFRIGERATOR  
FREEZER or  
MILK COOLER

## This CTI Student Is Training at Home in Spare Time for a Big-Pay Job . . .

As a CTI student, you build a complete, heavy-duty, commercial-type refrigeration high-side. You get all parts and tools without extra cost. You do 10 complete troubleshooting and service jobs. You build (and keep) an air conditioner, freezer, refrigerator or milk cooler. Only CTI sends 23 big kits—brings Shop Method training right into your home!

## Be a Success — Be Secure in AIR CONDITIONING AND REFRIGERATION

### Letters from Students Show Value of Training



"When I came home from the army, there was no work. Thanks to CTI training, I am now employed full time at good wages. I got 3 raises and a bonus. Have my own home."—*Daniel Stevens, Springfield, O.*

"Without the practical and theoretical training I received through CTI, I never could have started a business of my own. I have a small shop. Am financially independent."—*K. Sellman, Guthrie Center, Ia.*

"Am very glad I learned through CTI. I am now an able refrigeration technician. Am earning good wages, find my work interesting. I recommend CTI to any ambitious man."—*A. W. Heinrich, Kewanee, Ill.*



"I find the lessons very interesting and easy. Since my fifth lesson I have been working on refrigerators. I rebuild old ones and sell at a nice profit. Am planning a full time shop."—*W. O. Ward, Mich.*

"Your course proved to be very valuable to me. As a result of your training, my partner and I run our own repair shop. He is also a CTI graduate. We also employ a former CTI student as our outside repair technician."—*J. J. Giertuga, Chicago.*

"My training thru CTI has changed my life. It has changed it from working for bare necessities to my owning a business."—*J. J. Kish, E. Chicago, Ind.*

Do you really want to be a success? Then get into air conditioning and refrigeration! This old, established industry offers *security*. Because it's growing bigger every day, *thousands of new jobs must be filled*. Many pay up to \$125 a week and more. Most set the stage for you to open a shop. Find out how you can train at home in spare time. Just fill out and mail coupon for two new books that give the facts. *Both are free.*



R. C. Anderson  
President

### Over 150,000,000 Units Need Service and Repair

This is why the air conditioning and refrigeration industry needs trained technicians so badly: Over 150 million units are in use today. Each year, some 3 million refrigerators, 1 million freezers, and 2 million air conditioners are produced. Yet, experts say the surface has hardly been scratched. It takes tens of thousands of trained men to keep commercial and home units in working order.

### AUTO AIR CONDITIONERS

It is estimated that this year, over 300,000 new cars will have air conditioners. Tens of thousands of older models also are in the market. Already the auto industry is seeking trained men for this exacting work. Be one!



### Earn Cash as You Train

CTI training is so practical that soon after starting, many students do repair work in spare time for profit. It's not unusual for students to have a going business by the time they graduate. Assembling CTI kits, doing real repair jobs, you learn fast. No need to waste years in low-pay apprenticeship.

### Training You Can Trust

CTI home training was developed in our own resident shops—thoroughly tested in the field. CTI was the only civilian school to train men in refrigeration for the U.S. Army during WWII. That CTI is way-ahead in home instruction is proved by the practical training kits that we provide. You can't get better or more complete training.

### COMMERCIAL TRADES INSTITUTE

1400 Greenleaf Ave. Dept. R-291  
Chicago 26, Illinois

Mail me your book *Success in Air Conditioning and Refrigeration*, and *Sample Lesson*. Both FREE.

Name \_\_\_\_\_ Age \_\_\_\_\_

Address \_\_\_\_\_

City \_\_\_\_\_ Zone \_\_\_\_\_ State \_\_\_\_\_

Member National Home Study Council



### MAIL COUPON FOR 2 FREE BOOKS

You can have the full story on your opportunities by filling out and mailing coupon. CTI will send you two new books, just off the press. Act today.

• CTI graduates often open shops. You can start a business with a small investment. Start small, grow big!



Get the Facts First—then Decide



**WORLD'S  
BEST  
WANT-AD  
MEDIUM**

# CLASSIFIED ADVERTISEMENTS



Advertisements in this section \$1.25 per word, each insertion, minimum 10 words, payable in advance.  
To be inserted under proper classification, copy must be in our office the  
20th of the second month preceding date of issue  
F. W. Johnson, Manager, Classified Advertising  
Popular Mechanics Magazine, 200 East Ontario Street, Chicago 11, Illinois

## YOU'LL PROFIT

By reading and answering the classified ads in this section. Hundreds of opportunities for you to make and save money

### AUTOMOBILES, MIDGET CARS

**JEEP** Tops, American-Foreign convertible tops. Free catalogue. Mor-Nan, 307 Cambridge, Boston 14, Mass.

**FREE** Motor magazines; automobile literature; old, new and foreign; glossy photos, dealer books; shop manuals—Offered with non-profit organization. Write today; get on free mailing list. Auto Maniacs, Stockbridge, Mich.

**MICRO** Midget auto, 5 to 30 m.p.h. Runs on walk, lawn, street. Used in concessions. Ideal for boys 9 to 16. \$100. Details free. Micro Midget, 940 North 23rd St., Omaha, Nebraska.

**ANTIQUE** Automobile color slides. 2x2. Illustrated catalog free. Universal, Box 779A, Beverly Hills, Calif.

### AUTO SUPPLIES AND EQUIPMENT

**SENSATIONAL** Almost human dashboard cigarette lighter. It breathes. Insert cigarette, press button, it's lit. 6V.-12V. Red, green, blue, black, mahogany. \$1.69 postpaid. Cig-o-mat, Box 1063, Wilmington, Calif.

**AUTOMATIC** Headlight dimmer. Transistorized. Kit or ready to install. Nagor, Littleton, Massachusetts.

**FREE** Discount catalog—Speed, power, custom equipment. Alquist Engineering, Milford 7P, Pennsylvania.

**TRUCK-TRAILER** bus safety equipment. Lights, connectors, wheel parts, mirrors, etc. Information on request. Edward Ettinger, Route 1, Northport, New York.

**FUEL** Pumps, guaranteed new hi-quality. Any car, singles \$3.75; doubles \$9.00 prepaid. SaveWay, Box 1166, Ogden, Utah.

**UP TO \$50.00** each for new or used GM-110 diesel fuel injectors. Parts also purchased. Bruce W. Mayer, 2090 East 19th Street, Cleveland 15, Ohio.

**AUTO** Accessory and parts catalog. 1956 edition—all new! 180 pages. Save up to 50%. Over 75,000 items, including Hollywood accessories, hi-speed equipment, rebuilt engines, all parts and accessories for all cars and trucks! Hard-to-get parts! Send 25¢ (refundable). J. C. Whitney, 1919-PM Archer, Chicago 16, Ill.

**NEW** And used parts at savings. Complete guaranteed parts service for all models cars and trucks, 1924 and later. Largest in the West. Army parts specialists. No catalog, write for quotations. Fast mail order service. Pioneer Auto and Truck Parts Co., 734 W. 13th Avenue, Denver, Colorado.

**LATEST** Custom accessories. Items not in stores. New low prices. Continental tire kits, push-button doors, trunks, etc. New illustrated catalog, biggest ever. 25¢. Eastern Auto, 3319-A South Grand, Los Angeles 7, California.

**BRAND** New first quality tires. Tractor, truck, aircraft, passenger. Wholesale prices. Also all size army surplus used tires, at tremendous savings. Duddy's, 152 No. Beacon Street, Boston, Mass.

**GM71-110** Discarded injector parts wanted. Bonus on HV. Bares, 7120 Carnegie, Cleveland 3, Ohio.

**AUTOMOBILE** Drivers, etc. Material which insures positive grip on steering wheel; other uses. Price \$2.00. Ervin Kenitz, Lake City, Minnesota.

**BUY** Wholesale nationally advertised auto supply, thousands other products at big discount. Free "Wholesale Plan." American Buyers, Hertel Station, Buffalo 16-G1, N. Y.

**BEST** English chamois. Guaranteed. 20x30 \$2.70, quantities less. Salesmen inquiries invited. Babrok, Hudson Falls, N. Y.

**SENSATIONAL** (Patented) 100,000 mile motor treatment. "Lachapelle's" renews compression, power. Saves gas, oil, repairs. \$3.00 delivered. Money-back guarantee. You can't lose. Free circular. Write Joe Dillon, Authorized Warehouse, Agents Distributor, Box 32320, Bridgeport, Ohio. Exclusive agencies.

**JEEP** Owners—V8 power. Read Jeep owners ad, page 18.

**SHOK-Pruf** \$1.00. Special, 2 for \$1.00. Guaranteed. B-2307, Mesa, Ariz.

### AUTO TRAILERS

**EXCEPTIONAL** Expanding eight foot trailer. Accommodates family of five. Build yourself. Literature 10¢. Framar Company, Wilmington, Mass.

**TRAILER** Building manual \$1.00. Booklet 30¢. Kamcraft, Box 1153, Milwaukee 1, Wis.

### MOTORCYCLES, BICYCLES, MOTORSCOOTERS AND SUPPLIES

**PARTS.** Pistons, new, used. Harley Indian, Henderson, list 10¢. Ballak, 811 N. 9th, St. Louis 1, Missouri.

**MIDGET** Car \$15. Johnson outboard \$7. Whizzer \$11. Norton 15 h.p. \$12.50. Cushman \$35. Four airplane tires \$3. Mail-order only—Send 25¢ (35¢ for first class mailing) for directory-catalogue number 72 listing the above and hundreds of other bargains, homebuilder parts, plans, etc. Midget Motors Directory, Athens, Ohio.

**1000 BANKRUPT** Motorcycle bargains. Catalog 25¢. Wholesale motorcycle, bicycle parts. Write needs. Bunico, 146. Covington, Virginia.

**WHIZZER** Motors \$20.00; midget race car reasonable; motorscooter \$6.00; Cushman two-speed \$20.00. Send 25¢ (35¢ first class mail) for catalog #30 jammed with sensational bargains in wheels, motors, motorscooters, midget cars, motorbikes, construction plans, etc. Gail, 1313 Jefferson, Toledo, Ohio.

**RECONDITIONED** Motorcycles and motors. Chromium accessories. Complete stock Indian parts. Expert rebuilding. Fast service. Indian Motorcycle Sales, Kansas City 27, Missouri.

**BICYCLE** Supplies—At substantial savings. Goodyear tires, Cadet speedometers, Delta lights, sirens. Free delivery. Attleboro Cycle, 619 County, Attleboro, Mass.

**HARLEY-Davidsons**—Used bargains, shipped prepaid. New, used parts, accessories for current and obsolete models Bulletin, catalog 25¢. Knuth's (factory dealer), 2491 Fond du Lac, Milwaukee, Wis.

### AVIATION

**PROPELLERS,** Plans, supplies by world's oldest and largest manufacturer of special design airboat and snowplane propellers. Latest designs. Prompt delivery. Satisfaction guaranteed. 48 page catalog 25¢. Banks-Maxwell, Box 3301E, Ft. Worth 5, Texas.

**LIGHTPLANE** Manual blueprints. Circulars illustrated 30¢. Kamcraft, Box 1153, Milwaukee 1, Wis.

**AIRLINE** Steward-purser need fly only 85 hours monthly to earn \$285 or more. G.I. Free catalog. Airline Purser School, 1030 Nicollet, Minneapolis, Minnesota.

### ELECTRICAL SUPPLIES

**SMALL** Appliance parts toasters, steam irons, mixers, clock motors and coils, coffee makers, vacuum cleaners, etc. Send make and model. General Appliance Parts Company, Box 3711, Baltimore 14, Md.

**LAMP,** Electrical parts, wholesale. Thousands of items for repairing, converting. Catalog 25¢. Brown Lamp, Box 501, Welston Station, St. Louis 12, Mo.

**LAMPS,** Parts catalog containing wiring instructions 25¢. Gyro Lamps, 5402P Clark, Chicago 40.

### WELDING, SOLDERING, PLATING

**NEW** And different oxy-acetylene outfit welds, cuts, heats, brazes, with interchangeable tips. No attachments needed. Light, portable. Complete outfit, full instructions, only \$76.50. Special money-saving plan for oxygen and acetylene supply. Write for free literature today; Dept. M. Lindé Air Products Company, 30 East 42nd Street, New York 17, N. Y.

**ELECTRIC** Welder. Hundreds of money saving repairs with Unit electric welder. 110 volts ac-dc. Does comparable work to more expensive welders. Learn to weld—comes complete with instructions ready to plug in. \$7.95 postpaid. Ed Hasnerl, Knox, Indiana.

**"BUILD-UR-OWN"** a.c. welder and a.c. power plant with a good used engine and low cost Hobart generator. Welds anywhere and supplies 5kw stand-by power for any emergency. Write Hobartweld, Box M-883, Troy, Ohio.

**A.C. Welders,** 4 sizes. Lowest prices. Free literature. Holgerson's Serv., Canton, Kan.



**WELDERS**, 110/220, \$39.50. Morris, 1070 Inner Drive, Schenectady 3, New York.

**ACETYLENE** Welding outfits, new \$49.00; used \$29.00; arcwelders \$56.50. Eagle Welding, Dept. PM, 5085 Broadway, Chicago 40, Ill.

**ELECTROPLATING** Equipment, anodes and solutions for all types of plating. Instructions. Assemble your own plater and save. Free catalog. Ramyr, Dept. E-4, 1624 East First Street, Los Angeles 33, California.

### MACHINERY, TOOLS, SUPPLIES

**LAWNMOWER** Grinders — \$59.75 to \$259.50, light and heavy production. Turner-Claine, 430 Yellowstone, Pocatello, Idaho.

### ENGINES, MOTORS, DYNAMOS

**POWER** Plants. All sizes. Lowest prices. Builders Supply, Carrollton 1, Ill.

**1/2 HORSEPOWER** Motors, used, good, \$5.00 each, f.o.b. Plant Machinery Corp., Richmond & Norris Sts., Philadelphia 25, Penna.

**REWIND** Motors yourself. Complete instructions \$1.00. Lewis Mfg., Howell, Michigan.

**WINDING** Data. 275 motors, single and three phase, \$1.10. Data Company, Box 7631, Kansas City 28, Mo.

**A.C. Generators**: 750 watt \$42.50. 1500 watt \$67.50. Motors: 5 horse \$110. 3 horse \$87.50, 1 horse \$38.50. Butler, 1885 Milwaukee, Chicago.

### BOATS, OUTBOARD MOTORS

**BUY** Wholesale nationally advertised outboards, thousands other products at big discount. Free "Wholesale Plan." American Buyers', Hertel Station, Buffalo 16-HI, N. Y.

**HORSEPOWER**: Increased in outboards by new process. Free literature. Stark Company, Department G-86, Cedarburg, Wisconsin.

**PLANS**. Patterns catalogs; sailboat 25¢. powerboat 50¢. Marinecraft, Box 161-M, Brighton, Mass.

**FIBERGLAS** Boat coating. Plexiglas boat windshields—clear, blue, green tints. Wholesale-retail. Complete information catalog—15¢. Gem-O-Lite, Box 686M, North Hollywood, California.

**FIBERGLASS**. Free catalog. Sealite Fiberglass Process, 22259 Goddard, Dearborn, Michigan.

**FULL** Size, cut-to-shape boat patterns, blueprints, 7 1/2-38 feet. New 1956 illustrated "Build a Boat" catalog of 50 naval architect-designed cruisers, runabouts, sloops, skiffs, outboard boats, sailing, racing, houseboats, 50¢. Small boat hardware catalog, \$1.50. 1956 "How to Build a Boat" booklet, \$2.50. Cleveland Boat Blueprint Co., Dept. A-66, Box 1651, Cleveland 4, Ohio.

**FIBERGLAS** Permanent boat waterproofing. Special 25% summer discount. Complete kits, \$9.45 up. Guaranteed materials. Easy application. Full instructions. Free literature. Ajax Plastics, Dept. PM, P.O. Box 1323, Fort Worth, Texas.

**WHOLESALE!** Sea Legs boat kits, factory prices from \$31.98. Savings to 25%. Pre-assembled frames, pre-cut parts. Illustrated instructions. Penney Woodcraft Industries, Dept. C-71, Defiance, Ohio.

**OUTBOARD** Motor parts—New, used for all makes. Send list of parts needed. Enclose stamp. We save you money. Outboard Motor Mart, Inc., 229M State Street, Boston, Mass.

**FREE** Catalog! Boat kits, trailers, fiberglass, marine hardware, Luger Industries, Dept. M, 4452 Nicollet, Minneapolis, Minn.

**NEW**, Used, rebuilt marine motors. Marine conversions, fittings. Free catalog. Stokes Marine Supply, Dept. 24, Coldwater, Michigan.

**MARINE** Conversions for Ford and Jeep engines. Catalog 25¢. Lehman Manufacturing Company, 972D Broad Street, Newark 2, New Jersey.

**FORDS** And Jeeps 100% marine engines with famous Convo-Kits. Deluxe catalogue 25¢ coin. Oscomotors, 3627B Lawrence, Philadelphia 40, Penna.

**"GLASBOTE"** Plastic and glass cloth for boat covering. Complete information and material price list free. Buchanan Plastics, 1728 Hamilton Road, Okemos, Michigan.

**BOAT** Plans: Welded steel, wood, plywood. Inboards, cruisers, sail. Free literature. Please specify size, type. John B. Clark, N.A., Box 51, Bay Village, Ohio.

**BUY** Fiberglass boat coverings wholesale. Free literature, samples. Seiffert's, Box 31M, Deperre, Wis.

**BOAT** Plans. Full size patterns. Frame kits. Modern inboard and outboards for amateur builders. Complete new catalog 50¢ or specify requirements. Glen Design, Box 568, Compton, Calif.

### ATHLETIC EQUIPMENT, BODY BUILDING COURSES

**DISABLE** Any bully, with two fingers. Secrets, Ju-Jitsu, 96 pages, illustrations, \$1.50. Selco, P.O. Box 38, Cooper Station, New York 3, N. Y.

**4 MUSCLE** Courses 25¢. Fully guaranteed. Sids System, Southgate, California.

**BARBELLS**, Dumbbells, Courses. Free catalogue. Good Barbell Co., Reading, Penna.

### SPORTING GOODS, GUNS, FISHING TACKLE, ARCHERY, TRAPPING

**180 PROFUSELY** Illustrated pages antique pistols, swords, daggers, armor, etc. 50¢. Robert Abels, M860 Lexington Ave., New York 21.

**5000 BARGAINS**. Firearms, binoculars, war relics. Catalog 50¢. Smith Firearms, Runnemede, N. J.

**DIVING** Equipment for skin divers and professional divers. Send 25¢ for catalog and decompression chart. Desco, 212 N. Broadway, Milwaukee 2, Wisconsin.

**SAMPLE**: 25¢ Copy of "The Archers' Magazine." Send 10¢. 1200 Walnut Street, Philadelphia 7, Pennsylvania.

**MOLDS** For fisherman's sinkers, jigs, squids, casting and spinning lures. Free catalog. Sweet's Molds, Tonawanda 1, New York.

**SKIN** Divers, 3000 lbs. certified air compressing stations, 110v, \$200.00. Garrett, 3471 Weldner, Oceanside, N. Y.

**FORTUNE** Possible raising crickets and 12 inch African fishworms. Free literature. Carter Ranch, Plains, Georgia.

**NYLON** Rope, lines, cords. Every description for all household and sportsmen's uses. Finest made. Free catalog and samples. Beebe Cordage Co., Cranford 8, N. J.

**SCALE-A-KNIFE**, Fisherman's greatest necessity. Free details. W. Stille, 2512 Glenside, Muskegon, Mich.

**FREE**: Below wholesale fishing catalog. Fishing Tackle Mart, Dept. 58, Box 6737, Chicago, Ill.

**EXCITING** Golf game for all. Send \$1.00 for illustrated complete plans. Easily installed. Satisfaction guaranteed. Brownie's Mfg., Co., 5835 Fairmount, San Diego 20, Calif.

**FREE** Fishing catalog—132 pages. Over 3000 hard to find fishing specialties. Netcraft Company, Dept. PM8, Toledo 13, Ohio.

**FREE** Giant handbook! "How to Bow-hunt and Bowfish" 100's revealing secrets! Also tells how to improve shooting accuracy, select best equipment, make your own tackle, etc. Illustrated! Yours free with large bargain catalog. (Save 50% on archery equipment). Send 25¢ to cover mailing expenses refunded on first purchase. Supply limited! Hurry! Malibu Archery, 1036RAT South La Brea, Los Angeles 19, California.

**BUY** Wholesale nationally advertised sporting goods, thousands other products at big discount. Free "Wholesale Plan." American Buyers', Hertel Station, Buffalo 16-II, N. Y.

**CAMPING** Equipment, tents. Direct from manufacturer. World's largest selection. Send 15¢ for 120-page 1956 tent and camping equipment catalogue-handbook. Morsan Tents, 10-21R, 50th Ave., Long Island City 1, New York.

**GUNS!** We buy, sell, trade! Free! Send for latest list of used and new gun bargains, plus gun trading dope sheet. Describe your gun fully! Dept. CM-8, Klein's, 227 West Washington, Chicago 6, Ill.

**FISHWORMS**. Breeders, 100, \$1.00. Manual 50¢. Literature free. Three Oaks Ranch, Dresden, Tenn.

**REDWORMS** 500, \$2.50. Mealworms 200, \$1.00; 500, \$2.00. Dealers inquire. Skidmores Fishing Supplies, Dept. PM, Bellepoint, W. Va.

**LARGE** Catalog of modern, antique, foreign, domestic guns, 25¢. Buy, sell, trade, repair. Barlow's, 5565 So. Howell Ave., Milwaukee 7, Wisc.

**JEOP** Owners — V8 power. Read Jeep owners ad, page 18.

**HOW** To catch fish, scent secrets, 10¢. Johnston's, 312 Lake Avenue, Ithaca, New York.

**COLT** .38 Frontiers, new \$125; excellent .25 automatics \$24.50; Kentuckies \$39.50; Lugers \$39.50; P38's \$34.50; Springfield \$24.50. Catalog 50¢. Agramonte's, Yonkers 20, N. Y.

**SAVE 66 2/3%**! 1956 Wholesale buyers directory! Finest sporting goods! Free details! National Buyers Service, Box 3338ER, San Francisco.

**FISHERMEN** Catch your limit every time. Our free 1956 catalog tells you how. Hergert Company, Box 741, Coral Gables, Florida.

### BINOCULARS, TELESCOPES, MICROSCOPES, MAGNIFIERS

**REFLECTOR** Telescope kits \$6.25 (3") to \$175 (12"). Mirrors, cells, focusing mounts, tripods, eye systems. Anything, everything in telescopes. Free catalog. Also ready to use telescopes from \$25. Esco Products, Oakridge, New Jersey. Showroom, 166 Church Street, New York City.

**BINOCULARS**. Telescopes, microscopes, terrific values \$3.98 up. Request free money saving catalog. Criterion, Dept. P44, Hartford, Conn.

**BUILD** Your own reflector telescope. Complete kit: mirrors, eyepieces, tripod, all other accessories. Request free illustrated literature. Criterion Manufacturing, Dept. KPM20, Hartford, Conn.

**DYNASCOPE**—Sensational new reflector telescope. Send for details. Criterion Co., Dept. DP23, Hartford, Conn.

**AMAZING** Prices, precision binoculars and gunscopes. Free trial. Folder, "Binocular Selecting," catalog free. Prentiss Importers, Mercury Bldg., West Los Angeles 25, Calif.

**REFLECTING** Telescope, 60X, completely assembled \$29.75. Guaranteed observatory clearness. Free information. Skyscope, 475 Fifth Avenue, New York City 17.

**SAVE 35%** \$150,000.00 Binocular stock! Pocket sizes to 20X. \$3.95 to \$250.00. Also telescopes, riflescopes. Free 56-page 3-color catalog. United, 9043 S. Western, A-408, Chicago 20. Dealers wanted.

**EXTRAORDINARY** Binocular presentation. Write Sheehan & Company, Dept. A18, 1420 Kipling, Houston 6, Texas.

**WAR** Surplus bargains: Millions of lenses, instruments, telescopes, binoculars, components and complete line of astronomical telescope items. World's greatest optical market place! Send only \$1.00 for beginner's 10-lens kit and big instruction booklet stock 2-CH. Write for catalog CH, free! Edmund Scientific Corp., Barrington, New Jersey.

**400X** Telescopes easily made. Kit includes focusing tube, erector, five finished lenses and building instructions — \$3.75. Free booklet on completed telescopes, tripods, mirrors, lens kits, etc. Suffolk Science, Mattituck 3, New York.

### PETS—DOGS, BIRDS, RABBITS, HAMSTERS, ETC.

**GROW** Mushrooms. Cellar, shed. Spare, full time, year round. We pay \$3.50 lb. We paid John Betts \$7,977.76, he started as amateur. Free book. Mushrooms, Dept. 171, 2954 Admiral Way, Seattle, Wash.

**SPORTSMEN**: World's largest kennel offers 500 Pointers, Setters, Straight Cooners, Combination Hounds, Rabbit and Squirrel Dogs, Beagles, Fox and Wolf Hounds. Trial. Prices reasonable. Catalogue free. Smokey Mountain Kennels, Cleveland, Tennessee.

**BEAUTIFUL** Pure white pedigree police puppies. Ansonia Kennels, Mose, N. Dak.

**HUNTERS!** Raccoon Mountain and Short Creek kennels now combined. Large number of coonhounds, foxhounds, rabbit-hounds, beaglehounds, bird-dogs, puppies. Free literature and pictures. Trial. Dures Thomas, Owner, Box 464, Boaz, Alabama.



**MINK.** Quality breeding stock. Raising information. Cages, equipment. Huebl Minkerys, LeSueur, Minn.

**\$1,000 MONTHLY** Possible raising red-worms; large African nightcrawlers! Backyard, garage, basement. Illustrated booklet explains raising, packing, marketing. 25¢ postpaid! Ozark Worm Farm-J. Willow Springs, Missouri.

**MONTHLY Bird magazine** (budgies, canaries, finches, etc.). One year \$3.00. American Cage-Bird Magazine, 3449 N. Western Avenue, Dept. P.M., Chicago 18, Illinois.

**MAKE Money** raising chinchillas, mink, pigeons, rabbits, cavies for us. Free catalog. Keeney Brothers, New Freedom 2, Penna.

**HAMSTERS, Pair \$2.95.** Free booklet. Jer-Fre's Hamstery, 2425 Hoyt, Muskegon Heights 13, Mich.

**CHINCHILLAS**—High graded Blend-Trast, Willard George, Wholesale prices. Chinchillas, 21219 Figueroa, Torrance, Calif.

**MINK Raising information free.** Complete. Lake Superior Mink Farm, Superior, Eel, Wisconsin.

**RAISE Rabbits** successfully by knowing facts. 48 page illustrated book describing 25 breeds. Housing, feeding, breeding, marketing, etc. Plus bulletin, 25 cents. American Rabbit Association, 36 Arba Building, Pittsburgh, Penna.

**STANDARD Rabbit Journal,** Milton 3, Penna. Year \$1.00. Sample dime. Beginners manual 25¢.

**RAISE Rabbits.** Make money. Send 25¢ for market information, plans for housing, and prices of starting stock. A. Johnson, Box 694, Kansas City 41, Missouri.

**RAISE Nutria:** Vegetarian; odorless; valuable fur; exceptionally prolific; no known disease; standards and mutants. Terrific potential. Voight Farms, Atlanta 2, Texas.

**CHAMELEONS,** Alligators, snakes, monkeys. Snake leather sample with price list 25¢. Snake Farm, LaPlante, Louisiana.

**RAISE Angora,** New Zealand rabbits on \$500 month plan. Plenty markets. Free details. White's Rabbitry, Jackson, Mich.

#### PLANTS, SEEDS, BULBS, NURSERY AND GARDEN SUPPLIES

**RAISE Your shrubs, trees** from seed. Free planting guide, price list. Woodlot Seed Co., Norway 9, Michigan.

**WORLD'S Greatest cash crop.** Free information. Write Ginseng Gardens, Asheville, N. C.

#### FARMS, FARM LANDS, REAL ESTATE

**GOVERNMENT Land** available, 25 states, Alaska. Free information. Sledge Surveys, Macon, Mississippi.

**OZARKS!** \$7 Acre. Diversified listings free. Write: Armstrongs, Shook, Missouri.

**HOMESITES \$15 Monthly**—California's finest garden section. Morro Bay's scenic shores. Wonderful fishing, boating. Fertile soil, softest water, temperate climate, congenial community. Free literature. Richard Otto, Department M, San Luis Obispo, California.

**FLORIDA Acreage.** If you have some for sale, send description, price, to Clay Folsom, Box 1707, West Palm Beach, Fla.

**NEW Strout fall catalog.** Just out! Mailed free! Over 3000 bargains, 36 states, coast-to-coast. Farms, homes, businesses. World's largest! 56 years service. Strout Realty, (MF), 7 So. Dearborn St., Chicago 3, Ill.

**500,000 ACRES** California state government land low as \$5 acre minimum offer. Send 10¢ (coin) for information on available lists and maps of 40 to 640 acre tracts. Pacific Lands, 7419-F Beverly Blvd., Los Angeles 36, California.

**MISSISSIPPI River** and lake lots \$10 down. Way below market. Nerco, Box 3154, Minneapolis 3, Minn.

**SAVE Hundreds of dollars** when selling your real estate. For particulars, write Norman Realty, 80 Lovell Street, Worcester, Mass.

#### PROFITABLE OCCUPATIONS

**WHOLESALE Catalog!** 30-80% discounts! Appliances, musical instruments, typewriters, tools, watches, jewelry, cameras, housewares, etc. Consolidated Distributors, 7-14 Henry, Paterson 15, New Jersey.

**MAKE Money** writing short paragraphs! No tedious study. I tell you what to write, where and how to sell; and supply list of editors buying from beginners. Many small checks add up quickly. Write to sell, right away. Send for free facts, Benson Barrett, Dept. CP-27-V, 7464 Clark, Chicago 26.

**LEARN Free** how to become glamour photographer. Make big profits photographing beautiful models. Opportunities nation-wide. No previous experience or expensive equipment needed. Write for free illustrated Success Plan, Harrison's, 1031-C Magnolia Park Station, Burbank 20, Calif.

**MAKE Extra money** in your own workshop. Guaranteed plan. Chester Products, Box 513, Lansing 3, Mich.

**GROW Mushrooms.** Cellar, shed. Spare, full time, year around. We pay \$3.50 lb. We paid John Betts \$7,977.76, he started as amateur. Free book, Mushrooms, Dept. 99, 2954 Admiral Way, Seattle, Wash.

**BUY Wholesale** thousands nationally advertised products at big discount. Free "Wholesale Plan," American Buyers', Hertel Station, Buffalo 16-B1, N. Y.

**YOUR Own** wholesale business with no investment. Free catalog. Jay Norris Co., 487X Broadway, New York City.

**FOREIGN Jobs**—Latin America, Alaska, Canada, up to \$1500 monthly. Up-to-date 1958 foreign service directory gives complete information; hot list of firms hiring for military and civilian construction, aircraft, oil, exporters-importers, mining, \$1.00. How-when-where to apply. 9th successful year! Global Reports, Box 883-S, Hollywood 38, Calif.

**FREE Folio** "\$5,000-\$45,000: Unlimited Vacations." No merchandise, equipment. Unknown! Work home, sparetime! Haylings, Carlsbad, Calif.

**MUSHROOM** Spawn seed plus directions manureless, various, growing, marketing \$1.00. Free information, gladly. Luxur, 641 South 19th, Newark 3, New Jersey.

**RAISE Pheasants** on \$100 week plan. Little capital and space can make you independent. Free details. Great Central System, Columbus 1, Kansas.

**MAKE New** greaseless doughnuts in kitchen. Sell stores. Free recipes. Michael Ray, 3605 South 15th Ave., Minneapolis 7, Minnesota.

**BE The Popular Mechanics** representative in your neighborhood and earn big profits in your spare time. Write Popular Mechanics Magazine, Room 408M, 200 E. Ontario St., Chicago, Ill.

**FORTUNE** Possible raising fishworms and crickets. Free literature. Carter Wormery, Plains, Georgia.

**AUCTIONEERING**—Home study course. Diploma granted. Auction School, Ft. Smith, Ark.

**FREE Book** "505 Odd, Successful Businesses." Work home. Pacific, Oceanside, Calif.

**\$150 WEEK**—Easy! Start home Venetian blind laundry. Revealing book free. A.T. Co., 101 S. 44th, Philadelphia 4, Penna.

**SHAMPOOS,** Bath salts, beauty creams; unbelievable profits with easy home manufacture. Instructions \$1.00. K. Boardman, Box 219 Station D, Hamilton, Ontario.

**REPAIR Porcelain** enamel on appliances. Much needed service. Start full or part time business for less than \$30.00. Free information. Porcelain Enamel Repair Service, 422 Prospect, Buffalo 1, New York.

**DO-It-yourself** watch repair method. Write. Weber Service, Box 2489, Denver 1, Colo.

**MAKE Flexible** molds. Cast plaques, figurines. Free sample. Tooker, 630-M Chestnut, Hamilton, Ohio.

**TREE-Mushrooms!** Elixir, profitable. Spawn, instructions, \$1.00. OHGA, PM60, Sigakenkusatu, Japan.

**EVERYBODY** Likes candy. Learn to make professionally home. Our 45th year. Ragdale Candies, D6, East Orange, New Jersey.

**HOME Mailorder** beginner's manual, sources, instructions, opportunities. 25¢. Carnahan Bros., 9610 Acacia, Fontana, Calif.

**LEARN Real estate** by listening to records. Lee Institute, Brookline 46, Mass.

**WELDING** Pays big money. Learn easily at best equipped school in country. Non-profit school with low cost training. O.I. approved. Write Hobart Trade School, Box M-862, Troy, Ohio.

**MAGAZINE Subscriptions**—Largest commissions, bonus. Qualified Agency, 451HA Kingston, Brooklyn 25, N. Y.

**60% PROFIT** Cosmetics, \$25 day up. Hire others. Samples, details. Studio Girl Hollywood, Glendale, Calif., Dept. 1268H.

#### BOOKS, PERIODICALS, PICTURES, POSTCARDS

**BRITISH Book** bargains—All subjects. Stamp brings catalog. Transbooks, Box 72-PMC, Brooklyn 26, N. Y.

**SAVE Expenses.** Automobile book illustrated 35¢. Party games book 30¢. Persil, 436 N.Y. Ave., Brooklyn 25, N. Y.

**NATIONAL Geographic** Magazines, 1888-1956. Periodical Service, Box 465-PM, Wilmington, Delaware.

**BOOK Catalog,** 1000 interesting titles. Send 10¢. Books Publishing Co., Amityville 3, N. Y.

**OUT-Of-Print** books at lowest prices! You name it—we find it! Fast service. No obligation. International Bookfinders, Box 3003-PM, Beverly Hills, Calif.

**RARE Magazines,** catalog 10¢. Nationwide Magazine Exchange, Box 1375-P, San Antonio 6, Texas.

**HORSE Books**—Breaking, training, care. Carson, 1304 W. Kiowa, Colorado Springs, Colorado.

**BOOKFINDERS!** All subjects. Send wants! Jaher Book Service, 183 Hazelwood Drive, Westbury, N. Y.

**"SCIENCE Milestones"** Records march of science starting 400 years before Christ, right up to date. Amazing facts revealed. 312 pages packed with startling information that will thrill you. A real history of science. \$5.00. Literature free. Popular Mechanics Press, 200-SM East Ontario St., Chicago 11, Ill.

**MOFFATANA Bulletin,** mail \$1.00. 11303 75th Avenue, Edmonton, Alberta, Canada.

**MINIATURE Bibles,** 200 pages, 50¢. Three, \$1.00. Lamplighter, Box 30, St. Helena, California.

**FREE Catalog!** Bargains for everyone! Critic Books, 10020 Hawthorne, Inglewood, Calif.

**JOHN Friend,** bookbinder, can get the book you want. Free search service. Box 197PM, Cardiff, Calif.

**SUBSCRIBE To** Trailer Travel Magazine, one year \$2.50. Oldest, most informative widely read mobile publication. Sample copy 10¢. Woodall Publishing Company, 121-P West Wacker, Chicago 1, Ill.

**FLYING Saucer** books, magazines, rental plan. Write: New Era, BM-18 Melrose Building, Houston 2, Texas.

#### GAMES, TOYS, NOVELTIES

**NEW Game**—Teaches aircraft navigation. Uses real navigation charts, simulated airplane instrument panels. Pilots, teach your children, \$3.90 postpaid. Chart-Air, Hood River, Oregon.

**MAGIC TRICKS, PUZZLES, JOKER NOVELTIES**

**GO Ventriloquist,** all secrets told. Make money, surprise friends. Send 35¢ for information and receive free \$1.00 catalogue of dummies, dialogues, etc. Limited supply. Gough, R. 3, Hartford City, Ind.

**3100 NOVELTIES.** Jokes, tricks, gadgets, funmakers, hobbies. Big catalog 10¢. Johnson-Smith, D-202, Detroit 7.

**LEARN Ventriloquism,** easiest method. Details free. Smith, 2125 N. Bigelow, Peoria, Ill.

**WOODEN Nickels,** catalog, trick, 10¢. 1,500,399 tricks, jokes, Magico, Box 1375-P, San Antonio 6, Texas.

**500 TRICKS,** Douglas famous 120-page catalog, only 10¢. Fastest service to magicians for 30 years. Send 10¢ today. Douglas Magicland, Dept. 1, Dallas, Texas.

**SMOKEBOMBS** 25¢, 7 For \$1.00. Terrific! 4463-PM Greene, Philadelphia 44.

**BEST Magic,** Joker's novelties. Lower prices. Catalog 10¢. Top Hat, Evanston 12, Ill.

**DOLLAR Magic** set free with catalog 25¢. 4462-PM Germantown, Philadelphia.



FREE Trick and professional catalog of 600 tricks, \$1.00. Terry's Magic Studio, 1921-66th Street, Brooklyn 4, New York.

SENSATIONAL Magician's wand 25c. Vanishes handkerchief! Catalog included. Box 1352-PM, Philadelphia 5.

COMPLETELY illustrated 500 trick magic catalog 25c. Stowell, Woodstock, New York.

PROFESSIONAL Catalog, 175 pages, 25c. Williams, 900 Plymouth, Ellwood City, Penna.

SVENGALI Trick deck free with catalog 50c. 1746-PM Market, Philadelphia 3.

VENTRILLO, Professional voice-throwing instrument and catalog 25c. Box 971-PM, Philadelphia 5.

### COINS, TOKENS, CURRENCY

OLD Money wanted. Do you know that coin collectors pay up to \$100.00 for certain U. S. cents? And high premiums for all rare coins? We buy all kinds. Send 4c for large coin folder. May mean much profit to you. Numismatic Co., Dept. 20, Fort Worth, Texas.

UNCIRCULATED Sets, Singles, Coins and supplies. Free price lists. Louis Bell, Masonic Building, Decatur, Alabama.

36 DIFFERENT Foreign coins \$1.00. Robbins, 1007 Cleaveland, Montgomery 8, Alabama.

FIVE Foreign coins from Switzerland, Belgian East Africa, etc., plus foreign banknote, only 10c with coin approvals. Littleton Coin Company, Littleton R1, New Hampshire.

GET Profit and pleasure in collecting old coins. Send 10c for 56-page illustrated coin catalog. You'll be delighted with it. Send for it now. B. Max Mehl, 370 Mehl Building, Fort Worth, Texas. Largest rare coin establishment in U.S. Established 56 years.

6-IN-1 Special: Magnifying glass; check list; 25 coin envelopes; giant 60 page bargain catalog; ten different Indian pennies; Mexican ten-peso; All six, \$1.00 postpaid. Ben's Coin Shop, 31 North Clark, Chicago 2, Illinois.

FREE! Foreign coin, banknote and coin collectors illustrated catalog to approval service applicants. Send 3c postage. Tatham Coinco, Springfield 30, Mass.

SAN Francisco mint closed! Made only cents and dimes in 1955. In short supply and great demand. One each brilliant uncirculated, for 25c. Free coin lists with order. Bryson Stamp & Coin Company, 612 White, Toledo 5, Ohio.

BARGAIN Lists, Indianhead cent, 10c. Economy Sales, 157 Dean, Mansfield, Mass.

U. S. Large cent, 2c piece and bargain list, only \$1. Delmaco, Box 1123, Wilmington, Del.

MORGAN Dollars, 1878-87-90-91-97S \$2.00 ea. New illustrated catalog 25c. Shultz, Box 746, Salt Lake 10, Utah.

BRILLIANT Uncirculated 1954-S mint set, \$1.75. Armstrong, South 206 Howard, Spokane 4, Wash.

35 DIFFERENT Foreign coins \$1.00, 60 different \$2.00. Claud Denneev, 3406 S. Harwood, Dallas 15, Texas.

100 COINS And bills, \$1.00. Oddehon, Box 482, St. Louis, Mo.

55S CENT 10c. 55D quarter 90c. 55D dime 25c. Coin list free with order. Wiese, Box 8444, Dallas.

\$20 PAID For 20 Lincoln cents taken from circulation. Send \$1 for list of these cents. This dollar refunded with first purchase. Gasser, Box 34-615, Los Angeles 34, California.

### STAMP COLLECTING

30 DIFFERENT Commemoratives 1893 up 10c. U. S. approvals. K&B, Box 70, Brooklyn 23, N. Y.

TRAVEL Through 50 countries! A virtual world cruise! 50 stamps, each from a different country. Abyssinia to Zanzibar. Bargain unsurpassed! To new approval applicants, 5c. Avalon Stamp Co., Dept. M, Springfield, Mass.

FREE! World's 10 ugliest! Weird colors, valuable cut design. Send 3c postage today! Norrisco, Milwaukee 7, Wis.

TWO \$5.00 U.S. stamps plus 20 different, 10c with U.S. approvals. Irwin, Box 1105, Brooklyn 30, N. Y.

ECONOMICAL 1/2c, 1c, 2c, Approvals, 22,000 varieties available. Dresel, Box 270-N, New York City 25.

OLYMPIC Set, 1000 hinges only 10c. Approvals, Buckley, 208 Ludlow Bldg., Dayton 2, Ohio.

SELL Your surplus good grade stamps. Write, describing fully what you have. Vanroy Shirk, Lebanon, Pennsylvania.

FREE! Catalog! About stamps. Illustrated. Free! The Stampmart, Hartford 1, Connecticut.

FREE United States price list. Mark Hanna, 335 Fifth Ave., Pittsburgh 22, Penna.

50 DIFFERENT Argentine 10c. Approvals. Reuter, 611 W. 40th Pl., Los Angeles 37.

OLD Scarce U.S. seconds on approvals. Slight imperfections, lowest prices. Herfield, Clintonhill Sta., Newark 8, N. J.

U. S. Classics. Over 50 yrs. old, 15 selected old-timers. Missing in biggest collections. All 15 at less than 1c each. 10c with approvals. Jaro, Box 246-T, New York City 8.

50 DIFFERENT United States 5c with bargain approvals. Lists. Bookman, Box 3245-M, Madeira Beach, Fla.

AMAZING Offer! 200 United States stamps—including commemoratives, airmails, high denominations to \$1.00. Only 10c to approval applicants! Illustrated bargain lists free. Mystic Stamp Co., Dept. 80, Camden, New York.

WORLD'S Largest stamp (7 1/2 x 14 inches). A real curiosity! Retail for 50c, only 3c to approval applicants. Tatham Stamp Co., Springfield 30, Mass.

WEIRD Diamond shape coffee stamp! Lovely flower triangle! First American big commemorative, Greenland, idol dancer, etc. Free with approvals. Capital Stamp Co., Little Rock 2, Ark.

100 OLD United States between 1861 and 1935, \$1.00. Roush Stamps, 51 Chestnut, Mansfield, Ohio.

25 STAMPS For only 10c! This mammoth value includes airmails, pictorials; stamps from strange countries cataloging up to 25c each! Also approvals. Mystic Stamp Company, Camden 80, New York.

FAMOUS Men, jungle scenes, zoo. United States commemoratives, 100 others. Ten cents with request for thrifty approvals. Casner Stamps, 247-A Riverside, El Paso, Texas.

MINT Commemoratives at face! Send 25c for surprise packet of all different, mint U.S. commemoratives. Mint U.S. approvals too. Western, Box 1689P, Salinas, California.

UNITED States approvals. Select copies, used—mint. Kingsbury, Fairfax, Vermont.

ICELAND 10 Different beautiful stamps for only 10 cents to applicants for our good old fashioned approvals. Old Colony Stamp Co., Dept. A, Milford, Connecticut.

UNITED States commemorative collection containing 33 different, 10c approvals. White, 516-A Avenue L, Brooklyn 30, New York.

FREE! Flower triangles, others. Approvals. Delton Page, Box 201X, East Paterson, New Jersey.

START Your own stamp business. Send for free circular. Donald Shepard, Box 1147, Chicago 90.

100 DIFFERENT China 10c. Approvals. Coast, P.O. 2187H, Santa Ana, California.

100 YEAR Old United States stamps are sent on approval together with all commemoratives, airmails, etc. Also all foreign, Roosevelts, etc. Send 10c for 50 different U. S. and approvals. Globus, New York 10, N. Y., Dept. 213.

FREE! 55 British Colonies, 5c postage. Kensington Stamps, Buffalo 15, N. Y.

GIGANTIC Collection free. Includes triangles, early United States, animals, commemoratives, British Colonies, high value pictorials, etc. Complete collection plus big illustrated magazine all free. Send 5c for postage. Gray Stamp Company, Dept. PM, Toronto, Canada.

BERLIN Bishop set complete 25c. Approvals. Barricks, 1734 Seward, Detroit 6, Mich.

WOW! 135 All different Germany 10c. Zeppelins, semi-postals, airmails, high values. Big bargain lists and approvals included. Jamestown Stamp, Dept. A8PMC, Jamestown, N. Y.

NORTH Korea; worldwide collection. 25c with approvals. Boisvert, Greenbelt, Maryland.

FREE! Monaco wedding stamps, given applicants for approvals. Exotic, Box 482-MM, Coral Gables 34, Florida.

QUEER Country collection from Baden, Camerouns, Indo-China, Indonesia, Hong Kong, Madagascar, Malaya, Monaco, Rheinland-Pfalz, Saar, Saint Pierre, Togo. High values, low values. Bi-colors, tonicals. A collection in itself. Only 10c with beautiful inexpensive approvals. Clark Stamps, Dept. A-47, Muskegon Heights, Mich.

\$1500.00 CHINESE Commemorative colorful set 10c. Gerhardt, 405 East 6th, Austin 1, Texas.

WHY Pay more? Pick stamps from our large collections. 2c each. Just as purchased. Be first. Premiums given. U. S. also available. Roseland Stamps, Dept. A-35, Spring Lake, Mich.

KOREA Flowers, Formosa Chiang Kai-shek birthday issue, Hungary pictorials, Ceylon (elephant) Royal Visit, South Africa Cape of Good Hope triangle centennial, Italian Colony flowers. Nine bi-color maps, African wild animal set. Many more beauties. All for 25c with interesting approvals. Every continent represented in this collection. Modern Stamp Co., Dept. A-3, Ferrysburg, Mich.

FIRST U. N. set. Among world's prettiest. Only 10c. Approvals. Welles, Box 1246-R, New York City 8.

U. S. Stamps—At discount prices. Giant illustrated catalogue. Only 10c. Raymax, 37-VZ Maiden Lane, New York City 38.

FREE! Giant catalog offering thousands of bargains. Sent with beautiful approvals. Jamestown Stamp Co., Dept. E8PMC, Jamestown, N. Y.

125 DIFFERENT United States, \$1.00. Approvals. Utechts, 1143J North Keeler, Chicago 51.

100 DIFFERENT Austria 10c. Approvals. Aronson, Box F, Newton Centre 59, Mass.

TOPS! Free book, "How to Collect Stamps" Send for your copy today! Approvals. Littleton Stamp Co., Littleton E1, N. H.

40,000 VARIETIES Available on approvals, 1/2c upwards. Keigwin, Box 933B, Daytona, Florida.

EXCITING "Strange countries" packet. Free with approvals! Saxon, Orange, Calif.

1500 STAMPS, \$1.00 With approvals. Guyton, Box 1275, Monroe, Louisiana.

1-2c EACH! Thousands of exciting worldwide stamps. Free examination. Cole, Box 223-A, Buffalo 21, N. Y.

25 BRITISH Colonies, 50 Asia, 50 Hungary, 25 Netherlands, 50 Germany, plus surprise. 25c with approvals. Fried, Box 475, No. Hollywood 11, Calif.

BULGARIA Pictorials: 50 diff. 15 cents. approvals. Boger, Box 152, North Wales, Pennsylvania.

AMERICA'S Finest U. S. catalogue free. Stone's, 192 Washington, Boston 8, Mass.

PREMIUMS, Triangles, pictorials, free with approvals. Levin Otis, San Andreas, Calif.

FREE! 1956 Olympic set—Approvals. H & H Stamp Center, Box 76, Brooklyn 26, N. Y.

FREE With approvals, Spanish Zaragoza religious set. William, Diamond, Penna.

ZEPPELIN Stamp free, with approvals. Variety Stamps, 57-V Circuit, Newton Highlands 61, Mass.

25 PHILIPPINES 10c. Worthwhile worldwide approvals. Moffat's, 740-A Milton, Rock Hill, South Carolina.

UNITED States, Fine mint airmails, #C7, #C8, #C9, #C10. Only \$1.00. Approvals accompany. Whiton Paine, Westport 11, Connecticut.

DOMINICAN Republic, 10 pictorials, 10c with approvals. Seminole Stamps, Box 1138-P, Coral Gables 34, Florida.

SELL Stamps to our readers. Your ad in this space will be read by thousands of stamp buyers. I'll prove that to you. Write now for Folder "S." F. W. Johnson, Classified Advertising Manager, Popular Mechanics, 200 E. Ontario St., Chicago 11, Ill.

STAMP Surprise 5c with approvals. Clyde Bauer, 1700 Harvard Street Northwest, Washington, D. C.

300 DIFF. World wide 25c. plus surprise packet. Packet list free. Econopackets, Box 168, Riverside 9, Calif.



BEAUTIFUL Collection of the East. 35 different Egypt, 15 different Pakistan. 11 different old India officials, regular value \$1.73, but to approval applicants the 3 different collections only 35¢. Yorke Stamp Shop, 2560 Briggs, Bronx 58, New York.

14,000 DIFFERENT—Yours on our streamlined systematic club plan for only 50¢ weekly. Big shipment every two weeks. Details free. L. G. Ware, Baldwin 75, New York.

#### ANTIQUES, RELICS, INDIAN GOODS, CURIOS

SELECTED War arrowhead \$1.00. List 5¢. H. Talburt, Calico Rock, Ark.

TAHITI Hula skirts and curios. Yves Jarsillon, Box 467, Papeete.

SCALPING Knife, spearhead, thunderbird, drill, \$4.00. List free. Arrowhead, Box 1249, Hot Springs, Arkansas.

4 ARROWHEADS \$1.00. Spearhead \$2.00. Celt \$2.00. Stan's, 1138 Whittier, Columbus, Ohio.

MOROCCAN Hand of Fatimah gold luck charm airmailed. Send two dollars. I. Industries, 41 Vinas, Tangier, Morocco.

#### PRECIOUS STONES, MINERALS

AGATES, Gems, machines. Free list. Northwest Gems, 2819 North Warner, Tacoma 7, Washington.

CUT Gems, make jewelry—For profit or fun. 100 page magazine tells how; where to get supplies. Sample 25¢ or request free literature. Lapidary Journal, Del Mar 2, Calif.

EARTH Science, the rockhounds' national magazine. Subscription \$2.00, sample 25¢. Box 1357, Chicago 90.

FIND Uranium, tungsten, mercury, hundreds of other minerals with Mineralight. Free information kit on fun and profit in fluorescent minerals; hobby set. Write Dept. PM8, Ultra-Violet Products, San Gabriel, California.

SAPPHIRE, Topaz, tourmaline, garnet, peridot. Five uncut gem specimens, \$1.00. Ten polished gems, baroque shaped, \$1.00. Free big bargain list jewelry, gems, profitable, easy "do it yourself" projects. O'Brien's, 1116M Wilcox, Hollywood 38, Calif.

#### HOBBIES AND COLLECTIONS

WANTED—Cigarette, tobacco cards. Write Charles Bray, East Bangor, Penna.

NAZI Insignia. 12 different \$1.00. Medals, patches, armbands, flags, daggers. Illustrated lists, 10 cents. Medcrafts, 2004 35th St. S.W., Calgary, Canada.

SHIPS, Planes, cars, guns, leather, painting kits. Daters, 821 Divisadero Street, San Francisco 17, California.

MILITARY Miniatures. Civil War. Custer's Cavalry, American Revolution and U. S. Marines. Illustrated catalog 35¢. Bussler Miniatures, Dept. Z, 40 Howe St., Quincy 69, Mass.

FREE "Do-It-Yourself" leathercraft catalog. Tandy Leather Company, Box 791-V16, Fort Worth, Texas.

INVENTING Can be an interesting and profitable hobby. Write for complete particulars. Institute of American Inventors, Dept. 40-E 631-E St., N.W. Washington 4, D. C.

COLLECTORS Matchbook covers. 100 different unused, \$1.00. Catalog 25¢. Album \$3.00. Charles Edelman, 1311-C East 84, Cleveland 3, Ohio.

#### CAMERAS, PHOTO SUPPLIES

BASS Says: Quality cameras since 1910. When in Chicago visit the camera cross roads of the world, or write us for your favorite equipment, new or used. Satisfaction guaranteed. Bass Camera Co., Dept. AG, 179 W. Madison St., Chicago 2, Ill.

REAL Wholesale sources. Thousands nationally advertised products. Details free. Martex, 132-A Nassau St., New York 7, N. Y.

FLASH Bulbs. Cases only, 200 bulbs. \$13.00. Postage paid. Bluebird Photo, Box 1071, Topeka, Kansas.

FREE Catalog photo equipment, appliances, terrific savings 1956 Argus automatic projector \$44.50. Mailers Mart, Box 135-B1, New Rochelle, New York.

TRAVELERS. Name the spot—we have the slide! 4000 Kodachrome 2x2 slides and 1200 stereos, sent on approval. Send 25¢ (deductible from first order) for 40-page, illustrated catalog. Ernest K. Wolfe, 1315 Westwood, Los Angeles 24, California.

PHOTOGRAPHY For pleasure or profit. Learn at home. Practical basic training. Long established school. Free booklet. American School of Photography, 835 Diversey Parkway, Dept. 3441, Chicago 14.

BUY Wholesale nationally advertised cameras, photo supplies, thousands other products at big discount. Free "Wholesale Plan." American Buyers, Hertel Station, Buffalo 18-E1, N. Y.

OIL Coloring photographs—A fascinating hobby or profitable sideline for those with artistic talent. Learn at home. Easy simplified method. Free booklet. National Photo Coloring School, 835 Diversey Parkway, Dept. 343C, Chicago 14.

LEARN Camera repair. Easy, complete, approved home-study course. Free illustrated booklet. National Camera Repair School, Dept. E-8, Englewood, Colorado.

10,000 ROLLS Fresh snapshot film given away. Write today. Delco, Box AC362, Upper Darby, Penna.

SAVE 66 2/3%! 1956 Wholesale buyers directory! Finest cameras! Free details! National Buyers Service, Box 3338EX, San Francisco.

#### PHOTO FINISHING

NO Charge developing rolls. Pay for good prints only. Jumbos 4¢. Contacts 3¢. Failures refunded. Returned same day. Satisfaction guaranteed. Square Deal Photos, Hutchinson, Kansas.

EKTACHROME—Anscochrome processed. Mounted \$1.00. National Color Corporation, Box 55, Northside, Atlanta 5, Georgia.

ENLARGEMENTS! Eight 5x7's or five 8x10's, \$1.00. Wilart Enlargers, Box 967, Little Rock, Ark.

SPECIAL Gift with first roll developed and 8 dated jumbo prints, or 16 dated contact prints in wallet folder 40¢. 12 exposure 50¢. Owl Photo Co., Dept. 21, Weatherford, Okla.

ENLARGEMENTS, Heavyweight eight 5x7's or five 8x10's, \$1.00. Jack Koons, Huntington Mills, Luzerne County, Pennsylvania.

FIRST Class return—First class quality. Your films expertly processed, rushed to you by fast mail. Sparkling, enlarged prints: 8 exposure roll 50¢, 12—70¢, reprints 6¢. Unconditionally guaranteed. Photo Masters, Box 26-M, Philadelphia, Penna.

10,000 ROLLS Fresh snapshot film given away. Write today. Delco, Box AA362, Upper Darby, Penna.

12 JUMBOS From any size roll developed 35¢ with this ad only. PM Skrudland, Lake Geneva, Wisconsin.

FILMS Developed. Fast service. 8 exposure roll 40¢. 12 exposures 60¢. Reprints 5¢ each. 505 Developing Service, Box 505, Memphis, Tenn.

SPECIAL Introductory offer. 8 jumbos 25¢, 12—35¢. Western Photo, PM-86, Box 298, San Francisco 1, Calif.

4x5 DW Enlargements 10¢. 5x7's 20¢. 8x10's 30¢, ten wallets 50¢. Copy negatives 50¢. Photostats, slides, photo finishing. Overnight service. Rapid Reproduction, 419-17 Broadway, Joliet, Illinois.

BETTER Pictures faster, 8 oversize in album 35¢, 12, 50¢. Red Robin, Box A573C, Clifton Heights, Penna.

POLAROIDs Duplicated, negative and 3 prints like original 50¢. Delco, Box A362, Upper Darby, Penna.

TWO Beautiful prints from each picture on roll. 8 exposure 40¢; 12 exposure 50¢. Thirty-five years of satisfied customers. Quick service. Lens Photos, Dept. J-4, Janesville, Wis.

12 EXPOSURE Rolls, 39¢. Jumbo prints. Guaranteed work, one day service. Lincoln Studios, Dept. K, Box 13, Lincoln, Neb.

QUALITY Kodak finishing. 8 exposure roll 35¢; 12 exposure 50¢; 16 exposure 60¢. Reprints 4¢. Fast service. Guaranteed quality. 40 years continuous operation. Be a satisfied customer. We do color. Send for mailers. Mail Order Photo Service, Box 297, Watertown, Wisconsin.

COLOR, 24 Hour service. Ektachrome. Anscochrome, 20 mounted \$1.25. Free Kodacolor price list. Delco Film Lab, Box A362W, Upper Darby, Penna.

TWO Beautiful enlargements from each picture on roll. 8 exposures 55¢, 12 exposures 75¢. Cut Rate Photos, Dept. B-4, Janesville, Wis.

ROLL Developed, 8 beautiful enlarged prints 25¢; 12—35¢. (Trial) 10 reprints 40¢. Quick service. Willard's, Box 2553G, Cleveland, Ohio.

TOP Quality. Fast service. 8 jumbos 35¢. 16 contacts 40¢. Reprints—Jumbos 4¢; contacts 3¢. Satisfaction guaranteed. Free mailers, circulars. Fast-X-Foto, Box A, Jersey City, New Jersey.

8-HOUR Service on deluxe jumbo prints. 8-exposure roll developed and 8 jumbo prints 40¢, 12 exposure 55¢, 16 exposure 70¢; 35mm, 20 exposure 75¢, 36 exposure \$1.25. Jumbo deckle reprints 4¢ each. Contact prints made if specified. Bay Photo Service, P.O. Box 210, Oakland, California.

FREE Superpak album with 8 jumbos only 35¢. 12—50¢. Prompt superior service. Quality guaranteed. Mailers and circulars free. Grand Fotos, GPOB 1410, New York City 1.

#### MOTION PICTURES AND SOUND EQUIPMENT

DUMONTS Hi-Fi plastic recording tape. 1200 feet \$1.90, 600 feet \$1.45. Postage extra. Dumonts, 150 East 34th St., New York City.

16MM, 35MM, films—\$5. Exchanged. Buy, sell. Bryant Supply, Emporia, Va.

16MM. Sound-used projectors and films. Rental, sale, exchange, bargain prices. Free lists. Also 8 mm. Specify film size. National Cinema, 71 Dey Street, New York City.

8-16MM. Films. Free catalogue (with sample film 10¢). Garden, 690 Howard Avenue, Brooklyn, N. Y.

ALL Kinds 16mm. sound films. Sale. Cheap. Roshon, 335 Fifth, Pittsburgh 22, Penna.

FREE! Movie title "The End" with purchase of projection length film \$1.00. Valley Film Service, 16121 Sherman Way, Van Nuys, California.

5,000 8-16MM. Movie films. Free catalogues. International, Greenvale, N. Y.

TAPE Recorders, tape. Unusual values. Free catalog. Dressner, 69-02M 174 St., Flushing 65, N. Y.

MOVIE Camera film: 8mm. roll \$1.50. 16mm 100' \$3.00. Free processing. Better Films, 742 New Lots, Brooklyn, N. Y.

SAVE 50%! Guaranteed-fresh color, b.&w. movie film! 8mm., 16mm. Free catalog! Eso-R, 47th Holly, Kansas City 12, Missouri.

8-16MM. Kodachrome movies! Slides! Stereos! Illustrated catalog, dime. Refundable. Colonial, 247-X, Swarthmore, Penna.

#### MUSIC AND MUSICAL INSTRUMENTS

ACCORDIONS Wholesale. Latest models. Try before you buy. Lifetime guarantee. Wonderful trade deals. Catalog free. American Accordion Center, 5329-PM-8 Belmont, Chicago.

WHOLESALE Catalog! 30-80% discounts! Appliances, musical instruments, typewriters, tools, watches, jewelry, cameras, housewares, etc. Consolidated Distributors, 7-34 Henry, Paterson 15, New Jersey.

SONGWRITERS: Learn to arrange music with the "Lightning Arranger" (musical side rule). Plastic model: \$2.00. John Corley, 805 E. Main, Brenham, Texas.

ACCORDIONS—Direct from importer. Save 50% and more! Free trial. Lifetime guarantee. Trades accepted. Free catalog. Write Accordion Manufacturers, Dept. 86R, 2003 Chicago, Chicago 22, Illinois.

SONGWRITERS: Recording company wants new songs. Royalty basis. National sales, promotion if selected. Send material. Music Makers, Dept. E-24, Box 2507, Hollywood, Calif.

WANTED: Complete songs and lyrics, for consideration by nationally advertised record label. Coast to coast broadcasts assured. Co-operate with established composer. C. Isabel Maxer, Box 3896, Portland 8, Oregon.

SONGWRITERS. Free booklet successful songwriting. Gateway Songs, Box 2470, Hollywood 28, Calif.



**POEMS** Wanted for new songs. Send poems. Free examination. Immediate consideration. Songcrafters, Arcade Station, Nashville, Tenn.

**SONGS** Into dollars. Share \$29 million dollars yearly for new songwriters, poets. Songs composed, published, promoted by famous firm. Information, appraisal free. Send to Nordyke Publishing Co., 6000 Sunset Blvd., Hollywood 28PM, California.

**POEMS** Wanted to be set to music. Free examination. Send poems. McNeil, Master of Music, 510-PM S. Alexandria, Los Angeles, California.

**POEMS, Songs** wanted! Free examination. Bengol, 93 Jefferson, Chelsea 50, Massachusetts.

**FREE** Records of your song. Your words, my melody. Free information. Johnny Mack's Melody Mart, 1094 West 39th Street, Dept. A, Los Angeles 37.

**ACCORDIONS, Wholesale** to everyone. Save up to 60%. All national known brands. Free catalogue. Del Principe, 29 South Cicero, Chicago 44.

**POEMS** Wanted for new songs. Send poems. Immediate consideration. Crown Music Company, 1476 Broadway, New York City 36.

**WRITE** Songs. Big money and reputation. Write for information. J. Gordon Pub. Co., 4700 South California Avenue, Chicago.

**VIOLINMAKERS, Repairers.** Fine tone wood, and all violin supplies. Send for free wholesale price list. International Sales, 414-MPM E. Baltimore St., Baltimore 2, Maryland.

**SONGPOEMS** And lyrics wanted. Mail to: TinPan Alley, Inc., 1650 Broadway, New York 19, N. Y.

**SONGWRITERS:** Song poems wanted. \$100 advance royalty paid writer of best song selected each month. Hollywood Tunemiths, Dept. U, 1609 Vista Del Mar, Hollywood 28, Calif.

**SONGWRITERS!** Protect your ideas! Hold all poems, songs! Write for safe, correct procedure. Song Service, Dept. P, 333 W. 56th, New York City 19.

**FIANO** Playing by ear. Complete instructions \$2.00. Sullivan, Box 5381, Jacksonville, Florida.

**PHONOGRAPH** Records cheap. Catalogue. Paramount, MD-313 East Market, Wilkes-Barre, Penna.

**SWISS** Musical movements, \$1.90. Helax, 218 West 72nd Street, New York 23.

**CLARINETISTS!** Only Sonic, immediate response reeds contain 55B, magic cane blend ingredient. No squeaks! 2 for \$1.00 postpaid. State strength. Money-back guarantee. Broadus Manufacturing, Mason Street, San Diego 10, Calif.

**SACRED** Music composed to religious words. Reginald Belcher, Box 354, Morristown, New Jersey.

**PROFESSIONAL** Guitars 1/2 price. Literature. Guitars, Box 115, Streator, Ill.

**TO \$50** for poems—Greeting cards, magazines. Information free. Hobbies, 1603-B Sun Valley, Austin, Minnesota.

**SONGWRITER'S** Magazine 25c. Songsmith-P, 511 Thurston, Rochester 19, N. Y.

### RADIO, TELEVISION AND ELECTRONICS

**BIG** Crystal tube experimenter's catalog. Laboratories, 328-C Fuller, Redwood City, California.

### BUSINESS OPPORTUNITIES

**BECOME** Tax consultant. Graduates earn \$3,000 every tax season preparing returns evenings. State approved. Union Institute, 68 Hudson, Hoboken, 2L, N. J.

**START** A buying service, buy wholesale thousands nationally advertised products. Make big profits selling at sizable discounts. Postcard brings details. American Buyers, Hertel Station, Buffalo 16-C1, New York.

**MAIL** Order advertising agency executive reveals sensational no-risk advertising and merchandise methods. Start in office or home; minimum capital; positive profits. Free details: Impact! 2108 Payne, Dept. 11-8, Cleveland 14, Ohio.

**OPERATE** Profitable mail order business. Write Walter Service, 4159A East 112th, Cleveland 5, Ohio.

**AMBITIOUS?** We establish you in your own business, supply catalogues, circulars, etc. No stock to carry. We ship your orders, paid or c.o.d., under your name. Sell direct, to agents, by mail. Housewares, tableware, cutlery, hosiery, underwear, silverware, shirts, appliances, branded lines, etc. Rush postcard for free catalogues and money-making plans. Tooval Corp., Lindenhurst 818, N. Y.

**IMPORT-Export** opportunity, profitable, world-wide, mail-order business from home, without capital; or travel abroad. Established world trader ships instructions for no-risk examination. Experience unnecessary. Free details. Mellinger P701, Los Angeles 24.

**WHOLESALE** Catalog! 30-80% discounts! Appliances, musical instruments, typewriters, tools, watches, jewelry, cameras, housewares, etc. Consolidated Distributors, 7-11 Henry, Paterson 15, New Jersey.

**PROFITS** Stamping social security plates. Catalog free. General Products, 188-PM State, Albany 10, N. Y.

**GROW** Mushrooms. Cellar, shed. Spare, full time, year round. We pay \$3.50 lb. We paid John Betts \$7,977.76, he started as amateur. Free book. Mushrooms, Dept. 172, 2954 Admiral Way, Seattle, Wash.

**WANTED!** Home workers to assemble luggage and cases for ready market. Instructions, materials, tools, everything supplied. Free details. Abarsi, 807-BJ Sunset, Los Angeles 12.

**MAILORDER!** Amazingly successful new item. Big earnings. We furnish everything. Delta, 2139-G Logan, Youngstown 4, Ohio.

**FREE** Brochure! Import, export, opportunities. Warner, Box 6, Fort Scott, Kansas.

**MAKE** Profitable products. Sell mail-order. Catalogue free. International, 6347 Parnell PM8, Chicago 21, Illinois.

**HAVE** Profitable home mailorder business selling quilt pieces, remnants—Full, sparetime! Over 20,000,000 "repeat" prospects! Rush name for details of this amazing moneymaking business today! Coleman, Box 831-A, Newark 1, N. J.

**START** Your own fishing lure business. Send \$2.00 for 20 beautiful flatface lures (less hooks) returnable. Quaker City Mfg. Co., 3514-24 N. Lawrence St., Philadelphia 40, Penna.

**MAILORDER** Profits. Unusual dropship catalogue. Parile, Box 2501, San Antonio, Texas.

**MAKE** Flexible molds. Cast plaques, figurines, free sample. Tooker, 630-R Chestnut, Hamilton, Ohio.

**WANTED:** Home producers, to be subcontractors. Cast plastic products for manufacturers in our clearing house service. Thousands of easily-made items required. Cash in at home, without previous experience. Piastic Service Associates, Dept. 8-PM, East Boston 28, Massachusetts.

**11,000 NEW** Prospects daily. Baby record books, shoes, albums. Sell mailorder. Everything furnished. Free literature. No-Co-Ro, Capitola, California.

**WORK** At home—Sensational new plans for beginners. Free details. Shields, Box 164A, Miami 38, Florida.

**RARE** Opportunity for men in country and small towns. New company with proved plans that make you bigger profits. Write: Fire King, Dept. 24, Littleton, Colo.

**EXCEPTIONALLY** Profitable opportunity in tape recording. Write: Baron's, Lynden, Wash.

**WHOLESALE** List! Bibles, books, testaments. Johnson Wholesale Company, Box 12702, Dallas 17, Texas.

**LIQUID** Rubber, make flexible molds. Free sample. Chaney, 1130 E. 16th St., Jacksonville 6, Fla.

**WHOLESALE** Catalogue! Appliances, cameras, watches! Cam Company, 6806PM 20th Ave., Brooklyn 4, N. Y.

**COLOR** Concrete with chemicals. Marble-glaze cement benches, pottery. Home-shop. Hundred beautiful designs, made without molds. Birdbaths to waterfalls. Your chance for fame, fortune. 10c brings sample, pictures. Hollywood Cementcraft, 8527-R Wonderland, Hollywood 46, Calif.

**"MAILORDER** Laws and Regulations." Discusses federal, state, local licenses, necessary taxes, legal requirements governing mailorder businesses, \$1.00. "Mailorder Rules for Beginners." Additional helpful information, \$1.00. Play safe. Order both. Tasker, 105 East Custis, Alexandria, Virginia.

**MONEY** In saw and lawnmower sharpening sparetime at home. Free book. Virgil Foley Company, Columbia Heights, Minnesota.

**POPCORN** And potato chip equipment. Eakins, Box 933-A6, Springfield, Ohio.

**FREE** Folio "\$5,000-\$45,000, Unlimited Vacations." No merchandise, equipment. Unknown! Work home, sparetime! Haylings, Carlsbad, Calif.

**\$350** WEEK Cleaning venetian blinds. Patented machinery. Free literature. Robinson, 7213B, Indianapolis 1, Indiana.

**NATURAL** Molding rubber, extra thick. Free sample. W. Wooley, 115-A Donald, Peoria, Illinois.

**MAKE** Sell polishes, cleaners, anything. Formula catalog free. Kemixer, Park Ridge, Ill.

**EARN** Money at home! Homeworke Magazine tells how. Sample 25c. Sizemore, 20-H East Delaware, Chicago 11.

**BRED** Rare tropical fish at home. Earn big money! Learn secrets! Help fill huge demand. Amazing opportunity! Free plan. Tropical Fish Breeders, Los Angeles 61, Calif.

**BE** Appointed state notary public now. Write, Stationers, Helotes, Texas.

**COPUBLISH** Mail Sale Advertiser, leading mail order paper. Details, latest copy, dime. Vanroy Shirk, Lebanon, Penna.

**MINK** Raising information free. Complete. Lake Superior Mink Farm. Superior, EE1, Wisconsin.

**FREE** Book "505 Odd, Successful Businesses." Work home. Expect something odd! Pacific, Oceanside, Calif.

**BRONZE** Baby shoes. Instructions, equipment and mountings for genuine electroplated process. Free catalog. Hollywood Bronze Supply, Dept. B-3, 1624 East First Street, Los Angeles 33, Calif.

**YOUR** Own name brand business. No investment; no inventory. Part time or full time. Sell famous brands of appliances, housewares, silverware, radios, vacuum cleaners, lamps, tools, clocks, watches, jewelry, etc., etc., over 1000 items. Join thousands of successful independent dealers. Send for free catalog and dealer price list. H. B. Davis Corp., Dept. W, 145 W. 15 St., New York City.

**BIG** Profits raising fishworms and crickets. Free literature. Carter Farms, Plains, Georgia.

**GROW** Orchids at home—Profitable, fascinating. Year 'round, Maine to California. No greenhouse. Gorgeous cactleyas, cymbidiums, etc. Successful home grower shows you how. Full details free. Flowerland, 4622 Wilshire, Los Angeles 5.

**WE** Love our mailman—He leaves over \$1000.00 monthly in our rural mailbox. My college professor husband drafted a scientific home mailorder method. We bought a Texas ranch, live as we always wanted. Now we sell the Ranch Mailorder Method. Operates anywhere. Inquire: Eveningshade Ranch, Helotes, Texas.

**FIX** Typewriters. Inexpensive home course teaches factory secrets. Free booklet. Write, Typewriter, Tarentum 1, Penna.

**NEWEST** Spare, full-time home business. \$5 to \$10 hour possible. Paint with suede—The finish with touch and eye-appeal. Beautify auto dashboards, signs, radios, toys, figurines, lamps—1001 others. Complete, step-by-step instructions sent for no-risk examination. Free details. Coast, Los Angeles 61.

**\$70** WEEKLY—Home, spare time. Simplified mail bookkeeping. Immediate income—easy! Auditax, 34757A, Los Angeles 34.

**\$150** WEEK—Easy! Start home Venetian blind laundry. Revealing book free. A. T. Co., 101 S. 44th, Philadelphia 4, Penna.

**COLORGLAZED** Concrete pottery made without molds. Patented method. Cemetery products, novelties, tiles. Basement leak-sealing. Money-making projects. Booklet, details free. Men only. National Pottery Company, Grand Rapids, Minnesota.



**VENDING Machines**—Every description. New or used. Lowest prices—Start a route or sell outright. Mack Postal, 2952 Milwaukee, Chicago 18.

**WANT To make big money at home?** \$5 profit in an hour possible with invisible reweaving. Make tears, holes disappear from clothing, fabrics. Steady year-round demand from cleaners, laundries, homes. Details free. Fabricon, 8334 Prairie, Chicago 19, Illinois.

**YOUR Own business.** No investment. No inventory. Sell name brand nationally advertised items. Free catalog. Confidential wholesale price list. Normandy Dist. Co., Dept. PM, 133 Fifth Ave., New York 1, N. Y.

**INTERESTED Mail order?** Copies leading mail order magazines. All different. 25¢. Palm, Box 1221, Baton Rouge, La.

**BRUSH Plating outfits** for plating articles in the home and shop. No tanks necessary. Good income spare or full time. Free particulars. Gunmetal Co., Ave. H, Decatur, Illinois.

**HIGHEST Commissions** all magazines. Free catalogue, supplies, prizes, exclusive extras. Subscription Service Co., Box 2070, Birmingham, Alabama.

**LEARN Sewing machine big money repair, sales, service.** Machines, "everything" wholesale. Taylor Service, Box 2126, San Bernardino, Calif.

**INTERNATIONAL Mailorder business.** Complete setup service—Not just instructions. Hermes, 152 West 42, New York City 36.

**YOU Can make money at home in spare time** taking magazine renewal subscriptions. No capital or experience necessary. All supplies furnished. Write today! McGregor Magazine Agency, Dept. 500B, Mount Morris, Illinois.

**TOPFLIGHT Mail-order business opportunity.** Modest capital. Request convincing details. Stav, 147 Victoria Street, Kamloops 18, B.C., Canada.

**OPERATE Statement mailing service** from your home as our unit. Lifetime income! American, Mt. Airy, Maryland.

**50% PROFIT Baking** new greaseless doughnuts in kitchen. Grocers buy daily. Free recipes. M. Ray, 3605 South 15th, Minneapolis 7, Minnesota.

**\$1,000 MONTHLY** Possible in collection agency business. Free details. Write Cole Associates, Syracuse 2, N. Y.

**IMPORT-Export opportunities,** mailorder, details free. Jeffries, Box 66, Rutherfordton, N. C.

**OPPORTUNITY!** Start collection agency. Very profitable. Valuable franchise ready. Write: Edmondson, Box 4865-P, Atlanta 2, Georgia.

**MAKE 80¢ Profit** on every dollar selling merchandise by mail. Everything furnished. Write: Eastern, Box 142-A, Boston 24, Massachusetts.

**\$30,000 PER Year** in the meat business. No investment or experience required. Free information. Write Meats for Profit, 5801 Cleveland Ave., Worthington, Ohio.

**\$5,000 YEARLY.** Spare time at home. Nothing to buy. No local selling. Dignified. Guaranteed. Home Harvest, Rt. 3, Box 3491-A, Albuquerque, New Mexico.

**HOW To make money** with carnival games. 144 page book. 35 illustrations. Enormous profits possible full or part time. \$2.00 postpaid. Free details. Theron Fox, 1296 1/2 Yosemite, San Jose 28, California.

**UNUSUAL Mail order ideas,** products, projects, sources. Authentic information, guidance. Free details. Write: Fax, Box 1024, Galveston, Texas.

**IMPORT-Export opportunities.** Terrific profits. Little capital needed. Lists of foreign and domestic manufacturers and exporters. Mail order laws and regulations, instructions, complete \$1. Details stamp. WillRiet Co., 107-D Ilford Ave., North Arlington, N. J.

**"I Earn \$400.00 a week."** I've learned an amazing new method of printing colorful signs, banners, cards, posters, glasswear—anything. No printing press or other expensive equipment is necessary! Big money-making opportunity for anyone. Write for my secret and revealing home-business plan, you'll be amazed! Mr. Anderson, Screen Print Company, Dept. PM-3, Los Angeles 61, California.

**"HOW To Start a Business"** booklet sent free! If you know any trade, go into business for yourself! Learn the 9 easy steps to follow. We've guided 5,000 others to success. Revealing free booklet yours for the asking! Write! National Business Consultants, Office AT, Los Angeles 61, Calif.

**FREE Literature** describing money-making mailorder plans. National Service, Richland, Georgia.

**BUY 250,000 Articles** wholesale. Directory 104. Publishers, Drawer 1486-P8, Detroit 31.

**TO \$100.00 Weekly.** Sparetime, home operated mailorder business. Successful beginner's plan. Everything supplied. Lynn, 10420-M National, Los Angeles 34.

**WHOLESALE Buyers!** New 1956 "blue book" gives names of over 3000 jobbers, manufacturers who supply anything. Free details. Associated Wholesalers, 1016-D Starr, Burlington, Iowa.

**A Business of your own.** Earn \$125.00 a week in your spare time with the Ovengio infra-red oven. Hot sandwiches in minutes. Write Ovengio Sales, 4729 North Lincoln, Chicago.

**MAKE Tough,** attractive building plastic, easily, 800% profit. Exclusive district. Bays Laboratory, Oklahoma City 9.

**READY-Made home business.** Inquire! Opportunity, Box 642-H, Tallahassee, Fla.

**CASH From sawdust,** seventy methods. Tin-cans, thirty methods. Newspapers, eighteen methods. Instructions 50¢ each. All three \$1.00. Charles Company, 12-DXV, Norwood, Ohio.

**START Identification tag business.** Clearview Co., 172 Stanton St., New York City.

**FREE Samples.** "Dancing" elephants-mules. Windshield mounted. Smith Agency-51, Excelsior Springs, Missouri.

**SHARPEN Saws** and lawnmowers spare time or full time; very profitable; complete power equipment; easy to operate; no experience necessary; thousands of satisfied users. Free literature. Max Mfg. Co., 138 Stockton Ave., San Jose 26, California.

**CHARGE Auto,** flashlight batteries 2¢. Also three, quick cash. Inside secrets. Eleven others. \$1.00. Teycer, Box 1287P, Chicago 90.

**BUY Wholesale 750,000 products.** Details free. Carter, Box 6011-B, Chicago 80.

**FLEXIBLE Rubber molds** for plaster and Marbleite figurines. Sample and large illustrated catalog 25¢, refunded on first order. K-C Novelties, Dept. 16, Southampton, Mass.

**ADVERTISING Book matches**—Cash in on big demand; sell union label matches. Cuts for all businesses and political parties. Free powerhouse selling kit, low prices, protection guaranteed on repeat orders. Cash commissions. Superior Match Co., Dept. MX856, 7530 Greenwood, Chicago.

**MODERN Formulas** for easily making fastest selling big profit products. Valuable literature free! Miller, Chemist, 1517-K, Tampa, Florida.

**25,500 SALES** in two weeks! Amazing radio-mail order method. Free details. Broadcast Service, 1412-KM Great Northern Building, Chicago 4, Illinois.

**BOOKKEEPERS.** Keep books, small firms spare time. Manual latest technique by C.P.A., \$3.00. Modern Business, Box 406, Youngstown 1, Ohio.

**OPERATE Restaurant or diner.** Free booklet reveals plan. Write Restaurant Arts, BU-18, Fremont, Ohio.

**60% PROFIT Cosmetics** \$25 day up. Hire others. Samples, details. Studio Girl Hollywood, Glendale, Calif., Dept. 1268H.

**AMAZING Successes** through franchises! Become exclusive distributor, agency operator. Nationwide opportunities. Request details. National Franchise Reports, 333 North Michigan, Chicago 1.

**YOUR Own mailorder business** started at home, spare time. Profitable, fascinating. We show you how, supply everything. Free details. Cuddihy, 8-M Fairview, Jersey City 4, N. J.

**AMAZING Profits** home business. Start \$25.00. Guaranteed. Dickie, Quitman, Arkansas.

**AMERICA'S Greatest** wholesale catalog! Buy everything direct! \$1,000,000 stock. Save 66%! Best name appliances, housewares, cameras, tools, toys, sporting goods, jewelry. Large catalog \$1.00. Refundable. General Wholesalers, Box 3058E1, San Francisco.

**PLEASANT Profits**—Let us show you how to start your own complete scissors and tool sharpening business. Free details. Serr-Edge Inc., 9735 Lorain, Cleveland 2, Ohio.

**WHOLESALE Buyers directory.** New 1956 edition. Lists thousands wholesalers, manufacturers. Save personally 66% on everything you need. Free details! National Buyers Service, Box 338EP, San Francisco.

**DRAFTSMEN,** Make structural steel shop drawings at home. You can earn \$3.50 or more per hour. Send \$2.00 for select list of companies. Pride Service, P.O. Box 3837, Cleveland 10, Ohio.

**"STERIBOILER"** Fastest and easiest selling novelty on the market. Patented beautiful special white plastic submerison water heater (110 volt-1000 watt) brings water to boiling point in ten seconds. Every man, woman, co-worker or fellow-employee after seeing it demonstrated a sure fire and immediate customer. Make as much money you want, full or part time. Postpaid International Parcel Post package containing ten Steriboilers dispatched immediately after receipt \$15.00 money order or certified check. In registered airmail letter to Frank InterAmerican Manufacturing Corporation, Edificio Santa Beatriz, Lima, Peru.

### MONEYMAKING OPPORTUNITIES

**MAKE Money** writing short paragraphs! No tedious study. I tell you what to write, where and how to sell; and supply list of editors buying from beginners. Many small checks add up quickly. Write to sell, right away. Send for free facts. Benson Barrett, Dept. C-27-V, 7464 Clark, Chicago 26.

**START A buying service,** buy wholesale thousands nationally advertised products. Make big profits selling at sizable discounts. Postcard brings details. American Buyers, Hertel Station, Buffalo 16-D1, New York.

**GROW Mushrooms.** Cellar, shed. Spare, full time, year round. We pay \$3.50 lb. We paid John Betts \$7,977.76, he started as amateur. Free book. Mushrooms, Dept. 173, 2954 Admiral Way, Seattle, Wash.

**EARN Money** immediately repairing electric clocks without experience. \$3.00 investment. Details free. Puthuff, Box 1504, Santa Rosa, Calif.

**WANT To go in business** for yourself without capital? We show you how. Start part-time your own home. Postcard brings you details absolutely free. Topval Corp., Lindenhurst 720, N. Y.

**LEARN Technical Metaphysics** and insure your future. Easy, inexpensive correspondence course. Simplest method known. Diploma. Write: Premier College of Technical Metaphysics, 2532 McKenzie St., Vancouver 8, B. C., Canada.

**EARN Money** evenings copying and duplicating comic cartoons for advertisers. Adservice, Argyle 1, Wisconsin.

**GENERAL Contest Bulletin.** Issued monthly. Sample, 25¢. 1609 1/2 East 5th, Duluth, Minn.

**FREE Book "505 Odd, Successful Businesses."** Work home. Expect something odd! Pacific, Oceanside, Calif.

**READ Progressive Mailtrade,** the magazine that tells how to make money by mail. Dime brings sample and special offer. Progressive Mailtrade, Box 357, Sheboygan, Wisconsin.

**SELL Titania gems;** far more brilliant than diamonds. Catalog free. Diamondite, 2420-M 77th, Oakland 5, California.

**PRIZE Contests** provide fabulous and confidential home income opportunities! Here's how and where to win your share! Send stamp! National Contest Bulletin, Box 2685-P, Miami 16, Florida.

**\$150 WEEK—Easy!** Start home Venetian blind laundry. Revealing book free. A. T. Co., 101 S. 44th, Philadelphia 4, Penna.

**FREE Folio "\$5,000-\$45,000, Unlimited Vacations."** No merchandise, equipment. Unknown! Work home, sparetime! Haylings, Carlsbad, Calif.

**FORTUNE Possible** raising, fishworms and crickets. Free literature. Carter Hatchery, Plains, Georgia.

**CONVERT Cheap foods** into money making milk. Complete free information. Voight Farms, Lomira 2, Wisconsin; or Atlanta 2, Texas.

**ATTENTION: Typewriter owners.** Make handsome profits. Write today. Groves Company, 682, Hastings 8, Nebraska.

**IMMEDIATE Cash** for used plating equipment. Send description. Equipment Division, 1624 East First, Los Angeles 33, California.



\$50 TO \$100 Per week. No skill necessary. Send 25¢ for sample and details. Arrowhead Sales, 4588 So. Acoma, Englewood, Colo.

**START A** profitable subscription business in spare time! We need men and women (young or old) as representatives for all leading national magazines. Liberal commissions on all subscriptions. Supplies free. Send this ad with your name and address to: Agency Bureau, Dept. PM, Hearst Magazines, 250 West 55th St., New York 19, N. Y.

**MEN** And women wanted to start home business in spare time with little table-top rubber stamp machine. Easy to earn up to \$9.80 an hour without previous experience. Full particulars free by mail. Send postcard to Roberts, 1512 Jarvis, Room 78, Chicago 26, Illinois.

**SELL** Aluminum awnings. Baked enamel colors. All sizes. Write Jack Groff, Box 12054, Tampa, Fla.

**MEN-Women!** Start money-making plastic laminating business at home in spare time. Material that costs 11¢ brings back \$2.58. No canvassing or selling but mail orders bring in \$20 a day. Write for full particulars free. Rush name on postcard to Warner, Room 78, 1512 Jarvis, Chicago 26, Ill.

**FORMICA** Textolite, micarta. \$50.00 a day making countertops. Sample cutaway counter and complete instructions including trade secrets only \$4.00. House & Home, 204 George Street, New Haven 10, Conn.

**WHOLESALE** Catalog! 30-80% discounts! Appliances, musical instruments, typewriters, tools, watches, jewelry, cameras, housewares, etc. Consolidated Distributors, 7-27, Henry, Paterson 15, New Jersey.

**START** Big pay business at home in spare time. No experience needed to operate little table-top machine for bronzing baby shoes. Make \$5.46 profit on every pair. Full particulars free. Send postcard to Mason, 1512 Jarvis, Room 78, Chicago 26, Ill.

**EARN** \$50.00 Daily making mats, shoes and mud guards from old tires. S and S Patents Inc., 1307 North Clark St., Chicago 10, Ill.

**PHOTO** Christmas greetings bring big profits in your spare time. Show Whitehall's fast selling Christmas greetings, everyday cards, personalized stationery, napkins, gifts. Samples on approval; 1/2 price feature offer. Make big money fast. Whitehall Studios, 386 Cleveland, Elmira, N. Y.

**60% PROFIT** Cosmetics. \$25 day up. Hire others. Samples, details. Studio Girl Hollywood, Glendale, Calif., Dept. 1268H.

**BIG** Home earnings for you; selling information, \$10.00 an hour and more. No previous training; special talent needed. Literature free. Charles R. Coachman, 6805 North Independence, Oklahoma City 16, Oklahoma.

**BUY** Wholesale! Save 66 2/3%! Appliances, furniture, jewelry, toys, sporting goods, tools. Free details! National Buyers Service, Box 3338EB, San Francisco.

"WHERE To Find Products," \$2.50. Money-making guide. Sayer Associates, 1129-C Vermont, Washington 5, D. C.

**LOOKING** For something informative? Home work, mail order plans, and trade magazine 25¢. Warren Co., P.O. Box 11, Glenview, Ill.

#### FORMULAS. PLANS. ETC.

**PRACTICAL** Formulas. Lists free. Cummings, Chemist, Gordon Ave., Syracuse 4, N. Y.

**FORMULAS;** All kinds, latest, best. Literature free. Kemixal, Park Ridge, Ill.

**LATE**, Modern manufacturing formulas. List free. Moon Chemical, Martville, New York.

**MODERN** Formulas for today's fastest selling big profit products. Valuable literature free! Miller, Chemist, 1517-J, Tampa, Florida.

**FREE** Formula catalog. Anything analyzed \$35.00. Western Chemical, Salem, Oregon.

#### PLASTICS

**NEW** Liquid casting plastic, clear, colors. Embed real flowers, insects, photos, coins. Saw, drill, carve. Send 25¢ for handbook, "How to Cast with Liquid Plastic," and proved success plan showing how to make money at home. Castolite, Dept. J-101, Woodstock, Ill.

**PLASTIC**, Sheet, rod, tubing. Catalog 10¢. Coleman Sales, 5928 Cornell, Dearborn, Michigan.

**LAMINATING** Supplies. Free price list. Solomson, 46 Cornhill, Boston 8, Mass.

**PLEXIGLAS**. Cut to size. Clear. Any thickness. Colors. Rods. Tubing. McClarin Plastics, P.O. Box 168H, Hanover, Penna.

**LEARN** Plastics fabrication for spare time income. Low cost home training now available. Write for free booklet. Interstate Training Service, Dept. D-3, Portland 13, Ore.

**PLEXIGLAS** Square foot cost 1/8" \$1.20, 3/32" \$1.35, 3/16" \$1.58, add 15% for postage, write for list. Aircraft Plastics, P.O. Box 7924, Mt. Lebanon 16, Penna.

**PLASTIC** Repair kit welds breaks and cracks. Restores original finish. Complete kit \$3.00 cash, check, money-order. Rayther, Box 271, Station B, Toledo, Ohio.

**PLEXIGLAS**, Fiberglass, polyester, acetate. Unique wholesale-retail catalog—15¢. Gem-O-Lite, Box 886M, North Hollywood, California.

**PLEXIGLAS**, Lucite. Square foot cost, 1/16" \$1.18; 1/8" \$1.52; 3/16" \$1.86; 1/4" \$2.21; 3/8" \$3.23; 1/2" \$4.36. Colors add 10%. Send 15¢ for postage. Aristocrat Plastics, 23-25 Sussex Avenue, Newark.

#### CHEMISTRY

**SPECTROSCOPE** For quick chemical analysis \$3.00. Kutting Sons, Los Altos, Calif.

**ILLUSTRATED** Catalog: Chemistry, mineralogy, biology 20¢. Tracey Laboratories, Evanston, Illinois.

**HOME** Laboratory and apparatus kits, laboratory supplies. Catalog 25¢. John H. Winn, 124A West 23rd St., New York, N. Y. Established 1931.

**CHEMICALS** And apparatus for industrial, analytical, and private laboratories. Catalog 25¢. Dept. M-50, Biological Supply Co., 1176 Mt. Hope Ave., Rochester 20, N. Y.

**CHEMICALS**, Supplies. Catalog 25¢. refundable. Laboratory Sales, Box 161-E, Brighton, Mass.

**AMAZING** New book of science. Experiments, formulas and catalogue of laboratory supplies. Only 25¢. National Scientific Co., Dept. PM-8, 500 W. Road, Lombard, Ill.

#### AGENTS WANTED

**NEW** Bathroom deodorizer. Hangs on wall. Banishes odors bathroom, kitchen. Lighting seller. Samples sent on trial. Kristee Co., Dept. 50, Akron 8, Ohio.

**AMAZING** New "Touch-Glow" Christmas cards sell swiftly from free samples. \$62.50 profit on 50 boxes easy! Many tall cards, stationery, novelties, album of imprints. Profits to 100% plus gift bonuses. Samples on approval. Creative, 4401 Cermak, Dept. 509-D, Chicago 23.

**FREE!** Beautiful leather pictures 200% profit! Apartado 9036, Mexico 1, D. F.

**AGENTS** Opportunity. Grotesque, beautiful cypress knees, 50¢ up. Details. Gipple's Giftwares, DeLeon Springs 5, Fla.

**GOLDMINE** Of 600 money makers. Copy free. Specialty Salesman Magazine, Desk 5-B, 307 N. Michigan, Chicago 1.

**YOUR** Own business—Used suits \$1.50, overcoats 65¢, mackinaws 35¢, shoes 12 1/2¢, ladies coats 30¢, dresses 15¢. Enormous profits. Catalog free. Nathan Portnoy Associates, 805-AA West 12th Place, Chicago 7.

**GOLD** Or silver letters, numbers. Windows, doors, trucks. 1" to 6". 500% profits. Free samples. Atlas-T, 544 West 79th, Chicago 20.

**PRINTING**. Advertising salesmen—Excellent moneymaking sideline selling decalcomania name plates, small quantities, Automobile initials, sign letters. Free samples. Ralco, XL, Boston 19, Mass.

**\$1.00 PROFIT** Selling \$2.95 photo enlargement deal. Allen Studio, Riegler Bldg., Little Rock, Ark.

**AGENTS**—300% Profit selling genuine gold window letters; stores and offices. Free samples. Metallic Sign Letter Co., 431-D North Clark, Chicago.

**USED** And new watches \$2 up. Free list. Southern Watches, Gray, Georgia.

**YOUR** Ad in this space will get some good agents for you. Yes, I'll prove it. Write for Folder "A" right now. F. W. Johnson, Classified Advertising Manager, Popular Mechanics Magazine, 200 E. Ontario St., Chicago 11, Ill.

**EASY** Handwork makes fast-selling articles. Sample free. Sunmade Company, Brockton 64, Massachusetts.

**WANT** More business? Here's an amazing opportunity to increase your sales. Talk to thousands of interested readers of "Mechanica Popular." Our Spanish Edition covers the Latin American countries like a blanket. They're real mailorder buyers. Classified rate 75¢ per word. Try an ad in our next issue. Classified Advertising Department, Popular Mechanics Magazine, 200 East Ontario Street, Chicago 11, Ill.

**CALIFORNIA** Sweet smelling beads. Sensational sellers. Particulars free. Mission, 2328-PM W. Pico, Los Angeles 6, California.

**CHRISTMAS** Cards—144 exceptionally distinctive greetings, all with customer's name. To attract big-volume sales, line includes many cards specially designed for business firms and professional people. All popular subjects, wide price range. Unequaled in lavish treatment, unusual illustration, high-quality stock. Up to \$5 to \$100 commission on each sale. Full or part time. Experience unnecessary. Old, established firm. For complete sample kit, write Process Corp., 1950 S. Troy, Dept. MS-8, Chicago 23, Ill.

**MOORE** Made \$9.00 in an hour selling farmers. Hundreds of salesmen making good money full time or spare time with 3 leading poultry magazines welcomed everywhere. No investment or experience needed. Powerful sales kit free. Poultry Tribune, Box 468, Mount Morris, Illinois.

**EXTRA** Cash for you. Sensational tested fast selling items bring extra profits to you in spare time. No experience needed. Sell fabulous gifts, greeting cards, gadgets, personalized stationery, toys, from all over the world! Big money ahead for you if you write for brand new free colorful catalog at once! North Star, 735 Park Square, St. Paul, Minn.

**YOU** Can make money at home in spare time taking magazine renewal subscriptions. No capital or experience necessary. All supplies furnished. Write today! McGregor Magazine Agency, Dept. 500A, Mount Morris, Illinois.

**RUN** Spare-time greeting card and gift shop at home. Show friends samples of our new 1956 Christmas and all-occasion greeting cards and gifts. Take their orders and earn to 100% profit. No experience necessary. Costs nothing to try. Write today for samples on approval. Regal Greetings, Dept. 89, Ferndale, Mich.

**WHOLESALE** Catalog! 30-80% discounts! Appliances, musical instruments, typewriters, tools, watches, jewelry, cameras, housewares, etc. Consolidated Distributors, 7-10 Henry, Paterson 15, New Jersey.

**EXTRA** Cash in your spare time. No experience needed. Just show superb Elmira Christmas cards, name imprinted. Samples on approval. Bonus: Free box of cards; also 50% profit on first order. Elmira Greeting Card Co., 289 Clinton, Elmira, N. Y.

**TREMENDOUS** Profits! Every man, woman and child a customer. Used suits \$1.50, pants 35¢, dresses 20¢, shoes 20¢. Operate from store, home, car. Free catalog. Superior, 1250-A Jefferson, Chicago 7.

**AT** Last! Something new and sensational in latest tall Christmas cards. Make extra money fast! Show satins, velours, metallics. Gets easy orders. Pays up to 100% profit. 30 free samples. With name 50 for \$1.50. Big line. Amazing convertible pen-pencil, napkins, gifts, stationery. Several \$1.00 boxes on approval. Puro Greetings, 2801 Locust, Dept. 640-K, St. Louis 12, Mo.

**BUY** Wholesale thousands nationally advertised products at big discount. Free "Wholesale Plan." American Buyers, Hertel Station, Buffalo 16-A1, N. Y.



**MAKE 3 Days pay in day!** Amazing Name-in-Silver Christmas cards pay \$65 on 65 boxes! No experience needed. Sample book free, assortments on approval. "Southern Belle" doll free for promptness! Southern, 478 N. Hollywood, Dept. L-63, Memphis 12, Tenn.

**BIGGEST Christmas card profits.** Sensational "super-36" assortment pays \$1.25 profit on every box—\$50.00 on 40 boxes easy. 200 fast sellers double earnings! Tall cards, novelties, stationery, bargain specials. Assortments on approval. Color catalog, personalized album free. Midwest, 1113 Washington, Dept. 494-R, St. Louis 1, Mo.

**MAKE Extra money—with newest Christmas card assortments.** 21-card \$1.00, \$1.25, \$1.50 "tall-slim" Christmas, all occasion, religious assortments, gift wrappings, gifts, novelties, imprinted Christmas cards. Experience unnecessary. Profits to 100% plus cash bonus. Write for samples on approval, free \$1.00 gift offer, catalog, selling plan. Hedenkamp, 361 Broadway, Dept. PM-43, New York City.

**600 WAYS To make extra money!** Sell over 600 unique, profitable gifts, greeting cards, stationery, gift wraps, gadgets, in your spare time. World famous brands like Westinghouse included in line. Make up to 100% profit! No experience needed. Send for brand new big free colorful catalog and free money making plan today! Greetings Unlimited, 335 Park Square, St. Paul, Minn.

**IF You want to earn money fast.** I'll send you free sample stocking of newest stretch DuPont nylons to sell at only \$1 a pair. American Mills, Dept. 496, Indianapolis 7, Ind.

**SPARE Time greeting card business!** Show friends new type tall, parchment, photochrome Christmas, all occasion assortments. Make \$50, \$75, \$100 extra money. Bonus. Write for feature boxes on approval, 74 free samples personal Christmas cards, stationery, free catalog, selling guide. New England Art Publishers, North Abington 833-F, Mass.

**SELL Newest tall Christmas cards—Make 75¢ on sensational \$1.25 assortment.** 250 hottest gifts, cards, stationery, 50 exclusive personalized designs, super-roll gift wraps, 30 for \$1 box. Samples on approval, surprise offers, prompt action gift. Cardinal, 1400 State, Dept. J-79, Cincinnati 14.

**SHINE Shoes without polish.** New invention. Lightning seller. Shoes gleam like mirror. Samples sent on trial. Kristee Co., Dept. 52, Akron 8, Ohio.

**FREE Box of 21 nationally famous Christmas cards** included with other fast selling assortments sent on approval. Earn \$50.00 by selling only 50 boxes of our 900 series Christmas card assortment. Can be done in a few hours of your spare time. Sunshine Art Studios, Inc., Dept. PM8, Springfield 1, Mass.; Pasadena 1, Calif.

**\$1,000.00 A Month for making dramatic 3-second demonstration of amazing light-weight Presto fire extinguisher.** New chemical used by Airforce snuffs out fires instantly. Only \$4.95. Terrific commissions. Millions want it. Free kit. Merlite, 114 E. 32nd., Dept. P-52K, New York City 16.

**PICTURESQUE Overseas imports.** Excellent sales appeal. Two samples 10¢. Goodall, 68-W Joost, San Francisco 12.

**BIG Money-making opportunity.** Exclusive line work uniforms. Jackets, pants, shirts, coveralls. Advertising embroidered. Every business prospect. Outfit free. Master Co., 420 Water, Ligonier, Ind.

**60% PROFIT Cosmetics.** \$25 day up. Hire others. Samples, details. Studio Girl Hollywood, Glendale, Calif., Dept. 1268H.

**FAST Selling money makers!** Metallic ironing board cover; purse-shopping bag; many others including \$1 retailers. Quality Products, Dept. A, Box 748, Passaic, N. J.

**BUY Wholesale!** 100,000 name brand products! Save 66 2/3%! Big profits selling others spare time! Free details! National Buyers Service, Box 3338EE, San Francisco.

**REDUCING Machines.** Factory agents. 100% profit. Exclusive. Mary-Mac, 1012 Powhattan, Dallas 2, Texas.

## BUY IT WHOLESALE

**USED And new watches \$2 up. Free list.** Southern Watches, Gray, Georgia.

**FREE Gift catalog.** Wholesale catalogs, name brands. Edith's, Deep River, Conn.

**52 PAGE Illustrated wholesale catalog.** 10¢! Marpat, Box 1485, D-JUPM, Milwaukee, Wis.

**BUY Wholesale!** Nationally known brands. Catalog \$1.00. D'Auria, Box 355-PM, Jackson, Michigan.

**YOUR Wholesale cost as little as 25¢ on dollar!** Housewares, tableware, hosiery, shirts, underwear, appliances, branded lines, silverware, jewelry, etc. Sell direct, by mail or to agents. No stock to carry. We ship your orders, paid or c.o.d., under your name. Rush postcard for catalogues, confidential distributors' wholesale prices and money-making plans absolutely free. Topval Corp., Lindenhurst 524, N. Y.

**WHOLESALE Catalog!** 30-80% discounts! Appliances, musical instruments, typewriters, tools, watches, jewelry, cameras, housewares, etc. Consolidated Distributors, 7-20 Henry, Paterson 15, New Jersey.

**NEW Yarn flowers crafting.** Unusual tape measures. Illustrations free. Box 83, Elgin, Ill.

**WHOLESALE Catalog 75¢.** Jewelry, watches, appliances. Riddy Sale Co., 15218 Shiloh Rd., Cleveland 10, Ohio.

**WHOLESALE Catalog!** Appliances, cameras, watches. Postcard: Selbyco, Decatur 159, Illinois.

**WHOLESALE!** Appliances, housewares, jewelry! Postcard. Midwest, B-156-M, Pontiac, Illinois.

**BARGAINS, Joblots, closeouts.** 2000 items. Tremendous savings, clothing, toys, gifts, jewelry, television, etc. 25¢ brings wholesale catalog. \$1.00 merchandise certificate included free. Reliable Jobbing, 311-B North Desplaines, Chicago.

**FREE Lists.** 640,000 items wholesale. P. Cottage Industries, Omaha 12, Nebr.

**WESTINGHOUSE, Sunbeam, Hamilton-Beach, Presto, DeJur, Underwood, etc.** Free shipping. Catalog, \$2. McKenzie Thomson, 2470 Oak Street, Eugene, Ore.

## SALESMEN—DISTRIBUTORS

**SELL Calendars.** You make big money daily. Giant line. Every business buys. Also business printing, book matches, advertising specialties. Big sales outfit free. Write, Arrow Press, 515H Fourth Ave. So., Minneapolis, Minn.

**AD Matches!** Sell amazing designs—10, 20, 30, 40 and 240-light book matches. Bigger spot cash commissions; every business a prospect. Low prices for high quality. Repeats. Start without experience; men, women; full, part time. Buy nothing! Sales kit furnished. Match Corp., Dept. PM-80, Chicago 32, Illinois.

**BUY Wholesale thousands nationally advertised products at big discount.** Free "Wholesale Plan." American Buyers, Hertel Station, Buffalo 16-J1, N. Y.

**ANYONE Can sell famous Hoover uniforms for beauty stops, waitresses, nurses, doctors, others.** All popular miracle fabrics—Nylon, dacron, orlon. Exclusive styles, top quality. Big cash income now, real future. Equipment free. Hoover, Dept. H-100, New York 11, N. Y.

**NEW Invention.** \$4.95 fire alarm, paying up to \$1,100 a month. No wiring. Unlimited market. Dramatic demonstration. Free kit. Merlite (Alarm Div.), 114 E. 32nd St., Dept. F-53K, New York 16, N. Y.

**WILL You wear new suits and topcoats without one penny cost and agree to show them to friends?** You can make up to \$30.00 in a day even in spare time, without canvassing. Stone-Field, 532 South Throop Street, Dept. W-926, Chicago 7, Illinois.

**NEW Tubular ornamental iron:** Completely standardized. Tremendous opportunity in home improvement field. Distributors or dealers wanted east of the Mississippi and in Missouri. Write Englehauser Manufacturing Company, Lebanon 3, Ohio, for particulars.

**FOLLOW Up our direct mail campaign for easy sales on our printed specialties.** Free kits. Sanzo Specialties, Box 68, Endicott, New York.

**WHOLESALE Catalog!** 30-80% discounts! Appliances, musical instruments, typewriters, tools, watches, jewelry, cameras, housewares, etc. Consolidated Distributors 7-12 Henry, Paterson 15, New Jersey.

**WINDPROOF Cigarette lighter,** extra heavy chrome plated, asbestos wick, facsimile famous brand, selling retail \$3.50. Sample 75¢, 24—\$17.50 postpaid. Unconditionally guaranteed. Counselor, Box 84, Elmwood Station, Omaha 6, Nebraska.

**SALESMEN:** For fast selling imported merchandise, 40% commission. Write for free information. Box 4082, Corpus Christi, Texas.

**\$1,000.00 A Month for making dramatic 3-second demonstration of amazing light-weight Presto fire extinguisher.** New chemical used by Airforce snuffs out fires instantly. Only \$4.95. Terrific commissions. Millions want it. Free kit. Merlite, 114 E. 32nd., Dept. P-52K, New York City 16.

**USED And new watches \$2 up. Free list.** Southern Watches, Gray, Georgia.

**NEW Jobs open in selling!** Send name, address for five free issues of Opportunity Magazine's money-making guide, listing hundreds of companies who'll pay you well, full or part-time. No experience needed. Opportunity, 850 N. Dearborn, Dept. 17, Chicago 40, Ill.

**BUILD Sales by recruiting productive distributors selling direct or to retail outlets.** Secure most concentrated circulation through classified columns of Salesman's Opportunity. Write for facts. Gilbert, Salesman's Opportunity, Room 1700, 850 N. Dearborn, Chicago 16.

**GOOD Man can make \$3,000.00 next 90 days.** Every house in town wants amazing NiLite "cats-eye" lawn sign. Automatic selling plan pays profits everyday. Write today for free details. NiLite, 173 W. Madison, Dept. 301, Chicago.

**ADD \$20.00 To \$200.00 per week to your income with Miracle Bowls!** Sell door to door and store to store. Just add water and watch them grow. Write for free literature now. Miracle Bowls, Dept. 3, Littleton, Colorado.

**MINIATURES—Fruit trimmed straw baskets, hats, cut shells; birds of paradise; carved dogs, birds; Christmas decorations.** 300 illustrations plus 25 miniatures paired for earrings \$5.00. Lastufka Products, Box 10248, Tampa 9, Florida.

**ADVERTISING Book matches—Cash in on big demand; sell union label matches.** Cuts for all businesses and political parties. Free powerhouse selling kit, low prices, protection guaranteed on repeat orders. Cash commissions. Superior Match Co., Dept. M-856, 7530 Greenwood, Chicago.

**IMPORT, Sell unusual merchandise.** List 300 foreign companies \$1.00. Schuler, 319-A West 48th Street, New York 36, N. Y.

**INTRODUCING Fast selling patented close quarter saw, factory to you.** Retail \$1.00. Diesel Power Inc., Greenville, Penna.

## EMPLOYMENT INFORMATION

**COPYRIGHTED Reports on best paying jobs with travel, adventure, promotions.** Construction, aviation, shipping, laborers, clerical, trades, supervisory, factory, unusual opportunities. Many types of work. Skilled and unskilled. Foreign and state-side openings for men and women. Only \$2.00 (\$2.25 airmail), including registration-advisory service. Satisfaction guaranteed. Included absolutely free: Special reports on Alaska, Spanish airbase construction, South American opportunities and husband-wife foreign jobs. Research Services, Suite 207-PMG, Brown Building, St. Louis 5, Missouri.

**OVERSEAS Jobs—40 contractors' addresses.** \$1.00. Clement's, B-512, Fayetteville, Tenn.

**FOREIGN, Alaskan, U.S.A., job opportunities!** To \$1500.00 monthly! Million Americans employed overseas. Copyrighted reports. Who to contact for highest paying jobs. Laborers, trades, truck drivers, office, engineers, many others. 52 countries—St. Lawrence project, Spain, Latin America, northern projects, Europe. Year registration-advisory service. Application forms. Unconditional money-back guarantee! \$2.00 (airmailed \$2.25) c.o.d.'s accepted. International Reporter, St. Louis 1-PJ, Missouri.



**AVIATION** And guided missiles employment (U.S.A. and Canada). Companies, persons to contact and application blanks \$2.00. Pestech, Box 548R, St. Louis 1, Mo.

**JOB Information.** High pay. South America, the Islands, U.S.A., foreign countries. All trades. Clerical, labor, engineers, drivers, others. Women also. Companies pay overseas fare if hired. Write Section 92P, National Employment Information, 1020 Broad, Newark, N. J.

#### EDUCATIONAL AND INSTRUCTION

**DRAFTING—Design.** Architectural. Mechanical. Electrical. Structural. Aircraft mathematics. Physics. Estimating. Surveying. Veteran approved. Mondell Institute, 230 West 41 St., New York City.

**SCIENCE** Of memory simplified. Volume one free of Memorology. Memorology Studio, 2016 Sunnyside Ave., Chicago 25, Illinois.

**USED** Correspondence courses and books bought, sold, rented. Catalog free. Myrtle Vernon, Henagar, Ala.

**HELP** Yourself to abundant living. Our courses have aided students to richer fuller lives. Learn secret of contentment, happiness. Earn degrees Ps.D., Ms.D. Write for free book. College of Universal Truth Correspondence School, 23-C E. Jackson, Chicago.

**HAND Engraving;** learn at home. Write Box 116, Mishawaka, Ind.

**STUDY** For Doctor's degree of psychology, metaphysics and divinity. Correspondence courses only. College of Divine Metaphysics, Dept. P-M, 2811 North Illinois, Indianapolis 8, Indiana.

**LEARN** Mineralogy at home. Diploma course. Fortunes now being made in uranium and other minerals. Free catalog. Mineral Science Institute, Desk 2, 159 East Ontario, Chicago 11.

**HIGH** School diploma at home. Licensed teachers—Approved materials. Southern States Academy, Box 144-MX, Station E, Atlanta, Georgia.

I want to send you proof of the wonderful pulling power of Popular Mechanics classified pages. What's your proposition? Write me today. Include literature if possible. F. W. Johnson, Manager Classified Advertising, Popular Mechanics Magazine, 200 E. Ontario St., Chicago 11, Ill.

**BE** A real estate broker. Study at home. Write for free book today. GI approved. Weaver School of Real Estate, 2018P Grand, Kansas City, Missouri.

**EARN** While you learn. Auto and diesel mechanics master this top paying trade. Many graduates earn \$100 a week and up. Approved for Korean veterans. For free information write Dept. No. 256, Nashville Auto-Diesel College, Nashville 3, Tenn.

**BOOKKEEPERS!** Increase your earnings! Operate your own simplified "Dollar-A-Week" bookkeeping and tax service. Full or spare time. Details free. No obligation. Ellis, Box 200, Cedar Grove, North Carolina.

**WANT** A diesel job? New opportunities to increase income. Higher pay. More money. We can help you qualify. Tools. Shop method home training. Write today! Diesel, Tractor, Heavy Equipment Division, Interstate Training Service, Dept. B-3, Portland 13, Oregon.

**INVESTIGATOR** Training. Phillips Secret Service System, 1917-B North Keneth, Chicago 39.

**USED** Correspondence courses and educational books bought, sold, rented. Free catalog. Educational Exchange, Menlo, Georgia.

**STARTLING** Discovery! Amazing new, uncrowded profession. Know yourself, others; how they think, act. Big money, recognition, returns for those who qualify. Learn at home, spare time. Send only \$1.00 for secrets (regular price \$1.50). \$3.00 credit coupon given. Give age, occupation, your handwriting for surprise worth \$1.00. Estes, 2307-PM National Station, Springfield, Missouri.

**SWEDISH** Massage. We train you at home. Earn big profits from your own private practice or work with hospitals and doctors. Free catalogue. National Institute, Desk 4, 159 E. Ontario, Chicago, Ill.

**BOOKS:** Hundreds of subjects. Big catalog free. Popular Mechanics Press, 300-BC East Ontario St., Chicago 11.

**BOOKS.** Free 1956 catalog, 100 pages Text, vocational, educational, instructional subjects. Millions of volumes, new and used. Bargain prices. Books bought. Est. 1902. Long's College Book Co., Dept. PM, Columbus 1, Ohio.

**BLUEPRINT** Reading—Train at home. Learn to read blueprints with confidence in 10 easy lessons. Write today Belton School, 1059-V North Lawndale, Chicago 51.

**COMPLETE** Your high school at home in spare time with 59-year-old school. Texts furnished. No classes. Diploma. Information booklet free. American School, Dept. XC45, Drexel at 58th, Chicago 37, Illinois.

**STAMMERING** Habit broken and cured! Successful Emery correspondence course subject of Medical Record, Newweek articles. Write Emery Institute, Box 867 PM-9, Winter Park, Florida.

**LAW!** Law! Complete home study course. Given by experienced attorneys. Franklin School, Box 1344, Roanoke, Va.

**ENGINEERING** Degrees earned by home study. American College of Engineering (University of the West), Box 2724-B, Hollywood 27, California.

**EARN** College degree. Remain employed. Fremont College, 5625 Melrose Ave., Los Angeles 38, Calif.

**PHOTOGRAPHY** For pleasure or profit. Learn at home. Practical basic training. Long established school. Free booklet. American School of Photography, 835 Diversey Parkway, Dept. 344B, Chicago 14.

**FINISH** High school at home, spare time. No classes. Diploma awarded. Write for free catalog. Wayne School, Catalog HF-66, 2527 Sheffield, Chicago 14.

**GROW** Mushrooms. Cellar, shed. Spare full time, year round. We pay \$3.50 lb. We paid John Betts \$7,977.78, he started as amateur. Free book. Mushrooms, Dept. 174, 2954 Admiral Way, Seattle, Wash.

**WELDING** Training pays at Hobart Welding School, Box M-861, Troy, Ohio. VA contract. Best equipment. Catalog free.

**CORRESPONDENCE** Courses, books bought, sold. Free catalog. Bayles, 211 Essex, Hackensack, New Jersey.

**LEARN** Advertising—America's highest paid profession. Botts Advertising, 1211 Laura, Wichita, Kans.

**WANT** Strong, masculine voice? Send for free booklet. Perfect Voice Institute, 210 South Clinton, Studio 2HU-3, Chicago 6.

#### PLAYS, STORIES, MANUSCRIPTS

**ALL** The world loves an author. If you write, we appraise/sell. Write/phone. Daniel S. Mead, Literary Agt., 419 Fourth Ave., New York City 16; OR 9-1150.

**WANT** Your book published? Learn how we publish, advertise, promote, distribute. Many successes. Free booklet PM. Vantage, 120 West 31, New York City.

**WANTED:** Book manuscripts, all subjects considered. Greenwich Book Pub., Attn. Mr. Zealand, 489 Fifth Ave., New York City.

#### SPECIAL SERVICES

**GHOSTWRITING.** Folios, ads, etc., written. John Doran, 189 Prospect, Buffalo 1, New York.

**USE** Washington's famous research facilities! Assignments: Sayer Associates, 1129-C Vermont, Washington 5, D. C.

**THE** Drafting & Designing Service, 4024 So. Maplewood, Chicago 32, Illinois.

**VETERANS**—Papers scattered? Free folder! Records Holder Co., Charles Town, W. Va.

#### ARTISTS' SUPPLIES

**TEXTILE** Painting stencil catalog and sample 25¢. Ceramic catalog also. Aluminum Art Products, Dept. PM, 225 W. 8th, Kansas City, Mo.

**IF** Interested in artist frames, canvas, canvas boards, Red Sable brushes, etc., be sure to get our money saving price lists before buying. International Sales Co., 414-APM E. Baltimore St., Baltimore 2, Md.

#### CARTOONING, COMMERCIAL ART, SHOWCARD & SIGN PAINTING, TATTOOING

**"HOW** To Make Money With Simple Cartoons"—A book everyone who likes to draw should have. It is free; no obligation. Simply address Cartoonists' Exchange, Dept. 98, Pleasant Hill, Ohio.

**TATTOOING** Supplies. Free catalog. Spaulding & Rogers, Court St., Jacksonville, North Carolina.

**YOU** Can entertain with chalk talks. Catalog 10c. Balda The Cartoonist, Oshkosh, Wis.

**TATTOOING** Supplies, licensed course, illustrated brochures 25c. Zeiss, 728 Lesley, Rockford, Illinois.

**LEARN** Cartoons—E-Z-way. Folder \$1.00. Dallegro, 999 Kent Ave., Brooklyn, N. Y.

**PAINT** Signs—Master die cut, outline letter patterns. Complete assortment 1½" to 12" high, prepaid \$2.00. Eyerly, 583, Newton, Iowa.

**DRAW** Your way to fame. Free information. Cartoons-of-the-Month, Roslyn, N.Y.

**LEARN** Sign painting at home. Free talent test. Ben Kerns, Box 812-PM, Greenville, S.C.

#### ADVERTISING AGENCIES, LETTER WRITERS, FOR ADVERTISERS

**BEFORE** Advertising—Get instructive Ad-Guide and newspaper-magazine rate-book, free. Chicago Advertising Agency, Chicago 4.

**ADVERTISING,** Result-getting ads prepared, placed newspapers, magazines, radio, anywhere! Lowest rates. Catalogue free. Baker Advertising Agency, 189 W. Madison, Chicago 2.

**MAILING** Lists most any classification \$5.00 1000. Your circulars mailed with ours \$4.00 1000. Write for our literature. Dixie Mailers, King, N. C.

#### RUBBER STAMPS AND OFFICE SUPPLIES

**REFILLS** For Papermate pens. Blue, red, green, black. 6 for \$1.00 postpaid. Broadway Distributors, 1835A Santa Fe, Long Beach, Calif.

**1 LINES**—\$1.00. Fast, professional service. Satisfaction guaranteed! Artcraft, Box 8038, West Palm Beach 22, Florida.

**NAME** And address, free pad. \$1.00. Postpaid. Ascot, Mandarin, Fla.

**RUBBER** Stamps, 4 lines \$1.50. Rough-edge's. 2 Lionel, Clark 1, N. J.

#### TYPEWRITERS, DUPLICATORS, OFFICE DEVICES

**RECONDITIONED** Typewriters, duplicating, printing devices, \$25.00 up. Supplies. Appliances. DixieGraph, King, N. C.

**PORTABLE** Mimeograph! Uses no stencil, no ink. The newest, cleanest, smallest, lightest and cheapest. Weight 15 pounds. DuPont Distributors, P.O. Box 695, Dept. A, New York 1, N. Y.

**RAPID** Duplicator—Makes 50 to 75 copies quickly. Draw, type, sketch. Make copies on paper, cards, etc. Uses no stencils. Do 2 and 3 color work. \$3.95 postpaid. Hasner! Products, Knox, Indiana.

#### PRINTING, MULTIGRAPHING, MIMEOGRAPHING, GUMMED LABELS

**KROMEKOTE** Postcards your photo \$12.50 thousand. Bond envelopes small \$5.95, large \$6.95 thousand. Three line rubber stamp \$1.00. Professional workmanship. Brost Press, Rapid City, So. Dak.

**BUSINESS** Cards. Free style chart, samples. Robert Ham, Hallam, Nebraska.

**1,000** RAISED Letters business cards \$2.95. Samples. Pioneer, 195-H Quebec, Island Park, N. Y.

**OFFSET** Printing \$6.50—1000, 8½x11, 16 lb. National Letter, 251 W. 42 St., New York City 36.

**MIMEOGRAPHING**—Letters, pricelists, formulas, instructions. Lowest prices. Lem's Letter Shop, 5710 Stanton, Detroit 8.



ADS Running under this heading sell printing. Ask me for proof, I'll gladly send you amazing facts. Ask for Folder "P." F. W. Johnson, 200 E. Ontario St., Chicago 11, Ill.

FREE Catalog! Business printing, offset, mimeographing. D'Yarmett, 420 Columbian, Columbus 23, Ohio.

FREE Catalog business, personal printing. D. M. Press, Sebastopol, California.

BILLBOOKS, Statements, envelopes, rubber stamps. Eddirose, Bronx 72, N. Y. Free catalog.

100 LETTERHEADS, 100 Envelopes, 3 line rubber stamp—same copy, all \$2.25 postpaid. Cash with order, print plainly. Sooner Press, P.O. Box 2431, Oklahoma City, Okla.

PRINTED Stationery builds prestige. Samples free. Helle Company, Madisonville, Kentucky.

EXPERT Printing. All types. Get free details, now: Doswell, Box 2360, Norfolk 1, Virginia.

100 PENNYSAVERS, #6 3/4's, \$1.00, postpaid. Four lines. Redoprint, Ojai, Calif.

GUMMED Labels in rolls. Name and address in three lines, 1/2x1 3/4, 500, \$1.00. Business cards, \$3.95. Guaranteed mailed same day. Samples. Alexander, Box 474, Pomona, California.

MIMEOGRAPHING: Multi-colored; reasonably priced. Color guide 25¢. Price list free. Mimeo Press, 834 1/2 Falls Road, Rocky Mount, N. C.

RUSH Service! 100 8 1/2x11 letterheads \$2.00 postpaid. Bass Press, Knox, Indiana.

CIRCULARS, Booklets, letterheads, envelopes. Estimates free! Loneim Printers, Paulding, Ohio.

#### PRINTING OUTFITS AND SUPPLIES

DUPLICATING Machines, low priced. Free circular. Harold Osterhoudt, Poughkeepsie 2, New York.

PRESSES, Type cabinets, supplies. List for stamp. Lincoln Press Company, 220-H Hartwell, Fall River, Mass.

RUBBER Stamp making presses, hydraulic operated, electrically heated. Also supplies. Custom, Box 211-M, Springfield, Missouri.

MAKE Your own self-molding rubber stamps and printing cuts. Plexirubber, Argyle 1, Wisconsin.

DO Your own printing. Save money. Simple rules. We supply everything. Print for others; good profit. Raised printing like engraving too. Have home shop. Details free. Kelsey Presses, V-11, Meriden, Connecticut.

#### PATENT ATTORNEYS

INVENTORS—Take these preliminary steps toward patent protection. Sketch and describe your invention. Sign, date and have this disclosure witnessed by two people who understand your invention. Have us make a preliminary search among U.S. patents already granted for similar types of invention. We report on the probable patentability of your invention and recommend your further course of action. Write for our instructive booklet, "Patent Protection for Inventors" and convenient "Evidence of Invention" disclosure form. Victor J. Evans & Co., 231-J Merlin Building, Washington 6, D. C.

INVENTORS—If you believe you have an invention, you should find out how to protect it. The firm of McMorror, Berman & Davidson with offices in Washington, D. C., is qualified to take the necessary steps for you. Send for copy of our patent booklet "How to Protect Your Invention." We will also send you an "Invention Record" form. No obligation. They are yours for the asking. McMorror, Berman & Davidson, Registered Patent Attorneys, 1346 Victor Building, Washington 1, D. C.

PATENTS—Irving L. McCathran, 315 McLachlen Bldg., Washington 1, D. C. Registered Patent Attorney.

INVENTION Record form free and "Patent Information Every Inventor Should Have." Carl Miller, Registered Patent Attorney, Woolworth Building, New York.

REGISTERED Patent attorney offers services. Sanders, 6430 Evans, Chicago 37, Illinois.

C. A. Snow & Co.—M427, Snow Building, Washington 1, D. C. Registered Patent Attorneys. Write for information.

INVENTORS: When you are satisfied that you have invented something of value write me, without obligation, for information as to what steps you should take to secure a patent. Write Patrick D. Beavers, Registered Patent Atty., 935 Columbian Bldg., Washington 1, D. C.

INVENTORS: Without obligation, write for information explaining the steps you should take to secure a patent. John Randolph, Registered Patent Attorney, 203 Columbian Bldg., Washington 1, D. C.

CANADA—Ramsay Company Registered, 273 Bank Street, Ottawa, Canada.

PATENTS. "Proof of Invention" free. E. E. Vrooman, Registered Patent Attorney, 507 McKim Building, Washington 5, D. C.

"INVENTOR'S Guide" and "Record of Invention" free on request. Frank P. Ledermann, Registered Patent Attorney, 154 Nassau Street, New York City.

INVENTORS: Learn how to protect your invention. Unless the inventor is familiar with patent matters, he should engage a competent registered patent attorney or agent to represent him. We are registered to practice before the U. S. patent office and prepared to serve you in handling your patent matters. "Patent Guide for the Inventor" containing detailed information concerning patent protection and procedure with "Record of Invention" form will be forwarded to you upon request—without obligation. Clarence A. O'Brien & Harvey Jacobson, Registered Patent Attorneys, 61B-G District National Building, Washington, D. C.

#### FOR INVENTORS

IDEAS Developed for products and your profit with effective patent protection at low definite cost. Foreign patents: Canadian patents filed \$100.00. 30 yrs. in business. Joseph O'Brien, Patent-Development Engineer, 132 Nassau St., New York 38, N. Y.

INVENTORS—If you believe you have an invention, you should find out how to protect it. The firm of McMorror, Berman & Davidson with offices in Washington, D. C., is qualified to take the necessary steps for you. Send for copy of our patent booklet "How to Protect Your Invention." We will also send you an "Invention Record" form. No obligation. They are yours for the asking. McMorror, Berman & Davidson, Registered Patent Attorneys, 1347 Victor Building, Washington 1, D. C.

INVENTORS—Send for free patent information book and inventor's record. Registered Patent Attorney, Associate Examiner, Patent Office 1922-29, Patent Attorney & Advisor, Navy Department 1930-47. Gustave Miller, 86A Warner Building, Washington 4, D. C.

INVENTORS—This firm is registered to practice before the United States Patent Office and available to assist you in the preparation and prosecution of your patent application. "Patent Protection for Inventors" booklet containing detailed information and steps to take toward patent protection sent promptly upon request. No obligation. Victor J. Evans & Co., 232-J Merlin Building, Washington 6, D. C.

TOY Inventions needed for billion dollar market! Sell your own ideas. For valuable information, manufacturers to contact, how to contact, etc., send \$2.00. Toys, Box 271, Temple City, California.

PROTECT Your unpatentable inventions and ideas. \$1.00 to PS Co., Suite 307, 507 Fifth Avenue, New York City.

SEARCHES—Put your patent searches in the hands of a registered patent attorney or agent, as he qualifies to give a worthwhile patentability report. Record of invention form upon request and information on patent protection. Patrick D. Beavers, Registered Patent Attorney, 936 Columbian Bldg., Washington 1, D. C.

INVENTORS: Information on patent procedure furnished on request, without obligation. John Randolph, Registered Patent Attorney, 203 Columbian Building, Washington 1, D. C.

"INVENTOR'S Guide" and "Record of Invention" free on request. Frank P. Ledermann, 154 Nassau Street, New York 38, N. Y.

PATENT Searches \$5.00. 48-hour service. Free invention protection forms. Write Raymond L. Smith, Patent Searcher, 620 Sheraton Building, Washington 5, D. C.

INVENTORS: Learn how you can protect your invention. A specially prepared booklet "Patent Guide for the Inventor" containing detailed information concerning patent protection and procedure together with "Record of Invention" form will be promptly forwarded to you upon request—without obligation. We are registered to practice before the United States patent office and are prepared to serve you in the handling of your patent matters. Clarence A. O'Brien & Harvey Jacobson, Registered Patent Attorneys, 61A-G District National Building, Washington, D. C.

PATENT Searches \$5.00. 48-hour airmail service. Invention protection forms free. Write Patent Engineering Service, 711 14th Street N. W., Washington 5, D. C.

INVENTION Record form free and "Patent Information Every Inventor Should Have." Carl Miller, Registered Patent Attorney, Woolworth Building, New York.

PATENT Searches, including copies of nearest patents, \$6.00. Reports airmailed within 48 hours. More than 100 registered patent attorneys use my service. For free invention protection forms, write Miss Ann Hastings, P.O. Box 176, Washington 4, D. C.

INVENTORS: If you have an invention for sale, patented or unpatented, write Institute of American Inventors, Dept. 40A, 631-E St. N.W., Washington 4, D. C.

#### INVENTIONS WANTED

INVENTIONS Wanted. Patented; unpatented. Tremendous manufacturers lists. Global Marketing Service, 2420 77th, Oakland 5, California.

INVENTIONS Wanted now by my manufacturer-clients. Patented, unpatented. Write Adams, Patent Broker, 80-S Wall Street, Financial District, New York City.

CASH Buyers for ideas and inventions. Write National Inventors Institute, 457 Munsey Building, Washington 4, D. C.

INVENTORS. Give us the opportunity to explain our selling plan for your invention, gadget or device, patented or unpatented; free particulars available upon request. Demarest and Demarest, Box 95, Battle Creek, Michigan.

ESTABLISHED Manufacturer, with facilities to fabricate lightweight metal products, wants patented or unpatented items to manufacture. Write Tom Lee, Magnesium Products of Milwaukee, 742 W. Virginia St., Milwaukee 4, Wisconsin. Write for form to use when submitting your idea.

INVENTORS: Hundreds of manufacturers have requested our assistance in locating marketable new products. Complete information free. Institute of American Inventors, Dept. 40-D, 631-E St. N.W., Washington 4, D. C.

INVENTORS. Don't sell your invention patented or unpatented until you receive our offer. Write Cowgill, Box 298, Marion, Ohio.

INVENTIONS Wanted. Patented or patent pending. 25 years experience promoting inventions. National Service Bureau, 3120 Meramec, St. Louis 18, Mo.

SUPERIOR Promotions. Patented; unpatented inventions. Free, informative booklet, guidance. Superior, 338-344 North Rodeo, Beverly Hills, Calif.

FREE Promotion on some inventions. Write: Gombar Enterprises, 12591 Glenfield, Dept. 115, Detroit 13, Mich.

INVENTIONS Promoted. Guaranteed plan. Write for free booklet "Your Invention." Kessler Corporation, 581W, Fremont, Ohio.

AMERICAN Congress of Inventors—Quick response. Free "Thomas Edison's Formulas for Success." Inventors, Box 1481, Milwaukee 1, Wisconsin.

WILL Finance and manufacture your invention or formula if it appeals to us. National Research & Development Corp., 11 W. 42 St., New York 17, N. Y.

ATTENTION Inventors! To sell your invention advertise in Gadgets, Patents, Invention Magazine. Inventors' Service Bureau, 107 W. Van Buren, Chicago 5, Ill.



## PATENTS FOR SALE

**INVENTORS:** Test the commercial value of your patented or unpatented inventions, quickly and inexpensively. Write for free information. Institute of American Inventors, Dept. 40-B, 631-E St., N.W., Washington 4, D. C.

**INVENTIONS** For sale. Queries from manufacturers solicited. Kessler, Patent Broker, Fremont, Ohio.

## MANUFACTURING

**MODELS**—Small lot manufacturing. Metals, plastics, etc. Milburn, Burlington, Kentucky.

## MODELS, MODEL SUPPLIES

**BUILD** Miniature passenger hauling live steam locomotive with file and drillpress. We do machine work, you bolt it together. Catalog 50¢. Little Engines, Lomita, Calif.

**SHIP** And yacht model fittings; blueprints. Send 35¢ for illustrated catalog listing hundreds of items. A. J. Fisher, 1002-1 Etowah Ave., Royal Oak, Mich.

**SHIP** Models. Most complete line in New England. Kits, fittings, plans, books, tools, engines, motors. Illustrated catalog 30¢. James Bliss & Co., Inc., Dept. SM, 342 Atlantic Ave., Boston 10, Mass.

**BALSA** Wood and model aircraft. 40-page catalog 25¢. Sig Co., Montezuma, Iowa.

## HOME CRAFTSMEN

**LEATHERCRAFT,** Metal enameling, beadcraft, shellcraft, metal tooling, textile painting, many other crafts. Free big illustrated catalog. Kit Kraft, Dept. 238, Studio City 1, California.

**FREE.** Complete illustrated catalog, leathercraft kits, supplies. J. C. Larson Co., 820 S. Tripp, Dept. 6327-L, Chicago 24.

**89 FULL** Size jig saw patterns of beautiful shelves, ornaments, toys, novelties. Plus "How, Where to Sell." Only \$1.00. Mastercraft 84M, 7041 Olcott, Chicago 31, Illinois.

**BUY** Wholesale nationally advertised power, hand tools, thousands other products at big discounts. Free "Wholesale Plan." American Buyers', Hertel Station, Buffalo 16-F1, N. Y.

**KNOCKDOWN** Cedar chests. Lumber and veneers. Free price list. Giles & Kendall Company, Huntsville, Ala.

**STYLECRAFT** Sure fire hits. "Pre-traced" leather kits. Handbags, billfolds, filigree belts, over fifty other projects. Patterns on leather. Why trace? Just carve, assemble and lace. Large assortment "precarved" kits also available. Send 25¢ for catalog, free folder. Refunded first order. Apache Leather Company, 2804 E. Washington St., Phoenix, Arizona.

**KNOCKDOWN** Cedar chests and lumber. Free price list. Bedford Lumber Company, Shelbyville, Tennessee.

**18 FULL**-Size patterns. Save money with easy-to-use, professionally designed full-size patterns. Make money selling beautiful, useful furniture. Make modern step and cocktail tables; metal lamps; cupola; 12-foot outboard. All patterns test-built; sold with money-back guarantee. Get your free list of these convenient, economical patterns today. Popular Mechanics Press, 200-HH E. Ontario Street, Chicago 11, Illinois.

**LEATHERCRAFT.** Send 10¢ for new 60-page catalog of tools, supplies, kits, including metalcrafts, enameling, ceramics, all other crafts. Complete stock. Reasonable. Since 1910. Sax Bros., Dept. PM1, 1111 N. 3rd, Milwaukee, Wis.

**ALL** Crafts, supplies. Large free catalog. National Handicraft, 199 William Street, New York City 38.

**CERAMIC** Tile for bath wall, floors and tables. Applied with adhesive. Instructions furnished. Artistic Tile Co., 2562 First Ave. No., St. Petersburg, Fla.

**FREE** Catalog. 1560 patterns and designs. Craftplans, 1321-A South Michigan, Chicago 5.

**WOODWORKING** And cabinetmaking course for beginning and advanced home craftsmen. Only complete low-cost home training program available. Write for free booklet. Interstate Training Service, Dept. G-3, Portland 13, Ore.

**HOME** Floor plans, 31 all different. exterior designs, photos, colonials, contemporary, ranch. \$1 postpaid. Builders Association, 7810 Park Place Blvd., Houston 17, Texas.

**LEARN** Art metalcraft and jewelry making. Complete, inexpensive, home training course now available. Special tools and materials furnished. Write for free booklet. Interstate Training Service, Dept. L-3, Portland 13, Oregon.

**FOUR** Foot solar cooking mirror. Easily built with cardboard and aluminum foil. Details free. Complete plans 75¢. Flindt, 2117 Cedar St., Berkeley, Calif.

**GROW** Bamboo fishing poles, hedges. Shackell's, Rt. 5, Columbia, Miss.

**LAMP** Size cypress knee with nipple installed \$2.00. Cy Products, Dept. 2-W, Lafayette, La.

I want to send you proof of the wonderful pulling power of Popular Mechanics classified pages. What's your proposition? Write me today. Include literature if possible. F. W. Johnson, Manager Classified Advertising, Popular Mechanics Magazine, 200 E. Ontario St., Chicago 11, Ill.

**UNPAINTED** Furniture—Huge savings! Chests, headboards, bookcases, vanities, children's chifferobes, desks, 1/2 the price of finished furniture! Catalog 25¢. Van, Box 243-PM1, New Rochelle, N. Y.

**WOODWORKING** For home craftshoos. Full size plans of authentic 18th cent. envelope card table with tooled leather tops. Three big sheets, everything full size with simple Craft-Graph joinery and schedules for finished table. Only \$5. New measured-coverage finishing schedules for mahogany, walnut, pine; all free with plans or 10¢ each. Old South Patterns, Dept. B, Box 6187, Charlotte 7, N. C.

**BENCH** Vise, wedge type. Merely push stock in place. Made of aluminum alloy. \$2.45 postpaid. Flash Bridge Co., Holland, Michigan.

## DO IT YOURSELF

**PRE-Cut** homes. Save, buy direct from mill. Save labor. Free literature. Write: Do It Yourself Homes Company, Box 748, Lewistown, Penna.

**BACK**-Yard smoke pit. Plans and instructions \$2.00. Sullivan, Box 5381, Jacksonville, Florida.

**HEAT** Pump, patented heat from earth. featured Readers' Digest. Install your heating and cooling system. Complete detailed drawings \$10.00. Send check or money order. Webber Engineering Corporation, P.O. Box 217, Indianapolis 6, Indiana.

**PORTABLE** Solar cooker, full instructions how to make this powerful sun cooker. Be first to have one in your neighborhood. \$4.95. Gombar Enterprises, 12591 Glenfield, Dept. 115, Detroit 13, Michigan.

**SOLAR** Unit heats water free for trailers, homes, farm. Simple construction. Plans \$2.50. Information free. Solarex, Box 1174, San Bernardino, Calif.

**WROUGHT** Iron railing—Porches, stairways, 6' \$9.50. Free literature. Rex. Allquippa, Penna.

**ESTABLISH** Social dancing class. Easy, profitable. Details \$1.00. Leo Byrum, Sr., Route 2, Summerfield, N. C.

**CLOCK** Movements—Gorgeous dials, plans, kits. See ad page 227.

**BUILD** The patented Little Mint Paper Baler. Slickest baler for homes, offices, stores, etc. Plans and license \$1.00. L. M. Baler Co., Box 125-A, Wausau, Wisconsin.

**AIR** Conditioners—Home, automobile. See Kool Engineering ad page 24.

## WATCHES, OLD GOLD, JEWELRY

**RHINESTONES,** Jewellery settings, copper enameling, hobby kits. Illustrated catalog 10¢. J & M Novelties, Dept. CJ-3, Griffith, Indiana.

**WATCH** And clock repairing books. Free information. North American, Dept. 16H, 2320 N. Milwaukee, Chicago 47, Illinois.

**HELBROS** Watches, jewelry 70% discount. Catalog 25¢. Dorinda, Huntington Station 7, N. Y.

**WATCHMAKERS'**—Jewelers' supplies, instructions. Catalog 20¢. Bengale Company, Culver City, California.

**COSTUME** Jewelry supplies. Catalog and samples. 35¢. Largest line in America. Milady-Fair Co., G.P.O. Box 1328, New York City 1.

**USED** And new watches \$2 up. Free list. Southern Watches, Gray, Georgia.

**HIGHEST** Cash for old gold, broken jewelry, gold teeth, watches, diamonds, silverware, spectacles, platinum, mercury. Free information. Satisfaction guaranteed. Rose Refiners, Heyworth Bldg., Chicago 2.

## TOBACCO, SMOKERS' SUPPLIES

**CIGARS.** Tampa finest Havana tobacco. Hand made daily. Boxes 50's. Write. Special prices. Little Willie's. 2910 N. Blvd., Tampa 2, Florida.

**CIGARS!** Clear Havana seconds. \$3.95 box 50. Guaranteed. Tobacconist. 220 N. Clark, Chicago 1, Ill.

## FOR THE HOME

**FOAM** Rubber furniture cushions. Factory seconds. 50% discount. Free catalog. Perma-Foam, 236C Rhode Island Ave., East Orange, New Jersey.

**WEATHERVANES.** Lifetime aluminum, black finish, universal base. Satisfaction guaranteed. 31" high, \$15.50. Leehigh, 1932 Newcastle, Westchester, Ill.

## OF INTEREST TO WOMEN

**GOOD** Money in weaving. Weave rugs at home for neighbors on \$69.50 Union Loom. Thousands doing it. Booklet free. Union Looms, 153 Post St., Boonville, N. Y.

**SELL** Fine fabrics. Get yours wholesale. Box 863, Norwalk, Conn.

**WANT** To make big money at home? \$5 profit in an hour possible with invisible reweaving. Make tears, holes disappear from clothing, fabrics. Steady year-round demand from cleaners, laundries, homes. Details free. Fabricon, 8332 Prairie, Chicago 19, Illinois.

**\$2.00 HOURLY** Possible doing light assembly work at home. Experience unnecessary. Crown Industries, 8507-D West Third, Los Angeles 48, California.

**GOOD** Money in weaving. Weave rugs at home for neighbors on \$69.50 Union loom. Thousands doing it. Booklet free. Caricraft Co., Polk St., Boonville, N. Y.

**BOOKS;** Hundreds of subjects. Big catalog free. Popular Mechanics Press, 200-BC East Ontario St., Chicago 11.

**EMBROIDER** Stamped linens. Buy direct from manufacturer and save. Send for free catalog. Dept. 185, Merribee, 16 West 19th Street, New York 11, N. Y.

**GROW** Mushrooms. Cellar, shed. Spare, full time, year round. We pay \$3.50 lb. We paid John Betts \$7,977.76, he started as amateur. Free book. Mushrooms, Dept. 176, 2954 Admiral Way, Seattle, Wash.

**FREE**—Big new wholesale catalog! Up to 50% saving for you, family, friends on nationally-known gifts, jewelry, toys, appliances, Christmas cards, etc. Also make money selling part time! Write: Evergreen Studios, Box 846-D, Chicago 42, Ill.

**PROFITABLE** Home business. Make fast-seller chenille monkey trees, dolls, flowers. Terrific holiday demand. Information free. Velva, Bohemia 16, N. Y.

**KOOL** Hand tongs. Lift sterilized nursing bottles, instruments, fruit jars, baked potatoes, sweet corn, wieners, hot pans and many other items. Price 50¢ postpaid. Diesel Power, Inc., Greenville, Penna.

## WANTED—MISCELLANEOUS

**QUICKSILVER,** Sterling, silver solders, precious metals. Wholesale Terminal, Norwood, Massachusetts.

**BOOKS;** Hundreds of subjects. Big catalog free. Popular Mechanics Press, 200-BC East Ontario St., Chicago 11.



SCRAP Mercury (quicksilver) containers supplied — Tantalum, tungsten, silver, platinum. Metallurgical Products Company, Established 1909, 35th & Moore Sts., Philadelphia 45, Penna.

### PERSONAL

HONGKONG, China. Exciting rearmails \$1.00. Freeman, 35B McDonnell Road, Hongkong.

MAKE Sure your bank account always balances. New, amazing method. Never fails. Free details. Lawlor and Pike, Northport, N. Y.

"HOW Can I find out?" You can! Information confidentially developed. Any matter, person, problem. Worldwide. Officially licensed. Established 1922. William Herman, 170 Broadway, New York City.

BOOKS; Hundreds of subjects. Big catalog free. Popular Mechanics Press, 200-BC East Ontario St., Chicago 11.

CHICAGO — Mail forwarding address. Business, personal. Low rates. Continental, 20-M West Jackson, Chicago 4.

NORWAY. 3 Beautiful scenic viewcards re-aired \$1.00. Jarlums, Carl XII. gt. 26, Oslo.

CHILEAN Rearmails, 50¢. Hobbyists send wants. Viewcards, license plates, Indian souvenirs. Barcelo, Box 10365, Santiago, Chile.

BORROWING By mail. Loans \$100 to \$600 to employed men and women. Easy, quick. Completely confidential. No endorsers. Repay in convenient monthly payments. Details free in plain envelope. Give occupation. State Finance Co., 323 Securities Bldg., Dept. B-227, Omaha 2, Nebraska.

LEGAL Forms. Wills, leases, partnership, etc. \$1.00 each. Forms, Elizabethton 2, Tennessee.

EYEGLASS Hearing aids. Direct from factory to you. 10 percent discount. Guaranteed. Details free. Bedard, 47-F Lynnway, Lynn, Mass.

WASHINGTON, D. C., address. Remails 25¢. Monthly \$3.00. Sunday classified airmailed \$1.00. Metropolitan, Box 9107-PM, Arlington 9, Va.

NEW. Perfume like lip stick. Airmailed direct from Paris. Clayton Sales, 633-B Clayton, Wichita 12, Kansas.

10,000 ROLLS Fresh snapshot film given away. Write today. Delco, Box AB362, Upper Darby, Penna.

### REMAILING SERVICE

NEW York City—Remails 25¢. S. H. Brown, 178-39 Leslie Rd., St. Albans, L. I., 34, N. Y.

MONTREAL. Letter remailed 25¢, etc. R. Cote, 1567 East Laurier Street, Montreal, Que., Canada.

NEW York City. Remailing 25¢, also forwarding and shopping. Betty, 510 East 11th Street, New York City 9.

LETTERS Remailing 25¢. Received, forwarded, monthly rates. Box 195, Ft. Lauderdale, Fla.

KALAMAZOO Or Plainwell remails 25¢. Hendricks, Box 97, Plainwell, Michigan.

WASHINGTON Mailing address. \$10 quarterly. Sayer Associates, 1129-C Vermont, Washington 5, D. C.

LETTERS Remailing 25¢. Private receiving, rent box, other services. Write Gombor Enterprises, 12591 Glenfield, Dept. 115-A, Detroit 13, Mich.

LETTERS Remailing from San Francisco 25¢ each. Keith Service, 773-A Dolores.

SECRET Mail address \$3 month. Los Angeles classifieds airmailed \$1.00. Hedgpath, Box 830, Alhambra 23, California.

LETTERS Remailing 25¢. Sunday classified \$1.00. John Brevard, Sharondale Drive, Nashville, Tenn.

NOTRE Dame, South Bend, remails 25¢. Schaut, 619 Kamms, Mishawaka, Indiana.

CONFIDENTIAL Remailing, receiving-forwarding \$3.00 monthly. Employment classifieds \$1.00. International Commercial Systems Laboratories, Suite 301 M.I.C., 6435 Wilshire Boulevard, Los Angeles 48.

LETTERS Remailing 25¢. Received, forwarded. Monthly rates. Box 686, Kelowna, B. C., Canada.

REMAILS 25¢, Sunday classifieds, \$1.00. Lloyd's Enterprises, Box 8125, Denver 19, Colorado.

HONOLULU — 6 Viewcards \$1.00. Remailing free. Receiving, forwarding available. Fobel, 3132-P George Street, Honolulu.

### TREASURE FINDERS

GOLD, Silver, metal detectors. Geiger counters for uranium. Violetes. Sensational new fully guaranteed models. None finer. Information free. Detectron Corp., 5528 Vineland Ave., North Hollywood, California.

FIND Buried treasure, gold and silver, with Goldak's sensational 3 1/2 lb. "find-it" locator, only \$49.50. Write for free literature on complete line of mineral, metal locators; Geiger and scintillation counters. Goldak, 1541 W. Glenoaks Blvd., Glendale, Calif.

YOU Test your ore for 20 metals. Simple. \$7.50. Fee information. Mineralogist, Box 731, Centralia, Washington.

FOR Treasure locators, geiger, scintillation counters, mineralights, M-Scope. Fisher Research Laboratory. See advertisement page 237.

JEEP Owners — V8 power. Read Jeep owners ad, page 18.

URANIUM. Gold, silver treasure. New power-packed highly sensitive metal detectors, Geiger counters and mineralights. Kits and assembled models from \$12.50. Lightest weight, guaranteed, free literature. Electronic Applications, Box 8, Arlington 10, Virginia.

### FOR SALE—MISCELLANEOUS

HEARING Aid batteries, wholesale. Free list. Habs, Box 51, York, Penna.

BOOKS; Hundreds of subjects. Big catalog free. Popular Mechanics Press, 200-BC East Ontario St., Chicago 11.

TYPICAL Leather bags, skirt lengths. Free catalog. Mapilon, Box 268, Guatemala, C. A.

SMALL Imported pen-knives: Four blades, \$1.00 per dozen, \$8.00 gross. About two inches closed. Colored handles, lightweight. United, 121 Winkler, Houston, Texas.

### MISCELLANEOUS

BUY Wholesale thousands nationally advertised products at big discount. Free "Wholesale Plan." American Buyers, Hertel Station, Buffalo 16-K1, N. Y.

GROW Mushrooms. Cellar, shed. Spare, full time, year round. We pay \$3.50 lb. We paid John Betts \$7,977.76, he started as amateur. Free book, Mushrooms, Dept. 175, 2954 Admiral Way, Seattle, Wash.

WHOLESALE Catalog! 30-80% discounts! Appliances, musical instruments, typewriters, tools, watches, jewelry, cameras, housewares, etc. Consolidated Distributors, 7-13 Henry, Paterson 15, New Jersey.

1 THESSALONIANS 2, 13. Whitcomb, 308 Sycamore, Newport News, Va.

KEY Board with 6 fibre board tags. Solid brass jack link only \$1.75 pp. Wonderful gift. Home, office, church. Muller Tags, 9445 3rd St., Jacksonville 8, Fla.

CESSPOOLS, Septic tanks, outhouses, clogged drains, cleaned, deodorized without digging, pumping. Sursolvent reduces contents. Reclaims leachability. Old systems work like new. Free details. Electric Sewer Cleaning, Alliston 34, Mass.

LAUGH At yourself. Send \$3 and photo for caricature. Laugh, P.O. Box 359, Selma, Ala.

12 MEXICAN Archaeological photo post cards \$1.00. 12 color slides of colonial churches \$6.00. Sample 60¢ postpaid. Alex Martinez, Arista 150, San Luis Potosi, Mexico.

WAKE Up your mind! Be what you desire! Smash worries, fears, indecision, inferiority. Eye-opening, life-changing facts about self-discovery and self-training free. Write Applied Christian Psychology, Inc., Box 1924-Q, Louisville 1, Ky.

STUPENDOUS Mental power. Adults. Details 3¢. Delmar Wisdom, 846 Sunny-side, Chicago 40.

CONTACT Surplus dealers who have tremendous stocks of government and factory surplus. Send \$1 for list of 1000 dealers. G. E. Service, 210 Oneida Ave., Canton 8, Ohio.

SPANISH, 15 New stamps, 6 newspapers, 4 magazines, 12 island postcards or letter reairmailed. Choice: \$1.00 postpaid. Williams, Apartado 119, Las Palmas, Canary Islands.

UNUSUAL Conversation piece! Reproductions of Declaration of Independence, Bill of Rights, Constitution, and Gettysburg Address. 59¢ each—Set of four, \$3.00 postpaid! Fox Enterprises, Department 568, 1010 Euclid Avenue, Cleveland 15, Ohio.

CIGARETTES—Make 20 for 9¢. Facts free. Moberly, Box 810, Owensboro, Ky.

FREE: Exciting catalog packed with books covering most everything. Think of it—From cover to cover you will find described and illustrated hundreds of books telling how to fix and how to build almost anything. How to remodel your home; do your own decorating, plumbing, electrical work. Simplified books covering concrete work, carpentry, painting, furniture making and refinishing. How to build your own boat, home workshop tools. Best books on photography, welding, hobbies, homecraft. How to make a home freezer. Send for your free copy now. Popular Mechanics Press, 200-BC East Ontario St., Chicago 11, Ill.

JAPAN: Buy gifts direct from Japan. Kimono, model engines, lanterns, colored slides, novelties, others. Business information fee \$1.00. Send money orders. Clarence Yamagata, Room 202, Naka 7 Bldg. Marunouchi, Tokyo, Japan.

RECEIVE Magazine samples, mails, offers by hundreds. Get listed 25¢. Rorick, Cincinnati 26, Ohio.

YOUR Name wanted. We'll send 1000 publishers, mailers, wholesalers your name, on our list one year 25¢. Dixie Mailers, King, N. C.

BE Your own plumber. You can. Few inexpensive tools and our instructive book, "Home Plumbing Guide," shows and tells you how. Hundreds of photographs and diagrams. Easy to follow, 160 pages. \$3.50. Catalog free. Popular Mechanics Press, 200PG East Ontario St., Chicago 11, Ill.

DO It yourself. What? Repair TV, build furniture, make barbecue, plumbing repairs, build boats, do house wiring, remodel home, lay tile, modernize kitchen, repair home, and scores of other things you can do yourself. Books covering each subject, only 25¢. Send for descriptive list. It's free. Popular Mechanics Press, 200-LB East Ontario St., Chicago 11, Ill.

ORNAMENTAL Iron designs. Book of 1500 beautiful, practical designs for railings, columns, etc. Free literature. Cunningham, 3881 South 3200 West, Salt Lake City, Utah.

70 BIBLE Lessons, 25¢. Bulletin, Box 87, Cathedral Station, New York City 25.

EARTHWORMS Urgently needed! We shipped \$3,175.75 worth, first year, spare-time, backyard! Why can't you? Raising, marketing instructions, 10¢. Oakhaven-M, Cedar Hill, Texas.

BARGAIN. Exciting Little Library booklets, 25¢ each. Tool making, painting, welding, home improvement, games, models, plastics, lamp making, glass blowing, boats, photographs. Free catalog. Popular Mechanics Press, 200-LB East Ontario St., Chicago 11.

NEW Invention. Useful in the kitchen. Pat. pending. For ladies. Potato peeling aid. Yours free. Write for information. Jackson Industries, 514 N.E. Fremont, Portland 12, Oregon.

FAMOUS Roasty Toasty wiener tong, 27" long. Set of 4, \$1.50 prepaid. Allied Equipment Corporation, Bloomington, Ill.

PUZZLE Contestants: Trying for car? Raise score. Tips, instructions show how. Legitimate. \$1.00. Ellis, Mt. Vernon, Ill.

WORTHWHILE Big mails. Guaranteed. Year's listing. 25¢. Rite-Way, Sanford, Michigan.

"HOME Improvement Guide." New, amazing 192 page volume. Packed with ideas, plans for remodeling, decorating, landscaping, built-in projects. \$2.50 prepaid. Popular Mechanics Press, 200-HQ East Ontario St., Chicago 11.



# PREPARE FOR THE BEST JOBS

IN INDUSTRY

**TRAIN at HOME**  
IN YOUR SPARE TIME  
or at  
**ALLIED INSTITUTE**  
in Chicago

- MECH. ENGINEER
- DRAFTSMAN
- TOOL DESIGNER
- TOOL ENGINEER
- TOOL & DIE MAKER
- MASTER MACHINIST

## NO RECESSION FOR ALLIED TRAINED MEN

**MORE JOBS THAN GRADUATES** Shortages of Draftsmen, Designers, Tool Engineers, Machinists, Tool & Die Makers are so widespread that you can pick a highly paid key job and look forward to Achievement and Security.

You can begin your training in Short Courses and continue progressively to a Bachelor Degree in 26 months.

Allied is approved by Industry, Dept. of Education, Office of Public Instruction, State of Illinois, U.S. Veterans Admin., U.S. Dept. of Justice. Accredited: C. S. A.

SEND FOR  
**FREE**  
BOOKS

**ALLIED SCHOOL OF MECHANICAL TRADES**  
1338-42 South Michigan Ave. Dept. PM-8 Chicago 5, Illinois

SEND ME WITHOUT OBLIGATION INFO. ON YOUR COURSES:

HOME STUDY  RESIDENT  VETERAN  NON VETERAN

NAME \_\_\_\_\_

ADDRESS \_\_\_\_\_

AGE \_\_\_\_\_

CITY \_\_\_\_\_

COUNTY \_\_\_\_\_

STATE \_\_\_\_\_

# CHEMISTRY

## BIG LABORATORY GIVEN FREE!

Be a **CHEMIST!** One of the really **GREAT** professions! We teach you at home. Simplified (but thorough) course; no previous training required. Earn while you learn. This is a **GOLDEN AGE** for those with special knowledge! Diploma awarded! Send 25c for first lesson and KIT or \$1.00 for first 5 lessons and supplies including

**FREE!**

**URANIUM TESTER, CHEMICAL PUZZLE (worth \$2.50) and HOW TO MAKE 100 NEW CHEMICALS!**

**NATIONAL SCHOOL OF CHEMISTRY**

P.O. BOX 606-A

REDWOOD CITY, CALIF.

Say You Saw It in Popular Mechanics

## LEARN APPLIANCE REPAIR IN SPARE TIME AT HOME



### START YOUR OWN BUSINESS

50,000,000 POTENTIAL CUSTOMERS

New shop-method, home-training system gives you electrical know-how that used to take years to learn. Learn by building valuable testing kits, repairing your own and neighbors' appliances. Appliance repairmen often charge on the basis of \$5.00-\$6.00 an hour!

**FREE BOOK**

Shows you how you learn every phase of electrical appliance repair. How to make money while you learn. Write today for your **FREE** copy.

**CHRISTY TRADES SCHOOL**

DEPT. D-5703, 4804 N. KEDZIE AVE., CHICAGO 25

## AMAZING NEW PERSONAL POCKET RADIO



### LISTEN WHILE YOU WALK DOWN THE STREET!

Slips in any pocket—wt. only 7 ozs. Size 2 3/4" x 4 3/4" x 1 1/4". Beautiful Black Gold Plastic Case. NO HOOKUPS—NO WIRES—NO PLUG-INS! Self-contained. 150-hour life flashlight batteries and BUILT-IN ANTENNA. POSITIVELY NO AERIAL HOOKUPS EVER! GUARANTEED RECEPTION OF RADIO STATIONS TO 50 MILES up to 1500 miles for powerful stations! New patented Super-regenerative Duotriode tube and transformer audio stage for sharp selectivity and sensitivity! Easy to use top tuner (while walking). Tiny, plastic personal ear plug LETS YOU ALONE LISTEN WHILE YOU WALK. VISIT WORK, RIDE OR SLEEP ANYTIME—ANYWHERE. MONEY-BACK GUARANTEE AND ONE YEAR SERVICE GUARANTEE.

SEND ONLY \$5.00 (ck. mo) and pay postman \$14.95 plus postage on delivery or send \$19.95 for postpaid delivery. GET YOUR TINYTONE REAL POCKET RADIO now and be ready to listen to Civil Defense Alarms, news, music, sports, etc. on a moment's notice without bothering those around you. NOT AN UNWORKABLE, INCOMPLETE KIT OR PLAYTHING. BUT A REAL POCKET RADIO! Shipped complete with batteries—Ready to listen! Available only from: **WESTERN RADIO, Dept. APM-8, Kearney, Nebr.**

## ELECTRONICS SHORT-COURSE



**5 in 1 Resident Course**  
Consolidated 5 in 1 training includes Radio, Electronics, B/W Television, Color TV & Communications. Prepares for FCC radiophone license. All non-essentials excluded.

### 1 Short Course Embraces All 5

Thoro balanced, resident training 1/2 shop & 1/2 theory. Not a correspondence course. Approved for Veterans & Non-vets. Low tuition, EZ terms. Many jobs await our grads.

**OUR 26th YEAR EXCLUSIVELY ELECTRONICS**  
UTS an old established institution. Electronics-TV-Communications our exclusive course and not a sideline. 1000's grads from coast to coast. Limited enrollment guarantees individual, personalized attention. Write for enrollment schedule.

### UNIVERSAL TELEVISION SYSTEM INC.

1221 ADMIRAL BLVD.

KANSAS CITY 6, MO.

## RUPTURED?

Something different. Light. Cool. No leg straps. No elastic. No pressure on hips or spine. Inexpensive. Worn by Mechanics, Farmers, Doctors, etc., everywhere. Guaranteed. Write

**HAND-LOCK PRODUCTS**

EST. 1893  
DEPT. PM, PRESTON, ONT., CAN.

## DO IT YOURSELF BUT DO IT BETTER WITH THE RIGHT MATERIALS!



Get  
**Popular Mechanics DO-IT-YOURSELF Materials Guide**



### You Need This

How to select and how to use—Lumber, mill-work, plywood and hard-board—Exterior wall and roof materials—Hardwood floors and floor coverings—Wall and ceiling materials—Doors, windows, screens and weather stripping—Glass, the material of tomorrow—Plumbing pipes and fittings—Electrical equipment—Nails, screws, bolts, etc.—Hinges, locks and other hardware—Paints and miscellaneous products.

192 Fact filled pages.

667 how-to-do-it pictures

The Key to Buying and Using Lumber, Hardware and Other Home Workshop Materials

The right lumber. The right grade. The right fastenings, nails, screws, glue and other hardware. These are all just as important as the right design and the right kind of workmanship. It's true, whether you're fixing up the house, making a fine piece of furniture or knocking out a time-killing gadget. Get Popular Mechanics Materials Guide. Fills a long-felt need of home owners and home workshop fans. Has how-to-do-it information too. Send only \$2.95 for postpaid delivery. Money back if you want it in 5 days.

Popular Mechanics Press, Dept. 856, 200 E. Ontario St., Chicago 11



# New Rubber Stamp Business Pays Beginners <sup>UP</sup> <sub>TO</sub> \$9.20 an hr.

**Start at home in spare  
time with this little  
table top machine**

The multi-million dollar Rubber Stamp Business—once controlled by a few big companies—is now being taken over by small home operators—one in each community throughout the U.S. Men and women who have this inexpensive machine can turn out huge quantities of Rubber Stamps with special wording that buyers once were forced to order from big cities. Material costing only 27¢ makes a stamp that sells for \$1.80. The machine that does the work is simple and easy to operate and it turns out as many as six Rubber Stamps at a time each with different wording such as names, addresses, notices, stock numbers, prices and other "copy" needed by offices, factories and individuals. Working full capacity, it can earn as much as \$9.20 an hour for the operator! Now you can get into the big-pay business yourself, with your own home as headquarters. You don't need any experience. We supply everything, including complete instructions and eight ways to get business coming in fast. Start making up to \$9.20 an hour from the very beginning. Cash in on the profitable Rubber Stamp Business in your community right away.

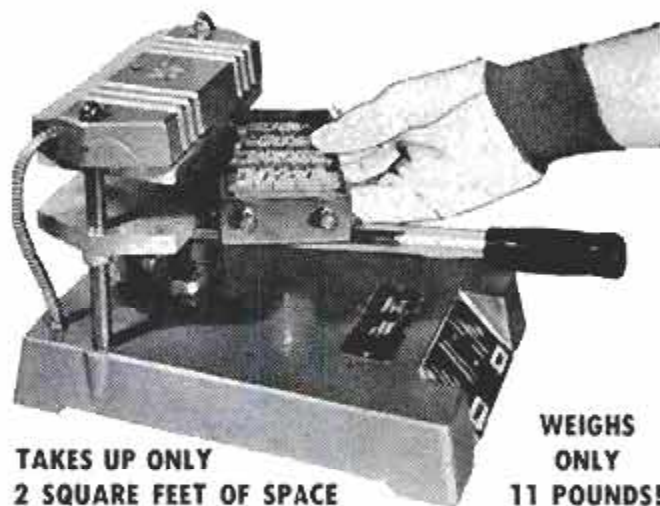

**TAKES UP ONLY  
2 SQUARE FEET OF SPACE**

**WEIGHS  
ONLY  
11 POUNDS!**

Read the complete and fascinating Rubber Stamp story in a big 110-page Book recently published by the Warner Electric Company. The book is profusely illustrated with more than 100 pictures and photographs. *And you can read it for a full two weeks without risking a penny of your own money.*

**Here's what the new  
WARNER PLAN Tells You  
about Making Money  
with RUBBER STAMPS**

### CHAPTERS

1. HOW TO have fun now and at the same time provide for a secure and prosperous future.
2. HOW TO check the advantages of operating a Rubber Stamp Business in your own community.
3. HOW TO acquire a general knowledge of the business based on a brief history of the Rubber Stamp.
4. HOW TO visualize the scope of the Rubber Stamp market.
5. HOW TO make a Rubber Stamp (general outline).
6. HOW TO assess the value of Warner Equipment.
7. HOW TO get acquainted with the "Tools of your Trade."
8. HOW TO make a Rubber Stamp (Specific procedure).
9. HOW TO mount a vulcanized Rubber Stamp.
10. HOW TO make "Special" Rubber Stamps.
11. HOW TO cut plastic Matrix Board for the chase.
12. HOW TO get the right price for the Rubber Stamps you make.
13. HOW TO price your complete Rubber Stamp Line.
14. HOW TO figure costs so you will be sure of a substantial profit on all the work you turn out.
15. HOW TO set up your workshop.
16. HOW TO get the most out of Warner's "Eight Tested Sources for Getting Business."
17. HOW TO operate at peak efficiency when YOU ARE YOUR OWN BOSS.
18. HOW TO get started on a cash outlay so small that you can get back your entire investment inside of two weeks.

## NEW WARNER SUCCESS PLAN

**Tells How to Build — Step by Step — to  
big profits and Personal Independence  
READ THIS PLAN FOR 2 WEEKS  
ENTIRELY AT MY RISK.**



**110 Pages  
More Than 100  
Pictures**

**Now Ready to Mail  
Tell Me Where To  
Send Your Copy**

**USE COUPON**

In this amazing Plan you will find exact and detailed instructions for starting a Home Business in spare time—without giving up your present job and without risking the loss of a single pay check. The Warner Plan shows you—with pictures, photographs and drawings—just how to make Rubber Stamps just as good as those turned out by the big companies. It shows how to get orders without canvassing or house-to-house selling. It shows you how to expand, how to get others to work for you and how to be SURE of at least twice the money you made on your present job for a life of personal independence.

But don't make any decision now. Read the Plan first—entirely at my risk. Then—after you have made a careful investigation—after you have talked things over with your family—only then do you decide what you want to do.

The thing to do now is to get full details which I will send you FREE. No salesman will call to urge you to buy anything. Mail coupon today—or just send me a postcard—and I will see that complete information goes out to you by return mail—postage paid.

**RUBBER STAMP DIVISION**

1512 Jarvis Ave., Dept. R-28, Chicago 26, Illinois

**RUBBER STAMP DIVISION  
1512 Jarvis Avenue, Dept. R-28  
Chicago 26, Illinois**

**SEND NO  
MONEY**

Please rush full particulars about the little machine that can get me started in the profitable Rubber Stamp Business at home in spare time. Everything you send me is FREE. No salesman will call.

Name \_\_\_\_\_

Address \_\_\_\_\_

City \_\_\_\_\_ Zone \_\_\_\_\_ State \_\_\_\_\_



**Build it Yourself!** Furniture • Furnishings • Work Benches • Children's Toys • Shelves • Boat • Cupola • Weathervane • With

**Popular Mechanics**  
**NEW**

# FULL SIZE PATTERNS

**Authentic Designs by Professional Designer**  
**Trace Patterns on Wood and Follow Simple Guides**  
**Every Step Made Easy for Building at Home**

Now, save money and turn out professional-looking jobs in your own home. Everything you need to know for building handsome furniture, a 12-foot outboard, toys for the children and many other items is contained in these patterns. Trace the patterns on the lumber, saw, smooth the edges and assemble—it's as easy as that. Every nail, screw, dowel and bolt is clearly located for you on the pattern. You can't make a mistake.



**Modern Step Table**

**No. 104.** Designed to be a companion piece for No. 103, described in the listing below, this table is 28 x 18 inches, upper step 24 inches high. Complete in one pattern. **50 cents**



**Personal Work Bench**

**No. 108.** This compact, sturdy work bench has sliding doors and a drawer. Top is 44 x 20 inches, 35 inches high. Lots of work space in small area. Two patterns in set. . . . **\$1.00**



**CRUSETTE**

**12 Foot Utility Outboard**

**No. 101.** Build this runabout at amazing savings with ordinary hand tools. Length 12 feet, beam 41½ feet. Complete material list and instructions included. Four patterns. . . . **\$2.00**



**Trundle Beds**

**No. 102.** These space-saving beds are safer for young people. 90 x 45½ inches. Top bed 40 inches, lower bed 23 inches high. Three patterns in set. . . . **\$1.50**

## 11 OTHER PATTERNS AVAILABLE

In addition to the 4 full-size patterns illustrated, there are 11 others in stock. If you've been looking for some good projects for your shop, you'll want more than one of them. These patterns have become so popular that the supply may soon be exhausted. It is not surprising that Popular Mechanics readers have responded enthusiastically to the original announcement of these patterns—just think of it, you can't go wrong! Every pattern has been proven for design and correct fit of parts—is guaranteed to please you! So act now, while all patterns are still available.

**No. 103. Modern Cocktail Table.** Matches No. 104 above. 40 x 19 inches, 13½ inches high. Plank top and metal grill inserts in sides. One pattern. . . . **50 cents**  
**No. 105. Toys for the Children.** "Giraffe Drawing Board" and "Buckling Bronco" riding toy. Pattern includes painting suggestions. One pattern. . . . **50 cents**  
**No. 106. Juvenile Chest Robe.** Has hanging storage space, two drawers and shelf, 30 inches wide, 16 inches deep, 39 inches high. Two patterns in set. . . . **\$1.00**  
**No. 107. Cupola and Weathervane.** 24 x 24 inches, 34 inches high, plus height of vane, which is made of metal or tempered hardboard. One pattern. . . . **50 cents**  
**No. 109. Valances and Trims.** Twelve designs included. Merely trace patterns on the wood, saw and assemble. Finishing suggestions given. One pattern. . . . **50 cents**  
**No. 115. Corner Table.** A new pattern to be used with the cocktail and step tables (Nos. 103 and 104) or alone. 29½ x 29½ inches, 18 inches high, plus an 8 inch diagonal step. One pattern. . . . **50 cents**

**No. 110. Decorative Wall Shelves.** Modern shelf with metal trim is 28 x 16 x 8 inches. Traditional shelf is 29½ x 16 x 8 inches. One pattern. . . . **50 cents**  
**No. 111. TV Chair.** Seat 22 inches deep, 24 inches wide. Overall, 27½ x 32½ inches, 26½ inches high. Sagless springs and foam rubber. Two patterns in set. **\$1.00**  
**No. 112. Modern Tub Chair.** Seat 22 inches deep, 24 inches wide. Overall, 28 x 27 x 27 inches. Sagless type springs and foam rubber. Two patterns in set. . . . **\$1.00**  
**No. 113. Sofa Bed.** 78¾ x 29¾ inches, 33 inches high, with removable bolster. Uses 4½ inch standard foam rubber or other mattress. Two patterns in set. **\$1.00**  
**No. 114. Love Seat.** Uses sagless type springs with foam rubber padding. 48 inches between arms, 21 inches deep. Overall, 55½ x 29 inches. Two patterns in set. . . . **\$1.00**

## Order Blank for Popular Mechanics Patterns

**Popular Mechanics Press • 200 E. Ontario St. • Chicago 11**

Send postpaid Popular Mechanics Full Size Patterns as indicated below. Remittance for \$\_\_\_\_\_ enclosed. I understand that any pattern which does not please me may be returned within 7 days for full refund. Dept. 856

Gentlemen: Please send me Full Size Pattern numbers:  
101 102 103 104 105 106 107 108 109 110 111 112 113 114 115  
(circle numbers desired)

Name: \_\_\_\_\_  
Address: \_\_\_\_\_  
City: \_\_\_\_\_ State: \_\_\_\_\_



**BRITAINS No. 1 RIFLE**

ACCURATE, POWERFUL

**SMLE No. 1 MARK III**

NATO CONVERSION ALLOWS RELEASE

**HUNTERS**  
**\$29<sup>95</sup>**

Pride of British troops throughout Empire today. Big Game hunters from Canadian wilderness to African Congo claim the powerful .303 caliber SMLE is best for all big game. Fastest bolt action in world. All milled parts. Long range sights 10-shot mag. 25" Bbl. cal. .303. **GUARANTEED EXCELLENT CONDITION** complete with sling and 20 rds. mil ammo. **FREE**. Addit. Mil ammo. \$7.50 per 100 rds. **SOFTNOSE SPORTING AMMO.** made by Rem. & Win., sold everywhere. Bayonet: \$1.95. **TO ORDER:** Send check, cash or M.O. \$10 for C.O.D. Calif. resid. add 4% state tax.

CANADIANS: Order (without red tape) rifles Spd. from G. K. Harper, Ltd., 18 Bayswater, Ottawa.

**GOLDEN STATE ARMS CORP.** 202 Armory Bldg., 1165 E. Colorado St., Pasadena 1, Calif.**POSTCARD PRINTER****\$10<sup>95</sup>**

Complete



Prints fast, easy on postcards, cartons, envelopes, etc. at a cost of only a few cents per 1,000. 30-day trial offer. Money-Back Guarantee. Send check or money order or write for additional information.

**JACOBI ADVERTISING**

208 S. LaSalle St., Chicago 4

**CRESCENT TOOLS***Give Wings to Work*ASK YOUR  
HARDWARE  
DEALER**WHAM-O BLOWGUN SET**  
for target and hunting

This amazing gun has the accuracy of a rifle. Compression of breath in barrel gives terrific air power. You won't believe your eyes!

**SPECIAL**  
**\$2<sup>98</sup>**

It can shoot over 200 ft. Average person can hit a 2" bullseye at 30 ft. Excellent for shooting small game. For target fun with friends, set up in patio or den. Set includes metal blowgun, rubber mouth-piece, three 5" steel darts and range target. Extra darts 6 for \$1. At sports dealers or send: **WAMO MFG. CO., Box S-45, San Gabriel, California**

All About

**TELEVISION**

**How to Replace Tubes Install Antennas Make Adjustments**

**Cut Down Repair Bills . . . Prevent Trouble**

John Derby, well-known TV engineer, tells and shows you how to save money on the servicing and repair of your TV set. He shows you just how you can locate trouble, and in most cases make repairs yourself in the matter of minutes.

**Special Picture Section SHOWS You HOW to Locate Trouble**

A special chapter contains actual photos of defective TV pictures. You merely compare the picture on your screen with pictures in the book, find the trouble at once and directions which tell just how to fix it. The very first time you use the **TV Repair Manual** your savings will exceed the small cost of the book. Order your copy now. Your money back in 7 days if it isn't entirely satisfactory.

**POPULAR MECHANICS PRESS, Dept. 856**  
200 E. Ontario St., Chicago 11, Ill.

Send at once my copy of the **TV Repair Manual**. Remittance for \$3.00 enclosed. If it isn't entirely satisfactory I may return it in 7 days for a full refund.

NAME \_\_\_\_\_  
ADDRESS \_\_\_\_\_  
CITY \_\_\_\_\_ ZONE \_\_\_\_\_ STATE \_\_\_\_\_  
☐ Send C.O.D. (U.S.A. only). Postage extra.

**CLOSE OUT! HEAVY DUTY 6-VOLT MOTOR**

ALL BRAND NEW! ORIGINAL PRICE \$16.50. Only

Just 1200 Left - Hurry!



A terrific buy! Oilite bearings. 1/4 inch shaft. High starting torque. Enclosed body. Perfect for car heater & defroster or any 6 volt battery operated mechanism. Send \$2. (\$1.49 plus 51c) and we'll ship postpaid on 10 day money back offer.

**\$1<sup>49</sup>****ILLINOIS MERCHANDISE MART, Dept. M-7, 1227 Loyola, Chicago 28, Ill.**

Instead of a job . . .  
train for a Career



Industrial growth . . . automation . . . technical advances create career opportunities for engineers, accountants, management experts. Share rewards awaiting college-trained men. Important firms visit campus regularly to employ Tri-State College graduates. Start any quarter in this world-famed college. *Approved for veterans.*

**Bach. of Science degree in 27 months**

In Mechanical, Civil, Electrical, Chemical, Aeronautical, Radio (TV-Electronics) Engineering. In 36 Months a B.S. in Business Administration (General Business, Accounting, Motor Transport Management majors). Capable students may accelerate. 36-weeks course in Drafting. *Intensive program: technical fundamentals stressed; comprehensive courses with more professional class hours. Small classes; personalized instruction. For earnest, mature students whose time and budget require accelerated courses and modest costs. Preparatory courses. Beautiful campus in friendly college town. Well-equipped, new and modernized buildings and laboratories. Enter Sept., Jan., March, June. Write Jean McCarthy, Director of Admissions, for "Your Career in Engineering and Commerce."*

**TRI-STATE COLLEGE**

486 College Avenue

Angola, Indiana

**Not Satisfied With Your Present Earnings?***Investigate***This NEW 2 in 1 BUSINESS OPPORTUNITY**

- Popular, Money-Making **HOT DRINK** and **HOT SOUP** Venders
- Handle Either or Both Types
- We Train You, We Set Up Routes

Eye-catching, easy-to-operate vending machines serve delicious, nationally known Hot Drinks (3) and Piping Hot Soups (5)! Our factory experts set up routes, train you to operate this year-round, big-volume business. **NO SELLING!** A minimum cash investment of \$1200.00 required. Up to 75% of equipment costs can be financed. Operate full or spare time.

How many machines can you handle? 10 units, doing nat'l 1954 average, would pay approx. \$13-\$16,000 yearly!

Write or wire giving age, address and phone. Details **FREE**. No obligation!

**SUPERIOR DISTRIBUTING CORP., Dept. CB,**  
4555 E. Warren Ave., Denver 22, Colo.





# TRAINED MEN NEEDED!

**BIG PAY!—GOOD FUTURE!**

- DIESEL                       ELECTRONICS  
 AUTO                          AUTOMATION

NEVER BEFORE has the opportunity been so good for the properly trained mechanic and technician to step into BIG PAY POSITIONS with rapid advancement and future security virtually assured.

YOUR SUCCESS depends on the quality of training you receive... and the reputation of the school you attend.

YOUR GUARANTEE we are giving the best in mechanical and technical training is proved by the fact... we have a waiting list of good pay positions for our graduates, with leading companies throughout the United States.

RESIDENT SHOP TRAINING is easier and costs less than you may think! We provide you with housing and part-time jobs while in school, plus free nation-wide placement service for graduates.

Check subject above in which you are interested and mail for

FREE BOOKLET

Your Future  
IN  
ELECTRONICS  
AND  
AUTOMATION

**BAILEY**  
Technical Schools

Veteran Approved

1634 S. Grand, St. Louis 4, Mo.

Your Future  
in  
DIESEL and  
AUTO  
MECHANICS

Name \_\_\_\_\_ Age \_\_\_\_\_  
 Street \_\_\_\_\_  
 Town \_\_\_\_\_ Zone \_\_\_\_\_ State \_\_\_\_\_

NEVER AT THIS LOW PRICE!

## GENUINE 120-POWER ACHROMATIC TELESCOPE

with Coated Lens and  
3-POWER FINDER attached

ONLY  
**\$18.95**  
PREPAID



**EXTRA BONUS GIFTS:**

- 108 page book, "Discover The Stars"
- Magic Star Finder Dial
- 220X & 400X Eyepiece lenses

### BRING THE MOON, PLANETS, STARS, PEOPLE 120 TIMES CLOSER, CLEARER, SHARPER.

Never before has an ACHROMATIC 120X telescope with range finder and tripod sold for anywhere near this amazing low price! Now you can not only explore the heavens and bring the moon, planets, stars, etc. 120 times closer, but you can also observe all distant objects, people, ships, etc. too, because all pictures are erect, and not upside down as in all astronomical telescopes. The kind of needle-sharp color-free viewing only a genuine achromatic lens can bring you. Ready for immediate use. Its 5 precision lenses bring you viewing at 40X—80X—120X, the tubes extend to 43", made of jet bakelite, finished in camera bellows black (for sharper, clearer images). Trimmed with gleaming brass. The 3 power finder scope mounted on main tube is a feature usually found on more expensive telescopes—brings difficult objects on target before observing with main scope. For extra stability 5 ft. hardwood folding tripod is equipped with heavy cast iron head fitted with Criterion's famous 360 degree all aluminum mount that locks instantly in any position. Obtainable only from Criterion, shipped prepaid. 4-Bonus gifts—108 page book "Discover The Stars," magic star finder dial that aids in locating stars ANYWHERE at ANY TIME of the year, and 220X and 400X eyepiece lenses included free of any cost for experiments. You must be completely satisfied with this super offer or your money back in full. Shipped to you complete, nothing else to buy, at the amazing low price of \$18.95. Without tripod \$14.95.

Send cash, check, or money order today to:  
Dept. PMA5, Criterion Co., 331 Church St., Hartford, Conn.

## WHERE-TO-BUY-IT INDEX

Source of supply appears after items commercially available

### AUTOMOTIVE

Built-in "visor" shades headlamp.....	70
Television camera lets engineers see under car in road tests..	86
Helicopter engines power this dragster.....	91
Degreaser in spray can (Minit Spray Co., 945 George St., Chicago 14) .....	101
Driverless tractor "stunts" for safety.....	105
Small crawler tractor with automatic transmission does many jobs (American Tractor Corp., Churubusco, Fort Wayne, Ind.) .....	119
Child-size custom car.....	140
Attachment permits shaver to be run in car (R.E.N. Mfg. Co., 5803 White Oak Ave., Encino, Calif.).....	220
Car refrigerator fits under dash (B & M Corporation, Houma, La.) .....	225

### AVIATION

Plane mounts retractable rotor (Hiller Helicopter, Palo Alto, Calif.) .....	71
Gas-turbine pod mounted on Navy fighter starts jet engine..	108
"Flying footballs" guide plane (Sylvania Electric Products, Inc., 1740 Broadway, New York City 19).....	128
Three-ton vacuum machine dries airfield runway in England.	128
T-58 turboshaft engine to power helicopters.....	219

### BOATS

Cradle on rails totes boat's across land to bypass dam.....	86
Motor-powered pontoon boat (Dallas Engineers Inc., Dallas, Pa.) .....	86
Inflatable canoe of rubberized fabric rolls up for portage....	102
Outboard-motor hydrojet takes place of propeller.....	103
Boat has underwater "eyes".....	213

### CONSTRUCTION

Domed college arena built without pillars.....	75
"Grocery boxes" make concrete forms (Manasha Container Corp. of California, Anaheim, Calif.).....	211
Air hammer drives ground rod.....	223

### HOUSE AND HOME

What's New for Your Home—	
Canvas playpen .....	106
Rubber webbing replaces springs.....	106
Cookie dropper .....	106
Nursing-bottle holder .....	107
Ruffle iron .....	107
Hose coupler snaps hose to faucet.....	107
Automatic appliance center for kitchen.....	107

### LAWN AND GARDEN

Lawn-mower accessories (Wind King Electric Mfg. Co., Merrill, Iowa) .....	71
Tiny bulb designed to twinkle (General Electric Co., Nela Park, Cleveland 12, Ohio).....	102
Adjustable lawn umbrella follows the sun (Snow Company, Omaha, Neb.) .....	109
Lawn drinking fountain (Texell Products Co., No. 3 Asbury Place, Houston 7, Tex.).....	230

### MISCELLANEOUS

Lock permits carrying dog safely in car trunk.....	71
Indian craftsman uses power tools (Dremel Mfg. Co., Racine, Wis.) .....	72
Big tree digger .....	87
House painting the hard way—on a unicycle.....	102
Electronic order taker put to work at drive-in restaurant (Automation Products Corp., 109 E. Nine Mile Rd., Farmdale 20, Mich.).....	103
Empire State beacons can be seen 300 miles.....	104
Judges' stand at race track rotates to follow the running....	104
Fire escape swings out (Walter J. Vroman, 363 Shaker Blvd., Ridgefield, N. J.).....	108
Golf-ball retriever used like cane (W. J. Watson Co., Box 323, Effingham, Ill.) .....	109
Push-button awning driven by motor (Automatic Awning Co. of America, Inc., 2619 W. Division St., Chicago 22).....	109
Coal car stands on end to dump load.....	113
126-foot ship moves in two sections down German highway...	113
New-look water tower.....	113
Spray-on patching compound covers damaged concrete (Allied Companies, 15 Peachtree Place, N.W., Atlanta, Ga.).....	119

(Continued to page 60)



**WHAM-O** \$1.50 40-LB. PULL!

HITS LIKE A RIFLE—KILLS RABBITS, SQUIRRELS. Powerful, silent, accurate. For hunting, target, routing pests. Sportsman's choice sold world over!

**HUNTING SLINGSHOT**

Heavy duty ash stock. 40 steel balls, extra rubber, target.

GUARANTEED: Professional model of Nat'l Slingshot Assn. At dealers, or write WAMO MFG. CO., Box X 82 San Gabriel, Calif. Send for FREE catalog on crossbows, knives, golf, baseball, .22 pistols, BB guns, blowguns.



**SAVE MONEY on SURPLUS PARTS for MILITARY TYPE TRUCKS & JEEPS**

4 & 6 wheel drive. FREE catalog to Jeep owners. State make truck or Jeep. (New Jeep Tops, steel or canvas all models). **AMERICAN AUTO PARTS CO., Inc., 1830 Locust, Kansas City, Mo.**

**SAY YOU SAW IT IN POPULAR MECHANICS**

**MASTER BASIC MACHINE SHOP WORK**

Henry Ford Trade School course, used by many schools, shows how to use hand and power tools, measuring instruments, all procedures of shop work. Job sheets help you practice as you learn. Use book 10 days FREE; then remit \$5.50 or return book. Write now for Ford—Shop Theory, on approval. McGraw-Hill Book Co., Dept. PM-8, 327 W. 41st St., New York 36, N.Y.

**Learn OIL BURNER SERVICING**

SPARE TIME LEARNING MEANS EARNING BIG MONEY

**WRITE FOR FREE LESSON**

**MASS. TRADE 161-A HIGH ST. BOSTON 10, MASS.**



"Greatest Invention Since the Hand Saw!"

**AMF De Walt Home Power Shop**

on Easy Terms



AMF De Walt's years-ahead design, including top-side cutting, makes all wood-working easier, faster, safer than ever before... makes you an expert! Save money on home repairs, build furniture, cabinets, even a carport or garage. Write today for Valuable FREE Illustrated Booklet.

AMF De Walt, Dept. PM-56-8, Lancaster, Pa. Division of AMERICAN MACHINE & FOUNDRY CO.

**HELPFUL BOOKS**

Send post card asking for FREE catalog Popular Mechanics Press, 200 E. Ontario, Dept. 601, Chicago 11

**MAKE \$5 PER HOUR WITHOUT A PRINTING PRESS**

**PRINTING** REVOLUTIONARY NEW SCREEN METHOD

**FREE** complete "BIG MONEY" Plan and SAMPLE

PRINT colorful signs, posters, banners, fabrics, wall paper, show cards—ANYTHING! Print on any surface. NO printing press or special equipment is needed with this amazing "approved" new printing secret. 300% profit on nearly every job. Easy to learn —NO EXPERIENCE or art ability necessary. Exceptional opportunity. Complete illustrated detailed plan and colorful sample FREE—Write: **SCREEN-PRINT COMPANY, Dept. 28 15127 S. Broadway, Los Angeles 61, Calif.**

**EARN AT HOME** SPARE or FULL Time



**GET POPULAR MECHANICS Home Improvement Guide Best "HOW TO" Book**

Inside—Outside —All Around the House



**Remodeling, Built-Ins, Decorating, Landscaping, Air Conditioning**

What does your home need—a major face-lifting—just a simple brightening-up—some extra room for a growing family? Whatever it is, start with Popular Mechanics HOME IMPROVEMENT GUIDE. Don't even plan an improvement until you see this practical, helpful book. It gives you the right answer—the correct step-by-step procedure—a wide choice of ideas—the latest styles and materials and it will save you money in a hundred different ways. Every project is "work tested" and presented in easy-to-understand language with 475 actual how-to-do-it pictures. Mail Coupon. Your money back if book does not please you.

**What Does Your Home Need? It's Here!**

- Does it need—a new look at the front, roof repairs, awnings, fences and walks, new porch, patio, carport, chimney or gutter repairs, new windows, storm sash, a smart new summer house?
- 16 fact-filled chapters cover these and many more improvements—Improvement and Remodeling Tips—Dressing Up the Outside—Landscape Improvements—Porches and
- Patios—Carports for the Modern Home—Roof Improvements—Doors and Windows—Painting the Outside—Dressing Up the Inside—Adding an Extra Room—How to Air Condition Your Home—Floors and Flooring—Home Plumbing Fixtures—Painting the Interior—Basement and Attic Remodeling—Kitchen Improvements—Adding Glamor to Your Bathroom—Built-In Units.

**How to Modernize Your Home**

**Make Your Home Worth More and More Save Money in a Hundred Different Ways**

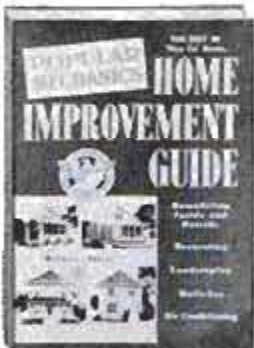

**MAIL THIS COUPON**

POPULAR MECHANICS PRESS Dept. B56, 200 E. Ontario St. Chicago 11

Send \_\_\_\_\_ copies Home Improvement Guide \$2.50 each. Purchase price to be refunded if I return book in 5 days.

( ) Remittance for \$ \_\_\_\_\_ enclosed. Send postpaid.

( ) Send COD. I will pay postman.

Name \_\_\_\_\_

Address \_\_\_\_\_

City \_\_\_\_\_ State \_\_\_\_\_



# Make BIG MONEY! Amazing New subzero INSULATED Jackets and Shoes!

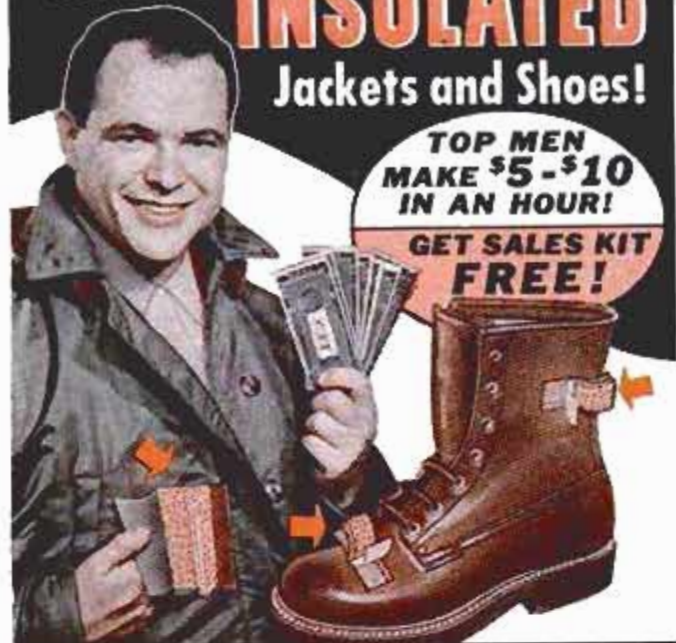

**TOP MEN  
MAKE \$5-\$10  
IN AN HOUR!  
GET SALES KIT  
FREE!**

**Same Type Subzero Insulation  
as in U.S. Army Coldbar Suit!  
QUICK CASH IN SPARE TIME!**



**HOLDS YOU AFLOAT  
INDEFINITELY!**

Now! Start a highly profitable business without investing a cent! Act quick, be **FIRST** in town to take orders for sensational new Mason **INSULATED** Jackets and Shoes... results of a remarkable scientific discovery: a new miracle insulation with thousands of vinyl air cells that provide perfect "dead air space" insulation! • **Keeps you WARM** even at Arctic temperatures! • **DRY** in downpours (can't absorb water)! • **Protected from strong WINDS!** It's the same type miracle insulation used in famous U.S. Army Coldbar Suit! Because Mason products are **not** sold in stores, folks **must** buy from **YOU!**

Take orders for just 2 Insulated Shoe & Jacket combinations a day in spare time and you'll earn \$90 Extra Income in one week!

### "Miracle" Features Make Money for You FAST!

Your friends, fellow workers, truck drivers, gas station, construction men — hundreds right around home will fill your pockets with cash! Lightweight jacket covered with water-repellent Nylon, has detachable hood. Both boots, shoes are rugged leather, feature Air Cushion innersoles, Neoprene Cush-N-Crepe outsoles. With this miracle combination, walk out in cold, wet, snowy or windy weather and stay warm and dry! **ADDED FEATURE!** Men wearing, Insulated Jacket & Shoes plus Mason's Insulated *Pants* can float in water *indefinitely!* Outdoorsmen will buy all **THREE** from you!

### 190 OTHER Money-makers!

You'll have 190 **OTHER** fast-selling shoes, jackets to help you build a big, repeat-order business! **EVERYBODY** needs shoes, jackets. Nationally advertised Mason products sell *fast*. You offer 170 styles for men, women: dress, sport, work shoes, boots, 28 jacket styles. **You actually feature more shoes in a greater range of sizes, widths than any store in your town!**

To start this exciting business *right away*, rush coupon NOW. You'll receive **FREE** a powerful Jacket & Shoe Sales Kit including Air Cushion demonstrator, How-to-make-Big-Money Booklet, *everything* else you need to start making **BIG CASH PROFITS** the very first hour!

**MASON SHOE MFG. CO., Dept. 336, Chippewa Falls Wis.**

## Send for FREE Outfit!

Mr. Ned Mason, Dept. 336,  
Mason Shoe Mfg. Co., Chippewa Falls, Wis.  
Yes! I want to be **FIRST** to take orders and make **QUICK CASH**  
in spare time with Mason's amazing new Insulated Jackets & Shoes!  
Rush my powerful **FREE** Sales Kit!

NAME.....  
ADDRESS.....  
TOWN.....STATE.....

Weather-forecast wheel predicts day in advance (Charles Billiard, 4529 Calumet, Fort Wayne, Ind.).....	119
One-pass tiller grinds up stalks (H & O Corp., Dexter, Mo.).....	134
Open-end eye shields stop wind with buffer of stagnant air (Gilbert S. Macraugh, Jr., 4402 Stanford St., Chevy Chase 15, Md.).....	134
Air blocks in hot-water heating pipes relieved by bubble breaker (Pinta Products, 83 Waterman Ave., Johnston 9, R. I.).....	135
Convertible freight car cuts shipping costs.....	135
Wireless home thermostat transmits radio signals (Minneapolis Honeywell Regulator Co., Minneapolis, Minn.).....	140
Chain-saw sculptor carves Paul Bunyan statue.....	207
Kit for outdoor grill assembled in minutes (Plasticrete Specialties Corp., Hamden, Conn.).....	209
Lure bristles with hooks (Turner Co., Hale, Mo.).....	209
Teach trout not to get caught.....	213
Goal lowered for small-fry teams (John S. Knox, Midland Public Schools, Midland, Mich.).....	215
Transistorized switchboard.....	215
Self-tightening electric plug (Eagle Electric Co., Inc., 23-10 Bridge Plaza South, Long Island City 1, N. Y.).....	225

### SCIENCE

Electronic bank clerk processes 50,000 accounts a day.....	101
Tiny mechanical heart will see use on humans.....	101
Antimoth virus.....	104
Electronic amplifier magnifies light 40,000 times (Dr. Ralph E. Sturm, Bendix Aviation Corp., Friez Instrument Div., Baltimore, Md.).....	129
Cosmic rays won't stop future space flights.....	140
Copper-glass bonding.....	219
Vaccine for pneumonia and grippe.....	223

### Radio-Television, Electronics

Electronic mixer for home recorders.....	141
--	-----

### Craftsman and Shop Notes Index

#### AUTOMOTIVE

Auto-engine dip stick improved for easier oil-level reading.....	176
Light and warning flag rocks to get motorists' attention.....	197
Avoid clashing gears when shifting into low.....	200

#### FISHING AND BOATING

Angler's apron is transparent waterproof tackle box.....	157
Big fish held by lower jaw to aid hook removal.....	157
Tape holds fishing-line sinkers.....	166

#### HOUSE AND HOME

Address-plaque letters "carved" in relief with blowtorch.....	164
Pressure venting tropical home.....	164
House current replaces batteries in focused-beam lantern.....	195
Gutters and metal roofs patched with glass-fiber screening.....	196

#### HOUSEHOLD HINTS

Solving Home Problems—	
Hacksaw blade taped to ruler cuts door bottom.....	162
Fire-safe receptacle for emptying ash trays.....	162
Window safety stop.....	162
Built-in aeration of soil in planting box.....	162
Metal-lath drying rack.....	162
Sagging door on small cabinet fixed with upholstery tack.....	163
Wooden drawer knobs that pull off.....	163
Hand saw that squeaks and binds.....	163
Rack for man's hat.....	163
Remove grass stains.....	163
Plastic sheet under high chair eases after-meal cleaning.....	166
Slide fastener on seat cushion permits quick removal of cover.....	166
Quick finish for home projects.....	169
Iron removes wallpaper.....	188
Antimar surface for casters.....	190
Eraser removes scuff marks from tile floors.....	190

#### MISCELLANEOUS

Bedding material stretched on frame for photo backgrounds.....	150
End-grain facing provides durable dart-board surface.....	150
Coffee cans under ladder rails prevent them from sinking.....	152
Dirt floor of crawl space sealed to stop excessive humidity.....	152

(Continued to page 62)



### 75c ea. for Finest Imported PRECISION PLIERS!

• Flat Nose • Combination • Diagonal Cutter • End Cutting Nippers • Round Nose • One Side Flat—One Side Round • Snipe

FOR JEWELERS, OPTICAL WORKERS, HOBBYISTS, CRAFTSMEN OF ALL KINDS! These superb German instruments are of deep-forged, heat-treated high quality tool steel, fabricated to most exacting specifications. All-over ground and polished to smooth hard surfaces. Smooth working joints with just the right tension. Jaws meet perfectly to safely and securely hold even the most delicate objects in the hard-to-reach corners and angles. Each plier is 4" long and a veritable gem of precision and strength.

75c each . . . ALL 7 for \$5.00 ppd.

### CHROME VANADIUM 60 Pc. Set WIRE GAUGE 29 Pc. DRILL SET CHROME VANADIUM DRILLS



Specially made for speed drilling. In sturdy plastic box roll. Finest alloy steel drills hardened and precision ground to the sharpest, longest lasting cutting edge obtainable; will easily and cleanly bite through hardwoods, plastics, aluminum, iron and the toughest steels. Unconditionally guaranteed for thousands of drillings. Full jobber lengths. Sizes by 64ths from 1/16" to 1/2". NOW . . . \$6.49 ppd. Also available with Turned Down Shanks to fit all 1/4" drills. In individual pocket roll. . . . \$8.95 ppd.

Top quality high test Chrome Vanadium Drills designed for speed drilling through toughest steels, woods, plastic, iron and aluminum. Precision ground, long-lasting cutting edges. Guaranteed to give years of satisfaction. A full 60 pc. set, Nos. 1 through 60. A \$14.95 value— NOW ONLY . . . \$5.40 PLUS 35c PP. & HULG.

Same set above available with Heat Metal Index container. Only . . . \$6.65 PLUS 35c PP. & HULG.

Send Check or M.O. C.O.D. for extra. MONEY BACK GUARANTEE  
SCOTT-MITCHELL HOUSE, INC. DEPT. M-227, 611 BROADWAY NEW YORK 12, N. Y.

## MANUFACTURE THIS BEAUTIFUL CONCRETE OUTDOOR FIREPLACE

Right In Your Own Backyard

\$4.00 Worth of Sand & Cement produces this Attractive Fireplace.

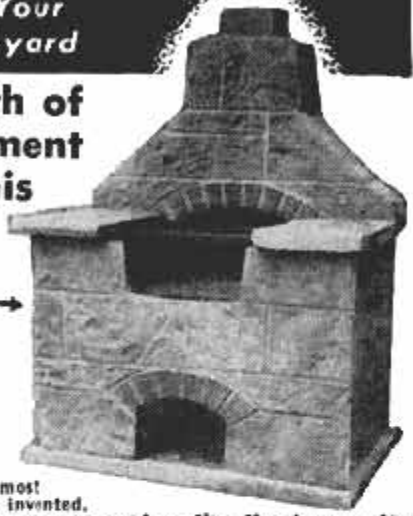

Sells on Sight from \$60. to \$80. Easy to start your own Profitable Business.

The General Fireplace Molds and Process are the most amazing and foolproof ever invented. Simple to operate. Two men can produce five fireplaces a day.

### BIG DEMAND!!

Sell all you produce to Department Stores, Homeowners, Parks, Nurseries and Picnic Groves. Fireplaces sell on sight. No experience necessary. We supply full operating instructions and equipment plus the know-how that spells BIG PROFITS. This is an outstanding opportunity for men of vision and small capital to get into a busy rich paying field. Don't delay, be the only exclusive manufacturer in your own home town. Mail coupon at once for full details as to how you can reserve your territory. Molds sold only on exclusive franchise.

GENERAL ENGINES CO., Inc., Dept. MF-86  
ROUTE 130, THOROFARE, N. J.

Mr. Tor of Philadelphia writes: Sold 250 in first 4 months. Selling to Sears Roebuck, John Wanamaker, and Gimbel Bros. in Philadelphia area.

Name .....  
Address .....  
City ..... Zone .....  
State .....

# Porter-Cable

Quality Electric Tools

## HOW TO BUILD Your Own GARAGE

Save Up to 50% of Usual Cost!

Get Popular Mechanics' brand new book *How to Build Your Own Garage* by Wayne Leckey, Assistant Shop Notes Editor, and find out how you can build your own garage at savings of 50% of usual cost. Leckey tells in clear step-by-step instructions and shows in big, clear photos, drawings and diagrams how to perform every building operation from laying the concrete to installing the final trim. There are 25 designs. Brick, frame, and concrete block fully covered. Send \$3.50 for your copy. 7-day money back guarantee.

POPULAR MECHANICS PRESS, 200 E. Ontario, Chicago 11, Ill.



115-Volt, A.C.  
**ELECTRIC GENERATOR**  
1750-Watt, 60-Cycle A.C., Single Phase  
Government Cost \$185.00

Brand New SURPLUS Fully GUARANTEED

Only \$99.50

Ideal as a permanent or stand-by unit for electricity IDENTICAL to your house current. Perfect for farms, camps, aboard ship, oil fields, mines, etc. Easily handles lights, refrigerator, deep freeze, oil burner, radio; power for saws, floodlights, drills, pumps, etc. ALL BALL BEARING! Operates at 3600 RPM. Drive with 3 1/2 HP or larger engine—or use power take off. Voltage self regulating. Standard base mtg. Two outlets. Size: 15" long, 8" dia. Wgt. 58 lbs. Delivers 1750 Watts CONTINUOUSLY!

SUPPLY LIMITED! ORDER DIRECT FROM AD  
Free Catalog of other Surplus, Hydraulics  
ROBERTS ELECTRIC CO., Dept. PM-484, 849 W. Grand, Chicago 22, Ill.

## PREPARE FOR BETTER JOB, BIGGER PAY IN SPARE TIME AT HOME

Today, choose the job you want—and prepare for it in time you might otherwise waste. Or if you are already in the work you like best, start training now for quicker promotion and increased pay. During more than 50 years AMERICAN SCHOOL has helped ambitious people to reach higher goals. Check subject that interests you and mail coupon for full information.

AMERICAN SCHOOL, Dept. GC45, Drexel at 58th, Chicago 37, Ill.  
Without obligation, please send FREE and postpaid, full particulars about the subject checked below.

<input type="checkbox"/> Accounting	<input type="checkbox"/> Contracting	<input type="checkbox"/> Mechanical Engineering
<input type="checkbox"/> Apprenticeship Courses	<input type="checkbox"/> Diesel Technician	<input type="checkbox"/> Mechanical Technology
<input type="checkbox"/> Architecture & Building	<input type="checkbox"/> Drafting—Building Trades	<input type="checkbox"/> Metalworking Courses
<input type="checkbox"/> Automotive Technician	<input type="checkbox"/> Drafting—Machine Trades	<input type="checkbox"/> Plumbing—Practical
<input type="checkbox"/> Better Foremanship	<input type="checkbox"/> Electrical Engineering	<input type="checkbox"/> Private Secretary
<input type="checkbox"/> Blueprint Reading	<input type="checkbox"/> Electricity—Practical	<input type="checkbox"/> Retail Merchandising
<input type="checkbox"/> Bookkeeping	<input type="checkbox"/> Electronics—Industrial	<input type="checkbox"/> Salesmanship—Outside
<input type="checkbox"/> Business Management	<input type="checkbox"/> HIGH SCHOOL COURSES	<input type="checkbox"/> Sheet Metal Work
<input type="checkbox"/> Civil Engineering	<input type="checkbox"/> Machinists	<input type="checkbox"/> Tool Making

NAME \_\_\_\_\_  
HOME ADDRESS \_\_\_\_\_  
CITY \_\_\_\_\_ STATE \_\_\_\_\_  
OCCUPATION \_\_\_\_\_ AOF \_\_\_\_\_  
Conditions: Write American School, Dept. GC45, 6083 Sherbrooke St. W, Montreal

MAIL COUPON NOW



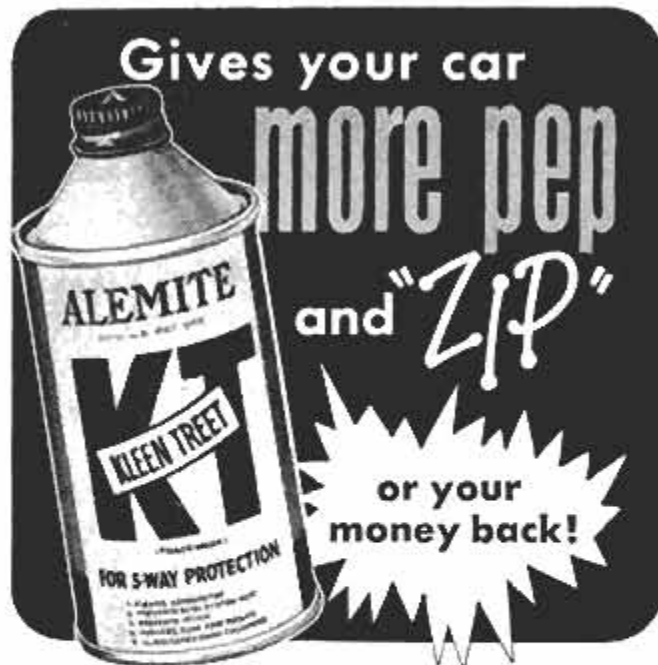

## Alemite Kleen Treet

**Just pour it in your gas tank!**

Kleen Treet is designed for modern engines — for today's sensitive and complex carburetors. Here's what it does:

1. Cleans gummy deposits from carburetor and fuel system—ends slow starts and stalls!
2. Improves combustion efficiency of engine, prevents knock and ping.
3. Eliminates ice formation in fuel lines.
4. Guards against engine-crippling rust flakes in fuel line and gas tank!
5. Lubricates fuel pump and piston rings for improved engine performance!

Add Kleen Treet to your gas tank today. **\$1.35**

**SATISFACTION GUARANTEED.** Ask for Alemite Auto Aids at your service station, car dealer or auto supply store.



### ALEMITE CD-2

Add a can to your crankcase for smoother performance . . . protection from ravages of stop-and-go driving.

### ALEMITE COOLING SYSTEM CONDITIONER

Removes and prevents rust. Avoids radiator clogging, over-heating. Simply pour in. Works while you drive.



# ALEMITE

MADE IN U.S.A.

## AUTO AIDS

Products of STEWART-WARNER CORPORATION

Hoop for weighing watermelons made from steel rods.....	155
Brass cap from lipstick tube adds glitter to flagstaff.....	156
Dinner bell adds country charm to ordinary lath trellis.....	156
Food color tints book edges.....	156
Tape behind fire extinguisher makes it easy to find in dark.....	156
Adjustable blade knife.....	161
Silent valet on wheels holds complete outfit of clothes.....	161
Novel fruit and flower stand.....	165
Print drier.....	167
Arrows attached to bow for fast repeat shots.....	168
Cleaning a chimney.....	168
Improvise better mousetrap.....	168
True water line marked on model.....	168
Knockdown picnic table stores in small space.....	169
Paint-pail brazier.....	175
Automobile transmissions drive front-delivery spreader.....	176
Junior-size bench and tool chest for the young craftsman.....	183
Eraser aids thumbtacking.....	187
Painted stripe outlines edges of driveway.....	187
Buried crossrail on child's swing eliminates side braces.....	188
Envelope liner protects pocket.....	190
Sandbag supports football on end for place kicking.....	190
Copper tubing makes grip-sleeve for lag screw in concrete.....	195
Proper storage of sandpaper improves performance.....	196
Two-wheel drum and barrel truck.....	196
Siphon of pipes and fittings drains pasture stock tank.....	200
Implement wheel guards tree against dogs digging at base.....	201

### OFFICE, SHOP AND STORE

Typewritten sheet aligned for typing in corrections.....	150
Paper clamps and pencil brace hold book open for reference.....	164
Ticket punch used for keying index cards and negatives.....	165

### TOOLS

V-block holder for drill bits.....	152
Modified socket-set extension provides "universal" action.....	180
Vibrationproofing setscrews.....	180
Power-tool vibrations dampened by using garden-hose washers.....	197
Revolutions counter from speedometer mileage indicator.....	201
Shopping for Tools—	
Builder's level has replaceable vial holders.....	202
Orbital sanding attachment for electric drill.....	202
Electric garden cultivator.....	202
Circle cutter cuts paper and film.....	202
Air filter for pneumatic tools.....	203
Belt sander can be used vertically or horizontally.....	203
Shaper attachment fits table saw.....	203
Adjustable wrench with two-step jaw.....	203

### WORKSHOP HINTS

Babbitt-metal block controls soldering-iron temperatures.....	152
Self locking of hasp prevented.....	152
Small boxes in bench drawer mounted inside front panel.....	155
Steel wool strains solvent poured out of bottle.....	156
How to clean a paint roller.....	157
How to do blind nailing.....	161
Plywood cut cleanly by table saw when placed on lumber scrap.....	164
Temporary rheostat improvised.....	164
Removable drain top.....	166
Splash shield for paint can.....	166
Block base prevents small paint can from tipping.....	168
Over-size pilot holes shimmed with lengths of wire solder.....	169
Clamp wrench used to flatten dowel for glue escape.....	174
Plastic drinking straw on spout extends reach of oil can.....	174
Chalked surface on saw table takes pencil markings.....	176
Slit section of rubber hose anchors tap-wrench handle.....	176
Proper setting of tailstock.....	180
Bar of solder cleans file teeth.....	183
Holes in aluminumware repaired with rivets.....	183
Practical light-duty anvil.....	183
Particles removed from paint with cheesecloth.....	187
Soft sanding block for curves.....	187
Stepladder legs locked together with cabinet-door catches.....	190
Tape sheathes scraper blade when stored in tool chest.....	195
Concealing nails in cabinetwork.....	196
Pliers used to drive brads into picture frame.....	196
Swivel blocks hold tapered work in vise.....	197
Anvil made from length of rail.....	200
Spring holder for welding rod.....	200
Threaded end of bolt cut without burring.....	200
On the Market—	
Concrete repairing and topping material.....	204
Solder-flux paste.....	204
Grounding plug-in strip.....	204
Carbon-monoxide detector.....	204
Porch and floor enamel.....	204



AMAZING ELECTRIC SPRAY GUN ELIMINATES EXPENSIVE AIR COMPRESSORS AND MOTORS

# MAKE MONEY! SAVE MONEY! With Amazing SUPER JET Spray Kit!

No Experience Needed To Operate Easy-To-Use All Purpose Spray Gun.

Now anyone can own a professional, all-purpose spray gun. Homeowners! Hobbyists! Handymen! Paint the fast, easy way with the amazing new Super Jet Spray Gun. Save money spray painting shelves, closets, cabinets, furniture, bookcases, doors and other things around the house. Make money in your spare time spraying fine finishes on automobiles, fences, metalwork and hundreds of other projects for your friends, neighbors or customers. Super Jet can pay for itself on the very first job. It costs just \$1.00 a week — no money down!

This lightweight, self-contained spray gun makes painting the easiest thing in the world because there are no tanks, no compressors, no complicated equipment to cause trouble or confusion. Simply plug Super Jet into any 110 Volt A.C. electrical outlet, fill the non-breakable aluminum container with paint and pull the trigger to start spraying. Spray paint, enamel, lacquer, varnish, shellac, insecticide, deodorants, liquid fertilizer, oil and water as easily as pointing your finger! Just about any liquid that pours easily, sprays easily when you use Super Jet!



### SELF-CLEANING!

Simply spray solvent through the gun after painting and Super Jet cleans itself in seconds... automatically!

### ONE CONTROL KNOB!

A simple turn to the right or left instantly adjusts Super Jet to atomize the material you are spraying!

### JEWEL NOZZLE

U.L. and C.S.A. approved

### ALL METAL

No Breakable Glass Or Plastic Polished Aluminum Jar

### AUTOMATIC PAINT STRAINER

Super Jet's ingenious fine-screen metal filter automatically strains paint and spray materials. Dirt, pigments, etc. are automatically filtered out and prevented from clogging gun!

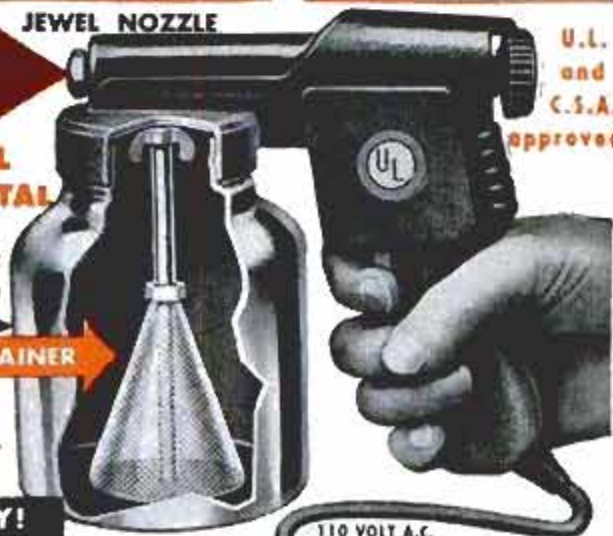

FREE TRIAL IS BEST PROOF! SEND NO MONEY!

### A COMPLETE SPRAY KIT! Only \$29.95-\$1. a week!

- NEW SUPER JET SPRAY GUN
- POLISHED ALUMINUM JAR
- AUTOMATIC PAINT STRAINER
- 15 FT. DISTANCE TUBING
- 23 FT. NEOPRENE CORD SET
- GEM NOZZLE DISC
- WALL CHART & INSTRUCTIONS
- STEEL CARRYING CASE

PLUS Your Name in 23 KARAT GOLD

**FREE!** Mail Coupon Today with order and get FREE 5-piece Screw Driver Set.



**EXTRA BONUS!** Send \$29.95 in full payment of your SUPER JET SPRAY KIT and receive as extra bonus tool kit pictured! Tempered steel 6 inch wrench, 7 inch pliers, screw driver blades and chuck, complete with carrying case. Not a toy!



### MAIL COUPON TODAY FOR 10 DAY FREE TRIAL

POWER PRODUCTS, Super Jet Division A-A2 175 East 87th Street, New York 18, N. Y.

Please send amazing new SUPER JET SPRAY KIT. I must be completely satisfied or I may return within 10 days for full purchase price refund, I am using payment plan checked below.

- PAYMENT IN FULL. Enclosed is \$29.95 (check or money order) in full payment. Be sure to send my FREE GIFT plus EXTRA BONUS.
- SIMPLIFIED BUDGET PLAN. (No Money Down) I will pay \$29.95 at \$1.00 per week plus postage and small credit service charge. (No credit charge if paid within 60 days.) Be sure to send my FREE GIFT!

YOUR NAME will be written in 23 Karat Gold on your kit. Please Print

NAME \_\_\_\_\_  
 ADDRESS \_\_\_\_\_  
 CITY \_\_\_\_\_ ZONE \_\_\_\_\_ STATE \_\_\_\_\_  
 EMPLOYED BY \_\_\_\_\_ POSITION \_\_\_\_\_  
 ADDRESS \_\_\_\_\_

**FULLY GUARANTEED!** 10 Day Free Trial plus 90 Day Guarantee Against Mechanical Defects.

POWER PRODUCTS, 175 EAST 87th STREET, NEW YORK CITY



At NASCAR Speed Weeks



## “Flying Mile” Records Prove Parts For Your Car

**Using the same electrical equipment** you get in your Auto-Lite equipped car, Race Drivers Tim Flock and Danny Eames recently roared to new NASCAR Speed Records. Flock led the field in Class 7 (over 300 cu. in.) in a '56 Chrysler with an average time of 139.373 mph. Eames piloted a '56 Dodge at 130.577 to top Class 6 (305 to 350 cu. in.).

Record-breaking runs like that demand perfect teamwork from spark plugs, points, coils, and distributors. Speed tests all over the country have *proved* the superior performance of Auto-Lite Original Service Parts. Get these same parts for *your* car at your nearby Auto-Lite Dealer.

**Here's the team that really works together for record-breaking performance.** Auto-Lite Contact Sets, Coils, Distributors, Condensers, and Voltage Regulators are ignition-engineered to spark *your* Auto-Lite equipped car for maximum results, too.



THE ELECTRIC AUTO-LITE COMPANY, TOLEDO 1, OHIO

Get full power performance with . . .

# AUTO-LITE

Original  
Service Parts



Auto-Lite manufactures over 400 products, including Spark Plugs, Batteries, Wire and Cable, and Automotive Electrical Systems . . . sold throughout the United States and Canada.



WRITTEN SO YOU CAN UNDERSTAND IT  
VOL. 106 NO. 2

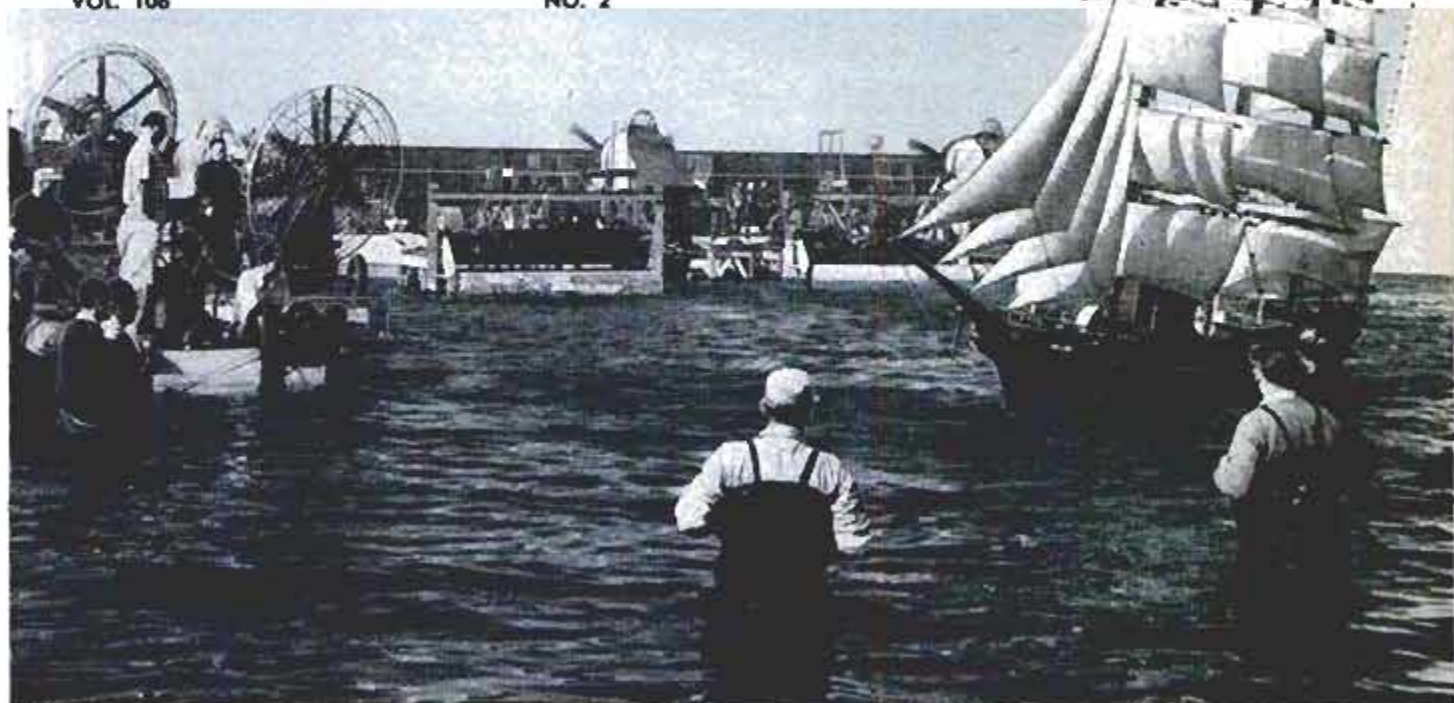

In a studio ocean *General Grant* sails again. Wind machines and modified plaxes in background ruffle water

## MOVIE MAGIC AND ILLUSIONS TAKE YOU *Around the World in 80 Days*

By Thomas E. Stimson, Jr.

HOLLYWOOD ALWAYS TRIES to conceal the fact that some of its most spectacular movies are ingenious illusions. Rarely does a studio give away the secrets of how special scenes are filmed.

Yet when producer Mike Todd was filming his \$5,000,000 *Around the World in 80 Days* he invited *Popular Mechanics* readers to see things that even most studio employees don't get a chance to watch.

He believes mechanically minded readers may enjoy learning the exacting technical problems involved in putting a special effect together. *PM* readers, more than most people, may appreciate the detailed craftsmanship that goes into creating a miniature set that looks full size on the screen.

So, accompanied by a studio official (no ordinary pass will do) let's walk onto the closed lot in Culver City where the ocean sequences of the Jules Verne story are being filmed. Our guide explains that most

This is actual size of the film taken with special camera. Lens is nine inches in diameter. Film is projected on wide, curved screen without distortion

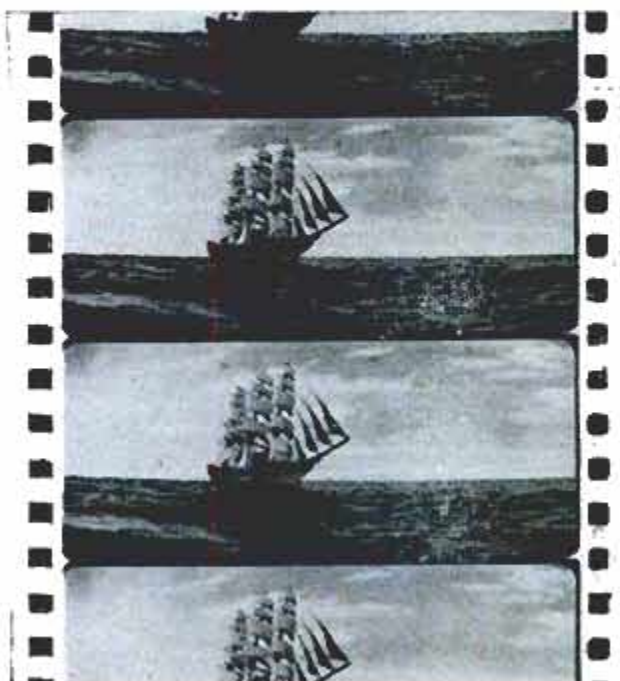





Workers tote coach of the model train to the tracks. Model duplicates a narrow-gauge train still in use

of the marine shots in the picture are made with models. It would be prohibitively expensive to round up three full-size clipper ships just for a few moments of action. Besides, the miniature shots will be technically superior to anything that could be made in full scale.

#### Water Dyed Blue

The studio "ocean" is a concrete tank 300 feet wide and 360 feet long. The water, dyed an ocean blue, is three feet deep. One

end of the tank is half an inch lower than the other sides and here the water continually overflows into a hidden trough, giving a realistic horizon. From the trough it is constantly pumped back into the tank.

Behind the trough is a 50-foot-tall background screen painted in imitation of a blue sky flecked with white clouds. The smog-brown Los Angeles sky won't be visible to the camera. Wave machines and wind machines are lined up along one side of the tank.

Special-effects men install a cartridge in locomotive which will provide realistic smoke during the filming





Here we shake hands with Lee Zavitz, veteran special-effects director, who is overseeing a trial run past the camera of the *General Grant*, a 27-foot-long scale model of an ocean clipper of the late '80s.

"Our problem," Lee says, "is absolute, convincing realism. Any tiny flaw will be magnified when the picture is shown.

"This ship sequence is fairly simple, merely a shot of a ship under full sail in the open ocean. Yet more than a dozen technicians are dovetailing their work on a tight schedule to get just the right effect."

### Cable Tows Ship

Lee explains that the miniature ship is attached to an underwater cable that tows it past the camera at the angle and speed desired. Steam and smoke that issue from the stacks of the auxiliary engine on the ship are produced by smoke cartridges. The tiny moving figures on deck are animated by battery-operated motors. The bow wave and stern wave are produced by jets of water from small water pumps attached below the model's water line. For complete realism, water is splashed along the model's sides just before a run is made. Not one detail is overlooked. Even the waves are scaled down.

"The appearance of the water more than anything else is apt to give away a miniature-ocean shot," Lee says. "The whole thing looks phony if the water isn't exactly right. First we set the wave machines to deliver an ocean swell scaled down to four inches instead of four feet. Next we want a little

Torrent of water, which supposedly weakened the structure, pours down miniature gully from hidden reservoir

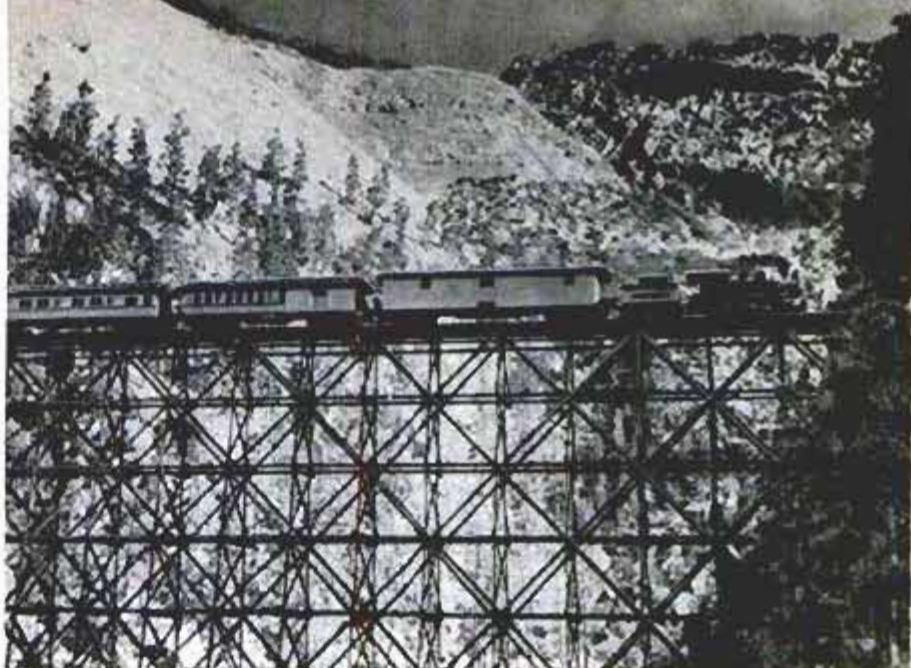

Special-effects men produced realistic scene of train crossing trestle. Hidden in trestle are cables to pull it down

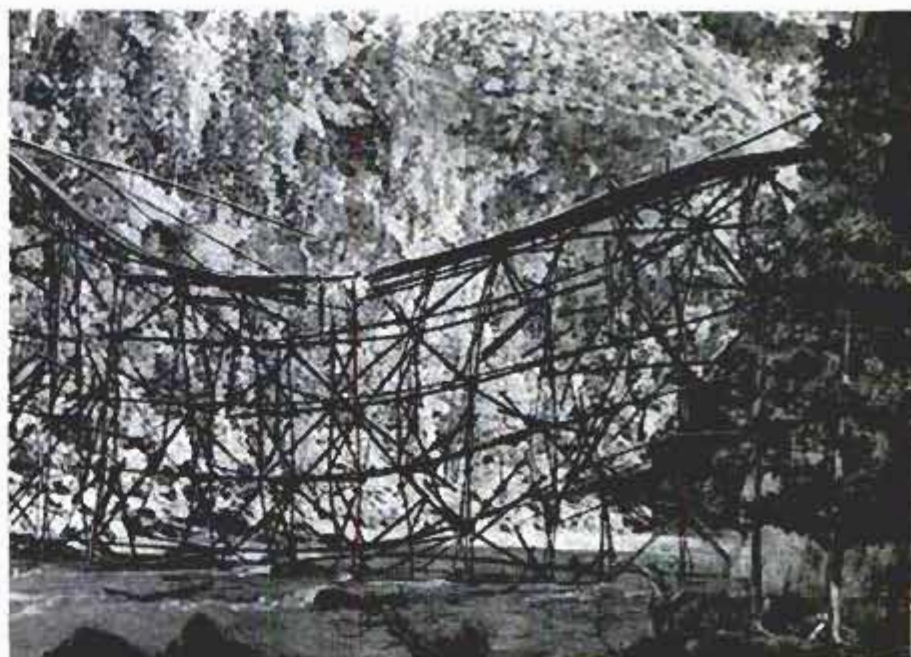

Cables are fastened to pipe hidden beneath the water. As the pipe turns, the timbers begin to break one at a time to bring down trestle just as the train thunders over the rails above







Sailing ship *Mongolia* actually is only 23 feet long. Lee Zavitz, special-effects director, adjusts rigging from the deck. Line behind the sails is top of the painted backdrop

chop on top of the water. This is created by wind machines that also fill the ship's sails and heel it over in the water. The wind machines also smooth out the crests of the swells so that rebounds from the sides of the tank won't be apparent."

In the long run it is the cameraman who makes or breaks a miniature scene. Head cameraman for *80 Days* is Lionel "Curley"

Sailmobile appears in film. The sail was made of rigid plastic so sequence could be filmed even in a calm



Ship appears to be full size in film. It is towed past the camera by an underwater cable

Lindon, who knows all the tricks in placing the camera so that a miniature looks perfect on the screen. Basically it is shooting from a low angle to get the proper perspective.

#### "Bug Eye" Lens

The Todd-AO (Todd-American Optical) process uses a 65-millimeter film in a camera fitted with a "bug eye" lens nine inches in diameter and of very short focal length. In the theater this film is projected on a wide, deeply curved screen without distortion. *Oklahoma!* was the first feature picture in which the process was used, and audiences were fascinated by the realism and third-dimensional effects that were achieved. The accompanying high-fidelity sound is projected from five or six loudspeakers placed above the screen.

#### World Adventure Story

*Around the World in 80 Days* tells the adventures of two travelers who hope to win a bet by traveling all the way around

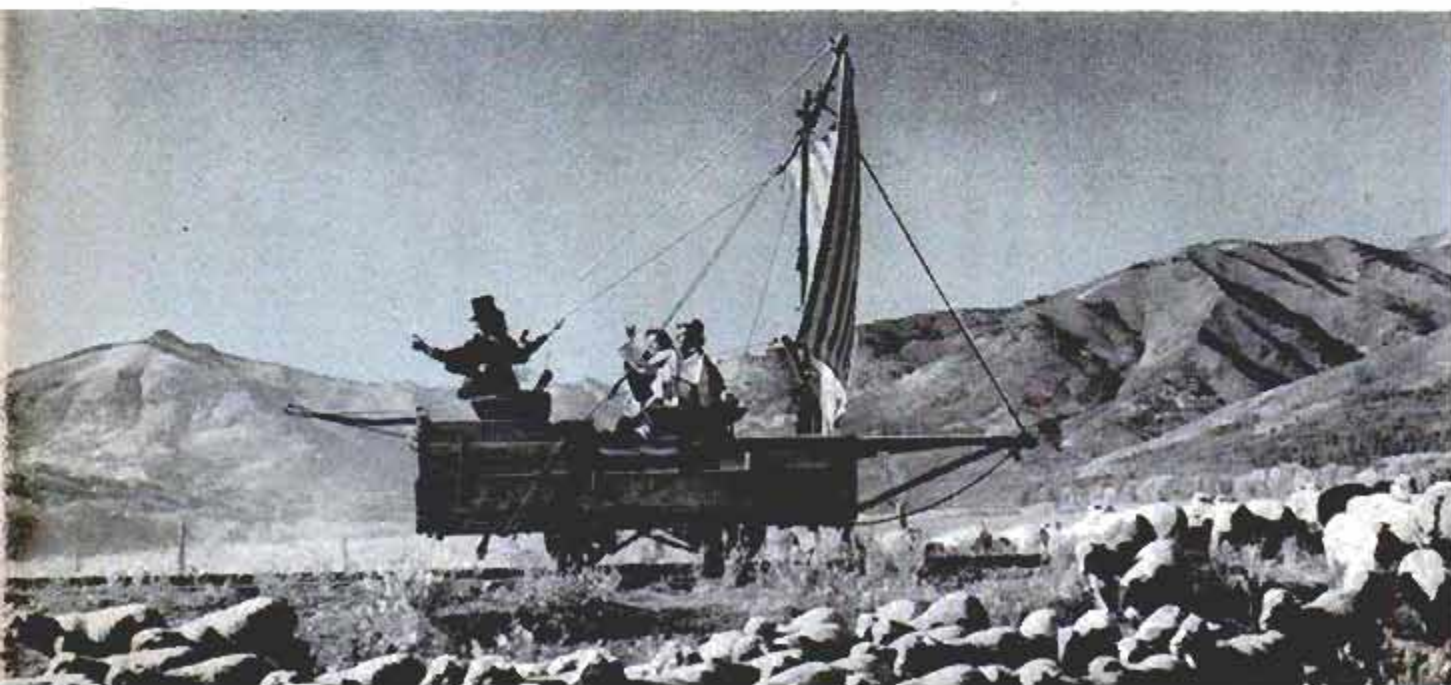





Studio painter adds finishing touch to tree made of a stalk of yucca plant with small juniper branches

the earth in 80 days. This was virtually an impossibility in 1872, the year in which the Jules Verne classic is laid, but by using a balloon, trains and the fastest available ships, the travelers manage to win their bet. En route they are plagued by the many difficulties that Verne wrote into his story.

Special-effects man sets trees into rocky bank behind the trestle, then gives forest a touch-up with sprayer



Part of film shows trip by balloon. Here huge crane moves the balloon across scene in front of camera

Most motion pictures star only a few well-known actors but *80 Days* uses 45 top Hollywood stars. David Niven, Cantinflas and Shirley MacLaine play the leads, and other parts are taken by Robert Newton, Frank Sinatra, Ronald Colman, Marlene Dietrich, Buster Keaton, Red Skelton,

(Continued to page 226)

Prop man adjusts rock in stream. Hidden pipe produces the effect of water rushing around the rock





## Built-in "Visor" Shades Headlamp



Test installation of new lamp and photocell control

HEADLIGHTS and inventors seem to attract each other. And understandably so. A bout with today's headlight glare in heavy traffic stimulates inventive minds.

Latest (and one of the most interesting) of glare eliminators is the Bone-Midland lamps, invented by Evan P. Bone of Cincinnati, Ohio.

Key to the Bone system is a movable

vane that pivots in front of each headlight filament, casting a shadow in which approaching cars travel.

Two separate but connected parts make up the system: (1) a photoelectric cell mounted at about eye level in the car; and (2) larger, more powerful headlamps equipped with the pivoting vane.

Light from an oncoming car strikes the photoelectric cell which "senses" the direction and, by remote control, moves the vane in front of the filament, positioning it so as to throw a shadow in the oncoming lane. To make the shadow sharply defined, the lamp uses an elliptical reflector that focuses the light rays precisely at the point where the vane operates.

The vane is made of a filtering material that blocks the blinding light rays while allowing the infrared rays to pass through. These infrared rays activate the photoelectric cell.



Above, a bird's-eye view shows how lamp keeps the oncoming car in shadow. At right, diagram explains it. Not shown is another vane ahead of electric eye that "senses" where oncoming car is. Below, the Bone lamp

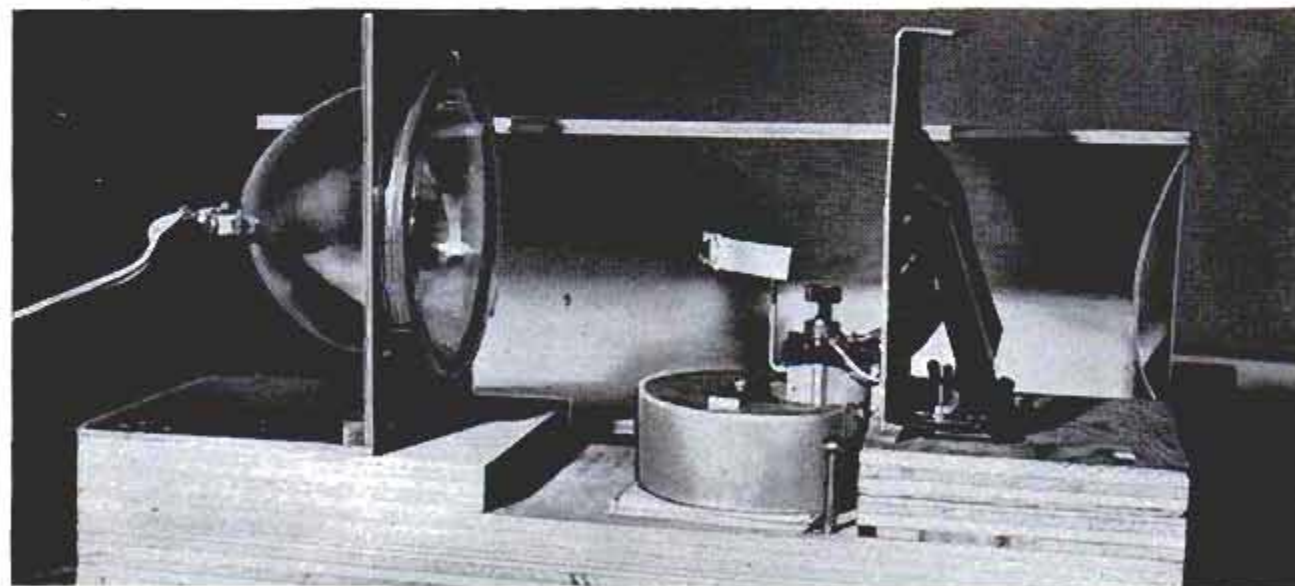
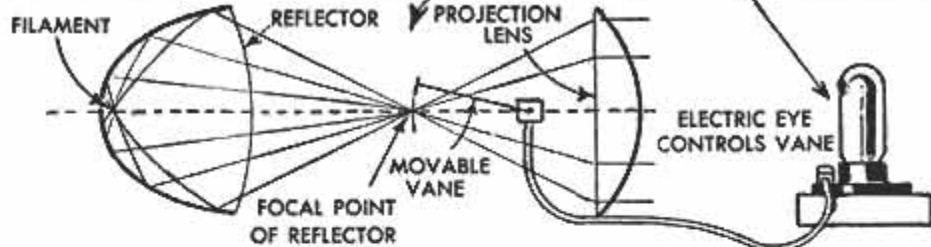





## Plane Mounts Retractable Rotor

Vertical take-offs and landings would be possible in a proposed plane that conceals a folding helicopter rotor in the wing above the fuselage. The rotor, powered by ramjet engines at its tips, would be unfolded and used only for up-and-down maneuvering. When cruising flight is reached, the rotor

would be stopped, folded to one third its 25-foot length and completely retracted into the wing. Installation would be relatively simple and light, since the unit is independent of the plane's principal power plant. Hiller Helicopters is preparing the design under an Air Force contract.

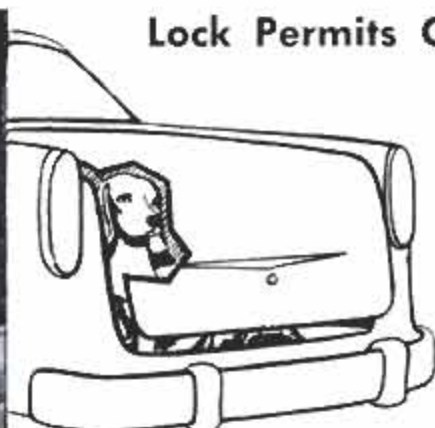

## Lock Permits Carrying Dog in Car Trunk

Now you can carry your dog safely in the trunk of your car. An auxiliary lock, attached to the striking block at the back end of the trunk compartment, keeps the lid open just enough to allow for ventilation of the compartment. When not in use, the unit can be flipped down out of the way for normal closing. The lock is available in several models to fit various cars.

## Lawn-Mower Accessories

Leg work is taken out of mowing by two accessories for a line of self-propelled lawn mowers. One is a stake-mounted reel with 50 feet of nylon cord that is payed out as the tethered mower automatically cuts an ever-widening circle. The other unit is a rubber-tired riding sulky that is hooked behind the mower. Its padded seat is at a comfortable height, and the sulky is so positioned that the mower's controls are easy to operate.

☐ The largest user of diesel engines in the world is the United States Navy.







# INDIAN CRAFTSMAN USES POWER TOOLS

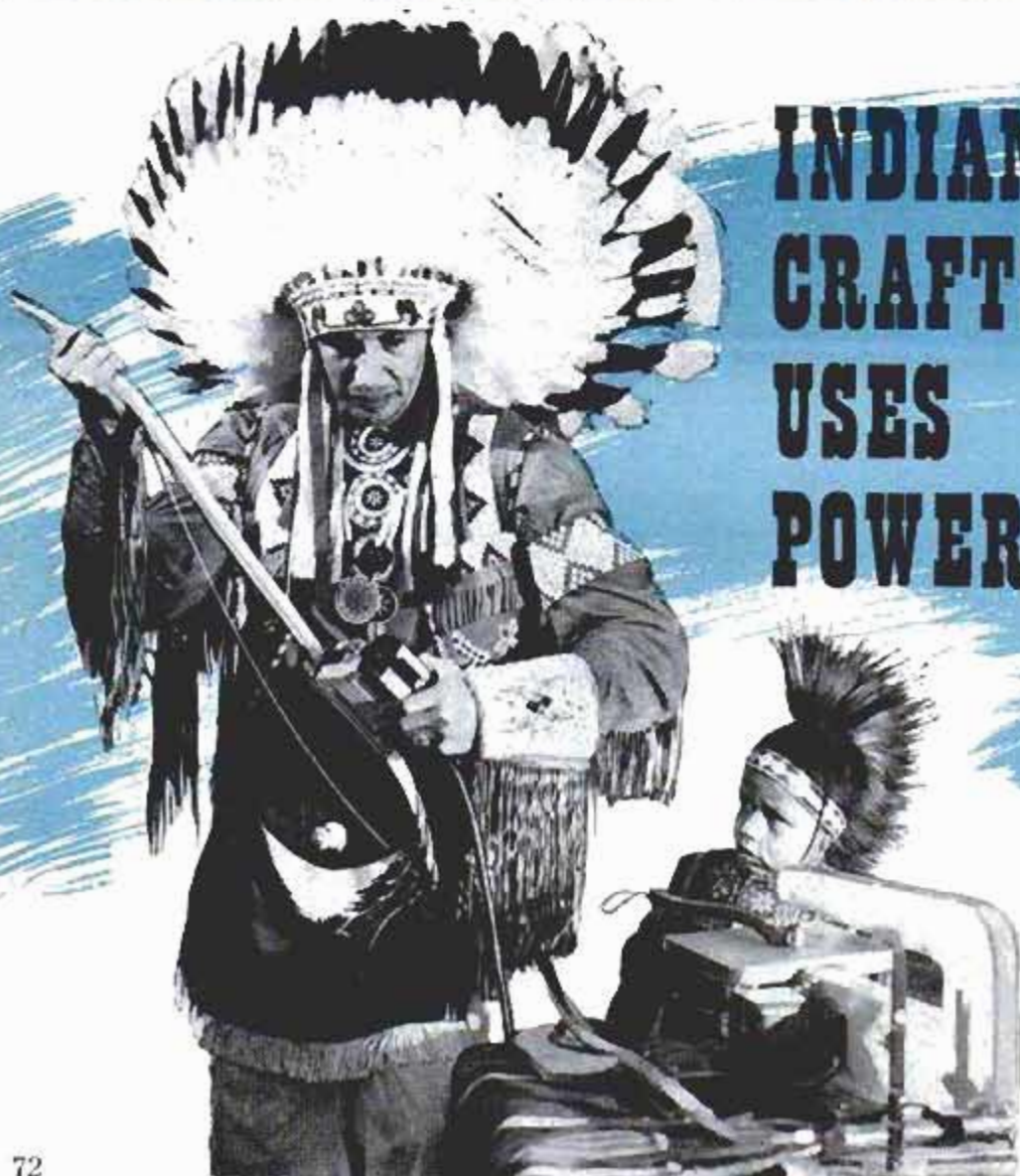

Photos by  
Frank P. Fritz



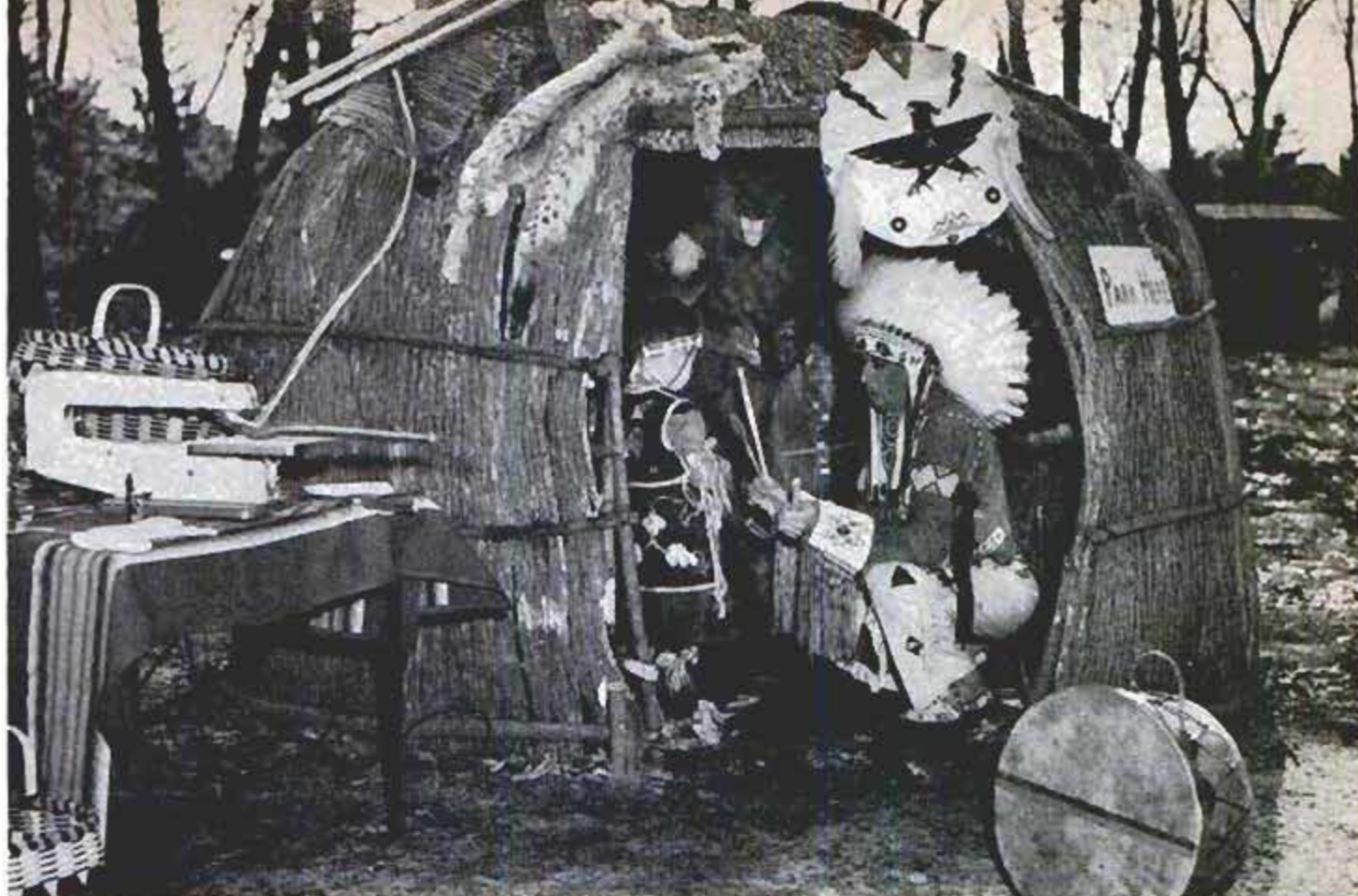

Chief Little Eagle deserts his tools to entertain young son in the wigwam he built as tourist attraction

**A**NCESTORS of Roger (Chief Little Eagle) Tallmadge of Wisconsin Dells, Wis., would be no more amazed than the tourists who visit there at the tools he uses to turn out traditional Indian craft. Little Eagle, a true 20th century Redman, uses an array of power tools to make tomahawks, spears, basket handles (hickory), peace pipes, totem poles and many other items. His drill kit has 36 small precision attachments—drills, grinders, sanders, buffers, polishers. He uses a portable jig saw and a bench-mounted circular saw. With these tools he figures he can turn out as much work in a day as all the men could in a week at the Sioux reservation where he was born. Time-saving power tools make it possible for Little Eagle to keep up his spare-time craft production while he serves as principal of the Davis Corner School, in Adams County, Wis. During the summer he works as a boat pilot on the Lower Dells and operates his own museum (admission free) adjoining his home on Highway 13. Helpers include his wife, Sannay-Me-Na-Ka; son, Walking on Blue Sky, and daughter, Shining Brightly. ★ ★ ★

AUGUST 1956

73



The chief fits a tomahawk blade in the handle as he stands behind array of his craft work. Below, at work in schoolroom





# Detroit Listening Post



By Leo Donovan

**I**T MAY LOOK QUIET, sound quiet and be quiet in hot, midsummer Detroit, but your Listening Post is buzzing with rumor. Under its placid surface, Detroit is turbulent as the industry rushes toward the '57 cars.

Here are some rumors, ranging from the wild, speculative to common-knowledge, informed-sources type. Take your pick.

## Long-Shot Rumors

**Chevrolet** may present a truly convertible hardtop model say spies. It may be announced after the regular announcement date which is late in October. It may even be part of a **Corvette** model. This is a real long shot, a rumor-monger's rumor.

Air suspension may be available as an extra-cost option on the **Buick Roadmaster**.

**Oldsmobile** may have a modification of the central-hydraulic system for accessories in its top line.

**Plymouth** may have a flashy sports-type station wagon, but cutbacks made necessary by the sluggish sales this year may force its postponement until 1958. But it just may make it for 1957.

**Hudson** and **Nash** are planning to go to air suspension, but not for 1957, unless they come up with a big surprise.

A good long-shot bet is that there will be no fuel injection in 1957 except in certain specials, notably the **Eldorado** and the **Chrysler 300**—even these two may not have it.

## Even-Money Rumors

It is likely (an even-money bet) that colored anodized aluminum panels will replace and augment chrome or stainless steel in many cars, especially **Chevrolet** and **Plymouth**. The favorite color (which is part of the metal and therefore nonchip-pable) will probably be gold.

**Ford** and **Mercury** will look unrelated in 1957—no more the brother act. Look for both to have considerable metal sculpturing (metal creases that eliminate the slab look from large stretches of sheet metal). Both will use sculptured roof panels. **Mer-**

**cury** will even have two-toned paint jobs on the roof. **Ford** may limit its roof sculpturing to the station wagons which will make them look less like panel trucks.

At least one of the **Chrysler** family will offer four headlights as optional in states that permit them. There are still some states that have not made four lights legal, although it is thought that police won't enforce the two-light law very strenuously if Detroit starts making cars that way.

**Cadillac** (with the **Eldorado**) is betting on police cooperation as is **Lincoln**. These three will have four large lights in front this year. They may not all be headlights though, two of them may simply be enlarged parking or "running" lights.

**Buick** may drop the regular four-door sedan in its Super and Roadmaster lines, limiting production of four-door models to the hardtop.

**Rambler**, now a separate line (not a **Hudson** or a **Nash**), is being beefed up to take a V8 engine. Rear end and driveshaft are to be modified to take added torque.

**Chevrolet** is expected to have a new transmission complete with a variable-pitch stator (like **Buick's**). The informant also hints that **Chevrolet** may offer two automatic transmissions so you have a choice between high performance and utter smoothness.

## Good-Bet Rumors

The entire **Chrysler** family will offer the three-speed PowerFlite (except **Plymouth**), torsion bars and ball joints in front (including **Plymouth**). In fact, everybody seems to be going to the ball-joint front end—it's simpler, maybe it's cheaper.

**Chevrolet** will not have a new body shell nor will **Pontiac**, but you'll never know it. Drastic sheet-metal changes plus 14-inch wheels, which are rumored to be on both of them, will make over-all appearance so different you'll swear they are all new. A lower, flatter hood and rear deck plus a sweeping aluminum panel of anodized aluminum will emphasize the rear fins of the **Chevrolet**. Taillights will be much higher.

**Ford** may have a General Motors' look about it, say insiders. Its windshield post will rake forward like **Oldsmobile**, its heater intake will be pressed into the cowl like **Chevrolet**. But then **Chevrolet** will probably have ball-joint front suspension like **Ford** and tailfins like **Plymouth**, so perhaps it's all part of the game.

Most certain of rumors is the fabulousness of the **Eldorado Brougham**. It is to be lush beyond belief. You'll want to take your shoes off before getting in. Likely are disk brakes and air suspension.

**Dodge's** fins will be spectacular and taillights as bright as Times Square.



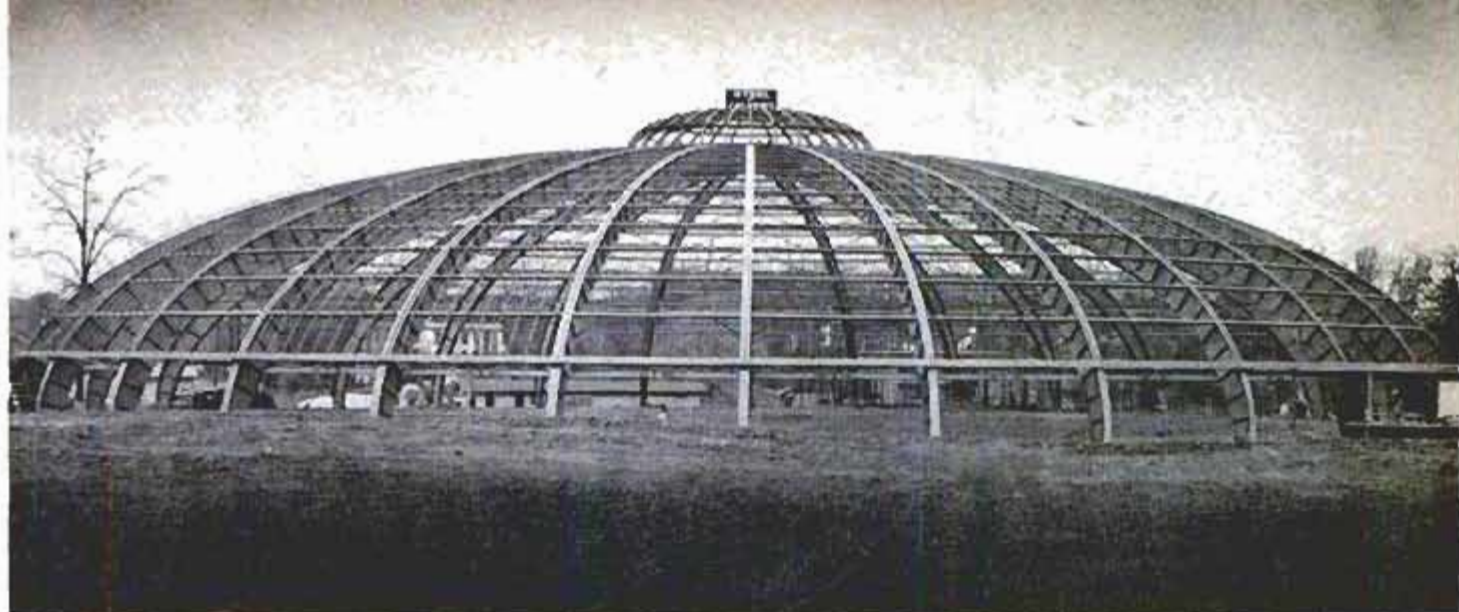

Completed framework of Alexander Memorial Center, in Atlanta, Ga., required 615 tons of structural steel

## Domed College Arena Built Without Pillars

ALL SPECTATORS at basketball games held in the Alexander Memorial Center, built by the Georgia Tech Athletic Association in Atlanta, Ga., will have an unobstructed view of the court. The building is a huge dome with no supporting pillars to block the view. This giant dome, 270 feet in diameter at the base and 75 feet high at its center, was built by erecting a center pole with a circular girder on it and then setting huge preshaped rib girders in place on the foundation and against the circular girder. After the rib girders were in place, the center pole was removed, leaving the dome to stand alone. In addition to its use as a basketball and physical education arena, the Memorial Center will also house a local radio station. Two wings attached to the dome will have concession stands for use during the games.

At right, center pole with its circular girder is set in place. Below, one after another the welded-steel rib girders are hoisted into final position







Equipped with outriggers to prevent rolling, test cars make screeching turns as they "wring out" new tires

What you want is a 100,000-mile tire. A 13-inch tire for that lower-looking body. Maybe in color to match your car. It all adds up to headaches for the rubber industry as

## TIREMAKERS RACE AGAINST TURNPIKE SPEEDS

By Leonard F. Hilts

**G**UARANTEED FOR 5000 MILES!" That slogan, painted on the side of an old red barn just outside of Chicago, has caused many a passing motorist to chuckle. It's part of a barely visible advertisement for automobile tires painted there some 40

years ago, and the brand of tire it extols is no longer made. But the old billboard sharply points up the progress the tire industry has made since then. For these days, 35,000 miles is considered average wear on a set of tires—and the industry has

Through the years, tires have become smaller and fatter. 1906 tire had life expectancy of about 2500 miles

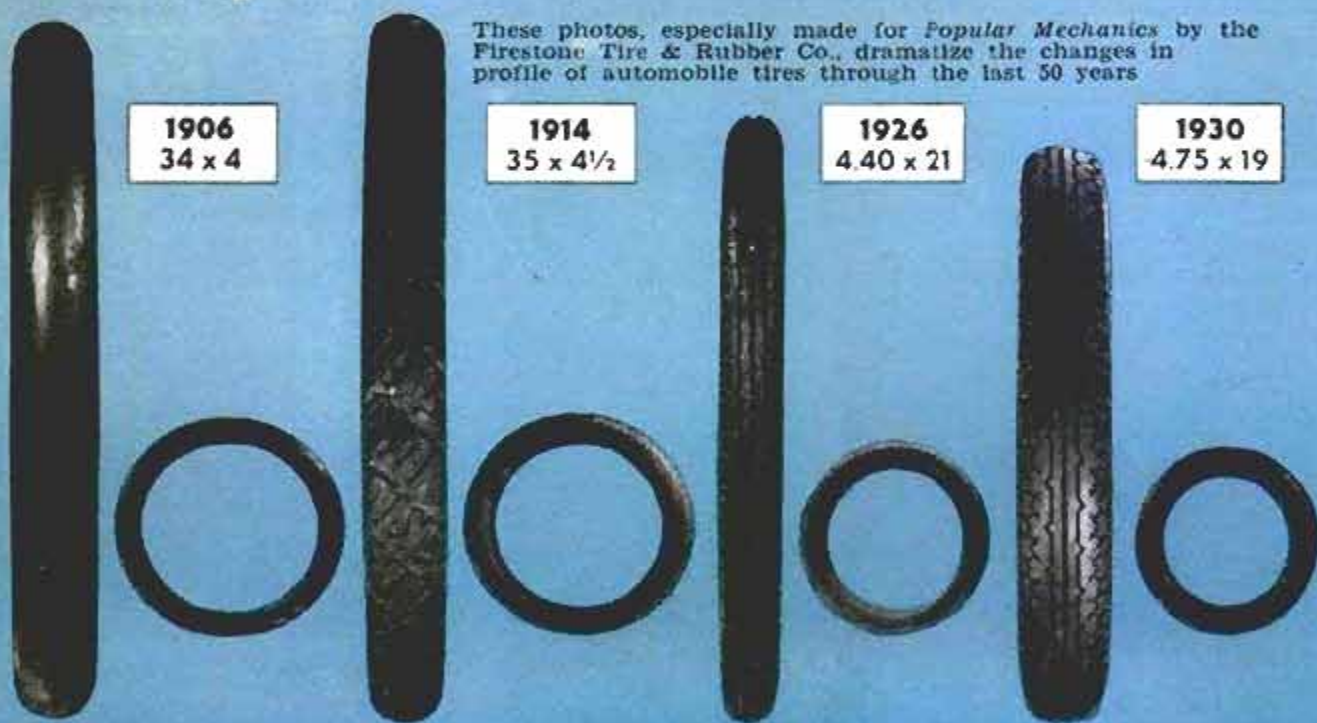



its sights set on producing a 100,000-mile tire.

But in spite of this remarkable record of improvement, tire designers are in trouble, trying to keep up with automotive design as it surges ahead. Cars have increased in weight and there have been amazing advances in horsepower in the past few years — as well as such improvements as the automatic shift, power steering and power brakes. All of these make serious demands on the tires.

To emphasize the demands a car makes on a tire, Goodyear engineers point out that in 1926 their tires could be expected to give a normal service of 12,500 miles on the vehicles of that day. That same tire would give only 6250 miles on today's cars. And the present-day 15-inch tire, which might be expected to last for 35,000 to 40,000 miles, would have given 68,000 miles of service on a 1926 car.

And now, to complicate matters, new high-speed turnpikes and freeways are stretching out across the nation. You can now drive from New York to Indiana without encountering a stoplight, and before the end of 1956 it will be possible to travel 1800 of the 2100 miles between Oklahoma City, Okla., and Augusta, Me., on four-lane divided highway; and much of that mileage will be done over high-speed, nonstop turnpikes. This means prolonged periods of fast driving which, in turn, means harder work for the tires through greatly increased heat and wear. So, in spite of the remarkable progress they have made already, tire designers are being pushed harder than ever today.



U. S. Rubber Company runs new "wire" tires through a bed of broken glass to demonstrate their toughness

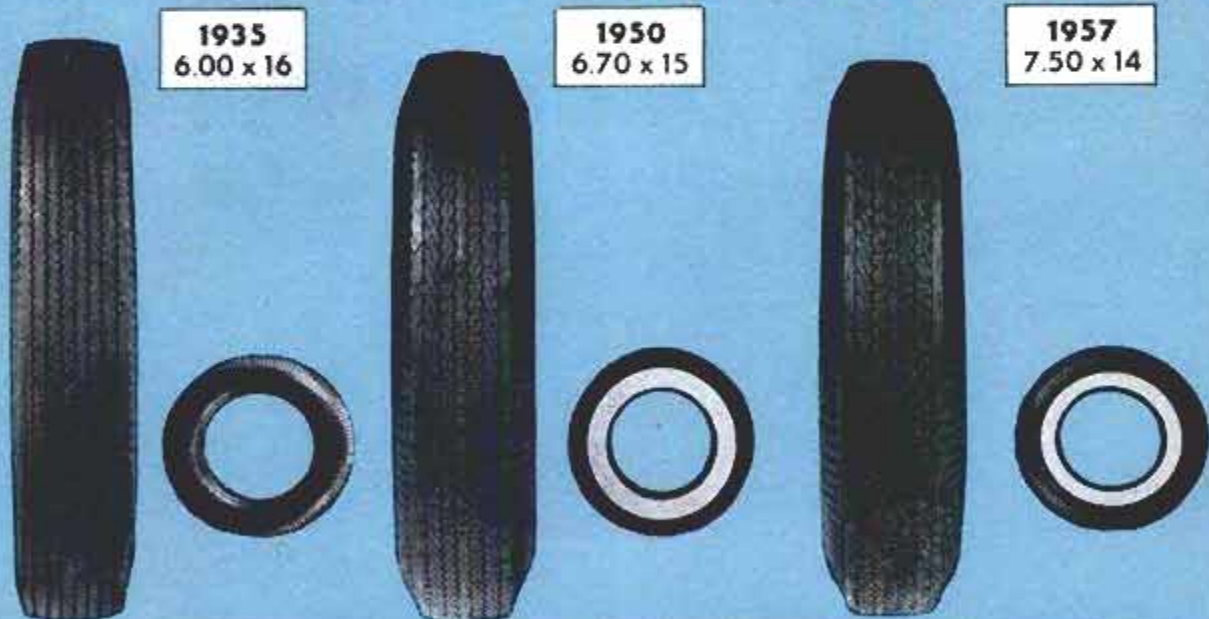





Above, tire makers delight in putting products through torturous tests. Pictures show Seiberling tire undergoing simulated jet landing at 125 miles per hour. Steel wheel was bent, but tire bounced back without single broken cord. At right, Firestone had to bring out forgotten molds as antique-car collectors demanded old tires for their prize automobiles

Tire men, too, are finding themselves squarely on the horns of a dilemma, because they have discovered that high-speed performance and passenger comfort don't go together. You can have one or the other, but you can't have both. And yet both are being demanded by automotive designers and the buying public. Coupled with this dilemma are the facts that tire cost must be kept down and tire design has to be in keeping with automotive styling.

Tire development today is a long series of compromises which attempt to solve all of these problems with one tire.

Peering into their rubber crystal balls, tire men are making predictions about the future of their product. Here are some of the things they are saying:

**No spare tire needed:** It won't be long before the spare tire disappears from automobiles—much to the delight of automotive designers, who have plenty of ideas about what to do with the space thus gained. In fact, one 1957 prestige car will be delivered without a spare—but will supply one if the buyer requests it. Goodyear has taken a step toward this goal by introducing a tubeless tire with an inner chamber—virtually a tire within a tire. In the event of a blowout or puncture of the outer tire, the car can be driven (up to 250 miles in tests) on the inner tire, which is nylon-reinforced rubber. Unlike other safety-tube tires, there is no valve or connection between the two air chambers of the tire. Instead of stopping to put on a spare after a blowout with these tires, the motorist





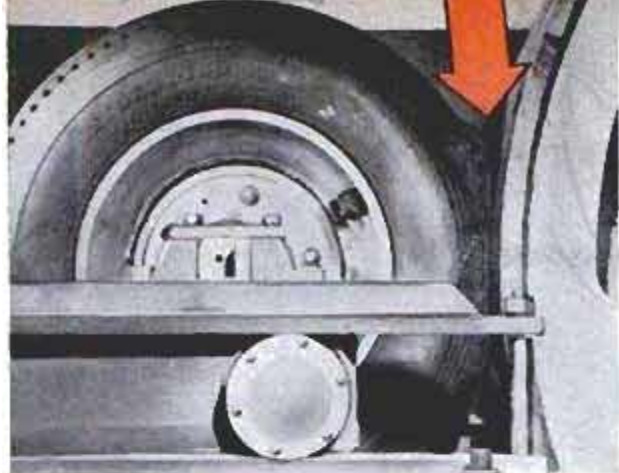

Tire turning against test wheel at 100 miles per hour shows what happens to tread rubber on road



Laboratory technician tests samples of new rubber compounds on abrasive wheel for wearing qualities

simply continues on to the next garage—or goes on home and has the injured tire repaired the next day.

**The 14-inch wheel:** 1957 automobiles will come out with a 14-inch wheel in place of the present 15-inch. This smaller inside diameter has been demanded by car designers—and it doesn't make the tire designers very happy because it raises problems. Its main purpose is to help with the longer, lower body lines of the future. While this smaller wheel actually won't lower the car body much, it will give a lower appearance. At the same time, the cross section of the tire will be increased somewhat, perhaps half an inch, and the air pressure will be reduced from 24 pounds to 20 pounds. This fatter, smaller tire, in addition to lowering the lines of auto bodies, will provide a softer ride than anything produced thus far.

**Even smaller wheels:** In the foreseeable

### Tips on Tire Care

1. Never drive at high speeds on brand-new tires. Give them a 1000-mile break-in at normal driving speeds.
2. If you do considerable highway driving, equip your car with "high performance" tires, which will take prolonged high speeds better and safer.
3. Never permit tires to go below recommended pressure. Rapid heat build-up and possible tire damage results.
4. When planning a long trip where prolonged high-speed driving is certain, increase air pressure in tires. A 24-pound tire will run considerably cooler at 28 pounds.
5. Apply brakes intermittently; don't jam them on. Avoid "hot rod" starts, fast cornering and sudden stops.
6. Keep wheels in balance and rotate tires every 5000 miles. Keep front wheels in alignment to avoid uneven tire wear.



At left, soft gum in self-sealing tire may soften at high speeds and settle in middle of tread. At right, Seiberling solution to this problem provides tiny bulk-headed compartments to hold soft gum in its place

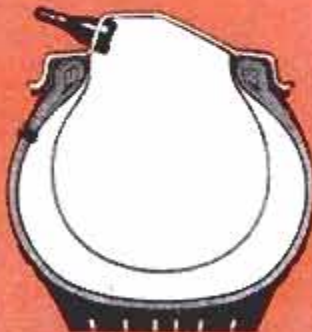

Left, Goodyear tire with separate inner and outer air compartments. After blowout, car rides on inner tire up to 250 miles. Right, Firestone tire with twin compartments has valve between. Slow deflation permits safe stopping







Engineers at General Tire Co. "fingerprint" huge tire to check area of ground contact under 18-ton load



U. S. Rubber engineer shows how up to eight miles of woven wire is bonded under tread of new "wired" tire

## Passenger-Tire Developments

- 1845—Robert William Thomson patents airtight tire for carriages.
- 1888—Dr. John Boyd Dunlop makes pneumatic tires containing air under pressure.
- 1889—Clincher tire.
- 1893—First cord tire.
- 1894—First pneumatic tire for automobiles.
- 1904—Straight-side, wire-bead tire.
- 1904—Average tire life 2000 miles.
- 1904—First use of carbon black to provide longer wear.
- 1907—First commercial demountable rim.
- 1908—Angular nonskid tread.
- 1920—Average tire life 10,000 miles.
- 1920—Gum-dipping of tire fabric.
- 1922—Balloon tire introduced.
- 1925—Twenty-one-inch tire.
- 1930—Average tire life 16,000 miles.
- 1930—Nineteen-inch tires.
- 1932—Experiments with tubeless tires.
- 1933—Experimental tires built with synthetic rubber.
- 1935—Mud and snow tires.
- 1937—First use of rayon fabric in passenger tires.
- 1942—Tubeless truck tires developed for war use.
- 1942—Major use of synthetic rubber to fill government orders for tires.
- 1942—Butyl inner tubes introduced.
- 1947—Nylon tires introduced.
- 1948—Superballoon tire.
- 1950—Fifteen-inch tire used on most new cars.
- 1954—General use of tubeless tires on 1955 cars.
- 1955—General use of tubeless tires on 1956 trucks.
- 1956—Fourteen-inch tires for 1957-model cars.

future there will be a reduction to a tire with 13-inch inside diameter—a tire size already being tested by several companies. In the old days, tires were 35 inches in diameter, with high air pressures—and provided a pretty hard ride. Tire size was gradually reduced and by 1935, when the 16-inch wheel with a tire carrying 28 pounds of pressure was introduced, tires began to mean something to the comfort of the passengers. This arrangement was replaced in 1950 by the 15-inch wheel. Each reduction in size has brought a smoother, softer ride.

However, tire men are worried about this trend to smaller and fatter tires. Their research shows that to obtain the best high-speed performance, the largest practical tire should be used—because at a given speed, the larger the tire the less the revolutions per mile and the cooler the tire temperature. And they know, too, that in a smaller, fatter tire there is some loss of stability and steering response. On such tires, for example, cornering would be sloppier.

Tests with two tires, one with a 28-inch outside diameter and the other with a 29.7-inch outside diameter, demonstrated the effect of size at high speeds. The smaller tire ran an average of 10 degrees hotter than the larger one at all speeds starting at 35 miles per hour. However, as the speed went over 85, the smaller tire became considerably hotter, and at 100 it was running 30 degrees hotter. Tire scientists noted that the larger tire ran cooler at 110 than the smaller one did at 100—which means that the larger tire would have a 10-mile-per-hour advantage in high-speed performance.

A few years ago such tests would have been important only to racing cars. But today's assembly-line passenger cars are



often capable of 100 to 120 miles per hour; and tomorrow's roads will give them the opportunity to run at high speeds for long periods of time. This means the high-speed performance index of a tire is important—and tire designers have good reason to be concerned over the smaller tires.

### Researchers Finding Answers

At the same time, rubber researchers are bringing some answers to this problem out of their laboratories. Nylon and super-rayon cords are being used for strength and cool running. Better carbon blacks and better synthetic-rubber formulas are producing longer-wearing qualities. Cord-dipping processes which help to bind the tread rubber to the body of the tire even in the presence of high heat are a big step forward. The main hope of researchers is to offset the undesirable qualities of the smaller tires by improving the qualities of tire materials and tire construction.

*Disappearing inner tube:* Within three years, the inner tube will have gone the way of the dodo bird. Most new cars reached dealers in 1955 equipped with tubeless tires, which Goodrich pioneered in 1947. Trucks have appeared with big, heavy-duty versions of the tubeless design and by 1957 the majority of all new trucks will be so equipped. To adapt the tubeless principle to trucks, a new rim had to be designed and standardized for the trucking industry. This has now been done and has resulted in a large saving in weight—as much as 120 pounds per axle for cast

Answers to problem of colored tires seems to be the detachable colored sidewall, held in place by rim  
Kraze Products, Inc.

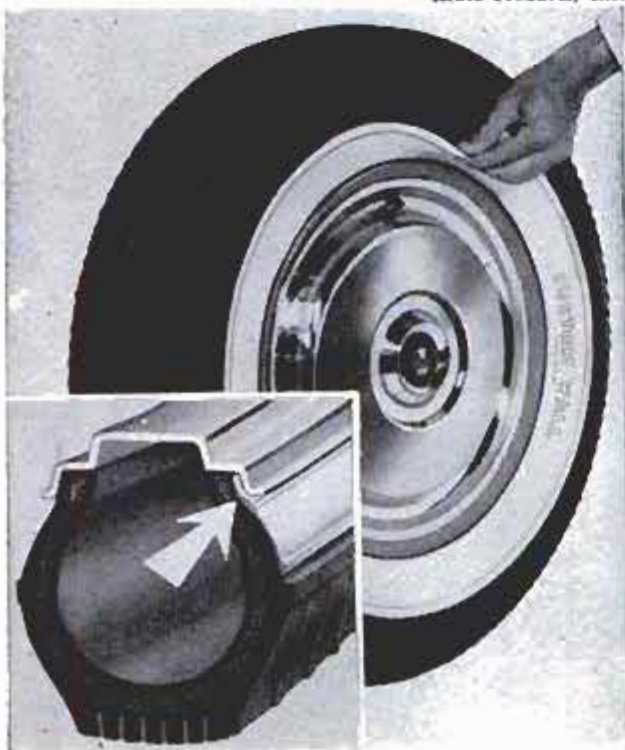

AUGUST 1956

spoke mountings and 160 pounds per axle for disk-wheel mountings. Whether used on cars or trucks, tubeless tires suffer less from blowouts and punctures than older types, providing an increase in safety at lower operating costs for the driver.

*Self-sealing tires:* Borrowing an idea from the self-sealing gas tanks developed for aircraft during the war, tire makers coated the inner walls of tubeless tires with soft gum. When a nail or other object penetrates the casing, the gum seals the hole and prevents air from escaping. Tires with this safety feature have been on the market for some time, but improvements continue to be made. In earlier models, the gum tended to soften and run toward the center of the tread at high speeds. This not only made the tire more vulnerable to punctures, but also threw the wheel out of balance.

### Bulkhead Construction

Typical of the effort to overcome such problems is the bulkhead construction recently offered by Seiberling. In this design, the gum is contained in bulkheaded compartments on the inside of the casing, and cannot change position even if softened by heat. Firestone has taken another step with a tubeless tire with gum-dipped nylon cord that has the self-sealing gum on the interior wall. Then it also has a safety diaphragm made of rubberized nylon cord—again, a tire within a tire. A valve connects the inner and outer chambers. In the event the casing is ruptured, the wheel will roll on the inner tire long enough to permit the driver to bring the car to a safe stop.

The tire buyer should keep in mind that such plus factors are usually offered only in higher-priced premium lines, with cost running considerably more than a standard set of tires.

*Colored tires:* One big debate in the industry is on the colored tire. Consumers have indicated that they want color in just about everything they buy, and some tire manufacturers think this will hold true for tires, too. In their premium line, U. S. Rubber already offers sidewalls of bright blue, green and brown. But others point out that to get shades to match or harmonize with all of the colors appearing on car bodies they would have to make and stock too many different colors. Next best answer seems to be the detachable colored sidewall, which fits against the tire and is held in place by the rim of the wheel. A number of manufacturers have them on the market now, including Goodyear and Firestone. Half a dozen colors are offered, all pastels which harmonize easily.

(Continued to page 232)



# Right Behind the Firemen Come the Salvage Squads

By Creighton Peet



Rolled-up cloth serves as dam to keep water pouring down the staircase from spreading

After 30 hours, firemen working in zero cold keep hoses on Michigan State Office Building

Flexible smoke-ejector tube is poked into basement to rid it of noxious fumes and gases

Los Angeles Fire Dept. photo





**E**VEN TODAY many people believe that firemen take a fiendish delight in smashing up furniture, kicking out windows and chopping needless holes in floors and walls. As for water—it's obvious, you will hear, that they keep pouring it in just for fun long after the need is over.

But the fact is there are more trained firemen today than ever before, and although firemen often must break windows and chop away a smoldering ceiling to save a house from "rekindle," there are, and for many years have been, special fire-patrol crews whose sole job is to look after property.

Whether they are working for the older outfits supported by the fire-insurance companies, or regular city fire departments, they have a rugged, dangerous job. They must enter a building almost as soon as the fire fighters do, and in a few seconds their chief must decide how much property can be saved from water damage, and how to go about it, before ceilings fall and floods of water, sometimes boiling hot, pour down on them. Fire patrols, which usually consist of around a dozen men, do their most extensive jobs in big mercantile buildings filled with valuable merchandise, where the fire may be confined to one or two floors. They also operate in private homes, but have less opportunity to do this particular kind of salvage work in small one-story structures.

#### **Meanwhile—Beneath the Fire . . .**

The difference between regular firemen and the fire-patrol men is that the latter usually work on the floors below those on which the fire is actually located. They cover everything possible with big 14 by 18-foot treated canvas or rubber covers, which they lug up stairways which have often turned to waterfalls. On occasion, if they are lucky, they may find an elevator still operating. But nearly always they will have to force locked doors with special tools, cut padlocks with giant nippers, and operate with no light but that from their flashlights. Water may be hot when it pours down from the region of the fire, but in winter the water flowing down into floors from which windows have been



Milwaukee Fire Dept. photo

This is what happens when salvage facilities aren't sufficient. Water from fire in Fargo, N. D., hotel poured into lobby and froze. Below, fire-patrol man carries tarp upstairs to spread over contents of floor below the fire, where water is coming in







Los Angeles Fire Dept. photo

Los Angeles firemen cover store shelves with tarpaulin to protect the goods from smoke and water damage

knocked out will eventually turn the floor into a skating rink, adding to the hazards.

From drills and experience, the men immediately know what to do. Small movable items of furniture like desks and typewriters are quickly pushed into piles in the center of the room to be covered, as are piles of merchandise. Open stock shelves are covered as well as possible. If necessary,

Water must be moved out quickly. Here, water from floor above is directed to runoff point with tarp

Fire Engineering photo



protective covers are nailed to any convenient surface through eyelet holes in the covers.

In older buildings the holes in ceilings where lighting fixtures are fastened, and those through which steam and water pipes pass, soon become gushing waterfalls. A big fire may take thousands, or even tens of thousands of gallons of water to extinguish,

Smoke exhaust fan ventilates area through hole chopped in floor. Smoke damage can ruin many goods

Fire Engineering photo





and it's only a matter of minutes until this water starts working its way through floors and ceilings to lower floors, and flowing down stairwells and elevator shafts.

And if it doesn't find a weak spot to work through in a hurry, the firemen on the floor above will soon chop a hole to speed it on its way. Disposing of this water as rapidly as possible, with a minimum of damage to the material in the building, is the job which keeps the fire patrol jumping.

### The Big Flush

In some older industrial buildings there are built-in scuppers or drains in corners of the floor, to take off any water which might be involved in the work done there. But these may be buried under tons of merchandise, or plugged up. In any event, fire patrols have a faster, surer way of finding access to a sewer. With big crowbars, they quickly pry up enough toilets from the floor to provide drainage for the water which is now rising all around them, and threatening the contents of still another floor—the one below them.

There are still other tricks to this trade. Using rolled-up covers, they form "dams" or dikes to channel the flood and keep it from spreading. A fire may be confined to one part of a big floor, but the water will quickly cover it all if not stopped.

### Out the Window

Another technique is "bagging." When a hole in a ceiling is pouring out a gusher, a big cover is placed under it with its sides supported to a height of two or three feet by chairs, tables, boxes or anything handy. Then, as this lake continues to rise, portable gasoline or electric pumps are rushed in with a short length of hose which discharges this water out of the nearest window. Because the building's electric line may be out, most fire patrols carry portable generators and lengths of cable to operate small portable pumps.

Covers can also be formed into troughs under a stream of water pouring from a ceiling, to discharge water through a window. At other times a number of covers

(Continued to page 234)



Los Angeles Fire Dept. photo  
Water channeled down stairway from fire above is directed to street by sawdust dikes that leave the surrounding carpets dry

Ballooned cover is hung from ceiling where opening has been made to let the water flow down and be chuted out window  
Underwriter's Fire Patrol photo





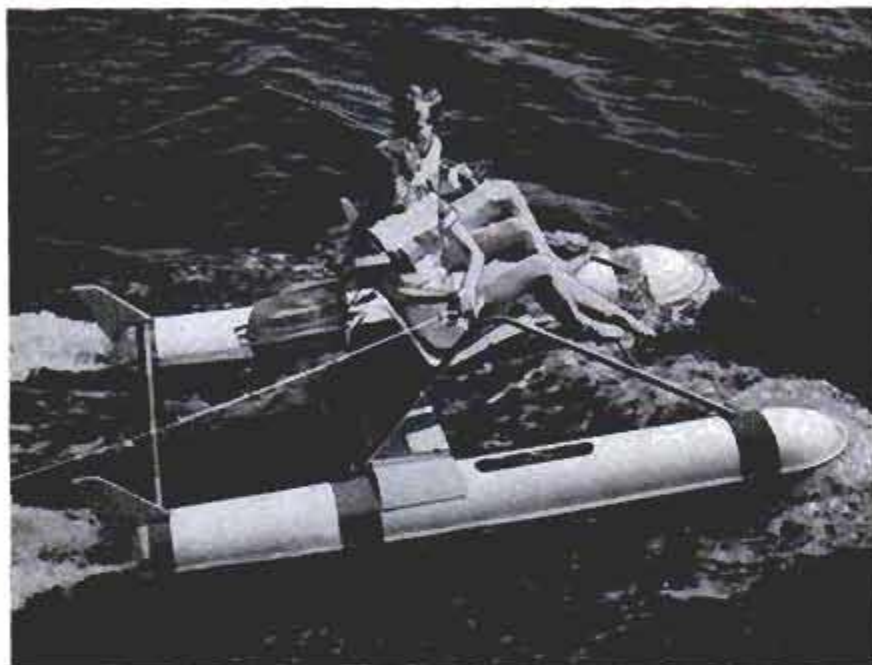

## Motor-Powered Pontoon Boat

Two 9-foot pontoons, made of polyester resins and glass fiber, are the hull of a new wave-skimming little pleasure boat for two persons. Each pontoon contains four airtight compartments for maximum safety. Power for the little craft can come from an outboard motor, a small airplane motor and propeller, or from paddles driven by pedals. A control stick attached to the seat operates a rudder for steering the lightweight craft.

## Cradle on Rails Totes Boats Across Land to Bypass Dam

Members of the Rock River Boat Association in Wisconsin have built a boat lift to bypass a dam, making 40 miles of the river navigable. A cradle rides on rails which go down into the water. The boat is floated into place and strapped to the cradle. The operator starts a motor which pulls the cradle out of the water. When the boat reaches the halfway mark in its 200-foot trip, the cradle is rotated 180 degrees to back the boat into the river.

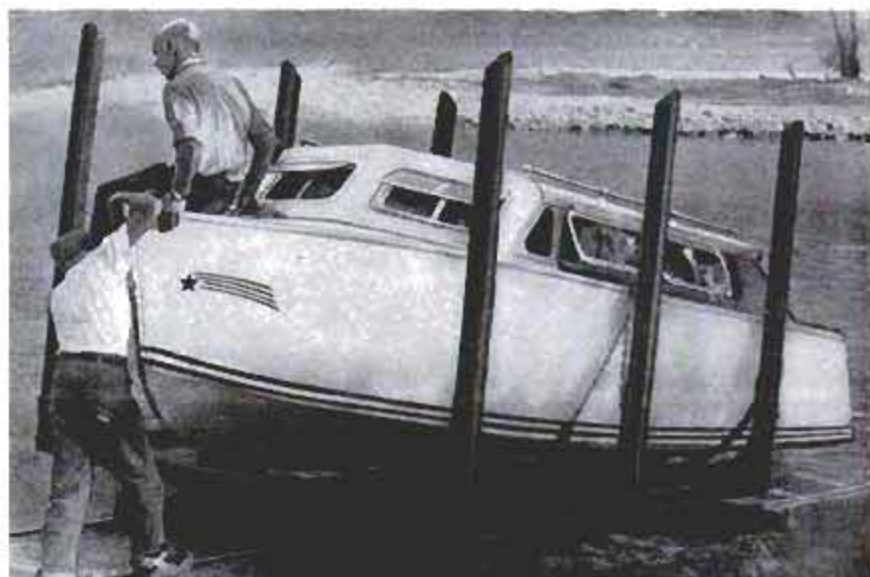

## Television Camera Lets Engineers See Under Car in Road Tests

Automotive engineers use television to see what happens under a car during testing. A small bomb-shaped camera that can be mounted almost anywhere beneath the car transmits to a television screen in the back seat. It can also broadcast the picture to the engineering laboratory so many engineers can watch the picture of the test at the same time.

Below, an engineer gets a TV closeup of the action of front suspension during the test

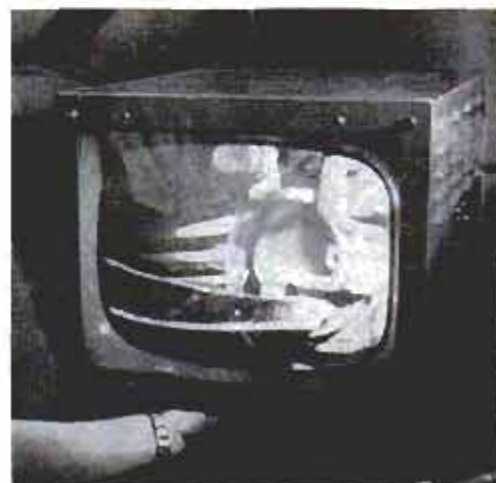



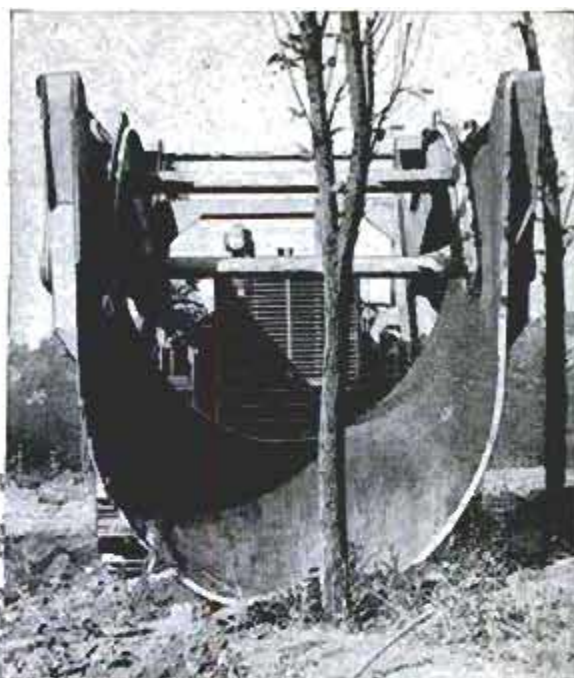

## BIG TREE DIGGER

SCOOPING UP a big bite of dirt six feet in diameter and three feet deep, a hydraulically operated tree digger is capable of transplanting trees up to 12 inches in trunk diameter and 40 to 60 feet in height. When transplanting even large trees, the scoop does not harm any of the important roots, and can complete the relocating in less than 30 minutes. The machine, invented by Edward Kluckhohn, of Naperville, Ill., is operated by one man.

Scoop lip is sharpened, and can cut through one foot of frozen ground. It will transplant trees up to 12 inches in trunk diameter and 60 feet high. One man can operate it

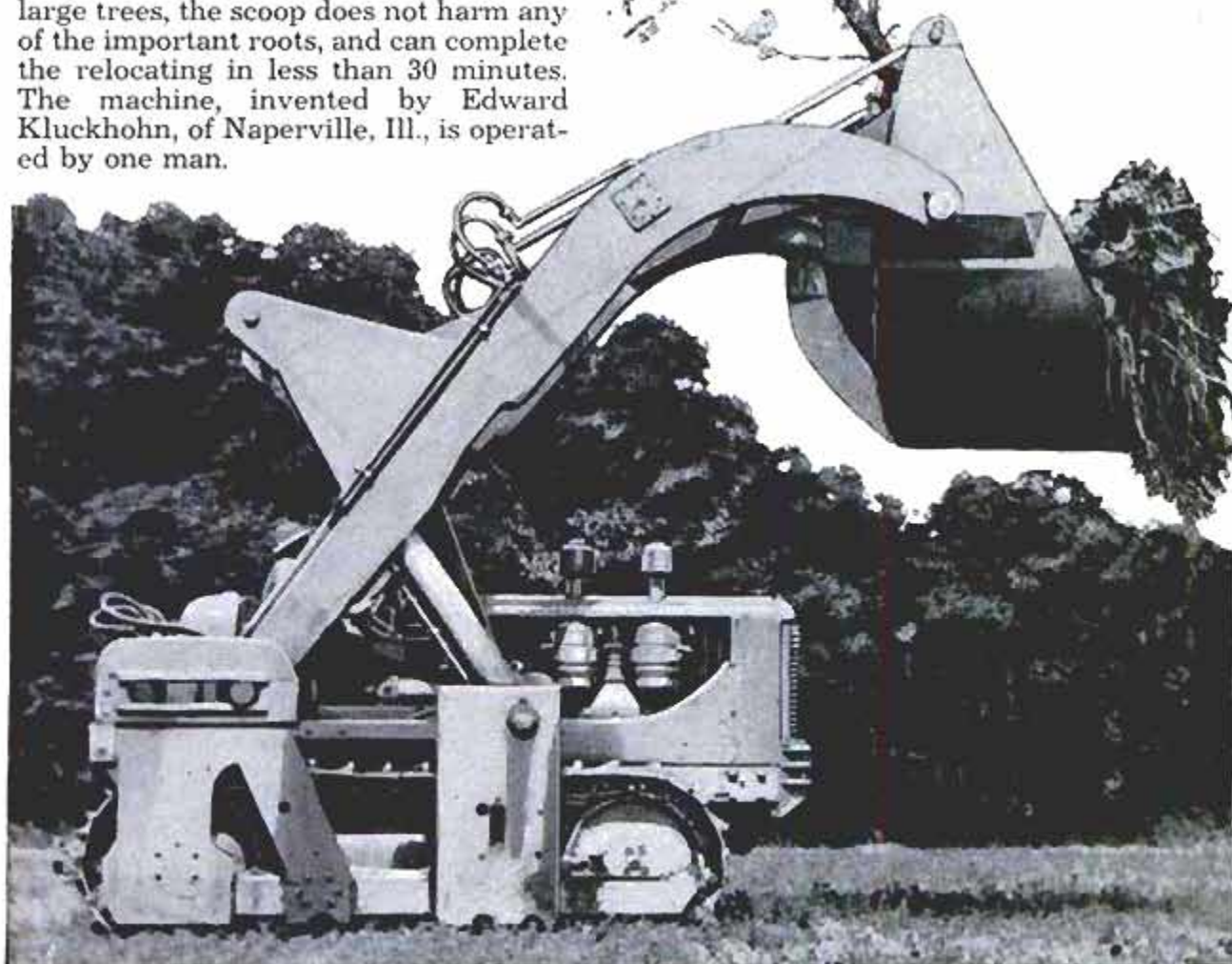



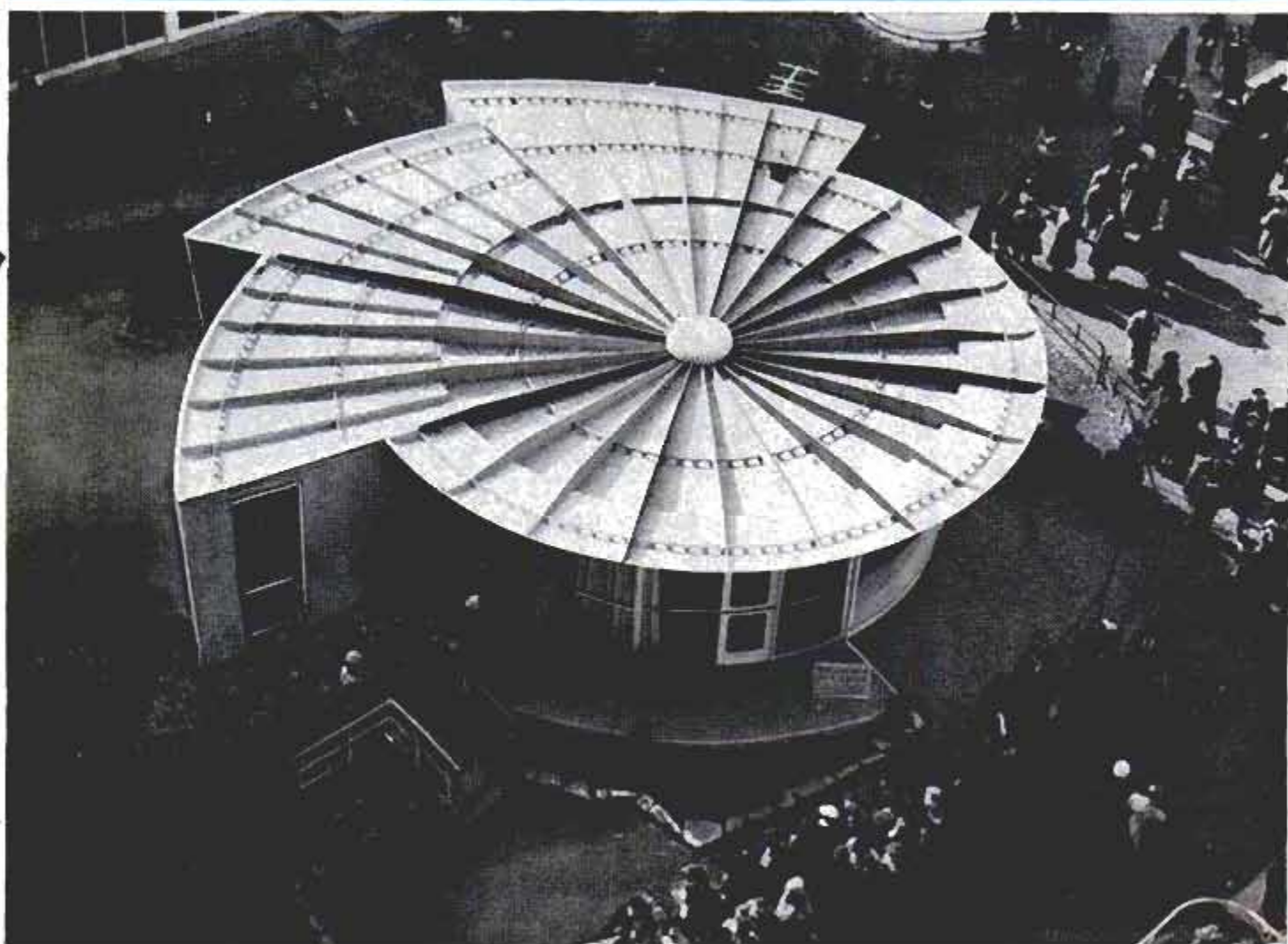
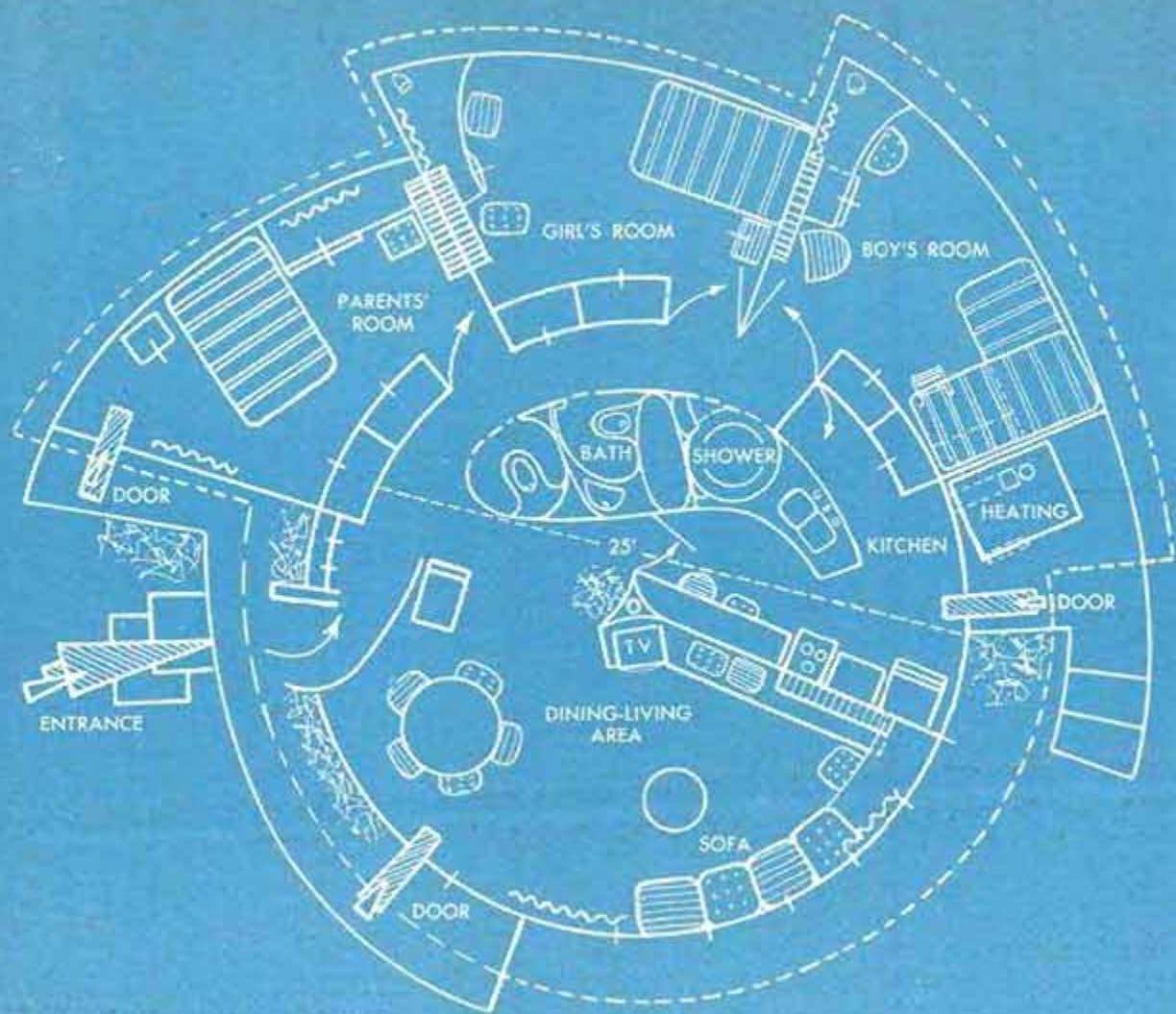



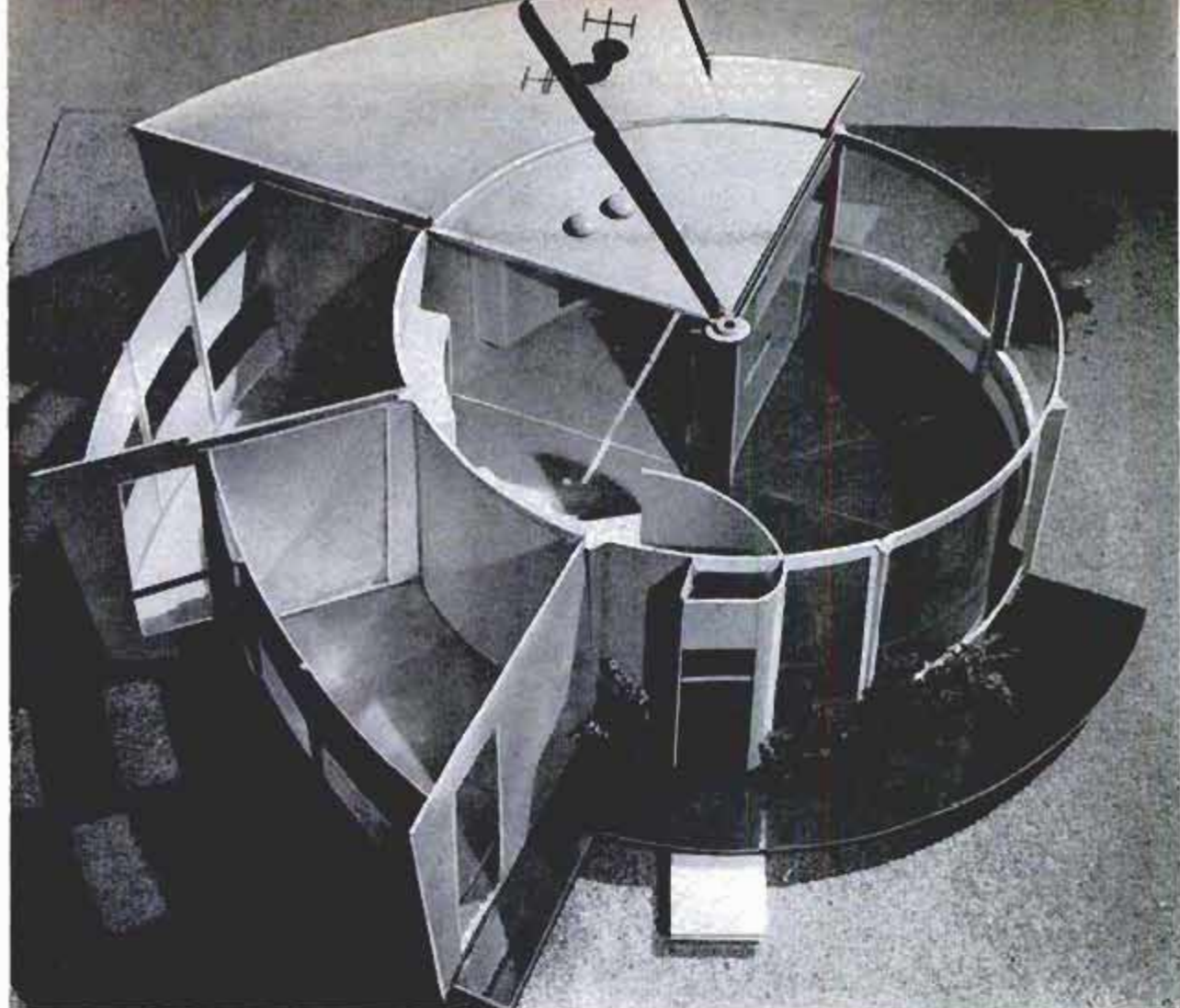

Cutaway model shows central living unit with curved window wall. Bedrooms are attached at the left side

## ***The Latest From Paris—an*** **ALL-PLASTIC HOUSE**

*By Leone and Lester Hayes*

**T**HE WORLD'S FIRST all-plastic house was recently exhibited in Paris at a home-furnishings show under the joint sponsorship of a French publication and the coal industry. Everything about the house is plastic—walls, ceilings, floors. The windows are Plexiglas; the entire bath and kitchen units and even the furniture and decorative fabrics are plastic. Only chair and table legs are metal. The house weighs nine tons or about  $\frac{1}{15}$  as much as if it were made of conventional materials. The central part of the house—itsself a complete living unit—can be set up in a few days, and from one to three bedrooms can be added in two hours each.

This is the first major plastics-molding job ever undertaken in France. There was no factory equipped for the project and no specialized workmen; the house was fabricated in an exhibition hall at the Paris

Furniture in boys' bedroom is all plastic, including "shell" beds and desk-book shelves. Walls and furnishings are washable and have "built in" color







Living room has nylon-cushioned sofa of molded plastic, glass-fiber chair and Plexiglas desk. Carpets in this all-plastic house are made of colorful nylon

fairgrounds by a crew of 40 men trained on the spot. Building the molds and casting the parts took four months, but the house is designed for low-cost quick mass production. At this preliminary stage, no price has been quoted for the house.

Five basic and 20 auxiliary wooden molds were constructed and polyester resin was hand applied over glass-cloth reinforcement (the same materials that go into glass-fiber chairs and auto bodies). For insulation, the outer walls are sandwiches of  $\frac{1}{16}$ -inch polyester-glass-cloth sheets with a filler of polystyrene foam (the brittle foamlike plastic used for Christmas ornaments). Floors are layers of the polyester sheets with inner core of two-inch Bake-

Single-mold plastic bath unit simplifies installation. It can be made in any color of the rainbow. Shower units are molded as separate compartments

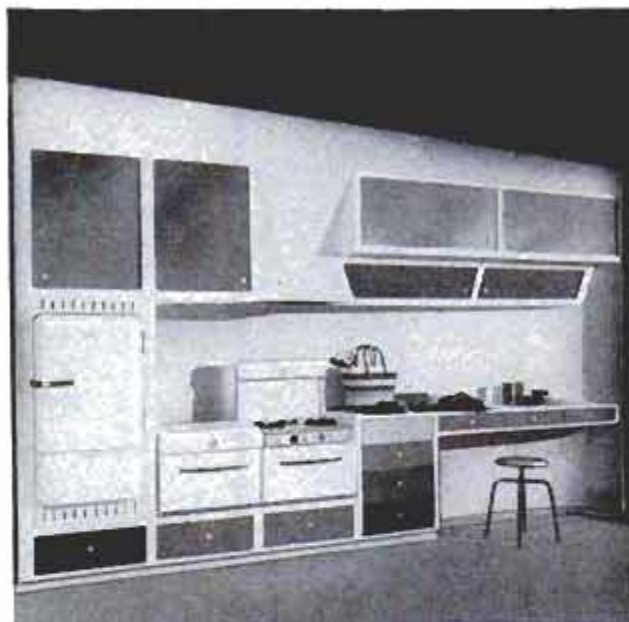
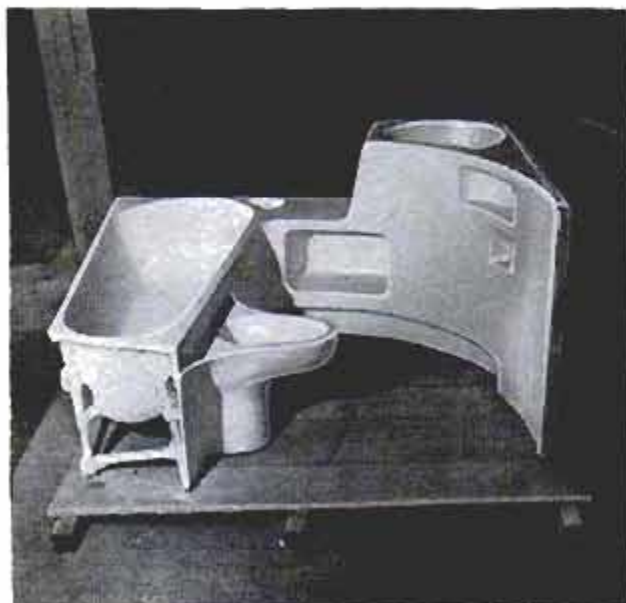

Entire kitchen unit, 12½ feet long, was cast in one mold. The doors and drawers are in various colors for decorative purpose and for ease in identifying

lite-treated honeycomb paper for sound-proofing. Inner walls are double layers of the polyester sheets.

The frame and floor of the central round unit are molded in wedge-shaped eighths of the whole that fit together like a pie. The roof-ceiling sections are also in eighths and lock together with fins that act as rain gutters, leading to the central drain that also services the kitchen and bath which are situated in the center of the house. Hot-air ducts are molded into the ceiling. Heat is supplied by an automatic plastic-encased coal-burning furnace.

"La Maison Plastique" is making headlines in France for the revolutionary use of plastic as a construction material. ★ ★ ★

To make section of house, workmen are coating glass-fiber reinforcement with polyester resins which set to an almost metal-like hardness. Crew numbered 40





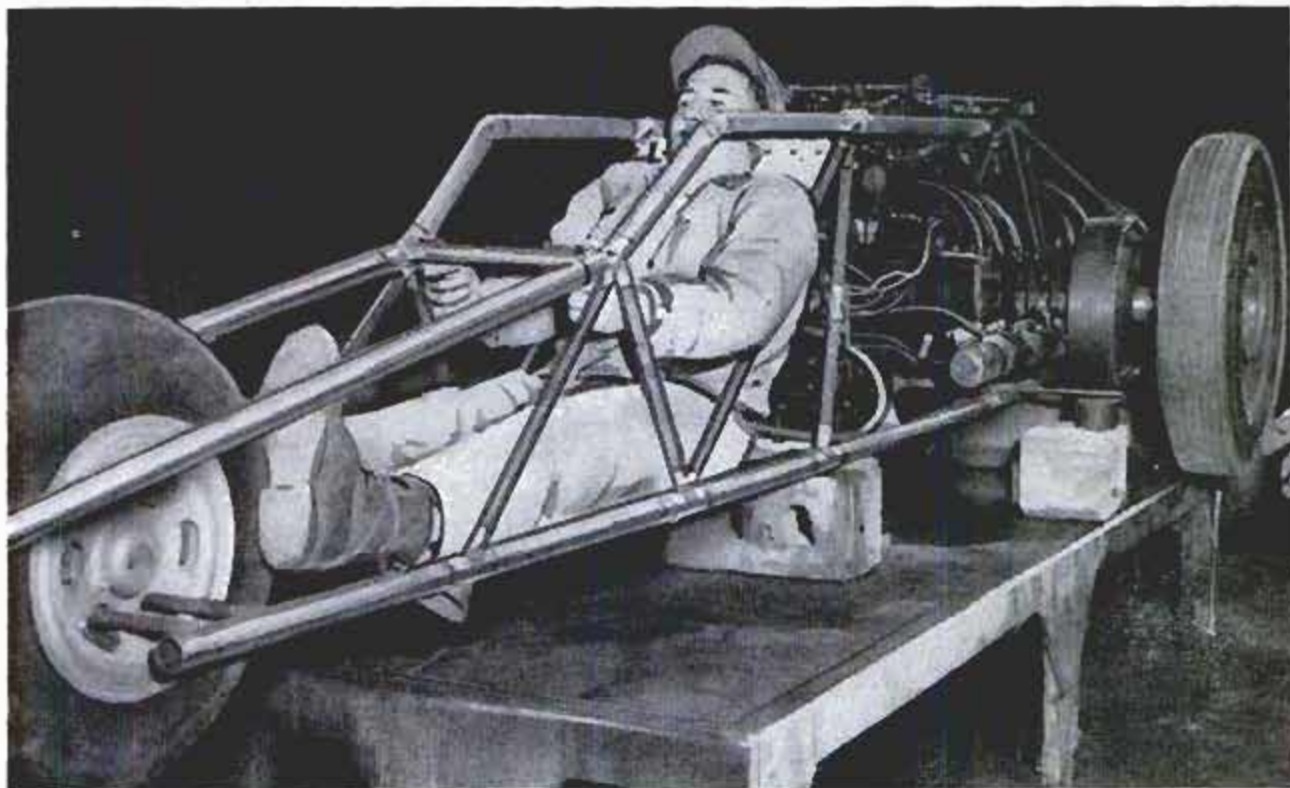

Art Arfons demonstrates driving position in the Monster. Car will have streamlined body as in sketch below

## Helicopter Engines Power This Dragster



MOST OF US would agree that airplane engines belong in airplanes. But not the three Arfons brothers of Akron, Ohio.

This trio of speed-seeking hot rodders (in the good and true sense of the term) have a habit of making airplane engines accelerate flightless vehicles to breathtaking speeds on a quarter-mile dragstrip.

Newest of the Arfons' kiwi-like speedsters is the Green Monster 9, powered by two helicopter engines. Combined, the two engines develop about 800 horsepower and, the three brothers claim, give the car power enough to break the record of 151 miles per hour held by another twin-engined car. That dragster combined an Oldsmobile and a Cadillac engine to set the record last year.

The Arfons held the record themselves in 1954 when an earlier Green Monster hit 132.35 miles per hour. It was powered by a 1450-horsepower Allison aircraft engine. Their 1955 version of the Green Monster used a Ranger Aircraft engine. The air-cooled helicopter engines (lighter than the water-cooled aircraft engines used

before are expected to provide more speed despite a lower power rating.

Along with more than 1000 hot rodders from all over the country, the Arfons' Monster will compete at the third annual World Series of Drag Racing held at Lawrenceville, Ill., sponsored by the Automobile Timing Association of America.

Two helicopter engines, below, are mounted over rear axle, the crankshafts joined by two pinions and a ring gear. Fluid clutches are inboard of the wheels. Original plans call for car to have three wheels, another may be added after testing

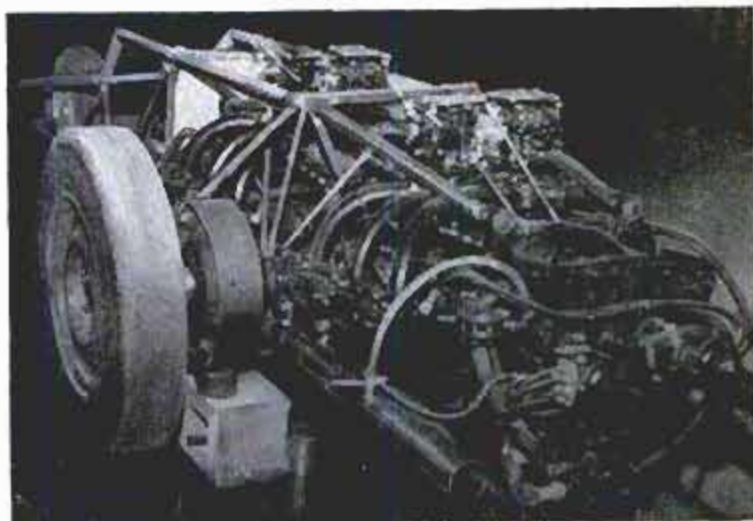





## DO NOT ENTER INFECTIOUS DISEASES

There is enough polio virus under strict control in this one small room to infect everyone in the world

By Thomas E. Stimson, Jr.

*Based on an interview with*

**Dr. Wendell M. Stanley, Nobel Laureate**

*Director of the Virus Laboratory,  
University of California*

**B**IOCHEMISTS believe the day is coming when they will be able to use laboratory chemicals to create organized structures that have some of the properties of living things.

Specifically, they hope to manufacture viruses that will grow and reproduce just as do their natural counterparts. When they succeed they will have taken a tremendous step toward the artificial creation of life itself.

Already, at the Virus Laboratory of the University of California, scientists have

gone part of the way toward building viruses from inert materials. Last year Dr. Heinz L. Fraenkel-Conrat and Dr. Robley Williams of the laboratory were able to create active viruses from the two materials of which these structures are composed.

Working with the virus that causes the mosaic disease in tobacco plants, they used a detergent to break down the virus into its two constituents, protein and a substance called nucleic acid. Each of these materials was rubbed on tobacco plants and was found to be totally inactive. Neither was



capable of causing disease. But when they were brought together again in a slightly acid solution, the mixture soon acquired the typical opalescent appearance of a virus solution.

Within 24 hours the protein and nucleic acid had arranged themselves into structures that had all the characteristics of the original viruses. They proved to be just as destructive. They had the same ability to reproduce.

This reconstitution marked the first time that a self-duplicating system had been assembled from inactive materials.

### Hybrid Viruses

More recently, protein from one strain of tobacco-mosaic virus and nucleic acid from another strain were used to produce hybrid viruses. These might be called wolves in sheep's clothing. One might expect them to behave as does the parent that contributed the protein, for it is the protein that largely determines the size and shape of the organism. Instead, the hybrids caused the same disease and did the same damage, or lack of damage, as did the parent from which the nucleic acid was taken.

The tobacco-mosaic virus is often used in basic research because it is easy to work with and can be produced in quantities. By studying it, general conclusions about other viruses can be reached and then followed up in detail.

Most viruses are smaller than bacteria, larger than the largest nonliving molecule. They occupy a sort of twilight zone between the living and dead. Many can be crystallized like inanimate matter, yet they reproduce just as if they were alive. They can mutate; that is, they can alter their character and pass on their new characteristics to their offspring.

Photographs made with color-translating microscope permit viewer to watch virus attack on tissue cell

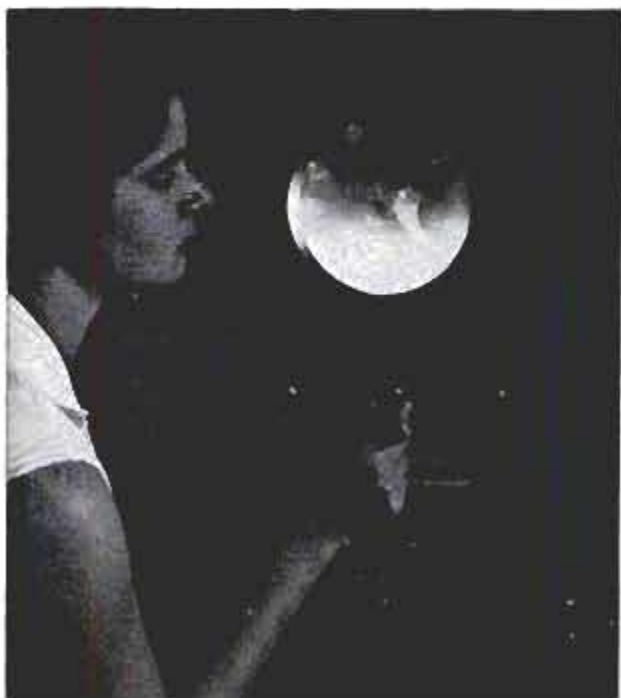

Refrigeration coils in centrifuge keep viruses alive while molecular weight of the substance is determined

Microscope, focused by TV, permits viewing under ultraviolet light, photography by visible light

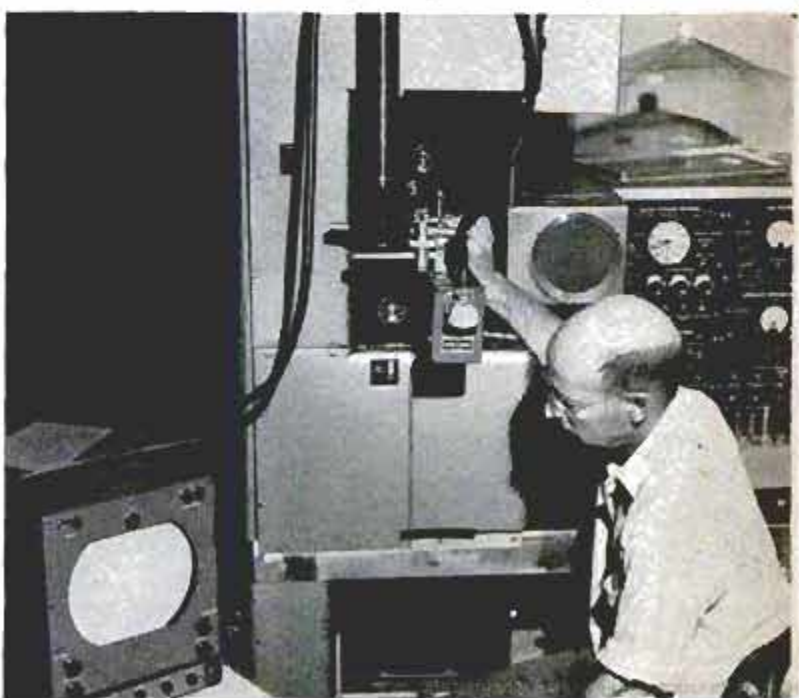





Complicated model is built to show a complex protein molecule. Such molecules, along with nucleic acid, form the viruses

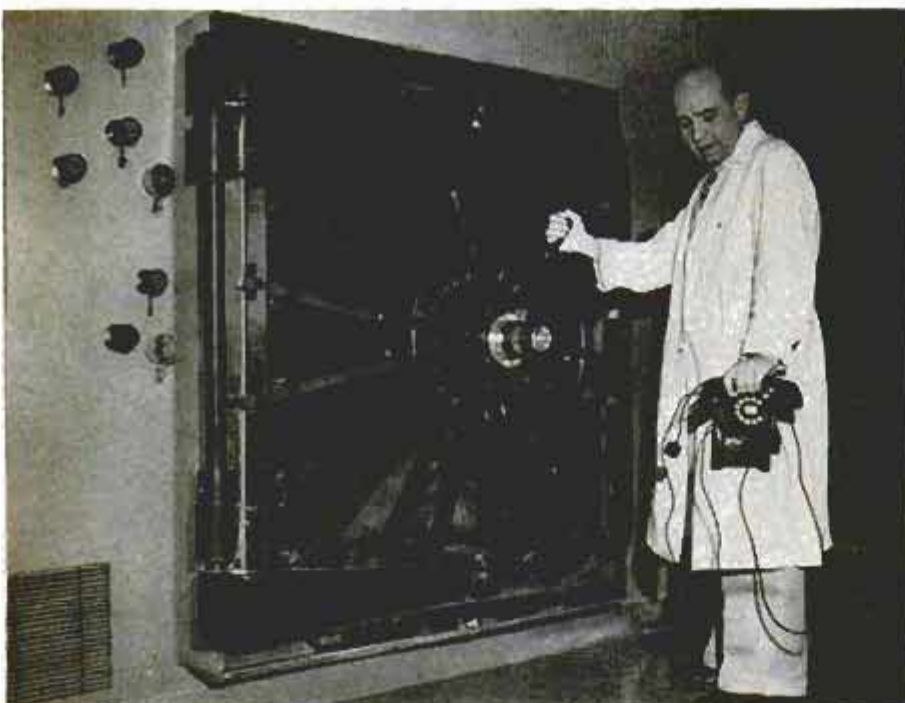

Equipment that must be removed from the isolation section goes into a steam autoclave for sterilization. Below, laboratory is one of the best-equipped centers for virus research. New type of electron microscope gives better photographic resolution



They come in many shapes. Photographed through an electron microscope that magnifies as much as 200,000 times, viruses that cause polio are found to resemble tiny tennis balls. Others that attack and destroy bacteria are hexagonal and are shaped somewhat like clubs. Those that cause tobacco mosaic resemble long rods.

The protein molecules of a virus are made up of smaller molecules of the amino acids, which are the basic building blocks of living tissue. There are about 21 varieties of amino acids. Basically, each is a different arrangement of carbon, nitrogen and hydrogen atoms, sometimes joined with atoms of other elements.

Generally the amino-acid molecules arrange themselves in the form of a helix in making up a protein molecule. This is the case in the rodlike protein of the tobacco-mosaic virus.

The nucleic-acid portion of a virus is arranged like strands that appear to be woven in and out among the protein molecules. Not very much nucleic acid is present, yet it appears that the nucleic acid determines the heredity of the whole organism. That is, it is responsible for the duplication of the structure, generation after generation. Recent evidence indicates that under certain very special conditions the nucleic acid alone may possess virus activity.

### Virus Diseases

Viruses are the cause of infantile paralysis or polio, influenza, yellow fever, smallpox, virus pneumonia and encephalitis, among other ills. They infect domestic animals with cattle plague, hog cholera, foot-and-mouth disease and the Newcastle disease of chickens. Still others attack almost everything that man grows. They destroy vegetables, grain and fruit. They cause the quick decline of citrus, tomato spotted wilt, alfalfa mosaic, tobacco mosaic and many other crop diseases.

They cause some cancers in animals and are suspected of causing some important forms of cancer in man. Cancer is not "catching," of course, like such virus diseases as mumps or polio.

Vaccines are excellent protection against some viruses, such as





Diagram shows how a hybrid strain of virus is made. "Doughnuts" in photo at left are fragments of the protein portion of virus. They formed the rodlike viruses at right when they were mixed with nucleic acid

smallpox. The smallpox virus mutates into a less virulent strain when introduced into the body of an animal such as a cow. The weak cowpox virus is then used to vaccinate humans. The human system produces antibodies to fight off the vaccine, and this protects against smallpox itself.

Some viruses can be inactivated with such a chemical as formaldehyde, then used as a vaccine. During the war the laboratory employed this technique to develop a vaccine that gives considerable protection against three strains of influenza, and this is now commercially available. The Salk vaccine against polio is a similar development.

(The common cold is probably made up of a whole family of ailments, some of which may be caused by influenza-type viruses and the so-called APC viruses—adenoids, pharynges and conjunctiva—of which there are more than a dozen strains. Investigators at the National Institute of Health have made some of these into a vaccine. It is reported that preliminary tests indicate that it may become very useful against common colds.)

#### Possible Hybrid Vaccines

But vaccines do not always provide 100 percent immunization. Thus the Salk vaccine has been described as being only 60 to 90 percent effective against paralytic

polio. At the Virus Laboratory the scientists are seeking new, positive ways of providing immunity to virus diseases. One field that is being explored is the hybrids. The research people want to take advantage of the fact that hybrids can be created that have the appearance of their "bad" parents but that are just as harmless as the "good" ones. It seems possible to create hybrids that are nonvirulent and that will cause the body to develop antibodies against virulent strains.

A further step would be to create a vaccine that consists only of the protein portion of a virus, with no nucleic acid at all. This, similarly, should immunize against attack, as has been demonstrated in studies of plant viruses. The protein structures, of course, would not be able to reproduce.

An eventual goal is to synthesize the protein portion; that is, to create it from laboratory chemicals. This may take five years or it may require 20 years of study. When this occurs, it should be possible to manufacture immunizing agents with ease, avoiding all the tedious and exacting steps that are now required.

Still other research is concerned with the unpredictable mutations that sometimes occur in viruses. This is important because mutation appears to be the reason why a normal cell suddenly changes into a cancer cell which then begins an uncon-





These are polio-virus crystals produced in laboratory. Largest contains 1,000,000,000 virus particles

trolled growth. Viruses are the simplest level upon which mutations can be studied.

The Virus Laboratory in Berkeley is possibly the world's most completely equipped center for research on the basic chemistry of living things. Aside from electron microscopes and ultracentrifuges, the laboratory uses a mass spectrometer, devices for making microbiological assays, and radioactive-tracer equipment.

One room is set up for chromatography and electrophoresis, new techniques for separating biological compounds. Experimentally, a television circuit connected to a microscope has been used. This combination makes it possible to view tissue cells on a TV screen while preparing to photograph the cells through a microscope.

In one small room alone there is enough active polio virus to infect every person on earth. Similar amounts of influenza and other disease-producing viruses are kept on hand, for these are the raw materials on which research is performed.

The portion of the laboratory in which these viruses are kept and studied is designated as an isolation section. It can be completely sealed off from the rest of the world. Its locked doors can be opened only with special keys. During studies on virulent cultures the research staff enter and leave through decontamination locks in which they take showers and change clothes.

A "contaminated vacuum" system pulls exhaust air from the isolation section through a bank of ultraviolet sterilizing lamps before the air is discharged to the atmosphere. No debris of infectious material ever leaves the isolation section; all such material is burned in a special incinerator in the section itself. A huge autoclave is built into one exterior wall of the section. Apparatus that needs to be removed from the area for overhaul can be placed in the autoclave for sterilizing, then removed via an outside door.

Reconstitution of viruses and the development of virus hybrids are only two of a number of important discoveries made at the laboratory. Here the freeze-drying technique was developed, by means of which minute organisms can be viewed through an electron microscope in their native, undamaged state. Here the purification and crystallization of the polio virus was first achieved, the first time that any animal virus had ever been crystallized. Here, too, the discovery was made of the value of human amnion tissue for culturing and growing polio virus. Not only is this material a safer medium for testing polio vaccines, but it may soon eliminate the need of importing from India the monkey keys that have been vital in polio studies.

The big job of the laboratory is to help in conquering the host of virus diseases that plague the world. At the same time, it is learning more and more about the big mystery of life, the way in which inanimate materials are joined together to become living things. ★ ★ ★

## Convair's Skylark 600 Is America's Newest Jetliner



Aimed at the medium-range air traffic of the future, the Convair Skylark 600 is the newest American jetliner to be announced. The Skylark will operate from 5000-foot runways, cruise at 609 miles per hour and carry 80 to 99 passengers. Cruising altitude will be 35,000 feet, and range will be 2000 miles. Four General Electric CJ-805 engines will power the craft.

Scientists have developed a new cold-cathode-type fluorescent lamp that causes no radio interference.



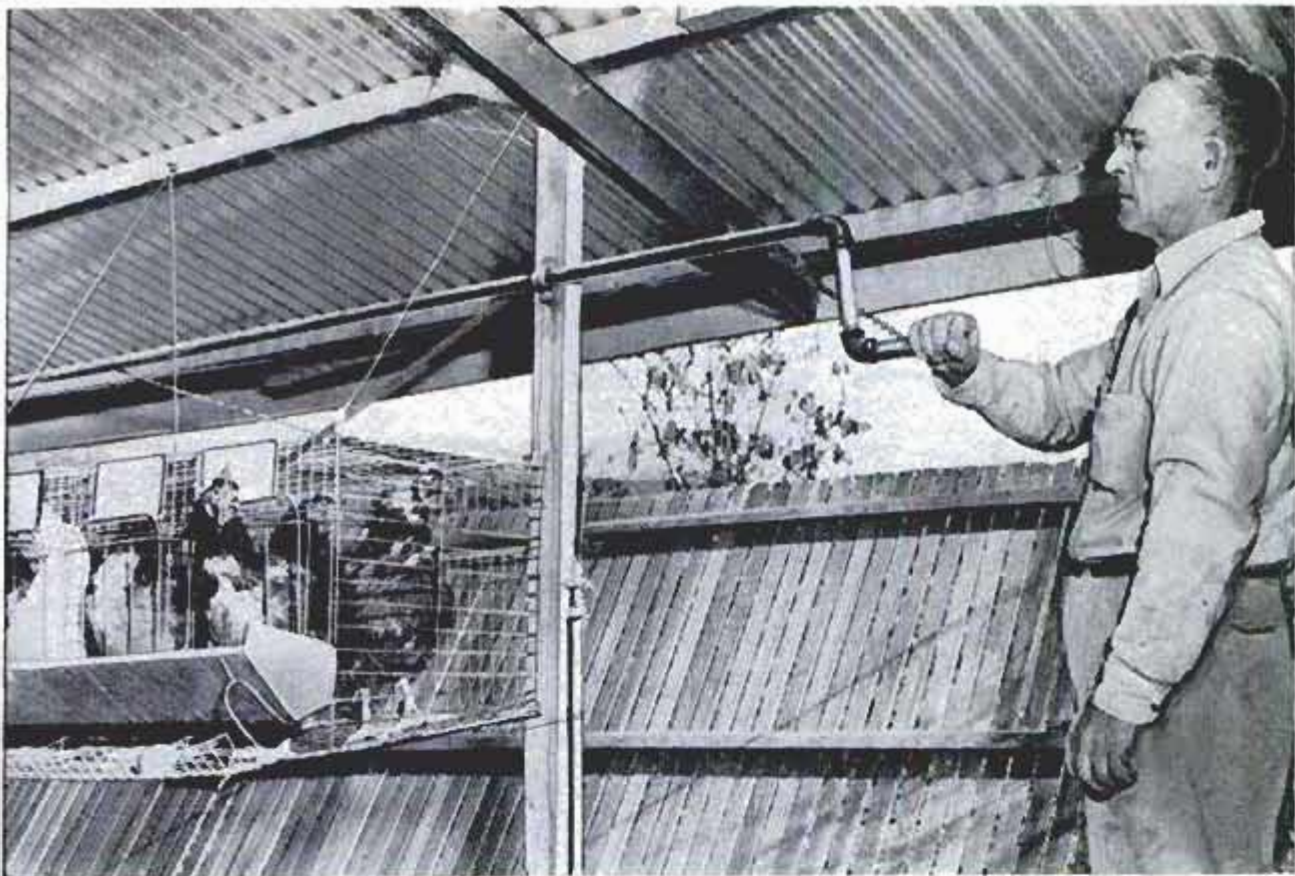

W. T. Ferris turns crank to lower or raise the side of chicken house and regulate the entry of cooling air

## Air Conditioning for the Chicken House

ENTIRE SIDES of buildings and large roof sections opened by a crank are among the many ingenious weather-control systems used by California poultrymen to fight the heat that can kill their birds.

The torrid temperatures which struck southern California the first three days of last September killed 1,000,000 chickens. One ranch lost 31,000 out of 50,000 birds. Some flocks of 500 to 1000 were completely wiped out.

But poultrymen who had the means of giving their birds plenty of roof shade, of allowing fast movement of hot air out of the buildings and a continuous flow of fresh air into them suffered only small losses. One well-protected flock of 25,000 birds had a mortality of only 100.

### Air Conditioning Saves Chickens

An excellent example of this type of "air conditioning" that eliminated loss is on the W. T. Ferris ranch near Yucaipa, Calif. The entire walls of each 100-foot house can be opened or closed at one time. Each wall is a single redwood-lath panel, six feet high,

Nonadjustable louvered side of Sheldon Crow poultry house helps keep inside temperature 10 degrees cooler

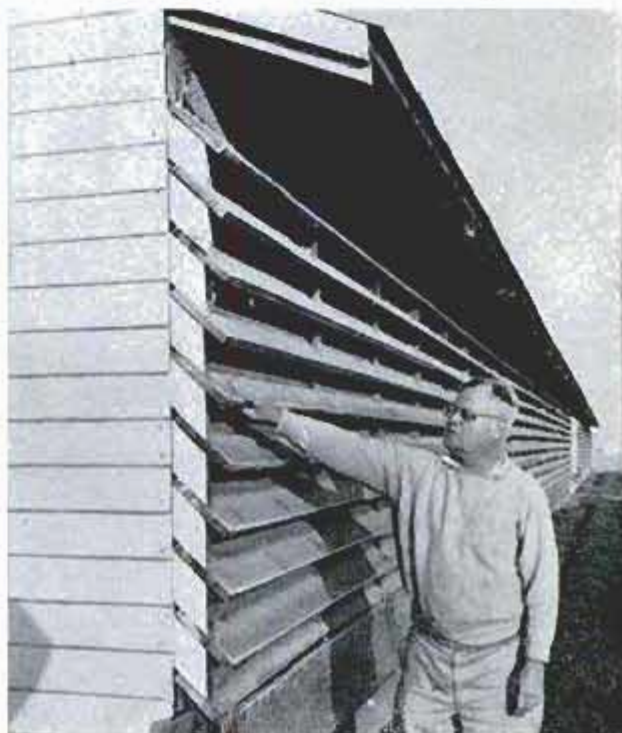



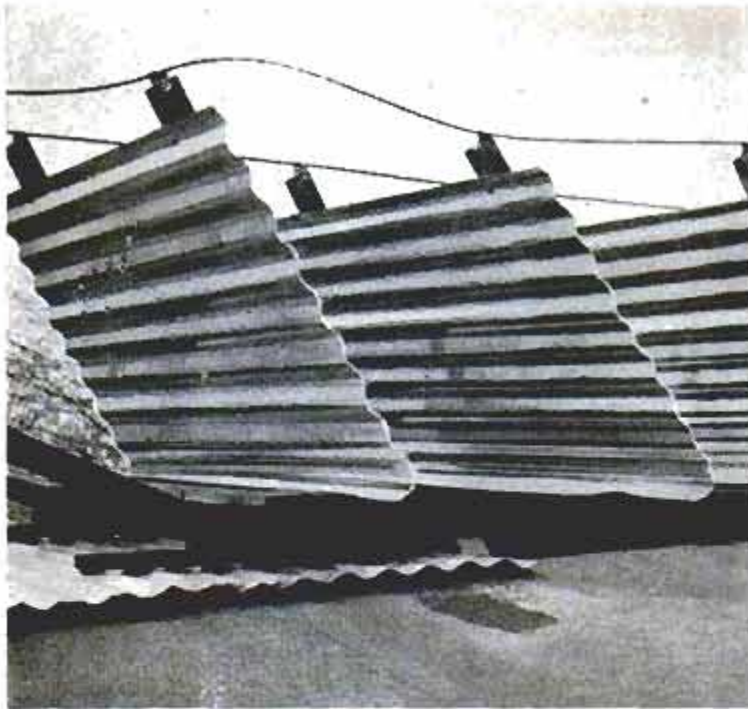

Fins on top of Clayton Smith laying house are raised to permit hot air to escape. Wires lead to winch that Smith cranks to open or close four-foot-wide roof opening that runs length of house

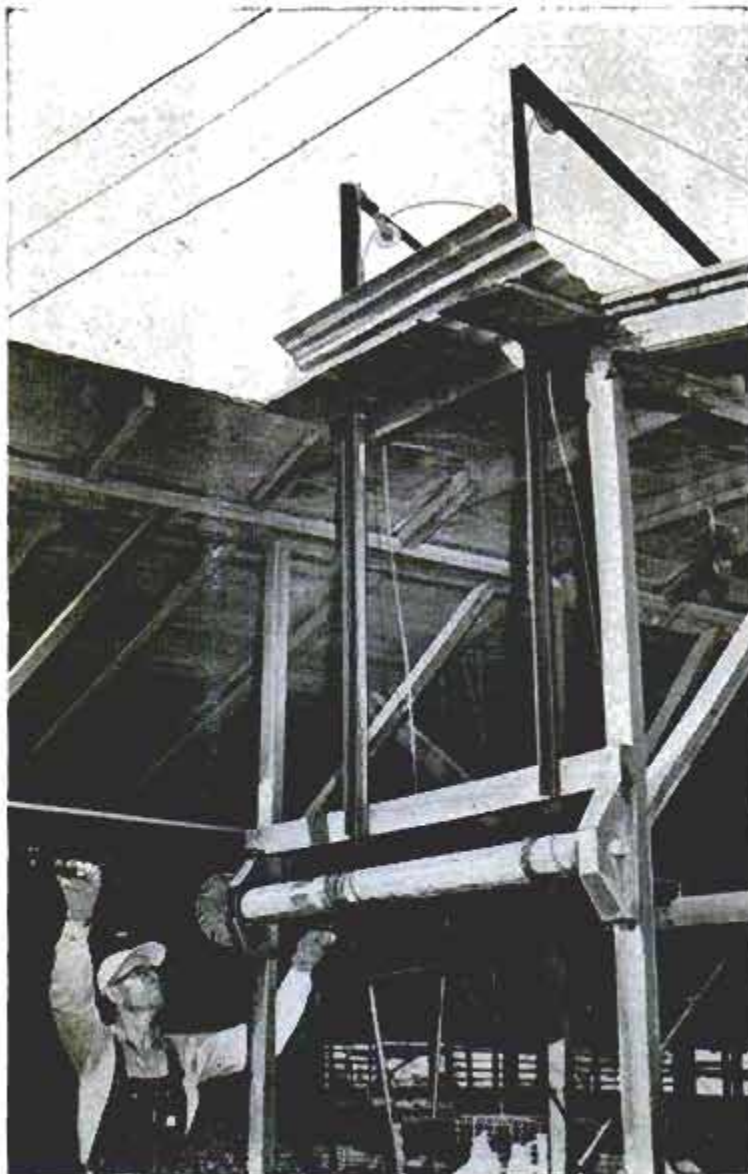

that is tilted outward and down by turning a crank. The wall is hinged at the bottom, and when it is opened it drops back from the eaves.

Short chains, fastened at five-foot intervals to the top cross piece of the wall, wind up on a 100-foot-long pipe that runs the length of the building. The  $\frac{3}{4}$ -inch pipe, held in place by metal clamps to the inside of the building studs, has a crank at one end made of short lengths of pipe and two elbows. The wall can be set at any angle desired or lowered flat to the ground to open completely the side of the house.

Clayton Smith of Palmdale, Calif., has developed a system that opens the roof as well as the sides of his laying house. This is necessary because the 200-foot-long building is 150 feet wide and not enough air can move in from the sides. The saw-tooth roof pattern has five peaks that run parallel to each other.

Each peak is ventilated from end to end with a series of five by two-foot aluminum fins that open up to allow foul air to exit through a four-foot-wide roof opening. The fins, connected by wires that lead to a winch, open or close together when the winch is turned with a crank.

The fins can be set at any angle from straight up to closed, enabling them to vent a maximum amount of air or to catch a prevailing breeze. In closed position, the fins rest on two by fours that leave a four-inch-high vent on each side.

The walls of this house are nothing but a series of doors, hinged at the sides, which open the sides of the house completely during warm weather.

The three by six-foot doors are made of corrugated aluminum mounted on frames of one by six-inch boards. Each door is hinged to a two-by-four wall stud and closes against the next stud, against a top plate and a bottom plate. Pulling or pushing a connecting rod enables one to open or close four doors at a time.

Smith's 112-foot-long rearing houses are of quite different design. Because the houses are narrow, no roof openings are necessary. Each wall is hinged at the



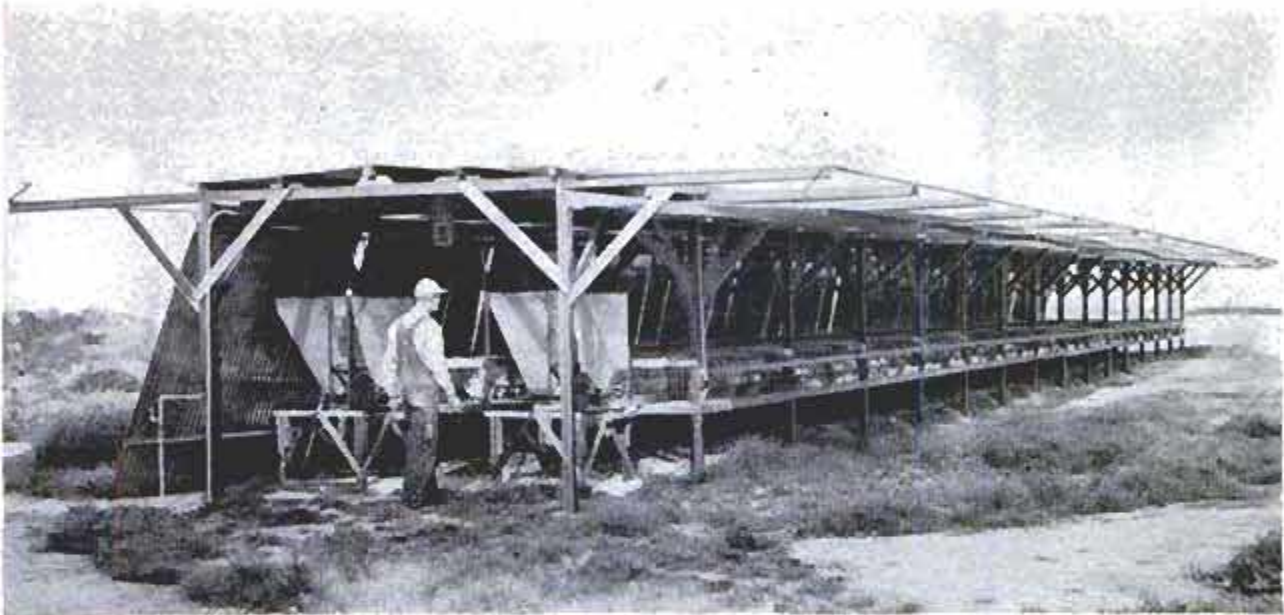

The sides of Smith's pullet house can be raised for cooling and extra shade. This house has no roof panels

top so that the sides can be opened for ventilation and extra shade.

The wall consists of eight-foot-wide aluminum panels mounted on a continuous frame. The space between the panels allows the building's side studding to set in the opening when the side is closed.

The horizontal rafters of the house are extended far out on each side to support a half-inch pipe that runs the length of the building. At each break between panels a length of sash chain fastens to the frame and up to the pipe. A crank is used to turn the pipe and wind up or unwind the chain, raising or lowering the entire side of the building. The lightweight aluminum and

the medium-weight framework boards make the arrangement possible.

Some poultrymen have found that opening only a portion of building sides gives good results.

Leo Zumwalt of Fulton, Calif., opens half of one wall of his poultry house by pulling a number of rods that raise sections of the galvanized-iron wall to form tiered awnings.

Weather is controlled in the Max Glick poultry houses at Lancaster, Calif., by adjustable wooden louvers installed along the entire length of the house.

Air conditioning on the Elmer Moreland ranch at Palmdale, Calif., is introduced by

Doors on Smith's laying house swing out rather than up. Connecting rods allow opening four doors at once





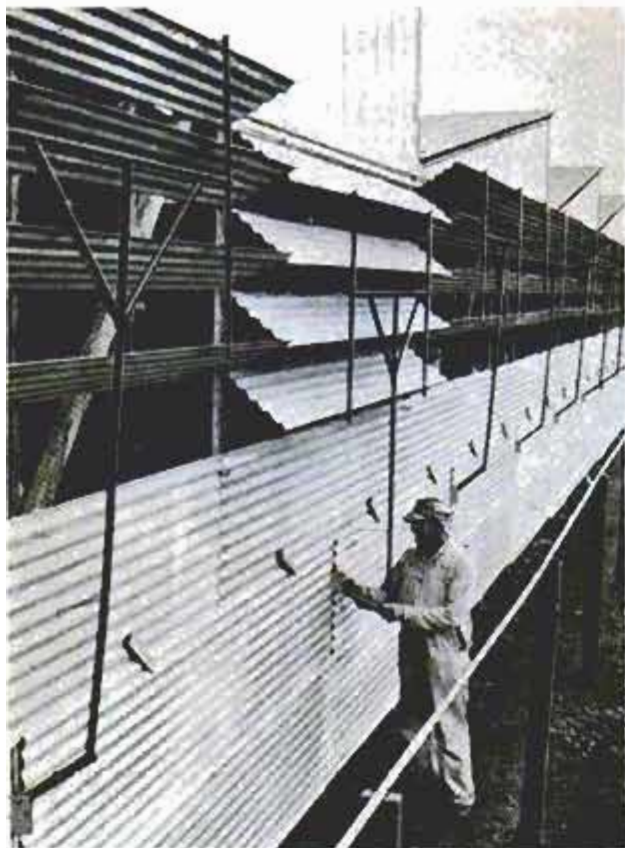

Panels in upper wall of Leo Zumwalt house open to any angle. Below, Elmer Moreland drops slatted panels. At right, Max Glick house has adjustable louvers



dropping sections of the slatted double wall, leaving every other slat open.

Sheldon Crow of Newman, Calif., has found he does not need a removable wall for good weather control. His walls consist entirely of heavy louvers that help to keep the inside temperature 10 degrees below the outside temperature.

Fred Ferris of Yucaipa, Calif., has developed a system of lath ventilator panels that are hinged at the top and attach to the outside eave of the building. The four-foot panels are swung up and outward and propped with a stick. They also furnish shade along the side of the poultry house.

#### Ventilation Is Necessary

Proper ventilation, poultrymen have found, is almost as necessary in winter as it is in summer. Plenty of clean, fresh air without drafts is always needed for the birds to breathe and to carry away the excessive moisture they create. A poorly ventilated house is an ideal environment for respiratory and other diseases.

The homemade California ventilation systems, by controlling air movement into the building and allowing hot and moist air to escape, promote poultry health and poultry profits. ★ ★ ★



### Elephant Takes to Florida Waters on 15-Foot-Long Skis



Latest Florida "tourist" to thrill to the joys of water skiing is a 1300-pound elephant recently seen gliding over the waves near Sarasota. Three-year-old Sunny, firmly anchored to a platform mounted on special skis 15 feet long and 2 feet wide, put on his act at a show sponsored by Sunshine Springs and Gardens. Supporting members of the cast included two humans.



## Tiny Mechanical Heart Will See Use on Humans

Not much bigger than a water glass is a low-cost oxygen pump that substitutes for the heart during operations. It has been successful in over 500 animal operations and its use on humans "is now imminent," according to Dr. Frank Gollan of the VA hospital in Nashville, Tenn. The \$250 unit is designed to replace previous large complex machines costing thousands of dollars and manned by several technicians.

## Degreaser in Spray Can

Removing grease from engines, motors and machinery is an easy project now. First the engine or motor is warmed up. Then a degreasing compound which comes in a spray can is sprayed over it and allowed to stand 15 to 20 minutes. During this time it softens the grease, so that later a simple flushing with water from a hose is all that is needed to wash off the grease. One can of the degreaser is enough to clean an automobile or truck engine thoroughly.

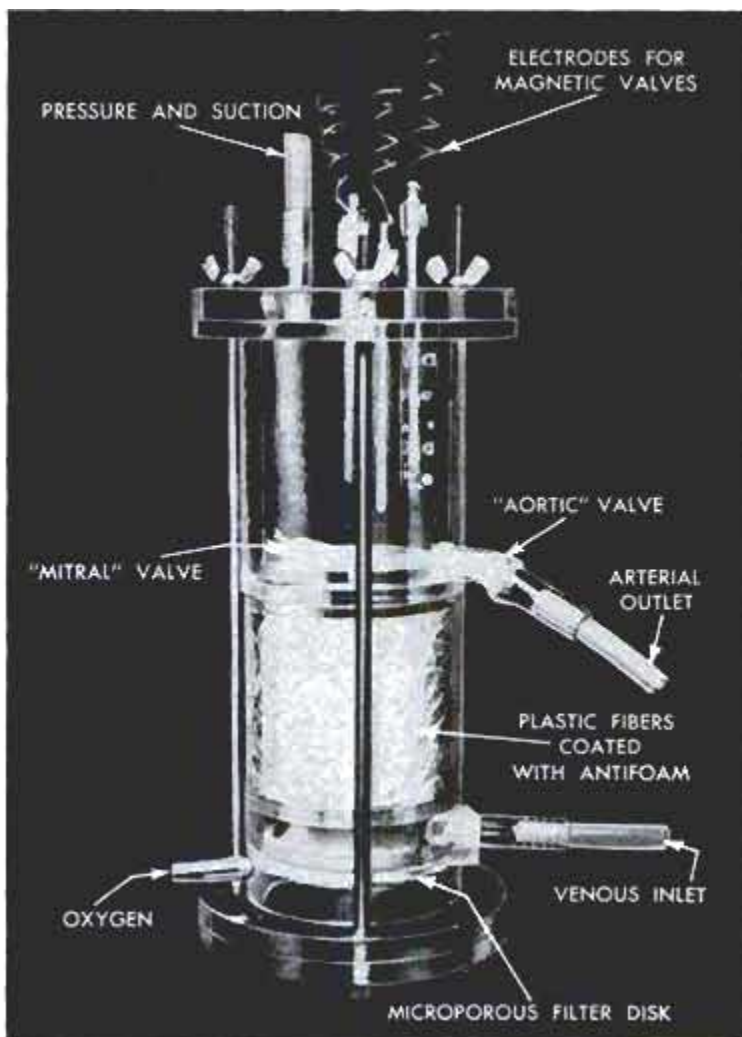

## Electronic Bank Clerk Processes 50,000 Accounts a Day

Capable of handling bookkeeping details on 50,000 checking accounts daily, the Bank of America's newest development in automation is an electronic brain made up of more than 1,000,000 feet of wiring, 34,000 diodes, 8000 vacuum tubes and weighing 25 tons. The machine reads checks by sens-

ing information printed on the back of each in magnetic ink and can't make mistakes. At the end of the month, printed statements for the bank's customers are turned out at the rate of 600 lines a minute. The machine has a special air-conditioning system to lower the heat it generates.

Electronic unit deposits, debits withdrawals, maintains balances and even prevents overdrawing of accounts





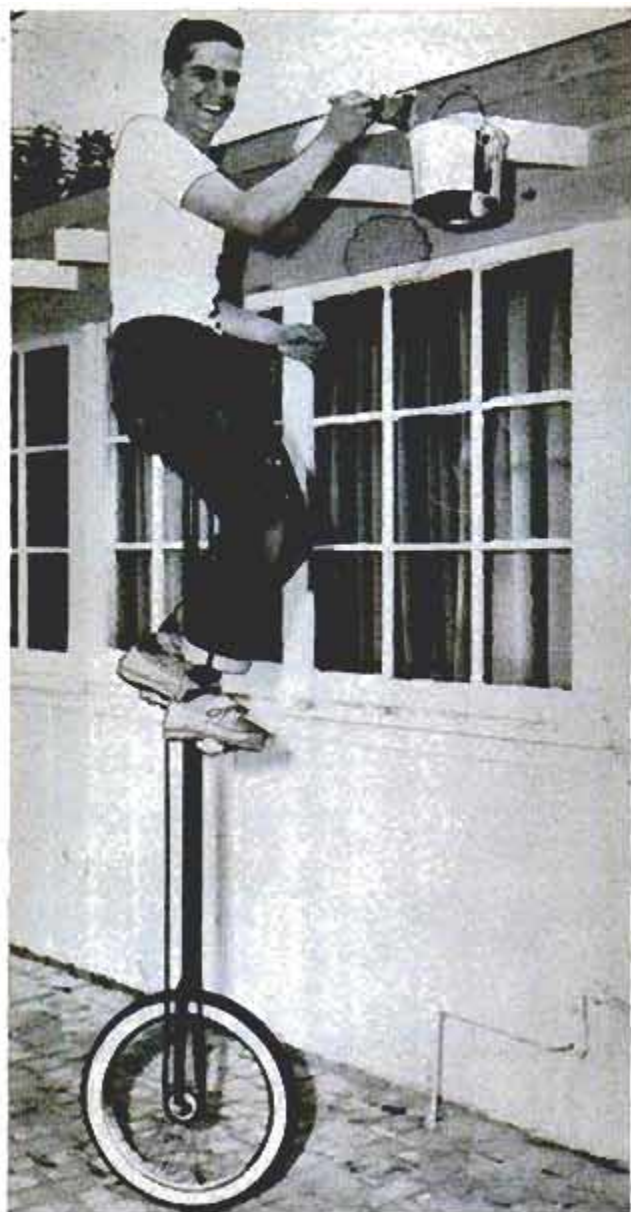

## House Painting the Hard Way —On a Unicycle

Sixteen-year-old Dale Bradley, of Santa Ana, Calif., is an expert unicycle rider who found himself faced with a problem when painting his house. He couldn't reach the eaves—and lugging a ladder around the job seemed cumbersome. So out came his unicycle, which put him at exactly the right height. (Note: This method is not recommended for those still riding the old-fashioned bicycle.)

## Tiny Bulb Designed to Twinkle

You can achieve a firefly effect in your garden with a string of bulbs that twinkle on and off. In each bulb is a small bimetallic strip that bends in one direction when it is heated up, in the opposite direction when it cools. This makes and breaks the electrical circuit to flash the bulb on and off.



The tiny bulb, the size of a rosebud, is intended for use in transformer-operated string sets like those used on Christmas trees. Wide use of the twinkling bulb during the Yule is expected.

## Inflatable Canoe of Rubberized Fabric Rolls Up for Portage

Pioneers once struggled to carry their canoes over portage trails between streams. The modern canoe owner, however, will simply let the air out of his inflatable craft, roll it up under his arm, and re-inflate it at the next river. The new canoe is a single seater, measuring seven feet in length, and is made of a rubberized fabric. The backrest and seat are cushioned in sponge rubber. The craft is manufactured in Great Britain.



☛ Synthetic blood vessels of knitted Orlon and woven nylon, used in artery grafts, are made without seams by a new method.



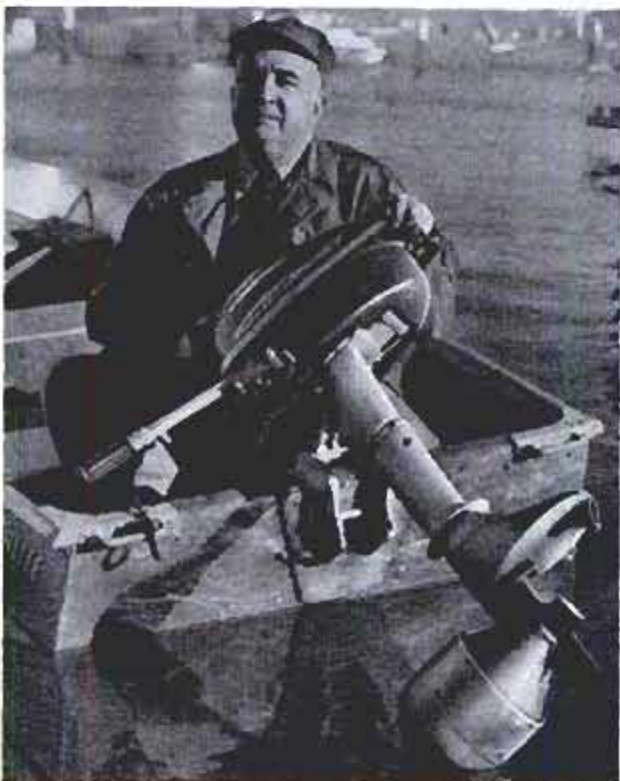

## Outboard-Motor Hydrojet Takes Place of Propeller

Underwater weeds and obstructions don't bother an experimental hydrojet that takes the place of a propeller on an outboard motor. Since it has no blades, the compact, inexpensive unit can't injure swimmers. When perfected and in production, the hydrojet is expected to equal the efficiency of a propeller and to cost little more. Water enters the cast-aluminum ovoid through a two-inch opening in its streamlined snout. A turbine-type impeller forces the water out through a ring opening halfway back to eject it over the streamlined tail without turbulence. The shape of the unit is said to make it superior to standard hydrojets. The new unit can also be adapted to inboards.

## Electronic Order Taker Put to Work at Drive-In Restaurant

Customers at electronically up-to-date drive-in restaurants can glance at a lighted menu card and phone their orders in by using a small intercom. The number of the customer's station appears on the receiver inside the restaurant. By flipping a switch,

the chef or cashier inside can reply to customer's questions. While waiting for his meal, the customer listens to music coming over the intercom. Brain of the entire system is an automatic "switchboard" inside the restaurant.

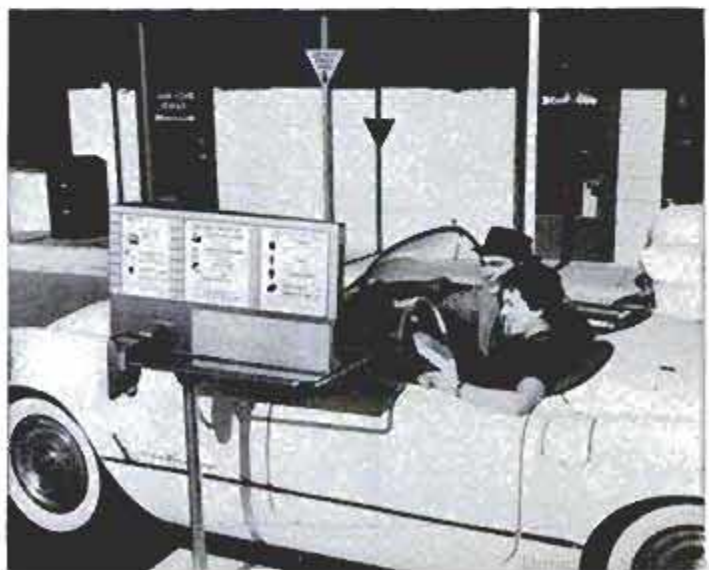



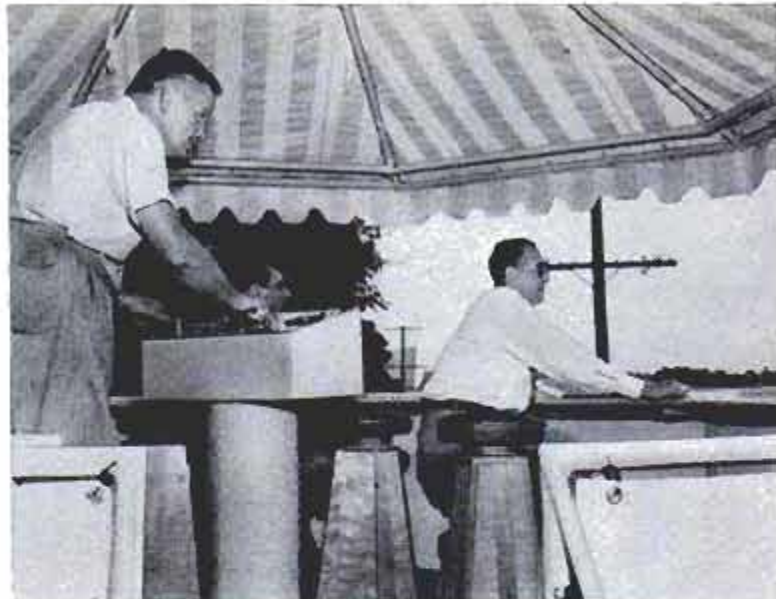

## Judges' Stand at Race Track Rotates to Follow the Running

Horse-race judges at the Indiana State Fair sit in a stand that rotates as the race progresses. Electrically operated, it turns at a variable speed controlled from a panel. The stand faces the starting gate and quick-

ly reaches top speed at the start, slows down for the back stretch and third turn, at times almost stopping, until finally it picks up speed for the finish. It gives eight officials an unobstructed view.

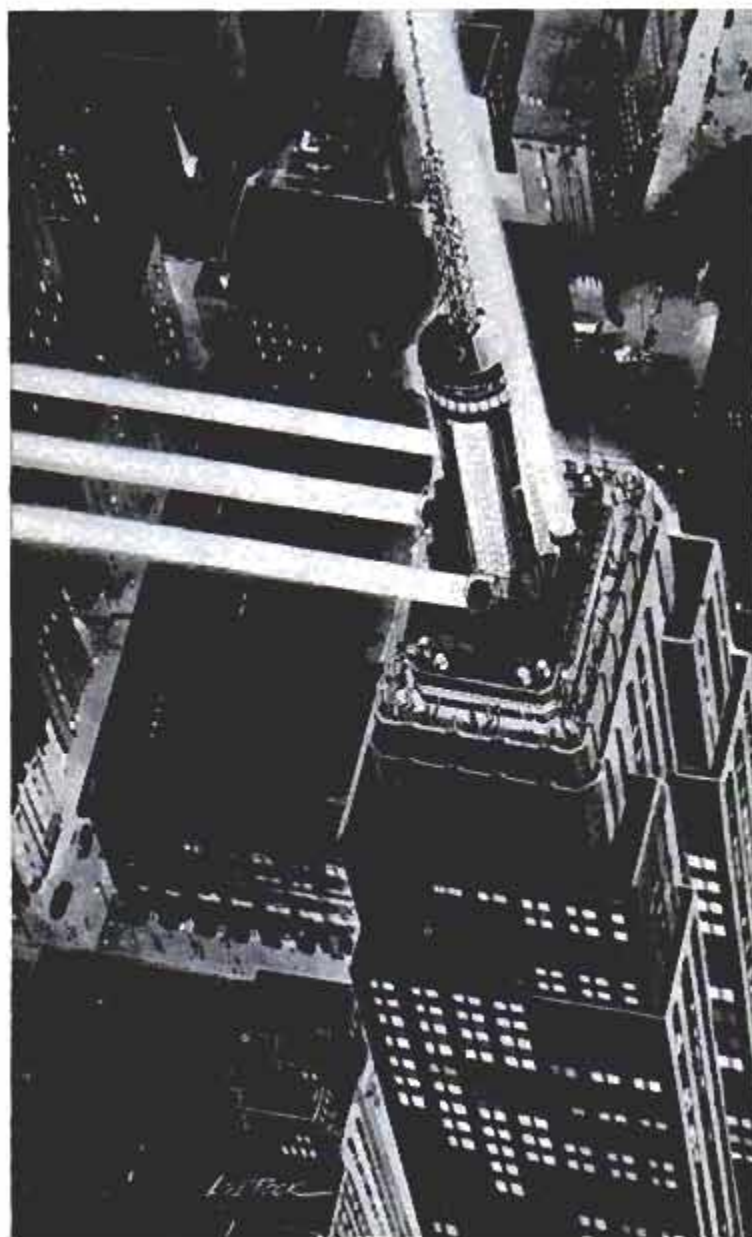

## Empire State Beacons Can Be Seen 300 Miles

New York's already spectacular skyline has been made even more so by four revolving beacons atop the Empire State Building. Under perfect conditions, engineers say, the lights could be seen 70 miles away by ground observers and 300 miles away by airline passengers. Generating a total of 1,800,000 candlepower, the beacons are said to represent the brightest continuous source of manmade light in the world. The path of the beams describes a complete horizontal circle around the building. After each beam completes a 180-degree horizontal arc, it turns upward and illuminates the tower as it completes the remaining 180 degrees in the circle.

## Antimoth Virus

British scientists have developed a virus which is deadly to the clothes moth. It can be sprayed or dusted on and kills the grub, not the grown moth. One disadvantage is that the virus will not stand up to dry cleaning, and treated fabrics would require a fresh application for every trip to the cleaners. Not yet available, it could be produced cheaply.



# Driverless Tractor "Stunts" for Safety

INSTEAD OF models, a riderless tractor is showing farmers how and why tractors tip over, killing some 700 persons each year. Agricultural engineers at Iowa State College rigged up the demonstration.

Two grounding switches were installed on the ignition system of a standard tractor, with ropes leading from them to shut off the engine at any time. Another rope led to the clutch. An inverted V-frame shields the steering wheel and another frame the radiator when the tractor tips backward. The fuel cap is sealed to prevent spilling when the tractor upends itself.

Spectators are shown that hitching to the rear axle or to any point above the center of gravity tends to make the tractor rear up and backward to crush the driver.

To show the danger of driving across slopes, the rear wheel is driven over increasingly steeper ramps—first with the rear wheels set close together, then with the wheels set to their maximum tread. A much steeper ramp is needed to tip the wide-tread tractor. "Once they see this, they spread the wheels out as soon as they're through plowing," engineers say.

With the steering wheel tied, the tractor is then run in a circle at a set speed. To illustrate the danger of hitting holes or obstructions when turning, a seven-inch block is tossed under the inside rear wheel, causing the tractor to topple. In a similar demonstration, the tractor makes increasingly smaller circles until it tips over at a speed of only six miles per hour.

When one wheel is run over ramp, tractor is guided by wooden rail between two front tires. Yank on rope will stop engine



Rear-axle hitch causes tractor to rear backward



Upended tractor rests on V-frame. Below, tractor jumps the steering rail of ramp and starts sidewise tip. This tractor was used because it adapts to remote control

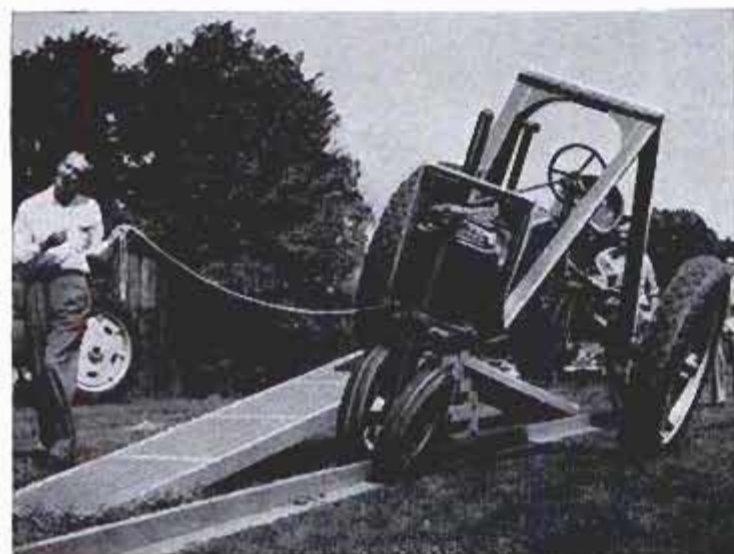



WHAT'S NEW FOR  
Your Home



1

**1. CANVAS PLAYPEN** is portable and can be washed in washing machine. Indoors, tentlike pen protects baby against drafts; outdoors, it serves as a sunshade. A canvas floor is sewn right in. Front panel is adjustable in height, so that pen can be used by children of various ages  
Tend-A-Tot Corp., Box 6009, San Diego 6, Calif.

**2. RUBBER WEBBING** replaces springs in new type of furniture construction from Denmark. Foam-rubber cushions, covered with fabric, are placed on the webbing to complete piece. Frame is of teakwood. Designs became available in this country this year  
Modernize, Inc., 660 Lake Shore Drive, Chicago



2

**3. COOKIE DROPPER** scrapes itself clean as it places dough on cookie sheet, eliminating need to use two spoons, and both hands. Made of stainless steel and six inches long, it requires only a squeeze of the hand, after dough is scooped up, to shape cookie  
Foley Manufacturing Co., Minneapolis 18, Minn.



3





**4. NURSING-BOTTLE HOLDER** suspends the bottle on an elastic cord over the baby's mouth where he can feed easily without danger of losing the nipple. Any size or shape of bottle can be used, and between feedings tripod can serve as a toy holder. Support is adjustable to fit any crib, bassinet or buggy

Stuart F. Faunce, 404 Sauk Trail, Park Forest, Ill.



**5. RUFFLE IRON** adapts for home use, an idea long used by tailors providing a small heated head across which material to be ironed, such as ruffles, pleats, etc., is pulled by hand. Only slight hand pressure is required. Dial regulates temperatures for different fabrics. Iron clamps easily to counter

Harris Industries, Inc., Stamford, Conn.

**6. HOSE COUPLER** snaps hose to faucet, eliminating tedious threading-on, dripping and corrosion-lock common to standard screw-on type of garden-hose coupling. Coupler works on patented vacuum-lock principle so that when water is turned on, pressure locks coupling, which is plastic, in place

Hunter Tool Co., 6608 S. Gretna Ave., Whittier, Calif.



**7. AUTOMATIC APPLIANCE CENTER** for kitchen provides ample current for simultaneous operation of five electrical devices. Wired for 220 volts, unit has provision for timing all five circuits. Three extension cords for plug-in appliances are built in, and the unit has its own circuit breakers with reset switches

Westinghouse Electric Corp.,  
246 E. Fourth St., Mansfield, Ohio

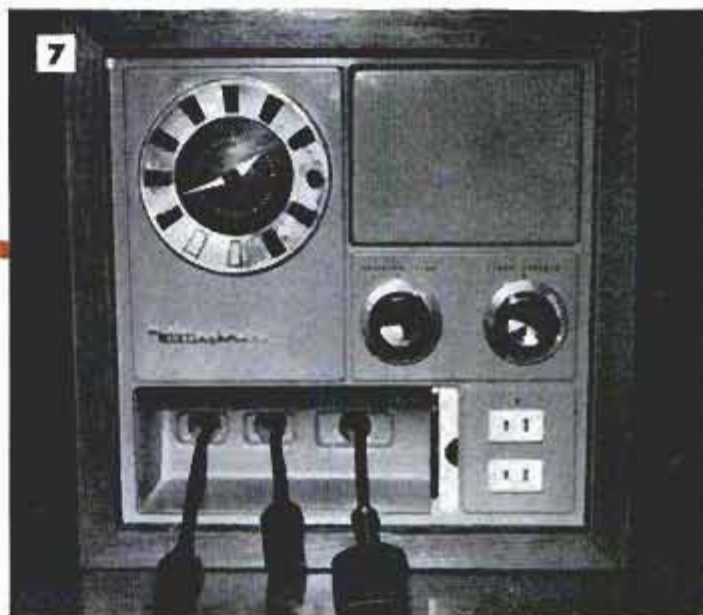





White arrow points to the gas-turbine starting pod. The pod can be carried on plane or mounted on wheels

## Gas-Turbine Pod Mounted on Navy Fighter Starts Jet Engine

Navy F3H-2N Demon jet fighters get started with the aid of a pod containing a gas turbine that compresses air for actuation of the starter. The unit can be attached to the plane or fitted with its own "landing

gear" and operated on the ground. The five by two-foot, 450-pound pod is of particular value during ferry flights or at bases where standard starting equipment is not available.



## Fire Escape Swings Out

Two and three-story dwellings can be equipped with a fire escape that swings out of concealment and lowers a rigid telescopic ladder at the touch of a lever. When not in use, it is folded compactly against a door. When the door is opened, an iron platform is swung down around the top of the ladder to aid descent. The unit operates by gravity and spring action. It is not yet in production.





Snoozin' in the shade on a summer afternoon is pleasanter under an umbrella that is easily adjusted to follow the path of the sun. A ball-and-socket joint at the top of the stem permits it to be tilted forward, back or to either side, and also permits the umbrella to be swung to any position in a full circle. The stem is offset to one side, so that all of the shade area under the umbrella may be utilized without interference. The cover is 54 inches square, of heavy-duty canvas and comes in solid colors or two-tones set off with a valance and fringe.

## Adjustable Lawn Umbrella Follows the Sun



## Golf-Ball Retriever Used Like Cane

For the practice driving range, a new device takes the work out of picking up golf balls. Used like a cane, the device will hold up to 20 balls, and picks them up when forced over them. A flexible plastic ring in the lower end permits the balls to enter the plastic cylinder, but will not let them drop out. A screw cap at the top makes it easy to unload the balls.

Retrieving a golf ball with the cane is simply a matter of placing the open bottom end of the cane over the ball and pushing down

## Push-Button Awning Driven by Motor

Store awnings are rolled up or down at the push of a button by a motorized unit that is installed on the average awning in an hour. A time clock or electric eye can be attached to the inside unit to roll the awning up or down automatically. The unit will operate any size awning and combines small size with simple installation.

☐ Ten million homes have been built in the United States since 1945, according to the National Association of Home Builders.

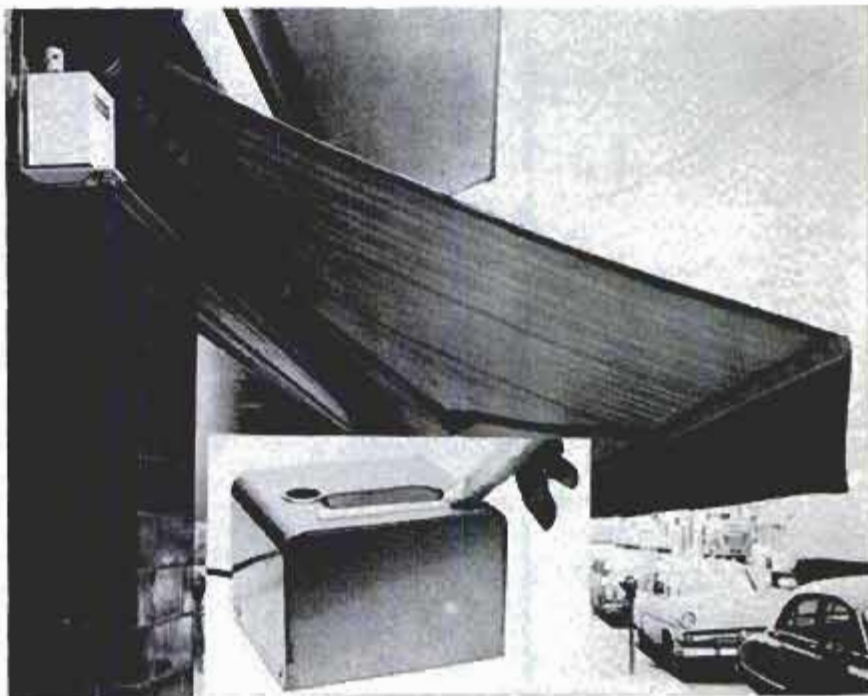



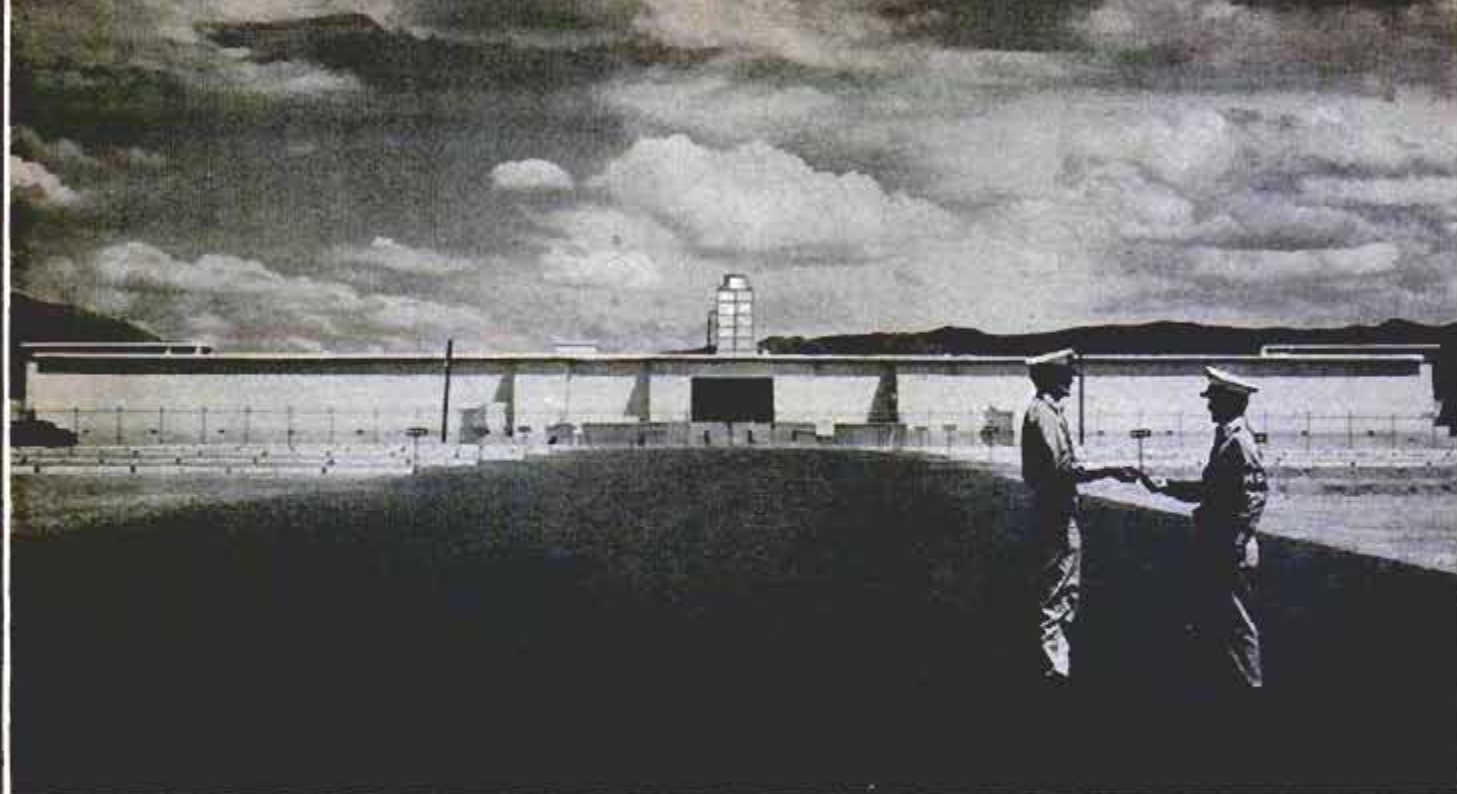

Grim facade of nation's atom-bomb school is windowless, has only one door. Tight security is maintained

*Out on the New Mexico desert is a concrete blockhouse nicknamed by its GI students "The Kremlin." This is where*

## Privates and Generals Study A-Bomb

*By William Harnin*

**T**HE "VAULT" is windowless. Its single door is threaded with silver burglar-alarm foil. About the entrance to the huge ultramodern structure in the New Mexico desert, armed MPs pace a 24-hour vigil, and a miles-long security fence warns off the unwary visitor.

This desert blockhouse, a honeycomb of classrooms, lecture halls, movie theaters and atomic laboratories, is called the Vault or, more ironically, by its GI students, "The Kremlin." It's the fortress heart of the nation's nuclear-training program for military personnel.

Located in the top-secret, heavily guarded military technical area on Sandia Base, home of the Armed Forces Special Weapons Project in Albuquerque, N. Mex., the hulking stone building is an atom-bomb college, a nuclear-weapons institute for privates, captains, corporals, even four-star generals who are learning in short four-day to six-week courses what makes an atom bomb tick. Here, Uncle Sam's military men of all services are studying the capabilities and limitations, the hazards and precautions of nuclear special weapons.

Mission of the Armed Forces Special

Weapons Project at Sandia Base is the training of service people in all atomic weapons: Bombs, artillery shells or any weapon which carries an atomic warhead. AFSWP is a partner in a giant interservice, interagency joint effort aimed at providing the United States with a supply of atomic-trained technicians.

Working closely in the program are the Atomic Energy Commission, which builds and develops nuclear weapons, later stockpiles them; the AFSWP which trains personnel, and develops and procures equipment for atom-weapons handling; and the Air Force Special Weapons Center at nearby Kirkland AFB which modifies and tests airplanes to transport and deliver nuclear bombs.

Students at the Kremlin, the nation's sole atom-bomb school, for the most part volunteers, study toward diplomas in nuclear supervision, atom technology and special-weapons mechanics. They wear no distinctive badge or insignia. Many are fresh from high school. Others are college graduates with several degrees. Their average age is 23 to 29. They're young, willing, possess good mechanical aptitudes. They hold one





of the highest IQs and educational levels of any military installation in the country. Even military policemen assigned to Sandia Base, because of the rigid security screen thrown about all of the Kremlin's atom instruction, are hand-picked.

### Study Nuclear Technology

Atom students at the Kremlin learn nuclear technology in lectures, movies, classroom demonstrations, in libraries and study halls. Daily, the atom men struggle with unfamiliar concepts of critical mass, radioactive decay, isotope and binding energy. They run through complicated preparatory drills, field-strip bombs, rebuild them again. A typical examination question:

"Explain the neutrino hypothesis." Another: "When is the critical mass level realized?"

Although the atom-bomb school was originally established to train military men, many senators, representatives of the Joint Committee on Atomic Energy and the Joint Chiefs of Staff visit the project periodically to be briefed on the latest developments in atomic ordnance.

During his term at the school, a student may learn the assembly, loading and handling of nuclear bombs and weapons. He memorizes the bomb inside and out. But only dummy bombs are handled, not live units.

Apart from a restricted study of atom

Left, a student learns safe-handling techniques. Right, books and class notes are kept in safe overnight





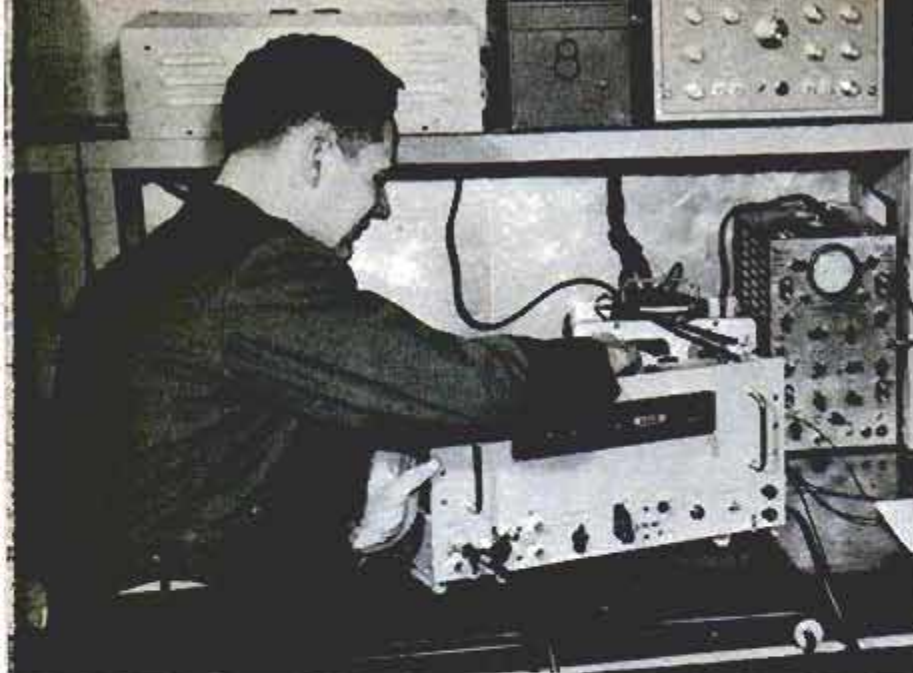

Courses at Sandia require from four days to six weeks to complete, and include nuclear electronic and electrical systems

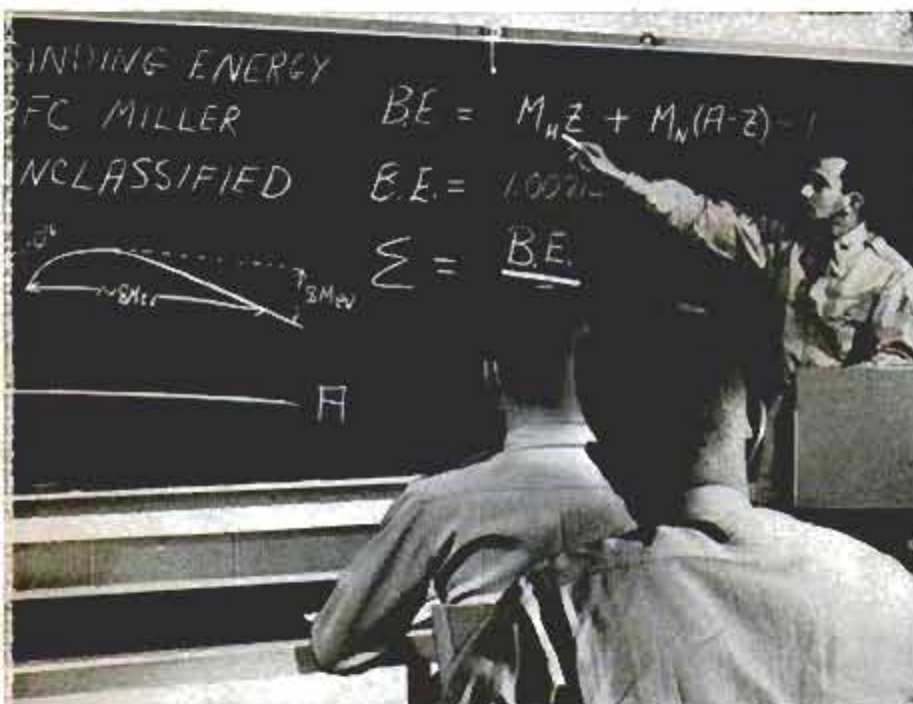

Above, a private first class who is an atomic physicist by trade teaches fundamentals of nuclear energy. Below, undergraduates are told about the Periodic Chart of the Atoms. Passing grade at Nuclear U. is 100; 15 to 20 percent fail



bombs and their structure, undergraduates at "Nuclear U." are given an educational foundation in radiological defense, effects of atomic explosions and military and elementary aspects of atomic energy. They are taught, essentially, atomic capabilities, not strategy or atomic tactics.

### Eager to Learn

A spokesman reveals that younger students are right at home in the Kremlin. They're eager to study the atom. They learn faster, retain it, are well motivated. Ten years ago when the bomb first became known, some military men experienced a natural reluctance when meeting an atom bomb face to face; the idea was too big, too unreal. But in the last decade, professional military men began to cultivate a familiarity with atomic weapons. "Now, because of the pressure of world events, some ask for assignments to the Kremlin."

Nowadays, these eager atomic technicians rehearse M-Day maneuvers, dressed in radiationproof clothing. In desert laboratories, under expert instructors, students pick up the essentials of radioactive monitoring. They reach out into the desert in Jeeps and carryalls, searching for hidden radioactive sources with geiger counters, scintillometers and other monitoring devices. Under conditions which re-create actual after-effects of an A-blast, Uncle Sam's atom scholars come to recognize the grim realities of nuclear warfare and atomic defense.

Instructors are selected for their knowledge, their atomic know-how and sometimes they're far outranked by their students. Corporals instruct captains; CPOs assist airmen. A brigadier general once needed refresher lessons in physics before attending important atom lectures in the Kremlin. The Army ordered a private first class to tutor the general!

### Under Tight Security

Despite heavy work loads and intensive study schedules, all work is carried on behind a tight security screen. Students are investigated by the FBI and AEC before beginning their studies; a top-secret security clearance is required

(Continued to page 210)



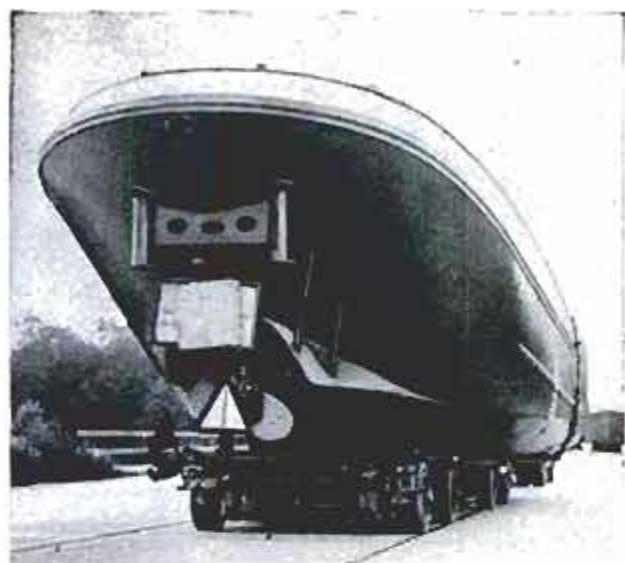

## 126-Foot Ship Moves in Two Sections Down German Highway

If you think portaging a canoe is hard work, you'll sympathize with a German firm that had to transport a 126-foot ship overland from one river to another. The ship, 16 feet wide and 14 feet high, was built as a front section of 71 feet and a

stern section of 55 feet. Two 16-wheel trailers, pulled by trucks at nine miles per hour, carried the sections down the highway. The ship was moved from its building site on the Danube to its launching point on the River Main and assembled there.

## Coal Car Stands on End to Dump Load

In a matter of seconds, a heavy-duty hoist upends and empties a freight car carrying 40 tons of coal. The hoist is installed at a gasworks in West Berlin. A winch arrangement does the work



AUGUST 1956



## New-Look Water Tower

There are still enough steam locomotives around Hamburg-Altona, Germany, to justify the erection of a new water tower to slake their thirst. Its shape, tapering outward from a narrow base, marks a new era in design. Atop it is a railroad-radio antenna

113





# PLAYGROUND WITH AN IMAGINATION

By Lee Elam and Leo Rosenhouse

**T**HERE is a gradual revolution taking place in playground design and equipment. Uninviting gray iron-pipe swings, slides, teeter totters and bars are being replaced with a new concept in play equipment that stimulates a child's interest, requires physical accomplishment and creativeness and the use of his imagination.

"Play is not a luxury but a necessity," explains William Penn Mott, Jr., president of the American Institute of Park Execu-

tives, and superintendent of the Park Department in Oakland, Calif. "It is something a child must have if he is to grow up properly.

"We know that play is an instinctive thing in a child, but this does not mean there need be no special provision for it. Thus we recognize that play-area equipment today needs revolutionizing so that it is radically different in its environment from anything that the average child encounters in his customary day-to-day existence."

When the Oakland Park Department cleaned house of all dilapidated and dangerous play equipment on its playgrounds and parks, it replaced outmoded toys and apparatus with new safe-sculptured play equipment, colorfully designed toys and functional play areas.

One of the most unusual and popular toys is a massive "fun tree" in Lakeside Park, on the shore of Lake Merritt, so-called because boys and girls can climb in, over, around and through it. The fun tree was designed to make

Ramplike walk extends over sandboxes to give children a place to run. Giant arch in background supports an array of swings





the small fry happy by the ingenious device of imaginary visualization.

The fantastic-looking "toy" is 30 feet long, 12 feet wide and several feet in height. It is made of plastic-laminated glass cloth on a metal-lath frame. The color is a pleasant lemon yellow.

Young minds make great things out of this creative piece. It has hand and foot holds for climbing, a limb shaped like a giant fish tail, tunnels for crawling, areas that look like the wings of an airplane and smooth surfaces that become slides. One day a youngster may pretend the fun tree is a ship from outer space, and the next, a wild animal. It can become a cave, a mountain, an ocean liner, railroad train, whale or a thousand and one other things whipped up in youthful imagination.

In this Lakeside Park play area, called the Kiwanis Kiddie Korner because the Lake Merritt Kiwanis Club donated funds for its construction, the usual straight geometrical pattern

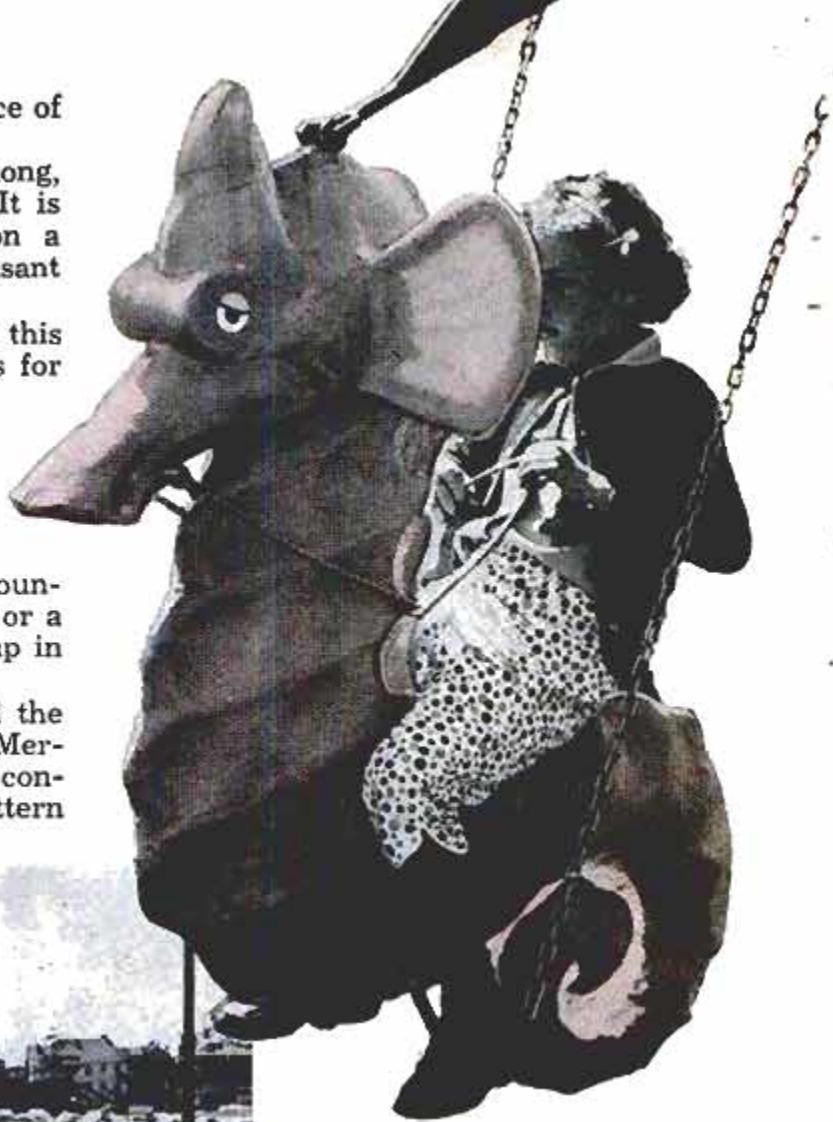

Seahorse swing, above, a novel jungle gym, left, and tiger slide, below, all tend to stimulate the imagination of children who flock to Oakland's new playgrounds featuring ingenious and safe equipment for all



of the oblong or square playground was discarded and replaced by free-flowing curves.

"Children don't play in a straight line," Mott explained. "They tend to run in a helter-skelter pattern. For that reason, we've made the Kiddie Korner an informal play area."

Curving sandboxes are set on various levels. A coral-and-black ramplike walk, arching over the sandboxes to give children a place to run, is terminated at one end by a drinking fountain and at the other by a circular pylon.

Swings hang from an arch that reminds

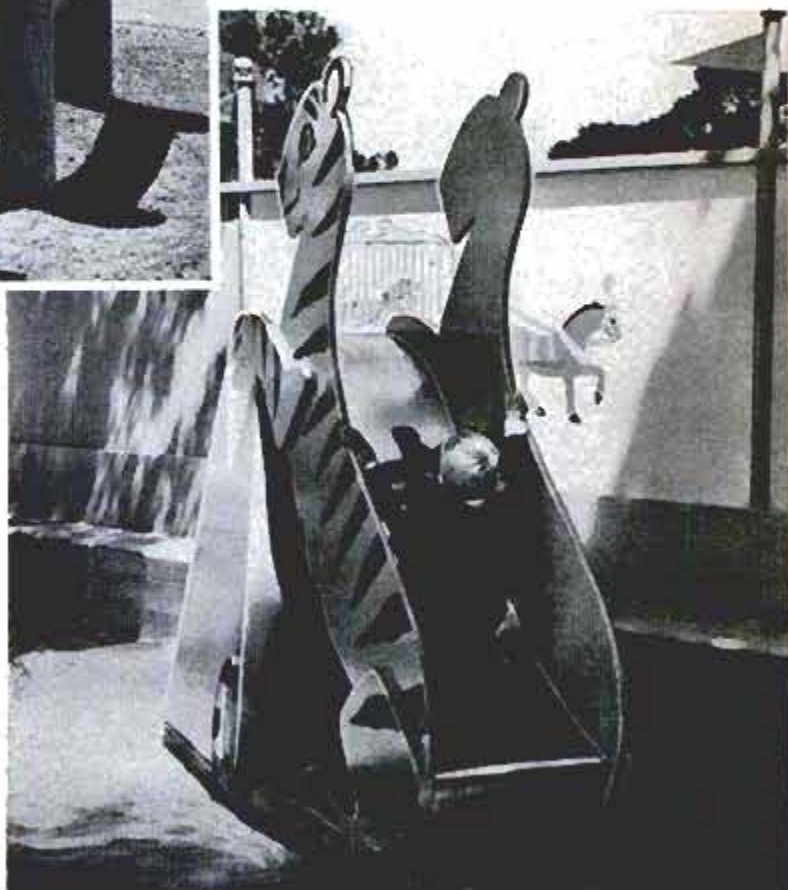



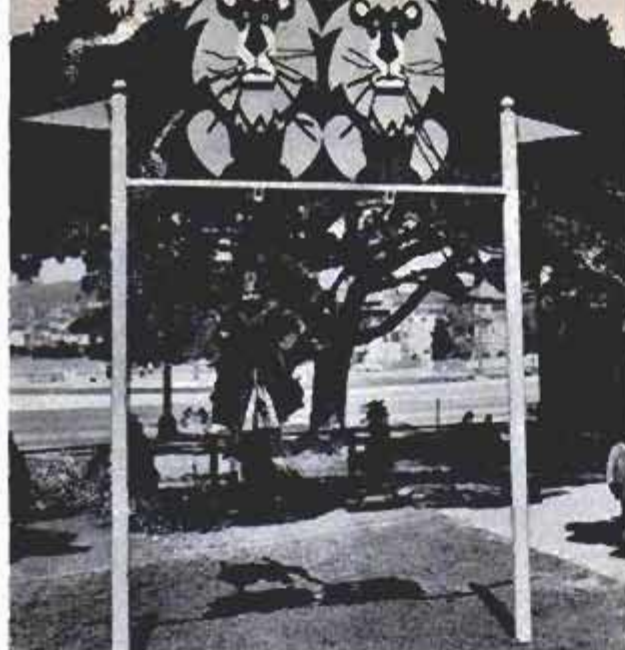

Above, brave child holds tails of "Soulful Lions" that form ropes for the swing

all of the nearby San Francisco Bay Bridge. The end posts are set away from the swings for safety. Two of the swings are in the shape of sea horses, made of plastic-laminated glass cloth set over a steel-lath armature.

#### Designed for Safety

The slide is designed for safety and simplicity. It is made entirely of two-inch pipe, with the exception of the steps. The pipes are welded together and, to form the slide floor, are arranged in a basketlike curve to give maximum safety. Legs, step mounts and hand bars are a continuation of pipe from the sliding surface, a design that gives maximum strength and makes it virtually indestructible by normal use. All sharp edges are eliminated.

An informally shaped play sculpture constructed of plastic-laminated glass cloth of lemon-yellow and sky-blue color, set over a steel-lath armature, provides the children with an opportunity for all types of cre-

Outer section of "curved basket" slide is bent to form ground supports. It is made of welded pipe

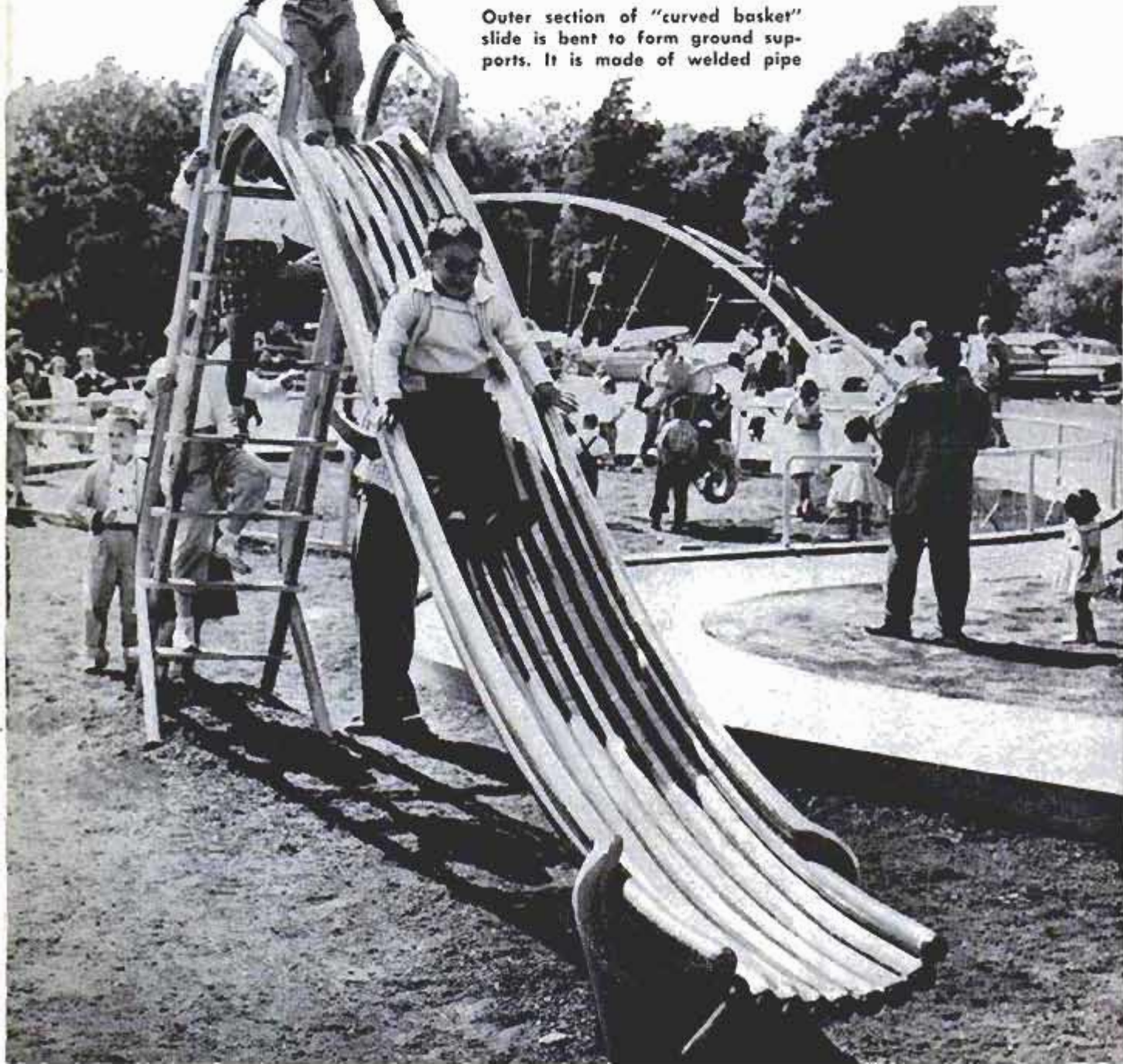



ative play. The sculpture resembles a giant curled leaf and because of its smooth construction, can be used as a slide or can be climbed over without tearing clothing or skin.

All these play units are surrounded by tanbark to take the shock of falls and tumbles and to prevent skinned knees and arms.

The Peralta Playground is a joyland for kids right in the heart of Oakland. It features a circus and carnival atmosphere, a portion of the grounds being given over to a circus play area and the remainder to a carnival of movement.

The playground was conceived by Mott when he visited a carnival on a vacant lot where the park is now located. He came away depressed after seeing girls and boys riding shoddy dangerous toys and play equipment. Also, he thought the carnival looked like a breeding ground for mischief and juvenile delinquency.

#### Ropes Are Lions' Tails

Now, the small fry who visit the circus play area ride a teeter-totter board that balances on the back of "Toto, the Roguish Clown"; slip down a slide formed by the backs of the "Kittenish Tigers"; sit in a swing whose ropes are the tails of two "Soulful Lions." A sandbox duplicates the sawdust in a circus ring.

The walls surrounding the circus area remind the tots of the legend of Humpty-Dumpty, for they are gaily decorated with fairyland figures. Other sections of the wall stress the circus atmosphere by pic-

turing gay animals. On top of the colorful wall circus pennants and streamers whip in the breeze. The wall serves as a protection for an area designated as a party center for the small fry who thrill to the circus atmosphere. All of the party furniture is of Lilliputian size to accommodate the kiddies at their fun fests.

"Every youngster lives in a fairyland and he should have a play area to match his imagination," reasons Mr. Mott.

"We adults look at things differently from youngsters, and the play areas grown-ups visualize for children are usually drab things that depress and disturb kids. We endeavor to make them so they will be bright, exciting and invigorating adventures. By watching the creativeness of small fry, we are able to give them toys and equipment which channel their boundless energy along favorable lines.

#### Piers Form Jungle Gym

"It was such an approach that brought us to placing in the circus area a jungle gym built to resemble the piers that jut out from Oakland's shoreline. Children, we found, need something massive they can climb in and over, like this grouping of smooth-painted concrete pipe and wood pilings."

The movement area of Peralta Playground features a dude ranch where children can ride on a live pony merry-go-round, a horse-drawn buggy, and an honest-to-goodness covered wagon pulled by lively but gentle horses.

There is a lake with a paddle-wheel boat

This merry-go-round provides live ponies and the junior cow hands are held to the saddles by safety belts







Playground's miniature dude ranch features covered wagon pulled by donkeys along "trail" of big corral

like the old Mississippi River steamboats. The children also have access to a mechanical merry-go-round and ride on beautifully carved horses in trotting or gallop position.

Surrounding this is a railroad track on which runs the Oakland Daylight, copied after the Southern Pacific's San Joaquin Daylight, made to one-quarter scale.

The recreational revolution in Oakland



"Toto, the Clown" gets no rest as gleeful children ride the teeter totter placed across his "tired" back

has created so much attention, the National Recreation Congress and the American Institute of Park Executives have asked for special reports and detailed plans on the design and features of the playgrounds.

Oakland citizens are pleased because their town has found the right way to blend creative ingenuity with their children's laughter and important recreational needs. ★ ★ ★

"Fun tree"—plastic-coated toy—is a boat to one child, a cave to another or perhaps a tricky space ship

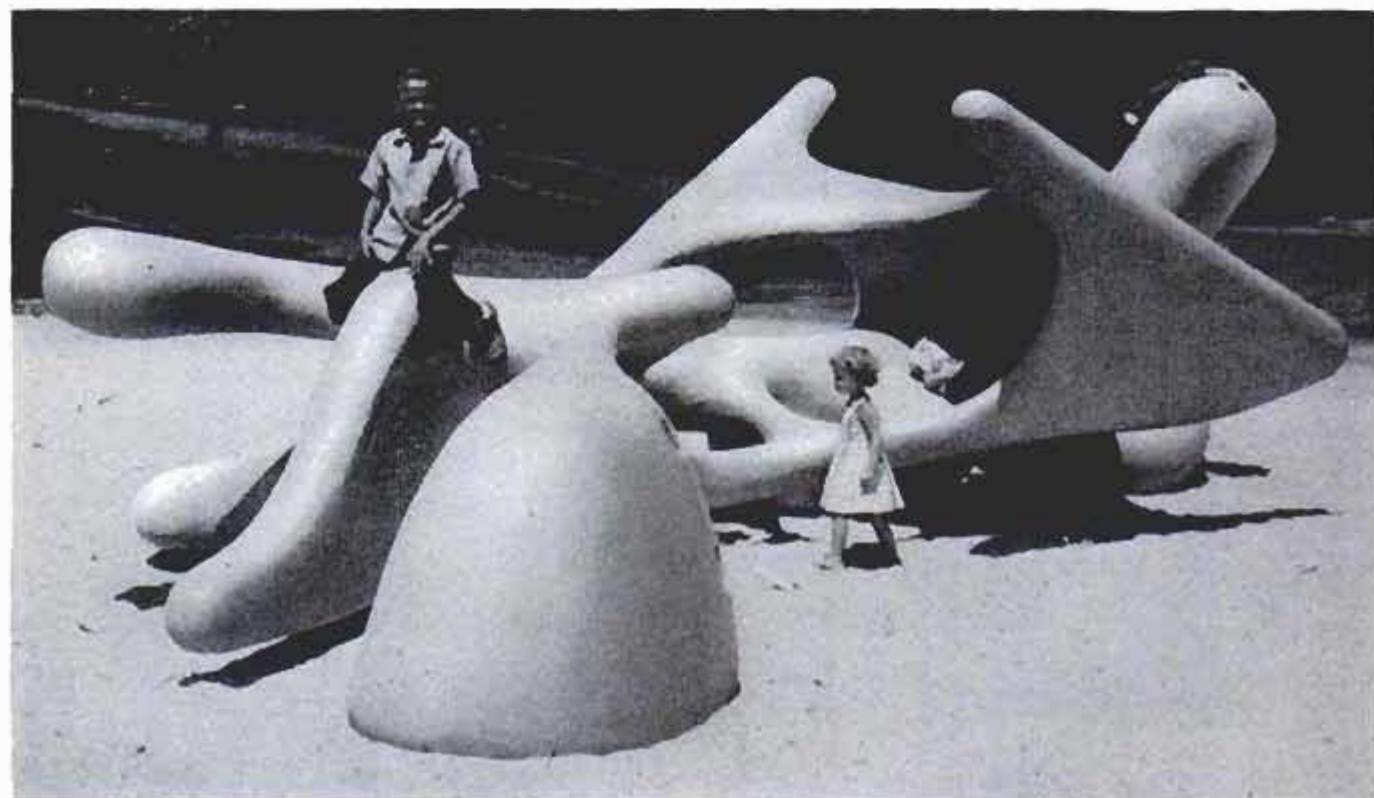



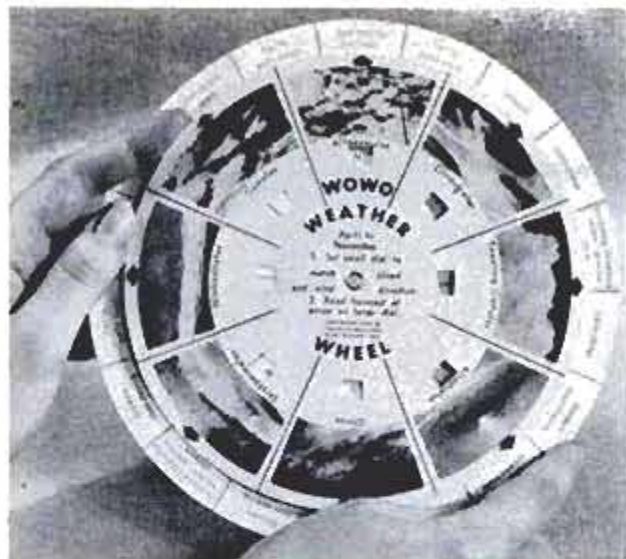

### Weather-Forecast Wheel Predicts Day in Advance

Clouds and wind direction enable you to forecast the weather with a "weather wheel" invented by a former Air Force meteorologist. Inventor Charles Billiard, now an English teacher in Fort Wayne, Ind., says the wheel is right 75 percent of the time. Made of two cardboard disks, it is simple to operate. On the inner disk of the wheel are eight photographs of different types of cloud formations. Beneath each cloud formation is a small window through which the user sets wind direction. Opposite the cloud formation, the user reads on the outer disk the weather prediction for the next 24 hours. Two different weather wheels are made: one for winter, one for summer.



### Spray-on Patching Compound Covers Damaged Concrete

Concrete that has been chipped or cracked can be patched with a latex-type binder that is mixed with portland cement. The damaged surface first is cleaned with picks, pneumatic tools or by sandblasting. Pneumatic application is recommended for large areas, but patches need only be troweled. Patches mixed with the new binder adhere to old concrete and are watertight.

### Small Crawler Tractor With Automatic Transmission Does Many Jobs

Both an automatic transmission and a torque-converter drive are standard equipment on a small, low-priced crawler tractor that adapts to many uses. The transmission features a constant-mesh gear train, combined with hydraulically operated clutches, which provide automatic shifting in any speed or direction without loss of momentum. The unit provides four speeds forward, up to 5.63 miles per hour, and four speeds reverse, up to 6.2 miles per hour. There is also an infinite number of in-between speeds with the torque converter. The transmission permits full-power turns with the touch of a finger, or

smooth pivot turns with hydraulic foot brakes. Many different types of tools can be affixed to the versatile machine.

Power shovel and leveler are among many tools that mount on the tractor





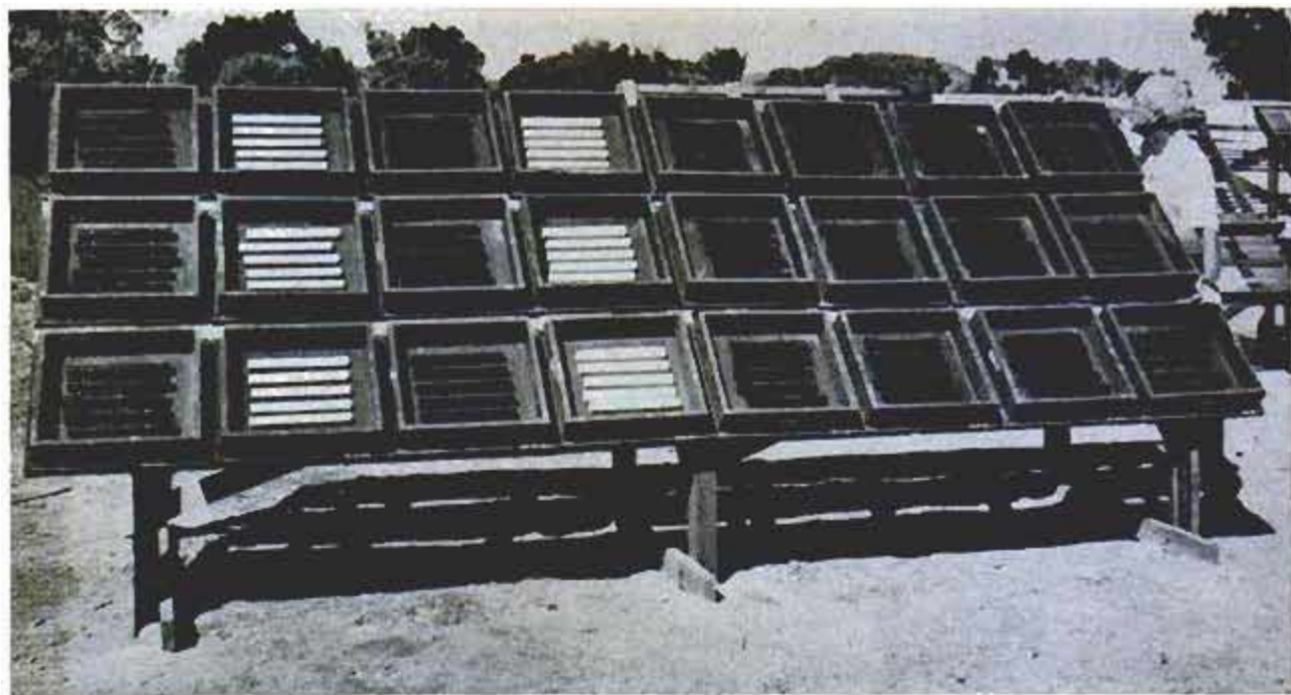

Mr. Caryl inspects samples of plastic pipe that are being exposed in glass cases to Arizona's sunlight

## The Sun Earns His Living for Him

By Joseph Stocker

**A**MERICAN INDUSTRY doesn't like to gamble with the sun. It prefers to have its facts well in hand before it ventures a new product onto the market. How, for instance, will an automobile finish stand up under the sun's heat? Will the plastic webbing of a patio chair fade in the sun and, if so, how quickly and how badly?

To get the answers, industry goes in heavily these days for exposure-testing. And exposure-testing has become an industry in its own right, albeit a modest one. In two of America's leading "sunshine states"—Florida and Arizona—resourceful entrepreneurs are making a living off the sun. Industry sends them its products, to be exposed to the brightest, hottest and most punishing sunlight to be found anywhere in the nation. Then they notify industry of the results—and get paid for it.

Cole R. Caryl of Phoenix, Ariz., is typical of these "sunshine scientists." He's founder, proprietor and one-man staff of a firm which he calls Desert Sunshine Exposure Tests. His clients include some of the largest manufacturing corporations in the country (and one in England). They send him just about everything under the sun for testing—plastics, paints, textiles, coated metals and whatnot. His job is to put them on outdoor racks, keep a careful eye on them, note any changes that take place under the impact of the sun's rays and so advise his clients.

Caryl, who's 63, is a chemist by profession. He used to work in the East, for big corporations. But eight years ago he decided he was fed up with crowds, commuting and cold weather. He headed for Arizona and bought a desert home on the outskirts of Phoenix.

How to make a living? Caryl scouted around and discovered that, while there were several exposure-testing businesses in Florida, there wasn't a single one in Arizona. And this despite the fact that Arizona could boast approximately 3700 hours of sunshine per year to Florida's 2400 hours. "Look at that sunshine going to waste," said Caryl to Mrs. Caryl. "We ought to make it work for us."

All in all, the desert state appeared to be a hot location for an exposure-tester, and Caryl decided to try his luck.

It sounds like an easy business to get into, and an even easier business to run. But Caryl says it isn't so. Although his capital investment was only \$100 (for his first set of racks and a promotional mailing to prospective clients), things were touch-and-go for a time.

Presently, however, the business took hold. Manufacturers paid Caryl good money for the use of his sunshine. He built more racks, and still more, until today he has racks scattered over an acre of desert.

An easy business to run? Hardly. Caryl works 12 to 15 hours a day at it. For ex-



posure-testing involves a good deal more than just putting things out in the sun and then taking them down a few months later.

Textiles, for example, have to be brought indoors every day at 3 p.m., then put out again at 9 a.m. the next day. That's because the American Association of Textile Chemists and Colorists decrees a standard test period of 9 a.m. to 3 p.m. for the sake of a uniform yardstick.

Then, too, various customers make special and exacting demands. One manufacturer sent sections of plastic garden hose to be exposed in the sun and directed that he be notified the very first day that a spot appeared on the hose. That would be evidence of what the manufacturer called "vinyl degradation." Caryl had to check the hose every day before the sun went down. (Sure enough a spot soon appeared.)

A wool processor sent Caryl 15 samples of his wool, in pastel shades, and ordered that they be given a one-hour exposure. That was all—just one hour. Caryl obediently mounted the samples on a rack, set his alarm clock and then, when the alarm went off, took down the samples. What the manufacturer wanted to find out was whether the wool would fade in that short period of time. It faded.

Then, at the other extreme, there was the case of the plastics manufacturer who sent Caryl sections of plastic pipe and asked him to leave them in water, out in the sun, for no less than five years. And still another firm, producing wires and cables, ordered a 20-year exposure of its products. "I call that my underground test," says Caryl wryly. "Twenty years from now I'll be underground."

At least one whole rack is given over entirely to automobile taillights. There's a reason for that. Some time ago a major carmaker came out with a new type of red plastic taillight. Within three months taillights were turning white in the sunnier sections of the country and motorists by



These are the exposed ends of plastic pipe Caryl is testing underground. Once a month he uncaps pipe ends and inspects them for water leakage, as shown

the scores were being stopped by traffic cops. "The manufacturer's face," says Caryl, "was as red as his taillights weren't." The carmaker decided to put his taillights through some exposure-testing since, quite obviously, the sun had been their undoing.

Besides keeping a weather eye on products he's testing, Caryl also needs to keep a weather eye on the weather. Some of his clients want to know, not merely that their samples are getting doused in sunshine, but exactly how much sunshine they're getting. To obtain precise measurements, Caryl had to invest in some scientific instruments. One is a pyrheliometer, which measures the energy of the sun. Another is an electronic recorder, which records the measurements on a graph. Still another is a machine which gauges the amount of ultraviolet in the sun's rays.

All told, these gadgets cost Caryl more than \$1000. But, even so, his unique business has an advantage over most other businesses. His principal raw material—sunshine—doesn't cost him a cent.

What about the future of the sunshine-exposure-testing business? Says Cole Caryl: "It looks very bright." ★ ★ ★

Part of Caryl's acre of exposure racks, these contain samples of vinyl film and other plastics for testing

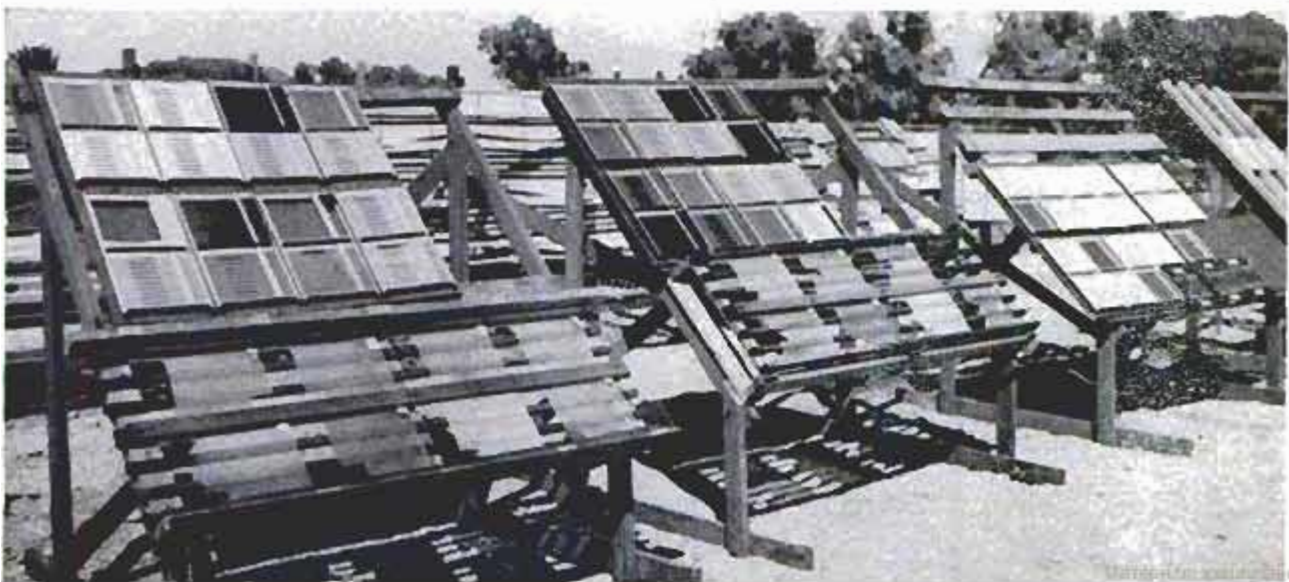



# OWNERS REPORT:

A lineup of experts checks the '56 Chevrolet in this down-to-earth report. Here's the dope from an automotive engineer, a veteran road tester and the owners themselves.

## What Do Chevrolet V8 Owners Like Best?

"In western language it's like mounting a fresh horse. It gets away and keeps going."

OKLAHOMA REALTOR

"I like the way it handles on corners. Its steering is easy. You can't buy a more responsive car."

IDAHO SALESMAN

## What Don't They Like?

"Poor gas mileage. I drive 15 miles to work, two of them in city traffic. I average 12 to 13 miles per gallon."

CONNECTICUT INSURANCE WORKER

"It has picked up 6 or 7 rattles already."

ARIZONA HORTICULTURIST



## Chevrolet Claims It's the 'Hot One.' Do Owners Agree?

"Mine hasn't been cooled off yet."

TENNESSEE BOOKKEEPER

"Can always get out of a traffic mousetrap."

MASSACHUSETTS SUPERVISOR

"I have 'outdrug' everything in town."

NEBRASKA TEACHER

"Like riding a runaway steer."

KANSAS RANCHER

"I don't need more power, I need more economy."

OKLAHOMA RANGER

## Would They Like More Acceleration?

Yes, would like more	15.5%
No, would not	80.1%
Undecided, no answer	4.4%

## Would They Like More Top Speed?

Yes, would like more	8.3%
No, would not	77.2%
Undecided, no answer	14.5%





Chevy's lugging power in mud and loose sand is above average, as are its handling and cornering ability

## Chevy V8 Is Hot, Say Owners

*As Told by Chevrolet V8 Owners*

**H**OW IMPORTANT is power? More than enough power, that is. Chevrolet has been advertising performance for a year or more. It has been promoting stock-car racing. It calls itself the "hot one." These moves have apparently paid off. Its sales are up—one of few makes that are.

Most Chevrolet V8 owners praise highly the power of their cars. More than three fourths of them (77.2 percent) say they definitely do not want any more top speed—the car has enough now. Only 8.3 percent say they would like more speed at the top; the other 14.5 percent are undecided.

Even more of the owners are satisfied with acceleration—80.1 percent stating that they do not want more acceleration. Surprisingly enough, 15.5 percent want more acceleration and 4.4 percent are undecided.

Owners seem to like horsepower and may even buy horsepower, but an amazing number of them are not too well informed on the subject. Asked to give the horsepower of their new cars, 17.9 percent state that they don't know how much horsepower their cars have. Another 22.7 percent wrote an answer, but it was obviously

(Continued to page 126)



**FLOYD CLYMER  
TESTS THE  
CHEVROLET V8**

**T**HE CAR tested was a Bel Air V8 four-door sedan with Powerglide and the extra-cost power pack. I drove from Los Angeles to Yuma, Ariz., returning via Desert Center and Palm Springs for a total of 604 miles, including some back-road driving in mountains and desert.

Terrific is the word that describes the performance of this car. The V8 engine has

been much improved over the one I tested last year. The car now performs more like a high-price than a low-price car.

Acceleration from a standstill is amazing. Maneuverability and roadability are far above average for a 115-inch-wheelbase car weighing 3293 pounds. Handling is excellent at all speeds. There is some, but not

(Continued to page 216)



# An Engineer Analyzes the Chevrolet V8

By Dale Kelly, SAE

**MODEL TESTED:** Bel Air four-door hardtop with V8 engine, one four-barrel carburetor, dual exhausts, Powerglide transmission, power brakes and steering. Rear-axle ratio: 3.55 to 1. Wheelbase: 115 inches. Tires: 6.70x15. Curb weight: 3625 pounds with gas tank half full (54 percent of this

weight was on the front wheels, 46 percent on the rear). Car said to have the 205-horsepower engine with 9.25 to 1 compression ratio. Barometer: 29.3 inches. Temperature: 70 degrees F. Payload: 400 pounds for acceleration and speed tests; 200 pounds for fuel economy.



## ACCELERATION TIME IN SECONDS

	0 to 20	0 to 40	0 to 60	0 to 80	1/4 mile
Ignition timed for regular gasoline	3.3	7.6	13.1	23	19.6
Ignition timed for premium gasoline	2.9	6.9	12.0	21	19.1

(The watch was started at the instant the accelerator was floored. The engine was not run up against the brakes before the start. All tests were in Drive range.)

**ESTIMATED TOP SPEED:** Measurements of inlet manifold vacuum at speeds less than top speed show that the top speed is about 100 miles per hour on regular gasoline and 105 on premium.



## FUEL ECONOMY (MILES PER GALLON)

	Steady 30 m.p.h.	Steady 50 m.p.h.	Steady 70 m.p.h.	Traffic Route
Ignition timed for regular gasoline	23.5	19.9	15.8	12.6
Ignition timed for premium gasoline	23.3	19.9	15.95	12.75

In the traffic test the car makes 10 full stops per mile and is driven fast enough to average 15 miles per hour.

**ESTIMATED ANNUAL GASOLINE BILL:** \$159 for 10,000 miles. Based on 2000 miles at 30 m.p.h., 5000 miles at 50 m.p.h., 1500 miles at 70 m.p.h. and 1500 miles in traffic, and on use of premium gasoline at 29 cents a gallon.



## SPEEDOMETER ERROR (MILES PER HOUR)

Indicated speed	20	30	40	50	60	70	80
True speed	18	28	37	47	56	66	76

## ODOMETER ERROR

The odometer was correct within one percent.



## DRIVER'S VISION

Some portion of the road could be seen 15 feet in front of the car (A in sketch) by an average driver (5 feet 9 inches tall); full width of the road could be seen 21 feet in front of the car (B in sketch).



## GROUND CLEARANCE

The bottom corner of the rear overhang would touch the ground if the car were driven through a dip whose profile had a radius of curvature of less than 28 feet (solid line in sketch). The center of the car would drag if the car were driven over a hump with a radius of less than 18 feet (dotted line in sketch). The exhaust pipes under the engine would drag if the car were driven in ruts deeper than 6.5 inches. The doors would open over a 12-inch curb.

## MISCELLANEOUS

**OCTANE REQUIREMENT:** The basic ignition timing had to be set to four degrees after top dead center for knock-free operation on an 85-percent-octane blend of octane and heptane, equivalent to typical regular gasoline (octane 82 Motor, 88 Research). The acceleration and gasoline mileage listed above for regular gasoline were obtained at this setting.

The best acceleration from standstill to 45 miles per hour was obtained with the ignition advanced to top dead center. The acceleration and gasoline mileage listed above for premium gasoline were obtained at this setting.

With any further advance, the engine knocked on a 90-percent octane blend of octane and heptane, equivalent to a typical premium gasoline (octane 85 Motor, 95 Research).

At the time of the test, the car had a 5000-mile accumulation of carbon. Another car of the same make and model could easily have an octane requirement several points higher or lower.

**STEERING:** From straight ahead, the steering wheel had to be turned 0.78 revolutions to complete a circle with an outside radius of 50 feet. The steering wheel turned 4.6 turns from lock to lock. Turn-circle diameter, curb to curb, was 40 feet; from wall to wall: 42.5 feet.

**TRUNK CAPACITY:** In addition to the spare tire and

tire-changing tools, the trunk could accommodate nine cardboard cartons of the size used for 48 tall cans of evaporated milk.

**WATER RESISTANCE:** The body was fairly well sealed against water leaks. In the high-pressure car wash a few drops of water entered the trunk, a few drops worked under the passenger doors, and about an ounce got onto one end of the rear-seat back.

In 9 out of 10 trips through the splash pan, several spark plugs shorted out for a few seconds. In three of these trips the engine stalled, but started and ran normally after 5 to 10 seconds. Brakes were not affected. A few drops of water worked under one door; no water entered the trunk.

**CENTER OF GRAVITY:** The center of gravity of the unloaded car was 23.6 inches above the ground.

**GASOLINE FILL RATE:** The gasoline tank could be filled at the rate of better than 14 gallons per minute when almost empty. No filling-station pump used during the test was capable of pumping faster than the inlet pipe could take it.

**BRAKES:** In general, the brakes worked well. The power-brake pedal required a very light pressure with vacuum assist and only a moderate pressure when the engine was not running. There was a vacuum reserve tank with sufficient capacity for two or three brake applications with the engine not running. The hand brake held the car on a 14-percent grade.



# Here's What Dale Kelly Tests—and Why

## Rear-Axle Ratio

Rear-axle ratio is the number of revolutions made by the driveshaft for one revolution of the rear wheels (3 to 4.5 in most modern American cars). In a car with a hand-shift transmission it is also the number of engine revolutions for one revolution of the rear wheels with the car in high gear. It is checked on each test car because almost every manufacturer has several rear axles available with different ratios. Normally, a low ratio is used with an automatic transmission, an intermediate ratio with a three-speed manual transmission and a high ratio with an overdrive transmission. There are usually other optional ratios that could be installed in the test car. Axle ratio does influence performance greatly. A low ratio usually results in quiet engine operation, improved fuel economy. A high ratio gives, with a manual transmission, better high-gear acceleration at moderate speeds and permits lower speeds without gear shifting.



## Weight Distribution

Measured simply by weighing front and rear wheels. A car with a substantial percentage of its weight on the drive wheels is less likely to be stuck in sand or snow. American cars have more weight on the front than rear.



## Weather Conditions

These have a slight bearing on power and acceleration. An increase of 0.3 inches in barometer reading or a reduction in temperature of 10 degrees will usually improve the power of an engine by about one percent.

## Fuel Economy

Constant-speed fuel economy is measured with a meter holding exactly 0.1 gallon. Traffic economy is measured over a half-mile course in which five equally spaced stops are made. The course is driven in two minutes. The gasoline is measured with a 250-cc. burette. The annual gasoline bill for 10,000 miles is first figured for each grade of gas. Then the average is calculated based on the estimated proportion of drivers who will require premium gasoline for satisfactory performance. For example, if substantial improvement is obtained with premium, we may estimate that 75 percent of the drivers would consider the extra two cents a gallon for premium gasoline well spent and our average will be based on three cars using premium for every one car using regular.



## Speedometer Error

We drive the car at a constant speed over an accurately surveyed distance noting the time on a previously calibrated stopwatch.

## Center of Gravity

We determine the height of the center of gravity by putting the front wheels on scales and noting the amount of weight transferred from the rear to the front wheels when the rear wheels are blocked two feet off the floor. A car with a low center of gravity is less likely to roll over in a tight turn or after a collision. It also feels more secure on the highway.



## Acceleration

With an automatic transmission, maximum acceleration is obtained by holding the car stationary with the brakes and pressing accelerator to the floor to bring engine up to its stall speed before starting a run. We do not believe such a figure is of interest to the average owner and therefore we use a more normal start. With engine at idle and brakes off, the accelerator is abruptly pressed to the floor and the stopwatch started at the same instant.

## Octane Requirement

All other things being equal, a car that can run on regular gasoline is more to be desired than one that knocks unless premium is used. Octane requirement is usually measured by running the engine on a mixture of two standard fuels: Heptane ( $C_7H_{16}$ ) and Iso-octane ( $C_8H_{18}$ ). Heptane knocks badly in any engine, no matter how low the compression ratio. Iso-octane will run without knocking at almost any compression ratio in use today. For our testing, two standard blends are used: 85 and 90 percent of Iso-octane. The 85-percent octane mixture is considered equivalent to a typical regular gasoline with an octane number of 82 when tested by the Motor method and 88 when tested by the Research method. The 90-percent octane mixture is the equivalent of premium gasoline with an octane number of 85 Motor and 95 Research. These percentages will be revised from year to year to keep up with gasoline improvements and with changes in the way engines respond to Motor and Research ratings.



Our tests are carried out in two parts. First, we determine how much the basic ignition timing must be advanced to get maximum power from the engine. Any more advance would result in a loss of power. Second, we find out how much the spark can be advanced without knocking on the 85 and 90-octane blends. These maximum-advance knock-free settings are used for our tests with premium and regular gasoline, except that the spark is never set for more advance than will deliver maximum power.





— Irving Seligmann photos

Sweptback fenders on some '56 cars make taillights vulnerable. Chevrolet's are 3 inches inside bumpers



Above, owners like the grille; in 1955, Chevy owners didn't like grille shape. Kelly praises the high-opening hood for engine accessibility, but distributor behind air cleaner, below, is quite difficult to work on



wrong. Guesses range from 45 (actually the taxable horsepower of the Chevrolet V8) to as much as 235 horsepower. Only 59.4 percent were able to state the horsepower of their Chevrolets correctly.

However, despite the power talk and the hot-one promotion, styling is the reason most often given by owners for buying a new Chevrolet. They seem to make their choice more on what a car looks like than how it performs. In fact, 58.8 percent state that styling is one of the important factors in their choice of a car and 20.9 percent say styling is the single most-important factor. Only 8.7 percent say the engine was the big reason, another 6.3 percent say Chevrolet's performance is the reason.

This year's Chevrolet V8 engine seems to be trouble-free for the most part. Only 1.5 percent of the owners had considerable engine trouble; 13.7 percent had some trouble; and 84.8 percent had no engine trouble at all to report. Most-frequent engine troubles are valves and carburetion.

Chevrolet owners do have complaints, although there is no single complaint that stands out as there often is in our Owners Reports. The most frequent complaint is a common one: Poor gasoline mileage (13.6 percent). Next come body rattles and squeaks (10.7 percent); third, poor paint and chrome (7.3 percent). The complaint percentages are lower than usual in our surveys.

Although they say they buy Chevrolet for its styling, more owners praise power and performance than any other single characteristic. Easily the best-liked features, power and performance are mentioned by 54.9 percent of the owners. Handling ease is second with 48.5 percent and third comes styling with 28.2 percent.

Supporting this attitude about performance is the fact that 81.8 percent of the owners say the Chevrolet is just as "hot" as claimed in the advertisements. A very small number (5.1 percent) say no, it is not the hot one. Another 13.1 percent say they don't know.

More than half the owners traded in a Chevrolet to buy the 1956 model, another 8.7 percent traded some other General Motors brand and 23.8 percent traded from outside the General Motors family.

About a fifth (20.4 percent) did not bother looking at any other car except Chevrolet before buying, 58.7 percent looked at Ford, 35.9 percent at Plymouth and 26.7 percent at Buick. Many, of course, looked at two or more competing cars before making their selection of a Chevrolet.

Only a few Chevrolet owners have safety belts in their new cars (7.4 percent). However, all these owners say they regularly use the belts: 57.1 percent wear them all



Owners from every state except Pennsylvania took part in this Owners Report on the 1956 Chevrolet

## The Owners Analyze the Chevrolet V8

### Over-All Rating of the Chevrolet V8

Excellent	Average	Poor
74.0%	23.0%	3.0%



#### Had trouble with V8 engine?

No trouble.....	84.8%
Some trouble.....	13.7%
Considerable trouble.....	1.5%

#### What was engine trouble?

Valves, tappets.....	2.9%
Carburetion.....	2.9%
Ignition.....	2.5%
Uses oil.....	2.5%

#### Performance Questions

##### Is it as "hot" as claimed?

Yes, it is.....	81.8%
Don't know.....	13.1%
No, it is not.....	5.1%

##### Would like faster acceleration?

Yes, would like it.....	15.5%
No, would not.....	80.1%
Undecided.....	4.4%

##### Would like more top speed?

Yes, would like more.....	8.3%
No, would not.....	77.2%
Undecided.....	14.5%

##### What is car's horsepower

Gave correct horsepower.....	59.4%
Gave incorrect horsepower.....	22.7%
Said didn't know hp.....	17.9%

#### Styling Questions

##### Best-liked exterior feature?

Grille.....	15.5%
Taillights.....	7.8%

##### Least-liked exterior feature?

Fender cutouts.....	8.3%
Gas-filler location.....	5.8%

##### Best-liked interior feature?

Upholstery.....	35.9%
Color matching.....	11.7%

#### Least-liked interior feature?

Dashboard design.....	18.4%
Floor covering.....	7.2%

#### Did styling influence choice?

Yes, did influence.....	58.8%
No, did not influence.....	34.4%
Undecided.....	6.8%

#### Miscellaneous Questions

##### Have safety belts in car?

Yes, have belts.....	7.4%
No, do not.....	92.6%

##### Are safety belts used?

(Asked of those with belts)	
Used all the time.....	57.1%
Used some of time.....	42.9%
Used none of time.....	0.0%

##### Would buy another Chevrolet?

Yes, would.....	60.0%
Might.....	35.0%
No, would not.....	5.0%

##### How is dealer service?

Excellent.....	52.5%
Average.....	33.5%
Poor.....	14.0%

##### Would buy from him again?

Yes, would.....	60.7%
No, would not.....	11.7%
Undecided.....	27.6%

##### What make car was traded?

Chevrolet.....	56.8%
Other GM make.....	8.7%
Non-GM make.....	23.8%
No trade, no answer.....	10.7%

##### Looked at other cars before buying?

No, did not.....	20.4%
Looked at Ford.....	58.7%

At Plymouth.....	35.9%
At Buick.....	26.7%
At Oldsmobile.....	16.5%
At Pontiac.....	18.0%
All other makes.....	24.4%

#### Why did they pick Chevrolet?

Exterior styling.....	20.9%
Previous experience.....	12.6%
V8 engine.....	8.7%
Trade-in deal.....	6.3%
Price.....	6.3%
Performance.....	6.3%

#### What should be changed?

Nothing at all.....	31.6%
Improve bodywork.....	7.8%
Gas-filler location.....	6.8%
Softer seats.....	5.8%
Restyle dashboard.....	5.3%

#### Best-Liked Features

Power, performance.....	54.9%
Handling ease.....	48.5%
Body styling.....	28.2%
Riding comfort.....	18.4%
Economy of operation.....	18.0%
Roadability.....	8.7%
Trouble-free V8 engine.....	4.9%

#### Most-Frequent Complaints

No complaints at all.....	30.1%
Uses too much gasoline.....	13.6%
Body rattles.....	10.7%
Poor paint, chrome.....	7.3%
Water, dust leaks.....	6.8%
Powerglide operation.....	6.3%
Dashboard design.....	6.3%
Poor tires.....	4.9%

the time and the other 42.9 percent wear them some of the time.

Here are some quotations from Chevrolet owners that describe how they feel about their new cars:

"In western language, it's like mounting a fresh horse. It gets away and keeps going."—Oklahoma realtor.

"There is no comparison between the 1955 and 1956 Chevrolets. The '55 gave me all kinds of engine trouble. The '56 has been wonderful and the mistakes are corrected. It is a wonderful car both for beauty and performance."—Ohio pharmacist.

"I have had it on the drag strip several times and have had no trouble with any car for the quarter mile. My best time on the quarter mile (dirt) was 16 flat."—Oklahoma used-car salesman.

"I drive about 40,000 miles a year. With

me economy comes first, then comfort, then performance. This car seems to excel in all three. If the top were an inch or two higher it would be nearly perfect."—Iowa feed dealer.

"Gas mileage before high-altitude jets were installed in the carburetor was 8.4 miles per gallon. It is now about 12 in city driving. But my car is noticeably slower on pickup since new jets were installed."—Utah truck driver.

"The gas mileage isn't too good because of the four-barrel carburetor plus Powerglide. It's a little hard getting into the back seat because it is a four-door hardtop."—North Dakota farmer.

"Horsepower keeps going up unnecessarily and gas mileage keeps going down. Top speed is too high."—Utah foreman.

(Continued to page 212)





## "Flying Footballs" Guide Plane

Described by one pilot as "resembling a white-hot football racing away in the fog," the electronic-flash approach system recently installed at New York International Airport is expected to reduce flight delays and lessen air-traffic-control problems. The system consists of 20 Strobeacon lights in a single row 2000 feet long in the approach path leading to the runway. Each Strobeacon employs a high-intensity xenon flash tube producing over 30,000,000 candle power. Each tube flashes twice per second, and the units flash in sequence toward the runway. To the approaching pilot, this gives the effect of an animated arrow pointing at the runway. In fog and low visibility, the Strobeacon units are visible long before other lights, and thus help to orient pilots just breaking out of instrument-flight conditions.

Line of high-intensity xenon flash tubes leading to landing runway flash in sequence to guide pilot

## Three-Ton Vacuum Machine Dries Airfield Runway in England

Flooded airfield runways are dried in a hurry with a vacuum machine that sucks up thousands of gallons of water in a day. (Water puddles are particularly dangerous for jet aircraft.) Used on English airfields, the three-ton suction machine dries a six-

foot swath as it is pulled behind a tractor. A three-horsepower engine drives the vacuum mechanism, which deposits water in a 500-gallon tank. The machine is an adaptation of a turf drier used for two seasons at a famous cricket grounds.

Pulled behind a tractor, giant vacuum sucks water into a storage tank, leaves behind a six-foot-wide dry strip

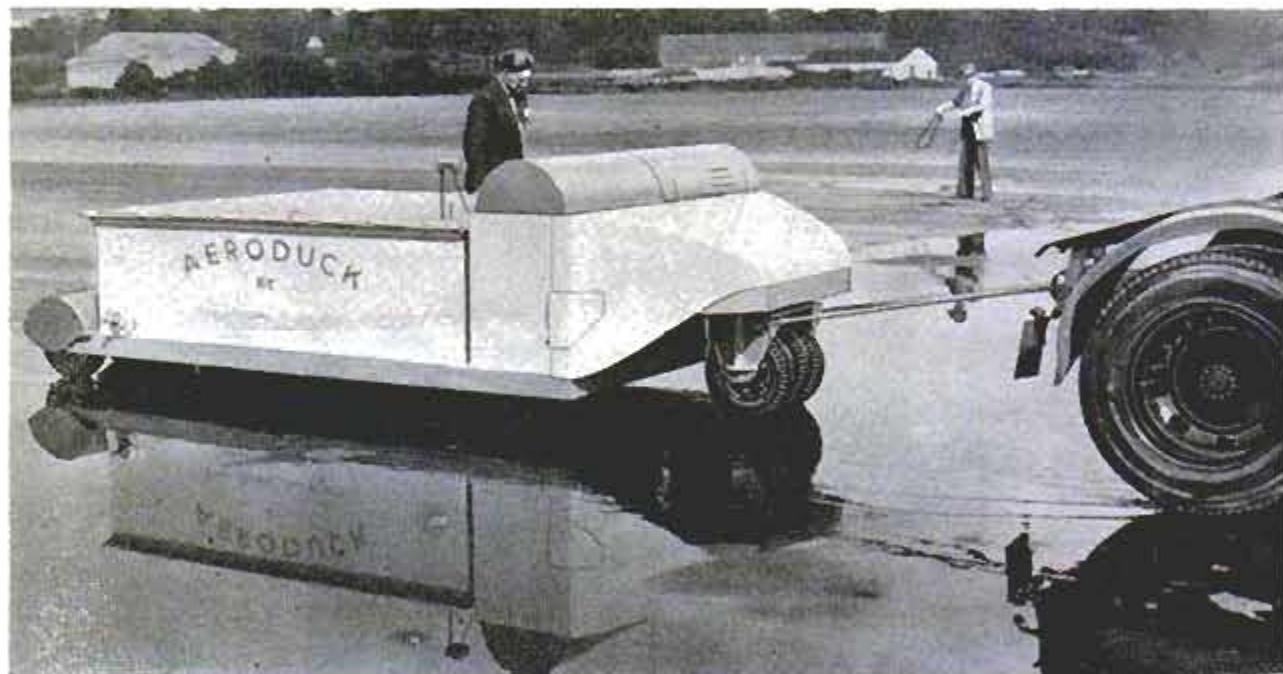





Remote-control fluoroscopic examination using Lumicon gives operator brighter picture to study



Bendix Aviation Corporation photographs

Attached to X-ray equipment, Lumicon can be used to prevent aircraft sabotage by screening passengers' luggage

## Electronic Amplifier Magnifies Light 40,000 Times

"SUDDENLY Mars stood out on the screen with a sharp steady image, giving us the best view of the planet we had ever had."

Thus Dr. Albert G. Wilson, director of the Lowell Observatory, described what he saw when the Lumicon, a new electronic device which amplifies light 40,000 times, was attached to the telescope at his observatory. Lumicon, actually a closed television circuit with amplifying lenses built in, is so sensitive that it will project a clear picture on a television screen when the subject is in a dark room lighted only by a glowing cigarette. When attached to the

Subject of this televised picture sat in darkened room, lighted only by glowing tip of her cigarette



200-inch telescope at Mount Palomar, it will increase light-gathering power to the equivalent of a 1200-inch telescope.

In addition to uses in astronomy, the Lumicon has industrial and medical applications. Attached to a fluoroscope or X-ray machine, it will give brighter pictures and make remote observation of X-ray results practical. Industrial X-ray machines will be much more flexible in their uses with Lumicon attached. And the manufacturers expect that eventually it will be used in television to reduce the amount of light required to receive and send programs.

Lumicon-amplified televised X-ray picture of a suitcase in which an electronic test meter is concealed

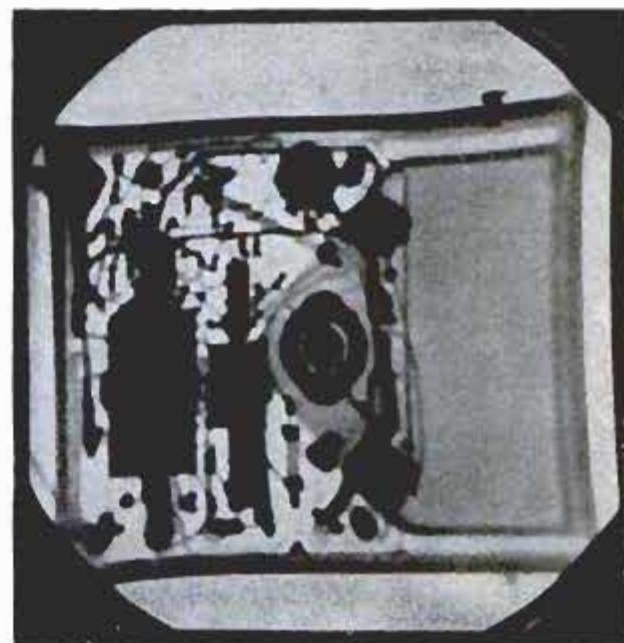



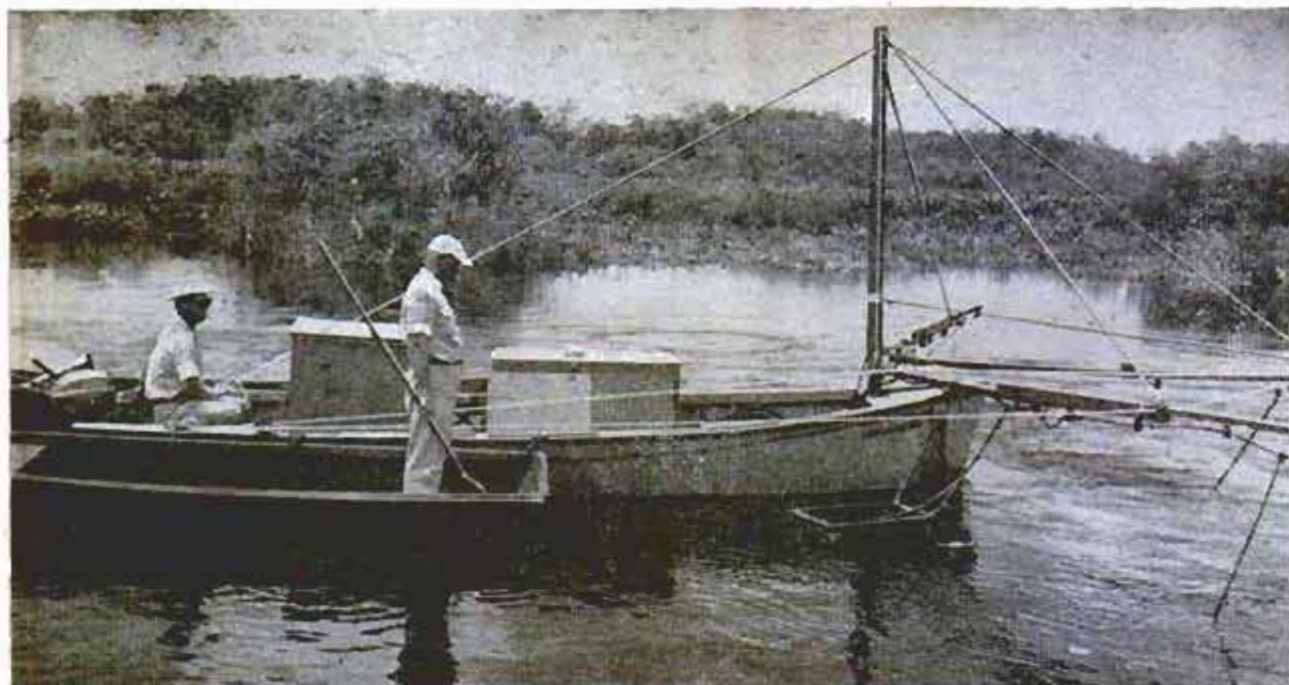

Fish-shocking boat cruises slowly through waters of the Everglades in Florida, destroying unwanted fish

## FISH SHOCKER PICKS ITS VICTIMS

By George X. Sand

LIKE MOST STATES, Florida with its 30,000 lakes and 1 out of every 12 inland acres comprising fishable water, has been plagued with the growing problem of "rough fish": such valueless predators as gars and mudfish which not only consume food required to sustain bass and bream and similar desirable species, but actually destroy such game fish. Because the state's economy is directly dependent upon tourists who come to enjoy sport fishing, it was decided something would have to be done quickly when the Florida Game and Fresh Water Commission discovered that the predators had increased until they represented 75 percent of the fish that swam through the Everglades canals, streams and lakes.





After considerable research Timothy R. O'Connell, Jr., a fish-management technician for the commission and an ex-Marine radar instructor, produced an electronic fish paralyzer that is proving capable of removing 500 pounds of such rough fish hourly from Florida waters. Unlike similar devices, O'Connell's shocker distinguishes between game fish and undesirable species, stunning only the latter. This is accomplished by varying the operating voltage to "tune in" on the frequency that will control the approach of unwanted fish.

"Scientists have long observed that fish swimming in an electrical field tend to form a natural alignment from the positive pole, just as iron filings align themselves around a magnet," says O'Connell. "Our fish shocker employs an extension of this natural alignment, taking control of the fish's muscles and deliberately maneuvering it toward the stunning pole or grid."

Fish are enticed into electrical field by tickler electrode. Once in the field, they are moved toward positive electrode and are stunned as they come in contact with square floating grid

The equipment which makes this possible is housed inside two large wooden boxes aboard a 20-foot boat. Supported at the bow of this skiff are three wooden booms, one of which extends outward for about 15 feet on either side while the third points straight ahead. At the end of each boom a copper electrode drops into the water, in conjunction with a heavy steel link chain (also submerged, and located a few feet farther along the boom toward the boat), to set up a strong electrical field beneath the surface. This field, in turn, controls the victim's movement toward a pair of floating electrical grids, one located on each side of the bow and close alongside.

The floating grids stun the attracted fish so that attendants, who stand in dinghies on either side of the mother craft, can reach down with dip nets to remove them for disposal.

The strange craft is trolled slowly

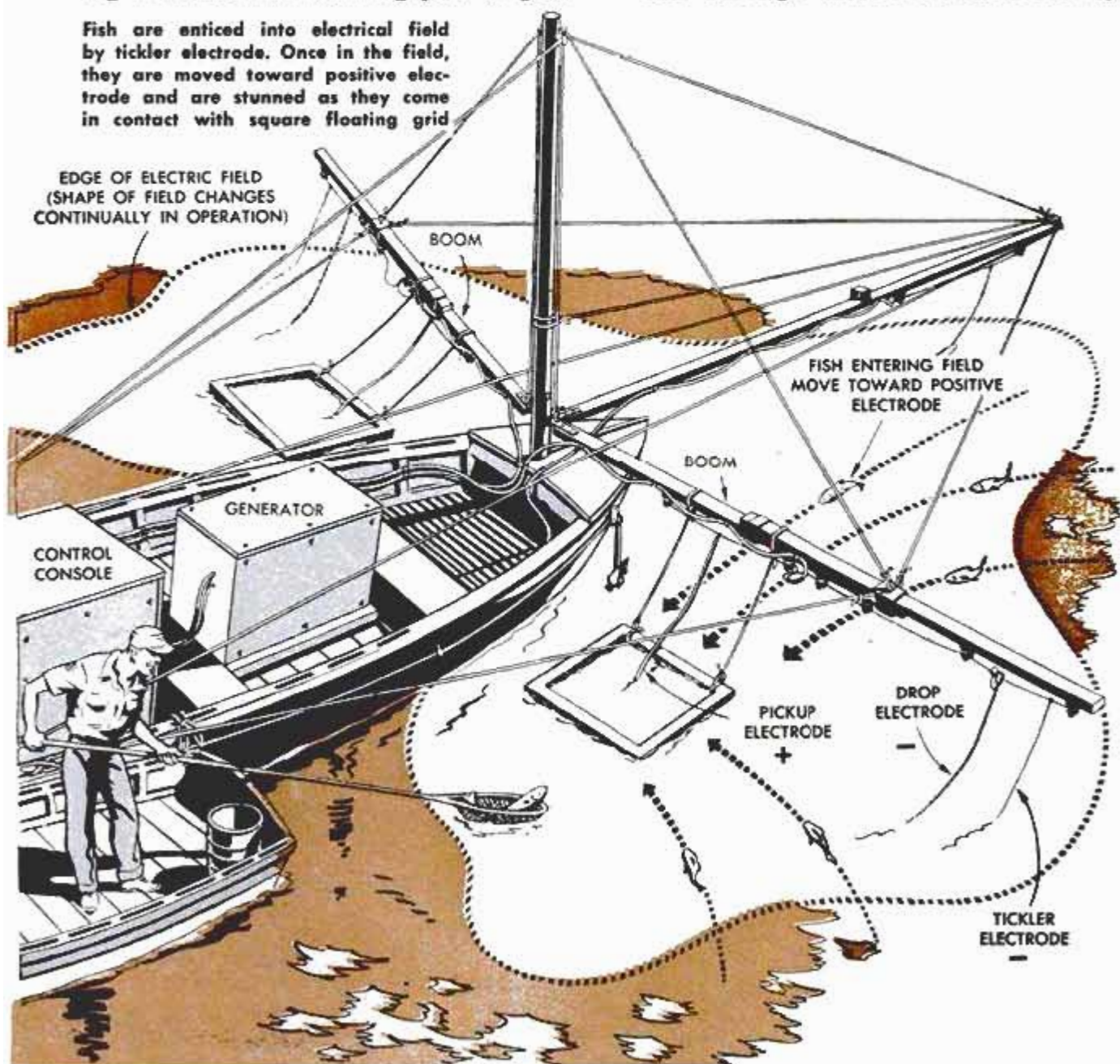



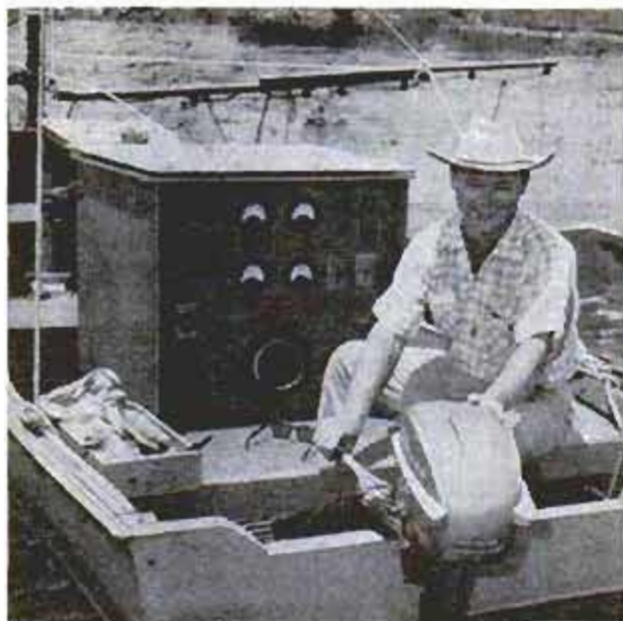

Inventor Timothy O'Connell, Jr., sits before the control panel on equipment box of his fish shocker

through Florida's grassy inland waterways, while O'Connell sits at the stern, facing a control panel. The box closest to the bow contains a 5000-watt Kohler gasoline-driven power plant, its alternating-current output controlled by a Powerstat.

The resultant electrical field is believed to be about 0.35 volts per square inch. It will vary with the temperature, cleanliness and PH factor (acidity-alkalinity ratio) of the water, since these all influence the conductivity.

The fish are "teased" from hiding under surface growths, and up from holes at the

bottom, by the "tickler" electrode. Once they respond and enter the current field the operator's controlled electrical jolts carry them helplessly toward the floating "hot seat," a two-foot-square floating framework of wire mesh.

The outfit is effective to depths of 10 feet. During a recent six-week experimental run in canals of the cross-state Tamiami Trail 40,000 pounds of mudfish and gar were destroyed, without appreciably harming the bream, bass and similar desirable fish.

It was decided to stun the unwanted fish, rather than kill them outright, since this permitted use of lower operating voltages and less-costly equipment. Too, such operation is not hazardous to personnel.

"We have best results," says the inventor, "when trolling between 5 and 10 a.m., and late in the evening. It seems the fish prefer to lie low around noon."

Plans are being made for night operation, with banks of powerful lights to reveal the doomed fish as they enter the electrical field.

O'Connell's working model cost \$1725. Simpler models are planned for use by biologists who, unlike the inventor, do not have a knowledge of electronics.

Removal of such rough fish by poison and similar means has not proven practical in the past because of the expense. In addition, usually all the fish—including the game varieties—had to be destroyed. This invited the added expense of restocking, not to mention the complaints of sportsmen thus deprived of their fishing. ★ ★ ★

Carefully kept records have revealed that different voltages affect fish according to length and species





# KEEPING UP WITH THE ATOM

**WILL WE EVER** be driving cars powered by atomic energy? Will individual reactors ever heat and air condition homes? Will we fly cross-country in atomic-powered planes?

These are just a few of the questions that have popped up around the peacetime atom. The answers are wrapped up in a still bigger question: Can scientists and engineers overcome the hazards of radiation?

It's quite possible at this moment to design atomic-powered planes and cars, to build small reactors for heating and air conditioning homes. But whether reactors ever will be built for these purposes is another question.

Charles G. Manly of the AEC recently pointed out some of the basic problems of radiation hazards. Until 1942, about the only persons exposed to those hazards were a few workers who painted radium on watch and instrument dials, and a few nuclear physicists. Then suddenly thousands of people were working with materials that released more radiation than had ever been imagined.

Radiations from these materials are the invisible plague of the atomic age. The cost of warding them off is fantastic, which is the principal reason why nuclear reactors are so expensive. Manly gives a simple ex-

ample: A laboratory dealing with these radiations must have shields of lead brick, requiring workbenches many times as strong as ordinary ones, requiring a floor much stronger than a conventional one, requiring an extremely heavy foundation.

Not only must workers be protected from the reactor, but the reactor must be self-contained so it cannot spew radioactivity into the atmosphere. And what if, by chance, the reactor should outwit the controls and there should be a sudden surge of power? Recently such an accident happened to the experimental reactor at Arco, Idaho. It damaged the core and released radioactivity into the building.

Tests with a runaway reactor have shown that if the reactor is properly designed, the sudden surge of power will automatically "shut itself off" with relatively small damage. However, as in the case of the Arco accident, dangerous radioactive materials will be released into the immediate area. If these escape into the earth or air, they no longer are under human control.

For these reasons the reactor must be self-contained, must exist in its own tiny world, a world that will wrap up its own mistakes should the impossible happen. Such a world is shown in the drawing below. This is an artist's conception of a new General Electric 10,000-kilowatt atomic power plant.

The spherical container is engineered to prevent any leakage to the atmosphere. In the extremely remote event of an accident, the power surge would be contained within the structure, and any radioactive materials from the reactor core would settle to the bottom of the sphere.

What does this mean in terms of cars and planes and atomic-heated homes? You could put a little reactor under your house or in your car, but obviously you'd spend a fortune protecting yourself from the radiation. Apparently there is no escape from this dilemma. The best guess of experts: No atomic autos. Homes heated and air conditioned by electricity from central atomic-power plants, but no individual reactors. Atomic military planes, where cost is a secondary factor, but no airliners.

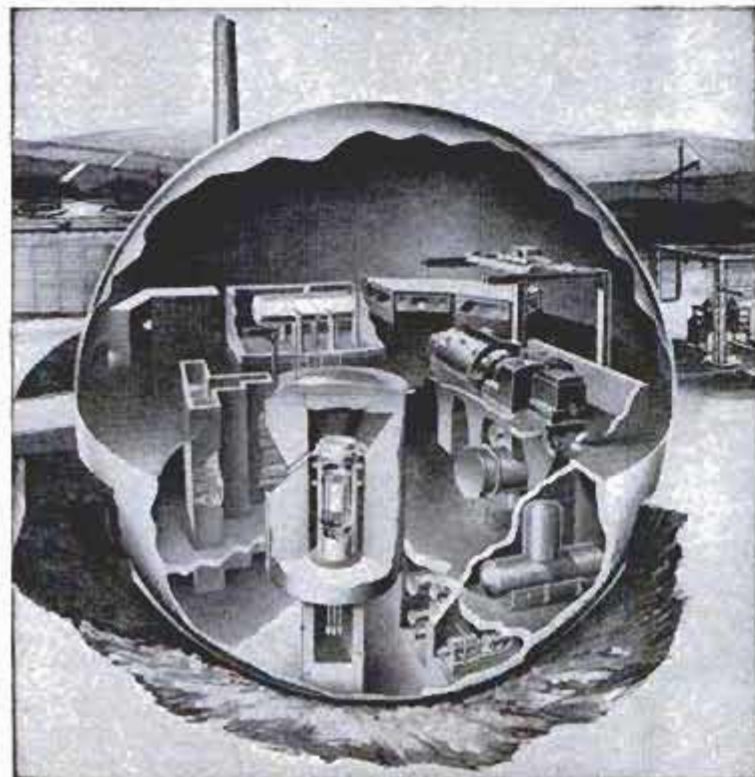





Model that protects only the eyes fastens to the head with a strap and rests on a plastic nosepiece

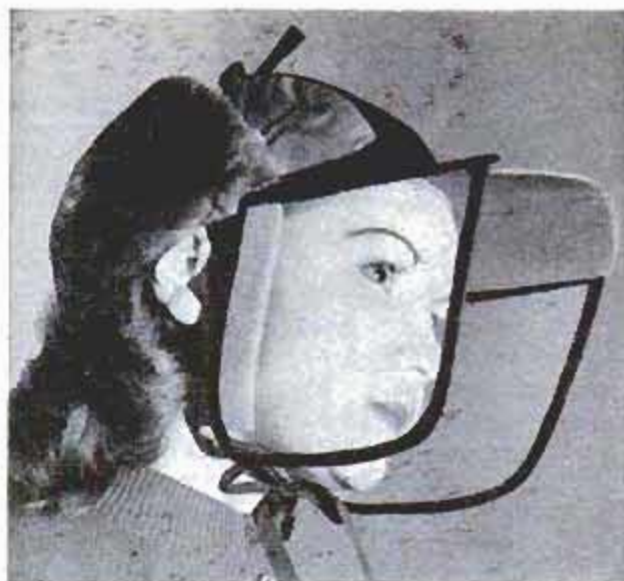

Ski-cap model has side shields which protect entire face. Snap-down sunglasses can be carried under peak

## Open-End Eye Shields Stop Wind With Buffer of Stagnant Air

Eyes are protected from head-on winds by transparent, open-end shields that fit around the face or eyes. A dead-air mass is created in front of the eyes and acts as a buffer against wind, flying grit and snow. In tests, an engineer wearing shields leaned into a 70-mile-per-hour wind but felt no visual discomfort. Two models have

been tested in the antarctic. One consists of a shield which protects only the eyes. The other is a long-billed ski cap with side shields protecting the face. Under the ski-cap peak are sunglasses which may be pulled down to shield the eyes from glare. Sunglasses used with the shields won't fog up from eye moisture.



## One-Pass Tiller Grinds up Stalks

At one pass a new farm machine completely prepares the soil for planting. The machine covers two to six acres per hour, grinding up uncut cornstalks, grass and weeds and turning them under, all in one operation. Soil knives on a rotating shaft till the soil to a depth of seven inches. The machine, powered by a 180-horsepower diesel engine, has four speeds forward and travels from 1½ to 12 miles per hour. It has sufficient power to cut and grind sagebrush, cotton stalks, grass, wheat straw and willows.

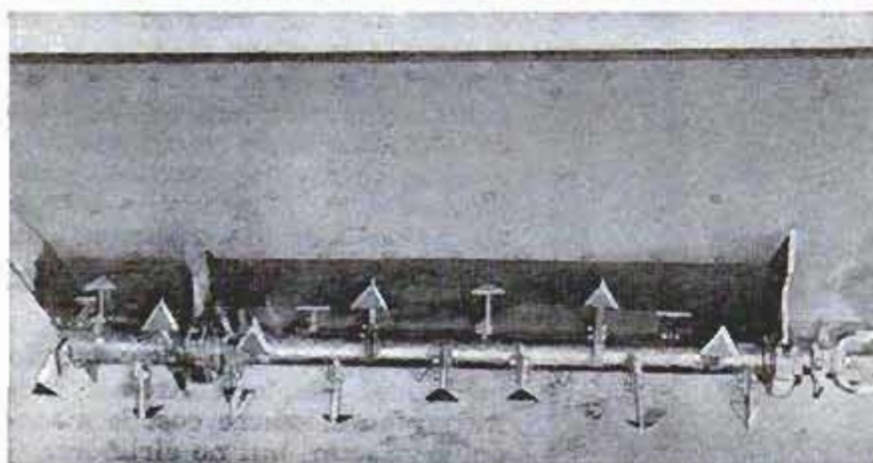

Tiller grinds up and buries cotton and cornstalks as it prepares soil for planting. Triangular soil knives shown at left have a tilling depth of seven inches



## Convertible Freight Car Cuts Shipping Costs

Freight cars that can be converted to whatever type of car is needed by a railroad are expected to cut shipping costs. Known as Adapto, the car is a 35-foot flatcar of new design. On this flatcar may be placed box, container-hopper, gondola, tank car, hopper car and caboose bodies. The car is capable of carrying over 70,000 pounds, three times its own weight, while the standard flatcar, weighing 56,000 pounds, can carry only twice its own weight. By eliminating 35 percent of the dead weight, an Adapto freight train will weigh as much as 800 tons less than an equivalent conventional freight train. On a 1000-mile haul, such as between New York and Chicago, this would mean a saving of approximately \$4000 in shipping costs. Two 17-foot containers or four 8-foot containers on the basic flatcar will make up the boxcar. These containers can be lifted off the flatcar at loading points and delivered to shippers for unloading and reloading, which will cut siding time for the flatcar.

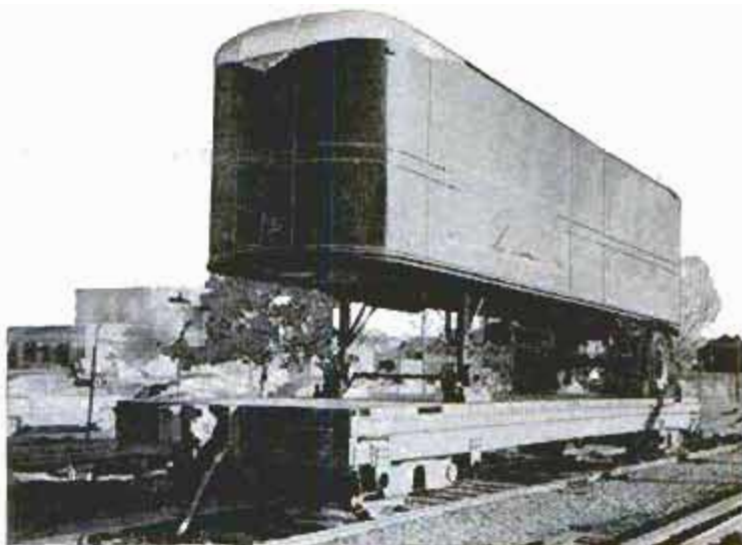

Adapto flatcar, in addition to being convertible, also can be used in railroad-truck piggyback service, as shown above



## Air Blocks in Hot-Water Heating Pipes Relieved by Bubble Breaker

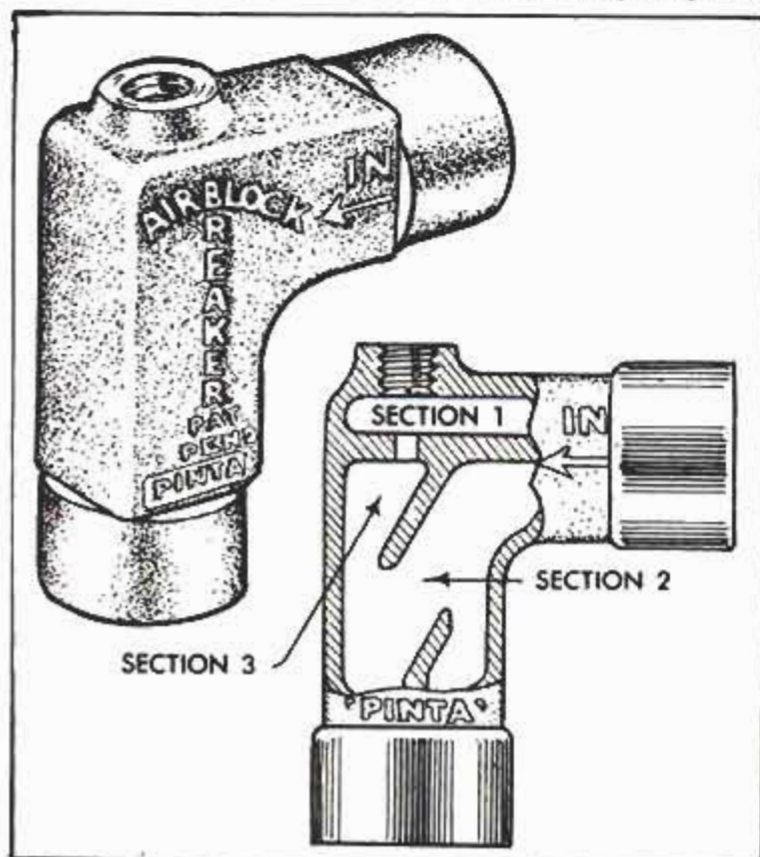

Air blocks are no longer a problem in hot-water heating systems, according to the inventor of a fitting for such systems. The fitting breaks up large bubbles which cause the blocks and mixes the air into the water. The manner in which the fitting works is shown in the drawing at the left. Water enters the upper end marked "in." Any air bubbles go into the area marked section one, while the water continues into section two. As the water passes through section two, it causes a jet action which pulls the air from section one. In section three, during this movement, the bubbles are broken and mixed so thoroughly, and traveling at such velocity, that they cannot form an air block through the rest of the hot-water heating system.

Less than two percent the size of previous models, a true-north-seeking gyrocompass of great accuracy has been developed for use in military aviation.





Show attracts 100,000 visitors during 10 days of Iowa State Fair. Exhibitors compete for \$500 in prizes

## KEYNOTE OF THE FARM GADGET SHOW:

*"I Just Built it  
Because I Needed it"*

*By Phil McCafferty*

**F**ARMERS who have turned inventors to concoct ingenious machines get a chance to exhibit their creations at the annual Farm Gadget Show of the Iowa State Fair.

Parts of automobiles, tractors and combines show up in surprising new forms.

Sixteen-year-old Marvin Negley copped a prize for his drill press made from the rear-axle assembly of a junked car he found on his father's farm.

Farmer Glen Stroburg, a proficient welder, found all the parts on his farm to build a rugged metal-cutting bandsaw. The frame came from a hay baler and the large wheels to drive the blade were originally auto flywheels. The unit performs as well as any commercial saw and features a worm-gear vise and adjustable hydraulic feed.

The Gadget Show, sponsored jointly by the Iowa State Fair and Cedar Rapids Radio-TV station WMT, draws 100,000 visitors each year. Among them are manufacturer's agents ready to clinch a deal with inventors for production of the best machines.

One exhibitor last year mingled unnoticed with the crowd to make notes of comments and criticisms and check the number of people who would buy his machine. He returned to his farm shop ready to tool up for quantity production.

Another entrant made stops along the way to the show to exhibit his brainchild to manufacturers. By the time he reached Des Moines he had a plant to produce it.

Greater production with less effort proved to be the main theme of the show.



Clifford Cruzen made his tractor-mounted posthole auger serve a time-saving double purpose. He made the auger interchangeable with a long spool made from a discarded well pipe. He uses the powered two-direction rotation of the attachment to roll up and unroll fence wire.

Judges, spectators and manufacturers marveled at a farm-built corn planter that plants eight rows of corn at a time—twice as much as the biggest standard planter. Inventor Denton Myers solved its transportation problem by designing it so that it can travel endwise along the highway and through gates.

Outstanding ingenuity and simplicity of design marked two other inventions. The first was a rotary mower with only one control—a clutch that swings the entire motor to tighten the belts that drive the cutter blade and the single rear power wheel. To reverse, you just spin the rear wheel 180 degrees. The driver sits on a salvaged corn-plow seat and steers with an old auto steering wheel.

Another neat idea was a tractor attachment

Boys' tractor has aircooled motor, auto transmission and cut-down differential. It's used to pull lawn mowers

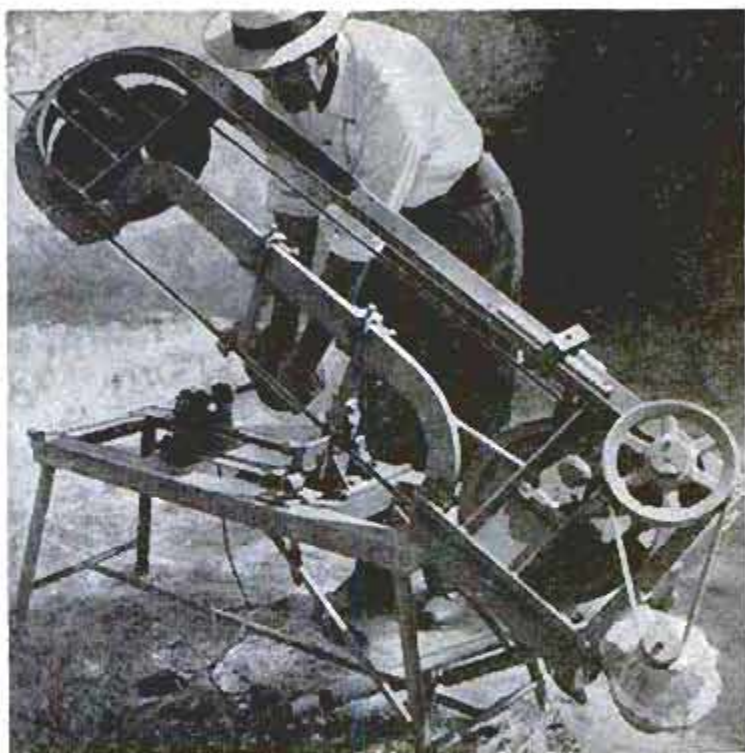

Metal-cutting bandsaw was made from scrap parts. Wheels that blade runs on are auto-flywheel gears. Frame is from hay baler

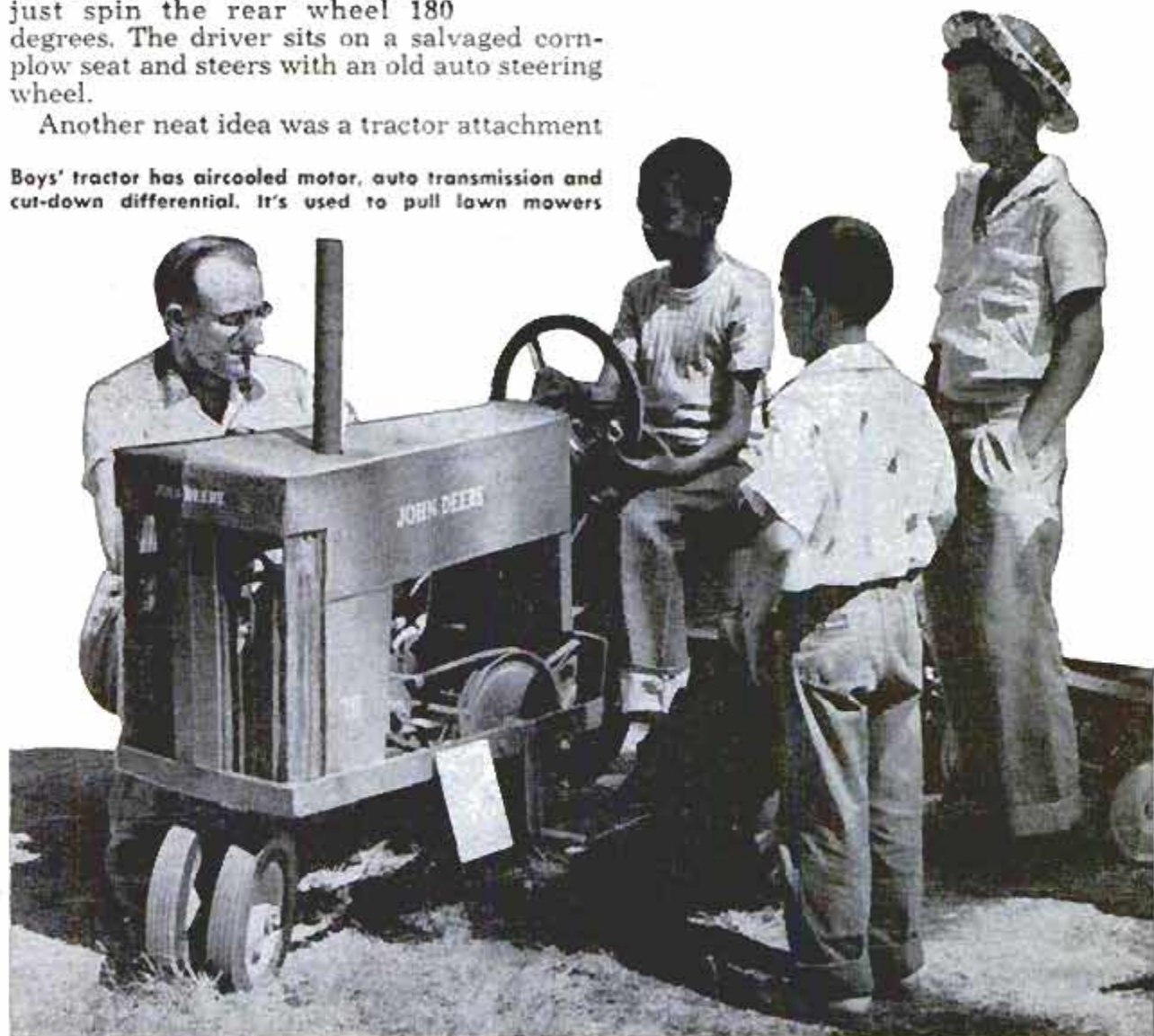



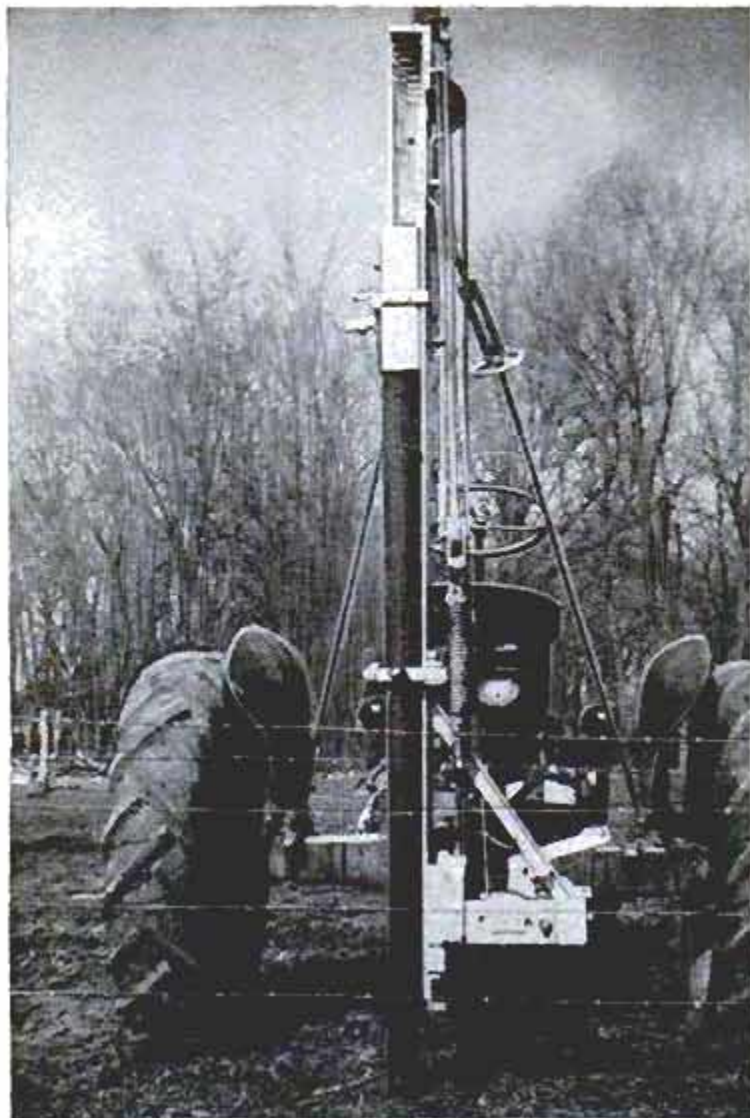

Mounted on tractor drawbar and driven by power take-off, this tool drives fence posts, pulls them out, quickly converts to become a wagon hoist, crane and winch. Below, bar joins tractor clutch and brake pedals together for safety and convenience



that drives fence posts, pulls posts, hoists farm wagons for grain dumping and acts as a crane-winch. Made from salvaged steel angle irons and implement gears, it is powered by the power take-off and fastens to the drawbar.

It works like a pile driver to pound posts into the ground. A simple cam arrangement controls the hammer stroke and a simple stop halts the hammer when the post is driven deep enough. While still in the vertical position, it converts to pull posts out of the ground. Cable and hook are attached to hoist wagons and lift heavy farm implements for repair. With the mast tipped, it becomes a portable crane. In addition, the cable can be payed out and slowly wound in with the winch. Designer John Hartl plans to manufacture it.

The prime attention-getter at the show was a child's size tractor, built by a young eastern Iowa farmer for his children from discarded auto parts and powered with an aircooled engine. It proved practical, too. Inventor Don Buch showed the judges how the kids mowed the lawn at home. It pulled three handleless mowers, cutting a swath nearly six feet wide.

A spectator under pressure from his small son offered to buy the tractor for \$450, but the deal was quickly scotched by Buch's four boys.

Special emphasis was placed last year on safety devices and equipment.

One entrant displayed huge buttons covered with reflecting tape that he pinned on his clothing while working on or near roads at night. A conscientious fellow brought a large sign he placed on the edge of the highway near his farm to warn motorists of danger when he tracks mud onto the road with his equipment. Other ideas ranged from a complex lighting system for tractors to a locking gas cap an alert farmer provided for his tractor. The cap key was simply riveted to the ignition key, making it impossible to gas up while the engine is running.

Howard Fountain of Iowa City found commercial possibilities in a simple device that locks the tractor foot brake and clutch pedals together. With it, it is possible to





Eight-row corn planter speeds planting. Stand-by wheels are lowered hydraulically for endwise transport

throw out the clutch and apply the brake at the same time. Fountain explains that this is not only safer, but convenient and energy-saving in some types of field work.

#### Rotary-Hoe Transport

First prize in the open class went to a transport for a rotary hoe, a wide machine that has a hard time getting through gates. Robert Louks made a carrier to pull the cumbersome hoe by its end rather than its

side. He was amazed at the reception the invention received. Hundreds of people asked about it and farm implement dealers vied to display their brand of hoe with the carrier.

Louks' modest comment was typical: "I don't know what all the fuss is about. It's just a couple of old combine wheels, some old scrap channel, angles, chain and a hydraulic cylinder. I just built it because I needed it." ★ ★ ★

Rotary hoes and other awkward equipment are chained to this transport, raised hydraulically for carrying

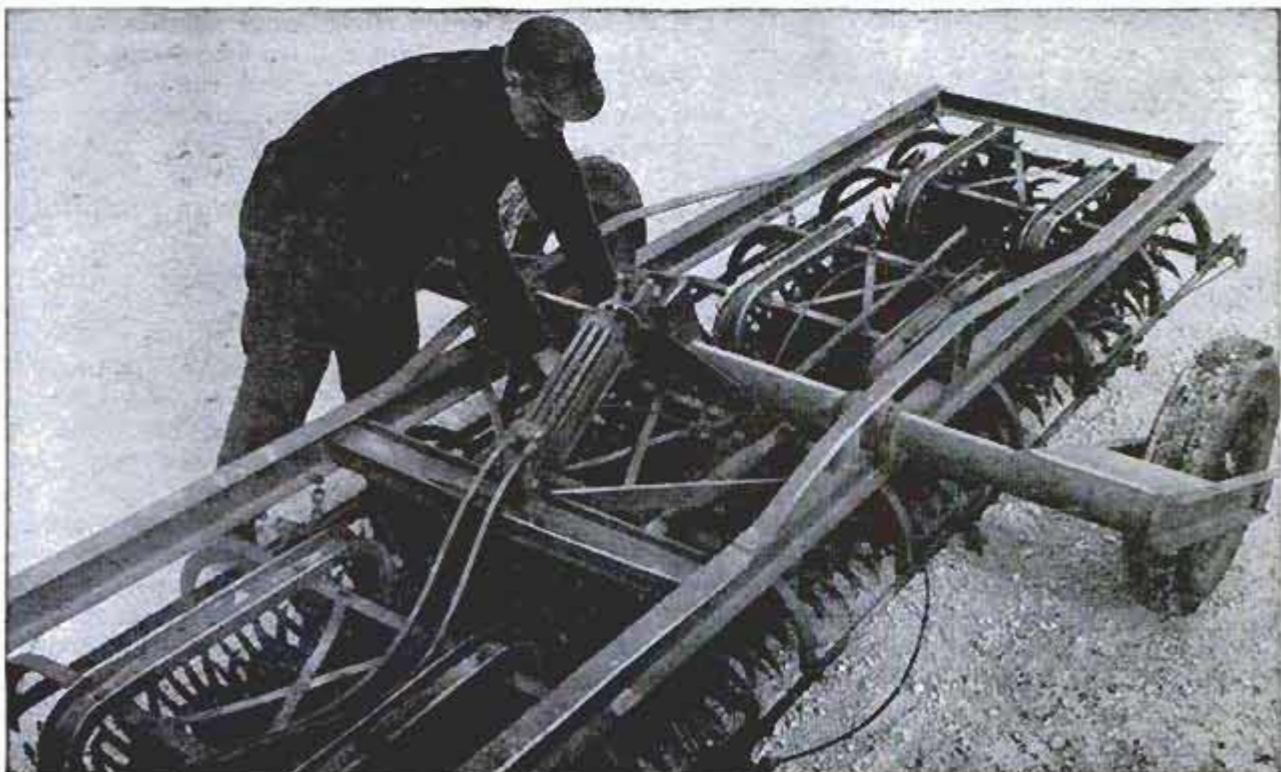



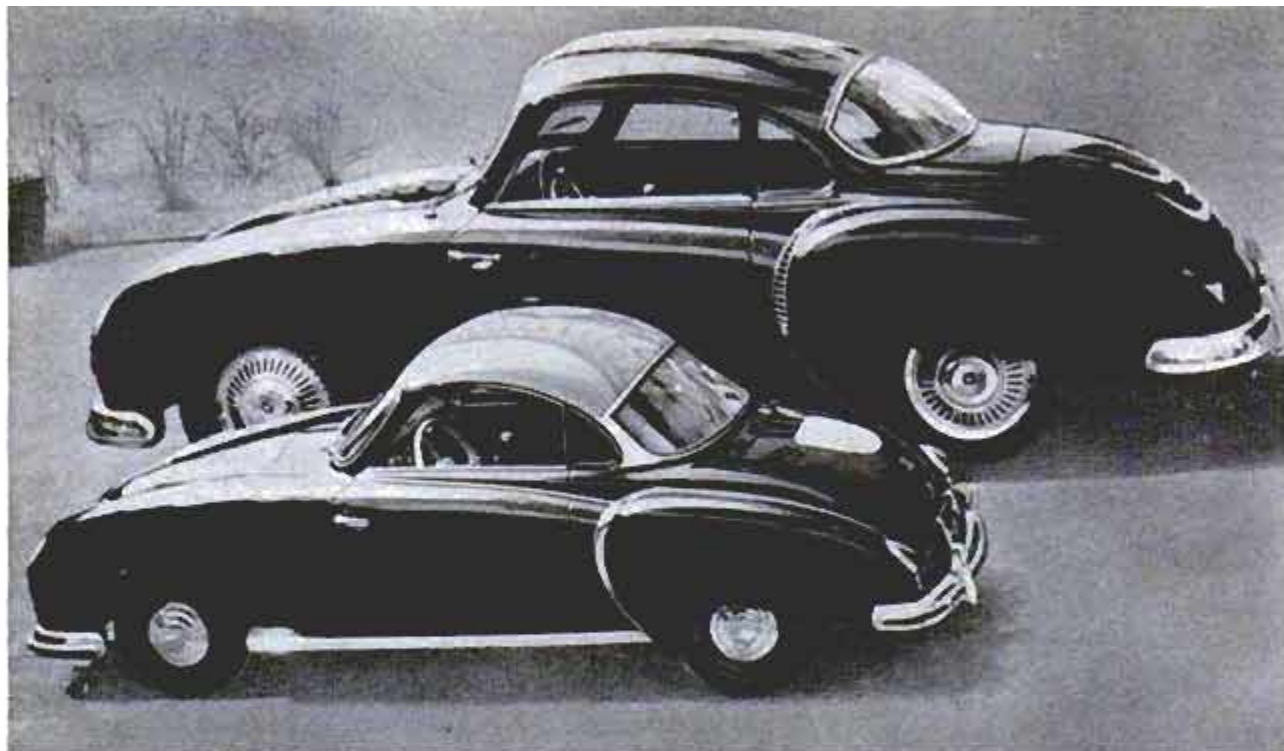

Manfred Goll photos



Little car duplicates its big brother in almost every respect. Big car is built on Renault chassis. Left, a small child towers over the Lilliputian automobile

### Child-Size Custom Car

At a cost of about \$400 and 2075 working hours, a master mechanic of Stuttgart, Germany, has built a faithful model of his custom sports car for his 13-year-old daughter. The car, powered by an air-cooled engine and equipped with three shifting gears, is 88 inches long and 31 inches high. It has a complete instrument panel, lights that can be dimmed, parking and stop lights, directional signals, a horn and windows that roll up and down. Adolf Hausle built the precision model in four years of his spare time, making all parts but the instrument panel, steering wheel, tires and horn. He exhibited it at the international automobile show in Frankfurt.

### Wireless Home Thermostat Transmits Radio Signals

No wiring is needed to hook up an experimental thermostat that controls a heating system by radio signals. Built into a standard heating thermostat is a tiny loop antenna and a crystal-controlled radio transmitter. When the temperature drops below the setting, the thermostat broadcasts a signal to a small radio receiver. The receiver converts the sound impulse into energy and operates a valve on hot-water and steam radiators, or opens and closes dampers. The unit is not in production, partly because of the lack of long-lived batteries to power the thermostat.

### Cosmic Rays Won't Stop Future Space Flights

Cosmic rays present no barrier to space travelers, tests at the University of California indicate. Yeast cells were bombarded with particles from a 60-inch cyclotron to determine the destructive power of heavy particles, which are present above 120,000 feet in the atmosphere. The heavy particles, which are widely dispersed in cosmic rays, caused little damage. Research suggests that a single heavy particle could not cause serious damage by striking a sensitive spot.



## ELECTRONIC MIXER For Home Recorders



By  
Dr. R. C.  
Hitchcock

WHILE TODAY'S tape recorders, even the low-cost, home-recording types, are capable of excellent performance, they suffer from one common limitation: Most of them can record from only a single source at a time. True, some have separate input jacks for high and low-level signals, but few of them have provisions for combining these so that signals from several sources can be recorded simultaneously.

By the simple addition of this compact mixer, any recorder can be converted to a professional-type instrument. With it, you can become your own audio engineer, mixing and blending up to four separate signals in any desired volume ratio. This greatly increases the variety of programs that can be recorded, and adds a professional touch to your recordings.

The mixer not only increases the ver-

satility of a recorder, but converts any ordinary amplifier into a public-address system, where it is often desirable to combine the output from two microphones, or mix a mike with a record player. Its high inherent amplification makes it suitable for use even with low-gain amplifiers.

### Design Features

A picture of the completed mixer, together with its companion recording-level indicator, is shown in the title illustration. Construction of the indicator will be described in a subsequent issue. From the schematic diagram, Fig. 1, it is seen that the unit contains two dual-triode 12AX7 tubes and a selenium rectifier, thus giving five-tube operation. This permits the isolation of the various channels to have a minimum of "break through" or "cross



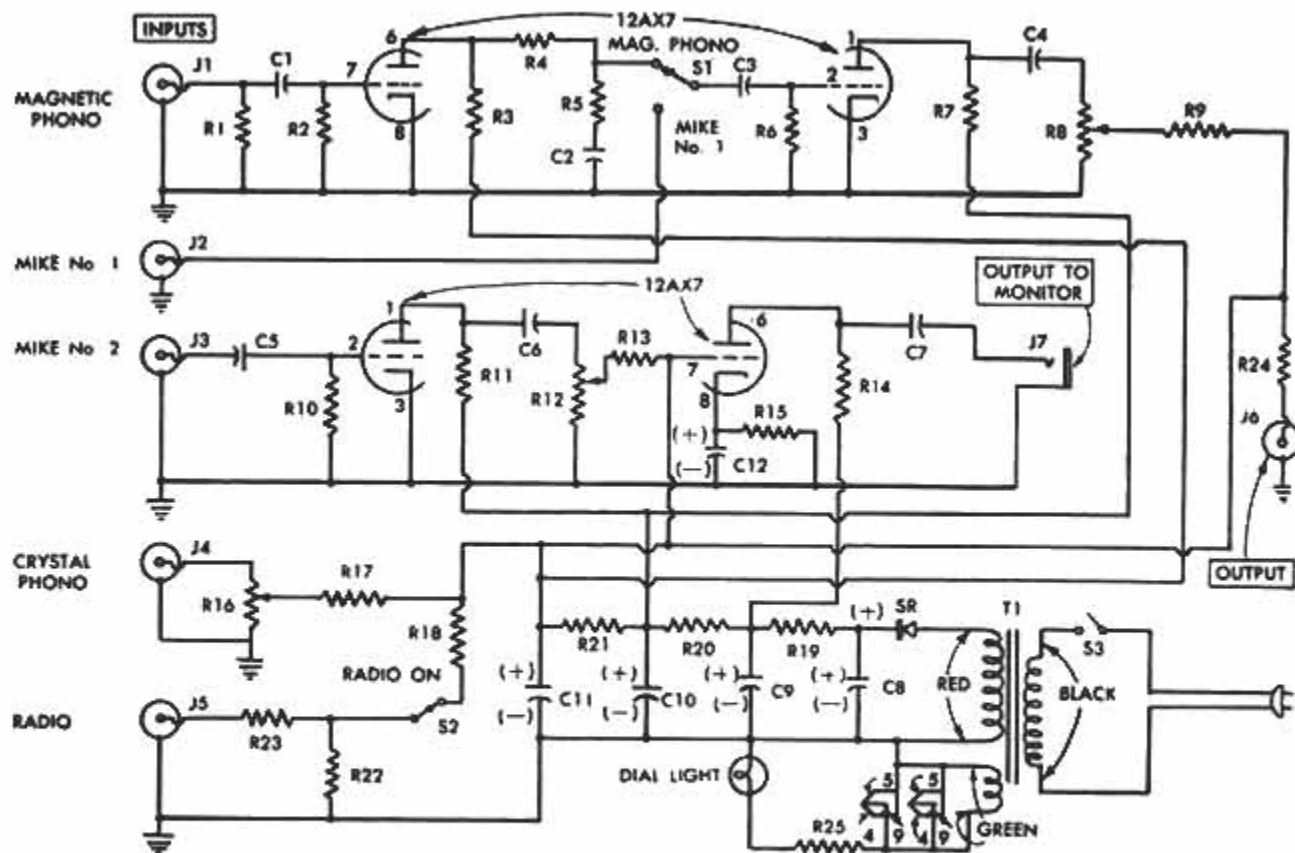

Fig. 1. Schematic diagram of versatile mixer-preamplifier for recording and public-address systems

### LIST OF MATERIALS

Resistors—All  $\frac{1}{2}$ -w. carbon unless otherwise specified

K=1000 M=1,000,000  
 R1, R19, R21=10K  
 R2, R6, R10=6.8M  
 R3=68K  
 R4=180K  
 R5=27K  
 R7, R11=33K  
 R8, R12, R16= $\frac{1}{2}$ M pot. audio taper, I.R.C. type Q13-133 or equiv.  
 R9, R13, R17, R18, R23=1M  
 R14=100K  
 R15=2.2K  
 R20=4.7K  
 R22, R24=470K  
 R25=10 ohms, 1-w., wire-wound

#### CAPACITORS

C1, C3, C5=.05 mfd. 200-v. tubular  
 C2=.01 mfd. 400-v. tubular  
 C4, C6=.02 mfd. 200-v. tubular  
 C7=.1 mfd. 200-v. tubular  
 C8=10 mfd. 150-v. electrolytic, Cornell-Dubilier type BBR or equiv.

C9, C10, C11=20/20/20 mfd. 150-v. electrolytic, Mallory type FP 311.2 or equiv.  
 C12=25 mfd. 6-v. electrolytic, C-D type BBR or equiv.

#### MISCELLANEOUS

T1=Power transformer—sec. 125-v., 15 ma. and 6.3-v., .6a. Stancor PS8415 or equiv.  
 SR=65 ma. selenium rectifier  
 S1=S.p.d.t. toggle switch  
 S2, S3=S.p.s.t. toggle switch  
 J1 through J6=Dual phono jacks (3 reqd.)  
 J7=Phone jack, Mallory infant type A-1  
 Tubes=12AX7 (2 reqd.)  
 Sockets=9-pin miniature, mica filled, Eby 9718 or equiv.  
 Cabinet=Bud type CU1581  
 12-point terminal strip—Jones type 2012  
 Knobs (3); line cord with plug; rubber grommet for  $\frac{1}{2}$ -in. hole; pilot light bracket (Johnson 147-306); pilot bulb (type 51); tube shields (2); package of 6-32 $\times$  $\frac{1}{4}$  machine screws and nuts; 15/32-32 hex nuts for switches (3); 3/8-32 hex nuts for controls (3); hookup wire; rosin-core solder; material for chassis and name plate (see text).

talk" before the actual mixing occurs in the output circuit. Five separate inputs are provided, three of which have independent volume controls.

Channel 1 is for a record player using a magnetic phono cartridge such as G-E or Pickering. This utilizes both sections of a 12AX7, one as an equalizer, the second as an amplifier. A switch, S1, converts this channel into an amplifier for mike 1, a high-impedance (crystal) microphone. Since such a microphone requires no equalization, the first tube section is cut out when the switch is thrown to the mike position.

The first triode of the other tube serves

as an amplifier for mike 2. The output of this stage is coupled through the volume control R12 and resistors R13 and R24 to the output jack, where it is combined with the signals from the other inputs. These combined signals also appear at the grid of the second triode section for further amplification. The output of this stage is great enough to drive a recording-level indicator or a low-gain amplifier.

Channels 4 and 5 are for crystal phono and radio inputs, respectively. Since the signals from such units are much stronger than those of a microphone or magnetic cartridge, they are attenuated by resistive



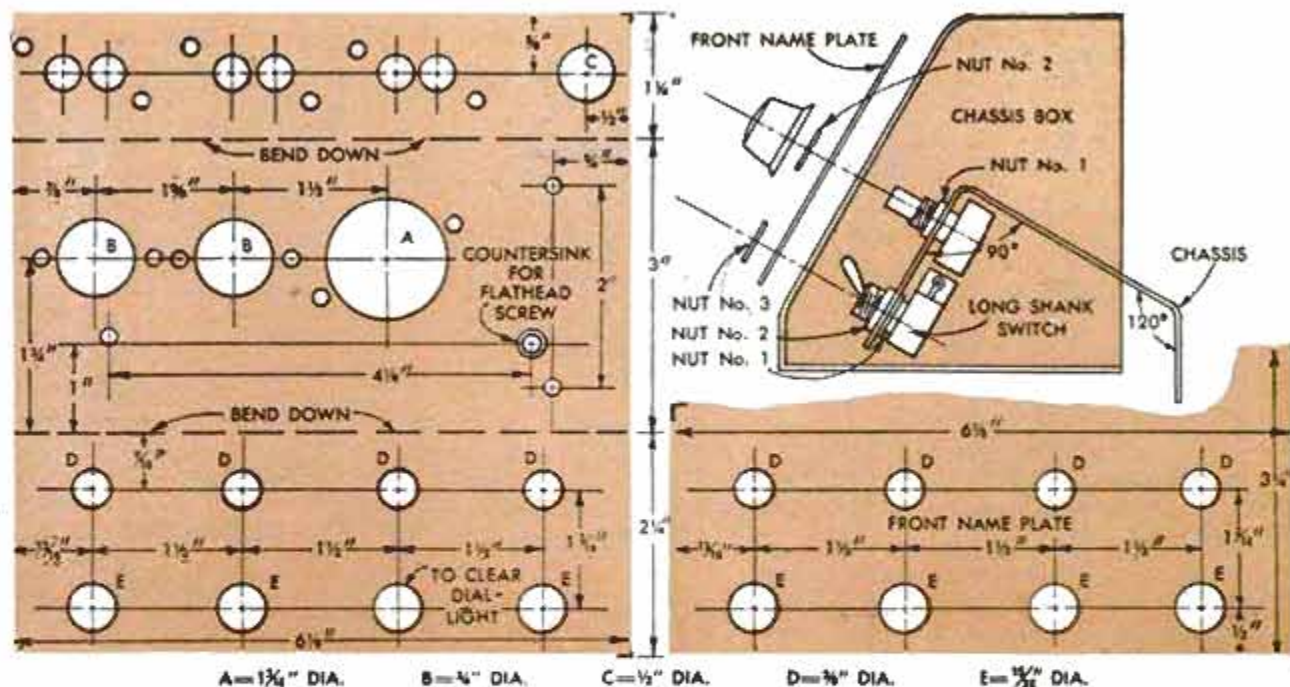

Fig. 2. Left, chassis layout, top view. Right, front name-plate layout and final installation details

voltage dividers so that they can be successfully mixed in the output. The approximate gain of each channel and the input voltage needed for .05 volts at the mixer output jack, J6, is as follows:

CHANNEL	INPUT	GAIN
Mag. phono	.003-v.	24 db
Mike 1 and 2	.01-v.	14 db
Crystal Phono	.5-v.	-20 db
Radio	1.0-v.	-26 db

### Construction

Layout and assembly for the chassis, name plate and case are illustrated in Fig. 2. The chassis is made from a piece of 1/16-in. soft aluminum which is easily bent to fit the commercially available metal case after the necessary holes have been drilled and punched. The holes in the name plate must line up with those in the front part of the chassis and in the case. To assure accuracy in the layout, drill small No. 27

Fig. 3. Parts location and initial wiring. Note spacing of ground-bus and filament leads away from chassis

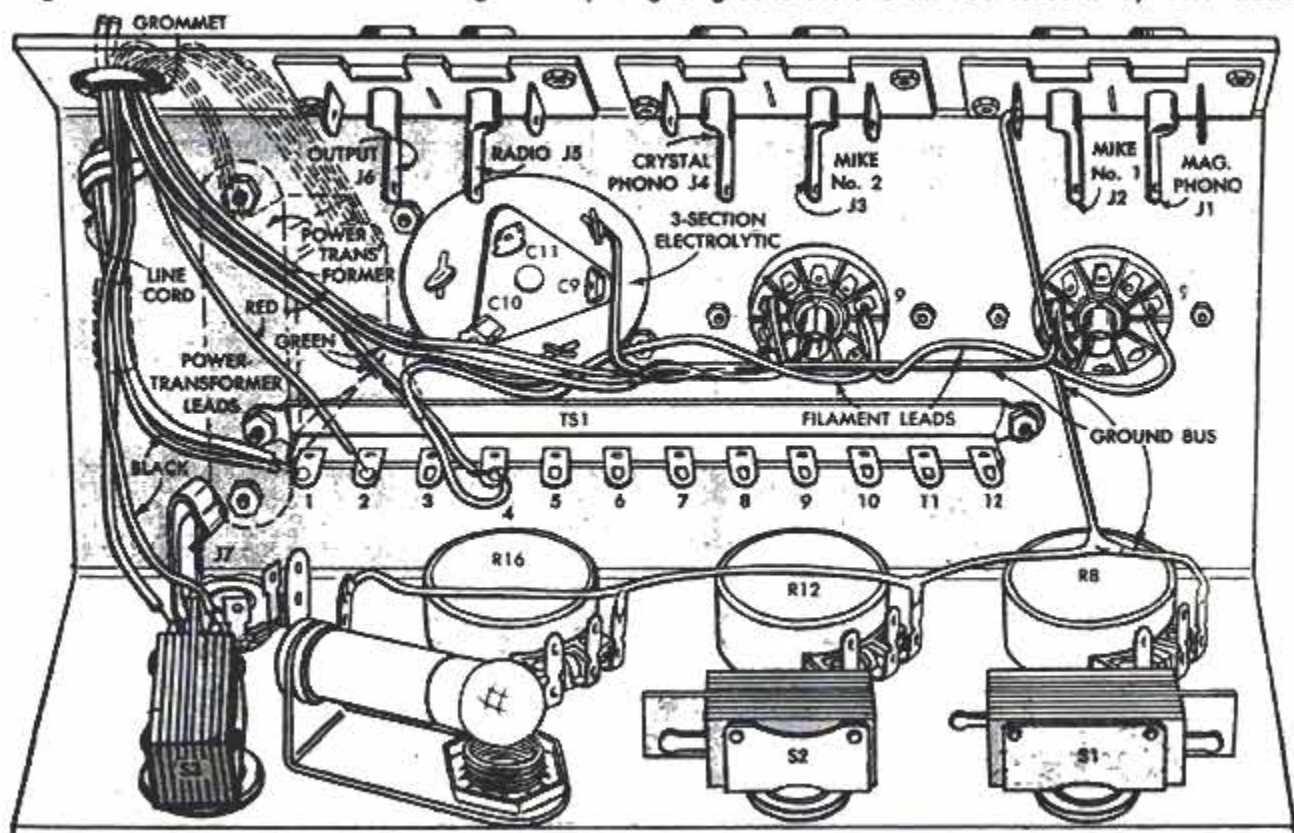



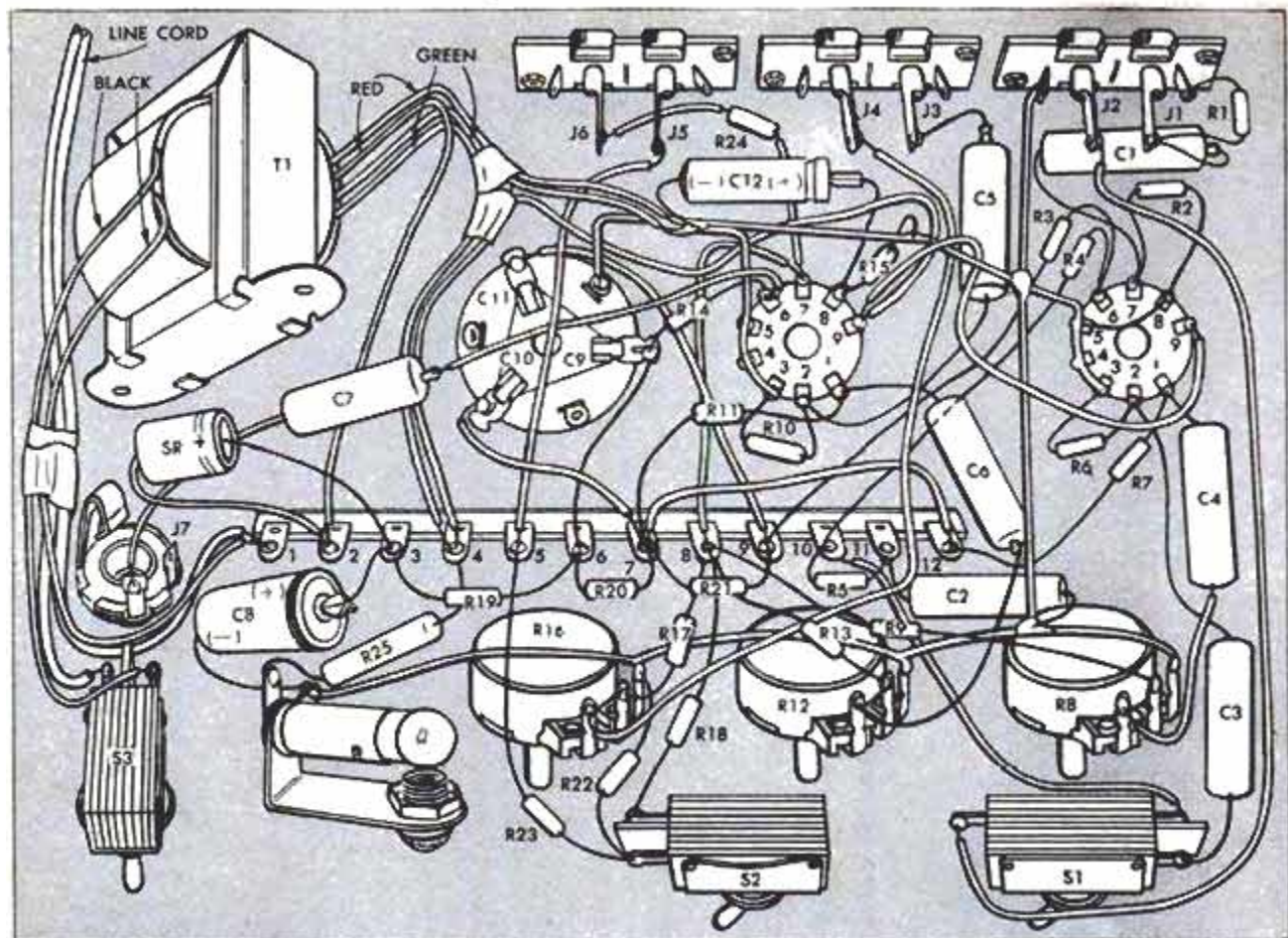

Fig. 4. Pictorial diagram. Point-to-point wiring of complete mixer-preamplifier, including initial wiring

pilot holes in the name plate at all hole locations. Then, use the name plate as a template for drilling corresponding holes in the chassis and case. Thereafter, drill the remaining chassis holes (before bending it to fit the case) and enlarge all holes to the proper dimensions.

India ink is used for all lettering on the name plate and back of the chassis. Roughen and clean the aluminum with an ink eraser before lettering and, when dry, cover it with clear lacquer to protect the finish.

Fig. 3 shows the location of the main parts on the chassis and the initial wiring.

Note that one of the terminal-strip mounting holes is directly beneath the power transformer. This hole should be counter-sunk from the top to permit flush-mounting of the transformer after the terminal strip is installed.

The electrolytic capacitor is mounted with its fiber insulating board above the chassis. All circuit ground connections are made to a common ground bus, No. 14 tinned copper wire, which is grounded to the chassis only at the input jacks. The ground bus wire from the electrolytic to

(Continued to page 222)

Fig. 5. Left, rear view of completed mixer. Right, under-chassis view shows exact location of small parts

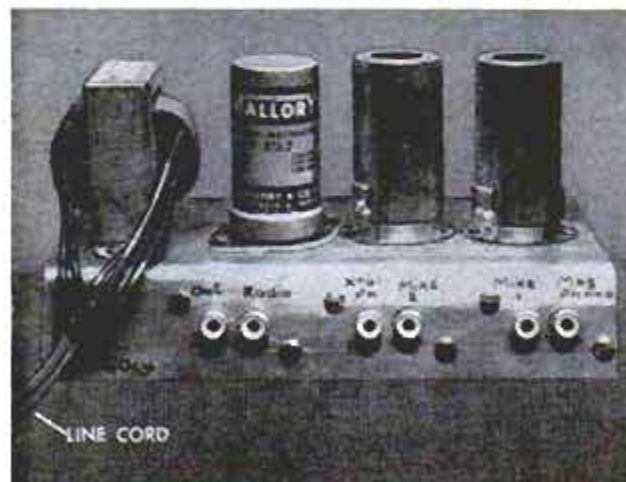



# the **POPULAR MECHANICS** CRAFTSMAN

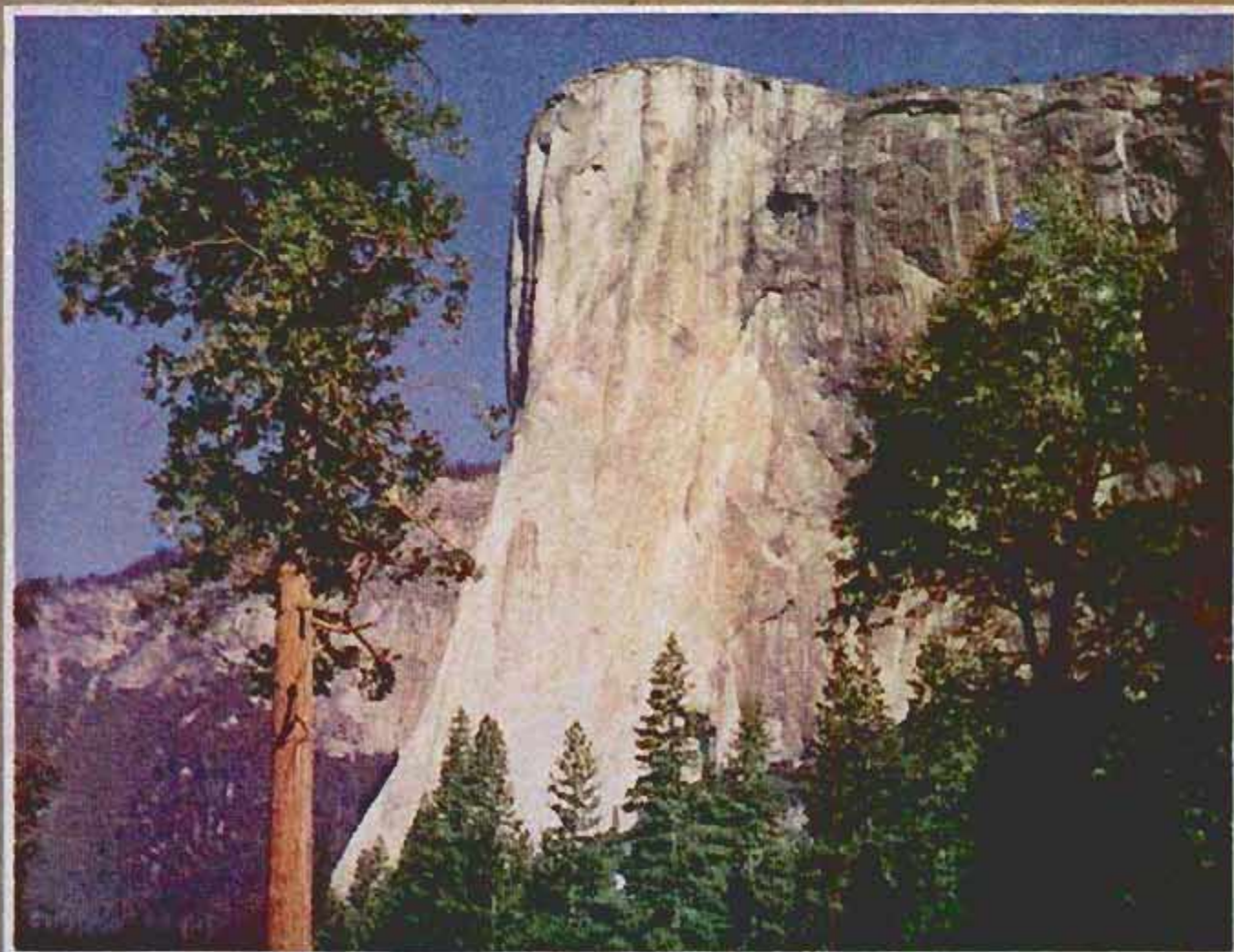

## Decorate with **PAPER TRANSPARENCIES**

By Theodosia Carpenter

THOSE FULL-COLOR ILLUSTRATIONS you have admired in magazines and newspapers can be made into "paper transparencies" and used for decorative purposes in much the same way that is now so popular with photographic transparencies. Materials required are a tablespoon, warm iron, water and prepared frisket, which is available at art-supply stores.

Frisket is a thin, transparent paper that has an adhesive coating on one side. When purchased, the adhesive is covered with a protective sheet of paper that must be removed before the frisket can





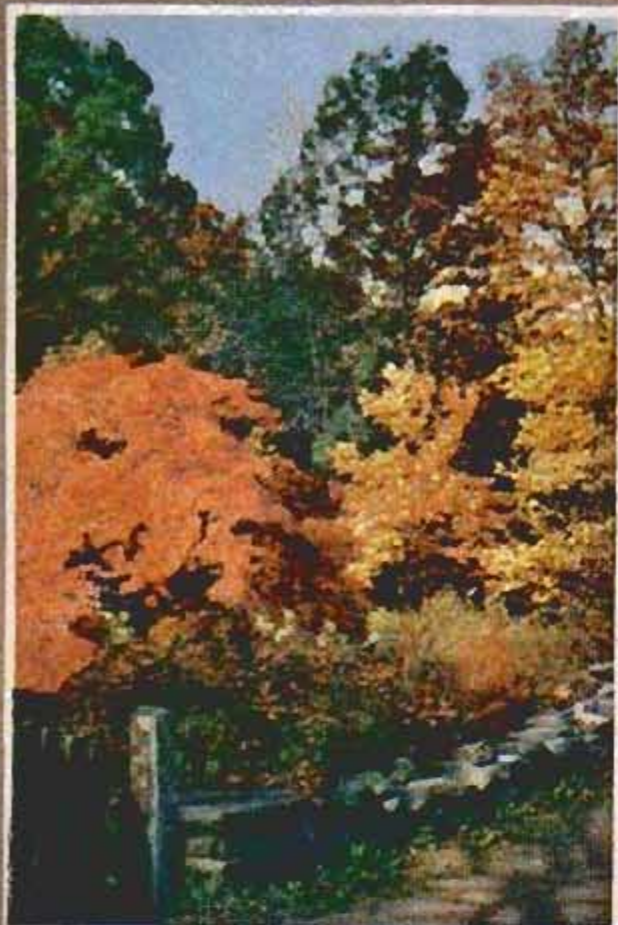

Above, brightly colored pictures small enough to be fitted in film-slide mounts can be used and handled in the same manner as color slides. Below, old lampshades can be renewed by applying paper transparencies to them to add beauty and character

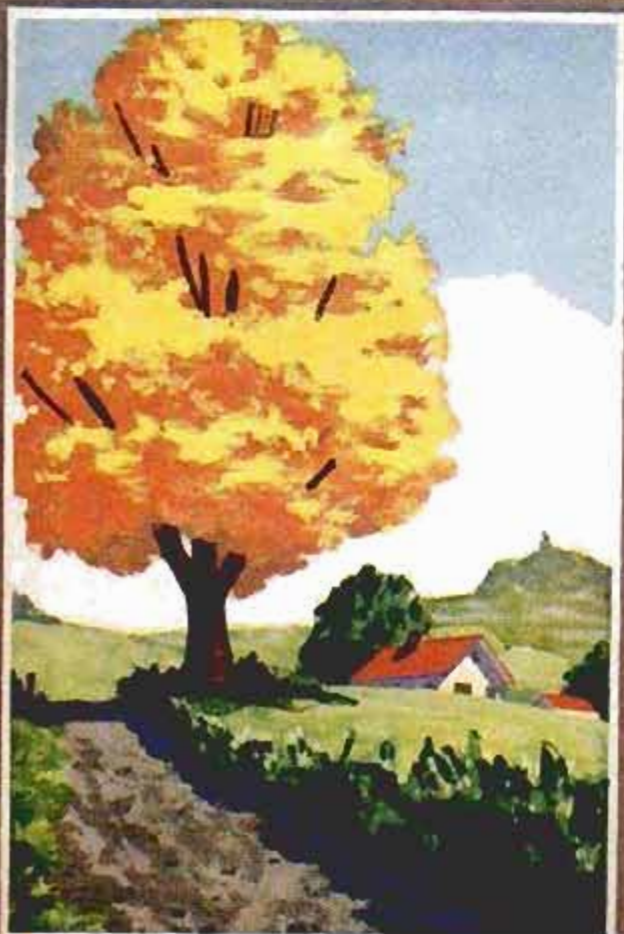

## Color Slides

be applied. However, before removing the paper, cut a piece of frisket to cover the illustration that is to be lifted. Then, as shown in the series of photographs on page 149, place the illustration on a flat, smooth surface and lay the frisket over it, adhesive side down. To assure that the frisket is in firm contact at all points, rub it with the back of a tablespoon until all air bubbles are removed. Next, place a piece of wrapping paper on the frisket and pass a warm iron over it which bonds the ink in the illustration to the adhesive of the frisket. Now immerse the frisket and illustration in a pan of lukewarm water. As shown in the illustration at the bottom of page 148, peel the paper away from the illustration as soon as it becomes loosened. If this is not done quickly enough, the paper may stick to the frisket and have to be rubbed off, which could very well damage the lifted illustration.

When the paper has been removed from the frisket you will have an illustration on a transparent sheet. Since the illustration is only as thick as the ink with which it was printed, it also will be quite transparent. However, because of the extreme thinness of the frisket, the transparency must be cemented to clear plastic sheeting to provide strength. To further strengthen and

## Lamp Shades

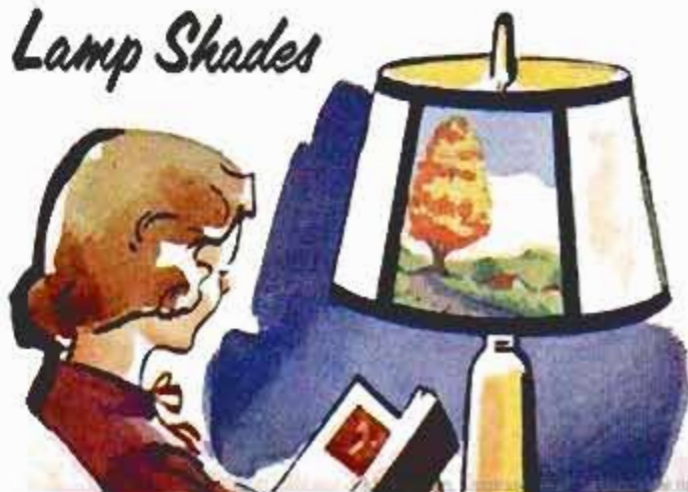





add to its clarity, spray the inked side with clear lacquer or plastic.

#### **Illuminated Pictures**

The brightly colored paper transparencies make excellent illuminated pictures and are used in much the same manner as film transparencies. First, cement the paper transparency to a sheet of translucent plastic. (Translucent, rather than transparent is used here because light diffusion is desired.) Then set the transparency into the grooved edges of a deep picture frame and mount a light behind it. A night light is made in a similar manner, as detailed at the bottom of page 149. Since a small bulb is used in a night light, the picture frame can be shallower than an illuminated picture used only for decoration.

#### **Color Slides**

Pictures small enough to be fitted in projection-slide mounts can be made into paper transparencies and used in the same manner as film slides. Simply trim the transparencies to fit cardboard mounts and insert them in a slide projector. To protect the transparencies against handling, spray them with clear lacquer or plastic.

#### **Lamp Shades**

Translucent or transparent lamp shades can be given a new and striking appearance

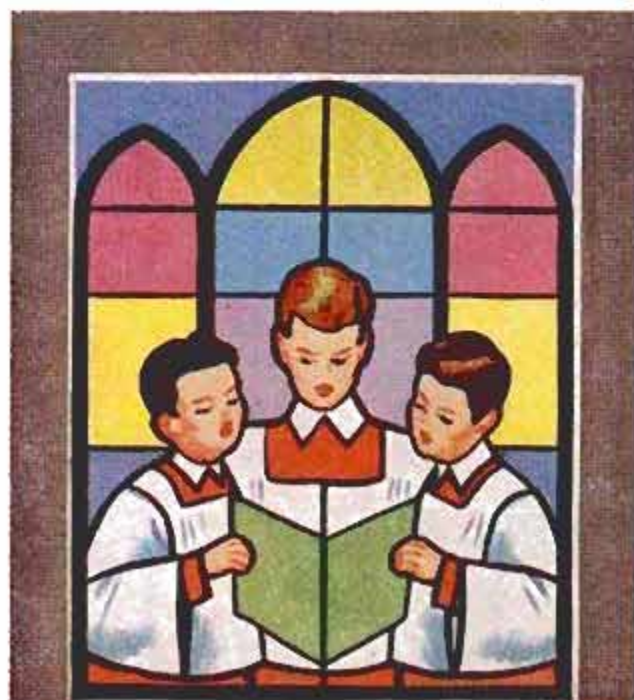



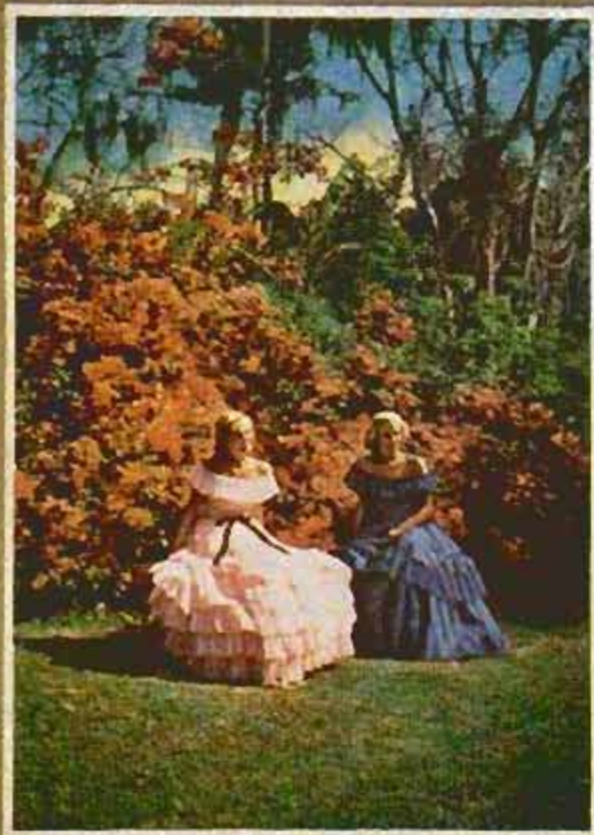

Above, paper transparencies can be made of any scene or subject that has been printed, then fitted in a frame to make illuminated pictures for desk or wall. Below, lovely illustrations on greeting cards can be removed with frisket and used for other purposes



## *Illuminated Desk Pictures*

by cementing one or more paper transparencies to the inside or outside surface. Light shining through the transparencies will make them glow with color. Imagination is the only limit to the various effects possible on lamp shades. A montage of scenes from a foreign country you would like to visit might make an interesting lamp-shade covering for a lamp in a den or study. Animal pictures or Mother Goose characters would go well on a lampshade in a child's room. Sealed between sheets of clear plastic, a paper transparency would add a touch of color to the shade of an outside entrance light.

### **Greeting Cards**

Inexpensive greeting cards can be given a touch of luxury by cutting out the pictures on them and lifting them from the paper with frisket. After cementing the pictures to pieces of clear plastic larger than the pictures, cement them to the back sides of the cards from which they were

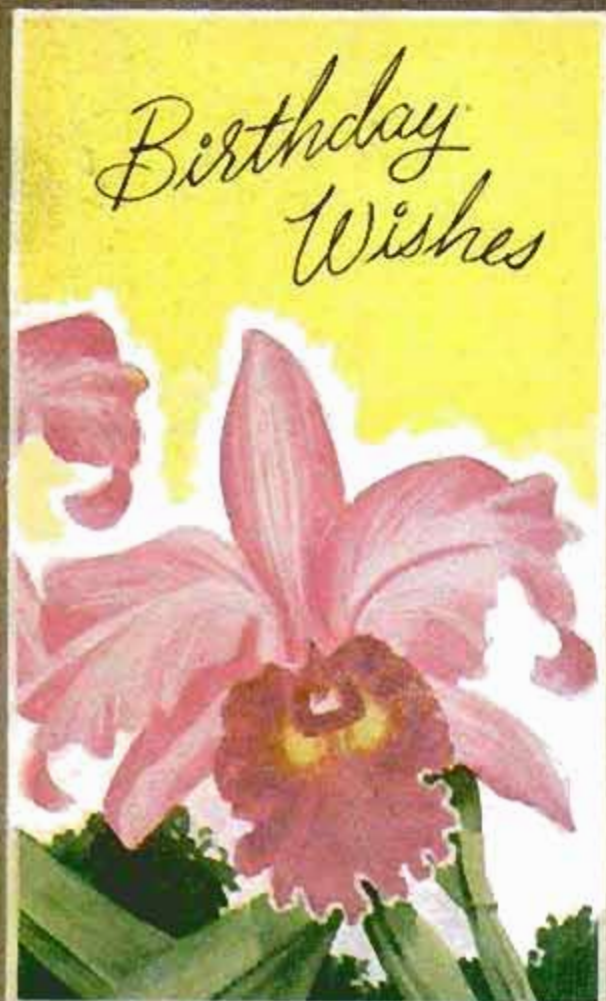





First step in using prepared frisket is to remove the sheet of protective paper from adhesive side



Next step is to place illustration face up on flat surface and cover with frisket, adhesive side down

cut, aligning them to fit the cutout areas. The cards then will have transparent illustrations, similar to those found on more expensive cards. Using a similar procedure you can make your own greeting cards. Illustrations clipped from magazines (including those shown here), removed from picture postcards or even discarded greeting cards can be made into paper transparencies suitable for greeting cards. Heavy white or colored paper is used for the cards. Make a cutout in each card slightly smaller than the transparency, which then is cemented to the back of the cutout. For a more finished appearance, cover the edges of the transparency with a paper frame.

#### Other uses

Ideas for uses for paper transparencies that have been described will suggest others. As examples: Illuminated pictures are just as attractive on desk or table top as they are on a wall. Making greeting cards with transparencies suggests the insertion of a transparent picture in the cover of a scrapbook for a novel appearance. Still another application would be illuminated faces for Halloween pumpkins.

Children confined to the house during bad weather will spend hours searching through magazines for likely pictures and then making them into paper transparencies. Mother need help only when it comes to using the iron. ★ ★ ★



Above, smooth out all air bubbles with back of spoon. Below, ironing completes transfer of ink to frisket



Detail below shows construction of simple night light that uses paper transparency in picture frame

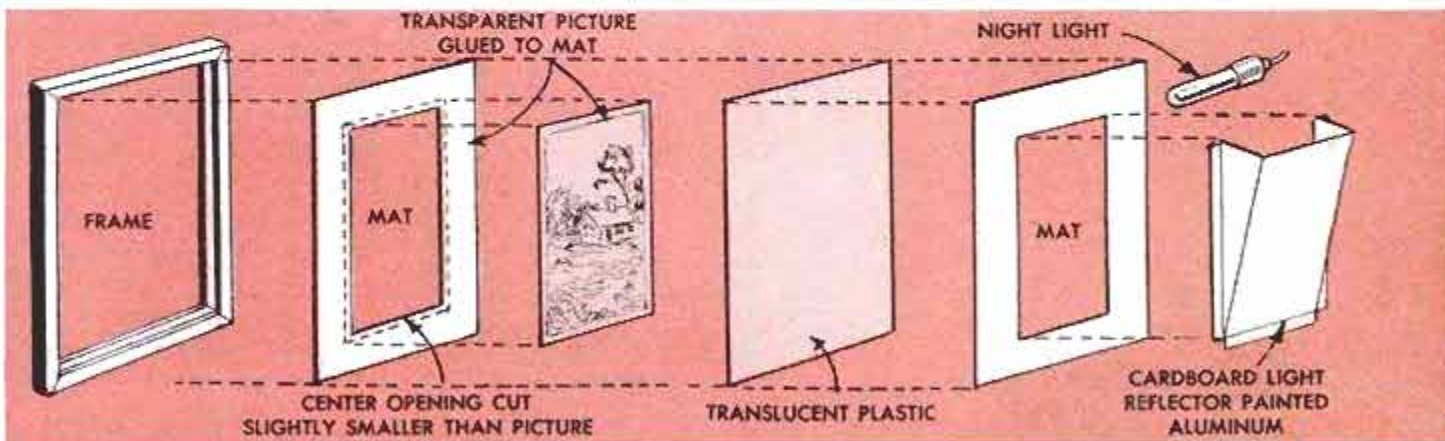



## End-Grain Facing Provides Durable Dart-Board Surface



A dart board that can really "take it" may be made from soft-wood-block ends, which are glued to a 2-ft. square of  $\frac{1}{4}$ -in. plywood. Any soft-wood can be used for the blocks, which should be sawed across the grain to produce  $\frac{1}{2}$ -in. width. If special care is taken to saw all the blocks the same width, much sanding will be eliminated.

A 2-in. border of soft-wood is cut to fit the plywood and nailed temporarily in place. Next, the blocks are

## Typewritten Sheet Aligned For Typing in Corrections



Next time you have to make perfectly aligned typing corrections, insert a piece of tracing paper with the sheet to be corrected so that it covers the error. The tracing sheet should be about one third the size

of the typed sheet so it can be removed without disrupting the position of the latter. With the tracing paper over the area to be corrected, make trial impressions on it and adjust the typewriter accordingly. When accurately aligned, remove the tracing paper and make the corrections.

temporarily in place. Then glue the blocks to the plywood with the end grain exposed, and held in place with weights, such as bricks or other heavy material. Use a generous amount of a good wood glue, since the porous end grain will readily absorb much of it. When the glue has set, remove the border and sand the target surface smooth. Then glue the border permanently in place and follow with two coats of tough resin varnish for an undercoat and two coats of white enamel for the finish coat. Paint the target with bright colors and mask the numbers in with tape.

Confusion in scoring can be avoided when a dart strikes a dividing line on the target, if the rings are separated by a fine wire tacked in place. The completed dart board should be mounted on a large piece of fiber board for protection of the surrounding wall and dart tips.

Asa Warren, Pana, Ill.

## Bedding Material Stretched on Frame for Photo Backgrounds

Effective backgrounds for many photographic purposes can be prepared by stretching bedding textiles, such as used

sheets, blankets and spreads, on a nail-studded frame. Such materials are obtainable in large widths without seams,

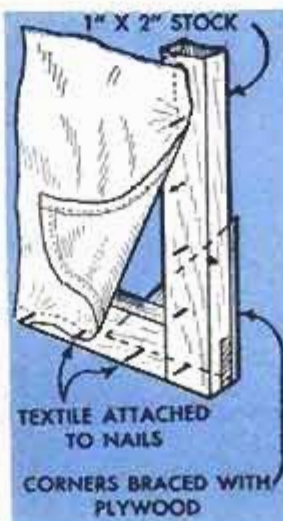

A framework of 1 x 2-in. stock is built as wide and long as the sheet to be normally used. The frame corners are braced with triangular pieces of plywood. Evenly spaced 4d finishing nails are driven through the frame and allowed to project. The bedding material is pushed onto the nail points and stretched just enough to eliminate wrinkles and present a smooth surface. —Michael Ligocki, Gary, Ind.



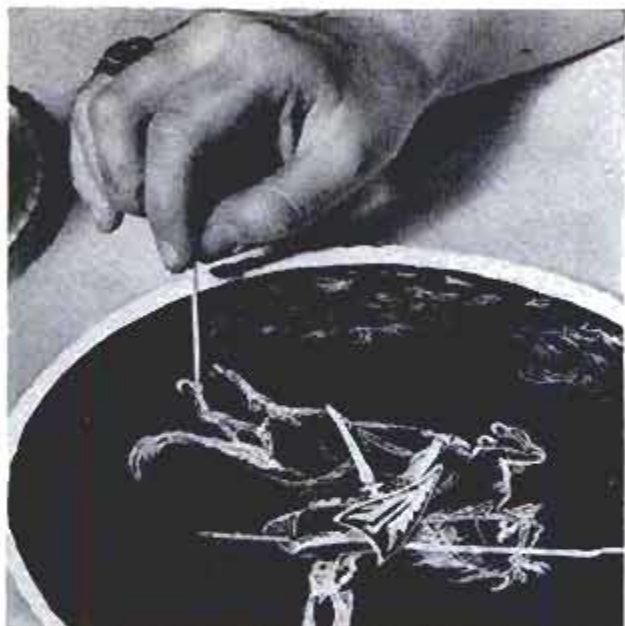

Above, pointed matchstick is used as "brush." Above right, plate is smoked over candle flame



## ETCHING IN SOOT

By Frank A. Woodfield

ALTHOUGH they have the appearance of steel etchings, the attractive sketches illustrated on this page are drawn in soot with a wooden splinter or matchstick. The "canvases" for the sketches are white dinner plates which have been prepared for use by holding them over a burning candle and allowing a thin, even coat of soot to be deposited. The edge of the plate then is wiped clean so that a white "frame" results.

The soot medium has both advantages and disadvantages over more conventional types of drawing materials. If a mistake is made, it cannot be corrected; the whole plate must be resmoked and the drawing redone. This also is an advantage since, if the artist is not satisfied with his work, he can erase the sketch by wiping the plate clean with a damp cloth. Resmoking the plate provides a fresh canvas.

To fix the finished sketch so that it will not smear, use thinned clear varnish. Pour about a tablespoonful onto the edge of the plate and let it flow onto the smoked portion. Move the plate slowly in various directions until varnish has flowed completely over the sketch, then stand the plate on edge and allow the surplus to drain off. When it stops draining, wipe the varnish from the unsmoked edge of the plate and allow it to dry thoroughly.



Samples of finished sketches are shown above. Below, artist displays one of her more detailed "etchings"







### Coffee Cans Under Ladder Rails Prevent Them From Sinking

When using a ladder on soft ground, place the rail ends in empty coffee cans. The cans will distribute the weight over a greater area and prevent the rails from sinking so deeply. Also, the cans prevent the ladder from sliding away from the structure against which it is leaning.

John W. Aberle, Saratoga, Calif.

### Babbitt-Metal Block Controls Soldering-Iron Temperature

To do good soldering work the copper tip on a soldering iron must remain well tinned, a condition which is not maintained if it is allowed to overheat between jobs. If your iron is not equipped with a thermostat control, each time you lay it down let the tip of the copper rest on a block of babbitt metal. This provision will draw off the excess heat while the iron is temporarily idle.



### Dirt Floor of Crawl Space Sealed To Stop Excessive Humidity

Excessive humidity in a crawl space can be prevented by sealing the ground with asphalt-saturated roll roofing to produce a vapor barrier. All litter should be removed from the crawl space and the ground raked smooth before applying the roofing paper. Use 55-lb. paper, laying it on the ground with the adjacent edges overlapped about 3 in. and joined together with roofing cement. Bring the outer edges up against the building walls about 6 in. and cement to the walls. Pipes or posts penetrating the vapor barrier should be wrapped with pieces of roofing paper which are cemented to the ground layer and tied to the pipe or post. All surfaces cemented should be dry and free of dirt. For mechanical protection, a 2 or 3 in. layer of gravel can be spread over the vapor barrier. As additional protection, the crawl area should have adequate air circulation, and the building should be surrounded by a system of drainage tile to remove excessive water.

### Self Locking of Hasp Prevented

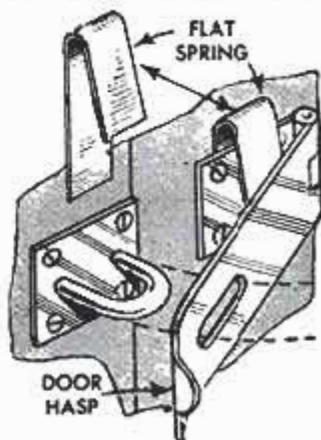

Where a hasp cannot be installed at an angle so that gravity will prevent it from locking accidentally, a small spring fastened under the hinged flange will serve the same purpose. Either a flat spring, as shown, or a coil spring can be used as long as it will

permit positioning the flange for proper locking when light pressure is applied. If a coil spring is used fasten it in place with one of the screws holding the hinged section of the hasp to the door.

### V-Block Holder for Drill Bits

This holder will simplify insertion of drill bits into their proper holes. Sloping sides guide the bits easily from either side to their respective holes drilled at bottom of the V-slot in the back. — G. E. Hendrickson, Argyle, Wis.





# USE LESS SOAP AND SAVE MONEY

*Excess soap is wasted in laundering, makes fabrics harder to rinse thoroughly*

By J. B. Mullen

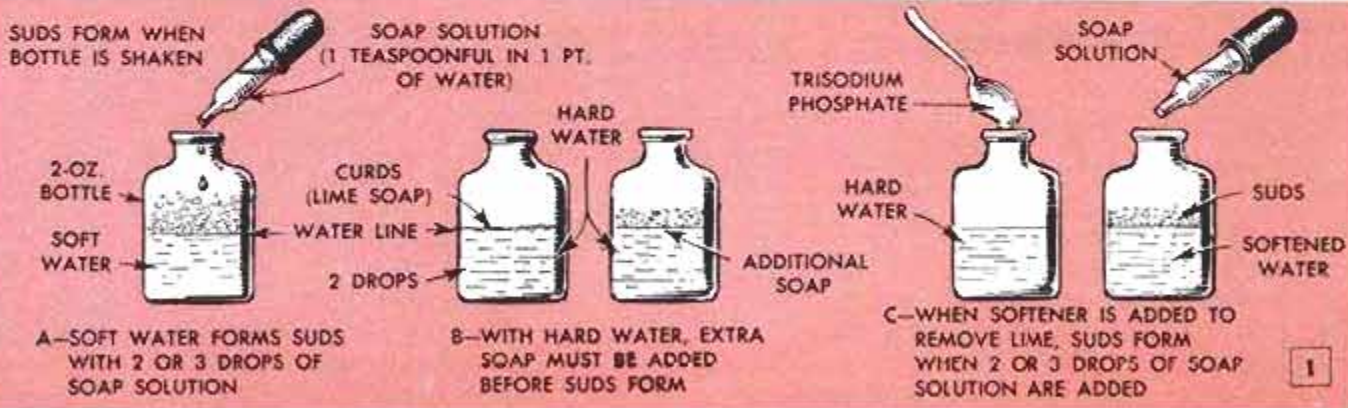

**I**F THERE is a heavy layer of suds in the washing machine at the end of the laundering cycle, you are using too much soap. Excess soap, no matter in what form it is used, is not only waste, but its presence makes fabrics much more difficult to rinse properly. There are simple tests of soap action which will enable you to determine the proper amount of soap to use for best results.

As an example, you can judge the correct amount to use with fair accuracy simply by observing the amount of suds remaining at the end of a laundering cycle. If there is only a light layer remaining you are using very nearly the correct amount. Soap and most synthetic detergents form at least some suds which offer a guide to the full utilization of either or both in the cleansing process. The thin layer of suds

at the end of the washing cycle usually indicates that sufficient soap or detergent is present for good detergent (cleansing) action.

## Testing Soap Action

A simple test will determine more accurately the amount of soap required for the most-efficient cleansing. This is based on the action of soap which develops from the manner in which the soap molecule is formed. The long, fatlike end of the molecule dissolves in the oil drops, Fig. 2, while the sodium end of the molecule dissolves in the water, that is, one end is attracted to oily or fatty substances and the other end is attracted to water. This dual property, oil-seeking at one end and water-seeking at the other, is responsible for the emulsifying action of soap which helps to

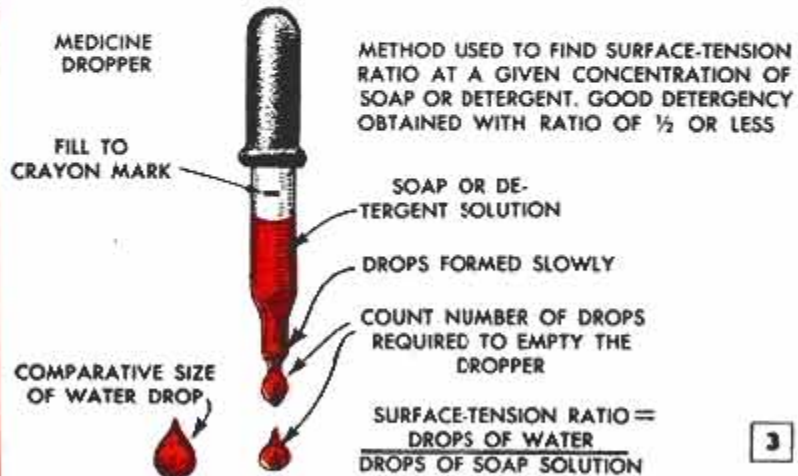
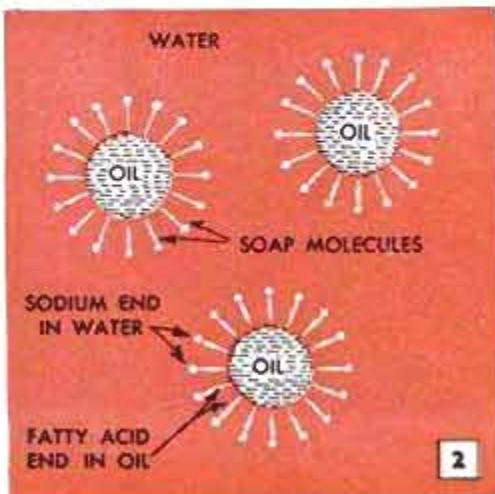



TABLE I EQUIVALENT AMOUNTS OF SOAP PRODUCT IN SMALL AND LARGE BATCHES		
Small Batch	Large Batch	
¼ tsp. per qt.	1 tsp. per gal.	
½ tsp. per qt.	2 tsp. per gal.	
1 tsp. per qt.	1 heaping tbsp. per gal.	
2 tsp. per qt.	3 tbsp. per gal.	

TABLE II WATER SOFTENING WITH SODIUM CARBONATE OR TRISODIUM PHOSPHATE		
Hardness of Water (grains per gallon)	Tsp. per gallon of Sodium Carbonate (Washing soda)	Tsp. per gallon of Trisodium Phosphate
10	½ tsp.	tsp.
20	1 tsp.	tsp.
30	1½ tsp.	1 tsp.

Photo courtesy The Permutit Co.

remove oil and grease from fabrics, your hands and other articles normally cleansed by washing in soapy water. The action of the molecules also has the property of lowering what is known as surface tension, or film strength, at the point where the watery liquid meets the oily liquid. This lowering of surface tension enables soap solutions to wet dirt particles and float them away.

Low surface tension is closely related to detergent action and can be used to measure the effectiveness of soap solutions. One method of measuring tension is shown in Fig. 3. Make a crayon mark on a medicine dropper as shown. Fill to the mark with water. Then expel the water slowly, drop by drop, counting each one. When the dropper has been emptied and the number of drops recorded, make a solution of the soap, or detergent, you ordinarily use, the solution containing about ¼ teaspoonful to 1 quart of water. Rinse the dropper with this solution, fill with the solution and repeat the drop-counting process. This time you will count more drops because of the

lower surface tension. As an example, suppose 30 drops of water emptied the dropper, but that it takes 45 drops of soap solution to empty it. These values will give a surface-tension ratio of 30 to 45, or roughly two thirds that of water alone. A stronger soap solution will lower the surface tension still more, but by increasing the soap content of the solution you will reach a point where still stronger solutions lower the surface tension very little, if any. As a rule, if you add sufficient soap (or detergent) to reduce surface tension to about one half that of water, good cleansing action will be obtained. Table I, Fig. 4, gives conversions for soap concentration from amounts used in test batches.

### Hard Water

Calcium and magnesium contained in hard water displace sodium from the soap molecule. When soap mixes with hard water an insoluble curd, or "lime soap," is formed. This curd forms a scum which clings to utensils and fabrics and is difficult to remove, especially from fabrics. A reasonably accurate check on the hardness of water (which varies in different localities) is to make the soap solution shown in Fig. 1, detail A. If available use a tincture of green soap in making the solution. In soft water, Fig. 1, A, 2 or 3 drops will form a good suds when the bottle is shaken, preferably after each drop is added. The same solution, in the same amount, in hard water, Fig. 1, B, will form the curd, or lime soap. More soap must be added before suds will form. The number of additional drops of soap solution required to form suds is roughly equal to the hardness of the water in grains per gal. This variation also is an indication of the percentage of extra soap required for cleansing in hard water, Fig.

Photos courtesy The Permutit Co.

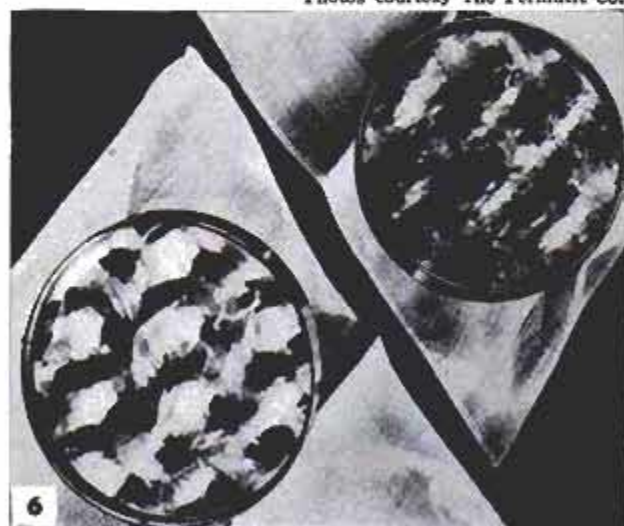
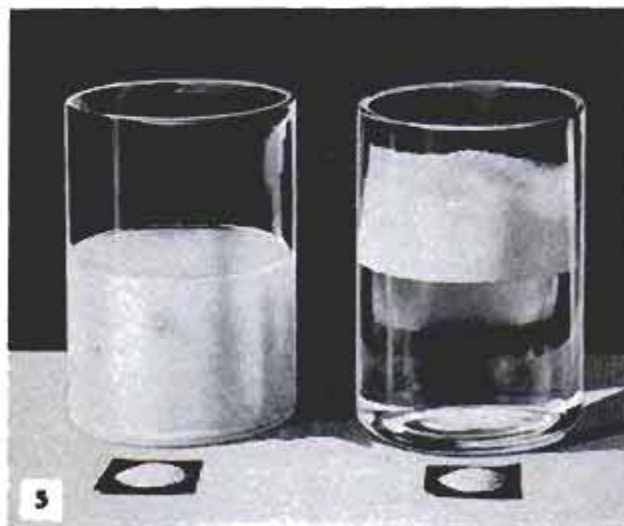



1, detail C. Rather than use the extra amount of soap required, which is expensive, you can add water-softening chemicals such as sodium carbonate (washing soda) or trisodium phosphate. Table II, Fig. 4, shows how much to add of either chemical, the amount depending on the hardness of the water. These chemicals are inexpensive and quite effective. As an example of how their use will reduce soap requirements in hard water, 1 oz. of trisodium phosphate used to soften water will save about 6 oz. of soap.

### Synthetic Detergents

When necessary to launder in hard water, synthetic detergents will prove economical. They do not react with the calcium in hard water to form insoluble, nondetergent scum. As a result fabrics rinse clean. This property gives detergents somewhat greater effectiveness when compared with softening chemicals, as soap will be precipitated on fabrics even when softening chemicals are added to the water.

### Water-Softening Equipment

Still another, and perhaps a better way to prepare hard water for laundering is the use of a water-softener unit, Fig. 4. The results of passing hard water through a softener unit are demonstrated in the two tumblers of water pictured in Fig. 5. Note the curd forming in the water in the tumbler at the left. Compare with the suds produced by adding a small quantity of soap to the water in the tumbler on the right, the water in the latter having been passed through a softener. Again compare the condition of the fabrics shown greatly enlarged in Fig. 6. That at the left in the photo has been washed and rinsed in softened water, while that on the right has been washed and rinsed in unsoftened water, leaving a deposit of scum which dulls the luster of the fabric. ★ ★ ★

## Hoop for Weighing Watermelons Made From Steel Rods

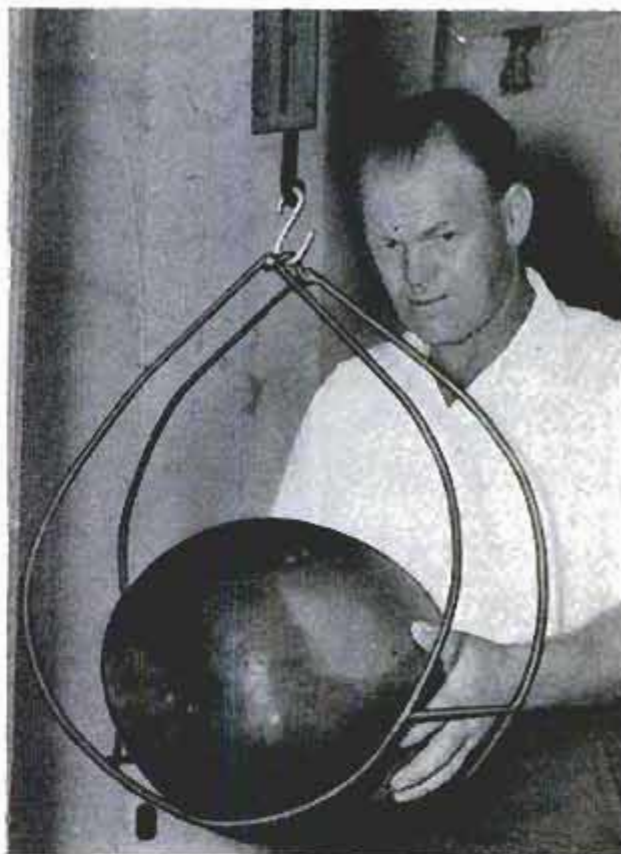

All sizes and shapes of watermelons can be weighed in this simple hoop attachment for a hanging spring scale. Two teardrop-shaped hoops, about 2 ft. in dia., are formed from light steel rods. Cross-bracing rods about 8 in. long are welded between the hoops near the bottom. A shorter curved piece is welded across the top to slip over the scale hook. Make a note of the weight of the attachment so it can be deducted from the amount shown on the scale when weighing watermelons. For weighing other produce, put hardware cloth on the cross-bracing rods.—C. F. Marley, Nokomis, Ill.

## Small Boxes in Bench Drawer Mounted Inside Front Panel

Small boxes of assorted hardware can be held against the front of the bench drawer by means of a long piece of elastic. Cut the elastic material from a discarded inner tube to a length slightly greater than the width of the drawer. Tack the strip, at both ends, horizontally across the inside of the drawer face board, and slip the containers in between the front of the drawer and the elastic band. Then place an additional tack through the strip and into the drawer panel between the containers.

☞ Your fingers will be kept cleaner when a handful of sawdust is mixed with the nails in your carpenter's-apron pocket.

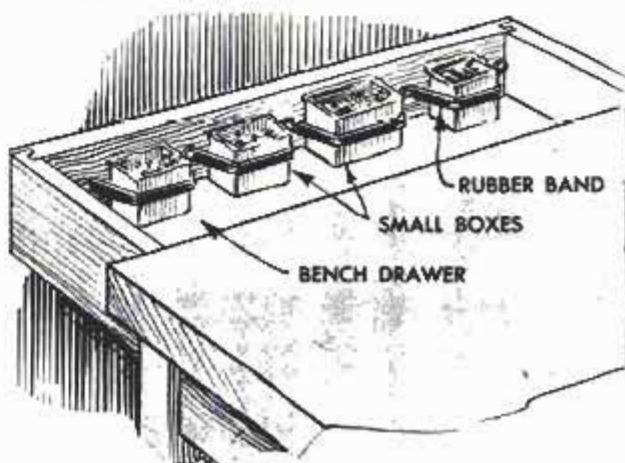



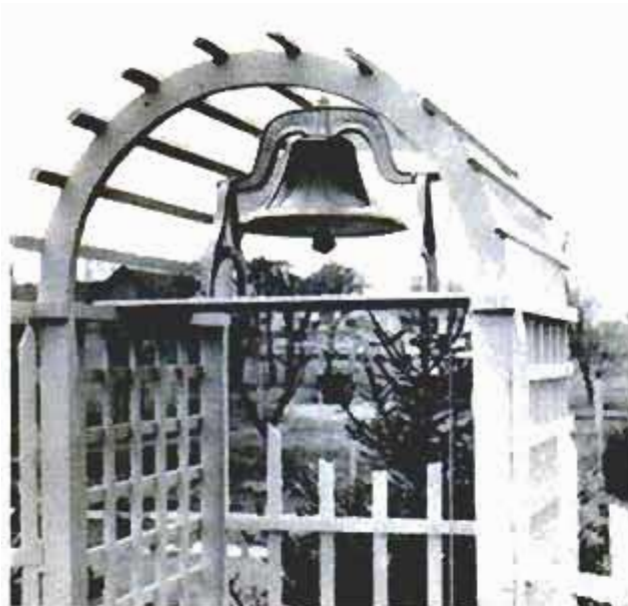

### Dinner Bell Adds Country Charm To Ordinary Lath Trellis

For a novel display of an old, farm-type dinner bell, mount the bell on a platform in a trellis as shown. The bell will be out of the way, yet add a distinctive touch of country charm to an ordinary trellis. To highlight its decorativeness, paint the bell and support members contrasting colors. Your family name can be applied on the finish with decal lettering followed by a protective coating of spar varnish.

Grover Brinkman, Okawville, Ill.

### Steel Wool Strains Solvent Poured Out of Bottle

Sediment can be strained out of paint solvent and other liquids by pouring them out of a bottle "corked" with loosely packed steel wool. Discard the steel wool when all the liquid has been poured through it.

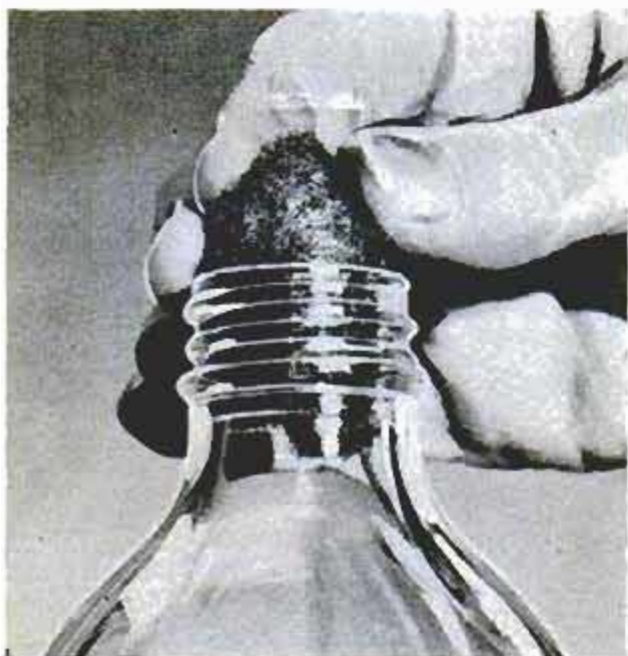

### Brass Cap From Lipstick Tube Adds Glitter to Flagstaff

Add a touch of military glitter to a small flagstaff by fitting the brass-plated cap from a lipstick tube to the tip. If the cap is too large to fit snugly, plug it with a piece of dowel, then drill it out to accommodate the end of the flagstaff.



### Food Color Tints Book Edges

To improve the appearance of a book, and make identification easier, tint the edges of the pages with food color. Clamp the pages tightly between two pieces of wood and rub on the color sparingly, going over it a second time if a darker shade is desired. Leave the pages clamped until dry to keep from staining the insides of the covers.



### Tape Behind Fire Extinguisher Makes It Easy to Find in Dark

To avoid costly delay in locating fire extinguishers in an emergency, place strips of luminous tape on the wall behind each one as shown in the detail. The markings will also indicate where extinguishers are to be placed after they have been re-filled or recharged.

Position and pattern of the stripes can be used to indicate type of extinguisher.

G. E. Hendrickson, Argyle, Wis.





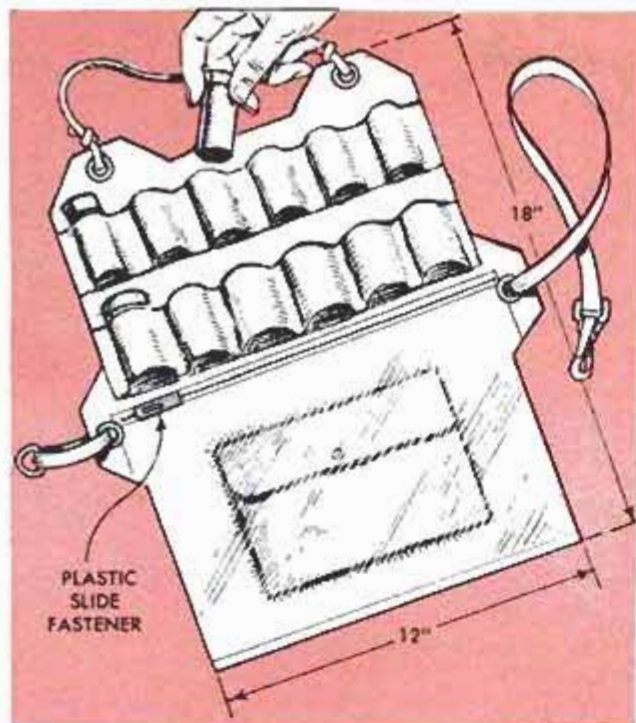

## Angler's Apron Is Transparent Waterproof Tackle Box

If you are a fishing enthusiast, this angler's apron is for you. No more fumbling through pockets for a particular lure, bait or leader. Everything is within easy reach in this apron that's really a transparent, waterproof tackle box. To make one, start with a piece of denim cloth approximately 14 x 18 in. (it's available in plaid as well as the usual blue) and trim it as shown in the detail, leaving tabs for straps to be attached later. Cover the denim on both sides with plastic material cut slightly larger, cementing or laminating it together along the edge. Then cement a transparent plastic pocket, equipped with a zipper, to the lower section of the apron. The enclosure used for the original apron also had a snap-

fastened envelope attached to one side. Obtain a dozen plastic vials of two sizes from your druggist. Hardware stores also sell nails and screws in small plastic containers which, though thinner, are still suitable. Position these along top of apron, with smaller vials above, and form pockets around them with a strip of plastic material, cementing it in place between them and below each row. Install metal grommets in the four tabs and attach a two-piece belt of 1/2-in. elastic. One section of the belt has a spring fastener which "locks" on a D-ring held by the other piece. Tie a length of rope to the upper grommets and apron is ready for you to use.

Lee Woods, Richfield, Idaho.

## Big Fish Held by Lower Jaw To Aid Hook Removal

To keep a big fish from thrashing around while trying to remove a hook grasp the fish firmly by the lower jaw and hold it open at an angle as shown. Few fish will move very much when held in this manner.

Clinton R. Hull, Santa Ana, Calif.

## How to Clean a Paint Roller

After scraping excess paint from a paint roller, remove the handle, insert a cork in both ends of the roller, and then place in a tennis-ball can with a small amount of solvent. The fibers of the roller will draw up the solvent which will then loosen the paint. For faster results, cover the can tightly and shake.

Leonard A. Kroll, Brooklyn, N. Y.







Boat is easy to launch on beach, hull is protected from sharp stones when inflatable rollers are used

# Launch Your Boat the Easy Way

By Ralph S. Wilkes

**W**HETHER you own a small rowboat or a large inboard runabout, use of one of these launching aids will take the backbreaking work out of getting the boat waterborne and also prevent damage to the hull.

A light boat or canoe can be protected from scratches and tears when it is hauled up on the beach by use of a wooden roller set in a frame similar to the one shown in Fig. 5. The roller can be turned to a cylindrical shape or shaped to fit the bottom of the hull. Inflatable rollers made of

rubber-lined canvas, Fig. 1, afford complete protection for the hull when used to launch or beach a boat. The rollers, manufactured by Airoller Company, come in several sizes and are inflated to low pressure by mouth or tire pump.

## Launch Boat From Trailer

Most manufactured boat trailers are constructed so that it is relatively easy to back the trailer into the water for launching or loading the boat. Some trailers, like the Holeslaw, Fig. 4, carry the boat

Entire boathouse is on tracks and is moved two or three times a season as the lake level changes

Use crank and tackle at bow and another at stern if hoist is used for heavy boats. Cover with tarpaulin

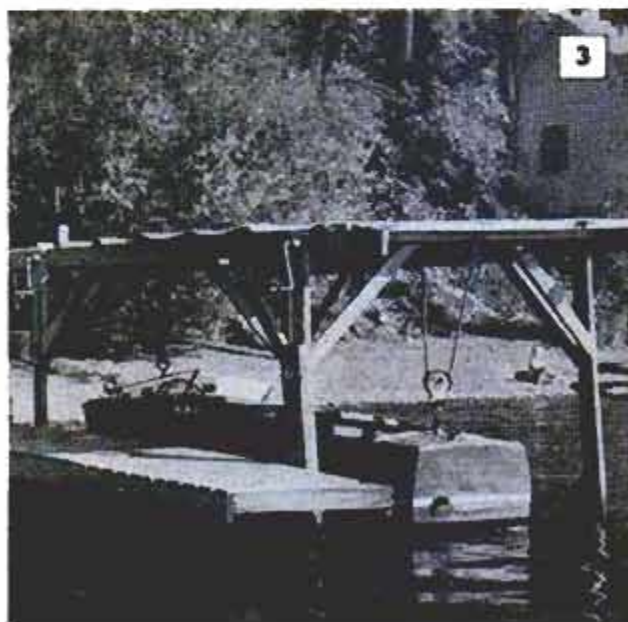
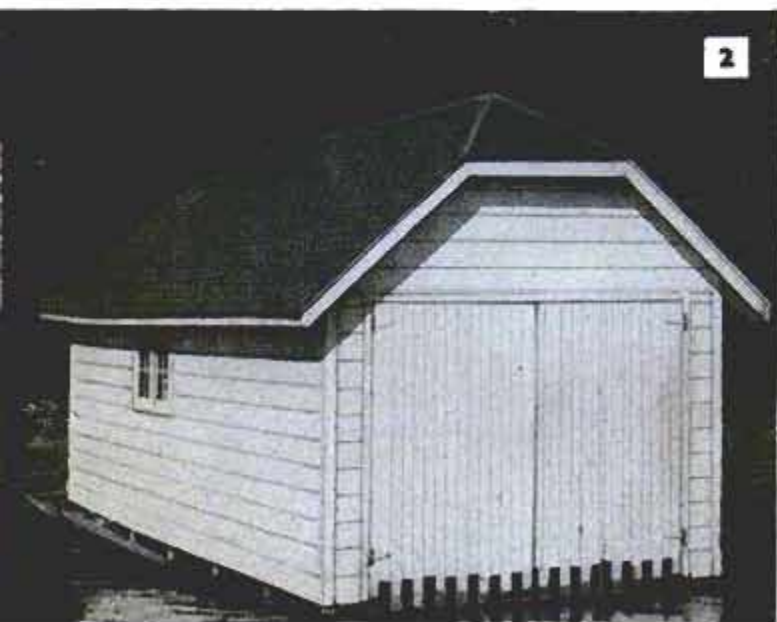



suspended at the bow and stern. Others, such as the TeeNee, Fig. 6, support the keel. For a heavy boat, sometimes it is necessary to haul boat and trailer up on the beach with a block and tackle as shown in detail A, Fig. 7, so that it can be hitched to a car.

### Boathouses

If you own property fronting on a body of water, a permanent shelter can be built for the boat. An unusual arrangement is shown in Fig. 2, in which case the entire boathouse is on tracks and is moved two or three times a season as the lake level changes. The structure is held in place by a cable attached to a tree. It has an electrically operated winch for raising the boat; also a sliding bar is used for opening and closing the doors from the landward side, detail B, Fig. 7. By extending every second board below the water line, the doors prevent rough water inside the boathouse, yet waves do not cause the pounding action which occurs when solid doors are used.

A boathouse that is designed to permit dry docking under a stationary shelter is shown in Fig. 10. An electrically operated winch pulls the boat, cradle and truck on a track that leads from the water to the boathouse.

### Boat Hoist and Shelter

A temporary shelter and launching device, used primarily to keep the boat out of the water when not in use during the season, consists of a block-and-tackle arrangement with the hoist end of the line wound on a 2-in. pipe to which a



Above, lightweight boat trailer carries small boat suspended at bow and stern by sling and snap for easy launching at beach



Wooden roller used for launching light boat or canoe can be turned to cylindrical shape or shaped to fit bottom of hull

Majority of trailers are type shown below, which carry boat supported by cradle with most weight on keel





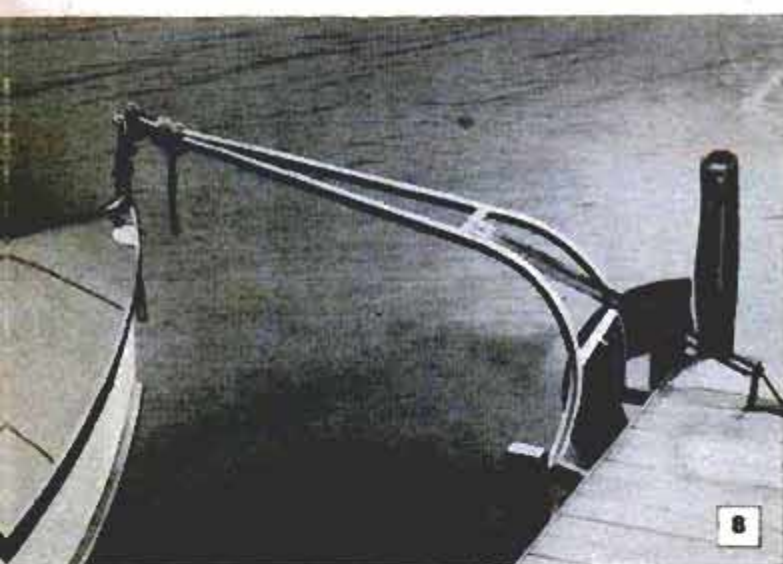
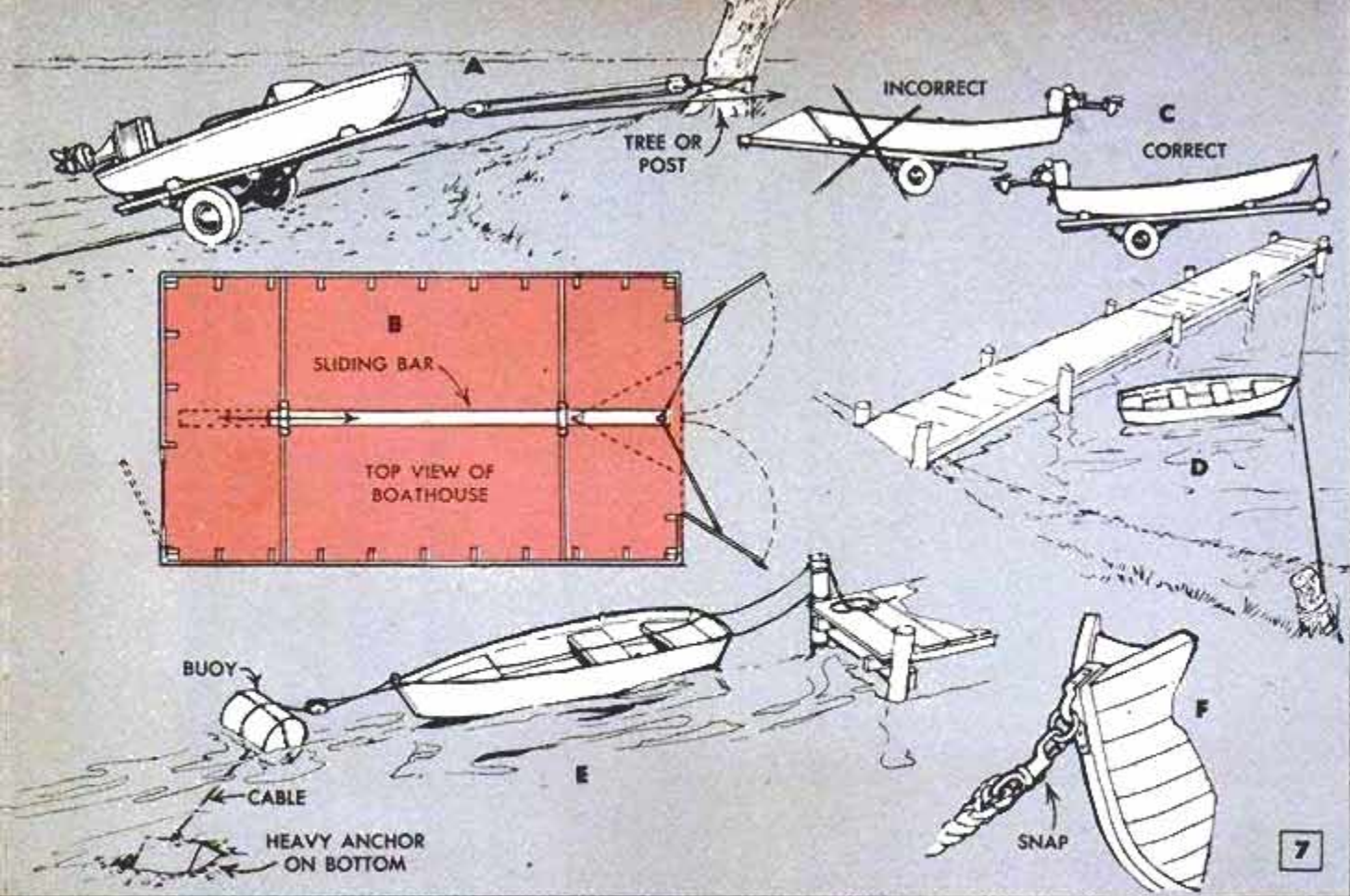

Davits mounted on dock and tied to boat at bow and stern rise and fall with waves, keep boat off dock

Treat wood framework of hoist with wood preservative before painting to prevent rot at water line

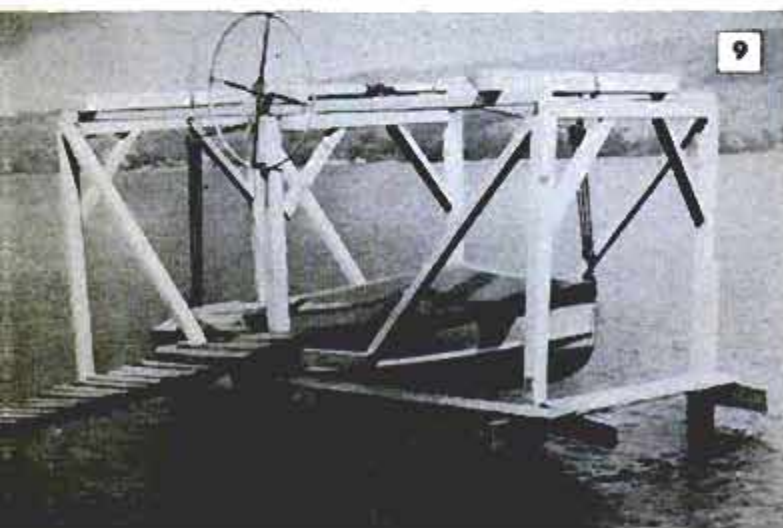

crank or wheel is attached. For light boats one crank is sufficient to operate both the bow and stern tackle as shown in Fig. 9; but heavier boats require a pipe and crank for each tackle, Fig. 3.

If you prefer to keep your boat at a dock, pad the piles and projecting parts of the dock with tire casings and keep two or more fenders between the boat and dock. For a mooring that will keep the hull entirely clear of the dock, tie the boat midway on a line secured to a post on shore and the end of the dock, detail D, Fig. 7. An alternate method is to tie the stern to the dock with one line and run another from the bow through a pulley attached to a buoy and secure it on the dock, detail E, Fig. 7. The boat also can be kept off the dock by two davits that rise and fall with the movement of the water, Fig. 8. ★ ★ ★

Electric winch, background, pulls boat cradle on track leading from water to inside boathouse





## Silent Valet on Wheels Holds Complete Outfit of Clothes

A full set of clothes for the man of the house from shoes to cuff links is held by this silent valet stand. A wooden contour-shaped hanger with the center hook removed is used to support a suit coat or jacket. The trouser bar above it is attached to the hanger with dowels and equipped with finishing-nail tie racks at both ends. Cut the tray for cuff links and tie bars from  $\frac{3}{4}$ -in. stock and recess the center of it to a depth of  $\frac{3}{8}$  in. Mount the tray between the  $\frac{3}{4} \times 1\frac{1}{2}$ -in. uprights which are beveled to the angle of the hanger at the top and have a dado at the lower ends to fit the caster rails.—Albert Leclair, Brownsburg, Quebec, Can.

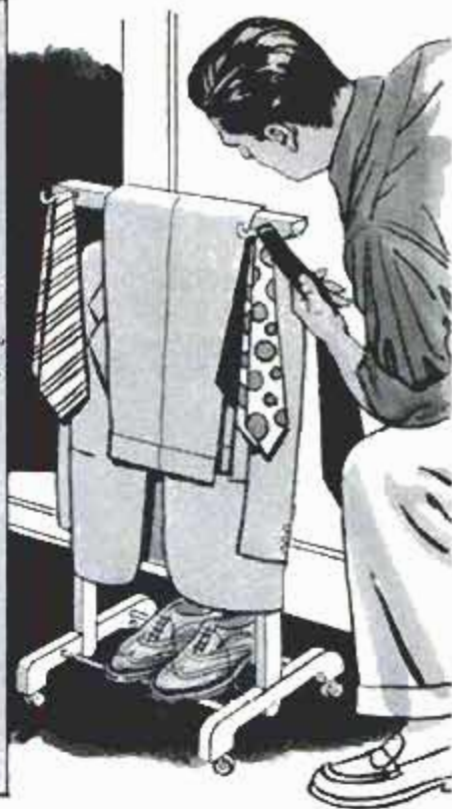
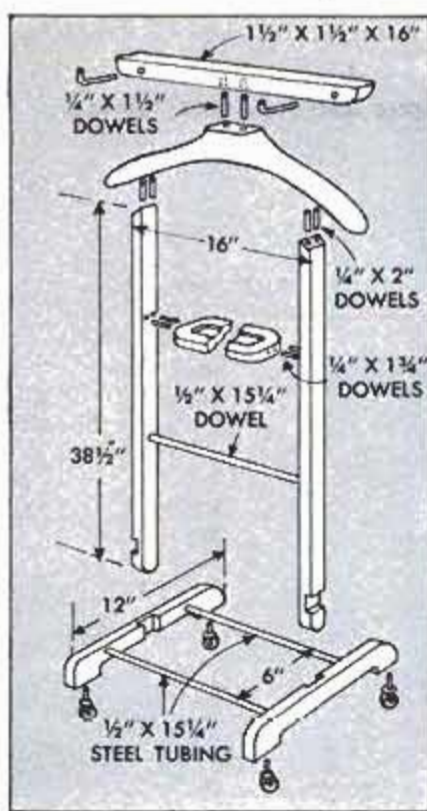

## Adjustable Blade Knife

This handy knife is made from a piece of metal  $2 \times 3$  in. folded in half and fitted over a single-edge razor blade. Three holes are drilled as shown, to accommodate screws that adjust and hold the blade in position. Blades having a reinforced back and three slots are preferred. The slots are necessary to obtain good adjustment of the blade in the holder.

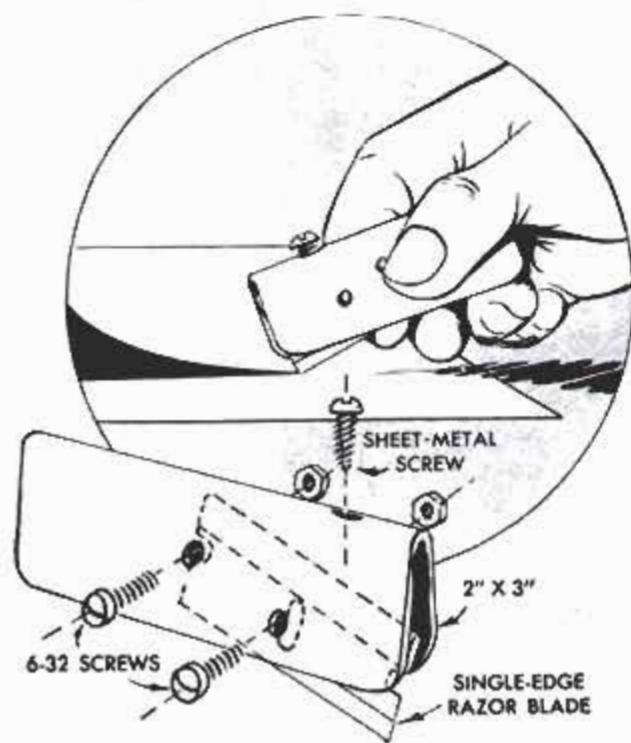

## How to Do Blind Nailing

Where one side of the work is inaccessible and you do not wish to mar the other side with hammer marks or exposed nail-heads, blind nailing is used. A good example is the installation of bannister posts and pickets. Remove the heads from regular nails and drive the blunt end partially into pilot holes drilled in one of the surfaces to be joined. Apply glue to the two surfaces to be joined and tap the other piece down onto the nail points. If hardwood is to be used for both pieces, matching holes should be drilled in each.

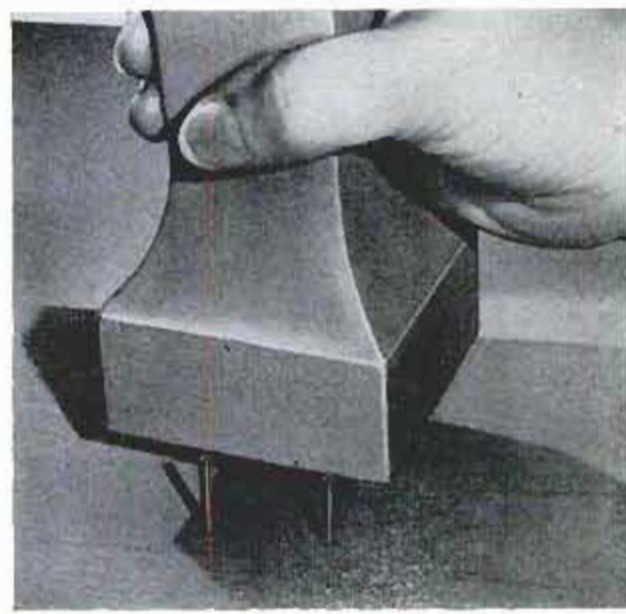



# SOLVING Home Problems



**FIRE-SAFE RECEPTACLE** for ashes emptied from ash trays can be provided by hooking tobacco can over edge of wastebasket. Even though ashes are hot they will not set paper in basket on fire. Bend lid of can back sharply to provide hook for holding it to basket

**TO PROVIDE BUILT-IN AERATION OF SOIL** in indoor planting box, install a liner of metal lath in the box before putting in the soil. Metal lath, which is cut easily with tin snips and can be shaped by hand, is available at most building-supply houses

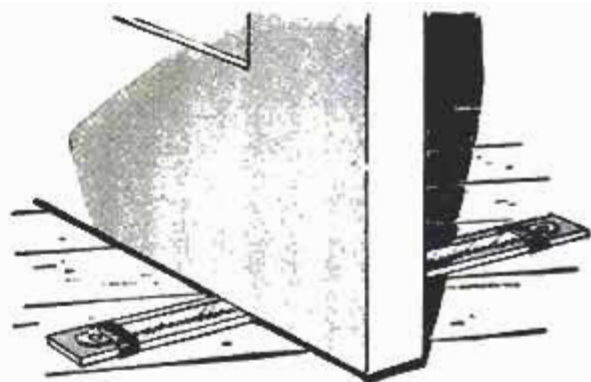
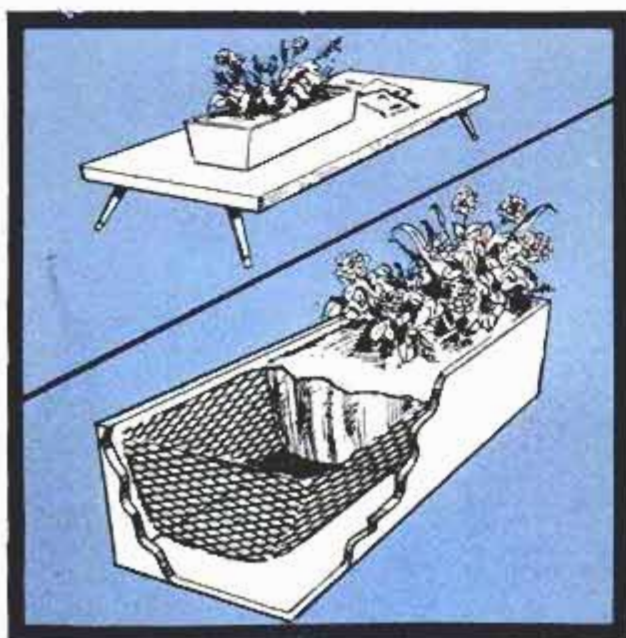

**HACKSAW BLADE TAPED TO RULER** will permit taking shallow cut across bottom edge of door that is binding or sticking without having to remove the door from its hinges. The blade does an effective job, while ruler protects the floor from damage

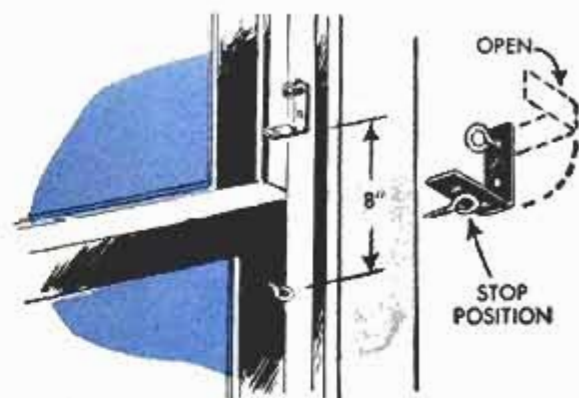

**WINDOW SAFETY STOP** prevents child from raising open window higher than predetermined point. Stop consists of screw eye driven into edge of lower sash as indicated, and short length of angle pivoted to stop strip with screw eye, 8 in. below upper eye

**METAL-LATH DRYING RACK** is lightweight and portable so it can be located wherever desired. Air circulates readily through mesh of the lath to assure fast drying. Rack can be made entirely of lath or fitted with wood or angle-steel frame and legs

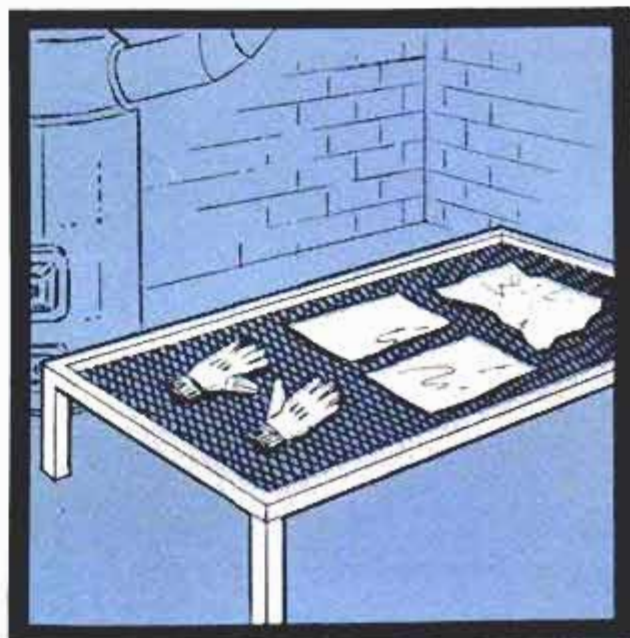



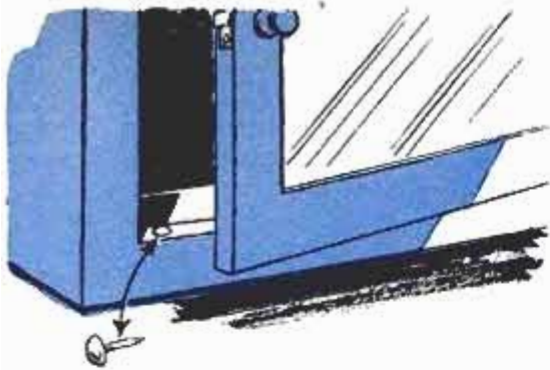

**SAGGING DOOR ON SMALL CABINET** will open and close with much less effort if an upholstery tack is driven into the cabinet frame at the point indicated. The round head of the tack will serve as glider to lift the door slightly and eliminate friction of wood on wood



**WOODEN DRAWER KNOBS** that pull off their metal screws because wood has worn away can be repaired by wrapping the screw threads with light cord or string. Dip wrapped screw in shellac, reinsert it in the knob and let it dry overnight before replacing knob on drawer

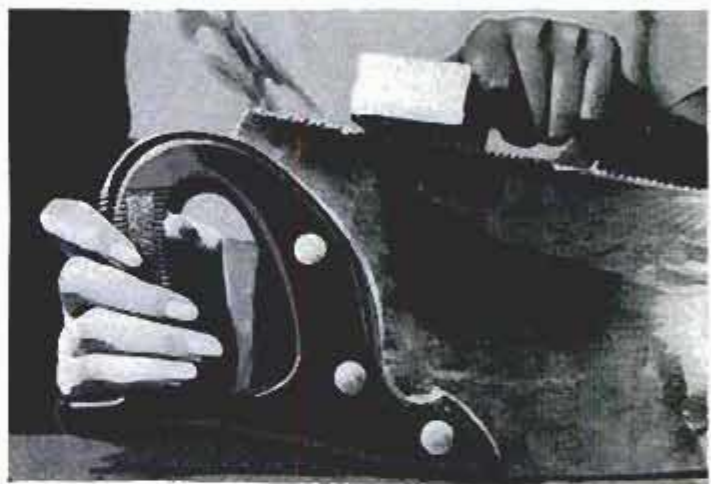

**HANDSAW THAT SQUEAKS AND BINDS** without cutting often can be made to cut by rubbing a bar of soap over the teeth and along sides of the blade. Soap also can be used to lubricate saw when cutting wood that is wet or heavy with resin that binds the blade

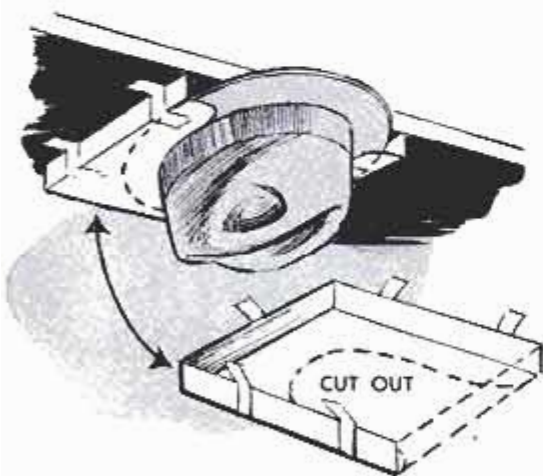

**RACK FOR MAN'S HAT** is made from shallow lid of large box. Cut lid as indicated in detail and tape it to lower surface of closet shelf so hat will be clear of other articles in closet and crown will not be crushed

**REMOVE GRASS STAINS** by first applying lard or other solid shortening to stained area and rubbing well. Then wash garment in hot suds. Alternate applications of peroxide and ammonia will remove grass stains from white materials





## Address-Plaque Letters "Carved" in Relief With Blowtorch

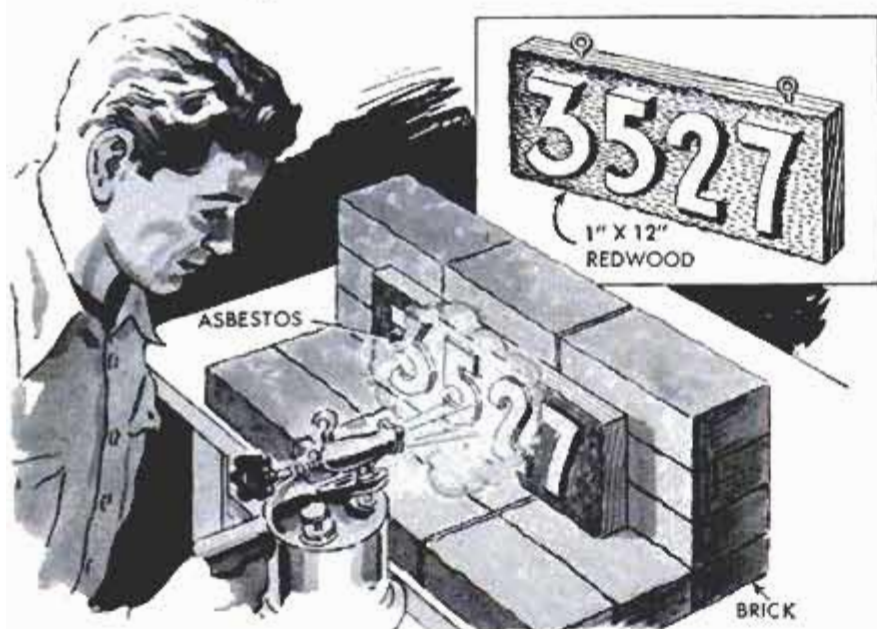

Using a blowtorch, you can easily "carve" your name and street number on a board to provide a rustic address plaque for the front yard. First, outline the letters on sheet asbestos and then cut out. After tacking them to the board, which should be at least 1-in. stock, apply the torch to the exposed wood around the letters, scraping away the charred wood and repeating the operation until the letters stand out in bold relief. To prevent a fire, arrange bricks as shown.—Russell Branch, Santa Cruz, Calif.

## Pressure Venting Tropical Home

Tropical homes are normally built with pressure-relieving openings in the closet ceilings to permit the doors to close. But on hot days these vents tend to exhaust the hot air from the attic into the rooms below. Covering them from above with a piece of rubber inner tube, nailed in place, keeps the hot air up in the attic and yet permits the doors to close.—Dick Downie, Oahu, Hawaii.

## Paper Clamps and Pencil Brace Hold Book Open for Reference

It is easy to keep a book open at a certain place for reference by using two paper clamps and a dowel or pencil. The clamps are fitted over the pencil and book pages as shown. Where such an arrangement is used frequently, it will be found better still to fasten a flat stick to the clamps permanently.

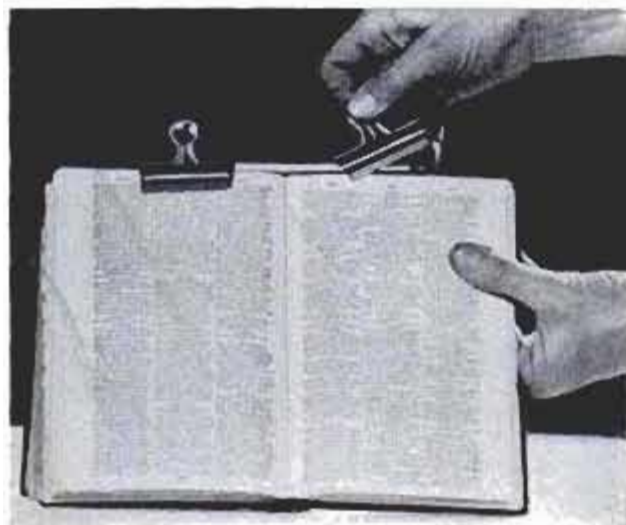

## Temporary Rheostat Improvised

A rheostat for experimental or temporary work with very low voltages can be improvised from a length of electric-heater element and a wooden clothespin. Metal foil is wrapped around the jaws of the clothespin and a wire is forced under the clothespin spring in contact with the foil. The clothespin then becomes the sliding-contact side of the rheostat circuit.

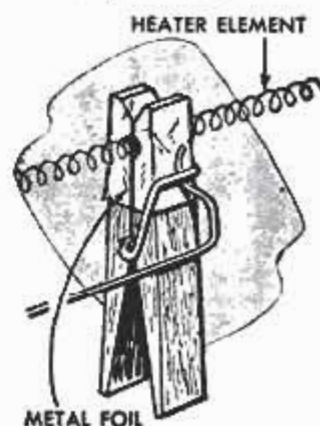

K. G. Hadd, Montpelier, Vt.

## Plywood Cut Cleanly by Table Saw When Placed on Lumber Scrap

To eliminate splintering on the underside of plywood when cutting it on a table saw, place the plywood on a piece of scrap lumber and run both pieces through the saw. Any damage resulting from the saw blade will be on the underside of the scrap and the cut in the plywood will be smooth and clean. The same procedure is used when sawing lumber that is to be finished on both sides.

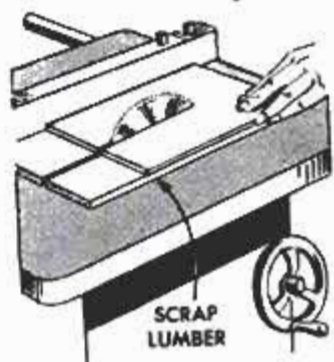



WTM 58

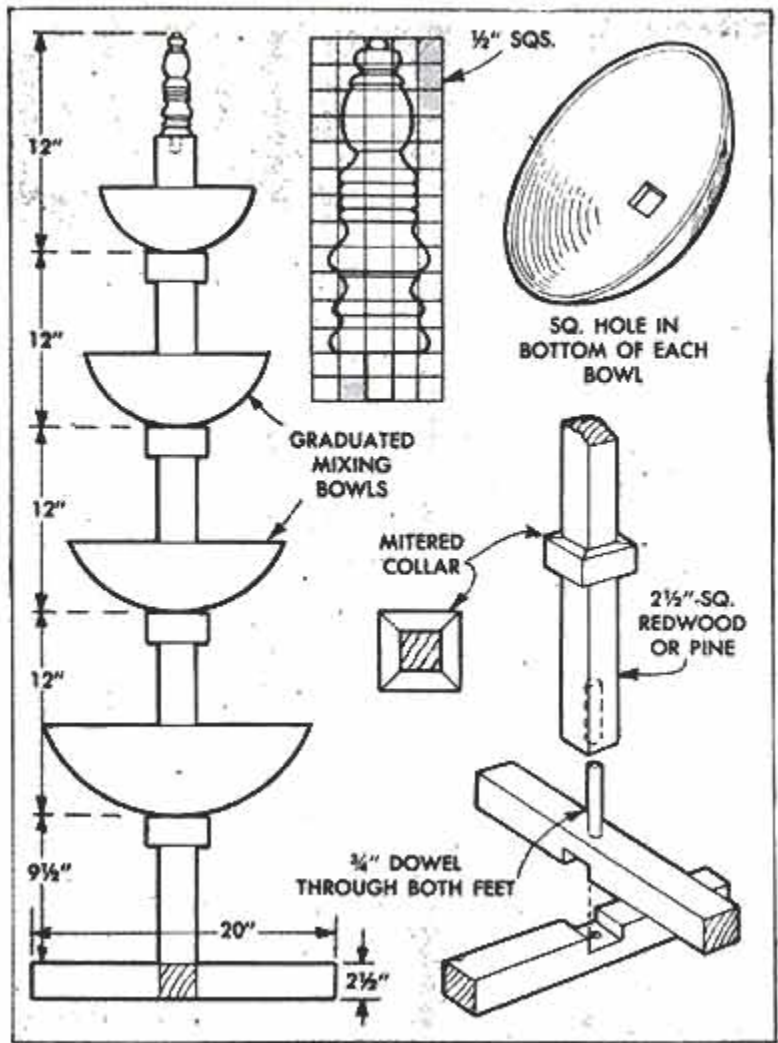

## Novel Fruit and Flower Stand

An interesting display for artificial flowers and fruit is this set of graduated mixing bowls mounted at 1-ft. intervals on a square standard. First, a 2½-in. square hole is cut in the bottom of each bowl, after which the bowls are slipped over the standard and a square, mitered collar is nailed under each bowl as shown in the detail. Mortise the members for the feet at right angles to each other and drill and insert a lightly glued dowel through both feet and well into the bottom of the standard. The

top piece of the standard can be turned on a lathe following the pattern outlined in the squared diagram, or a plain top piece may be substituted if desired. If wooden bowls are used, varnish bowls and stand. When bowls are metal or plastic, paint the stand a matching or contrasting color. Except for the bowls, the stand is made of 2½-in. redwood, with a length of ¾-in. dowel used to secure the feet to the standard. An inverted bowl could be used for the base.—Hi Sibley, Nuevo, Calif.

## Ticket Punch Used for Keying Index Cards and Negatives

For punch marks of uniform depth when keying index cards or sheet-film negatives, clamp a small plastic clothespin on one jaw of a ticket punch so that the cards can be butted against it. A punch that cuts a diamond-shaped hole is most suitable for this purpose. The clothespin should be clamped on the punch jaw with the hole in it and a rubber band wrapped tightly around both jaws of the pin to prevent the latter from moving off position.

Walter E. Burton, Akron, Ohio.

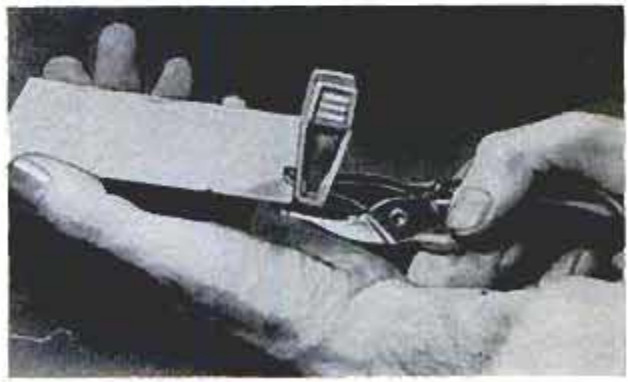



## Plastic Sheet Under High Chair Eases After-Meal Cleaning



Rug or floor cleaning after each feeding of a small child is simplified when a sheet of plastic cloth is spread out on the floor underneath the high chair as shown. After the child has been fed, remove the high chair, fold the sheet in from all four corners and shake the contents off into a waste basket. The plastic will not become stained and is easily washed free of dirt and grease. Attach furniture glides to the chair legs to protect the plastic cloth.

Clinton R. Hull, Santa Ana, Calif.

## Tape Holds Fishing-Line Sinkers

Split-shot sinkers will not be lost or mislaid easily, whether carried in a pocket or tackle box, if first placed between two strips of tape. They may be readily removed with the point of a knife blade individually as needed.

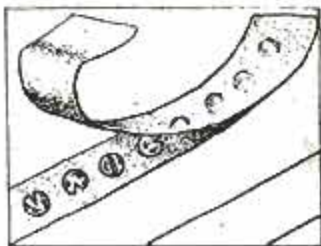

## Slide Fastener on Seat Cushion Permits Quick Removal of Cover

In homes where pets are permitted to sleep on the seats of upholstered furniture, resulting in the need for more frequent cleaning, it is a distinct advantage to have the cushion covers quickly removable. This is made possible by installing a slide fastener at the rear edge of each cushion where it is not seen.



## Splash Shield for Paint Can

A section of automobile inner tube stretched over the top of a paint can provides a perfect splash shield when paddle-mixing. The shield also returns excess paint from the brush to the can. — H. J. Gerber, Stillwater, Okla.



## Removable Drain Trap

Are you tired of the periodic job of opening the bathtub drainpipe to retrieve jewelry, a toothbrush, or other small article? Then this removable drain trap is your answer. Take a 4 x 4-in. piece of sheet copper or aluminum and cut rectangular teeth along one side as shown in the illustration. Bend the teeth upward, and then roll the sheet metal into a tube slightly overlapping the butt edges. Drill or punch two holes across from each other at the edge opposite from the curved teeth, and run a length of wire in an arc between them to form a handle. The trap is then inserted in the top of the drainpipe, far enough down so as not to interfere with the stopper, and still close enough to be reached by the hand for removal. The diameter of the tube should be adjusted so tension will keep it at any point inside the drain, therefore the vertical edges should not be permanently joined together.

S. N. Stresnic, Bayside, N. Y.

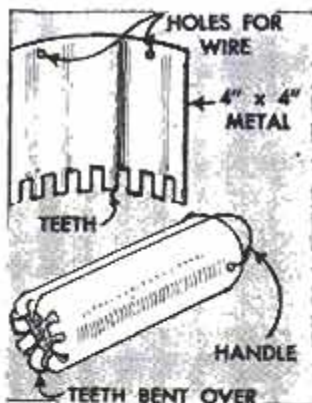



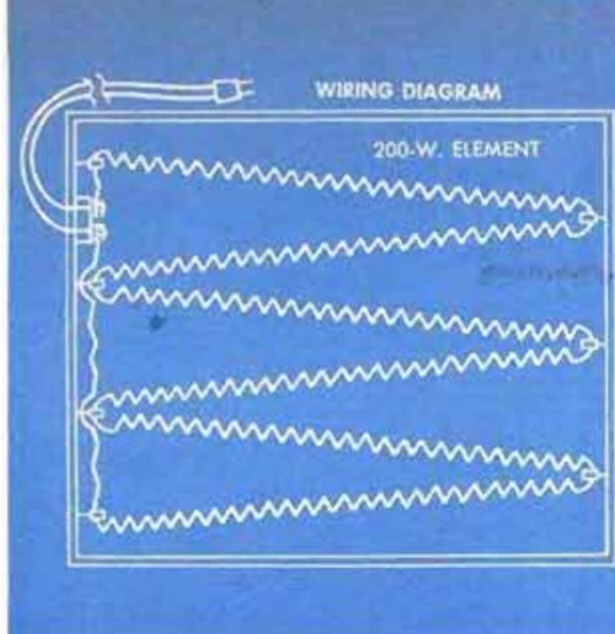

# PRINT DRIER

By Jack Wall

DRYING THE PRINTS is the most time-consuming part of printing your own pictures when you have to air-dry them on ferrotype tins. This is particularly true when drying 8 x 10 prints. In this case, an electric print drier is the answer and here's one that will dry eight 8 x 10 prints in about 12 min. The drier is designed to take two standard 18 x 24-in. chrome-finish ferrotype tins, which are loaded in the usual way and then placed in the drier under canvas hold-down aprons.

The heating element is housed in a curved plywood frame that is covered on both sides with sheet metal and which is pivoted between the uprights of a U-shaped

stand so the drier can be flipped over for loading both sides. The heating unit consists of three 600-watt toaster replacement elements that are wired in series by joining them end to end and twisting together. When stretched evenly between standoff insulators consisting of cup hooks and porcelain rings, the chrome-nickel wire provides approximately a 200-watt element. The connector between the element and heater cord is from an electric iron.

The pattern for the curved ends of the drier is given in dotted line. This is actually a half pattern which is one-half actual size. Notched metal brackets to which the hold-down aprons are hooked are screwed to the ends of each piece. A valve handle is used as a knob to flip the drier.

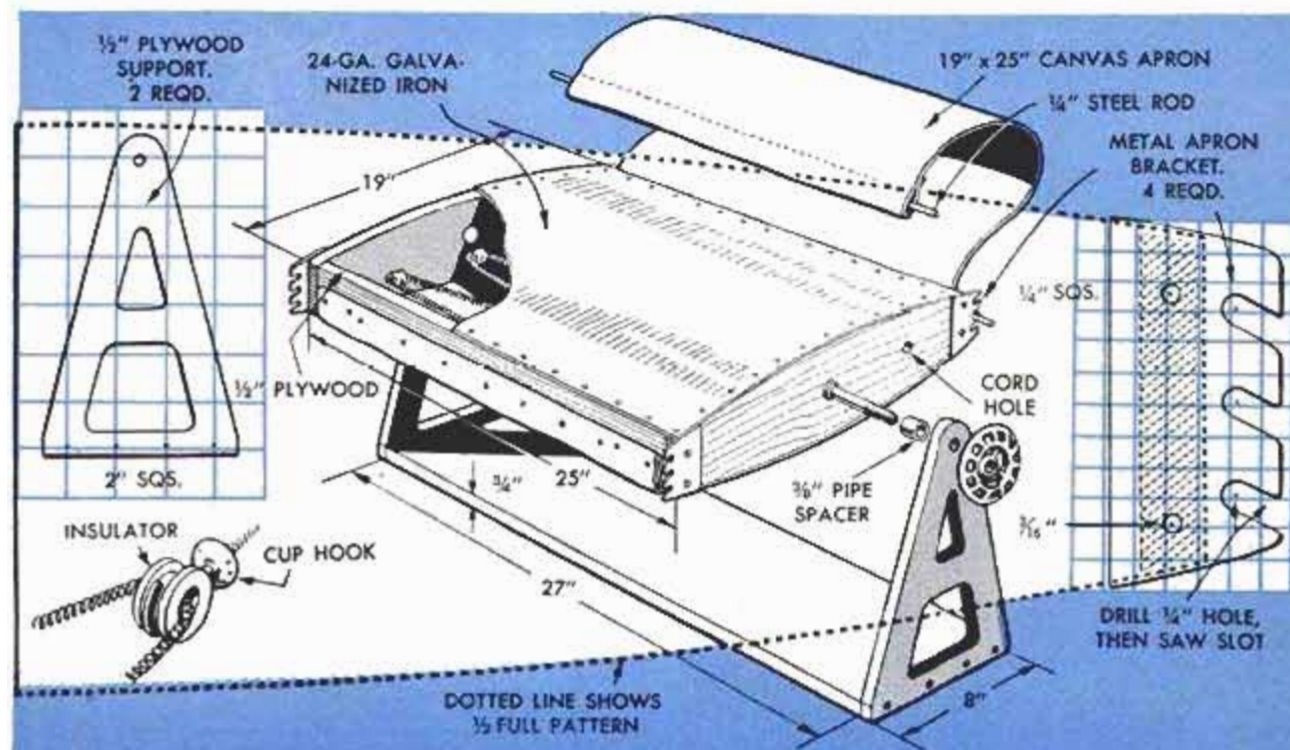



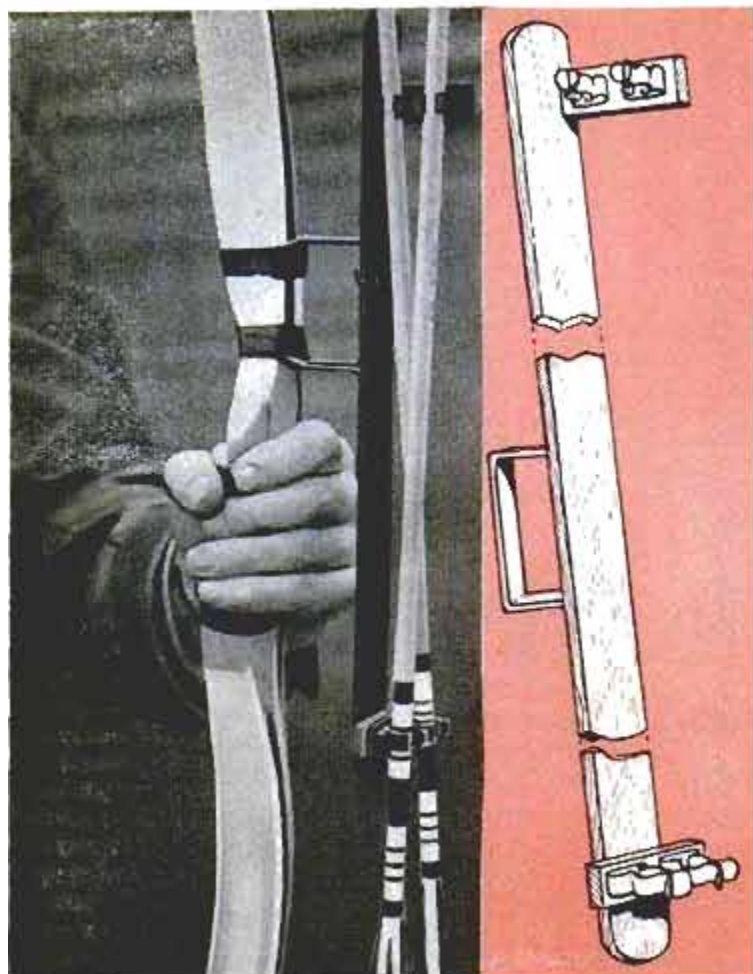

### Arrows Attached to Bow For Fast Repeat Shots

Bow-and-arrow hunters will be ready for the kill if additional arrows are carried on the bow as shown. The arrows are held in small broom clips which are screwed to two short pieces of wood mounted at right angles to each other on opposite ends of a long strip of wood. The 90-deg. twist gives tension to the arrows which holds them in place when the bow vibrates from a shot. A length of strap steel, bent in a U-shape, is screwed to the holder and taped to the bow joining them together.

Don Neal, North Warren, Pa.

### Cleaning a Chimney

To clean a chimney, stuff a burlap bag with straw so it fits snugly inside the chimney, weight it with bricks, and suspend it from a rope. Lower and raise the bag inside the chimney from the roof. The soot will fall to the bottom where it can be removed through the clean-out door.

### Block Base Prevents Small Paint Can From Tipping

A small paint can or bottle can be prevented from tipping by clamping it in a wooden base as shown in the photograph. To make the base, place the container on a scrap piece of 1 or 2-in. stock and draw the outline on the top surface of the wood. Cutting in from one edge, jig or bandsaw along the inside of the circular line, returning the blade through the starting slot. Then drill a hole across the slot and insert a long bolt equipped with a wing nut. The slot should be wide enough so that tightening the wing nut causes the block to grip the side of the container.

Frank A. Javor, North Bergen, N. J.

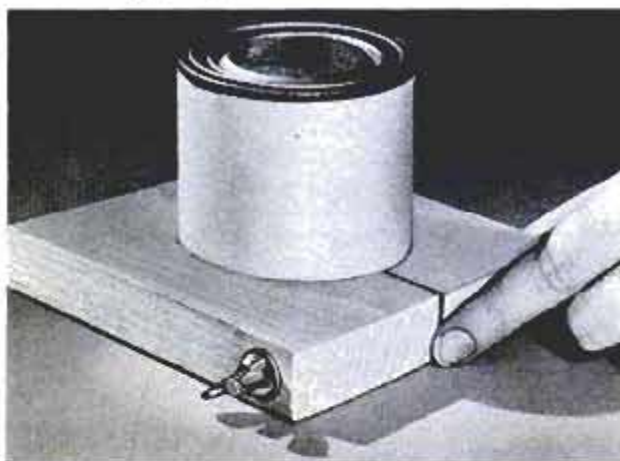

### Improvise Better Mousetrap

A metal platform soldered to the trigger on a mousetrap will make it impossible for the mouse to reach the bait without springing the trap. If the trigger is made of wood, glue a piece of cardboard to it.

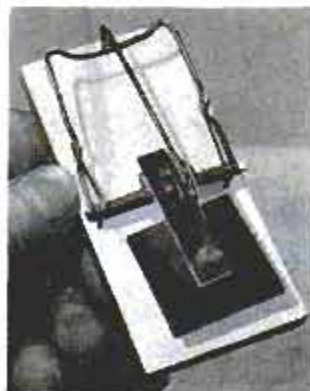

### True Waterline Marked on Model

Ship-model builders, here is a quick easy method for establishing the waterline on a hull, regardless of its shape. Using a container large enough to float the vessel in, fill it with water and spread a thin film of metallic paint on the surface. Holding the model fore and aft, lower it slowly into the water till it reaches the sailing or floating level. Remove and set it aside until dry and the mark of metallic paint will serve as a guide in painting.

Roger Hawthorne, Stamford, Conn.



## Knockdown Picnic Table Stores in Small Space

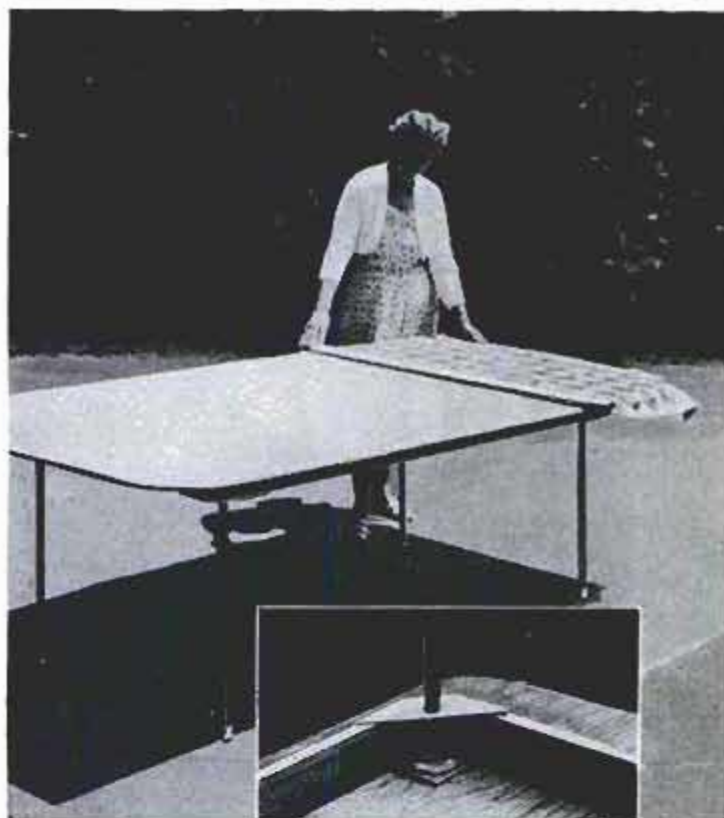
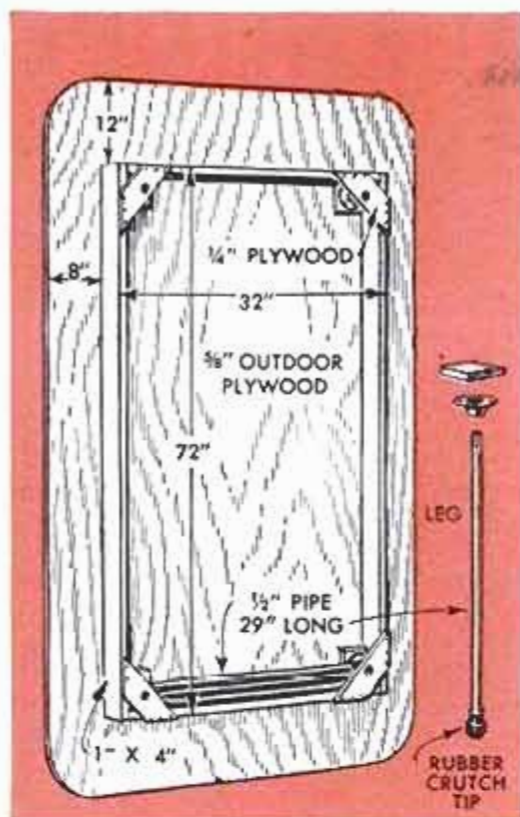

A 4 x 8-ft. sheet of  $\frac{5}{8}$ -in. exterior plywood serves as the top for this picnic table, which is equipped with removable pipe legs, and seats 12 comfortably. The corners are rounded and the top braced underneath with a box frame of 1 x 4s. Two pieces 72 in. long and two pieces  $30\frac{1}{2}$  in. long comprise the frame and are nailed on from above. Pipe legs with rubber crutch tips are turned into pipe flanges screwed to 4-in.-sq. blocks attached to the top at the inside corners of the framing.

To steady the legs, drill holes slightly smaller than the pipe through four 3 x 10-in. strips of  $\frac{1}{4}$ -in. plywood 1 in. from one side and equidistant from the ends. Fit the legs through the strips which are then nailed to the framing, after which the extending corners are cut off. When the table is not in use, the legs are removed and stored between the angular braces at one end as shown. Oil the pipe threads to make the legs turn easily in the flanges.

Clinton R. Hull, Santa Ana, Calif.

### Oversize Pilot Holes Shimmed With Lengths of Wire Solder

If you inadvertently drill wood-screw pilot holes oversize, drop a length of wire solder into each hole. As the screws are driven the soft solder will be jammed against the side of the hole and the screw and provide a snug fit for the latter.

Frank A. Javor, North Bergen, N. J.

### Quick Finish for Home Projects

Oil stain mixed with a good quality of furniture wax in paste form makes a quick easily applied finish for home woodworking projects. The mixture can be rubbed on with a rag or diluted for brush application. It is best to experiment on a scrap piece of wood to determine the proper proportions for the desired effect.

Arthur C. Shults, South Bend, Ind.





WTM 58

# THESE PIECES COMPLETE YOUR PATIO FURNITURE

By Tom Riley

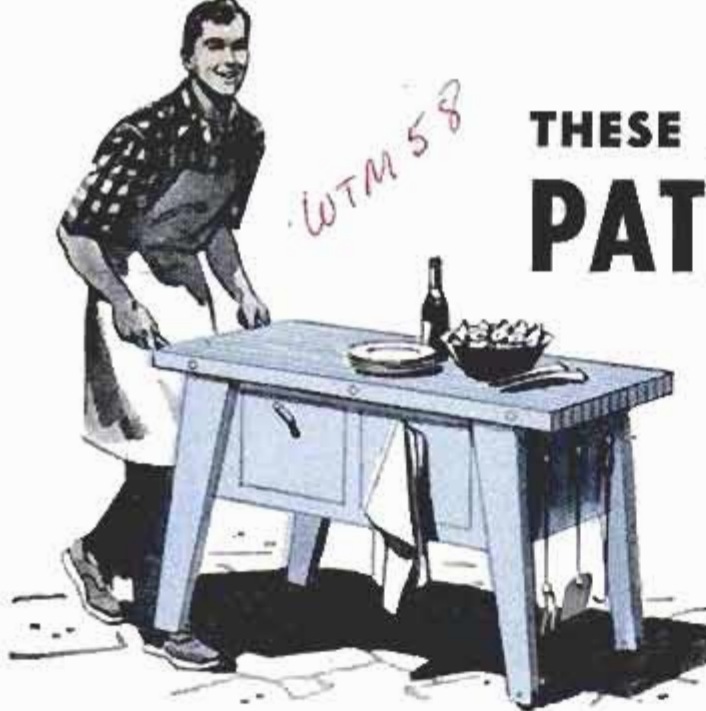

NOW THAT YOU have completed the two-way lounge and the barbecue cart presented last month, you probably are anxious to take on the remaining pieces of the group, namely, chuck counter, drop-leaf planter and patio "wheel chair."

## The Chuck Counter

Designed for the outdoor chef, this rolling chuck counter will follow a portable grill anywhere on the patio. Its chopping-block top is practically immune to carving knives as well as the weather. The two doors open a large compartment that will store the miscellany of barbecue equipment, and the doors swing down when needed to give extra shelves for salts, basting sauces and the like. Both the chopping-block handles and door pulls are pegs that serve as hooks for the chef's towel and glove. One or both ends can have hooks for the barbecue fork, basting brush and tongs.

Left, both fence and miter gauge serve as stops in aligning tie-rod holes in pieces of chopping block

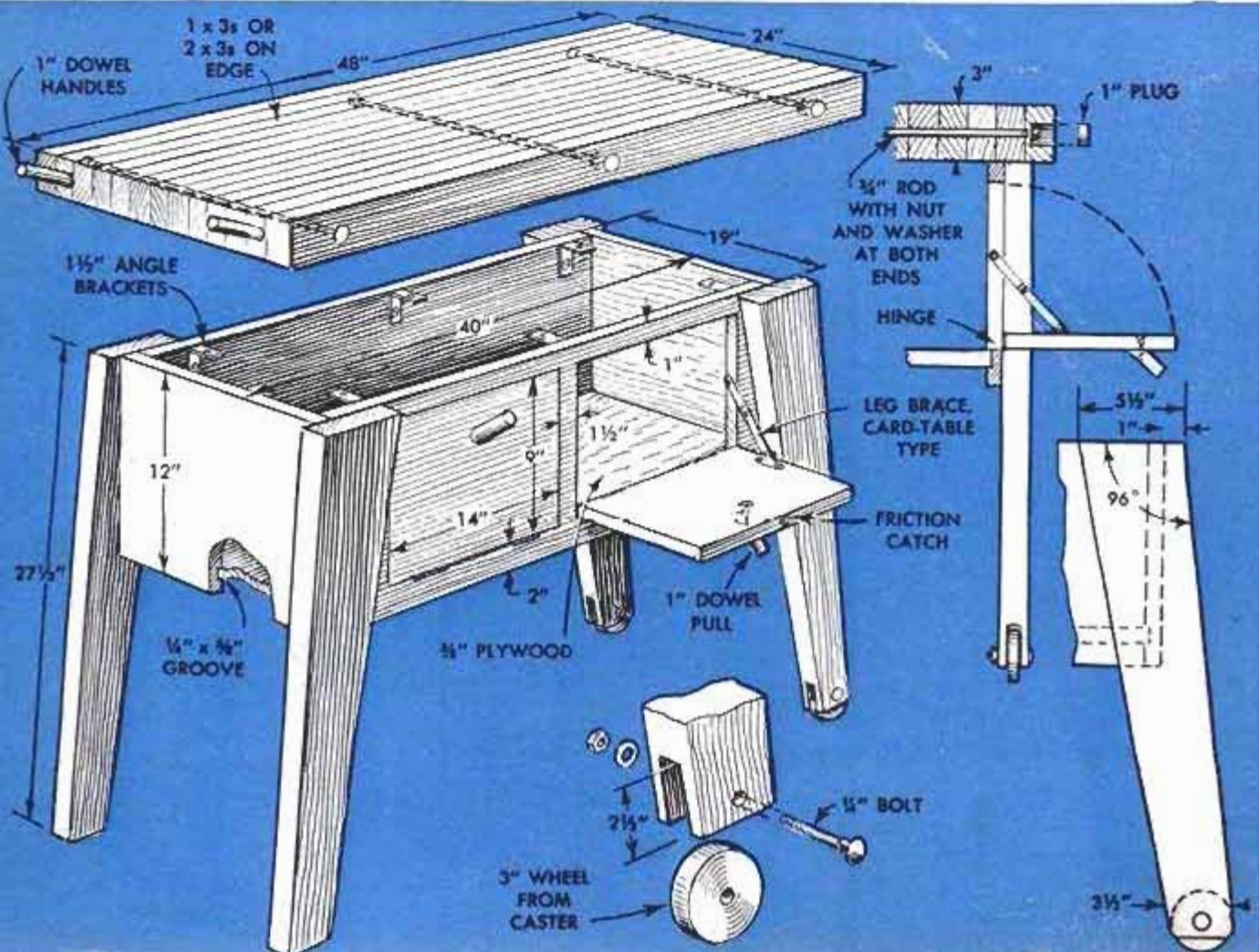
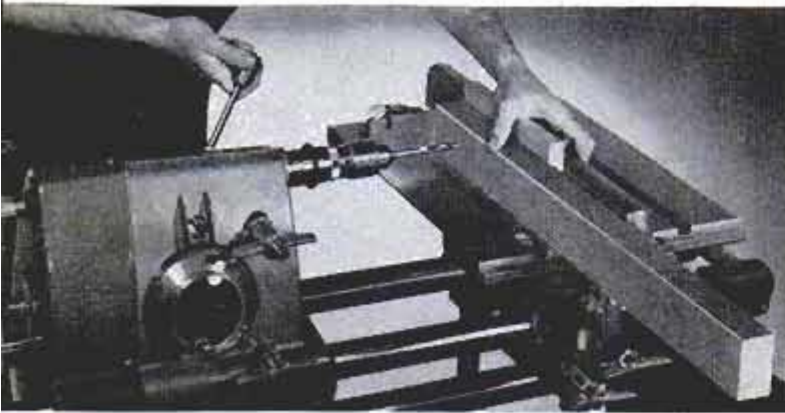



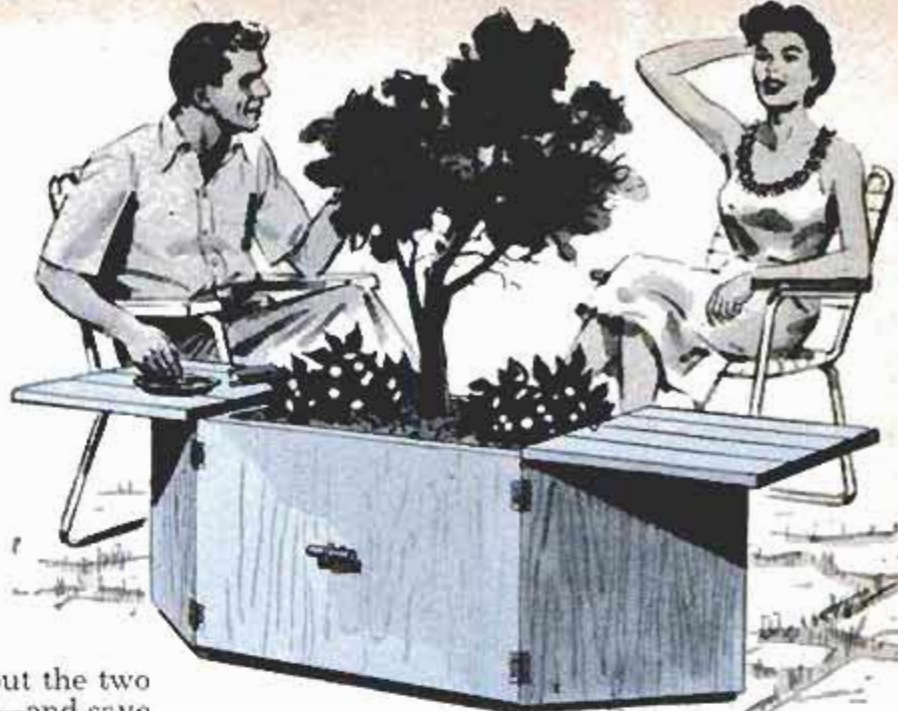

The counter consists of a box to which the legs are fastened and a chopping-block top that is attached to the box by six angle brackets. Construct the box of  $\frac{3}{4}$ -in. exterior plywood. On the door side, carefully cut out the two  $9 \times 14$ -in. openings with a jigsaw—and save the cutouts for the doors. Set the  $\frac{3}{4}$ -in. plywood bottom in grooves cut in the sides and assemble with waterproof glue and galvanized finish nails.

From 2 x 6 stock, first cut all four legs alike. Then shorten the two "wheel" legs  $\frac{3}{4}$  in. at the bottom and slot them as shown to receive rubber or plastic wheels obtained from 3-in. casters. Fasten the four legs to the plywood box with glue and 2-in. screws from the inside.

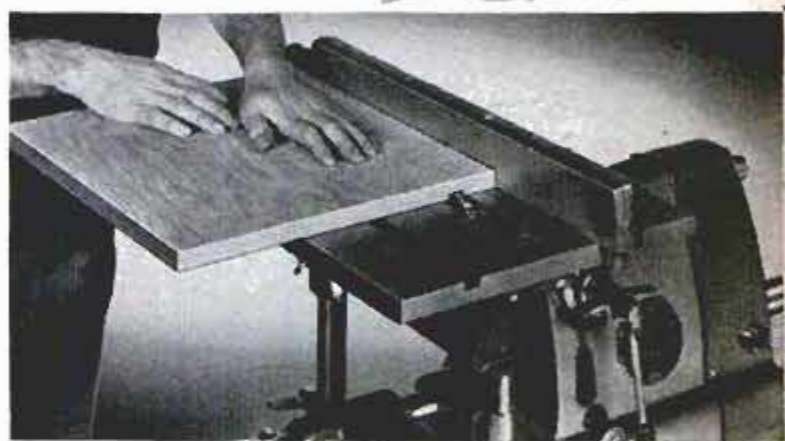

Right, grooves, in the side pieces of the planter, which house the bottom are cut quickly with dado saw

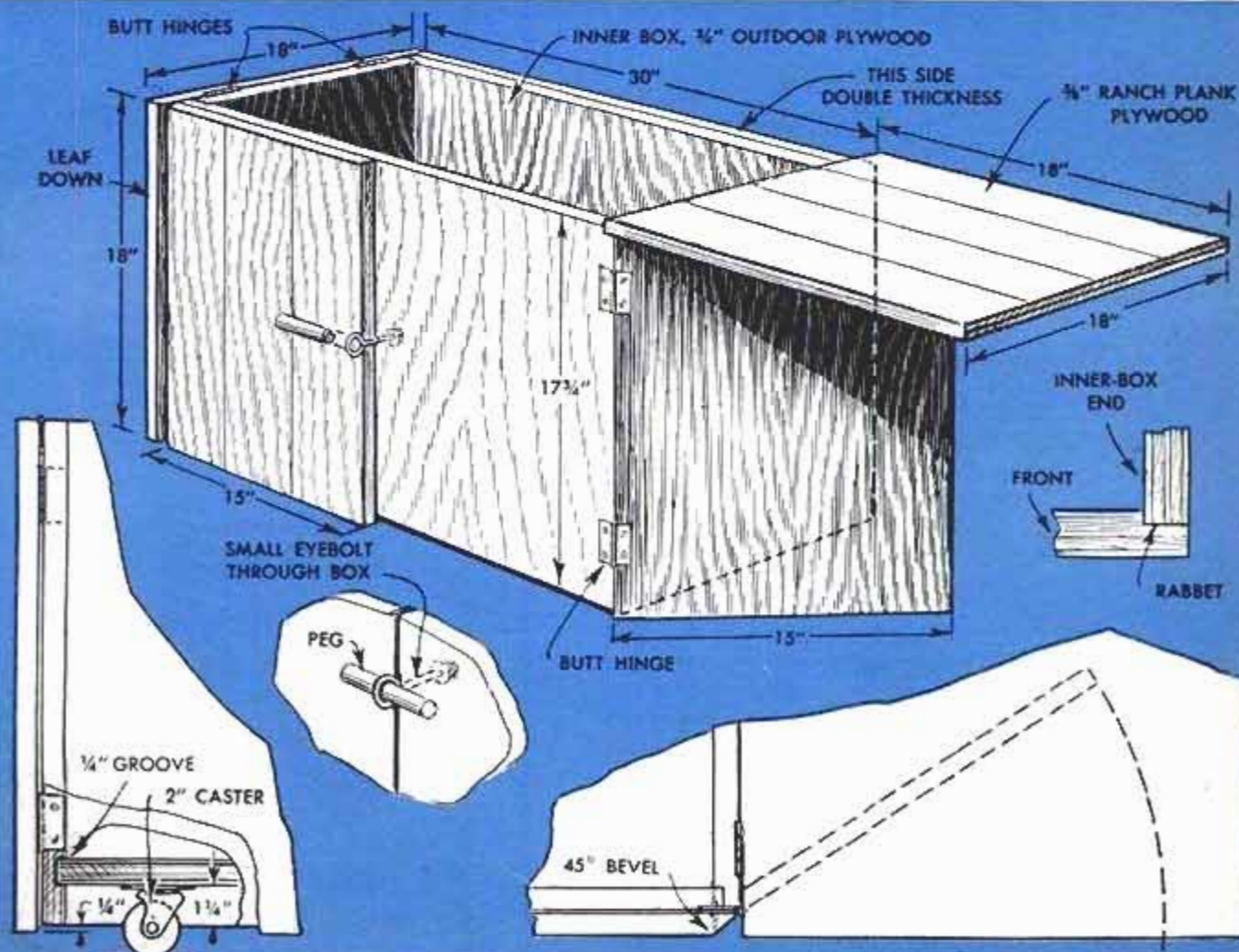



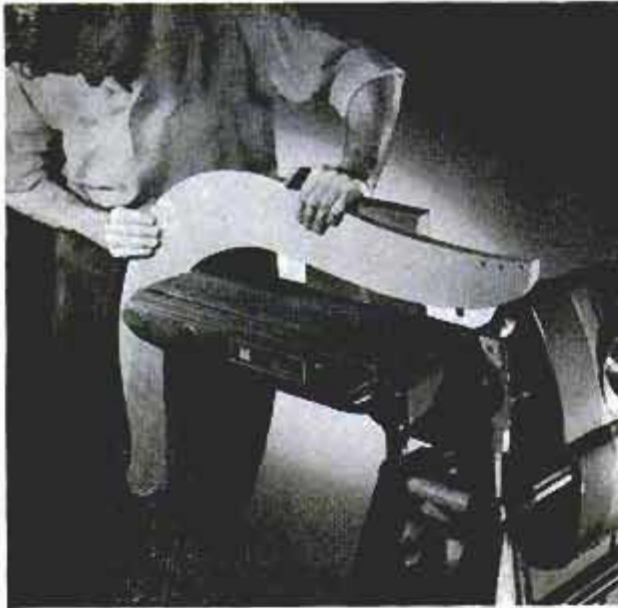

After each two-piece side frame of patio chair is glued and doweled, joint is sanded flush at edges

The chopping-block top can be of any clear soft or hard wood, 1 x 3 or 2 x 3 stock. Use dry wood so the block will not shrink and drill aligned holes through all the pieces so that three  $\frac{3}{8}$ -in. rods can pass through. Clamp pieces together evenly. The photo, page 170, shows how to do this on a multipurpose drill press. All pieces first are cut to same length. Then the miter gauge is locked in the table slot to space the holes evenly from the ends of the work, and the rip fence and table keep them square and at the same height. With an ordinary drill press, you can clamp two wooden blocks to the table to improvise a similar setup. Spread waterproof glue on the sides of the pieces and assemble, using the threaded  $\frac{3}{8}$ -in. rods as clamps. When dry, sand the top and edges, with a belt sander, if available, and simply finish the block with two or three coats of cooking oil. Stain or paint the rest of the counter as desired.

### Drop-Leaf Planter

Before constructing this unique planter box, you should decide whether it is to hold decorative plants or a dwarf tree for shade. The dimensions shown are ample for most plantings, but for a dwarf flowering tree the height and width are best changed from 18 to 24 in. Also note that casters (four of the platform type) are mounted underneath the box. Wood blocks will serve, but the casters will allow your planter to be rolled up to a chair at refreshment time and out of the way when hosing the patio floor. The drop leaves can be raised whether or not the planter is against a wall.

First, build the inner box of  $\frac{3}{4}$ -in. exterior fir plywood, rabbeting the corners and setting the bottom in grooves. For

healthy plantings, fill the bottom of the completed planter with two or three in. of gravel to give drainage. Then add the soil and plants.

### The Patio "Wheel Chair"

This full-size lounge chair is designed for comfort, yet it can be moved about your patio as easily as a small folding chair. And it can be rolled out on the lawn, where its legs will not sink in when used. For a standard lounge chair, simply replace the wheel assembly with the alternate front legs.

By constructing the curved sides of two pieces splined together, all wood parts of this chair can be obtained from a 4 x 4-ft. piece of  $\frac{3}{4}$ -in. plywood. Use exterior plywood, vertical grain redwood or fir preferably. First lay out on wrapping paper a full-size pattern of the sides. Draw a line for the joint, but leave the pattern in one piece to be able to check your completed sides before gluing. It's best to mark out all chair parts on the plywood before cutting anything.

Sand the edges of the sides to finish

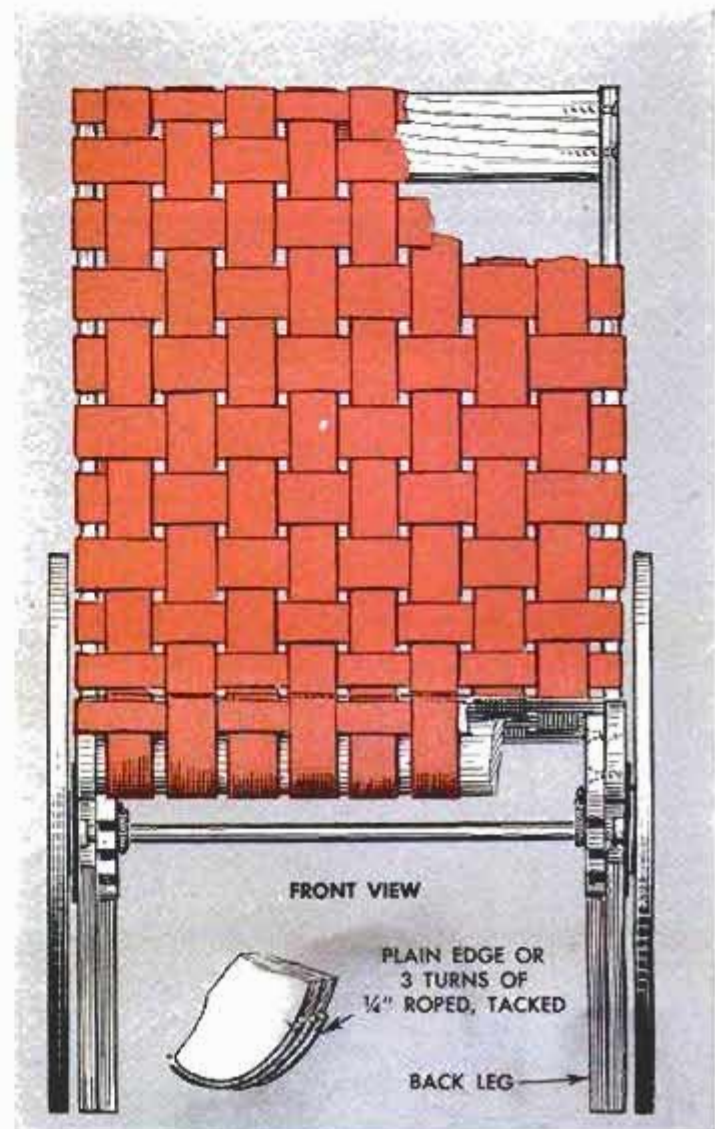





You have a choice of making the patio chair with or without wheels. If you make it with four legs, the front ones take the place of the large plywood disks and the notched brackets that provide a means of adjusting the chair. The drawing on the following page shows how all the parts for the chair can be laid out economically on a 4 x 4-ft. panel

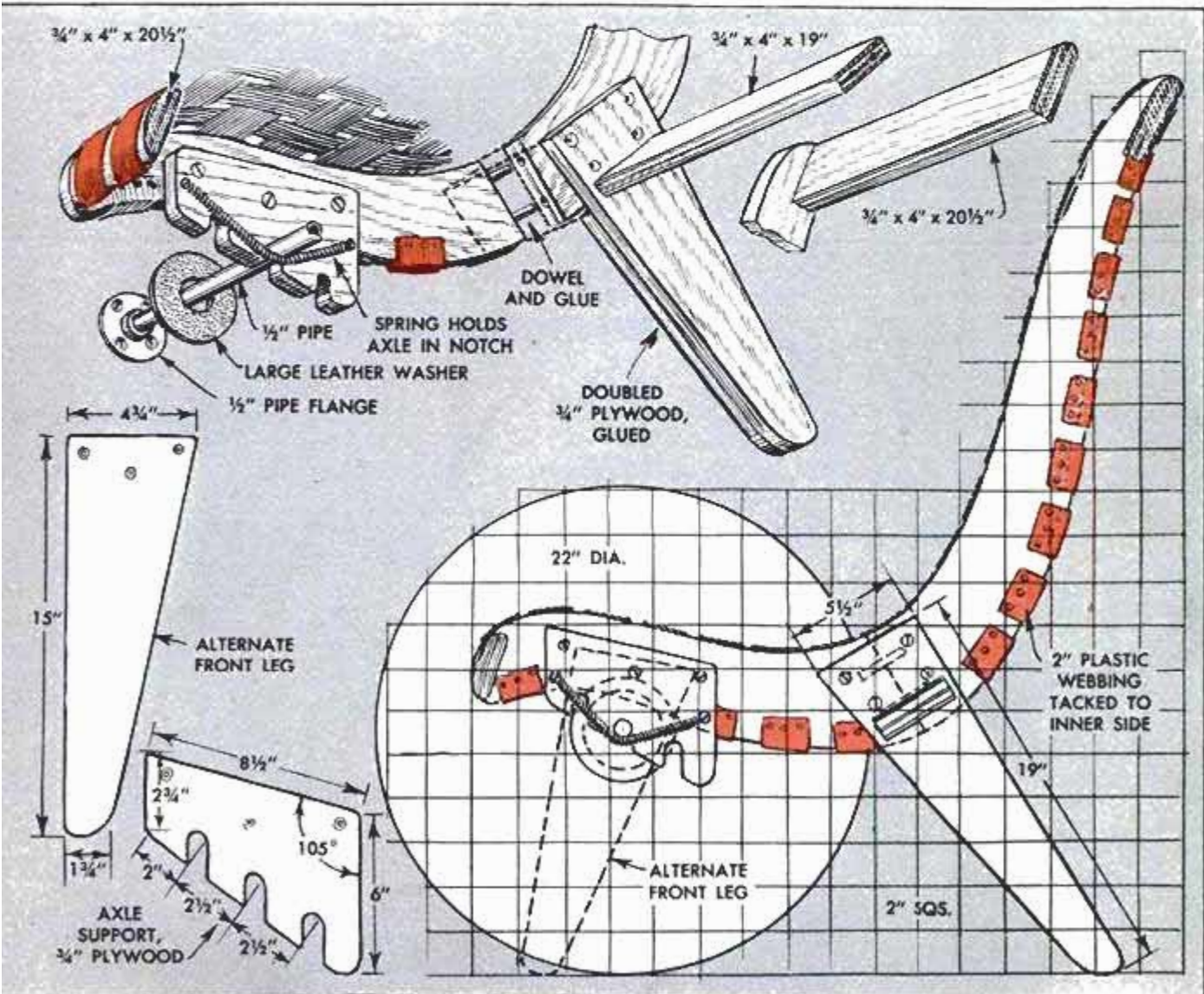





$\frac{3}{4}$ " x 48" x 48" OUTDOOR PLYWOOD

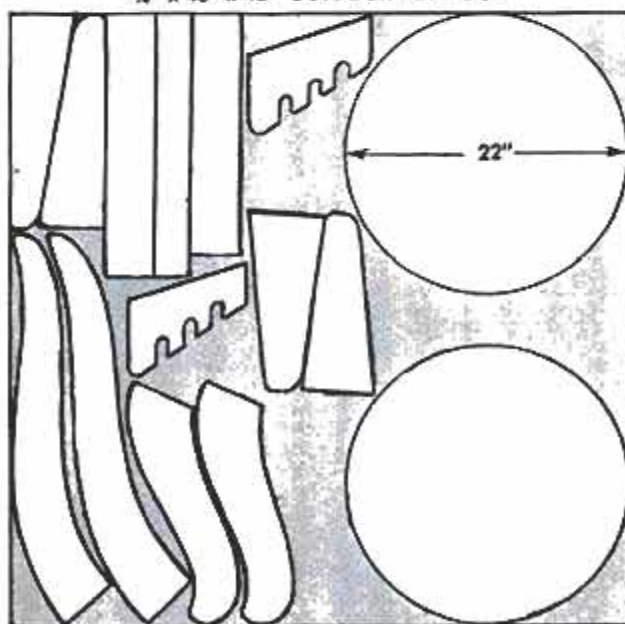

Left, perfectly round wheels for the patio chair can be formed with a disk sander by pivoting the work

smoothness before attaching the three cross pieces with glue and #8-2 in. galvanized screws. If you have a belt or disk sander, use it to round the  $\frac{3}{4}$  x  $3\frac{1}{2}$ -in. front plywood cross piece. Otherwise, substitute a  $1\frac{1}{4}$  x  $3\frac{1}{2}$ -in. cross piece of solid wood here, which is easier to round by hand. Rear legs are of two pieces of the plywood glued together. Either curve the upper end of the shorter piece on your jigsaw or cut a flat on the chair sides at this point to have a tight butt fit. Attach the legs with glue and  $1\frac{1}{4}$ -in. screws, using the pattern to position them.

A slight change in the position of the axle supports, or alternate front legs, will give any tilt to the chair you may desire. Attach the supports with screws, no glue, at this time and make any final adjustment later. Cut shallow saw kerfs on the face of the 22-in. plywood wheels to simulate boards and, if a 12-in. disk sander is available, use the trick shown of pivot-sanding the edges perfectly smooth. Screw the pipe flanges to the wheels and place 5 or 6-in.-dia. washers of stiff leather or  $\frac{1}{8}$ -in. hardboard over them to prevent wear on the wood frame. Stain or paint the assembled frame. Then cover with 100 ft. of 2-in. Tufweb or similar heavy plastic webbing available at outdoor-furniture stores. Tack the crosswise strips first, stretch tight and space about  $\frac{1}{2}$  in. apart. Then interweave the eight longer strips. ★ ★ ★

### Clamp Wrench Used to Flatten Dowel for Glue Escape

To prepare dowel pins for glue escape squeeze the sides with a clamp wrench. Use just enough pressure to put a flat on each side of the dowel. Moisture from the glue will cause the flat sides to swell back to the original shape for a tight fit.

Ken Murray, Colon, Mich.

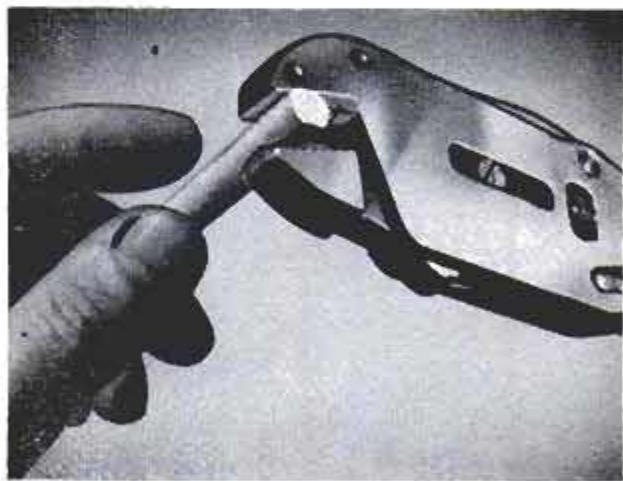

### Plastic Drinking Straw on Spout Extends Reach of Oil Can

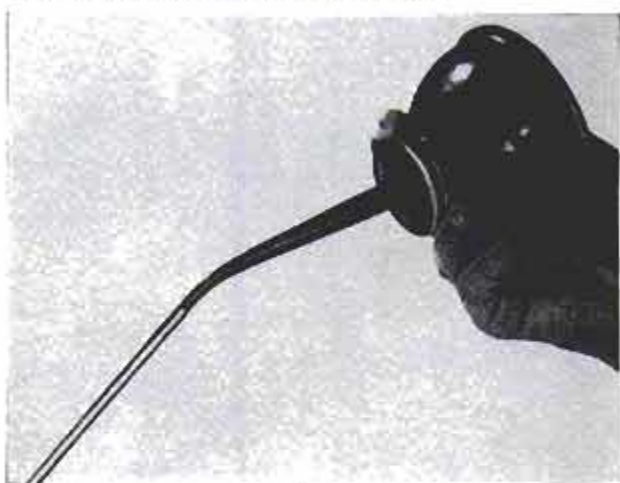

Lubricating in hard-to-reach locations is less of a problem if an oil-can spout is fitted with an extension consisting of a plastic drinking straw. It may be necessary to warm the end of the straw and expand it with an ice pick or center punch to permit it to be slipped onto the oil-can spout.



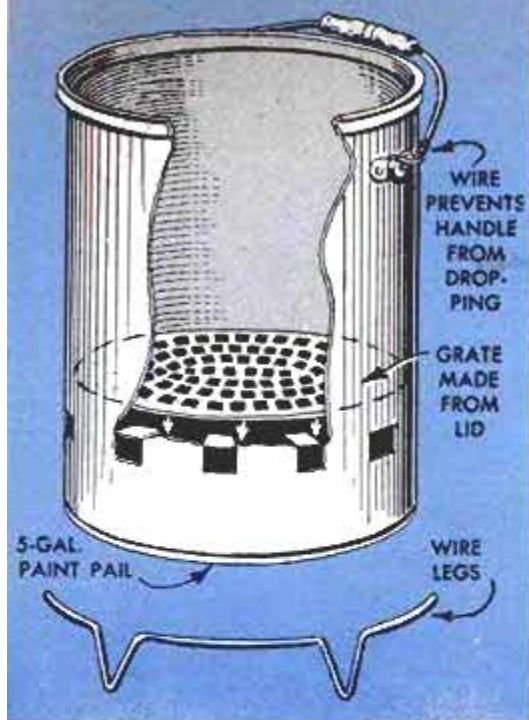

Not as fancy, perhaps, as you'll find in a store but what could be more simple to make—and inexpensive

## PAINT-PAIL BRAZIER

By Larry W. Smith

TEMPTING, mouth-watering steaks can be done to a turn on this neat little charcoal brazier, which was once a 5-gal. paint pail. You'll need the complete pail, including the lid, since the latter is used for the grate. Burn out any hardened paint that's in the pail and scrape the interior clean. Tabs that support the grate 3 in. up from the bottom are formed by cutting square openings in the side of the pail and bending the metal inward. The holes thus formed provide necessary draft openings. The holes are located around the pail by first laying them out on a strip of paper. Make the openings about 1-in. square and spot about 12 along the strip so they will

be equally spaced around the pail. Stick the paper to the pail and make a punch mark at the corners of each square. Remove the paper and drill a  $\frac{1}{8}$ -in. hole at each mark. Now, using a narrow metal-cutting saw, cut from the top holes to the bottom holes of each square and then from hole to hole across the bottom. Bend each square inward to form a tab to support the grate.

The grate is made by first cutting away the rim of the lid with tin snips and then punching out square air holes with a cold chisel. A trim looking stand for the brazier is made by bending two lengths of heavy wire to the shape shown, following the curvature of the pail, and then snapping them in place against the inside of the bottom rim. Use a cake cooler for a grill.

Below, square air holes are cut in side of can with metal-cutting saw. Center, wire hook holds bail up and away from side of pail. Right, series of holes in lid converts it to grate. Use cold chisel to cut holes







PENCIL MARK

### Slit Section of Rubber Hose Anchors Tap-Wrench Handle



To prevent a T-handle of a tap wrench from sliding off-center inadvertently when cutting a thread, drill and slot a short piece of rubber hose and fit it over the handle as indicated in the drawing. The friction induced by the rubber will

prevent the handle from sliding too readily, yet allow it to be centered without difficulty, or placed off-center for easier turning.

### Chalked Surface on Saw Table Takes Pencil Markings

To speed the work of cutting short lengths on a circular saw without using the fence and stop normally employed, chalk an area of the table top adjacent to the blade so that it will readily receive pencil markings. The marks are easily erased when no longer required or when necessary to change the length of the measurement.

### Auto-Engine Dip Stick Improved For Easier Oil-Level Reading

The difficulty of noting the crankcase oil level upon withdrawal of the dip stick from your auto engine can be avoided when the portion of the stick between the "add oil" and "full" marks is ground hollow. Grinding can be done with a thin, rounded-face wheel or with the edge of a flat-faced wheel. The depression will cause the oil to remain at the indicated level a sufficient time to permit a correct reading. Since the oil-level marks will be ground away, note their location on the back of the stick and file new notches on the hollowed face accordingly.

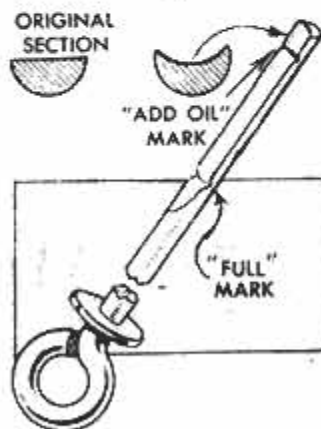

D. Coats, Winnipeg, Manitoba, Can.

### Automobile Transmissions Drive Front-Delivery Spreader

The spreader disk on this farm-built spreader is located at the front of the box for convenience in powering the disk and

apron by the tractor power take-off through two automobile transmissions. One transmission is located at the center of the wagon-frame extensions in front of the box and is coupled directly to the power take-off. The opposite end of the transmission drives the spreader-disk shaft, which is mounted in a roller bearing taken from discarded machinery. Teeth cut from steel angle are bolted to the face of the spreader disk, which is cut from sheet steel. A second auto transmission is belt-driven from the first transmission and drives the bar-and-chain apron. — A. M. Wettach, Mt. Pleasant, Iowa.

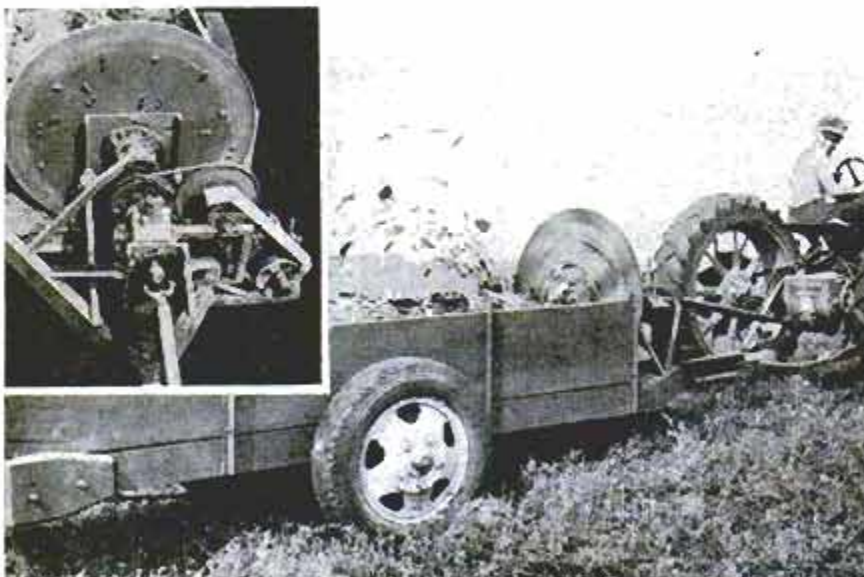



WTM 58

# Outboard-Motor Davit

GETTING a heavy outboard motor in or out of a boat at a dock is easy with a davit and tackle like the one shown.

To make the davit bend an 8-ft. length of 1-in. pipe into an L-shape as shown and drill a  $\frac{1}{4}$ -in. hole  $\frac{3}{4}$  in. from the upper end of the pipe and another hole the same diameter 1 ft. from the other end. A  $\frac{1}{4}$ -in. eyebolt is fastened in the first hole to hold the tackle block and a  $\frac{1}{4}$ -in. carriage bolt 3 in. long is fastened in the second hole. The thread on the carriage bolt should be at least  $1\frac{1}{2}$  in. long, so that a nut can be turned on the bolt on each side of the pipe to lock the bolt firmly in place, leaving  $1\frac{1}{2}$  in. extending beyond the pipe for snubbing the tackle rope.

## Base Holds Davit Upright

As a base for holding the davit upright, drive a  $1\frac{1}{4}$ -in. pipe adjacent to the dock so that the top of the pipe is 18 to 20 in. above the floor of the dock. A piece of flat iron clamped over the pipe and screwed to a dock timber will hold the davit in position. Slip the lower end of the davit into the base pipe, attach the block and tackle and the davit is ready for use. Davit and tackle can be swung over the dock to pick up the motor and then swung over the water to lower the motor onto the transom of the boat. Reversing the procedure will permit the motor to be lifted from the boat to the dock where it can be placed on a motor cart.

When hoisting or lowering a motor the boat should be tied close to the dock by a stern line and bow line. Always secure the free end of the tackle rope on the davit or a dock cleat when stepping from boat to dock.—Walt Durbahn, Highland Park, Ill.

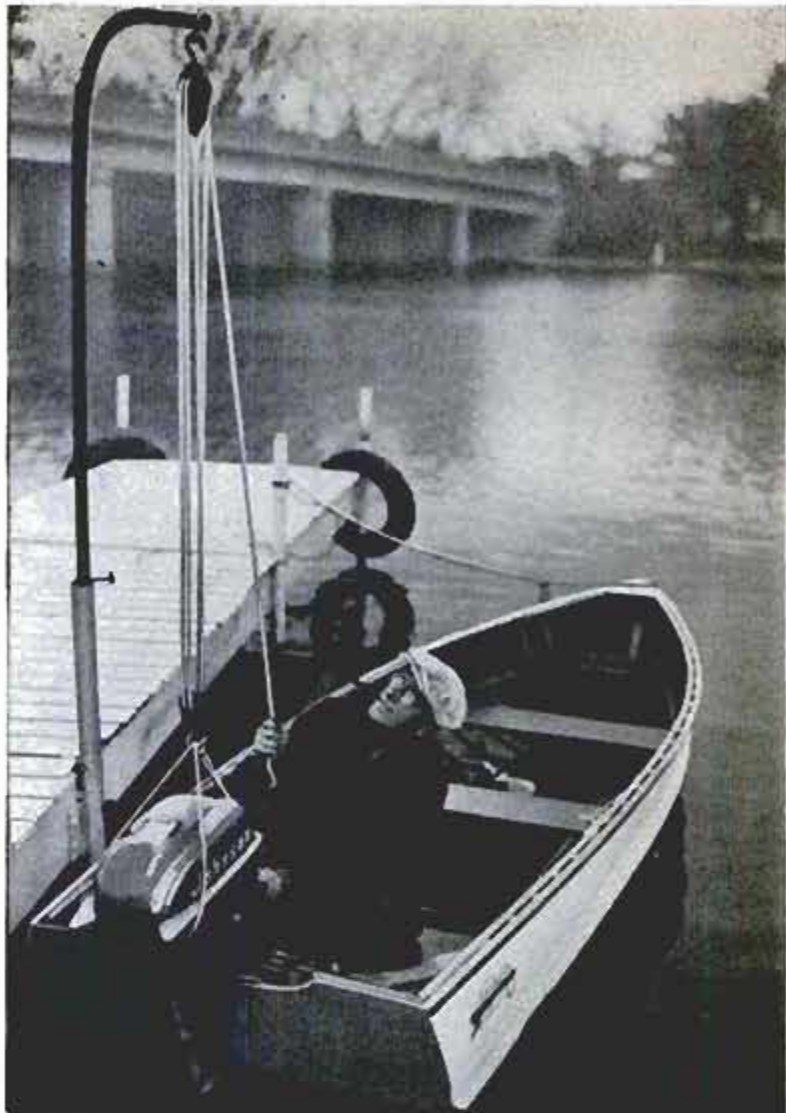

Above, motor is steadied with one hand until clear of boat to prevent damage to transom and propeller. Below, before lifting motor off dock make certain motor sling is well secured to lower-tackle block

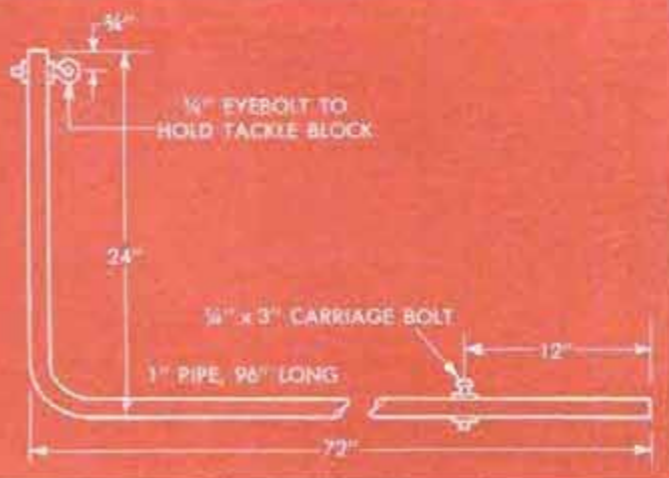



# HANDWOVEN FLOWERPOT COVER

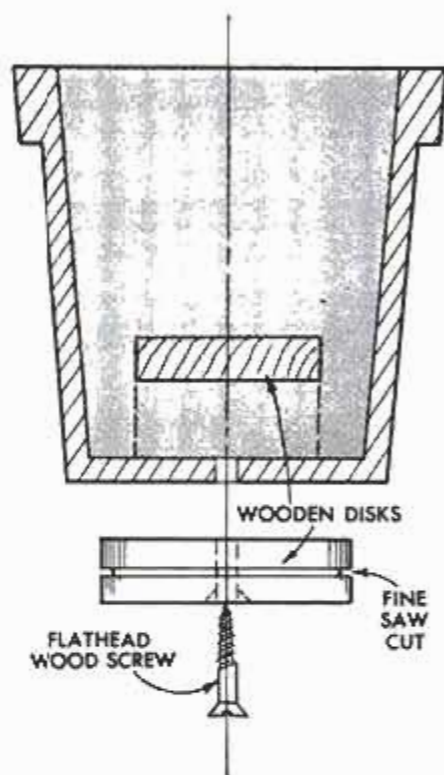

**C**LAY FLOWERPOTS, although extremely practical for growing plants indoors, are not especially attractive when placed in a modern decor, and have the added disadvantage of being broken fairly easily. However, any clay flowerpot can be given both beauty and resistance to shatter

**1.** Screw grooved base disk to bottom of flowerpot, then insert tapered ends of cane strips firmly in groove

by weaving a cane basket to fit it. No special skill is required to weave the basket, and the only fixtures needed, besides the pot, which is used as a form, are two wooden disks. Both disks are cut from  $\frac{3}{4}$ -in. stock, one being smaller and fitting inside the pot. The other disk should be large

**2.** Slip rubber band or wire ring up around strips so that they are forced up against side of flowerpot

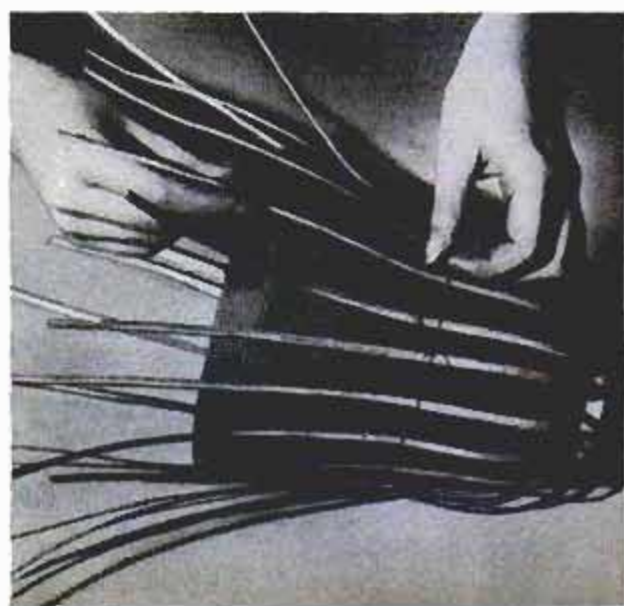
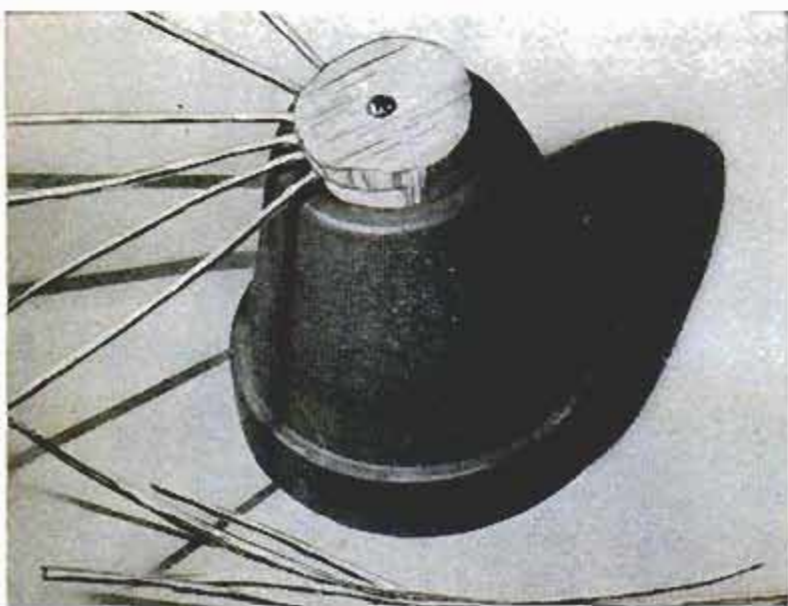



enough to provide a firm base for the flowerpot, since it will become part of the finished basket. A groove is cut around this base disk with a fine-toothed saw to receive the tapered ends of the vertical cane strips that are used for weaving the basket. To hold the base disk on the pot, drill and countersink it to accommodate a flatheaded wood screw. Pass this screw through the disk and through the hole in the bottom of the pot and drive it into the smaller disk inside the pot, as indicated in the detail. Now, taper the ends of a number of cane strips and insert them in the groove around the base, Fig. 1. When a full circle of strips has been inserted, bend them up alongside the pot and hold them with a heavy rubber band or piece of wire as indicated in Fig. 2. Cane strips now are woven between the vertical strips as in Fig. 3. Pull each strip firmly and push it down against the lower strips so the weave is solid and

even. After a few horizontal strips have been woven, the rubber band or wire can be removed and the vertical strips will stay in place. Continue weaving up to a point just below the widened rim of the flowerpot. At this height a reinforcing strip is inserted, Fig. 4. The reinforcing can be several of the flat strips, or a single round one. Besides providing rigidity, the reinforcing produces a finished appearance at the basket top. After the reinforcing has been woven in, remove the wood screw and slip the basket off the flowerpot. Weave the projecting ends of the vertical strips around the reinforcing strip and trim off any that are too short to be woven. If the cane has been soiled or stained by your hands, scrub it with a brush and water, then allow to dry thoroughly. To permit easy cleaning, varnish or shellac the basket. It also can be painted, but the natural color of the cane usually is more attractive. ★ ★ ★



**3.** Weave horizontal strips between the vertical strips, pushing each row down against the next lower row

**5.** Remove basket from flowerpot and weave projecting ends of vertical strips around reinforcing strip



**4.** At point just below rim of flowerpot, insert reinforcing strip to strengthen finished basket

**6.** Finished basket is left its natural color, then varnished or shellacked to permit easier cleaning

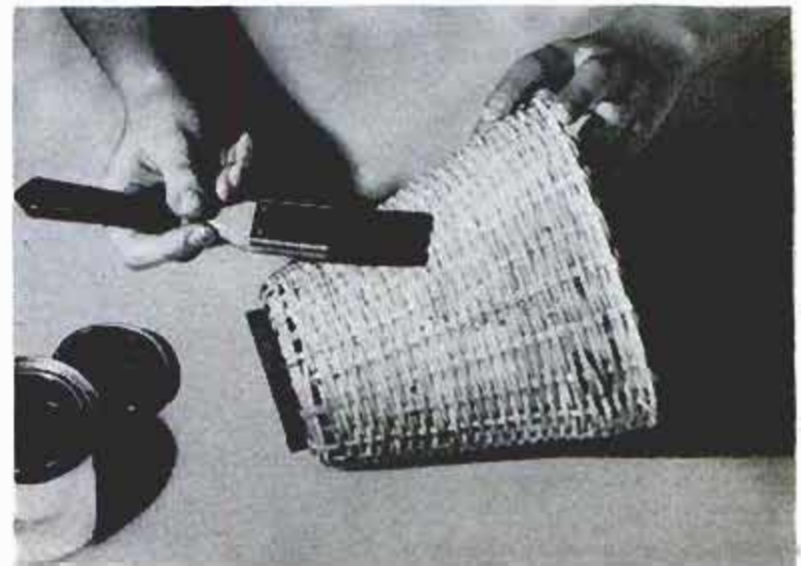



## Saw-Table Extension Folds for Storage

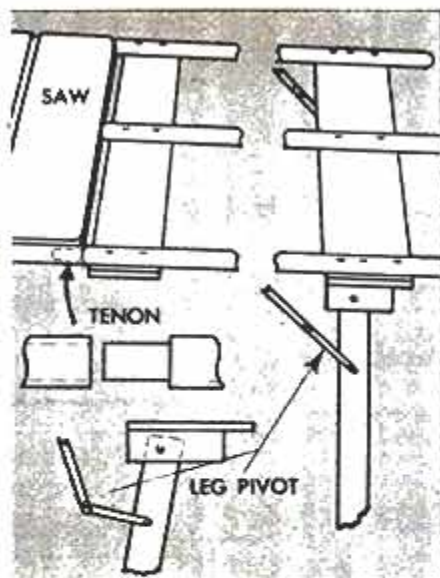

An extension for a saw table, utilizing dowels for its top, will enable one man to handle and cut large pieces of stock, such as plywood and hard-board sheets. On saws like the one illustrated, that have tubular ripping-fence guides, a tenon is cut on the ends of the dowels to slip snugly inside the open tubes. On saws with flat guides, the dowel ends can be squared and clamped on the table against the guides. Another method of attaching would be to drill holes in the flange on

### Vibrationproofing Setscrews

Setscrews used to hold pulleys on the shafts of power tools often become loose due to vibration. To prevent this from happening, replace each original setscrew with two shorter ones. The first screw is turned down tightly against the shaft, and the second is turned down against the first, locking both in place.—Burton L. Wollenzien, Grand Junction, Colo.

### Modified Socket-Set Extension Provides "Universal" Action

Universal-socket action is provided for the straight sockets in one mechanic's toolbox by using a modified socket extension. The drive end of the extension is ground off as indicated in the detail, so a straight socket can "rock" on the extension. The center portion of the extension end is left intact to provide a positive connection for driving the socket.

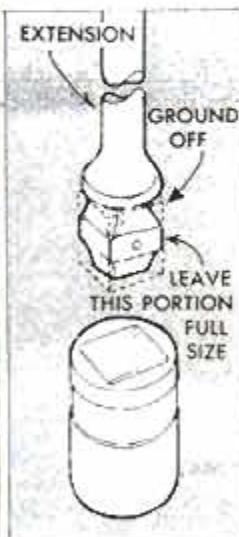

the side of the saw table to allow bolting on a 2 x 2 that has been drilled to receive the ends of the dowels. The cross pieces of the extension are made of lengths of scrap wood. The two legs are pivoted and fitted with folding braces, permitting the extension to be folded for storage. In the photo, the saw guard has been removed for purposes of illustration. The guard should be used at all times wherever practical.

Paul Fryar, Long Beach, Calif.

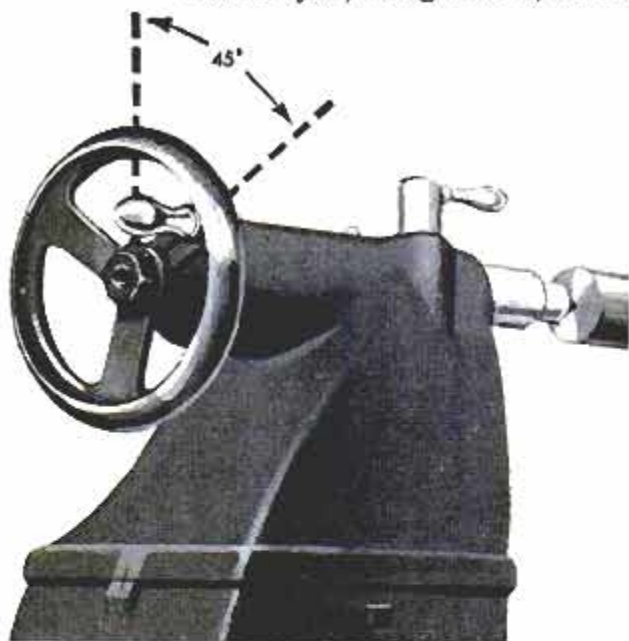

### Proper Setting of Tailstock

When properly set, the knob on the tailstock-spindle handwheel should be between the top and one-eighth of a turn down clockwise. This has proven to be the most convenient position for the knob if the wheel has to be backed up (counterclockwise) due to the work expanding when heated.



# Prospect for Uranium With a Roll of Film

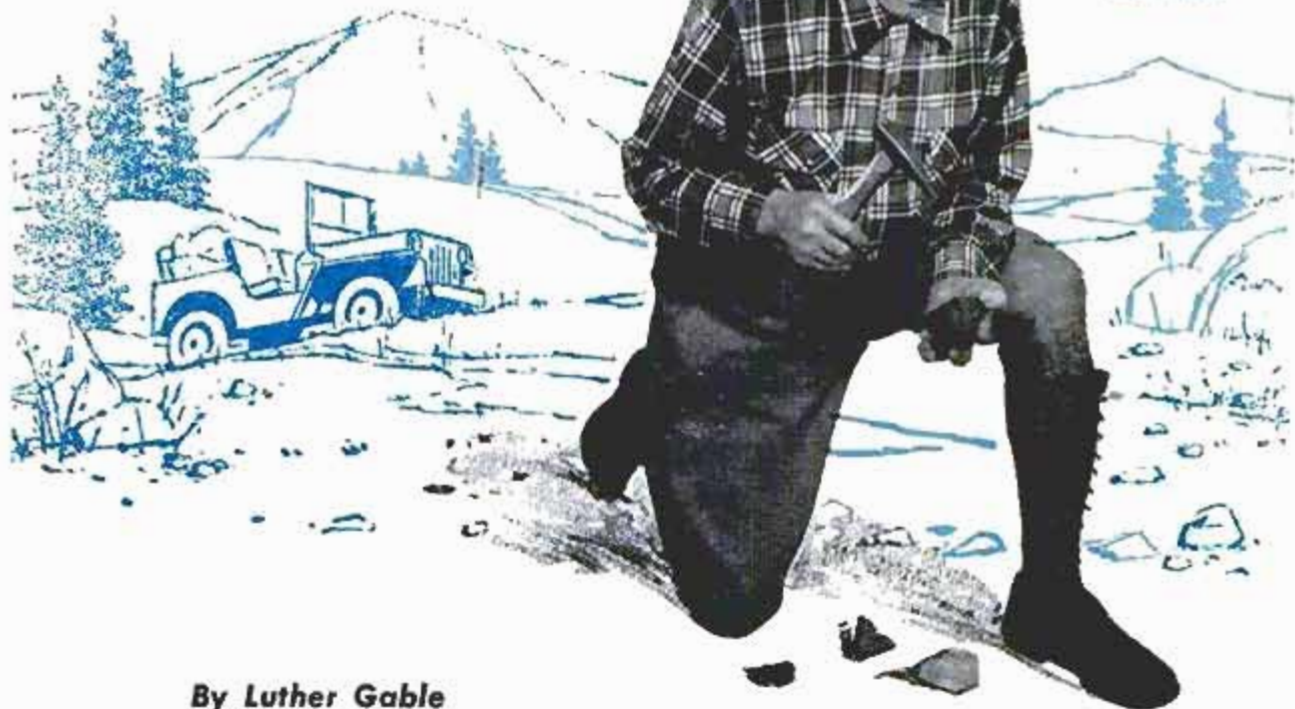

By Luther Gable

**YOU DON'T NEED** an expensive geiger counter to prospect for uranium. Just look for rocks, sand, ledges and outcroppings that bear a canary-yellow stain—one of the characteristics of the oxide of uranium visible to the naked eye. If a sample of one of these materials is found to be unusually heavy for its size, there may be uranium present. When collecting specimens suspected of bearing uranium, enter the location and date of each find in a log book. Then, place the specimens on unexposed photo film in a light-tight container for several days. At the end of this time, develop the film and if light-struck areas appear on the negatives, it is likely that you have found uranium.

## Comparing Values

A good means of providing a comparative scale of values for determining the approximate percentage of uranium contained in a specimen, which has been checked by the film-exposure method, is to obtain an ore sample of known uranium content and prepare a negative with it. Samples of specimens that prove valuable by this rudimentary assaying can be sent to the nearest State Bureau of Mines or State Geological Survey for a percentage-analysis report. Be sure to include an estimate of the amount of ore available for each specimen.

When preparing specimens for processing, cut the film, which may be of any size

or index, a high index number being preferable, into 2-in. squares. Then slip the squares into opaque envelopes. These may be made from black construction paper. (Note that this entire procedure of cutting film and inserting it in envelopes must be done in total darkness.) Place the envelopes in a lightproof drawer or box with one or more small, flat metal objects on top of each envelope. At this point it is important that the emulsion side of the film face upward. Use one penny on one envelope,

When print is made from negative exposed by radioactive specimen, light-struck areas appear white

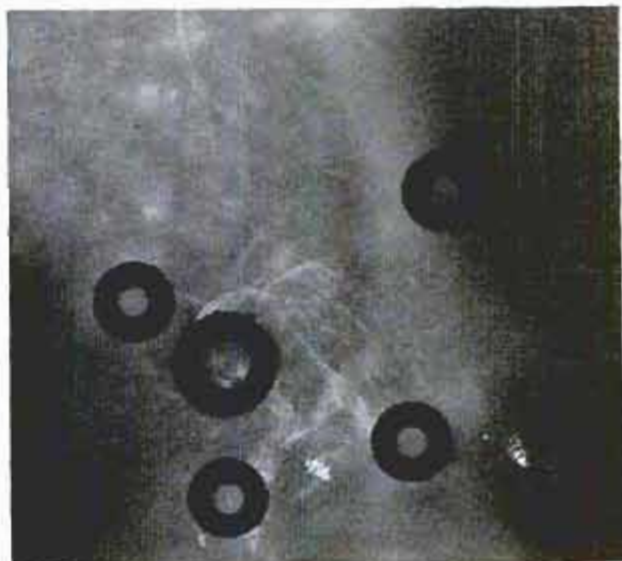



two on another, dimes, quarters, flat iron washers or keys on the envelopes so that no two are alike.

### Mark Samples With Tape

At the time ore specimens are collected, attach a small piece of adhesive tape to each. In the log book, opposite the number, record the exact location for each specimen and an estimate of the quantity of ore at the location, in addition to the date of the find. Then, number the negative envelopes and place the appropriate specimen on each. Record in the log book the location of specimens according to the number and type of metal objects on a particular envelope. The pieces of metal serve to identify the specimens and produce a silhouette on the negatives for easier evaluation. Allow a space of at least 3 in. between the film packages to avoid contamination between specimens.

If sand or fine fragments are being tested, place the material in a coin envelope and treat it the same as a rock specimen. Seal the drawer or box containing the specimens with adhesive tape.

### Examine Carefully

At the end of a week remove the film from each envelope and develop it the same as film used for photographic purposes. Then, examine each negative carefully for light-struck or fogged areas which, if present, may have been caused by radiation from uranium in the sample. A small amount of radiation will penetrate the envelopes and affect the emulsion on the negatives, leaving a light silhouette where the metal objects are located.

If you have been fortunate enough to have found a high-grade ore, the entire film may appear light-struck, including the area under the metal. For more-accurate test results in the latter case, run the specimen through another test under the same conditions but for a period of only one or two days. If a strong silhouette is produced on the negative this time, you have a very high-grade ore. For information on how to stake out a claim and begin mining operations, write your State Bureau of Mines or the AEC, Washington, D. C. ★ ★ ★



Above, uranium in specimen acts like X ray, penetrates opaque envelope and film emulsion except where blocked by metal

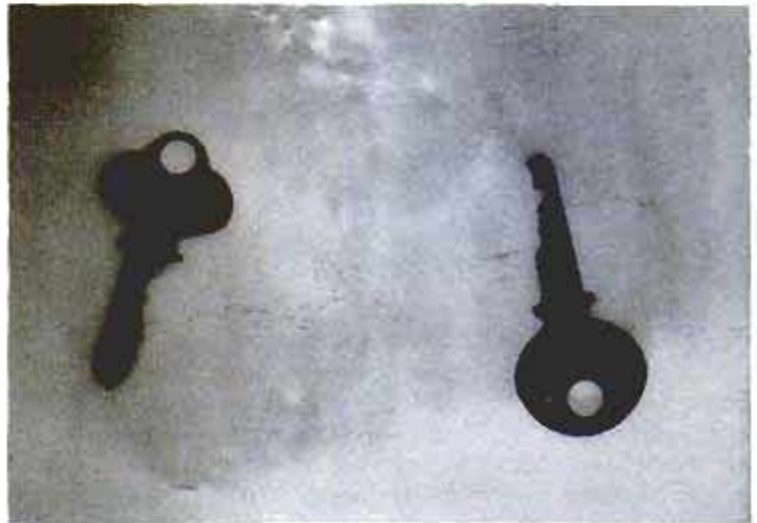

Above, heavy white area on print made from this test indicates a very rich ore sample. Below, ore samples are placed on envelopes containing squares of unexposed film in drawer





## Junior-Size Bench and Tool Chest for the Young Craftsman

Keep Junior interested in crafts by helping him build this junior-size workbench and tool chest. Cut the four legs and two cross pieces from 1 x 3-in. stock and assemble them with wood screws. Then fasten the legs to a  $\frac{3}{4}$ -in. plywood top using right-angle metal brackets. A length of 1 x 4-in. stock is attached to one edge of the top for a backstop. The floor of the tool chest is  $\frac{1}{2}$ -in. plywood cut to fit on top of the cross pieces between the legs. The box frame of 1 x 4-in. stock is made  $3\frac{1}{2}$  in. shorter than the bottom panel so that the cover will clear the legs.—J. R. Tate, Ottawa, Ont., Can.

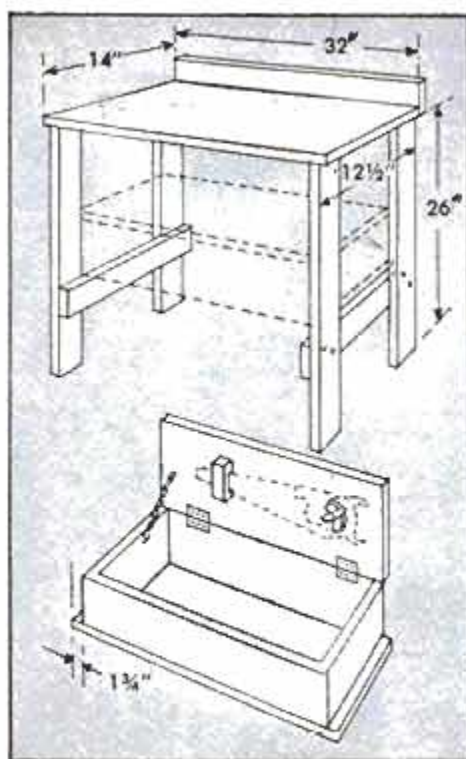

## Practical Light-Duty Anvil



An old flatiron mounted in a wooden block provides a good light-duty anvil for working small metal parts. Gouge a recess in the top of the block to bring the soleplate flush with the top

surface, taper one end of the block to the contour of the iron and then bolt it in place.—M. C. Anderson, San Lorenzo, Calif.

## Bar of Solder Cleans File Teeth

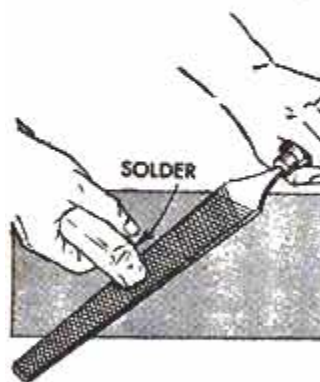

If a strip of copper or other soft metal is not at hand, a badly clogged file can be cleaned by using a bar of solder in the same manner as the other metals would be used. The solder is rubbed across the

teeth so the embedded material is pushed out the side of the teeth. Occasionally drawing a file across a piece of carpenter's chalk will keep the teeth from becoming clogged when filing lead, babbitt or other soft material.

## Holes in Aluminumware Repaired With Rivets

It is not practical to repair small holes in aluminum containers by soldering, but they may be plugged with aluminum rivets. First, round the hole by turning a tapered punch into it, leaving the burr to be crushed against the rivet. Then, insert the rivet with the head inside the container and resting on a steel block, and complete the riveting.

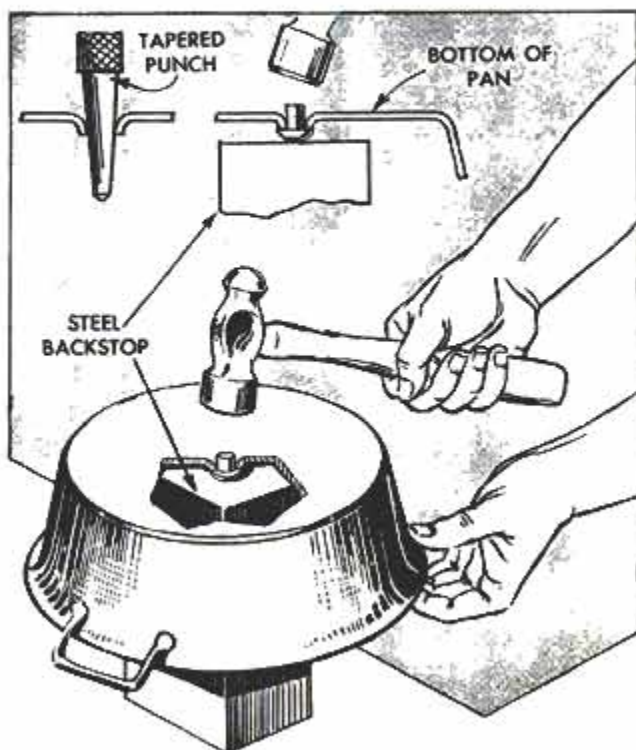



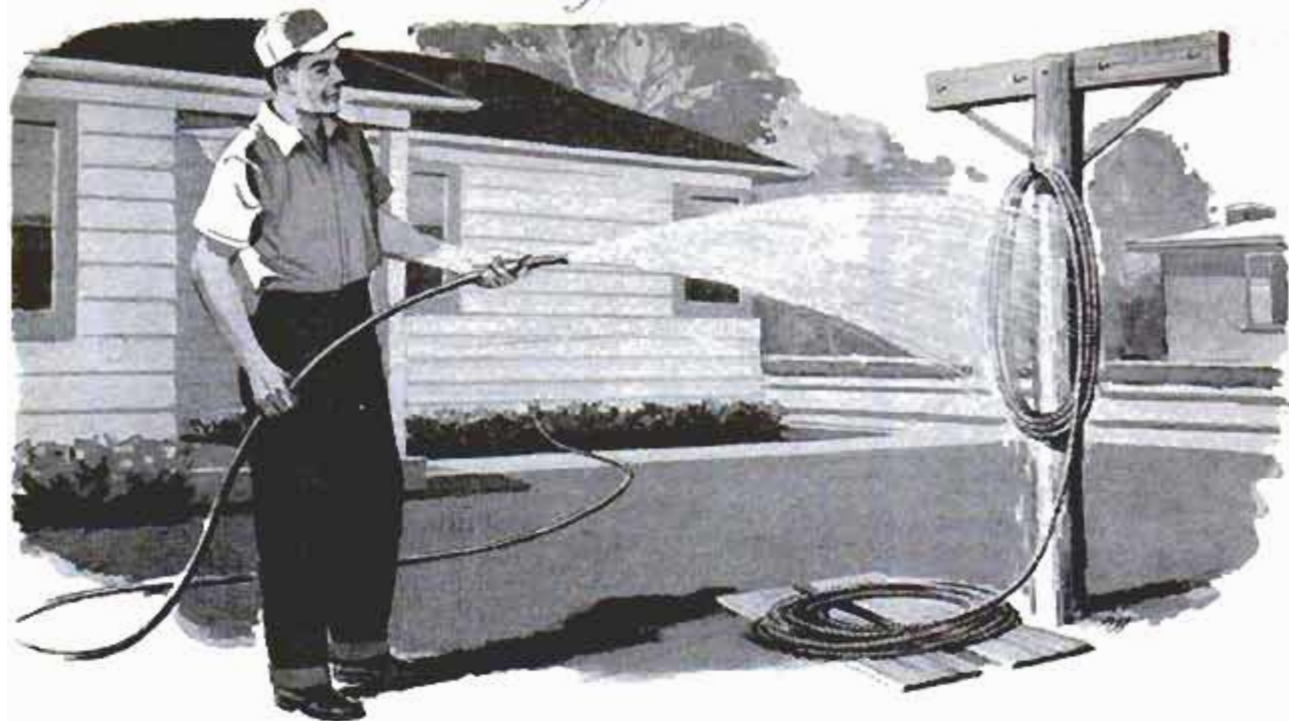

# Make Your Rope Last Longer

By Earl F. Wobek

**W**HETHER YOU USE rope around the home, farm or for other purposes it will last longer and afford safer, more dependable performance when a few simple rules are used to guide you in its selection, care and handling. Rope construction has a definite effect on all its characteristics, such as flexibility, tensile strength and abrasion resistance.

In the manufacture of rope, fibers are twisted into yarns, yarns into strands, and then three or more strands are twisted into a complete rope, Fig. 1. By controlling the amount of twist, a hard, standard, medium-soft, soft or extra soft rope can be made. For most uses a standard-lay (twist) rope is best. A hard rope has less strength but more abrasion resistance. A soft rope handles easily but abrades more readily.

For most purposes rope made from natural fibers (Manila, sisal, hemp, cotton and linen) is more suitable than rope made from synthetic fibers, such as Dacron, nylon and glass fiber. Rope of the latter type is designed for use around chemicals, high temperatures and other special uses. Natural-fiber rope is pliable, resists surface abrasion well and is available in a variety of sizes.

A third factor to be considered when selecting rope, in addition to lay and type of fiber, is the size and breaking strength. How strong should a rope be? Good practice dictates a 5 to 1 ratio between the rope and load it is to lift, when the rope is new. For example, if you intend to

lift a load of 1000 lb., a rope with a minimum breaking strength of 5000 lb. should be used. Referring to a manufacturer's size-and-strength specifications sheet, Plymouth Cordage Company, Plymouth, Mass., in this case, Manila rope  $\frac{3}{4}$  in. in dia. with a minimum breaking strength of 5400 lb. is a safe rope size to use. As rope becomes older, that ratio should be increased.

## Block and Tackle

The tackle ordinarily used for hoisting, lowering or moving heavy objects consists of two blocks and a rope. The strength of the block, not the strength of the rope, determines the load limit. A good rope is always stronger than the block for a given size of pulley or sheave. Use the largest diameter sheave practicable and reeve the rope properly as shown in the diagrams in Fig. 4. In reeving, what is to be the becket end of the rope should be passed through the blocks away from the fall (hauling part) and toward the becket. This eliminates having to pull all the rope through all sheaves of the blocks.

When tackle is used to lift a weight, the pull required on the fall rope can be determined by dividing the weight by the number of ropes, or parts, running from the movable or lower block in most cases. Add a friction loss of 10 percent for each sheave 3 in. in dia. or larger, in both fall and movable blocks. For example, a load to be lifted is 1000 lb. The tackle consists of 2 double blocks, 4 sheaves, 4 rope parts



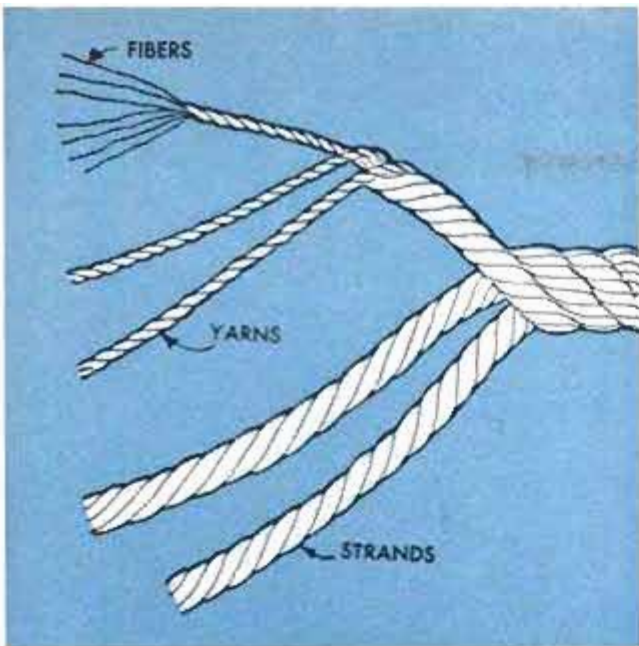

1. Fibers are twisted into yarns, yarns into strands, then three strands are twisted into a right-laid rope



2. Unwind new right-laid rope counterclockwise from inside of coil, unwind left-laid rope, clockwise

at the movable block. Mechanical advantage is 4. Friction loss at 4 sheaves is 40 percent.

1000 lb. plus 40 percent equals 1400 lb.

1400 lb. divided by 4 equals 350 lb.

Pull needed on fall rope is 350 lb.

### Proper Use of Rope

Good rope usage starts when the new coil arrives. To avoid kinks, which weaken a rope, lay the new coil on the floor with the inside end on top. Unwind right-laid rope counterclockwise, Fig. 2. If it uncoils clockwise, turn the coil over, pass the end through the coil, and uncoil.

Adding or removing twist from a rope destroys its balance. Too much twist results in kinks, Fig. 3; too little causes the strands to harden and lose their strength.

A knot should not be used to join ropes permanently. Always splice. A knot retains only about 50 percent of the strength of the rope, while a properly made splice retains 85 to 95 percent. The free ends of a rope should always be bound or "whipped" to prevent unraveling of the strands.

### Keep Rope off Ground

Needless surface wear can be avoided by keeping rope off the ground. Grit and sand not only abrade the surface but also work into the rope lays and cut the fibers. Avoid tying or pulling rope over sharp corners. If it is necessary for rope to be in contact with the ground or a sharp corner, protect the rope at that point by wrapping it with canvas or other soft material. The diagram, Fig. 6, shows weights of pull exerted on rope parts of slings at various angles. In each case a 2000-lb. load is lifted. Note that the pull required to lift 2000 lb. is the same as the load only at zero

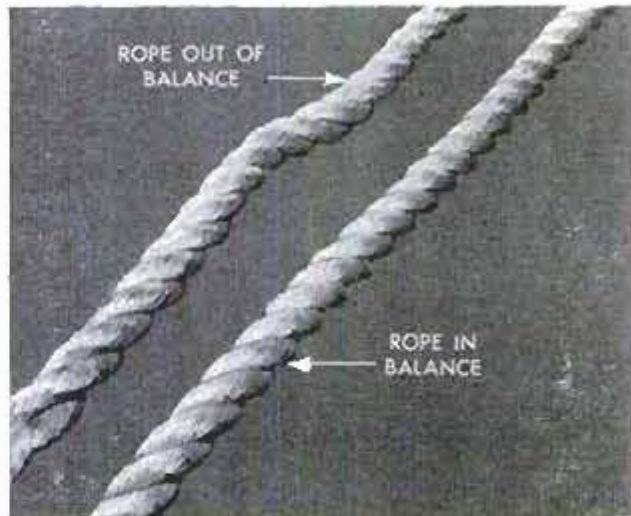

3. Adding or removing twist from rope destroys its natural balance, producing kinks and loose strands

4. When making up block and tackle, pass bucket of rope through blocks according to numbered sequence

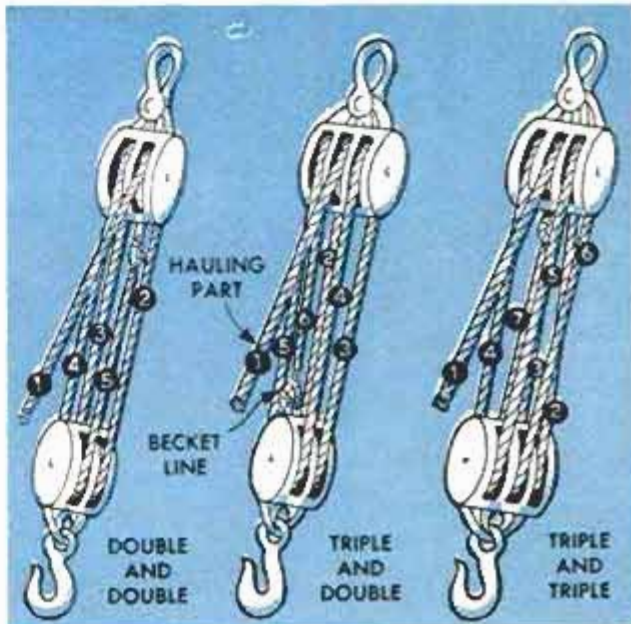



degrees from the vertical. At a 120-deg. angle the strain on the rope is doubled, and is almost four times as great with an angle of pull at 150 deg. There is an absolute disregard for rope economy and a real danger to life and property when slings are used at an angle of pull greater than 90 deg. Some of the strain put on the outer fibers of rope at sharp bends can be reduced by using pads of burlap or cloth between the load and the rope, Fig. 5.

### Rope Care

When not in use rope should be stored in a dry, cool room that is well ventilated to avoid dry rot or mildew. Place rope in loose coils on open grates high above the floor, or hang it on wooden pegs. Never store a wet rope before drying it thoroughly. A rope subject to alternate wetting and drying loses its strength more quickly than when it is wet all the time.

Rope that is badly soiled or laden with dirt should be washed in clean water and dried before it is stored or used again. To do this dip the rope in a basin of water, or hang the rope in loops over a bracket outside and hose it as shown in the illustration at the beginning of this article. Be careful not to drive the dirt in deeper by too much water pressure.

### Check Rope Regularly

Inspect new rope carefully for damage before using it. It may have been carelessly stored or handled after leaving the manufacturer. New, good Manila rope is hard but pliant, with a smooth silky feel. Its color is yellow, with a silvery or pearly luster. Sisal rope is yellowish-white with no gloss. Hemp is softer than Manila and usually dark gray in color.

Rope that is in use should be inspected periodically for defects. When checking on external wear, look for abrasions and broken or cut fibers on the outside. When surface threads are worn halfway through on small rope, discard it.

To detect internal wear look for variations in size or roundness of strands, indicating torn or cut fibers. Suspicious places can be checked by unwinding the rope. Also look for white powdery residue caused by grinding the fibers at a bend in the rope that is under heavy strain.

Color of a rope is a good indication of its condition. Chemicals or animal excretions burn brown spots into rope, making it unsafe. A rope that has lost its luster, or is discolored and has a musty odor is not safe. If inner yarns are bright, clear and unspotted, the rope still has life. But a rope that has lost its feel, pliability or stretch, or appears dry and brittle should be replaced at once. ★ ★ ★

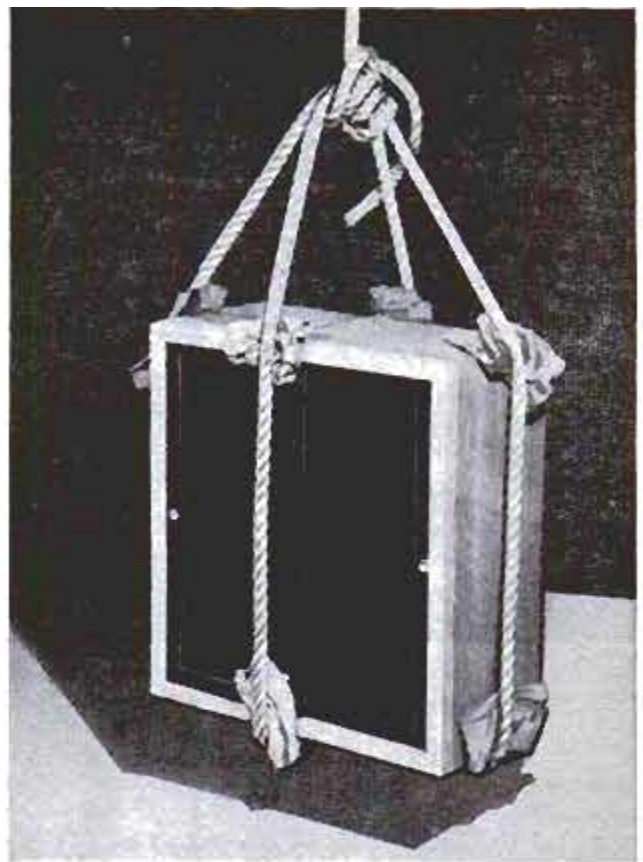

5. Strain put on rope at sharp bends is reduced by placing burlap or cloth between container and rope

6. Weights between arrows are for each part of rope, showing wide-angle slings cause excessive strain

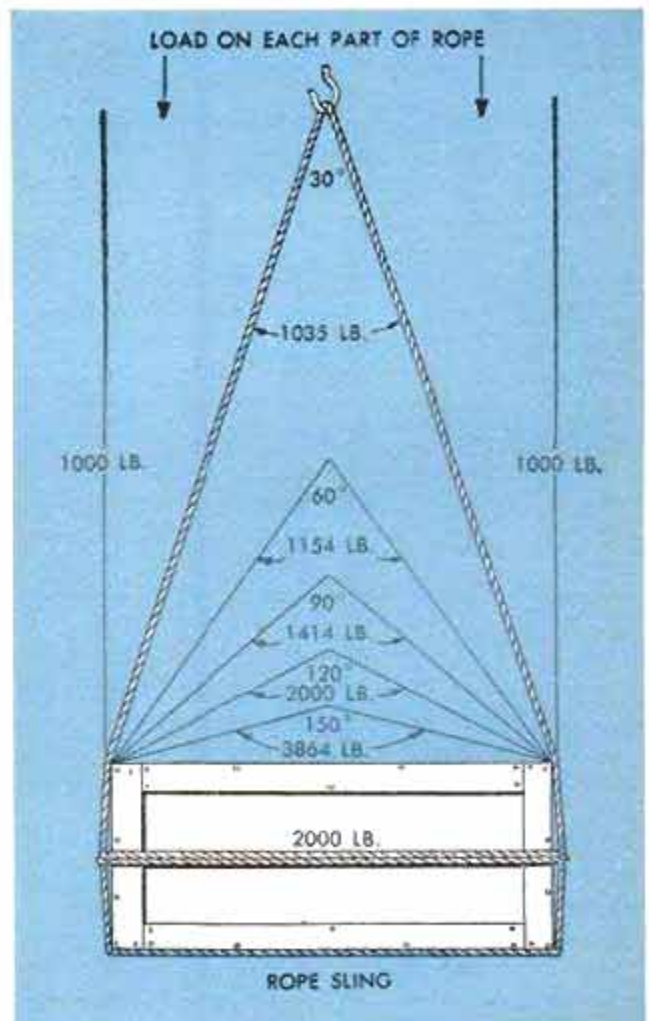



# Painted Stripe Outlines Edges of Driveway

Winding driveways, and straight ones, too, are easier to follow at night if a border stripe has been painted along each edge. Asphalt driveways can be marked with white or yellow paint, and concrete pavement with black paint applied a few inches in from the edge. If luminous concrete paint is available in your area an even more significant stripe can be painted, which will glow and indicate from a distance the location of the driveway and where to turn in off the street. The stripes help prevent your driving over the edge of the lawn, or into an adjoining drainage ditch.

## Eraser Aids Thumbtacking

If you frequently are required to thumbtack notices to a bulletin board, try putting a  $\frac{1}{16}$ -in. slice of rubber eraser under the head of each tack. The rubber protects the paper against tearing out at the corners and holds the tack head away from the board so it can be removed easily.—Mrs. Michael Fey, New York City.

## Soft Sanding Block for Curves



A soft sanding block for sanding curved surfaces can be made by wrapping sandpaper around a rolled scrap of sponge rubber. A double fold is made at the point where the edges of the sandpaper join, and they are bound together with paper fasteners. An old

sponge-rubber kneeling pad can be cut up to supply the soft core, or a rubber bath sponge may be used. In some cases, a small hand towel rolled tightly will do as a substitute for the rubber.

## Problem With Tire "Thump"?

What causes tire "thump" and what can be done to eliminate it, is the subject of a feature in the September issue. Included is a simple test any motorist can make to quickly determine which tire is causing the trouble.

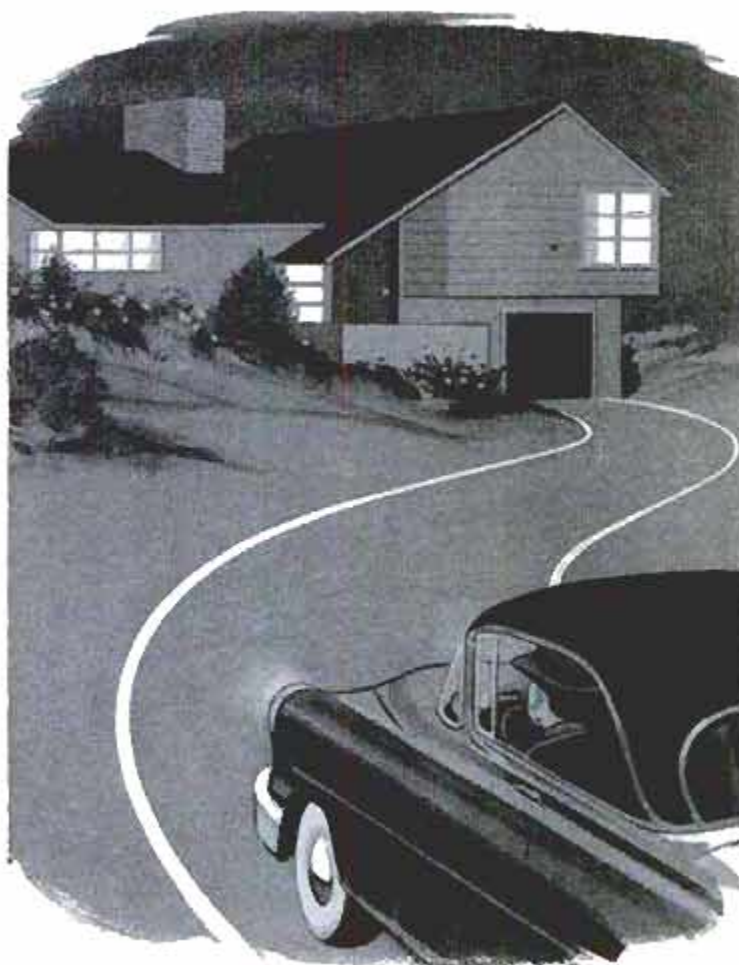

## Particles Removed From Paint With Cheesecloth

Paint that contains hardened particles and other foreign matter is restored to a useful condition by straining it through cheesecloth. Hold a small piece of the cloth tightly over half of the open end of the can and pour the paint through it into another container. It may be necessary to fold the cloth double to remove all the small particles from the paint.

O. A. Nelson, Seattle, Wash.





## Buried Crossrail on Child's Swing Eliminates Side Braces



An underground crossrail fastened to the upright posts of this child's swing prevents them from working loose in the ground and eliminates the need for exposed braces and guy wires which cause falls and injuries. The crossrail and surfaces of the posts that are below ground level should be adequately treated with a wood preservative to prolong the life of the swing. Better still, embed the timbers in concrete allowing for a depth of a few inches of soil or sod between the posts to prevent injury from striking the concrete should the child accidentally fall off the swing.

## Iron Removes Wallpaper

In removing wallpaper there are always several stubborn areas where the paper does not come loose with the usual wetting and scraping method. An ordinary steam iron held over these spots for a few seconds will loosen the paper sufficiently to allow removal by the usual scraping method.

R. M. Woodbury, Natick, Mass.

## Beautiful, Useful Furniture You Can Build WITH FULL-SIZE PATTERNS

You can make sturdy, good-looking furniture, toys, valances, metal lamps—even a 12-foot utility outboard with PM Full-Size Patterns. They were all drawn by a professional designer and built in our shop to test fit of parts and construction details.

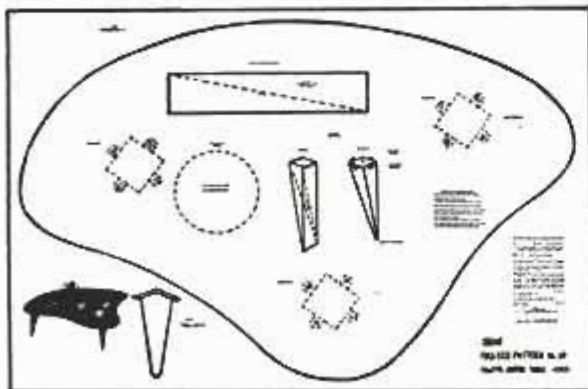

No. 116. Palette Coffee Table

Above is an actual photograph of Pattern No. 116, a Palette Coffee Table, which is 31½ x 47½ inches at its widest points. It can be made in one evening, if you have a bandsaw for making the curved cuts. Pattern includes complete construction and finishing details. 50c.

Modern Cocktail Table, No. 103. This table is 40 x 19 inches; 15½ inches high. With its metal grill inserts and plank top, it's modern in design and solid as a rock. One pattern—costs only 50 cents.



Love Seat, No. 114. Designed in the Lawson style, this love seat goes with either modern or traditional settings. Uses sag-less type wire springs and foam-rubber padding. Two patterns in the set: \$1.00.



Trundle Beds, No. 102. These beds save space and are safer for youngsters as there is no ladder to climb; have storage headboards, and use standard size mattresses. Three patterns: \$1.50.



Order today! And ask about the other 20 patterns, all guaranteed to be good—or your money back!

## POPULAR MECHANICS PATTERNCRAFT

200 EAST ONTARIO STREET  
CHICAGO 11, ILLINOIS



# SHOP NOTES

## Lathe Drawbar Operates This EXPANDING MANDREL

By C. W. Woodson

FOR MATCHING WORK having a hole through the center, there's nothing that will speed up the operation like an expanding mandrel that can be rapidly tightened and untightened by the lathe drawbar. In use, the work is slipped over the end of the mandrel and the latter is expanded to lock it securely by a turn of the drawbar handwheel.

The basic part of the tool is made from a blank No. 3 Morse-taper center. The hole for the drawbar is drilled the full length of the blank and the large end is tapered to receive the expanding plug, or expander. The large end is then slit as indicated, a hole being first drilled at the end of each slot, and a hole is cross drilled to take a round key which keeps the expanding plug from turning when the drawbar is tightened. The expanding plug itself is turned to shape by threading it on the end of a rod and chucking it in the lathe. This should be turned to a perfect fit in the



mandrel hole. The hole through the center is tapped for the drawbar, which consists of two parts, the threaded bar and the handwheel. These parts are shown in the center detail. The handwheel can be machined to any diameter desired with the face chamfered and knurled. The hub of the handwheel is pinned to the round drawbar with two  $\frac{1}{16}$ -in. pins as shown. If desired,  $\frac{1}{8}$ -in. pins can be used.

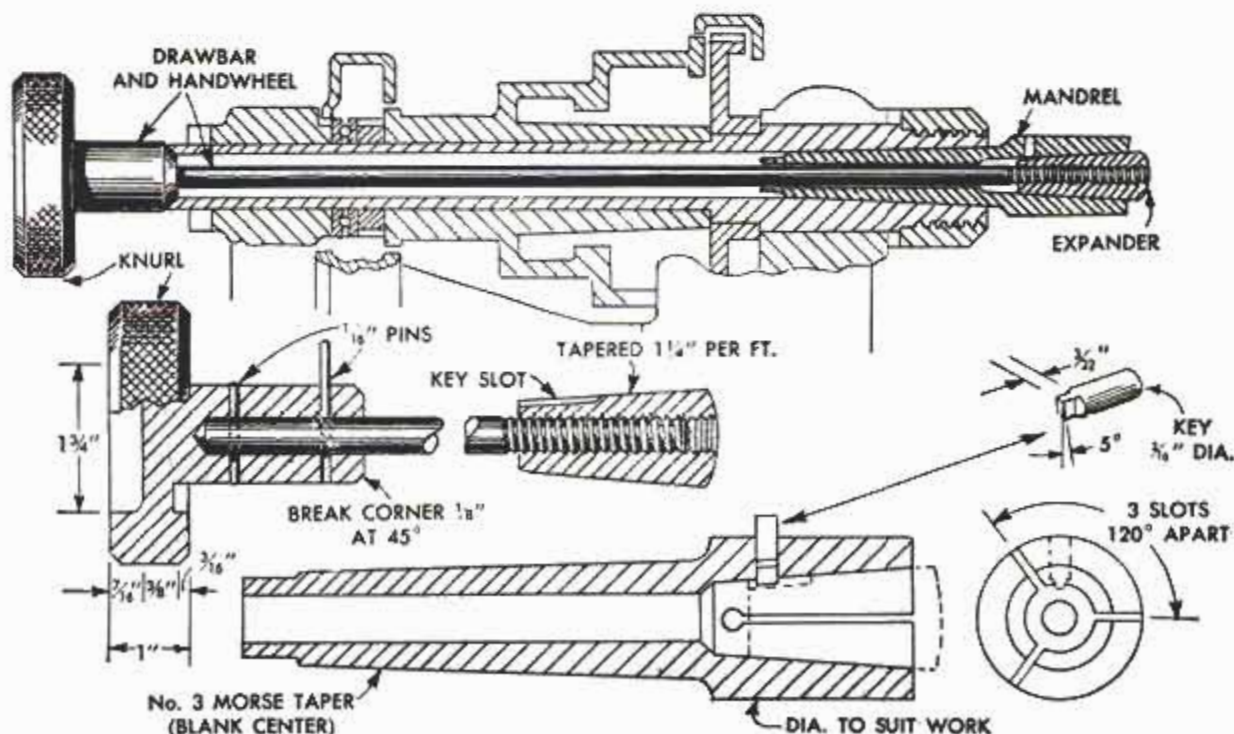



## Sandbag Supports Football on End for Place Kicking



Filled with sand, a cloth tobacco sack will serve as a handy tee on which to prop a football for practice or place kicking. The tee will be especially useful when playing on grass or hard ground where dirt can not be scraped into a mound on which to prop the ball. It is also small enough to be carried in a pocket between plays.—G. E. Hendrickson, Argyle, Wis.

## Envelope Liner Protects Pocket

An ordinary envelope, of the size used for personal stationery, can be made into a shirt pocket protector. Cut the envelope as shown, seal the remaining flap and fold one of the severed ends over the outside of the pocket. Pencils and pens are then inserted inside the envelope, protecting the pocket and the shirt from lead and ink marks.—Robert L. Hay, Rochester, N. Y.



## Eraser Removes Scuff Marks From Tile Floors



A hard-rubber eraser will usually remove spots and scuff marks from tile floors. Even when rubbing with steel wool while the floor is wet proves futile, erasing may easily eradicate the blemish after the floor has dried.

## Antimar Surface for Casters

A covering of adhesive tape on rubber or composition casters that are mounted on furniture will prevent them from making unsightly marks on the floor. Wrap the tape around the caster wheels two full turns to prevent it from unraveling. The tape will also reduce the noise caused by rolling the furniture across the floor.

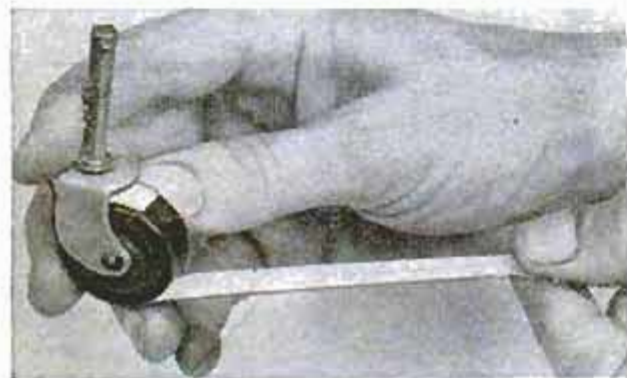

## Stepladder Legs Locked Together With Cabinet-Door Catches

The annoyance of having the legs of a stepladder swing apart while it is being carried can be overcome easily with one or two friction-type cabinet-door catches installed about a foot from the bottom end of the ladder. The legs are simply pulled apart when the ladder is set up for use, and snapped back together for carrying.

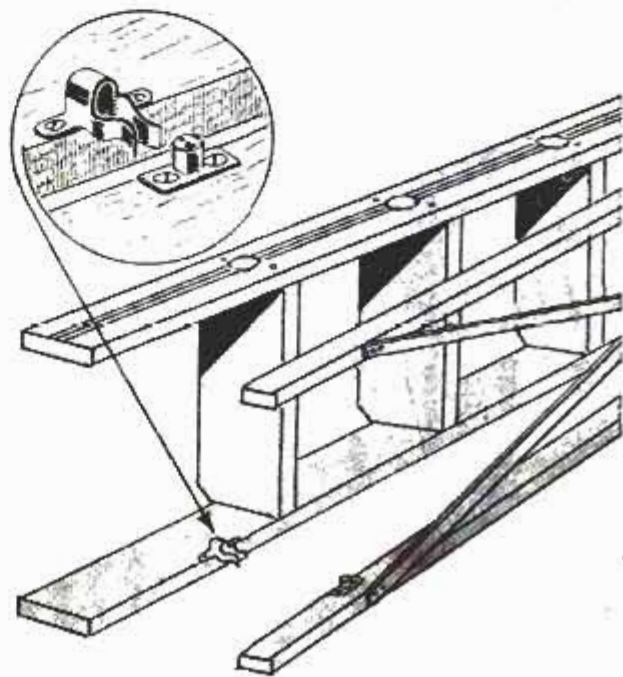



## Installing or Replacing SMALL WATER SYSTEMS

Careful planning and proper installation are vital for efficient and convenient operation

By Enno R. Haan

AS THE GREATER PORTION of a plumbing system usually is concealed, careful planning, good workmanship and the best quality of materials will minimize maintenance troubles, including possible replacement of pipe at considerable expense and inconvenience.

### Adequate Pipe Size

Increased water demands occasioned by modern conveniences such as automatic dish and clothes washers, water softeners, air conditioners that use water for cooling and extra showers frequently tax a system beyond its capacity. Most plumbing complaints, outside those easily cured by minor repairs, generally are caused by undersize piping. Piping that is too small can cause whistling noises due to high water velocity, aggravate water hammer and permit back-flow. The latter condition exists when undersize pipes restrict the flow of water so that if a faucet on the first floor of a house is opened, there is not enough volume of water to flow up to a faucet on the second floor. Often a partial vacuum will result in the piping on the second floor. Should a spray hose be connected to a faucet and dropped in the bottom of a filled bathtub, opening the faucet will permit the vacuum in the lines to siphon the water from the tub and discharge it through an open faucet on the floor below. The remedy for this condition is to replace the existing undersize piping.

Piping that was of adequate size originally, may become undersize because of lime and corrosion deposits inside. Another cause of insufficient flow and pressure in water pipe, which has the same effect as undersize pipe, is too many changes of direction in pipelines, involving an excessive number of fittings and often the wrong kind of valves. To determine the proper size to use is comparatively easy by following the

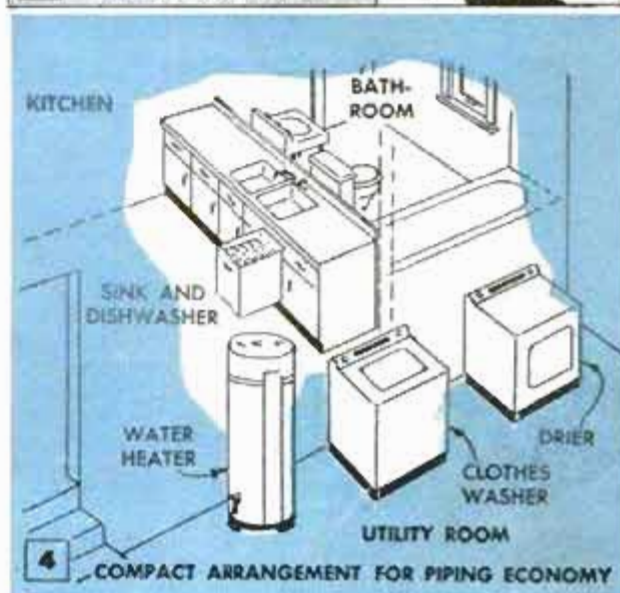
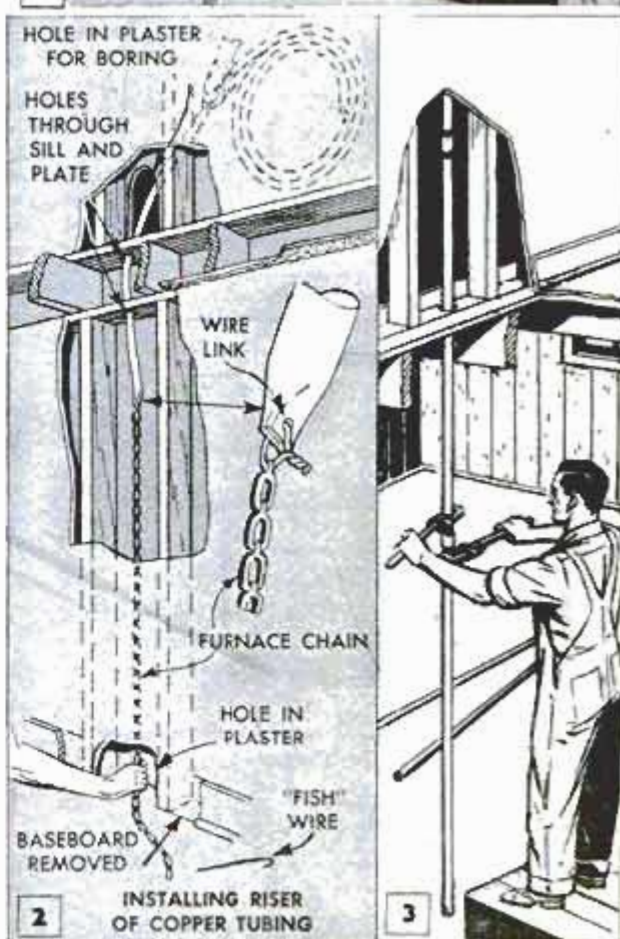



A WATER DEMAND			B FLOW RATE AND REQUIRED PRESSURE FOR COMMON FIXTURES					
A—Rate of flow in gallons per minute (g.p.m.) per fixture B—Estimated peak demand for each branch under conditions of simultaneous use			FIXTURE	G.P.M.	P.S.I.*			
2 sill cocks	10	5	Lavatory	5	8			
Laundry tub	8		Bath tub	10	5			
Clothes washer	8	8	Shower	8	5			
Kitchen sink	7.5		Flush-tank water closet	3	12			
Dishwasher	7.5	7.5	Flush-valve water closet	15 - 40 <sup>†</sup>	10 - 20 <sup>†</sup>			
1st floor lavatory water closet*	5		Sill cock and 50 ft. hose	5	30			
Bathroom No. 1 lavatory water closet*	5		* Flow pressure per sq. in. at entrance † Due to design variations					
Bathroom No. 1 shower	8	8	C APPROX. RESISTANCE TO FLOW OF THREADED FITTINGS, ETC., IN EQUIVALENT FOOT VALUES OF SAME-SIZE PIPE					
Bathroom No. 2 lavatory water closet*	5		FITTING OR DEVICE	PIPE SIZE OF FITTINGS				
Bathroom No. 2 bath tub	10	10		1/2	3/4	1	1 1/4	1 1/2
Total flow of all fixtures	83		90° elbow	0.9	1.3	1.8	2.2	2.7
Peak demand for house		38.5	45° elbow	0.6	0.9	1.2	1.5	1.8
*Tank-type water closets			Tee, side to end or reverse	2.2	3.4	4.4	5.5	6.7
			Tee, end to end	0.7	1.1	1.5	1.8	2.2
			Union or coupling	0.6	0.8	0.9	1.2	1.5
			Globe valve	10.0	15.0	20.0	25.0	30.0
			Angle valve	5.0	7.0	10.0	12.0	15.0
			Gate valve	0.4	0.5	0.7	0.9	1.1
			Swing check valve			3-20		
			Vertical check valve			10-26		
			H.w. tank, vert. 30-gal.		17.0			
			H.w. tank, horiz. 30-gal.		5.0			
			Water meter		14.0			
			Water softener equals 50 to 200 ft. (if unknown use 125)					5

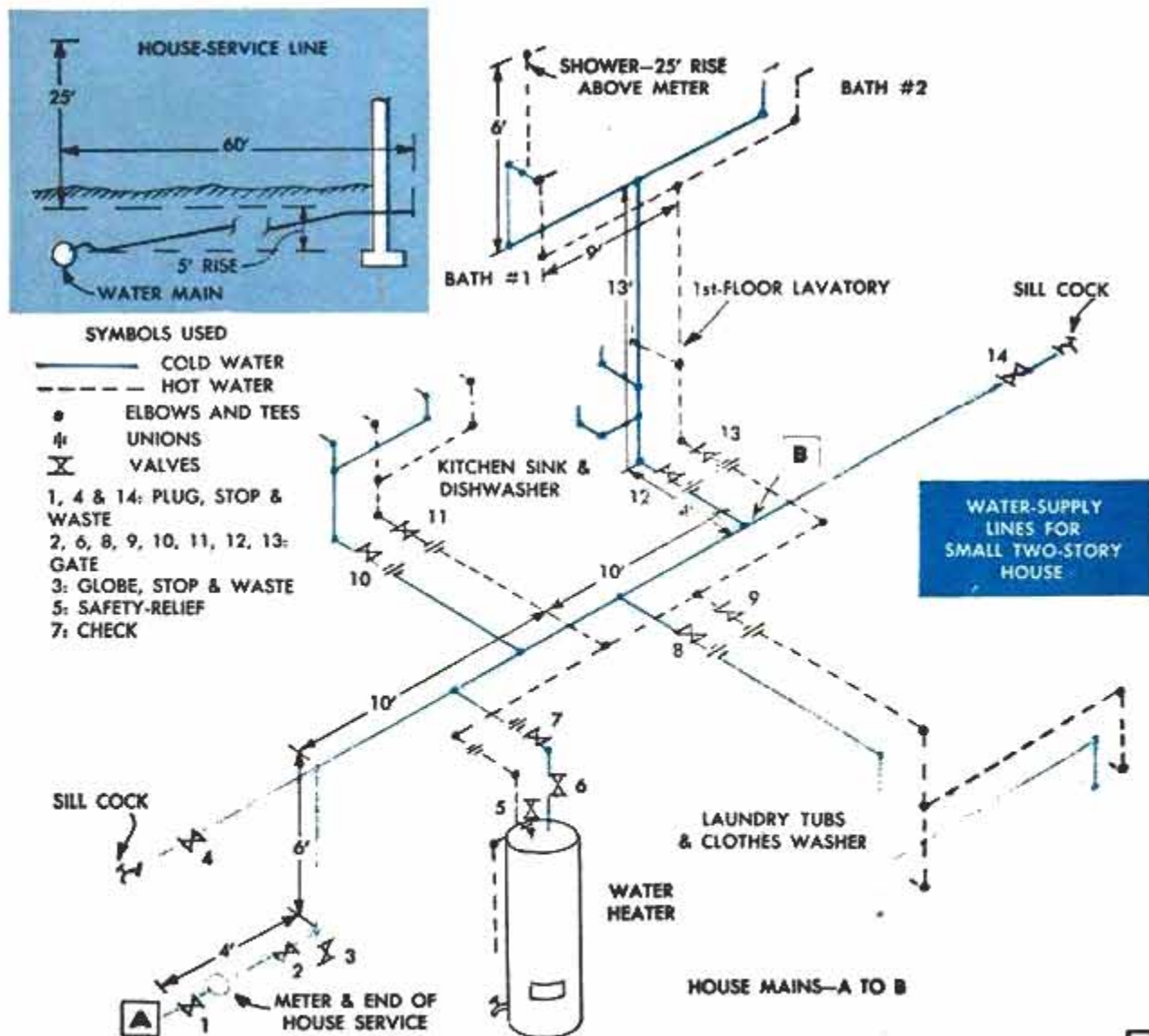



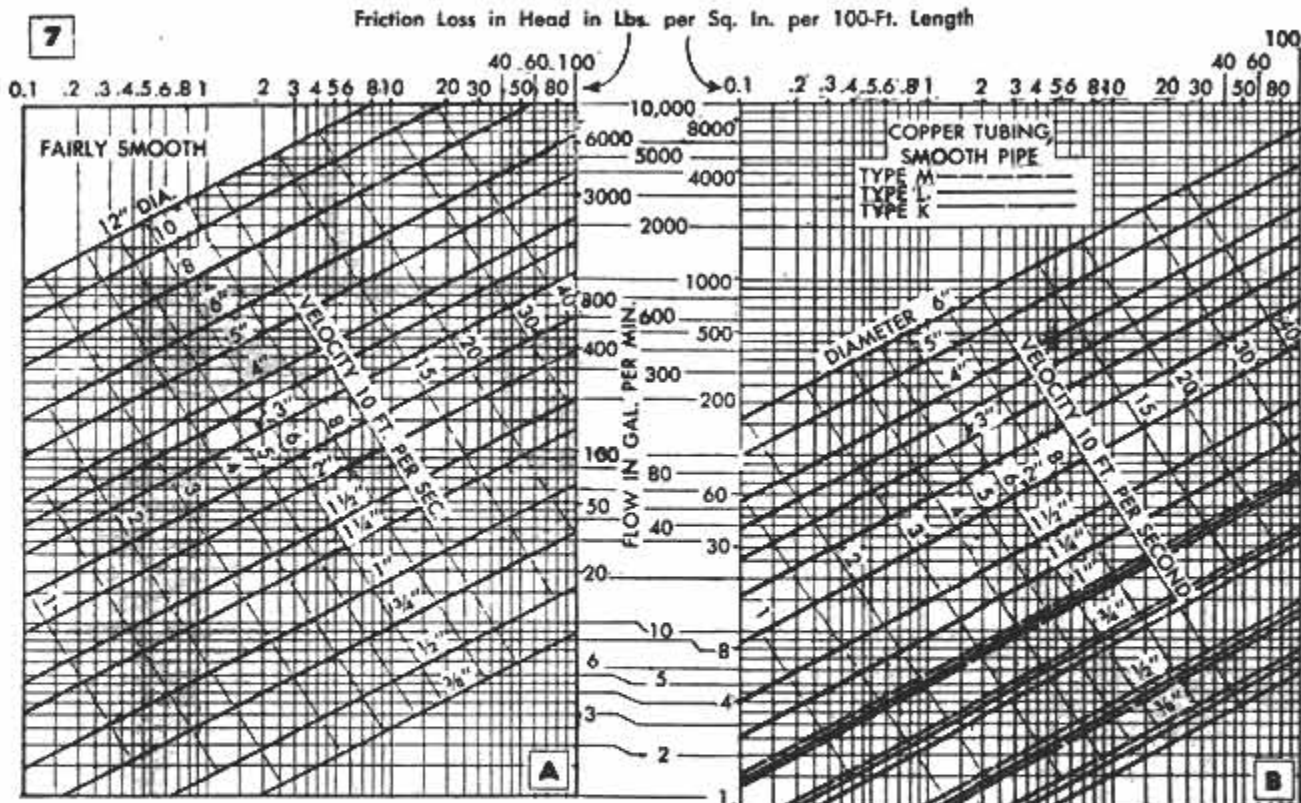

**Table C**

**STEPS OF PROCEDURE**

1. Multiply rise by .43 (weight of water 1 ft. high having a cross section of 1 sq. in.) This gives loss of pressure due to rise.
2. Add 10 to finding of step 1. (10 is average minimum p.s.i. pressure for satisfactory flow at top outlet, not including a flush-valve type of water closet.)
3. Find length of pipe from water source to highest and farthest outlet. (If water softener is to be used, add its pipe-equivalent resistance also, Table C, Fig. 5, when size of house service is figured.)
4. Subtract finding of step 2 from pressure at water source. Multiply result by 100 and divide by the finding of step 3. This gives approximate pressure loss (average) per 100 ft. of pipe, caused by friction.
5. Locate finding of step 4 on or between vertical lines of Chart A or B, Fig. 7 (depending on pipe type). Locate peak demand on or between horizontal lines. If intersection coincides with, or is very close to a diagonal line, this line indicates proper pipe size to use. If intersection comes between diagonal lines, use next higher one.

**EXAMPLE** (Refers to drawing and water-demand list) Object: To find required size of house-service line.  $30 \times .43 = 12.90$

$$12.90 + 10 = 22.90$$

$$60 + 4 + 6 + 10 + 10 + 4 + 13 + 9 + 6 = 122 \text{ ft.}$$

Assume pressure at water main is 50 p.s.i.

$$\frac{(50 - 22.90) \times 100}{122} = 22$$

Galvanized wrought-iron pipe is used. Refer to Chart A, Fig. 7. Locate 22 with vertical lines and 42 with horizontal lines. Intersection shows size pipe to use is 1 1/4 in.

procedure given in table C, Fig. 7. Information from the tables in Fig. 5 is used to determine factors that can be interpreted on chart A or B in Fig. 7.

**Solving Installation Problems**

Installing water lines in an existing house usually involves some difficulties. Where concealment of piping in an unobstructed partition is desired, one method is to use copper tubing, Figs. 1 and 2. When rigid pipe is used it can be cut in lengths of about 6 ft. and passed up through a partition from the basement, Fig. 3. Each length is screwed to another length by means of a pipe coupling. A cap is screwed to the upper end of the first length to protect the

threads and keep out debris. To avoid removing more plaster than necessary when these methods cannot be followed, risers sometimes are run through closets where they are not conspicuous. Or, they are run up in a corner of a room and concealed with a panel. Cold-water lines in such locations should be insulated to prevent them from sweating when the warm air in the house contacts the cold pipe.

**Short Pipelines**

For economy and efficiency, pipelines should be as short as possible. Often risers that supply appliances in adjacent rooms, Fig. 4, can be run through a common partition. If hot-water lines are short, only a



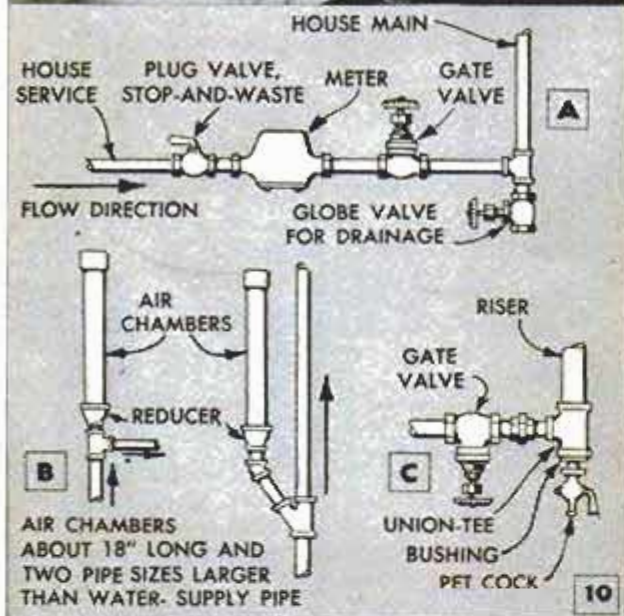

small amount of water need be wasted before hot water is available.

### Where to Insulate Pipes

Insulation on hot-water lines, Fig. 8, prevents losses from heat radiation, prevents warming of adjacent cold-water pipes and makes hot water available quicker in frequently used lines. Usually hot and cold-water lines run parallel but not closer than 6 in. Do not install water pipes in outside walls unless absolutely necessary and then only if they are adequately insulated against freezing or, in warm climates, against heating. Use waterproof, antisweat insulation on cold-water pipes where water is likely to drip on plaster, furniture or tools, or where it can collect at the base of risers and cause rotting of a sill.

### House-Service Line

The supply line from the water main to the house generally is buried 4 ft. underground to protect it from freezing and mechanical injury. It should be run as straight as possible, sloping toward the water main for drainage. It should never pass underneath a sewer line, it should be laid at

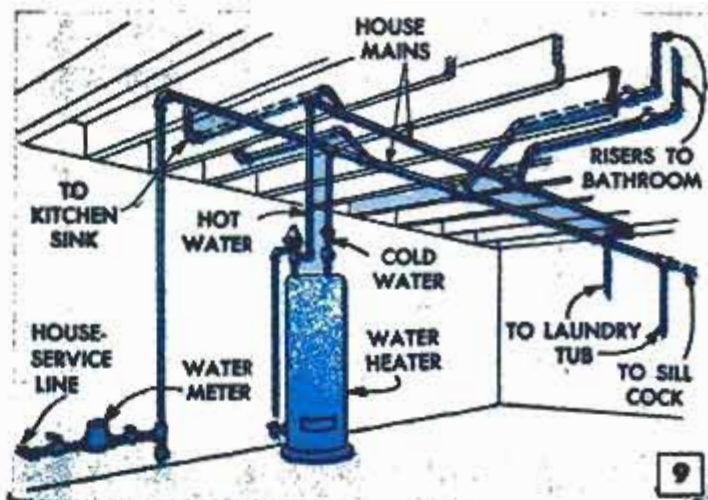

least 12 in. above the top of the latter—always on compact, undisturbed earth. Generally, galvanized, wrought-iron pipe is used, although copper is more durable and is required by some building codes. The line should not be smaller than  $\frac{3}{4}$  in. A plug-type, stop-and-waste valve often is installed at the house end.

### House Mains

These lines, shown in Figs. 6 and 9, start at the service-line entrance and supply all branch lines. Horizontal lengths are supported at 5 to 8-ft. intervals, securely but not rigidly. A gate valve for shut-off purposes and a globe valve for drainage are installed as shown in detail A, Fig. 10. Pipe must have a slight slope for drainage, without sags, pockets and U-sections to trap water. Generally it is best to have the house mains the same size as the house-supply line. Pipe to a water heater or softener should not be less than  $\frac{3}{4}$  in.

### Branch Lines

Use gate valves to shut off branches individually. Globe valves are used only if there is surplus pressure, as they introduce considerable resistance to water flow. Pipes supplying two or more fixtures should not be less than  $\frac{3}{4}$  in., and those to individual fixtures  $\frac{1}{2}$  in., although  $\frac{3}{8}$ -in. pipe often is used for short runs to home lavatories or toilet flush tanks.

### Air Chambers

Air chambers, which eliminate or reduce water hammer, are shown in details B and C, Fig. 10. For best results, air chambers in average home-plumbing systems should be about 18 in. long and two pipe sizes larger than the supply pipes to which they connect. Periodic renewal of the air which gradually is absorbed by the water compressing it, is done by "bleeding" the line. A drain petcock at each riser, detail C, permits this without shutting off the entire system. ★ ★ ★



## House Current Replaces Batteries in Focused-Beam Lantern

A portable lantern used primarily to illuminate work indoors can easily be converted to 110-v. house current eliminating the constant replacing of dead batteries. The best type of lantern to adapt is one that can be focused on the immediate work area. Mount the lantern on a piece of plywood large enough to also accommodate a step-down transformer. The transformer should have only a few volts' output from the secondary. To determine the correct voltage for the bulb in the lantern, temporarily wire a rheostat into the circuit, measure across its terminals after it has been adjusted for the best brightness possible from the bulb and permanently wire a resistor of the required amount into the circuit. The switch on the

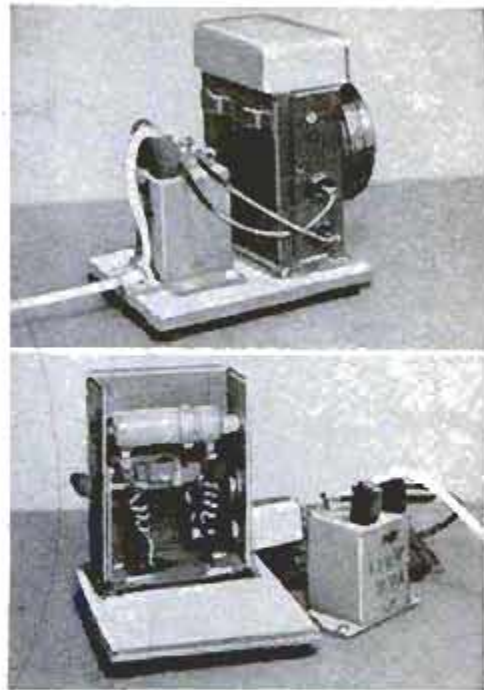
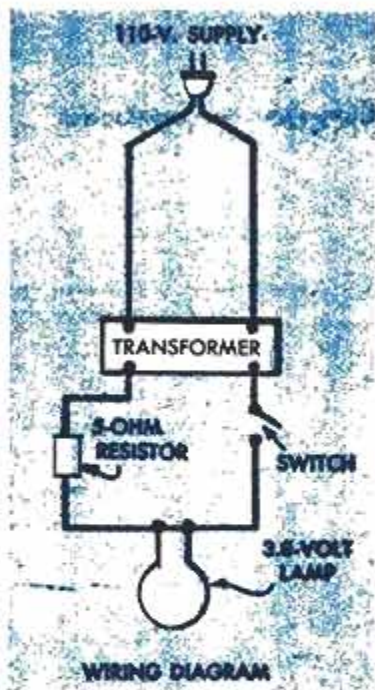

lantern is also wired in for turning the light on and off. Be sure to insulate the power cord connection to the transformer.

George P. Pearce, Albuquerque, N. Mex.

## Copper Tubing Makes Grip-Sleeve For Lag Screw in Concrete

Fastening material to a concrete or brick wall is made easier and the job more permanent when a length of copper tubing is dented with a staple or bent finishing nail as shown and inserted in the hole in the wall as required. A slot sawed into the outer end of the tubing will make it easier to insert and allow for expansion as the thicker part of the screw is turned in, fastening the work to the wall as shown.

Carl S. Bates, Chicago.

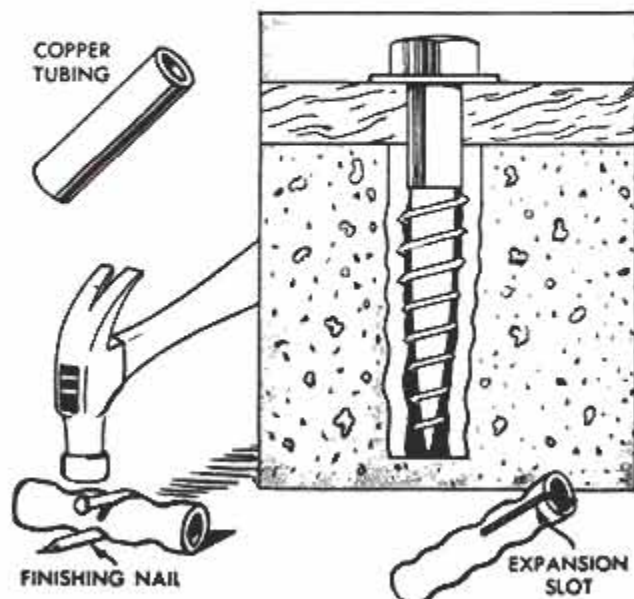

## Tape Sheathes Scraper Blade When Stored in Tool Chest

The edge of a wood or paint scraper is less likely to become dulled when stored with other tools if covered with masking tape. Also, apply the tape to any other sharp edges or projections on the scraper to protect against the possibility of accidentally injuring the hands when removing the scraper from the tool chest.

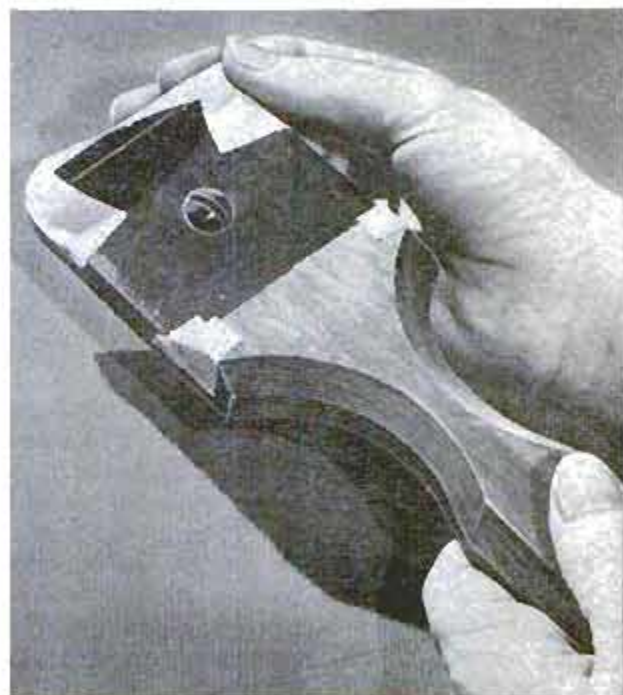





### Two-Wheel Drum and Barrel Truck

Moving steel drums and wooden barrels is an easy task with this two-wheel hand truck. Axle and wheels may be purchased, or removed from a broken wagon or tricycle. Handles are formed from two lengths of pipe, and may be equipped with rubber grips. The circular base, cross piece and angular braces are cut from  $\frac{1}{8}$  x 1-in. flat steel.—C. F. Marley, Nokomis, Ill.

### Gutters and Metal Roofs Patched With Glass-Fiber Screening



surface around the leak. Then press a piece of screen down into the cement and allow it to dry. After a few days, add a finish coat of cement to cover the screen.

Sharp edges on chipped glass can be rubbed smooth with fine sandpaper, making the glass safe to handle.

### Proper Storage of Sandpaper Improves Performance

Storage conditions for sandpaper affect its performance and wearing qualities. Too frequent changes in relative humidity will cause strains to be set up between the backing and adhesive which may weaken the bond. Excessive humidity just prior to use will cause it to clog rapidly, while extremely dry conditions will tend to curl the paper. Attempts to straighten it will only result in cracking and disintegration of the abrasive surface. To prevent these reactions, sandpaper should be stored in a room having a reasonably constant temperature of from 60 to 80 degrees and a relative humidity of about 50 percent. Do not store sandpaper near a source of heat or where moisture is excessive, such as next to windows which show signs of condensation.

### Pliers Used to Drive Brads Into Picture Frame

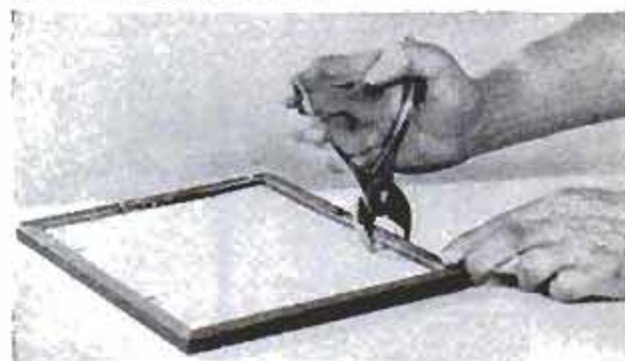

Ordinary slip-joint pliers opened to the widest setting are handy for pressing brads into small picture frames. This method is much safer and easier than using a hammer. One jaw of the pliers is covered with adhesive tape to prevent marring the frame. The brad is held in position with one finger until it is started.

### Concealing Nails in Cabinetwork

For exceptionally fine cabinetwork, the heads of finishing nails can be completely concealed by "blind setting," in preference to filling the nail holes with putty or crack filler. At the point of nailing, a small chip of the wood is lifted with a gouge, and the nail is driven into the resulting recess, and set. Then glue is applied and the chip resealed.

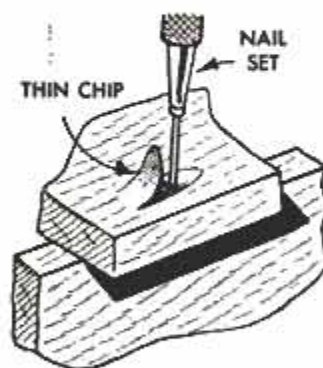



## Swivel Blocks Hold Tapered Work in Vise

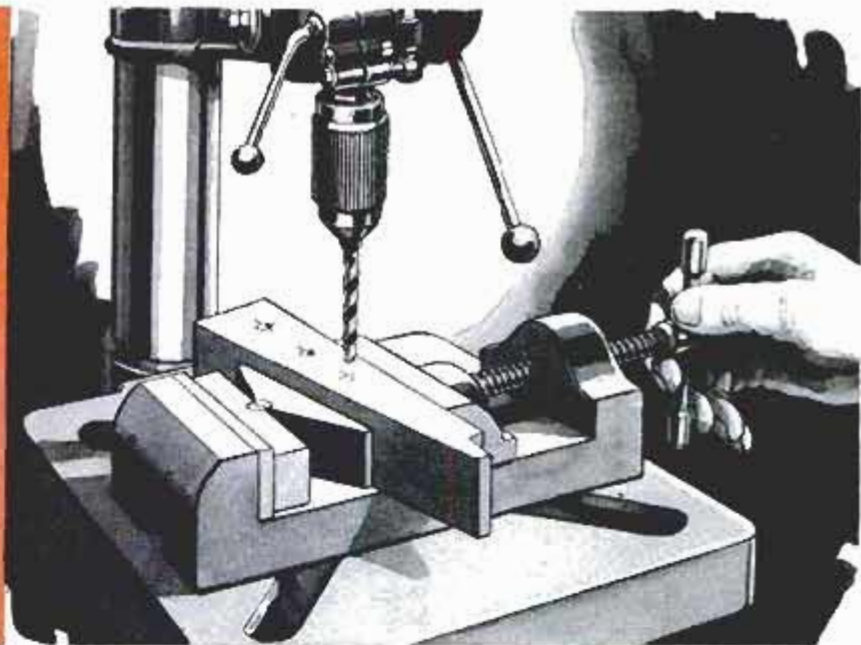
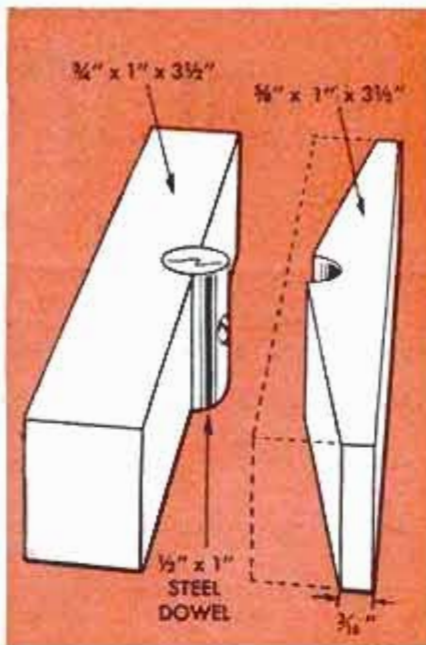

Holding tapered work in a drill-press vise is no problem when this set of swivel blocks is used. The set consists of a fixed, flat block and a triangular-shaped swivel block that pivots on a steel dowel screwed to the fixed block. Two  $\frac{3}{4} \times 1 \times 3\frac{1}{2}$ -in. pieces of cold-rolled steel are clamped to-

gether and a  $\frac{1}{2}$ -in. hole is drilled so that half the hole is in each piece. Next, one of the pieces is beveled and reduced to  $\frac{5}{8}$  in. at the center. A  $\frac{1}{2}$ -in. steel dowel then is cross-drilled to receive a flatheaded screw that turns in a hole in the fixed block.

C. W. Woodson, Chicago.

## Light and Warning Flag Rocks To Get Motorists' Attention

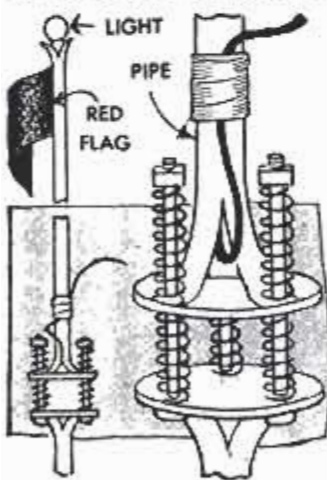

This wig-wag warning flag and light make a good safety marker for use on tractors and farm equipment driven on highways after dark. The red flag is mounted on a 4-ft. length of pipe, each end of which is cut lengthwise with a hacksaw to form three segments. Those at the top are spread to hold a small light, while those at the bottom are spread to form feet, which are drilled to accommodate bolts. One end of a shorter length of pipe also is cut into three segments and spread and drilled to match the bottom end of the longer pipe. A pair of transmission rings fitted with springs and bolts as shown are connected between the two pieces of pipe. A universal-joint clamp installed at the bottom of the assembly permits easy attachment. The signal light has a cord to reach an on-off dash switch.

## Power-Tool Vibrations Dampened By Using Garden-Hose Washers

Annoying sounds resulting from vibration in power tools often can be eliminated by using garden-hose washers as vibration dampeners. In many cases only one washer is needed, as in the example shown, where a single washer is placed under the wheel-guard nut on a bandsaw to silence a rattle. The rubber washers also can be used as replacements for the rubber collars used on the bolts between power tools and stands.





# HOW WOULD YOU DO IT?

By Chris Nelson

*In what way can a circular saw be used to cut a spiral groove in a dowel or larger cylinder, such as a table leg?*

**ROTATE THE WORK AGAINST THE BLADE.** First, clamp the miter gauge solidly to the table with a C-clamp. The angle at which the gauge is set will determine the spacing of the spiral, while the depth of the spiral is fixed by a combination of the spacing between the miter gauge and the blade and the height of the blade above the table. Hold the stock down against the table firmly and turn it slowly against the blade. Use a crosscut blade to cut a fine groove, as shown on the dowel in the upper photo. For a wider groove on heavier stock, as on the cylinder in the lower photo, use a dado blade. To assure a clean-cut groove, use a sharp blade. Cut the groove in one pass, since successive passes usually will chip the edges of the groove.

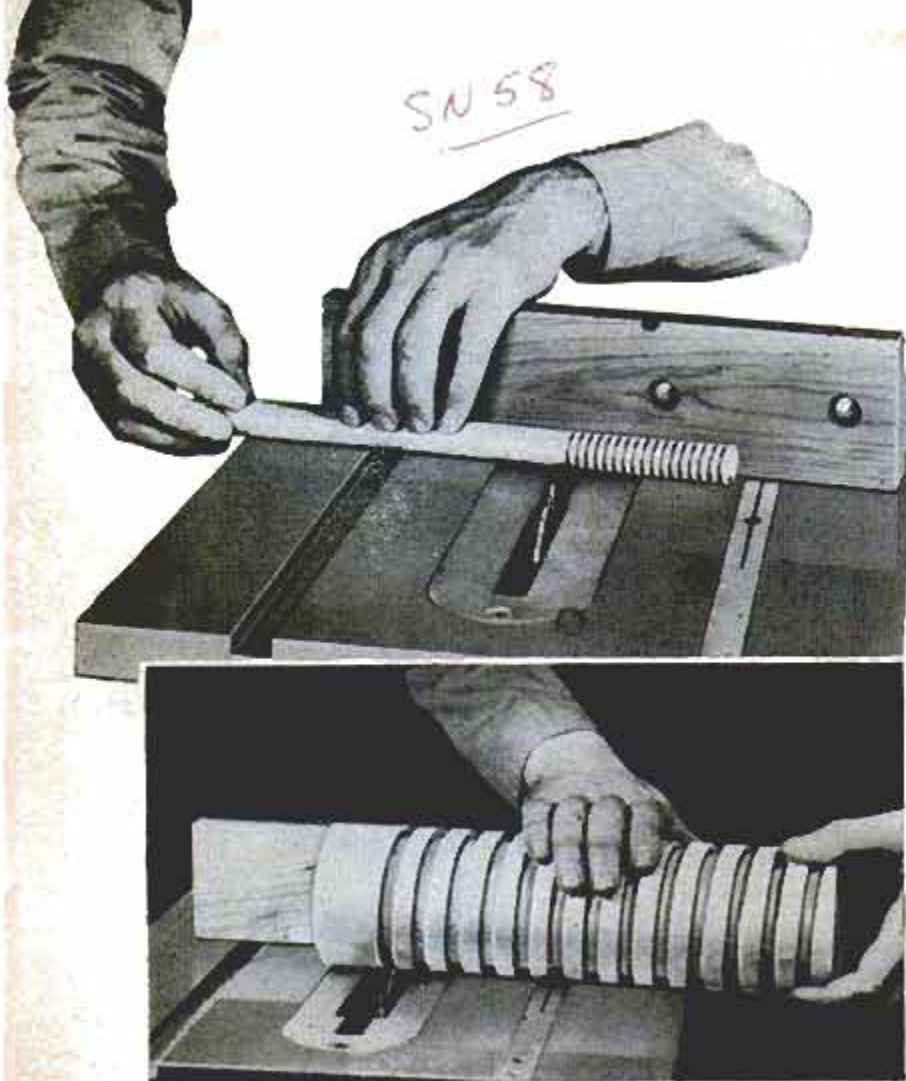

*How can you use a circular saw to prepare wood so that it can be bent without being steamed?*

**KERF THE STOCK ON ONE SIDE.** Make a series of saw cuts across part or all of a piece of wood and it can be bent to a remarkably small radius without being soaked or steamed. This is a useful technique when you are making such items as garden arbors, drum tables and round stools. The two lower photographs show a simple method of guiding work and assuring uniform kerfing. Drive a pin—a nail will do—into the miter-gauge extension, placing each kerf over it to make the next.

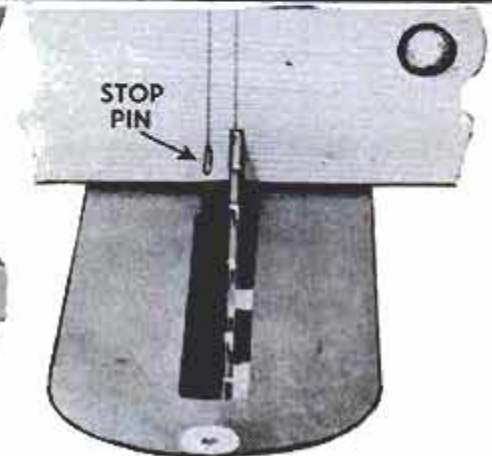
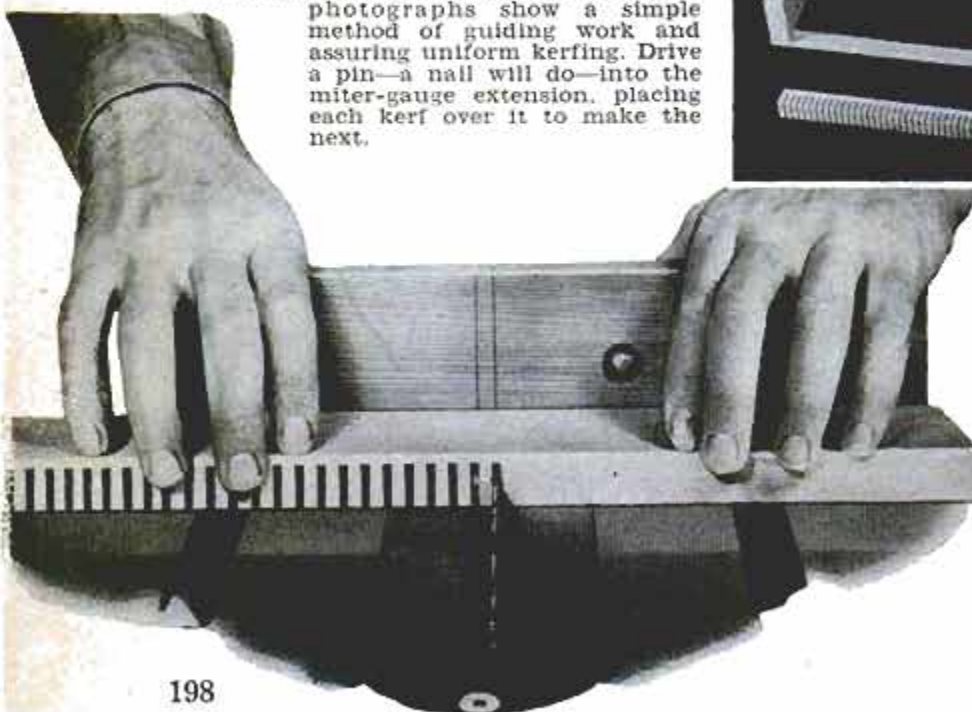
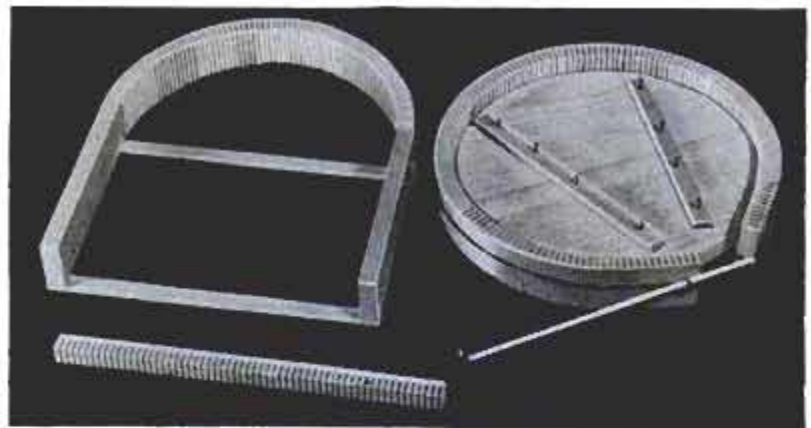



**To make fancy molding strips on a circular saw, what do you do?**

**KERF BOTH SIDES OF THE STOCK, THEN RIP IT IN STRIPS.** Alternate the kerfs as shown in the photograph. Use either a saw blade or a dado head. Kerfs can vary both in width and depth to provide a variety of moldings. Rip the kerfed pieces into strips as thick as you wish the molding to be deep, since what was the edge of the stock now will be the face of the molding. Some cove molding can be kerfed in this manner to provide unusual designs. To keep the kerfs evenly spaced, use a stop pin on the miter-gauge extension in the manner previously described for kerfing stock for bending.



**What kind of a jig can be used on table saw to permit rabbeting the edges of circular work?**

**USE A VERTICAL JIG.** The jig is made of two pieces of 1-in. lumber, one of the pieces having a semicircular cut in it to receive the work. Clamp the jig to the rip fence, then gradually raise the blade until the rabbet is the right width. Rotate the work into the blade slowly.

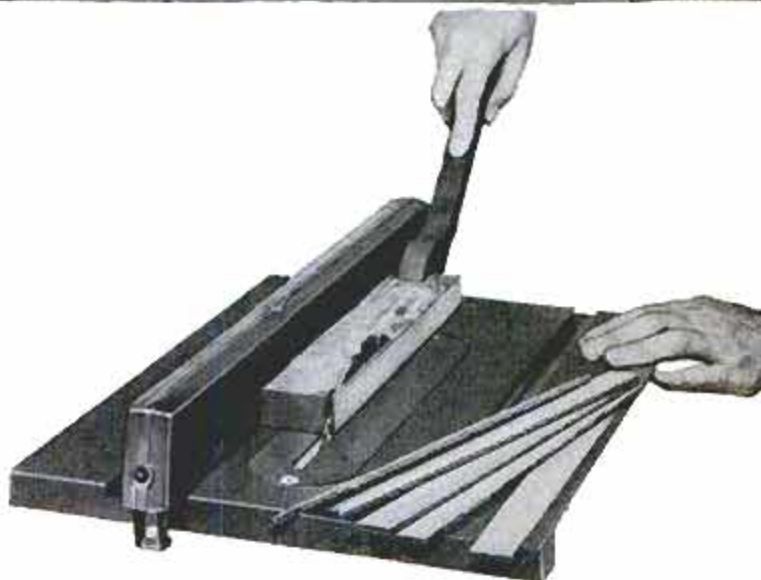
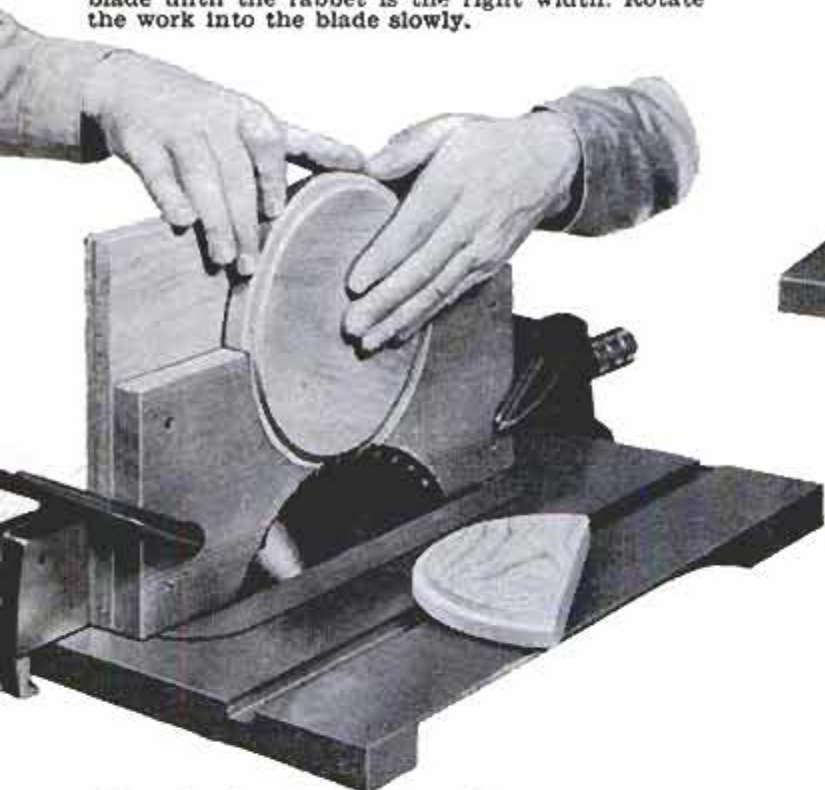

**For maximum safety, what method should be used for ripping thin strips on a circular saw?**

**USE A PUSH STICK.** As shown above, a push stick permits you to keep both hands clear of the blade when ripping thin strips. Be sure the blade is sharp. A dull blade easily jams, and may kick the work up and back into the operator's face. For any narrow ripping operation, a push stick should be used. When a long piece of work is being ripped, use the stick to push the last foot of stock past the blade.

**What is the expert's way of cutting a large number of odd-shaped pieces to identical size and shape?**

**PATTERN SAWING.** Begin by making a master pattern—a piece cut to the size and shape you want. Drive two nails through it so they project slightly. Press the pattern down on the work, which should be cut to approximate size and shape. Run the pieces through the saw with the pattern riding against a guide block. The guide block is a T-shaped block clamped to the rip fence as shown in the photograph. The outside face of the saw blade must be flush with the edge of the guide block.

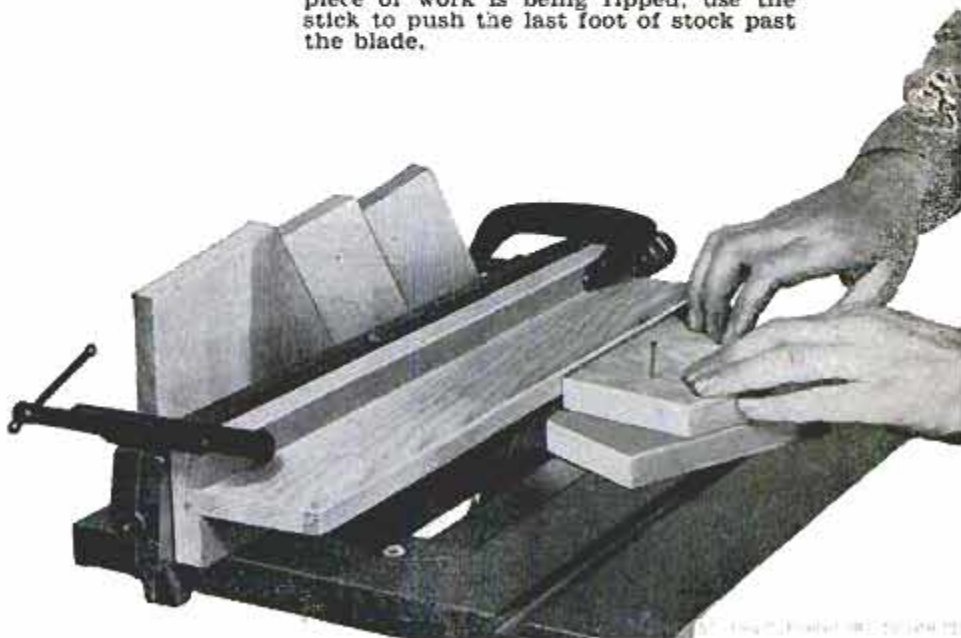



## Siphon of Pipes and Fittings Drains Pasture Stock Tank



Livestock tanks are quickly emptied for cleaning or moving by using a U-shaped siphon of pipes and fittings. The siphon is held under water until full, then one end is sealed with the hand and lifted out of the tank to the position shown. The siphon should be long enough to reach the bottom of the tank so it will empty practically the entire contents. Do not rest the end of the siphon flat against the bottom of the tank as it will become clogged with silt and shut off the flow of water.

## Threaded End of Bolt Cut Without Burring

Threaded ends of bolts and screws can be cut without leaving a burr by running two hex nuts onto the threads, the face of the second nut being flush with the line of cut. Clamp the inner nut in a vise and run a hacksaw blade along the outer edge of the two nuts as shown in the detail.

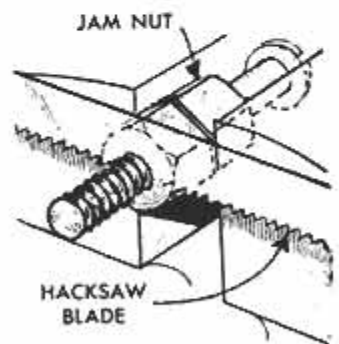

Clamp the inner nut in a vise and run a hacksaw blade along the outer edge of the two nuts as shown in the detail.

Carl S. Bates, Chicago.

## Avoid Clashing Gears When Shifting Into Low

To avoid clashing gears in an automobile transmission when shifting from neutral into low, first shift from neutral into second and then into low. Second gear has a synchromesh mechanism which stops the gears quietly enabling smooth shifting into low.

Charles E. Cohn, Chicago.

## Anvil Made From Length of Rail

For an extra-heavy-duty anvil with plenty of work space use an inverted length of railroad rail as a striking plate. The one shown in the photograph is supported on three pipe legs braced with pieces of angle iron all welded together to form a solid work surface.

## Spring Holder for Welding Rod

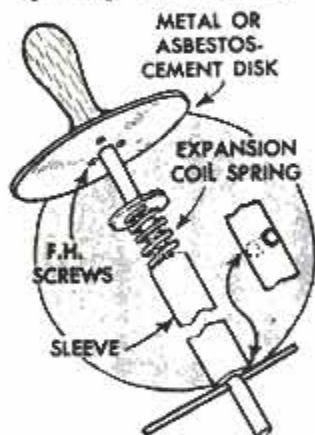

Under constant pressure of a coil spring, the sliding sleeve of this welding-rod holder bears tightly against the welding rod, which keeps the latter in position, assuring good electrical contact between the holder and the rod. A disk of  $\frac{1}{4}$ -in. metal or asbestos-cement board 6 in. in dia. is drilled to fit on the shank and is attached to the end of the wooden handle by means of three flathead wood screws.

Enno R. Haan, Evanston, Ill.





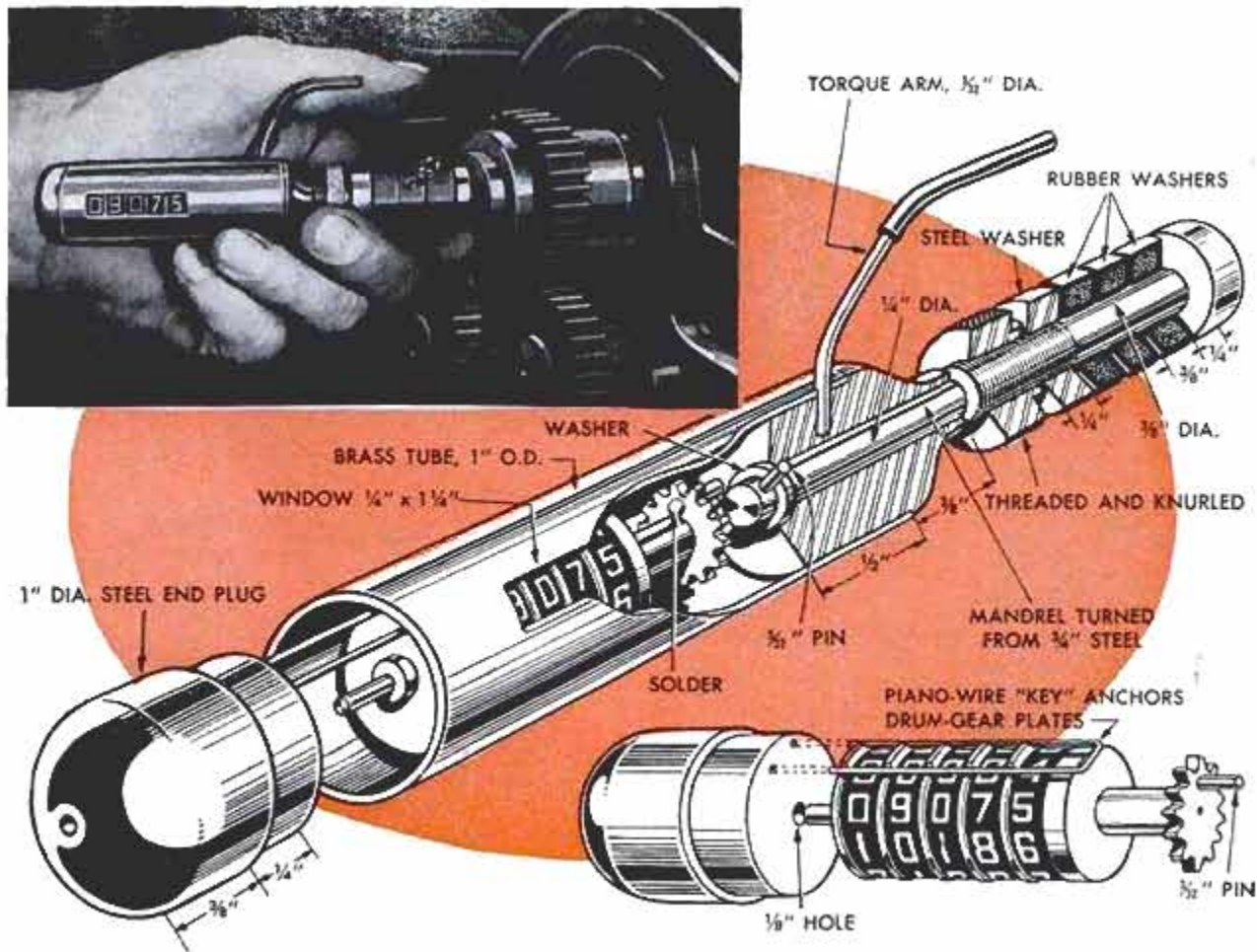

## Revolutions Counter From Speedometer Mileage Indicator

This revolutions counter, designed for use on lathes when winding transformer coils, is built around the mileage indicator of a discarded speedometer. The mandrel is turned from a length of steel rod and threaded to accommodate a knurled sleeve. Rubber washers followed by a steel washer of the same size are slipped on the mandrel ahead of the sleeve. The wide end of the mandrel and the washers should be a sliding fit inside the lathe spindle so that turning the knurled sleeve against them will "lock" the counter in place. The small

end of the mandrel is cross-drilled to receive a pin which drives the counter by means of another pin mounted off-center on the drive gear. The housing is a length of brass tubing in which a window has been cut to reveal one row of indicator numerals. Machine the two plugs to fit tightly in the housing and then center-drill them for the shaft of the counter. A torque arm is mounted in the side of the housing which, when held, keeps the counter from turning with the spindle.

Keith Heryford, Cedarville, Calif.

## Implement Wheel Guards Tree Against Dogs Digging at Base

To get certain protection against dogs digging in the loose ground at the base of a young tree, remove the hub from an old iron farm implement wheel and place the rim with spokes attached around the trunk as shown in the photograph. Loose ground within the rim is left undisturbed by the dogs so that growth of the sapling is not disrupted.—C. F. Marley, Nokomis, Ill.

When storing a roll of rosin-core wire solder after using it, pinch the end shut with a pair of pliers. This will prevent the rosin core from leaking out.





# SHOPPING FOR TOOLS



**BUILDER'S LEVEL** has replaceable snap-in vial holders having magnifying crystals, or lenses, which give accurate readings, even at a distance. Four-screw mountings prevent distortion of crystals. Frame is of aluminum or magnesium with precision-machined edges and flats. Comes in lengths from 24 to 48 in.

Empire Level Mfg. Co., 10930 W. Potter Rd., Milwaukee, Wis.



**ORBITAL SANDING ATTACHMENT** for  $\frac{1}{4}$ -in. portable electric drill can be mounted quickly without disassembling any part of either unit. Dismounts just as easily. Bottom, or sole, plate of sander unit is wider than drill housing, permitting tool to work within a fraction of an inch of any surface at right angles

Black & Decker Mfg. Co., Towson 4, Md.

**ELECTRIC GARDEN CULTIVATOR** hoes, mulches, aerates, blends fertilizers and kills weeds in vegetable and flower gardens. Full-length control handle permits operator to work from standing position. Works between closely spaced row crops. Motor-driven tines loosen and pulverize soil, forming fine mulch

Porter-Cable Machine Co., Syracuse 8, N. Y.



**CIRCLE CUTTER** is the answer to the problem of cutting true circles in paper, cardboard, masking materials, negatives and film. Centering leg is fitted with a chuck which holds an ordinary phonograph needle. A specially ground cutting blade is chucked in the swinging leg. Both legs and handle are adjustable

Mark Specialty Co., 183 St. Paul St., Rochester, N. Y.

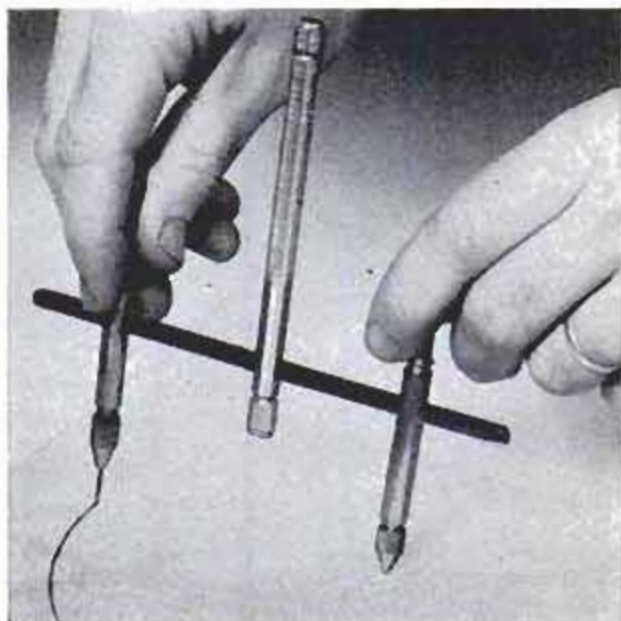



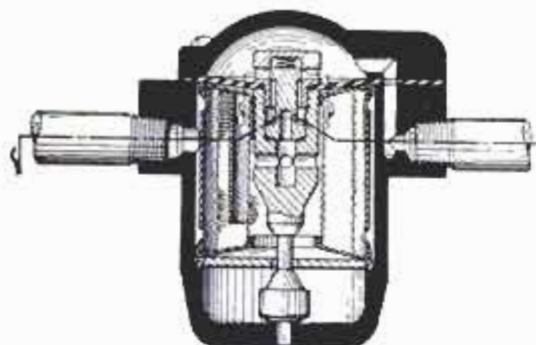
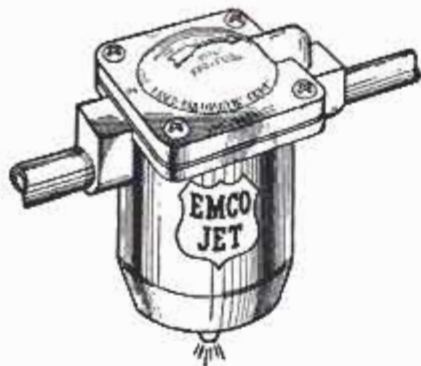

**AIR FILTER** attaches to nearly all types of pneumatic tools. Traps and discharges the sludge, rust and other abrasive substances that sometimes find their way into air lines. Parts will not corrode, become inoperative

Emco Pneumatic Corp., 1317-19 Locust St.,  
Des Moines, Iowa

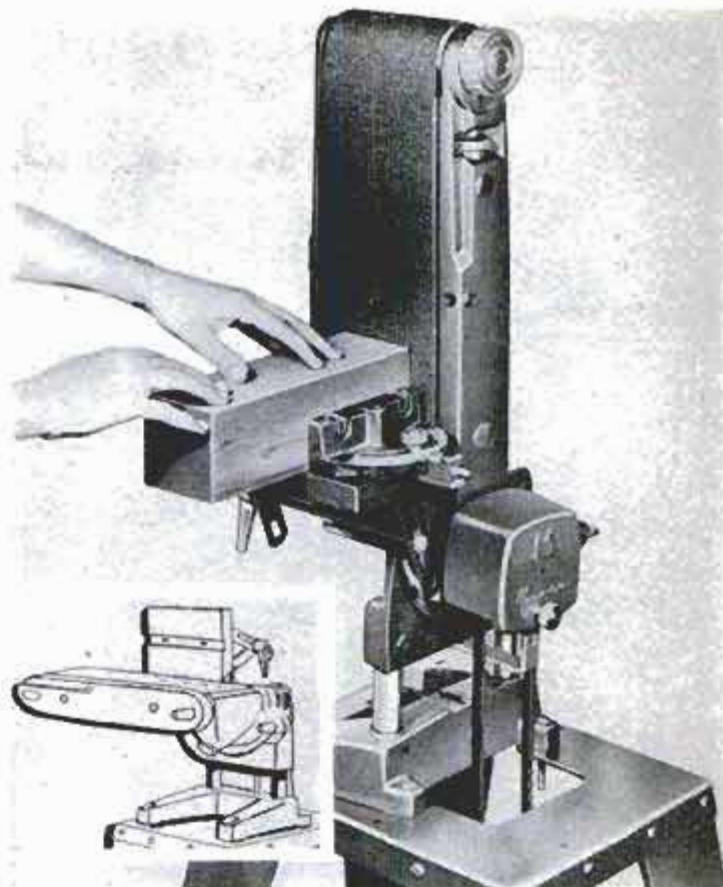

**BELT SANDER** takes a 6-in. abrasive belt and can be used in the vertical position for squaring stock, or in the horizontal position for surface-sanding. Grooved sanding table can be changed quickly to either of the positions pictured. In the horizontal position, table can be used on either side of belt

Magna Engineering Corp., Menlo Park, Calif.

**SHAPER ATTACHMENT** fits on a table saw with spindle projecting as pictured. Special insert replaces regular insert in table. Shaper spindle takes any shaper cutter having  $\frac{1}{2}$ -in. bore. Cutter can be raised and lowered  $\frac{3}{4}$  in. Spindle is driven by the saw motor through a half-crossed belt. Special table insert includes a vertical pin for starting curved cuts

Lee Tool Co., P.O. Box 12, Galeburg, Ill.

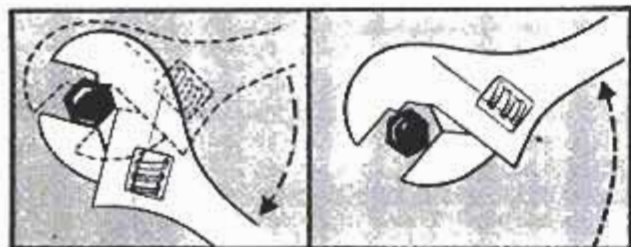
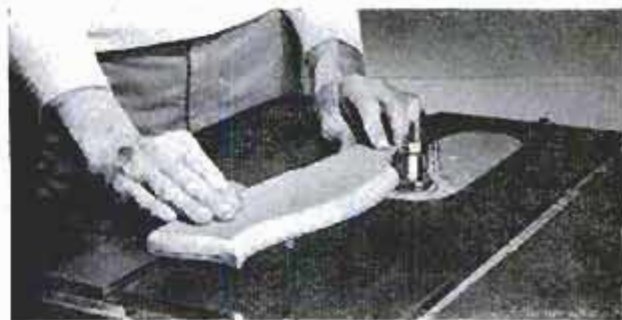

**ADJUSTABLE WRENCH** with two-step upper jaw permits a ratchet action without added mechanism. Second step holds on work stroke but releases nut when handle is reversed, thus giving a ratchet action without use of conventional ratchet and dog. Works equally well as regular wrench when outer step of jaw is used. Of course, it is then necessary to lift wrench at end of stroke, swing handle, and replace on nut

The Tedd Co., P.O. Box 1021, Rockford, Ill.





*On the*  
**MARKET**  
FOR THE DO-IT-YOURSELFER

**CONCRETE REPAIRING AND TOPPING MATERIAL** (left) comes in a package containing cementing materials, latex in liquid form and a handy trowel. To prepare, powder is mixed with latex according to instructions and applied with trowel. Repairs cracks or holes in concrete walls, floors, driveways, walks, steps

Latex Concrete Co., Div. of the Camp Co.,  
10 W. 70th St., Chicago 10



**SOLDER-FLUX PASTE** is supplied in a plastic squeeze bottle. Cleans, fluxes and solders all common metals with application of heat by soldering iron, torch, or furnace. Comes in 1/2 and 1-lb. plastic containers

Anchor Metal Co., 244 Bnorum St., Brooklyn 6, N.Y.

**CARBON-MONOXIDE DETECTOR** shows instantly the presence of concentrations of carbon monoxide in garages, autos and in homes where coal-burning furnaces, gas appliances may be in faulty operation

Richard Industrial Instrument Co.,  
7301 Penn Ave., Pittsburgh 8, Pa.

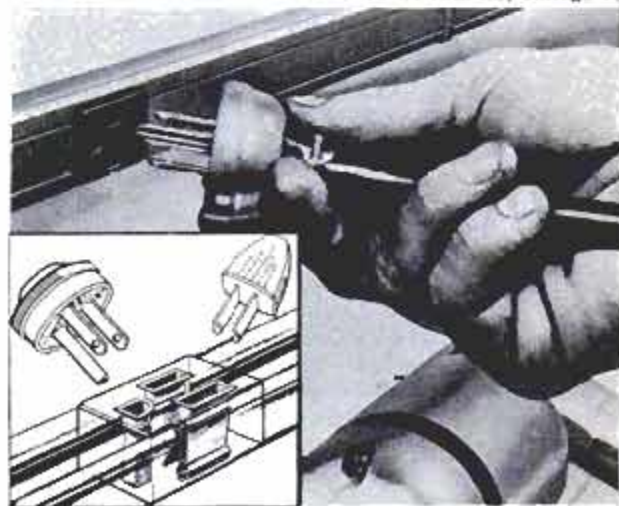
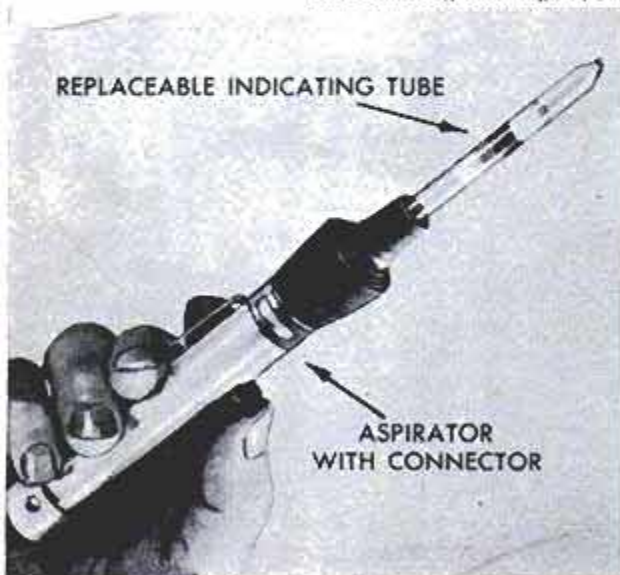

**GROUNDING PLUG-IN STRIP** with receptacles located 6 to 18 in. apart protects both tools and operators. Plug-in receptacles take two or three-pronged plugs. Strips can be installed in any convenient location

National Electric Products Corp.,  
2 Gateway Center, Pittsburgh 99, Pa.

**PORCH AND FLOOR ENAMEL** is formulated especially to withstand the heavy foot traffic in homes and offices. Covers and levels without brush or lap marks. Spreads easily. Available in 11 attractive floor colors

Sapoli Paints, Inc., 229 E. 42nd St., New York City





# You'll never outgrow a Retina!



KODAK RETINA IIIc CAMERA—HEART OF THE GREAT RETINA SYSTEM OF PHOTOGRAPHY!

There's a wonderful feeling of confidence that goes with owning a Kodak Retina Camera. By itself, it is unsurpassed as a top-quality picture-maker. As the heart of a *complete system of photography*, its versatility is almost limitless. Whatever field of 35mm picture-making intrigues you next month . . . next year . . . you have a camera capable of helping you explore it!

Your photo dealer will gladly show you the great combination of features available *only* in a Retina. And ask him about the wonderful family of specialized Retina Photo Aids that will open the doors to a lifetime of exciting picture-taking adventures. Retina IIc Camera, *f*/2.8, \$139.50. Retina IIIc Camera, *f*/2 with built-in exposure meter (shown above), only \$190.

**Ask about small down payment, easy terms**

*Prices include Federal Tax and are subject to change without notice.*

**Eastman Kodak Company**  
Rochester 4, N. Y.

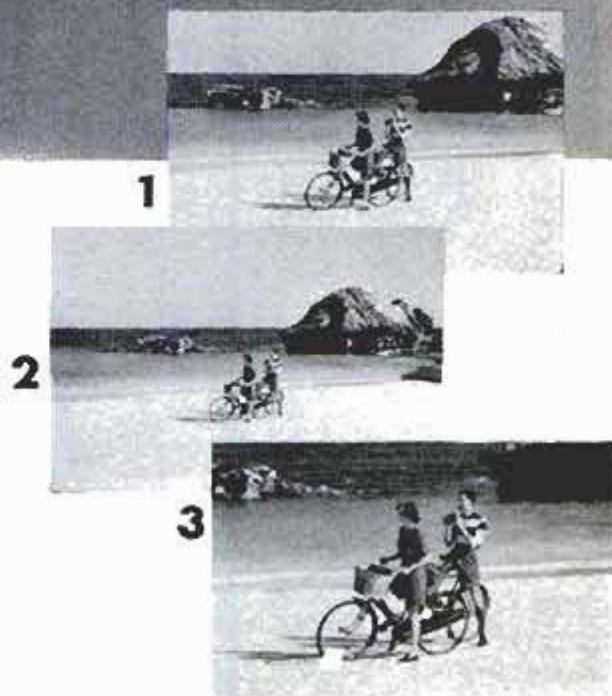

1. Regular view with the Retina 50mm lens that comes with the camera
2. Wide-angle view with auxiliary Retina Curtar 35mm Lens Component, \$62.50
3. Telephoto view with auxiliary Retina Longar 80mm Lens Component, \$82.50
4. Kodak Retina 35-80 Optical Finder for use with wide-angle, telephoto lenses, \$17.50

**Kodak**  
TRADE MARK



the  
big  
thing

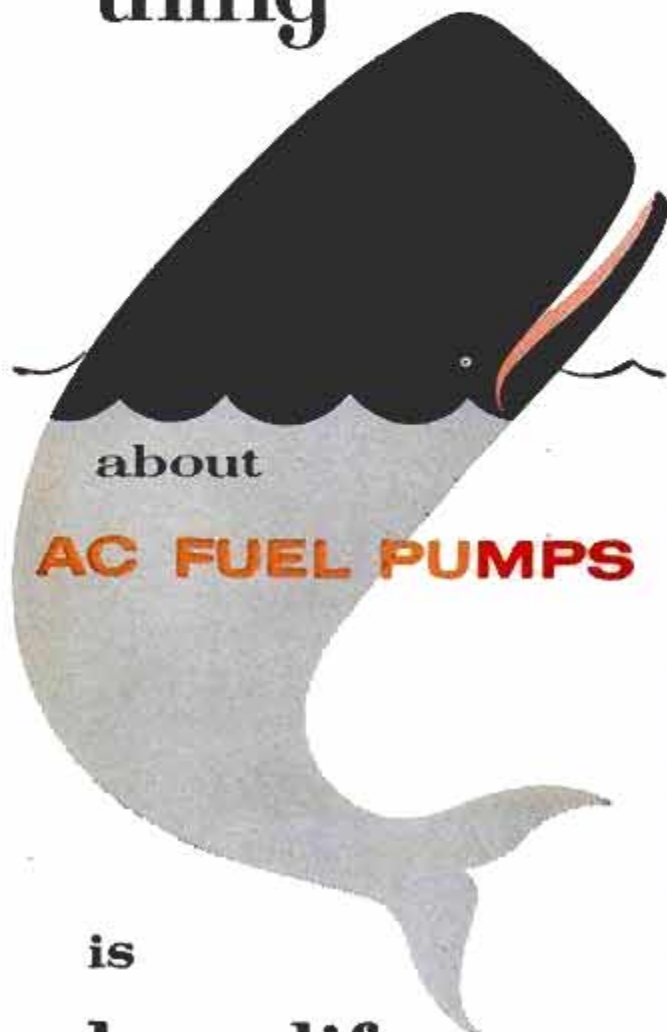

is  
long life

WHEN YOU REPLACE...  
REPLACE WITH AC



AC SPARK PLUG



THE ELECTRONICS DIVISION OF GENERAL MOTORS

## Clinic for Homemakers



As a service to our readers in solving the hundreds of problems pertaining to a home—inside or out—the editors of *Popular Mechanics* invite you to present your problems to The Clinic Editor for help and advice. Address your questions to The Clinic Editor, *Popular Mechanics Magazine*, 200 East Ontario Street, Chicago 11, Ill.

### Metal-Sash Putty



**Q**—The large picture window in my living room has a metal frame and I have recently noticed that the putty is cracked and broken away from the glass in several places. It appears that the whole sash needs puttying, as otherwise it may leak in time. I understand that ordinary putty, such as is used on wooden sash, cannot be used on metal sash frames. What do I use and do I mix it myself, or can I buy it in ready-to-use form?

—Y. O., R. I.

**A**—There are specially prepared glazing compounds available. These are elastic; that is, they never harden to the extent that ordinary putty does, and are not affected by extremes of temperature and exposure. Specially treated oils are used in the compounds to maintain this elasticity over long periods of time. When applying these compounds be sure to follow the instructions in all details, and do a thorough job of removing rust and old putty, or compound, before reputtying. Be sure that the glass is clean. If you wish you can prepare a compound yourself by mixing about 60 percent whiting, 30 percent paste white lead and 10 to 15 percent litharge with sufficient linseed oil to bring the mixture to a workable consistency. However, we would recommend that you use a prepared compound, rather than making your own.

### Defective Joists



**Q**—We live in an older two-story home and lately I've noticed that the ends of the floor joists have apparently crushed somewhat where they bear on the center beam. There is a wall directly above the beam on the first floor and the plaster is cracked at the point where the wall meets the ceiling in an upstairs room. How can I repair this defect?

—A. K., Mass.

**A**—If we can judge correctly from your description it would appear that undue weight is concentrated on the floor joists at the points where the

(Continued to page 208)





## Chain-Saw Sculptor Carves Paul Bunyan Statue

Ex-logger Paul Bresee might be called the Paul Bunyan of whittlers. In 1949 Bresee quit the woods to sell chain saws. An inveterate whittler, he put away his pocketknife and began carving with a chain saw. The results are not only spectacular, but they demonstrate the saw's versatility to prospective buyers. To date he has carved a 16-foot chain, a six-foot woman and a 16-foot statue of Paul Bunyan.



# Summertime is fix-up time

Summer chores can be simplified if you keep your lawn and gardening tools sharp with a Nicholson or Black Diamond file. For example:



Blades of your rotary lawn mower should be touched up regularly with the famous Handy file. The double-cut side is used for fast metal removal, the single-cut side for smoothing and sharpening.



Sharp hoes and rakes cut down on achin' backs! Use the popular all-around Mill file for garden cutting tools.



Stop that screen door from sticking with the versatile 4-in-Hand. Half round and flat, file and rasp, it's four files in one. Ideal for a multitude of summer uses.

*Nicholson and Black Diamond files are available at all good hardware stores.*



**NICHOLSON FILE CO.**

Providence 1, R.I.



(In Canada: Nicholson File Company of Canada Ltd.,  
Port Hope, Ontario)

**NICHOLSON FILES**  
**A FILE FOR EVERY PURPOSE**



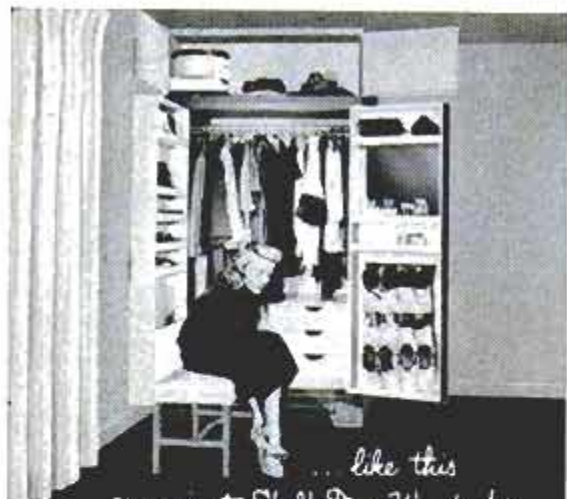

... like this convenient Shelf-Door Wardrobe

You can Afford Expensive Ideas with  
**Fir Plywood**



... or this practical Child's Storage Unit

THAT'S the wonder of fir plywood. It offers so much, so reasonably. Whether you build, remodel or do-it-yourself . . . indoors or out . . . for built-ins, siding or sheathing . . . you'll find fir plywood fits your plans and your budget. Created by nature, improved by man, fir plywood is real wood made larger, stronger . . . better looking, more versatile.



Grademarked for your protection, fir plywood comes in standard grades as well as special textured or overlaid panels. DFPA industry grademarks attest quality, performance, value.

Plans Available; See your lumber dealer or write (USA Only) Douglas Fir Plywood Association, Tacoma 2, Wash., Dept. 9. Please order plans by name, enclose 10c for each.

(Continued from page 206)

edges are being crushed. This may be due to some peculiarity of the house construction, or to undue weight concentrated on one or both of the floors above, or to a defect in the floor joists themselves. However, judging from your description, adjacent joists are affected and from this one would ordinarily assume that the crushing of the wood is due to excessive load. You do not say whether or not the beam has sagged under the strain. Check the possibility of excessive load first (two pianos, one above the other on the first and second floors, might possibly do it). Redistribute the load if possible. Then examine the joists carefully to determine if they have been weakened by dry rot. If not, then it may be practicable to raise the floor by means of jacks and install new joists, bolting the new joists directly to the original ones.



#### Water Hammer

Q—I have an older type hot-water heating system and, near the end of this year's heating season, we noticed a sharp hammering sound in the water pipes. Sound was similar to that one would hear if the pipes were struck a sharp blow with a hammer. There seems to be no other source of this peculiar sound. What is the cause of this and is there a remedy?—H. E., Minn.

A—Are you sure that the sound you hear is in the heating system and not in the plumbing? In some cases it is difficult to determine with certainty. In a heating system such as you describe the sounds you hear usually—but not always—are due to a partial stoppage somewhere in the hot-water lines near the boiler. This interferes with normal circulation of water, often to such an extent that steam is generated. Steam forcing its way past the partial obstruction, usually a hard lime deposit, causes the sound you describe. In some plumbing systems air pockets develop, generally in a long riser to a faucet. When the faucet is opened water forcing its way past the air "bubble" causes the sharp hammering sound referred to by plumbers as water hammer. A common remedy is to install an air chamber at the end of a long horizontal run of pipe. The air chamber is simply a length of pipe 2 to 4 ft. long and a size larger than that in the horizontal run. The air chamber is capped and the lower end turned into a street elbow. The horizontal run is cut, the ends threaded and a pipe tee with coupling is installed. This arrangement permits installation of the air chamber. Of course, the method of installation must be adapted to each system. This may require some changes in procedure from that described.

#### Fireplace Smokes

Q—I live in a new basementless home. My fireplace smokes each time a fire is started. There are no trees or other obstructions nearby. Does the small size of the house have any bearing on the problem? If not, what is the cause and remedy?—F. L., W. Va.

A—We assume the fireplace has been properly constructed and that the flue is of the correct height and size. This being so, the only other likely cause is a variation in air pressure. Even a slight variation can cause a fairly strong downdraft in the flue, forcing smoke back into the room. The trouble occurs most frequently in new homes of exceptionally tight construction, with weather-stripped windows and doors which are kept tightly closed during fall and winter months. Often a smoking fireplace is cured simply by opening a window a few inches to permit atmospheric pressure to equalize. Some homeowners have cured a smoking fireplace by fitting a fresh-air intake to the heating system, thus equalizing pressure and preventing a reduction of the oxygen content of the air inside the house. This is especially helpful where the furnace is installed in a utility room.





### Kit for Outdoor Grill Assembled in Minutes

Ten minutes is all the time needed to put together an outdoor grill made from patented concrete blocks supplied in kit form. And when the grill must be shifted to a new spot in the yard, it is only a matter of minutes to tear it down and rebuild it. The kit comes complete with the concrete blocks, a counter which rings the unit like a collar and a heavy wire cooking grill. The concrete blocks are made in an attractive mulberry color.

### Lure Bristles With Hooks

Hooks project in every direction from a new fishing lure. The lure has a central cage formed by a spiral wire. Worms or bugs are tucked inside this steel coil. Around the perimeter are six double hooks which also can be baited if the angler desires. The hooks are held by machine screws and some can be removed to comply with local regulations if necessary.

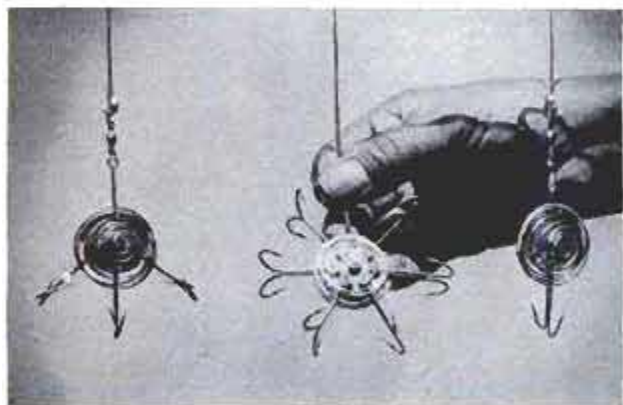

for quick clean cuts . . .

## RIDGID Heavy-Duty Pipe Cutter

Powerfully built—guaranteed not to warp or break, always tracks perfectly . . . Famous RIDGID thin-blade or heavy-duty cutter wheels of tool steel roll easily, cleanly through any pipe. Special wheels for stainless steel, cast iron. Every cutter factory-tested. For your work or home, it's most for your money—buy it at your Hardware Store!

Genuine  
**RIDGID**  
The World's Most  
Popular Pipe Wrench



The Ridge Tool Company, Elyria, Ohio, U. S. A.



# This TRUSCON DOUBLE-HUNG STEEL WINDOW is easy to install *Yourself!*

It's the Truscon® Series 138 Steel Window. Your dealer has them ready to install. Hammer, screwdriver and level are all you need. And because they're steel, they can't rot, warp, swell or shrink—*will never stick or rattle.*



All bronze hardware is factory-attached. Stainless steel weather stripping and tape balances are built in. There are types and sizes for every home style—with storms and screens available, too.



## Get this FREE BOOKLET that shows how

Step-by-step guide and clear pictures are easy to follow—with helpful tips on professional methods. Truscon Steel Windows can be installed in frame, brick veneer, masonry and concrete-block construction. Send coupon below.

## TRUSCON STEEL DIVISION REPUBLIC STEEL

YOUNGSTOWN 1, OHIO



TRUSCON STEEL DIVISION,  
REPUBLIC STEEL

1126 Albert Street • Youngstown 1, Ohio

Please rush free book showing how to install  
Truscon Double-Hung Steel Windows, Series 138.

Name \_\_\_\_\_

Address \_\_\_\_\_

City \_\_\_\_\_ Zone \_\_\_\_\_ State \_\_\_\_\_

C-1963

## Privates and Generals Study the A-Bomb

(Continued from page 112)

before they learn the nation's atom secrets. No classroom notes are taken home or to the barracks. All written notes, manuals, material, computations, are locked into safes overnight.

The highly secret atom training is conducted in two phases: Individually, at first; later as a member of a nuclear team.

### Grade Must Be 100

There are no "passing" grades. A man either learns his atom lessons 100 percent or he doesn't pass. Tough examinations weed out 15 to 20 percent of each class, one school spokesman said. "A nuclear technician's got to know his stuff. No one makes mistakes with the atom."

Because nuclear weapons comprise the nation's major striking potential in event of war, students at the school are bound with terrible responsibilities. They're aware that each bomb may create wind up to 800 miles per hour, fires at 20,000,000 degrees. They know that each weapon—according to David Lilienthal, first chairman of the AEC—costs about \$1,000,000.

Instructors at the school hold master's and Ph.D. degrees from the nation's best scientific schools and universities. Some are draftees who served as physicists and scientists at the Los Alamos, N. Mex., scientific laboratory. Others are fresh from engineering schools.

### Admiral in Command

Head of AFSWP Field Command which operates Nuclear U. is youthful-looking Rear Adm. Frank O'Beirne, USN, a naval aviator who was in command of Naval Patrol Squadron 22 when the Japanese attacked Pearl Harbor. He is 52. An air-minded naval officer, he once participated in the National Air Races with Charles Lindbergh.

Surprising development during daily classroom lectures at the nation's first nuclear university has been GI improvement in design and operation of nuclear weapons. The Kremlin's students frequently suggest alteration of the weapon under study.

Graduation from the Albuquerque school is entered on the student's military-service record. Nuclear studies continue for each student after graduation, however, during his assignment to posts around the globe. Servicemen are often reassigned to the Kremlin for postgraduate study of new weapons. This has become necessary due to the fantastic rate of improvement in the nation's nuclear armaments. ★ ★ ★



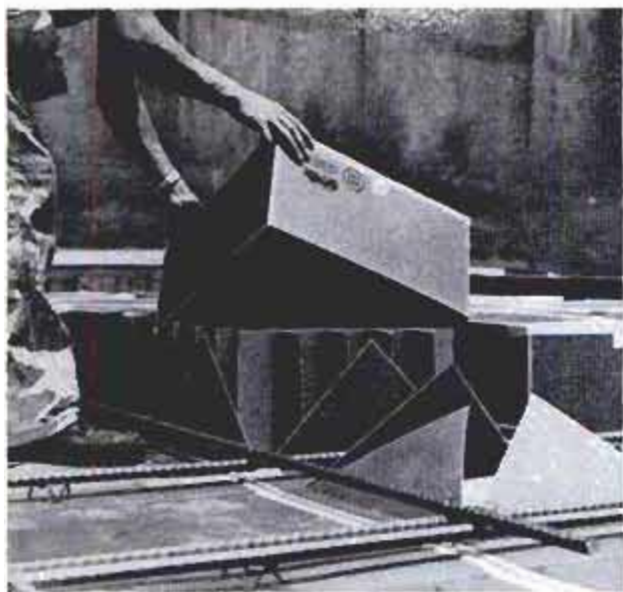

Photos courtesy Fiber Containers and Paperboard Mills

## "Grocery Boxes" Make Concrete Forms

Fiberboard boxes, similar to ordinary grocery boxes, now are being used as inexpensive forms for concrete work. The boxes are used in a new construction technique in which the successive floors of a building are cast at ground level and then jacked into place. Egg-crate partitions strengthen the boxes, and triangular flaps anchor them in place. The boxes are placed to form hollow areas or coffer in the slab. When the slab is jacked into place, the forms can be removed. The resulting hollow spaces save up to 40 percent of the steel and concrete required for a solid slab, yet are said to give the same floor-load capacity.

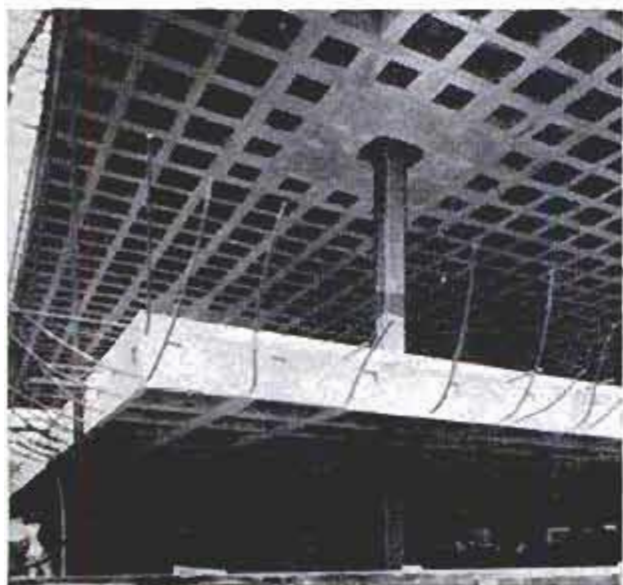

Graphite lubricant is sprayed into hard-to-reach corners with a new six-ounce aerosol bomb.

## Two pumps in one!

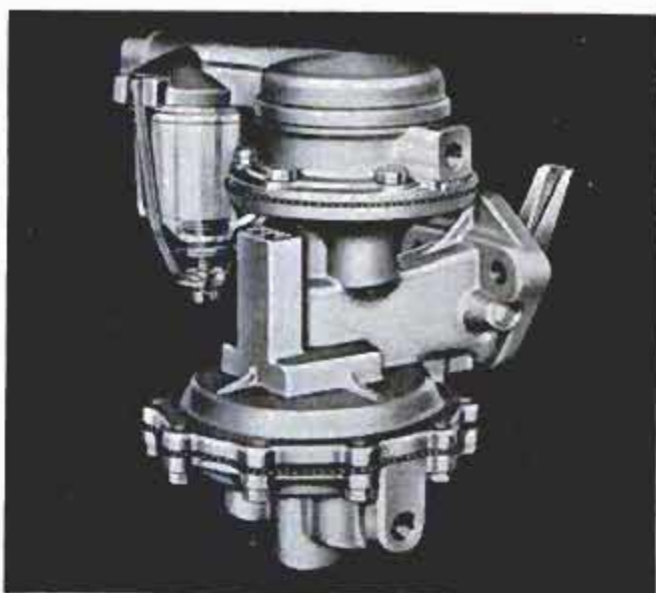

## ... THE CARTER



## FUEL AND VACUUM PUMP

This versatile CARTER combination fuel pump provides continuous vacuum for your windshield wipers—at any speed or on acceleration.

You also have the high capacity of the CARTER fuel pump and the high-efficiency of the CARTER ceramic fuel filter... all built into one compact unit. It's easy and economical to install. See your CARTER dealer, or ask your serviceman.

**CARTER CARBURETOR**  
DIVISION OF **OCF** INDUSTRIES  
INCORPORATED  
ST. LOUIS 7, MISSOURI



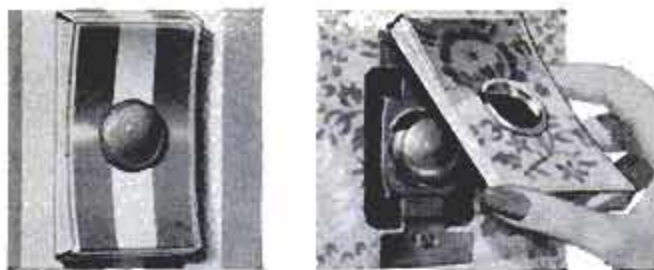

\$1.95 complete—at leading hardware, electric and department stores.

## Ever See A Light Switch Like This?

New decorator light switch easiest yet to install! Honeywell Tap-Lite is a new kind of wall switch. Transparent plate snaps off for decorating; just add your own wallpaper, drapery material, or one of the colored inserts provided. It's simple to replace old switches; Tap-Lite has screwless terminals. Quiet and easy to operate. Tap—it's on! Tap—it's off!

Tap-Lite by

MINNEAPOLIS  
**Honeywell**



**BE PRECISE**

Say **STANLEY**

It's A Good Rule



**FREE  
MAGNA  
VIEW BOX**

Easy to use 8' tape rule—Model 1208W  
\$1 19 at your hardware store.

Other Stanley Rules from 75¢ up, 6 ft. to 12 ft., and each in the reuseable plastic box with the magnifying lens. You'll use the rule—you'll use the box.

Write Stanley Tools, 6208 Elm St., New Britain, Conn., for free booklet on measuring tools and how to use them.

**STANLEY**

## Owners Report on the '56 Chevrolet

(Continued from page 127)

"I like the smooth, fast pickup of the Powerglide transmission. But they should build in more economy (this car should give 20 miles per gallon on the highway) and leave horsepower where it is for the next 20 years."—Connecticut sheet-metal smith.

"Seems to have a very sensitive carburetor or timing setup. Tuneups seem to last only 1000 miles and, even though I use same type of gasoline, it invariably ends up loping."—Florida Air Force man.

"Hugs the corners. It's catlike. Climbs hills easily. Clean lines."—Maine salesman.

"Nice looking. Good vision from all seats. Good brakes."—South Carolina mechanic.

"Handling excellent at over 75 miles per hour. No mushy feeling on corners."—Louisiana foreman.

"I drive 100 miles every day taking my son to school. I go through several small towns and numerous stoplights. Easy handling, automatic transmission and instant response make this chore a pleasure."—Indiana housewife.

"Rides very well, especially on rough country roads. Lots of punch for such a little engine. Seems like it's empty under the hood."—Iowa farmer.

"Dealer service is the best I have heard of in this section."—Kentucky truck driver.

"Heater air intake below windshield should be sloped to take in more air. I have a 60-mile rural mail route I cover daily, averaging four stops a mile. It's a good place to bring out faults in an auto. I am very well pleased, generally speaking. It could steer easier. Would recommend it to anyone for rigorous service."—Kansas mail carrier.

"I like the almost vertical steering wheel and the solid body."—Nebraska teacher.

"Car has to be brought into the dealer too many times for little adjustments which have been taken care of very satisfactorily."—New Hampshire realtor.

"Too much junk in the taillights. Too hard to keep clean. Grille is the same way."—Washington, D. C., mechanic.

"Don't like location of gas cap inside taillight. Gasoline is usually spilled when filling. The taillight wires are generally soaked with gas and I worry about a spark causing a fire."—Connecticut printer.

"A baffle in rear fender would keep small rocks from getting in around gas cap. When you open the taillight the small stones fall around the frame and you can't close it until you pick them out. In winter it packs

(Continued to page 214)



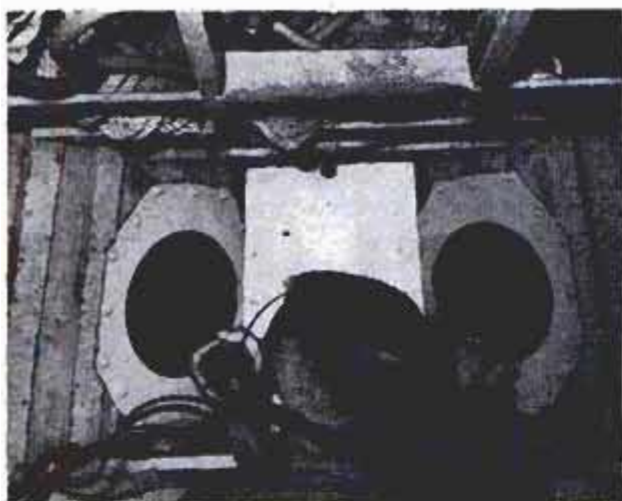

## Boat Has Underwater "Eyes"

Underwater "eyes" in the bow of a skin divers' boat enable a crew member to keep a sharp lookout for good fishing grounds, buried treasure and dangerous reefs. Reports to the skipper are made by sound-powered phone. The two underwater viewing ports are Navy-surplus port-light lenses the same thickness as the hull. Inner and outer brass reinforcing plates serve as window frames. Rubber gaskets and calking compounds keep the water out. The boat is the *Maray*, which makes charter trips to Catalina Island, pausing en route for skin-diving forays by its passengers.

## Teach Trout Not to Get Caught

Conservationists at Michigan State College are teaching hatchery-raised trout to be wary as their wild cousins. The fish were in the habit of surfacing when they heard the splash of rations being tossed on the water at feeding time. In the wild state, a similar splash means a fisherman's fly, a predatory otter or blue heron. Now, baby trout that surface at the sound of a splash are given a mild electric shock that teaches them to hide from a splash.

# KLEINS

**AID TO YOUR CRAFTSMANSHIP**

These three pliers—a Klein Side Cutting Plier, Long Nose Plier and Oblique Cutting Plier—belong in every workman's kit. They put the exclamation point after your good workmanship! For a century Klein has stood for the finest in pliers and Kleins are still the standard of comparison by which other pliers are judged. There is a type and size of Klein Plier for every job—all famous for Klein quality "since 1857."



Your hardware store has Kleins in stock or can get them for you quickly. Look for this new display board. It shows the most popular items in the Klein line.

**Mathias KLEIN & Sons**  
 Established 1857 Chicago, Ill., U.S.A.  
 7200 McCORMICK ROAD • CHICAGO 45, ILLINOIS



# STOP SAGGING REARS!



with  
LOW-COST

## AIR LIFT PNEUMATIC SPRING BOOSTERS

Car got that "middle age spread" look? Even new cars need help for overloads of luggage, equipment or extra passengers. AIR LIFTS fit between leaf springs and frame — inflate with air to support overloads up to 1000 lbs! Perfect for vacation trips, and so easy to install. See your dealer or write for his name.



FREE . . . tip-packed literature on Air Lift remedies for sagging rears. Write Dept. 48.



AIR LIFT COMPANY,  
LANSING, MICHIGAN

## FROM ALL OVER THE WORLD...

news you want to hear with a



## hallicrafters Model S-38D—Only \$49.95

It's a fascinating, exciting hobby to listen in on the whole wide world by short wave with Hallicrafters S-38D radio. With this exceptional receiver you enjoy not only standard broadcasts . . . but can choose from the 3 international short wave bands. You, too, will praise the performance of Hallicrafters S-38D radio . . . the choice of countless governments as well as radio experts the world over. Hear the S-38D at your nearest Electronic Parts Distributor today—\$49.95 . . . or write

# hallicrafters

CHICAGO 24, ILLINOIS

full of snow and has to be blown out before you can put in gas."—South Dakota farmer.

"Don't like radio speaker on right-hand side. Driver can't hear it unless volume is turned up until passenger complains. I installed a rear-seat speaker for this reason."—Vermont salesman.

"Only one ash tray in front. Good for driver, not for passenger."—New Jersey salesman.

"Sun reflects from dashboard. Should be covered with nonglare material."—Wyoming editor and publisher.

"It has just enough trim not to be plain. It's not a chromed zebra. Trouble-free operation. I may not have a prestige car, but I've got peace of mind with this car."—California serviceman.

"As a family car the Chevrolet station wagon is tops. Horsepower is about all anyone can use on the roads we have today."—Washington service-station owner.

"Low, flat hood gives very good forward visibility."—Nebraska farmer.

"I know my car is always ready to go at the turn of the switch. Has plenty of pickup and after a long day's drive I am always relaxed. I'm proud to drive it."—New Mexico private secretary.

"I have never checked gas mileage on a trip. On my rural mail route I average about 12 miles per gallon. This is good for the conditions. The trouble with cars is they just aren't made for use under the conditions that we have."—North Dakota mail carrier.

"Rear-view mirror is in the way when looking to right. Battery is hard to get at for checking water."—Maryland printer.

"Exterior paint isn't as good as it should be, but other makes aren't any better."—South Dakota student.

"Too much wiring visible under dashboard."—Florida watchmaker.

"Oil filter and distributor hard to get at to change or repair."—Kansas rancher.

"Steering wheel should be lowered and extended. Seats need more padding."—Idaho salesman.

Here are some owners' complaints and suggestions which are not limited to the Chevrolet but are general comments on the industry:

"Outside rear-view mirror should be standard equipment for safety reasons."—Missouri housewife.

"Cars of today have too many gadgets."—Wyoming custodian.

"As a highway patrolman I see too much speed being displayed, but if some cars had the extra power for passing, in my belief, there would be fewer accidents."—Nevada police officer.

(Continued to page 216)





Courtesy of Parents' Magazine



**New edition of bright ideas!**

"FRIENDLY HOME IDEAS IN WESTERN PINE"—85 photographs, many in color. Traditional and contemporary ideas and finishes for building and remodeling with cheerful Western Pines. Write for FREE copy to WESTERN PINE ASSOCIATION, Dept. 513-N, Yeon Building, Portland 4, Oregon.

# MORE SPACE!

**BUILD IT IN EASILY, ECONOMICALLY WITH CABINETS OF WESTERN PINES**

Make your kitchen more useful, more beautiful with handsome Western Pine cabinets. It's *easy* because of the extreme workability of the Western Pines. And it's economical, too!

Your joy for the extra space will be heightened by the rich grain, texture and color of these well-seasoned woods. They are easy to maintain and take all kinds of paint, stain or varnish. Or they can be waxed then rubbed to a silken, natural glow.

Whether you do it yourself or have it done, you'll be happy you chose Western Pines. See your lumber dealer for details.

## The Western Pines

**Idaho White Pine**

**Ponderosa Pine**

**Sugar Pine**

and these woods from the Western Pine Mills

WHITE FIR - INCENSE CEDAR

RED CEDAR - DOUGLAS FIR

ENGELMANN SPRUCE

LOGEPOLE PINE - LARCH

are manufactured to high standards of seasoning, grading, measurement

Today's Western Pine Tree Farming Guarantees Lumber Tomorrow

## Goal Lowered for Small-Fry Teams

Two public-school officials of Midland, Mich., have developed a device to permit the standard basketball goal to be lowered from the regulation height of 10 feet to a more convenient one of eight feet for small-fry basketball teams. The device is a frame of welded magnesium extrusions that can be attached to any backboard, and adjusts through a screw mechanism operated by a long crank. The device has proved so successful that a company has been formed to market it.

## Transistorized Switchboard

There are no vacuum tubes and no mechanical stepping switches in a transistorized all-electronic telephone switchboard developed for the Navy. It is one fourth as heavy and less than one half the size of a corresponding electro-mechanical board and has no dust, wear or corrosion problems. The unit is not yet in production.





the plier you'll reach for  
9 times  
out of 10\*

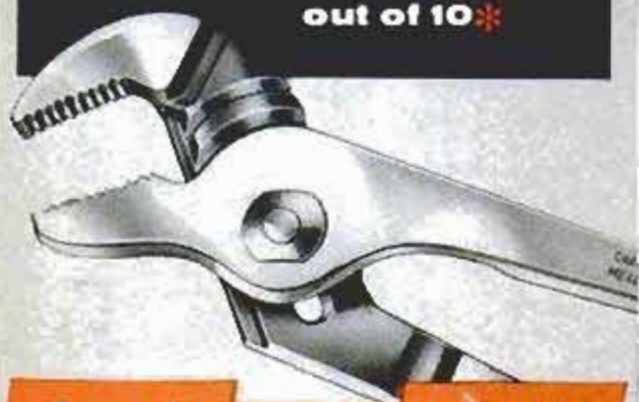

**CHAN NEL LOCK**

**No. 420**

\*because no other plier  
does so many jobs so well

**GRIPS LIKE A  
PIPE WRENCH**

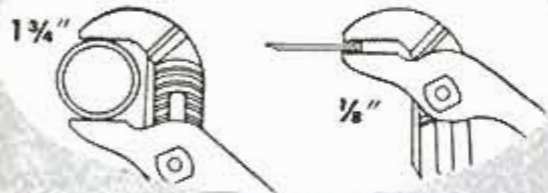

Mechanics tell us that our Channellock No. 420 is the handiest plier of them all . . . the plier they reach for more often than any other. They like its all 'round usefulness . . . its pipe-wrench grip . . . its big jaw-opening . . . its streamlined design for hard-to-get-at jobs. And you'll like Channellock for the same reasons. Ask your hardware man for a Channellock 420.

**BE SURE IT'S A GENUINE CHANNELLOCK**



**CHAMPION DEPARTMENT TOOL CO. MEADVILLE, PA.**

"To me a horn ring which extends completely around the wheel is very important. I can think of at least eight times my horn has prevented an accident. Would have bought a competitive car (better trade-in allowance) if it had a full horn ring. I was amazed at their dealer's attitude that the horn was not important. I would rather blow my horn at a child about to run into the road than to depend upon a safety belt to keep me alive and forget about the child."—Connecticut insurance man.

"I believe Chevrolet and all manufacturers would do well to discontinue quoting misleading so-called records made by specialized cars."—Indiana office worker.

"All manufacturers should improve soundproofing to quiet road noise. They should refuse to use tires that thump."—California machinist.

That's it—the story of the 1956 Chevrolet V8 as told by those who know it best, the owners themselves. For a technical analysis of the car turn to Dale Kelly's report on page 124. For the opinions of a veteran car tester, read what Floyd Clymer says beginning on page 123. ★ ★ ★

## Floyd Clymer Tests the 1956 Chevrolet V8

(Continued from page 123)

excessive, body roll on sharp curves. Only on the hardest bumps at above-average speeds would the springs bottom.

There is little road shock or vibration at the wheel and but slight hood and fender flutter at high speed. There is a slight steering-wheel drag to give some road "feel" to the power-steering unit. Steering should be faster than it is, especially in view of the power assist.

### Engine Has Power Pack

The test car had the 265-cubic-inch engine that develops 205 horsepower with the power pack which includes a four-barrel carburetor, dual exhausts, a 9.25:1 compression ratio. Without the power pack, the V8 engine develops 170 horsepower. The engine runs with unbelievable smoothness and has very little vibration at any speed. Low-speed torque is excellent. The car really gets down and lugs under a heavy engine load. In the desert heat and on long pulls up sandy, steep inclines there was no evidence of overheating.

Powerglide is a torque converter plus planetary gears. Any automatic transmission takes a beating when driven in low gear in desert heat or up long, steep grades, but I found no troubles of any kind with

(Continued to page 218)



Protect your home against  
power interruptions  
with an...

## ONAN Emergency ELECTRIC PLANT

Provides dependable stand-by electricity for heating system, pumps, freezer, lights, appliances. Keeps home safe, livable. Automatic start and stop. Find out how little it costs!

Write for Folder!

**D. W. ONAN & SONS, INC.**  
3644 University Ave. S. E. • Minneapolis 14, Minnesota

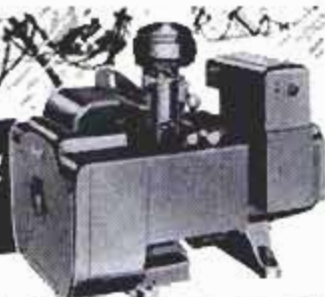

**A SIZE FOR EVERY NEED**  
500 to 50,000 watts.  
Compact, quiet-running.  
Gasoline-powered.  
Priced from \$255.00

## DITCH-WITCH TRENCHER



Portable DITCH-WITCH digs 4 1/2" or 6" clean, even ditches to 36" depth in all types of soil. Four rugged models. Complete unit — self-propelled. OUTDIGS 8 MEN  
Write for Illustrated Literature

The CHARLES MACHINE WORKS  
620 B Street Perry, Okla.

## NEW, IMPROVED CALCULATOR FOR WOODWORKERS only 25c

Instantly gives information on lumber, nails, concrete mixes, painting materials, etc. Convenient, simple to read. Just set dial for nail specifications, to convert linear to board feet, find bit sizes for screws, compare characteristics of woods. 6" diameter heavily varnished cardboard. Send 25c, no stamps, please to Greenlee Tool Co., 2108 Columbia Avenue, Rockford, Illinois.



## Exclusive Double-Bearing HEAVY-DUTY PUMPS

IRRIGATE • DRAIN • CIRCULATE • SPRAY  
Up to 7,500 GPH. 3,000 GPH from 25' well. Use 1/4 to 1 HP motor. 1 1/4" inlet; 1" outlet. Stainless shaft.  
TYPE X-2 oilless bronze bearings. **\$10.95**  
Won't rust.  
TYPE XB—Ball bearing model. **\$12.95**  
Postpaid if cash with order. Rush your order today

**MONEY BACK GUARANTEE**  
Centrifugal and Gear Pumps in All Sizes  
LABAWCO PUMPS, Belle Mead 2, N. J.



## FIND HIDDEN RICHES!

NOW—find buried treasure, gold, silver, and metal objects, with sensational 3 1/2-lb. locator—GOLDAK'S "FIND-IT"... only \$49.50 complete with earphones, batteries, instructions.

Manufacturers of metal detection devices since 1933.

Write for FREE literature full line metal, mineral locators; geiger and scintillation counters.

**GOLDAK CO.** 1542 W. Glenoaks Blvd., Glendale, Calif.



## KING MIDGET

World's  
Lowest  
Priced  
Car!



NOW—32 PAGE BOOK filled with photos, drawings, specifications, records, wholesale price, and Rider Agents plan if no dealer near you. Send 25c for book, or send \$1 (refunded first order) for it plus actual operating book and service manual.

MIDGET MOTORS MFG. CO., ATHENS 1, OHIO



## OWN YOUR BUSINESS

### Start in Spare Time with a FOLEY SAW FILER

Here is a steady repeat CASH business you can start at home in your basement or garage, while you are working at your regular job. No experience is necessary to turn out perfect cutting saws—"the first saw I sharpened came out 100%." I think the Foley Saw Filer is a marvel of perfection," write Clarence E. Parsons. Every saw you sharpen will bring you new customers. You will find you can make up to \$3 to \$5 an hour—\$20 to \$30 a week in your spare time as a starter. With a Foley Saw Filer you can file all hand saws, also band and cross-cut circular saws. It is easy to operate—simple adjustments—no eyestrain. Patented jointing principle evens up all irregular teeth and makes an old saw cut just like new.

### This Free Book Shows How to Start

"MONEY MAKING FACTS" shows you how to get plenty of saws to file without canvassing, and how you can develop into a general repair shop that will be your own business. This is a helpful, practical book that tells just what to do—send for your free copy today. No salesman will call.



### Send for FREE BOOK

FOLEY MFG. CO., 816-6 Foley Bldg.  
Minneapolis 18, Minn.

Send me free book "MONEY MAKING FACTS"

Name \_\_\_\_\_

Address \_\_\_\_\_





## Prevents Vapor Lock

IN YOUR CAR OR TRUCK

Vapor lock is not only annoying, but can burn out exhaust valves and result in expensive repair bills. The Bendix® Electric Fuel Pump positively prevents vapor lock. Simple to install. Get your Bendix Electric Fuel Pump at any independent garage or service station.

\*REG. U. S. PAT. OFF.



**FREE:** A complete descriptive folder is yours for the asking. Write us today.

### Bendix

## ELECTRIC FUEL PUMP

Grand Prix Winner

ECLIPSE MACHINE DIVISION, BENDIX AVIATION CORP.  
ELMIRA, N. Y.

## Speedy Sprayer

### mobile paint sprayer

Choice of craftsmen for 35 years! Saves time, paint and money. Quickly gives flawless finish to walls, furniture, screens, fences and handiwork. Sprays all materials; ¼ H.P. motor. Diaphragm principle assures clean, oil-free air. Never needs lubrication. With gun, less motor. **No. 890 Speedy Sprayer . . . \$38<sup>50</sup>**

Add wheels with Wheel Kit No. 909. Includes 6" wheels, handle, fittings. **\$6.95**

**FREE!**

Write for  
"How to Spray"  
Booklet and  
Literature.

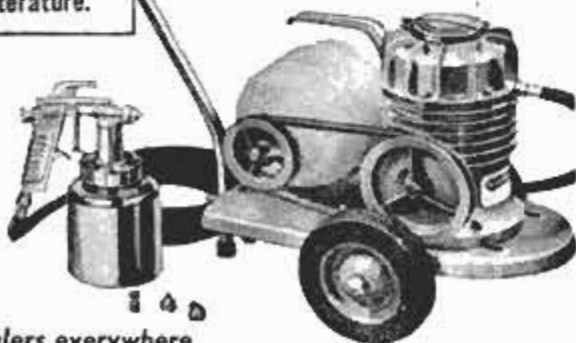

At dealers everywhere

**W. R. BROWN CORPORATION**  
2635 N. NORMANDY AVE., CHICAGO 35, ILLINOIS

this one. Shifting is smooth at all speeds. By depressing the throttle you can downshift at speeds below 50 miles per hour. One objection I have to Powerglide is that no downshift from top gear is possible above 50. I'd like to see this downshift take place at any speed up to 65, which would help in passing.

When slowing from high speeds there was some evidence of brake fade, but the fade was not excessive. There was no squeak to the brakes such as on some earlier Chevrolets I have tested. Pedal operation is easy and smooth.

### Vision Is Good

Front, side and rear vision is good. The body is solid and the doors open and close easily. There were no inside body dust leaks. A high-pressure hose test showed no water leaks. Body rumble and wind noise at high speeds are below average. Cranks require 3½ turns for opening or closing the windows. All doors can be locked without using a key when leaving the car. This is convenient although occasionally I have locked the key inside and no doubt others have done the same.

The interior finish is of high quality. Driving position is comfortable. Seat-cushion springs are good, but the springs in the back or vertical cushion of the front seat seemed weak. The small of my back sometimes hit the brace inside the seat back when going over rough bumps.

On long, open stretches, the speedometer needle hit 104 miles per hour. I estimate the actual top speed at over 100. The speedometer on the test car was one of the most accurate I have used.

### Dash Has Good Design

The instrument panel is well designed. However, the upper portion of the horn ring is in line of vision of the speedometer numerals—an annoying feature. I once said if I owned a Chevrolet I'd saw off the upper half of the horn ring and I haven't changed my mind. Nicely arranged and in clear view is the shift-indicator quadrant. I like the fact that Low and Reverse are alongside each other to allow for quick shifting when rocking the car in mud or snow. Chevrolet continues to use warning lights for oil and generator. I prefer needle indicators.

Throttle and brake pedals are close together and about the same height, facilitating quick movement between the two.

The top of the dashboard on the test car was padded and black, thus diminishing reflections. The center of the steering hub comes to a point. It may be attractive, but

(Continued to page 220)



# DELTA HOME WORKSHOP Special!



GET THIS FAMOUS DELTA SAW-JOINTER NOW . . .

(8" tilt arbor saw, 4" jointer)

for as little as  
**\$7.10**  
a month

AND YOU GET \$16.95 DELTA SABER  
SAW ATTACHMENT

(for curve cutting, sanding, filing)

absolutely  
**FREE**  
of extra charge



TAKE UP TO 24 MONTHS TO  
PAY ON TERMS TO SUIT YOU!



It's a real special—genuine DELTA quality and big savings, too! Act now—visit your Delta Dealer (listed under "TOOLS" in the Yellow Pages of your telephone book), or leading hardware and department stores.



another product by  
**ROCKWELL**



Delta Power Tool Division,  
Rockwell Manufacturing Co.  
502H N. Lexington Ave., Pittsburgh 8, Pa.



- Please send name of my nearest Delta Dealer.  
 Please send Delta Homecraft Catalog.

Name \_\_\_\_\_

Address \_\_\_\_\_

City \_\_\_\_\_ County \_\_\_\_\_ State \_\_\_\_\_

## T-58 Turboshaft Engine to Power Helicopters

An aircraft gas-turbine engine called the most powerful turboshaft, pound for pound, packs more than 1000 horsepower into a 59-inch, 325-pound frame. Made by General Electric for the Navy, the engine, designated the T-58, will give superior performance to helicopters in terms of endurance, payload, range and speed. It is expected to increase the payload of the average utility helicopter by 100 percent. The Sikorsky S-58 helicopter has been announced as the flight-test vehicle for the engine, which is only five feet long and 16 inches in diameter.

### Copper-Glass Bonding

Copper is bonded to glass by a new method in which the bonding temperature exceeds the melting point of copper. The bond is integral and permanent, it is reported. The copper won't peel or discolor, retains its bright color where it contacts the glass and can be plated and soldered.





## FIXIT TIPS...

WITH "SCOTCH" BRAND  
MASKING TAPE



**PAINTING A WAGON?** Use this stretchy tape to make professional-looking stripes. Tape fits tight on curves, paint won't bleed through.

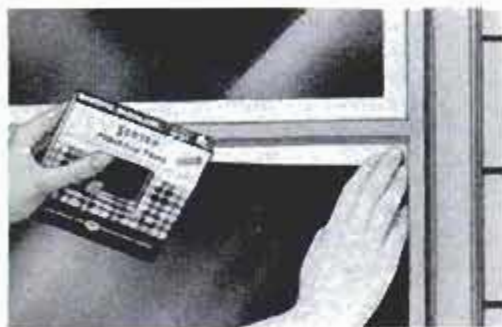

**SPEED YOUR JOB,** keep it neat with "SCOTCH" Brand Masking Tape. Applies easily from cutter-edge carton, strips clean. Get 39¢, 69¢, 98¢, \$1.69 sizes wherever paint is sold.

© 1956, Minnesota Mining & Mfg. Co., St. Paul 6, Minn.

PRODUCT OF  
**3M**  
RESEARCH

## FINISH CONCRETE OR MASONRY WALLS WITH WALLBOARD OR WOOD PANELS— *Do It Yourself* this easy, low-cost way!

Just attach *Gemco Anchor Nails* (16" apart) to walls with waterproof *Tuff-Bond Adhesive*. These will hold furring strips securely in place. Then nail wallboard or wood panels to furring strips... and the job is done. It's that simple! All you need is the *Gemco Anchor Nail Kit*... at better dealers everywhere. If your dealer cannot supply you, write...

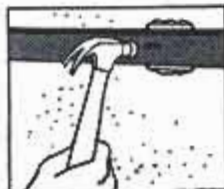
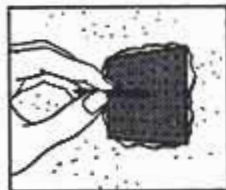

Goodloe E. Moore, Incorporated, Danville 2, Ill.

from a safety standpoint it is not good. It should be flattened and lowered.

The emergency brake is efficient, but requires considerable pressure to operate. The steering wheel is too close to the left front door. The column should be moved farther to the right. The key-switch starter is well located. Chevrolet sticks to the design that permits the key to be removed while the engine is running. This is necessary on cars that use single-key arrangement if the trunk is to be made theftproof in parking lots.

### Exhausts Below Bumper

I like the dual exhausts extending below the rear bumper and not through it. This keeps the bumper cleaner and there is less danger of soiling clothing as you walk past. The front bumper is impractical because of its pointed projections which may cause trouble when pushing a stalled car or parking in close quarters. The large parking lights in front are well located and seem well protected.

Gasoline mileage was good, considering that the power-pack Chevrolet has terrific acceleration and top speed. These, of course, reduce economy, but the public seems to want these features and is willing to accept less economy as a result. Premium gasoline is desirable, there being considerable pinging on regular gas. ★ ★ ★

## Attachment Permits Shaver To Be Run in Car

Electric shavers usually run on 115-volt house current can be operated in an automobile on current drawn from the car radio. One end of an attachment called "Radio-Shaver" is plugged into the socket of the rectifier tube of the radio. The shaver is plugged into a socket on the other end which is fastened to the dashboard. Once the attachment is installed, the tube is replaced so that the radio will operate normally. Installation of the attachment requires no soldering.

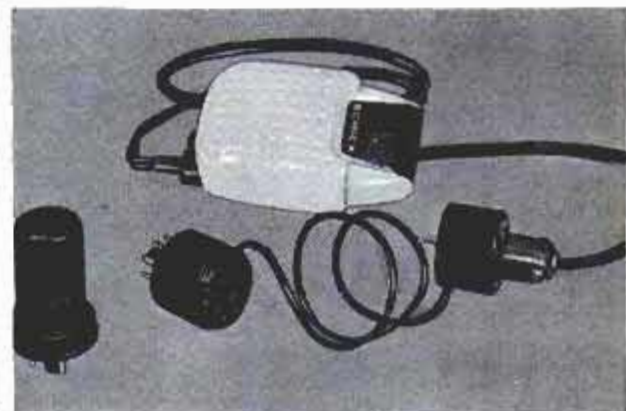



# With a Harley-Davidson **HUMMER** you can save up to **\$585** a year

on transportation to and from work!

If you're thinking of buying a car primarily for transportation to work, stop for a minute, check chart at right to see how much money you can save by getting a Harley-Davidson Hummer!

But in addition to savings in money, a Harley-Davidson Hummer saves time in traffic, ends your parking problems

And don't forget, a Hummer packs plenty of pleasure in every mile. Man, it's really invigorating to hit the road with your Hummer after a hard day's work.

See your nearby dealer today or write us for free literature. You'll be glad you did—money-wise, pleasure-wise.



## COMPARE THESE YEARLY COSTS

Based on \$7000 automobile and \$345 Hummer (avg. national price) Both machines purchased on one-third down payment.

AUTO		HUMMER	
Depreciation (25%)	\$500	Depreciation (25%)	\$ 87
Insurance*	120	Insurance*	100
Interest on loan	66	Interest on loan	14
License*	16	License*	5
Gas and oil (5200 miles annually, 15 miles per gal., 30¢ per gal.)		Gas and oil (5200 miles annually, 100 miles per gal., 30¢ per gal.)	20
Plus \$5 per year for oil	109		
	<b>\$811</b>		<b>\$226</b>

\*Based on average figures.

## HARLEY-DAVIDSON MOTOR CO.

DEPT. P • MILWAUKEE 1, WISCONSIN

### Find HIDDEN TREASURES

GOLD, SILVER, PRECIOUS METALS with the Famous Model 27 Metal Detector. Lightweight, ultra-sensitive, low cost. None finer. Also GEIGER COUNTERS for uranium and the VIOLITE for tungsten. INFORMATION FREE

THE **Detectron** CORP.  
5528 Vineland Ave., No. Hollywood, Calif.



### make your own **Gems** 32.50

The Gem Maker comes complete with all necessary equipment, including a super-charged diamond blade for sawing, and all wheels for grinding, shaping and polishing; also complete instructions. The complete equipment as shown, less motor and belt, for only \$32.50, f.o.b., Burlington, Wisconsin. Write today for information and literature.

**B & I MANUFACTURING CO.**  
Dept. P, Burlington, Wis.



SEND FOR  
**FREE CATALOG**



### Money-Making Tools!

It's easy to own the same "pay-off" tools used and endorsed by America's top-earning mechanics! You can start building your own kit with basic Snap-on sets—add others any time. Never sold in stores—direct to users only. Send today for free catalog!

Snap-on Tools Corporation  
8062-H 28th Ave., Kenosha, Wis.



SAY YOU SAW IT IN  
POPULAR MECHANICS

## SEAL YOUR TIRES AGAINST FLATS!



Now, you can give your present tires the puncture protection of premium priced tires — for only \$2.49

per tire! New Seal-A-Tube, a tried and proven fluid chemical compound, seals punctures as they happen — instantly, permanently. Easily inserted into your present tubes or tubeless tires through air-valve. Spreads a protective coating over entire inner surface. When nail penetrates, Seal-A-Tube immediately puts air-tight seal around it. When nail is removed, Seal-A-Tube instantly seals hole. Only \$9.96 for four-wheel puncture protection. Send check or Money Order today.



Satisfaction Guaranteed or Money Refunded

**Seal-a-tube** PRODUCTS, INC.

1268 Columbus Ave. • Boston 20, Mass.





## CUTTING PLIERS

- Cut Cleaner!
- Last Longer!

Hand Honed,  
Electrically  
Hardened  
Cutting Edges

Carefully heat treated for perfect cutting edges; powerful jaws and precision alignment. If you want good cutting pliers, buy P&C!

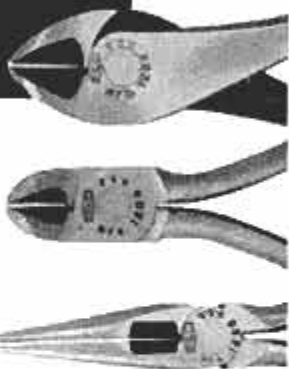

SHOP from P&C tool merchandisers, in more than 11,000 stores coast to coast. Send 10c for big tool catalog.



P&C . . . the best tools money can buy



**TOOL CO.**

Dept. H4, Box 5926  
PORTLAND 22, OREGON  
SCHILLER PARK, ILL.

## NEW! Giant AUTOMOTIVE CATALOG

1956 Edition! Everything for car, truck, custom-styled car, hot rod . . . at **LOWEST PRICES!**

**SAVE UP TO 50%** on all parts, accessories! Only complete automotive buying guide . . . 75,000 items . . . 180 pages! Thousands of **hard-to-find parts**; equipment, parts for 1920 to 1956 models; **Hollywood accessories** never before offered; **hi-speed parts**. Send your name and address and 25c (refundable with first \$5.00 order) to:

J. C. Whitney & Co. 1917 Archer, Dept. P-8, Chicago 16, Ill.



## POWER GALORE FROM TINY BATTERY-OPERATED MOTORS

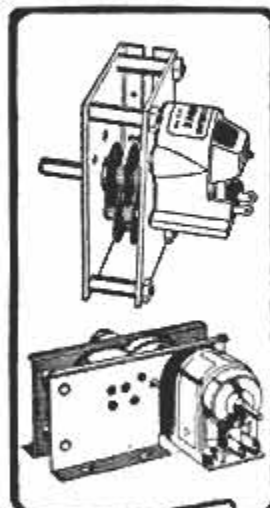

No. 1049 Gear Train with Hi-Drive Motor delivers high power at approx. 6 RPM on 3 volts—higher speeds on higher voltages. No. 3000 gives many speeds from 30 to 400 RPM. For hobby uses, research and small industrial devices. This list of quality motors and power kits may help solve a gift or technical problem for you.

- No. 8-100 Hi-Drive Motor, 3-6V. . . . . \$2.50
- No. 9-100 Same for 6-12V. . . . . \$3.00
- No. 3-100 Tiny Atom Motor, 1.5-3V. . . . . \$2.00
- For higher voltages. . . . . \$2.50
- No. 3113N Tiny Atom motor assembly kit with many acc. . . \$3.50
- No. 1300N Small accessories kit. \$1.00
- No. 3700 Large accessories kit. \$3.00
- No. 4000 DeLuxe accessories kit with motor. . . . . \$5.00
- No. 700 Super-Power kit with motor, speed reducer, all accessories. . . . . \$10.00
- No. 88 Kit of 8 pulleys—2 belts \$2.00
- \*No. 3000 Vari-speed gear unit. \$4.00
- \*No. 1049 Gear train with Hi-Drive motor No. 8-100. . . \$5.95
- Same with No. 9-100 Motor. . . \$6.45

\* Item illustrated. Ask for FREE Cat. All Wilson's motors have Permanent Alnico Magnets. Remit with order and we pay postage in U.S.A. No C.O.D. Add 3% Sales Tax for delivery in Ohio. Write Dept. PM.

For quick delivery see your local dealer — or order direct

**WILSON'S OF CLEVELAND**

425 Lakeside Ave., N.W. • Cleveland 13, Ohio

## Electronic Mixer For Home Recorder

(Continued from page 144)

pin numbers 3, 4 and 5 of the two 12AX7 tube sockets should be installed so that it is spaced about 1¼ in. below the chassis base. The filament lead from pin 9 of the first tube is wrapped around this bus before being connected to pin 9 of the second tube. Another lead from pin 9 of the second tube is again wound around the bus before being finally connected to lug 4 of TS1. This keeps the "hot" filament leads away from the chassis and prevents the induction of hum into critical grid and plate circuits.

The complete point-to-point wiring of all parts is shown in Fig 4. The "initial wiring" is repeated here to present an over-all wiring diagram. Although the parts in this diagram are shown in their approximate positions, they have been spread out in order to show each connecting point. The under-chassis photo in Fig. 5 will help you in the correct placement of the various resistors and capacitors. Be sure to observe polarity in wiring the tubular electrolytics C8 and C12. The 6.8-meg. grid resistors R2, R6 and R10 should be installed close to, but not touching the chassis.

### Cables

The mixer is connected to a recorder or amplifier with shielded cable. The cable should not exceed 6 ft. in length to prevent loss of high frequencies. Terminate each end of the cable with the type of plug required to fit the particular jack with which it is to be used. Prefabricated cables with various types of connectors on each end are commercially available from radio-parts houses.

### Operation—With Tape Recorder

Since the mixer provides a relatively high gain, the recorder may be operated at reduced-volume level where hum and noise are at a minimum. To set up the recorder for best results, turn up the volume control about halfway and record a few feet of tape with nothing connected to the recorder input. Play the tape back to see if there is excessive hum or hiss. If so, turn the volume down a little and repeat this process until tape reproduction is "quiet."

Now connect the mixer output to the recorder microphone input jack and connect a cable from your microphones, record player or radio to the proper mixer input jack. All volume adjustments to obtain

(Continued to page 224)



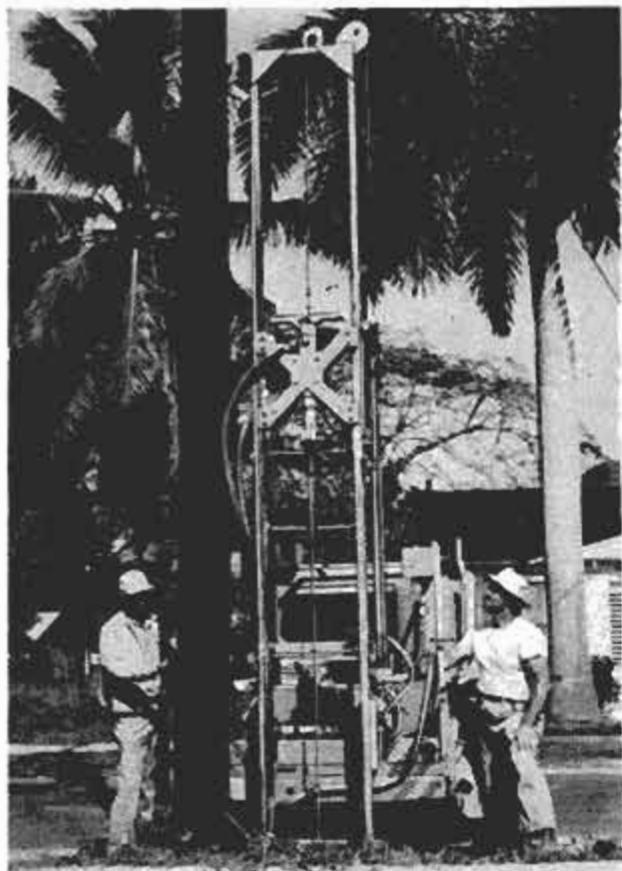

### Air Hammer Drives Ground Rod

Power-company workers in Florida are using a mobile air-hammer outfit mounted on the tail of a light truck to speed the setting of ground rods around transformer and transmission poles. The air hammer slides in a tall steel frame. The 10-foot copper-clad steel ground rod is held by spring-hinged guides as the descending hammer sinks it into the ground. Additional rods may be coupled to the first rod to extend the rod to 20 feet or more. Hydraulic power from the truck's power take-off raises the guiding frame from its horizontal carrying position and lifts the hammer into operating position.

### Vaccine for Pneumonia And Grippe

Army scientists have developed a successful vaccine against the pneumonias, grippe and certain other acute respiratory diseases. Trials with the vaccine at Fort Dix, N. J., have cut the number of such cases by more than 80 percent. The viruses against which the vaccine protects cause more than half of all hospitalized cases of respiratory disease in military recruit-training camps. The vaccine, developed with killed viruses, reaches maximum effectiveness within one week, enabling doctors to stop training-camp epidemics before they really get started.



"It's the plus that sold me on  
**TWINSULATION**  
—rock wool plus reflective aluminum"

"TWINSULATION gives me the advantages of *two* insulations. It's made of thick blankets of rock wool wrapped completely with an aluminum covering. Rock wool, with its millions of insulating air cells, blocks the passage of heat. The shiny aluminum surface reflects the heat of the sun's rays in summer and helps retain household heat during the winter.

"Because of this *combination* of materials, TWINSULATION cuts winter fuel bills up to 25%... lowers summer house temperatures as much as 15°.

"TWINSULATION® blankets are firm and easy to handle. To install, just tuck them between studs and rafters, and staple the edges. Your Gold Bond® dealer can supply all the materials you need. See him soon."

SEND FOR  
ILLUSTRATED  
BOOKLET

**Gold Bond**

BUILDING PRODUCTS



National Gypsum Company, Dept. PM86, Buffalo 2, N. Y.  
Please send me a copy of the booklet "Home Insulation," that tells all about Gold Bond TWINSULATION... what it will do for my home, how it will cut my fuel bills. I enclose 10¢ to cover costs.

Name \_\_\_\_\_

Address \_\_\_\_\_

City \_\_\_\_\_ Zone \_\_\_\_\_

County \_\_\_\_\_ State \_\_\_\_\_



## MAKE YOUR KITCHEN COOL AND ATTRACTIVE



### VENTILATING HOOD BY TRADE-WIND

Easily installed in a wood or metal cabinet over your stove. Choose one of the three powerful Trade-Wind Ventilators to exhaust all heat, cooking odors and grease. Hood is made of genuine copper laminated to steel. Rich antique finish. 30", 36", 39", 42", 48" lengths available. Ask your electric dealer or mail coupon today.

Trade-Wind Motorfans, Inc.

7755 Paramount Blvd., Dept. PM, Rivera, Calif.

Please send information and prices on the Salem Ventilating Hood.

Name \_\_\_\_\_

Address \_\_\_\_\_

### MONEY for MEN ALL FREE

THE PLASTEX Industry needs manufacturers on small scale and for big production of Lamp and Clock Stands, Art Goods and Novelties in Plastex and Marble imitation. Experience unnecessary. Eye material makes regular 10¢ store sellers. Rubber moulds furnished for speed production. Small investment brings good returns. We are now placing big Chain Store Orders with manufacturers. Ambitious men have chance for real prosperity. Our Free booklet will interest and benefit you.

**PLASTEX INDUSTRIES, Dept. A**  
3400 Third Ave. New York 56, N. Y.



... 5-HP Gravely Tractor does every lawn, garden, field job easier, better! All-gear Drive, Power Reverse. New "Power vs Drudgery" Booklet FREE! Write today... and ask about the NEW EASY PAY PLAN.

(Push-button Starter Optional Equipment)

**GRAVELLY**  
BOX 863 DUNBAR, W. VA.  
FIELD-TESTED FOR 34 YEARS

the correct recording level are made with the mixer controls. When recording from a radio, the signal is taken from across the speaker voice coil and the volume is adjusted with the radio volume control, since no separate mixer control is provided for this function.

Unless a recording-level indicator or some other type of monitor is used, you may have to experiment a bit to determine what volume-control settings will provide the best mixing action. But, with a little practice, you will soon be able to obtain the desired effects.

#### Operation—With Audio Amplifier

To operate the mixer with a low-gain amplifier, as a PA system, connect a cable between the monitor jack and the phono input of the amplifier. The signal voltage at this jack is approximately two volts, operating into a high-impedance load. This is more than enough to drive any amplifier to its full rated power output. For high-gain amplifiers, the signal is taken from the regular output jack of the mixer and fed to the microphone input of the amplifier.

#### Operating Suggestions

If the mixer introduces excessive hum, reverse the line-cord plug of the mixer and recorder, one at the time, to find the combination which reduces hum to a minimum. Connecting a wire from the mixer case to a cold-water pipe or similarly grounded metal object may reduce hum by as much as 10 db.

If hum persists, check for a poor or missing ground connection. Try new 12AX7 tubes. Make sure that the phono plugs are making good contact with the grounded shells of the input jacks. Reverse leads to speaker voice coil if hum occurs while recording from radio.

While using the mixer, turn the volume controls of any unused channel fully counterclockwise.

The magnetic phono and mike 1 inputs cannot be used simultaneously. Make sure that the front-panel selector switch is in the correct position when recording from either of these. ★ ★ ★

#### CORRECTION

Our May article on speaker enclosures states that the "Klipschorn" is available in kit form. Actually, only the Klipsch-designed "Shorthorn" can be purchased as a kit. The authentic reproduction for which the "Klipschorn" is famous can be obtained only from a factory-assembled model.



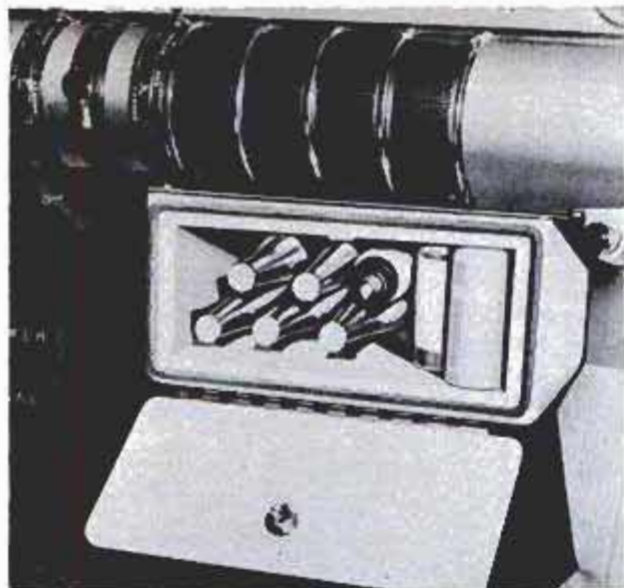

### Car Refrigerator Fits Under Dash

Easier to install than a car radio, a mechanical refrigerator mounts under the center of the dashboard. In it, the motorist can keep beverages and perishables cool as he drives. It is excellent for families traveling with bottle-fed babies. The refrigerator operates on power provided by vacuum from the manifold, according to the manufacturer. Gasoline from the fuel tank is used as the refrigerant and is piped into the carburetor after use. The price of the unit is around \$90.

### Self-Tightening Electric Plug

You can wire a new type of electric plug in a few seconds without the use of tools. The cord is pushed through a top slot and out a side slot. The free end of the cord is then pushed down on top of a copper prong that furnishes the contact. Any pull on the cord simply tightens the contact. The plug keeps the cord close against the wall to prevent it from being yanked out accidentally. Its spring prongs fit tightly into the outlet and finger grips aid in inserting or disconnecting the plug.

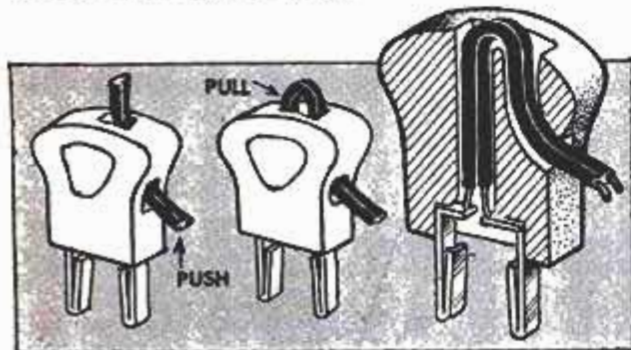

At 60 miles per hour about 60 barrels of water are circulated through the radiator of the average car every hour.

## Easy Way To Make PERMANENT CONCRETE REPAIRS



Get Weld-Crete . . . the amazing, liquid bonding agent which enables you to permanently bond new concrete . . . or cement topping . . . directly to old concrete. Eliminates need for chipping, drilling, roughening, scarifying of old concrete base. Ideal for permanently repairing concrete floors, steps, walls, driveways, curbs, sidewalks, ceilings. Weld-Crete also permanently bonds new concrete directly to brick, wood, masonite, gypsum board, concrete block, metal, ceramic tile . . . even glass! Job-proved for over 8 years. Specified by leading architects and contractors because they know a Weld-Crete bond is ageless . . . never lets go! Tensile strength over 660 lbs. per sq. inch. Shear strength about 400 lbs. per sq. inch. Apply to old surface with brush or spray gun. Then finish off with new concrete or cement topping. Covers 250-400 sq. ft. per gallon depending on surface conditions.

If your building supply or hardware dealer doesn't have Weld-Crete, write for literature . . . or send check or money order for "Get Acquainted" Trial Quart. Only \$3.49 postage prepaid. Address Larsen Products Corporation, 4939 Elm St. Bethesda, Md.

## Say You Saw It in Popular Mechanics

Superior's New Streamlined Model TC-55

# TUBE TESTER



QUICKLY AND EFFICIENTLY TESTS RADIO AND TV TUBES INCLUDING: SEVEN PIN MINIATURES; EIGHT PIN SUBMINIARS, OCTALS AND LOCTALS; NINE PIN NOVALS

**YOU CAN'T INSERT A TUBE IN THE WRONG SOCKET.**

It is impossible to insert the tube in the wrong socket when using the new Model TC-55. Separate sockets are used, one for each type of tube base. If the tube fits in the socket it can be tested.

**"FREE-POINT" ELEMENT SWITCHING SYSTEM.**

The Model TC-55 incorporates a newly designed element selector switch system which reduces the possibility of obsolescence to an

absolute minimum. Any pin may be used as a filament pin and the voltage applied between that pin and any other pin, or even the "top-cap."

**CHECKS FOR SHORTS AND LEAKAGES BETWEEN ALL ELEMENTS.** The Model TC-55 provides a super sensitive method of checking for shorts and leakages up to 5 Megohms between any and all of the terminals.

**ELEMENTAL SWITCHES ARE NUMBERED IN STRICT ACCORDANCE WITH R.M.A. SPECIFICATION.**

One of the most important improvements, we believe, is the fact that the 4 position fast-action snap switches are all numbered in exact accordance with the standard R.M.A. numbering system. Thus, if the element terminating in pin No. 7 of a tube is under test, button No. 7 is used for that test.

The Model TC-55 comes complete with operating instructions and charts. Use it on the bench—use it for field work. A streamlined carrying case, included at no extra charge, accommodates the tester and book of instructions.

**26<sup>95</sup>** F.O.B. N.Y.C.

**SHIPPED ON APPROVAL NO MONEY WITH ORDER — NO C.O.D.**

Try it for 10 days before you buy. If completely satisfied then send \$6.95 and pay balance at rate of \$3.00 per month for 4 months — **No Interest or Finance Charge Added.** If not completely satisfied, return to us, no explanation necessary.

MOSS ELECTRONIC DIST. CO., INC. Dept. D-258, 3849 Tenth Ave., N. Y. 34, N. Y.

Please rush one Model TC-55. If satisfactory I agree to pay \$6.95 within 10 days and balance at rate of \$3 per month. If not satisfactory, I may return for cancellation of account.

Name .....  
Address .....  
City ..... Zone ..... State .....



# GET UP AND GO WITH A TRIUMPH

## FUN! INDEPENDENCE! ECONOMY!

Go where you want to go; do what you want to do. Be independent. Have more fun! Enjoy the thrill of motorcycling at its BEST with a gleaming, precision-made Triumph! Easy to ride . . . exciting to own . . . real economy, too—60 to 90 miles and up per gallon. Triumph's two-level cushion seat means real comfort for two! Priced surprisingly low, with easy terms available. See your nearest Triumph dealer for a free demonstration. He will teach you to ride.



RUSH THIS COUPON to nearest address below. Dept. P  
**THE TRIUMPH CORP.**      **JOHNSON MOTORS, INC.**  
 Towson, Baltimore 4, Maryland      267 W. Colorado St.  
    Pasadena 1, Calif.

Send me absolutely FREE the 1956 Triumph Motorcycle catalogue in full color. If under 16 years of age, check square for special pictures.

NAME \_\_\_\_\_  
 ADDRESS \_\_\_\_\_ PHONE \_\_\_\_\_

## NOW-SHOPSMITH® for as little as \$3 per week

Start enjoying SHOPSMITH now for only \$29 down, \$3 weekly. Start saving now! Savings on projects and home repairs can more than equal weekly payments. See your hardware dealer or Montgomery Ward store. Write for 2 big, free, illustrated books. SHOPSMITH, Dept. 324-B, Menlo Park, Cal., or Box 2808, Ft. Wayne, Ind.

## MORE \$\$\$ PER HOUR WITH MODERN IMPROVED LAWMOWER SHARPENER



Write for free booklet 10A

Compare Before You Buy

NO CHANGE IN PRICE FOR OVER 10 YRS

**\$263.00** Complete with 1/2 H.P. Motor  
 f.o.b. Pasadena, Calif.

**MODERN MFG. CO.**

160 N. FAIR OAKS, PASADENA, CALIF.

Grinds All Reel Type Mowers  
 Hollow Grinds or Flat Grinds Bed Knives

Engine, oil, or gasoline are not removed from power mowers. Wheels, handle and roller remain in place. Modern's precision grinding assures repeat business. 100% Steel Construction

Faster—Easier to operate

## Around the World in 80 Days

(Continued from page 69)

George Raft and Joe E. Brown, to name only a few. Some of the stars are on the screen for only a few moments and you catch only fleeting glimpses of them.

The Todd players traveled to England, Spain, India and Japan to shoot portions of the picture, but most of the special effects were created in Hollywood or near Durango, Colo., where some of the highlights of the race across the United States were recorded.

Part of this journey had to be undertaken on a sailmobile improvised from a wagon that was made to travel along a railroad track. The vehicle looks like a wagon with a sail, to be sure, but it was built around a motor handcar. The picture company couldn't afford to wait for a stiff wind. Glass fiber and plastic were used to shape a sail that appears to be bellied by the wind.

In Colorado, Lee Zavitz had the job of finding a way to photograph, close-up, the thrilling ride of a bareback rider who was dashing through a forest. With the 140-degree bug-eye camera this promised to be a spectacular sequence on the screen.

### Invisible Saddle

Zavitz built a tiny saddle for the horse, invisible to the camera, and attached a pair of shafts to it forward of the rider's legs. The shafts went straight toward the ground, then trailed to the rear where they were attached to the wheeled dolly that carried the camera. The horse actually tows the camera. The audience gets all the thrills of a wild ride through the woods.

Stunts like that are easy. The big special effect that called for lots of study and weeks of preparation was the building and wrecking of a miniature railroad trestle. In Colorado the film company made full-scale scenes of the locomotive and old-fashioned cars of a narrow-gauge railroad that is still operating. The story called for the train to make a dash across a trestle that had been weakened by a raging river below it. The 100-foot-tall trestle was to collapse just as the train safely cleared it.

The trestle is part of an existing railroad and couldn't be wrecked, so the scene was filmed in Hollywood.

First the mountain background had to be matched on a scale of about two inches to the foot. A small canyon in the Hollywood hills, literally a gully, was reshaped to conform to the appearance of the Rockies. A forest of miniature trees, each consisting of a stalk from the desert yucca bush drilled to accept juniper branches,

(Continued to page 228)



## SAVE MONEY ON YOUR COMPRESSED AIR



buy this complete  
SMITH 45-P air compressor

Right for spray painters, plumbers, contractors, monument shops, tire changing trucks, maintenance shops, quarries, utilities, many other users. Delivers 45 plus cu. ft. per minute; pressure up to 150 PSI. Powered by Wisconsin 4-cyl. air-cooled engine; uses less than 1 gal. gasoline an hour! Most compact, biggest-value compressor for its capacity anywhere! Other models to 230 cfm.

write for  
**FREE**  
brochure

**GORDON SMITH & COMPANY, Inc.**  
411 College Street, Bowling Green, Ky.

## CAR BURNING OIL?

Oil consumption reduced, compression improved by this simple treatment which forms self-lubricating seal at piston top. Gives new car performance up to 10,000 miles. Installed through spark plug holes.

**\$4.95** tube, most cars.



Prices in Canada Slightly Higher  
**HOLT'S Piston Seal** Cylinder Compound  
See Your Neighborhood Auto Accessory and Parts Replacement Store, or Write for Full Details  
**TREGLOWN CO., INC., FANWOOD 92, N. J.**  
CANADA: Treglown, Ltd., 1386 Greene Ave., Montreal 6

**YIPEE - A SAWHORSE IN A Jiffy**

Jiffy Brackets and 2x4s are all you need. Set up and knocked down in a jiffy—no nails, screws, or bolts required. Easy to move or store. Sold by hardware and building supply stores everywhere, or order direct.

GRAND HAVEN STAMPED PRODUCTS CO., Grand Haven, Mich.

**BUILD FINE GRANDFATHER CLOCK NOW**

The simple sensible Red-i-Kut way as thousands have — SAVE HALF. SHOP TESTED PLANS "SPIRIT OF THE CENTURY" Narrow waist 83" tall or stately straight side "SPIRIT OF AMERICA." EASY-TO-FOLLOW photograph PLANS tell all—plus BROCHURE of heavy brass weight Westminster, tube chime, movements, gorgeous bronze-silver dials, 3/4" solid mahogany case kits. Send \$1.00 today—Both plans \$1.50 NOW.

Kuempel Chime Clock Works, 28 Kuempel Bldg., Minneapolis 16, Minn.

Works in seconds!

**Loosens Rusted Bolts**  
nuts, screws, "frozen" parts!

**LIQUID WRENCH**

AT HARDWARE STORES, GARAGES  
SERVICE STATIONS EVERYWHERE

For information write manufacturer  
Radiator Specialty Co., Charlotte, N. C.

**"DO IT YOURSELF"**  
IT'S EASY WITH  
**KESTER SOLDER**

Soldering's really a "cinch"... when you use time-tested, reliable KESTER... available everywhere.

FREE! "Soldering Simplified"... 16-page how-to-solder booklet. At your dealer or write direct.

**KESTER SOLDER COMPANY**  
4251 Wrightwood Avenue Chicago 39, Illinois

## How to fit a boy and his hobbies into your attic



**Build it for \$13<sup>00</sup> a month\***  
with Gold Bond Products

It's easy to add a room with Gold Bond Building Products, because they're designed to work together.

Take this attic room, for example. To keep it snug and warm in winter (and up to 15° cooler in summer) line it with Gold Bond TWINSULATION®. (Staple blankets between studs and rafters.) For a good-looking, sound-absorbent ceiling, nail or staple up Gold Bond Insulation Tiles (interlocking edges hide fasteners). For walls, use big, sturdy panels of Gold Bond Gypsum Wallboard. Conceal joints with Gold Bond's Tape Joint System. Then, finish the whole room off in a day with quick-drying Gold Bond® Velvet... the washable latex paint.

See your Gold Bond dealer today for all the materials you need.

\*COST BASED ON MATERIALS ONLY SPREAD OVER 36 MONTHS.  
PRICES VARY SLIGHTLY IN SOME LOCALITIES.

SEND FOR  
ILLUSTRATED  
BOOK

**Gold Bond**  
BUILDING PRODUCTS



National Gypsum Company, Dept. PM86  
Buffalo 2, New York

Please send Gold Bond's "How-to-Do-It" Plan #19 with step-by-step directions for building an attic room. Enclosed is 10¢ to cover mailing.

Name \_\_\_\_\_  
Street \_\_\_\_\_  
City \_\_\_\_\_ Zone \_\_\_\_\_  
County \_\_\_\_\_ State \_\_\_\_\_



**THE ORIGINAL PACKAGED BOAT KITS**

Made ONLY by *Custom-Craft*

Top Performance, Design, Styling! Over 70 Models 8 to 21 ft

World's largest line! Over 200 Boats: Kits, Formed-Hulls, Semi & Custom-Finished! All types: Prams -Cruisers! Easy to build! Flying Stern, Tredonic bottom, Bulkhead construction.

**Send 25¢ for KIT CATALOG**

52 pages! Includes Victory Series, hardware, paint accessories, Fiberglass! Send \$1.00 for Catalog Plus "Boating Handbook". DEALERS-AGENTS INQUIRE

**BOAT PLANS & PATTERNS Frame-Pac Kits**

World's largest selection: over 200 plans, full-size patterns, frame-pac kits! Designed strictly for amateurs! All types: prams, kayaks, racers, runabouts, catamarans, houseboats, cruisers - inboard-outboard 8-40" wood-plywood-steel!

**Send 25¢ for PLAN CATALOG**

Catalog PLUS "Boatbuilding Handbook" \$1.00

DEPT. PM CUSTOM-CRAFT - BUFFALO 7, N.Y.

There's a **Katolight**

**ELECTRIC PLANT**

for every portable or standby power need.



● COMMERCIAL ● FARM  
 ● HOSPITAL ● HOME

Katolight Portable Power Plants give you electric power anywhere - anytime. Standby Plants permit uninterrupted operation of all electrical equipment despite power failure. Extra high overload capacity, long life, dependability. Full line from 350 Watts to 75 KW and larger.

WRITE FOR NEW FOLDER KATOLIGHT CORPORATION, Box 891-22 Mankato, Minn.



**MENDS MOST ANYTHING**

"HOLDS LIKE IRON"

Used by fine furniture makers. Ideal for home and office. In ¼ oz. or 2½ oz. sizes.

**Automatic Saw Set...**

**MAKE EXTRA PROFITS!**

Set 400 teeth per minute on hand or band saws, 4 to 16 point, with the BeMaCo Automatic Saw Set. Fast, accurate, true hammer-anvil action sets teeth uniformly, eliminates tooth breakage. Used profitably by saw shops and manufacturers everywhere. Every machine positively guaranteed!

Write for details - today!



Saw Machine Division 23-C

**BEAVER MFG. CO.**

800 ISIS AVENUE • INGLEWOOD, CALIF.

dressed up the mountainsides. The rocky gorge and the rushing river at its bottom were matched by using photographs of the actual scene as guides.

There's more to creating a realistic river in flood stage than you might think, even in miniature. One of the problems is the sheer volume of water required. This was solved by storing all the water in a small reservoir and in a number of huge dump tanks, all upstream out of camera range. When the water was released into the river a satisfactory flood came pouring downstream.

### Water Pipes Add Swirls

But the torrent didn't have the swirling white crests and the swift treacherous currents of an actual river in flood, so these were added artificially. Water pipes were laid in the river bed with spray heads attached to provide swirls of current.

Lee Zavitz explains that building the miniature trestle was easy, but engineering it so that it would collapse at the right time and in the right manner took a lot of thought. The trestle was built of wood, each small stick representing an actual timber in the real structure. Construction details had to be perfect. A flaw such as a hammer mark around a nail would be magnified to the size of a basketball on the screen, giving away the whole scene.

### Pipe Collapses Trestle

"After the trestle was built we placed a four-inch pipe across its bottom, extending from one side of the river to the other," Zavitz says. "The pipe was hidden by the water. Then we ran concealed cables from various parts of the trestle down to the pipe and attached them at different points. Thus, when the pipe was rotated by a motor the cables wound around it. The cables tightened one at a time and successively brought down different portions of the trestle. The whole collapse had to occur in just the same way that an actual trestle would weaken and fall."

The scaled-down train used in the scene was a modern miniature that was rebuilt to match the actual train used in Colorado. Such details as the engine cab, stack, headlight and whistle were all reproduced exactly. Batteries were used for interior lighting. The engine had its own boiler and produced its own steam. Black smoke for the stack came from a smoke cartridge.

"It would have been simple to send the train across the trestle under its own power," Zavitz remarks, "and we might have done this if the story called for the train to run off the trestle and crash in the river. But the running of the train and

(Continued to page 230)



# IDEAS FROM WELDWOOD

## THIS MONTH'S PROJECT—POWER SHOP WORKBENCH



It's a workbench, shop cabinet and power tool table, all in one. Designed by the DeWalt Power Tool people, for use with the DeWalt radial-arm power shop, this handsome bench is also adaptable to other power equipment, or to a plain work surface-storage cabinet. (See coupon for free plans.)

To be sure of sound, sturdy construction; DeWalt specifies Weldwood Products for this project. Weldwood Fir Plywood is used for sides, bottom and doors, while Weldwood Perwood is used on the back to hold extra blades, grinding wheels, etc. And this workbench will take a lot of wear and tear because

the work surface is Weldwood Duraply®—the plywood with the special tough overlay that's twice as wear-resistant as ordinary plywood. Duraply's supersmooth surface also assures you of no splinters, virtually no checking, and better painting qualities.

### This Month's Hints

**Leaky cellar doors?** If your cellar is constantly wet because rain leaks through battered cellar doors, replace the doors with panels of  $\frac{3}{4}$ " Duraply®. A Duraply panel has no cracks or seams so water can't leak through . . . and Duraply is weather-proof, too. You'll find that Duraply's supersmooth surface makes painting easier. E. G., Lynn, Massachusetts.

Got a table, TV set or bench with a worn, scratched top? Here's how to fix it up like new. Get a  $\frac{1}{8}$ " thick piece of Weldwood Plywood (birch, oak, or any other wood); cut to proper size and glue on as a new top with Weldwood Contact Cement. Then you can paint, or finish natural. To conceal plywood edges, edge the furniture with new Weldwood Flexible Wood Trim. C. F., Van Dyke, Michigan.

**Traveling fun.** Take a square of Weldwood Plywood—about  $6\frac{1}{2}$ " x  $6\frac{1}{2}$ "—drill holes in it about  $\frac{3}{4}$ "

### THE WELDWOOD QUESTION BOX

**Q.** After installing Weldwood Paneling, I've got some odd-sized scrap pieces left over. What can I do with them?

**A.** If you have pieces of different species and of the same thickness, you can make interesting bread and cake boards.

Bond strips together with Weldwood Resorcinal Glue . . . let it set . . . when dry, finish with 2 coats of Satinlac®. These decorative, mosaic-like boards will last and last, and are definitely a conversation piece. Your own imagination is the only limit on how attractive you can make them.

**HAVE A QUESTION?** Send it to "The Weldwood Question Box," 55 West 44th St., New York 36, N. Y.

apart and you have the beginning of a nonslip checkerboard to use while traveling. Checkers can be made of dowels cut to about 1" length. T. P., Albany, New York.

#### \$10 FOR YOUR IDEAS

for "This Month's Hints," if accepted for publication. (Hints must apply to some Weldwood product.) Send them to "Weldwood Hint Editor," 55 West 44th St., New York 36, N. Y.



## Weldwood®

A product of

**United States Plywood Corporation**

*Weldwood—The Best Known Name in Plywood*

United States Plywood Corporation  
P. O. Box 540, Lancaster, Pa.

PM 8-56

Please send me FREE plans, detailed drawing and material list for the DeWalt Power Shop Cabinet.

NAME.....

ADDRESS.....

CITY.....STATE.....



# it's NEW! it's ALL IN ONE LEVEL · SQUARE · TAPE

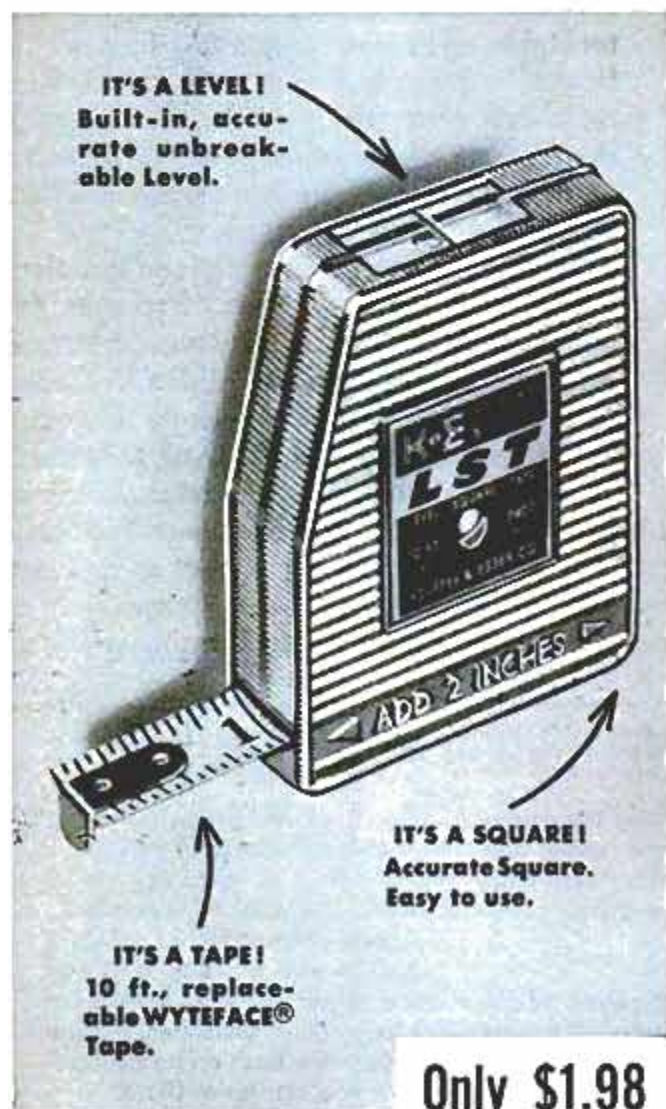

Only \$1.98

at your hardware store

## with all these features

- Sliding end hook for accurate inside and outside measurements.
- Rugged die-cast construction.
- Long-wearing chrome plated finish.

Made by K&E, manufacturer of fine engineering instruments!



**KEUFFEL & ESSER CO.**  
Hoboken, N. J.

collapse of the trestle had to be timed to a fraction of a second. Nothing could be left to chance. There could be no trial runs, no rehearsals.

"So the train was dragged across the trestle by a cable you don't see on the screen. It was hidden between the rails at the top of the trestle. The cable was attached to a winch that was geared to move the train at a speed of five feet per second. That way we dovetailed its run with that of the motor that turned the pipe to wreck the structure."

The scene went off exactly as planned, with the train rushing across the trestle which collapsed immediately behind it. The effect cost all of \$40,000 to create and lasts about half a minute on the screen. It was worth it. Todd defies any readers to find one flaw in the scene that would reveal it as a miniature. ★ ★ ★

## Lawn Drinking Fountain

Hot, thirsty kids are encouraged to drink more water—outside—by a drinking fountain connected to the garden-hose hydrant. A special sill cock provides two outlets so that the hose need not be detached. Six feet of supply line permit placing the fountain away from shrubs or flower beds. The nylon valve is easily operated by the smallest youngster. The fountain has an aluminum stand, plastic bowl and a movable drain line that can be used to water flowers.





For your Ford—always specify the carburetor with the

# THRIFTY FLOW

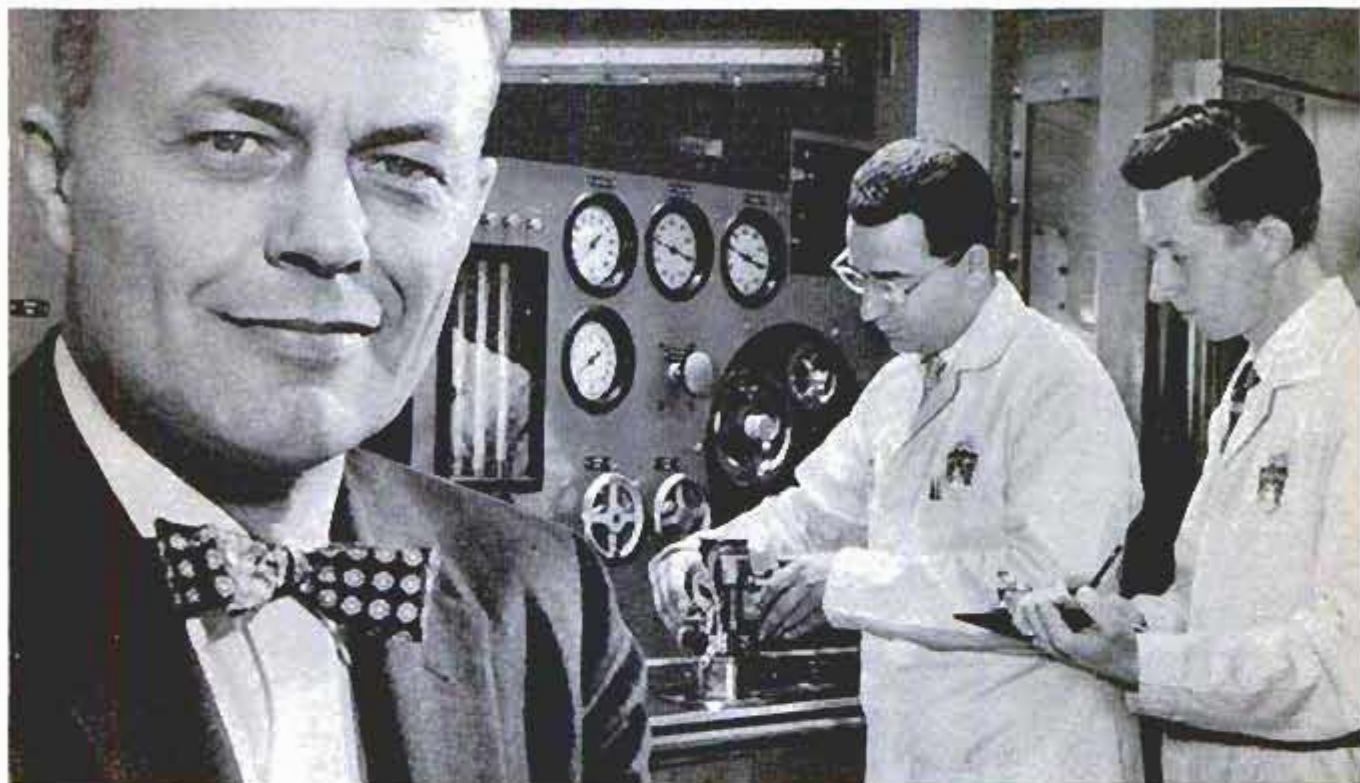

"Genuine Ford Carburetors are inspected before assembly and 100% flow-checked (above) after assembly," says Paul Clayton, Ford's Executive Engine Engineer. "Duplicating the flow of fuel and air to your engine from idle to high, this check makes sure the carburetor delivers to your engine *no more gas than necessary* for top performance. You can be sure of a thrifty flow when you specify a *Genuine Ford* carburetor."

***All Genuine Ford Parts are made right to save you money and trouble!***

Every Genuine Ford Part—be it a carburetor, oil filter, battery or spark plug—is made to the same rigid specifications as the original part that it's replacing. Specifications set by the *same* men who originally built your car. That's why, when *any* replacement will add to your Ford's performance, it pays to specify "Genuine Ford Parts."



Keep your Ford all Ford

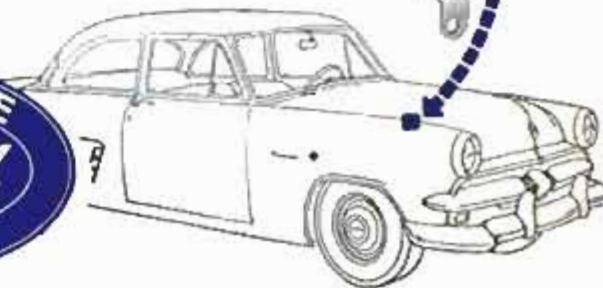



**MAKE YOUR OWN  
BOLTS, BRACES,  
HANGERS!**



**REDI-BOLT®  
THREADED STEEL RODS**

Save repair and construction time. Just cut to length; heat and bend; add std. nuts. Seven sizes: 1/4", 5/16", 3/8", 7/16", 1/2", 5/8", and 3/4". Handy lengths of 24" and 36". Available in galvanized or blue rust-resistant finish.

Sold in Leading Hardware Stores

**REDI-BOLT, Inc.**

5330 Indianapolis Blvd., East Chicago, Indiana



MARCO 14  
\$189.50 Delivered

WRITE FOR FREE FOLDER

Marine ASSOCIATES  
BOX 618 W. LONG BEACH 11, CALIF.

**Marine KIT BOATS-DO IT YOURSELF-SAVE 50%**

8' to 14' models, factory to you, no dealers, mahogany decks and framework, all brass fastenings. 14' hull kits as low as \$129.50 including freight charges. CATALOG 35c includes Kits, Hardware, Trailers, Fiberglass.

**HONEST  
CONSTRUCTION**



Honest value has been built into every Gerstner Chest for 50 years. Send for Free Catalog.

**GERSTNER TOOL CHESTS**  
456 Columbia St., Dayton 7, Ohio

**\$3 to \$5 an hour  
IN SPARE TIME**

**WITH NEW FOLEY  
PRECISION GRINDER**

Make \$3 to \$5 an hour in your own spare time business. Low cost machine sharpens circular saws, rotary mower blades, ice shaves, doors sanding, polishing, buffing. Easy to operate—no experience needed. Send coupon today for Free circular. No salesman will call.

**FOLEY MFG. COMPANY**  
873-6 Foley Bldg.  
Minneapolis 18, Minn.

Send Free Circular on Foley Precision Grinder.

Name \_\_\_\_\_

Address \_\_\_\_\_

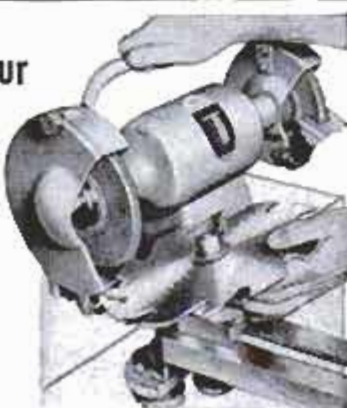

**Tiremakers Race Against  
Turnpike Speeds**

(Continued from page 81)

**Wire tires:** The use of wire in tire construction isn't new; it's been done in Europe for years, and Firestone in this country has been making wire-reinforced tires for use on buses and trucks since 1943. But during the past year "wired" tires caused a stir as U. S. Rubber brought out its wire-shielded tire. This is a tubeless tire with a fine screen of wire mesh embedded in the casing between the tread rubber and the cord. The wire strengthens the tire, increases its resistance to cuts and makes it rupture-proof. Chief difference between U. S. Rubber's wire tire and others is that others use wire in the cord in the sidewall. Such tires must be carefully watched to see that pressure is kept up, for any running at low pressures will flex the wires in the sidewall to the breaking point, ruining the tire. By putting it only in the tread, U. S. Rubber solved this problem and produced a rugged, safe tire.

**High-performance tires:** Developed originally for use on sports cars and during races, high-performance tires are getting more attention now because of the high-speed driving problem in the years ahead. These tires are engineered to run better and cooler at sustained high speeds—with less emphasis on comfort. They have nylon cords, special compounds in the cord body to give adhesion between plies and between tread and casing, and tread patterns to distribute the weight better at high speeds.

Tire engineers say that original-equipment tires in recent years have improved high-speed characteristics, so they will have long lives at speeds driven by most motorists. They also say that if you drive a late-model car at high speeds regularly, it would be wise to consider equipping your car with high-performance tires.

There was a time when a motorist planning a trip of several hundred miles allowed for two or three stops for tire repairs. Last year, the American Automobile Association estimates, out of 60,000,000 cars on the road, 12,000,000 stops were made for tire troubles—in other words, one motorist in five had difficulty. Each year this figure gets better, in spite of tougher driving conditions, so the tiremakers are staying ahead in their race against speed. But to maintain that lead, they have to burn the midnight oil, because the turnpikes are coming up fast. ★ ★ ★

☐ Baghdad, Iraq, is the site of the first television station in the Middle East.



## GROBAN FOUR-WAY OPEN CENTER HYDRAULIC CONTROL VALVE

ITEM #126—Four-way open center control valve, with built-in adjustable relief valve factory set at 1000 P.S.I. Spring loaded neutral position. For use with one double acting cylinder. In neutral position cylinder is locked and pump unloaded. Can be used as single unit or mounted in series. Has 3/4" pipe thread inlet and outlet, 1/2" pipe thread cylinder ports. Finger grip handle. Ship. wt. 10 1/2 lbs. AN OUTSTANDING BUY!

F.O.B. Chicago **21.50**

## HYDRAULIC LIFT CYLINDERS

• For Fork Lift Trucks • For Presses • Loading Ramps • Lifts 12500 lbs. Heavy duty hydraulic cylinders, at big savings.

ITEM #502—4" Bore—36" Stroke—134" Piston Rod. Wt. 95 lbs. F.O.B. Chicago..... **72.00**

ITEM #503—4" Bore—34" Stroke—134" Piston Rod. Wt. 135 lbs. F.O.B. Chicago..... **96.00**



## HOBART 2 H.P. D.C. ELECTRIC MOTOR

ITEM #315—Rated 24 volts, 90 amps, 4000 R.P.M. Has 1/2" spline shaft on both ends of motor. Ball bearing construction, as specified for use with electric wheelchair design Popular Mechanics March issue, 1953. Convertible for use on 6 to 12 volts. Shipping Wt. 21 lbs. Dimensions: 11" x 5" x 6 1/2". F.O.B. Chicago..... **13.00**



ORDER DIRECT FROM AD SATISFACTION GUARANTEED  
Send Payment Or Purchase Order Today  
For Phone Orders call Webster 9-3793

**FREE!—NEW CATALOG**  
1956 EDITION, 56 PAGES, chock-full of unsurpassed War Surplus Equipment Bargains for farm, home, factory, workshop. Write letter today.

## SHOP BY MAIL and SAVE at GROBAN'S

### FACTORY-TO-YOU-VALUE PORTABLE ELECTRIC LIGHT PLANTS

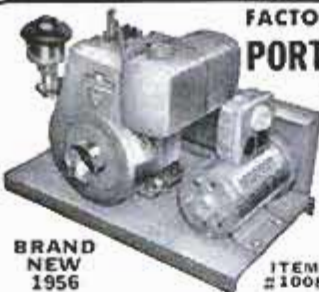

BRAND NEW 1956

ITEM #1008

#### POWER TO OPERATE:

- Electric Saw, Electric Drills, Pipe Bender.
- Refrigerator, Deep Freezer, Incubator.
- Water Pump, Radio, Lights, Air-conditioner.

COMPACT—FITS IN THE TRUNK OF YOUR CAR  
**1000 WATTS OUTPUT**, continuous duty. 115 Volts A.C. 60 cycles, 9 amps. Powered by husky, easy starting Clinton engine. Engine and generator operate at 3600 R.P.M. for maximum efficiency at minimum weight. Both units are mounted on steel base, with heavy sheet metal belt guard. Generator is self regulating, and is equipped with outlet box containing fuse and 2 A.C. convenience receptacles. Cost only 5c an hour to operate. Dimensions: Length 20 1/2", Width 12", Height 16". Shipping wt. 100 lbs. F.O.B. Chicago..... **149.50**

**700 WATT-GENERATOR SET**—same as above, slightly smaller—with Briggs-Stratton Engine—Model 708—F.O.B. Chicago..... **129.50**

ITEM #2008—**2000 WATTS**—115 V. A. C. generator set, powered by husky, fast starting Briggs-Stratton engine. Mounted on portable steel carrying base for easy handling. —Just right for small cottage and cabins needing inexpensive 2000 Watts of electricity. Ship. Wt. 190 lbs. F.O.B. Chicago..... **295.00**

## BRAND NEW HEAVY DUTY TWO UNIT VICKERS HYDRAULIC PUMP

- For Hydraulic Presses • For Lift Trucks • For Tractors • For Road Machinery

ITEM #417

The Vickers model V-2129-FLH is actually two hydraulic pumps on a common shaft. The large hydraulic pump is rated at 21 G.P.M., 1000 lbs. P.S.I. at 1200 R.P.M., for conventional hydraulic system and the small pump is rated at 3 G.P.M. and 1000 lbs. P.S.I. for power steering or for a second hydraulic system. Rotation counterclockwise. Use them individually or collectively. Dimensions: 13 3/4" Long X 9" in diameter with 1" shaft. 1 1/2" inlet port and 1 1/4" outlet port on large pump. 1" inlet port and 3/4" outlet port on the small pump. Shipping Wt. 66 lbs. Worth \$212.50. Now priced below the value of the smallest pump! F.O.B. Chicago..... **69.50**



## U.S. NAVY ALL BRONZE CENTRIFUGAL PUMP



These all bronze Centrifugal Pumps are ideal for use as marine bilge pumps, circulating pumps, fire protection or irrigation, car-washing, dewatering, basement sump pumping, lawn sprinkling. Will pump water, oil, brine, gasoline, DDT and sulphur compounds. Equipped with 6" adjustable 'V' pulley, 2" dia. inlet and outlet, 180 GPM capacity. Inlet and outlet take hose with 2 1/4" inside diameter. Dimensions: 11" x 8" x 11".

ITEM #384

Total head-feet	Speed	H.P.	GPM
25	3600 RPM	3	180
35	3000 RPM	1 1/4	90
20	2400 RPM	1 1/2	75

Back plate may be rotated for most convenient inlet position. Gov't acquisition cost \$96.00. Shipping weight 31 lbs. F.O.B. Chicago..... **29.50**

## 300 AMP. D. C. GENERATORS IDEAL FOR WELDING GENERATORS

Type R-1, ITEM #91 rated 300 Amps.—30 Volts, Mid. by Jack & Heinz, Government Acquisition Item. Cost \$380.00. Ship. wt. 55 lbs. Dimensions: 16" x 10" x 7". Complete with instructions to connect as Welder. F.O.B. Chicago..... **35.00**



ITEM #90—When connected as a welder, this unit will deliver 200 amps for a sustained period and 250 amps for intermittent service. This generator is widely used for shop-built portable welders. Rated 200 amps, 28 volts, 2500 R.P.M., using 10 H.P. Dimensions: 15" L. x 6" W. x 8 3/4" H. Splined drive shaft. Gov't. Acq. cost \$300.00. Ship. Wt.: 51 lbs. F.O.B. Chicago..... **22.50**



ITEM #99—12 V.—50 Amps.—Leece-Neville generator for autos, trucks, road machinery, boats and battery charges. Precision aircraft quality construction, with life-time grease sealed ball bearings and heavy insulated windings. Standard 4-bolt square mounting flange, spline shaft. Dimensions: 16" L. X 8 1/2" Dia. Wt. 23 lbs. Gov't. Acq. cost—\$92.00. Now..... **16.50**  
F.O.B. Chicago

**GROBAN SUPPLY CO.** Dept. PM-1  
1139 S. WABASH AVE., CHICAGO 5, ILL.

## MAGNETS

5 Assorted Size Magnets \$1.00. Powerful Pocket Magnet W/ case \$1.00. Hot Pad Magnets—large size 8/\$1.00. Bulletin Board Magnets 5/\$1.00. Slender Magnets—pencil type 2/\$1.00. Retrieving Magnets—extra power, heavy duty—30 lb. pull \$4.00, also 50-75-100 lb. pull. Explore, learn Electricity, Magnetism, Electro magnets, complete kit and instructions with 22 experiments and models..... \$3.95  
**TRANSISTOR RADIO KIT**—all parts & instructions—powerful..... \$7.95  
Also—Rods, discs, bars, horseshoes. Send stamp for catalog—Specify your requirements—100% SATISFACTION GUARANTEED.  
PARK MAGNETS, 268, 1557 GREENBAY RD., HIGHLAND PARK, ILL.

Say You Saw It in Popular Mechanics



## 10" TILT/ARBOR SAW BUILD-IT-YOURSELF from GIL-BILT KITS-PLANS

Sturdy wood, steel, and aluminum construction, NEW DEPARTURE ball bearings. Capacity and performance of floor saws selling for \$150.00 and up. Plans, all metal parts in kit with 10" comb. blade \$25.90, less blade \$22.95. F.O.B. St. Louis. Detail PLANS-PATTERNS only \$1.00 postpaid.  
Build-it-yourself 12" and 18" Bandsaws, 6" Belt Sander, Shaper. Simplified plans, build easily with hand tools only. Advertised and sold for 8 years, over 30,000 units in use. Money back guarantee. **FREE CATALOG.**  
GILLIOM POWER TOOLS, Dept. 80-M, Lambert Field, St. Louis 21, Mo.

## Make Big Money with HOBART simplified WELDING

Set up your own welding business with one low cost Hobart welder and earn hundreds of dollars! Big capacity, low cost models open up new welding opportunities—let you get the "BIG PAY" jobs. Built in convenience features, at no extra cost, let you turn out top notch work.  
HOBART BROTHERS CO., BOX M-86 Troy, Ohio, Phone 21223

**HOBART simplified WELDING**



"One of the world's largest builders of arc welders"



## Right Behind the Firemen Come the Salvage Squads

(Continued from page 85)

are laid end to end and overlapping, so as to form a channel down a stairway or even down a fire ladder.

In modern buildings with concrete-slab floors, there is not so much danger of water pouring through holes around light fixtures or pipes, but it is often necessary to form dams of rolled-up covers to keep water out of elevator shafts and stairwells. However, unless ample provision is made to drain this water off in a very short time their precautions will be useless, as it will rise above these cloth dams and go flooding down to lower floors. When it is realized that anywhere from 6000 to 10,000 gallons of water per minute are often thrown into a fire, it is obvious that getting rid of it can be a serious problem. Pouring down the stairwells, it can do damage on a dozen or more floors—and in the case of a fire on the 18th floor of the Pennsylvania Hotel (now the Statler) in New York some years ago, water rose several inches in the lobby before the situation was under control.

### The Cover-Up

In a small fire in a suburban house two or three covers may be sufficient to pro-

tect the piled-up furnishings of one or two rooms. But a big industrial building may make use of 20, 50 or even 100 covers. In the spectacular Lansing, Mich., fire some years ago when the upper floors of the state's office building filled with irreplaceable community records caught fire, all fire companies in town contributed covers until a total of 250 were in use.

The Minneapolis Fire Department, typical of modern, well-equipped outfits, requires that each ladder company report to a fire with 10 covers, and each engine company with two more.

### No Sale for Smoked Fur

Venting smoke is also an important function of fire-patrol companies, not simply for their own safety, but to prevent damage to merchandise. Hundreds of thousands of dollars worth of furs, for example, can be ruined by a comparatively brief period in a smoke-filled room. Once thoroughly impregnated with smoke, the smell is extremely difficult to remove permanently. For this work firemen either use existing air ducts, or chop holes in walls or floors and install portable electric exhaust fans. Even after the fire is out and the hoses have stopped pouring water into a building, the fire-patrol men have a lot to do.

(Continued to page 236)

# \$500 FOR YOUR OLD HAND SAW OR POWER SAW!

ANY MAKE OR CONDITION!



Your old hand or power saw (any make or condition) is good for a \$5 trade-in allowance towards purchase of the amazing new Syncro "210" True Cut Jig Saw at your tool dealer! This husky, massive, precision-built saw has big 15" throat, 100 sq. in. table—cuts 1 3/4" wood accurately—curved or straight! Powered with famous Syncro Reciprocating Motor—greatest achievement of power research. No belts, cams, gears. No rotating parts to wear out. Motor guaranteed against burn-out during ownership.

See your tool dealer today—trade in your old hand saw and save \$5! Offer ends Dec. 31, 1956.



MODEL 210  
LISTS:

\$29.95

Less \$5 Trade-In

or... \$24.95

\$ For \$ OUT-CUTS ALL OTHERS

# SYNCRO

210 JIG SAW

SYNCRO CORPORATION • DEPT. T-C6 • OXFORD, MICHIGAN U. S. A.

WORLD'S LARGEST MANUFACTURER OF RECIPROCATING MOTORS



# AMAZOY LIKES HEAT PLANT IT NOW!

Because AMAZOY grows from live grass plugs, it develops best and spreads fastest when planted in this hot weather. Unlike seed that dries out and dies in heat, AMAZOY likes it hot! When planted now AMAZOY stays rich green even in blistering heat, drought or water shortage. Gives amazing results.



## EASY TO PLANT - GROWS IN ANY SOIL

AMAZOY comes direct to you in pre-cut living grass plugs - NOT messy sod or wasteful seed. When planted on 1-ft. centers in checkerboard pattern, gives hundreds of transplants yearly. Grows where other grasses have failed. Perfect for hills, for clay, sandy soil - even beaches. Guaranteed not to winter-kill.

## CHOKES OUT CRABGRASS, WEEDS

Grows so thick it chokes out weeds and crabgrass. Resists diseases, even insects can't live in it.

## SAVES WORK. TAKES WEAR AND TEAR

Because AMAZOY grows slowly upward, cuts mowing by two-thirds. Gives a careful, perennial lawn ideal for paths and children's play areas; so resilient it takes heavy trampling - springs right back. Costs less in the long run than any grass known because it never needs reseeding.

## GUARANTEED TO GROW IN YOUR SOIL

Scientifically packed to reach you fresh and vigorous. AMAZOY'S method and specially winter hardened stock are so proven we guarantee every plug. Goes off color after heavy frost. Regains rich green beauty every spring. Any plug failing to grow will be replaced absolutely FREE.

## ORDER FROM WORLD'S LARGEST GROWER

Our thousands of satisfied customers have made us the world's largest producers of this outstanding lawn grass. Take no chances. Avoid risk of lost labor and disappointment with inferior grades. Order genuine AMAZOY today.

Dept. 282, ZOYSIA FARMS 602 N. HOWARD ST., BALTO. 1, MD.  
333 N. MICHIGAN AVE., CHICAGO 1, ILL.

# Your Lawn STAYS GREEN When Others Burn Brown!

ORDER MEYER Z-52, THE ZOYSIA GRASS  
APPROVED AND RECOMMENDED BY U. S. GOV'T.

- KILLS CRABGRASS & WEEDS
- 2/3 LESS MOWING
- NEVER NEEDS RESEEDING
- GROWS IN ANY SOIL!

APPROVED BY U. S. GOLF ASSN.  
PLANTED ON PIMLICO TURF RACE TRACK

AVAILABLE NOW  
FOR IMMEDIATE  
DELIVERY FROM  
WORLD'S LARGEST  
GROWER

FREE! Reg. \$4.95



Exclusive 2-WAY STEP-ON PLUGGER With orders of \$11.98 or more, we enclose our new patented Step-On Plugger... plugs lawn and destroys harmful competing grass at same time. NO ONE ELSE CAN OFFER YOU THIS WORK-SAVING GROWTH-PRODUCING 2-WAY PLUGGER.

The approved strain of Meyer Z-52 is the ONLY ZOYSIA sold under exclusive AMAZOY TRADE-MARK (reg. U. S. Pat. Off.) Certified to be highest caliber Meyer Z-52 Zoysia - the new lawn grass developed and released by U. S. Gov't. as most satisfactory lawn grass ever grown.

## ORDER BY MAIL CUT OUT COUPON

### Dept. 282, ZOYSIA FARMS

602 N. Howard St., Baltimore 1, Md.  
333 N. Michigan Ave., Chicago 1, Ill.

Ship the following order of AMAZOY Meyer Z-52.

50 Plugs	\$4.98	300 Plugs and Free Plugger	\$24.98
100 Plugs and Free Plugger	\$11.98	650 Plugs and Free Plugger	\$49.98

West of Miss. River only, add 75c per 50 plugs for shipping.

(We pay postage East of Miss. R.) Sorry No C.O.D.'s  
I enclose  check  Money Order  Cash

Name \_\_\_\_\_  
Address \_\_\_\_\_  
City \_\_\_\_\_ Zone \_\_\_\_\_ State \_\_\_\_\_

## Guaranteed Auto Parts at Western Auto



### ELECTRIC WELDER AC or DC 110 Volts

The "Little Marvel" all-metal welder, 5-year written guarantee. Welds 1/8" metal or money back. Repairs tanks, tools, fenders, machine parts, etc. Complete with everything - rods, unit, eye shield, directions. \$6.95 plus 50c postage. Flame torch accessory for soldering, cutting, brazing \$3.95 complete with carbons, brass rods, flux. \$2.00 Deposit on C.O.D. 75 ampere 1/4 inch Transformer Welder \$21.95 F.O.B.

ESSAY MFG. CO., Dept. 51, Quincy 69, Mass.

**\$6.95** Complete

### 180° OFFSET DRIVE

86 TO 1 REDUCTION GEAR For use where tremendous power at low take-off RPM is desired, 6 gears rotate on self-lubricated Hi-Speed Ball Bearings. 3/4"x1 1/4" shafts. 5"x6"x6" overall. \$8.95 Postpaid. Use with fractional H.P. motor.

KARL ORT, Dept. PMS, York, Pa.



## \$40 for 1 1/2 DAY'S SPARE TIME WORK GRINDING LAWMOWERS

Yes, J. H. B. writes, "not bad for a 76 year old young fellow earning \$40 for a day and a half's work" . . . and others are making even bigger money with the Universal Model B Lawnmower Grinder. You, too can make good spare or full time profits in your own business in your garage or basement. We furnish everything you need. Write today. No cost or obligation. Dept. M-86.



**ROGERS**  
MANUFACTURING CO.  
LINDSEY, OHIO



## Steel 5-Shelf Unit

75 Inches High  
36" Wide - 12" Deep



Hundreds of Uses  
• Offices • Churches  
• Schools • Garages  
• Stores • Homes  
• Shops • Greenhouses  
• Hobby Shops

Adjustable shelves, back braced... green metallic finish... Shipped K. D.

**10.88** F.O.B. Detroit

15" depth 12.38  
18" depth 13.88

Extra Shelves  
12" deep 1.50, 15" deep 1.75  
18" deep 2.00

### MOHAWK LUMBER & SUPPLY COMPANY

M 14525 W. Chicago Blvd., Detroit 28 Mich.

Ship \_\_\_\_\_ Shelf Units as follows... 12" deep \_\_\_\_\_ 15" deep \_\_\_\_\_ 18" deep \_\_\_\_\_  
and extra shelves \_\_\_\_\_ 12" \_\_\_\_\_ 15" \_\_\_\_\_ 18" ... F.O.B. Detroit.

\$3 deposit with C.O.D. orders Enclosed  Check  M.O. for \$ \_\_\_\_\_

NAME \_\_\_\_\_  
Ship via ADDRESS \_\_\_\_\_  
 FREIGHT  EXPRESS CITY \_\_\_\_\_ STATE \_\_\_\_\_





● It's Easy To Fix With a SAKRETE MIX. Do it in '56!

Patch It • Build It • Repair It



● For the SAKRETE 48-page booklet with photos, diagrams and instructions for "Do it yourself" cement jobs, see your building supply dealer, lumber dealer or hardware store or send 25 cents to —

SAKRETE, Inc.  
P. O. Box 11, Dept. A  
Cincinnati 17, Ohio

Gravel Mix —  
Sand Mix —  
Mortar Mix —



**SAKRETE**

DO A BETTER JOB  
with **DREMEL**  
Straight-Line-Action  
**SANDERS!**  
Send for FREE  
Power Tool Catalog  
**DREMEL MFG. CO.**  
RACINE, WIS.



**LIVING**  
"As You Like It!"



NEW  
LUXURY-COMFORT-AT LOWEST COST

SEE  
**Cardinal** DE LUXE  
MOBILE HOMES

You revel in luxury and "take-it-easy" living in a Cardinal De Luxe Mobile Home! See distinctive exterior designs . . . spacious interiors . . . luxurious furnishings and decor . . . modern utilities and conveniences. A model for every need and budget. Write for Folder — and name of nearest dealer.

**CARDINAL INDUSTRIES**  
Middlebury 51, Indiana

With long-handled squeegees they push water into sewers and down drains.

### Wet-Blanket Brigades

The use of special fire patrols to protect property first started around 1839, when some individual fire-insurance companies, interested in reducing their losses, organized such groups. They worked with the firemen, using first wet blankets and later special mats and covers. Each insurance company provided its customers with metal plaques, "fire marks," fastened to the outside of the buildings it insured, so that their fire-patrol boys would know whether they should bother with a fire. If insured by another company, they let it alone.

But not long after this, the Association of Fire Insurance Companies was formed which hired 40 men (at \$250 a year) to patrol the mercantile district of New York City during the night.

### Whee!

In the early days, fire companies were often more social clubs than anything else, and the members had more zest than knowledge of how to put out a fire. Very often they did more damage with axes and water than the fire. One fire-fighting technique of early days called for the use of a tremendous iron hook fastened to a long rope. A fireman would climb a ladder, snag the hook into the framework of the building, and the crew would then pull the building to the ground, where "it was easier to fight the fire." By 1866 fire-patrol units supported by insurance companies were operating in 21 major cities, and many of these are still in existence.

But just as private fire-fighting companies have given way to municipally supported fire departments, so the insurance companies' fire patrols have been disappearing, and their functions taken over by city fire departments. The first of the old fire patrols closed in 1921 in Mobile, Ala. Today only nine cities still have such outfits, and many of these are much reduced. Fire departments are, generally speaking, so well trained today that they do as little damage as possible, and nearly all of them have special salvage outfits.

Locally, still another factor is at work to keep damage in homes, stores and factories to a minimum today. It has been strongly impressed on fire-department personnel that it is extremely bad public relations to smash up property needlessly. Firemen who want raises, better pension plans and the good will of the communities in which they live and work might find this to be expensive fun. ★ ★ ★



**\$5000 PER DAY AND MORE**



**SERRATING AND SHARPENING TABLE KNIVES**

**SAW-KEEN** PORTABLE, ELECTRIC, EASY - TO - OPERATE

Be your own boss, work anywhere, full or part time. Every restaurant, hotel, drive-in, etc., repeat customers. Serrated (saw-edged) table and steak knives in great demand. \$98.50 investment returns first week. Guaranteed. Write today for proven daily profit plan.

**CUTTER-CRAFT** 58-L SOUTH RAYMOND PASADENA 1, CALIF.

**RETAIL PRICE \$125.00**  
**FACTORY TO YOU \$79.95**



**SUPERSHOP** includes precision-built 8" tilting table saw, vertical and horizontal drill press, 30" lathe, sander, grinder. 100% BALL BEARING. Write for FREE catalog, full details, trial plan. Easy Pay Plan.

**POWER TOOLS, INC.** 186 YATES AVENUE BELLEVILLE, WIS.

**EXPLORE FOR TREASURE!**



Find gold, silver, coins, jewelry, battle relics! Treasure-Metal-Mineral Detectors. M-SCOPE. Used worldwide for Treasure Hunting. Mineralights. Geiger. Scintillation Counters. Prices from \$14.75. Fully GUARANTEED. Time Payment Plan. FREE Treasure and Uranium booklets. New outfitting catalog. **FISHER RESEARCH LAB., INC.** Dept. PM-1. Palo Alto, Calif.

**Get New 128 Page Catalog of WOOD AND WOODWORKING MATERIALS**



**WORLD'S LARGEST SELECTION—Lowest Prices** Your buying guide for finest kiln dried domestic and rare imported woods, inlays, bendings, matched plywood, mouldings, ornaments, etc. Biggest selection of tools and hard-to-find hardware. Packed with scroll saw patterns, projects, wood facts and money making ideas. Enclose 75c (refunded on first order) to help pay mailing and handling costs. Write today to **CRAFTSMAN WOOD SERVICE CO.** 2729 S. Mary St., Dept. A-8, Chicago 8, Ill.

**FREE AMAZING NEW BOOK "HOW TO ANSWER ADS"**



Never before have you seen anything like this. Tells you in simple language the correct way to answer ads. Gets you quicker replies—better results, and greater satisfaction. Will save you time and money and it's ABSOLUTELY FREE. No obligation whatever. Every reader of advertising should have this booklet. Send a postcard for your copy NOW. F. W. Johnson, Popular Mechanics Magazine, Room 800-A, 204 East Ontario Street, Chicago 11, Illinois.

**WHOLESALE TOOL CATALOG**



**MAKE EXTRA MONEY**

**Start Your Own Business**

Sell tools part time, full time. Save money for your industrial and institutional use. A MILLION DOLLAR INVENTORY AT YOUR FINGERTIPS. Buy NATIONALLY ADVERTISED hand tools, hardware, fans, motors, power tools, paints, etc., NO INVESTMENT REQUIRED. Buy at you need it. Up to 50% DEALERS DISCOUNT. Send \$1 Deposit for mammoth wholesale dealers catalog. \$1 refunded on first purchase or returned if you are not 100% satisfied. **SILVO HARDWARE CO., Dept. PM-8, 108 Market St., Phila. 6, Pa.**

**WAR SURPLUS BARGAINS SAVE UP TO 90%**

**BUILD YOUR OWN ARC WELDER, LIGHT PLANT OR BATTERY CHARGER**

**Complete Kit \$39.95**

Kit consists of: 1 Famous Navy NEA-5 Generator. New Combination AC-DC Type. AC voltage—115 V. DC voltage—24 V. 200-300 Amps. 2 complete generators in 1... 2 separate fields & 2 separate armatures on same shaft yet no larger than regular aircraft generator. Ideal for home, farm & shop lighting plants by hooking wires to AC side which will give 1200 watts. DC side can be used for charging batteries, welding & operating war surplus low voltage hobby motors & equipment. Also in kit: 1 Voltage Regulator DC. 1 Voltage Regulator AC. 1 Reverse Current Relay. 1 Ammeter and Shunt. 1 Voltmeter. 0 to 30 Volts. 1 Rheostat. 1 Electrode Holder. 1 Giant Toggle Switch. Welder's Shield. Wiring diagram for hookup as welder. Wt. under 100 lbs. Approx. GOVT. COST \$600. Kit, \$39.95. Navy NEA-5 Generator (only) — same as above... if purchased separately: \$27.50.

**PIONEER MAGNETIC COMPASS**



For boats, trucks, cars. By Pioneer Instrument Co., Div. of Bendix, No. 1829-2A. Contains screw-type heeling compensator, removable drawer-type compensator, screw-type horizontal compensator and spider-type compensator. All devices for elimination of errors caused by effects of magnetism. Has constant deviation corrector and course setter. Notable dial engraved with compass card graduations. Complete with book of instructions, light and mounting screws and shock mounts. Shpg. Wt. 10 lbs. Approx GOVT cost \$100. NEW. \$13.95

**NEW PUMP AND MOTOR**



Pump has 1" connections, built-in relief valve, adjustable up to 1500 lbs. Max capacity 8 GPM. 1 1/2 H.P., 24-volt motor. 4000 RPM. Can be used on 12 or 36 volts. Govt. cost approx. \$350 — our price — NEW — \$9.95.

**MICROMETERS** Chrome plated, precision engineered, carefully tooling to give long life. All new 0-1" cap. \$2.25 ea., 1-2" cap. \$3.50.

**NEW! BIG CATALOG** Largest ever... just out... new low prices. Send 25c for your copy today. Prices F.O.B. Culver City unless otherwise stated. Check, cash or money order. 50% deposit for C.O.D.

**AIRBORNE SALES CO., INC. DEPT. PM 856**  
8501 Stellar Drive, Culver City, Calif.

**RADIO CONTROL YOUR MODEL PLANES BOATS CARS**

**"CUSTOM MIDGET" RADIO \$9.98**

LICENSE FREE BAND

OPERATES SAME AS \$50.00 SETS. INCLUDES LONG RANGE TRANSMITTER RADIO, RECEIVER RADIO AND CONTROL ACTUATOR ALL 3 EASY ASSEMBLY WITH OUR PARTS AND PLANS \$9.98. PLANS ALONE \$1.

**RADIOMODELS BOX 36 DEPT. PM BALTIMORE 6, MARYLAND**

DETAILED INFORMATION RE: A RADIO CATALOGUE 25c  
SPECIAL "SUPPLY SOURCE DIRECTORY" & \$7.00 SUPPLY COUPON... \$1.00  
BOOK "RADIO CONTROL OF MODEL AIRCRAFT" CONTAINS 14 PLANS \$3.98  
RADIO CONTROL GARAGE DOOR DETAILS... \$1.00

**Say You Saw It in Popular Mechanics**

**ONLY \$2.00 POSTPAID**



**Professional Woodworking CLAMPS ONLY \$2.00**

Now for the first time, these clamps are available to the home craftsman. Holds work securely and in all positions, straight or at an angle. 100% better than "C" clamps. Won't mar your work. Packed in kits, complete less jaws. Make the jaws yourself, any shape, in 1 hour with "easy, simple-to-follow" instructions and save 50%. Screws accurately machined from high tensile steel. Clamps open 2 inches.

**Each \$2.00, 4" Each \$2.50, 8" Each \$2.75**

In lots of 4 Clamps 10% discount—(most gluing jobs require 4). Send M.O. or check—we pay postage.

**PORTER & DIETSCH, INC., DEPT. 100**  
2459 University Ave. St. Paul, Minn.



Schupack's Amazing Tool Bargains! Save up to 100%

**75 Mounted Wheels & Miniature Cutters**, Regular \$11.00 value **\$4.50**  
 For cutting and grinding on paid wood, metal or plastic. Includes 25 mtd. wheels and points on 3/32" shanks; 24 miniature cutters on 3/32" shanks; 25 short shank min. cutters. Will fit all electric drills and hand grinders.

**FLEXIBLE SHAFT—ONLY \$4.95** Post-paid  
 Fits all electric drills & hand power tools. 354½" long. Oilite bearings. Core of specially wound, high carbon steel wire in flexible steel casing. Will accommodate tool shafts up to ¼" dia. For lathes, electric drills, etc.

**2 DRUM SANDERS**  
 With 12 Bands in Assorted Grits. ½" dia. x 1" long on ¼" arbor with 12 Post-bands \$1.50 Post-paid  
 One drum, 1" dia. x 1" long on ¼" arbor Post-with 5 extra sleeves \$1.00 Post-paid

**12 MOUNTED WHEELS** and points on ¼" shank \$2.85  
 For grinding on plastic wood, soft & hard metals. Regular Value \$8.40. **\$2.60** P.P.  
**18 Mounted points on 3/32" shank \$2.50**; 12 mtd. wheels on ¼" shank \$3.00

**18 Rotary Cutters** P.P. \$5.85  
 Assorted sizes cutter on ¼" or 3/32" shank. Will fit all hand grinders. Ideal for cutting wood, metal, or plastic. Brand new.

**ADAPTER CHUCK**  
 With 2 interchangeable collets, opening from 3/32" to 1", on ¼" mandrel. Price each only \$1.50. P.P. Adapter Chuck. From 60 to 80 on 3/32" in. Mandrel \$1.00  
 4 Woodwork Drills from 1/2" to 1/2" on ¼" shank \$2.00  
 No C.O.D.'s please. New Illustrated Catalog 10c

SCHUPACK SUPPLY CO. 7331 COLTAGE GROVE AVE. DEPT. PM-10 CHICAGO 19, ILL.

**CUT EXACT CIRCLES CURVED PATTERNS**

**"ARCO JIG-SAW"**  
 with Circle-Cutter (up to 20" dia.) & Rip Gage (fits any ¼" drill). Has speed of 875 saws. Cuts 2x4's, plywood, metals, etc. Incl. blade. At your dealer or try it on our 10-day trial. Send check, M.O. (ppd.) C.O.D. a post. **ARROW METAL PRODUCTS CO.**, Dept. PM-8, 140 West Broadway, N.Y. 13, N.Y.



\$10.95

**NEW! RECLAIMO**  
 ELECTRICALLY HEATED  
**Oil RE-REFINING Filter**  
 A Wm. Schwalge Product  
**Super-Efficient Filtration**  
 for TODAY'S Car-Truck-Tractor Engines  
 Folder with full details FREE  
**RECLAIMO MFG. CO.** 6251 Touhy Avenue  
 Dept. M-86, Chicago 30, Ill.

**ELECTRIC SELF STARTER**

for small aircooled engines up to 12 horsepower.—All kits designed for easy installation on lawn-mowers, garden-tractors, etc.

Write for details regarding Dealerships and Distributorships  
**CHIEF INDUSTRIES, Dept. P.M., Dowagiac, Michigan**

Also Eshelman TRACTORS. Riding ROTARY MOWERS. ROTARY TILLERS at amazing savings. Write for Free Literature

**ESHELMAN GOLF CAR** GASOLINE ENGINE  
 70 MILES PER GAL. GAS UP TO 20 MILES PER HR.  
 1/5 the cost of most other cars. Ideal for golfers, industrial plants, farms, etc. Also Child's 2 pass. Car. Free Literature Writer: **ESHELMAN, Dept. MC-58, 109 Light St., Balto. 2, Md.** PATENTED

**Need an extra \$1,000, \$2,000, or more? Make it with an IDEAL LAWNMOWER SHARPENER**

There are thousands of lawnmowers in your locality: Average \$1,000 profit per 250 mowers with customer satisfaction and repeat business assured. Provide this essential service with an Ideal Lawnmower Sharpener, the only machine that grinds the reel to "fit" the bed knife. Compare by any standard. The Ideal, backed by 53 years of experience, costs no more. Write today for complete, free catalog.

**THE FATE-ROOT-HEATH COMPANY**  
 Dept. PM-8 Plymouth, Ohio

**PAY RAISING—EXTRA MONEY BOOKS**

Use these books to prepare for a better job—bigger pay—to start a profitable spare time or full time business of your own, improve your home, or start a hobby. Popular Mechanics specializes in supplying outstanding self-help books on many subjects. Send for our FREE catalog.

- PROJECTS IN METAL**  
 44 make-it-yourself articles, fireplace sets, chimney and shutter ornaments, lanterns and lamps, iron tables, mail boxes, decorative novelties, etc. More than 300 photographs and working drawings. 66 pages. \$1.00
- METAL NOVELTIES**  
 Hand-wrought copper, pewter, brass, iron, etc. How to make attractive desk sets, ash tray, book ends, serving tray, candlesticks. 37 different articles are described. More than 200 photographs and easy to follow instructions. 88 pages. \$1.00
- THE COMPLETE BOOK OF GARDEN MAGIC**  
 Contains the gardening experience of 25 years. 17 full color plates. 334 pages \$3.95
- NEW AMERICAN HOMES**  
 A beautiful plan book of larger homes, containing 88 designs. \$1.00
- MODERN KITCHEN CABINETS**  
 You can remodel your kitchen by building up-to-date cabinets. \$2.00
- THE VETERINARY ADVISER**  
 Furnishes simple practical advice relative to the prevention and treatment of the common ailments of farm livestock including horses, cattle, sheep, swine and poultry. 111 pages. 98c
- BETTER HOMES AND GARDEN COOK BOOK**  
 Best seller cookbook. \$3.95
- SCIENCE OF WATCH REPAIRING SIMPLIFIED**  
 Brings out difficult problems and explains them in a simple manner. \$3.00
- FASCINATING PEN FLOURISHES**  
 You can start at the beginning and make the simplest strokes and finish with the highest degree of skill attained in this art. \$1.00
- HOW TO MAKE CARTOONS**  
 The History and technique \$1.00
- HOW TO SUCCEED WITH BEES**  
 More than 100 successful plans to produce big crops of honey. 66 pages. \$1.00
- HOW TO BUILD FENCES AND GATES**  
 A Sunset Book. How to select the best fence or gate, how-to-do-it plans. 225 pictures \$1.50
- HOW TO PLAN AND BUILD YOUR FIREPLACE**  
 A Sunset Book. Working drawings for construction of residential fireplace and chimney. \$1.00
- PROPAGATION OF PLANTS**  
 Every conceivable method of budding and grafting is plainly described by text and picture. A handy reference book for nurserymen, greenhouse-men, experimenters, teachers. Profusely illustrated. 639 pages. \$4.50
- OUTDOOR MECHANICS**  
 Easy to follow instructions for the home owner who wishes to beautify his home grounds. Build outdoor recreational facilities and living conveniences that will extend the walls of your home to include the greatest possible living enjoyment for the entire family. 66 pages. \$4.95
- ESTIMATING FOR THE BUILDING TRADES**  
 The most complete and practical book we have ever seen on the estimating of all material and labor costs for every phase of the building trades as related to residences and other moderate sized buildings. \$6.75
- BIRD HOUSES, FEEDERS, BATHS**  
 There are hundreds of designs to choose from, a variety of only the best examples and can be made from a wide range of materials—lath, scraps, logs, celluloid, concrete, metal, etc. 80 pages, illus. \$1.00
- LEATHER PROJECTS**  
 A series of better than average articles on tooled leather in the modern manner—with eight items on tooled leather, eleven for the ladies, and three interesting descriptive pieces on leather chasing. More than 400 photos and drawings. 88 pages. \$1.00
- BUILDING READING FOR THE BUILDING TRADES**  
 2nd edition. 111 pages 69 illus. A standard reference for the building tradesman. \$1.75
- CARPENTRY**  
 3rd edition. This popular revision contains a special new section on farm buildings. 441 pages. \$2.50
- HOW TO PLAN A HOUSE**  
 The why and the how of home designs. Stimulating, creative ideas that are practical and easy to understand. 400 illus. 384 pages. \$4.95
- HOW TO REMODEL A HOUSE**  
 Fundamentals of factors influencing remodeling—factors which if overlooked may lead to discomfort, inefficiency and even structural weakness. \$5.25
- PRACTICAL MATHEMATICS**  
 2nd edition. Glenn M. Hobbs, Dalziel, McKinney. The ways and means of acquiring and retaining the arithmetic skills that are so important in everyday life. Includes simple equations, graphs. \$3.00
- 100 WAYS TO BE YOUR OWN BOSS**  
 A practical expert guide to small business that can be started with \$200 to \$5,000 including exceptional little-known opportunities in profitable uncrowded fields. \$2.49
- HOUSEHOLD MECHANICS**  
 An ideal "fix-it" book that tells clearly and simply how to get after home maintenance troubles. Includes material on painting, care of electrical appliances, care of doors and windows, water supply. Has excellent actual job projects, graphically presented. 241 pages. \$3.50
- CARPENTRY & JOINERY**  
 A beginner's text on the principles of modern residential construction. Anyone with a set of tools and building materials can, by following the author's directions, learn modern carpentry. \$4.75
- HOUSE CONSTRUCTION DETAILS**  
 For journeyman carpenters and house carpenters who work from stock plans and wish to make changes. It is a working guide in detailing every step in house construction. \$4.75
- TOOL DESIGN**  
 This practical education in tool designing stimulates the inventive ability and provides the reader with up-to-date practice in the field of modern production. 498 pages, 450 illus. \$5.00
- POPULAR TOOLS AND MATERIALS**  
 Describes over fifty of the hand operated tools in most common use. A wealth of information to school children of nine years of age and up. Material is attractively presented, accurate and timely. \$5.00

**MAIL THIS COUPON TODAY**

Check the books you want, write your name and address below, and mail this advertisement with money order or check. Outside U. S. A. include 15% additional for shipping charges.  
 Books selected will be mailed promptly on our "money back if you're not entirely satisfied" guarantee.

Name \_\_\_\_\_  
 Address \_\_\_\_\_  
 City \_\_\_\_\_ State \_\_\_\_\_  
**Mail to POPULAR MECHANICS PRESS**  
**DEPT. 856—200 EAST ONTARIO ST., CHICAGO 11, ILL.**



GIGANTIC  
SAVE-TO-70%

# MAIL SALE

WAR SURPLUS  
EXCESS INVENTORY  
BANKRUPT STOCK

## GIGANTIC SUMMER SALE

To reduce our immense stocks of the finest war surplus items, we offer hundreds of amazing buys—SEND FOR LARGE FREE CATALOG. All items shown here sent prepaid except when stated "F.O.B."

### TYPICAL SURPLUS BARGAINS

- Boat-Truck 6-v Elec. Winch (F.O.B.) \$46.71
- Childs Elect. Car Motor, 6-v (F.O.B.) \$19.46
- Elect. Golf Car Motor, 6-v (F.O.B.) \$19.46
- AC Electric Buzzer (110-v) \$64c
- AC Electric Bell (110-v) \$79c
- Army Power Plant, 3000-w, 115-v \$349.50
- Army Power Plant, 1000-w, 115-v \$169.50
- Army DC Generator, 3000-w 115-v \$58.75
- Surveyors Level—Leading Make \$42.95
- Gear Reduction Unit, 1 to 85 (1 hp.) \$7.95
- Weed Spray, 5-row, Complete (\$175) \$79.50
- Electric Auto-Pulse Fuel Pump, 6-v \$6.95
- GE Amplifier, Rectifier, 110-v (\$175) \$6.97
- Desk Telephone (make antique lamp) \$1.99
- Truck or Boat Winch (1000 lb.) \$8.95
- Govt. Prismatic Periscopes (cost \$20) \$2.99
- Pump, Irrigation 280 g.p.m., 2 1/2" \$44.37
- Pump, Irrigation 140 g.p.m., 1 1/2" \$24.61
- Window and Attic Fan Kit (24") \$12.95
- Air Corps Boat—one man, rubber \$26.95
- Air Powered Tree Trimmer (\$89.50) \$15.37
- Hand Hydraulic Pump System \$10.21

- Govt. Wind Direction Unit \$18.71
- Air Compressor, single cyl. 150 lb. \$19.95
- Hydraulic Tractor Pump (1000 lbs.) \$45.50
- Govt. Fire-Burglar Alarm System \$5.87
- Finest AC Voltmeters (0-300-v) \$5.94
- RF Thermo Ammeter (0-120 m.a.) \$6.91
- 1,000,000 BTU Heater-Blowers \$98.31
- Gas. Eng. Type (F.O.B.) \$91.00
- Offset Plate Maker—Remington-Union (F.O.B.) \$44.91
- Industrial Thermometer 15 ft. tube—20-220° \$8.31
- Instrument Transformer (100 to 3 amps) \$9.81
- Hydraulic Hose (30"x1 1/2") w/couplings \$2.71
- Hydraulic Hose (15"x1 1/2") w/couplings \$8.61
- Dynamometers 12-v to 1000-v (\$175.00) (F.O.B.) \$7.93
- Radar Receiver-Transmitter (\$226) (F.O.B.) \$7.91
- Griger Tubes (make-ur-own) \$6.00 \$1.31
- Chromalux Strip Heater, 500-w, 110-v \$2.49
- SPECIAL SALE ON ALL WEED SPRAY EQUIPMENT (Write)

## SPECIAL OF THE MONTH!

### GIANT FRESNEL FLOODLIGHT

- Amazing multi-element fresnel lens Govt. mammoth light. Throws wide-angle intensely bright light over large area. Built like lights used in Government light houses.
- Wonderful advertising unit for use on roof, marquees, lighting fronts of buildings, parking lots, playgrounds, etc.
- Complete with clamp-on color filter (for special color effects) and two 110-v, 1000-w Mazda bulbs. Lamp has built-in 110-v, 60-cycle cooling fan. Dimensions: 44" high x 31" wide x 29" deep. Brand new in orig. crates. Govt. Cost \$825. Brand new in orig. crates. Sixty Day Special **\$44.61** F.O.B. Lincoln



ORDER FROM AD or write us for big FREE CATALOG 1000s of items! Motors, sporting goods, hand-electric tools, watches, etc. We pay freight except where stated "F.O.B."

**BURDEN SALES COMPANY**  
810 "O" St., LINCOLN, NEBRASKA

**SOUTH BEND MACHINE TOOLS**

## Send for FREE Catalog

Engine Lathes	Milling Machines
Toolroom Lathes	Shapers
Turret Lathes	Pedestal Grinders
Drill Presses	Attachments

Indicate Machine interested in

SOUTH BEND LATHE • SOUTH BEND 22, INDIANA

## Wholesale! TOOLS! GUNS! CAMERAS!

AGENTS — BUY TOOLS, PHOTO EQUIP., SPORTING GOODS, JEWELRY AND THOUSANDS OTHER NATIONALLY ADVERTISED PRODUCTS AT BIG DISCOUNTS. BIG PROFITS SELLING TO OTHERS.

POSTCARD BRINGS FREE COPY "THE WHOLESALE PLAY"

### AMERICAN BUYERS SERVICE

HERTEL STATION, DEPT. 15, BUFFALO 16, NEW YORK

Get up to  
40% off

## SEND ME

**POPULAR MECHANICS**  
MAGAZINE

every month so I am sure to see each new issue. Here's

\$3.50 for 1 year  
 \$8.00 for 3 years

name \_\_\_\_\_

address \_\_\_\_\_

city \_\_\_\_\_ zone \_\_\_\_\_ state \_\_\_\_\_

Hand this order to your newsdealer or send it to

**POPULAR MECHANICS**  
200 East Ontario St. Chicago 11, Ill.

## Grips the screw!

Drives it too!

**Quick-Wedge**  
**SCREW-HOLDING**  
**SCREWDRIVER**

7" to 14" blades, 4 bit sizes  
Available with shockproof plastic covered tubing  
Unconditionally guaranteed

**ASK FOR IT AT YOUR DEALER**  
Kedman Co., 233 So. 5th W., Salt Lake City

# JEEPS

## and 4 Wheel Drives NEED FREE-LOCK HUBS

<p style="text-align: center;"><b>FRONT DRIVE WITH FREE-LOCK</b></p> <p style="text-align: center;"><b>LOW OPERATING COSTS</b></p> <p style="text-align: center;">ONLY WHEELS MOVE ALL PARTS STOP</p> <p style="text-align: center;">IN 2-WHEEL DRIVE NO PARTS MOVING!</p>	<p style="text-align: center;"><b>FRONT DRIVE WITHOUT FREE-LOCK</b></p> <p style="text-align: center;"><b>HIGH OPERATING COSTS</b></p> <p style="text-align: center;">WHEELS MOVE ALL THESE PARTS MOVE</p> <p style="text-align: center;">IN 2-WHEEL DRIVE OVER 100 PARTS MOVING—WEARING!</p>
--	---

**EASILY INSTALLED ON EACH FRONT WHEEL**

and by a quick easy finger tip turn of the lock-control engage or disengage the front wheels from the front drive axles. Results in free wheeling the front wheels in 2-wheel drive, or fast engaging for 4-wheel drive. When front wheels are free wheeling, front drive is idle . . . STOPS FRONT-DRIVE WEAR, INCREASES VEHICLE POWER, and gives MORE MILES PER GALLON OF FUEL.

Buy from your Dealer  
**WRITE FOR FREE FOLDER**  
**FREE-LOCK CORPORATION**  
5801 N. Federal Blvd., Denver 11, Colo.  
EASTERN OFFICE: 360 Bedford Ave., Brooklyn, N. Y.



# WOLVERINE HORSEHIDE WORK GLOVES

Must be  
**Best**  
Or Your  
Money Back

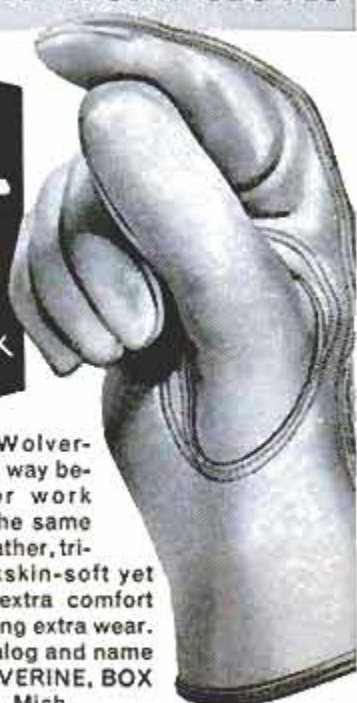

Only Wolverine's are sold this way because no other work gloves give you the same amazing super-leather, triple-tanned buckskin-soft yet hickory tough...extra comfort PLUS money saving extra wear. Write for free catalog and name of dealer to WOLVERINE, BOX PM-81, Rockford, Mich.

## WEAR A PAIR 7 DAYS

...your money back in full if you don't agree they're the best work gloves you ever wore

Also Eshelman  
2 Passenger  
**SPORT &  
GOLF Cars**  
1/5 the cost  
of most  
other cars  
70 Miles per Gal.  
Write for FREE  
Literature  
Dept. R-58. Eshelman, 109 Light St., Balto. 2, Md.

## ESHELMAN TRACTORS

LOW AS \$99

Plows • Cultivates • Saws  
Dozers • Harrows  
• Snow-Plows • Rolls  
• Mowers • Mows • Tills  
Eshelman Tractors,  
Fillers, Riding Rotary  
Mowers for Better  
Lawns and Gardens.  
Advertised in GOOD  
HOUSEKEEPING. Thou-  
sands of Satisfied Users.



2 to 8  
HP

Shipping Points: BALTIMORE • CHICAGO • RENO

## INTERIOR WOOD FINISHING

*made easy*

DRIES IN 30 MINUTES. Now, anyone can get professional results in a few hours instead of days.

*deft*

## WOOD FINISH

Clear, semi-gloss bar top finish. SEALS, PRIMES, FINISHES. It's trouble-free. No thinning. Will not darken. No brush marks. Use on paneling, floors, cabinets, furniture, any interior wood surface.



Wherever paints are sold, or write for free booklet. Dept. 31

DESMOND BROS. 1826 W. 54th St., Los Angeles 62, Calif.

## HANDY TIPS YOU CAN USE!



1 Use **DOOR-EASE** Stainless Stick Lubricant to stop squeaks and sticking the clean and easy way. Apply like a crayon on doors, friction catches, windows, screens, zippers, etc., 15c. Large Size, 39c

2 Use **AMERICAN Dripless Oil** for best lubrication and rustproofing of guns, fine mechanisms and appliances. Runs in—won't run out. 29c.

3 Use **LOCK-EASE Graphited Lock Fluid** to give car locks and other locks best year-round protection against freezing, sticking and rust. 39c.

At leading stores, or send \$1.00 for **SPECIAL KIT** of all large sizes to Dept. M-8 American Grease Stick Co., Muskegon, Mich.

## VOLUME BLOWERS FOR HEATING, VENTILATING, EXHAUSTING

Air Condition Your Car. Make Car Heaters. Ventilate fumes and heat from boat bilges and galleys. Make Heat Boosters, Exhausters, Coolers, Dryers and dust collectors with this **BARGAIN-100** cu. ft. per minute Blower. Blower overall 9"x8"x8". Heavy sheet metal construction. Made by large manufacturer to sell at three times our price. **B-6B** Blower complete—190 CFM, with 6 volt, direct current motor. . . . Postpaid \$12.50  
**B-10A** Blower, complete with 110 volt, 60 cy., AC Motor. . . . Postpaid \$13.50  
**C. MARSHALL SALES, 3546 Fullerton Ave., Dept. P-8, Chicago 47**



## SENSATIONAL NEW HIGH SPEED DRILL MASTER

NOW turns the ordinary shop drill into **HIGH SPEED DRILL PRESS** at a big saving. When **DRILLMASTER** is used on a 3,000 rpm drill press its top speed will be 20,000 rpm. Does the work of expensive high speed drill presses on brass, aluminum, plastics and cast iron where high speed drilling is necessary. Available for work of any size runs. Fits any 1/2" chuck, holding drills from 5/32 to 3/8". Shafts are heat treated and ground. Ball bearings and oil impregnated bearings and gear train are housed in cast aluminum. Precision made throughout. **\$62.50** Feb. MAIL ORDER TODAY only. **\$62.50** Chgo. Wt. ON C.O.D. ORDERS WE REQUIRE A 10% DEPOSIT. 22 DIRZIUS MACHINE SHOP "E", 1423-25 So. 52nd Ave., Cicero 50, Ill.

## SOON—BIG NEWS Shopmaster POWER TOOLS

## 24" ATTIC FAN KIT



Easy to assemble. Belt-driven. Blade, shaft, 2 self-aligning bearings, 2 pulleys, 2 collars, and V-belt. Everything you need, except frame and 1/4-hp motor, to make your own house cooler. Send for complete list of fan parts. **ONLY \$9.95** SAVE \$46.00

**PENNA. WHOLESALE DISTRIBUTORS**  
104 N. 6th St., Phila. 6, Pa.

## SAY YOU SAW IT IN POPULAR MECHANICS

## A DRY BASEMENT

ONLY  
**\$79.50**  
with a **DIXIE**

The **DIXIE AIR DRYER** rids your basement of musty, costly dampness. No fancy cabinet or frills—just a full size dehumidifier that keeps your basement dry as a bone. Install yourself in minutes. • Plug in and forget it.



ORDER DIRECT OR FOR FURTHER INFO WRITE DEPT. B

**ADAMS EQUIPMENT, INC.**

511 SOUTH JACKSON, JACKSON, MICH.



## 3400 RPM - 1/2 HP POWER SAW



### RIPS - CROSSCUTS CUTS A FINISHED 2x4 LIKE KNIFE THROUGH BUTTER

COMPARES TO  
SAWS SELLING  
UP TO \$49.50

**1998** Complete with  
5-1/2" Blade

A rugged, professional type, adjustable saw. Will cut any angle from 0 to 45°. Has an adjustable 0 to 6" rip fence. Safety-trigger switch on handle. Full 1/2 HP Universal AC-DC, 110-120 Volt, 60 cycle motor. Weighs only 6 1/2 lbs. Thousands already sold. Your satisfaction guaranteed.

EXTRA SAW BLADES - Available in Rip, Crosscut or Combination. Please Specify **235EA.**

### NEW POWER SAW BENCH TABLE

This sturdy, precision made bench-saw table converts our famous power saw (above) to a handy bench saw. Permits angle and bevel cuts, rip, crosscut & comes with rip fence and miter guide. 14" x 16" table, 6" high.

NEW  
ONLY  
**995**

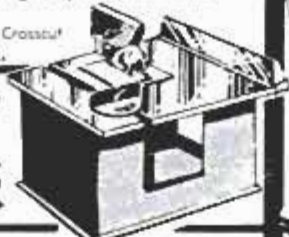

### 1/4" ELECTRIC DRILL with "JACOBS" CHUCK

One of the greatest Drill Values ever offered. Has heat treated gears, self-lubricating bronze bearings and genuine Jacobs type Chuck. Fully air cooled. Safety trigger switch. A tool of many uses for drilling, grinding, sawing, punch-press, etc.

NOW **995**

### SAVE ON UNIVERSAL JOINTS

90° to 180° UNIVERSAL  
Has a heavy duty, solid cast Bronze body. Rotates from 90° to 180° as desired. Has 29/32" diam. steel shafts with ball & socket joint. Excellent condition. . . . **595**

Write TODAY for complete list of many other types of Universal Joints, Halsts, etc.

### SAVE ON METAL WORKING CARBON STEEL TWIST DRILLS

Made by Cleveland, Morse, etc. All are Unused and in excellent cond.  
3/16" Aircraft, threaded shank, 9 ea. \$1.16  
1/16" Taper Shank . . . . . 89ea.  
3/64" Taper Shank . . . . . 99ea.  
2" diam. Taper Shank . . . . . \$2.29ea.  
No. 10 wire gauge, Strk. Shank . . . 15ea.  
SAVE on Surplus Drills. Hundreds more in stock. Write for complete list of other sizes and remarkable prices.



### NEW HEAVY DUTY CHAIN SAW

WITH 18-INCH CHAIN and GUARD  
Here is a portable gas engine powered, chain saw that cuts logs up to 18" dia. Has a two-cycle, air-cooled engine with dual accelerator controls and grip-right handles. Develops a high cutting speed for straight or angle cuts. Built for rugged, heavy duty use. With solid aluminum chain guard. **1595**



### 133PC. POWER TOOL ACCESSORY KIT

A complete accessory set for ALL small jobs. Can be used with any electric drill or grinder. Contains 133 pieces which include grind, polish, cut-off & buffing wheels, sanding discs, steel cutters, mandrels, burnisher, mounted stones and knife edge rubber wheels. Save 50% . . . **198**



### NEW 4-SPEED BARBEQUE MOTOR

Ideal for Barbeque Spit, Home Shop, etc. Has four take-off shafts turning at 5, 25, 150 & 4000 RPM. Operates on 110 volt, 60 cycle current. A \$24.95 VALUE . . . . . **895**



### PALLEY HYDRAULIC BARGAIN

VICKERS BRASS FOUR-WAY VALVE - An example of our Values. Will stand 2500 PSI. A heavy duty valve with ALL Brass Body. Closed center, off in neutral. For use with all liquids. **3750**

FREE HYDRAULIC EQUIPMENT CATALOG - No. C-3 - Fully illustrated and priced. Save up to 85%. Includes Pumps, Fittings, Valves, Motors, etc.

**Palley's**

2263 E. VERNON AVE., DEPT. PM-8  
LOS ANGELES 58, CALIF

FROM IMPORTER  
**SAVE 50%**

PRICES  
LESS  
THAN  
WHOLESALE

## PHILIPPINE LUAN MAHOAGANY PLYWOOD

For Paneling Dens, Offices, etc. Use in Cabinets, Furniture, etc. Rotary Cut. Both sides sanded. Bonded with finest resin adhesive. Face side unjointed. Shipped at lowest rates.

1/8" x 3 ft. x 6 ft.  
\$500 VAL.  
MIN. ORDER  
8 SHEETS

**179**  
SHEET

FREE  
SAMPLE  
ON  
REQUEST

1/4" x 4 ft. x 8 ft.  
950 VAL.  
MIN. ORDER  
4 SHEETS

**449**  
SHEET



### SAVE 40% - TRANSLUCENT FIBERGLAS PANELS

Use it to cover patio, for interior decor, as walls, partitions and many other uses. Ideal for the home or office & in new construction. Finest quality, many widths and lengths. Variety of colors. FREE Sample and Booklet. In 85¢ per sq. foot value.

ONLY  
**49¢**  
SQ. FT.

## SAVE UP TO 50% ON SPORT DIVING EQUIPMENT

**BUILD YOUR OWN DIVING LUNG - SAVE**  
up to 1100. Our special folder contains complete instructions showing how it's done. Kit includes Air Bottles, Pressure Regulator, Hoses, Safety Belt, Shoulder Harness, Clamps, Mouth Piece, Valves, etc. . . . .



Has latest info on Diving Equipment. Plus an illustrated and described article on "How to build your own Diving Lung". **\$150.00 value**

### CORNELIUS AIR COMPRESSOR

A 3 stage, 1500 PSI air compressor. Has a built-in 1/3 HP, 27 volt, 20 Amp DC motor. Compressor will deliver 40 cubic feet of air per minute. Has a built-in safety valve. Can be adapted to fill underwater diving tanks, spray tanks, for inflating, etc.

**GENERAL ELECTRIC AIR COMPRESSOR**  
A 2 stage AC or DC type compressor. Develops 1000 PSI. Has a 1/3 HP, 27 Volt, series wound motor. Ideal for spraying, inflating, painting, etc.

**PALLEY AIR TANKS**  
- UNDERWATER AIR TANKS -  
I.C.C. Approved for 800 PSI.  
22 cu. ft. capacity. 5" dia., 19" long. **1095**  
38 cubic ft. cap. 7 1/2" dia., 9" long. **1495**

**PALCO SUPREME DIVING PRESSURE REGULATOR**  
NEW **3950**

Has one-piece hose, mouthpiece and built-in non-return valves. Designed for use on ALL Air Tanks with standard Oxygen Valves. Built for us by one of countries leading underwater equipment makers. Order Direct and SAVE 50%.

**ARMY PICKA TOCK**  
Small, easy to use and pack. Has 12" steel head with pick on one side, mallet on other. 16 1/2" hardwood handle. With case. **198**

**NEW ARMY CANTEEN and REISSUE CUP and BELT**  
One quart aluminum canteen and cup fit into insulated canvas cover. Your choice of web pistol belt with grommets to hold extra gear or cartridge belt. With extra pockets for items. . . . **259**

**BOLO KNIFE**  
15" long. **198**

Top quality steel blade. Comes with belt sheath. Ideal for clearing brush.

**FREE BOOKLET**  
**JUST OFF THE PRESS**  
And Loaded with RED HOT BUYS for the whole family! Outdoor and Camping equipment, Optical items, Sporting Goods, Model Supplies & many more. See These Bargain Buys! Send for it Today!

Order From This Ad. Pay by M.O. or check. P.O.'s acceptd. from D&B firms. 1/2 deposit with C.O.D.'s. All Prices FOB Los Angeles. W&W's

**SIMPLIFY PREVENTIVE MAINTENANCE WITH MACHINE TOOL RECONDITIONING & THE ART OF HAND SCRAPING (2nd printing)**  
SEND FOR FREE FOLDER DESCRIBING ILLUSTRATED BOOK  
MACHINE TOOL PUBLICATIONS, 382 Holly Ave., St. Paul 2, Minn.

**Dwyer WIND-SPEED INDICATOR**  
Unlike the costly and complicated instruments, the Dwyer is actuated by a simple air tube. Pressure derived from the wind itself forces indicating liquid up calibrated tube. Windspeed is read directly, in both MPH and Beaufort Scale, the same way you read a thermometer. Satisfaction guaranteed or your money back.  
**F. W. DWYER MFG. CO.**  
P.O. Box 373-PM • Michigan City, Indiana



## Say You Saw It in Popular Mechanics

**WELD BRAZE**  
**SOLDER CUT**

Acclaimed by thousands of Homeowners, Mechanics and Hobbyists as the welder of 1901 uses. Easily operated from properly wired 110 volt AC or DC line. The ideal gift with a life-long use. . . . Order today on 10 day money back guarantee.  
**FOUR-WAY WELDER CO., Dept. F2-H**  
1810 S. Federal St. • Chicago 16, Ill.



**4WAY**  
ONLY  
**\$14.75**  
f.o.b. factory

**WELDER**  
Complete with Twin Carbon Arc Torch and accessories . . . to handle all metal-craft work.



**Now! a SCREW DRIVER with**

**4 TIMES THE DRIVING POWER**



**RATCHET Palm Grip**  
Makes Screw Driving EASY

**INDUSTRY**  
**HOME**  
**ELECTRICAL**  
**HOBBY**

The extra radius of the Palm-Grip Ratchet greatly increases leverage, enabling **FOUR TIMES** the full turning power at the extreme end of the driver. With ratchet removed, Palm-Grip drivers are quality, conventional hand tools.

**PALM-GRIP QUALITY TOOLS**  
A variety of 40 different hand tools fit the Palm-Grip Ratchet. Conventional, Phillips, Frearson and Clutch type screw drivers, also nut drivers and socket adapters. Women marvel at the added power it offers with comfortable grip.

Look for this display at Hardware, Electrical, Auto and Building Supply Stores or write for free descriptive folder.

**Palm Grip**  
**RATCHET DRIVERS**

**KIPTON INDUSTRIES, INC.**  
ROYERSFORD, PA.



**SIoux**

**FLAT SANDER**

**Persuasive with Abrasive**

Oscillating, orbital action at 4,000 cycles a minute produces the finest finish in a hurry on any material which you would sand by hand.

Better built by **SIoux**. No. 1850... **\$4780**



**SANDS WOOD SATIN SMOOTH**

**SANDS JOINTS SMOOTH**

**SANDS RUST OFF METAL**

**SIoux**

Write **TODAY** for more information

**ALBERTSON & CO., INC.** • **SIoux CITY, IOWA, U.S.A.**

**SAW SHARPENING IS EASY**



Sensational new Super Filer No. 11 joints and sharpens both hand and circular saws 6" to 10" with all teeth the correct height, depth, pitch and bevel. Easy to use—when file hits hardened steel roller, teeth are finished. Saw runs true and smooth with no side pull. Complete with special 8" file. **\$9.95** post-special 8" file. **\$2.95**

"**TRU-CIRCLE**" saw set automatically sets teeth at 10° or more **\$2.95**

**NEW! 7-in-1 HEX-KEYTAINER**

Always ready when needed—seven most popular socket screw wrenches in one convenient tool, sizes .050 to 3/16. Fits set screws from No. 3 to 3/8—cap screws from No. 1 to 1/4. In handy plastic case. **\$1.25** post-paid

**MONEY BACK GUARANTEE - CATALOG FREE**

**A. D. MCBURNEY, 5908 Hollywood Blvd., Hollywood 28, Cal., Dept. A-86**

**ONE-BAG MIXER THAT TRANSPORTS**



Universal Transmix® transports, mixes and dumps cement, silage, dirt, etc. P. T. O. driven—no gears or chains. Can be installed or removed in 15 minutes. Fits Ford, Ferguson, AC-WD, IHC Super C, H&M, Case VAC, J. D.-40, Oliver 55, and other 2- and 3-plow tractors. Unconditionally guaranteed. See your dealer or write, giving tractor model, to

**UNIVERSAL PULLEYS COMPANY**  
371 NORTH MOSLEY • WICHITA, KANSAS

**NEW, EVEN FINER HULL AUTO COMPASS**



The quality that continuously has made HULL the most widely used is now even finer... your best insurance for carefree Summer travel. \$4.95 and \$6.50. At your dealer's. Write for literature.

**HULL MANUFACTURING CO.**  
P. O. Box 246-D8—Warren, Ohio

**BRONZE FOUNDRY** Schools and Home Workshops

Make your own castings of aluminum, copper, bronze, silver. Foundry sets are available in three sizes including 2400 Deg. F. blast furnaces. See advertisements in March or Apr. issues, free Circular.

**KANSAS CITY SPECIALTIES CO.**  
P.O. Box 6022 Dept. P-8 Marysville, Kan.

**"SPEEDY" DRILL GRINDING GUIDE**



One piece cast Aluminum drill holding jig, use with grinding wheel or disc sander to re-point dull and broken twist drills up to 1/2" diameter. Single. Anyone can use it. Money back guarantee. Order to-day direct from factory. **1.00**

**BRASS CASTING CO. BOX 3056, MEMPHIS 9, TENN.**

**DO MORE PLANING JOBS WITH LOW COST BELSAW**



Exclusive **MONEY-MAKING** Features: Full 12 1/4" x 6" capacity • Power feeds at 14" to 34" a minute • Provides for Grinding Knives in the Cutter-head • Attachments for Jointing, Rabbeting, Tongue, Matching, Groove. Convert low cost rough lumber into high priced stock. Easy to make flooring and popular patterns. Send Today for **FREE** Literature and Prices.

**Belsaw Machinery Co, 2057 Field Bldg., K.C. 11, Mo.**

**GENUINE ALNICO MAGNETS**



**AMAZING. PERMANENT. NON-ELECTRIC. HIGHLY PRACTICAL.** Conduct interesting experiments. Hundreds of uses. Retrieve valuable steel items such as guns, tackle from fresh or salt water; tools from tanks & drains, **GUARANTEED**. Try any magnet one week. Money back if you are not well-pleased.

No. M-710 Has pull of 225 lbs. on flat steel block..... **\$16.50**  
No. M-625 Has pull of 125 lbs. on flat steel block..... **\$9.50**  
No. M-575 Has pull of 75 lbs. on flat steel block..... **\$6.50**  
No. M-500 Has pull of 50 lbs. on flat steel block..... **\$4.50**  
No. M-47 Hot Pad Magnets. 10 for **\$1.00**..... **50** for **\$4.87**  
No. M-35 Hobbyist assortment of 8 small magnets..... **\$1.50**

Send **M.O.** or check. We pay postage. Sorry no **C.O.D.'s.**

**MIAMI MAGNET COMPANY, 3240 N.W. 27th Ave., Miami 42, Fla.**



**PORTABLE LIGHT PLANTS**

**1300-1500 WATT PLANT**  
115 v. 60 cyc. AC Push Button Start. Powered by a 3 1/2 HP. Clinton engine. Combines big output with easy portability. Provides emergency power for operating any oil burner, sump pump, freezer, television, lights, communications systems, etc. which require up to 1500 watts. (Item 22). Wt. 110 lbs. Reg. \$475 value. Factory price... **\$239.50**  
Briggs engine. Electric starting & battery charging built-in! Factory price... **\$279.50**  
**MASTER-LITE 2500 Watt Plant**  
110/120 v. 60 AC. Powerful plant, ruggedly constructed and yet designed for easy portability. Can be started by rope or built-in 12 v. electric push button starter. Built-in winding to charge battery. Powered by a big 6.10 HP Briggs engine, complete with all accessories. Includes control box, voltmeter, and handy plug-in power receptacle. An ideal plant for permanent or stand-by service. Wt. 225 lbs. Reg. price \$645.00. (Item 21) Factory Price... **\$329.50**  
**3500 Watt Plant Push Button Start** (Item 23)  
115 v. 60 cyc. AC. Similar to above, but larger and 33% more capacity. Wt. 270 lbs. Reg. \$760. Factory Price... **\$379.50**  
**DUAL VOLTAGE 110/220** for Item 21 or 23—\$30 additional.

**HEATING & VENTILATING FAN**  
(Item 10) Easily installed in furnace pipes. Forces even heat to all rooms. Over range removes kitchen smoke and odors. Powerful, continuous duty motor, 110-120v. AC. Mount in wall or ceiling to ventilate any area. Quiet, super-efficient fan moves huge volume of air. (400 to 600 CFM).  
8" Pipe, wt. 5 lb. .... **\$6.85**  
9" Pipe, wt. 6 lb. .... **\$7.85**  
10" Pipe, wt. 7 lb. .... **\$8.85**  
12" Pipe, wt. 8 lb. .... **\$9.85**  
**HEAVY DUTY FAN**  
Suitable for spray booths, restaurant exhausts, poultry houses, etc. 10" Fan, wt. 8 lbs. (Item 10E) ..... **\$11.95**  
12" Fan, wt. 10 lbs. (Item 10D) ..... **\$12.95**  
**HIGH SPEED BARN FAN** similar to above, but larger, high speed motor moves huge volume of air.  
12" Fan (Item 10F) ..... **\$14.95**  
14" Fan (Item 10G) ..... **\$17.95**

**Variable Speed Selector**  
Heavy duty, made by E. F. GOODRICH for industrial use. Provides instant speed changes for any drive. For machine tools, dryers, printing, conveyors, production lines, hoists—any operation requiring variable speed. Employs reliable "trouble free" planetary system. No hydraulic power losses. Infinite range, smooth operation, easy installation. 3 sizes: 1/2-1 hp. 36 lbs.; 1-2 hp. wt. 55 lbs.; 2-3 hp. wt. 105 lbs.; Reg. list \$228, \$252 and \$352. Our prices... **\$79.50, \$89.50 and \$114.50**

**MASTER DC ARC WELDERS**  
Now a portable rugged, industrial type welder with terrific performance, yet at a price hundreds of dollars less than you'd expect. Senior model made for years of trouble-free, continuous service. High capacity DC welding unit enables you to tackle any job with confidence—easily welds anything up to 2" plate using from 1/16" to 1/4" rods. Built-in stabilizer and cooling system makes arc easy to strike and hold. Dual control rheostat provides heat soldering, brazing and welding from 30 to 300 amps. Complete with instructions, guarantee and triple V-belt or flat pulley. Easy to hook up and easy to operate. **WELDER ONLY — DUAL CONTROL MODEL.** Same as above, but drive with your tractor, jeep or gas engine of 14 HP or more. (Item 33a.) Wt. 110 lbs. \$450 value. .... **\$119.50**  
**WELDER ONLY — INDUSTRIAL MODEL** Same as above but with ceramic rotary type rheostat providing 74 different heat settings for all types of welding (Item 33b) ..... **\$139.50**  
**COMPLETE POWER MASTER** Illustrated above; powered by a 14.0 hp. air cooled Wisconsin engine. Wt. 185 lbs. (Item 280) Compares with welder costing \$1200. Factory Special ..... **\$449.50**  
**WELDING KIT** Two 10 ft. leads, welding helmet, electrode holder, ground clamp. Sold only with welder at... **\$10.50**

**TERRIFIC SAVINGS**

**at MASTER MECHANIC'S BEDROCK FACTORY PRICES!**

**600-700 WATT PLANT**  
(Item 24)  
115 v. 60 cyc. AC Powered by a rugged 2 HP. easy starting Briggs engine. No wiring necessary: just plug in and operate. Plenty of current for any oil burner, freezer, brooder, emergency lights, etc. which require up to 700 watts. Ideal for television and radios. Complete with voltmeter and built-in winding to charge 6 v. auto batteries. (Item 24) Wt. 75 lbs. Easily fits in car trunk. Be prepared if storm knocks out power lines. **\$143.50**  
Regular \$275.00 value  
1000-1200 Watt Plant (Item 45) Same as Item 24 but larger generator and engine with 50% greater output. .... **\$199.50**  
We make every type and size of light plants—Write, giving us your requirements!

**CARRY-IT COMPRESSOR**  
Perfect portable air supply for spraying paint, insecticides, tire inflation, etc. Hi pressure 2 x 1 3/4" piston-type compressor powered by a 1/2 H.P. capacitor type motor—develops up to 150 lbs. pressure. Built-in 500 cu. in. Steel tank tested to 400 lbs. Complete with safety valve, gauge and shut-off valve. A better buy than outfit selling for \$100 or more. (Item 226) Wt. 55 lbs. Factory Special ..... **\$74.95**

**RUBBER HOSE**  
Genuine Neoprene Hose—outlasts ordinary rubber 3 to 1. Reinforced with super tough cotton cord plies—yet completely flexible. Equipped with standard thread male and female fittings. Pump water for irrigation, stock tanks, barns, fire fighting, etc.—or pump gas and fuel oil. Volume factors prices—save more than 60%.

Inside Dia.	Length	Price
1"	10 ft.	5.95
1 1/4"	10 ft.	8.95
1 1/2"	25 ft.	13.95
1 3/4"	50 ft.	24.75
1 3/4"	100 ft.	49.95
1 1/2"	10 ft.	10.95
1 1/2"	25 ft.	14.75
2"	10 ft.	16.50
2"	25 ft.	19.50
2 1/2"	10 ft.	21.50
2 1/2"	25 ft.	21.75
3"	10 ft.	25.50

**1 1/2" I.D. HIGH PRESSURE STEAM NOSE** per ft. .... **\$1.00**  
**AIR HOSE** Heavy duty, 1 1/4" I.D., 2 braided (150 lb. pressure) with standard couplings, 20 ft. lengths each. .... **\$2.95**  
**PAINT SPRAY MATERIAL HOSE** 3/4" I.D. Synthetic Thickol inner tube and neoprene cover—finest made! 25 ft. lengths with standard couplings. (Item 62) each... **\$7.50**

**JET STEAM MASTER**  
Now, a super efficient portable steam generator that produces live steam at 100 lbs. pressure in 60 seconds from a cold start! Produces large volume of high pressure steam on 2 pints of fuel oil. Instantly cleans sticky grease, dirt, rust, old paint, etc. off implements and road machinery. Pays for itself in a few weeks. Sterilizes soil. Sterilizes as it cleans—milk equipment, etc. Fully automatic—oil fired with new, built-in lifetime bronze water circulating pump. Draws water from faucet or bucket. Simple and safe—anyone can use it! Built-in safety valve. Complete with 12 ft. of hi-pressure steam hose and new triple efficiency steam gun that automatically mixes in soap solution if desired. Wt. 250 lbs. Item 483. .... **\$329.50**  
Special factory price

**LESS THAN WHOLESALE**

**GIANT 2000-2500 WATT PLANT**  
110-120 v. 60 cyc. AC. Absolutely the best made—exclusive dynamically balanced armature; heavy windings develop up to 5000 watt overload for portable starting. Skid mounted—portable. Powered by an easy starting Briggs or Wisconsin 6 HP engine—complete with all accessories; engine easily disconnected for other uses. Big outlet box, voltmeter, no wiring necessary. Ample current for all purposes. Factory warranty. (Item 31) Wt. 210 lb. Reg. price \$585. Special at... **\$299.50**  
Same plant with electric self starter (Item 31a) ..... **\$359.50**  
Generator only and control box... **\$169.50**  
**DUAL VOLTAGE 110-220** available on any of above models for \$28.00 additional.

**DIESEL LIGHT PLANT**  
(Item 1660) Diesel Master—11-12 kw. 110/220 v. AC single or 3 phase. 1800 rpm direct connected. Electric Self-starting. Engineered for permanent power where continuous low-cost, heavy duty service is important. Wt. 1350 lb. Reg. list \$850.00. Factory Price... **\$1895.00**

**EXTENSION CORD**  
Heavy duty and very flexible. Neoprene 14-2 cable, 20 year quality. Wt. 12 lbs. (Item 185) 100 ft. Complete with rubber plug and outlet. A terrific buy at only **\$8.95**  
**NO. 10-2 POWER CABLE** Heavy duty, very flexible, rubber covered, 50 ft. with male and female fittings. Wt. 9 lbs. (Item 592a) **\$10.45**  
50 ft. without fittings (Item 592) ..... **\$9.45**  
**NO. 12-2 POWER CABLE** Very flexible rubber covered, special outside shield for grounding power tools, etc. 50 ft. (Item 109) Wt. 8 lbs. **\$6.95**, 100 ft. (Item 200) ..... **\$12.95**  
**NO. 14-8 Connector Power Cable**, heavy duty very flexible, rubber covered, with 8 contact plug & socket. Ideal for tractor-trailer connections (Item 780) 15 ft. .... **\$9.95**

**HI-FLO Centrifugal PUMP**  
Completely self-priming! No foot valve required. Tremendous capacity—100 gal. per min. 1" Special Impeller enables pump to handle muddy or sandy water. Simple to operate—simply start engine and watch the water go. Powered by a rugged, easy-starting 2 HP Briggs engine. Pre-lubricated sealed bearings for years of heavy low-cost service. Big 1 1/2" Model. Item 602. Wt. 70 lbs. **\$134.50**  
Factory price... **\$134.50**  
2" Model (150 gal. per min.) with 2 1/4" hp. engine. Item 502a. 90 lbs. Fac. Spec. **\$154.50**

**JET FLOW BLOWER**  
Tremendous air movement (1800 CFM) and quiet operation make this double inlet 10" turbine blower unbeatable for heating, cooling, drying and air conditioning. Ideal for attic or barn ventilation, converting gravity heating to forced air; spray booth exhausts, etc. Operates with any 1/2, 1/2 or 1 1/2 HP motor. Overized, long life bearings. Includes variable speed motor pulley and belt. Dimensions 19" h x 18" x 16 1/2". Outlet opening 13" x 11 1/4". Wt. 45 lbs. Item 245. Reg. \$54.50. **\$29.50**  
Factory Special  
**HEAVY DUTY 1 1/2 HP motor for above \$17.95**

**Rugged, ball bearing WINCH**  
Sturdy ball bearing winch—super tough aluminum alloy construction. Powered by an easy starting 2 1/4 HP Briggs gas engine two gear reduction drive—it exerts up to 3000 lbs. of terrific force for hoisting materials or pulling. Combination gear and pulley reduction results in tremendous multiplication of engine power. Idle pulley clutch arrangement and built-in drum brake (with ratchet hand lever) enables operator to ease loads down gently and lock at any point desired. Drum handles 400 ft. of 3/8" cable or 600 ft. of 1/2" cable. Ideal for contractors, farm implement trailers and unlimited other uses! (Item 795) Wt. 125 lbs. Only... **\$149.50**  
**HAND WINCH**—Same winch with large crank handle for extra leverage and 2 speed drive. (Item 794) Wt. 60 lbs. **\$59.50**

Send check or M.O. Prices f.o.b. Factory. 10 day Money back guarantee. SEND 10c for... **BIG 1956 Catalog**  
**MASTER MECHANIC MFG. CO., DEPT. 88-M Burlington, Wis.**





When the other kids ask...

# WHAT DOES YOUR DAD DO?

How does your boy answer them?

Sure... you're his hero. You *know* that. But sometimes it can get kinda tough if the other kids don't seem to understand about the "old man."

It's not that you *like* to be chained to the same old job. Maybe you just *had* to leave school too soon. Maybe the war inter-

fered. Anyway, here you are, stuck because you just don't have enough formal training.

**Well, Mister, You Can Still Make the Grade!**

It isn't easy. You've got to have grit and determination and the will to succeed. As long as you have

these, I.C.S. can put you on the road to real prestige, advancement and security. Your family can really be proud of you!

## Spare-time I.C.S. Study Pays Off:

I.C.S. gives you practical, dollars-and-sense training — the kind that pays off. You choose from 256 courses. You get personalized, sympathetic guidance. You advance as rapidly as your time and ability permit. Does it work? Thomas Dyke was a coal miner with no high school education. He studied with I.C.S., worked his way up to licensed engineer. Today, his income is above the average for college trained engineers. *And this kind of training can work for you!*

**THREE FREE BOOKS—  
SEND TODAY!**

**BOOK No. 1 — "How to Succeed."**  
A gold mine of helpful job tips.

**BOOK No. 2 — An outline of job opportunities in the field that interests you most.**

**BOOK No. 3 — A sample I.C.S. (math) lesson text that shows you the I.C.S. clear, step-by-step teaching method. Send the coupon today—no obligation!**

**For Real Job Security—Get an I. C. S. Diploma! I. C. S., Scranton 9, Penna. Member, National Home Study Council**

## INTERNATIONAL CORRESPONDENCE SCHOOLS

**65<sup>TH</sup>  
YEAR**

**BOX 58626H, SCRANTON 9, PENNA.**

Without cost or obligation, send me "HOW to SUCCEED" and the opportunity booklet about the field BEFORE which I have marked X (plus sample lesson):

### ARCHITECTURE and BUILDING CONSTRUCTION

- Air Conditioning—Refrig.
- Architecture
- Architectural Interiors
- Building Contractor
- Building Estimator
- Building Maintenance
- Carpentry and Mill Work
- Heating
- Painting Contractor
- Plumbing
- Reading Arch. Blueprints

### ART

- Cartooning
- Commercial Art
- Fashion Illustrating
- Magazine Illustrating
- Show Card and Sign Lettering
- Sketching and Painting

### AUTOMOTIVE

- Auto Body Rebuilding
- Auto Elec. Technician
- Auto-Engine Tune Up
- Automobile Mechanic

### AVIATION

- Aeronautical Engineering Jr.
- Aircraft & Engine Mechanic

### BUSINESS

- Advertising
- Bookkeeping and Accounting
- Business Administration
- Business Correspondence
- Public Accounting
- Creative Salesmanship
- Federal Tax
- Letter-writing Improvement
- Office Management
- Professional Secretary
- Retail Business Management
- Sales Management
- Stenographic-Secretarial
- Traffic Management

### CHEMISTRY

- Analytical Chemistry
- Chemical Engineering
- Chem. Lab. Technician
- General Chemistry
- Natural Gas Prod. & Trans.
- Petroleum Engineering
- Plastics
- Pulp and Paper Making

### CIVIL, STRUCTURAL ENGINEERING

- Civil Engineering
- Construction Engineering
- Highway Engineering
- Reading Struct. Blueprints
- Sanitary Engineering
- Structural Engineering
- Surveying and Mapping

### DRAFTING

- Aircraft Drafting
- Architectural Drafting
- Electrical Drafting
- Mechanical Drafting
- Mine Surveying and Mapping
- Plumbing Drawing and Estimating
- Structural Drafting

### ELECTRICAL

- Electrical Engineering
- Electrical Maintenance
- Electrician  Contracting
- Lineman

### HIGH SCHOOL

- Commercial  Good English
- High School Subjects
- Mathematics

(Partial list of 256 courses)

### LEADERSHIP

- Foremanship
- Industrial Supervision
- Leadership and Organization
- Personnel-Labor Relations

### MECHANICAL AND SHOP

- Gas—Electric Welding
- Heat Treatment  Metallurgy
- Industrial Engineering
- Industrial Instrumentation
- Industrial Supervision
- Internal Combustion Engines
- Machine Design-Drafting
- Machine Shop Inspection
- Machine Shop Practice
- Mechanical Engineering
- Quality Control
- Reading Shop Blueprints
- Refrigeration
- Sheet Metal Worker
- Tool Design  Toolmaking

### RADIO, TELEVISION

- Industrial Electronics
- Practical Radio TV Eng'ng
- Radio and TV Servicing
- Radio Operating

### TELEVISION TECHNICIAN

### RAILROAD

- Air Brake Equipment
- Car Inspector
- Diesel Engineer & Fireman
- Section Foreman

### STEAM AND DIESEL POWER

- Combustion Engineering
- Diesel—Elec.  Diesel Eng's
- Electric Light and Power
- Stationary Fireman
- Stationary Steam Engineering

### TEXTILE

- Carding and Spinning
- Cotton, Rayon, Woolen Mfg.
- Finishing and Dyeing
- Loom fix'g  Textile Des'g'ng
- Textile Eng'g  Throwing
- Warping and Weaving

### MISCELLANEOUS

- Domestic Refrigeration
- Marine Engineering
- Ocean Navigation
- Professional Engineering
- Short Story Writing
- Telephony

Name \_\_\_\_\_ Age \_\_\_\_\_ Home Address \_\_\_\_\_

City \_\_\_\_\_ Zone \_\_\_\_\_ State \_\_\_\_\_ Working Hours \_\_\_\_\_ A.M. to P.M. \_\_\_\_\_

Occupation \_\_\_\_\_

Canadian residents send coupon to International Correspondence Schools, Canadian, Ltd., Montreal, Canada. . . . Special tuition rates to members of the U. S. Armed Forces.





## From cluttered attic to cozy den!



Just see how you can transform an unused space with a few tools and Gold Bond Insulation Planks and Tiles! Isn't it cozy? And it will be warmer in winter, comfortable in summer, because it's Gold Bond-insulated.

**FIRST THE WALLS** go up—fast! Gold Bond Insulation Planks are lightweight, easy to handle, easy to install. Just nail or staple them (interlocking edges hide the fasteners). The Planks come with a flame-resistant finish—in ivory or a random assortment of

four harmonizing colors. They can be painted to match individual color schemes, too.

**THEN THE CEILING** of Gold Bond® Insulation Tiles is nailed or stapled in place (again, interlocking edges hide the fasteners). The Tiles (and Planks, too) sponge up noise, keep your new room restfully quiet.

**SEE YOUR LOCAL GOLD BOND DEALER** for materials and helpful advice. And ask him about easy terms.

# Gold Bond

BUILDING PRODUCTS

NATIONAL GYPSUM COMPANY

Gold Bond  
HOW-TO-DO-IT  
PLAN #14

### MAIL THIS COUPON NOW!

National Gypsum Company, Dept. PM86  
Buffalo 2, New York  
Please send me Gold Bond's "How-to-do-it"  
Plan #14... giving complete instructions on  
how to apply Insulation Planks and Tiles.



**FREE LITERATURE.**  
Mail the coupon today  
for an illustrated manual  
that shows how you  
can build a room just as  
attractive as this.

Name \_\_\_\_\_

Address \_\_\_\_\_

City \_\_\_\_\_ Zone \_\_\_\_\_

County \_\_\_\_\_ State \_\_\_\_\_



**GO**

Don't drive a sluggish car...

*with that*

*"new  
car  
feel..."*

Your car CAN be a joy to drive! Bring back that grand "new-car feel" with an alert, responsive engine—see your Doctor of Motors for a power-restoring overhaul with Perfect Circle 2-in-1 Chrome piston rings.

In PC's 2-in-1 Chrome set, the top compression ring was specially designed to perform where pressures are greatest, heat is highest, and lubrication is poorest. The new Type "98" oil ring with self-expand-

ing spacer assures a uniform pressure against the cylinder wall, plus a side sealing action on the ring groove. Both rings are plated with thick, solid chrome that resists wear, more than doubles the life of cylinders, pistons and rings.

For full-powered performance with positive oil control, Doctors of Motors everywhere install and recommend Perfect Circle 2-in-1 Chrome piston rings—a sure way to bring back that "new-car feel."

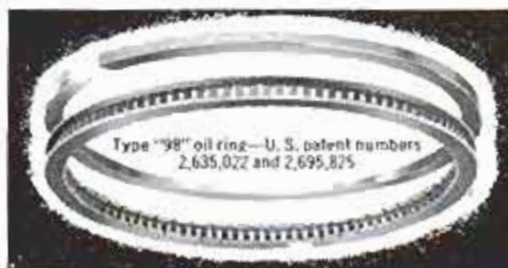

*Better Mechanics everywhere install*

**PERFECT CIRCLE**

2-in-1 Chrome piston rings... *The Standard of Comparison*

Perfect Circle Corporation, Hagerstown, Ind.; The Perfect Circle Co., Ltd., Don Mills, Ont.