

REPORT ON THE '56 FORD

35 CENTS

POPULAR MECHANICS

MAGAZINE

WRITTEN SO YOU CAN UNDERSTAND

REG. U.S. PAT. OFF. TRADE MARK, G.P.O. AT BRITAIN No. 40424

REG. U.S. PAT. OFF.

JULY 1956

Tripont Sloop
—Page 110



THE **SEA-HORSE** IS AT HOME ON WATERS EVERYWHERE

Most anywhere you trailer your boat, you'll find that Johnson has been there ahead of you. Johnson dealers are everywhere. And they are trained and equipped for *expert* outboard service. That is one of the reasons Johnson motors perform so faultlessly so long. You don't see this factor when you buy an outboard — but you feel its influence ever after!

FREE! Write for the Sea-Horse Booklet describing all 1956 models and features. Complete, factual, helpful.

JOHNSON MOTORS, 400 Pershing Road, Waukegan, Ill.
A DIVISION OF OUTBOARD MARINE AND MANUFACTURING COMPANY
In Canada: Manufactured by Johnson Motors, Peterborough



JAVELIN*	30 hp ..	\$582.00
SEA-HORSE 30*	30 hp ..	552.00
SEA-HORSE 30	30 hp ..	462.00
SEA-HORSE 15*	15 hp ..	452.00
SEA-HORSE 15	15 hp ..	362.00
SEA-HORSE 10	10 hp ..	321.00
SEA-HORSE 7½	7½ hp ..	241.00
SEA-HORSE 5½	5½ hp ..	216.00
SEA-HORSE 3	3 hp ..	146.00

Johnson

SEA-HORSES

FOR DEPENDABILITY

*Electric Starting . . . Prices f. o. b. factory, subject to change . . . All models except the "3" have separate Mile-Master Fuel System . . . All ratings are OBC certified brake horsepower at 4000 rpm (30's at 4500).

Texaco Tips On Car Care



* Check battery water level

Now, during the hot summer months, it's wise to check your battery water level more frequently than usual. Water evaporates quickly under high temperature, in just a few days can drop below top of plates, drying them out, reducing power and permanently damaging the battery. Maintain water level approximately $\frac{3}{8}$ " above plates. And to protect battery terminals from corrosion, scrape or wire brush both clamps and terminal posts until clean and then apply a coating of light grease.

* Enjoy powerful engine performance

For fast starts, top passing power and performance — for all the power you paid for — use *Advanced Custom-Made Havoline*, the motor oil that out-performs them all. It keeps your engine clean, guards against wear and rust. Get the best motor oil your money can buy — *Havoline!* The man to see is your Texaco Dealer, the best friend your car has ever had!

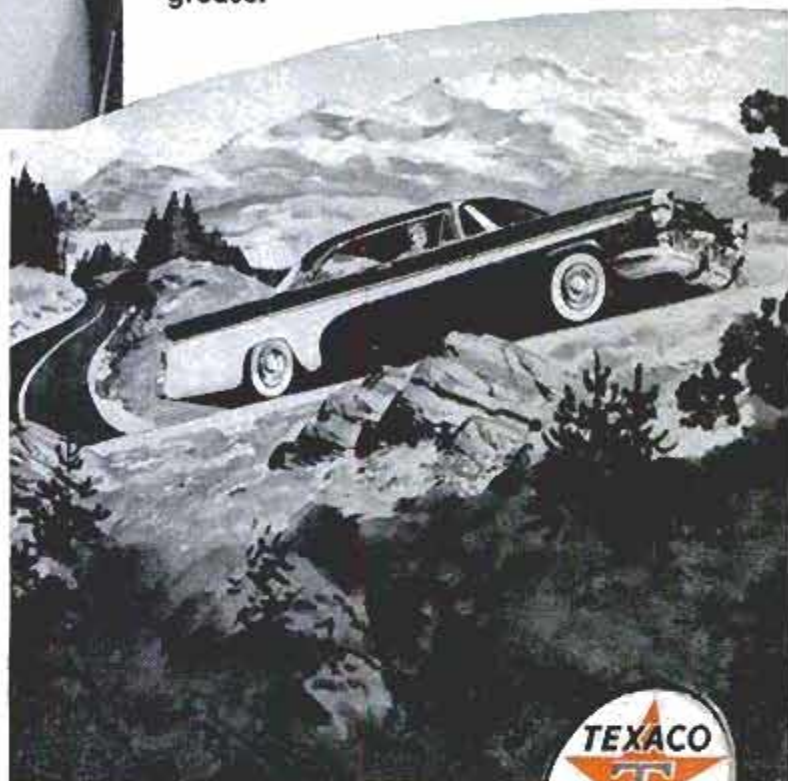

TEXACO DEALERS IN ALL 48 STATES

Texaco Products are also distributed in Canada and in Latin America



THE
TEXAS
COMPANY

A NEW FEATURE!

ELECTRIFIED

PACEMAKER GRAPHIC® 45



- ① Rangefinder button also used to actuate solenoid.
- ② Solenoid used to trip shutter.
- ③ Shutter synchronizes flash.
- ④ Shoe clip for flash.

ADDS NEW CONVENIENCE

Eliminates external wiring to shutter, which means no dangling wires and no need to disconnect the trip cord when closing the camera. Permits the camera to be held and allows the shutter to be released with the left hand while an electronic flash unit is held off the camera with the right hand. Accommodates any inexpensive clip-on flash unit such as the Graflash B-C.

BOUNCE FLASH

Can be tripped with the thumb or forefinger of the left hand which normally holds the camera. This, of course, leaves the right hand free to aim an electronic flash or conventional flash such as the Graflite Jr. Previously only the regular Graflite offered such convenience.

TAKE 20 MONTHS TO PAY

Electrified Pacemaker Graphics are available in two models equipped with f/4.7 Optar lens in fully synchronized shutter and built-in Graphic Rangefinder: CFE-93 Crown Graphic . . . \$325.50; SFE-93 Speed Graphic . . . \$381.50. Pay as little as \$17.58 a month. See your Graflex dealer listed in the "Yellow Pages" of your telephone book or write Graflex, Inc., Department PM-76, Rochester 8, N. Y.

Prices include federal tax where applicable and are subject to change without notice. Prices are slightly higher in Canada.

GRAFLEX® *Price-Winning Camera*

GRAFLEX, INC., ROCHESTER 8, N. Y.



Robot Conductor For Railroads

Displayed at the 34th Annual Trade Fair at Milan, Italy, a mechanical train conductor gives information to passengers in two languages. The device tells the passengers where and when the train stops, what points of interest are being passed, and supplies other information normally supplied by railway employees. The information is read from a paper roll in a viewing box. The roll is prepared to cover six days of the train's operation and moves in ratio to the train's speed. The device will be put into experimental use by the Italian State Railways.

Teleprinter Receives and Types Messages Sent to Plane

Operating at 100 words per minute in a British Overseas Airways Stratocruiser on a test flight over the Atlantic, an airborne teleprinter received radio messages intended for the flight crew and typed them on message blanks. The flight was an experiment to test the new device which is aimed at cutting down excessive radio communications over busy airways and increasing the accuracy of communications. The teleprinter is automatic and requires no attention from the pilot other than switching from the British to the Newfoundland frequency midway across the ocean.

☛ Forest fires caused by dry lightning may be prevented in the future by seeding the cumulus clouds which are the source of the lightning with silver-iodide particles, if tests now being conducted in northern Arizona prove successful. There are 6000 such fires each year in the western states.

Popular Mechanics Magazine

Registered in U. S. Patent Office and Canada

H. H. WINDSOR, Founder

H. H. WINDSOR, JR., Editor and Publisher

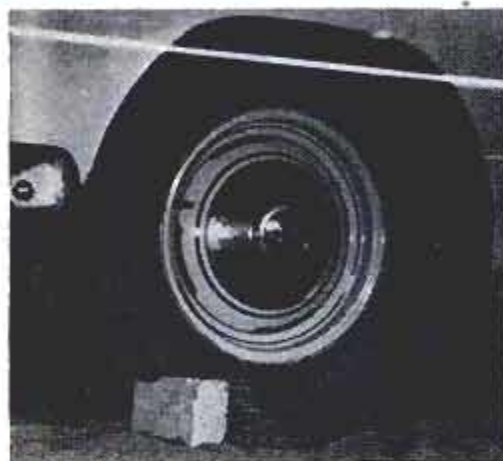

Next Month

EVER HIT a brick going 50 miles per hour? Chances are it was harder on the tire than on you, for the tire was engineered to protect you from such punishment. Tires for today's driving must take an incredible beating and bounce back for more. But what about tomorrow's tire? It must be even tougher to withstand the heat of high-speed driving on the superhighways. To make the problem knottier, auto designers want 14 and even 13-inch tires to make cars look lower and sleeker. What will tomorrow's tire be like? A feature next month gives you the real dope on the 100,000-mile tire, the tire to match the color of your car or your wife's hair, the tire so dependable you can throw away your spare. As a bonus you'll find inside tips from the experts on how to keep your tires rolling for thousands of extra miles.

Sources of further information not listed in the index, starting on page 58, about articles in this issue, frequently are shown in the Where-to-Find-It List prepared for each issue. A copy may be obtained by readers, without charge, from Bureau of Information, Popular Mechanics, 200 East Ontario Street, Chicago 11, Ill.

Published monthly by Popular Mechanics Company, 200 E. Ontario St., Chicago 11, Ill. H. H. Windsor, Jr., president; Wm. Harrison Petridge, exec. vice-pres.; Franklin S. Forsberg, operations vice-pres.; D. F. Windsor, vice-president and secretary-treasurer; H. H. Windsor III, vice-president; W. T. Windsor, vice-president; Joseph R. Buell, Jr., advertising manager; Alan M. Deyoe, circulation manager. Single copy in the United States and Canada, 35 cents; subscription rates in the United States and possessions, Canada, Philippines and countries of the Pan-American Postal Union, 1 year \$3.50; 2 years, \$6.00; 3 years, \$8.00. To all other countries add \$1.00 a year over United States prices for overseas postage. If you plan to move, notify us at least 30 days in advance so you will not miss an issue. Give both your old and new addresses. Entered as Second Class Matter, September 15, 1903, at the Post Office at Chicago, Illinois, under Act of March 3, 1879. Entered as Second Class Matter at Post Office Dept., Canada. Registered as Second Class Matter at the Post Office at Mexico, D. F., Mexico, June 20, 1954. Copyright 1956 by Popular Mechanics Company. Copyright under International Copyright Union. Copyright in France. All rights reserved under Pan-American Copyright Union. Printed in the United States of America.

Volume 106

JULY 1956

Number 1

Address all communications to: 200 E. Ontario St., Chicago 11, Ill.

Managing Editor.....Roderick M. Grant
 Assistant Managing Editor.....Wayne Whittaker
 Shop Notes and Crafts Editor.....James R. Ward
 Radio-Television, Electronics Editor.....Lothar Stern
 Associate Editor.....Clifford B. Hicks
 Associate Editor, Automotive.....Arthur R. Railton
 Associate Editor, Shop Notes and Crafts.....Wayne C. Lecky
 Associate Editor, Shop Notes.....W. Clyde Lamme
 Assistant Editor, Crafts.....Jay W. Hedden
 Assistant Editor, Makeup.....John C. Dalen
 Automotive Correspondent.....Leo Donovan
 Art Director.....Frank Beatty
 Assistant Editors—Leonard F. Hiltz, Elliott H. McCleary, Emily M. Rice,
 Earl F. Wobeck
 Eastern Editor.....Richard F. Dempewolff
 Empire State Bldg., Room 2906, New York City 1
 Western Editor.....Thomas E. Stimson, Jr.
 Suite 1010, 3460 Wilshire Blvd., Los Angeles 5, Calif.
 London Manager.....Douglas W. Wedderspoon
 Eagle House, Jermyn St., London S. W. 1, England
 Director, Bureau of Information.....Allan Carpenter
 200 E. Ontario St., Chicago 11

Advertising Offices

Chicago: 200 E. Ontario St., Whitehall 4-0100; New York: Empire State Bldg., 350 Fifth Ave., Longacre 5-7580; Detroit: General Motors Bldg., TRinity 5-8711; Cleveland: Hanna Bldg., 1422 Euclid Ave., PProspect 1-0456; Los Angeles: Tishman Bldg., 3460 Wilshire, DUnkirk 2-8458; San Francisco: Russ Bldg., 235 Montgomery St., YUkon 2-0823.

In This Issue...

Assault on Forty-Fathom Pit	65
We'll Conquer Antarctica With Wings	72
The Jail That Modern Science Built	79
Detroit Listening Post	84
School for Forest Rangers	86
How Atoms Generate Power	91
Keeping Up With the Atom	94
Drive-In Dream Castles	97
What's New for Your Home	106
The Tripont Sloop	110
The Owners Report on the '56 Ford	116
How to Stay Alive in the Water	124
Mile-a-Minute Midgets	128
They're Making Artificial Moonlight	136
Radio, TV and Electronics	145

For the Craftsman...

Furnish Your Patio — Part I	149
More Storage Space in Your Home	153
You'll Have Fun on Water Skis	158
Solving Home Problems	170
Selecting the Right Awning or Canopy	182
Electroplating Without Cyanides — Part II	191
How Would You Do It?	198
Shopping for Tools	202
Clinic for Homemakers	206

See pages 58, 60 and 62

for other items and manufacturers of available products

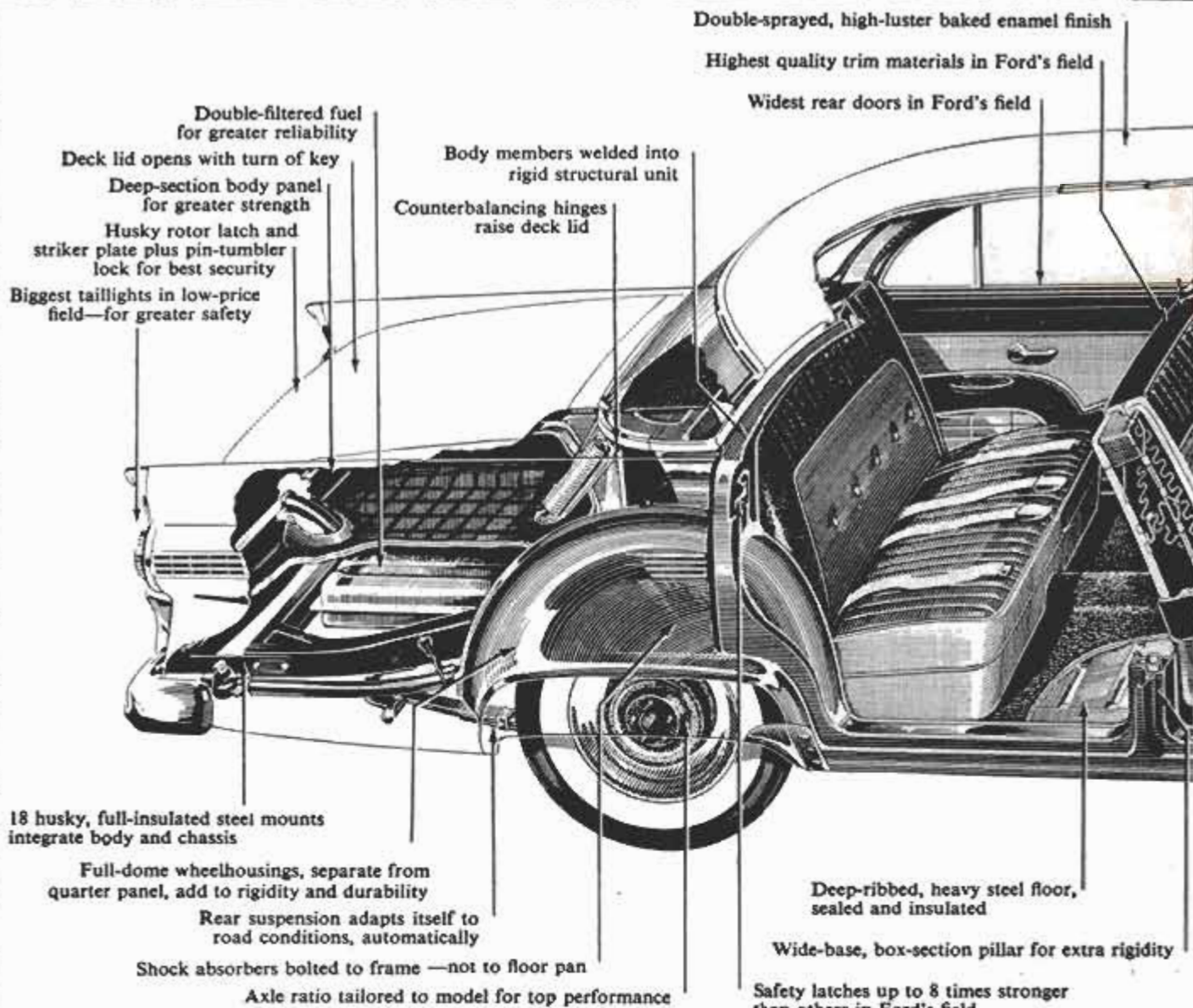

Let's take a look at the

"Inner FORD"

*Here you see why the '56 Ford gives you
greater durability...longer life...fewer repair bills*

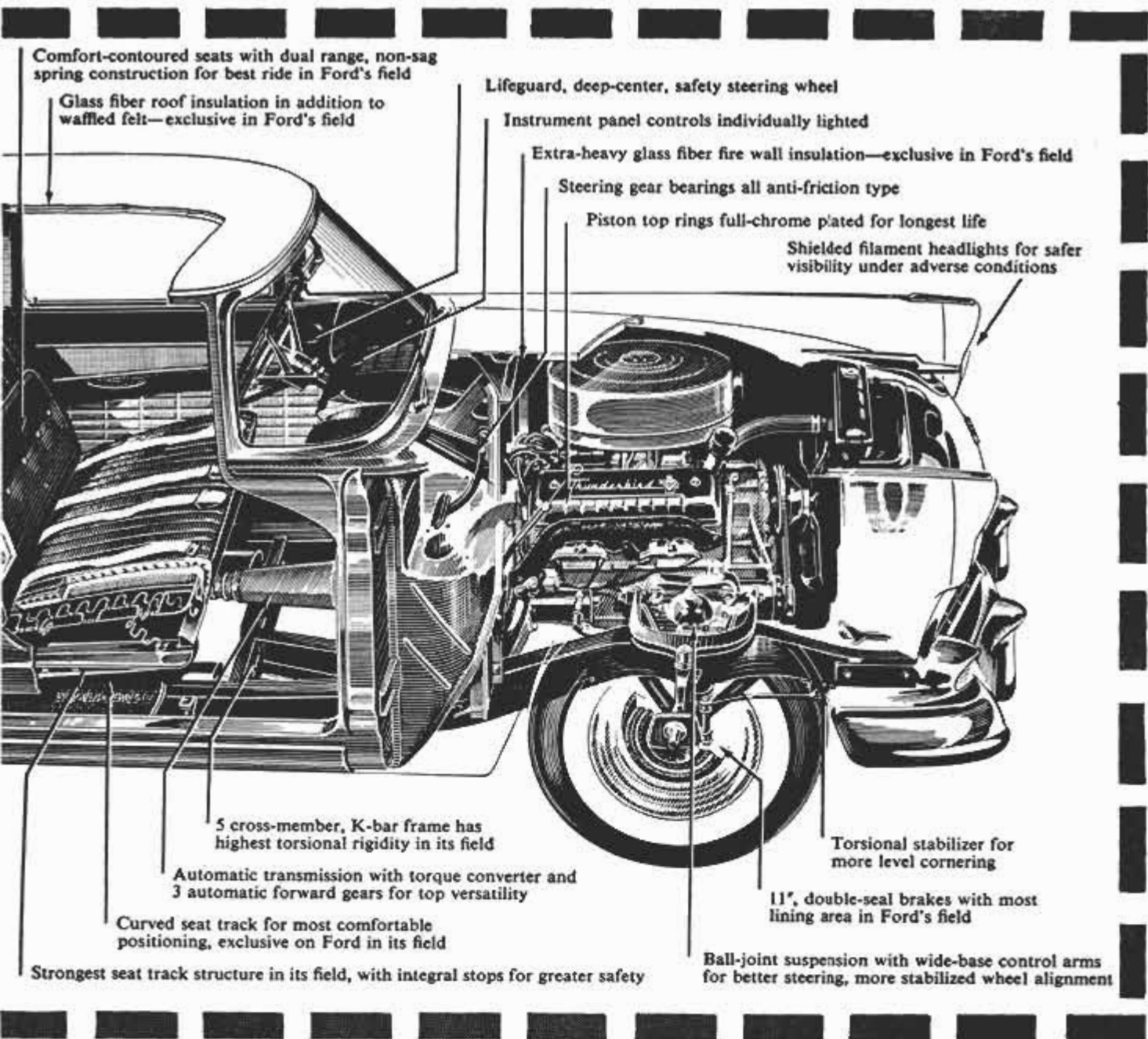

This cutaway view of a Ford Sedan gives you a look at the Inner Ford, the part you seldom see. Look it over carefully. Count up the features that Ford gives you—at low prices—that many manufacturers offer only in their most expensive cars, if at all. Then you'll understand why we say "Ford is the *fine* car at half the fine-car price!"

This One



8T5R-WPY-89A3

FORD Division of FORD MOTOR COMPANY

Job-Designed! PROTO Professional-Quality Pliers for Your Needs!

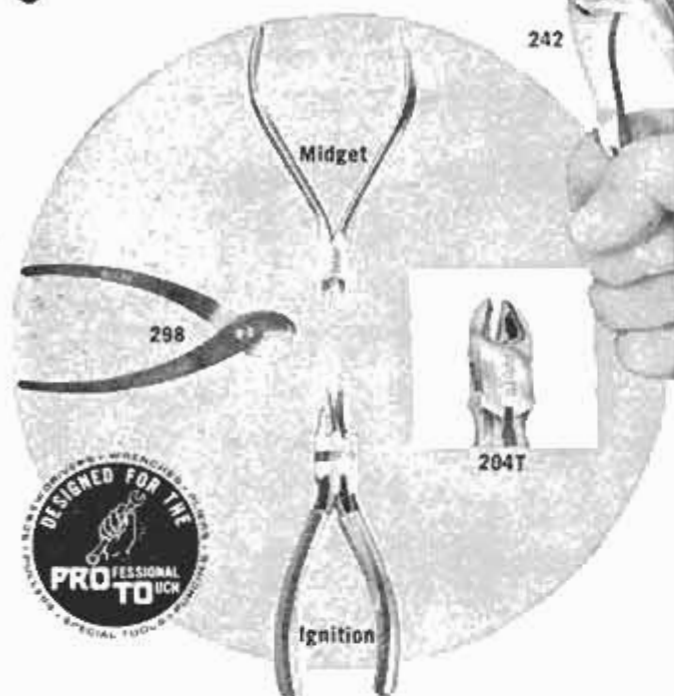

NEW! Multiple-Groove Joint Utility Plier. Gives you a wide range of openings for hundreds of jobs. 242-7½" and 243-9½"; **NEW! Mighty Midget Plier for Electronics.** You'll like the feel of these pliers for working on small objects or in tight places. 6 models, 4" to 4¾". **NEW! "Snip-Grip" Plier.** Plastic inserts in cutting edges hold end of wire after you cut it. Prevents electrical shorts, protects you from injury. 204T-4½"; 206T-6"; **NEW! Electronics & Ignition Cutting Plier.** Cutter is close to tip. Spring opens long narrow jaws. 224G-6"; **Also NEW! Comfortable "Handeze" Plier Grips.** Slip on easily, fit tight, are long wearing. Reduce fatigue. **NEW! V-Notch Wire Stripper.** Two V-notches cut through insulation, slight side pressure strips it. 298-5½".

**And... the Sensational Multi-Plier!
Increases grip 10 times!**

"A Chest of tools in one." 234-8".

All recent additions feature the outstanding "professional quality" of the broad PROTO plier line. Fine alloy steels, sturdy construction, carefully fitted joints, correct leverage, properly shaped teeth, positive cutting edges, ease of operation. See the PROTO plier line at your dealer's, or send 10¢ for catalog of entire line to **PROTO TOOLS** 2205 Santa Fe Ave., Los Angeles 54, Calif. Eastern Factory, Jamestown, N.Y. Canadian Factory, London, Ont.



ACROSS THE DESK



To the Editor:

This is to inform you that MCB does not stand for Marine Construction Battalion.

MCB, which should have a prefix of USN, stands for United States Naval Mobile Construction Battalion. In your April issue the article "The Seabees Build a Town" you referred to us as Marines, which we are not and no part of.

J. S. McCool,
G. A. Jensen,
USNMCB 9,
c/o Fleet P.O.,
San Francisco, Calif.

The above letter from Cubi Point, Philippines, was followed next day by this:

Congratulations on the fine articles by Dick Dempewolf in your April and May 1956 issues concerning the Navy's Operation Deepfreeze in the Antarctic.

As this command was quite deeply involved in outfitting and training many personnel engaged in this operation, it noted with great concern the erroneous reference made to "MCB(S)" as Marine Construction Battalion (Special). The MCBs are composed of personnel of the Navy's famed Seabees and are utilized in the construction of overseas bases for the Navy.

Your prompt noting of this misconception will be greatly appreciated by the Seabees of the Navy.

Thomas J. Doyle,
Commander, CEC, U.S. Navy,
Chief Staff Officer,
U.S. Naval Construction
Battalion Center,
Davisville, R. I.

Noted, with our apologies to the Navy's Seabees.

To the Editor:

Having worked as a temporary helper in another Christmas rush at the post office, I'd like to express a few thoughts which might help the postal system pay its own way, improve in service and save the taxpayers' money.

First, a little automation is in order. The post office uses entirely too much muscle power and not nearly enough machinery—in this day of rocket aircraft, electronic

(Continued to page 10)

5 reasons why ACCOUNTING



offers you MORE MONEY... and SUCCESS!

REASON #1. If you were an expert accountant right now, chances are you would find yourself among the highest-paid of all professional men and women. Even back in "depression years," accountants earned more than many men in other major professions.

REASON #2. The demand for accountants is great—everywhere. All businesses must have trained accountants to cope with ever-growing requirements. It's a profession offering wide opportunity—always—to the man who knows.

REASON #3. You can fit into any business, anywhere in the country—because accounting principles are universal. Think what this means in terms of security and independence!

REASON #4. Accounting is open to all. Any man or woman of good intelligence, who enjoys figure work and is willing to follow LaSalle's systematic "problem method" plan, can rapidly qualify for a highly profitable, enjoyable lifetime career... and he doesn't have to finish his training before beginning to "cash in."

REASON #5. Without losing a day from your present work, you can prepare in spare hours at home, at low cost, under LaSalle's step-by-step "Problem Method" of "learning by doing." This famous plan accounts for LaSalle's remarkable record of having trained one out of every 13 of all Certified Public Accountants in the U. S. . . . and of having put many thousands of others into high-paying careers.

Send today for Free Sample Lesson and "Accountancy, the Profession That Pays." Learn about the several great fields of opportunity . . . and LaSalle's time-tested plan for helping men and women to rapid advancement, higher income, greater prestige and professional standing. The coupon below will bring this information to you—without cost or obligation.

MAIL THE COUPON—NOW
Member, National Home Study Council

GET FREE SAMPLE LESSON



LaSalle Extension University
— A Correspondence Institution —

Dept. 764H 417 S. Dearborn St., Chicago 5, Ill.

Please send me, free of all cost or obligation, a sample lesson in Accounting . . . also, your latest illustrated book, "Accountancy, the Profession That Pays."

Name.....Age.....

Address.....

City, Zone, State.....

LASALLE
417 S. Dearborn St.,
CHICAGO 5, ILL.

JULY 1956

SKIPPED ME AGAIN!

POOR BURT! HE MISSED OUT ON THAT PROMOTION AGAIN!



I WAS DETERMINED TO MAKE GOOD IN MY JOB...BUT DETERMINATION, I FOUND, WAS NOT ENOUGH!

I HAD PLENTY OF EXPERIENCE. AND THE BOSS SEEMED TO LIKE ME. I LACKED JUST ONE THING—TRAINING!

SORRY, BURT! I KNOW YOU'VE WORKED HERE LONGER. BUT TED HAS THE SPECIAL TRAINING WE NEED. YOUR CHANCE WILL COME ...SOMEDAY!



I. C. S. IS THE OLDEST AND LARGEST CORRESPONDENCE SCHOOL IN THE WORLD. 256 COURSES. PERSONALIZED INSTRUCTION. CAREER GUIDANCE. EASY-PAY PLAN. DIPLOMA TO GRADUATES.

SIX MONTHS LATER... I.C.S. SENT MY BOSS REGULAR REPORTS OF MY PROGRESS. THEN ONE MORNING...

BURT, I'VE JUST MADE YOU THE ASSISTANT MANAGER OF YOUR DIVISION...AT \$15 MORE A WEEK. AND THE WAY YOU'RE GOING NOW, THIS IS JUST THE BEGINNING.



GOSH! THANKS MR. TAYLOR!

I GOT IT, HONEY! I GOT THE PROMOTION! OUR MONEY WORRIES ARE OVER! TODAY'S OUR LUCKY DAY!

TODAY AND THE DAY YOU MAILED THAT I.C.S. COUPON!



WHY NOT MAKE THIS YOUR LUCKY DAY? LET I.C.S. PUT YOU ON THE ROAD TO MORE PAY, RAPID ADVANCEMENT, REAL JOB SECURITY. HERE'S THE FAMOUS COUPON. MAIL IT NOW!

I WAS TIRED OF WAITING FOR "SOMEDAY."
I MADE UP MY MIND TO ACT! I'D GET THE
TRAINING I NEEDED...SOMEHOW!
JANE HAD A SUGGESTION...

I CAN'T QUIT MY
JOB AND GO BACK TO
SCHOOL! AND I SURE
DON'T WANT THAT
NIGHT CLASS
ROUTINE IN
THE CITY!

WHY NOT STUDY
AT HOME?...THE
WAY DAD DID...
WITH I.C.S.



JANE SHOWED ME AN I.C.S.
ADVERTISEMENT IN POPULAR
MECHANICS. THERE WAS THE
FAMOUS COUPON. AND THERE WAS
EXACTLY THE COURSE I WANTED..

SAY, THEY'LL SEND ME
A CAREER KIT FREE...
THREE BIG SUCCESS
BOOKS.

DAD SAYS
HE NEVER
WOULD
HAVE BEEN
MANAGER IF IT
WEREN'T
FOR I.C.S.



FREE!

I. C. S. CAREER KIT CONSISTING OF...

- 1 "HOW TO SUCCEED"
32-PAGE GOLD MINE
- 2 CAREER CATALOG...
OPPORTUNITIES IN YOUR
FIELD.
- 3 SAMPLE LESSON (MATH)
SHOWS I.C.S. METHOD.

For Real Job Security—Get an I. C. S. Diploma!

I. C. S., Scranton 9, Penna.

Member, National
Home Study Council

INTERNATIONAL CORRESPONDENCE SCHOOLS

65TH
YEAR

BOX 90626G, SCRANTON 9, PENNA.

Without cost or obligation, send me "HOW TO SUCCEED" and the opportunity booklet about the field

BEFORE which I have marked X (plus sample lesson):

- | | | | | |
|--|---|--|---|--|
| <p>ARCHITECTURE and BUILDING CONSTRUCTION</p> <ul style="list-style-type: none"> <input type="checkbox"/> Air Conditioning—Refrig. <input type="checkbox"/> Architecture <input type="checkbox"/> Architectural Interiors <input type="checkbox"/> Building Contractor <input type="checkbox"/> Building Estimator <input type="checkbox"/> Building Maintenance <input type="checkbox"/> Carpentry and Mill Work <input type="checkbox"/> Heating <input type="checkbox"/> Painting Contractor <input type="checkbox"/> Plumbing <input type="checkbox"/> Reading Arch. Blueprints <p>ART</p> <ul style="list-style-type: none"> <input type="checkbox"/> Cartooning <input type="checkbox"/> Commercial Art <input type="checkbox"/> Fashion Illustrating <input type="checkbox"/> Magazine Illustrating <input type="checkbox"/> Show Card and Sign Lettering <input type="checkbox"/> Sketching and Painting <p>AUTOMOTIVE</p> <ul style="list-style-type: none"> <input type="checkbox"/> Auto Body Rebuilding <input type="checkbox"/> Auto Elec. Technician <input type="checkbox"/> Auto-Engine Tune Up <input type="checkbox"/> Automobile Mechanic | <p>AVIATION</p> <ul style="list-style-type: none"> <input type="checkbox"/> Aeronautical Engineering Jr. <input type="checkbox"/> Aircraft & Engine Mechanic <p>BUSINESS</p> <ul style="list-style-type: none"> <input type="checkbox"/> Advertising <input type="checkbox"/> Bookkeeping and Accounting <input type="checkbox"/> Business Administration <input type="checkbox"/> Business Correspondence <input type="checkbox"/> Public Accounting <input type="checkbox"/> Creative Salesmanship <input type="checkbox"/> Federal Tax <input type="checkbox"/> Letter-writing Improvement <input type="checkbox"/> Office Management <input type="checkbox"/> Professional Secretary <input type="checkbox"/> Retail Business Management <input type="checkbox"/> Sales Management <input type="checkbox"/> Stenographic-Secretarial <input type="checkbox"/> Traffic Management <p>CHEMISTRY</p> <ul style="list-style-type: none"> <input type="checkbox"/> Analytical Chemistry <input type="checkbox"/> Chemical Engineering <input type="checkbox"/> Chem. Lab. Technician <input type="checkbox"/> General Chemistry <input type="checkbox"/> Natural Gas Prod. & Trans. <input type="checkbox"/> Petroleum Engineering <input type="checkbox"/> Plastics <input type="checkbox"/> Pulp and Paper Making | <p>CIVIL, STRUCTURAL ENGINEERING</p> <ul style="list-style-type: none"> <input type="checkbox"/> Civil Engineering <input type="checkbox"/> Construction Engineering <input type="checkbox"/> Highway Engineering <input type="checkbox"/> Reading Struct. Blueprints <input type="checkbox"/> Sanitary Engineering <input type="checkbox"/> Structural Engineering <input type="checkbox"/> Surveying and Mapping <p>DRAFTING</p> <ul style="list-style-type: none"> <input type="checkbox"/> Aircraft Drafting <input type="checkbox"/> Architectural Drafting <input type="checkbox"/> Electrical Drafting <input type="checkbox"/> Mechanical Drafting <input type="checkbox"/> Mine Surveying and Mapping <input type="checkbox"/> Plumbing Drawing and Estimating <input type="checkbox"/> Structural Drafting <p>ELECTRICAL</p> <ul style="list-style-type: none"> <input type="checkbox"/> Electrical Engineering <input type="checkbox"/> Electrical Maintenance <input type="checkbox"/> Electrician <input type="checkbox"/> Contracting <input type="checkbox"/> Lineman <p>HIGH SCHOOL</p> <ul style="list-style-type: none"> <input type="checkbox"/> Commercial <input type="checkbox"/> Good English <input type="checkbox"/> High School Subjects <input type="checkbox"/> Mathematics | <p>LEADERSHIP</p> <ul style="list-style-type: none"> <input type="checkbox"/> Foremanship <input type="checkbox"/> Industrial Supervision <input type="checkbox"/> Leadership and Organization <input type="checkbox"/> Personnel-Labor Relations <p>MECHANICAL AND SHOP</p> <ul style="list-style-type: none"> <input type="checkbox"/> Gas—Electric Welding <input type="checkbox"/> Heat Treatment <input type="checkbox"/> Metallurgy <input type="checkbox"/> Industrial Engineering <input type="checkbox"/> Industrial Instrumentation <input type="checkbox"/> Industrial Supervision <input type="checkbox"/> Internal Combustion Engines <input type="checkbox"/> Machine Design-Drafting <input type="checkbox"/> Machine Shop Inspection <input type="checkbox"/> Machine Shop Practice <input type="checkbox"/> Mechanical Engineering <input type="checkbox"/> Quality Control <input type="checkbox"/> Reading Shop Blueprints <input type="checkbox"/> Refrigeration <input type="checkbox"/> Sheet Metal Worker <input type="checkbox"/> Tool Design <input type="checkbox"/> Toolmaking <p>RADIO, TELEVISION</p> <ul style="list-style-type: none"> <input type="checkbox"/> Industrial Electronics <input type="checkbox"/> Practical Radio TV Eng'ng <input type="checkbox"/> Radio and TV Servicing <input type="checkbox"/> Radio Operating | <ul style="list-style-type: none"> <input type="checkbox"/> Television Technician <p>RAILROAD</p> <ul style="list-style-type: none"> <input type="checkbox"/> Air Brake Equipment <input type="checkbox"/> Car Inspector <input type="checkbox"/> Diesel Engineer & Fireman <input type="checkbox"/> Section Foreman <p>STEAM AND DIESEL POWER</p> <ul style="list-style-type: none"> <input type="checkbox"/> Combustion Engineering <input type="checkbox"/> Diesel—Elec. <input type="checkbox"/> Diesel Eng's <input type="checkbox"/> Electric Light and Power <input type="checkbox"/> Stationary Fireman <input type="checkbox"/> Stationary Steam Engineering <p>TEXTILE</p> <ul style="list-style-type: none"> <input type="checkbox"/> Carding and Spinning <input type="checkbox"/> Cotton, Rayon, Woolen Mfg. <input type="checkbox"/> Finishing and Dyeing <input type="checkbox"/> Loom Fix'g <input type="checkbox"/> Textile Des'g <input type="checkbox"/> Textile Eng'g <input type="checkbox"/> Throwing <input type="checkbox"/> Warping and Weaving <p>MISCELLANEOUS</p> <ul style="list-style-type: none"> <input type="checkbox"/> Domestic Refrigeration <input type="checkbox"/> Marine Engineering <input type="checkbox"/> Ocean Navigation <input type="checkbox"/> Professional Engineering <input type="checkbox"/> Short Story Writing <input type="checkbox"/> Telephony |
|--|---|--|---|--|

Name _____ Age _____ Home Address _____

City _____ Zone _____ State _____ Working Hours _____ A.M. to P.M. _____

Occupation _____

Canadian residents send coupon to International Correspondence Schools, Canadian, Ltd., Montreal, Canada. . . . Special tuition rates to members of the U. S. Armed Forces.

the
big
thing

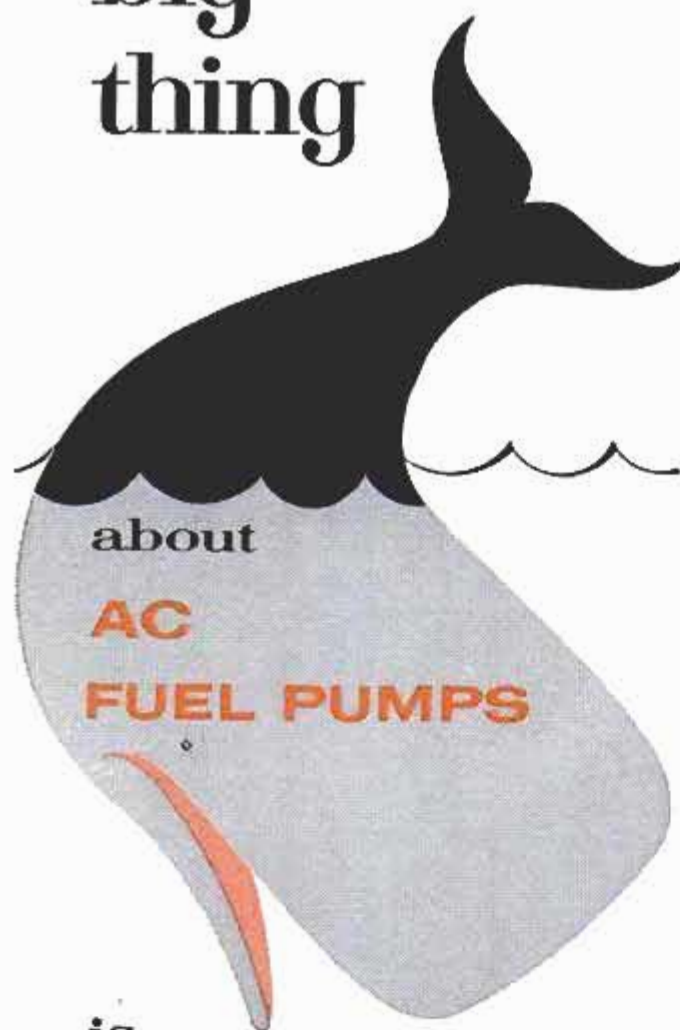

is

endurance

WHEN YOU REPLACE...
REPLACE WITH AC



AC SPARK PLUG 
THE ELECTRONICS DIVISION OF GENERAL MOTORS

(Continued from page 6)

brains and atomic power. Take the mailbag for example. Millions of pieces of parcel post last Christmas went their various ways in those filthy, inefficient, archaic contrivances called mailbags. The man-hours tied up in filling, emptying, labeling, delabeling, sorting, storing, counting, folding and baling mailbags must be astronomical. If we must have mailbags they should be elastic, with an elastic cord, a slide fastener that lets them open completely at once, and a label that extends a quarter inch from the holder for quick removal. But we'd be better off to junk them entirely.

How can we get along without them? By automating. Building conveyor belts, mail pipelines, first between cities and later within towns themselves, much as a sewer system or telephone net is established. Intercity pipelines, endless-belt affairs carrying mail both ways at once could be built along the railroads, thus simplifying right-of-way procurement as well as avoiding a loss to the railroads of mail revenue. Such a system would require a couple of items long needed. One is a sorting machine—which could easily be perfected (see *PM*, June 1953 and October 1955) especially if the other item were adopted—a number-code address system.

The second basic idea is that the citizen meet more specific obligations than just paying for his stamps. For example, now no standard mailbox is required, no number or name must be visible on the house, the postman is often required to walk far into yards or hallways or business offices to deliver the mail. When a person moves into town he is not required to check in at the post office; the obligation is all on the post office to find out who the new family is, where they live and where they want their mail put.

Now if five to eight numbers can automatically locate any telephone in our cities, surely a code address system would speed present-day mailbag-type sorting as well as work into a future automatic-pipeline system. Machines can read numbers, and one of the obligations of citizenship should be the acceptance of a code address assigned by the post office to speed mail delivery.

For example, a letter going cross-country by rail today (or the mailbag enclosing it) is probably sorted an average of eight to ten times. This is about seven or eight times too many. I think a pipeline system could be built that would be completely automatic except for rural routes, with something like a small postage meter attached to every in-the-house outlet, for correctly attaching the code to each letter

(Continued to page 14)

TRAIN AT HOME IN SPARE TIME

Make More Money Servicing Radio-TV Sets



Opportunities are Increasing

Training PLUS OPPORTUNITY is an ideal combination for success. And today's OPPORTUNITY field is Radio-Television. Over 125 million home Radios plus 30 million sets in cars and 40,000,000 Television sets means big money for trained Radio-TV Technicians. More than 4,000 Radio and TV broadcasting stations offer interesting and important positions for technicians, operators. Color Television, portable TV sets, Hi-Fi, other developments assure future growth.

It's the trained man who gets ahead. The fellow who uses his spare time to develop knowledge and skill gets the better job, drives a better car, lives in a better home, is respected for what he knows and can do. If you want a career with a future—find out how you can train at home for Radio-Television Servicing or Broadcasting.

Increase Your Income - Have a Spare Time Business Start Soon to Make \$10, \$15 a Week Extra

Soon after enrolling, many N.R.I. students start to earn \$10, \$15 a week extra in spare time fixing sets. Some pay for their training this way. Some make enough extra to start their own Radio-TV shops. Some keep on with their regular jobs, and use this added income for extra luxuries, comforts, security.

You Learn by Practicing with Kits N. R. I. Sends

When you train by the N.R.I. "50-50" method, you study the basic principles from easy-to-understand lessons AND learn by practicing with actual equipment N.R.I. furnishes. You learn with your hands and your head. As part of our servicing training N.R.I. sends kits of parts to build the AC-DC Radio Receiver and Vacuum Tube Voltmeter shown below. Use them to get practical experience.

make tests, earn extra money fixing sets. N.R.I. training is practical—gets quick results. And you LEARN-BY-DOING. The equipment you build "brings to life" things you read about in the lessons.

Find Out What Radio- Television Offers You

Since 1914 — for over 40 years — N.R.I. has trained thousands of men for successful careers in Radio-TV. You get personal attention, helpful advice from experts. Diploma when you graduate. So fill out Coupon now. Get a FREE sample of an ACTUAL LESSON. Also get 64 page catalog that tells opportunities, shows equipment you get. Cost of N.R.I. courses low, available on easy terms. National Radio Institute, Dept. 6GA, Washington 9, D. C.



Lesson and Catalog
FREE



VETERANS
Available under
G.I. Bills

Find out what the
Oldest and Largest
Home Study Radio-
TV School offers

**MAIL
NOW!**

National Radio Institute

Dept. 6GA, Washington 9, D. C.

Mail me Sample Lesson and 64-Page Catalog
FREE. (No salesman will call. Please write plainly.)

Name _____ Age _____

Address _____

City _____ Zone _____ State _____

Approved Member National Home Study Council

IMPORTER'S SACRIFICE SALE!

World Famous KORIAM Hunting Knives

from Solingen, Germany

REG. 3.95—NOW 1/2 PRICE **1.98**

Take Your Pick— all one low price!

These unique hand forged hunting knives are made by world-renowned craftsmen of SOLINGEN, GERMANY. Sharp, rugged blades are genuine KORIAM steel. The handsome, unusual designs have won recognition in sports circles thruout Europe. American hunters and fishermen, too, have been quick in expressing their enthusiastic approval. Over 100,000 already sold here! Now you, too, can get your favorite design—direct from the importer at a rock-bottom price! The blades are actually sharp enough to shave with; will stand up against most rugged treatment. Genuine leather scabbard tailored for each knife — metal tipped for sharp pointed models. Lengths 9 to 10 inches. The tough, sturdy KORIAM steel made in Germany assures you years of dependable service. Their sleek graceful lines also provide ideal rec room or dendorations. Dandy gifts for men—and a sportsman's delight! Import supply limited. The low \$1.98 price for both knife and scabbard means you'll have to act fast! Send \$1.98 for prompt prepaid delivery, or order COD plus postage. Your money back if not delighted. Check desired model in coupon below.



A
Helen of
Troy
Golden
Hued
Handle

B
Black
Forest
Hunting
Knife

NEW DELUXE
MODEL

C
Monarch
Stag &
Chrome
Handle
with
Tri-Color
Etched
Blade

MAIL TODAY!

THORESEN'S, Dept. 6-G-800
352 Fourth Avenue,
New York 10, N. Y.

RUSH Koriam Knife checked below at 1.98 ea. on 5-day home trial. Include deluxe leather sheath. If not satisfied, I'll return knife for quick refund.

CHECK MODEL DESIRED:

A (Helen of Troy) B (Black Forest) C (Monarch)
 No. 75—3-Color Flashlite (99c plus 11c postage, total—1.10)

Name _____
Address _____
Town _____ Zone _____ State _____

SPECIAL!

Powerful Flashlite
Changes Colors like
Magic... RED,
WHITE or GREEN!

NOW YOURS
AT 1/2 PRICE **99c**

Presto! . . . at your fingertips . . . automatic switch gives you powerful white, red or green beam visible miles away. Spotlite and floodlite combined. So dependable for home, farm, office, factory. Lifesaving friend in highway emergencies. Thousands in use by police in all states. Over 100,000 sold for 1.98 to 2.98. For a limited time only 99c plus 11c mailing costs (total 1.10). Order by No. 75.



INVENTORS

Learn how to protect your invention. The U. S. Patent Laws provide that any new and useful art, machine, article of manufacture, or composition of matter, or any new and useful improvement thereof, may be patented if the act of invention is involved. Therefore, every inventor with a valuable invention should take advantage of the Patent Laws and proceed for patent protection in order to safeguard his rights.

A patent gives the inventor the exclusive right to prevent others from making, using, or selling the invention claimed in the patent for a period of seventeen years.

The Patent Laws were enacted for the benefit of the inventor to give him protection for the features of his invention which are patentable. These features must be properly and concisely set forth and claimed in a formal application for patent, in order to comply with the requirements of the Patent Laws. For that reason, unless the inventor is familiar with patent matters, he should engage a competent registered patent attorney or agent to represent him. We are registered to practice before the U. S. Patent Office and are prepared to serve you in the handling of your patent matters.

A specially prepared booklet entitled "Patent Guide for the Inventor", containing detailed information with respect to patent protection and procedure, together with a "Record of Invention" form will be promptly forwarded to you without obligation upon request.

CLARENCE A. O'BRIEN & HARVEY JACOBSON

Registered Patent Attorneys

61-G DISTRICT NATIONAL BUILDING

WASHINGTON 5, D. C.

free!

1956 ALLIED

ELECTRONIC SUPPLY CATALOG

324
value-packed
pages

Save on Everything
in TV and Radio
Parts & Equipment



Everything for Experimenters,
Builders, Amateurs, Servicemen,
Engineers & Hi-Fi Specialists

Send for ALLIED's big 324-page value-packed guide to *everything* in TV, Radio and Electronics! Select from the world's largest stocks of High Fidelity systems and components; recorders and phono equipment; TV tubes, antennas and accessories; Amateur station equipment and supplies; P.A. systems; test instruments; latest build-your-own kits; industrial electronic supplies—plus *everything* in electronic parts, tubes, transistors, tools and books. Save on everything in Electronics—send today for your FREE 1956 ALLIED Catalog.

Everything in Electronics
From One Reliable Source

send for it

FREE
CATALOG

ALLIED RADIO

ALLIED RADIO CORP., Dept. 5-G-6
100 N. Western Ave., Chicago 80, Ill.

Rush FREE 1956 ALLIED 324-Page Catalog

Name _____

Address _____

City _____ Zone _____ State _____

(Continued from page 10)

or package and incidentally for keeping tabs on the bill, without licking stamps.

A package arriving today in my town must be loaded by hand on a truck at the railroad station, driven to the Parcel Post Annex, unloaded by hand onto a motorless dock truck, pushed inside the building, the bag unloaded again and emptied laboriously (always by hand) onto a short conveyor which spreads it out for the first sorting. Then comes the problem: SW, NE, SE, or NW? The package is tossed into the appropriate tub which, when full, is pushed down to long racks of open-mouthed mailbags—all of which have to be strung on the racks by hand of course. Now comes the big mental waste—which bag, in which rack, for each piece of mail? This one is for 2306 Blank Boulevard. Let's see—Blank Boulevard (not Blank Place, or Blank Avenue, but Blank Boulevard). It should be in rack 3 or 5 or 7. But this package is for the 2300 block, and this sack says 1200 to 2100 only. The next one with Blank Boulevard on it (and seven other streets) says 100 to 1199 only. Hmm . . . And so it goes, for each piece of mail, to be sorted again by the postman out in his truck before it reaches your door. Multiply one town by a thousand and one package by a million, add a few billion letters and you get an idea of the waste of human energy and thought inherent in this system.

And, incidentally, there is a simple way to eliminate the Christmas strain on postal facilities if we want to. Just double postal rates on December 1, triple them on December 15 until Christmas; and I predict there won't ever be a peak rush that the regulars won't be able to handle.

Starr Jenkins,
Albuquerque, N. Mex.

To the Editor:

I have read the article in the May issue on recharging dry cells. This was not a new idea to me. During the war I was employed in a machine shop, and the men would depend on me to recharge the batteries for them. I welded brackets to an angle iron, allowing for the contact to the negative side at the bottom. The positive side was made of an insulated plug with a center tip to contact the positive pole of the last battery. Since that time I have recharged many kinds of dry cells—lantern, radio, hearing-aid and other types. The important thing to remember is that the batteries should not be allowed to become completely exhausted. We recharged the same batteries many times after I educated the users.

James A. Peters,
Allentown, Pa.

56,134

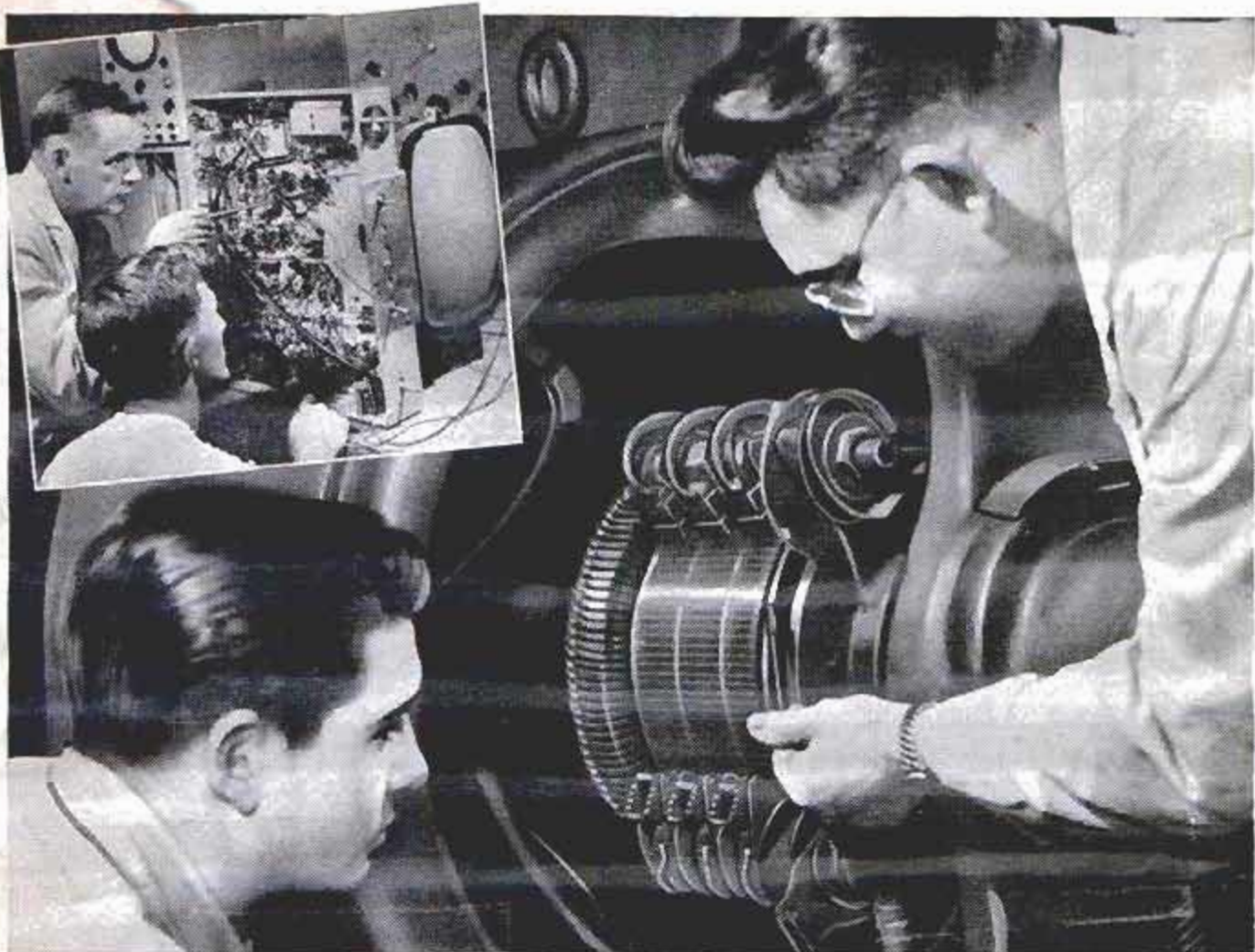

TRAIN FOR A FUTURE IN

Electricity or Television

-ELECTRONICS **-RADIO-COLOR TV**

IN GREAT SHOPS OF COYNE—
Largest, Oldest, Best Equipped
School Of Its Kind In The U. S.

Veterans and Non-Veterans

Whether 17 or up to 45 years of age, prepare for your future now. Don't be satisfied with a "No Future" job. Train the Coyne way for a better job in a field that offers a world of opportunities in the years ahead.

WE TRAIN YOU IN CHICAGO

Learn the easier, practical way at Coyne, on real, full size equipment. No advanced education or previous experience needed. Lifetime employment service to graduates.

Train in the shops of Coyne—where thousands of successful men have trained for nearly sixty years—Coyne is the oldest, best equipped school of its kind—established in Chicago in 1899.

FINANCE PLAN Enroll now. You may pay most of tuition later. Part time employment help for students.

CLIP COUPON NOW for big new illustrated Coyne book. No obligation; no salesman will call. Get vital facts now!

Training in
REFRIGERATION
and
ELECTRICAL
APPLIANCES
can be included

Mail Coupon
Today for
BIG FREE
BOOK



"Guide to Careers in
ELECTRICITY-ELECTRONICS
and TELEVISION-RADIO"

B. W. COOKE, President
COYNE ELECTRICAL SCHOOL
500 S. Paulina St., Chicago 12, Ill., Dept. B6-72H

Send BIG FREE book and details of your training offer. This does not obligate me and no salesman will call. I am interested in:

- ELECTRICITY-Electronics
 TELEVISION-Radio-Color TV

Name.....

Address.....

City.....State.....

B. W. COOKE, President

COYNE
ELECTRICAL SCHOOL

FOUNDED 1899

A TECHNICAL TRADE INSTITUTE OPERATED NOT FOR PROFIT
500 S. PAULINA STREET, CHICAGO, Dept. B6-72H
ELECTRICITY * RADIO * TELEVISION * REFRIGERATION * ELECTRONICS

Knowledge
That Has
Endured
With the
Pyramids

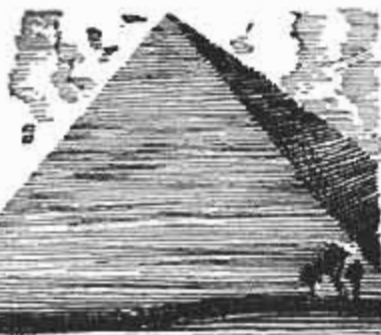

A SECRET METHOD FOR THE MASTERY OF LIFE

WHENCE came the knowledge that built the Pyramids? Where did the first builders in the Nile Valley acquire their astounding wisdom that started man on his upward climb? Did their knowledge come from a race now submerged beneath the sea? From what concealed source came the wisdom that produced such characters as Amenhotep IV, Leonardo da Vinci, Isaac Newton, and a host of others?

Today it is known that they discovered and used certain *Secret Methods* for the development of their inner power of mind. They truly learned to master life. This secret art of living has been preserved and handed down throughout the ages and today is extended to those who dare use its profound principles to meet and solve the problems of life in these complex times.

This Sealed Book—FREE

The Rosicrucians (not a religious organization) have prepared an unusual book, which will be sent free to sincere inquirers, in which the method of receiving these principles and natural laws is explained. Write today for your copy of this sealed book. Possibly it will be the first step whereby you can accomplish many of your secret ambitions and the building of personal achievements... Address your inquiry to: Scribe T.T.F.



The Rosicrucians
(AMORC)
San Jose, California

BECOME AN EXPERT IN TRAFFIC and TRANSPORTATION

TODAY qualified men in this field earn \$4,000 to \$10,000 and up. Thousands are needed. We train you in spare time at home for executive positions in Traffic Management.

LaSalle's complete Traffic and Transportation program gives you a thorough knowledge of this field. Program covers Transportation Agencies—How to Ship by Rail, Express, Water, MOTOR TRUCK, Air, Freight Forwarder and Mail Carriers.

Investigate the splendid opportunities available. Low cost-easy terms. Placement counsel and help. Write today for FREE 48-page book "Traffic and Transportation—the Fast Growing Profession."

LASALLE EXTENSION UNIVERSITY
A Correspondence Institution

417 S. Dearborn St., Dept. 764T, Chicago 5, Illinois

TELEPHONES



Desk Stand Style
Slightly used but in excellent condition
Many Valuable Uses

Inter-House Phones House to Barn, etc.
Loud Speakers Microphones
Educational Purposes, Toys, etc.

Come complete, ready to use with wiring diagrams included. Two complete for only \$5.00 **\$2.75** Postpaid in U.S.A.
TELEPHONE LAMP KIT—with illustrated instructions for making Desk Telephone Lamp including all parts (harp, nipples, push switch, cord, plug, etc.)... \$6.50 Ppd. (Shade is not included).

MICROPHONE, Dept. X-4002, 1760 W. Lunt Ave., Chicago 26, Ill.

REAL ESTATE BE A BROKER

PAYS BIG! SEND FOR FREE, BIG, ILLUSTRATED CATALOG NOW! Graduates report making substantial incomes. Start and run your own business quickly. Men, women of all ages learn easily. Course covers Sales, Property Management, Appraising, Loans, Mortgages, and related subjects. **STUDY AT HOME** or in classrooms in leading cities. Diploma awarded. Write TODAY for free book! No obligation.

Approved for World War II and Korean Veterans
WEAVER SCHOOL OF REAL ESTATE (Est. 1936)
2020R Grand Avenue Kansas City, Mo.



LEARN PLASTICS



COMPLETE LOW COST SHOP METHOD
HOME TRAINING NOW AVAILABLE

Get in on Big Money opportunities in Plastic molding, casting, forming, carving, etc. Earn as you learn with Interstate's professionally prepared course. All plastic materials furnished.

WRITE FOR
FREE
BOOKLET

INTERSTATE TRAINING SERVICE
DEPT. C-3, PORTLAND 13, OREGON

SAY YOU SAW IT IN POPULAR MECHANICS

See the Greatest Show on Earth with this
GIANT ASTRONOMICAL TELESCOPE

\$15.00
FULL PRICE



Delivered ready for use. Has 45X, 75X and 100 power individually mounted eyepieces with brass focusing tube plus sun projector lens for observing sun spots and solar storms. Steel telescope tube 50 in. long. Rigid 6 ft. tripod adjustable to any height. Steel forked mounting with closely machined aluminum tripod head assembly assures extra fine adjustments. This professional type instrument provides full power with clear vision at all times. See the moons of Jupiter, our own moon, planets, milky way, double stars, star clusters, etc. All for only \$15.00 FOB Mattituck. Sent express. COD orders require \$5.00 deposit. Satisfaction guaranteed. 200X and 400X eyepieces available at \$2.00 ea.

SUFFOLK SCIENCE SERVICE
Dept. TD-7 MATTITUCK, N. Y.

INVENTORS

If you believe that you have an invention, you should find out how to protect it. The first step is to have a search made of the prior pertinent U. S. patents. If a report on this search indicates that the invention appears patentable you can apply for a patent, and the specifications and claims should be prepared.

The firm of McMorrow, Berman & Davidson, with offices in Washington, D. C., is qualified to take the necessary steps for you. We can make a preliminary search on your invention, advise you whether we think it can be patented, and prepare your application for patent.

Unless you are fully familiar with the U. S. Patent Laws, we recommend that you engage the services of a Registered Patent Attorney to protect your interests. The patent laws are *your* laws. A patent gives you the right to prevent others from making, using or selling the invention claimed in your patent for a period of 17 years.

Use these patent laws for your protection. Investigate whether your invention can be patented. If you have what you believe to be an invention, we suggest that you have this firm make a search for you.

Send for a copy of our Patent Booklet entitled "How To Protect Your Invention," containing information about patent protection and patent procedure. Along with this we will also send you an "Invention Record" form, for your use in writing down and sketching details of your invention. We will mail them promptly. No obligation. They are yours for the asking.

McMORROW, BERMAN & DAVIDSON

Registered Patent Attorneys

PATENTS • COPYRIGHTS • PATENTS

135-Y VICTOR BUILDING, WASHINGTON 1, D. C.

Hey SKINNY!

...YER RIBS ARE SHOWING!



I Can Make YOU a New Man, Too In Only 15 Minutes a Day!

PEOPLE once laughed at my skinny 97-lb. body. I was ashamed to strip for sports. Girls made fun of me behind my back. THEN I discovered "Dynamic Tension." It made me such a complete specimen of manhood that I hold the title, "The World's Most Perfectly Developed Man."

What's My Secret?

When you look in the mirror and see a healthy, husky, handsome, fellow smiling back at you—you'll be amazed at how fast "Dynamic Tension" GETS RESULTS. It's the easy, NATURAL method you can practice in your own room—JUST 15 MINUTES EACH DAY. No gadgets to fool with. You simply use the dormant muscle-power in your own body—watch it grow into solid LIVE MUSCLE. See your shoulders broaden... your scrawny chest swell with inches of new muscle...

CHARLES ATLAS
Holder of title, "The World's Most Perfectly Developed Man"

those spindly legs and arms bulge with new power... and your whole body starts to feel "alive," full of zip and go!

FREE MY 32-PAGE ILLUSTRATED BOOK 15 YOURS—NOT FOR \$1 OR 10c—BUT FREE

Send now for my book, *Everlasting Health and Strength*, 32 pages of photos, valuable advice. Shows what "Dynamic Tension" can do for YOU. Answers vital questions for fellows who want a better build. It's yours—ABSOLUTELY FREE! Rush coupon to me personally; CHARLES ATLAS, Dept. 87, 115 East 23rd St., New York 10, N. Y.



CHARLES ATLAS, Dept. 87,
115 East 23rd St., New York 10, N. Y.

Send me—absolutely FREE—a copy of your famous book, *Everlasting Health and Strength*—32 pages, crammed with photographs, answers to vital questions and valuable advice. This book is mine to keep, and sending for it does not obligate me in any way.

Name _____ Age _____
(Please print or write plainly)
Address _____
City _____ State _____

INSURED TIRE SERVICE

POPULAR BRANDS

FREE INSURANCE POLICY given with each used tire sold. We guarantee the amount of service you pay for.

NOWHERE CAN SUCH QUALITY BE FOUND AT SUCH LOW PRICE!

SPECIAL!
Product 10% on orders for two or more used tires

YOU CAN'T LOSE!!

Super Quality — Rugged Performance — 6 Months Insured Service		Supreme Quality — Nothing Finer — 12 Months Insured Service	
600x16	\$3.65 670x15	\$3.95 700x16	\$4.45 760x16
650x15	3.85 670x16	4.05 710x15	4.35 820x15
650x16	4.25 700x15	3.95 760x15	4.45 850x17
600x16	\$5.25 475x15	\$5.45 700x15 (6)	\$10.45 700x20
600x16 (6)	6.75 640x15	4.95 750x16 (8)	15.95 780x20 (8)
650x16	5.75 670x15	5.35 700x17	11.95 750x20 (10)
650x16 (6)	7.25 710x15	5.45 750x17	16.45 825x20
700x16	6.35 760x15	5.95 750x15	10.95 900x20
750x16 (6)	8.45 800x15	6.35 30x5	11.25 1000x20
550x18	4.95 820x15	6.35 600x20	10.95 1100x20
550x17	4.75 550x15	5.35 650x20	11.75 1000x22
650x15	5.25 670x15	5.15 32x6 (8)	11.95 1100x22
700x15	5.35 700x16 (6)	10.25 32x6 (10)	12.75 1100x24
Whitewalls \$1.00 extra.			

MIDLAND TIRE SALES
Speedy shipments on Mail Orders, F.O.B. Chicago. Insurance policy sent with each order. Deduct 10% on orders for 2 or more used tires. Send CHECK or MONEY ORDER.—No COD's.
3761 S. Normal, Dept. PM-48, Chicago 9, Ill.

GIANT BALLOONS

They're really BIG—surplus U.S. Govt. (new overage) Neoprene weather, target balloons. GREAT FUN in the backyard; at parties, picnics, dances, fairs, TERRIFIC for high school and college PROMS. They attract BIG CROWDS to business openings, civic events, conventions, exhibitions, trade shows. ORDER TODAY! Great for gift. Approx. inflated sizes:
3 ft. dia., 49c—5 ft. dia., 99c
10 ft. dia., \$1.59—13 ft. dia., \$1.95
Postage paid on prepaid orders.
Calif. residents please add sales tax.

VOLUME SALES CO., War Assets Division
Dept. PM-755 3930 Sunset Blvd. Los Angeles 29, Calif.

Learn ACCOUNTING

Business Administration

Bookkeeping, secretarial and allied subjects at home in your spare time or attend nationally approved resident school. Write for FREE Success Book giving complete details on courses, plans, rates and employment opportunities. G.I. approved. Write Dept. A.

Hills BUSINESS UNIVERSITY AND EXTENSION SCHOOL
619 W. MAIN ST. OKLAHOMA CITY 2, OKLAHOMA

Print Your Own

Cards, stationery, circulars, tags, labels, photo and movie titles, advertising, etc. Save money. Print for Others. Good Profit! Easy rules sent. Raised Printing like Engraving, too. Sold direct from factory only. Write for free catalog of outfits and all details. **KELSEY PRESSES, M-37, Meriden, Conn.**

POW!!! hunting slingshot

- accurate—powerful—silent
- kills small game, pests
- hits like a rifle

\$1.50 postpaid (no cod's)

Used by expert marksmen!
 7" hardwood stock, 45 lb. pull. Has double rubber for double power. FREE!—target, extra rubber and big supply heaviest steel balls used by experts. Illustrated catalog. Authorized model of Slingshot Assn.
 order today from— **I. I. STONE DEPT. B-7, 1616 Oak St. Santa Monica, Calif.**

Everything You Need For UNDERWATER Sports and Adventure

DIVEMASTER

SKIN AND LUNG DIVING EQUIPMENT

Leading nationally known and foreign made products. Inspection tested at money saving prices. Underwater Breathing Apparatus, Swimming Masks and Fins, Diving Masks, Spear Guns, Water Skis, Diving Suits, etc. Send 25c for Illustrated Catalog.

(Dealer Inquiries Invited)
U. A. S. CORPORATION, Dept. PM-57
 5637 W. 63rd Place, Chicago 38, Ill.

NOW...from DTI's MILLION DOLLAR TRAINING CENTER

Learn to master TELEVISION AUTOMATION ELECTRONICS

RADIO - ELECTRONICS
by getting **EVERYTHING YOU NEED!**

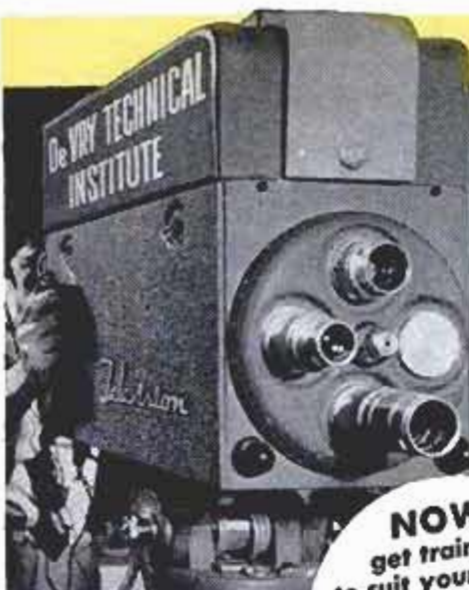

NOW—
get training
to suit your NEEDS

TAKE YOUR
CHOICE

Come to
DTI's
great CHICAGO
LABORATORIES

...one of the Nation's FINEST!

Now, in the heart of the nation's TV Center, you can get all of your preparation in DTI's big, modern, wonderfully equipped training laboratories. Loads of commercial equipment and ample, well qualified instructors help you get a thorough, practical preparation in the SHORTEST POSSIBLE TIME. Part time student Employment assistance can help you pay your way while in training.

EMPLOYMENT SERVICE

As soon as you complete either the Chicago Laboratory or Home Training, you'll find DTI's grand Employment Service ready to help you start earning real money. Get full facts. Mail coupon today.

MILITARY SERVICE: If subject to military service, the training information we have for you should prove very helpful. Mail coupon today.

89 WAYS TO EARN MONEY
IN TELEVISION
RADIO ELECTRONICS

ACT NOW! MAIL COUPON TODAY
Get this publication FREE!

MEMBER OF NATIONAL HOME STUDY COUNCIL
DeVry Technical Institute
4141 BELMONT AVE., CHICAGO 41, ILL. DEPT. PM-7-M

I would like your Opportunity News Bulletin showing "89 Ways to Earn Money in Television-Radio-Electronics"; also, complete facts about the training opportunity made possible by your organization.

Name _____ Age _____
Address _____ Apt. _____
City _____ Zone _____ State _____

DTI's Training is available in Canada



ABOVE: You build and keep this big 5 INCH commercial-type oscilloscope — one of the most useful test units used in TV today.



Build and keep this BIG DTI Engineered TV set—easily converted to U.H.F. (DTI offers another home training, but without the TV set.)

Use 16mm. **MOVIES** Only DTI provides you with the loan of visual training movies at home to help you master important basic points faster... easier... better!



"One of America's Foremost Electronics Training Centers"



DeVry Technical Institute

CHICAGO 41, ILLINOIS

FORMERLY

DeFOREST'S TRAINING, INC.

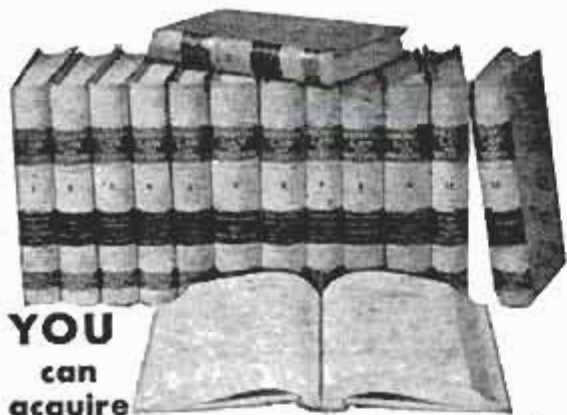

YOU
can
acquire

LAW NIGHTS AT HOME! LL. B. DEGREE

LaSalle's famous Law Library—used as reference in many Law libraries and Law offices—has enabled thousands to master Law surprisingly fast, in spare hours at home, for business and professional advancement.

These 14 remarkable volumes, compiled by leading professors and lawyers, cover the whole basic field of Law in condensed, orderly, simplified manner.

You advance rapidly with this great library, plus special lectures furnished. We guide you step-by-step with personalized Problem Method of instruction . . . you learn by doing—handling legal problems—not by memorizing rules.

Send for two FREE booklets, "Law Training for Leadership," and "Evidence," answering questions about Law and its value to you, and telling how LaSalle Law graduates are winning rapid advancement in business and public life. Mail coupon below. No obligation.

LA SALLE EXTENSION UNIVERSITY A Correspondence Institution

417 S. Dearborn St. Dept. 764L Chicago 5, Ill.

Send me your two FREE booklets described above, without obligation.

Name.....Age.....

Street.....

City, Zone & State.....

LEARN WATCH REPAIRING

AT HOME Modern, original instruction. Prepare for a position or start in business after completing our course. Write Today!
WISCONSIN SCHOOL OF WATCH REPAIRING
2908 N. 44th St. Dept. M Milwaukee 10, Wis.

Paint STRIPES with New "PAINT PEN"!

Straight, Curved or Parallel Lines

Use like a fountain pen with any color paint to stripe furniture, bikes, autos, model planes, toys, linoleum, wall board. Beautiful clean, crisp results every time. Can't clog or smear. Also use with glue, tempera, textile paint or ceramic under glaze. Paints on wood, glass, plastic, metals, fabrics and paper. Tool complete with tip for 1/16" stripe only \$1.25 post-paid. Other complete tools with following tips, 1/64", 1/32", 3/64", 5/64", 3/32", 1/4" — \$1.75 each. Extra tips 90¢ each. Entire kit with tool and 7 tips — \$5. A 1/4" tip only \$1.20 each. C.O.D.'s postage collect.

New! "DOUBLE-STRIPER" 5 Way Combination Model only \$3.25

Double Stripes — one wide and one narrow or two wide or two narrow at the same time.

FREE Send postcard for complete information—**ORDER TODAY.**



\$1.25

DEALERS: Master Paint Stripping Tool in display cartons of 1 doz. FAST, PROFITABLE SALES. Write for new discounts.
HOME CRAFTSMEN! New Paint Stripping Tool gives "professional" results every time, simple, easy to use. Send \$1.25 now.
MANUFACTURERS: Write today for information about industrial models and production stripping tools.

WENDELL MFG. CO., Dept. 319
4234 Lincoln Ave., Chicago 18, Ill.

Shrinks Hemorrhoids New Way Without Surgery

Science Finds Healing Substance That Relieves Pain—Shrinks Hemorrhoids

For the first time science has found a new healing substance with the astonishing ability to shrink hemorrhoids and to relieve pain — without surgery.

In case after case, while gently relieving pain, actual reduction (shrinkage) took place.

Most amazing of all — results were so thorough that sufferers made astonishing statements like "Piles have ceased to be a problem!"

The secret is a new healing substance (Bio-Dyne*) — discovery of a world-famous research institute.

This substance is now available in suppository or ointment form under the name Preparation H.* Ask for it at all drug counters — money back guarantee. *Reg. U. S. Pat. Off.

SHORTHAND in

6
WEEKS

Famous SPEEDWRITING shorthand. 120 words per minute. No symbols; no machines; uses ABC's. Easiest to learn, write and transcribe. Lowest cost. 350,000 taught by mail. For business and Civil Service. Typing available. 33rd year. Write for FREE booklet to: SCHOOL OF

Speedwriting
Dept. 1507-B, 55 W. 42 St., New York 36 (R)

"YOU ARE UNDER ARREST!"



Help Bring Crooks to Justice Through Scientific CRIME DETECTION!

We have taught thousands this exciting, profitable, pleasant profession. Let us teach you in your own home. Learn Finger Printing, Firearms Identification, Police Photography, Secret Service Methods thoroughly, quickly, at small cost. Over 800 of all American Bureaus of Identification employ I.A.S. students or graduates. Write stating age, for "Blue Book of Crime."

(A Correspondence School Since 1918)

INSTITUTE OF APPLIED SCIENCE, 1920 Sunnyside Ave., Dept. 135B, Chicago 40, Ill.

"How to Make Money with Simple Cartoons"



A book everyone who likes to draw should have. It is free; no obligation. Simply address

FREE BOOK

CARTOONISTS' EXCHANGE
Dept. 97 Pleasant Hill, Ohio

GIANT FREE CATALOG of OPTICAL BARGAINS



ASTRONOMICAL TELESCOPE HEADQUARTERS
Complete Line of Astronomical Telescope Parts and Assembled Telescopes. Also huge selection of lenses, prisms, war surplus optical instruments, parts and accessories. Telescopes, microscopes, binoculars, etc. Fresnel Lenses for making Solar Furnace. **SEND ONLY \$1.00** for beginner's 10-lens kit and big instruction booklet Stock 2-H. Ask for FREE catalog H.

EDMUND SCIENTIFIC CORP., Barrington, N.J., U.S.A.

SAY YOU SAW IT IN POPULAR MECHANICS

Learn BAKING At Home

Baking is one of America's high industries in wages. Nearly DEPRESSION-PROOF. Thorough basic home course lays sound foundation. If you have aptitude, write for FREE Booklet, "Opportunities in Commercial Baking."
NATIONAL BAKING SCHOOL
835 Diversey Parkway Dept. 135B Chicago 14.



NATIONAL SCHOOLS

proudly presents

FOR MEN
WHO WANT
TO EARN
MORE MONEY

TELERAMA • ALL 8 BRANCHES OF TELEVISION • ELECTRONICS • RADIO IN ONE DYNAMIC, MODERN SHOP METHOD, HOME TRAINING COURSE

*Registration applied for

Another great advance in **HOME STUDY TRAINING**. Let National Schools, of Los Angeles, a practical Technical Resident Trade School for over 50 years, train you at home by Shop-Method, for today's unlimited opportunities in **ALL 8 BRANCHES** of the Television, Electronics, Radio Industry.

Check all you receive in *One Master Course at One Low Tuition*

1. Television — Including Color TV
2. Radio — FM and AM
3. Industrial Electronics
4. Sound Recording and Hi-Fidelity
5. Preparation for FCC License
6. Automation
7. Radar and Sonar
8. Communications

ALL OF THIS MODERN, NEWEST, PRACTICAL EQUIPMENT IS YOURS TO KEEP!

- Parts to Build a modern TV set, including large screen Picture Tube.
- Parts to build a powerful Superhet Receiver, standard broadcast and short wave.
- Parts to conduct many experiments and build Continuity Checker, RF Oscillator, TV Circuits, Audio Oscillator, TRF Receiver, Signal Generator.
- Professional Multimeter
- These are a **MUST** for all technicians.

YOU DO MANY PRACTICAL JOBS.

You do servicing, circuit analysis and many other down-to-earth experiments. You build a modern TV set from the ground up... with equipment kits we give you, including a new large screen picture tube and professional Multimeter, at no additional charge.

EARN AS YOU LEARN! Many of our students earn their entire tuition and more in Spare Time jobs we show them how to do while learning. **YOU GET GRADUATE ADVISORY SERVICE, TOO.**

ALL YOURS
TO KEEP

L. J. ROSENKRANZ

President of NATIONAL SCHOOLS



This Master-Shop-Method course is completely up-to-date. Here in Los Angeles, the TV and Electronics center of the world, we are able to keep in constant touch with the industries' latest developments. As a student, you will quickly master all phases at home... in your spare time. Your earning power will grow with every lesson. Just as thousands of National Schools graduates do every day, you can handle servicing, manufacturing, repairing, hundreds of other jobs, or make good money in your own business. **SECURE YOUR FUTURE—NOW. SEND COUPON BELOW.**



IN THESE MODERN TV STUDIOS, SHOPS AND LABORATORIES, your Shop Method Home Study Course was developed by experienced instructors and engineers. What an advantage that is to you at home — each lesson is tested, proved, easy to understand. You can master the most up-to-date projects, such as color TV set repair, printed circuits — even prepare for F.C.C. License and industrial electronics without taking a special course. **TAKE YOUR FIRST STEP NOW TO A TOP-PAY JOB IN TV, ELECTRONICS, RADIO. SEND COUPON BELOW TODAY.**

APPROVED FOR
VETERANS
AND
NON-VETERANS

NATIONAL SCHOOLS

4000 S. FIGUEROA ST., LOS ANGELES 37, CALIF.

187 N. LA SALLE ST., CHICAGO 1, ILL.

IN CANADA: 811 W. Hastings St., Vancouver, B. C.

NATIONAL SCHOOLS

TECHNICAL TRADE TRAINING SINCE 1905

Los Angeles, California

GET FAST SERVICE—MAIL NOW TO OFFICE NEAREST YOU!

NATIONAL SCHOOLS, DEPT. RB-76

4000 S. FIGUEROA ST. OR 187 N. LA SALLE ST.
LOS ANGELES 37, CALIF. CHICAGO 1, ILL.

Rush free TV-Radio "Opportunity" Book and sample lesson. No salesman will call.

NAME _____ BIRTHDAY _____ IS _____

ADDRESS _____

CITY _____ ZONE _____ STATE _____

VETERANS: Give Date of Discharge _____



MEMBER



FREE!

Fully illustrated "CAREER" BOOK in TV, Radio, Electronics. AND actual Sample Lesson—yours at no cost, no obligation **SEND COUPON NOW—TODAY!**



I'll Send You This Famous TRAVIS BIKE MOTOR AT TREMENDOUS 30% SAVING



IF YOU'LL AGREE TO DEMONSTRATE TO YOUR BIKE-RIDING FRIENDS



AMAZING NEW RIDER-DEMONSTRATOR PLAN CAN PAY FOR YOUR MOTOR... AND BRING YOU EXTRA CASH, TOO!

If you'll agree to demonstrate to friends, we'll sell you a rugged, powerful 1 1/2 H.P. world-famous Travis Motor for your own bike at amazing low Demonstrator Price of 30% off! Just ride around town and see how everyone wants a Bike Motor like yours. Only 3 orders and your own Travis is paid for—costs you nothing. Then you keep on making wonderful profits in your spare time!

World's Lowest-Priced Bike Motor . . . Unequaled Features!

SAFE . . . mounts on front fork away from rider, always under control of bike brakes. **POWERFUL** . . . climbs hills, carries heavy loads. **SMOOTH-RIDING** . . . 2-cycle airplane-type multi-finned air cooled engine, ball bearing construction, direct drive to front wheel (no belts or pulleys to break). **LIGHT-WEIGHT** . . . only 17 lbs., perfectly balanced. **MOUNT IN LESS THAN 30 MINUTES** . . . anybody can do it with just pliers and screwdriver. **FITS ALL BIKES** . . . boys' or girls', balloon or lightweight. Motorcycle-type control. Unconditionally guaranteed . . . carries unique LIFE-TIME Factory Rebuilding Policy.

FREE! Rush name, address NOW for complete details of amazing Rider-Demonstrator Plan that saves you 30% and shows you how Travis pays for itself, makes EXTRA MONEY for you. Everything FREE. No obligation. Write:



TRAVIS PRODUCTS CO. 224 W. HURON, DEPT. G-3 CHICAGO 10, ILL.

... TURN CONCRETE INTO GOLD!



MAKE UP TO \$75 A DAY IN YOUR OWN BUSINESS

If you want to have your own business — to start a business on your own — here's your big opportunity! New high speed, low cost General block machine produces up to 1,000 concrete blocks a day. Sell all you make to builders, supply houses, and others for homes, factories, buildings, garages. Cash in on the building boom! You can make profits at 100% to 150% — up to \$75 a day! General block machine equipped with 1/2 h.p. electric motor — or can be supplied with gasoline engine — works anywhere, in little space, indoors or out. Operates from ordinary house light socket. Simple, foolproof 3 step operation — so easy a child can do it. Makes superior 3 core blocks any size from 4" to 12". Also makes chimney, sink, corner and other types. Blocks meet any building code anywhere in the country. Materials — sand, water, cement, available anywhere. Simple illustrated operating instructions and mixing formulas for cement and cinder blocks supplied with each machine. Write for FREE folder with full information.

MOTOR DRIVEN

R.L.T. of New York City reports: "MY GENERAL BLOCK MACHINE PAID FOR ITSELF IN FIRST 2 WEEKS!" Hundreds now in use the world over! Write for FREE details today!

EXTRA

book gives floor plans for 6 sensational concrete block bungalows. Tells how to lay blocks, lay out building lines, mix concrete, build steps, porch and concrete floors all at great savings. Written by experts. Can save many times the cost of the machine! Get it now! No strings attached. Send \$1.

BOOK SENT FREE IF YOU BUY MACHINE. \$1 REFUNDED IF YOU BUY LATER.

GENERAL ENGINES CO.

DEPT. M-76, ROUTE 130, THOROFARE, N. J.



4-WAY COMBINATION KNIFE, FORK, SPOON SET WITH BOTTLE OPENER



This handy little set is made of non-corrosive stainless steel with beautifully colored, easy to clean plastic handles. Knife and fork slide snugly into each other's handles. Spoon slips into pocket on knife handle, making a neat little package that's safe to carry. Fits easily into pocket, purse or glove compartment of car.

Wonderful for barbecues, picnics, or the home. Ideal for campers, hunters, fishermen

Please Specify Color. Order Today from
LEON RUMMEL 328 E. Washington Blvd. Los Angeles 15, Calif.

Available in red, yellow, green and ivory.
\$1.25 PER SET PPD.
4 sets only \$5.00 Ppd.
Knife and fork set, without spoon, \$1.00 Ppd.



Free! 75 ORIENTALS

Brought to you from the farthest ends of the earth—these exotic valuable genuine STAMPS of the Orient! 75 all-different from Borneo, Siam, China, Japan, Hong Kong, Malaya, Sarawak, Singapore — and other exciting mysterious lands of the Far East. EXTRA! Free booklet, Bargain Catalog, other fascinating offers. Send 10c for mailing expenses.

JAMESTOWN STAMPS, C7PM JAMESTOWN, N. Y.

YOU BUILD 'EM — WE SELL 'EM EARN UP TO \$50.00 A DAY AT HOME

Participate in our national sales and sub-contract plan — spare time — full time. You assemble special luggage and cases for photographers, musicians, salesmen, and all types of portables. We supply complete instructions — materials — tools — everything. No previous experience necessary. Free details. Abars! Casecraft, Dept. AH, 807 W. Sunset Blvd., Los Angeles 12, Calif.

MONEY in DONUTS

Make new greaseless donuts! Start in kitchen. No smoke. Sell stores. HALF PROFIT. Cash daily. Free recipes. No obligation. Write! MARTIN RAY CO., 3605 SO. 15th AVENUE, MINNEAPOLIS 7, MINN.

Secrets of VENTRILOQUISM Now Revealed!



Easy to learn in 60 to 90 days with our Home Study Course. RESULTS GUARANTEED. Make Money! Be Popular! Have Fun! Big Opportunity! Radio, Television, Stage Appearances! For FREE information regarding price and terms WRITE. You must state your Age. Dummy Catalog 25c. FRED MAHER SCHOOL OF VENTRILOQUISM Box 36, Studio PM-7 Kensington Station Detroit 24, Michigan

Build a Boat for Fun or Profit

Popular Mechanics

23 BOATS
You Can Build



Complete Patterns and Working Drawings

Build the boat you have always wanted. Build it for fun or to sell at a profit. Get Popular Mechanics 23 BOATS YOU CAN BUILD — row boats, canoes, sail boats, power boats and other craft including a 25 ft. cabin cruiser that steps four; 11 1/2 ft. car-top row boat; 8 ft. duck boat; 15 ft. sailing knockabout — in all, 23 of the most popular boats. Book includes more than 500 photos, plans, diagrams and working drawings, plus step by step instruction that anyone can follow. Only simple tools needed. Material list of lumber, hardware, fittings, etc. included. Order today, under money-back guarantee. Only \$2.75 postpaid.

Row Boats, Canoes
Sail Boats, Power
Boats and Others



POPULAR MECHANICS PRESS, Dept. 756, 200 E. Ontario St., Chicago 11



Instead of a job . . . train for a Career



Industrial growth . . . automation . . . technical advances create career opportunities for engineers, accountants, management experts. Share rewards awaiting college-trained men. Important firms visit campus regularly to employ Tri-State College graduates. Start any quarter in this world-famed college. Approved for veterans.

Bach. of Science degree in 27 months

In Mechanical, Civil, Electrical, Chemical, Aeronautical, Radio (TV-Electronics) Engineering. In 24 Months a B.S. in Business Administration (General Business, Accounting, Motor Transport Management majors). Capable students may accelerate. 36-weeks course in Drafting. *Intensive program: technical fundamentals stressed: comprehensive courses with more professional class hours. Small classes: personalized instruction. For earnest, mature students whose time and budget require accelerated courses and modest costs. Preparatory courses. Beautiful campus in friendly college town. Well-equipped, new and modernized buildings and laboratories. Enter Sept., Jan., March, June. Write Jean McCarthy, Director of Admissions, for "Your Career in Engineering and Commerce."*



TRI-STATE COLLEGE

476 College Avenue

Angola, Indiana

HOW TO FIX ANY CAR

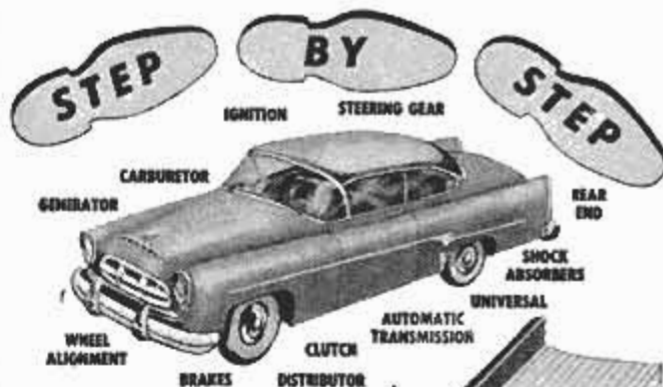

FREE 7-DAY TRIAL

ANY tune-up, service or repair job on ANY car can be as easy as A-B-C . . . when factory experts show you how-to-do-it one step at a time. That's why no job's too tough to handle when you've got MOTOR'S brand-new AUTO REPAIR MANUAL at your elbow!

Book "starts from scratch" — tells you WHERE to start, what TOOLS to use. Whether you're a beginner or an expert mechanic—you can "breeze through" ANY repair on ANY make or model car built from 1946 through 1956!

Everything You Need to Know
in 1000 Big ILLUSTRATED Pages!

NEW, REVISED, 1000-Page Edition contains the "meat" from over 160 OFFICIAL shop manuals—simplified for YOU. 23,436 essential repair specifications on over 737 chassis models. More than 2,900 "this-is-how" pictures. 225,000 service and repair facts. Leads beginners every step of the way. Time-saving factory repair procedures for experts. Instructions and pictures so clear you CAN'T go wrong. Used by U. S. Army and Navy. 2,000,000 COPIES SOLD!

Try Book FREE 7 Days

SEND NO MONEY! Pay postman nothing. Make Manual PROVE to you what it's got. Unless you agree this is the greatest time and work savor you've ever seen—return book in 7 days and pay nothing. Mail coupon today to: MOTOR BOOK DEPT., Desk 1G, 250 W. 55 St., N. Y. 19

Same FREE Offer On MOTOR'S
New Truck Repair Manual

Brand new! Covers EVERY job on EVERY popular make gasoline and Diesel truck, made from 1946 thru 1955. FREE 7-Day Trial. Check proper box in coupon.



MOTOR'S AUTO REPAIR MANUAL

Covers 737 Models
— 1946 thru 1956

- | | |
|-------------|-------------|
| Buick | Imperial |
| Cadillac | Kaiser |
| Chevrolet | Lincoln |
| Chrysler | Mercury |
| Clipper | Nash |
| Continental | Oldsmobile |
| Crosley | Packard |
| De Soto | Plymouth |
| Dodge | Pontiac |
| Ford | Rambler |
| Frazier | Studebaker |
| Henry J | Thunderbird |
| Hudson | Willys |

Industrial growth . . . automation . . . technical advances create career opportunities for engineers, accountants, management experts. Share rewards awaiting college-trained men. Important firms visit campus regularly to employ Tri-State College graduates. Start any quarter in this world-famed college. Approved for veterans.

Bach. of Science degree in 27 months

In Mechanical, Civil, Electrical, Chemical, Aeronautical, Radio (TV-Electronics) Engineering. In 24 Months a B.S. in Business Administration (General Business, Accounting, Motor Transport Management majors). Capable students may accelerate. 36-weeks course in Drafting. *Intensive program: technical fundamentals stressed: comprehensive courses with more professional class hours. Small classes: personalized instruction. For earnest, mature students whose time and budget require accelerated courses and modest costs. Preparatory courses. Beautiful campus in friendly college town. Well-equipped, new and modernized buildings and laboratories. Enter Sept., Jan., March, June. Write Jean McCarthy, Director of Admissions, for "Your Career in Engineering and Commerce."*

TRI-STATE COLLEGE

476 College Avenue Angola, Indiana

FREE 7-DAY TRIAL

ANY tune-up, service or repair job on ANY car can be as easy as A-B-C . . . when factory experts show you how-to-do-it one step at a time. That's why no job's too tough to handle when you've got MOTOR'S brand-new AUTO REPAIR MANUAL at your elbow!

Book "starts from scratch" — tells you WHERE to start, what TOOLS to use. Whether you're a beginner or an expert mechanic—you can "breeze through" ANY repair on ANY make or model car built from 1946 through 1956!

Everything You Need to Know
in 1000 Big ILLUSTRATED Pages!

NEW, REVISED, 1000-Page Edition contains the "meat" from over 160 OFFICIAL shop manuals—simplified for YOU. 23,436 essential repair specifications on over 737 chassis models. More than 2,900 "this-is-how" pictures. 225,000 service and repair facts. Leads beginners every step of the way. Time-saving factory repair procedures for experts. Instructions and pictures so clear you CAN'T go wrong. Used by U. S. Army and Navy. 2,000,000 COPIES SOLD!

Try Book FREE 7 Days

SEND NO MONEY! Pay postman nothing. Make Manual PROVE to you what it's got. Unless you agree this is the greatest time and work savor you've ever seen—return book in 7 days and pay nothing. Mail coupon today to: MOTOR BOOK DEPT., Desk 1G, 250 W. 55 St., N. Y. 19

Same FREE Offer On MOTOR'S
New Truck Repair Manual

Brand new! Covers EVERY job on EVERY popular make gasoline and Diesel truck, made from 1946 thru 1955. FREE 7-Day Trial. Check proper box in coupon.

**MOTOR'S
AUTO
REPAIR
MANUAL**

Covers 737 Models
— 1946 thru 1956

Buick	Imperial
Cadillac	Kaiser
Chevrolet	Lincoln
Chrysler	Mercury
Clipper	Nash
Continental	Oldsmobile
Crosley	Packard
De Soto	Plymouth
Dodge	Pontiac
Ford	Rambler
Frazier	Studebaker
Henry J	Thunderbird
Hudson	Willys

MAIL COUPON NOW FOR 7-DAY FREE TRIAL

MOTOR BOOK DEPT.
Desk 1G, 250 W. 55th St., New York 19, N. Y.

Rush to me at once (check box opposite book you want):

MOTOR'S New AUTO REPAIR MANUAL. If O.K. I will remit \$2 in 7 days, \$2 monthly for 2 months and a final payment of 9¢ (plus 35¢ delivery charges) one month after that. Otherwise I will return the book postpaid in 7 days. (Foreign price, remit \$5.00 with order.)

MOTOR'S New TRUCK REPAIR MANUAL. If O.K. I will remit \$2 in 7 days and \$2 monthly for 3 months, plus 35¢ delivery charges with final payment. Otherwise I will return book postpaid in 7 days. (Foreign price, remit \$10 cash with order.)

Print Name..... Age.....

Address

City..... State.....

Check box and save 35¢ delivery charge by enclosing WITH coupon entire payment of \$6.95 for Auto Repair Manual (or \$8 for Truck Repair Manual.) Same return-refund privilege.

**SANFORIZED
N&W
WORK CLOTHES**

Sold by
25,000 stores

**Home Craftsmen And
Do-It-Yourself Fans—**

You're dressed for the job — and neatly, too — when you wear N&W work and leisure clothes. Full line for men and women.

Guaranteed by
Good Housekeeping

AMERICAN
MADE
CERTIFIED
WARRANTY
INSTITUTE OF LONDON

N&W INDUSTRIES, Inc. Lynchburg, Virginia
Jackson, Mississippi

TERMITES

**Kill Termites Yourself with ARAB
U-DO-IT TERMITE CONTROL**

Costs \$20.00 to protect 5-room house for 5 years. Harmless to flowers and shrubs. FREE FOLDER and prices at Bldg. Supply Dealers or write **FEDERAL CHEMICAL CO., INC.**, 2701 Winthrop Ave., Indianapolis, Dept. PM 756.

IT'S EASY . . .

MAKE MONEY IN PHOTOGRAPHY

If you are over 17—good pay and fascinating work await you in photography! Start making money quickly in sparetime—step into your own studio or exciting career job. LEARN-BY-DOING method trains you at home! Write TODAY for FREE catalog. Also Resident Training. Co-ed. 46th Year. Approved for Veterans.

NEW YORK INSTITUTE OF PHOTOGRAPHY
Dept. 49, 10 West 33 Street, New York 1, New York
46th YEAR

SAY YOU SAW IT IN POPULAR MECHANICS

**Worry of
FALSE TEETH**

Slipping or Irritating?

Don't be embarrassed by loose false teeth slipping, dropping or wobbling when you eat, talk or laugh. Just sprinkle a little **FASTEETH** on your plates. This pleasant powder gives a remarkable sense of added comfort and security by holding plates more firmly. No gummy, gooey, pasty taste or feeling. Its **alkaline** (non-acid). Get **FASTEETH** at any drug counter.

DRAFTSMEN



**CASH BIG
PAY CHECKS!**

**Train Now for
more success,
greater security**

**LEARN AT HOME IN SPARE TIME
(or at college in Chicago)**

Check the want ads in any newspaper—SEE the big-pay opportunities open to you as a draftsman. What's more, you can learn this well-paid, prestige profession at home—quickly, easily! No special talent needed. Get complete, step-by-step Chicago Tech lessons in the mail, spend a few pleasant hours studying each week. In a short time you'll be a well-trained draftsman, ready to take your pick of many good jobs. Act now!



Free Information—Mail Coupon Today!

Get **FREE TRIAL LESSON** plus information about C.T.C. practical training. Learn what successful Chicago Tech graduates say about high pay and opportunities in drafting. No charge, or obligation.

CHICAGO TECHNICAL COLLEGE

H-254 Tech Bldg., 2000 So. Michigan Ave.
Chicago 16, Illinois

Mail me **FREE** lesson with facts about big opportunities in **DRAFTING**.

Name _____ Age _____

Address _____

City _____ Zone _____ State _____

BUILD YOUR OWN AIR CONDITIONERS

From Junked Refrigerators for a Few Dollars
INSTRUCTION BOOKS SHOW YOU NOW... 75c EACH

SPECIAL OFFER
2 Books—\$1.00
3 Books—\$1.50
or all 5 for \$2.00

"HOW TO BUILD a Low Cost Air Conditioner"

"HOW TO BUILD an Automobile Air Conditioner"

"HOW TO BUILD a Low Cost Home Freezer"

"HOW TO BUILD an Electrostatic Precipitator"

"HOW TO BUILD a Low Cost Dehumidifier"

Complete "Install-It-Yourself" Air Conditioner kits for home and automobile, 2 Ton capacity, Brand New Parts—\$124.40 and up.

COOL ENGINEERING CO., Dept. W-7, 3716 Belmont, Chicago 18, Ill.

FREE!
Instructions
and Literature
on kits.

AMAZING NEW PERSONAL POCKET RADIO

**LISTEN WHILE YOU
WALK DOWN THE STREET!**



Sits in any pocket—wt. only 7 ozs. Size 2 1/2" x 4 1/2" x 1 1/2". Beautiful Black Gold Plastic Case. NO HOOKUPS—NO WIRES—NO PLUG-INS! Self-contained, 150-hour life flashlight batteries and **BUILT-IN ANTENNA**. POSITIVELY NO AERIAL HOOKUPS EVER! **GUARANTEED RECEPTION OF RADIO STATIONS TO 50 MILES** up to 1500 miles for powerful stations! New patented Super-regenerative Diode tube and transformer audio stage for sharp selectivity and sensitivity! Easy to use top tuner (while walking). Tiny, plastic personal ear plug. **LET'S YOU ALONE LISTEN WHILE YOU WALK, VISIT, WORK, RIDE OR SLEEP ANYTIME—ANYWHERE. MONEY-BACK GUARANTEE AND ONE YEAR SERVICE GUARANTEE.**

SEND ONLY \$5.00 (cbr. mo) and pay postman \$14.95 plus postage on delivery or send \$19.95 for postpaid delivery. GET YOUR TINY TONE REAL POCKET RADIO now and be ready to listen to Civil Defense Alarms, news, music, sports, etc. on a moment's notice without bothering those around you. NOT AN UNWORKABLE, INCOMPLETE KIT OR PLAYTHING, BUT A REAL POCKET RADIO! Shipped complete with batteries—Ready to listen! Available only from: **WESTERN RADIO, Dept. APM-7, Kearney, Neb.**

LEARN AT HOME



Send for
FREE BOOKLET

INSTITUTE OF LOCKSMITHING
Dept. P-80, 15 Park Avenue, Rutherford, N. J.
Lic. by N. J. State Board of Education
Approved for Veterans

Learn this profitable business from experts in your spare time. Locksmiths have no "slow" seasons or layoffs; they are always in demand. Age or minor physical handicap can't stop you. America's only recognized locksmithing school can teach you easily and quickly. Simple, illustrated lessons plus materials and tools supplied. Make money while learning. Get into this uncrowded field now!

EARN WHILE YOU LEARN



UPHOLSTERY BE YOUR OWN BOSS

Practical, low-cost, LEARN-BY-DOING UTS Course, complete with tools, materials, frames, trains you quickly AT HOME in spare time. Start making money in Upholstery almost at once! Big **FREE** illustrated book and **FREE** sample lesson show you how—give full facts about business, job opportunities for men and women. Write **TODAY!** Also Resident Training. **VET Approved.**
UPHOLSTERY TRADES SCHOOL
Dept. EL-309 721 Broadway, New York 3, N.Y.

TASOPE PHOTO-ENGRAVING PLANTS



Establish your own profitable **PHOTO-ENGRAVING** business. Make cuts for newspapers, printers, and advertisers. Make etched name plates, plaques etc. Instructions furnished, no experience necessary. Sold direct from factory since 1931. First five hundred cuts sold locally or by mail will pay for plant and pay you well for your time. Write for **FREE** catalog.

TASOPE, DEPT. PM-7, AURORA, MO.

STUDY TO BE A DOCTOR of Psychology or Metaphysics

Obtain a Ps.D., Ms.D., or Ph.D. Be a Teacher, Lecturer or Accredited Practitioner. Teach others how to achieve Health, Happiness and Contentment. Chartered by State. Correspondence Courses only. Write for **FREE** book telling how.

THE NEOTARIAN FELLOWSHIP

Desk 8, Pickwick Building Kansas City 6, Missouri

DRAINS cellars, cisterns, wash tubs; \$7.95 IRRIGATES - CIRCULATES - SPRAYS



Type P Pump has 1,001 uses. Up to 3000 GPH; 400 GPH 60' high; or 1800 GPH from 25' well. Use 1/2 to 3/4 HP motor. Coupling included free. 1" inlet; 3/4" outlet. Stainless shaft. Won't rust or clog! Postpaid if cash with order. Rush your order today.

MONEY BACK GUARANTEE
Centrifugal and Gear Pumps in All Sizes
LABAWCO PUMPS, Belle Meade 7, N. J.

CABINET MAKING



LOW COST HOME TRAINING COURSE FOR BEGINNERS & ADVANCED CRAFTSMEN
Make money. Learn skills and secrets of fine woodworking and tool use. Professionally prepared shop method training tells and shows how. Covers everything. Easy to master.

Write for **Free Booklet**
INTERSTATE TRAINING SERVICE
DEPT. F3, PORTLAND 13, OREGON

SAY YOU SAW IT IN POPULAR MECHANICS

FREE—Amazing Book on RHEUMATISM, ARTHRITIS

If you suffer aches, pains and discomforts of Rheumatism, as manifested in **ARTHRITIS, NEURITIS, SCIATICA or LUMBAGO**, send today for this **FREE** Book. It reveals important facts about why drugs and medicine give only temporary relief without removing cause. Explains a proven, specialized system of treatment that may save you years of distress. No obligation. Write for this **FREE** Book today!
BALL CLINIC, DEPT. 756, EXCELSIOR SPRINGS, MO.

CAVITEX

Superfine
Masonry

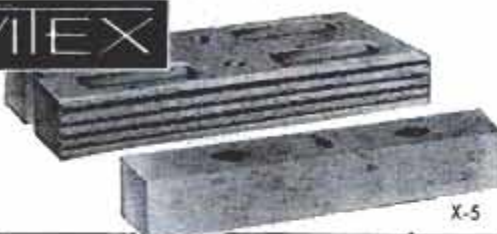

X-5

Manufacturing Rights Now Available in 427 Territories

Cavitex offers building owners the ultimate in masonry at sensationally low costs. Designed in line with today's architecture. Long and low. Large color range. Modular in all dimensions. Strong—safe—enduring. Suited to all types of wall construction—8" solid, cavity, partition, veneer.

As a local manufacturing opportunity, Cavitex has tremendous potentials. Local materials are processed by local labor for local consumption. Vast economies effected. That's why Cavitex has price-appeal to buyers and profit-appeal to producers. Hundreds of territories are open.

Cavitex manufacturers operate in franchise-protected territories and with exclusive privileges. Extensive sponsor cooperation. Basic machinery available on lease. Write or wire for book "Opportunity, Unlimited" and tentative reservation of territory.

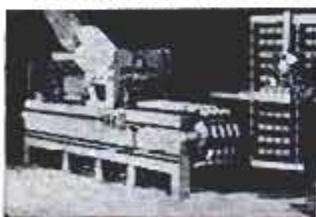

W. E. DUNN MFG. CO.
409 W. 24th St. Holland, Mich.
In Canada
Dunn Masonry Machinery, Ltd.
844 Dundas Highway
Cooksville, Ontario

LAW FREE BOOK

THE LAW
TRAINED
MAN

Write today for a FREE copy of illustrated law book, "THE LAW-TRAINED MAN," which shows how to earn the professional Bachelor of Laws (LL.B.) degree through home study of the famous Blackstone Law Course. All necessary books and lessons provided. Moderate cost; convenient monthly terms. Write for FREE law training book today.

Blackstone School of Law, 225 N. Michigan Ave.
Founded 1890 Dept. 50 B Chicago 1, Ill.

PORTABLE CAR COVER

Protect Against RAIN • SUN • DUST

Heavy Vinyl Plastic
(formerly \$8.95)

Long-lasting plastic, folds compactly, off and on in a lippy, sturdy elastic binding gives extra security. State make, model and year



Send \$6.95 plus 35¢ postage or sent C.O.D.
Extra Heavy Plastic Gauge \$8.95 + 45¢ postage.
BEA SALES, Dept. B-1, 125 E. 46th St., New York 17

JEEP OWNERS

STA. WAGONS • JEEPSTERS • PICK-UPS!

RE-POWER with Ford 6 or V-8 engines. Our F-1 ADAPTOR-CONVERSION KITS fit ALL Willys Jeeps including 1956. Kit No. 4-K for 1949-56 Ford engines in 1954-56 Pickups & Sta-Wagons priced at \$52.85 incl. Fed. tax. Kits for 1932-56 Ford engines in ALL other Willys Jeeps . . . \$43.25 Tax incl. Write today for free details or send check or M.O. for prepaid shipment. Tell us year engine you will use and whether 2 or 4 Whl-Dr. ORDER NOW FOR EARLY SHIPMENT.

HOOSIER MACHINE PRODUCTS CO.

312 S.E. 6th St.

Pendleton, Oregon



GET MAXIMUM USE OF 4-WHEEL DRIVES!

MAKE 2 VEHICLES OUT OF 1!

Your 4 w. d. is a 4 w. d. work horse or 2 w. d. "pick-up" as you need it—as you shift! No drag, gear whine, shimmy in 2 w. d.; big savings in gas, tires, repairs. For all 4 w. ds. to 1½ tons at dealers or write:

WARN HUBS

WARN MANUFACTURING CO.
Riverton Box 6064-A7 Seattle 28, Wash.

AUDELS Carpenters and Builders Guides

4 vols \$6



Inside Trade Information for Carpenters, Builders, Joiners, Building Mechanics and all Woodworkers. These Guides give you the short-cut instructions that you want—including new methods, ideas, solutions, plans, systems and money saving suggestions. An easy progressive course for the apprentice and student. A practical daily helper and Quick Reference for the master worker. Carpenters everywhere are using these Guides as a Helping Hand to Easier Work, Better Work and Better Pay. To get this assistance for yourself, simply fill in and mail FREE COUPON below.

Inside Trade Information On:

How to use the steel square—How to file and set saws—How to build furniture—How to use a mitre box—How to use the chalk line—How to use rules and scales—How to make joints—Carpenters arithmetic—Solving mensuration problems—Estimating strength of timbers—How to set girders and sills—How to frame houses and roofs—How to estimate costs—How to build houses, barns, garages, bungalows, etc.—How to read and draw plans—Drawing up specifications—How to excavate—How to use settings 12, 13 and 17 on the steel square—How to build hoists and scaffolds—skylights—How to build stairs—How to put on interior trim—How to hang doors—How to lath—lay floors—How to paint.



Step up your own skill with the facts and figures of your trade. Audels Mechanics Guides contain Practical Inside Trade Information in a handy form, Fully Illustrated and Easy to Understand. Highly Endorsed. Check the book you want for 7 DAYS FREE EXAMINATION. Send No Money. Nothing to pay Postman.

MAIL ORDER

AUDEL, Publishers, 49 W. 23 St., NEW YORK 10, N. Y.



Check NOW!

You Can
Look Over
Any Guide
In Your
Own Home
—
Start the
Easy Pay-
ments If
Satisfied

MAIL THIS TODAY



Please send me _____ for FREE EXAMINATION books marked X below. If I decide to keep them I agree to mail \$1 in 7 Days on each book or set ordered and further mail \$1 monthly on each book or set until I have paid price, otherwise I will return them.

- AUTOMOBILE MECHANICS GUIDE, 1664 Pages. \$4
- TRUCK & TRACTOR GUIDE, 1299 Pages . . . 4
- DIESEL ENGINE MANUAL, 575 Pages . . . 2
- MACHINISTS HANDY BOOK, 1650 Pages . . . 4
- WELDERS GUIDE, 400 Pages . . . 1
- BLUE PRINT READING, 416 Pages . . . 2
- MATHEMATICS & CALCULATIONS, 700 Pages. 2
- SHEET METAL PATTERN LAYOUTS, 1100 Pages. 4
- SHEET METAL WORKERS HANDY BOOK, 388 Pgs. 1
- MECHANICAL DRAWING GUIDE, 160 Pages . . . 1
- MECHANICAL DRAWING & DESIGN, 480 Pages . 2
- AIRCRAFT WORKER, 240 Pages . . . 1
- TELEVISION SERVICE MANUAL, 434 Pages . . . 2
- RADIOMANS GUIDE, 1040 Pages . . . 4
- ELECTRONIC DEVICES, 216 Pages . . . 2
- ELECTRIC MOTOR GUIDE, 1000 Pages . . . 4
- WIRING DIAGRAMS (Light & Power), 272 Pgs. 1
- ELECTRICIANS EXAMINATIONS, 250 Pages . . . 1
- ELECTRIC POWER CALCULATIONS, 425 Pages. 2
- HANDY BOOK OF ELECTRICITY, 1440 Pages. . . 4
- ELECTRIC DICTIONARY, 9000 Terms . . . 2
- ELECTRIC LIBRARY, 7000 Pages (12 Book Set) 18
- SHIPFITTERS HANDY BOOK, 250 Pages . . . 1
- REFRIGERATION & Air Conditioning, 1280 Pgs. 4
- MILLWRIGHTS & MECHANICS GUIDE, 1200 Pgs. 4
- POWER PLANT ENGINEERS GUIDE, 1500 Pages . 1
- ENGINEERS & FIREMANS EXAMS, 525 Pages . 1
- PUMPS, Hydraulics & Air Compressors, 1658 Pgs. 4
- OPERATING ENGINEERS LIBRARY (3 Books) . . 9
- MECHANICAL DICTIONARY, 950 Pages . . . 4
- GARDENERS & GROWERS GUIDES (4 Book Set) 6
- CARPENTERS & BUILDERS GUIDES (4 Book Set) 6
- PLUMBERS & Steamfitters Guides (4 Book Set) 6
- MASONS AND BUILDERS GUIDES (4 Book Set) 6
- PAINTERS & DECORATORS MANUAL, 450 Pgs. 2
- HOUSE HEATING GUIDE, 1000 Pages . . . 4
- OIL BURNER GUIDE, 384 Pages . . . 1
- HOME APPLIANCE SERVICE GUIDE, 800 Pages . 4

Name _____

Address _____

Occupation _____

Employed by _____ PM-7

Inventors

Take these necessary preliminary steps promptly to protect your invention by applying for a United States patent—

Sketch and describe your invention. Sign, date and have this disclosure witnessed by two people who understand your invention. Have us make a preliminary search among U. S. patents already granted for similar types of invention. We then report to you on the probable patentability of your invention and recommend your further course of action.

Write for our instructive booklet, "Patent Protection for Inventors" and our convenient "Evidence of Invention" disclosure form. No obligation.

VICTOR J. EVANS & Co. *Merlin M. Evans*
REGISTERED PATENT ATTORNEY

230-H MERLIN BUILDING, WASHINGTON 6, D. C.

NEVER AT THIS LOW PRICE! GENUINE 120-POWER ACHROMATIC TELESCOPE

with Coated Lens and
3-POWER FINDER attached

ONLY
\$18.95
PREPAID

EXTRA BONUS GIFTS:

- 108 page book, "Discover The Stars"
- Magic Star Finder Dial
- 220X & 400X Eyepiece lenses

BRING THE MOON, PLANETS, STARS, PEOPLE 120 TIMES CLOSER, CLEARER, SHARPER.

Never before has an ACHROMATIC 120X telescope with range finder and tripod sold for anywhere near this amazing low price! Now you can not only explore the heavens and bring the moon, planets, stars, etc. 120 times closer, but you can also observe all distant objects, people, ships, etc. too, because all pictures are erect, and not upside down as in all astronomical telescopes. The kind of needle-sharp color-free viewing only a genuine achromatic lens can bring you. Ready for immediate use. Its 5 precision lenses bring you viewing at 40X—80X—120X, the tubes extend to 43", made of jet bakelite, finished in camera bellows black (for sharper, clearer images). Trimmed with gleaming brass. The 3 power finder scope mounted on main tube is a feature usually found on more expensive telescopes—brings difficult objects on target before observing with main scope. For extra stability 5 ft. hardwood folding tripod is equipped with heavy cast iron head fitted with Criterion's famous 360 degree all aluminum mount that locks instantly in any position. Obtainable only from Criterion, shipped prepaid. 4-Bonus gifts—108 page book "Discover The Stars," magic star finder dial that aids in locating stars ANYWHERE at ANY TIME of the year, and 220X and 400X eyepiece lenses included free of any cost for experiments. You must be completely satisfied with this super offer or your money back in full. Shipped to you complete, nothing else to buy, at the amazing low price of \$18.95. Without tripod \$14.95.

Send cash, check, or money order today to:
Dept. PMA4, Criterion Co., 331 Church St., Hartford, Conn.

HOW TO GROW

ORCHIDS

AT HOME

Most enjoyable hobby I know. People drove 100 miles to see this plant... 10 flowers, 8 1/2 inches across!
Thomas Hurst-Utah

Learn how you may have real ORCHID FLOWERS blooming in YOUR OWN HOME within a few weeks. Successful home grower now reveals his secrets. Shows you how to grow gorgeous CATTLEYAS CYMBIDIUMS, EPIDENDRUMS, etc. in your living room. No previous experience needed. World's most fascinating hobby—PROFITABLE HOME BUSINESS. Big profit orders come from friends, neighbors, florists, etc. FREE—real ORCHID SEEDS and full details, including PLAN FOR STARTING YOUR OWN BUSINESS—SEND NO MONEY. Write today.

FREE! REAL ORCHID SEEDS & \$\$\$ PLAN

TROPICAL FLOWERLAND, Dept. 317
4622 Wilshire Blvd., Los Angeles 5, Calif.

YEAR 'ROUND ANY CLIMATE NO Green House

How to Learn ORCHID SEEDS

Learn to MOUNT BIRDS

Tan SKINS, make up FURS

Be a Taxidermist. Double your hunting fun. We teach you at home. Mount Birds, Animals, Fish, Heads, common specimens. Fun and profits. Decorate home and **MAKE MONEY**. Mount game, tan for others. Big profits in spare time. **WRITE TODAY.** 100 game pictures in **FREE BOOK**. Hunters, get your copy. It's **Now Free**. Send post card. State your **AGE**. **NORTHWESTERN SCHOOL OF TAXIDERMY** Dept. 2507 Omaha, Nebraska

Would You Like to Make **\$1,000 A MONTH?**

That's what Stanley Hyman made selling the amazing new Presto Fire Extinguisher! Many others "cleaning up" — so can you! Amazing tiny new extinguisher ends fires fast as 2 seconds. Guaranteed for 20 years! Sells for only \$1.95! Write for Free sales kit. (If you want a regular Presto to use as a demonstrator send \$3.00. Money back if you wish.) Marlite Industries, Presto Div., Dept. P-15H, 114 E. 32nd St., New York 16, N. Y.

Learn MECHANICAL DENTISTRY

A profession offering unlimited opportunities. Most modern and complete course embracing every branch from Plate to Porcelain Work, which prepares you to work for Dentists or start your own business. Individual instruction—practical training in day or night school. No books—no classes. Catalog upon request. **MCCARRIE SCHOOL OF MECHANICAL DENTISTRY** 207 N. Broad Street Dept. 55 Philadelphia 7, Penna.

BUY IT WHOLESALE!

GET UP TO 40% OFF
Agents—Start Buying Service at Home. Get big-name merchandise for clients up to 40% off. Sales easy as you can give sizeable discounts, still make fat commissions. Postcard brings FREE COPY "The Wholesale Plan."
FREE! "THE WHOLESALE PLAN!"
American Buyers Service

HERTEL STATION, DEPT. R, BUFFALO 16, N. Y.

Say You Saw It in Popular Mechanics

WORLD'S LOWEST PRICED ADDING MACHINE

Counts up to 999,999,999
IDEAL FOR BUSINESS AND PERSONAL USE—GUARANTEED ACCURATE. Not a toy. Operates with only a finger flick. Adds, subtracts, multiplies, divides. Counts up to one billion. Pays for itself over and over. Ideal Gift—for Business, Income Tax and School use. **MONEY BACK GUARANTEE.** Send name and address. Pay postman only \$2.95 plus postage. Beautiful rich-looking Leatherette Case included at no extra cost. Money back in 10 days if not delighted. **AGENTS WANTED.**
CALCULATOR MACHINE CO., (Mfrs.)
Box 84 Dept. JY-56 Glenview, Illinois



Vest Pocket
FREE TRIAL
\$2.95

only
TOTAL COST SEND NO MONEY



22 YEARS AT THIS ADDRESS
 AN ESTABLISHED POLICY OF CAREFUL SELECTION ASSURES YOU MANY HAPPY MILES. BE WISE—TRY ONE—YOU'LL BUY MORE! WE WELCOME COMPETITION. NO ONE CAN TOUCH OUR QUALITY & PRICE! White Walls \$1.00 EX. 50 Years of Combined family experience in High Quality tires. "FREE TUBE," PARTIALLY USED TIRES. FREE FACTORY-TESTED TUBE

TAKE THE 10% DISCOUNT WE OFFER & PUT MONEY IN YOUR POCKET! EVERYBODY **10% off** ON EVERY TIRE MAY TAKE

12 MOS. WRITTEN GUARANTEE WE SPECIALIZE IN TRUCK TIRES Matched Tires Shipped all over USA and Foreign Countries. IMMEDIATE SHIPMENTS Same Day. Depend on STANDARD for SERVICE.



Selected for Toughest Jobs — Prices Shaved to the Bone

600-18	\$5.22	475-19	\$5.32	700-15(6)	\$8.72	700-20	\$11.92
600-16(6)	5.42	640-15	4.92	750-16(8)	9.92	750-20(10)	14.72
650-16	5.42	670-13	5.22	700-17	10.92	750-20(8)	10.92
650-16(6)	6.42	710-15	5.32	750-17	12.92	825-20	18.52
700-16	6.22	760-15	5.42	825-15	15.92	900-20	18.72
750-16(6)	7.42	800-15	5.72	800-20	6.62	1000-20	19.72
550-18	4.82	820-15	5.72	850-20	10.72	1100-20	19.72
550-17	4.72	670-16	5.15	32x6(8)	10.32	1000-22	20.92
650-15	5.22	760-16	7.72	32x6(10)	12.32	1100-24	23.72
700-15	5.32	700-16(6)	7.72	780-15	11.92	1110-22	20.02

"EXTRA SPECIAL" Fully guarantee all size 4-ply pass. FREE TIRE with 2 or more of these. W.W. \$1.00 Extra. Factory Tested Tube given. **GIANT TIRE SALE \$7.42 EA.**

Thousands of tires shipped all over the U.S.A. All tires shipped F.O.B. Phila. Send Check or M.O. with this ad. Dept. 2. No C.O.D. **STANDARD - 834 N. Broad St., Philadelphia 30, Pa.**



168 EASY WAY TO MAKE EXTRA MONEY

Selling NEW TYPE Greeting Cards Make \$50, \$75, \$100 — more! Show friends amazing value Christmas. All Occasion boxed assortments, gift wrappings, novelties. Profits to \$1.00 per box plus bonus. Write today for Free Trial outfit of feature boxes on approval. FREE Catalog.

FREE 74

Samples Personal Christmas Cards Stationery just for writing us!

NEW ENGLAND ART PUBLISHERS
 North Abington 736, Mass.

New Tall Mammor-ous Christmas Card Ass't.

Finish HIGH SCHOOL AT HOME

Complete 4 Yrs. in 12 Months

Learn More! Earn More! Enter professional or technical schools. Advance Socially. Live a Happier, Fuller Life. Individual Courses or complete schedule. **WRITE FOR SCHOOL BULLETIN.**

ACADEMY FOR ADULTS

30 W. Washington, Dept. PM-76, Chicago Ill.

MAKE TREMENDOUS PROFITS

Have fun! Earn Big Money! Cast plaster figurines, bookends, plaques, novelties at home in your spare time with X.L. rubber molds! NO EXPERIENCE NEEDED! Models and rubber for 3 molds, only \$1.50 ppd. Send 25c (refunded with order) for 40 page catalog now!

PLASTIC ARTS STUDIO 3403 SO. MADISON, DEPT. PM2 MUNCIE, INDIANA



BIG STINKY FLYTRAP FOR OUTDOOR LIVING AT BEST

Catches Over 25 Kinds of Flies

No Garden-Barbecue complete without one. Amazing Action—Irresistible Lure—Nothing like it. Genuine Big Stinky Fly Trap complete with Fluid. (Protected by U.S. Patent) **\$3.95**

two **\$7.00**

Check or M.O. — Money Back Guarantee — We Pay Shipping

BIG STINKY, P.O. Box 235, Waukesha, Wis.



PUMP WATER FAST!

Drains Wash Tubs, Cellars, Cisterns. Famous #7 pumps 2800 gph. 420 gph. at 75' high or 1600 gph. from 25' well. Sturdy rustproof alloy metal. Six blade impeller. 3/4" inlet, 1/2" outlet. Standard pipe threaded. Uses any 1/2 to 1/2 H.P. Motor. Will not leak or clog. Iron clad guarantee. Send check, M.O., or sent C.O.D. **\$795** IN U.S.

Irrigate, Fill Tanks, Draw Well Water. Heavy duty #8 pumps 7000 gph. — 1000 gph. 75' high 3000 gph. from 25' well. Rustproof alloy metal. 8 blade impeller. 1" inlet, 1" outlet. Standard pipe threaded. Will not leak or clog. Iron clad guarantee. Send check, M.O., or sent C.O.D. **\$1195**

Free Catalogue—Gear Pumps, Large Centrifugal Pumps, Deep and Shallow Well Pumps, Sump Pumps.

MOORE MANUFACTURING CO.
 SWEDSBORO T., NEW JERSEY

94.6% OF BAILEY GRADUATES ARE EMPLOYED AT TOP PAY IN THE FIELDS WHICH THEY WERE TRAINED!



DIESEL-AUTO MECHANICS DESPERATELY NEEDED!

We have a far greater demand for our students than we can fill!

We can show you an actual waiting list of leading companies throughout the world who have tried Bailey graduates — found them outstanding, and are coming back for more!

Bailey Graduates are Successful . . . RECEIVE BIG PAY — HAVE SECURE FUTURE!

The Famous Bailey Course prepares you for BOTH Diesel and Gasoline Mechanics.

This is a must—due to the advent of using Diesel principles, such as 'Fuel Injection' on passenger cars . . . use of gasoline engines for starting Diesel engines, etc. You learn all this at Bailey in the amount of time ordinarily required to learn just one of these subjects. **ALL FOR THE PRICE OF ONE.**

Don't be satisfied with a 'futureless', one-type job — learn how you can make big money now! Write today for Free Booklet that takes you on a step-by-step camera tour through our spacious, modern shops — See Bailey students in action as they Learn-by-doing with the Famous Bailey Method of training!

We provide you with housing and part time jobs while in school, plus nation-wide placement service for graduates.

BAILEY Technical SCHOOLS

1634 S. GRAND ST. LOUIS 4, MO.

MAIL TODAY!

Please mail immediately this free booklet without obligation.

FREE BOOKLET



Name.....

Address.....

City..... State.....

APPROVED FOR VETERAN . . . NON-VETERAN

IN YOUR CAR RADIATOR... GUARANTEED TO STOP RUST!

**WATER STAYS
CRYSTAL CLEAR
FOR OVER
ONE YEAR**

Just one can of
MAC'S NO. 13 re-
moves rust and scale
... prevents costly
repairs. Get MAC'S
NO. 13 today.



**AT SERVICE
STATIONS EVERYWHERE**

MAC'S SUPER GLOSS CO., INC.
Los Angeles 42, California

Superior's New Model 70 UTILITY TESTER FOR REPAIRING ALL ELECTRICAL APPLIANCES MOTORS • AUTOMOBILES • TV TUBES

As an electrical trouble shooter the Model 70:



- Measures A.C. and D.C. Voltages, A.C. and D.C. Current, Resistances, Leakage, etc.
- Will measure current consumption while the appliance under test is in operation.
- Incorporates a sensitive direct-reading resistance range which will measure all resistances commonly used in electrical appliances, motors, etc.
- Leakage detecting circuit will indicate continuity from zero ohms to 5 megohms (5,000,000 ohms).
- Will test toasters, irons, Broilers, Heating Pads, Clocks, Fans, Vacuum Cleaners, Refrigerators, Lamps, Fluorescents, Fans, Switches, Thermostats, etc.
- Will test all TV tubes for open filaments, inter-element shorts, burned out tubes, etc.

As an Automotive Tester the Model 70 will test:

- Both 6 Volt and 12 Volt Storage Batteries • Generators • Starters • Distributors • Ignition Coils • Regulators • Relays • Circuit Breakers • Cigarette Lighters • Stop Lights • Condensers • Directional Signal Systems • All Lamps and Bulbs • Fuses • Heating Systems • Horns • Also will locate poor grounds, breaks in wiring, poor connections, etc.
- Handsome round-cornered molded bakelite case, 3 1/4" x 5 1/2" x 2 1/4". Complete with all test leads. Also included is a 64 page book giving detailed instructions for testing all electrical appliances, automotive equipment, TV tubes, etc. Only **\$15.85**

**SHIPPED ON APPROVAL
NO MONEY WITH ORDER - NO C. O. D.**

Try it for 10 days before you buy. If completely satisfied then send \$3.85 and pay balance at rate of \$4.00 per month for 8 months — No Interest or Finance Charge Added! If not completely satisfied, return to us, no explanation necessary.

MOSS ELECTRONIC DIST. CO., Inc.
Dept. D-244, 3849 Tenth Ave., N. Y. 34, N. Y.
Please rush me one Model 70. If satisfactory I agree to pay \$3.85 within 10 days and balance at rate of \$4 per month until total price of \$15.85 plus postage is paid. If not satisfactory, I may return for cancellation of account.

Name _____
Address _____
City _____ State _____

New Table Top Invention Puts You In... PROFITABLE RUBBER STAMP BUSINESS

Home Operators now make
\$9.40 AN HOUR in business once monopolized by a few big companies



Special rubber stamps bring high prices—cost only pennies to make on new, low-cost table top machine. Take 27 cents worth of material, make perfect stamps, the kind businesses and offices now buy by the dozen at \$1.80 each. Make up to \$9.40 an hour. Start in spare time in your own home. Run machine on kitchen table using ordinary electrical outlet. Make any kind of stamp. We'll send you free information without obligation about this established, highly profitable business, now open to individuals for the first time. For free information send name today on a post card to Rubber Stamp Div., 1512 Jarvis Ave., Dept. R27, Chicago 26, Ill.

ADJUSTING

Men needed in exciting, fast growing field of Claims Adjusting. Many Earning Up to \$125 Week in this fascinating work. Excellent positions with airlines, railroads, steamship lines, insurance companies and government offices. Also big opportunities for your own spare time business. Easy to learn. We train you at home. Send TODAY for FREE book.

UNIVERSAL SCHOOLS

University Park, Box 8202, Dept. PM-7, Dallas 5, Texas

**IT
FLOATS**



**SOLINGEN STEEL NON-RUSTING
Skin Diver's KNIFE**

Based on traditional design favored by Oriental pearl divers. Limited supply just imported. Sleek graceful lines from finger-grip, polished bamboo handle to the tip of its razor-sharp, double-edged blade make it a beauty to behold—a treasure to own. Belt loops on rot-proof rubber sheath specially angled for under-water accessibility—like original "Singapore Shark-Sticker." Guaranteed to satisfy the most discriminating knife collector and professional skin diver. This Oriental \$3.95 Post-paid plus all rubber sheath. Only.....
**BIG THREE, Inc. DEPT. MP-7, 1109 SIXTH AVENUE
NEW YORK 36, N. Y.**

**how to cash in
on your ideas**

IDEA EVALUATION & PROFESSIONAL HELP
FOR INVENTORS AND IDEA MEN WHO WANT
TO FIND WAYS TO CAPITALIZE ON THEIR
IDEAS. WRITE TODAY FOR FREE DETAILS.

National Institute of Design and Invention
BOX 127-C SAN MATEO CALIFORNIA

ELECTRICIANS

Simplified conduit bending data. Plastic, Pocket size. Punched to fit most six ring, pocket size, loose leaf binders. 40¢ including pocket case. **PAL NOTES, UNDERWOOD, N. D.**



DOLLARS for 18¢?

Yes, buy U. S. \$1.00 values for 18¢ abroad. Get new, big profit mail order plan proved by 100,000 cash orders shipped from overseas. You carry no stock. Full or part time—even from home. Export and travel abroad opportunities too. Details with bargain import examples FREE. Write **MELLINGER CO.** Dept. P257 1717 Westwood, Los Angeles 24, Calif.

RUPTURED

BE FREE FROM TRUSS SLAVERY

NOW there is a new modern Non-Surgical treatment that permanently corrects rupture. These Non-Surgical treatments are so certain, that a Lifetime Certificate of Assurance is given. Write today for our New FREE Book that gives facts that may save you painful and expensive surgery, and tells how non-surgically you may again work, live, play and love and enjoy life in the manner you desire. There is no obligation. **Excelsior Hernia Clinic Dept. 8305 Excelsior Springs, Mo.**

SALESMEN WANTED

Prefer men over 50. Earnings \$5000 to \$8000 per year, calling on hardware stores and lumber yards, selling and installing Popular Mechanics show windows. No window trimming experience necessary (we train you) but selling experience essential. Must have automobile. Average territory consists of about 5 counties. Salesmen have exclusive territory. Home every night.

Not a get rich quick scheme but steady dignified work by which a skilled, industrious salesman can earn a good living. This company, in cooperation with Popular Mechanics and the leading manufacturers of tools, equipment and materials, offers retailers traffic-stopping window displays to retail hardware stores and lumber yards at a nominal cost. All equipment furnished. Endorsed by many retailers, jobbers and manufacturers. Much repeat business. Extras offer additional earning opportunity. Desirable but not necessary to have knowledge of hardware and lumber lines. Personal training given.

For details write to Window Displays, Inc., giving all the facts about yourself. If your letter indicates that you might qualify, an appointment will be made for an interview.

WINDOW DISPLAYS, INC.

1580 SHERMAN AVENUE EVANSTON, ILLINOIS



I Made \$14,839 in 1 Year SERVICING RADIATORS!

Rex Ryan (Iowa) and hundreds of others earn \$8,000-\$20,000 a year servicing auto-truck-tractor radiators the Inland way. Inland, largest radiator servicing equipment mfr., offers the complete package — equipment, merchandising, "Pays-for-itself" financing, and Free training school for customers.

WRITE for FREE Radiator Servicing Folder.

INLAND MFG. COMPANY Dept. PM-7
1108 Jackson St., Omaha 2, Nebr.

LEARN METALCRAFT

and JEWELRY MAKING

Low Cost Home Training Now Available

Make money. Learn profitable skills and arts of decorative metal and jewelry crafts. Course is complete. Professionally prepared. Easy to master. Special tools and materials furnished.

Write for Free Booklet INTERSTATE TRAINING SERVICE
DEPT. K-3 PORTLAND 13, OREGON

Say You Saw It in POPULAR MECHANICS

HUNTERS! CONFISCATED RUSSIAN RIFLES \$1495

AMMUNITION
FREE 20 rounds full jacketed ammo included with each rifle purchase. Additional cartridges: \$7.50 per 100 rds. This ammo is for the Russian Moisin 7.62 MM. and also for the Moisin Nagant. We now have 7.62 MM softnose hunting ammo... 150 gr. 20 rds. \$2.95.



This is the late Russian Model 6 shot bolt action 7.62 MM Moisin Rifle, appr. 30" barrel. Mechanically perfect. Outside: good. Bare: fair. Ballistics: 2820 FPS with 150 grain bullet. An excellent hunting cartridge. Hinged floor plate. The Russians won the International Meet in Venezuela (1954) with this model rifle made for the Czar by Remington & Westinghouse. These guns were confiscated from Communist revolutionaries and placed on the free world market. They are of the type used by Red Chinese in Korea. The sale of these guns in no way aids any country behind the iron curtain. A once-in-a-lifetime collector's item. This is the lowest price we have ever seen which would allow a man to equip himself for big game hunting. For C.O.D. send \$5 deposit.

GOLDEN STATE ARMS CORPORATION 169 Armory Bldg., 1165 East Colorado St., Pasadena 1, Calif.

FOR YOUR TECHNICAL EDUCATION COME TO THE COLLEGE OF TECHNOLOGY

UNIVERSITY OF HOUSTON

(Located in Houston, Texas)

Select from one of these fields NOW.

- Air Conditioning & Refrigeration Technology
- Air Cond., Ref., and Sta. Engr. Technology
- Diesel Technology
- Diesel Electric Technology
- Drafting Technology
- Electrical Technology
- Electronic Technology

Prepare for your Future NOW . . .

- Latest methods and equipment • Excellent faculty
- Accredited curricula • Extensive free counseling and guidance service • Full college activities • Beautiful 275 acre campus • Co-educational • Opportunity for part-time job while you learn • Graduate placement • University T.V. and Radio stations • G.I. approved—V.A. on campus
- Open to high school graduates or equivalent. Opportunity for graduates of the above technical programs to continue education and earn a Bachelor of Applied Science degree—
- Sept., Feb., and June semesters. • FREE brochure.

Mark X before the program of your choice.

Tear out ad and send in with name and address.

COLLEGE OF TECHNOLOGY, University of Houston

DEPT. 176, 3801 Cullen Blvd., Houston, Texas

18 ft. Outboard Cruiser,
plywood construction.



Build a Boat at 1/3 the cost

with CLEVELAND'S full size, cut-to-shape boat patterns, detailed blueprints, and specifications. Choose from huge selection of modern Naval architect-designed cruisers, runabouts, outboards, racers, houseboats, sailing, etc. 7½-38 ft. Send 50c (coin) for latest illustrated catalog. "How to Build a Boat" booklet \$2.50.

CLEVELAND BOAT BLUEPRINT CO. DEPT. 106, BOX 1651,
CLEVELAND 4, OHIO



**YOUR MIRROR WILL SHOW
MUSCLES OF IRON**
IN JUST 10 DAYS says Joe Louis

**Are YOU
TIRED? UPSET?
FAT? SKINNY?
NERVOUS?**

*Let Joe
Help You*

Yes, you can build a powerful body... gain more confidence and be the envy of your friends! That's the promise of Joe Louis and other great stars. These great stars know you want ACTION — and they promise it — FAST.

**CONDITIONING SECRETS
BY TEN CHAMPIONS**

\$1.00

Yogi Berra, Kid Gavilan and Ted Kluszewski have prepared an exciting Conditioning Course for your home that is easy to do... lots of fun.

Set of Special Exercises for only one dollar. Results

guaranteed in 10 days or your money back. EXTRA—Joe Louis' Fight Secrets if you act now!

THE NATIONAL SPORTS COUNCIL

33 W. 46th Street, New York 36, N.Y.—Dept. P-76



**BIG MONEY... LEARN
ELECTRICAL APPLIANCE
REPAIRING!**



Start Your Own Business

New short-cut, shop-method, home training system gives you electrical know-how that used to take years to learn. Learn at home by building valuable testing kits, repairing your own and neighbors' appliances.

FREE ILLUSTRATED BOOK

**EARN
\$5.00 to
\$6.00 &
MORE
PER HOUR**

Shows you every phase of electrical appliance repairing and electrical equipment servicing. Rush name for your copy and SPECIAL form for paying from earnings while learning.

CHRISTY TRADES SCHOOL
Dept. D-5603, 4804 N. Kedzie, Chicago 25

Not Satisfied With Your Present Earnings?

Investigate

**This NEW 2in1
BUSINESS
OPPORTUNITY**

- Popular, Money-Making HOT DRINK and HOT SOUP Venders
- Handle Either or Both Types
- We Train You, We Set Up Routes

Eye-catching, easy-to-operate vending machines serve delicious, nationally known Hot Drinks (3) and Piping Hot Soups (5)! Our factory experts set up routes, train you to operate this year-round, big-volume business. NO SELLING! A minimum cash investment of \$1290.00 required. Up to 75% of equipment costs can be financed. Operate full or spare time.

How many machines can you handle? 10 units, doing nat'l 1954 average, would pay approx. \$13-\$18,000 yearly!

Write or wire giving age, address and phone. Details FREE. No obligation!

SUPERIOR DISTRIBUTING CORP., Dept. CB,
4555 E. Warren Ave., Denver 22, Colo.



LAST CHANCE
to get your Famous
What to Make Books

**Profit—
Pleasure—
Projects
in Each
Volume**



Famous WHAT TO MAKE books are going fast. Don't delay — last chance to buy. Each volume and project different. Complete illustrated building instructions. Projects for home — family — hobbies. Contains ceramics, cabinets, house trailer, novelties, handicrafts, lamps, toys, chairs, metal work, photography, tables, plus thousands of other pleasure projects to make.

Vol. 1— 490 copies	Vol. 7—1660 copies
2—1340 "	8—1885 "
3—1665 "	9—1190 "
4—1280 "	10— 555 "
5—1340 "	11—no copies left
6—1595 "	12— 860 copies

NEW LOW LOW PRICE

Take advantage of this clearance sale. Sold originally at \$1.75, any volume yours at the new low figure of 98c. Hurry, mail coupon for your volumes today. Any five volumes \$4.00.

Save — Save — Save
Were \$1.75 Now 98c

HURRY—MAIL COUPON TODAY

Popular Mechanics Press
200 East Ontario Street
Chicago 11, Illinois

Gentlemen:

Please send me the following volumes of the famous WHAT TO MAKE series. I have drawn a circle around the volumes I want. Volumes — 1 2 3 4 5 6 7 8 9 10 12. I am enclosing a check or money order at 98c for each volume or any five volumes for only \$4.00.

Name _____

Address _____

City _____ State _____

LEARN MEAT CUTTING AT NATIONAL

Pay After Graduation



The steady dependable trade of Meat Cutting taught easily in 8 short weeks. YOU LEARN BY DOING under actual meat market conditions in big modern school at Toledo.

For beginners or men with experience. Get a profitable store of your own. Remember, PEOPLE MUST EAT! Big pay jobs. Free employment help. Thousands of successful graduates.

Buying, cutting, percentage, pricing, advertising, selling, etc. A complete retail meat education. National School established 33 years. Get National training NOW. Pay your tuition in easy weekly payments

after you graduate. Send coupon for FREE 52 page school catalog — TODAY. G.I. approved.

National School of Meat Cutting, Inc., Dept. 50-D, Toledo 4, Ohio

Send me your FREE school catalog on National Training at Toledo in Meat Cutting, Meat Merchandising and Self Service Meats. No obligation. No salesman will call.

Name _____ Age _____

Address _____

City _____ State _____

Approved for training Korean Veterans

POWER MOWER KITS FREE PLANS

Have one of the finest mowers money can buy. Write for FREE PLANS and PARTS LIST showing you how to SAVE MONEY by assembling Triangle's POWER MOWERS.

SPECIAL FACTORY PRICES
Kits, Parts, Engines, Wheel, etc. 18" and 20" sizes; 3 or 4-wheel models; belt or direct drive. Latest improvements, sturdy construction. money-back guarantee fully told in FREE color folder. Also complete TRIANGLE MOWERS ready to mow at low Factory Prices. Write today.

▼ **TRIANGLE MFG. CO., Dept. MA-76, Ft. Scott, Kan.**

Write Like This **Complete OUTLINE FREE!**

MIRACULOUS IMPROVEMENT in your Penmanship in six hours practice with Grooved Letters. No failures. Inexpensive. No charges unless you're satisfied after 6 hours practice.

WRITE OZMENT BOX 665
34-P, ST. LOUIS, MISSOURI

WHEELS WHEELS WHEELS

7" Disc Wheel 1/4" Tire 3/4" sleeve	45c ea.
8" Disc Wheel 1 1/4" Tire 1 1/2" sleeve	70c ea.
7" Disc Wheel 1" Tire 1 1/2" ball bearing	80c ea.
8" Disc Wheel 1 1/4" Tire 1 1/2" ball bearing	\$1.00 ea.
6" Disc Wheel 1.50 semi-pneum. Tire 1 1/2" B.B.	\$1.35 ea.
8" Disc Wheel 2" semi-pneum. T. 1 1/2" B.B.	\$1.50 ea.
10" Disc Wheel 1.75 semi-pneum. T. 1 1/2" B.B.	\$1.50 ea.
12" Disc Wheel 2.75 semi-pneum. Tire 1 1/2" B.B.	\$3.50 ea.
12" Disc Wheel 1.75 semi-pneum. T. 1 1/2" B.B.	\$1.85 ea.

Above wheel prices includes hub cap. Plus Postage. C.O.D.'s accepted.
AXLES—Sizes 5/16 in., 3/8 in., 1/2 in.—Cut to size—End holes drilled.

UNITED WHEEL STAMPING CO.
12131 S. PEORIA STREET PM-7 CHICAGO 43, ILLINOIS

10-Foot BULL WHIP



HARD HITTING! LOUD CRACKING! Experts knock ashes off cigars. Yank people off feet. Used by trainers, ranchmen. Loud cracker like shot-gun blast. 4-ply hand plaited all leather. With loop handle.

6-ft. whip \$1.98. 8-ft. \$2.69. 10-ft. \$3.29 Postpaid
Johnson Smith Company, Dept. 329, Detroit 7, Mich.

Catalog of 3100 Novelties 10c

Send 10c for amazing catalog of novelties, live animals; scientific supplies, hobbies, funmakers, planes & boats, looms, magic tricks, joke articles, unusual seeds, gadget timesavers, cameras, optical goods, projectors, movies, lucky jewelry, religious novelties, disguises, musical instruments, stamps, coins, puzzles, fortune tellers, radios, auto & bike accessories, telescopes, magnifiers, compasses, banks, smokers' gadgets, artists' supplies, printing sets, toy guns, motors, shockers, knives, billfolds, guns, rifles, sports, books, games, plants, etc. Send 10c (3 for 25c—get for friends!).
JOHNSON SMITH & CO., Dept. 329 Detroit 7, Michigan



256 X AREA MAGNIFYING Telescope \$2.98

POWERFUL! Close-up view blocks or miles away! See without being seen. Examine craters of moon, sports, action, etc. Magnifies 256 times area. Precision ground 5-lens optical system, brass fittings, comfortable rubber moulded eyepiece, imitation black leather finish. 14 1/2-in. closed; 19 1/2-in. open; 1 1/4-in. diameter.
With black carrying case, ONLY \$2.98
JOHNSON SMITH COMPANY Dept. 329 DETROIT 7, MICHIGAN

Auto Service Men . . . STEP UP YOUR PAY!



Be an EXPERT in Scientific Engine Tune-Up and Service!

Sun-trained experts in the use of electronic engine test equipment are in demand now! They MAKE MORE MONEY because they know how to use the "tools" which can quickly and profitably keep today's complex engines tuned up to their full power and economy levels!

You Can Provide This Service and Increase Your Earnings—it's easy the Sun way!

Sun Electric Corporation, Chicago—world's largest

New Sun School Makes it Easy!

Costs are LOW . . . plan NOW to increase your skill and position in the industry! Send for complete information . . . FREE Brochure!

manufacturer of automotive test equipment—Now offers a completely new service training program. Train with specialists in the fully-equipped Sun Technical Training School, at Sun's Chicago headquarters. Learn the latest on any or all of these subjects:

- Test Equipment Operation . . . on Modern engines! You use every piece of Sun equipment!
 - Automotive Electricity . . . full coverage with accent on generators and regulators!
 - Modern Tune-Up Procedures . . . Carburetion—how to do it fast, accurately, prevent comebacks!
 - Service Merchandising . . . how to sell all work needed by customer!
- G. I. Bill Approved!

**Sun Electric Corp., Dept. PM-7
Harlem & Avondale Ave., Chicago 31, Ill.**

NAME _____
COMPANY _____
ADDRESS _____
CITY _____ ZONE _____ STATE _____

PREPARE FOR THE BEST JOBS

IN INDUSTRY

TRAIN at HOME

IN YOUR SPARE TIME

or at **ALLIED INSTITUTE** in Chicago

- MECH. ENGINEER
- DRAFTSMAN
- TOOL DESIGNER
- TOOL ENGINEER
- TOOL & DIE MAKER
- MASTER MACHINIST

NO RECESSION FOR ALLIED TRAINED MEN

MORE JOBS THAN GRADUATES Shortages of Draftsmen, Designers, Tool Engineers, Machinists, Tool & Die Makers are so widespread that you can pick a highly paid key job and look forward to Achievement and Security.

You can begin your training in Short Courses and continue progressively to a Bachelor Degree in 26 months.

Allied is approved by Industry, Dept. of Education, Office of Public Instruction, State of Illinois, U. S. Veterans Admin., U. S. Dept. of Justice. Accredited: C. S. A.

SEND FOR **FREE BOOKS**

ALLIED SCHOOL of MECHANICAL TRADES
1338-42 South Michigan Ave. Dept. PM-7 Chicago 5, Illinois

SEND ME WITHOUT OBLIGATION INFO. ON YOUR COURSES:

HOME STUDY RESIDENT VETERAN NON VETERAN

NAME _____

ADDRESS _____

AGE _____

CITY _____

COUNTY _____

STATE _____

GET UP AND GO WITH A TRIUMPH

FUN! INDEPENDENCE!

ECONOMY! Go where you want to go; do what you want to do. Be independent. Have more fun! Enjoy the thrill of motorcycling at its BEST with a gleaming, precision-made Triumph! Easy to ride... exciting to own... real economy, too—60 to 90 miles and up per gallon. Triumph's two-level cushion seat means real comfort for two! Priced surprisingly low, with easy terms available. See your nearest Triumph dealer for a free demonstration. He will teach you to ride.



RUSH THIS COUPON to nearest address below. Dept. P
THE TRIUMPH CORP. **JOHNSON MOTORS, INC.**
Towson, Baltimore 4, Maryland 267 W. Colorado St.
Pasadena 1, Calif.

Send me absolutely FREE the 1956 Triumph Motorcycle catalogue in full color. If under 16 years of age, check square for special pictures.

NAME _____

ADDRESS _____

PHONE _____



Make \$5.00 an Hour

CASH PROFIT

The Day You Start!

Start Your Own Business at Home... Sharpen Household, Garden and Shop Tools in Spare Time

Turn your spare time into Big Cash Profits with the new Belsaw Sharp-All. No experience needed to sharpen knives, scissors, shears, ice skates, mower blades, hedge trimmers, axes, chisels and circular saws... just about any household, garden and shop tool. Your own CASH business. No inventory... no calls to make.

Learn how easily you can start your own spare time business. Amazing low cost easy-payment plan. Send postcard for

FREE BOOK

BELSAW SHARP-ALL CO., 717 Field Bldg., Kansas City 11, Mo.



OWN a Business

If employed, start part time. Alert dealers can gross \$5 hourly profit on own service plus \$3 on EACH serviceman. Clean, revive, moth-proof rugs & upholstery on location. No shop needed. Services nationally advertised. Repeat customers. Easy to learn. We locally train and assist you. Quickly established. Easy terms. Send today for FREE booklet. No obligation.

DURACLEAN CO., 6-167 Duraclean Bldg., Deerfield, Ill.

MOTORIZE YOUR BARBECUE!

Easily rigged up by anyone. Handles whole ham or 4 small chickens. Commercial-quality thruout—2 r.p.m. gear-head motor (110V-AC)—spring-tension bronze bearing permits spit removal—

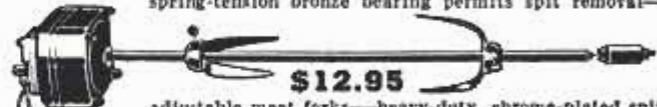

\$12.95

adjustable meat forks—heavy-duty, chrome-plated spit. Limited time, introductory offer. Postpaid. (\$13.95 Denver and West).

B & R SALES CO. — Dept. PM756 — Muncie, Indiana

PLEASE SEND ME



for the time checked.
I am enclosing...

1 year \$3.50

2 years \$6.00

name _____

address _____

city _____

zone _____

state _____

C-76

Hand this order to your newsdealer or send it to

POPULAR MECHANICS
200 East Ontario St. Chicago 11, Ill.

Sell the POKET-ROKET... one of the nicest tools we've seen in a long time! It's a natural for the handyman, housewife, or Boy Scout.

Unlike any other tool, it has three 5 inch German steel blades that dress game and frozen foods, prune trees, and saw through iron pipes.

Those wishing to sell the Poket-Roket (retail price \$2) may order one dozen for \$10 postpaid from U.S. agent: John Adams & Co., Dept. M8, 25th Ave. S.E. and University, Minneapolis 14, Minnesota, or send \$1 for sample.

Supply is limited, so orders will be filled on a first-come first-serve basis.



Also FREE Photo Book of Strong Men

Stop being **SKINNY** like I was

Quickly **GAIN 25 LBS.** of

HANDSOME, POWER-PACKED MUSCLES like I did

Send for these **5 AMAZING PICTURE COURSES**

All **5 FREE** before \$1 price goes back

1. How to **GAIN MIGHTY ARMS**
2. How to **GAIN A BIG CHEST**
3. How to **GAIN A MIGHTY BACK**
4. How to **GAIN POWERFUL LEGS**
5. How to **GAIN A GRIP OF STEEL**

Send 10¢ for postage for all 5 items



Before

Jowett Institute, Dept. PM-67, 220 Fifth Avenue, N. Y. 11, N. Y.

RCA offers you the finest training

at home in

Radio-TV

electronics

TV servicing

Color TV

SEND FOR THIS FREE BOOK NOW!

The instruction you receive and equipment you get (and keep) will start you on your way. Pay-as-you-learn. You pay for only one study group at a time. This 52 page book contains complete information on Home Study Courses for the beginner and the advanced student.



RCA INSTITUTES, INC.
A SERVICE OF RADIO CORPORATION OF AMERICA
350 WEST FOURTH STREET, NEW YORK 14, N. Y.

RCA Institutes, Inc., Home Study PM-76
350 West Fourth St., New York 14, N. Y.

Without obligation, send me FREE CATALOG on Home Study Courses in Radio, Television and Color TV. No salesman will call.

Name
Please Print

Address

City Zone State

MEN WANTED

Earn \$100 Per Week and up
AUTO DIESEL MECHANICS

Master a trade with a future—learn Auto-Diesel mechanics in our shops. You learn with tools on real equipment. Earn while you learn. Many of our graduates earn \$100 per week and up. No previous experience necessary. Day and night courses. Approved for veterans. Write for free bulletin.

NASHVILLE AUTO-DIESEL COLLEGE

226 7th Ave., N., Dept. 75

Nashville 3, Tenn.



LOCKSMITHING

Practical Up-to-Date Course — ONLY \$4.95

53 Illustrated self-instruction lessons. Easy to learn. Full price only \$4.95 postpaid—or C.O.D. plus postage. Satisfaction guaranteed or full refund! Mail your order today. **NELSON HALL CO.**, 210 S. Clinton St., Dept. GU-2, Chicago 6, Ill.

YOUR OWN BUSINESS **EARN \$25 DAY** SPARE TIME

OPPORTUNITY TO EARN FULL TIME \$15,000.00 or more annually. Business of your own. No selling nor merchandise to buy. Over 5,000 persons operating these exclusive offices. Free booklet.

FRANKLIN CREDIT SCHOOL

Box 1344-PM

Roanoke, Virginia



SAY YOU SAW IT IN POPULAR MECHANICS

HIGH BLOOD PRESSURE?



New simplified gauge tests blood pressure at home! This instrument detects internal changes which lead to unexpected strokes, heart and kidney damage, insomnia, headaches, etc. No experience or assistance needed to test pressure accurately. Operating instructions also include information on what to do to prevent or reduce the damaging effects of high blood pressure. These useful instruments are fully guaranteed and actually pay for themselves within a week. Order now for immediate shipment.

THE STANDARD UNIT \$6.50 postpaid Or C.O.D. plus postage. Contains everything that is needed, including functional stethoscope.

THE DELUXE UNIT (photo) \$9.75 postpaid Or C.O.D. plus postage. Same outfit as standard unit, but includes genuine professional stethoscope.

JOY SPECIALTY COMPANY, Scientific Instrument Div.
2320-A W. HUBBARD STREET CHICAGO 12, ILL.

Learn at Home to Fix Electric Appliances

Better Pay—More Opportunities

Get into a field where there is important work, good pay, a good future for the trained man. Today's automatic electric appliances need expert service. Up to 10 million are sold each year. Owners pay well to have them fixed properly.

A Way To Extra Money

This is your opportunity for a better job, extra earnings or a business of your own. Soon after starting you can earn many extra dollars fixing toasters, clocks, fans, vacuum cleaners, etc., for your neighbors, friends. Keep your job while learning. The record, reputation and 40 years' experience of NRI back up this course. It's the training you need to learn Appliance Servicing at home in your spare time.



Tester Furnished

With this NRI course you get parts to build professional type Appliance Tester. It takes guess work out of servicing at home. Get started toward this profitable career now. Mail coupon for Sample Lesson and Book FREE. Address: Electric Appliance Training, NRI, Dept. AG6, Washington 9, D.C.

MAIL—Lesson and Book—FREE

NATIONAL RADIO INSTITUTE

Dept. AG6, Washington 9, D. C.

Send me Lesson and Book Free. No Salesman will call.

Name.....Age.....

Address.....

City.....Zone.....State.....

APPROVED MEMBER, NATIONAL HOME STUDY COUNCIL

The finest of Gifts...

ENCYCLOPAEDIA BRITANNICA



CT

Colorcreting Can Be Your Big Opportunity

Local Colorcretors are Needed Everywhere

Colorcreting is a small investment enterprise, rich in sales potentials, high in income possibilities. Work is easy and fascinating. No experience required; we supply complete instructions.

Colorcreting is a building-beautifying process, with Colorcrete being pneumatically applied to new or old masonry surfaces such as concrete or stucco. Lasts indefinitely—25 years or more. Easily cleaned. Gleaming white, or a choice of 30 colors.

Colorcrete equipment is compact and portable. Easy to operate and practically wear-proof. Easy-payment terms when desired. Write at once for Opportunity Book.

COLORCRETE

Colorcrete Industries, Inc.
570 Ottawa Ave., Holland, Michigan

IN CANADA: DUNN MASONRY MACHINERY LIMITED
1020 Dundas Highway, Cooksville, Ont.

WAR SURPLUS BARGAINS
STARK'S

WAR SURPLUS BARGAINS

\$500,000.00 INVENTORY for QUICK LIQUIDATION

Surplus items—hundreds of them for home, shop, factory, farm and outdoor use. New items, used items, reconditioned items—all at tremendous savings—all priced for quick sale.

Page After Page of Values

This big catalog shows page after page of amazing money saving values. Write for your copy today. Send 10c to cover postage, mailing, etc. Write today! **SEND TODAY FOR YOUR COPY**

10c

STARK'S

212 W. Madison St.
Dept. PM-567
CHICAGO 6, ILL.

"We're looking for people who like to draw..."



says Norman Rockwell, one of America's 12 Most Famous Artists. If you like to draw, you may have talent to become a successful artist, spare or full time. Find out with our remarkable 8-page Free Art Talent Test. Thousands paid \$1 to take it. Get it FREE. No obligation. Send your name, address, age to: Famous Artists Schools, Dept. 6-G, Westport, Conn.



Easy to make your own BOWS—ARROWS—EQUIPMENT

Illustrated Hand-Book 84 pgs. \$1, tells you how! Large Colored Catalog 5c—Send for it!

Ask your dealer for "Stemmler's Archery" (Oldest Mfr. in U.S.A.)

L. E. STEMLER CO.
Manorville (Box 1) L. I., N. Y.

\$2.95 OR 2 FOR \$5.00!

Genuine Telephone Company Upright Telephones, tested and guaranteed with 50 ft. of wire, like new battery and inter-communication instructions. Complete line of telephones, dial, magnets, extension, etc. Write for free list. All shipments FOB. Simpson, Pa. C.O.D. orders, 50% deposit. **TELEPHONE ENGINEERING CO., Dept. 786, Simpson, Pa.**

REPAIR ANY WATCH

... Swiss or American

Unique Sweazy System starts you making repairs right away. Develops your skill step-by-step. Teaches modern methods... professional short cuts. Learn by personal attendance or spare time home study. Approved for veterans. Free Sample Lesson. No obligation. Write today!

CHICAGO SCHOOL OF WATCHMAKING
2330 Milwaukee, Dept. 176, Chicago 47, Ill.

Do a Real Professional-Like Job Yourself and SAVE

HOW to PAINT

With Brush and Spray

Covers All Painting Methods and Materials

You can do professional-like painting and finishing jobs yourself and save about two-thirds of the cost. Sam Brown, noted craft authority, makes it so easy for you in his book, **HOW TO PAINT WITH BRUSH AND SPRAY**. Order your copy now and enjoy this tremendous saving. It covers exterior painting, wall and interior decorating, furniture finishing, concrete painting—every type of painting with brush, spray gun, roller and other methods. Tells what finish is best; what materials to use, etc. No previous experience needed. Fully illustrated. Order by mail. Only \$2.50. Money back if not pleased.

POPULAR MECHANICS PRESS, Dept. PM756
200 E. ONTARIO ST., CHICAGO 11, ILL.



YOURS FREE!

VUER-PROJECTOR & Full Color Slide Kit—Authentic \$4.95 Value!



If You're Interested In BREEDING TROPICAL FISH For Profit & Pleasure

This handsome, precision-viewing instrument and color slides are yours FREE—just for showing your interest in Tropical Fish Breeding! See gorgeous BETTAS, colorful TETRAS, exotic ANGEL FISH, etc., in the vibrant beauty of full color! Convince yourself Tropical Fish Breeding is the profitable, easy-to-start home business for you! Breed them in your living room, spare-room, anywhere. Success is assured because we'll buy every fish you produce! No experience or costly equipment needed. Start spare-time, on a "shoestring"... build a \$10,000 home business! Investigate!

Write today for FREE details on "Profit-Proven" Success Plan & Vuor! (If under 17, ask for plan A.)

TROPICAL FISH BREEDERS OF AMERICA
Dept. D-7
Los Angeles 61, Calif.



STOP BURNING OIL

SAVE \$75 ON OVERHAUL, DO IT YOURSELF IN 15 MINUTES

MORE POWER MILEAGE SPEED

GUARANTEED TOP CAR PERFORMANCE FOR AT LEAST 15000 MILES WITH EACH TREATMENT

INCREASE COMPRESSION PICK UP

Just put our **AUTO LIFE** into your engine. It instantly goes to work to put a metal film around the rings and cylinder walls. With just 15 minutes of your time you have the equivalent of an expensive overhaul, for the fraction of the cost. It's so easy, anyone can do it. Nothing else to buy. **SEND NO MONEY.** We will send you **AUTO LIFE C.O.D.** plus postage. Or send \$3.95 NOW and receive it postpaid. If after trying **AUTO LIFE** for 30 days, your car doesn't **STOP OIL BURNING, GET MORE PEP, BITTER GAS MILEAGE** and are not completely satisfied, we will immediately refund your money.

AUTO CHEMICAL LIFE IND., Dept. F-3, 230 Division St., N.Y. 2, N.Y.

LAW

Men and women **STUDY AT HOME** for Business Success and **LARGER PERSONAL EARNINGS**, 44 years expert instruction—over 114,000 students enrolled, LL.B. Degree awarded. All text material furnished. Easy payment plan. Send for **FREE BOOK**—"Law and Executive Guidance"—NOW!

AMERICAN EXTENSION SCHOOL OF LAW
Dept. H-13, 201 N. Wells St., Chicago 6, Illinois

MONEY in WORMS

Big money made raising fishworms and crickets. Billions used yearly—in unlimited market—sell by mail—We teach you how to raise and where to sell. Learn about our new, exclusive 6 to 12 inch African King worms—in demand everywhere. Free literature. **CARTER WORM RANCH, PLAINS, GEORGIA**

IMMEDIATE DELIVERY

MARCOT KEY MACHINE

Marcot No. 8 Key Machine, 1956 Model \$123.00
Auto Code Book and Depth Keys... 13.75
Yale Padlock Code Book and Depth Keys... 6.25
45 Doz. Asst. Cylinder Key Blanks... 35.46
Set-Locksmithing Tools, Pins & Springs... 10.50
5 Locksmithing Manuals and Instruction Books... 10.25

\$199.21

SEND FOR CATALOG

A. J. MARCOTTE CO. 1200 N. KEDZIE AVE. DEPT. PM-7, CHICAGO 51, ILL.

RUPTURED? Write for New Relief **FREE!** **FACTS**

ENJOY NEW FREEDOM of action, peace of mind and comfort at work or play. Proven, patented **MILLER** holds your rupture back Day & Night—will bring you lasting relief! Has helped thousands of others! For **FREE** facts in plain wrapper—

Send Name and Address to **FRED B. MILLER, Manufacturer**
DEPT. 10, HAGERSTOWN, MARYLAND

ENTIRELY DIFFERENT

DIESEL MECHANICS IN DEMAND



Learn to earn big pay in **DIESEL** in our large, modern equipped Chicago school and shop. No previous experience or training necessary. We help you find living quarters and part time job while in school. Complete, practical courses taught in the following trades, under the supervision of experienced, expert technicians.

APPROVED FOR CIVILIANS OR GI'S

— CHOOSE YOUR TRADE —

CHECK HERE	WEEKS
<input type="checkbox"/> DIESEL MECHANICS	20
<input type="checkbox"/> AUTO MECHANICS	20
<input type="checkbox"/> BODY & FENDER	16 2/3
<input type="checkbox"/> GAS-ARC WELDING	4 - 12
<input type="checkbox"/> REFRIGERATION	13 1/2
<input type="checkbox"/> AIR CONDITIONING	8 1/3
<input type="checkbox"/> MACHINIST TRADE	30
<input type="checkbox"/> ADVANCED MACHINIST (includes tool & die)	32 1/2
<input type="checkbox"/> PIANO TUNING & REPAIR	36

CHOOSE YOUR ENGINEERING COURSE

These courses are intended as terminal education for men who wish to enter the Diesel-Automotive and Refrigeration-Air Conditioning fields as technicians. These courses are designed to prepare men for supervisory positions. Students with a high school education, or equivalent, will be accepted.

<input type="checkbox"/> DIESEL AUTOMOTIVE ENGINEERING	2 years
<input type="checkbox"/> REFRIGERATION & AIR COND. ENGINEERING	18 months

FREE EMPLOYMENT HELP

Start your career with Greer by checking your interest above and mail coupon for complete information at no obligation.

NAME _____ AGE _____
STREET _____
TOWN _____ ZONE _____ STATE _____

Established 1902 — Over 50,000 Graduates.
54 years of continuous trade school experience to guide your training.

GREER SHOP TRAINING
Box G, 2236 S. Michigan Ave.
Chicago 16, Illinois

INVENTORS

PROTECT YOUR INVENTION BY A U. S. PATENT. SEND FOR FREE "INVENTION RECORD" FORM AND "PATENT INFORMATION EVERY INVENTOR SHOULD HAVE."

CARL MILLER
REGISTERED PATENT ATTORNEY
WOOLWORTH BLDG., 35th FLOOR, 76A
NEW YORK CITY

INVENTORS

I shall be pleased to furnish you, upon request, with full information relative to patent procedure—without any obligation on your part.

PATRICK D. BEAVERS
Registered Patent Attorney
934 Columbian Building Washington 1, D. C.

INVENTORS

Whether an invention is patentable can be substantially determined by a search of the U. S. Patent records. Without obligation, write for information explaining the steps you should take to secure a patent.

JOHN N. RANDOLPH
Registered Patent Attorney
201 Columbian Building, Washington 1, D. C.



MAGNESIUM Regularly \$69.50—\$59.50! Made in Japan by skilled optical craftsmen to rigid UNITED requirements and unconditionally guaranteed! **30 DAY NO RISK TRIAL.** Return for refund if dissatisfied. Cash orders postpaid. C.O.D.'s require \$2.00 deposit. Leather case, straps included! Add 10% Federal tax. **UNITED BINOCULAR CO.,** 4043 S. Western, Dept. ARF-508, Chicago 20. **DEALERS WANTED.**

15 x 65
Regularly \$59.50
SALE \$49.50

Exclusive with UNITED! Enjoy tremendous power, wide field of view and brilliant illumination. Streamlined designing, using lighter, stronger metals make this 15 Power binocular easier to hold and use than many glasses half its power. Water-dust resistant. Objective lenses are 65 mm—almost 3" across! 8 1/2" x 9 1/2" 51 oz.! Bears the famous UNITED "Seal of Quality" assuring peak performance, quality workmanship and proper pricing. Same Model 39 oz. binoculars are available in Japan.

FOR MOTORING Safety



AUTO SEAT BELT SIGNAL

New illuminated reminder . . . just like the airliners! The words "Fasten Safety Belts" light up when you turn on ignition . . . visible to all passengers. Signal stays on one minute . . . turns off automatically! Engineered for safety. Non-breakable housing. Easy to install . . . clips over sun visor. Specify 6 or 12 volts. Send \$4.95, we ship postpaid. (C.O.D. orders postage extra). *Money-back guarantee.*

THE MYERS CO. 600 South Washington, Dept. 210
PARK RAPIDS, MINNESOTA

INVENTORS

Send for
PATENT INFORMATION
Book and
INVENTOR'S RECORD
without obligation
GUSTAVE MILLER
76-PM WARNER BUILDING
WASHINGTON 4, D. C.

REGISTERED PATENT ATTORNEY
ASSOCIATE EXAMINER
U.S. PAT. OFF. 1922-1929
Patent Attorney & Advisor
U. S. NAVY DEPT. 1930-1947
PATENT LAWYER

PATENTS
C. A. SNOW & CO.
REGISTERED PATENT ATTORNEYS
WRITE FOR INFORMATION TO
428 SNOW BUILDING, WASHINGTON 1, D. C.

Say You Saw It in Popular Mechanics

ACCORDIONS *Save 1/2*
Finest Italian makes! Buy direct at Amazing Savings! 5 DAY TRIAL. Low down payment, easy terms. FREE color catalog, lowest wholesale prices. Write today to **Accordion Manufacturers & Wholesalers Outlet** 2003 West Chicago Avenue, Dept. R-76, Chicago 22, Illinois

Learn **OIL BURNER SERVICING**
SPARE TIME LEARNING MEANS EARNING BIG MONEY
MASS. TRADE 161-A HIGH ST. BOSTON 10, MASS.
WRITE FOR FREE LESSON

SEND ME



every month so I am sure to see each new issue. Here's

- \$3.50 for 1 year
 \$8.00 for 3 years

name _____
address _____
city _____ zone _____ state _____ B-76

Hand this order to your newsdealer or send it to
POPULAR MECHANICS
200 East Ontario St. Chicago 11, Ill.

5 Engineering Technicians
needed for each engineer



Become an
**ENGINEERING
TECHNICIAN**
at **M SOE**
in Milwaukee

Industries need five technicians for every engineer—and there is a critical shortage of both. Top jobs are waiting for well-trained men. Join the engineering team!

M SOE's unique educational program of technical institute and collegiate engineering courses offers you step-by-step advancement. You can become a qualified engineering technician in 12 to 18 months, ready to begin your career in industry. Or you may continue your studies, without loss of time or credit, to earn a Bachelor of Science degree in engineering in 36 to 42 months. Prepare yourself for the opportunities ahead in one of these M SOE courses:

**ENGINEERING TECHNICIAN
COURSES**

MECHANICAL: Air Conditioning — Industrial Technology
ELECTRICAL: Radio — Television — Electronics — Electrical Power Technology

**BACHELOR OF SCIENCE
DEGREE COURSES**

MECHANICAL ENGINEERING: Refrigeration, Air Conditioning and Plant Engineering option, or Metals Fabrication and Industrial option
ELECTRICAL ENGINEERING: Electronics major or Power major

M SOE's complete, modern facilities include specialized technical laboratories and equipment, visual aid theater, and reference library. Fully accredited technical institute courses approved for veterans; 50,000 former students; excellent placement record for graduates.



4 TERM OPENINGS YEARLY
SEPTEMBER, JANUARY, APRIL, JULY

Clip and Mail Today!

**MILWAUKEE
SCHOOL OF ENGINEERING**

Dept. PM756, 1025 N. Milwaukee St. MS-41
Milwaukee 1, Wisconsin

Please send me free career booklets on:
 Mechanical Engineering and Technology
 Electrical Engineering and Technology
 Radio-Television

I am interested in
(name of course)

Name..... (Age).....

Address.....

City and State.....

If veteran, give discharge date.....



Foolish To Pay More—Dangerous To Pay Less!

One look will prove they're more than worth the difference. Entire stock of our family-safe Top Grade, 40,000 mile Passenger Tires, (worn very slightly) at **PRICES LISTED BELOW!** It's cheaper than offers of \$1 off or "Free Tire Offers" on ordinary used tires. "The Blatt Name famous in tires for 40 Years—I don't just repair it, I offer a free fast REPLACEMENT guarantee on ANY defective tire within 12 months." Frt. Excl. Choose your favorite brand, we'll send if poss. Not recaps or retreads.

GOOD YEAR Firestone

U.S. Goodrich, General, Atlas, Lee & others. **FREE** This pictured tire ash tray given with 2 or more tires!

12 MONTH TIRE GUAR. & FREE FACTORY-TESTED TUBE

600-16	\$5.29	670-15	\$5.19	700-17	\$9.99	750-17	\$12.99
650-16	5.69	710-15	5.39	700-20	8.99	600-16(0)	5.69
700-16	5.79	760-15	5.39	750-20	9.99	650-16(0)	6.49
640-15	4.89	800-15	5.69	825-20	16.99	700-16(0)	7.09
700-15	4.99	820-15	5.69	900-20	15.99	700-15(0)	7.89
475-19	5.39	550-17	5.36	1000-20	17.29	650-20	8.99
WHITEWALLS	\$1.00	EXTRA		1100-20	17.29	750-16	7.99

MARVIN BLATT 6th & Sprag Garden Sts. Philadelphia, Pa. AA Guar. & Mos. 900-16 \$9.99 900-16 \$13.99 750-20 10.59 750-20 17.99

Send Check or M.O. & this ad for fast shipment. FOB Phila. I personally select your tires—as if my future depended on it. Read that top line again.

BIG TOP MUSCLE DAN Save 60% on FAMOUS "TV — BIG TOP"



DAN LURIE BARBELLS

FREE—60 MUSCLE BUILDING COURSES—68 HOW TO DO IT PHOTOS
SEND FOR FREE CATALOG
50 lb. set. \$ 8.48 + 150 lb. set. \$20.48
100 lb. set. \$13.98 + 200 lb. set. \$25.98
Order by mail—50% with order. Balance C.O.D. Extra wts. 13c lb. FOB Plant.
DAN LURIE BARBELL CO.
Dept. 659C, 52M7 Bristol St., Brooklyn 12, N. Y.
LET MUSCLE DAN MAKE YOU A MAN.
Results guaranteed or money back

FREE! BOAT KIT CATALOG

14' Model Pictured
42 TOP PERFORMING MODELS, 8' thru 18'
... from \$39.25 incl. frt.
Runabouts, Cruisers, Convertibles, Fishing, etc. for every purpose with modern styling, advanced design. No experience necessary, amateurs can easily assemble. Save 1/2 to 3/4 "factory-built" prices!
FIBERGLAS TRAILERS, ACCESSORIES
LUIGER INDUSTRIES, INC. DEPT. B-7 3404 Lyndale S. Minneapolis 8, Minn.

It Pays to be TALLER

You can be impressively taller, increase your business & social potential. Staturaid shoes help you win new heights in life. Choose elevation you desire, in 35 smart styles. Free Catalog P-1.
BURGER CO., 433 E. 148 ST., NEW YORK 55, N. Y.

60 POWER TELESCOPE \$3.98

VARIABLE EYEPIECE 20X-40X-60X — BRASS BOUND NEW! Three telescopes in one. 3 different magnifications. 20 power for ultra-bright images with 40 and 60 power for extra long range. Guaranteed to bring distant objects, people, sports events, ships, moon, stars, etc. 60 times as close.
Most powerful for any length near the moon. ey. 5 sections. Closes to 1 ft. long. Contains 4 ground and polished lenses. Also used as a powerful compound microscope. Directions included. Mass production enables us to offer this instrument at amazing price of \$3.98 complete. Money back guarantee. We pay postage. Get yours now.
CRITERION CO., 331 Church St., Hartford, Conn., Dept. PMB 36

BUILD YOUR OWN WINDOW FAN

Save 1/2 or More
Enjoy Cool Comfort

ORDER TODAY—A factory-packed fan kit containing fan blade, self-contained bearing and shaft assembly, two pulleys, and belt, plus easy assembly instructions. You use your own 1/2 HP or larger motor and lumber for frame. Iowa Residents add 2 1/2% Sales Tax. If cash with order, we prepay shipment. If C.O.D., send 25% deposit.

Size	RPM	Approx. CFM	Price
20"	882	3990	\$12.90
24"	682	4890	\$14.90
30"	430	5880	\$17.90

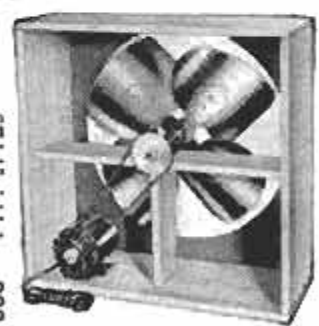

Send for **FREE** complete Fan and Parts Catalog.
KLOPPENBORG FOUNDRY & FAN CO.
211 MARQUETTE STREET DAVENPORT, IOWA

SAVE MONEY WITH THESE NEW DO-IT-YOURSELF BOOKS

- 1. HOW TO PAINT INSIDE AND OUT:** Step-by-step instructions. Easy to follow illus.
- 2. HOW TO LAY LINOLEUM AND TILE:** How to get the best from your labors. Diagrams.
- 3. HOW TO REMODEL YOUR BASEMENT AND ATTIC:** Planning ideas, hints, instructions. Illus.
- 4. HOW TO TAKE CARE OF YOUR LAWN:** Detailed guide to a perfect lawn and healthy shrubs.
- 5. HOUSE WIRING AND ELECTRICAL REPAIRS:** Ideas and instructions for the homemaker. Diagrams.
- 6. SMALL BOATS YOU CAN BUILD:** Plywood dinghy, 15-ft. sailing knockabout, 8-ft. duckboat, etc.
- 7. PLUMBING REPAIRS MADE SIMPLE:** Fix faucet noises, water hammer, clogged pipes yourself.
- 8. FENCES, GATES, TRELLISES AND WALKS:** Variety of fences, etc., with instructions, diagrams.
- 9. BUILT-IN FURNITURE FOR YOUR HOME:** Wall cabinet, wardrobe, linen closet, crib, etc.
- 10. BUILD YOUR OWN BARBECUE:** Stone and brick fireplaces, grills, barbecue pits, etc.
- 11. LAWN AND GARDEN PROJECTS:** Picnic furniture, folding chairs, garden pool, etc.
- 12. THREE LOW-COST HOMES YOU CAN BUILD YOURSELF:** Build your own home—save half the cost.
- 13. 125 SIMPLE HOME REPAIRS:** Stop faucet leaks, replace sash cords, cut glass, etc.
- 14. SIMPLE TELEVISION REPAIRS:** Only a screwdriver, pliers and soldering iron necessary.
- 15. MODERNIZE YOUR KITCHEN:** Planning for convenience and economy. Ideas, diagrams.
- 16. SIMPLE AUTO REPAIRS:** Treasury of troubleshooting tips for motorists, covering engine, etc.
- 17. HOW TO WINTERIZE YOUR HOME:** Prepare for bad weather. Make storm windows, repair roofs, etc.
- 18. HOW TO SET UP YOUR HOME WORKSHOP:** Detailed layout plans for basement conversion. Diagrams.

ONLY 25¢ EACH
6 FOR \$1.25
18 FOR \$3.25

USE HANDY ORDER COUPON BELOW

POPULAR MECHANICS PRESS, Dept. 756
 200 E. Ontario Street, Chicago 11, Illinois

Gentlemen: Please send copies of book nos.: 1: 2: 3: 4: 5: 6: 7: 8:
 9: 10: 11: 12: 13: 14: 15: 16: 17: 18: (circle numbers desired)

Remittance enclosed

Send C.O.D. (\$2.00 or more) I enclose \$ _____

Name _____

Address _____

City _____ Zone _____ State _____



Shaky
table?



Build up short leg with *New Plastic Wood*. Makes a permanent fix that won't chip, crack or peel. And *New Improved Plastic Wood* has a finer grain — minimum shrinkage!



NEW "PLASTIC WOOD"

Handles like putty—hardens into wood.

**ENGINEERING
DEGREE IN
27 MONTHS**

INDIANA TECHNICAL COLLEGE

B. S. DEGREE, Aeronautical, Chemical, Civil, Electrical, Mechanical and Electronic Engineering (inc. Radio and TV), Drafting, One-year, Low rate, Earn Board, Large Industrial center, Students from 48 states, 21 countries. Demand for graduates, G.I. Government approved. Enter September, December, March, June. Write today for catalog. 1676 E. Washington Boulevard, Fort Wayne 2, Indiana.

Build Your Own Professional Instruments — Save 50%



EICO[®]
World's largest manufacturer of Kits & Instruments

Vacuum Tube Voltmeter

KIT \$25.95 Easy Instructions
46 models to choose from
Factory Wired \$39.95

Write for **FREE** new 1956 Catalog PM-7

Electronic Instrument Co., Inc. 84 Withers St., B'klyn 11, N.Y.

695

FREE WIN A TRACTOR FREE

WRITE FOR ENTRY BLANK

NOTHING TO BUY

**HEAVY OIL-PH-BALL BEARINGS
PUMPS MILLIONS OF GALS.**

IRRIGATE, SPRAY, DRAIN OR FILL ANYTHING—

ANYWHERE! Will not Rust—Clog—or Leak. Pat-

ented Seal, Pumps 2800 gph, 420 gph at 75'

—high or 1600 gph from 25' well. Six blade

impeller. Threaded for pipe, 3/4 inlet, 1/2 outlet.

Use 1/2 to 3/4 hp motor . . . 7500 gph 9.95

Heavier 2800 gph 8.95 Heavier 11.95

Check, MO or COD—Money Back Guarantee

FREE Literature—Comparison Charts

**U. A. T. ENG. & MFG. CO. HICKSVILLE 273,
NEW YORK**

**IF YOU "EAT, SLEEP & LIVE" CARS—LEARN HIGH-PAY
AUTO MECHANICS & Diesel!**



DON'T LOSE OUT—FIND OUT! At Home in Spare Time prepare for profitable Mechanic work, or own Business! Easy to learn by our Shop-Method Training. Low tuition. TOOLSET included. Earn

as you Learn. Age and education no barrier!

Rush coupon for **FREE BOOK AND LESSON!**

**OK FOR
VETS**

MAIL NOW TO OFFICE NEAREST YOU!

(mail in envelope or paste on postal card)

NATIONAL SCHOOLS, Dept. DB-76

4000 SO. FIGUEROA STREET OR 187 N. LA SALLE ST.

LOS ANGELES 37, CALIF. OR CHICAGO 1, ILL.

Rush free Auto Mechanics Book & Lesson! No obligation!

NAME _____ BIRTHDAY _____ 19____

ADDRESS _____

CITY _____ ZONE _____ STATE _____



Electronic Flash Gun Has Variable Output

Photographers can adjust the light output of a new electronic flash gun to suit the demands of the picture. A flick of a switch provides any of four intensities: 50, 100, 150 or 200 watt-seconds output. With this adjustment, the photographer can take close-ups with fast film or long shots with slower, color film. He can vary exposure without having to change "f" numbers or increase the action-stopping ability of the light by reducing output. Important to photographers is the fact that the new unit, the Strobflash IV, has complete interchangeability with cords, plugs and other accessories of previous models.

Musical Telephone Ring

Telephones that sound a musical tone instead of ringing are being tested around Crystal Lake, Ill., by Bell Telephone Laboratories. The pleasant signal stands out above general room noise and can be heard at great distances. Its greater energy in the middle frequency range allows it to be heard more easily by the partially deaf. Transistors operating with the same amount of power required for phone conversations furnish the energy, which is much less than that required to ring a bell. The tone emanates from a louvered section in the base of the set.

☞ A New York engineer has been granted a patent on a hot-weather suit which is cooled by dry ice. It is not yet manufactured.

Get info.. PLASTIC LAMINATING AT HOME!



Get **ORDERS** and **CASH** from your mailman—do work in **SPARE TIME** at home—or expand into **FULL TIME** business. Send coupon for Free facts about the newest and most fascinating of all home operated businesses. For the first time a simplified machine brings the fabulous profits of **Plastic Sealing** and **Plastic Laminating** within the reach of the small operator. Anyone can learn to operate the machine with a few minutes practice—then with our **Magic Mail Plan** can get mail orders pouring in daily with cash in every envelope. **No canvassing—no selling.** We even

**Make \$20 to \$30 a Day by..
MAGIC MAIL PLAN!**

supply the circulars you mail to bring back cash and orders. Don't waste a minute. Rush your name. We'll send you **FREE** and postpaid, pictures, prices, details, and all the facts you need to start. Mail coupon or send name on postcard. No charge. Warner Electric Co., 1512 Jarvis Av., Dept. L-107, Chicago 26, Ill.

Make Thousands of Beautiful Art Creations

**COSTUME JEWELRY • CIGARETTE BOXES
TRAYS • CANDLESTICKS • COASTERS
LAMP BASES • BOOK ENDS...ALL IN
SPARKLING COLORED PLASTIC**



THIS MAN... is taking out of the machine a Plastic Sealing Job—ordered by mail—only 11c in material cost brings back \$2.58 in cash by mail. Capacity of machine: **\$25.00 profit per hour of operation.**

**WARNER ELECTRIC CO., 1512 Jarvis Av.
Dept. L-107, Chicago 26, Ill.**
At no cost to me, please rush complete details postage prepaid. I am under no obligation.

Name _____
Address _____
City _____ Zone _____ State _____

ROAD TO RICHES

You can be the next uranium millionaire! Government guarantees huge bonus! **PRI** instruments from \$29.95. See your local dealer today! **FREE CATALOG!** Write **PRI, 4223 PM W. Jefferson Los Angeles 16, California**



PEE WEE BATTERYLESS "LIFETIME" RADIO



REALLY WORKS—FOR LIFE! Works WITHOUT TUBES, BATTERIES OR ELECTRICAL PLUGS. Will never run down or burn out. World's smallest, SMALLER THAN A PACK OF CIGARETTES! GUARANTEED TO RECEIVE LOCAL RADIO STATIONS ANYTIME—ANYWHERE YOU GO! Sensational new Ferrite Selective Tuner—Permalloy crystal diode, super SPEAKERPHONE, double black and gold plastic case.

SEND ONLY \$2.00 (bill ck. ord. and pay postpaid \$4.99 C&D postage on arrival or send \$4.99 for postpaid delivery. SENT COMPLETE READY TO LISTEN WITH LIFETIME GUARANTEE. Nothing extra to buy—ever. Available only from: MIDWAY COMPANY Dept. WPM-7 KEARNEY, NEBRASKA

★ WORK FOR UNCLE SAM ★

U. S. GOV'T. JOBS! AS HIGH AS \$4,525.00 YEAR TO START. Men, women, 18-55. Experience often unnecessary. Write immediately for **FREE 36-PAGE BOOK** with partial list of positions, salaries, sample tests, and full particulars telling how to qualify for them. (Not Gov't. Controlled)

Franklin Institute, Dept. T-93, Rochester 4, N. Y.

250 POWER.....



Complete Telescope Lens Kit only **\$3.49** postpaid
Conquer Space, Explore the Universe, Planets, Moon Craters, New Stars, etc. Complete Lens Kit consists of 80 inch focal length ground and polished objective lens, eyepiece lenses for 50 POWER, 100 POWER, 150 POWER, 200 POWER, 250 POWER, and all necessary lens fittings. Easy to make from simple step by step instructions. (Tripod and mount not included.) Money back guarantee.
BUSSE SALES CO., Hartford 1, Conn., Dept. PM 47

you may think you're TALL enough..but what do others think?

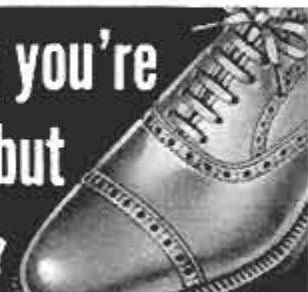

If you're always overlooked when the boss looks for a "take-charge-man", **DO SOMETHING ABOUT IT!** Step into "ELEVATORS", step up and be noticed! These amazing height-increasing shoes make you almost 2 inches taller, instantly...confidentially. Only you know the secret, but everyone notices the difference in your looks. So, don't just think you're tall enough—**BE SURE!** For free booklet write **STONE-TARLOW CO., INC., DEPT. PM7-56 BROCKTON 68, MASS.**

PREPARE FOR BETTER JOB, BIGGER PAY IN SPARE TIME AT HOME

Today, choose the job you want—and prepare for it in time you might otherwise waste. Or if you are already in the work you like best, start training now for quicker promotion and increased pay. During more than 50 years **AMERICAN SCHOOL** has helped ambitious people to reach higher goals. Check subject that interests you and mail coupon for full information.

AMERICAN SCHOOL, Dept. GB45, Drexel at 58th, Chicago 37, Ill. Without obligation, please send **FREE** and postpaid, full particulars about the subject checked below.

- | | | |
|--|---|---|
| <input type="checkbox"/> Accounting | <input type="checkbox"/> Contracting | <input type="checkbox"/> Mechanical Engineering |
| <input type="checkbox"/> Apprenticeship Courses | <input type="checkbox"/> Diesel Technician | <input type="checkbox"/> Mechanical Technology |
| <input type="checkbox"/> Architecture & Building | <input type="checkbox"/> Drafting—Building | <input type="checkbox"/> Metalworking Courses |
| <input type="checkbox"/> Automotive Technician | <input type="checkbox"/> Drafting—Machine | <input type="checkbox"/> Plumbing—Practical |
| <input type="checkbox"/> Better Foremanship | <input type="checkbox"/> Electrical Engineering | <input type="checkbox"/> Private Secretary |
| <input type="checkbox"/> Blueprint Reading | <input type="checkbox"/> Electricity—Practical | <input type="checkbox"/> Retail Merchandising |
| <input type="checkbox"/> Bookkeeping | <input type="checkbox"/> Electronics—Industrial | <input type="checkbox"/> Salesmanship—Outside |
| <input type="checkbox"/> Business Management | <input type="checkbox"/> HIGH SCHOOL COURSES | <input type="checkbox"/> Sheer Metal Work |
| <input type="checkbox"/> Civil Engineering | <input type="checkbox"/> Machinists | <input type="checkbox"/> Tool Making |

NAME _____ OCCUPATION _____
HOME ADDRESS _____
CITY _____ STATE _____
Canadians: Write American School, Dept. GB45, 6083 Shorbrooke St. W., Montreal

MAIL COUPON NOW

INVENTORS

PROTECT YOUR INVENTION BY A U. S. PATENT. SEND FOR FREE "INVENTION RECORD" FORM AND "PATENT INFORMATION EVERY INVENTOR SHOULD HAVE."

CARL MILLER
REGISTERED PATENT ATTORNEY

WOOLWORTH BLDG., 35th FLOOR, 76A
NEW YORK CITY

INVENTORS

I shall be pleased to furnish you, upon request, with full information relative to patent procedure—without any obligation on your part.

PATRICK D. BEAVERS
Registered Patent Attorney

934 Columbian Building Washington 1, D. C.

INVENTORS

Whether an invention is patentable can be substantially determined by a search of the U. S. Patent records. Without obligation, write for information explaining the steps you should take to secure a patent.

JOHN N. RANDOLPH
Registered Patent Attorney

201 Columbian Building, Washington 1, D. C.



MAGNESIUM Regularly \$69.50—\$59.50! Made in Japan by skilled optical craftsmen to rigid UNITED requirements and unconditionally guaranteed! **30 DAY NO RISK TRIAL.** Return for refund if dissatisfied. Cash orders postpaid. C.O.D.'s require \$2.00 deposit. Leather case, straps included! Add 10% Federal tax. **UNITED BINOCULAR CO.** 9043 S. Western, Dept. ARP-508, Chicago 20. **DEALERS WANTED.**

15 x 65
Regularly \$59.50
SALE \$49.50

Exclusive with **UNITED!** Enjoy tremendous power, wide field of view and brilliant illumination. Streamlined designing, using lighter, stronger metals make this **15 Power** binocular easier to hold and use than many glasses half its power. Water-dust resistant. Objective lenses are 65 mm—almost 3" across! 8 1/2" x 9 1/2" 5 1/2 oz.! Bears the famous **UNITED "Seal of Quality"** assuring peak performance, quality workmanship and proper pricing. Same Model 39 oz.

FOR MOTORING *Safety*



AUTO SEAT BELT SIGNAL

New illuminated reminder . . . just like the airliners! The words "Fasten Safety Belts" light up when you turn on ignition . . . visible to all passengers. Signal stays on one minute . . . turns off automatically! Engineered for safety. Non-breakable housing. Easy to install . . . clips over sun visor. Specify 6 or 12 volts. Send \$4.95, we ship postpaid. (C.O.D. orders postage extra). *Money-back guarantee.*

THE MYERS CO.

600 South Washington, Dept. 210
PARK RAPIDS, MINNESOTA

INVENTORS

Send for
PATENT INFORMATION
Book and
INVENTOR'S RECORD
without obligation

GUSTAVE MILLER
76-PM WARNER BUILDING
WASHINGTON 4, D. C.

REGISTERED PATENT ATTORNEY

ASSOCIATE EXAMINER
U.S. PAT. OFF. 1922-1929
Patent Attorney & Advisor
U. S. NAVY DEPT. 1930-1947
PATENT LAWYER

PATENTS
C.A. SNOW & CO.
REGISTERED PATENT ATTORNEYS
WRITE FOR INFORMATION TO
428 SNOW BUILDING, WASHINGTON 1, D. C.

Say You Saw It in Popular Mechanics

ACCORDIONS

Finest Italian makes! Buy direct at Amazing Savings! **5 DAY TRIAL.** Low down payment, easy terms. **FREE** color catalog, lowest wholesale prices. Write today to **Accordian Manufacturers & Wholesalers Outlet** 2003 West Chicago Avenue, Dept. R-76, Chicago 22, Illinois



Learn
OIL BURNER SERVICING
SPARE TIME LEARNING MEANS EARNING BIG MONEY
WRITE FOR FREE LESSON
MASS. TRADE 161-A HIGH ST. BOSTON 10, MASS.

SEND ME



every month so I am sure to see each new issue. Here's

- \$3.50 for 1 year
 \$8.00 for 3 years

name _____

address _____

city _____

zone _____

state _____

B-76

Hand this order to your newsdealer or send it to
POPULAR MECHANICS
200 East Ontario St. Chicago 11, Ill.

YOURS FREE!

VUER-PROJECTOR & Full Color Slide Kit—Authentic \$4.95 Value!



If You're Interested In BREEDING TROPICAL FISH For Profit & Pleasure

This handsome, precision-viewing instrument and color slides are yours FREE—just for showing your interest in Tropical Fish Breeding! See gorgeous BETTAS, colorful TETRAS, exotic ANGEL FISH, etc., in the vibrant beauty of full color! Convince yourself Tropical Fish Breeding is the profitable, year-round home business for you! Breed them in your living room, spare-room, anywhere. Success is assured because we'll buy every fish you produce! No experience or costly equipment needed. Start spare-time, or a "shoestring" ... build a \$10,000 home business! Investigate!

Write today for FREE details on "Profit-Proven" Success Plan & Vuor! (Under 17, ask for plan A.)

TROPICAL FISH BREEDERS OF AMERICA Dept. D-7 Los Angeles 61, Calif.



STOP BURNING OIL

SAVE \$75 ON OVERHAUL, DO IT YOURSELF IN 15 MINUTES

MORE POWER MILEAGE SPEED

GUARANTEED TOP CAR PERFORMANCE FOR AT LEAST 15000 MILES WITH EACH TREATMENT

INCREASE COMPRESSION PICK UP

Just put our **AUTO LIFE** into your engine. It instantly goes to work to put a metal film around the rings and cylinder walls. With just 15 minutes of your time you have the equivalent of an expensive overhaul, for the fraction of the cost. It's so easy, anyone can do it. Nothing else to buy. **SEND NO MONEY.** We will send you **AUTO LIFE C.O.D.** plus postage. Or send \$3.95 NOW and receive it postpaid. If after trying **AUTO LIFE** for 30 days, your car doesn't **STOP OIL BURNING, GET MORE PEP, BETTER GAS MILEAGE** and are not completely satisfied, we will immediately refund your money.

AUTO CHEMICAL LIFE IND., Dept. F-3, 230 Division St., N.Y.-2, N.Y.

LAW

Men and women **STUDY AT HOME** for Business Success and **LARGER PERSONAL EARNINGS**, 44 years expert instruction—over 114,000 students enrolled. LL.B. Degree awarded. All text material furnished. Easy payment plan. Send for **FREE BOOK**—"Law and Executive Guidance"—NOW!

AMERICAN EXTENSION SCHOOL OF LAW
Dept. H-13, 201 N. Wells St., Chicago 6, Illinois

MONEY in WORMS

Big money made raising fishworms and crickets. Billions used yearly—unlimited market—sell by mail—We teach you how to raise and where to sell. Learn about our new, exclusive 4 to 12 inch African R. worms—in demand everywhere. Free Literature. **CARTER WORM RANCH, PLAINS, GEORGIA**

IMMEDIATE DELIVERY

MARCOT KEY MACHINE

Marcot No. 8 Key Machine, 1956 Model \$123.00
Auto Code Book and Depth Keys. . . . 13.75
Yale Padlock Code Book and Depth Keys . . . 6.25
45 Doz. Ass't. Cylinder Key Blanks. . . . 35.46
Set-Locksmithing Tools, Pins & Springs . . . 10.50
5 Locksmithing Manuals and Instruction Books. . . . 10.25

\$199.21

SEND FOR CATALOG

A. J. MARCOTTE CO. 1200 N. KEDZIE AVE. DEPT. PM-7, CHICAGO 51, ILL.

RUPTURED? Write for New Relief **FREE!** **FACTS**

ENJOY NEW FREEDOM of action, peace of mind and comfort at work or play. Proven, patented MILLER holds your rupture back Day & Night—will bring you lasting relief! Has helped thousands of others! For **FREE** facts in plain wrapper—

Send Name and Address to **FRED B. MILLER, Manufacturer** DEPT. 1G, HAGERSTOWN, MARYLAND

ENTIRELY DIFFERENT

DIESEL MECHANICS IN DEMAND



Learn to earn big pay in **DIESEL** in our large, modern equipped Chicago school and shop. No previous experience or training necessary. We help you find living quarters and part time job while in school. Complete, practical courses taught in the following trades, under the supervision of experienced, expert technicians.

APPROVED FOR CIVILIANS OR GI'S

— CHOOSE YOUR TRADE —

CHECK HERE	WEEKS
<input type="checkbox"/> DIESEL MECHANICS	20
<input type="checkbox"/> AUTO MECHANICS	20
<input type="checkbox"/> BODY & FENDER	16 2/3
<input type="checkbox"/> GAS-ARC WELDING	4 - 12
<input type="checkbox"/> REFRIGERATION	13 1/2
<input type="checkbox"/> AIR CONDITIONING	8 1/2
<input type="checkbox"/> MACHINIST TRADE	30
<input type="checkbox"/> ADVANCED MACHINIST (includes tool & die)	32 1/2
<input type="checkbox"/> PIANO TUNING & REPAIR	36

CHOOSE YOUR ENGINEERING COURSE

These courses are intended as terminal education for men who wish to enter the Diesel-Automotive and Refrigeration-Air Conditioning fields as technicians. These courses are designed to prepare men for supervisory positions. Students with a high school education, or equivalent, will be accepted.

<input type="checkbox"/> DIESEL AUTOMOTIVE ENGINEERING	2 years
<input type="checkbox"/> REFRIGERATION & AIR COND. ENGINEERING	18 months

FREE EMPLOYMENT HELP

Start your career with Greer by checking your interest above and mail coupon for complete information at no obligation.

NAME _____ AGE _____
STREET _____
TOWN _____ ZONE _____ STATE _____

Established 1902 — Over 50,000 Graduates.
54 years of continuous trade school experience to guide your training.

GREER SHOP TRAINING
Box G, 2236 S. Michigan Ave.
Chicago 16, Illinois

**WORLD'S
BEST
WANT-AD
MEDIUM**

CLASSIFIED ADVERTISEMENTS



Advertisements in this section \$1.25 per word, each insertion, minimum 10 words, payable in advance.

To be inserted under proper classification, copy must be in our office the

20th of the second month preceding date of issue

F. W. Johnson, Manager, Classified Advertising

Popular Mechanics Magazine, 200 East Ontario Street, Chicago 11, Illinois

YOU'LL PROFIT

By reading and answering the classified ads in this section. Hundreds of opportunities for you to make and save money

AUTOMOBILES, MIDGET CARS

MICRO Midget auto, 5 to 30 m.p.h. Runs on walk, lawn, street. Used in concessions. Ideal for boys 9 to 16. \$100. Details free. Micro Midget, 940 North 23rd St., Omaha, Nebraska.

NON-Profit organization offers automobile literature—Old, new and foreign; dealer books, service manuals, glossy photographs. Write today; get on free mailing list. Auto Maniacs, Stockbridge, Mich.

ANTIQUÉ Automobile color slides. 2x2. Illustrated catalog free. Universal, Box 779A, Beverly Hills, Calif.

AUTO SUPPLIES AND EQUIPMENT

REMANUFACTURED Voltage regulators for popular 6 volt cars, light trucks. Original equipment makes, new guarantee. \$5.45 postpaid. Send make, year, model, check or m.o. Southwest Auto Regulator, 3104 W. McDowell Rd., Phoenix, Arizona.

SENSATIONAL Almost human dashboard cigarette lighter. It breathes. Insert cigarette, press button, it's lit. 6V.-12V. Red, green, blue, black, mahogany. \$1.69 postpaid. Cig-o-mat, Box 1063, Wilmington, Calif.

AUTOMATIC Headlight dimmer. Transistorized. Kit or ready to install. Nazog, Littleton, Massachusetts.

FOGLIGHTS For only 98¢. Amber press-on lenses. Fit all cars. Sell on sight. FogMaster Co., 205 W. 19th, New York City 11.

FOR Quick, easy money giving our product for free trial. No selling. Write: Gene, San Gabriel 1, California.

BUY Wholesale nationally advertised auto supply, thousands other products at big discount. Free "Wholesale Plan." American Buyers, Hertel Station, Buffalo 16-G, N. Y.

FREE Discount catalog—Speed, power, custom equipment. Almuist Engineering, Milford 7P, Pennsylvania.

FORD T and A parts? Try best source old car parts anywhere. Wisneski, Milwaukee 7, Wis.

TRUCK-TRAILER-bus safety equipment. Lights, connectors, wheel parts, mirrors, etc. Information on request. Edward Ettinger, Route 1, Northport, New York.

GENUINE Chamois—English. Quality guaranteed. 20x30, \$2.70. Quantities less. Territories open. Babrok, Hudson Falls, N. Y.

POLICE Type automobile two-way radio antennas. Now available. All sizes. Free booklet. Eastern Antenna Supply, Box 154, Buffalo, N. Y.

POWER, Speed, mileage? Try new "Supercharge," sensational fuel conditioner. Sample? Rush \$1.00. Power-pills, Box 3095M, Riverside, Calif.

JEEP Owners—V8 power. Read Jeep owners ad, page 25.

FUEL Pumps, guaranteed new hi-quality. Any car, singles \$3.75; doubles \$9.00 pre-paid. SaveWay, Box 1166, Ogden, Utah.

ONLY \$5.00. No installation, no connection, no tools needed. Just drop new Solatone anticarbon electronic cell in fuel tank and save on tune-up, sparkplugs and gasoline. Money back. If your dealer can't supply you, order to: Hydrocarbon Mfg., 2808 McKinney, Dallas, Texas.

UP To \$50.00 each for new or used GM-110 diesel fuel injectors. Parts also purchased. Bruce W. Mayer, 2090 East 19th Street, Cleveland 15, Ohio.

NEVER Change oil. 12 $\frac{1}{2}$ ¢ refill filter. Tissu-Pak, B1115, Sacramento 5, Calif.

AUTO Accessory and parts catalog, 1956 edition—all new! 180 pages. Save up to 50%. Over 75,000 items, including Hollywood accessories, hi-speed equipment, rebuilt engines, all parts and accessories for all cars and trucks! Hard-to-get parts! Send 25¢ (refundable). J. C. Whitney, 1919-PM Archer, Chicago 16, Ill.

NEW And used parts at savings. Complete guaranteed parts service for all models cars and trucks, 1924 and later. Largest in the West. Army parts specialists. No catalog, write for quotations. Fast mail order service. Pioneer Auto and Truck Parts Co., 734 W. 13th Avenue, Denver, Colorado.

LATEST Custom accessories. Items not in stores. New low prices. Continental tire kits, push-button doors, trunks, etc. New illustrated catalog, biggest ever. 25¢. Eastern Auto, 3319-A South Grand, Los Angeles 7, California.

BRAND New first quality tires. Tractor, truck, aircraft, passenger. Wholesale prices. Also all size army surplus used tires at tremendous savings. Duddy's, 152 No. Beacon Street, Boston, Mass.

BONDED Brake linings installed on your own 8 shoes for all cars \$10.00. North, 1601 Clybourn, Chicago 14, Illinois.

GM71-110 Discarded injector parts wanted. Bonus on HV. Bares, 7120 Carnegie, Cleveland 3, Ohio.

AUTO TRAILERS

TRAILER Parts catalog. Largest in mid-west. Send 25¢. Refundable. Hanna Trailer Supply, 615 West Layton, Milwaukee, Wis., Dept. M.P.

EXCEPTIONAL Expanding eight foot trailer. Accommodates family of five. Build yourself. Literature 10¢. Framar Company, Wilmington, Mass.

MOTORCYCLES, BICYCLES, MOTORSCOOTERS AND SUPPLIES

MIDGET Car \$15, Johnson outboard \$7, Whizzer \$11, Norton 15 h.p. \$12.50. Cushman \$35. Four airplane tires \$3. Mail-order only. Send 25¢ (35¢ for first class mailing) for directory-catalogue number 72 listing the above and hundreds of other bargains, homebuilder parts, plans, etc. Midget Motors Directory, Athens, Ohio.

MOTOR Scooter parts. Send 25¢ for list. Give make and model of scooter. Motor Scooter Parts Co., Dept. P7, Box 7211, Indianapolis 1, Indiana.

BICYCLE Supplies—At substantial savings. Goodyear tires, Cadet speedometers, Delta lights, sirens. Free delivery. Attleboro Cycle, 619 County, Attleboro, Mass.

SERVICYCLE \$30.00; Whizzer motorbike \$25.00; Cushman motorscooter \$25.00; midget auto \$25.00. Rush 25¢ (35¢ first class mail) for new catalog #959 listing many other amazing bargains in motors, midget cars, motorscooters, motorbikes, construction plans. Associated, Box 534, Toledo, Ohio.

MOTORCYCLE Repair manuals. C-Z parts. Catalog 10¢. F. D. Hirsch & Co., Peace Dale, R. I.

1000 BANKRUPT Motorcycle bargains. Catalog 25¢. Wholesale motorcycle parts. Write needs. Bunico, 146, Covington, Virginia.

RECONDITIONED Motorcycles and motors. Chromium accessories. Complete stock Indian parts. Expert rebuilding. Fast service. Indian Motorcycle Sales, Kansas City 27, Missouri.

HARLEY-Davidsons—Used bargains, shipped prepaid. New, used parts, accessories for current and obsolete models. Bulletin, catalog 25¢. Knuth's (factory dealer), 2491 Fond du Lac, Milwaukee, Wis.

AVIATION

BUILD Jet helicopter. Detailed plans \$6.00. Apache Aircraft, Elgin, Ariz.

PROPELLERS, Plans, supplies—World's oldest and largest manufacturer of special design airboat, snow sleigh propellers. Prompt delivery. Satisfaction guaranteed. 48 page catalog 25¢. Banks-Maxwell, Box 3301E, Ft. Worth 5, Texas.

AIRLINE Steward-purser. Fly 85 hours monthly. Starting salary \$235 up. G.I. approved. Free catalog. Air-Purser School, Room 8, 1030 Nicollet Ave., Minneapolis, Minnesota.

POWER Hammer! Sheet metal cutter. Circular on plans. Rush name. Mauoin, Tipp City 5, Ohio.

BUY Surplus aircraft, fuselages, accessories, engines, instruments, electronics, transceivers. Direct from U. S. government surplus depots. List and procedure \$1.00. Brody, Box 8-PMB, Sunnyside 4, New York.

FREE, 4 Authentic photos, size 3 $\frac{1}{2}$ x5", world's greatest planes. Free catalog. Send 25¢ for handling. Aviation Photo Exchange, Box 75084-1, Los Angeles 5, Calif.

BATTERIES, GENERATORS

BATTERYLESS Flashlight. Operates without batteries. Dynalite generates its own power. Pocket size. \$3.00. Standard, Box 134, Seaford, N. Y.

EDISON Nickel storage batteries. Any voltage, any amperage. Unconditionally guaranteed. Power plants, generators, motors. Literature. Hawley Smith Co., Croton Falls 1, N. Y.

ELECTRICAL SUPPLIES

LAMP, Electrical parts, wholesale. Thousands of items for repairing, converting. Catalog 25c. Brown Lamp, Box 501, Wellston Station, St. Louis 12, Mo.

LAMPS, Parts catalog containing wiring instructions 25c. Gyro Lamps, 5402P Clark, Chicago 40.

TELEPHONE Transmitter. Hand set type. Suitable for inter-house phones, speakers or any communication purpose. Delivered two for \$1.00. No c.o.d.'s. Telephones, Dept. C-825, 1760 Lunt, Chicago 26.

UNIQUE Electrical repair. Instructions \$1.00. Details free. Marnel, Box 7642, Denver 15, Colorado.

WELDING, SOLDERING, PLATING

A.C. Welders, 4 sizes. Lowest prices. Free literature. Holgerson's Serv., Canton, Kan.

WELDERS, 110/220, \$39.50. Morris, 1070 Inner Drive, Schenectady 3, New York.

ACETYLENE Welding outfits, new \$49.00; used \$29.00; arcwelders \$56.50. Eagle Welding, Dept. PM, 5085 Broadway, Chicago 40, Ill.

ELECTROPLATING Equipment, anodes and solutions for all types of plating. Instructions, Assemble your own plater and save. Free catalog. Ramyr, Dept. E-4, 1624 East First Street, Los Angeles 33, California.

BUY Welding supplies direct from manufacturer. Cable, welding rods, helmets, etc. Portable arc-welders and kits at tremendous savings. Free factory catalog! LeJay 47, Minneapolis, Minnesota.

"BUILD-UR-OWN" a.c. welder and a.c. power plant with a good used engine and low cost Hobart generator. Welds anywhere and supplies 5kw stand-by power for any emergency. Write Hobartweld, Box M-763, Troy, Ohio.

NEW, Comprehensive, welding manuals now available. Write Marnel, Box 7642, Denver 15, Colorado.

MACHINERY, TOOLS, SUPPLIES

ADJUSTABLE Pipe jaws for 1/4" to 2" pipe. Fits jaws of any bench vise, in any position. \$1.75 postpaid. Sold on money-back guarantee. H. A. Johnson, P. O. Box 62, Fruitvale Station, Oakland, Calif.

LAWN MOWER Grinders — \$59.75 to \$259.50, light and heavy production. Turner-Cline, 430 Yellowstone, Pocatello, Idaho.

"SPEEDY" Drill Grinding Guide order from ad on page 243.

HOW To magnetize screwdrivers, wrenches, etc. Really simple. Only \$1.00. Al Rheinlander & Sons, 3211 Martin Ave., Evansville 12, Ind.

ENGINES, MOTORS, DYNAMOS

1/2 HORSEPOWER Motors, used, good, \$5.00 each, f.o.b. Plant Machinery Corp., Richmond & Norris Sts., Philadelphia 25, Penna.

REWIND Motors yourself. Complete instructions \$1.00. Lewis Mfg., Howell, Michigan.

WINDING Data, 275 motors, single and three phase, \$1.10. Data Company, Box 7631, Kansas City 28, Mo.

A.C. Generators: 750 watt \$42.50, 1500 watt \$67.50. Motors: 5 horse \$110, 3 horse \$87.50, 1 horse \$38.50. Butler, 1885 Milwaukee, Chicago.

BOATS, OUTBOARD MOTORS

OUTBOARD Motor parts—New, used for all makes. Send list of parts needed. Enclose stamp. We save you money. Outboard Motor Mart, Inc., 229M State Street, Boston, Mass.

FREE Catalog! Boat kits, trailers, fiberglass, marine hardware. Luger Industries, Dept. M, 4452 Nicollet, Minneapolis, Minn.

NEW, Used, rebuilt marine motors. Marine conversions, fittings. Free catalog. Stokes Marine Supply, Dept. 24, Coldwater, Michigan.

MARINE Conversions for Ford and Jeep engines. Catalog 25c. Lehman Manufacturing Company, 972D Broad Street, Newark 2, New Jersey.

FORDS And Jeeps 100% marine engines with famous Convo-Kits. Deluxe catalogue 25c coin. Oscomotors, 3627B Lawrence, Philadelphia 40, Penna.

"GLASBOTE" Plastic and glass cloth for boat covering. Complete information and material price list free. Buchanan Plastics, 1728 Hamilton Road, Okemos, Michigan.

FIBERGLAS Permanent boat waterproofing. Special 25% spring discount. Complete kits, \$9.45 up. Guaranteed materials. Easy application. Full instructions. Free literature. Ajax Plastics, Dept. PM, P.O. Box 1323, Fort Worth, Texas.

BOAT Plans: Welded steel, wood, plywood. Inboards, cruisers, sail. Free literature. Please specify size, type. John B. Clark, N.A., Box 51, Bay Village, Ohio.

BOATS, Big savings. All types. Free information. Boats, Henrietta, N. Y.

SCAMP, Motorized surf board, plans, kits, complete boats. Dean's Marine Engineering, Janesville, Wisconsin.

MARINE Conversion, Willys to Cadillac, engines, kits and parts. Catalogue and conversion hints free. Barr Marine, 2706 Castor Avenue, Philadelphia 34, Penna.

ALUMINUM Boats. Grumman lifetime aircraft construction. More pleasure. Less maintenance. Free catalog—boats or canoes. Metal Boat Company, 3776 South, Marathon, N. Y.

BIG Stock rebuilt inboard and outboard motors, 1 1/2 to 50 h.p. All popular models. \$35 up. Propellers for all boats. Boat supply catalog, send 25c. Masters, 212 W. Chicago Ave., Chicago 10.

BUY Fiberglass boat coverings wholesale. Free literature, samples. Seifert's, Box 31M, Depere, Wis.

BOAT Plans. Full size patterns. Frame kits. Modern inboard and outboards for amateur builders. Complete new catalog 50c or specify requirements. Glen Design, Box 568, Compton, Calif.

BUY Wholesale nationally advertised outboards, thousands other products at big discount. Free "Wholesale Plan." American Buyers', Hertel Station, Buffalo 16-H, N. Y.

WATER Skis \$21.95. Kits \$10.95 up. Boat ladders \$9.45. Enterprise Products, 28400 Gilchrist, Willoughby, Ohio.

HORSEPOWER: Increased in outboards by new process. Free literature. Stark Company, Dept. G-76, Cedarburg, Wis.

ATHLETIC EQUIPMENT, BODY BUILDING COURSES

100 TRICK Knockouts for self-defense \$1.—1c each. Priest, Box 251, Evanston 1, Illinois.

BARBELLS, Dumbbells. Courses. Free catalogue. Good Barbell Co., Reading, Penna.

MUSCLE Development while sitting car or chair. Simple method shown in illustrated copyrighted booklet. Refund guarantee. \$2.00. Mathias, Box 206-M, Miami 47, Fla.

BE Taller! Coach's unique "Inch-At-A-Time" instructions teach new pathways to more height, both genuine and simulated. \$1.00 complete. Super manuscript with valuable added methods, exercises, \$2.00. No c.o.d.'s. Marty Snyder, Box 195-MLK, Union City, N. J.

SPORTING GOODS, GUNS, FISHING TACKLE, ARCHERY, TRAPPING

CATCH Fish with new Slo-Poke weedless popper baits. Green, black, yellow or pearl. Spinning size \$1.25. Casting size \$1.35 postpaid. Pioneer Manufacturing Company, Middlebury, Indiana.

FREE: Below wholesale fishing catalog. Fishing Tackle Mart, Dept. 57, Box 6737, Chicago, Illinois.

FREE Giant handbook! "How to Bow-hunt and Bowfish" 100's revealing secrets! Also tells how to improve shooting accuracy, select best equipment, make your own tackle, etc. Illustrated! Yours free with large bargain catalog. (Save 50% on archery equipment). Send 25c to cover mailing expenses refunded on first purchase. Supply limited! Hurry! Malibu Archery, 1036RJY South La Brea, Los Angeles 19, California.

180 PROFUSELY Illustrated pages antique pistols, swords, daggers, armor, etc. 50c. Robert Abels, M860 Lexington Ave., New York 21.

GOOD BARGAINS. Firearms, binoculars, war relics. Catalog 50c. Smith Firearms, Atlanticville, N. J.

JAP Rifle altering to 30-06, \$6.00. Jap-shells, \$3.75. Catalog 5c. T. P. Shop, West Branch 11, Mich.

DIVING Equipment for skin divers and professional divers. Send 25c for catalog and decompression chart. Desco, 212 N. Broadway, Milwaukee 2, Wisconsin.

SAMPLE: 25c Copy of "The Archers' Magazine." Send 10c. 1200 Walnut Street, Philadelphia 7, Pennsylvania.

MOLDS For fisherman's stinkers, jigs, squids, casting and spinning lures. Free catalog. Sweet's Molds, Tonawanda 1, New York.

CAMPING Equipment, tents. Direct from manufacturer. World's largest selection. Send 15c for 100-page 1956 tent and camping equipment catalogue-handbook. Morsan Tents, 10-21, 50th Ave., Long Island City 1, New York.

CATCH Fish with smell. Old timer's secret recipes, formulas, processes, 10c. Johnson's, 312-F Lake Avenue, Ithaca, New York.

CAMPERS, Outdoorsmen, scouts! Send 15c for our "Camptown, U.S.A." giant catalog. Thousands of bargains. I. Goldberg & Co., 429 Market St., Philadelphia 6, Penna.

SKIN Divers, 3000 lbs. certified air compressing stations, 110v, \$200.00. Garrett, 3471 Weldner, Oceanside, N. Y.

FORTUNE Possible raising crickets and 12 inch African fishworms. Free literature. Carter Ranch, Plains, Georgia.

HOW To be a gunsmith. 400 page illustrated course. \$3.95. Pioneer Press, Harriman, Tennessee.

NYLON Rope, lines, cords. Every description for all household and sportsmen's uses. Finest made. Free catalog and samples. Beebe Cordage Co., Cranford 8, N. J.

DUPONT Tynex monofilament spinning line. Free information. Mor Industries, Neeses, S. C.

GOLFERS—Break 90? You can. Write Golf Associates, Box 963, Alliance, Ohio.

BUY Wholesale! Best lines sporting goods! Direct factory representatives! Large catalog \$1.00. Refundable. General Wholesalers, Box 3038E, San Francisco.

FREE Fishing catalog—132 pages. Over 3000 hard to find fishing specialties. Netcraft Company, Dept. PM7, Toledo 13, Ohio.

BUY Wholesale nationally advertised sporting goods, thousands other products at big discount. Free "Wholesale Plan." American Buyers', Hertel Station, Buffalo 16-I, N. Y.

JEOP Owners—V8 power. Read Jeep owners ad. page 25.

FISHERMEN, Catch your limit every time. Our free 1956 catalog tells you how. Herget Company, Box 741, Coral Gables, Florida.

ED'S Own Super Cold-Blue. Restores, protects, revalues your guns. \$1.50. 22 rifles \$9.00 up. Super Bargain catalog 50c. Agramonte's, Yonkers 20, N. Y.

BINOCULARS, TELESCOPES, MICROSCOPES, MAGNIFIERS

AMAZING Prices, precision binoculars and gunsopes. Free trial. Folder, "Binocular Selecting," catalog free. Prentiss Importers, Mercury Bldg., West Los Angeles 25, Calif.

400 POWER Telescope easily made. Kit includes focusing tube, erector, five finished lenses and instructions—\$3.75. Giant astronomical telescope complete with tripod \$15.00. Free information. Suffolk Science, Mattituck 3, N. Y.

REFLECTOR Telescope kits \$6.25 (3") to \$175. (12"). Mirrors, cells, focusing mounts, tripods, eye-systems. Anything, everything in telescopes. Free illustrated catalog. Also ready to use telescopes from \$26 to \$176. Inquiries to Esco Products, Dept. PM, Oakridge, N. J.; Sales showroom 186 Church St., New York City.

REFLECTING Telescopes, mirrors, kits. Lowest prices anywhere. Free catalogue. Aurora Telescope Company, 266 Avenue C, Bayonne, N. J.

REFLECTING Telescope, 60X, completely assembled \$29.75. Guaranteed observatory clearness. Free information. Skyscope, 475 Fifth Avenue, New York City 17.

BUILD Your own reflector telescope. Complete kit: Mirrors, eyepieces, tripod, all other accessories. Request free illustrated literature. Criterion Manufacturing, Dept. KPM-19, Hartford, Conn.

SAVE 35% \$150,000.00 Binocular stock! Pocket sizes to 20X, \$3.95 to \$250.00. Also telescopes, riflescopes. Free 56-page 3-color catalog. United, 9043 S. Western, A-408, Chicago 20. Dealers wanted.

BINOCULARS, Telescopes, microscopes terrific values \$3.98 up. Request free money saving catalog. Criterion, Dept. P43, Hartford, Conn.

EXTRAORDINARY Binocular presentation. Write Sheehan & Company, Dept. A17, 1920 Kipling, Houston 6, Texas.

WAR Surplus bargains: Millions of lenses, instruments, telescopes, binoculars, components and complete line of astronomical telescope items. World's greatest optical market place! Send only \$1.00 for beginner's 10-lens kit and big instruction booklet Stock 2-CH. Write for catalog CH, free! Edmund Scientific Corp., Barrington, New Jersey.

DYNASCOPE—Sensational new reflector telescope. Send for details. Criterion Co., Dept. DP22, Hartford, Conn.

PETS—DOGS, BIRDS, RABBITS, HAMSTERS, ETC.

CHAMELEONS, Horned toads, baby turtles prepaid two for \$1.00. Reptile list, tanned snake skin sample, 25¢. Snake Farm, Laplace, Louisiana.

MINK, Quality breeding stock. Raising information. Cages, equipment. Huebl Minkerys, LeSueur, Minn.

\$1,000 MONTHLY Possible raising red-worms; large African nightcrawlers! Backyard, garage, basement. Illustrated booklet explains raising, packing, marketing. 25¢ postpaid! Ozark Worm Farm—J. Willow Springs, Missouri.

MONTHLY Bird magazine (budgies, canaries, finches, etc.). One year \$3.00. American Cage-Bird Magazine, 3449 N. Western Avenue, Dept. P.M., Chicago 18, Illinois.

\$5,199.90 WAS Paid to John Betts, in few weeks. Grow mushrooms. Cellar, shed. Spare, full time year round. We pay \$3.50 lb. Free book. Mushrooms, Dept. 171, 2954 Admiral Way, Seattle, Wash.

MAKE Money raising chinchillas, mink, pigeons, rabbits, cavies for us. Free catalog. Keeney Brothers, New Freedom 2, Penna.

HAMSTERS, Pair \$2.95. Free booklet. Jer-Fre's Hamstery, 2425 Hoyt, Muskegon Heights 13, Mich.

BEEKEEPERS—\$1,000,000 French industry. Read "Miracle of Royal Jelly," \$2.50. L. Smith & Co., Box 2003, Hartford, Conn.

CHINCHILLAS—High graded Blend-Trast, Willard George, Wholesale prices. Chinchillas, 21219 Figueroa, Torrance, Calif.

MINK Raising information free. Complete. Lake Superior Mink Farm, Superior, E.E1, Wisconsin.

RAISE Rabbits successfully by knowing facts. 48 page illustrated book describing 25 breeds. Housing, feeding, breeding, marketing, etc. Plus bulletin, 25 cents. American Rabbit Association, 36 Arba Building, Pittsburgh, Penna.

EXTRA Money raising Angora, New Zealand rabbits. Write Martin's Rabbitry, Morganfield, Ky.

STANDARD Rabbit Journal, Milton 3, Penna. Year \$1.00. Sample dime. Beginners manual 25¢.

CHINCHILLAS, Registered. Unbelievable prices. Far-West Chinchilla, 1446A Jones, San Francisco 9, California.

PROFITS! Raise Nutria beavers. Herb Miller, 513 Kent, Lubbock, Texas.

RAISE Rabbits. Make money. Send 25¢ for market information, plans for housing, and prices of starting stock. A. Johnson, Box 694, Kansas City 41, Missouri.

WILD Animal pets—Mammals, birds, reptiles. Catalog 10¢. Ray Singleton, Rattlesnake, Fla.

PEDIGREED Police puppies. White or cream. Ansonia Kennels, Mose, N. Dak.

ANGORAS, Chinchillas—World's most profitable rabbits! Catalog free. Grinsteads, Edwardsville, Illinois.

RAISE Nutria: Vegetarian; odorless; valuable fur; exceptionally prolific; no known disease; standards and mutants. Terrific potential. Voigt Farms, Atlanta 2, Texas.

PLANTS, SEEDS, BULBS, NURSERY AND GARDEN SUPPLIES

RAISE Your shrubs, trees from seed. Free planting guide, price list. Woodlot Seed Co., Norway 9, Michigan.

WORLD'S Greatest cash crop. Free information. Write Ginseng Gardens, Asheville, N. C.

FARMS, FARM LANDS, REAL ESTATE

BEAUTIFUL Texas resort sites \$149.50. Nothing down, \$7.50 month. Write free maps, literature. Gordon Danner, Pipe Creek, Texas.

CALIFORNIA Ranch and farm sites. \$50 down. Terrific investment. Future or immediate occupancy. High pay jobs nearby. Free catalog. Pioneer Ranches, Inc., 7419-F Beverly Blvd., Los Angeles 36, Calif.

FLORIDA—2½ Acres; \$10 down, \$10 monthly; full price \$495. High elevation, near Gulf of Mexico. Suitable farming, citrus, poultry. Free information. Sunshine State Land & Development Co., Brooksville, Florida, Dept. PM-1.

FLORIDA Bargain homes. Low taxes. Cummins Realty Agency, Box 848, Eustis, Florida.

GOVERNMENT Land available. 25 states, Alaska. Free information. Sledge Surveys, Macon, Mississippi.

OZARKS! \$7 Acre. Diversified listings free. Write: Armstrongs, Shook, Missouri.

HOMESITES \$15 Monthly—California's finest garden section. Morro Bay's scenic shores. Wonderful fishing, boating. Fertile soil, softest water, temperate climate, congenial community. Free literature. Richard Otto, Department M, San Luis Obispo, California.

STROUT Catalog—Mailed free! Farms, homes, businesses, 34 states, coast-to-coast, 3,046 bargains described. World's largest; 56 years service. Strout Realty, 7-MP Sc. Dearborn St., Chicago 3, Ill.

FLORIDA—Beautifully wooded Green Hills tracts. Near famous Panama City pleasure resort. World's finest beaches. Many lakes. Best fishing. Water sports. 10 and 20 acre garden farms and money-making tung groves. Lowest prices, easy terms. Booklet free. Wendell Wood, Fountain, Florida.

PROFITABLE OCCUPATIONS

\$5,199.90 WAS Paid to John Betts, in few weeks. Grow mushrooms. Cellar, shed. Spare, full time, year round. We pay \$3.50 lb. Free book. Mushrooms, Dept. 99, 2954 Admiral Way, Seattle, Wash.

YOUR Own wholesale business with no investment. Free catalog. Jay Norris Co., 487X Broadway, New York City.

FOREIGN Jobs—Latin America, Alaska, Canada, up to \$1500 monthly. Up-to-date 1956 foreign service directory gives complete information; hot list of firms hiring for military and civilian construction, aircraft, oil, exporters-importers, mining, \$1.00. How-when-where to apply. 8th successful year! Global Reports, Box 883-S, Hollywood 28, Calif.

FREE Folio "\$5,000-\$45,000; Unlimited Vacations." No merchandise, equipment. Unknown! Work home, sparetime! Haylings, Carlsbad, Calif.

MUSHROOM Spawn seed plus directions manureless, various, growing, marketing \$1.00. Free information, gladly. Luxur, 641 South 19th, Newark 3, New Jersey.

RAISE Pheasants on \$100 week plan. Little capital and space can make you independent. Free details. Great Central System, Columbus 1, Kansas.

MAKE New greaseless doughnuts in kitchen. Sell stores. Free recipes. Michael Ray, 3605 South 15th Ave., Minneapolis 7, Minnesota.

BE The Popular Mechanics representative in your neighborhood and earn big profits in your spare time. Write Popular Mechanics Magazine, Room 408M, 200 E. Ontario St., Chicago, Ill.

FORTUNE Possible raising fishworms and crickets. Free literature. Carter Wormery, Plains, Georgia.

WHOLESALE Catalog! 30-80% discounts! Appliances, musical instruments, typewriters, phonographs, watches, jewelry, recorders, housewares, etc. Consolidated Distributors, 21-14 Lafayette, Paterson 15, New Jersey.

AUCTIONEERING—Home study course. Diploma granted. Auction School, Ft. Smith, Ark.

FREE Book "505 Odd, Successful Businesses." Work home. Pacific, Oceanside, Calif.

\$150 WEEK—Easy! Start home Venetian blind laundry. Revealing book free. A.T. Co., 101 S. 44th, Philadelphia 4, Penna.

LEARN Real estate by listening to records. Lee Institute, Brookline 47, Mass.

SHAMPOOS, Bath salts, beauty creams; unbelievable profits with easy home manufacture. Instructions \$1.00. K. Boardman, Box 219 Station D, Hamilton, Ontario.

WELDING Pays big money. Learn easily at best equipped school in country. Non-profit school with low cost training. G.I. approved. Write Hobart Trade School, Box M-762, Troy, Ohio.

BUY Wholesale thousands nationally advertised products at big discount. Free "Wholesale Plan," American Buyers', Hertel Station, Buffalo 16-B, N. Y.

MAKE Flexible molds. Cast figurines, plaques. Free sample. Tooker, 630-M Chestnut, Hamilton, Ohio.

MAKE Signs. Just nail on. Hoag's Sign Letters, 507 E. Chicago Blvd., Tecumseh, Michigan.

WHOLESALE Catalog \$75,000 merchandise jewelry, watches, appliances. Riddy Sale Co., 15218 Shiloh Rd., Cleveland 10, Ohio.

REFRIGERATION Made childishly simple. Non-technical basic theory book. Quickly start own business. Adcox Enterprises, 2210 N. 48th Street, E. St. Louis, Illinois.

MAGAZINE Subscriptions. Largest commissions, bonus. Qualified Agency, 451GA Kingston, Brooklyn 25, N. Y.

JOBS Paying to \$350 weekly now available on overseas and American projects. Men and women. All trades. Transportation paid. Free information. Write Transworld, Dept. M7, 200 W. 34th St., New York, N. Y.

MAKE Money writing short paragraphs! No tedious study. I tell you what to write, where and how to sell; and supply list of editors buying from beginners. Many small checks add up quickly. Write to sell, right away. Send for free facts. Benson Barrett, Dept. CP-27-U, 1751 Morse, Chicago 26.

BOOKS, PERIODICALS, PICTURES, POSTCARDS

NATIONAL Geographic Magazines, 1888-1956. Periodical Service, Box 465-PM, Wilmington, Delaware.

BOOK Catalog. 1000 interesting titles. Send 13¢. Books Publishing Co., Amityville 3, N. Y.

FREE Catalog! Bargains for everyone. Critic Books, 10020 Hawthorne, Inglewood 2, Calif.

OUT-Of-Print books at lowest prices! You name it—we find it! Fast service. No obligation. International Bookfinders, Box 3003-PM, Beverly Hills, Calif.

RARE Magazines, catalog 10¢. Nationwide Magazine Exchange, Box 1375-P, San Antonio 6, Texas.

JOHN Friend, bookfinder. Any book, any subject obtained for you promptly. Foreign books, too! Box 197PM, Cardiff, Calif.

HORSE Books—Breaking, training, care. Carson, 1304 W. Kiowa, Colorado Springs, Colorado.

BRITISH Book bargains. All subjects. Catalog free. Wants solicited. Transbooks, Box 22-PMB, Brooklyn 26, N. Y.

FREE List, book bargains. Williamsburg Books, Box 90, Brooklyn 11, N. Y.

BOOKS. Free 1956 catalog, 100 pages. Text, vocational, educational, instructional subjects. Millions of volumes, new and used. Bargain prices. Books bought. Est. 1902. Long's College Book Co., Dept. PM, Columbus 1, Ohio.

BOOKFINDERS! All subjects. Send wants! Jaher Book Service, 183 Hazelwood Drive, Westbury, N. Y.

"SCIENCE Milestones." Records march of science starting 400 years before Christ, right up to date. Amazing facts revealed. 312 pages packed with startling information that will thrill you. A real history of science. \$5.00. Literature free. Popular Mechanics Press, 200-SM East Ontario St., Chicago 11, Ill.

GAMES, TOYS, NOVELTIES

NEW Game — Teaches aircraft navigation. Uses real navigation charts, simulated airplane instrument panels. Pilots, teach your children. \$3.99 postpaid. Chart-Air, Hood River, Oregon.

MAGIC TRICKS, PUZZLES, JOKER NOVELTIES

3100 NOVELTIES, Jokes, tricks, gadgets, funmakers, hobbies. Big catalog 10¢. Johnson-Smith, D-202, Detroit 7.

LEARN Ventriloquism, easiest method. Details free. Smith, 2125 N. Bigelow, Peoria, Ill.

BE A magician! Large professional catalog of latest tricks. 35¢. Ireland, C-109 North Dearborn, Chicago 2, Illinois.

WOODEN Nickels, catalog, trick, 10¢. 1,500,399 tricks, jokes, Magico, Box 1375-P, San Antonio 6, Texas.

500 TRICKS. Douglas famous 120-page catalog, only 10¢. Fastest service to magicians for 30 years. Send 10¢ today. Douglas Magicland, Dept. 1, Dallas, Texas.

SMOKEBOMBS 25¢. 7 For \$1.00. Terrific! 4463-PM Greene, Philadelphia 44.

BEST Magic, Joker's novelties. Lower prices. Catalog 10¢. Top Hat, Evanston 12, Ill.

DOLLAR Magic set free with catalog 25¢. 4462-PM Germantown, Philadelphia.

FREE Trick and professional catalog of 600 tricks, \$1.00. Terry's Magic Studio, 1921—66th Street, Brooklyn 4, New York.

SENSATIONAL Magician's wand 25¢. Vanishes handkerchief! Catalog included. Box 1352-PM, Philadelphia 5.

JOKESTERS' Printed novelties! Hundred, \$1.00. Sebastian, 10934 Hamlin, North Hollywood, California.

COMPLETELY Illustrated 500 trick magic catalog 25¢. Stowell, Woodstock, New York.

PROFESSIONAL Catalog, 175 pages, 25¢. Williams, 900 Plymouth, Ellwood City, Penna.

SVENGALI Trick deck free with catalog 50¢. 1746-PM Market, Philadelphia 3.

NEW! Color changing trick deck. Does 15 tricks! \$1.00. Beck, 684 Irving Park, Chicago.

VENTRILLO, Professional voice-throwing instrument and catalog 25¢. Box 971-PM, Philadelphia 5.

COINS, TOKENS, CURRENCY

PAYING \$4.00 For \$1 gold coins: \$6.00 for \$2½; \$10.00 for \$3; \$15.00 for \$10. Acme, Box 6184, Albuquerque, New Mexico.

UNCIRCULATED Sets, Singles. Coins and supplies. Free price lists. Louis Bell, Masonic Building, Decatur, Alabama.

AMERICAN Coins! Stamps! Extensively! Sullivan, 127-FF East Fourth, St. Paul 1, Minnesota.

OLD Money wanted. Will pay fifty dollars for nickel of 1913 with Liberty head (no buffalo). We pay cash premiums for all rare coins. Send 4¢ for large coin folder. May mean much profit to you. Numismatic Co., Dept. 20, Fort Worth, Texas.

36 DIFFERENT Foreign coins \$1.00. Robbins, 1007 Cleaveland, Montgomery 8, Alabama.

FIVE Foreign coins from Switzerland, Belgian East Africa, etc., plus foreign banknote, only 10¢ with coin approvals. Littleton Coin Company, Littleton R1, New Hampshire.

GET Profit and pleasure in collecting old coins. Send 10¢ for 56-page illustrated coin catalog. You'll be delighted with it. Send for it now. B. Max Mehl, 370 Mehl Building, Fort Worth, Texas. Largest rare coin establishment in U.S. Established 66 years.

6-IN-1 Special: Magnifying glass; check list; 25 coin envelopes; giant 60 page bargain catalog; ten different Indian pennies; Mexican ten-peso; All six, \$1.00 postpaid. Ben's Coin Shop, 31 North Clark, Chicago 2, Illinois.

FREE! Foreign coin, banknote and coin collectors illustrated catalog to approval service applicants. Send 3¢ postage. Taham Coinco, Springfield 30, Mass.

SAN Francisco mint closed! Made only cents and dimes in 1955. In short supply and great demand. One each, brilliant uncirculated, for 25¢. Free coin lists with order. Bryson Stamp & Coin Company, 612 White, Toledo 5, Ohio.

40 DIFFERENT Selected coins, \$1.00. Oddehon, Box 482, St. Louis, Mo.

BARGAIN Lists, Indianhead cent, 10¢. Economy Sales, 157 Dean, Mansfield, Mass.

U. S. Large cent, 2¢ piece and bargain list, only \$1. Delmaco, Box 1123, Wilmington, Del.

\$3,000.00 FOR 1913 Liberty head nickel. Dimes 1894-S, 1895-O, 1916-D. Quarters 1827, 1896-S, 1901-S, 1913-S, 1923-S, we pay \$5.00 to \$1,500.00. Certain dates—Lincoln cents, \$60.00. Indianheads, \$60.00. Large cents, \$500.00. Eagle cents, \$200.00. 2¢ pieces, \$45.00. 3¢ pieces, \$60.00. Half-dimes, \$500.00. Shield nickels, \$100.00. Old dimes, \$300.00. 1875 Canadian quarter, \$50.00. Hundreds of others worth \$5.00-\$500.00. Wanted—Half dollars, dollars, gold coins, paper money, etc. Know their true value. Our large illustrated guarantee buying-selling catalogue, giving complete all coin information—Send \$1.00. Purchase catalogue before sending coins. Catalogue money refundable. Worthycoin Corporation, Leaders Numismatic Quotations, K-112-C, Boston 8, Massachusetts.

GOLD—Mexican. Minimum order \$100. Kay's, Box 3578, Amarillo, Texas.

MORGAN Dollars, 1878-87-90-91-925 \$2.00 ea. New illustrated catalog 25¢. Shultz, Box 746, Salt Lake 10, Utah.

WANTED 1936 Proof sets, \$225.00. Acme, Box 6184, Albuquerque, New Mexico.

ROLLS Uncirculated 1955S, 1955D dimes \$7.00, 1955S cents \$1.75. Jack Turner, Prescott, Arizona.

ELEPHANT Coin, lists 145 countries, 10¢. World Coin, Box 401, Davenport, Iowa.

BRILLIANT Uncirculated complete sets—Jefferson nickels \$19.75; Roosevelt dimes \$14.95; Franklin \$15.24.75. Giant bargain catalogue 50¢. Bebee's, 4514 North 30th, Omaha 11, Nebraska.

\$20 PAID For Lincoln cents taken from circulation. Send \$1 for list of these cents. This dollar refunded with first purchase. Gasser, Box 34-615, Los Angeles 34, California.

STAMP COLLECTING

CANADA—Newfoundland collection including early issues, commemoratives, pictorials and high values. Plus set of fascinating triangle stamps. Plus set of unused British Colonies. Plus large stamp book. All four offers free. Send 10¢ to cover postage. Empire Stamp Corp., Dept. PM, Toronto, Canada.

PICTORIAL Angola, Mozambique, Hungary, a beautiful assortment of stamps, 3 sets depicting wildlife in color, plus 100 attractive stamps, 10¢ to approval applicants. Modern Stamp Co., Dept. A-1, Ferrysburg, Mich.

TERRIFIC Value! Summer clearance sale! Sets, singles, etc. \$5.00 parcels. Worth double! Guaranteed. Ed Groark, 4 Brighton, Boston 29, Mass.

WOW! 135 All different Germany 10¢. Zeppelins, semi-postals, airmails, high values. Big bargain lists and approvals included. Jamestown Stamp, Dept. A7PMC, Jamestown, N. Y.

ANTIGUA, Bermuda, Cayman Islands, Ceylon, Dominica, Egypt, Fiji, Grenada, Hong Kong, Indonesia, Jamaica, Malaya, Singapore, Suriname, are in our bargain packet. Bi-colors, topicals, high values. Every continent represented. 333 different beauties. 25¢ with attractive approvals. Roseland Stamps, Dept. A-37, Spring Lake, Mich.

PAYING High prices for approvals? Try ours at 1¢ and 2¢ in books of 1,000. Special offers and U.S. available. Clark Stamps, Dept. A-45, Muskegon Heights, Mich.

DEALERS—Wholesale list. Postage 3¢. Frank, 5031 Queensberry, Baltimore 15, Maryland.

FREE! Mint British Colonies from Brunei, Papua, New Guinea, Caymans, Gilbert Ellice, Seychelles, Sarawak, Grenada. Free with approvals. Viking, Great Neck 8, N. Y.

FIRST U. N. set. Among world's prettiest. Only 10¢. Approvals. Welles, Box 1246-R, New York City 8.

U. S. Stamps—At discount prices. Giant illustrated catalog. Only 10¢. Raymax, 37-VZ Maiden Lane, New York City 38.

100 BRITISH Colonies 10¢. Approvals. Neal, 5950 Tower, Riverside, Calif.

FREE With approvals, Spanish Zaragoza religious set. William, Diamond, Penna.

FREE! Giant catalog offering thousands of bargains. Sent with beautiful approvals. Jamestown Stamp Co., Dept. E7PMC, Jamestown, N. Y.

FREE Gift with worldwide different approvals. J&J, 123 Monument, West Medford, Mass.

NEWFOUNDLAND Caribou set, 10¢ with approvals. Nevin Otis; San Andreas 5, California.

BERLIN Bishops set 25¢. Approvals. Barricks, 1734 Seward, Detroit 6, Mich.

CUBAN, 25 Between 1878 and 1945. 25¢. Free 3 Vatican "Vision of Christ." Gerhardt, 405 E. 6th St., Austin 1, Texas.

500 WORLDWIDE Mixture. Big variety, 25¢. Monjar, Fairmount, Cincinnati 14, Ohio.

TRIANGLES, 13 Different 10¢ with approvals. Nickerson, 310 Idaho, La Habra, California.

FIRST Day covers. Low priced approvals. Stamps, 102 Sweden, Caribou, Maine.

30 DIFFERENT Commemoratives 1893 up 10¢. U. S. approvals. K&B, Box 70, Brooklyn 23, N. Y.

3 SOUVENIR Sheets, regular 50¢ value, only 10¢ with approvals. Variety Stamps, 57-S Circuit, Newton Highlands 01, Mass.

500 FINE Mixed U.S. 15¢. Wright, 201 Mealey, Hagerstown, Maryland.

TRAVEL Through 50 countries! A virtual world cruise! 50 stamps, each from a different country. Abyssinia to Zanzibar. Bargain unsurpassed! To new approval applicants, 5¢. Avalon Stamp Co., Dept. M, Springfield, Mass.

FREE! Monaco's Grace Kelly-Prince Rainier wedding stamps given applicants for our exotic approvals. Exotic Stamps, Box 482-MM, Coral Gables 34, Florida.

FREE! World's 10 ugliest! Weird colors, valuable cut design. Send 3¢ postage today! Norrisco, Milwaukee 7, Wis.

TWO \$5.00 U.S. stamps plus 20 different, 10¢ with U.S. approvals. Irwin, Box 1105, Brooklyn 30, N. Y.

ECONOMICAL ½c, 1c, 2c, Approvals, 22,000 varieties available. Dresel, Box 270-N, New York City 25.

OLYMPIC Set, 1000 hinges only 10¢. Approvals, Buckley, 208 Ludlow Bldg., Dayton 2, Ohio.

SELL Your surplus good grade stamps. Write, describing fully what you have. Vanroy Shirk, Lebanon, Pennsylvania.

FREE! Catalog! About stamps. Illustrated. Free! The Stampmart, Hartford 1, Connecticut.

FREE United States price list. Mark Hanna, 335 Fifth Ave., Pittsburgh 22, Penna.

50 DIFFERENT Argentine 10c. Approvals. Reuter, 611 W. 40th Pl., Los Angeles 37.

OLD Scarce U.S. seconds on approvals. Slight imperfections, lowest prices. Hernefield, Clintonhill Sta., Newark 8, N. J.

U. S. Classics. Over 50 yrs. old. 15 selected old-timers. Missing in biggest collections. All 15 at less than 1¢ each. 10¢ with approvals. Jaro, Box 246-T, New York City 8.

50 DIFFERENT United States 5c with bargain approvals, lists. Bookman, Box 8245-M, Madeira Beach, Fla.

100 DIFFERENT U.S.—50¢. Approvals. Utechs, 1143A North Keeler, Chicago 51.

AMAZING Offer! 200 United States stamps—including commemoratives, airmails, high denominations to \$1.00. Only 10¢ to approval applicants! Illustrated bargain lists free. Mystic Stamp Co., Dept. 80, Camden, New York.

FREE Sample! Interesting, illustrated, informative! National Stamp News, Anderson, South Carolina.

WORLD'S Largest stamp (7½ x 14 inches). A real curiosity! Retail for 50¢, only 3¢ to approval applicants. Tatham Stamp Co., Springfield 30, Mass.

WEIRD Diamond shape coffee stamp! Lovely flower triangle! First American big commemorative, Greenland, idol dancer, etc. Free with approvals. Capital Stamp Co., Little Rock 2, Ark.

100 OLD United States between 1861 and 1935, \$1.00. Roush Stamps, 51 Chestnut, Mansfield, Ohio.

225 STAMPS For only 10¢! This mammoth value includes airmails, pictorials; stamps from strange countries cataloging up to 25¢ each! Also approvals. Mystic Stamp Company, Camden 80, New York.

FAMOUS Men, jungle scenes, zoo, United States commemoratives, 100 others. Ten cents with request for thrifty approvals. Casner Stamps, 247-A Riverside, El Paso, Texas.

14,000 DIFFERENT—Yours on our streamlined systematic club plan for only 50¢ weekly. Big shipment every two weeks. Details free. Sjoquist, Box 217, Valley Stream 75, New York.

MINT Commemoratives at face! Send 25¢ for surprise packet of all different, mint U.S. commemoratives. Mint U.S. approvals too. Western, Box 1689P, Salinas, California.

UNITED States approvals. Select copies, used—mint. Kingsbury, Fairfax, Vermont.

TRINIDAD. 12 Different. 10¢ with approvals. Seminole Stamps, Box 1138-P, Coral Gables 34, Florida.

ICELAND 10 Different beautiful stamps for only 10 cents to applicants for our good old fashioned approvals. Old Colony Stamp Co., Dept. A, Milford, Connecticut.

UNITED States commemorative collection containing 33 different. 10¢ approvals. White, 516-A Avenue L, Brooklyn 30, New York.

FREE! Flower triangles, others. Approvals. Delton Page, Box 201X, East Paterson, New Jersey.

START Your own stamp business. Send for free circular. Donald Shepard, Box 1147, Chicago 90.

100 DIFFERENT China 10¢. Approvals. Coast, P.O. 2187H, Santa Ana, California.

100 DIFFERENT Austria 10¢. Approvals. Aronson, 91 Marion, Brookline 46, Mass.

1-2¢ EACH! Thousands of exciting worldwide stamps. Free examination. Cole, 43-A Rinewalt, Buffalo 21, N. Y.

111 DIFFERENT! Triangles, giants, topicals galore! 10¢ to approval applicants! Evden, Box 128, Valley Stream 52, New York.

FREE Sample stamp newspaper, information on collecting, special lists. Approvals. Littleton Stamp Co., Littleton A1, New Hampshire.

100 DIFFERENT U.S. commemoratives. 60¢. 500 different stamps, 60¢. Both for \$1.00. Approvals. Kairis, 7948 Whipple, Chicago 29, Ill.

100 YEAR Old United States stamps are sent on approval together with all commemoratives, airmails, etc. Also all foreign, Roosevelt, etc. Send 10¢ for 50 different U. S. and approvals. Globus, New York 10, N. Y. Dept. 213.

AMIGOS! 101 Different South America 25¢. Pictorials, airmails, commemoratives. Worthwhile approvals included. Moffat's, 740-A Milton, Rock Hill, S. C.

FREE! \$1 Mint set with each \$2 purchase. Approvals. Farmer, 6919 Camrose, Los Angeles 28.

OLD U.S., famous Americans, flags, commemoratives, 25 stamps 10¢ to new applicants for approvals. Metropolitan Stamps, Box 312H, Jackson Heights, N. Y.

212 MIXED Foreign 10¢. Approvals. Kopels, 3201 Argyle, Chicago 25, Illinois.

MINERALS. Gems wanted. Exchange valuable U.S., foreign stamp collection. Fraser, 26 Peppertree, Portuguese Bend, Calif.

INVERTED Frame stamp—1874 Denmark—and other old stamps only 25¢ to approval buyers. W. Torgesen, Cornelia, Georgia.

\$4.00 CATALOG British Empire. \$1.00. No junk. Jefferson, Amherst, N. S.

BEAUTIFUL Introductory packet, 10¢ with approvals. Johnson, 1105 Ninth, Hawarden, Iowa.

PRIVATE Collector pays cash for collections. Send stamps, receive check within week. Florman, 69-24 224 St., Bayside, N. Y.

FOUR Different Rainier or Fipex 25¢ with approvals. References please. Peirce, Red Cloud, Nebr.

FREE! 55 British Colonies, 5¢ postage. Kensington Stamps, Buffalo 15, N. Y.

BIG U.S. 72 page catalogue 10¢. Stone's, 192 Washington, Boston 8, Mass.

ANTIQUES, RELICS, INDIAN GOODS, CURIOS

INDIAN Relics, baskets, weapons. Illustrated lists 10¢. Rush, 3 Fourth St., Belvidere, N. J.

5 AFRICAN Arrowheads \$1.00. Waters, 1383-85 East 26th, Brooklyn 10, New York.

SELECTED War arrowhead \$1.00. List 5¢. H. Talburt, Calico Rock, Ark.

SELLING 50,000 Indian relics, etc. List free. Lear's, Glenwood, Arkansas.

TAHITI Hula skirts and curios. Yves Jarsaillon, Box 467, Papeete.

SCALPING Knife, spearhead, thunderbird, drill, \$4.00. List free. Arrowhead, Box 1249, Hot Springs, Arkansas.

MEXICAN Custom hand-made jewelry and miniature novelties. All kinds Mexican handicraft. Wholesale only. Request catalog. Francisco de Arkos, Laredo, Tex.

PRECIOUS STONES, MINERALS

SAPPHIRE, Topaz, tourmaline, garnet, peridot. Five uncut gem specimens. \$1.00. Ten polished gems, baroque shaped. \$1.00. Free big bargain list jewelry, gems, profitable, easy "do it yourself" projects. O'Brien's, 1116M Wilcox, Hollywood 38, Calif.

GEMCUTTING—Silvercraft illustrated magazine. Tells how to cut gems, make jewelry. 150 ads illustrating equipment, gems for collectors, cutters. Free literature. Lapidary Journal, Del Mar 2, Calif.

HOBBIES AND COLLECTIONS

FREE "Do-It-Yourself" leathercraft catalog. Tandy Leather Company, Box 791-V16, Fort Worth, Texas.

25 AMERICAN And foreign hotel baggage labels \$1.00. Lists 25¢. H. Copleston, 1555 Odell, New York 62, N. Y.

NAZI Medals listings, 10¢. Kingstons, 920 Third B338, Seattle 4, Washington.

INVENTING Can be an interesting and profitable hobby. Write for complete particulars. Institute of American Inventors, Dept. 40-E 631-E St., N.W. Washington 4, D. C.

NAZI Insignia, 12 different, \$1.00. Medals, armbands, flags, daggers. Illustrated lists. Medcrafts, 1923 34th St. S.W., Calgary 2, Canada.

65 ASSORTED Army patches, insignias, ribbons (irregulars) \$1.00. Surprise included. Lhgeo, 19-X East 16th St., New York City 3, N. Y.

INSIGNIAS. 100 Assorted military ribbons, patches. Mail \$2.00. Victory Salvage, 8211 South Alameda Street, Los Angeles, California.

CAMERAS, PHOTO SUPPLIES

BASS Says: Quality cameras since 1910. When in Chicago visit the camera cross roads of the world, or write us for your favorite equipment, new or used. Satisfaction guaranteed. Bass Camera Co., Dept. AG, 179 W. Madison St., Chicago 2, Ill.

REAL Wholesale sources. Thousands nationally advertised products. Details free. Martex, 132-A Nassau St., New York 7, N. Y.

PHOTOGRAPHY For pleasure or profit. Learn at home. Practical basic training. Long established school. Free booklet. American School of Photography, 835 Diversey Parkway, Dept. 3441, Chicago 14.

20 TO 50% Discount everything photographic, giftware. Free catalogue. Dart, 3812E Atlantic Avenue, Brooklyn 24, N. Y.

WOBBLY Movies, blurred stills? Try "Pocket-Pod." \$1.00. Haines Mfg., Box 371, Troy, Ohio.

BUY Wholesale nationally advertised cameras, photo supplies, thousands other products at big discount. Free "Wholesale Plan." American Buyers, Hertel Station, Buffalo 16-E, N. Y.

FREE Catalog photo equipment, appliances. Terrific savings. Latest Argus C-3 outfit \$48.90. Mailers Mart, Box 135-B9, New Rochelle, New York.

10,000 ROLLS Fresh snapshot film given away. Write today. Delco, Box C362, Upper Darby, Penna.

PHOTO FINISHING

TWO Beautiful prints from each picture on roll. 8 exposure 40¢; 12 exposure 50¢. Thirty-five years of satisfied customers. Quick service. Lens Photos, Dept. J-4, Jareville, Wis.

12 EXPOSURE Rolls, 39¢, jumbo prints. Guaranteed work, one day service. Lincoln Studios, Dept. K, Box 13, Lincoln, Neb.

TWO Beautiful enlargements from each picture on roll. 8 exposures 55¢. 12 exposures 75¢. Cut Rate Photos, Dept. B-4, Janesville, Wis.

ROLL Developed, 8 beautiful enlarged prints 25¢; 12—35¢. (Trial) 10 reprints 40¢. Quick service. Willard's, Box 2553G, Cleveland, Ohio.

QUALITY Kodak finishing. 8 exposure roll 35¢; 12 exposure 50¢; 16 exposure 60¢. Reprints 4¢. Fast service. Guaranteed quality. 40 years continuous operation. Be a satisfied customer. We do color. Send for mailers. Mall Order Photo Service, Box 297, Watertown, Wisconsin.

TOP Quality. Fast service. 8 jumbos 35¢. 16 contacts 40¢. Reprints—Jumbos 4¢; contacts 3¢. Satisfaction guaranteed. Free mailers, circulars. Fast-X-Photo, Box A, Jersey City, New Jersey.

8-HOUR Service on deluxe jumbo prints. 8-exposure roll developed and 8 jumbo prints 40¢. 12 exposure 55¢. 16 exposure 70¢; 35mm. 20 exposure 75¢. 36 exposure \$1.25. Jumbo deckle reprints 4¢ each. Contact prints made if specified. Bay Photo Service, P.O. Box 210, Oakland, California.

FREE Superpak album with 8 jumbos only 35¢. 12—50¢. Prompt superior service. Quality guaranteed. Mailers and circulars free. Grand Fotos, GPOB 1410, New York City 1.

6 OR 8 Picture roll 35¢. 12 or 16 picture roll 55¢. Each roll developed and printed in handy pocket wallet. Send coin with roll. No c.o.d.'s. Mailing containers sent free. DeLuxe Film Service, Box 1268-A, Shreveport, Louisiana.

FROM Rolls or negatives, Jumbos 4¢. Regulars 3¢. This ad and \$1.00 for 30 jumbos or 8—5x7. Guaranteed. Square Deal Photos, Hutchinson, Kansas.

ENLARGEMENTS! Eight 5x7's or five 8x10's, \$1.00. Willart Enlargers, Box 967, Little Rock, Ark.

SPECIAL Gift with first roll developed and 8 dated jumbo prints, or 16 dated contact prints in wallet folder 40¢. 12 exposure 50¢. Owl Photo Co., Dept. 21, Weatherford, Okla.

ENLARGEMENTS. Heavyweight eight 5x7's or five 8x10's, \$1.00. Jack Koons, Huntington Mills, Luzerne County, Pennsylvania.

SPECIAL Introductory offer. 8 jumbos 25¢. 12—35¢. Western Photo, PM-76, Box 298, San Francisco 1, Calif.

FIRST Class return—First class quality. Your films expertly processed, rushed to you by fast mail. Sparkling, enlarged prints; 8 exposure roll 50¢. 12—70¢, reprints 6¢. Unconditionally guaranteed. Photo Masters, Box 26-M, Philadelphia, Penna.

12 JUMBOS From any size roll developed 35¢ with this ad only. PM Skrudland, Lake Geneva, Wisconsin.

4x5 DOUBLEWEIGHT Enlargements 10¢. 5x7's 30¢. 8x10's 30¢. Overnight service. Rapid reproduction, 419-17N Broadway, Joliet, Illinois.

WEST'S Finest service: 8 exposures, 25¢; 12, 35¢. Jumbos: 8, 40¢; 12, 55¢; 20, \$1.00. Leo's Studio, Dishman, Wash.

PHOTO Or negatives professionally enlarged. Ten 4x6s, one colored, \$1.00. All colored \$3.00. Portraitco, PM780, Sweetwater, Texas.

100 PHOTOSTAMPS! \$1.50 And your returnable picture. Sayer, 1129 Vermont, Washington 5, D. C.

10,000 ROLLS Fresh snapshot film given away. Write today. Delco, Box A362, Upper Darby, Penna.

BETTER Pictures faster, 8 oversize in album 35¢. 12, 50¢. Red Robin, Box 573C, Clifton Heights, Penna.

MOTION PICTURES AND SOUND EQUIPMENT

PRE-Recorded tape, recording tape, accessories, discounts. Eisco Sales, West Hempstead, N. Y.

5,000 8-16MM. Movie films. Free catalogues. International, Greenvale, N. Y.

TAPE Recorders, tape. Unusual values. Free catalog. Dressner, 69-02M 174 St., Flushing 65, N. Y.

MOVIE Camera film: 8mm. roll \$1.50, 16mm. 100' \$3.00. Free processing. Better Films, 742 New Lots, Brooklyn, N. Y.

SAVE 50%! Guaranteed-fresh color, b.&w. movie film! 8mm., 16mm. Free catalog! Eso-R, 47th Holly, Kansas City 12, Missouri.

8-16MM. Kodachrome movies! Slides! Stereos! Illustrated catalog, dime. Refundable. Colonial, 247-X, Swarthmore, Penna.

16MM. Sound-used projectors and films. Rental, sale, exchange, bargain prices. Free lists. Also 8 mm. Specify film size. National Cinema, 71 Dey Street, New York City.

8-16MM. Films. Free catalogue (with sample film 10¢). Garden, 690 Howard Avenue, Brooklyn, N. Y.

ALL Kinds 16mm. sound films. Sale. Cheap. Roshon, 335 Fifth, Pittsburgh 22, Penna.

MUSIC AND MUSICAL INSTRUMENTS

SONGWRITERS. Free booklet successful songwriting. Gateway Songs, Box 2470, Hollywood 28, Calif.

POEMS Wanted for new songs. Send poems. Free examination. Immediate consideration. Songcrafters, Arcade Station, Nashville, Tenn.

SONGS Into dollars. Share \$29 million dollars yearly for new songwriters, poets. Songs composed, published, promoted by famous firm. Information, appraisal free. Send to Nordyke Publishing Co., 6000 Sunset Blvd., Hollywood 28PM, California.

POEMS Wanted to be set to music. Free examination. Send poems, McNeil, Master of Music, 510-PM S. Alexandria, Los Angeles, California.

POEMS, Songs wanted! Free examination. Bengol, 93 Jefferson, Chelsea 50, Massachusetts.

SONGWRITERS! Send poems, songs. Music Service, 243 West 72nd St., PM, New York City 23.

FREE Records of your song. Your words, my melody. Free information. Johnny Mack's Melody Mart, 1094 West 39th Street, Dept. A, Los Angeles 37.

ACCORDIONS, Wholesale to everyone. Save up to 60%. All national known brands. Free catalogue. Del Principe, 29 South Cicero, Chicago 44.

POEMS Wanted for new songs. Send poems. Immediate consideration. Crown Music Company, 1476 Broadway, New York City 36.

WRITE Songs. Big money and reputation. Write for information. J. Gordon Pub. Co., 4700 South California Avenue, Chicago.

VIOLINMAKERS, Repairers. Fine tone wood, and all violin supplies. Send for free wholesale price list. International Sales, 414-MPM E. Baltimore St., Baltimore 2, Maryland.

SONGPOEMS And lyrics wanted. Mail to: TinPan Alley, Inc., 1650 Broadway, New York 19, N. Y.

SONGWRITERS: Recording company wants new songs. Royalty basis. National sales, promotion if selected. Send material. Music Makers, Dept. E-23, Box 2507, Hollywood, Calif.

ACCORDIONS — Direct from importer. Save 50% and more! Free trial. Lifetime guarantee. Trades accepted. Free catalog. Write Accordion Manufacturers, Dept. 76R, 2003 Chicago, Chicago 22, Illinois.

SONGWRITERS: Song poems wanted. \$100 advance royalty paid writer of best song selected each month. Hollywood Tunemasters, Dept. U, 1609 Vista Del Mar, Hollywood 28, Calif.

SONGWRITERS! Protect your ideas! Hold all poems, songs! Write for safe, correct procedure. Song Service, Dept. P, 333 W. 56th, New York City 19.

POEMS Wanted for musical setting. Send poems. Free examination. Five Star Music Masters, 630 Beacon Bldg., Boston, Mass.

ACCORDIONS Wholesale. Latest models. Try before you buy. Lifetime guarantee. Wonderful trade deals. Catalog free. American Accordion Center, 5329-PM7 Belmont, Chicago.

MAGAZINE Old records, 6 issues. \$1.00. Record Research, 131 Hart, Brooklyn 6, N. Y.

PIANO Playing by ear. Complete instructions \$2.00. Sullivan, Box 5381, Jacksonville, Florida.

ARRANGING, \$10; Printing; orchestrating, \$25. Horst, 9 East Philadelphia Street, York, Penna.

RADIO, TELEVISION AND ELECTRONICS

TRANSISTOR Radio, 12,000 mile range. Kit \$7.95. Ekeradio, Pasadena, California.

WALKIE-Talkie. Build wireless two-way portable radiophone for less than \$10.00. Plans 50¢. Springfield Enterprises, Box 54-B7, Springfield Gardens 13, N. Y.

TELEVISION Multiple receptacle power cord. Eliminates tangle of wires between set and wall. Postpaid \$2.98. Marcel Mfg. Co., 1005 Saadi, Houma, La.

TUBES-TV, radio, transmitting, special purpose types. Bought, sold, exchanged. Send details to P. M. Gensler, W2LNI, 512 Broadway, New York 12, N. Y.

HAVE Colored television now. Send \$1.50 for any size screen 12" to 37". M. Pennybaker, R. D. 3, Plain City, Ohio.

BUSINESS OPPORTUNITIES

RARE Opportunity for men in country and small towns. New company with proved plans that make you bigger profits. Write: Fire King, Dept. 24, Littleton, Colo.

EXCEPTIONALLY Profitable opportunity in tape recording. Write: Baron's, Lynden, Wash.

BUY Wholesale! 100,000 name brand products! Save 66%!! Big profits selling others spare time! Free details! National Buyers Service, Box 3338EE, San Francisco.

WHOLESALE List! Bibles, books, testaments. Johnson Wholesale Company, Box 12702, Dallas 17, Texas.

LIQUID Rubber, make flexible molds. Free sample. Chaney, 1130 E. 16th St., Jacksonville 6, Fla.

OPERATE Profitable mailorder business. Splendid opportunity. For details write, Thomas L. Bond, 1637 W. Vernon, Phoenix, Ariz.

WHOLESALE Catalogue! Appliances, cameras, watches! Cam Company, 6806PM 20th Ave., Brooklyn 4, N. Y.

COLOR Concrete with chemicals. Marble-glaze cement benches, pottery. Home-shop. Hundred beautiful designs, made without molds. Birdbaths to waterfalls. Your chance for fame, fortune, 10c brings sample, pictures. Hollywood Cementcraft, 8527-R Wonderland, Hollywood 46, Calif.

EARN \$10,000 Yearly raising Angora rabbit wool for us. Information 25c coin. American Angora Company, Malta 12, Montana.

"MAILORDER Laws and Regulations." Discusses federal, state, local licenses, necessary taxes, legal requirements governing mailorder businesses, \$1.00. "Mailorder Rules for Beginners." Additional helpful information, \$1.00. Play safe. Order both. Tasker, 105 East Custis, Alexandria, Virginia.

IMPORT-Export opportunity, profitable, world-wide, mail-order business from home, without capital; or travel abroad. Established world trader ships instructions for no-risk examination. Experience unnecessary. Free details. Mellinger F701, Los Angeles 24.

MONEY In saw and lawnmower sharpening sparetime at home. Free book. Virgil Foley Company, Columbia Heights, Minnesota.

POPCORN And potato chip equipment. Eakins, Box 933-A6, Springfield, Ohio.

FREE Folio "85,000-\$45,000, Unlimited Vacations." No merchandise, equipment. Unknown! Work home, sparetime! Haylings, Carlsbad, Calif.

\$250 WEEK Cleaning venetian blinds. Patented machinery. Free literature. Robinson, 7213B, Indianapolis 1, Indiana.

NATURAL Molding rubber, extra thick. Free sample. W. Wooley, 115-A Donald, Peoria, Illinois.

MAKE-Sell polishes, cleaners, anything. Formula catalog free. Kemixer, Park Ridge, Ill.

EARN Money at home! Homemaker Magazine tells how. Sample 25c. Sizemore, 20-H East Delaware, Chicago 11.

PLASTERCRAFT Molds, liquid rubber, plasters, flocks, candle supplies. Catalog and manual free. Blue Rapids Supply, Blue Rapids, Kansas.

WHAT'S New in mailorder? Let "Mailorder World," published monthly, keep you informed. Sample, 25c. Wayte, 1233 Elden, Los Angeles 6, Calif.

BREED Rare tropical fish at home. Earn big money! Learn secrets! Help fill huge demand. Amazing opportunity! Free plan. Tropical Fish Breeders, Los Angeles 61, Calif.

BE Appointed state notary public now. Write. Stationers, Helotes, Texas.

COPUBLISH Mail Sale Advertiser, leading mail order paper. Details, latest copy, dime. Vanroy Shirk, Lebanon, Penna.

MINK Raising information free. Complete. Lake Superior Mink Farm, Superior, EEL, Wisconsin.

FREE Book "505 Odd, Successful Businesses." Work home. Expect something odd! Pacific, Oceanside, Calif.

BRONZE Baby shoes. Instructions, equipment and mountings for genuine electroplated process. Free catalog. Hollywood Bronze Supply, Dept. B-3, 1624 East First Street, Los Angeles 33, Calif.

YOUR Own name brand business. No investment; no inventory. Part time or full time. Sell famous brands of appliances, housewares, silverware, radios, vacuum cleaners, lamps, tools, clocks, watches, jewelry, etc., etc., over 1000 items. Join thousands of successful independent dealers. Send for free catalog and dealer price list. H. B. Davis Corp., Dept. W, 145 W. 15 St., New York City.

BIG Profits raising fishworms and crickets. Free literature. Carter Farms, Plains, Georgia.

GROW Orchids at home — Profitable, fascinating. Year 'round, Maine to California. No greenhouse. Gorgeous cattleyas, cymbidiums, etc. Successful home grower shows you how. Full details free. Flowerland, 4622 Wilshire, Los Angeles 5.

WE Love our mailman—He leaves over \$1000.00 monthly in our rural mailbox. My college professor husband drafted a scientific home mailorder method. We bought a Texas ranch, live as we always wanted. Now we sell the Ranch Mailorder Method. Operates anywhere. Inquire: Eveningshade Ranch, Helotes, Texas.

FIX Typewriters. Inexpensive home course teaches factory secrets. Free booklet. Write, Typewriter, Tarentum 1, Penna.

NEWEST Spare, full-time home business. \$5 to \$10 hour possible. Paint with suede—The finish with touch and eye-appeal. Beautify auto dashboards, signs, radios, toys, figurines, lamps—1001 others. Complete, step-by-step instructions sent for no-risk examination. Free details. Coast, Los Angeles 61.

IMPORT-Export mailorder opportunities! Details. Warner, Box 6, Fort Scott, Kansas.

\$46 FROM Square foot plywood; jigsaw necessary. Details free. Woodart, Bridgewater, Mass.

\$70 WEEKLY—Home, spare time. Simplified mail bookkeeping. Immediate income—easy! Auditax, 34757A, Los Angeles 34.

\$150 WEEK—Easy! Start home Venetian blind laundry. Revealing book free. A. T. Co., 101 S. 44th, Philadelphia 4, Penna.

COLORGLAZED Concrete pottery made without molds. Patented method. Cemetery products, novelties, tiles. Basement leak-sealing. Money-making projects. Booklet, details free. Men only. National Potteries Company, Grand Rapids, Minnesota.

\$5,199.90 WAS Paid to John Betts, in few weeks. Grow mushrooms. Cellar, shed. Spare, full time year round. We pay \$3.50 lb. Free book. Mushroom, Dept. 172, 2954 Admiral Way, Seattle, Wash.

VENDING Machines—Every description. New or used. Lowest prices—Start a route or sell outright. Mack Postel, 2952 Milwaukee, Chicago 18.

WANT To make big money at home? \$5 profit in an hour possible with invisible reweaving. Make tears, holes disappear from clothing, fabrics. Steady year-round demand from cleaners, laundries, homes. Details free. Fabricon, 8334 Prairie, Chicago 19, Illinois.

YOUR Own business. No investment. No inventory. Sell name brand nationally advertised items. Free catalog. Confidential wholesale price list. Normandy Dist. Co., Dept. PM, 133 Fifth Ave., New York 1, N. Y.

INTERESTED Mail order? Copies leading mail order magazines. All different. 25¢. Palm, Box 1231, Baton Rouge, La.

BRUSH Plating outfits for plating articles in the home and shop. No tanks necessary. Good income spare or full time. Free particulars. Gunmetal Co., Ave. H, Decatur, Illinois.

HIGHEST Commissions all magazines. Free catalogue, supplies, prizes, exclusive extras. Subscription Service Co., Box 2070, Birmingham, Alabama.

REAL Wholesale sources, thousands nationally advertised products. Details free. Martex, 132-B Nassau St., New York 7, N. Y.

LEARN Sewing machine big money repair, sales, service. Machines, "everything" wholesale. Taylor Service, Box 2126, San Bernardino, Calif.

INTERNATIONAL Mailorder business. Complete setup service—Not just instructions. Hermes, 152 West 42, New York City 36.

FRANCHISE Opportunities nationwide! Profitable distributorships, dealerships, agencies. Request interesting information immediately. National Franchise Reports, 333 North Michigan, Chicago 1.

YOU Can make money at home in spare time taking magazine renewal subscriptions. No capital or experience necessary. All supplies furnished. Write today! McGregor Magazine Agency, Dept. 500B, Mount Morris, Illinois.

TOPFLIGHT Mail-order business opportunity. Modest capital. Request convincing details. Stav, 147 Victoria Street, Kamloops 18, B.C., Canada.

IMPORT Your own products in small lots. Also start profitable mail-order business using International drop shipment method. Capital unnecessary. Free details. Georgia Overseas Trading Company, Dept. W, 715 Persons Bldg., Macon, Ga.

TO \$100 Weekly operating home mail-order business. Write, National Service, Richland, Georgia.

MAILORDER. Your golden gimmick for success. Free book tells all. How, Box 725-A, St. Louis, Missouri.

MAILORDER Success assured. Inquire. Red Kerce, Dept. 2651, Tallahassee, Fla.

METALIZE Baby shoes, jewelry, gifts. Free catalog. Publisher, Box 73136, Los Angeles 3.

OPERATE Statement mailing service from your home as our unit. Lifetime income! American, Mt. Airy, Maryland.

OPERATE Mailorder folio business! Free plan. Ballard's, 425 East Catherine, Louisville 3, Ky.

TYPIST Operate profitable mail-order business. General Sales, 336 Roosevelt St., Creve Coeur 8, Ill.

BIG Money in the dry cleaning business! Learn at home in spare time. We teach you where, when and how to open your own shop. Start with very small investment. Send for free details about this amazing new course. Imperial School, Dept. C-1, 1700 Touhy Ave., Chicago, Ill.

GET Proof there is money in shellcraft. Write today for information and free sample of shells. National Shellcraft, 5604—34th St. No., St. Petersburg, Fla.

"I Earn \$400.00 a week." I've learned an amazing new method of printing colorful signs, banners, cards, posters, glasswear—anything. No printing press or other expensive equipment is necessary! Big money-making opportunity for anyone. Write for my secret and revealing home-business plan, you'll be amazed! Mr. Anderson, Screen Print Company, Dept. PM-7, Los Angeles 61, California.

ADVERTISING Book matches—Cash in on big demand; sell union label matches. Cuts for all businesses and political parties. Free powerhouse selling kit, low prices, protection guaranteed on repeat orders. Cash commissions. Superior Match Co., Dept. MX756, 7530 Greenwood, Chicago.

START A buying service, buy wholesale thousands nationally advertised products. Make big profits selling at sizable discounts. Postcard brings details. American Buyers, Hertel Station, Buffalo 16-C, New York.

50% PROFIT Baking new greasless doughnuts in kitchen. Grocers buy daily. Free recipes. M. Ray, 3605 South 15th, Minneapolis 7, Minnesota.

HOW To fix watches overnight. "Do it yourself method." 70 drawings, 65 troubles, wholesalers listed. Unconditional refund 7 days. Manual \$1.50 postpaid. Weber Service, Box 2489, Denver 1, Colo.

OPERATE Restaurant or diner. Free booklet reveals plan. Write Restaurant Arts, BU-17, Fremont, Ohio.

HAVE Profitable home mailorder business selling quilt pieces, remnant—Full, sparetime! Over 20,000,000 "repeat" prospects! Rush name for details of this amazing moneymaking business today! Coleman, Box 821-A, Newark 1, N. J.

SPECIALIZED Magazines. 5,166 different publications—All businesses, trades, vocations, professions, sports, hobbies, etc. Free list. Write today. Commercial Engraving Publishing Company, 34C North Ritter, Indianapolis 19, Indiana.

MAKE Flexible molds. Cast figurines, plaques. Free sample. Tooker, 630-R Chestnut, Hamilton, Ohio.

WANTED: Home producers, to be subcontractors. Cast plastic products for manufacturers in our clearing house service. Thousands of easily-made items required. Cash in at home, without previous experience. Plastic Service Associates, Dept. 7-PM, East Boston 28, Massachusetts.

WANTED! Home workers to assemble luggage and cases for ready market. Instructions, materials, tools, everything supplied. Free details. Abarst, 807-BH Sunset, Los Angeles 12.

"HOW To Start a Business" booklet sent free! If you know any trade, go into business for yourself! Learn the 9 easy steps to follow. We've guided 5,000 others to success. Revealing free booklet yours for the asking! Write! National Business Consultants, Office PJY, Los Angeles 61, Calif.

WHOLESALE Buyers! New 1956 "blue book" gives names of over 3000 jobbers, manufacturers who supply anything. Free details. Associated Wholesalers, 1016-D10 Starr, Burlington, Iowa.

MAILORDER! New item. Big earnings. Everything furnished. Delta, 2139-F Logan, Youngstown 4, Ohio.

EARN Steady profits supplying stores with our fast selling tricks, jokes and puzzles. Small investment required. Robbins Co., 127-R West 17th St., New York City.

BUY Wholesale! Resell at big profits. Brand name merchandise—Appliances, cookware, housewares, watches, jewelry, dry goods, clothing, sporting goods, toys, gifts, etc. Free 124 page illustrated color catalog with confidential cost sheet. Merit Home Products, Dept. PM-7, 107 Manhattan Ave., Brooklyn 6, N. Y.

MAKE Profitable products. Catalogue free. International, 6347 Parnell PM-7, Chicago 21, Illinois.

\$1,000 MONTHLY Possible in collection agency business. Free details. Write Cole Associates, Syracuse 2, N. Y.

TIN Cans. Turn them into cash. Thirty methods. Sawdust, seventy methods. Newspapers, eighteen methods. Instructions 50¢ each. All three \$1.00. Charles Company, 12-DXT, Norwood, Ohio.

VITAMINS. Outstanding opportunity. No investment necessary. Lifetime income guaranteed. Spare or full time. Chemo, Nicetown Station, Philadelphia, Penna.

MAIL Order advertising agency executive reveals sensational no-risk advertising and merchandise methods. Start in office or home; minimum capital; positive profits. Free details: Impact! 2108 Payne, Dept. 11-7, Cleveland 14, Ohio.

BECOME Income tax consultant. Many graduates earn \$3,000-\$5,000 in 3-month season, part-time. We train you; help you start. State approved. Union Institute, 68 Hudson, Hoboken 2K, New Jersey.

IMPORT-Export opportunities, mailorder, details free. Jeffries, Box 66, Rutherfordon, N. C.

OPPORTUNITY! Start collection agency. Very profitable. Valuable franchise ready. Write: Edmondson, Box 4865-F, Atlanta 2, Georgia.

SELL New nationally advertised 17 jewel watches. Steady income. Your cost \$8.95. Catalog. Result Sales, Dept. M, 580 Fifth Ave., New York City.

MAILORDER Unusual imports. Catalogue free. Parile, Box 2501, San Antonio 6, Texas.

MAKE Unbreakable recording disks. 24 each. Armand Busico, 1035 Jackson St., Philadelphia 48, Penna.

MAKE 80¢ Profit on every dollar selling merchandise by mail. Everything furnished. Write: Eastern, Box 142-A, Boston 24, Massachusetts.

"I'll Set you up in your own business free" Read this startling mailorder offer by a man who makes mailorder pay him \$40,000 year. Literature 10¢. House of Better Books, 722PM East Silver Spring, Milwaukee 17, Wisconsin.

\$10,000 OPPORTUNITY. No experience. Franchise \$1. Moneyback guarantee. Strategic 6228M, Charlotte 7, N. C.

EARN At home. No selling. No mail-order. Good earnings. Folder free. Logan, 18B S. E. 3rd, Evansville 8, Ind.

\$30,000 PER Year in the meat business. No investment or experience required. Free information. Write Meats for Profit, 5801 Cleveland Ave., Worthington, Ohio.

\$5,000 YEARLY. Spare time at home. Nothing to buy. No local selling. Dignified. Guaranteed. Home Harvest, Rt. 3, Box 3491-A, Albuquerque, New Mexico.

SHARPEN Saws and lawnmowers spare time or full time; very profitable. Complete power equipment; easy to operate; no experience necessary; thousands of satisfied users. Send for details including operating suggestions and shop layouts absolutely free. Max Manufacturing Co., 138 Stockton Ave., San Jose 26, California.

HOW To make money with carnival games. 144 page book, 35 illustrations. Enormous profits possible full or part time. \$2.00 postpaid. Free details. Theron Fox, 1296½ Yosemite, San Jose 28, California.

FREE! Business ideas folio. Authentic, hitherto unpublished. Mailaway, Box 79, Bethpage, Long Island.

FREE! "Mailorder writing" information. MGB, 425 East Catherine, Louisville 3, Kentucky.

LIQUID Marble—Brushed, sprayed! Mold novelties, tile. Particulars free. Marbleizing Service, Edwardsville, Illinois.

11,000 NEW Prospects daily. Baby record books, shoes, albums. Sell mailorder. Everything furnished. Free literature. No-Co-Ro, Capitola, California.

AMBITIOUS? We establish you in your own business, supply catalogues, circulars, etc. No stock to carry. We ship your orders, paid or c.o.d., under your name. Sell direct, to agents, by mail. Housewares, tableware, cutlery, hostery, underwear, silverware, shirts, appliances, branded lines, etc. Rush postcard for free catalogues and money-making plans. Topval Corp., Lindenhurst 718, N. Y.

FINANCE Your own business! Free literature. Advance, Box 1377-BG, Miami 8, Florida.

SELL By mail. Big profits. John Hall Agency, 509 Fifth Avenue, New York 17, New York.

UNUSUAL Mail order ideas, products, projects, sources. Authentic information, guidance. Free details. Write: Fax, Box 1024, Galveston, Texas.

MONEYMAKING OPPORTUNITIES

"HOW To Make a Living in Florida." Book of valuable facts, information, ideas and opportunities \$1.00 postpaid. Money-back guarantee. Postcard for further description. Gaystar, Fort Richey, Florida.

EARN Money evenings copying and duplicating comic cartoons for advertisers. Adservice, Argyle 1, Wisconsin.

GENERAL Contest Bulletin. Issued monthly. Sample, 25c. 1609 1/2 East 5th, Duluth, Minn.

FREE Book "505 Odd, Successful Businesses." Work home. Expect something odd! Pacific, Oceanside, Calif.

READ Progressive Mailtrade, the magazine that tells how to make money by mail. Dime brings sample and special offer. Progressive Mailtrade, Box 357, Sheboygan, Wisconsin.

SELL Titania gems; far more brilliant than diamonds. Catalog free. Diamonite, 2420-M 77th, Oakland 5, California.

PRIZE Contests provide fabulous and confidential home income opportunities! Here's how and where to win your share! Send stamp! National Contest Bulletin, Box 2685-P, Miami 16, Florida.

\$150 WEEK—Easy! Start home Venetian blind laundry. Revealing book free. A. T. Co., 101 S. 44th, Philadelphia 4, Penna.

\$5,199.90 WAS Paid to John Betts, in few weeks. Grow mushrooms. Cellar, shed, Spare, full time year round. We pay \$3.50 lb. Free book. Mushrooms, Dept. 173, 2954 Admiral Way, Seattle, Wash.

MAKE Money at home. Spare time. Free literature tells how. Maletto, 1312 So. Clinton, Berwyn, Illinois.

FREE Folio "\$5,000-\$45,000, Unlimited Vacations." No merchandise, equipment. Unknown! Work home, sparetime! Haylings, Carlsbad, Calif.

FORTUNE Possible raising, fishworms and crickets. Free literature. Carter Hatchery, Plains, Georgia.

CONVERT Cheap foods into money making mink. Complete free information. Voight Farms, Lomira 2, Wisconsin; or Atlanta 2, Texas.

ATTENTION: Typewriter owners. Make handsome profits. Write today. Groves Company, 682, Hastings 8, Nebraska.

BUY Wholesale direct! Western states. Save 40% freight charges! Appliances, tools, toys, jewelry, sporting goods. Large catalog, \$1.00. Refundable. General Wholesalers, Box 3058E, San Francisco.

BUY Wholesale! Save 66%! Appliances, furniture, jewelry, toys, sporting goods, tools. Free details! National Buyers Service, Box 3338EB, San Francisco.

IMMEDIATE Cash for used plating equipment. Send description. Equipment Division, 1624 East First, Los Angeles 33, California.

MAKE \$5,000 Yearly sparetime raising mink, chinchillas, nutria, etc. Free booklet reveals proved plans. Write: Furs, 588 Mt. Pleasant Road, Toronto 1, Canada.

START A buying service, buy wholesale thousands nationally advertised products. Make big profits selling at sizable discounts. Postcard brings details. American Buyers, Hertel Station, Buffalo 16-D, New York.

SELL By mail. Start your own business on low capital. Work at home. Free information. Jayelle, Box 181, Imperial, Penna.

TO \$100.00 Weekly. Sparetime, home operated mailorder business. Successful beginner's plan. Everything supplied. Lynn, 10420-M National, Los Angeles 34.

\$50 TO \$100 Per week. No skill necessary. Send 25¢ for sample and details. Arrow-head Sales, 4588 So. Acoma, Englewood, Colo.

NEW Manual. "Huge Home Earnings, Answering Questions." Work sparetime. Detailed information makes it so easy! Send only \$1. Information free. Lowell Service, Box 468, Wellsboro, Penna.

STOP T.V. commercials with a new sound remote control switch. Instructions. \$2.98. Agents invited. Kash Co., 25 Johnson Ave., Newark, N. J.

MEN And women wanted to start home business in spare time with little table-top rubber stamp machine. Easy to earn up to \$9.80 an hour without previous experience. Full particulars free by mail. Send postcard to Roberts, 1512 Jarvis, Room 77, Chicago 26, Illinois.

EARN At home working for us. \$1.00 for sample and instructions. Rub-R-Craft Industries, Box 271, Dept. QJ, Chelsea, Michigan.

MAKE Money writing short paragraphs! No tedious study. I tell you what to write, where and how to sell; and supply list of editors buying from beginners. Many small checks add up quickly. Write to sell, right away. Send for free facts. Benson Barrett, Dept. C-27-U, 1751 Morse, Chicago 26.

PLEASANT Profits—Let us show you how to start your own complete scissors and tool sharpening business. Free details. Serr-Edge Inc., 9735 Lorain, Cleveland 2, Ohio.

MAILORDER Business profitable. Spare time, home, small capital. Free details. Arthur King Isaacs, 523 Market St., Oxford, Penna.

MEN-Women! Start money-making plastic laminating business at home in spare time. Material that costs 11¢ brings back \$2.58. No canvassing or selling but mail orders bring in \$20 a day. Write for full particulars free. Rush name on postcard to Warner, Room 77, 1512 Jarvis, Chicago 26, Ill.

START A profitable subscription business in spare time! We need men and women (young or old) as representatives for all leading national magazines. Liberal commissions on all subscriptions. Supplies free. Send this ad with your name and address to: Agency Bureau, Dept. PM, Hearst Magazines, 250 West 55th St., New York 19, N. Y.

NEW General, religious, comedy "7x11" signs—cost 7¢, sell 50¢. Sample free! Lowy, 812 Broadway, Dept. 933, New York City 3.

WANT To go in business for yourself without capital? We show you how. Start part-time your own home. Postcard brings you details absolutely free. Topval Corp., Lindenhurst 620, N. Y.

START Big-pay business at home in spare time. No experience needed to operate little table-top machine for bronzing baby shoes. Make \$5.46 profit on every pair. Full particulars free. Send postcard to Mason, 1512 Jarvis, Room 77, Chicago 26, Ill.

AMAZING New "Silver-Life" retractable ball pens guaranteed to write one full year. \$1.69 values now 3 for \$1.00. Silver-Life guaranteed 1 year refills 6 for \$1.00. Standard retractable pens 5 for only \$1.00. Standard refills 10 for \$1.00. Imprint and quantity prices. Free advertising specialties idea catalog. Send check, money-order today. Moneyback guarantee. Academy Ideas, 2046 Eastchester Road, Dept. PM-1, New York City.

EXTRA Cash in your spare time. No experience needed. Just show superb Elmira Christmas cards, name imprinted. Samples on approval. Bonus: Free box of cards; also 50% profit on first order. Elmira Greeting Card Co., 287 Clinton, Elmira, N. Y.

RAISE Earthworms. Start now. Small investment—large profits. Send \$1.50 for 100 breeders with instructions. Soil Saver Service, Pawlet, Vermont.

AMAZING Snap-apart beads! Newest jewelry sensation! Free details. Belmar, 24 Walkway, Baltimore 20, Md.

MAILORDER! Sell to doctors, lawyers, accountants, and small businesses. Kroboth, W. 1118A Grace, Spokane, Wash.

EXPORT — IMPORT

JAPAN Trade Guide, 1956 English edition, enables you to make big profits importing from Japan! Published under supervision of Japanese government. 700 pages. Includes import-export regulations, customs, shipping, patents, etc. and 110-page directory listing 2,000 sources of products. Price \$10.75 postpaid—Or write for brochure. Japan Trade Guide, Box 3452 Terminal Annex, Los Angeles 54, Calif.

FORMULAS, PLANS, ETC.

"FORTUNES In Formulas." 900 page book, over 10,000 formulas, plus catalog of chemicals mentioned, only \$4.75, postpaid anywhere. Details free. Chemical Co., 3760 St. Catherine Rd., Montreal 26, Can.

MILLER'S Modern manufacturing formulas make fastest-selling products that get the business and pay. Fifty years supplying the best. Valuable literature free. Miller, Chemist, 1317-F, Tampa, Florida.

PRACTICAL Formulas. Lists free. Cummings, Chemist, Gordon Ave., Syracuse 4, N. Y.

FORMULAS; All kinds, latest, best. Literature free. Kemixal, Park Ridge, Ill.

PRODUCT Analysis, manufacturing formulas, processes developed. Moderate fees. Plastics, Box 1574, Boston 4, Mass.

PLASTICS

LAMINATING Supplies. Free price list. Solomonson, 46 Cornhill, Boston 8, Mass.

FLEXIGLAS. Cut to size. Clear. Any thickness. Colors. Rods. Tubing. McClarin Plastics, P.O. Box 168H, Hanover, Penna.

FLEXIGLAS. Lucite. Square foot cost, 1/16"-\$1.15; 1/8"-\$1.52; 3/16"-\$1.86; 1/4"-\$2.21; 5/16"-\$3.23; 1/2"-\$4.36. Colors add 10%. Send 15¢ for postage. Aristocrat Plastics, 23-25 Sussex Ave., Newark, N.J.

LEARN Plastics fabrication for spare time income. Low cost home training now available. Write for free booklet. Interstate Training Service, Dept. D-3, Portland 13, Ore.

NEW Liquid casting plastic, clear, colors. Embed real flowers, insects, photos, coins. Saw, drill, carve. Send 25¢ for handbook. "How to Cast with Liquid Plastic," and proved success plan showing how to make money at home. Castolite, Dept. H-101, Woodstock, Ill.

CHEMISTRY

ILLUSTRATED Catalog: Chemistry, mineralogy, biology 20¢. Tracey Laboratories, Evanston, Illinois.

AMAZING New book of science. Experiments, formulas and catalogue of laboratory supplies. Only 25¢. National Scientific Co., Dept. PM-7, 500 W. Road, Lombard, Illinois.

HOME Laboratory and apparatus kits, laboratory supplies. Catalog 25¢. John H. Winn, 124A West 23rd St., New York, N. Y. Established 1931.

CHEMICALS And apparatus for industrial, analytical, and private laboratories. Catalog 25¢. Dept. M-50, Biological Supply Co., 1176 Mt. Hope Ave., Rochester 20, N. Y.

BOOKLETS: 60 pages each! "Beginners Chemistry," "Chemistry," "Einstein's Relativity," "Physics," "Atomic Theory," "Electron Theory," "Scientific Oddities," "Light," "Sound," "Heat," "Electricity," "Radio," "Astronomy," "Useful Tables," "Geometry," "Mathematical Oddities," "Scientific Terms." Order by titles, 10¢ each. Franks, 3121 South Racine, Chicago 8.

AGENTS WANTED

NEW Era in ball point pen values makes this the easiest selling item on market today of any item. Gives you a big opportunity for steady big commissions. Prospects unlimited. Comparison cover name test proves that Guaranteed "Value" ball point pens many times out-perform nationally advertised higher-priced pens. Standard size. Guaranteed quality refills. miracle ink. Many new features first time shown, in imprinting, modern packaging and smart styling. Special designed ball point pens for hotels, banks, etc. Send for our planned selling instructions and confidential price list of entire Guaranteed line. Value Pen Co., 475 Fifth Ave., Dept. F, New York 17, N. Y.

MAKE Extra money with newest Christmas card assortments. 21-card \$1.00, \$1.25, \$1.50 "tall-slim" Christmas, all occasion, religious assortments, gift wrappings, gifts, novelties, imprinted Christmas cards. Experience unnecessary. Profits to 100% plus cash bonus. Write for samples on approval. Free \$1.00 gift offer, catalog, selling plan. Hedenkamp, 361 Broadway, Dept. PM-42, New York City.

60% PROFIT On cosmetics—Famous nationally advertised Hollywood cosmetics pay 60%! Make \$25-day up! Hire others. For free samples, details, write Studio Girl, Glendale, Calif., Dept. 12670.

\$50, \$75, \$100 FOR YOU! Show friends new type Christmas, all occasion greeting card assortments, gift wrappings, novelties. Profits to \$1.00 per box. Bonus. Write today for feature boxes on approval, 7¢ free samples personal Christmas cards, stationery, free catalog. New England Art Publishers, North Abington 733-C, Mass.

NEW Bathroom deodorizer. Hangs on wall. Banishes odors bathroom, kitchen. Lightening seller. Samples sent on trial. Kristee Co., Dept. 50, Akron 8, Ohio.

SELL Newest tall Christmas cards—Make 75¢ on sensational \$1.25 assortment. 250 hottest gifts, cards, stationery. 50 exclusive personalized designs, super-roll gift wraps, 30 for \$1 box. Samples on approval, surprise offers, prompt action gift. Cardinal, 1400 State, Dept. H-79, Cincinnati 14.

MOORE Made \$9.00 in an hour selling farmers. Hundreds of salesmen making good money full time or spare time with 3 leading poultry magazines welcomed everywhere. No investment or experience needed. Powerful sales kit free. Poultry Tribune, Box 467, Mount Morris, Illinois.

BIGGEST Christmas card profits. Sensational "Super-36" assortment pays \$1.25 profit on every box—\$50.00 on 40 boxes easy. 200 fast sellers double earnings! Tall cards, novelties, stationery, bargain specials. Assortments on approval. Color catalog, personalized album free. Midwest, 1113 Washington, Dept. 494-P, St. Louis 1, Mo.

\$1,000.00 A Month for making dramatic 3-second demonstration of amazing light-weight Presto fire extinguisher. New chemical used by airforce snuffs out fires instantly. Only \$3.98. Terrific commissions. Millions want it. Free kit. Merlite, 114 E. 32nd, Dept. P-51H, New York City 16.

FREE Box of 21 nationally famous Christmas cards included with other fast selling assortments sent on approval. Earn \$50.00 by selling only 50 boxes of our 900 series Christmas card assortment. Can be done in a few hours of your spare time. Sunshine Art Studios, Inc., Dept. PM7, Springfield 1, Mass. Pasadena 1, Calif.

AT Last! Something new and sensational in latest tall Christmas cards. Make extra money fast! Show satins, velours, metallics. Gets easy orders. Pays up to 100% profit. 30 free samples. With name 50 for \$1.50. Big line. Amazing convertible pen-pencil, napkins, gifts, stationery. Several \$1.00 boxes on approval. Puro Greetings, 2801 Locust, Dept. 640-J, St. Louis 12, Mo.

NEW Household item, tremendous market, fast seller, big profits. Send for details and free sample offer. M & M. 842 Third Ave., Dept. PM-4, New York City.

AMAZING New "Touch-Glow" Christmas cards sell swiftly from free samples. \$62.50 profit on 50 boxes easy! Many tall cards, stationery, novelties, album of imprints. Profits to 100% plus gift bonuses. Samples on approval. Creative, 4401 Cermak, Dept. 509-D, Chicago 23.

BUY Wholesale thousands nationally advertised products at big discount. Free "Wholesale Plan." American Buyers, Hertel Station, Buffalo 16-A, N. Y.

RUN Spare-time greeting card and gift shop at home. Show friends samples of our new 1956 Christmas and all-occasion greeting cards and gifts. Take their orders and earn to 100% profit. No experience necessary. Costs nothing to try. Write today for samples on approval. Regal Greetings, Dept. 89, Ferndale, Michigan.

MAKE Up to 100% profit in your spare time! No experience needed! Sell from big free catalog. Tremendous selection of unique gifts, gadgets, greeting cards, including world-famous brands like Westinghouse! Don't waste valuable time! Cash in on extra profits. Send for free colorful catalog and free money making plan today! Hurry! Greetings Unlimited, 334 Park Square, St. Paul, Minnesota.

EASIEST \$65 You'll ever make! Show amazing "Magic-Lustre" Christmas cards. 65 boxes pay \$65. Personalized cards 25 for \$1. Assortments on approval, free sample book "Southern Belle" doll free for promptness. Southern, 478 N. Hollywood, Dept. K-63, Memphis 12, Tenn.

NEW Plastic mending tape. Just press on! Repairs clothing instantly. Lightning seller. Samples sent on trial. Kristee Co., Dept. 51, Akron 8, Ohio.

OPPORTUNITY For making extra cash! Sell unique gifts, gadgets, greeting cards, gift wraps, from one of the largest, most exciting lines in America! Over 600 "hot sellers" from all over the world! Don't wait! Send for big free colorful catalog at once! Sell full or spare time. No experience needed. North Star, 734 Park Square, St. Paul, Minn.

NEW, Different auto necessity. A must for all auto riders. Nothing else like it. 100% profit. Repeats. Free details. Hygienic Products, Box 1034, Oak Park, Ill.

FREE! Beautiful feather pictures 200% profit! Apartado 9036, Mexico 1, D. F.

BIG Profits! Sell miracle "no ring" spot remover in stick form. Non-inflammatory. Guaranteed. Free details. M & M. 842 Third Ave., Dept. PM-1, New York City.

AMAZING New "Colorama" sample kit makes money like the mint. Contains 96 different retractable ball pen color combinations. Top quality pens, imprinted—Priced from 23¢ each. Prospects buy on sight. Steady repeats. Big cash profits galore. Send \$2 deposit for kit worth \$5, refundable first order. Academy Ideas, 2046 Eastchester Road, Dept. PM-2, New York City.

FAST Selling money makers! Metallic ironing board cover; purse-shopping bag; many others including \$1 retailers. Quality Products, Dept. A, Box 748, Passaic, New Jersey.

IF You want to earn money fast. I'll send you free sample stocking of newest stretch DuPont nylons to sell at only \$1 a pair. American Mills, Dept. 495, Indianapolis 7, Ind.

AGENTS Opportunity. Grotesque, beautiful cypress knees, 50¢ up. Details. Gipple's Giftwares, DeLeon Springs 5, Fla.

UP To \$200 weekly selling amazing puncture proofing compound. Terrific seller. Big profit. Free details. M & M. 842 Third Ave., Dept. PM-2, New York City.

MEN-Women agents: Sensational new money-makers—Beautifully hand-painted, plastic personalized photo enlargements, compacts, rings, bracelets, lockets, etc. Simply take orders, pocket 40% commission. We deliver and collect. Sales outfit free. Novelco, 3343 North Avenue, Chicago 47.

GOLDMINE Of 600 money makers. Copy free. Specialty Salesman Magazine, Desk 5-B, 307 N. Michigan, Chicago 1.

HOME Motorized massage. Big money! Mary Mac, 1012 Powhattan, Dallas 2, Tex.

YOUR Own business—Used suits \$1.50, overcoats 65¢, mackinaws 35¢, shoes 12½¢, ladies coats 30¢, dresses 15¢. Enormous profits. Catalog free. Nathan Portnoy Associates, 605-AA West 12th Place, Chicago 7.

GOLD Or silver letters, numbers. Windows, doors, trucks. 1" to 6". 500% profits. Free samples. Atlas-T, 544 West 79th, Chicago 20.

PRINTING. Advertising salesmen—Excellent moneymaking sideline selling decalcomania name plates, small quantities. Automobile initials, sign letters. Free samples. Ralco, XL, Boston 19, Mass.

\$1.00 PROFIT Selling \$2.95 photo enlargement deal. Allen Studio, Riegler Bldg. Little Rock, Ark.

AGENTS—300% Profit selling genuine gold window letters; stores and offices. Free samples. Metallic Sign Letter Co., 431-D North Clark, Chicago.

USED And new watches \$2 up. Free list. Southern Watches, Gray, Georgia.

YOUR Ad in this space will get some good agents for you. Yes, I'll prove it. Write for Folder "A" right now. F. W. Johnson, Classified Advertising Manager, Popular Mechanics Magazine, 200 E. Ontario St., Chicago 11, Ill.

EASY Handwork makes fast-selling articles. Sample free. Sunmade Company, Brockton 64, Massachusetts.

WANT More business? Here's an amazing opportunity to increase your sales. Talk to thousands of interested readers of "Mechanica Popular." Our Spanish Edition covers the Latin American countries like a blanket. They're real mailorder buyers. Classified rate 75¢ per word. Try an ad in our next issue. Classified Advertising Department, Popular Mechanics Magazine, 200 East Ontario Street, Chicago 11, Ill.

CALIFORNIA Sweet smelling beads. Sensational sellers. Particulars free. Mission, 2328-PM W. Pico, Los Angeles 6, California.

BUY IT WHOLESALE

WHOLESALE. Famous brands. Welch 7802 West Hicks Street, Milwaukee 14, Wis.

WHOLESALE Catalog! Appliances, cameras, watches. Postcard: Selbyco, Decatur 258, Illinois.

WHOLESALE Catalog! 30-80% discounts! Appliances, musical instruments, typewriters, phonographs, watches, jewelry, recorders, housewares, etc. Consolidated Distributors, 21-20 Lafayette, Paterson, New Jersey.

ELECTRIC Guitars, amplifiers, accordions, wholesale. Free catalog. Carvin, PM287, Covina, Calif.

REAL Wholesale sources thousands nationally advertised products. Details free. Martex, 132-C Nassau St., New York 7, N. Y.

USED And new watches \$2 up. Free list. Southern Watches, Gray, Georgia.

BUY Wholesale. Famous brands. Catalog 25¢. Golden Feather Service, 1061-A Atlantic, Long Beach 13, Calif.

FREE Gift catalog. Wholesale catalogs, name brands. Edith's, Deep River, Conn.

FREE Booklet. Save 50% on vitamins. All formulas. Vitamins, Philadelphia 40, Penna.

52 PAGE Illustrated wholesale catalog. 10¢! Marpat, Box 1485, D-JUPM, Milwaukee, Wis.

NEW Lever-ratchet screwdriver. Quick-change blades. Free circular. Wiltron, Box 765, No. Hollywood, Calif.

BUY Wholesale! Nationally known brands. Catalog \$1.00. D'Auria, Box 355-PM, Jackson, Michigan.

BUY Wholesale. Name brands. \$1.00 catalog deposit. Refunded on \$15.00 order. V. & G. Co., P.O. Box 146, Marion, Ohio.

YOUR Wholesale cost as little as 25¢ on dollar! Housewares, tableware, hosiery, shirts, underwear, appliances, branded lines, silverware, jewelry, etc. Sell direct, by mail or to agents. No stock to carry. We ship your orders, paid or c.o.d., under your name. Rush postcard for catalogues, confidential distributors' wholesale prices and money-making plans absolutely free. Topval Corp., Lindenhurst 424, N. Y.

WHOLESALE! Appliances; housewares; jewelry! Free details. Midwest, B-156-M, Peotiac, Illinois.

SALESMEN—DISTRIBUTORS

USED And new watches \$2 up. Free list. Southern Watches, Gray, Georgia.

NEW Jobs open in selling! Send name, address for five free issues of Opportunity Magazine's money-making guide, listing hundreds of companies who'll pay you well, full or part-time. No experience needed. Opportunity, 850 N. Dearborn, Dept. 17, Chicago 40, Ill.

BUILD Sales by recruiting productive distributors selling direct or to retail outlets. Secure most concentrated circulation through classified columns of Salesman's Opportunity. Write for facts. Gilbert, Salesman's Opportunity, Room 1700, 850 N. Dearborn, Chicago 10.

TOP-Flight business opportunity. The conditions governing it are extraordinary, unique. Its promise is spectacular. It presents one of the most promising selling opportunities for agents it is possible to conceive. Convincing facts mailed on request. Natural Food Supplement Co., Box 1277A, Colorado Springs, Colo.

SALESMEN Wanted. Commission basis. Work glove line. David's Gloves, Inc., Springfield, Ohio.

GOOD Man can make \$3,000.00 next 90 days. Every house in town wants amazing Nilite "cats-eye" lawn sign. Automatic selling plan pays profits everyday. Write today for free details. Nilite, 173 W. Madison, Dept. 301, Chicago.

ADD \$20.00 To \$200.00 per week to your income with Miracle Bowls! Sell door to door and store to store. Just add water and watch them grow. Write for free literature now. Miracle Bowls, Dept. 3, Littleton, Colorado.

ADVERTISING Book matches—Cash in on big demand; sell union label matches. Cuts for all businesses and political parties. Free powerhouse selling kit, low prices, protection guaranteed on repeat orders. Cash commissions. Superior Match Co., Dept. M-756, 7530 Greenwood, Chicago.

BREATHTAKING Demonstration instantly sells revolutionary Rid-O-Rust. Banishes rust forever. \$1.00 prepaids trial pint. Davis Laboratories, 520 Nebraska St., Dept. A-2, Sioux City, Iowa.

\$6.73 PROFIT On every sale of Lightning portable adding machines. Retail \$14.95. Write for details. Lightning Adding Machine Sales Co., Dept. CI, 2306 W. Slauson Ave., Los Angeles 43, Calif.

CALENDARS. Advertising novelties, matches. All styles, including religious, varnished, 12 sheet, girls. Hundreds of advertising novelties, book matches, etc. Fleming Calendar Co., Sales Division, 6539 Cottage Grove, Chicago 37, Ill.

AD Matches! Sell amazing designs—10, 20, 30, 40 and 240-light book matches. Bigger spot cash commissions; every business a prospect. Low prices for high quality. Repeats. Start without experience; men, women; full, part time. Buy nothing! Sales kit furnished. Match Corp., Dept. PM-79, Chicago 32, Illinois.

\$1,000.00 A Month for making dramatic 3-second demonstration of amazing light-weight Presto fire extinguisher. New chemical used by airforce snuffs out fires instantly. Only \$3.98. Terrific commissions. Millions want it. Free kit. Merlite, 114 E. 32nd, Dept. P-51H, New York City 16.

SELL Calendars. You make big money daily. Giant line. Every business buys. Also business printing, book matches, advertising specialties. Big sales outfit free. Write, Arrow Press, 5150 Fourth Ave. So., Minneapolis, Minn.

BUY Wholesale thousands nationally advertised products at big discount. Free "Wholesale Plan." American Buyers, Hertel Station, Buffalo 16-J. N. Y.

ANYONE Can sell famous Hoover uniforms for beauty shops, waitresses, nurses, doctors, others. All popular miracle fabrics—Nylon, dacron, orlon. Exclusive styles, top quality. Big cash income now, real future. Equipment free. Hoover, Dept. G-100, New York 11, N. Y.

NEW Product! Keeps neckties tied perfectly. Free information. Sample 25¢. Acro Sales, 10527 Divine, Detroit 13.

EMPLOYMENT INFORMATION

FOREIGN, U. S. employment information, construction work, all trades, welders, operating engineers, pipefitters, carpenters, clerical, etc. Good pay. \$1.00. Employment Information, 412(R) Albee Building, Washington 5, D. C.

COPYRIGHTED Reports on best paying jobs with travel, adventure, promotions. Construction, aviation, shipping, laborers, clerical, trades, supervisory, factory, unusual opportunities. Many types of work. Skilled and unskilled. Foreign and state-side openings for men and women. Only \$2.00 (\$2.25 airmail), including registration-advisory service. Satisfaction guaranteed. Included absolutely free: Special reports on Alaska, Spanish airbase construction, South American opportunities and husband-wife foreign jobs. Research Services, Suite 207-PMF, Brown Building, St. Louis 5, Missouri.

SAN Francisco, Oakland help wanted columns \$1.00. State sex, and paper. Howard, Box 26, Oakland 4, Calif.

JOB Information—High pay. South America, the Islands, USA, foreign countries. All trades. Clerical, labor, engineers, drivers, others. Women also. Companies pay overseas fare if hired. Write Section 92P, National Employment Information, 1020 Broad, Newark, N. J.

FOREIGN Jobs list. Satisfaction guaranteed. \$1. Rathe, Box 26131, Los Angeles 26, Calif.

FLORIDA Job opportunities—Men-women. Write Millers Service, Inverness, Fla.

AVIATION And guided missiles employment (U.S.A. and Canada). Companies and persons to contact, \$2.00. Pestech, Box 548N, St. Louis 1, Missouri.

EDUCATIONAL AND INSTRUCTION

LEARN Another language at home with Linguaphone, the world's standard conversational method on fine, life-like recordings. You learn to speak French, Spanish, German, Japanese, Modern Greek—Any of 34 modern languages easily, quickly, naturally. It's like living in another country. Complete language courses available for free trial. Send for free book and details of free trial. No obligation. Linguaphone Institute, T-83-076 Rockefeller Plaza, New York City 20.

USED Correspondence courses and books bought, sold, rented. Catalog free. Myrtle Vernon, Henagar, Ala.

CONVICT Script lesson with free brochure, handwriting character analysis self-taught. Lucas Syst. m, 2419 Sunset Boulevard, Los Angeles 26, California.

COMPLETE Your high school at home in spare time with 59-year-old school. Texts furnished. No classes, Diploma. Information booklet free. American School, Dept. XB45, Drexel at 58th, Chicago 37, Illinois.

BLUEPRINT Reading—Train at home. Learn to read blueprints with confidence in 10 easy lessons. Write today Belton School, 1059-S North Lawndale, Chicago 51.

EARN Degree. Free bulletin. Home-study only. Midwestern Bible School, 1060 Broadripple, Indianapolis.

PHOTOGRAPHY For pleasure or profit. Learn at home. Practical basic training. Long established school. Free booklet. American School of Photography, 835 Diversey Parkway, Dept. 344B, Chicago 14.

FINISH High school at home, spare time. No classes. Diploma awarded. Write for free catalog. Wayne School, Catalog HF-65, 2527 Sheffield, Chicago 14.

WELDING Training pays at Hobart Welding School, Box M-761, Troy, Ohio. VA contract. Best equipment. Catalog free.

HELP Yourself to abundant living. Our courses have aided students to richer fuller lives. Learn secret of contentment, happiness. Earn degrees Ps.D., Ms.D. Write for free book. College of Universal Truth Correspondence School, 23-C E. Jackson, Chicago.

HAND Engraving; learn at home. Write Box 116, Mishawaka, Ind.

STUDY For Doctor's degree of psychology, metaphysics and divinity. Correspondence courses only. College of Divine Metaphysics, Dept. P-M, 2811 North Illinois, Indianapolis 8, Indiana.

LEARN Mineralogy at home. Diploma course. Fortunes now being made in uranium and other minerals. Free catalog. Mineral Science Institute, Desk 2, 159 East Ontario, Chicago 11.

HIGH School diploma at home. Licensed teachers—Approved materials. Southern States Academy, Box 144-MX, Station E, Atlanta, Georgia.

PIANO Tuning pays. Big money in spare time. Learn at home in 30 days. No musical knowledge necessary. Phonograph, records, tools and instructions furnished. Free catalog. Capital Tuning School, 16 Southwest Second, Fort Lauderdale, Fla.

I want to send you proof of the wonderful pulling power of Popular Mechanics classified pages. What's your proposition? Write me today. Include literature if possible. F. W. Johnson, Manager Classified Advertising, Popular Mechanics Magazine, 200 E. Ontario St., Chicago 11, Ill.

\$5,199.90 WAS Paid to John Betts, in few weeks. Grow mushrooms. Cellar, shed. Spare, full time, year round. We pay \$3.50 lb. Free book. Mushrooms, Dept. 174, 2954 Admiral Way, Seattle, Wash.

BE A real estate broker. Study at home. Write for free book today. GI approved. Weaver School of Real Estate, 2018P Grand, Kansas City, Missouri.

EARN While you learn. Auto and diesel mechanics master this top paying trade. Many graduates earn \$100 a week and up. Approved for Korean veterans. For free information write Dept. No. 256, Nashville Auto-Diesel College, Nashville 3, Tenn.

BOOKKEEPERS! Increase your earnings! Operate your own simplified "Dollar-A-Week" bookkeeping and tax service. Full or spare time. Details free. No obligation. Ellis, Box 200, Cedar Grove, North Carolina.

USED Correspondence courses and books sold and rented. Money back guarantee. Catalog free. (Courses bought.) Lee Mountain, Pisgah, Alabama.

WANT A diesel job? New opportunities to increase income. Higher pay. More money. We can help you qualify. Tools. Shop method home training. Write today! Diesel, Tractor, Heavy Equipment Division, Interstate Training Service, Dept. B-3, Portland 13, Oregon.

LEARN Free how to become glamour photographer. Make big profits photographing beautiful models. Opportunities nation-wide. No previous experience or expensive equipment needed. Write for free illustrated Success Plan. Harrison's, 1031-C Magnolia Park Station, Burbank 10, Calif.

INVESTIGATOR Training. Phillips Secret Service System, 1917-d North Kenneth, Chicago 39.

USED Correspondence courses and educational books bought, sold, rented. Free catalog. Educational Exchange, Menlo, Georgia.

ENGINEERING Degrees earned by home study. American College of Engineering (University of the West), Box 27724, (B) Hollywood 27, Calif.

BE Popular. Win friends. Gain self-confidence. Influence people. \$2.00 reveals secret rules. Human Relations, 2149-B Melante Dr. N.E., Atlanta, Ga.

LEARN To remember; faces, names, anything. New amazing simple method. Easily mastered. Sample lesson free. Memory Studio, 2016 Sunnyside, Chicago 25.

DRAFTING—Design. Architectural, Mechanical, Electrical, Structural, Aircraft, Mathematics, Physics, Estimating, Surveying, Veteran approved. Mondell Institute, 230 West 41st, New York City.

STAMMERING Habit broken and cured! Successful Emery correspondence course subject of Medical Record, Newsweek articles. Write Emery Institute, Box 867 PM-8, Winter Park, Florida.

TRANSFORM Yourself via subconscious. Free brochure. Box 847 (H-7), Ocean Park, Calif.

STARTLING Discovery! Amazing new, uncrowded profession. Know yourself, others; how they think, act. Big money, recognition, returns for those who qualify. Learn at home, spare time. Send only \$1.00 for secrets (regular price \$1.50). \$3.00 credit coupon given. Give age, occupation, your handwriting for surprise worth \$1.00. Estes, 2307-PM National Station, Springfield, Missouri.

WANT Strong, masculine voice? Send for free booklet. Perfect Voice Institute, 210 South Clinton, Studio 2GU-2, Chicago 6.

VITAL Message of world-wide importance to everybody. Compiled by scientist-critic. Copy \$1.00. Conrad Stadick, Searles 7, Minn.

CRIMINOLOGY. Diploma course. Boston School Criminology, Box 2121-M, Boston 3, Massachusetts.

SWEDISH Massage. We train you at home. Earn big profits from your own private practice or work with hospitals and doctors. Free catalogues. National Institute, Desk 4, 159 E. Ontario, Chicago, Ill.

BOOKS; Hundreds of subjects. Big catalog free. Popular Mechanics Press, 200-BC East Ontario St., Chicago 11.

LEARN Real estate business for highly profitable life-time career, study at home, pass any state exam. Low cost, money-back guarantee. Free literature. Act now for a profitable 1956. Seavy Realty Institute, 13346F Bessemer St., Van Nuys, Calif.

PLAYS, STORIES, MANUSCRIPTS

WANT Your book published? Learn how we publish, advertise, promote, distribute. Many successes. Free booklet PM. Vantage, 120 West 31, New York City.

WANTED: Book manuscripts, all subjects considered. Greenwich Book Pub., Atten. Mr. Zealand, 489 Fifth Ave., New York City.

SPECIAL SERVICES

INFORMATION. Assignments, Research. Licensed bonded investigator. Grant, 34 Park Row, New York City 38.

GHOSTWRITING. Folios, ads, etc. written. John Doran, 310 E. Harrison, Seattle, Washington.

MANUFACTURING Source, any article \$1.00. Lombard, 296 West Fifth, South Boston 27, Mass.

ARTISTS' SUPPLIES

TEXTILE Painting stencil catalog and sample 25¢ Ceramic catalog also. Aluminum Art Products, Dept. PM, 225 W. 8th, Kansas City, Mo.

IF Interested in artist frames, canvas, canvas boards, Red Sable brushes, etc., be sure to get our money saving price lists before buying. International Sales Co., 414-APM E. Baltimore St., Baltimore 2, Md.

CARTOONING, COMMERCIAL ART, SHOWCARD & SIGN PAINTING, TATTOOING

DRAW Your way to fame. Free information. Cartoons-of-the-Month, Roslyn, N.Y.

LEARN Sign painting at home. Free talent test. Ben Kerns, Box 812-PM, Greenville, S.C.

LEARN Cartooning! Professional instruction! Details free! Cartoonists, 2776 California Court, Lincoln 10, Nebraska.

TATTOOING Supplies. Free catalog. Spaulding & Rogers, Court St., Jacksonville, North Carolina.

YOU Can entertain with chalk talks. Catalog 10c. Balda The Cartoonist, Oshkosh, Wis.

TATTOOING Supplies, licensed course, illustrated brochures 25c. Zeiss, 728 Lesley, Rockford, Illinois.

ADVERTISING AGENCIES, LETTER WRITERS, FOR ADVERTISERS

ADVERTISING, Result-getting ads prepared, placed newspapers, magazines, radio, anywhere! Lowest rates. Catalogue free. Baker Advertising Agency, 189 W. Madison, Chicago 2.

ADVERTISING Ratebook leading newspapers, magazines, free. Chicago Advertising Agency, Chicago 4.

MAILING Lists most any classification \$5.00 1000. Your circulars mailed with ours \$4.00 1000. Write for our literature. Dixie Mailers, King, N. C.

RUBBER STAMPS AND OFFICE SUPPLIES

RUBBER Stamps, 4 lines \$1.50. Rough-edge's, 2 Lionel, Clark 1, N. J.

NAME, Address rubber stamp \$1.00. Quality work. Cook, 1750 Manhattan Bch. Blvd., Manhattan Beach, Calif.

3 LINES \$1.00. Fast, professional service. Satisfaction guaranteed. Arcraft, Box 8038, West Palm Beach 18, Florida.

THREE Lines \$1.00. Free stamp pad. Barber, R.R. 3, Marengo, Ohio.

TYPEWRITERS, DUPLICATORS, OFFICE DEVICES

SPECIAL Sale—70% off. Amateur printers, public stenographers, hobbyists, small schools. Hilco Model #4 duplicators for sale while they last in original cartons \$19.95 (incl. tax). Send money order to Technygraph Company, Techny, Illinois. Shipped prepaid.

PORTABLE Mimeograph! Uses no stencil, no ink. The newest, cleanest, smallest, lightest and cheapest. Weight 15 pounds. DuPont Distributors, Dept. A, P.O. Box 695, New York 1, N. Y.

RECONDITIONED Typewriters, duplicating, printing devices. \$25.00 up. Supplies. Appliances, DixieGraph, King, N. C.

PRINTING, MULTIGRAPHING, MIMEOGRAPHING, GUMMED LABELS

CATALOG: Printing, offsetting, mimeographing. Carol Ann, 1863 Edgewood, Norfolk 3, Virginia.

OFFSET Printing \$6.50 — 1000. 8 1/2 x 11, 16 lb. National Letter, 251 W. 42 St., New York City 36.

SPECIALIZING Letter heads, envelopes. Samples free. Inkdaubers, 9333 Longfellow, Jackson, Mich.

QUALITY Printing, mimeographing, signs. Selco Products, Department PM-756, Danvers, Massachusetts.

BUSINESS Cards, 2000 mailing labels \$4.85. Samples. Brown, 1714 Cardinal, Indianapolis 27, Ind.

1,000 RAISED Letters business cards \$2.95. Samples. Pioneer, 195-G Quebec, Island Park, N. Y.

MIMEOGRAPHING—Letters, pricelists, formulas, instructions. Lowest prices. Lem's Letter Shop, 5710 Stanton, Detroit 8.

ADS Running under this heading sell printing. Ask me for proof. I'll gladly send you amazing facts. Ask for Folder "P." P. W. Johnson, 200 E. Ontario St., Chicago 11, Ill.

36 PAGE Illustrated printing catalog free. Graves, Box 461, Canyon, Texas.

FREE Catalog! Business printing, offset, mimeographing. D'Yarmett, 420 Columbian, Columbus 23, Ohio.

FREE Catalog business, personal printing. D. M. Press, Sebastopol, California.

BILLBOOKS, Statements, envelopes, rubber stamps. Eddirose, Bronx 73, N. Y. Free catalog.

QUALITY Printing. Lowest prices. Estimates free. Stone Press, 203 West Allegheny Avenue, Philadelphia 33, Penna.

GUMMED Roll Labels, 500 personal or business, three lines \$1.00. One day service. Alexander, Box 474, Pomona 1, Calif.

GOOD Printing! Rush service. Prices low. Bass Press, Knox, Indiana.

250 BOND Letterheads, 8 1/2 x 11. \$2.50 postpaid. Henne, 126-15 Jamaica Avenue, Richmond Hill 18, N. Y.

1000 PRINTED Name and address gummed labels \$1.00. No c.o.d.s. Print clearly. Sheldon, 115 Ninth, Philipsburg, Penna.

100 LETTERHEADS, 100 Envelopes, 3 line rubber stamp—same copy, all \$2.25 postpaid. Cash with order, print plainly. Sooner Press, P.O. Box 2431, Oklahoma City, Okla.

MIMEOGRAPHING—High quality, reasonable prices. Free samples, pricelists. Mail-Mc-Mimeo, 920 Vanburen, Milwaukee 2.

QUALITY Printing reasonable. Free sample. Econoprint, Box 625, Whittier, Calif.

PRINTING OUTFITS AND SUPPLIES

RUBBER Stamp making presses, hydraulic operated, electrically heated. Also supplies. Custom, Box 211-M, Springfield, Missouri.

MAKE Your own self-molding rubber stamps and printing cuts. Plexirubber, Argyle 1, Wisconsin.

DO Your own printing. Save money. Simple rules. We supply everything. Print for others: good profit. Raised printing like engraving too. Have home shop. Details free. Kelsey Presses, V-11, Meriden, Connecticut.

QUALITY Stock cuts, proofs 25c. Velazquez, 3124 3rd Avenue, New York City 51.

PRESSES, Type cabinets, supplies. List for stamp. Lincoln Press Company, 220-G Hartwell, Fall River, Mass.

PATENT ATTORNEYS

PATENTS—Irving L. McCathran, 315 McLachlen Bldg., Washington 1, D. C. Registered Patent Attorney.

INVENTION Record form free and "Patent Information Every Inventor Should Have." Carl Miller, Registered Patent Attorney, Woolworth Building, New York.

INVENTORS—Take these preliminary steps toward patent protection. Sketch and describe your invention. Sign, date and have this disclosure witnessed by two people who understand your invention. Have us make a preliminary search among U.S. patents already granted for similar types of invention. We report on the probable patentability of your invention and recommend your further course of action. Write for our instructive booklet, "Patent Protection for Inventors" and convenient "Evidence of Invention" disclosure form. Victor J. Evans & Co., 231-H Merlin Building, Washington 6, D. C.

REGISTERED Patent attorney offers services. Sanders, 6430 Evans, Chicago 37, Illinois.

C. A. Snow & Co.—M427, Snow Building, Washington 1, D. C. Registered Patent Attorneys. Write for information.

INVENTORS: When you are satisfied that you have invented something of value write me, without obligation, for information as to what steps you should take to secure a patent. Write Patrick D. Beavers, Registered Patent Atty., 935 Columbian Bldg., Washington 1, D. C.

INVENTORS: Without obligation, write for information explaining the steps you should take to secure a patent. John Randolph, Registered Patent Attorney, 203 Columbian Bldg., Washington 1, D. C.

PATENTS. "Proof of Invention" free. E. E. Vrooman, Registered Patent Attorney, 507 McKim Building, Washington 5, D. C.

INVENTORS: Learn how to protect your invention. Unless the inventor is familiar with patent matters, he should engage a competent registered patent attorney or agent to represent him. We are registered to practice before the U. S. patent office and prepared to serve you in handling your patent matters. "Patent Guide for the Inventor" containing detailed information concerning patent protection and procedure with "Record of Invention" form will be forwarded to you upon request—without obligation. Clarence A. O'Brien & Harvey Jacobson, Registered Patent Attorneys, 61B-G District National Building, Washington, D. C.

"INVENTOR'S Guide" and "Record of Invention" free on request. Frank P. Ledermann, Registered Patent Attorney, 154 Nassau Street, New York City.

INVENTORS—If you believe you have an invention, you should find out how to protect it. The firm of McMorow, Berman & Davidson with offices in Washington, D. C., is qualified to take the necessary steps for you. Send for copy of our patent booklet "How to Protect Your Invention." We will also send you an "Invention Record" form. No obligation. They are yours for the asking. McMorow, Berman & Davidson, Registered Patent Attorneys, 1345 Victor Building, Washington 1, D. C.

FOR INVENTORS

INVENTORS—If you believe you have an invention, you should find out how to protect it. The firm of McMorow, Berman & Davidson with offices in Washington, D. C., is qualified to take the necessary steps for you. Send for copy of our patent booklet "How to Protect Your Invention." We will also send you an "Invention Record" form. No obligation. They are yours for the asking. McMorow, Berman & Davidson, Registered Patent Attorneys, 1344 Victor Building, Washington 1, D. C.

INVENTORS! Have you good patentable idea? Write Mr. Metzler, 11 West 42nd, New York City.

LOSING Money on patentable ideas? Misled? Know laws, procedures, court decisions. Easy reading course covering everything. \$6.95. George Heitman, Meeker Ave., Allendale, N. J.

"INVENTOR'S Guide" and "Record of Invention" free on request. Frank P. Ledermann, 154 Nassau Street, New York 38, N. Y.

YOUR Product improved for sales and patentability and patents skillfully filed in your name low definite fee basis. Canadian patents filed \$100.00. Joseph O'Brien Patent-Engineer, 30 years in business. 132 Nassau St., New York 38, N. Y.

INVENTORS: Learn how you can protect your invention. A specially prepared booklet "Patent Guide for the Inventor" containing detailed information concerning patent protection and procedure together with "Record of Invention" form will be promptly forwarded to you upon request—without obligation. We are registered to practice before the United States patent office and are prepared to serve you in the handling of your patent matters. Clarence A. O'Brien & Harvey Jacobson, Registered Patent Attorneys, 61A-G District National Building, Washington, D. C.

CREATE Successful inventions! Positive, proven method. Write Waldman, Box 121, Brownsville Sta., Brooklyn 12, N. Y.

PATENT Searches \$5.00. 48-hour air-mail service. Invention protection forms free. Write Patent Engineering Service, 711 14th Street N. W., Washington 5, D. C.

INVENTORS: If you have an invention for sale, patented or unpatented, write Institute of American Inventors, Dept. 40A, 631-E St. N.W., Washington 4, D. C.

PATENT Searches, including copies of nearest patents, \$6.00. Reports airmailed within 48 hours. More than 100 registered patent attorneys use my service. For free invention protection forms, write Miss Ann Hastings, P.O. Box 176, Washington 4, D. C.

INVENTION Record form free and "Patent Information Every Inventor Should Have." Carl Miller, Registered Patent Attorney, Woolworth Building, New York.

INVENTORS—This firm is registered to practice before the United States Patent Office and available to assist you in the preparation and prosecution of your patent application. "Patent Protection for Inventors" booklet containing detailed information and steps to take toward patent protection sent promptly upon request. No obligation. Victor J. Evans & Co., 232-H Merlin Building, Washington 6, D. C.

INVENTORS—Send for free patent information book and inventor's record. Registered Patent Attorney, Associate Examiner, Patent Office 1922-29, Patent Attorney & Advisor, Navy Department 1930-47, Gustave Miller, 76A Warner Building, Washington 4, D. C.

SEARCHES—Put your patent searches in the hands of a registered patent attorney or agent, as he qualifies to give a worthwhile patentability report. Record of invention form upon request and information on patent protection. Patrick D. Beavers, Registered Patent Attorney, 936 Columbian Bldg., Washington 1, D. C.

INVENTORS: Information on patent procedure furnished on request, without obligation. John Randolph, Registered Patent Attorney, 202 Columbian Building, Washington 1, D. C.

PATENT Searches \$5.00. 48-hour service. Free invention protection forms. Write Raymond L. Smith, Patent Searcher, 620 Sheraton Building, Washington 5, D. C.

CONSULT George Spector, assistant examiner U. S. Patent Office (1948-51), 18 John Street, New York City.

INVENTIONS WANTED

INVENTIONS Promoted. Guaranteed plan. Write for free booklet "Your Invention." Kessler Corporation, 571W, Fremont, Ohio.

AMERICAN Congress of Inventors—Quick response, free "Thomas Edison's formula for success." Inventors, Box 1481, Milwaukee 1, Wisconsin.

INVENTIONS Wanted. Patented: unpatented. Tremendous manufacturers lists. Global Marketing Service, 2420 77th, Oakland 5, California.

INVENTIONS Wanted now by my manufacturer-clients. Patented, unpatented. Write Adams, Patent Broker, 80-S Wall Street, Financial District, New York City.

CASH Buyers for ideas and inventions. Write National Inventors Institute, 457 Munsey Building, Washington 4, D. C.

INVENTORS. Give us the opportunity to explain our selling plan for your invention, gadget or device, patented or unpatented; free particulars available upon request. Demarest and Demarest, Box 95, Battle Creek, Michigan.

ESTABLISHED Manufacturer, with facilities to fabricate lightweight metal products, wants patented or unpatented items to manufacture. Write Tom Lee, Magnesium Products of Milwaukee, 742 W. Virginia St., Milwaukee 4, Wisconsin. Write for form to use when submitting your idea.

SUPERIOR Promotions. Patented: unpatented inventions. New, informative booklet on request. Superior, 338-344 North Rodeo, Beverly Hills, Calif.

INVENTORS: Hundreds of manufacturers have requested our assistance in locating marketable new products. Complete information free. Institute of American Inventors, Dept. 40-D, 631-E St. N.W., Washington 4, D. C.

INVENTORS. Don't sell your invention patented or unpatented until you receive our offer. Write Cowgill, Box 298, Marion, Ohio.

INVENTIONS And patents promoted. A-1 service for inventors for many years. Write Adam Fisher Co., 5418 Idaho, St. Louis, Mo.

INVENTIONS Wanted. Patented or patent pending. 25 years experience promoting inventions. National Service Bureau, 3120 Meramec, St. Louis 18, Mo.

PATENTS FOR SALE

PATENT 2742956—Combination walking cane, chair and clothing tree. Royalty basis. Salvatore Cannata, 175 West Palisade Avenue, Englewood, New Jersey.

INVENTORS: Test the commercial value of your patented or unpatented inventions, quickly and inexpensively. Write for free information. Institute of American Inventors, Dept. 40-B, 631-E St., N.W., Washington 4, D. C.

MANUFACTURING

METAL Parts manufactured. Satisfaction guaranteed. For sale fishing spears, newfangled broom holder. Gold stamping machine prints on leather, plastic, etc. Line Tool, Base Line, Michigan.

METAL Spinning to specifications. Triangle Metal, 2194 1/2 Flatbush Ave., Brooklyn 34.

MODELS—Small lot manufacturing. Metals, plastics, etc. Milburn, Burlington, Kentucky.

MODELS, MODEL SUPPLIES

STEAM Engines, boilers, castings. Catalog 35¢. Anton Bohaboy, 2297 Price, Rahway, N. J.

SHIP And yacht model fittings: blueprints. Send 35¢ for illustrated catalog listing hundreds of items. A. J. Fisher, 1002-1 Etowah Ave., Royal Oak, Mich.

SHIP Models. Most complete line in New England. Kits, fittings, plans, books, tools, engines, motors. Illustrated catalog 30¢. James Bliss & Co., Inc., Dept. SM, 342 Atlantic Ave., Boston 10, Mass.

BALSA Wood and model aircraft. 40-page catalog 25¢. Sig Co., Montezuma, Iowa.

HOME CRAFTSMEN

RUBBER Molds, liquid rubber, leathercraft, unpainted figurines, paints and supplies. Catalog 10¢. Steece Bros., Box 177-S, Sioux Falls, S. D.

KNOCKDOWN Cedar chests. Lumber and veneers. Free price list. Giles & Kendall Company, Huntsville, Ala.

STYLECRAFT Sure fire hits. "Pre-traced" leather kits. Handbags, billfolds, liligree belts, over fifty other projects. Patterns on leather. Why trace? Just carve, assemble and lace. Large assortment "precarved" kits also available. Send 25¢ for catalog, free folder. Refunded first order. Apache Leather Company, 2304 E. Washington St., Phoenix, Arizona.

KNOCKDOWN Cedar chests and lumber. Free price list. Bedford Lumber Company, Shelbyville, Tennessee.

18 FULL-Size patterns. Save money with easy-to-use, professionally designed full-size patterns. Make money selling beautiful, useful furniture. Make modern step and cocktail tables; metal lamps; cupola; 12-foot outdoor. All patterns test-built; sold with money-back guarantee. Get your free list of these convenient, economical patterns today. Popular Mechanics Press, 200-11H E. Ontario Street, Chicago 11, Illinois.

LEATHERCRAFT. Send 10¢ for new 60-page catalog of tools, supplies, kits, including metalcrafts, enameling, ceramics, all other crafts. Complete stock. Reasonable. Since 1910. Sax Bros., Dept. PM1, 1111 N. 3rd, Milwaukee, Wis.

ALL Crafts, supplies. Large free catalog. National Handicraft, 199 William Street, New York City 38.

CERAMIC Tile for bath wall, floors and tables. Applied with adhesive. Instructions furnished. Artistic Tile Co., 2562 First Ave. No. St. Petersburg, Fla.

FREE Catalog. 1560 patterns and designs. Craftplans, 1321-A South Michigan, Chicago 5.

WOODWORKING And cabinetmaking course for beginning and advanced home craftsmen. Only complete low-cost home training program available. Write for free booklet. Interstate Training Service, Dept. G-3, Portland 13, Ore.

HOME Floor plans, 31 all different. exterior designs, photos, colonials, contemporary, ranch. \$1 postpaid. Builders Association, 7810 Park Place Blvd., Houston 17, Texas.

FREE. Complete illustrated catalog. leathercraft kits, supplies. J. C. Larson Co., 820 S. Tripp, Dept. 6227-L, Chicago 24.

MAKE Garden-fresh looking flowers. Guaranteed results. Course \$2.00. Miken, Box 193, Lemoyne, Penna.

LEATHERCRAFT. Metal enameling, beadcraft, shellcraft, metal tooling, textile painting, many other crafts. Free big illustrated catalog. Kit Kraft, Dept. 237, Studio City 1, California.

101 FULL Size patterns. Smart, new, gifts, novelties, lawn figures, shelves, action windmills, alphabets. Plus "Make Money Jig Sawing." Only \$1.00. Mastercraft 75M, 7041 Olcott, Chicago 31, Illinois.

LEARN Art metalcraft and jewelry making. Complete, inexpensive, home training course now available. Special tools and materials furnished. Write for free booklet. Interstate Training Service, Dept. L-3, Portland 13, Oregon.

BUY Wholesale nationally advertised power, hand tools, thousands other products at big discounts. Free "Wholesale Plan." American Buyers', Hertel Station, Buffalo 16-P, N. Y.

DOWEL Centers: Insure perfect matched holes. 1 pair ea. 1/4"-3/8"-1/2" \$1.00. Ken-Kraft, Box 596, Manhattan Beach, Calif.

129 NEW Full-size jigsaw patterns. Artist-drawn. \$1. Craftplans, 1321-A South Michigan, Chicago 5.

LAMP Size cypress knee, with nipple installed \$2.00. Cy Products, Dept. 2-V, Lafayette, La.

DO IT YOURSELF

MAKE Your own dinette sets, coffee tables, stools, beautifully twisted solid wrought iron, satin finish plastic glides. Write Auburn Ornamental, Northport, Mich.

NEW Solar unit heats water free for trailers, homes, farm. Simple construction. Plans \$2.50. Solarex, Box 1174, San Bernardino, Calif.

PRE-Cut homes. Save. buy direct from mill. Save labor. Free literature. Write: Do It Yourself Homes Company, Box 748, Lewistown, Penna.

BACK-Yard smoke pit. Plans and instructions \$2.00. Sullivan, Box 5381, Jacksonville, Florida.

BUILD Beautiful, fireproof, everlasting houses at half price! Illustrated booklet \$1.50. Severance Publishers, Oyster Bay, N. Y.

60 PAGE Booklets! "Cement Work," "Upholstering," "Woodworking," "Mechanical Problems," "Electricity," "Radio," "Useful Tables," "Scientific Oddities," "Mathematical Oddities," "Greenhouse." Order by titles. 10¢ each. Franks, 3121 South Racine, Chicago 8.

BUILD-It-yourself. New plans, never before available. Electronics home protection. Do-it-yourself in one hour. Burglars don't have a chance. Money back if not satisfied. \$1.00 plus six cents stamps. Make your home burglar proof. S. J. Kasper, 768 N.W. 113 St., Miami 50, Fla.

CLOCK Movements—Gorgeous dials, plans, kits. See ad page 241.

AIR Conditioners—Home, automobile. See Kool Engineering ad page 24.

PLANS. Build portable core drill. \$1.00. Isles, Center Box 25, Redding, Conn.

MAKE Your own. Jeweler's or Mannheim or Pinchblack gold. All free formulas. Very old, \$1.00. Superweid of USA, DeKalb, Texas.

BOOKS: Hundreds of subjects. Big catalog free. Popular Mechanics Press, 200-BC East Ontario St., Chicago 11.

"DO It Yourself Encyclopedia". 12 giant volumes (3,000 pages) packed with thousands of ideas, plans, gadgets and projects you can do yourself. How to weld, paint, repair most anything. How to make boats, deepfreeze, draperies, jigsaw projects and just scores of other items. How to do electric wiring, plumbing, room building. How to modernize kitchens, bathrooms. Greatest, most complete fix-it library ever offered. Written so you can understand it. You'll be thrilled when you see what these 12 big volumes contain. It's simply sensational. You must really see them to fully appreciate this exciting fix-it library. You'll fall in love with them just as soon as you open the first volume. I'll send you a descriptive circular that will open your eyes to the greatest, most complete and beautifully illustrated "Fix-it" library you ever laid your eyes on. Send a postal right now. Popular Mechanics Press, 200-DY East Ontario St., Chicago 11, Illinois.

WATCHES, OLD GOLD, JEWELRY

HELBROS Watches, jewelry 70% discount. Catalog 25¢. Dorinda, Huntington Station 7, N. Y.

WATCHMAKERS'—Jewelers' supplies, instructions. Catalog 20¢. Bengale Company, Culver City, California.

COSTUME Jewelry supplies. Catalog and samples, 35¢. Largest line in America. Milady-Fair Co., G.P.O. Box 1328, New York City 1.

USED And new watches \$2 up. Free list. Southern Watches, Gray, Georgia.

HIGHEST Cash for old gold, broken jewelry, gold teeth, watches, diamonds, silverware, spectacles, platinum, mercury. Free information. Satisfaction guaranteed. Rose Refiners, Heyworth Bldg., Chicago 2.

MAKE Rhinestone jewelry. Complete introductory kit and illustrated catalog \$1.00. Catalog alone 10¢. J & M Novelties, Dept. CH-3, Griffith, Indiana.

WATCH And clock repairing books. Free information. North American, Dept. 16G, 2320 N. Milwaukee, Chicago 47, Illinois.

TOBACCO, SMOKERS' SUPPLIES

CIGARS! Clear Havana seconds, \$3.95 box 50. Guaranteed. Tobacconist, 220 N. Clark, Chicago 1, Ill.

RAZORS, BLADES, SHARPENING

100 RAZOR Blades—Double, single, \$1.00. Electric shavers—men, women, \$3.95. Starke's, Box 1202, Daytona Beach, Florida.

OF INTEREST TO WOMEN

LADIES' Dupont nylons; 3 pairs \$1.89. R. Plumb, Herkimer, N. Y.

EMBROIDER Stamped linens. Buy direct from manufacturer and save. Send for free catalog. Dept. 184, Merribee, 16 West 19th Street, New York 11, N. Y.

GOOD Money in weaving. Weave rugs at home for neighbors on \$69.50 Union Loom. Thousands doing it. Booklet free. Union Looms, 153 Post St., Boonville, N. Y.

\$5,199.90 WAS Paid to John Betts in few weeks. Grow mushrooms. Cellar, shed. Spare, full time, year round. We pay \$3.50 lb. Free book. Mushrooms, Dept. 176, 2954 Admiral Way, Seattle, Wash.

SELL Fine fabrics. Get yours wholesale. Box 863, Norwalk, Conn.

WANT To make big money at home? \$5 profit in an hour possible with invisible reweaving. Make tears, holes disappear from clothing, fabrics. Steady year-round demand from cleaners, laundries, homes. Details free. Fabricon, 8332 Prairie, Chicago 19, Illinois.

\$2.00 HOURLY Possible doing light assembly work at home. Experience unnecessary. Crown Industries, 8507-D West Third, Los Angeles 48, California.

WANTED—MISCELLANEOUS

PRODUCTS Wanted to sell Firestone, Woolworth, Sears, department stores. Established 1919. Salespower, Box 818, Cleveland 22, Ohio.

QUICKSILVER, Sterling, silver solders, precious metals. Wholesale Terminal, Norwood, Massachusetts.

BOOKS; Hundreds of subjects. Big catalog free. Popular Mechanics Press, 200-BC East Ontario St., Chicago 11.

SCRAP Mercury (quicksilver) containers supplied—Tantalum, tungsten, silver, platinum. Metallurgical Products Company, Established 1909, 35th & Moore Sts., Philadelphia 45, Penna.

PERSONAL

BORROWING By mail. Loans \$100 to \$600 to employed men and women. Easy, quick. Completely confidential. No endorsers. Repay in convenient monthly payments. Details free in plain envelope. Give occupation. State Finance Co., 323 Securities Bldg., Dept. A-227, Omaha 2, Nebraska.

LONG-Beach mailing address \$3.00 month. Thousands job opportunities in California \$1.00. Lenormand, 722 Magnolia, Long-Beach, California.

HONGKONG, China. Exciting reair-mails \$1.00. Freeman, 35B McDonnell Road, Hongkong.

MAKE Sure your bank account always balances. New, amazing method. Never fails. Free details. Lawlor and Pike, Northport, N. Y.

"HOW Can I find out?" You can! Information confidentially developed. Any matter, person, problem. Worldwide. Officially licensed. Established 1922. William Herman, 170 Broadway, New York City.

BUY Vitamins direct. Amazing savings. Catalog free. Matoska, White Bear, Minn.

BOOKS; Hundreds of subjects. Big catalog free. Popular Mechanics Press, 200-BC East Ontario St., Chicago 11.

CHICAGO—Mail forwarding address. Business, personal. Low rates. Continental, 20-M West Jackson, Chicago 4.

10,000 ROLLS Fresh snapshot film given away. Write today. Delco, Box B362, Upper Darby, Penna.

NOTRE Dame, South Bend remails, 25¢. Schaut, 619 Kamms, Mishawaka, Indiana.

LEARN To remember. Read Memorology ad under Educational and Instruction.

YOU Save. New exciting imports each month. Information free. Clayton Sales, 633-A Clayton, Wichita 12, Kansas.

NO Seasonal unemployment in booming Houston, Texas. Sunday classifieds \$1.00. Remails 25¢. Todd, Box 426, Bryan, Texas.

AIR Academy site Sunday classifieds \$1.00, remails 25¢. Box 153, Colorado Springs, Colorado.

FREE. Secret of success revealed. Write. Mind Power Institute, 207 Riverfront, Bend, Oregon.

REMAILING SERVICE

MAIL Received-forwarded, \$3 month. Hedgpeth, Box 830, Alhambra 23, Calif.

NEW York City—Remails 25¢. S. H. Brown, 178-39 Leslie Rd., St. Albans, L. I., 34, N. Y.

GOLDRUSH Towns. Remail postage, special envelopes supplied, 4 different \$1.00. Sample 35¢. Skeeter, Box 128, Woodlake, Calif.

MONTREAL. Letter remailed 25¢, etc. R. Cote, 1567 East Laurier Street, Montreal, Que., Canada.

NEW York City. Remailing 25¢, also forwarding and shopping. Betty, 510 East 11th Street, New York City 9.

LETTERS Remailled from Canada 35¢. 1 affix Canadian stamp. Six view cards 35¢. Pennants or souvenirs \$1.00. Ross, 83 Belhaven Rd., Toronto 8, Ont.

REMAILS From seaway port 25¢. Bylon, 17167 Bentler, Detroit 19, Michigan.

LETTER Remailing. Receiving-forwarding address for rent. Details free. William McLaughlin, 800 Stewart, Columbus 6, Ohio.

PITTSBURGH, Pennsylvania. Letters remailed 25¢; six \$1.00. P.O. 255, Export, Pennsylvania.

WASHINGTON Mailing address, \$10 quarterly. Sayper Associates, 1129 Vermont, Washington 5, D. C.

TREASURE FINDERS

TREASURE, Metal, mineral detectors. M-Scope. Used worldwide for treasure hunting. Mineralights, Geiger, scintillation counters. Prices from \$14.75. Fully guaranteed. Use our time payment plan. Free booklets on treasure hunting, uranium prospecting. Free catalog. Fisher Research Lab., Inc., Dept. PM-C1, Palo Alto, Calif.

GOLD, Silver, metal detectors. Geiger counters for uranium, Violites. Sensational new fully guaranteed models. None finer. Information free. Detectron Corp., 5528 Vineland Ave., North Hollywood, California.

URANIUM Finding made easy! Completely transistorized Geiger counters. Extra sensitive. Lightweight. Scientifically engineered. Unconditionally guaranteed. Also complete line prospecting instruments from \$19.95. Write for free information, techniques. Universal Atomics Corp., Dept. PM7, 19 East 48th Street, New York City.

GEIGER Counter uses CK-722 and TV parts for constant hi voltage. Diagram, parts list, 25¢. George's TV, Savannah, Mo.

JEEP Owners—V8 power. Read Jeep owners ad, page 25.

LITHIUM. The wonder metal. Free booklet describes prospecting information, uses, etc. Nu-Age, Box 123, Calgary, Alberta, Canada.

FIND Buried treasure, gold and silver, with Goldak's sensational 3½ lb. "find-it" locator, only \$49.50. Write for free literature on complete line of mineral, metal locators; Geiger and scintillation counters. Goldak, 1541 W. Glenoaks Blvd., Glendale, Calif.

FIND Uranium, buried treasures, valuable minerals and metals with completely transistorized detectors! You can buy for less from world's oldest and reputable supplier of prospecting instruments. Get the same electronic metal detectors, Geiger and Scintillation counters, mineralights, dip needle, assay kits, etc., we sell to U.S. and friendly foreign governments, treasure hunters, mining companies and week-end prospectors. Prices as low as \$14.95. We repair and trade all makes! Get free literature on profitable prospecting and prospecting for recreation. Write, come-in or phone—we have the detection instrument you want! Radiac Co., Inc., Dept. PM7, 489 Fifth Ave., New York 17, N. Y.

FOR SALE—MISCELLANEOUS

\$18 SHOES \$6.75, Prepaid, 9½ B, 10B only. Army officer shoes. Guarantee. Allied, Box 183, Everett, Mass.

"FREEMS"—Tricky reflectors for cars, bicycles, etc. The unusual gift for young and old! \$1.00 ppd. King, 101 Brookway Dr., Greenville, S. C.

THOUSANDS Surplus radar reflectors fraction govt. cost. Bargain, now \$1.00. A.C.A. Service, 201 N. 12th St., Sacramento, Calif.

HEARING Aid batteries, wholesale. Free list. Habs, Box 51, York, Penna.

BARBECUE Owners use "Shure-Lite" strips for starting charcoal or wood fires. Send \$1.00 for package of 10—postpaid, to: Capitol Service, 342 Hanover Street, Boston, Massachusetts.

GABARDINE Trousers. Desirable colors and sizes. \$4.95 postpaid. Yale Clothing, Meriden, Conn.

BOOKS; Hundreds of subjects. Big catalog free. Popular Mechanics Press, 200-BC East Ontario St., Chicago 11.

MISCELLANEOUS

JAPAN: Buy gifts direct from Japan. Kimono, model engines, lanterns, colored slides, novelties, others. Business information fee \$1.00. Send money orders. Clarence Yamagata, Room 202, Naka 7 Bldg., Marunouchi, Tokyo, Japan.

NAME, Address, stamped on key checks, dog tags, duplicate keys, 50 cents each. Eidson's One Stop Service, 421 W. 18 St., Jacksonville, Fla.

SEPTIC Tank, cesspool troubles ended. Sea-Cal, new miracle enzyme product ends odors, pumping, digging. Free details, send postcard. Forest City Chemicals, 411 So Chicago, Rockford, Illinois.

FREE: Exciting catalog packed with books covering most everything. Think of it—From cover to cover you will find described and illustrated hundreds of books telling how to fix and how to build almost anything. How to remodel your home; do your own decorating, plumbing, electrical work. Simplified books covering concrete work, carpentry, painting, furniture making and refinishing. How to build your own boat, home workshop tools. Best books on photography, welding, hobbies, homecraft. How to make a home freezer. Send for your free copy now. Popular Mechanics Press, 200-BC East Ontario St., Chicago 11, Ill.

RECEIVE Magazine samples, mails, etc. by hundreds. Get listed 25¢. Rorick, Cincinnati 26, Ohio.

STUPENDOUS Mental power. Adults. (Details 10c.) Delmar Wisdom, 846 Sunny-side, Chicago 40.

YOUR Name wanted. We'll send 1000 publishers, mailers, wholesalers your name, on our list one year 25c. Dixie Mailers, King, N. C.

WHOLESALE Catalog! 30-80% discounts! Appliances, musical instruments, typewriters, phonographs, watches, jewelry, recorders, housewares, etc. Consolidated Distributors, 21-13 Lafayette, Paterson 15, New Jersey.

BE Your own plumber. You can. Few inexpensive tools and our instructive book, "Home Plumbing Guide," shows and tells you how. Hundreds of photographs and diagrams. Easy to follow. 160 pages. \$3.50. Catalog free. Popular Mechanics Press, 200PG East Ontario St., Chicago 11, Ill.

FREE Wholesale catalogs! Sporting equipment, cameras, homewares, everything. Econ-O-Mart, Whippany 2, New Jersey.

BIG Mails, four months listing, 25c. Wright Publications, 2270 Hubbard, Memphis 8, Tenn.

\$5,199.90 WAS Paid to John Betts in few weeks. Grow mushrooms. Cellar, shed. Spare, full time, year round. We pay \$3.50 lb. Free book. Mushrooms, Dept. 175, 2954 Admiral Way, Seattle, Wash.

DO It yourself. What? Repair TV, build furniture, make barbecue, plumbing repairs, build boats, do house wiring, remodel home, lay tile, modernize kitchen, repair home, and scores of other things you can do yourself. Books covering each subject, only 25c. Send for descriptive list. It's free. Popular Mechanics Press, 200-LB East Ontario St., Chicago 11, Ill.

"HOME Improvement Guide." New, amazing 192 page volume. Packed with ideas, plans for remodeling, decorating, landscaping, built-in projects. \$2.50 pre-paid. Popular Mechanics Press, 200-HG East Ontario St., Chicago 11.

ORNAMENTAL Iron designs. Book of 1500 beautiful, practical designs for railings, columns, etc. Free literature. Cunningham, 3881 South 3200 West, Salt Lake City, Utah.

70 BIBLE Lessons, 25¢. Bulletin, Box 87, Cathedral Station, New York City 25.

TANNERS Manufacturers hair-calf rugs. Indian tom-toms. Free circular. Tspc. Box 4146, San Antonio, Texas.

FREE Gift and gadget catalog. Gille's. 1228 Main, Green Bay, Wis.

THREE Texas papers dollar. Mail forwarded three dollars month. Brookfield, Cypress, Pecos, Texas.

CESSPOOL Trouble? Use Sursolvent, the miracle cesspool and septic tank cleaner. No pumping necessary. Restores systems to a condition approaching newness. To maintain the highest degree of potency in our product, best results are obtained when purchased direct from factory. Consequently not obtainable in hardware stores. Electric Sewer Cleaning Co., Boston 34, Mass.

EARTHWORMS Urgently needed! We shipped \$3,175.75 worth, first year, spare-time, backyard! Why can't you? Raising, marketing instructions, 10¢. Oakhaven-M, Cedar Hill, Texas.

BUY Wholesale thousands nationally advertised products at big discount. Free "Wholesale Plan." American Buyers, Hertel Station, Buffalo 16-K, N. Y.

BARGAIN. Exciting Little Library booklets. 25¢ each. Tool making, painting, welding, home improvement, games, models, plastics, lamp making, glass blowing, boats, photographs. Free catalog. Popular Mechanics Press, 200-LB East Ontario St., Chicago 11.

FORGIVENESS. Acts 26. Whitcomb. 308 Sycamore, Newport News, Va.

REPRODUCTIONS Of world-famous documents! Declaration of Independence, Bill of Rights, Constitution, and Gettysburg Address. 59¢ each—Set of four, \$2.00 postpaid! Fox Enterprises, 1010 Euclid Avenue, Cleveland 15, Ohio.

PRESERVE Living flowers indefinitely. Free details. Spera, Box 596, Toronto 1, Canada.

RECEIVE Samples, magazines, catalogs, opportunities, 10¢. American Directory, Lening, Texas.

SOCIAL Security card sealed in sparkling, protective plastic—25¢. Full wallet size items, 50¢. Plastic Press, Box 13-M, St. Louis 14, Missouri.

GUARANTEED Big mails! Full year's listing, 25¢. Rite-Way, Sanford, Michigan.

MINIATURE Decals. International code flags, for seagoing identification-boating accessories, lockers, luggage, leather, K-ass. 1/2" size 3/\$1.00, 1 1/2" 50¢ ea. Barnacle Phil, Box 6096, Arlington 6, Va.

REPAIR Your own automatic washer and drier and that of your neighbor. Save high costs. Complete instructions in "Maintenance and Repair of Laundry Equipment." Only \$1.98 postpaid. Laundry Division, Box 2457, San Antonio 6, Texas.

EUROPEAN Luggage stickers, free list. Sloan, 621 Columbia, Warsaw, Indiana.

BOYS! Girls! Make hundreds of different things with Twist-Kraft. Make miniature flowers, figures, animals, furniture, houses and loads of other interesting things with these multi-colored fuzzy wires. To get your complete set send only \$1 to: E. T. Gilbert Mfg. Co., 228-236 South Ave., Rochester 4, New York.

NEW Invention. Useful in the kitchen. Pat. pending. For ladies. Potato peeling aid. Yours free. Write for information. Jackson Industries, 514 N.E. Fremont, Portland 12, Oregon.

LEFT Handed? Send for free list of articles made special for left hand use. Make ideal gifts. Left Hand Products, Box 402, Warren, Ohio.

SAVE Expenses. Repairs, Gasoline. Illustrated automobile book 35 cts. Dealers discount. Persil, 436 N. Y. Ave., Brooklyn 25, N. Y.

"SHOCKING" Expose! Catfish caught with telephone apparatus! Complete details, \$1.00. Pop. Box 6122, Houston 6, Texas.

AUTO Train AT HOME for a GOOD JOB MECHANICS

A better job, big pay and security—America's No. 1 industry offers you all 3! Make up to \$125 a week and more. Train quickly at home—earn as you learn. Tools and Tune-Up Kit sent. Write for 2 FREE BOOKS.

COMMERCIAL TRADES INSTITUTE, Dept. A-313
1400 GREENLEAF AVENUE CHICAGO 26, ILL.

ENGINEERING DEGREE IN 27 MONTHS

B. S. DEGREE IN

Aeronautical, Chemical, Civil, Electrical, Mechanical and Electronic Engineering (inc. Radio and TV)
Big Demand for Graduates

Hundreds of young men are earning B. S. ENGINEERING DEGREES annually in this recognized institution — year around classes optional. New terms start quarterly. Many students earn a major part of their college expenses in this large industrial center.

Low tuition. Competent instruction. Thorough, intense practical program. Modern, well-equipped laboratories including new physics laboratory and modern wind tunnel. Individualized instruction emphasized.

Government approved for G.I.'s. Engineering preparatory courses. Students from 48 states and 21 foreign countries. Enter September, December, March and June. Send coupon for free catalog and full information. Enroll now.

INDIANA TECHNICAL COLLEGE

576 E. Washington Boulevard, Fort Wayne 2, Indiana

Please send me free information on B.S. Engineering Degree in 27 months as checked.

Aeronautical, Chemical, Civil, Electrical,
 Mechanical, Electronics

Name _____

Address _____

SALESMEN WANTED

Prefer men over 50. Earnings \$5000 to \$8000 per year, calling on hardware stores and lumber yards, selling and installing Popular Mechanics show windows. No window trimming experience necessary (we train you) but selling experience essential. Must have automobile. Average territory consists of about 5 counties. Salesmen have exclusive territory. Home every night.

Not a get rich quick scheme but steady dignified work by which a skilled, industrious salesman can earn a good living. This company, in cooperation with Popular Mechanics and the leading manufacturers of tools, equipment and materials, offers retailers traffic-stopping window displays to retail hardware stores and lumber yards at a nominal cost. All equipment furnished. Endorsed by many retailers, jobbers and manufacturers. Much repeat business. Extras offer additional earning opportunity. Desirable but not necessary to have knowledge of hardware and lumber lines. Personal training given.

For details write to Window Displays, Inc., giving all the facts about yourself. If your letter indicates that you might qualify, an appointment will be made for an interview.

WINDOW DISPLAYS, INC.

1580 SHERMAN AVENUE EVANSTON, ILLINOIS

FREE New FAN—Shutter—Motor—Catalogue



Packed with the Largest Selection of Fan equipment
BUY FROM MFR. and SAVE MONEY

• Attic Fans • Exhaust Fans • Pedestal Fans • Shutters
• Motors • Tub Enclosures
• Sewing Machines • Awning
Attic or Window Fan Kit. Includes Steel Blade—2 Pulleys—2 Bearings—2 Collars—Shaft—Instructions—Easy assembly.
VISIT US OR SEND FOR FREE COPY TODAY
Enclose postage with check or money order. Dealers invited.

Fantex and Torrington Fan Kits

FANTEX KITS	SIZES	WT.	LIST PRICE	SALE PRICE
	16"	7 lbs.	\$15.90	\$7.95
	20"	8 lbs.	17.90	8.95
	24"	10 lbs.	19.90	9.95
TORRINGTON KITS				
	22"	17 lbs.	\$25.90	\$12.05
	24"	20 lbs.	30.70	15.35
	28"	22 lbs.	31.90	15.95
	30"	25 lbs.	31.40	16.70
	36"	30 lbs.	42.86	21.27

Dept. M, N.Y. 423 Broome St., N.Y. 13
DETROIT 14030 W. 6 MI. Mich. 35
LOUISVILLE 710 W. Market, KY.

ALBIN MACHINE

Also Eshelman
2 Passenger
SPORT & GOLF Cars
1/5 the cost of most other cars
70 Miles per Gal.
Write for FREE Literature
Dept. R-57, Eshelman, 109 Light St., Balto. 2, Md.

ESHELMAN TRACTORS

LOW AS \$99

Plows • Cultivates • Saws
Dozer • Harrows
• Snow-Plow • Rolls
• Hauls • Mows • Tills
Eshelman Tractors, Fillers, Riding Rotary Mowers for Better Lawns and Gardens. Advertised in GUMM HOUSEKEEPING. Thousands of Satisfied Users.



Shipping Points: BALTIMORE • CHICAGO • KENO

ONLY \$495
FREE FOLDER

18 FT CRUISER

BOAT KITS

12 Models as low as \$39.95 (freight included). Fiberglass boat covering kits, marine supplies, etc. Free folders.

TAFT MARINE WOODCRAFT
DEPT. PM-7 636-39th Ave. N.E., Minneapolis 21, Minn.

WHOLESALE CATALOG Big Discounts!

Buy direct from manufacturers and SAVE. Over 800,000 items at deep-cut prices. Many nationally advertised brands! Start a buying service at home. Make big profits operating your own Discount House. Free confidential information—mail postcard today.



DEVELOP A HE-MAN VOICE!
Write for FREE book "How to Strengthen Your Voice for Greater Success" by Eugene Feuchtinger. No obligation. Book will be mailed at once in plain wrapper, postpaid. Just send your name and address. State age.
PERFECT VOICE INSTITUTE, 210 S. Clinton St., Studio GU-2, Chicago 6, Ill.

NEW BENJAMIN SUPER CO₂ GAS CARBINE—\$16.50

HI-LO (2 Stage) Jet Power
Cal. .177 or .22

IDEAL FOR TARGET & SMALL GAME

SAFE—ECONOMICAL—ACCURATE

CONVENIENT—PRACTICAL—NON TOXIC

EASY TO OPERATE—NO PUMPING—NO FLINCHING.

Get 40 SHOTS from each 10¢ STANDARD SIZE CO₂ (Soda) CARTRIDGE. Up to ¾" penetration.

Ask your DEALER for DEMONSTRATION.

BENJAMIN AIR RIFLE CO.,
896 MARION ST., ST. LOUIS 4, MO., U.S.A.

FREE folder

Build Your Own Walks, Driveway, Outdoor Fireplace, Steps, Etc. What to Make With CONCRETE

The terrific high costs of even little concrete jobs are mostly for labor. Get Popular Mechanics **WHAT TO MAKE WITH CONCRETE** and save all the labor costs while making your home or farm ship-shape. You can lay foundations, sidewalks and driveways; build steps, outdoor fireplaces, sandboxes, tennis courts, garden and swimming pools and other installations at very little cost. Book shows all—tells all—how to make the right mixture, plan, apply and gives 50 professional short cuts. Hundreds of pictures. Only \$2.00 postpaid. Order today. Money back if not pleased.

POPULAR MECHANICS PRESS
Dept. 756, 200 E. Ontario Chicago 11, Ill.



PLAY RIGHT AWAY ANY INSTRUMENT

—even if you don't know a single note now!

NOW IT'S EASY to learn ANY instrument. No boring exercises. Even if you don't know a single note now, we'll have you playing delightful pieces **RIGHT AWAY**—right from your **FIRST** lesson! And properly **BY NOTE**. Simple as A-B-C. Make amazing progress. No special "talent" needed. Learn at home in spare time, without a teacher. Only a few cents per lesson. Soon you can play any piece you wish. 900,000 students. (Now in our 58th successful year.)

FREE 36-PAGE ILLUSTRATED BOOK

—Just send this ad, with your name and address filled in below to: **U. S. School of Music, Studio 307, Port Washington, N. Y.** (No obligation, no salesman will call.)



Name _____
Address _____

CHEMISTRY

BIG LABORATORY GIVEN FREE!

Be a **CHEMIST!** One of the really **GREAT** professions! We teach you at home. Simplified (but thorough) course; no previous training required. Earn while you learn. This is a **GOLDEN AGE** for those with special knowledge! Diploma awarded! Send 25¢ for first lesson and **KIT** or \$1.00 for first 5 lessons and supplies including

FREE!

URANIUM TESTER, CHEMICAL PUZZLE (worth \$2.50) and HOW TO MAKE 100 NEW CHEMICALS!

NATIONAL SCHOOL OF CHEMISTRY
P.O. BOX 606-A REDWOOD CITY, CALIF.

Say You Saw It in Popular Mechanics

High School at Home

MANY FINISH IN 2 YEARS

No classes. No time wasted going to and from school. Progress as fast as your time and abilities permit. Standard H. S. texts supplied. Thousands enroll each year in this 59-year-old school. Send for **FREE** descriptive booklet.

AMERICAN SCHOOL, Dept. HB45
Drexel at 58th St., Chicago 37, Ill.
Without obligation, please send **FREE** descriptive booklet.

Name _____
Address _____
Complete Canadian Courses available. Write American School, Dept. HB45, 6083 Sherbrooke St. W., Montreal

SOLD DIRECT, FACTORY-TO-YOU NOW ONLY
8" TILT ARBOR POWER SAW \$19⁹⁵
SAW



Write for FREE Catalog — Big Bargain on Power Tools.

Save big money. Quality 8" Tilt Arbor Power Saw sold direct from manufacturer. All cast iron & steel construction. Crosscuts, rips, bevels, mitres, dadoses, cuts compound angles. Uses any standard 1/4 to 1/2 h.p. motor. Regular \$4.95 8" Simonds blade included. Try for 10 days. If you are not delighted FOR ANY REASON, return saw for absolute money back refund. Shipped express collect. Send check, M.O., or sent C.O.D.

AMERICAN MACHINE & TOOL CO.
 ROYERSFORD 18, PA.

BUY SURPLUS EQUIPMENT DIRECT FROM U. S. GOVERNMENT!

Now buy surplus boats, jeeps, camping equipment, sporting goods, parts, gadgets, electronic equipment, etc., often at unheard of prices direct from U. S. Gov't. Send today for pocket size directory listing over 500 Army, Navy, Air Force and other gov't. salvage depots . . . many of them right in your area! Indexed. Easy to refer to. Tells how to bid on valuable goods gov't. is disposing of. Gives all information needed to get advance notice of gov't. surplus sales!



ACT TODAY . . . Send \$1 For Your Directory write now:

INTERNATIONAL SURPLUS 604 KERR BLDG., DEPT. Z-1 DETROIT 26, MICHIGAN

GET THE HABIT OF OUR CLASSIFIED ADS. READING

Wonderful Opportunities Amazing Bargains

STUDY INDUSTRIAL DESIGN

You can train at Art Center School in California with practicing-professionals for upper-level jobs in INDUSTRIAL DESIGN. Recent graduates have been added to the staff at General Motors, Chrysler, Raymond Loewy, Henry Dreyfuss, etc. Majors in transportation, general product design, structures, community development, packaging, display. 4-year degree courses. Learn to combine imaginative design with technical proficiency, coordinate utility and beauty. Stimulating environment. Field trips. Advantages of mild Southern California climate and nearby holiday spots. Accredited. Coed. Placement service. Established 25 years. New terms February, June, September. Catalog.

ART CENTER SCHOOL, Edward M. Adams, Director 5353 WEST THIRD STREET, LOS ANGELES 5, CALIFORNIA

100 BEST Woodworking Projects



SELECTED FOR YOU BY POPULAR MECHANICS EDITORS Enjoy the fun — the pride — of making things. Get 100 BEST WOODWORKING PROJECTS, complete with simplified instruction, plans, diagrams and more than 400 how-to-do-it pictures. Make all kinds of furniture, baby carriages, clocks, lamps, book shelves, fireplaces and other useful articles at little or no cost. Send only \$2.00 with name and address. Money back if not pleased.

POPULAR MECHANICS PRESS, Dept. PM756, 200 E. Ontario St., Chicago 11

FOLDING TOILET

When you go fishing, camping, boating, hunting
 Portable toilet uses disposable bags. Traveling John is as simple to use as flushing. Have your own toilet on next trip. Standard height, folds flat. "At Home" style seat, lightweight—4 lbs. Order today. Only \$11.95 each ppd. with a supply of plastic bags. Satisfaction guaranteed. Makes a clever gift.



GOODE PRODUCTS, 7548 Maie Ave., Los Angeles 1, Calif.



Auto Bench Provides Play And Sleeping Area

You can transform the rear of your car into a level play and sleeping area for children with a folding bench made from a kit. The bench fits between the front and rear seats. The kit includes folding iron legs and fixtures that can be attached to a 1 by 5-foot plywood board (not furnished). Safety clips are included to prevent accidental release of the brace. The strong channel-iron legs are rubber-tipped to prevent slippage.

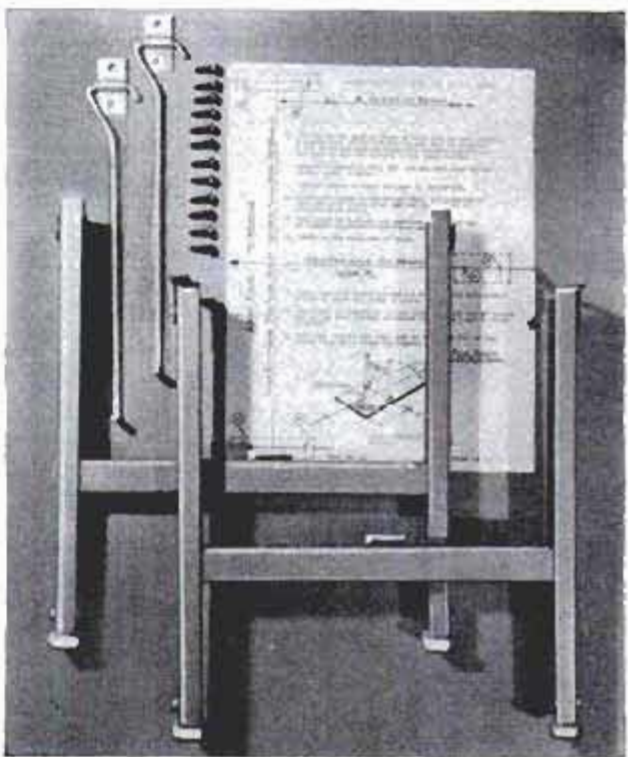

POLIO FACTS FOR 1956

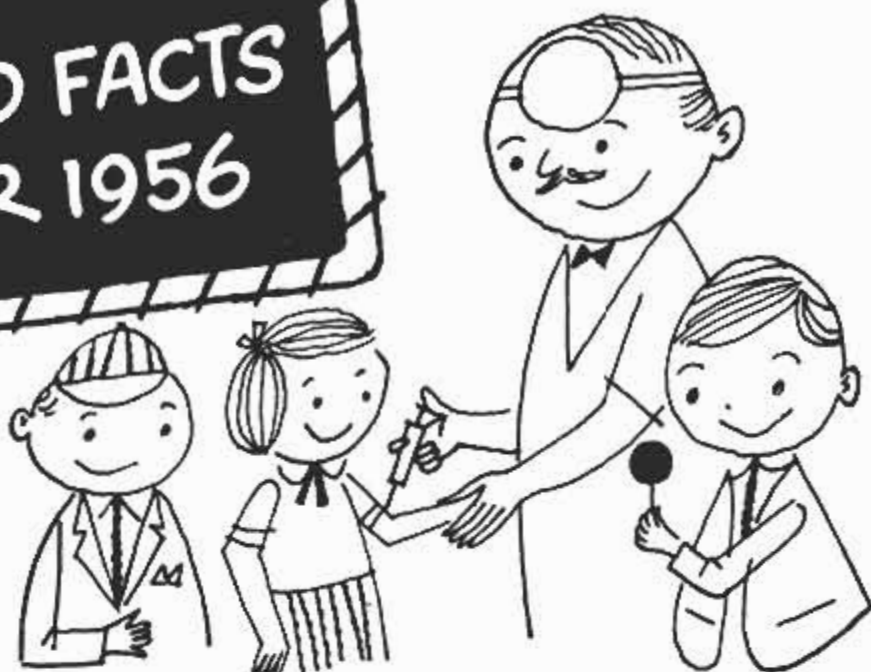

GET YOUR POLIO VACCINE AS SOON AS YOU CAN...

MEANTIME, FOLLOW THESE PRECAUTIONS:



THE NATIONAL FOUNDATION FOR INFANTILE PARALYSIS

MAKE USEFUL, ATTRACTIVE ARTICLES OF

ALUMINUM

Book gives 125 plans, plus directions for working with aluminum. Make screens, tables, toys, garden items, etc. Send no money. Read book 10 days FREE, then send low price of \$3.95. Order now—DO IT YOURSELF WITH ALUMINUM. Address Dept. PM-7.

McGraw-Hill Book Co. 330 W. 42nd St. New York City 36



New Black & Decker 6½" H.-D. Saw!

Extra Capacity • Extra Safety • Extra Power
Extra Convenience • Extra Adjustment Features!
See your B&D dealer for demonstration. The Black & Decker Mfg. Co., Dept. M-76, Towson 4, Md.

RADIO Engineering. All phases radio & electronics theory & practice; television; FM; broadcasting; servicing; aviation, marine & police radio. Prepare for good pay; 18-month course. Graduates in demand by major companies. Enter Jan., March, June, Sept. Regular campus life. Write for catalog. **VALPARAISO TECHNICAL INSTITUTE, Dept. D, Valparaiso, Ind.**

FREE AMAZING NEW BOOK "HOW TO ANSWER ADS"

Never before have you seen anything like this. Tells you in simple language the correct way to answer ads. Gets you quicker replies—better results, and greater satisfaction. Will save you time and money and it's ABSOLUTELY FREE. No obligation whatever. Every reader of advertising should have this booklet. Send a postcard for your copy NOW. F. W. JOHNSON, Popular Mechanics Magazine, Room 600-A, 204 East Ontario Street, Chicago 11, Ill.

how to answer ads

x-acto
KNIVES • TOOLS
HANDICRAFT KITS



NO. 79
VIZI-DOME
WOODCARVING
SET \$3.60

X-ACTO, INC.
48-41 Van Dam St.
Long Island City, N. Y.

Send 20¢ for 28-page Catalog

Learn All About Cars!

**AUTO MECHANICS — AUTOMATIC TRANSMISSIONS
ACETYLENE AND ARC WELDING
BODY AND FENDER REPAIR**

Day-Night School 30 Years in the Same Location

WOLVERINE SCHOOL OF TRADES

Approved Under the G.I. Bill of Rights by the State Board of Education

**WOLVERINE SCHOOL OF TRADES, Dept. PM
1400 West Fort St., Detroit 16, Mich.**

Name _____

Address _____

City _____

State _____

**I'LL PAY YOU
\$30 PER HOUR
TO ASSEMBLE THIS
2½ H. P. OUTBOARD**

"Assemble this first quality full 2½ horsepower outboard motor yourself in two hours and save \$69 off its regular \$119.95 value. All you need is a screwdriver and crescent wrench and you'll have a sleek, smooth-running powerhouse that will let you cruise or troll any 10, 12 or 15 ft. fishing or pleasure craft, and your cost will be less than half any other 2½ H.P. outboard on the American market or your money back! Absolutely all precision parts including gaskets and spark plug. All you do is add fuel. Complete step-by-step illus. instructions. FEATURES: Air cooled, 2½ hr. cruising, 1 to 3 M.P.H. speed, Full pivot, forward and reverse, double transom clamps. Weight: 22 lbs. All parts warranted. It's brand new and a fine product. Try it and let me know how you like it."

Frank E. Williams, Pres.

CONTINENTAL SPEED KIT (complete)....\$59.95

\$20 dep. for C.O.D. Shipped F.O.B. Culver City, Calif. resid. add 4% state tax.

CONTINENTAL MANUFACTURING CORP.
Washington Blvd. at Motor Avenue, Culver City 2, Calif.



Porter-Cable

Quality Electric Tools

140-1 REDUCTION GEAR!

Make your own winches, hoists, wagon unloaders, stump pullers or fence stretchers. Sturdy Aircraft quality. Built-in (removable) 24 V. AC. motor & clutch. High torque. Low speed. 1003 uses. Bendix price \$285.00. Wght. 42#. Good used \$14.80. Brand New only \$17.89. SEND DIME FOR COMPLETE CATALOGUE

K. ORT, Dept. P.M.7, YORK, PA. F.O.B.



LEARN DIESEL AT HOME

Train to specialize! Run and repair these remarkable precision machines. Opportunities world-wide. Learn tricks of trade at home: finish quickly in our big Chicago training shops. Send name now for FREE BOOK.



UTILITIES ENGINEERING INSTITUTE, Est. 1927
2521 SHEFFIELD AVE., DEPT. DC-58, CHICAGO 14, ILLINOIS

"SEA CRAFT"

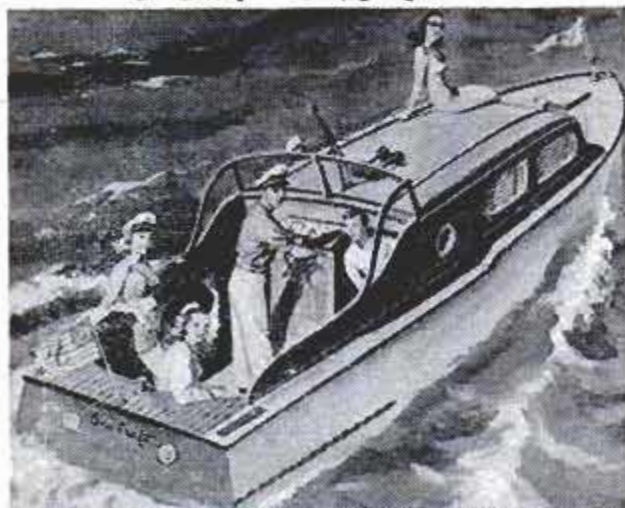

Build this luxurious cabin cruiser yourself and save money. What a beauty it is! A 25-foot boat readily adaptable as a sport fisher, express cruiser, or utility boat. Cruises effortlessly at 15 knots with a marine engine or converted auto motor. Its spacious cabin sleeps four and has a galley complete with fresh-water tank, sink, and cook stove. Has open cockpit large enough for fishing, lounging, etc.

During war the Coast Guard used "Sea Craft" for ship-to-shore travel. Order today your complete set of seven large-size blueprints scaled 1 inch to the foot. These, plus a 40-page two-color illustrated booklet giving step-by-step instructions, only \$10.00.

POPULAR MECHANICS PRESS

200 EAST ONTARIO ST., Dept. 756, CHICAGO 11, ILL.

WHERE-TO-BUY-IT INDEX

Source of supply appears after items commercially available

AUTOMOTIVE

Auto bench provides play and sleeping area..... 56
Metropolitan 1500 (American Motors, 14250 Plymouth Rd., Detroit 32, Mich.)..... 70
Chain-hung truck hopper lowers to ground level..... 85
Transparent fenders are feature of Farina-styled Alfa Romeo. 85
Window grille keeps locked car cool while parked (Protecto Vent Co., 7100 Brompton Rd., Baltimore 7, Md.)..... 96
Cradle tips Volkswagen for easier repairing.....104
Engine costs less to make.....114
Sleeping cabin bolts to truck.....127

AVIATION

Teleprinter receives and types messages sent to plane..... 2
Plastic light plane has molded fuselage..... 59
Jets used as spotters for atomic artillery..... 71
Gun camera with automatic lens to take jet combat pictures (Fairchild Camera & Instrument Corp., Robbins Lane, Syosset, Long Island, N. Y.)..... 77
One-man helicopter can be folded up..... 78
British turbocopter127

BOATS

Outboard-powered "aquatic sports car" hits 30 miles per hour (Lone Star Boat Mfg. Co., Inc., P.O. Box 698, Grand Prairie, Tex.) 70
Nonsinkable catamaran can be powered by an outboard or paddle (Sellock Watercycle Co., Inc., Catamaran Div., Boca Raton, Fla.) 90
Tilt-and-turn attachment helps load boat on trailer (Tee Nee Trailer Co., 215 E. Indianola Ave., Youngstown, Ohio)..... 95
Sled towed behind boat takes diver on undersea tour (Dalton Mfg. Co., 104 Mill St., Dalton, Pa.).....113
Outboard-motor lock prevents theft (Windsor Machine Products, Inc., Windsor, Vt.).....142
Whirling beam on circular tank tests boat models at 100 knots144
Folding boat (Porta Co., Inc., 32 Neponset St., Canton, Mass.).....223
Automatic boat bailer (R. Lellan Shoemaker, Frontier Hotel, Newcomerstown, Ohio)227

FARM AND FARMING

Electromechanical auctioneer speeds sale of livestock.....122
Homemade winder reels in wire.....127
Elephant grass142
Planter covers 1280 acres in one day.....142

HOUSE AND HOME

Weed puller with teeth yanks out crab grass by the roots (Downs & Co., Dept. C.J, Evanston, Ill.)..... 61
What's New for Your Home—
Combination scoop and funnel measures ingredients.....106
Drooping clotheslines tightened quickly.....106
Modern planter serves as room divider.....106
Coffee table converts to dining table.....106
Cooking meats quicker with heat-conducting pins.....107
Ice crusher attachment for kitchen blender.....107
Electrostatic broom attracts dust.....107
Two-drawer food warmer keeps dinner hot.....107
Perforated disk drains grease from bacon.....107
Clothes drier for the back yard.....108
Detachable leg rest provides comfort.....108
Folding wringer for clothes washer.....108
Baking soda sprayed from can makes home fire extinguisher109
Plastic cutter cuts lattice design in pie crust.....109
Kitchen knife with adjustable arm.....109
Portable garbage disposal unit.....109
Hangers in a closet kept separated.....109

MISCELLANEOUS

Robot conductor for railroads..... 2
Musical telephone ring..... 38
Electronic flash gun has variable output (Graflex, Inc., 154 Clarissa St., Rochester 8, N.Y.)..... 38
Dial-a-stamp dispenser installed in post office..... 70
Night-glowing bike tires increase road safety..... 70
Smithsonian has termites..... 89
Lightweight knee rest padded with foam rubber (Armstrong Products Corp., Huntington 12, W. Va.)..... 89
Squeeze bulb starts siphon (Wilton-Woods, Inc., P.O. Box 1105, Cleveland 3, Ohio)..... 90
Hydraulic trailer lowers to ground for loading (West Point Products Corp., West Point, Pa.)..... 95

(Continued to page 60)

Plastic Light Plane Has Molded Fuselage

PLASTIC PLANES, long the goal of the light-airplane industry, have become a reality now that Taylorcraft has announced two new models made of glass-reinforced plastic. The entire external fuselage, most of the wing, doors, seats, gas tanks, wheel pants, instrument panel and other smaller parts of these planes are made from the plastic. Only the rudder and elevator surfaces are fabric-covered. One model, called the Ranch Wagon, is a four-place job powered by a 225-horsepower engine. The second is an agricultural version of the first, designed for crop spraying, dusting and seeding. It can carry a 1200-pound load of chemicals or other supplies.

The plastic planes can be produced with one fourth of the engineering man-hours, one sixth of the production man-hours and 20 percent of the tool costs of a similar standard model. The material is dent resistant, will not rust or rattle, and can be repaired at a fraction of the cost of metal.

Improved operations are a factor, too, since the smooth finish of the fuselage adds up to 12 miles per hour to the speed of the plane. Because all parts are made in dies or molds, they may be interchanged.



Large, low-cost dies are used to shape each half-fuselage in one piece. The plastic is light in weight and helps to insulate cabin

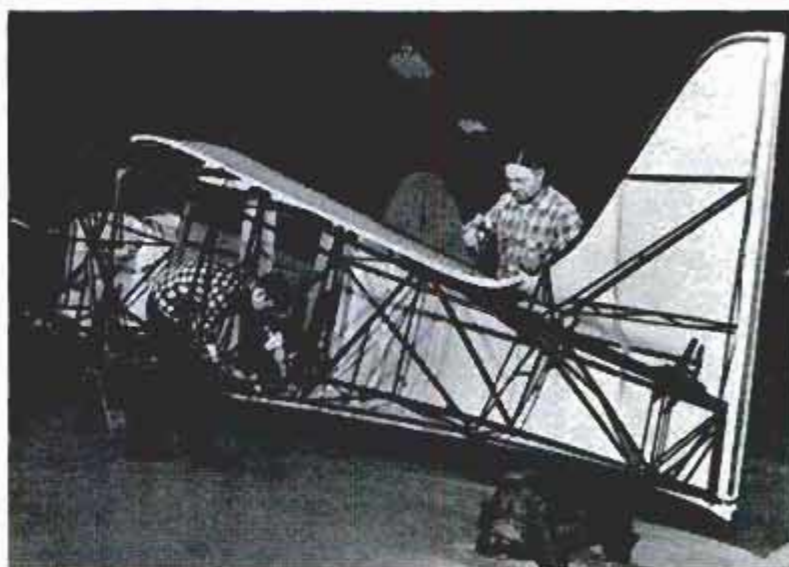

Right and left halves of the fuselage are placed together over a welded tubular frame to make the complete fuselage. Any portion of the fuselage can be made in the die, for replacement of damaged sections. Below, the Topper, Taylorcraft's agricultural version of the plastic plane, can carry 1200-pound load of chemicals



WHOLESALE TOOL CATALOG

MAKE EXTRA MONEY

Start Your Own Business

Sell tools part time, full time. Save money for your industrial and institutional use. **A MILLION DOLLAR INVENTORY AT YOUR FINGERTIPS.**

Buy **NATIONALLY ADVERTISED** hand tools, hardware, fans, motors, power tools, paints, etc., **NO INVESTMENT REQUIRED.** Buy as you need it. Up to **50% DEALERS DISCOUNT.**

Send \$1 Deposit for Dealers Card and mammoth dealers catalog. \$1 refunded on first purchase or returned if you are not 100% satisfied.

SILVO HARDWARE CO., Dept. PM-7, 108 Market St., Phila. 6, Pa.

FIX YOUR FORD

FIX YOUR PLYMOUTH

FIX YOUR CHEVROLET

FIX YOUR CAR SAVE

Three great handbooks for mechanics, car owners, by Bill Toboldt, Editor, Motor Service Magazine.

□ **FIX YOUR PLYMOUTH**—Covers all models '56 to '46. Brings you know-how of hundreds of top Plymouth service men. Step-by-step repair procedure, money-saving shortcuts, kinks, how to increase gas mileage, make car run better, faster, worth more. \$2.95 postpaid.

□ **FIX YOUR FORD**—Similar to Plymouth book but covers all Fords '55 to '32. \$2.95.

□ **FIX YOUR CHEVROLET**—Similar to Plymouth book but covers all Chevys '55 to '46. \$2.95. Check books weekly.

clip and mail with check or U.S. bill **TODAY, MONEY BACK GUARANTEED.**

GOODHEART-WILCOX CO., 1321-A South Michigan, Chicago 5.

SPARE-TIME MONEymaking OPPORTUNITIES

READ OUR CLASSIFIED ADS

HUNDREDS OF BARGAINS AMAZING OFFERS

SOON — BIG NEWS

Shopmaster POWER TOOLS

MAKE BIG PAY OR OWN A BUSINESS

Learn AIR CONDITIONING AND REFRIGERATION

Play safe—choose your future in Air Conditioning, a billion-dollar industry that's growing every day. New CTI Shop-Method plan teaches installation and repair at home. You get 23 practical training kits—motor, compressor, gauges, controls, refrigeration hi-side, tools, supplies. You build an air conditioner, freezer, refrigerator or milk cooler. Write today for **FREE BOOK.**

COMMERCIAL TRADES INSTITUTE, Dept. R-290
1400 Greenleaf Ave. Chicago 26, Illinois

LEARN TO BECOME A GAME WARDEN

or GOVT HUNTER. Join FORESTRY, FISHERY, or WILDLIFE Services. Excellent opportunities! Good pay (\$2500 to \$10,800 a year). Pleasant Work, Prestige, Real Security, Healthful Working Conditions, and Retirement Income can all be yours. Help fill the demand in your area. Make your love of the outdoors become your business. Learn at home in spare time—it's Easy! Fun! Fascinating!

FREE! (if over 17 years old.) Complete, illustrated booklet that gives you complete facts. **SUPPLY LIMITED—send your name and address now—TODAY!**

HOME STUDY EDUCATORS, Dept. R-7
1036 S. La Brea Los Angeles 19, Calif.

TELEVISION NEEDS TRAINED MEN

Train AT HOME for a top-pay job or your own business. No experience needed. "Learn by doing" with 15 big radio-TV kits, including TV receiver. Licensed by N.Y. State; Approved for Veterans. Write for **FREE BOOK & SAMPLE LESSON. RADIO-TELEVISION TRAINING ASSOCIATION, Dept. M7-C, 52 E. 19th St., N. Y. 3, N. Y.**

HIGH WAGES!

Are being paid to Operators of Bulldozers, Draglines, Back Hoes, Earth-movers and Motor Graders. Contractors want our graduates. Learn these skills NOW

National School of Heavy Equipment Operation
P.O. Box 8243-D-8, Charlotte, N. C.

Please send me your School Catalog **FREE**

Name _____
Street Address _____
City _____ State _____

Hi-level train 96

Plastic dome for stadium 104

Motionless magnetic refrigerator cools to minus 459 degrees F. 114

Self-propelled concrete mixer picks up sand and cement 115

Cows heat house 115

Smog hunters "shoot" offenders with car-mounted cameras. 122

Floating fire barrier protects Boston Harbor 132

Remote-control wiring device eliminates central transformer (Pyramid Instrument Corp., Lynbrook, Long Island, N. Y.) 133

Hot water shrinks fabric to produce 3D effect (United States Rubber, 1230 Ave. of the Americas, New York City 20) 133

Inventory computer cuts Army's red tape 134

Monorail roller coaster is fun ride at German fairs 134

Musical blackboard plays for students in West Germany 135

Roof of trailer turns into boat (D & B Sales and Service, 184 Worcester St., Wellesley, Mass.) 135

When bridges fail—take to the river! 135

Versatile Army typewriter prints in 50 languages (Ralph C. Coxhead Corp., 720 Frelinghuysen Ave., Newark 5, N. J.) 139

Experimental typewriter types words and phrases 143

Summer skier keeps his feet dry by skiing across river on logs 240

SCIENCE

"Blackboard X ray" uses charged plate for film 77

Speedy X-ray analyzer spots unknown materials (X Ray News Bureau, General Electric, 4855 Electric Ave., Milwaukee 1, Wis.) 78

Iceberg's age told by oxygen content of bubbles 133

Rainfall indicator (Airttronic Research, Inc., 5522 Dorsey Lane, Washington 16, D. C.) 223

Gas pellets protect fruit (University of California, Riverside, Calif.) 232

SPORTS AND CAMPING

Rounded-top tent has no center pole (Evon Products Co., Box 173, Evon, Ohio) 78

Self-propelled water skis skim along at 40 miles per hour 89

Tent that sleeps seven unfolds from 39-pound package (Morsan Tents, 10-27 50th Ave., Long Island City 1, N. Y.) 90

Exercising chair (Health-O-Giser, 1201 Isabel St., Burbank, Calif.) 105

Shotgun choke changes automatically to produce three patterns 105

Two-pound cookstove burns ultrasafe fuel (The Vulcan Radiator Co., 773 Capitol Ave., Hartford 6, Conn.) 139

Golf handicapper (Lifeguard Corp., 4124 N. Knox Ave., Chicago 41) 227

Radio-Television, Electronics

Station to station transceiver 145

Hi-fi goes modern 145

TV in step with the times 145

Versatile R-C substituter 145

Craftsman and Shop Notes Index

AUTOMOTIVE

Auto-caravan lead car identified by pennant 157

Leak in radiator core sealed with aid of steel wool 197

Bumper jack and tow chain help break tire seal 200

FARM AND FARMING

Parts-storage bins installed on machine-shed wall 190

Steel sawhorse legs made from cultivator wheels 190

Oil drum and spreader wheel make self-feeder for hogs 196

Steel plate welded to hinge prevents screws loosening 196

HOUSE AND HOME

An easy-to-build glass-fiber pond 164

Sprinkler rate of flow measured in empty coffee can 165

Chinese-oven barbecue 166

Plastic wind screens 173

A lightweight garage door 189

HOUSEHOLD HINTS

Punching heavy fabric 156

Toy dishes make meals fun for sick child in bed 162

Painted cottage-cheese boxes are colorful flowerpots 163

Extra handle on garbage-can lid permits easier removal 165

Handy wall rack for magazines 165

Cut plants kept fresh longer by crushing ends of stem 168

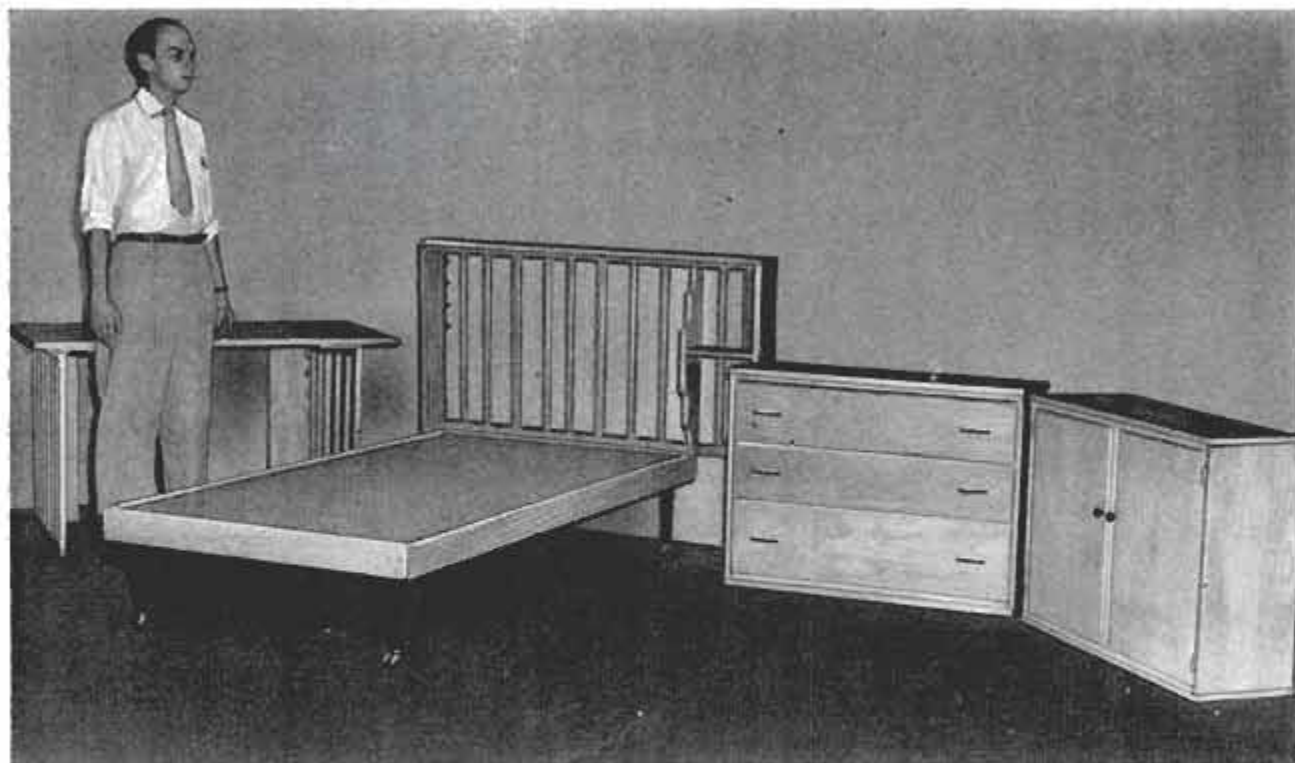

Baby bed with built-in chests at left becomes full-size bed, two chests and desk



Furniture for Baby Grows up With Him

Now parents can get a baby bed that grows up with the child. The baby bed is built on a platform as big as a full-size twin bed. At one end is a chest of three drawers and at the other is a small closet. The mattress can be placed at five different levels. When the child grows older, the bed is disassembled and becomes a complete set of furniture for the bedroom. Included are a full-size twin bed, two chests and a desk. The railed sides of the baby bed become the headboard of the larger bed.

Weed Puller With Teeth Yanks Out Crab Grass by the Roots

Crab grass and other lawn pests are removed quickly with a small weed puller. The teeth of the tool are slipped into the roots, the handle given a slight downward thrust and the weed is out, roots and all. Plantain, buckhorn, dandelion, Johnson grass and other weeds are removed as easily. Large areas can be cleared in a short time and reseeded without the waiting period required by strong chemical sprays.

It takes 67,000 nails weighing 390 pounds to construct a well-built \$15,000 five-room frame house, according to Wood Research Laboratory, Virginia Polytechnic Institute.

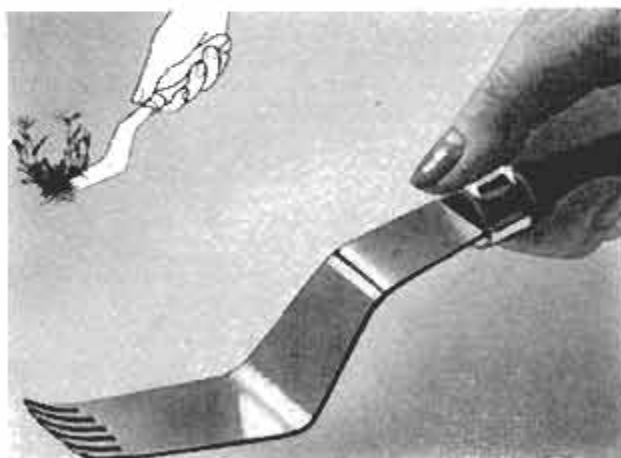

FREE!

FREE!



Capitol High Fidelity record

Nothing to buy or join. \$1.49 hi-fi record, "LA DANZA" with 30 minutes of Spanish music excitingly recorded by Hollywood Bowl Symphony Orchestra. Listen to "LA DANZA" for two minutes on world famous RADIO CRAFTSMEN high fidelity, then take record home as free gift. Offer limited to first 1,000. Write for name of nearest dealer:

RADIO craftsmen INC.
4223L West Jefferson Boulevard
Los Angeles 16, California
SUBSIDIARY OF PRECISION RADIATION INSTRUMENTS

WELDING may aid your **SUCCESS**
Arc and Acetylene Welding Metallurgy; Heliarc, etc. This is home, spare-time training for men who appreciate the importance of welding and want to advance in the field, get promotion, enlarge own shop, etc. Send for FREE BOOK, Utilities Engineering, 2523 Sheffield, Dept WC-13, Chicago 14

"THINGS TO MAKE ON TOOLS YOU OWN"

NEW DELTA hard bound book. Describes wide selection of projects to be built on tools you own—only \$1.00. Send for FREE folder on complete Delta Library: Delta Power Tool Div., Rockwell Manufacturing Co., 502G N. Lexington Ave., Pittsburgh 8, Pa.

FREE OUTFIT STARTS YOU IN BIG MONEY SHOE BUSINESS!



Run your own profitable "shoe store" business from home! Represent fast growing million dollar firm in full or spare time. We give you—FREE—complete Starting Outfit that makes you \$217 EXTRA each month for just 2 easy orders a day. Feature 195 fast-selling dress, sport, work shoe styles for men and women. Air-cushion shoes, many other special features! Sizes 2½-15—AAAA to EEEE. Draw on 200,000 pair stock. Also horsehide jackets. Start now selling to friends, folks where you work. Rush postcard for FREE Outfit!
MASON SHOE, Dept. 407
Chippewa Falls, Wis.

(Continued from page 60)

Loose wires in circuit breaker cause unnecessary opening.....	163
Roof insulation ventilated.....	168
Solving Home Problems—	
Glass castor cup holds wet umbrella.....	170
Shade-roller brackets quiet rattles of Venetian blinds.....	170
Table salt applied to ice cubes hastens chilling of beverages.....	170
Tea strainers hinged together make a handy sudser.....	170
Wooden drawers can be made to slide easily.....	170
Doors that sometimes stick.....	171
Sheet of clear plastic holds recipe booklet flat.....	171
Steam or hot-water pipes made attractive.....	171
Glass-fiber covering.....	171
Strip of adhesive tape over center terminal of flashlight.....	171
Ornamental house-plant shelves hook over window sill.....	172
Uses for aluminum-foil piepans.....	172
Two-plug wall receptacle adapted for remote-control operation.....	176
Paper-plate spacers protect stacked china dishes.....	180
Coasters from aluminum foil.....	180
Utility kitchen table fitted with breadboard.....	180
Recipe board marks off ingredients as they are used.....	180
Graphite grease protects standpipe threads.....	181
Pivoted stop on drawer back automatically kept vertical.....	194
Keep fireplace damper closed for better air conditioning.....	232

MISCELLANEOUS

Corkscrew end on wire "fork" secures wieners.....	156
Guard fence placed in window prevents child from falling.....	157
Rubber stoppers serve as feet for tubular-steel furniture.....	157
Fancy picture-frame molding from embossed-leather belt.....	163
Overhead garage door locked with large C-clamp.....	163
Liquid-glue applicator enlarged by winding pipe cleaner on it.....	163
Fish-cleaning job is easier and faster with clamp board.....	165
Name written with sparkler photographed by time exposure.....	166
Striped sleeve on guy wire provides safety factor.....	168
Trash box fastened to mower saves steps when cutting lawn.....	168
Band and button secure cover.....	172
Copper wire wound on sewer pipe keeps tree roots out of joints.....	172
Finishing your water skis.....	174
Indian headdress for youngster is made of feathers and tape.....	181
Renovating old books, and new ones worn from extensive use.....	181
Clipper rounds tag corners.....	181
Sandbag plugs drain while repairing lines.....	188
Width of thin material measured more easily when bent.....	190
Corrugated cardboard strip makes simple crayon holder.....	194
Fluted milk-bottle covers are handy art-color pans.....	194
Asphalt shingle prevents blowtorch sliding off pitched roof.....	200

SHOPPING FOR TOOLS

Magnifier attaches to micrometer.....	202
Saw-drill combination power tool.....	202
Threading-die holder for power threading.....	202
Drill jig.....	202
Veneer trimmer.....	203
Air-operated impact wrench.....	203
Air-powered caulking gun.....	203
Air-powered drill head.....	203
Shop vacuum cleaner.....	204
Planer attachment.....	204
Impact wrench attachment.....	204
Combination power tool.....	204

WORKSHOP HINTS

Muffin pan used as drawer to store small parts.....	156
Tape tearproofs sandpaper.....	157
Magnet holds brush upright in paint can.....	166
Measurements recorded on ruler.....	176
Jointer shaves leather.....	188
Related parts stored in jars.....	190
Extending length of T-bolts to clamp large work to table.....	193
Tool for valve core removal.....	193
Screws seal punctured can.....	194
Handy wooden miter box for use on saw horse.....	194
Setup to grind jointer knives.....	195
Tailstock faceplate adapter.....	196
Grooved plate on bandsaw table prevents marring of work.....	196
Nail inserted in cotter-key eye prevents damage.....	197
Six small anvils for home metalworking shops.....	197
Eyeglass case holds drill bits.....	200
Socket-wrench adapter from discarded auger bit.....	200
Lathe used as gluing clamp.....	201
Heat-forming plastic with dies and fixtures.....	201

IMPORTANT NOTICE—It is the intention of this magazine to provide its readers with information regarding the latest developments in the mechanical arts. We take no responsibility as to whether the disclosures contained in our articles are covered by patents and advise readers to investigate this subject before making, using, or selling any of the products, machines, or processes described in order to avoid possible liability for patent infringements.

Completed Popular Mechanics Ranch Type House and exact scale pictorial room and suggested furnishing layout. To right of dotted line is BASIC HOUSE. Expansion to the left. Designed for easy building in two convenient steps.



Basic house includes living room, dining area, two bedrooms, kitchen, bath, utility room and car port. Can be built for about \$5000.

More than 100,000 families have built their own homes in the past few years, doing all of the work, or most of it themselves. Right now, one of every five homes being built is at least partially owner-built. This proves that you too, if you can use hammer and saw, can build your own home and save more than one-half of the cost.



Add
When You
Need More
Room

When expanding you add garage and breezeway, and car port becomes third bedroom. About \$2500.

Build the Basic
House First



Get this Newest Popular
Mechanics "Build-It-Yourself"
Book and Building Plans and Save
Many Thousands of Dollars

Book gives complete step by step instruction in simple language. Hundreds of pictures, actual photos and diagrams, showing every phase of construction, guide you from start to finish. Ten working size blueprints give floor plans, elevations, notes on construction, framing, lumber list, specifications, plumbing and wiring diagrams.

part of it. And at the same time, save in labor costs, more than he spends for material.

Order Book and Plans Now

Use the handy coupon below to order your copy of the RANCH-TYPE HOUSE BOOK AND PLANS. Read the book; study the plans and then you will be prepared to go right ahead when you are ready to build. Even if you have the house mainly built by others, you can still enjoy a tremendous savings by using the instructions and blueprints from Popular Mechanics.

Read How and See How - Simplified Instruction

You read "how-to-do-it" in the book. You see how it looks in actual pictures. You follow the plans for dimensions and details. You make use of labor-saving kinks and special methods developed especially for the project.

No Previous Building Experience Required

Any ordinary handy man, using only simple tools, can build this house with little or no assistance and enjoy every



Use This Handy Order Coupon

POPULAR MECHANICS PRESS, Dept. 756
200 E. Ontario St., Chicago 11, Ill.

Send at once my copy of the Ranch-Type House Book and Plans as checked below:

- Remittance enclosed Send C.O.D. (postage extra)
- | | |
|--|---------|
| <input type="checkbox"/> Ranch Type House Book | \$ 3.50 |
| <input type="checkbox"/> Set of 10 Blueprints | 13.50 |
| <input type="checkbox"/> Book and Blueprints | 15.00 |
| <input type="checkbox"/> Duplicate Set of Blueprints | 5.00 |

Name _____

Address _____

City _____ Zone _____ State _____

Beat the High Cost of Home Owning It's Easier Than You Think

Here is a dream home that can become a reality without too much worry about money. Build this beautiful Ranch Type Home yourself. Simply follow the Popular Mechanics RANCH TYPE HOUSE BOOK AND PLANS. You can save \$7,000 to \$10,000 and have one of the most desired homes of these times. You can build it all now—or part of it—and add garage, breezeway and another bedroom later on without affecting the basic house.

**Modern Design • Fully Finished • All-Season
Build this Home Anywhere and Save**

Designed for Popular Mechanics by John F. Whelan, famous West Coast architect and designer of homes and entire villages. It's a year round house, 81 feet long and 29 feet wide. Fully insulated. Finished outside and inside with durable plywood and requires no plastering. Brick "island wall" and big fireplace in living room. Heating, unique ventilating system and latest development in electric wiring included. A dream home that can easily come true and a home that can grow with the family.

Reduced size illustrations from book. Building roof truss on floor for easy construction. Mrs. Tom Riley, Portland, Oregon, shingles the roof on her Popular Mechanics Ranch Type House



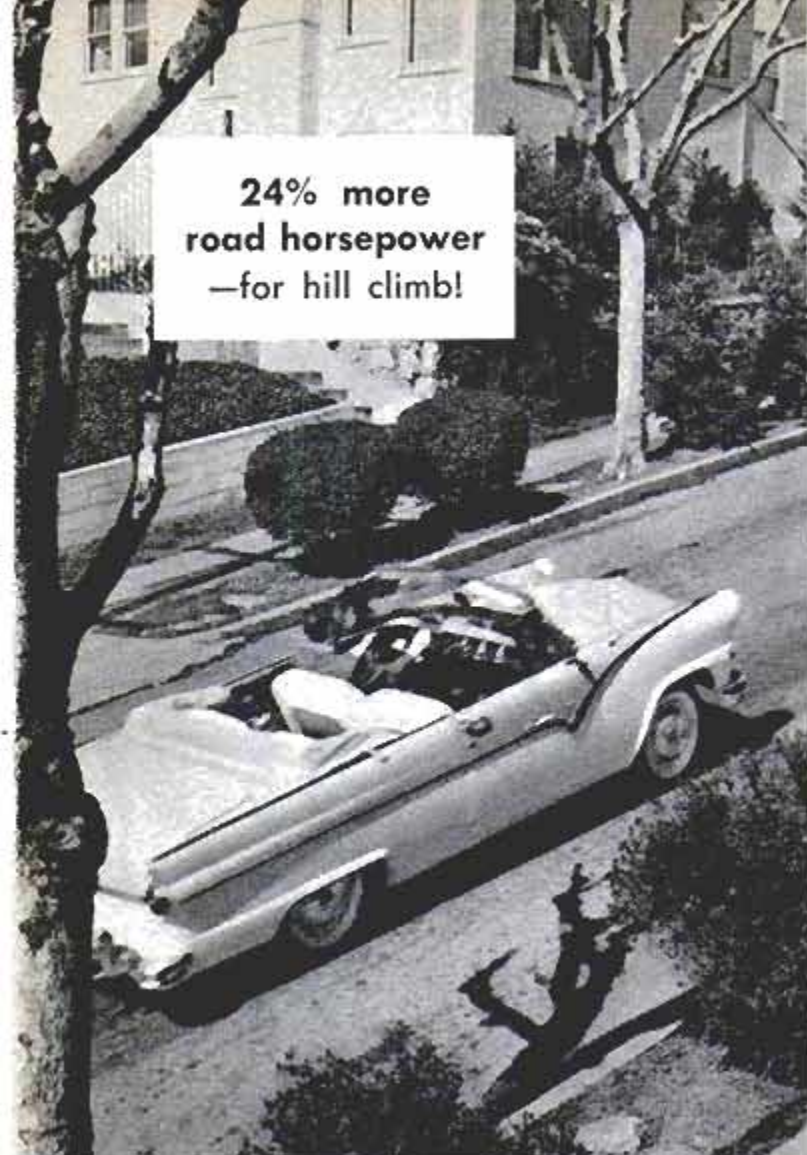

24% more
road horsepower
—for hill climb!

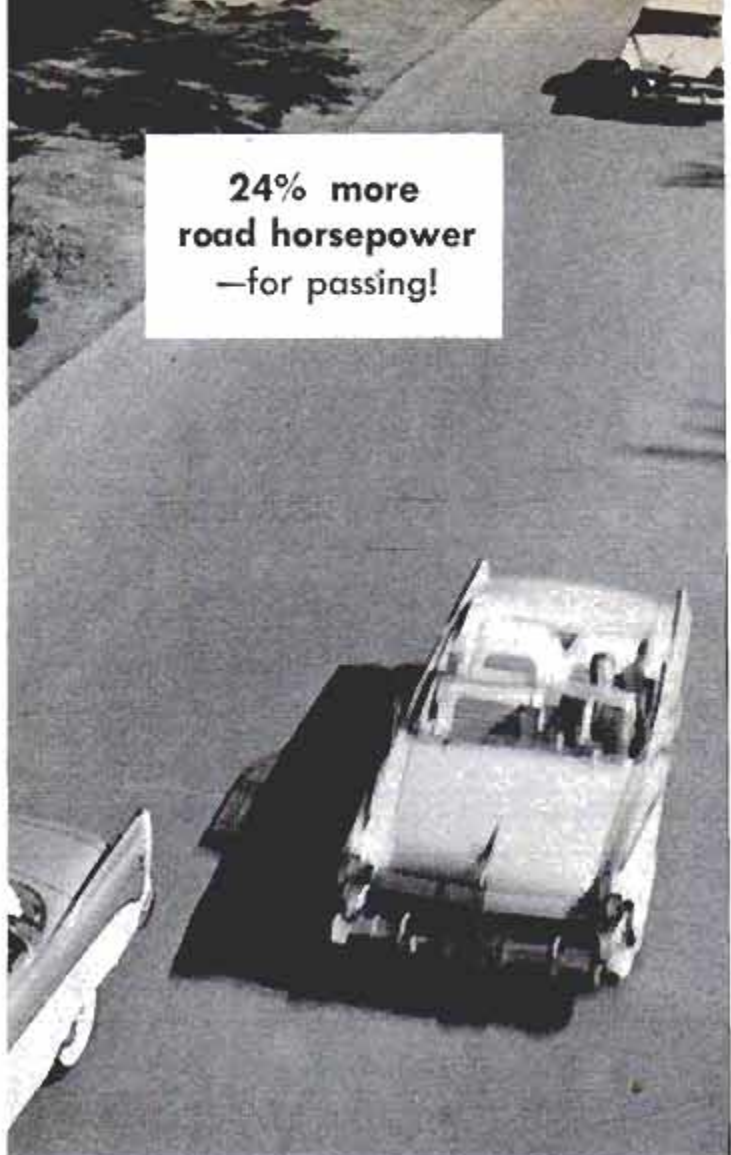

24% more
road horsepower
—for passing!

In cars that have gone about 10,000 miles without a spark plug change—

New Champions can increase road horsepower by 24%!

TESTS with major makes of cars prove it! Independent engineers took cars whose plugs had run 10,000 miles or so and tested them for power — first with their regular plugs, then with 5-rib Champions with the new Powerfire electrodes.

Nothing about these cars was changed except their spark plugs. Yet there was an *immediate* increase in their road horsepower — the real power actually delivered at the rear wheels! *The average road horsepower gain for all cars tested was 24%!*

It comes down to this: There just never has been a spark plug to match these new Champions with their Powerfire electrodes! Replace your old plugs with new 5-rib Champions today — and you'll feel the difference *at once!*

CHAMPION

LOOK FOR THE 5 RIBS



ORDINARY ELECTRODE POWERFIRE ELECTRODE



New Powerfire electrode stands up better in today's engines. Photo shows how ordinary electrode burns away. Champion's Powerfire electrode, after identical use, is still good for miles of powerful service!

POPULAR JULY 1956 MECHANICS

WRITTEN SO YOU CAN UNDERSTAND IT
VOL. 106 NO. 1



"Suddenly the explorer's feet slipped from the pipe . . . His safety belt held him over a 16-story drop"

ASSAULT ON **FORTY-FATHOM PIT**

By Warren Rogers

CAVES ARE SCATTERED around the country in every state except Delaware. An army of 2000 spare-time explorers is constantly adding to the cave lore of the nation—breaking a dark and often dangerous trail for scientists to follow. The National Speleological Society recently announced the discovery of 32 miles of caves under Flint Ridge in central Kentucky. These caves are beyond the one in

which Floyd Collins was trapped in 1925 when seeking a new entrance to famous Crystal Cave which he found in 1917.

Another victory for "cavemen," also in Kentucky, was last year's successful assault on Forty-Fathom Pit, deep within James Cave. This feat was termed "impossible" by veteran rock-climbing experts who first looked into its depths and called it the nation's toughest underground

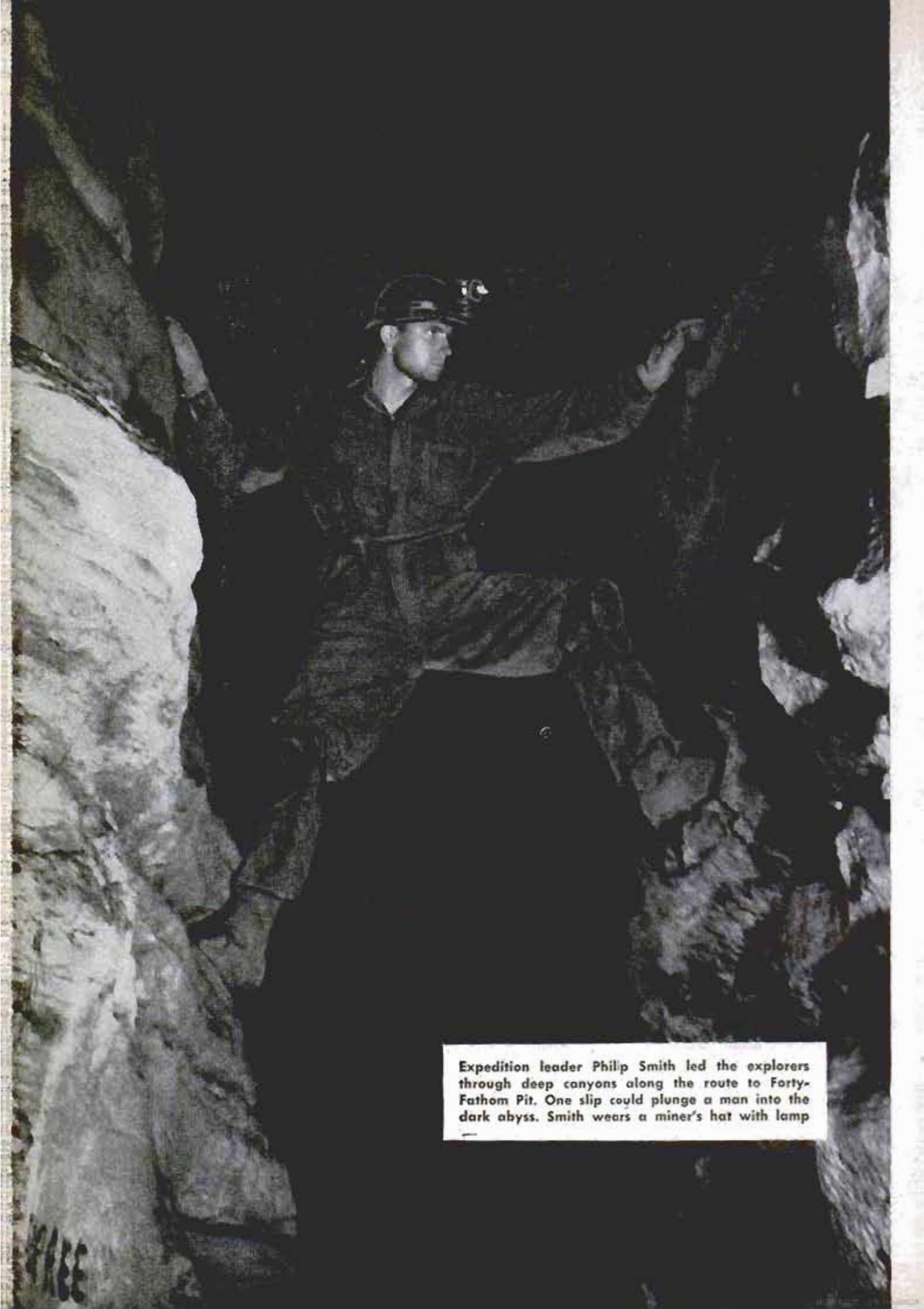

Expedition leader Philip Smith led the explorers through deep canyons along the route to Forty-Fathom Pit. One slip could plunge a man into the dark abyss. Smith wears a miner's hat with lamp

FREE



Cables fastened to the top rung of the pipe bridge hold it in position as the explorers jockey it forward

challenge. From near the top could be seen an inviting but inaccessible passage opening on the far side of the shaft across 30 feet of black air. At first, it was thought that the passage could be reached with standard mountain-climbing techniques calling for pitons (iron pegs) to be driven into crevices in the rock wall. An explorer could hook his safety line into the eye of one of these spikes, then pound in others as he progressed.

But there weren't any crevices in the walls of Forty-Fathom Pit. The smooth, unbroken walls were like concrete—hard and sheer. Philip Smith, a husky, experienced explorer of the big-cave country in Kentucky, Pennsylvania and Tennessee, believed that the pit could be bottomed and crossed, regardless of the experts' opinions. He found 13 cave explorers who were willing to try it with him, then laid plans for an expedition. One of his key men was Burnell Ehman, a machinist and auto-parts wholesaler. To him he gave the job of designing and building a rig that would carry at least one man safely to the other side of a deep hole.

Before the jump-off day, Smith assembled the group for a field test of the un-

usual equipment. At a gorge, whose walls dropped 40 feet into a river, the explorers pushed an insecure-looking pipe bridge toward the opposite cliff. The pipe was ordinary water pipe sawed into four-foot sections, coupled with bolts. Sections had to be that short to fit through a tiny, curving crawlway about 18 inches in diameter and as long as a football field—the only known route to the pit.

One end of the bridge was bent upward at an angle to rest securely on the other side. Steel bars were welded to it so an explorer could pull himself up after crossing, and steel loops provided anchors for a block and tackle as well as guy ropes. Although the sagging pipe would clear-span 30 feet, a block and tackle rigged at the middle increased its maximum safe load to one half ton.

Expedition leader Smith hooked his safety belt onto a welded ring designed to slide along the pipe as he moved. He started across, hanging under the pipe in raccoon-fashion with the roar of water below drowning out all sound. As he moved out, curious bystanders wondered why he chose this precarious method of crossing the gorge instead of using a perfectly



Eyebolts are sunk into the hard limestone walls at the brink of the pit. Safety lines are hooked into eyes

Four-foot sections of steel pipe were bolted together to make the bridge for spanning the pit



Below, this is the three-man survey party that attempted to find an alternate (easy) route to the far side of Forty-Fathom Pit. They mapped more than a mile but could find no way to cross



satisfactory footbridge less than a mile away. He climbed safely to the other side and yelled back to the group that the pipe had passed the test. The expedition was ready to assault Forty-Fathom Pit.

Eight hours prior to the arrival of the main party, a three-man surveying team entered the cave to map and mark the route to the objective, a quarter mile underground. With an accurate map, the leader could determine whether unexplored alternate routes would lead to the far side of the pit. The survey revealed no passages leading to the other side of the pit.

"Surveyors" Do It the Hard Way

A strange caravan donned miners' hard hats fitted with brass carbide lamps. They shouldered sections of pipe and flexible cable ladders as they filed into the cathedrallike entrance room and squeezed into the opening of the crawlway. Working as a team they relayed their supplies forward, then crawled ahead to repeat the process. By noon, all equipment, including a field telephone connecting them with their topside camp, lay at the edge of the pit. Sledge hammers drove rock drills deep into the hard limestone. Sweaty explorers took turns swinging at the steel bits. Every man was tied to lengths of rope to prevent slipping on the rocky slope tilting into the pit.

Two hours later, four eyebolts juttied out of the wall from their anchors. One team



Working on a tilting slope at brink of pit, one of the men drills hole into ceiling for block and tackle

bolted pipe sections together while another rigged the block and tackle.

Two men moved out to a rock promontory as the pipe clanked forward. They guided the free end of the bridge toward the mouth of the virgin passage beyond them. Rocks pelted down the shaft, ricocheted off the sides and finally, after several seconds, exploded faintly on the bottom.

After three hours of alternately pushing the bridge out and pulling it back to try again, the exhausted explorers shot dubious glances toward Smith. He looked dejected, but there was still tomorrow.

The group spent part of the next morning rigging a 200-foot ladder to explore the bottom of the pit. The ladder, made of steel cables with aluminum rungs, didn't look strong enough to support the weight of a monkey, let alone a fully loaded cave explorer. The leader climbed down anxiously.

In 15 minutes he stood on a ledge at the 197-foot mark. Below him the shaft continued downward. He estimated the distance from his position to the apparent bottom at 50 feet, but the explorer was at the end of the ladder. He had descended deeper into a Kentucky pit than anyone before, proving Forty-Fathom Pit more than a hundred feet deeper than its nearest rival, 139-foot X Pit in nearby Floyd Collins' Crystal Cave.

When Smith returned from his record-breaking descent he rested while others

prepared the ropes for one last attempt. Backs bent into the ropes. Veins stood out on a dozen foreheads. Through brute force more than luck, the pipe inched into position. They tied it off, then prepared to send a man across.

Everyone held his breath as the man started across. The bridge was holding, just as it had during the test. Suddenly the explorer's feet slipped from the pipe! With a loud metallic sound he stopped, dangling beneath the pipe like a trapeze artist. His safety belt held him over a 16-story drop. After resting a moment, he hoisted his legs over the pipe and continued his journey.

On the other side he pushed into the blackness. He returned shortly to announce the discovery of another pit around the bend in the passage to the right. Did Smith want him to continue exploring? Smith did, but unless they cleared out immediately, they would all be late for work. The explorer agreed to return after he had written a note for future conquerors to read on the far side of the pit. The man returned; they started out, dragging equipment, pipe and rope behind them.

The week-end cave explorers had run into their old enemy: Time. To be sure, they'll return to James Cave and, time permitting, will press even deeper into the black, uncharted passage. But they won't forget the first time they executed the horizontal and vertical conquest of Kentucky's deepest underground pit. ★ ★ ★



Outboard-Powered "Aquatic Sports Car" Hits 30 Miles Per Hour

Automotive design distinguishes a glass-fiber "aquatic sports car" that is powered by an outboard motor. The boat has a downswept hood, French headlights, high tail fins and a sleek interior. It carries four passengers and comes equipped with radio,

docking lights, running lights, vinyl upholstery and plastic-foam flotation. The craft is 14 feet long, has a 64-inch beam and a 24-inch depth and can be fitted with a 40-horsepower motor that gives it a top speed of 30 miles per hour.



Metropolitan 1500

With 24 percent more power, the new American Motors Metropolitan has a top speed of 78 miles per hour and goes up to 40 miles per gallon. It has a larger engine of 90.89 cubic inches or 1489 cubic centimeters, hence the model designation "1500." Compression remains 7.2 to 1. Horsepower is 52 (up from 42 last year). Style changes include the grille, two-tone paint with a chrome separator and a flattened hood (previous models had a simulated air scoop).

Dial-a-Stamp Dispenser Installed in Post Office

You dial the number of stamps you want on a machine recently tested at New York City's General Post Office. The unit, which costs \$4000, delivers two-cent, three-cent and airmail six-cent stamps. In addition, it makes changes and even says "thank you." The customer places a nickel, dime or quarter in the slot before dialing.

Night-Glowing Bike Tires Increase Road Safety

Bicycle tires that glow in the dark make for greater safety on the road. Glowing colors—red, blue or green—cover the entire tread and extend into the tire sidewalls for greater visibility. The color is built into the rubber and will not wear out, fade or scuff during the life of the tire.



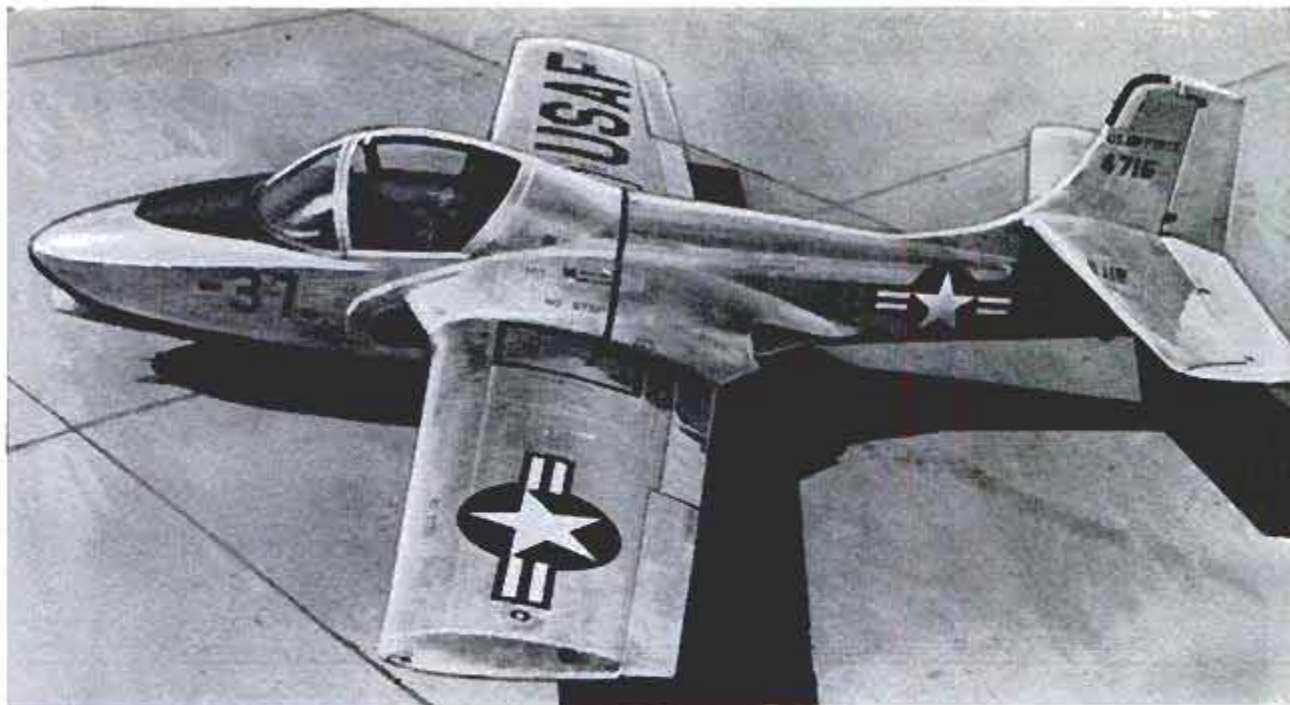

First of the Cessna T-37 jet trainers intended as spotters for atomic artillery will be delivered in October

Jets Used as Spotters For Atomic Artillery

PREVIEWING the speed, power and terror of atomic warfare on the ground, the Army has been given top priority in the production of T-37 jet trainers for use as the "eyes" of its 280-millimeter atomic cannon. Up to now, the Army has been using L-19 and L-20 scout planes for artillery spotting, but the top speed of these little ships is about 100 miles per hour—too slow to enable them to spot their targets and get out of the area before the atomic blast.

"The speed with which atomic-age forces will assemble, strike and disperse," an Army spokesman declared, "makes it essential that we be able to identify a target within minutes and destroy it before it disperses."

The T-37, with a top speed of 395 miles per hour, can get in and get out in time to do the job and stay alive. Furthermore, one T-37 can spot targets for a battalion or more of the big guns covering a target area of several hundred square miles.

The T-37s, which will be on loan to the Army from the Air Force, were chosen over the older but faster T-33 because in addition to a good top speed, they can be flown slowly enough for spotting.

Atomic artillery, like 280-millimeter cannon below, is designed to hit rapidly moving targets such as tank concentrations



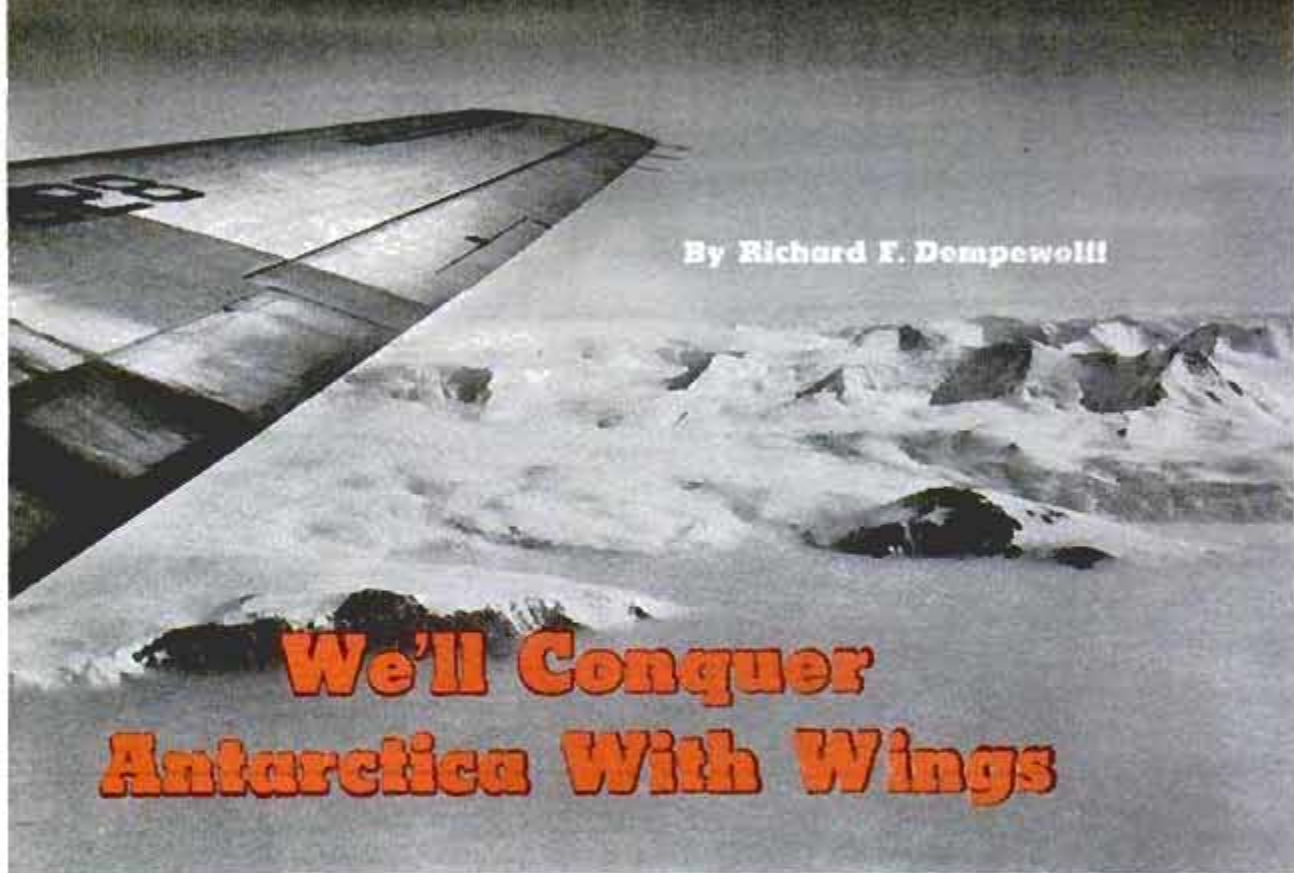

By Richard F. Dempewolf

We'll Conquer Antarctica With Wings

National Geographic Society photo

Fourteen-thousand-foot peaks of Britannia Range, 90 minutes' flight from McMurdo, push through clouds

WITH A SPECTACULAR blue flash, eight jato bottles clamped to the sides of Comdr. J. W. EntriKin's P2V Neptune cut loose. Standing in hard-packed snowdrifts on Antarctica's McMurdo Sound, we watched the heavily loaded plane surge forward as its boat-size ski-wheel landing gear skimmed the ice runway. The hot blast vaporized the snow surface of the strip. Frigid polar air instantly condensed the vapor and left a fog curtain one half mile long behind the orange wing

tips of the twin-engine patrol bomber. "Buno 122465" was off on the fourth of ten historic flights made last January over the south polar ice plateau. As south polar flights go, it began in routine fashion. Climbing above the chaos of crevasse-ridden glaciers and 12,000-foot mountains west of McMurdo, EntriKin and his crew of five winged 1250 miles beyond Wilkes Land, into an unexplored region dramatically called "the area of inaccessibility." If you

balanced a map of Antarctica on a pin point, the region in a 1000-mile circle around it would approximate the boundaries of this no man's land.

At a control panel behind the P2V's navigator compartment, photographer T. H. Stallings flicked a switch occasionally. The triple-lens horizon-to-horizon Trimetrigon cameras in the plane's sleek belly automatically photo-mapped — with proper overlap—the bleak mountains and endless, featureless snow prairie below. Every half hour, navigators took sun fixes, using a periscope sextant that poked through a special socketlike hole in the overhead. They made observations through an eyepiece inside the plane.

Rear Adm. George Dufek, left, commanding officer, checks chart of expedition's polar flights. Captain Ketchum, deputy commander, is with him

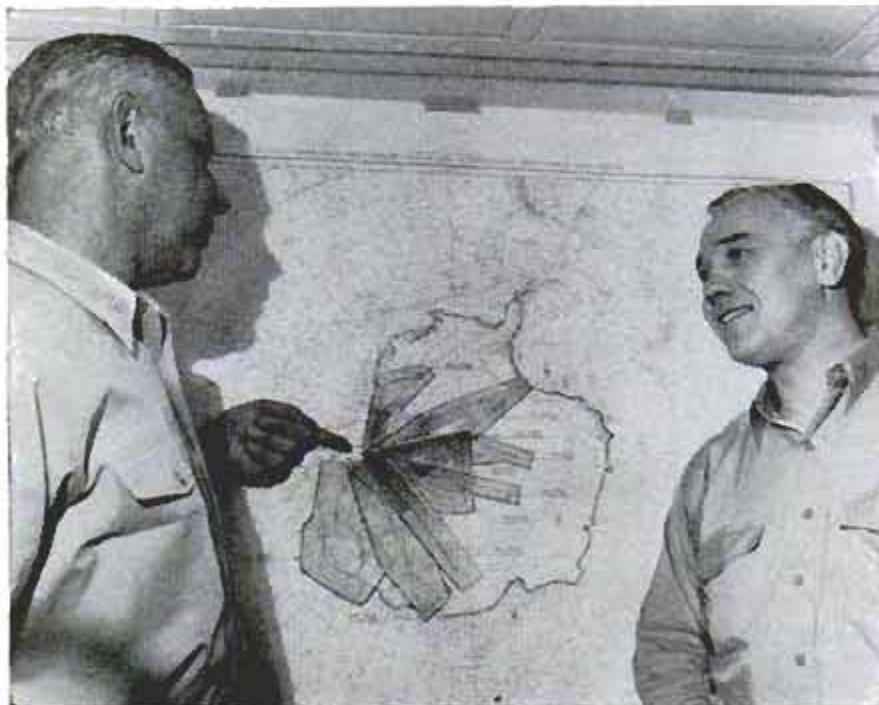



Ice for the runway at McMurdo Sound was tested for thickness with a seven-foot motorized chain saw

Qualified fliers drifted in and out of the cabin, taking turns at the controls and watching the radio altimeter to make sure the high plateau wasn't creeping up beneath them. More than one plane has landed on it in full flight. Mostly, they flew on automatic pilot or, as they put it: "We've turned her over to George."

Back aboard the Navy cargo ship *Wyandot*, used as air-control center at its mooring on the northern edge of McMurdo's bay ice, regular position reports from the plane crackled through. For six unbroken hours, crews in the radio shack

and CIC (Combat Information Center) listened drowsily to the dit-das coming in, and watched the glowing green radar sweeps in the darkness. Somebody went out for a container of coffee to break the monotony.

At that instant, every man in CIC leaned forward, electrified. The unmistakable Morse SOS . . . SOS . . . flooded earphones and loudspeakers. Pencils flew across pads as the grim words spelled themselves out. A thousand miles out over the 12,000-foot-high polar plateau. Entrikin's starboard engine was failing. Maximum altitude for a

All photos except title picture, page 72, taken by Richard F. Dempewolf, *Popular Mechanics'* Editor with Task Force 43

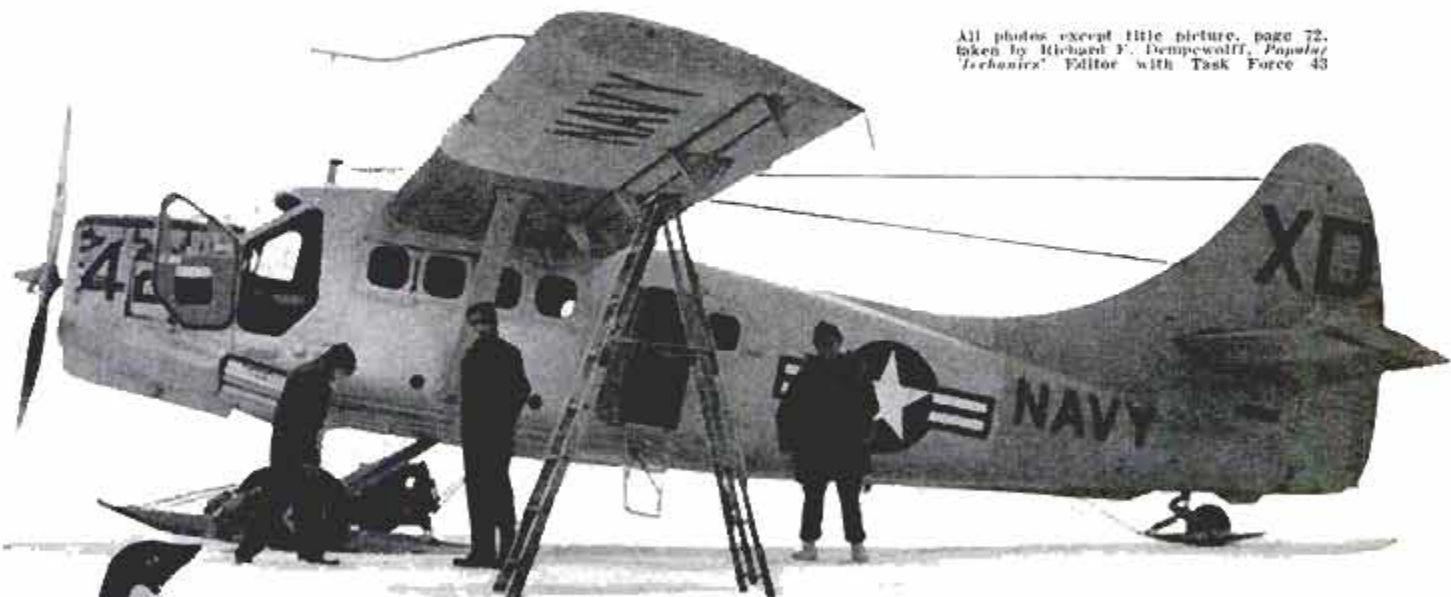

One of Deepfreeze's four deHavilland Otters is surveyed by an Adie penguin. All during the antarctic operations, the Adies represented the "Sidewalk Superintendents' Club," as groups of them continually wandered up to see what was going on. The Otters were brought down to site in ships, stripped of wings and other parts, then unloaded and assembled for work

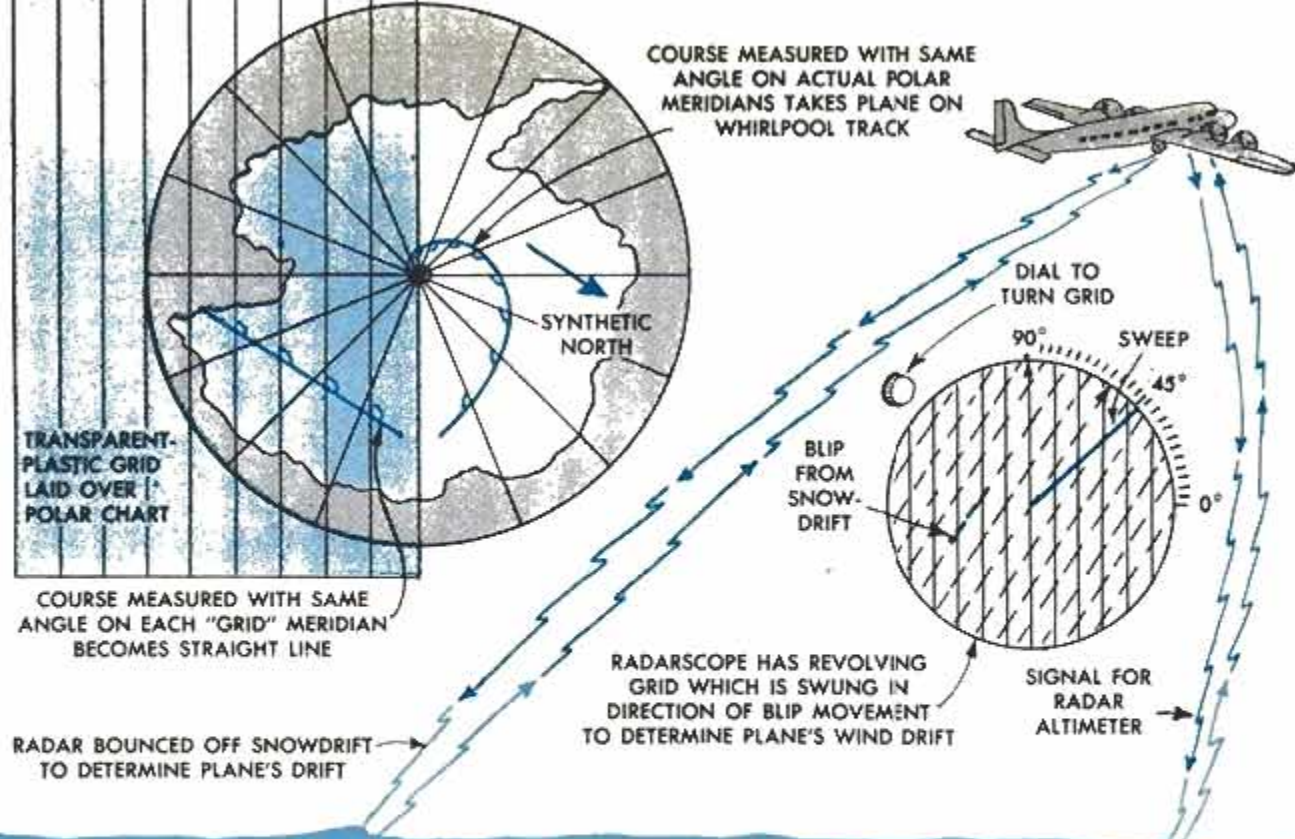

HOW PLANES NAVIGATE OVER THE POLAR PLATEAU

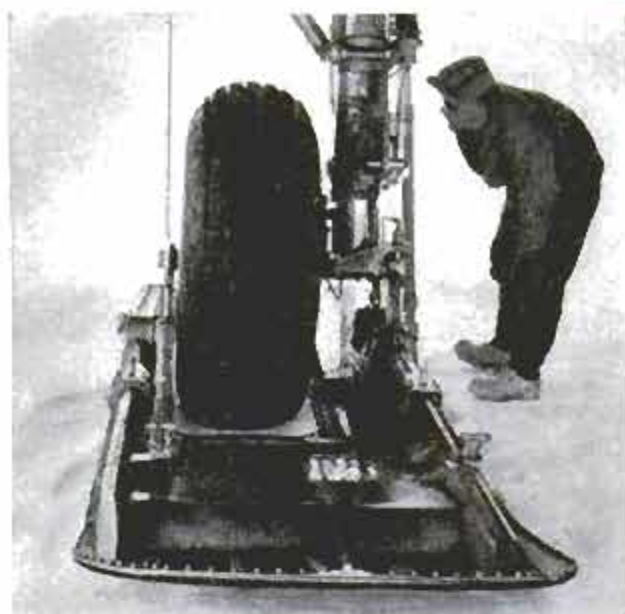

Above, crewman examines ski-wheel assembly on a P2V. Ski can be lifted so plane can land on wheels

loaded P2V on one engine is only 6000 feet. "What are the chances for rescue?" an operator asked.

"Zilch!" somebody muttered.

On board Buno 122465, men were battling to keep the crippled plane flying. Their situation seemed hopeless. Only a few hundred feet below stretched an eternity of featureless, windswept snow that no human foot had ever trod. They were dropping toward it—fast. Temperature was five below zero. They knew no ground-rescue party could travel the 1000-mile round trip across Antarctica's hazardous, unexplored interior to reach them. Their 45-day survival rations and equipment couldn't see them halfway if they tried to "walk out." Another long-range ski plane might land on the soft snow. But chances were it would never take off again. No one has yet





One of Deepfreeze's plane-crash victims is brought back from survival tent where he had stayed 14 hours

dared land a heavy plane deliberately on the polar plateau.

Loose Gear Overboard

"The engine sputtered and backfired violently every few minutes," Entrikin reported later. "She gobbled precious fuel at a rate of 1400 pounds per hour. Revolutions per minute fluctuated wildly." Entrikin jettisoned his bomb-bay gas tanks and ordered all loose gear thrown overboard. Out went personal belongings, cooking gear—everything but precious radio and survival equipment. Slowly the radio altimeter crept up again. Heaters were turned off to save 30 gallons of fuel per hour. Within minutes, canteen water in the cockpit froze solid and crewmen shivered in their insulated clothing.

For 5½ hours it was a touch-and-go race with certain death. Back at McMurdo you could taste the tension. Emergency crews scurried around the ice to marshal survival equipment, refuel and hang jato bottles on search-and-rescue planes. All aircraft frequencies went silent to provide clear channels for the cripple. Grim-faced men trooped through air control for orders, and departed to carry them out.

A four-engine Skymaster and a second Neptune roared away to find the wobbling plane. A few minutes later everyone breathed more easily. The scouting planes had homed in on a speck in the sky 120 miles westward. It was Entrikin and crew, skimming the Antarctic highlands. Some

minutes later Entrikin shot a neat one-engine landing on the ice runway, and the shivering crew was helicoptered to the ships to thaw out. The Neptune's gas tanks contained 150 gallons—about 20 minutes more of flying time.

Long-Range Aerial Probes

Entrikin's reason for being 1000 miles out over the heart of Antarctica was not just curiosity or sightseeing. This flight, like the nine other long-range probes made by Operation Deepfreeze pilots, was part of a 10-day crash program of aerial exploration and mapping that covered about a third of the southernmost continent's 3,000,000 square-mile unexplored interior. Most of the desolate reaches over which they flew had never been seen by man. Tracks included four passes over the South Pole, transcontinental stabs toward the coastal ice of the Weddell Sea, on the opposite side of Antarctica, and into the far reaches of Wilkes Land below the Indian Ocean. More than 22,000 feet of aerial film mapped about 1,000,000 square miles for—according to one Navy photographer—"the big Antarctic picture." Once assembled, these pictures will help cartographers fill some of the vast blanks in current charts of the silent continent.

Deepfreeze's air fleet, Air Development Squadron Six (VX-6 for short), under Comdr. Gordon K. Ebbe, consisted of two four-engined R5D Skymasters, two helicopters, two ski-wheel P2V Neptunes and



Scarlet trail flags were planted in holes in the ice and frozen in place to outline the runway boundaries



Take-offs were impossible for the big planes without jato. Four bottles were mounted on side of each plane

Jato is smokeless, but heat melted snow particles which instantly condensed in extreme cold, leaving a trail

four ski-wheel deHavilland Otters. On board the ice breakers, operating from fantail landing platforms, were the aerial jitneys of the expedition — four Sikorsky seven-man helicopters of Helicopter Unit Two, captained by red-bearded Lt. Comdr. Bill Shockley.

Otters and helicopters rode ships to McMurdo's snowbound mountains. The bigger planes made history. Winging south from New Zealand, they had flown the 2300 miles over wild polar seas on the first nonstop flight ever made to Antarctica from another continent.

To prepare for the fly-in, a special site had to be found and made into a safe home base. "We need sound, flat ice for a two-mile run, with four inches of snow on top to allow braking and prevent skidding," Commander Ebbe explained as he took off in one of Bill Shockley's choppers to shop for his airport.

Forty miles south of the ships, only 800 miles from the pole, they found it—a vast ice prairie at the base of 13,500-foot Mount Erebus. Here, working in minus-20 degree weather, with a 40-mile wind howling down from the slopes of the steaming volcano, Seabees readied the strip. A seven-foot chain saw driven into ice at strategic

(Continued to page 224)





Conventional X-ray tube above patient directs beam through him to register electrostatic image on plate



General Electric photos

Electrostatic image becomes visible when sprayed with powder in developer. Below, picture has 3D quality

Speedy "Blackboard X-Ray" Uses Charged Plate for Film

X-ray pictures are obtained in 40 seconds with a process that uses dry metal plates instead of film. A self-contained, portable unit designed for Civil Defense supplies its own power and is unaffected by radioactivity that contaminates X-ray film. The plates can be wiped off and reused.

A conventional X-ray tube is used. The image is produced on a selenium-coated aluminum plate which is charged before exposure. The X rays, passing through the body, discharge the plate partially and variably depending upon the varying densities of bone and tissue in the patient. The result is a latent electrostatic image on the plate, which is then made visible in a unit which sprays the plate with powder that adheres heavily or lightly to the pattern, like iron filings around a magnet. The fast-acting "blackboard X-ray" is called xeroradiography.

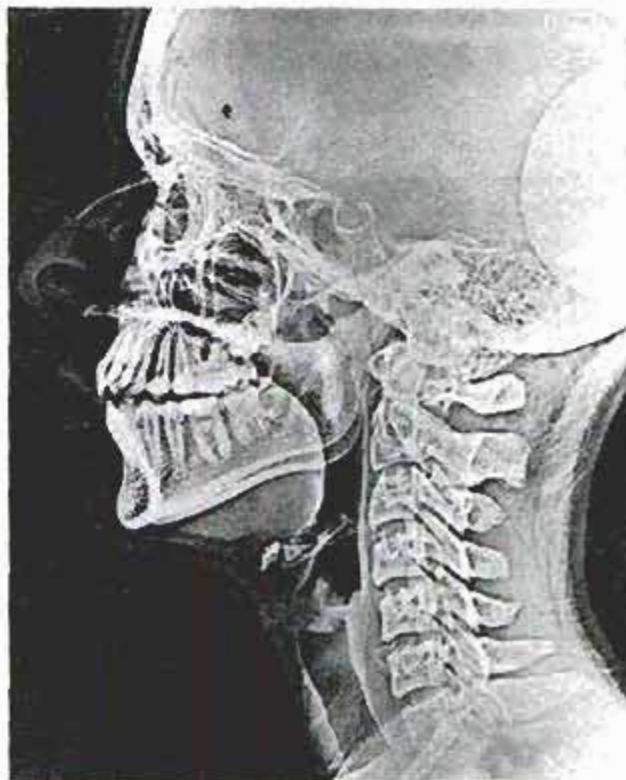

Gun Camera With Automatic Lens to Take Jet Combat Pictures

Better motion pictures of aerial combat will be taken by jet fighters with a new gun camera which has a lens that automatically opens or closes according to light conditions. When engaged in a dogfight, a plane may be pointed at the sun one moment and at dark terrain the next. In older cameras, this meant part of the film was underex-

posed and part overexposed. In the new camera, the illumination received through the lens is automatically compared 64 times each second to the light from a reference lamp inside the camera. If there is a difference in intensity between the two, the lens diaphragm changes to the proper opening to make them match.



Arches of steel tubing support tent, eliminating center pole and giving high headroom and an unusual amount of usable space. Tent is made of forest-green water-repellent duck and has plastic-screen windows in sides

Rounded-Top Tent Has No Center Pole

Taking a cue from the covered wagons of the pioneers, an inventor has brought out a new camping tent with rounded top and no center pole which is supported by rounded metal arches stuck into the ground. The entire frame comes apart in short pieces which are easily carried. The ends of the tent can be left open, or closed during bad weather. The packed tent makes a compact 18-pound shoulder pack.

Speedy X-Ray Analyzer Spots Unknown Materials

Unknown materials are identified quickly with an X-ray diffraction instrument that has a built-in proportional counter and pre-amplifier. No geiger counter is needed. An orienting device makes it possible to identify single crystals of matter and to analyze fibers and wires by the reflection method. A helium-tunnel assembly greatly extends fluorescent analysis, increases sensitivity and permits accurate qualitative analysis of such elements as sulphur, chlorine, potassium and calcium. The unit is in production.



One-Man Helicopter Can Be Folded Up

Developed by the United States Navy, the XRON-1 Rotorcycle is a small, one-man helicopter that can be folded into a small package for easy transportation. With the pilot aboard, the Rotorcycle weighs only 500 pounds, but despite the light weight, has such advanced features as a contrarotating rotor system. The ship can accommodate engines from 40 to 75 horsepower. Flight information is at present restricted, but the test pilot described it as the easiest-to-fly helicopter he's ever handled. Production for the first two years will go to the Navy. After that, a company spokesman said, it may be possible to make the midget machines available to the public.



THE JAIL THAT MODERN SCIENCE BUILT

By Jack B. Kemmerer

ULTRAMODERN in all respects, the new eight-floor Los Angeles Police Building makes available to the city's police department the most scientific building ever used by a law-enforcement group.

Termed the best law-enforcement facility in the world by experts, the building is attracting attention from police officials in all parts of the United States and Canada.

Built of reinforced concrete, with pre-cast-concrete partitions being used in many cases, the building's eight floors plus basement contain 407,826 square feet of floor space. There are 25,000 square feet of glass windows, all fixed in rigid frames and the building is completely air conditioned, with 300,000 cubic feet of air moving through the structure each minute.

The exposed ceilings are false baffles, with almost four feet of space to the bottom of the floor above. All wiring, heat

Spectrograph analyzes inorganic materials, has proven valuable in hit-and-run cases where make and model of car can be identified from a bit of paint





Doors throughout building are push-button operated and only two men have keys, which are seldom used

All exits to central jail have double doors. The second cannot be opened until the first has been closed



and air-conditioning ducts, and water pipes are contained in this easily accessible space.

Show-Ups in Auditorium

The new police facility contains many unique installations, most of which were specifically designed for the building. These unusual features are located throughout the building. On the first floor is the modern auditorium which is perhaps the most versatile installation in the building. With its seating capacity of 453, it is used for conducting show ups, as a classroom and as a motion-picture theater.

The central jail lies directly behind the auditorium and was placed in this location so that ramps could be built between it and the auditorium for easy movement of prisoners to and from the show-up.

First Jail in 1860

In 1860, just 96 years ago, the jail of Los Angeles was located a few blocks from where the new police facilities building now stands. This jail, built of adobe, had a large log running the length of the detention room. Prisoners were chained, and by driving a large spike through the chain into the log, the prisoners were kept from escaping. The new jail is a far cry from those days and is a paradise in comparison to the old adobe building. Today, there are no bars on the windows. Instead, they are glazed with a nonbreakable tempered glass that has more than enough strength to hold the strongest man. This jail is probably as near escapeproof as it is possible to build one.

Nerve Center

Also on the same floor is the nerve center of the police department—the Communications Division. Special thought was given to this custom-built communications installation, since rapid and accurate communications play an extremely vital role in modern-day law enforcement. This is especially true of a city like Los Angeles, with the largest area of any city in the world to patrol.

Located on the second floor is the very busy division known as Records and Identification, or as the department refers to it, the "Memory Room." Probably the one thing required above all others by the officer in the field is the availability of records. Without these, he cannot tell who is wanted, nor can he tell, for example, if an abandoned car he is investigating is stolen or not. An important feature of accurate, readily accessible records is the fact that they can be used to establish a pattern—known as the *modus operandi* or "M.O." Once this pattern has been established, it is often possible to determine exactly who

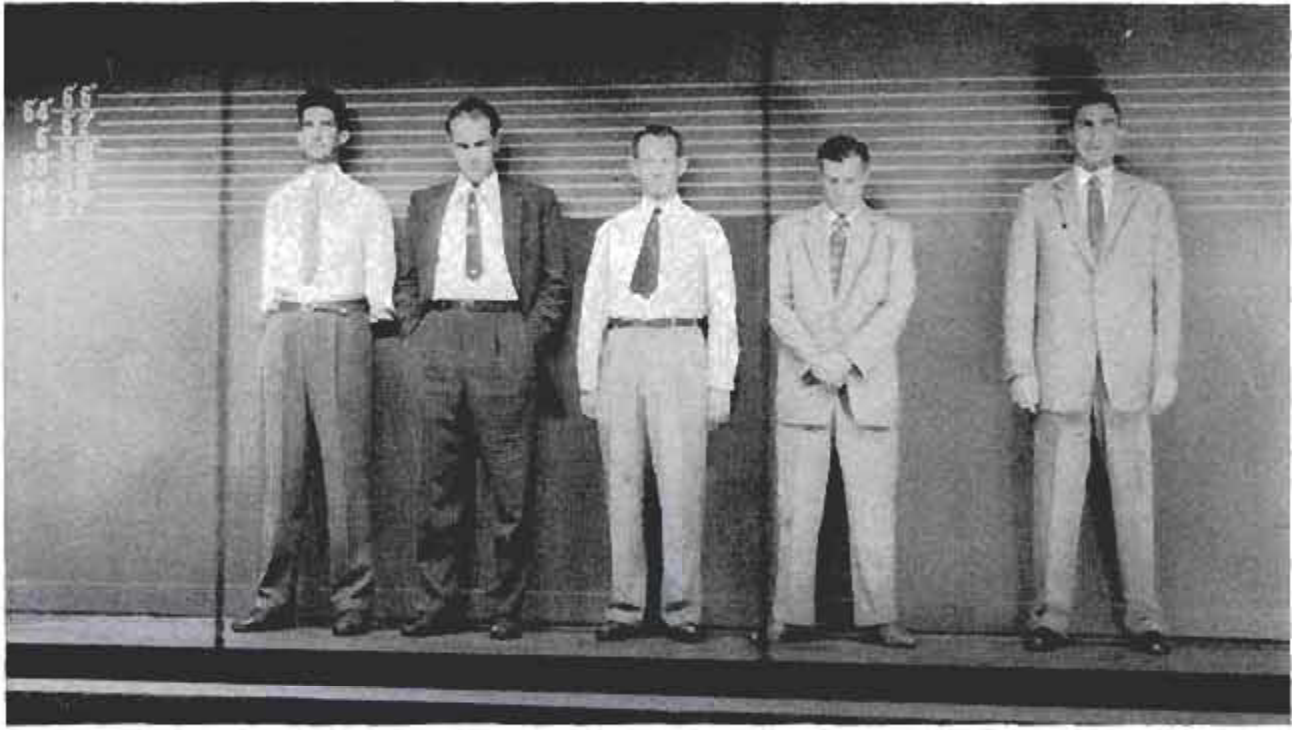

Show-up stage is protected by wire screen. Above, the lineup as seen by the audience through the screen

the perpetrator of a crime is before he is caught. This division handles almost 4000 inquiries daily concerning individual records.

The fourth floor contains a division that probably has brought the greatest amount of international attention to the department—the Scientific Investigation Division. This division has long been recognized as one of the finest in the world and is also the largest of any police department, occupying the entire floor. The men working in the laboratories located here are top experts in their fields, and the names of Lts. Lee Jones and Ray Pinker have become household words to those engaged in law-enforcement work all over the world.

Moving up to the seventh floor, we find the Planning and Research Division. This division has many responsibilities. It is their job to seek out problems, then find the solutions. They are constantly at work, probing into the many facets of law-enforcement work.

A vital part of the division is the Statistical Unit. This was the first unit of a police department anywhere to install a complete array of IBM equipment and make the fullest use of it to solve their problems.

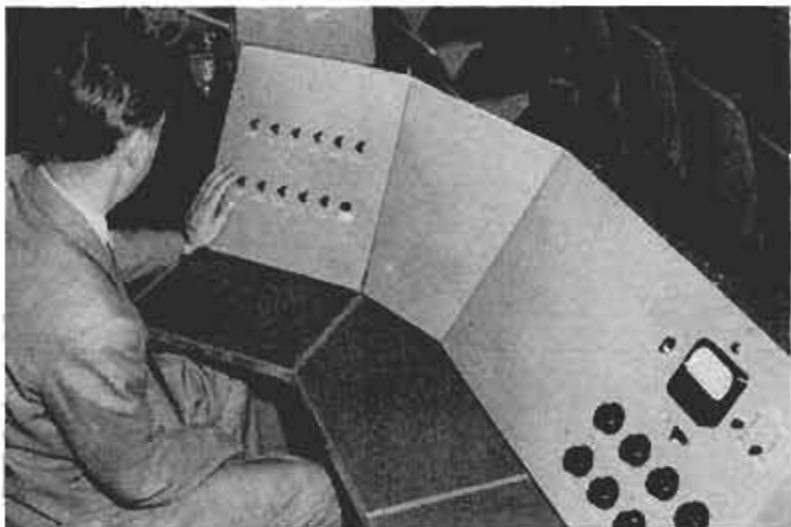

Above, a control console at rear of auditorium re-creates lighting conditions under which suspects might have been seen. Below, view from stage, showing wire screen. Suspects cannot see audience

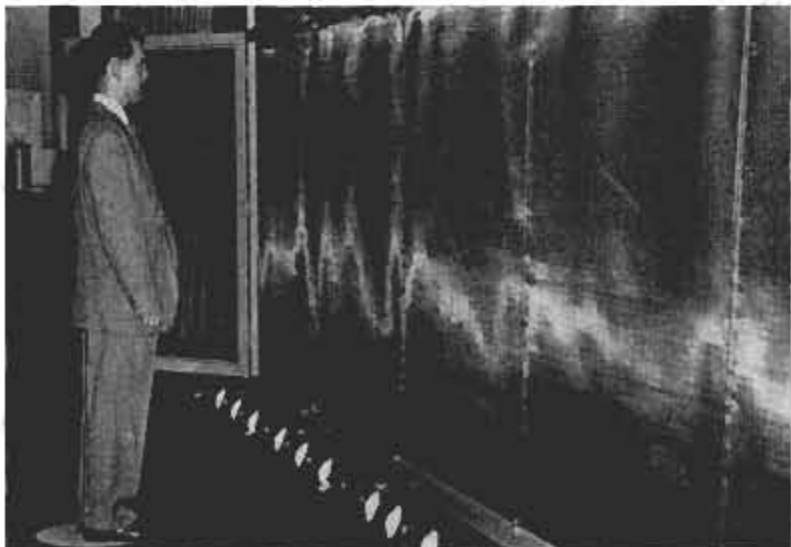



Complaint board is entirely automatic. Incoming calls are sent electronically to an open position. If all positions are busy, a call bank stores them until one is open, then releases them in the proper sequence

Special tempered unbreakable glass is used throughout jail to replace steel bars except on cell doors, permitting better supervision with less personnel. Soft Neoprene floors in detention cells reduce self-injuries



Lie detector is housed in soundproof room. Observers can watch tests on it through one-way mirrors without being seen or heard

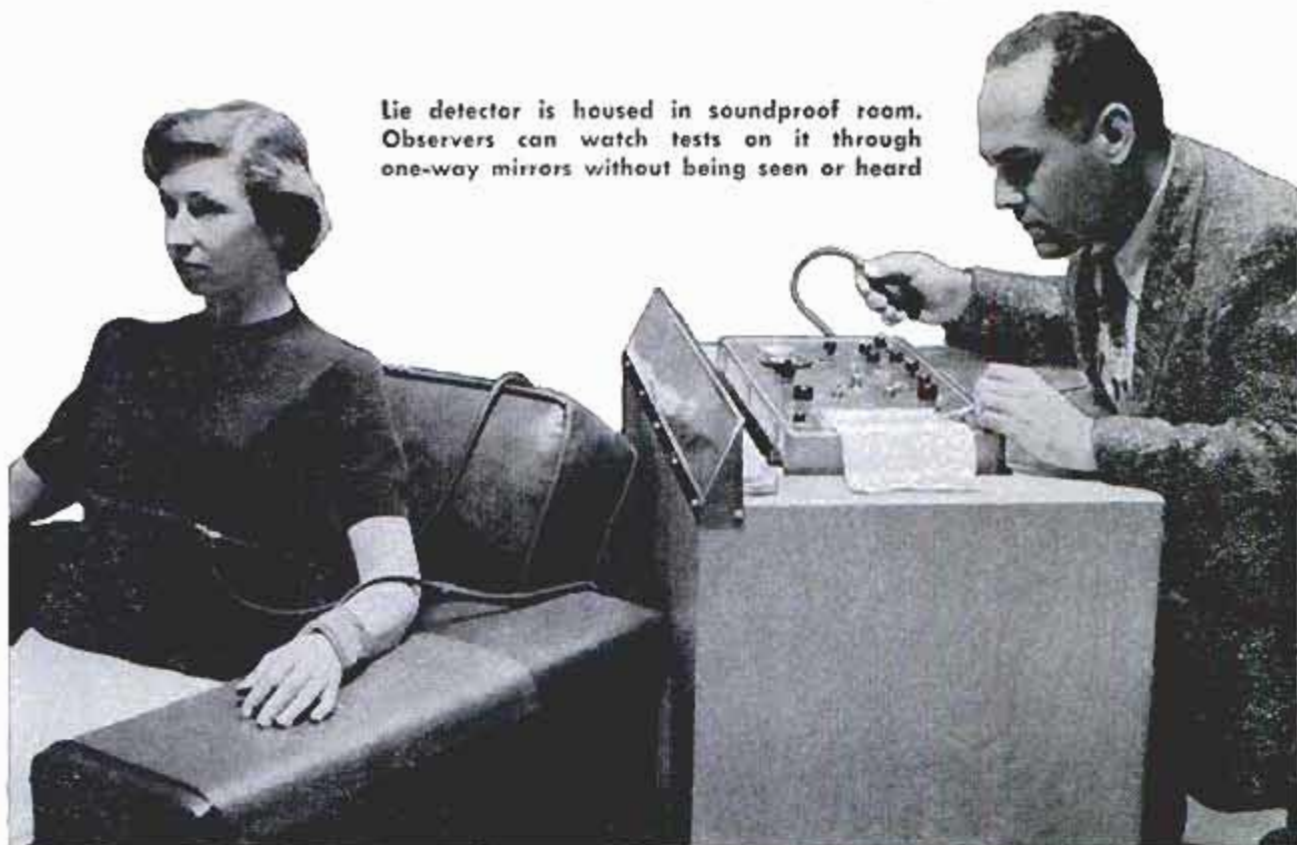

The Property Division, on the ground or basement floor, handles more than \$4,000,000 worth of property annually. It is called on to handle all items of evidence, from furs to ice cream to pocketknives and guns. A large walk-in cold vault is provided to safeguard all perishable goods. The department once stored a partially eaten ice-cream bar in dry ice for several

months. This bar was vital evidence in a case in which the teeth marks in the bar were used to establish the identity of an individual.

Surrounded by the most modern equipment, and with all important divisions located within easy reach in one building, the Los Angeles police can provide better law enforcement for a growing city. ★★

Bullets for ballistics tests are acquired by firing suspected gun into a tank of water nine feet deep

Balloon-blowing test given drunken driver is rechecked in laboratory, gives alcohol content of blood

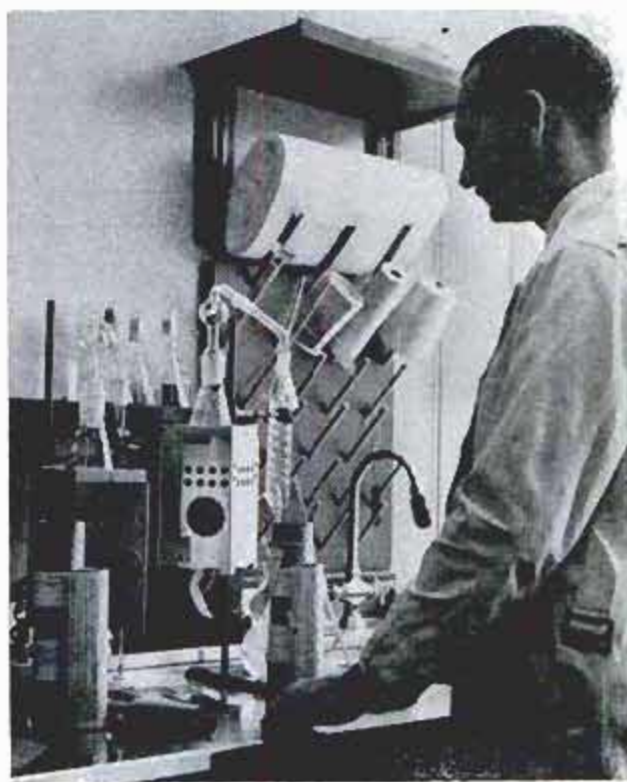
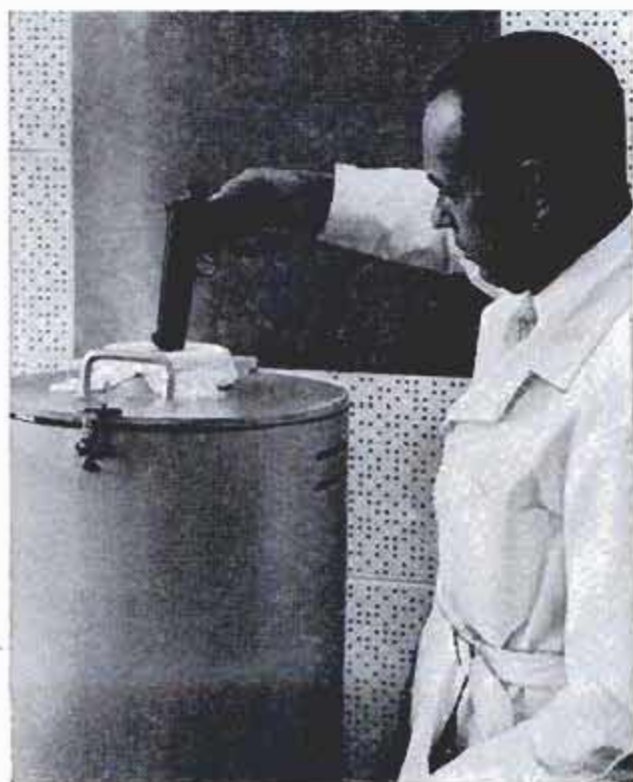

Detroit Listening Post



By Leo Donovan

IF YOU EXPECT revolutionary changes in automobiles in the near future—don't. At least, not at General Motors. No matter what the ads say after the new cars are out.

You have the word of Harlow H. Curtice, President of General Motors. Curtice said recently that we should not expect revolutionary advances "because the hundreds of millions of dollars we spend annually for new tooling represent a tremendous risk. If we are wrong in anticipating the likes of the public, it could be quite disastrous. The public never demonstrated in the past a willingness to accept so-called revolutionary changes, but is quite willing to accept changes on an evolutionary basis."

So there you have it—the cars of the future will change gradually, not radically.

Asked if he would consider the free-piston engine (which GM has been publicizing widely) a revolutionary change, Curtice said he thought it would be, but that he didn't expect it to be available for 10 years or so. He definitely discounted any change to rear engines in the foreseeable future.

Oldsmobile is installing an unbelievably complex cylinder-head assembly machine for production of its 1957 engines. On display at the GM Technical Center dedication, the machine made it apparent that no startling changes are coming in the 1957 Rocket engines. Unused stations on the assembly machine are set aside for future design changes (such as fuel injection and valve rotators, for example) but they obviously won't be in time for 1957.

Superprestige for \$8000

There are still some who insist that 1957 will be a revolutionary year. Insiders say the Cadillac Eldorado Brougham will be a startling and exciting car in appearance and performance. It is to be a superprestige car, selling for about \$8000 and built in limited quantity. Some think it may be sold as a "loss leader" for prestige purposes. Look for the compound-curve windshield, one that sweeps up into the roof as well as

around the sides—the receding-hairline approach to windshield design. If the public takes to it, this will probably be a feature of the 1958 General Motors family of cars.

Certain low-volume Chrysler cars are expected to have the new windshield and if everything goes well, the new shape will be standard by 1958.

Chrysler will look different, but don't expect a shift from the wedge-shaped pattern it pioneered this year. It is the trend of the future, Chrysler maintains. Tailfins are coming on other makes—Ford, for instance.

Pontiac's unhappy showing in the General Motors' sales picture this year could result in radical (if not revolutionary) changes. Informers say the only unchanged part of the Pontiac sheet metal will be the roof. The body shell will be the same, but look for new grille, fenders, hood, tail-lights and trunk deck. The ever-present chrome striping (Silver Streaks) will run along the sides and will be a single wide band instead of parallel stripes. By 1958, this identification device may be extinct.

Cheaper and Better

The 1957 Eldorado Brougham may be the first American car with air-oil suspension. But the whole industry will move that way shortly. Reason? In volume, it is expected that air-oil will be cheaper than torsion bars and better, too. When something's cheaper and better, it's bound to come!

Soon Hudson and Nash will stop competing with each other. Probably Nash will take the upper-medium-price field. Hudson the lower-medium-price field. The Rambler may soon be a separate name, not the Hudson Rambler or Nash Rambler, but just the Rambler.

The power race continues—and will. The biggest cars are running out of power. Some multiple-carburetion costs are fabulous. Fuel-injection systems may soon be as cheap and certainly will offer the added power margin needed for these final years of the reciprocating engine.

If the '57 Eldorado has fuel injection as is now being guessed, you can be sure that the Continental or Lincoln will have it. And that will likely mean that the Imperial and maybe the Chrysler 300 will have it too, although company officials deny this.

Maybe we've reached the end of the dream-car era! One major company that had a dream truck on its schedule for fall showing (it was already being worked on in an Italian body shop) has scrapped the whole project. The industry may have agreed that too much dream-car publicity has made current models unexciting and has contributed to sagging sales. We'll see.



Transparent Fenders Are Feature of Farina-Styled Alfa Romeo

Racing drivers will be able to watch the front tires of an Alfa Romeo sports car with a Farina-styled body. A transparent section in each fender permits viewing the tread condition, at least while the pavement is dry.

Chain-Hung Truck Hopper Lowers to Ground Level

Loads are lifted from ground level by a German dump truck with a hopper hung from a pivoting frame. The frame, driven by hydraulic cylinders, pivots in a 120-degree arc to lift the hopper onto the truck. A support swings down behind each rear wheel to prevent the truck from tipping backward. The chain-hung hopper can be loaded by hand. One can be left at the site to be filled while the other is on the truck.

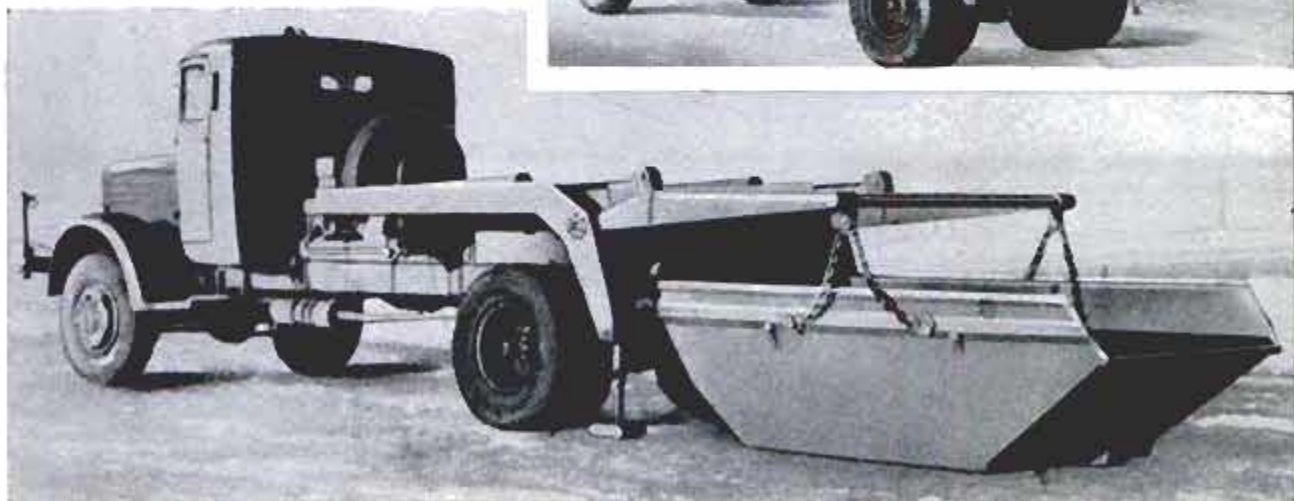
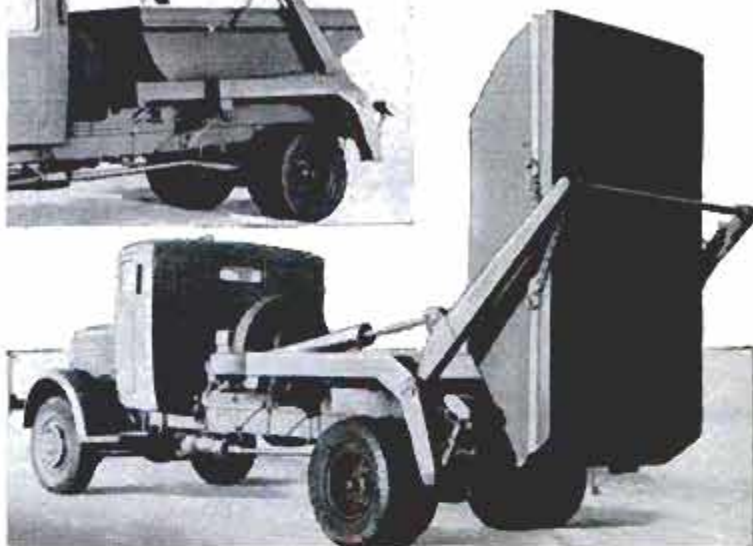

School for Forest Rangers

By
William Gilman



WHEN DRIVING along Route 3 through the heart of the Adirondacks, it's easy to bypass the tiny hamlet of Wanakena, N. Y. And it's hard to realize that America's oldest and biggest school of its kind is nearby. Despite its standing, however, the Ranger School run by the

State University of New York's College of Forestry has only 60 students. Its very specialized job is turning out young men trained to guard and administer our forest lands.

The campus, a neatly landscaped cluster of buildings beside the Oswegatchie River,

Tyro rangers above march in step with log hung from hooks. Below, they break up rock in building a trail

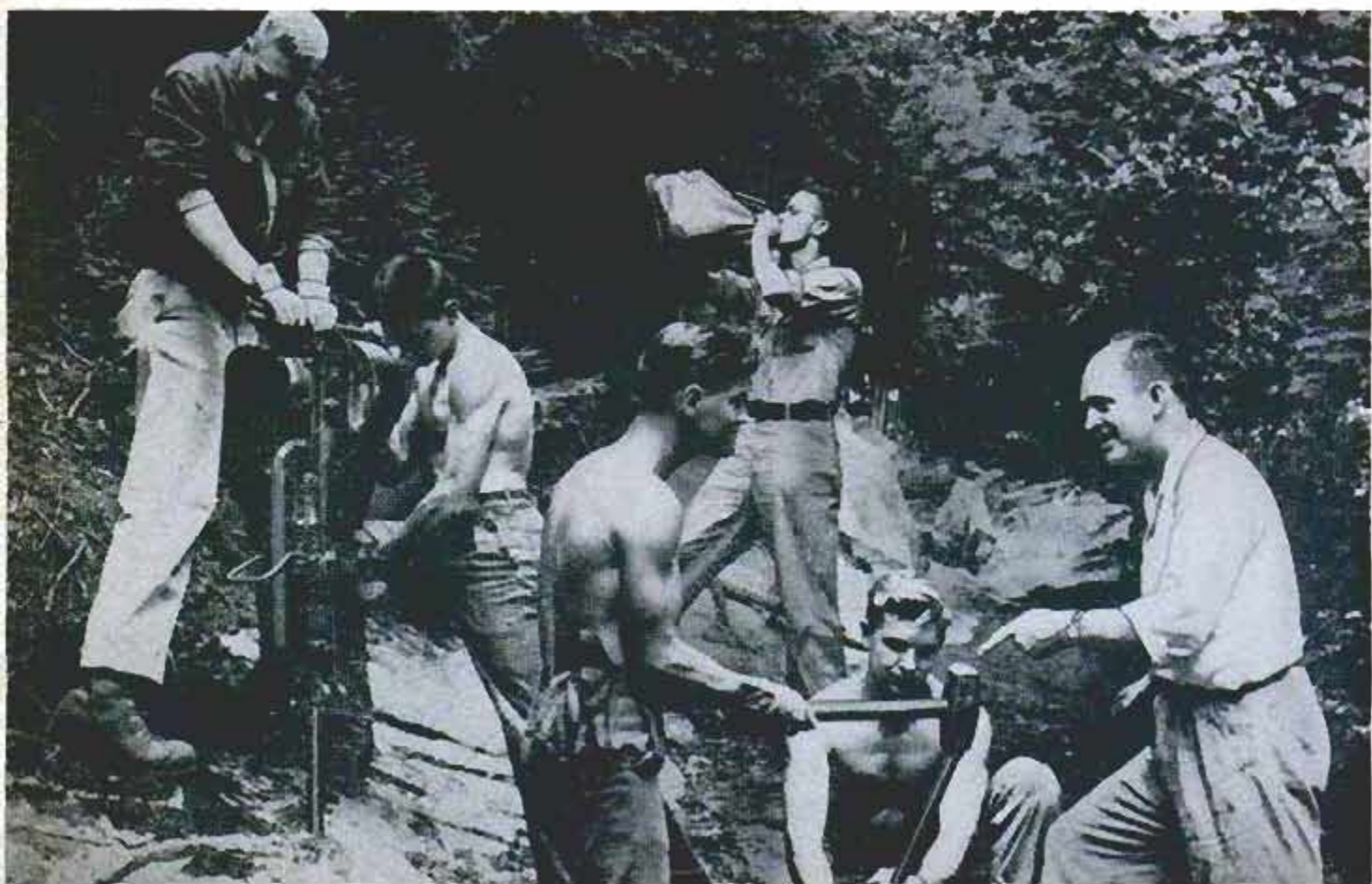



After rocks have been broken up, some are rolled out of the way and others are saved for building trail

is surrounded by a 2300-acre forest preserve.

Here students learn fire fighting, surveying, tree growing, logging and all the other skills needed to manage a park or a commercial tree farm. Most of the trainees are fresh from high school, although the top age limit is 35.

Some alumni of the school have drifted from forestry into odd but related pursuits. One has become the uncrowned king of Anticosti Island in the St. Lawrence River, producing mountains of pulp wood, with canned deer livers for a sideline.

Another cabled back to his company's New York headquarters from the jungle in Venezuela, ordering a rush shipment of water pumps with internal piping big enough "for alligators to pass through."

And there's alumnus Otto Pike in Puerto Rico who grows orchids in his grapefruit orchard.

Smaller pieces of rock become road bed of trail and will stop washouts. Big flat pieces laid along edge form retaining wall





James Dubuar, school director, aids students practicing surveying. Mapmaking is another standard course



Prof. Orrin Latham shows students how to lengthen their reach with pruning saw bolted to ax handle

Among the visitors to Wanakena are professional foresters from as far away as Finland and Thailand, interested in seeing this school that turns out qualified forest rangers in only 11 months. There are no vacations during that period, of course, and little time for teen-age horseplay.

In off hours, the candidates go fishing, hunting or canoeing, but genial James F. Dubuar, the school's director, is quick to point out that this is a place for learning a highly specialized trade, not a haven for would-be Davy Crocketts. Oddly, most of the students come from cities and larger towns, not from the backwoods or even rural regions.

Graduates scatter all over the world in their profession, which is hungry for recruits. Even in the depression the Ranger School was able to place 80 percent of its graduates immediately. Those "old grads" are now sending their sons and nephews back to become chips off the old block.

★ ★ ★

School mascots Johnny and Billy Hensel learn the crosscut saw under guidance of father, a faculty member





Self-Propelled Water Skis Skim Along at 40 Miles Per Hour

You can reach a speed of 40 miles per hour on a pair of "motorized water skis" recently shown in San Francisco. A 16-horsepower outboard motor is mounted on a pontoon between the skis, providing

plenty of power. The craft is steered by the rider's shifting his weight and tilting the pontoon, which automatically turns the motor. The rider stays upright by grasping the crossbar of a metal standard.

Lightweight Knee Rest Padded With Foam Rubber

Gardening and any other work that requires kneeling is eased with a lightweight knee rest padded with foam rubber. Chrome-plated risers on each end act as handles and as supports in getting up or down. A trough at the front holds seed packages, gloves and tools. The 17-inch wide unit is especially useful in waxing, cleaning, laying or repairing floors.

Smithsonian Has Termites

More than 230,000 specimens of termites from 1286 distinct species are under glass at the Smithsonian Institution, most of them contributed by Agriculture Department entomologist Dr. Thomas E. Snyder.





Tent That Sleeps Seven Unfolds From 39-Pound Package

Tentmakers have come up with a model equipped with a screened-in "back porch." Cots can be placed under this canopy to increase capacity to seven persons. The tent

proper has six-foot-high walls, four insect-proof windows which open or close from the inside, canvas floors and a zippered, insectproof front door. Lightweight aluminum telescoping poles support the tent, which weighs only 39 pounds and will fit into a small section of the car trunk.



Squeeze Bulb Starts Siphon

You don't get a mouthful of gasoline when you siphon fuel with a special tube. You just insert the tube in the fluid, squeeze the air from a rubber bulb, and open a valve to let the fluid run. With it, boat motors and garden equipment can be fueled from an auto tank, and aquariums and sink traps can be drained. The siphon is corrosion-resistant and it is not damaged by acids.

Nonsinkable Catamaran Can Be Powered by an Outboard or Paddle

Fun and safety are built into an eight-foot catamaran that features two nonsinkable hulls. The hulls are made of marine plywood sealed with rubber and do not require yearly caulking. Two models are available, one to accommodate one double

paddler plus passengers, and the other up to three double paddlers kayak style. Both come fitted with a motor support for outboard operation. Each is equipped with two seven-foot oars, four canoe paddles and a ten-foot double-bladed paddle.





When the lights went on at Arco, Idaho, electric power from atomic energy went to work for the first time. This report tells you

HOW ATOMS GENERATE POWER

By Rafe Gibbs

ON THE NIGHT of July 17, 1955, thunder rolled down from the Lost River Mountains and lightning whipped across Arco, Idaho. Then, like candles snuffed out by the wind, all the lights in the town went out.

A rancher in a cafe struck a match and held it in front of his weathered face; patrons in a local movie theater whistled; a mother, bathing her children, wondered if

she should get out the Christmas candles. But within a minute the lights went on again and Arco was back to normal—or so the folks thought.

What the rancher, the theater patrons and the mother didn't know until afterward was that the storm hadn't been responsible for the power interruption. The interruption was manmade and, for more than an hour afterward, this little part of the nation

Pictured at top of page is Arco, Idaho, on night it was lighted by atomic power. Below, same view in daylight
Argonne National Laboratory photos



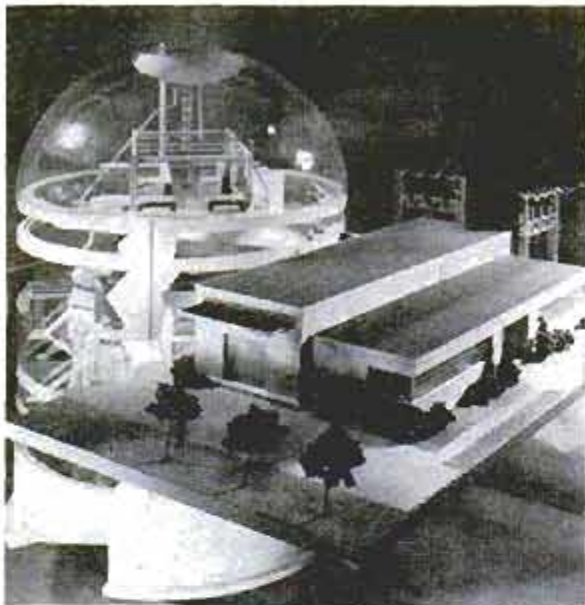

Above, a model of Argonne National Laboratory's experimental boiling-water reactor, which is now being completed. It will generate 5000 kilowatts

was making history as the first town in the world ever to be powered and lighted by atomic energy.

Only a few of the community's 1200 inhabitants were in on the secret when the power switch was made. But even when word of the experiment began to leak out, the townspeople were not too impressed. Arco has long been accustomed to strange phenomena. It is located near the Craters of the Moon—weird black lava cones and caves that look like the surface of the moon as seen through a telescope. And the Big Lost River runs beside the town, only to vanish into the desert beyond. Recently, since the National Reactor Testing Station was established out in the same desert, there have been many unusual happenings—such as the development of the first atomic-powered engine for the submarine *Nautilus*.

Then came the big Atoms for Peace Conference in Geneva, Switzerland, and the experiment in the

quiet little Idaho town made headlines around the world. Among the scientists at Geneva, the Arco story dominated conversations in numerous languages. For this was the big step from laboratory experiment to practical application. The scientists had long known that electricity could be produced with atomic energy, but this was the first time their theories had been put to the test of practical use.

As the Arco story unfolded in their morning papers, citizens throughout the world suddenly woke up to the fact that in reality the Atomic Era had started. Atomic power had already driven a submarine and now it was producing electricity for heat and power. The next question was "What comes after Arco?"

One official of the Atomic Energy

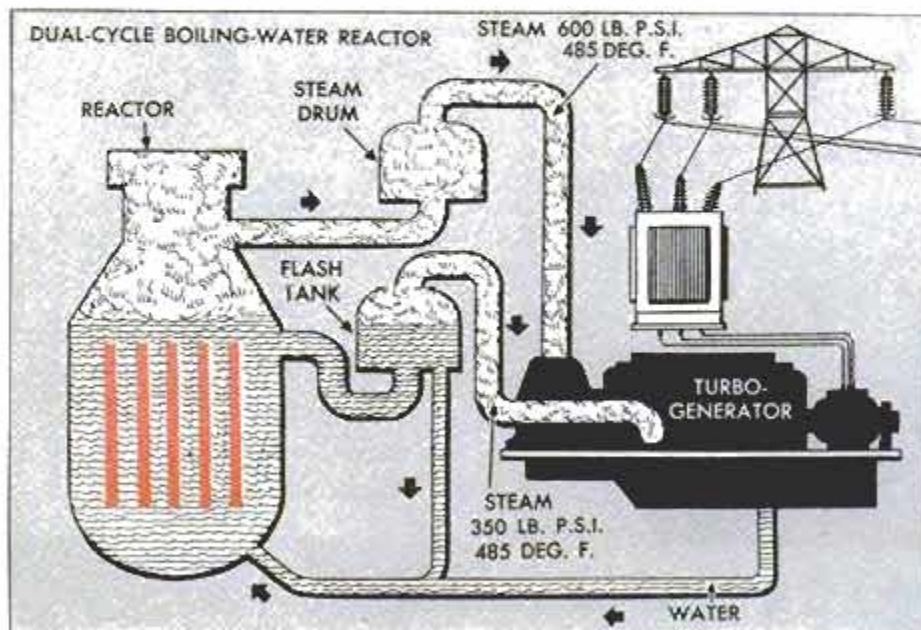
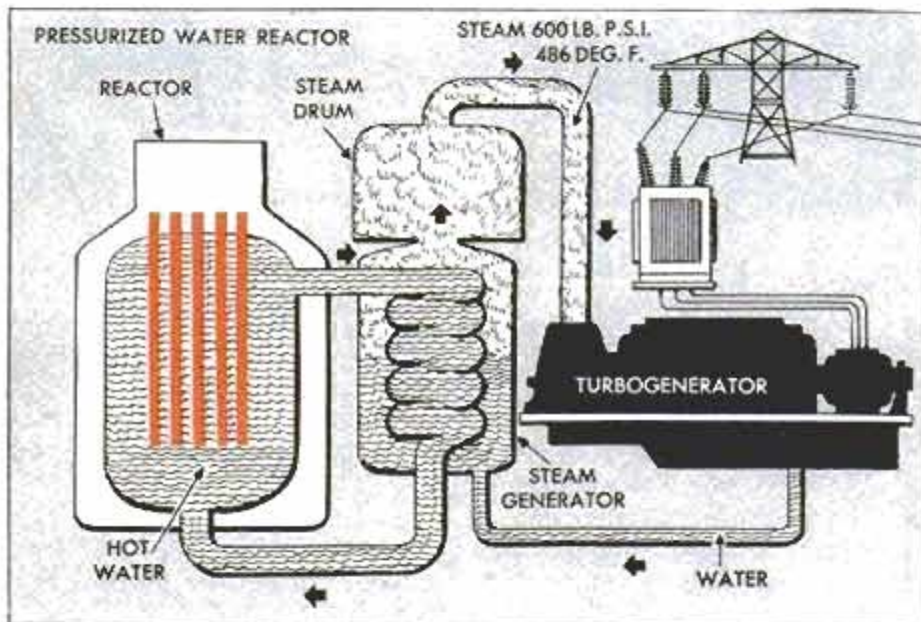

Simplified diagrams show operation of two types of boiling-water reactors. A third variation of this group powers submarine *Nautilus*

Commission estimates that 10 per cent of all U.S. power will come from the atom in 1975 and that the percentage will increase rapidly from then on. England expects that half of its power will be produced by the heat of fission in 1975. Civilization is going to depend more and more on A-power. The world's coal pile and its petroleum reserves are being used up rapidly, while more deposits of fissionable materials are being discovered all the time. On a B.T.U. basis, the known reserves of uranium are 22 times as great as the known reserves of coal, gas and oil.

A pound of uranium, smaller than a golf ball, has energy equal to 1500 tons of coal. The trouble is that only a percentage of this power can be turned into electricity. The best experimental power reactors in use today are no more than 20 to 22 percent efficient. On that basis, a pound of uranium is equal to 300 tons of coal. Because of this, and also because of the expense of protecting personnel and processing wastes, electrical power from the atom costs considerably more than power from the "fossil" fuels.

To learn more-efficient ways of getting power out of the atom, and to bring the cost down to more practical levels, the AEC has begun a five-year research program, with private industry cooperating to a large extent. Various kinds of power reactors are being designed and built for comparative studies, to improve prototype designs and to gain further technical information for scientific use.

It should be remembered that an atomic reactor does not create electricity directly. What it produces is heat. In a power plant which uses atomic energy, a turbo-generator manufactures the electricity, just as it does in a plant using coal or oil. But in the atomic plant, a reactor developing heat through fission replaces the furnace which produces heat when coal or oil is burned in it. In both cases, the heat is used to boil water or some other liquid, converting it to steam. And the steam then operates the turbo-generator to produce the electricity.

(Continued to page 234)

Aqueous homogeneous reactor eliminates need for expensive solid-fuel elements, and also acts as breeder of fissionable U-233

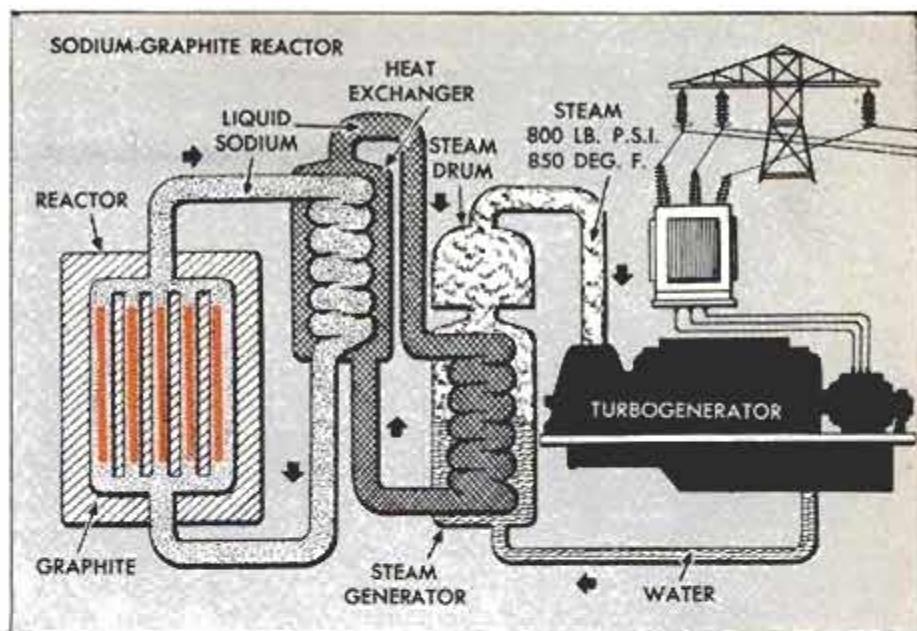

Above, diagram of sodium-graphite reactor, of type which will drive submarine *Sea Wolf*. Below, breeder creates new fuel

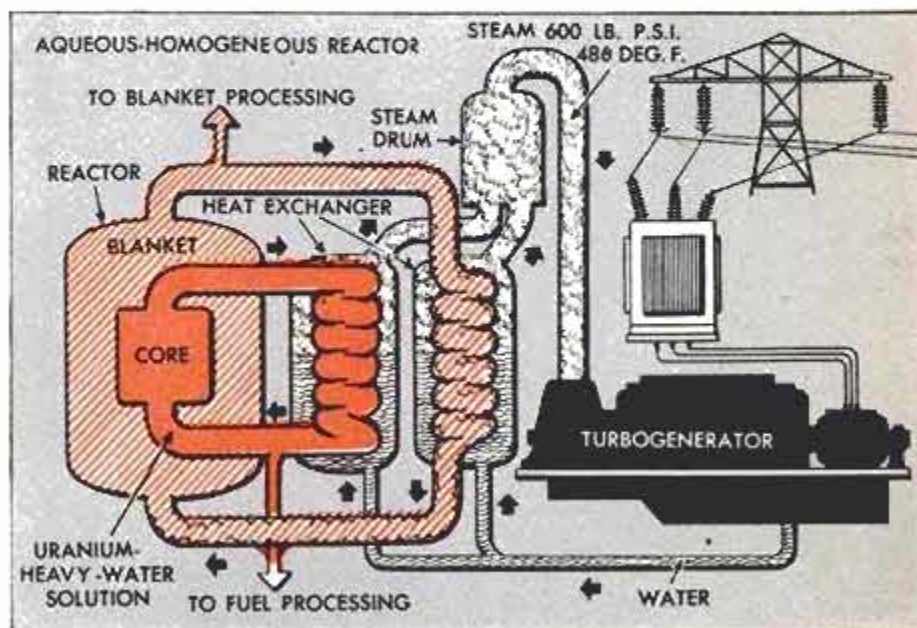
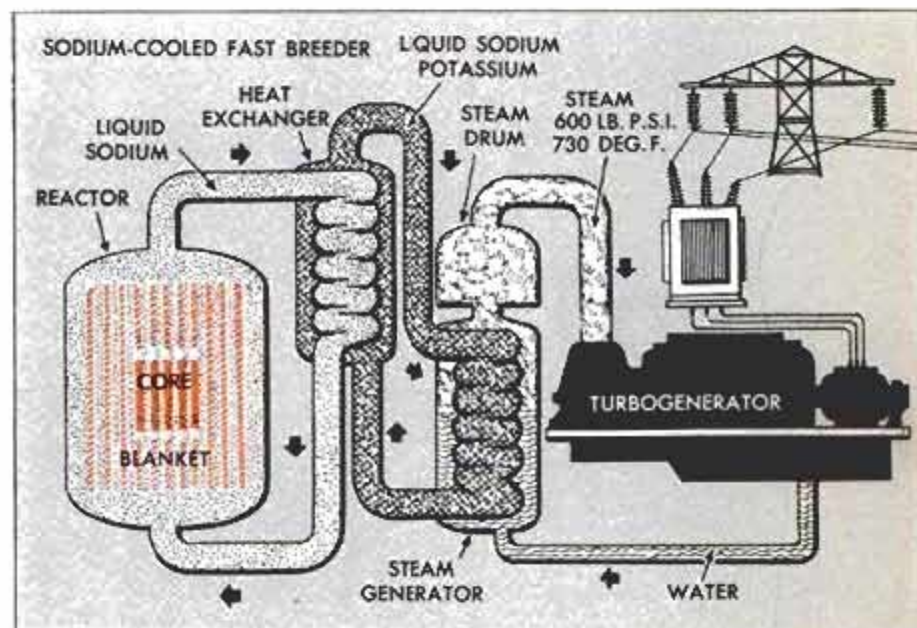



KEEPING UP WITH THE ATOM



FOR THE FIRST TIME in history, single atoms have been photographed on the surface of a solid. Here you see the result. Each dot is a single atom measuring $\frac{1}{1,000}$ of $\frac{1}{1,000,000}$ inch in diameter!

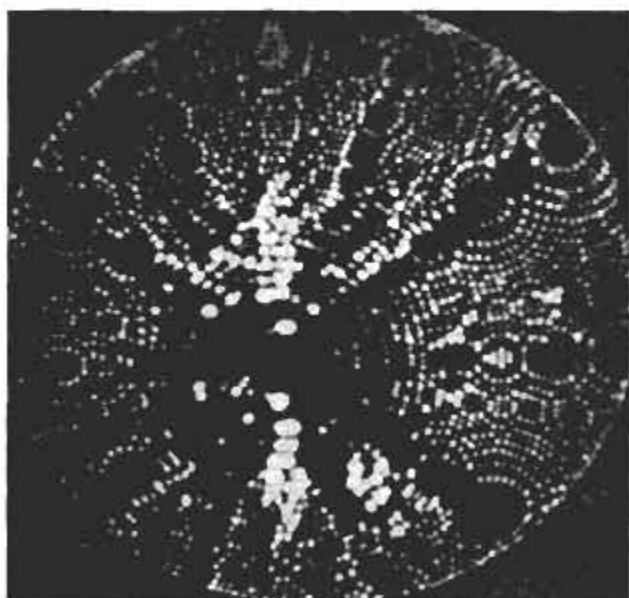

Even this figure does not give any real conception of the size of the minute particles with which the atomic physicist works. Each dot on the photograph is an atom, but within each atom, and about 20,000 times smaller than the total dot, is a nucleus. Revolving around it are much, much smaller electrons.

The photograph is the achievement of Dr. Erwin W. Muller, professor of physics at Pennsylvania State University. He used a field ion-emission microscope which he invented and which is capable of magnification up to 5,000,000 times.

Doctor Muller's surprising achievement, performed for Air Research and Development Command, will permit the study of films on the surface of metals, and may throw light on the migration of atoms, corrosion, friction, wear and lubrication.

Physicists who explore this unbelievably small world of the atom are always searching for better tools. The higher the energy of an atom smasher, the more useful it is. Energies of these big smashers are measured in billions of electron volts (BEV). Here are the ratings of the new or proposed smashers:

- **3 BEV**—to be built at Princeton.
- **6 BEV**—this instrument, which accelerates electrons instead of protons, will

be built by Harvard University and Massachusetts Institute of Technology.

- **10 BEV**—scheduled to go into operation in Russia this year.
- **25 to 30 BEV**—the proton synchrotron now under construction at Brookhaven.
- **100 BEV**—a proposed new design by Dr. Lee C. Teng of Argonne National Laboratory.
- **1000 BEV or more**—under study by Midwestern Universities Research Association. The principle of this instrument is to use two atom smashers which will fire atomic bullets head-on into each other!

Why build such big machines? Scientists will use them to study particles already known as well as to create new particles. For example, antimatter, a particle difficult to conceive because it apparently is just the opposite of matter, was discovered with a six BEV machine last fall. Cosmic rays may yield their mysteries if man is able to achieve similar energies.

And ultimately such research usually leads to very practical applications. For example, a baby brother of the huge atom smashers went into operation at Stanford University a few weeks ago. The 6,000,000-volt machine converts a beam of electrons into X rays which are expected to destroy cancerous growths deep within the body with minimal—compared to conventional X-ray—damage to outer layers of skin. The operator sits at a control board and observes the patient through a three-inch window. Inside the room, the patient sits in a power-driven chair or lies on a table and is held motionless with clamps. As much as 80 percent of the X-ray beam's output penetrates to the deepest part of the body. The cancer gun already is in use treating selected cancer patients.





The two-wheeled trailer has no axle, is supported in riding position by a sturdy fork in front of each wheel

Hydraulic Trailer Lowers to Ground for Loading

You can roll garden tractors and other heavy equipment right onto a two-wheel trailer that lowers to the ground for loading. A hand-operated pump just behind the trailer hitch causes two hydraulic cylinders to raise or lower the box. There is no axle on the trailer. Each wheel is mounted on a fork like the front fork of a bicycle. When hydraulic pressure is released, the forks tilt toward the ground and lower the trailer body. The eight by four-foot box has a road clearance of 10 inches.

Releasing hydraulic pressure causes trailer box to lower to ground. Box is raised with hand-operated pump behind hitch

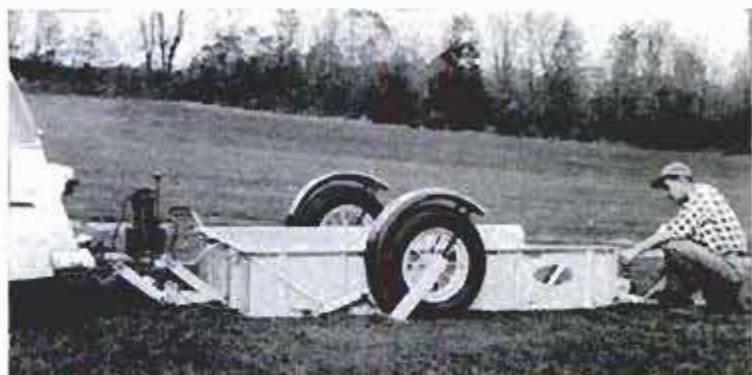

Tilt-and-Turn Attachment Helps Load Boat on Trailer

Loading a boat aboard a trailer directly from the water without detaching the trailer from the car can be pretty tricky, since the keel of the boat has to be lined up with the trailer tongue constantly. But the problem can be simplified with a device

which lets the trailer tilt backward and move from side to side at will. With it, the trailer can easily be kept in line with the boat's keel. After the boat is trailered, the tilt-and-turn device locks in a horizontal position with its own coupler.

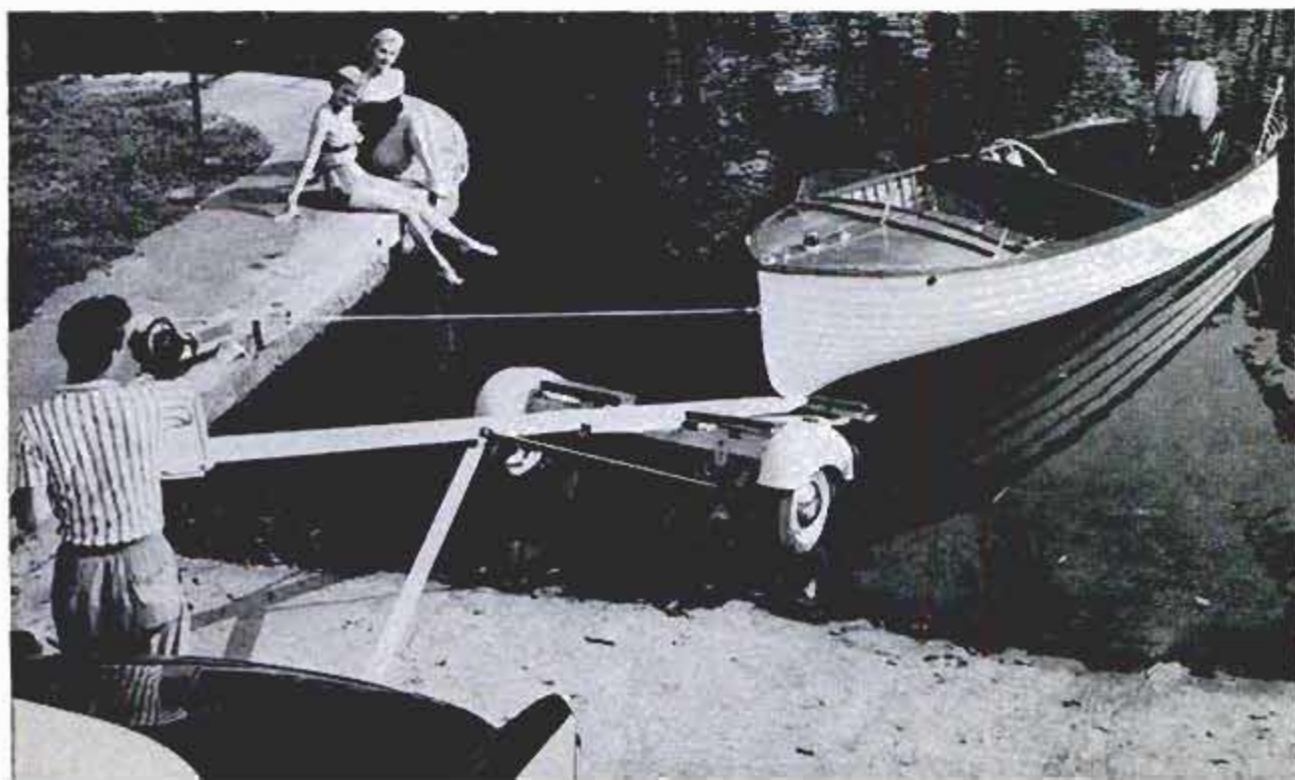



Passengers ascend stairway to seats on upper level, where they have a good view of scenery on Santa Fe route

Hi-Level Train



Passengers are now riding high aboard the Santa Fe's new El Capitan. The train is made up of cars 15½ feet high, two feet higher than conventional cars. Each car has two levels, with the passengers seated in the upper level. They ride four feet higher than they do in regular chair cars. In the lower level are vestibules, rest rooms and luggage storage space. With the vestibules eliminated, the new cars have 28 more seats than older cars. Passengers enter through doorways at the center of each car and ascend a central stairway to the seating level. In the diner, the upper level is devoted entirely to table space. An electric kitchen occupies the lower deck, and food is transported to the upper level on two elevators.

Entry door is located in the center of each car. Lower level is used for baggage storage and rest rooms

Window Grille Keeps Locked Car Cool While Parked

Ventilating a locked car that is parked in the hot summer sun is a problem that most motorists face. It is solved by a sturdy metal grille that fits into the car window without hooks or screws. It takes only a second or two to install. The grille is also useful while driving. With it in position, the window can be lowered without being concerned about pets or children falling out. Sizes are available to fit different cars.



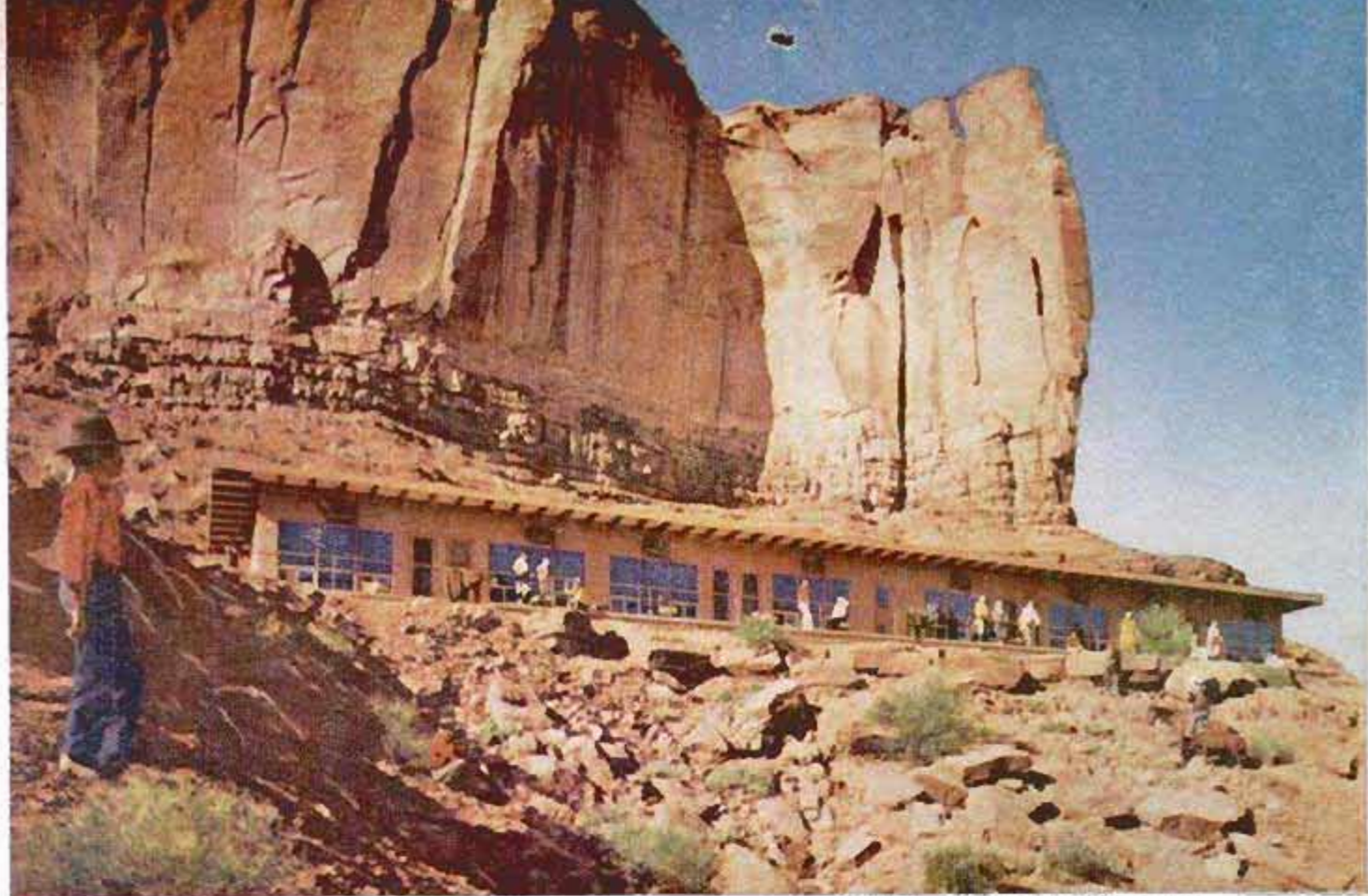

Goulding's Lodge, Monument Valley, Utah

Typical of modern luxury motels, this lodge at Monument Valley, Utah, clings to a roadside canyon cliff

Sixty-six million touring Americans will sleep this year in the 60,000-odd motels along our highways and oceansides. The ramshackle clapboard farmyard cabins of yesterday are now

DRIVE-IN DREAM CASTLES

By Richard F. Dempewolf

MOTELS ARE ON THE MARCH. They're trekking downtown on stilts. At some of them, this summer, you'll drive into a street-level dock beneath your lavish room on the floor above. Other many-storied urban hotel-motels will provide free subterranean parking and hoist you to bed on elevators. On the highways, new multi-million-dollar drive-ins are sprawling out to provide fabulous luxuries for the 66,000,000 sleepy Americans who, according to the American Automobile Association, will be touring the country this year in some 23,000,000 cars.

The gleaming hostelries will offer vacationers and overnighters everything from water skiing and deep-sea fishing

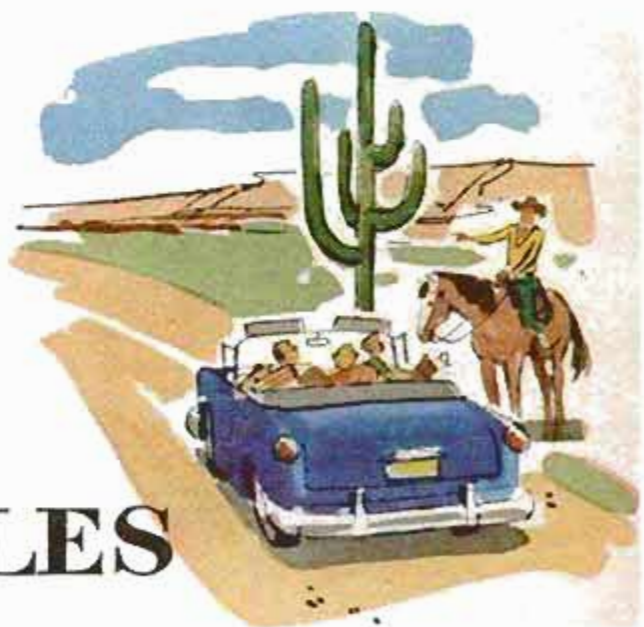

Folding walls divide large rooms into living and sleeping areas

Ball-Cove Hotel, Fort Lauderdale, Fla.





Golden Gate, Miami Beach, Fla.

One giant tourist castle in Miami Beach, Fla., combines a hotel, a motel, apartments and villas, has 630 rooms

to games of giant checkers on huge outdoor checkerboards set in velvet lawns. Nearly all the new places feature not only full-size floodlit swimming pools, but satellite wading pools for the kiddies as well, not to mention playhouses and playgrounds. Inside, the weary traveler will find deluxe suites with built-in kitchens and folding walls to separate living and sleeping areas, and carpeted in "ankle-deep" wall-to-wall broadloom. Free TV, handy ice-cube ma-

chines, air conditioning and soundproofing are as standard as doorknobs, and some imaginative innkeepers have even installed "gyrating" mattresses that will rock you to sleep for an extra quarter.

Drive-in castles of 1956 come in startling forms, perched in startling places. Some cling to parapets of roadside cliffs overlooking spectacular views. On the Florida and California coasts, where they swarm the beaches and resort spots, neonlit en-

Pool at Galveston, Tex., motel is spanned by arched bridge for diving

Jack Tar Hotel, Galveston, Tex.





Motel deVille, New Orleans, La.

This 150-room motel is in the heart of the New Orleans business district

trance towers, Venetian bridges and spiral ramps vie for tourist attention. Behind them, 200 to 400-unit hostelries sprawl in a gaudy array of shapes and sizes, from individual plaster and stucco wigwams to four-story seaside palaces, with South Sea Island roof structures for atmosphere. More than one Florida beach motel has stretched its "fingers" into the sea to provide free pier parking for customers who arrive in yachts. Motorcar-parking docks for land-roving customers are on the shore side. If you happen to be touring in a heli-

copter or airplane, several mammoth western motels can accommodate you (with free parking) on their new private heliports and landing strips.

It all began back in 1860, when an enterprising pioneer named Jack Morrow built some log huts alongside the Santa Fe Trail where, for a few pennies, drivers and families in lumbering covered wagons could taste the luxury of a straw bed after weeks on the road. Morrow did so well he added more cabins, plus a roadside tavern where he sold supplies and meals.

Another of Miami's luxury motels features Papuan architecture, free fishing and sail-it-yourself cruisers

Castaways Motel, Miami, Fla.

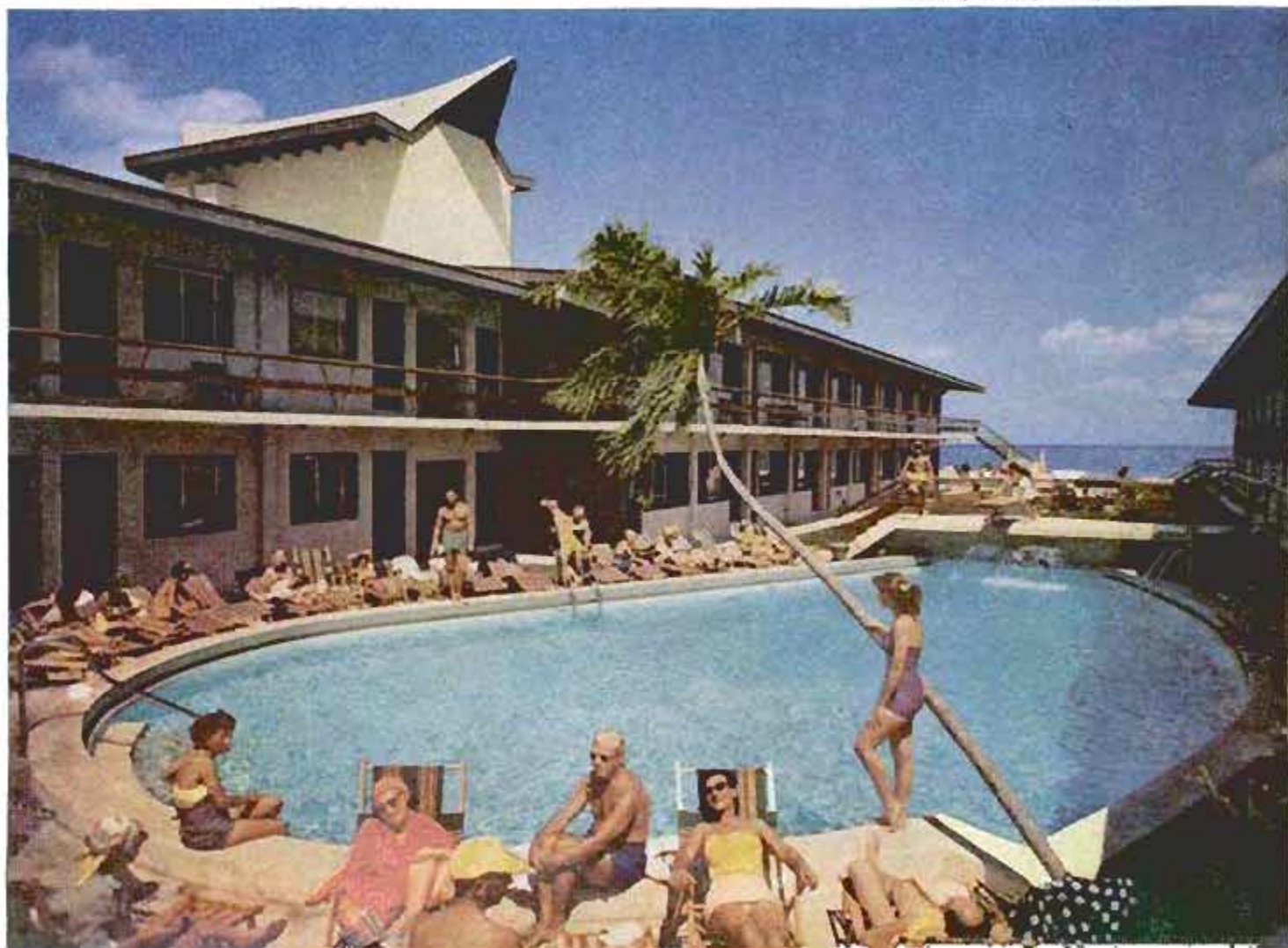



Key Colony Motel, Marathon, Fla.

This looks like a small city, but it's a motel at Marathon, Fla. Raised swimming pool is in foreground

Oddly, no imitators showed up to cash in on the idea for 65 years. Then, in 1925, Arthur Heineman, a Los Angeles architect, drew plans for a chain of drive-in hotels along the coast of California to catch the growing auto-tourist trade. Only one was built—at San Luis Obispo. Though the establishment never made history, its name did. It was called Milestone Mo-tel, contracted from “motor hotel”—a word destined to become part of the language. For the next 15 years, thousands of farmers and country residents with highway frontage threw up clapboard cabins, offering the traveler four walls, rickety bedstead, mattress, trickling cold water, homemade lamp table and used chair (bring your own sheets and blankets) and called it a motel. Then, with the end of World War II and gas rationing, America took to the roads and motels jumped into big business. The

20,000 auto courts dotting the country in 1946 had zoomed to nearly 60,000 by last summer, and they were still mushrooming at a rate of about 4000 per year. Reason: Steady prosperity, increasing population and the fact that 86 percent of all Americans now travel by car—for business and pleasure. But the biggest reason, any motel man will tell you, is that today's motel offers phenomenal luxuries that put most hotels and many vacation resorts to shame.

The modern owner thinks nothing of plowing \$1,000,000 or \$2,000,000 into his elaborate establishment, which may cost him \$7000 to \$15,000 per unit. To add “tone,” he may not even call his place a “motel.” It will be the something-or-other highway hotel, motor hotel, motor court, tourist court, drive-inn or similar variations on the same theme. Whatever its name, besides all the comforts and more

No modern motel is complete without its swimming pool and sunning area

Fresno Hacienda, Fresno, Calif.



Illustration of a mountain landscape with a lake and a boat.

Children get their share of the luxuries, too. This motel at Ormond Beach, Fla., has playhouses, a play school, nurses and attendants

Ellenor Village, Ormond Beach, Fla.



of a modern in-town hotel, it is bound to have the informal conveniences of the old-time motel. "Today's motorist wants to roll in after a day of driving, park his car by himself near his room, unpack and eat dinner in a sports shirt," explains one successful motelkeeper. "He's not interested in the city-hotel problem of turning the car over to the doorman for parking in an expensive garage blocks away, and tipping his way in and out of the place all dressed up in business clothes."

For this reason, in-town motels have used architectural gymnastics to maintain the easy parking and easy living features of their country cousins.

It is at the swank 150-room Motel deVille, right in New Orleans' business district, where the traveler parks his car free in bays on street level beneath his room. Luxurious walnut and mahogany-paneled rooms and suites are in two levels above this "garage," resting on massive reinforced concrete stilts. The weary tourist may reach his room by elevators or stairways, via outside "deck" corridors whose redwood rails are laced with yellow canvas to provide privacy and a restful "shiplike" atmosphere.

New Orleans isn't the only place with a city motel buried in the business district. One of the pioneers was Rochester, New York's multistory, 137-room Treadway Inn, with parking court and elevators, right in the heart of "automobile row." Half a dozen downtown motels have sprung up in San Francisco in the past two years. One, a 14-floor steel skeleton building with all-glass exterior like the UN Secretariat, is smack on Nob Hill. Chicago's brand new

motel, The Sands, recently opened on the North Side, right next door to the famous Edgewater Beach Hotel. It features restaurant, swimming pool and cocktail lounge.

Stiff competition has inspired many new luxury features in today's motels. "If the place across the road adds something new," explains W. H. Farmer, owner of a southern chain of Alamo Plaza courts, "you've got to go him one better or lose some customers." Recently, Farmer put in a 50-foot swimming pool at his 73-unit Dallas court "in self-defense." He also bought 65 TV sets outright to keep from "bothering his guests with that quarter coin box."

Result of this fight for the tourist dollar has been a pile-up of features and services some of which can make your head swim. Some, like Holiday Motor Hotel in Mechanicsburg, Pa., have built revolving stages and huge halls for business conventions. In La Jolla, Calif., Del Charro's management installed a ticker tape for roving Wall-Streeters. At the huge (267 units with 88 more being built) Fresno Hacienda in Fresno, Calif., travel-weary guests may languish in rooms or on sun decks beside any of three pools, while a self-propelled "barmobile" wheels around the motel's 20 acres distributing cool liquids to road-parched throats. More energetic folk may prefer hoofing it over to the Hacienda's lounge. Here, while sipping, they can watch through the world's biggest plate-glass viewing window while a pair of "mermaids" go through a graceful underwater routine in a big swimming tank set in the wall behind the service bar. The Hacienda also "throws in" a coffee shop, big dining room, floor show, and a barber shop.



Indian Village, San Bernardino, Calif.

Unusual appearance of these tepee units at San Bernardino, Calif., helps to attract passing tourists

Motels keep ahead of the times as many add heliports and landing strips to attract air travelers. This heliport at Fort Worth, Tex., was the first Western Hills Motel, Fort Worth, Tex.



At small motels and big, operators cram attractions and services to lure the wanderer. At the Bali-Cove, a two-story tropical court in Fort Lauderdale, Fla., vines cover the curling wrought-iron stair and balcony rails, and a lush swimming pool reflects the U-shaped court. White-coated busboys hustle around before dawn delivering fresh, free orange juice and newspapers through tiny doors that open on closet-type kitchenettes inside. Rooms have plastic accordion dividers that convert them to separate living and sleeping suites, or open to make big single rooms. Besides the usual swimming, refrigerated rooms and tile baths, the 77-room Desert Inn in Phoenix, Ariz., has built into every area of its lawns, concrete shuffleboard courts, and huge checker and chess platforms surrounded by garden furniture. While spectators lounge and watch, players move foot-high chessmen across the big pads. In Houston,



Sixty-foot pylon advertising motel in New Orleans is hollow, contains air conditioner for dining room

Tex., the 46-unit Grant Motel is one that has installed the "gyramatic" mattresses. These lullaby items are operated from the foot of the bed by a silent motor, tied into the pivot-hung mattress by oscillating rods. "The rocking goes clear through your bones," according to E. H. Grant, the motel's owner who has a list of "regulars"

with a standing order for rockaby beds. The bigger the motel, the more fabulous everything gets. Hank Green's Western Hills (original estimate \$400,000; actual cost \$2,000,000), on U. S. 80 near Fort Worth, Tex., was one of the first of the super-ultra-whoppers when its clustered
(Continued to page 210)

Space utilization is keynote of modern motels. Here cars and swimming pool are on ground level, rooms above
Motel de Ville, New Orleans, La.





Mechanic tightens nuts on old auto wheel which is welded to cradle, fastening it to the brake drum



Long iron bar is slipped over pipe on cradle and mechanic grasps it high up to rock the cradle over

Cradle Tips Volkswagen For Easier Repairing

Two men can turn a small car over on its side in two minutes with a cradle invented by a Hamburg, Germany, mechanic. Designed originally for the Volkswagen, the cradle will soon speed the repair of all types of autos. The back and front wheels are taken off the car on one side and each replaced by a rim welded to a cradle. The rims are bolted to the brake drums like wheels, iron bars are slipped over sockets on the cradles and the automobile is pulled over with little effort.

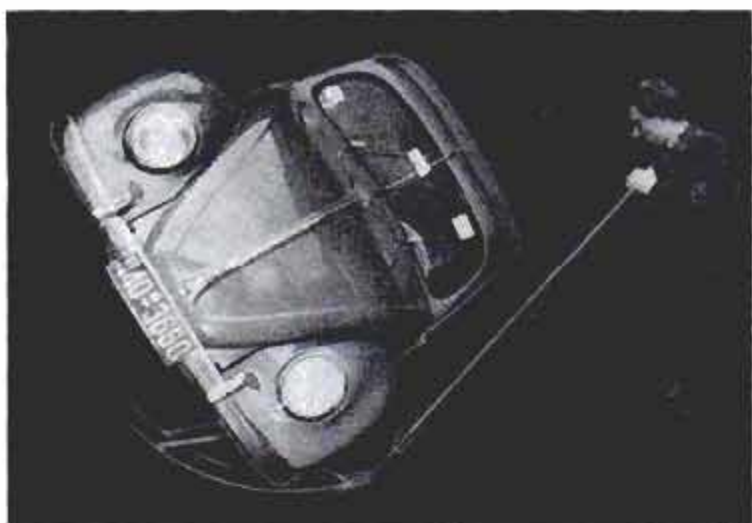

Putting weight on ends of bars, men easily tip car on its side

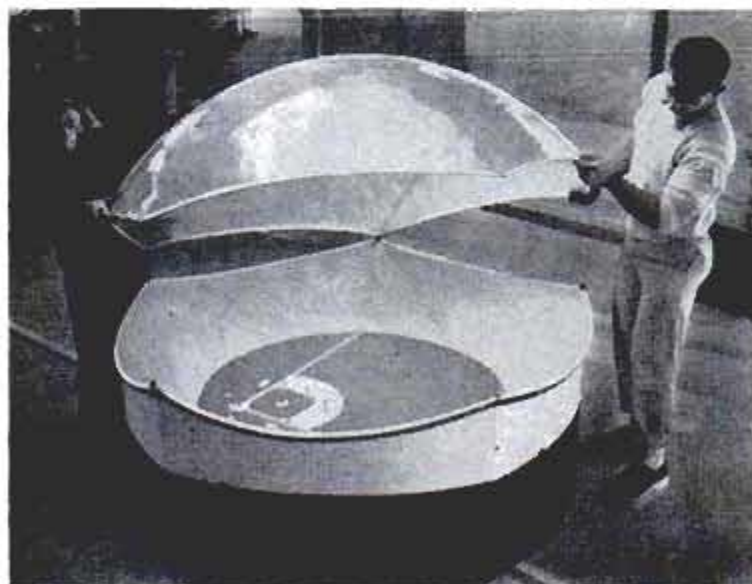

Plastic Dome for Stadium

Rain checks will be ancient history as far as the Brooklyn Dodger Baseball Club is concerned if present ideas for their new stadium are put into effect. The new stadium, in the idea-and-model stage, has been proposed by R. Buckminster Fuller, famed as the designer of the dome which covers the Ford Rotunda Building in Dearborn, Mich. A lightweight plastic dome, supported by aluminum trusses, would put a cover on the stadium that would tower 300 feet above the playing field at its highest point. The interior would be air conditioned.

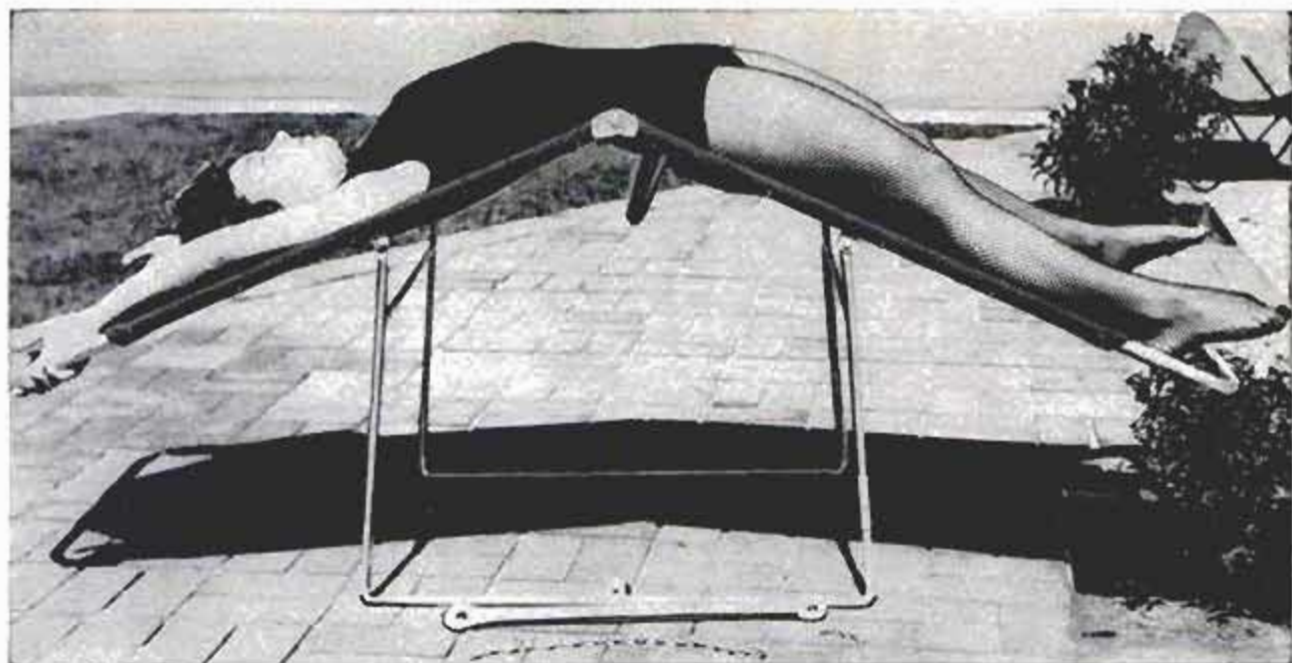

Exercising Chair

Body-toning exercises can be performed on a steel-and-canvas unit that adjusts to several different positions. It can also be used as a lounge chair or sun-bathing cot. The tubular-steel frame, which hinges at the middle for exercising back and abdominal muscles, is supported by legs of solid steel. A small chain locks the chair in any position from a broad V shape to a similar inverted V. When straight, it can be inclined in either direction in the manner of a teeter-totter.

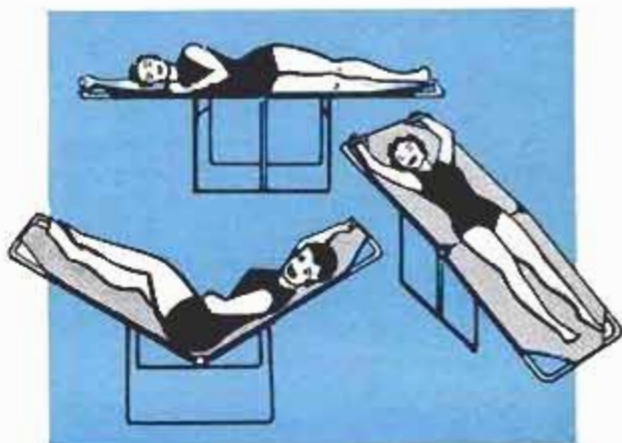

Shotgun Choke Changes Automatically to Produce Three Patterns

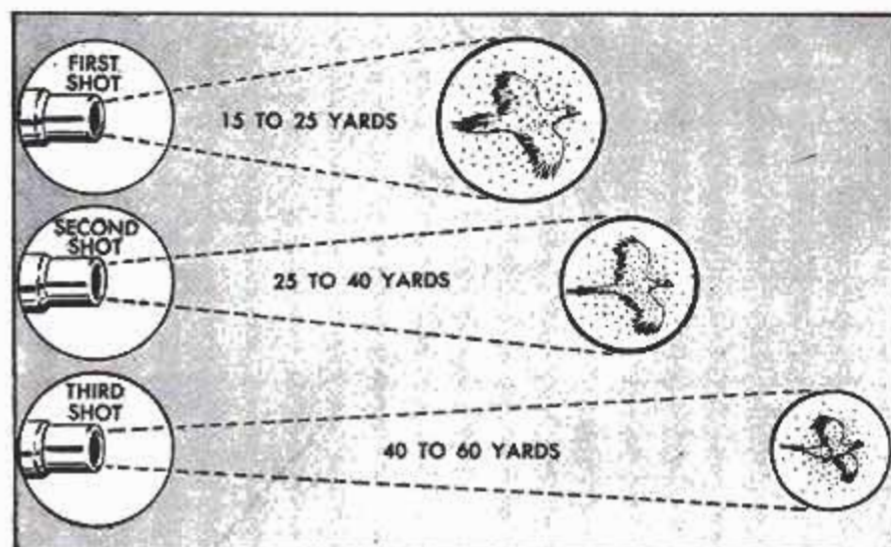

Hunters now have a shotgun choke that produces automatically the proper shot pattern at three different distances when the gun is fired three times. The hunter's first shot gives a 30-inch killing pattern at 15 to 25 yards. The choke instantly adjusts itself and the second shot produces a dense pattern at 25 to 40 yards. The third shot gives a full-choke setting at 40 to 60 yards. With this progressive action the hunter can fire three shots at the game with the proper pattern for each shot. The choke also can be locked in any of the three positions or adjusted manually between shots.



WHAT'S NEW FOR Your Home

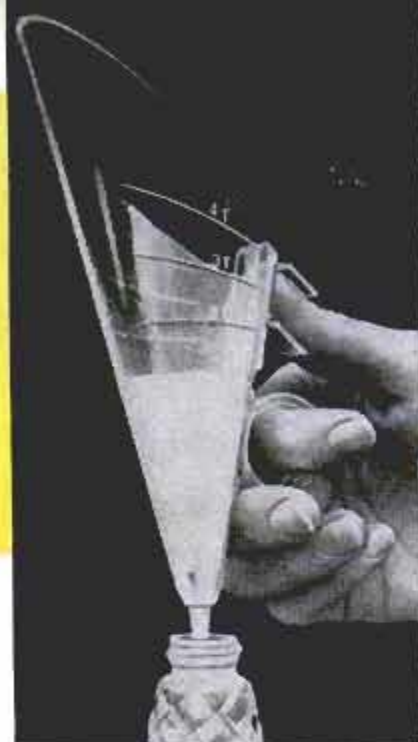

COMBINATION SCOOP and funnel makes it easy to scoop up powders and liquids, measure them and then funnel into bottles. After ingredients are in scoop, they are released by thumb-controlled knob on side.

Chester H. Nicodemus and Co., 447 Clinton Heights Ave., Columbus, Ohio



DROOPING CLOTHESLINES can be tightened quickly if they're equipped with a self-locking tightener. The tightener is for wire or plastic clotheslines only, can also be used to tighten fence and TV guy wires.

Deane Smith Sales, 3930 Urbandale Ave., Des Moines 10, Iowa

MODERN PLANTER that also serves as a room divider is made of maple. The wooden rack holds plastic bowls in brass holders that can be moved to various positions so that you can vary the wall's design.

Eaymor, 225 Fifth Ave., New York City 10



COFFEE TABLE from which to serve guests during pleasant conversations converts to a bridge or dining table that is 27 inches high at a touch. Available with wooden or plastic top in mahogany, limed oak, maple and ebony.

Paglia Furniture Co., Elizabethtown, N. C.





MEATS CAN BE COOKED QUICKER and with less shrinkage by the insertion of hollow, heat-conducting pins. Oven heat converts liquid inside pin to steam

Thermo Pin Corp. of America, Box 406, Mineola, Long Island, N. Y.



ICE CRUSHER ATTACHMENT fits any model of the Waring Blendor, quickly turns ice cubes into sparkling crushed ice for frappes, desserts, salads and drinks

Waring Products Corp., 25 West 43rd St., New York City 36



PERFORATED DISK made to fit into bottom of 10-inch skillet cooks "greaseless" bacon with less shrinkage. The disk, made of aluminum, spreads the heat evenly and cuts the cooking time

S.P.R. Company, 6425 Epworth Blvd., Detroit, Mich.



ELECTROSTATIC BROOM, with the sweeping head made of sponge rubber, picks up dust by "magnetic" action. No dust settles elsewhere after sweeping. Sweepings are released from broom head by washing

Wells Specialty Company, North Liberty, Ind.

TWO-DRAWER FOOD WARMER that can be built into kitchen-cabinet bases will keep dinner hot for hours. Food will not get soggy, discolor or lose flavor, because each drawer has separate humidity control

McGraw Electric Co., Elgin, Ill.



Manufactured by McGraw Electric Co., Elgin, Ill.

WHAT'S NEW FOR
Your Home

Continued from preceding page

CLOTHES DRIER for the back yard lowers with a few turns of the crank so the clothes can be hung easily, then raised two feet for drying. It has 140 feet of line, spins freely in the wind to help drying. In between wash days, the hanger can be converted to a large garden umbrella.

Hazel's Hoist Inc.,
821 South Street,
Long Beach, Calif.

DETACHABLE LEG REST converts any chair to a contour chair to provide comfort for aching legs. Available in green or maroon, the unit folds flat for storage. Rest measures 15½ by 28 inches.

Damar Products Inc.,
233 Frelinghuysen Ave.,
Newark 5, N. J.

FOLDING WRINGER, attached to a full-sized clothes washer, permits the top of the washer to be used as a table when the machine is not in use. A 20 by 25-inch table-top cover comes with the washer, with a glass-fiber surface which won't chip or rust. The wringer has a lock to prevent it from folding while in use.

Apex Home Appliance Div.,
Apex Electrical Mfg. Co.,
Cleveland, Ohio



BAKING SODA sprayed from a can by means of a special nozzle and propellant is the latest in home fire extinguishers. Can provides a six-to-seven-second spray of powder which covers area 30 inches in diameter from distance of 10 feet

Safe, Inc., 2800 Parkridge Ave.,
Marionette, Wis.

STORAGE REEL for sprinkler hose, electric cord, clothes line and other items protects them from kinking and cracking during storage. Made of rugged, welded construction, reel will store up to 50 feet of plastic hose

Specialty Mfg. Co.,
2356 University Ave.,
St. Paul, Minn.



CUT A LATTICE DESIGN in pie crust in one motion with a heavy-duty plastic cutter. Simply lay the cutter on the rolled dough, press down and design is cut

House of Schiller, 180 N. Wacker Dr., Chicago 6



KITCHEN KNIFE with adjustable arm and serrated blade permits carver to cut slices of a roast or ham to any thickness he desires. Use for any slicing job

Ernest J. Ecker, P.O. Box 403, South Gate, Calif.

PORTABLE GARBAGE DISPOSAL unit rests in the sink when needed and lifts out for storage. Holds half a gallon of refuse, and releases it in drain

The Free Sewing Machine Co.,
9835 W. Pico Blvd., Los Angeles, Calif.



HANGERS IN A CLOSET can be kept separated by means of crimped strips of metal nailed to the clothes pole. Strips come in 12-inch lengths with tiny nails

Tom Hodgson, 1218 Grove Way, Concord, Calif.



*There's Something New
on Cape Cod Waters—*

THE TRIPONT SLOOP

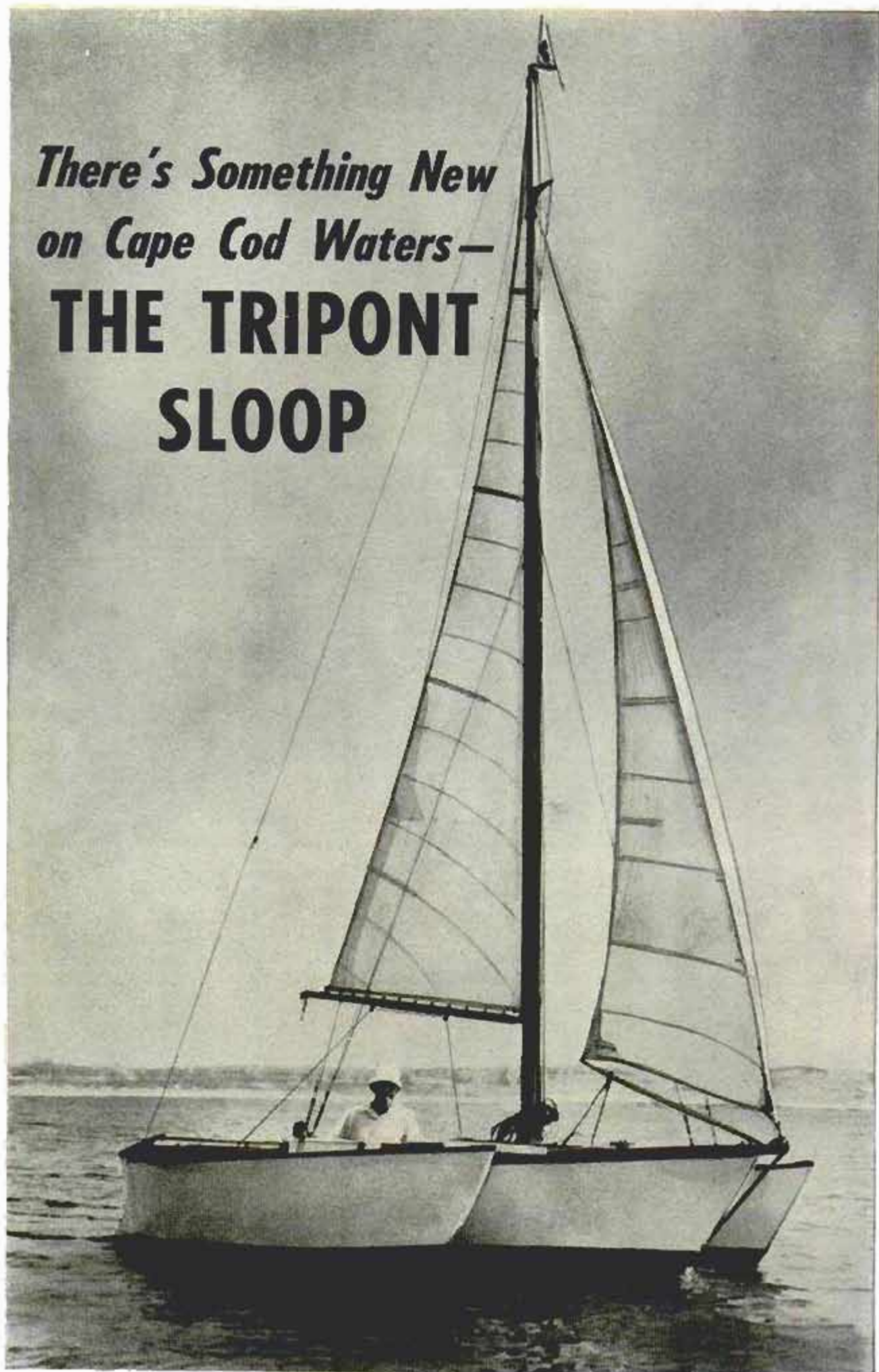

By Calvin D. Campbell

A MIGHTY STRANGE craft is sailing the waters off Cape Cod these days. Yankee sailors—men who really know the clean lines of a ship—are doffing their Nantucket caps to the tripont sloop.

The craft is the result of 15 years of study, design and work by Dr. Edwards Herman, a retired physician who lives in Lincoln, Mass. The tripont is the natural outgrowth of several catamarans—twin-hulled craft—which Doctor Herman built in the past and which touched off a great deal of talk by conventional yachtsmen.

The tripont, as the name implies, is a three-hulled craft with a large hull in the center and a smaller hull on each side. The stability thus is comparable to that of the time-tested outrigger.

According to Doctor Herman, a catamaran tends to nose dive in rather rough water and is subject to tremendous structural stresses. The doctor's studies and experience led him to the conviction that a three-hulled boat would eliminate these conditions, yet the craft still would retain most of the catamaran's superior speed.

To prove his theories, even to himself, Doctor Herman first built a scale model three feet long. After testing it, the 71-



Dr. Herman and his son head out to sea in unique craft, which will carry six but is designed for overnight cruising by two

year-old physician went into production on the full-size tripont.

Paper Patterns

Shopping the lumberyards, he came across a supply of Paraná pine, a very hard Brazilian wood which he could pick up at a bargain. It proved ideal for the tripont. Before building the unique craft he traced out full-size patterns on carpenter's brown paper, then cut the parts to fit the pattern.

The center hull is 18 feet long and has a short bowsprit. The beam measures 2½ feet at the waterline and flares out to 4½

Tripont's designer fits the tiller to his three-hulled craft. Oak cross members tie the hulls together





Before starting the full-size tripont, Dr. Herman built a scale model to test seaworthiness of design

feet at the deck. Across the hull and fastened solidly to it are four oak cross members. These connect the three hulls. The two outer hulls are each 11 feet long.

Drawing 17 inches of water, the tripont can carry six persons although it is designed for cruising for only two. The cruising facilities are excellent, and were designed by Doctor Herman and his wife.

Two folding bunks stretch across the cockpit. A canvas tent can be rigged over these bunks and across the three hulls during overnight cruises. When not in use, the bunks can be partly folded back to provide a foot-wide shelf.

The bedding (and bunks, too, when they are not to be used for some time) is stowed in the two smaller hulls. In the remaining space of the three hulls are stored a two-burner stove, several cooking utensils, an ample supply of food, a 5½-horsepower outboard motor with fuel for it, and any personal belongings that the crew wants to take along on the cruise.

According to the builder, the tripont steers more steadily, is more maneuverable and comes about better than the catamarans he has built in the past. Somewhat slower, it still makes good speed and is amazingly seaworthy in heavy seas. ★ ★ ★

Boatbuilder checks the 26-foot pine mast in his basement workshop. The mast carries 120 feet of mainsail and a 70-sq.-foot jib. Dr. Herman built the tripont sloop with only two power tools, a saw and a drill press

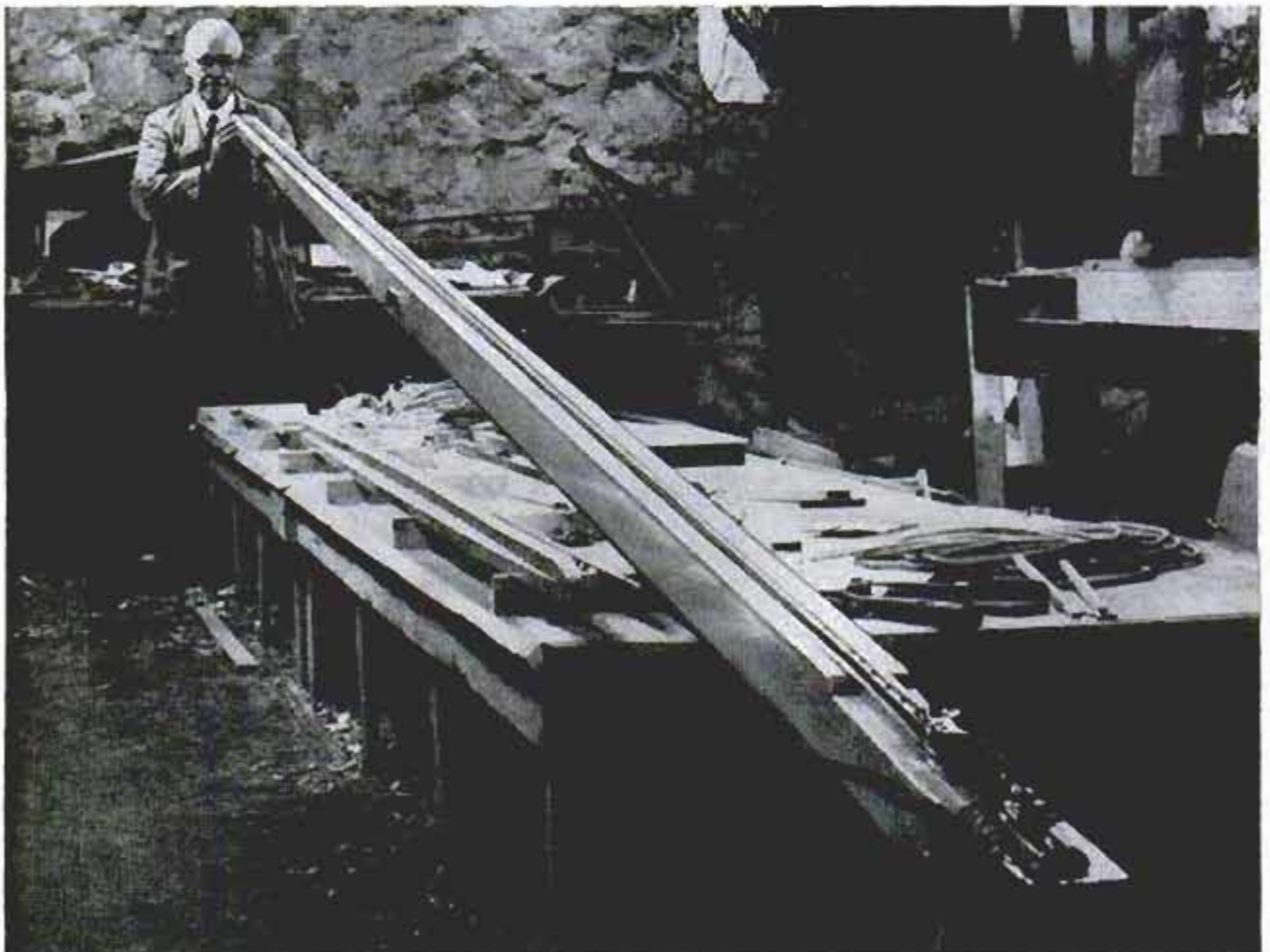

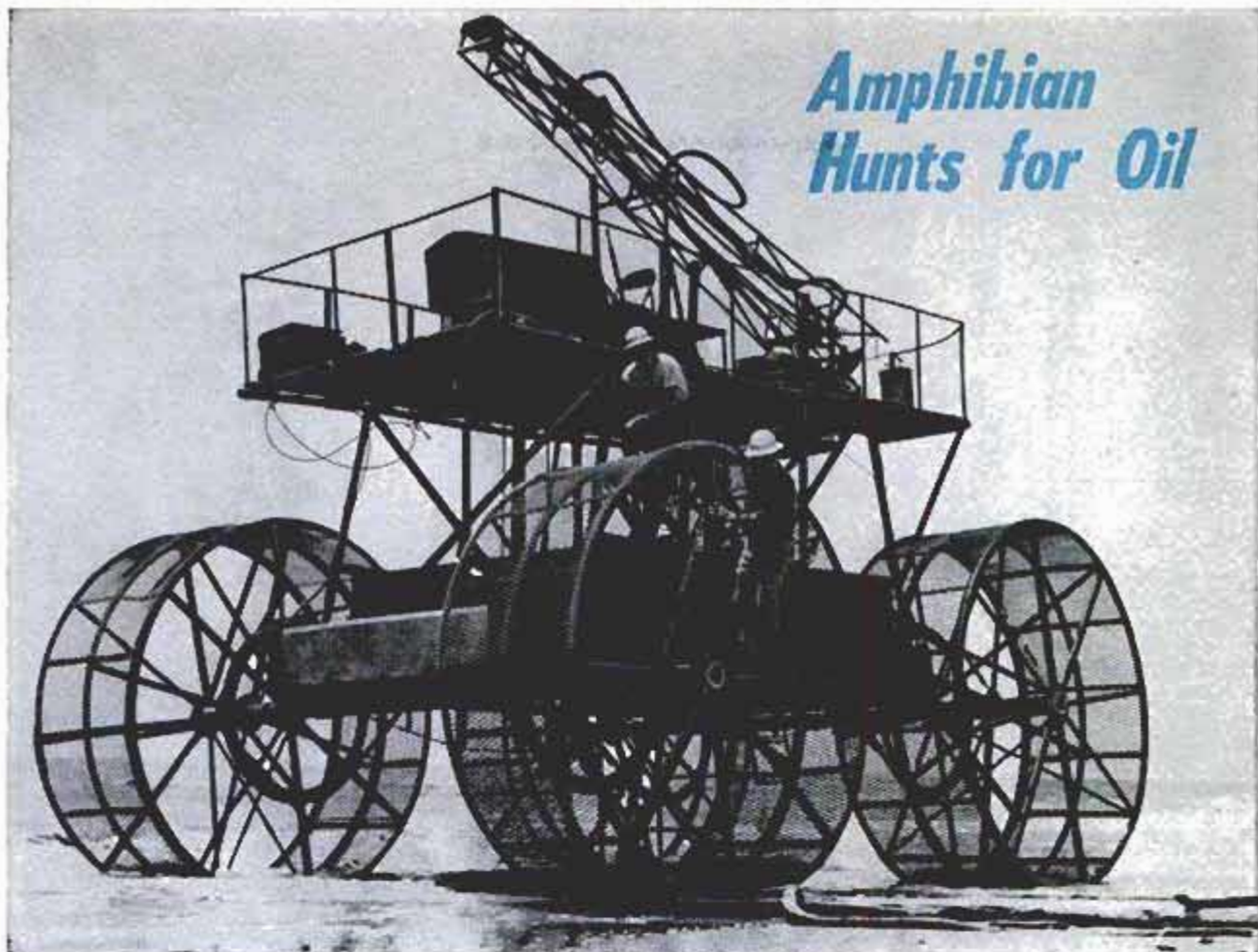

Offshore oil exploration is being aided by an amphibious vehicle capable of wading in water 18 feet deep. Built in Louisiana, it is used for seismographic exploration in

water too deep for land vehicles and too shallow or too rough for boats. Tanks at the axle level are emptied or filled with water to provide flotation or ballast.

Sled Towed Behind Boat Takes Diver on Undersea Tour

Skin divers can explore the depths on a submarine sled that can be controlled with one hand. The sled, towed behind a boat, can be made to dive, surface, turn and roll. It will submerge when towed at speeds as low as 3 miles per hour and as high as 15 miles per hour. If the diver leaves the sled

it will rise to the surface. Equipment can be lashed to the sled for underwater use by the diver.

Diver lies on the submarine sled and operates controls with his hands to dive, surface, turn or roll. When diver leaves the sled it automatically comes to the surface. Gear can be lashed to the sled

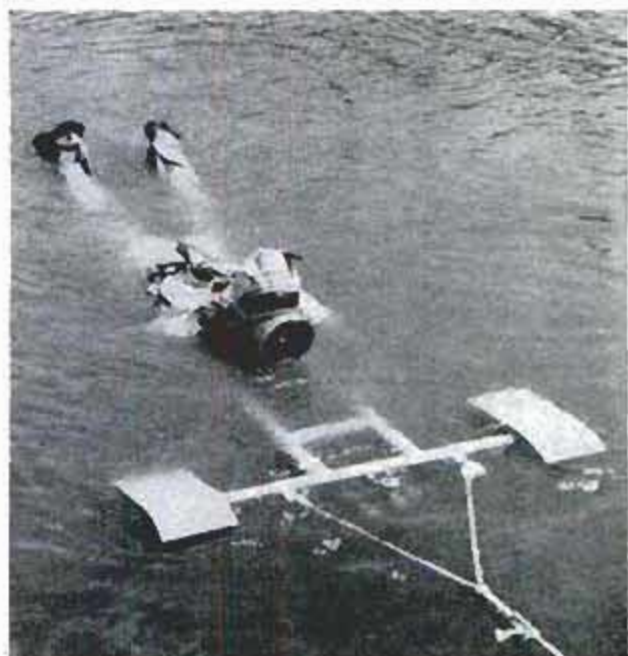
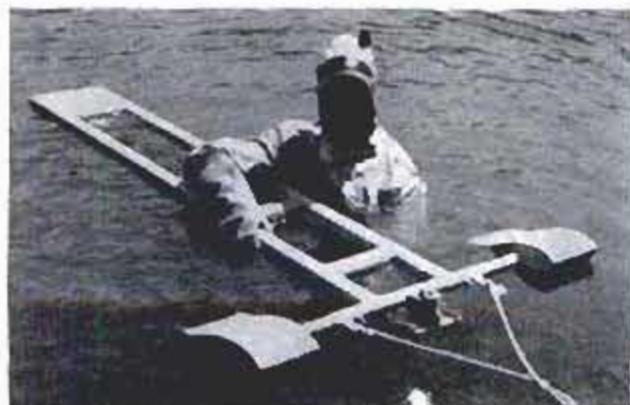

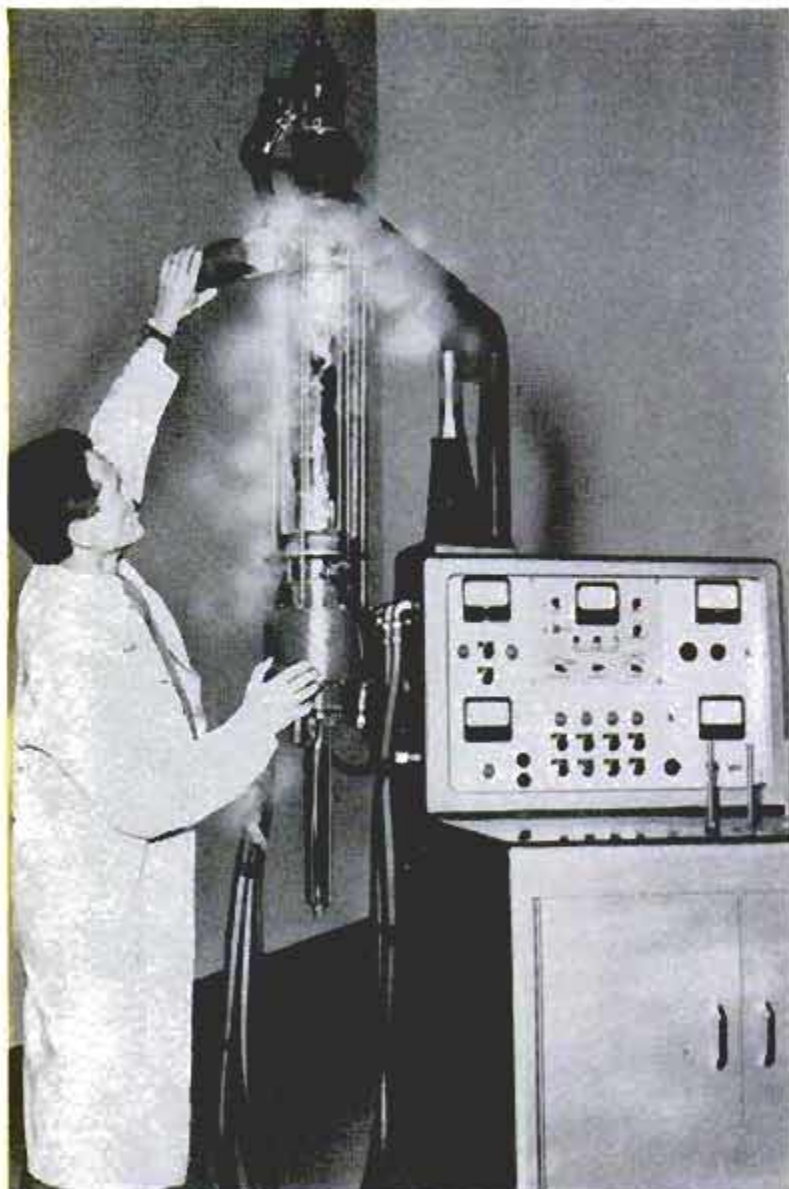
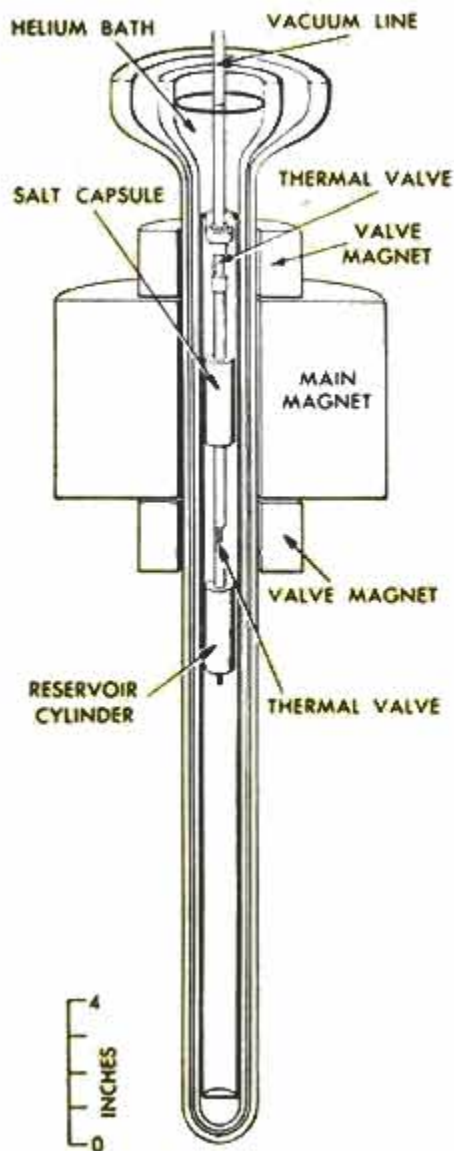

Motionless Magnetic Refrigerator Cools to Minus 459 Degrees F.

There are no moving parts or fluids in a laboratory refrigerator that cools a small cylinder to minus 459 degrees Fahrenheit (almost absolute zero). Key part of the refrigerator is a capsule filled with a chemical salt that loses its heat when magnetized. Heat flows through metal rods, in stages, from reservoir cylinder to chemical salt to a helium bath. Each time the salt is magnetized it loses its heat to the helium bath.

When it is demagnetized, it draws heat from the reservoir cylinder. Thermal valves—thin strips of metal joining breaks in the rod—keep the heat flowing the right way. They conduct heat when magnetized, stop heat when demagnetized. Scientists plan to use the refrigerator in studying subtle changes in atoms and molecules. At extremely low temperatures the particles become quiet and are more easily observed.

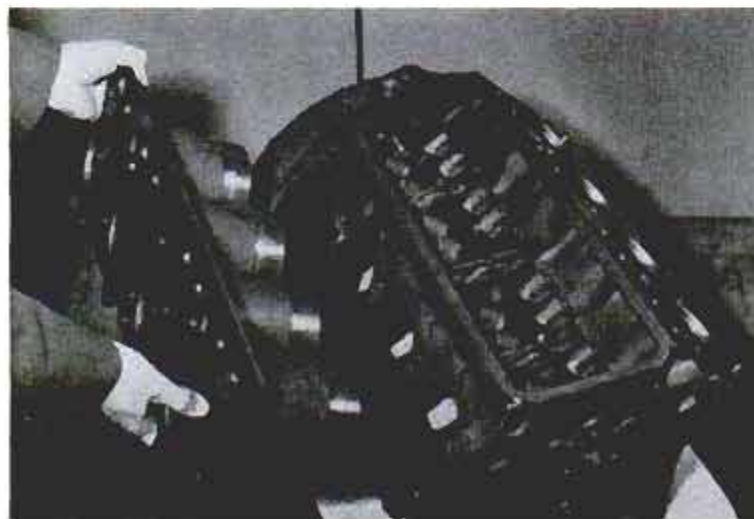

Engine Costs Less to Make

In a new, less-expensive method of making automobile engines, the engine cylinders and top deck are not cast with the block, but are a separate assembly. Expensive baked-sand coring is eliminated or drastically reduced. Better material can be used in cylinders, softer iron in the block. A more durable engine results.

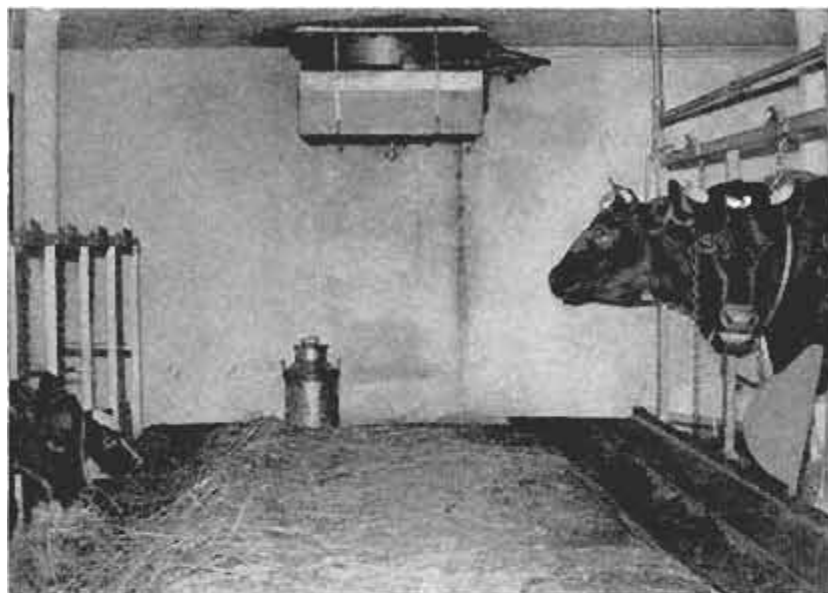

Ever hear of cows heating a house? Tage Espersen of Nannerup, Denmark, decided it was costing too much to heat his home, so he put his cows to work as a heat source. The heating system works on the same principle as a refrigerator. Normally the temperature of Espersen's stable, because of insulation, rises too high, and the stable must be ventilated. The heating system draws the warm air through screened openings into a heater unit, where a water filter washes away any impurities and odors. The hot, purified air then strikes a cooling coil which lowers the air temperature about

Cows Heat House

nine degrees. This cool, fresh air then is circulated

back into the stable.

Meanwhile the heat which has been absorbed by the cooling coil is regained in a condenser and passed on to a hot-water tank. The hot water then is circulated through radiators in the farmhouse. Thermostats permit the temperature of the dwelling to be kept at a steady 70 degrees.

Fourteen cows provide enough heat and hot water for the house. The cost of the electricity for the system is less than half the cost of heating the house with either coal or oil.

Self-Propelled Concrete Mixer Picks Up Sand and Cement

Capable of carrying two cubic yards, a self-propelled concrete mixer picks up its own sand and cement and mixes it between sand pile and delivery point. The new machine, called the Solo-Mix, lifts four tons of sand and cement with its elevator, empties it into a large mobile mixer and then

turns in its own radius to pour finished concrete into nearby footings, foundations or slabs. It can load, mix and discharge in a 10-minute cycle and is intended for on-the-job use, rather than as an over-the-road hauler. All operations are controlled by one man from the driver's seat.

Operated by one man, the self-propelled mixer picks up sand and cement, mixes it as it proceeds

Machine lifts four tons of sand and cement into its mixer, completes load-mix-discharge cycle in 10 minutes

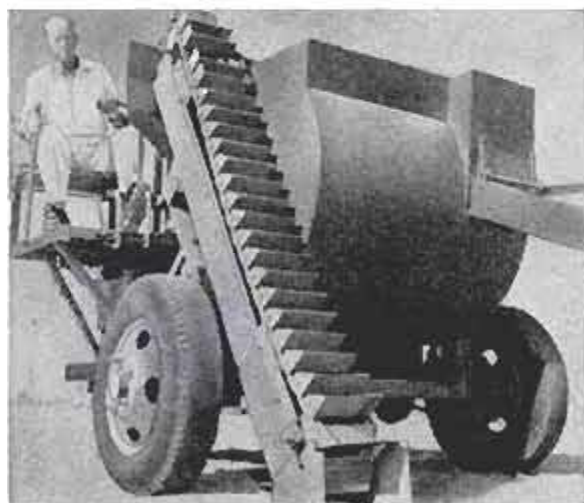

OWNERS REPORT:

What Is the Best-Liked Feature?

Power, performance say 58.3% of the owners

"It has a snappy, dependable engine that will take a lot of top-speed driving."

ILLINOIS WELDER

"I like that fast acceleration on takeoff. Most of all I like the power when passing, especially on hills."

VIRGINIA CARPENTER

What Is the Most-Frequent Complaint?

Body rattles, squeaks say 16.2% of the owners

"Doors rattle and leak. Rear end whines. Mechanics don't seem to know what's wrong."

ALABAMA CRANE OPERATOR

"Very, very noisy in body as well as engine and seats."

RHODE ISLAND SAILOR

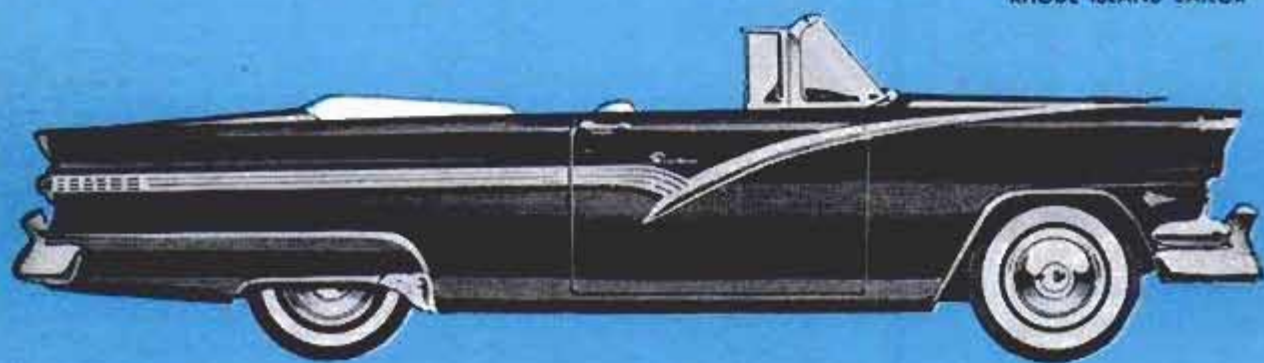

HOW MANY HAVE SEAT BELTS?

No belts	84.3%
Belts front seat only	15.7%
Belts front and rear seats	0.0%

ARE SEAT BELTS USED?

Wear them all the time	21.9%
most of the time	34.4%
some of the time	25.0%
none of the time	18.7%

SAFETY QUOTATIONS

"Best thing Ford ever did."

UTAH BACTERIOLOGIST

"A must for me from now on."

GEORGIA SALESMAN

"Should be standard if really safer."

MICHIGAN PRIEST

"Ripped clothing on belts twice so I took them out."

SOUTH CAROLINA GOVERNMENT WORKER

"Safety emphasis is idiotic as long as that hood ornament sticks out in front."

OHIO ADVERTISING MAN



**As Told
By Owners of
1956 Fords**

Ford owners rate styling as tops, specifically praising chrome trim and two-toning of Fairlane series

Ford V8 Has Plenty of Power, Say the Owners; Only 3.4 Percent Wear Seat Belts All the Time

FORD, more than any other auto maker, has been selling "safety." What has the public response been? Our Owners Report on the 1956 Ford provides an answer.

The public, apparently, is not taking to seat belts. Despite the fact that safety

groups, scientific and otherwise, stress the value of belts, the public does not seem anxious to buy them and, once having bought them, is not anxious to use them.

Only 15.7 percent of the Ford owners in

(Continued to page 119)

CLYMER TESTS THE FORD

By Floyd Clymer

MY TEST of the 1956 Ford Crown Victoria Skyliner was the longest and most grueling PM test I have ever made. Total mileage was 3098 miles from Los Angeles to Colorado Springs, Colo., and return. It ranged from Death Valley, Calif., (203 feet below sea level) to the snow-covered Monarch Pass in Colorado (11,312 feet above sea level). I put the Ford through every tough test I could think of. Even with wide-open throttle on long mountain grades or in desert heat there was no evidence of overheating or underpower.

Gasoline economy was reasonable at moderate speeds, but not too good at high speeds. I'm not easy on a throttle. A more conservative driver would get better mileage than I do. Two quarts of oil were added in the first 2500 miles.

The speedometer needle at times indicated 116 miles per hour, but a speedometer check showed an actual top speed of approximately 7 percent less.

Although the front springing is quite soft and

(Continued to page 220)

Clymer's road test of the 1956 Ford V8 went from the extremes of snow-packed Monarch Pass down to sun-parched Death Valley



11,312 FEET ABOVE SEA LEVEL



AT SEA LEVEL



203 FEET BELOW SEA LEVEL

An Engineer Analyzes the Ford With 225-Hp. V8

By Dale Kelly, SAE

MODEL TESTED: Fairlane four-door sedan with Fordomatic transmission, power seats and steering, and 312-cubic-inch, 225-horsepower V8 engine. Compression ratio: 9.0 to 1. This engine is an extra-cost option available only on Fairlane and station wagon models. Weight: 3750 pounds with gas tank half full (59 percent on front wheels, 41 percent on rear). Rear-axle ratio: 3.22 to 1. Tires 7.10x15. Wheelbase (measured): 115½ inches left, 115½ inches right. Barometer 29.74 inches, temperature 67 degrees F., payload 400 pounds for acceleration and top-speed tests, 200 pounds for fuel economy.

ACCELERATION



TIME IN SECONDS	0-20	0-40	0-60	0-80	¼ mile
Ignition timed for regular gasoline	4.0	7.4	14.0	25.0	20.35
Ignition timed for premium gasoline	3.6	7.1	13.4	23.4	19.9

(The watch was started the instant accelerator was floored. The engine was not run up against the brakes before the start. All tests were in Drive range, but the accelerator pedal was pushed past the detent, so that low, intermediate and high gears were used.)

FUEL ECONOMY



MILES PER GALLON	Steady 30 m.p.h.	Steady 50 m.p.h.	Steady 70 m.p.h.	Traffic Route
Ignition timed for regular gasoline	20.4	17.6	13.9	10.7
Ignition timed for premium gasoline	20.7	18.1	14.5	10.9

ESTIMATED ANNUAL GASOLINE BILL: \$176 for 10,000 miles. Based on 2000 miles at 30 m.p.h., 5000 miles at 50 m.p.h., 1500 miles at 70 m.p.h. and 1500 miles in traffic, and on the assumption that 25 percent of users will be able to get satisfactory performance on regular (27 cents a gallon), the rest requiring premium (29 cents a gallon).

SPEEDOMETER ERROR



MILES PER HOUR	20.0	30.0	40.0	50.0	60.0	70.0	80.0
Indicated speed	20.0	30.0	40.0	50.0	60.0	70.0	80.0
True speed	19.0	28.5	38.0	47.0	56.0	65.0	74.0

ODOMETER ERROR

The odometer indicated the correct mileage within one percent.

DRIVER'S VISION

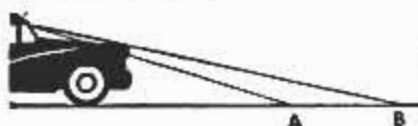

Some portion of the road could be seen 15 feet in front of the car (A in sketch) by an average driver (5 feet 9 inches tall); full width of the road could be seen 22 feet in front of the car (B in sketch).

GROUND CLEARANCE



The bottom corner of the rear overhang would touch the ground if the car were driven through a dip whose profile had a radius of curvature of less than 22 feet. The center of the car would drag if the car were driven over a hump with a radius of less than 15.5 feet.

The differential would drag if the car were driven in ruts deeper than 8 inches. The doors would open over a 13-inch curb.

MISCELLANEOUS

OCTANE REQUIREMENT: The basic ignition timing had to be set to two degrees after top dead center for knockfree operation on an 85-percent octane blend of octane and heptane, equivalent to typical regular gasoline (88 octane Research). Acceleration and gasoline mileage listed above for regular gasoline were obtained at this setting.

The best acceleration from standstill to 45 miles per hour was obtained with the ignition advanced to three degrees before top dead center. The acceleration and gasoline mileage listed above for premium gasoline were obtained at this setting.

With any further advance, the engine knocked on a 90-percent octane blend of octane and heptane, equivalent to typical premium gasoline (95 octane Research).

Note that in this car, with a 700-mile carbon accumulation, there was a noticeable loss in acceleration when the car was tuned for regular gasoline. Another car of the same model could, however, have an octane requirement several points higher or lower.

STEERING: From straight ahead, the steering wheel had to be turned 0.85 revolution to make the outside of the outer front wheel travel in a circle with a radius of 50 feet. The steering wheel turned 4.5 turns from lock to lock. The diameter of the turning circle, to the outside of the outer front tire, was 41.5 feet; that of the walled circle in which the car could turn was 44.25 feet. Steering-wheel diameter: 18 inches.

TRUNK CAPACITY: In addition to spare tire and tools, the trunk could accommodate 12 cardboard cartons of the size used for 48 tall cans of evaporated milk.

INTERIOR SOUND LEVEL: Inside the car the noise level with all windows closed was 92 decibels at 40 m.p.h., 95 decibels at 60 m.p.h. on a smooth road.

CENTER OF GRAVITY: The center of gravity of the unloaded car was 24.5 inches above the ground.

GASOLINE FILL RATE: The gasoline tank could be filled at the rate of better than 14 gallons per minute when almost empty. No filling-station pump used during the test was capable of pumping faster than the inlet pipe could take it.

BRAKES: Partly because the rear wheels carried only 41 percent of the total weight, the rear wheels locked first on a severe application, causing the rear of the car to swerve sideways. Otherwise the brakes worked well. The parking brake held the car on a 14-percent grade.

VENTILATION: The air inlets were low at the front of the car, where they would be likely, in heavy traffic, to take in exhaust gas from the car ahead.

WATER RESISTANCE: Car was washed in an automatic high-pressure car wash and driven through a standard splash pan. In the wash test, a few ounces of water got past the door seals; none got into the trunk. In the splash test no water entered the car. In neither test were the brakes or ignition affected.



Owners from 47 states (color) took part in the Ford survey. The one state not included is Pennsylvania

The Owners Analyze The 1956 Ford V8

OVER-ALL RATING

Excellent	Average	Poor
68.0%	29.5%	2.5%

Had trouble with engine?

No trouble	74.5%
Some trouble	21.6%
Considerable trouble	3.9%

What was engine trouble?

Carburetor	3.4%
Valves, tappets	3.4%
Camshaft	2.9%
Unspecified noises	2.9%

Would like more top speed?

Yes	7.3%
No	72.7%
No answer	20.0%

Would like faster acceleration?

Yes	21.0%
No	69.3%
No answer	9.7%

Did styling influence choice of car?

Yes, it did	56.6%
No, it did not	38.5%
No answer	4.9%

Best-liked styling feature?

Chrome side trim	13%
Front grille	13%
Taillights	10%
Two-toning	10%

Least-liked styling feature?

Chrome side trim	8%
Exhausts in bumper	4%

Best-liked interior feature?

Dashboard design	27%
Upholstery	22%
Steering wheel	13%

Least-liked interior feature?

Floor covering	11%
Ash tray	8%
Dash indicator lights	5%

What make car was traded?

Ford	47.8%
Mercury or Lincoln	5.9%
Other make	33.7%
No trade, no answer	12.6%

Would buy Ford next time?

Yes, would	56.1%
Might	40.9%
No, would not	3.0%

How is dealer service?

Excellent	54.2%
Average	37.6%
Poor	6.2%

Would buy from him again?

Yes, would	63.4%
No, would not	7.8%
No answer	28.8%

Best-Liked Features

Power, performance	58.3%
Handling ease	42.6%
Exterior styling	30.9%
Riding comfort	18.6%
Safety features	10.3%

Economy of operation	7.8%
Driver's vision	7.4%
Roadability	6.4%

Most-Frequent Complaints

No complaints at all	32.4%
Body rattles, squeaks	16.2%
Uses too much gasoline	14.2%
Poor body work, assembly	10.8%
Hard to enter front seat	8.8%
Noisy engine	7.4%
Body too light	6.4%
Water and dust leaks	6.4%

Why Did They Buy Ford?

Exterior styling	20.6%
Previous ownership	15.7%
Best deal on old car	9.3%
Performance	8.8%
V8 engine	7.8%
Safety features	5.4%

What About Safety?

Have padded dash, visors	48.0%
Have seat belts, front only	15.7%
Have belts, front and rear	0.0%

How often are belts worn?

<i>(asked only of those with belts)</i>	
Worn all the time	21.9%
Worn most of time	34.4%
Worn some of time	25.0%
Worn none of time	18.7%

the survey have seat belts in the front seat. None has them in both front and rear seats. Of those whose Fords have belts, only 21.9 percent say they wear them all the time (this is only 3.4 percent of all the Ford owners in the survey). Another 34.4 percent wear them most of the time; 25.0 percent wear them some of the time and a surprising 18.7 percent never wear them although the car is equipped with them.

Padded dashboard and sun visors are more popular with owners—48.0 percent having them in their 1956 Fords. Many more owners are enthusiastic about the "deep-dish" steering wheel which is standard equipment on all 1956 Fords.

Here are some typical quotations of Ford owners on the subject of safety:

"Was involved in a bad accident last August and believe if I had my present Ford I would not have been hurt as badly and maybe not at all."—Iowa farmer.

"I wear the belts all the time. I had an accident and know how they help."—Michigan businessman.

"Belts make driving more comfortable. They help on rough roads and when cornering."—Nevada communications man.

"I like the safety wheel and padded dash. Would never use belts."—Vermont clerk.

"Would never buy another car without belts and safety equipment."—Air Force pilot.

"I wear the belts only when I drive at high speed."—New Mexico oil worker.

"My wife loves the safety features, especially for our youngsters."—Iowa salesman.

"I do not have belts because of fear of ridicule."—Michigan priest.

"I have seat belts but don't ever wear them. I just don't want to be pinned in if wrecked."—Oklahoma bus driver.

"Safety stress is fine, but it's idiotic as long as that hood ornament sticks out in front."—Ohio advertising man.

"They should find something to take the place of belts. People think they are too much trouble."—Nevada electrician.

"Present measures are 'red herrings'. Reducing top speed to reasonable figure



Best-liked feature of the 1956 Ford V8 is its power and performance, of which this picture is evidence would be real safety contribution."—Wyoming chemist.

What Do They Like Best?

These safety features placed fifth on the list of best-liked features of Ford owners with 10.3 percent mentioning them. First on the list is power and performance, with

Frequent complaint of owners is that the wrap-around windshield makes getting in and out more difficult

58.3 percent concurring. Second comes handling ease, with 42.6 percent; third is exterior styling with 30.9 percent, and fourth is riding comfort with 18.6 percent.

The following quotations describe the best-liked features:

"I like the smooth and fast take-off in any gear as I gradually mash the accelerator."—Indiana factory worker.

"Good performance at normal driving speeds."—Iowa farmer.

"I drove to California. It goes too fast. Did 115 m.p.h. in Texas without trying very hard."—Oklahoma salesman.

"Smoothest running, easiest handling car I ever owned. Plenty of power at any speed."—Colorado carpenter.

"Handles very well in traffic."—California mechanic.

"Best looking car on the road today."—New Mexico service-station owner.

"My black-and-white Victoria is the most beautiful car on the road."—Wyoming hospital worker.

"It rides like a larger and heavier car."—Montana housewife.

"I like the safety features. I can drive with more confidence. The belts increase my comfort. I don't slide on the seat."—Florida traveling salesman.

What Don't They Like?

Although nearly a third of the Ford V8 owners make no complaints at all (32.4 percent), there are others who are not so satisfied. The most-frequent complaint is body rattles and squeaks (16.2 percent). Second on the list is poor gasoline economy



(14.2 percent); third is careless body assembly (10.8 percent); fourth is the fact that the wrap-around windshield makes it awkward to get into the front seat (8.8 percent), and fifth is engine noise (7.4 percent).

The following describe these and other complaints in order of frequency of mention:

"Doors rattle and leak. Rear end whines. Mechanics don't seem to know what's wrong."—Virginia carpenter.

"Should get better mileage. Mileage was cut considerably by snow tires this winter. Got only 8 to 12 miles per gallon. Now getting 13 to 16."—Illinois farm advisor.

"Although Fordomatic takes much work out of driving, I believe the extreme sacrifice in gas mileage is too much. I get from 13 to 15 miles per gallon."—Rhode Island sailor.

"Factory work on my car was very poor. Screws around windows and doors were either loose or stripped. I removed the back seat looking for rattles and found several screws missing. The padding was falling out of the bottom of the back seat and one spring had broken loose."—California draftsman.

"I hit my knee against windshield post when getting into front seat."—Nebraska insurance agent.

"A driver with short legs who has to have seat close to steering wheel has trouble getting in and out past windshield post."—Rhode Island clerk.

"I don't like the racket of the overhead valves. Ford engines always ran so quiet until they went to overhead valves."—Arkansas letter carrier.

"Noisy engine. It was souped up at a sacrifice of smoothness."—

"Car is not heavy enough for the power of its engine."—Idaho farmer.

"Doors leak during hard rain."—Alabama pastor.

"Doors difficult to close and then get stuck."—Georgia school principal.

"Poor front end. Cannot keep wheels in alignment."—Michigan conservation officer.

"Front end too hard on tires."—Arkansas farmer.

(Continued to page 216)



Had no engine trouble say 74.5 percent of Ford owners; some trouble, say 21.6 percent; considerable trouble, say 3.9 percent

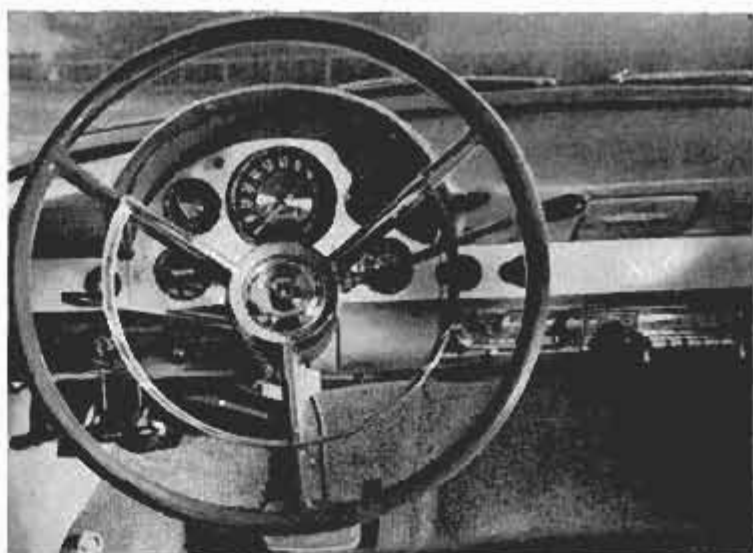

Above, owners like instrument panel and safety steering wheel. Below, they complain that padded dash makes ash-tray opening so narrow cigarettes often burn plastic covering. Some say protruding radio and heater knobs were not designed for safety





Cattle buyer pushes button by his seat to indicate he'll buy at the price recorded on auction board

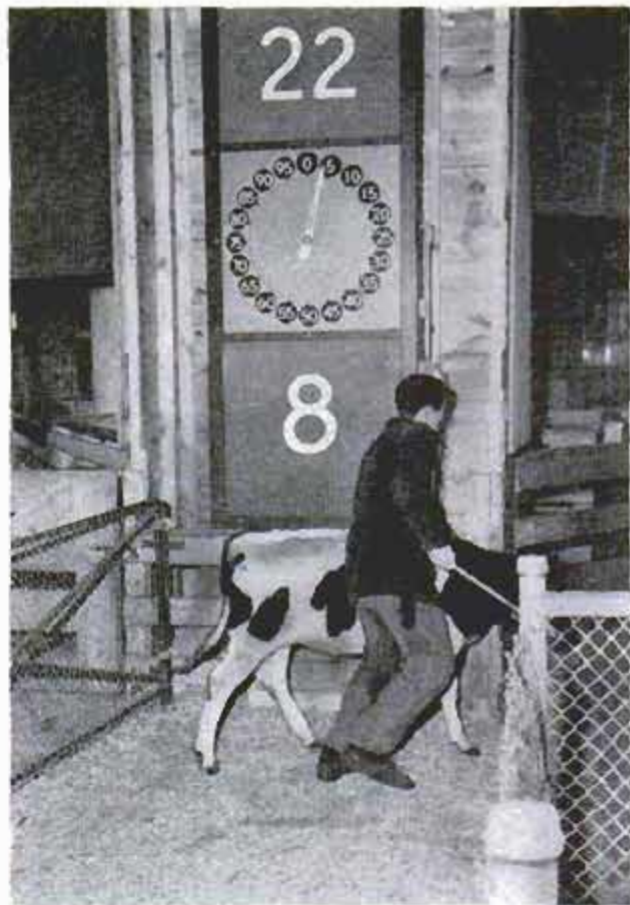

Calf is sold at \$22.05 per hundredweight. The 22 on board is for dollars, the 8 is for buyer's seat

Electromechanical Auctioneer Speeds Sale of Livestock

Livestock is sold at twice normal speed with a Dutch electromechanical auctioneer installed at the Ontario Stock Yards in Toronto. Bidding follows the Dutch pattern and starts at the top price asked. The seller presses a button and his maximum per-hundredweight price appears on a large screen. The hand of a clocklike dial begins to turn automatically to indicate the lower-

ing of the price by cents. After every revolution, the dollar price on the top screen lowers until a buyer presses a button by his seat. The buyer's number appears on a lower screen to indicate that the animal is sold. The system brings all offers into the open and bars private deals. The unit costs \$2000 and another \$8000 to wire up the 48 buyers' benches in front of it.



Smog Hunters "Shoot" Offenders With Car-Mounted Cameras

Attempting to reduce smog in the Los Angeles, Calif., area, officers of the Air Pollution Control District patrol constantly, warning and arresting violators of air-pollution ordinances. To gather evidence for use in court, each officer's car is equipped with a special tripod which holds a camera aimed through the windshield. The officer can drive and take pictures at the same time, making it possible for him to trail a smoking diesel truck while he takes the necessary pictures. Until the cameras were put in the cars, officers found it difficult to make their charges stick when violators were brought to court. Motor vehicles account for 1050 tons of pollutants out of the 3400 released daily in the area.



Drawing with radioactive ink is done on a flat surface to keep ink from running. Ink is not dangerous



Geiger counter measures radioactivity to determine required exposure time—from half a day to six months

Atomic Inks for Art

By Hilda Voorhies Nystrom

DRAWING INKS spiked with radioactive isotopes are among the latest peaceful by-products of atomic research. The "hot" ink, which may revolutionize the art of lithography, transmits rays strong enough to expose photographic print paper laid over a drawing made with the ink. The resulting print is a perfect mirror image of the original drawing, with an accuracy of detail that is almost impossible to obtain in conventional lithographic work. And thousands of copies can be made from the original drawing with no loss of detail.

The idea was conceived by Dr. Harry Wheeler, Associate Professor of Botany at Louisiana State University, who works with radioactive fungi in his research. Wheeler's wife and lithography instructor Caroline Durieux collaborated in the unique experiment.

Mrs. Durieux feels that the process will do for art what high-fidelity has done for sound—broaden the range of textures and shades. The biggest stumbling block to commercial use is the lack of a printer's plate sensitive enough to take the radioactive drawings, but Doctor Wheeler feels these will be developed before long.

After exposure of design to photo paper, print is developed and fixed just as any photoprint would be



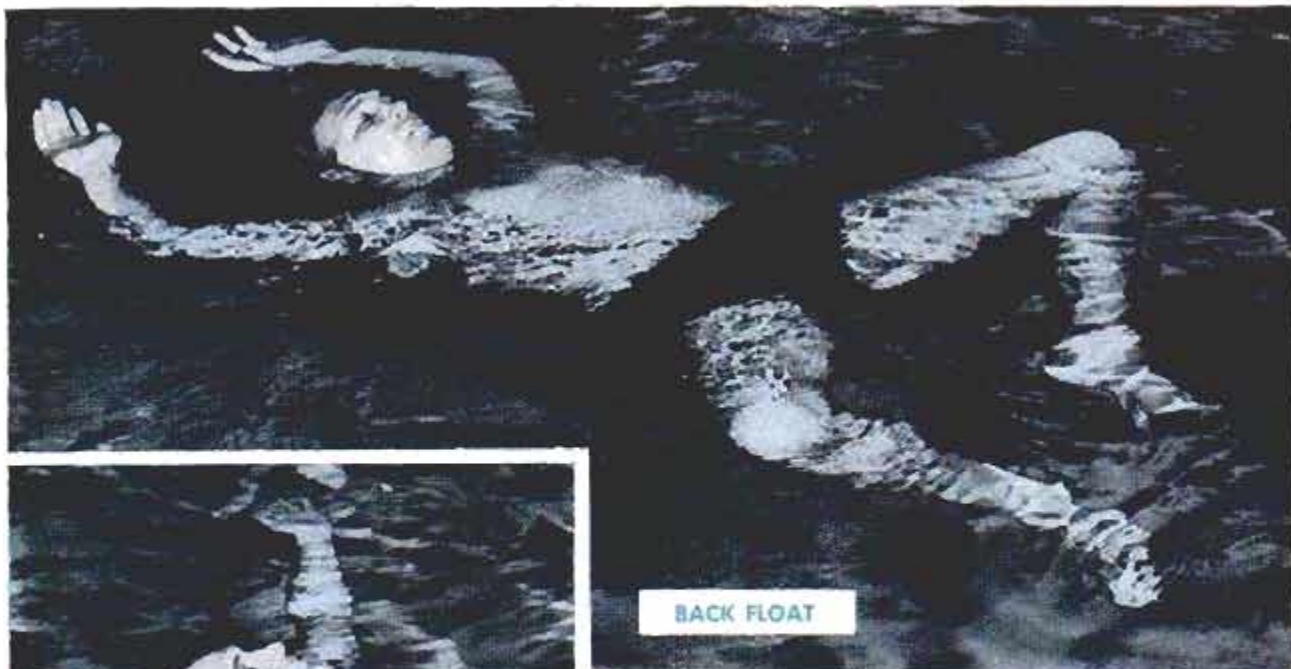

BACK FLOAT

Back float is most comfortable. Bent position of legs and arms gives greatest buoyancy. Use it to rest during swimming, to float for survival in calm water. Gentle sculling or kicking may be necessary but burns energy



VERTICAL FLOAT

Vertical float is natural for some. Gently push water downward with hands in fishtail flipping of wrists. Pretend you're walking up stairs with feet close together, extending feet downward eight to ten inches at each step

Treading water uses energy fast, but helps you keep warm in cold water, is necessary in righting capsized boat. Scull with hands in figure-eight motion. Move feet as in bike pedaling or use egg-beater, frog or scissors kick

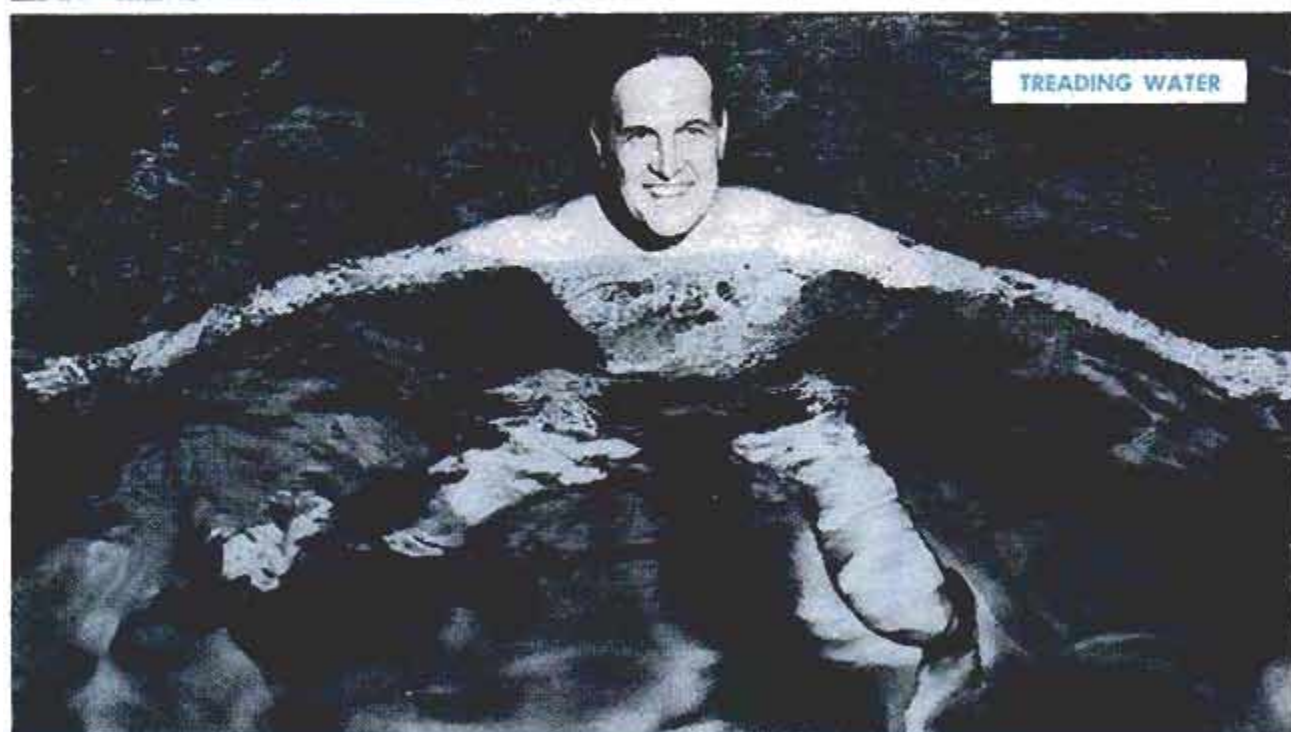

TREADING WATER

How to Stay Alive in the Water

By Elliott H. McCleary

YOU MAY BE an excellent swimmer, but knowing how and when to float is your best guarantee of survival.

Adolph Kiefer, former Olympic swimming star, shows here the best methods of keeping afloat, whether you're waiting for rescue, have swum too far and are tired, have the cramps, are trying to right a boat or are being numbed by chill water.

If you're in a small boat that's slowly filling with water, stay with the boat. Even with a big hole in the bottom and filled to the brim with water, it will keep afloat its rated capacity. That is true if it is a canoe or wooden boat, or a plastic, molded plywood or metal boat that has been made buoyant with plastic foam. A capsized boat will support as many persons in the water as can grasp hands across it.

James Carnahan, who supplied technical advice for this article and is Water Safety Director of the Chicago Chapter, American Red Cross, points out that the average human body is almost light enough to float unaided. Proper breathing

Drownproofing, survival float taught by Georgia Tech's Fred Lanoue, keeps you up indefinitely. Use it if you're waiting for help, if you get cramps or are tired from swimming. Below are Lanoue's rules

1. (A) With lungs full of air, float face down, arms and legs dangling, back of neck on surface. (B) get ready for slow, downward push, using arms, legs or both

2. Exhale through nose while raising head just high enough to get chin out of water. Be sure to keep the shoulders underwater

3. The instant the head is vertical make downward thrust with arms which supports body during the inhale through the mouth

4. As soon as lungs are full, drop face down to horizontal and immediately give another long slow thrust backward and downward. Then relax with head, arms and legs dangling, holding all air for four or five seconds while slowly floating up





STAY WITH THE BOAT

American Red Cross photos



Boat completely filled with water holds its rated capacity. Passengers sit on floor. If they were on seats, boat would float lower in water. Users of capsized boat stay up by grasping hands across keel. Boat supports as many as can grasp hands across it

Jellyfish float is used when removing clothes in water. Take off one article between each breath; one shoe, then the other, pants next and shirt last. To get a breath, relax, kick and at same time push down with hands to raise head for air. Then submerge again



JELLYFISH



plus mild kicking or sculling if necessary, are all that are needed for floating. If you're thin or heavily muscled, you'll have to kick a little harder than your well-padded, more buoyant friends, for body type does make a difference. Some can read a newspaper while lying in the water. A very few are "sinkers" who can't float motionless.

In all floating, keep plenty of air in the lungs except when getting a breath. Take few breaths and deep breaths, but never wait until the last minute to breathe. Keep calm, and keep your arms below or on the water. You can't float if your arms are above the water.

You can learn the different methods shown here safely if you practice with someone who can rescue you. It's a good idea to practice floating and boat emergencies before they arise. Then, both your brain and your muscles will know what to do.

★ ★ ★

British Turbocopter

Called a turbocopter, a new British Fairey helicopter spins its rotor by means of compressed air blown through jet tips. Forward motion is obtained by a blast from a jet tube at the back of the fuselage. The jet stream plays across the rudder for easy steering and torque compensation. The pilot faces forward, while an observer faces backward in the cabin, giving the two-man crew 360 degrees of visibility.



Homemade Winder Reels in Wire

Old telephone wires are reeled in with a homemade rig that looks like an extra pair of wheels mounted on the front of a farm tractor. One of the "wheels" is the wire reel, which can be taken apart so that the reeled wires can be slipped off. The other is an auto wheel that serves as a pulley for the belt from the tractor. The tractor is braked during reeling operations. The outfit was devised and is operated by Glen Ellis, a farmer of Hebron, Ind., who helps manage a rural telephone system in his neighborhood.

Sleeping Cabin Bolts to Truck

You can add living quarters to a $\frac{1}{2}$ or $\frac{3}{4}$ -ton pickup truck by mounting a special glass-fiber cabin in the truck box. Attached or detached in minutes, the cabin can transform a working truck into a camping unit for weekend hunting or fishing trips. The truck with cabin mounted can also serve as a panel truck during the week. Four bolts with wing nuts secure the cabin to the truck box.



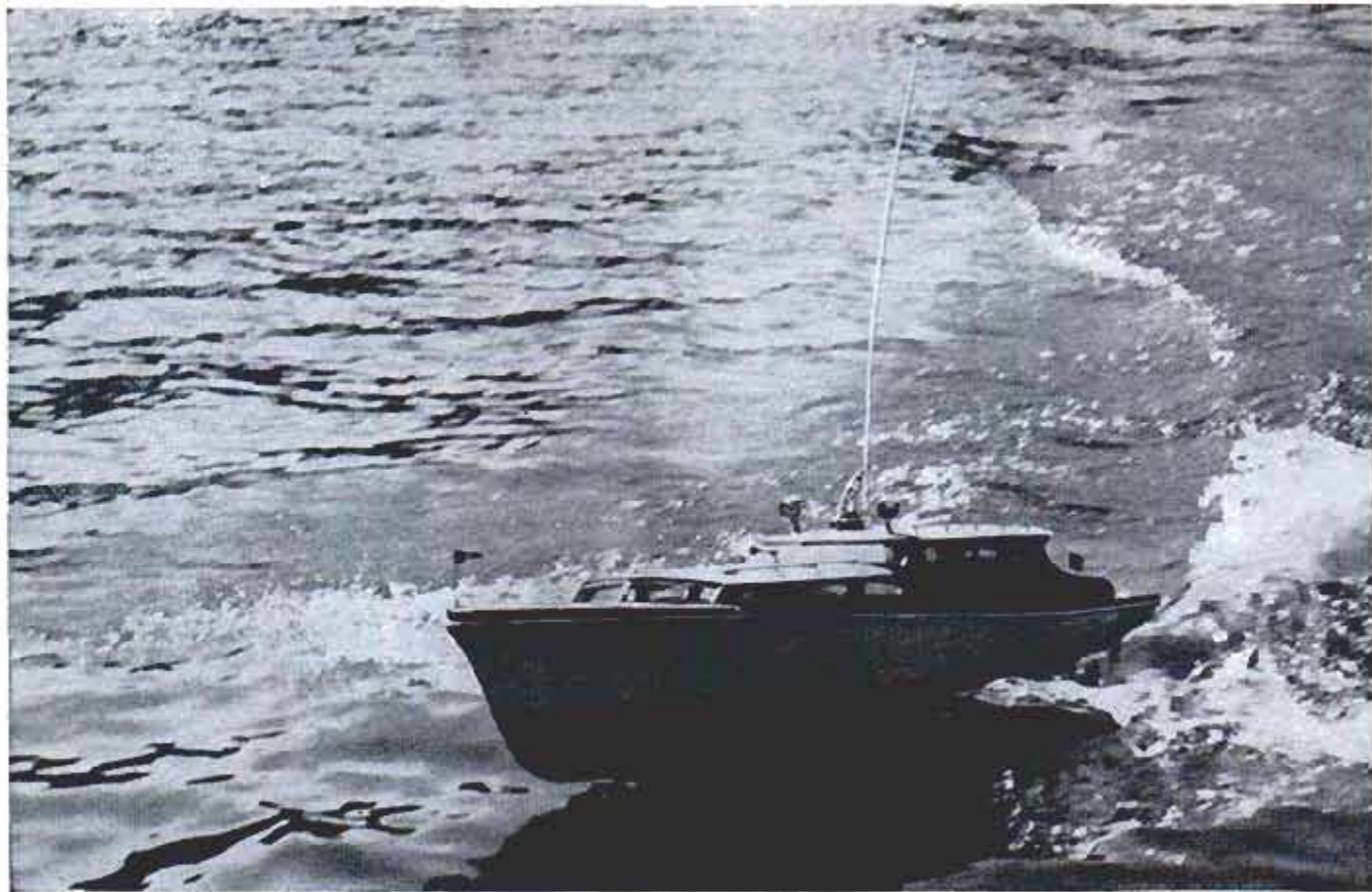

Mile-a-Minute Midgets

By Hal Roth

Electric motor powered by special storage battery drives this 32-foot-cruiser replica for about one hour

Five-channel radio receiver allows operator to select right or left rudder, increase or decrease speed

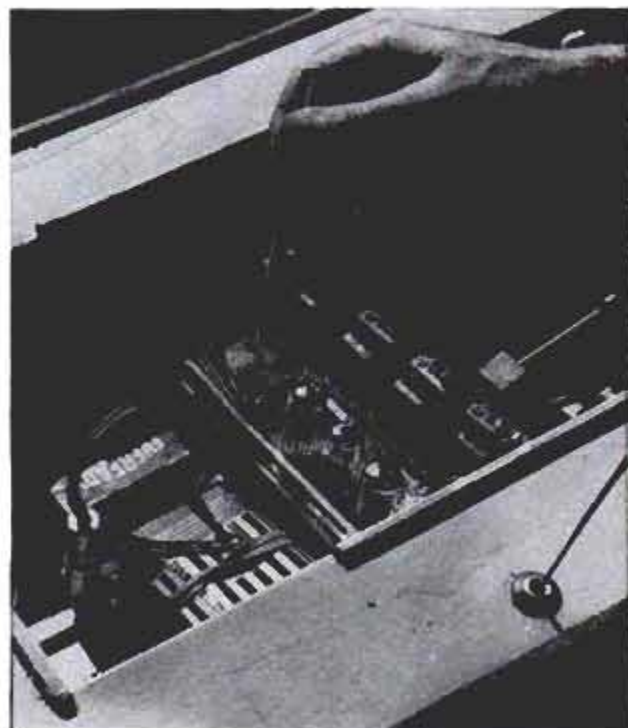
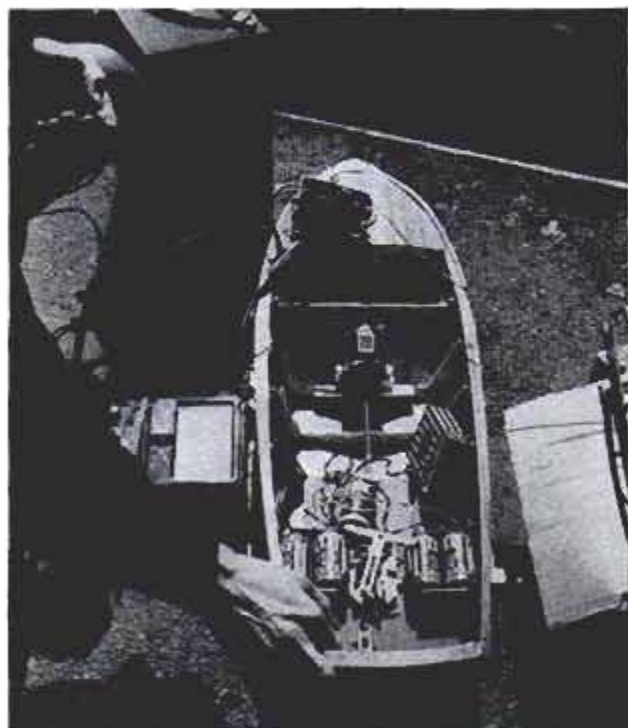

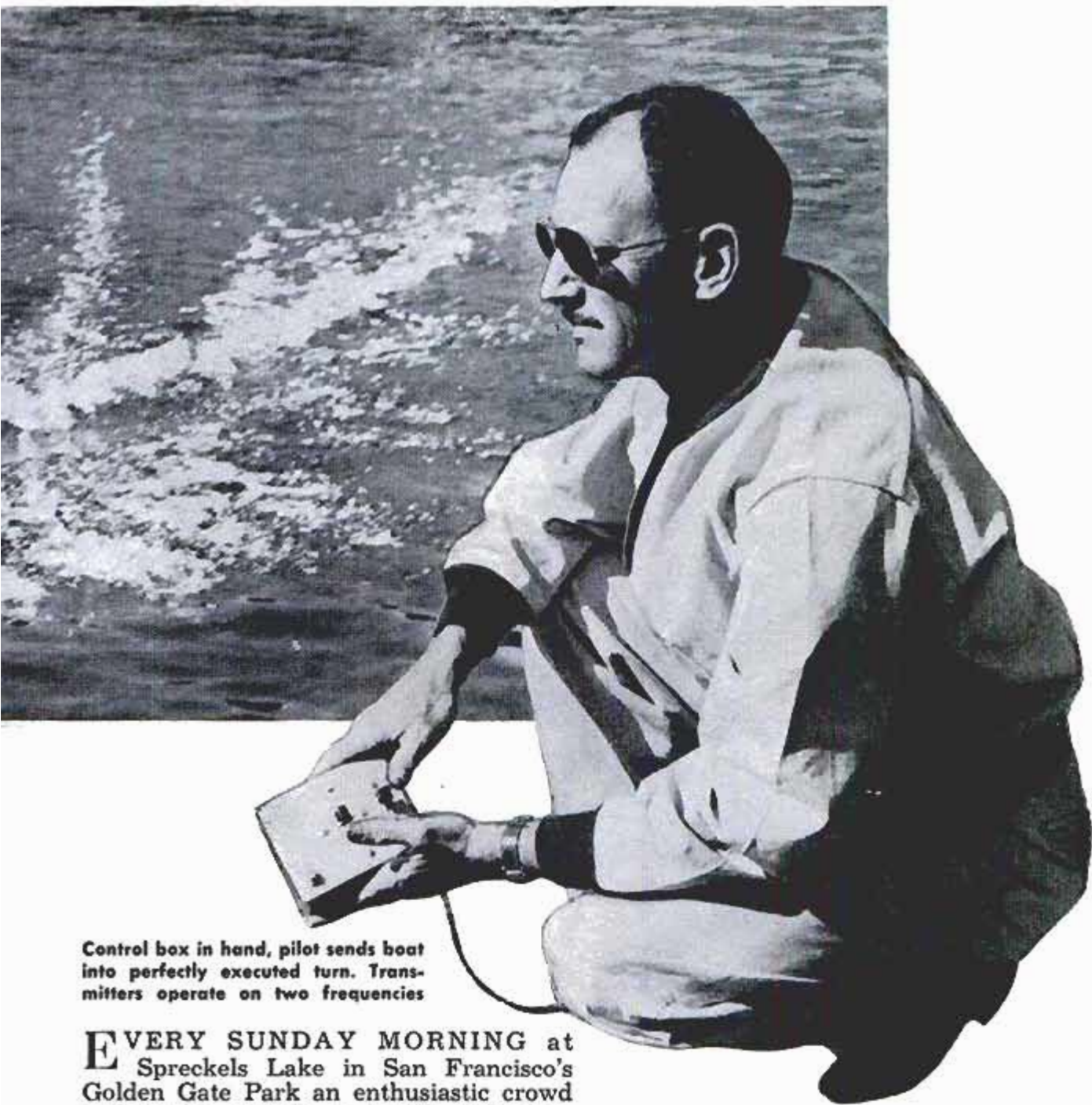

Control box in hand, pilot sends boat into perfectly executed turn. Transmitters operate on two frequencies

EVERY SUNDAY MORNING at Spreckels Lake in San Francisco's Golden Gate Park an enthusiastic crowd gathers to operate or watch radio-controlled model boats.

Model boats can be divided roughly into four classes: sailboats; powered racers running a circular course on a cable; free-running power boats; and radio-controlled model boats. Each class has its devotees and amazing models with incredible control devices have been constructed. For example, Walt MacWilliams of Philadelphia, holds the world's speed record for model boats (running a circular course and bridled to a cable revolving around a center pivot) of 81.44 miles per hour.

With radio-controlled boats the object is realism and full control—which includes both the cruising pattern and speed of execution. Since a typical radio-controlled boat may weigh 35 pounds and be 4½ feet long, a few extra ounces aren't important (as

with radio-controlled model planes) and very complicated control units have evolved. For example, in one radio unit, a Rockwood type, the transmitted signal can be picked up on any of five channels, each of which can operate a control (right rudder, left rudder, full throttle, siren, etc.). The radio signal causes a reed to complete a contact which impels a relay to actuate an electric motor that can operate the control through a complicated worm-gear linkage.

The power to work everything comes from batteries and the electrical equipment is designed to draw minimal current. Engine vibration is another problem since the delicate radio contacts often have gaps of only a few thousandths of an inch. Since any water in the radio gear would cause



With engines turning over, model cruiser valued at \$250 is started from shore by hand. Then radio takes over

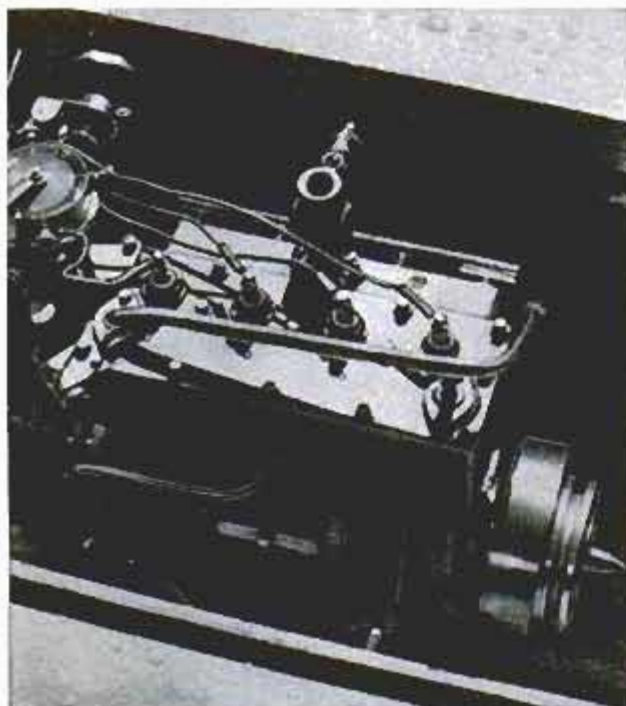

Four-cylinder power plant built by two model-boat makers features downdraft carburetor, water cooling

Engine is started and final adjustments made with boat in water. Top is put in place and cruise begins



short circuits, the boats must be watertight, yet the equipment must be accessible. Hatches and removable cabins are usual.

The boats have plastic hulls and are patterned after full-size cruisers. The most time-consuming chore is the making of the small detailed fittings such as spotlights, railings, flags, horns, etc., although kit manufacturers are beginning to supply custom fittings.

Driving power comes from an inboard-mounted engine, usually of a four-stroke-cycle design since high revolutions per minute are not required and a smooth-running low revolutions per minute, more powerful engine is better capable of a sustained cruise without overheating. Most of the engines are built by the modelers themselves. Model plane engines of the glow-plug type (two-stroke cycle) are sometimes used, but the inability to throttle down, excessive fuel consumption and considerable vibration make them less popular. The engines are usually cooled by picking up water, running it through a cylinder head shroud, and discharging it overboard.

Radio control of the engine speed is by spark or fuel adjustment. A small reversible electric motor controlled by the radio can be connected with the spark distributor or two sets of ignition points (high and low) can be used. The other method is to fit the carburetor with two needle valves (high and low speeds), each controlled by a radio-actuated butterfly, but this is often unsatisfactory for idling or slow cruising.

A second radio frequency for modeling purposes has recently been granted by the FCC. Heretofore each model had to be run in turn, i.e., only one radio transmitter and one model could be operated at a time, otherwise the signals would overlap. Now with two radio bands, two boats suitably equipped, can run together.

Although the old timers (after one successful run you're an old timer) generally



Platform on pole at shore end of floating fire barrier is control station for operating 400-foot booms

Floating Fire Barrier Protects Boston Harbor

View from beneath installation, showing the hollow steel booms which would be lowered in event of fire

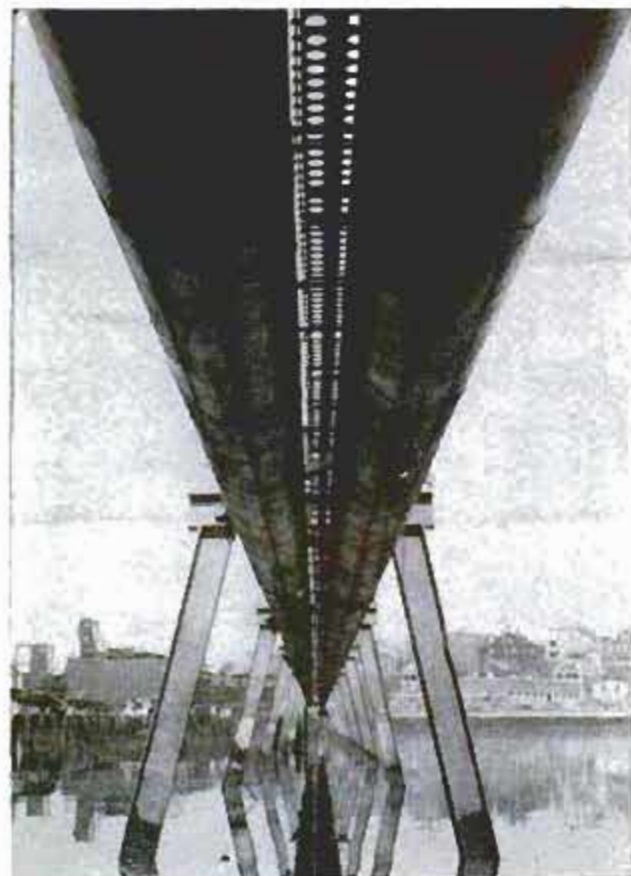

FIFTY-ONE PERCENT of all the oil storage tanks in New England are located along the banks of the Chelsea River above Boston Harbor. There is always a certain amount of seepage entering the water and, as a result, there is danger of surface fire which might spread to the shipping in the harbor itself. To prevent this, the Port of Boston Commission has built the world's first waterway fire-prevention boom, locating it across the Chelsea at the point of confluence with the Mystic River. The floating boom would enable the Boston Fire Department to close the waterway in the event of fire, and prevent flaming oil from floating down into the shipping lanes. The controlling device consists of two 400-foot hollow steel booms, built in 40-foot sections connected by universal joints. They can be moved both vertically and horizontally, and are suspended under a steel walkway. Control panel to operate booms is located on a platform on the river bank.

☐ A patent has been granted to a New Jersey inventor on a method of controlling the sex of chicks so that a poultry farmer can hatch either all male or all female chicks, as desired. The method is to dip fertile eggs for five seconds into a bath of male or female hormone.

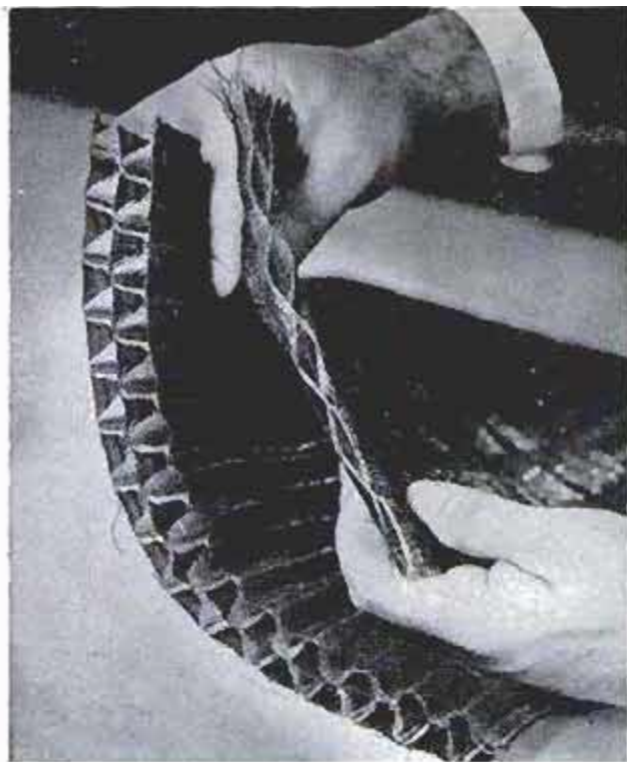

Woven fabric held in the fingers is dipped in hot water. Some fibers shrink to produce puffed fabric



Half of this piece has been dipped, other half remains flat. Below, fabrics are made in many designs

Hot Water Shrinks Fabric To Produce 3D Effect

Fabrics in three dimensions are now possible through a new technique of controlled shrinkage. The fabrics, developed by United States Rubber Co., are woven flat but are given permanent pockets by dipping them in boiling water. Woven on a regular loom, the fabrics combine conventional fibers with polyethylene yarn. The boiling water shrinks the polyethylene, forming puffs in the fabric. The puffs will not collapse or flatten out permanently even after periods of long compression. The first use for the fabrics will be in upholstery, including automobile seats. Eventually it may be used for rugs, with the rug and underlayment combined in one piece.

Remote-Control Wiring Device Eliminates Central Transformer

Remote control of lighting fixtures in the home became practical when the low-voltage relay system was introduced. However, the operation depended on a centrally located transformer and it has been restricted to new homes. A new individual low-voltage wiring device with a built-in transformer fits into the average outlet box and requires no central transformer. It can be installed easily in either old or new houses. The wiring involved in such an installation is simpler since there is no need to wire each relay back to a box.



Iceberg's Age Told by Oxygen Content of Bubbles

Scientists report that they may be able to determine the age of an iceberg by testing gas bubbles trapped in the ice for oxygen content. Ice formed 1,000,000 years ago contains bubbles with a slightly lower oxygen content than that of today's atmosphere. This suggests that the cold climates of that age might have curbed the photosynthetic activity of green plants.

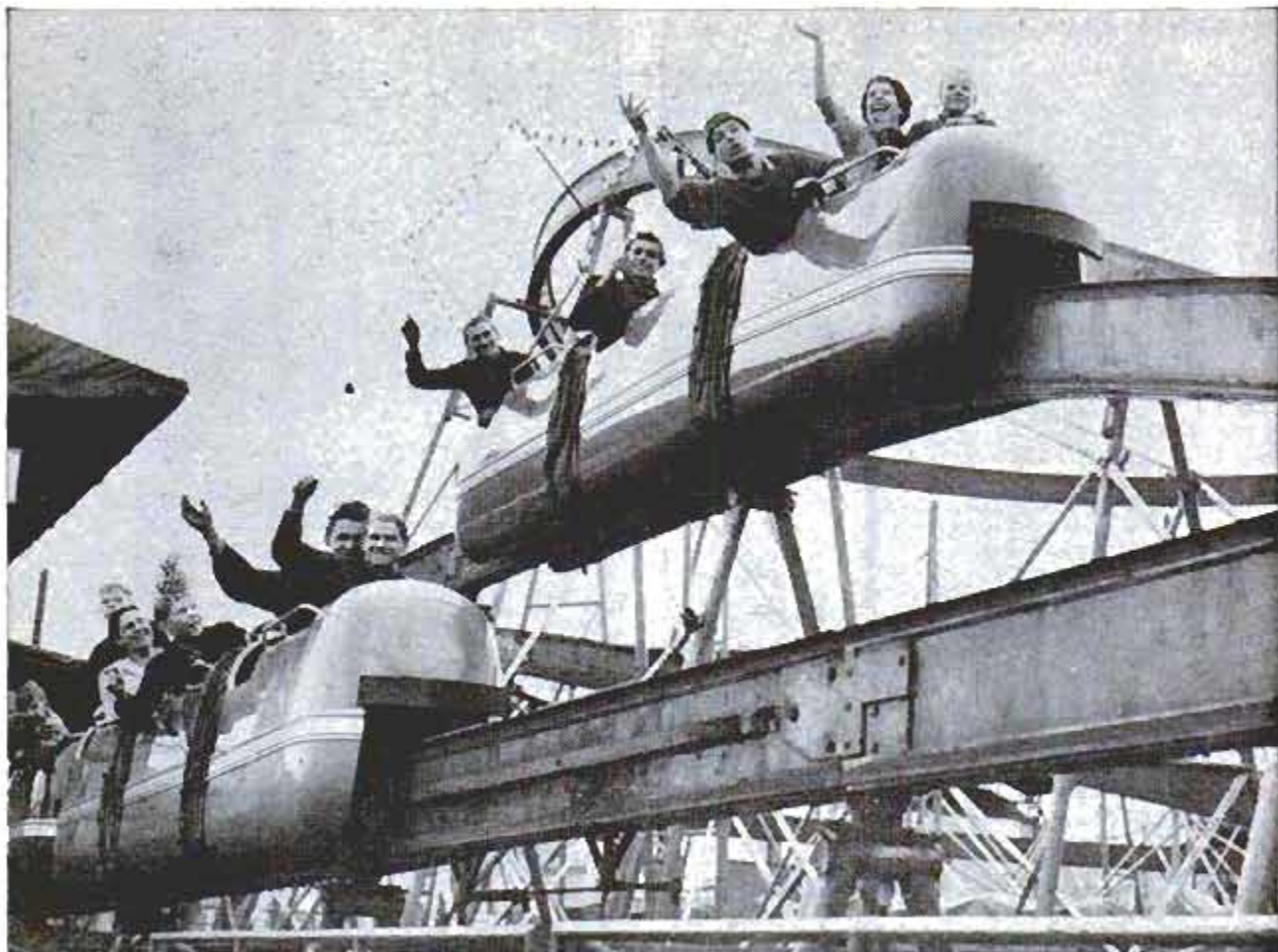

Passengers enjoy themselves on monorail roller coaster, biggest hit on German fair circuit in recent years

Monorail Roller Coaster is Fun Ride at German Fairs

Future spaceship pilots test their nerve by riding a new monorail roller coaster in Hamburg, Germany. The design of the roller coaster follows that of a monorail

railroad built near Cologne several years ago. As an amusement device the monorail has been one of the biggest hits on the German fair circuit this year.



Inventory Computer Cuts Army's Red Tape

Months of paper work are converted into minutes of push-button operations by a \$4,000,000 computer purchased by the Army. The complex machine, developed by RCA, can electronically "read" or "write" at a rate of 10,000 letters or digits per second. It will be used by the Ordnance Tank-Automotive Command to control replacement parts for vehicles. It can determine in minutes the supply of any item at any ordnance depot in the nation and can forecast future requirements. There are 200,000 different categories of these replacement parts, ranging from bolts to engines. Inventory records are stored on reels of magnetic tape which are run through the machine at 80 inches per second.

Musical Blackboard Plays for Students in West Germany

Music teaching is speeded by a tuneful electronic blackboard invented by E. Ahlborn in Germany. Notes are written with ordinary chalk on the fixed lines of the blackboard. Touching the notes with a pointer completes an electrical contact and the corresponding notes are sounded on an electric organ. A keyboard is used in conjunction with the blackboard to add tones for a chord.

Teacher touches note on board and note sounds on organ. Small keyboard is used to add other tones

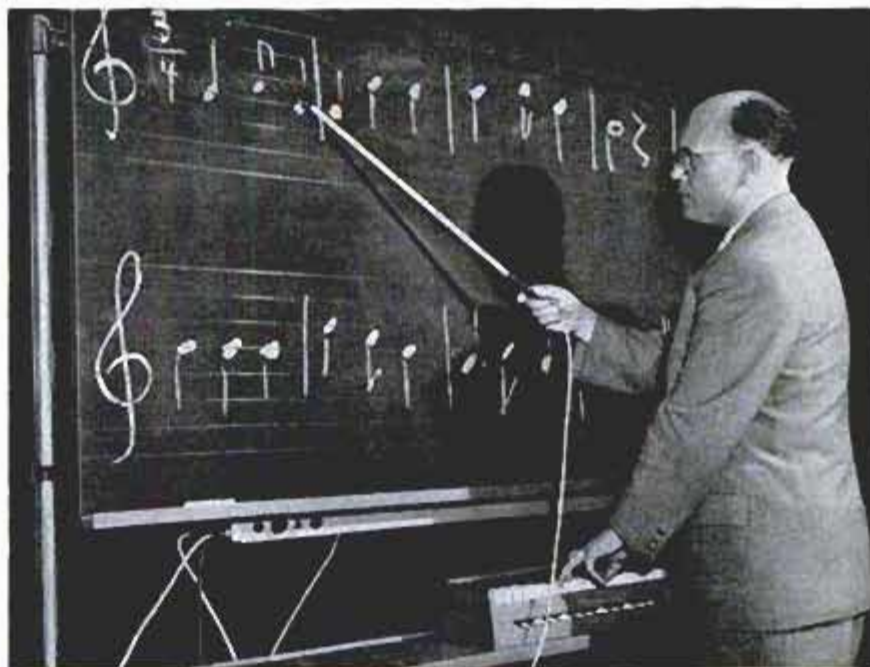

When Bridges Fail— Take to the River!

Getting a truck loaded with a 24-ton boiler plant across a river in Colombia proved a tough task, for the bridge wouldn't take the load. Finally, with a bulldozer towing it, the "semi" forded the stream. The bulldozer was again enlisted to push the truck back up on the highway. The boiler plant, destined for a tire factory in Bogota, remained in a seaport for five months before a mover was found. The 437-mile journey took seven days.

Roof of Trailer Turns Into Boat

Sleeping two people comfortably and boasting a compact little kitchen, a new automobile trailer features a built-in boat. The boat, a 12-foot glass-fiber model turned bottom side up, is used as the roof of the trailer. The boat can be lifted down and put in the water in five minutes. A windproof cover protects trailer's contents when the boat is in use.



They're Making ARTIFICIAL MOONLIGHT

By Thomas E. Stimson, Jr.

LUMINOUS CLOUDS that shed artificial moonlight over large areas can be created at will, though at very great expense. That's the conclusion of Dr. Joseph Kaplan and other aeronomists who are studying chemical reactions that take place in the upper atmosphere.

In one recent test an air glow twice as bright as Venus and about four times the apparent diameter of the moon was produced 60 miles above the earth. The glow lasted for about 10 minutes. It was created by nitric-oxide gas that was released from an Aerobee rocket.

The gas behaved like a catalyst and caused pairs of atmospheric oxygen atoms to unite into molecules, a reaction that produces light. The experiment paralleled a natural phenomenon that occurs in the upper atmosphere: Oxygen molecules broken

apart by solar radiation during the day are later recombined, producing a portion of the very faint air glow known as the "light of the night sky." Infrared and ultraviolet radiations as well as visible light are emitted in the process.

Scientists say there's a chance that enough infrared, or heat, is produced to provide the energy for driving a rocket ship at high altitude for almost any length of time. Already, in small-scale laboratory studies, enough heat has been created to turn a piece of metal red hot. For upper-air transportation they visualize a ramjet type of power plant, virtually an open tube. Oxygen atoms that enter at one end would strike a mesh of catalytic material and would form into molecules that would exhaust at the other end of the tube, the heat of the reaction providing useful thrust.

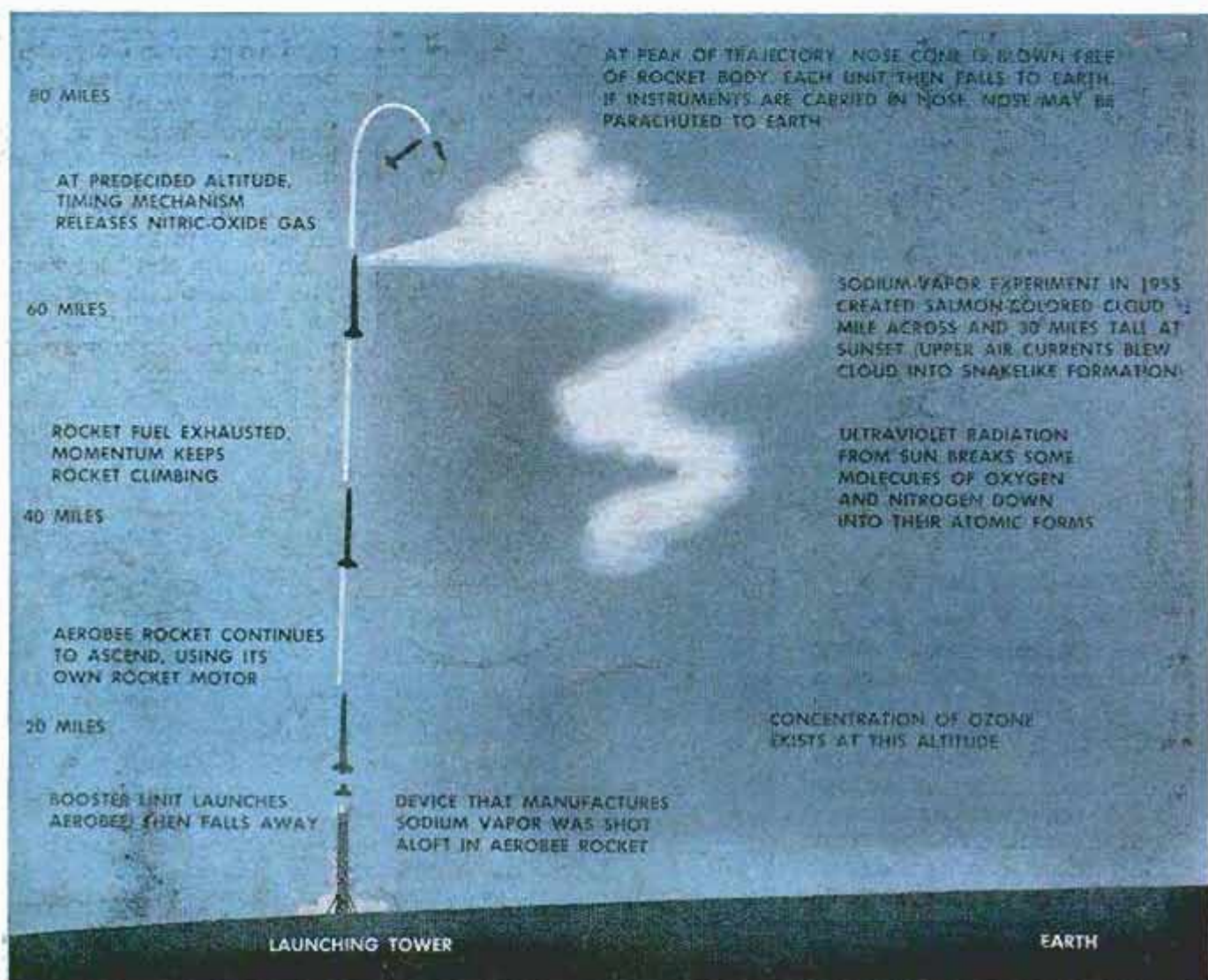

Technician installs color movie camera in instrument rack of Aerobee rocket. Two sodium generators used in first test are at bottom of rack. Rack is housed in nose cone at right. Holes in nose cone, from top, are for camera, photometer and for gas emission

The recent luminous-cloud experiment was performed at Holloman Air Force Base in New Mexico by a team from Cambridge Research Center under the direction of Dr. Murray Zelikoff. It is part of an extensive program for investigating various chemical reactions that take place in the upper atmosphere, many of which already have been duplicated in the laboratory. The nitric-oxide experiment, for instance, was first demonstrated in evacuated glass chambers at UCLA under the direction of Doctor Kaplan, head of the university's physics department.

Other air glows under study in the laboratory include the combination of atomic nitrogen and ozone, atomic oxygen and ozone, and the mixture of atomic hydrogen and nitrogen.

In a prior investigation at Holloman, the Air Force scientists created an immense sodium-vapor lamp in the twilight sky. Four pounds of sodium vapor were

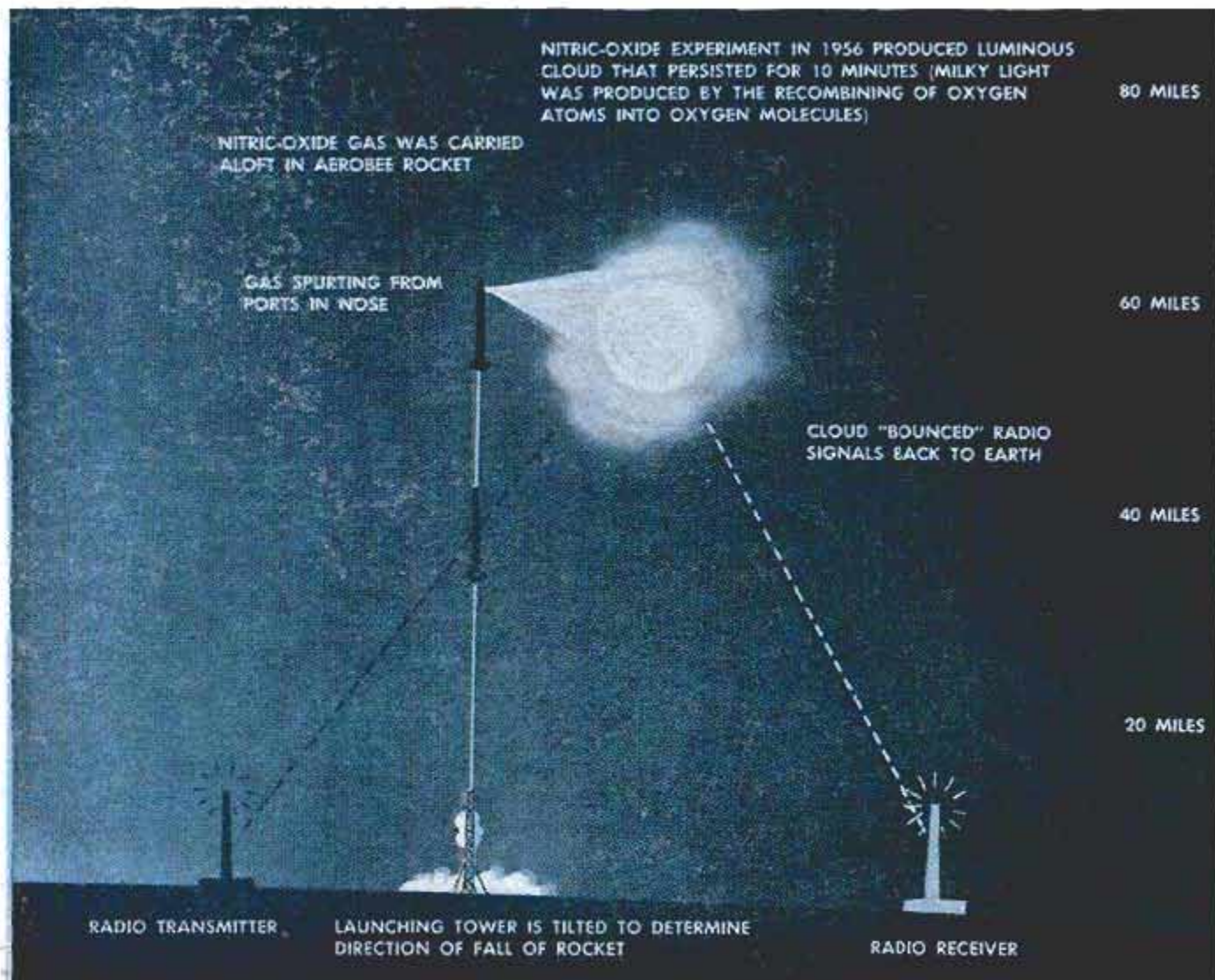
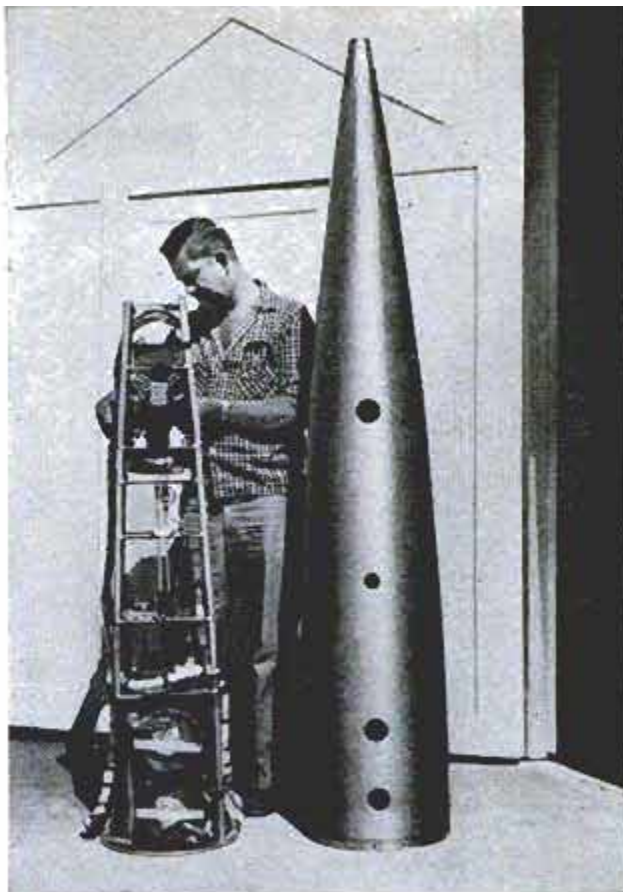

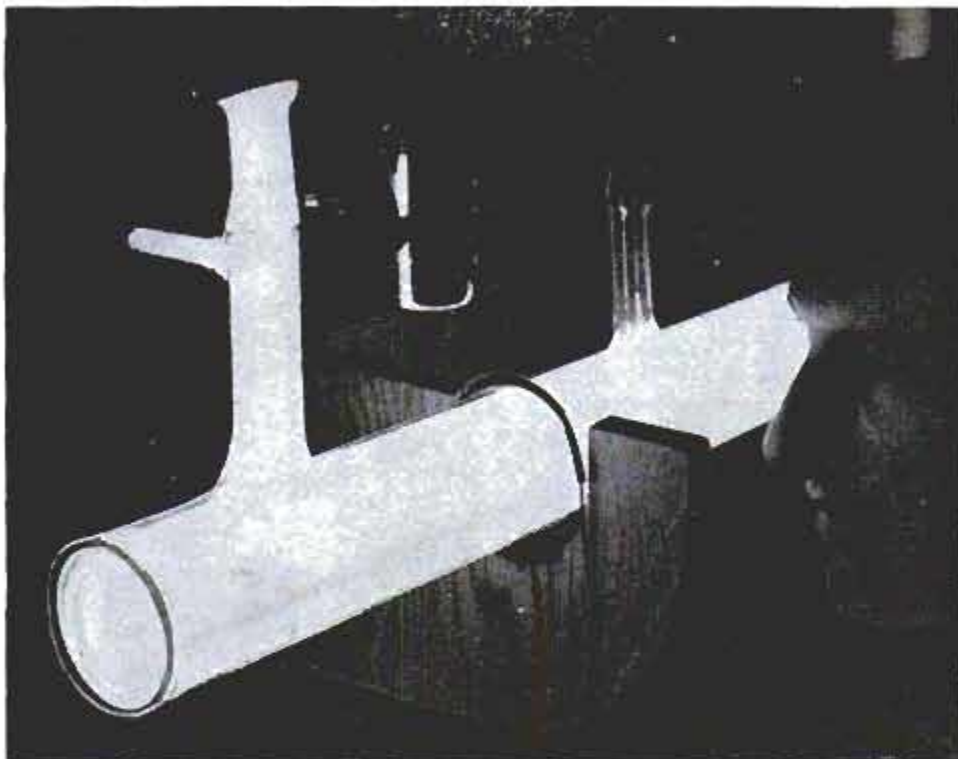

Action of nitric oxide on atomic oxygen produced milky light in tube in lab test

expelled from a rocket during the time it was ascending from 40 to 70 miles altitude. The resulting cloud, half a mile wide and 30 miles tall, gave off a dim, salmon-colored light that continued to glow well after the sun ceased to illuminate it. New information about conditions in the upper atmosphere, including the mechanism by which atmospheric sodium is excited, was obtained.

The nitric-oxide gas experiments indicate that luminous clouds producing twice the light of the moon and lasting for hours could be made. A series of the clouds could also act as reflectors to bounce radio waves along a desired path. ★ ★ ★

Rocket was launched, left, from 142-foot tower. Below, it is raised into position

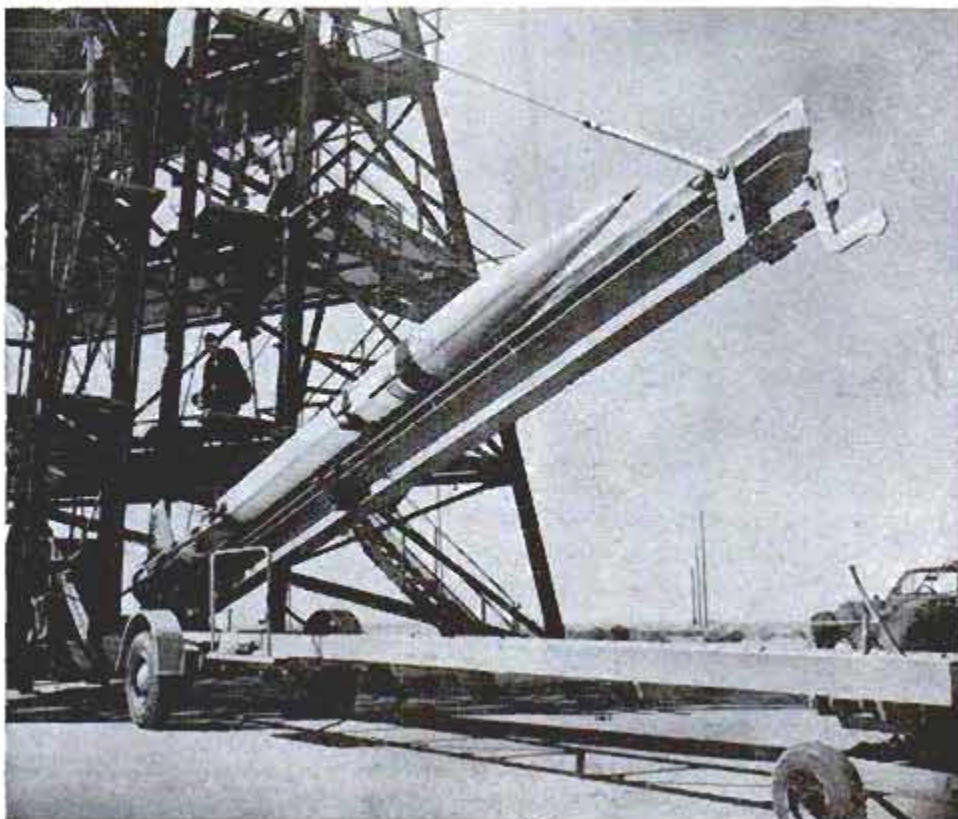



Type font of one language is quickly exchanged for that of another. Operator follows some code for all



Operator unfamiliar with language follows code of interpreter. Below, coded words and printed result

Versatile Army Typewriter Prints in 50 Languages

Army typists who know only English can now type messages in over 50 languages on one machine. The 40-pound unit, a modified Vari-Type with interchangeable type fonts, would be used in communicating with native populations. A linguist, following a code, transcribes the message into numbers for characters; diagonals, circles and squares for punctuation. With the proper font in the machine, the operator punches the keys that correspond to the figures on the paper and the message is reproduced in a form resembling commercial printing. The result is photographed, a plate is made, and printing begins. The machine is equipped to cope with languages as complex as Burmese, which has over 700 characters in its alphabet. A reverse-carriage model types from right to left in writing such languages as Hebrew, Arabic, Persian, Jowi, Urdu, Malayan and Pushtu. The compact machine will be used in mobile printing units.

15 (13) 14

(1) 24 (2) 34 (3) 44 (4) 54 (5) 64 (6) 74 (7) 84 (8) 94 (9) 104 (10) 114 (11) 124 (12) 134 (13) 144 (14) 154 (15) 164 (16) 174 (17) 184 (18) 194 (19) 204 (20) 214 (21) 224 (22) 234 (23) 244 (24) 254 (25) 264 (26) 274 (27) 284 (28) 294 (29) 304 (30) 314 (31) 324 (32) 334 (33) 344 (34) 354 (35) 364 (36) 374 (37) 384 (38) 394 (39) 404 (40) 414 (41) 424 (42) 434 (43) 444 (44) 454 (45) 464 (46) 474 (47) 484 (48) 494 (49) 504 (50)

64 8 11 24 41 44 55 11-14 11 25 25-26 4 9-7 11 14 8 7 30 /

17-9-7-25-3 2 3 12-11-21-26 6 2 16-20-9 11-11-9 20-7-9-4 11-15-9 17 25 /

15 11 2 9-7-17 3 12 1 17-9-7-5 11 3 14-11-27-9-7-9-7-9 /

24 5 2 200,000 24-7 14 20-5-21-14-24 2 16 11 17 11-7-24-19 24

7.

ԱՄԵՐԻԿԱՅԻ ՀԱՅՈՒԹԵԱՆ ՎԻՃԱԿ ՈՒԱՍ ԴԵՐԸ

Միացեալ Նահանգերու Հայու-
թիւնը կը կազմէ մեր կարեւորագոյն
գաղութը: Իր թիւը կը հաշուուի
մօտ 200,000 եւ հետզհետէ կ'աւել-



Two-Pound Cookstove Burns Ultrasafe Fuel

Campers can now heat their food on a two-pound stove that fits into a knapsack and burns a solid that can't explode, melt, run or spill. The solidified naphtha-gasoline fuel produces a blue-white, odorless, carbon-free flame that is hotter than alcohol, kerosene or gasoline. Each fuel container weighs 2.54 ounces and will burn approximately 72 minutes. Two aluminum cooking utensils of one-quart and 1½-pint capacities enclose the four by five-inch stove when it is not in use.



Motor that turns drive shaft is encased in housing beside Bailey. It is gauged by automobile speedometer

"Rube Goldberg" Film Developer

TECHNICALLY, the rumbling monster that sprawls through three tiny rooms of Bob Bailey's Houston, Tex., photo lab is a motion-picture-film processor.

It looks like nothing else on earth because Bailey built it without ever having seen a commercial processor.

He decided in 1951 that he wanted a film processor that would do some things he'd been told commercial models either couldn't do or did poorly. Into it went such things as windshield wipers, a floor fan, rubber hose, a kitchen sponge, auto fan belts, baby diapers and the speedometer from an ancient Ford.

Drawing gives cutaway view of entire process in which 16-millimeter movie film is developed and dried

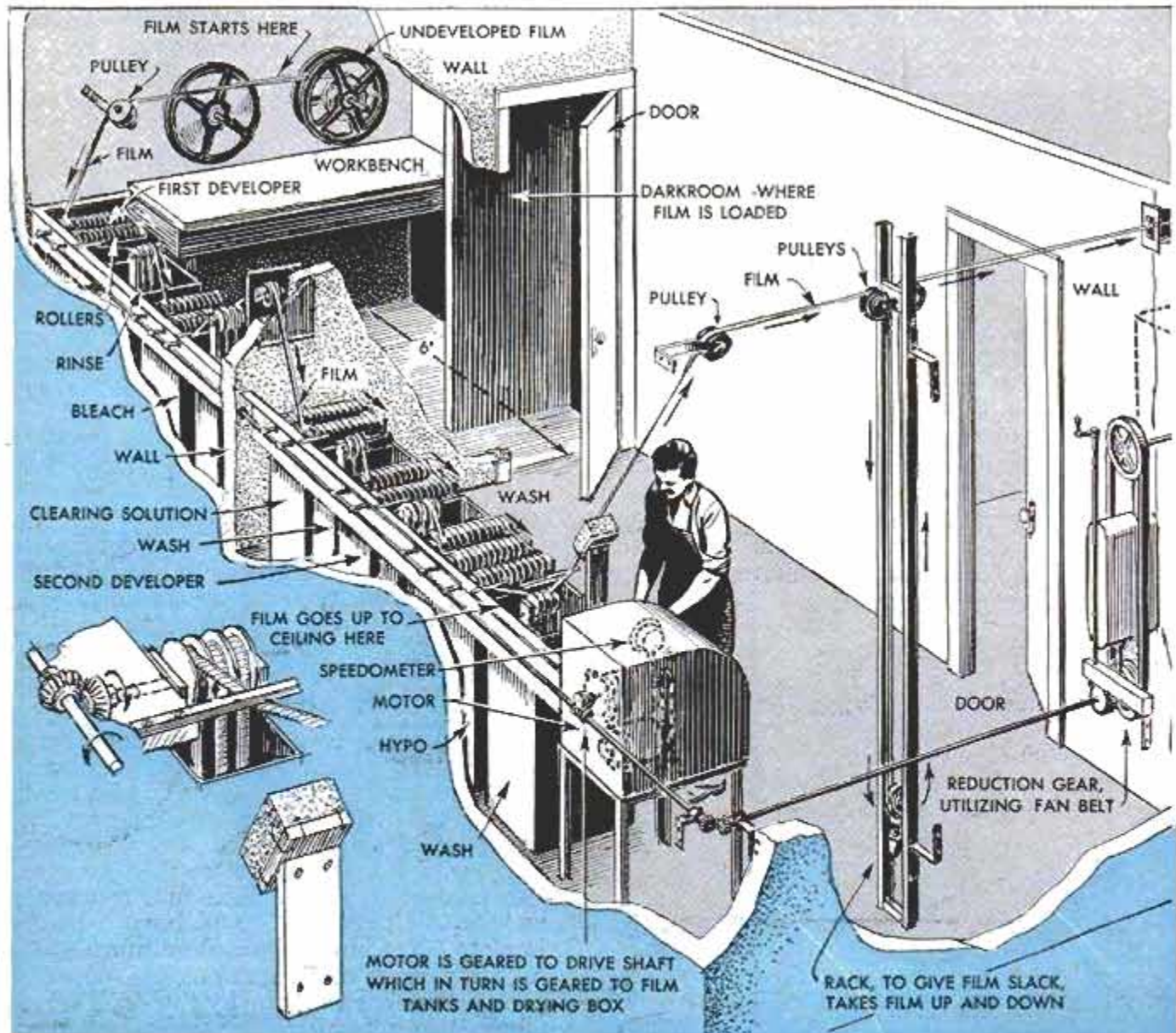

Into one end feeds undeveloped 16-millimeter film. With the first developing tanks inside a light-tight room, the film can be developed "by inspection"—unusual in movie-film work. Then the film goes through the wall, through more solutions, over and around pulleys until it passes through a wall into the third room where a large drying box full of heat lamps dries it thoroughly.

The entire process takes less than 10 minutes. And the erratic route is actually carefully planned to provide more flexibility of operation. Film or leader breaks can be repaired as the machine continues running, powered by its half-horsepower electric motor.

It took Bailey and a me-

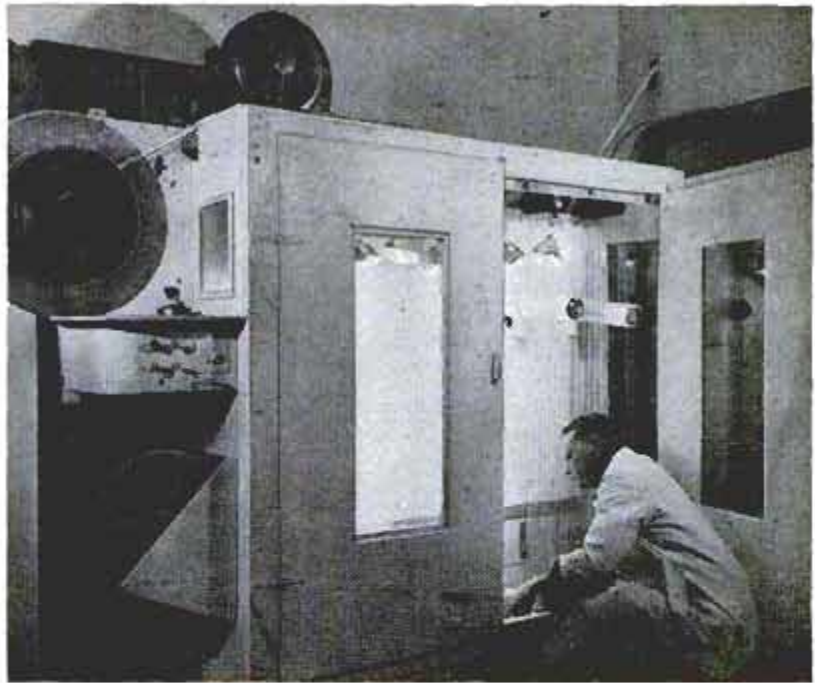

Drying box is about twice the size of comparable commercial units to allow for drying all kinds of reversal and positive film. Fan on top circulates air through drier. Dried film is wound on spool at left

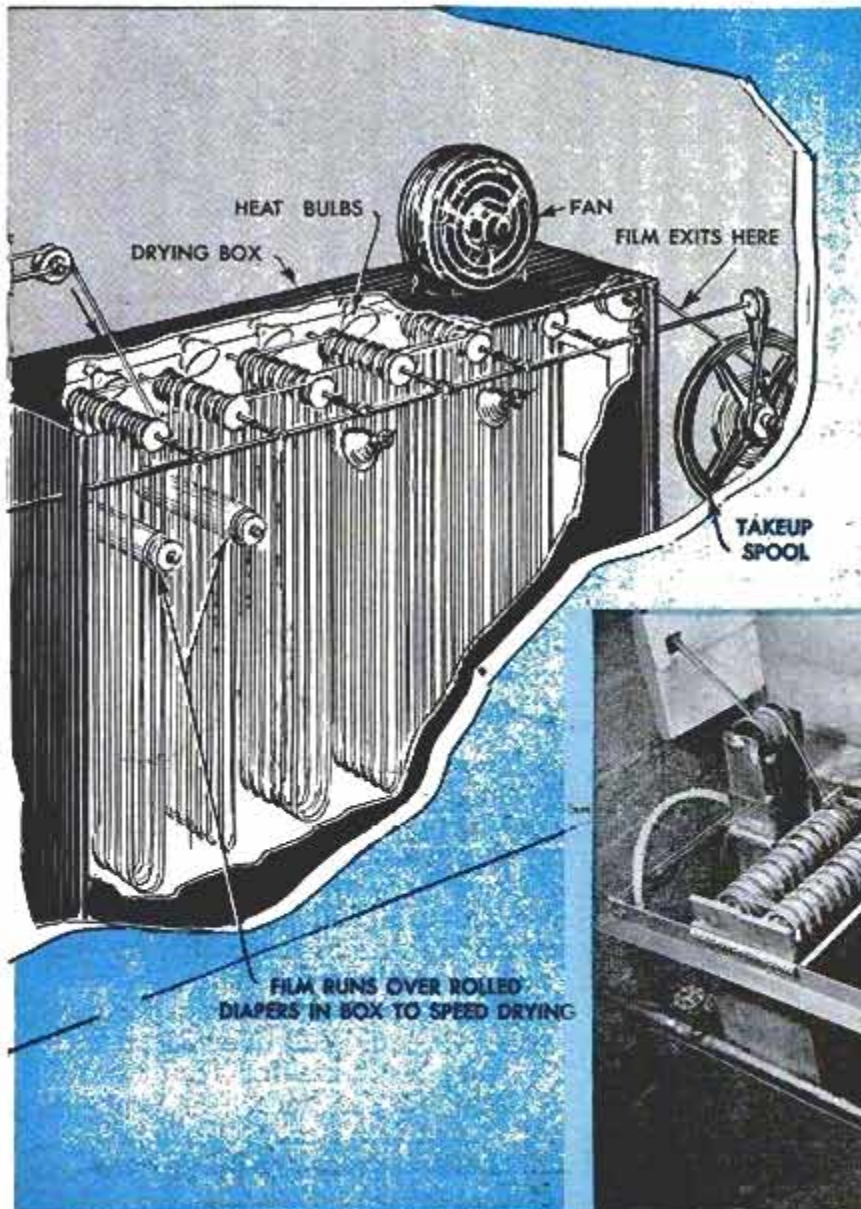

chanic friend five months, \$6000 and many headaches to make the machine. Bailey is glad he built it. As a result, he's the major film processor in the area. He's now planning another "monster" to process color film.

But he's not encouraging anyone else to follow suit, for several reasons. He's an inventor with a creation he can't patent. Even if he could, it wouldn't sell. "How," he grins, "could I package and sell something that looks like that?" ★ ★ ★

Film passes in and out of each tank many times. First developer, bleach are in 20-gallon stainless-steel tanks

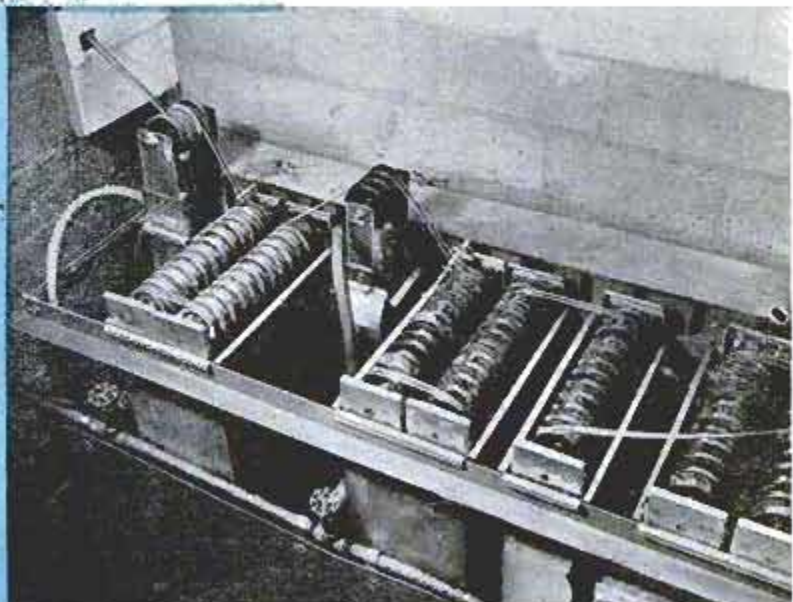



Seed for the huge machine is hauled in trucks. Automatic augers send seed spouting into the drill bins



Intricate hitch, supported by 23 wheels, is made of steel beams and pipe. Floodlights permit night work



Machine stretches across Texas farmland. Made by assembling 11 standard drills, it plants swath 154 feet wide

Planter Covers 1280 Acres in One Day

Sweeping across the plains of Texas is a giant farm machine that plants 70 acres of wheat per hour. The planter was designed and built by Tom Moran of Dumas, Tex., who uses it on his 11,600 acres of farmland. The giant machine plants a swath 154 feet wide. Moran hooked together 11 standard 14-foot drills with an intricate hitch made

of H-beams and pipe. Twenty-three rubber wheels support the hitch. Floodlights on the hitch permit 'round-the-clock operation. Seed trucks with automatic grain augers load the drill bins. It takes about 45 minutes to refuel the big tractor and reload the drills. One man operates the hitch which plants about 1280 acres in 24 hours.



Elephant Grass

All farm animals except sheep will eat a giant grass imported to Texas from Puerto Rico and Hawaii as a possible new range fodder. Commonly known as elephant grass because of its size, the plant grows as tall as 16 feet when fertilized and irrigated. Under range conditions it grows in clumps four to five feet tall. Well over 60 tons of cuttings suitable for feed lots are obtained per acre, per year, when grown as a crop. Economic studies of the grass are being conducted at San Antonio.



From a wide variety of specially-designed type styles, you may choose the one best suited to express the personality of your company

If we can be of further assistance, please do not hesitate to contact us.

Yours truly

H. W. Wilson
Sales Department

Experimental Typewriter Types Words and Phrases

At the touch of a single key button, a new experimental typewriter prints any one of 42 words or phrases, each having 18 characters or less, at the rate of 150 words per minute. The typewriter is a standard electric machine, while connected to it, out of sight in a desk drawer, is a memory system. The typewriter retains all its normal

functions until the typist touches a foot switch. Then each key types a word or phrase which it has been assigned. The typist decides what is to be stored in the memory unit, and because of this memorizing the code is easy. At present the machine is experimental and no plans have been made to market it.

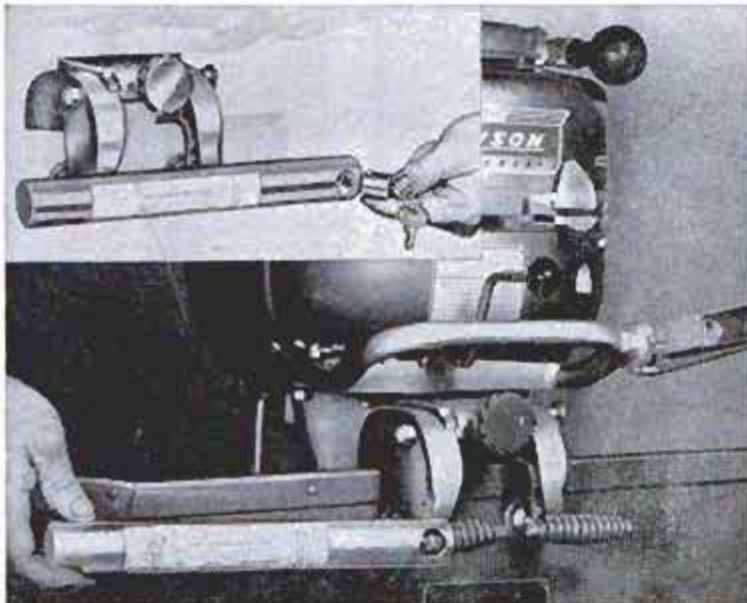

Outboard-Motor Lock Prevents Theft

There's no need to remove an outboard motor from the boat every night when a small lock is used as protection against theft. A split tube is slipped over the motor clamps and the key-operated lock inserted in a hole in the tube. The tube fits all motors with cast-type handles, and a converter is available for smaller motors with pin-type handles. The lock also keeps motor clamps from loosening through vibration.

Shipments of finished steel products in 1955 totaled 84,717,444 net tons, highest in history.

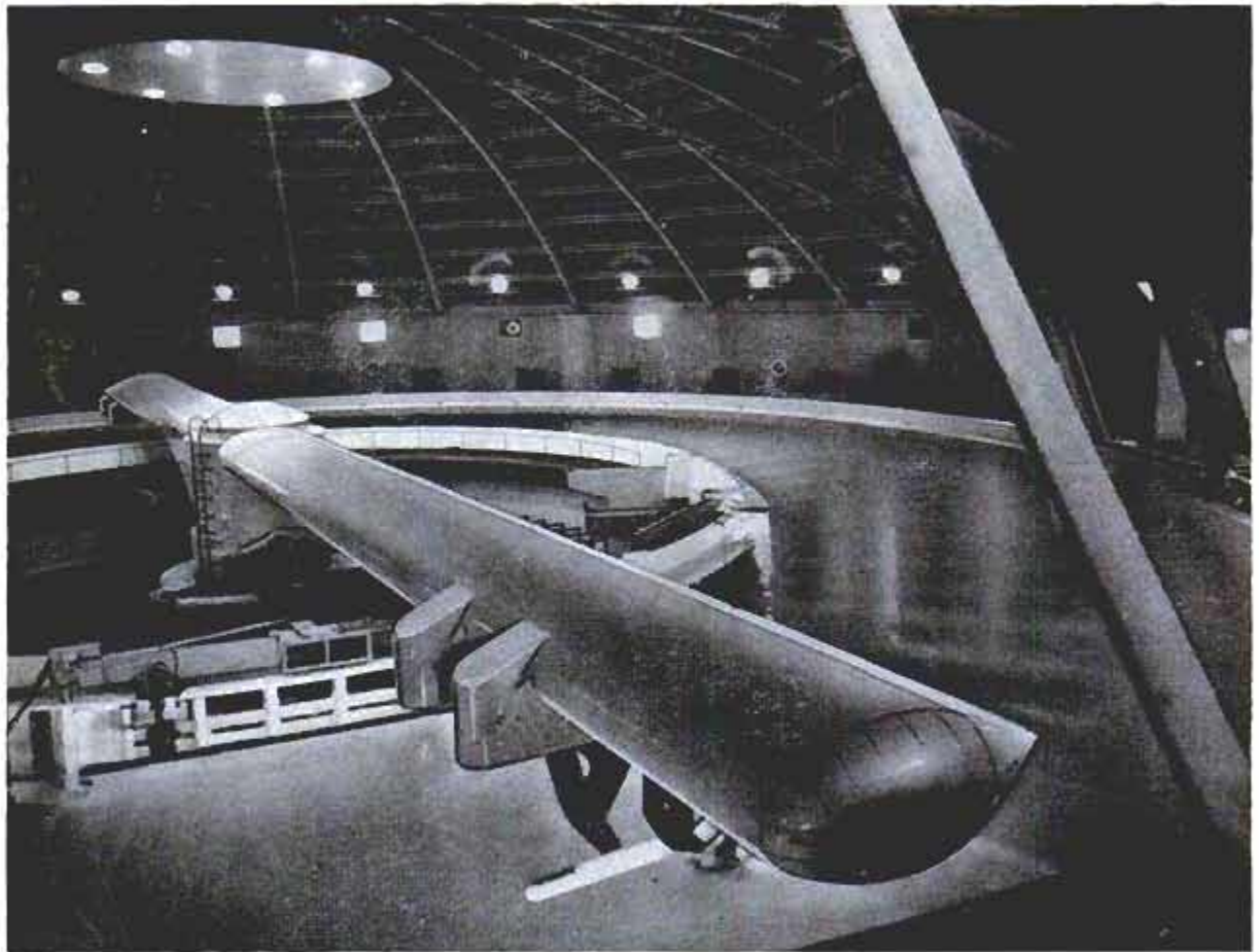

Test models, supported by strut attached to whirling beam, are run around channel at depth of five feet

Whirling Beam on Circular Tank Tests Boat Models at 100 Knots

Scientist-frogman makes underwater adjustments on model prior to test run



WHAT wind tunnels do for aviation research, a new testing tank may do for underwater studies. Models underslung in the water of the 1,000,000-gallon circular tank are sped at 100 knots, drawn by a rotating beam that spans the diameter of the tank. The metal beam is 122 feet long and weighs 60 tons. The test facilities are located at the Admiralty Research Laboratory at Teddington, England. Another feature of the Underwater Hydrodynamic Research facilities is a 29-foot-deep tank with a glass wall for observation. Missiles and other objects are shot down into the water for study of the behavior of bodies launched into the water from the air.

Radio Television Electronics

Station-to-Station

This new, FCC-approved transceiver provides practical radio communications over an unobstructed radius exceeding 10 miles. It is said to operate successfully at one half mile through almost any obstructions. You don't have to be a technical expert to use these units. Simply plug them into any standard 115-v. a.c. or 6-v. d.c. power source, push a button, and you're on the air. No tuning is required since all units are factory adjusted to a frequency of 465 megacycles. A station license is easily obtained by any U. S. citizen over 18 years old, merely by filling out a simple form.

Each unit consumes only 18 watts of operating power.



Hi-Fi Goes Modern

Departing from the usual cabinet design, this new high-fidelity-speaker system is styled to harmonize with contemporary furnishings. The lightweight foam-plastic sphere, only 18 inches in diameter, is designed as an infinite-baffle enclosure which provides essentially flat frequency response from 40 to 19,000 c.p.s. with its built-in 8-in. coaxial speaker. The enclosure is available separately, if desired. The spherical shape is said to improve sound dispersion of all frequencies. The sound can be directed to any desired point by rotating the sphere in its removable stand.

In Step With the Times

Television is following the modern trend towards lighter weight and slimmer figures. All three of the sets illustrated total less than the weight of the smallest table model available five years ago.

The small 13-pounder being held by the young lady includes 12 tubes plus five semiconductor diodes and two rectifiers. Its 9-inch picture tube is large enough for comfortable viewing. Largest set has 17-inch picture tube and weighs only 32 pounds. Sets will operate with fold-away rabbit-ear antennas which can be attached to the back of the case.

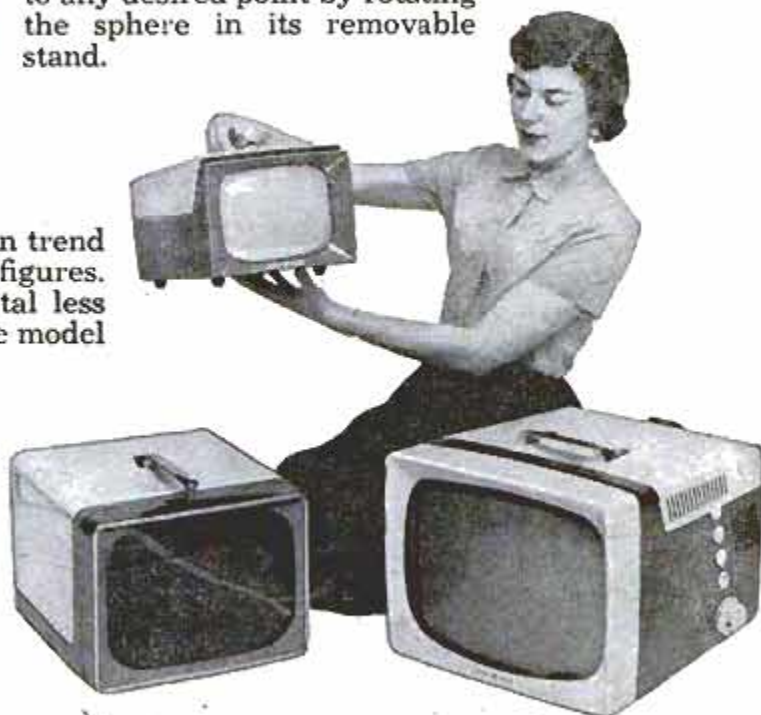

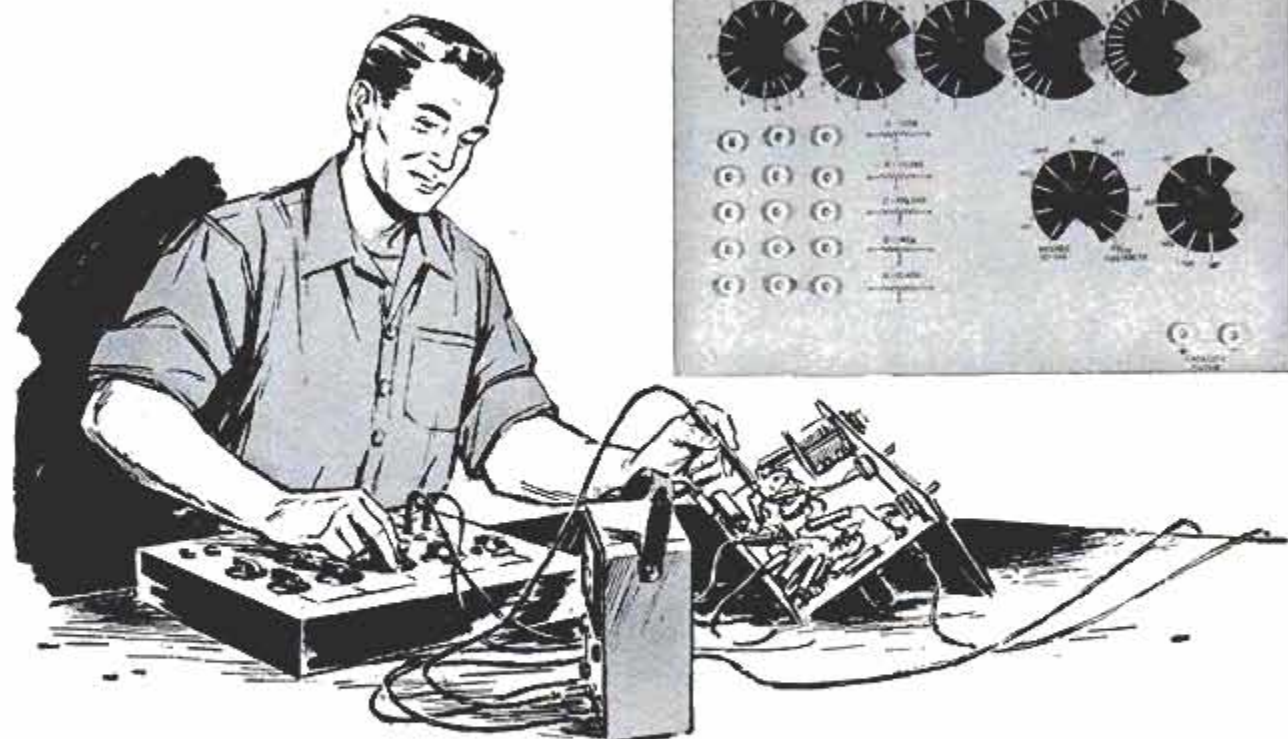

Versatile R-C Substituter

WHETHER you are an experimenter or a serviceman, a resistance-capacitance substitution box can be a valuable addition to your workbench. While not considered a piece of test equipment, the applications for such a unit are so numerous that it may quickly become one of your most-used instruments.

To demonstrate the versatility of this substituter, let's look at some of its more important applications.

To determine if a capacitor in an electronic circuit is open circuited, the suspected unit is "bridged" with a new one of similar value. Even if this new unit is available, bending its fragile leads so that they make good contact at the desired points requires a steady hand and consid-

erable concentration. With the substituter the job is greatly simplified because any required value can quickly be clipped into the circuit, leaving both hands free for other tests.

Hum and noise-producing amplifier stages are commonly isolated by short-circuiting the control grids of the various tubes to B- with a metal screwdriver. In a crowded chassis, this is often difficult because the tube-socket terminals are not accessible. With the substituter, the 40-mfd. capacitor is used for this purpose. The capacitor shorts out any signal, hum or noise voltage without disturbing the d.c. voltages. By clipping the negative lead to B- and using the other as a probe, this test is accomplished rapidly and efficiently.

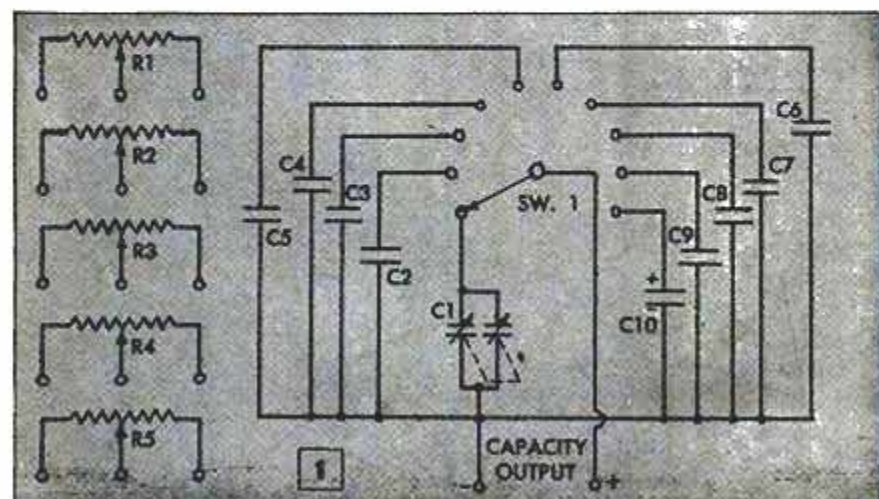

LIST OF MATERIALS

POTENTIOMETERS

(all linear taper)

- R1—1,000 ohms, 4 watt w.w.
- R2—10,000 ohms, 4 watt w.w.
- R3—100K ohms, carbon
- R4—1 megohm, carbon
- R5—10 megohms, carbon

CAPACITORS

- C1—variable (any value)
- C2 through C9—.001, .0022, .0047, .01, .022, .047, .1, .5 mfd.
- C10—40 mfd. 450 v. electrolytic (any desired capacitor values may be substituted)

SW1—11-position rotary switch (Mallory type 12h1L)

MISCELLANEOUS

- pin jacks (17), pointer knobs (7), test leads, hookup wire, solder (rosin core), wood for panel or box.

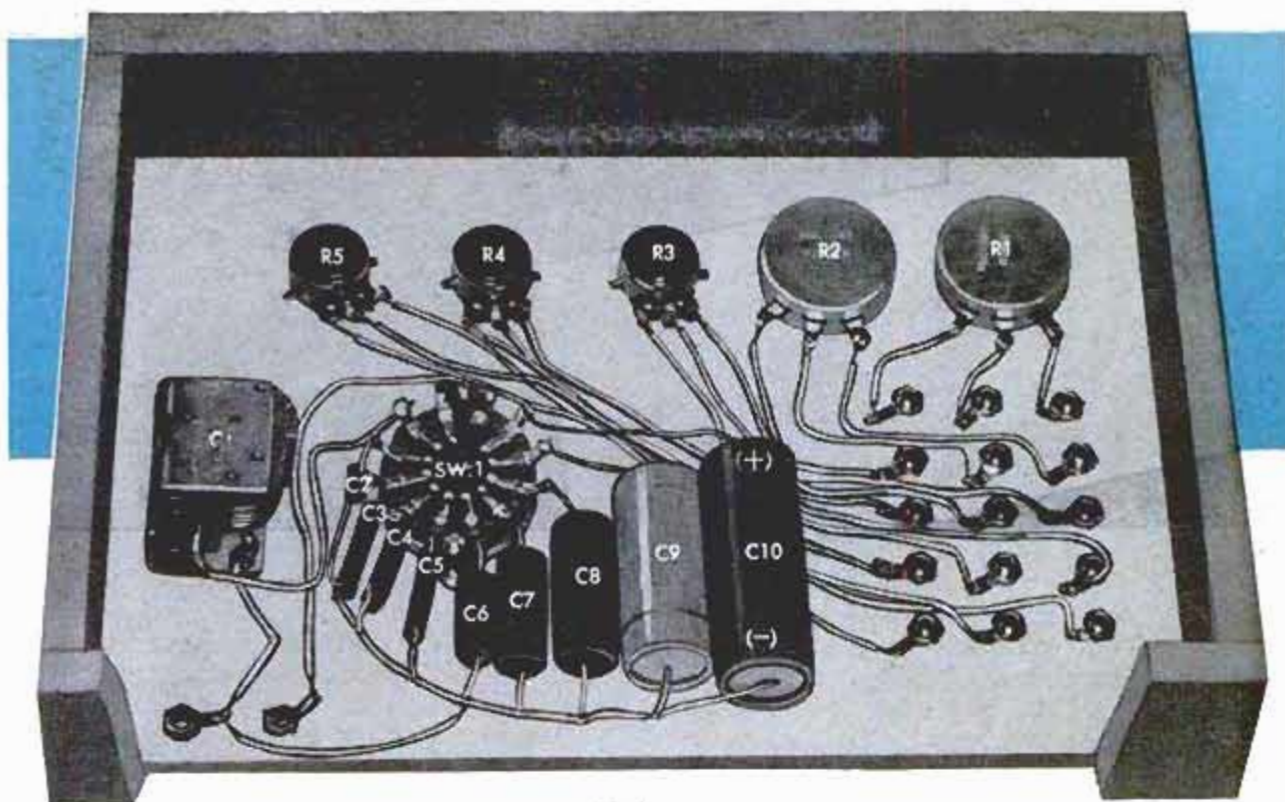

2

How often have you soldered one resistor after another into an experimental circuit before finding the value which gave best results? This time-consuming job is virtually eliminated by the substituter. Just clip in a potentiometer and adjust its value for optimum performance.

During the course of an average day's work, the serviceman or experimenter will undoubtedly find numerous other tasks which are simplified or speeded up through the use of a substitution box.

The construction of this substituter is shown schematically and pictorially in Figs. 1 and 2.

For maximum versatility, each potentiometer is wired so that it can be used by itself, either as a control or as a variable resistor. By connecting jumper wires between various jacks, the unit is converted

into a resistance decade as shown in Fig. 3.

An ohmmeter is used for calibrating the individual controls on homemade dial scales which are glued to the panel. Standard, fixed capacitors, connected to a multi-position rotary switch, provide a large number of capacitor values. To reduce the required number of switch positions, a variable capacitor is used to obtain low values. This unit can be calibrated with a capacity bridge or an audio-signal generator and vacuum-tube voltmeter. Fig. 4 shows the calibration setup for the generator-meter method. The generator, set for the highest volume and frequency output, is connected as shown. When the variable is rotated to the point where the voltage at (2) is exactly half of the voltage at (1), the capacity of the variable is equal to that of the calibrating capacitor. ★ ★ ★

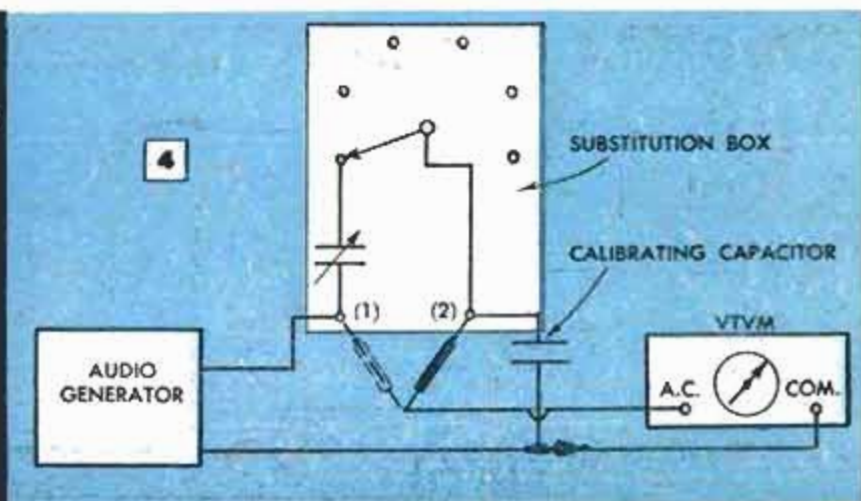
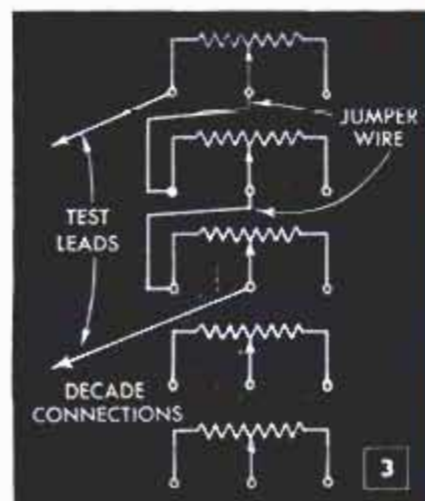



VARIABLE D.C. SUPPLY FOR TRANSISTOR EXPERIMENTERS

By Forrest H. Frantz, Sr.

TRANSISTOR experimenters will appreciate the usefulness of this variable d.c. power supply. It is simple and inexpensive to build, but provides all the flexibility needed for transistor work. Thus, the need for separate batteries, with their shelf-life limitations and interconnecting difficulties is entirely eliminated.

The open-circuit output voltage of the power supply is variable from zero to approximately 50 volts, while maximum current, with the supply short-circuited, is about 8 ma. This current is purposely limited so that there is little danger of damaging a transistor provided that the correct voltage polarity is applied to its elements. Since the output voltage of the supply drops rapidly as load current increases, a directly calibrated dial is not practical.

In the model, the control is calibrated from zero to 10, but this has little bearing on the actual output voltage. Note, however, that there are two sets of calibration numbers: one with the zero point on the left, the other with the zero on the right. This is necessary because the power supply can be used with either a negative or posi-

tive ground, an essential feature for transistor work. The desired polarity is obtained by using either the negative or positive binding post in conjunction with the grounded one.

For transistor circuits requiring more current, the maximum output may be increased to 15 ma. by reducing R1 to 10,000 ohms. Lower values should not be used to prevent damage to the transformer.

Schematic and pictorial diagrams for this simple power supply are shown below. When installing the binding posts, the two outside ones, (+) and (-), should be insulated from the chassis by means of shouldered fiber washers. The center one is not insulated. The color-coded leads in the pictorial are from the power transformer mounted above the chassis. The green wires are the unused filament leads.

In use, the supply voltage can be monitored with a vacuum-tube voltmeter.

LIST OF MATERIALS

T1—Stancor PS-8415 power transformer (secondary, 125 v. 15 ma.); R1—22,000 ohms, 2-watt; R2—10,000 ohms, 3-watt pot.; C1—50-30 mfd./150 v. elec. cap.; SR—selenium rectifier (20 ma.); 3 binding posts (2 insulated); aluminum chassis; line cord with plug; pointer knob; 3-lug terminal strip; hookup wire; solder.

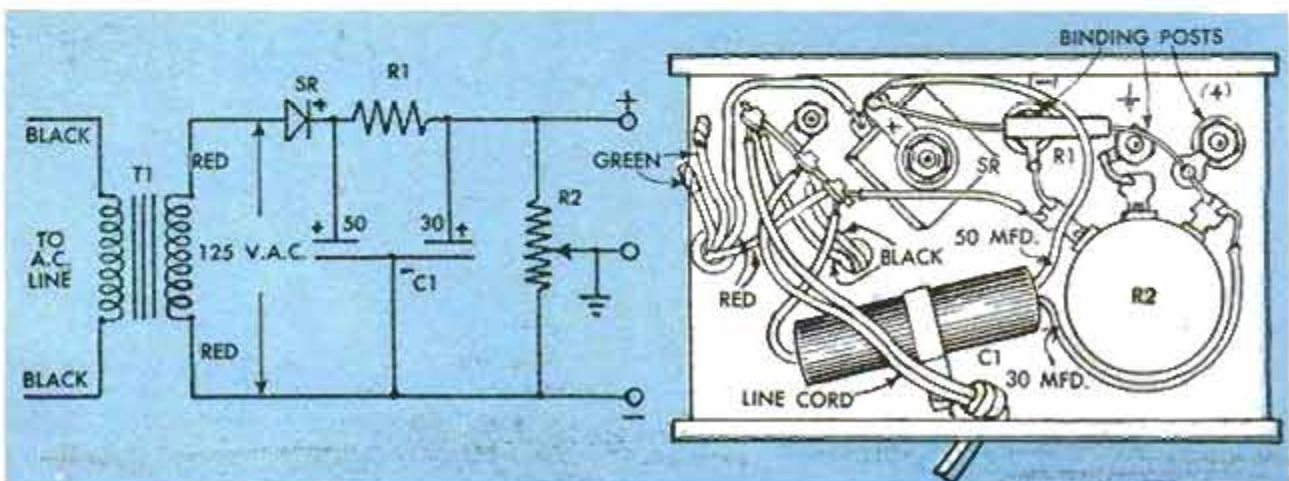

the

POPULAR
MECHANICS

CRAFTSMAN

WTM 58



FURNISH YOUR PATIO

with this ranch-modern furniture. Complete set of five pieces brings all the comforts of indoor living outdoors—all summer long

PART I

NEEED SOME lazy furniture for your patio? You'll want to copy these unusual designs that Tom Riley sends us from the West Coast. Set includes two-way lounge, barbecue cart, chuck counter, patio "wheelchair" and drop-leaf planter. Part I details the construction of the lounge and cart. How to build the others will be described next month.

The Two-Way Lounge

The two-way lounge is a novel piece of patio furniture. As pictured above, it serves a dual purpose. Raise the adjustable backrests and it becomes an inviting twin lounge for two persons. Raise just the back and the piece converts to a large, comfortable sofa which will easily seat four people.

The two-way lounge is designed to take two standard 24 x



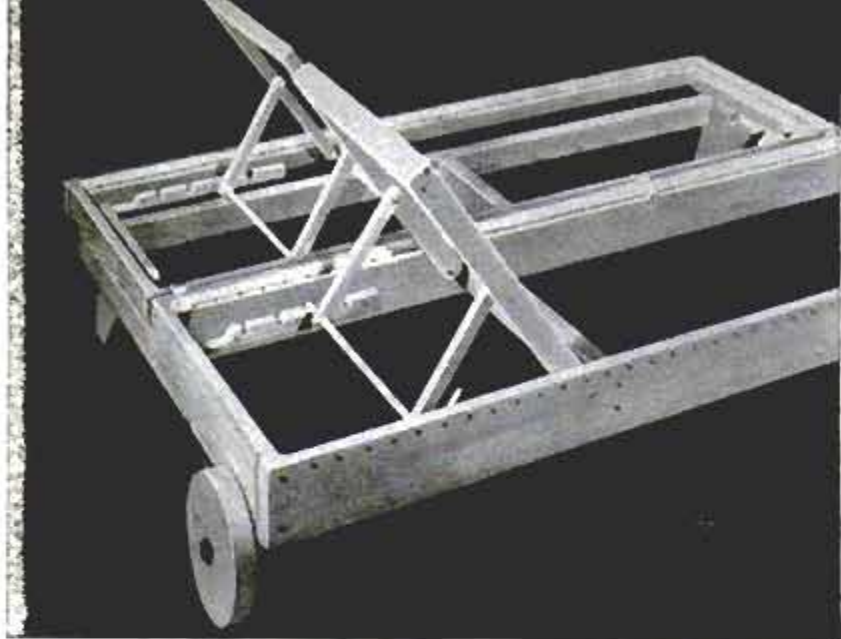

Left, rear backrest is made narrower than front one to permit it to retract flush in dovetail back

Below left, lounge wheels are trued on lathe after being rough-sawed from 2 x 10 material

Below right, fence on drill-press table aligns rope holes so all will be 1/2 in. in from edge

72-in. cotton-filled or foam-rubber pads. Redwood makes the most durable frame although you can use regular lumberyard material, such as fir or pine, and paint it. The front, center and end rails of the stepped frame are cut from 2 x 6 material, while the narrow back rail can be ripped from a length of 2 x 4. Notice how the end rails are cut out to receive

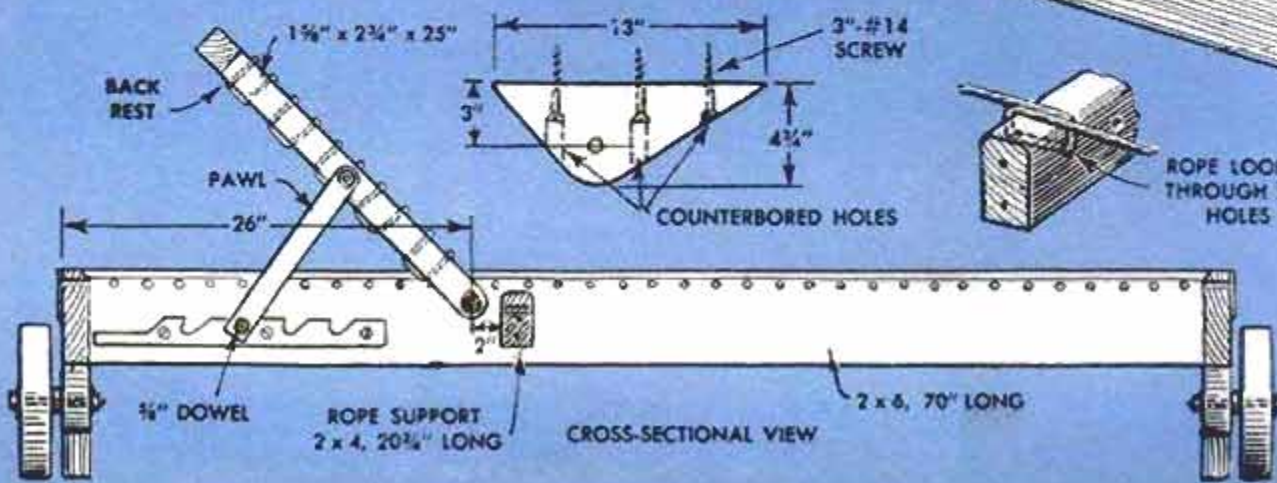
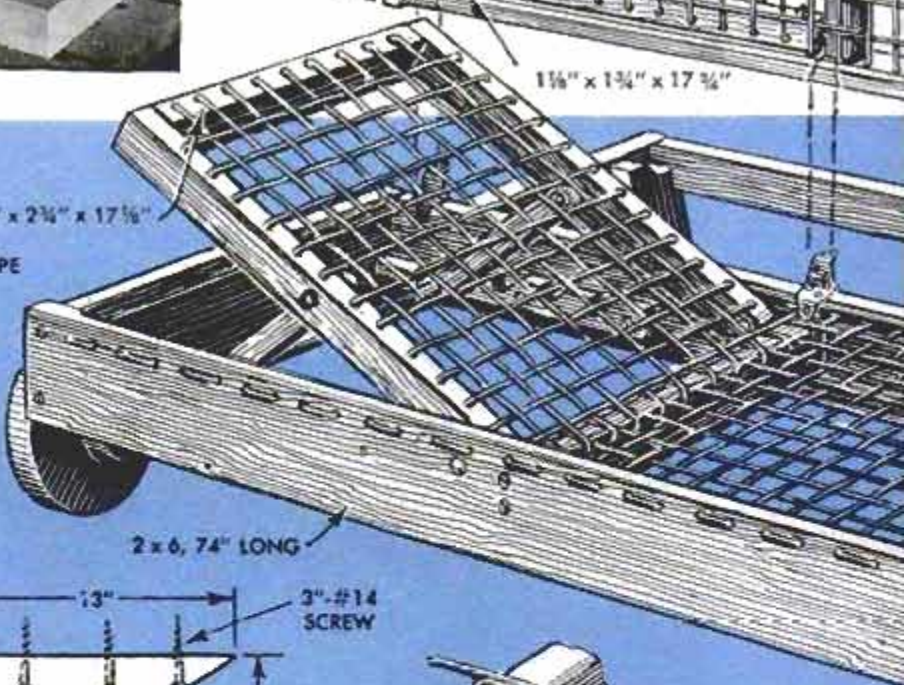
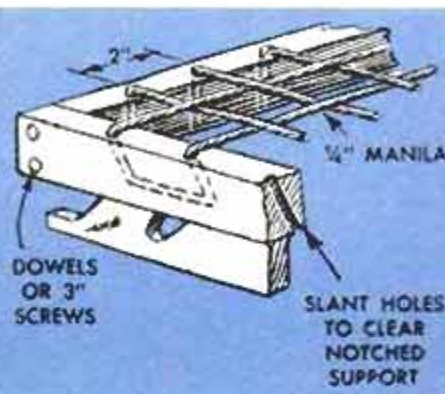
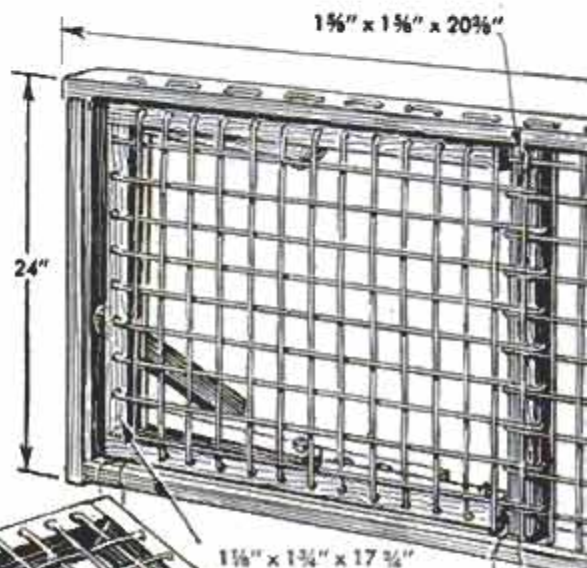
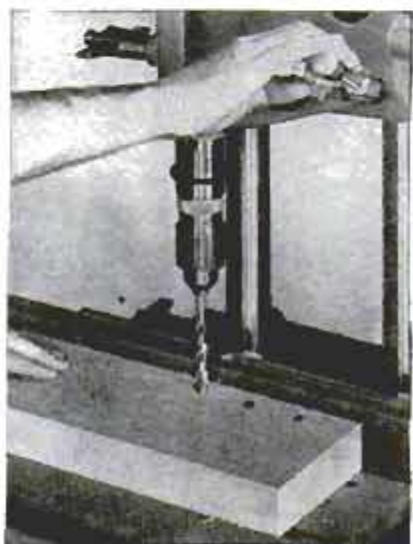
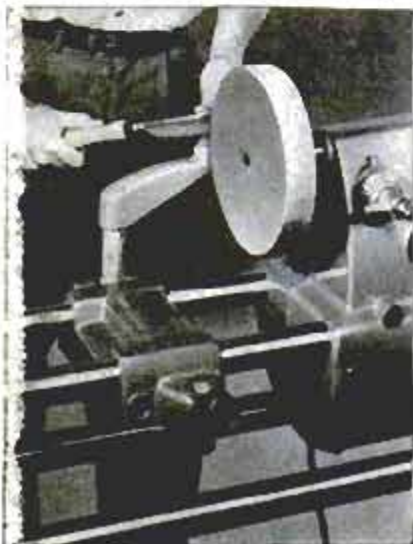

the separate hinged daveno back. Rope holes are spaced 2 in. apart, on centers, and $\frac{1}{2}$ in. down from the top edge. The holes are bored along the full length of the pieces even though the rope is not laced crosswise past the backrests. Before the frame members are screwed and glued together, the inside upper edges are chamfered as indicated. The wheels are bandsawed from 10-in. stock, lathe-trued and then mounted to triangular-shaped brackets glued and screwed securely to the front corners of the frame. Use washers on the wheels to provide clearance. Follow the pattern in cutting the rear legs and notch their tops to engage pawls which support the daveno back. Both front and rear sections of the frame are braced with $1\frac{5}{8}$ -in. spreader

members, the upper edges of the front one being rounded. Holes are bored through the latter for the rope. Both adjustable backrests are supported by pawls fitted with $\frac{5}{8}$ -in. dowels which hook in notched members screwed to the inside of the rails. Notice that the rope holes in the side members of the backrests are bored at an angle so the rope will clear the notched pieces.

The daveno back is assembled similarly, the holes being spaced the same and the rope woven in a similar manner. Since the frame members of the daveno back are narrower than the front pieces, the backrest is made of $1\frac{1}{8}$ -in. stock to permit it to fold flat and even with the rest of the back. Four 3-in. strap hinges are used to hinge the back to

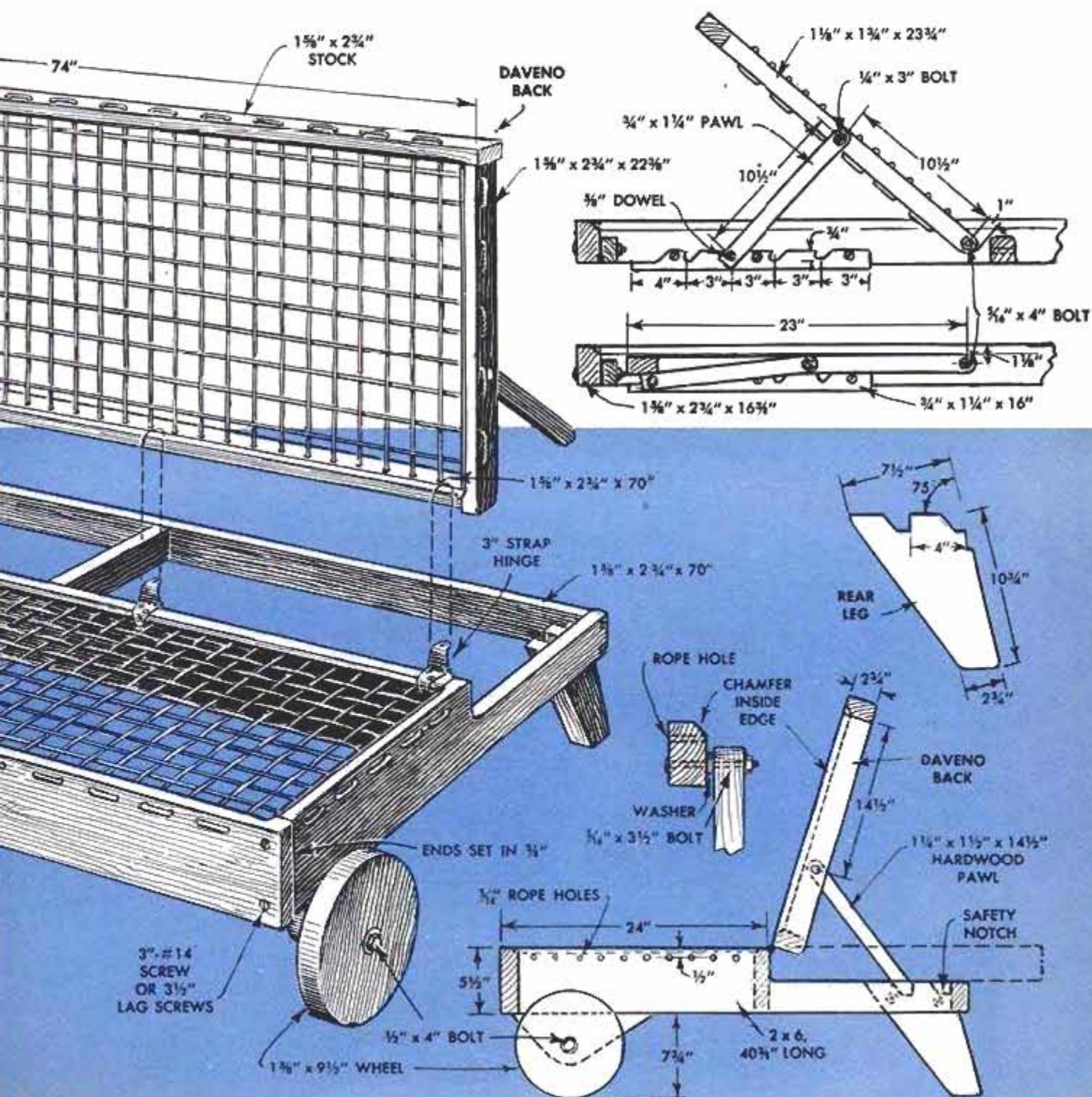

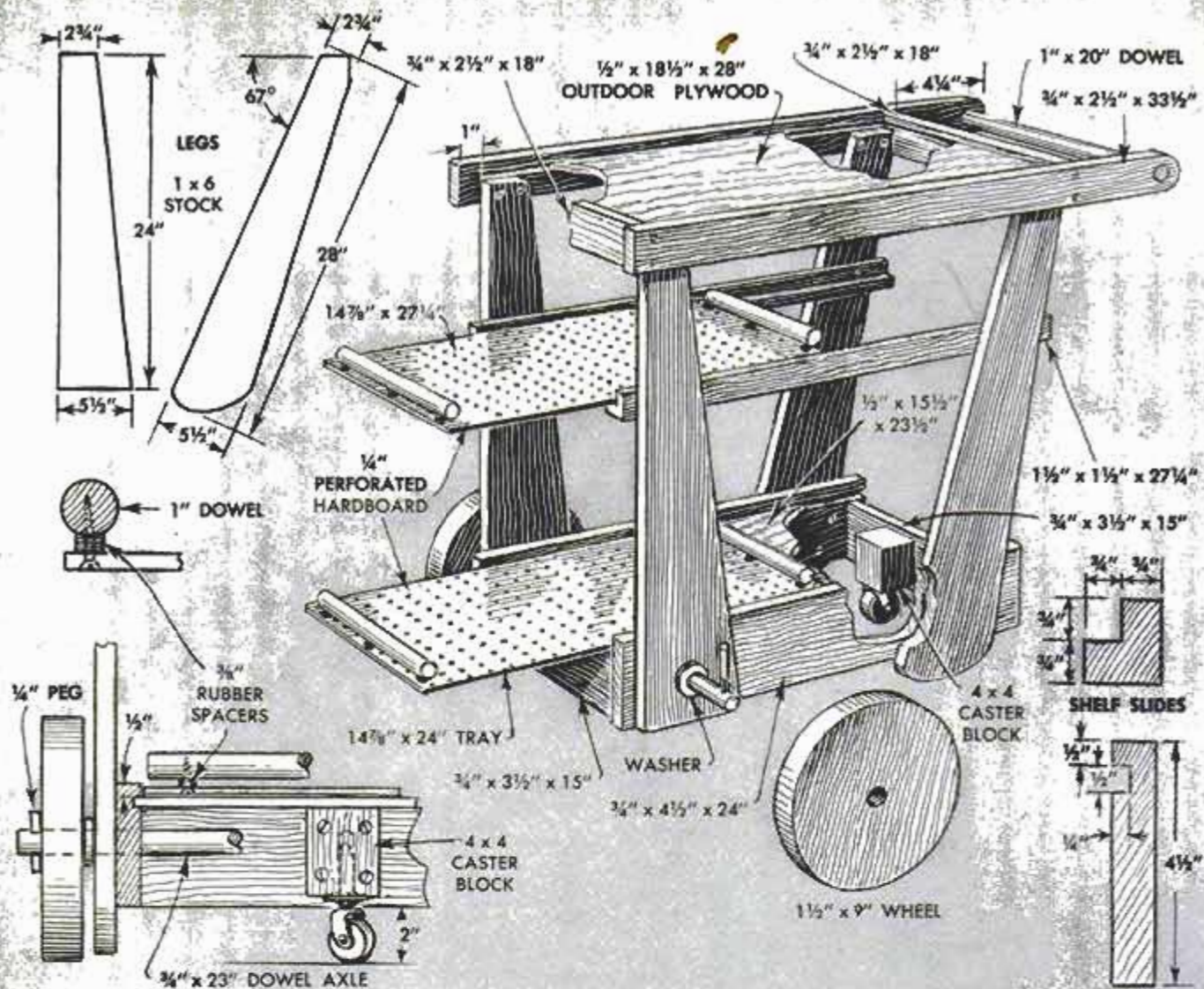

the lounge frame and the ends of the hinges are bent over as shown. Be sure the inside rail of the daveno frame is set in $\frac{3}{8}$ in. to provide room for the rope.

Paint Before Stringing Rope

Whether you paint or stain the wood, it should be done before stringing the rope. Thread the rope lengthwise first, back and forth from the top of the backrests, through the rope supports and to the far ends. Leave enough slack at the rope-support pieces to let the backrests fold down; then weave crosswise, stretching the rope tightly by hand. You'll need about 300 ft. of $\frac{1}{4}$ -in. manila rope. The rear lounge pad will ordinarily stay in place when the daveno back is up. But if you wish, you can attach it with four of the pad's upholstery buttons. Snip these off and attach them to short lengths of fine wire. Then push the wire through the pad and secure to the rope.

Making the Barbecue Cart

This rugged serving cart is designed for outdoors—and for service. Its three levels will hold the makings of a complete dinner. The two lower shelves are actually trays that slide out from either end for ease of

loading and unloading. The cart utilizes a single caster at the rear so the cart need not be tilted as it is pushed about.

First build the two boxes that form the top and bottom shelves. You can use any clear $\frac{3}{4}$ -in. material for the boxes and legs. Dado $\frac{1}{4}$ -in. grooves into the sides of the lower box and into the sides and ends of the upper box for plywood tops. An excellent idea is to cover the top shelf with counter-top plastic. Cement the plastic to the plywood before assembly and increase the width of the groove for the extra thickness. Assemble the boxes with waterproof glue and galvanized finishing nails. The legs are secured to the boxes with glue and $1\frac{1}{4}$ -in. screws driven from the inside. The center tray guides are fastened in the same manner. After attaching the legs, drill two $\frac{3}{4}$ -in. holes for the dowel axle. The two wheels can be bandsawed or turned. Small $\frac{1}{4}$ -in. pegs hold them on the axle. Use washers between the wheels and frame for clearance. A 2 or 3-in. ball-bearing furniture caster will serve at the rear. This is fitted in a wooden block glued to the underside of the plywood and to the rear of the box on the inside.

(Continued next month)

More Storage SPACE IN YOUR HOME

By Ed Packer



LACK OF STORAGE SPACE, a problem in many small apartments and in some homes, often can be solved by installing shell-type cabinets and by the use of drawers and fixtures located in areas not normally considered usable for storage. The area above a radiator or behind a door in a kitchen, for example, is an excellent location for a high, shallow cabinet, Fig. 1, that will accommodate brooms, mops and an ironing board. This cabinet is a shell type, which means that it consists of a frame of 1 x 2 lumber over which is nailed $\frac{1}{8}$ -in. hardboard. The frame is nailed or screwed directly to the wall and, if possible, should be positioned so that the nails or screws are driven into the 2 x 4 studding.

Fasten to Studding

In some cases it may be necessary to add one or more cross pieces at the back of the frame through which screws can be driven into the studding, to assure that the cabinet is firmly attached to the wall. Corner angles can be used to brace the frame of a cabinet that does not seem rigid enough. The wall forms the back of the cabinet, and in some cases the ceiling will be the top. If a cabinet is located in the corner of a room, the adjacent walls can be used as the back and one side of the cabinet. Shelves in the shell-type cabinets are cut from $\frac{1}{4}$ -in. plywood and are supported on $\frac{1}{4}$ -in. rods fitted in aligning holes drilled through the vertical front members of the cabinet and through the back members. If

Shell-type cabinet over radiator or behind door provides storage for mops, brooms and an ironing board

it is desired to make the shelves adjustable, drill a line of holes at each location. Fitting the rods in different holes permits quick adjustment of shelf spacing.

Portable Clothes Pole

Cramped quarters also present problems in doing housework, such as when ironing shirts, dresses and other garments that must be hung on coat hangers rather than being folded for storage. A portable clothes pole is the answer to this problem. The pole is a length of light tubing or heavy curtain rod with a hole drilled in each end. Long S-hooks, bent from coat-hanger wire, have one end fitted in the holes in the pole and the other end slipped into holes drilled in the top edge of a door-frame, as shown in Fig. 2.

Bathroom Drying Rack

When hand laundry is done in a bathroom washbasin, a convenient self-storing" drying rack can be located above or near the basin if the side of a cabinet or a closet wall is near the basin. As indicated in Fig. 3, the telescoping rack is a length of tubing or pipe which slides inside a pipe of larger diameter. The latter is screwed into a pipe flange that is screwed to the cabinet or wall. Because pipe threads are tapered, it will be necessary to retap the threads in the flange from the flat side if the flange is used as shown in the detail.



Portable clothes pole hangs from doorframe and saves steps when freshly ironed clothes, such as shirts, must be hung on clothes hangers as shown

When the rack is mounted on a cabinet the larger pipe should be located close to the underside of a shelf so it does not interfere with items on the shelf below. If the pipe is run through a closet wall it should be located so as not to interfere with the clothing, or may be positioned so it can be used as a clothes pole in the closet.

Bedclothes Storage

Storage for bed linens and blankets can be provided in a bedroom without using any floor space by installing a shell-type cabinet between a wall and the ceiling. The ceiling forms the cabinet top, one wall is the back and adjacent walls can form the cabinet ends. Hardboard doors can be hinged at the top to swing up against the ceiling, but a neater, more convenient closing can be had by making sliding doors as detailed in Fig. 4. Slides are simply wooden strips nailed to the inside edges of the cabinet framing. A trim strip across the front provides a finished appearance.

More Closet Space

Closets are another area where proper arrangement will add many cubic feet of storage space. Dustfree storage for hats and gloves can be provided by installing lightweight aluminum drawers on the bottom of an existing shelf, Fig. 5. Each drawer consists of an aluminum pan—its size is determined by the space available—to which are bolted lengths of aluminum angle as indicated in the left-hand detail. Slides for the drawers are made by screwing strips of wood and aluminum to the underside of the shelf as shown. Inexpensive cabinet

Clothes-drying rack in bathroom is self-storing, consisting of pipe or tubing that telescopes into support pipe held in flange screwed to cabinet side

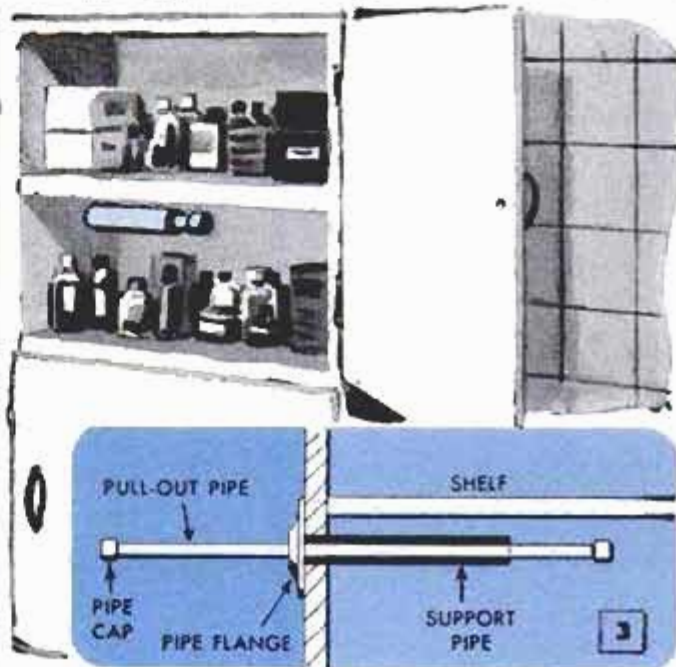

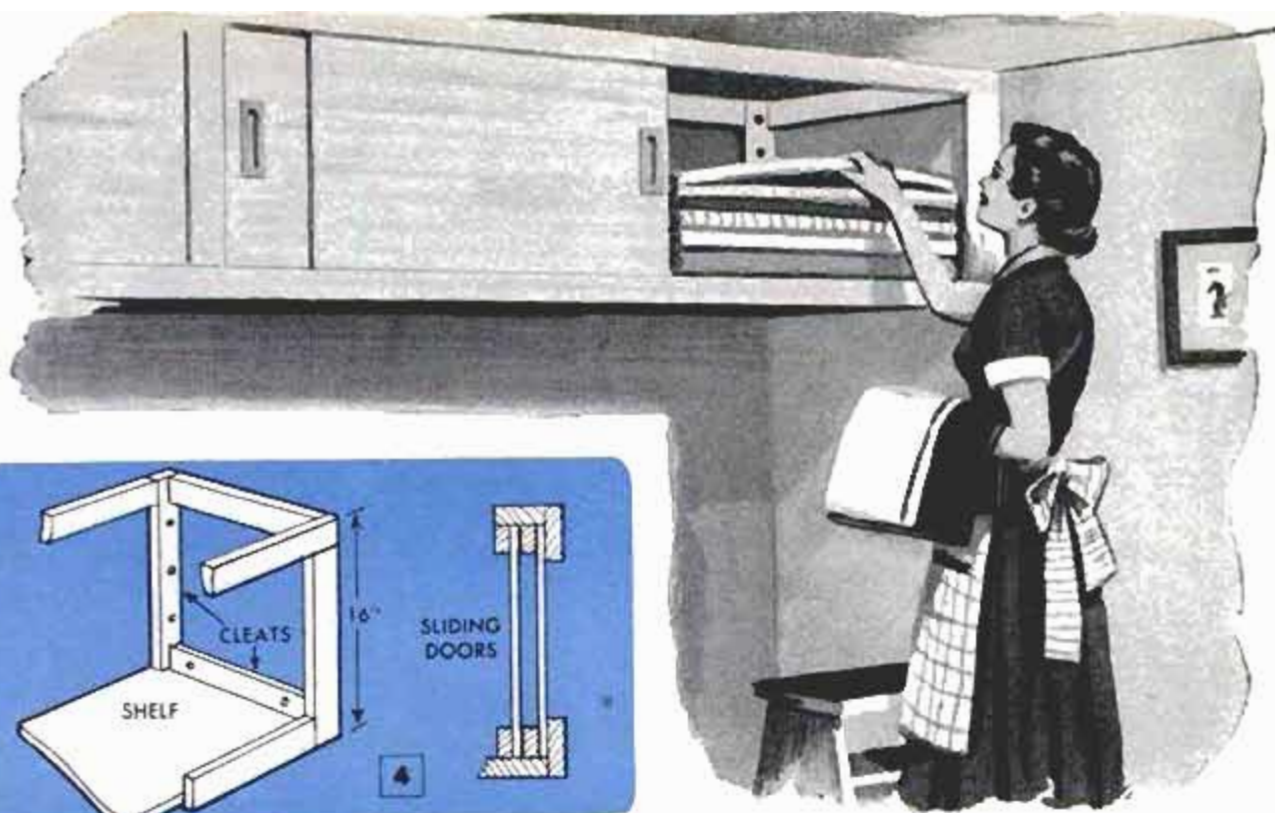

Storage for bed linens and blankets is provided by shell-type cabinet located between wall and ceiling

handles can be used for drawer handles. Overhead shoe storage in the closet is arranged by installing a shelf cut from a length of 1 x 4 across the doorframe high enough to provide head clearance, as shown in the right-hand detail in Fig. 5. A "tree" is provided for each shoe by bending a length of coat-hanger wire in a U-shape to the dimensions shown in the detail. Each tree then is fitted in holes drilled in the shelf.

Storage Under Refrigerator

If a refrigerator is the small, apartment

size it often can be placed on a platform, Fig. 6, so that space below the platform can be used for storage. This type refrigerator usually is low enough so that raising it about a foot does not locate its shelves too high for easy reach. The platform on which the refrigerator is placed has three closed sides and can be made of 1-in. lumber, well braced, or from a strong packing case that has one end removed. For convenient access to the space beneath the platform, a drawer, fitted with casters, is made. Again, a packing case could be used. A sheet of plywood is fastened to the

Closet space is fully utilized by installing drawer for hat and glove storage and overhead rack for shoes



outer end of the box to provide a neat appearance and a cabinet or drawer pull is screwed to the plywood. The drawer below the refrigerator is an ideal location for household tools, shoe polish and other miscellaneous items that are used only occasionally.

Shell-Type Base Cabinets

Shell-type cabinet construction also can be used for base cabinets. A sheet of $\frac{1}{2}$ or $\frac{3}{4}$ -in. plywood is used for the top and is



Drawer under raised refrigerator is ideal storage place for tools, shoe polish and miscellaneous items

supported on a 1 x 2 frame covered with hardboard. To assure that the top is well supported, screw the upper cross pieces of the cabinet to the wall in several places. If necessary, fit a vertical frame member from the floor to the top frame member at the back and sides of the cabinet to assure that the top is solid. Base cabinets located in such places as between a range and wall or between a range and an existing cabinet require only a top and door, since wall and range form the cabinet back and sides in one case, and the range, base cabinet and wall form the back and sides in the other. When building base cabinets, provide a toe space. ★ ★ ★

Punching Heavy Fabric

Numerous holes for eyelets can be punched more rapidly in heavy fabric when a piece of rubber inner tube is first placed beneath the material. Less effort is needed to drive the punch, and the rubber surface automatically ejects it from each hole.

St. Clair Rodriguez, Baton Rouge, La.

Corkscrew End on Wire "Fork" Secures Wieners



When making forks from lengths of wire for roasting wieners or toasting marshmallows over an open fire, twist the end of each fork in the shape of a corkscrew. This will hold the food more securely and prevent it from being accidentally dislodged and dropped into the coals or sand. A length of friction tape wrapped around each fork handle will protect the hands and provide a better grip.

G. E. Hendrickson, Argyle, Wis.

Muffin Pan Used as Drawer To Store Small Parts

One homeowner converted this muffin pan into a handy workbench drawer, which provides individual receptacles for nails, screws, tacks, and other small parts used around the house. The lips of the pan ride on L-shaped runners fastened to the underside of the bench top with screws.

Frank A. Javor, North Bergen, N. J.



Guard Fence Placed in Window Prevents Child from Falling

An effective guard for preventing a child from falling out of an open window is easily made from wood strips bolted together as shown. Length of the cross pieces should be $\frac{1}{4}$ in. less than the width of the window sash and then spaced 7 in. apart. Nuts and bolts should be countersunk flush with the wood surface, and the ends of the cross pieces rounded with sandpaper to prevent binding in the window frame. In most cases, the weight of the window is sufficient to hold the fence in place. However, screw hooks and eyes may be installed on the outside to prevent older children from pulling the guard out. To place the fence in the window first raise the lower sash, then pivot the horizontal bars of the guard up at an angle, slip the lower end in between the stop strips, drop the other end in place and pull the sash down on it. Give the fence a finish to match the sash.

Paul W. Patton, Chillicothe, Ohio



Tape Tearproofs Sandpaper

When it is necessary to use narrow strips of sandpaper on turnings and other small, curved surfaces, the abrasive can be made tearproof by applying a cellophane-tape backing to it. The tape should be applied to the sandpaper before it is cut to prevent overlapping of the adhesive, which might interfere with sanding.

Frank A. Javor, North Bergen, N. J.

Rubber Stoppers Serve as Feet For Tubular-Steel Furniture

Solid-rubber stoppers are excellent non-skid replacements for plastic feet on legs of tubular-steel furniture. The stoppers should be tapered to fit snugly inside the leg, and may be cut to have a flange at the bottom to cover the outer edges.

Charles H. Coleman, Aurora, Ill.

Auto-Caravan Lead Car Identified by Pennant

It is easy to keep a car caravan together while driving in heavy traffic if a pennant is tied to the raised aerial of the lead car. Any brightly colored scarf, piece of cloth or a red handkerchief will serve the purpose. Left on the aerial after arrival at the picnic or other such gathering where the grounds are large, the pennant offers late-comers a means of locating their group. Knot the pennant securely to the aerial to prevent it from blowing off when driving fast. If there is no ornamental knob on top of the shaft, tape the pennant in place.



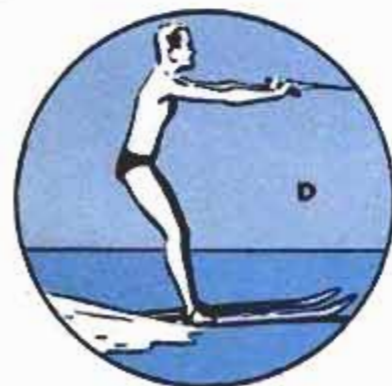

Photos courtesy Cypress Gardens and American Water Ski Association
 Aquaplaning behind a fast boat is no float ride yet it's one of safest water sports

You'll Have Fun on **WATER SKIS**

By Ralph S. Wilkes

So say the experts. After you've held that tow rope just once you'll understand what they mean

SUN ON OPEN WATER, a fast boat and flying spray, these are exhilarations that combine into one big thrill in water skiing. In its several forms from aquaplaning to shoe skiing, it's rated the top water sport for all good swimmers. If you can't swim don't apply until you've learned to handle yourself in the water, or be content to wear a life jacket.

If you can ride a bicycle you usually can handle an aquaplane on the first try, but you might find the going a bit wobbly on shoe skis behind a boat doing 25 miles per hour, which is average shoe-ski speed. Aquaplane speeds range from 10 miles per hour up, so if you're a beginner start with the aquaplane. And if you think an aquaplane ride can be little more than a float trip, take a look at the photo above.

Experts differentiate, and rightly, between aquaplaning and freeboarding and the other forms of the sport in which various types of skis are used. But all forms of the sport require development of skill and coordination and a fairly delicate sense of balance. The aquaplane, freeboard and saucer, Figs. 1 and 2, require similar techniques when starting and planing either in deep or shallow water, but the skis, Figs. 3 to 6 inclusive, call for higher boat speeds and different handling. Details A to D inclusive, at the left, show the procedure in starting a run on water skis in fairly deep water. At the start you assume the position shown in detail A, with the tips of the skis out of the water. From this

Water skiers usually take off on regular water skis in the manner shown in the four steps A, B, C and D inclusive, pictured at left. Deep-water start begins in a crouching position, A, and ends in standing position, D, with knees slightly flexed

position through B, C and D you simply hang onto the tow rope, let the boat pull you to the standing position and away you go. From there on you either spend your time skiing, or swimming until the boat driver comes about and picks you up. But if you've had a few practice runs on the aquaplane, freeboard or saucer you will have gotten the hang of it and the chances are you'll do all right.

Details at the right show the usual practice when starting with either the freeboard or saucer. Start in the prone position, first step, one hand holding the tow rope, the other gripping the leading edge of the saucer. As the boat speed increases, come up on your knees as in the second step, then up on one knee, third step, with the left hand still gripping the edge of the saucer. Now comes the critical fourth step where you rise to the standing position. The trick is to come first to a crouching position with both feet planted firmly on the board, then let go of the saucer and rise to the standing position in an easy motion. Much the same technique is used in taking off with the freeboard, although some skilled freeboarders take off standing. Take-off is simplified with the aquaplane as you have the hand rope, which gives somewhat surer control, Fig. 1.

After you've mastered aquaplaning, freeboarding and saucering you'll want to try slalom skiing. In this sport you can start, as with regular water skis, as in the steps pictured on the opposite page or you can start from a boat dock as in the three steps illustrated at the top of page 160. Starting by either method, you discard one ski after you get going. See the center illustration at the top of page 160, also the photo at the right. Also note that the slalom skier in the photo is using a single tow rig, whereas the double, or two-handed, tow rig is generally recommended, Fig. 7. It gives somewhat surer control, especially for beginning slalom skiers. After some practice the slalom skier will be able to start with only one ski and it is then that the double tow rig is the greatest aid to balance. It also helps when pulling in for sharp turns on a slalom course, Fig. 8.

Shoe skis are the next thing to

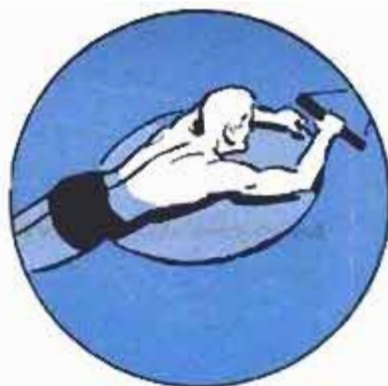

HOW TO GET UP ON A FREEBOARD OR "FLYING SAUCER"

First two steps in saucer take-off (freeboarders often take off standing) are from prone to kneeling position as in two views above. Note that in both steps left hand holds edge of saucer



Still holding edge of the saucer the rider places one foot on the disk, then comes up to standing position and away he goes

Try slalom skiing only after you've mastered regular water skis. Advanced slalomers make high-speed runs on marked courses





HOW TO TAKE OFF ON A SLALOM SKI

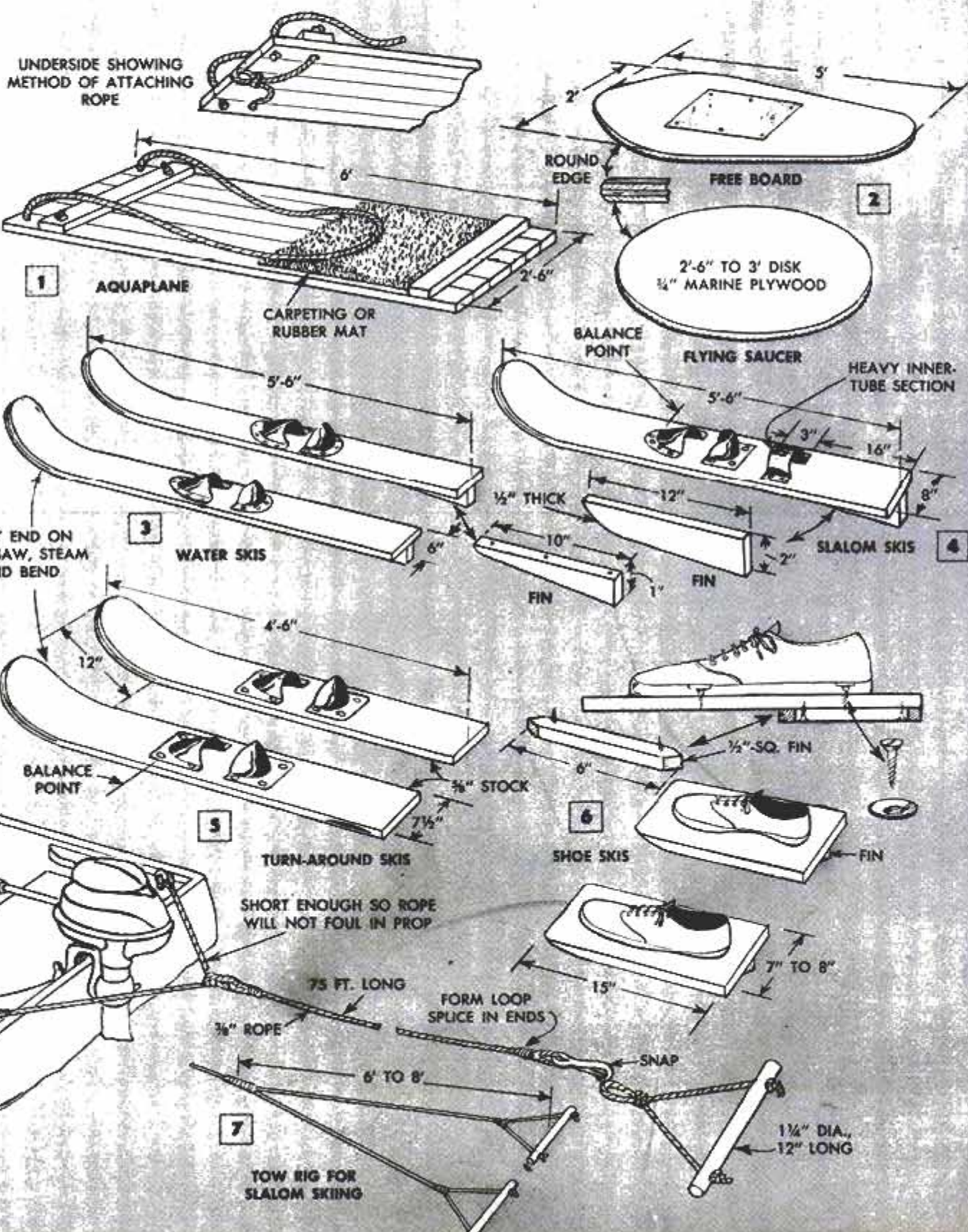



USING SHOE SKIS

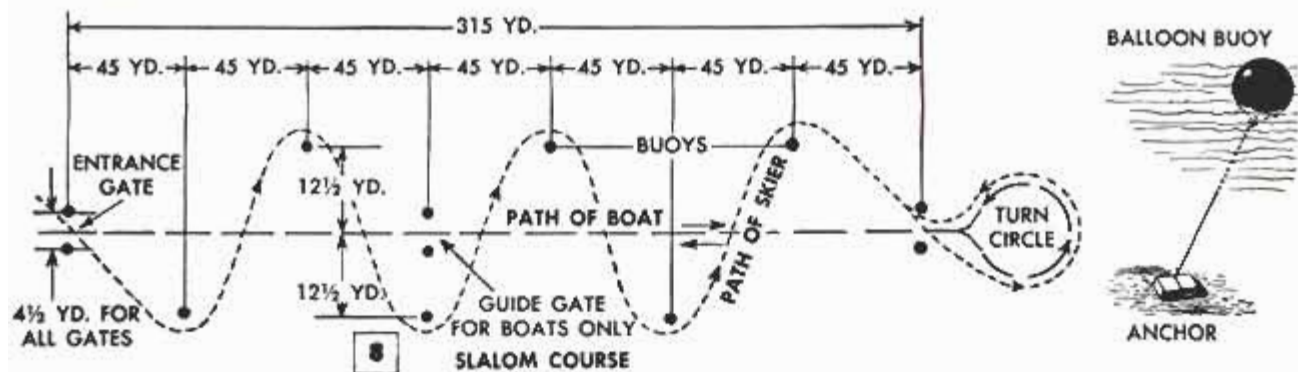

Detail shows a slalom course marked by balloon buoys. Note how skier's path crosses that of the towing boat

barefoot skiing and, if you feel venture-some enough to try them, Fig. 6 shows how they are made by attaching a pair of rubber-soled sneakers to two boards, or "shoes," of the dimensions given. The three illustrations in Fig. 8 show how you take off from a boat dock, standing on regular water skis, which you discard one at a time, and then continue the run on the shoes. Note that the water skis, slalom ski and shoe skis have fins, the slalom ski being slightly wider and having a larger fin to give greater stability. Bindings on the water skis, slalom skis and turn-around skis can be cut from a heavy truck inner tube and attached to the skis with cement reinforced with screws and washers, or you can purchase ready-made bindings at a nominal cost. Note that the slalom ski has a special toe binding for that other foot.

Turn-around skis take some learning. Even good skiers find them tricky. Although Fig. 5 shows them turned up only at one end, some skiers will prefer to have them turned up equally at both ends. The turn-around skier starts the run facing forward as with the conventional water skis. After he is well into the run (about 20 miles per hour) he drops to the crouching position and turns, facing backward. It's a neat trick if you can do it without a spill. Some water skiers face backward at the start by reversing the bindings on regular water skis so that they can face backward with the turned-up ends of the skis facing forward, that is, toward the towing boat. They then maintain this backward position throughout the run.

All types of skis, Figs. 3, 4 and 5, can be made from selected pine or poplar, straight-grained stock $\frac{5}{8}$ in. thick being about the right weight. The ends to be curved are slotted on the bandsaw for a distance of 10 to 12 in. and the slotted ends are steamed and bent over a wooden form, clamping in place until dry. Then remove from the form, spread the saw kerf slightly and apply waterproof glue between the plies. Replace in the form and clamp until the glue dries. Again remove from the form and fill the slight crack at the end of the bandsaw kerf with boat-calking compound. Next, round

Freeboarders like easy swing of long freeboard runs on smooth water. It's a genuinely satisfying sport





EXECUTING TURN-AROUND



Turn-arounds are done in four steps beginning with position shown at upper left. Difficult stage of maneuver is to keep the trailing ends of skis from digging in as you come around



Water shoes are just one step from skiing on your bare feet, and that also is done by professionals and skilled amateurs

all corners with sandpaper, apply a sealer and follow with two coats of marine enamel in the color desired. Sand lightly between coats and rub down the last coat with fine steel wool to give a perfectly smooth surface, especially on the bottom of each ski.

The aquaplane, Fig. 1, consists of several 6-ft. lengths of stock glued and cleated together. The surfaces should be thoroughly sanded, especially the bottom surface, before finishing with sealer and enamel. You also can make a more professional aquaplane with a rounded forward end by using $\frac{3}{4}$ -in. marine plywood. Sand the edges smooth, fill any openings in the core stock with boat-calking compound, and finish with marine enamel. Or, if you use mahogany-faced plywood, finish with two or more coats of spar varnish, sanding lightly between coats and rubbing down the last coat with fine steel wool. Much the

same construction and finishing procedure applies to the freeboard and saucer, these being made of plywood, of course. Note especially the shape of the freeboard, which is pear-shaped with an extreme width of 2 ft.

For towing, use about 75 ft. of $\frac{3}{8}$ -in. rope. Fig. 7 shows one way of attaching to the boat. The yoke should be short enough so that the rope cannot foul the prop when it goes slack. If the tow rope is to be used for both aquaplaning and skiing, loop-splice a snap at the outer end so that the change from aquaplane tow to ski tow can be made quickly.

Don't try aquaplaning, freeboarding, saucering or skiing in unknown waters and, unless you're exceptionally skilled, don't engage in these sports when the wind is strong enough to kick up a rough chop in fresh water or even a moderate swell in salt water. ★ ★ ★

Toy Dishes Make Meals Fun for Sick Child in Bed

Toy dishes are ideal for serving meals to a sick child when he must remain in bed. Illness reduces appetite and the smaller portions held by the toy dishes often are generous enough to satisfy the child. Food served in this way seems more like a game than a meal and the child will be intrigued and eat more food than he might otherwise. The small dishes aid mother too, since she can serve the whole meal on a small tray

that can be held on the child's lap. When serving food to adults who are ill, the toy dishes also can be useful. The tiny sugar and creamer contain enough for an individual serving and samples of food that the patient would like to taste can be served on the toy plates with a minimum of waste. Attractive to the sick person, the colorful dishes also make serving more interesting.

Blanche Campbell, Las Vegas, Nev.

Fancy Picture-Frame Molding From Embossed-Leather Belt

An embossed-leather belt that is no longer wearable can be used to make fancy picture-frame molding as shown. Glue the material to wooden strips of the same width and attach a narrower $\frac{1}{4}$ -in.-thick strip on the back surface to retain the enclosed picture. Then cut the stock to form the four sides of the frame, mitering the corners together using glue and small brads. The entire frame may then be finished with bronze or silver paint, especially if the embossing is worn and discolored too much to be polished.

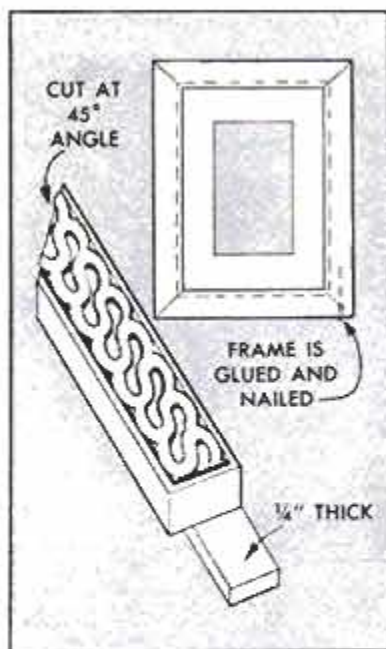

Overhead Garage Door Locked With Large C-Clamp

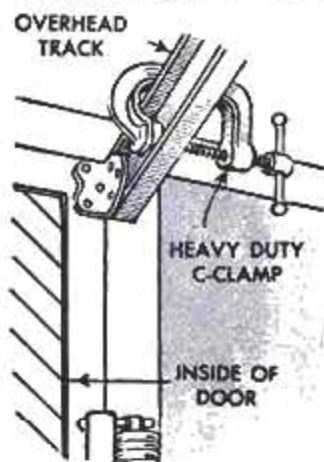

An overhead garage door that has no lock built into it can be locked if a large C-clamp is tightened at the door end of the heavy overhead track. When the clamp is in place, it is impossible to open the door from the outside.—Rex Eidson, Portland, Ore.

Painted Cottage-Cheese Boxes Are Colorful Flowerpots

Cottage-cheese containers are attractive flowerpots, when painted a bright color and the lids used as saucers. After the containers and tops have been washed and allowed to dry, apply one coat of enamel in the color desired and pierce a small hole in the bottom of each container for drainage. Small decals can be applied on the sides of the containers and on the lids, for added color. Some salad and ice cream containers also can be used for this purpose.

Kathryn M. Wilson, Pontiac, Mich.

Ⓛadders should be given a transparent finish of wood preservative or exterior varnish so that cracks and weak sections in the wood, which may lead to breaks, may be seen.

Liquid-Glue Applicator Enlarged By Winding Pipe Cleaner on It

When the applicator attached to the cap of a liquid-glue bottle is too small for practical use, failing to hold enough glue, increase its size with pipe cleaners. Wrap the cleaners around the applicator stem, as shown, to the desired thickness and the glue will hold them in place. When the pipe-cleaner wrapping becomes hardened replace it with a fresh one.

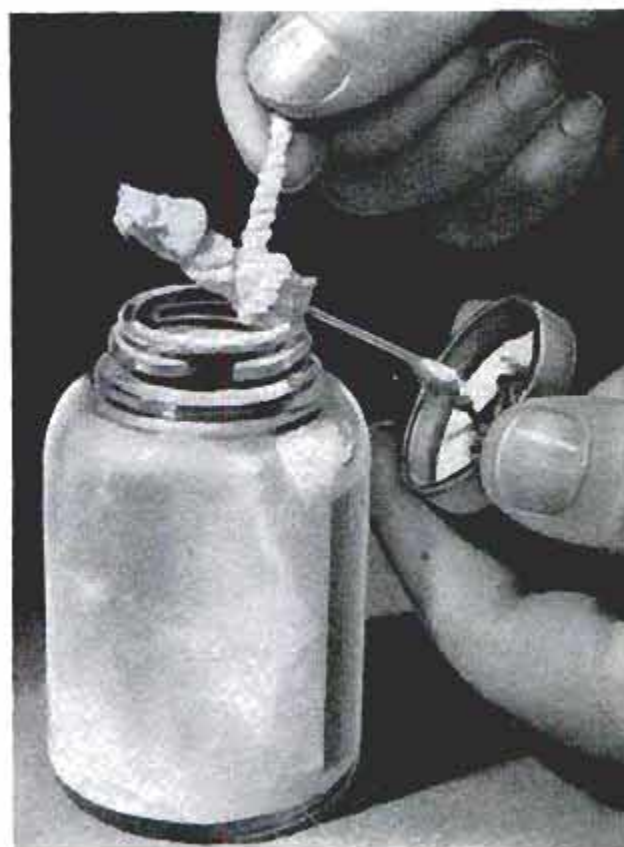

WTM 58

An Easy-to-Build GLASS-FIBER POND

By Boris Volg



NO OTHER FEATURE will add as much natural beauty to your landscaping as a pond, stocked with fish and planted with water lilies and other aquatic plants. Such a pond now can be built in a short time, without heavy labor, and with no tools except a shovel, broom, paintbrush and tin snips. Glass-fiber cloth and polyester resins are the building materials required.

First, dig a shallow excavation the size and shape desired, then wet the dirt and "trowel" it with a broom so it is fairly smooth. Next, lay the cloth in place in the

excavation, lapping it over the top edge a couple of inches. Lap all joints 2 in. Mix the resin according to the manufacturer's directions and apply it to the cloth with the paintbrush. Holes and tears in the cloth can be patched with a piece of the cloth and resin. Allow the cloth to dry, then trim the top edge with the tin snips. Paint the cut edge with resin and smooth it over to eliminate any sharp edges.

Because the glass-fiber-resin combination is inert, fish and plants can be placed in the pond as soon as it is filled with water.



After hole has been excavated and wet soil smoothed with broom, cut glass-fiber cloth to fit in pond

Trim dried cloth with tin snips, paint edge with resin to eliminate sharp edges. Patch all holes



Use paintbrush and saturate cloth with resin. Patch holes with cloth and resin, allow to dry completely

Ignore sand or dirt stuck in resin, fill pond with water, drop in fish, add flowers and job is done



Fish-Cleaning Job Is Easier and Faster With Clamp Board

Half the job of scaling and cleaning the fish you catch is in keeping them from slipping out of your grip. The clamp board shown at right solves this problem by effectively holding the fish while you use both hands to do the cleaning. The pivoting clamp bar presses the tail of the fish against nail points which grip the fish. The bar is held down by a stiff coil spring that adjusts to the thickness of the tail.

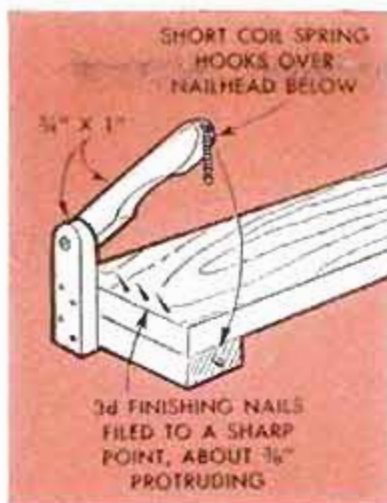

Sprinkler Rate of Flow Measured In Empty Coffee Can



To decide when enough water has been sprinkled on plantings for the recommended 2-in. depth-of-soil soak is difficult, unless some means of measuring the rate of deposit of water on the surface of the ground is devised. One gardener solved this

problem by setting an empty coffee can in the medium range of his sprinkler. The time required to fill the can with 3 in. of water is the equivalent sprinkling time needed to soak the soil to a depth of 2 in.

Extra Handle on Garbage-Can Lid Permits Easier Removal



Women who find it difficult to remove the lid from a garbage can will welcome an extra handle attached near the edge of the lid as shown, permitting pulling force to be applied where it is needed. This entails less exertion than pulling the lid up with the center handle.

The extra handle is attached with small bolts, washers and nuts. A single strip of flat metal replacing the two washers on the inside will give greater rigidity.

Handy Wall Rack for Magazines

Two 16-in.-square panels of perforated hardboard spaced by wedge-shaped wooden ends comprise this handy wall rack for holding magazines. The panels are fastened to the side wedges with 3/4-in. wood screws. The back panel is installed an inch above the tops of the end pieces allowing for a cleanout groove below, and hangs neatly on the wall from right-angle curtain hooks. A wire rack, designed for "Peg-Board" use, can be attached through the holes on the front panel to hold smaller magazines and pamphlets. For a larger wall rack simply fasten longer panels of 16-in.-wide perforated hardboard on the side wedges.

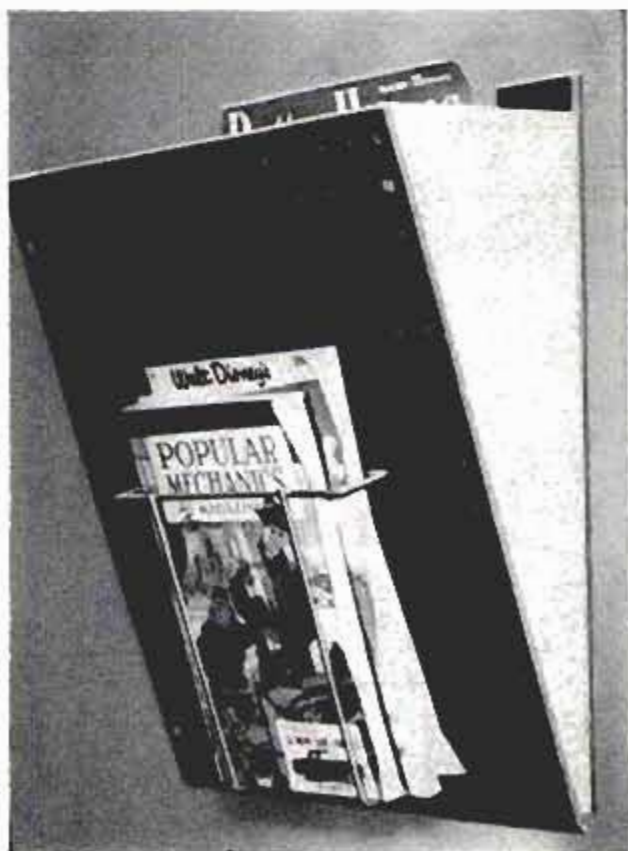

WTM 58

CHINESE-OVEN BARBECUE

By Brewster Morgan

(Courtesy of Arizona Highways Magazine)

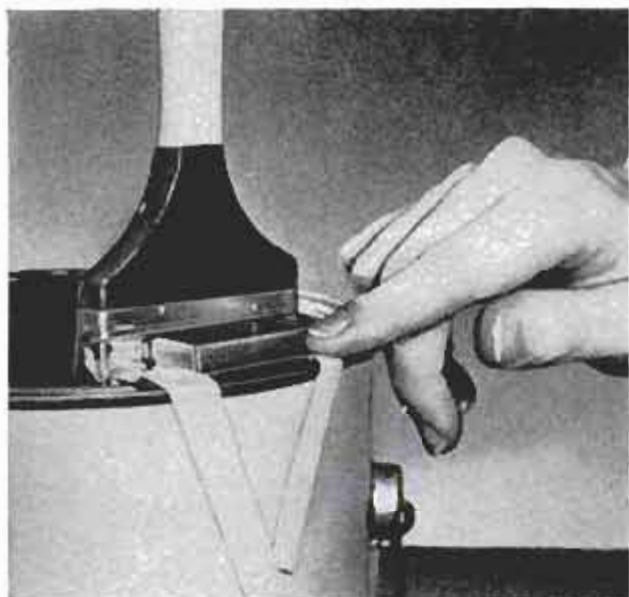

Magnet Holds Brush Upright In Paint Can

When interruptions make it necessary to set your paintbrush aside for a moment, a magnetic door latch taped to the rim of the paint can will hold the brush upright with the bristles in the paint. With this provision the paint will not dry on the bristles and there is no chance for it to run on the heel or handle of the brush, as often happens when the latter is laid on its side.

Name Written With Sparkler Photographed By Time Exposure

Names written in the air with Fourth-of-July sparklers are photographed by one camera fan. The camera is set on a tripod to assure steadiness and the shutter set for time exposure. The lens is stopped down to f:16. Focus is accurately measured from camera to sparkler. To be sure of an underexposed background that will print black,



the photographs are taken on a moonless night with no lights. As soon as the sparkler is lighted, the camera shutter is opened. The sparkler is used as though it were a piece of chalk being used to write the name in large letters on a blackboard. After the film is developed, the negative is printed in reverse so the name reads correctly.—Don Honick, Chicago.

CALLED A CHINESE OVEN, the barrel-shaped barbecue pit illustrated on the facing page cooks foods slowly and smokes them, a process that imparts a flavor duplicated by no other method. An advantage of smoking is that meats, fish and vegetables can be cooked together without interchange of flavors.

The oven can be built as easily as most barbecue pits, and usually requires less space. Oven dimensions are only suggested, since its size would depend on the amount of food that will be smoked. Flagstone, brick or poured concrete can be used for the foundation. Heat-resistant mortar then is used to set a layer of firebricks on the foundation for the oven floor. About three courses up, the angle-steel lintel is fitted over the firebox opening. Two metal rods, which support the meat racks, are mortared in place about three courses from the oven top. If the oven is not as barrel-shaped as you wish, this can be corrected by doing some "sculpting" with the fire-resistant plaster troweled over the inside and outside of the oven. When applying the plaster, insert screw anchors to provide a means of attaching the lid and its flat-steel support. Trowel the top of the barrel flat as shown in the side view.

The support is a length of flat steel bent at its top end and fitted with a pulley over which is run the cord holding the lid counterbalance. A wooden block on the support acts as a lid stop. Sheet metal is used for the lid which is hinged as indicated. A 6-in. hole in the lid center provides draft, and is covered by an 8-in. disk fitted with a handle that is pivoted to the lid. This is the adjustable damper. The meat rack consists of sharpened hooks bent from heavy wire and slipped over metal rods that lay in notches filed in the support rods. Vegetables, hot dogs and the like are smoked on the wire grid suspended from the support rods on wires. Heavy screen wire is used for the catch grid which is designed to catch any food falling from above. Sheet metal is used to form the three-piece drip pan located in the bottom of the oven.

Firewood should be of a type that makes fragrant smoke, such as hickory. Build the fire in the firebox outside the oven. Allow plenty of cooking time, since smoking takes longer than other methods. ★ ★ ★

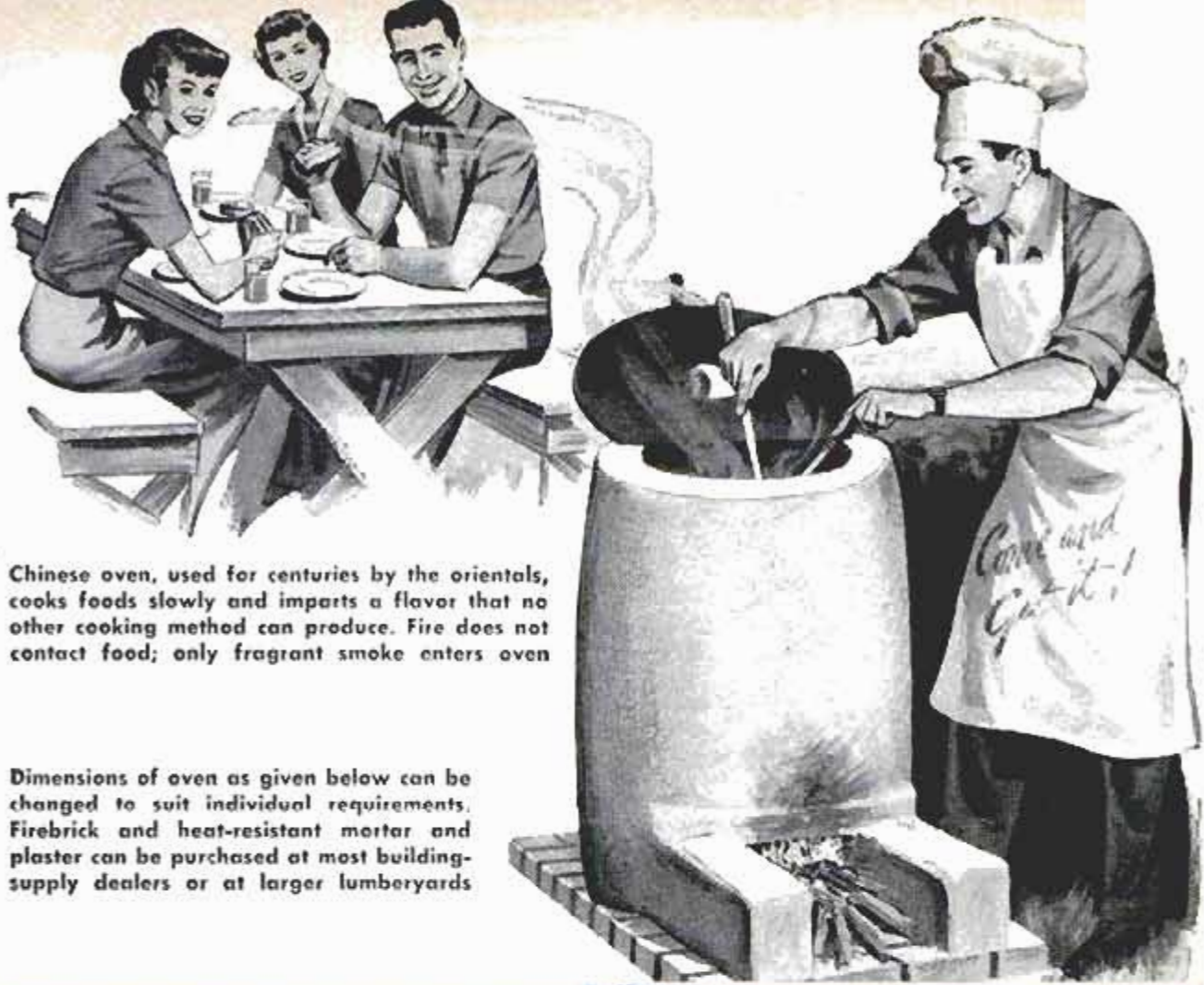

Chinese oven, used for centuries by the orientals, cooks foods slowly and imparts a flavor that no other cooking method can produce. Fire does not contact food; only fragrant smoke enters oven

Dimensions of oven as given below can be changed to suit individual requirements. Firebrick and heat-resistant mortar and plaster can be purchased at most building-supply dealers or at larger lumberyards

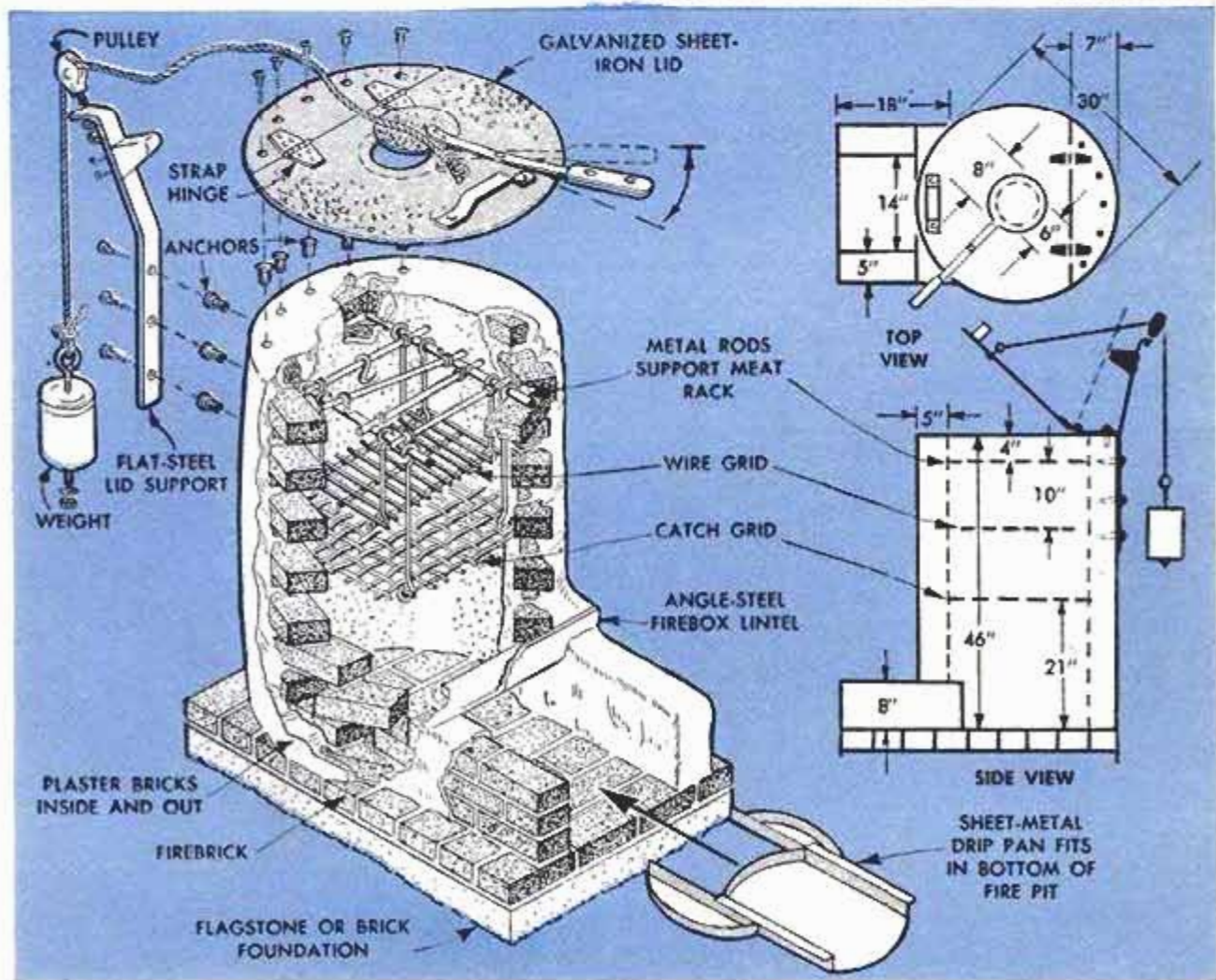

Trash Box Fastened to Mower Saves Steps When Cutting Lawn



A wooden box bolted or wired to the lawn-mower handle becomes a very useful container for trash picked up in the process of mowing a lawn. Twigs, stones, paper and bones can be deposited in the box saving frequent trips to the trash can. When the mower is not in use, gas, oil and adjustment tools may be stored in the container.

R. S. Howard, Milton, Wis.

Striped Sleeve on Guy Wire Provides Safety Factor

A utility-pole guy wire that is located so it presents a hazard to motorists and pedestrians can be made more conspicuous by covering it with a striped sleeve. The sleeve is a length of garden hose slit to fit over the wire. Coat with reflective-type paint.



Loose Wires in Circuit Breaker Cause Unnecessary Opening

If the circuit breaker in the line cord on your washing machine or other appliance opens frequently when there is no apparent cause, the trouble may be due to loose connections in the plug. Remove the cover from the plug and tighten the screws that hold the wires in place. The latter may have worked loose, causing sufficient current resistance to open the breaker.

Roof Insulation Ventilated

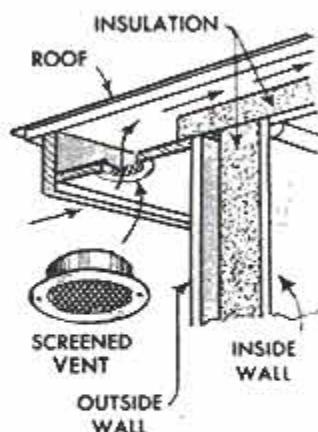

When roof rafters also serve as ceiling joists for the rooms below, spaces between the joists adjacent to the insulated ceiling can be ventilated by installing screened vents in the eaves or roof overhang. One or two vents should be located at the ends of each joist

space. As a substitute for the vents, the eaves can be provided with a continuous screen-covered slot about 1 in. wide.

☐ Minimize the adhesion of dust to newly varnished work by suspending it upside down with string or rope until dry. Dust will not collect on the lower surfaces and vertical sides which will later be exposed to view.

Cut Plants Kept Fresh Longer By Crushing Ends of Stems

Woody-stemmed plants which seem to wilt quickly when cut for an indoor bouquet can be kept fresh for a longer time by crushing the lower few inches of the stems with a hammer. The broken fibers of the stems present a greater area of absorption, thus carry more wilt-preventing water to the blooms.



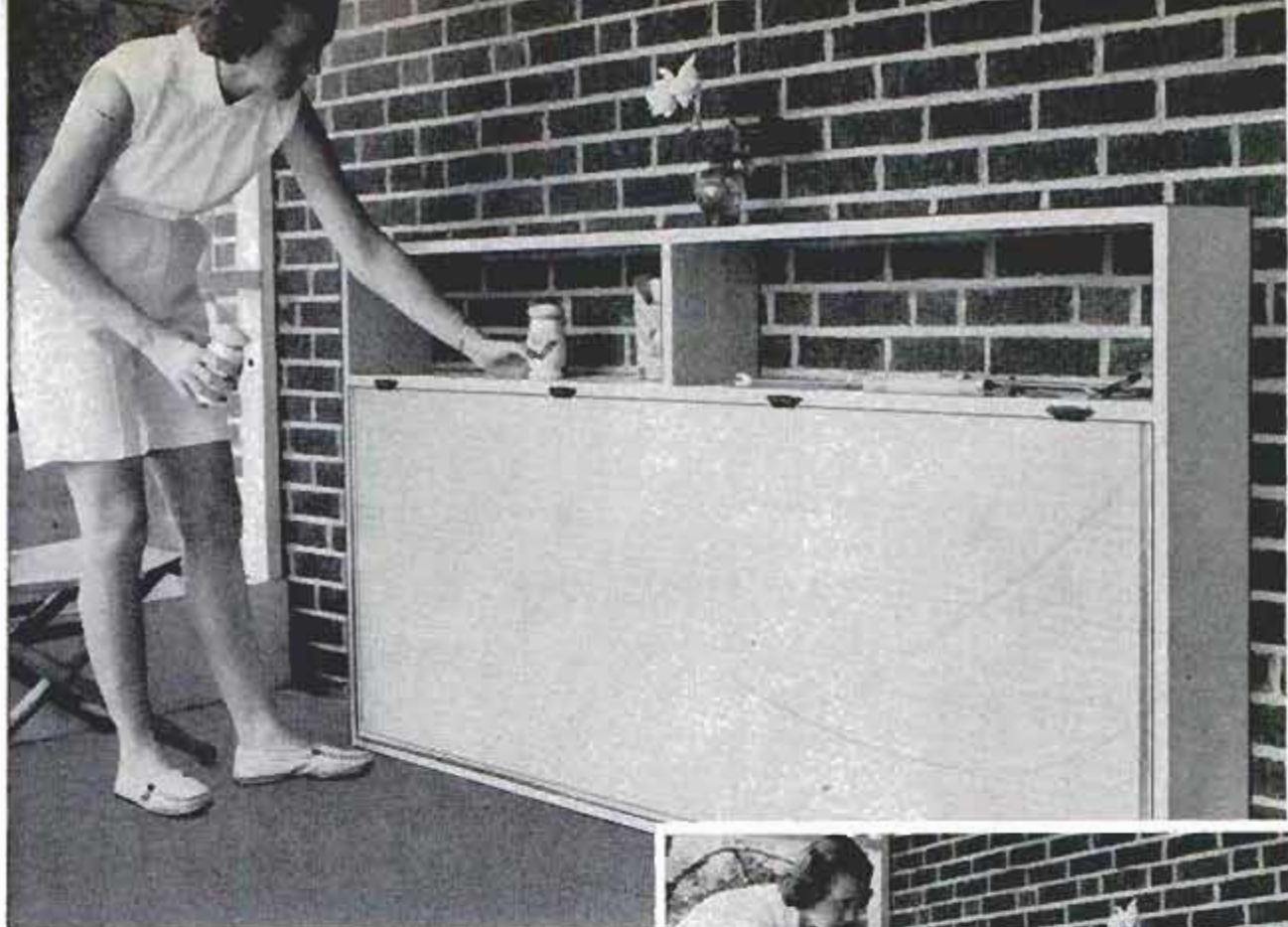

WTM
58

Outdoor Table

Eating outside is a real pleasure with this attractive and convenient table on which to serve meals. Attached to wall of house in screened patio, the table folds into decorative piece of furniture when not in use. Ordinary lumber free of knots can be used for all wooden parts but plywood table top. Dimensions given can be modified to suit individual space and seating requirements. Use plastic laminate to cover table, and protect edges with metal molding

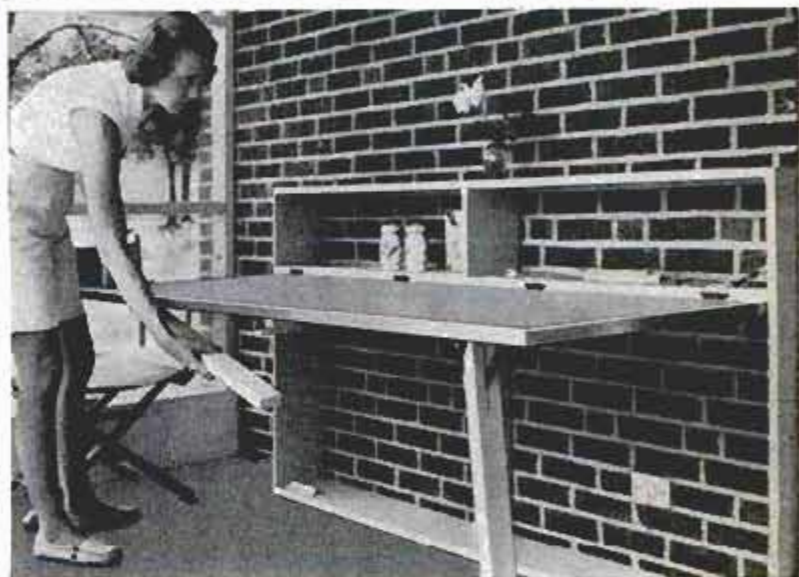

By Clifford B. Hicks

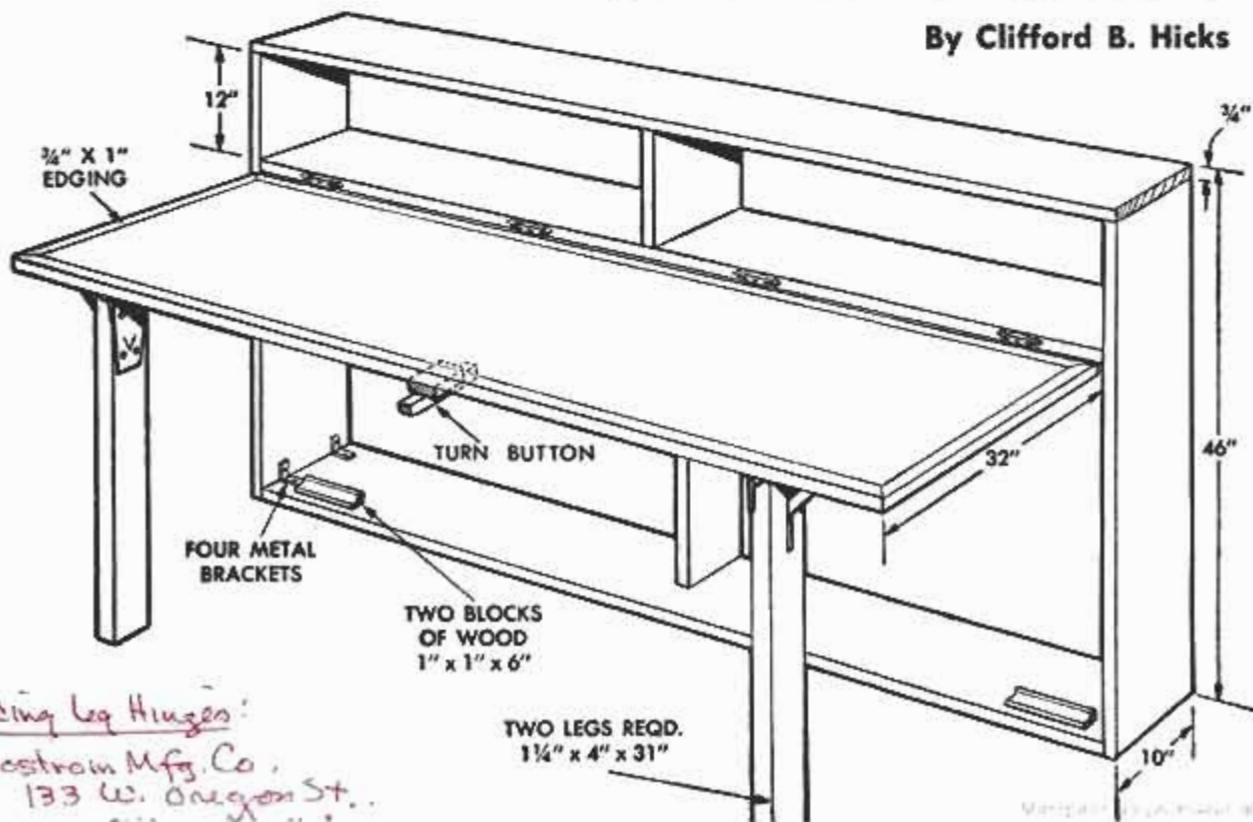

Folding Leg Hinges:
Bostrom Mfg. Co.
133 W. Oregon St.

TWO LEGS REQ.
1 1/4" x 4" x 31"

SOLVING

Home Problems

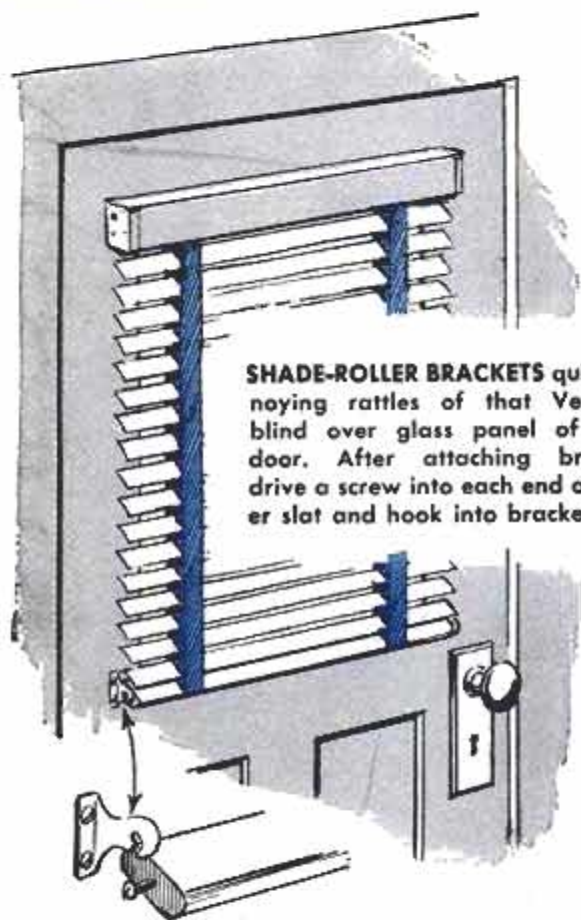

SHADE-ROLLER BRACKETS quiet annoying rattles of that Venetian blind over glass panel of front door. After attaching brackets drive a screw into each end of lower slat and hook into bracket slots

TEA STRAINERS hinged together as pictured, using a short length of brass wire, make a handy sudser when filled with soap flakes or "shavings" from a bar of laundry soap. Takes only a few seconds to raise a heavy suds in the dishpan or washing machine

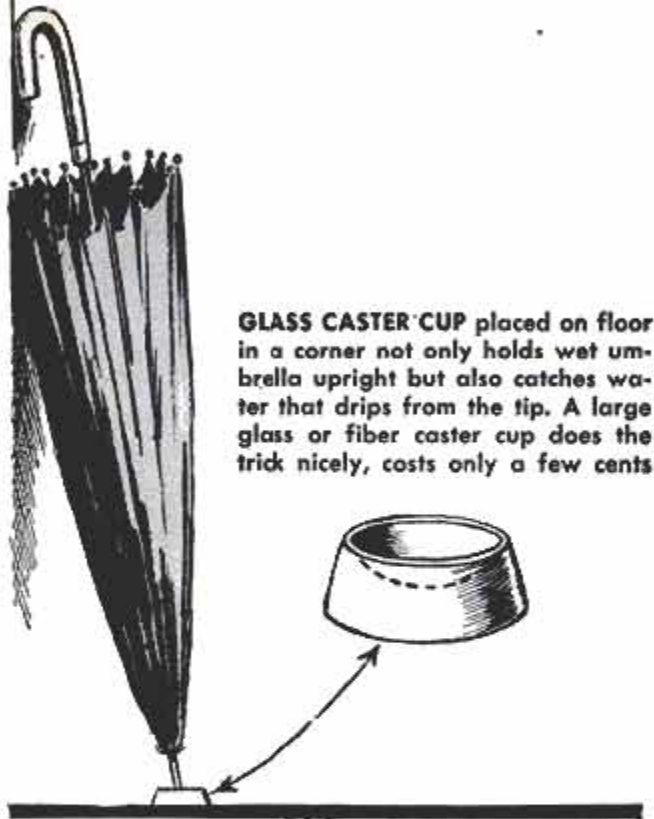

GLASS CASTER CUP placed on floor in a corner not only holds wet umbrella upright but also catches water that drips from the tip. A large glass or fiber caster cup does the trick nicely, costs only a few cents



TABLE SALT applied generously to chopped ice or cubes hastens chilling of beverages at the picnic table. Trick is even more effective if you apply salt in layers as the container is filled with ice

WOODEN DRAWERS that are heavily loaded can be made to slide easily by "lubricating" lower edges of sides with a bar of laundry soap or a cake of paraffin. Just rub lower edge of drawer side with a corner of the cake, or bar, in the manner pictured

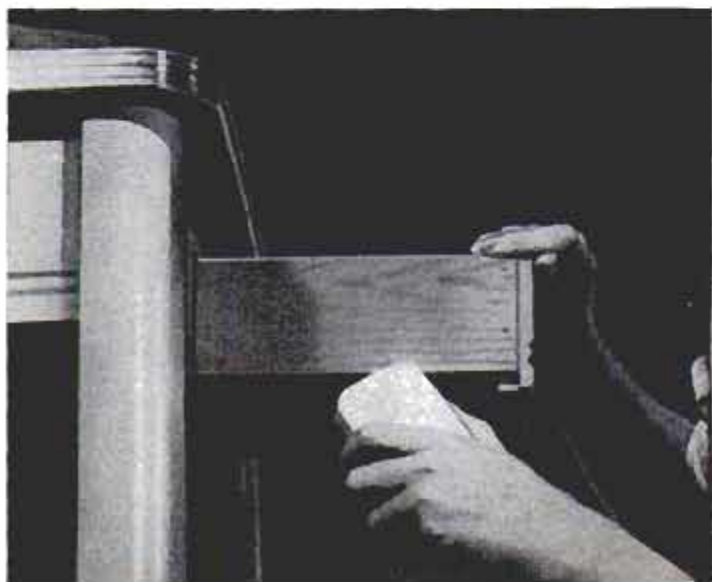

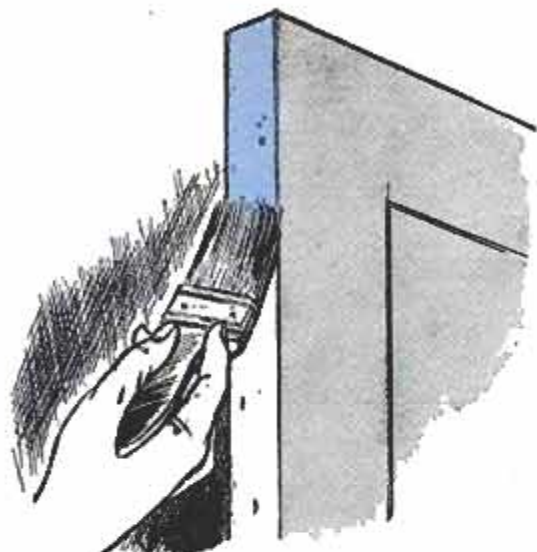

DOORS sometimes stick due to accumulated coats of paint on edges. Remove old finish to bare wood with a nonflammable remover and refinish with one new coat of paint

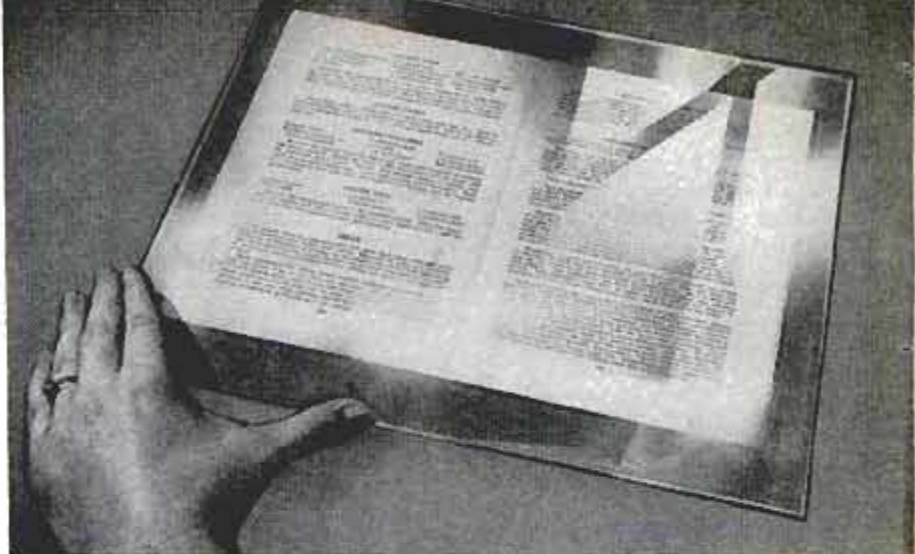

SHEET OF CLEAR PLASTIC holds that unruly recipe booklet flat so you can read it easily even while mixing ingredients. A rectangular piece of plastic $\frac{1}{8}$ in. thick does the job nicely, even holds a heavy cookbook open to the desired page number

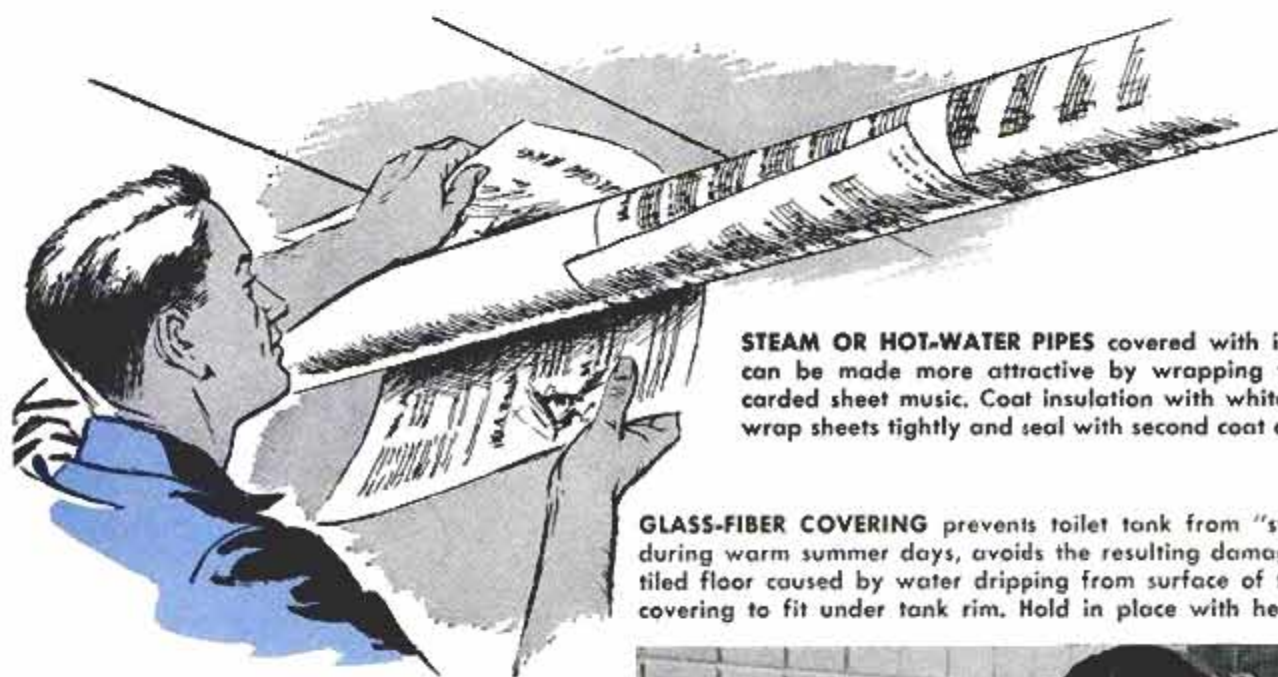

STEAM OR HOT-WATER PIPES covered with insulation can be made more attractive by wrapping with discarded sheet music. Coat insulation with white shellac, wrap sheets tightly and seal with second coat of shellac

GLASS-FIBER COVERING prevents toilet tank from "sweating" during warm summer days, avoids the resulting damage to the tiled floor caused by water dripping from surface of tank. Cut covering to fit under tank rim. Hold in place with heavy cord

STRIP OF ADHESIVE TAPE pressed tightly over center terminal of flashlight battery prevents excessive drain should the terminal come in contact with any metallic object while battery is stored. Crossed strips of tape are even more effective





Uses for Aluminum-Foil Piepans

Small aluminum piepans, purchased with frozen pies and meals, can be utilized in many ways around the home. Besides making bright waterproof coasters for flower vases, potted plants, or beverage glasses, they can be inverted and molded into lids for small bowls, jars, cups and tumblers. They make fine emergency ash trays too, and can be folded together and discarded with the ashes still inside. When filled with water, the pans can be used to soak and remove stamps from envelopes. Several pans kept in the shop are handy for sorting small parts. One can easily be bent into a spout for pouring tacks and other small items back into their containers. In the garden, tie them to fruit trees to scare birds.

Band and Button Secure Cover

A large button sewed to a rubber band is ideal for securing bag-shaped equipment covers in a hurry. After the cover is placed over the equipment the rubber band is stretched around the open end and "buttoned" as shown. Coarse thread should be used for fastening the button to the band to prevent it from cutting into the rubber. To keep the band handy, stitch one end of it to the cover.



Copper Wire Wound on Sewer Tile Keeps Tree Roots Out of Joints

Bare copper wire wound around sewer tile at each joint will help to prevent small roots from entering and eventually blocking the tile since roots that come in contact with the copper will be killed. Even if the sewer line should settle so that joints are no longer sealed the copper windings will protect the openings. Open-tile septic systems can be similarly protected with copper wire wound on both ends of each tile. Roots are attracted to the sewers to procure moisture, but the copper kills the fine roots before larger ones can become established.

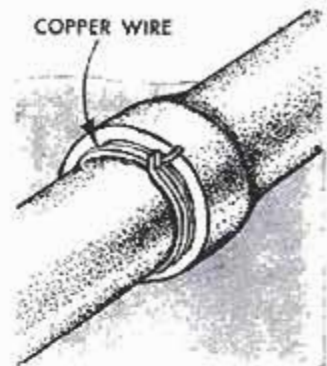

Ornamental House-Plant Shelves Hook Over Window Sill

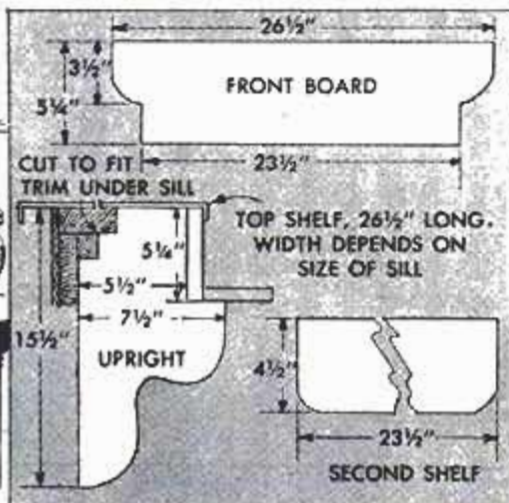

Additional space for your favorite house plants is provided by installing detachable shelves which hang over the window sills as shown at left. The top shelf is a piece of $\frac{1}{8}$ -in.-thick sheet metal $26\frac{1}{2}$ in. long with a $\frac{5}{8}$ -in. lip along both of the side edges. The inside edge is attached to the front board with brass upholstery tacks, also used on the lower shelf.—Robert Dalton, Roseville, Mich.

WTM
58

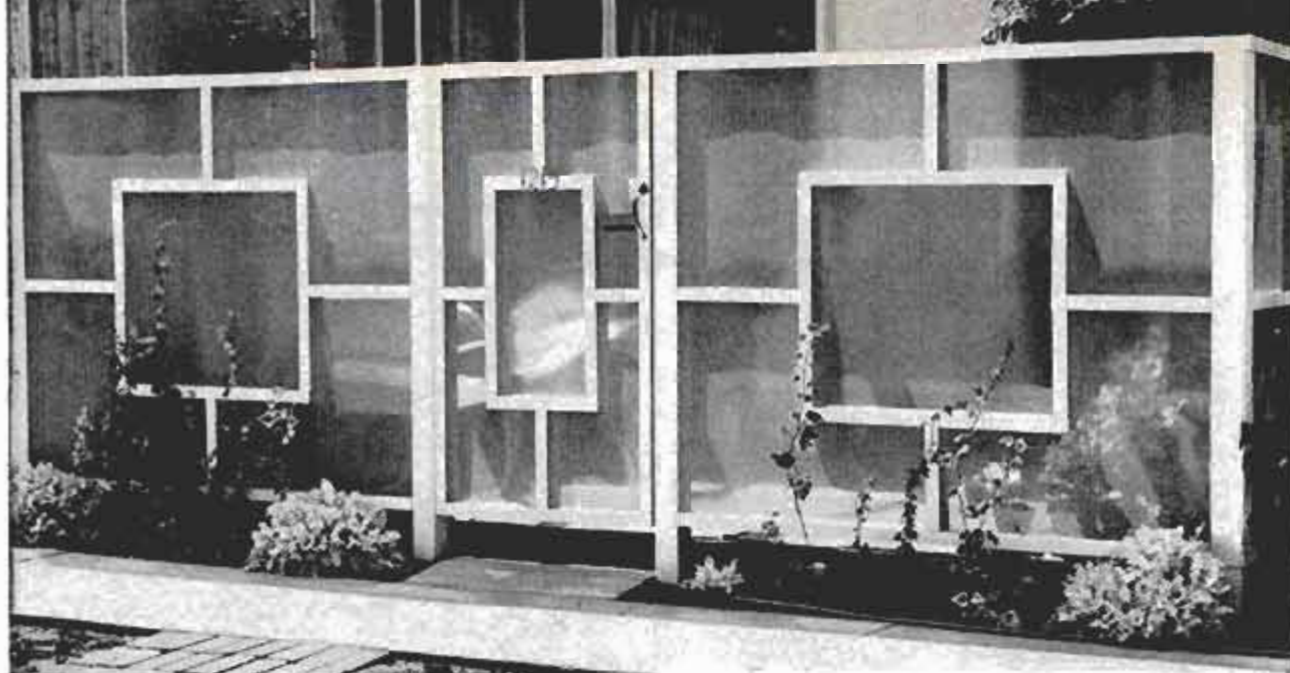

Framework of modern design makes attractive patio wind screen when covered with plastic-coated screen wire

PLASTIC WIND SCREENS

PLASTIC-COATED SCREEN WIRE, such as Screen Glass, has been found excellent for making attractive low-cost wind screens. The material is relatively inexpensive, offers a degree of privacy and is fairly durable. It is applied and stretched like screen wire, tacking the plastic-coated material to a post-supported framework and covering the tacks with screen molding. While not as durable as translucent glass fiber, the low cost of the plastic-coated material makes it feasible to replace it periodically like the wire on window screens. Strips 12 to 14 in. wide interlaced over posts set 3 ft. apart produce the attractive basket-weave screen pictured below. The right-hand detail shows how rabbeted strips are used to conceal the edges when translucent glass fiber is used to cover a screen.—Hi Sibley, Nuevo, Calif.

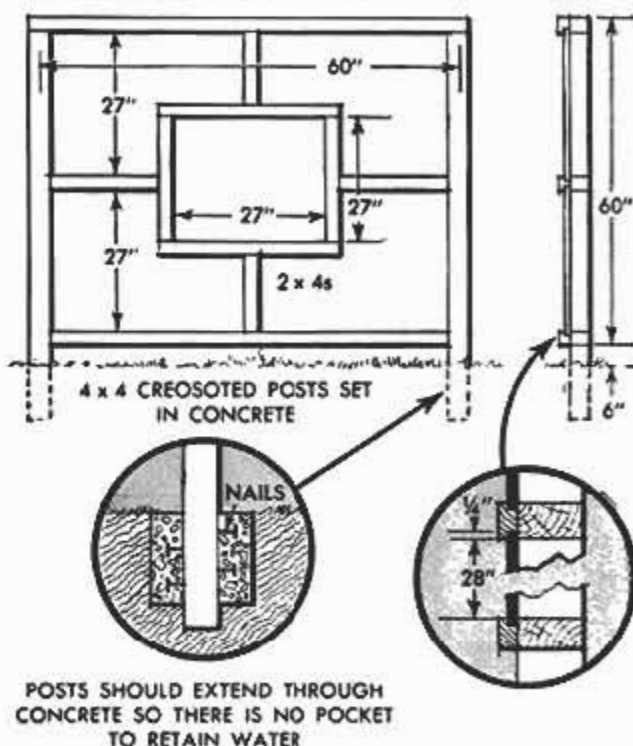

Strips of plastic-coated screen wire interlaced and tacked to 4 x 4 posts produce basket-weave screen below

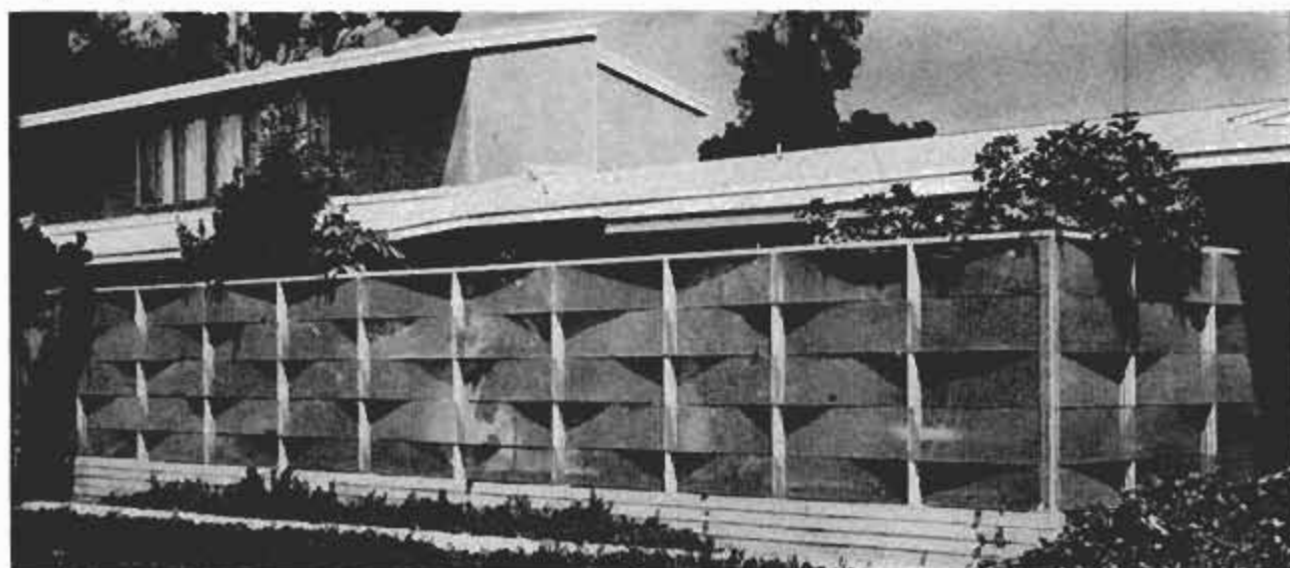

WTM '57

Photos and information courtesy of Minnesota Mining and Manufacturing Co.

Finishing Your Water Skis

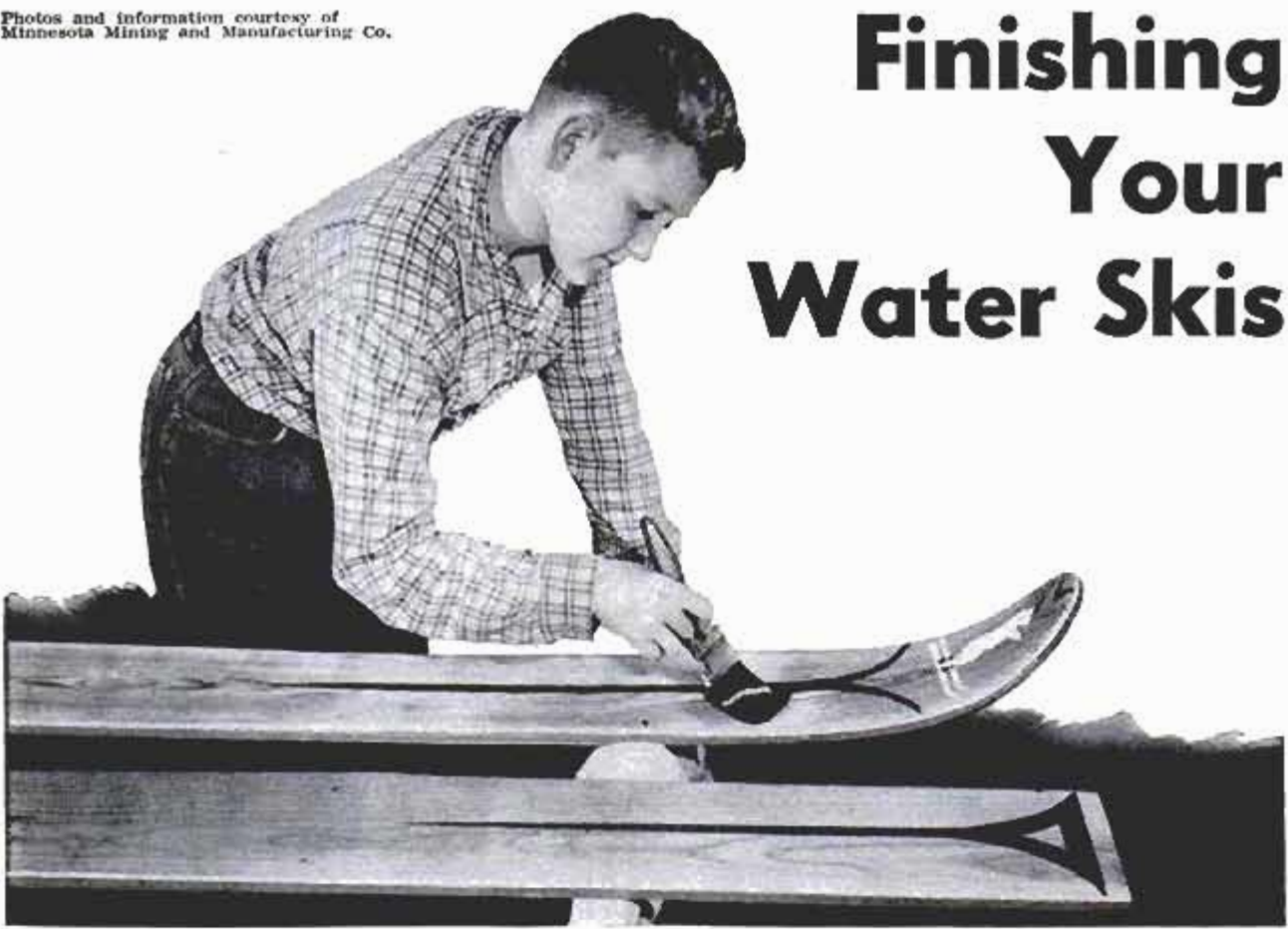

Above, marine varnish applied before and after the design is applied protects skis from water damage



A touch of originality is illustrated above in the "brand" designs being painted on the toe of each ski. Masking tape is used to outline the design

The design is complemented, below, with stripes of contrasting color running the length of the skis

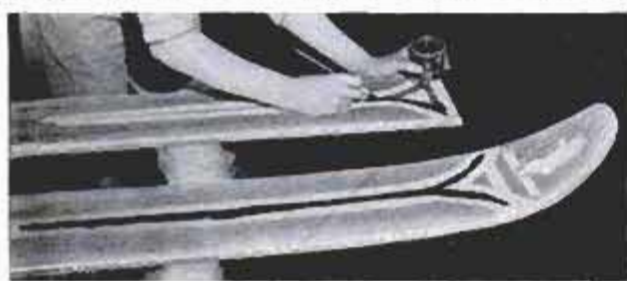

EASY-TO-FINISH water-ski kits are now available to the home craftsman, and at a saving in cost when compared to the price of a finished pair of skis. The kits come complete with two steam-bent pieces of ash wood, keel strips, precut foot harness and all necessary hardware. In finishing, it is advisable to first bevel the upper edges of the skis, then sand them smooth for a fast low-friction surface. A ball of putty or a rubber sanding block should be used when sanding the curved toes to prevent gouging into the wood. Light staining will then bring out the grain, after which a coat of good marine varnish is applied. Keel strips are attached with the tapered ends forward and foot harness installed in predrilled holes. A design may be painted on the skis as shown. ★ ★ ★

Below, rubbing compound is used to produce a luster on the finish. A satin effect is created by sanding with extra-fine waterproof sandpaper and water. An application of waterproof wax will protect the finish and minimize water friction

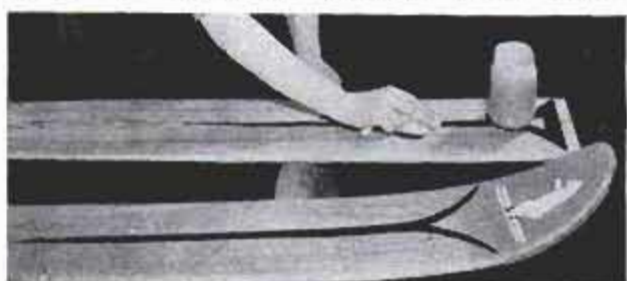



Top edges are beveled, and the entire surface sanded with waterproof sandpaper dipped in water



Keel strips, above, are mounted on the bottom of the skis at the rear, each one approximately 1 in. in from the side and rear edges. Place the tapered ends of the keel strips toward the front end of the skis

Right, your youngster will be proud, too, after he makes his own personalized set of water skis. And just think of the water fun he'll have this summer

Below, toe harness is attached to the skis with wood screws 2½ in. ahead of the holes predrilled for the heel harness. Bolts are pushed up through the holes and the adjustable heel harness attached

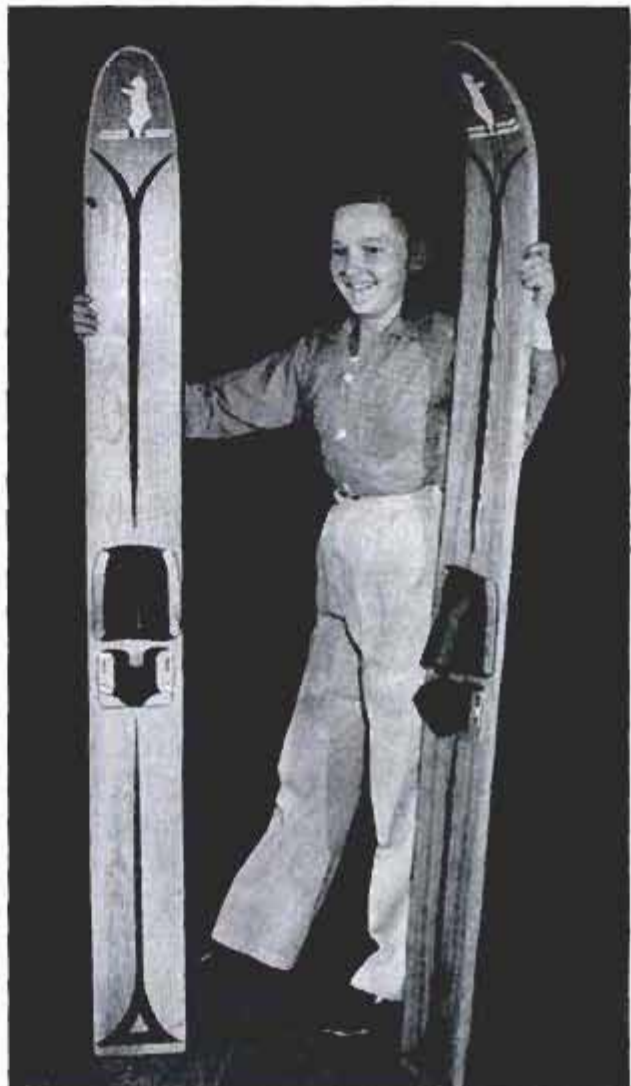
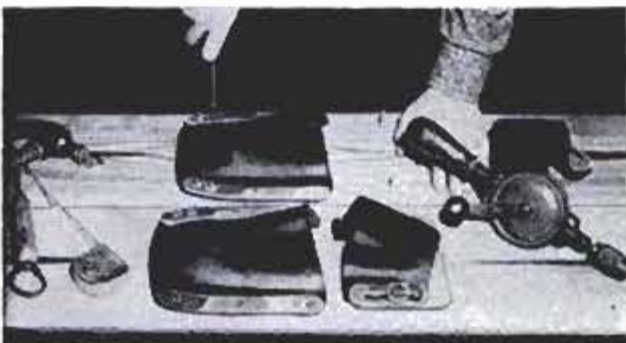

Two-Plug Wall Receptacle Adapted For Remote-Control Operation

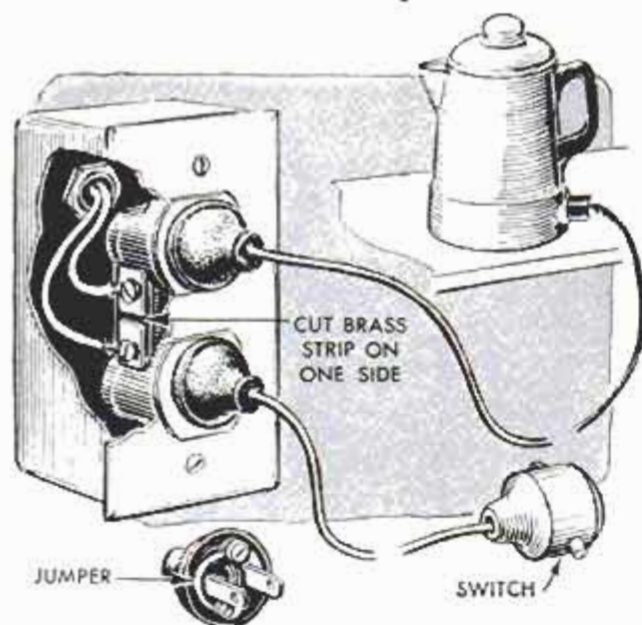

Cutting one of the brass tap strips on a two-plug electrical wall receptacle permits remote-control operation of an electrical device plugged into one of the outlets. When mounting in a receptacle box connect the line service leads to the two screws of the severed tap strip as indicated in the illustration. The remote-control switch is made from a feed-through pendulum-type light switch, which is connected to a length of cord equipped with a male plug at the opposite end. Insert the remote-control unit into one of the outlets and the appliance into the other. For normal use of the receptacle replace the remote-control unit with a male plug having a jumper wire between the prongs.

Thomas Fagan, North Bessemer, Pa.

Measurements Recorded on Ruler

When taking measurements, errors are less likely to happen if you write the measurements down on a strip of waterproof adhesive tape which has been attached to the ruler or yardstick. When no longer needed, the figures can be easily erased and the tape reused.



Air forced into attic by exhaust fan is discharged through vents cut in underside of roof overhang

HOUSE COOLED

WHEN an attached garage shares a common attic with a house, as in the examples shown in the photographs at the tops of these pages, the situation is ideal for the installation of an attic exhaust fan in the garage ceiling. The Lau Blower Co., of Dayton, Ohio, has developed such an installation and finds that it eliminates many of the disadvantages present when the fan is installed in the ceiling of a home with a low-pitched roof. First, since the installation is made outside of the living quarters, dirt and dust which result when the fan opening is cut do not cause any inconvenience to the homeowner. Air exhausted into the attic is discharged through louvers fitted in the overhang of the roof. Since the louvers are outside the house, their installation also causes no inconvenience.

If a large fan is located in the ceiling under a low roof, the short distance between fan and roof results in considerable fan noise. When the fan is installed in the garage, it can be located below the ceiling line, which provides more clearance between roof and fan, thus reducing fan noise. And, since the fan is located outside the house, noise of both motor and fan are less apparent inside the house.

When the fan is located in the garage ceiling it can be used to cool the whole house or just to "air wash" the attic. When the house is to be cooled, the outside garage door is closed and the door between the house and garage is opened. Air then flows through the house, into the garage and through the fan into the attic. If the fan is used just to air-wash the attic, the door between the house and garage is closed and the outside garage door is opened. Outside air then is drawn through the fan and out



Common attic shared by house and attached garage, as in house pictured above, presents an ideal situation for locating attic exhaust fan in ceiling of garage, where it is isolated from the main living area

by Fan in Garage

the louvers in the roof overhang. Air-washing the attic in this manner is a definite advantage when air conditioning later is installed in the home. In this particular case it will permit the use of a 3-ton air conditioner, when normally a 5-ton unit would have been required.

Actual installation of the fan in the garage ceiling is not difficult. First, the opening is cut through the plaster, which is removed. Ceiling joists are not cut. The fan then is mounted on a framework consisting of short lengths of 2 x 4s bolted to the ceiling joists, with crosspieces spiked between them. Canvas strips are fitted between the framework and the fan body, both as sound insulation and to prevent recirculation of air past the fan. An adjustable louver is mounted on the frame under the fan, then the sides of the framework are covered with hardboard.

If an attic exhaust-fan installation, as described, is being considered for your own home, it is advisable to consult local building codes. In some instances fire regulations require the door between the garage and house always to be closed. ★ ★ ★



Above, fan opening is cut through garage ceiling, leaving joists intact, after which fan-supporting framework is suspended under opening as below. Be sure framework is level so fan is supported solidly to assure that fan and motor will operate quietly

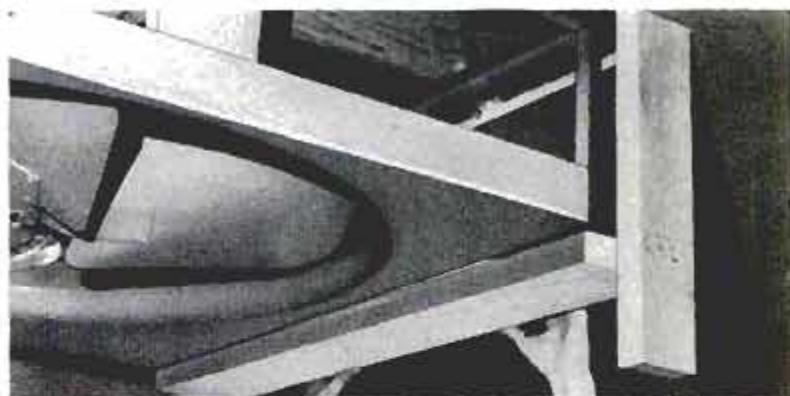

Lower left, finished installation of fan presents neat appearance and provides ample headroom. Timer and control switch are located on wall. Lower right, canvas strips fitted between wooden framework and fan frame prevent recirculation of exhausted air

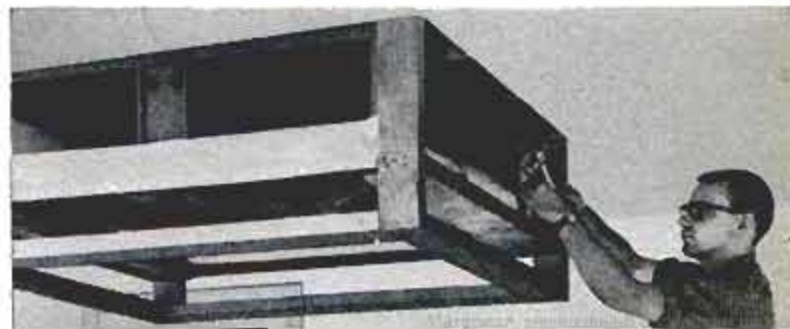

'VACATIONPROOF' Your Home

YOU'RE ON VACATION and have taken care of the usual things around the house before leaving. But what about the valuables that should have been deposited in a vault, the hot-water heater and refrigerator that could have been turned off to save on the next utility bill, and the call to local police asking them to keep a watchful eye on the house in your absence? These added precautions wisely taken will guarantee a vacation free of worry. ★ ★ ★

Inform local police of length of time you plan to be away so they can give special attention to home

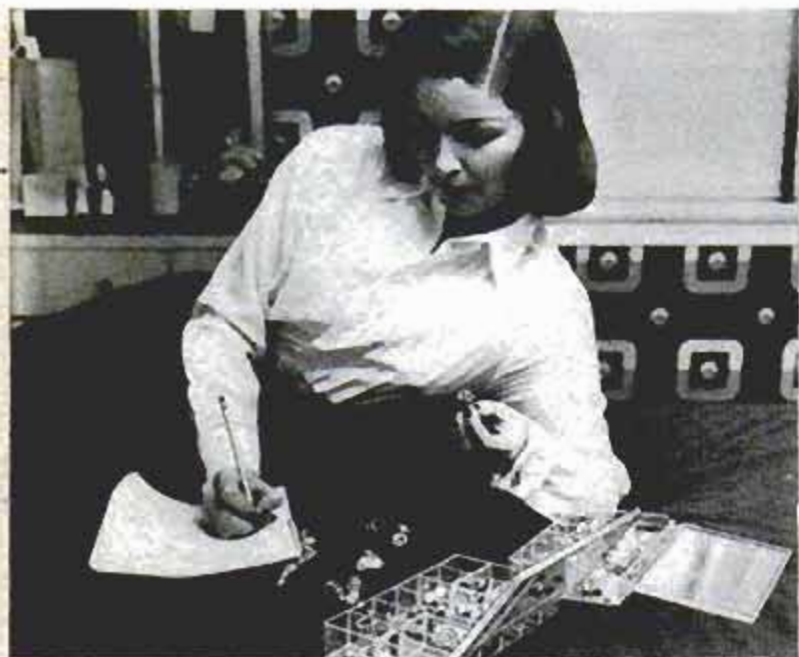

Above, take inventory of jewelry and documents, serial numbers from large objects. Store important items in a vault. Below, cover upholstered furniture with cotton sheets to prevent fading, since draperies and blinds should be left in normal position to give impression house is occupied



Silverware wrapped in nontarnishing paper, above, will protect it during the period you're away and will save a cleaning job later. Below, move TV set away from window if it is normally placed there. Disconnect outside antenna from back of set and unplug electrical connection from wall receptacle





To prevent accidents or fires resulting from faulty electrical installations turn current off at main switch, unless you want to keep a light burning



If vacation is longer than two weeks, defrost the refrigerator, remove all perishables, pull electrical connection from outlet and leave door open



Above, be sure burners on gas stove are shut off tight. Main gas valve needn't be turned off since pilot light burns small amount of gas. Below, set plants on overturned soup plates in bathtub, with water in tub just up to top of pots and washcloth in water leading to soil to draw water for plants



Hot-water heater, above, should be turned off at main heater valve so fuel or electricity is not wasted heating and reheating water that will not be used until you return. Below, hang all woolen clothes in closets, apply liberal amount of a good mothproof product and keep the doors closed



Recipe Board Marks Off Ingredients as They Are Used

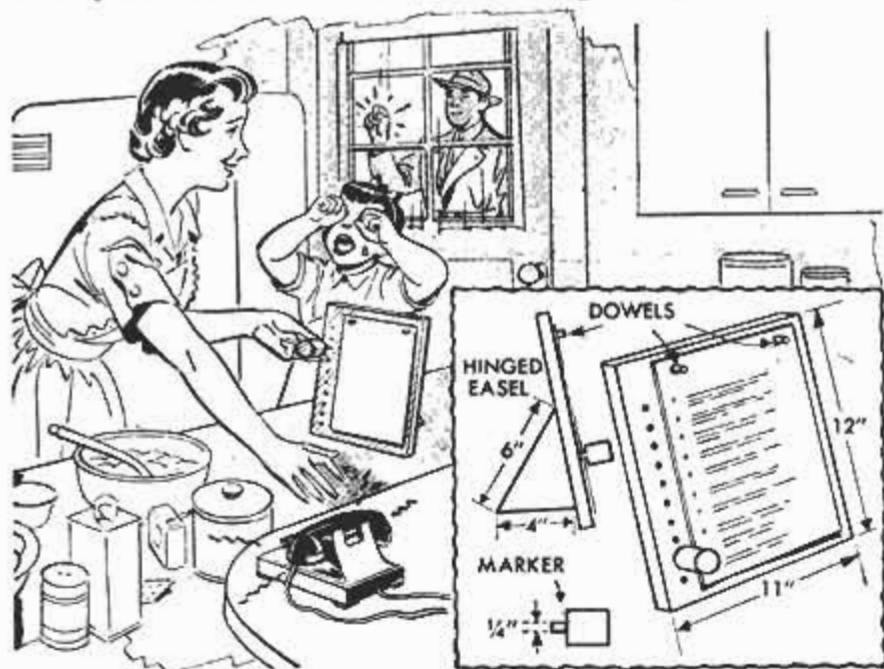

If your attention is diverted or you are called from the kitchen while mixing the ingredients of a recipe, this plywood board will help avoid errors. The recipe is typed or written on punched paper which is then hung from dowel pegs set in the board near the top. The holes along the side for the movable marker are spaced about $\frac{1}{2}$ in. apart. The marker itself is a 1-in. dowel with a $\frac{1}{4}$ -in. dowel set into it, and is moved to check off each ingredient as it is used. —W. S. Head, El Cajon, Calif.

Utility Kitchen Table Fitted With Breadboard

Many older kitchens do not have enough counter space for cutting and preparing of food. This lack can be alleviated by removing the top from a wood or metal utility table and replacing it with a cutting block which is bolted to the table through the original screw holes. From underneath, mark these holes on the bottom of the board, and then drill matching holes through it. Countersink the heads of the bolts in the top surface of the board, and cover them with a wooden plug or wood filler. As an added feature, casters may be installed on the legs to make the table easy to roll about.

Edward L. Fisher, Milwaukee, Wis.

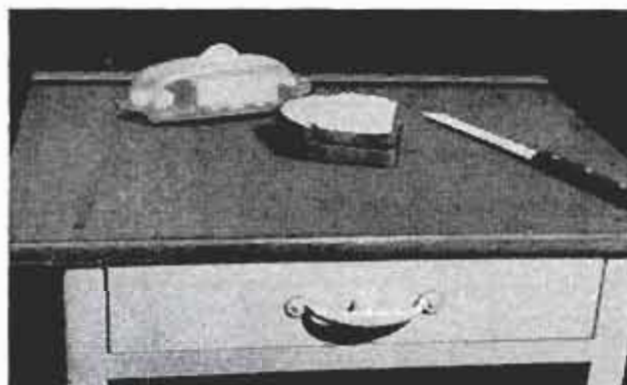

Is Your Plumbing Outmoded?

Increased water demands brought on by the addition of modern automatic appliances frequently tax a dated water system beyond its capacity. What you can do to remedy an overburdened system is explained in an August feature

Coasters From Aluminum Foil

Temporary coasters for drinking glasses can be made from aluminum foil when you are giving a party and need a large number of coasters in a hurry. First, draw a circle on a sheet of aluminum foil 1 in. larger than the bottom diameter of the glass on which it is to be used. Then cut the pattern with pinking shears, center the glass on the aluminum foil and turn up the edges against the sides of the glass. Several coasters can be cut out at the same time.

Blanche Campbell, Los Angeles, Calif.

Paper-Plate Spacers Protect Stacked China Dishes

Paper plates used as spacers between stacked china plates protect the glazed surfaces from scratching and rubbing when removing and replacing them on the shelf. The cushioning effect of the paper plates also eliminates much of the handling noise, and the dishes are easily packed for moving with additional protection provided.



Indian Headdress for Youngster Is Made of Feathers and Tape

Your youngster will have many hours of enjoyment wearing an Indian headdress like the one shown. In fact, he can easily assemble the headpiece himself with masking tape and colored feathers. First, cut a piece of tape slightly longer than the circumference of the head and place it, gummed side up, on a table. Then stick the quill ends of the feathers onto the adhesive, cover them with another piece of tape, and tape the assembly together in a circle. Attach feathers to a short piece of tape for a tail.—K. Greif, Vestal, N. Y.



Renovating Old Books, and New Ones Worn From Extensive Use

Books that have become damaged can be restored with a few simple repairs and little effort. All torn pages should be patched with cellulose library tape. Single loose pages should be trimmed and pasted to an adjacent page. If a group of pages is loose sew them together and stitch them to the binding. Several strips of adhesive tape placed across the back will tie a loose binding together. Extend the ends of the tape out $\frac{3}{4}$ in. and stick it to the covers. Flaking glue on the binding should be removed and a fresh coat applied. Replace worn and torn cover material with a sheet of plastic, extending it around the edge of the covers

and gluing it on the inside. The title from the original covering can be glued to the plastic or fitted into an opening from the back side of the plastic. Loose front and back covers are secured by pasting a 1-in. strip of typing paper between the cover and the first flyleaf as a "hinge." Stiff cardboard attached with adhesive tape, and covered with plastic can be substituted for missing covers. Clothespins are used to hold the plastic in place until the glue dries. By using two or more colors of plastic as a code, volumes are identified quickly.

Zoe A. Tilghman, Oklahoma City, Okla.

Clipper Rounds Tag Corners

A pocket nail clipper is a handy tool for rounding the corners of cardboard tags and other pieces of thin nonmetallic material to prevent curling of corners and improve their appearance. The clipper can also be used for cutting identifying notches in tags or file cards as a means of coding them for future reference.

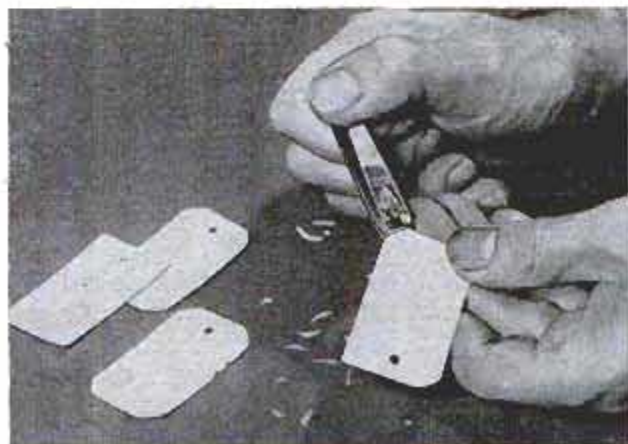

Graphite Grease Protects Standpipe Threads

A small amount of graphite grease applied to the threads of a standpipe used in a basement floor drain or swimming pool will prevent it from "freezing" in the coupling and protect both members from corrosion. When it is necessary to unscrew the standpipe the lubricated threads will permit its removal with less effort.

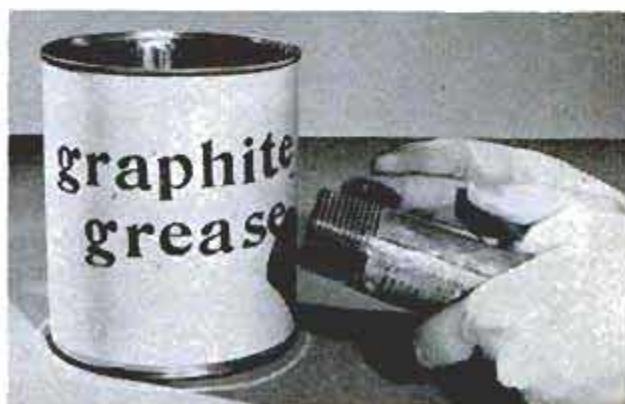

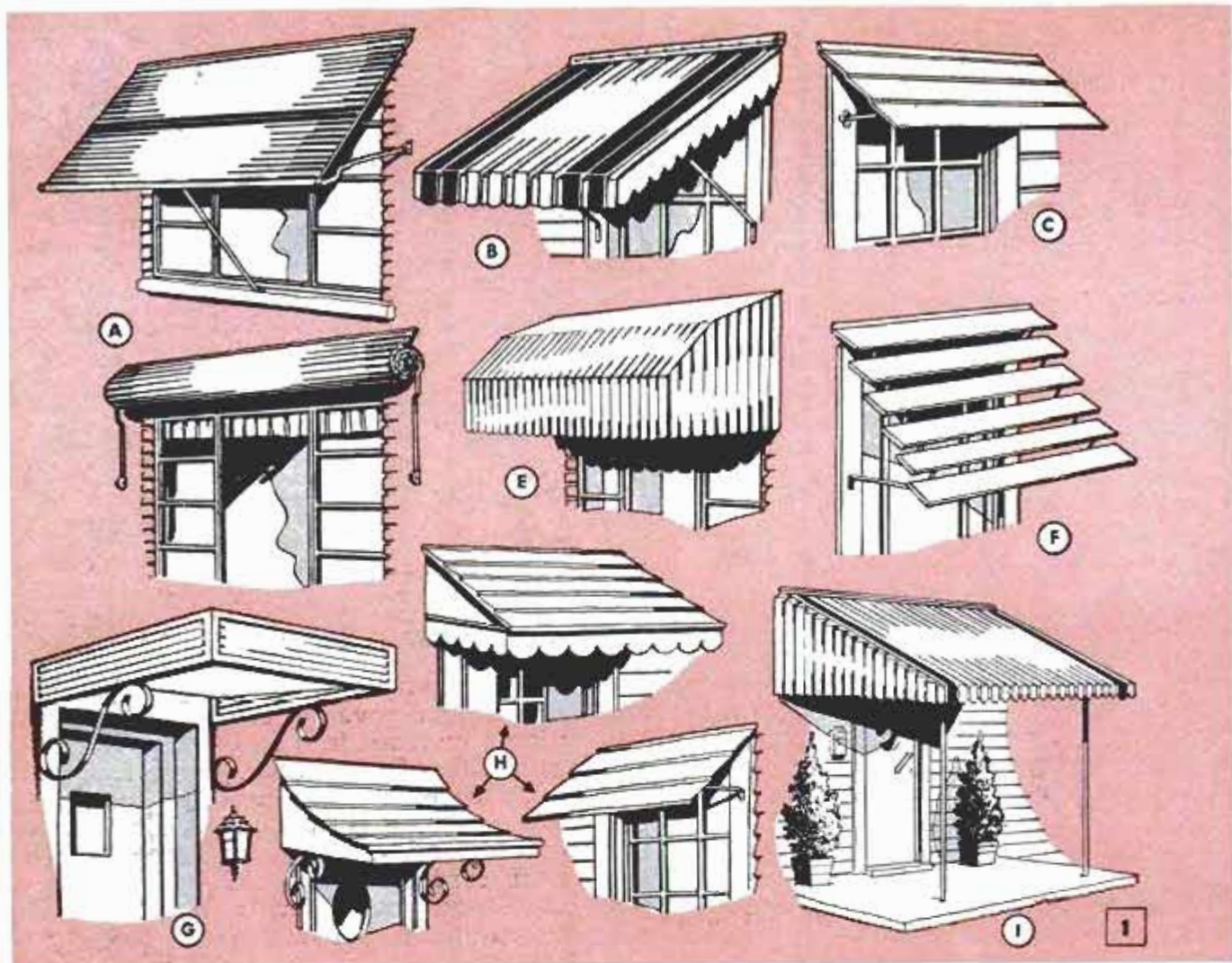

Childers Mfg. Co. photo



SELECTING THE

By E. R. Haan

ALTHOUGH the main function of window awnings and door canopies is to provide shade and protection against rain and sleet, their design should harmonize with the style of a house. Other important considerations in selecting awnings are: The kind of windows that must be covered, how much shade and rain protection is necessary and how much light and visibility can be sacrificed. Durable, rigid materials now extensively used for the newest types of permanent awnings and canopies include prefinished sheet metal, such as aluminum, and translucent glass fiber which is available in many colors.

Awning Styles

Awnings of the kind shown in detail A, Fig. 1, consist of interlocking, pivoting aluminum slats that allow the awnings to be rolled up out of the way when desired. These awnings need not be removed and stored for the winter months. Detail B

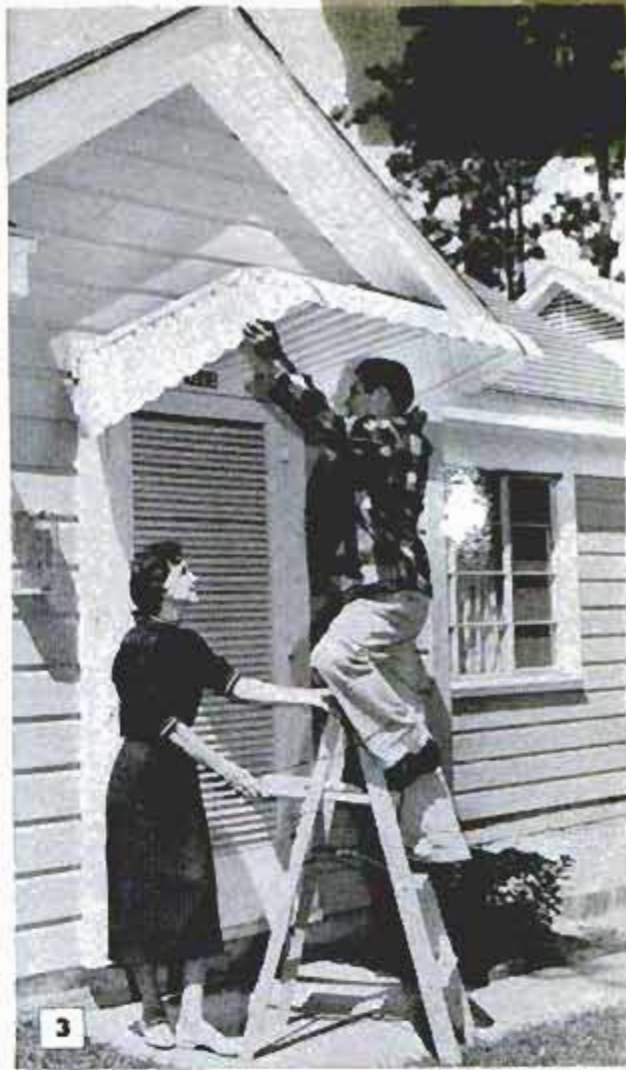
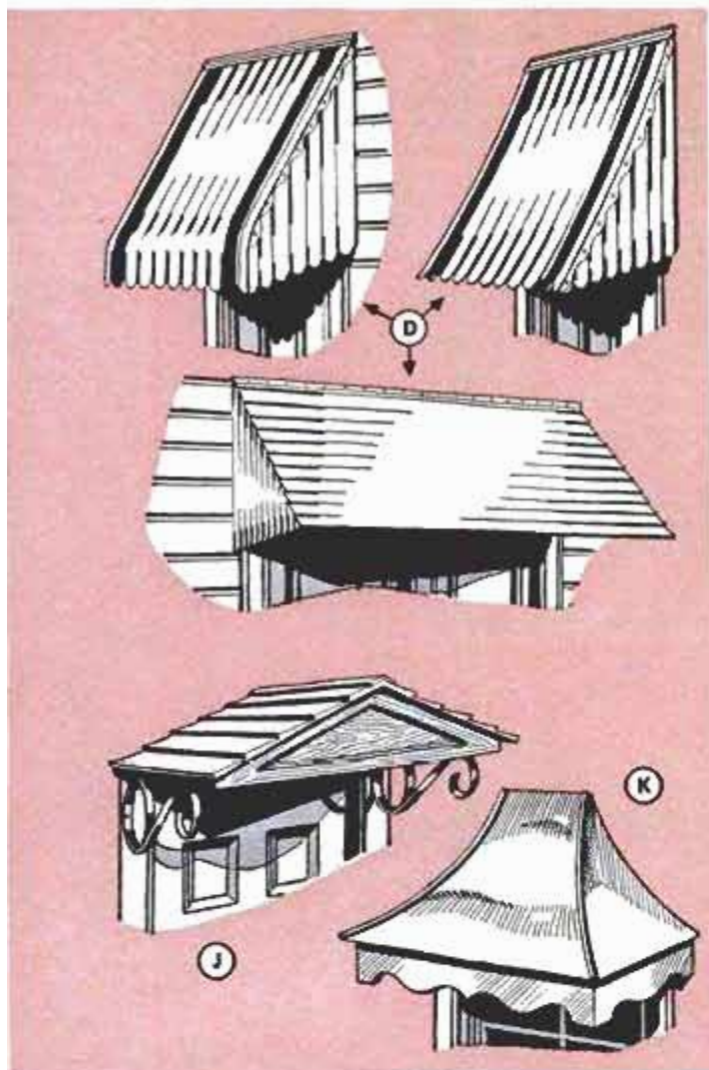

Childers Mfg. Co. photo

RIGHT AWNING OR CANOPY

shows a rigid, sheet-metal awning that can be installed at practically any angle and is therefore convenient for use over casement windows as well as double-hung windows. Small, light-saver awnings, detail C, consist of metal or glass-fiber panels arranged at an angle over a window and held in place by means of small brackets and metal rods. Their particular advantage is that they provide some shade and protection against rain with a minimum sacrifice of light and visibility. Detail D shows three styles of awnings that have enclosed sides. The two having curved tops are made of aluminum, while the third has a straight top and is made of glass fiber. Awnings that have enclosed sides should be provided with adequate means of ventilation to prevent the formation of hot-air pockets and permit better circulation of air through the top of an opened window. A style of awning having enclosed sides, and a top that fits closely over a casement window, is shown in detail E. The awning shown in detail F has wide slats which are separated

to provide more visibility and ventilation.

Types of Door Canopies

Door canopies not only provide shelter, but also help protect doors against rain. Appropriate for many ranch houses, the canopy in detail G has aluminum sides and front and a roof of glass fiber. While this canopy appears to have a flat roof, it actually fits between the sides, and slopes at a slight angle to shed water. Holes in the front corners of the roof permit the water to drain.

Detail H shows three simple canopies that have sloping roofs. These may consist simply of a small inclined panel with open sides and no front apron. If there are sides and front, these may be plain, scalloped or otherwise shaped. The roof may consist of metal slats arranged horizontally or vertically, or it may consist of a single piece of covering material.

Detail I shows a larger canopy that serves to cover the entire stoop or small porch at an entrance. Because of its size and weight,

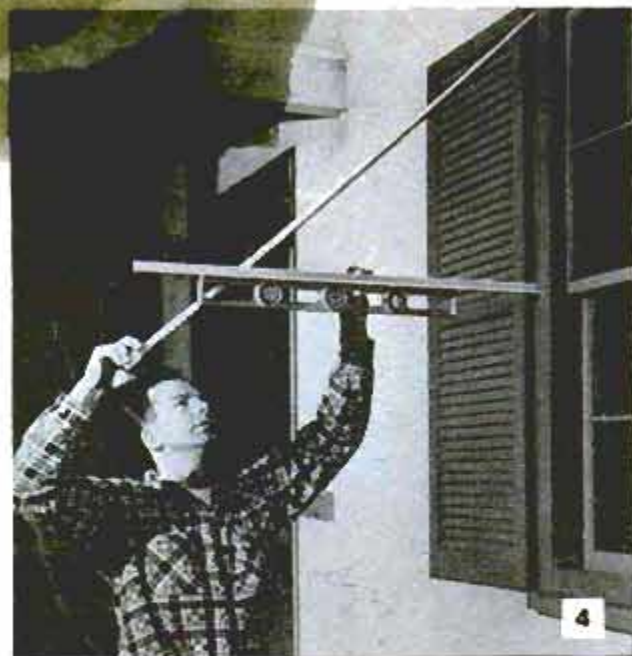

it requires supporting columns. Other styles of canopies are the gable-roof type, detail J, and the hip-roof type, detail K. Prefabricated canopies in various sizes such as the one in Fig. 2, come in kit form, enabling homeowners to assemble and install them quickly and easily as shown in Fig. 3.

Glass Fiber for Awnings

Glass-fiber panels have numerous advantages for awnings. The material is translucent, extremely durable, comes in many colors and is available in various forms, such as plain, corrugated or step-shape to simulate a shingle roof. It can be sawed, drilled and otherwise worked with hand or machine tools. Awnings with enclosed sides can be made of this material and a frame of aluminum angle, as shown in Figs. 4 to 9.

Making Glass-Fiber Awnings

As shown in Fig. 4, awning dimensions are determined by supporting a straight-edge and level outward from the vertical center of the window, while a rule is held diagonally from the top of the window to a predetermined mark on the straightedge. The awning should project from the wall a distance equal to one half the window height. Add 2 in. to the length of the top panel for a 1/2-in. overhang at the top and a 1 1/2-in. overhang at the bottom.

Frame pieces detailed in Fig. 8 are cut from 1/8 x 3/4 x 3/4-in. angle. To bend the stock, it is necessary to notch one side as detailed in Fig. 10. Bending often can be done by hand as shown in Fig. 5, the metal being held firmly with a screwdriver or other tool.

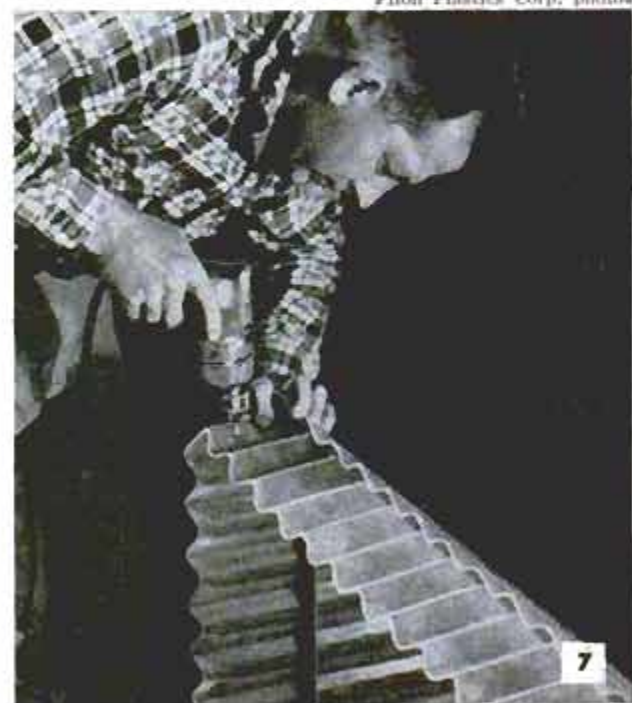
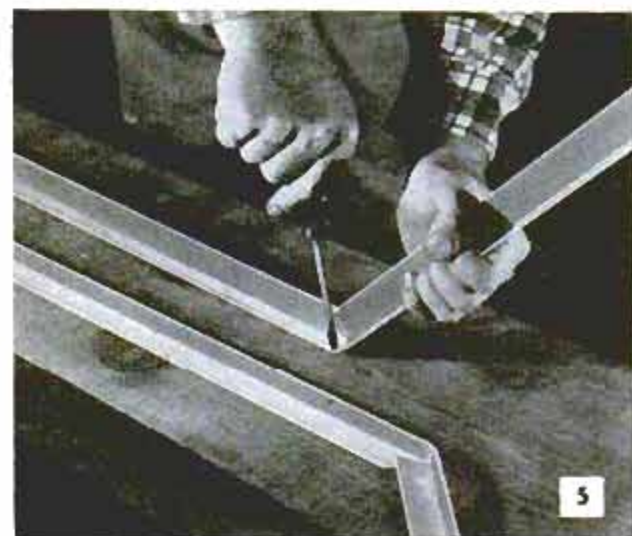

Filon Plastics Corp. photos

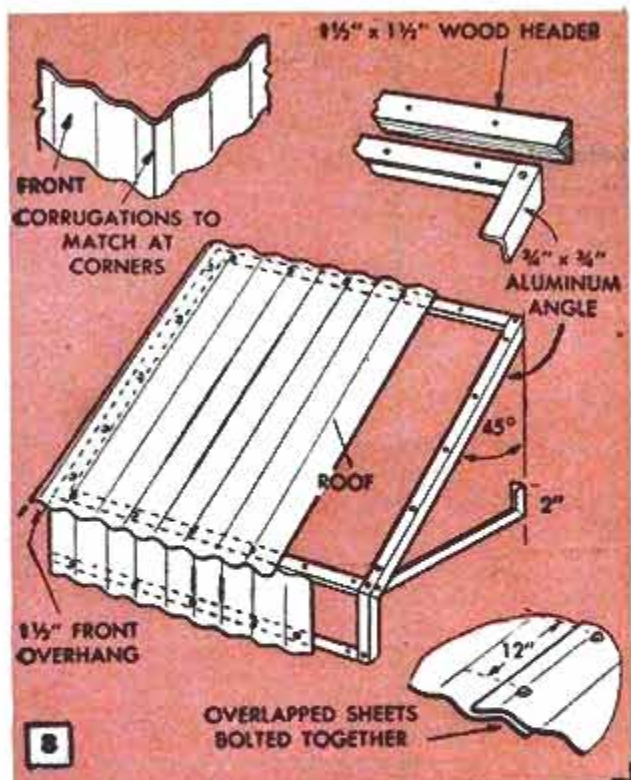

Fig. 6 shows the roof panel being assembled on the frame pieces. Assemble the frame with 8-32 aluminum machine screws, $\frac{1}{2}$ in. long. Fasten the glass fiber to the frame with No. 8 self-tapping metal screws $\frac{5}{8}$ in. long, after drilling $\frac{1}{8}$ -in. pilot holes about 6 in. apart.

Next, attach the side frame pieces and cut the glass-fiber sides to extend 5 in. below them. Then cut the front apron 5 in. wide, cutting it so that the end corrugations of this piece and the side pieces match. Then drill holes as shown in Fig. 7, and fasten.

Note from the detail in Fig. 8 that a wood header strip having a triangular cross section is screwed to the top of the window frame, and that the awning frame is fastened to the wood strip with screws driven through both the glass fiber and the frame as in Fig. 9. For awnings wider than the width of glass-fiber panels, two panels are overlapped and bolted together as detailed in Fig. 8.

Simplified Awnings

Practical for both casement and double-hung windows, the awning shown in Fig. 10 consists simply of a glass-fiber panel on a frame of aluminum angle. The awning is located a sufficient distance above casement window frames, at a suitable angle, to avoid interference with opening the windows. The braces are aluminum rods pivoted to U-shaped brackets screwed to the house. The rods pass through both frame and glass fiber and are topped by decorative arrowheads, which can be cut



Filon Plastics Corp. photo

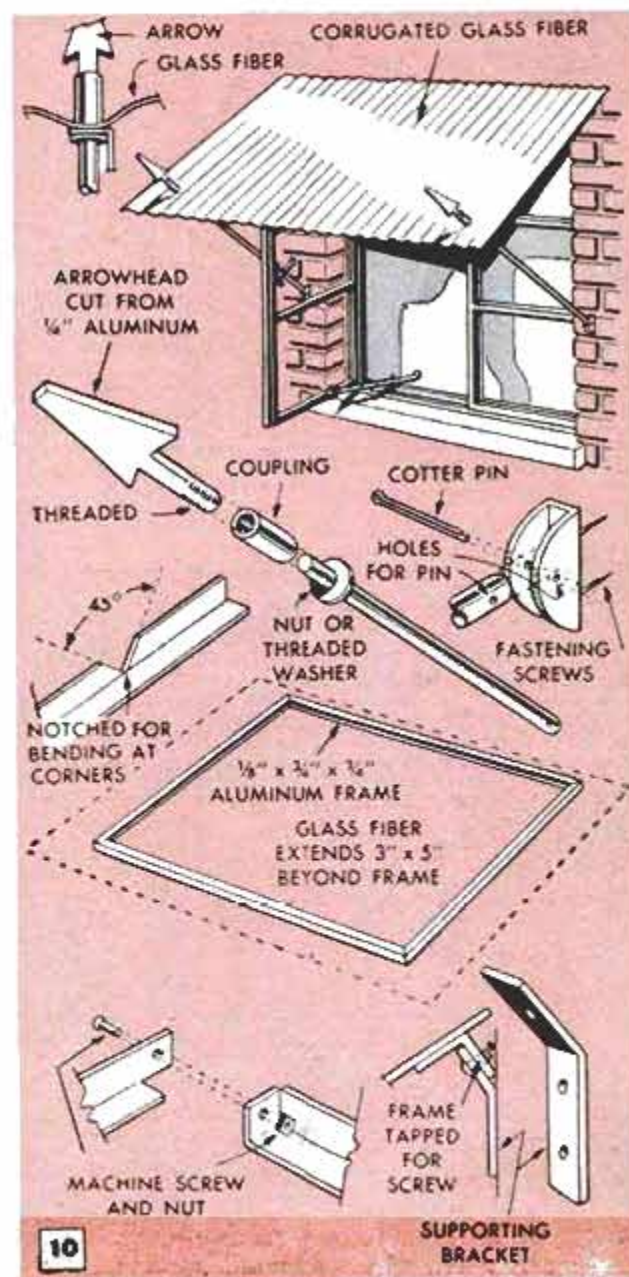

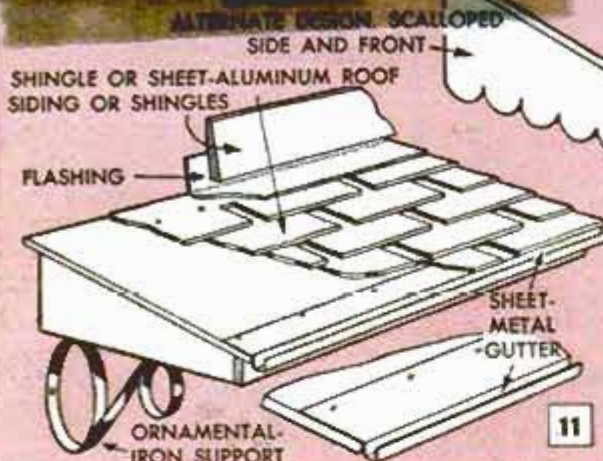
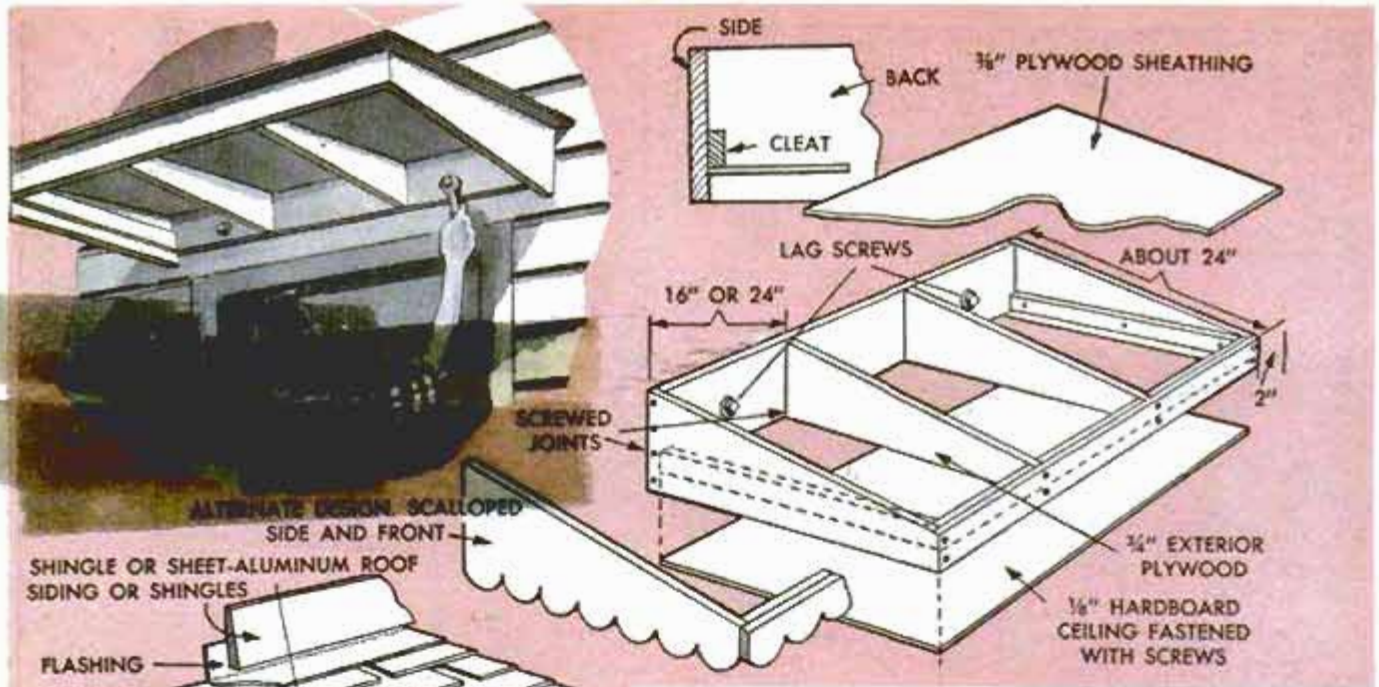

from 1/4-in. sheet aluminum or purchased. Figs. 11 to 14 detail four door canopies made from stock materials. Exterior-type plywood may be used for framework and sheathing. For the roof you can use ordinary shingles matching those of the house roof, or tempered hardboard, sheet aluminum or glass fiber. Lag screws are used for fastening to the house wall. If possible, the screws should be driven through wall sheathing into studs. On brick walls, expanding sleeves are used to receive the screws.

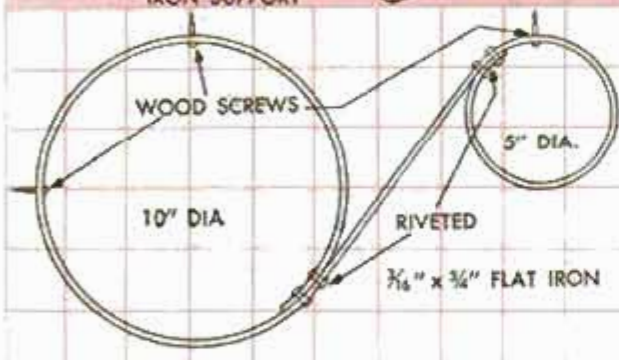

Canopies detailed in Figs. 11, 12 and 14 have wood and plywood frames and ceilings of tempered hardboard. The latter are screwed to the frame after the canopy has been fastened to the wall. The outer fascia pieces of the sides and front extend below the frame pieces and thus conceal the edges of the ceiling.

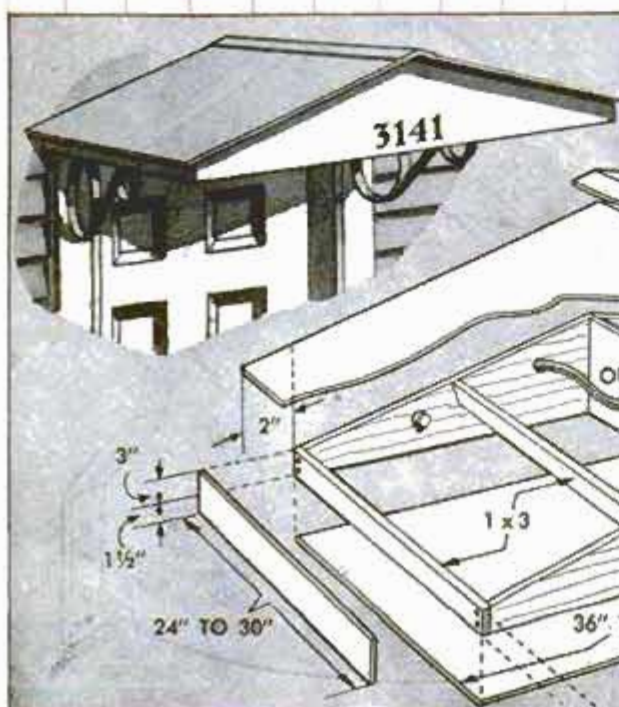

The canopy shown in Fig. 13 consists of aluminum and glass fiber. Front and side

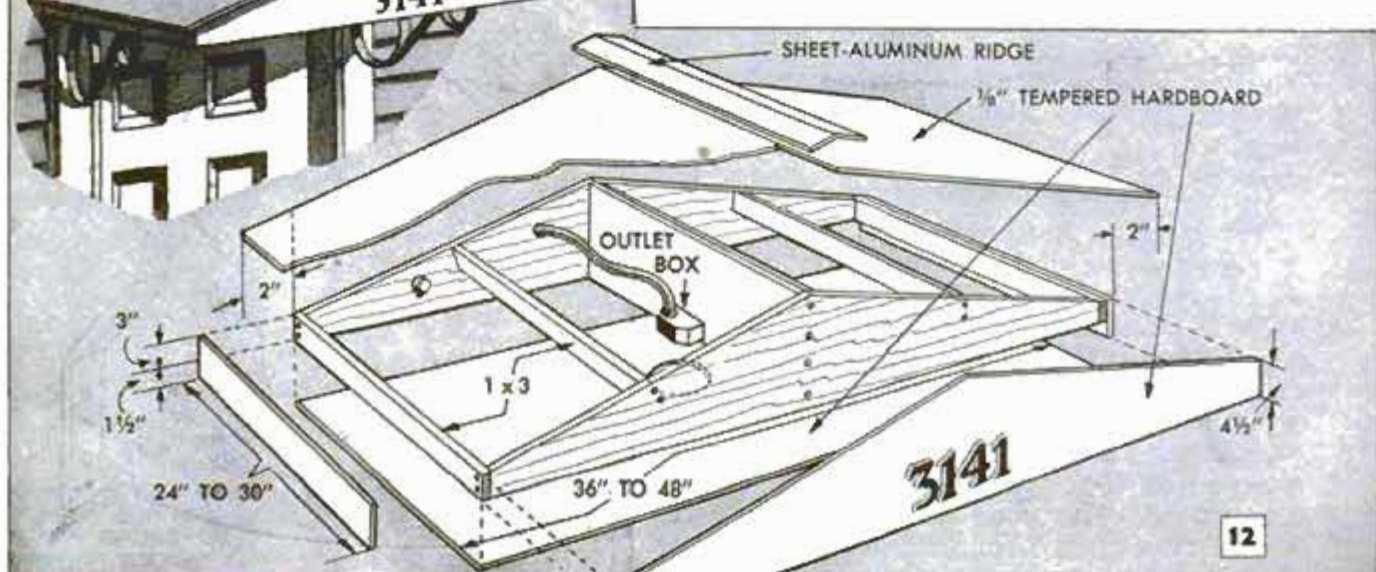

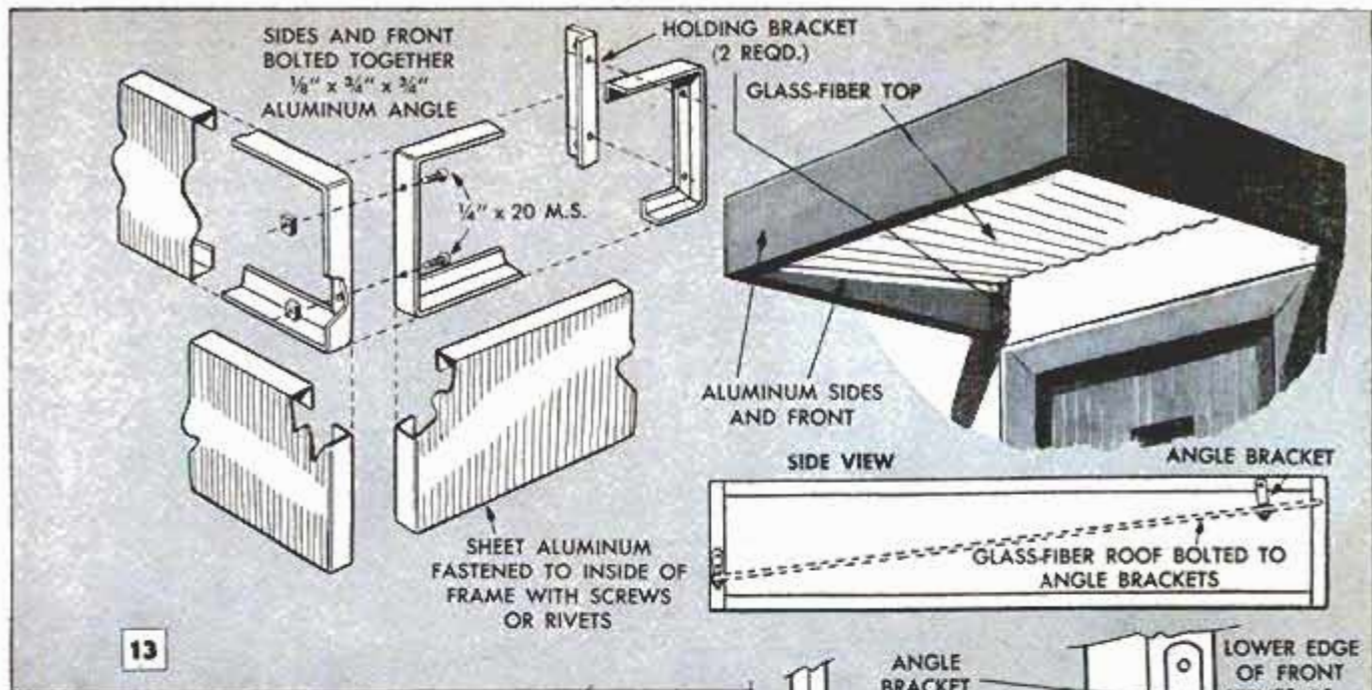

frames are of aluminum angle covered with sheet aluminum which are bent and attached by means of rivets or self-tapping screws. The front and side panels are bolted together as shown. Angle brackets are bolted to the side frames and to the glass-fiber roof so the latter will be inclined to drain water into the front panel which has drain holes in the ends. A canopy of this type, not larger than 36 in. square, can be mounted with heavy angle brackets as shown.

Considerable care is required in making the roof of the canopy detailed in Fig. 14. First, cut the back panel and mount it on a temporary base. Then, to get the rafters cut to the correct curve, place them in position and run parallel lines from the back panel to the rafter. Vertical lines on the panel are projected on the rafter to plot a curve which then can be sawed with a bandsaw. The roof consists of three pieces of copper, steel or hardboard. ★ ★ ★

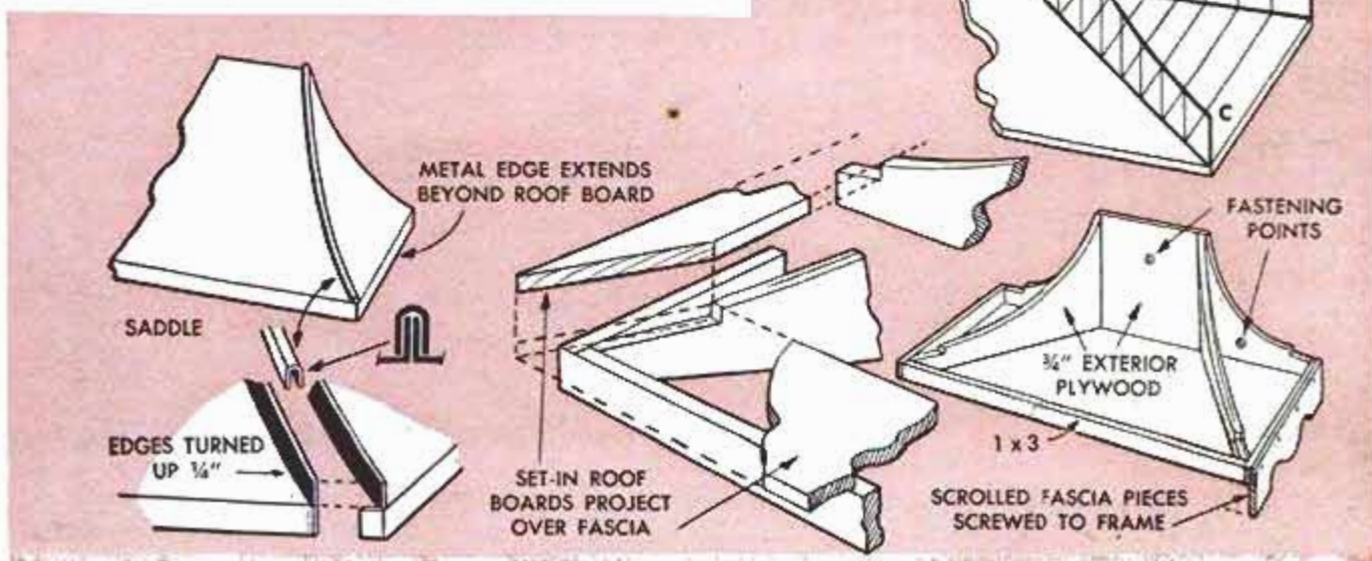
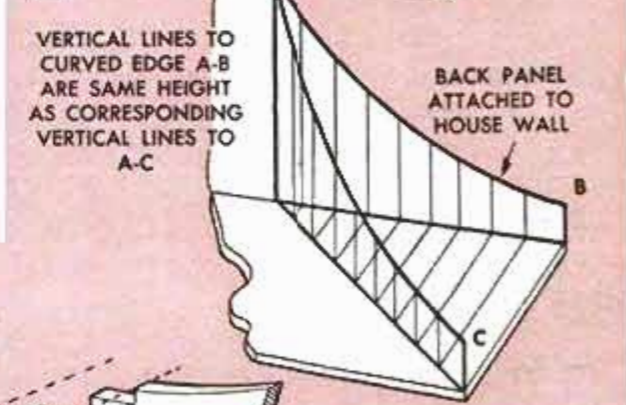
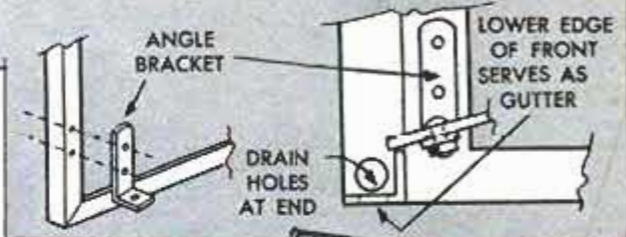

Sandbag Plugs Drain While Repairing Lines

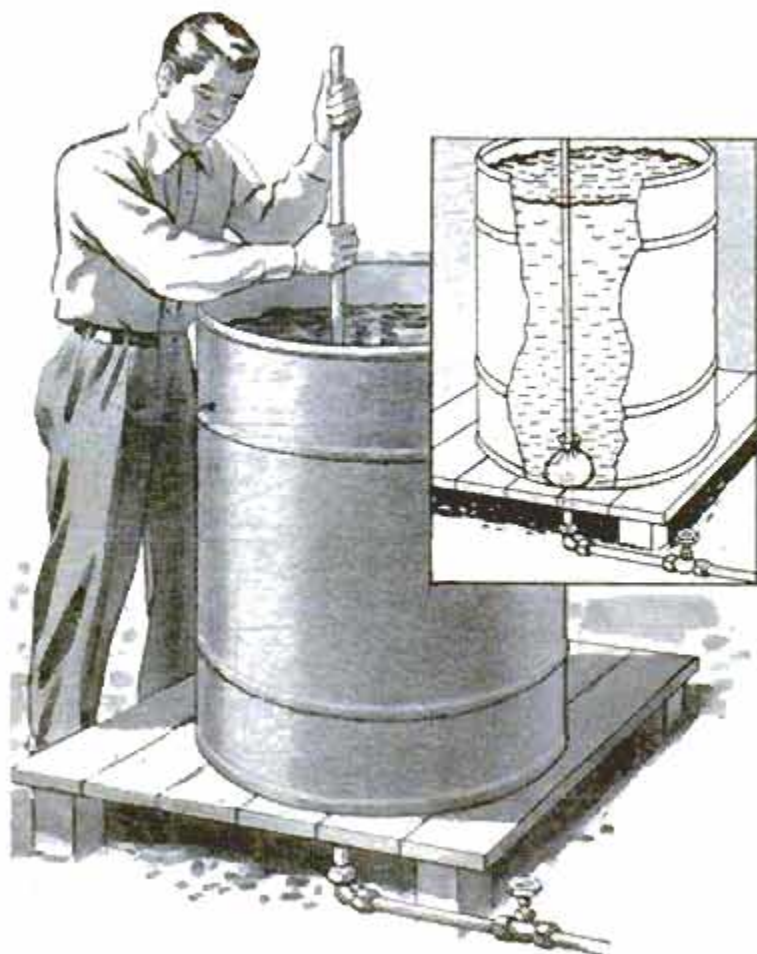

Repairs can be made to the distribution lines of a surface tank, including the removal of the main shutoff valve, while the tank is full, by plugging the drain with a small sandbag. To do so, partly fill a strong sugar bag with sand, tie it firmly to the end of a long pole, and lower it into the tank, pressing it against the drain opening. When the distribution line is dismantled at any point to replace the damaged part, suction of the liquid in the line will draw the sandbag into the drain, forming a seal. When repairs are finished the plug can be pulled out by means of the pole attached to it.—L. M. Geddes, Murwillumbah, N.S.W., Australia.

Jointer Shaves Leather

Leather strapping can be shaved to a required width or thickness, when tacked to the ends of a board and passed over the blades of a jointer. If a jointer is not available, mount the board in a vise and shave the material with a hand plane.

L. H. Weber, Havana, Ill.

Do-It-Yourself MATERIALS GUIDE for the Homeowner and Handyman

Cross Indexed for Easy Use

If you've ever walked into a hardware store without knowing exactly what you need (and walked out without being sure of what you'd bought), you'll want a copy of this new guide that lists *all* the specifications for *all* Do-It-Yourself materials. With this book, you'll know exactly what to look for, and how to save money when you buy.

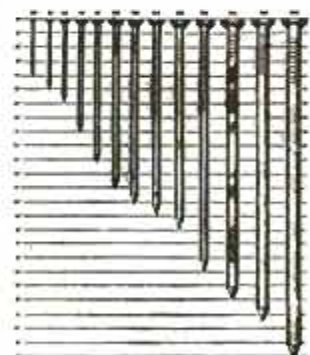

Need to know how long a 50d (penny) nail is? In the Do-It-Yourself Materials Guide, charts like the one at the left (4½ times larger in the book) will show you it's 5¾ inches.

The chart at the right, of common wood-screw sizes and gauges, is typical of the dozens of illustrations (all much larger) in the book. Now you'll know how to choose and where to use building and hobby materials.



A Key to Buying and Using:

Adhesives	Fuses	Plumbing
Bolts	Glass	Plywood
Bricks	Hinges	Roofing
Conduit	Locks	Siding
Doors	Millwork	Tile
Glass fiber	Paint	Wiring

... Plus 31 other basic products. For only \$2.95 you can get this 160-page guide that will *save you time and money every time you buy supplies*. So send your order today to:

POPULAR MECHANICS PRESS, 200 East Ontario Street, Chicago 11, Illinois

SHOP NOTES

A LIGHTWEIGHT GARAGE DOOR

ARE YOU PLANNING to replace the heavy, hinged frame doors on your garage? Then why not build a lightweight overhead door using corrugated-aluminum sheets for facing? Square and plumb the opening before starting the installation of the door. Referring to the detail below, assemble the door to fit your particular garage. Taper the diagonal braces from full width at the center to the width of the side members at the ends. For ease in handling, the aluminum should not be applied until after the hardware and lifting mechanism have been installed and the door hung in place. The cheapest and simplest lifting mechanism can be fabricated with counterweights attached to the door with chains or ropes, concealing the weights between the studs on one wall of the garage. However, spring balance or power-driven mechanisms can be purchased complete with mounting instructions. The thickness of the wood stock used in the door may have to be increased to accommodate certain mechanisms. As a last step, install weather stripping on the bottom edge of the door and then apply the corrugated sheets, using aluminum nails or screws and overlapping the edges.

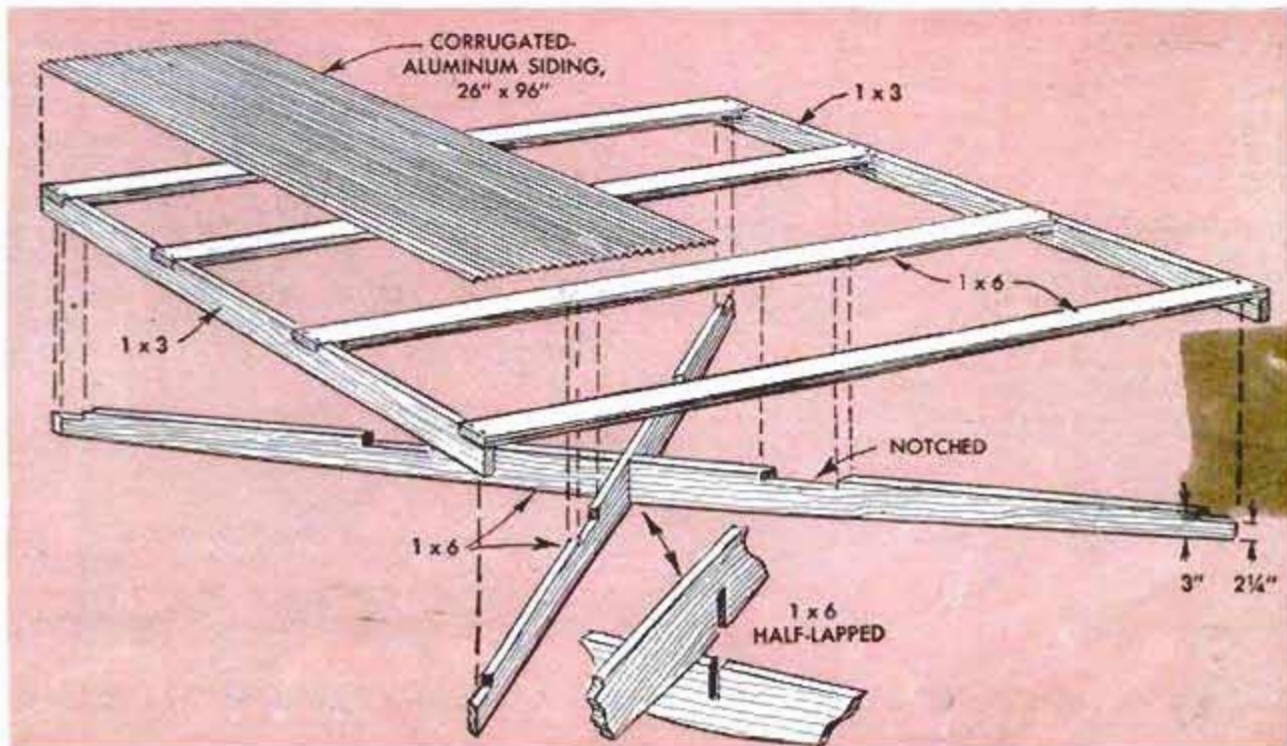

Parts-Storage Bins Installed On Machine-Shed Wall

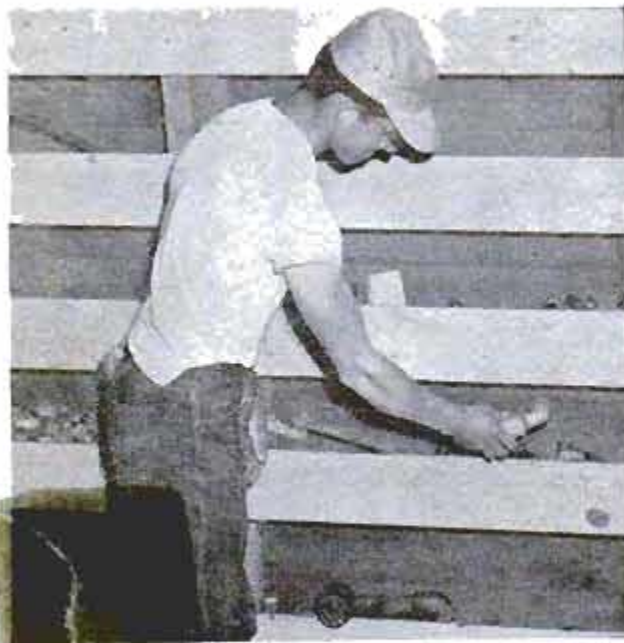

A parts-storage facility such as this one, which was built by an Iowa farmer on one wall of his machine shed, offers convenient storage for the variety of parts and materials needed on a modern farm. Ordinary lumber is nailed between the studs for the bottom member of each bin and 1 x 6-in. lumber is nailed across the studs for the sides as shown. To accommodate small parts, the side member of one horizontal row of bins should be 3 in. high.

Width of Thin Material Measured More Easily When Bent

To measure the width of a strip of thin material, such as photographic film, with a micrometer or caliper bend it to form a loop. A stiffening effect is produced by the bend that prevents the material from yielding under pressure of the measuring instrument, permitting greater accuracy.



Related Parts Stored in Jars

When storing small parts, such as bolts and matching nuts, glass fruit jars joined at their lids are handy, space-saving units. The jars may be of the same size or vary, depending upon the relative sizes and quantities of the parts stored in them. Fasten the lids together by soldering or riveting. Always unscrew the lid first from the jar that is right side up.

Steel Sawhorse Legs Made From Cultivator Wheels

Sections cut from the wheel rims of a horse-drawn cultivator were used by one farmer as legs for sawhorses. The sections are welded in pairs to form an A-shape, with an angle-steel spreader welded between. The top ends of the legs then are heated, bent over and drilled so a 2 x 6 can be bolted to the top ends. Angles are bolted to the underside of the 2 x 6, bent down and welded to the center of the spreader.

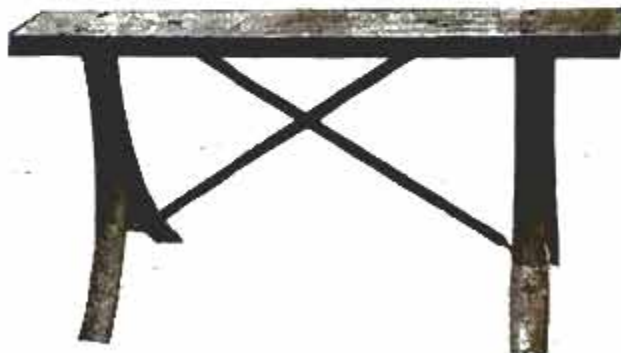

SN 58

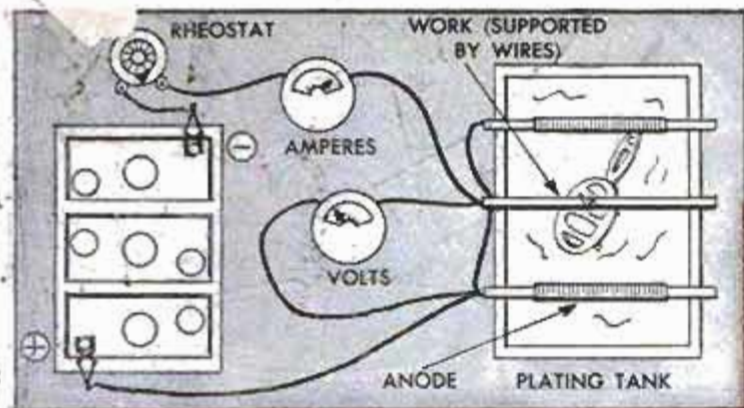

12



Electroplating Without Cyanides

PART II

By J. B. Mullen

A THIN LAYER of zinc, electroplated on aluminum from a special fluoborate solution, provides an adherent coating on top of which other metals can be successfully plated. Ordinary plating solutions cannot be used directly on aluminum because the high chemical activity of this metal causes the plating deposits to be rough and in many cases nonadherent over a portion of the work. On the other hand, if the metal is zinc-plated with a special fluoborate solution, durable and uniform deposits from all standard plating solutions are possible. The fluoborate plating solutions described in Part I of this series

are especially recommended for plating zinc-coated aluminum as their use eliminates the hazards present in other electroplating processes which make use of cyanides. However, it should be remembered that fluoborates, like many other chemicals, are toxic and must be handled and used with reasonable care. This also is especially true of certain of the chemicals which must always be used in the steps preparatory to plating.

Polishing Aluminum

The first step in the preparation of aluminum for plating is especially important

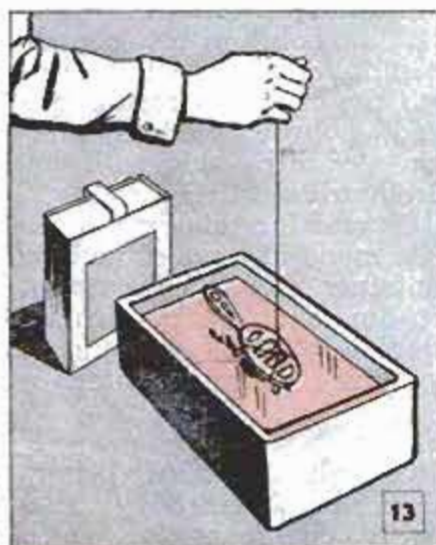

13



14

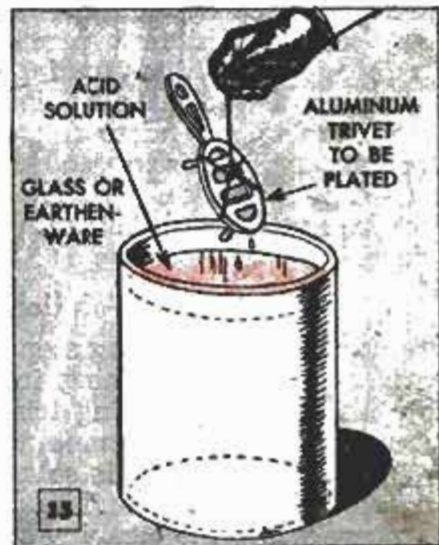

15

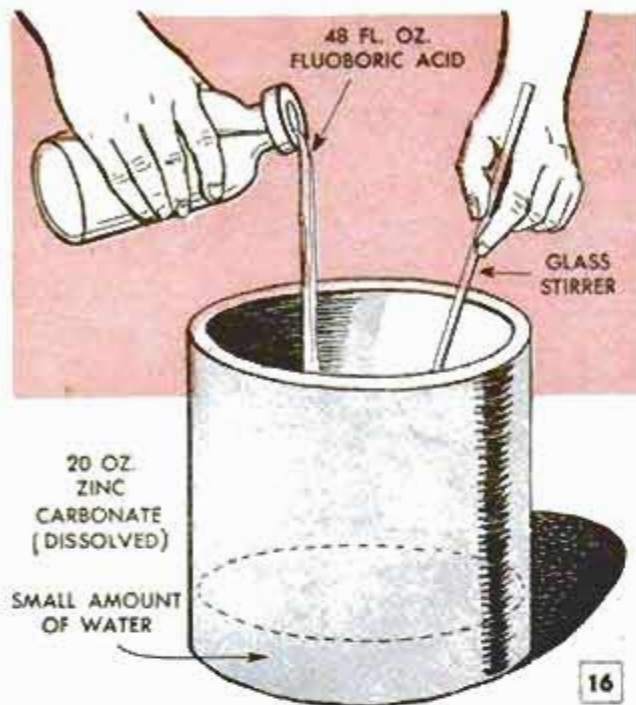

because of the oxide film which forms readily whenever the metal is exposed to the air. Because of this peculiarity, preparations for carrying out the preliminary steps should be made beforehand so that there is no appreciable delay in carrying them through to the zinc-plating stage. Aluminum, either in the form of castings or fabricated sheets, must be buffed and polished to a degree of smoothness equal to that desired in the finished job. This is because the plating will be no smoother than the surface over which it is applied.

Degreasing Aluminum

Immediately after polishing, the metal must be degreased and cleaned. Degreasing can be done by dipping the item in a solvent such as carbon tetrachloride, Fig. 13. This solvent must always be used outdoors as it gives off a toxic vapor which is a definite health hazard in any enclosed area such as a room or basement. Be sure that all grease and buffing compound are removed in this first preparatory step. Castings, such as the aluminum trivet pictured, need special attention as buffing compound may tend to collect on certain portions of the casting and cannot be removed by dipping alone. These areas may require a mild scrubbing with a soft-bristle brush.

Alkaline Solution

Follow the degreasing step immediately with a thorough cleaning in an alkaline solution made by adding trisodium phosphate, 3 oz., and sodium metasilicate, 3 oz., to 1 gal. of water. This solution must be heated to 170 deg. F. and held at that temperature while the cleaning step is carried

out, Fig. 14. Permit the work to remain in the hot solution for 3 to 5 min., then rinse thoroughly in running water. This hot solution is calculated to remove the last traces of grease, compound and any dirt that may have been present at the start of the cleaning process. The alkaline solution also will etch the surface of the metal slightly. You can test the effectiveness of the steps just carried out by examining the bright surfaces after rinsing. If the metal is not clean the water film will break, indicating the presence of traces of grease or compound or other foreign substances. If the metal is chemically clean the water will form a continuous, unbroken film. If the film breaks it is necessary to repeat the cleaning process, first scrubbing the work in a hot detergent solution rather than a solvent and then repeating the alkaline cleaning.

Acid Solution

Hot-alkaline cleaning is followed by an acid dip, Fig. 15, the solution being made by adding two pints of nitric acid to one pint of water. If the part is of cast aluminum, use instead a solution made by mixing three volumes of nitric acid with one volume of hydrofluoric acid. Hydrofluoric acid attacks glass and for this reason the solution must be made in a wax-lined jar or a plastic container. Using either solution, immersion time should range from 2 to 15 sec. Immediately after dipping rinse the work thoroughly in running water.

Zinc-Plating Solution

After the acid dip aluminum is free from the normal oxide film. It must be immediately plated with a coating of zinc, which

prevents further oxidation and serves as a foundation on which copper and other metals can be plated. A zinc-plating solution is made as in Figs. 16 and 17, the solution consisting of fluoboric acid, 48 fl. oz., zinc carbonate, 20 oz., ammonium chloride, 2 oz., and water to make 1 gal. Dissolve the zinc carbonate in the fluoboric acid, adding enough water to control frothing as the reaction proceeds. Then add the ammonium chloride, Fig. 17, and dilute with water to a total volume of 1 gal. Filter the solution.

A representative setup for plating small items is shown in Fig. 12. If nothing else is at hand to serve as a plating tank, an old battery case is just the thing. Clean the interior thoroughly before using. The zinc-plating solution must be heated to about 140 deg. F. in a water bath as in Fig. 18. Hang zinc sheets from the anode (positive) support bars and suspend the work on a wire from the center support bar which is connected to the negative terminal of the battery. No switch is needed in the circuit as current should be on when the work is put in the solution. Plate for about 2 min., adjusting the rheostat to put about $\frac{1}{2}$ v. across the tank. Then remove the work, rinse thoroughly in running water and transfer it immediately to the next plating operation. Avoid drying or handling the work.

Although plating solutions containing

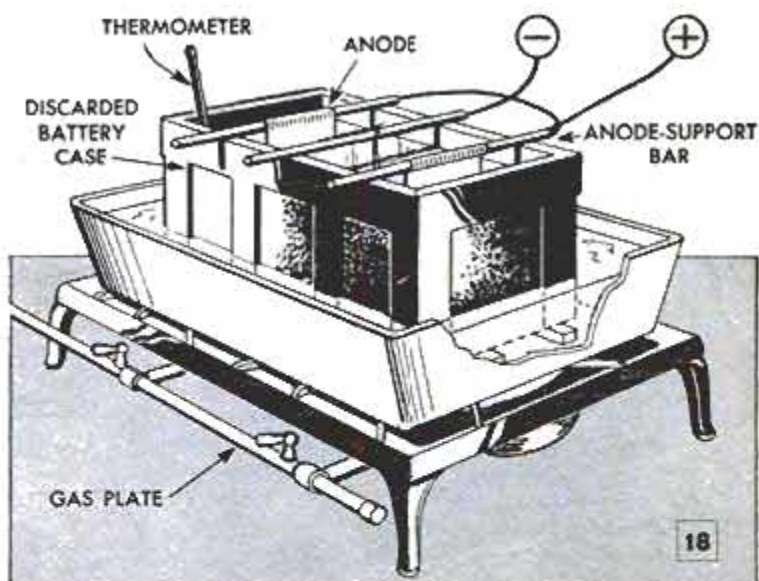

cyanides can be used for plating zinc-coated aluminum, the fluoborate solutions, Part I of this series, are especially effective for plating copper and nickel over zinc. A suggested cycle, or schedule, for a nickel finish calls for a copper strike, 5 min. at $1\frac{1}{2}$ v., copper plate 30 min. at 4 v. and nickel plate, 45 min. at 2 v., using the fluoborate solution. Rinse the work thoroughly after each plating operation to avoid contaminating solutions, one with another. The nickel surface can be buffed to a high polish, using a lime buffing compound, and then chromium-plated or lacquered. If a copper finish is desired, omit the nickel plate, polish to the desired luster and then lacquer. ★★★

Extending Length of T-Bolts to Clamp Large Work to Table

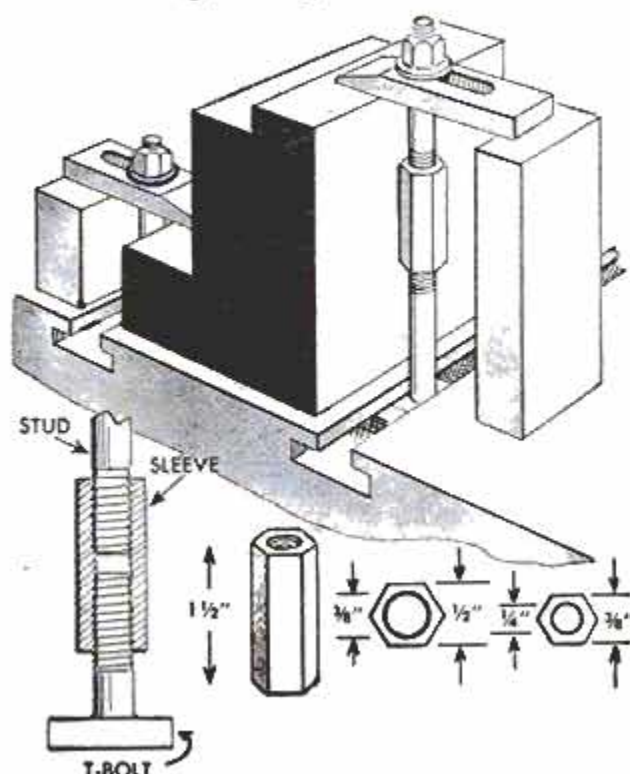

T-bolts that are too short to clamp large work to the table can be extended to any required length by means of a hexagonal coupling and stud bolt of the same diameter and thread. The extension studs can be made up in various lengths. The extension couplings are cut from hexagonal steel rod which is drilled lengthwise and tapped to receive the T-bolt and stud in opposite ends.—C. W. Woodson, Chicago.

Tool for Valve Core Removal

A handy tool for removing inner-tube valve cores can be made from an old screwdriver with $\frac{1}{64}$ -in.-dia. shank. Cut off the blade and saw a slot across the end as shown.—H. Neustadt, New York City.

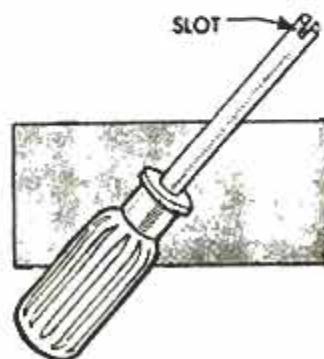

Handy Wooden Miter Box for Use on Sawhorse

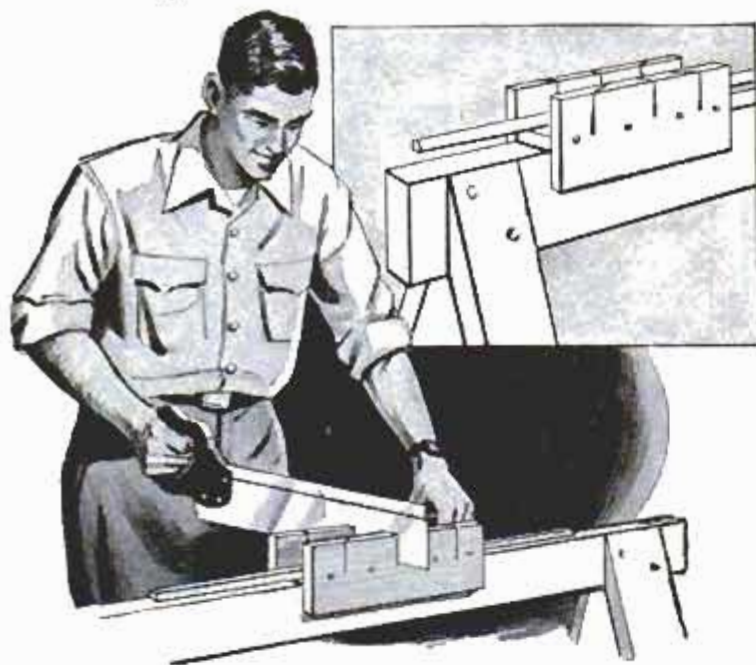

A wooden miter box for use when sawing quarter round and small moldings can be constructed from three pieces of scrap lumber in a few minutes. The box is designed to fit snugly over a sawhorse, which supports it at a convenient height and provides for good portability of the unit.

Screws Seal Punctured Can

After puncturing a can to pour out part of the contents, plug the holes with sheet-metal screws. Better than wooden plugs, scraps of cloth or paper, the screws prevent evaporation, eliminate pollution and look much neater.

C. H. Hardy, Whittier, Calif.

Fluted Milk-Bottle Covers are Handy Art-Color Pans

Milk-bottle caps which are crimped and waxed are ideal color pans when doing artwork. Samples of paints may also be mixed in the caps and applied to a test panel to determine the color best suited for a particular job. The caps can be discarded after each project, or filed away for future refer-

ence and thus become especially valuable in matching a particular color previously used. They take less space to store than conventional metal pans since they are wafer thin and can be stacked one inside the other.—George R. Karsten, Grand Rapids, Mich.

Corrugated Cardboard Strip Makes Simple Crayon Holder

To keep a child's crayons from rolling and getting underfoot place them on a strip of corrugated cardboard. The indentations keep the crayons in orderly arrangement and protect them from damage.



Pivoted Stop on Drawer Back Automatically Kept Vertical

To prevent a drawer from being pulled out too far, install a simple stop of the kind shown. It is a piece of hardwood pivoted to the back of the drawer with a wood screw. Because the part of the stop that is below the pivot—about $\frac{3}{4}$ of the length—is heavier than the part above the pivot, the stop automatically is kept in a vertical position. A sheet-metal guard may be installed over the stop to keep it from being pushed out of position by items in the drawer. The drawer is removed simply by turning the stop to a horizontal position with one finger.

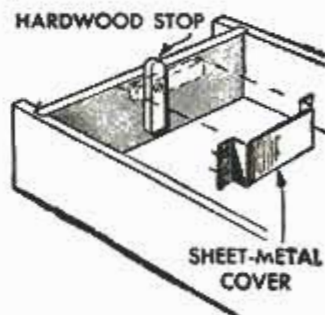

☐ The bowling-ball bag can double as a carrying case for a press-type camera, flash gun and other photographic equipment. Available in inexpensive canvas or fine leather, it is designed to carry a heavy weight.

SN 58

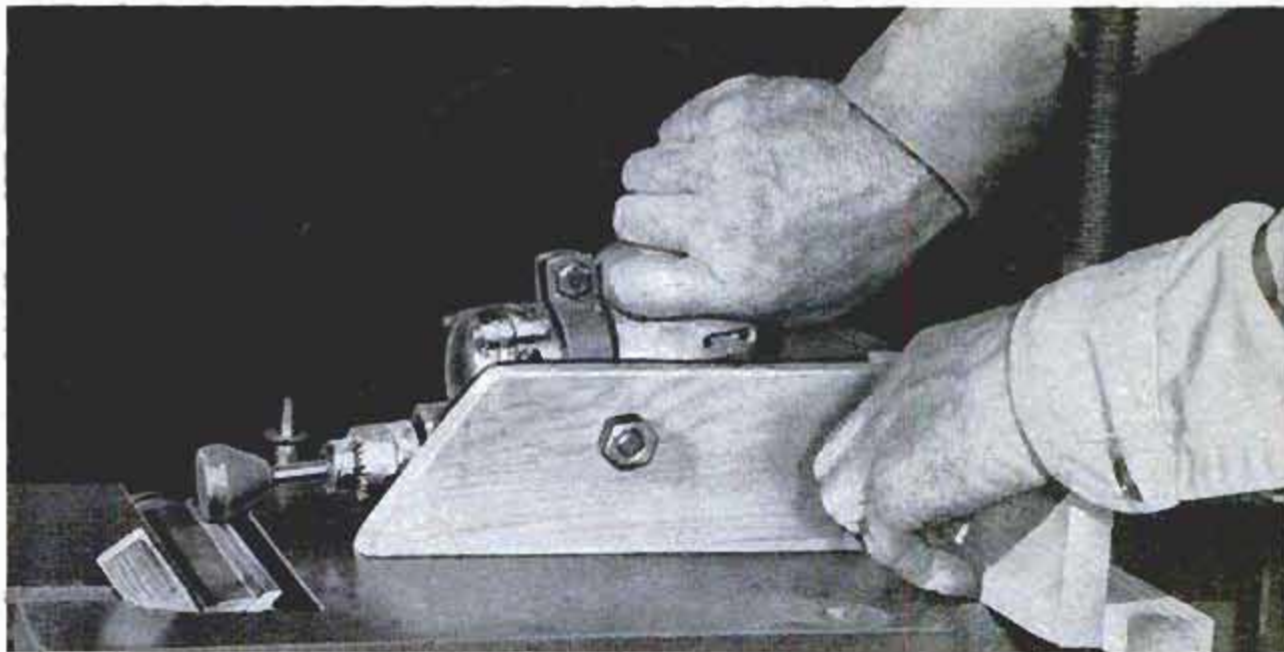

Setup To Grind JOINTER KNIVES

TO AVOID the difficulty of adjusting jointer knives uniformly after sharpening them, try grinding them right in the machine. A grinding wheel of the shape indicated chucked in an electric drill will do the job if the drill is clamped in a jig to slide on the jointer table. In use, position the knife and grinding wheel so their beveled surfaces are at identical angles. Lock the drill and cutterhead in these positions, using a wooden wedge to lock the head. Then clamp a guide across the table for a fence to position the sliding jig. Measuring the space between the knife edge and the table will permit identical positioning of each knife and assure grinding the blades at the proper angle.

Jim Reilly, South Fork, Colo.

Above, when grinding jointer knives with this jig, be sure cutterhead is held securely with wedge

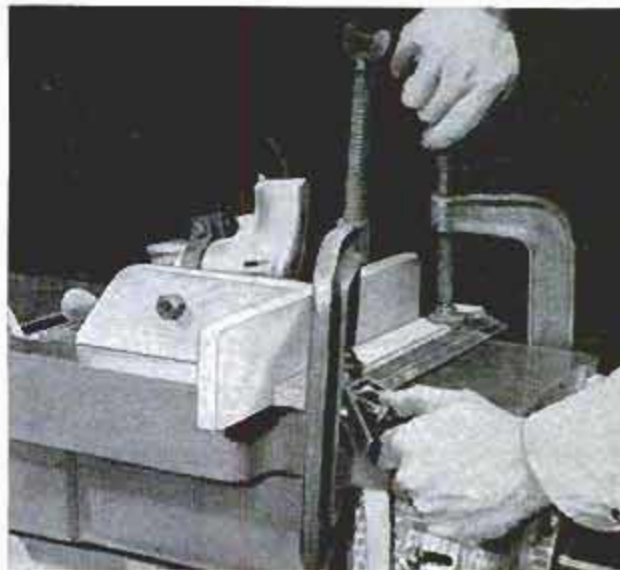

Above, clamp fence across table to position sliding jig. Below, distance between edge of knife and edge of table is measured carefully so that each blade can be advanced to same position before grinding it

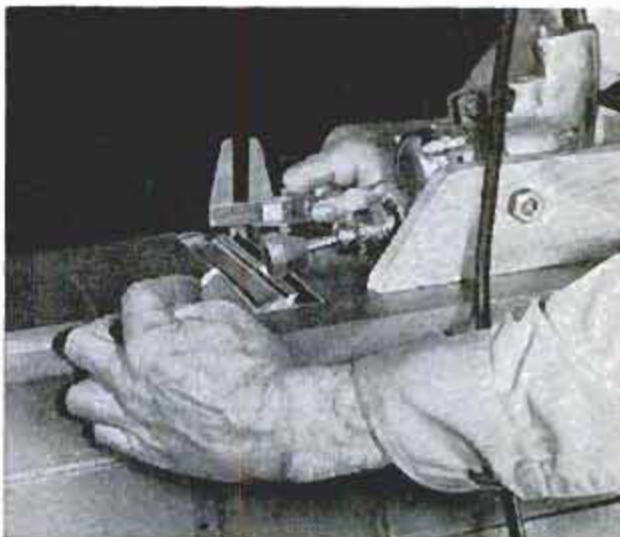
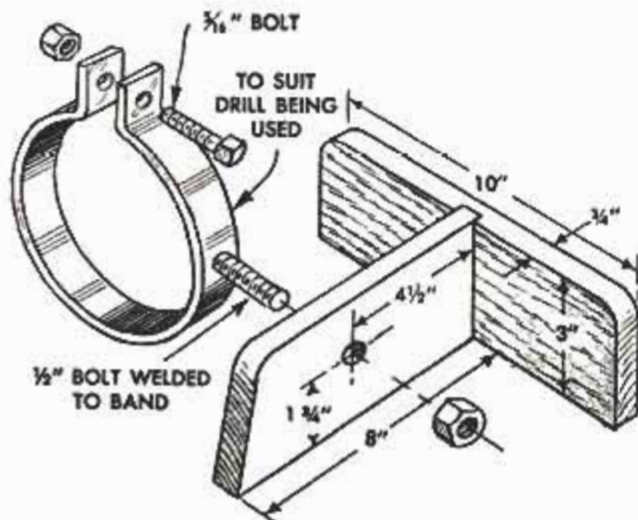

Grooved Plate on Bandsaw Table Prevents Marring of Work



Bandsaw tables in a large aircraft manufacturing plant have been covered with a grooved-metal work surface. Chips and waste particles of metal fall into the indentations in the top plate where they have less chance to mar the material being cut

Steel Plate Welded to Hinge Prevents Screws Loosening

To prevent the screws from pulling out of the hinges on a heavy barn door, one farmer welded a triangular-shaped piece of 1/4-in. steel plate to the edge of each hinge and bolted it to the door with carriage bolts. The plate is welded at right angles on one flange of each hinge and drilled to accept the bolts which absorb most of the weight of the door sideways, since they run into the door from the side rather than the edge.

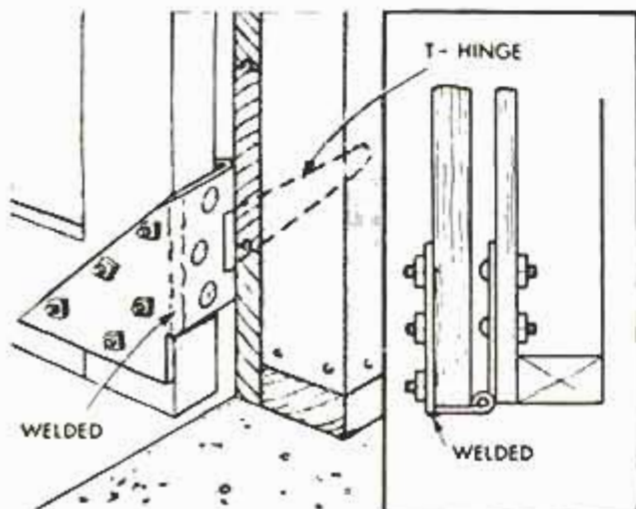

Oil Drum and Spreader Wheel Make Self-Feeder for Hogs

This sturdy 50-gal. capacity self-feeder cannot be upset by large hogs and is ideal for use on concrete floors. It is built from an oil barrel with both ends removed and set on a base made from a manure-spreader wheel. Alternating spokes are cut free at the hub and bent up, where they are welded to an iron tire two feet in diameter. The lower spokes and hub are covered by a cone of concrete 12 in. high in the center and 18 in. in diameter, which allows room for feed to slide out as it is eaten. The barrel can be easily removed when it is necessary to clean it or move the self-feeder.

Tailstock Faceplate Adapter

This simple attachment, shown in the detail, will allow a lathe faceplate to be used as a drill pad when mounted in the tailstock spindle.

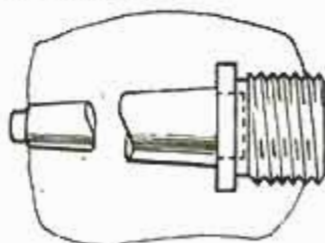

It will also serve to mount the 4-jaw chuck in the tailstock when larger work must be held in position for drilling. The tapered shank for the attachment can be salvaged from a discarded drill bit of the type having a tapered shank. To make the threaded nose, recess a piece of hex stock to take the straight end of the drill-bit shank in a drive fit. Then shoulder and thread the nosepiece, the threads being cut to the same pitch diameter as those on the spindle nose of the lathe.

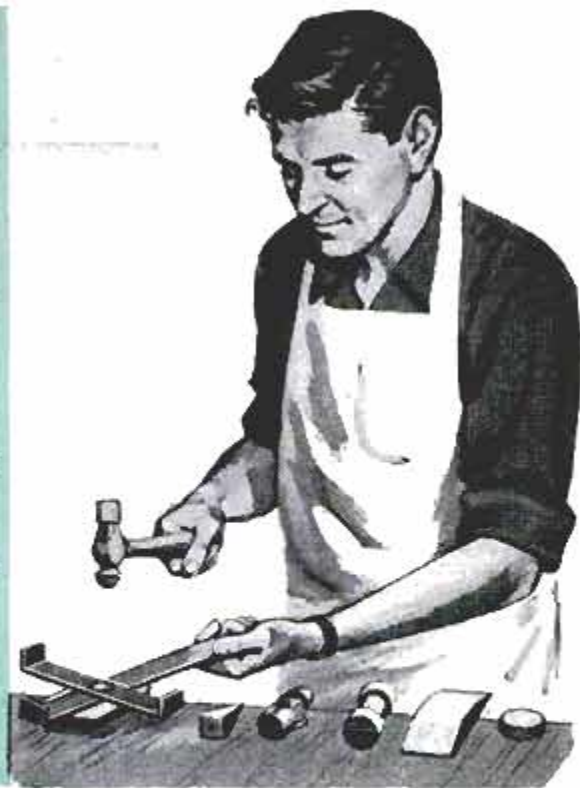
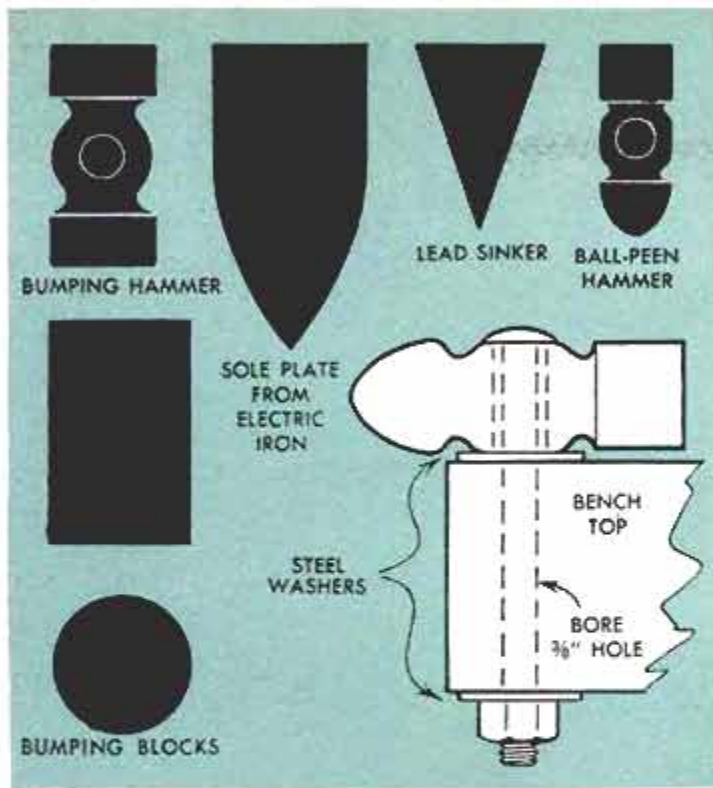

Six Small Anvils for Home Metalworking Shops

If you like to make objects requiring light metalwork, bolt these assorted anvils to your workbench at one end for easier and better metalworking. The sole plate from an old electric iron, the head of a ball-peen hammer, a large pyramid-shaped fishing sinker, the head of a bumping hammer and two bumping blocks used for auto-body repair make up the six anvils. The sole plate is bolted to the bench by means of the tapped holes on its top side. Tap a

$\frac{1}{4}$ to $\frac{3}{8}$ -in. hole in the underside of the bumping blocks and sinker for fastening. The hammer heads are attached as shown in the detail. The hammer heads, sole plate and rectangular bumping block should be attached close to the edge of the bench so that they can be turned around for additional shapes to hammer on. When not in use, projecting ends can be swung over the bench. Paint sides of anvils a bright color.
Russell J. Love, San Marino, Calif.

Nail Inserted in Cotter-Key Eye Prevents Damage

The eye of a cotter key will not become distorted when driving the key in a tight-fitting hole, if a nail is held in it. A nail can be used in the same way when it is necessary to remove the same cotter key. After straightening the clinched key, slip the nail in the eye and pull the key out with the claw of a hammer.

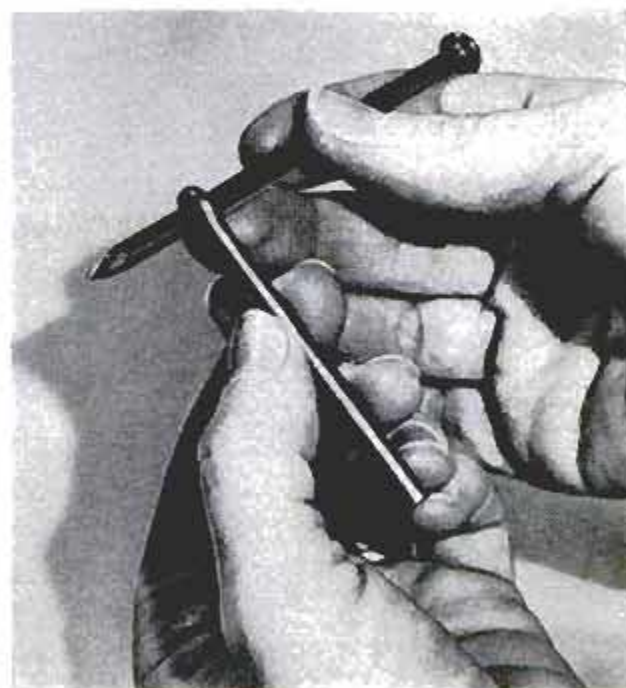

Leak in Radiator Core Sealed With Aid of Steel Wool

When a car radiator springs a leak in its core too large for radiator sealant to plug, stuff small bits of steel wool in and around the hole. Then pour sealant into the radiator in the usual manner. The sealant fills the smaller openings in the steel wool and thus seals the larger hole in the core. This repair is only temporary and the radiator should be repaired by soldering at the first opportunity.

SN 58

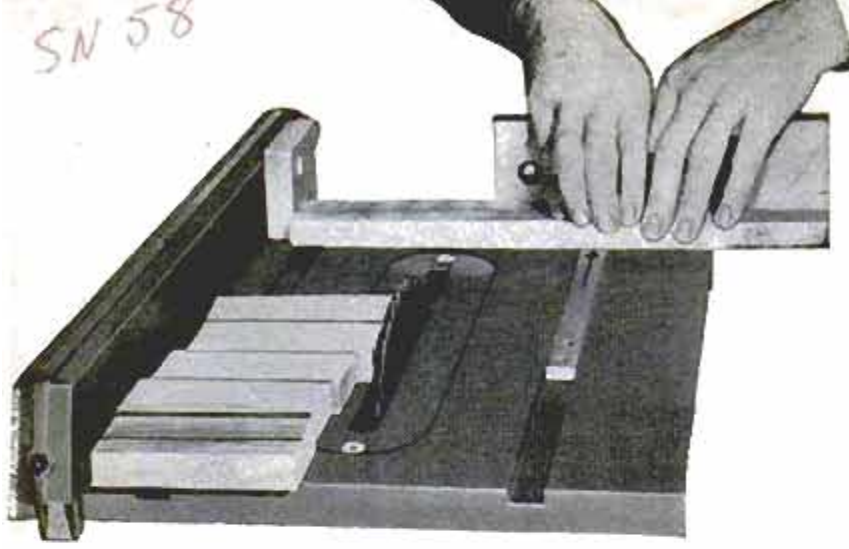

HOW WOULD YOU DO IT?

By Chris Nelson

What's the quickest, safest way to mass-cut duplicate work on a circular saw?

USE A STOP BLOCK. If you use the fence alone as a stop, the work will catch between the saw and fence and be thrown with considerable force. Always attach a block to the fence as shown above to provide clearance for the severed pieces. Block may be clamped.

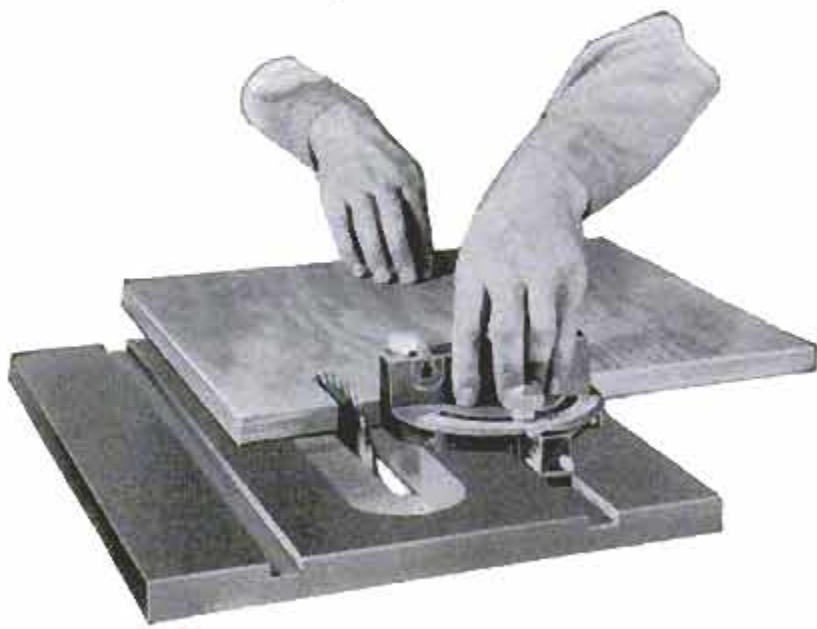

When a circular saw does not have a front table extension, how can you crosscut wide pieces of plywood or lumber?

TURN THE MITER GAUGE AROUND. Plywood and lumber up to a certain width can be handled easily on a small table saw by turning the miter gauge around and holding the work against it in the manner shown above. When the material is greater than 14 in. wide or so, it is best to treat it as a ripping job and guide it by the fence.

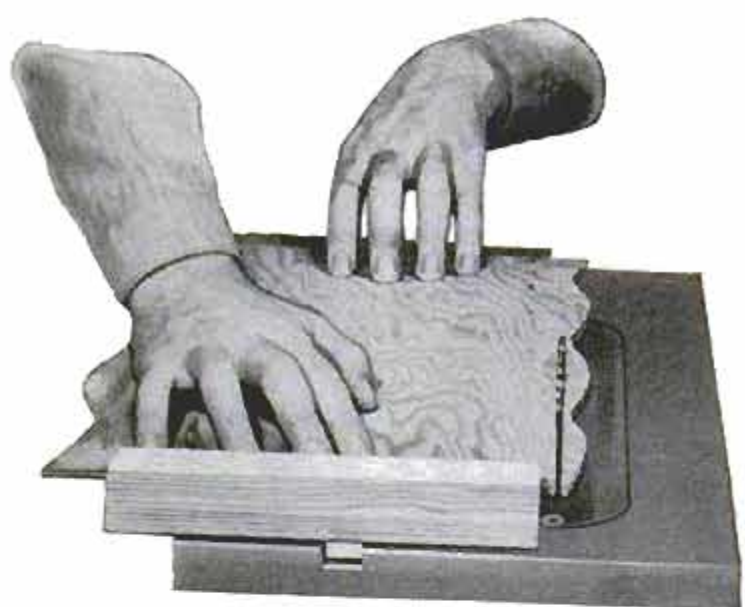

How can you rip a board of which neither edge is straight enough to ride against the fence?

MAKE A SQUARING BOARD. This consists of an auxiliary table of 1/2-in. plywood with a cleat across the front. A second cleat, just wide enough to slide freely in the table slot, is attached to the underside of the plywood. The work is held against the front cleat as pictured above to square one edge of the board. With one edge straight, the fence can be used.

How can you keep the work from creeping when cutting miters?

FACE THE MITER GAUGE WITH SANDPAPER. Sandpaper glued to the face of the miter gauge, or to an extension attached to the gauge, provides a nonslip surface that will help keep the work from creeping while being cut at an angle. Use fine grade of sandpaper.

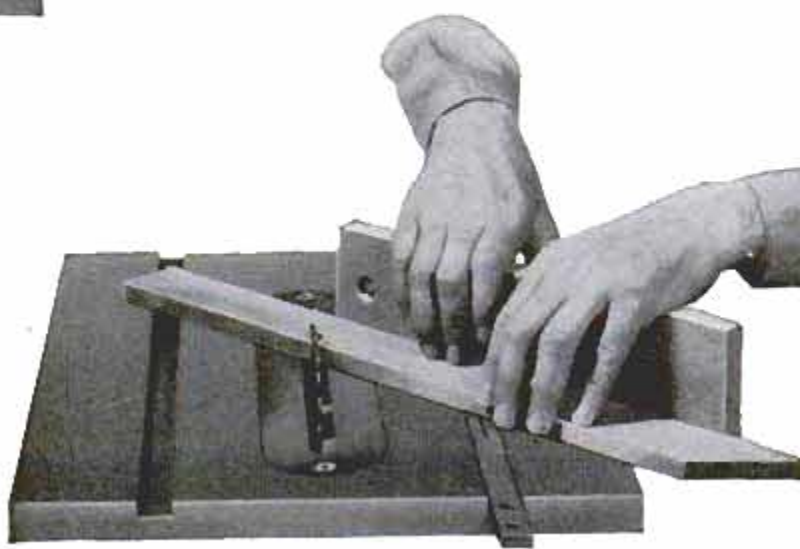

What simple jig can one make to speed up duplicate cutting of wide dados?

A STEP JIG. Clamp a stepped block to the corner of your saw table. Each step in it should be cut to equal the width of your dado saw. Besides speeding up the operation, the jig will accurately gauge the first and last cuts to assure each dado being the same width.

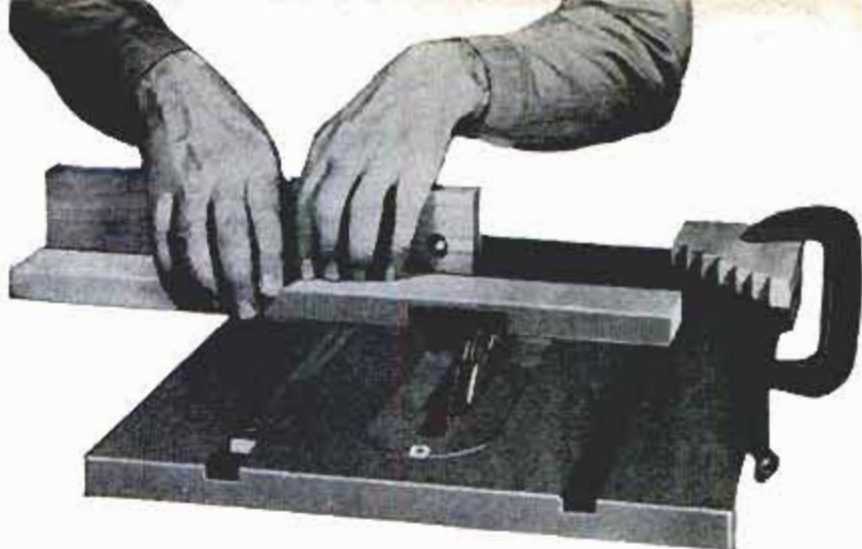

What fixture can I make that will hold work against the fence when grooving narrow pieces?

A SPRING STICK. A series of saw kerfs made in a board make an excellent spring hold-down when clamped to the saw table to bear against the work. Spring action of thin strips brings pressure against work, holding it firmly against fence.

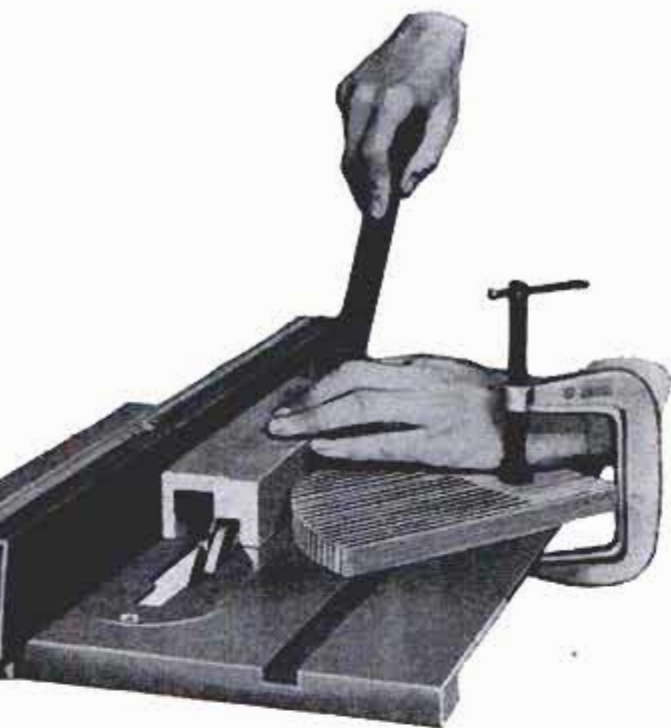

What's the safest, fastest way to cut small wedges in quantity for making wedged joints?

MAKE A WEDGE TEMPLATE. A wedge-shaped notch in the side of a block permits wedges to be cut rapidly by holding stock in notch as work is fed through saw. Stock is turned over in notch after each cut. Grain should run lengthwise.

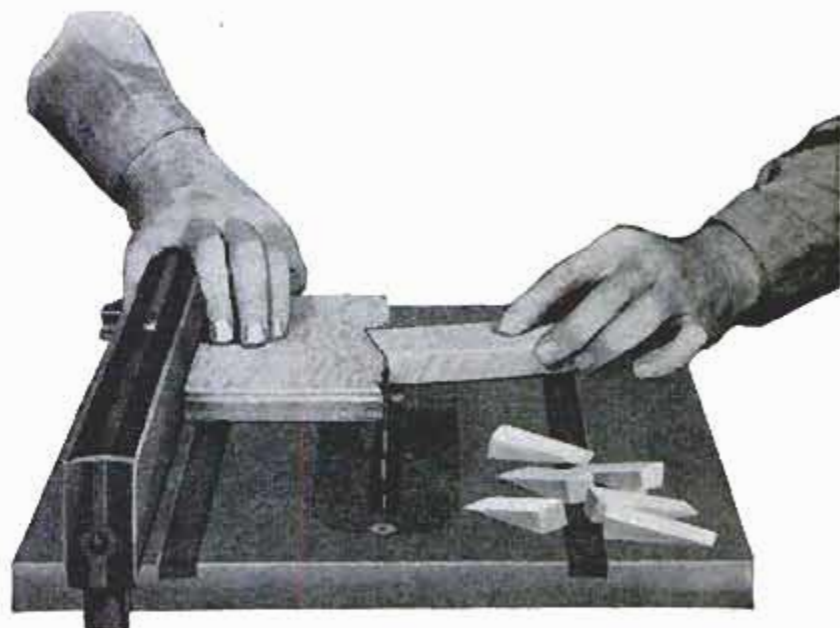

How can I use my circular saw to make cove molding?

PASS WORK ACROSS BLADE DIAGONALLY. Clamp a straight strip of wood at an angle to the saw table as shown at the left. Start out with saw blade $\frac{1}{16}$ in. above table and pass work slowly over blade. Continue to make successive passes of work, raising blade about $\frac{1}{16}$ in. each time. Angle of guide strip determines shape of cove. Edge of work is ripped off to produce cove molding. Gutter and chalk-rail molding is formed by positioning work over center of blade.

How can work be dished on a circular saw?

ROTATE THE WORK OVER THE BLADE. Cut a V-shape in a board and clamp it to the saw table as at right. Then place the disk-shaped work in the V-notch of the jig so that it is centered over the saw blade. With the blade projecting no more than $\frac{1}{16}$ in., slowly rotate the work. Raise the blade $\frac{1}{16}$ in. and repeat.



Asphalt Shingle Prevents Blowtorch Sliding off Pitched Roof



To keep his blowtorch from sliding off a sloping roof while making eaves-trough repairs, one tinsmith mounted the torch on a slate-surfaced asphalt shingle as shown. Four slots are cut in the shingle to form tabs. Then the rim of the torch is inserted so that the slate surface of the shingle faces down to provide the necessary friction between the torch and roof.

Eyeglass Case Holds Drill Bits

An ordinary eyeglass case provides a fine container for small drill bits and tools used in the workshop. These cases are felt-lined and have a strong spring hinge that keeps the cover closed tightly. Cutting edges are protected and the bits or tools will not fall out. If several cases are used, label them according to contents for quick identification.

Edward L. Fisher, Milwaukee, Wis.



Socket-Wrench Adapter From Discarded Auger Bit

An adapter for driving socket-head wrenches with a carpenter's brace can be made from a worn auger bit. After cutting off the twisted part, file four flats on the shank to fit the sockets. A pin inserted in a hole drilled through the shank prevents the sockets from sliding beyond the flats. As a means of holding them on the adapter, drill a hole in one of the flat sides nearly through the shank with a No. 30 bit, and fit a 1/8-in. steel ball backed by a coil compression spring in the hole. Then peen over the surface edge of the hole to retain the ball so that only one third of it projects beyond the surface.

Walter E. Burton, Akron, Ohio.



Bumper Jack and Tow Chain Help Break Tire Seal

When changing tires, the bond between tire and wheel rim can be broken with the aid of a bumper jack placed under a chain that is looped down through the center of the wheel, around the tire, and locked end to end. Operating the jack lever upward will force the base of the jack down on the tire, thus separating the tire from the rim. If the tire does not immediately loosen, light pressure with the heel of your shoe on the tire close to the rim will break the seal. After one side is free, flip the wheel over and repeat the process on the opposite side and the tire can then be readily removed.—Phil Freed, Chicago.

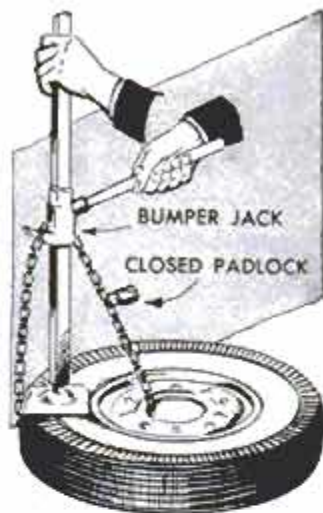

Threads on nuts and bolts can be protected from corrosion if they are given a coat of clear shellac before using them. The shellac also will seal a bolt in its hole when used in wood.

SN 58

Heat-Forming Plastic With Dies and Fixtures

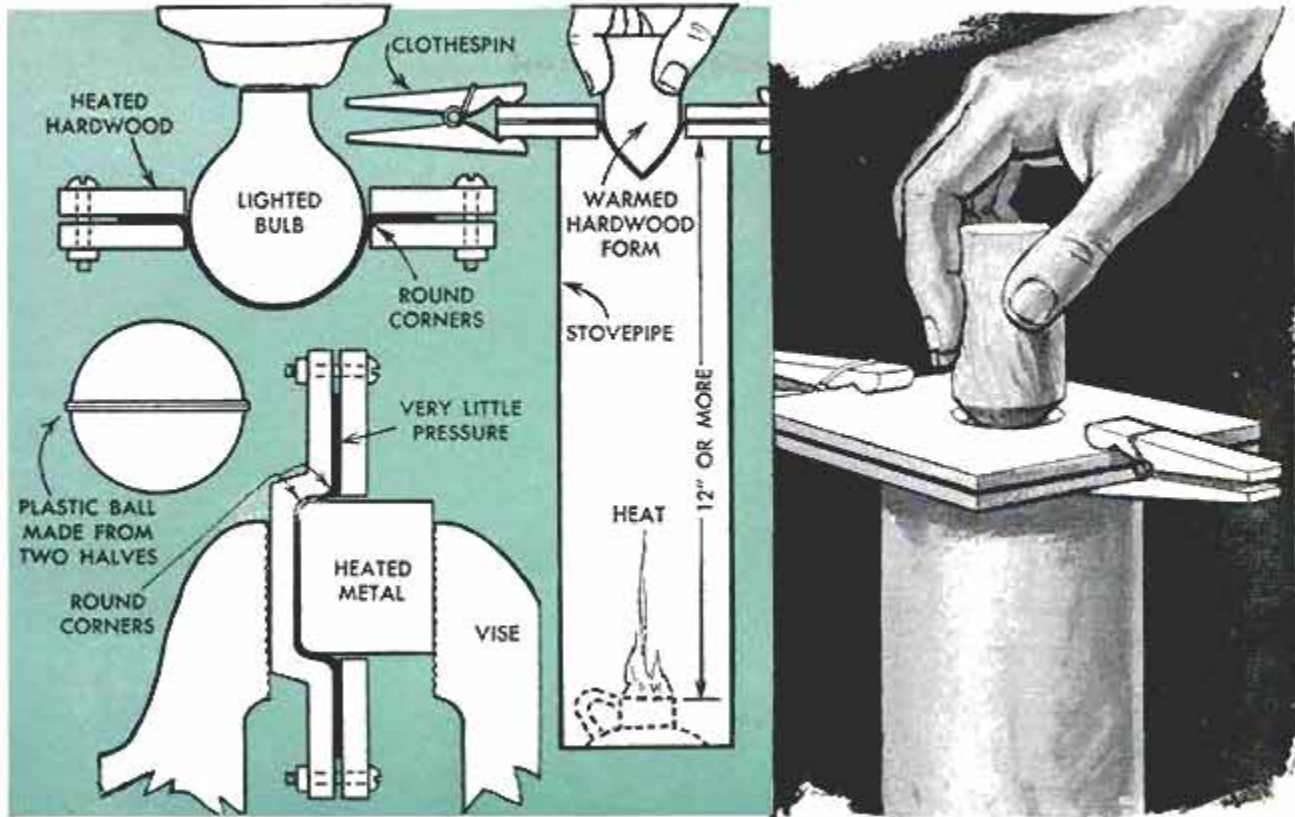

Forming thermoplastic sheets into cones, hemispheres and cups of uniform size and shape can be done in the home workshop by the proper application of heat and pressure, and the use of simple dies and fixtures. Hemispheres, which can be cemented together in pairs to make plastic globes, require a fixture consisting of two squares of hardwood or hardboard in which holes are bored. The squares are bolted or clamped together with the plastic sandwiched between them. A light bulb is used both as a die and a heat source, so the holes in the fixture should have diameters equal to that of the largest diameter of the bulb plus two thicknesses of plastic. The die and fixture are shown in the upper left-hand detail. As indicated, all corners in the fixture are rounded to prevent the plastic from breaking or cracking at these points. Some practice will be required to determine the correct amount of heat and pressure to be applied to the plastic. Too much heat will cause the plastic to bubble, and too little will permit it to crack or break. Not enough pressure on the die will fail to form the plastic, while too much will force the die through the material.

Cones are formed by using a hardwood die, or form, as indicated in the right-hand detail. The fixture is similar to the one used for hemispheres, but a different heat source is required. A short length of stovepipe set upright as shown provides an ideal "oven" when a small oil lamp, Bunsen

burner or large light bulb is placed in the bottom to heat the fixture which is placed on top. Provision must be made to allow air to enter the lower end of the stovepipe, both for combustion and for cooling. In all cases of forming thermoplastics heat must be applied to the die as well as the fixture to assure that the plastic stays warm and workable. Spring-type clothespins make excellent quick-acting clamps for holding the two halves of a fixture together, when quantity production is desired.

Cups are formed by using a setup as shown in the lower detail. Because the plastic must be drawn, or stretched, to a greater extent to make the cups than to make either cones or hemispheres, the fixture and die should be of metal. The plastic is clamped lightly in the fixture, then the die and fixture are placed in a vise so steady pressure can be applied uniformly.

Carl S. Bates, Chicago.

Lathe Used as Gluing Clamp

When a suitable clamp is not available for holding glued stock, your woodworking lathe may be used as a substitute. Glue the pieces and place them between the head and tailstock, using a small faceplate on the headstock, and adjusting the tailstock to apply pressure. An additional block of wood should be placed in front of the tailstock quill to prevent the latter from marring the work.

SHOPPING FOR TOOLS



SAW-DRILL combination power tool is available in 21-piece kit containing $\frac{1}{4}$ -in. heavy-duty utility drill with geared chuck and 13 twist-drill bits. Saw attachment with 5-in. combination blade has adjustments for depth and bevel cutting, adjustable fence for rip cutting, and automatic-telescoping lower-blade guard for safety

Black & Decker Mfg. Co., Towson 4, Md.

MAGNIFIER attaches to micrometer, slide rule, height gauge and other instruments for easy reading of vernier scales and height gauges. Magnifier is fitted with 5X lens and attached by means of setscrew. Since device can be used at safe distance from operator's eyes, eye strain is said to be prevented

Englass Co., Inc., 57 Shady Way, Rochester, N. Y.



THREADING-DIE HOLDER for power threading of rod, small parts up to $\frac{1}{2}$ -in. dia. and up to 6 in. long when $1\frac{1}{2}$ -in.-o.d. round threading dies are used. Fitted with No. 2 or 3 Morse taper, the holder travels automatically according to the feed required for particular thread size

Stone Welding & Machine Works, Honeoye, N. Y.



DRILL JIG fastened on C-clamp or bar clamp holds drill bit on exact point hole is to be drilled. Also used as dowel jig. Takes $\frac{1}{4}$, $\frac{5}{16}$, $\frac{3}{8}$ and $\frac{1}{2}$ -in. drills. The jig can be indexed on two axes for more accurate alignment of hole

M. D. Lee Tool Co., Rochester 17, N. Y.

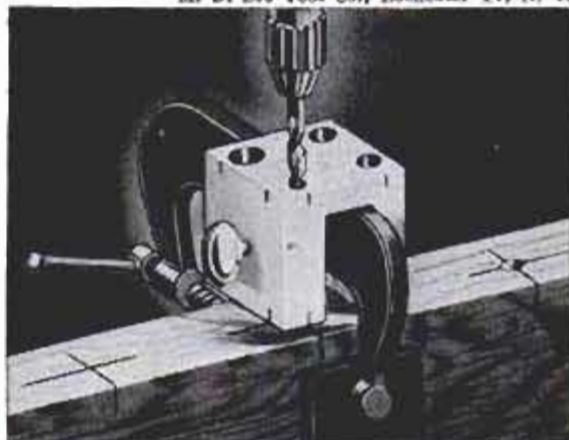



VENEER TRIMMER is lightweight portable electric tool that simultaneously cuts tops and bottoms of veneer strips glued to edges of work. Space between trimming blades is adjustable so that tool can accommodate various thicknesses of the work

Albert Fezer, Esslingen A.N.-Zell,
South Germany



AIR-OPERATED IMPACT WRENCH uses torsion-bar principle to control torque. Tool accurately impacts nut to desired preset torque for precision tightness, then automatically shuts off. While nut is being turned, tool operates at normal power and speed, but when required torque is reached and resistance to turning is equal to preset stress in torsion bar, impact mechanism rebounds and trips rubber-faced shutoff valve. Operation is reversible, and no air-pressure regulator is required, since tool operates at full power and speed

Ingersoll-Rand, 11 Broadway, New York City 4

AIR-POWERED CALKING GUN requires only light pressure on trigger to start flow of compound. Release of trigger trips valve that lets air escape and stops flow of compound. Gun will operate on 40 to 100-lb. air pressure. To fill gun, cap is removed in two turns and gun mouth placed in can of bulk calking. Pulling out loading rod creates suction to quickly fill gun. Loading rod then is pushed back into gun out of way. Three nozzles with individual end shapes to cover nearly every calking application are supplied with each gun

Calbar Paint and Varnish Co.,
2612-26 N. Martha St.,
Philadelphia 25, Pa.



AIR-POWERED DRILL HEAD is basically an air piston that advances an air motor which rotates drill. Par-A-Matic unit brings advantages of automation to drilling and tapping at low cost. Units are available for automatic or semiautomatic operation

with remote-control valve that can be automatic or controlled by one operator. Unit has speeds from 500 to 17,000 r.p.m., adjustable stroke from $\frac{3}{8}$ to 2 in. in increments of $\frac{1}{32}$ in. Needle-valve feed-rate controls feed from small fraction up to 8 in. per sec.

Aro Equipment Corp., Bryan, Ohio

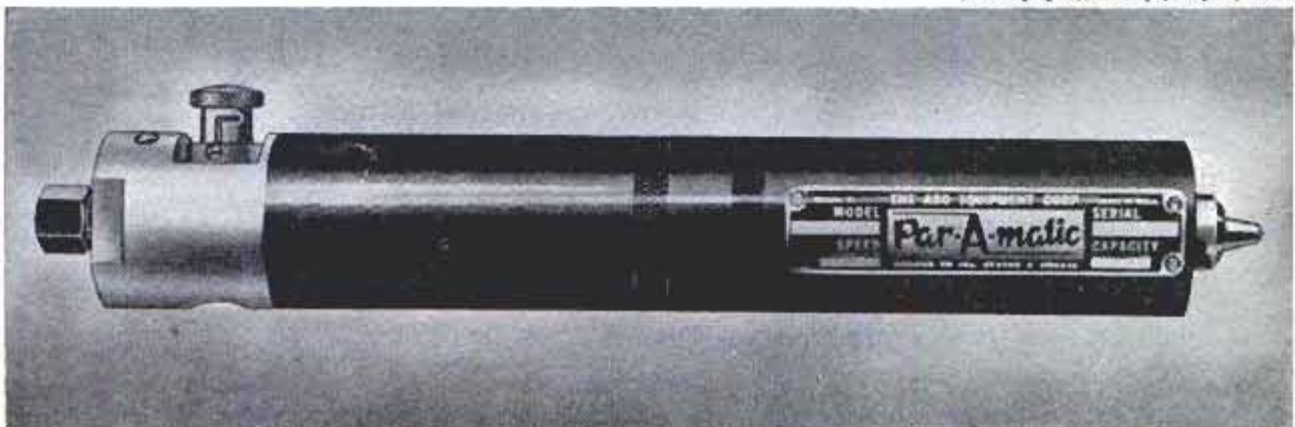



SHOP VACUUM CLEANER removes sawdust and dirt around machines, deposits it in standard-size ash-can unit it is mounted on. Unit's $\frac{1}{2}$ -hp. motor drives an 8-in. blower

Crafttools, Inc., 401 Broadway, New York City 13

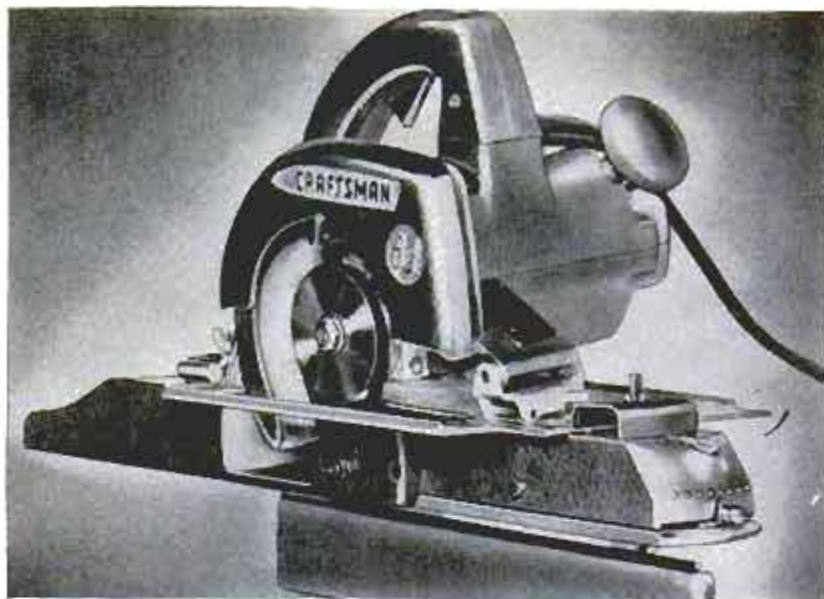

PLANER ATTACHMENT for electric handsaw has over-all length of $20\frac{3}{4}$ in. and adjustable front shoe of $7\frac{3}{4}$ in. High-speed steel blades permit a $2\frac{1}{2}$ -in.-wide cut with depth of cut from 0 to $\frac{1}{8}$ in. Removable fence is adjustable from 0 to 45 deg. in either direction

Rotex Mfg. Co., 8805 Sovereign Row, Dallas 22, Tex.

AN IMPACT-WRENCH attachment, right, can be chucked in most types of portable electric drills and drill presses to serve as a speedy nut runner. Weight of the device is 2 lbs. with $2\text{-}5/16$ -in. dia. One model delivers four blows per revolution, three others give two blows

Airborne Sales, 8501 Stellar Dr., Culver City, Calif.



COMBINATION POWER TOOL includes vertical drill press, 8-in. tilting-arbor saw and tilting sander, horizontal drill press and heavy-duty lathe, all mounted on a portable workbench. Saw blades lock at any

angle up to 45 deg. Sander also takes grinding wheels, buffers, wire wheels. Vertical drill press equipped with $\frac{1}{2}$ -in. chuck with spindle travel of $2\frac{1}{4}$ in. Lathe has $8\frac{1}{2}$ -in. swing, provides 32 in. between centers

American Machine & Tool Co., Inc., Royersford, Pa.

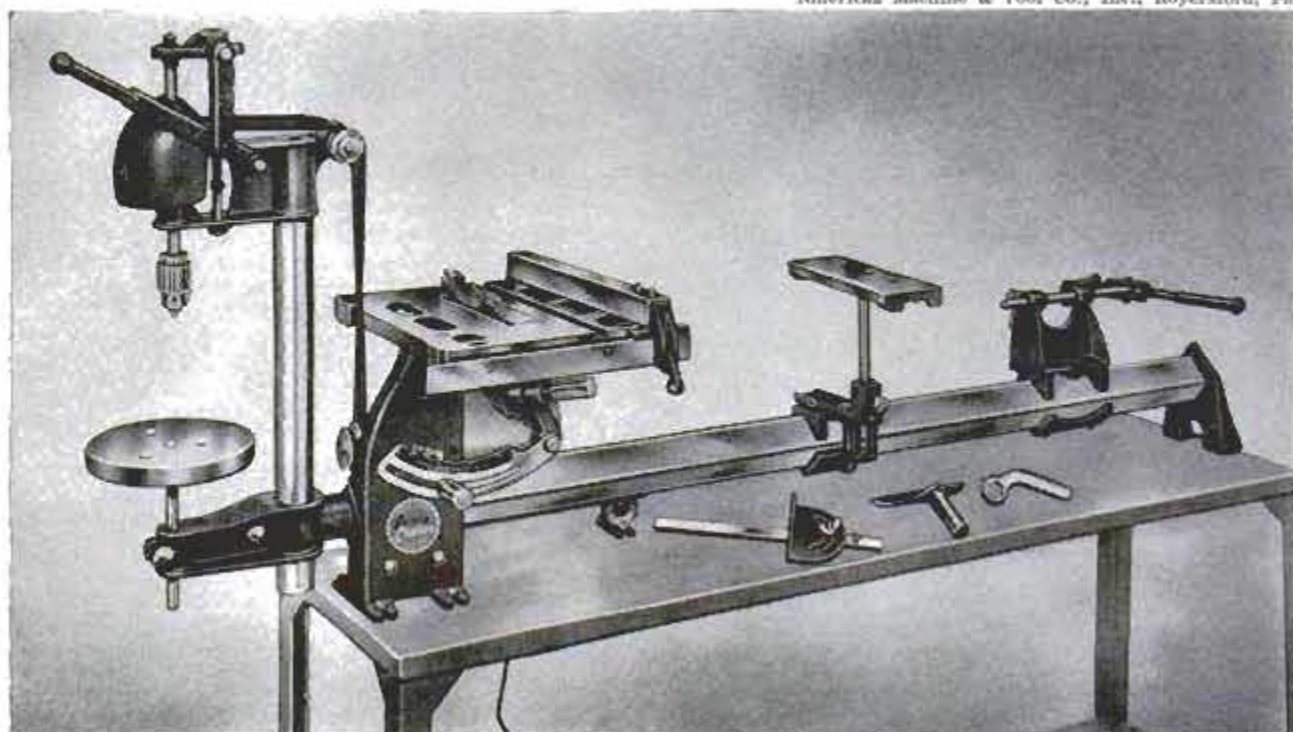

NOW YOU CAN GET PICTURES YOU COULD NEVER GET BEFORE!

KODAK PHOTO AIDS

Here are 8 ways to add to your summer photo fun



Filters for realism—You can use filters to accent clouds, cut down haze, improve tonal values. And here's the easy, low-cost way to buy them. A selection of top-popular filters, "custom-tailored" to your camera in a handy "swing-out" *Kodak Filter Kit* costs as little as \$6.



S-t-e-a-d-y does it! All the steadiness of a tripod with none of the bulk or bother . . . and at a fraction of the cost. *Kodak Flexiclamp* fits most camera models, clamps securely to anything from a chair back to a garden fence. (Fine for holding extension flash units, too.) \$5.95.

Tip-top flash unit—Top efficiency and economy—*both* in this new pocket-size flashholder by Kodak. The *Kodalite Super-M* is battery-condenser powered for long life, efficient illumination . . . is designed for peak results with low-cost M-2 bulbs. Fits most flash cameras. \$9.95.



Don't be a "forgotten man"! Get into the family snapshots yourself by using a *Kodak Auto Release*. Fits any camera having a cable release socket, gives you up to 10 seconds to move into your picture scene and get set for the shutter click. Only \$3.86.



Protection . . . plus—Protect your camera and, at the same time, provide yourself with extra picture-taking convenience. *Kodak Field Cases* afford full protection, yet their hinged-front design keeps you set to shoot. From \$2.65.



Show color slides any time, anywhere! Just slip a slide in your *Kodaslide Pocket Viewer*, point it toward the light, and view the image 4-times enlarged. Folds to less than an inch thick for convenient carrying. Only \$1.95.

Print snaps any time, anywhere—Even the kids can develop negatives and make prints with an easy-does-it *Kodak Photo-Hobby Outfit*. Great to take along on vacation—see your pictures quicker . . . and it's fine "rainy-day" diversion, too. From \$9.95 complete.



Kodaslide Dial-Lite Viewer—plugs into any house circuit. Brightness control knob dims or brightens light to suit subject being viewed. Adjustable lens. Complete with desk tray for holding slides and viewer, \$12.95.



Prices are list, include Federal Tax, and subject to change without notice

Eastman Kodak Company
Rochester 4, N. Y.

Kodak
TRADE MARK

Finish-it-Yourself

with these

Weldwood Wizards



Want a natural finish? A stained finish? A blond, pickled or wiped effect? They're yours, quickly and easily—with Weldwood's finishing Wizards. It's smart to keep all three handy.

Help kill that wild grain with **CLEAR FIRZITE**

Why risk an ugly wild grain finish when staining fir plywood, when a starting coat of Clear Firzite is so easy to apply. Helps tame that wild grain, makes fir plywood look like costlier woods. And for beautiful oak, walnut or mahogany effects, just add colors in oil.



For woody blond, pickled and wiped effects—use

WHITE FIRZITE

Gives that woody blond finish without a "painty" look. Perfect, too, for pickling and wiping. For pastel tones, add colors in oil. And use White Firzite as an undercoat... it's a sealer and primer in one. Helps prevent grain raise and checking on soft wood and fir plywood paint jobs.



For a fast, modern, natural finish—use **SATINLAC**

Cuts finishing time drastically because it dries out of dust in 3 to 4 hours. Satinlac brings out and protects the natural grain and beauty of any wood—soft or hard, plywood or solid lumber. Easy to apply—easy to maintain.



Ask your hardware, paint, or lumber dealer about these Weldwood Finishing Wizards... or mail coupon for FREE leaflets.

UNITED STATES PLYWOOD CORPORATION
Box 525 - New York 46, N. Y. PM7-65

Send me leaflets on:

Satinlac White Firzite Clear Firzite

NAME _____

ADDRESS _____

CITY _____ ZONE _____ STATE _____

Clinic for Homemakers



As a service to our readers in solving the hundreds of problems pertaining to a home—inside or out—the editors of Popular Mechanics invite you to present your problems to The Clinic Editor for help and advice. Address your questions to The Clinic Editor, Popular Mechanics Magazine, 200 East Ontario Street, Chicago 11, Ill.

Paneling Darkens

Q—A year ago I installed pine paneling in my kitchen and finished with white shellac and wax. Some of the boards have darkened, some to a very deep shade of brown, some with dark streaks, and in others the knots have turned almost black. Is this due to the wood or the finish? How do I correct the defect?—E. N., Tenn.



A—Many woods, especially knotty pine, gradually darken on exposure to the light. The reds and browns in the wood tend to intensify just as you have described. Some homeowners consider this a desirable characteristic of the wood, as the aging process usually brings out the full beauty of each individual piece. We know of no way of restoring the original newness of the panels, or boards, that we would consider practical other than the somewhat tedious job of scraping the surface of the boards to expose new wood. We would not recommend that you attempt this due to the labor and time involved. We can recommend, however, that you wax the wood periodically.

Damaged Arborvitae

Q—Among my evergreens is a fairly large arborvitae which is located near the corner of the house. Last winter water dripping from a faulty gutter apparently was blown into the top of this evergreen where it froze during a sleet storm. Weight of the ice bent the tip of the tree. Is there any way of straightening it?
G. N., Ind.



A—We're rather doubtful. The chance that the tip will straighten of its own accord grows more remote as time passes. In some instances it is practical to attach a 1 x 1-in. strip to the trunk with twisted wire, placing strips of rubber cut from inner tube between the wire and the trunk, or passing the wires through short lengths cut from discarded garden hose—anything that will protect the trunk of the tree from damage by the wires. The top end of the strip should extend above the bend a distance equal to the length of the bent portion of the tip. Then lift the tip about a third of the way up and tie it in this position. Leave it

(Continued to page 208)

Glue-It-Yourself

with one of these

4 Weldwood® Wizards



Make sure you use the right glue for the job. Weldwood has developed four different types of adhesives to help you on any gluing job. Keep all 4 of these Weldwood Wizards handy at your workbench. They'll solve your gluing problems speedily, easily, successfully!

For gluing that boat of yours, use **WELDWOOD WATERPROOF RESORCINOL GLUE**



100% waterproof! Defies the elements! Use it for every gluing job that needs *complete protection* from climate, weather, water (even boiling, freezing or salt!), mold, fungus, etc. On boats, in damp basements, for outdoor furniture, or fixing golf clubs, etc., you can always depend on Weldwood Waterproof Glue.

¼ pts., \$1.00. Also available in pts., qts., gals.

Ready to use, for fast, all-around gluing — **WELDWOOD PRESTO-SET® GLUE**

Yes, ready to use; sets fast and glues like magic. Presto-Set is the Weldwood-perfected white glue that bonds any combination of wood, cloth, paper, fabrics, leather, etc. Odorless — and so clean to work with. New, easy-to-use plastic dispensers. 19¢, 29¢, 49¢ and larger.



For applying plastic surfaces without clamps — use **WELDWOOD CONTACT CEMENT**



Bonds instantly, permanently, on contact — without clamps or presses. Easy new way to surface table tops, kitchen counters, etc., with Micarta and other plastic laminates. Easy new nail-less way to install plywood panels. Scores of other uses in home, hobby, garage. 29¢, 40¢, 70¢ and larger.

For gluing wood joints like a pro — use **WELDWOOD Plastic Resin GLUE**

Powerful powder — easy to mix. Actually makes glued joints stronger than the wood itself. Favorite of top furniture-makers. America's most popular glue. Highly water-resistant, stain and rot-proof. 15¢, 35¢, 65¢ and larger.



Remember —

There's a special Weldwood Wizard for every gluing job. Ask your lumber, paint or hardware dealer... or mail coupon for **FREE** leaflets.

UNITED STATES PLYWOOD CORPORATION
Box 525 — New York 46, N. Y. PM7-6G

Send me leaflets on:

- Weldwood Plastic Resin Glue
 Weldwood Waterproof Resorcinol Glue
 Weldwood Presto-Set Glue
 Weldwood Contact Cement

NAME _____

ADDRESS _____

CITY _____ ZONE _____ STATE _____

Care and Feeding of Engines



BY
S. P. CORP

WHERE'S THAT OIL LEAK?

When your car is on the hoist, see if the rear of the engine is covered with oil. This could mean a leak (1) from rear main bearing oil seal, (2) from front bearing oil seal, or (3) if you have automatic transmission, from the torque converter.

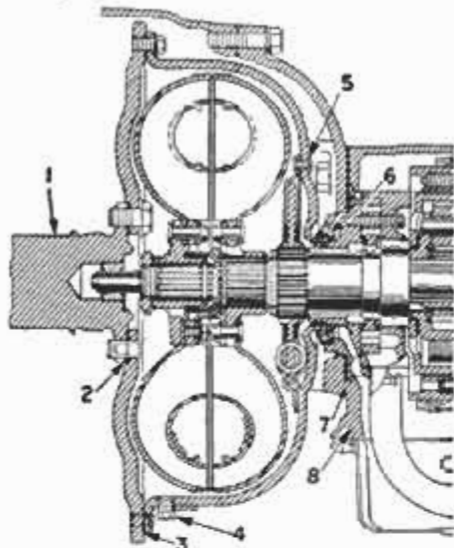

TORQUE CONVERTER

To locate leak, add $\frac{1}{2}$ teaspoon of oil-soluble dye to crankcase oil after engine is warmed up, and let engine run until dye is well mixed. Stop engine, wipe off outside oil, put clean paper under car. Run engine for two minutes at 1000 r.p.m. Colored oil on paper shows main bearing leak.

- (1) Uncolored oil shows leak in torque converter.
- (2) Between crankshaft and flywheel; tighten bolts.
- (3) Torus cover and flywheel; tighten bolts. (4) Oil drain plug. (5) Dampener rivets. (6) Front cover oil seal. (7) Front cover gasket or pump cover. (8) Oil pan to case gasket.

SEND FOR FREE BOOKLET



A postal card request will bring your free copy of the new revised edition of "Care & Feeding of Engines," a 24-page illustrated manual of engine care. It can save you a lot of money. When you re-ring, insist on SEALED POWER KromeX Ring Sets for long wear, fast break-in, and immediate oil control. Sealed Power, Dept. G-7, Muskegon, Mich.

Sealed Power

PISTON RINGS

(Continued from page 206)

for 10 days or more, then raise it further and again tie in place. Continue the process over a period of time until the tip is again back to the vertical position. Although never fully reliable, this procedure sometimes works satisfactorily. Much depends on the age of the evergreen and whether or not it is maintaining vigorous growth. Perhaps it is worth trying, at least you are not likely to do any serious harm. The other alternative is to remove the bent tip entirely. For this job we suggest that you obtain the services of a recognized tree surgeon.

Gutter Lining

Q—The gutters on my home are of the round type and are beginning to leak. Examination shows the metal to be rusted through, fine pinholes in the metal causing the leaks. I do not wish to renew them for a year or so. Can I repair them temporarily?
C. A., W. Va.



A—There are several methods of prolonging the life of gutters which have been damaged by rust, but one of the simplest is the use of aluminum foil as a patch. Ordinary foil such as that available for household use will do very well. First clean the affected area thoroughly, using emery cloth and a wire brush to remove all the rust from the inside of the gutter. Then paint the area with asphalt or a prepared gutter paint. Before the paint sets, lay the sheet of foil over the painted area and press into contact with the paint, being careful not to break the foil at any point. Allow the paint to dry thoroughly, then coat the foil, also the inside of the gutter along its entire length with a prepared gutter paint.

Mildew

Q—This year I planted sweet peas in a long row and trained them to an improvised trellis. They made an excellent growth, even though they were within a few feet of a row of shrubbery on the lot line. However, just before blooming the leaves of the sweet-pea vines became coated with a white, powdery substance. Within a short time the leaves began to wither. There were less than half the blooms I should have had from such a large planting. What is this white coating on the leaves and how can I prevent it?—R. N., Ky.

A—Judging from your description the sweet-pea plants were attacked by one of the many forms of powdery mildew. These bear common names which associate them with the host plant. There are apple and pear mildews, grape, rose and so on. The fungi which cause the white coating tend to overlap on various plants and the appearance of the mildew on any one host plant usually is a warning of possible attack on other garden plants. Generally the first indication of infestation is a grayish-white, felt-like coating, or mold, on the leaves. As a rule it makes its first appearance on the underside of the leaf, but sooner or later it will appear on both sides. If the disease is not arrested at this stage or earlier, it spreads rapidly. Infected leaves curl and die as you describe, the effect being that of almost complete defoliation of the plant. Mildew develops most rapidly when days are warm and nights cool. It does not require an environment where dampness is present over long periods of time. Although it is generally associated with cool, shady locations, it can originate and develop almost as rapidly on plants growing in the open where there is plenty of sunlight and air circulation. Because of this it is not always possible to prevent or minimize attack by powdery mildew by locating plantings in dry, sunny plots. For many years gardeners used repeated applications of sulphur and lime-sulphur mixtures to combat mildew infestations and these materials still are fairly reliable as fungicides. However, they now are being gradually supplanted by other materials less difficult to apply and even more effective as fungicides. These are not one-plant products but can be used to protect nearly all types of ornamental plantings against mildew infestation.

IDEAS FROM WELDWOOD

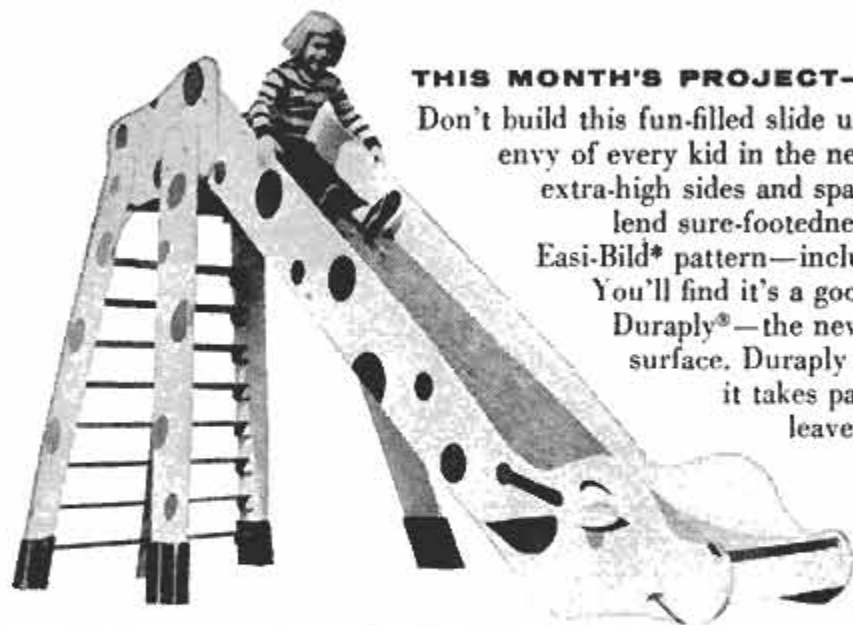

THIS MONTH'S PROJECT—"JOLLY GIRAFFE" SLIDE

Don't build this fun-filled slide unless you want your children to be the envy of every kid in the neighborhood. The "Jolly Giraffe" Slide's extra-high sides and spacious steps are two safety features that lend sure-footedness to eager young feet. (To get full-size Easi-Bild* pattern—including painting directions—see coupon.) You'll find it's a good idea to build the "Jolly Giraffe" with Duraply®—the new *kind* of plywood with a tough, smooth surface. Duraply is completely weatherproof, and—since it takes paint better and holds it longer—you can leave it outside all year without any damage. Send for the "Jolly Giraffe" pattern today. It will give the kids years of fun . . . it will give you a lot of enjoyment making it.

*Trademark Registered Easi-Bild Pattern Co.

The Weldwood Question Box

Q. I want to put some rough flooring down in my unfinished attic so that I can use it as storage space now . . . with the possibility we'll make a bedroom or two up there later. What should I use for flooring?

A. We aren't just prejudiced when we say use plywood. Weldwood Plyscord means a big saving in time, trouble and money. Plyscord panels are unfinished and unsanded—so they're very economical and just right for flooring. Plyscord comes in widths from 2' to 4' and in lengths from 6' to 10', so you can easily find just the sizes you need. If your joists are on 16" centers use 3/4" thick Plyscord; if joists are on 2' centers, use 1/2" Plyscord. Plyscord is ideal for attic flooring because it comes in large sheets and is made with mildew-proof glue. And its strength is greater than even diagonally laid planking. Because Plyscord lies flat, it will make a good subflooring if you decide to put in

This Month's Hints —

CUTTING PLYWOOD:

Hand-sawing a 4' x 8' sheet of plywood isn't difficult if you use this trick. Support the panel firmly on chairs or "horses" and, after sawing a foot or so, wedge a screwdriver into the "slot" you've just sawed. This will keep the plywood sections separated and prevent the saw from binding.

Power-sawing plywood . . . or any wood . . . may produce

edge-splintering if you cut too fast. To avoid this, use a combination blade that's sharp. If it's important to have perfect results, attach a strip of masking tape to the back of the panel where the saw blade cuts through.

\$10 for your ideas

for "This Month's Hints," if accepted for publication. (Hints must apply to some Weldwood product.) Send them to "Weldwood Hint Editor," 55 West 44th St., New York 36, N. Y.

tile, linoleum or hardwood flooring, later.

Q. Our living room ceiling has a persistent crack that's defied a dozen patching jobs. We've investigated replacing the whole ceiling, but that's much too expensive. Can you suggest something?

A. Yes. Weldtex® squares, which can be attached to low-priced furring strips, will end your cracking and patching troubles. Weldtex has

a distinctive striated texture which can be painted or finished natural. Sizes of squares are 11 3/4", 12", 16" and 24". And it's not expensive! Enough Weldtex squares to cover a full 10' x 12' ceiling will cost you less than \$35.

HAVE A QUESTION?

Send it to "The Weldwood Question Box," 55 West 44th Street, New York 36, N. Y.



Weldwood®

A product of

United States Plywood Corporation

Weldwood—The Best Known Name in Plywood

United States Plywood Corporation, Pattern Dept.
P. O. Box 215, Pleasantville, New York

Enclosed find \$1.00 for which please send me Pattern #63—
"Jolly Giraffe" Slide. PM7-56

NAME.....

ADDRESS.....

CITY.....STATE.....

NEW UTILITY PLIER!



Crescent's No. P210 Utility Plier is completely new... revolutionary! Not a "slip-joint" plier, not to be confused with conventional lap-joint "pump" pliers. Its double-strong box joint design is absolutely unique. It will grip flat, square, hex or round objects with powerful leverage. Handsomely finished in rust-resistant zinc plate.



QUICK, POSITIVE ADJUSTMENT

This cut-away view shows joint construction with its extra generous bearing surface at the arrow point.

\$300

Sold by hardware stores everywhere.



Crescent is our trade-mark, registered in the United States and abroad, for wrenches and other tools. Sold by leading distributors and retailers everywhere and made only by

CRESCENT TOOL COMPANY, JAMESTOWN, N. Y.

Drive-In Dream Castles

(Continued from page 103)

ranch-type buildings first sprawled across the prairie in 1951. Even today it's a super-motel by any standard. Many of its more than 200 refrigerated rooms and suites sport balconies and wood-burning fireplaces. Bamboo-laced cabana apartments surround the kidney-shaped pool. No guest is more than a few steps down the corridor from a free-ice-cube machine. Motor-driven buggies deliver meals to rooms, if desired. Carpets have a large assortment of free-form colored splotches woven in. "Built-in food and ink spots and cigarette burns," explains Green. "Now let 'em spill anything; we won't worry." In the big paneled dining room guests pick their own steaks and brand them with an iron that burns R, M, or W (rare, medium, or well) into the meat for the chef's information. Western Hills also provides customers with facilities such as barber, beautician, car laundry, and has a separate set of rooms for guests' maids and chauffeurs, plus a kennel wing for dogs and pets. Suite occupants get a two-car garage, two baths and free golf. Recently, Green added a \$100,000 heliport to all this — "against a possible wave of future airborne travelers." Though more than 100 landings have been made on the pad, some newspaper editors have muttered suspicions that the heliport brings Green far more publicity than helicopters.

Up the line in Tulsa, Okla., Roy Morgan, owner of lavish, rambling Western Village, went Green one better by putting in not only a heliport, but a 1700-foot airstrip and radio station for pilots, plus a direct line to the weather bureau. Small-plane pilots cruising over the Panhandle can go out over the 122.8-megacycle band and contact Western Village radio to reserve a room and plane parking space for the night. A lounge and gasoline pump stand ready to service both pilot and plane. The unique Fly-tel Mo-tel has already played host to several meetings of Flying Farmer officials.

Chances are that few motels will fill their rooms with airborne overnights for some time. But satisfying every whim of John Traveler is the order of the day, and motels without frills soon find their "No Vacancy" sign gathering dust, while more enterprising managers down the road get the business. Typical of the extremes to which larger motels go are the extras ballyhooed by the 305-room Del Camino in El Paso, Tex., near the Gateway to Mexico. Here, amid Spanish gardens and architecture, surrounding a big, heated, filtered pool, 500 people are bedded on goose-down pillows

(Continued to page 212)

**SIX TANK TRUCKS of oil surge through
your AC OIL FILTER every 5000 miles!**

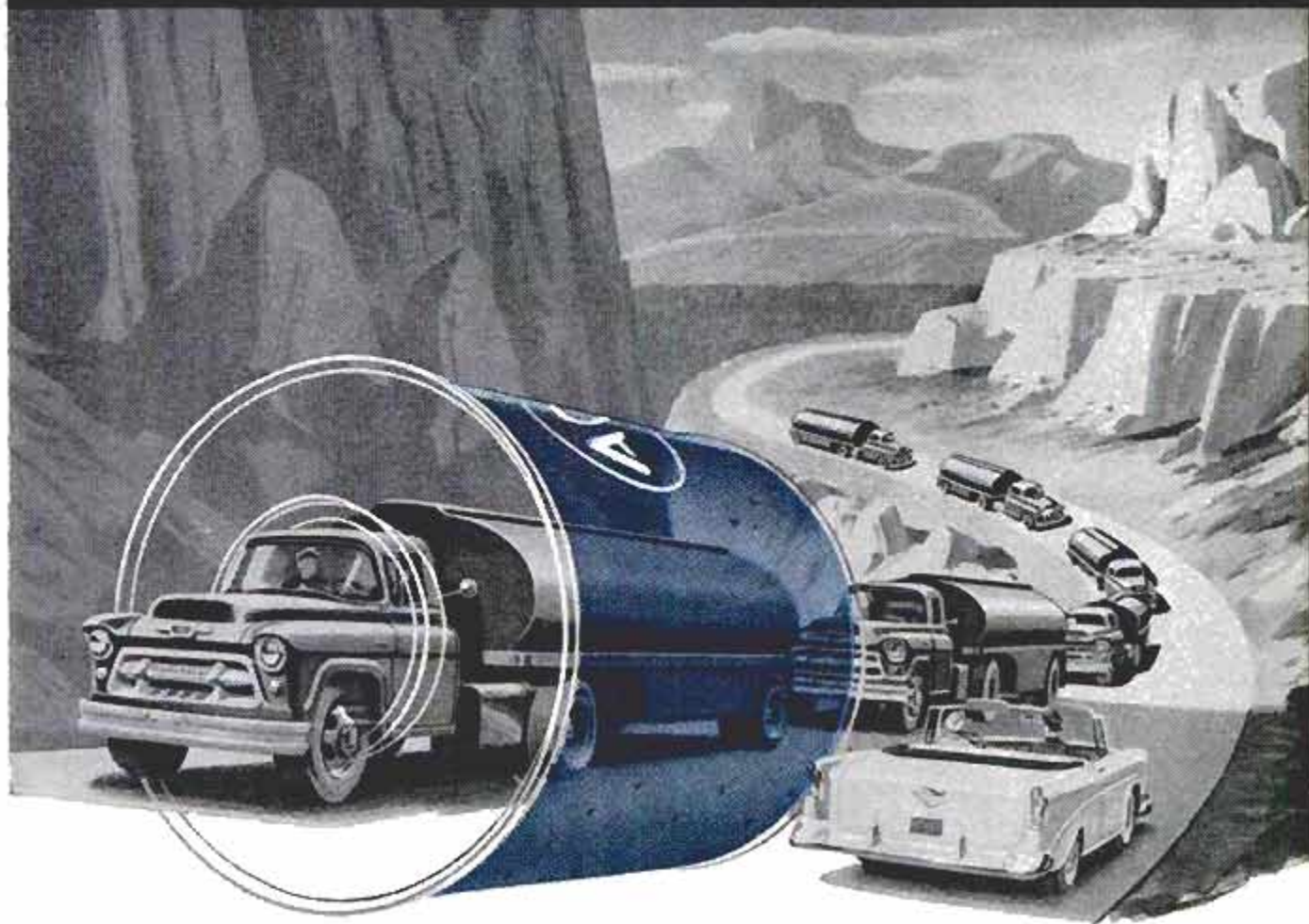

Here are the FACTS about the miraculous job done by a full-flow AC OIL FILTER

Every 30 seconds your car is running, all of the oil in the crankcase takes a cleaning trip through the oil filter. The magnitude of this filtering job—removing damaging bits of dirt, metal, grit and carbon from the equivalent of 36,000 gallons of oil every 5000 miles—calls for the qualities that are built into AC Oil Filters. Huge filtering area, specially processed filtering material and parallel packing of AC Oil Filters insure efficient, protective filtering over every mile of the recommended period between filter changes. You make a change for the better when you change to AC.

Watch **WIDE WIDE WORLD** and **BIG TOWN** • NBC-TV



AC SPARK PLUG



THE ELECTRONICS DIVISION OF GENERAL MOTORS



*A fastener that
grips fixtures to
walls quickly,
securely...*



★STAR WALLGRIPS



makes any fixture-hanging job a simple task. Fixtures can be quickly removed or replaced when redecorating without disturbing the WALLGRIP. Send for new booklet "The Hang of Things", showing how to fasten all kinds of fixtures to any type of wall.

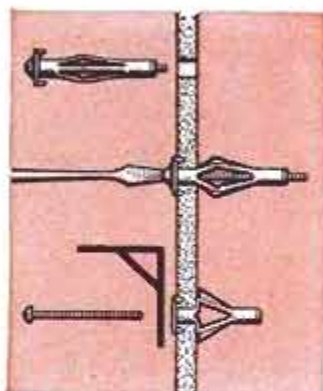

How WALLGRIPS work in hollow walls:

1. Insert in Hole. Wings spread as bolt is tightened.
2. Positive Stop tells WALLGRIP is set.
3. Remove bolt and replace through fixture and tighten.

★STAR EXPANSION

Fasteners for Home and Industry

Dept. PM-7 142 Liberty Street
New York 6, N. Y.

Please send me a FREE copy of the book "The Hang of Things".

Name _____

Address _____

City _____ Zone _____ State _____

and 1000 are fed daily. Via 24-hour room-telephone service visitors can get baby-sitter service, special baby beds, airline and limousine service, or satisfy any need in the motel's own shopping center.

Such services cost operators money and, in some places, an overnight motel room is more expensive than a similar one in the local hotel. "Our rates have more than doubled since the war," admits one motel proprietor. "Three dollars was a good rate in 1945; today eight isn't unusual. But with tips, parking fees and other hidden charges at the hotel, the tourist still wins at the motel."

The fact is—especially in resort areas of Florida and California—some motels have mushroomed to a point where you can't tell if they're motels, hotels, or even complete cities. Ellinor Village, at Ormond Beach, Fla., looks for all the world like a tremendous housing development. Its 650 separate bungalows for rent by day, week or month, line its own palm-shaded streets. With shopping center, country club and recreation areas the village is actually a complete community.

On Miami Beach's dazzling gold coast, twin 50-foot stone pylons on each side of plushy Collins Avenue mark the entrances to the Golden Gate. With 650 rooms spread over 28 acres, this motel metropolis is everything rolled into one. On the ocean-side, fronting a 500-foot sand beach, a 150-room four-story hotel connects by tunnel under Collins Avenue with the bay side. Extending half a mile back to the inland waterway, is a vast city of apartment, villa and motel accommodations varying from \$12 to \$45 a day per room in season. Practically all rooms interconnect and, if your family is growing, you can have a suite with as many as 16 rooms. Are you sailing, or driving? For 10 cents per foot per day, you may park your yacht outside your yacht-club apartment, or live aboard and hook into the service facilities at each of the 20 slips at the Golden Gate's private piers. The 800-car parking docks are free. Do you prefer fresh water or salt? Try the beach, either of two swimming pools, or the wading pool if you don't swim. Maybe you'd rather ferry over to the motel's private island on the motor-driven raft and join a pirate party, shipwreck party or roast-pig barbecue. If you'd rather just sit in your room and muse, you may do it in solid comfort on your specially designed studio bed. When used for sleeping it's level. During the day it slides one foot back into the wall on a track that gives it a pitch to the rear like any davenport.

Resort motels go all out for recreational

(Continued to page 214)

Built-in balance lets a race driver do this

By ED COLE, Chevrolet Chief Engineer

There's a saying among race drivers: "You can't beat a Chevy through a corner." And though we didn't design the 1956 Chevrolet as a race car, we're flattered.

We know that one of the main reasons Chevrolet clings to the road like a magnet is *balance*—the correct weight distribution between front and rear wheels. A car that is "nose-heavy" tends to plow straight forward in a sharp turn. And because the rear end is light it also tends to break traction and skid.

Note this important fact: *a Chevrolet V8 has less weight on the front wheels than any other full-size car!*

The stock car racer you see here barreling through a turn is clinging at the very limit of traction—an acid test that you may never give your car. But the *balance* that has made Chevrolet the NASCAR Short Track champion by a wide, wide margin is just as vital for you at 30 miles per hour on a wet, slippery black-top road. This new feeling of stability is something you'll enjoy trying for yourself . . . so why not let your dealer arrange a demonstration drive as soon as you can. . . . Chevrolet Division of General Motors, Detroit 2, Mich.



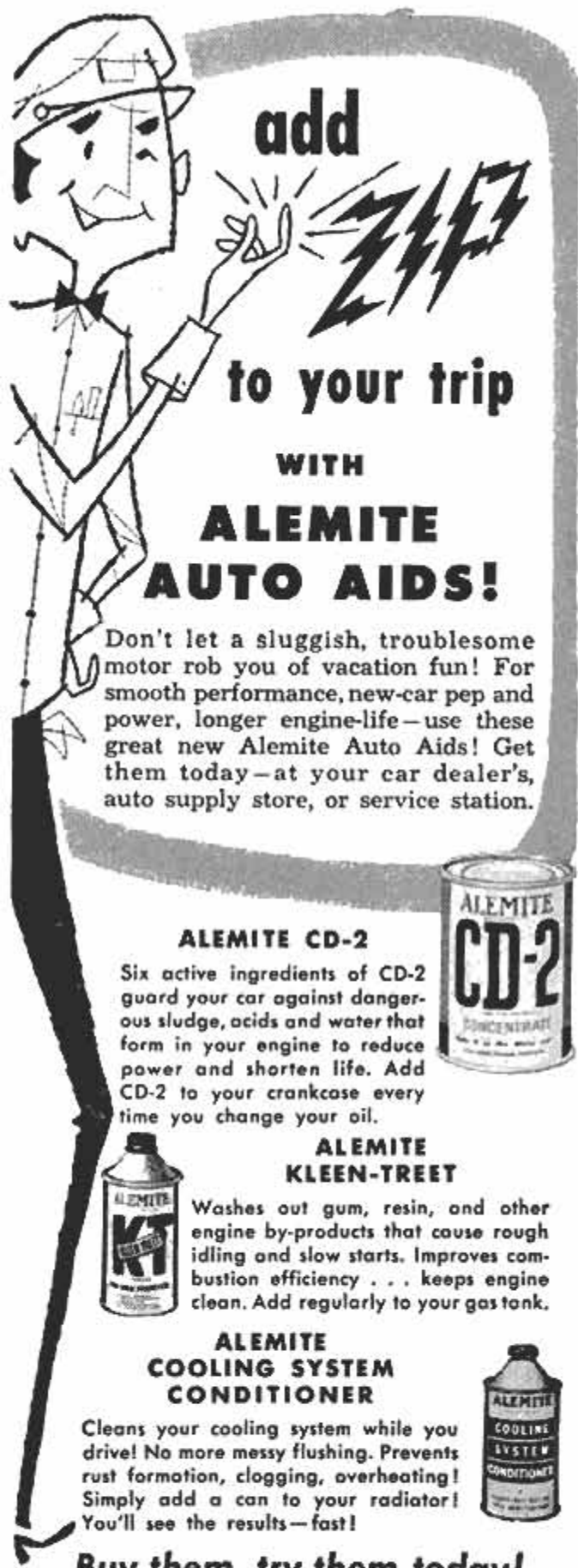

add

to your trip

WITH

ALEMITE AUTO AIDS!

Don't let a sluggish, troublesome motor rob you of vacation fun! For smooth performance, new-car pep and power, longer engine-life—use these great new Alemite Auto Aids! Get them today—at your car dealer's, auto supply store, or service station.

ALEMITE CD-2

Six active ingredients of CD-2 guard your car against dangerous sludge, acids and water that form in your engine to reduce power and shorten life. Add CD-2 to your crankcase every time you change your oil.



ALEMITE KLEEN-TREET

Washes out gum, resin, and other engine by-products that cause rough idling and slow starts. Improves combustion efficiency . . . keeps engine clean. Add regularly to your gas tank.



ALEMITE COOLING SYSTEM CONDITIONER

Cleans your cooling system while you drive! No more messy flushing. Prevents rust formation, clogging, overheating! Simply add a can to your radiator! You'll see the results—fast!



Buy them, try them today!

ALEMITE

MADE IN U.S.A.

AUTO AIDS

Products of STEWART-WARNER CORPORATION



activities, aimed at keeping the tourist for lengthy stays, and to encourage return visits. Drive up Collins Avenue and you'll suddenly be confronted by an enormous coral cliff from which water cascades into a pond, forming an animated sign announcing The Castaways. Activities at this 172-room Papuan palace are enough to exhaust the most confirmed extrovert. You can fish free from a private dock, with rod and tackle furnished by the management, or join an organized deep-sea fishing party. The motel maintains a fleet of Scottie Craft cabin cruisers that guests may drive themselves, too. Water-skiing instructions are available, not to mention swimming or dancing lessons. Free movies, and Kaffe klatsches liven up the evenings. Grass skirts and leis are passed out to the gals on "Hawaiian Night," 10-gallon hats and kerchiefs on "Chuck Wagon Night."

Even smaller highway courts hit the "atmosphere trail" now and then. Frank Redford's chain of seven motels is designed to look like Indian villages, with wigwams encircling central lounging lawns, spotted with rustic furniture. Typical is his 19-wigwam village on Highway 66 in San Bernardino, Calif. Each unit, designed to look exactly like a bona fide wigwam with triangular, roll-back entry, is actually of wood-frame construction covered with stucco and secured to a slab. The insulated units are fir paneled inside, with special windows and built-in drain ports to keep rain from the cone-shaped dwellings.

Whether it's a wigwam or urban citadel, the motel is in its heyday, and it looks like a long, happy day for both motelkeepers and Customers. New, superelaborate chains are on the way. Howard Johnson, the ice-cream man, has announced the start of a huge new chain to be run in conjunction with his famous roadside restaurants. Huge franchise chains such as Travelodge, Master Host, Holiday Inns, plan more expansion. Self-policing member organizations like Quality Courts, Superior Courts, AAA require more and better facilities for the traveler each year. The Sheraton Hotel chain has announced its entry into the field with a \$2,500,000 "highway hotel" on the New York Throughway, near Tarrytown, N. Y. To top them all, Hot Shoppes, another national restaurant chain, is building Marion Motor Hotel—a four-story mammoth which they call "the world's largest drive-in." The \$4,000,000 structure occupying seven acres on the Potomac River "10 minutes from the White House," will boast 348 room units.

Even hotel men grudgingly confess their highway rivals are going onward and upward. ★ ★ ★



got a

MECHANICAL SKILL?

You'll go places FASTER in the **U.S. AIR FORCE!**

HERE'S WHY: Men with mechanical skills find that they can get ahead in the U. S. Air Force. As an Airman, you'll have the chance to develop your technical ability and learn a skill that will pay well — and win you extra stripes. Such interesting

career fields as Aircraft and Engine Maintenance, Rocket Propulsion and Intricate Equipment Maintenance are open to you, if you qualify.

Don't delay—visit your local Air Force Recruiter, or mail the coupon.

SEND FOR YOUR FREE BOOKLET
Entitled: Pocket Guide to Air Force Opportunities



M-28-PM3

Paste coupon on postcard and mail to

AIRMAN RECRUITING INFORMATION BRANCH
BOX 2202, WRIGHT-PATTERSON AFB, OHIO

Please send more information on my opportunities for enlisting in the U. S. Air Force. I am between the ages of 17-34 and reside in U. S. A. or possessions.

Name _____

Address _____ Age _____

City _____ Zone _____ State _____

U. S. AIR FORCE

Looking for Something?



TOOLS



**FROM TOOLS
TO TREE SERVICE
WHATEVER YOU NEED**

Find It Fast
In The
'Yellow Pages'



Ads with this emblem make your shopping easier

Ford V8 Has Plenty of Power, Say The Owners

(Continued from page 121)

No Engine Trouble: 74.5%

Just about three quarters of the V8 owners report no engine trouble at all. Another 21.6 percent say they had some trouble and 3.9 percent had considerable. Most-frequent engine troubles were with the carburetor and automatic choke and the valves (3.4 percent each). Another complaint is that the camshaft had to be replaced (2.9 percent).

"Broke valve stem and spring."—Connecticut school director.

"Camshaft lobe wore down."—Iowa service-station operator.

"Blowing head gaskets."—Michigan Air Force man.

More Best-Liked Features

The following quotations from Ford V8 owners describe other best-liked features and are listed in order of frequency:

"Very good gas mileage. We drove our Fairlane 8590 miles on a trip, averaging better than 18 miles per gallon. No oil between changes."—North Dakota farmer.

"Excellent vision over the front and sides."—Kansas repairman.

"Holds the road well and I like the Fordomatic."—New Mexico rancher.

"I drive under the most adverse conditions. Country roads are rough and muddy in winter, rough and dusty in summer. Ford engines can take it. This body is best built of any Ford I ever owned."—Arkansas farmer.

"I like the V8 engine. It's the best auto engine ever built."—South Dakota owner.

"Has good trade-in value. Looks up-to-date even when two or three years old."—North Dakota rancher.

"Starts easily no matter how cold."—South Dakota social worker.

"Upholstery is beautiful. Easy to clean."—Connecticut auditor.

"Easy to park because of raised rear fenders."—Maryland farmer.

"Well-planned dashboard, especially the lighting of knobs."—New York contractor.

"I am a farmer and need a car that can clear ruts and rocks. The Ford is far superior in this respect."—North Dakota farmer.

"Rear lights give plenty of protection."—New Jersey housewife.

"I can travel in country and through pastures without shaking it to pieces."—North Dakota farmer.

(Continued to page 218)

NOW... FROM LENNOX... WORLD LEADER IN HOME COMFORT...

a whole-house air conditioner only \$599

Complete two-ton
pre-wired unit.
Ductwork and
installation extra.
(Unit price higher in Canada)

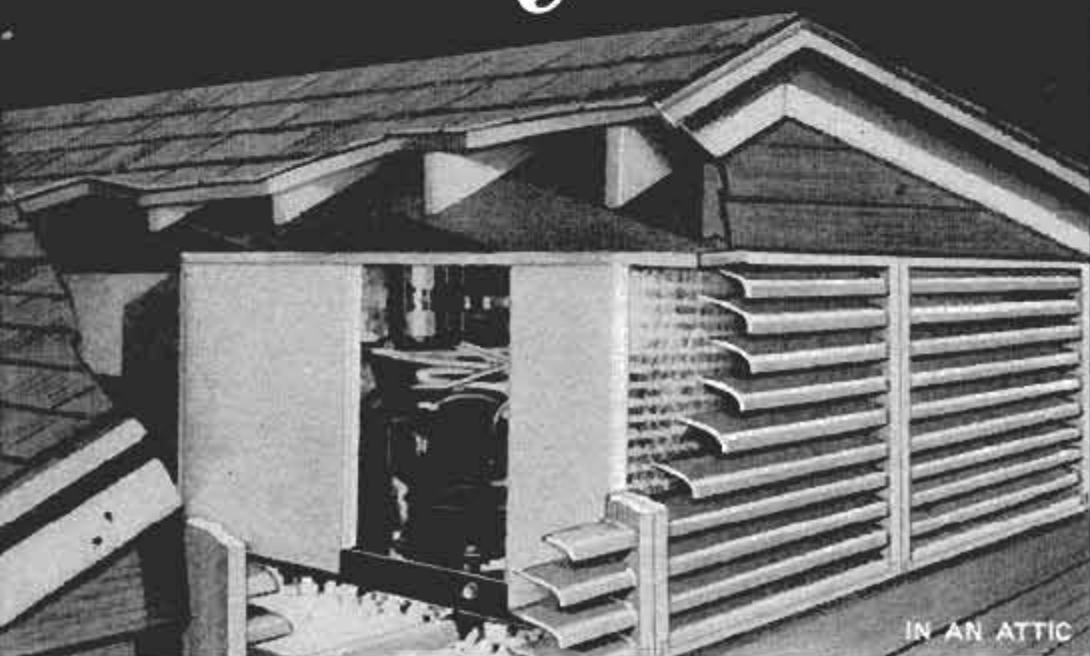

IN AN ATTIC

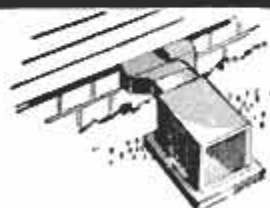

OUTSIDE OF CRAWL SPACE



ON A FLAT ROOF



IN A BASEMENT WALL

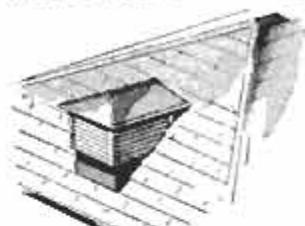

AS A HIP ROOF DORMER

No matter how your home is designed... no matter how you heat it, you can economically install the new Lennox Stowaway Air Conditioner

Lennox, leader in the development of home comfort systems since 1895, announces one of the great engineering achievements of our time—a high quality central air conditioner that costs just \$599. Unexcelled in operating economy, it actually consumes up to 40% less electric current than many other air-cooled air conditioners of the same capacity.

Any middle-income family can now enjoy and afford whole-house air conditioning with this new Lennox Stowaway unit. It requires no plumbing, no water tower, no expensive wiring; has two compressors for maximum comfort. Every style of home has a place for it—either inside or outside, upstairs or downstairs. For it's so compact that it can be neatly "stowed away" most anywhere—to cool and dehumidify the air throughout your entire home.

No matter how you heat your home, it's economical to install this amazingly quiet Lennox air conditioner. Existing ducts will do, if you heat with forced warm air. If you have hot water, steam or radiant heat, a space heater, wall heaters or floor furnace, the simplest ductwork is all you need.

Your Lennox dealer-expert will give you a free estimate on installing a Lennox Stowaway Air Conditioner, available in 2-ton, 3½-ton and 5-ton sizes.

**BUY NOW ON
EASY PAY PLAN!**

See your factory-trained Lennox dealer-expert, listed in the yellow pages of your phone directory under "Air Conditioning" or "Furnaces." He can bring you whole-house cooling today on liberal financing terms.

MORE FAMILIES BUY

LENNOX

THROUGH MORE THAN 5,600 HOME COMFORT SPECIALISTS



© 1956 Lennox Industries Inc.; Marshalltown and Des Moines, Ia.; Syracuse, N. Y.; Columbus, O.; Ft. Worth, Tex.; Los Angeles, Calif.; Salt Lake City, Utah; Decatur, Ga. In Canada: Toronto, Montreal, Calgary.

REPLACE YOUR

OLD WOOD CELLAR DOOR



WITH A MODERN ALL-STEEL BILCO DOOR

DO IT YOURSELF

IN JUST 3 TO 4 HOURS

Think of it! Only a few hours of pleasant work to replace your unsightly, troublesome wood hatchway with a lifetime, weathertight BILCO . . . the door installed on tens of thousands of new homes.

PAYS FOR ITSELF! Cost so little, yet never needs repair or replacement. Operates at a touch. Smooth, trim appearance adds amazing new beauty to your home.

Rush coupon TODAY for free folder and "Do It Yourself" pamphlet showing step by step replacement of wood hatchway.



THE BILCO CO.
DEPT. 331C
NEW HAVEN, CONN.

AMERICA'S FINEST
BASEMENT DOOR

Gentlemen: Please send me "Do It Yourself Pamphlet" along with other literature showing sizes.

Name _____

Street _____

City _____ State _____

And More Complaints

The following describe additional complaints, listed in order of frequency:

"Worst paint of any car."—Massachusetts supervisor.

"Hard to start when engine is hot."—Florida bookkeeper.

"Fordomatic whines. Seems to shift hard."—Washington, D. C., naval officer.

"Fordomatic very difficult to use in snow and ice."—Minnesota engineer.

"No weight in rear end. Gets stuck in snow where most cars do not."—Connecticut government worker.

"Engine hard to get at. Some dealers make a labor charge for changing oil-filter cartridge."—South Carolina accountant.

"Generator too low. Distributor difficult to get at."—Wisconsin mechanic.

"Tires no good. I've seen eggs closer to being round."—Nebraska engineer.

"Ash tray too far in, causes cigarette to burn padded dash."—Arizona serviceman.

"Rear-view mirror so low can't see traffic approaching from right."—Colorado motel owner.

"Gravel gets into hub caps."—North Dakota school superintendent.

"Heater burns those in front, freezes those in rear."—Idaho mechanic.

"Rear bumper is discolored from exhaust."—Colorado carpenter.

Suggested Changes

We asked Ford V8 owners to list the one change they would like to see made in their cars. Here are some of the most interesting:

"Change places of ignition switch and wiper control."—Kentucky evangelist.

"Vent ducts should be below windshield to avoid sucking in snow and dirt on gravel roads."—North Dakota farmer.

"Smaller taillights. Appear much too big for size of car."—Washington repairman.

"Sacrifice frills to make necessities of better quality."—California professor.

"Trunk opening should extend down to floor level."—Oregon farmer.

"Put more money into mufflers so they would last."—Vermont patternmaker.

"Red light is okay for oil but not for ammeter."—California Air Force captain.

"Redesign front license-plate holder so it won't always get bumped."—California mechanic.

"Eliminate noise of power steering when wheels cut sharp."—Florida owner.

That is the story of the 1956 Ford V8 as told by the owners. For an engineer's version, turn to page 118. For the opinion of a veteran driver, Floyd Clymer, turn to page 117. ★ ★ ★

HOW TO GET A SAFE MUFFLER AND SAVE UP TO \$8.00 BESIDES

26 gauge inner shell—22 gauge outer shell.
Double shell lasts longer.

Non-clogging extruded holes—
no whistling, no restriction.

16 gauge, spun-locked,
blowout-proof steel heads.

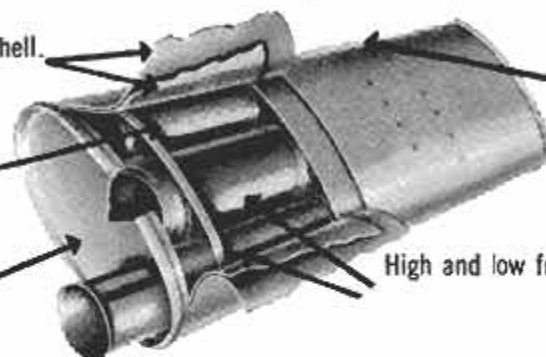

Crimped seams
eliminate
weak points.

High and low frequency tuning chambers.

A leaking muffler is dangerous *long before* it gets noisy. One hatful of carbon monoxide gas can kill you in 2½ hours. One cupful slows your reactions *dangerously*. You're safer with Silentone's double wrapped shell, a third heavier than in ordinary mufflers. It protects you against dangerous leaks, makes your muffler dollar go farther by lasting up to 33% longer.

And do you know why so many new cars have duals? Modern engines need them to conserve their

greater horsepower. So think how important it is if you have a single muffler that it be a good one. Silentone® gives you more power, yet costs less. Scientifically designed to keep back pressure at a minimum, it assures you top performance and mileage. Many stores install Silentone at big savings to you. Buy Silentone and save up to \$8. P.S. If you prefer that deep mellow tone, get Dynatones. They're engineered, not packed. Write for name of your nearest store.

Sold only by America's leading automotive chain stores

SILENTONE MUFFLERS • DYNATONE • GLASS-PACKED
Dept. 2G, Toledo 1, Ohio

NOW—SHOPSMITH® for as little as \$3 per week

Start enjoying SHOPSMITH now for only \$29 down, \$3 weekly. Start *saving* now! Savings on projects and home repairs can more than equal weekly payments. See your hardware dealer or Montgomery Ward store. Write for 2 big, free, illustrated books. SHOPSMITH, Dept. 323-B, Menlo Park, Cal., or Box 2888, Ft. Wayne, Ind.

Find HIDDEN TREASURES

GOLD, SILVER, PRECIOUS METALS with the Famous Model 27 Metal Detector. Lightweight, ultra-sensitive, low cost. None finer. Also GEIGER COUNTERS for uranium and the VIOLITE for tungsten. INFORMATION FREE

THE *Detection* CORP.
5528 Vineland Ave., No. Hollywood, Calif.



Protect your home against
power interruptions
with an...

ONAN Emergency ELECTRIC PLANT

Provides dependable stand-by electricity for heating system, pumps, freezer, lights, appliances. Keeps home safe, livable. Automatic start and stop. Find out how little it costs!

Write for Folder!

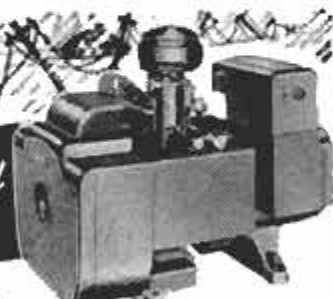

A SIZE FOR EVERY NEED
500 to 50,000 watts.
Compact, quiet-running.
Gasoline-powered.
Priced from \$255.00

D. W. ONAN & SONS, INC.
3642 University Ave. S. E. • Minneapolis 14, Minnesota

Homasote Handbook

WEATHERFOOT
HOMASOTE
INSULATING-BUILDING
BOARDS

AS THICK UP TO
8' x 14'
IN A WIDE VARIETY
OF PORTS AND THICKNESSES

HOMASOTE COMPANY
CHICAGO, ILL. 60611



An ornamental ceiling AT MINIMUM COST

Few features grace your home as well as a paneled or recessed ceiling. Easy and inexpensive to build, a truly modern ceiling can now be yours — because of Homasote.

Homasote is different because it insulates, sound-deadens, and beautifies your ceiling — all in one material. Homasote gives so much more for so little — makes expensive-looking dreams come true in your home.

You can afford a modern ceiling. You can build one

yourself — or have one built — easily and quickly. And your ceiling is built right and built to last, because the Homasote Handbook gives the know-how.

The illustrated section on ceilings in the Handbook is only one of many subjects — all backed by 46 years' experience in the making of quality products. Mail the coupon for your copy — plus 3 fully-illustrated folders suggesting 18 interesting and practical make-it-at-home projects, including furniture.

MAKE IT AT HOME—WITH HOMASOTE

HOMASOTE COMPANY
Department G-1, Trenton 3, N. J.

- I enclose 10¢ for Homasote Handbook.
 I enclose 10¢ for 3 Make-It-At-Home Folders.

Name
Address
City Zone .. State

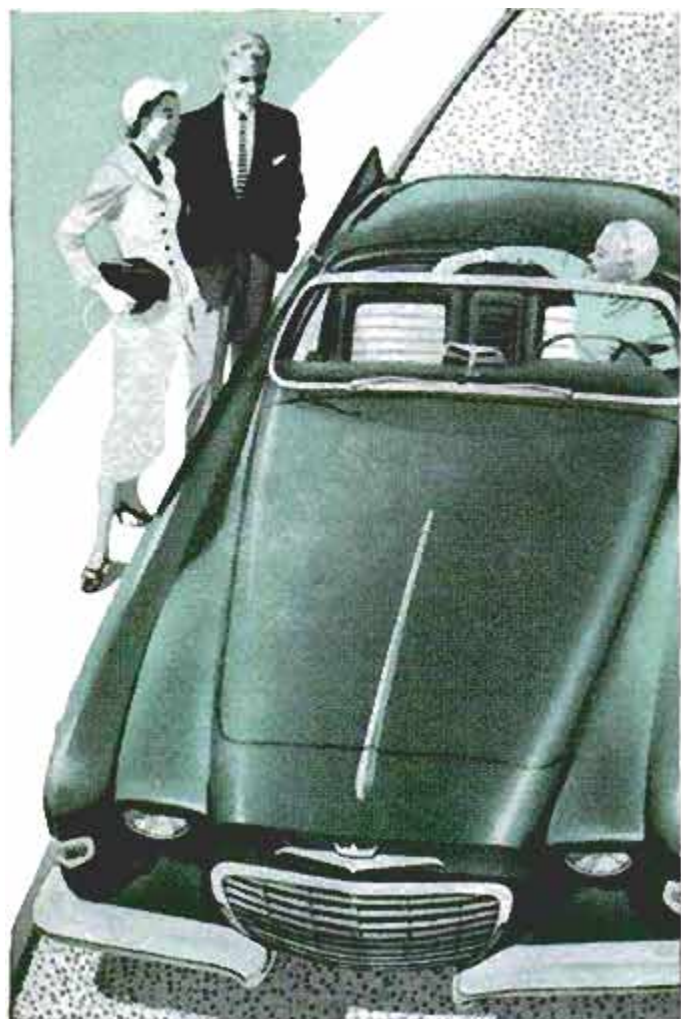

Proved in tomorrow's engines—
 Quaker State is best
 for your car today!



Super-refined from Pure Pennsylvania Grade Crude
 Oil, world's finest. Famous for performance,
 protection, economy! Try it!

QUAKER STATE OIL REFINING CORP., OIL CITY, PA.
 Member Pennsylvania Grade Crude Oil Association

Clymer Tests the Ford

(Continued from page 117)

there is some roll on the corners, the car handled exceptionally well, even on sharp curves and over rough bumpy roads. The hard-driving, long-distance driver may prefer a stiffer front end.

Power Brakes Are Smooth

The power brakes with fixed anchor, are smooth, effective and have little tendency to fade when used at high speeds or in braking while descending steep mountain grades.

The test car had Fordomatic transmission (a three-element torque converter with planetary gears, and a good one) and a rear-axle ratio of 3.22 to 1 (especially suitable for high-speed cruising).

Our car had the 292-cubic-inch V8 engine (which Ford now calls the Thunderbird Y-8 engine) with 8.4-to-1 compression ratio and a four-barrel carburetor. Its horsepower is 202 at 4600 revolutions per minute.

The Fordomatic transmission is efficient and smooth shifting. By floorboarding the accelerator, you can downshift up to 65 miles per hour. If the throttle is held wide open, the upshift takes place at 68 miles per hour. Locked in Low range, the car has terrific acceleration. This gear is valuable for use in braking when descending steep grades.

Ford's power steering is of the linkage-booster type. There is a 25-percent steering effort, which gives a slight drag on the wheel and some "feel" of the road. The steering wheel, lock to lock, requires almost 4.75 turns. It should be less for a power-operated steering unit. I like faster steering.

There was minimum engine or body vibration, although there was considerable hood and front-fender tip flutter at cruising speed on rough roads. The body seems well insulated and solid and there was but slight body noise or rumble at high speeds.

The location of the instruments is excellent and there is no upper half horn ring to obstruct vision. The speedometer, clock, fuel, temperature, generator and oil indicator lights, as well as shift-lever indicator, are neatly housed in one group, well protected by a top shroud to eliminate reflections at night. The shift positions are different from most other automatic-transmission cars. These positions are entirely satisfactory, but I'd like to see positions on all makes standardized, as it is bothersome in two-car families where the shift positions of different cars are not identical.

(Continued to page 222)

TO PREVENT RUST
AND LUBRICATE,
NOTHING'S AS GOOD
AS LUBRIPLATE



TRY LUBRIPLATE! Not an old-fashioned oil that runs off or gets gummy. LUBRIPLATE is a new, white and clean, semi-fluid lubricant that stays put.

• In handy 25¢, 50¢ and \$1.00 tubes at Sporting Goods, Hardware, Marine and Auto Supply Stores.

• Dealers write to LUBRIPLATE DIVISION, Fiske Bros. Refining Co., Newark 5, N.J.

LUBRIPLATE
THE MODERN LUBRICANT

NEW! AUTOMOTIVE CATALOG

Giant 1956 Edition! Everything for car, truck, custom-styled car, hot rod . . . at **LOWEST PRICES!**

SAVE UP TO 50% on all parts, accessories! Only complete automotive buying guide . . . 75,000 items . . . 180 pages! Thousands of **hard-to-find** parts, equipment, parts for 1920 to 1956 models! **Hollywood accessories** never before offered: **hi-speed parts.** Send your name and address and 25¢ (refundable with first \$5.00 order) to:

J. C. Whitney & Co. 1917 Archer, Dept. P-7, Chicago 16, Ill.



Exclusive Double-Bearing HEAVY-DUTY PUMPS

IRRIGATE • DRAIN • CIRCULATE • SPRAY
Up to 7,500 GPH, 3,000 GPH from 25' well. Use 1/4 to 1 HP motor. 1 1/4" inlet; 1" outlet. Stainless shaft. TYPE W-2 oilless bronze bearings. **\$10.95**

TYPE XB—Ball bearing model. **\$12.95**
Postpaid if cash with order. Rush your order today

MONEY BACK GUARANTEE
Centrifugal and Gear Pumps in All Sizes
LABAWCO PUMPS, Belle Mead 2, N. J.



MAGNETS

5 Assorted Size Magnets \$1.00. Powerful Pocket Magnet W/case \$1.00. Hot Pad Magnets—large size 8/\$1.00. Bulletin Board Magnets 8/\$1.00. Slender Magnets—pencil type 2/\$1.00. Retrieving Magnets—extra power, heavy duty—30 lb. pull \$4.00, also 50-75-100 lb. pull. Explore, learn Electricity, Magnetism, Electro magnets, complete kit and instructions with 22 experiments and models. \$3.98 **TRANSISTOR RADIO KIT**—all parts & instructions—powerful. . . . \$7.95 Also—Rods, discs, bars, horseshoes. Send stamp for catalog—Specify your requirements—100% **SATISFACTION GUARANTEED.** **PARK MAGNETS, 267, 1557 GREENBAY RD., HIGHLAND PARK, ILL.**



The Modern **PLASTIC**
for lasting Home Repairs

PERMANENTLY mends cracks or holes in wood, tile, stone or plaster. Sticks and stays put—Does not chip, shrink or fall out. Easy to use. Economical. Mold it, chisel it, polish or paint it. The big 4-lb. can is obtainable from your lumber, paint or hardware dealer at \$1.25; or will be shipped direct postpaid (in U. S.) for \$1.50. Complete satisfaction guaranteed or your money refunded.

DONALD DURHAM CO.
Box 804-T Des Moines, Iowa

FREE PLAN

Tells How to Start
Your Own Business

**FILING
SAWS**



Saws come
from 20 and
30 miles

Files Thousands of Saws
in Spare Time

"I rented a two-car garage and have all the work I can do. Some days I start 6:30 in the morning. I get work 20 and 30 miles from my place of business."
—Charles H. Smith

"I have done 4 or 5 thousand saws in my spare time in the 4 1/2 years since I got the outfit, and they are all coming back with repeat orders."
—Len Crego.

FOLEY FILED SAWS BRING NEW CUSTOMERS

Here is a steady repeat CASH business that pays up to \$3 to \$5 an hour, and you can start in your own basement or garage in your spare time. Every saw you sharpen with the machine accuracy of the Foley Saw Filer is an ad that brings more customers. S. M. Hollingshead wrote to us: "I am doing very well with my Foley Filer, and I am glad I invested in your machinery. It is very satisfactory and works very well in the small community in which I live."

You can file all hand saws, also band and crosscut circular saws on the Foley Saw Filer. The adjustments are simple—there is no eyestrain—and you can start right away to turn out perfect cutting saws. "The first saw I sharpened with my Foley Saw Filer came out 100%. I think it is a marvel of perfection."—writes Clarence E. Parsons.

"**MONEY MAKING FACTS**" explains how you can get business from hardware stores, home owners, farmers, carpenters, schools, mills, factories, etc. Just think—with a modest investment, no overhead, no stock of goods to carry, you can start right in on a cash business that will help pay the rent, buy groceries, or a new car. Get the facts—send coupon today for this practical, money making plan. No salesman will call.



Send for **FREE BOOK**

FOLEY MFG. CO., 716-6 Foley Bldg., Minneapolis 18, Minn.

Send me free book "**MONEY MAKING FACTS**"

Name _____

Address _____



Solders in ONE operation... just apply Swif and heat

SWIF is a real 50/50 tin-lead solder in paste form with flux combined. Just apply Swif and heat. All extra preparatory steps are eliminated by its one-step cleaning, tinning and soldering action. It makes perfect soldered connections with the heat of a match, torch, or soldering iron. Tube holds enough Swif for hundreds of jobs. Swif has been used by professional plumbers for years. At hardware, hobby, plumbing and auto stores. 59c per tube. Slightly Higher in Canada. Send For Free Literature.

HERCULES CHEMICAL CO., Inc.
416 B'way., New York 13, N. Y.

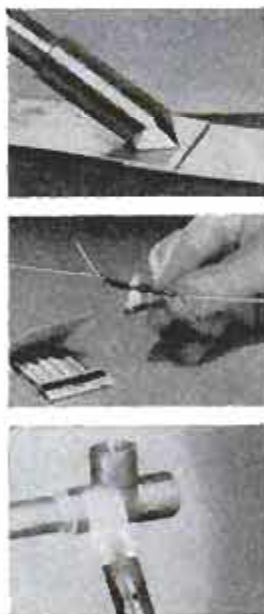

Jet King POCKET-SIZE BUTANE BLOW TORCH

**SOLDERS!
BRAZES!
FIXES LEAKS!**



ONLY
\$1.95
WITH CHARGERS

Every do-it-yourself and hobby fan needs this Kidde JET KING butane Blow Torch. No dangerous containers of inflammable liquids to store... a tiny, clean, safe charger does the job. Just the tool you've been looking for to do dozens of jobs in home or hobby... TV, appliance, lamp, radio or plumbing repairs... precision soldering, brazing or metal craft. Useful, too, for starting charcoal fires.

Each charger gives 30 minutes of intense 3500° pinpoint flame. Extra chargers, 2 for 39¢. Money back guarantee. At leading hardware and hobby stores... or send check or money order, we pay postage.

Kidde

KIDDE MANUFACTURING CO., INC.
Dept. PM-1
42 Farrand Street, Bloomfield, N. J.

Please send me _____ JET KING BLOW TORCHES plus; _____ boxes extra chargers (limit 2 boxes per torch).

My check , money order for \$_____ is enclosed.

Name _____

Street _____

City _____

State _____

The high-beam warning light is small, poorly located and hard to see quickly at night. It is directly below the 60 mile-per-hour point at the top of the speedometer and the speedometer needle hides it at that speed. The defroster and heater are effective, but the controls are more complicated than necessary. At times I found it difficult to adjust to the right degree of heat.

I do not like the left-hand-operated key starter, but the southpaws will enjoy it.

The glove-compartment door requires considerable one-finger effort to open, and the lid drops too far when opened, sometimes whacking the knees of a tall passenger. It is not a good arrangement.

The driving position is easily adjusted to fit each individual and cushions are well padded with good springing. Interior appointments are all of high quality. The doors open and close easily. Outside handles have push-button latches. The body seems tight and, during a rather severe duststorm and a high-pressure water test, no dust or water leaked into the body. Twice during the long test, squeaks and rattles developed, but they disappeared as mileage accumulated.

Vision in every direction is excellent and the high fender tips, front and rear, are convenient guides for parking or maneuvering in narrow places.

The dual exhaust pipes extend through the rear bumper, which is a neat arrangement. However, soot and dirt soon gather along the bumper edge, making it easy for a person to soil his clothing when walking around the rear of the car in close quarters.

The hand brake has close ratchet graduations and is easily operated. The pendulum-type brake pedal is fine, but for those who still operate throttle and brake with the right foot, the pedal is too high from the floor, as there is a four-inch travel between the closed throttle position and the off brake-pedal position.

Ford's center-fill gas tank is practical and I can't understand why other makers do not copy it. However, the 17-gallon tank is too small for today's cars as in certain isolated regions it may be a long distance between filling stations, especially at night in the west.

Although I have some minor criticisms of the new Ford, I found many highly desirable features such as: the "big car" solid feel; the excellent acceleration; exceptional performance in Low gear; ability to maintain long, sustained high speeds with little effort, and comfortable ride—returning to Los Angeles I drove 900 miles the last day and no low-priced car has ever given me a more comfortable ride with less fatigue.

★ ★ ★

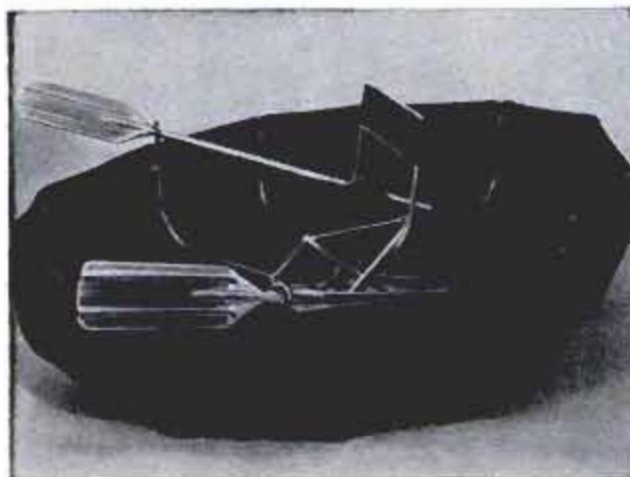

Folding Boat

Fishermen and duck hunters can carry along a new folding boat and assemble it in one minute. Detachable ribs made of aluminum tubing form the framework of the boat. A cover, made of heavy cloth coated with Vinylite, slips over this framework. The resulting boat measures six feet by four feet and draws only two inches of water with 200 pounds aboard. A folding chair and lightweight oars are included. The boat, complete with chair and oars, weighs only 24 pounds.

Rainfall Indicator

Rainfall is continuously measured and recorded on a moving chart by a compact electric instrument. The collected water acts as an electrolyte to complete a circuit and turn on a heater that evaporates the water. The amount and rate of electricity needed for evaporation indicate precipitation. The unit measures total rainfall to the nearest .01 inch and an expanded lower range for extremely low rainfall has a minimum sensitivity less than .002 inch per hour. Optional features include snowfall measurement, an alarm circuit to signal the onset of precipitation and a flood-warning alarm circuit preset at a critical rate.

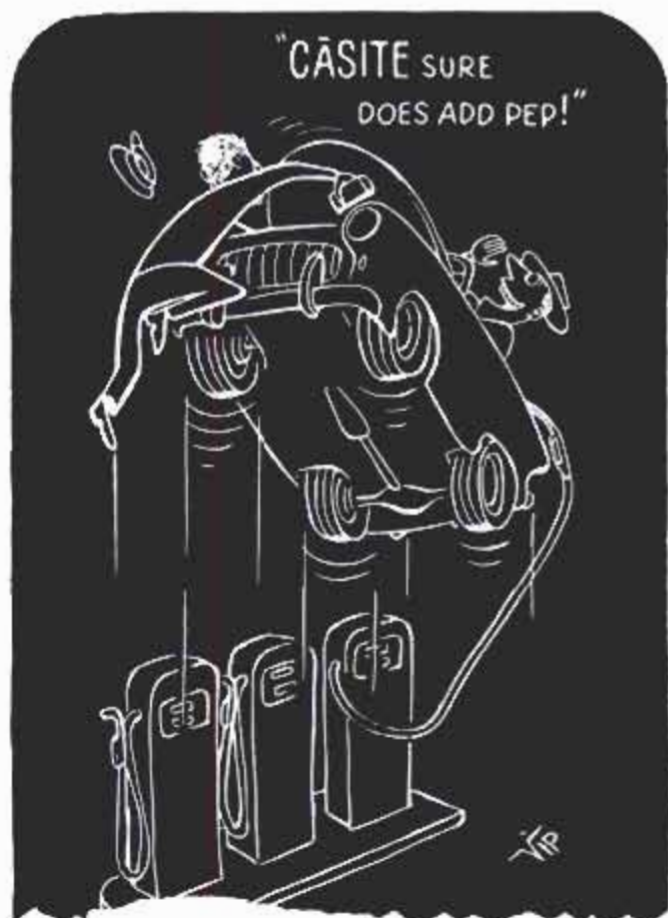

TUNE-UP when you GAS-UP

A pint in the crankcase . . . a pint through the air intake . . . restores pep and performance—frees sticky valves and rings—keeps your engine clean or *Double-Your-Money-Back!*

HASTINGS MANUFACTURING CO., HASTINGS, MICH.

CASITE



Buy these Hastings Products with confidence:
Casite, Wear Reducer, Piston Rings,
Oil Filters, Spark Plugs

Window or Attic
FANS at amazingly
SAVE LOW COST!

ANYONE
 CAN DO IT!

up to **75%**
 WITH FAMOUS
**FAN
 KITS**

No special tools or skill
 required. Absolute MON-
 EY-BACK GUARANTEE.
 Only a few pieces of
 lumber and new or used
 1/4 HP 1750 RPM motor
 required in complete
 thousands in use.



Aluminum fan spider,
 masonite blades. Shaft,
 Oilite bronze bearings, col-
 lars, pulleys, belt and bolts.
 Step-by-step instructions
 sent you makes assembling
 fast and easy for standard or
 horizontal installations.



DEALER INQUIRIES IN-
 VITED. Write for spe-
 cial money-making of-
 fer!

- | | |
|--|---------|
| 30" Fan cools average home, 6,000 CFM | \$14.95 |
| 36" Fan cools larger home, 8,000 CFM | 17.95 |
| 24" Fan cools smaller homes, 4,500 CFM | 13.95 |
| 20" Fan cools apt., offices, etc., 2,800 CFM | 12.95 |
- Money order or check with order shipped postpaid, \$3.00 de-
 posit on C.O.D. orders. Circular free.

FAN KIT COMPANY

154-N NO BELVEDERE • MEMPHIS, TENN.

Red Devil
WOOD SCRAPERS



High carbon steel replaceable blades.
 Hardwood enamelled handles designed
 for easy holding. Scrapers clean in sec-
 onds. A model for every job (blade
 widths of 2 1/2", 1 1/2" and 1") priced to
 suit your budget.



FREE

#10 How to Prepare Surfaces for Fin-
 ishing. Illustrated instructions on
 preparing masonry, wood and metal
 surfaces for painting.

Red Devil Tools. Dept. 146
 2400 Vauxhall Rd., Union, N. J.

Please send FREE copy of "HOW TO PREPARE SURFACES FOR FINISHING."

NAME _____
 ADDRESS _____
 CITY _____ ZONE _____ STATE _____

1413

**We'll Conquer Antarctica
 With Wings**

(Continued from page 76)

spots proved it thick enough to support
 the 72,000-pound Skymasters. Scarlet trail
 flags were frozen in holes, marking off a
 runway 9000 feet long and 300 feet wide.

Antarctica didn't give up easily, though.
 One Seabee work crew creeping across the
 ice through a blizzard in a Weasel, tumbled
 into a big crack and spent two harrowing
 days on the ice until helicopters could res-
 cue them. A ski-wheel Otter with seven
 men aboard, crashed on take-off and left
 its battered occupants stranded in a surviv-
 al tent on the wind-swept wilderness for
 14 hours until sleds and stretchers were
 found to bring them out. A ponderous sled
 train, hauling Ground Control Approach
 equipment from ship to strip, nosed into a
 10-foot crack and had to be abandoned.
 That left the world's southernmost airport
 without equipment to bring its planes home
 through treacherous blizzards or whiteout.

In spite of it all, on the big day, six ships
 of Task Force 43 stationed themselves at
 250-mile intervals across the polar sea be-
 tween McMurdo and New Zealand, form-
 ing a unique chain of radar beacons to
 guide the big planes in. Tethered to that
 electronic leash, eight medium-range Navy
 craft lumbered from runways of two New
 Zealand airports. Besides the Skymasters
 and Neptunes there were twin-engine
 Dakotas and two twin-engine Albatrosses.
 Fierce headwinds that gobbled fuel at
 phenomenal rates forced the Dakotas and
 Albatrosses to turn back after 900 miles.
 But 14 hours after take-off, the other four
 settled toward McMurdo's frozen water
 under a brilliant midnight sun. In one
 Neptune, less than an hour's fuel remained.
 "Routine, that's all it was," announced one
 grinning pilot as he stepped to the ice.

Cold-Weather Flying

With VX-6 established on its icy base,
 the business of getting flights under way
 during the short good-weather period be-
 gan. Problems were strictly unique.

Antarctica's deep sub-zero temperatures
 play havoc with aircraft. Ice crystals form
 in gas lines. Fuel a plane to capacity on a
 frigid day and, when the temperature rises,
 the gas will expand and spill all over the
 place. Moisture freezes on radio-aerial in-
 sulators, so the base can't contact the
 planes in flight. Oil solidifies. Tires of
 parked planes develop frozen flat spots
 where they squash against the ice, result-
 ing in a bumpy, "square wheel" take-off.
 Grease freezes wheels rigid so they skid

(Continued to page 226)

REPAIR MUFFLER AND EXHAUST LEAKS in 10 min.

The plastic gas-tight seal sets hard, withstands heat and vibration. Prevents carbon monoxide gas poisoning.

SETS LIKE A WELD — NO TOOLS NEEDED

* \$1.69 per can

Holt's GUN-GUM

MUFFLER PLASTIC SEAL

Write for Full DETAILS

See Your Neighborhood Auto Accessory and Parts Replacement Store
TREGLOWN CO. INC. FANWOOD 89, N.J.
 * TRADE MARK REGD. CANADA: 1366 GREENE AVE, MONTREAL 6 (PRICES HIGHER)



Holt's HAVE THE ANSWER!

WORN ENGINE BURNING OIL!
 Increases miles per gallon!
 Restores compression!
 Reduces oil bills!



\$4.95 Tube for most cars

Forms self-lubricating seal at piston top. Inserted through spark plug holes. Used by millions of motorists. Tested and approved by motoring experts.

* PISTON SEAL

DITCH-WITCH TRENCHER



Portable DITCH-WITCH digs 4 1/2" or 6" clean, even ditches to 36" depth in all types of soil. Four rugged models. Complete unit — self-propelled. **OUTDIGS 8 MEN**
 Write for Illustrated Literature

The CHARLES MACHINE WORKS
 620 B Street Perry, Okla.

CUT RADIO CHASSIS HOLES IN 1-1/2 MINUTES OR LESS

Quickly make accurate round, square, key, or "D" openings... in metal, bakelite or hard rubber... with GREENLEE Radio Chassis Punches. Simply turn with a wrench. Many sizes. Write for details. Greenlee Tool Co., 2107 Columbia Avenue, Rockford, Illinois



MENDS MOST ANYTHING

"HOLDS LIKE IRON"

Used by fine furniture makers. Ideal for home and office. In 1/4 oz. or 2 1/2 oz. sizes.

make your own Gems 29.50 F.O.B.

The Gem Maker comes complete with all necessary equipment, including a super-charged diamond blade for sawing, and all wheels for grinding, shaping and polishing; also complete instructions. The complete equipment as shown, less motor and belt for only \$29.50, f.o.b., Burlington, Wisconsin. Write today for information and literature.

B & I MANUFACTURING CO.
 Dept. 5 Burlington, Wis.



ELECTRIC WELDER AC or DC 110 Volts

The "Little Marvel" all-metal welder, 5-year written guarantee. Welds 1/8" metal or money back. Repairs tanks, tools, fenders, machine parts, etc. Complete with everything — rods, unit, eye shield, directions. \$6.95

\$6.95 Complete

plus 50c postage. Flame torch accessory for soldering, cutting, brazing \$3.95 complete with carbons, brass rods, flux. \$2.00 Deposit on C.O.D. 75 ampere 1/4 inch Transformer Welder \$21.95 F.O.B.

ESSAY MFG. CO., Dept. 51, Quincy 69, Mass.

KING MIDGET

World's Lowest Priced Car!



NOW — 32 PAGE BOOK filled with photos, drawings, specifications, records, wholesale price, and Rider Agents plan if no dealer near you. Send 25c for book, or send \$1 (refunded first order) for it plus actual operating book and service manual.

MIDGET MOTORS MFG. CO., ATHENS 1, OHIO

SPRAY PAINT the EASY WAY!

Unique BECKER CO. SPRAY GUN Goes to the Job . . . Without Attachments!

No Hoses, Wires, Compressors!

At last—a completely portable spray gun you can carry to the job as easily as a water pistol! Powered by CO₂ cartridges . . . provides up to 1,000 lbs. pressure. Container holds 21 oz. of liquid, reloads in a flash. Nozzle adjusts from stream to finest spray. At your dealer's or order direct. Remit in full for post-paid shipment. Or send \$2 now, pay postman balance plus COD fee.



ONLY \$19.95

with 10 cartridges

SULLIVAN-BECKER CO.

Dept. 116-G, KENOSHA, WIS.



Save miles and minutes with an
Airguide-AUTO COMPASS

Points the right way all the way. Neatly styled for today's smart car interiors. Fits all cars, easy to install and adjust, easy to read.

Super-power Alnico V Magnet and aircraft type compensators assure steady dependable performance under all driving conditions. Three models to choose from—

No. 84 NON-ILLUMINATED\$5.95

No. 85 WIRE-ILLUMINATED (by car power) 6.95

No. 86 SELF-ILLUMINATED (with long-life self-contained flash cell) Shown below..... 6.95

CHOICE OF 5 SMART COLORS IN EACH MODEL



Made and Guaranteed by
AIRGUIDE INSTRUMENT CO., CHICAGO 47, ILL.

2 rules in One

for both regular
 and "inside"
 measuring

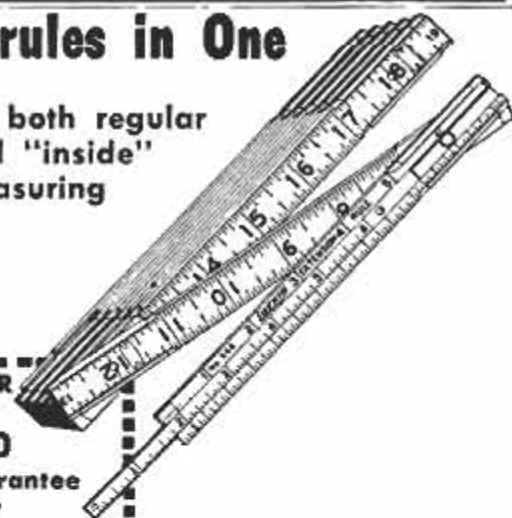

LOOK FOR
 THE
 RED END
 your guarantee
 of quality

LUFKIN X-46
EXTENSION WOOD RULE

Hundreds of thousands of Craftsmen the world over prefer the Lufkin X-46 because . . . it's extra durable with sections 50% thicker than standard . . . it has rust-proof triple-locking joints that maintain accuracy . . . it has brass strike plates to prevent wear . . . it has bold markings embedded right into the wood . . . it's made of select straight-grained hard maple. Buy a Lufkin X-46 and be equipped for accuracy and speed on both regular measurements and inside measuring of doors, windows, etc. You'll find it the finest, most durable wood rule you ever used.

BUY **LUFKIN** TAPES • RULES • PRECISION TOOLS
 AT YOUR HARDWARE OR TOOL STORE
 354 THE LUFKIN RULE CO., SAGINAW, MICHIGAN

instead of rolling. Even skis give pilots trouble. When parked, they freeze to the snow and must be pried loose. A ski-equipped plane on snow handles like a seaplane on water. There are no brakes. When landing, the plane keeps going. It's hard to maneuver. "I hit the drifts to slow down and help make turns," one pilot explained to me.

Antarctica boasts the world's worst flying conditions. The vast continent (about the size of the United States and Australia combined) sits on the bottom of the world like an overturned saucer. In the center of a land mass ringed and slashed by bleak uncharted mountain ranges, is the flat, windswept polar plateau. In places the endless table rises gradually to 14,400 feet. Even a veteran pilot can't tell by eye if it's 100 or 1000 feet under him on a clear day. "A picture of it anyplace," according to one Navy photographer, "is like a snapshot of a bedsheet."

Arctic Whiteout

Worse for VX-6 pilots than the blizzards that howl across this snow prairie were the whiteouts that engulfed it. Whiteout is not, as many people think, a fog or snow condition. Visibility may be hundreds of miles. But the overcast sky matches the white of the snow, erasing all signs of horizon. There are no shadows; depth perception is lost in a two-dimensional world. "You can be flying upside down and not know it," one pilot explains. "It's like flying around inside a frosted globe."

It was allegedly because of a whiteout that Lt. Hal Kolp, burly VX-6 Marine pilot of the first long-range flight on January 3, wound up at the South Pole instead of western Wilkes Land, where he was headed. "We paralleled a whiteout," he reported later, "and that course took us over the pole. It was perfectly flat, with long, gentle snowdrifts that made it look like a stationary white sea with moderate swells. We dropped to 500 feet and threw out smoke bombs, lamp black, ink and a piece of cardboard. Everything disappeared in the soft snow."

The report indicated snow too soft for landing planes there next year, when 20 men and 350 tons of material—including a big snow tractor—are to be flown in by the 18th Air Force, to construct a South Pole base. A few days later, however, Admiral Byrd and Dr. Paul Siple, Deepfreeze's senior scientist, made a second flight over the bottom of the world and decided Kolp's gadgets must have fallen into thick, blowing drift. Such drifting snow can be raised 50 feet off the ice by 100-knot winds. From

(Continued to page 228)

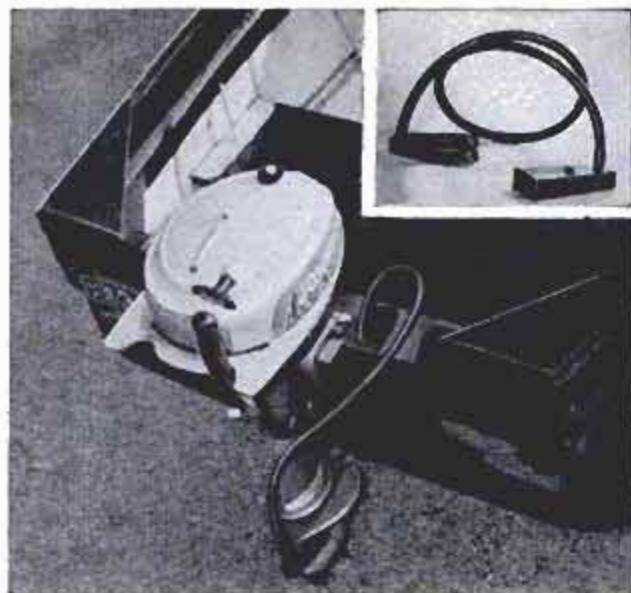

Automatic Boat Bailer

Boats are bailed automatically by a new attachment for an outboard motor. An aspirating nozzle is attached to the motor housing near the propeller. A tube connects it with a float valve in the bottom of the boat. When the motor is in operation, suction is created inside the tube. The float valve opens when any water is present. Some outboard motors are factory equipped with automatic bailers, but the new bailer can be installed on any motor of five horsepower or larger. The speed of the boat has little effect on the bailer, as it is the speed of the propeller which determines how fast the bailer operates.

Golf Handicapper

You can determine golf handicaps quickly and accurately with a compact computer. The 10 selected scores are dialed with a stylus through a curved slot in the face of the metal unit. The correct handicap appears in a window on the face.



Sound your Z...make it

EASY ON OIL FOR KEEPS

because -



Pennzoil with Z-7 keeps engines clean

It's true—you'll use less oil when you use Pennzoil with Z-7! For this different Pennsylvania motor oil has an all-oil lubricating body that stays tough under even the most intense engine heat and pressures. It also prevents formation of carbon, sludge and other oil-wasting deposits. By keeping rings, valves and bearings clean and free, Pennzoil with Z-7 keeps the whole engine smooth-running, safe, and easy on oil—not for just a few miles after an oil change, but for keeps. Get Pennzoil with Z-7, The Tough-Film® oil, now, in the exact seasonal grade for your car!



IN EVERY STATE,
AT DEALERS WHO
CARE FOR YOUR CAR



MEMBER PENN. GRADE CRUDE OIL ASSN.
PERMIT NO. 2, OIL CITY, PA

the air it appears solid. Doctor Siple reported sastrugi, or long thin drifts of snow, pointing like arrows in all directions, indicating light variable winds that should pack the snow solidly enough for next year's big operation.

Jet-Assisted Take-Offs

All VX-6 flights roared out of McMurdo Sound with the blue flame of jato bottles gleaming against their sides for an added push. Most headed south through the great Beardmore Glacier, traditional gateway to the high polar plateau. "How do you get to the South Pole?—You go to the Beardmore Glacier and turn right," was a standard gag bandied between plane crews.

To fuel, planes flew 40 miles to the ships, landed beside them on the ice edge, and took gasoline through a 1000-foot hose. Some even took off on their polar missions from beside the ships. Few flights had the tense drama of Entrikin's, but several crews had experiences they'll never forget.

Flying over unexplored wilderness west of McMurdo, Lt. Comdr. Hank Jorda and his boys saw what they believed to be new mountain ranges, with 12,000-foot peaks, reaching away for nearly 100 miles to the southeast. "They were brownish rock in sedimentary layers, only partly snow covered," Jorda reported. The plane barely made its discovery when a leak developed in the oxygen system. Hours of flying at 13,000 feet found everyone dazed and befuddled in the first stages of anoxia. "We had trouble adding and solving the simplest navigational problems," Jorda revealed when their plane finally landed at the base.

Endless White Wilderness

What's it like to fly out over that white wilderness? "You go on forever above an endless table of nothing but ice with feathery patterns of sastrugi rippling the surface," reported one correspondent who drew the lucky card and made a 14-hour flight into unknown territory. "It leaves you speechless, and you wonder many things. What's under it? At one time it was subtropical, but how far beneath the surface is the ground? Or is it really a great inland sea encircled by mountainous islands? No one really knows. You think of your family, and wonder why you ever had those infinitesimal arguments."

For thousands of miles, all that many of the flight crews saw below was a dirty white blur—Antarctica's trick of refraction, when light bounces off floating ice crystals, resulting in zero visibility. That's what happened when one Skymaster finally circled the pole. "About 800 feet below was the magical spot from which all directions

are north," noted one disgruntled observer, "and I couldn't see a thing."

The crew members spent their time at picture-taking chores, rubbing frozen feet and reading whodunits. Monotony of the flight was broken by meals cooked on ranges in the plane. The thoughts of most crew members were never far from the grim reality that if their plane were forced down, chances of survival would depend largely on their ability to walk home. Most planes carried enough survival gear to support the crew for 60 days on half rations, but few men entertained much hope of getting out if they landed.

"Chances would have been about one in a thousand," according to pilot Hank Jorda. "You'd spend the rest of your life down there—and your life would be real short."

Actually, every life on every flight hung on the thin thread of mechanical efficiency—and the ability of the busy navigator to bring his ship some 1500 miles out from, and back to a tiny point on McMurdo's ice.

Radio Altimeters Essential

"The 'hairiest' thing about flying in Antarctica," according to Capt. Hank Partridge, navigator observer for the USAF with Deepfreeze, "is the altitude of the polar plateau and uncharted mountain peaks. The stratosphere is at ground level. The plateau may look like a billiard table, but actually it can creep up under you from 9000 to 14,400 feet. If you kept a firm altitude you'd run right into it. So you watch the radio altimeter, and when it hits 400 feet—start climbing."

All Deepfreeze planes carried radio altimeters. The gadget sends out a radio wave that echoes back from the terrain below, much like a ship's sonar that sounds ocean depth. The navigator makes his reading from a cathode tube like a small radarscope in the cab.

Finding the way across limitless white expanses makes the polar navigator's job really tough. "Magnetic compasses spin, dip and dance around like mad, due to the nearby south magnetic pole," Partridge explains. "So we use a free-running gyro compass with north as the destination and call it synthetic north."

On ordinary charts for temperate zones, a straight-course line will cross each meridian at nearly the same angle, providing a navigator with a constant figure for checking course along the route. At the pole, however, meridians converge sharply. "If you measured the same angle on each meridian," says Hank, "and flew your plane on the heading you got, you'd wind up flying in a snail-shell series of diminishing

(Continued to page 230)

Just what paste wax needed - a built-in cleaner!



**Johnson's J-Wax
new Paste Wax Discovery
does the cleaning work for you!**

**Start right in waxing! No extra
cleaner needed—nothing else to buy!**



Here's what you've been waiting for—a paste wax with a cleaner built right in! Johnson's new J-Wax saves you hours of pre-cleaning. J-Wax takes the dirt off for you—replaces grime with a crystal-clear coating of wax. Even the dirt you can't wash off loosens instantly and disappears as you rub on this new self-cleaning paste wax.

Then watch the high brilliant luster that comes as you buff. J-Wax sets smooth and hard—bonds itself into a long-lasting wax-tight seal. Gives your car tough wax protection it needs for any weather. And look! The colors are far brighter, truer—even the chrome glistens.

Get your car ready now for the months ahead—with J-Wax. It's the easiest, fastest way to genuine wax protection—*paste wax protection!*



Pete Penn says:

"Best of Class..."

"That's what automotive engineers say about motor oil made from nature's finest crude... Pennsylvania."

From crude to crankcase, every brand of Pennsylvania motor oil has outstanding *natural* advantages that make it *best for protecting and lubricating* today's high-speed, precision-fitted engines.

Take a tip from Pete Penn. At your next oil change, refill with a brand of Pennsylvania motor oil . . . available at good dealers around the world.

Today's BEST Oils

Start with Nature's Best Crude

...and that means Pennsylvania!

INSIST ON A BRAND OF



© 1954

PENNSYLVANIA GRADE CRUDE OIL ASSOCIATION, Oil City, Penna.

PENNSYLVANIA
Motor Oil

circles until you finally disappeared in your own exhaust stack." To avoid any such calamity, Partridge and other polar navigators use a transparent plastic grid of parallel lines that they lay atop the chart they're using. "They're really synthetic meridians," he explains. "We call it 'flying the grid.'" By flying the grid, and using synthetic north, the polar navigator has it made—provided he doesn't run into white-out, blizzard or the ground.

VX-6 had its taste of bitter medicine. Pilot Bob Streich and co-pilot Glen Lathrop were bringing three Seabees and a photographer back to Little America from a trail-party camp 600 miles out in Marie Byrd Land. "Everything was fine during the first hour," Streich told me later. "Then suddenly we hit freezing rain and blizzard-driven snow. We couldn't see the front end of the cowl. I was trying to turn out of it when I saw the radio altimeter unwinding—and I knew this was it!"

Plane Hits Mountain

A second later, the plane rammed head-on at 80 miles per hour into the side of a bleak polar mountain. The belly slammed against the slope and the craft skidded uphill to a roaring finish. Miraculously, the slide saved the day. Not one man sustained a scratch. By canny use of survival techniques, the seven survivors were able to preserve themselves and start walking the 110 miles across the North Alexandra mountains to Little America. When they were found, seven days later, they had only 85 more miles to go.

The wild flurry of rescue attempts to save these men resulted in the crash of a Navy Neptune in South American jungles while flying from Maryland to Antarctica to help in the search; a smashed wing on another Otter while being ferried to the area, and total loss of a third Otter when it dropped from the crane of the *Glacier* as it was being swung ashore at Little America.

In addition to these losses, three of VX-6's helicopters "bit the dust" during the short Antarctic summer—one whirling into the water when its servomechanism went haywire. The other two just plain wore out under the stresses and strains of cold-weather flying.

But by the time the big planes flew back to the States, there was little doubt that wings over Antarctica had advanced the clock by a good many ages. The map and exploration work achieved by VX-6 planes in 10 days would have taken overland trail parties a good 50 years to accomplish. Otters, flying back and forth between bases

(Continued to page 232)

**MORE \$ \$ \$ PER HOUR WITH
MODERN IMPROVED
LAWNMOWER SHARPENER**



Write for
free
booklet
10A

Grinds All Reel
Type Mowers
Hollow Grinds or
Flat Grinds Bed Knives

Engine, oil, or gasoline
are not removed from
power mowers. Wheels,
handle and roller re-
main in place.
Modern's precision
grinding assures re-
peat business.
100% Steel Construction

Compare
Before You Buy

Faster—Easier to
operate

NO CHANGE IN PRICE FOR OVER 10 YRS.

\$263.00 Complete with 1/2 H.P. Motor
f.o.b. Pasadena, Calif.

MODERN MFG. CO.

160 N. FAIR OAKS, PASADENA, CALIF.

**SUPER-LIGHT LEVEL
HAS MAGNIFIED VIALS!**



**EMPIRE
ACRA-LITE
No. 1521**

A craftsman's dream! Acra-Lite Magnesium Level
is ONE THIRD Lighter — for easier, faster han-
dling. Easier to read, too. Super-accurate vials have
"Pull-Vue" magnifying cover plates. Get YOURS
today — at your dealer, or order direct.

New Empire Acra-Lite Magnesium Level No. 1521,
24" Only 26" 48"
\$6.70 \$7.60 \$13.50

EMPIRE LEVEL MFG. CO.

10930 W. POTTER RD., DEPT. E.M., MILWAUKEE 13, WIS.

**THE BEST
IN PLIERS?**

CHAN NEL LOCK

CHAMPION D'ARMENT TOOL CO., MEADVILLE, PA.

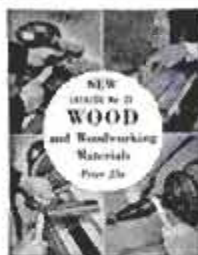

Get New 128 Page Catalog of
**WOOD AND WOODWORKING
MATERIALS**

WORLD'S LARGEST SELECTION—Lowest Prices
Your buying guide for finest kiln dried domestic and
rare imported woods, inlays, bendings, matched ply-
wood, mouldings, ornaments, etc. Biggest selection
of tools and hard-to-find hardware. Packed with scroll
saw patterns, projects, wood facts and money mak-
ing ideas. Enclose 25c (refunded on first order) to
help pay mailing and handling costs. Write today to
CRAFTSMAN WOOD SERVICE CO.
2729 S. Mary St., Dept. A-7, Chicago 8, Ill.

**DO IT
YOURSELF**

It's Easy
With ...



Soldering's really a "cinch"
... when you use time-
tested, reliable KESTER ...
available everywhere.

FREE! "Soldering Simplified"
... 16-page how-to-solder
booklet. At your dealer or write direct.

KESTER SOLDER COMPANY

4251 Wrightwood Avenue Chicago 39, Illinois

**AT LAST! Make Floors, Patios,
Driveways and Walks Look
Different — use ROX**

**TESTED
FOR
YEARS**



Something new
and exciting in
decorating! Now



Rox shows you how to design a shuffleboard,
a hopscotch block and many other interest-
ing or decorative patterns for porches, base-
ment floors, driveways and patios. See booklet
below. If you are tiling your floor, seal out
moisture with Rox first. And remember . . .
Rox is guaranteed not to blister or peel!

**Beautiful, Durable Exteriors
with ROX**

Masonry walls absorb
tons of water—this water,
if not kept out, can de-
teriorate masonry. Rox
becomes part of the
masonry surface itself as
it seals this surface and
protects against water even in gale driven
rains. Rox adds distinctive exterior beauty.



Before



After

**Guaranteed to Protect Basements
Against Water Leakage!**

With Rox,
you can con-
vert your
basement to
a usable re-
creation room
or workshop
where tools are safe from moisture.



Before



After

*Rox is available in 5 colors and white at
authorized Rox dealers in U.S. and Canada.*

**Helpful Booklet
Gives Game Diagrams
and Beauty Hints**

Illustrated in color to help you apply
that professional decorator touch as
you protect and beautify your base-
ment and masonry surfaces. Dia-
grams and explanations to make
shuffleboard and other games or
decorative designs on floors, patios,
driveways, walks, etc., and give
new interest to masonry walls. Send
15c for handling. Rox Products Co.,
Dept. M7, Detroit 27, Michigan.

© ROX PRODUCTS CO.



choose your ride



SOFT

MEDIUM

FIRM

This is the only genuine adjustable shock absorber. A twist of the wrist gives the ride you want—for your make of car, your kind of driving. Only Gabriel has it... AjustOmatic!

Gabriel

AJUST-O-MATIC

SHOCK ABSORBERS

The Gabriel Company • Cleveland, O.

and forward camps saved months of weary lumbering in slow-going snow vehicles. Helicopters airlifted men and materials between ships and base sites on a round-the-clock basis, set cartographers on inaccessible pinnacles, and poked into places even dog teams could never reach.

Commuter Service Next Year

Next year, the air attack against Antarctica's icy barriers will be even more intensive. "There will probably be commutation service between New Zealand and McMurdo Sound," says Rear Adm. George Dufek, head of Task Force 43. An earth runway will be carved from the volcanic ridges. Early in the season, with a fuel cache established at the foot of Beardmore Glacier, Otters will head out over the plateau and land on the pole. The 18th Air Force's flying boxcars, flown by Capt. Art Grafe, D. I. Mallory, Hank Partridge, Jim Cummings and Lts. John Tomasch and Ernie Schmid, will air drop prefabricated buildings and one light tractor over inland bases. To brief themselves on the ins and outs of Antarctic aviation, all these men made flights with VX-6 planes over the polar plateau this year.

"All you have to remember," says Hank Partridge, "is that the ice, like the sea, is not dangerous—but it is extremely unforgiving. A polar pilot learns to keep his head out of his back pocket—or else." ★★ ★

Keep Fireplace Damper Closed For Better Air Conditioning

Odd as it may seem, under certain weather conditions of high humidity and moderate temperature, chimney air flow can be reversed. If the fireplace damper is open, this reversal permits moist outside air to pour down the chimney and into the house. If your home is air conditioned, the engineers of Lennox Industries, Inc., suggest you check to see that the fireplace damper is closed before turning on the air-conditioning system. The potential extra-cooling load that might result if the damper is left open, could prevent achieving maximum comfort from the system as well as increase the cost of cooling.

Gas Pellets Protect Fruit

Gas-producing pellets that protect citrus fruit from mold have been developed by the University of California. The pellets, which release ammonia, are scattered through each crate or incorporated on sheets of paper placed on the fruit. The method is cheaper and more effective than wrapping each fruit in chemically treated tissue.

ORDER DIRECT FROM AD.
SATISFACTION GUARANTEED. Send Payment or Purchase Order Today. To place phone orders call WEBSTER 9-3793.

**BRAND NEW 1 H.P.
12 Volt Electric Motor**

ITEM #308
Rated 1 H.P.—100 amps., 2600 R.P.M., 12 volts, D.C.—This double shaft motor of ball-bearing construction may be run on 6 volts for lower horsepower requirements—Standard 5/8" shafts, flange mountings—Dimension: 5" x 4" x 4 1/2". Ship. wt. 19 lbs. A real value at..... **12.50** F.O.B. Chicago

• For electric wheel chairs (Pop. Mech. design—Mar.-1963)
• For electric golf carts
• For self-propelled scooters, children's midge-et cars.

**GROBAN HYDRAULIC
SPEED REDUCER
with FINGERTIP CONTROL**

ITEM #115
FOR: • Reamer Drives • Midget Cars • Feed Mills • Canning Machines • Conveyors • Lathes • Milling Machines • Motor Boats • Cream Separators • Garden Tractors • Pumps.
Variable output speeds from 0 to input speed available by moving control handle. Locking handle maintains setting. Use input power of 1/4 to 1 1/2 H.P. Shafts 3/4" diam. Input rotation counter-clockwise facing shaft. Input speed 750 R.P.M. 7 1/2" x 7 1/2" x 11 1/2". Output rotation reversible. Ship. wt. 31 lbs. Complete with 2 qts. of oil and full instructions. F.O.B. Chicago..... **54.50**

SHOP BY MAIL and SAVE at GROBAN'S

**MASTER & SLAVE
HYDRAULIC REMOTE CONTROL SET**

ITEM #415—Designed for remote operation of controls on engines, boats, special machinery, etc. Eliminates complicated mechanical linkages, cables, pulleys, etc. The master unit connects to the slave unit with a single 1/4" tube. When master control lever is moved, slave lever follows exactly. Light, compact, aluminum alloy construction. Dim. of both units: 5 1/4" W, 9" H, 1 3/4" D, (exclusive of handle) Ship. Wt. 8 lbs. F.O.B. Chicago..... **27.50** pair
(Note — tubing not supplied)

**HIGGINS BRONZE CENTRIFUGAL PUMP
PUMPS ALMOST ANYTHING**

ITEM #414
Fine for: • Irrigation • Sump Pumping • Sewer Drainage
75 gallons per minute @ 2400 R.P.M. Higgins Type PNB, Model K, marine bilge pump. Open impeller design for handling muddy water. Delivers 75 gallons per minute, 30 foot head with 3/4 H.P. motor. Pump body and impeller are made of solid bronze, with alloy steel 1/2" diameter shaft, 1 3/4" long. Rotation of the pump is clockwise. Inlet has 1 1/2" pipe thread. Plain 1 1/2" outlet for hose connection. Shipping weight 23 lbs. F.O.B. Chicago..... **23.50**

DOUBLE ACTION HYDRAULIC CYLINDERS

ITEM #310—3 1/2" bore, 11" stroke. Alloy steel cylinder wall. Micro-Honed and all steel 1 1/4" diameter piston rod, 10 1/2" overall length. Clevis mounting at base and shaft. Will lift 9625 lbs. with 1000 PSI Pump Pressure. Uses 3/8" tubing fittings. Fittings to pipe thread: two 3/8" MPT @ 35c. A \$102.00 value. Shipping weight 11 lbs. F.O.B. Chicago..... **25.00**
ITEM #16-C—1 1/2" bore, 26" stroke. Will lift 1760 lbs. with 1000 lbs. pump pressure. Great for hay loaders, etc. 1" stainless steel piston rod. Postpaid..... **16.95**

HYDRAULIC LIFT CYLINDERS

• For Fork Lift Trucks • For Presses • Loading Ramps • Lifts 12500 lbs. Heavy duty hydraulic cylinders, at big savings.
ITEM #502—4" Bore—36" Stroke—1 3/4" Piston Rod. Wt. 95 lbs. F.O.B. Chicago..... **72.00**
ITEM #503—4" Bore—54" Stroke—1 3/4" Piston Rod. Wt. 135 lbs. F.O.B. Chicago..... **96.00**

**GROBAN SUPPLY CO. Dept PM-7
1139 S. WABASH AVE., CHICAGO 5, ILL.**

FREE! — NEW CATALOG

1956 EDITION, 36 PAGES, chock-full of unsurpassed War Surplus and newly manufactured Equipment Bargains for farm, home, factory, Workshop. Write letter today.

**BELT DRIVEN
A. C. GENERATORS**

Item #700
Ideal for powering electric tools, oil burner, refrigerator, lights, or other appliances requiring up to 700 watts of power. **700 WATTS**, 115 Volts, 60 cycles A.C. 3600 R.P.M. Compact, self-regulating generator with V Belt pulley and double outlet receptacle. Rotation counterclockwise. May be driven by tractor or auxiliary gasoline engine. Requires 2 HP minimum. Dimensions: 10" long x 8" high x 6" wide. Shipping wt. 27 lbs. F.O.B. Chicago..... **59.50**

Model 1010 — 1000 WATTS
(Same as above) F.O.B. Chicago..... **79.50**
2000 Watt Generator..... **149.50**

**SAVE \$30.30 ON THIS PESCO
HYDRAULIC CONTROL VALVE**

ITEM #371V
FOR SAFE POSITIVE CONTROL OF HYDRAULIC CYLINDERS AND MOTORS — BUILT-IN RELIEF VALVE — FACILITATES EASY VALVE — VALVE — TO operate one double acting cylinder • OPEN CENTER — with valve in neutral, cylinder is locked in position and pump is unloaded. • SPRING RETURN TO NEUTRAL • FULLY BALANCED PLUNGER • EASILY STACKED INTO 2, 3, or 4 valve combinations for multiple cylinder operation. • 8 gal. per min. capacity, at 1500 P.S.I. — 3/8" pipe ports • CONNECT PUSH RODS TO HANDLE FOR REMOTE CONTROL • EASY MOUNTING • LIST PRICE — \$36.80 • YOU SAVE \$30.30. DIMENSIONS — 9" x 4 1/2" x 3 1/2" — Ship. Wt. — 8 lbs. F.O.B. Chicago..... **16.50**

**GENUINE ALNICO
MAGNETS**

AMAZING, PERMANENT, NON-ELECTRIC, HIGHLY PRACTICAL. Conduct interesting experiments. Hundreds of uses. Retrieve valuable steel items such as guns, tackle from fresh or salt water; tools from tanks & drains. **GUARANTEED**. Try any magnet one week. Money back. If you are not well-pleased,
No. M-710 Has pull of 225 lbs. on flat steel block..... **\$16.50**
No. M-625 Has pull of 125 lbs. on flat steel block..... **\$9.50**
No. M-575 Has pull of 75 lbs. on flat steel block..... **\$6.50**
No. M-500 Has pull of 50 lbs. on flat steel block..... **\$4.50**
No. M-47 Hot Pad Magnets, 10 for \$1.00..... **50 for \$4.87**
No. M-35 Hobbyist assortment of 8 small magnets..... **\$1.50**
Send M.O. or check. We pay postage. Sorry no C.O.D.'s.

MIAMI MAGNET COMPANY, 3240 N.W. 27th Ave., Miami 42, Fla.

**\$40 for 1 1/2 DAY'S SPARE TIME WORK
GRINDING LAWMOWERS**

Yes, J. H. B. writes, "not bad for a 76 year old young fellow earning \$40 for a day and a half's work" . . . and others are making even bigger money with the Universal Model B Lawnmower Grinder. You, too can make good spare or full time profits in your own business in your garage or basement. We furnish everything you need. Write today. No cost or obligation. Dept. M-76.

**ROGERS
MANUFACTURING CO.
LINDSEY, OHIO**

SAY YOU SAW IT IN POPULAR MECHANICS

**Easy Way To Make
PERMANENT
CONCRETE REPAIRS**



Get Weld-Crete . . . the amazing, liquid bonding agent which enables you to permanently bond new concrete . . . or cement topping . . . directly to old concrete. Eliminates need for chipping, drilling, roughening, scarfing of old concrete base. Ideal for permanently repairing concrete floors, steps, walls, driveways, curbs, sidewalks, ceilings. Weld-Crete also permanently bonds new concrete directly to brick, wood, masonite, gypsum board, concrete block, metal, ceramic tile . . . even glass! Job-proved for over 8 years. Specified by leading architects and contractors because they know a Weld-Crete bond is ageless . . . never lets go! Tensile strength over 660 lbs. per sq. inch. Shear strength about 400 lbs. per sq. inch. Apply to old surface with brush or spray gun. Then finish off with new concrete or cement topping. Covers 250-400 sq. ft. per gallon depending on surface conditions.

If your building supply or hardware dealer doesn't have Weld-Crete, write for literature . . . or send check or money order for "Get Acquainted" Trial Quart. Only \$3.49 postage prepaid. Address Larsen Products Corporation, 4939 Elm St. Bethesda, Md.

BUY DIRECT FROM MAKER and SAVE!
COMPLETELY AUTOMATIC
"SEA-HORSE"
DIVING LUNGS



New Improved

\$169 VALUE

2-TANK UNIT

99⁵⁰

COMPLETE
 Approx. 2 Hours
 Underwater Time

SINGLE TANK
 Outfit Complete

\$110 Value
 Approx. 1 Hour
 Underwater Time **\$69**

The 2-stage demand REGULATOR automatically releases air as needed; effortless breathing in any position, includes both emergency and warning device; I.C.C. approved tanks . . . 84 cu. ft. cap. at 2000 psi; non-return mouthpiece keeps water out of hose; adjustable harness. 2-Tank wt. 55#. 1-Tank 30#.

SIGNED GUARANTEE of SATISFACTION

FREE Valuable Booklet on SAFETY in Skin Diving with each Diving Lung. Full instructions included. Send Check or Money Order. If C.O.D., 25% with order. WE PAY R.R. FREIGHT CHARGES ANYWHERE IN U.S.A. Write for Literature TODAY . . . Club Inquiries Invited

DIVING INDUSTRIES [Division of HONUS WAGNER CO.]

813 LIBERTY AVE. DEPT. PM-7 PITTSBURGH 22, PA.

NOW You Can DRILL SAW, REAM, CUT
... ALL WITH ONE BIT!

Beaver's new improved Hi-Speed side cutting drill bit can be used on any electric drill, drill press, lathe, etc. Made from the finest American hi-speed steel. 3 1/4" long, 2" side cutting section, 1/4" diameter. Designed to cut steel, wood, plastic, aluminum, etc. MONEY back guaranteed. Specify types desired. All Purpose, Wood and Heavy Metal. BUY From Your Dealer or send check or money order today. Dealer inquiries invited.



BEAVER
Hi-Speed-SAW
DRILL BITS

ONLY **\$2.45** each 3 for \$7.00

BEAVER DRILL & TOOL CO., 30088 McGee Trafficway, Kansas City, Mo.

BUILD YOUR OWN POWER TOOLS-

With **GIL-BILT PARTS-PLAN KITS**

PLANS **only \$1.00 EACH POSTPAID**



10" TILT/ARBOR SAW

Sturdy wood, steel, and aluminum construction, NEW DEPARTURE ball bearings. Capacity and performance of floor saws selling for \$150.00 and up. Plans, all metal parts in kit with 10" comb. blade **\$25.90**, less blade **\$22.95**. F.O.B. St. Louis. Detail PLANS—PATTERNS only \$1.00 postpaid.

12-IN. BAND SAW

Ball bearing drive, rigid cast aluminum wheels, rubber tires. Handles stock up to 6 inches thick. Cuts to center of 24" circle. 18 x 18 inch tilt table. Capacity and performance of band saws selling for \$80 and up. Plans and all metal parts in kit with 1/4" blade **\$23.95**. Detail PLANS—PATTERNS only \$1.00 postpaid.

For shipments up to 600 miles, add 5%; over 600 add 10%. Amount in excess of actual postage will be refunded. Also Build-it-yourself 16" Band Saw, 6" Belt Sander, Shaper, 8" Tilt-Table Saw. Simplified plans, build easily with hand tools only. Advertised and sold for 8 years, over 30,000 units in use. Money back Guarantee. FREE CATALOG.



GILLIOM. POWER TOOLS DEPT. 80-G, LAMBERT FIELD ST. LOUIS 21, MISSOURI

How Atoms Generate Power

(Continued from page 93)

There are three major types of reactor cycles included in the AEC's research program and in the private developments. One is a boiling-water cycle, another a pressurized-water cycle and the third a liquid-metal-cooled cycle. Each type of cycle attempts to produce steam for the generator in the most efficient manner.

One side issue being investigated is the fact that some of the reactors have an ability to "breed" new atomic fuels at the same time they are producing useful heat. Thorium placed in such a reactor system is slowly converted to fissionable U-233. Eventually only thorium would need to be added to such a reactor to keep the chain reaction going. This happy condition, a furnace manufacturing its own fuel, may have an important effect on the cost of electricity produced by atomic reactors.

There are five main groups of reactors, each utilizing one of the three basic cycles, being considered either in the AEC's program or as private ventures.

Boiling-water reactor: In simple form this is a chamber containing a number of rods of fissionable material, plus control rods that can be withdrawn to bring on a chain reaction. The heat thus created is taken up by water that circulates through the reactor to keep it cool. The water produces steam which drives a turbine.

Power for Submarines

One variation of this is the pressurized-water reactor, the type that powers the submarine *Nautilus*, using water under 2000 pounds' pressure per square inch. The water attains a temperature of 465 degrees F. before boiling, producing superheated steam. A modification of this pressurized-water reactor is now under construction at Shippingport, Pa., and is intended to create 60,000 kilowatts of electrical power. The Yankee Atomic Electric Co. of New England proposes to build one of this type to produce 134,000 kilowatts, for completion in 1959.

Consolidated Edison of New York contemplates a reactor to be completed in 1950 that would create 236,000 kilowatts of electricity. This would be a pressurized-water reactor with an oil-fired superheater added to the cycle to raise the temperature of the steam to around 1000 degrees F. About 140,000 kilowatts of the total would be generated by nuclear fission.

Dual-Cycle Boiling-Water Reactor: Another boiling-water reactor is the dual-cycle design developed by the Argonne

(Continued on page 236)

MAKE UP TO \$25 DAY

sharpening Discs with New Machine

Now you can quickly sharpen farm discs in a farmer's own yard or shop. New portable Foley Disc Sharpener jacks up barrow, rotates discs as it grinds them—takes only 1 or 2 minutes per blade. Saves farmers time and trouble—no dismantling or hauling to town—and you can make up to \$25 a day. Foley equipment easily carried in car trunk.

FREE PLAN—shows how to start in spare time CASH business. No experience needed—no salesman will call on you. Write today.

C. H. FOLEY CO.
COLUMBIA HEIGHTS, MINN.



SOUTH BEND Light Ten Lathe

Highly accurate and versatile for better than average work, 10" swing. Send for free catalog.

SOUTH BEND LATHE
South Bend 22, Ind.



DO A BETTER JOB with **DREMEL** Straight-Line-Action SANDERS!

Send for FREE Power Tool Catalog
DREMEL MFG. CO.
RACINE, WIS.



Guaranteed Auto Parts at Western Auto

24" ATTIC FAN KIT



Easy to assemble. Belt-driven. Blade, shaft, 2 self-aligning bearings, 2 pulleys, 2 collars, and V-belt. Everything you need, except frame and 1/4-hp motor, to make your own house cooler. Send for complete list of fan parts.

PENNA. WHOLESALE DISTRIBUTORS
104 N. 6th St., Phila. 6, Pa.

ONLY \$9.95

SAVE \$46.00

Wholesale! TOOLS! GUNS! CAMERAS!

AGENTS—BUY TOOLS, PHOTO EQUIP., SPORTING GOODS, JEWELRY AND THOUSANDS OTHER NATIONALLY ADVERTISED PRODUCTS AT BIG DISCOUNTS. BIG PROFITS SELLING TO OTHERS.

Get up to 40% off

POSTCARD BRINGS FREE COPY "THE WHOLESALE PLAN"
AMERICAN BUYERS SERVICE

HERTEL STATION, DEPT. 15, BUFFALO 16, NEW YORK

FREE AMAZING NEW BOOK "HOW TO ANSWER ADS"

how to answer ads

Never before have you seen anything like this. Tells you in simple language the correct way to answer ads. Gets you quicker replies—better results, and greater satisfaction. Will save you time and money and it's ABSOLUTELY FREE. No obligation whatever. Every reader of advertising should have this booklet. Send a postcard for your copy NOW. F. W. Johnson, Popular Mechanics Magazine, Room 600-A, 204 East Ontario Street, Chicago 11, Illinois.

WAR SURPLUS AND OTHER BARGAINS SAVE UP TO 90%



PIONEER MAGNETIC COMPASS

For boats, trucks, cars. By Pioneer Instrument Co., Div. of Bendix, No. 1820-2A. Contains screw-type heeling compensator, removable drawer-type compensator, screw-type horizontal compensator and spider-type compensator. All devices for elimination of errors caused by effects of magnetism. Has constant deviation corrector and course setter. Rotatable dial engraved with compass card graduations. Complete with book of instructions, light and mounting screws and shock mounts. Shpg. Wt. 10 lbs. Approx. GOVT cost \$400. NEW. \$13.95

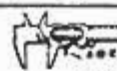

"HELIOS" ORIGINAL TOOLMAKERS VERNIER CALIPERS

ULTRAPRECISION—Imported. Used by machinists at Lockheed, Douglas, Bendix, GM, RCA, GE, Model S1/2E. Genuine Helios. Hardened lapped precision surfaces. 1/1000" and 1/128" graduations. Handy slide roll and thumb lock. Quick, accurate depth. A \$33 value. De Luxe Finish. ALL NEW. Just \$7.95. Leather carrying case. \$1 extra.



MICROMETERS Chrome plated, precision engineered, carefully toolled to give long life. All new 0-1" cap. \$2.25 ea. 1-2" cap. \$3.50.



WOOD PROPELLER

Originally intended for govt radio & target planes. Now the perfect "prop" for den, trophy room, game room or boy's bedroom. Clock, barometer or photo can be inserted easily into center (complete with mounting holes). Top grade bird's-eye maple; flawless, smooth, highly varnished; 30" tip to tip. Can be used to operate ice sleds, etc. Approx. GOVT COST \$57. New—\$3.95



P1 GENERATORS

Electric Auto-Lite, 200 Amps, 24 Volt, 4400 RPM. Dandy arc welder. Wt. 33 lbs. Approx. GOVT cost \$450. Like NEW. \$12.90 incl. easy diagram.

RI GENERATORS

RI Jack & Heintz. Rated 300 Amps, 30 Volts. Approx. GOVT. COST \$450. Perfect, like new. Wt. 60 lbs. \$27.50

NEW PUMP AND MOTOR

Pump has 1" connections, built-in relief valve, adjustable up to 1500 lbs. Max capacity 6 GPM, 1 1/2 H.P., 24-volt motor, 4000 RPM. Can be used on 12 or 36 volts. Govt. cost approx. \$350—our price—NEW—\$9.95.



NEW! 1956 CATALOG

Largest ever... just out... new low prices. Send 25c for your copy today. Prices F.O.B. Culver City unless otherwise stated. Check, cash or money order. 25% deposit for C.O.D.

AIRBORNE SALES CO., DEPT. PM 756
8501 Stellar Drive, Culver City, Calif.

STANLEY

Screw-Mate.

4 JOBS AT ONCE EASY!



Every screw you drive in a Screw-Mated hole has maximum holding power and fits exactly... does a real, professional job!

GET A SET FOR YOUR WORKBENCH

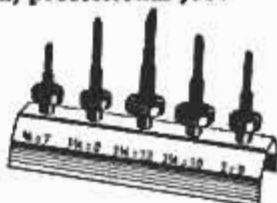

Screw-Mate Set No. 1525B

Stanley Screw-Mate is at your hardware store in 22 sizes @ 75¢ each... 2 large sizes @ \$1.25 each. If your dealer can't supply you, order this handy holder with 5 most popular sizes—3/4" x #7, 1" x #8, 1 1/4" x #8, 1 1/4" x #10, 1 1/2" x #12. Ask for No. 1525B and enclose check or money order for \$3.69. Send to Stanley Tools, 627 Elm St., New Britain, Conn. We'll pay return postage.



GRAVELY makes tough Jobs EASY!

Powerful!

Rotary Mower is only one of 21 tools

... 5-HP Gravelly Tractor does every lawn, garden, field job easier, better! All-gear Drive, Power Reverse. New "Power vs Drudgery" Booklet FREE! Write today... and ask about the NEW EASY PAY PLAN.

(Push-button Starter Optional Equipment)

GRAVELY
BOX 763 DUNBAR, W. VA.
FIELD-TESTED FOR 34 YEARS

THE PAYSWELL ALL-PURPOSE

Sprayer
by
SELCO

Compressor, Motor, Gun
... All in ONE Unit
Sprays At 50 Lbs. Pressure

- ★ points
- ★ liquid plastics
- ★ lacquers
- ★ deodorants
- ★ liquid waxes
- ★ disinfectants
- ★ fireproofing
- ★ rust inhibitors
- ★ wood preservatives

For Further Information Write

SELCO CORPORATION, 224 W. 7th, St. Paul, Minn.



PUMP FASTER with a "HY-JET"!

Made of aircraft grade aluminum alloy, this rugged #10 centrifugal pumps up to 4500 G.P.H. Ideal for irrigating—draining—filling—spraying. Uses 1/6 to 3/4 H.P. motor. Rust-proof 1/2" shaft, oilless bearing, 3/4" suction, 1/2" discharge, std. pipe threads, adaptable to garden hose... **\$8.95**
Heavy-Duty HY-JET #20 fills and empties pools, ponds, etc. Extra powerful—up to 8000 G.P.H. Use 1/4 to 3 H.P. motor. Rugged, rust-proof 1/2" shaft, oilless bearing, 1 1/4" suction, 1" discharge, std. threads... **\$11.95**
Prepaid if cash with order. Send Check or M.O. \$2 deposit if COD. Money-back guarantee.



MACK EQUIPMENT & MACHINE CO.
329 No. Indiana Ave. Atlantic City, N. J.

TORQUE SPECIFICATIONS

for over 70 makes and more than 700 models of automobiles (US and Foreign), trucks, tractors, outboards, motorcycles, diesel aircraft, marine and small aircraft engines. SPARK PLUG—WHEEL BEARING—VALVE SPRING DATA and many helpful torque tips... Plus handy torque chart for all screws—No. 4 to and including large 2 inch bolts. 31 pages of factory approved information.

Send 25 cents to

TORQUE WRENCH

333 W. First St., Elmhurst, Illinois



National Laboratory, which converts some of the water into steam inside the reactor chamber itself. General Electric plans to build one of this type for Commonwealth Edison of Chicago and its associates in the Nuclear Power Group, with a capacity of 180,000 kilowatts. Boiling-water reactors as a group appear to be about 22 percent efficient in converting atomic energy into heat and thus into electricity.

Homogeneous Fuel Reactor: One of these, under construction at Oak Ridge, consists of a container into which a suspension of enriched uranium salts in water is pumped until enough uranium is present to produce a chain reaction. The container is surrounded by a neutron reflector and has control rods to adjust the criticality. The fuel solution becomes hot in the reactor chamber and is continuously pumped through a heat exchanger where it delivers much of its heat to a separate water system, producing steam.

One advantage of this system is that it eliminates the need for expensive solid-fuel elements which must be replaced periodically. It is also a breeder. Thorium in heavy water circulates in the blanket surrounding the core and is slowly converted into fissionable U-233, which can then be used as fuel.

Push-Pull Type

One variation conceived at Los Alamos is a push-pull homogeneous reactor. In this, two reactor chambers are connected by a tube in which the enriched fuel solution is placed. This "soup" is first pumped into one of the reactor chambers where criticality is attained. Heating up, some of the liquid turns to steam and the pressure of the steam forces the solution back through the tube, where it loses much of its heat to a heat exchanger, and into the other reactor chamber. Here the heating cycle is repeated. The fuel solution is thus forced back and forth, continually giving up some of its heat in the heat exchanger. A separate water system in the heat exchanger, thus heated, provides steam for driving a turbine.

Sodium-Graphite Reactor: Metallic sodium melts at 208 degrees, becomes a gas at 925 degrees. These properties make it very attractive for conducting heat at ordinary pressures. Atomics International, a division of North American Aviation, Inc., is using molten sodium instead of water in a power reactor that will be operating this year and that will deliver an estimated 75,000 kilowatts of electrical power.

In this design, the reactor core consists of rods of U-238 enriched with U-235, plus

(Continued to page 238)

GIGANTIC
SAVE-TO-70%

MAIL SALE

WAR SURPLUS
EXCESS INVENTORY
BANKRUPT STOCK

GIGANTIC SUMMER SALE

To reduce our immense stocks of the finest war surplus items, we offer hundreds of amazing buys—SEND FOR LARGE FREE CATALOG. All items shown here sent prepaid except when stated "FOB."

TYPICAL SURPLUS BARGAINS

- Golf Car Battery (6-12v) motors (FOB) \$19.46
- Hydraulic Pump, 12-v, 1000 lb. FOB \$41.90
- Air Compressor, sing. cyl. 150 lb. \$19.95
- Irrigation Pump, 280 g.p.m. 2 1/2" \$44.37
- Irrigation Pump, 140 g.p.m. 1 1/2" \$24.61
- Army Power Plant, 3000 watt, 115-v \$349.50
- Army Power Plant, 2000 watt, 115-v \$269.95
- Army DC Generator, 115-v, 3000-w \$58.75
- Gear Head DC Motor, 6 or 12v. \$8.72
- Weed Spray Outfit, 5-row (\$175) \$97.65
- Hydraulic Cylinder 2"x10", 3000-lb. lift \$17.50
- Hand Winch, Red. gear type 1000-lb. lift \$8.95
- Surveyors Level and Tripod, leading make \$42.95
- Campers Power Plant, 500-w, 115-v DC \$79.50
- AC-DC Power Rectifier, 110-v to 300-v FOB \$15.61
- Farm Telephone, Magneto (cost \$25) \$9.95

- Govt. Prismatic Periscopes (cost \$20) \$2.99
- Engineer's Stop Watch, precision \$9.97
- Portable Air Supply, Spraying Tank Unit \$13.49
- Air Powered Tree Trimmer (\$69.50) \$15.37
- Hydraulic Cylinder 1 1/2"x4" (\$75) \$3.49
- Hydraulic Tractor Pump 1000-lb., 12-gpm \$45.50
- Giant Fresnel Advertising Light (\$280) \$49.50
- Govt. Wind Direction Remote Indicating Units (\$121) \$18.71
- Govt. First Aid Kits for Trucks \$6.95
- Window or Attic Fan Kit (24") \$12.95
- Diving Unit (mask, harness & 50' hose) \$12.91
- Blackhawk Hand Hyd. Pump & Reserv. FOB \$19.21
- Finest Paint Spray Gun (1-qt.) \$9.95
- Edwards Alarm Bell 110-v AC (\$3.95) .69c
- Spectacular Revolving Beacon Searchlight (\$1000) FOB \$101.79
- Electric Auto-Pulse Fuel Pump 6-v. \$6.95
- G.E. Amplifier-Rectifier 110-v AC (\$150) \$6.97
- Govt. Fire-Burglar Alarm Unit \$5.87
- Desk Telephones (make antique lamp) \$13.99
- G.E. 0-300 amp DC Ammeter \$6.89

SPECIAL OF THE MONTH BOAT & TRUCK ELECTRIC WINCH

Operates from 6 or 12-v battery over 1000-lb. capacity

- Powerful expensive Govt. ball bearing motor with built-in 100-to-1 ratio precision reduction gear. Gives smooth powerful pull on winch cable.
- Hundreds of applications. Mount on boat trailers, boat docks, raising anchors, etc.
- Ideal for trucks, farm equipment trailers, industrial uses. Cuts labor loading costs 90%.
- Wt. 54 lbs. 17"x12"x2". Drum holds 40' 1/4" or 75' 3/16" cable. Orig. Govt. \$46.71. Cost over \$200. F.O.B. Lincoln.



ORDER FROM AD or write us for big FREE CATALOG 1000s of items! Motors, sporting goods, hand-electric tools, watches, etc. We pay freight except where stated "F.O.B."

BURDEN SALES COMPANY
909 "O" St., LINCOLN, NEBRASKA

RETAIL PRICE \$125.00
FACTORY TO YOU \$79.95

SUPERSHOP includes precision-built 8" tilting table saw, vertical and horizontal drill press, 30" lathe, sander, grinder. 100% BALL BEARING. Write for FREE catalog, full details, trial plan. Easy Pay Plan.



POWER TOOLS, INC.

185 YATES AVENUE
BELLOIT, WIS.

YOUR TRAVEL DREAMS COME TRUE!

Go where you please, stay as long as you like. Explore the byways, relax by a rippling stream... enjoy the sea, the woods, the mountains—travel care-free with all the comforts of home. Write today for Free booklet!



AIRSTREAM TRAILERS Dept. H
110 CHURCH ST., JACKSON CENTER, OHIO
1755 N. MAIN ST., LOS ANGELES 31, CALIF.

HELPFUL BOOKS

Send post card asking for FREE catalog
Popular Mechanics Press, 200 E. Ontario, Dept. 601, Chicago 11

NEW! **RECLAIMO**
ELECTRICALLY HEATED
Oil RE-REFINING Filter
Super-Efficient Filtration
for TODAY'S Car-Truck-Tractor Engines
Folder with full details FREE
RECLAIMO MFG. CO. 6251 Touhy Avenue
Dept. M-76 Chicago 30 Ill.

Drive with Confidence
DINSMORE Auto Compasses
Shows you the right way—the short cuts. Saves time, money. Write for new compass history folder, "Pants—Knives—Compasses," and name of nearest dealer.
DINSMORE INSTRUMENT CO., 1802-33 Kelso St., Flint 1, Mich.

\$5000 PER DAY AND MORE
SAW-KEEN PORTABLE, ELECTRIC, EASY - TO - OPERATE
Be your own boss, work anywhere, full or part time. Every restaurant, hotel, drive-in, etc., repeat customers. Serrated (saw-edged) table and steak knives in great demand. \$98.50 investment returns first week. Guaranteed. Write today for proven daily profit plan.
CUTTER-CRAFT 58-K SOUTH RAYMOND PASADENA 1, CALIF.

FREE CATALOG Choose your genuine Gerstner Chest from our Free Catalog.
GERSTNER TOOL CHESTS
456 Columbia St., Dayton 7, Ohio

Grips the screw!
Drives it too!
Quick-Wedge SCREW-HOLDING SCREWDRIVER
2" to 14" blades, 4 bit sizes
Available with shockproof plastic covered tubing
Unconditionally guaranteed
ASK FOR IT AT YOUR DEALER
Kedman Co., 233 So. 5th W., Salt Lake City

earn BIG money
Set up your own welding business with one low cost Hobart welder and earn hundreds of dollars! Big capacity, low cost models let you get the "BIG PAY" jobs—weld, or run tools, lights, pumps, motors, etc.
HOBART arc welding
Built-in convenience features for easy welding at no extra cost, let you turn out top notch work.
HOBART BROTHERS CO., BOX M-76, Troy, Ohio

AC Weld or AC Power
Air Cooled Arc Welder

IT'S A SNAP!

MANUFACTURING



Ornamental Concrete

BIG PROFITS

Imagine - A Business Of Your Own - so interesting and so much fun that it's like getting paid to play. That's what the Ornamental Concrete Business can mean for you. Products made in CMC Molds practically sell themselves on sight - truly an excellent Money-Making Opportunity - AND, starting costs are astoundingly low! OVER 200 DIFFERENT MOLDS TO CHOOSE FROM.

IT'S A SIMPLE "DO-IT YOURSELF" PROJECT WHEN YOU USE DURABLE C M C ALUMINUM MOLDS

Perhaps you have wondered how the products are made. With CMC's new book as a guide, it's a SNAP! After a few minor preparations, you simply fill the mold with concrete, let it set, remove the mold, and there's your product. Could anything be easier?



THIS BRAND-NEW BOOK TELLS YOU "HOW TO TURN CONCRETE INTO GOLD"

CMC, The World's Largest Manufacturer of Specialty Molds for Making Ornamental Concrete Products, has left nothing undone to make this Big, 88-Page (8 1/2" x 11") Book an "Indispensable MANUAL" for the Ornamental Concrete Industry. It describes the more than 200 different CMC Molds and presents large, clear photographs of the products you can make, AND...it gives complete "From Start To Finish Instructions" (Priceless Trade Secrets)! IT'S A MUST! GET THE FULL STORY TODAY.



SEND ONLY \$2.00 For YOUR COPY
Rushed To You By First Class Mail

(All Foreign except Canada, Mexico, and Cuba - \$5.00)

CONCRETE MACHINERY COMPANY, INC.
Dept. PM Hickory, North Carolina

... Your assurance of a job well done!

KATO A.C. GENERATORS

A WIDE VARIETY FOR ANY ELECTRICAL APPLICATION!

Adaptable to all well-known makes of engines. 350 Watts through 500 KVA and larger. To 600V. Odd frequencies from 25 to 400 cycles. Also, Rotary Converters, High Frequency Changers, Motor Generator Sets.



FREE FOLDER

KATO Engineering Company
1402 First Ave., Mankato, Minn.

LEISURE TIME SPENT PROFITABLY

Most hobbies are fun but few are as profitable as woodworking. Handy household articles... children's toys attractive and useful furniture for the home... all can be made easily and economically with a set of Rogers easy-to-follow Project Plans. When working with Rogers Glue you are assured maximum strength. Always uniform - ready to use - clear and dependable - Rogers Glue is made only from the finest materials.

Send only 15c for Rogers Special Offer: A full-sized jar of Rogers Glue - a set of illustrated, easy-to-follow Project Plans and the new 1955 edition of Rogers Book of Woodworking Shop Notes. Leisure time can be both satisfying and profitable. Write.



Over 3,885
lbs. Actual
Tensile
Strength per
Square Inch.

ROGERS

the best LIQUID FISH GLUE
GLOUCESTER, MASS.



the usual control rods. The reactor is surrounded by walls of graphite that act as a moderator, slowing down the fast neutrons.

Hot sodium that is circulated through pipes in the core attains a temperature of more than 900 degrees. The liquid metal then flows to a heat exchanger and yields much of its heat to a second liquid-circulating system. Two sodium systems are used because the first becomes highly radioactive during the process.

Increased Efficiency

A General Electric version of this reactor will be used to drive the submarine *Sea Wolf*. Sodium-graphite reactors are expected to have an efficiency approaching 30 percent. Ultimately the circulating sodium may be brought up to a heat of 1200 degrees, with a corresponding rise in efficiency.

Sodium-Cooled Fast Breeder: Another reactor employing sodium as a coolant is the sodium-cooled fast breeder. Instead of slowing down the neutrons with graphite, as is done in the sodium-graphite reactor, this design permits the fast neutrons produced by the fissioning U-235 in the core to strike a blanket containing U-238 atoms. This converts them into fissionable plutonium and, according to the theory, more than one plutonium atom will be produced for every U-235 atom consumed. Detroit Edison and its associates are planning to use this type of reactor for a 100,000 kilowatt reactor station to be completed in 1960.

Atom Power for Large Ships

There are modifications of the reactors outlined above, each seeking a slightly different way of attaining the greatest efficiency. Separate studies are being made, too, of reactors that would serve as power plants for large ships. Aircraft propulsion and packaged power units for the military also are being studied, but a great deal of research will be necessary before they become practical. The military power plants would be small central stations that could be transported to areas where electric power is needed.

So the answer to the question "What happens after Arco?" is simple. Arco was the first public step in a chain reaction that is rapidly picking up speed. Nuclear energy will become increasingly important in our lives—at a rate faster than most people think. It is startling to realize how much progress has been made since the first reactor was built under the grandstand at Stagg Field, on the University of Chicago campus in 1942—only 14 years ago. Yet the course of history already has been changed by it. ★ ★ ★

Buy Direct from the Factory—for Home, for Office, for Industry

SAVE 50% Sturdy Steel Shelving

• ADJUSTABLE • LIFETIME QUALITY
• EACH SHELF HOLDS 300 POUNDS

LAST TWICE AS LONG
CARRY ARE THE WEIGHT
ARE AS DURABLE . . . YET

COST HALF AS MUCH AS WOOD
Reliable Adjustable Steel Shelves
75 inches high, 36 inches wide, 12 inches deep

All you need is a screwdriver to assemble these rugged, lifetime steel units for 1001 uses. All parts precision tool fabricated to fit snug and smooth.

You'll take these shelves wherever you move to. Takes only minutes to assemble. Strong, practical, fireproof, portable. change them at will—to fit YOUR needs. Any combination of shelf depths—any number of shelves and spacing. Adjustable on 1½-inch centers. Finished in durable green baked enamel.

18-inch SHELF UNITS
75x36x18-inch 3-shelf units with back-way braces. Extra shelves \$1.75 each. F.O.B. Factory. Complete

100% SATISFACTION
OR YOUR MONEY BACK

HALF PRICE

DIRECT FROM THE FACTORY

\$8.88

EACH COMPLETE F.O.B. Factory



Sections Easily Combined

Each set complete with 4 uprights, 5 shelves, nuts, bolts and side and back braces. Extra shelves, \$1.30 ea. with nuts, bolts.

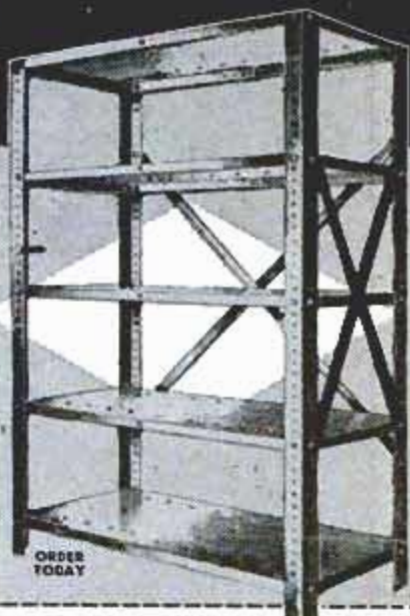

ORDER TODAY



OFFICES
Here is the perfect answer to all your office storage problems. Use for papers, books, records, supplies.

HOMES
For garage or basement; for tools, paint or what-have-you. Finish them to match walls or wood-work of home.

STORES
Units easily combined to fit any store layout. Perfect for display of cans, boxes, dry goods or merchandise.

PLANTS
Strong, rugged steel units keep all your parts, tools, supplies and catalogs well organized at all times.

Reliable Manufacturing Dist., Inc.

8008 E. Washington St., Indianapolis 19, Ind.

Enclosed please find \$_____ for the following units of steel shelves:

NUMBER OF UNITS NUMBER EXTRA SHELVES

12" SIZE _____

18" SIZE _____

Ship immediately, F.O.B. Factory Check M.O.

NAME _____

STREET _____

CITY _____ STATE _____

CUT EXACT CIRCLES CURVED PATTERNS

"ARCO JIG-SAW"

with Circle-Cutter (up to 20" dia.) & Rip Gage fits any ¼" drill. Has speed of 555 saws. Cuts 2x4's, plywood, metals, etc. Incl. blade. At your dealer or try it on our 10-day trial. Send check, M.O. (ppd.) C.O.D. + post. **ARROW METAL PRODUCTS CO., Dept. PM-7, 140 West Broadway, N.Y. 13, N.Y.**



\$10.95

VARIABLE SPEED

HYDRAULIC POWER TRANSMISSION



It has Infinite Speeds 0 to 550, Reverse, Automatic Overload Protection; Adjustable Torque up to 150 inch pounds. ¾" Input and Output Shafts. It will handle ½ to 1½ H.P. Motor. Case measures 7½" long, 7" high, 6½" wide. **VALUE OVER \$300.** Shipping Wt. 25#. On C.O.D. Orders we require a 10% only **\$54.50** Fob. Chicago

DIRZIUS MACHINE SHOP "B" 1423-25 So. 52nd Ave., Cicero 50, Ill.

SEND FOR
FREE CATALOG



Money-Making Tools!

It's easy to own the same "pay-off" tools used and endorsed by America's top-earning mechanics! You can start building your own kit with basic Snap-on sets—add others any time. Never sold in stores—direct to users only. Send today for free catalog! **Snap-on Tools Corporation** 8062-G 28th Ave., Kenosha, Wis.



Snap-on Tools
THE CHOICE OF BETTER MECHANICS

USE GENUINE

MOLLY

RELIABLE OR A SIGN OF HOPE
Guaranteed by
Good Housekeeping
IS NOT AN ADVERTISED PRODUCT



THE
PERFECT
FASTENER

To hold ANYTHING
Securely in Hollow Walls,
Floors and Ceilings

OVER
100,000,000
IN USE!

Unlike nails and screws, Molly allows you to install fixtures securely and exactly where you want them—not where studs are. Molly ends loose fixtures, crumbled plaster and broken walls. Molly reinforces the area in which used, won't pull through. Unlike other types of fasteners, Molly anchorage is permanent—fixtures can be removed and replaced in the same anchor. Molly is inexpensive and money-back guaranteed.

Write for Free Folder • Available Wherever Hardware Is Sold



ALWAYS ASK FOR GENUINE
MOLLY
CORP.
READING, PA.
DEPT. G7

SCREW ANCHORS



Summer Skier Keeps His Feet Dry by Skiing Across River on Logs

Summer is skiing weather for Kenneth Lambert of Berlin, N. H. No water skier, he does ski across the Androscoggin River without getting wet. He's a log scaler for the Brown Pulp and Paper Company and

he skis across log jams in the river to measure their size and estimate the number of logs. Regular snow skis are used to distribute Lambert's weight over several logs and keep him dry on his trip.

AMAZING SAFE JIG SAW
MOST POWERFUL OF ITS KIND
 CUTS 1 1/2" soft WOOD, thin metal, plastic! Syncro "208" is very QUIET for apartment use. SAFE for kids. POWERFUL for Dad's use. Any length cuts. Stroke adjustable. Portable. COMPLETE with BUILT-IN Motor. \$24.95 at dealers or postpaid. Free Circular.
SYNCRO
 Electric Jig Saw
 SYNCRO Corporation,
 Dept. 1-B6, Oxford, Michigan.



Say You Saw It in Popular Mechanics

20% OFF KIT BOATS - DO IT YOURSELF - SAVE 50%



MARCO 14
 \$189.50 Delivered

WRITE FOR FREE FOLDER
 at home kit complete - various
 * ACCESSORIES * FIBERGLAS
Marine ASSOCIATES
 BOX 6188 W. LONG BEACH 11, CALIF.

8' to 14' models, factory to you, no dealers, mahogany decks and framework, all brass fastenings, 14' hull kits as low as \$129.50 including freight charges. CATALOG 35c includes Kits, Hardware, Trailers, Fiberglass.

Reg. U. S. Pat. Off.



BUILD 16 RADIO
 CIRCUITS AT HOME WITH THE NEW DELUXE PROGRESSIVE RADIO "EDU-KIT"

A PRACTICAL HOME RADIO COURSE only **\$19.95**

All parts, tools, instructions, punched metal chassis, printed circuit materials, electric Soldering Iron, Tester included. Unconditional Money-Back Guarantee.

PROGRESSIVE "EDU-KITS" INC.
 Rm. 547B, 497 Union Ave., Brooklyn 11, N.Y.

MAIL COUPON OR POST CARD

Please Rush me Free Descriptive Literature concerning "EDU-KIT." Also send me Free Radio, TV, Hi-Fi Servicing Literature. No obligation.

NAME _____
 ADDRESS _____

YES! SEND



directly
 to my door
 every month

I am enclosing
 \$3.50 for 1 year
 \$8.00 for 3 years

name _____
 address _____
 city _____ zone _____ state _____ A-76

Hand this order to your newsdealer or send it to
POPULAR MECHANICS
 200 East Ontario St. Chicago 11, Ill.

BUILD WELDER OR LIGHT PLANT

Instruc. incl.	TYPES	AMPS	VOLTS	PRICE
DELCO	P1	200	24	\$15.50
J & Heitor	R1	300	24	\$25.50
G-1, 160-250 amps, 30V, new \$19.50 used \$12.95				
G.E. #511, AC-DC gen. 200 amps, 30V, D.C. 1250 watts, 800 cy. 115V, A.C. Battery chg. & light instr. incl. New \$27.50 used \$17.50				
Flexible Coupling to fit G-1, P-1 or R-1, \$4.95				
Rheostat #R27, or Carbon Pile Volt. Reg. Instructions incl. \$6.95 ea.				
NEW GLIDER TOW BAR with quick release lever for trailers, winch lines etc. Rated 100,000 lbs. Size 14"x 3 1/2". Wt. 10 lbs. \$6.95.				
(5) SENSATIONAL SELSYNS. For controlling distance operations, etc. \$8.95 per pair. (6) Solenoid VALVES. Bendix #81500 for hydraulics, distance operation, etc. Up to 1500 P.S.I. \$7.50 per pair. (7) BEAM ROTATOR MOTOR #101 for TV, HAM, FM, reversible, 2 R.P.M. for D.C. or 110V, A.C. Gov'l. cost \$150. \$8.95. Instructions incl. (8) SOLENOID #804 gives 1/2" or 1 1/4" travel; powerful for locks, switches, etc. D.C. & appl. for A.C. \$6.50 per pair. (9) CUNO OIL FILTER for autos, filters without cartridge replacements, 3/4" ports \$4.95. PURGLATOR #255 for trucks & tractors, 1" ports \$4.95 postpaid.				

General SALVAGE CO. SALE

(1) NEW ELECTRIC LINEAR ACTUATOR gives 5 1/4" stroke, 800 lbs. thrust & 1750 lbs. static load. Motor is 24 VDC, 1/2 H.P., 9 Amps, 7500 RPM & appl. for 115V. A.C. Instructions incl., \$8.95.

PUMPS WITH MOTORS for 12-24VDC

(2) Black & Decker, 3 G.P.H. 1/75 H.P. 1/4" ports, Oil-Water, \$8.95

(3) *Thompson, 300 G.P.H., 1/4 H.P. 1" ports. Fuel-Water, \$7.95. (4) *Pesco, 200 G.P.H. 1/2 H.P. 1" ports. Fuel-Water, \$12.95. (5) Chandler Evans, 400 G.P.H. 1/2 H.P. 1" ports. Oil-Water, \$14.50. (6) Romeco, 300 G.P.H. 28 H.P. 3/4" ports. Hyd.-Water, \$19.50.

* Applicable for 110V. A.C. Instructions included.

(5) ROTARY GEAR PUMP #101 for hydraulic, water, or vacuum, 180 G.P.H. 200 P.S.I., 28" Vacuum \$7.95

(7) VOLTMETER D.C. 30 Volts, 0-300 Ohms, \$5.95 TACHOMETER INDICATOR 0-10,000 R.P.M. New \$8.95. HYDRAULIC PRESSURE GAUGE, 0-2000 P.S.I. 1/4" ports, \$4.95. AMMETER-380 Amps., \$4.95

Vacuum & Suction Gauge with 0 to 10" Mercury range \$3.95. Oxygen Regulator type A-12, 1800 P.S.I. \$6.95. Fuel Level Gauge with dual pointers up to 60 gal., 2" face, \$3.95.

NEW HYDRAULIC CYLINDERS

Air or Oil	Bore	Stroke	Shaft	Price
#11	1 1/2"	6"	5/8"	\$7.50
#27	2 3/4"	6"	3/4"	\$6.50
#12	4"	10 3/4"	1-5/16"	\$29.50
#511	3 1/2"	2 1/2"	1 1/4"	\$27.50
#11	3"	2 1/4"	1-3/16"	\$34.50

(7) HYDRAULIC PUMP BARGAINS 1500 P.S.I. MFG. TYPE R.P.M. G.P.H. PRICE

Pesco (Gear) 1500 108 \$12.95

Pesco (Gear) 4300 360 \$15.50

Stratopower 3750 (450 cu. in.) \$19.50

Vickers 507 cu. in. 3750 \$25.50 410 cu. in. \$17.50

NEW FOUR WAY OPEN CENTER CONTROL VALVE has built in adj. relief for 1 to 4 D.A. cylinders. 3/4" ports, #1060 \$14.50. #4W11 four way with 1 handle for 1 D.A. cyl. \$8.95.

(7) FOUR WAY SOLENOID VALVES. Instruction for 24 V.D.C. & appl. for 110V. A.C. off in neutral, 3/4" #1213, \$12.50 #324 with 1/2" ports, \$9.95. #322 one way normally closed 1/2" ports, \$2.35.

BARGAINS FROM PREVIOUS ADS

- * Accumulators, ball type, 2000 P.S.I. 5 1/4" dia. \$7.95. 7 1/2" dia. \$9.95. 10 1/2" dia. \$17.50.
- * Relief valves, 1/2" port, \$4.95. 2 p. \$2.50.
- * 3/4" Ton hoist & 12 ft. cable, \$18.50

CHANDLER EVANS, Oil or water Pump, 400 G.P.H. Adj. relief, 1" ports, \$8.95.

GENERAL SALVAGE CO. CHECK OR M.O.
2922 E. 27 St., Dept. 77, Kansas City 27, Mo.

PUT A STOP TO THOSE HARD TO OPEN DRAWERS!!!

NYLSLIDES

YOU CAN INSTALL THESE NYLON DRAWER GUIDES & GLIDES quickly and easily for a lifetime of trouble free operation. WRITE FOR FREE LITERATURE OR SEE YOUR DEALER TODAY

HARDWARE DESIGNERS INC. BOX 115 DEPT. M-8 IRVINGTON, N. J.

only 39c per drawer

DO MORE PLANING JOBS WITH LOW COST BELSAW

Exclusive MONEY-MAKING features: Full 12 1/4" x 6" capacity • Power feeds at 14" to 34" a minute • Provides for Grinding Knives in the Cutter-head • Attachments for Jointing, Rabbeting, Tongue, Matching, Groove. Convert low cost rough lumber into high priced stock. Easy to make flooring and popular patterns. Send Today for FREE Literature and Prices.

Belsaw Machinery Co., 2057 Field Bldg., K.C. 11, Mo.

LOW DOWN PAYMENT EASY TERMS

BUILD FINE GRANDFATHER CLOCK NOW

The simple sensible Red-i-Nut way as thousands have — SAVE HALF. SHOP TESTED PLANS "SPIRIT OF THE CENTURY" Narrow waist, 83" tall or stately straight side "SPIRIT OF AMERICA." EASY-TO-FOLLOW photopack PLANS tell all—plus BROCHURE of heavy brass weight Westminster, tube chime, movements, gorgeous bronze-silver dials, 3/4" solid mahogany case kits. Send \$1.00 today—Both plans \$1.50 NOW.

Kuempel Chime Clock Works, #8 Kuempel Bldg., Minneapolis 16, Minn.

SAY YOU SAW IT IN POPULAR MECHANICS

RADIO CONTROL YOUR MODEL PLANES BOATS CARS

"CUSTOM ONLY" MIDGET RADIO \$9.98

LICENSE FREE BAND

OPERATES SAME AS \$50.00 SETS INCLUDES LONG RANGE TRANSMITTER RADIO, RECEIVER RADIO AND CONTROL ACTUATOR FOR ALL 3 EASY ASSEMBLY WITH OUR PARTS AND PLANS \$9.98. PLANS ALONE \$1.

RADIOMODELS BOX 36 DEPT. PM BALTIMORE 6, MARYLAND

DETAILED INFORMATION & RADIO CATALOGUE 29c

SPECIAL "SUPPLY SOURCE DIRECTORY" & \$7.00 SUPPLY COUPON... \$1.00

BOOK "RADIO CONTROL OF MODEL AIRCRAFT" CONTAINS 14 PLANS \$3.98

RADIO CONTROL GARAGE DOOR DETAILS... \$1.00

Save on a New GARAGE - Complete Popular Mechanics Plans Only \$2

G1 G5 G8

G2 G6 G9

G3 G7 G10

G4

One, One and One-Half and Two-Car, Modern Stylish Garages — Frame, Brick and Block Construction. Specially Prepared for "Weekend Carpenters." Material List Included.

Use a set of these Popular Mechanics plans and build a garage yourself. Or get a set for your contractor or builder to follow. Made from famous architect's drawings in Popular Mechanics easy-to-understand style. 10 different garages—10 sets of plans—only \$2 each. Plans consist of two full size working blueprints with all details and dimensions and a fully itemized material list. All plans adaptable to frame, brick or block construction with slight modification.

Super-Detailed and Simplified Plans

Anyone without previous experience can follow these plans and build a good, stylish, up-to-date garage at a big saving. Order plans you want by number below. Clip and mail the coupon today.

How to Build Your Own GARAGE

Complete build-a-garage instruction from excavation to final finish, step by step, 25 designs and many usable ideas. Cuts garage costs in half. Cloth binding, 128 large size pages, 529 pictures. Postpaid \$3.50.

How to Build Your Own GARAGE

Select and Check Plans Wanted • Mail this Handy Coupon

POPULAR MECHANICS PRESS, Dept. 756
200 East Ontario Street, Chicago 11

I enclose remittance for \$_____. Send me Popular Mechanics Garage Plans as indicated. Check here if you want book "How to Build Your Own Garage" (Remit \$3.50 additional).

Name _____

Address _____

City _____ State _____

TWO CAR

- G1 Frame 20x20
- G3 Frame 20x20
- G5 Brick 20x21
- G8 Frame 20x20
- G10 Frame 20x26

ONE AND ONE-HALF CAR

- G4 Frame 14x20
- G7 Brick 14x20
- G9 Frame 15x20

ONE CAR

- G2 Frame 12x20
- G6 Block 20x20

why... YOU SHOULD EQUIP YOUR TRAILER WITH



BULL DOG
 ● AXLE ASSEMBLIES
 ● JACKS ● COUPLERS

BULL DOG straight or drop axles in single or tandem—capacities up to 10,000 lbs. steel axles—any width—and the famous safety-engineered "Torq-Less" axles for all types of trailers.

JACKS—Bull Dog Jacks make hitching and parking a one-man job . . . easy to install.

COUPLERS—Bull Dog Couplers hitch or unhitch mobile homes in a moment.

Write today for **FREE** descriptive folder 13-J.



HAMMER BLOW TOOL COMPANY
 WAUSAU • WISCONSIN

Heavy Duty REDUCTION UNIT

- 85-to-1 Speed Reduction
- 20 RPM with 1750 RPM Motor
- Regularly \$69.50

Only **\$1175** Prepaid

FULLY GUARANTEED



For use where tremendous power at low speed is required . . . such as drilling large holes in metal or wood; digging post holes; turning large nuts and bolts, etc. Can not be stalled. Does all those hard jobs that ordinary power tools can't handle plus any other low speed application. Has 6 heavy-duty gears running on 8" high-speed ball bearings. Input shaft is 3/4" dia., output shaft 1/4" dia. Overall size 5"x6"x6". Weight 4 lbs.

SUPPLY LIMITED! ORDER FROM AD! We Pay Shipping

ROBERTS ELECTRIC CO., Dept. PM-483, 849 W. Grand, Chicago 22, Ill.

BOAT KITS 28 MODELS—8 to 19 ft.
 \$39 up—FREE FREIGHT

SAVE 2/3!
 Easy-to-build
MAHOGANY
 DECKS & FRAMES
 SEND 10¢ for CATALOG
 Includes Hardware—Trailers—Fiberglass



Boat Plans—Patterns—Frame Kits

Build over 50 modern boats from large scale plans, available with FULL-SIZE patterns, new PRE-FAB frame kits! All types: prams to cruisers, 6 to 25 ft. Best buy for Amateurs! SEND 10¢ for CATALOG.

Craig Craft
 Tonawanda, N. Y.

• New BUILD-IT-YOURSELF Window Fan Kit
 20, 24 & 30" Blade Fan Part Kits, less frame

These FAN KITS provide LOW COST, high efficiency belt driven fans, for COOLING nature's way. Dynamically balanced, highly polished, completely assembled Aluminum Blade, Rubber Mounted Bearings, 3/4" Shaft, Collars, Motor and Fan Pulleys & Belt Instructions included in factory packed carton. Complete less motor.

SHIPPED SAME DAY
 Easily Assembled

- | | |
|---|---------|
| 20" BLADE & COMPLETE KIT. ONLY | \$12.95 |
| 24" BLADE & COMPLETE KIT. ONLY | \$15.95 |
| 30" BLADE & COMPLETE KIT. ONLY | \$19.95 |
| <i>(For vertical installation add \$1.50 for ball bearing assembly)</i> | |
| WESTINGHOUSE 1/4 H.P. Fan Motor. 110 V.-A.C. Rubber mounted SPECIAL | \$10.00 |
| TWO SPEED 1/4 H.P. Motor. SPECIAL | \$17.50 |



F.O.B. Chicago

C. MARSHALL SALES, 3546 W. Fullerton Av., Dept. P-7, CHICAGO 47

MONEY MEN ALL DATA FREE

THE PLASTEX Industry needs manufacturers on small scale and for big production of Lamp and Clock Stands, Art Goods and Novelties in Plastic and Marble imitation. Experience unnecessary. 1/2¢ material makes regular 10¢ store sellers. Rubber moulds furnished for speed production. Small investment brings good returns. We are now placing big Chain Store Orders with manufacturers. Ambitious men have chance for real prosperity. Our Free booklet will interest and benefit you.

PLASTEX INDUSTRIES, Dept. A
 3400 Third Ave. New York 56, N. Y.

NEW POWER for your CAR!

To restore power, pick-up and economy replace worn engine bearings with Federal-Mogul Oil-Control Bearings. They are engineered for the job—ask your mechanic!

NEW, EVEN FINER HULL AUTO COMPASS

The quality that continuously has made HULL the most widely used is now even finer . . . your best insurance for carefree Summer travel. \$4.95 and \$6.50. At your dealer's. Write for literature.

HULL MANUFACTURING CO.
 P. O. Box 246-07—Warren, Ohio

BRONZE FOUNDRY Schools and Home Workshops

Make your own castings of aluminum, copper, bronze, silver. Foundry sets are available in three sizes including 2400 Deg. F. blast furnaces. See advertisements in March or Apr. issues, free Circular.

KANSAS CITY SPECIALTIES CO.
 P.O. Box 6022 Dept. P-7 Marysville, Kan.

Save on all PLUMBING JOBS

When You Build • When Making Improvements • Repairs • Maintenance

Get POPULAR MECHANICS Home Plumbing Guide



How to plan plumbing installations, select materials and fixtures.

How to save money on all plumbing jobs using approved methods.

Easy to Do Professional-Like Jobs and Save Over One-Half

Get the Popular Mechanics HOME PLUMBING GUIDE. It shows how you can do every kind of plumbing job yourself and save from a few to hundreds of dollars. Covers plans, layouts, installation, maintenance and repair. Shows what materials to get and use, where to get them and how to do a proper job with approved methods. Few, other than the simplest tools are required and some of these can be rented. Don't pay high prices for work you can do yourself. Get the HOME PLUMBING GUIDE for only \$3.50. You will be amazed how jobs you thought difficult are simplified.

Clip This Ad and Mail Money Back if Not Pleased

Invest only \$3.50. Use the book for 7 days. Then if you are not satisfied return it for full refund of your money. Sent C.O.D. (U.S.A. only) if you prefer.



- 15 Ways to Save Money**
 All about modern home plumbing
 How to use plumbing tools
 Getting acquainted with pipe
 Planning home plumbing systems
 Installing and maintaining home drainage systems
 Private sewage disposal systems
 Causes and cures of drainage troubles
 Installing home water lines
 Private water supply systems
 Water Heaters
 Water Conditioning
 Water system troubles and cures
 Installing and caring for fixtures
 What to do with valves and faucets
- Over 500 How-to-do-it Pictures Guide You

POPULAR MECHANICS PRESS, Dept. 756, 200 E. Ontario St., Chicago 11

FAMOUS PALLEY MIXES

GADGET MIX - Consists of 5 pounds of Rivets, Spacers, Bolts, Screws, Gears, Wheel Bearings, Springs, Clamps, and many more. ALL for ONLY... **1.19**

BEARING MIX - Approximately 20 needle and Ball and Roller bearings. New and Used. Sizes: 1/2" to 4". Some of these cost the Gov't \$10 apiece. Never such a value. 5 lbs. ONLY... **1.59**

FILE MIX - Ten assorted Files, 4" to 12", includes 3 Vixens, half rounds bastard, mills, etc., in seconds and used but in good condition. 1 Vixen alone worth our price for entire mix. **1.99**

PULLEY MIX, No. PM-1 - You'll want this one around. 10 micarta & metal pulleys ranging from 1" to 5" with ball and one piece bearings. These are surplus pulleys, the best made with 100% of uses. A WONDERFUL BUY!!! **2.95**

NEW NYLON ROPE

Very finest quality. Lustrous white color.

SIZE	Strength	PRICE
1/4" Nylon	1100 lbs.	9c run ft.
3/8" Nylon	2700 lbs.	17c run ft.
1/2" NYLON	5000 lbs.	27c run ft.
11/16" Nylon	135000	39c run ft.
15/16" Nylon	17500 lbs.	57c run ft.
1" Nylon	18000 lbs.	62c run ft.

180° OFFSET DRIVE - For use where tremendous power at low take-off RPM is desired. 6 gears rotate on self-lubricating, hi-speed roller bearings. 85 to 1 gear ratio. Shafts are 1/4" & 3/8" dia. USED **5.95**
NEW in excellent condition... **8.95**

UNIVERSAL JOINTS

90 to 180° UNIVERSAL - Has a heavy duty, solid cast Bronze body. Rotates from 90° to 180° as desired. Has 29/32" dia. steel shafts. Ball and socket joint. **5.95**

In excellent condition and in many sizes and types. Listed below are a few examples.

- TUBULAR SHAFT TYPE**
- 1/2" OD x 3/8" ID x 2-3/8" long **75c**
 - 5/8" OD x 1/2" ID x 3-1/16" long **75c**
 - 1" OD x 3/4" ID x 3-3/8" long **1.10**
 - 3/4" OD x 5/8" ID x 3-1/4" long **1.25**
 - 1/2" OD x 3/8" ID x 2-5/16" long **.75c** with Neoprene Dust Cap
- HEAVY DUTY TUBULAR TYPE**
- 6" OD x 13/16" ID x 4-3/16" long **1.65**
 - 3-1/4" OD x 1-1/4" ID x 3-11/16" long with gimbal ring in center. **1.65**
- HEAVY DUTY SOLID SHAFT**
- 1-1/4" diameter x 3-3/4" long **1.95**
- ORDER BY ABOVE NUMBERS -

Palley's 2261 EAST VERNON AVE. DEPT PM-7 LOS ANGELES 58, CALIF.

PHILIPPINE MAHOGANY Luan PLYWOOD AT LESS THAN WHOLESALE

For Paneling Dens, Offices, etc. Use in Cabinets, Furniture, etc. Rotary cut. Both sides sanded. Banded with finest resin adhesive. Face side jointed. Shipped at lowest rates.

SAVE 50%
3MM (1/8") x 3 FT. x 6 FT. **179** PER SHEET
\$500 VALUE
MINIMUM ORDER 8 SHEETS

FREE SAMPLE ON REQUEST

1/4" x 4 FT. x 8 FT. **950 VAL.**
MIN. ORDER 4 SHEETS **449** PER SHEET

3400 RPM 1/2 HP POWER SAW
COMPARES TO SAWS SELLING UP TO \$49.50 WITH A 5 1/2" BLADE **Only 19.98**
RIPS - CROSSCUTS CUTS A FINISHED 2x4 LIKE A KNIFE THROUGH BUTTER

A rugged, professional type, adjustable saw. Will cut any angle from 0 to 45°. Has an adjustable (0 to 6") rip fence. Safety-trigger switch on handle. Full 1/2 HP Universal AC DC, 110-120 Volt, 60 cycle motor. Weighs only 8 1/2 lbs.

EXTRA SAW BLADES - Available in Rip, Crosscut or Combination. Please Specify... **2.25** each

NEW POWER SAW BENCH TABLE

A sturdy, precision made bench-saw table to convert our famous power saw (above) to a handy home bench saw. Permits angle & bevel cuts, rip, crosscut and comes with a rip fence and mitre guide. Size: 14" x 16" table, 6" high. NOW **9.95**

1/4" ELECTRIC DRILL
A tremendous Value. Has heat treated, high speed gears - self-lubricating bronze bearings and a genuine Jacobs type Chuck. Fully air cooled. Has a Safety-trigger switch. A tool of many uses - drilling, grinding, sawing, polishing, as a drill-press, etc. Order while stocks complete **9.95**

NEW VERTICAL DRILL STAND CONVERTS THE ABOVE DRILL TO A DRILL PRESS

Makes the above drill even more versatile. Sturdily built with an adjustable drill bracket mounted on a steel column. Gives a 4 to 1 leverage with the handle. Feed travel is 2-1/4". Centre-line of the stand column is 4-1/2". Base can be bolted to your workbench. A \$14.95 Value for ONLY... **9.95**

NEW H.V.Y. DUTY CHAIN SAW
WITH 18-INCH CHAIN AND GUARD
A portable, gas engine powered chain saw that makes a cut up to 18". Has a two-cycle air cooled engine with dual accelerator controls and grip-right handles. Develops a high cutting speed for straight or angle cuts. Built for rugged, heavy duty use. **159.95**
Comes with solid aluminum chain guards... **\$249.50 value**

A COMPLETE CAMP KIT 3.95
12 Pc. SPORTSMAN'S KNIFE
Contains a regular knife, fork, spoon, fish scaler & bone saw, scissors, draw knife, can & bottle opener, corkscrew, awl punch, screw-driver and metal file. Mounted in a rugged 4-5/8" bone handle. Complete with a genuine leather holster for your belt.

Order from this Ad. Pay by Money Order or Check. 1/2 Deposit with C.O.D.s. All prices are F.O.B. our Los Angeles Warehouse. Order Today.

GIVE THE KIDS A THRILL

CRYSTAL RADIO
3.95 NEW

A GENUINE CRYSTAL RADIO SET. Picks up standard broadcast stations without using batteries or electricity. Just plug-in headset, antenna and ground wires, then tune-in your favorite program. You'll be amazed at the STRONG, CLEAR SIGNAL. Has a 100 KC tuning range. Comes complete with Receiver, Antenna and Ground Wires PLUS a 2000 Ohm Headset. Order Today.

SOUND POWER PHONES

Originally used by the Navy for gun control. Ideal for emergency communication because each set is 'sound powered'. Will operate up to 1/2 mile distance.

Set includes 2 phones w/ chest plate, 2 headsets, 35 feet of wire. **9.95 PER SET**

AIR CORPS RUBBER BOATS

Ideal for Fishing or Hunting. Made to Gov't specs. Reconditioned and ready-for-use. Supply Limited.

1 MAN **Only 22.95**
6-7 MAN **NOW 69.50**

HAND AIR PUMP **3.95**
COLLAPSIBLE OARS **1.25 EACH**

SURPLUS BARGAIN

No. 79 HYDRAULIC CYLINDER - Will give 20,000 pounds thrust using 1500 PSI line pressure as delivered from one of our hydraulic pumps. Gives up to 40,000 lbs. thrust with 3,000 PSI. Has a 4" bore and 18" stroke. Overall length 30 1/2 inches. Reconditioned and Checked **37.50**

SAVE 50% ON NEW PALLEY HYDRAULIC CYLINDERS

Send for Special HYDRAULIC CATALOG SUPPLEMENT - Shows entire line of new hydraulic equipment designed especially to fill the needs of industry. Also SAVE up to 85% on War Surplus Hydraulic Equip. including Pumps, Valves, Fittings, etc.

PORTABLE WINCH HOIST
A 'swing around' type hoist. Will lift up to 1500 lbs. with 21 to 1 gear ratio. Has 12 ft. of 3/16" steel cable. **22.50**

FREE BOOKLET on Camping and Hiking Equipment. Showing complete line of our imported Ruckstocks as well as Sleeping Bags, camp accessories, etc. Booklet C-8.

"SPEEDY" DRILL GRINDING GUIDE

One piece cast Aluminum drill holding jig, use with grinding wheel or disc sander to resharpen dull and broken twist drills up to 1/2" diameter. Simple. Anyone can use it. Money back guarantee. Order to-day direct from factory. **1.00**

BRASS CASTING CO. BOX 3056, MEMPHIS 9, TENN.

STOP SLAMMING DOORS WITH AIREZE

SCREEN DOOR CHECK
Positive compressed air action works every time! 2-minute installation. Cannot rust. Money back guar. At most hardware counters, or order direct. **\$1**
CANNON PRODUCTS INC.
8513 TAHONA DRIVE, SILVER SPRING, MD.

SAY YOU SAW IT IN POPULAR MECHANICS

WELD BRAZE SOLDER CUT **4WAY ONLY \$14.75** f.o.b. factory

Acclaimed by thousands of Homeowners, Mechanics and Hobbyists as the welder of 1001 uses. Easily operated from properly wired 110 volt AC or DC line. The ideal gift with a life-long use... Order today on 10 day money back guarantee.
FOUR-WAY WELDER CO., Dept. F2-G 1810 S. Federal St. • Chicago 16, Ill.

Complete with Twin Carbon Arc Torch and accessories... to handle all metal-craft work.

SAW SHARPENING IS EASY

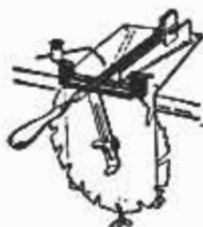

Sensational new Super Filer No. 11 joints and sharpens both hand and circular saws 6" to 10" with all teeth the correct height, depth, pitch and bevel. Easy to use—when file hits hardened steel roller, teeth are finished. Saw runs true and smooth with no side pull. Complete with special 8" file \$9.95 ppd. "TRU-CIRCLE" saw set automatically sets teeth at 10° or more \$2.95.

SUPER SAW FILER NO. 6

Automatic controls



DEPTH ANGLE PITCH

Automatic DEPTH CONTROL Rollers

IT'S NEW!

Perfect bevel and angle maintained, and fool-proof depth control for all Rip, Crosscut and Handsaws. Precision made and calibrated for instant setting at desired angle. Can be used in any vise or clamp. Complete with file, only \$6.50 ppd.

NEW! 7-in-1 HEX-KEYTAINER

Always ready when needed—seven most popular socket screw wrenches in one convenient tool, sizes .050 to 3/16. Fits set screws from No. 3 to 3/4—cap screws from No. 1 to 1/2. In handy plastic case. \$1.25 paid

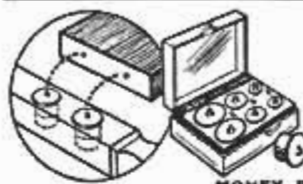

FOOL PROOF DOWEL CENTERS

Assure positive, quick alignment of mating units with ADM Dowel Centers. Insert in drilled holes, press mating piece against points, tap lightly. Centers inscribe exact location for opposite holes. Pairs of 3 popular sizes (6 centers)—for 1/4", 3/8", 1/2" holes. \$1.00 post-paid

MONEY BACK GUARANTEE — CATALOG FREE

A. D. McBURNEY, 5908 Hollywood Blvd., Hollywood 28, Cal., Dept. A-76

Say You Saw It in Popular Mechanics

NEW! Arco HOLE SAW

with exclusive new AUTOMATIC SLUG EJECTOR

4 HOLE SAWS IN ONE!

Fits any electric drill, drill press, lathe, motor. Automatic slug ejector pops out slug immediately. This saw works 3 times as fast as other hole saws that sell for twice as much! Cuts 1", 1 1/4", 2" and 2 1/2" holes cleanly, accurately. Cuts wood, plastics, metals, formica, wall board, etc. Has extra grooves in tool head to accommodate 1 1/4", 1 3/4" and 2 1/4" blades. Consists of sturdy alloy tool head, 4 finest quality shatterproof blades, automatic slug ejector and 1/4" drill bit. Only \$4.95 ppd.



DELUXE ARCO HOLE SAW—Same as above but has 7 blades, cuts 1", 1 1/4", 1 3/4", 1 3/4", 2", 2 1/4" and 2 1/2" holes. Only \$6.50 ppd.

Send Check or M.O. C.O.D. fee extra. MONEY BACK GUARANTEE

SCOTT-MITCHELL HOUSE, INC. DEPT. H5-7, 611 BROADWAY NEW YORK 12, N. Y.

most amazing blade you ever saw!

Tyler SPYRAL BLADE

SAWS METAL, WOOD, PLASTIC, ETC.

up or down, right or left, even in circles!



Does what no other Blade can Do. Fits Standard Coping Saw or Hacksaw Frames. NO special adapters needed! World's safest saw blade.

You'll find hundreds of uses for Tyler Spyral Blades. There's nothing like them! The first important improvement in blades since the invention of the saw. Fun to use...cuts so fast and easy; no chipping or tearing—leaves clean smooth edge.

AT YOUR HARDWARE DEALER, OR SEND \$1.00 FOR... 12 Spyral Coping Saw blades—OR—3 Spyral Hacksaw blades

TYLER MANUFACTURING CO. 1005 W. Arbor Vitae Ave., Inglewood, Calif.

A DRY BASEMENT

ONLY \$79.50

with a DIXIE

The DIXIE AIR DRYER rids your basement of musty, costly dampness. No fancy cabinet or frills—just a full size dehumidifier that keeps your basement dry as a bone. Install yourself in minutes. Plug in and forget it.



ORDER DIRECT OR FOR FURTHER INFO WRITE DEPT. B

ADAMS EQUIPMENT, INC. 511 SOUTH JACKSON, JACKSON, MICH.



"FIRE UP"

YOUR ENGINE AT ALL SPEEDS WITH AUTO-LITE RESISTOR SPARK PLUGS WITH

POWER TIP

LOOK FOR THE PROTRUDING TIP!

Works in seconds



Loosens Rusted Bolts nuts, screws, "frozen" parts!

LIQUID WRENCH

AT HARDWARE STORES, GARAGES SERVICE STATIONS EVERYWHERE

For information write manufacturer Radiator Specialty Co., Charlotte, N. C.

SAVE MONEY on SURPLUS PARTS for MILITARY TYPE TRUCKS & JEEPS

4 & 6 wheel drive. FREE catalog to Jeep owners. State make truck or Jeep. (New Jeep Tops, steel or canvas all models). AMERICAN AUTO PARTS CO., Inc., 1830 Lonest, Kansas City, Mo.

Metal Turning Lathe for Model Makers



Ball bearing headstock spindle. Bed length, 12"; swing, 4 1/2"; between centers, 7"; adjustable tailstock; mounting bolts. Complete with face plate & driving dog. Ship. wt. 27 lbs. Guaranteed. F.O.B. Lansing. \$29.95

Send for Free Descriptive Folder

ROSEMOOR MFG. CO., 2501 Bernice Rd., Lansing, Illinois

Need an extra \$1,000, \$2,000, or more? Make it with an IDEAL LAWNMOWER SHARPENER

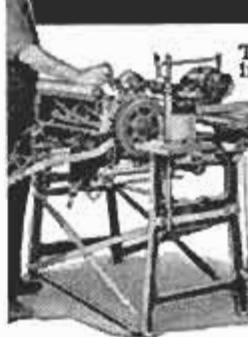

There are thousands of lawnmowers in your locality; Average \$1,000 profit per 250 mowers with customer satisfaction and repeat business assured. Provide this essential service with an Ideal Lawnmower Sharpener, the only machine that grinds the reel to "fit" the bed knife. Compare by any standard. The Ideal, backed by 53 years of experience, costs no more. Write today for complete, free catalog.

THE FATE-ROOT-HEATH COMPANY Dept. PM-7 Plymouth, Ohio

PORTABLE LIGHT PLANTS

GIANT 2000-2500 WATT PLANT

110-120 v. 60 cyc. AC. absolutely the best made — exclusive dynamic-ally balanced armature; heavy windings develop up to 3000 watt overload for motor starting. Skid mounted — portable. Powered by an easy starting Briggs or Wisconsin 6 HP engine—complete with all accessories; engine easily disconnected for other uses. Big outlet box, voltmeter, no wiring necessary. Ample current for all purposes. Factory warranty. (Item 31) Wt. 210 lb.

Reg. price \$385. Special at... **\$299.50**
Same plant with electric self starter (Item 31a)... **\$359.50**
Generator only and control box... **\$169.50**

DUAL VOLTAGE 110-220 available on any of above models for \$28.00 additional.

HI-LINE 6000 WATT PLANT
(Item 162) Push Button Start 115-230 v. 60 cyc. A.C. A brute of a power plant with a rugged 14.6 hp. Wisconsin engine. Plenty of electricity for ranges, water heaters, freezers, pumps, machinery, etc. Affords both 110 and 220 volts. Ideal where heavy current is needed. Wt. 500 lbs. Easily worth \$995. With crank start... **\$585.50**

Same plant, but with self-starter, **\$645.00**
We make every type and size of light plants — Write, giving us your requirements!

HI-FLO Centrifugal PUMP

Completely self-priming! No foot valve required. Tremendous capacity—100 gal. per min. 1". Special impeller enables pump to handle muddy or sandy water. Simple to operate—simply start engine and watch the water go. Powered by a rugged, easy-starting 2 HP Briggs engine. Precision sealed bearings for years of heavy low-cost service. Big 1 1/2" Model. Item 502. Wt. 70 lbs. Factory price... **\$134.50**

2" Model (150 gal. per min.) with 2 1/2 HP engine. Item 502a. 90 lbs. Fact. Spec. **\$154.50**

BIG JOE Portable Pump

A powerful pump that handles up to 15,000 gal. per hour. Easy to operate. Self-priming (after initial prime), no foot valve needed—resulting in 25% more capacity. Exclusive impeller design provides maximum rate of water per horsepower, yet handles water containing a large percentage of stone, gravel and mud. 2 in. suction and discharge. Powered by an easy starting 5 hp. Wisconsin engine and mounted on steel skids. Wt. 250 lbs. (Item 503). Factory price... **\$275.00**
Big rubber tired wheels. \$20 additional.

MASTER DC ARC WELDERS
Now a portable rugged, industrial type welder with terrific performance, yet at a price hundreds of dollars less than you'd expect. Senior model made for years of trouble-free continuous service. High capacity DC welding unit enables you to tackle any job with confidence—easily welds anything up to 2" plate using from 1/16" to 1/4" rods. Built-in stabilizer and cooling system makes arc easy to strike and hold. Dual control rheostat provides low heat soldering, brazing and welding from 30 to 300 amps. Complete with instructions, guarantee and triple V-belt for flat pulley. Easy to hook up and easy to operate. **WELDER ONLY — DUAL CONTROL MODEL.** Same as above, but drive with your tractor, jeep or gas engine of 14 HP or more. (Item 58a.) Wt. 110 lbs. \$450 value... **\$119.50**
WELDER ONLY — INDUSTRIAL MODEL same as above but with ceramic rotary type rheostat providing 74 different heat settings for all types of welding (Item 58b) **\$139.50**
COMPLETE POWER MASTER (Illustrated above) powered by a 14.6 hp., air cooled Wisconsin engine. Wt. 480 lbs. (Item 280) Compares with welder costing \$1200. Factory Special... **\$449.50**
WELDING KIT Two 10 ft. leads, welding helmet, electrode holder, ground clamp. Sold only with welder at... **\$10.50**

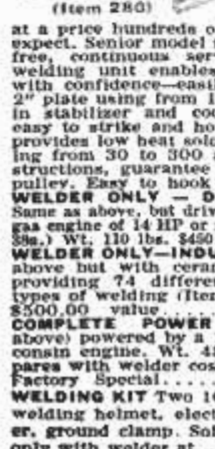
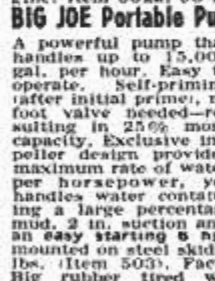

buy at factory prices direct from MASTER MECHANIC

SAVE (Item 24) 600-700 WATT PLANT

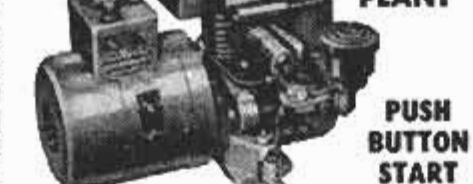

115 v. 60 cyc. AC Powered by a rugged 2 HP. easy starting Briggs engine. No wiring necessary; just plug in and operate. Plenty of current for any oil burner, freezer, brooder, emergency lights, etc. which require up to 700 watts. Ideal for television and radios. Complete with voltmeter and built-in winding to charge 6 v. auto batteries. (Item 24) Wt. 75 lbs. Easily fits in car trunk. Be prepared if storm knocks out power lines. **\$143.50**
Regular \$275.00 value.
1000-1200 Watt Plant (Item 45) same as Item 24 but larger motor and engine with 30% greater output. **\$199.50**

HEATING VENTILATING FAN

(Item 10) Easily installed in furnace pipes. Forces even heat to all rooms. Over range removes kitchen smoke and odors. Powerful, continuous duty motor, 110-120v. AC. Mount in wall or ceiling to ventilate any area. Quiet, super-efficient fan moves huge volume of air. (400 to 600 CFM).
8" Pipe, wt. 5 lb. **\$6.85**
9" Pipe, wt. 6 lb. **\$7.85**
10" Pipe, wt. 7 lb. **\$8.85**
12" Pipe, wt. 8 lb. **\$9.85**
HEAVY DUTY FAN. Semi-enclosed motor, suitable for spray booths, restaurant exhausts, poultry houses, etc. 10" Fan, wt. 8 lbs. (Item 10E) **\$11.95**
12" Fan, wt. 10 lbs. (Item 10D) **\$12.95**
HIGH SPEED BARN FAN similar to above, but larger, high speed motor moves huge volume of air.
12" Fan (Item 10F) **\$14.95**
14" Fan (Item 10G) **\$17.95**

CONDITIONAIRE VENTILATING FANS

Save big money installing your own exhaust fan. Efficient propeller type blade moves huge volume of air quietly and effortlessly. Heavy welded frame — pre-drilled for easy installation. Just cut opening and bolt in place. Continuous duty motors. Ideal for attics, restaurants, garages, barns, chicken houses, etc. Control manually or with thermostat.
Blade Opening CFM Wt. Item
10" 18 1/2" 325 19 lb. 365a **\$27.95**
18" 19 1/4" 3600 27 lb. 365b **\$31.95**
20" 21 1/4" 4100 30 lb. 365c **\$39.95**

CARRY-IT COMPRESSOR

Perfect portable air supply for spraying paint, insecticides, tire inflation, etc. Hi pressure compressor powered by a 1/2 H.P. capacitor type motor — develops up to 150 lbs. pressure. Built-in 500 cu. in. steel tank tested to 400 lbs. Complete with safety valve, gauge and shut-off valve. A better buy than outfits selling for \$100 or more. (Item 226) Wt. 55 lbs. Factory Special... **\$74.95**

Rugged, ball bearing WINCH

Sturdy ball bearing winch—super tough aluminum alloy construction. Powered by an easy starting 2 3/4 HP Briggs gas engine thru gear reduction drive — it exerts up to 3000 lbs. of terrific force for hoisting materials or pulling. Combination gear and pulley reduction results in tremendous multiplication of engine power. Idler pulley clutch arrangement and built-in drum brake (with ratchet hand lever) enables operator to ease loads down gently and lock at any point desired. Drum handles 400 ft. of 3/4" cable or 600 ft. of 1/2" cable. Ideal for contractors, farm implement trailers and unlimited other uses! (Item 795) Wt. 125 lbs. Only... **\$149.50**
HAND WINCH—Same winch with large crank handle for extra leverage and 2 speed drive. (Item 794) Wt. 60 lbs. **\$59.50**

Send check or M.O. Prices f.o.b. Factory. 10 day Money back guarantee. SEND 10c for... **MASTER MECHANIC MFG. CO., DEPT. 70-M**

LESS THAN WHOLESALE

1300-1500 WATT PLANT
115v. 60 cyc. AC Push Button Start. Powered by a 3 1/2 HP. Clinton engine. Combines big output with emergency power for operating any oil burner, pump, freezer, television, lights, communications systems, etc. which require up to 1500 watts. (Item 22). Wt. 110 lbs. Reg. \$475 value. Factory price... **\$239.50**
1750 Watt Plant Powered by 4.5 Briggs engine. Electric starting & battery charging built-in! Factory price... **\$279.50**

MASTER-LITE 2500 Watt Plant
110/120 v. 60 cyc. AC. A powerful plant, ruggedly constructed and yet designed for easy portability. Can be started by rope or built-in 12 v. electric push button starter. Built-in winding to charge battery. Powered by a big 5.10 HP Briggs engine, complete with all accessories. Includes control box, voltmeter, and handy plug-in power receptacle. An ideal plant for permanent or stand-by service. Wt. 226 lb. Reg. price \$645.00 (Item 21) Factory Price... **\$329.50**
3500 Watt Plant Push Button Start (Item 23) 115 v. 60 cyc. AC. Similar to above, but larger and 33% more capacity. Wt. 270 lbs. Reg. \$760. Factory Price... **\$379.50**
DUAL VOLTAGE 110/220 for Item 21 or 23 —\$30 additional.

RUBBER HOSE

German Neoprene Hose — contains ordinary rubber 3 to 1. Reinforced with super tough cotton cord plies — yet completely flexible. Equipped with standard thread male and female fittings. Perfect water for irrigation, stock tanks, home, barn, fire fighting, etc. — or pump gas and fuel oil. Volume factory prices—save more than 60%.

Inside Dia.	Length	Price
1 1/2"	10 ft.	5.95
1 1/2"	10 ft.	8.95
1 1/2"	25 ft.	13.95
1 1/2"	50 ft.	24.75
1 1/2"	100 ft.	49.95
1 1/2"	10 ft.	10.95
1 1/2"	25 ft.	14.75
1 1/2"	10 ft.	16.50
2"	10 ft.	9.50
2"	14 ft.	21.50
2 1/2"	10 ft.	21.75
3"	10 ft.	25.50

1 1/2" I.D. HIGH PRESSURE STEAM HOSE per ft. **\$1.00**
AIR HOSE Heavy duty, 1/4" I.D., 2 braided (150 lb. pressure) with standard couplings. 30 ft. lengths. **\$2.95**
PAINT SPRAY MATERIAL HOSE 3/8" I.D. Synthetic thick inner tube and neoprene cover—finest made! 25 ft. lengths with standard couplings. (Item 62) each... **\$7.50**

EXTENSION CORD

Heavy duty and very flexible. Neoprene 14-2 cable. 20 year quality. Wt. 12 lbs. (Item 185) 100 ft. Complete with rubber plug and outlet. A terrific buy at only **\$8.95**
No. 10-2 POWER CABLE. Heavy duty, very flexible, rubber covered. 50 ft. with male and female fittings. Wt. 9 lbs. (Item 592a) **\$10.45**
50 ft. without fittings (Item 592) ... \$9.45
No. 12-2 POWER CABLE. Very flexible rubber covered, special outside shield for grounding power tools, etc. 50 ft. (Item 199) wt. 8 lbs. **\$6.95.** 100 ft. (Item 200) ... **\$2.95**
No. 14-8 Conductor Power Cable, heavy duty very flexible, rubber covered, with 8 contact plug & socket. Ideal for tractor-trailer connectors (Item 796) 15 ft. **\$9.95**

JET STEAM MASTER

Now, a super efficient portable steam generator that produces live steam at 100 lbs. pressure in 60 seconds from a cold start! Produces large volume of high pressure steam on 2 pints of fuel oil. Instantly cleans sticky grease, dirt, rust, old paint, etc. of implements and road machinery. Pays for itself in a few weeks. Sterilizes soil. Sterilizes as it cleans—milk equipment, etc. Fully automatic—oil fired with new, built-in efficient bronze water circulating pump. Draws water from faucet or bucket. Simple and safe — anyone can use it; built-in safety valve. Complete with 12 ft. of hi-pressure steam hose and new triple efficiency steam gun that automatically mixes in soap solution if desired. Wt. 250 lbs. Item 483. **\$329.50**
Special factory price...

SEND 10c for... **BIG 1956 Catalog**

The life you save may be your own!



Check Your BRAKE FLUID, Too!

You can replace your motor—but NOT your life. When you change oil—have your brake fluid checked too. Leaks and evaporation may have dangerously lowered your brake fluid supply to a point where you won't have full braking power in an emergency.

Don't Take Chances on YOUR Life!

- 1 Have your brake fluid checked at least each time you get an oil change.
- 2 Beware of dangerously inferior brake fluids.

BOWES brake fluid



IS SAFE

Certified to equal or exceed
S.A.E. specifications R71 or R72.

When your service station uses Bowes Brake Fluid you may be sure he is more interested in YOUR life and welfare than the very few pennies difference between safe and unsafe brake fluid.

BOWES "SEAL FAST" CORP., INDIANAPOLIS 7, IND. • HAMILTON, ONT., CANADA • LONDON, ENG.
BOWES PACIFIC CORPORATION, RIVERSIDE, CALIFORNIA

Make these Beautiful Furniture Pieces

yourself

with

FORMICA®
Laminated Plastic



Send for the patterns

After you've had the satisfying experience of resurfacing a sink top or furniture with Formica you'll want to extend this do-it-yourself fun to other projects. If you've run out of things to resurface, why not send for one of our Easi-Bild Patterns* and start from scratch. The record cabinet and the step table are just two of the nine fascinating Formica projects available in patterns. When you select a color or wood grain from the more than 70 in the Formica Sunrise Line, choose well—it lasts a long time. Just check the patterns you want and send cash with order. We'll send with your patterns, complete instructions for using Formica and Formica contact Bond Cement—and tell you where you can buy Formica in your area.

*Registered Trade Mark Easi-Bild Pattern Co.

DEMAND THIS CERTIFICATION

This mark certifies genuine

WASH OFF WITH LOTS OF BAR SOAP / ON A DAMP CLOTH

Seeing is believing. If this wash-off identification is not on the product, it's not FORMICA.



FORMICA PATTERN DEPARTMENT

4596 Easi-Bild Pattern Co.
Pleasantville, N.Y.

Gentlemen: Enclosed is cash, check, or money order for the patterns as checked below.

- | | |
|---|---|
| <input type="checkbox"/> No. 90 Bar or Dining Counter35 | <input type="checkbox"/> No. 557 Favorite Window50 |
| <input type="checkbox"/> No. 99 Modern End Table25 | <input type="checkbox"/> No. 3 Kitchen Unit50 |
| <input type="checkbox"/> No. 127 Step End Table50 | <input type="checkbox"/> No. 192 Record Cabinet Bar35 |
| <input type="checkbox"/> No. 201 Kitchen Cabinets 1.00 | <input type="checkbox"/> No. 309 Coffee Table35 |
| <input type="checkbox"/> No. 537 Decorators Desk..... .50 | |

Name _____

Address _____

City _____ Zone _____ State _____

AMERICA'S TOP BALLPLAYERS SMOKE

Camels

AMERICA'S TOP CIGARETTE



HANK BAUER, Yankee outfielder: "I've been smoking Camels over 15 years now!"



TED KLUSZEWSKI, Redlegs, says: "Camels taste rich and smoke mild."



BOB LEMON, Cleveland hurler: "Camel's my choice for flavor and mildness!"



HARVEY KUENN, Tiger shortstop: "Camel's the richest-tasting smoke I've found."



RICHIE ASHBURN, N.L. batting champ: "Can't touch Camels for good, rich taste."



WARREN SPAHN, Milwaukee lefthander: "Camels sure have what it takes."



JACKIE JENSEN, Boston Red Sox slugger: "No other smoke comes close to Camels!"



WHITEY LOCKMAN, N. Y. Giants: "I've switched to Camels—they're the best!"



TOMMY BYRNE, Yankee pitcher: "Camels have more flavor—smoke real mild!"



YOGI BERRA, great Yankee catcher: "Camels' good, rich taste is a pleasure."



BOB GRIM, Yankee pitcher: "Camels taste rich, smoke smooth and mild."

More pure pleasure!

That's what you get in Camels — by far America's most popular cigarette! Camels give more pleasure to more smokers today than any other brand. Try Camels — you'll see why!



HARVEY HADDIX, Phillies, states: "Camels have richer flavor, and they're mild."



BILLY PIERCE, White Sox southpaw: "I go for Camels! Taste rich, smoke mild."



JOE COLLINS, Yanks, reports: "Camels' rich flavor and real mildness are great!"

R. J. Reynolds Tobacco Co.,
Winston-Salem, N. C.

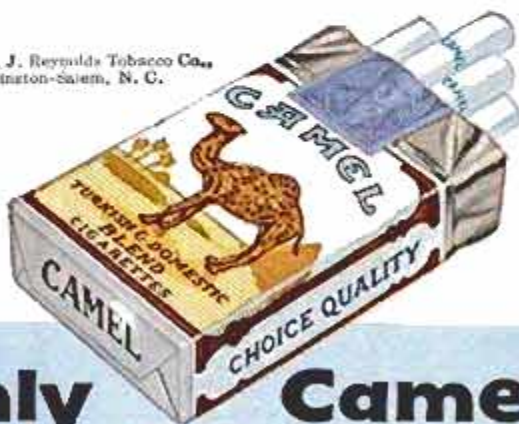

JERRY COLEMAN, Yankee infielder: "I sure enjoy a mild, rich-tasting Camel."



BILLY HOFT, Tiger hurler: "Can't beat Camels' good, rich taste. Mild, too!"

Only Camels taste so rich, yet smoke so MILD!