

MAY 29 WES.

POPULAR MECHANICS

MAGAZINE

WRITTEN SO YOU CAN UNDERSTAND IT

REG. TRADE MARK, GREAT BRITAIN, NO. 410528

REG. U.S. PAT. OFF.

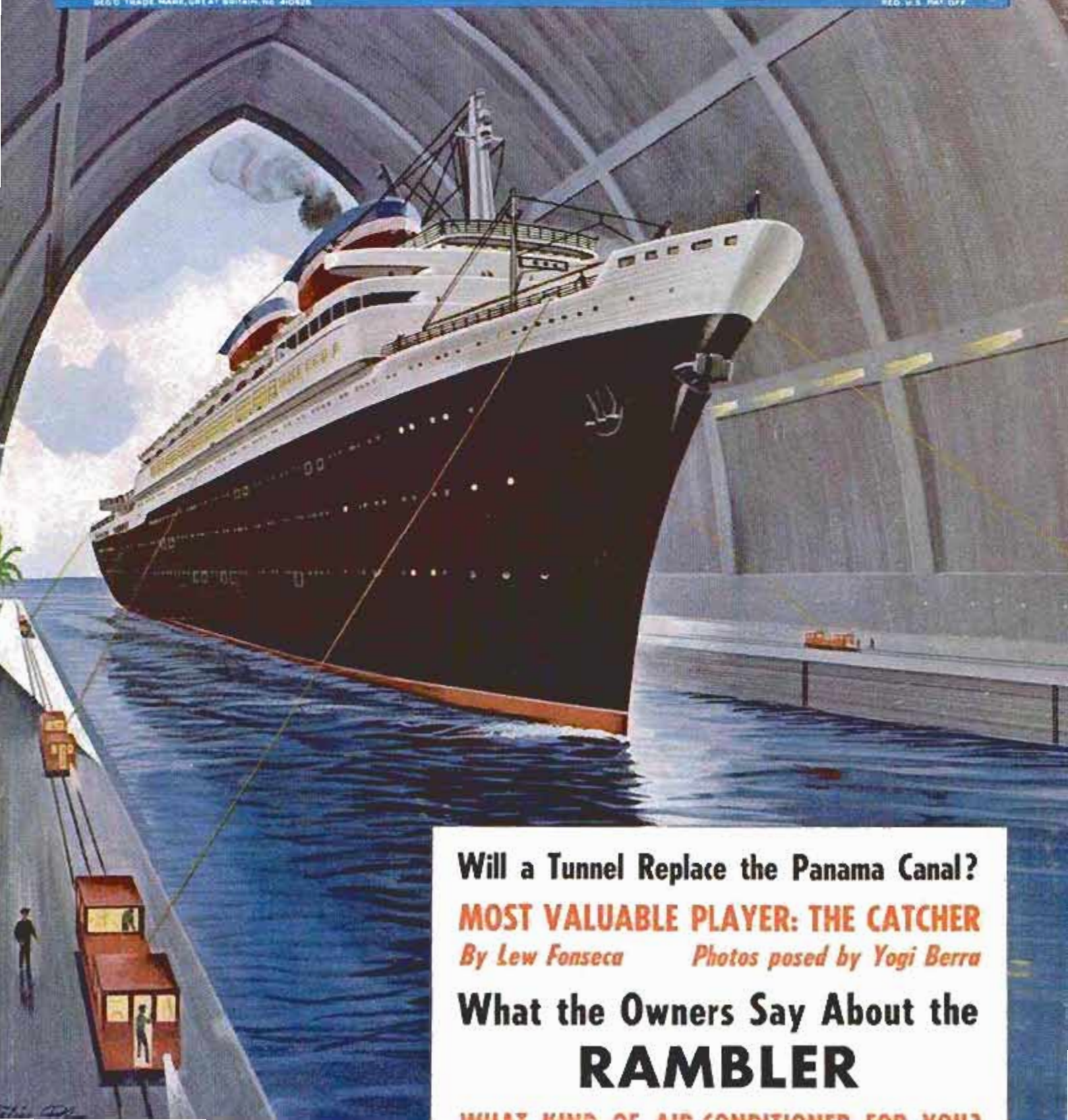

Will a Tunnel Replace the Panama Canal?

MOST VALUABLE PLAYER: THE CATCHER

By Lew Fonseca Photos posed by Yogi Berra

What the Owners Say About the
RAMBLER

WHAT KIND OF AIR CONDITIONER FOR YOUR

See what DEPENDABILITY has done for Eve!



No Other

OUTBOARD MOTOR IS BUILT LIKE A JOHNSON SEA-HORSE. NONE! THE MANUFACTURER WHO HAS BUILT MORE OUTBOARD MOTORS THAN ANYONE ELSE, HAS MORE EXPERIENCE IN BUILDING THEM BETTER. THAT'S

Johnson!

9 MODELS • THE JAVELIN (30hp)
SEA-HORSE 30. Electric or Manual
SEA-HORSE 15. Electric or Manual
SEA-HORSE 10 • SEA-HORSE 7½
SEA-HORSE 5½ • SEA-HORSE 3

The Johnson Sea-Horse is a *family* motor. For a very good reason. It's DEPENDABLE. Ask commercial users. They choose Johnsons, and *work* them—hour after hour, year after year—the *very same models you buy for pleasure!* Yes—DEPENDABILITY makes Johnson the family motor. See the nine new models for '56—all smartly styled in Johnson's new Holiday Bronze—all *quiet*—and featuring quicker, smoother starting than you've ever known before!

FREE! Write for the Sea-Horse Booklet on 1956 models and features. Complete, factual, helpful.

JOHNSON MOTORS, 400 Pershing Rd., Waukegan, Illinois
A DIVISION OF OUTBOARD, MARINE & MANUFACTURING COMPANY
In Canada: Manufactured by Johnson Motors, Peterborough

Johnson SEA-HORSES ARE DEPENDABLE

Men with mechanical skills:

measure yourself against this yardstick



Mechanics Creed

Upon my honor I swear that I shall hold in sacred trust the rights and privileges conferred upon me as a certified mechanic. Knowing full well that the safety and lives of others are dependent upon my skill and judgment, I shall never knowingly subject others to risks which I would not be willing to assume for myself, or for those dear to me.

In discharging this trust, I pledge myself never to undertake work or approve work which I believe to be beyond the limits of my knowledge; nor shall I allow any superior to persuade me to approve aircraft or equipment as airworthy against my better judgment; nor shall I permit my judgment to be influenced by money or other personal gain; nor shall I pass as airworthy aircraft or equipment about which I am in doubt, either as a result of direct inspection or uncertainty regarding the ability of others who have worked on it to accomplish their work satisfactorily.

I realize the grave responsibility which is mine as a certified mechanic, to exercise my judgment on the airworthiness of aircraft and equipment. I, therefore, pledge unyielding adherence to these precepts for the advancement of aviation and for the dignity of my vocation.

This challenging creed has made the U. S. Air Force the finest technical service in the world. If you are a man who feels a deep sense of satisfaction from the knowledge of a job well done, the U. S. Air Force offers you a rewarding and exciting life. Skills you acquire in the Air Force will help you choose and succeed in your future career.

**YOU GO PLACES FASTER ON THE
ALL VOLUNTEER TEAM**

THE U. S. AIR FORCE

JUNE 1956

**Paste Coupon on Postcard
and mail to**

M-45-PM2

**Airman Recruiting Information Branch
Box 2202
Wright-Patterson AFB, Ohio**

Please send more information on my opportunities for enlisting in the U. S. Air Force. I am between the ages of 17-24 and reside in U. S. A.

This One



3ACY-ESO-JOJJ

Look *Forward* to carefree summer driving

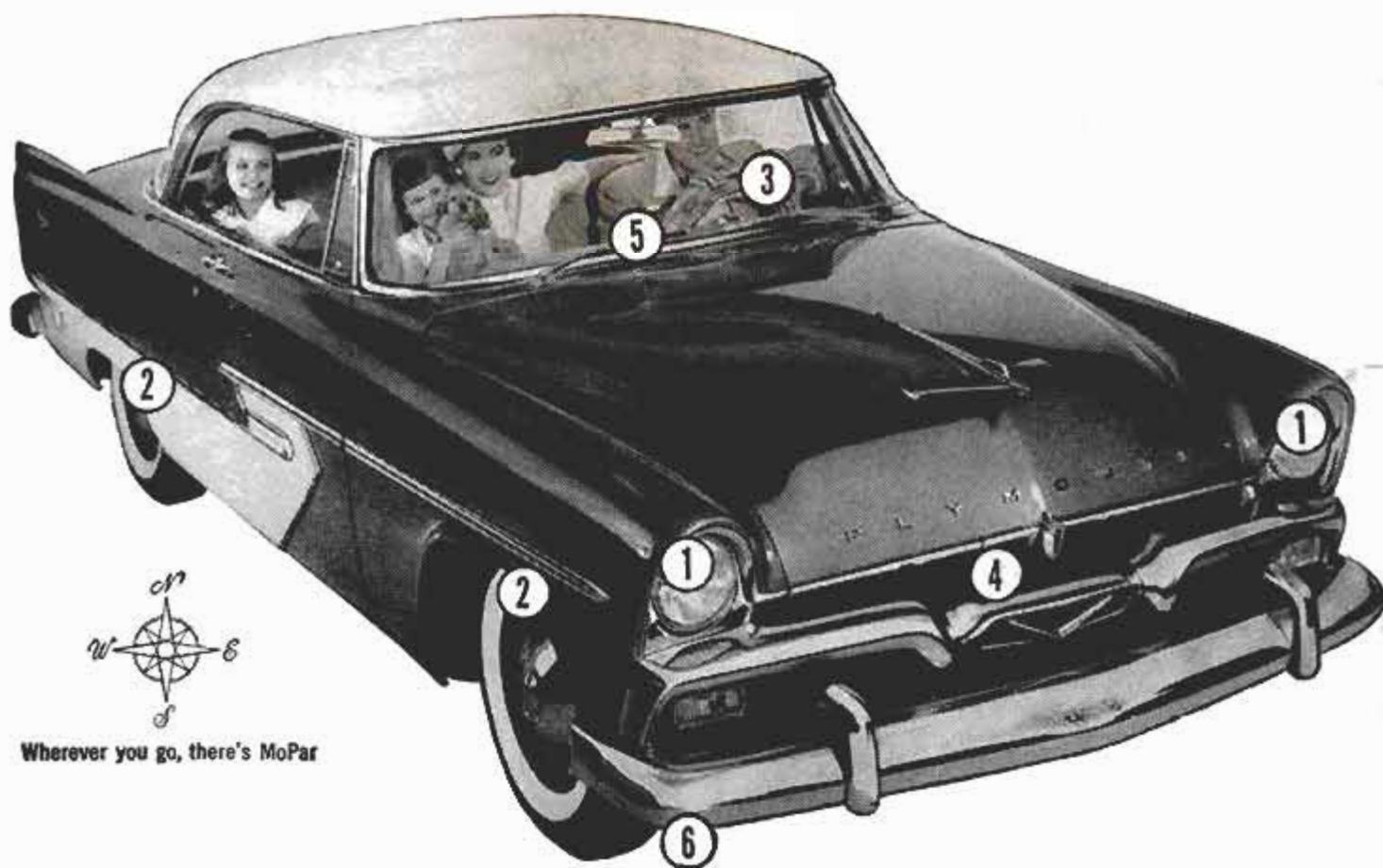

Wherever you go, there's MoPar

Get a **MOPAR** Vacation Checkup Now

at any Plymouth, Dodge, De Soto or Chrysler dealer and at better repair shops everywhere

6-point MOPAR check list
for cars with
"the forward look" 

1. LIGHTS
2. BRAKES
3. STEERING
4. COOLING
5. VISION
6. LUBRICATION

Are you sure your car is in shape for summer driving? Why wonder and worry—be sure with a MoPar Vacation Checkup!

You're sure of service from factory-trained mechanics. You're sure of trouble-free MoPar parts—the only parts engineered especially for Plymouth, Dodge, DeSoto, Chrysler and Imperial cars and Dodge Job-Rated Trucks. They're guaranteed by Chrysler Corporation!

Going north, south, east or west? Drive carefree with a MoPar Vacation Checkup!

MOPAR

CHRYSLER CORPORATION

PARTS DIVISION

Popular Mechanics Magazine

Registered in U. S. Patent Office and Canada

H. H. WINDSOR, Founder

H. H. WINDSOR, JR., Editor and Publisher



Next Month

OLD-TIME New England sailors are doffing their Nantucket caps to a strange craft sailing the waters around Cape Cod. It's a tripont, a three-hulled sloop designed and built by a 71-year-old physician, Dr. Edwards Herman. An experienced catamaran builder and sailor, Doctor Herman says the three-hulled craft doesn't tend to nose-dive in rough water like a catamaran, steers more steadily and is more maneuverable. A feature in July tells how the tripont was built and how it handles even in heavy seas.

Information not listed on articles in the index, starting on page 58, frequently is listed in the WHERE-TO-FIND-IT LIST, which is available to readers without charge. A copy may be obtained by writing to the Bureau of Information, *Popular Mechanics*, 200 E. Ontario, Chicago 11, Ill.

Published monthly by Popular Mechanics Company, 200 E. Ontario St., Chicago 11, Ill. H. H. Windsor, Jr., president; Wm. Harrison Petridge, exec. vice-pres.; Franklin S. Forsberg, operations vice-pres.; D. F. Windsor, vice-president and secretary-treasurer; H. H. Windsor III, vice-president; W. T. Windsor, vice-president; Joseph R. Buehl, Jr., advertising manager; Alan M. Deyoe, circulation manager. Single copy in the United States and Canada, 35 cents; subscription rates in the United States and possessions, Canada, Philippines and countries of the Pan-American Postal Union, 1 year \$3.50; 2 years, \$6.00; 3 years, \$8.00. To all other countries add \$1.00 a year over United States prices for overseas postage. If you plan to move, notify us at least 30 days in advance so you will not miss an issue. Give both your old and new addresses. Entered as Second Class Matter, September 15, 1903, at the Post Office at Chicago, Illinois, under Act of March 3, 1879. Entered as Second Class Matter at Post Office Dept., Canada. Registered as Second Class Matter at the Post Office at Mexico, D. F., Mexico, June 20, 1950. Copyright 1956 by Popular Mechanics Company, Copyright under International Copyright Union. Copyright in France. All rights reserved under Pan-American Copyright Union. Printed in the United States of America.

Volume 105 JUNE 1956 Number 6

Address all communications to: 200 E. Ontario St., Chicago 11, Ill.

Managing Editor.....	Roderick M. Grant
Assistant Managing Editor.....	Wayne Whittaker
Shop Notes and Crafts Editor.....	James R. Ward
Radio-Television, Electronics Editor.....	Lothar Stern
Associate Editor.....	Clifford B. Hicks
Associate Editor, Automotive.....	Arthur R. Railton
Associate Editor, Shop Notes and Crafts.....	Wayne C. Lecky
Associate Editor, Shop Notes.....	W. Clyde Lamme
Assistant Editor, Crafts.....	Jay W. Hedden
Assistant Editor, Makeup.....	John C. Dalen
Automotive Correspondent.....	Leo Donovan
Art Director.....	Frank Beatty
Assistant Editors—Leonard F. Hilts, Elliott H. McCleary, Emily Mullaney, Earl F. Wobeck	
Eastern Editor.....	Richard F. Dempewolf
Empire State Bldg., Room 2906, New York City 1	
Western Editor.....	Thomas E. Stimson, Jr.
Suite 1010, 3460 Wilshire Blvd., Los Angeles 5, Calif.	
London Manager.....	Douglas W. Wedderspoon
Eagle House, Jermyn St., London S. W. 1, England	
Director, Bureau of Information.....	Allan Carpenter
200 E. Ontario St., Chicago 11	

Advertising Offices
Chicago: 200 E. Ontario St., Whitehall 4-0100; New York: Empire State Bldg., 350 Fifth Ave., LOngacre 5-7580; Detroit: General Motors Bldg., TRinity 5-8711; Cleveland: Hanna Bldg., 1422 Euclid Ave., PRospect 1-0456; Los Angeles: Tishman Bldg., 3460 Wilshire, DUmkirk 2-8458; San Francisco: Russ Bldg., 235 Montgomery St., YUkon 2-0823.

In This Issue . . .

Lightning Plays Queer Pranks	65
We Drove a Turbine Car Coast-to-Coast	72
On the Trail of the Spray	78
Spring Cleaning on an Alpine Highway	82
Detroit Listening Post	84
Why Not Build a Tunnel for Ships?	85
Most Valuable Player—the Catcher	90
Tropical Fish Are Fun	97
Water Is Pumped a Mile High to Cattle Ranch	102
The Owners Report on the '56 Rambler	106
Skin-Diver Talk	116
What's New for Your Home	122
What's New in Boating	126
Teen-Age Mechanics	136
Keeping Up With the Atom	141
Radio, TV and Electronics	145

For the Craftsman . . .

From Laminated Hull to Finished Boat	149
Push-Button Climate Control	158
Patios on Sloping Lots	170
Take-Apart Playhouse	178
Use the Right Paint Roller	182
Electroplating Without Cyanides—Part I	197
Shopping for Tools	202
Clinic for Homemakers	206

See pages 58, 60 and 62

for other items and manufacturers of available products



24% more road horsepower—for hill climb!



24% more road horsepower—for passing!

Champion introduces a great new spark plug

Tests prove new Champions give big power boost to cars that have gone about 10,000 miles without a spark plug change. If you haven't changed your plugs recently, put in new Champions—and feel the difference immediately!

You just can't imagine what a difference new 5-rib Champions can make in your car's actual road horsepower.

But this difference has been proved—without a shadow of a doubt—in tests conducted by one of the country's largest independent research centers. Regular passenger cars whose plugs had gone roughly 10,000 miles were tested first with their regular plugs; then with new Champions.

Nothing about these cars was changed except their spark plugs. Yet there was an immediate increase in their road horsepower—the real power actually delivered at the rear wheels!

Some of the results were spectacular.

plugs had gone 10,000 miles actually showed a gain of 72.5% in road horsepower! A 1954 V-8, whose plugs had gone 12,000 miles, got a boost of 53.5%. Some cars, of course, showed smaller gains; 20% in the case of one 1955 V-8 and only 6.5% (the smallest gain) in another. *But the average road horsepower gain for all cars tested was a fraction over 24%!*

And what a difference these new plugs can make in your car's starting! Tests show Champions reduced starting time by as much as 71%—with an average of 39% for all cars tested!

If you haven't changed plugs recently, it's high time to install new Champions. Whatever your car, these great new plugs give you



24% more road horsepower—for the straightaway!



Quicker starts, too—39% quicker!

-it can increase road horsepower by 24%!

SEE HOW MUCH BETTER AND LONGER NEW CHAMPIONS
STAND UP IN TODAY'S HIGH-POWER ENGINES

ORDINARY ELECTRODE

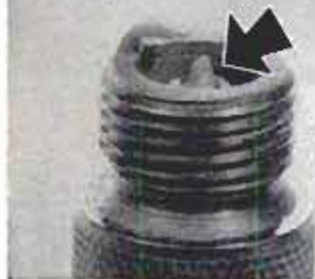

POWERFIRE ELECTRODE



New Powerfire electrode makes the difference! Both of these spark plugs have been subjected to identical use in a modern high-compression engine. You can see the old style electrode (left) is badly pitted and burned away. Plugs like that in your car often misfire . . . waste power and gas. Champion's new Powerfire electrode (right) is still able to give many more miles of powerful, economical performance.



YOU'RE HIRED

WHEN PROPERLY TRAINED
AS AN
ALL-AROUND MECHANIC



NOW YOU GET BOTH AUTO MECHANICS (AT HOME, AND DIESEL IN SPARE TIME) IN ONE LOW TUITION COURSE

Train right. Don't be a "one engine mechanic." Learn all engines, including diesel. The qualified, all-around mechanic can pick and choose, specialize anywhere, repair anything, from foreign cars to diesel jobs — he's always in demand where pay is tops.

National Schools of Los Angeles, a leader since 1905, brings its famous training shops to your home — to give you everything you need to make good in today's opportunity-filled Auto Mechanics & Diesel industry.

Earn as you learn. We show you how. Free technical consultation service with qualified staff. Job Placement Service.

COURSE COVERS:

- all engines
- fuel injection
- automatic transmissions
- overhauling
- rebuilding
- customizing
- servicing, maintenance



THIS SET OF LIFETIME TOOLS AND ALL-METAL TOOL BOX ARE YOURS TO KEEP, AS PART OF YOUR COURSE.

NATIONAL SCHOOLS

4000 S. FIGUEROA ST., LOS ANGELES 37, CALIF.
187 N. LA SALLE ST., CHICAGO 1, ILL.
IN CANADA: 811 W. Hastings St., Vancouver, B. C.

NATIONAL SCHOOLS

TECHNICAL TRADE TRAINING SINCE 1905
Los Angeles, California

GET FAST SERVICE — MAIL NOW TO OFFICE NEAREST YOU!

NATIONAL SCHOOLS, DEPT. DB-66

4000 S. FIGUEROA ST. OR 187 N. LA SALLE ST.
LOS ANGELES 37, CALIF. CHICAGO 1, ILL.

Send FREE Auto-Mechanics Book and Sample Lesson
No obligation, no salesman will call.

NAME _____ BIRTHDAY _____ 19 _____

ADDRESS _____

CITY _____ ZONE _____ STATE _____

VETERANS: Give Date of Discharge _____

ACROSS THE DESK



Do-It-Yourself Car Wash

Car owners on the western fringe of Philadelphia who do not have car-washing facilities can take over the enclosed car-washing section of Harry K. Means Service Station for just 1½ cents a minute.



In addition to making the space available to car owners, Means also furnishes water, rags, soap and whisk broom without extra charges.

The average do-it-yourself car washer completes the job in little more than one half hour.

Charles P. FitzPatrick,
Philadelphia, Pa.

To the Editor:

Hang your heads in shame! You didn't mention Volkswagen, probably one of the best—(what can I call it? It doesn't seem to fit into the car category)—dreams on the road, in that Auto Section in February. You mentioned Sports Cars but no VW; you mentioned the U. S. cars but no VW. For

(Continued to page 8)



To the man who wants to enjoy
an ACCOUNTANT'S CAREER



IF you're that man, here's something that will interest you.

Not a magic formula—not a get-rich-quick scheme—but something more substantial, more practical.

Of course, you need something more than just the desire to be an accountant. You've got to pay the price—be willing to study earnestly, thoroughly.

Still, wouldn't it be worth your while to sacrifice some of your leisure in favor of interesting home study—over a comparatively brief period? Always provided that the rewards were good—a salary of \$4,000 to \$10,000 and up?

An accountant's duties are interesting, varied and of real worth to his employers. He has *standing!*

Do you feel that such things aren't for you? Well, don't be too sure. Very possibly they *can* be!

Why not, like so many before you, investigate LaSalle's modern Problem Method of training for an Accounting position?

Just suppose you were permitted to work in an accounting firm under the personal supervision of an expert accountant. Suppose, with his aid, you studied accounting principles and solved problems day by day—easy ones at first—then more difficult ones. If you could do this—and could turn to him for advice as the problems became complex—soon you'd master them all.

That's the training you follow in principle under the LaSalle Problem Method.

You cover accounting from Basic Accounting right through Accounting Systems and Income Tax Procedure. As you go along, you absorb the principles of General Accounting, Auditing and Basic Cost Accounting. Then you may choose Commercial Accounting, Industrial Accounting or Public Accounting and prepare for the C. P. A. examinations.

Your progress is as speedy as you care to make it—depending on your own eagerness to learn and the time you spend in study.

Will recognition come? The only answer, as you know, is that success *does* come to the man who is really *trained*. It's possible your employers will notice your improvement in a very few weeks or months. Indeed, many LaSalle graduates have paid for their training—with increased earnings—before they have completed it! For accountants, who are trained in organization and management, are the executives of the future.

Send Today For Free Book

"Accountancy, The Profession That Pays"

For your own good get all the facts about this completely new and modern accounting training. Write for Free book "Accountancy, The Profession That Pays," which will prove that Accounting offers brilliant futures to those who aren't afraid of serious home study, and will show the wide range of opportunities that exist today. No cost or obligation. If you want a position of higher income, greater prestige and professional standing . . . MAIL THE COUPON NOW!

Over 4,200 Certified
 Public Accountants among
 LaSalle alumni

Member, National Home Study Council



LASALLE EXTENSION UNIVERSITY

A CORRESPONDENCE INSTITUTION

417 S. Dearborn St. Dept. 664H Chicago 5, Ill.

I want to be an accountant. Send me without obligation, Free book, "Accountancy, The Profession That Pays."

Name.....Age.....
 Address.....
 City, Zone & State.....

(Continued from page 6)

a boo-boo like that we'll have to give you 500 lashes across the bare nose with a wet noodle.

Paul M. Roland,
Philadelphia, Pa.

Stand by, Mr. Roland. We expect to give the VW the full treatment before long in an Owners Report.

Our SS United States Under Power



If you see a miniature edition of the SS *United States* churning the waters in the Los Angeles area, we hope you recognize it as the model presented on the cover and in the Craftsman Section of *PM* back in December 1952 and following issues.

C. W. Hering of Los Angeles built the ship from *PM* plans, but added a motor and radio controls . . . and the model cruises majestically!

"My model is built from your blueprints with the exception of the width," writes Mr. Hering. "I wanted this model to operate in water. My previous experience tells me that a 36-inch ship with 4-inch beam with



a lot of superstructure will not stay upright unless you put a lot of lead in the bottom, and by the time you add electric driving motors and radio and all needed batteries, you get below the water line and



nearly swamp. Thus if your deck is shown 2 inches wide, my similar deck will be 3½ inches wide, and everything else is in that proportion. I am using two ¾-inch bronze

(Continued to page 10)

New greaseless way to keep your hair neat all day



Prevents dry, unruly
"panda hair"

New Vitalis keeps hair in place and prevents dryness with V-7, the *greaseless* grooming discovery.

You never have an overslick, plastered-down look. Try it. You'll like it.



ANOTHER FINE PRODUCT
OF BRISTOL-MYERS

New VITALIS® Hair Tonic with V-7.

if you're in your twenties or early thirties, here's a solid-gold opportunity to make

BIG MONEY

BY 35



We're willing to wager that, given the proper guidance and training, you can at least double your present income within the next few years.

We'll put up three interesting and valuable books to help prove this point.

One is the gold-mine of helpful career tips, "How to Succeed."

Another is a handbook outlining opportunities in your particular field of interest (see list in coupon below).

The third is a sample lesson in Basic Mathe-

matics which demonstrates how easily yet how thoroughly I.C.S. helps you master a subject.

These books will be especially useful to you if you are between 20 and 35—provided you want to enjoy the rewards of success before you reach middle age. Actually, the famous I.C.S. method of "Success Conditioning" knows no age limit. It's never too late to learn.

Hurry up your future! Mark and mail the coupon today.

For Real Job Security—Get an I. C. S. Diploma! I. C. S., Scranton 9, Penna. Member, National Home Study Council

INTERNATIONAL CORRESPONDENCE SCHOOLS

65TH YEAR

BOX 04626F, SCRANTON 9, PENNA.

(Partial list of 256 courses)

Without cost or obligation, send me "HOW TO SUCCEED" and the opportunity booklet about the field

BEFORE which I have marked X (plus sample lesson):

- | | | | | |
|--|---|--|---|--|
| <p>ARCHITECTURE and BUILDING CONSTRUCTION</p> <ul style="list-style-type: none"> <input type="checkbox"/> Air Conditioning—Refrig. <input type="checkbox"/> Architecture <input type="checkbox"/> Architectural Interiors <input type="checkbox"/> Building Contractor <input type="checkbox"/> Building Estimator <input type="checkbox"/> Building Maintenance <input type="checkbox"/> Carpentry and Mill Work <input type="checkbox"/> Heating <input type="checkbox"/> Painting Contractor <input type="checkbox"/> Plumbing <input type="checkbox"/> Reading Arch. Blueprints <p>ART</p> <ul style="list-style-type: none"> <input type="checkbox"/> Cartooning <input type="checkbox"/> Commercial Art <input type="checkbox"/> Fashion Illustrating <input type="checkbox"/> Magazine Illustrating <input type="checkbox"/> Show Card and Sign Lettering <input type="checkbox"/> Sketching and Painting <p>AUTOMOTIVE</p> <ul style="list-style-type: none"> <input type="checkbox"/> Auto Body Rebuilding <input type="checkbox"/> Auto Elec. Technician <input type="checkbox"/> Auto-Engine Tune Up <input type="checkbox"/> Automobile Mechanic | <p>AVIATION</p> <ul style="list-style-type: none"> <input type="checkbox"/> Aeronautical Engineering Jr. <input type="checkbox"/> Aircraft & Engine Mechanic <p>BUSINESS</p> <ul style="list-style-type: none"> <input type="checkbox"/> Advertising <input type="checkbox"/> Bookkeeping and Accounting <input type="checkbox"/> Business Administration <input type="checkbox"/> Business Correspondence <input type="checkbox"/> Public Accounting <input type="checkbox"/> Creative Salesmanship <input type="checkbox"/> Federal Tax <input type="checkbox"/> Letter-writing Improvement <input type="checkbox"/> Office Management <input type="checkbox"/> Professional Secretary <input type="checkbox"/> Retail Business Management <input type="checkbox"/> Sales Management <input type="checkbox"/> Stenographic-Secretarial <input type="checkbox"/> Traffic Management <p>CHEMISTRY</p> <ul style="list-style-type: none"> <input type="checkbox"/> Analytical Chemistry <input type="checkbox"/> Chemical Engineering <input type="checkbox"/> Chem. Lab. Technician <input type="checkbox"/> General Chemistry <input type="checkbox"/> Natural Gas Prod. & Trans. <input type="checkbox"/> Petroleum Engineering <input type="checkbox"/> Plastics <input type="checkbox"/> Pulp and Paper Making | <p>CIVIL, STRUCTURAL ENGINEERING</p> <ul style="list-style-type: none"> <input type="checkbox"/> Civil Engineering <input type="checkbox"/> Construction Engineering <input type="checkbox"/> Highway Engineering <input type="checkbox"/> Reading Struct. Blueprints <input type="checkbox"/> Sanitary Engineering <input type="checkbox"/> Structural Engineering <input type="checkbox"/> Surveying and Mapping <p>DRAFTING</p> <ul style="list-style-type: none"> <input type="checkbox"/> Aircraft Drafting <input type="checkbox"/> Architectural Drafting <input type="checkbox"/> Electrical Drafting <input type="checkbox"/> Mechanical Drafting <input type="checkbox"/> Mine Surveying and Mapping <input type="checkbox"/> Plumbing Drawing and Estimating <input type="checkbox"/> Structural Drafting <p>ELECTRICAL</p> <ul style="list-style-type: none"> <input type="checkbox"/> Electrical Engineering <input type="checkbox"/> Electrical Maintenance <input type="checkbox"/> Electrician <input type="checkbox"/> Contracting <input type="checkbox"/> Lineman <p>HIGH SCHOOL</p> <ul style="list-style-type: none"> <input type="checkbox"/> Commercial <input type="checkbox"/> Good English <input type="checkbox"/> High School Subjects <input type="checkbox"/> Mathematics | <p>LEADERSHIP</p> <ul style="list-style-type: none"> <input type="checkbox"/> Foremanship <input type="checkbox"/> Industrial Supervision <input type="checkbox"/> Leadership and Organization <input type="checkbox"/> Personnel-Labor Relations <p>MECHANICAL AND SHOP</p> <ul style="list-style-type: none"> <input type="checkbox"/> Gas—Electric Welding <input type="checkbox"/> Heat Treatment <input type="checkbox"/> Metallurgy <input type="checkbox"/> Industrial Engineering <input type="checkbox"/> Industrial Instrumentation <input type="checkbox"/> Industrial Supervision <input type="checkbox"/> Internal Combustion Engines <input type="checkbox"/> Machine Design-Drafting <input type="checkbox"/> Machine Shop Inspection <input type="checkbox"/> Machine Shop Practice <input type="checkbox"/> Mechanical Engineering <input type="checkbox"/> Quality Control <input type="checkbox"/> Reading Shop Blueprints <input type="checkbox"/> Refrigeration <input type="checkbox"/> Sheet Metal Worker <input type="checkbox"/> Tool Design <input type="checkbox"/> Toolmaking <p>RADIO, TELEVISION</p> <ul style="list-style-type: none"> <input type="checkbox"/> Industrial Electronics <input type="checkbox"/> Practical Radio TV Eng'ng <input type="checkbox"/> Radio and TV Servicing <input type="checkbox"/> Radio Operating | <ul style="list-style-type: none"> <input type="checkbox"/> Television Technician <p>RAILROAD</p> <ul style="list-style-type: none"> <input type="checkbox"/> Air Brake Equipment <input type="checkbox"/> Car Inspector <input type="checkbox"/> Diesel Engineer & Fireman <input type="checkbox"/> Section Foreman <p>STEAM AND DIESEL POWER</p> <ul style="list-style-type: none"> <input type="checkbox"/> Combustion Engineering <input type="checkbox"/> Diesel—Elec. <input type="checkbox"/> Diesel Eng's <input type="checkbox"/> Electric Light and Power <input type="checkbox"/> Stationary Fireman <input type="checkbox"/> Stationary Steam Engineering <p>TEXTILE</p> <ul style="list-style-type: none"> <input type="checkbox"/> Carding and Spinning <input type="checkbox"/> Cotton, Rayon, Woolen Mfg. <input type="checkbox"/> Finishing and Dyeing <input type="checkbox"/> Loom Fix'g <input type="checkbox"/> Textile Des'ing <input type="checkbox"/> Textile Eng'g <input type="checkbox"/> Throwing <input type="checkbox"/> Warping and Weaving <p>MISCELLANEOUS</p> <ul style="list-style-type: none"> <input type="checkbox"/> Domestic Refrigeration <input type="checkbox"/> Marine Engineering <input type="checkbox"/> Ocean Navigation <input type="checkbox"/> Professional Engineering <input type="checkbox"/> Short Story Writing <input type="checkbox"/> Telephony |
|--|---|--|---|--|

Name _____ Age _____ Home Address _____

City _____ Zone _____ State _____ Working Hours _____ A.M. to P.M. _____

Occupation _____

Canadian residents send coupon to International Correspondence Schools, Canadian, Ltd., Montreal, Canada. . . . Special tuition rates to members of the U. S. Armed Forces.

**NOW...Push-Button Focusing
as close as 9" without parallax...**



with the *Graphic 35*

and NEW PROXIMETERS!

Never before has close-up photography with the Graphic 35 been so easy and accurate. With these amazing auxiliary lenses on the camera, you can view your subject and focus it with the coupled rangefinder as close as 9"! The Graphic 35 itself focuses as close as 3 feet, but with the Proximeter I it focuses to 17 1/2"; with the Proximeter II, to 12"; with the I and II in combination, to 9". (All distances figured from front of lens.)

CORRECTS FOR PARALLAX—You need not worry about parallax—the variation between viewfinder field of view and what the lens records on your film. Proximeter lenses fit on the camera lens and automatically correct both viewfinder and rangefinder for the distance at which you are shooting. No measuring of distances. Proximeter plus exclusive Push-Button focusing do it for you. Minimum areas covered: Proximeter I, approx. 9" x 14"; Proximeter II, approx. 6" x 9"; I and II combined, approx. 4 1/2" x 7". Diagrams below show how they work.

DIAGRAM A: Rangefinder (1) normally focuses upon subjects as close as 3 feet.

DIAGRAM B: Lens segment (2) in front of rangefinder bends light rays from subject, allowing rangefinder focusing for extreme close-ups.

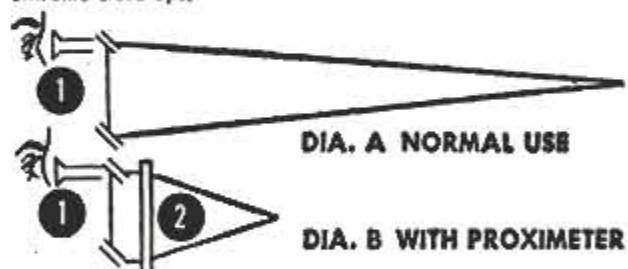

Graphic 35 with f/3.5 lens: \$77.50; with f/2.8 lens: \$87.50; Proximeter I or II: \$22.95. Pay only 10% down—take up to 20 months to pay! For Graphic 35 folder see your Graflex Dealer or write Dept. PM-66, Graflex, Inc., Rochester 8, N. Y.

GRAFLEX® Price-Winning Camera

Prices include federal tax where applicable and are subject to change without notice. Prices are slightly higher in Canada.

(Continued from page 8)

propellers driven by two 6-volt motors off a 6-volt Willard wet battery, steered by E. C. steering relay and radio-operated by Citizenship 27 1/2-meg. radio. I get about 15 percent above scale speed and about 500 yards radio control. I have had many compliments on both the appearance on shore and action in the water."

To the Editor:

Please send your Precut - House book as advertised. I bought your Ranch Style House book about 2 1/2 years ago and built it. I figure I've got about \$8500 in the house. I used the bench-build method and eight-inch cement blocks for the foundation, with a four-inch block and a cement brick on top to make the same shape as the cement foundation in the plans. I surely would not have a house today if it was not for your inspiring book and plans. I was offered \$19,000 for it last spring.



Matthew A. Civilette,
124 Howard St.,
Fredonia, N. Y.

To the Editor:

Here are pictures of "Kaligah, the only wooden Indian in the world with an electronic brain." I thought you might get a kick out of seeing what I conceived



in a moment of boredom at a local club. It took three months of hard work to build Kaligah out of California redwood and Erector parts. Inside his manly chest are located two amplifiers, a large power supply, relays and two Erector motors (see

(Continued to page 34)



J. E. SMITH
President, National Radio Institute. 40 years' experience training men at home for Radio-TV.

I Will Send You A **SAMPLE LESSON FREE** to show you how easy, practical it is to **Train at Home for Good Radio-Television Jobs**



America's Fast Growing Industry Offers You Good Pay Plus a Bright Future

TRAINING plus OPPORTUNITY is the PERFECT combination for ambitious men. Let me send you a sample lesson from my course to prove you can keep your job while TRAINING at home in your spare time for better pay and a brighter future. I will also send my 64-page book to show you that Radio-Television is today's field of OPPORTUNITY for properly trained men.

Make \$10, \$15 a Week Extra
Many men I train fix neighbors' Radios, make extra money, soon after they enroll. Actual equipment you build gives you practical experience.

Television's Growth is Making More Jobs, Prosperity

Radio is bigger than ever and television is growing fast. Government, Aviation, Police, Ship, Microwave Relay, Two Way Communications for buses, taxis, railroads are other growing fields for Radio-Television trained men.



Mail Coupon—Find Out About This Tested Way to Better Pay

Take NRI training for as little as \$5 a month. Many NRI graduates make more in two weeks than the total cost of my training. Mail coupon today for Actual Lesson and 64-page Book—Both FREE. J. E. SMITH, National Radio Institute, Dept. GFA, Washington 9, D. C. Our 40th Year.



I Trained These Men



"I have a regular job as a police captain and also have a good spare time Radio and Television service business. Just opened my new showrooms and shop."—C. W. LEWIS, Pensacola, Florida.

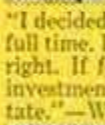

"I decided to quit my job and do TV work full time. I love my work and am doing all right. If fellows knew what a wonderful investment NRI is, they would not hesitate."—W. F. KLINE, Cincinnati, Ohio.



"Thanks to NRI, I operated a successful Radio repair shop. Then I got a job with WPAQ, later WBOB and now am an engineer for WHPE."—VAN W. WORKMAN, High Point, N. Carolina.

You Learn by Practicing with Equipment I Send



Nothing takes the place of practical experience. That's why NRI training is based on LEARNING BY DOING. My training includes kits of parts which you use to build equipment and get practical experience on circuits common to both Radio and Television. Shown at left is the low-power Broadcasting Transmitter you build as part of my Communications Course.



AVAILABLE TO **VETERANS** UNDER G.I. BILLS

Good for Both—FREE

Mr. J. E. Smith, President, Dept. GFA
National Radio Institute, Washington 9, D. C.
Mail me Sample Lesson and 64-page Book, FREE.
(No salesman will call. Please write plainly.)

Name _____ Age _____
Address _____
City _____ Zone _____ State _____
VETS write in date of discharge _____
Approved Member, National Home Study Council

Now...anything you can see brought up 15 times closer!

from 1 to 50 miles

new, amazing

POWERHOUSE

EXTRA LONG RANGE

TELESCOPE

\$12.95
VALUE

NOW **4.99**

- Metal Draw Tubes!
- Extra Sharp!
- Deluxe Model!
- Converts into Microscope!



ENJOY THRILLING VIEWS OF PLANETS!

Spend endless hours of sheer enjoyment by observing the moon and other planets at far closer range! Educational too for children as well as adults! Yes! the POWERHOUSE TELESCOPE lets you and your family travel into outer space without leaving the earth!

FREE
PORTABLE TRIPOD

225 TIMES AREA
MAGNIFICATION

From
this



to this



These two dramatic photos of the Washington Monument prove beyond words the terrific power of this amazing telescope. The tiny photo is as the naked eye sees it miles from the nation's capital. The big picture is what the POWERHOUSE gives you—225 times the area!



POWERFUL LENSES REACH OUT INTO OUTER SPACE

Miles melt away. 15 miles become only one. Anything your eye can see—even celestial bodies—are brought closer. They look bigger, clearer, sharper. Observe the moon and its changing phases. Search the skies for the new man-made satellites being launched by the U. S. Navy. Try it on distant buildings, people, ships at sea, sports, airplanes, birds and wild animals—WITHOUT BEING SEEN!

BUY DIRECT & SAVE

Buy direct from importer! Reg. 12.95 value—yours for 4.99, with Table Tripod & dust protector. Send only 4.99 cash, m.o. or check for prompt delivery. (COD's plus postage extra). Satisfaction GUARANTEED or your 4.99 back. Have fun! Have thrills! Order TODAY!

MADE IN GERMANY by 101 YEAR OLD PLANT

This extra long range POWERHOUSE TELESCOPE was developed by a reputable German factory. Known for quality products for over 100 years. Not a toy with cardboard tubes! A real optical instrument with heavy-duty METAL draw tubes and PRECISION MADE lenses of amazing power. Every detail reflects German know-how and legendary workmanship.

7 SUPER FEATURES

1. Polished METAL tubes. 2. Smooth focusing. 3. Contoured eyepiece. 4. Interior coated objective lens as in expensive binoculars. 5. Permits viewing even in moonlight. 6. Deluxe quality finish thruout. 7. Converts quickly into a compound microscope! NOW the super power lenses give you greater range and magnification than famous American binoculars selling for up to \$250.00.

THORESEN'S, Dept. 6-F-43
352 FOURTH AVE. NEW YORK 10, N. Y.

MAIL TODAY

THORESEN'S, Dept. 6-F-43
352 Fourth Avenue, New York 10, N. Y.

RUSH _____ POWERHOUSE TELESCOPES and Free Tripod at cut price of 4.99 each, on 7 day trial, money back guarantee.

- Check, cash, or m.o. herewith. RUSH prepaid.
 Send C.O.D. plus postage fees.

Name _____

Address _____

Town _____ State _____

INVENTORS

Learn how to protect your invention. The U. S. Patent Laws provide that any new and useful art, machine, article of manufacture, or composition of matter, or any new and useful improvement thereof, may be patented if the act of invention is involved. Therefore, every inventor with a valuable invention should take advantage of the Patent Laws and proceed for patent protection in order to safeguard his rights.

A patent gives the inventor the exclusive right to prevent others from making, using, or selling the invention claimed in the patent for a period of seventeen years.

The Patent Laws were enacted for the benefit of the inventor to give him protection for the features of his invention which are patentable. These features must be properly and concisely set forth and claimed in a formal application for patent, in order to comply with the requirements of the Patent Laws. For that reason, unless the inventor is familiar with patent matters, he should engage a competent, registered patent attorney or agent to represent him. We are registered to practice before the U. S. Patent Office and are prepared to serve you in the handling of your patent matters.

A specially prepared booklet entitled "Patent Guide for the Inventor", containing detailed information with respect to patent protection and procedure, together with a "Record of Invention" form will be promptly forwarded to you without obligation upon request.

CLARENCE A. O'BRIEN & HARVEY JACOBSON

Registered Patent Attorneys

61-F DISTRICT NATIONAL BUILDING

WASHINGTON 5, D. C.

These great minds were Rosicrucians . . .



Francis Bacon Benjamin Franklin Isaac Newton

WHAT SECRET POWER DID THEY POSSESS?

Why were these men great?

How does anyone—man or woman—achieve greatness? Is it not by mastery of the powers within ourselves?

Know the mysterious world within you! Attune yourself to the wisdom of the ages! Grasp the inner power of your mind! Learn the secrets of a full and peaceful life!

Benjamin Franklin, statesman and inventor . . . Isaac Newton, discoverer of the Law of Gravitation . . . Francis Bacon, philosopher and scientist . . . like many other learned and great men and women . . . were Rosicrucians. The Rosicrucians (NOT a religious organization) have been in existence for centuries. Today, headquarters of the Rosicrucians send over seven million pieces of mail annually to all parts of the world. Address: Scribe T.O.S.

THIS BOOK FREE

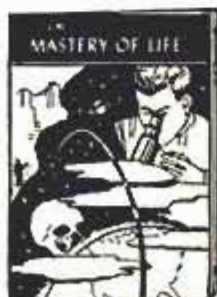

The ROSICRUCIANS

San Jose (AMORC) California, U.S.A.

SEND THIS COUPON

Scribe T.O.S.
The ROSICRUCIANS
(AMORC)
San Jose, California, U.S.A.

Please send me the free book, *The Mastery of Life*, which explains how I may learn to use my faculties and powers of mind.

Name _____
Address _____
City _____
State _____

If You Can Light a Match... You Can
MAKE UP TO \$1,000⁰⁰ AND MORE IN A MONTH

Amazing... New... Super Sensitive
MERLITE FIRE ALARM
HOWLS 1/5 MILE WARNING
When You Hold a Lighted Match Near It

Make sensational 3-second "Lighted Match" Demonstration, pocket biggest earnings of your life, full time or spare time! Simple test proves new Merlite Fire Alarm so sensitive to fire, a lighted match "triggers" the unmistakable irritating "howl," audible 1/5 mile away! No installation, no connection to house current (which can fail in fire); self-contained. Hang on wall like a picture, always on guard. Only \$4.95, less batteries. Homes, farms, stores, offices, factories buy 4 to 12 at a time when you show how Merlite "smells" any fire before danger point. Make up to \$2.70 on each one; up to \$1,000 and more profit in a month!

FREE! Rush name, address for exciting money-making facts, complete Illustrated Sales Kit **FREE**—everything you need to make money first day. If you wish Merlite Fire Alarm Demonstrator, complete with batteries (\$3.50), send no money, we send C.O.D. Or enclose \$3.50 and we pay shipping charges. Money-back guarantee. Many localities now open—write TODAY!

MERLITE INDUSTRIES (Fire Alarm Div.)
114 E. 32nd ST. DEPT. F-15G NEW YORK 16, N. Y.
In Canada: Mopa Co., Ltd., 371 Dowd St., Montreal 1, P. Q.

GIANT BALLOONS



They're really BIG—surplus U.S. Govt. (new overage) Neoprene weather, target balloons. GREAT FUN in the backyard: at parties, picnics, dances, fairs. TERRIFIC for high school and college PROMS. They attract BIG CROWDS to business openings, civic events, conventions, exhibitions, trade shows. **ORDER TODAY!** Great for gift. Approx. inflated sizes:
3 ft. dia., 49¢—3 ft. dia., 99¢
10 ft. dia., \$1.59—13 ft. dia., \$1.95
Postage paid on prepaid orders.
Calif. residents please add sales tax.

VOLUME SALES CO., War Assets Division
Dept. PM-656 3930 Sunset Blvd. Los Angeles 29, Calif.

SAY YOU SAW IT IN POPULAR MECHANICS

A "GOOD HAND" HELPS YOU SUCCEED!

LEARN TO WRITE WELL

Handwriting quickly improves with our easy-to-understand picture lessons! Put your spare time to good use; send today for **FREE BOOKLET OF PENMANSHIP COURSES AND SUPPLIES** or check volumes wanted below at \$1 each:
 Business Writing Artistic Writing
 Card Writing Bird & Design Flourishing
 Engraving Alphabets, COMPLETE SET \$4.50. Act now!
TAMBLYN SCHOOL of PENMANSHIP
S.A. Ziller, Pres., 442 Ridge Bldg., Kansas City, Mo., USA

INSURED TIRE SERVICE
POPULAR BRANDS
FREE INSURANCE POLICY given with each used tire sold. We guarantee the amount of service you pay for.
NOWHERE CAN SUCH QUALITY BE FOUND AT SUCH LOW PRICE!

SPECIAL!
Deduct 10% on orders for 2 or more used tires

YOU CAN'T LOSE!!

Super Quality — Rugged Performance — 6 Months Insured Service	
600x16 \$3.65 670x16 \$3.95 700x16 \$4.45 760x16 \$4.75	
650x16 3.85 670x16 4.05 710x16 4.35 820x16 4.95	
650x16 4.25 700x16 3.95 760x16 4.45 850x17 4.65	
Supreme Quality — Nothing Finer — 12 Months Insured Service	
600x16 \$5.25 475x19 \$8.45 700x16(8) \$10.45 700x20 \$12.50	
600x16(6) 6.75 640x15 4.95 750x16(8) 15.95 750x20(8) 15.50	
650x16 5.75 670x15 3.35 700x17 11.95 750x20(10) 17.50	
650x16(6) 7.25 710x15 5.45 750x17 16.45 825x20 21.50	
700x16 6.35 760x15 3.95 750x18 10.95 900x20 19.95	
750x16(6) 8.45 800x15 6.35 30x5 11.25 1000x20 20.45	
550x18 4.95 820x15 6.35 600x20 10.95 1100x20 21.25	
550x17 4.75 550x15 3.35 650x20 11.75 1000x22 21.95	
650x15 5.25 670x16 3.15 32x6(8) 11.95 1100x22 22.75	
700x15 5.35 700x16(6) 10.25 32x6(10) 12.75 1100x24 25.95	
Whitewalls \$1.00 extra.	

MIDLAND TIRE SALES
Speedy shipments on Mail Orders. F.O.B. Chicago. Insurance policy sent with each order. Deduct 10% on orders for 2 or more used tires. Send CHECK or MONEY ORDER.—No COD's.
3701 S. Normal, Dept. PM-47, Chicago 9, Ill.

Train in Big
COYNE
Shops

GREAT OPPORTUNITY FIELDS!

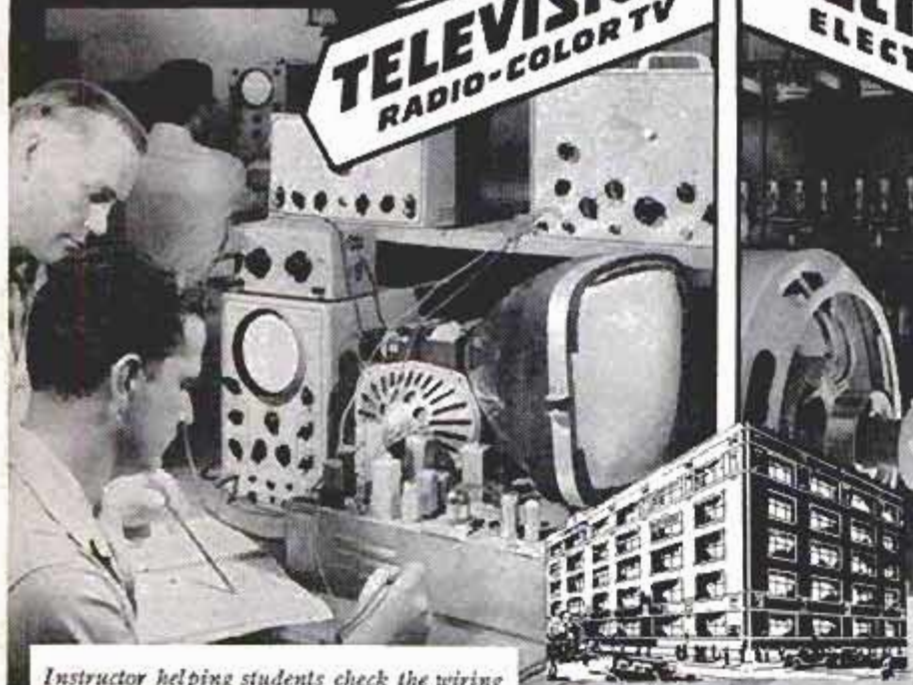

Instructor helping students check the wiring and trace the circuits of television receivers.



Instructor explaining operation and testing of a large Motor Generator.

This big fire-proof building is occupied entirely by Coyne.

YOUNG MEN AND OLDER MEN— PREPARE FOR A CAREER WITH A FUTURE!

Conditions are changing. Many "one operation" jobs will not last. Don't be satisfied with a "no future" job. Whether 17 or up to 45 years of age, train the Coyne way for a better job and a real future in Electricity-Electronics or Television-Radio, fields that offer a world of opportunities.

TELEVISION-RADIO-COLOR TV

Here at COYNE you're trained for Testing, Trouble-Shooting and Servicing on AM and FM Radio Units, Auto Radio, Television, etc. Thousands of Coyne trained men in good jobs or own well paying TV-Radio businesses of their own.

ELECTRICITY ELECTRONICS

Big opportunities everywhere—city, town and country, in Power Plant Work, Motors, Industrial Electronics, Armature Winding, Home and Factory Wiring, Appliances, Refrigeration, Maintenance, Illumination, etc.

WE TRAIN YOU IN CHICAGO

Our famous Practical-Technical method gives you practical experience on a massive outlay of equipment plus necessary technical training right here in the great Coyne shops.

Training in Refrigeration and Electric Appliances can be included.

Training offered to VETERANS and NON-VETS alike

START NOW—PAY LATER
Enroll now, pay most of tuition later. Part time employment help for students. Lifetime employment service to Graduates.

B. W. COOKE, President

COYNE
ELECTRICAL SCHOOL

FOUNDED 1899

A TECHNICAL TRADE INSTITUTE OPERATED NOT FOR PROFIT
500 S. PAULINA STREET, CHICAGO, Dept. A6-72H
ELECTRICITY ★ RADIO ★ TELEVISION ★ REFRIGERATION ★ ELECTRONICS

OLDEST AND BEST EQUIPPED SCHOOL OF ITS KIND IN THE U.S.

Mail Coupon for Big FREE Book!

Whether you prefer Television-Radio or Electricity-Electronics, mail coupon TODAY and we'll mail you a Big, fully Illustrated Book "Guide to Careers in Electricity-Electronics and Television-Radio" which describes all the training we offer. **No salesman will call.**



B. W. Cooke, President
COYNE ELECTRICAL SCHOOL, Dept. A6-72H
500 S. Paulina St., Chicago 12, Ill.

Send me your Big Free book. I am interested in field checked below. This does not obligate me.

- TELEVISION-RADIO
 ELECTRICITY-ELECTRONICS

Name _____

Address _____

City _____ State _____

**94.6% OF BAILEY
GRADUATES ARE EMPLOYED
AT TOP PAY IN THE FIELDS
WHICH THEY WERE TRAINED!**



**DIESEL-AUTO MECHANICS
DESPERATELY NEEDED!**

We have a far greater demand for our students than we can fill!

We can show you an actual waiting list of leading companies throughout the world who have tried Bailey graduates — found them outstanding, and are coming back for more!

BAILEY Graduates are Successful . . . RECEIVE BIG PAY — HAVE SECURE FUTURE!

The Famous Bailey Course prepares you for BOTH Diesel and Gasoline Mechanics.

This is a must—due to the advent of using Diesel principles, such as 'Fuel Injection' on passenger cars . . . use of gasoline engines for starting Diesel engines, etc. You learn all this at Bailey in the amount of time ordinarily required to learn just one of these subjects, ALL FOR THE PRICE OF ONE.

Don't be satisfied with a 'futureless', one-type job — learn how you can make big money now! Write today for Free Booklet that takes you on a step-by-step camera tour through our spacious, modern shops — See Bailey students in action as they Learn-by-doing with the Famous Bailey Method of training!

We provide you with housing and part time jobs while in school, plus nation-wide placement service for graduates.

BAILEY Technical SCHOOLS

1634 S. GRAND ST. LOUIS 4, MO.

MAIL TODAY!

Please mail immediately this free booklet without obligation.

FREE BOOKLET



Name.....

Address.....

City..... State.....

APPROVED FOR VETERAN . . . NON-VETERAN

**Shrinks Hemorrhoids
New Way Without Surgery**

Science Finds Healing Substance That Relieves Pain—Shrinks Hemorrhoids

For the first time science has found a new healing substance with the astonishing ability to shrink hemorrhoids and to relieve pain — without surgery.

In case after case, while gently relieving pain, actual reduction (shrinkage) took place.

Most amazing of all — results were so thorough that sufferers made astonishing statements like "Piles have ceased to be a problem!"

The secret is a new healing substance (Bio-Dyne*) — discovery of a world-famous research institute.

This substance is now available in suppository or ointment form under the name Preparation H.* Ask for it at all drug counters—money back guarantee. *Reg. U. S. Pat. Off.

'How to' MAKE MONEY with Simple CARTOONS



A book everyone who likes to draw should have. It is free; no obligation. Simply address

FREE BOOK

CARTOONISTS' EXCHANGE

Dept. 96D Pleasant Hill, Ohio

LEARN METALCRAFT and JEWELRY MAKING

Low Cost Home Training Now Available



Make money. Learn profitable skills and arts of decorative metal and jewelry crafts. Course is complete. Professionally prepared. Easy to master. Special tools and materials furnished.

Write for Free Booklet INTERSTATE TRAINING SERVICE DEPT. K-3 PORTLAND 13, OREGON

MONEY in DONUTS

Make new greaseless donuts. Start in kitchen. No smoke. Sell stores. HALF PROFIT. Cash daily. Free recipes. No obligation. Write! MARTIN RAY CO., 3605 SO. 15th AVENUE, MINNEAPOLIS 7, MINN.

BECOME AN EXPERT IN

TRAFFIC and TRANSPORTATION

Traffic men earn \$4,000 to \$10,000 and up. Thousands of firms need experts on rates, tariffs, regulations. We train you thoroughly in spare time at home for executive traffic jobs. Personal training under traffic authorities. Write for free book "Traffic and Transportation."

LASALLE Extension University, 417 So. Dearborn St. A Correspondence Institution Dept. 664T Chicago 5, ILL.

See the Greatest Show on Earth with this **GIANT ASTRONOMICAL TELESCOPE**

\$1500 FULL PRICE



Delivered ready for use. Has 45X, 75X and 100 power individually mounted eyepieces with brass focusing tube plus sun projector lens for observing sun spots and solar storms. Steel telescope tube 50 in. long. Rigid 6 ft. tripod adjustable to any height. Steel forked mounting with closely machined aluminum tripod head assembly assures extra fine adjustments. This professional type instrument provides full power with clear vision at all times. See the moons of Jupiter, our own moon, planets, milky way, double stars, star clusters, etc. All for only \$15.00 FOB Mattituck. Sent express. COD orders require \$5.00 deposit. Satisfaction guaranteed. 200X and 400X eyepieces available at \$2.00 ea.

SUFFOLK SCIENCE SERVICE Dept. TD-6 MATTITUCK, N. Y.

INVENTORS

If you believe that you have an invention, you should find out how to protect it. The first step is to have a search made of the prior pertinent U. S. patents. If a report on this search indicates that the invention appears patentable you can apply for a patent, and the specifications and claims should be prepared.

The firm of McMorrow, Berman & Davidson, with offices in Washington, D. C., is qualified to take the necessary steps for you. We can make a preliminary search on your invention, advise you whether we think it can be patented, and prepare your application for patent.

Unless you are fully familiar with the U. S. Patent Laws, we recommend that you engage the services of a Registered Patent Attorney to protect your interests. The patent laws are *your* laws. A patent gives you the right to prevent others from making, using or selling the invention claimed in your patent for a period of 17 years.

Use these patent laws for your protection. Investigate whether your invention can be patented. If you have what you believe to be an invention, we suggest that you have this firm make a search for you.

Send for a copy of our Patent Booklet entitled "How To Protect Your Invention," containing information about patent protection and patent procedure. Along with this we will also send you an "Invention Record" form, for your use in writing down and sketching details of your invention. We will mail them promptly. No obligation. They are yours for the asking.

McMORROW, BERMAN & DAVIDSON

Registered Patent Attorneys

PATENTS



COPYRIGHTS



PATENTS

135-X VICTOR BUILDING, WASHINGTON 1, D. C.

Hey SKINNY!

...YER RIBS ARE SHOWING!



DO NOT LET HIM HIT YOU JOE!

WATCH WHAT YOU SAY, FELLA!

SHUT UP YOU BIRD OF BONES!

WHEN IT IS TIED OF BEING A SKINNY SCARECROW CHARLES ATLAS SAYS HE CAN MAKE ME A NEW MAN I'LL GAMBLE A STRAP AND DENIS FREE BOOK!

BOY! IT DIDN'T TAKE LONG WHAT A BUILD! NOW I'LL TAKE CARE OF THAT BULLY!

HERE'S A LOVE-TAP FROM THAT "BIRD OF BONES" REMEMBER?

OH JOE! YOU ARE A REAL HEAVY AFTER ALL!

WHAT A MAN!

AND HE USED TO BE SO SKINNY!



I Can Make YOU a New Man, Too In Only 15 Minutes a Day!

PEOPLE once laughed at my skinny 97-lb. body. I was ashamed to strip for sports. Girls made fun of me behind my back. THEN I discovered "Dynamic Tension." It made me such a complete specimen of manhood that I hold the title, "The World's Most Perfectly Developed Man."

What's My Secret?

When you look in the mirror and see a healthy, husky, handsome, fellow smiling back at you—you'll be amazed at how fast "Dynamic Tension" GETS RESULTS. It's the easy, NATURAL method you can practice in your own room—JUST 15 MINUTES EACH DAY. No gadgets to fool with. You simply use the dormant muscle-power in your own body—watch it grow into solid LIVE MUSCLE. See your shoulders broaden... your scrawny chest swell with inches of new muscle... those spindly legs and arms bulge with new power... and your whole body starts to feel "alive," full of zip and go!

FREE MY 32-PAGE ILLUSTRATED BOOK IS YOURS—NOT FOR \$1 OR 10c—BUT FREE

Send now for my book, *Everlasting Health and Strength*. 32 pages of photos, valuable advice. Shows what "Dynamic Tension" can do for YOU. Answers vital questions for fellows who want a better build. It's yours—ABSOLUTELY FREE! Rush coupon to me personally: CHARLES ATLAS, Dept. 86, 115 East 23rd St., New York 10, N. Y.



CHARLES ATLAS, Dept. 86, 115 East 23rd St., New York 10, N. Y.

Send me—absolutely FREE—a copy of your famous book, *Everlasting Health and Strength*—32 pages, crammed with photographs, answers to vital questions and valuable advice. This book is mine to keep, and sending for it does not obligate me in any way.

Name _____ Age _____
 (Please print or write plainly)
 Address _____
 City _____ State _____

Free! AIRMAIL COLLECTION



Get this spectacular collection of all-different, genuine Airmails from strange, far-away countries in Asia, Africa, Europe, the exotic Orient! World's largest airmail, scarce \$27 stamp, old Zeppelin, many, many others. A truly remarkable collection containing stamps worth up to 40c each at catalog prices! EXTRA: new illustrated booklet "Men Against the Sky." PLUS Bargain Catalog and other unusual offers. Send 10c for mailing costs. ACT NOW!
 JAMESTOWN STAMP CO. DEPT. F6PM JAMESTOWN, N.Y.

ALL NYLON Auto Seat Cover!

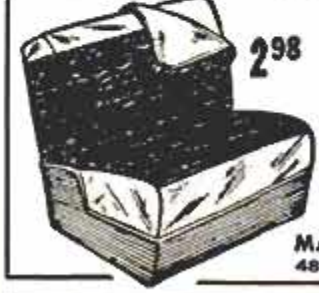

298
 NYLON auto seat cover that is TOUGH! Will resist Rough Treatment Without Damage. No Installation Problem—No Tacks or Nails Needed. GUARANTEED TO FIT OR MONEY BACK WITHIN 10 DAYS! WASHABLE—Dries in One Hour. Split Style for Folding Front Seat and Solid Style for Either Front or Rear Seats. Price ONLY \$2.98 For Front Split Or Solid Seat and ONLY \$5.50 for BOTH Front and Rear Seats. Postpaid add 25c. Or Shipped COD.

MARDO SALES CORP., Dept. NN-5
 480 Lexington Ave., New York 17, N.Y.

LEARN MEAT CUTTING

Train quickly in 8 short weeks at Toledo for a bright future with security in the vital meat business. Big pay, full-time jobs—HAVE A PROFITABLE MARKET OF YOUR OWN! Pay after graduation. Diploma given. Job help. Thousands of successful graduates. Our 33rd year! Send NOW for FREE catalog. No obligation. GI approved.
 NATIONAL SCHOOL OF MEAT CUTTING, Dept. 50-F, Toledo 4, Ohio

LEARN WATCH REPAIRING

AT HOME Modern, original instruction. Prepare for a position or start in business after completing our course. Write Today!
 WISCONSIN SCHOOL OF WATCH REPAIRING
 2908 N. 44th St. Dept. M Milwaukee 10, Wis.

SAY YOU SAW IT IN POPULAR MECHANICS

POW!!! hunting slingshot

- accurate—powerful—silent
- kills small game, pests
- hits like a rifle

\$1.50 postpaid (no cod's)



Used by expert marksmen! 7" hardwood stock, 45 lb. pull. Best rubber. FREE!!—extra rubber and big supply heaviest steel balls used by experts, illustrated catalog.

order today from— J. J. STONE DEPT. B-61616 Oak St. Santa Monica, Calif.

PUMP WATER FAST!

Drains Wash Tubs, Cellars, Cisterns. Famous #7 pumps 2800 gph. 420 gph. at 75' high or 1600 gph. from 25' well. Sturdy rustproof alloy metal. Six blade impeller. 3/4" inlet, 1/2" outlet. Standard pipe threaded. Uses any 1/2 to 1/2 H.P. Motor. Will not leak or clog. Iron clad guarantee. Send check, M.O., or sent C.O.D. IN U.S.

Irrigate, Fill Tanks, Draw Well Water. Heavy duty #8 pumps 7000 gph. —1000 gph. 75' high 3000 gph. from 25' well. Rustproof alloy metal. 8 blade impeller. 1" inlet, 1" outlet. Standard pipe threaded. Will not leak or clog. Iron clad guarantee. Send check, M.O., or sent C.O.D. \$1195

Free Catalogue—Gear Pumps, Large Centrifugal Pumps, Deep and Shallow Well Pumps, Sump Pumps.

MOORE MANUFACTURING CO.
 SWEDSBORO 1, NEW JERSEY

NOW...from DTI's MILLION DOLLAR TRAINING CENTER

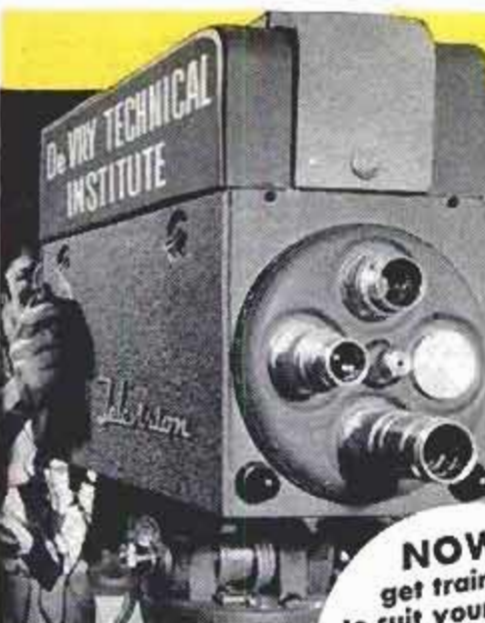

Learn to master TELEVISION AUTOMATION ELECTRONICS

RADIO - ELECTRONICS by getting EVERYTHING YOU NEED!

NOW—
get training
to suit your NEEDS

TAKE YOUR
CHOICE

Come to
DTI's
great CHICAGO
LABORATORIES
...one of the Nation's FINEST!

Now, in the heart of the nation's TV Center, you can get all of your preparation in DTI's big, modern, wonderfully equipped training laboratories. Loads of commercial equipment and ample, well qualified instructors help you get a thorough, practical preparation in the SHORTEST POSSIBLE TIME. Part time student Employment assistance can help you pay your way while in training.

EMPLOYMENT SERVICE

As soon as you complete either the Chicago Laboratory or Home Training, you'll find DTI's grand Employment Service ready to help you start earning real money. Get full facts. Mail coupon today.

MILITARY SERVICE: If subject to military service, the training information we have for you should prove very helpful. Mail coupon today.

89 WAYS TO EARN MONEY
IN TELEVISION
RADIO ELECTRONICS

ACT NOW! MAIL COUPON TODAY
Get this publication FREE!

DeVRY TECHNICAL INSTITUTE MEMBER OF NATIONAL HOME STUDY COUNCIL
4141 BELMONT AVE., CHICAGO 41, ILL. DEPT. PM-6-M

I would like your Opportunity News Bulletin showing "89 Ways to Earn Money in Television-Radio-Electronics"; also, complete facts about the training opportunity made possible by your organization.

Name _____ Age _____
Address _____ Apt. _____
City _____ Zone _____ State _____

DTI's Training is available in Canada



ABOVE: You build and keep this big 5 INCH commercial-type oscilloscope — one of the most useful test units used in TV today.



Build and keep this BIG DTI Engineered TV set—easily converted to U.H.F. (DTI offers another home training, but without the TV set.)

Use 16 mm. **MOVIES** Only DTI provides you with the loan of visual training movies at home to help you master important basic points faster... easier... better!



"One of America's Foremost Electronics Training Centers"



DeVRY TECHNICAL INSTITUTE

CHICAGO 41, ILLINOIS

FORMERLY

DeFOREST'S TRAINING, INC.

Brand New!

MOTOR'S AUTO REPAIR MANUAL Now! 3 Books in 1

- 1 Completely New "TROUBLE-SHOOTER" Section lists over 2,000 car troubles; helps you spot the one you're after in a jiffy!
- 2 HOW to Service, Repair and Overhaul All Car Parts, Systems and Components—including Engines, Generators, Voltage Regulators, Rear Axles, ALL Automatic Transmissions, Power Steering and Brakes, etc.
- 3 Step-by-Step Instructions and Pictures for Repairing Parts on Each Specific Make and Model—with all essential specifications and dimensions for over 737 models; ALL these MAKES:

TELLS and SHOWS You Step-by-Step How to



FREE 7-DAY TRIAL

FIX ANY PART OF ANY CAR

Whether a BEGINNER or EXPERT Mechanic — You Can Now "Breeze Through" ANY Auto Repair Job with This New 3-in-1 Manual—2900 Pictures and Simple A-B-C Instructions Make Everything EASY!

Now you can find and fix ANY trouble on any car built from 1946 thru 1956! MOTOR'S brand-new Manual makes every job a "cinch" with clear pictures and step-by-step instructions. Here's the "know-how" from over 160 Official Factory Manuals, boiled down into one big, complete, fully illustrated guide. NO GUESSWORK. Tells you where to start, what tools to use. Covers everything you need to know to repair 737 chassis models. Over 1000 Giant pages, 2,900 "this-is-how" pictures, 291 "Quick-Check" charts—23,436 essential specifications and pictures so clear you can't go wrong! Even a green beginner can do a good job with this manual to guide him. And experienced mechanics find many time-saving methods that amaze them!

Some FREE Offer On MOTOR'S TRUCK Repair Manual
Covers every job on every popular make gas and Diesel truck (1946-1955). For FREE 7-Day Trial check proper box in coupon.

SEND NO MONEY—Try Book 7 Days FREE—Just mail coupon! Unless delighted, return book in 7 days and pay nothing!
MOTOR Book Dept., Desk 1F, 250 W. 55th St., N.Y. 19, N.Y.

MAIL COUPON NOW FOR 7-DAY FREE TRIAL

MOTOR BOOK DEPT.
Desk 1F, 250 W. 55th St., New York 19, N. Y.

Rush to me at once (check box opposite book you want):

MOTOR'S New AUTO REPAIR MANUAL. If O.K., I will remit \$2 in 7 days, \$2 monthly for 2 months and a final payment of 95c (plus 35c delivery charges) one month after that. Otherwise I will return the book postpaid in 7 days. (Foreign price, remit \$9 cash with order.)

MOTOR'S New TRUCK REPAIR MANUAL. If O.K., I will remit \$2 in 7 days, and \$2 monthly for 3 months, plus 35c delivery charges with final payment. Otherwise I will return book postpaid in 7 days. (Foreign price, remit \$10 cash with order.)

Print Name _____ Age _____

Address _____

City _____ State _____

Check box and save 35c shipping charge by enclosing WITH coupon entire payment of \$6.95 for Auto Repair Manual (or \$8 for Truck Repair Manual). Same 7-day return-refund privilege applies.

MAGIC MAIL PLAN

that comes with this Little Machine CAN MAKE YOU \$5.00 AN HOUR



The machine is turning out a job that will bring operator \$2.58, by mail. Material cost, only 11c!

Write today for free facts about the newest and most fascinating of all new home operated businesses. For the first time, a simplified machine brings the fabulous profits of Plastic Sealing and Plastic Laminating within reach of the small operator. Anyone can learn to operate it with a few minutes practice. Then—with our MAGIC MAIL PLAN—can get mail orders pouring in daily with cash in every envelope.

No Canvassing or Selling
Fill orders at home in spare time to start. Then expand to full time business. We even supply circulars to bring back cash and orders. Rush name for all the facts you need to start. A postcard will do. No charge.

WARNER ELECTRIC CO., Dept. L-106
1512 Jarvis, Chicago 26, Illinois

Secrets of VENTRILOQUISM Now Revealed!

Easy to learn in 60 to 90 days with our Home Study Course. **RESULTS GUARANTEED.** Make Money! Be Popular! Have Fun! Big Opportunity! Radio, Television, Stage Appearances! For FREE information regarding price and terms **WRITE**. You must state your age. Dummy Catalog 25c.

FRED MAHER SCHOOL OF VENTRILOQUISM
Box 36, Studio PM-6 Kensington Station
Detroit 24, Michigan

250 POWER

Complete Telescope Lens Kit only **\$3.49** postpaid

Conquer Space. Explore the Universe. Planets, Moon Craters, New Stars, etc. Complete Lens Kit consists of 80 inch focal length ground and polished objective lens, eyepiece lenses for 50 POWER, 100 POWER, 150 POWER, 200 POWER, 250 POWER, and all necessary lens fittings. Easy to make from simple step by step instructions. (Tripod and mount not included.) Money back guarantee.

BUSSE SALES CO., Hartford 1, Conn., Dept. PM 46

ACCORDIONS

Finest Italian makes! Buy direct at Amazing Savings! **5 DAY TRIAL.** Low down payment, easy terms. **FREE** color catalog, lowest wholesale prices. Write today to **Accordion Manufacturers & Wholesalers Outlet**
2003 West Chicago Avenue, Dept. R-66, Chicago 22, Illinois

Save 1/2

JEEP OWNERS

STA. WAGONS • JEEPSTERS • PICK-UPS!

RE-POWER with Ford 6 or V-8 engines. Our F-J ADAPTOR-CONVERSION KITS fit—ALL—Willys Jeeps including 1956. Kit No. 4-K for 1949-56 Ford engines in 1954-56 Pickups & Sta-Wagons priced at \$52.85 incl. Fed. tax. Kits for 1932-56 Ford engines in ALL other Willys Jeeps . . . \$43.25 Tax incl. Write today for free details or send check or M.O. for prepaid shipment. Tell us year engine you will use and whether 2 or 4 Whi-Dr. **ORDER NOW FOR EARLY SHIPMENT.**

HOOSIER MACHINE PRODUCTS CO.
312 S.E. 6th St. Pendleton, Oregon

GET MAXIMUM USE OF 4-WHEEL DRIVES!

MAKE 2 VEHICLES OUT OF 1!

Your 4 w. d. is a 4 w. d. work horse or 2 w. d. "pick-up" as you need it—as you shift! No drag, gear whine, shimmy in 2 w. d.; big savings in gas, tires, repairs. For all 4 w. ds. to 1 1/2 tons at dealers or write:

WARN HUBS
WARN MANUFACTURING CO.
Riverton Box 6064-A6 Seattle 88, Wash.

LOCK-O-MATIC!

- Automatic free-wheeling 2 w. d.
- Automatic 4 w. d. forward & reverse
- Locking control for "snid-id" 4 w. d.

APPROVED Jeep EQUIPMENT

RCA offers you the
 finest training
 at home in
Radio-TV
 electronics,
 TV servicing,
 Color TV

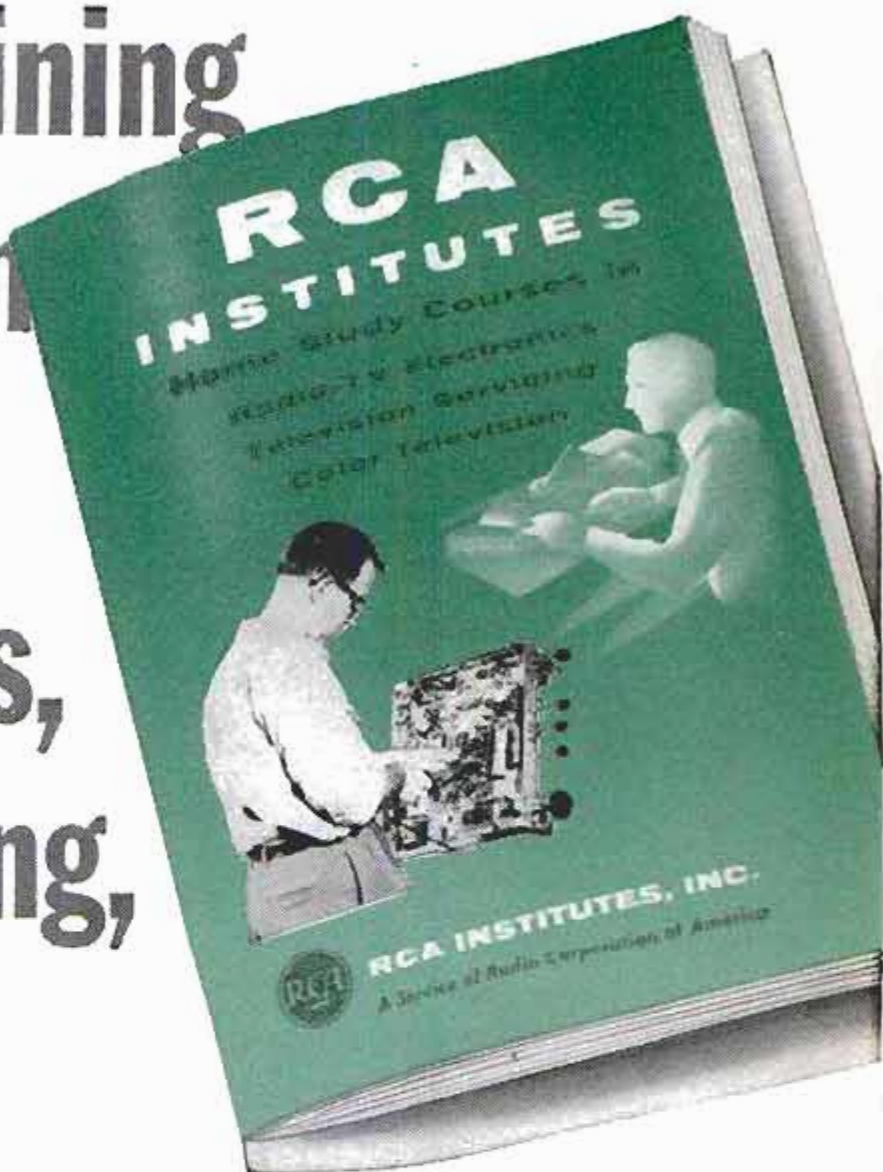

**SEND FOR THIS FREE
 BOOK NOW!**

The instruction you receive and equipment you get (and keep) will start you on your way. Pay-as-you-learn. You pay for only one study group at a time. This 52 page book contains complete information on Home Study Courses for the beginner and the advanced student.



RCA INSTITUTES, INC.
 A SERVICE OF RADIO CORPORATION OF AMERICA
 350 WEST FOURTH STREET, NEW YORK 14, N.Y.

RCA Institutes, Inc., Home Study PM66,
 350 West Fourth Street New York 14, N. Y.
 Without obligation, send me FREE CATALOG
 on Home Study Courses in Radio, Television
 and Color TV. No salesman will call.

Name
 Please Print
 Address
 City Zone State

IMPORTANT

Be sure to write
 for RCA Institutes
 catalog before
 signing up for any
 Radio-TV course

DRAFTSMEN



**CASH BIG
PAY CHECKS!**

**Train Now for
more success,
greater security**

**LEARN AT HOME IN SPARE TIME
(or at college in Chicago)**

Check the want ads in any newspaper—SEE the big-pay opportunities open to you as a draftsman. What's more, you can learn this well-paid, prestige profession at home—quickly, easily! No special talent needed. Get complete, step-by-step Chicago Tech lessons in the mail, spend a few pleasant hours studying each week. In a short time you'll be a well-trained draftsman, ready to take your pick of many good jobs. Act now!



Free Information—Mail Coupon Today!

Get **FREE TRIAL LESSON** plus information about C.T.C. practical training. Learn what successful Chicago Tech graduates say about high pay and opportunities in drafting. No charge, or obligation.

CHICAGO TECHNICAL COLLEGE

G-254 Tech Bldg., 2000 So. Michigan Ave.
Chicago 16, Illinois

Mail me **FREE** lesson with facts about big opportunities in **DRAFTING**.

Name _____ Age _____

Address _____

City _____ Zone _____ State _____

Not Satisfied With Your Present Earnings?

Investigate

**This NEW 2 in 1
BUSINESS
OPPORTUNITY**

- Popular, Money-Making **HOT DRINK** and **HOT SOUP** Venders
- Handle Either or Both Types
- We Train You, We Set Up Routes

Eye-catching, easy-to-operate vending machines serve delicious, nationally known Hot Drinks (3) and Piping Hot Soups (5)! Our factory experts set up routes, train you to operate this year-round, big-volume business. **NO SELLING!** A minimum cash investment of \$1290.00 required. Up to 75% of equipment costs can be financed. Operate full or spare time.

How many machines can you handle? 10 units, doing nat'l 1954 average, would pay approx. \$13-\$16,000 yearly!

Write or wire giving age, address and phone. Details **FREE**. No obligation!

SUPERIOR DISTRIBUTING CORP., Dept. CB,
4555 E. Warren Ave., Denver 22, Colo.



SHORTHAND IN 6 WEEKS

**Write 120 words per minute
Age no obstacle—LOWEST COST**

Famous **SPEEDWRITING** shorthand. No symbols; no machines; uses ABC's. Easiest to learn and use. Fast preparation for a better position. Nationally used in leading offices and Civil Service. 120 words per minute—50% **FASTER** than Civil Service requirements. Over 300,000 taught by mail or through classroom instruction. The very low cost will surprise you. Typing available. 33rd Year. Schools in over 400 cities in U.S., Canada, Cuba, and Hawaii. **WRITE FOR FREE BOOKLET TO: SCHOOL OF**

**DID YOU SEE
READER'S DIGEST
ARTICLE ON**

Speedwriting
Dept. 1506-6, 55 W. 42 St., N.Y. 36

LEARN TO MOUNT BIRDS



ANIMALS, FISH, PETS

Be a Taxidermist. Save your hunting **TROPHIES**. Have fine home-museum. Hunters, save and **MOUNT** your beautiful **DUCKS, QUAIL, DEER, TAN SKINS, FURS, Great Fun, Spare-time PROFITS.** **FREE BOOK** Tells ALL about it, 100 fine wild-game pictures, 48 pages. **SEND TODAY, don't delay.** Get this **WONDERFUL FREE BOOK, MEN AND BOYS.** Learn Taxidermy, Double your hunting pleasure. Rush letter or **POSTAL** today. **STATE YOUR AGE.** **N. W. SCHOOL OF TAXIDERMY, Dept. 2506, Omaha, Neb.**

REAL ESTATE BE A BROKER

PAYS BIG! SEND FOR FREE, BIG, ILLUSTRATED CATALOG NOW! Graduates report making substantial incomes. Start and run your own business quickly. Men, women of all ages, learn easily. Course covers Sales, Property Management, Appraising, Loans, Mortgages, and related subjects. **STUDY AT HOME** or in classrooms in leading cities. Diploma awarded. Write **TODAY** for free book! No obligation. Approved for World War II and Korean Veterans. **WEAVER SCHOOL OF REAL ESTATE (Est. 1936)**
2020R Grand Avenue Kansas City, Mo.

**FREE
BOOK
TELLS
HOW**

Free Book on Arthritis and Rheumatism

HOW TO AVOID CRIPPLING DEFORMITIES

Explains why drugs and medicines give only temporary relief and fail to remove the causes; tells all about a specialized non-surgical, non-medical treatment which has proven successful for the past 37 years. Write for this 36-page **FREE BOOK** today.

Ball Clinic Dept. 756 Excelsior Springs, Mo.



TRAIN WRECK STAMPS!

Cuba's famous stamps of 1946, showing actual train wreck scene! Complete set of 3, a dramatic display for your collection, only 10¢. Handsome, exciting stamps to look over, too, without charge or obligation.

WINTHROP STAMP CO., Dept. P-6, GROTON, CONN.

TELEPHONES



Desk Stand Style

Slightly used but in excellent condition

Many Valuable Uses

Inter-House Phones House to Barn, etc.
Loud Speakers Microphones
Educational Purposes, Toys, etc.

Come complete, ready to use with wiring diagrams included. **\$2.75** Postpaid in U.S.A.
Two complete for only \$5.00
TELEPHONE LAMP KIT—with illustrated instructions for making Desk Telephone Lamp including all parts (harp, nipples, push switch, cord, plug, etc.)
... \$6.50 Ppd. (Shade is not included).

MICROPHONE, Dept. X-3902, 1760 W. Lunt Ave., Chicago 26, Ill.

Make Money Manufacturing Concrete Drain Tile



Manufacturers of concrete drain tile are in the driver's seat. Why? Because their basic costs are not burdened by freight, distribution and breakage costs—items which the clay tile people have to pass along. Net results: concrete tile can sell for less, yet show a generous profit.

The market is big—and getting bigger. Not only because of increased farm drainage, but also because drain tile are needed in home building, reclamation projects, highway construction, and many other purposes.

Tile made on the Champion are outstanding in quality—dense, strong, uniform and truly round. All sizes up to 12" diameter. Easy to make, because the Champion Machine is simple, compact, and requires no skilled labor. Business is a low-investment opportunity, with equipment available on terms. Write for catalog.



W. E. DUNN MFG. CO.
522 W. 24th Street, Holland, Mich.



IN CANADA: DUNN MASONRY MACHINERY LIMITED
970 Dundas Highway, Cooksville, Ont.

IT'S EASY...

MAKE MONEY IN PHOTOGRAPHY

If you are over 17—good pay and fascinating work await you in photography! Start making money quickly in sparetime—step into your own studio or exciting career job. LEARN-BY-DOING method trains you at home! Write TODAY for FREE catalog. Also Resident Training. 46th Year. Approved for Vets.

NEW YORK INSTITUTE OF PHOTOGRAPHY
Dept. 49, 10 West 33 Street, New York 1, New York
46th YEAR

MONEY in WORMS

Big money made raising fishworms and crickets. Billions used yearly—unlimited market—Sell by mail—We teach you how to raise and where to sell. Learn about our new, exclusive 6 to 12 inch African Redworm—in demand everywhere. Free Literature. CARTER WORM RANCH, PLAINS, GEORGIA

Send for **FREE** 112 page
Illustrated Catalog of Farm, Home,
and Workshop Bargains.

Write to **WELLWORTH TRADING COMPANY**
Dept. F-6

1832 S. WABASH AVE.

CHICAGO 16, ILL.

you may think you're
TALL enough..but
what do others think?



If you're always overlooked when the boss looks for a "take-charge-man", DO SOMETHING ABOUT IT! Step into "ELEVATORS", step up and be noticed! These amazing height-increasing shoes make you almost 2 inches taller, instantly...confidentially. Only you know the secret, but everyone notices the difference in your looks. So, don't just think you're tall enough—BE SURE! For free booklet write

STONE-TARLOW CO., INC., DEPT. PM6-56, BROCKTON 68, MASS.



LAW TRAINING FOR BUSINESS

(In spare time at home)
Earn L.L.B. Degree

Thousands of men and women who never intend to practice Law are studying it in spare time at home as an aid to business advancement.

Today Law is involved in practically every business decision. In many lines of work it is almost indispensable. Law training develops keen, clear, quick, correct and decisive thinking.

You can study LaSalle's American Law and Procedure right in the privacy of your own home—progressing as rapidly as your time and ability permit. For nearly 50 years we have helped over 1,350,000 ambitious people get ahead in the business world.

A MOST UNUSUAL LAW LIBRARY

This training includes the 14-volume LaSalle Law Library—AMERICAN LAW AND PROCEDURE—that is the basis of all our instruction service. This library has been compiled by leaders in the field of Law. It covers the whole field in an orderly and simple manner that is easy to learn and understand. Collateral reading and printed lectures, furnished at regular intervals, supplement the texts. Law instructors personally supervise your program. Under the LaSalle method you learn by actually solving legal problems—not just memorizing rules.

WRITE FOR TWO FREE BOOKS

Send the coupon below TODAY and find out how you can qualify for the many fine openings available to the law-trained man. In our FREE books "Law Training for Leadership" and "Evidence" you will find answers to your questions about the study of Law and the LaSalle method.

—MAIL COUPON TODAY—
LA SALLE EXTENSION UNIVERSITY
A Correspondence Institution

417 S. Dearborn St. Dept. 664L Chicago 5, ILL.
Please send me, FREE, "Law Training for Leadership" and "Evidence."

Name.....

Address.....

City.....Zone.....State.....

FOR YOUR

TECHNICAL EDUCATION

COME TO THE

COLLEGE OF TECHNOLOGY

UNIVERSITY OF HOUSTON

(Located in Houston, Texas)

Select from one of these fields NOW.

- Air Conditioning & Refrigeration Technology
- Air Cond., Ref., and Sta. Engr. Technology
- Diesel Technology
- Diesel Electric Technology
- Drafting Technology
- Electrical Technology
- Electronic Technology

Prepare for your Future NOW . . .

- Latest methods and equipment • Excellent faculty
- Accredited curricula • Extensive free counseling and guidance service • Full college activities • Beautiful 275 acre campus • Co-educational • Opportunity for part-time job while you learn • Graduate placement • University T.V. and Radio stations • G.I. approved—V.A. on campus
- Open to high school graduates or equivalent. Opportunity for graduates of the above technical programs to continue education and earn a Bachelor of Applied Science degree—
- Sept., Feb., and June semesters. • FREE brochure.

Mark X before the program of your choice.

Tear out ad and send in with name and address.

COLLEGE OF TECHNOLOGY, University of Houston

DEPT. 166, 3801 Cullen Blvd., Houston, Texas

Anvil-Brand



12-STAR
pants and
matched
shirts

Longer wear
-easier care

Slip into an Anvil matching set and you're well-dressed for work, recreation or leisure. Tough, twill cloth in colors, sturdy stitching, laundry-tested. So economical you can easily lay in several outfits. At your favorite store.



ANVIL BRAND factories
HIGH POINT / NORTH CAROLINA



FREE FACTORY-TESTED TUBE
22 YEARS AT THIS ADDRESS

Guarantees are as reliable as the company giving them. Our Guarantees accepted by the Public with satisfaction for 22 Years. "The Most Protection for the Least Money."

Partially Used Tires — NOT RECAPS
CHECK MY GUARANTEE & PRICES!
FOOLISH TO PAY MORE — DANGEROUS TO PAY LESS
12 MOS. WRITTEN GUARANTEE WITH EVERY TIRE

Selected for Toughest Jobs — Tops in Value		Specialists in Truck Tires—	
600-16	\$5.12	475-19	\$5.32
600-16(G)	5.52	640-15	4.72
650-16	5.52	670-15	5.02
650-16(G)	6.32	710-15	5.25
700-16	5.62	760-15	5.22
750-16(G)	7.42	800-15	5.52
550-17	4.62	820-15	5.52
650-15	5.12	550-15	5.22
700-15	4.82	700-16(G)	8.22
		700-15	10.82
		750-16(G)	10.62
		700-17	10.62
		750-17	10.82
		800-20	10.62
		650-20	10.92
		32x6(8)	10.72
		32x6(10)	12.62
		750-15	10.82
		700-20	9.82
		750-20(8)	9.72
		750-20(10)	15.62
		825-20	17.92
		900-20	18.92
		1000-20	19.22
		1100-20	19.22
		1000-22	20.22
		1100-22	20.22

WHITE WALLS \$1.00 EXTRA

"EXTRA SPECIAL" Fully Guaranteed all size 4-ply pass. FREE TIRE with 2 or more of these.—W. W. \$1.00 \$7.72
Extra. Factory Tested Tube given. GIANT TIRE SALE.

Previously \$10.00 Values Shaved to the Bone on Price—The Same Mi-Grade Tires You See Advertised Elsewhere at Higher Prices

Thousands of tires shipped all over the U.S.A. All tires shipped F.O.B. Phila. Send Check or M.O. with this ad. Dept. 2. No C.O.D.

STANDARD 834 N. Broad St., Philadelphia 30, Pa.

FREE! 107 BRITISH COLONY STAMPS

All different from Britain's farflung colonial empire. Catalog value \$2.50.

FREE STAMP MAGAZINE. Approvals.

Send 10c for handling. Act now!

NIAGARA STAMP COMPANY
St. Catharines 77, Ont., Canada



I Made \$14,839 in 1 Year SERVICING RADIATORS!

Rex Ryan (Iowa) and hundreds of others earn \$5,000-\$20,000 a year servicing auto-truck-tractor radiators the Inland way. Inland, largest radiator servicing equipment mfr., offers the complete package — equipment, merchandising, "Pays-for-itself" financing, and Free training school for customers.

WRITE for FREE Radiator Servicing Folder.
INLAND MFG. COMPANY Dept. PM-6
1108 Jackson St., Omaha 8, Nebr.

BUY IT WHOLESALE!

Agents-Start Buying Service at Home. Get big-name merchandise for clients up to 40% off. Sales easy as you can give sizeable discounts, still make fat commissions. Postcard brings FREE COPY "The Wholesale Plan."

FREE! "THE WHOLESALE PLAN"

American Buyers Service

HERTEL STATION, DEPT. R, BUFFALO 16, N. Y.

START YOUR OWN IDENTIFICATION TAG SERVICE

FREE BOOKLET tells you how to start a very profitable Identification Tag Service with the new Clearview Nameplate Machine which stamps individual names and numbers on all kinds of Identification tags and plates: Key tags—Dog tags—Social Security plates—Identification bracelets—Bath house tags and scores of other purposes too numerous to mention. Write now for complete details.

The CLEARVIEW CO., 172 Stanton St., New York City

DRAINS cellars, cisterns, wash tubs; IRRIGATES - CIRCULATES - SPRAYS \$7.95

Type P Pump has 1,001 uses. Up to 3000 GPH; 450 GPH 80' high; or 1800 GPH from 25' well. Use 1/8 to 3/4 HP motor. Coupling included free. 1" inlet; 3/4" outlet. Stainless shaft. Won't rust or clog! Postpaid if cash with order. Rush your order today.

Centrifugal and Gear Pumps in All Sizes
LABAWCO PUMPS, Belle Meade 7, N. J.

Learn BAKING At Home

Baking is one of America's high industries in wages. Nearly DEPRESSION-PROOF. Thorough basic home course lays sound foundation. If you have aptitude, write for FREE Booklet, "Opportunities in Commercial Baking."

NATIONAL BAKING SCHOOL
835 Diversey Parkway Dept. 135A Chicago 14, Ill.



NEW INVENTION REPLATES

by **ELECTROPLATING**
RESTORES HOME, AUTO METALS
CHROME-SILVER-GOLD!

NEW BRILLIANCE WITH SAME PROCESS AS PROFESSIONAL PLATERS
SILVER-CHROME-GOLD, ETC.



REPLATED, Quickly, Easily
Now—with an amazing new invention, APPL-I-COTER, you plate hundreds of items, using the mild, safe current of 2 flashlight batteries in its handle. ALL YOU DO is simply hold disk on Applicator to metal, dip brush into solution—and plate as you brush. It's Easy, Quick, Genuine plating.

RESTORES METALS LIKE NEW
Replates Silver, Chrome, Nickel, Steel, Gold and Brass—all worn Spots, Stains, "Blisters," Silverware, Trays, Teapots, Rins of Holloware and other items can look like new again with this exclusive Electroplating process. Restore all your valuable Gold jewelry with amazing APPL-I-COTER. The plating you apply becomes an indestructible part of the metal itself!

QUICKLY BUILDS-UP A THICK NEW PLATING WITH EACH APPLICATION.



COMPLETE PLATING KITS:

- MET-L-COTE:** For Chrome & other white metals... \$3.95
- SILV-R-COTE:** For Silver-plating with pure Silver.. \$4.95
- GOLD-COTE:** Gold Plate with 24 K. Gold.. \$6.95
- Copper \$3.95; Rhodium \$8.95
- ALL 5 METALS**.....\$19.95 (You Save \$8.80)



BRILLIANT AUTO TRIM — You'll be mighty proud of the Dazzling new finish on your car's bumpers and trim after replating with MET-L-COTE... and remember, each time you electroplate worn areas you build up a lasting layer of coating that tremendously lengthens the life of original trim.

MET-L-COTE is constantly used in leading hospitals, and in doctors and dentists offices to Replate surgical instruments—Also in hotels and restaurants to RESTORE cutlery.

EMPIRE MERCHANDISING CO.
Dept. J-656
28 E. First St., Mt. Vernon, N.Y.

MONEY-BACK GUARANTEE

Please rush the Complete Plating Kits including Solution, New Pocket Applicator & full simple instructions I have checked below. I enclose full price, sent postpaid, or send C.O.D. plus postage.

- MET-L-COTE—\$3.95
- GOLD-COTE—\$6.95
- RHODIUM—\$8.95
- SILV-R-COTE—\$4.95
- COPPER-COTE—\$3.95
- ALL 5 METALS—\$19.95 (Save \$8.80)

NAME _____
ADDRESS _____
CITY _____ STATE _____

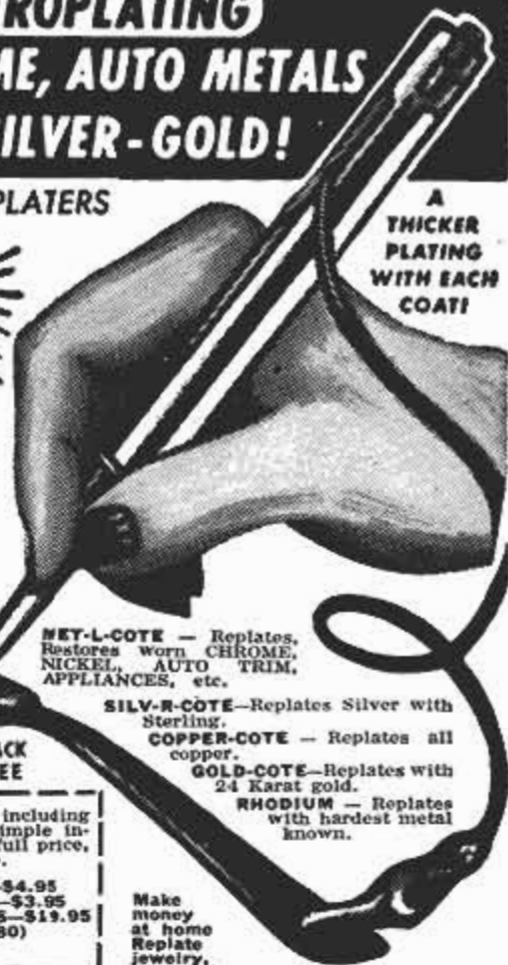

A THICKER PLATING WITH EACH COAT!

MET-L-COTE — Replates, Restores worn CHROME, NICKEL, AUTO TRIM, APPLIANCES, etc.

SILV-R-COTE—Replates Silver with Sterling.

COPPER-COTE — Replates all copper.

GOLD-COTE—Replates with 24 Karat gold.

RHODIUM — Replates with hardest metal known.

Make money at home Replate jewelry, silver, chrome. Earn up to \$10 per hour.

RESTORE YOUR TREASURES—MAKE THEM VALUABLE AGAIN

Empire Mds. Co., 28 E. First St., Mt. Vernon, N.Y.

MODERN TRANSPARENT ROOF

Genuine Dupont Plastic NEW FALSE PLATE

From Your Old, Loose Plate NO IMPRESSION NEEDED New, revolutionary Duplication System actually transforms your old, loose, cracked, chipped plate into a new, natural-pink Dupont Plastic Plate with same teeth or new, natural matched teeth. ONE DAY SERVICE!

Only \$18.95

30-DAY MONEY-BACK TRIAL

Plates Repaired \$5.00

SEND NO MONEY—just your name and address for FREE details. Save at our low price! Highest prices paid for Dental Gold. **ALL-STATE DENTAL LABORATORIES, 22 W. Madison, Dept. 915, Chicago 2.**

TERMITES

Kill Termites Yourself with ARAB U-DO-IT TERMITE CONTROL

Costs \$20.00 to protect 5-room house for 5 years. Harmless to flowers and shrubs. FREE FOLDER and prices at Bldg. Supply Dealers or write **FEDERAL CHEMICAL CO., INC., 2701 Winthrop Ave., Indianapolis, Dept. PM 656.**

LEARN AT HOME

Key to Success

LOCKSMITHING

Learn this profitable business from experts in your spare time. Locksmiths have no "slow" seasons or layoffs; they are always in demand. Age or minor physical handicap can't stop you. America's only recognized locksmithing school can teach you easily and quickly. Simple. Illustrated lessons plus materials and tools supplied. Make money while learning. Get into this uncrowded field now!

INSTITUTE OF LOCKSMITHING
Dept. P-79, 15 Park Avenue, Rutherford, N. J.
Lic. by N. J. State Board of Education
Approved for Veterans

Send for **FREE BOOKLET**

The finest of Gifts...
ENCYCLOPAEDIA BRITANNICA

TERRIFIC!

16 x 50

Regularly sold at \$69.50

NOW \$36.93



Brand New, sealed in water-proofed Plastic Bags, just as they came from the factory. BUT, we will not sell them as Brand New because the cases are blighted and show marks where the cases rubbed against one another inside of the packing cases. We do Guarantee the binoculars to be A-1 mechanically and optically! Large front lens (2" across!) assures greater illumination and brighter, sharper images. Weighs 27 oz., stands 7" high! **ORDER NOW** while 126 pair last!

20 POWER

BRAND NEW! Never in the 100 years since Carl Zeiss invented binoculars has it been possible to get a 20 POWER PRISMATIC BINOCULAR that weighs only 18 ounces! Precision made. Individual focus. They have removable screw-in protective lens caps. Lens are color corrected. Tremendous 20 POWER gives you crisp, clear viewing. Regularly \$39.95 now... **\$29.95**

UNCONDITIONALLY GUARANTEED 30 DAY TRIAL!
If not satisfied return for full refund. Made in Japan. Leather case, straps included. Add 10% Fed. tax. Cash orders prepaid. C.O.D.'s require \$2.00 deposit. **UNITED BINOCULAR CO., Dept. ARF-308, 9043 S. Western Ave., Chicago 20. DEALERS WANTED!**

Inventors

Take these necessary preliminary steps promptly to protect your invention by applying for a United States patent—

Sketch and describe your invention. Sign, date and have this disclosure witnessed by two people who understand your invention. Have us make a preliminary search among U. S. patents already granted for similar types of invention. We then report to you on the probable patentability of your invention and recommend your further course of action.

Write for our instructive booklet, "Patent Protection for Inventors" and our convenient "Evidence of Invention" disclosure form. No obligation.

VICTOR J. EVANS & Co. *Merlin M. Evans*
REGISTERED PATENT ATTORNEY

230-G MERLIN BUILDING, WASHINGTON 6, D. C.

... TURN CONCRETE INTO GOLD!



MOTOR DRIVEN

R. L. T. of New York City reports: "MY GENERAL BLOCK MACHINE PAID FOR ITSELF IN FIRST 2 WEEKS!"
Hundreds now in use the world over!
Write for FREE details today!



MAKE UP TO \$75 A DAY IN YOUR OWN BUSINESS

If you want to have your own business — to start a business on your own — here's your big opportunity! New high speed, low cost General block machine produces up to 1,000 concrete blocks a day. Sell all you make to builders, supply houses, and others for homes, factories, buildings, garages. Cash in on the building boom! You can make profits of 100% to 150% — up to \$75. a day! General block machine equipped with 1/2 h.p. electric motor — or can be supplied with gasoline engine — works anywhere, in little space, indoors or out. Operates from ordinary house light socket. Simple, foolproof 3 step operation — so easy a child can do it. Makes superior 3 core blocks any size from 4" to 12". Also makes chimney, sash, corner and other types. Blocks meet any building code anywhere in the country. Materials — sand, water, cement, available anywhere. Simple illustrated operating instructions and mixing formulae for cement and cinder blocks supplied with each machine. Write for FREE folder with full information.

EXTRA

Amazing illustrated

book gives floor plans for 6 sensational concrete block bungalows. Tells how to lay blocks, lay out building lines, mix concrete, build steps, porch and concrete floors all at great savings. Written by experts. Can save many times the cost of the machine! Get it now! No strings attached. Send \$1.

BOOK SENT FREE IF YOU BUY MACHINE.
\$1 REFUNDED IF YOU BUY LATER.

GENERAL ENGINES CO.
DEPT. M-66, ROUTE 130, THOROFARE, N. J.



MEN WANTED

To Train as Builders, Estimators & Contractors

Predictions are that the building industry will continue at a high level for many years. Now you can take advantage of this "boom." The American Technical Society (non-profit organization) now offers to train men in their spare time at home to help gain the trade related knowledge needed for every phase of building, estimating and contracting. No classes to attend. No interference with present work. Text furnished. Lessons come direct to your home. Progress as fast as your time and ability permit. Diploma awarded. Low tuition rates. Write today for complete information to Dept. PM656.

AMERICAN TECHNICAL SOCIETY

850 E. 58th STREET

CHICAGO 37, ILLINOIS



3 Speed PHONO

Finest Performance at lowest cost

Surpasses every critical test

"AUDIO CRAFT" offers you a new 3-Speed Long-playing Phono Chassis which gives faultless reproduction. This exceptional Hi-Fi Accessory has constant speed; no "wow's" ... Mounted in "anti-microphonic" manner ... 2 top quality pickup heads for microgroove and regular recordings are included ... Biggest value on the market! Rush request for literature, prices.
AUDIO CRAFT, INC., G.P.O. Box 504, N.Y.C. 1, U.S.A.

LEARN PLASTICS



COMPLETE LOW COST SHOP METHOD HOME TRAINING NOW AVAILABLE

Get in on Big Money opportunities in Plastic molding, casting, forming, carving, etc. Earn as you learn with Interstate's professionally prepared course. All plastic materials furnished.

WRITE FOR FREE BOOKLET

INTERSTATE TRAINING SERVICE
DEPT. C-3, PORTLAND 13, OREGON

YES! SEND



directly to my door every month

I am enclosing

- \$3.50 for 1 year
 \$8.00 for 3 years

name

address

city

zone

state

A-66

Hand this order to your newsdealer or send it to
POPULAR MECHANICS
200 East Ontario St. Chicago 11, Ill.

"How to Go into Business for YOURSELF"

If you know a trade or occupation—why not go into business for yourself? Why not make the profits others are now making?

IT'S EASY TO START A NEW BUSINESS. It's easier than you think—once you learn the 9 easy steps of building a new business of your own. National Business Consultants has shown over 5000 others how to be successful—let us show YOU too. We guide you every step of the way with sound, proved simple business practices. **EXPAND YOUR OWN BUSINESS.** Learn our tested, profit-making methods for business success. If you already own a business, let N.B.C. guide you too. You'll be amazed. **SEND FOR FREE BOOKLET TODAY!** "How to Start a Business" is jam-packed with revealing information. In easy-to-understand language it explains how to start and make any kind of business profitable. Free for the asking! Sent to you in confidential plain envelope. *Just write:*
NATIONAL BUSINESS CONSULTANTS, Office P-6, Los Angeles 61, Calif.



BOTH FREE!
 Rush Name on Postcard Today!

THE Big Favorite[®] WORK CLOTHES

SANFORIZED

Home Craftsmen And Do-It-Yourself Fans—

Make neat, longwearing Big Favorite work and leisure clothes your "uniform" for workshop and do-it-yourself jobs. Many fashionable, practical styles.

25,000 DEALERS, COAST TO COAST



THE FAVORITE GARMENT CO. Lynchburg, Va. Jackson, Miss.

SCIENTIFIC CRIME DETECTION



IT'S EASY TO LEARN
 Let us teach you in your own home. Learn Finger Printing, Firearms Identification, Police Photography, Criminal Investigation Methods thoroughly, quickly, at small cost. Over 800 Bureaus of Identification in the U. S. employ I. A. S. students or graduates. Write today, stating age.

INSTITUTE OF APPLIED SCIENCE, 1920 Sunnyside Ave., Dept. 135-A
 (A Correspondence School Since 1916) Chicago 40, Ill.

Finish HIGH SCHOOL AT HOME

Complete 4 Yrs. in 12 Months

Learn More! Earn More! Enter professional or technical schools. Advance Socially. Live a Happier, Fuller Life. Individual Courses or complete schedule. **WRITE FOR SCHOOL BULLETIN.**

ACADEMY FOR ADULTS

30 W. Washington, Dept. PM-66, Chicago 111.

TERMITES IN YOUR HOUSE?

GET RID OF THEM YOURSELF!

DON'T PAY \$300.00 AND UP TO ERADICATE TERMITES FROM YOUR HOME OR PREVENT INFESTATION. DO IT YOURSELF IN ONE AFTERNOON. EASILY! QUICKLY! INEXPENSIVELY WITH "TERM-OUT"! SEND STAMP FOR HANDBOOK.



COMPASS RESEARCH

90-A CLAIRTON BLVD., PITTSBURGH 36, PA.



Stammering?

BREAK THAT HABIT NOW!
 SUCCESSFUL EMERY CORRESPONDENCE COURSE FEATURED IN NEWSWEEK & MEDICAL RECORD. WRITE TODAY FOR FREE INFORMATION.

EMERY INSTITUTE

P.O. Box 867-PM6 Winter Park, Florida

NATIONAL SCHOOLS

proudly presents

TELERAMA • ALL 8 BRANCHES OF TELEVISION • ELECTRONICS • RADIO •
 IN ONE DYNAMIC, MODERN SHOP METHOD, HOME TRAINING COURSE

You get and keep ALL this modern, newest, practical equipment!

* Registration applied for



YOU COVER ALL 8 BRANCHES IN ONE MASTER COURSE. ONE LOW TUITION

1. Television—including color TV
2. Radio — FM & AM
3. Industrial electronics
4. Sound recording and Hi-Fidelity
5. Preparation for FCC License
6. Automation
7. Radar & Sonar
8. Communications

- Parts to build a modern TV set, including large screen Picture Tube.
- Parts to build a powerful Superhet Receiver, standard broadcast and short wave.
- Parts to conduct many experiments and build — • Continuity Checker • RF Oscillator • TV Circuits • Audio Oscillator • TRF Receiver • Signal Generator
- Professional Multitester
- A MUST for all technicians

FOR MEN WHO WANT TO EARN MORE MONEY!
 Another great advance in Home Study Training. Let National Schools, of Los Angeles, a practical Technical Resident

Trade School for over 50 years, train you at home by Shop-Method, for today's unlimited opportunities in ALL 8 BRANCHES of the Television, Electronics, Radio industry.

YOU DO MANY PRACTICAL JOBS — including servicing, circuit analysis. Build a modern TV set from ground up, with equipment kits we send you, including a new large-screen picture tube and professional Multitester, at no additional charge. You receive an experiment lesson with each kit.

EARN AS YOU LEARN. Many of our students earn their entire tuition and more in Spare Time jobs we show them how to do while learning. YOU GET GRADUATE ADVISORY SERVICE, TOO.



SEND FOR FREE FACT-BOOK AND FREE SAMPLE LESSON!
 Mail coupon now to office nearest you.

NATIONAL SCHOOLS

4000 S. FIGUEROA ST., LOS ANGELES 37, CALIF.
 187 N. LA SALLE ST., CHICAGO 1, ILL.
 111 CANADA, 811 W. Hastings St., Vancouver, B. C.

NATIONAL SCHOOLS

TECHNICAL TRADE TRAINING SINCE 1905
 Los Angeles, California

GET FAST SERVICE — MAIL NOW TO OFFICE NEAREST YOU!

NATIONAL SCHOOLS, DEPT. RB66
 4000 S. FIGUEROA ST. LOS ANGELES 37, CALIF. OR 187 N. LA SALLE ST. CHICAGO 1, ILL.

Rush free TV-Radio "Opportunity" Book and sample lesson. No salesman will call.

NAME _____ BIRTHDAY _____ 19 _____

ADDRESS _____

CITY _____ ZONE _____ STATE _____

VETERANS: Give Date of Discharge _____

Step Up Your Pay Learn to Fix APPLIANCES

ACT NOW-Fast Growing Field Needs More Electric Appliance Technicians

Electrical appliance repair offers you good pay, SECURITY. Every wired home today averages 8 electrical appliances. Up to 10 million new appliances are sold every year. Owners pay well to keep them in repair. That means a fast growing need for trained men.

Learn with Tester You Build

Our training includes the parts to build a multi-use appliance tester that helps you find electrical defects easily. It equips you to do professional troubleshooting; helps you start making money soon after you enroll.

Earn \$3, \$4, \$5 Hour Spare Time

Fix toasters, irons, fans, etc. for friends and neighbors in spare time. Jobs done in basement or spare room can earn you \$3 to \$5 an hour. Mail coupon today.

AT HOME IN SPARE TIME



Lesson and Book **FREE** MAIL NOW



NATIONAL RADIO INSTITUTE, Dept. AF6, Washington 9, D.C.

Please send me Electrical Appliance Training lesson and book free. (No salesman will call.)

Name _____ Age _____

Address _____

City _____ Zone _____ State _____

Approved Member National Home Study Council

105 POWER SUPER TELESCOPE



Everything for the Astronomer, Hobbyist, Student, & Scout in this complete astronomical super value telescope combination. Comes ready for immediate use, consists of brilliant 33x-05x-105x telescope, 5 foot hardwood Tripod, carrying case for scope, Star Explorer map, 108 page book "Discover the Stars." 3 foot telescope (closes to 18 inches) is brass bound, has 4 precision lenses that will bring distant objects, people, moon, stars, ships, etc., 105 times closer. 11,025 area magnification. All images erect. Sturdily built tripod is equipped with universal mount that has 360 degree horizontal range & 180 degree vertical range. Locks in any position with one simple adjustment. The Star Explorer map enables you to find any star automatically. This marvelous all purpose instrument is proclaimed by Scientists as a most unusual development. Everyone that has used it is amazed at its performance and value. It will fascinate the entire family. Shipped to you complete, nothing else to buy, at the amazing low price of.....

\$11.95 POST PAID

Satisfaction guaranteed or money refunded. We pay all delivery charges. Send check or money order to DEPT. PMS16

CRITERION CO. 331 CHURCH ST., HARTFORD I, CONN.

Valves Sticking? Get PYROIL

CLEANS, LUBRICATES, RESTORES LOST POWER



25¢

Now... Free 'em

Pyroil "A" added to your gas clings to valves and stems so carbon can't keep valves open. Eliminates overheating. Increases power. Saves gas and repairs. Get Pyroil "A" today. Save more... buy in pints, quarts, gallons.

Write for trial offer. Dept. PM-66,

IN CANADA 30¢



PYROIL COMPANY, LaCrosse, Wis., U.S.A. Toronto, Canada

SUPER LUBRICANTS - WORLD FAMOUS SINCE 1929

TASOPE PHOTO-ENGRAVING PLANTS



Material Cost Of This Cut 34¢ Selling Price \$1.00 And Up

Establish your own profitable PHOTO-ENGRAVING business. Make cuts for newspapers, printers, and advertisers. Make etched name plates, plaques etc. Instructions furnished, no experience necessary. Sold direct from factory since 1931. First five hundred cuts sold locally or by mail will pay for plant and pay you well for your time. Write for FREE catalog.

TASOPE, DEPT. PM-6, AURORA, MO.

IMMEDIATE DELIVERY

MARCOT KEY MACHINE



Marcot No. 8 Key Machine, 1958 Model	\$123.00
Auto Code Book and Depth Keys	13.75
Yale Padlock Code Book and Depth Keys	6.25
45 Dog, Asst. Cylinder Key Blanks	35.46
Set-Locksmithing Tools, Pins & Springs	10.50
5 Locksmithing Manuals and Instruction Books	10.25
	\$199.21

SEND FOR CATALOG

A. J. MARCOTTE CO. 1200 N. KEDZIE AVE. DEPT. PM-6, CHICAGO 51, ILL.



MECHANICAL DENTISTRY

To make Crowns, Plates, Bridgework, etc., for Dentists. Easy practical way to learn mechanical dentistry at home in spare time. FULL EQUIPMENT OF TOOLS AND MATERIALS INCLUDED WITH COURSE. Low tuition. Easy terms. Write for FREE BOOK about this money making profession that is not affected by machine age.

McCARRIE SCHOOL OF MECHANICAL DENTISTRY 207 N. Broad St., Dept. 54, Philadelphia 7, Pa.

POWER MOWER KITS FREE PLANS

Have one of the finest mowers money can buy. Write for FREE PLANS and PARTS LIST showing you how to SAVE MONEY by assembling Triangle's POWER MOWERS.



SPECIAL FACTORY PRICES

Kits, Parts, Engines, Wheel, etc. 18" and 20" sizes; 3 or 4-wheel models; belt or direct drive. Latest improvements, sturdy construction, money-back guarantee fully told in

FREE color folder. Also complete TRIANGLE MOWERS ready to mow at low Factory Prices. Write today.

▼ TRIANGLE MFG. CO., Dept. MA-66, Ft. Scott, Kan.

Watch Repairing Pays Big Money Learn at home



Watch repairers in great demand. Train step-by-step in 10 easy lessons. We furnish all tools and 15 jewel watch and practice movement. Turn spare time into cash. A licensed school. Low cost. Send for FREE book today.

ILLINOIS SCHOOL OF WATCH REPAIRING 2870 Elston Ave., Dept. PM66, Chicago 18, Ill.

RUPTURED BE FREE FROM TRUSS SLAVERY

NOW there is a new modern Non-Surgical treatment that permanently corrects rupture. These Non-Surgical treatments are so certain, that a Lifetime Certificate of Assurance is given. Write today for our New FREE Book that gives facts that may save you painful and expensive surgery, and tells how non-surgically you may again work, live, play and love and enjoy life in the manner you desire. There is no obligation. Excelsior Hernia Clinic Dept. 8305 Excelsior Springs, Mo.

THE MASONIC CASUALTY COMPANY



OFFERS

ACCIDENT—HEALTH—HOSPITALIZATION INSURANCE AT COST

- Non Cancellable
- Benefits Not Prorated
- No Medical Examination
- No Paid Agents
- Coverage On or Off the Job

FIRST 3 MONTHS PROTECTION FOR MEMBERSHIP FEE \$2.00 FOR MASONS ONLY under 56 yrs. of age WRITE AT ONCE

THE MASONIC CASUALTY COMPANY

80 BOYLSTON STREET, Dept. P-6, BOSTON 16, MASS. NO AGENT WILL CALL

Aluminum Miles-Per-Gallon Computer

Know your gas mileage? Handy slide rule gives you the answer. No adding—no dividing, just slide gauge over bar. PPD..... **\$1**

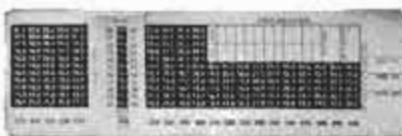

MRMCO, 800 S. Ada St., PM-6, Chicago 7, Ill.

LAW

Men and women **STUDY AT HOME** for Business Success and **LARGER PERSONAL EARNINGS**, 44 years expert instruction—over 114,000 students enrolled. LL.B. Degree awarded. All text material furnished. Easy payment plan. Send for **FREE BOOK**—"Law and Executive Guidance"—**NOW!**

AMERICAN EXTENSION SCHOOL OF LAW

Dept. H-12, 201 N. Wells St., Chicago 6, Illinois

SPARE TIME PROFITS EARN MONEY AT HOME

Cash in on this pleasant and profitable business. Re-string Rackets full or spare time. No experience or skill required. Easy to learn. Full line of finest quality, guaranteed Stringing Tools, Frames. Gut and Nylon Strings.



FREE CATALOG INSTRUCTIONS WRITE TODAY

W. A. BICKEL & CO., 803 South Blvd., Dept. PM-6, Oak Park, Ill.

FREE! 100 FOREIGN STAMPS

All genuine, unpicked, unsorted—just as received from Europe, Asia, Africa, Near East, Far East—from everywhere! Plus a beautiful souvenir of World's Rarest Stamp and our valuable "Stamp Collector's Guide". Other valuable offers also included for your **FREE** inspection!

Send 10c for postage and handling to **GARCELON STAMP CO., DEPT. 6PMM CALAIS, MAINE**



Everything You Need For

UNDERWATER

Sports and Adventure

DIVEMASTER

SKIN AND LUNG DIVING EQUIPMENT

Leading nationally known and foreign made products. Inspection tested at money saving prices. Underwater Breathing Apparatus, Swimming Masks and Fins, Diving Masks, Spear Guns, Water Skis, Diving Suits, etc. Send 25c for Illustrated Catalog.

(Dealer Inquiries Invited)

U. A. S. CORPORATION, Dept. PM-56 5637 W. 63rd Place, Chicago 38, Ill.



Engineers Needed!
—say national industrial leaders

Become a

MECHANICAL ENGINEER

OR

ENGINEERING TECHNICIAN

at

MSOE in Milwaukee

Yes, engineers are needed — and for every professional engineer, industry also requires five trained engineering technicians.

Choose MSOE to prepare yourself for a worth-while career in mechanical engineering or technology.

Complete laboratories, and field trips to some of the largest and most progressive industrial plants in Milwaukee—machine shop of the world.

Courses approved for veterans — A non-profit institution of higher learning. — Governing board and advisory committees of leading industrialists.

Choose from these courses —

MECHANICAL ENGINEERING

BS Degree in 36-42 mos. Options in plant engineering, metal fabrication, and industrial.

ENGINEERING TECHNICIAN

Associate in Applied Science Degree in 18 mos. Optional study in air conditioning, industrial engineering technology.

TECHNICAL SERVICE COURSE

Service certificate in 6 mos. Optional study in refrigeration, metals fabrication.

A complete series of courses in Electrical Engineering, with majors in electronics and electrical power, is also available.

TERMS OPEN JULY, SEPTEMBER, JANUARY, APRIL

MILWAUKEE SCHOOL OF ENGINEERING

Mail coupon for more information

Milwaukee School of Engineering
Dept. PM-656, 1025 N. Milwaukee St.
Milwaukee, Wisconsin

MS-30

Please send the new illustrated career booklet on Mechanical Engineering and Technology.

Name.....

Address.....

City..... State.....

If veteran, give date of discharge.....

Would you pay
to start
a



Business of Your Own?

HERE is the opportunity to turn a few spare-time hours each week into a business with a big-time future. We are a 26-year old manufacturer with a tremendously successful product. You operate from your home. No high-powered selling required. This is strictly a service business which is paying Big Dividends to hundreds now operating. No house-to-house selling—business is done with selected retail stores. You need no special equipment or large stock inventory. An investment as small as \$71.16 can prove to you our plan will work. Why not find out NOW about this great opportunity.

Mail Coupon today for full particulars

NOVO, Inc.

Dept. PM-6, 1166 Milwaukee Ave., Chicago 22, Ill.

Please send—without obligation—details about how I can start my own business for as little as \$71.16.

NAME _____

ADDRESS _____

CITY _____ ZONE _____ STATE _____

MAKE UP TO \$20 A DAY WITH

EASISHARP



MONEY
MAKING
SALES PLAN FREE

tailor, dressmaker—everybody uses scissors and all need sharpening two to four times a year. Don't let some one else beat you to this opportunity. Write immediately to

SERR-EDGE MACHINE CO., 9731 Lorain Ave., Cleveland, Ohio

Big profits in your spare time sharpening scissors. We show you how to start making money immediately. This is your chance now to have your own business and a steady income. Sharpen a pair of scissors in less than two minutes. A child can operate it. Weighs only 10 lbs. Every home, barber, and all need sharpening

Paint STRIPES with New "PAINT PEN"!

Straight, Curved or Parallel Lines

Use like a fountain pen with any color paint to stripe furniture, bikes, autos, model planes, toys, linoleum, wall board. Beautiful clean, crisp results every time. Can't clog or smear. Also use with glue, tempera, textile paint or ceramic under glaze. Paints on wood, glass, plastic, metals, fabrics and paper. Tool complete with tip for 1/16" stripe only \$1.25 postpaid. Other complete tools with following tips, 1/64", 1/32", 3/64", 5/64", 3/32", 1/4" — \$1.75 each. Extra tips 90¢ each. Entire kit with tool and 7 tips—\$5. A 1/4" tip only \$1.20 each. C.O.D.'s postage collect.

New! "DOUBLE-STRIP" 5 Way

Combination Model only \$3.25

Double Stripes—one wide and one narrow or two wide or two narrow at the same time.

FREE Send postcard for complete information—or ORDER TODAY.



\$1.25

DEALERS: Master Paint Stripping Tool in display cartons of 1 doz. FAST, PROFITABLE SALES. Write for new discounts.

HOME CRAFTSMEN! New Paint Stripping Tool gives "professional" results every time, simple, easy to use. Send \$1.25 now.

MANUFACTURERS: Write today for information about industrial models and production stripping tools.

WENDELL MFG. CO., Dept. 318
4234 Lincoln Ave., Chicago 18, Ill.

FILMS DEVELOPED 1/2 PRICE

ONLY 40¢ A ROLL FOR 8 EXPOSURES, 12 EXPOSURES . . . 55¢. STOCK UP WITH 3 ROLLS NAME BRAND FILM . . . 99¢. COLOR AT EQUALLY LOW PRICES. FILM DEVELOPED AND RETURNED SAME DAY RECEIVED. MONEY-BACK GUARANTEE + NEW ROLL OF FILM IF NOT SATISFIED.

Please find \$_____ for:

developing _____ rolls of film

Please send _____ rolls of name brand film

127 620 120 116 616

Please send free mailing envelope & price list

PHOTO WHIZ • Hillside Manor 10, L. I., N. Y.



Easy to make your own BOWS—ARROWS—EQUIPMENT

Illustrated Hand-Book 84 pgs. \$1, tells you how! Large Colored Catalog 5¢—Send for it!

Ask your dealer for "Stemmler's Archery" (Oldest Mfr. in U.S.A.)

L. E. STEMMLER CO.

Manorville (Box 1) L. I., N. Y.

MOTORIZED YOUR BARBECUE!

Easily rigged up by anyone. Handles whole ham or 4 small chickens. Commercial-quality thruout—2 r.p.m. gear-head motor (110V-AC)—spring-tension bronze bearing permits spit removal—

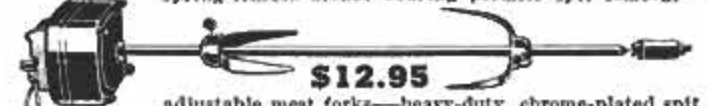

\$12.95

adjustable meat forks—heavy-duty, chrome-plated spit. Limited time, introductory offer. Postpaid. (\$13.95 Denver and West).

B & R SALES CO. — Dept. PM656 — Muncie, Indiana



HIT CAMERA

Miniature vest pocket camera so tiny it will fit in the palm of your hand. Makes beautiful clear enlargements. Comes with genuine pigskin case. Uses 14 MM film. Guaranteed. We pay postage. Camera with genuine pigskin case . . . \$2.95
14 MM. film 10 exposures on roll, 6 rolls . . . 1.50
AL'S MUSIC COMPANY, SHAWANO WISCONSIN



EARN
WHILE YOU
LEARN

UPHOLSTERY BE YOUR OWN BOSS

Practical, low-cost, LEARN-BY-DOING UTS Course, complete with tools, materials, frames, trains you quickly AT HOME in spare time. Start making money in Upholstery almost at once! Big FREE illustrated book and FREE sample lesson show you how—give full facts about business, job opportunities for men and women. Write TODAY! Also Resident Training. VET Approved.

UPHOLSTERY TRADES SCHOOL
721 Broadway, New York 3, N.Y.

Dept. EH-300



YOU CAN BUILD A VIOLIN FOR PLEASURE OR PROFIT

Now you can build a rich toned mellow violin modeled after a famous "Strad." YOU CAN MAKE A STRADIVARIUS VIOLIN contains 8 full scale plans plus complete instructions. You work directly from the plans with no confusing scale of dimensions to translate. Detailed instructions for each step including varnishing and stringing—even shows how to build your own tools. Cloth bound. Order today from

POPULAR MECHANICS PRESS . . . \$3.50
200 EAST ONTARIO STREET, CHICAGO 11, ILLINOIS

60 POWER TELESCOPE \$3.98

VARIABLE EYEPIECE 20X-40X-60X — BRASS BOUND NEW! Three telescopes in one. 3 different magnifications. 20 power for ultra-bright images with 40 and 60 power for extra long range. Guaranteed to bring distant objects, people, sports events, ships, moon, stars, etc. 60 times as close.

Most powerful for anywhere near the moon. Contains 4 ground and polished lenses. Also used as a powerful compound microscope. Directions included. Mass production enables us to offer this instrument at amazing price of \$3.98 complete. Money back guarantee. We pay postage. Get yours now. CRITERION CO., 331 Church St., Hartford, Conn. Dept. PMB 35



WAR SURPLUS BARGAINS

WAR SURPLUS BARGAINS

\$500,000.00 INVENTORY for QUICK LIQUIDATION

Surplus items—hundreds of them for home, shop, factory, farm and outdoor use. New items, used items, reconditioned items—all at tremendous savings—all priced for quick sale.

Page After Page of Values

This big catalog shows page after page of amazing money saving values. Write for your copy today. Send 10c to cover postage, mailing, etc. Write today! **SEND TODAY FOR YOUR COPY**

10c

STARK'S 212 W. Madison St.
Dept. PM-566
CHICAGO 6, ILL.

SHEET METAL BRAKES

Forms angles, locks, pans, etc. New eccentric clamps. All steel construction. Size 15"—16 gauge steel, \$23.50; 36"—22 ga. \$35.50; 48"—24 ga. \$52.00. Stand \$8.00.

16 ga. Metal Bender 49" size, \$42.00
1/4" x 12" Angle Former \$15.50
14 ga. 6" Compound lever shear \$29.00

SEND FOR FREE CATALOG

YKKE MFG. CO., 4158-P Jason St., Denver 11, Colo.



LAW FREE BOOK THE LAW TRAINED MAN

Write today for a FREE copy of illustrated law book, "THE LAW-TRAINED MAN," which shows how to earn the professional Bachelor of Laws (LL.B.) degree through home study of the famous Blackstone Law Course. All necessary books and lessons provided. Moderate cost; convenient monthly terms. Write for FREE law training book today.

Blackstone School of Law, 225 N. Michigan Ave.
Founded 1890 Dept. 50 A Chicago 1, Ill.

It Pays to be TALLER

You can be impressively taller, increase your business & social potential. Staturaid shoes help you win new heights in life. Choose elevation you desire, in 35 smart styles. Free Catalog P.

BURGER CO., 433 E. 148 ST., NEW YORK 55, N. Y.

YOU BUILD 'EM — WE SELL 'EM
EARN UP TO \$50.00 A DAY AT HOME

Participate in our national sales and sub-contract plan—spare time—full time. You assemble special luggage and cases for photographers, musicians, salesmen, and all types of portables. We supply complete instructions—materials—tools—everything. No previous experience necessary. Free details. Abarsi Casecraft, Dept. AG, 807 W. Sunset Blvd., Los Angeles 12, Calif.

4-WAY COMBINATION KNIFE, FORK, SPOON SET WITH BOTTLE OPENER



This handy little set is made of non-corrosive stainless steel with beautifully colored, easy to clean plastic handles. Knife and fork slide snugly into each other's handles, spoon slips into pocket on knife handle, making a neat little package that's safe to carry. Fits easily into pocket, purse or glove compartment of car.

Wonderful for barbecues, picnics, or the home. Ideal for campers, hunters, fishermen

Please Specify Color. Order Today from
LEON RUMMEL 328 E. Washington Blvd.
Los Angeles 15, Calif.

Available in red, yellow, green and ivory.
\$1.25 PER SET PPD.
4 sets only \$5.00 Ppd.
Knife and fork set, without spoon, \$1.00 Ppd.

DIESEL MECHANICS IN DEMAND

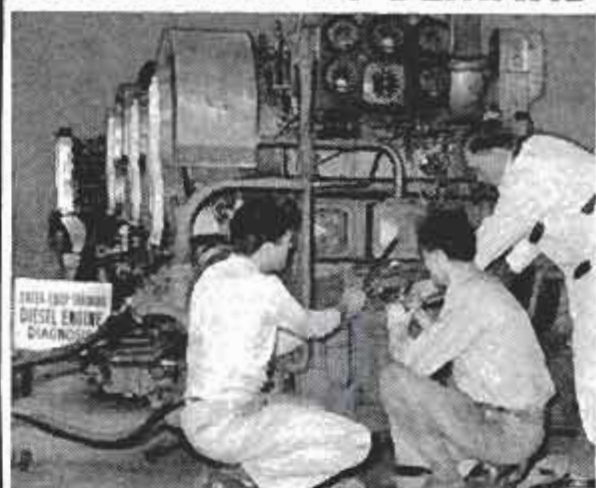

Learn to earn big pay in DIESEL in our large, modern equipped Chicago school and shop. No previous experience or training necessary. We help you find living quarters and part time job while in school. Complete, practical courses taught in the following trades, under the supervision of experienced, expert technicians.

APPROVED FOR CIVILIANS OR GI'S

— CHOOSE YOUR TRADE —

CHECK HERE	WEEKS
<input type="checkbox"/> DIESEL MECHANICS	20
<input type="checkbox"/> AUTO MECHANICS	20
<input type="checkbox"/> BODY & FENDER	16 2/3
<input type="checkbox"/> GAS-ARC WELDING	4-12
<input type="checkbox"/> REFRIGERATION	13 1/2
<input type="checkbox"/> AIR CONDITIONING	8 1/3
<input type="checkbox"/> MACHINIST TRADE	30
<input type="checkbox"/> ADVANCED MACHINIST (includes tool & die)	32 1/2
<input type="checkbox"/> PIANO TUNING & REPAIR	36

CHOOSE YOUR ENGINEERING COURSE

These courses are intended as terminal education for men who wish to enter the Diesel-Automotive and Refrigeration-Air Conditioning fields as technicians. These courses are designed to prepare men for supervisory positions. Students with a high school education, or equivalent, will be accepted.

<input type="checkbox"/> DIESEL AUTOMOTIVE ENGINEERING	2 years
<input type="checkbox"/> REFRIGERATION & AIR COND. ENGINEERING	18 months

FREE EMPLOYMENT HELP

Start your career with Greer by checking your interest above and mail coupon for complete information at no obligation.

NAME _____ AGE _____

STREET _____

TOWN _____ ZONE _____ STATE _____

Established 1902 — Over 50,000 Graduates.

54 years of continuous trade school experience to guide your training.

GREER SHOP TRAINING

Box F, 2236 S. Michigan Ave.
Chicago 16, Illinois

GET UP AND GO WITH A

TRIUMPH

FUN! INDEPENDENCE!

ECONOMY! Go where you want to go, do what you want to do. Be independent. Have more fun! Enjoy the thrill of motorcycling at its BEST with a gleaming, precision-made Triumph! Easy to ride . . . exciting to own . . . real economy, too—60 to 90 miles and up per gallon. Triumph's two-level cushion seat means real comfort for two! Priced surprisingly low, with easy terms available. See your nearest Triumph dealer for a free demonstration. He will teach you to ride.



RUSH THIS COUPON to nearest address below. Dept. P
THE TRIUMPH CORP. JOHNSON MOTORS, INC.
 Towson, Baltimore 4, Maryland 267 W. Colorado St.
 Pasadena 1, Calif.

Send me absolutely FREE the 1956 Triumph Motorcycle catalogue in full color. If under 16 years of age, check square for special pictures.

NAME _____
 ADDRESS _____
 PHONE _____

Superior's New Model 70 UTILITY TESTER FOR REPAIRING ALL ELECTRICAL APPLIANCES MOTORS • AUTOMOBILES • TV TUBES

As an electrical trouble shooter the Model 70:

- Measures A.C. and D.C. Voltages, A.C. and D.C. Current, Resistances, Leakage, etc.
- Will measure current consumption while the appliance under test is in operation.
- Incorporates a sensitive direct-reading resistance range which will measure all resistances commonly used in electrical appliances, motors, etc.
- Leakage detecting circuit will indicate continuity from zero ohms to 5 megohms (3,000,000 ohms).
- Will test toasters, irons, Broilers, Heating Pads, Clocks, Fans, Vacuum Cleaners, Refrigerators, Lamps, Fluorescents, Fans, Switches, Thermostats, etc.
- Will test all TV tubes for open filaments, inter-element shorts, burned out tubes, etc.



As an Automotive Tester the Model 70 will test:

- Both 6 Volt and 12 Volt Storage Batteries • Generators • Starters • Distributors • Ignition Coils • Regulators • Relays • Circuit Breakers • Cigarette Lighters • Stop Lights • Condensers • Directional Signal Systems • All Lamps and Bulbs • Fuses • Heating Systems • Horns • Also will locate poor grounds, breaks in wiring, poor connections, etc.

Handsome round-cornered molded bakelite case, 3 1/4" x 5 1/4" x 3 1/4". Complete with all test leads. Also included is a 64 page book giving detailed instructions for testing all electrical appliances, automotive equipment, TV tubes, etc. Only **15⁹⁵**

SHIPPED ON APPROVAL NO MONEY WITH ORDER — NO C. O. D.

Try it for 10 days before you buy. If completely satisfied then send \$3.85 and pay balance at rate of \$4.00 per month for 3 months — No Interest or Finance Charges Added! If not completely satisfied, return to us, no explanation necessary.

All prices net, F.O.B., N.Y.C.
MOSS ELECTRONIC DIST. CO., Inc.
 Dept. D-239, 3849 Tenth Ave., N.Y. 34, N.Y.
 Please rush 1 Model 70. I agree to pay \$3.85 within 10 days after receipt and \$4.00 per month thereafter.
 Name _____
 Address _____
 City _____ State _____

BAITLESS LURE

CHARMS FISH



Draws all kinds for the fastest biting you ever saw. Special combination hooks and brilliant red imitation meat bait saturated with newly discovered attractor makes Baitless Lure the gem of them all. Be the envy of your friends. Send only a dollar for this thrilling combination postpaid and enjoy fishing as you never have before. Satisfaction assured.

combination postpaid and enjoy fishing as you never have before. Satisfaction assured.

BAITLESS LURE CO.

P. O. Box 1369 PM-656 Glendale, Calif.

OWN a Business



If employed, start part time. Alert dealers can gross \$5 hourly profit on own service plus \$3 on EACH serviceman. Clean, revive, moth-proof rugs & upholstery on location. No shop needed. Services nationally advertised. Repeat customers. Easy to learn. We locally train and assist you. Quickly established. Easy terms. Send today for FREE booklet. No obligation.

DURACLEAN CO., 6-166 Duraclean Bldg., Deerfield, Ill.

BUILD YOUR OWN AIR CONDITIONERS

From Junked Refrigerators for a Few Dollars INSTRUCTION BOOKS SHOW YOU HOW... 75c EACH

- "HOW TO BUILD a Low Cost Air Conditioner"
 - "HOW TO BUILD an Automobile Air Conditioner"
 - "HOW TO BUILD a Low Cost Home Freezer"
 - "HOW TO BUILD an Electrostatic Precipitator"
 - "HOW TO BUILD a Low Cost Dehumidifier"
- Complete "Install-It-Yourself" Air Conditioner kits for home and automobile, 2 Ton capacity. Brand New Parts—\$124.40 and up.

SPECIAL OFFER
 2 Books—\$1.00
 3 Books—\$1.50
 or all 5 for \$2.00

FREE!
 Instructions and Literature on kits.

KOOL ENGINEERING CO., Dept. W-6, 3716 Belmont, Chicago 18, Ill.

Write Like This

YOUR penmanship can be improved in 3 hours or corrected to your satisfaction in 10 hours' practice with my **DEFINITE HAND CONTROLS**. New way!

WRITE **OZMENT** BOX 665 34-P, ST. LOUIS, MISSOURI

Complete OUTLINE FREE!

Learn ACCOUNTING Business Administration

Bookkeeping, secretarial and allied subjects at home in your spare time or attend nationally approved resident school. Write for FREE Success Book giving complete details on courses, plans, rates and employment opportunities. G.I. approved. Write Dept. A.

Hills BUSINESS UNIVERSITY AND EXTENSION SCHOOL
 619 W. MAIN ST. OKLAHOMA CITY 2, OKLAHOMA



ELECTRIFY YOUR SEWING MACHINE! NEW LOW PRICE!

Buy direct and saved! Kit comes fully wired, installed in a jiffy. Fits all machines. ALL-NEW PARTS! **\$9.95 90 DAY Guarantee**

- AC-DC Motor & bracket
 - Multi-speed foot control
 - Cord set & block
 - 11 1/2 x 60 c
 - Full instructions
 - Steel pulley & belt
- BONUS: 10 day free trial. Reg. \$2.95 Sewlite given FREE with kit. Reg. \$7.99 plinking shears only \$1 with order. Send no money. Kit sent U.O.D. Or send money order and we'll pay postage. State whether wheel on your machine turns towards or away from you. Shipping wt. 6 lbs.

SENIOR SEWING MACHINE CO., Box 142, Dept. PM08, Bklyn 6, N. Y.

FREE AMAZING NEW BOOK "HOW TO ANSWER ADS"



Never before have you seen anything like this. Tells you in simple language the correct way to answer ads. Gets you quicker replies—better results, and greater satisfaction. Will save you time and money and it's **ABSOLUTELY FREE**. No obligation whatever. Every reader of advertising should have this booklet. Send a postcard for your copy NOW. F. W. Johnson, Popular Mechanics Magazine, Room 600-A, 204 East Ontario Street, Chicago 11, Illinois.



MEN! TRAIN NOW FOR
A BIG PAY FUTURE IN
DIESEL
& SCIENTIFIC MOTOR TUNE-UP

- Diesel Construction
- Diesel Engine Repairman
- Diesel Operator
- Industrial Maintenance
- Auto Engine Rebuilding
- Bus & Truck Maintenance

Go places with **DIESEL!** Farms, factories and power plants, trains, ships, trucks, busses all use **DIESEL POWER**. . . all need **DIESEL-trained men!** You can start your **DIESEL** training at home, in spare time, with tested, proved U E I training. Course includes practical work on Diesel engines under skilled instructors. You learn the operation, maintenance servicing of all types of Diesel engines. **PLUS** Scientific Motor Tune-up. **ACT NOW!** If you have mechanical ability, diploma not necessary. Write now for **Free Book** "EARNING POWER in DIESEL." Act Today!

UTILITIES ENGINEERING INSTITUTE

2521 Sheffield Ave., Dept. DC-57, Chicago 14, Ill. (Founded 1927)

Stamp Collectors
SENSATIONAL
MONACO WEDDING



Have You Seen Grace? Grace Kelly-Prince Rainier Wedding Issue Complete Set of postage is yours, included in Monaco Collection with Giant Historical Set portraying Washington, Lincoln, Roosevelt & Eisenhower including Diamond shaped stamps, Triangles, Saints & Princes. All together with a 48 Page Stamp Dictionary for only 25c to introduce our bargain approvals. **STAMPEX CO., P.O. Box 47-AM, White Plains, N. Y.**

Complete set & more
Only
25c

WHEELS WHEELS WHEELS

7" Disc Wheel 3/4" Tire 3/4" sleeve	45c ea.
8" Disc Wheel 1 1/8" Tire 1 1/2" sleeve	70c ea.
7" Disc Wheel 1" Tire 1 1/2" ball bearing	80c ea.
8" Disc Wheel 1 1/8" Tire 1 1/2" ball bearing	\$1.00 ea.
6" Disc Wheel 1.50 semi-pneum. Tire 1 1/2" S.B.	\$1.35 ea.
8" Disc Wheel 2" semi-pneum. T. 1 1/2" S.B.	\$1.50 ea.
10" Disc Wheel 1.75 semi-pneum. T. 1 1/2" S.B.	\$1.50 ea.
10" Disc Wheel 2.75 semi-pneum. Tire 1 1/2" S.B.	\$3.50 ea.
12" Disc Wheel 1.75 semi-pneum. T. 1 1/2" S.B.	\$1.85 ea.

Above wheel prices include hub cap. Plus Postage. C.O.D.'s accepted. AXLES—Sizes 5/16 in., 3/8 in., 1/2 in.—Cut to size—End holes drilled.

UNITED WHEEL STAMPING CO.
12131 S. PEORIA STREET PM-6 CHICAGO 43, ILLINOIS

GIANT FREE CATALOG of OPTICAL BARGAINS



ASTRONOMICAL TELESCOPE HEADQUARTERS
Complete Line of Astronomical Telescope Parts and Assembled Telescopes. Also huge selection of lenses, prisms, war surplus optical instruments, parts and accessories, Telescopes, microscopes, binoculars, etc. Fresnel Lenses for making Solar Furnace. **SEND ONLY \$1.00** for beginner's 10-lens kit and big instruction booklet Stock 2-H. Ask for **FREE** catalog H.

EDMUND SCIENTIFIC CORP., Barrington, N. J., U.S.A.

CABINET MAKING

LOW COST HOME TRAINING COURSE FOR BEGINNERS & ADVANCED CRAFTSMEN

Make money. Learn skills and secrets of fine woodworking and tool use. Professionally prepared shop method training tells and shows how. Covers everything. Easy to master.

INTERSTATE TRAINING SERVICE
DEPT. F3, PORTLAND 13, OREGON

RUPTURED? Write for New Relief FACTS **FREE!**

ENJOY NEW FREEDOM
of action, peace of mind and comfort at work or play. Proven, patented **MILLER** holds your rupture back Day & Night—will bring you lasting relief! Has helped thousands of others! For **FREE** facts in plain wrapper—

Send Name and Address to
FRED B. MILLER, Manufacturer
DEPT. 1F, HAGERSTOWN, MARYLAND



ENTIRELY DIFFERENT

WHAT ALL AUTO MECHANICS WANT TO KNOW

1664 PAGES



This Big Practical Book gives full information with working diagrams covering the principles, construction, ignition, service and repair of modern cars, trucks and buses.

Diesel Engines, Hydramatic & Fluid Drives Fully Explained.

A complete Guide of 1664 pages, with over 1500 illustrations showing inside views of working parts, with instructions for service jobs.

IT PAYS TO KNOW

How to fit pistons—How to locate engine knocks, How to fit connecting rod bearings—How to service main bearings—How to recondition valves—How to time valves—How to adjust fan belts—How to adjust carburetors and chokes, How

to rebuild a clutch—How to service automatic transmissions—How to service brakes—How to adjust steering gear—How to cope with ignition troubles—How to service distributors—How to time ignition—How to "tune up" an engine.



\$4 COMPLETE • PAY \$1 A MO.
TO GET THIS ASSISTANCE FOR YOURSELF SIMPLY FILL IN AND MAIL COUPON TODAY.

Step up your own skill with the facts and figures of your trade. **Audel's Mechanics Guides** contain Practical Inside Trade Information in a Handy Form. Fully illustrated and Easy to Understand. Highly Endorsed. Check the book you want for 7 DAYS **FREE EXAMINATION**. Send No Money. Nothing to pay postman.

MAIL ORDER



Check NOW!

You Can Look Over Any Guide In Your Own Home — Start the Easy Payments If Satisfied

AUDEL, Publishers, 49 W. 23 St., NEW YORK 10, N. Y.
Please send me for **FREE EXAMINATION** books marked x below. If I decide to keep them I agree to mail \$1 in 7 Days on each book or set ordered and further mail \$3 monthly on each book or set until I have paid price, otherwise I will return them.

- AUTOMOBILE MECHANICS GUIDE, 1664 Pages. \$4
- TRUCK & TRACTOR GUIDE, 1299 Pages . . . 4
- DIESEL ENGINE MANUAL, 575 Pages . . . 2
- MACHINISTS HANDY BOOK, 1650 Pages . . . 4
- WELDERS GUIDE, 400 Pages . . . 1
- BLUE PRINT READING, 416 Pages . . . 2
- MATHEMATICS & CALCULATIONS, 700 Pages. 2
- SHEET METAL PATTERN LAYOUTS, 1100 Pages 4
- SHEET METAL WORKERS HANDY BOOK, 388 Pgs. 1
- MECHANICAL DRAWING GUIDE, 160 Pages . . . 1
- MECHANICAL DRAWING & DESIGN, 480 Pages 2
- AIRCRAFT WORKER, 240 Pages . . . 1
- TELEVISION SERVICE MANUAL, 434 Pages . . . 2
- RADIODIAGNOSIS GUIDE, 1040 Pages . . . 4
- ELECTRONIC DEVICES, 216 Pages . . . 2
- ELECTRIC MOTOR GUIDE, 1000 Pages . . . 4
- WIRING DIAGRAMS (Light & Power), 272 Pgs. 1
- ELECTRICIANS EXAMINATIONS, 250 Pages . . . 1
- ELECTRIC POWER CALCULATIONS, 425 Pages. 2
- HANDY BOOK OF ELECTRICITY, 1440 Pages. . . 4
- ELECTRIC DICTIONARY, 9000 Terms . . . 2
- ELECTRIC LIBRARY, 7000 Pages (12 Book Set) 18
- SHIPFITTERS HANDY BOOK, 250 Pages . . . 1
- REFRIGERATION & Air Conditioning, 1280 Pgs. 4
- MILLWRIGHTS & MECHANICS GUIDE, 1200 Pgs. 4
- POWER PLANT ENGINEERS GUIDE, 1500 Pages 4
- ENGINEERS & FIREMANS EXAMS, 525 Pages . . . 1
- PUMPS, Hydraulics & Air Compressors, 1658 Pgs. 4
- OPERATING ENGINEERS LIBRARY (3 Books) . . . 9
- MECHANICAL DICTIONARY, 550 Pages . . . 4
- GARDENERS & GROWERS GUIDES (4 Book Set) 6
- CARPENTERS & BUILDERS GUIDES (4 Book Set) 6
- PLUMBERS & Steamfitters Guides (4 Book Set) 6
- MASONS AND BUILDERS GUIDES (4 Book Set) 6
- PAINTERS & DECORATORS MANUAL, 450 Pgs. 2
- HOUSE HEATING GUIDE, 1000 Pages . . . 4
- OIL BURNER GUIDE, 384 Pages . . . 1
- HOME APPLIANCE SERVICE GUIDE, 800 Pages 4

MAIL THIS TODAY

Name _____
Address _____
Occupation _____
Employed by _____

P6



YOUR RIFLE CAN BE TWICE AS ACCURATE

Open rear sights cut the accuracy of modern guns and ammunition *in half*. Lyman precision receiver sights deliver *all the accuracy* built into your rifle.

SPECIFY LYMAN SIGHTS With a receiver and front sight combination for all popular rifles, you can have Lyman Sights for your gun for as little as \$6.50. You can't buy more accuracy at any price!

FREE CATALOG Discover how you can double your shooting accuracy. Send for free, full-color 24-page catalog. Describes all Lyman Products for Shooters.

THE LYMAN GUN SIGHT CORP.
MIDDLEFIELD • CONNECTICUT

CHEMISTRY

BIG LABORATORY GIVEN FREE!

Be a **CHEMIST!** One of the really **GREAT** professions! We teach you at home. Simplified (but thorough) course; no previous training required. Earn while you learn. This is a **GOLDEN AGE** for those with special knowledge! Diploma awarded! Send 25c for first lesson and KIT or \$1.00 for first 5 lessons and supplies including

FREE!

URANIUM TESTER, CHEMICAL PUZZLE (worth \$2.50) and HOW TO MAKE 100 NEW CHEMICALS!

NATIONAL SCHOOL OF CHEMISTRY

P.O. BOX 606-A

REDWOOD CITY, CALIF.

**WHOLESALE
CATALOG
Big Discounts!**

Buy direct from manufacturers and **SAVE**. Over 800,000 items at deep-cut prices. Many nationally advertised brands! Start a buying service at home. Make big profits operating your own Discount House. Free confidential information—mail postcard today.

R. GLASS PUBLISHING CO., Ellwood City 2, Penna.

Learn All About Cars!

**AUTO MECHANICS — AUTOMATIC TRANSMISSIONS
ACETYLENE AND ARC WELDING
BODY AND FENDER REPAIR**

Day-Night School 30 Years in the Same Location

WOLVERINE SCHOOL OF TRADES

Approved Under the G.I. Bill of Rights by the State Board of Education

WOLVERINE SCHOOL OF TRADES, Dept. PM
1400 West Fort St., Detroit 16, Mich.

Name _____

Address _____

City _____ State _____

below) which are used to turn his head and operate his arm. Inside his head are located two electric tuning eyes, a relay for operating his lower jaw in synchronism with his voice, a microphone and several other items.

The robot is controlled from a remote panel, which can be located up to 50 feet from the robot. A hidden hearing-aid microphone in its forehead keeps the operator in touch with all that goes on around the robot, and enables the operator to carry on a conversation with anyone through the robot's "voice."

Kaligah's eyes are radio-tuning eyes (Type 6AF6) and the iris operates with the voice. His lower jaw is hinged and is operated with a relay in perfect synchronism with the voice. His head turns to face whoever he is speaking to and he extends his right arm to hand the person a pamphlet or shake hands.

A tape recorder can be plugged into the remote-control panel and any kind of program may be played through the robot.

Kaligah has been used in all kinds of advertising stunts and he always attracts a crowd.

T. L. Kidd,
Kingsburg, Calif.





Instead of a job . . . train for a Career



Industrial growth . . . automation . . . technical advances create career opportunities for engineers, accountants, management experts. Share rewards awaiting college-trained men. Important firms visit campus regularly to employ Tri-State College graduates. Start any quarter in this world-famed college. *Approved for veterans.*

Bach. of Science degree in 27 months

In Mechanical, Civil, Electrical, Chemical, Aeronautical, Radio (TV-Electronics) Engineering. In 18 Months a B.S. in Business Administration (General Business, Accounting, Motor Transport Management majors). Capable students may accelerate. 36-weeks course in Drafting. *Intensive program: technical fundamentals stressed; comprehensive courses with more professional class hours. Small classes: personalized instruction.* For earnest, mature students whose time and budget requires accelerated courses and modest costs. Preparatory courses. *Beautiful campus in friendly college town. Well-equipped, new and modernized buildings and laboratories. Enter June, Sept., Jan., March.* Write Jean McCarthy, Director of Admissions, for "Your Career in Engineering and Commerce."



TRI-STATE COLLEGE

466 College Avenue

Angola, Indiana

"WE'RE LOOKING FOR PEOPLE

WHO LIKE TO DRAW" . . . says Norman Rockwell, one of America's 12 Most Famous Artists. If you like to draw, you may have talent to become a successful artist, spare or full time. Find out for sure with our scientific, 8-page **Free Art Talent Test**. Thousands paid \$1 to take it. Get it FREE. No obligation. Send your name, address, age to: Famous Artists Schools, Dept. 6-F, Westport, Conn.



MAKE TREMENDOUS PROFITS

Have fun! Earn Big Money! Cast plaster figurines, bookends, plaques, novelties at home in your spare time with X.L. rubber molds! NO EXPERIENCE NEEDED! Models and rubber for 3 molds, only \$1.50 ppd. Send 25c (refunded with order) for 40 page catalog now!

PLASTIC ARTS STUDIO 3403 SO. MADISON, DEPT. PM2 MUNCIE, INDIANA

GROW WITHOUT SOIL

You can grow vegetables, flowers or rare plants without soil (HYDROPONICS) every day of the year. Start this fast, clean EASY way to grow any plant for fun or PROFIT now. Big returns from small space. Send postcard today for FREE picture book showing how others from every state are succeeding in this new wide open field.

GILBERT CO. BOX 56, 525 SPRUCE STREET SAN DIEGO 3, CALIFORNIA

SAY YOU SAW IT IN POPULAR MECHANICS

Foolish To Pay More—Dangerous To Pay Less!

One look will prove they're more than worth the difference. Entire stock of our family-safe Top Grade, 40,000 mile Passenger Tires, (worn very slightly) at **PRICES LISTED BELOW!** It's cheaper than offers of \$1 off or "Free Tire Offers" on ordinary used tires. "The Blatt Name famous in tires for 40 Years—I don't just repair it, I offer a free fast REPLACEMENT guarantee on ANY defective tire within 12 months." Frt. Excl. **CHOOSE YOUR FAVORITE BRAND. Not Recaps or Retreads.**

GOOD YEAR **Firestone**

U.S. Goodrich, General, Atlas, Lee & others. **FREE** This pictured tire ash tray given with 2 or more tires!

12 MONTH TIRE GUAR. & FREE FACTORY-TESTED TUBE

800-16	\$5.28	670-15	\$5.18	700-17	\$9.98	600-16(6)	\$5.68
850-16	5.68	710-15	5.38	700-20	8.98	650-16(6)	6.48
700-16	5.78	760-15	5.38	750-20	9.88	700-16(6)	7.08
640-15	4.88	800-15	5.68	825-20	16.58	700-15(6)	7.88
700-15	4.98	820-15	5.68	900-20	15.58	650-20	8.98
475-19	5.38	850-17	5.38	1000-20	17.28	750-16	7.58
				1100-20	17.28	750-17	12.98

WHITEWALLS \$1.00 EXTRA

MARVIN BLATT & Spring Garden Sts. Philadelphia, Pa. **MILITARY MUD-GRIP TIRES**
AA Guar. 6 Mos. AAA 12 Months
900-16 \$9.58 900-18 \$13.98
750-20 10.58 750-20 17.98

Send Check or M.O. & this ad for fast shipment. FOB Phila. I personally select your tires—as if my future depended on it. Read that top line again.

free!

1956

ALLIED

ELECTRONIC
SUPPLY
CATALOG

324
value-packed
pages

Save on Everything
in TV and Radio
Parts & Equipment

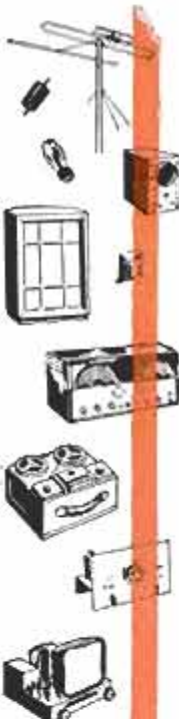
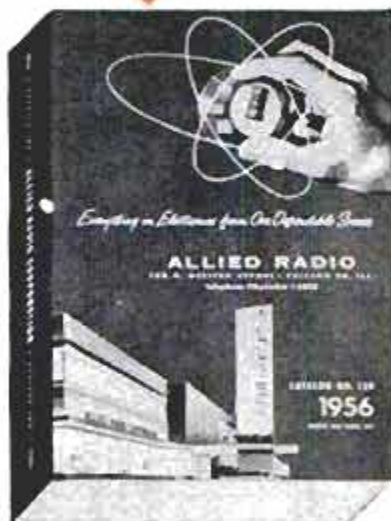

Everything for Experimenters,
Builders, Amateurs, Servicemen,
Engineers & Hi-Fi Specialists

Send for ALLIED's big 324-page value-packed guide to *everything* in TV, Radio and Electronics! Select from the world's largest stocks of High Fidelity systems and components; recorders and phono equipment; TV tubes, antennas and accessories; Amateur station equipment and supplies; P.A. systems; test instruments; latest build-your-own kits; industrial electronic supplies—plus *everything* in electronic parts, tubes, transistors, tools and books. Save on everything in Electronics—send today for your FREE 1956 ALLIED Catalog.

Everything in Electronics
From One Reliable Source

send for it

FREE
CATALOG

ALLIED RADIO

ALLIED RADIO CORP., Dept. 5-F-6
100 N. Western Ave., Chicago 80, Ill.

Rush FREE 1956 ALLIED 324-Page Catalog

Name _____

Address _____

City _____ Zone _____ State _____

New Tiny Pocket Radio

Listen in
Secret
\$2.98

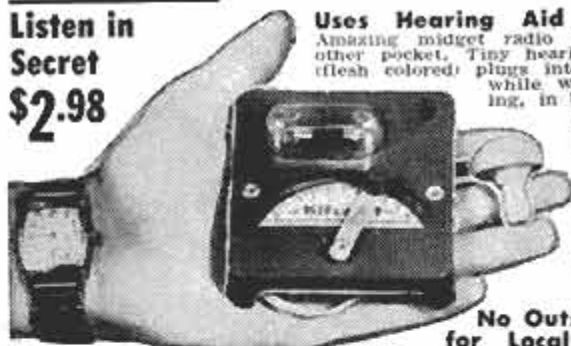

Uses Hearing Aid Earphone
Amazingly tiny radio fits shirt or other pocket. Tiny hearing-aid phone (flesh colored) plugs into ear. Listen while working, playing, in bed. Sleep to music. Hear ball games, news, stories.

**No Tubes!
No Batteries!
New Diode Rectifier!**

No Outside Aerial for Local Stations!

Germanium diode rectifier. Self-powered miracle element takes place of tube in usual radio. No electricity. No expense. Plays day & night forever. Never wears out. Dial tuner covers complete broadcast band.

Complete! Ready for Use! No Building!

Nothing to assemble or build. Beautiful red plastic case about size of cigarette package. To operate connect phone. For local reception, a pipe, telephone, certain metal objects, fence, etc. acts as aerial. Long distance reception also. Money back guarantee. Midget Radio (without phone) \$2.98 Postpaid. Imported Hearing-Aid Phone (Fits Ear) \$1.98 Postpaid. Regular Phone \$1.25 Postpaid. Send orders to:

Johnson Smith Company, Dept. 317, Detroit 7, Michigan

Catalog of 3100 Novelties 10c



Send 10c for amazing catalog of novelties, live animals, scientific supplies, hobbies, funmakers, planes & boats, looms, magic tricks, joke articles, unusual seeds, gadget timesavers, cameras, optical goods, projectors, movies, lucky jewelry, religious novelties, disguises, musical instruments, stamps, coins, puzzles, fortune tellers, radios, auto & bike accessories, telescopes, magnifiers, compasses, banks, smokers' gadgets, artists' supplies, printing sets, engines, motors, shavers, knives, billfolds, guns, rifles, sports, books, games, plants, etc. Send 10c (3 for 25c—get for friends!).

JOHNSON SMITH & CO. Dept. 317 Detroit 7, Michigan

10-Foot BULL WHIP



HARD HITTING! LOUD CRACKING! Experts knock ashes off cigarettes. Yank people off feet. Used by trainers, ranchmen. Loud cracker like shot-gun blast. 4-ply hand plaited all leather. With loop handle.

6-ft. whip \$1.98. 8-ft. \$2.69. 10-ft. \$3.29 Postpaid

Johnson Smith Company, Dept. 317, Detroit 7, Mich.

Say You Saw It in Popular Mechanics

CAVITEX

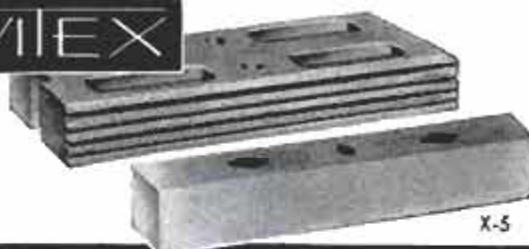

Superfine
Masonry

X-5

Manufacturing Rights Now Available in 427 Territories

Cavitex offers building owners the ultimate in masonry at sensationally low costs. Designed in line with today's architecture. Long and low. Large color range. Modular in all dimensions. Strong—safe—enduring. Suited to all types of wall construction—8" solid, cavity, partition, veneer.

As a local manufacturing opportunity, Cavitex has tremendous potentials. Local materials are processed by local labor for local consumption. Vast economies effected. That's why Cavitex has price-appeal to buyers and profit-appeal to producers. Hundreds of territories are open.

Cavitex manufacturers operate in franchise-protected territories and with exclusive privileges. Extensive sponsor cooperation. Basic machinery available on lease. Write or wire for book "Opportunity, Unlimited" and tentative reservation of territory.

W. E. DUNN MFG. CO.
409 W. 24th St., Holland, Mich.
In Canada
Dunn Masonry Machinery, Ltd.
844 Dundas Highway
Cooksville, Ontario

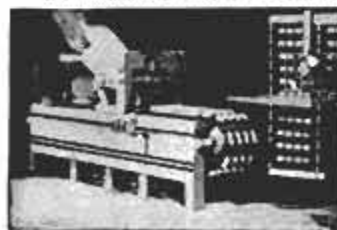

INVENTORS

PROTECT YOUR INVENTION BY A U. S. PATENT. SEND FOR FREE "INVENTION RECORD" FORM AND "PATENT INFORMATION EVERY INVENTOR SHOULD HAVE".

CARL MILLER
REGISTERED PATENT ATTORNEY

WOOLWORTH BLDG., 35th FLOOR, 66A
NEW YORK CITY

INVENTORS

Whether an invention is patentable can be substantially determined by a search of the U. S. Patent records. Without obligation, write for information explaining the steps you should take to secure a patent.

JOHN N. RANDOLPH

Registered Patent Attorney

201 Columbian Building, Washington 1, D. C.



PATENTS

C. A. SNOW & CO.

REGISTERED PATENT ATTORNEYS

WRITE FOR INFORMATION TO
428 SNOW BUILDING, WASHINGTON 1, D. C.

INVENTORS

Send for
PATENT INFORMATION
Book and
INVENTOR'S RECORD
without obligation

GUSTAVE MILLER
66-PM WARNER BUILDING
WASHINGTON 4, D. C.

REGISTERED PATENT ATTORNEY

ASSOCIATE EXAMINER
U. S. PAT. OFF. 1922-1929
Patent Attorney & Advisor
U. S. NAVY DEPT. 1930-1947
PATENT LAWYER

CASH IN ON YOUR IDEAS

EXPERT, PROFESSIONAL ASSISTANCE FOR INVENTORS AND IDEA MEN WHO NEED HELP IN GETTING IDEAS INTO PRODUCTION. LOW FEES, FREE DETAILS.

National Institute of Design and Invention
P.O. BOX 1272 SAN MATEO, CALIFORNIA

INVENTIONS For Sale

Our clients have excellent inventions in many fields to be manufactured and marketed on a cash, royalty or license basis. Full description of clients' inventions will be sent if you state your field of interest. **INVENTORS: WE ALSO WANT INVENTIONS OF EVERY TYPE.** Write for details.

GLOBAL MARKETING SERVICE
2420 77th Avenue Dept. M5 Oakland 5, Calif.

INVENTORS

I shall be pleased to furnish you, upon request, with full information relative to patent procedure—without any obligation on your part.

PATRICK D. BEAVERS

Registered Patent Attorney

934 Columbian Building Washington 1, D. C.

THIS TANK HOLDS

**4,538 TROPICAL FISH
WORTH \$2,456⁶⁵!**

WOW!

-AND YOU BREED
THEM IN YOUR SPARE
TIME - IN YOUR HOME



YES BOB, I BREED THEM
IN MY BACK PORCH. THEY
ALMOST SELL THEMSELVES.
TOO, BELIEVE ME
THE 'BOOM'
HAS STARTED

DID IT COST
YOU MUCH
TO START?

NO - ONLY A FEW DOLLARS,
A LITTLE SPACE AND MY SPARE
TIME AND THE LITTLE KNOWN
BREEDING SECRETS ARE
ALL YOU NEED TO START. IF
YOU'RE INTERESTED - LEARN
THE FACTS TODAY! - THE
'BIG BOOM' HAS STARTED
SO CASH IN ON IT
NOW!

If you have a little space in a SPARE ROOM, PORCH, BASEMENT, GARAGE ... ANYWHERE. Investigate this "chance of a lifetime" opportunity of breeding rare tropical fish for profit. The tropical fish "BOOM" IS JUST BEGINNING and here's your opportunity to cash in on it now. Experts estimate \$780 MILLION DOLLARS will be spent on tropical fish within next ten years. Investigate now - Rush coupon below.

Join others that are saying:
"Business prospects amazing." J.
K., Ga. "Dealers want all I can
breed." J. P., Ore. "Pays off large
dividends." R. D., N. Y., etc.

1 and 2 FREE!
(BOTH)

MAIL THIS
COUPON
BELOW
TODAY!

SOME TROPICAL FISH LAY TO 600 EGGS AT A TIME. That's why tropical fish breeding is so profitable. Nature multiplies your \$\$.

This advertisement is an
URGENT APPEAL OPPORTUNITY
Orders backlogged in many areas. RUSH coupon NOW!

15121 S. Broadway
Los Angeles 61, Cal.

Tropical Fish Breeders of America, Dept. D-6
15121 S. Broadway, Los Angeles 61, Calif.
Please Rush FREE COLORFUL BOOKLET and amazing VUER-PROJECTOR KIT details to me. Both Free! Sending for these does not obligate me in any way.

Name _____ Age _____
Address _____
City _____ Zone _____ State _____

STUDY INDUSTRIAL DESIGN

You can train at Art Center School in California with practicing professionals for upper-level jobs in INDUSTRIAL DESIGN. Recent graduates have been added to the staff at General Motors, Chrysler, Raymond Loewy, Henry Dreyfuss, etc. Majors in transportation, general product design, structures, community development, packaging, display, 4-year degree courses. Learn to combine imaginative design with technical proficiency, coordinate utility and beauty. Stimulating environment. Field trips. Advantages of mild Southern California climate and nearby holiday spots. Accredited. Coed. Placement service. Established 25 years. New terms February, June, September. Catalog.

ART CENTER SCHOOL, Edward M. Adams, Director
5353 WEST THIRD STREET, LOS ANGELES 5, CALIFORNIA

RADIO Engineering. All phases radio & electronics theory & practice; television; FM; broadcasting; servicing; aviation, marine & police radio. Prepare for good pay; 18-month course. Graduates in demand by major companies. Enter Jan., March, June, Sept. Regular campus life. Write for catalog.
VALPARAISO TECHNICAL INSTITUTE, Dept. D, Valparaiso, Ind.



... Swiss or American
Unique Sweazy System starts you making repairs right away. Develops your skill step-by-step. Teaches modern methods... professional short cuts. Learn by personal attendance or spare time home study. Approved for veterans. Free Sample Lesson. No obligation. Write today!
CHICAGO SCHOOL OF WATCHMAKING
2330 Milwaukee, Dept. 166, Chicago 47, Ill.

I'll Send You This Handsome SAMPLE CASE - FREE



and Show You How to Make
Up to \$30.00 in a Day

Mail coupon for this Free Tailoring Sample Case packed with 150 beautiful, big-value suit and overcoat fabrics. Take orders from friends, fellow-workers, others, for fine quality, made-to-measure clothes. Pocket big cash profits in advance. Because wearing our suits and overcoats brings more orders, we make it easy for you to get your own clothes without 1c cost. No experience is needed. **SATISFACTION GUARANTEED. SEND NO MONEY.** Just fill out and mail coupon - today!

**PIONEER TAILORING COMPANY, Dept. T-1116
CONGRESS & THROOP STREETS - CHICAGO 7, ILLINOIS**

**PIONEER TAILORING CO., Dept. T-1116
Congress & Throop Sts., Chicago 7, Ill.**

Dear Sir: I WANT A MADE-TO-MEASURE SUIT TO WEAR AND SHOW, without paying 1c for it. Rush details and Sample Kit of actual fabrics, ABSOLUTELY FREE.

NAME _____ AGE _____

ADDRESS _____

CITY _____ STATE _____

HUNTERS! CONFISCATED RUSSIAN RIFLES \$14.95



**RUSSIAN RIFLE
AMMUNITION FREE**

20 rounds full jacketed ammo included with each rifle purchase. Additional cartridges: \$7.50 per 100 rds. This ammo is for the Russian Moisin 7.62 MM, and also for the Moisin Nogant. We also now have 7.62 MM softnose hunting ammo., 150 gr. for deer, bear and No. Amer. big game. 20 rds. \$2.95.

GOLDEN STATE ARMS CORPORATION
155 ARMORY BLDG., 1165 E. Colorado St., Posadero, Calif.

This is the late Russian Model 7.62 MM Moisin Rifle, appr. 30" barrel. Mechanically perfect. Outside: good. Bore: fair. Ballistics: 2820 FPS with 150 grain bullet. Ammunition available everywhere in U.S., an excellent hunting cartridge. Hinged floor plate. Russian ordnance marks on receiver. The Russians won the International Meet in Venezuela (1954) with this model rifle. These guns were confiscated from Communist revolutionaries and placed on the free world market. They are of the type used by Red Chinese in Korea. The sale of these guns in no way aids any country behind the iron curtain. A Once-In-A-Lifetime collector's item. This is the lowest price we have ever seen which would allow a man to equip himself for big game hunting. For C.O.D. send \$5 deposit. Calif. residents add 4% state tax.

DIESEL Heavy Equipment

Men now being selected for Training!



You may qualify to be trained in the Tractor and Heavy Equipment industry which offers high pay positions for trained men. If you are mechanically inclined . . . reliable . . . if you are not now making \$125 per week, you owe it to yourself to write for free facts, without obligation, about this training and our placement advisory service. Remember, trained men are needed in this industry. Fill in the information below or write us about your background or qualifications immediately.

MAIL COUPON TODAY!

TRACTOR TRAINING SERVICE
DEPT. PM-3, 1525 E. 53rd, CHICAGO, ILLINOIS

Please rush me full information about opportunities in the Diesel field.

Name _____ Age _____

Address _____

City & State _____

PREPARE FOR THE BEST JOBS

TRAIN at HOME
IN YOUR SPARE TIME
or at
ALLIED INSTITUTE
in Chicago

- MECH. ENGINEER
- DRAFTSMAN
- TOOL DESIGNER
- TOOL ENGINEER
- TOOL & DIE MAKER
- MASTER MACHINIST

NO RECESSION FOR ALLIED TRAINED MEN

MORE JOBS THAN GRADUATES Shortages of Draftsmen, Designers, Tool Engineers, Machinists, Tool & Die Makers are so widespread that you can pick a highly paid key job and look forward to Achievement and Security.

You can begin your training in Short Courses and continue progressively to a Bachelor Degree in 26 months.

Allied is approved by Industry, Dept. of Education, Office of Public Instruction, State of Illinois, U.S. Veterans Admin., U. S. Dept. of Justice. Accredited: C. S. A.

SEND FOR
FREE
BOOKS

ALLIED SCHOOL of MECHANICAL TRADES
1338-42 South Michigan Ave. Dept. PM-6 Chicago 5, Illinois

SEND ME WITHOUT OBLIGATION INFO. ON YOUR COURSES:

HOME STUDY RESIDENT VETERAN NON VETERAN

NAME _____

ADDRESS _____ AGE _____

CITY _____ COUNTY _____ STATE _____

FULLY GUARANTEED TIRES COST LESS!

Nationally famous FIRESTONE, GOODRICH, U. S. ROYAL, GOODYEAR, and other makes. Every tire selected and inspected for your safety.

HIGH GRADE TIRES GUARANTEED 12 MONTHS		WHITE WALL TIRES \$1 EXTRA	
800x16 4.14	700x16 5.14	32x6(8) 8.84	825x20 14.24
850x16 4.54	670x15 4.74	32x6(10) 10.84	900x20 13.34
680x15 4.34	650x20 7.84	750x20(8) 8.54	1000x20 14.14
700x15 4.64	700x20(8) 8.94	750x20(10) 9.94	1100x20 16.14

AAA PREMIUM GRADE GUARANTEED 12 MONTHS		NEW TREAD GUAR. 12 MOS.	
550x15 5.48	700x15 5.98	760x15 5.58	750x20(10) 14.98
600x16 5.28	700x16 6.78	550x17 5.48	825x20 18.68
600x16(6) 6.58	700x16(6) 7.98	600x20 9.78	900x20 18.98
640x15 5.68	750x16(6) 6.98	650x20 10.88	1000x20 19.98
650x15 5.78	800x15 6.88	700x20 12.88	1000x22 21.98
650x16(6) 6.98	820x15 7.48	32x6(8) 10.48	1100x20 20.98
650x15 5.98	710x15 6.08	32x6(10) 12.48	1100x22 21.98
670x16 6.18	550x18 5.98	750x20(8) 12.98	1100x24 23.98

MILITARY SPECIAL AA Guaranteed 12 Months—
900x16 10.98 | 1000x20 19.98
750x20 10.98 | 1100x20 21.98

AAA GUARANTEED 12 MONTHS
900x16 14.98 • 750x20 16.48

Largest stock of used tires in the East. Thousands of satisfied customers. Write for Free Catalogue. MONEY ORDER OR CHECK WITH ORDER. NO C.O.D.'s

PYRAMID TIRE CO.
1333-35 North 8th St.
Dept. M., Phila. 22, Pa.



DOLLARS for 18¢?

Yes, buy U. S. \$1.00 values for 18¢ abroad. Get new, big profit mail order plan proved by 100,000 cash orders shipped from overseas. You carry no stock. Full or part time—even from home. Export and travel abroad opportunities too. Details with bargain import examples FREE. Write MELLINGER CO. Dept. F256 1717 Westwood, Los Angeles 24, Calif.

SAVE MONEY • FACTORY PRICED

OLYMPIC PRECISION BARBELLS

Satisfaction guaranteed. 50% down, balance C.O.D. Send check or money order today. Your best buy.

50 LB. SET \$7.95 Extra Weights 10c a lb.

PRODUCTS RESEARCH AND DEVELOPMENT CO.
DEPT. A., MARKET ST. NAT'L BANK BLDG. • PHILA. 7, PA.

GENUINE INCA CHINCHILLAS

Registered 86 to 92 stock 7A to 12A. \$75.00 a pair, \$100.00 colony. You can't make much money but can have lots of fun. Will buy your young. O. T. McBRIDE, 2203 Burbank, Richmond, California.

GROW ORCHIDS AT HOME

World's most thrilling hobby - profitable home business. Single Orchid plant may multiply into many—each as valuable as the first. Successful home grower shows you how! Raise gorgeous Cattleyas, Cymbidiums, Epidendrums, on living-room table. Big-profit orders come from friends, neighbors, florists, etc.—also Mail Orders. Illustrated secrets of the experts in simple "show-how" language AND blooming-size Orchid plants sent at NO RISK. Everything you need to start - for pleasure or profit. FREE - full details - SEND NO MONEY. Write today. TROPICAL FLOWERLAND, Dept. 316, 4622 Wilshire, Los Angeles 5, Calif.

SEWS LEATHER AND TOUGH TEXTILES LIKE A MACHINE

With SPEEDY STITCHER Automatic Sewing Awl, anyone can quickly and skillfully sew or repair anything made of LEATHER, CANVAS, NYLON, PLASTIC, or other heavy materials. Sew firm, even lock-stitches like a machine. Gets into hard-to-reach places. Specially made for heavy duty sewing on LUGGAGE, FOOTWEAR, RUGS, AWNINGS, SAILS, SADDLERY, UPHOLSTERY, OVERALLS, AUTO-TOPS, SPORTS GEAR, and other tough sewing jobs. Here's the handiest tool you'll ever own. Will save you many times its small cost. Comes ready for instant use . . . complete with bobbin of waxed thread and 3 different types of diamond-pointed needles. Easy-to-follow directions will make you an expert in minutes. Extra needles and waxed-thread always available. Save money, send \$1.98 for post-paid delivery. If C.O.D., \$1.98 plus postage. MONEY BACK GUARANTEE.

SPORTSMAN'S POST
366 Madison Ave., Dept. A-346, New York 17

ONLY 1.98



Make SURE, SAFE INSULATED ELECTRICAL CONNECTIONS

The New

SUPER ~~CHAMP~~ Hand Tool

The ONE Tool for ALL Wire Sizes used in Home Wiring, Appliances, Automobiles.

DOES ALL THESE THINGS BESIDES

CRIMPS Solderless Terminals and Connectors without solder or tape for safe connections.

STRIPS Wire sizes #22-#10. Gauges assure proper length for sure, safe crimp.

CUTS Wire, making clean, sharp cut through insulation and Conductor.

SHEARS Bolts and screws without damaging threads — no filing or hack sawing.

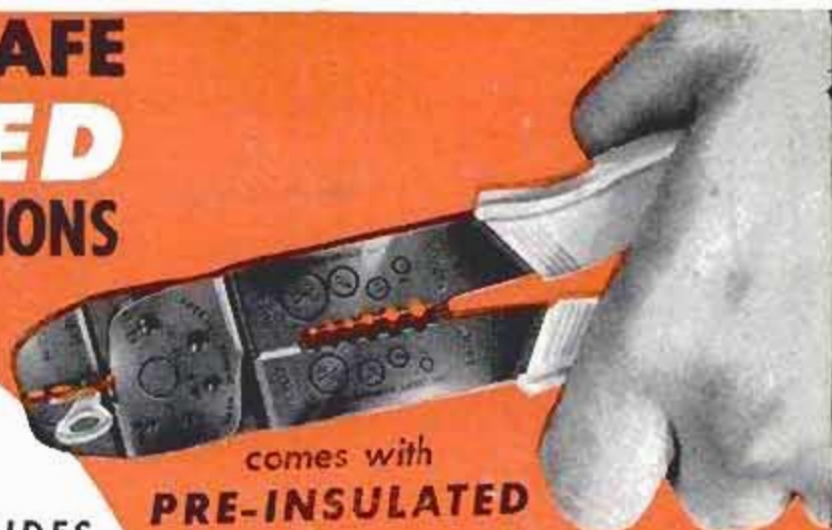

comes with
PRE-INSULATED



FREE with Each TOOL

ORDER DIRECT—USE COUPON

Satisfaction guaranteed or money back.
Send check or money order for \$3.95.
(Ohio residents add 12c sales tax.)

T. W. Berger, Inc.

National Distributor Consumers and Dealers

AIRCRAFT-MARINE PRODUCTS, Inc.

210 J Mariemont Center Bldg., Cincinnati 27, Ohio

Only
\$3.95

Post Paid

T. W. Berger, Inc.
National Distributor Champ Tool
210 J Mariemont Center Bldg., Cincinnati 27, Ohio

Send me post paid the new super Champ Hand Tool. I am enclosing \$3.95. (Ohio residents add 12c sales tax.)

check money order

NAME

ADDRESS

CITY.....ZONE.....STATE.....

**ENGINEERING
DEGREE IN
27 MONTHS**

INDIANA TECHNICAL COLLEGE

LOCKSMITHING

Practical Up-to-Date Course — ONLY \$4.95
53 illustrated self-instruction lessons. Easy to learn. Full price only \$4.95 postpaid—or COD plus postage. Satisfaction guaranteed or full refund! Mail your order today. **NELSON HALL CO.,** 210 S. Clinton St., Dept. FU-2, Chicago 6, Ill.



SAY YOU SAW IT IN POPULAR MECHANICS

we're sorry...

that we have not had the production to supply all the demand for Life-Time 50,000 Mile Spark Plugs. New equipment and greatly accelerated production enable us now to make immediate delivery. If you have ordered and your check has been returned, please place your order again. Life-Time Spark Plug Sets may be ordered from this advertisement. We will postpay at regular retail price. Specify make, model and year of car. Set of 6, \$7.14; set of 8, \$9.52.

DISTRIBUTORSHIPS

Some additional distributorships are now available. If you have already written us regarding your area, please contact us again. If you have not written before, please send us an outline of your previous business experience and qualifications.

CONTINENTAL MANUFACTURING CORP.
Washington Blvd. at Motor Ave.



Culver City 146, California

**MANUFACTURE THIS BEAUTIFUL
CONCRETE OUTDOOR FIREPLACE**

Right In Your
Own Backyard

**\$4.00 Worth of
Sand & Cement
produces this
Attractive
Fireplace.**



**Sells on Sight
from \$60. to \$80.
Easy to start your
own Profitable
Business.**

The General Fireplace
Molds and Process are the most
amazing and foolproof ever invented.
Simple to operate. Two men can produce five fireplaces a day.

BIG DEMAND!!

Sell all you produce to Department Stores, Homeowners, Parks, Nurseries and Picnic Groves. Fireplaces sell on sight. No experience necessary. We supply full operating instructions and equipment plus the know-how that spells **BIG PROFITS**. This is an outstanding opportunity for men of vision and small capital to get into a busy rich paying field. Don't delay, be the only exclusive manufacturer in your own home town. Mail coupon at once for full details as to how you can reserve your territory. **Molds sold only on exclusive franchise.**

GENERAL ENGINES CO., Inc., Dept. MF-66
ROUTE 130, THOROFARE, N. J.

Mr. Tor of Philadelphia writes:
Sold 250 in first 4 months. Selling to Sears Roebuck, John Wanamaker, and Gimbel Bros. in Philadelphia area.

Name

Address

City.....Zone.....

State

No need to wait any longer

Now

You can afford this

Award

swimming pool

in your own BACKYARD!

DAVIS PRODUCTS, INC., Dept. PM-66
1631 Tenth St., Santa Monica, Calif.

Name _____

Address _____

City _____ Zone _____ State _____

Send Do It Yourself Kit Information Send name of nearest Award Dealer

Revolutionary Award Pools, America's finest, cost up to \$700 less to install. Exclusive laminated **BOLTAFLIX*** sheathing by **GENERAL TIRE & RUBBER CO.** saves hundreds of dollars in maintenance and servicing. Eliminates upkeep expense... gives full protection from algae, fungus, slime. No cracking, seepage, rust, discoloring... completely waterproof. *Never needs painting or draining. Always sparkling clear.*

For the first time the Award Pool is now also available in a **DO IT YOURSELF KIT** complete with Boltaflex Liner—Filtration system—Illustrated Building Manual and Instructions—Plans—Drains and Fittings. Unconditionally guaranteed by the largest manufacturer of Bolta-lined pools in America. Mail coupon for complete details.

ONLY
\$795⁰⁰
12 x 27 ft.
6½ ft. deep

DAVIS PRODUCTS, INC.

Award Pools
DIVISION

1631 Tenth St., Santa Monica, Calif.



DRAW ME!

TRY FOR A \$37500 SCHOLARSHIP IN PROFESSIONAL ART

Winner of contest gets a complete art course—free training for a well-paid career in advertising art, illustrating or cartooning!

Many successful artists today have studied with the art school offering this scholarship. It's the world's largest home study art school, founded over 40 years ago. You're trained by professional artists. You get individual coaching, personal guidance.

As prize winner, you also receive a Professional Drawing Outfit—and a series of valuable Art Text-books to which more than forty leading artists have contributed. Try for this free art course!

ART INSTRUCTION, INC., STUDIO 6136
500 S. 4th Street, Minneapolis 15, Minn.

Please enter my attached drawing in your "Draw Me" contest. PLEASE PRINT

Name _____ AGE _____
Address _____ Phone _____
City _____ Zone _____ County _____
State _____ Occupation _____



DRAW THIS GIRL'S HEAD

5 inches high. Use pencil only. All drawings for July 1956 contest must be received by July 31. None returned. Winner notified. Amateurs only. Our students not eligible. Mail your drawing today.

**WORLD'S
BEST
WANT-AD
MEDIUM**

CLASSIFIED ADVERTISEMENTS



Advertisements in this section \$1.25 per word, each insertion, minimum 10 words, payable in advance.

To be inserted under proper classification, copy must be in our office the 20th of the second month preceding date of issue

F. W. Johnson, Manager, Classified Advertising

Popular Mechanics Magazine, 200 East Ontario Street, Chicago 11, Illinois

YOU'LL PROFIT

By reading and answering the classified ads in this section. Hundreds of opportunities for you to make and save money

AUTOMOBILES, MIDGET CARS

100 ANTIQUE And foreign car silhouette cut-outs on card stock 3 x 5 inches with easels. \$1.00 set. 2 sets \$1.95. Hall Products, Box 5340, Los Angeles 55, Calif.

MIDGET Auto plans \$1.25. Buy our parts. Gillmore, Box 26, Bowling Green, Ohio.

BOYS' Power-driven auto. Build your own. Plans 25 cents. Sypher Co., Sta. F., Toledo, Ohio.

NON-Profit organization offers automobile literature, old, new and foreign; dealer books, service manuals; glossy photographs; free motor magazines. Write today; get on free mailing list. Auto Maniacs, Stockbridge, Mich.

1956 SUPERIGNITIONITER. Starting, pep, mileage. Barbells wholesale. EG, Elmsford, New York.

AUTO SUPPLIES AND EQUIPMENT

ALUM-A-Sill protects and beautifies your car window sills \$1.00. Alum-A-Sill Co., McAllen, Texas.

OVERHEATING Stopped with Vapor-Kool engine cooler. Not a gadget. Over 12,000 in use. Install yourself. Write Vapor-Kool Mfg. Co., Highland, Calif.

RADIOS Custom for 1952 through 1956 Fords \$38.90. Free literature. Nordic Radio, Box 582, Evanston, Illinois.

BUY Wholesale nationally advertised auto supply, thousands of other products at big discount. Free "Wholesale Plan." American Buyers, Hertel Station, Buffalo 16-G1, N. Y.

SENSATIONAL! Almost human cigarette lighter. It breathes. Insert cigarette, press button, it's lit. 6V-12V. \$1.69 postpaid. Agents wanted. Cig-o-mat, Box 1063, Wilmington, Calif.

RADIATOR Like-new using Ion-20 cleaner, guaranteed. \$3.00 in plastic squeeze bottle. Wong Laboratories, 3259 Madison, Cincinnati 9, Ohio.

TEACH Driving safely—Our dual brake fits all cars. Attached or detached in 2 minutes, postpaid \$6.95. Reliable Mfg., Box 234, Elizabeth, N. J., Dept. A-C.

AUTO Parts, truck parts sent anywhere. Mechanics discounts. Send year, model number. Merit Auto Parts, 86 W. Broadway, New York City.

AUTO Radios. Lowest prices. State year. Cherry Radio, Philadelphia 40, Pennsylvania.

FUEL-Injectors, aluminum fuel tanks, carburetors, engine adaptors, speed, power, mileage equipment. Catalog 50c refundable. Moon Automotive, 10935 S. Bloomfield Ave., Santa Fe Springs, California.

BONDED Brake linings installed on your own 8 shoes for all cars \$10.00. North, 1601 Clybourn, Chicago 14, Illinois.

GM71-110 Discarded injector parts wanted. Bonus on HV. Bares, 7120 Carnegie, Cleveland 3, Ohio.

JEEP Owners—V8 power. Read Jeep owners ad, page 20.

MOTORIST Save gasoline vacuumating overrich mixtures. For free particulars to install demonstrator on your car write Vacuumatic, Dept. 859, Wauwatosa, Wis.

UP To \$50.00 each for new or used GM-110 diesel fuel injectors. Parts also purchased. Bruce W. Mayer, 2090 East 19th Street, Cleveland 15, Ohio.

NEVER Change oil. 12 1/2¢ refill filter. Tissu-Pak, B1115, Sacramento 5, Calif.

AUTO Accessory and parts catalog. 1956 edition—all new! 180 pages. Save up to 50%. Over 75,000 items, including Hollywood accessories, hi-speed equipment, rebuilt engines, all parts and accessories for all cars and trucks! Hard-to-get parts! Send 25¢ (refundable). J. C. Whitney, 1919-PM Archcr, Chicago 16, Ill.

CHILDREN'S Safety belts. Heavy rayon webbing. Permits child to stand or sit. Money-back guarantee. Send \$2.00. M. Kent, 1796 University Ave., New York City 53.

SAFETY Belts. Free literature, samples. Sabelco, Box 1142, Poughkeepsie, N. Y.

"DANDY" Back rest for automobile \$3.95 post paid-U.S. Frank Veale Mfg. Co., Inc., Columbus, Indiana.

FORD T parts? Try best source old car parts anywhere. Wisneski, Milwaukee 7, Wis.

NEW And used parts at savings. Complete guaranteed parts service for all models cars and trucks, 1924 and later. Largest in the West. Army parts specialists. No catalog, write for quotations. Fast mail order service. Pioneer Auto and Truck Parts Co., 734 W. 13th Avenue, Denver, Colorado.

LATEST Custom accessories. Items not in stores. New low prices. Continental tire kits, push-button doors, trunks, etc. New illustrated catalog, biggest ever, 25c. Eastern Auto, 3319-A South Grand, Los Angeles 7, California.

BRAND New first quality tires. Tractor, truck, aircraft, passenger. Wholesale prices. Also all size army surplus used tires, at tremendous savings. Duddy's, 152 No. Beacon Street, Boston, Mass.

AUTO TRAILERS

TRAILER Manual blueprints \$2.00. Booklet 30¢. Kamcraft, Box 1153, Milwaukee 1, Wis.

TRAILER Parts catalog. Largest in mid-west. Send 25¢. Refundable. Hanna Trailer Supply, 615 West Layton, Milwaukee, Wis., Dept. M.P.

MOTORCYCLES, BICYCLES, MOTORSCOOTERS AND SUPPLIES

MOTOR Scooter parts. Send 25¢ for list. Give make and model of scooter. Motor Scooter Parts Co., Dept. P6, Box 7211, Indianapolis 1, Indiana.

BICYCLE Supplies—Goodyear tires and tubes. All sizes. Low prices. Free delivery. Write Attleboro Cycle Supply, 619 County, Attleboro 2, Massachusetts.

WHIZZER Motors \$20.00; midget race car reasonable; motorscooter \$6.00; Cushman two-speed \$20.00. Send 25¢ (35¢ first class mail) for catalog #30 jammed with sensational bargains in wheels, motors, motorscooters, midget cars, motorbikes, construction plans, etc. Gail, 1313 Jefferson, Toledo, Ohio.

1000 BANKRUPT Motorcycle bargains. Catalog 25¢. Bunico, 146, Covington, Va.

RECONDITIONED Motorcycles and motors. Chromium accessories. Complete stock Indian parts. Expert rebuilding. Fast service. Indian Motorcycle Sales, Kansas City 27, Missouri.

PARTS, Pistons, new, used. Harley, Indian, Henderson, list 10c. Ballak, 811 N. 9th, St. Louis 1, Missouri.

HARLEY-Davidsons — Used bargains, shipped prepaid. New, used parts, accessories for current and obsolete models. Bulletin, catalog 25c. Knuth's (factory dealer), 2491 Fond du Lac, Milwaukee, Wis.

DOODLEBUG Motorscooter \$15; Whizzer \$14; Servicecycle \$20; Salsbury \$40; Crosley convertible \$25; outboard motorboat engine \$5. (Mailorder only.) Send 25¢. (35¢ for first class mailing) for directory-catalogue number 71 listing these and hundreds of other bargains in Homebuilders parts, plans, etc. Midget Motors Directory, Athens, Ohio.

AVIATION

BUY Surplus aircraft; fuselages; accessories; engines; instruments; electronics—Direct from U. S. government depots. List and procedure \$1.00. Brody, Box 8PMA, Sunnyside 4, New York.

AIRLINE Steward-purser. Fly 85 hours monthly. Starting salary \$235 up. G.I. approved. Free catalog. Air-Purser School, Room 1, 1030 Nicollet Ave., Minneapolis, Minnesota.

PROPELLERS, Plans, supplies for air boats, snow sleighs. Catalog 10c. Gano Propellers, Box 3284-A, Ft. Worth, Texas.

HELICOPTERS 1 And 3 man. Construct own. Plans \$3.50, \$6.00 respectively. Mayberry Aircraft, P.O. Box 343, St. Clair Shores, Michigan.

BUILD Jet helicopter. Detailed plans \$6.00. Apache Aircraft, Elgin, Ariz.

SPORT Plane manual blueprints \$2.00. Circulars 25¢. Kamcraft, Box 1153, Milwaukee 1, Wis.

POWER Hammer! Sheet metal cutter. Circular on plans. Rush name. Maupin, Tipp City 5, Ohio.

PROPELLERS, Plans, supplies—World's oldest and largest manufacturer of special design airboat, snow sleigh propellers. Prompt delivery. Satisfaction guaranteed. 48 page catalog 25c. Banks-Maxwell, Box 3301E, Ft. Worth 5, Texas.

CONSTRUCT Jet helicopter; plans \$6.50. Autorotating Heliglider \$4.50. Amalgamated Helicopter, P.O. Box 384, Windsor, Ont., Canada.

BATTERIES. GENERATORS.

EDISON Nickel storage batteries. Any voltage, any amperage. Unconditionally guaranteed. Power plants, generators, motors. Literature. Hawley Smith Co., Croton Falls 1, N. Y.

ELECTRICITY From sunlight! Solar energy! Build electric plants, ovens, water, pool heaters, refrigerators, stills. See April Popular Mechanics. Send \$3.00. Receive: plans cooker, patent disclosure, solar cigarette lighter, first lesson "Solar Engineering," written by scientists. Hedger Science Company, P.O. Box 357-A, Lakeside, California.

ELECTRICAL SUPPLIES

REFRIGERATION Surplus. New Freon hermetic unit, with freezing coil. List \$98.00, \$42.50 f.o.b. New cold controls list \$11.00, \$4.25. Sterling, 3916 W. Montrose, Chicago 18.

LAMP. Electrical parts, wholesale. Thousands of items for repairing, converting. Catalog 25¢. Brown Lamp, Box 501, Wellston Station, St. Louis 12, Mo.

CONDUIT Bending data. Plastic, pocket size 40¢. Pal-Notes, Underwood, N. D.

TELEPHONE Transmitter. Hand set type. Suitable for inter-house phones, speakers or any communication purpose. Delivered two for \$1.00. No c.o.d.'s. Telephones, Dept. C-725, 1760 Lunt, Chicago 26.

TRANSFORMERS 10 VA. 60 cycles. 110-120 VA. line 60¢, \$55.00. C. Columbia, 325 W. Columbia, Evansville, Ind.

AVERAGE \$10.00 Per hour. Unique electrical repair. Instructions \$1.00. Box 7642, Denver 15, Colorado.

ELECTRICITY. Magnetism set. 23 instructive experiments. Induction coil, telegraph, motor. \$3.98 postpaid. Free details. Technifun, 8420 Cedarbreak, Houston 24, Texas.

LAMPS. Parts catalog containing wiring instructions 25¢. Gyro Lamps, 5402P Clark, Chicago 40.

WELDING, SOLDERING, PLATING

LEARN Correct welding technique. Arc or torch manual \$1.00 each; both \$2.00 postpaid. Marnel, Box 7642, Denver 15, Colorado.

"BUILD-UR-OWN" a.c. welder and a.c. power plant with a good used engine and low cost Hobart generator. Welds anywhere and supplies 5kw stand-by power for any emergency. Write Hobartweld, Box M-663, Troy, Ohio.

PERFECT Flame burning with amazing Necco torch guides. Free illustrated folder. New Era Engr. Co., 458 W. 29th Street, Chicago 16, Ill.

A.C. Welders. 4 sizes. Lowest prices. Free literature. Holgeron's Serv., Canton, Kan.

WELDERS, 110/220, \$39.50. Morris, 1070 Inner Drive, Schenectady 3, New York.

ACETYLENE Welding outfits, new \$49.00; used \$29.00; arcwelders \$56.50. Eagle Welding, Dept. PM, 5085 Broadway, Chicago 40, Ill.

ELECTROPLATING Equipment, anodes and solutions for all types of plating. Instructions. Assemble your own plater and save. Free catalog. Ramyr, Dept. E-4, 1624 East First Street, Los Angeles 33, California.

NEW. Timesaving oxy-acetylene outfit welds, cuts, heats, brazes. Just change tips. Light, compact, portable. Thrifty to operate, ruggedly built. Complete outfit and instructions, only \$76.50. Special economy plan for supplying gas cylinders. Write for free literature: Dept. M, Linde Air Products Company, 30 East 42nd Street, New York 17, N. Y.

MACHINERY, TOOLS, SUPPLIES

HOW To magnetize screwdrivers, wrenches, etc. Really simple. Only \$1.00. Al. Rheinlander & Sons, 3211 Martin Ave., Evansville 12, Ind.

LAWNMOWER Sharpeners—New, \$59.75 to \$259.50. Light and heavy duty, production. Turner-Cline, 430 Yellowstone, Pocatello, Idaho.

SUN Combustion efficiency tester \$75.00. Vacuum compression gauge \$2.00. Tire theft hose \$2.00. Battery gravity temperature hydrometer \$2.00. New Mall 6 1/2" electric saws \$29.95. New 1/4" electric drills \$9.95. Jacobs 1/4" hex key chucks \$2.00. All items prepaid. Ace Surplus Sales, 5159 S. Christiana Ave., Chicago 32, Illinois.

SHEBEL Saw filer files all saws. Circular. A. P. Shebel, 730 So. 2nd St., Milwaukee 4, Wis.

YOU Can cut threads on any lathe, drill press or hand. Write Box 63, Maywood, Illinois.

LAWNMOWER Sharpeners; popular makes. New, used, rebuilt. Write: C. Russell, 216 W. 90th Street, Bloomington, Minn.

SURVEYING INSTRUMENTS

GUARANTEED Factory rebuilt transits and levels, sale or rent, with purchase option. We will repair, trade or buy old instruments. Write for list M-66. Warren-Knight Co., Manufacturers of Surveying Instruments, 136 N. 12th St., Philadelphia 7, Penna.

ENGINES, MOTORS, DYNAMOS

A.C. Generators 750 watt \$42.50, 1500 watt \$67.50, motors 1/2 horse \$15.00, 1 horse \$35.00, 2 horse \$65.00. Butler, 1885 Milwaukee, Chicago.

1/2 HORSEPOWER Motors, used, good, \$5.00 each, f.o.b. Plant Machinery Corp., Richmond & Norris Sts., Philadelphia 25, Penna.

NEW Gasoline engines \$29.50. Equipments, Catalog 10¢. Loren Products, Danville, Illinois.

POWER Coil winder plans \$1.00. Return privilege. Thomotors, Harrison, Arkansas.

REWIND Motors yourself. Complete instructions \$1.00. Lewis Mfg., Howell, Michigan.

WINDING Data. 275 motors, single and three phase, \$1.10. Data Company, Box 7631, Kansas City 28, Mo.

GAS Engines 1 1/2 h.p. "Continental" (4 cycle) horizontal driveshaft. New factory sealed cartons. Were priced \$67.50, now \$29.95 f.o.b. Boston. Literature, money-back guarantee free. Northern, 173 Merrimac Street, Boston 14, Mass.

BOATS, OUTBOARD MOTORS

BARGAINS Galore—Wheels, windshields, hundreds different items. Marine, Box 681 C, Mendota, Minnesota.

FIBERGLASS Top marine grade. Yard or kit. Ontario Fiberglass Co., Box M, Ontario, N. Y.

OUTBOARD Motor parts—New, used for all makes. Send list of parts needed. Enclose stamp. We save you money. Outboard Motor Mart, Inc., 229M State Street, Boston, Mass.

FREE Catalog! Boat kits, trailers, fiberglass, marine hardware. Luger Industries, Dept. M, 4452 Nicollet, Minneapolis, Minn.

NEW. Used, rebuilt marine motors. Marine conversions, fittings. Free catalog. Stokes Marine Supply, Dept. 24, Coldwater, Michigan.

MARINE Conversions for Ford and Jeep engines. Catalog 25¢. Lehman Manufacturing Company, 972D Broad Street, Newark 2, New Jersey.

FORDS And Jeeps 100% marine engines with famous Convo-Kits. Deluxe catalogue 25¢ coin. Oscomotors, 3627B Lawrence, Philadelphia 40, Penna.

"GLASBOTE" Plastic and glass cloth for boat covering. Complete information and material price list free. Buchanan Plastics, 1728 Hamilton Road, Okemos, Michigan.

FIBERGLAS Boat coating. Plexiglas boat windshields—clear, blue, green tints. Wholesale-retail. Complete information catalog—15¢. Gem-O-Lite, Box 686M, North Hollywood, California.

FIBERGLAS Permanent boat waterproofing. Special 25% spring discount. Complete kits, \$9.45 up. Guaranteed materials. Easy application. Full instructions. Free literature. Ajax Plastics, Dept. PM, P.O. Box 1323, Fort Worth, Texas.

BOAT Plans: Welded steel, wood, plywood. Inboards, cruisers, sail. Free literature. Please specify size, type. John B. Clark, N.A., Box 51, Bay Village, Ohio.

HOOD-A-Boat. Make it yourself from two certain scrap auto hoods obtainable at junk yards all over the country. Length 10 ft., beam 49 in., depth 15 in. Sturdy, yet easy to build. Send \$1.00 today for clever, simple plans including actual photo. Robert Cashman, 4443 Youngstown Road, Warren, Ohio.

FIBERGLAS, Complete stocks. Send 30¢ for two fully illustrated handbooks on coating and molding. Allied Resin Products, 216 Milk St., Boston 9, Mass.

BOAT Plans. Full size patterns. Frame kits. Modern inboard and outboards for amateur builders. Complete new catalog 50¢ or specify requirements. Glen Designs, Box 568, Compton, Calif.

ALUMINUM Boats. Grumman lifetime aircraft construction. More pleasure. Less maintenance. Free catalog—Boats or canoes. Metal Boat Company, 3766 South, Marathon, N. Y.

BUY Wholesale nationally advertised outboards, thousands other products at big discount. Free "Wholesale Plan." American Buyers', Hertel Station, Buffalo 16-H1, N. Y.

SCAMP. Motorized surf board, plans, kits, complete boats. Dean's Marine Engineering, Janesville, Wisconsin.

BOATS. Save money. All types, 12 page jam-packed list for \$1.00. Boats, Box 6, Henrietta 6, N. Y.

WHOLESALE: Sea Legs boat kits, factory prices from \$31.98. Savings to 25%. Pre-assembled frames, pre-cut parts, illustrated instructions. Penney Woodcraft Industries, Dept. C-68, Defiance, Ohio.

MARINE Conversion, Willys to Cadillac, engines, kits and parts. Catalogue and conversion hints free. Barr Marine, 2706 Castor Avenue, Philadelphia 34, Penna.

FIRE Extinguisher—Protect outboards, boats, autos. "Presto," science's midget miracle extinguisher. Send \$4.95, postpaid. Forest City Chemicals, 411 So. Chicago, Rockford, Illinois.

FIBERGLAS Boat covering, kits and bulk materials. Complete line. Wholesale prices. Representatives wanted. Plastic Sales, 3023-D McGee Trafficway, Kansas City, Mo.

ATHLETIC EQUIPMENT, BODY BUILDING COURSES

FREE Catalogue, 1000 items. 10¢ for postage appreciated. Dr. Thompson, 919 Fourth, Manhattan 30, Kansas.

100 TRICK Knockouts for self-defense \$1.—1c each. Priest, Box 251, Evanston 1, Illinois.

BARBELLS, Dumbbells. Courses. Free catalogue. Good Barbell Co., Reading, Penna.

KEEP Fit with "7:25 a.m." exercise. 50¢. Hennery's, Cleveland 7, Ohio.

MUSCLE Development while sitting car or chair. Simple method shown in illustrated copyrighted booklet. Refund guarantee. \$2.00. Mathias, Box 206-M, Miami 47, Fla.

SPORTING GOODS, GUNS, FISHING TACKLE, ARCHERY, TRAPPING

180 PROFUSELY illustrated pages antique pistols, swords, daggers, armor, etc. 50¢. Robert Abels, M860 Lexington Ave., New York 21.

5000 BARGAINS, Firearms, binoculars, war relics, Catalog 50¢. Smith Firearms, Runnemed, N. J.

JAP Rifle altering to 30-06, \$6.00. Jap-shells, \$3.75. Catalog 5¢. T. P. Shop, West Branch 11, Mich.

DIVING Equipment for skin divers and professional divers. Send 25¢ for catalog and decompression chart. Desco, 212 N. Broadway, Milwaukee 2, Wisconsin.

SAMPLE: 25c Copy of "The Archers' Magazine." Send 10c. 1200 Walnut Street, Philadelphia 7, Pennsylvania.

MOLDS For fisherman's sinkers, jigs, squids, casting and spinning lures. Free catalog. Sweet's Molds, Tonawanda 1, New York.

CAMPING Equipment, tents. Direct from manufacturer. World's largest selection. Send 15¢ for 100-page 1956 tent and camping equipment catalogue-handbook. Morsan Tents, 10-21, 50th Ave., Long Island City 1, New York.

CATCH Fish with smell. Old timer's secret recipes, formulas, processes, 10¢. Johnson's, 312-F Lake Avenue, Ithaca, New York.

CAMPERS, Outdoorsmen, scouts! Send 15¢ for our "Camptown, U.S.A." giant catalog. Thousands of bargains. I. Goldberg & Co., 429 Market St., Philadelphia 6, Penna.

SKIN Divers, 3000 lbs. certified air compressing stations, 110v, \$200.00. Garrett, 3471 Weldner, Oceanside, N. Y.

FREE Below wholesale fishing catalog. Fishing Tackle Mart, Dept. 56, Box 6737, Chicago, Ill.

SKIN Diver's catalog. Free. Shows everything from aqua-pencil to submarine! Skis. Trunks. Books. Premiums. Aquafun P-M, Davenport, Iowa.

FREE Fishing catalog—132 pages. Over 3000 hard to find fishing specialties. Netcraft Company, Dept. PM6, Toledo 13, Ohio.

FORTUNE Possible raising crickets and 12 inch African fishworms. Free literature. Carter Ranch, Plains, Georgia.

HOW To be a gunsmith. 400 page illustrated course. \$3.95. Pioneer Press, Harriman, Tennessee.

BUY Wholesale nationally advertised sporting goods, thousands other products at big discount. Free "Wholesale Plan." American Buyers', Hertel Station, Buffalo 16-II, N. Y.

FREE Giant handbook! "How to Bow-hunt and Bowfish" 100's Revealing Secrets! Also tells how to Improve Shooting Accuracy, select best equipment, make your own tackle, etc. Illustrated! Yours free with large bargain catalog. (Save 50% on archery equipment). Send 25¢ to cover mailing expenses refunded on first purchase. Supply limited! Hurry! Malibu Archery, 1036RJE South La Brea, Los Angeles 19, California.

NYLON Rope, lines, cords. Every description for all household and sportsmen's uses. Finest made. Free catalog and samples. Beebe Cordage Co., Cranford 8, N. J.

FISHING Tackle—30% to 50% off! Also guns and camping equipment. Cash or credit. Free bargain catalog. Write to: Klein's, Dept. C-M-5, 227 W. Washington St., Chicago 6, Ill.

DUPONT Tynex monofilament spinning line. Free information. Mor Industries, Neeses, S. C.

.25 AUTOMATIC Pistols—Famous makers, like new, regularly \$37.50, special \$24.50! 1,000,000 antique-modern guns, accessories. Catalog 50¢. Agramonte, Yonkers 20, N. Y.

GOLFERS—Break 90? You can. Write Golf Associates, Box 963, Alliance, Ohio.

SKINDIVERS. Send 25 cents for our giant diving equipment catalog. Price refunded on first purchase. New England Diving Equipment, Box 3, Dept. A, North Chelmsford, Mass.

JEEP Owners—V8 power. Read Jeep owners ad, page 20.

FISHERMEN Catch your limit every time. Our free 1956 catalog tells you how. Hergert Company, Box 741, Coral Gables, Florida.

BUY Wholesale! Best lines sporting goods! Direct factory representatives! Large catalog \$1.00. Refundable. General Wholesalers, Box 3058E, San Francisco.

BINOCULARS, TELESCOPES, MICROSCOPES, MAGNIFIERS

BUILD Your own reflector telescope complete kit: Mirrors, eyepieces, tripod, all other accessories. Request free illustrated literature. Criterion Manufacturing, Dept. KPM 18, Hartford, Conn.

AMAZING Prices, precision binoculars and gunscopes. Free trial. Folder, "Binocular Selecting," catalog free. Prentiss Importers, Mercury Bldg., West Los Angeles 25, Calif.

DYNASCOPE—Sensational new reflector telescope. Send for details. Criterion Co., Dept. DP 21, Hartford, Conn.

WAR Surplus bargains: Millions of lenses, instruments, telescopes, binoculars, components and complete line of astronomical telescope items. World's greatest optical market place! Send only \$1.00 for beginner's 10-lens kit and big instruction booklet stock 2-CH. Write for catalog CH, free! Edmund Scientific Corp., Barrington, New Jersey.

AMERICA'S Only direct mail binocular factory. Also repair specialists. 40th year better binocular values. Write, DuMaurier Mfgs., Elmira 20, N. Y.

BINOCULARS, Telescopes, microscopes, terrific values \$3.98 up. Request free money saving catalog. Criterion, Dept. P 42, Hartford, Conn.

SAVE. Buy United. America's largest selection. 103 models. \$3.95 to \$250.00. Use on 30 day no risk offer! Free 56 page binocular, telescope, riflescope catalog. United, 9043 S. Western, A-108, Chicago 20. Dealers wanted.

400 POWER Telescope easily made. Kit includes focusing tube, erector, five finished lenses and instructions—\$3.75. Giant astronomical telescope complete with tripod \$15.00. Free information. Suffolk Science, Mattituck 3, N. Y.

REFLECTOR Telescope kits \$6.25 (3") to \$175. (12"). Mirrors, cells, focusing mounts, tripods, eye-systems. Anything, everything in telescopes. Free illustrated catalog. Also ready to use telescopes from \$26 to \$176. Inquiries to Esco Products, Dept. PM, Oakridge, N. J.; Sales showroom 166 Church St., New York City.

REFLECTING Telescopes, mirrors, kits. Lowest prices anywhere. Free catalogue. Aurora Telescope Company, 266 Avenue C, Bayonne, N.J.

REFLECTING Telescope, 60X, completely assembled \$29.75. Guaranteed observatory clearness. Free information. Skyscope, 475 Fifth Avenue, New York City 17.

JOE'S Binoculars, 4827 Second, Detroit 1, Michigan. Lowest prices, all sizes, binoculars, microscopes, telescopes catalog.

PETS—DOGS, BIRDS, RABBITS, HAMSTERS, ETC.

MONTHLY Bird magazine (budgies, canaries, finches, etc.). One year \$3.00. American Cage-Bird Magazine, 3449 N. Western Avenue, Dept. P.M., Chicago 18, Illinois.

\$5,199.90 WAS Paid to John Betts, in few weeks. Grow mushrooms. Cellar, shed. Spare, full time year round. We pay \$3.50 lb. Free book. Mushrooms, Dept. 171, 2954 Admiral Way, Seattle, Wash.

MAKE Money raising chinchillas, mink, pigeons, rabbits, cavy for us. Free catalog. Keeney Brothers, New Freedom 2, Penna.

HAMSTERS, Pair \$2.95. Free booklet. Jer-Fre's Hamstery, 2425 Hoyt, Muskegon Heights 13, Mich.

BEEKEEPERS—\$1,000,000 French industry. Read "Miracle of Royal Jelly," \$2.50. L. Smith & Co., Box 2003, Hartford, Conn.

CHINCHILLAS—High graded Blend-Trast. Willard George. Wholesale prices. Chinchillas, 21219 Figueroa, Torrance, Calif.

MINK Raising information free. Complete. Lake Superior Mink Farm, Superior, Eel, Wisconsin.

RAISE Rabbits successfully by knowing facts. 48 page illustrated book describing 25 breeds. Housing, feeding, breeding, marketing, etc. Plus bulletin. 25 cents. American Rabbit Association, 36 Arba Building, Pittsburgh, Penna.

EXTRA Money raising Angora, New Zealand rabbits. Write Martin's Rabbitry, Morganfield, Ky.

STANDARD Rabbit Journal, Milton 3, Penna. Year \$1.00. Sample dime. Beginners manual 25¢.

CHINCHILLAS. Registered. Unbelievable prices. Far-West Chinchilla, 1446A Jones, San Francisco 9, California.

PROFITS! Raise Nutria beavers. Herb Miller, 513 Kent, Lubbock, Texas.

PEDIGREED Police puppies. White, cream, black and cream, \$40 to \$60. Ansonia Kennels, Mose, N. Dak.

RAISE Angora, New Zealand rabbits on \$500 month plan. Plenty markets. Free details. White's Rabbitry, Jackson, Mich.

CHINCHILLAS, Graded, registered. \$25.00 up. Kellen, 1163 West Front, Plainfield, New Jersey.

RAISE Rabbits. Make money. Send 25¢ for market information, plans for housing, and prices of starting stock. A. Johnson, Box 894, Kansas City 41, Missouri.

CHINCHILLA Feed and care booklet \$1.00. Harty, 4120 Chester, Philadelphia 4, Penna.

\$1,000 MONTHLY Possible raising red-worms; large African nightcrawlers! Backyard, garage, basement. Illustrated booklet explains raising, packing, marketing. 25¢ postpaid! Ozark Worm Farm-J, Willow Springs, Missouri.

CHINCHILLAS—\$65.00 Pair with babies. Krystal-Blu, 4855 Cecelia, Bell, Calif.

PLANTS, SEEDS, BULBS, NURSERY AND GARDEN SUPPLIES

WORLD'S Greatest cash crop. Free information. Write Ginseng Gardens, Asheville, N. C.

TRELLIS, All metal, adjustable to 10 ft., high, 2 to 4 ft. wide. Can be installed at an angle. Can't rust. \$6.95 postpaid, no c.o.d. Cadco Sales, Tombstone 1, Arizona.

FARMS, FARM LANDS, REAL ESTATE

TEXAS Land: Small parcels for recreation or retirement. Near mammoth fresh water lake. Electricity, phones and city water. Total cost \$149.50 each. Nothing down, \$7.50 monthly. Guaranty title policies at no added cost. Write for free photos, map, etc. No obligation. Write Hugh Matlock, Pipe Creek, Texas. Dept. P.M.

FLORIDA Bargain homes. Low taxes. Cummins Realty Agency, Box 848, Eustis, Florida.

GOVERNMENT Land available, 25 states, Alaska. Free information. Sledge Surveys, Macon, Mississippi.

\$5.00 MONTHLY Buys 40 acres productive land; near town; good fishing; price \$250.00; free list. Box 425-P, Carthage, Mo.

OZARKS! \$7 Acre. Diversified listings free. Write: Armstrongs, Shook, Missouri.

HOMESITES \$15 Monthly—California's finest garden section. Morro Bay's scenic shores. Wonderful fishing, boating. Fertile soil, softest water, temperate climate, congenial community. Free literature. Richard Otto, Department M, San Luis Obispo, California.

STROUT Catalog—Mailed free! Farms, homes, businesses, 34 states, coast-to-coast, 3,046 bargains described. World's largest; 56 years service. Strout Realty, 7-MP So. Dearborn St., Chicago 3, Ill.

FLORIDA—Beautifully wooded Green Hills tracts. Near famous Panama City pleasure resort. World's finest beaches. Many lakes. Best fishing. Water sports, 10 and 20 acre garden farms and money-making tung groves. Lowest prices, easy terms. Booklet free. Wendell Wood, Fountain, Florida.

TEN Acres Missouri land, \$90. Warranty deed. Free list. John Calvert, Plant City, Florida.

CALIFORNIA Ranches \$50 down. Huge investment profits. Future or immediate occupancy. Plenty jobs nearby. Free catalog. Pioneer Ranches, Inc., 7419-F Beverly Blvd., Los Angeles 36, California.

PROFITABLE OCCUPATIONS

MAGAZINE Subscriptions. Largest commissions, bonus. Qualified Agency, 451FA Kingston, Brooklyn 25, N. Y.

STAY Home. Make big profits. Operate collections. Course \$3.00 or write for free details. Kipp, 608 Boone National, Boone, Iowa.

FRANCHISED Distributorships, dealerships, agencies produce handsome incomes. Alert yourself! Request particulars. National Franchise Reports, D-528, 333 North Michigan, Chicago 1.

\$5,199.90 WAS Paid to John Betts, in few weeks. Grow mushrooms. Cellar, shed. Spare, full time, year round. We pay \$3.50 lb. Free book. Mushrooms, Dept. 99, 2954 Admiral Way, Seattle, Wash.

YOUR Own wholesale business with no investment. Free catalog. Jay Norris Co., 487X Broadway, New York City.

FOREIGN Jobs—Latin America, Alaska, Canada, up to \$1500 monthly. Up-to-date 1953 foreign service directory gives complete information; hot list of firms hiring for military and civilian construction, aircraft, oil, exporters-importers, mining, \$1.00. How-when-where to apply. 9th successful year! Global Reports, Box 883-S, Hollywood 28, Calif.

FREE Folio "\$5,000-\$45,000; Unlimited Vacations." No merchandise, equipment. Unknown! Work home, sparetime! Haylings, Carlsbad, Calif.

MUSHROOM Spawn seed plus directions manureless, various, growing, marketing \$1.00. Free information, gladly. Luxur, 641 South 19th, Newark 3, New Jersey.

RAISE Pheasants on \$100 week plan. Little capital and space can make you independent. Free details. Great Central System, Columbus 1, Kansas.

MAKE New greaseless doughnuts in kitchen. Sell stores. Free recipes. Michael Ray, 3605 South 15th Ave., Minneapolis 7, Minnesota.

BE The Popular Mechanics representative in your neighborhood and earn big profits in your spare time. Write Popular Mechanics Magazine, Room 408M, 200 E. Ontario St., Chicago, Ill.

FORTUNE Possible raising fishworms and crickets. Free literature. Carter Wormery, Plains, Georgia.

WHOLESALE Catalog! 30-80% discounts! Appliances, musical instruments, typewriters, phonographs, watches, jewelry, recorders, housewares, etc. Consolidated Distributors, 21-14 Lafayette, Paterson 15, New Jersey.

AUCTIONEERING—Home study course. Diploma granted. Auction School, Ft. Smith, Ark.

FREE Book "505 Odd, Successful Businesses." Work home. Pacific, Oceanside, Calif.

\$150 WEEK—Easy! Start home Venetian blind laundry. Revealing book free. A.T. Co., 101 S. 44th, Philadelphia 4, Penna.

LEARN Real estate by listening to records. Lee Institute, Brookline 47, Mass.

MUSHROOMS Grown boxes. Manureless process. Spawn \$1.00. Gordons, 553 William, Winnipeg, Manitoba.

BUY Wholesale thousands nationally advertised products at big discount. Free "Wholesale Plan." American Buyers' Hertz Station, Buffalo 16-B1, N. Y.

TAKE Watches apart, clean, assemble. Original self-taught method. 70 drawings, 65 troubles, wholesalers. Manual \$1.50 postpaid. Unconditional refund. Details free. Weber Service, Box 2489, Denver 1, Colo.

FOREIGN, Alaskan, U.S.A. jobs! Earn to \$1500.00 monthly. Million Americans employed overseas. Opportunities galore. Latest copyrighted reports. Who to contact for highest paying jobs. Laborers, trades, truck drivers, equipment operators, helpers, clerks, engineers, many others. Over 52 countries—St. Lawrence project, Spain, Latin America, northern projects, Europe, Pacific, etc. Year registration-advisory service. Application forms. Unconditional money-back guarantee. Act today! Only \$2.00. Airmailed \$2.25. (C.O.D.'s accepted). International Reporter, St. Louis 1-PF, Missouri.

SHAMPOOS, Bath salts, beauty creams; unbelievable profits with easy home manufacture. Instructions \$1.00. K. Boardman, Box 219 Station D, Hamilton, Ontario.

WELDING Pays big money. Learn easily at best equipped school in country. Non-profit school with low cost training. G.I. approved. Write Hobart Trade School, Box M-662, Troy, Ohio.

JOBS Paying to \$350 weekly now available on overseas and American projects. Men and women. All trades. Transportation paid. Free information. Write Transworld, Dept. M6, 200 W. 34th St., New York, N. Y.

BOOKS, PERIODICALS, PICTURES, POSTCARDS

RARE Magazines, catalog 10¢. National Magazine Exchange, Box 1375-P, San Antonio 6, Texas.

JOHN Friend, bookfinder. Any book, any subject obtained for you promptly. Foreign books, too! Box 197PM, Cardiff, Calif.

TAINTER'S Book Shop, Temple, N. H. Books on everything. Try our search service.

UNUSUAL Books 10¢ each. Mills, 6711 Sunset, Hollywood 28, Calif. Send stamp for catalog.

HORSE Books—Breaking, training, care. Carson, 1304 W. Kiowa, Colorado Springs, Colorado.

FINE Used novels, 2—\$1.00. Pocket novels, 9—\$1.00. Postpaid. State type wanted. Old books, magazines, comics, found reasonably. Rush wants. Pik-A-Book Co., 2729 South Robertson Blvd., Los Angeles 34, Calif.

BOOKS. Free 1956 catalog, 100 pages. Text, vocational, educational, instructional subjects. Millions of volumes, new and used. Bargain prices. Books bought, Est. 1902. Long's College Book Co., Dept. PM, Columbus 1, Ohio.

BOOKFINDERS! All subjects. Send wants! Jaher Book Service, 183 Hazelwood Drive, Westbury, N. Y.

"SCIENCE Milestones." Records march of science starting 400 years before Christ, right up to date. Amazing facts revealed. 312 pages packed with startling information that will thrill you. A real history of science. \$5.00. Literature free. Popular Mechanics Press, 300-EM East Ontario St., Chicago 11, Ill.

NATIONAL Geographic Magazines, 1888-1956. Periodical Service, Box 465-PM, Wilmington, Delaware.

BOOK Catalog, 1000 interesting titles. Send 10¢. Books Publishing Co., Amityville 3, N. Y.

FREE Book list, 3000 titles. Old Favorites, 36 Yonge, Toronto, Canada.

FREE Catalog! Bargains for everyone. Critic Books, 10020 Hawthorne, Inglewood 2, Calif.

OUT-Of-Print books at lowest prices! You name it—we find it! Past service. No obligation. International Bookfinders, Box 3003-PM, Beverly Hills, Calif.

MAGIC TRICKS, PUZZLES, JOKER NOVELTIES

"102 MAGIC Tricks" plus 500 trick catalog 50¢. Stowell, Woodstock, New York.

500 TRICKS, Douglas famous 120-page catalog, only 10¢. Fastest service to magicians for 30 years. Send 10¢ today. Douglas Magicland, Dept. 1, Dallas, Texas.

SMOKEBOMBS 25c, 7 For \$1.00. Terrific! 4463-PM Greene, Philadelphia 44.

BEST Magic. Joker's novelties. Lower prices. Catalog 10¢. Top Hat, Evanston 12, Ill.

DOLLAR Magic set free with catalog 25c. 4462-PM Germantown, Philadelphia.

FREE Trick and professional catalog of 600 tricks, \$1.00. Terry's Magic Studio, 1921—66th Street, Brooklyn 4, New York.

SENSATIONAL Magician's wand 25c. Vanishes handkerchief! Catalog included. Box 1352-PM, Philadelphia 5.

PROFESSIONAL Catalog, 175 pages, 25c. Williams, 900 Plymouth, Ellwood City, Penna.

SVENGALI Trick deck free with catalog 50c. 1746-PM Market, Philadelphia 3.

WOODEN Nickels, catalog, trick, 10¢. 1,500,399 tricks, jokes, Magico, Box 1375-S, San Antonio 6, Texas.

VENTRILLO, Professional voice-throwing instrument and catalog 25c. Box 971-PM, Philadelphia 5.

COINS, TOKENS, CURRENCY

GOLD Bargains—\$5 gold \$9.85; \$10 gold \$19.85; \$20 gold \$39.85. Giant bargain catalogue 50¢. Bebee's, 4514 North 30th, Omaha 11, Nebraska.

555 CENT 10¢. Send dime for extensive list American coins and free coin. Wise, Box 8444, Dallas, Texas.

35 DIFFERENT Foreign coins, \$1.00. Claud Denney, 3406 S. Harwood, Dallas 15, Texas.

\$12,500 FOR One silver dollar! What are other U.S. coins worth? Fell's U.S. Coin Book gives value of all U.S. coins from Colonial times to present. Also, how to collect them, what makes them valuable, how to sell coins, and everything else. Profusely illustrated, hard-cover book. \$2.00 postpaid from: Fell Publishers, 386B-16 Fourth Ave., New York City 16.

YOUR Old coins wanted by coin collectors. Wanted list 25¢. Coin Collectors Exchange, 2246 El Camino, Redwood City, Calif.

36 DIFFERENT Foreign coins \$1.00. Robbins, 1007 Cleaveland, Montgomery 8, Alabama.

OLD Money wanted. Will pay \$100.00 for 1894 dime, S. mint, \$50.00 for 1913 Liberty Head nickel (not buffalo). Big premiums paid for all rare coins. Send 4¢ for large coin folder. May mean much profit to you. Numismatic Co., Dept. 20, Fort Worth, Texas.

\$3,000.00 FOR 1913 Liberty head nickel. Dimes 1894-S, 1895-O, 1916-D. Quarters 1827, 1896-S, 1901-S, 1913-S, 1923-S, we pay \$5.00 to \$1,500.00. Certain dates—Lincoln cents, \$60.00. Indianheads, \$60.00. Large cents, \$500.00. Eagle cents, \$200.00. 2¢ pieces, \$45.00. 3¢ pieces, \$80.00. Half-dimes, \$500.00. Shield nickels, \$100.00. Old dimes, \$300.00. 1875 Canadian quarter, \$50.00. Hundreds of others worth \$5.00-\$500.00. Wanted—Half dollars, dollars, gold coins, paper money, etc. Know their true value. Our large illustrated guarantee buying-selling catalogue, giving complete all coin information—Send \$1.00. Purchase catalogue before sending coins. Catalogue money refundable. Worthycoin Corporation, Leaders Numismatic Quotations, K-140-C, Boston 8, Massachusetts.

FIVE Foreign coins from Switzerland, Belgian East Africa, etc., plus foreign banknote, only 10¢ with coin approvals. Littleton Coin Company, Littleton R1, New Hampshire.

GET Profit and pleasure in collecting old coins. Send 10¢ for 56-page illustrated coin catalog. You'll be delighted with it. Send for it now. B. Max Mehl, 370 Mehl Building, Fort Worth, Texas. Largest rare coin establishment in U.S. Established 56 years.

6-IN-1 Special: Magnifying glass; check list; 25 coin envelopes; giant 60 page bargain catalog; ten different Indian pennies; Mexican ten-peso; All six, \$1.00 postpaid. Ben's Coin Shop, 31 North Clark, Chicago 2, Illinois.

FREE! Foreign coin, banknote and coin collectors illustrated catalog to approval service applicants. Send 3¢ postage. Tatham Coinco, Springfield 30, Mass.

MORGAN Dollars; 1878, 1887, 1890, 1891, 1897 S mint unc. \$2.00 ea. Illustrated catalogue. 25c. Shultz, Salt Lake 10, Utah.

SAN Francisco mint closed! Made only cents and dimes in 1955. In short supply and great demand. One each, brilliant uncirculated, for 25c. Free coin lists with order. Bryson Stamp & Coin Company, 612 White, Toledo 5, Ohio.

40 DIFFERENT Selected coins, \$1.00. Oddehon, Box 482, St. Louis, Mo.

SENSATIONAL Illustrated U.S. 16 page coin list 10¢. Stoney, 192 Washington, Boston 8, Mass.

UNCIRCULATED Sets and singles—Coin supplies. Dealers write for wholesale prices. Louis Bell, Masonic Bldg., Decatur, Alabama.

BARGAIN Lists, Indianhead cent, 10¢. Economy Sales, 157 Dean, Mansfield, Mass.

LINCOLN Cents 1910-S, 1913-S, 1921-S, 1924-S, 1926-S, 1933-D all for \$2.00. Gasser, Box 34615, Los Angeles 34, California.

GENUINE Pirate "pieces of eight" over 125 years old \$4.00 each. Five different silver dollars of the world \$8.50. Melvin Came, Hillcrest Drive, Dover, N. H.

U. S. Large cent, 2¢ piece and bargain list, only \$1. Delmaco, Box 1123, Wilmington, Del.

20 DIFFERENT Indian head cents \$1.00. Lists free. Chelsea, 10 West 18 St., New York City 11.

STAMP COLLECTING

SWITZERLAND Prize package! 50 different, including trains, castles, commemoratives, bi-colors, pictorials. All for 10¢ with approvals. Molzan, 720 Pomona, El Cerrito 8, California.

FIFTY Different British colonials. Plus dozen Confederates (facsimiles) dime! Approvals. Gene's, 1707 N. Congress, Austin, Texas.

FREE 6 Rare Roosevelts with approvals. Moore, 909 Andrus, Orlando, Fla.

TRAVEL Through 50 countries! A virtual world cruise! 50 stamps, each from a different country. Abyssinia to Zanzibar. Bargain unsurpassed! To new approval applicants, 5¢. Avalon Stamp Co., Dept. M, Springfield, Mass.

FREE! Monaco's Grace Kelly-Prince Rainier wedding stamps given applicants for your exotic approvals. Exotic Stamps, Box 482-MM, Coral Gables 34, Florida.

VENEZUELA 50 Different \$1.00. Alfredo Lafuente, Estación Servicio Mérida, Carretera Antimano, Caracas.

ILLUSTRATED New issue booklet 20¢. 50¢ deductible. Ace Stamps, Jamesburg, N. J.

GRACE Kelly-Monaco wedding mint free. Dolin, 31 Parkrow, New York City 38.

BERLIN Bishops set 25¢. Approvals. Barricks, 1734 Seward, Detroit 5, Mich.

ZEPPELIN Stamp free with foreign approvals. (Postage appreciated.) Variety Stamps, 57-Z Circuit, Newton Highlands 61, Mass.

WHOLESALE U.S. and foreign. H. Wilhelm, 16566 Mendota, Detroit 21, Mich.

100 DIFFERENT Worldwide 25¢. Approvals. A. F. Jayne, 2010 22 St. S., St. Petersburg 5, Fla.

100 DIFFERENT France, 10¢. Approvals. Goley, Box 95, Oaklyn 6, N. J.

PICTORIAL Packet from Antigua, Barbados, British Guiana, British Honduras, Burma, Curacao, Leewards, Rhodesia, Trinidad, Tobago, and many other hard to get countries. Bicolors, topicals. Tremendous value. Each stamp a beauty. 10¢ with inexpensive, attractive approvals. Wolverine Stamps, Dept. A-27, Fruitport, Michigan.

KOREA Flowers, Formosa Chiang Kai-shek birthday issue, Hungary pictorials, Ceylon (elephant) Royal Visit, South Africa Cape of Good Hope triangle centennial, Italian Colony flowers. Niue bicolor maps, African wild animal set. Many more beauties. All for 25¢ with interesting approvals. Every continent represented in this collection. Modern Stamp Co., Dept. A-3, Ferrysburg, Mich.

GIGANTIC Collection free. Includes triangles, early United States, animals, commemoratives, British Colonies, high value pictorials, etc. Complete collection plus big illustrated magazine all free. Send 5¢ for postage. Gray Stamp Company, Dept. PM, Toronto, Canada.

U.S. Stamps—At discount prices. Giant illustrated catalog. Only 10¢. Raymax, 37-VZ Malden Lane, New York City 38.

FIRST U.N. set. Among world's prettiest. Only 10¢. Approvals. Welles, Box 1246-R, New York City 8.

300 DIFFERENT Given free with approvals. Particulars. Windsor Stamps, 8834 Cornell Ave., Chicago 17.

HOW Many of your album pages would a few stamps complete? Want to fill them? Try our approval books of 1,000 at 1¢ and 2¢. Values will amaze you. Also U.S. Roseland Stamps, Dept. A-36, Spring Lake, Mich.

FREE. Mint British Colonies from Brunel, Papua, New Guinea, Caymans, Gilbert Ellice, Seychelles, Sarawak, Grenada. Free with approvals. Viking, Great Neck 8, N. Y.

40,000 VARIETIES Available on approvals, 1/4¢ upwards. Keigwin, Box 933B, Daytona, Florida.

FREE! World's 10 ugliest! Weird colors, valuable cut design. Send 3¢ postage today! Norrisco, Milwaukee 7, Wis.

77 DIFFERENT U.S.—25¢. Approvals. Utechts, 1143D North Keeler, Chicago 51.

513 DIFFERENT Worldwide from Cunha, Sudan, Libya, etc., cataloging over \$10 only 35¢. Approvals. Littleton Stamp Co., Littleton, Q1, N. H.

FREE! Giant catalog offering thousands of bargains. Sent with beautiful approvals. Jamestown Stamp Co., Dept. E6PMC, Jamestown, N. Y.

INVEST \$1.00. Get 10 beautiful, valuable, complete mint pictorial sets and free lists. Higher values, 15 for \$2.00; 25 for \$5.00. Investment Stamps, 8720 Elizabeth, Chicago 20.

WOW! 135 All different Germany 10¢. Zeppelins, semi-postals, airmails, high values. Big bargain lists and approvals included. Jamestown Stamp, Dept. A6PMC, Jamestown, N. Y.

TWO \$5.00 U.S. stamps plus 20 different, 10¢ with U.S. approvals. Irwin, Box 1105, Brooklyn 30, N. Y.

BULGARIA Pictorials: 50 diff. 15 cents. Approvals. Boger, Box 152, North Wales, Pennsylvania.

ECONOMICAL 1/2c, 1c, 2c. Approvals, 22,000 varieties available. Dresel, Box 270-N, New York City 25.

100 YEAR Old United States stamps are sent on approval together with all commemoratives, airmails, etc. Also all foreign, Roosevelts, etc. Send 10¢ for 50 different U. S. and approvals. Globus Stamp Co., 268-4th Ave., New York 10, N. Y. Dept. 213.

FREE U.S. stamps. 1943 occupied nations flag, airmails, commemoratives included, collection of 25 different U.S., plus \$5.00 stamp. Everything for 10¢ mailing charge. Approvals. Willett Stamps, 141-A, E. Main St., Mount Kisco, N. Y.

OLYMPIC Set, 1000 hinges only 10¢. Approvals. Buckey, 208 Ludlow Bldg., Dayton 2, Ohio.

SELL Your surplus good grade stamps. Write, describing fully what you have. Vanroy Shirk, Lebanon, Pennsylvania.

FREE! Catalog! About stamps. Illustrated. Free! The Stampmart, Hartford 1, Connecticut.

FREE United States price list. Mark Hanna, 335 Fifth Ave., Pittsburgh 22, Penna.

50 DIFFERENT Argentine 10¢. Approvals. Reuter, 611 W. 40th Pl., Los Angeles 37.

OLD Scarce U.S. seconds on approvals. Slight imperfections, lowest prices. Herfield, Clintonhill Sta., Newark 8, N. J.

THOUSANDS Of exciting stamps, all different, yours for 1c, 2c each. Fill your album for pennies! Big collection sent for free examination. Cole, 43-A Rinewall, Buffalo 21, N. Y.

U. S. Classics. Over 50 yrs. old. 15 selected old-timers. Missing in biggest collections. All 15 at less than 1c each. 10¢ with approvals. Jaro, Box 246-T, New York City 8.

50 DIFFERENT United States 5c with bargain approvals, lists. Bookman, Box 8245-M, Madeira Beach, Fla.

AMAZING Offer! 200 United States stamps—including commemoratives, airmails, high denominations to \$1.00. Only 10¢ to approval applicants! Illustrated bargain lists free. Mystic Stamp Co., Dept. 80, Camden, New York.

FREE Sample! Interesting, illustrated, informative! National Stamp News, Anderson, South Carolina.

300 DIFF. World wide 25c, plus surprise packet. Packet list free. Econopackets, Box 168, Riverside 9, Calif.

WORLD'S Largest stamp (7 1/2 x 14 inches). A real curiosity! Retailers for 50c, only 3c to approval applicants. Tatham Stamp Co., Springfield 30, Mass.

WEIRD Diamond shape coffee stamp! Lovely flower triangle! First American big commemorative, Greenland, idol dancer, etc. Free with approvals. Capital Stamp Co., Little Rock 2, Ark.

100 OLD United States between 1861 and 1935. \$1.00. Roush Stamps, 51 Chestnut, Mansfield, Ohio.

225 STAMPS For only 10¢! This mammoth value includes airmails, pictorials; stamps from strange countries cataloging up to 25c each! Also approvals. Mystic Stamp Company, Camden 80, New York.

FAMOUS Men, jungle scenes, zoo, United States commemoratives, 100 others. Ten cents with request for thrifty approvals. Casner Stamps, 247-A Riverside, El Paso, Texas.

14,000 DIFFERENT—Yours on our streamlined systematic club plan for only 50¢ weekly. Big shipment every two weeks. Details free. Sjoquist, Box 217, Valley Stream 75, New York.

MINT Commemoratives at face! Send 25¢ for surprise packet of all different, mint U.S. commemoratives. Mint U.S. approvals too. Western, Box 1689P, Salinas, California.

UNITED States approvals. Select copies, used—mint. Kingsbury, Fairfax, Vermont.

TRINIDAD. 12 Different. 10c with approvals. Seminole Stamps, Box 1138-P, Coral Gables 34, Florida.

200 DIFFERENT. Including Macau, Rhodesia, Caymans. 10c to approval applicants. Evden, Box 128, Valley Stream 50, New York.

ICELAND 10 Different beautiful stamps for only 10 cents to applicants for our good old fashioned approvals. Old Colony Stamp Co., Dept. A, Milford, Connecticut.

100 JAPAN 10c. With approvals, Goulds Stamps, Box 631, San Francisco.

UNITED States commemorative collection containing 33 different. 10¢ approvals. White, 516-A Avenue L, Brooklyn 30, New York.

DIFFERENT. 500, 50¢; 1000, \$1.25; 2000, \$3.00; 5000, \$12.00 with approvals, wholesale. K. S. Holmes, London, Canada.

QUEEN Elizabeth mint sets. Barbados, Caymans, Dominica, Tristan, Gibraltar, Leewards. 21 bicolors, 25¢. Approvals. Gannon Stamps, Box 931, Canton 1, Ohio.

SENSATIONAL Illustrated U.S. 72 page catalogue free. Stone, 192 Washington, Boston 8, Mass.

FREE! Flower triangles, others. Approvals. Delton Page, Box 201X, East Paterson, New Jersey.

U. S. Revenues on approval. El Jay Stamps, Box 286, New York 36, New York.

START Your own stamp business. Send for free circular. Donald Shepard, Box 1147, Chicago 90.

WANTED—Stamp collections, accumulations. Murray Gold, 62-95p Saunders, Rego Park 74, N. Y.

CANADIAN Animal packet 10¢ with approvals. Lister, 196 Carling, Ottawa, Can.

350 DIFFERENT World, 25¢. Pictorials, triangles. Approvals. Edgar, Box 437M, Punxsutawney, Penna.

COMPLETE Israel mint sheet, \$1.00. Approvals. Hefter, Main St., Nanuet, N. Y.

100 DIFFERENT China 10¢. Approvals. Coast, P.O. 2187H, Santa Ana, California.

30 DIFFERENT Commemoratives 1893 up 10¢; U.S. approvals, 10 mint sets 15¢. Foreign approvals, K & B, Box 70, Brooklyn 23, N. Y.

STAMP Wallet plus 285 diff. worldwide. 25¢ with approvals. Fried, Box 475, No. Hollywood 11, Calif.

1956 ANTARCTIC Expedition set mint 15¢; approvals. H & H Stamp Center, Box 76, Brooklyn 26, N. Y.

100 DIFFERENT Austria 10¢. Approvals. Aronson, 91 Marion, Brookline 46, Mass.

45 DIFFERENT U.S. 10¢, approvals. Standard, 10840 Woodview, Parma Hts. 30, Ohio.

COLLECTORS Outfit 5¢! Stamp album, packet of stamps, gauge, lists. Approvals included. Adventure, Buckland, Conn.

99 DIFFERENT Latin Americans, just 10¢. Approvals included. Fred Pittsley, South Montgomery, Napa, Calif.

CUBA, 50 Different \$1.00. Patallo, P.O. Box 1291, Havana, Cuba.

FOREIGN Mixture. Half pound \$2.50, full pound \$4.75 postpaid U.S.A. Ladue Stamp Co., Creve Coeur, Mo.

MONACO Wedding set packets, 25¢. Stoll, 2637 Burnett, Louisville 10, Ky.

999 DIFFERENT Worldwide with approvals. Jacobsen, 4395 Broadway, New York 40, N. Y.

1000 DIFFERENT, \$1.00 With approvals. Louis Golden, 6721 Eastwood, Philadelphia 49.

TURKEY. 100 Different, only 25¢ with quality approvals. Livingstonville Stamp Co., Middleburg 7, New York.

U.S. \$5 Coolidge 35¢. Approvals. Gatewood, Box 346, Winston-Salem, N. C.

MOZAMBIQUE Company set free. Approvals. Weitz, Box 83F, Orange, N. J.

MONACO Nudes complete 10¢. Approvals. Royal Stamp Company, Tamaqua, Penna.

ANTIQUES, RELICS, INDIAN GOODS, CURIOS

SELECTED War arrowhead \$1.00. List 5¢. H. Talburt, Calico Rock, Ark.

SELLING 50,000 Indian relics, etc. List free. Lear's, Glenwood, Arkansas.

TAHITI Hula skirts and curios. Yves Jarsaillon, Box 467, Papeete.

5 ARROWHEADS \$1.00. Guaranteed perfect. Navajo Shop, 687 So. Patton Court, Westwood, Colo.

FOR Profit or pleasure read Antiques Magazine monthly, 1 year \$7.00. Hamilton Agency, Box 272, West Haven 16, Conn.

SCALPING Knife, spearhead, thunderbird, drill, \$4.00. List free. Arrowhead, Box 1249, Hot Springs, Arkansas.

PRECIOUS STONES, MINERALS

FASCINATING Illustrated catalog. Semi-precious gems, exotic materials, ebony, ivory, curios, jewelry projects, kits, supplies, lore. Only 25¢. Sam Kramer, 29 W. 8th, New York City 11.

FIND Uranium, tungsten, mercury, hundreds of other minerals with Mineralight. Free information kit on fun and profit in fluorescent minerals; hobby set. Write Dept. PM8, Ultra-Violet Products, San Gabriel, California.

SAPPHIRE, Topaz, tourmaline, garnet, peridot. Five uncut gem specimens, \$1.00. Ten polished gems, baroque shaped, \$1.00. Free big bargain list jewelry, gems, profitable, easy "do it yourself" projects. O'Brien's, 1116M Wilcox, Hollywood 38, Calif.

GEMCUTTING — Silvercraft illustrated magazine. Tells how to cut gems, make jewelry. 150 ads illustrating equipment, gems for collectors, cutters. Free literature. Lapidary Journal, Del Mar 2, Calif.

RADIOACTIVE Uranium ore specimens for prospectors and collectors, \$2.00 prepaid. Lists free, write: Uranium 61, Box 1122, Denver 1, Colorado.

HOBBIES AND COLLECTIONS

SOUVENIRS Of the southern states. State decals 15¢. State plates 9½ inch \$1.75. State ash trays \$1.00. State pens 50¢. Real cotton boll with seed and planting instructions 50¢. Southern cook book, over 300 Dixie recipes \$1.00. Southern fried chicken recipe as we prepare it in the south 50¢. Postage prepaid, quality merchandise. Welch Sales Co., Toomsaba, Miss.

FREE "Do-It-Yourself" leathercraft catalog. Tandy Leather Company, Box 791-V16, Fort Worth, Texas.

25 AMERICAN And foreign hotel baggage labels \$1.00. Lists 25¢. H. Copleston, 1555 Odell, New York 62, N. Y.

MATCHBOOKS For collectors. Catalog 25¢. Charles Edelman, 1311-C East 84, Cleveland 3, Ohio.

NAZI Medals listings, 10¢. Kingstons, 920 Third B338, Seattle 4, Washington.

INVENTING Can be an interesting and profitable hobby. Write for complete particulars. Institute of American Inventors, Dept. 40-E 631-E St., N.W. Washington 4, D. C.

NAZI Insignia, 12 different, \$1.00. Medals, armbands, flags, daggers. Illustrated lists. Medcrafts, 1923 34th St. S.W., Calgary 2, Canada.

GROW Giant crystals! Send dime for booklet explaining hobby. Crystocraft Company, College Station, Texas.

65 ASSORTED Army patches, insignias, ribbons (irregulars) \$1.00. Surprise included. Lhgeo, 19-X East 16th St., New York City 3, N. Y.

CAMERAS, PHOTO SUPPLIES

LEARN Camera repair. Easy, complete, approved home-study course. Free illustrated booklet. National Camera Repair School, Dept. E-6, Englewood, Colorado.

PHOTOGRAPHY For pleasure or profit. Learn at home. Practical basic training. Long established school. Free booklet. American School of Photography, 835 Diversey Parkway, Dept. 3441, Chicago 14.

TRICK Photography plus giant German photo index 50¢. Photronics, 135 Main, Woburn, Mass.

BUY Wholesale nationally advertised cameras, photo supplies, thousands other products at big discount. Free "Wholesale Plan." American Buyers, Hertel Station, Buffalo 16-E1, N. Y.

NEW Kodak Brownie 8mm. movie camera \$24.50. Tremendous savings. Photo equipment, appliances, free catalog. Camera Shoppe, Box 601-PM, Mt. Vernon, New York.

BASS Says: Quality cameras since 1910. When in Chicago visit the camera cross roads of the world, or write us for your favorite equipment, new or used. Satisfaction guaranteed. Bass Camera Co., Dept. AG, 179 W. Madison St., Chicago 2, Ill.

ATTENTION Camera owners. Can you use several hundred dollars? See Polypix ad in "Moneymaking Opportunities."

REAL Wholesale sources. Thousands nationally advertised products. Details free. Martex, 132-A Nassau St., New York 7, N. Y.

PROFESSIONAL Camera buyer sells wholesale plus very nominal service fee. Five year guarantee. Minimum \$100. References: First National Bank Colchester, Dun & Bradstreet. Bonded. State your need exactly, in duplicate, enclosing return envelope. Justin Hartley, 10 years at 13 Main Street, Colchester 10, Connecticut.

PHOTO FINISHING

12 JUMBOS From any size roll developed 35¢, with this ad only. PM Skrudland, Lake Geneva, Wis.

BEAUTIFUL Hand colored 8x10 enlargement with free leatherette frame made from your B&W or Kodachrome negative, snapshot, photo or color transparency. \$1.75, c.o.d.s welcome. Falls Pictorial, Box 92, Dept. C, Arlington 10, Va.

COPY Negatives from any print or transparency 30¢. Miller Photo, Holdrege, Nebr.

SOMETHING Different. Soil resistant, loose leaf albums. Trial offer, 8 exposures 30¢; 12, 45¢. Jim Dandy, Dept. 8, Newberry, South Carolina.

TWO Beautiful prints from each picture on roll. 8 exposure 40¢; 12 exposure 50¢. Thirty-five years of satisfied customers. Quick service. Lens Photos, Dept. J-4, Janesville, Wis.

EKTACHROME—Anochrome processed. Mounted \$1.00. National Color Corporation, Box 55, Northside, Atlanta 5, Georgia.

12 EXPOSURE Rolls, 39¢, jumbo prints. Guaranteed work, one day service. Lincoln Studios, Dept. K, Box 13, Lincoln, Neb.

ENLARGEMENTS. Heavyweight eight 5x7s or five 8x10s, \$1.00. Jack Koons, Huntington Mills, Luzerne County, Penna.

TWO Beautiful enlargements from each picture on roll. 8 exposures 55¢. 12 exposures 75¢. Cut Rate Photos, Dept. B-4, Janesville, Wis.

ROLL Developed, 8 beautiful enlarged prints 25¢; 12—35¢. (Trial) 10 reprints 40¢. Quick service. Willard's, Box 2553G, Cleveland, Ohio.

BETTER Pictures faster, 8 oversize in album 35¢, 12, 50¢. Red Robin, Box 573C, Clifton Heights, Penna.

DELCO'S June special. Free roll of film with your order. 8 exposure roll developed oversize in album, 49¢; 12, 59¢. Delco Film Lab, Box 3622, Upper Darby, Penna.

SPECIAL Introductory offer. 8 jumbos 25¢, 12—35¢. Western Photo, PM66, Box 298, San Francisco 1, Calif.

SUPERFINE Professional enlargements. Roll, negatives or photo 12 4x6s and 3 5x7s \$1.00. Texas Studios, Sweetwater 1, Texas.

QUALITY Kodak finishing. 8 exposure roll 35¢; 12 exposure 50¢; 16 exposure 60¢. Reprints 4¢. Fast service. Guaranteed quality. 40 years continuous operation. Be a satisfied customer. We do color. Send for mailers, Mail Order Photo Service, Box 297, Watertown, Wisconsin.

TOP Quality. Fast service. 8 jumbos 35¢, 16 contacts 40¢. Reprints—Jumbos 4¢; contacts 3¢. Satisfaction guaranteed. Free mailers, circulars. Fast-X-Photo, Box A, Jersey City, New Jersey.

8-HOUR Service on deluxe jumbo prints. 8-exposure roll developed and 8 jumbo prints 40¢, 12 exposure 55¢, 16 exposure 70¢; 35mm. 20 exposure 75¢, 36 exposure \$1.25. Jumbo deckledge reprints 4¢ each. Contact prints made if specified. Bay Photo Service, P.O. Box 210, Oakland, California.

FREE Superpak album with 8 jumbos only 35¢. 12—50¢. Prompt superior service. Quality guaranteed. Mailers and circulars free. Grand Fotos, GPOB 1410, New York City 1.

6 OR 8 Picture roll 35¢. 12 or 16 picture roll 55¢. Each roll developed and printed in handy pocket wallet. Send coin with roll. No c.o.d.s. Mailing containers sent free. DeLux Film Service, Box 1268-A, Shreveport, Louisiana.

FROM Rolls or negatives. Jumbos 4¢. Regulars 3¢. This ad and \$1.00 for 30 jumbos or 8—5x7. Guaranteed. Square Deal Photos, Hutchinson, Kansas.

ENLARGEMENTS! Eight 5x7s or five 8x10s, \$1.00. Willart Enlargers, Box 967, Little Rock, Ark.

SURPRISE Gift with first roll developed. 8 jumbo superpak album prints or 16 contact prints 40¢. 12 exposure roll 50¢. Certificate for 3 5x7 enlargements. Dept. B-21, Owl Photo Co., Weatherford, Okla.

MOTION PICTURES AND SOUND EQUIPMENT

DUMONTS Hi-Fi plastic recording tape. 1200 feet \$1.90, 600 feet \$1.45. Postage extra. Dumonts, 150 East 34th St., New York City.

PRE-Recorded tape, recording tape, accessories, discounts. Efsco Sales, West Hempstead, N. Y.

8-16MM. Free catalogue (with sample film 10¢). Garden, 690 Howard Ave., Brooklyn, N. Y.

TAPE Recorders, tapes; wholesale prices. Carstan, 215 E. 88, New York City 28.

16 MM. Sound-used projectors and films. Rental, sale, exchange, bargain prices. Free lists. National Cinema, 71 Dey Street, New York City.

5,000 8-16MM. Movie films. Free catalogues. International, Greenvale, N. Y.

TAPE Recorders, tape. Unusual values. Free catalog. Dressner, 69-02M 174 St., Flushing 65, N. Y.

MOVIE Camera film: 8mm. roll \$1.50, 16mm. 100' \$3.00. Free processing. Better Films, 742 New Lots, Brooklyn, N. Y.

SAVE 50%! Guaranteed-fresh color, b.&w. movie film! 8mm., 16mm. Free catalog! Eso-R, 47th Holly, Kansas City 12, Missouri.

8-16MM. Kodachrome movies! Slides! Stereos! Illustrated catalog, dime. Refundable. Colonial, 247-X, Swarthmore, Penna.

CASH For old 35mm. silent movies. Also sound and certain 16mm. bought, sold. Details dime. Studios, Box 382, Lima, Ohio.

8-16 SHORTS, Features, 50%. Sale. library. Sound, silent. 10-1600' reels used \$7.90. Mogulls, 112 W. 48, New York City.

MUSIC AND MUSICAL INSTRUMENTS

ACCORDIONS Wholesale. Latest models. Try before you buy. Lifetime guarantee. Wonderful trade deals. Catalog free. American Accordion Center, 5329-PM6 Belmont, Chicago.

CLARINETISTS! Only Sonic, immediate response reeds contain S5B, magic cane blend ingredient. No squeaks! 2 for \$1.00 postpaid. State strength. Money-back guarantee. Broadus Manufacturing, Mason Street, San Diego 10, Calif.

SONGWRITERS: Recording company wants new songs. Royalty basis. National sales, promotion if selected. Send material. Music Makers, Dept. E-22, Box 2507, Hollywood, Calif.

POEMS Wanted for musical setting. Send poems. Immediate consideration. Five Star Music Masters, 630 Beacon Bldg., Boston, Mass.

ACCORDIONS — Direct from importer. Save 50% and more! Free trial. Lifetime guarantee. Trades accepted. Free catalog. Write Accordion Manufacturers, Dept. 66R, 2003 Chicago, Chicago 22, Illinois.

ELECTRIC Accordions! Terrific discounts! Catalogs, dime. Accordions, 505 Cherry, Norristown, Penna.

SONGWRITERS. Free booklet successful songwriting. Gateway Songs, Box 2470, Hollywood 28, Calif.

POEMS Wanted for new songs. Send poems. Free examination. Immediate consideration. Songcrafters, Arcade Station, Nashville, Tenn.

SONGS Into dollars. Share \$29 million dollars yearly for new songwriters, poets. Songs composed, published, promoted by famous firm. Information, appraisal free. Send to Nordyke Publishing Co., 6000 Sunset Blvd., Hollywood 28PM, California.

POEMS Wanted to be set to music. Free examination. Send poems. McNeil, Master of Music, 510-PM S, Alexandria, Los Angeles, California.

POEMS, Songs wanted! Free examination. Bengol, 93 Jefferson, Chelsea 50, Massachusetts.

SONGWRITERS! Send poems, songs. Music Service, 243 West 72nd St., PM, New York City 23.

FREE Records of your song. Your words, my melody. Free information. Johnny Mack's Melody Mart, 1094 West 39th Street, Dept. A, Los Angeles 37.

ACCORDIONS, Wholesale to everyone. Save up to 60%. All national known brands. Free catalogue. Del Principe, 29 South Cicero, Chicago 44.

POEMS Wanted for new songs. Send poems. Immediate consideration. Crown Music Company, 1476 Broadway, New York City 36.

WRITE Songs. Big money and reputation. Write for information. J. Gordon Pub. Co., 4700 South California Avenue, Chicago.

VIOLINMAKERS, Repairers. Fine tone wood, and all violin supplies. Send for free wholesale price list. International Sales, 414-MPM E. Baltimore St., Baltimore 2, Maryland.

SONGPOEMS And lyrics wanted. Mail to: TinPan Alley, Inc., 1650 Broadway, New York 19, N. Y.

SONGWRITERS: Music composed and songs arranged by hit songwriter! Correct procedure explained. Song Service, P, Indian Lake, New York.

RADIO, TELEVISION AND ELECTRONICS

BUILD 16 Radio circuits at home, only \$19.95 complete. Free dynamic radio and electronics tester, set of tools, soldering iron. No experience or additional parts required. A practical home radio and electronics course. Unconditional money-back guarantee. Order direct or send for descriptive literature. Free valuable radio, TV and Hi-Fi repair manuals on request. Progressive Edu-Kits Inc., 497 Union Ave., Room 46B, Brooklyn 11, N. Y.

KITS, Hi-Fi tuner, Geiger counter, intercom, etc. Sierra Scientific, PM9, 5415 York, Los Angeles 42.

EXCLUSIVE! Ultra modern sun-powered transistor radio kit. Pocket size. Complete with simple instructions. Only \$6.88 post-paid. Phones \$1.95. Write for bargain catalog. Lektron, Dept. C, 28 Gardner, Chelsea, Mass.

TRANSISTOR Radio plans, 50¢ kit, \$4.50. Cook, 4003-M Roosevelt, Midland, Texas.

15 TESTED One-tube circuits, catalog and "Radiobuilder" magazine—25¢. Laboratories, 328-C Fuller, Redwood City, California.

WHOLESALE, Recorders, Tapes, Radios, Phonographs, Catalogue, Towers, Box 155, Philadelphia 5.

BUSINESS OPPORTUNITIES

YOUR Opportunity to become a successful manufacturer of world famous KoolVent ventilated aluminum awnings. 25 profitable plants now operating coast to coast. No experience required; KoolVent will train intelligent, aggressive individuals and businesses wishing to expand with the \$400,000,000 and growing aluminum awning business. Minimum capital required: \$25,000 to \$40,000. Exclusive franchises to manufacture and sell KoolVents—the great name in the aluminum awning field—are available now in Connecticut, Maine, New Hampshire, Vermont, North Dakota, Kansas, New Jersey, Nebraska and Oklahoma. Send full details in first letter to: KoolVent of America, Director of Franchises, P.O. Box 9536, Pittsburgh, Pennsylvania.

WHOLESALE Buyers' service! Buy nationally advertised merchandise wholesale. Sell way below retail. Fabulous profits. Write Wholesale Buyers, Box 22-PP, St. Louis 3, Missouri.

FINANCE Your own business. Expand! Know "How and Where to Raise Capital." Free details. Advance Publishing, Box 1377-BF, Miami 8, Florida.

RARE Opportunity for men in country and small towns. New company with proved plans that make you bigger profits. Write: Fire King, Dept. 24, Littleton, Colo.

MAIL Order opportunity. Free details. Nebesco, 365 Wood, New Bedford, Mass.

FREE! "Mailorder writing" information. MGB, 425 East Catherine, Louisville 3, Ky.

NEW Mailorder opportunity! Profitable. Information, Bradley, Box 135, Madison 1, Wisconsin.

137 PLANS For starting home business. Details: Shumaker, 2623-M Columbus, New Orleans 19, Louisiana.

WANTED: Home producers, to be subcontractors. Cast plastic products for manufacturers in our clearing house service. Thousands of easily-made items required. Cash in at home, without previous experience. Plastic Service Associates, Dept. 6-PM, East Boston 28, Massachusetts.

LISTINGS Of all kinds of New England businesses. Yankees Listing, Box 112, Malden 48, Mass.

EARN \$1000 Month up. Man-woman, full time-part time from home. \$1900 starts you. Write: V. Pres., Box 86, Youngstown, Ohio.

EXCEPTIONALLY Profitable opportunity in tape recording. Write: Baron's, Lynden, Wash.

AMAZING Home business. Terrific profits. Make, sell sensational cleaner for woodwork, tile, 12¢ makes gallon. Sells \$2.00. Formula \$1.00. Details free. Money-back guarantee. Sayco Cleaner, Eden, Ala.

BUY Wholesale! 100,000 name brand products! Save 66%! Big profits selling others spare time! Free details! National Buyers Service, Box 3338EE, San Francisco.

GET The latest. Best low cost homework starting mail offers. Everything furnished. Orders filled. Rush name. Modern Industries, 405 E. Chestnut St., Wauseon, Ohio.

\$26,500 SALES In two weeks! Amazing radio-mail order method. Free details. Broadcast Service, 1412-JA Great Northern Building, Chicago 4, Illinois.

STEADY Income mailing catalogs! Everything furnished! Sample, details \$1.00 deposit. Co-Operative, 170 So. 17th, San Jose 12, Calif.

EARN Money at home! Profit maker tells you how, \$1.00. Order now. JFC, 1083 W. View, Decatur, Illinois.

UNUSUAL Mail order ideas, products, projects, sources. Authentic information, guidance. Free details. Write: Fax, Box 1024, Galveston, Texas.

EXCLUSIVE Distributors. Amazing paint-on, aromatic, red cedar powder! Add water; makes cedar closets, chests, attics! Fast sales stores, supermarkets, builders. Attractive plastic bags; big profits. Free samples, details. Plant, 90-D Summit Ave., Brookline, Mass.

WHOLESALE List! Bibles, books, testaments. Johnson Wholesale Company, Box 12702, Dallas 17, Texas.

MAKE \$3 An hour sharpening scissors and shears. Details free. Flory, 3741 Rufe Snow Dr., Fort Worth 11, Tex.

LIQUID Rubber, make flexible molds. Free sample. Chaney, 1130 E. 18th St., Jacksonville 6, Fla.

OPERATE Profitable mailorder business. Splendid opportunity. For details write, Thomas L. Bond, 1637 W. Vernon, Phoenix, Ariz.

YOU'LL Be amazed at the tremendous profit possibilities in selling the world's finest family and educational reference Bibles! Many make \$30,000 yearly as full or part time distributors! Get my free proven Bible sales course plus magnificent seven color, 52 page catalog of 50 Morocco grain, genuine leather covered Bibles, and Bible story books. For the whole story write: Joseph W. Cain, Wholesaler, Box 5065, AT San Antonio 1, Texas.

WHOLESALE Catalogue! Appliances, cameras, watches! Cam Company, 6806PM 20th Ave., Brooklyn 4, N. Y.

COLOR Concrete with chemicals. Marble-glaze cement benches, pottery, Home-shop. Hundred beautiful designs, made without molds. Birdbaths to waterfalls. Your chance for fame, fortune, 10¢ brings sample, pictures. Hollywood Cementcraft, 8527-R Wonderland, Hollywood 46, Calif.

MINIATURE Trees. Why pay \$2.00-\$10.00 for growing secrets? Free details. Tiny Trees, Box 3084-P, Chicago 54.

EARN \$10,000 Yearly raising Angora rabbit wool for us. Information 25¢ coin. American Angora Company, Malta 12, Montana.

HAVE Home business! Get \$10.00 merchandise orders by mail. Keep \$8.00. Everything furnished. National, Box 88W, Dorchester 22, Massachusetts.

HOW And where to obtain capital. Particulars free. Star Service, Wapakoneta, Ohio.

"MAILORDER Laws and Regulations." Discusses federal, state, local licenses, necessary taxes, legal requirements governing mailorder businesses, \$1.00. "Mail-order Rules for Beginners." Additional helpful information, \$1.00. Play safe. Order both. Tasker, 105 East Custis, Alexandria, Virginia.

IMPORT-Export opportunity, profitable, world-wide, mail-order business from home, without capital; or travel abroad. Established world trader ships instructions for no-risk examination. Experience unnecessary. Free details. Mellinger F701, Los Angeles 24.

REBUILT Batteries; repair dolls; make rubber stamps; "60 Ideas" free. Universal, Box 1078-A, Peoria, Ill.

MONEY In saw and lawnmower sharpening sparetime at home. Free book. Virgil Foley Company, Columbia Heights, Minnesota.

POPCORN And potato chip equipment. Ekins, Box 933-A6, Springfield, Ohio.

FREE Folio "\$5,000-\$45,000. Unlimited Vacations." No merchandise, equipment. Unknown! Work home, sparetime! Haylings, Carlsbad, Calif.

\$250 WEEK Cleaning venetian blinds. Patented machinery. Free literature. Robinson, 7213B, Indianapolis 1, Indiana.

NATURAL Molding rubber, extra thick. Free sample. W. Wooley, 115-A Donald, Peoria, Illinois.

TO \$100.00 Weekly. Sparetime, home operated mailorder business. Successful beginner's plan. Everything supplied. Lynn, 10420-M National, Los Angeles 34.

MAKE-Sell polishes, cleaners, anything. Formula catalog free. Kemixer, Park Ridge, Ill.

EARN Money at home! Homemaker Magazine tells how. Sample 25¢. Sizemore, 20-H East Delaware, Chicago 11.

PLASTERCRAFT Molds, liquid rubber, plasters, floccs, candle supplies. Catalog and manual free. Blue Rapids Supply, Blue Rapids, Kansas.

WHAT'S New in mailorder? Let "Mail-order World," published monthly, keep you informed. Sample, 25¢. Wayte, 1233 Elden, Los Angeles 6, Calif.

BREED Rare tropical fish at home. Earn big money! Learn secrets! Help fill huge demand. Amazing opportunity! Free plan. Tropical Fish Breeders, Los Angeles 61, Calif.

BE Appointed state notary public now. Write. Stationers, Helotes, Texas.

COPUBLISH Mail Sale Advertiser, leading mail order paper. Details, latest copy, dime. Vanroy Shirk, Lebanon, Penna.

MINK Raising information free. Complete. Lake Superior Mink Farm, Superior, EE1, Wisconsin.

FREE Book "505 Odd, Successful Businesses." Work home. Expect something odd! Pacific, Oceanside, Calif.

BRONZE Baby shoes. Instructions, equipment and mountings for genuine electroplated process. Free catalog. Hollywood Bronze Supply, Dept. B-3, 1624 East First Street, Los Angeles 33, Calif.

YOUR Own name brand business. No investment; no inventory. Part time or full time. Sell famous brands of appliances, housewares, silverware, radios, vacuum cleaners, lamps, tools, clocks, watches, jewelry, etc., etc., over 1000 items. Join thousands of successful independent dealers. Send for free catalog and dealer price list. H. B. Davis Corp., Dept. W, 145 W. 15 St., New York City.

BIG Profits raising fishworms and crickets. Free literature. Carter Farms, Plains, Georgia.

GROW Orchids at home—Profitable, fascinating. Year 'round, Maine to California. No greenhouse. Gorgeous cactleys, cymbidiums, etc. Successful home grower shows you how. Full details free. Flowerland, 4622 Wilshire, Los Angeles 5.

WE Love our mailman—He leaves over \$1000.00 monthly in our rural mailbox. My college professor husband drafted a scientific home mailorder method. We bought a Texas ranch, live as we always wanted. Now we sell the Ranch Mailorder Method. Operates anywhere. Inquire: Eveningshade Ranch, Helotes, Texas.

FIX Typewriters. Inexpensive home course teaches factory secrets. Free booklet. Write, Typewriter, Tarentum 1, Penna.

NEWEST Spare, full-time home business. \$5 to \$10 hour possible. Paint with suede—The finish with touch and eye-appeal. Beautify auto dashboards, signs, radios, toys, figurines, lamps—1001 others. Complete, step-by-step instructions sent for no-risk examination. Free details, Coast, Los Angeles 61.

IMPORT-Export mailorder opportunities! Details. Warner, Box 6, Fort Scott, Kansas.

MAKE New greasless doughnuts in kitchen. Sell stores. Half profit. Free recipes. M. Ray, 3605 South 15th, Minneapolis 7.

\$46 FROM Square foot plywood; jigsaw necessary. Details free. Woodart, Bridgewater, Mass.

\$70 WEEKLY—Home, spare time. Simplified mail bookkeeping. Immediate income—easy! Auditax, 34757A, Los Angeles 34.

\$150 WEEK—Easy! Start home Venetian blind laundry. Revealing book free. A. T. Co., 101 S. 44th, Philadelphia 4, Penna.

SELL Real merchandise by mail. Four ways. Everything supplied. Orders filled. Big profits. Charles, Box 32-P, New York 63, N. Y.

COLORGLAZED Concrete pottery made without molds. Patented method. Cemetery products, novelties, tiles. Basement leak-sealing. Money-making projects. Booklet, details free. Men only. National Potteries Company, Grand Rapids, Minnesota.

\$5,199.90 WAS Paid to John Betts, in few weeks. Grow mushrooms. Cellar, shed. Spare, full time year round. We pay \$3.50 lb. Free book. Mushrooms, Dept. 172, 2954 Admiral Way, Seattle, Wash.

VENDING Machines—Every description. New or used. Lowest prices—Start a route or sell outright. Mack Postel, 2952 Milwaukee, Chicago 18.

WANT To make big money at home? \$5 profit in an hour possible with invisible reweaving. Make tears, holes disappear from clothing, fabrics. Steady year-round demand from cleaners, laundries, homes. Details free. Fabricon, 8334 Prairie, Chicago 19, Illinois.

\$30.00 A Day profits raising earthworms. Illustrated booklet. 25¢ postpaid. North St. Paul Worm Farm-D, North St. Paul 9, Minn.

YOUR Own business. No investment. No inventory. Sell name brand nationally advertised items. Free catalog. Confidential wholesale price list. Normandy Dist. Co., Dept. PM, 133 Fifth Ave., New York 1, N. Y.

INTERESTED Mail order? Copies leading mail order magazines. All different, 25¢. Palm, Box 1221, Baton Rouge, La.

BRUSH Plating outfits for plating articles in the home and shop. No tanks necessary. Good income spare or full time. Free particulars. Gunmetal Co., Ave. H, Decatur, Illinois.

\$1,000 MONTHLY Possible in collection agency business. Free details. Write Cole Associates, Syracuse 2, N. Y.

HIGHEST Commissions all magazines. Free catalogue, supplies, prizes, exclusive extras. Subscription Service Co., Box 2070, Birmingham, Alabama.

PROFITS Stamping social security plates. Catalog free. General Products, 188-PM State, Albany 10, N. Y.

RECEIVE Advance notice of new products and inventions. Wealth of ideas. Send 50¢ to New Products, Box 582, Austin 63, Texas.

REAL Wholesale sources, thousands nationally advertised products. Details free. Martex, 132-B Nassau St., New York 7, N. Y.

DOLLARS: Baby record books, Kitty Kat shoes, My Baby's Album, eleven thousand new prospects daily, sold by mail, use our literature. No-Co-Ro, Capitola, Calif.

SAVE Gasoline! Proof trial. Agents: Fantastic earnings! Cross Company, Eutawville, S.C.

LEARN Sewing machine big money repair, sales, service. Machines, "everything" wholesale. Taylor Service, Box 2126, San Bernardino, Calif.

INTERNATIONAL Mailorder business. Complete setup service—Not just instructions. Hermes, 152 West 42, New York City 36.

FRANCHISE Opportunities nationwide! Profitable distributorships, dealerships, agencies. Request interesting information immediately. National Franchise Reports, 333 North Michigan, Chicago 1.

YOU Can make money at home in spare time taking magazine renewal subscriptions. No capital or experience necessary. All supplies furnished. Write today! McGregor Magazine Agency, Dept. 500B, Mount Morris, Illinois.

BE Your own boss. Inside information how hundreds successful businesses started. Free booklet. Carmillo Products, Dept. P.M., La Mesa, California.

WHOLESALE Buyers! New 1956 "blue book" gives names of over 3000 jobbers, manufacturers who supply anything. Free details. Associated Wholesalers, 1016-D8 Starr, Burlington, Iowa.

AMAZE Friends. Rapid mental multiplication. Free lesson shows how. Math Institute, Box 204, Mobile, Ala.

OPERATE Restaurant or diner. Free booklet reveals plan. Write Restaurant Arts, BU-16, Fremont, Ohio.

PROFITABLE Home mail-order business on \$5. capital. Details free. Leviathan, 406 South Main, Los Angeles.

SPECIALIZED Magazines give you new ideas. Examine current copies, one or all those covering your field. 5,168 different publications—All businesses, trades, vocations, professions, sports, hobbies, etc. Free list. Write today. Commercial Engraving Publishing Company, 34C North Ritter, Indianapolis 19, Indiana.

DISCOUNT Catalogue free! Appliances, housewares, jewelry, watches. Famous quality brands, beautifully illustrated. International Consolidated Merchandising Corporation, Box 6480-PM, Los Angeles 55, California.

"I Earn \$400.00 a week." I've learned an amazing new method of printing, colorful signs, banners, cards, posters, glasswear—anything. No printing press or other expensive equipment is necessary! Big money-making opportunity for anyone. Write for my secret and revealing home-business plan, you'll be amazed! Mr. Anderson, Screen Print Company, Dept. PM-8, Los Angeles 61, California.

WORK At home. Make money. Amazing opportunities. Free details. Coleman, Box 821-A, Newark 1, N.J.

AMBITIOUS? We establish you in your own business, supply catalogues, circulars, etc., ship orders under your name, paid or c.o.d., show you exactly what to do. Household items needed in every home. Sell direct, by mail or through agents. Catalogue, plans, details, absolutely free. Write Topval Corp., Lindenhurst 618, N.Y.

ADVERTISING Book matches—Cash in on big demand: sell union label matches. Cuts for all businesses and political parties. Free powerhouse selling kit, low prices, protection guaranteed on repeat orders. Cash commissions. Superior Match Co., Dept. MX656, 7530 Greenwood, Chicago.

START A buying service, buy wholesale thousands nationally advertised products. Make big profits selling at sizable discounts. Postcard brings details. American Buyers, Hertel Station, Buffalo 16-C1, New York.

TOPFLIGHT Mail-order business opportunity. Modest capital. Request convincing details. Stav, 147 Victoria Street, Kamloops 18, B.C., Canada.

"HOW To Start a Business" booklet sent free! If you know any trade, go into business for yourself! Learn the 9 easy steps to follow. We've guided 5,000 others to success. Revealing free booklet yours for the asking! Write! National Business Consultants, Office PJE, Los Angeles 61, Calif.

WANTED! Home workers to assemble luggage and cases for ready market. Instructions, materials, tools, everything supplied. Free details. Abaral, 807-BG Sunset, Los Angeles 12.

OPERATE Profitable mail order business. Write Walter Service, 4159A East 112th, Cleveland 5, Ohio.

MAKE Profitable products. Catalogue free. International, 6347 Parnell PM-6, Chicago 21, Illinois.

OPERATE Profitable mail-order business. National Specialties, 5334 Pedley, Riverside, Calif.

BUY Wholesale! Resell at big profits. Brand name merchandise—Appliances, cookware, housewares, watches, jewelry, dry goods, clothing, sporting goods, toys, gifts, etc. Free 124 page illustrated color catalog with confidential cost sheet. Merit Home Products, Dept. PM-6, 107 Manhattan Ave., Brooklyn 6, N. Y.

100% PROFIT Sell finest sharpener, knives, scissors, lawn mowers, etc. glass cutter on handle. Send \$1.00 for sample full description. Cash Company, 9015 Wilshire Blvd., Beverly Hills, California.

NEW Tubular ornamental iron: Completely standardized. Tremendous opportunity in home improvement field. Distributors wanted in Ohio, Indiana, Michigan, Illinois, Kentucky and Wisconsin. Write Enghauser Mfg. Co., Lebanon 3, Ohio, for particulars.

IMPORT Your own products in small lots. Also, start profitable mail-order business using international drop shipment method. Capital unnecessary. Free details. Georgia Overseas Trading Company, Dept. W, 715 Persons Bldg., Macon, Ga.

EASY Money sharpening scissors. Two methods. Details free. W. Zell, Summitville, PM2, Indiana.

EXTRAORDINARY Business opportunities via inexpensive self-teaching capsule course "Air Conditioning Simplified." Free particulars. Kowalaki, 208 East Main, New Britain 2, Conn.

HOW To make money with carnival games. 144 page book. 35 illustrations. Enormous profits possible full or part time. \$2.00 postpaid. Theron Fox, 1296 1/2 Yosemite, San Jose 26, Calif.

BRONZE Baby shoes. The Beachcraft way. Formula. Instructions. \$2.00. Beachcraft, 115 Springfield St., Lawrence, Mass.

ATTENTION: Saw filers—Professional or beginners. Get expert advice \$1.00. Critic. Conrad Stadick, Searles 7, Minn.

BEAUTIFUL Hand made jewelry fashioned from authentic Florida shells. No investment necessary, we drop-ship for you. Samples \$1.00 (value \$3.00). Inquiries welcomed. Ray Caudle, P.O. Box 5903, Birmingham 9, Ala.

YOU Are cordially invited to learn the secrets of operating a successful saw shop. Send for free literature. Max Manufacturing Company, Dept. A, 138 Stockton Avenue, San Jose 26, California.

TO \$100 Weekly operating home mail-order business. Write, National Service, Richland, Georgia.

MAILORDER. Your golden gimmick for success. Free book tells all. How, Box 725-A, St. Louis, Missouri.

\$200 WEEKLY Reported! No selling. Free booklet. T. J. Surface, Roanoke 4, Virginia.

BIG Money, spare or full time. Details, catalog \$1.00. W-D, Box 312, Seneca Falls, N. Y.

25¢ BIG Mail, new sales opportunities. Dahle, Box 7PM1, Omaha 10, Nebraska.

MAILORDER Success assured. Inquire. Red Kerce, Dept. 2651, Tallahassee, Fla.

METALIZE Baby shoes, jewelry, gifts. Free catalog. Publisher, Box 73136, Los Angeles 3.

OPERATE Statement mailing service from your home as our unit. Lifetime income! American, Mt. Airy, Maryland.

OPERATE Mailorder folio business! Free plan. Ballard's, 425 East Catherine, Louisville 3, Ky.

RAISE Crickets, worms. Free literature. Three Oaks Ranch, Dresden, Tenn.

SAWDUST. Turn it into cash. Seventy methods. Tin-cans, thirty methods. Newspapers, eighteen methods. Instructions 50¢ each. All three \$1.00. Charles Company, 12-DXT, Norwood, Ohio.

TYPIST Operate profitable mail-order business. General Sales, 336 Roosevelt St., Creve Coeur 8, Ill.

MONEYMAKING OPPORTUNITIES

START A buying service, buy wholesale thousands nationally advertised products. Make big profits selling at sizable discounts. Postcard brings details. American Buyers, Hertel Station, Buffalo 16-D1, New York.

NEW 1956 Lamp parts catalog showing everything you need to make and repair most types of lamps. Everything at lowest wholesale prices. Send only 25¢ today for both catalog and wholesale price list. Gearon Co., Dept. 503-B6, 27 S. Desplaines, Chicago 6, Ill.

WANT To go in business for yourself without capital? We show you how. Start part time your own home. Postcard brings details absolutely free. Topval Corp., Lindenhurst 520, N.Y.

"HOW To Make a Living in Florida." Book of valuable facts, information, ideas and opportunities \$1.00 postpaid. Money-back guarantee. Postcard for further description. Gaystar, Fort Richey, Florida.

\$25.00 PROFIT Daily. Details 3¢. Chegwidden, Box 182PM, Dover, New Jersey.

SELL Aluminum awnings. Baked enamel colors, all sizes. Write Jack Groff, Box 10254, Tampa, Fla.

OWN Collection Agency office. Pays big. Free details. Franklin Credit, Roanoke 7, Virginia.

INCREASE Your income. Free details. Bercher, Box 500, Shreveport, Louisiana.

SELL Nameplates, desk signs. Free sample outfit. Universal, Dept. M, Box 25, Cambridge 39, Mass.

FREE Literature! 500 money making plans. Barnes, 8401N Miami Ave., Miami 38, Fla.

HOME Makers wanted. Big profits. Details free. John Hall Agency, 509 Fifth Avenue, New York 17, New York.

EARN Money evenings copying and duplicating comic cartoons for advertisers. Adservice, Argyle 1, Wisconsin.

\$20.00 RETURNS \$400.00. Lifetime repeats. Sample \$1.00. Refundable. Ezee, Bayport 7, Mich.

MAKE Spare time money preparing and mailing sales literature. Adams Surveys, 3513-AT Sunset Blvd., Los Angeles 26, Calif.

EARN \$50.00 Daily making mats, shoes and mud guards from old tires. S and S Patents Inc., 1307 North Clark St., Chicago 10, Ill.

GENERAL Contest Bulletin. Issued monthly. Sample, 25¢. 1609½ East 5th, Duluth, Minn.

FREE Book "505 Odd, Successful Businesses." Work home. Expect something odd! Pacific, Oceanside, Calif.

READ Progressive Mailtrade, the magazine that tells how to make money by mail. Dime brings sample and special offer. Progressive Mailtrade, Box 357, Sheboygan, Wisconsin.

SELL Titania gems; far more brilliant than diamonds. Catalog free. Diamonite, 2420-M 77th, Oakland 5, California.

PLASTIC Laminating. Pleasure and profit. Self-sealing. No machines. Complete home kit, \$1.00. Mountainside 1, Springwater, New York.

PRIZE Contests provide fabulous and confidential home income opportunities! Here's how and where to win your share! Send stamp! National Contest Bulletin, Box 2685-P, Miami 16, Florida.

\$150 WEEK—Easy! Start home Venetian blind laundry. Revealing book free. A. T. Co., 101 S. 44th, Philadelphia 4, Penna.

\$5,199.90 WAS Paid to John Betts, in few weeks. Grow mushrooms. Cellar, shed. Spare, full time year round. We pay \$3.50 lb. Free book. Mushrooms, Dept. 173, 2954 Admiral Way, Seattle, Wash.

LEARN Technical metaphysics and insure your future. Easy, inexpensive correspondence course. Simplest method known. Diploma. Write: Premier College of Technical Metaphysics, 2532 McKenzie St., Vancouver 8, B. C., Canada.

MAKE Money at home. Spare time. Free literature tells how. Maletó, 1312 So. Clinton, Berwyn, Illinois.

FREE Folio "\$5,000-\$45,000. Unlimited Vacations." No merchandise, equipment. Unknown! Work home, sparetime! Haylins, Carlsbad, Calif.

PLEASANT Profits—Let us show you how to start your own complete scissors and tool sharpening business. Free details. Serr-Edge Inc., 9729 Lorain, Cleveland 2, Ohio.

FORTUNE Possible raising, fishworms and crickets. Free literature. Carter Hatchery, Plains, Georgia.

PRINTING, Office supplies wholesale. Save 50%. Royal, Box 368-A, Cleveland 27, Ohio.

LET Others do the work. You receive profit. Send only \$1.00 for sample and complete instructions. Caudle, P.O. Box 5903, Birmingham 9, Ala.

CONVERT Cheap foods into money making mink. Complete free information. Voight Farms, Lomira 2, Wisconsin; or Atlanta 2, Texas.

ATTENTION: Typewriter owners. Make handsome profits. Write today. Groves Company, 682, Hastings 8, Nebraska.

\$50.00 TO \$100.00 Per week. No skill necessary. Send 25¢ for sample and details. Arrowhead Sales, 4588 So. Acoma, Englewood, Colo.

WONDERFUL Home business. Pays excellent profits. Work sparetime. Brand new manual explains all. Be your own boss. Amazing information free. Lowell Service, Box 468, Wellsboro, Penna.

BUY Wholesale direct! Western states. Save 40% freight charges! Appliances, tools, toys, jewelry, sporting goods. Large catalog, \$1.00. Refundable. General Wholesalers, Box 3058E, San Francisco.

AMAZING Offer. Shellcraft kit, for making jewelry, \$1.00. Free catalogue. Sea Shells, 10 West 18, New York City 11.

MAILORDER Offers, samples, etc. 25¢. Douglass, 3324 Welsh Road, Philadelphia, Penna.

BUY Wholesale! Save 66%!! Appliances, furniture, jewelry, toys, sporting goods, tools. Free details! National Buyers Service, Box 3338EB, San Francisco.

MAKE Money with your camera. Amazing new low cost color enlargements can bring you hundreds of dollars in spare time. Nothing else like it! Send 10¢ for samples and eye-opening facts. Dept. PM-6A, Polypix Co., 723 S. Wells, Chicago 7, Illinois.

EXPORT — IMPORT

JAPAN Trade Guide, 1956 edition, just out May 20th! Importers-exporters currently showing tremendous profits! Manufacture your item in Japan. Contains over 700 pages including latest individual Japanese industrial surveys, import-export regulations, shipping, patents, etc., plus comprehensive mercantile directory. Published in English by Japan's leading financial press under direct supervision of Japanese government. Price \$10.75 U.S.A. Send for free illustrated brochure and literature. Japan Trade Guide (PM), Box 3452 Terminal Annex, Los Angeles 54, California.

BEAUTIFUL Hand carved African imports. Excellent mail order items. Literature free. Trans-World Sales, P.O. Box 343, Beacon, N. Y.

FORMULAS, PLANS, ETC.

MILLER'S Modern manufacturing formulas make fastest-selling products that get the business and pay. Fifty years supplying the best. Valuable literature free. Miller, Chemist, 1517-F, Tampa, Florida.

PRACTICAL Formulas. Lists free. Cummings, Chemist, Gordon Ave., Syracuse 4, N. Y.

FORMULAS; All kinds, latest, best. Literature free. Kemixal, Park Ridge, Ill.

PRODUCT Analysis, manufacturing formulas, processes developed. Moderate fees. Plastics, Box 1574, Boston 4, Mass.

HOW To make money with formulas. Formuco, 4015 So. Lincoln, Englewood 2, Colorado.

LIFETIME Business. Manufacture extremely profitable chemical products. Lists free. Thermolab, Peoria 4, Ill.

FREE Formula catalog. Anything analyzed \$35.00. Western Chemical, Salem, Oregon.

PLASTICS

PLASTICS Home-craft course for men and women. Tells and shows how to make hundreds of fast selling plastics products. All plastics and materials for 23 projects included in course. No special tools needed. Course pays for itself. Write for free booklet. Interstate Training Service, Dept. D-3, Portland 13, Oregon.

LAMINATING Supplies. Free price list. Solomon, 46 Cornhill, Boston 8, Mass.

PLEXIGLAS. Cut to size. Clear. Any thickness. Colors. Rods. Tubing. Mc-Clarín Plastics, P.O. Box 168H, Hanover, Penna.

PLEXIGLAS, Lucite. Square foot cost, 1/16"-\$1.15; 1/8"-\$1.52; 3/16"-\$1.86; 1/4"-\$2.21; 5/16"-\$3.23; 1/2"-\$4.36. Colors add 10%. Send 15¢ for postage. Aristocrat Plastics, 23-25 Sussex Ave., Newark, N.J.

NEW Liquid casting plastic, clear, colors. Embed real flowers, insects, photos, coins. Saw, drill, carve. Send 25¢ for handbook. "How to Cast with Liquid Plastic" and proved success plan showing how to make money at home. Castolite, Dept. G-101, Woodstock, Ill.

PLEXIGLAS Square foot cost 1/8" \$1.20, 5/32" \$1.35, 3/16" \$1.58, add 15% for postage, write for list. Aircraft Plastics, P.O. Box 7924, Mt. Lebanon 16, Penna.

PLEXIGLAS, Fiberglass, polyester, acetate. Unique wholesale-retail catalog—15¢ Gem-O-Lite, Box 686M, North Hollywood, California.

WE Seal in plastic: Soc. security, wallet-size cards, and photos 25¢. Ray Putt, 1640 Dyre Street, Philadelphia 24, Penna.

CHEMISTRY

HOME Laboratory and apparatus kits, laboratory supplies. Catalog 25¢. John H. Winn, 124A West 23rd St., New York, N. Y. Established 1931.

CHEMICALS, Supplies. Catalog 25¢, refundable. Laboratory Sales, Box 161-E, Brighton, Mass.

CHEMICALS And apparatus for industrial, analytical, and private laboratories. Catalog 25¢. Dept. M-50, Biological Supply Co., 1176 Mt. Hope Ave., Rochester 20, N. Y.

BOOKLETS: 60 pages each! "Beginners Chemistry," "Chemistry," "Einstein's Relativity," "Physics," "Atomic Theory," "Electron Theory," "Scientific Oddities," "Light," "Sound," "Heat," "Electricity," "Radio," "Astronomy," "Useful Tables," "Geometry," "Mathematical Oddities," "Scientific Terms." Order by titles, 10¢ each. Franks, 3121 South Racine, Chicago 8.

AMAZING New book of science. Experiments, formulas and catalogue of laboratory supplies. Only 25¢. National Scientific Co., Dept. PM-6, 500 W. Road, Lombard, Illinois.

AGENTS WANTED

MEN-Women agents: Sensational new moneymakers—Beautifully hand-painted, plastic personalized photo enlargements, compacts, rings, bracelets, lockets, etc. Simply take orders, pocket 40% commission. We deliver and collect. Sales outfit free. Novelco, 3343 North Avenue, Chicago 47.

FREE! Beautiful feather pictures. 200% profit! Apartado 9036, Mexico 1, D. F.

GOLDMINE Of 600 money makers. Copy free. Specialty Salesman Magazine, Desk 5-B, 307 N. Michigan, Chicago 1.

HOME Motorized massage. Big money! Mary Mac, 1012 Powhattan, Dallas 2, Tex.

YOUR Own business—Used suits \$1.50, overcoats 65¢, mackinaws 35¢, shoes 12½¢, ladies coats 30¢, dresses 15¢. Enormous profits. Catalog free. Nathan Portnoy Associates, 605-AA West 12th Place, Chicago 7.

GOLD Or silver letters, numbers. Windows, doors, trucks. 1" to 6". 500% profits. Free samples. Atlas-T, 544 West 79th, Chicago 20.

PRINTING, Advertising salesmen—Excellent moneymaking sideline selling decalcomania name plates, small quantities. Automobile initials, sign letters. Free samples. Ralco, XL, Boston 19, Mass.

\$1.00 PROFIT Selling \$2.95 photo enlargement deal. Allen Studio, Riegler Bldg., Little Rock, Ark.

AGENTS—300% Profit selling genuine gold window letters; stores and offices. Free samples. Metallic Sign Letter Co., 431-D North Clark, Chicago.

USED And new watches \$2 up. Free list. Southern Watches, Gray, Georgia.

YOUR Ad in this space will get some good agents for you. Yes, I'll prove it. Write for Folder "A", right now. F. W. Johnson, Classified Advertising Manager, Popular Mechanics Magazine, 200 E. Ontario St., Chicago 11, Ill.

EASY Handwork makes fast-selling articles. Sample free. Sunmade Company, Brockton 64, Massachusetts.

WANT More business? Here's an amazing opportunity to increase your sales. Talk to thousands of interested readers of "Mechanica Popular." Our Spanish Edition covers the Latin American countries like a blanket. They're real mailorder buyers. Classified rate 75c per word. Try an ad in our next issue. Classified Advertising Department, Popular Mechanics Magazine, 200 East Ontario Street, Chicago 11, Ill.

MEN, Women, make money spare time plus new car as bonus for encouragement. Amazing hosiery guaranteed to wear without holes, snags, and runs, or replaced free. For example, lovely 60 gauge nylons guaranteed for as long as 1 1/2 years, or replaced free. Write Wilknit, 1766 Wash., Greenfield, Ohio.

60% PROFIT On cosmetics—Famous nationally advertised Hollywood cosmetics pay 60%! Make \$25-day up! Hire others. For free samples, details, write Studio Girl, Glendale, Calif., Dept. 1266G.

CALIFORNIA Sweet smelling beads. Sensational sellers. Particulars free. Mission, 2328-PM W. Pico, Los Angeles 6, California.

FREE Tableware. Write for details. Central Sales, Clarendon, Ark.

\$1.00 DOWN Payment gives you \$4.00 commission selling Catholic crucifix or Bible. Dignified easy sales. Baker, 4011 W. Olympic, Los Angeles.

BIG Profits! Sell miracle "no ring" spot remover in stick form. Non-inflammable. Guaranteed. Free details. M & M, Dept. 1-PM, 842 Third Ave., New York City.

ONCE In a life time, several houseware items. Sell on sight. Write for details. Big profits. Jahn, Box 8, Park Ridge, Ill.

BUY Wholesale thousands nationally advertised products at big discount. Free "Wholesale Plan." American Buyers, Hertel Station, Buffalo 16-A1, N.Y.

MOORE Made \$9.00 in an hour selling farmers. Hundreds of salesmen making good money full time or spare time with 3 leading poultry magazines welcomed everywhere. No investment or experience needed. Powerful sales kit free. Poultry Tribune, Box 466, Mount Morris, Illinois.

NEW Household item, tremendous market, fast seller, big profits. Send for details and free sample offer. M & M, Dept. 4-PM, 842 Third Ave., New York City.

\$1,000.00 MONTHLY! Full or part time. Nylons. Arenel Mills, 1209 W. Chicago, Chicago 22, Illinois.

NEW Magic metallic ironing board cover. Sells on demonstration. Send for free sample. Take orders immediately. Quality Products, Dept. A, Box 748, Passaic, N. J.

UP To \$200 weekly selling amazing puncture proofing compound. Terrific seller. Big profits. Free details. M & M, Dept. 2-PM, 842 Third Ave., New York City.

MAKE Extra money—With newest Christmas card assortments. 21-card \$1.00, \$1.25, \$1.50. Tall-Slim Christmas, all occasion, religious assortments, gift wrappings, gifts, novelties, imprinted Christmas cards. Experience unnecessary. Profits to 100% plus cash bonus. Write for samples on approval. Free \$1.00 gift offer, catalog, selling plan. Hedenkamp, 361 Broadway, Dept. PM-41, New York City.

MONEY Maker! Free starting kit. Society Name Labels, Waverley 79, Mass.

BIG Profits selling ties (\$2.00 value) \$6.50 dozen. Free catalog. Empire Cravats, 611-PM Broadway, New York 12.

\$100 WEEKLY. Sell household products. Write: Ree, Box 78, New York 32.

MAKE Up to \$50 weekly sparetime writing orders for stainless steel tableware, guaranteed 50 years. Details free. Block, 35-A Hoeltzer, Rochester, New York.

BUY IT WHOLESALE

BUY Wholesale Nationally advertised appliances, radios, watches, etc. Catalog \$1.00 (refundable). D'Auria, Box 355-PM, Jackson, Michigan.

WHOLESALE Catalog! 30-80% discounts! Appliances, musical instruments, typewriters, phonographs, watches, jewelry, recorders, housewares, etc. Consolidated Distributors, 21-20 Lafayette, Paterson, New Jersey.

WHOLESALE Name brands, illustrated catalog 50c. Refundable. Distributors, Box 106A, Hudson, New York.

FREE Lists. 640,000 items wholesale. P. Cottage Industries, Omaha 12, Nebr.

BUY Wholesale! Television, radios, refrigerators, freezers, water heaters, air conditioners, sewing machines, power tools, housewares, etc. Catalog 10c. Marpat, Box 1485, D-PPM, Milwaukee, Wis.

ELECTRIC Guitars, amplifiers, accordions, wholesale. Free catalog. Carvin, PM287, Covina, Calif.

REAL Wholesale sources thousands nationally advertised products. Details free. Martex, 132-C Nassau St., New York 7, N. Y.

USED And new watches \$2 up. Free list. Southern Watches, Gray, Georgia.

BARGAINS, Joblots, closeouts. 2000 items. Tremendous savings, clothing, toys, gifts, jewelry, television, etc. 25c brings wholesale catalog. \$1.00 merchandise certificate included free. Reliable Jobbing, 311-B North Desplaines, Chicago.

BIG Discounts on name brand merchandise. Catalog \$1.00 refundable. Edward Clemens, 318 W. Bridge St., Morrisville, Pennsylvania.

DISCOUNTS To 80%. 750 name brand home items \$1.00. Labelle Company, 140 Harlem Ave., Glenview, Illinois.

YOUR Cost as little as 25c on dollar! Household items needed in every home. Sell direct, by mail or to agents. Catalogue, confidential distributors' wholesale prices and money-making plans absolutely free. Rush postcard to Topval Corp., Lindenhurst 334, N.Y.

WHOLESALE Catalog! Appliances, cameras, watches. Postcard: Selbyco, Decatur 257, Illinois.

NEW Lever-ratchet screwdriver. Interchangeable blades. Free circular. Wiltron Company, Box 765, North Hollywood, Calif.

LEARN Wholesale buying secrets. Details free. Wholesalers, 25 West Lane, Columbus 1, Ohio.

FREE Wholesale catalog. Appliances, cameras, watches, tools, sporting goods, summer needs. Housewares, 7502-D Cottage Grove, Chicago 19.

BUY Wholesale. Famous brands. Catalog 25c. Golden Feather Service, 1061-A Atlantic, Long Beach 13, Calif.

FREE Gift catalog. Wholesale catalogs, name brands. Edith's, Deep River, Conn.

WHOLESALE! Nationally advertised brands. Appliances, jewelry, radios, television. 100 page catalog. \$1.00, refundable. Overton Sales, 6770 Hartford, Detroit 10, Michigan.

SALESMEN—DISTRIBUTORS

SALESMEN: A brand new tool—Shops and garages. No competition. 100% profit. Get the details. Shuler Machine Co., Ontario, Oregon.

\$60 WILL Earn \$10,000. Long needed invention. Proved sales plan. Send no money. Details free. Write Cyclo, Dept. 131, 3816 Dahlia, Denver, Colorado.

SELL Calendars. You make big money daily. Giant line. Every business buys. Also business printing, book matches, advertising specialties. Big sales outfit free. Write. Arrow Press, 515-F Fourth Ave. So., Minneapolis, Minn.

ADVERTISING Book matches—Cash in on big demand; sell union label matches. Cuts for all businesses and political parties. Free powerhouse selling kit, low prices, protection guaranteed on repeat orders. Cash commissions. Superior Match Co., Dept. M-656, 7530 Greenwood, Chicago.

BIG Money-making opportunity. Exclusive line work uniforms. Jackets, pants, shirts, coveralls. Advertising embroidered. Every business prospect. Outfit free. Master Div., 689 Water, Ligonier, Ind.

BUY Wholesale thousands nationally advertised products at big discount. Free "Wholesale Plan." American Buyers, Hertel Station, Buffalo 16-J1, N.Y.

AD Matches! Sell amazing designs—10, 20, 30, 40 and 240-light book matches. Bigger spot cash commissions; every business a prospect. Low prices for high quality. Repeats. Start without experience; men, women; full, part time. Buy nothing! Sales kit furnished. Match Corp., Dept. PM-78, Chicago 32, Illinois.

USED And new watches \$2 up. Free list. Southern Watches, Gray, Georgia.

NEW Jobs open in selling! Send name, address for five free issues of Opportunity Magazine's money-making guide, listing hundreds of companies who'll pay you well, full or part-time. No experience needed. Opportunity, 850 N. Dearborn, Dept. 17, Chicago 40, Ill.

BUILD Sales by recruiting productive distributors selling direct or to retail outlets. Secure most concentrated circulation through classified columns of Salesman's Opportunity. Write for facts. Gilbert, Salesman's Opportunity, Room 1700, 850 N. Dearborn, Chicago 10.

PRINTING, Calendar, novelty salesmen: America's best deal. New, hot best selling samples free. Write. South's largest. Nationwide, Arlington, Texas.

SIX! \$1.00 Mailorder items. Proven successful money-makers everywhere. Evans Manufacturing, 5930 Comey, Los Angeles 34, California.

EARN Big money giving samples away. Chico, North Madison 3, Ohio.

WILL You wear new suits and topcoats without one penny cost and agree to show them to friends? You can make up to \$30.00 in a day even in spare time, without canvassing. W. Z. Gibson, 500 South Throop St., Dept. T-626, Chicago 7, Illinois.

TOP-Flight business opportunity. The conditions governing it are extraordinary, unique. Its promise is spectacular. It presents one of the most promising selling opportunities for agents it is possible to conceive. Convincing facts mailed on request. Natural Food Supplement Co., Box 1277A, Colorado Springs, Colo.

SELL "Lazy man's polish" a merchandising wonder. Ask for details. Lusco, Inc., Cleveland 3, Ohio.

KANT-Spill garbage can holders retail \$2.49; your commission 40%; easy to sell. Just show them. Write Southern Sales Co., Box 804, Oklahoma City, Okla.

VITAMINS: One adult in four potential customer for Geriatrex Twin Kit, all-natural vitamin-mineral supplement especially developed for adults over 40. Free permanent-profit-plan gives details on big profits; part or full time. Geriatrex Products, Sales Division, 1035 Linden, Allentown, Penna.

EMPLOYMENT INFORMATION

JOB Information—High pay, South America, the Islands, USA, foreign countries. All trades. Clerical, labor, engineers, drivers, others. Women also. Companies pay overseas fare if hired. Write Section 92F, National Employment Information, 1020 Broad, Newark, N. J.

CONFIDENTIAL Reports on best paying jobs with travel, adventure, promotions. Construction, aviation, shipping, laborers, clerical, trades, supervisory, factory, unusual opportunities, all types of work. Skilled and unskilled. Foreign and state-side openings for men and women. Only \$2.00 (\$2.25 airmail), including year registration-advisory service. Satisfaction guaranteed. Included absolutely free: Special reports on Alaska, Spanish airbase construction, South American opportunities, and husband-wife foreign jobs. Research Services, Suite 207-PME, Brown Building, St. Louis 5, Missouri.

JOB On ships! Experience unnecessary. Employment information. Transoceanic, Box 494-P, Baltimore 3, Maryland.

WESTERN Dude ranches need wranglers, waitresses, horseshoers, secretaries, cooks, cowboys. Write, McCue, Bar A Ranch, Carson, Wash.

FOREIGN Jobs list. Satisfaction guaranteed. \$1. Rathe, Box 26131, Los Angeles 26, Calif.

JOB In all lands. Over \$1 billion in wages will be paid by firms listed in latest complete list. Every type worker needed. Send \$2 for airmailed list. Absolute money-back guarantee. World Wide Employment, Box 5391B, Metro Sta., Los Angeles, Calif.

INFORMATION Pertaining to construction projects and employment in foreign countries and U. S. Good pay. Mail \$1.00 to Employment Information, 412(P) Albee Building, Washington 5, D. C.

WANT To become lead man, supervisor or executive? Better jobs require a "resume." Obtain our comprehensive brochure. Send \$1.00. Administrative Employment Service, P.O. Box 128, Huntington Park, California.

EDUCATIONAL AND INSTRUCTION

CARPENTRY Taught by kits. Industrial arts shops. Write: State Building Congress, 515 Henry Building, Portland 4, Ore.

TRANSFORM Yourself via subconscious. Free brochure. Box 847 (H-6), Ocean Park, Calif.

OWN A collection agency. Pays big. Franklin Credit, Roanoke 7, Virginia.

HAND Engraving; learn at home. Write Box 116, Mishawaka, Ind.

EARN Degree. Free bulletin. Home-study only. Midwestern Bible School, 517 Merchants Bank Bldg., Indianapolis.

BECOME A doctor of psychology or metaphysics. Learn secret of contentment, happiness. Win degree of Ps.D. or Ms.D. Correspondence only. Free book. College of Universal Truth, 23-C East Jackson Blvd., Chicago 4, Ill.

STUDY For Doctor's degree of psychology, metaphysics and divinity. Correspondence courses only. College of Divine Metaphysics, Dept. P-M, 2811 North Illinois, Indianapolis 8, Indiana.

LEARN Mineralogy at home. Diploma course. Fortunes now being made in uranium and other minerals. Free catalog. Mineral Science Institute, Desk 2, 159 East Ontario, Chicago 11.

HIGH School diploma at home. Licensed teachers—Approved materials. Southern States Academy, Box 144-MX, Station E, Atlanta, Georgia.

PIANO Tuning pays. Big money in spare time. Learn at home in 30 days. No musical knowledge necessary. Phonograph, records, tools and instructions furnished. Free catalog. Capital Tuning School, 16 Southwest Second, Fort Lauderdale, Fla.

I want to send you proof of the wonderful pulling power of Popular Mechanics classified pages. What's your proposition? Write me today. Include literature if possible. F. W. Johnson, Manager Classified Advertising, Popular Mechanics Magazine, 200 E. Ontario St., Chicago 11, Ill.

\$5,199.90 WAS Paid to John Betts, in few weeks. Grow mushrooms. Cellar, shed. Spare, full time, year round. We pay \$3.50 lb. Free book. Mushrooms, Dept. 174, 2954 Admiral Way, Seattle, Wash.

BE A real estate broker. Study at home. Write for free book today. GI approved. Weaver School of Real Estate, 2018P Grand, Kansas City, Missouri.

INVESTIGATOR Training. Phillips Secret Service System, 1917-B North Kenneth, Chicago 39.

SECRET Investigation. Experience unnecessary. Investigators particulars free. George Wagner, M125 West 86th, New York 24.

EARN While you learn. Auto and diesel mechanics master this top paying trade. Many graduates earn \$100 a week and up. Approved for Korean veterans. For free information write Dept. No. 256, Nashville Auto-Diesel College, Nashville 3, Tenn.

BOOKKEEPERS! Increase your earnings! Operate your own simplified "Dollar-A-Week" bookkeeping and tax service. Full or spare time. Details free. No obligation. Ellis, Box 200, Cedar Grove, North Carolina.

USED Correspondence courses and books sold and rented. Money back guarantee. Catalog free. (Courses bought.) Lee Mountain, Pisgah, Alabama.

WANT A diesel job? New opportunities to increase income. Higher pay. More money. We can help you qualify. Tools. Shop method home training. Write today! Diesel, Tractor, Heavy Equipment Division, Interstate Training Service, Dept. B-3, Portland 13, Oregon.

PHYSICAL Therapy and massage. We train you at home. Earn big profits from your own private practice or work with hospitals and doctors. Free catalogue. National Institute, Desk 4, 159 E. Ontario, Chicago, Ill.

PIANO Tuning pays. Learn this profitable profession at home easily with patented Tonometer and mechanical aids. No knowledge music necessary. Diploma granted. Write for booklet. Niles Bryant School, 3731 Stockton Blvd., Dept. P, Sacramento 20, California.

U.S. Civil service tests! Training until appointed. Men-women, 18-55. Start high as \$377.00 month. Many jobs open. Qualify now! Get free 36-page illustrated book showing salaries, requirements, sample tests. Write: Franklin Institute, Dept. T-24, Rochester, N.Y.

USED Correspondence courses and educational books bought, sold, rented. Free catalog. Educational Exchange, Menlo, Georgia.

LEARN Free how to become glamour photographer. Make big profits photographing beautiful models. Opportunities nation-wide. No previous experience or expensive equipment needed. Write for free illustrated Success Plan. Harrison's, 1031-C Magnolia Park Station, Burbank 10, Calif.

COMPLETE Your high school at home in spare time with 59-year-old school. Texts furnished. No classes. Diploma. Information booklet free. American School, Dept. XA45, Drexel at 58th, Chicago 37, Ill.

WANTED: More new writers for TV-radio, magazines, business publications, motion pictures. Learn at home for extra income or exciting full time career. Many students earn while learning. Professional instruction. Send today for free lesson and book. Palmer Institute of Authorship, Desk TM-66, 1680 N. Sycamore, Hollywood 28, California.

BLUEPRINT Reading—Train at home. Learn to read blueprints with confidence in 10 easy lessons. Write today Belton School, 1059-Q North Lawndale, Chicago 51.

EARN \$125 Per week! 200,000 turbo-jet specialists needed now. Qualify for jet industry's biggest opportunities. Enroll in first all-jet aircraft home study course. Complete information. United Jet Institute, San Francisco International Airport, San Francisco, California.

COLLEGE Reading list. Complete: \$1. Absorb these basic books (free at libraries) for college education equivalent. Also included: "100 Greatest Books" list; greatest authors list, curriculum of leading college: "How to Attend College at Home." All for \$1 if sent before July. Satisfaction or money back. College Home Study, Box 921, White Plains, N.Y.

HIGH School—No classes. Study at home. Spare time. Diploma awarded. Write for free catalog HF-64. Wayne School, 2527 Sheffield, Chicago 14, Ill.

INVESTIGATOR Training. Free details. Write Colo. School Investigation, Box 1876, Denver, Colo.

EARN College degree. Remain employed. Fremont College, 915-P Grandview St., Los Angeles 6, Calif.

WELDING Training pays at Hobart Welding School, Box M-661, Troy, Ohio. VA contract. Best equipment. Catalog free.

CORRESPONDENCE Courses, books bought, sold. Free catalog. Bayles, 211 Essex, Hackensack, New Jersey.

85 EYEMAGINATION Alphabets that demonstrate visual language. Postpaid \$1.00. Reymers, Falls Village, Conn.

ENGINEERING Degrees earned by home study. American College of Engineering (University of the West), Box 27724, (B) Hollywood 27, Calif.

WANT Strong, masculine voice? Send for free booklet. Perfect Voice Institute, 210 South Clinton, Studio 2FU-2, Chicago 6.

BE Popular. Win friends. Gain self-confidence. Influence people. \$2.00 reveals secret rules. Human Relations, 2149-B Melante Dr. N.E., Atlanta, Ga.

PLAYS, STORIES, MANUSCRIPTS

WANT Your book published? Learn how we publish, advertise, promote, distribute. Many successes. Free booklet PM. Vantage, 120 West 31, New York City.

WANTED: Book manuscripts, all subjects considered. Greenwich Book Pub., Atten. Mr. Zealand, 489 Fifth Ave., New York City.

SPECIAL SERVICES

GHOSTWRITING. Folios, etc. written. John Doran, 1823 N.E. 8 Avenue, Portland, Oregon.

2000 CASH Remitters, linotyped, from daily orders, \$5.00. Poulson, 428 West Century Boulevard, Los Angeles 3, California.

INFORMATION. Assignments. Research. Licensed bonded investigator. Grant, 34 Park Row, New York City 38.

INFORMATION On anything. Ferguson Research Specialists, 116-14 141 St., South Ozone Park 36, N.Y.

INFORMATION! Any subject! Certified research! Griffith, 613 Latham, Wynnewood, Pennsylvania.

ARTISTS' SUPPLIES

IF Interested in artist frames, canvas, canvas boards, Red Sable brushes, etc., be sure to get our money saving price lists before buying. International Sales Co., 414-APM E. Baltimore St., Baltimore 2, Md.

CARTOONING, COMMERCIAL ART, SHOWCARD & SIGN PAINTING, TATTOOING

"HOW To Make Money With Simple Cartoons"—A book everyone who likes to draw should have. It is free; no obligation. Simply address Cartoonists' Exchange, Dept. 96C, Pleasant Hill, Ohio.

YOU Can entertain with chalk talks. Catalog 10c. Balda The Cartoonist, Oshkosh, Wis.

TATTOOING Supplies, licensed course, illustrated brochures 25c. Zeiss, 728 Lesley, Rockford, Illinois.

SIGNS Anyone can make, write Hoag's Sign Letters, 507 East Chicago Blvd., Tecumseh, Michigan.

LEARN Cartooning! Professional instruction! Details free. Cartoonists, 2776 California Ct., Lincoln 10, Nebraska.

PAINT Signs—Master die cut, outline letter patterns. Complete assortment 1½" to 12" high, prepaid \$2.00. Eyerly, 583, Newton, Iowa.

DRAW Your way to fame. Free information. Cartoons-of-the-Month, Roslyn, N.Y.

LEARN Sign painting at home. Free talent test. Ben Kerns, Box 812-PM, Greenville, S.C.

ADVERTISING AGENCIES, LETTER WRITERS, FOR ADVERTISERS

MAILING Lists most any classification \$5.00 1000. Your circulars mailed with ours \$4.00 1000. Write for our literature. Dixie Mailers, King, N. C.

BEFORE Advertising—Get instructive Ad-Guide and newspaper-magazine rate-book, free. Chicago Advertising Agency, Chicago 4.

WOMEN Mail buyer's names \$5.00 thousand. Du-Rite, 624 East 17th, Indianapolis 2, Indiana.

ADVERTISING. Result-getting ads prepared, placed newspapers, magazines, radio, anywhere! Lowest rates. Catalogue free. Baker Advertising Agency, 189 W. Madison, Chicago 2.

RUBBER STAMPS AND OFFICE SUPPLIES

3 LINES—\$1.00. Fast, professional service guaranteed. Artcraft, P.O. Box 8038, West Palm Beach 2, Florida.

RUBBER Stamps, 4 lines \$1.50. Rough-edge's, 2 Lionel, Clark 1, N. J.

QUALITY Rubber stamps, 60¢ up. Catalog. Creative, Box 5005, St. Louis 15, Mo.

RUBBER Stamps by professional craftsmen. 3 lines \$1.00. Price list. South Coast Press, P.O. Box 2074, San Bernardino, Calif.

3 LINES, \$1.00. Fast service. Catalogue. Johnson, 443 MacDonough, Brooklyn 33, N. Y.

DISTINCTIVE Personal printer, automatic inking unit, self contained case, three lines. \$1.00. Standard, Box 134, Seaford, N. Y.

NAME. Address rubber stamp \$1.00. Quality work. Cook, 1750 Manhattan Bch. Blvd., Manhattan Beach, Calif.

THREE Lines \$1.00. Free stamp pad. Barber, Marengo, Ohio.

TYPEWRITERS, DUPLICATORS, OFFICE DEVICES

PORTABLE Mimeograph! Uses no stencil, no ink. The newest, cleanest, smallest, lightest and cheapest. Weight 15 pounds. DuPont Distributors, Dept. A, P.O. Box 695, New York 1, N. Y.

RECONDITIONED Typewriters, duplicating, printing devices, \$25.00 up. Supplies. Appliances, DixieGraph, King, N. C.

PRINTING, MULTIGRAPHING, MIMEOGRAPHING, GUMMED LABELS

LITHOGRAPHED Circulars with sales impact our specialty. Samples free. Bandy Color Press, Gainesville, Texas.

MIMEOGRAPHING—Letters, pricelists, formulas, instructions. Lowest prices. Lem's Letter Shop, 5710 Stanton, Detroit 8.

ADS Running under this heading sell printing. Ask me for proof. I'll gladly send you amazing facts. Ask for Folder "P." F. W. Johnson, 200 E. Ontario St., Chicago 11, Ill.

125 LETTERHEADS 8 1/2 x 11. \$1.00 Postpaid. Envelopes same. Econoprint, Box 625, Whittier, California.

QUALITY Mimeographing, printing. Free samples. Currier, PM, New Lebanon Center, N. Y.

FREE Cut. 1000 embossed cards \$4.00 postpaid. Farrell, Box 452, Buffalo 5, N. Y.

250 LETTERHEADS. Envelopes, cards \$5.25. Samples. E and T Printing, Route 20, Pottstown, Penna.

36 PAGE Illustrated printing catalog free. Graves, Box 461, Canyon, Texas.

FIRST Quality. 250 letterheads or envelopes \$2.50. Economist, Solon, Iowa.

BUSINESS Cards. Free style chart, samples. Robert Ham, Hallam, Nebraska.

POSTCARDS. 100, \$1.00. Personalized \$2.00. 200, \$3.00. 1000, \$11.00 delivered. Free samples. McKeown, 107P South Capitol Avenue, Indianapolis, Ind.

QUICK Service printing. Letterheads, envelopes, etc. Free booklet. Harold Kroll, Seymour, Wisconsin.

1000 NOTEHEADS \$4.95; Envelopes \$5.65; statements \$4.85. Commercial, Box 36, Boston 34, Massachusetts.

FREE Catalog! Business printing, offset, mimeographing. D'Yarmett, 420 Columbian, Columbus 23, Ohio.

FREE Catalog business, personal printing. D. M. Press, Sebastopol, California.

BUSINESS Cards. 24 kinds available, embossed or flat printing. Samples. Jaynar, Box 723B, Oak Lawn, Illinois.

RUSH Service! 100 8 1/2 x 11 letterheads. \$2.00 postpaid. Bass Press, Knox, Indiana.

1,000 RAISED Letters business cards \$2.95. Samples. Pioneer, 195 Quebec, Island Park, N. Y.

"HOW To Buy and Use Printing." Free booklet tells how to cut costs, choose paper, type. Catalog included. R-K Press, 825 Powdermill Lane, Philadelphia 31, Penna.

BILLBOOKS. Statements, envelopes, rubber stamps. Eddirose, Bronx 72, N. Y. Free catalog.

GUMMED Roll Labels. 500 personal or business, three lines \$1.00. One day service. Alexander, 996E Monterey, Pomona, California.

SENSIBLY Priced business printing. Special! 250 8 1/2 x 11 bond letterheads, 250 #10 heavyweight envelopes, \$6.95. Postpaid, guaranteed. Free samples, quotations. Sparks Company, Box 4096, Austin, Texas.

PRINTING OUTFITS AND SUPPLIES

MAKE Your own rubber stamps and printing plates. Box 4308-M, Mobile, Ala.

MAKE Your own self-molding rubber stamps and printing cuts. Flexirubber, Argyle 1, Wisconsin.

DO Your own printing. Save money. Simple rules. We supply everything. Print for others; good profit. Raised printing like engraving too. Have home shop. Details free. Kelsey Presses, V-11, Meriden, Connecticut.

PRESSES. Type cabinets, supplies. List for stamp. Lincoln Press Company, 220-F Hartwell, Fall River, Mass.

RUBBER Stamp making presses, hydraulic operated, electrically heated. Also supplies. Make any kind. Large profits. Custom, Box 211-M, Springfield, Missouri.

PATENT ATTORNEYS

CANADA—Ramsay Company Registered, 273 Bank Street, Ottawa, Canada.

PATENTS—Irving L. McCathran, 315 McLachlen Bldg., Washington 1, D. C. Registered Patent Attorney.

INVENTION Record form free and "Patent Information Every Inventor Should Have." Carl Miller, Registered Patent Attorney, Woolworth Building, New York.

REGISTERED Patent attorney offers services. Sanders, 6430 Evans, Chicago 37, Illinois.

C. A. Snow & Co.—M427, Snow Building, Washington 1, D. C. Registered Patent Attorneys. Write for information.

INVENTORS: When you are satisfied that you have invented something of value write me, without obligation, for information as to what steps you should take to secure a patent. Write Patrick D. Beavers, Registered Patent Atty., 935 Columbian Bldg., Washington 1, D. C.

PATENTS. "Proof of Invention" free. E. E. Vrooman, Registered Patent Attorney, 507 McKim Building, Washington 5, D. C.

INVENTORS: Without obligation, write for information explaining the steps you should take to secure a patent. John Randolph, Registered Patent Attorney, 203 Columbian Bldg., Washington 1, D. C.

INVENTORS: Learn how to protect your invention. Unless the inventor is familiar with patent matters, he should engage a competent registered patent attorney or agent to represent him. We are registered to practice before the U. S. Patent Office and prepared to serve you in handling your patent matters. "Patent Guide for the Inventor" containing detailed information concerning patent protection and procedure with "Record of Invention" form will be forwarded to you upon request, without obligation. Clarence A. O'Brien & Harvey Jacobson, Registered Patent Attorneys, 61B-D District National Building, Washington, D. C.

"INVENTOR'S Guide" and "Record of Invention" free on request. Frank P. Ledermann, Registered Patent Attorney, 154 Nassau Street, New York City.

INVENTORS—If you believe you have an invention, you should find out how to protect it. The firm of McMorro, Berman & Davidson with offices in Washington, D. C., is qualified to take the necessary steps for you. Send for copy of our patent booklet "How to Protect Your Invention." We will also send you an "Invention Record" form. No obligation. They are yours for the asking. McMorro, Berman & Davidson, Registered Patent Attorneys, 1343 Victor Building, Washington 1, D. C.

INVENTORS—Take these preliminary steps toward patent protection. Sketch and describe your invention. Sign, date and have this disclosure witnessed by two people who understand your invention. Have us make a preliminary search among U.S. patents already granted for similar types of invention. We report on the probable patentability of your invention and recommend your further course of action. Write for our instructive booklet, "Patent Protection for Inventors" and convenient "Evidence of Invention" disclosure form. Victor J. Evans & Co., 231-G Merlin Building, Washington 6, D. C.

FOR INVENTORS

LOSING Money on patentable ideas? Misled? Know laws, procedures, court decisions. Easy reading course covering everything. \$6.95. George Heitman, Meeker Ave., Allendale, N. J.

"INVENTOR'S Guide" and "Record of Invention" free on request. Frank P. Ledermann, 154 Nassau Street, New York 38, N. Y.

INVENTORS—Send for free patent information book and inventor's record. Registered Patent Attorney. Associate Examiner. Patent Office 1922-29. Patent Attorney & Advisor, Navy Department 1930-47. Gustave Miller, 66A Warner Building, Washington 4, D. C.

YOUR Product improved for sales and patentability and patents skillfully filed in your name low definite fee basis. Canadian patents filed \$100.00. Joseph O'Brien, Patent-Engineer, 30 years in business. 132 Nassau St., New York 38, N. Y.

AMERICAN Congress of Inventors—Quick response, free "Thomas Edison's formula for success." Inventors, Box 1481, Milwaukee 1, Wisconsin.

CREATE Successful inventions! Positive, proven method. Write Waldman, Box 121, Brownsville Sta., Brooklyn 12, N. Y.

INVENTORS: Learn how you can protect your invention. A specially prepared booklet "Patent Guide for the Inventor" containing detailed information concerning patent protection and procedure together with "Record of Invention" form will be promptly forwarded to you upon request—without obligation. We are registered to practice before the United States Patent Office and are prepared to serve you in the handling of your patent matters. Clarence A. O'Brien & Harvey Jacobson, Registered Patent Attorneys, 61A-D District National Building, Washington, D. C.

PATENT Searches \$5.00. 48-hour airmail service. Invention protection forms free. Write Patent Engineering Service, 711 14th Street N. W., Washington 5, D. C.

INVENTORS: If you have an invention for sale, patented or unpatented, write Institute of American Inventors, Dept. 40A, 631-E St. N.W., Washington 4, D. C.

PATENT Searches, including copies of nearest patents, \$6.00. Reports airmailed within 48 hours. More than 100 registered patent attorneys use my service. For free invention protection forms, write Miss Ann Hastings, P.O. Box 176, Washington 4, D. C.

INVENTION Record form free and "Patent Information Every Inventor Should Have." Carl Miller, Registered Patent Attorney, Woolworth Building, New York.

SEARCHES—Put your patent searches in the hands of a registered patent attorney or agent, as he qualifies to give a worthwhile patentability report. Record of invention form upon request and information on patent protection. Patrick D. Beavers, Registered Patent Attorney, 936 Columbian Bldg., Washington 1, D. C.

INVENTORS: Information on patent procedure furnished on request, without obligation. John Randolph, Registered Patent Attorney, 203 Columbian Building, Washington 1, D. C.

PATENT Searches \$5.00. 48-hour service. Free invention protection forms. Write Raymond L. Smith, Patent Searcher, 620 Sheraton Building, Washington 5, D. C.

INVENTORS—This firm is registered to practice before the United States Patent Office and available to assist you in the preparation and prosecution of your patent application. "Patent Protection for Inventors" booklet containing detailed information and steps to take toward patent protection sent promptly upon request. No obligation. Victor J. Evans & Co., 232-G Merlin Building, Washington 6, D. C.

INVENTORS—If you believe you have an invention, you should find out how to protect it. The firm of McMorro, Berman & Davidson with offices in Washington, D. C., is qualified to take the necessary steps for you. Send for copy of our patent booklet "How to Protect Your Invention." We will also send you an "Invention Record" form. No obligation. They are yours for the asking. McMorro, Berman & Davidson, Registered Patent Attorneys, 1342 Victor Building, Washington 1, D. C.

INVENTIONS WANTED

SUPERIOR Promotions. Patented; unpatented inventions. New, informative booklet on request. Superior, 338-344 North Rodeo, Beverly Hills, Calif.

INVENTORS: Hundreds of manufacturers have requested our assistance in locating marketable new products. Complete information free. Institute of American Inventors, Dept. 40-D, 631-E St. N.W., Washington 4, D. C.

INVENTORS. Don't sell your invention patented or unpatented until you receive our offer. Write Cowgill, Box 298, Marion, Ohio.

INVENTIONS And patents promoted. A-1 service for inventors for many years. Write Adam Fisher Co., 5418 Idaho, St. Louis, Mo.

INVENTIONS Wanted. Patented or patent pending. 25 years experience promoting inventions. National Service Bureau, 3120 Meramec, St. Louis 18, Mo.

INVENTIONS Wanted. Patented; unpatented. Tremendous manufacturers lists. Global Marketing Service, 2420 77th, Oakland 5, California.

INVENTIONS Wanted now by my manufacturer-clients. Patented, unpatented. Write Adams, Patent Broker, 80-S Wall Street, Financial District, New York City.

INVENTIONS Promoted. Write for free booklet "Your Invention." Kessler Corporation, 561W, Fremont, Ohio.

CASH Buyers for ideas and inventions. Write National Inventors Institute, 457 Munsey Building, Washington 4, D. C.

INVENTORS. Give us the opportunity to explain our selling plan for your invention, gadget or device, patented or unpatented; free particulars available upon request. Demarest and Demarest, Box 95, Battle Creek, Michigan.

ESTABLISHED Manufacturer, with facilities to fabricate lightweight metal products, wants patented or unpatented items to manufacture. Write Tom Lee, Magnesium Products of Milwaukee, 742 W. Virginia St., Milwaukee 4, Wisconsin. Write for form to use when submitting your idea.

PATENTS FOR SALE

CARDBOARD Or sheet metal unspillable fruit picking bucket 2,384,974. Art Neumann, 619 North Michigan, Chicago 11.

INVENTIONS For sale. Queries from manufacturers solicited. Kessler, Patent Broker, Fremont, Ohio.

NOVEL Inventions wanted. We pay all manufacturing, distribution expenses. Mail \$1. Examination fee. Weyman Co., A116, 939 Vander Hoeven, San Antonio 9, Texas.

INVENTORS: Test the commercial value of your patented or unpatented inventions, quickly and inexpensively. Write for free information. Institute of American Inventors, Dept. 40-B, 631-E St., N.W., Washington 4, D. C.

MANUFACTURING

MODELS—Small lot manufacturing. Metals, plastics, etc. Milburn, Burlington, Kentucky.

MODELS, MODEL SUPPLIES

SHIP And yacht model fittings; blueprints. Send 35c for illustrated catalog listing hundreds of items. A. J. Fisher, 1002-1 Etowah Ave., Royal Oak, Mich.

SHIP Model kits and fittings including clippers, trawler, fishermen, frigates, privateer, radio control tug, etc. Send 25¢ for 1956 catalog. Model Shipways, Box 85, Bogota, N. J.

SHIP Models. Most complete line in New England. Kits, fittings, plans, books, tools, engines, motors. Illustrated catalog 30¢. James Bliss & Co., Inc., Dept. SM, 342 Atlantic Ave., Boston 10, Mass.

BALSA Wood and model aircraft. 40-page catalog 25¢. Sig Co., Montezuma, Iowa.

MODEL Hobbyists! Books, magazines, plans—Catalogs 25¢. David Bair, 725 Walden, Winnetka, Illinois.

HOME CRAFTSMEN

LAMP Size cypress knee with nipple installed \$2.00. Cy Products, Dept. 2-U, Lafayette, La.

FREE. Complete illustrated catalog, leathercraft kits, supplies. Also big metalcraft catalog. Write now for either or both. J. C. Larson Co., Dept. 6175, 820 S. Tripp, Chicago 24.

LEATHERCRAFT. Metal enameling, beadcrafter, shellcraft, metal tooling, textile painting, many other crafts. Free big illustrated catalog. Kit Kraft, Dept. 236, Studio City 1, California.

BUY Wholesale nationally advertised power, hand tools, thousands other products at big discounts. Free "Wholesale Plan." American Buyers', Hertel Station, Buffalo 16-F1, N. Y.

101 FULL Size patterns. Smart, new, gifts, novelties, lawn figures, shelves, action windmills, alphabets. Plus "Make Money Jig Sawing." Only \$1.00. Mastercraft 65M, 7041 Olcott, Chicago 31, Illinois.

RUBBER Molds, liquid rubber, leathercraft, unpainted figurines, paints and supplies. Catalog 10c. Steece Bros., Box 177-S, Sioux Falls, S. D.

FREE Handicraft supply and project catalog. American Handicrafts, Box 1479-FM, Fort Worth, Texas.

GRANDFATHER Clocks. Build a tubular chime at factory prices. Send 50c. Wills Bros., 237 S. Ellwood Ave., Baltimore 24, Maryland.

WOODWORKING Course for home craftsmen. Twenty-two manuals. Over 1000 pages. 75 training projects. Only complete home training program available today. Carefully written, profusely illustrated. Covers everything from wood selection to final finishing. Complete instruction in care and use of all hand and power tools. Prepared by expert manual training instructors. Write for free booklet. Interstate Training Service, Dept. D-4, Portland 13, Oregon.

KNOCKDOWN Cedar chests. Lumber and veneers. Free price list. Giles & Kendall Company, Huntsville, Ala.

STYLECRAFT Sure fire hits. "Pre-traced" leather kits. Handbags, billfolds, filigree belts, over fifty other projects. Patterns on leather. Why trace? Just carve, assemble and lace. Large assortment "precarved" kits also available. Send 25c for catalog, free folder. Refunded first order. Apache Leather Company, 2804 E. Washington St., Phoenix, Arizona.

KNOCKDOWN Cedar chests and lumber. Free price list. Bedford Lumber Company, Shelbyville, Tennessee.

18 FULL-Size patterns. Save money with easy-to-use, professionally designed full-size patterns. Make money selling beautiful, useful furniture. Make modern step and cocktail tables; metal lamps; cupola; 12-foot outboard. All patterns test-built; sold with money-back guarantee. Get your free list of these convenient, economical patterns today. Popular Mechanics Press, 200-HH E. Ontario Street, Chicago 11, Illinois.

LEATHERCRAFT. Send 10c for new 60-page catalog of tools, supplies, kits, including metalcrafts, enameling, ceramics, all other crafts. Complete stock. Reasonable. Since 1910. Sax Bros., Dept. PM1, 1111 N. 3rd, Milwaukee, Wis.

ALL Crafts, supplies. Large free catalog. National Handicraft, 199 William Street, New York City 38.

PLASTICS Home-craft course for men and women. Tells and shows how to make hundreds of fast selling plastics products. All plastics and materials for 23 projects included in course. No special tools needed. Course pays for itself. Write for free booklet. Interstate Training Service, Dept. D-4, Portland 13, Oregon.

AROMATIC Red cedar lumber. Small lots shipped anywhere. 3/4", 25¢; 1/2", 20¢; B.F.; 3' to 7' long. R. E. Johnson, Robertsville, Mo.

CERAMIC Tile for bath wall, floors and tables. Applied with adhesive. Instructions furnished. Artistic Tile Co., 2562 First Ave. No., St. Petersburg, Fla.

GRANDFATHER Clock movements, dials, blueprints, kits. Wholesale catalog 25¢. Mason-Sullivan, Noroton, Conn.

BAMBOO. 2 To 3 inch diameter, make many tropical items. Limited supply. 10 lengths each 4 feet long \$5.00 f.o.b. Welch Sales, Toomsaba, Miss.

WOODCRAFTERS—We buy what you make from our patterns. Easy to make, no special tools needed. Send \$1 for patterns and complete instructions. Satisfaction guaranteed. Wm. Rice, 188 Pine St., Kingston 32, New York.

HOMECRAFTERS! Jigsaw operators! No more tracing or painting. Our method prints finished designs, any pattern, on any surface in seconds! Simple. Economical. Assorted designs, instructions \$1.00. Craftalids, Box 568-PM, Danville, Illinois.

DO IT YOURSELF

BE A pioneer. Saw to suit or build with northern hardwood miniature logs 1/2 to 1 inch diameter. Enough for cabin 8"x12", seven inches high. Money-back guarantee. Postpaid, states only, \$3.00. Tree Farms, Taylors Falls, Minnesota.

PUTTY Like a craftsman. Send 60c for Glaput putty tool, postpaid. Smooths putty in uniform slant. Meters corners. Adjustable. Sets glazier points. Blaco Manufacturing, Cleveland 3, Ohio.

MA-Kit-Yourself 5" disc sander. Convert vacuum cleaner motors. Details, blueprint, \$1.00. Postpaid. The Ashmores, Box 676, Pearl City, Illinois.

MAKE Your own dinette sets, coffee tables, stools. Beautifully twisted solid wrought iron, satin finish plastic glides. Write Auburn Ornamental, Northport, Mich.

EASILY Built junior bowling alleys. Plans 25¢. Square, Excelsior, Minn.

MAKE Unbreakable recording disks 2¢ each. Armand Busico, 1035 Jackson St., Philadelphia 48, Penna.

BOOKS: Hundreds of subjects. Big catalog free. Popular Mechanics Press, 200-BC East Ontario St., Chicago 11.

60 PAGE Booklets! Cement Work, Upholstering-Caning, Woodworking, Greenhouse, Mechanical Problems, Electricity, Heat, Radio, Useful Tables, Scientific oddities. Order by titles. 10¢ each. Franks, 3121 South Racine, Chicago 8.

BUILDING A garden tractor, whirlcut, lawn truck? Need parts, forward-reverse drive? Write Eaton Roller & Mfg. Co., 300 North Meridian, Eaton, Ind.

BUILD Inexpensive concrete blockmaker—1/2 h.p. Motor operated, also hand. Write, C. Lee, Mountain View, Okla.

CLOCK Movements—Gorgeous dials, plans, kits. See ad page 227.

AIR Conditioners—Home, automobile. See Kool Engineering ad page 32.

PAINT Signs—Outline letter patterns, brushes, supplies. Eyerly, 583, Newton, Iowa.

"DO It Yourself Encyclopedia." 12 giant volumes (3,000 pages) packed with thousands of ideas, plans, gadgets and projects you can do yourself. How to weld, paint, repair most anything. How to make boats, deepfreeze, draperies, jigsaw projects and just scores of other items. How to do electric wiring, plumbing, room building. How to modernize kitchens, bathrooms. Greatest, most complete fix-it library ever offered. Written so you can understand it. You'll be thrilled when you see what these 12 big volumes contain. It's simply sensational. You must really see them to fully appreciate this exciting fix-it library. You'll fall in love with them just as soon as you open the first volume. I'll send you a descriptive circular that will open your eyes to the greatest, most complete and beautifully illustrated "Fix-it" library you ever laid your eyes on. Send a postal right now. Popular Mechanics Press, 200-DY East Ontario St., Chicago 11, Illinois.

WATCHES, OLD GOLD, JEWELRY

MAKE Rhinestone jewelry. Complete introductory kit and illustrated catalog \$1.00. Catalog alone 10c. J & M Novelties, Dept. CG-3, Griffith, Indiana.

RHINESTONES. Send \$2.98 for six gross, value \$7.00, free bargain list, catalog. Ebert, Box P183, East Orange, New Jersey.

10 SWISS Watches \$18.00. Catalog 10c. Berkowitz, 1150 Castlehill, New York 62.

WATCH And clock repairing books. Free information. North American, Dept. 16P, 2320 N. Milwaukee, Chicago 47, Illinois.

MEN'S Wrist watches. Written guarantee. \$10.95. Billera, 38 Circle Drive, Hicksville, New York.

HELBROS Watches, jewelry 70% discount. Catalog 25¢. Dorinda, Huntington Station 7, N. Y.

WATCHMAKERS—Jewelers' supplies, instructions. Catalog 20c. Bengale Company, Culver City, California.

COSTUME Jewelry supplies. Catalog and samples. 35c. Largest line in America. Milady-Fair Co., G.P.O. Box 1328, New York City 1.

USED And new watches \$2 up. Free list. Southern Watches, Gray, Georgia.

HIGHEST Cash for old gold, broken jewelry, gold teeth, watches, diamonds, silverware, spectacles, platinum, mercury. Free information. Satisfaction guaranteed. Rose Refiners, Heyworth Bldg., Chicago 2.

RAZORS, BLADES, SHARPENING

TRAVELING? Shave in car. Anywhere! Adapter plugs into car radio, only \$2.98. Guaranteed to operate Schick, Sunbeam, Remington-foursome, Norelco electric shavers. R.E.N., 5803K White Oak Ave., Encino, Calif.

FOR THE HOME

YOUR Name beautifully engraved on sign for front door. Only \$1.00. Engravers, P.O. Box 113, Malden-on-Hudson, N. Y.

PEN And ink sketch of your own home or camp, made and put on letter-paper, informals, playing cards, etc. for you. Same of friend's house makes fine gift. Tift, 111 Tift Road, Dover, New Hampshire.

FOAM Rubber furniture cushions. Factory seconds, 50% discount. Free catalog. Perma-Foam, 236C Rhode Island Ave., East Orange, New Jersey.

MOUNTAIN Fresh filtered water from your faucet. \$5.00 attachment. James Willard, Box 1579, Chicago 90.

OF INTEREST TO WOMEN

HANDMADE Gifts—Crocheting. Free price list. Susan Fink, Eaton, Ohio.

FRENCH Reweaving manuscript, complete instructions \$2.00. Daniel Hillard, Frankfort, Ky.

GOOD Money in weaving. Weave rugs at home for neighbors on \$69.50 Union Loom. Thousands doing it. Booklet free. Union Looms, 153 Post St., Boonville, N. Y.

\$5,199.90 WAS Paid to John Betts, in few weeks. Grow mushrooms. Cellar, shed, Spare, full time, year round. We pay \$3.50 lb. Free book. Mushrooms, Dept. 176, 2954 Admiral Way, Seattle, Wash.

SELL Fine fabrics. Get yours wholesale. Box 863, Norwalk, Conn.

WANT To make big money at home? \$5 profit in an hour possible with invisible reweaving. Make tears, holes disappear from clothing, fabrics. Steady year-round demand from cleaners, laundries, homes. Details free. Fabicon, 8332 Prairie, Chicago 19, Illinois.

MOTHERS! Three 8x10 enlargements your baby \$1.00. Send negatives, no prints. Star Photo P.M., Box 16, Andover, Mass.

WANTED—MISCELLANEOUS

QUICKSILVER, Sterling, silver solders, precious metals. Wholesale Terminal, Norwood, Massachusetts.

BOOKS: Hundreds of subjects. Big catalog free. Popular Mechanics Press, 200-BC East Ontario St., Chicago 11.

SCRAP Mercury (quicksilver) containers scrap—Tantalum, tungsten, silver, platinum. Metallurgical Products Company, Established 1909, 35th & Moore Sts., Philadelphia 45, Penna.

PERSONAL

MAKE Sure your bank account always balances. New, amazing method. Never fails. Free details. Lawlor and Pike, Northport, N. Y.

ANY Pennsylvania newspaper classified section \$1.00. Remails 25¢. Conrad, 3821 Locust Lane, Harrisburg, Penna.

BOOMING Southwest jobs, opportunities, galore. Dallas Sunday classified airmailed \$1.00. H. Zimmerman, Box 331, Dallas, Texas.

BORROWING By mail. Loans \$100 to \$600 to employed men and women. Easy, quick. Completely confidential. No endorsers. Repay in convenient monthly payments. Details free in plain envelope. Give occupation. State Finance Co., 323 Securities Bldg., Dept. W-227, Omaha 2, Nebraska.

THREE Texas papers, dollar. Mail forwarded \$3.00 month. Brookfield, 709 Cypress, Pecos, Texas.

HEAR Better with your hearing aid. Free booklet. Wallace Cheek, Gloucester, Mass.

LETTERS Remailed 25¢. Classified 75¢. Lewis, Box 8053, San Antonio, Texas.

HAVE Miami address \$3.00 monthly. Letters remailed 25¢. Shaffer, 7715 N.W. 2 Ct., Miami 50, Fla.

JOBS—Southern California, men-women. Los Angeles or San Diego Sunday classified \$1.00. Peltcher, 4781 El Cajon, San Diego 15, California.

PITTSBURGH, Pennsylvania. Letters remailed 25¢, six \$1.00. P.O. 255, Export, Pennsylvania.

LONG-Beach mailing address \$3.00 month. Classified ads jobs airmailed \$1.00. Lenormand, 722 Magnolia, Long-Beach, Calif.

PHILADELPHIA, Sunday classified airmailed \$1.00. Remails 25¢ each. Unlimited remails per month \$3.00. Harty, 4120 Chester, Philadelphia 4, Penna.

AIR Academy construction, Sunday classified \$1.00. Remails 25¢. Box 153, Colorado Springs, Colorado.

HONEST Hearted Christians, Bible course free. Victory Service, 656PM, Emmaus, Penna.

THE Courier! Sample of this fast growing mailorder publication for stamp! Courier, 910 Marion, Pharr 22, Texas.

"HOW Can I find out?" You can! Information confidentially developed. Any matter, person, problem. Worldwide. Officially licensed. Established 1922. William Herman, 170 Broadway, New York City.

BUY Vitamins direct. Amazing savings. Catalog free. Matoska, White Bear, Minn.

BOOKS: Hundreds of subjects. Big catalog free. Popular Mechanics Press, 200-BC East Ontario St., Chicago 11.

CHICAGO—Mail forwarding address. Business, personal. Low rates. Continental, 20-M West Jackson, Chicago 4.

REMAILING SERVICE

LETTER Remailing, receiving-forwarding address for rent. Details free. William McLaughlin, 800 Stewart, Columbus 6, Ohio.

REMAILS 25¢. Sunday classifieds, \$1.00. Hopkins, 811 Wohl, 2111 St. Charles, New Orleans, Louisiana.

REMAILS From seaway port. 25¢. Bylon, 17167 Bentler, Detroit 19, Michigan.

LETTERS Remailed from Canada 35¢. I affix Canadian stamp. Ross, 83 Belhaven Rd., Toronto 8, Ontario.

FABULOUS Carlsbad caverns Remails from Carlsbad 25¢. Box 1063, Carlsbad, New Mexico.

MONTREAL, Letter remailed 25¢, etc. R. Cote, 1567 East Laurier Street, Montreal, Que., Canada.

LETTERS Remailed 25¢. Confidential remailing-receiving-forwarding address. \$2.00 monthly. Write for details. International Courier Service, Box 6480-PM, Los Angeles 55, California.

MAIL Received-forwarded. \$3 month. Hedgpeh, Box 830, Alhambra 23, Calif.

NIAGARA Falls or Buffalo remail 25¢. Sunday classified \$1.00. Farrell, Box 452, Buffalo 5, N. Y.

NEW York City—Remails 25¢. S. H. Brown, 178-39 Leslie Rd., St. Albans, L. I., 34, N. Y.

REMAILS 25¢. Sunday classified \$1.00. Adele's, 739 Marshall, Rochester 11, N. Y.

GOLDRUSH Towns. Remail postage, special envelopes supplied. 4 different \$1.00. Sample 35¢. Skeeter, Box 128, Woodlake, Calif.

TREASURE FINDERS

GOLD, Silver, metal detectors. Geiger counters for uranium. Vio-Lites. Sensational new fully guaranteed models. None finer. Information free. Detectron Corp., 5528 Vineland Ave., North Hollywood, California.

FIND Buried treasure, gold and silver, with Goldak's sensational 3 1/2 lb. "find-it" locator, only \$49.50. Write for free literature on complete line of mineral, metal locators; Geiger and scintillation counters. Goldak, 1541 W. Glenoaks Blvd., Glendale, Calif.

URANIUM Finding made easy! Completely transistorized Geiger counters. Extra sensitive. Lightweight. Scientifically engineered. Unconditionally guaranteed. Also complete line prospecting instruments from \$19.95. Write for free information, techniques. Universal Atomics Corp., Dept. PM4, 19 East 46th Street, New York City.

GOLD And silver indicators. Price \$30. Box 51, Plant City, Fla.

GEIGER Counters. Kit \$15.95, send \$5. balance c.o.d. Catalog. American Laboratories, 471 Clifton Avenue, Newark 4, N. J.

LITHIUM. The wonder metal. Free booklet describes prospecting information, uses, etc. Nu-Age, Box 123, Calgary, Alberta, Canada.

GEIGER Counter! Build your own inexpensively in one evening. Complete drawings, diagrams and easy instructions, \$2.00. Box 2723C, Colorado Springs, Colo.

URANIUM Prospector's Guidebook—Map, portfolios. Details. Uranium, Box 788-T, Washington, D. C.

TRANSISTORIZED Geiger counter, meter, probe, speaker, inexpensive batteries, \$59.50. Blackwell Electronics, 2801 W. College, Denver, Colo.

JEEP Owners—V8 power. Read Jeep owners ad, page 20.

FOR Treasure locators, geiger, scintillation counters, mineralights, M-Scope. Fisher Research Laboratory. See advertisement page 215.

FIND Uranium, buried treasures, valuable minerals and metals with completely transistorized detectors! You can buy for less from world's oldest and reputable supplier of prospecting instruments. Get the same electronic metal detectors, Geiger and Scintillation counters, mineralights, dip needle, assay kits, etc., we sell to U.S. and friendly foreign governments, treasure hunters, mining companies and week-end prospectors. Prices as low as \$14.95. We repair and trade all makes! Get free literature on profitable prospecting and prospecting for recreation. Write, come-in or phone—we have the detection instrument you want! Radiac Co., Inc., Dept. PM6, 469 Fifth Ave., New York 17, N. Y.

FOR SALE—MISCELLANEOUS

BARBECUE Owners use "Shure-Lite" strips for starting charcoal or wood fires. Send \$1.00 for package of 10-postpaid, to: Capitol Service, 342 Hanover Street, Boston, Massachusetts.

GABARDINE Trousers. Desirable colors and sizes. \$4.95 postpaid. Yale Clothing, Meriden, Conn.

MIDGET Bible 40¢. Baker, 4206 West Carroll Ave., Chicago 24, Illinois.

HEARING Aid batteries, wholesale. Free list. Habs, Box 51, York, Penna.

MISCELLANEOUS

GERMAN Craftsmanship—Eleven piece drafting set, \$3.95. Micrometer, \$8.50. Illustrated literature. Macleans, 312 Belanger, Houma, La.

BE One of the world's most famous whistlers. Learn to imitate birds and beasts—Gadget fits in mouth unseen with full instructions how to use. Price \$1.00. M. B. Service, Rt. 9, Box 71, Fort Worth, Texas.

WEST Indies. Any information \$1.50. Unusual souvenirs \$2.50. Brice, Green Gables, Halfwaytree, Jamaica.

"MULTIFLEX" Pastry lifter. A sensational help in kitchen. Free literature. Kellogg, Box 155, Stratford, Connecticut.

RECEIVE Hundreds samples, magazines, offers. Large list 25¢. Mail Center of Los Angeles, 7101 Apperson, Tujunga, Calif.

JAPAN: Buy gifts direct from Japan. Kimono, model engines, lanterns, colored slides, novelties, others. Business information fee \$1.00. Send money orders, Clarence Yamagata, Room 202, Naka 7 Bldg., Marunouchi, Tokyo, Japan.

BIG Mails, 25¢ listing with us will fill your mailbox with mail. C. M., Box 1211-S, Chattanooga, Tennessee.

BUY Wholesale thousands nationally advertised products at big discount. Free "Wholesale Plan." American Buyers, Hertel Station, Buffalo 16-K1, N. Y.

REFILLS For Papermate pens. Blue, red, green, black. 8 for \$1.00 postpaid. Broadway Distributors, 1835A Santa Fe, Long Beach, Calif.

LARGE American flags, new, wool bunting, 9 feet wide, 16 feet long \$15.00, postage paid. Army Surplus, Morrilton, Ark.

"SHOCKING" Expose! Catfish caught with telephone apparatus! Complete details, \$1.00. Pop, Box 6122, Houston 6, Texas.

UNUSUAL Surprise gift. Useful to everyone. Send 10 cents to Pyramid, P.O. Box 6, Mission, Kansas.

IMPORTED Chrome ice tongs \$1.00. M. E. Looy, 7709 N. Ashland, Chicago 26, Ill.

RAZOR Blades, double-edged surgical steel guaranteed 100—\$1.00. Starke's, Box 1202, Daytona Beach, Florida.

WE Will answer your question, \$1 return. Institute, Box 979, Houston 1, Tex.

NAME, Address, stamped on key checks, dog tags, duplicate keys, 50 cents each. Eidson's One Stop Service, 421 W. 18 St., Jacksonville, Fla.

SEPTIC Tank, cesspool troubles ended. Sea-Cal, new miracle enzyme product ends odors, pumping, digging. Free details, send postcard. Forest City Chemicals, 411 So. Chicago, Rockford, Illinois.

70 BIBLE Lessons, 25¢. Bulletin, Box 87, Cathedral Station, New York 25.

TAGS Made to order. 129 Andover Road, Billerica, Mass.

FREE: Exciting catalog packed with books covering most everything. Think of it—From cover to cover you will find described and illustrated hundreds of books telling how to fix and how to build almost anything. How to remodel your home; do your own decorating, plumbing, electrical work. Simplified books covering concrete work, carpentry, painting, furniture making and refinishing. How to build your own boat, home workshop tools. Best books on photography, welding, hobbies, homecraft. How to make a home freezer. Send for your free copy now. Popular Mechanics Press, 200-BO East Ontario St., Chicago 11, Ill.

CESSPOOL Trouble? Use Sursolvent, the miracle cesspool and septic tank cleaner. No pumping necessary. Restores systems to a condition approaching newness. Electric Sewer Cleaning Co., Boston 34, Mass.

RECEIVE Magazine samples, mails, offers by hundreds. Get listed 25¢. Rorick, Cincinnati 26, Ohio.

STUPENDOUS Mental power. Adults. (Details 10c.) Delmar Wisdom, 846 Sunny-side, Chicago 40.

YOUR Name wanted. We'll send 1000 publishers, mailers, wholesalers your name, on our list one year 25c. Dixie Mailers, King, N. C.

WHOLESALE Catalog! 30-80% discounts! Appliances, musical instruments, typewriters, phonographs, watches, jewelry, recorders, housewares, etc. Consolidated Distributors, 21-13 Lafayette, Paterson 15, New Jersey.

BE Your own plumber. You can. Few inexpensive tools and our instructive book, "Home Plumbing Guide," shows and tells you how. Hundreds of photographs and diagrams. Easy to follow. 160 pages. \$3.50. Catalog free. Popular Mechanics Press, 200PG East Ontario St., Chicago 11, Ill.

FREE Wholesale catalogs! Sporting equipment, cameras, homewares, everything. Econ-O-Mart, Whippany 2, New Jersey.

PANNING Gold lesson—Free mail-order catalog, mining supplies, mineral books. Old Prospector, Box 729D1, Lodi, Calif.

BIG Mails, four months listing, 25c. Wright Publications, 2270 Hubbard, Memphis 8, Tenn.

\$5,199.90 WAS Paid to John Betts in few weeks. Grow mushrooms. Cellar, shed. Spare, full time, year round. We pay \$3.50 lb. Free book. Mushrooms, Dept. 175, 2954 Admiral Way, Seattle, Wash.

SALVATION. Feb. 5. Whitcomb, 308 Sycamore, Newport News, Va.

DO It yourself. What? Repair TV, build furniture, make barbecue, plumbing repairs, build boats, do house wiring, remodel home, lay tile, modernize kitchen, repair home, and scores of other things you can do yourself. Books covering each subject, only 25c. Send for descriptive list. It's free. Popular Mechanics Press, 200-LB East Ontario St., Chicago 11, Ill.

FISHWORMS Urgently needed! We shipped \$3,175.75 worth, first year spare-time, backyard! Why can't you? Raising, marketing instructions, 10¢. Oakhaven-M, Cedar Hill, Texas.

"HOME Improvement Guide." New, amazing 192 page volume. Packed with ideas, plans for remodeling, decorating, landscaping, built-in projects. \$2.50 pre-paid. Popular Mechanics Press, 200-HG East Ontario St., Chicago 11.

ORNAMENTAL Iron designs. Book of 1500 beautiful, practical designs for railings, columns, etc. Free literature. Cunningham, 3881 South 3200 West, Salt Lake City, Utah.

BARGAIN. Exciting Little Library booklets, 25¢ each. Tool making, painting, welding, home improvement, games, models, plastics, lamp making, glass blowing, boats, photographs. Free catalog. Popular Mechanics Press, 200-LB East Ontario St., Chicago 11.

LIPS SORE?



BEST FOR

COLD SORES **CHAPPED LIPS** **FEVER BLISTERS**

POCKET SIZE 39c

HIGHER IN CANADA

MAKE BIG PAY OR OWN A BUSINESS

Learn AIR CONDITIONING AND REFRIGERATION

Play safe—choose your future in Air Conditioning, a billion-dollar industry that's growing every day. New CTI Shop-Method plan teaches installation and repair at home. You get 23 practical training kits—motor, compressor, gauges, controls, refrigeration hi-side, tools, supplies. You build an air conditioner, freezer, refrigerator or milk cooler. Write today for **FREE BOOK**.

COMMERCIAL TRADES INSTITUTE, Dept. R-282
1400 Greenleaf Ave. Chicago 26, Illinois

NEW BENJAMIN SUPER CO₂ GAS CARBINE—\$16.50



HI-LO (2 Stage) Jet Power
Cal. .177 or .22

RIFLED
Shoots
Pellets
& Darts

IDEAL FOR
TARGET & SMALL GAME

SAFE—ECONOMICAL—ACCURATE
CONVENIENT—PRACTICAL—NON TOXIC

EASY TO OPERATE—NO PUMPING—NO FLINCHING.
Get 40 SHOTS from each 10r STANDARD SIZE CO₂ (Soda) CARTRIDGE. Up to ¾" penetration.
Ask your DEALER for DEMONSTRATION.

BENJAMIN AIR RIFLE CO.
896 MARION ST., ST. LOUIS 4, MO., U.S.A.

FREE Folder

20% KIT BOATS—DO IT YOURSELF—SAVE 50%



MARCO 14
\$189.50 Delivered

WRITE FOR FREE FOLDER

Accessories • Fiberglass

Marine ASSOCIATES
BOX 618W LONG BEACH 11, CALIF

8' to 14' models, factory to you, no dealers, mahogany decks and framework, all brass fastenings, 14' hull kits as low as \$129.50 including freight charges. **CATALOG 35c** includes Kits, Hardware, Trailers, Fiberglass.

GIANT 6-FT. GOVT. SURPLUS 59c



Great Fun for Kids and Adults at Beach, Playground or Water Sports. Inflate to Giant 6 ft., 21 ft. Round, with Air or Gas. Flying Advt. Visible for miles. Terrific for attracting crowds at Openings, Fairs, Roadside Stands, Gas Stations, Sport Events. Use as Water Markers and Buoys. Made of genuine Neoprene Rubber for extra durability. Surplus. Never Used. Sold at fraction of cost. Add 10c handling cost per order. 59c ea. 2 for \$1, 5 for \$2, 13 for \$5. Huge 10 ft., \$1 ea. Huge 20 ft., \$2 ea. No C.O.D.s. Dealers Wanted.

NOVEL MFG. 33 2d Ave., Dept. G-1569 New York 3, New York

PREPARE FOR BETTER JOB, BIGGER PAY IN SPARE TIME AT HOME

Today, choose the job you want—and prepare for it in time you might otherwise waste. Or if you are already in the work you like best, start training now for quicker promotion and increased pay. During more than 50 years AMERICAN SCHOOL has helped ambitious people to reach higher goals. Check subject that interests you and mail coupon for full information.

AMERICAN SCHOOL, Dept. GA45, Drexel at 58th, Chicago 37, Ill.
Without obligation, please send **FREE** and postpaid, full particulars about the subject checked below.

<input type="checkbox"/> Accounting	<input type="checkbox"/> Diesel Technician
<input type="checkbox"/> Apprenticeship Courses	<input type="checkbox"/> Drafting—Building
<input type="checkbox"/> Architecture & Building	<input type="checkbox"/> Drafting—Machine
<input type="checkbox"/> Automotive Technician	<input type="checkbox"/> Electrical Engineering
<input type="checkbox"/> Better Foremanship	<input type="checkbox"/> Electricity—Practical
<input type="checkbox"/> Bookkeeping	<input type="checkbox"/> Electronics—Industrial
<input type="checkbox"/> Business Management	<input type="checkbox"/> HIGH SCHOOL COURSES
<input type="checkbox"/> Civil Engineering	<input type="checkbox"/> Mechanical Engineering
<input type="checkbox"/> Contracting	<input type="checkbox"/> Mechanical Technology
<input type="checkbox"/>	<input type="checkbox"/> Metalworking Courses
<input type="checkbox"/>	<input type="checkbox"/> Plumbing—Practical
<input type="checkbox"/>	<input type="checkbox"/> Private Secretary
<input type="checkbox"/>	<input type="checkbox"/> Retail Merchandising
<input type="checkbox"/>	<input type="checkbox"/> Salesmanship—Outside
<input type="checkbox"/>	<input type="checkbox"/> Sheet Metal Work
<input type="checkbox"/>	<input type="checkbox"/> Tool Making

NAME _____ OCCUPATION _____ AGE _____
HOME ADDRESS _____ CITY _____ STATE _____
CITY _____ STATE _____
Canadians: Write American School, Dept. GA45, 1610 Sherbrooke St. W, Montreal

MAIL COUPON NOW 

18 ft. Outboard Cruiser,
plywood construction.

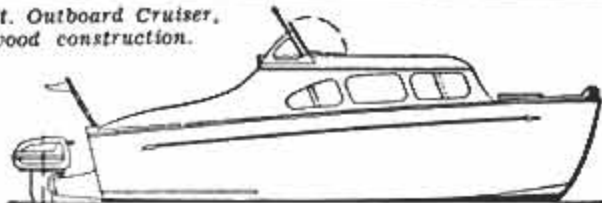

Build a Boat at 1/3 the cost

with CLEVELAND'S full size, cut-to-shape boat patterns, detailed blueprints, and specifications. Choose from huge selection of modern Naval architect-designed cruisers, runabouts, outboards, racers, houseboats, sailing, etc. 7 1/2-38 ft. Send 50c (coin) for latest illustrated catalog. "How to Build a Boat" booklet \$2.50.

CLEVELAND BOAT BLUEPRINT CO. DEPT. 106, BOX 1651, CLEVELAND 4, OHIO

BIG PROFITS WITH UNUSUAL MEDIUM—That's Why

IOWA CITY Operator:
—Net \$90.00 in 1 1/2 Days
OSHKOSH Operator:
—Net \$780.00 in 4 Days

Only patented non-coin Dispenser—NO service calls—NO intricate parts. Only a small deposit is required on these HOT-POPCORN Dispensers. As a start place 25 to 50 units in spots of your choice in Schools, Candy Stores and Taverns. They'll earn \$30.00 to \$60.00 for your half to full day's effort.

Part or Write for FREE Particulars Today
full time **A.B.C. POPCORN CO.,**
3441 West North Ave. Dept. P CHICAGO 47



Wholesale
Popcorn & Supplies

OWN YOUR OWN BUSINESS!

Repair electrical appliances of friends and neighbors.
Service electrical equipment in factories, stores, etc.

New Shop Method home training system. Rush name today for FREE BOOK and special form for getting Electronic kit, illustrated instructions on new easy payment plan. Pay us later with your EARNINGS WHILE LEARNING.

CHRISTY TRADES SCHOOL 4804 N. Kedzie Ave. Dept. D-5503, Chicago 25

ENGINEERING DEGREE IN 27 MONTHS

Big Demand for Graduates

Aeronautical, Chemical, Civil, Electrical, Mechanical and Electronic Engineering (inc. Radio and TV)

Hundreds of young men are earning B. S. ENGINEERING DEGREES annually in this recognized institution — year around operation. New terms start quarterly. Many students earn a major part of their college expenses in this large industrial center.

Low tuition. Competent instruction. Thorough, intense practical program. Modern, well-equipped laboratories including new physics laboratory and modern wind tunnel. Individualized instruction emphasized.

Government approved for G.I.'s. Engineering preparatory courses. Students from 48 states and 21 foreign countries. Enter June, September, December and March. Send coupon for free catalog and full information. Enroll now.

INDIANA TECHNICAL COLLEGE

566 E. Washington Boulevard, Fort Wayne 2, Indiana

Please send me free information on B.S. Engineering Degree in 27 months as checked.

Aeronautical, Chemical, Civil, Electrical,
 Mechanical, Electronics

Name _____

Address _____

OUTDOOR KITCHEN



Written Step-by-Step For You!

Now you can have a beautiful outdoor kitchen to enjoy all summer long. Tom Riley, well-known building authority, tells and shows you how you can build your own outdoor fireplace, Chinese oven, barbecue pit or grill. There are complete building instructions included.

A Standard Piece of Equipment

Once the almost exclusive luxury of Western ranches, the outdoor barbecue now is a coast-to-coast American institution. Every year more families take to this pleasant and gracious way of outdoor dining and entertaining. Now with this book, you can join in with a minimum of expense and the utmost in results. Mr. Riley, an old hand around the barbecue ovens of Oregon, has prepared this complete book, in order that you may find the ideal outdoor fireplace for your particular back yard. He not only gives you many fireplaces from which to choose, but he also gives you money-saving short cuts in construction, hints on firing up and cooking and for extra good measure a collection of fire-tested recipes ranging from tasty frankfurters to filet of sole al fresco.

No Experience or Special Tools Needed

Complete step-by-step building instructions with diagrams, photos and drawings make construction a cinch. There are designs for brick, field country stone, cement, concrete block and poured concrete, and many examples of each. With the know-how gained from this book, yours can be the most popular back yard in town and, besides you'll have lots of fun.

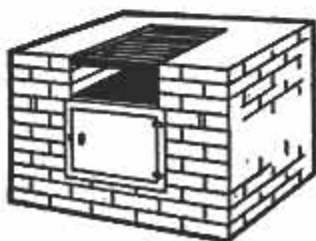

Special Section of 40 Tested Recipes!

Here are some secrets of successful barbecuing — the best fuels to use, ways to maintain proper draft, and hints on firing up and cooking that will enable you to capture the authentic barbecue flavor in the foods you serve to family and friends. So that your fare won't be confined to wieners and hamburgers, Tom Riley also tells you how to prepare and serve such barbecued delicacies as ribs, roasts, fowl, fish, special sauces, and various vegetables.

Partial Contents

Which Barbecue for you? Barbecue Fireplaces, Portable Grill, Masonry Grill, Barbecue Pits, Chinese Ovens, Infra Red Roasters, Combination Barbecues. Construction plans. Basic Fireplace Foundation, Barbecue Fireplace of poured concrete, stone construction, Firing Up! Types of Charcoal, Hardwood, Softwood, Compressed Sawdust, Cooking Temperature, Flame Tested Recipes, Charcoal Broiled Steaks, Barbecued Spareribs, special section of cooking methods employing various vegetables not usually associated with outdoor cooking, and much more.

7-Day Money Back Guarantee

Send for your copy of OUTDOOR KITCHEN, today. Read and use it for 7 days. If it isn't entirely satisfactory, return it for a full refund. We know once you have looked your copy over, and found the fireplace for your backyard, you won't part with this book under any conditions.



Use This Handy Order Coupon

POPULAR MECHANICS PRESS
200 E. Ontario St., Chicago 11, Illinois

Gentlemen:

Please send my copy of HOW TO BUILD AND USE YOUR OWN OUTDOOR KITCHEN, now. Enclosed is my remittance of \$2.00. If I am not completely satisfied with the book I will return it for a full refund after 7 days.

Name _____

Address _____

City _____ Zone _____ State _____

Send C.O.D. I will pay postman

UNMATCHED SPEED FOR OUTBOARDS



of all makes of 7½ HP and up on racing boats and fast runabouts is provided with the famous Michigan AQUA-JET propellers. No re-building of lower unit is necessary. Each propeller is specifically engineered for the motor on which it is to be used. Other propellers for superior performance in water skiing and general purpose operation; also, a complete line of fine boat fittings are described in our 1956 Outboard Catalog—the OUTBOARDERS' BIBLE. It's FREE. Write Michigan Wheel Company, Dept. P-6, Grand Rapids 3, Mich.

THE EASY WAY TO DETAIL SCALE MODELS

Just lift the cap on Magic Marker to mark, color, paint patterns, decorate models, mark metalwork, identify tools. Amazing color brilliance, clear solid lines, any width. On paper, wood, glass, metal, plastic, leather, painted surfaces.

At Stationery, Hardware and Art stores

SPEEDRY PRODUCTS, Inc.
Dept. A-6, Richmond Hill 18, N.Y.

69¢ 3 for \$2
Slightly Higher West Coast

INSTANT DRY WATERPROOF PERMANENT 9 COLORS



BOWHUNTERS' OUTFITS

Save by mail! Sets include custom-grade laminated bows, matched arrows, top-brand quivers, etc. Also complete line glass bows, archery equipment. Terrific values! Amazing FREE TRIAL plan! Investigate!

Complete Sets \$16.00 up

FREE! How to Hunt with Bow, How to Choose a Bow, Booklets and Catalog

SAVE 50%

HOW TO



MALIBU ARCHERY CO., Dept. R-6, 1036 S. La Brea, L. A. 19, Calif.

Say You Saw It in Popular Mechanics

PLEASE SEND ME



for the time checked.
I am enclosing . . .

1 year \$3.50
 2 years \$6.00

name _____

address _____

city _____ zone _____ state _____

c-66

Hand this order to your newsdealer or send it to

POPULAR MECHANICS

200 East Ontario St. Chicago 11, Ill.



BE YOUR OWN MUSIC TEACHER



Send for Free Book Telling How Easily You Can Learn Piano, Guitar, Accordion, ANY Instrument This EASY A-B-C Way

NOW IT'S EASY to learn music at home. No tiresome "exercises." No teacher, just **START RIGHT OUT** playing simple pieces. Thousands now play who never thought they could. Our pictured lessons make it easy as A-B-C to learn to play popular music, hymns, classical and any other music. Only a few cents a lesson. Over 900,000 students! (Our 58th successful year.)

Mail Coupon for FREE BOOK

Find out why our method can teach you quickly, easily, inexpensively. Write for 36-page illustrated Book. No obligation. Mention your favorite instrument. Just mail coupon below.

U. S. SCHOOL OF MUSIC
Studio 306
Port Washington, N. Y.

FREE BOOK

U. S. SCHOOL OF MUSIC, Studio 306, Port Washington, N. Y.

Please send me Free 36-page illustrated Book. I would like to play (Name instrument) _____

Instrument _____ Have you Instrument? _____

Name _____

(Please Print)

Address _____

AUTO MECHANICS

Train AT HOME for a GOOD JOB

A better job, big pay and security—America's No. 1 industry offers you all 3! Make up to \$125 a week and more. Train quickly at home—earn as you learn. Tools and Tune-Up Kit sent. Write for 2 FREE BOOKS.

COMMERCIAL TRADES INSTITUTE, Dept. A-307
1400 GREENLEAF AVENUE CHICAGO 26, ILL.

★ WORK FOR UNCLE SAM ★

U. S. GOV'T. JOBS! AS HIGH AS \$4,525.00 YEAR TO START. Men, women, 18-55. Experience often unnecessary. Write immediately for FREE 36-PAGE BOOK with partial list of positions, salaries, sample tests, and full particulars telling how to qualify for them. (Not Gov't. Controlled)

Franklin Institute, Dept. S-93, Rochester 4, N. Y.

AMAZING NEW PERSONAL POCKET RADIO

LISTEN WHILE YOU WALK DOWN THE STREET!



Slips in any pocket—wt. only 7 ozs. Size 2 3/4" x 4 3/4" x 1 1/4". Beautiful Black Gold Plastic Case. NO HOOKUPS—NO WIRES—NO PLUG-INS! Self-contained. 150-hour life flashlight batteries and BUILT-IN ANTENNA. POSITIVELY NO AERIAL HOOKUPS EVER! GUARANTEED RECEPTION OF RADIO STATIONS TO 50 MILES up to 1500 miles for powerful stations! New patented Super-regenerative Diode tube and transformer audio stage for sharp selectivity and sensitivity! Easy to use top tuner (while walking). Tiny, plastic personal ear plug.

LETS YOU ALONE LISTEN WHILE YOU WALK, VISIT, WORK, RIDE OR SLEEP ANYTIME—ANYWHERE. MONEY-BACK GUARANTEE AND ONE YEAR SERVICE GUARANTEE.

SEND ONLY \$5.00 (ck. mo) and pay postman \$14.95 plus postage on delivery or send \$19.95 for postpaid delivery. GET YOUR TINYTONE REAL POCKET RADIO now and be ready to listen to Civil Defense Alarms, news, music, sports, etc. on a moment's notice without bothering those around you. NOT AN UNWORKABLE, INCOMPLETE KIT OR PLAYTHING. BUT A REAL POCKET RADIO! Shipped complete with batteries—Ready to listen! Available only from: **WESTERN RADIO, Dept. APM-6, Kearney, Nebr.**

LIBERTY STEMS FROM THE HOME



Father's Day

GRANDPA'S, TOO

JUNE 17

Remember Dad

RADIO CONTROL YOUR MODEL

"CUSTOM MIDGET" RADIO ONLY \$9.98
 LICENSE FREE BAND
 OPERATES SAME AS \$50.00 SETS, INCLUDES LONG RANGE TRANSMITTER RADIO, RECEIVER RADIO AND CONTROL ACTUATOR ALL 3 EASY ASSEMBLY WITH OUR PARTS AND PLANS \$9.98. PLANS ALONE \$1.

PLANE BOATS CARS
 DETAILED INFORMATION & RADIO CATALOGUE 25c
 SPECIAL "SUPPLY SOURCE DIRECTORY" & \$7.00 SUPPLY COUPON... \$1.00
 BOOK "RADIO CONTROL OF MODEL AIRCRAFT" CONTAINS 14 PLANS \$3.98
 RADIO CONTROL GARAGE DOOR DETAILS... \$1.00

RADIOMODELS BOX 36 DEPT. PM. BALTIMORE 6, MARYLAND

14' Model Pictured
42 TOP PERFORMING MODELS, 8' thru 18'
 ... from \$39.25 incl. frt.

Runabouts, Cruisers, Convertibles, Fishing, etc. for every purpose with modern styling, advanced design. No experience necessary, amateurs can easily assemble. Save 1/2 to 3/4 "factory-built" prices!

FIBERGLAS, TRAILERS, ACCESSORIES

FREE! BOAT KIT CATALOG

LUIGER INDUSTRIES, INC. DEPT. B-6 3404 Lyndale S. Minneapolis 8, Minn.

Say You Saw It in Popular Mechanics

High School at Home

MANY FINISH IN 2 YEARS

No classes. No time wasted going to and from school. Progress as fast as your time and abilities permit. Standard H. S. texts supplied. Thousands enroll each year in this 59-year-old school. Send for FREE descriptive booklet.

AMERICAN SCHOOL, Dept. HA45
 Drexel at 58th St., Chicago 37, Ill.
 Without obligation, please send FREE descriptive booklet.

Name.....
 Address.....
 Complete Canadian Courses available. Write American School, Dept. HA45, 1610 Sherbrooke St. W., Montreal

WHERE-TO-BUY-IT INDEX

Source of supply appears after items commercially available

AUTOMOTIVE

Parking-fine collector.....112
 Road map in compact holder shows one section at a time (Mrs. Damar, 1135 Damar Bldg., Newark 5, N. J.).....124
 Dog seat for cars (Tote-A-Pup Co., 114 N. Church, Cynthiana, Kentucky).....131
 Cab riders take a number.....140
 Plastic patching stick (Treglown Co., Inc., 137 South Ave., Fanwood, N. J.).....236

AVIATION

F104A Starfighter is world's fastest combat plane..... 71
 Russian jetliner makes first appearance in West..... 89
 International airstrip straddles border.....133
 Silence jet's roar with large sieve.....133
 Pilotless photo drone takes aerial pictures.....144

BOATING AND FISHING

German snack boat brings refreshments right to boaters....121
 Old truck top serves as boat.....139
 Water-ski towboat steered by skier.....144
 Slip-on boot cleats anchor fishermen (CMG Industries, Box 611PM, Laramie, Wyo.).....250

HOUSE AND HOME

Ocean-liner model..... 71
 Electric tool edges lawns and trims hedges..... 96
 Folding clothes drier has no moving parts.....121
 What's New for Your Home—
 Water-pressure system.....122
 Portable mixer.....122
 Mower that combines features of rotary and reel types....122
 Vertical broiler for electric ranges.....123
 Folding picnic table.....123
 Utility stool.....123
 Intercom for the home.....123

INDUSTRY

One-man paper baler chops, blows and bales four tons per hour (Balemaster Div., East Chicago Machine Tool Corp., East Chicago, Ind.)..... 96
 Automatic wiring machine.....125
 Hangers grip ceiling beams to support maintenance scaffolds (Bil-Jax, Inc., Archbold, Ohio).....125
 Tower balanced on a ball.....130
 Revolving work platform tops railroad car.....133

MISCELLANEOUS

First U. S. monorail has trial run..... 77
 Crawler tractor made at home.....105
 Experimental photo film made of flexible vinyl plastic.....105
 German motorcycle has push-button shift.....113
 Feed detergent to turkeys.....124
 Meter figures phone charges.....124
 Rain meter triggers alarm to awaken municipal pump operator.....124
 Open-air movie theater in Berlin seats 25,000 spectators...131
 Underwater camera case.....134
 Vertical cutting knives boost capacity of forage harvester (King-Wyse, Inc., Archbold, Ohio).....134
 Lounge chair folds into case (Leisure Industries, 96-09 Metropolitan Ave., Forest Hills 75, N. Y.).....139
 Vacuum cleaner turns lifesaver.....139
 Tiny prompter for speakers unreels magnified script (Underwood Corp., 1 Park Ave., New York City 16).....140
 Bell ringer.....217
 Pencil magnifier (Mark Specialty Co., 183 St. Paul St., Rochester, N. Y.).....217
 Talking directory.....234
 Garden guide line (Bobins Co., P. O. Box 298, Fairfield, Conn.).....240

(Continued to page 60)



COUNTESS MARA LOVES MALE ORDERS

Automatic Tie Press. Precision-made in England exclusively for Countess Mara. Mechanical "gentleman's gentleman" to keep fine ties at their increased best. Removes wrinkles from wearing; keeps new look. Maroon, Black, Ivory. (Specify color.) Gift-wrapped. \$16.50 ppd.

Cravat Case. Keeps ties handsome at home, fresh when traveling. Packs compactly. Quality grosgrain silk, lined with Countess Mara tie silk, plastic-protected. Loop for hanging. \$7.50 ppd.

Countess Mara, 338C Park Ave., New York 22, N. Y. (PLaza 9-2488)



Please send me:

- Automatic Tie Press (Color:.....) at \$16.50 each, postpaid
 Cravat Case, at \$7.50 each, postpaid
 Please charge my account ()
 Check enclosed ()

Name
 City Address
 State

PEE WEE BATTERYLESS "LIFETIME" RADIO



REALLY WORKS - FOR LIFE!
 Works WITHOUT TUBES, BATTERIES OR ELECTRICAL PLUGS. Will never run down or burn out! World's smallest. SMALLER THAN A PACK OF CIGARETTES! GUARANTEED TO RECEIVE LOCAL RADIO STATIONS ANYTIME—ANYWHERE YOU GO! Sensational new Ferrite Selective Tuner — Perma-Crystal diode, Super SPEAKERPHONE, durable black and gold plastic case.

SEND ONLY \$2.00 (bill ck. mo) and pay postman \$4.99 COD postage on arrival or send \$6.99 for postpaid delivery. **SENT COMPLETE READY TO LISTEN WITH LIFETIME GUARANTEE.** Nothing extra to buy — ever. Available only from: **MIDWAY COMPANY Dept. WPM-6 KEARNEY, NEBRASKA**

HOW TO FIND URANIUM and other ATOMIC MINERALS

New book tells everything about finding and identifying atomic ores—staking, protecting, and cashing in on your claim. See **PROSPECTING FOR ATOMIC MINERALS** for 10 days FREE, then return or pay \$3.95. McGraw-Hill, Dept. PM-8, 327 W. 41 St., N.Y. 36, N.Y.

BE YOUR OWN BOSS

Make Hundreds of \$ Spare or Full Time Work

NO EXPERIENCE NEEDED

Here is the ideal business with no previous experience or large investment required and no high-priced equipment to buy. A business that will return dollars for the pennies you invest.

YOU CAN CAST ANYTHING

With *Flexible Mold Making and Ornamental Casting*, an amazing fact-packed book, you learn how you can cast practically any article in concrete, plaster, imitation marble or any other casting material using a marvelous new process. You can make ash trays, novelties, garden and lawn ornaments and hundreds of other highly profitable items that cost you but a few cents and sell for as much as \$5.00 and more. Why you can even make true-to-life full-sized busts of your neighbors and friends.

NO EXPENSIVE MOLDS TO BUY

Why buy high-priced molds from others? Learn how you can make your own molds quickly, easily and inexpensively with materials that can be used over and over. You get copyrighted formulas, complete instructions and detailed how-to-do-it photographs as well as complete sources of supply for the few inexpensive materials you need. This is the only book printed in America today that contains instructions for making profitable papier-mache casts.

MONEY BACK GUARANTEE

Start on your road to extra income and independence today. Send only \$1.98 for your copy of *Flexible Mold Making and Ornamental Casting*. Complete satisfaction guaranteed or your money refunded within seven days.

POPULAR MECHANICS PRESS, Dept. 46
 200 E. ONTARIO ST., CHICAGO 11, ILL.

You can make simply and cheaply



BUSTS



GARDEN URNS



NOVELTIES



TILE



STATUARY

NOW! YOU CAN TEST YOUR OWN TV AND RADIO TUBES



All of them—even picture tube! It's easy and safe with this A.B.C. Tester. Simply insert tube in socket. Pilot light instantly indicates if tube needs replacement. A precision instrument. Rugged metal case (not plastic). Operates on AC or DC. One service call saved pays for tester. Only \$3.95 postpaid (Deluxe model \$4.95) or C.O.D. plus charges. Instructions included. 5 Year Guarantee.

OMEGA ELECTRONICS, Dept. T-183, 4700 W. Washington Blvd., Chicago, Ill.



A
GOOD
LAW
TO
BREAK

The law of averages says that cancer will kill one out of every six Americans. But the law does not have to prevail. You can help break it in two ways. By having a thorough medical checkup every year ... and by sending a contribution to your Unit of the American Cancer Society or to Cancer, c/o your town's Postmaster. Fight cancer with a checkup and a check.

AMERICAN CANCER SOCIETY

**NOW DRIVE UP TO
20,000 MILES
and MORE . . .
WITHOUT AN OIL CHANGE**

- PREVENTS ACID ACTION
- RETARDS OXIDATION
- HYDRAULIC VALVE LIFTS KEPT AT PEAK EFFICIENCY

EASY TO INSTALL
SIMPLY REPLACE
YOUR OIL DRAIN
PLUG



POS-MET

OXIDATION INHIBITOR

\$3.98
POST PAID

**TRUCKS
\$4.48**

POS-MET OIL DRAIN PLUG IS UNCONDITIONALLY GUARANTEED OR MONEY REFUNDED MANUFACTURED UNDER DIRECT LICENSE FROM THE NATIONAL RESEARCH COUNCIL OF THE CANADIAN GOVERNMENT

INTERNATIONALLY ACCLAIMED!

POS-MET—recently acclaimed in all leading Canadian and American Newspapers and Magazines is NOW available to American Car and Truck owners. POS-MET—based on a development by scientists of the National Research Council of the Canadian Government—is capable of giving you up to 20,000 miles and more without an oil change. It is a new calcium alloy that prevents rather than reduces acid content. Oxidation is retarded and the performance of the entire engine is improved. Maintenance costs are reduced.

DO NOT CONFUSE WITH MAGNESIUM

Only a highly positive metal can do what we claim. The POS-MET alloy does not require that an acid content be present in the oil before going to work. Foreign particles are kept in suspension—close tolerance parts are free to function at maximum efficiency—Hydraulic Valve Lifts are kept completely free of sludge, which assures you that the lifter will not collapse.

TO: POS-MET PRODUCTS INC.
1764 E. 7 Mile Rd., Detroit, Michigan
IN CANADA WRITE: POSITIVE METALS & ALLOYS
Toronto 15, Ontario

Enclosed is \$3.98 for Passenger Car Unit • Enclosed is \$4.48 for Truck Unit • FLEET DISCOUNTS ON REQUEST

FROM: _____

CHECK MONEY ORDER CASH

MAKE OF CAR MODEL YEAR

(Continued from page 58)

SCIENCE

Reservoir evaporation	62
Blast wave speeds at 18,000 miles per hour through shock tube	70
Satellite rocket will resemble shell	70
Miniature weather station (Fries Instrument Div., Bendix Aviation Corp., 1400 Taylor Ave., Towson, Baltimore 4, Maryland)	112
Sunlight replaces wind for pumping water	113
Machine re-creates history to aid prospecting for oil	121
Plant breeding speeded	130
Improved X-ray tube takes high-speed pictures	131
Physicists create rare minerals with heat and pressure	134
Ocean dams would thaw North	135
Patient helps self to pain relief	140
Milwaukee glacier	220

Craftsman and Shop Notes Index

AUTOMOTIVE

6-volt accessories used with 12-volt systems	170
Auto windshield cleaned with corn cob	187
Simplify timing of V8 engine	190
Faulty voltage regulator "shorted" out of circuit	201

FARMS AND FARMING

Rack under rural mailboxes shelters large packages	164
Steel guard on sickle-bar mower prevents damage to fence posts	190
Feeding trough for sow	190
Large-capacity milk-can rack	194
Tank trailer for hauling water to grazing field	194
Rack on litter-carrier hoist used to handle poultry feed	196
Fly screen in pipe tee prevents clogged sprinkler	196
Coupling handle on tractor plow provides safety feature	201

HOUSE AND HOME

An easy method for temporary enclosure with wire mesh	156
"Wagon wheel" gate	164
Calking compound seals cracks where sidewalk joins wall	168
Electrified kerosene lanterns provide rustic yard lights	168

HOUSEHOLD HINTS

Nail kegs set in fireplace for use as wood boxes	153
Cork scours knife blade	176
Cleaning gilded frames	181

LAWN AND GARDEN

Lighted flower beds add to color of lawn-party decorations	153
Removable birdhouse floor makes cleaning easy	153
Aluminum foil protects barbecue grill from corrosion	156
Pan mounted on broomstick is portable outdoor table	156
Chair "pontoons" protect lawn	168
Chicken-wire flower frogs	176
Toothpicks locate seedlings	176
White tabs on croquet arches easily seen for twilight game	186
Ferris-wheel planter is unusual yard ornament	186
Lawn chair equipped with wheels and adjustable foot rest	186
Barbecue cooks food with infrared lamps	187

MISCELLANEOUS

Carlocks serve double purpose	153
Identification badges fastened to clothes without pins	155
Paper maps pasted to muslin	156
Tape tab removes friction lid	156

(Continued to page 62)

IMPORTANT NOTICE—It is the intention of this magazine to provide its readers with information regarding the latest developments in the mechanical arts. We take no responsibility as to whether the disclosures contained in our articles are covered by patents and advise readers to investigate this subject before making, using, or selling any of the products, machines, or processes described in order to avoid possible liability for patent infringements.

You too can become a chain store tycoon in a few short weeks!

*Self-Service Toy Racks In Local
Stores Are Revolutionizing Old Sales Methods,
Earning Big Profits for Distributors*

By Joseph F. Parrish
22 Hunt Lane, Crestline, California

"When I sold my grocery store and was appointed by Amen Industries last March as an independent Distributor for their self-service toy line, it turned out to be one of the luckiest things I ever did.

"I had watched the 'help-yourself' type of merchandise revolutionize the grocery business, and if the same thing was about to happen in the toy industry, believe me, I wanted in on the ground floor! The way it worked out, the Toy Carousels, as the racks are called, have given me the 'toy department concession' in many types of shops and stores.

"In less than a year, our original 5 racks have grown to a chain of 30 locations, and a single location has taken in as much as \$50 per week. The merchandise sells itself. All my wife and I do is spend six or seven days a month covering the route in our new station wagon to pick up the cash and re-stock our racks."

NEW PROFITS FROM AUTO ITEMS!

"When Amen added its new line of auto accessories recently, I took this on too. From first indications, this will just about double my income.

"The store owners are tickled pink with the extra business the racks bring. I'm my own boss with a growing income, and a solid future, and I still have time to enjoy life. What more can a man ask?"

BIG OPPORTUNITIES OPEN FOR YOU!

If you are qualified, here's how you may become an Amen independent Distributor of toys and auto items. You'll be using a proven, sure-fire merchandising technique to serve two multi-million dollar markets.

RACKS WORK WHILE YOU RELAX

Toy and auto accessory "help yourself" display racks work for you the year 'round. Following a proven step-by-step business plan, which we furnish, you set them in Food Markets, Drug Stores, Service Stations—wherever people stop and shop. Toys and auto accessories are impulse purchases. These colorful racks, with their hundreds of high quality products priced from only 9¢ to 99¢, attract customers like a magnet! You need only a few minutes per week to service each location. Simply collect from the store owner for the items sold, and replace with new ones. It's that simple!

MERCHANDISE GUARANTEED TO SELL

You're completely protected. Any slow-moving item or unsold seasonal item can be returned for free exchange, dollar for dollar. Your stock always has 100% value. In addition, we help by furnishing you free point-of-sale display material, sales promotion items, and give-away toys.

THOUSANDS OF STORES NEED THIS SERVICE!

We can help start your own chain of dealer outlets immediately. Work either full or part time. We furnish everything—stocks, racks, and the complete



Convenient Amen self-service display racks put toys within easy reach of every type of shopper.

AMEN DISTRIBUTORS PROFIT CHART

When Each Rack Sells An Average Of	Average			
	Net Profit Per Item	10 Racks Monthly Profit	20 Racks Monthly Profit	30 Racks Monthly Profit
30 Items Daily...	10¢	\$900.00	\$1800.00	\$2700.00
20 Items Daily...	10¢	\$600.00	\$1200.00	\$1800.00
10 Items Daily..	10¢	\$300.00	\$600.00	\$900.00

Amen Distributors Profit Plan, which is based on years of successful Distributors' experience. Please do not apply unless you have a good reputation, and are prepared to invest from \$500 to \$1000 in inventory if your application is accepted. You pay nothing for your Distributorship, only for the merchandise, on which you make a handsome profit. Amen Industries backs you in every possible way. We even arrange company financing to help established Distributors expand.

EXAMINE PLAN AT OUR EXPENSE!

We'll send complete information about the Amen Organization, including the Distributor Profit Plan, sample assortment of Toys and Auto Items in the exclusive, 3-D transparent, "Amen-ized Pak," specimen display and promotional material, and all other details. Study the Profit Plan. Show the samples to stores in your community, then make your decision. This can be the start of a profitable new career, or make your spare time pay big dividends, but you must act now. Just airmail the form below to Mr. Sol B. Amen, President of Amen Industries, Inc., enclosing cash or money order for \$10.00. (This is a good faith deposit, refundable in case you are not interested, and return all material within 10 days, or it can be applied on your first order.) Don't delay; let us hear from you at once.

Amen Industries, Inc. Dept. PM-66

14620 Arminta Street, Panorama City, California

Mr. Sol B. Amen, President Amen Industries Inc. Dept. PM-66
14620 Arminta Street, Panorama City, California

Enclosed is my good faith deposit for \$10.00. Please rush the complete Amen Distributor's package. I agree to study it carefully and let you know within 10 days whether or not I want to become an Amen Distributor. If not, I'll return all material for a full refund.

Mr./Mrs./Miss _____ Age _____

Address _____ Years in Community _____

City _____ State _____ Phone _____

Do You Drive A Car? _____ Are You In Good Health? _____

CLEAN YOUR CARBURETOR

Feel the difference!



- ✓ Get more power
- ✓ Get faster starts
- ✓ Use less gas



- Don't let a dirty, gummed up carburetor rob your car of power . . . when it's so easy and inexpensive to clean it with GUMOUT
- GUMOUT cleans carburetors fast . . . without fuss
- Just add GUMOUT to your gas tank . . . or ask your serviceman to run it directly through your carburetor
- GUMOUT is great for POWER MOWERS and OUTBOARDS, too! A clean carburetor gives you quicker starts, smoother power
- Sold by service stations, auto supply stores & hardware stores

SEND FOR **FREE**

46-page
"CARBURETOR HANDBOOK"

GUMOUT DIVISION
Pennsylvania Refining Co.
2671 Lisbon Road
Cleveland 4, Ohio

Cool footpath on beach provided by spray hose.....	164
Arrows held by ground quiver bent from wire coat hanger.....	168
Matches taped in tackle box kept dry for emergency.....	168
Envelope-flap sealing device made from can and broom handle.....	176
Leaf designs reproduced on paper.....	185
Rubber hose removes burrs from clothing.....	186
Trailer refrigerator kept neat.....	186
Refill cartridge changes fountain pen to ball point.....	188
Combination food hamper and picnic table.....	189
On the Market—	
Basement waterproofer.....	204
Counterbalanced, double-hung sash.....	204
Paint-and-plaster mix.....	204
Plywood trim kit.....	204
Wood trim in strips of veneer thickness.....	204

SHOPPING FOR TOOLS

Miter clamp.....	202
Perspectograph speeds up draftsman's job.....	202
Pocket magnet is fountain pen size.....	202
Guide for hand tap.....	203
Height gauge.....	203
Sheet-metal brake.....	203
Spark-plug socket.....	203
Swinging bins over the workbench.....	203

WORKSHOP HINTS

Wire grating in solvent can holds brushes above sediment.....	157
Needle files stored in toothbrush case.....	164
Carpenter's square used as improvised dividers.....	176
Improvised vise holds handsaw for sharpening and setting.....	181
Black piano keys make modern door pulls.....	181
Light chains and snap hooks improvised from cotter pins.....	181
Long boards to be edge-planed held on sawhorse with C-clamp.....	184
Adjustable rope clamp for gluing column members together.....	188
Box-type downspouts assembled by crimping male-end corners.....	188
Reinforcing thin sandpaper.....	188
Safe chip-removal method for blind recesses in wood or metal.....	190
Stop pin lengthens drill bit.....	190
Asbestos gaskets seal better when soaked in kerosene.....	193
Carpenter's pencil clip made from clothespin.....	193
Jig for crossdrilling cylinders.....	193
Pipe union serves as revolving-table or tool bearing.....	193
Motor-switch extension handle improvised for use on jigsaw.....	196
Overlap cut gives perfect miter.....	196
Multiple baking pans with handle provide portable parts tray.....	201

Reservoir Evaporation

Huge losses from evaporation in water reservoirs may be checked by floating a chemical on top of the water. The coating, only 1/10,000,000 inch thick, is being applied to various bodies of water in the Southwest by the Southwest Research Center of San Antonio, Tex. According to the institute, Texas alone loses 7,000,000 acre feet of water each year by evaporation. Total water usage in Texas, it is reported, is 8,000,000 acre feet per year. The coating is noninjurious to aquatic life and has no effect on water for drinking, or for industrial and agricultural purposes.

☞ Jupiter has an atmosphere containing such gases as hydrogen, ammonia and methane and a temperature of about 200 degrees below zero.



DON'T RISK WATER-BORNE INFECTION!

WATER PURIFICATION KIT ONLY..... 7.95

Cocci are bacteria, present in many raw waters. Streptococci cause "Strep Throat." Others are blood poisoning; milk souring; eggs rotting; Human and animal disorders.

Complete water purification unit removes bacteria, hardness, taste, odor. Can be installed by anyone. No cutting, tapping, threading or drilling. Filter elements, valves, reagents are all included. Standard pipe and fittings to install are obtainable anywhere. 10 to 100 PSI; for farms, homes, boats, swimming pools, industry, civil defense atomic survival emergencies. 100 GPM filter kit \$7.95. Chlorinator, fluoridator kit (with chemicals) \$9.95. 5000 grain water softener kit \$10.95. Shipped postpaid, money back guarantee.

SPECIAL ALL 3 KITS (\$28.85 VALUE)..... \$24

Complete plans and specifications only \$3.00; refunded on first order. Don't risk disease! Don't delay! Send cash, check or M.O. today. No C.O.D.'s, please.

NORMAN, 1302 S. Figueroa St., Los Angeles 15, Calif.

MEN WANTED

Earn \$100 Per Week and up

AUTO DIESEL MECHANICS

Master a trade with a future - learn Auto-Diesel mechanics in our shops. You learn with tools on real equipment. Earn while you learn. Many of our graduates earn \$100 per week and up. No previous experience necessary. Day and night courses. Approved for veterans. Write for free bulletin.

NASHVILLE AUTO-DIESEL COLLEGE

226 7th Ave., N., Dept. 75

Nashville 3, Tenn.

TELEVISION NEEDS TRAINED MEN

Train AT HOME for a top-pay job or your own business. No experience needed. "Learn by doing" with 15 big radio-TV kits, including TV receiver. Licensed by N.Y. State; Approved for Veterans. Write for FREE BOOK & SAMPLE LESSON. RADIO-TELEVISION TRAINING ASSOCIATION, Dept. M6C, 52 E. 19th St., N. Y. 3, N. Y.

STUDY TO BE A DOCTOR of Psychology or Metaphysics

Obtain a Ps.D., Ms.D., or Ph.D. Be a Teacher, Lecturer or Accredited Practitioner. Teach others how to achieve Health, Happiness and Contentment. Chartered by State. Correspondence Courses only. Write for FREE book telling how.

THE NEOTARIAN FELLOWSHIP

Desk 8, Pickwick Building

Kansas City 6, Missouri

STRUCTURAL DRAFTSMEN

Shortage of detailers has forced many Structural Steel Fabricators to have shop drawings made by outside draftsmen.

\$3.50 per hour is very little compared to what you can earn by contracting to make drawings at home. There seems to be no end in sight to this terrific BUILDING BOOM. Send only \$2.00 with name and address to PRIDE S. S. SERVICE, P.O. Box 3837, Cleveland 10, Ohio and we will mail you a select list of very busy Fabricators from all over the United States. . . ACT-NOW!



DEVELOP A HE-MAN VOICE!

Write for FREE book "How to Strengthen Your Voice for Greater Success" by Eugene Feuchtinger. No obligation. Book will be mailed at once in plain wrapper, postpaid. Just send your name and address. State age. PERFECT VOICE INSTITUTE, 210 S. Clinton St., Studio FU-2, Chicago 8, Ill.

HELPFUL BOOKS

Send post card asking for FREE catalog
Popular Mechanics Press, 200 E. Ontario, Dept. 601, Chicago 11

OIL BURNER SERVICING

Learn at home in your spare time.
Earn big money

MASS TRADES 161A HIGH ST., BOSTON 10, MASS.

WRITE FOR FREE SAMPLE LESSON!

FROM ALL OVER THE WORLD...

news you want to hear with a



hallicrafters Model S-38D—Only \$49.95

It's a fascinating, exciting hobby to listen in on the whole wide world by short wave with Hallicrafters S-38D radio. With this exceptional receiver you enjoy not only standard broadcasts . . . but can choose from the 3 international short wave bands. You, too, will praise the performance of Hallicrafters S-38D radio . . . the choice of countless governments as well as radio experts the world over. Hear the S-38D at your nearest Electronic Parts Distributor today—\$49.95 . . . or write

hallicrafters

CHICAGO 24, ILLINOIS

only \$95 freight incl. Write For FREE FOLDER

12 ft. SPORTBOAT KIT Includes ready-cut parts and hardware. Models low as \$39.00 freight incl.

TAFT MARINE WOODCRAFT
Dept. PM-6, 636 39th Ave. N.E., Minneapolis 21, Minn.

Get This Big ALUMINUM SHELTER

for Your Home...at a Huge 35% Saving...



If you agree to show it to friends, neighbors in spare time and let it pay for itself and **MAKE BIG MONEY FOR YOU!**

Sensational low-cost Aluminum Shelter makes perfect carport, patio covering, screened porch, playhouse, etc., at 1/2 the price less than you'd pay contractor to build one! Get yours at generous 35% Distributor Discount, simply by agreeing to show to friends, neighbors, others. Easy to take orders and make good money spare time . . . only two orders and your Demonstrator pays for itself. Big CASH PROFIT for each order . . . and you don't invest 1c in inventory!

Nothing Like It on Market . . . Amazing Features!

Four styles to choose . . . each strong, rugged ribbed Lifetime Aluminum . . . reflective insulation cooling in summer . . . watertight, with built-in rain gutters. Can be painted. Attaches to house or stands separately. Qualifies for home-improvement loans.

FREE! Rush name, address TODAY for complete illustrated literature and details of remarkable OWNER-DEMONSTRATOR PLAN that pays you cash in spare time. Everything FREE, no obligation. Limited number Demonstrator Shelters available, so write NOW!

FUTURELINE, Shelter Division, Dept. J-54
173 W. Madison St., Chicago 2, Ill.

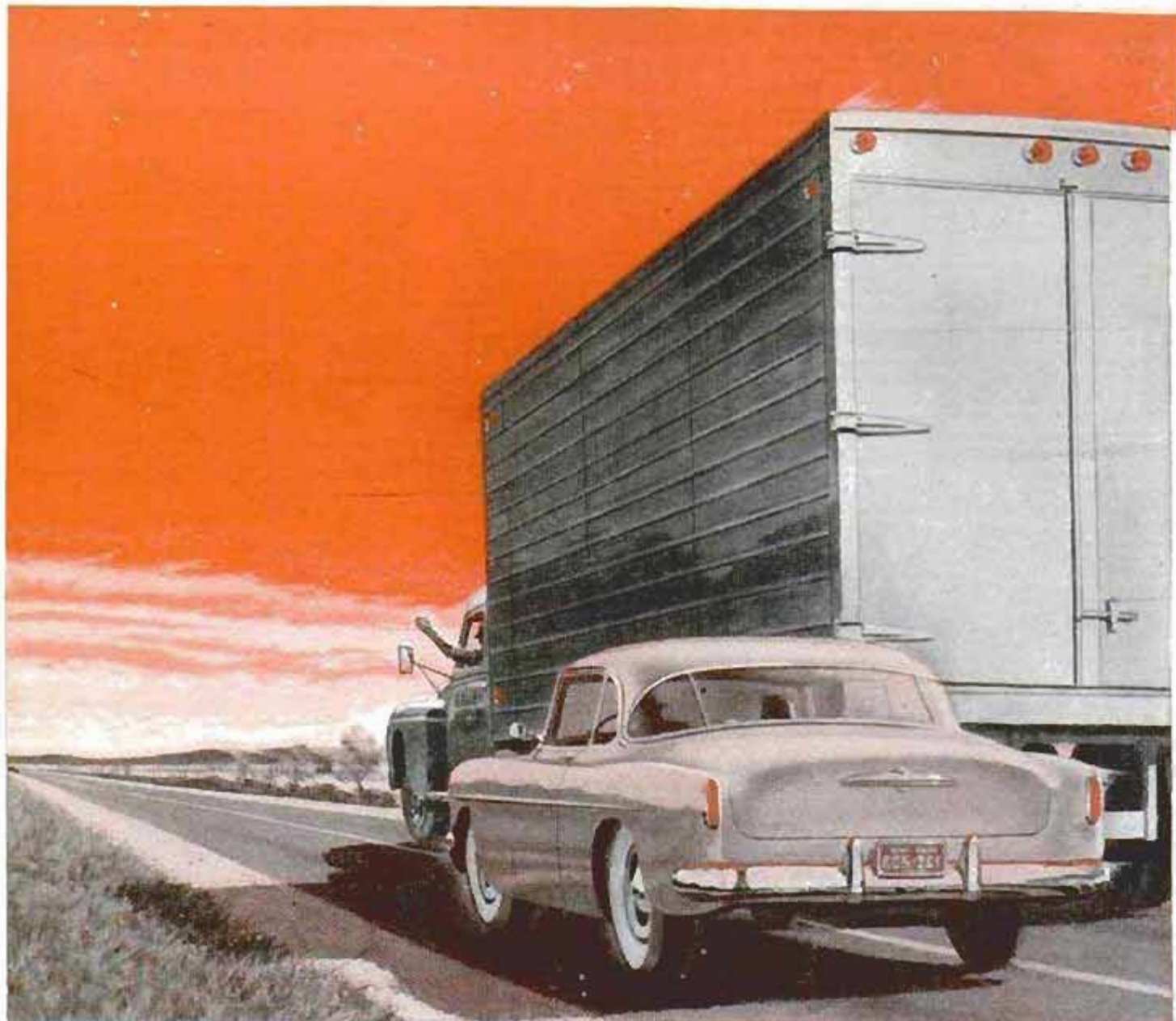

Can YOUR car do it safely?

if not ... see your Doctor of Motors!

When the careful, courteous truck driver waves you on with the "all clear to pass"—is your car responsive or reluctant? Could be it's time for a check-up by your Doctor of Motors, and if your engine needs new piston rings, ask him to install the finest—a set of Perfect Circle's 2-in-1 Chrome.

In Perfect Circle's 2-in-1 Chrome set, the top compression ring was specially designed to perform where pressures are greatest, heat is highest and lubrication is poorest. The new Type "98" oil ring with self-

expanding spacer assures a uniform pressure against the cylinder wall plus a side sealing action on the ring groove. And both rings are plated with thick, solid chrome that resists wear, more than doubles the life of cylinders, pistons and rings.

Enjoy that "new car feel"—thousands of extra miles of sustained power with positive oil control. Ask your mechanic, your Doctor of Motors, to install Perfect Circle's 2-in-1 Chrome set with the new Type "98" oil ring in your engine!



Better Mechanics everywhere install

PERFECT CIRCLE

2-in-1 chrome piston rings

THE STANDARD OF COMPARISON

Perfect Circle Corporation, Hagerstown, Ind.; The Perfect Circle Co., Ltd., Toronto, Ont.





Surprised boy! Bolt split a tree overhead and demolished cart in which he was sitting—without harm to him

Lightning Plays Queer Pranks

By Clifford B. Hicks

SINCE THE DAYS of the cave man, lightning has flashed fear and fascination into the human mind. At this moment about 3600 thunderstorms are lashing the earth. Hidden in the swirling depths of these storms is a power that dwarfs the energy of the H-bomb. An infinitesimal part of this power manages to escape,

crackling out in a sudden bolt of lightning.

The most predictable thing about these lightning bolts is that they are utterly unpredictable. They perform weird, wonderful and sometimes tragic tricks. Lightning occasionally brings death. It may also bring striking evidence of Nature's sense of humor hidden in rumbling "laughter."



General Electric photo

In lightning laboratory, a strand of wire vanishes in a jagged streak of flame as 5,000,000 volts of artificial lightning vaporize the metal completely. Engineers use such bolts to study natural lightning

One lightning bolt struck a building, setting it afire, then accommodately leaped to a nearby fire-alarm box, touching it off to bring firemen who put out the blaze.

Then there's the case of the young boy who was sitting in a cart beneath a tree. Lightning suddenly split the tree, knocked the sides of the cart from around the boy and left him unharmed.

Surprised Horse!

There's a horse in northern New York State that must be one of the most surprised animals of all time. A bolt struck Old Dobbin and knocked off his shoes but otherwise left him unharmed. And it's hard to beat the true story of the woman who was lying in bed, her hair in bobby pins, when lightning struck the house. The bolt turned the bobby pins into curling irons and gave the woman a permanent wave, but didn't harm so much as a hair of her head. Still another bolt executed a cow in New Hampshire without even touching the farmer who was milking her. Over in France, lightning once killed all the black sheep in a flock without touching a single white mutton chop.

What is lightning? Ben Franklin proved that it is a form of electricity, but a thundercloud still wraps its lightning bolts in blackness. Scientists, disclaiming any really precise knowledge, now believe that storms cook up their thunderbolts according to the following recipe:

The swirling drafts of a thunderstorm create positive and negative charges—electricity. Through a process not yet completely understood, the turbulence of the



Early Pikes Peak weatherman went to roof of building during storm. Whirling anemometer was a "solid ring of fire," chimney a "flaming arrow" and his fingers, wristbands and mustache were electrified

air sorts out the charges, dropping the negative ones to the bottom of the heap and pushing the positive ones up to the top of the cloud. This is an unbalanced situation which Nature abhors. The negative charges, denied their positive mates, start attracting positive charges from the earth below. These positive charges soon are scurrying along the surface of the ground toward the spot right under the cloud. If you are standing on the ground you can't feel them, but occasionally they produce weird halos called St. Elmo's fire around objects under the cloud. These positive charges pile up on the ground, striving desperately to reach their opposite numbers on the bottom of the cloud but prevented from making the jump by the air, which serves as a layer of insulation.

Lightning Strikes Upward

But eventually the attraction becomes so great that the charges literally punch a hole through the air. Then . . . *bang!* In a tremendous surge, or series of surges, the positive charges leap up to their mates. Thus, in most cases, lightning actually strikes upward. The stroke travels about 100,000 times as fast as sound. The speed confuses the human eye which sees the stroke as something downward from the menacing cloud. The downward stroke in most cases is an optical illusion.

The upward stroke is what does the damage, killing some 500 persons a year in the United States. Over a period of years, a good deal of money, time and brains has been hurled at the problem of how to minimize damage by lightning. The best example of such research is the General



Electric High-Voltage Engineering Laboratory at Pittsfield, Mass., where scientists cook up and throw their own thunderbolts.

Such bolts represent 5,000,000 volts of electricity. In some experiments they are hurled through copper wire, converting the metal instantly into a gas amid a spectacular shower of sparks. Other thunderbolts are tossed at model houses, clothier's dummies, power lines and trees. Scientists even move the big lightning generator outdoors through a 50-foot door and hurl thunderbolts at anything nearby.

Lightning Traps

Artificial thunderbolts aren't the only phase of lightning research. Engineers also are operating lightning traps throughout the country. Their basic goal is to photograph and examine natural lightning in the wink of an eye as it strikes. On top of the University of

Lightning strikes between clouds across Chicago's skies. Instrument traps are set up to photograph lightning bolts





St. Elmo's fire plucked hat from observer atop Pikes Peak, made his fingers spark and knocked him from roof

Pittsburgh tower in 1947, for example, the engineers trapped a superbolt, believed to be the largest ever recorded. The bolt consisted of five separate surges, at least one of which contained an estimated 345,000 amperes of electricity—enough to service 200,000 homes!

Despite this research, scientists still are far from being able to predict the vagrant whims of the storm cloud. There is an average of 10 lightning strokes per square mile in the United States each year. Any one of these strokes may produce some wacky results.

About a year ago a bolt struck a church belfry in Maryland. It surged through the automatic chime system, short-circuited key wires and touched off a long program of church hymns. Another stroke belted a potato patch; when the spuds were dug up they were fully roasted and ready to eat.

Tricks on Pikes Peak

Such strokes are weird, but for some of the weirdest electrical phenomena ever witnessed, leaf through the journal of the first weathermen ever stationed atop Pikes Peak. Entries in the diary were made as

far back as 1874. The journal was found recently among some old records at the High Altitude Observatory in Boulder, Colo., by Dr. Walter Orr Roberts and Kathryn Virnelson of the observatory. It is replete with descriptions of bristling mustaches and sparkling fingers—St. Elmo's fire playing its tricks.

Robert Seyboth, the weatherman in charge, and 13 men from the Signal Service started the highest weather station ever established up to that time. They probably would have been leery of the job if they had known the strange events they were about to witness. They settled down in a fortlike structure of stone set solidly on a ridge near the summit of Pikes Peak. On the roof of the dwelling was a standard wind vane and an anemometer, whose whirling cups measured wind velocity. Inside the building was a barometer. A telegraph key served as Seyboth's link to the world far below.

The worst hazard to life on the summit was not wind, cold or snow, but the violent electrical storms. To make measurements on the wind vane and anemometer the observer had to climb up on the roof.

Hair-Raising Experience

On the night of June 9, 1882, the observer noticed that as he ascended the roof his fingers were tipped with fire. Suddenly every hair on his head stood on end and crackled. About him was the peculiar odor of ozone. The sensation of electrical discharges jumping from his fingers became painful and the prickly sensation on his scalp unbearable. To protect his head he tried to put on his black felt hat. The hat was about two inches from the top of his head when a fiery stroke knocked him from the roof. Still alive, he picked himself up and beat a glowing retreat to his quarters.

The report for one summer day states: "Heavy thunder and lightning nearly all day. Bright sparks flew around the office, so that several tourists wrapped themselves in blankets for protection." The tourists probably were no more frightened than one observer who, with true scientific detachment, noted that during a thunderstorm his pulse increased from a steady 76 per minute to 120 per minute, and his heart seemed to be pounding rather than beating!

Flashing Telegraph Wire

Another observer reported: "During the fall of sleet a peculiar 'singing' or 'sizzling' noise on the telegraph wire was distinctly heard. At 8:45 p.m., upon opening the door, a most curious and beautiful phenomenon was seen. The telegraph line on the summit was distinctly outlined in brilliant light, which was thrown out from the wire in beautiful scintillations. On near approach to the wire these little jets of flame could be plainly observed. They issued from the wire in little streams about the size of a lead pencil, and of the brightest violet color. They were constantly jumping from point to point. There was no heat, though it was impossible to touch one of these little flames, for as soon as they were approached by a finger they would instantly

(Continued to page 236)



Bolt in lightning lab shows that a golf club with a steel shaft can actually become a lightning rod



Lightning dug this furrow in ball park, killing three players. Below, theory of lightning origin

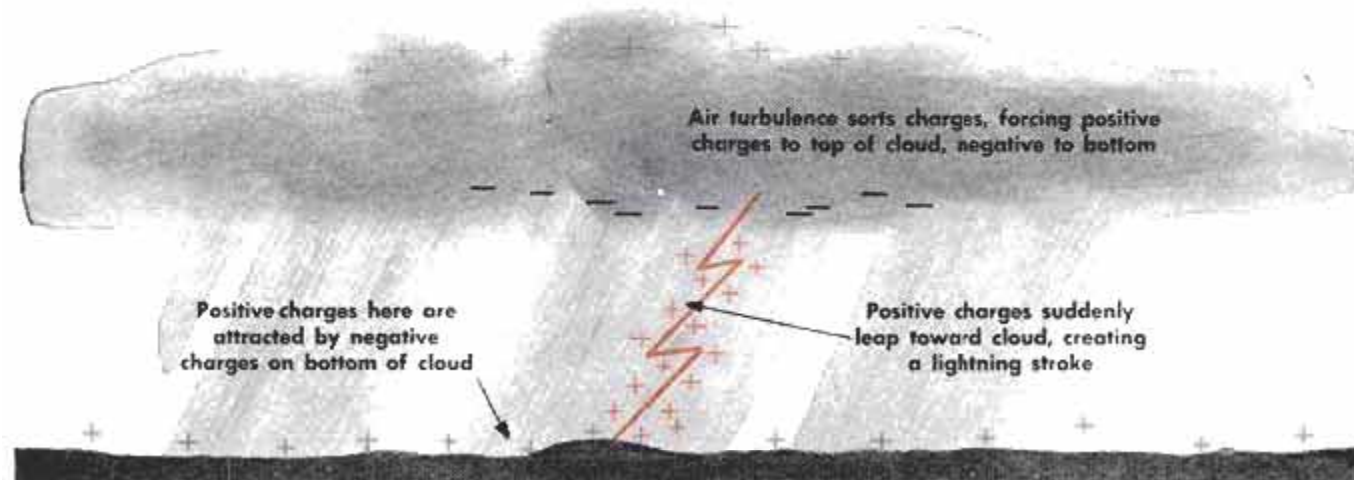

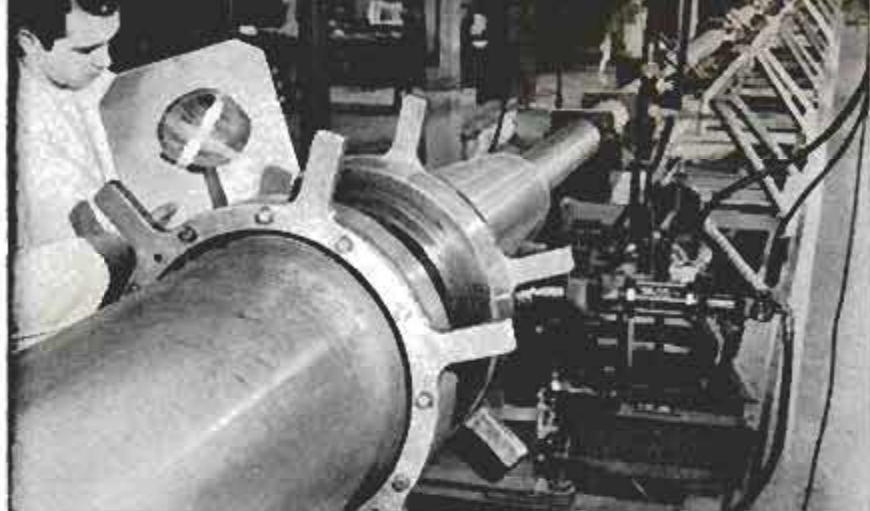

Metal diaphragm placed between tank and end of tube is ruptured on scored lines as gases explode into tube

Blast Wave Speeds at 18,000 Miles Per Hour Through Shock Tube

Guided-missile scientists can now create a shock wave that travels at 18,000 miles per hour and is accompanied by a temperature of 15,000 degrees— $1\frac{1}{2}$ times the heat at the sun's surface. The blast and heat last only an instant, but are enough to reveal the effects of the earth's atmosphere on a rocket or satellite traveling at 25 times the speed of sound. A near vacuum is created in the 100-foot-long, four-inch-

diameter shock tube before the test begins. A huge cylinder at one end is pumped full of gases until pressure reaches 2000 pounds per square inch and bursts a metal diaphragm to send the shock wave racing through the tube and into a shock-absorbing expansion tank at the opposite end. Pressure-sensitive instruments and an electronically operated camera record the blast. Upon firing, the firing tube recoils.

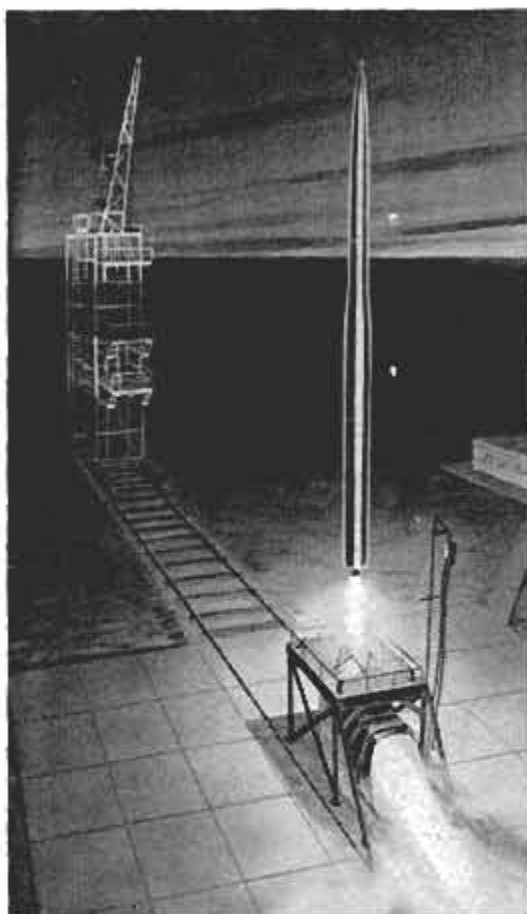

Artist's drawing shows the launching platform and the rail-mounted tower which will be used to service the satellite rocket. Diagram shows the anticipated trajectory of the satellite until it enters its orbit traveling some 25,000 feet per second

Satellite Rocket Will Resemble Shell

Few details have been released on the earth-satellite project, but an artist's conception shows that the three-stage rocket will resemble a giant rifle shell complete with bullet. The drawing, along with information on the trajectory, was released by the Navy and the Martin Company, which is building the rocket vehicle.

The first-stage rocket is about 45 feet long. It will carry the vehicle to an altitude of 30 or 40 miles, then drop off. The second stage has a cone-shaped nose which, during burning, will be jettisoned. By this time the satellite will be at an expected altitude of 200 to 400 miles, and the third stage will boost its speed to about 18,000 miles per hour. The satellite probably will be separated from the third-stage shell, though both satellite and shell will continue in the orbit until atmospheric drag causes both to drop and burn.

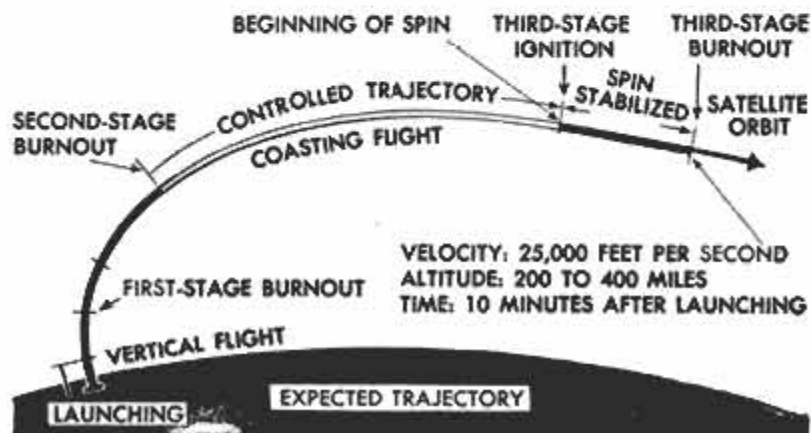



Thin stubby wing of Starfighter gives it appearance of missile. Wing tanks can be added for greater range

F-104A Starfighter Is World's Fastest Combat Plane

Wings are disappearing from planes and soon will follow the guy wire into oblivion. That was proved when Lockheed unveiled its supersonic fighter, the fabulously fast F-104A Starfighter. Wings on the Starfighter reach only 7½ feet from fuselage to tip, are 5 inches thick at the root and 2 inches thick at the tip. The leading edge is razor-sharp and must be covered with a felt pad to protect the ground crew while the plane is in the chocks. Described as the fastest combat plane ever built, the F-104A is estimated to have a top speed of better than 1500 miles per hour—which is nudging against the thermal barrier. A British Fairey Delta 2 holds the official world speed record of 1132 miles per hour, set on March 10, 1956. Pilots watching the first demonstration flights of the F-104A were amazed to note that its speed in a climb was equal to its speed in level flight. Power is supplied by a General Electric

J-79 engine delivering an estimated 15,000 pounds of thrust—the equivalent of 60,000 horsepower at 1500 miles per hour. The plane has gone into production for the Air Force in both single and twin-seat models and will soon be delivered in quantity. All flight data is highly restricted, but estimates give the F-104A a combat radius of 800 miles, an outside range of 2200 miles, a flying weight with wing tanks of 19,000 pounds and a service ceiling of 60,000 feet. Engineers point out that it weighs about half as much as presently operating fighters, yet has more punch plus tremendous speed. One feature is downward ejection for the pilot in the event of a bailout. In an emergency, the pilot pushes a button; automatically he is strapped into the seat at the ankles, the cockpit is depressurized and the seat is shot out the belly of the plane. At a safe distance, the pilot is automatically separated from the seat.

Ocean-Liner Model

Antoine Paya, a mason of Bordeaux, France, has built a six-foot model of an ocean liner from sheet metal that he riveted and bolted together. A gasoline motor geared to four forward speeds can push the boat along at 12 miles per hour. The craft has seven turrets, seven hoists and seven lifeboats, all operating perfectly. There are also 12 winches, 180 cabins, 80 portholes, 160 small rooms, three promenade decks as well as seven stairways.



A FIRST IN AUTOMOTIVE HISTORY: WE DROVE A TURBINE CAR COAST-TO-COAST

By George J. Huebner, Jr.

Executive Engineer, Research, Chrysler Corporation

OUR TURBINE CARAVAN was rolling along the Pennsylvania Turnpike at about 55 miles per hour. Dashboard gauges showed everything to be normal. Suddenly, a state-police car pulled up alongside and signaled us to halt.

I swung the Chrysler Turbine Special over to the side of the road.

"What's wrong, officer?" I asked.

"Nothing," he answered with a grin. "We just wanted to see what's under the hood."

And he was typical of hundreds of curious folk from New York to California. They just wanted to see what was under the hood of a conventional-looking 1956 Plymouth that rolled past with a new sound in automotive engineering—the smooth, steady whine of air in continuous motion.

More often than not, however, they went away wondering what all the fuss was about. The gas-turbine engine they saw was so different from what they were used to that it must have left them unconvinced.

But what they saw was an engine that may well revolutionize the auto industry within 10 years. After driving the turbine car from coast to coast in four days—four days with varied weather and traffic conditions—I am more convinced than ever of the gas turbine's potentialities.

The turbine engine we used develops 120 horsepower, yet is comparable to the propulsion power of a piston engine of about 165 horsepower because it needs fewer power-draining accessories like water pumps, fans, mufflers and automatic transmissions. It is 215 pounds lighter than

LOS ANGELES

FLAGSTAFF

ALBUQUERQUE

OKLAHOMA CITY

AMARILLO



CALIFORNIA



ARIZONA

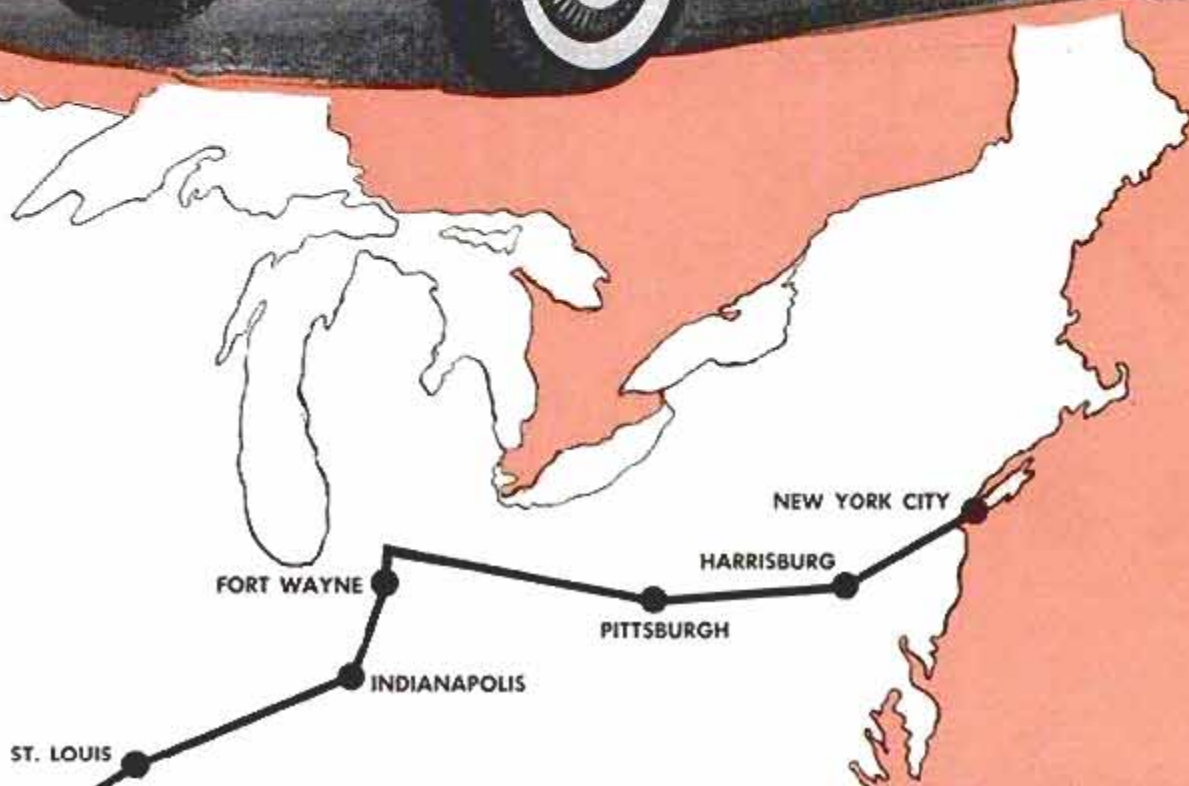

OHIO



NEW YORK

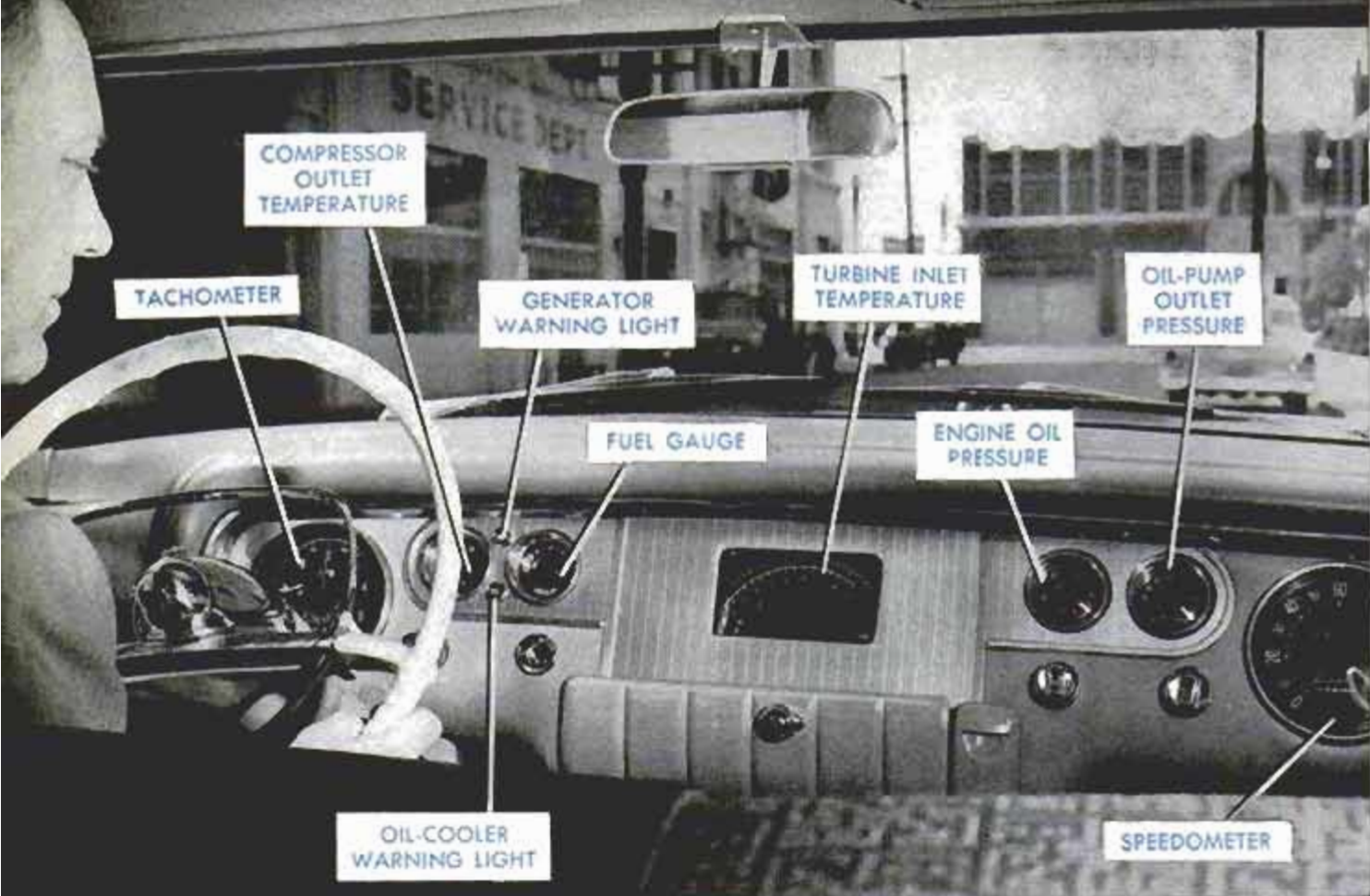

Some of these instruments are for engineering purposes and would not be installed on a production-line car

the equivalent piston engine and has only a fifth as many parts.

It needs no carburetor, no distributor. It has no complex ignition system. Once the fire is started by the single spark plug, it maintains itself and the plug no longer sparks. It has no radiator because it cools itself with the air it breathes as it runs. It is, in fact, a true aircooled engine, cooling itself internally. It takes in over six times as much air as it needs to burn the fuel. This extra air keeps the engine from burning itself up. It lowers the combustion temperature of the gas from about 3500 degrees (which would burn up any metal we have) to about 1500 degrees before it hits the turbine. This air rush also insulates the combustion flame, keeping it from touching the walls of the combustion chamber. The walls would melt if subjected directly

to the flame which is like a huge blowtorch.

This engine has no muffler, yet its noise is no more objectionable than that of the conventional piston engine. It needs no muffler because it has no noisy explosions to be muffled. Its power comes from the continuous burning of fuel under pressure.

Our experimental turbine has a characteristic whine—a combination of the sound of vast quantities of air being drawn into the compressor and the sound of the reduction gear. We have already been able to cut the reduction-gear whine drastically and expect to reduce air noise by acoustical treatment in subsequent models.

We averaged about 45 miles per hour during the coast-to-coast run. Most of the time we drove at around 55 miles per hour. Ed Mason, Chrysler's chief engineer of mechanical research, spelled me at the wheel.

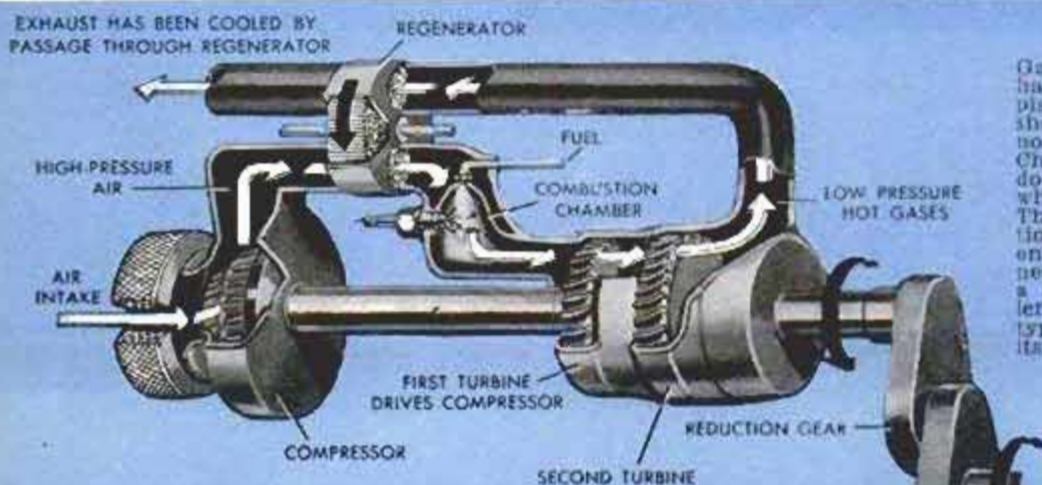

Gas-turbine engines are simple, having a fifth as many parts as piston engines. This drawing shows how they operate. It is not necessarily a sketch of the Chrysler engine, although it does explain the principle on which all gas turbines run. There is no mechanical connection between the first and second turbines, thus the engine needs no clutch. Shown here is a rotating regenerator. Chrysler has not announced what type of regenerator it has in its engine.

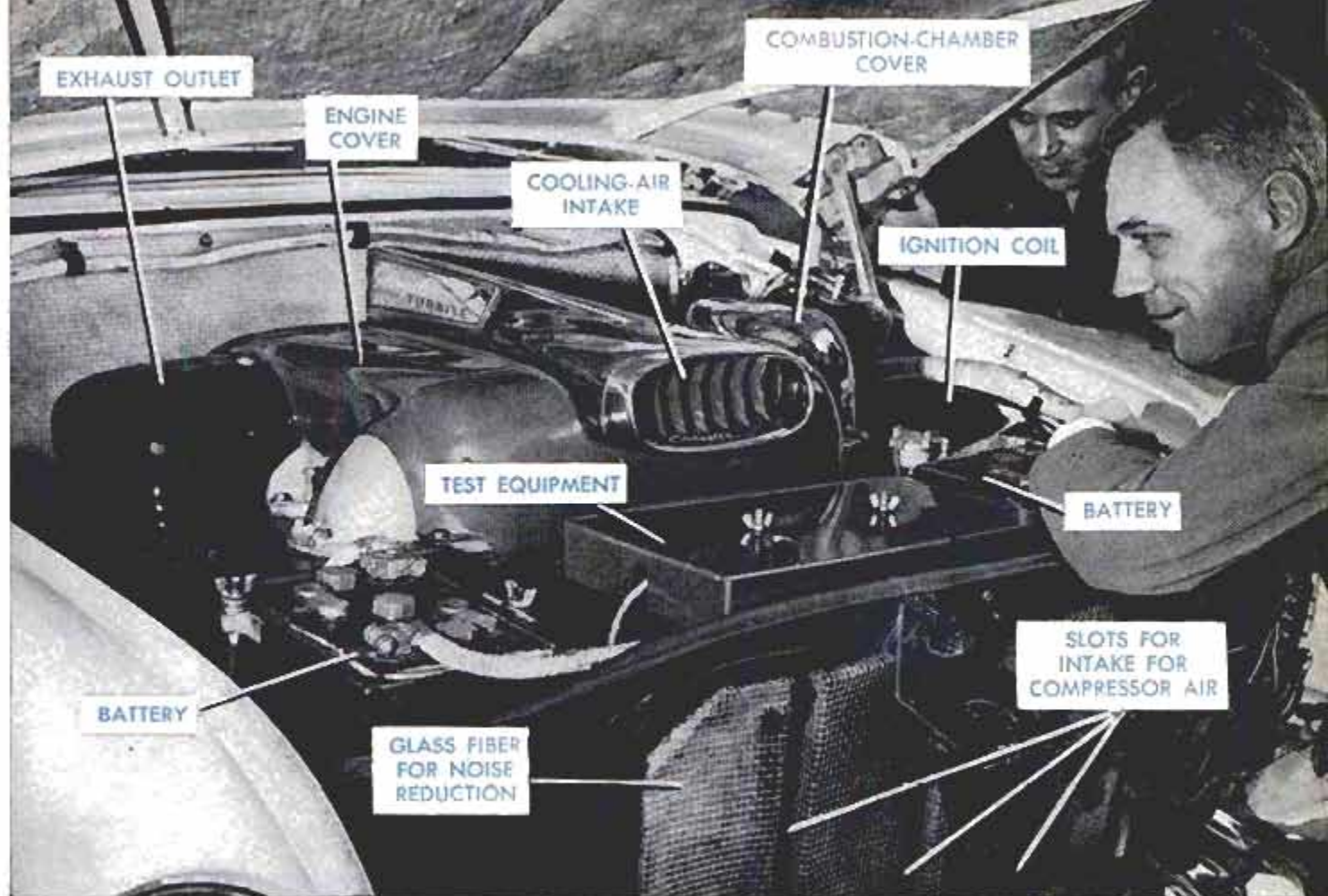

George Huebner, right, looks under the hood of the Turbine Special, the car he describes in this article

While one of us drove, the other flew to the next changeover point to sleep before the car caught up with him. Other crew members worked in relays.

Our caravan was pretty much self-sufficient. We had a truck carrying spare parts (we needed them only twice) and a supply of gasoline. The turbine will burn just about any type of fuel, but we used white, unleaded gasoline exclusively. Once we refueled at a commercial filling station, the

In Ohio, an overheated bearing in the reduction gear (the result of an oil leak) was replaced in 2½ hours



rest of the time we drew on the stock in the truck.

We averaged between 13 and 14 miles per gallon. With kerosene we might have averaged 18 miles per gallon because of its higher heat content. But we wanted to stay with a fuel you may be using in tomorrow's turbine. Kerosene is not abundant enough to supply millions of cars. The ultimate automotive turbine fuel will probably be a blend of several petroleum fuels.

In Arizona, a cracked casting was replaced and the entire engine taken down for inspection in 5 hours

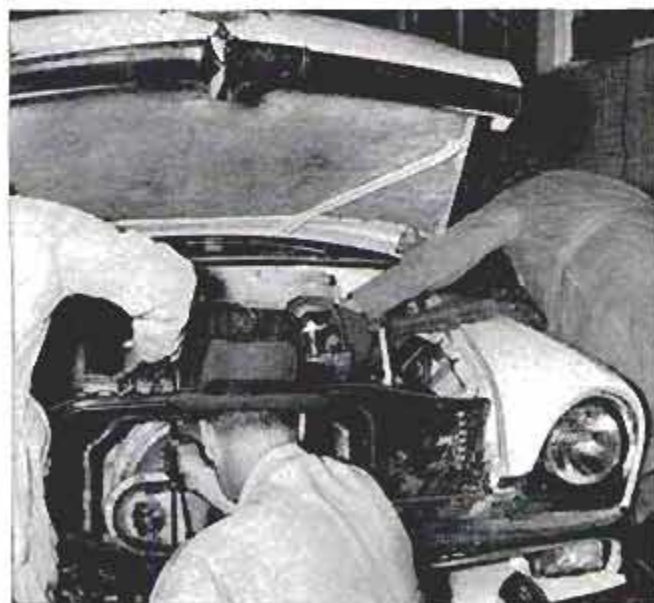



Test instruments were mounted on rear seat. Radio-telephone kept contact with other cars in caravan

What is it like to drive a turbine car? It's exciting not only because you realize you may be driving the car of tomorrow, but because it is so smooth and so much under control. It is amazingly quiet. First, there are no explosions, but more important is the fact that there are no vibrations created by such reciprocating parts as valves, pistons, rocker arms and all the other machinery that make up a piston engine.

It is so quiet inside the car that you become aware of road noises you have never heard before. This, incidentally, poses an exciting challenge to our chassis engineers. It is so quiet and smooth that I can say it is like being towed on the end of a rubber rope.

There have been stories that turbines are fine for open highways, but won't work in today's traffic. I drove the turbine in mid-morning New York City traffic and in early-morning Los Angeles Freeway traffic and we didn't seem to hold up anybody. And remember that this engine is not the one we will offer the public. This is the beginning, but a most successful beginning.

We did have some trouble. Twice we had to stop for repairs. Neither breakdown in-

Fuel was drawn from a supply truck that accompanied the test car. It used only white, unleaded gasoline



Three cars of the caravan wait at a grade crossing. The Turbine Special ran smoothly in heavy traffic

involved any flaw in the basic turbine design. The first trouble was in central Ohio where a bearing overheated in the reduction gear (the only transmission the car needs, by the way). We were losing oil through a cracked oil line and the lubricant shortage scored the bearing. We replaced line and bearing in 2½ hours.

The second trouble came at Winslow, Ariz., where we noticed an unusual hissing noise and discovered a crack in the compressor-intake casting. We decided to change the casting and check over the entire engine. It took only five hours to tear down the power plant and put it together again.

To drive a turbine you turn the ignition key, as usual. This produces a steady spark in the single spark plug and also switches on the starter motor. You let the key snap back to its normal position. The starter winds up the engine.

When the compressor section reaches a speed of 2500 revolutions per minute, fuel sprays into the combustion chamber. The spark ignites it and the burning, expanding gas helps the starter spin the turbine wheel and compressor. The starter still operates

(Continued to page 252)

Filler pipe for gas tank is inside trunk. Exhaust duct occupies space where filler is on standard car





Monorail exhibit drew thousands. Height of rail at loading point is 10 feet. Standard operating height is 30

First U. S. Monorail Has Trial Run

AMERICA'S first monorail train is undergoing tests on a 970-foot pilot line in Houston, Tex. Hailed as one answer to America's urban transportation problem, monorails have proved fast, safe and economical in European use.

The 55-foot Houston train is in two parts: power units and engineer's cabin on top of the rail, and passenger coach below. The rail is a steel pipe 30 inches in diameter, supported by inverted-J towers that are 30 feet high and spaced 55 feet apart.

The train rides on eight rubber-tired wheels while 16 rubber guide wheels hold it in place on the rail. Two 305-horsepower gasoline engines drive the unit, which someday may achieve a speed of 250 miles per hour.

The glass-fiber coach seats 60 and stands 50, is seven feet high and eight feet wide inside.

A monorail line, backers say, could be built at the rate of one or two miles per week for \$500,000 per mile. That's over twice the cost of a regular railroad but $\frac{1}{2}$ the cost of a subway. A two-track line would cost \$700,000. Chief advantages: it takes no right-of-way, can operate above a busy street.



Coach seats 60 and carries 50 standees, is 7 feet high and 8 feet wide inside. It is suspended from power units that run on top of the rail. Pilot model has glass-fiber skin

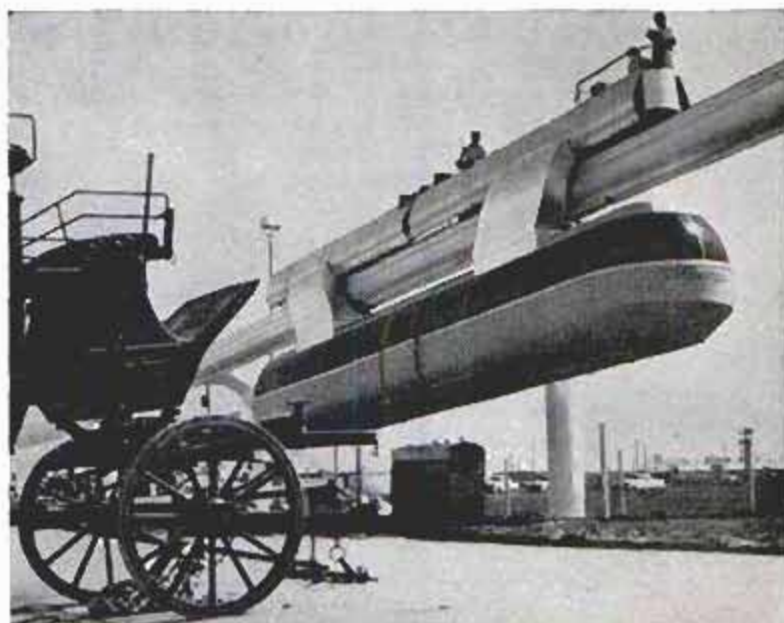

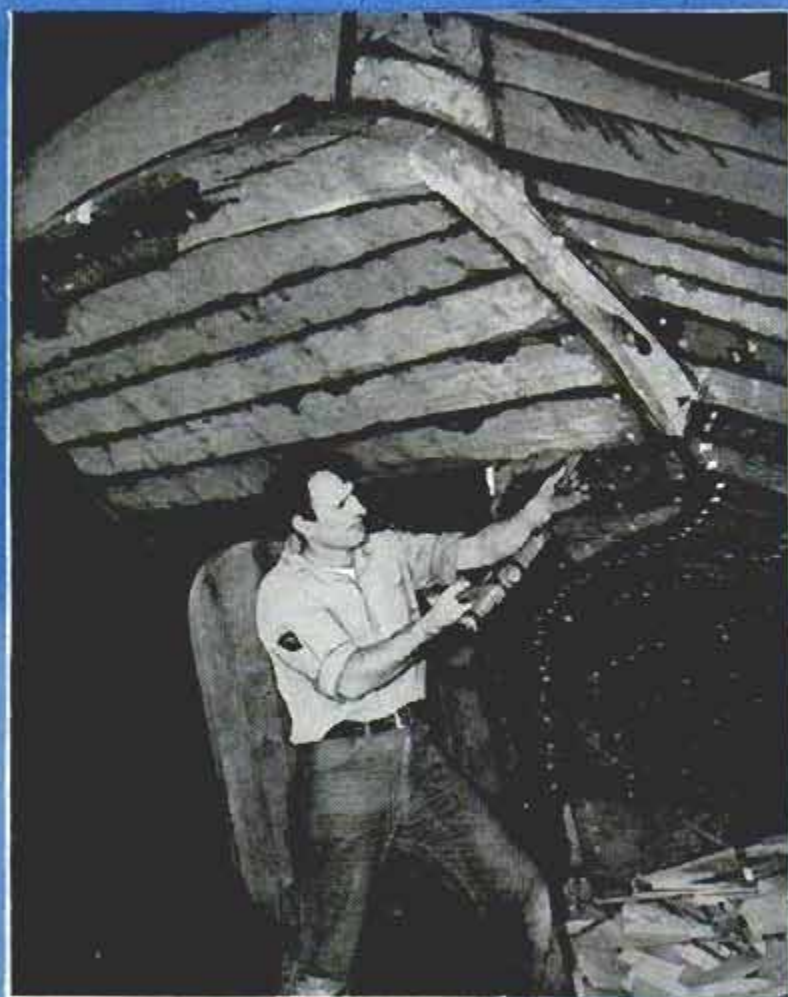
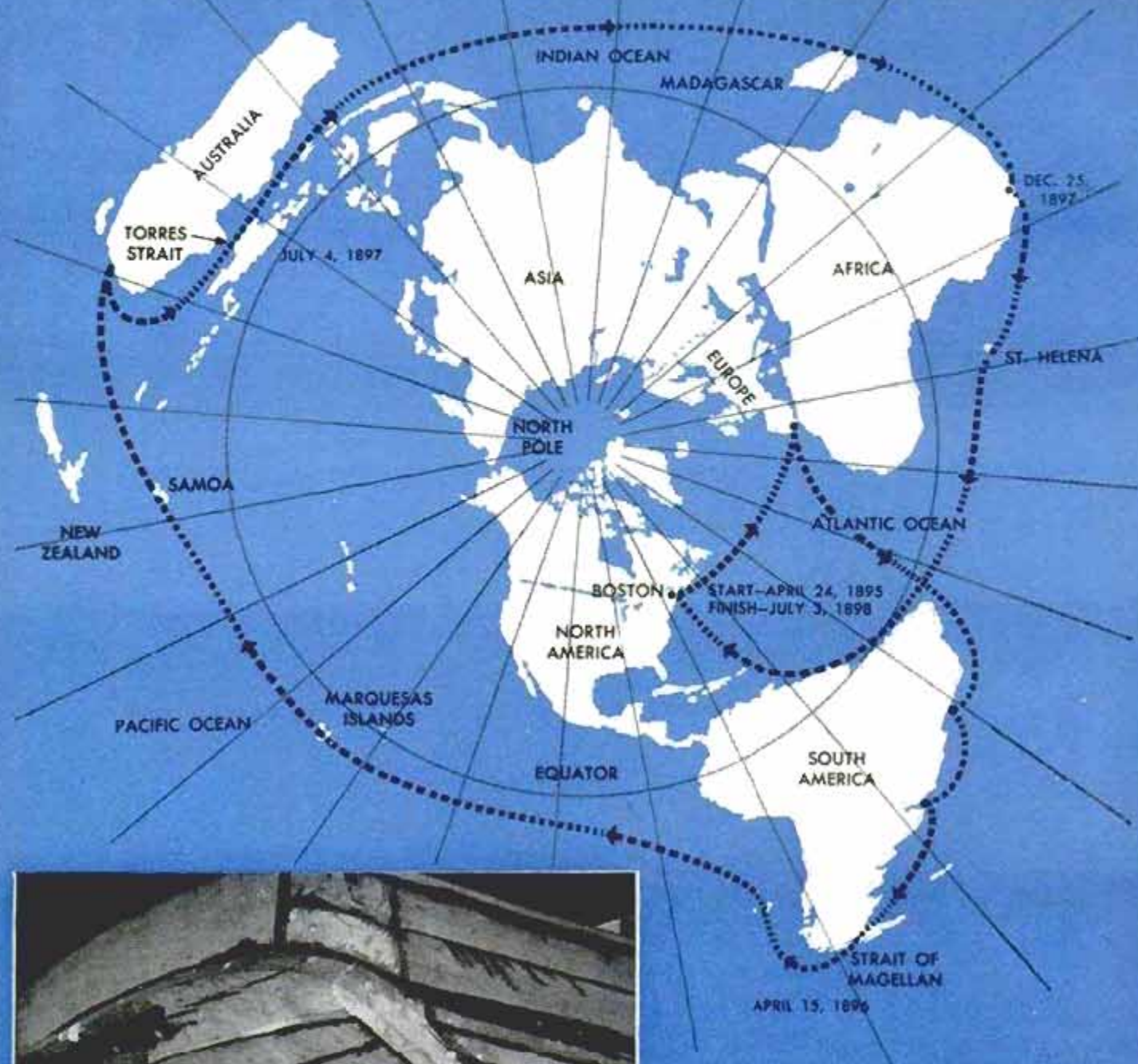

Map shows round-the-world route taken by Slocum 60 years ago. Carr hopes to match his feat with replica of the *Spray*

There were over 1500 feet of seams to be calked in the hull alone. Job took several weeks. Carr uses old-time building methods

Nearly 60 years ago Joshua Slocum sailed alone around the world. Now a Yankee farmer is building a yawl for a repeat performance—

On the Trail of the *Spray*

By Gordon P. Manning

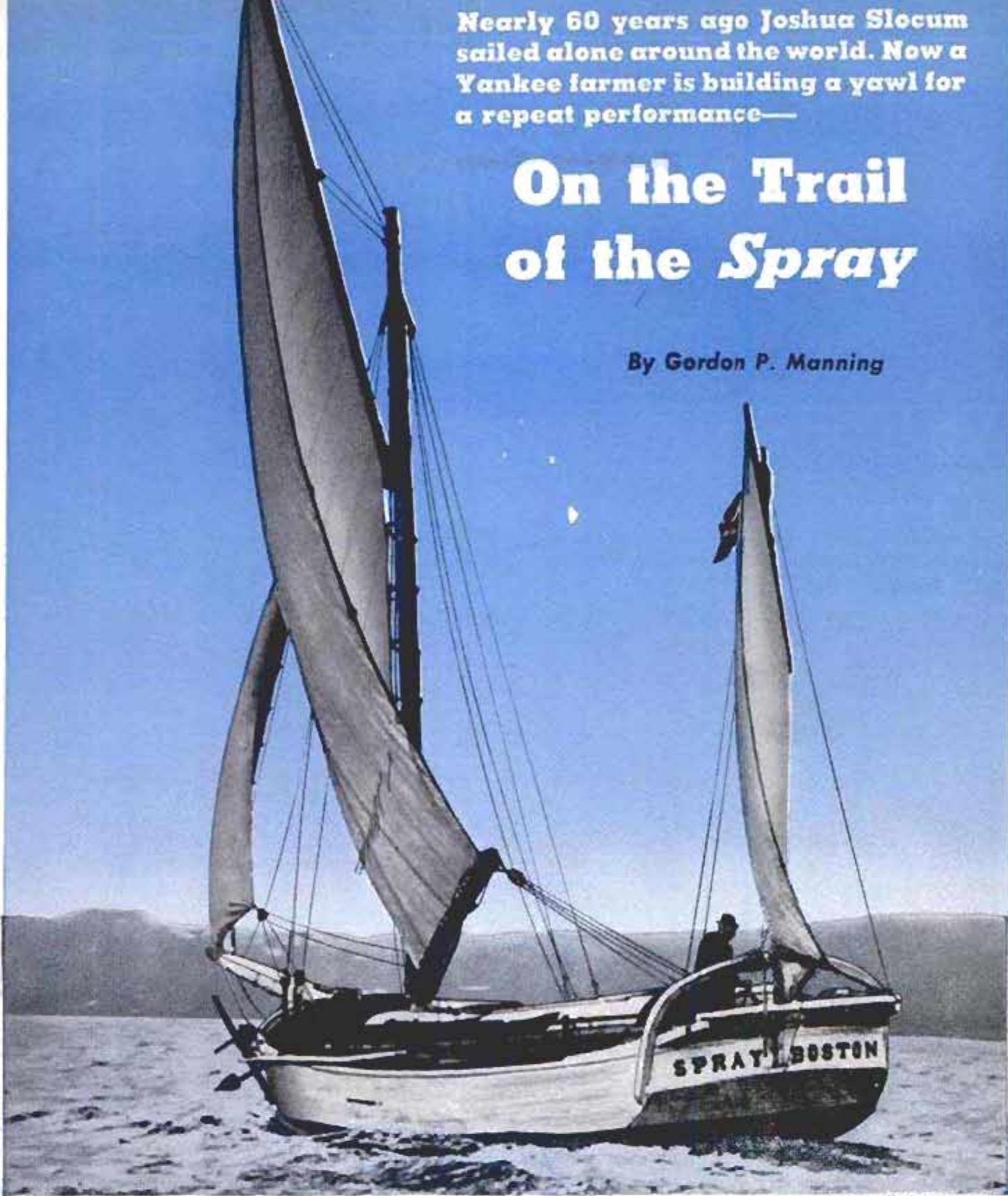

Courtesy Yachting Magazine

This is the boat Joshua Slocum sailed around world. Here it is rigged as a yawl, as will be Carr's replica

SPURRED ON by his dream, a 39-year-old farmer from the hill country of Vermont, 20 miles from the nearest water, is today completing a most remarkable deep-water sailboat. It is remarkable because it has been built entirely by hand, by one man, over a period of four years, without the benefit of power tools or equipment. Robert Carr of Monkton, Vt., is right now putting the finishing touches on his 36-foot yawl, a perfect replica of the *Spray* in

which the famous Capt. Joshua Slocum cruised alone around the world, just before the turn of the century. The trip lasted more than three years, and young Bob Carr dreams of the day when he, too, will head his small craft into the faraway harbors of the world.

Carr has elected to build his ship in the manner of his forefathers—with a few simple tools, like the saw, adz, chisel and bit. Visitors looking for his workshop have



Photos by Ernest Swanbeck

Hull stands ready for outside planking. Bulwark frames are just being installed above deck line. Below, Carr uses an adz to dress down oak elbow



difficulty finding it, due to its diminutive size. When they do, they are amazed to discover only a few basic hand tools—not a power tool among them. For that matter, there is no electricity on Bob's farm, either.

Now, after four years of almost continuous labor on the craft, all that remains is to finish calking the hull, paint the ship and haul her overland to Lake Champlain for the launching. Masts, rigging, sails, cabin and hull are complete awaiting the great day. Once out in Lake Champlain, Carr will rig and outfit her near Burlington, test her, and then head south through the Champlain Barge Canal into the Hudson River. From there he will go down to the open sea.

It's an Extraordinary Craft

But let's take a look at this extraordinary sailboat which is now being built in a crude shed on Bob Carr's back-country farm in Vermont. The *Sirius* (as he has named her after the brightest of the stars) measures 36 feet long, has a beam of 14 feet and a draft of 7 feet, following exactly the dimensions of the original *Spray*. She has a large cabin aft, which will be Bob's living quarters, containing bunk, galley and head, with plenty of space to store huge quantities of food and provisions. Up on the forward deck is a cargo hatch opening on a large hold which can be used for commercial cargo if he ever wants to carry it. A door in the bulkhead connects the two areas. On deck, a neat, homemade dinghy rides upside down between cabin house and hatch, protected from wind and wave. For drinking water, he will use the old-fashioned oak water cask lashed on deck.

The high bulwarks of the *Sirius* will make it easier to walk around during bad weather and cut down Carr's chances of being washed overboard. He steers the



Each bolt and nail on exterior planking of hull was painted, countersunk and plugged with a wooden plug



White-oak rudder has bronze bearing at foot of its six-inch post. Horizontal pins tie blade to post

craft from the wheel just aft of the cabin, and through two ports in the cabin end he can see his inside compass in all kinds of weather. She is rigged as a yawl, and Bob is fitting everything out to be easily handled by him alone. His anchors are mounted in convenient spots on deck up forward, where at a moment's notice he can cut the lashings and they will drop overboard. There will be no motor in *Sirius*, because Bob Carr is one sailor who hates gasoline. When you ask him how he expects to get along without a motor, he answers, "If Captain Slocum didn't need a motor, why should I?"

Bob took his plans from a little drawing which he found in Slocum's book, *Sailing Alone Around the World*. The minute drawing showed the profile, plan view and several sections. He enlarged these to full-sized working drawings, which he then made fair and smooth in his own mold loft. By this last step he assured himself of a proper hull when his work was finished. Experts who have seen the boat and studied the lines say it will be exactly like its famous predecessor, right down to the size of each spar in her rigging, the thickness of every plank and the shape of the hull.

(Continued to page 242)

Carr completes calking of deck seams on the forward deck. Behind him is windlass. Cabin top is in foreground





Dangling on the face of the precipice, the workman uses a long steel bar to break away loosened rocks

Spring Cleaning *on an* Alpine Highway

DANGER! FALLING ROCKS. The Swiss, a painstaking people, spring-clean their mountain highways each year to minimize such dangers.

With an eye to the tourist trade attracted to the William Tell country by its rugged mountain scenery, the Swiss spend much time and money to prevent rockfalls.

Before the spring thaw, highway workers dangle over precipices breaking off all loosened rocks that are potential dangers to motorists on the highway below.

The work is arranged so only small sections of the highway are blocked at one time since it must be done in daylight when traffic is heaviest.

Shown here are scenes along the famed Swiss Axenstrasse, the great Alpine scenic highway hewn out of rock through the rugged mountains into Italy. ★ ★ ★

Despite intense preventive action, landslides sometimes occur, carrying away sections of the Alpine highway

Birnback photos





So tourists won't be delayed too much, the Swiss use the most modern equipment to repair damage quickly



By knocking away these loose rocks and debris, the workmen minimize number of dangerous landslides

At times traffic is held up while overhanging rocks are broken loose and sent tumbling down onto the highway



Detroit Listening Post



By Leo Donovan

IT'S OPEN SEASON on predictions. Everybody's doing it—making statements about gas turbines, free-piston engines and even atomic power plants. There seems to be little mention of fuel injection these days—maybe because it's too near.

Chrysler does not deny the rumor that its entire lineup of 1957 cars (from Plymouth to Imperial) will have torsion-bar suspension in the front end. Such a change would make Chrysler the second major American producer to go to torsion bars, Packard having brought out a full torsion-bar suspension in 1955. The Chrysler bars run about half way back on each side. Nobody seems willing to guess why the changeover, but it may be that more space is needed in the engine compartment. Or it could be simply that it's better.

The luxurious Imperial will have its own body next year, rumor has it, to improve its attraction in the fine-car field. The 1957 300 (presumably the 300C) will also have its own styling treatment but won't be out until early in 1957.

By the way, it is now generally agreed that all the 1957 cars (except specials like the 300) will be out by the end of November. A national automobile show in New York City early in December makes it imperative for everybody to be ready by then.

Air Suspension for 1957?

The air-suspension rumor continues, despite denials from on high. Spies report that Cadillac will be first in the domestic passenger-car field with air suspension. The system will be a modification of the highly successful suspension used by GMC on buses. Cadillac may have a new and different rear axle, these same spies say.

Lincoln is reported to be preparing an ultraswank model as it continues to try to break into the Cadillac business. The Continental Mark II will have refinements, but no basic body changes for 1957.

Most industry forecasters seem to feel that Pontiac and Chevrolet will be given only major appearance changes and that

the big year for these two is 1958. It is known that the big cars, Cadillac, Buick and Oldsmobile, will be all-new for 1957.

There is still talk about moving the transmission to the rear end, mainly as a styling aid to eliminate the big hump in the front floorboard (and also, of course, to improve weight distribution).

Apparently such a move would introduce other problems more serious than the hump. Now the story is that half the transmission will go to the rear and half will remain up with the engine. The torque converter, being a narrow doughnut, can be snuggled against the engine while the more bulky gearbox and control mechanisms are moved to the rear axle. A few lengths of tubing are all that is needed to pipe oil back to operate the controls.

The 1957 Chrysler lineup of cars is expected to be even lower than anticipated. Speculation is that they will all be as low as the Jaguar hardtop coupe. Seems hard to believe. One observer who saw a 1957 Chrysler drive by (well shrouded with slip covers) claims the car is low all right, but not that low. So take your choice. The slip covers couldn't hide the rakish tailfin shape. If you like fins, you'll love Chrysler. This lowered body means step-down design. Remember when Hudson had it?

Free-Piston Engine

General Motors announced a free-piston experimental automobile recently. It has no thirst problems, being able to burn just about anything from whale oil to peanut oil. If you would like a detailed explanation of the principle, dig out your *Popular Mechanics Magazine* for September 1950 and read the "Revolution of the Free-Piston Engine." It tells the whole story.

General Motors modified the usual design by a Siamese arrangement with four cylinders instead of the conventional two. This was done to make the engine compact enough to fit under the hood of an automobile. Little is known about the car's performance because there was no time for road or track tests before announcement.

There is a big hassle over the relative merits of gas-turbine and free-piston engines. You'll find supporters of each.

Another reliable rumor is that there will definitely be fuel injection in the 1957 models—but not in the regular models. One company is planning to offer it on its high-performance car that will be introduced in February or March 1957.

It is also pretty well established that windshields will wrap upward as well as sideways on the new bodies. With more glass area and less headroom, motorists are going to be forced into wearing caps. Better get into the cap business!

The Panama Canal lies open and exposed to attack by modern bombers. Ships wait in line for their turns to thread its outgrown passage from sea to sea. A Chilean engineer proposes a solution to the growing problem:

WHY NOT BUILD A TUNNEL FOR SHIPS *From Atlantic to Pacific?*

By Jorge Cortinez Delfino

Engineer, State Collective Transportation Company, Chile

AT THE TIME the Panama Canal was built it was a tremendous engineering project. Planners expected the Canal to serve the needs of shipping for all time. The locks were built 1000 feet long and 110 feet wide in the belief that they would handle any ship ever built.

Today there are several merchant vessels afloat that are too large to pass through the locks. In addition, there are several ships in the United States Navy that cannot pass through the Canal, and others are under construction or planned that will be much too large to navigate the waterway. This severely restricts the military use of the Canal, the purpose for which it was built. Also,

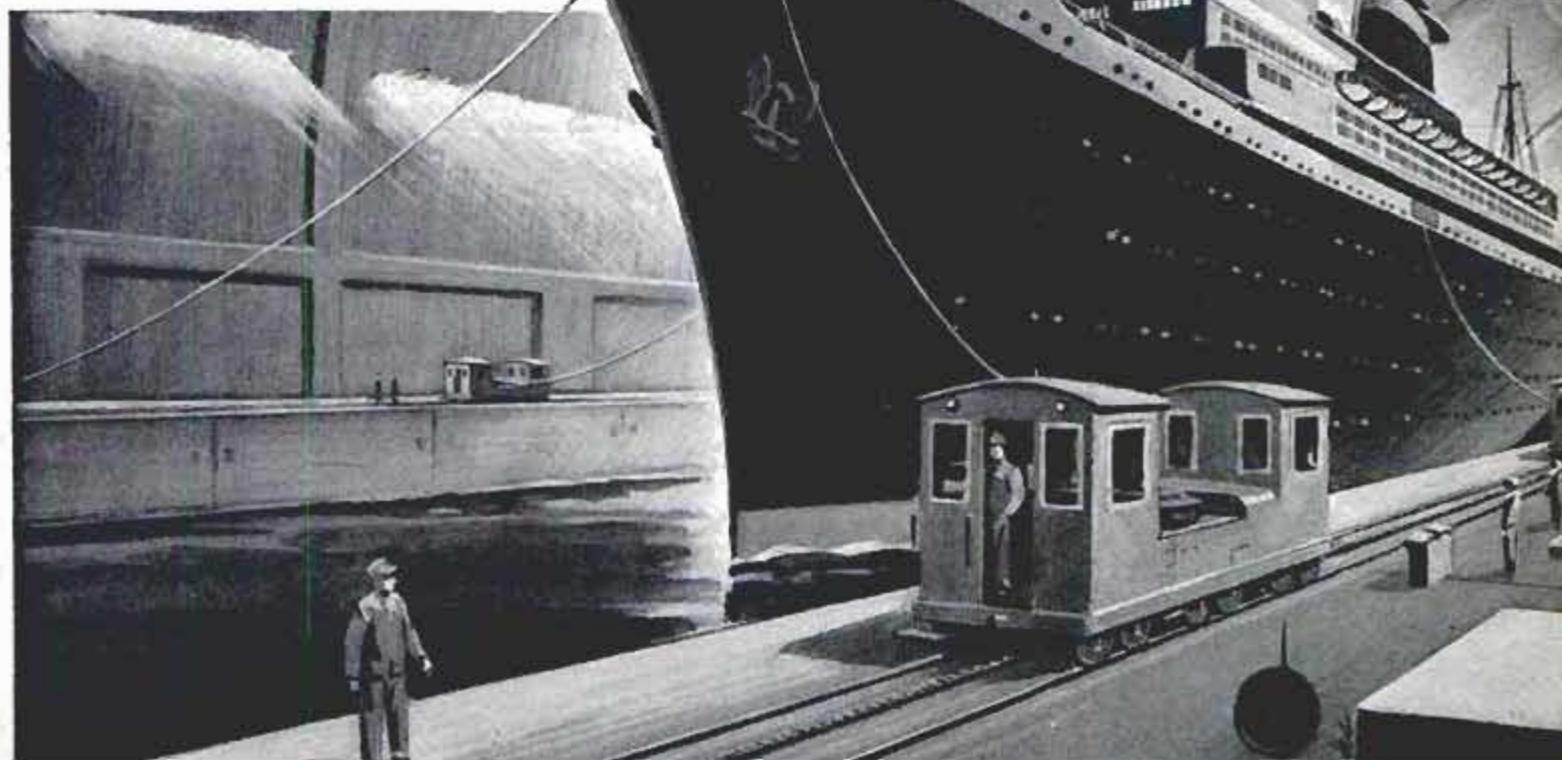

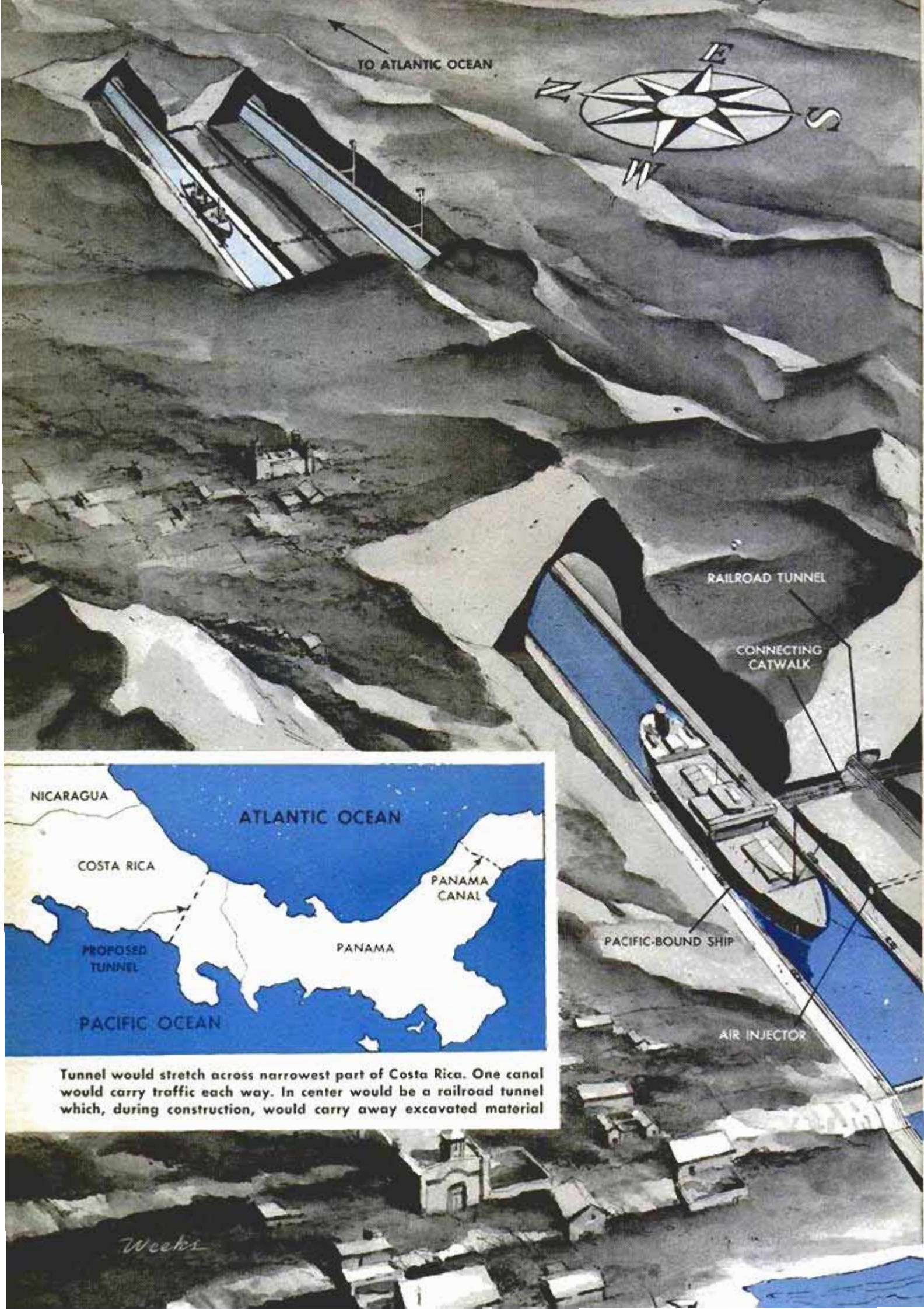

TO ATLANTIC OCEAN



RAILROAD TUNNEL

CONNECTING CATWALK

PACIFIC-BOUND SHIP

AIR INJECTOR

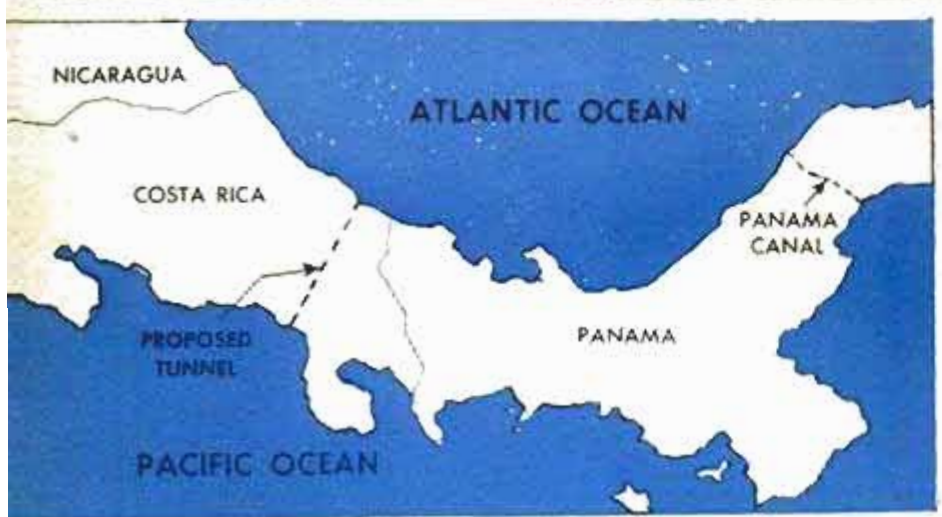

Tunnel would stretch across narrowest part of Costa Rica. One canal would carry traffic each way. In center would be a railroad tunnel which, during construction, would carry away excavated material

Weeks

the Canal is difficult to protect from air attack.

One other factor to be considered is the tremendous flow of traffic through the Canal. Ships now may wait for days for their turns in the locks.

What can be done to solve these problems? Several proposals have been under study for years. Under one plan, additional and larger locks would be built at some distance from the present ones. However, this project would result in certain navigational hazards because of unavoidable sharp turns in the new channel. Also, the Canal would be as open to enemy attack as it is as present.

Another proposal is to convert the Canal into a sea-level one. In this case, all locks would be eliminated except for a small tidal lock which would control the differences between the tides in the Atlantic and Pacific. This would reduce the upkeep and permit more ships to negotiate the Canal. However, it would require the construction of many miles of dams to divert from

the Canal the torrents of water during the rainy season. And again the Canal would be relatively open to enemy attack.

New Sea-Level Canal

A brand new sea-level canal somewhere on the isthmus of Central America would solve many of the problems. Several studies have been made of possible locations. Sites have been suggested across Nicaragua, Mexico and another area of Panama. Such sea-level canals, regardless of their location, still do not solve the problem of enemy attack.

My Chilean compatriot, Roberto Gomez Alvarez, and I have proposed a plan which we feel will solve all the problems of ship transit between the two oceans. This plan has been studied and approved by engineers and topographers of recognized standing in the Western Hemisphere. United States Army and Navy engineers have also studied the proposal, and it has been called to the attention of the United States Congress.

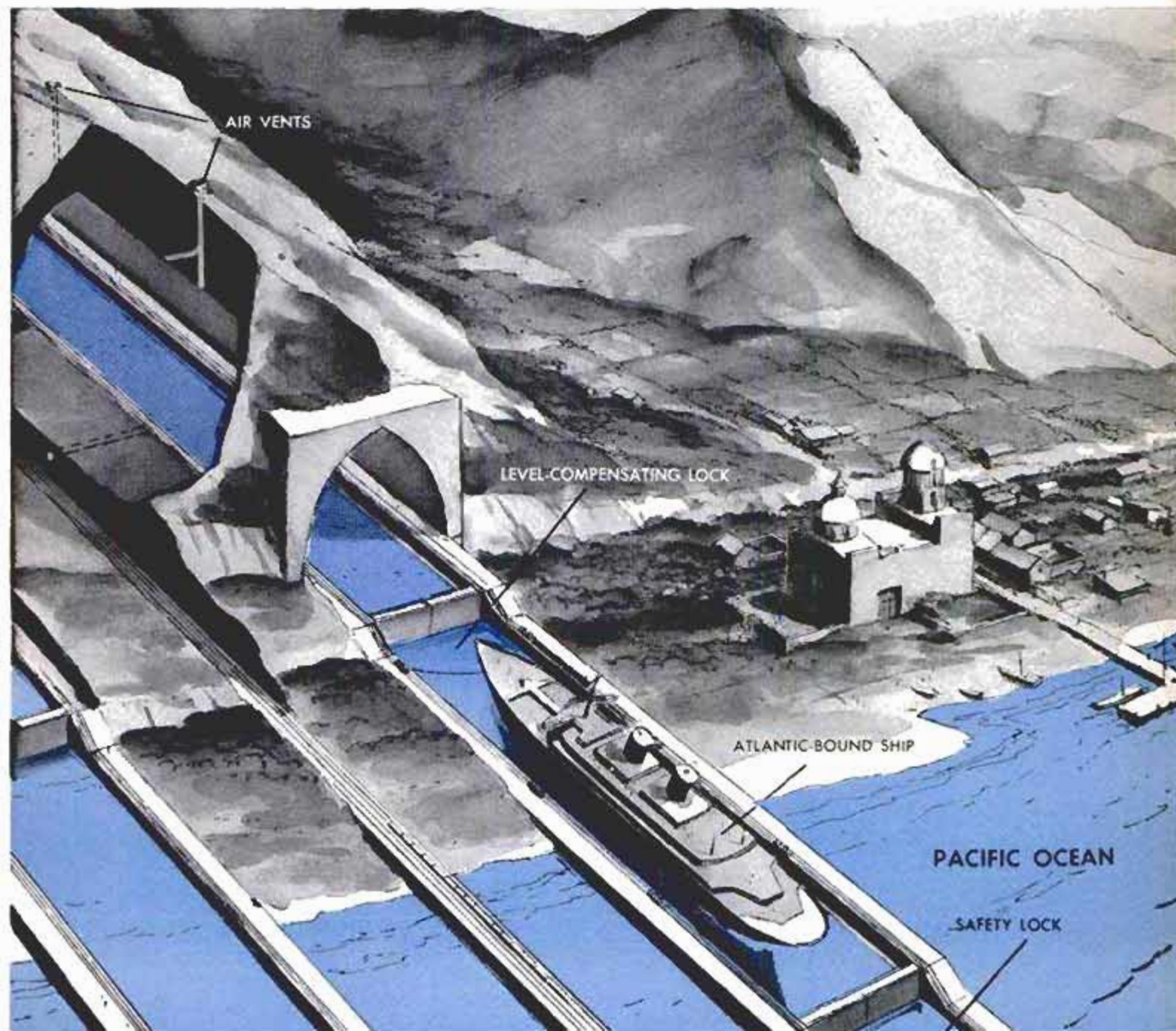



Today a ship must wait its turn to pass through Panama Canal. Some naval ships are too big for the locks

In essence, the proposal is to *tunnel* a sea-level canal through the mountains of Costa Rica. More accurately, two tunnels would be built, one to move ships from the Atlantic to the Pacific, the other for transit in the opposite direction.

Toward that end, we are seeking to obtain from the government of Costa Rica the concession of a strip of territory five miles wide from coast to coast (about 50 miles long). Elements of the press of Costa Rica have given their support to the project, which would be a source of permanent income to that country.

Two tunnels would be built about 600 feet apart. Between them, and as a supplement to both, would be a railroad tunnel.

Trolleys Pull Ships

Each tunnel would be egg-shaped with its narrow end at the top. A platform on each side would accommodate the electric trolleys which would pull the ships through the tunnel. It would be impossible for ships to proceed under their own power because of the problem of ventilating the poisonous fumes from their huge engines.

The railroad tunnel would serve from the beginning of construction as a pilot tunnel, and would play an important part in the removal of the tremendous quantities of earth and rock which would have to be excavated.

The terrain selected for this gigantic engineering job is of volcanic origin thousands of years old. Its solidity is unquestioned. To eliminate the chance of minor rock slides within the tunnels, the arches would be covered with two-inch steel rods and a layer of concrete 40 inches thick.

It is quite possible that much of the cost of excavation would be paid by the excavated material itself. The site is close to known deposits of petroleum and uranium.

Ventilating the tunnels poses problems, but not insoluble ones. Vertical chimneys

would be drilled about every 1500 feet. Horizontal air-injector pipes would be built into the tunnels. Air brought in through these pipes would be exhausted through the chimneys.

Two Generating Plants

It would be advisable to build two generating plants, one at each end of the tunnels, to provide electricity for lighting the tunnels, powering the trolleys and serving the settlements for personnel who would work in the tunnels.

The excavated material would be used to build two artificial ports, one at each end of the waterway. These not only would protect the boats, but also the entrances to the canals.

Compensating locks probably should be built at each end of the tunnels. These would maintain a constant water level within the tunnels and protect them against strong currents from the ocean.

What are the advantages of this proposal? It is obvious the tunnels would be free from storms, collisions, navigational hazards and fog. Fog, incidentally holds up all traffic through the Panama Canal many times during each rainy season.

One of the primary advantages would be the relative ease with which the canal could be protected from enemy attack. It is true that the compensating locks could be destroyed or damaged. However, the protection of these two small areas is a far different problem from protecting a canal for its entire length. And it seems quite possible that the tunnels would still be navigable even if the locks were destroyed, though navigation might be considerably more difficult.

Someday, perhaps, we will see ships moving along beneath 5000 feet of solid volcanic rock. Statesmen, engineers and laborers will have answered the question: Why not build a tunnel for ships? ★ ★ ★



Above, Russian TU-104 at London airport. Below, the new Boeing 707, is larger, faster and with longer range



Russian Jetliner Makes First Appearance in West

LATEST JET AIRLINER to make its public debut is the Russian Tupolev 104, a 50 to 70-passenger liner which recently brought an official party to London. Tagged at first as a startling advance in jet aviation, the TU-104 has been re-evaluated by aviation observers in the light of new information about its performance. The plane resembles the Badger, medium bomber of the Russian Air Force, and apparently some standard fuselage sections, such as the nose, are used in both planes. On the flight to London, the plane averaged 446 miles per hour, and may have a top cruising speed of 500. Cruising altitude has been announced by the Russians as 33,000 feet. Because the cabin is not as highly pressurized as are British and American jetliners, passengers will be required to wear oxygen masks, which hang beside each seat, when the plane goes over 37,000 feet. Range of the TU-104 seems to be around 2000 miles. Most surprising features of the plane were the jet engines, enclosed in nacelles 40 feet

long. From Russian statements, and also from computations based on the size of the intake openings, air observers believe them to deliver around 15,000 pounds of thrust, equal to the latest British and American power plants. Thick wings and unclean fuselage lines keep the speed down in spite of the high thrust according to the experts. Observing the low speed, the payload capacity and range, airmen rate the TU-104 right along with the Mark II Comet—a medium-range, medium-speed plane as far as commercial airliners in international competition are concerned. The Boeing 707 and the Douglas DC-8, new American jets, will have cruising speeds of 575 miles per hour, ranges of 5000 miles, and passenger-carrying capacities up to 146. The British Comet Mark IV will cruise at 500 miles per hour carrying 58 passengers over a range of 2870 miles. It seems likely that the Russian plane will first see international service on routes between Moscow and the Scandinavian capitals.

Most Valuable Player ...the Catcher

By Lew Fonseca

Major-league player for 12 years; former Batting Champion of the American League; former manager, Chicago White Sox; now Director of Promotion, American and National Leagues of Professional Baseball Clubs.

Photos posed by Yogi Berra

New York Yankee catcher; three-time winner of the American League's Most Valuable Player Award.

LAST YEAR Yogi Berra was named the most valuable player in the American League for the third time. In my opinion, this recognition of a great backstop is one of the finest things that has happened in baseball since Abner Doubleday blasted a hit across a cow pasture back in 1839 to invent the game.

For 12 years I was a major-league player, and a club manager for three. Since hanging up my spikes 20 years ago I have served as Director of Promotion for both the American and National Leagues of Professional Baseball Clubs. During this lifetime in baseball I have become convinced that the catcher is the unsung hero of the game. Too many spectators consider the catcher just another member of the team.

It's too bad this feeling seems to accompany the battered old ball gloves which are



Immovable object! Berra, one of the most rugged men in baseball, blocks plate with entire body, tags runner with both hands



passed down from father to son. Not enough catcher's mitts make that switch from big hands to little ones. Half a million boys between 8 and 12, to the everlasting credit of Little League baseball, now are playing ball. Toss a ball and bat onto the playground on that first warm day of spring and you'll be swept off your feet as these youngsters dash madly for every position on the field. Every position, that is, except the receiving station. Nobody wants to catch.

Yet this is the most fascinating position on the field. The catcher is one of the two men who are in on every play. He must be built for rugged action. He not only plays his own position but, in effect, every other position on the field, for he's the manager's right-hand man, the strategist, the field general. Matter of fact, he runs the show.

"Feel" for the Game

In addition to his playing ability, the catcher more than any other player must have an extra sense, a "feel" for the game. He must know the weakness, the strength,

Photo series shows Berra's quick recovery. After tagging the runner, he's immediately ready for a throw to a base. Below, catcher wears about eight pounds of gear, may lose that much weight in game





Best signals are simple finger signs that won't confuse the pitcher. Deceptive signals may be necessary if there's a runner on second. Right, open palm can signal a pitchout for a pickoff



Basic posture during signals and before pitch is the full crouch. Catcher squats on the balls of his feet with about an arm's reach between himself and elbow of batter

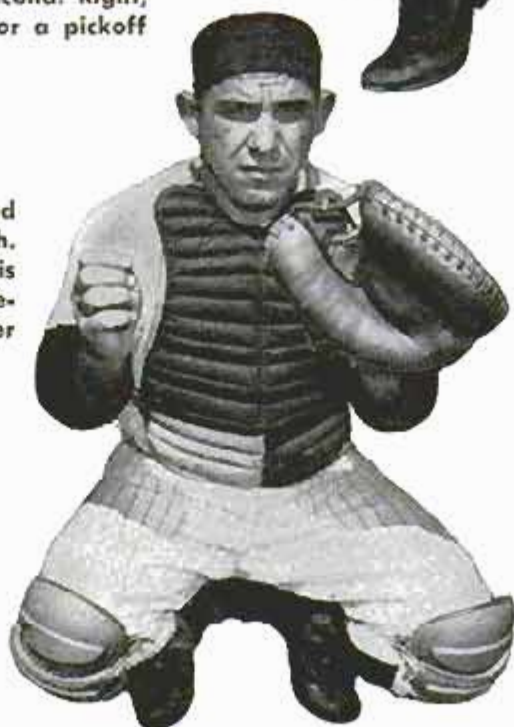

Half crouch at left is used to receive the ball. Left foot is slightly in front of right, knuckles of right hand are toward the pitch. Right, Yogi uses entire body to block pitch in dirt or wide one



the blind spot, the thinking process of every batter. He must sense when a pitcher is tiring. He must anticipate the strategy of the opposing manager, sense when the hit-and-run, the bunt or the steal is on, and decide in a split second on his counter-strategy. He must hold the team together in the clutch.

And, last of all, he must be a good hitter to earn his place on the team.

Add up all these requirements and you get something of a superman on the diamond. There haven't been many such backstops in the business. The all-time greats would have to include Mickey Cochrane, Gabby Hartnett, Bill Dickey and Ray Schalk among others. From today's catchers you'd have to list Yogi, Roy Campanella and the promising Del Crandall. You go on from there.

These are the hard workers who never "Jake" on the job. They literally sweat out the battle in the armor of their trade. Take Yogi as an example. He wears some eight pounds of equipment through many a

blistering afternoon, and may lose just about that many pounds in catching a game. That, plus the fact that he must be the immovable object that guards the plate, is the reason the catcher must be a rugged man.

We recently analyzed the movements of some of the finest backstops in the business to produce a baseball film for the major leagues. This probably was the first comprehensive study of how top-notch platemen approach their craft. Any beginner can get a whale of a lot out of their recommendations, and any fan who watches the catcher at work can have twice as much fun at the ball park. Take a look at how the catchers say to catch.

Full crouch. The full crouch is your basic posture as a catcher. Squat on the balls of your feet with the legs spread comfortably, just as close to the batter as possible. (In the old days of baseball, the catcher stood far back of the plate and caught every pitch on the first bounce!) A good way to judge your position is to put a full arm's reach between you and the elbow of the batter. From this full crouch you give the . . .

Signals. These are the sign language of



In playing a foul, catcher knows that the spin of the ball will make it curve back toward the infield. He always plays foul over his head, never walks or runs backward to catch it

Foul! Yogi snatches off his mask, but holds it until he locates the ball, then tosses it in opposite direction so he won't fall over it

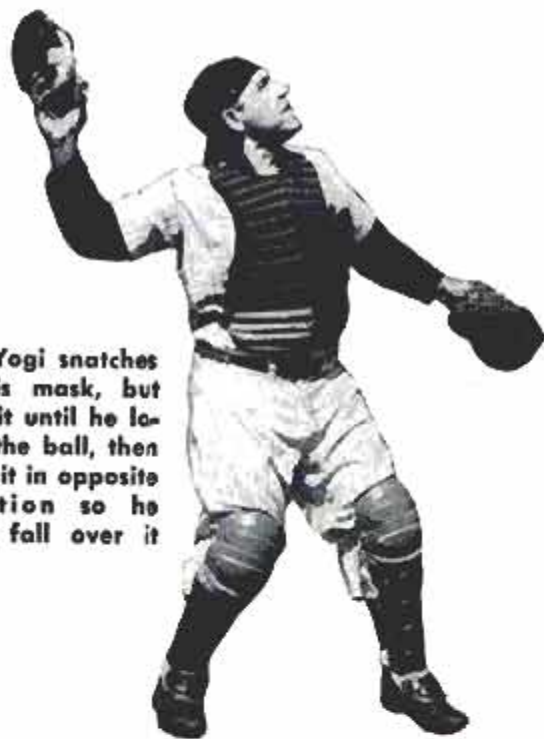



Bunt! Instead of holding mask, Berra flips it back over his head as he strides forward. Below, popup is fielded overhead. Never watch high fly constantly

There's nothing flashy about Berra when he fields bunts but he's considered one of the best in the business. He uses both hands, comes up ready for throw



baseball. Use the legs and mitt to hide the signal. The best signals are the simplest. Use plain finger signs. Complex signals only tend to confuse the pitcher. However, a runner on second base can swipe your signals because he can see them almost as well as the pitcher. With a runner on second, many catchers give three different signals for the pitch, then a fourth signal to indicate which of the first three was the proper one. You can also set up a plan in advance: During the first three innings use the first signal, during the next three innings the second signal, etc. Main thing is to keep your signals and pattern as simple as possible. An extended thumb or palm can signal a pickoff if you plan to try a pickoff or if you feel the runner may be going.

Half crouch. After the signal, extend the mitt as a target for the pitch and rise to the half crouch. We've found that good catchers, regardless of build, have surprisingly similar half crouches. The spread of the feet averages two feet four inches, and the left foot is slightly in front of the right. This position will save you a split second in going after a foul or striding into throwing position.

Catching the ball. Want to break a finger? It's easy. Hold the bare hand rigid, fingers pointing toward the pitcher!

Drawings show how batters tend to foul pitches. A good catcher senses which direction the ball is going as soon as he hears ball bloop off bat



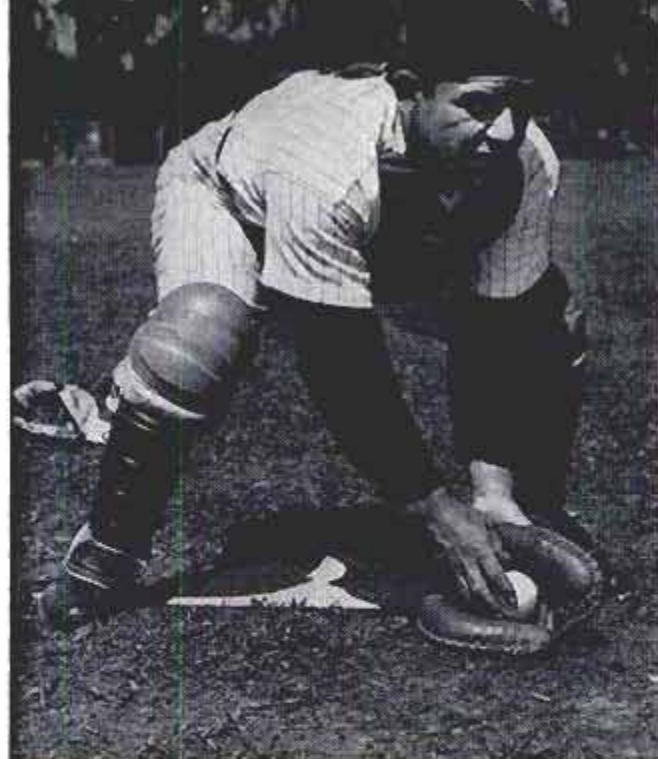

In guarding home plate, Yogi makes sure he has the ball firmly in his glove, holds it with both hands

To avoid injury, hold your bare hand relaxed with the thumb curled inside the fingers and *the back of the knuckles toward the pitcher*. Any foul which strikes the bare hand then will bend the knuckles in their natural flexing direction.

On a pitch wide to the right, step out quickly with the right foot. Use the left foot in the opposite direction. *Never cross your legs*. For a ball in the dirt, go down on one or both knees. The main thing to remember is to get just as much of your body as possible in front of every pitch. Don't just reach out and snag the wild ones—get your whole body in front of them.

Catching foul flies and popups. This is an art that comes from study and long practice. In his amazing career, Gabby Hartnett muffed only one foul fly! You can use science to help you judge flies. It's a physical fact that a foul fly *always tends to curve back toward the infield* because of the spin imparted to the ball by the bat. This means you are actually catching a curve ball and must judge its trajectory.

(Continued to page 248)

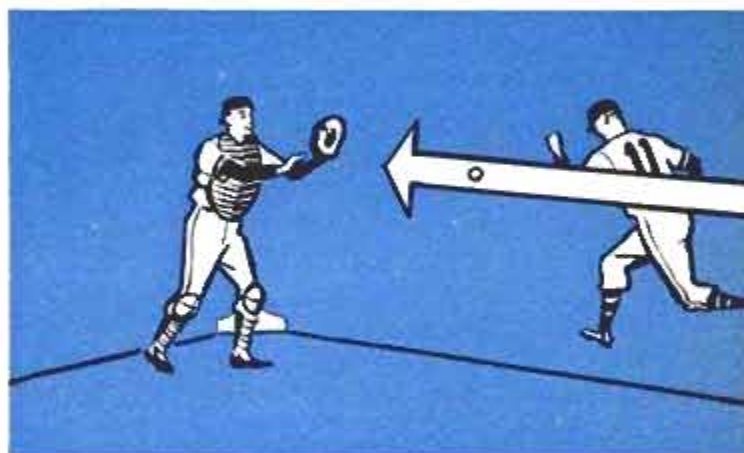

Catcher can't block plate until he has ball. Drawings show receiving position for throw from either side

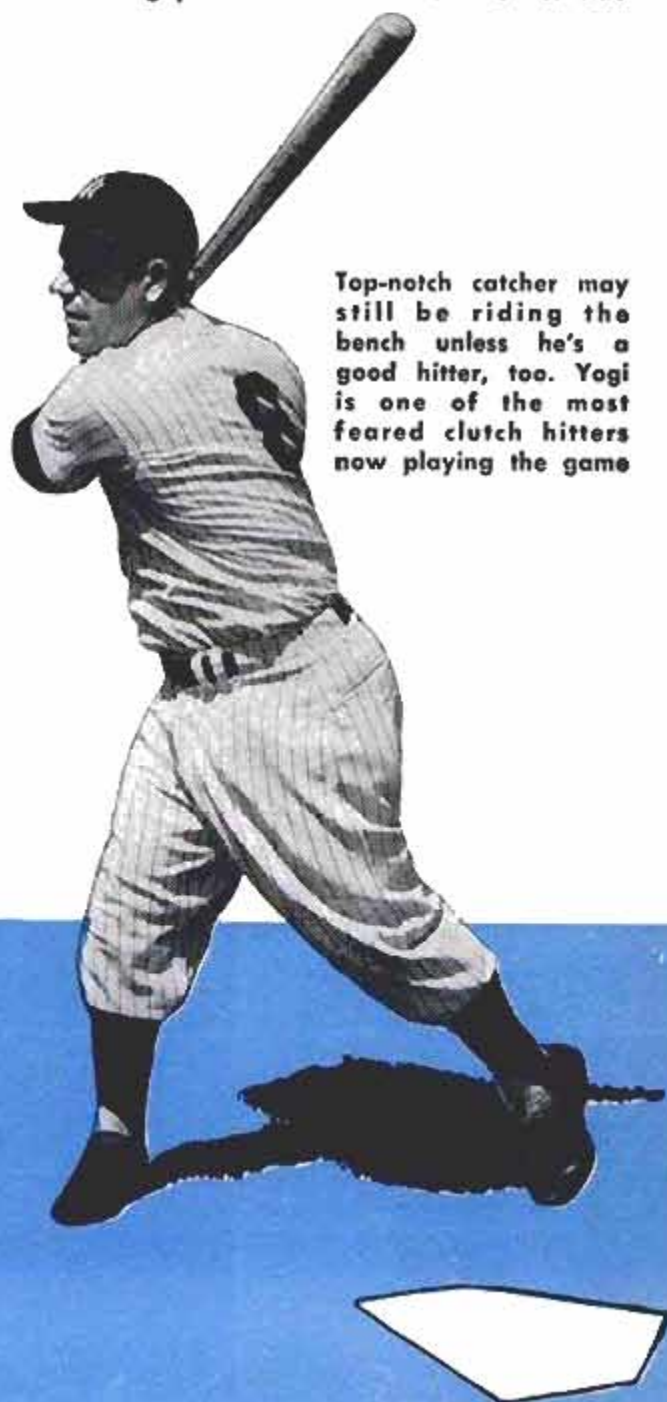

Top-notch catcher may still be riding the bench unless he's a good hitter, too. Yogi is one of the most feared clutch hitters now playing the game



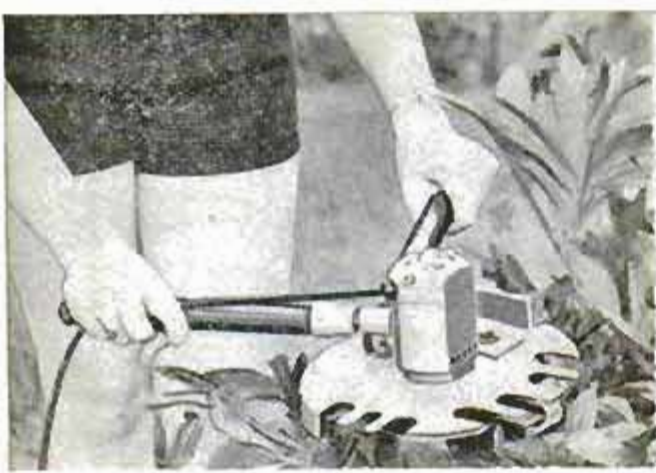

With two short handles in place, the cutting blade is held horizontal and used to trim hedges and bushes



Equipped with long handle, blade is used in vertical position to edge lawn. Depth of cut is adjustable

Electric Tool Edges Lawns and Trims Hedges

With a new electric lawn tool you can trim and edge the grass as well as trim hedges and bushes. The tool is powered by a $\frac{1}{8}$ -horsepower motor developing 17,000 revolutions per minute. The cutting blade

is adjustable for depth. The tool can be used horizontally as a lawn and hedge trimmer and vertically as an edger. It has a 4-foot handle for lawn work and two 16-inch handles for trimming hedges.

One-Man Paper Baler Chops, Blows and Bales Four Tons Per Hour

One man can operate a unit that bales up to four tons per hour of scrap paper, corrugated boxes, wax and tissue papers and cellophane. The material feeds into a chopper, is blown into a hopper and drops into the ramming unit. Photoelectric-eye switches control the ram cycle so that uniform amounts are baled. The operator wire-ties the bales, up to 1000 pounds, while other bales are being formed.

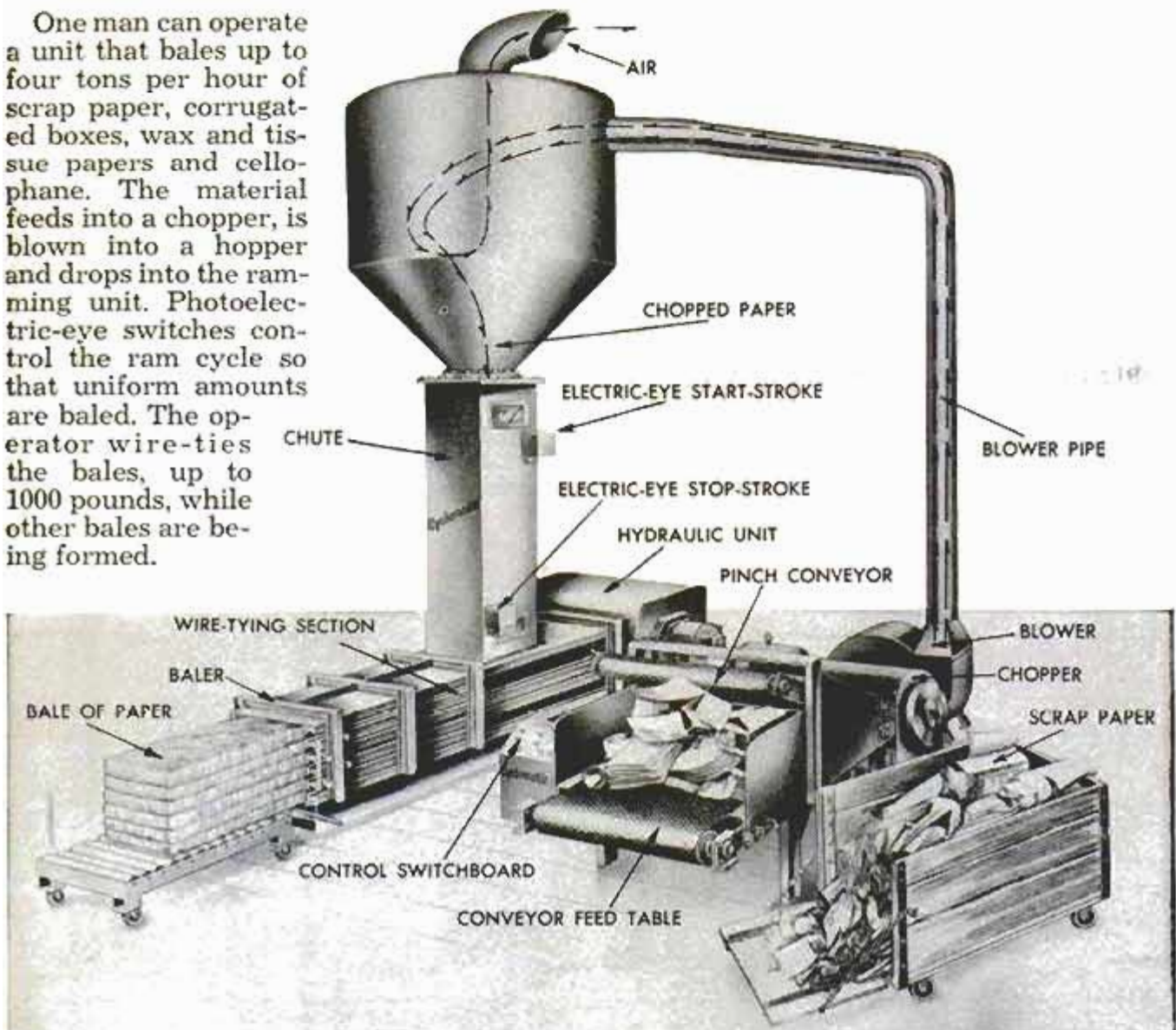



Tropical Fish Are Fun

By Richard F. Dempewolff

SILVERY, BLACK-STRIPED angelfish with swooping tendrils are staring at people through oval picture frames on living-room walls nowadays. Behind them, inside the wall, swaying water plants may hide a collection of other glamorous, rainbow-hued "tropicals"—lavender and blue-

speckled pearl gouramis; darting, black-striped barb; gold and black swordtails; odd-shaped hatchet fish from the Amazon; dazzling blue and red neon tetras from Brazil. If they don't like the view from the living-room side of their "bowl," they can try the other side and watch the antics





These are tropical fish for the home aquarium. Some are common; a few are rare and expensive. 1. Dwarf gourami; 2. Silver hatchet fish; 3. Gold wag platy; 4. Orange dorsal black sailfin molly; 5. Barbus Sumatranus; 6. Neon tetra; 7. Red swordtail hybrid; 8. Guppies; 9. Head-and-tail-light tetra; 10. Aqua-strain guppy; 11. Headstander; 12. Pompadour fish; 13. Kissing gouramis; 14. Black tetra; 15. Rasbora heteromorpha; 16. Plecostomus; 17. Corydoras aeneus; 18. Blood-red platy; 19. Angelfish; 20. Zebra fish; 21. Spotted scot; 22. Blue betta; 23. Red betta; 24. Piranha. Latter three must be kept isolated

of people in the dining room. Here a second picture frame outlines the opposite side of this underwater wonderland. This new aquarium fits between the studs in an ordinary house partition.

Today's tanks — and the multicolored finny denizens in them — are a far cry from the narrow-necked bowls in which Grandma kept dime-store goldfish. Pet fish never had it so good.

Stroll through the humid, tank-lined corridors of such places as the Aquarium Stock Company operated by Len Berkitz and Lew Dalwin in New York and Los Angeles, or the grottoes of John and Elinor Groetzinger's Westchester Aquarium in White Plains, N. Y., and you think you're in a miniature world of Jules Verne. Fish glare at you from eerily illu-

minated windows in a score of unlikely places. A pair of white kissing fish, mouths stuck together like suction cups, hide behind swaying green fronds inside the top shelf of a modern step table. A school of striped barbs scurries through the skeleton of a wrecked galleon inside a mahogany radio cabinet. Whole families of mollies and guppies live in a big what-not on the wall. Wrought-iron room dividers made up of tiers of tanks house special breeds of fierce, incompatible tropicals. Lights for one fancy aquarium are hidden under the sloping roof of a miniature Chinese pagoda on a wrought-iron stand. There are gleaming triangular tanks for room corners, octagonal tanks for anyplace, big tanks for the wealthy, little ones for beginners.

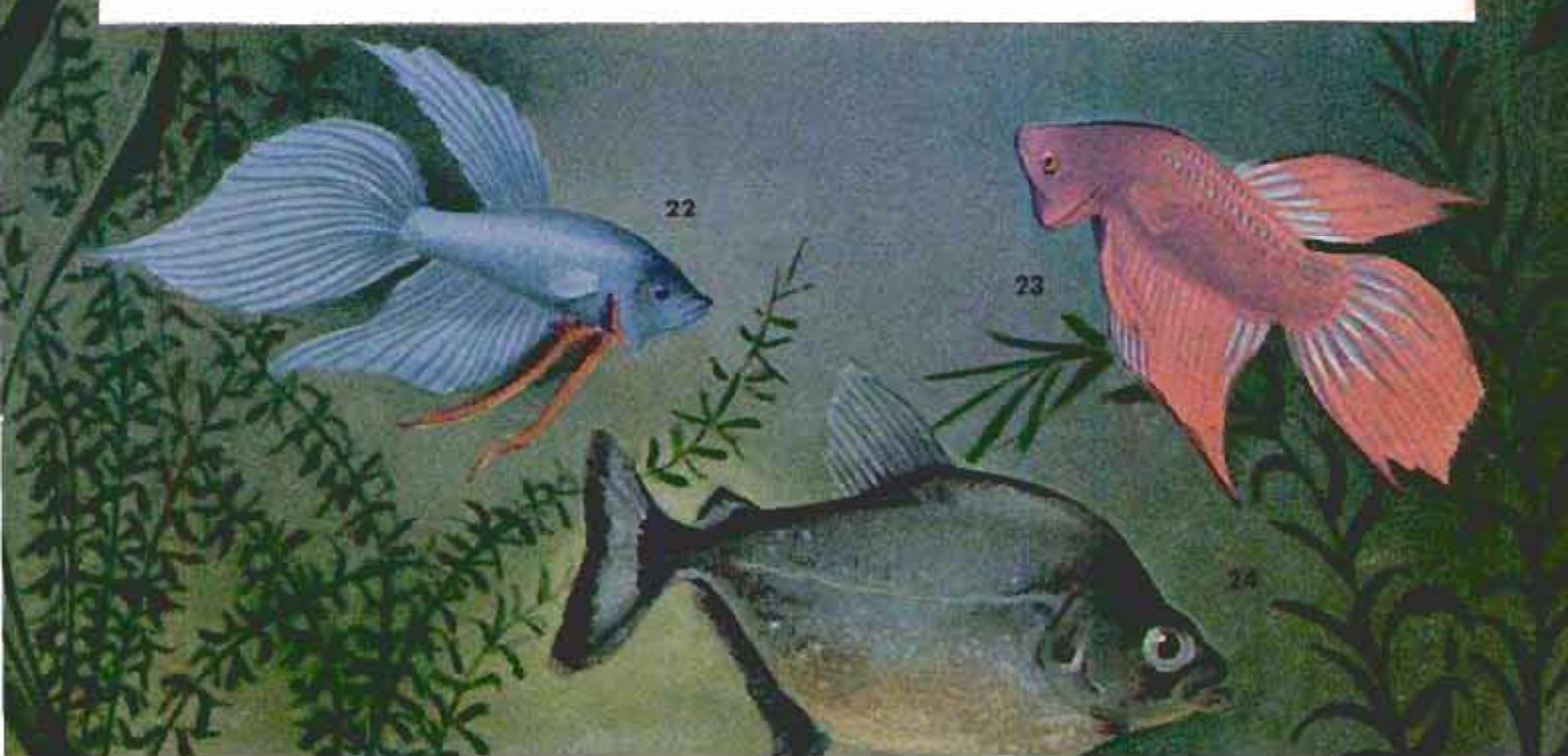

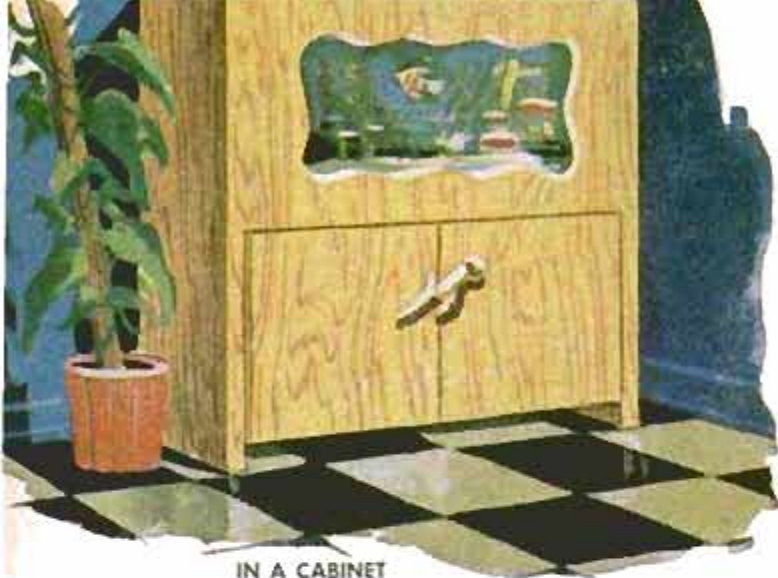

IN A CABINET

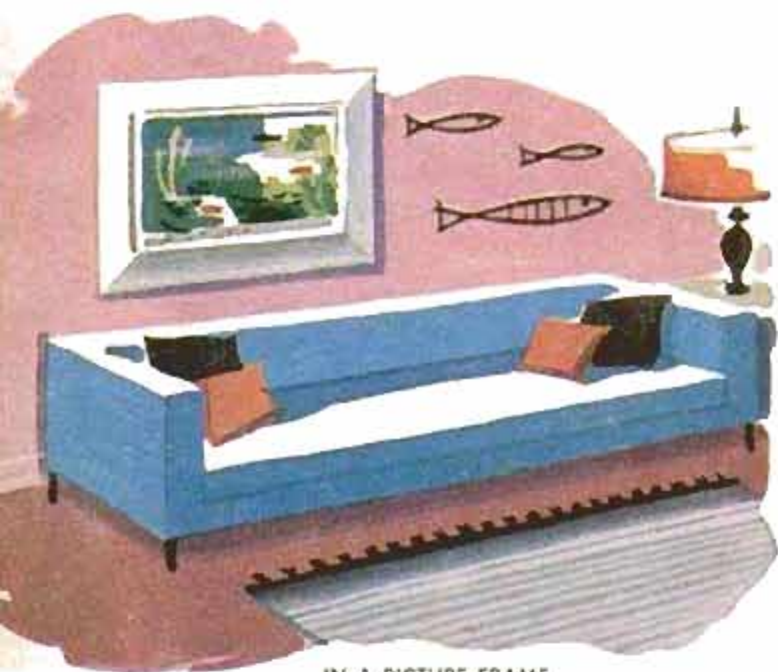

IN A PICTURE FRAME

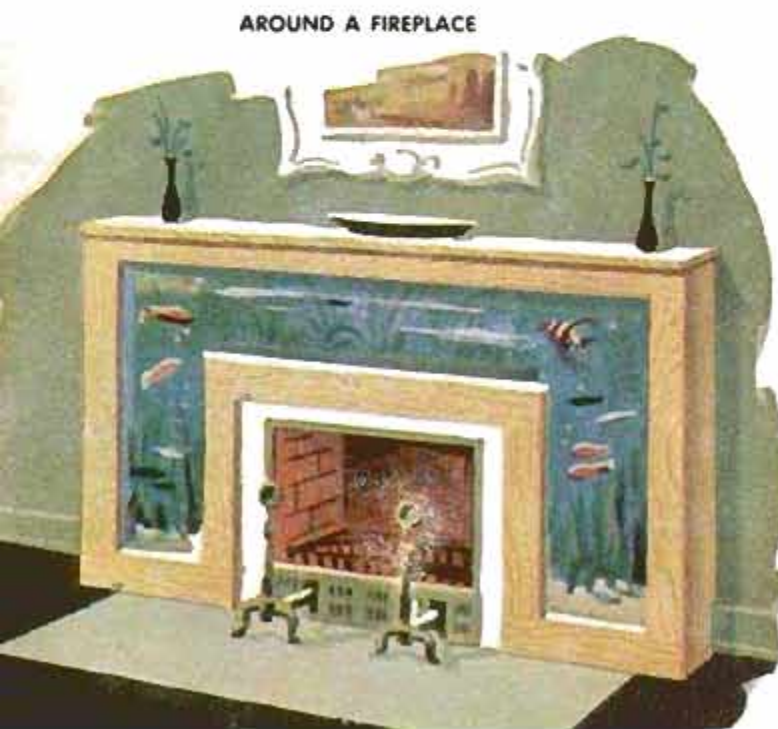

AROUND A FIREPLACE

No longer are bubbling aerators and filters just ugly tubes stuck inside the tank. Bubbles rise realistically from the helmets of brightly colored ceramic deep-sea divers or the stacks of "sunken vessels." Dalwin's attendants clean aquarium bottoms with plastic vacuum-cleaner-like dip sticks that are hooked to the filter system for power. Groetzingers' men pump a similar gadget by hand. They suck dirt from the bottom without picking up any gravel. Some air-pump and filter motors come housed in carved teakwood boxes. Pampered finny pets can live in "water conditioned" comfort, where thermostatically controlled heaters keep the temperature hovering at an even 75 degrees day and night. You can even buy modern medication like aureomycin and terramycin specially prepared to cure fish of odd diseases.

Sounds expensive, and it can be if you want to get ultrafancy. C. W. Coates, aquarist for the New York Zoological Society, points out that tank equipment should be picked with great care. It is possible in theory, he says, to keep a healthy, balanced aquarium of tropicals in a bucket or hole in the ground. However, says Doctor Coates, a sensible outfit for any beginner has a minimum of gadgetry. His list includes a good tank, a quarter-inch glass siphon or two for sucking out decaying foods and debris from the tank bottom, a long, quarter-inch dowel for planting in a deep tank, another with a flat, notched end for arranging rocks and plants without disturbing the fish, and fine steel wool to clean green algae from the tank sides. Three nets of various size (to pluck one, a few or all the fish from the tank), a thermometer and two enamel buckets complete the list. With this basic equipment, according to Coates, anyone may start one of the most fascinating hobbies in the world. Where you go from there



IN THE CORNER

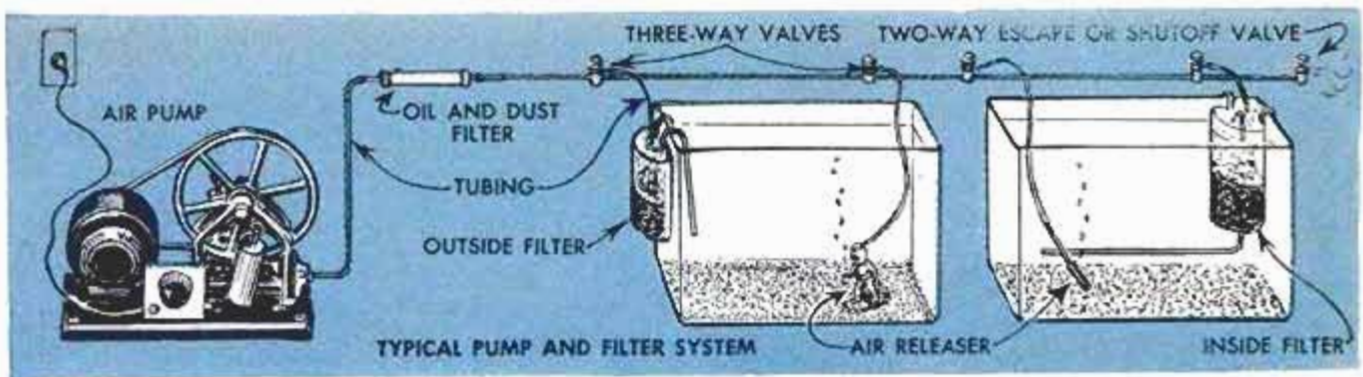

depends on your pocketbook and good sense in choosing useful accessories.

Right now, 12,000,000 amateur aquarists in this country are finding relaxation and fun watching a tankful of tropicals live, love, fight, prepare odd breeding nests and rear their wiggly fry. The unusual pets are noiseless, cost little to maintain and need little attention. They'll survive a two-week stretch without food at vacation time. Put them in a balanced aquarium with plants, sand or gravel, a rock or two for atmosphere, and you have an underwater fantasia right in your living room. The water plants with odd names like hornwort, ludwigia, baby tears, water sprite, color fern, Amazon sword plant, jessica and duckweed not only make an underwater garden for your tank, but oxygenate the water and provide hiding places for baby fish and timid fellows.

It's impossible to describe all the tropicals available today. Nearly 200 kinds from the rivers of Mexico, South America, India, Siam, Africa and Indo-China find their way into homes. They go under a mighty list of tongue-twisting Latin names. But most can be found under family "handles," like mollies, cichlids, danios, rasboras, gouramis, bettas, panchax, tetras, platys, barbs, swordtails and guppies. They represent all the colors of the rainbow. Guppies are the cheapest, most popular and widely known of the tropicals. They're hardy, easy to keep, brightly colored and range up to an inch long. Experts like Dalwin and the Groetzingers usually recommend them for beginners.

Whether you start with guppies or something more rare and glamorous, you're in for some surprises. Tropical fish are like no other pets on earth. Most are compatible, timid and neighborly. A few are not.

"Some," explains Dalwin, "are antisocial, like bettas. These fierce, vividly colored three-inch fellows with flowing fins are Siamese fighting fish. In Siam (now Thailand), people carry them singly in jars. They are pitted against each other like fighting cocks, and bets are placed on the winner. They tear each other to shreds."

(Continued to page 210)

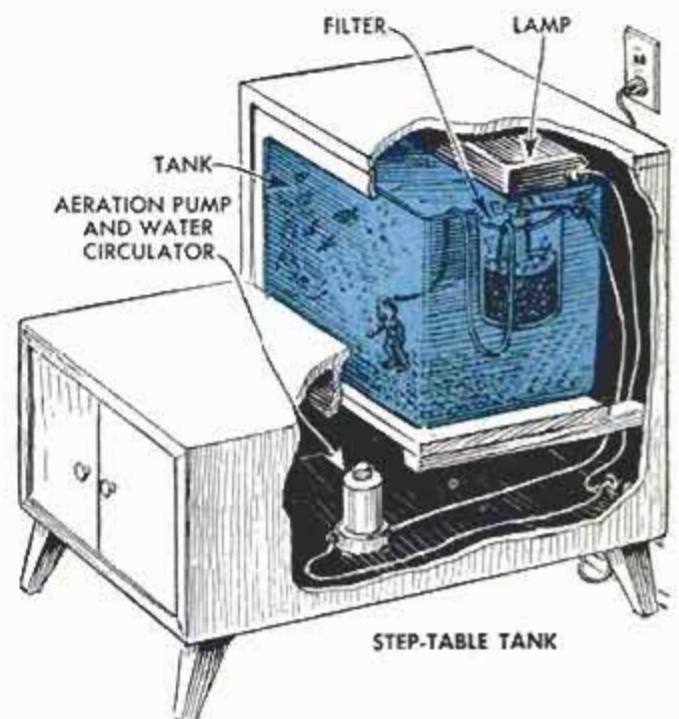
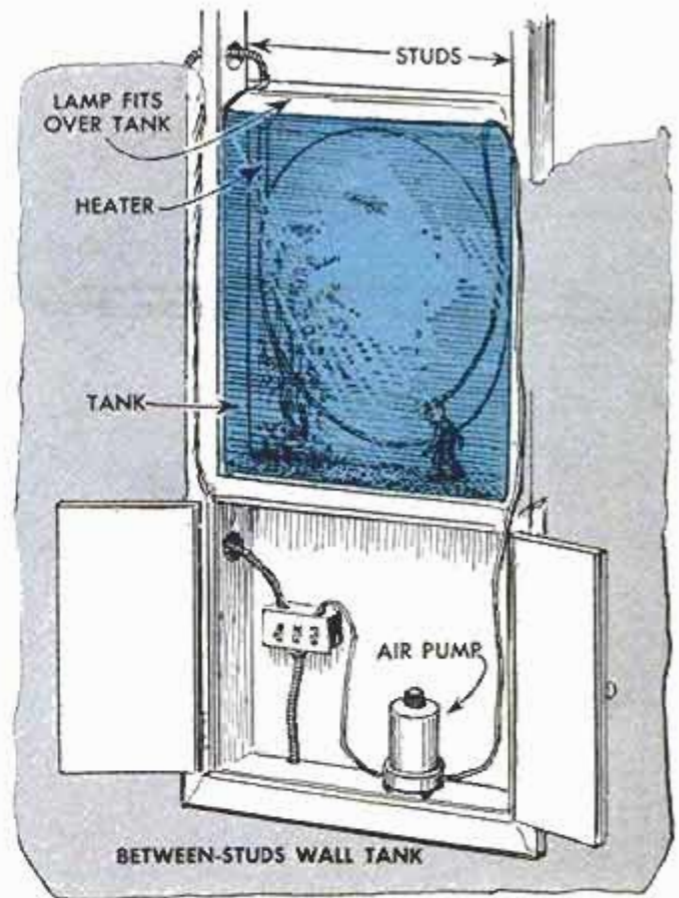



Seashore well, filled mostly with salt water, also provides fresh water for cattle grazing 15 miles away

Water Is Pumped a Mile High To Hawaiian Cattle Ranch

By Norman K. Carlson

CATTLE ON the mile-high mountain lands of Kona, Hawaii, have their drinking water delivered direct from seashore wells. It isn't pure water by many a grain of salt, but it is potable to the grass eaters. Nor is it cheap water; the rancher spends 60 cents a month to keep each animal happy. But there is no longer the nag-

ging fear of drought haunting the rancher.

Kona is on the west side of the island of Hawaii. Its long slope is made up of numerous lava flows, the newest one being only five years old. The spewed-out rock stretches from the top of Mauna Loa's 13,680 feet to the sea.

This rather long slope has sharp rainfall

5600

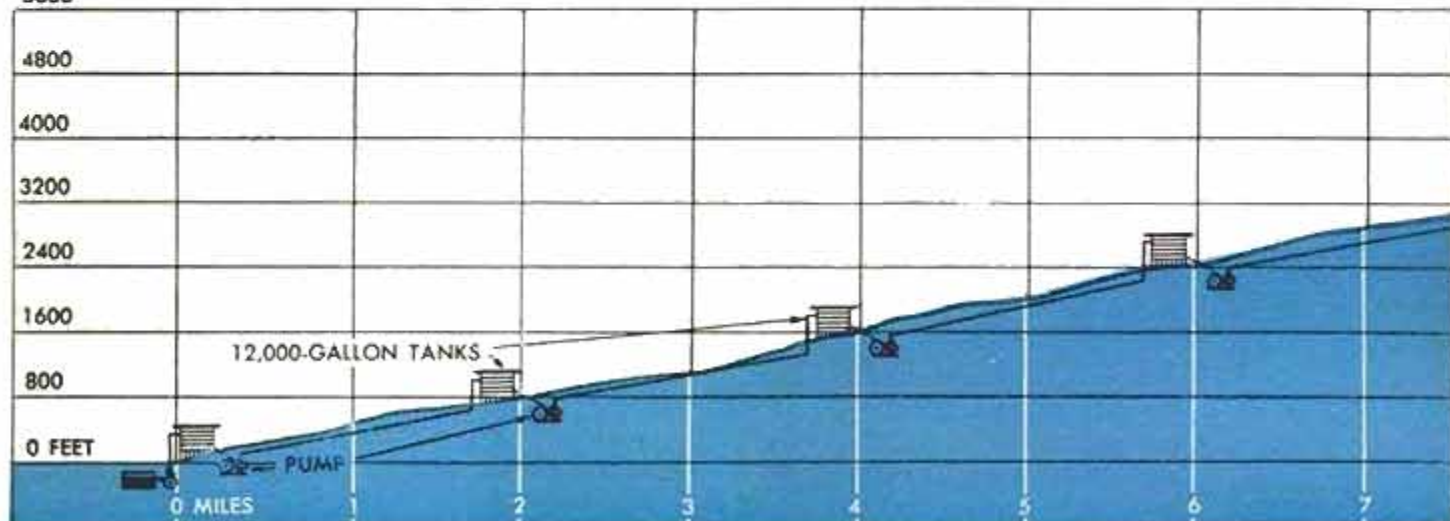

differences. At the shore line and up to 1000 feet it is dry. From 1000 to 2500 feet the coffee grows, well irrigated by 55 to 70 inches of rain. Above the coffee, and in a belt up to two miles wide, 120 inches of rain fall each year. Then above this the rain decreases until at the top of the mountain only 15 inches or so fall each year.

It is from the wet belt that the cattle get most of their water. The rains fall on the very porous ground and quickly disappear through the permeable rocks, trickling down to the ocean in millions of pencil-like rivulets, all underground. But there can be dry weather in Kona, even in the wet belt. It can last for two or three months, creating a major problem.

To gain weight or produce calves a cow needs about 10 gallons of water a day. Five hundred head of cattle gulp 150,000 gallons of water a month.

Roofs Collect Water

To get this water for the livestock, the ranchers have built roofs of galvanized iron, some small and some an acre or two in area. From these sheds the rain is channeled into 100,000 to 500,000-gallon wooden and steel tanks.

Where it rains 120 inches a year, an acre shed yields 3,250,000 gallons of water. But a 1,000,000-gallon storage tank can cost \$50,000 or more. So far, it has not been practical to build reservoirs in the porous lava.

The Horseshoe One Ranch had 12 big tanks flattened by 1950's

Diagram shows how brackish water is pumped from well at seashore, then carried by stages up mountain to the troughs



Huge metal roofs have been built on the islands to collect rainwater, which then is drained off into redwood storage tanks and saved for future use. Below, engines of the new water system are started by hand. They pump water up the mountainside

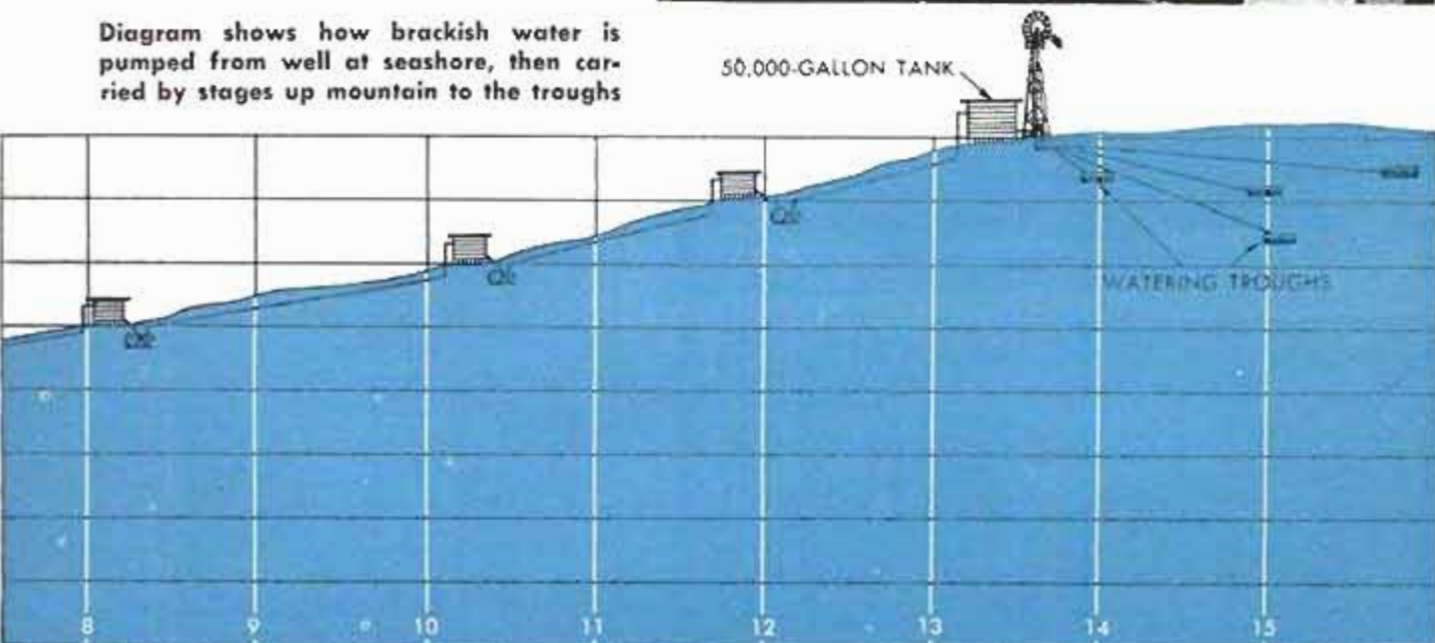

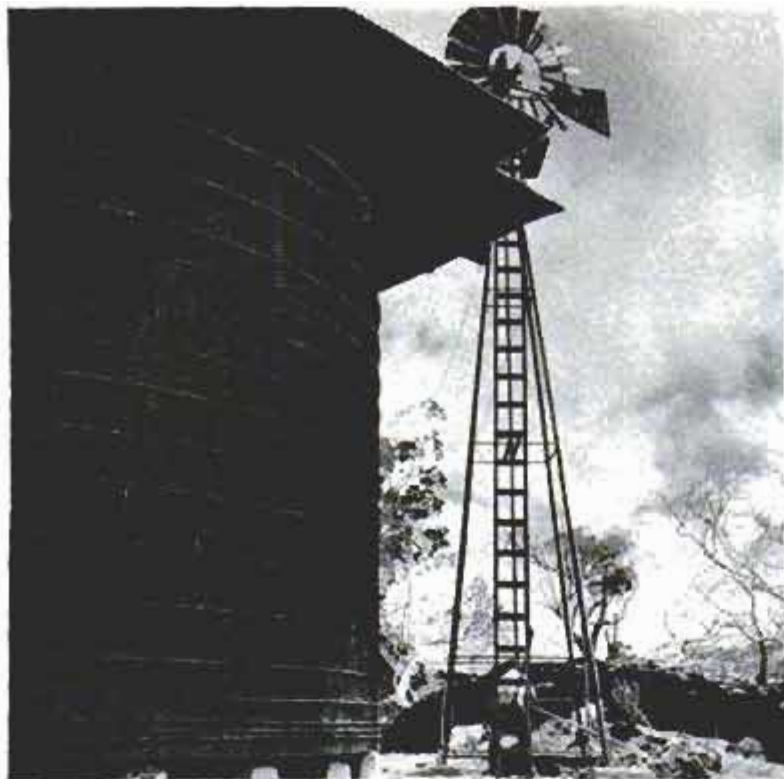

On top of the mountain is a huge storage tank. A windmill pushes the water from the tank to the grazing cattle two miles away

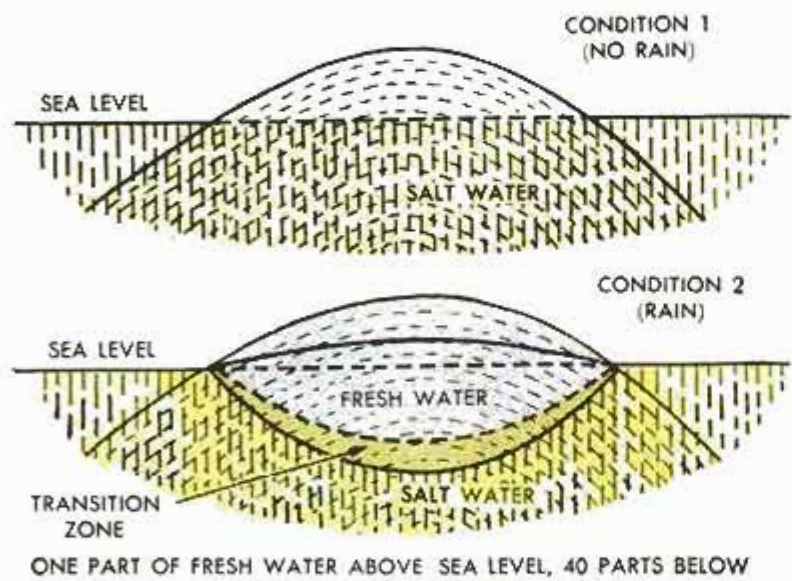

After a rain a lens of fresh water appears inside a well of salt water at the seashore. Below, a floating tank supports the intake pipe which draws off the somewhat brackish water

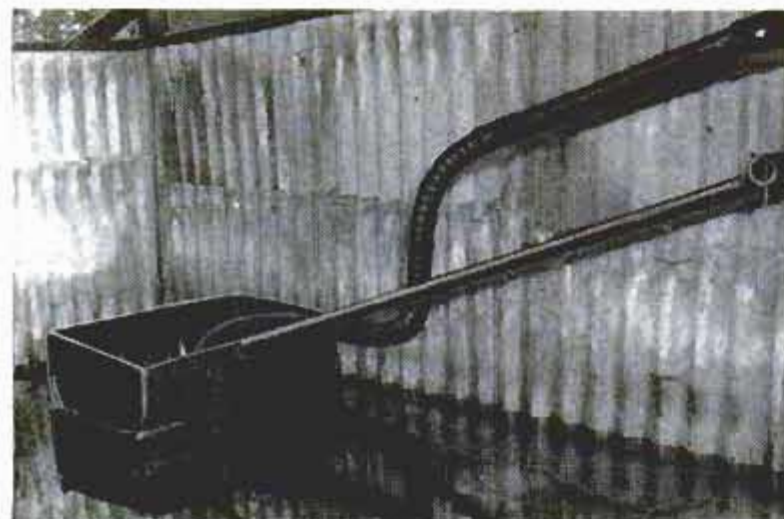

earthquakes. So, instead of replacing the tanks, this outfit built a pumping system.

Workers cased an old Hawaiian well along the seashore and dropped the pump into a lens of fresh water right in the middle of the salt water.

The theory of a fresh-water lens was first announced by two Germans in 1900. It is called the Ghyben-Herzberg principle. Dr. Chester K. Wentworth, a noted geologist in Hawaii, puts the essence of the principle this way: "There is a hydrostatic balance between fresh water and salt water in the permeable rocks of an oceanic island. The fresh water of the main ground-water body floats on sea water with one part above sea level and 40 parts below. There is a continuous recharge of water from the rains that fall on the mountain lands and trickle down through the lava."

The purity of water differs with each well and its location. From the Horseshoe One well at Nawaa-waa Bay, the jet pump scoops up water that averages 225 grains of salt to the gallon. A cow can drink water that has 400 to 700 grains of salt. Standards for human consumption are below 25. Sea water averages about 2000 grains of salt.

Pump Skims Surface

The Kealakekua Ranch skims the surface of a large pool of water. A halved 50-gallon barrel floats on the water and holds the suction end of the pump. Depending upon the tide, the water pumped varies from 90 to 130 grains of salt.

At the ocean front, the water from the Horseshoe One well is jetted into a 12,000-gallon redwood tank. From this tank another pump takes over and boosts the water up 800 feet through 1½-inch galvanized pipe. At 800-foot elevation another engine and pump lift the water another 800 feet. And so it goes for 13 miles and 5600 feet above the ocean, seven stages in all. At the end of the system there is a 50,000-gallon tank and close by a windmill; the windjammer pumps the water from the tank and pushes it through ¾-inch pipe for another two miles.

It takes heavy pumps and engines to lift the water load. The

(Continued to page 220)

Crawler Tractor Made at Home

Parts from a 1946 Plymouth furnished the transmission, rear end and clutch of a miniature crawler tractor built by Charles Weber of Elkhart, Ind. Weber built the four-by-eight-foot tractor in one year of his spare time. The machine has a seven-horsepower Wisconsin air-cooled engine equipped with an electric starter. A 20-to-1 gear ratio gives a top speed of five miles per hour. A hydraulic system operates the bulldozer blade. The track for the vehicle was made from flat bar steel.

Test DDT Danger On Humans

To test the dangers of DDT for the U. S. Public Health Service, 14 volunteers ate DDT daily for a full year without harm, some of them consuming every day 200 times the amount an average person would eat in the residue left on fruits and vegetables sprayed with the insect killer.

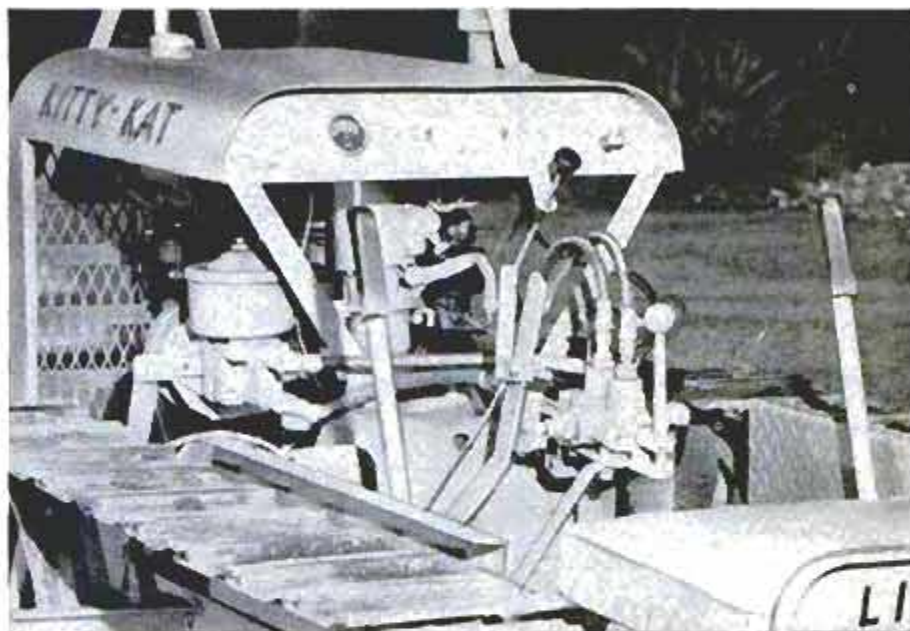

Tractor mounts full set of controls. Below, hydraulics regulate blade

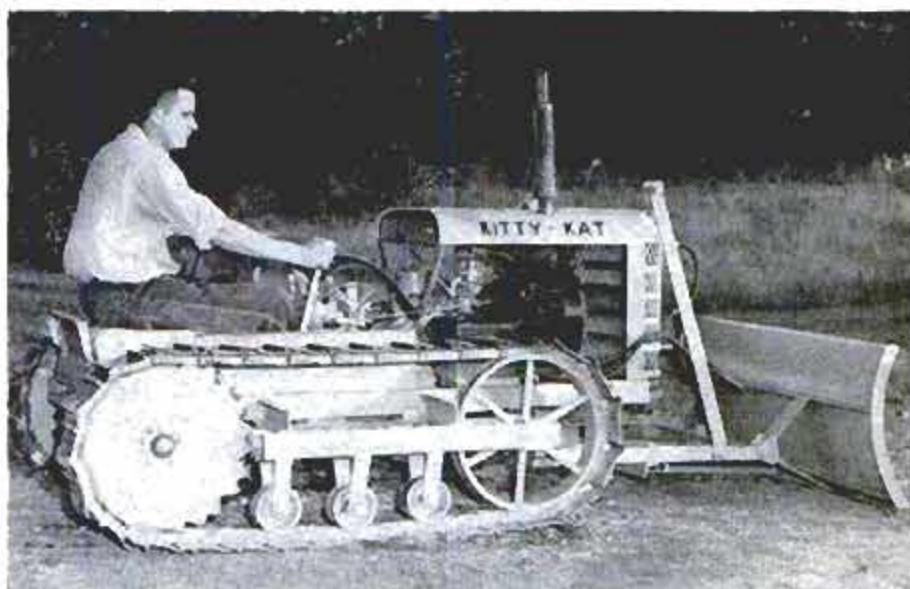

Experimental Photo Film Made of Flexible Vinyl Plastic

Newest experimental photo film is a thin, flexible sheet of vinyl plastic impregnated with a photosensitive compound. When exposed to a photo negative and ultraviolet light, the film develops a continuous-tone photographic image that extends through from its top to its bottom surfaces. In moderately heavy film, this deep image produces a three-dimensional effect. The depth of the image and the durability of vinyl plastic combine to produce a photograph that will withstand much wear and rough handling. The film may be practical for use in the manufacture of license plates, maps and blueprints, wear-resistant

floor tile, forgeryproof identification passes, display signs, and for interior decoration. The film is easier to store safely.

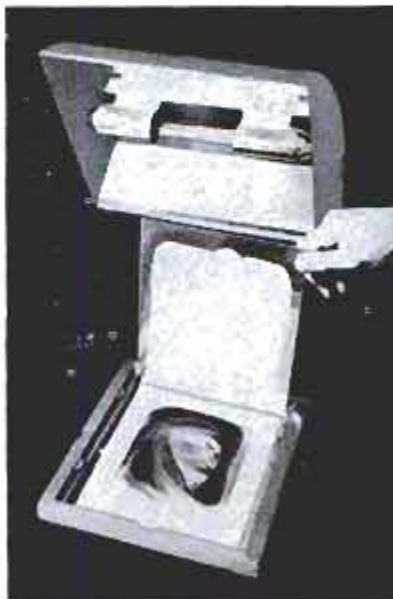

Mark an in the square after the most accurate answer. Write as many comments as you wish.

1. I own a 1956 Rambler hardtop overdrive sedan station wagon
 It has standard transmission Hydra-Matic
2. It has been driven 4,000 miles to date.
3. It averages 21 miles per gallon in city driving: 25 miles per gallon on long trips.
4. It uses no oil some oil considerable oil How much? Very easy to drive and park
5. Here is what I like best about my Rambler: Easy ride. Reclining seats are wonderful for long trips
6. Here are my specific complaints: Hose clamps and has checked more carefully - espec.
7. The one feature that did the most to convince me to buy a Rambler
8. I have had no trouble with the engine some trouble considerable trouble

BEST-LIKED FEATURE, SAY OWNERS

OWNERS REPORT:

THEIR MOST-FREQUENT COMPLAINT

5. Here are my specific complaints: Doesn't even come close to the manufacturer's claim of 27 miles per gallon but dealer plans to put on a new carburetor
7. The one feature that did the most to convince me to buy a Rambler: Reclining seats
8. I have had no trouble with the engine some trouble considerable trouble
 Describe the trouble: None
9. Rambler's over-all performance is Outstanding Average Below average . I would like would not like additional horsepower and acceleration. More top speed? Yes No
10. The car has power steering does not have power steering . I rate the way it handles as Outstanding Average Below average Comment: _____
11. I rate the exterior styling Outstanding Average Below average . The feature of the exterior styling I like most is None strikes me as outstanding
 The styling feature I like least is Have no criticism of styling
 Exterior styling did did not play an important part in my choice of this Rambler.
12. I rate the interior design Outstanding Average Below average . The feature of the interior I like most is the interior - its reclining seats - the heater
 The interior feature I like least is None
 I do do not use the reclining seats. I have have not slept overnight in the twin-bed arrangement. Comment: Bed is not long enough. I like the seats
13. Here are my suggestions for changes in the Rambler: More realistic gas mileage

OWNERS WANT DASHBOARD CHANGED

13. Here are my suggestions for changes in the Rambler: CIGARETTE LIGHTER AND CLOCK ARE TOO FAR FROM DRIVER - HYDRAMATIC DIAL DOESN'T LIGHT UP
14. I have have not owned a Rambler before. It was was not a station wagon.
 The Rambler seems to get bigger every year. I like don't like this trend. Why? I LIKE A SMALL CAR
 Station-wagon owners only: Comment, pro and con, on the station wagon as a family car:
BOUGHT A WAGON BECAUSE OF GROWING FAMILY. WE CARRY BUGGIES PLAY PENS ETC. AND STILL HAVE ROOM FOR COMFORT
 I would would not buy another station wagon. Why? I LIKE SPACIOUS FEELING
15. My dealer service is Excellent Average Poor . I would would not buy from him again.
16. I traded a '54 RAMBLER (year and make) to buy this Rambler. The trade-in allowance was Above average Average Below average
17. I looked at the following makes before buying a Rambler: PLYMOUTH
 I didn't buy one of them because GOOD LUCK WITH '54 RAMBLER
18. I would buy another Rambler when buying another car I would not
19. Over-all, I rate the 1956 Rambler

MAIL PROMPTLY IN:

Name _____

Street _____



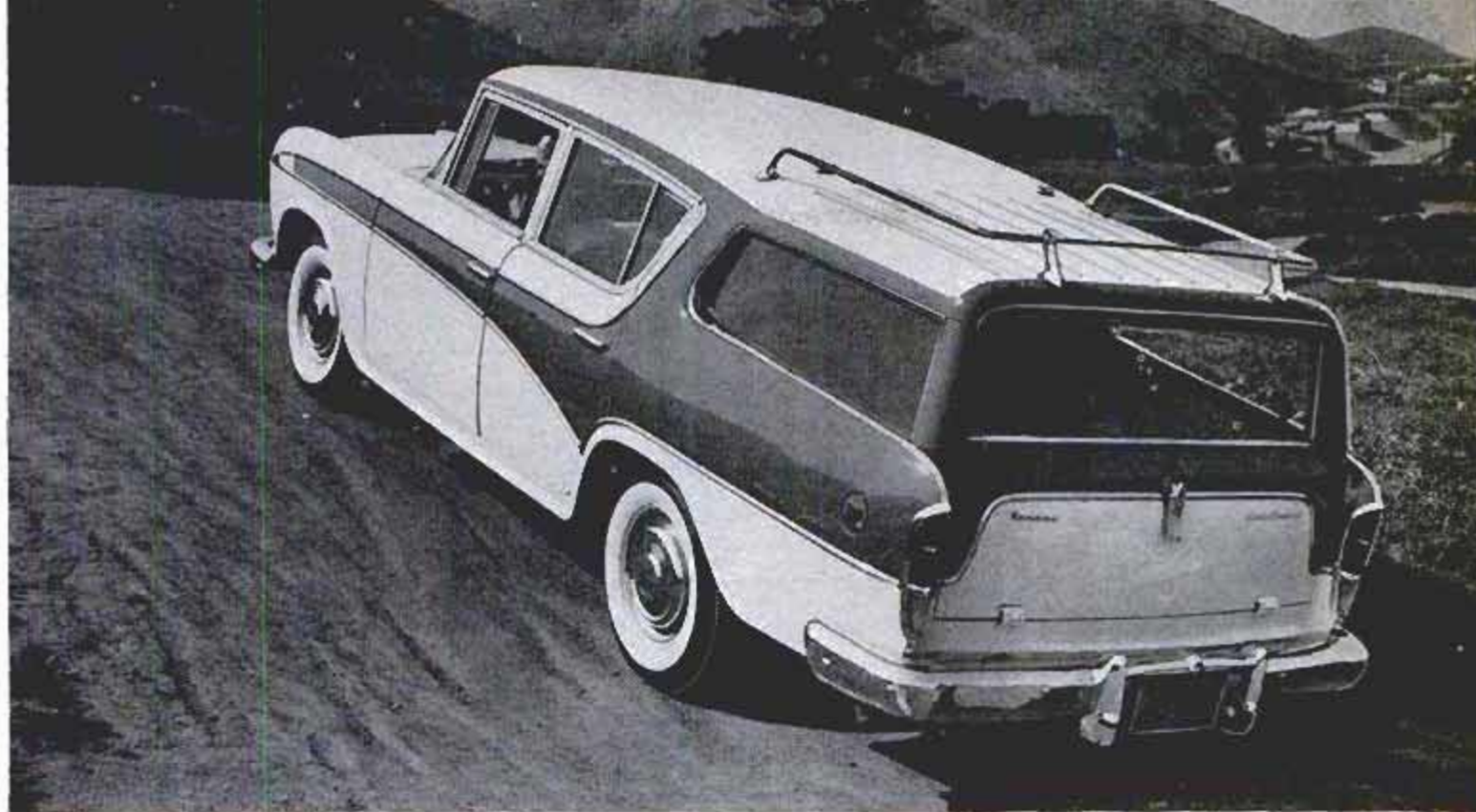

Rambler Cross Country is a popular family car. It comes with luggage rack on roof. Rear window winds down

Rambler Is Small But Roomy And Easy to Park, Say Owners

As Told By Owners of the Rambler

ARE STATION WAGONS practical? Sales certainly indicate they are. Each year the percentage of station wagons sold goes up sharply—it is the fastest-growing body style there is.

To find out how practical the wagon is,

we asked Rambler Cross Country owners about their experiences. Rambler sells a higher percentage of wagons than any other manufacturer—several times higher, in fact.

(Continued to page 109)



CLYMER ROAD TESTS THE 1956 RAMBLER

By Floyd Clymer

HOW DOES a small (by American standards, at least) car perform? To find out, I tested the Rambler station wagon.

The Rambler is stable with little body roll. Due to its short wheelbase (108 inches), it responds quickly to the steering wheel. The suspension system makes for good roadability and the coil springs, front and rear, afford a comfortable ride.

There is some tendency for the rear end to hop around. This is caused by the additional unsprung weight on the rear, the result of the torque-tube drive. The short wheelbase contributes to this tendency also. I have never liked the added unsprung weight of the torque-drive units, but the system does have one excellent

(Continued to page 230)

AN ENGINEER ANALYZES THE 1956 RAMBLER

By Dale Kelly, SAE

Model tested: Super four-door sedan with Hydramatic transmission. Rear-axle ratio: 3.58 to 1 (standard for cars with air conditioning). The car tested, however, was not air conditioned; for such cars the usual ratio is 3.31 to 1. This ratio would have given slightly better top speed and fuel econ-

omy and possibly slightly poorer acceleration. Curb weight: 3190 pounds with gas tank half full (56 percent of this weight was on the front wheels, 44 percent of this weight was on the rear wheels). Measured wheelbase: 107.5 inches left, 108.75 inches right.

ACCELERATION



TIME IN SECONDS	0-20	0-40	0-60	0-80	¼ mile
Ignition timed for regular or premium gasoline	3.9	9.6	18.5	45	22.2

(Watches started instant accelerator was flooded. Engine not run up against brakes before start. Drive 4 range used. Barometer reading was 29.45 inches; temperature was 75 degrees Fahrenheit during tests.)

Top speed: The top speed of this car was about 87 m.p.h.

FUEL ECONOMY



MILES PER GALLON	Steady 30 m.p.h.	Steady 50 m.p.h.	Steady 70 m.p.h.	Traffic Route
Ignition timed for regular or premium gasoline	22.6	19.2	15.0	12.7

ESTIMATED ANNUAL GASOLINE BILL—\$153 FOR 10,000 MILES. Based on 2000 miles at 30 m.p.h., 5000 miles at 50 m.p.h., 1500 miles at 70 m.p.h. and 1500 miles in traffic, and on the use of regular gasoline at 27 cents a gallon.

SPEEDOMETER ERROR



MILES PER HOUR	20	30	40	50	60	70	80
Indicated speed	19	28	37	46	54	63	72
True speed							

ODOMETER ERROR

The odometer indicated 5.5 percent more than the actual distance traveled or 105.5 miles for an actual 100.

DRIVER'S VISION

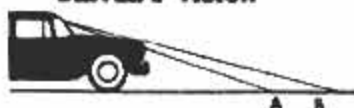

Some portion of the road could be seen 11 feet in front of the car (A in sketch) by an average driver (5 feet 9 inches tall); full width of the road could be seen 18 feet in front of the car (B in sketch).

GROUND CLEARANCE



The end of the tail pipe would drag if the car were driven through a dip whose profile had a radius of curvature of less than 29 feet (solid line in sketch). The muffler would drag if the car were driven over a circular hump with a radius of less than 18.5 feet (dotted line). The oil pan would drag if the car were driven in ruts deeper than 6 inches. The doors would open over a 12.5-inch curb.

MISCELLANEOUS

Octane requirement: The best acceleration from standstill to 45 m.p.h. was obtained with the basic ignition timing set to 5 degrees before dead center; this setting was used for all tests. On an 85-percent octane blend of octane and heptane, equivalent to typical regular gasoline (88 octane Research), the ignition timing could be advanced beyond this point without causing knock, consequently there was no possibility whatever of getting better performance from a higher-octane fuel. This engine has a rated compression ratio of 7.4 to 1, lower than any other 1956 model. The test car had only a 500-mile accumulation of carbon and its octane requirement would undoubtedly increase with increasing mileage. Another car of the same make and model could easily have an octane requirement several points higher or lower.

Steering: From straight ahead, the steering wheel had to be turned 0.8 revolution to complete a circle with an outside radius of 50 feet. Lock to lock, the wheel required 4.75 turns. Turn-circle diameter, curb to curb, was 38.2 feet; from wall-to-wall, 40.4 feet. Steering-wheel diameter: 17 inches.

Center of gravity: The center of gravity of the unloaded car was 24 inches above the ground.

Interior sound level: Inside the car the sound level with all windows closed was 92 decibels at 40 m.p.h., 95 decibels at 60 m.p.h. on a smooth road.

Water resistance: The car was fairly well sealed against water leaks. A few drops got past the doors when the car was washed in a high-pressure car wash; about an ounce got into the trunk in both the car wash and the splash-pan test. In neither test were brakes or ignition affected.

Trunk capacity: In addition to spare tire and tools, the trunk accommodated 12 cardboard cartons of the size used for 48 tall cans of evaporated milk.

Gasoline fill rate: With the tank nearly empty, gasoline spilled out the filler pipe when pumped at more than 10 gallons per minute. Many pumps are capable of pumping gas faster than the pipe will take it.

Brakes: In general, the brakes worked well. A woman driver had some difficulty in setting the hand brake tight enough to hold on a 14-percent grade.

Observations: This is one car that does not have a dangerous spearlike ornament projecting from the front of the hood.

A U-shaped steel trap is bolted to each corner of the frame. It is intended for use in tying the car down during shipping, but would also make a very convenient attachment for a tow rope.

The engine is of conservative design and the manufacturer recommends, for normal use, a straight mineral oil (ML grade) about 10 cents a quart cheaper than the MS-DG recommended for many other late models.

Rambler owners in 29 states (in color) from coast to coast tell you about their cars in this report

The Owners Analyze The 1956 Rambler

OVER-ALL RATING OF THE RAMBLER

Excellent	73.4%
Average	23.6%
Poor	3.0%



Had trouble with engine?

No trouble	84.4%
Some trouble	14.2%
Considerable trouble	1.4%

What was engine trouble?

Carburetor	6.3%
Water in gas line	2.8%
Noisy valves	0.9%
Oil leaks	0.9%
Miscellaneous	4.7%

Performance Questions

How is performance?

Outstanding	62.0%
Average	35.4%
Below average	2.6%

Would like more horsepower?

Yes, would	22.4%
No, would not	77.6%

Would like more top speed?

Yes, would	11.1%
No, would not	88.9%

How is over-all handling?

Outstanding	79.8%
Average	19.2%
Below average	1.0%

Styling Questions

How is exterior styling?

Outstanding	65.4%
Average	33.2%
Below average	1.4%

Best-liked style feature?

Large glass area	17.1%
Grille, headlights	16.9%
Colors, three-toning	11.3%
Rollbar	4.8%

Least-liked style feature?

Rollbar paint treatment	13.6%
Headlight arrangement	3.9%
Rear end too high	3.7%
Rear-door shape	3.7%

Did styling influence your choice?

Yes, did influence	52.6%
No, did not influence	43.6%
Undecided	3.8%

Like trend toward larger car?

Yes, do like trend	79.2%
No, do not like it	20.8%

Miscellaneous Questions

Have owned Rambler before?

Yes, have before	40.5%
No, have not	59.5%

Would buy Rambler next time?

Yes, would	60.1%
Might	35.9%
No, would not	4.0%

Would buy station wagon again?

Would buy another wagon	94.9%
Would not	5.1%

(Asked of wagon owners only)

How is dealer service?

Excellent	57.0%
Average	28.6%
Poor	14.4%

Would buy from him again?

Yes, would	81.5%
No, would not	18.5%

What make car was traded?

Traded Rambler	33.4%
Other American Motors	28.7%
Non-American Motors	31.2%
No trade, no answer	6.7%

Best-Liked Features

Handling ease	59.1%
Ride, comfort, seats	46.3%
Economy of operation	39.0%
Exterior styling	29.4%
Easy to park	15.8%
Roominess	15.0%
Driver vision	14.4%
Performance	13.4%

Most-Frequent Complaints

No complaints at all	31.3%
Uses too much gasoline	15.5%
Dashboard design	14.4%
Poor assembly work	8.2%
Water leaks	8.2%
Hydra-Matic operation	6.8%
Radio poor	5.4%
Poor paint job	4.1%
Rattles	4.1%

Why Did They Buy Rambler?

Advertised economy	35.1%
Exterior styling	16.1%
Previous ownership	9.8%
Small exterior size	5.7%
Price	4.1%

The result? Owners like the wagon. Of those who now own a station wagon, 94.9 percent will buy another wagon when they buy a new car. Most of the 5.1 percent who said they wouldn't have some special reason that does not involve the wagon itself (for example, the family will have grown or will no longer be living in the country).

Here are some quotations from owners of station wagons:

"To date, it has been ideal. Problems of other cars, such as where does the playpen go, the dog and other necessities, have been eliminated."—Illinois general manager.

"How can you beat it? I use it in my car pool to haul six adults to work, then on week ends haul 4-by-8 sheets of plywood. On long trips, it's a mobile playground for the baby."—Illinois sales engineer.

"It makes a safe place for the children to ride. They cannot open the windows and fall out."—Oklahoma utility worker.

"We buy trunks in other cars but seldom use them. Rear of wagon is more convenient."—Ohio machinist.

"Not being a family man I bought the wagon for fishing and hunting trips. Just the thing for that."—Michigan airline agent.

"Station wagon is the answer to a fisherman's dream. Room for four persons to sleep."—Utah locomotive engineer.

"We have two cars and the station wagon is easily the one in most demand."—Wisconsin executive.

"Before we bought this Rambler we tried all makes. The Rambler is the one wagon comfortable on long trips."—Ohio engineer.

But there are some who have complaints, even about the wagon:

"Good except for the rear-seat clamps. When the seat is folded down, the clamps are dangerous for children playing in rear."—Ohio student.

"Height from ceiling to floor at rear of

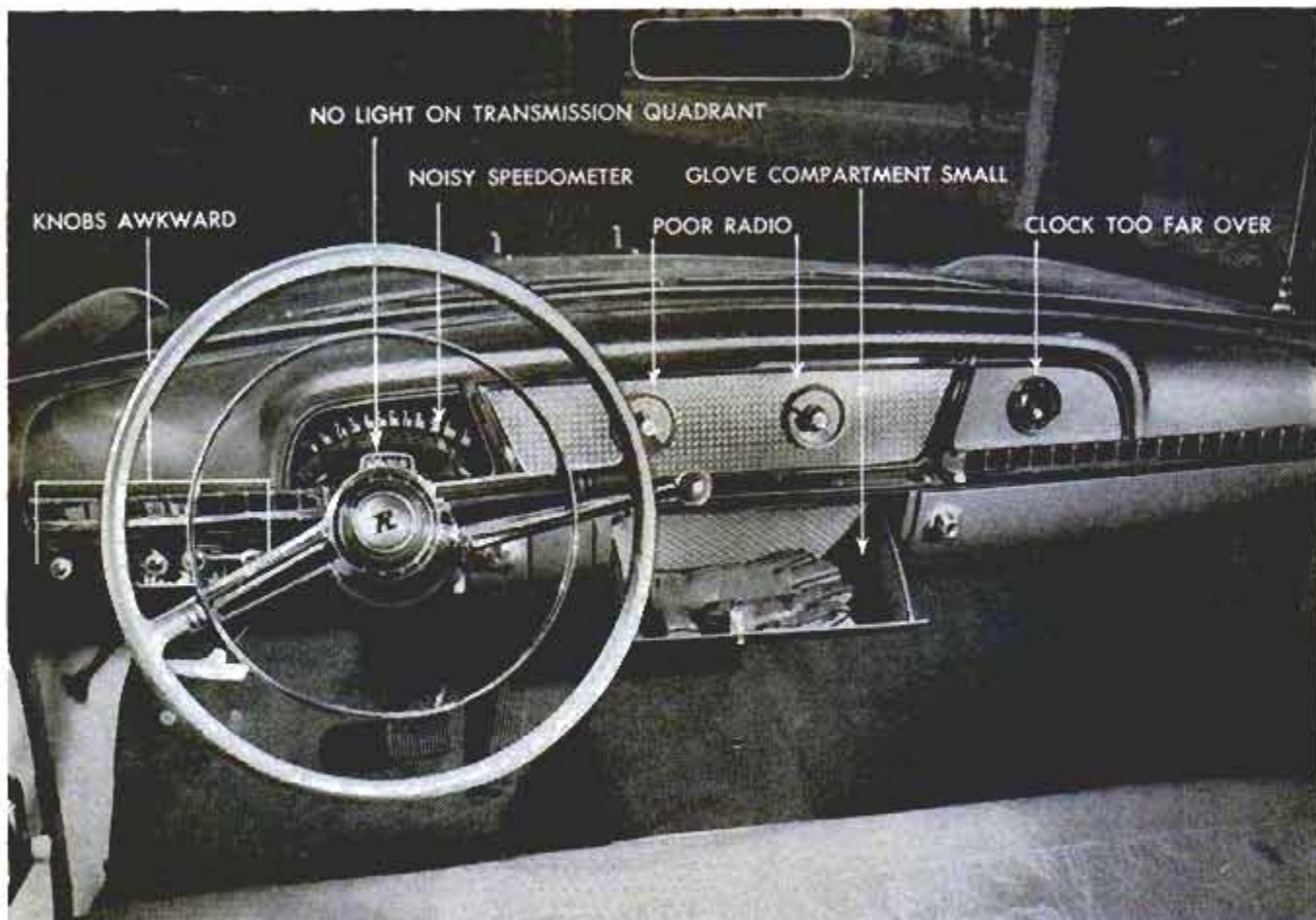

Principal area of complaint by owners is the dashboard. Labels on this photograph point out what they say

wagon should be increased.”—Michigan dry cleaner.

“Should pipe heat into rear of station wagons.”—Indiana painter.

“Would like more space in spare-tire compartment.”—Illinois cabinetmaker.

“I don’t like station wagons. I always smell exhaust fumes in one and I carry

Spare tire is carried under floor of station wagon. There is no upper half of rear door to bang head on

tools and don’t like noise they make. I don’t own one now.”—Tennessee plumber.

Best-Liked Features

That should have convinced you about station wagons. Now what about the Rambler over-all? The feature Rambler owners like the most is its fine handling ability,

Owners report the six knobs for heater, lights and wiper are awkward and clumsy. Some pull off easily



59.1 percent listing it. Second on the best-liked list is riding comfort and the reclining-seat feature (46.3 percent). Third is economy of operation (39.0 percent).

"We have driven this car over 600 miles a day on several occasions and find it does not leave us all tired out. Seems to have good road balance." — South Dakota driller.

"Ease of handling makes driving in heavy traffic much more pleasant than in any other car I've driven."—Kentucky reporter.

"This Rambler was bought for my wife. It is more pleasure to drive in traffic than my other car that costs plenty more. Now I use the Rambler for the business and she uses the other car. May have to buy her another Rambler to keep her happy." — California businessman.

"We have two other cars (both big cars), but since getting the Rambler find ourselves using it for everything, leaving the other two cars in the garage. Can't praise the Rambler enough. It's an exceptionally fine woman's car." — New Jersey housewife.

"I recommend this car to anyone who, like myself, has found driving has become a drudgery. I can say with emphasis, I enjoy motoring once again."—New Jersey businessman.

Riding comfort is the second best-liked feature:

"This is my 35th car and the first small car since back in the '20s. I was apprehensive about comfort at first since I travel a lot, but my 1800-mile trip was agreeably surprising."—Virginia salesman.

(Continued to page 224)



If you want room, you get plenty of it in the Rambler Cross Country. Its interior is much wider than in previous models. Here the wagon is shown with its rear seat folded into floor

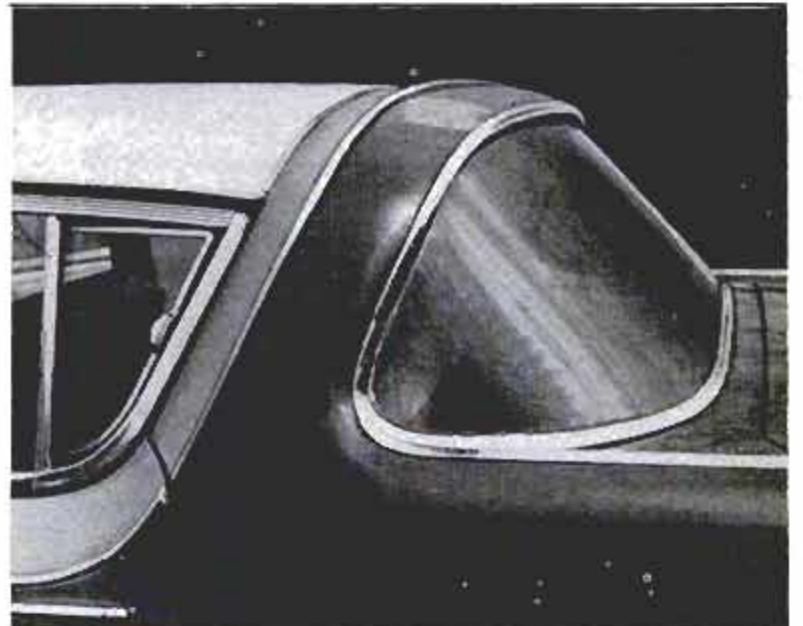

Above, some owners dislike the bold rollbar styling over the rear window. Others praise it as a safety factor. Below, the new and distinctive sedan styling has a refreshing tautness



Miniature Weather Station

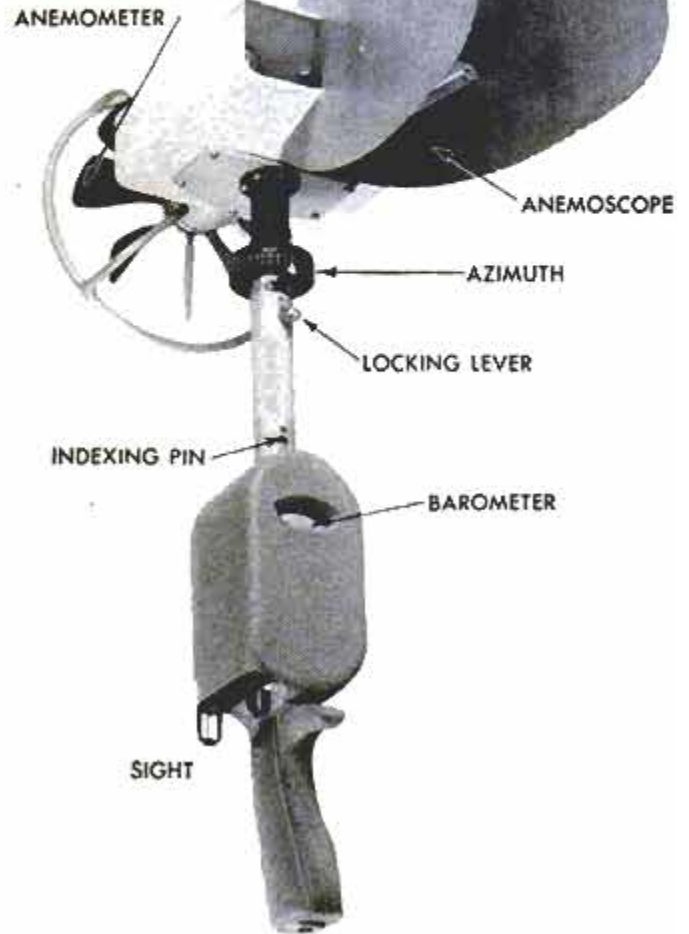
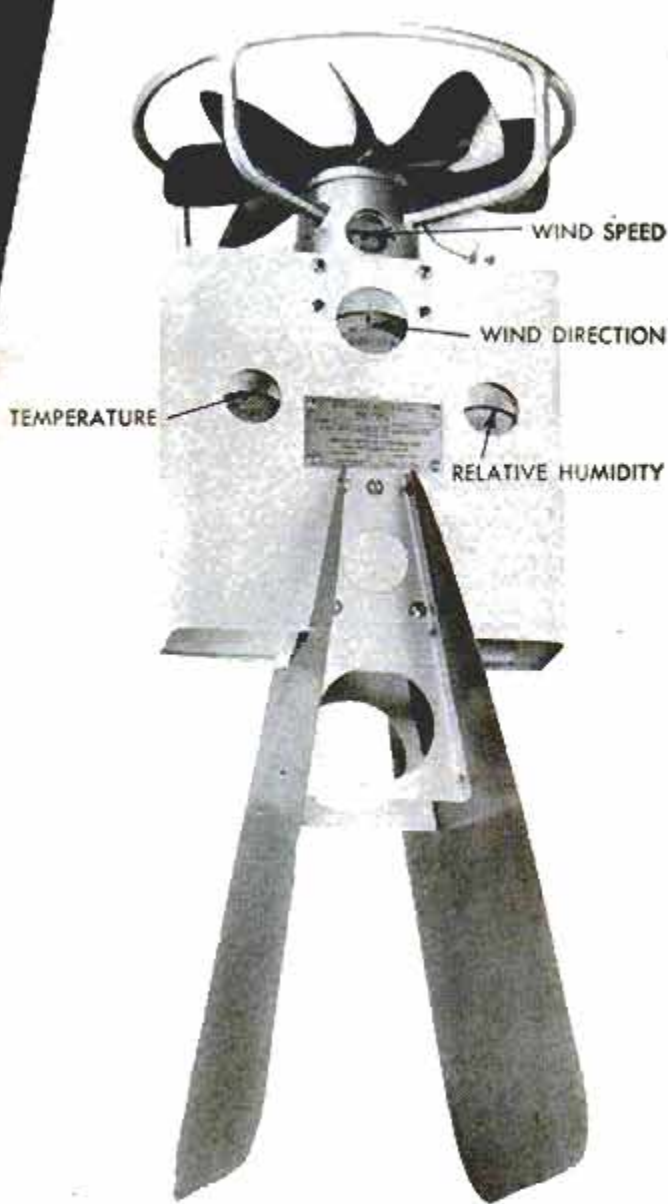

Weather readings at sea in darkness or during rough weather will no longer be difficult, now that a miniature weather station has been developed for the Navy. When held at arm's length for a few moments, the sensing elements of the set measure surface atmospheric pressure,

temperature, relative humidity, wind speed and direction. A lever locks all readings in place for subsequent noting and recording in a sheltered area. The weather set was designed primarily to supplement standard permanent weather instruments under conditions which make it impracticable.



Parking-Fine Collector

Parking fines are paid into a small metal unit that takes the violator's ticket number and issues a receipt. The special ticket placed on the violator's car by a policeman is inserted in the unit. Coins in the amount of the fine—25 cents or more—are placed in the device and a crank is turned. Part of the ticket bearing the serial number is cut off and kept in the collection box. The receipt stub retained by the motorist is marked "paid."

☐ Age of the universe is 5,400,000,000 years, give or take a billion, according to a committee report on a 20-year study made by astronomers from Lick, Palomar and Mount Wilson observatories.

Sunlight Replaces Wind For Pumping Water

Solar pumps may take the place of windmills in areas where sunlight is plentiful and the wind doesn't blow every day. One solar pump, developed in Italy and now being tested by Stanford Research Institute, develops from 1 to 1½ horsepower.

The pump consists of three black panels with side reflectors that transmit solar heat to pipe coils containing liquid sulphur dioxide. The heat converts this liquid into steam and the steam operates a one-cylinder pumping engine, after which it is reduced to liquid again in a water-cooled condenser and is recycled to the heating coils.

Also being considered for further research by the institute is a means of obtaining water from the air to help alleviate California's growing water shortage. Preliminary testing has been done on a simple sheet of metal painted black and reinforced underneath by fiber-board insulation.

Moisture-laden air, at a temperature of about 60 degrees, passes over the metal, which has a temperature of 40 to 50 degrees. The resulting condensation produces tiny droplets of water which roll into a bucket placed at the base. The system is effective only at night, during seasons when moisture and temperature permit condensation.



Heating surface of solar pump has 120 square feet, plus side reflectors to concentrate heat. The one-cylinder engine below the panels is run by steam from sulphur dioxide raised to the boiling point by the solar panels. It develops one horsepower



German Motorcycle Has Push-Button Shift

Motorcyclists who ride a new German motor bike shift gears electrically with a push-button shift control. The keyboard, or control panel, is mounted on the left handle bar. There are four buttons on the panel, the transmission having four speeds forward (no reverse gear is provided on motorcycles, of course). According to the manufacturer, this is the first time a push-button shift has been incorporated in a two-wheeled vehicle. Being electric, the shifting is done instantly when the button is pushed.

☐ Average life of a television picture tube is about four years.

Earth-Eating Monster 656 Feet Long

MORE AWESOME and powerful than any of the dragons of mythology, a giant dredger scoops lignite from a huge pit near Cologne, Germany. A wheel 52 feet in diameter rotates at the end of a long boom to scoop up the material in buckets and deposit it on a conveyor belt. The belt carries the lignite to the center of the machine and dumps it in railroad cars parked below. Shortwave radio signals from the dredger control the movement of the rail cars.

The 5500-ton machine, 656 feet long, has 18 crawler units for feet. One of the 116 electric motors on the dredger powers the huge digging wheel as its 12 toothed buckets scoop up the mineral.

The mining machine, built by two German firms, cost \$5,000,000 and is said to be the largest of its kind in the world. Two more are under construction.

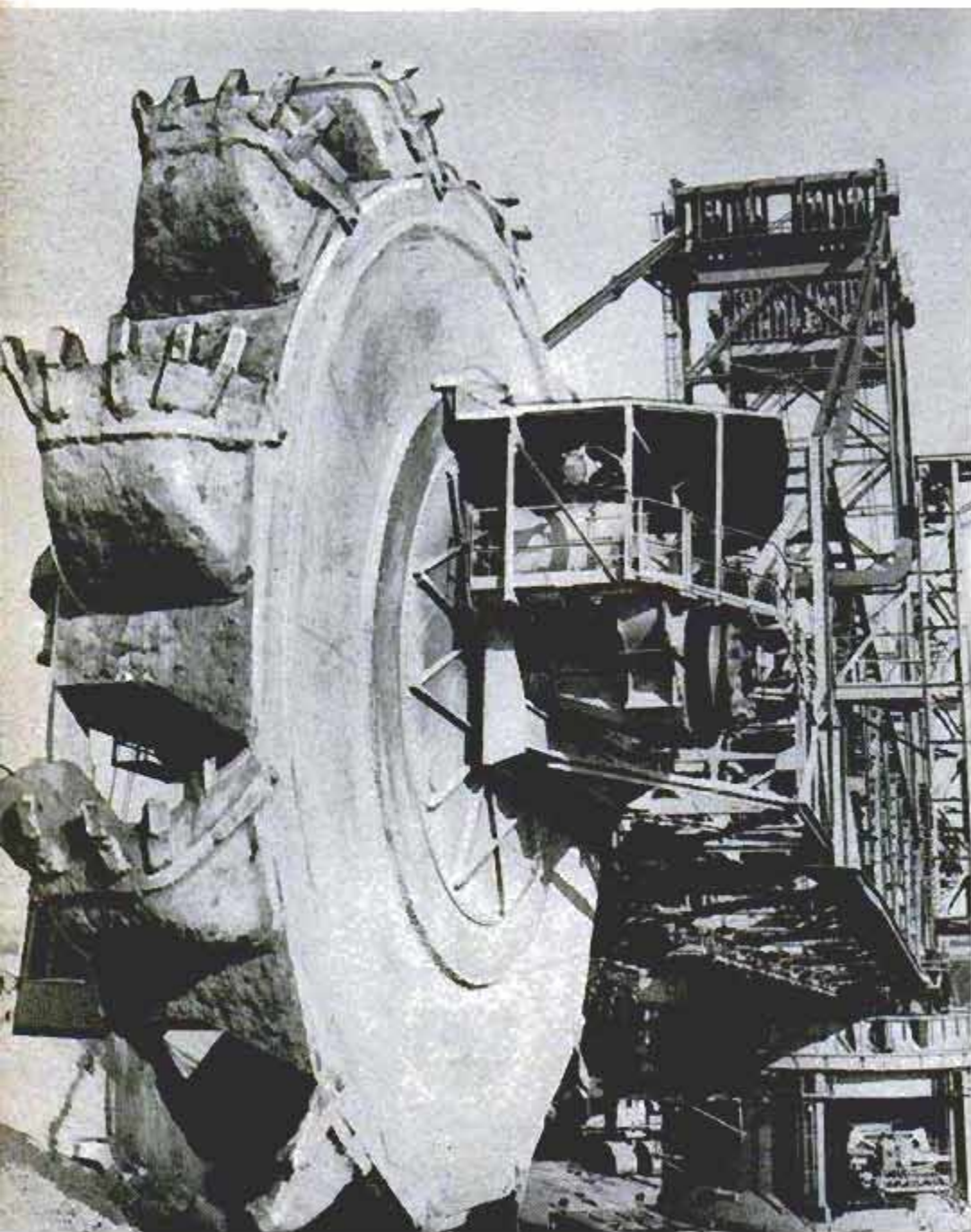

Teeth on buckets of the dredger's digging wheel chew out huge bites. The wheel has 52-foot diameter

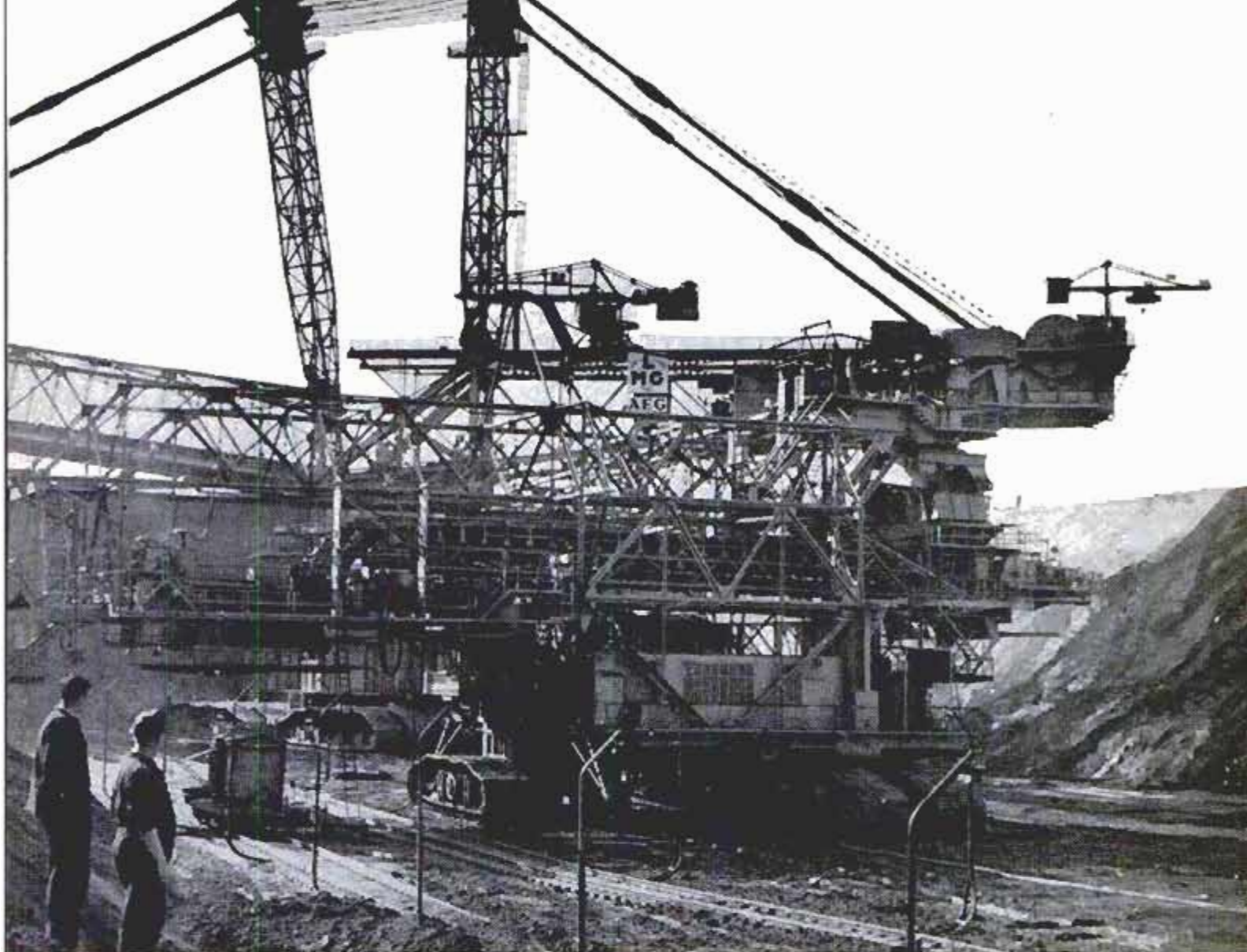

Giant dredger moves on 18 crawler units. Conveyor belt carries lignite to railroad cars underneath the machine

Controller of the machine's appetite is operator in a cabin mounted near the wheel. He controls the speed and depth of the bite with levers and switches

Dredger's wheel dwarfs a bulldozer in the huge pit it has eaten out. Two more dredgers of the same giant proportions are under construction by German firms

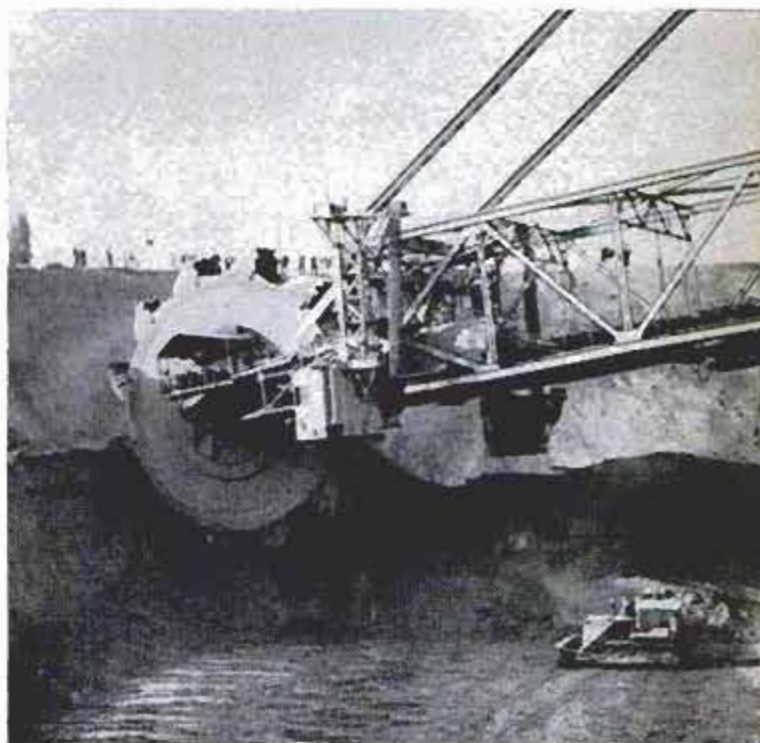



One arm held directly over the head is the signal for immediate help and should not be used except as an emergency signal either above or below the surface



Left, "Surface at once!" is indicated by raising arm with pointed finger and moving the arm up and down. Skin diver is wearing rubber diving suit



Right, danger signal is given by holding finger or extended hand across the throat. Gear includes knife and lead weights around diver's body

SKIN-DIVER TALK

By Thomas E. Stimson, Jr.

GOOD COMMUNICATION—especially in a time of emergency—is recognized as an important safety aid in any type of endeavor. In order that skin divers may communicate with each other under water or on the surface, the California Council of Diving Clubs has adopted a new safety signaling system. The club hopes that it may develop into an international language for skin divers.

The hand signals advocated by the club are based on natural actions that help convey the meanings of various motions. Bob Retherford, safety chairman of the Sea Sabres Club of Downey, Calif., worked out the system. He believes the signals may help reduce fatal accidents among skin divers who follow approved safety rules ("Skin Divers Play It Safe," *Popular Mechanics*, June 1955). All signals in Retherford's system are performed by one hand alone. The system may be used by every diver regardless of whether he wears a simple faceplate or a complete artificial-lung unit. Most of the signals in the system are shown in the illustrations on these pages.

One of the signals not shown here consists of four short blasts of a boat horn or one mounted along the shore. This signal means: "Get out of the water immediately!" The four blasts indicate an emergency condition, such as the presence of a large shark in the immediate area. Two long blasts of the horn are a recall signal to bring divers in to discuss a change of plans.

Another important signal is given by slapping

Right, holding finger to ear means "Ears not clearing properly." Diver is wearing depth gauge strapped to right arm

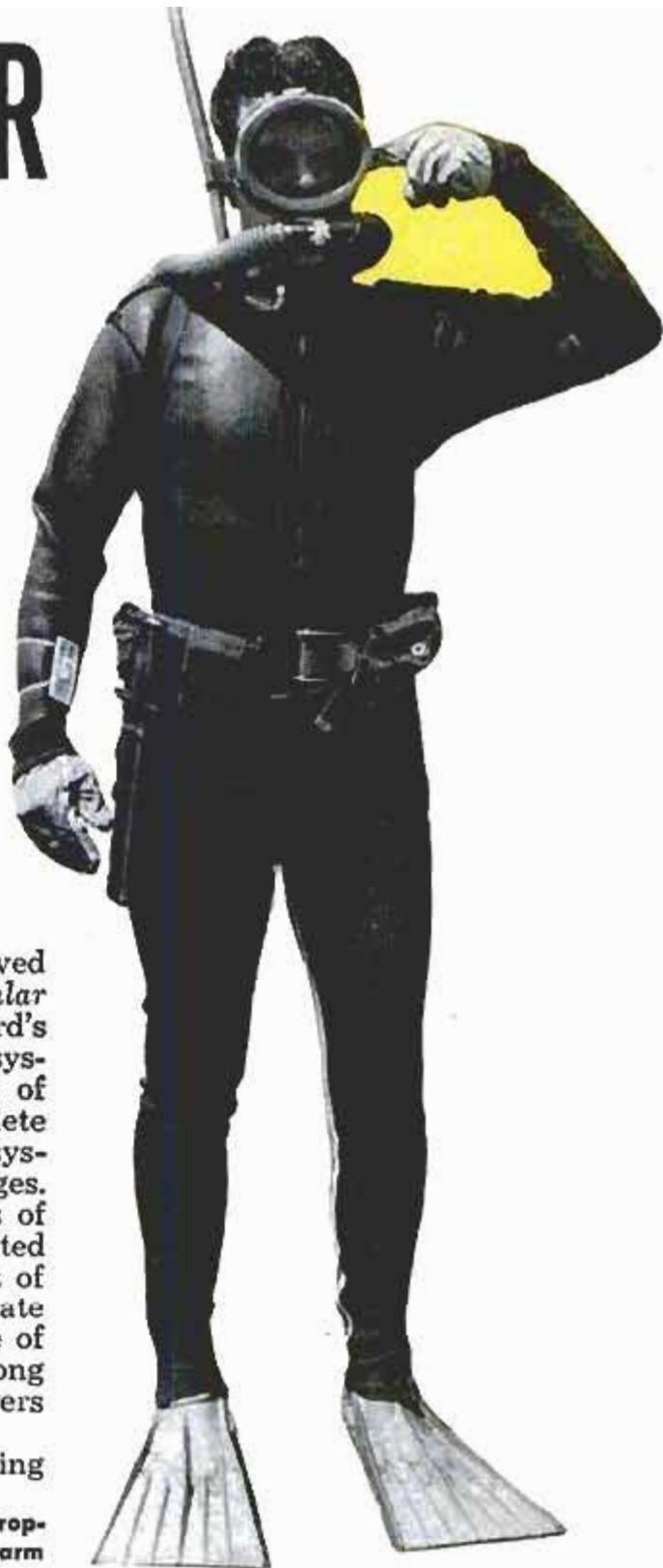

One of skin diver partners tows an inner tube used as a float. Gunny sack tied to the tube will hold fish





CRAMPS
FIST CLENCHED AND UNCLENCHED
AND POINT TO AREA AFFECTED



NO!
FOREFINGER WAVED
SIDE TO SIDE

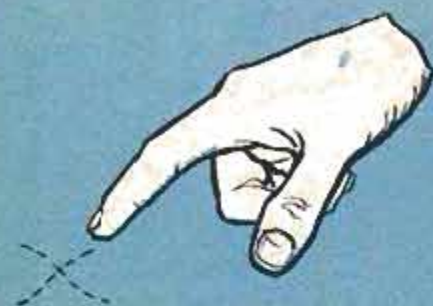

LEAKAGE IN DRY SUIT
CRISSCROSS MOTION ACROSS
STOMACH OR AREA OF LEAK



WAIT!
FLAT OF HAND
TOWARD PARTNER



FATIGUE
PALM UP IS RAISED
AND LOWERED



NAUSEA
HAND PLACED OVER MOUTH
AND WITHDRAWN

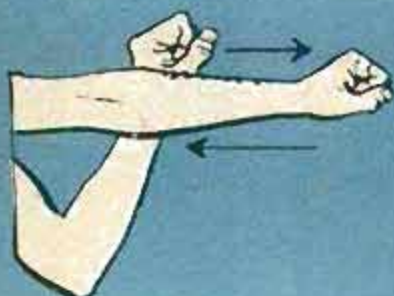

COLD
FIST CLENCHED AND ARM EXTENDED
AND RETRACTED SEVERAL TIMES



COME HERE!
WAVING IN WITH
PALM OF HAND



LOOK BEHIND YOU
HITCHHIKER'S SIGNAL



**YOU'RE GOING TOO DEEP —
NO FARTHER FOR ME**
POINTING DOWN WITH FINGER
AND USING "NO" SIGNAL



LOST BUDDY
STRIKE SURFACE WITH CUPPED
PALM. BUDDY SHOULD HEAR AND
SURFACE. SOUND GOES 70 FEET



LOBSTER OR CRAB
WIGGLING FINGERS



FISH
WIGGLE PALM OF HAND IN
DIRECTION OF FISH

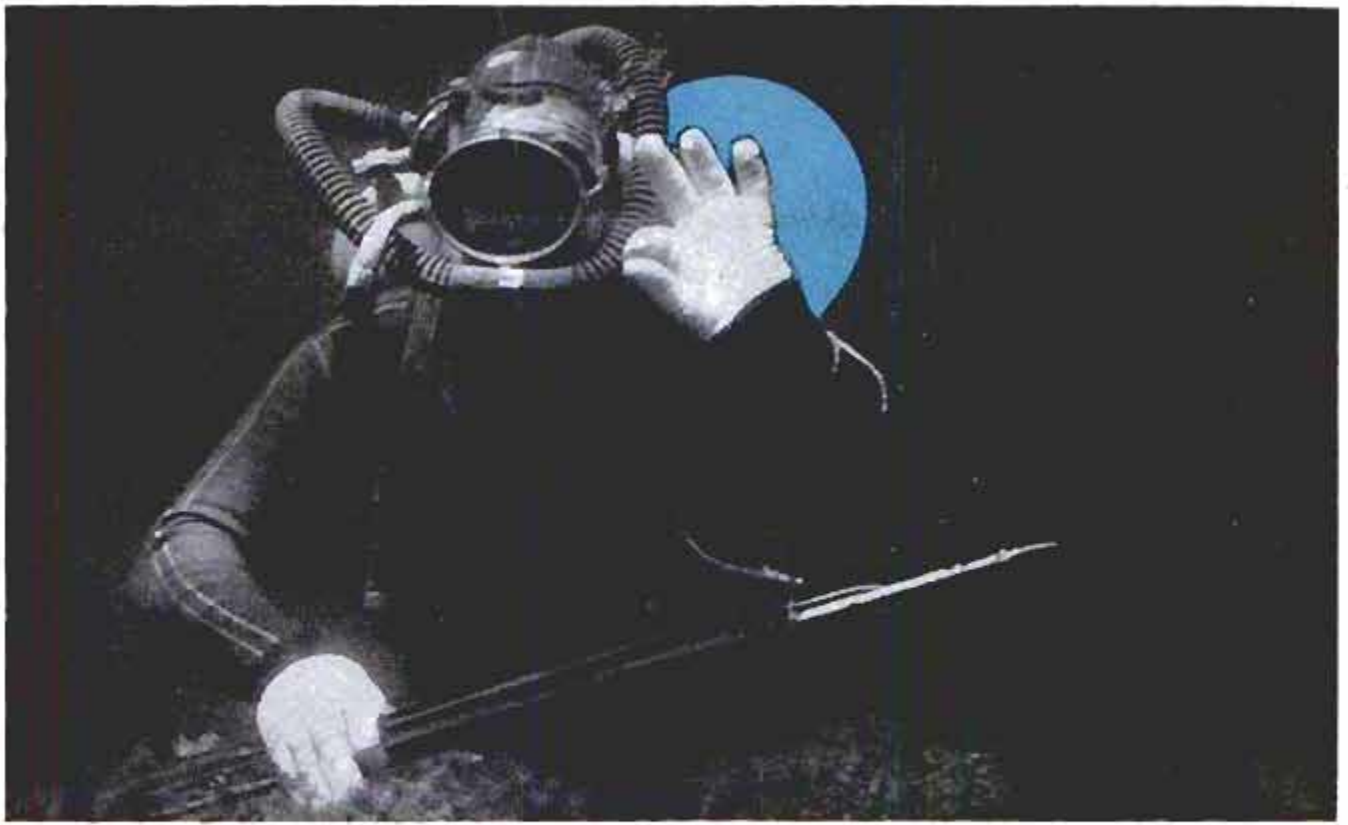

This is the signal for "Okay" or "I agree." Tips of thumb and forefinger touch, other fingers extended

the surface of the water with a hand. This makes an explosive sound that can be heard as far as 70 feet below. A diver can use this signal when he has ascended and cannot find his diving partner. The partner should surface at once when he hears the signal.

Some hand signals describe types of quarry, such as a V sign to indicate the presence of a shark or wriggling the fingers to indicate lobsters. The basic safety signals have been recommended for national adoption. Quarry signals may be changed to fit local conditions. ★ ★ ★



"I need air! Give me your mouthpiece." This signal is given by pointing at mouthpiece of diving lung

Members of many skin-diver clubs have adopted the V signal to indicate the presence of a menacing shark



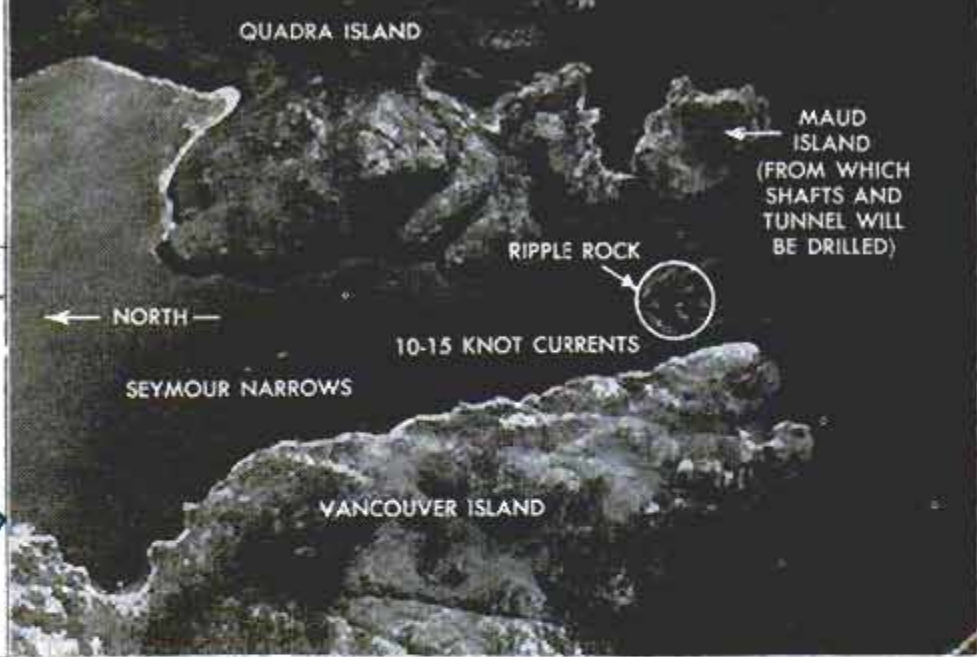

Fourteen large ships and over 100 small ones have been lost or damaged on Ripple Rock or in its whirlpools

Blast to End Sailors' Peril at Ripple Rock

RIPPLE ROCK, the terror of ship captains who use the Inside Passage to Alaska, is going to get its head blown off.

The menace to navigation is located in Seymour Narrows between Vancouver Island and the mainland, about 100 miles north of Vancouver. Nearly all coastwise shipping uses the channel, which is a half mile wide and 325 to 400 feet deep. The obstruction consists of twin underwater peaks that rise to within 9 and 20 feet of the surface at low water, near the middle of the channel.

Not only is Ripple Rock a hazard in itself, it produces vast turbulence and giant whirlpools in the 10 and 15-knot tidal currents that race through Seymour Narrows. Small craft have capsized in the whirlpools and large ships are pulled off their courses.

The condition is so dangerous that most ships wait for slack tide at each end of the strait like cars on Main Street waiting for a green light. Then they have 20 to 40 minutes to make their way through the two-mile-long Narrows and past the rock. Even so, strong winds can still drive a ship perilously close to the submerged peaks.

It is estimated that since 1875 some 14 large ships have been lost or damaged on Ripple Rock, in addition to well over 100

smaller craft, with a loss of 114 lives. Delays by vessels waiting for slack water in the Narrows have been estimated as amounting to millions of hours per year.

Engineers have tried to blast the tops off the pinnacles without success. In one case the fast currents snapped the anchor cables holding the drilling barge almost as fast as they could be replaced. In another attempt it was found impossible to drill shot holes because of the pitching and swaying of the barge in the turbulent water.

In an all-out attack to end the menace once and for all the Canadian Department of Public Works is financing a new idea. A 500-foot shaft is to be sunk on an adjoining island and a 2370-foot tunnel will be run under the channel to a point beneath Ripple Rock. The miners will then drill upward from two locations and will excavate numerous small chambers under each of the two pinnacles. The spaces will be packed with a total of 750 tons of high explosive. The resulting blast is expected to blow off the top 75 feet of each peak.

Two construction firms have united to perform the \$2,639,000 job. The big blast, and the final taming of Seymour Narrows, are scheduled to take place in late 1957 or early 1958.

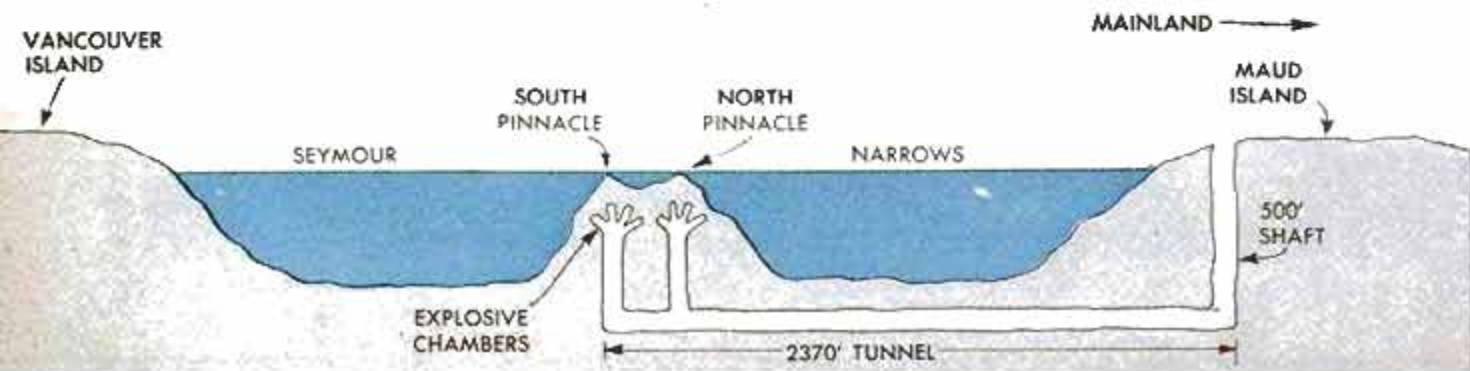

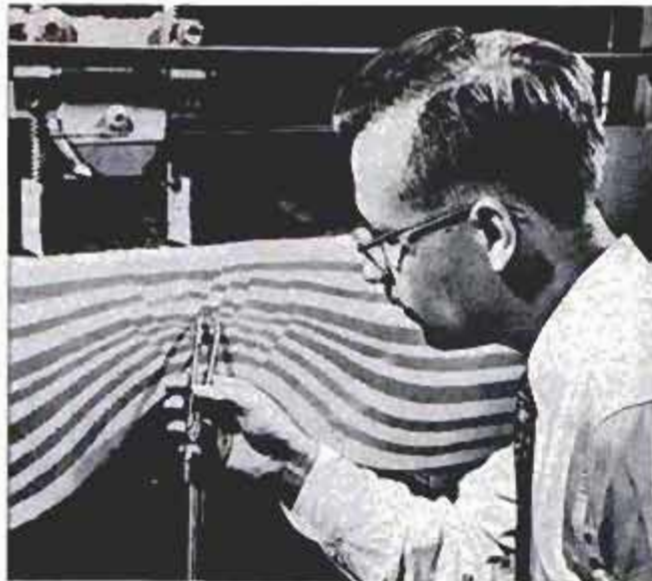

Machine Re-Creates History To Aid Prospecting for Oil

Geologists of the Gulf Oil Corporation, trying to learn more about where the earth has hidden its oil, have built a machine which re-creates the passage of 200,000,000 years in the earth's crust. A hopper deposits clay in a glass case to simulate sand and rock strata. Then a mechanical salt dome bears against the bottom of these formations, just as it happened under the earth's surface. A salt dome is salt deposited by an ancient sea which is forced upward by the pressure of heavier rocks around it. The salt-dome action causes the model's strata of clays to fracture, creating structural traps. Such traps may catch and hold oil, and so are a major goal of oil prospectors. Already the model has shown faults at an unsuspected distance from the dome that caused them, giving new clues about where to search for oil.



Folding Clothes Drier Has No Moving Parts

Warm air currents, induced by heating elements in the side of a fold-out cabinet, dry laundry without the use of moving parts. A load from a small washing machine can be placed on the nine rails of the compact drier, which folds to a size of 18 by 36 by 3¾ inches for carrying. The three sides of the extended unit are made of plastic sheeting. The unit, made in England, shuts off automatically when folded. A red light indicates that it is turned on.

German Snack Boat Brings Refreshments Right to Boaters

Midstream delivery service for swimmers and boaters is the specialty of this floating snack bar in West Berlin's Havel River. A boatowner with an eye for business sails up and down the river selling

food, coffee, cigarettes and other items that people on an outing might want. To get what they crave, the sport fans need do no more than hail the passing snack boat, and they get immediate delivery.

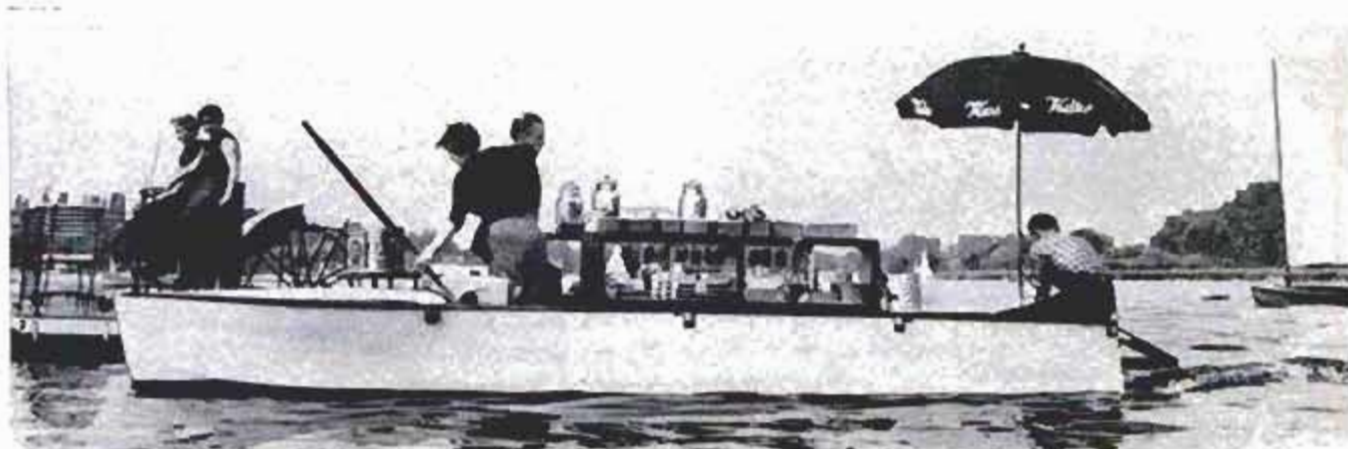

WHAT'S NEW FOR Your Home



1. WATER-PRESSURE SYSTEM is enclosed in a gleaming kitchen cabinet. A jet pump driven by an electric motor mounted on the 12-gallon tank delivers



up to 760 gallons of water per hour. The unit acts as the sole pump to draw water directly from a 25 to 80-foot well. Gauge, switches mount on control panel
Clayton Mark Co., 1000 Deming St., Evanston, Ill.

2. PORTABLE MIXER also serves as knife sharpener. Sharpener, concealed by a snap-in cover, is ready for use as soon as mixing blades are removed. Steel guides hold the blade at correct angle for honing. Mixer has three speeds, chrome-steel blades
Steam-O-Matic Corp., 6618 E. 37th St., Kansas City 41, Mo.

3. MOWER that combines the features of rotary and reel types has multiple overlapping blades that revolve at 5000 revolutions per minute. Each stem is cut by impact from the top down. Grass is chopped into a fine mulch. Cover stops flying sticks, stones
Henderson Mfg. Co., Fisher, Ill.



4. VERTICAL BROILER for electric ranges cooks both sides of meat at same time. Searing action like charcoal broiler seals in juices and preserves flavor. Grease drains off quickly into lower pan, practically eliminating smoke. Distance between heating elements and meat rack is controlled by turn of a knob. Broiler fits old and new models of maker's range line

Gibson Refrigerator Co., Greenville, Mich.

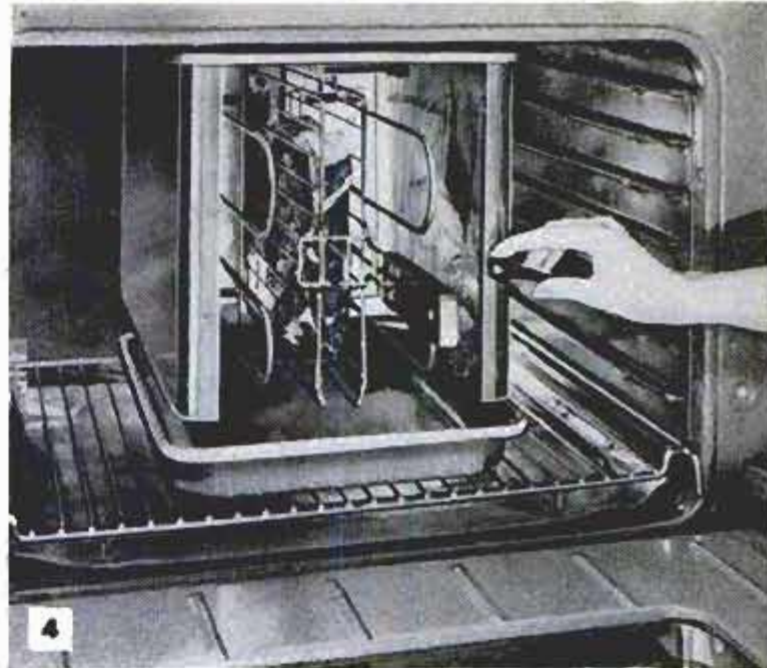

5. FOLDING PICNIC TABLE made from kit collapses in minutes for storage. Lumber is furnished by customer. Wrought-iron legs and supports are attached to a table top of any desired length from four to eight feet. When the legs are unfolded, seat boards hook into place. The legs are "ski type" that will slide across the lawn easily when table is moved during mowing

Belson Mfg. Co., East River Rd., North Aurora, Ill.

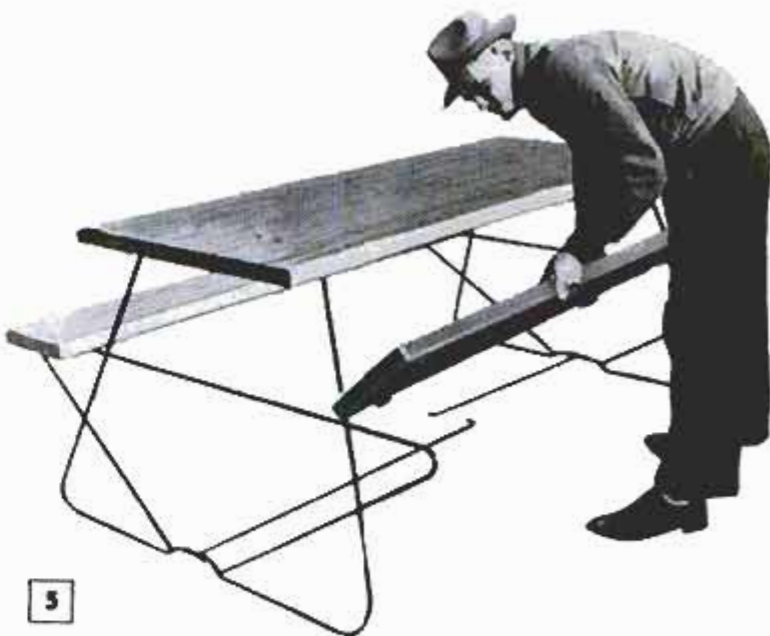

6. UTILITY STOOL has steps on all four sides. Circular bracings for the legs are actually the steps on which the user climbs. Eight nonskid treads insure safe stepping while flaring legs provide wide, sturdy base. Rubber-tipped feet don't mark floors. The stool can also be used as an accessory furniture piece on porches and patios to hold flowerpots or magazines

Trembo Products Div., 1517 St. Clair Ave., Cleveland 14, Ohio

7. INTERCOM for homes ends necessity of opening door to talk to strangers. The electronic unit is designed for two-way communication between any central point in the house and both front and rear doors. Its warm-up time is two seconds, according to the manufacturer. Weatherproof outside unit is built into exterior wall. Master unit is either built-in or surface-mounted

Republic Electronic Industries Corp., 31 W. 27th St., New York City





Meter Figures Phone Charges

Cost of long-distance calls can be computed on a meter built into this West German telephone. The meter is installed just below the dial. Meters made their appearance along with West German long-distance dialing.



Road Map in Compact Holder Shows One Section at a Time

Fighting a cumbersome road map isn't necessary when you have a map contained in a small frame. Pressing side levers brings different sections of the country into view. You can outline your route with crayon on the map's transparent cover.

Rain Meter Triggers Alarm to Awaken Municipal Pump Operator

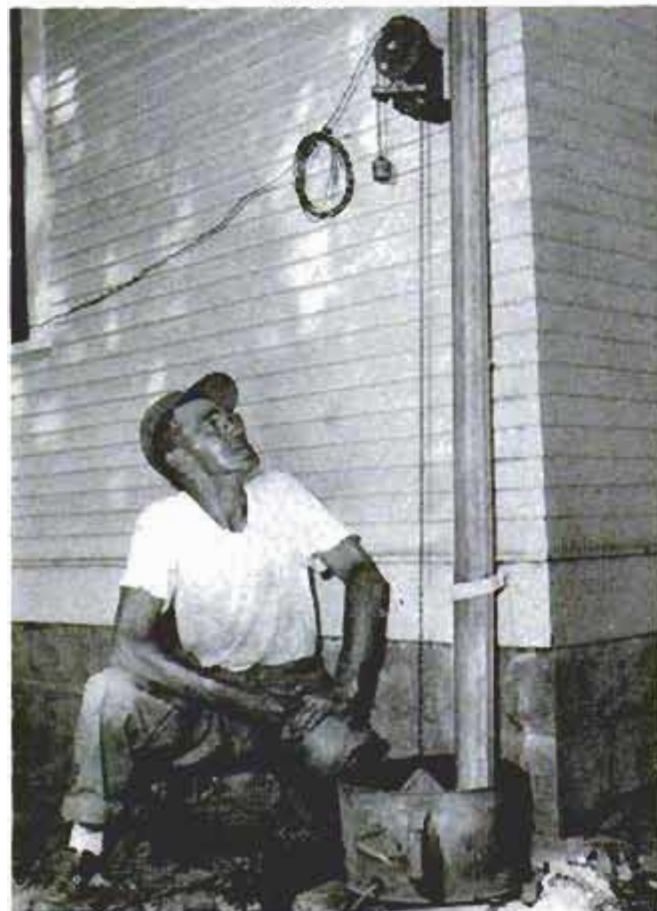

Rainfall triggers a homemade alarm built by Walter Gibler of Council Bluffs, Iowa. Gibler, pump operator at the municipal sewage lift station, must be awakened at night when rain threatens to overload automatic operation of the lift station. Heart of the device is an old float switch salvaged from a discarded automatic pump. Gibler has placed the float bulb in a pan under a house-roof downspout. When runoff accumulates to six inches in the pan, the float bulb trips the switch and rings a doorbell in the Gibler bedroom. The six-inch water depth means a general rain of at least $\frac{1}{4}$ inch, sufficient to require auxiliary pumping at the lift station, which raises all runoff and sanitary sewage 7.8 feet to provide a gravity flow to outlets in the Missouri River.

Feed Detergent to Turkeys

Detergent added to the feed of turkeys enables them to digest whole grain more easily, a study has found. When a trace of the washing compound was added to the feed of 235 birds, they gained more weight on less feed. No toxic effects were noted.

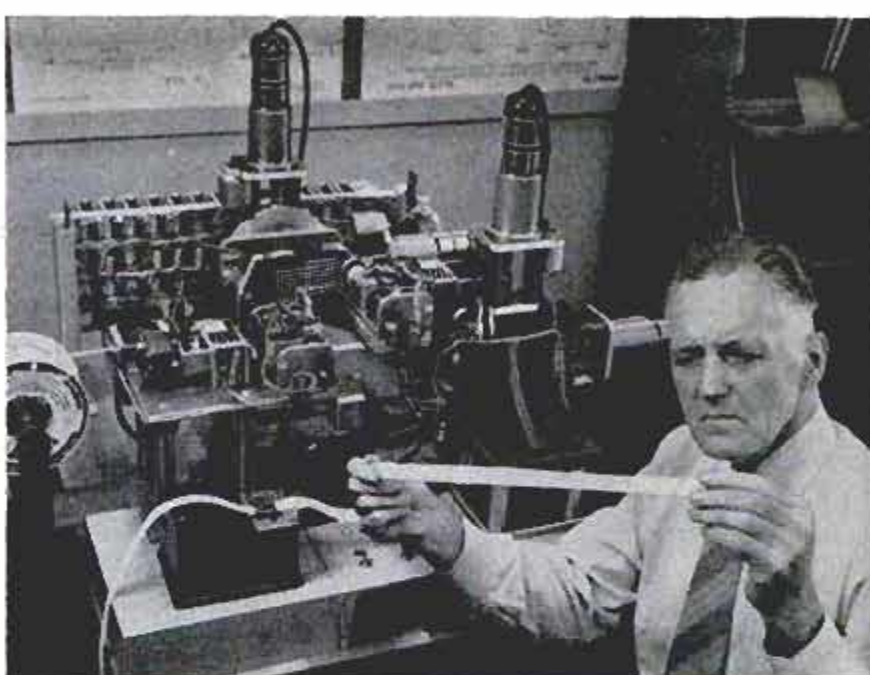
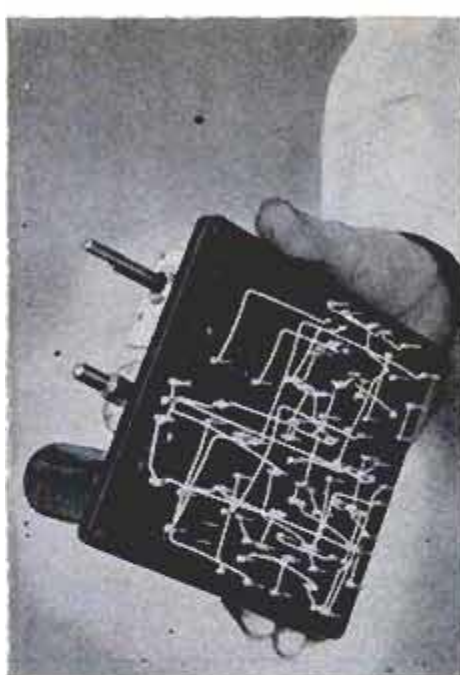

All electrical connections for radio receiver are made by automatic machine, which follows punched tape

Complex electrical apparatus is wired by a machine that follows directions indicated on punched tape. The experimental machine, developed at Bell Telephone Laboratories, uses two spindles to make solderless connections. One spindle draws wire from a large spool to a connecting terminal. A second spindle cuts

Automatic Wiring Machine

the wire to the correct length. The spindles remove insulation from each end of the wire as they whip the bare wire ends around the rectangular terminals. The process is then repeated at the next terminal. The machine can be used with similar plastic panels on which are different tubes, resistors and other electrical components.

Hangers Grip Ceiling Beams to Support Maintenance Scaffolds

Scaffolds for painting and other maintenance work can be hung from ceiling beams with a new kind of support. The unit hooks around the lower flange of a steel beam with a tonglike clamp and has a 14-inch stirrup to hold planks or metal catwalks.

Provision is made for bracing and guard rails. The length of a unit is adjusted from 6 to 11 feet with a pin inserted through the telescoping steel tubing. The hangers are most valuable where machinery or other obstructions rule out standard scaffolds.

Hanger clamps flange in viselike grip. Pin holds adjusted position. Series of hangers support catwalks



What's New in Boating



ALL OVER the land, boat lovers, who have been going around all winter with that faraway gleam in the eye, have popped to life. For the past two months, since the boat shows closed, you could hardly hear yourself think, for the sound of hulls being scraped and varnish being swished on. And now, with "*Little Lulu III*" all gleaming and shipshape, Mr. Boat Lover is out on the water churning a wake.

Boating is rapidly becoming the largest outdoor sport in the nation, and a lot of new items have been added to it since Mr. B. L. put *Lulu* away last fall—things that will add to his enjoyment. And there are some unusual boats just out which might tempt him, too. On these pages we present a quick roundup of the newer boats and accessories to bring Mr. B. L. up-to-date. ★ ★ ★



Racing at the top of the opposite page are two self-propelled, unsinkable aquaplanes. With an outboard motor in bow, each glass-fiber boat weighs 155 lbs.
Luria-Cournand, Inc., Havre de Grace, Md.

Above, for ski-minded fans, a single-cockpit boat with storage facilities for skis, gas tanks and gear under aft deck—and towing eyes on transom
Feather Craft Inc., 450 Bishop St., NW, Atlanta, Ga.

Skier at bottom of opposite page soon will be skimming over the water behind a new 33-horsepower motor with a unique tow ring that makes steering easier
Scott-Atwater Mfg. Co., 2901 E. Hennepin Ave., Minneapolis, Minn.

Below, a houseboat that's at home in water and on the road. Sleeping four, it's 26 feet long and 8 feet in beam, with wheels that retract into the hull
Neptuna Corp., 723 Sonora St., Glendale, Calif.

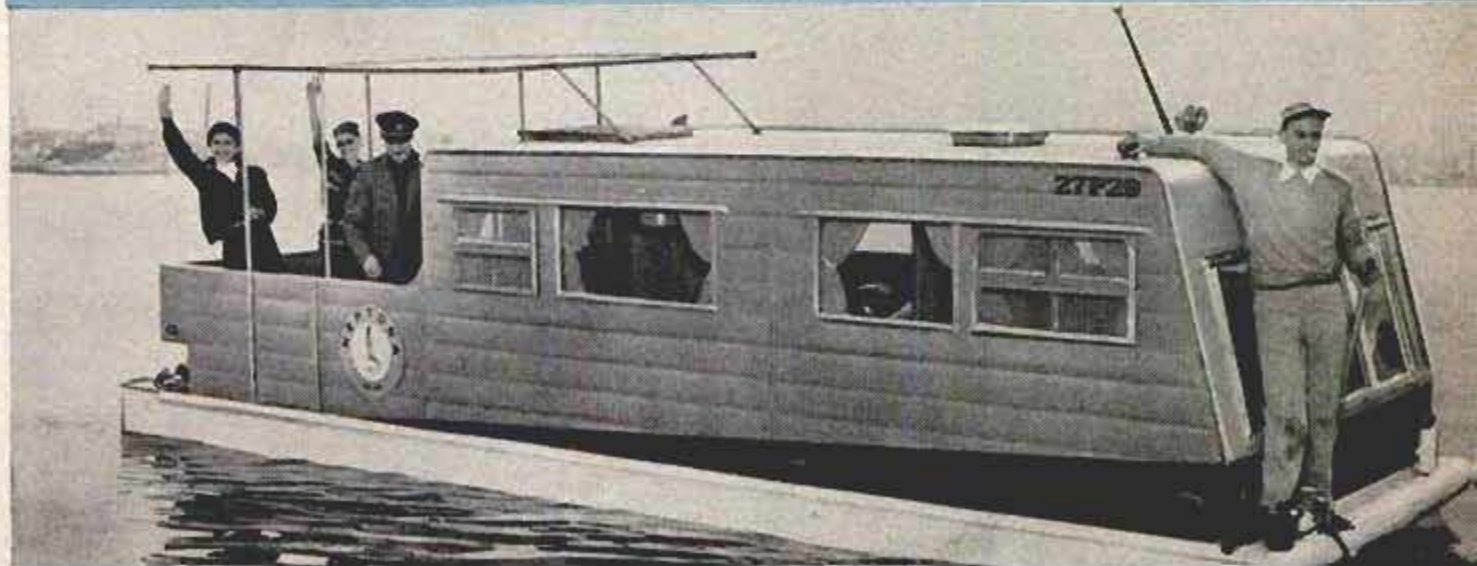
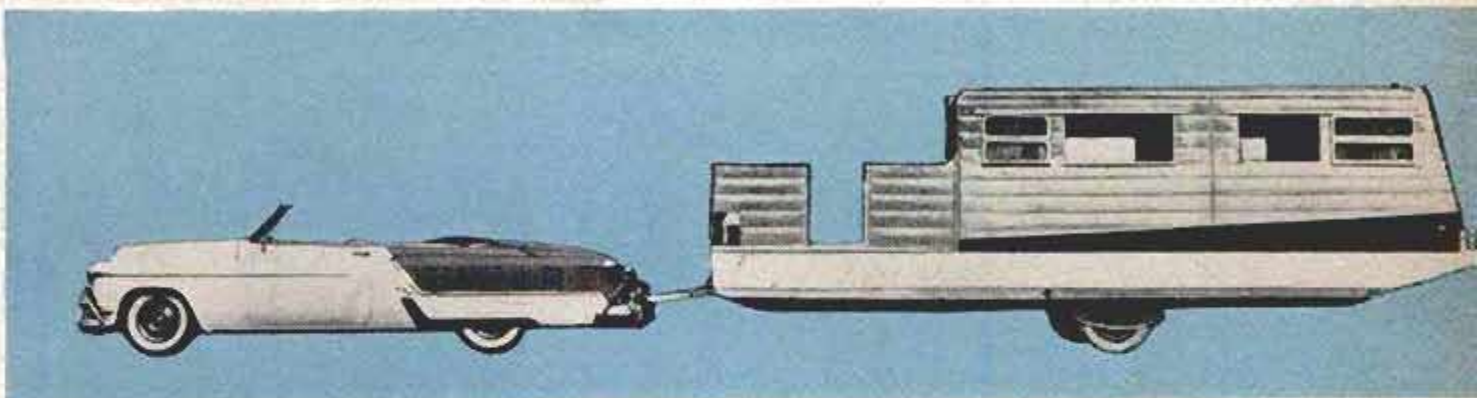



Houseboating goes as modern as tomorrow's ranch home in this twin-hulled 44-foot job. Powered by two 100-horsepower engines, it has everything including hot and cold running water. Even air conditioning is available. Interior has bathroom with shower, a modern galley, stateroom and lounge

Falls City Flying Service, Inc.,
Bowman Field, Louisville, Ky.

Biggest sailboat ever made with a glass-fiber-reinforced hull is the 42-foot auxiliary ketch, *Arpege*. Thin shell of mahogany veneer placed over forms shaped the boat and was covered with 19 layers of plastic-impregnated glass-fiber cloth. The 16-ton boat was built for scientific expedition in the Pacific

Luria-Courmand, Inc., Havre de Grace, Md.

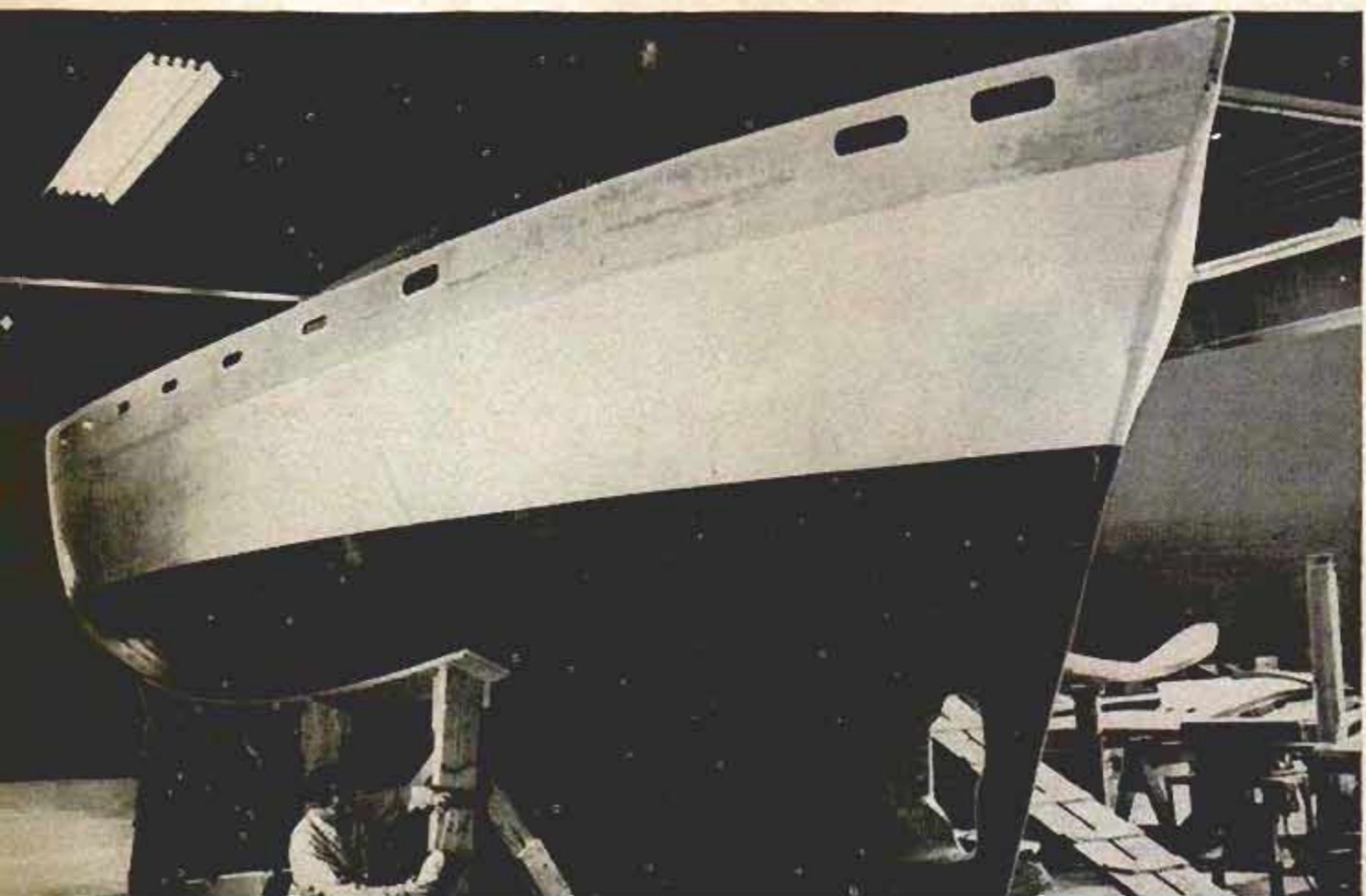

Completely transparent 8-foot plastic pram brought out as a tender for larger boats can be rowed easily or powered by an outboard motor up to three horsepower. Handles easily to make it an excellent boat in which youngsters can learn

Sudbury Laboratories,
South Sudbury, Mass.

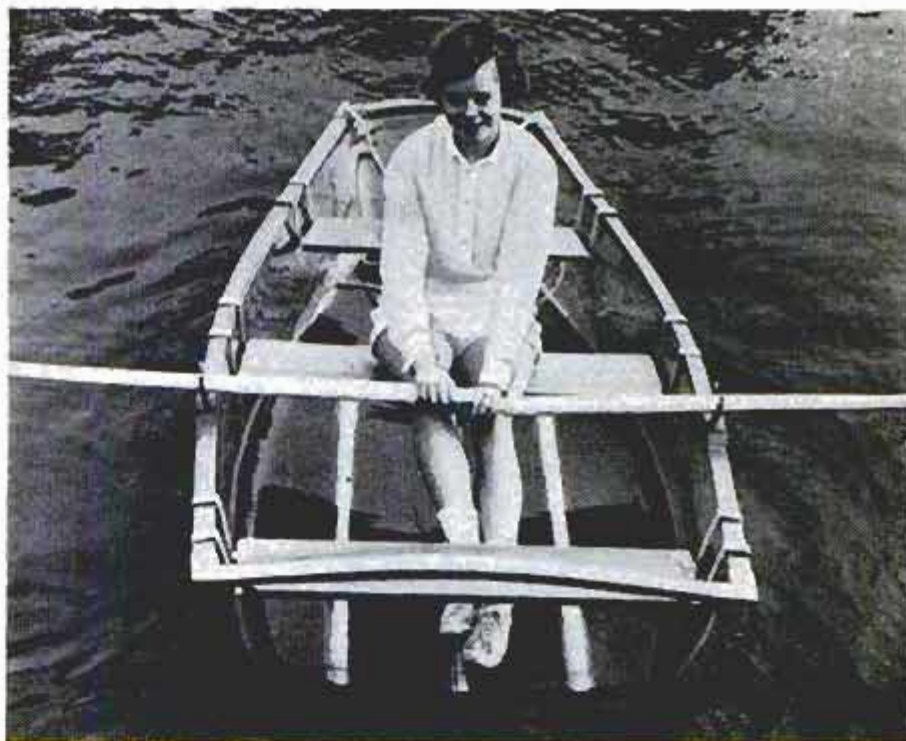

Even the old life preserver has been modernized. This one, 20 inches in diameter, is of molded plastic foam which will not absorb water, covered with glass-fiber cloth and plastic. Built right in are flare guns, a dye marker and lines for lashing

Surface Coating Engineers,
211 Woodward Ave.,
Kalamazoo, Mich.

For the boating enthusiast who wants the convenience of remote steering by wheel, there is a kit which employs automotive steering principles and eliminates tiller ropes. Aimed at the outboard owner, kit is adaptable to all craft regardless of size

Gemmer Mfg. Co.,
6400 Mt. Elliot St.,
Detroit 11, Mich.

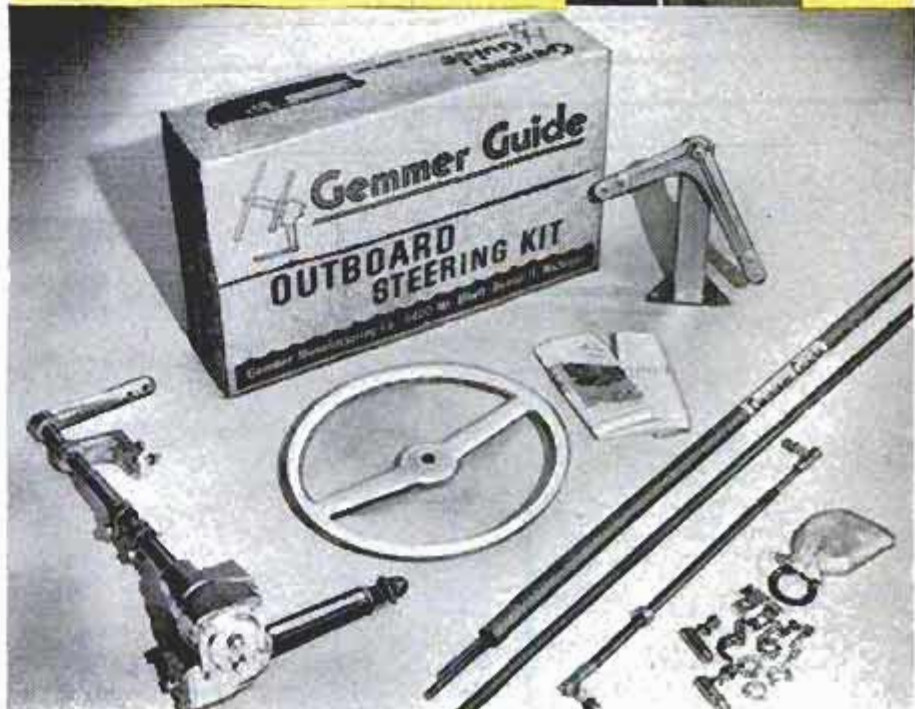

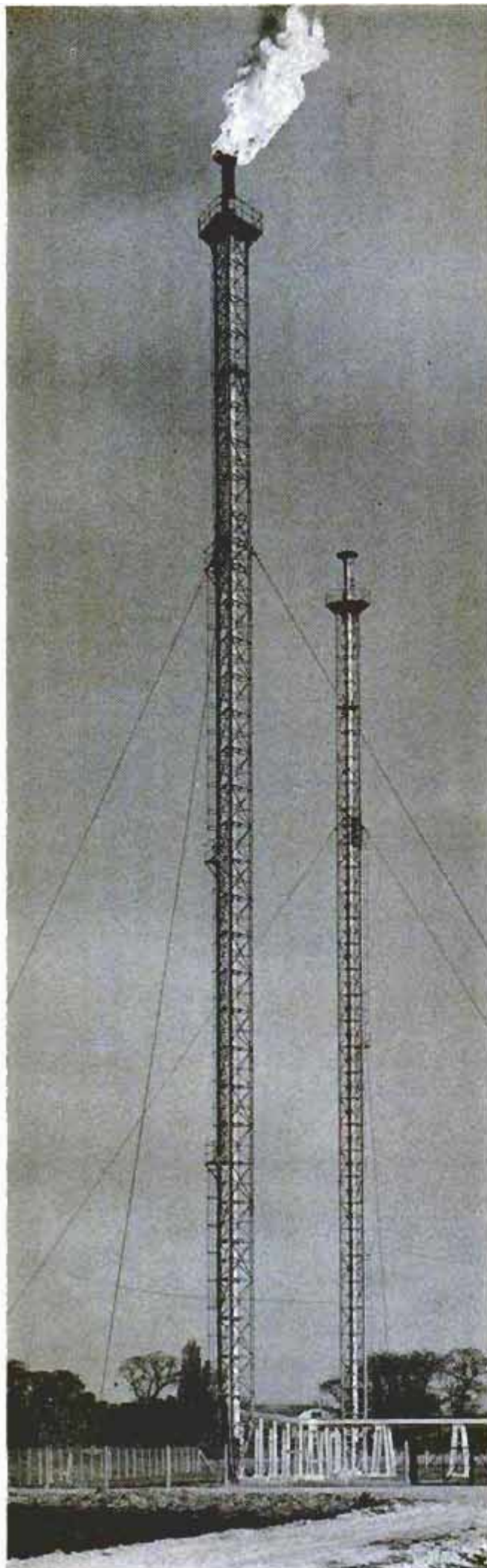

Workman inserts two-inch-thick steel ball into the base plate. Ball acts as rocker bearing between the recessed plates of the mast base and the foundation

Tower Balanced on a Ball

Rigid, 250-foot-tower stacks erected on marshy ground in Wales are each balanced on a steel ball only two inches in diameter. The ball, set between the recessed plates of mast base and foundation, acts as a rocker bearing. Three guy wires keep the 21-ton structure upright, but allow it to sway up to 2½ feet from a vertical position in a 75-mile-per-hour wind. Waste gases from an oil refinery flow up the stacks and are burned as they exit.

Plant Breeding Speeded

Disease-resistant plant strains can be developed in a hurry by using a method perfected at Louisiana State University. A poisonous toxin that acts like the disease itself is used to inoculate the seed. The few seedlings that are not knocked out by the inoculation form the basis for a disease-resistant strain. The method, first used with oats, shortens development time from 15 years to one year. Under old methods, wild varieties had to be crossed and recrossed to develop an entirely new variety that might be resistant to a disease.

☛By turning a key on the dashboard, the owner of a Cadillac can automatically close and lock the trunk by remote control.

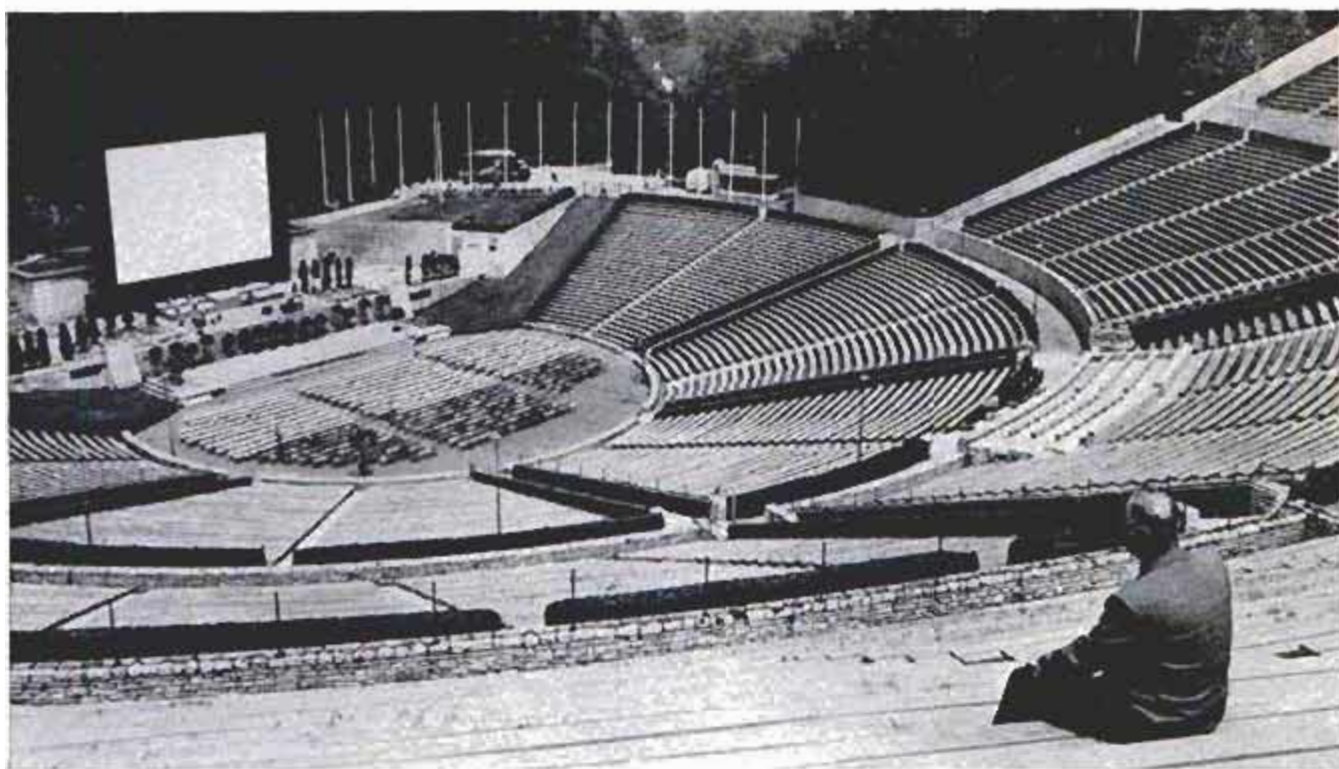

Open-Air Movie Theater in Berlin Seats 25,000 Spectators

One of the largest movie theaters in the world is the *Waldbühne*, an open-air amphitheater in Berlin that seats 25,000. It was the site of the Berlin Film Festival. The

powerful projector used must be cooled by compressed air. The cinema screen is made of linen. This year, it is expected, the theater will be equipped with Cinemascope.

Improved X-Ray Tube Takes High-Speed Pictures

X-ray pictures at speeds up to $\frac{1}{1000}$ second are now possible using an ultrashort-exposure tube developed at the University of Oregon Medical School under the direction of Dr. Charles T. Dotter. The maximum speed previously possible was $\frac{1}{120}$ second. Because of the high speed of the tube, specific information about the rapid and involuntary movements of the heart can now be obtained, and it will be of help in heart-surgery cases. The detail in the ultrashort-exposure films is superior to the slower, older types and all blurring is eliminated.



Dog Seat for Cars

Fido can now ride in comfort when you take him on automobile trips, sitting in his foam-rubber padded seat. The seat is actually an open-top metal crate intended for use on the car's front seat. Measuring 8 by 14 by 18 inches, it folds for storage and can be adjusted for height. The seat is held in place by two long handles which attach to the back of the car seat.



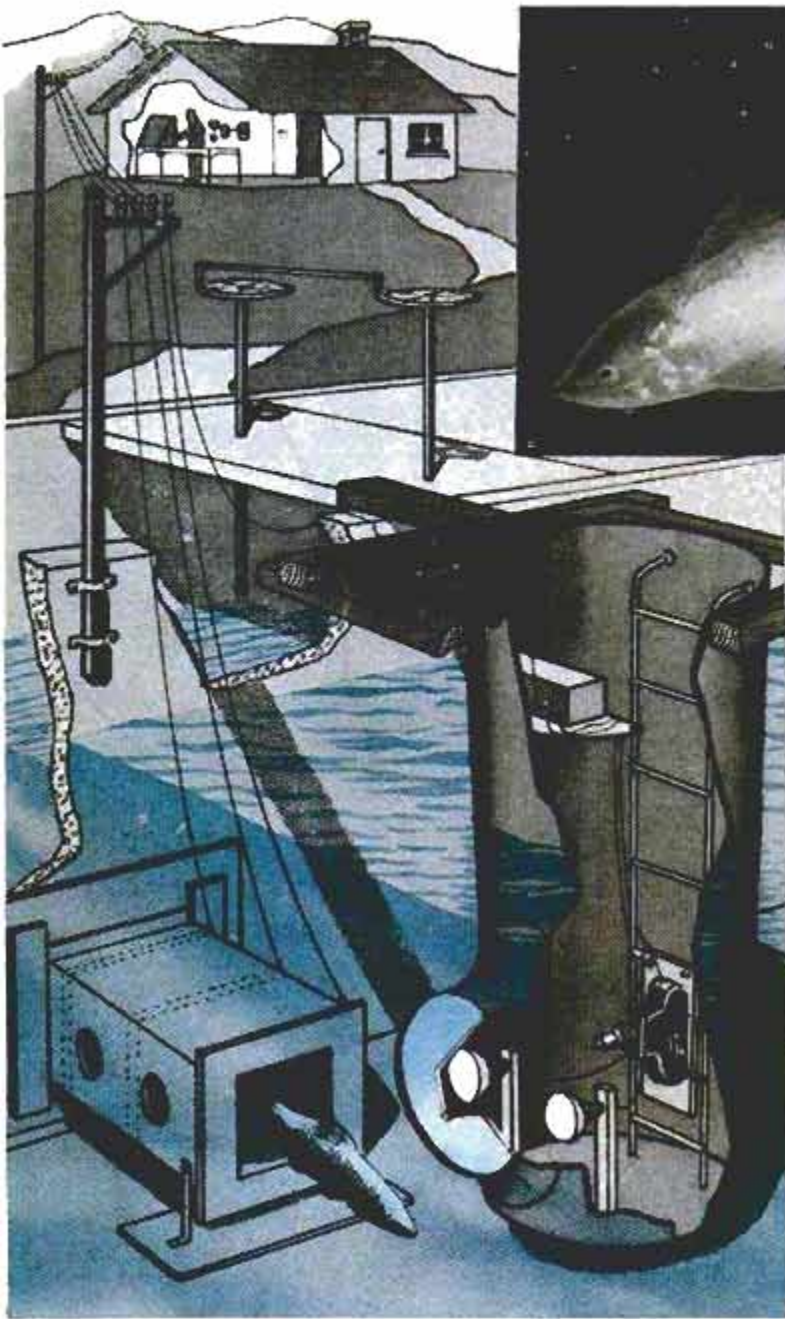

Fish Snap Candid Photos While Swimming Locks

FISH ARE SNAPPING photographs of themselves at Ballard Locks near Seattle, Wash. A concrete and steel cylinder has been installed in the locks with the top barely clearing the water. Near the bottom of the cylinder is a window, and inside is a 16-mm. camera and lighting equipment. Fish swim through a boxlike arrangement in the locks. Having greater electrical conductivity than water, they trigger an "electronic bridge," causing the camera to snap a photo. About 2000 fish can be photographed on a single 50-foot roll of film. The equipment is set up to photograph only the large fish, not the many small fry. A passing fish also flashes a count of itself to a laboratory nearby. The equipment gives scientists a record of the numbers, size, species and sex of fish in the Pacific Coast area.

As fish passes through opening, it triggers camera and lights. Above right is a photograph taken by the camera. Below, fish also flashes signal to this counting equipment in the laboratory. Below right, tank is swung into position in locks

U.S. Fish and Wildlife Service photos



Revolving Work Platform Tops Railroad Car

Trouble shooters fixing trolley lines on the German Federal Railway stand on a revolving bridge that's mounted on a diesel-electric car. The bridge can be turned, lowered or raised hydraulically. The men get their instructions via walkie-talkies. Twenty of the cars, furnished with tools and able to travel even when power lines are dead, will be put into service in the Ruhr district.

Silence Jet's Roar With Large Sieve

Jet aircraft may be quieted in the near future by a sievelike silencer which can be turned on or off by the pilot at will. The silencer changes the low roar to a high-pitched hiss, and much of the sound is transferred beyond the range of human hearing. The pitch of the sound is raised by forcing the gases through many tiny holes instead of one large opening. The device is designed to be used when landing, taking off and idling, and to be turned off in high flight. During flight, the silencer is stowed like a collapsible drinking cup.



International Airstrip Straddles Border

Straddling the United States-Canadian border at a point 18 miles north of Scobey, Mont., is the only airfield in the world that crosses an international boundary. It is a landing strip 120 feet wide, dedicated in June of 1955 and built to serve the residents of the area, flying farmers and ranchers who find the airplane an important means of transportation. Customs stations for both the United States and Canada are located on the strip. Funds for its construction were furnished by the Montana Pilots Association, the county and the state aeronautics commission.

☐ Contaminated water can be sterilized economically by exposure to ultraviolet radiation from powerful bactericidal lamps, according to Dr. Rudolph Nagy of Westinghouse Lamp Division Research Department.

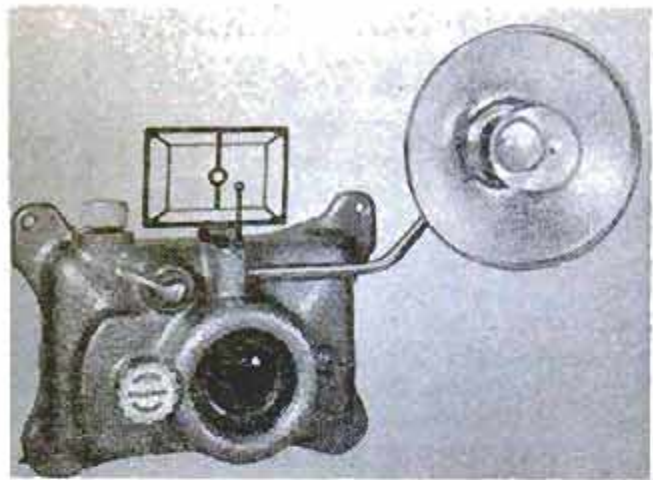

Watertight flash unit on underwater camera case permits taking color pictures far below the sea

Underwater Camera Case

Skin-diving photographers can enclose a Leica or similar 35-millimeter camera in a watertight case that protects it at a depth of 200 feet. Full external control is provided, and the watertight flash unit permits taking color pictures. The case is made in England.

Physicists Create Rare Minerals With Heat and Pressure

Rare minerals have been created at U.C.L.A.'s Institute of Geophysics by duplicating conditions that form minerals deep in the earth's crust. Temperatures as high as 1800 degrees Fahrenheit combined with pressures up to 1,200,000 pounds per square inch do the job. Jade has been

created from feldspar, aragonite from limestone and various dense aluminous minerals from ordinary clay. Coesite, a dense mineral occurring 40 miles or more below the earth's crust, was made from common quartz. A laboratory device called the "simple squeezer" was used in the tests.

Vertical Cutting Knives Boost Capacity of Forage Harvester

Vertical cutting knives and feed rolls permit a new forage harvester to handle large capacities efficiently. The vertical arrangement reduces the distance of crop travel between knife and blower. Feed rolls and

cutting knives are powered through universal joints. The harvester has attachments for field-chopping corn and other row crops, windrowed hay or straw and standing hay or grass.

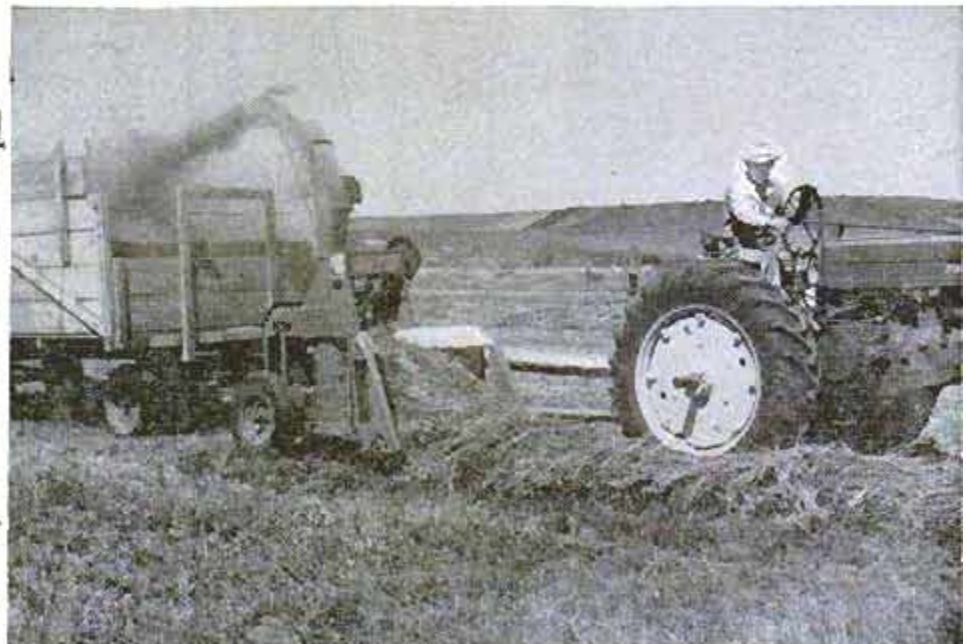
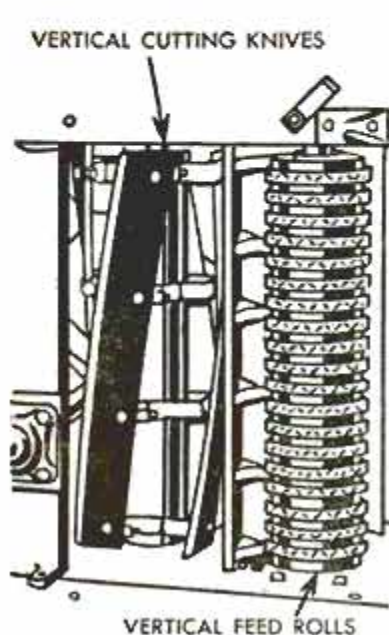

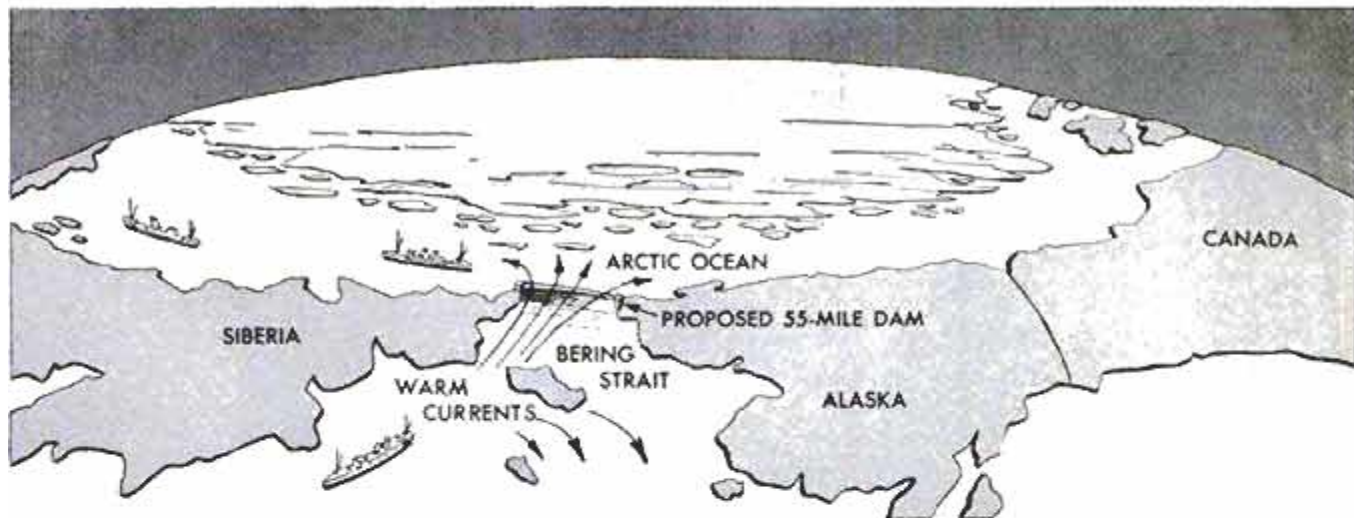

Ocean Dams Would Thaw North

TWO PROJECTS proposed by Soviet scientists would divert ocean currents to warm the frigid North. One of these would be a 55-mile dam connecting Siberia with Alaska. The other would be a five-mile causeway between Siberia and Sakhalin.

The Siberia-Alaska dam would keep icebergs and arctic currents out of the Pacific. Warm southern currents would sweep unchecked up the eastern shore of Siberia and down the western coast of North America. In addition, warm Pacific water would be pumped into the Arctic Ocean to change the frozen North into a blossoming landscape. A 2,000,000-kilowatt atomic power station would drive this artificial "Gulf Stream." By breaking the grip of the Arctic Sea over Siberia and Canada, the Russians say, the development would transform the climate of Northern Asia, America and northeast Europe.

American experts believe that the dam, which would have a maximum depth of 200 feet, could be built at immense cost, but would not be practicable.

The five-mile causeway across the Tatar Strait would join Siberia and Sakhalin Island to block cold currents which flow south from the Sea of Okhotsk into the Sea of Japan. Only the warm waters of the so-called Black Current would circulate in this body of water. It is claimed this would raise the temperature of the Sea of Japan some 35 degrees and warm the entire four main islands of Japan, Korea and the coast of Siberia bordering on the Sea of Japan. The causeway, according to Prof. B. A. Wasil of the Illinois Institute of Technology, would be no longer than many dams and causeways already built. Only 13 to 29½ feet deep, it would take two years to build and could be designed to resist the flow of ice. The project has long been dreamed

Proposed 55-mile dam across Bering Strait would stop icebergs and cold currents from entering Pacific, allow warm currents to flow unhindered along coasts

Proposed five-mile causeway across the Tatar Strait would block cold currents that now flow down into Sea of Japan. Surrounding land would be warmed



of, and the idea does not belong solely to the Russians.

On the other hand, qualified American scientists believe that the proposed Bering Strait dam is a project in which there is no sincere interest on the part of any of the nations involved, and that the Soviet scientists have publicized the possibility of this dam on various occasions merely for propaganda purposes.



Glenn Winnie, sponsor of the mechanics' club, watches the boys do a tuneup. He is second from the right

TEEN-AGE MECHANICS

By Edward Janicki

Not all the work is on recent models. Here, a club member loosens the cables before he takes out the battery of this Model A Ford



THEY KEEP late hours at the Higgins Garage in Ferndale, Mich., on Mondays, sometimes past midnight, although the place closes at 6 p.m. It's not that there is so much repair business, nor is it the night for the weekly poker party. It's the night a bunch of boys—some 80 of them—get together to fix their cars.

The youngsters are members of the Teen-Age Mechanics Club, a group of boys, ranging in age from 14 to 18, who like to tinker with automobiles. They're not a hot-rod club. They are boys who own their own cars and want to learn how to repair them, to improve them and to make them safer.

Organized by Glenn Winnie, a car salesman for Higgins, the club is now in its fourth year. Winnie got the idea for the club one night during a Parent-Teachers-Students Association meeting in Ferndale. "Why can't we have a mechanics' club?" asked one youngster.



When the boys get in too deep and need help, the mechanics of the garage are available for professional advice

Winnie, father of four teen-age boys himself, took it from there, asked his boss, George Higgins, if he could use the garage one night a week. Higgins liked the idea, even donated a few dollars so the boys could buy some tools. The local Kiwanis club contributed 25 uniforms.

The boys now work with their own hand tools, paid for out of weekly dues of 25 cents a meeting. Higgins allows the boys to use the heavier equipment in the garage, such as welding torches, hoists, jacks and testing equipment. He says that in the three years the club has been in operation, none of his equipment has been damaged, and none of the hundreds of small hand tools owned by the garage have ever been touched.

As can be expected of youngsters working with tools, there have been a couple of casualties. One youngster caught his finger in a car door; another "welded" a finger, but was back the following Monday eager to work on his car.

"We stress front-end and brake work," Winnie says. "And when these kids work on their cars they respect them. They drive more carefully than they otherwise would." The club has been lauded by various civic organizations and the police, and letters from as far away as Texas come in inquiring about it.

There's more to mechanics than repairs. The club members learn to grease and do other maintenance





Complete overhauls are part of the program. These members are pulling a flathead V8 before tearing it down



Left, occasionally the shop teacher from the local high school (at left in photo) stops in to advise

Winnie himself supervises the club each Monday. Periodic meetings are held to discuss problems and purchase of tools. Occasionally a local high-school instructor of mechanics stops in to give Winnie and the youngsters a hand. A local automotive company donated a '53 Buick engine for the boys to experiment on.

The club not only keeps the youngsters out of mischief but is providing a stepping stone for some of them toward their ambitions. At least 15 of the boys are planning to become automobile engineers.

The boys are pledged to help anyone on the highway who is having auto trouble and all refuse remuneration for their services. One boy, who recently helped a motorist in distress, was offered \$5. He turned it down, handed the motorist a card which read "We enjoy extending this courtesy to you as members of the Higgins Teen-Age Mechanics Club." On the other side the motorist read: "If appreciated, please drop us a card to let us know." There have been scores of grateful letters from motorists.

Activities are not limited to the club. Winnie occasionally takes the boys to local auto shows and on trips through automobile assembly plants. Where do they get the money? Winnie and Higgins help out. The boys had \$300 in the bank several months ago, but had to buy special tools, such as torque wrenches and reamers. ★ ★ ★

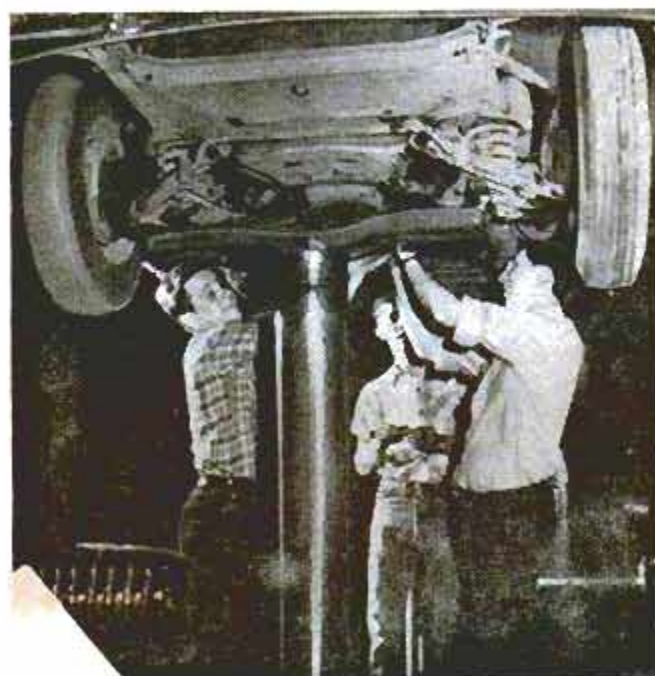

Thanks to the cooperating garage owner, members are furnished items like this lift and a welding outfit

Vacuum Cleaner Turns Lifesaver

During emergencies in the future, a housewife may pull out her vacuum-cleaner attachments, take out the resuscitator and save a life. The Air Force Medical Service has developed a vacuum-cleaner attachment that produces breathing cycles at any desired rate for an insensible person. As the person begins to breathe manually, the resuscitator adjusts itself to his own rate of respiration. One vacuum cleaner running on power from a disaster truck can keep seven persons breathing at once.



Lounge Chair Folds Into Case

You can carry a new lightweight, folding lounge chair in a small carrying case that is slung from the shoulder. The sturdy aluminum frame of the chair adjusts to two sitting positions and folds easily and compactly for carrying. The seat is made of water-repellent duck or of woven plastic that can easily be cleaned with a moistened cloth. The chair is designed for travelers and bathers.

Old Truck Top Serves as Boat

Dubliner Joe Acton has found the perfect use for an abandoned truck top. He's turned it upside down, installed a five-horsepower outboard motor, and now scoots up and down the river at a top speed of 16 miles per hour. The craft, which "will almost stand on its nose," came from the surplus-parts pile of Acton's automotive shop.

Joe Acton executes sharp turn as he displays the maneuverability of craft





Cab Riders Take a Number

People arriving by train in Philadelphia no longer have to scramble madly to find a taxi since one of the city's cab companies has installed a machine which issues numbered checks. The passenger takes his number, waits until it is called over a loudspeaker, and then gets into the appointed cab. The system was tested for a year to make sure of approval by the public before permanent installation.



Patient Helps Self to Pain Relief

Take a deep breath and say good-bye to aches and pains. You won't notice the drill in your tooth, the knife lancing an infection or pain from any minor operation. A new rubber mask and cylinder, holding half an ounce of a recently developed drug called Trilene, does the trick. It is attached to the patient's wrist, and he applies the drug himself when he feels pain. After a few whiffs, the pain subsides. If the patient gets enough Trilene to become unconscious, his hand goes limp and the mask falls away. The inhaler was designed by Dr. C. R. Stephen of Duke University Hospital and George Newton of the University's Research Laboratory.

Tiny Prompter for Speakers Unreels Magnified Script



Busy executives can now give speeches aided by a midget version of TV's Teleprompter. The portable, electromechanical unit measures only 11½ by 8½ by 5½ inches and fits into an attached case. The case and unit together weigh less than 19 pounds. The text or notes that appear on the prompter are previously prepared on a special translucent sheet fastened to the roll. The roll, holding an hour-long speech, can be loaded into a prompter as easily as film in a camera. A hand control governs the speed at which the speech notes move across the screen.

550 New Drugs in One Year

The research firm of Arthur D. Little, Inc., reports that more than two thirds of the drugs prescribed today did not exist 10 years ago. In 1900, it was considered progress if one valuable medical substance was discovered in 25 years; last year about 550 new pharmaceuticals were introduced.

KEEPING UP WITH THE ATOM

NAVIES ALL OVER the world, thanks to the atom, may be experiencing the most convulsive change in naval design since the first fleet took to the high seas.

Here's some of the latest scuttlebutt concerning the seagoing atom.

Less than a year ago the success of the nuclear-powered submarine was a matter of speculation. Now Rear Adm. H. G. Rickover, who fought for the *Nautilus*, flatly predicts that all major naval ships started after 1960 will be powered by reactors.

Already the *Nautilus* is outmoded by submarines either under construction or in the planning stage. The *Sea Wolf*, the second atomic sub, will slip away on its shake-down cruise later this year. And another new sub undoubtedly will make naval history. It will be powered by two reactors instead of one, and will sport a teardrop-shaped hull. Half a dozen other nuclear subs are in the planning stage.

The atom also is finding its way into the hulls of surface ships. A light cruiser powered by multiple reactors and designed to fire guided missiles likely will be sailing the high seas by 1959. And it now appears that the first nuclear-powered aircraft carrier will be finished sometime in 1961. According to Adm. Arleigh Burke, this ship will be about as big as the USS *Forrestal*, though quite different in appearance as it will have no stacks and will boast two separate island superstructures.

Biggest challenge to naval designers right now is to shoehorn a reactor into the cramped hull of a destroyer. Another problem is the design of the first nuclear-powered naval plane. Five different companies are now working for the Navy on this project. As a matter of fact, naval men predict the first atomic plane will be a seaplane.

The goal, of course, is to rebuild the Navy from the keel up into a high-speed atomic-powered striking force that will not suffer the drag of today's slow-moving tankers.

This country naturally has no monopoly on plans to power ships with nuclear fuel. According to reports, the Soviet Union is developing a nuclear-powered icebreaker 512 feet long. The ship, unique in conception, apparently will shoot out jets of steam, produced by the heat of the reactor, to melt a passage through the ice. Its speed will be about 24 knots.

Norway, too, is active in atomic-ship design, though in the merchant-fleet field. She

may well be the first country to produce an atomic ship that can compete economically with existing ships. Since the war, Norway has built her merchant fleet into the second largest in the world, but because of the scarcity of domestic fuel the fleet is dependent upon imports of fuel oil. Norway is attempting to obtain enriched nuclear fuel from this country.

No, that's no Navy man in the weird picture below, though someday sailors may have similar outfits on hand. The man with the antennas sprouting from his helmet has long been cartooned. Now he is here.

At the Hanford plutonium plant, employees don this eerie costume when they check the radiation intensity in a "hot" zone. The mask and clothing protect them from radioactive contamination. The man in the mask is reporting instrument readings via a throat microphone. His words are broadcast to a radio receiver elsewhere.





Periscopes won't be practical for lightplanes, but CAA has already approved a rear-view mirror for them

Periscopes for Airplanes

By Paul N. Janes

LONG AN INTEGRAL PART of the submarine, the periscope is now being carried into the skyways in the hope of providing increased safety for air transportation. Some research experts of the Civil Aeronautics Administration predict that every air transport will be equipped with two periscopes in the years immediately ahead.

The idea behind the use of the special sighting equipment is to aid a pilot in avoiding mid-air collisions with planes which approach his craft from angles outside his normal field of vision.

Information provided by radio to pilots from on-the-ground radar observers is exceedingly helpful in many instances, but sometimes a pilot does not learn quickly enough that another airplane is heading his way.

Aeronautical engineers say the periscopes definitely won't be practical for use in light airplanes, but they point out that the CAA already has approved a rear-view mirror designed to give a lightplane pilot increased visibility.

The big-plane periscopes would be in-

tended for use during landing and take-off operations, and would be expected to be of most value in bright daylight when air-safety officials say mid-air collisions are most likely to occur.

Operation of the periscopes in airliners would call for the addition of an extra crew member in some instances, as the pilot and copilot, busy during landings and take-offs, would have no time to make periscope observations. But proponents of the periscope plan say an airline stewardess could make the observations without interference with her other duties.

One periscope would have an "eye" in the bottom of the plane's fuselage, while the other would search the sky above. A single observer would operate both, one at a time, inspecting the areas below and above the plane, and at the sides and the rear. A dial on the pilot's instrument panel would show him just where the periscope "eye" was looking. When the periscope observer sighted an approaching plane, he would press a button to signal the pilot who, by looking at the dial, could tell where the neighboring plane was flying.

The periscope is described by some CAA experts as "the best solution we have found so far for the terminal area mid-air crash situation." They add, though, that "it may not be the final answer."

One periscope installed in a CAA transport for test purposes was developed by the Farrand Optical Company of New York City. It utilizes a great number of lenses, and has a rotating head or "eye." It can be constructed in any length, depending on the size of the airplane.

Alan L. Morse, head of the CAA Aircraft Division, emphasizes that he and his fellow workers are most concerned about daytime mid-air collisions. Contrary to the belief of many persons, it's much easier to have a mid-air crash in bright daylight than at night or in soupy weather, Morse asserts.

"Of course, air traffic is heavier in the daytime and in good weather, but other factors enter into the situation. On a clear night, you can see a plane with flashing lights easily when it is 30 miles away, but a plane can't be seen easily in daylight beyond three miles."

Thomas M. Edwards, chief of the instruments and accessories branch of the CAA Aircraft Division, emphasizes that some system for increasing the "conspicuity" of airplanes should be coupled with periscopes. A good many conspicuity techniques are being evaluated. Fluorescent paint patterns have been found effective close-up, but not at long distances.

A solar reflector which uses the sun for power and has a rotating omnidirectional mirror also is being tested, and has been found to be useful up to five miles.

Yet to be tested in flight is high-intensity daytime lighting calling for use of a mercury-arc vapor-type lamp capable of producing 2,000,000 candlepower in a concentrated beam.

For flying outside of airport areas, airplanes of the future probably will depend on some type of proximity warning device utilizing infrared rays or UHF or VHF radio waves. But this type of equipment probably would be valueless in airport areas where the presence of so many planes would keep the warning equipment in almost continuous operation. ★ ★ ★



Periscope being evaluated in flight tests by Civil Aeronautics Administration representatives for use in transport planes

This is what a lightplane pilot sees in his rear-view mirror. Such visibility of nearby planes provides additional safety

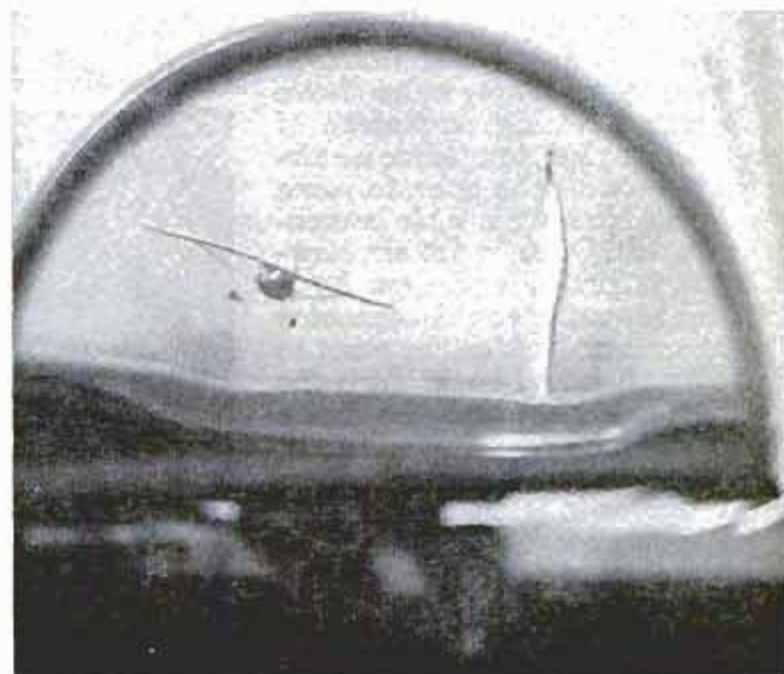



Water-Ski Towboat Steered by Skier

Automation takes over even in the water-skiing field, as two Austrian banking officials come up with a self-piloted towing rig which eliminates the speedboat pilot. The rig consists of a 6½-foot motorboat, steered and controlled by a 10-foot extension arm. Already in the water, the prototype travels up to 25 miles per hour but the inventors hope to increase the speed to 50 when the design is refined and ready for the market. The 18-horsepower engine on the boat is equipped with an electric starter, and in the event that the skier falls into the water an automatic cutoff stops the engine immediately. The inventors believe that the rig will cost about one fourth the price of a standard motorboat of comparable speed and power.

Steering and controlling his own towboat, water skier skims water at 25 miles per hour. Dead-man control cuts engine if skier falls

Pilotless Photo Drone Takes Aerial Pictures

Combat aerial photos in future wars will be taken without risking the lives of pilots or aerial photographers. Developed by the U.S. Army Signal Corps, a small, radio-controlled, camera-carrying drone will make this possible. The drone, officially designated as the RP-71, can operate in all kinds of weather, and take still or motion pictures anywhere from several hundred feet to more than four miles above the earth. One big advantage of the drone is that it requires no airfields from which to operate, since it is jetted from a portable launching catapult. Once in the air, however, it is propeller-driven by a gasoline motor. A control operator on the ground guides the craft to its destination and back. Then the engine is stopped and the drone comes down by parachute. With it, tactical commanders can have aerial photos in less than an hour.

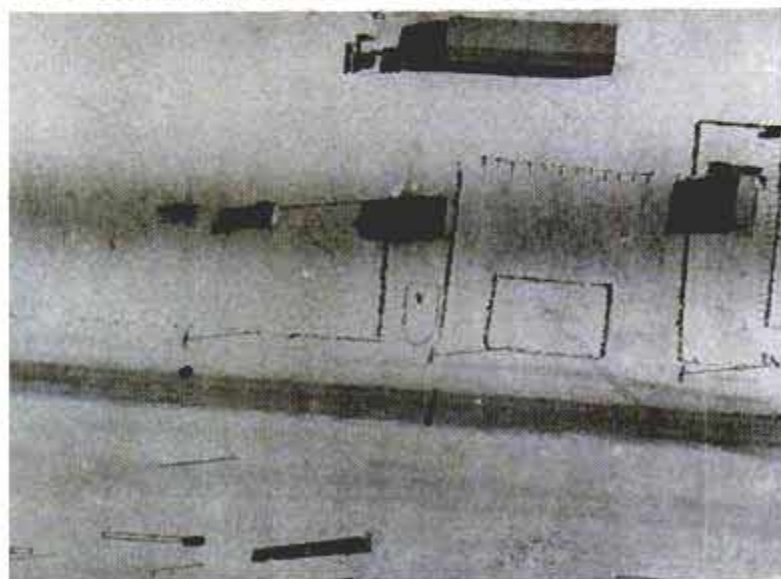

Lower photo at right is aerial view of Camp Irwin, Calif., taken at 500 feet by photo drone. Above, drone on catapult ready for launching



6-TRANSISTOR SUPERHET PORTABLE

By
James A. McRoberts

IT'S not the cost, it's the upkeep" is a common lament of outdoor fans who like radio entertainment. If you buy batteries "by the dozens" to satisfy the appetite of

your portable radio, try building this all-transistor set. You'll find that upkeep of this set will probably save enough during the first season's operation to compensate

Six-inch-long chassis is made from sheet aluminum. Use actual parts as templates for exact hole spacing

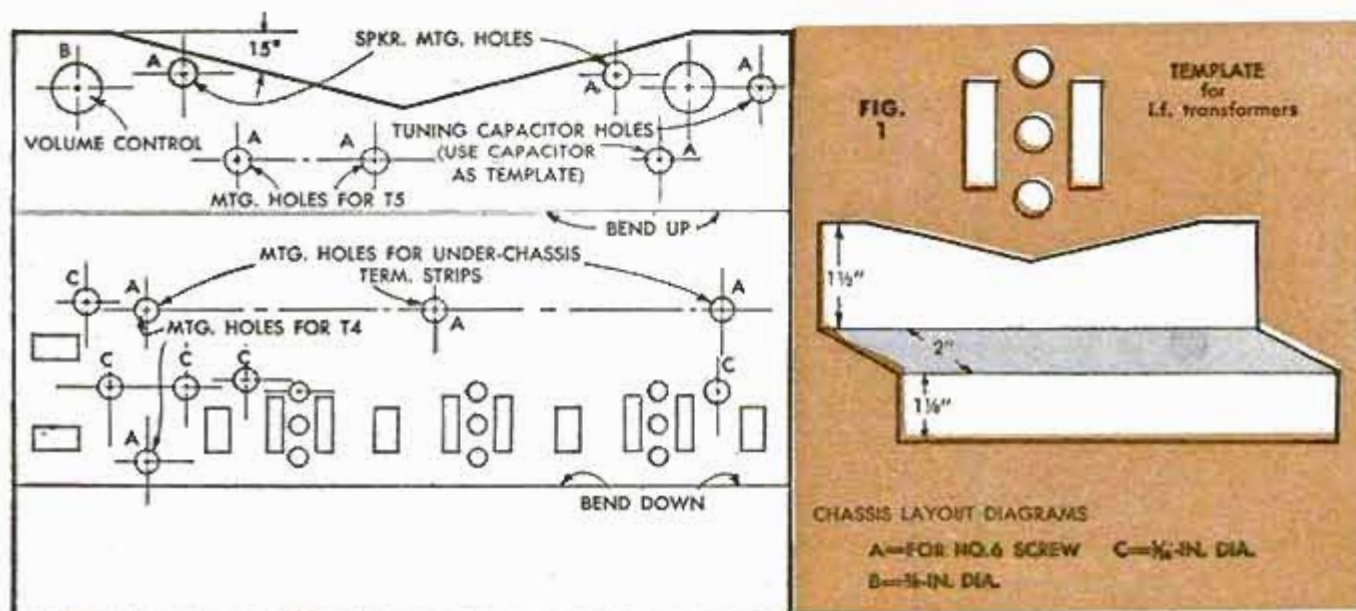
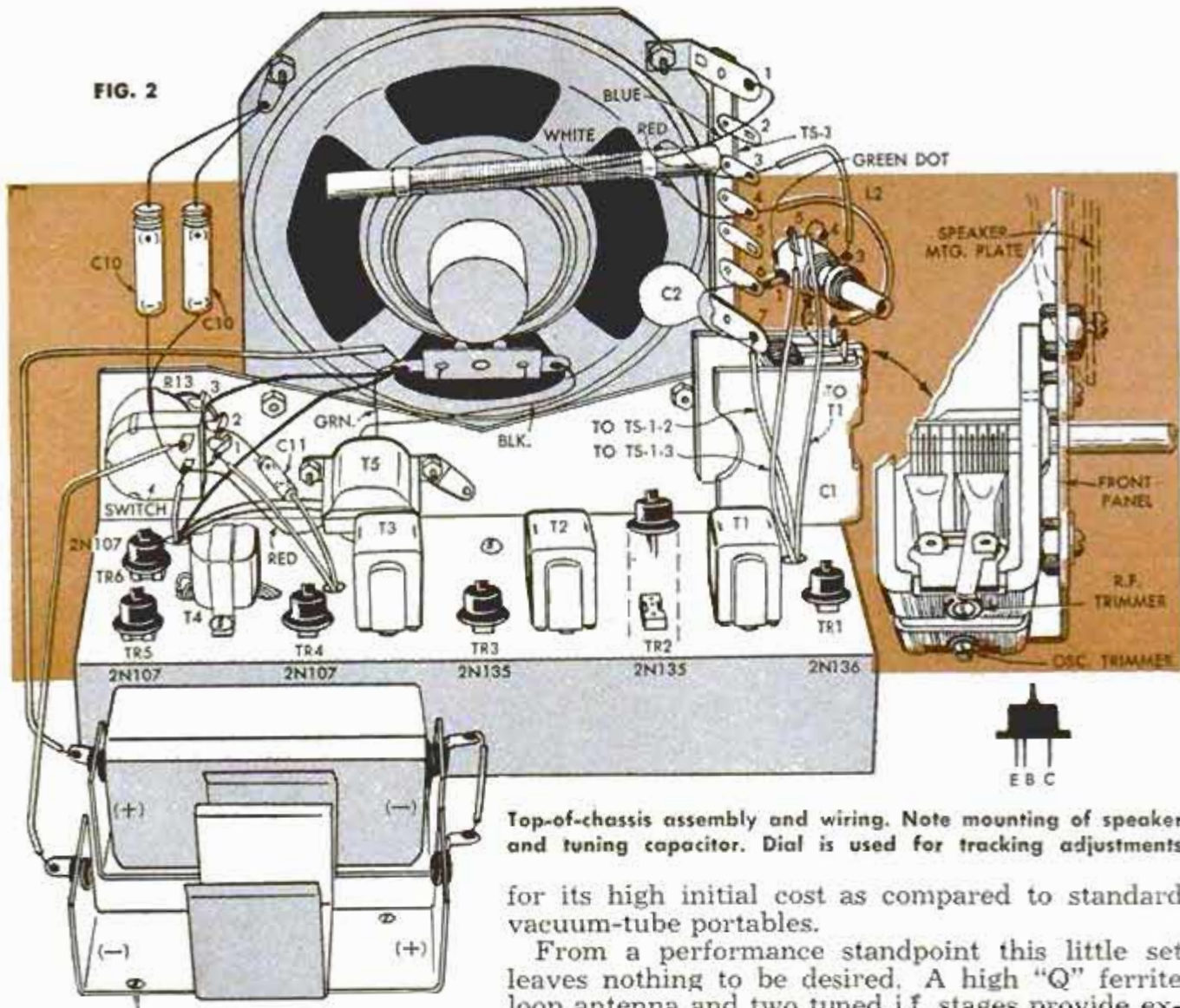

FIG. 2



Top-of-chassis assembly and wiring. Note mounting of speaker and tuning capacitor. Dial is used for tracking adjustments

for its high initial cost as compared to standard vacuum-tube portables.

From a performance standpoint this little set leaves nothing to be desired. A high "Q" ferrite loop antenna and two tuned i.f. stages provide excellent gain and selectivity, while a push-pull output stage and 4-in. speaker impart unusually good tone quality. Class B operation of the output stage assures maximum economy.

If you've never built a radio before, better skip this project until you've tried a few simpler ones. But, if you're handy with a soldering iron and have done some previous radio building, you should have

Initial wiring. Black dots indicate connections to be soldered

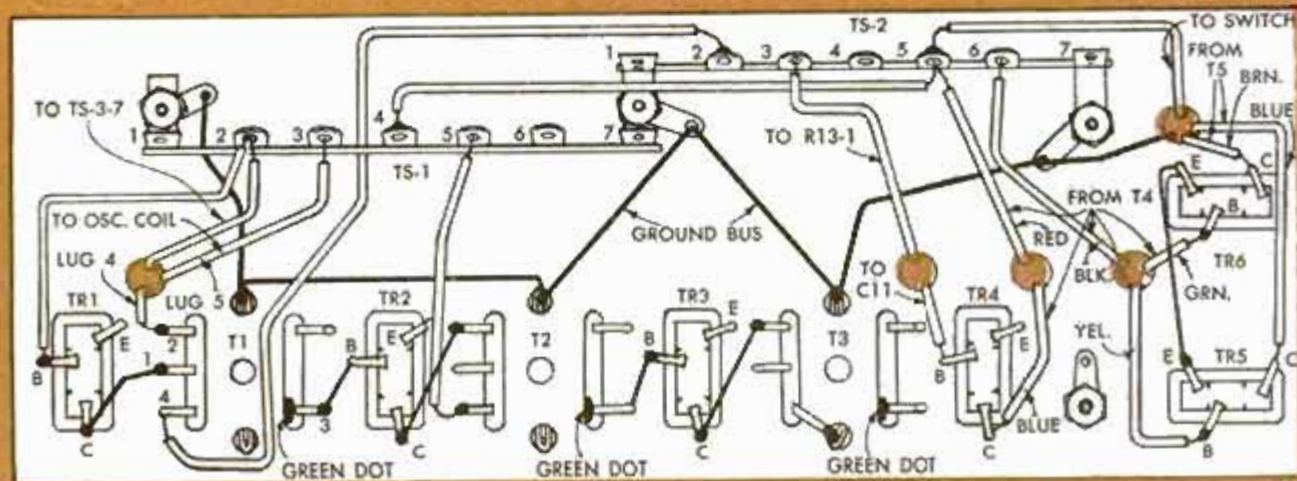

FIG. 3

no trouble following the recommended procedure.

Construction

Step 1. The chassis: Cut, drill and form the chassis, using a piece of "do it yourself" aluminum which is available from most hardware stores. Fig. 1 shows the approximate location and sizes of the mounting holes. Holes for the transistor sockets and i.f. transformers should be cut slightly undersize and filed to the correct dimensions using the actual parts as guides.

Step 2. Mounting the parts (See Fig. 2):

1. Insert transistor sockets through the chassis from the top and fasten these in place with their retainer clips.

2. Mount audio transformers (T4, T5) and terminal strips TS-1 and TS-2. A common mounting screw is used for T4 and one end of TS-1. Insert a shakeproof solder lug under each terminal-strip nut.

3. Mount the volume control and i.f. transformers. The correct mounting positions for the i.f.s are shown by the green dots in the under-chassis view of Fig. 3. Though identical in appearance, T3 is electrically different from T1 and T2. See parts list for identification. To hold the transformers securely, bend their mounting lugs underneath the chassis.

4. Mount the speaker and tuning capacitor (see Fig. 2) with No. 6-32 machine screws. These screws should not exceed $\frac{3}{16}$ in. in length or they will interfere with the opening of the capacitor plates. Longer screws may be used by inserting a nut between the capacitor and speaker frames and the panel, as shown in the illustration. Terminal strip TS-3 is mounted on the speaker. To prevent lug 7 of this strip from touching the speaker frame, break off its mounting base. Tape a piece of heavy cardboard to the front of the speaker to prevent

any possible accidental damage to the cone.

Step 3. Initial wiring: Begin the wiring with the ground bus which shows as a heavy, solid line in Fig. 3. This is a length of bare No. 22 wire which must be kept close to the chassis. All other wires in Fig. 3 should be as short and direct as possible. Solder only those connections indicated with a black dot. To other connections, additional parts will be added in the subsequent wiring view.

Wires running from points below the chassis to components mounted above may be properly connected by comparing Figs. 2 and 3.

Step 4. Final wiring: Complete the under-chassis wiring as shown in Fig. 4. Position all parts so that their leads cannot short against those of other components. Insulate any leads which might contact other bare wires.

Connections to the i.f. transformer lugs and oscillator-coil terminals should be soldered as quickly as possible. Excessive heat to those terminals may damage the fine coil wires.

Observe polarity (+ and -) on all electrolytic capacitors and do not permit their metal cases to short against the chassis or other wire leads. Insulate them with rubber tape if necessary.

The loop antenna may be temporarily taped to the speaker frame while its leads are being wired into the circuit.

Step 5. Final testing: (Transistor leads should be left long until the unit has passed the following tests. Then they may be cut to approximately $\frac{1}{4}$ -in. lengths.)

After checking the completed assembly against pictorial and schematic diagrams, install the batteries with the polarity as shown in Fig. 2. With no transistors in the sockets, turn the volume control to maximum. Plug transistor TR-6 into its socket

Final under-chassis wiring pictorial. Keep all bare wires well separated to prevent short circuits

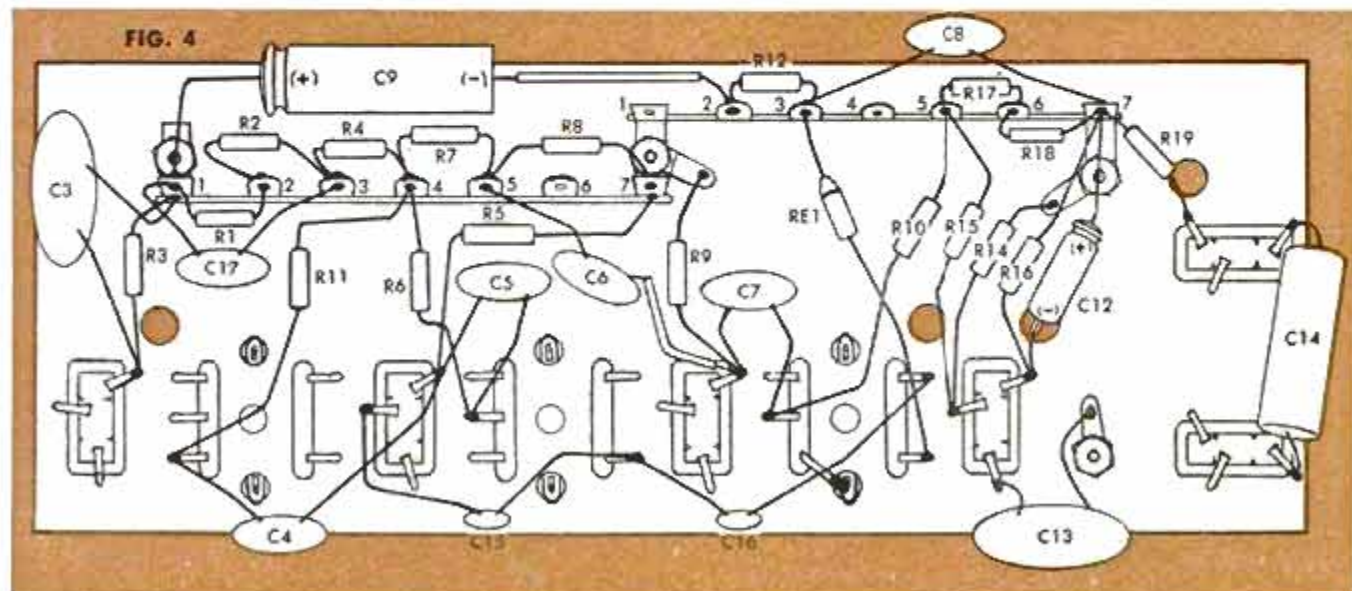

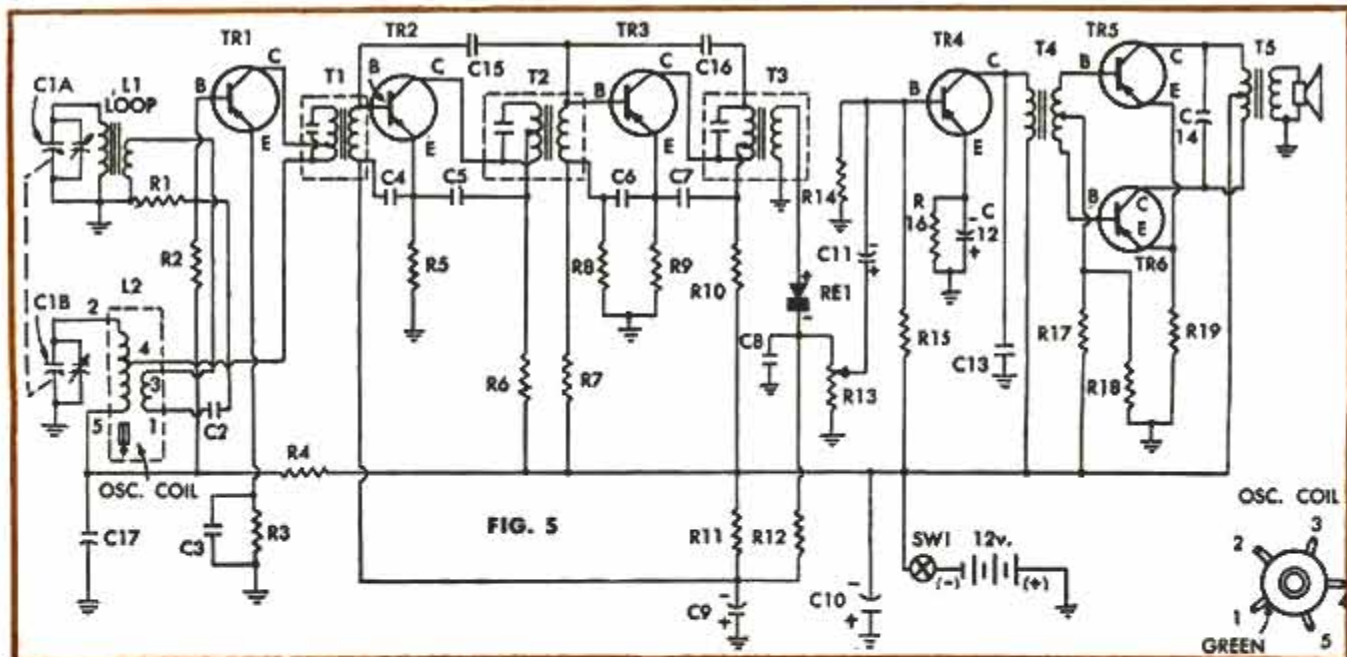

Schematic diagram of 6-transistor portable radio

making sure that the various leads go into the proper socket holes. A faint click will be heard as the transistor leads contact the socket pins. Leaving TR-6 in its socket, plug in TR-5. Again, a click should be heard. Continue this procedure with TR-4, TR-3, TR-2 and TR-1, in that order. With each insertion the volume of the click should increase. If a transistor fails to produce a click, turn off the set immediately and remove the transistor from the socket. Carefully check the socket wiring to locate a possible wiring error.

I.f. alignment: Because original factory

(Continued to page 238)

Flexible plastic retainers hold antenna in cabinet

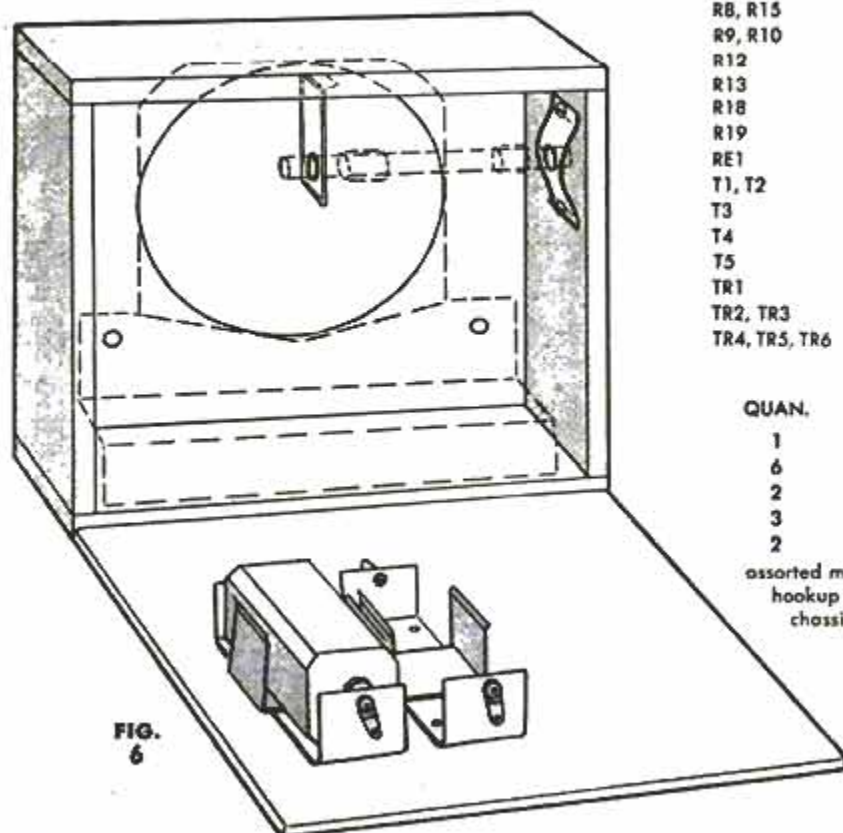

FIG. 6

LIST OF MATERIALS

SYMBOL	MANUFACTURER'S NO.	DESCRIPTION
C1A, C1B	Lafayette MS-261	2-gang variable, max. cap.—123 and 78 mmfd.
C2, C4, C5, C6, C7, C8, C17	Lafayette C-601	.01 mfd. ceramic
C3, C13	Lafayette C-601	.005 mfd. ceramic
C9	Sprague TE-1128	10 mfd., 12-v. electrolytic
C10 (2 reqd.)	Barco P25-50	100 mfd., 25-v. electrolytic (two 50 mfd. units in parallel)
C11	Barco PT12-2	2 mfd., 25-v. electrolytic
C12	Sprague TE-1087	10 mfd., 6-v. electrolytic
C14	Lafayette X1060	.05 mfd.
C15, C16	Lafayette C-601	5 mmfd. ceramic
L1	Lafayette MS-264	loop antenna
L2	Lafayette MS-265	oscillator coil
R1		27,000 ohms, 1/2-watt
R2, R11		100,000 ohms, 1/2-watt
R3, R16		1,000 ohms, 1/2-watt
R4, R14		6,800 ohms, 1/2-watt
R5		330 ohms, 1/2-watt
R6, R17		4,700 ohms, 1/2-watt
R7		47,000 ohms, 1/2-watt
R8, R15		33,000 ohms, 1/2-watt
R9, R10		2,200 ohms, 1/2-watt
R12		3,300 ohms, 1/2-watt
R13	Lafayette VC-27	5,000-ohm control with switch
R18		68 ohms, 1/2-watt
R19		12 ohms, 1/2-watt
RE1	Raytheon 1N295	crystal diode
T1, T2	Lafayette MS-268	1st and 2nd i.f. transformer
T3	Lafayette MS-269	3rd i.f. transformer
T4	Lafayette AR-109	audio-interstage transformer
T5	Lafayette AR-119	audio-output transformer
TR1	GE 2N136	r.f. transistor
TR2, TR3	GE 2N135	i.f. transistors
TR4, TR5, TR6	GE 2N107	audio transistors

MISCELLANEOUS

QUAN.	DESCRIPTION
1	4-in. speaker with 3.2-ohm voice coil
6	transistor sockets with retainer clips
2	6-v. batteries, RCA VS-06B
3	terminal strips, CINCH 55A
2	battery holders, Lafayette MS-175
assorted machine screws, nuts, lock washers and ground lugs, hookup wire (No. 22), rosin-core solder, knobs, material for chassis and case	

(ALL ELECTRONIC PARTS USED IN THE MODEL WERE OBTAINED FROM LAFAYETTE RADIO, 100 SIXTH AVE., NEW YORK CITY)



FROM HULL TO FINISHED BOAT *Buy a Laminated Hull—Complete It Yourself*

By E. F. Lindsley

CUSTOMIZING a molded-plywood hull was the method I used to build a boat that fitted my particular needs, required the minimum amount of time to assemble and was priced within my budget. The boat was to be a family outboard runabout, so seats, center deck and stern deck, as well as foredeck, were required. Decks in center and stern are removable, as are the seats and seat backs. When the boat is used for a fishing trip these items are removed to provide plenty of room for fishermen and their gear. The foredeck is permanently attached, since it provides additional hull rigidity and dry storage in rough water. If the boat were to be used only for fishing, where more room is needed, the foredeck could be replaced by a simple V-shaped breasthook.

Although a laminated-plywood boat hull can be purchased in any state of assembly from the raw hull up, Fig. 1, to reduce construction time the one chosen had a stem and transom installed at the factory. The transom was braced by

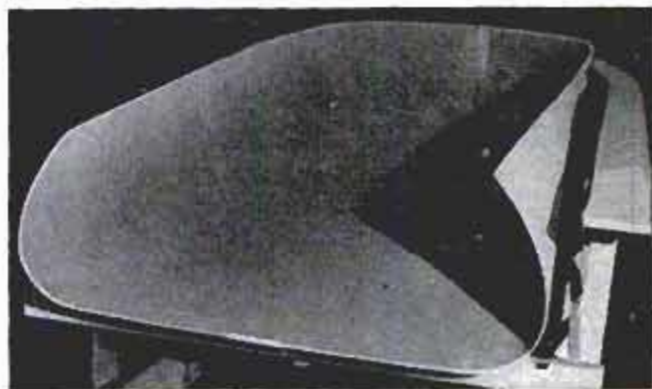

1. Boat can be purchased in any form from raw hull, shown above, to completed boat, ready for painting

2. Choice of materials and fittings are strictly up to the builder; in the boat shown below, plywood rear deck is removable



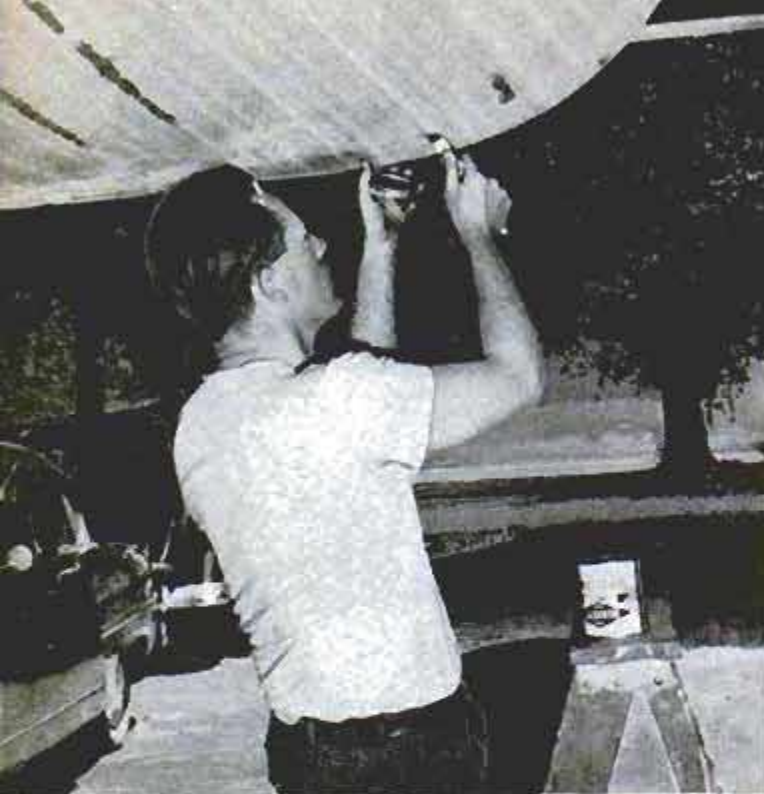

3. Boat is hoisted to convenient working height and marine surfacing putty is used to fill imperfections



4. Before installing cap rails, top edge of hull is planed to be flush with top edge of gunwale strips

5. Below, removable rear deck is assembled on hull to assure good fit. Marine glue is used in all joints



"knees" that fit against the transom and against hull stringers that also had been installed by the factory. If you install your own transom, use the best-quality wood available and use extreme care in gluing and securing it to the hull. The transom must carry the full weight of an outboard engine and resist the thrust of the propeller as well.

Spray rails and gunwale strips can be installed by the builder, but were purchased "factory installed" to save time. Although light in weight, a laminated-plywood hull is bulky and awkward to handle. For this reason it was necessary to use two light block and tackles, one at the bow and one at the stern, to hoist the hull to a convenient working height. The blocks were fastened to overhead beams in the garage and the hull could be pulled up out of the way so an automobile could be driven in. Since most garages do not have a high ceiling, it is best to hang the boat so it is over the area where the hood of a car is located. The boat can be raised high enough to clear the hood.

After trimming and sanding the hull, marine surfacing putty is used to fill minor imperfections in the plywood, Fig. 3. Then one or two coats of primer are applied, which protect the wood from the bumping and rubbing it will receive while the boat is being finished, as well as providing an undercoating for the final coat of paint.

The upper structure of the boat is a matter of individual choice. If desired, solid-mahogany cap rails, decks, seats and seat backs may be installed, Fig. 2, for appearance' sake. In a boat used only for fishing or other rough service, these items could be replaced by simple chafing strips along the gunwales, with a plywood foredeck attached directly to the strips.

It is characteristic of a laminated-plywood hull for the top edge to curl in slightly, thus reducing the beam at this point.

6. Plywood is "clamped" to deck beams while glue dries by using finishing nails in wooden blocks





7. Hull-spreader jack can be made from scraps of wood or auto bumper jack can be used as shown here

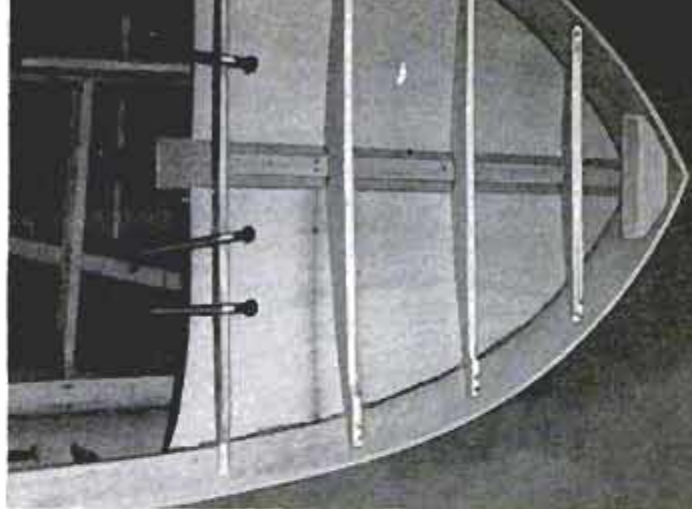

8. Foredeck and cap rails can be assembled and installed as a unit, as above, or assembled on boat

Before marking the shape of the cap rails, determine from the manufacturer's specifications what the beam should be and use a hull-spreader jack, Fig. 13, to obtain the correct dimension. The jack can be made from scraps of wood to the shape indicated. A wooden cam forces the jack shoe outward when one hand is used to apply pressure on the cam lever. The hull spreads easily. An automobile bumper jack also could be used. Near the bow the jack is inserted between the gunwales, Fig. 7. At wider points, one end of the jack is fitted against a bottom stringer and the other end against a wooden block clamped inside the gunwale. Cap rails are bandsawed to shape from solid stock, Fig. 9. The forward portion of the cap rails should be grooved to receive the edges of the plywood foredeck, as detailed in Fig. 13, to assure a strong, watertight joint. A pattern can be made for the cap rails by laying light cardboard along the edge of the hull and tracing along it with a pencil or, with some assistance, the stock itself can be held on the edge of the hull and marked. Before installing the cap rails, detail Fig. 13, trim the edge of the hull so it is flush with the gunwale strips, Fig. 4.

The plywood foredeck, deck beams and cap rails can be assembled and installed as a unit, Fig. 8, or assembled on the boat, Fig. 10. The stern deck is removable, but is assembled on the boat to assure a good fit, Fig. 5. One method of "clamping" the plywood to the deck beams while the glue is drying is to use thin blocks of wood held with finishing nails. To remove the nails, split the blocks and the projecting nail-heads can be grasped readily with a hammer claw or nippers. Fill the nail holes with marine putty, sand smooth and varnish. For a neater job of covering the heads of countersunk screws that are used to fasten the horizontal braces between the hull and transom, wood pegs wiped with glue are

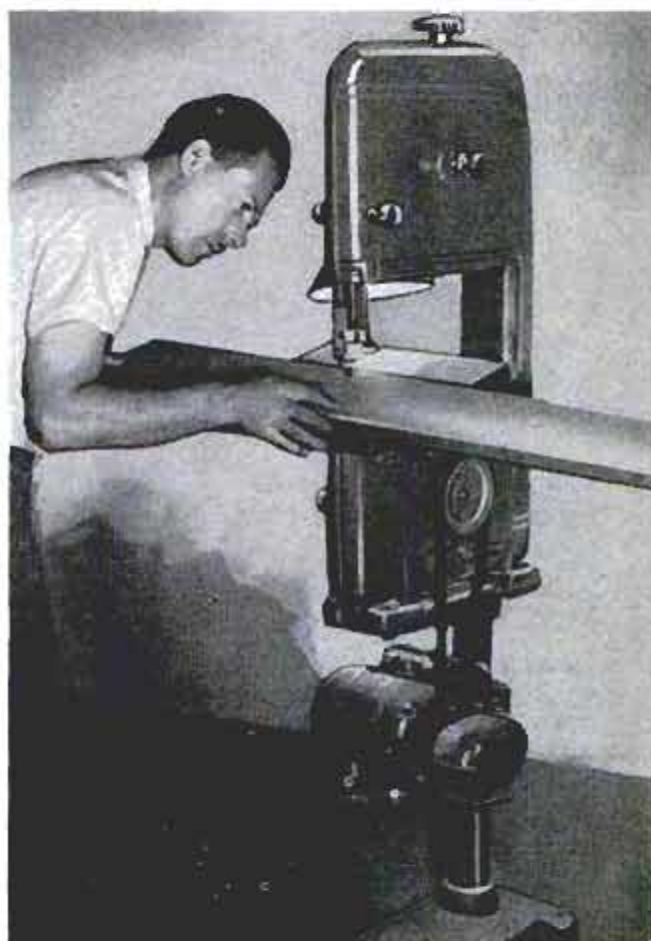

9. Cap rails are bandsawed from solid stock. Wood choice is up to builder; mahogany was used here.

10. Beams of removable decks are attached to underside of cap rails by means of bolts and wing nuts



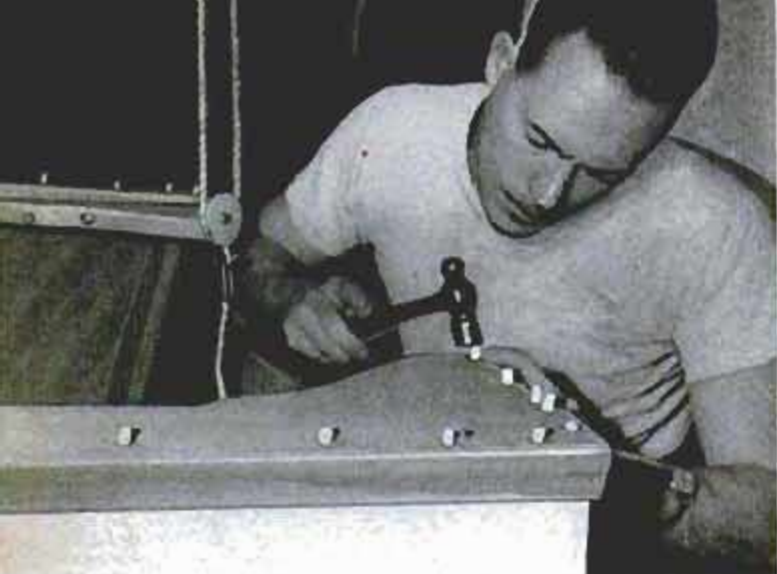

11. Heads of countersunk screws are covered by wood pegs instead of putty. Pegs are cut flush with surface

tapped into place, Fig. 11. When the glue has set, cut the pegs flush to the wood with a chisel and sand smooth.

Seats are cut so they fit on inner thwart rails and fore and aft movement is prevented by blocks screwed and glued to the rails. Seat backs pivot forward and can be left out when an open boat is required, Fig. 12. The back of the rear seat gives access to the area under the rear deck where the gasoline tank and battery are located.

The center deck is another optional item, installed primarily for appearance, although it does provide a rigid cross bracing at the center section of the boat. Like the rear deck, the center deck is built on beams that extend across the boat. As shown in the lower left-hand detail in Fig. 13, the beams extend under the cap rail, and are



12. Seats fit across inner thwarts, are held by blocks. Seat backs pivot forward, are separate and removable

screwed to it. In the case of the center and rear decks, carriage bolts are set in the cap rail and wing nuts are used to hold the beams up under the cap rail.

Hardware and fittings for the boat are determined by the use for which the boat is designed and how much is to be spent. If the boat is to be used in a salt-water area, stainless-steel fittings would be less affected than brass, though more expensive.

The lead illustration of this article shows the boat on a test run. The bow is riding too high because of the weight of the motor and the operator. Remote controls for the motor later were installed so the boat could be controlled from the front seat. Moving the driver to a forward position brought the center of gravity forward allowing the boat to ride in a more level position. ★ ★ ★

13. Cross section shows assembly of gunwale strip, cap rail and deck beams. Hull-spreader jack is wood

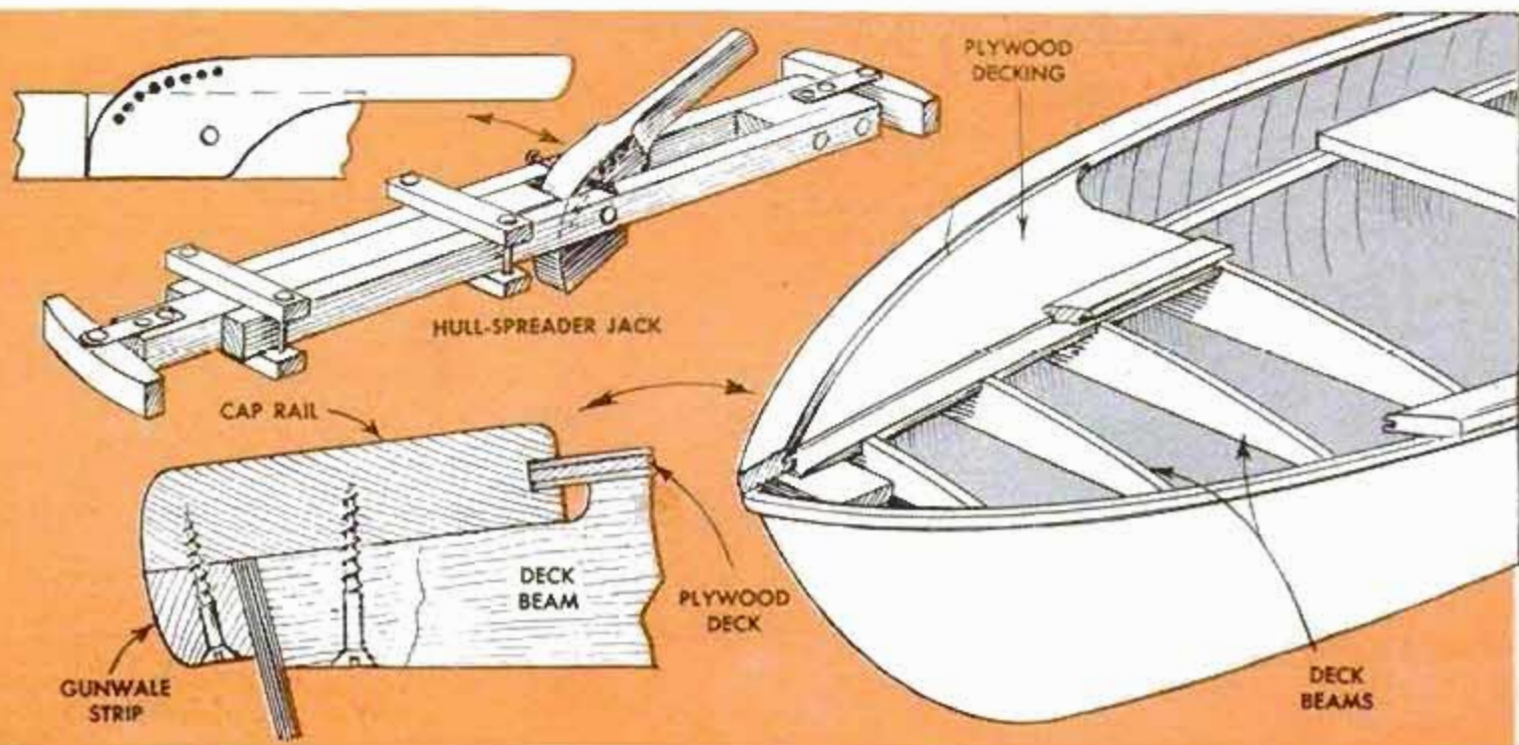

Lighted Flower Beds Add to Color of Lawn-Party Decorations

An added decoration for nighttime lawn parties can be obtained by illuminating flower beds and garden walks with strings of outdoor-type Christmas-tree lights mounted in sheet-metal reflectors shaped and painted to resemble flowers. Tin cans will furnish the metal for the reflectors, which are cut and bent as shown in the detail. A $\frac{1}{2}$ -in.-high strip at the base of each reflector is bent to form a clip that grips the light-bulb socket. Stiff coat-hanger wire in 15-in. lengths is soldered to each reflector to provide a stand that can be pushed into the ground. White bulbs should be used if the

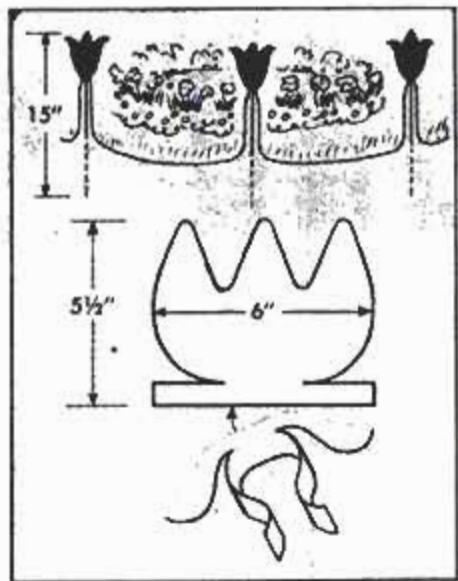

lights are intended for general illumination, but colored bulbs will do more to enhance the appearance of adjacent flowers.

Oarlocks Serve Double Purpose

Two pairs of mounted oarlocks not only give you a choice of rowing positions in a small boat, but the unused pair also makes excellent rests for idle oars, as shown. Objection to the empty horns as an accident hazard is overcome because they are filled by the oars. If drop-type oarlocks are used, they can be dropped inside the gunwales when not in use.

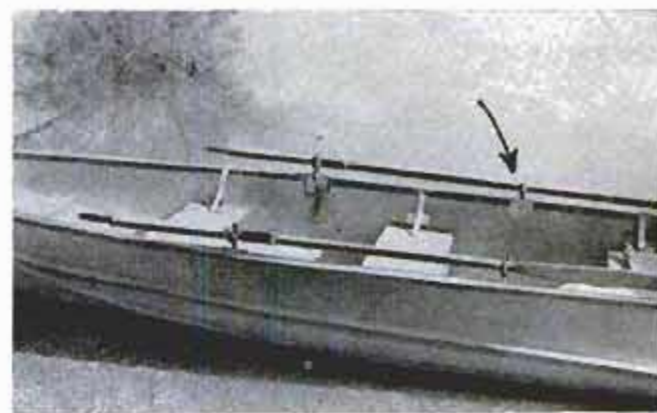

Nail Kegs Set in Fireplace For Use as Wood Boxes

One homeowner, building an outdoor fireplace in his back yard, installed two nail kegs as permanent wood boxes. The kegs, 18 in. deep, were treated with creosote as a preservative and set into the wings of the fireplace as shown in the photo. Two harrow disks serve as covers for the boxes. Jerome Narveson, Northfield, Minn.

Removable Birdhouse Floor Makes Cleaning Easy

Two screw hooks will hold a removable floor of a birdhouse secure, and yet permit cleaning which is appreciated by birds that prefer nesting in clean houses. Saw two slots opposite each other in the floor cut from $\frac{1}{8}$ -in. tempered hardboard, which has less tendency to warp than wood. Drive 1-in. brass screw hooks into the ends of the house so the L-shaped ends can be turned sidewise to lock the floor of the house in place.

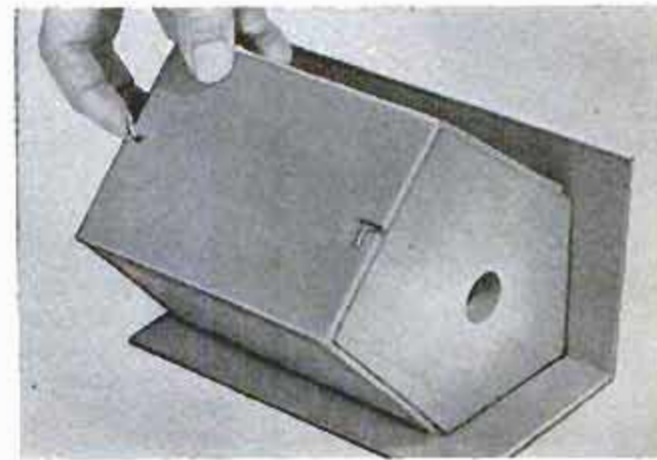

TACKLE BOX of Plywood

By George X. Sand

This lightweight tackle box can be carried either by side handles or an adjustable leather carrying strap



Ample storage space is provided in the lid and trays for a good selection of lures, leaders, line, camera and film. Fishing reels, two vacuum bottles and miscellaneous gear are easily stowed in the bottom



WANT an inexpensive tackle box that will remain dry inside under most conditions and provide adequate storage space for all your fishing accessories, a camera and a hearty lunch? This marine-plywood box will do the job. The bottom is partitioned to provide compartments for two vacuum bottles, reels and similar equipment. Above these compartments are trays for lures, camera, etc., and a large pocket inside the lid stores flat articles such as line, leaders and snelled hooks. Two brass handles and a leather carrying strap offer alternative means of carrying it.

Constructing the Box

First step is to build the box of $\frac{3}{8}$ -in. plywood. Cut the plywood according to the dimensions given in the diagram. Be sure to allow $1\frac{3}{8}$ in. for the lid in the over-all height. Sand all members smooth, apply waterproof glue along each surface to be joined, and nail the top, side and end pieces together with 1-in. brass brads. You now have a box that is enclosed on all sides but the bottom. The top will be cut off later to make the lid. This will assure a perfect fit between box and lid.

Next, turn the box over and glue the vertical partition in place, then the tray-support members in both compartments, each $1\frac{1}{2}$ in. up from the bottom. For added strength use 1-in. brads and allow the glued surfaces to set overnight. Wood clamps can be used to advantage here, although they are not a must.

After the bottom of the box is glued and nailed in place, the top is sawed off to make the lid, which will provide storage space for miscellaneous flat items when an aluminum sheet is screwed to $\frac{3}{4}$ x $\frac{1}{2}$ -in. wood spacer strips to form a pocket between the lid and metal, as indicated in the detail. The lid is attached to the box with a 23-in. strip of brass piano hinge.

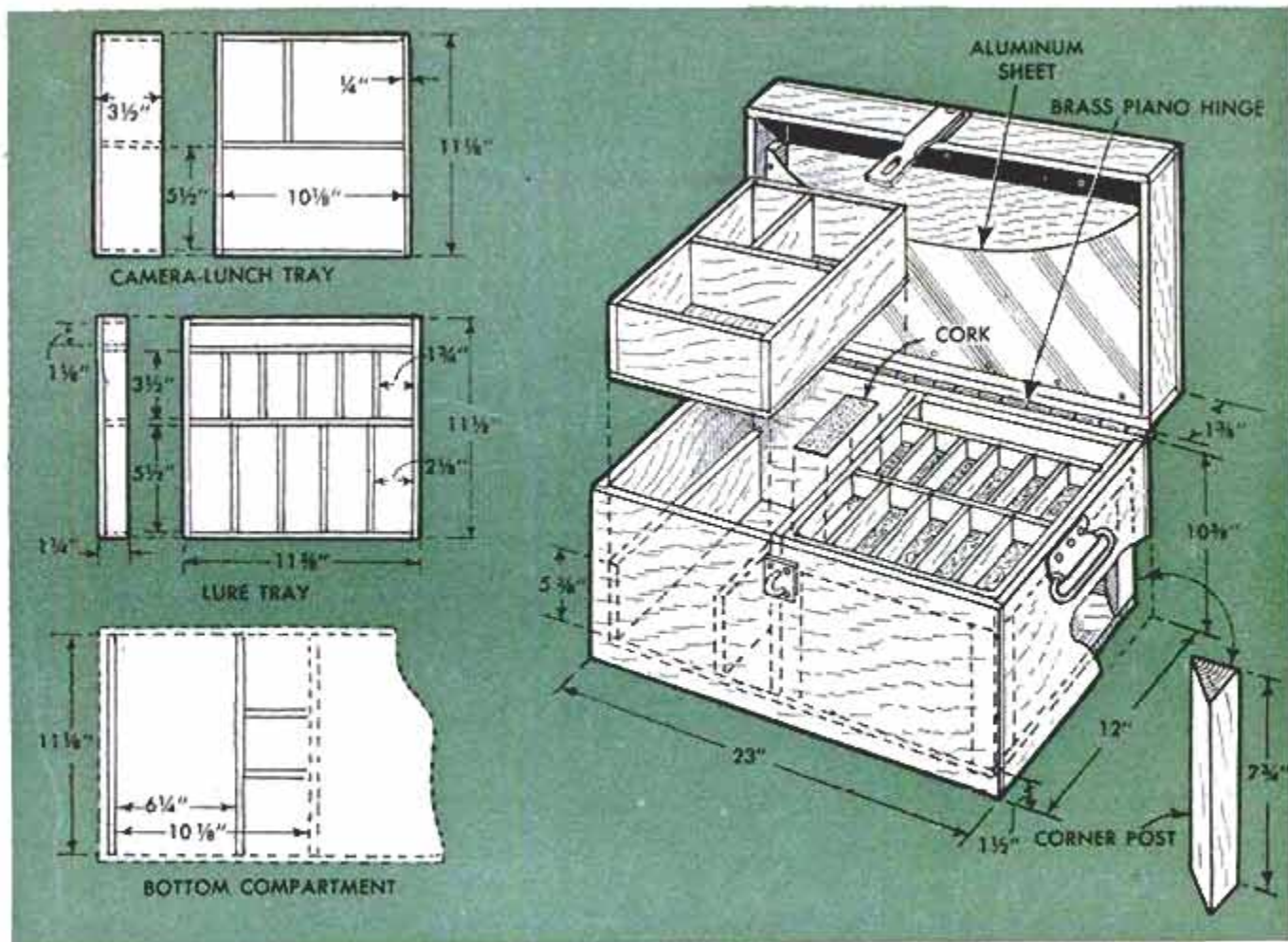

Next, a carrying handle is bolted to each end of the box. Use small brass bolts and countersink the heads to fit flush on the inside. The same procedure applies for mounting the lock hasp and staple, which are centered at the front of the box. Two lengths of doubled $\frac{3}{4}$ -in. leather strap fitted with adjustable buckles and snap hooks can be snapped on the handles for one-hand carrying.

Trays

The lure tray and the camera-lunch tray are made from $\frac{1}{4}$ -in. plywood. These may be partitioned as suggested or modified to suit individual requirements. After the partitions have been glued and nailed in posi-

tion, glue thin sheet cork in the bottom of each lure compartment to protect the finish of the lures.

Under the camera-lunch tray, and acting as a support for one side of it, are the vacuum-bottle and miscellaneous-equipment storage compartments (lead sinkers, first-aid equipment, etc.). The longest member is cut from $\frac{3}{8}$ -in. plywood while $\frac{1}{4}$ -in. material is used for the short partitions. All three pieces are glued and nailed to the bottom and sides of the box to complete construction of the tackle box. Additional hooks, brackets and pockets can be installed in the box where desired to accommodate some special gadget or extra tackle. ★★★

Identification Badges Fastened to Clothes Without Pins

Factory employees who are required to wear identification badges can save the wear and damage to outer garments where the badges are pinned by using discarded ball-point pens or automatic pencils to carry the badges. Simply drill a tiny hole through the pen or pencil cap, insert the badge pin and fasten it. A bit of solder may be used on the clasp for security. Changing the badge from one garment to another is then as simple as shifting a pen from one coat to another.—Glen F. Stillwell, Manhattan Beach, Calif.

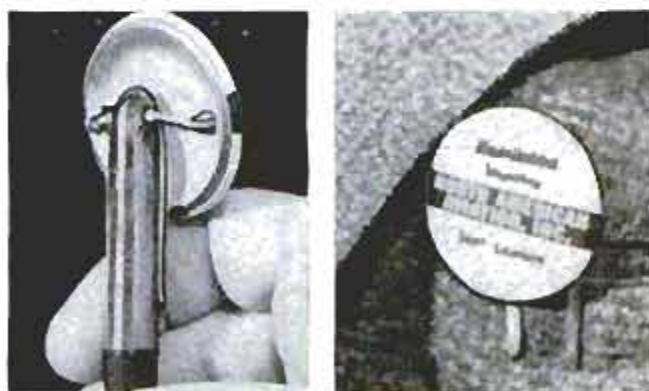

Pan on Broomstick Is Portable Outdoor Table



For a portable table that can be used outdoors with a lawn chair, sharpen one end of a 3-ft. length of broomstick or other suitable material and attach a piepan or serving tray to the opposite end. Fasten the pan with a wood screw, inserting a washer between it and the post so that the pan can be rotated to reach objects situated on the far side of it. To set up the table simply thrust the pointed end into the ground beside your chair. It can be used to hold pencils, reading matter, stationery and other light objects. A set of these tables made from matching serving trays are perfect for serving outdoor snacks. Partitioned plastic plates can be similarly mounted for use as paint palettes.

An Easy Method for Temporary Enclosure With Wire Mesh

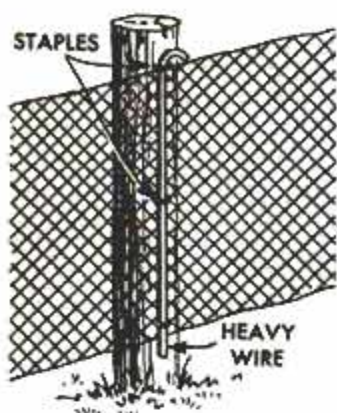

When putting up a temporary fencing to protect flowers or confine pets, use of this method of attaching the wire will permit quick installation and removal. Staples, placed according to the style and height of the fence

and aligned vertically with each other, are driven part way into wooden posts. The wire mesh is hung over the staples, and lengths of stiff wire with one bent end are slipped over the fencing through staples.

Tape Tab Removes Friction Lid

Press-on jar or can lids can be removed easily if tape tabs are placed under them when sealed. Adhesive tape is cut in pieces about 2 in. long, and each piece is folded lengthwise for about two thirds its length, leaving an area of exposed tape, which is then pressed to the inside of the lid so that the folded section extends outside. The projecting tape serves as a handy tab when the cover is placed on the container, and pulling straight up on it will raise the lid in a jiffy.



Victor H. Lamoy, Upper Jay, N. Y.

Aluminum Foil Protects Barbecue Grill from Corrosion



Sheet aluminum foil used to line the basin of a barbecue broiler protects the metal from corrosion due to heat and moisture. Because the foil stays bright to reflect the heat it also increases the efficiency of the grill.—Clinton R. Hull, Santa Ana, Calif.

Paper Maps Pasted to Muslin

Good-quality paper maps can be protected and preserved by pasting them to sheets of muslin with ordinary wallpaper paste. The maps then can be tacked to rollers made from lengths of broomstick and kept rolled up and out of the way when not in use.

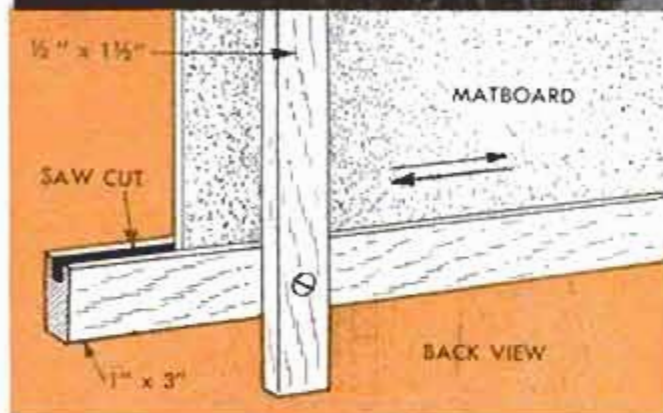
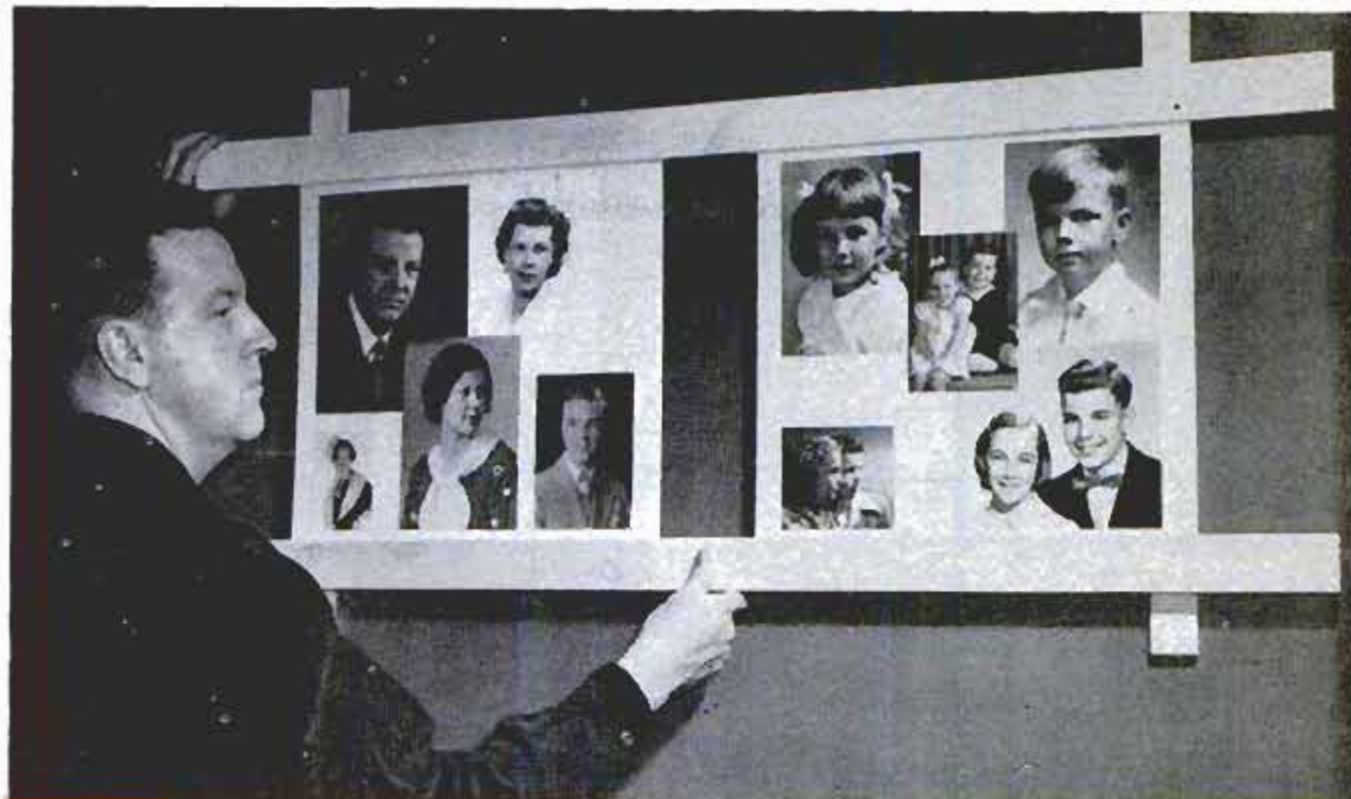

WALL RACK DISPLAYS YOUR FAVORITE PHOTOS

Why not get your favorite photographs out of hiding and make them part of the decorative theme of your home? This simple rack will enable you to display the photographs neatly.

First, mount the photographs on heavy matboard by means of dry-mount tissue, which is available at most photo-supply stores, then slip the matboard into a grooved frame or wall rack that is screwed to a wall in some location where the photographs will be displayed prominently.

To change the "scene," it then is only necessary to slide out one matboard and slip in another on which are different photographs.

The frame can be made to any dimension proportional to the wall on which it will be located. The slotted horizontal pieces are 1 x 3-in. stock, and the vertical supports are 1/2 x 1 1/2-in. material. Size of the lumber can be increased for a larger frame or decreased for one that is smaller. Occasionally wax the grooves.

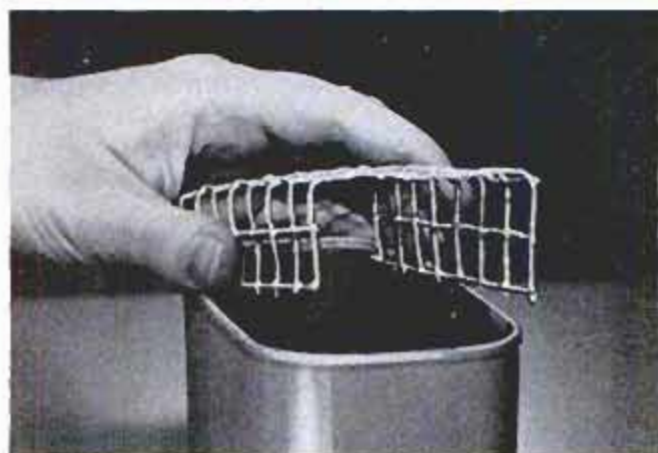

Wire Grating in Solvent Can Holds Brushes Above Sediment

Paint solvent will last longer and brushes will remain cleaner if a grating made from a piece of hardware cloth is fitted in the bottom of the can in which the brushes are stored in solvent. Bend the hardware cloth to form a U-shape as shown. Residue from the brushes settles down through the grating and is not stirred up each time another brush is inserted in the can. Occasionally strain the solvent to remove paint residue.

R. F. Donovan, Guttenberg, N. J.

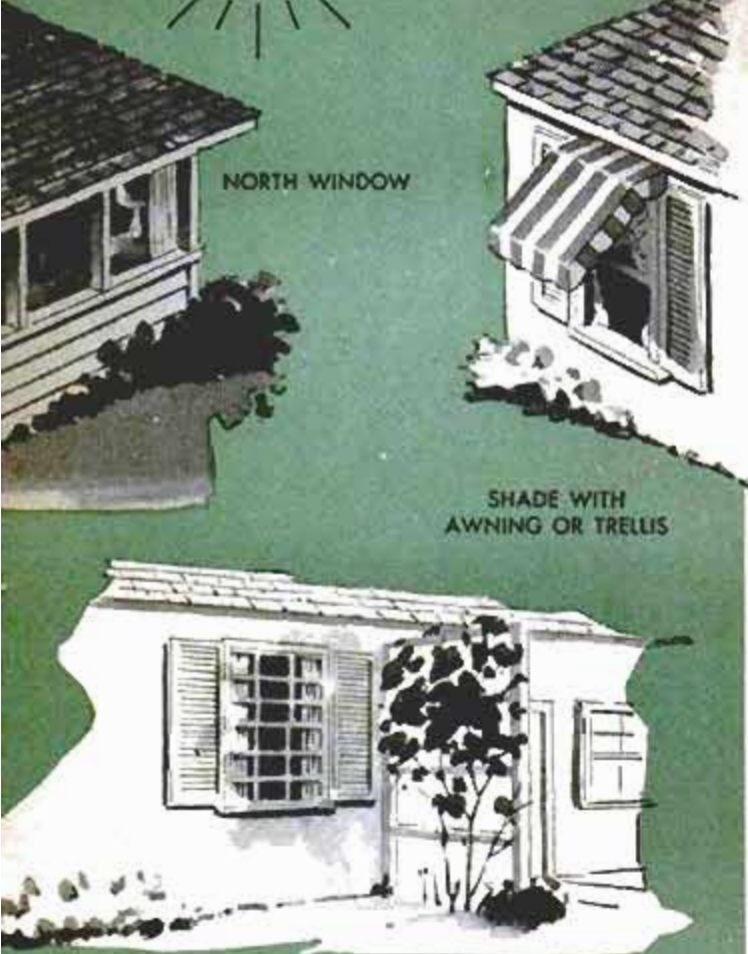

NORTH WINDOW

SHADE WITH
AWNING OR TRELLIS

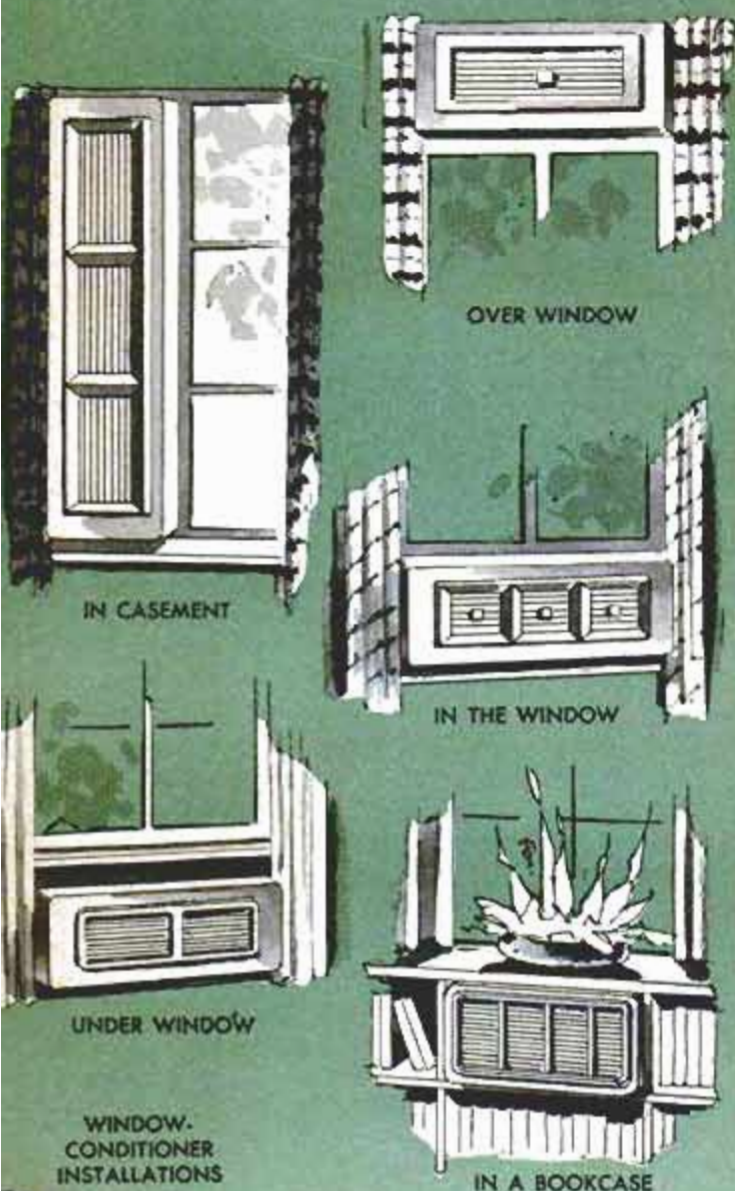

IN CASEMENT

OVER WINDOW

IN THE WINDOW

UNDER WINDOW

WINDOW
CONDITIONER
INSTALLATIONS

IN A BOOKCASE

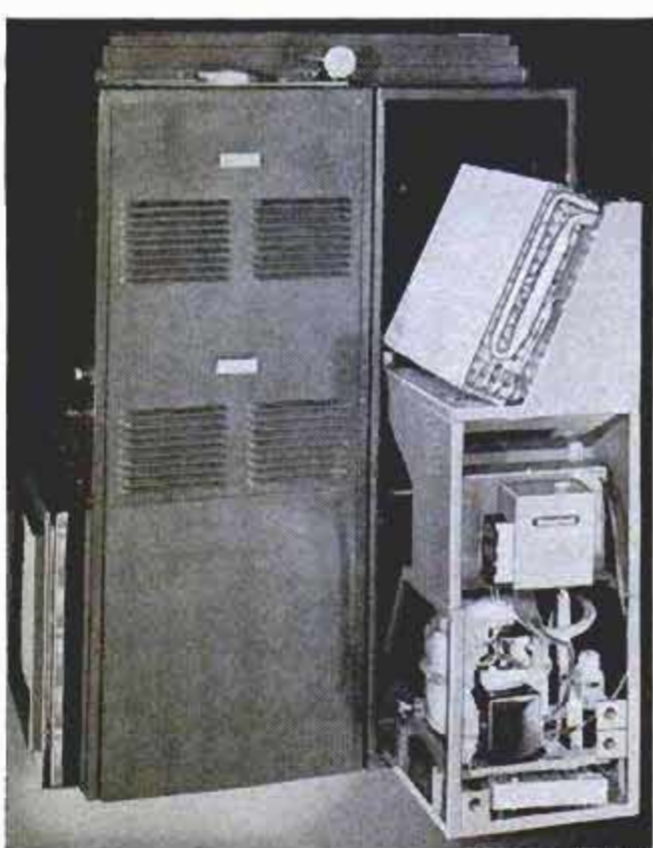

Mitchell

Adapted to installation in old and new homes, new homes especially, this unit features a cooling chassis which can be purchased separately and added

Push-Button

NO ONE UNIT of a modern home will afford the comfort to every member of your family that a modern air conditioner will provide. And when it is paired with an automatic heating unit you really have year-round push-button control of the climate within your home.

Air conditioners fall in two general categories, window units to cool one or two rooms and central units to cool the entire house. The window units have certain advantages which make them desirable for those who can best utilize this type of air conditioning. No ductwork is required and no special wiring, except for the larger sizes, and the units can be installed either in the window, under the window or above it, or through the wall. Certain of the newer models of room conditioners can be installed without noticeable projections either inside or outside the room. The units are highly efficient and operate under average conditions at very low cost. Nearly all such units can be equipped with temperature controls.

Electrically powered home air conditioners operate on essentially the same principle. Referring to the simplified diagram on page 160, which illustrates a room-type conditioner, the motor-driven compressor,

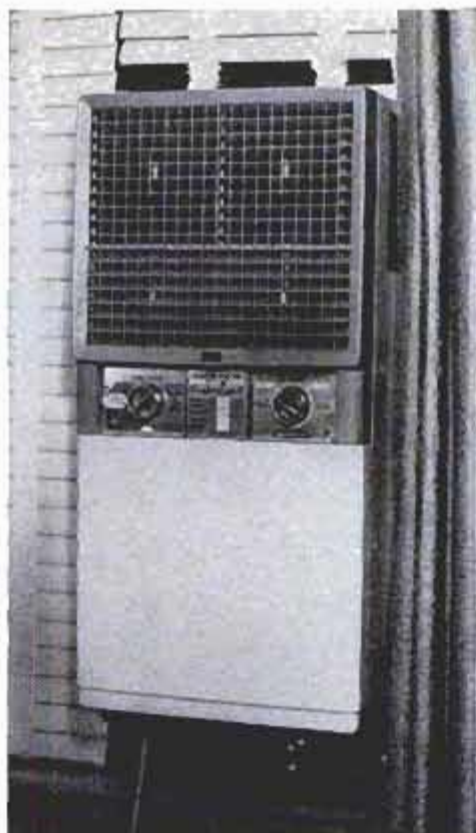

Emerson

New unit that fits in a casement is of panel design. Installation extends only a few inches beyond the draperies

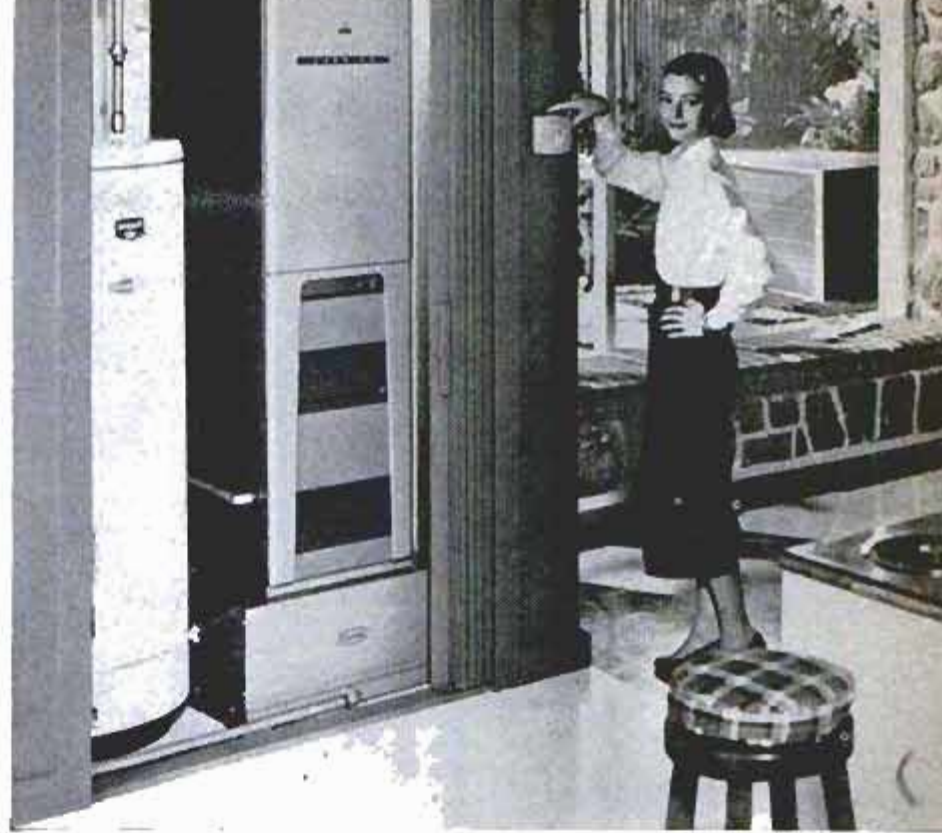

Carrier

Unit heating and air conditioning in the latest design fits in utility room with condenser unit outside house. Note compact, neat design. Temperature is automatically controlled at all times

Climate Control

A, is the heart of the refrigerating system. Starting the refrigerating cycle at the evaporator, or cooling coil, C, the refrigerant changes from a liquid to a gas within this coil. In the changing state the refrigerant absorbs heat from the coil which in turn absorbs heat from the air blown by fan E through the filter, F. The heat-carrying gas then is conducted (through tubing) to the compressor, A, where it is compressed and carried to the condenser coil, B. Within the condenser coil the refrigerant (under pressure) condenses back to a liquid, releasing the heat it carries to the coil which, in turn, dissipates the heat to the air circulated over it by fan D. The liquid refrigerant then returns to the cooling (evaporating) coil to repeat the cycle. After passing through the filter, F, and over cooling coil, C, the cooled and filtered air is discharged into the room, or through a duct system if the installation is of the central-unit type designed to cool the entire house.

The larger installations consist essentially of the same units as those in the window conditioners except that size and capacity of the units increase and often they are located separately, the heavy condensing unit being placed outside where its weight is no installation problem. This type of in-

stallation is typical where the existing heating system can be utilized to circulate cooled air, the cooling, or evaporator, unit being installed in the plenum of the furnace. In this case the condensing and cooling units are connected by means of copper-tubing lines to carry the refrigerant. Such systems are now made sufficiently flexible to solve almost any special installation problem. In the larger installations (other than window conditioners) air, which has become heated and made humid through indoor use, is taken back from the rooms by means of ducts and recirculated after being cooled and freshened. In this respect, the larger installations differ from the window conditioners, which draw air from outside the house. Some of the larger installations make use of water, which is passed through

WIRING REQUIREMENTS				
Hp.	Voltage	Separate Circuit?	Wire Size	Fuse With Time Lag
1/3 hp.	115	No	---	---
1/2 hp.	115	Yes	No. 14	15 amp.
3/4 hp.	115 or 230	Yes	No. 12	20 amp.
1 hp.	230	Yes	No. 12	20 amp.
1 1/2 hp.	230	Yes	No. 12	20 amp.



Rheem

Here cooling unit is located in the furnace plenum, with the condenser located either in another room or entirely outside the house. Copper lines provide for circulation of coolant between the two units



Serve

This window air conditioner mounts flush with the draperies. It is also adaptable to built-in or through-the-wall installations. Has six-position, push-button control. Styled to harmonize with room colors

Careful planning of a new home can do much toward lightening the load on the air-conditioning equipment. Tree shade is important, even that from a small tree can make an appreciable reduction in operating cost

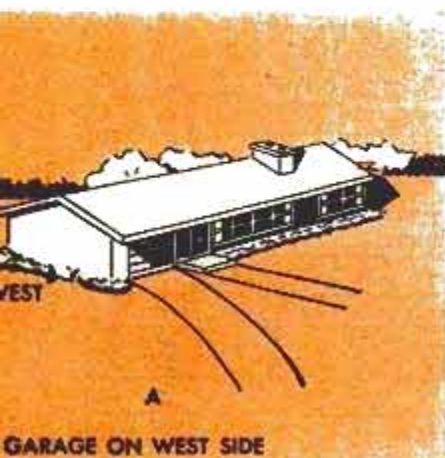

A

GARAGE ON WEST SIDE

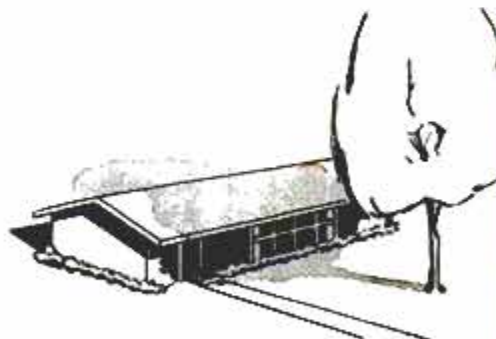

B

TREE SHADE

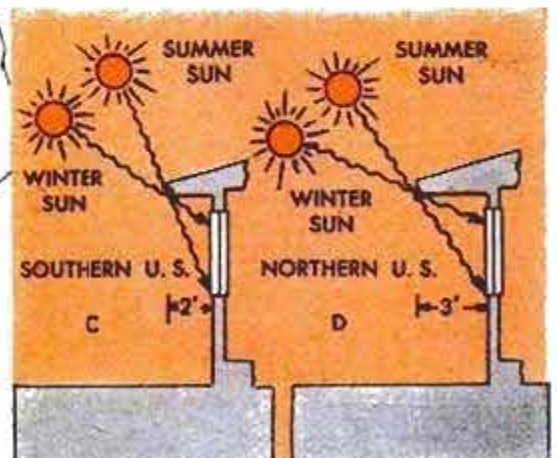

POPULAR MECHANICS



Gibson

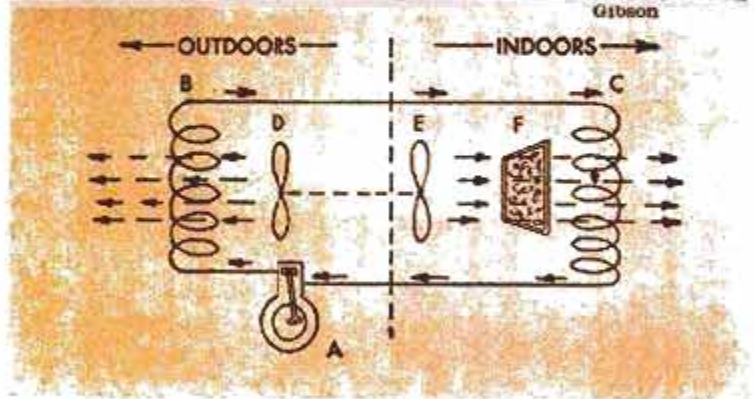

cooling towers located on the roof or anywhere above grade where there is adequate air circulation, the purpose of the tower being the dissipation of heat through evaporation of condensate.

However, manufacturers have tended to concentrate on the waterless systems in the effort to solve the twin problems of space requirements and economy. One variation from window and central-unit cooling is the self-contained console-type cooling unit, for use with or without duct systems, especially designed for cooling two to four rooms at a time. Such units are individually somewhat less in initial cost and they have an added advantage in that they can be installed without cutting into existing walls and floors to install a duct system. Some other conditioners provide two complete refrigerating systems in each

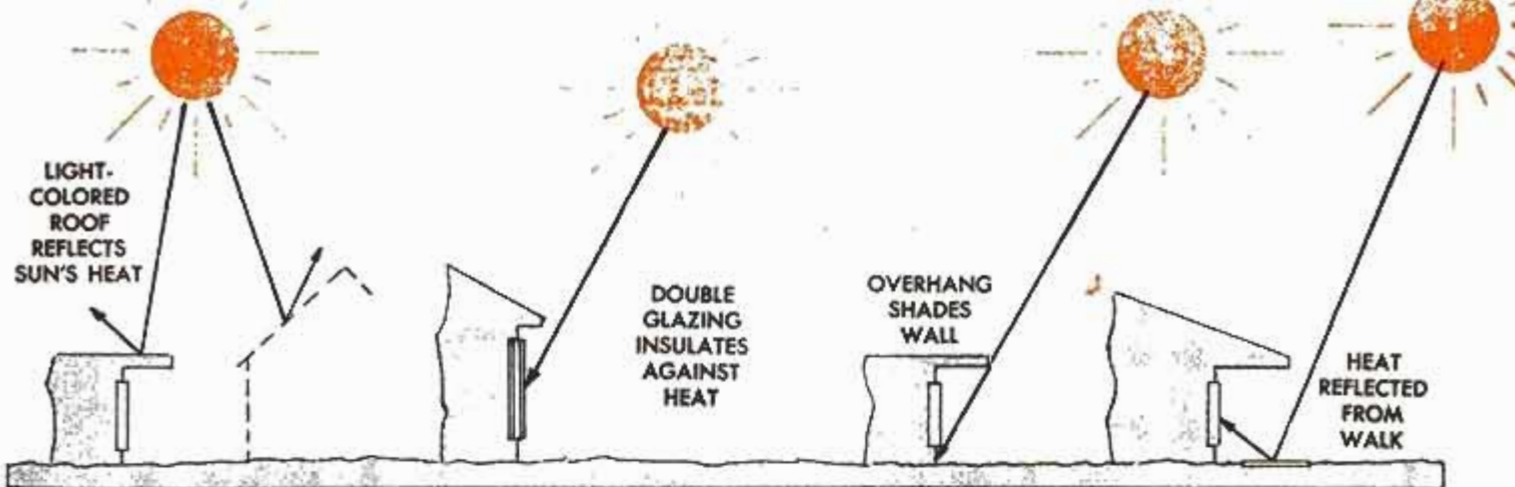

unit, only one of which is in operation during normal weather conditions. The second unit cuts in only when the load increases beyond normal capacity of first unit. This arrangement is said to effect a marked decrease in operating cost. During this year another manufacturer will offer an all-year gas-operated air conditioner which will provide both heating and cooling for the entire home by means of a single gas-operated heat exchanger.

If you are planning a new home, probably the best and least expensive installation is the central unit that cools in summer and heats in winter, both processes being thermostatically controlled to effect the greatest operating economy. The added cost of the air-conditioning equipment over that of a heating installation alone can be at least partially offset by the construction savings possible in a completely air-conditioned home. Since cross ventilation in the air-conditioned home no longer need be a design factor, economical rectangular floor plans are possible, featuring fixed window sash, elimination of screens and construction of solid walls on the east and west exposures. For those whose homes are equipped with forced-air heating systems the next best thing is to air-condition the entire house by making use of the present duct system and the furnace blower. Most



Westinghouse
Single-dial control, illuminated control panel and an electronic air cleaner are special features of this room-size air conditioner. Thermostat maintains the desired temperature and humidity of the air in the room. Air cleaner removes pollen, dust and smoke

In a walled patio located on the east, west or south sides of the house avoid use of light-colored flagstones, as these will reflect sun's heat into house. Same is true of walks and driveways near house walls

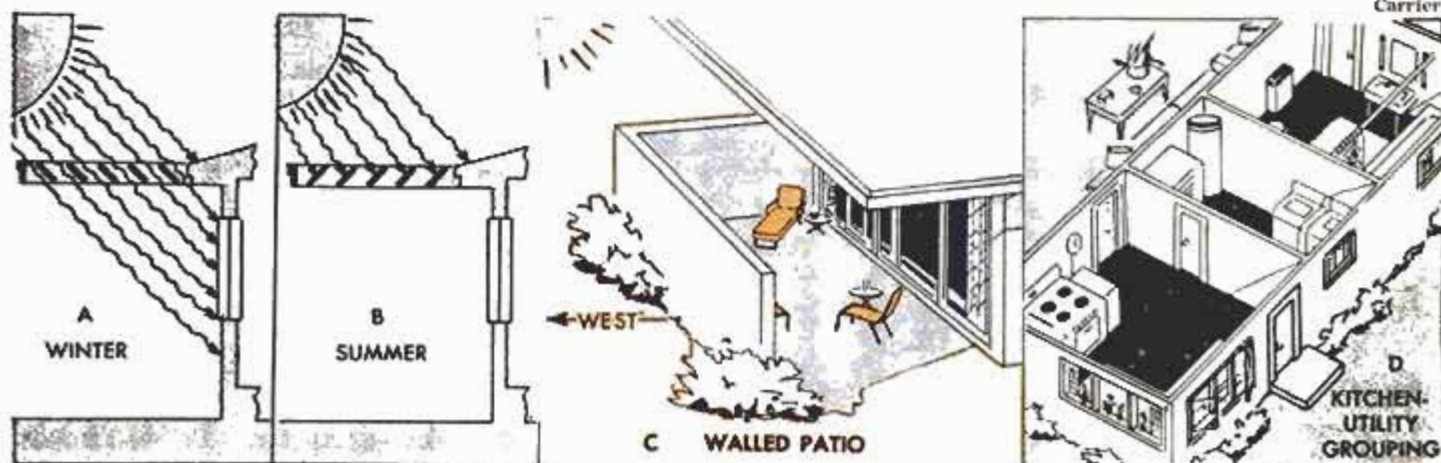

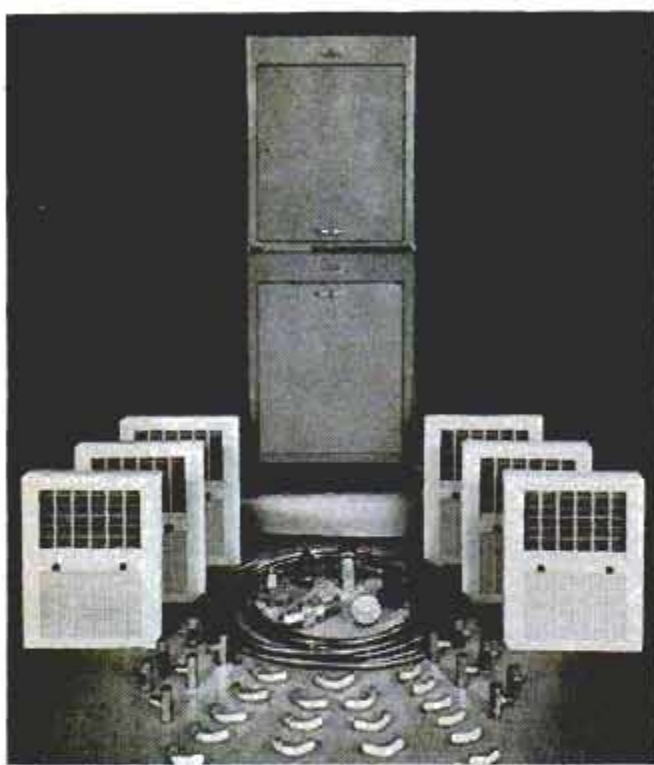

Heatmaster

Complete home heating and cooling is provided for by this ready-to-install system which operates as a hot-water heating unit in cold weather and as a cooling system in summer. Water is chilled by cooling unit and circulated through individual recessed room units

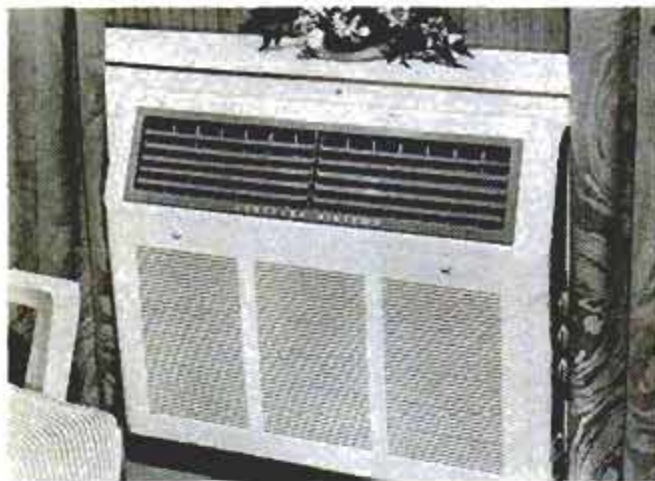

Chrysler

Above, this room conditioner is completely flush with outside wall when installed. Extends only slightly beyond draperies on room side of wall. Below, although it can be installed in a window, this unit also is adapted to through-the-wall installation

General Electric

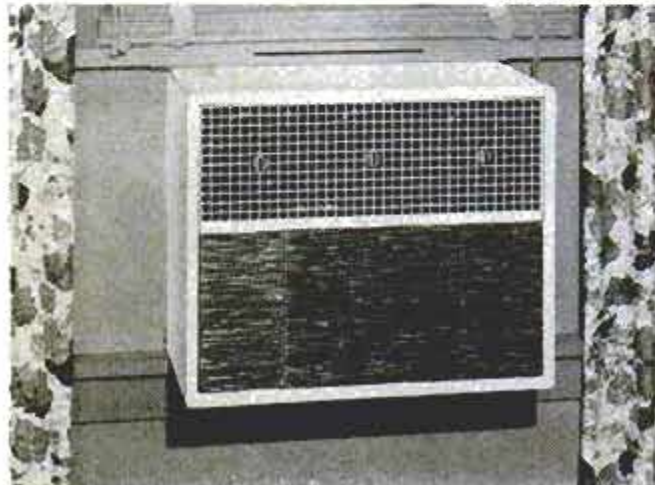

gravity heating systems can be adapted to a similar air-conditioning installation with the addition of a suitable blower. For those with hot-water or steam-heated homes, attic installation of an air-conditioning system with ducts is possible and at a reasonably economical figure. For those planning new homes there also is available a heating unit especially designed for addition of an air-conditioning unit at a later date. The cooling unit is simply installed in a compartment provided for it in the original heating unit.

Much can be done by the homeowner himself, both before and after installation of air-conditioning equipment, to lighten the work load on the unit. A new home should be located to take advantage of all available shade, windows and roof overhang should be planned to prevent entrance of direct rays of the summer sun and reflecting surfaces should be located so that they do not direct the heat of the sun into the house. Driveways, terraces, patios and walks on the south, east and west sides of the house should be of dark materials which do not reflect light and heat. Note details A to D inclusive on pages 160 and 161. A small shade tree can cut the cooling load appreciably even though it is effective during only a part of the long summer day. A large shade tree with heavy foliage is even more valuable, while a house that is completely shaded by large trees requires only about half as much cooling as will the same house standing in the open and unprotected.

Likewise wide overhangs, window awnings and blinds, wall, ceiling and attic insulation, light-colored roofs and sealed dual-paned sash are construction features which are a valuable help in reducing operating costs of all types of air conditioners. Open-sided awnings alone will keep out up to 50 percent of summer's heat. A light-colored roof can reflect up to 50 percent of the sun's heat. Proper insulation will account for about the same amount.

When planning a new home it's a good idea to locate the garage on the west end of the house as in detail A, page 160. In this position the garage serves as an effective heat barrier. Avoid a light-colored floor in a walled patio, detail C, page 161. Often an exposed window, particularly a large one, can be protected adequately from the summer-sun's rays with an adjustable louver as in details A and B, page 161. Also in new-home construction it is sometimes recommended that a kitchen-utility-bath grouping be worked into the floor plan as in detail D, page 161. This arrangement tends to confine heat and humidity-producing activities such as cooking, bathing and laundering to a comparatively small area

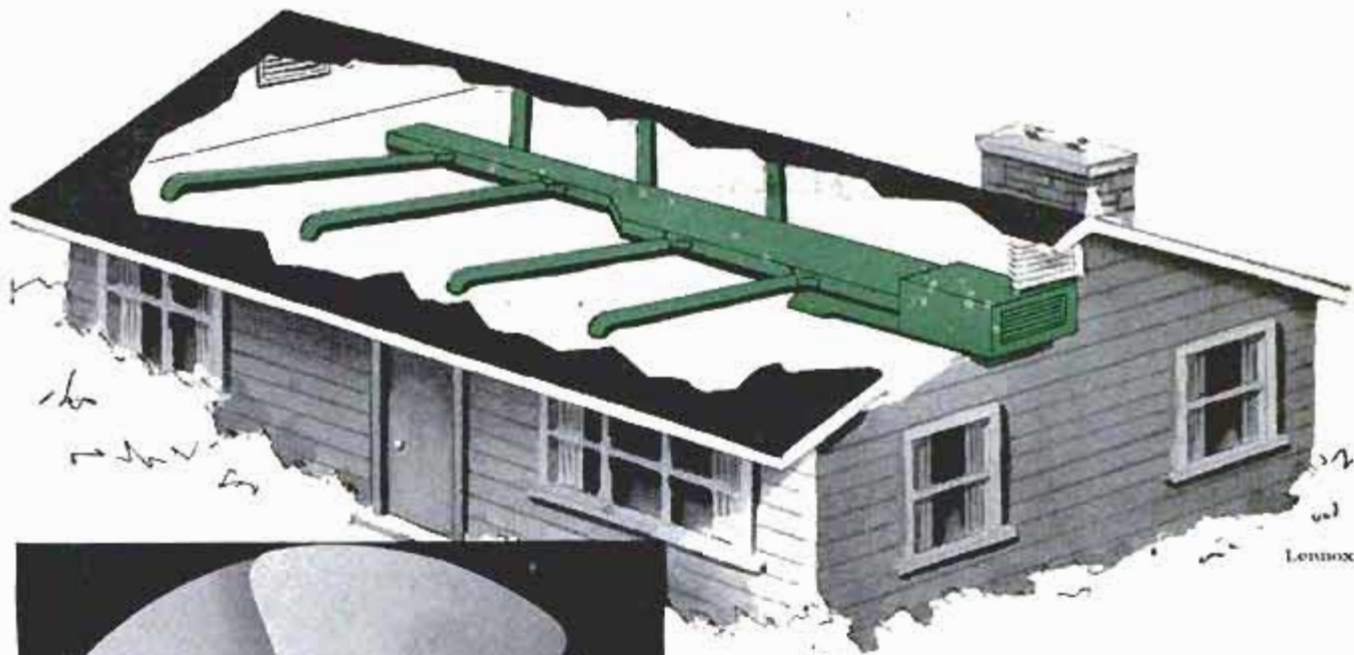

Lennox

This unit air-conditioning system can be installed in the attic. Provides rainproof air handling and two-stage cooling in a unit of minimum over-all size

and reduces the load on the cooling unit.

In older homes where air-conditioning equipment is installed it is frequently recommended that storm sash be sealed, storm doors be weather-stripped and left on the year 'round, and that adequate insulation be added where necessary to shield against heat transmission from the attic and through walls. Awnings that effectively shade windows on the east, south and west sides of older homes will usually return the investment in savings on operating costs of an air-conditioning system. Light-colored exterior paint on walls and trim also contributes its reflective properties quite effectively.

★ ★ ★

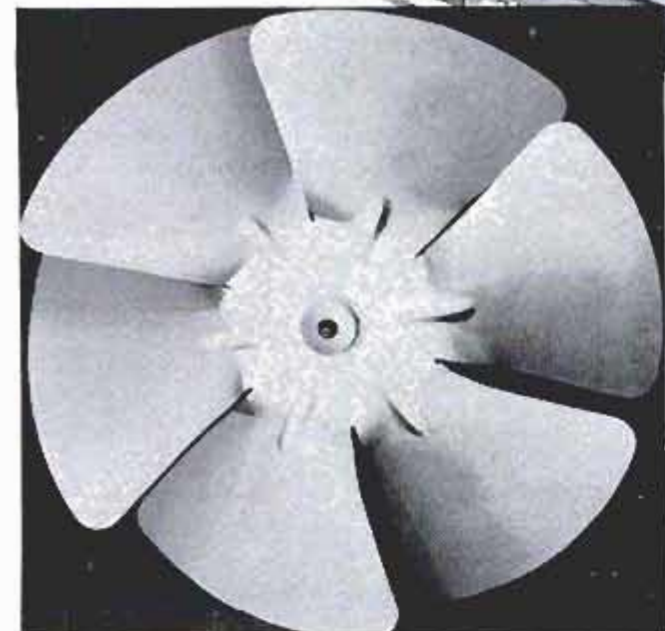

Axial fan with which attic unit is fitted accounts for its high efficiency, minimum space requirements and exceptionally quiet operation under all conditions

Designed to fit in a window only 27 in. wide this room conditioner features simple twin controls, a compact housing that fits nearly flush with draperies. Attractive grille is finished to harmonize with room

Mitchell

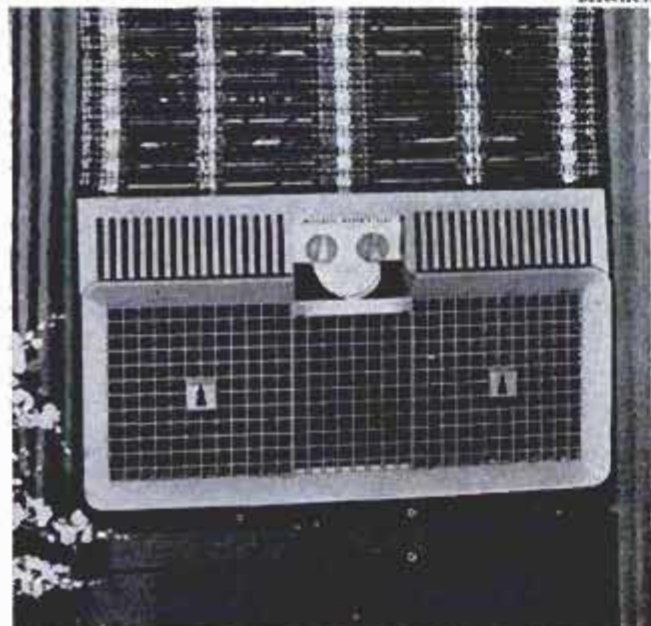

Space-saving central system is designed for year-round air conditioning with condensing unit placed outside in any convenient location. Uses same duct-work for cooling, heating. Cooling unit is in plenum

Chrysler

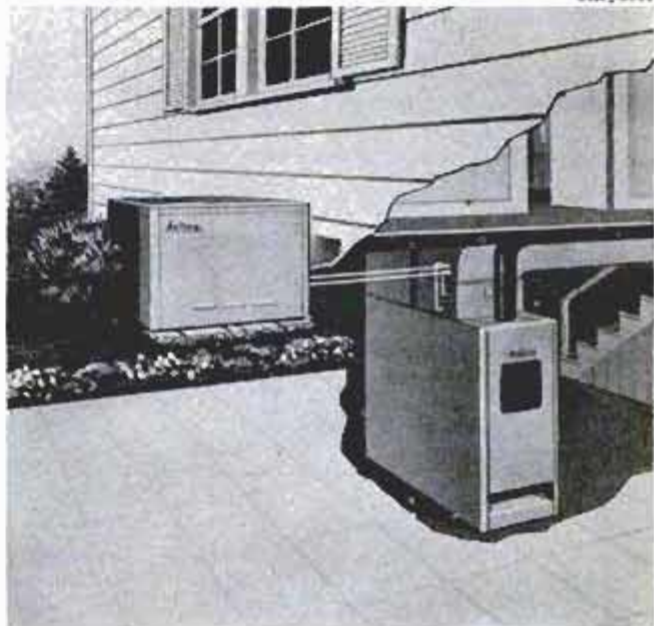

Cool Footpath on Beach Provided By Spray Hose

At a municipal beach, bathers previously tortured by walking barefoot a considerable distance across hot sand to the water's edge now have a delightful cool path. This service is provided by spraying a strip of beach with water by means of perforated flat spray hose. The water pressure is adjusted so the spray rises no higher than 2 ft. off the ground, which will dampen and cool an area of sand on either side of the hose, yet not reach the bather's jackets or shirts.

6-Volt Accessories Used With 12-Volt Systems

Adapt 6-volt automobile accessories to cars with 12-volt systems by attaching the positive lead to the center-cell connecting strap of the 12-volt battery. A large alligator clip soldered to the lead will do the trick.



Rack Under Rural Mailboxes Shelters Large Packages

The parcel rack attached to the underside of this rural mailbox stand affords protection against rain and snow for packages too large to insert in the box. Also, the wide, open front on the rack permits the mailman to deposit parcels easily, without the discomfort, loss of time and damage to packages that result when they are forced into a mailbox. The rack is made of 1 x 2-in. wood framework and is screened on three sides. It has a galvanized, sheet-metal roof and a hardboard floor.



"Wagon Wheel" Gate

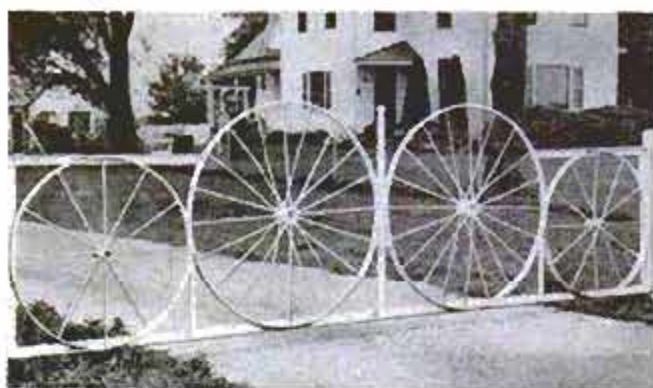

Steel wheels from obsolete farm implements welded in a frame of steel angles from a dismantled windmill tower comprise this quaint and original farm gate

Needle Files Stored In Toothbrush Case

Force strips of corrugated cardboard, cut parallel with the corrugation, into the bottom half of an empty toothbrush case. You now have a handy container, with separate pockets, for carrying needle files.



MODERN CANDLESTICK HOLDERS

THESE DISTINCTIVELY different candleholders follow the modern trend toward irregular shapes in three dimensions. The basic material is a 2-ft. length of 1 x 8-in. wood stock. Paper templates made according to the specifications below are used to lay out the individual pieces. For best appearance, the grain should run lengthwise in the base and be slanted up toward the back in the holders. The four triangular-shaped pieces which will be attached to the larger uprights can be cut from the scrap strips left from cutting out the base. The grain on these pieces should correspond with that of the uprights so that glued joints will be inconspicuous. Sand all parts thoroughly, giving particular attention to surfaces of joints to be glued. Then glue the holders together, clamping them firmly until dry. Meanwhile, drill the base for the wood screws that will fasten the holders to it, countersinking each hole from the bottom. Drill matching holes of smaller diameter in the holders and attach them to the base. Next, drill the holes for the candles to a depth of $\frac{3}{4}$ in. and bevel the sides of each hole to fit the bottom taper of the candles.

Nicholas M. Margetis, Madison, Wis.



A small potted ivy or a spray of pine boughs placed between the holders adds contrast to the sharp lines

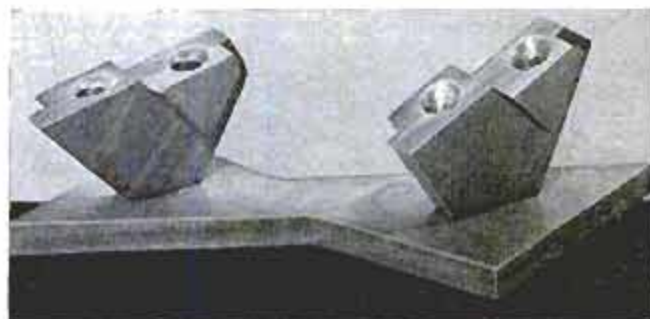

Offsetting one of the holders so that the two are not parallel to each other helps promote the irregular motif. The lines of the holders should not match

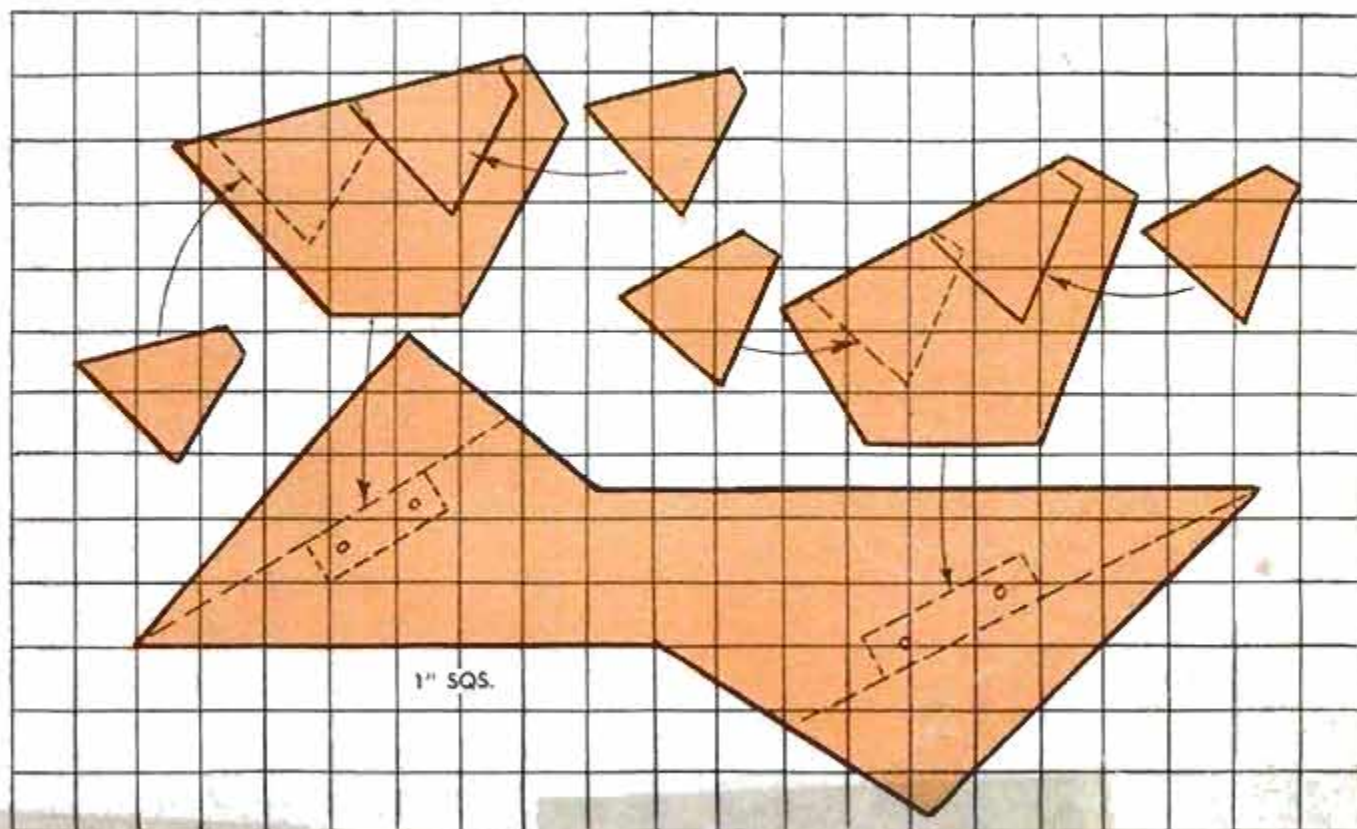

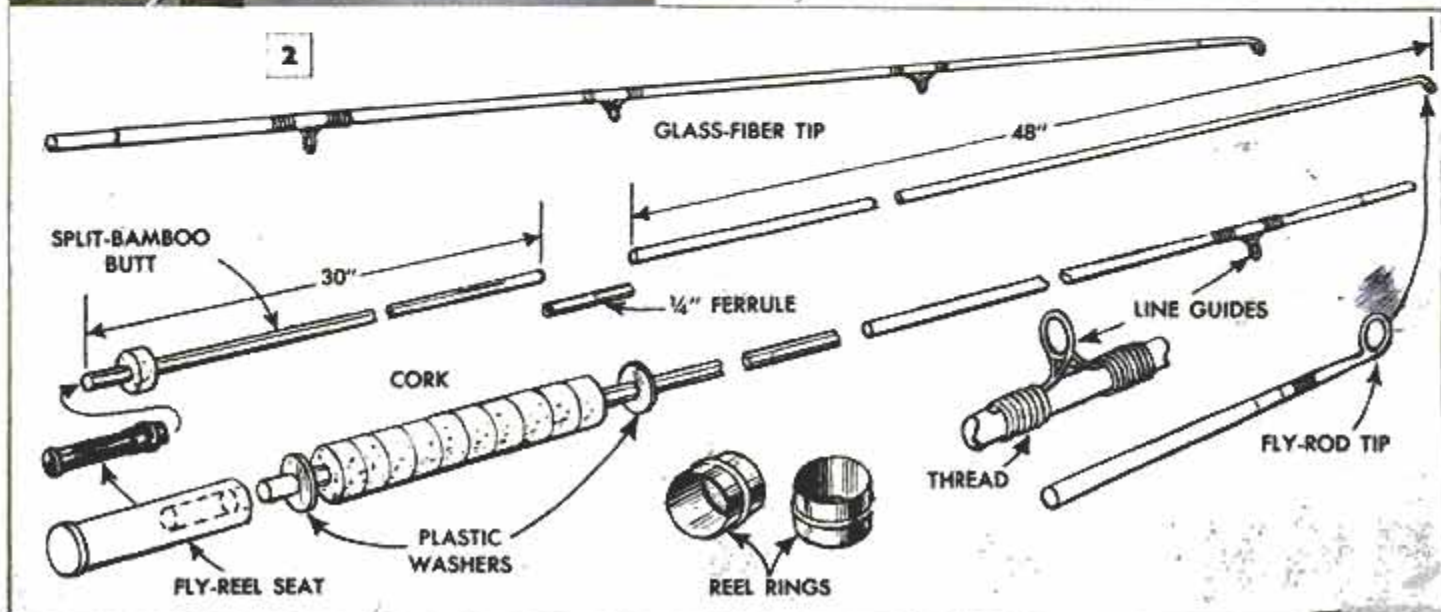
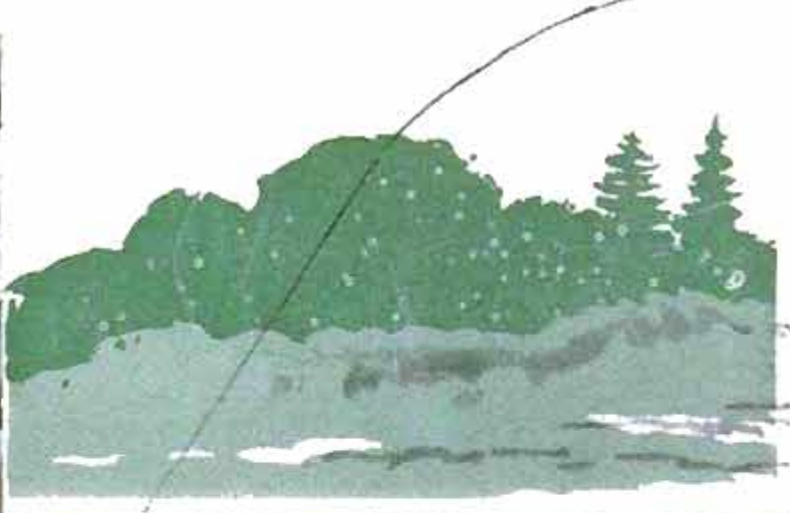

"TAILOR MADE" CASTING ROD

By Joe Ott

CONTROLLED flexibility is the added advantage I now include in the design of tailor-made casting rods made for my own use. The secret is to use a combination of a bamboo butt and a glass-fiber tip. Weight and length of the bamboo determine the weight and balance of the rod, the glass fiber controls flexibility. If more spring is desired, the bamboo butt is shortened and the glass-fiber tip is made longer in relation to the over-all length of the rod. Reversing the ratio will proportionately stiffen the rod.

Parts for assembling the rod are shown in Figs. 2 and 7, and are available at the shops of custom-rod makers and some sports stores. As with any custom-made rod, type and number of fittings are left to the discretion of the individual. Lengths given for the glass-fiber and bamboo sections of the rod are only suggested and can be changed to suit. Remember that the top end of the butt and lower end of the tip must fit in the same size ferrule. Average

handle length is about 11 in., requiring 22 cork rings $\frac{1}{2}$ in. thick.

Assemble the rings on the bamboo butt, attach all line guides, ferrules and fittings with masking tape, Figs. 3 and 4, and tape on a reel. Check the rod now for flexibility and balance and shorten the bamboo or glass-fiber sections to suit your personal requirements. Keep in mind that the finished length of the rod should be somewhere between 6 and 7 ft. The rod will be long enough for a fly rod and light enough for a spinning outfit. If a fly-reel seat is to be used, glue the end of the butt in a length of dowel drilled to receive it. The dowel can be turned or filed down to provide a snug fit for the reel seat. Drive a $\frac{1}{16}$ -in. rustproof-metal pin through the seat, dowel and into the bamboo.

When making the handle, glue on all but two of the cork rings. Turn the handle to size and shape so the reel rings fit snugly on the center portion but cannot slip off the end. Slip on the rings, then glue on

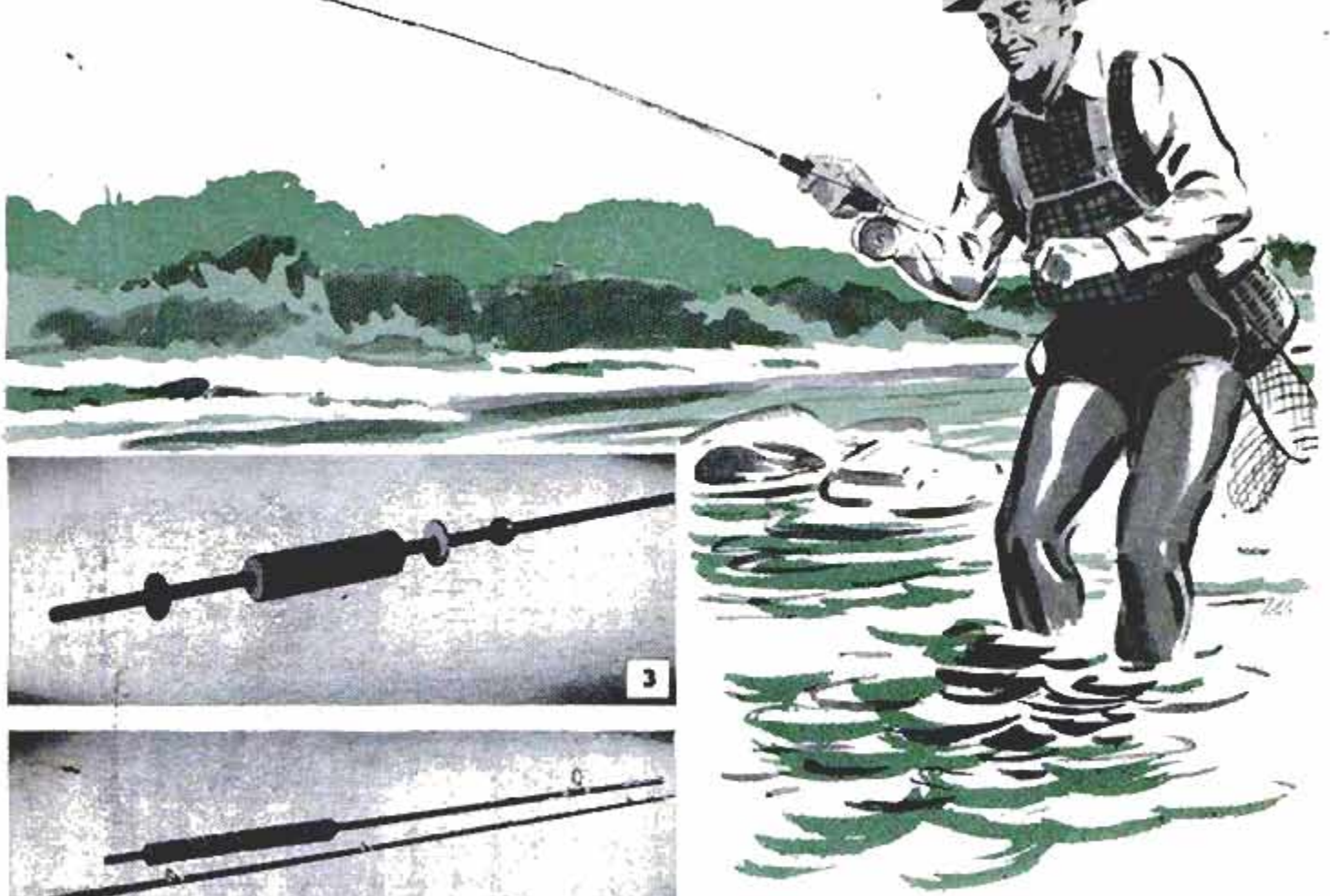

3

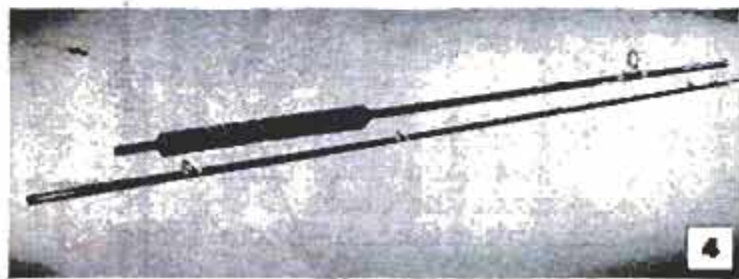

4

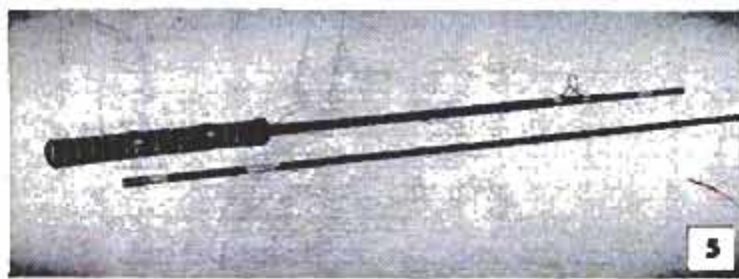

5



6

the last two corks. Shape them so the rings cannot slip off that end of the handle. The handle can be reinforced at its forward end with a bell-shaped winding check. File a flat on the handle for a spinning-reel seat and the handle should now appear as in Fig. 5 or 6, depending on the type of rod.

If a fly-reel seat is not used, a butt plate is screwed to the end of the handle. To prevent the butt from splitting when the butt-plate screw is driven into it, the bamboo is wrapped with thread, then wiped with glue. Two contrasting colors of thread are used to bind the guides, ferrules and winding check with a rod winder, Fig. 1. If the guides have thick bases, file them to a slight taper. Attach the guides to the rod with masking tape, then wind tape on the rod at each taper, so it can be filed down, continuing taper of guide base. ★ ★ ★

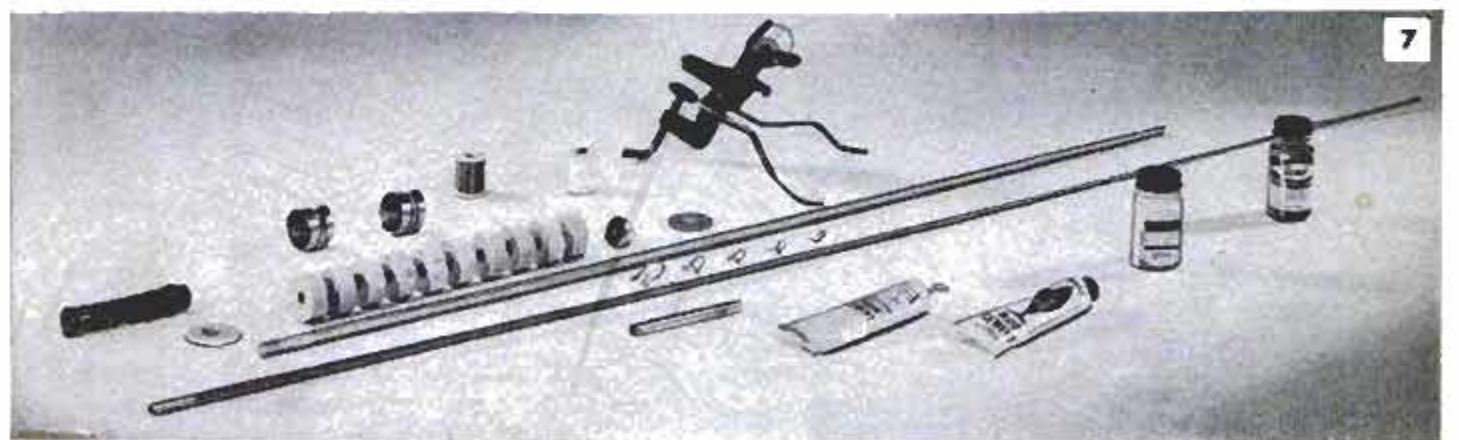

7

Arrows Held by Ground Quiver Bent From Wire Coat Hanger



A handy ground quiver that will hold a dozen arrows in an upright position within easy reach of an archer can be made from a wire coat hanger. After straightening out the coat hanger, form a loop about 6 in. in dia. at one end of the wire and bend it at right angles as shown. In use, the quiver is merely stuck into the ground.

R. M. Woodbury, Natick, Mass.

Electrified Kerosene Lanterns Provide Rustic Yard Lights

To provide his front yard with lights to match rustic fencing, one homeowner installed electrified kerosene lanterns on pipe posts on either side of the gate. The lanterns are electrified by installing sockets



and running outdoor-type cable down through the posts and underground to a fused outlet inside the house.

Lena Anken Sexton, Inkom, Idaho.

Calking Compound Seals Cracks Where Sidewalk Joins Wall

A sidewalk laid directly against a masonry wall will tilt toward the wall after a few years of exposure to water and the effects of an excavation unless the joint between the two constructions is kept tightly sealed. To prevent this damage the joint should be sealed with calking compound, which will remain flexible enough to allow movement due to frost heaving and expansion and contraction. Before applying the compound, debris must be removed from the joint to a depth of 1 in. When the joint is dry, oakum is tamped in to $\frac{1}{4}$ in. below the surface of the walk, followed by a layer of calking compound which is allowed to project slightly above the surface. It is important that the crack between the walk and foundation be dust-free for a good seal.



Chair "Pontoons" Protect Lawn

The legs of a lawn chair will not sink into the ground, leaving unsightly holes, if you place two narrow boards under the legs like runners. Placed flat on the ground, the boards serve as pads. The manner of attaching them to the legs depends upon the type of chair. Scrap lumber from packing boxes may be used for this purpose. After the boards are attached, they may be painted to match the color of the chair.

Blanche Campbell, Los Angeles, Calif.

Matches Taped in Tackle Box Kept Dry for Emergency

A ready supply of dry matches is kept on hand when on a camping or fishing trip if a book of matches is taped on the inside of your tackle-box lid. Only the back of the match cover need be fastened,

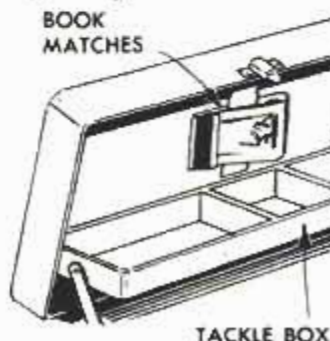

permitting use of the matches without having to remove the tape. Since the cover is held firmly in place it is easy to strike a match with one hand while holding a fishing rod with the other.

DECORATE WITH WHEELS

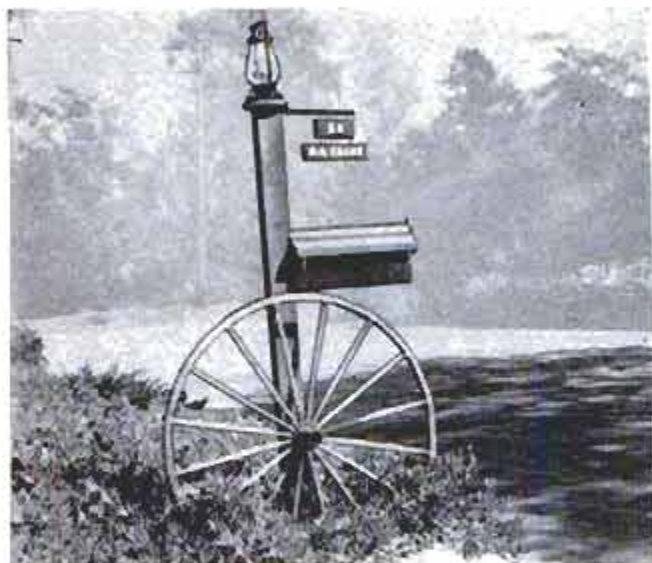

Single wagon wheel adds to rustic appearance of lantern and mailbox on post located at side of highway

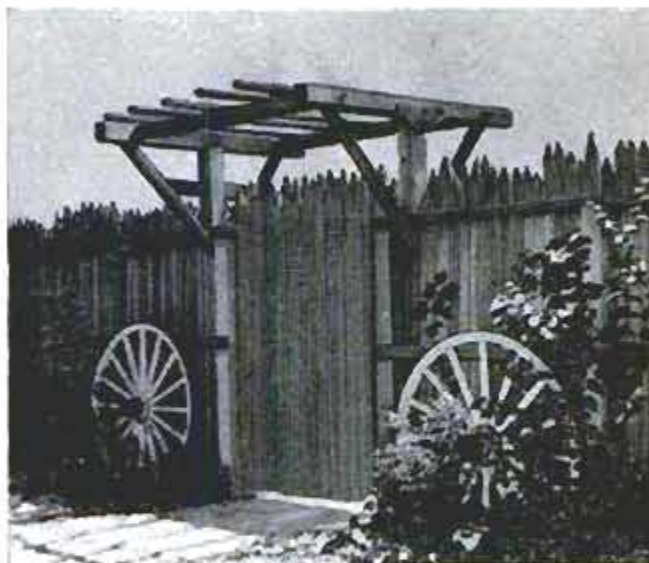

Light-colored wheels contrast well with darker tone of stockade-type fence made from rough-cut wood

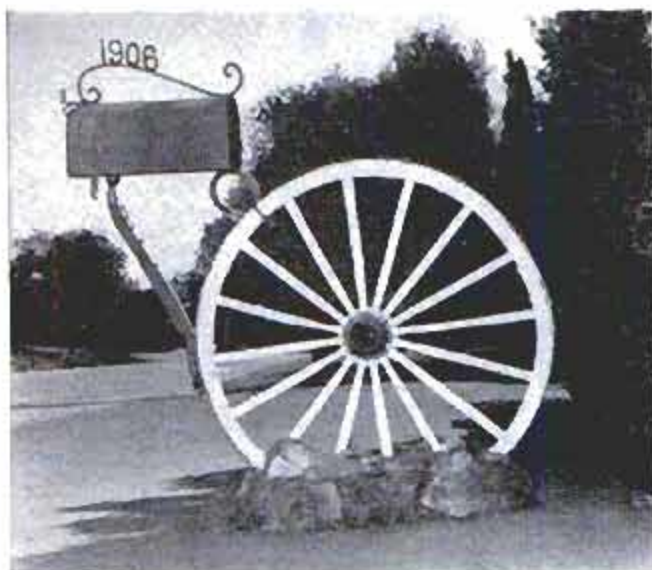

Above, wheel forms simple and attractive support for mailbox that is attached directly to steel tire. Below, wheels form strong and unusual fence that achieves open effect often lacking in other types of fencing

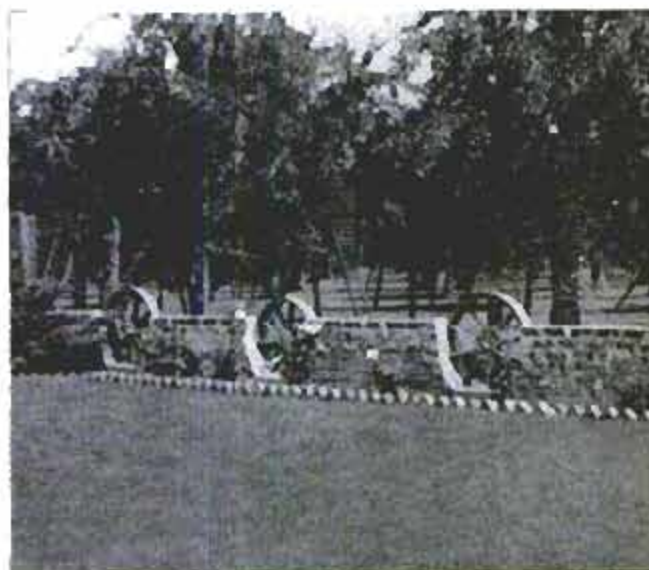

Above, heavy-spoked artillery wheels have heavy appearance that blends with massive brick wall. Below, strong and symmetrical, wagon wheels add a definitely handsome look to these driveway gates

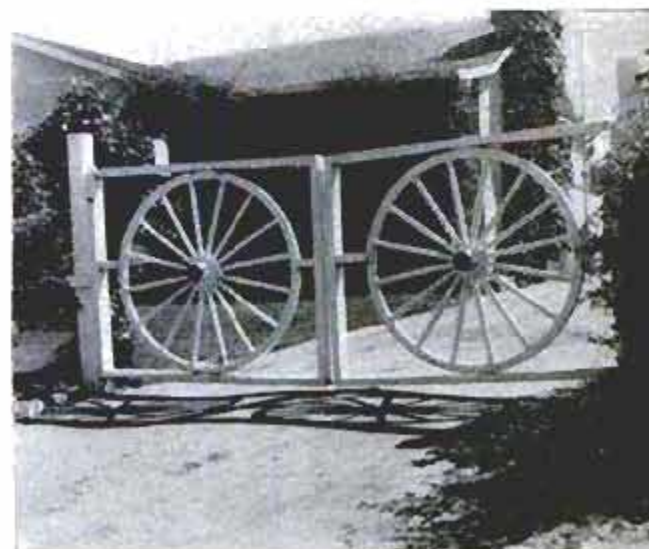
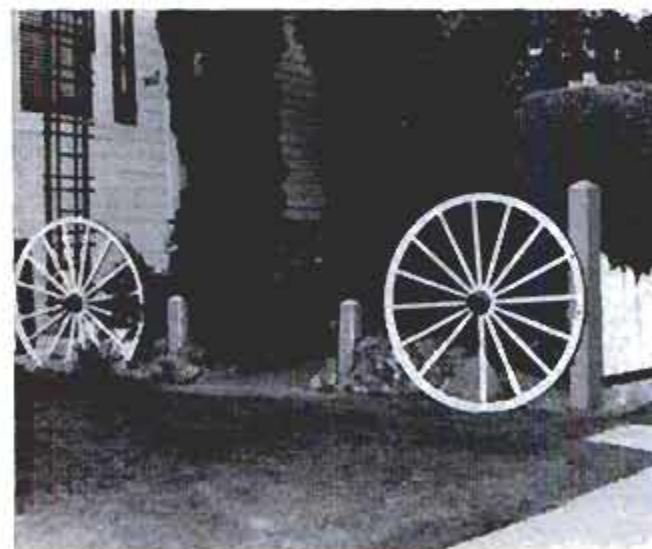

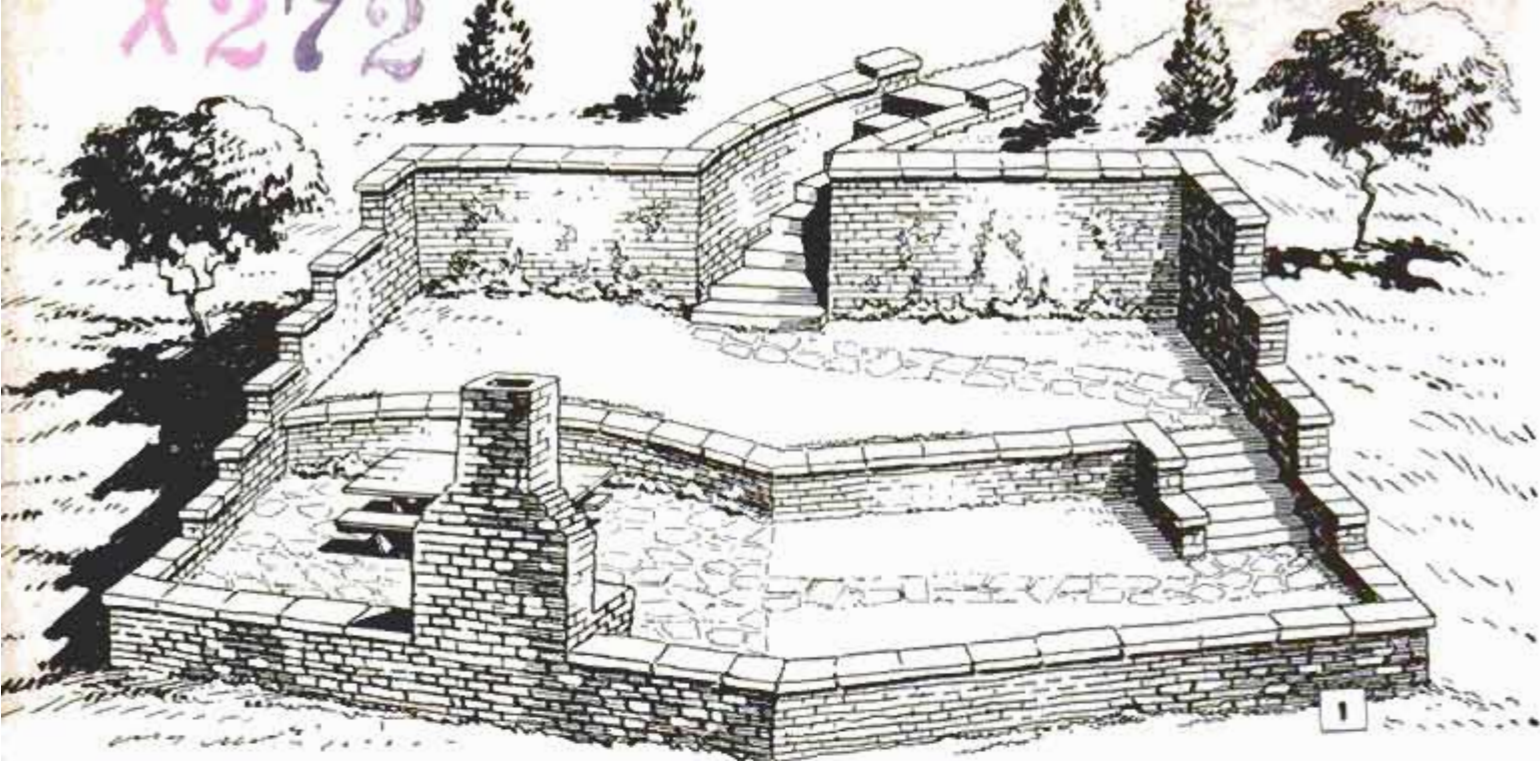

When you're planning a recreational area on a sloping lot it's quite natural to think of flagstone walks and walls of stone. Project pictured above is especially adapted to a fairly steep downward slope

PATIOS

BUILDING A PATIO or outdoor recreational area on level ground is a comparatively simple procedure, and you have a variety of materials and plans from which to choose. But if your lot slopes away from a point near the back door, either up or down, the prospects of achieving something both attractive and useful can appear less hopeful. However, there are materials and plans that belong. As an example, there's a lot of easy informality and beauty in stone and stonework is a natural on a slope.

If your lot slopes down rather steeply, then a two or three-level recreational area, Fig. 1, may be the solution. A plan view of this area is shown in detail A, Fig. 2. Fig. 3 pictures a similar project in process of construction. A variation is shown in Figs. 7 and 10, this design being suitable for a lot that slopes either up or down. In both designs the walls are not only ornamental features, they also serve as retaining walls to hold earth in place until grass and shrubs are well established.

Details B and C in Fig. 2 suggest ways of planning such a project. Both are somewhat exaggerated for purposes of illustration and are intended only to show in a general way how to proceed. First, have the plan of the project clearly in mind, know precisely where your lot lines are and whether or not local codes require a permit. Lay out the location of the walls, the plan including one curved wall, or section of wall. Then excavate for the foot-

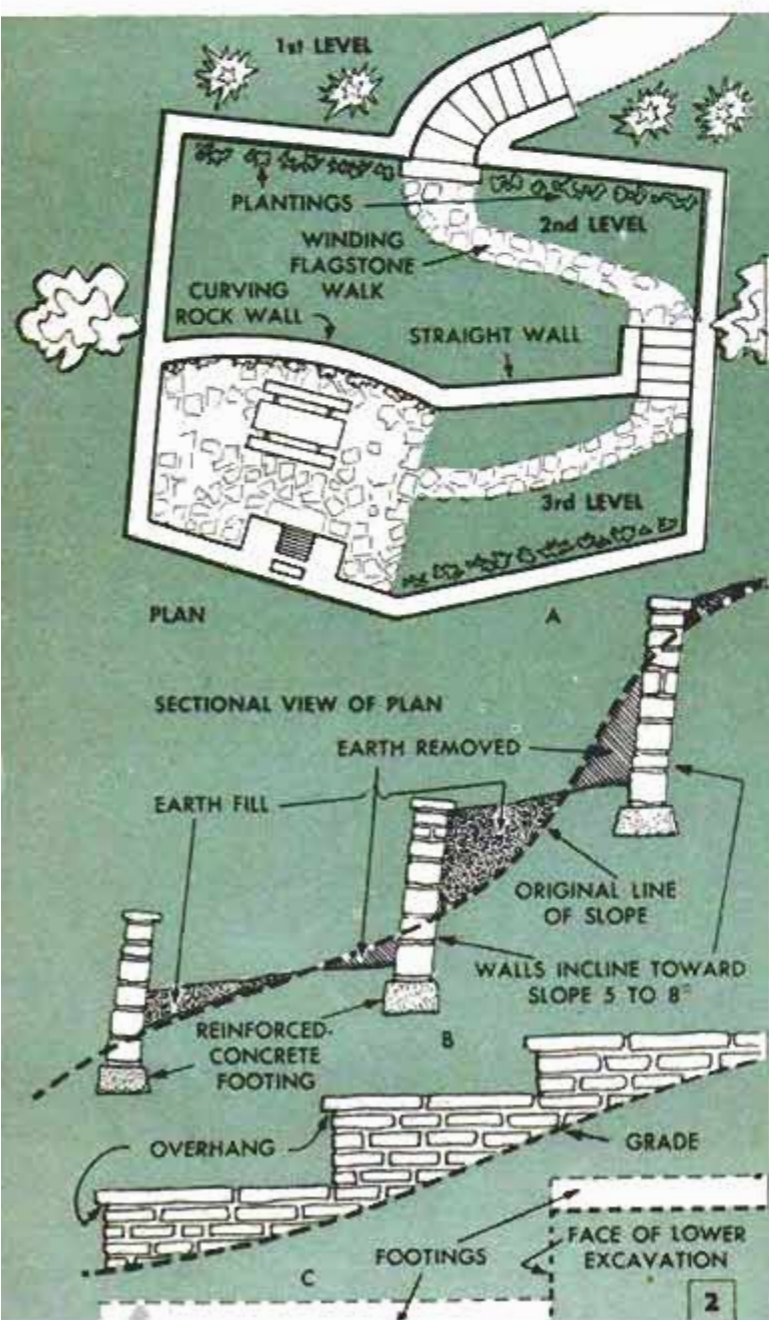



Photos by Sakrete

on SLOPING LOTS

By W. Clyde Lammey

ings and square up earth shoulders against which the walls will be laid, Fig. 11. Usually it's best to begin this job at the high side of the slope and work down, shoveling a part of the excavated earth onto the slope above, detail E, Fig. 5. Ordinarily, it's good practice to carry the side walls up the slope in a series of steps, excavations for the footings being made as in detail C, Fig. 2. Of course, special conditions may require somewhat different procedures than those outlined. If the slope is moderately steep, requiring walls 4 to 6 ft. in height at some points, all stonework should be mortared. Low walls not subject to appreciable pressure from above can be laid up dry (without mortar) as in detail E, Fig. 4. However, this is not good practice on single-course walls much above 3 ft. in height. Another procedure which is permissible on low walls laid up with mortar is leaving open joints, or voids, detail B, Fig. 5, the purpose being to encourage the growth of rock plants. However, the best construction requires that all joints be mortared.

Time was when mortar had to be mixed from separate ingredients at the job site. Now you can purchase it ready-mixed in sacks. Just empty the dry contents of the sack onto a platform of boards, or into a shallow, watertight box, add water according to instructions on the container, mix and it's ready to use, Fig. 8. This dry, pre-mixed product makes a smooth, cement mortar of just the right plasticity.

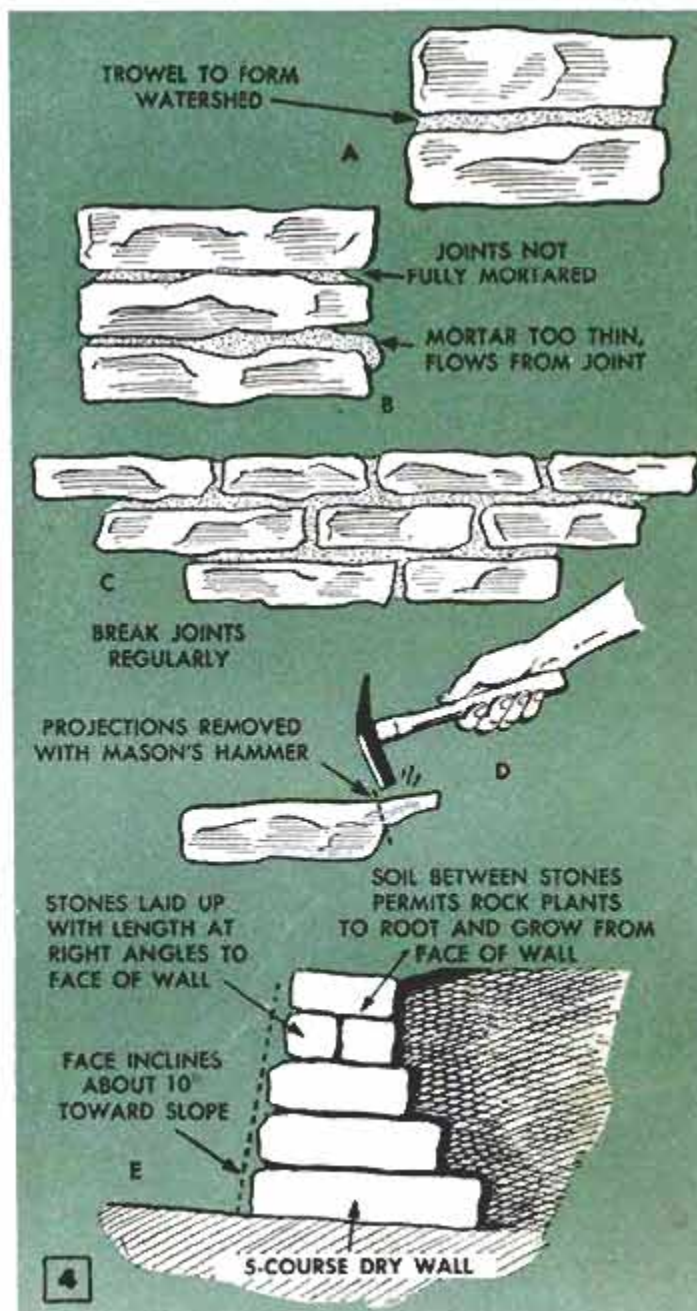

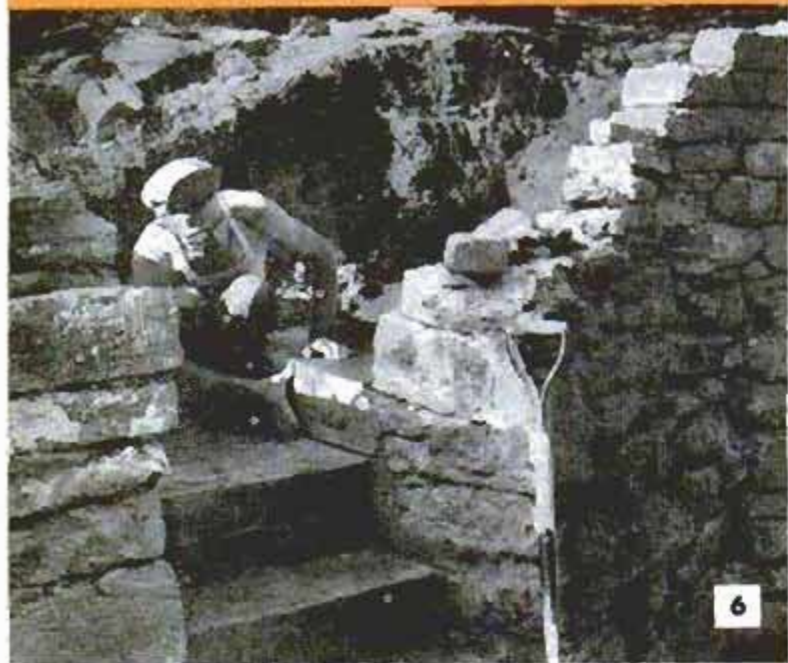
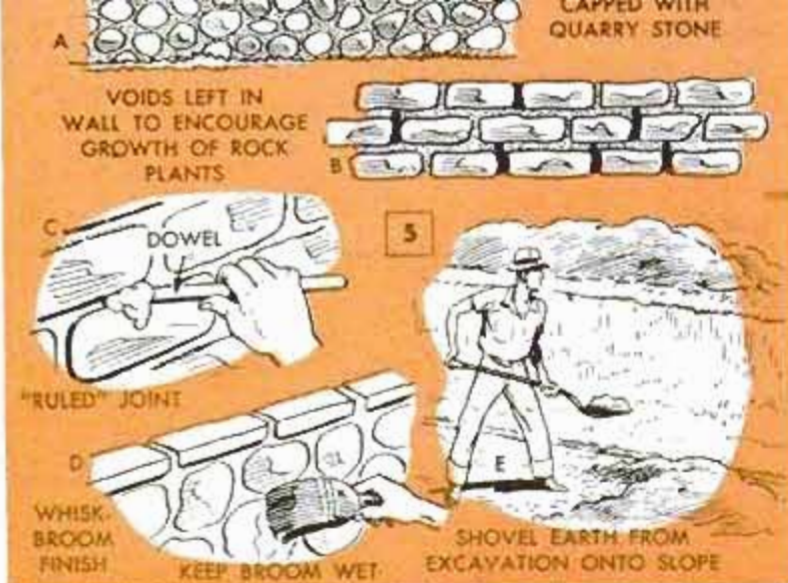

Recreational area below is designed to be adapted to a lot that slopes either up or down in relation to the house. When built against slope one stairway is omitted. Use natural stone

The tricks in laying up neat and durable walls of stone are not difficult to master, but the procedure requires careful attention to details. Stones of a more or less regular size generally are easiest to handle and lay, details A and C, Fig. 4, but appearance-wise many will prefer uncut stone and field stone, Figs. 3 and 6 and detail A, Fig. 5. Due to the irregularity of shape, the latter two types usually require more time in bedding, also a greater quantity of mortar. Ordinarily the mortar mix should be slightly stiffer when laying uncoursed walls of field stone. When laying up walls with any type of stones avoid skimping on the amount of mortar used in bedding each individual stone, detail B, Fig. 4. Projections that interfere with proper bedding often can be broken off with a hammer as in detail D, Fig. 4. To prevent large stones from forcing the mortar out of the joints, bed them on small stones which will support each stone and give a mortar joint of the proper thickness.

When laying up a stone wall against an earth face, or shoulder, avoid the representative faults indicated in detail A, Fig. 9. Fill all voids with mortar, or mortar and rubble (small stones), as you go along, detail B, Fig. 9. Some masons prefer to build the wall a few inches from the earth face, detail B. The back face of the wall is then coated with mortar (back-

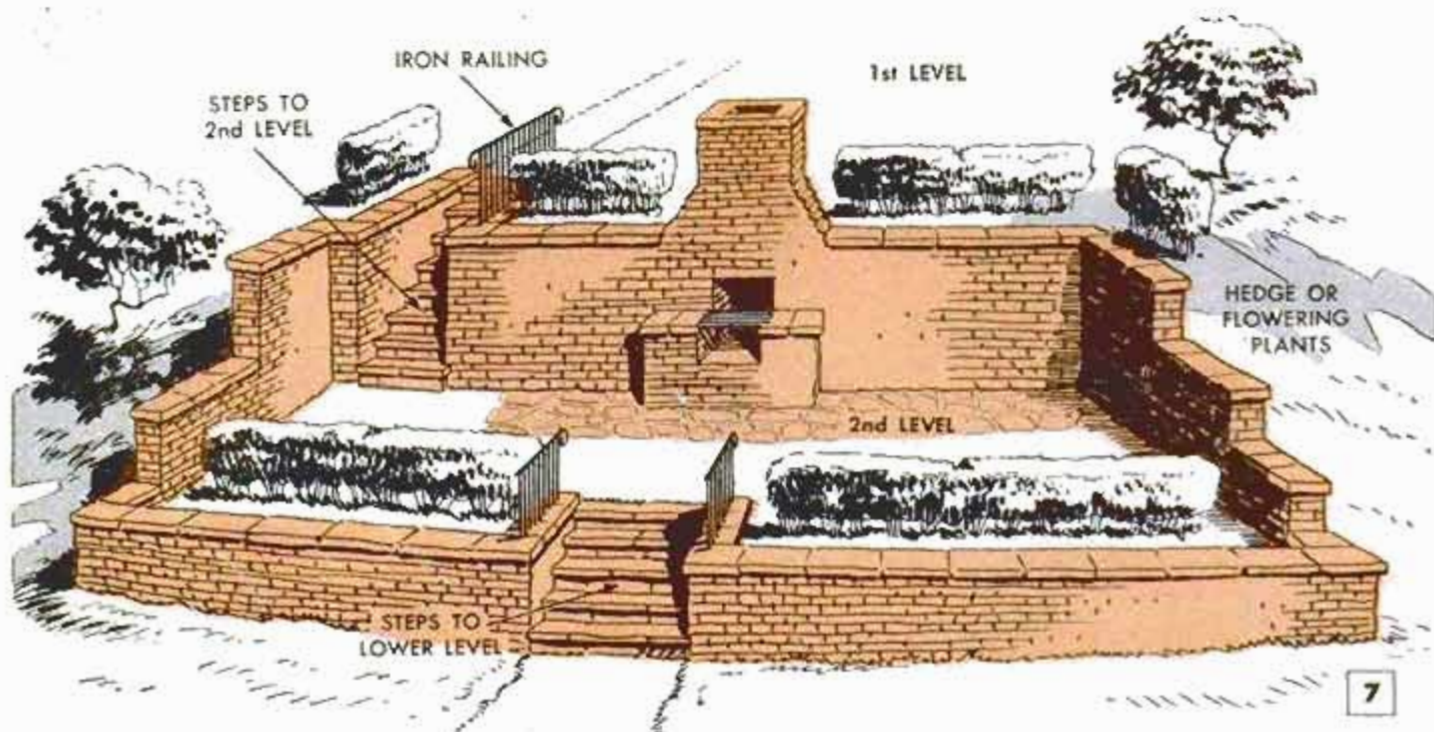

plastered) as it is laid up, thus presenting a smooth surface to the earth fill. However, in the type of wall construction pictured this is not always considered necessary.

In details C and D, Fig. 5, two methods of finishing, or "striking," mortared joints are shown. In stonework having more or less regular joints, detail C, Fig. 5, it is possible to obtain a rather attractive effect by raking the mortar lightly with a short length of $\frac{3}{4}$ -in. dowel having one end rounded, the procedure producing what is sometimes referred to as a "ruled" joint. The second method, more commonly used to finish walls built with field stone, is shown in detail D, Fig. 5. These methods are not considered orthodox by all stonemasons, but they are simpler for those with less experience to carry out. In either case the job must be done before the mortar sets. The first, detail C, Fig. 5, should be done while the mortar is still soft, but the latter step, detail D, should not be attempted until the mortar has stiffened (set) slightly.

When building steps you have the choice of pouring concrete in wooden forms or laying up with individual stones, Figs. 6, 7 and 8. Use of step-sized stones is perhaps easiest as no forms are required. Single step-sized stones should be supported on smaller stones or bricks, Fig. 8, and the joints mortared. ★ ★ ★

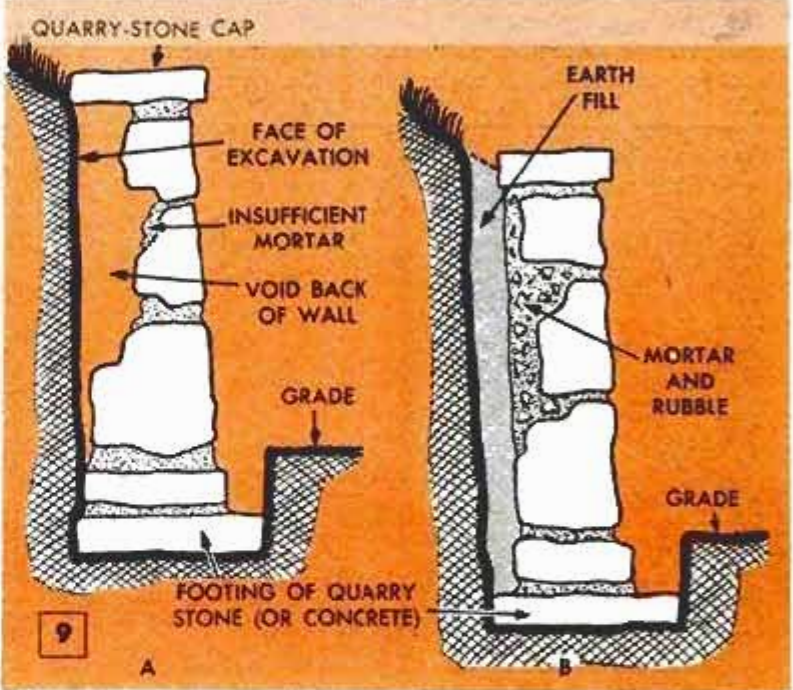

First step usually is to square earth shoulder against which wall is laid. Next is to excavate for stone or concrete footings

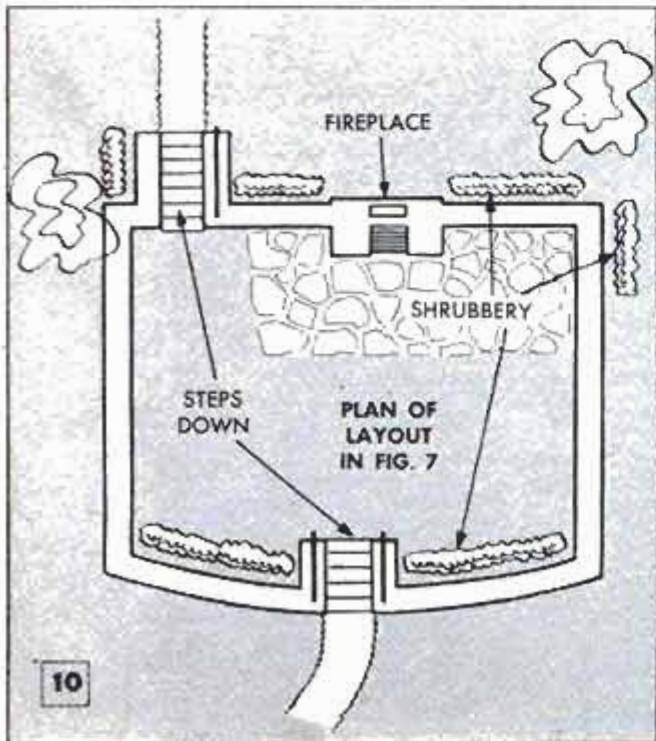

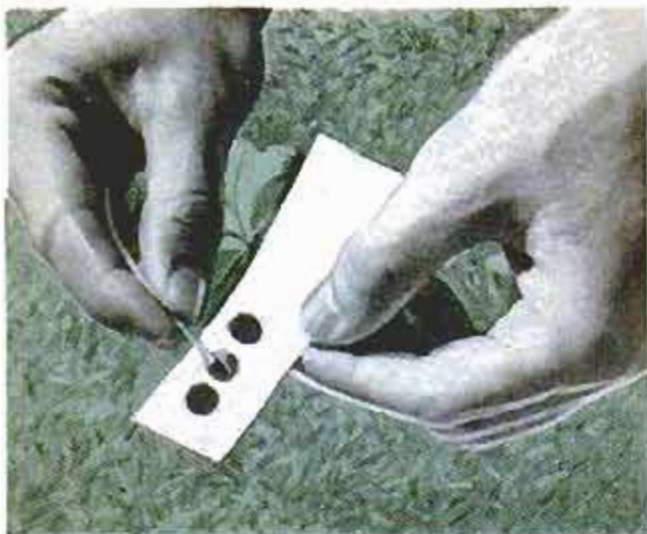

1. Test for potassium requires that a drop of sap from freshly cut plant stem be placed on each of three orange-colored spots on test strip. After about a minute, wet each spot with developer



2. Squeeze one drop of the plant sap onto the center of the blank area of the test strip, to be used for testing the plant's phosphorus content. Do not make test for phosphorus, but go on to nitrogen test



3. To make nitrogen test, use toothpick to dip out tiny bit of nitrate powder from plastic vial in testing kit. Spread powder around an area near the end of the test strip as indicated in photograph above



4. Wrap powder and paper around freshly cut plant stem as above, and press firmly to wet powder with plant sap. Powder will turn healthy pink if sufficient nitrogen is present. Lighter pink indicates lack

5. For phosphorus-content test, place one or two drops of developing fluid over plant sap which you squeezed onto blank area of test strip. Make sure developer thoroughly moistens all of sap

6. As soon as spot of sap is moistened, press metal strip against it for about 10 sec. If spot turns dark blue, it indicates plant is absorbing enough phosphorus. A lighter color shows lack of mineral



Tissue-Paper Soil Tests

By Edward Mickley

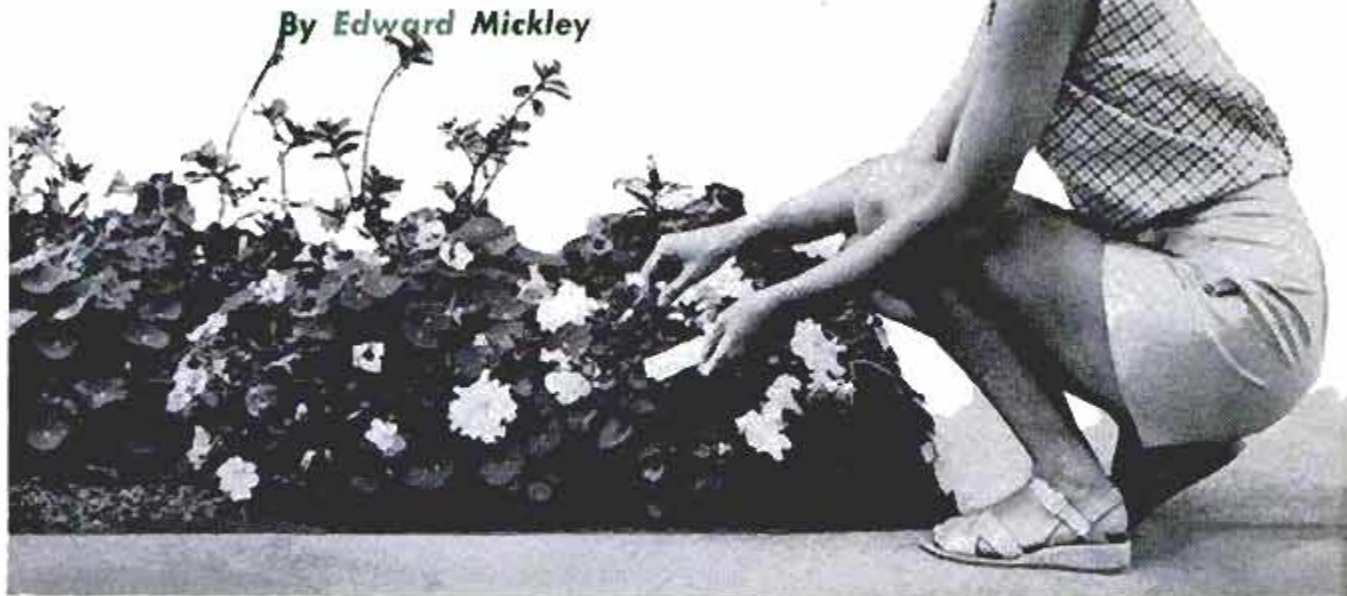

HAVE YOU EVER HAD disappointing results with a garden, even though you applied plant foods and minerals that soil tests indicated were in short supply? One of the reasons for this is that plants of different types vary in their need for certain plant foods. Lawn grasses, for example, need much more nitrogen than they do phosphorus or potassium. On the other hand, roses and other large flowering shrubs require quantities of phosphorus and potassium and only small amounts of nitrogen.

With a testing kit now available, it is possible to determine what minerals should be added to the soil by directly testing the plants. The kit consists of chemically treated strips of tissue paper, nitrate powder, a metal strip and developing fluid which is prepared by filling a dropper bottle in the kit with water.

To test a plant, hold one of the tissue strips with the orange-colored spots facing up, and squeeze a drop of sap from a freshly cut plant stem onto each of the spots, Fig. 1. Squeeze another drop of sap onto the center of the blank area of the tissue strip, Fig. 2.

Testing for Nitrogen

With a toothpick, dip out a tiny bit of nitrate powder and spread it around near the blank end of the tissue strip, Fig. 3. Then fold the paper and powder over a cut plant stem, Fig. 4, pressing firmly to make sure the sap thoroughly wets the nitrate powder. Now open the paper and examine the color of the powder. If it is still white or only a light pink, the plant being tested is starved from lack of nitrogen. A healthy

pink color shows the plant is receiving the correct amount of nitrogen, dark pink, or a reddish color indicates that the plant is absorbing too much. An excess of nitrogen often causes a lush growth that encourages fungus growths and other plant diseases.

Testing for Phosphorus

Wet the spot of sap squeezed onto the blank area of the paper strip with one or two drops of developing liquid, Fig. 5, and immediately press the metal strip from the kit onto the moistened spot and hold it there for about 10 sec., Fig. 6. The spot will turn a dark-blue color if the plant is receiving enough phosphorus. Lack of the mineral shows as a light-blue color; the lighter the blue, the less the phosphorus.

Testing for Potassium

When the sap from a plant stem has been on the three orange-colored spots for at least a minute, wet each spot with a drop of developer. If there is sufficient potassium in the plant sap, the spots will remain orange-colored. When all the spots turn yellow, only the barest minimum of potassium is being absorbed by the plant.

The spot at the end of the strip is most sensitive and will stay orange when the sap contains only about 1000 parts per million (p.p.m.) of potassium. The second spot stays orange when there are 2000 p.p.m. and the third spot stays orange when there are at least 3000 p.p.m. Speckling of the color on any of the spots indicates there is less potassium in the sap than is needed to keep the spot completely orange. If only the end spot stays orange, most plants need additional potassium for good growth. ★★

Envelope Moistener Made From Can and Broom Handle



This handy device for sealing envelopes (left) can be made from a square typewriter-ribbon can, a length of broom handle or dowel for a roller and two nails. After the broom handle has been cut the right length, drive a small nail in each end for a shaft. File a notch in two sides of the can as shown in the detail and install the roller assembly. A sardine can may be used in place of a typewriter-ribbon can, if the latter is not available.—Domingo Ferrer Gonzalez, Remedios, Cuba.

Toothpicks Locate Seedlings



Toothpicks placed beside each seedling in a window box or flower garden will aid in weeding and cultivating so that the slow-growing ones are not pulled out by mistake. Since the characteristics of a seedling vary from the time it

breaks the surface until the features of the growing plant are evident it is best to observe the germination cycle so that the seedlings can be distinguished when they do appear.

Cork Scours Knife Blade

Replacing the generally used cloth with a large cork when scouring the blades of sharp-edged knives will minimize chances of cut fingers. Also, the dampened cork permits applying firm pressure over a fairly large area, assuring a quicker and better job of cleaning than is possible with a cloth.



Chicken-Wire Flower Frogs



One housewife makes her own flower frogs from discarded chicken wire, which is cut and bent to fit each container. The large mesh accommodates flower stems with greater ease than standard frogs. To permit better positioning of flowers, a frog can be placed an inch off the bottom of the container in addition to the one at the top.

Carpenter's Square Used As Improved Dividers

When a pair of dividers is too small for a particular job, a carpenter's square will serve as a substitute instrument. Drive two nails to form the diameter of the circle and with a pencil held in the corner of the square, slide it around the nails with the inside of the blade always touching both nails. One half of the circle is scribed with each swing of the square around the nails.

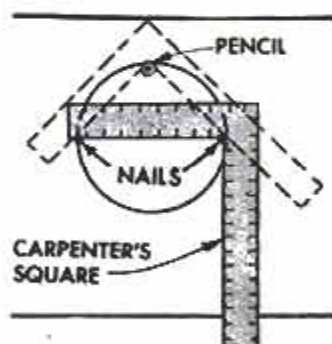

Ted Otsu, Vancouver, B. C., Can.

NOVEL DRESSING TABLE

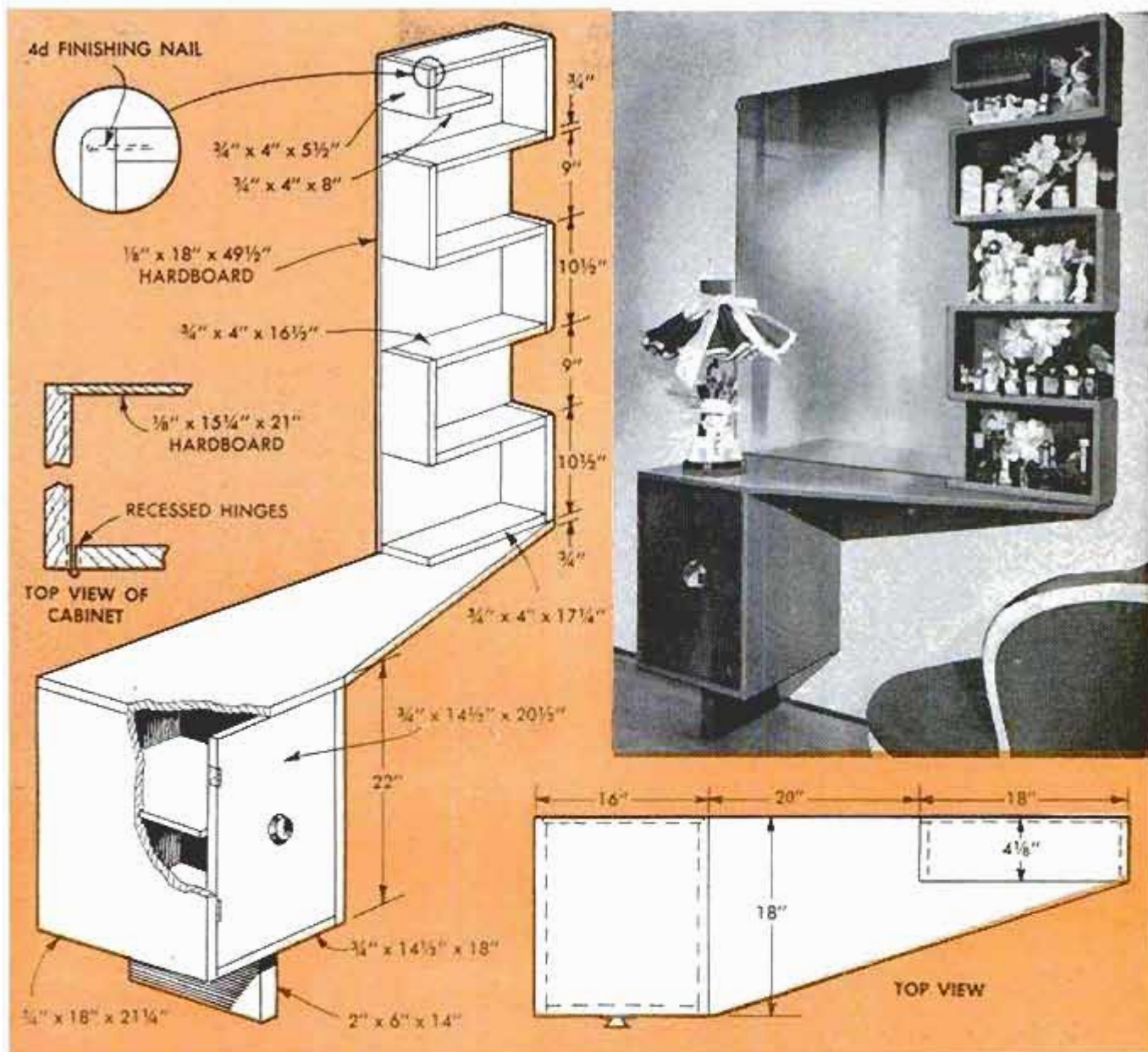

DEFINITELY INTERESTING and unusual in design, this dressing table has the added appeal of requiring only hand tools for its construction. The table top is cut out first and can be hardwood or hardwood-faced plywood. Strips of hardwood veneer or Wood Tape glued to the edge of the plywood will produce the effect of solid lumber. Fir plywood covered with wood-grained plastic laminate also may be used.

Finishing nails are used to assemble the shelves, which are glued and nailed to a piece of 1/8-in. hardboard cut to the dimensions given. All nails are countersunk and covered with wood putty to provide a smooth appearance. As indicated in the detail, the corners of the shelves are rounded and sanded smooth. Hardboard is sufficient to support the shelves, since the assembled dressing table is screwed directly to the wall. Locate wall studs by tapping on the plaster, then use screws that are long

enough to pass through the plaster and drive into the studs. Support the top of the table on a strip screwed to the wall and drive screws through the hardboard back of the shelf assembly directly into the wall.

The safelike cabinet under the table is made from the same stock as the top. Its hardboard back may be rabbeted into the sides if power tools are available, or nailed to blocks recessed 1/8 in. inside the cabinet. Grooves can be cut in the cabinet sides to support the shelf or, alternatively, the shelf simply can be nailed, with the nail-heads countersunk and covered with putty. Hinges on the cabinet door are recessed as indicated for a more finished appearance. The knob on the door can be metal or wood. Color should harmonize with room decor.

A mirror smaller than the one shown can be used, but it should be fitted in a frame that fills the space between top and shelves.

Hi Sibley, Nuevo, Calif.



Photos by Don Hontch

This little 6 x 8-ft. prefab, designed by The Masonite Corp., makes an exciting dream home for tiny tenants

TAKE-APART PLAYHOUSE

Comes apart in easy-to-handle sections so it can be set up indoors during winter for year-round play. Made of durable hardboard, it takes paint beautifully

A PLAYHOUSE is far from an inexpensive toy, but when it is designed for year-round play, it becomes less of a luxury when you consider the additional hours of fun it will afford your youngsters compared to other seasonal toys.

While it is true that a lot of basements will not permit setting up the house in its

Modular panels make erection simple. Intermediate panels are interchangeable to vary window location

entirety, its take-apart feature makes it possible to erect a smaller version of the house where space is limited. The walls and roof panels are interchangeable like the parts of a construction toy so that just half the house can be set up for indoor play. Basement headroom will be of no concern in most cases as the total height

One lag screw anchors each panel to floor; two $\frac{1}{4}$ x 2 $\frac{1}{2}$ -in. carriage bolts fasten panel to panel



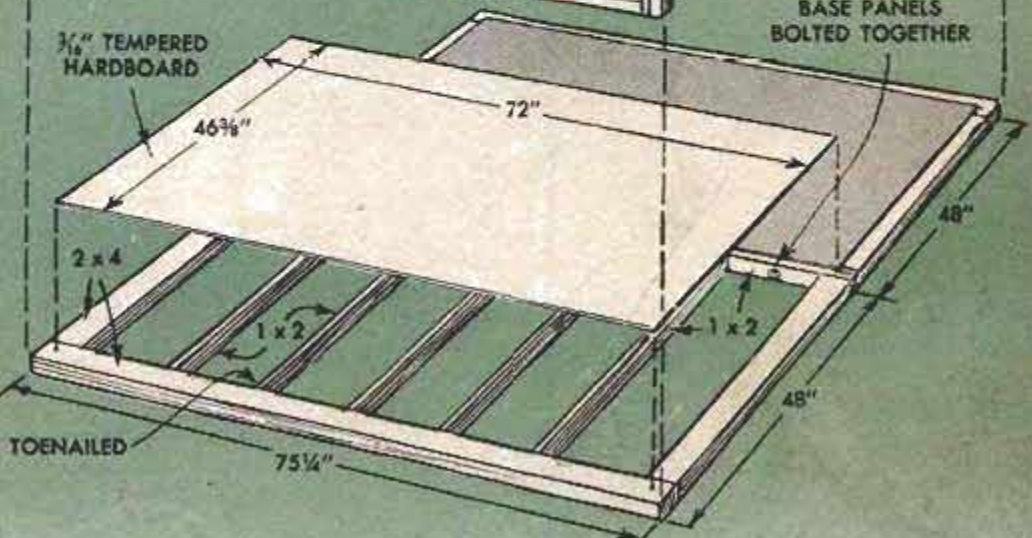
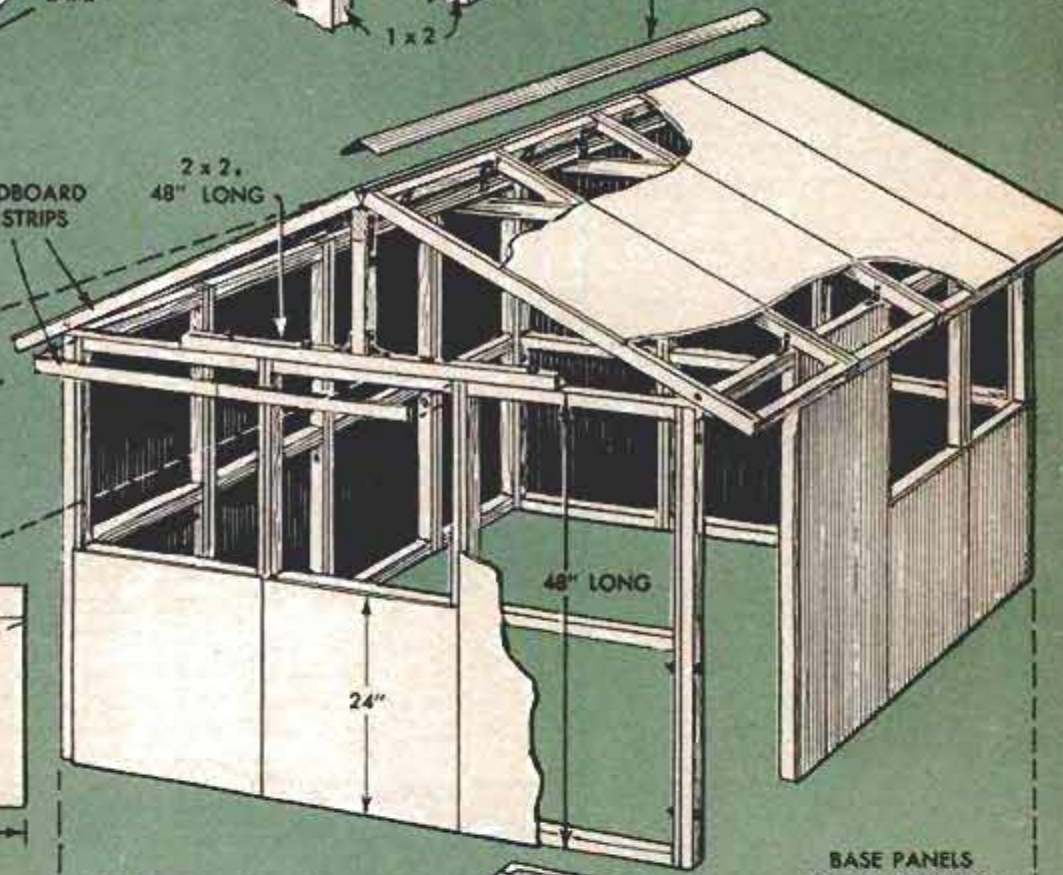
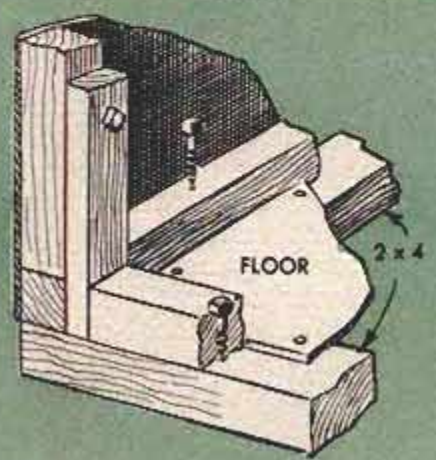
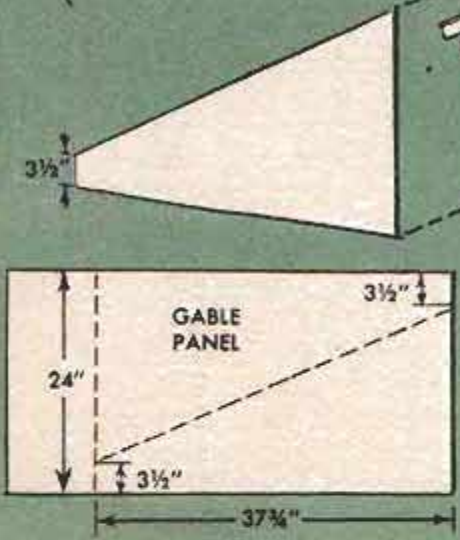
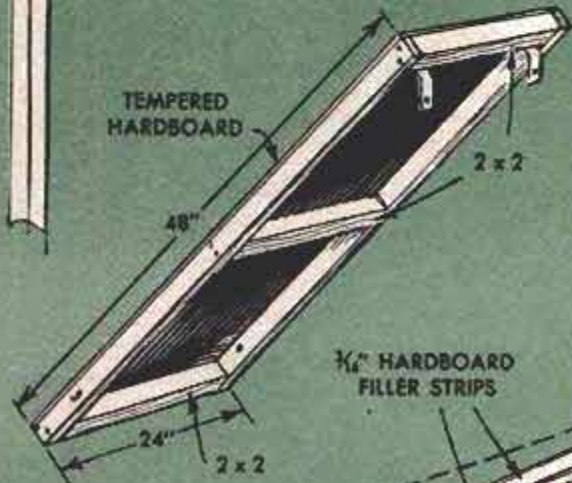
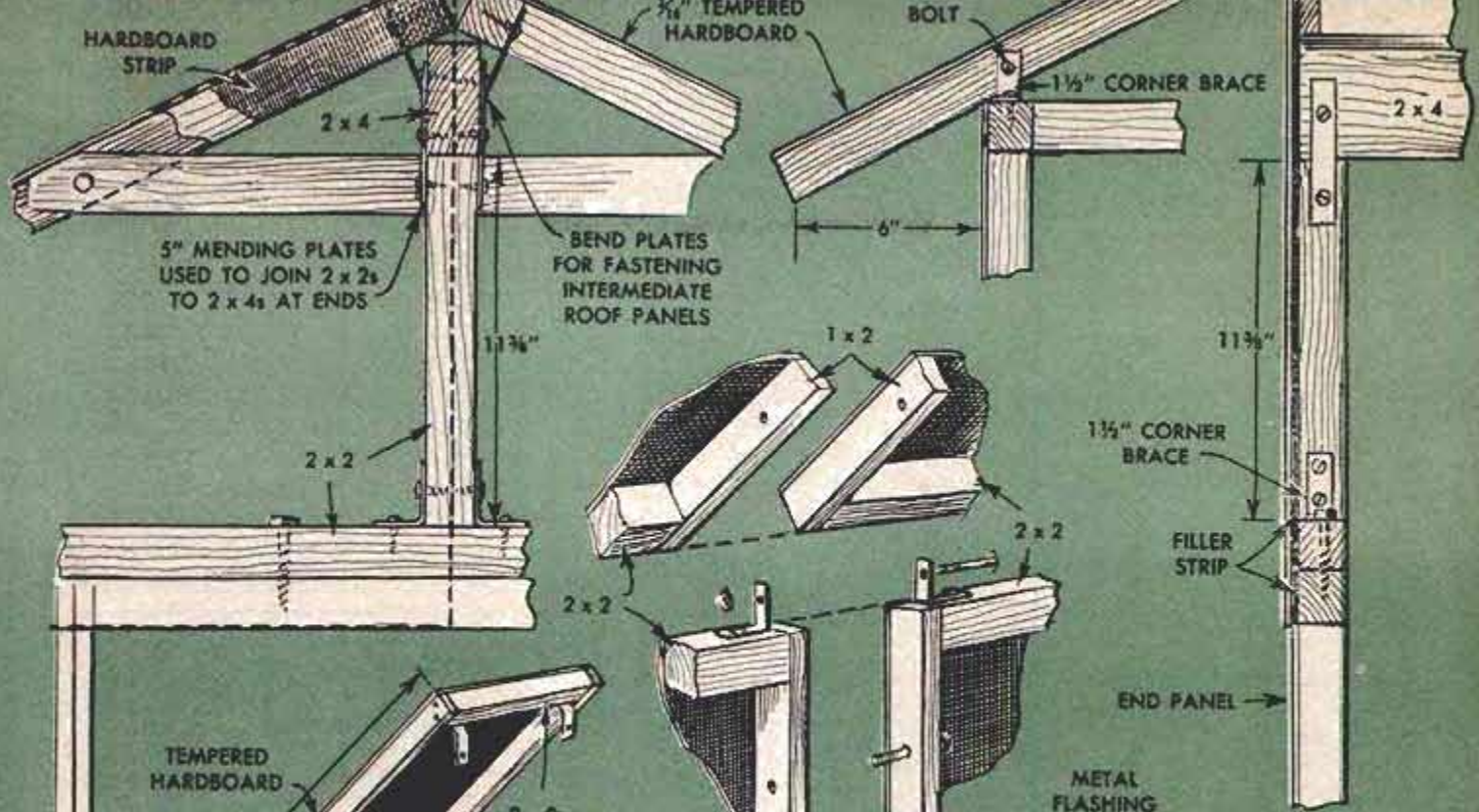

5" MENDING PLATES USED TO JOIN 2x2s TO 2x4s AT ENDS

BEND PLATES FOR FASTENING INTERMEDIATE ROOF PANELS

1 1/2" CORNER BRACE

FILLER STRIP

END PANEL

METAL FLASHING

BASE PANELS BOLTED TOGETHER

TOENAILED

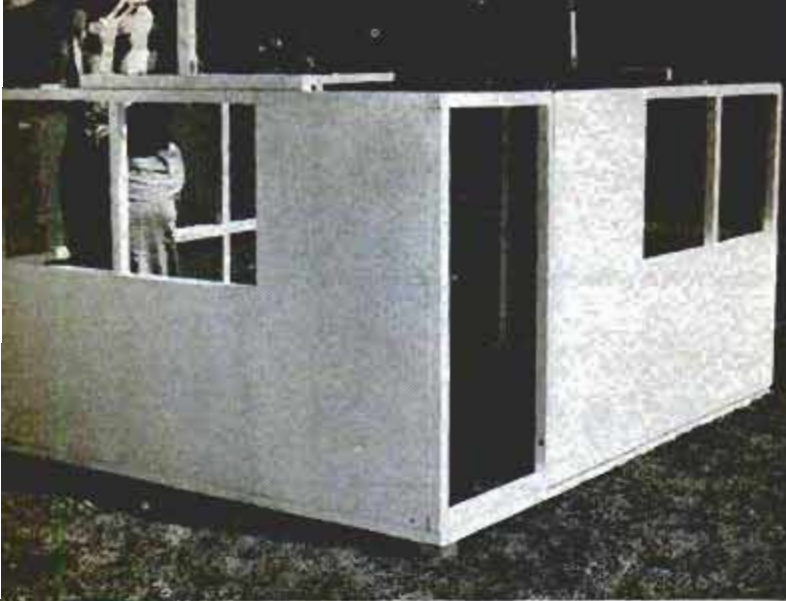

Ridge board is supported at each end by 2 x 2 posts which are fastened to walls with metal angle brackets



Above, two 1 x 2 members are used to tie each side of the roof together after the panels are all in place. Below, individual roof panels are attached to the ridge board with screws and mending plates, the plates being bent



of the house is a little more than 6 ft. Window and door openings can be rearranged, and screens and movable sash, as well as a door, may be added.

Framework of Stock Lumber

Except for the two floor panels which measure 4 x 6 ft., all others are made 2 x 4 ft. Counting the door panel, which really isn't a panel but rather a three-sided frame, you'll need 14 wall panels, including 4 corner panels, and 8 roof panels. The corner panels differ from the others in that a 2 x 2 is used along one side instead of a 1 x 2. Other than this, all panels are assembled exactly alike, using 2 x 2s for the cross members and 1 x 2s for the side members. These are nailed together to form simple frames which are covered on the outside with $\frac{3}{16}$ -in. tempered hardboard. Four of the panels are made half panels to provide window openings.

The two frames for the floor panels are assembled from 2 x 4s and 1 x 2s, the latter being set on edge and the 2 x 4s placed flatwise. The top sides are floored with hardboard. By ripping $1\frac{5}{8}$ in. from the long side of two 4 x 6-ft. sheets, the hardboard will be just the right size to leave a $1\frac{5}{8}$ -in. border around the four sides.

Panels Bolted Together

Pick a level spot of ground to place the floor after bolting the panels together from the underside. Start erecting the walls by fitting a corner panel first. As with all panels, a single lag screw in the center of the bottom rail is used to fasten the corner panel in place. Two bolts are used, one at top and bottom, to join each panel to the succeeding one. After the walls are erected, a 2 x 2 stiffening member, 48 in. long, is lag-screwed to the top of the end walls, bridging the center panels. This member supports the 2 x 4 ridge board to which the roof panels are fastened with mending plates. Angle brackets anchor the roof panels to the walls. Each gable end of the house is faced with two hardboard panels cut from a 2 x 4-ft. sheet. To make these overhang the covering on the wall panels and provide a drip edge, narrow filler strips of the material are first nailed to the outside edges of the end roof panels, the posts and the stiffening members. The gable panels are fastened with roundheaded screws. Finally, the ridge is covered with a sheet-metal flashing, and 1 x 2 braces are installed on the inside of the house to join both halves of the roof. ★ ★ ★

Improved Vise Holds Handsaw for Sharpening and Setting

In the absence of a saw-filing vise, a substitute can be improvised from three short lengths of 2x4s, spiked together as illustrated. Vertical slots are cut in each upright and at opposite angles so that the saw, when inserted in them, will be bowed to approximately the degree indicated in the detail. Bowing of the blade holds it securely in the slots of the vise. Addition of a third upright at the center of the vise will help dampen noise and vibration when filing.

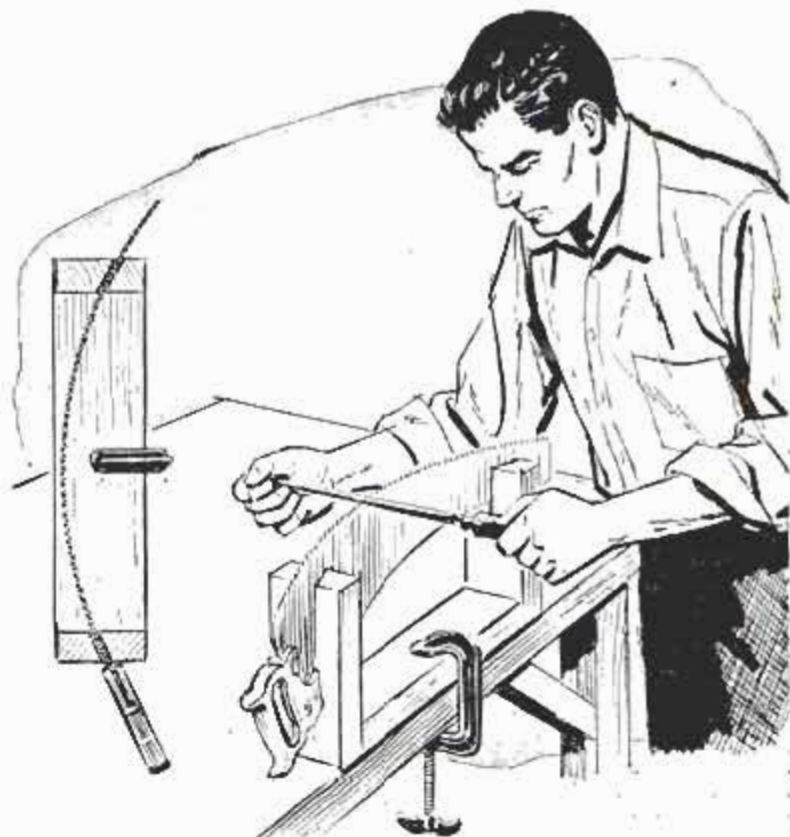

Cleaning Gilded Frames

A weak solution of ammonia and water will clean gilded picture frames. First dust the frame, and then go over it with a clean cloth dampened in the ammonia solution. If exceptionally dirty, allow the frame to stand for about 10 min. and then go over it again. Dry by blotting with a soft cloth.

Light Chains and Snap Hooks Improvised From Cotter Pins

It is easy to make light chains, snap hooks and "sister" hooks from cotter pins, using pliers to cut the pins, bend the ends and link them together, as shown in the drawing below. Select a size of cotter pin best suited for the purpose.

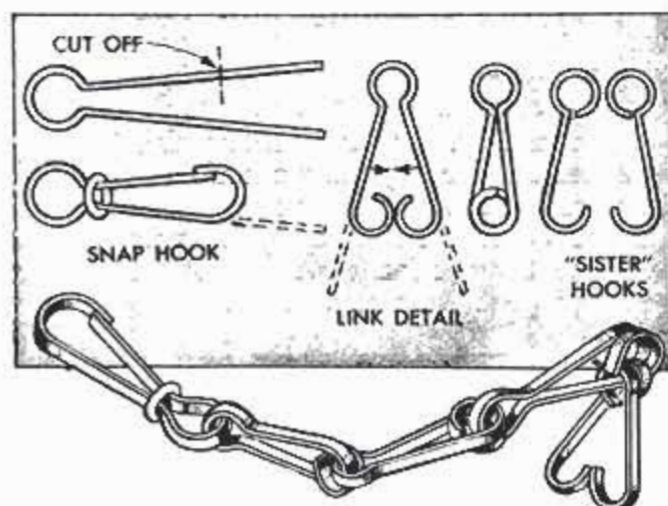

Black Piano Keys Make Modern Door Pulls

Prefinished ebony pulls for cabinet or closet doors can be made from the black keys on an old piano and attached with glue and wood screws. A thin knife edge inserted between the key and its wood base usually snaps it free. Sanding removes any wood fibers that cling to the bottom.

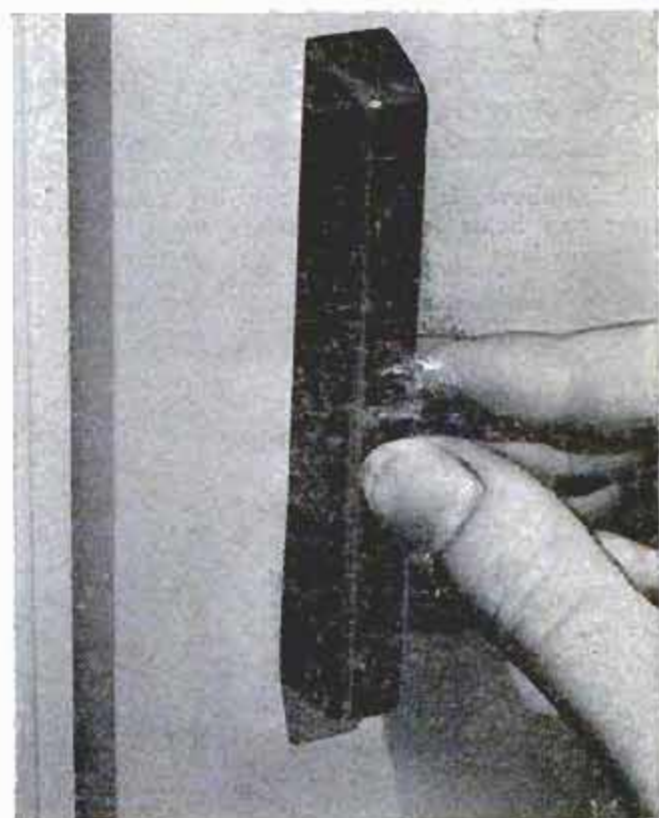

Pick a Flattering Awning!

Like selecting the right hat, just any old awning or canopy should not be hung on your house. They should harmonize and become a part of its particular style. A six-page feature in the July issue gives helpful pointers on choosing the right awning. Also shows the handy homeowner how to make his own, using glass fiber, wood or metal



Although it cannot be used for applying rubber or water-base paints, lamb's wool does an excellent job of applying oil-base paints on irregular surfaces such as woven-wire fencing, as shown above

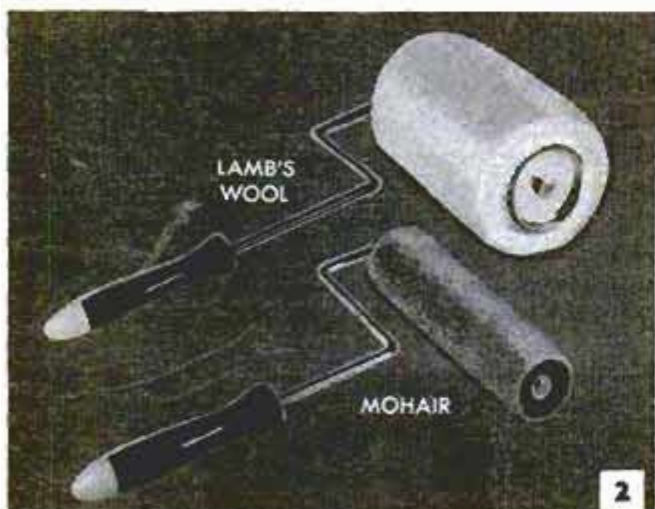

Mohair, above, is ideal for applying enamels. Its short nap holds less paint, flows enamels better. Long-nap lonel, below, is excellent for use on masonry. Pronel is used on fairly smooth surfaces



USE THE RIGHT PAINT ROLLER

By Jay W. Hedden

IF YOU WANT to do a good paint job with a roller, don't use just any cover on the roller. Modern paints require covers especially designed for their applications, as do the various painted surfaces. For example, wool, which was the first practical material used for the covers of paint rollers, absorbs moisture from water-base paints and causes the fibers to lose their resiliency and paint-holding qualities. To overcome these problems, the EZ Paint Corporation, in conjunction with fabric and chemical companies, developed synthetic fabrics which do not have the disadvantages of the natural fibers.

Long-nap lonel, Fig. 3, is a densely woven synthetic material that is used for applying paint to masonry and other rough surfaces. Its long fibers are abrasion-resistant and force paint into the many irregularities of this type surface. Applying most types of paint to smooth or semismooth surfaces is done well by pronel, Fig. 3. Its fibers do not break or "finger" and cause an undesired mottled effect.

Lamb's wool, Fig. 2, still has definite advantages for some types of applications with oil-base paints. As an example, painting woven-wire fences, Fig. 1, is done quickly and efficiently with wool.

Mohair, Fig. 2, is a short-nap fabric that is excellent for applying enamels and rubber-base paints to smooth surfaces. Because its short fibers hold less paint than other types, it flows enamels better and reduces "orange peel" to a minimum.



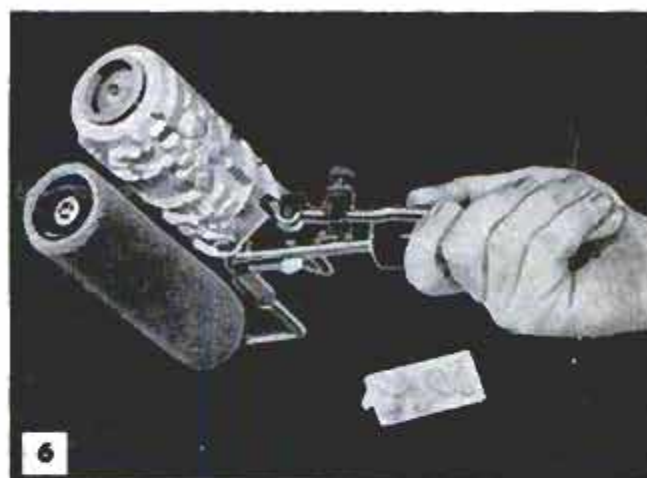
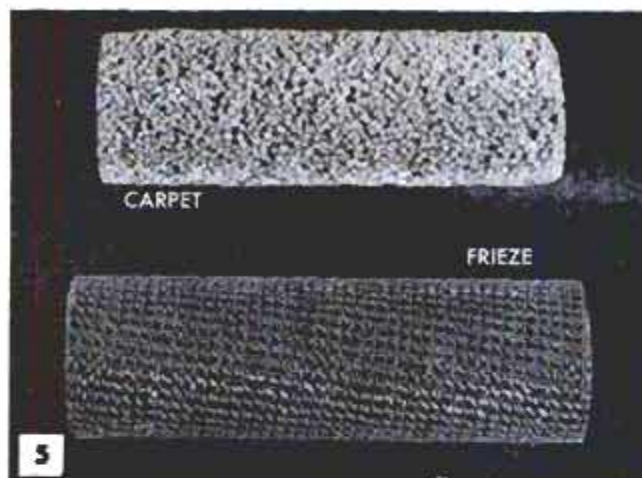

Short-nap lonel, Fig. 4, is comparable to pronel in the quality of the finish it produces. Dacron, shown in Fig. 4, is used for application of exterior paints on wood siding. Carpet, Fig. 4, is used for obtaining a stipple effect with oil-base paints. A stippling effect also is obtained with frieze, Fig. 5, which is used to apply texture paints on dry-wall construction to produce a semirough plaster appearance.

Figs. 6 and 7 show a specialized roller used for "printing" a pattern on a painted surface. The roller attachment is clamped to the handle of a regular roller, which, when dipped in paint, rolls paint onto the printing roller. A hand stamp is used to finish the pattern in areas not reached by the roller. ★ ★ ★

Special roller, above, is attached to regular roller to make "printed" pattern on painted surfaces. Below, paint from regular roller then is rolled against printing roller which transfers it to painted surface



PAINT-ROLLER GUIDE

INTERIOR FINISHING (Covers are listed in order of preference)

	Alkyd Resin Flat	Latex Rubber-Base Flat	Interior Wall Primer	Flat Oil Base	Enamel, Glass and Semigloss	Enamel, Flat or Satin Finish	Rubber-Base Texture Paints	Water-Base and Emulsion-Type Paints	Shellac or Stain	All Aluminum Points
Sand Finish Plaster and Dry Wall	Pronel Lonel Mahair	Pronel Lonel Mahair	Pronel Lonel Mahair	Pronel Lonel Mahair	Mahair Pronel Lonel	Pronel Lonel Mahair	Frieze Carpet	Pronel Lonel		
Putty Coat or Smooth Plaster	Pronel Lonel Mahair	Mahair Pronel Lonel	Pronel Lonel Mahair	Pronel Lonel Mahair	Mahair Pronel Lonel	Mahair Pronel Lonel	Frieze Carpet	Mahair Pronel Lonel		
Light Spanish Plaster	Pronel Lonel	Pronel Lonel	Pronel Lonel	Pronel Lonel	Pronel Lonel	Pronel Lonel		Pronel Lonel		
Heavy Spanish Plaster	Long nap Lonel	Long nap Lonel	Long nap Lonel	Long nap Lonel	Long nap Lonel	Long nap Lonel		Long nap Lonel		
Acoustical Surfaces								Pronel Lonel		
Woodwork	Mahair Pronel Lonel			Mahair Pronel Lonel	Mahair Pronel Lonel	Mahair Pronel Lonel			Mahair Dacron	Pronel Lonel Dacron
Stippling Surfaces	Carpet Frieze			Carpet Frieze			Frieze Carpet	Sponge Frieze		

EXTERIOR FINISHING (Covers are listed in order of preference)

	Bonding, Cement Points	Exterior Latex Base	Exterior PVA (Polyvinyl Acetate)	House paints (Over Primer)	Exterior Trim Enamels (Over Primer)	Waterproofing, Clears	Exterior Varnishes	Stain	Aluminum Points
Light Stucco Smooth Concrete	Pronel Lonel	Pronel Lonel	Pronel Lonel	Pronel Lonel	Pronel Lonel	Pronel Lonel			
Heavy Stucco Rough Masonry	Long nap Lonel	Long nap Lonel	Long nap Lonel	Long nap Lonel	Long nap Lonel	Long nap Lonel			
Brick	Long nap Lonel	Long nap Lonel	Long nap Lonel	Long nap Lonel	Long nap Lonel	Long nap Lonel			
Wood Siding				Dacron Pronel	Dacron Pronel		Mahair Dacron	Mahair Dacron	Pronel Dacron
Asbestos Siding		Pronel Lonel	Pronel Lonel	Dacron	Dacron Pronel				

Long Boards To Be Edge-Planed Held on Sawhorse With C-Clamp

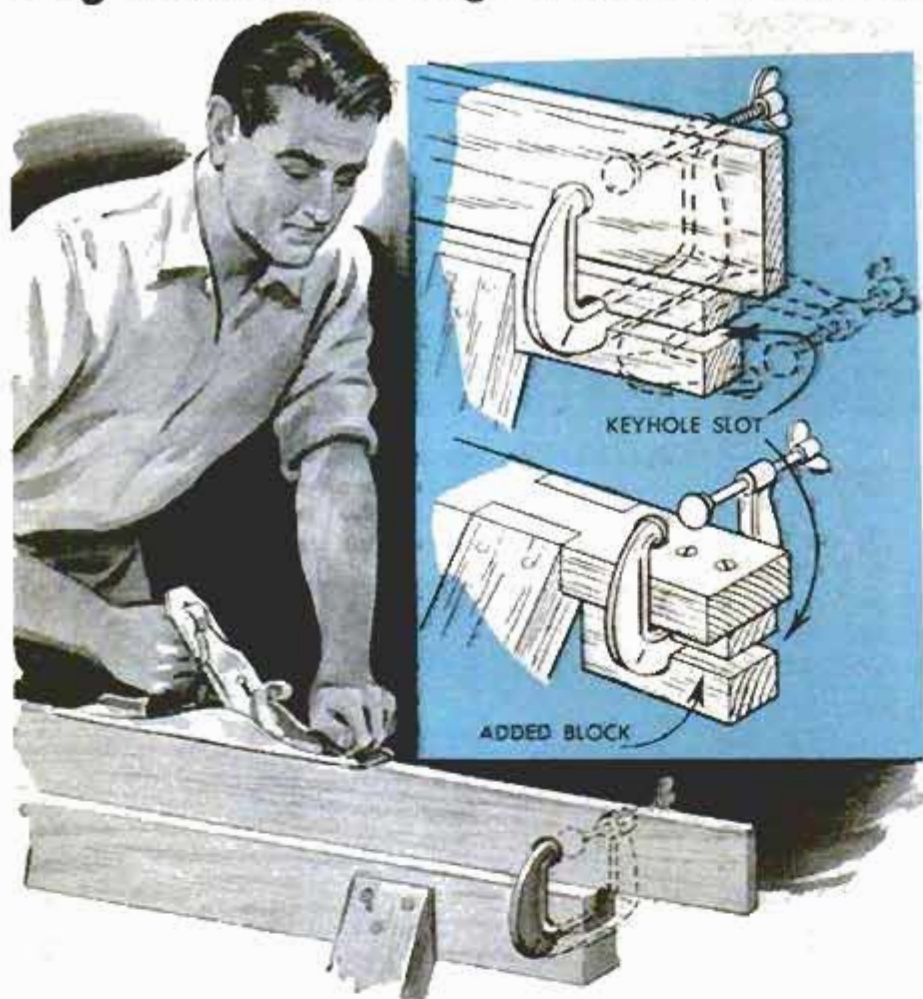

Edge-planing of long boards is easier when they are held vertically with a C-clamp fitted in a keyhole slot at the end of a sawhorse. Where the top member is thick enough in height the slot is made directly in it, otherwise a small block is screwed to the bottom side for the purpose. A hole is bored and saw cuts made to form the keyhole, the exact size being determined by the dimensions of the C-clamp used. The clamp is held in a horizontal position to slip it into the slot, and is then turned vertically to hold the work. Widths of the slot and hole must be square with the width of top surface of the horse so that the work will be held flush against this surface. Leather or rubber disks on the clamp jaws prevent marring the work.

Build This House Yourself!

Save 65% Easily!

Two bedrooms, a spacious living room, bath, carport, compact dining room and kitchen all in a space 24 x 46 feet. You can build the Precut House in three stages, using any of numerous floor plans—all of which are designed to provide maximum comfort with minimum cost. Think of it! You can build that house you've always wanted. You can make a livable shell for only \$1800. The second stage will give you a summer home with all conveniences for only \$2800. When you add the third stage, you have a luxury home for year 'round living, in any climate, for only \$3800!



Livable Shell—\$1800; Summer Home—\$2800; Luxury Home—\$3800; Simplified How-To-Do-It Instructions—Hundreds of Pictures—Working Blueprint Plans!

You can build the house with the book alone. The plans make it easier. The book gives lists of materials required, all measurements and dimensions, suggestions for financing and tells in words and shows in pictures every detail of construction. Richard Dempewolff, author of the "Precut House" book, built the house in 1650 man hours for \$3731.23—complete!

Features of Expensive Homes are included: built-in furniture, unusual amount of closet space, adaptability to various interior arrangements, and materials designed especially for amateur builders. The book is \$2.50 and a complete set of 10 blueprints \$12.50 (a duplicate set is \$5.00). You can place a C.O.D. order or mail your remittance in full.

Order book and plans from

POPULAR MECHANICS BOOKSHOP

208 E. Ontario St.

Chicago 11, Ill.

LEAF DESIGNS

Reproduced on Paper



THE INTERESTING patterns of leaves can be permanently reproduced on paper using screen-process poster ink. These unique printed designs are perfect for decorative purposes and make possible a much neater report for school or scouting credit. First, place a small daub of ink on a piece of glass and work it out evenly with a rubber photoprint roller. Then, spread a sheet of newspaper on a table, lay a leaf face-down on the paper, and apply ink to the leaf with the roller. Invert the leaf on a sheet of absorbent paper, such as heavy art paper, cover it with a clean sheet of newspaper, and roll the area covered by the leaf. When the leaf is peeled off it will leave a printed reproduction of its design.

Don Honick, Chicago.



Screen-process ink is daubed on a sheet of glass, rolled down even



Work the roller back and forth until fully coated with the ink



Lay leaf face-down on newspaper. Apply ink generously with roller

After pressing, carefully peel the leaf from the drawing paper, leaving a perfect printed reproduction



Ferris-Wheel Planter Is Unusual Yard Ornament

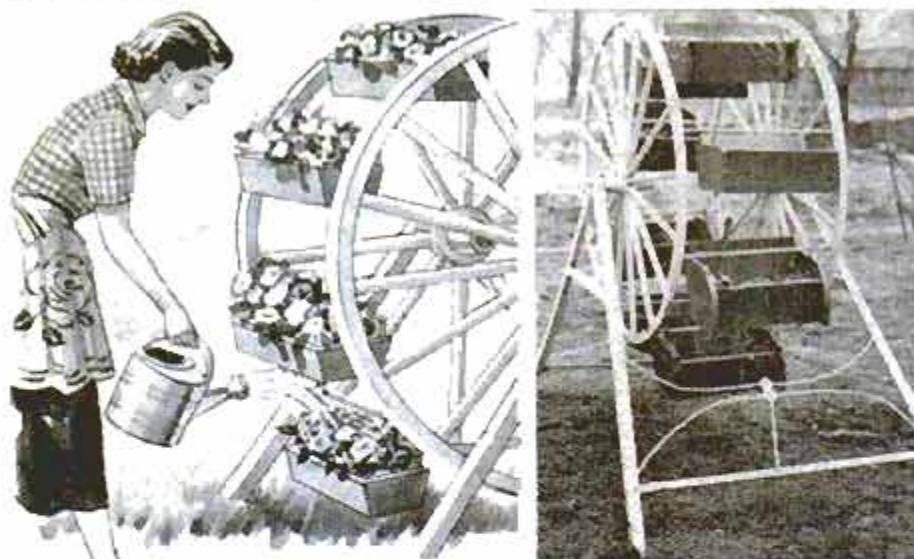

Like the seats on a real Ferris wheel, the eight flower boxes on this miniature replica are self-leveling and can be individually watered and tended by simply rotating the buggy wheels which are utilized to form the sides. The two wheels rotate on a pipe axle supported by a tripod-type framework, and the flower boxes are hung from equally spaced tie rods. Grover Brinkman, Okawville, Ill.

White Tabs on Croquet Arches Easily Seen for Twilight Game

When played on dark days or in the growing shadows of late afternoon, a game of croquet will progress more rapidly with the help of white tabs fastened to the croquet arches. The tabs, plainly visible at a distance, can be made easily by using short lengths of adhesive tape folded around the centers of the arches with the ends stuck together and allowed to hang.

Trailer Refrigerator Kept Neat

People who travel with house trailers will find toy balloons a boon in holding contents of the trailer refrigerator safely in place when on the road. Low in cost, the balloons inflate to any size and tuck into odd-shaped spaces to hold food containers snugly. Being waterproof, they can be used alongside ice blocks.

Mrs. Harvey Muller, Danboro, Pa.

Rubber Hose Removes Burrs From Clothing

Prickly burrs and weed seeds are easily removed from clothing with a piece of ribbed garden hose mounted on a dowel which serves as a handle. Place the cloth on a flat surface and then "brush" it with the hose. The result will be a more thorough job than is possible with a whisk broom, and with less difficulty. Hard-to-remove thorns come loose without having to cut them with a knife, which could damage the fabric. The dowel-rod handle should fit loosely enough to allow the hose to revolve around it.



Lawn Chair Equipped With Wheels and Adjustable Footrest

Your lawn chairs will be easier to move and more comfortable if they are equipped with wheels and an adjustable footrest.

Mount the wheels on an axle passed through holes drilled at the bottom of the front legs. The footrest is supported on 30-in. lengths of 1-in. electrical tubing which slide inside two 30-in. pieces of 1 1/4-in. tubing. Fasten the larger tubing at the bottom of the rear runners and above the axle on the front legs. Use 1 x 8-in. stock with a 1 x 4-in. heel stop for the footrest. Attach short pieces of steel angle to the ends of footrest, then bolt assembly to ends of smaller tubing.



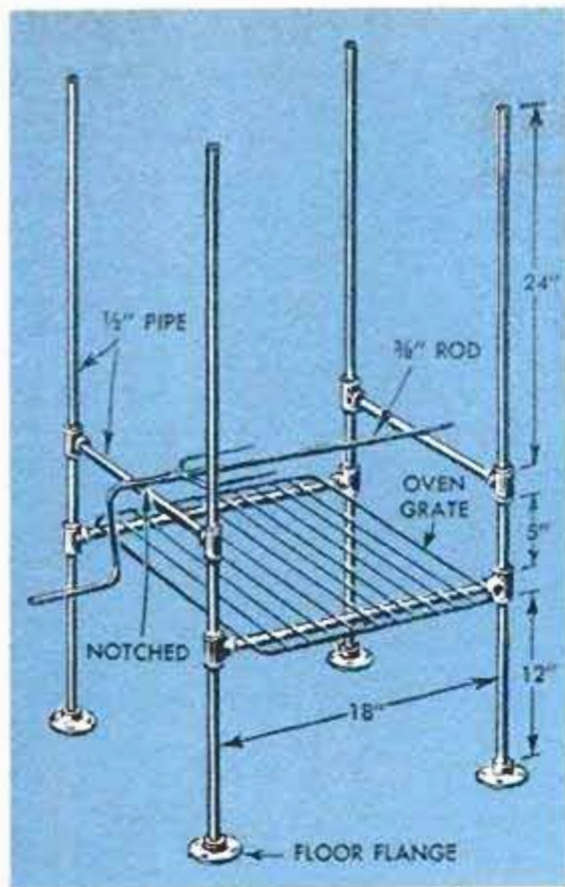

Barbecue Cooks Food With Infrared Lamps

Neither smoke nor flame is a problem with this barbecue that utilizes infrared heat to roast meats. Also, only a small amount of heat is apparent, since infrared rays must penetrate an object before they cause heat. Because the penetrating rays roast food more rapidly than conventional methods, natural juices have less chance to escape, and foods barbecued under the lights are more succulent and retain more of their natural flavor.

The barbecue itself consists of a frame of $\frac{1}{2}$ -in. pipe, assembled to the dimensions given in the detail. Floor flanges on the lower ends of the four legs can be used to bolt the frame permanently to one spot, or the barbecue may be used as a portable unit. For winter storage the frame may be disassembled. Each piece should be marked

to aid in quick reassembly. An oven grate makes a fine ready-made grill, or one can be assembled from heavy wire. The spit is bent from $\frac{3}{8}$ -in. rod. A U-shaped fork with sharpened tines is welded or riveted to the spit rod to hold roasts, hams and the like. An aluminum cookie sheet or pan is ideal for use as a drip pan, since it also reflects heat back into the food being barbecued under the lamps.

Photoflood spring-type clamps are used to hold the sockets into which the infrared lamps are screwed. The lamps should be the industrial-type which have a hard-glass face that will not crack or explode when grease or water is spattered against them. Do not use the ordinary "heat lamp" type of bulbs. Four 250-watt infrared lamps will use about 1000 watts.

Auto Windshield Cleaned With Corncob

One service-station operator uses corn-cobs as cleaning pads for removing bugs and other clinging debris from his customers' automobile windshields. The cobs are dipped into plain or soapy water and rubbed over the windshield until all the dirt is loosened, after which the glass is rinsed and dried. Each cob can be used many times, if it is rinsed after each cleaning.

Walter E. Burton, Akron, Ohio.



Adjustable Rope Clamp for Gluing Column Members Together

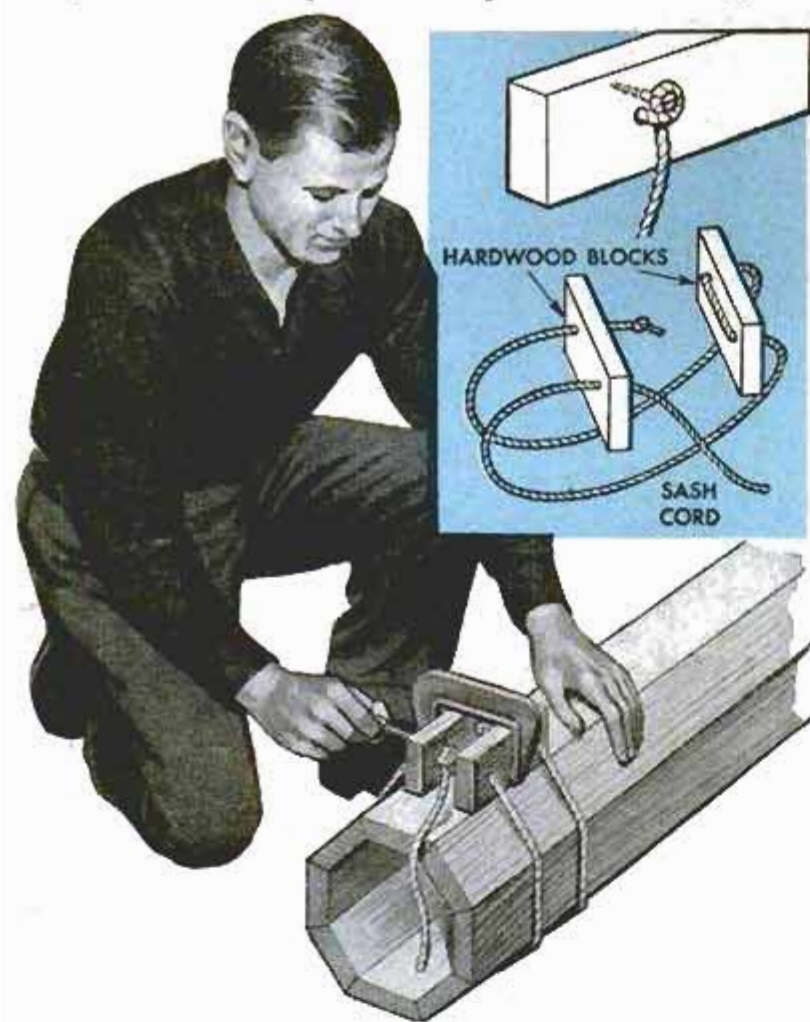

When numerous pieces of wood are to be glued together to form a round or polygonal column, one or more rope clamps like the one illustrated will prove helpful in holding the unit together while the glue dries. A length of sash cord is passed through matching holes bored in two hardwood blocks as shown, which are in turn held together by a C-clamp. To use the tackle, the rope loops are brought around the column, adjusted to proper length, and the free end locked by looping it on a wood screw installed in one of the blocks. The C-clamp straddles the blocks to pull them up tight.

Reinforcing Thin Sandpaper

Finer grades of sandpaper, which have a tendency to tear when clamped in a holder and used, can be reinforced by putting a piece of masking tape down the center on the back of the paper. Additional strength is possible by taping edges of the sandpaper that are clamped into the holder.

John A. Moore, Ruston, La.

Refill Cartridge Changes Fountain Pen to Ball Point

A fountain pen which has become defective is easily converted to an attractive ball-point pen by inserting a refill cartridge in the barrel. Remove the penpoint assembly and prepare the opening to receive the refill cartridge. If a small fitting remains inside, enlarge the hole in it to $\frac{7}{32}$ in., the diameter required to accommodate the cartridge. If the hole is too large, wrap several turns of cellophane tape around the writing end of the cartridge to give it a snug fit when it is inserted in the barrel of the pen.



Box-Type Downspouts Assembled By Crimping Male-End Corners

Coupling of box-type downspouts often is a difficult job for the handy homeowner because the indented male end of a section will not always fit inside the next section, even after the rippled sides of the wider piece are hammered flat. This problem is solved by crimping the corners of the smaller end with a pair of pincers, being sure not to puncture the metal. This reduces the over-all cross-section and yet preserves the square shape, which would not be the case if the narrow end was squeezed out of shape to fit into the wider end. It also eliminates the need to disrupt the rippled effect which is carried the full length of the pipe, since the ripples on the wider end do not have to be flattened to accommodate the crimped piece.—Andrew Vena, Philadelphia, Pa.





Plywood cabinet is portable food hamper that converts to sturdy picnic table with two extension leaves

Combination Food Hamper and Picnic Table

THIS EASILY CARRIED picnic cabinet provides a hamper for food and dishes and a sturdy table on which to spread a picnic lunch. Two hinged leaves on top swing open to double the top surface of the table. Two doors secure the contents when carrying the cabinet, and then become the legs when the food is removed and the cabinet is set up for use as a table. Since there are no complicated joints the cabinet can be built with hand tools, entirely of 1/2-in. plywood.

The dividers or shelves can be modified to accommodate large or small vacuum bottles and other containers. Assemble the four sides and top first, using waterproof glue and 6d galvanized finishing nails. Next, glue and nail the dividers and the 1 x 1-in. leg and leaf supports. Each door is fastened to a leg support with two 1 1/2 x 2-in. galvanized hinges, each leaf with three hinges the same size. Accurate positioning of leg and leaf supports assures proper angle of table legs and leaves when in opened position. Install the three catches and metal carrying handle after painting or varnishing all surfaces of the completed cabinet.

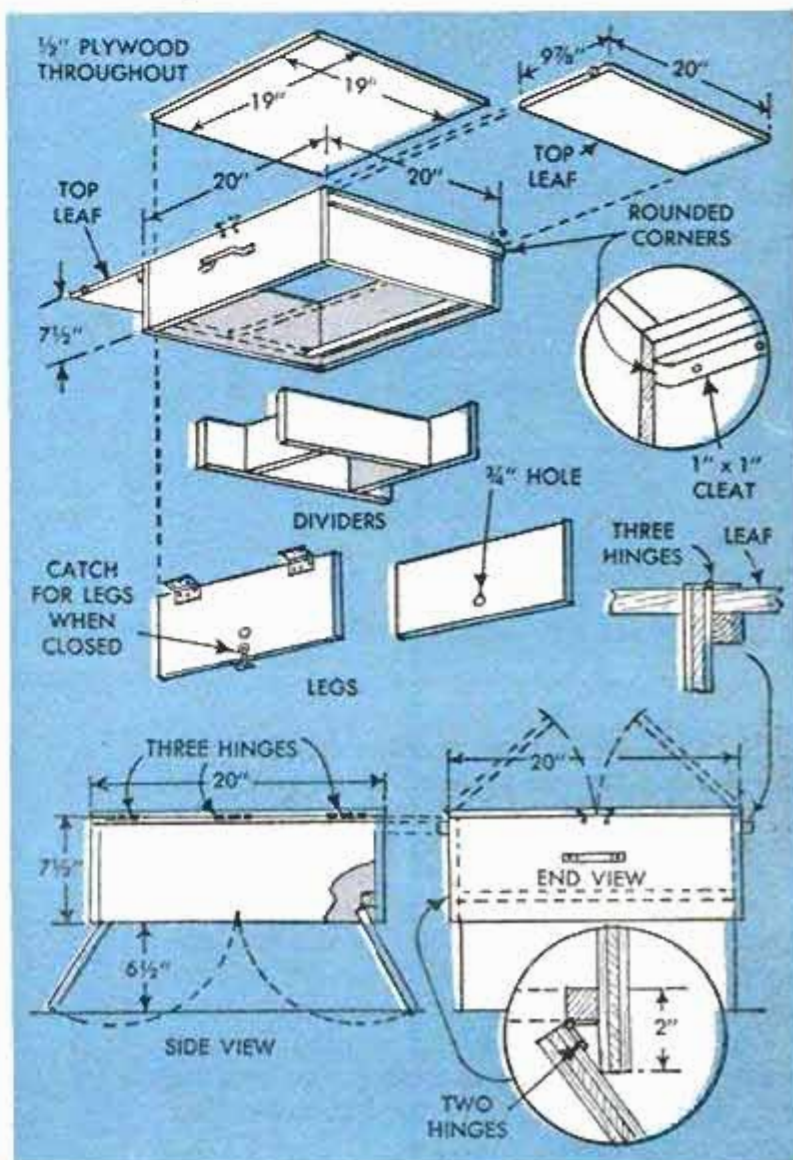

Safe Chip-Removal Method for Blind Recesses in Wood or Metal



When wood or metal work cannot be turned over to shake out chips from blind holes, do not attempt to blow the chips out directly and possibly have them fly into your eyes. Instead, use a length of small-diameter rubber tubing, slipping one end into the hole and blowing on the other. When rubber tubing is not available, rigid metal tubing or a long soda straw can be used by slipping it through the center of a paper or cardboard disk which will act as a chip shield.

Simplify Timing of V8 Engine

On some modern V8 engines it is difficult to reach the spark plugs to attach a timing-light lead. To overcome this problem, one mechanic connects the lead to the spark-plug wire at the distributor by using a connector "bar." The bar is a length of copper tubing that is fitted in the distributor cap in place of the spark-plug wire. The upper end of the tube is shaped to accommodate the plug wire. The timing-light lead then is snapped over the exposed tubing to assure a positive connection.

Stop Pin Lengthens Drill Bit

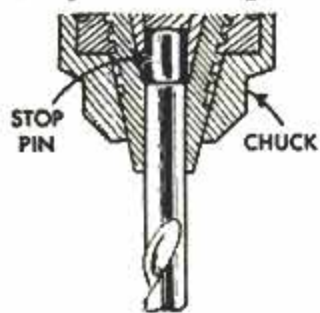

To lengthen a drill bit that is a little too short for a specific drilling operation, insert a stop pin in the chuck ahead of the bit. With this arrangement, exact drilling depth can be gauged and main-

tained. To attempt precision drilling with a short bit installed part way up in the chuck, without a stop pin, results in slippage of the bit and inaccuracy of depth. The pin should be small enough in diameter so that it is not gripped by the chuck jaws.

Feeding Trough for Sow

Old disk blades from a harrow, if rimmed with a welded metal band and the shaft hole sealed, are ideal individual feed troughs for sows in their pens. The blade hugs the ground so that a sow cannot put her snout under the edge to tip it, and the pan is heavy enough so that it will not move when in use.



Steel Guard on Sickle-Bar Mower Prevents Damage to Fence Posts

To keep from splintering fence posts and severing fence guy wires when using a sickle-bar mower, one farmer installed flat steel guards on the ends of the cutter bar. The guards are about 2 in. wide and rounded at the front outside corner as shown in the photograph. Short lengths of tubing are welded against the inside edge of each guard and slip over the points on the adjacent ledger teeth, after which holes corresponding to the last bolt hole on either end of the cutter bar are drilled in the guards. The guards are then bolted in place. When in use, they tend to steer the mower around obstructions.





Six Ways to Reinforce Joints on Woodwork

MAKE YOUR FURNITURE and other woodwork last longer and be more serviceable by reinforcing weak or loose joints. Of the many types of joints used in woodworking, the simpler ones shown here may be used either in new construction or in repairing loose joints in any existing construction.

A quick and sturdy repair for corners, when pieces are simply butted together, is to use two dowels. Drill two holes through the outer member and well into the adjacent member and drive in glue-coated dowels. These should be flattened slightly on one or more sides to allow air and excess glue trapped at the bottom of the holes to escape. Trim the dowels flush and refinish. For an extra-strong joint use three dowels.

For picture frames, and other articles having mitered joints where inconspicuous bracing is required, use a thin piece of wood. Saw a slot across the joint to take a thin wooden block snugly. Apply a thin coat of glue to both sides of the block, insert it and clamp until dry. The block should be trimmed to fit flush and a matching finish applied on the exposed edge before it is glued.

When a joint is weakened by rot or splitting and replacement is not warranted,

Thin piece of wood glued in groove cut across mitered joint provides inconspicuous reinforcement

By
R. F. Donovan

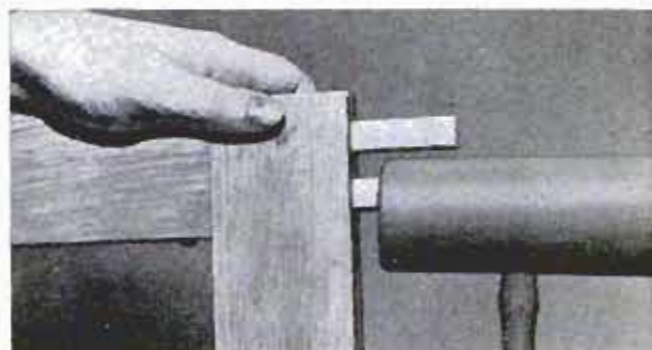
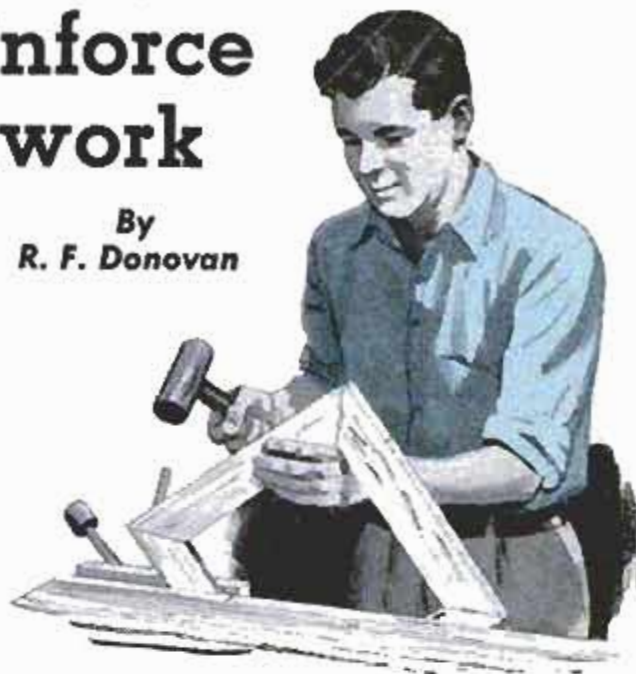

Above, members that are butted together are reinforced by drilling and fitting joint with dowels. Below, triangular block of wood fastened on inside surface of joint strengthens deteriorated members

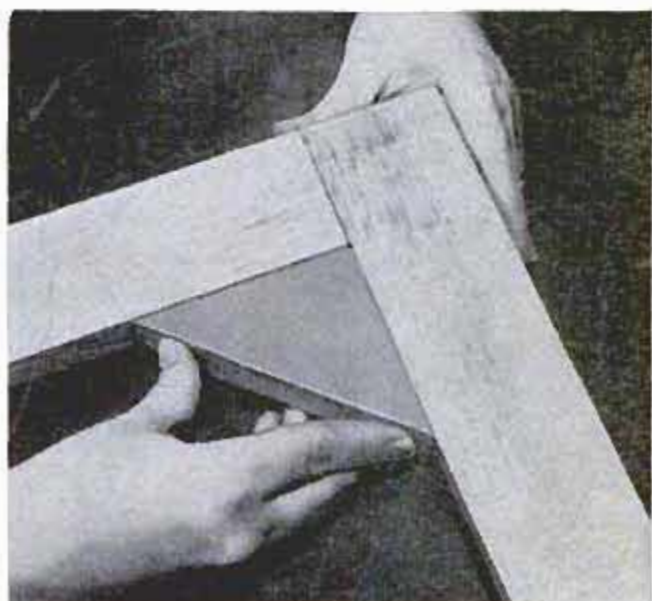
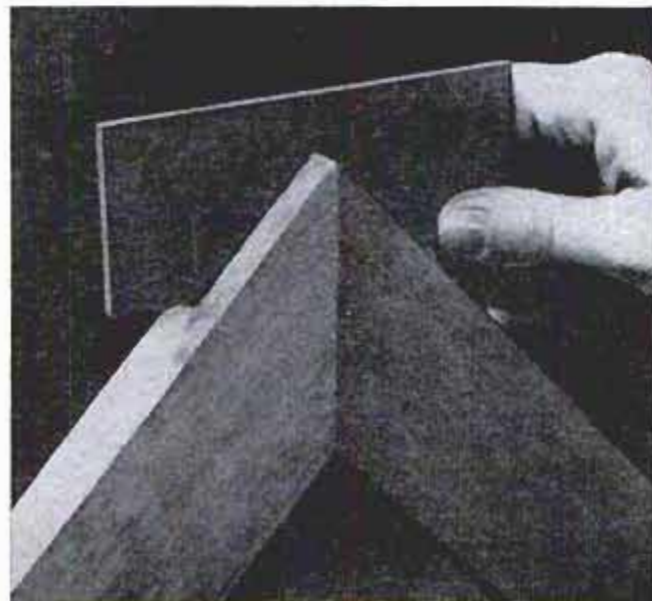

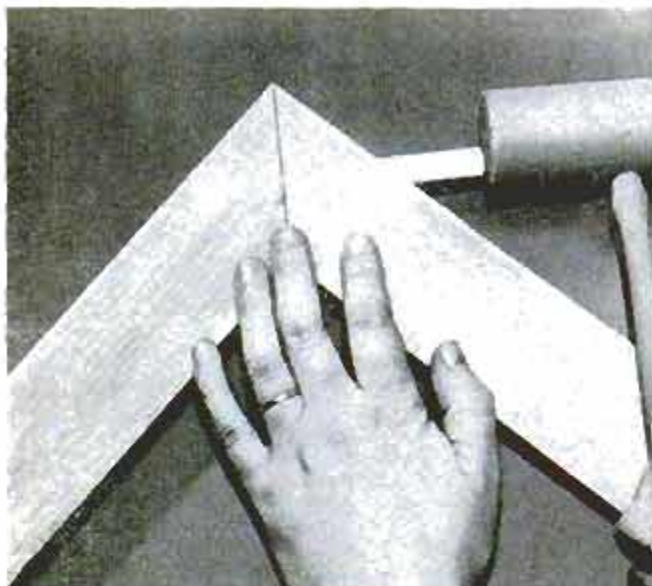

Above, for alternate repair of mitered joint glue dowel in hole drilled across joint at right angle

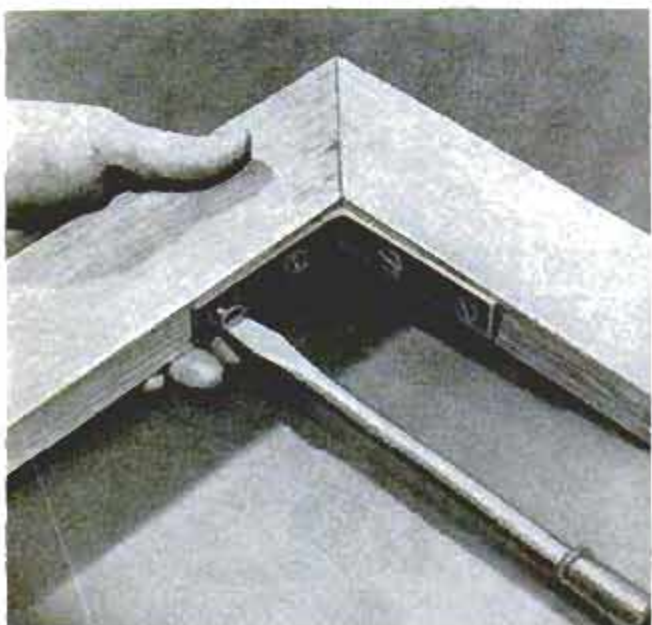

Metal brackets are easy to install on mitered joint, above, when appearance is secondary consideration. Below, triangles of thin plywood fastened on both sides of joint provide extra-strong reinforcement

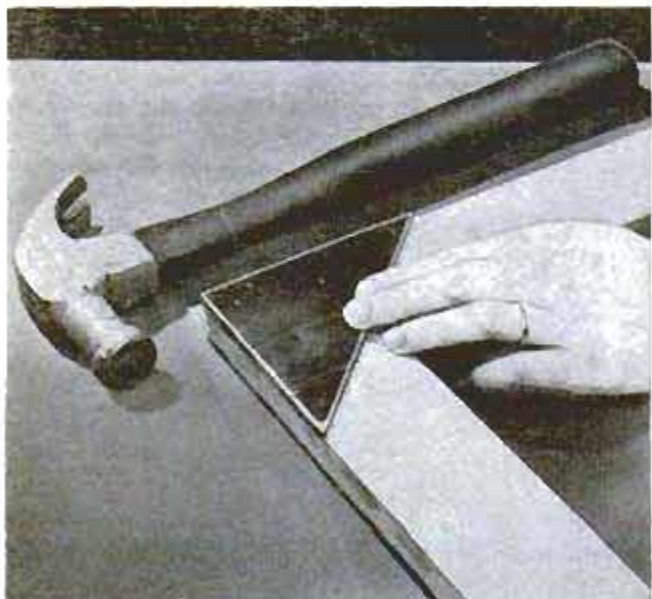

fit a triangular wooden block snugly on the inside surface of corner and screw it in place. Drill pilot holes in the block and corner members and use screws long enough to penetrate sound wood.

Another method of strengthening a mitered joint is to drill both pieces at right angles to the joint and drive in a glue-coated dowel. Where members are of sufficient width reinforce the joint with two dowels. Trim and finish dowel ends when the glue is dry.

To save time when reinforcing a mitered corner use metal angle brackets on screen doors, windows and other places where appearance is not too important; brackets can be painted over to make them less noticeable. Also, these brackets are suitable for strengthening purposes where a surface is out of view, such as in drawers and the underside of some tables and benches.

A very sturdy repair, and one that may be used when added thickness is no problem, can be made by gluing and nailing a thin plywood gusset over the corners of a joint. For added strength, gussets may be used on both sides of the joint. A sheet-metal gusset can be used where added thickness would prohibit this type of repair.

On a mortise-and-tenon joint subject to strain, such as the rungs on a chair, try locking the tenon with a small dowel. To do this, first glue and clamp the parts together. Then, at right angles to the joint, drill a hole through mortise and tenon, coat the dowel with glue and drive it into the hole to pin the end of the tenon tightly in the mortise. Trim away the projecting portion of the dowel, sand the surface smooth and refinish to match. Use of a hardwood block under hammer protects the dowel and surface of furniture. ★ ★ ★

When driving dowel for mortise-and-tenon repair use hardwood block to protect dowel and furniture

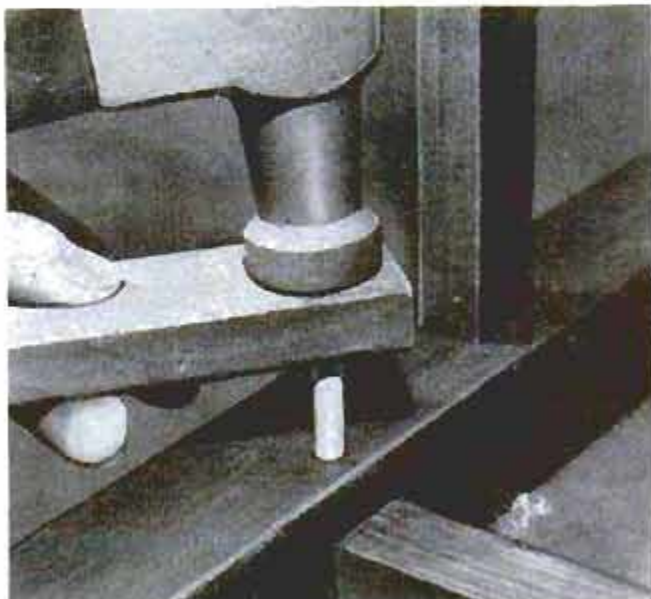

Pipe Union Serves as Revolving-Table or Tool Bearing

An ordinary pipe union can be converted into a sturdy bearing pivot for a revolving table or tool such as the vise shown in the detail. The collar is tapped at the leading edge for a lock screw which grips the piece the collar is threaded on, and another hole is also tapped in the collar at the sealing lip for a thumbscrew which, when tightened, prevents the sleeve inside from turning. Weld a pipe stand to the bottom and a table to the top.

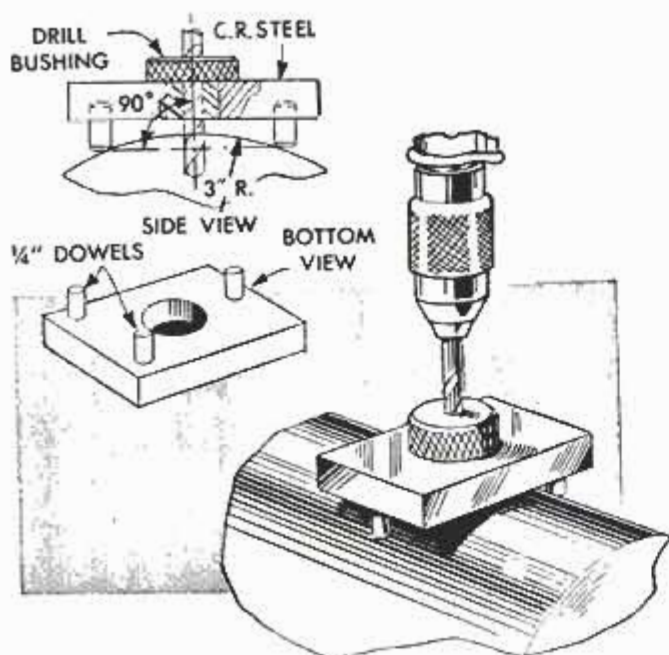
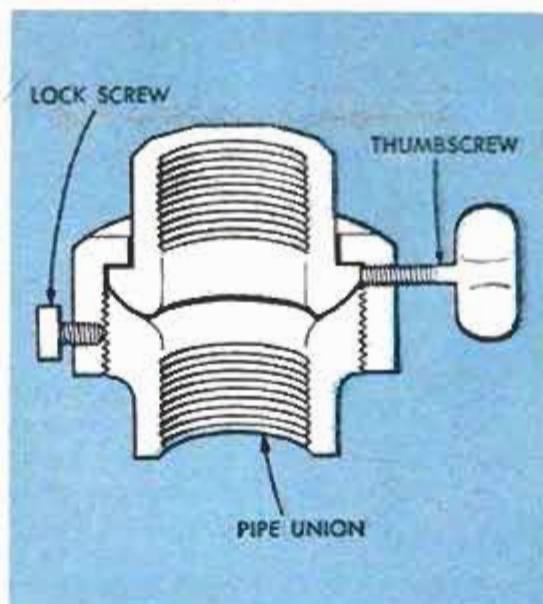

Jig for Crossdrilling Cylinders

When drilling cylindrical work in a drill press, or with a portable drill, the problem of drilling holes precisely on the radial line is solved by using this simple jig and drill-bit guide. It consists of a rectangular piece of flat steel center-drilled to take hardened drill bushings which are tight fitting but removable. The jig is supported by three steel dowel pins that are driven into blind holes drilled in the bottom of the jig block. All pins must project down exactly the same distance, and are located as indicated in the detail. In use, the jig is placed on the work in the desired location. The drill bit is then lowered into the hole in the bushing which must be held or clamped to the work. Also, clamp the work in place so that it does not roll while being drilled.

Victor H. Tauferner, Hawthorne, Calif.

Carpenters' Pencil Clip Made From Clothespin

A flat carpenter's pencil will not fall out of your pocket if it is fitted with a clip made from a spring-type clothespin. Replace one leg of the clothespin with the pencil, grooving it to receive the spring as shown.

Asbestos Gaskets Seal Better When Soaked in Kerosene

When replacing asbestos gaskets in boiler fittings, steam lines, and other places where there is contact with live steam, a better seal will be obtained if each gasket is soaked in kerosene for a few minutes before installing it. The softened material will be forced into all the uneven places when the joint is tightened.

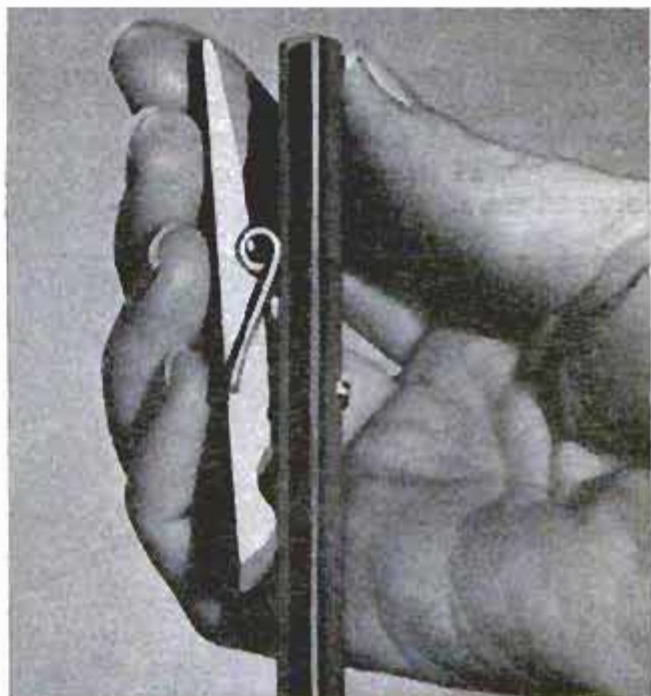



Tank Trailer for Hauling Water To Grazing Field

A 300-gal. tank mounted on a two-wheel trailer and towed by a tractor is used by one farmer to carry water to scattered grazing fields, where it is emptied into stock-watering tanks by means of a gravity-feed pipe-and-hose outlet. The frame and supports for the tank are made of channel and angle-iron members welded together and mounted on a front-wheel assembly from an old car. A jack telescopes into a pipe under the front end for use when the trailer is not hitched to the tractor. Any self-propelled vehicle with a suitable hitch can be used to tow the tank trailer.

Large-Capacity Milk-Can Rack

Assembled from lengths of pipe, this inexpensive rack holds large numbers of 20-qt. milk cans off the floor, allowing air to circulate freely about them for quick drying and airing. The rack, which has three tiers and accommodates 54 cans, is 12 ft. long, 14 in. wide and measures 3 ft. between tiers.



Up Outboard Performance With Suitable Propeller

WHETHER you use an outboard motor-boat for fishing, towing water skiers, racing or as a passenger-carrying runabout, the diameter, pitch and blade area of the propeller act as a transmission in controlling the performance which the boat and motor will give. The same situation exists here as in an automobile, in which an engine of a certain power turning a drive shaft at a known speed must propel a craft of known weight and performance potentialities. Yet, many outboard owners are not aware of this fact and obtain far from optimum performance from their boats.

The illustration at the bottom of the next page shows the three main types of propellers. The two-bladed one is designed for high speed. The one with three blades is the average-duty propeller normally installed on the motor and good for all-around use. It offers a compromise between the high speed of a two-bladed propeller and the low-speed, four-bladed one. The latter is designed for use on heavy outboard cruisers.

As power increases, so does the number of propeller models. In the 10 to 15-hp. range motors are put to the greatest variety of uses, from operating a heavy 16-ft. work boat to driving a 10-ft. racer. The table below will help you to select one or more propellers most suitable for your needs.

Propeller blades that are damaged cause destructive vibration and reduce speed. Battered edges on an aluminum-alloy propeller can be trimmed with a file, but bronze propellers should be reconditioned by a reputable repairman, since a "pitch block," shown on page 195, is needed for reshaping.

Bob Whittier, Stoughton, Mass.

TABLE OF DIMENSIONS FOR PROPELLERS

Diameter	Pitch	No. Blades	Application
8½"	11½"	2	Racing runabouts, light loads
9"	7"	3	Heavy boats, heavy loads, 16-18 ft. cruisers, one engine, 19-23 ft. cruisers, twin engines
9"	8½"	3	14-16 ft. boats, 1-4 passengers
8½"	11"	3	12-14 ft. runabouts, 1-2 passengers
8¾"	9"	3	14-16 ft. runabouts, all loads, skis
9"	7"	4	16-18 ft. cruisers, one engine



The main purpose in changing a propeller is to permit the motor to operate at its maximum efficient speed



Bronze propeller is hammered true on "pitch block," a metal form that is shaped to predetermined pitch

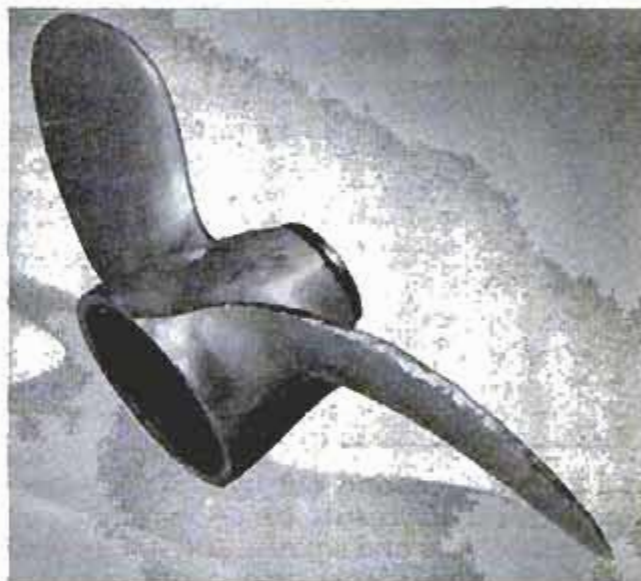

When repairing battered edge of aluminum-alloy propeller, file equal amount of metal from each blade

Propellers are constructed with two, three or four blades, depending upon size of motor and service



Motor-Switch Extension Handle Improved for Use on Jigsaw

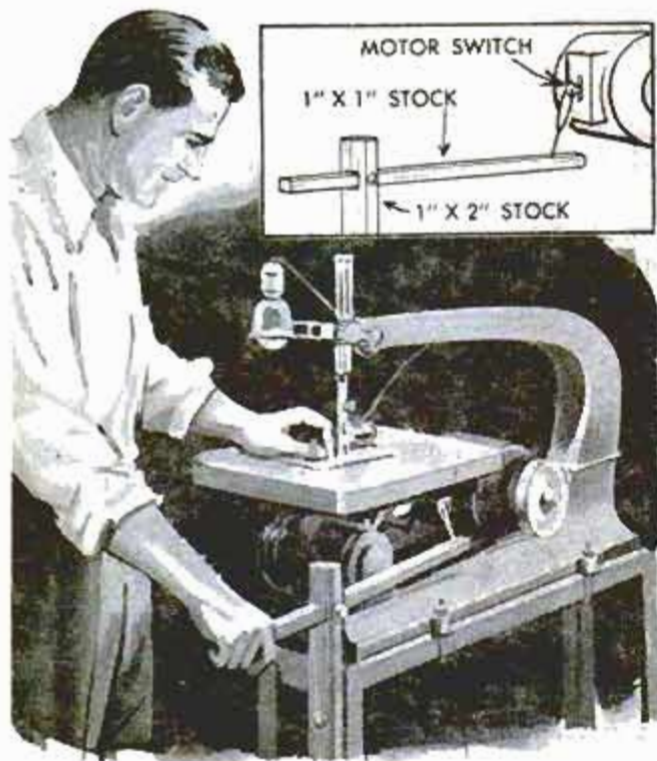

The wooden handle attached to the switch of this power jigsaw enables the operator to start or stop the motor instantly, merely by dropping a hand from the table to the handle. The handy device saves time on inside cuts, when it is necessary to start and stop the saw frequently, and is an added safety feature for a jigsaw equipped with a motor switch that is difficult to reach quickly. The handle and upright members for the device are cut from 1-in. lumber and fastened to the stand as shown. The handle is connected to the switch with a length of stiff wire or small-diameter rod, depending upon the type of switch.

Richard Garland, La Porte, Colo.

Rack on Litter-Carrier Hoist Used to Handle Poultry Feed

This wooden platform offers an excellent facility for distributing grains to feeding stations in a poultry house when it is attached to a litter-carrier hoist in the place of the litter bucket. When it is necessary to clean out the litter from the pens, the bucket is returned to the hoist. This arrangement works best where feeders throughout the pens are the large type holding a bag or two of feed.

Charles L. Stratton, Hollis, N. H.

Overlap Cut Gives Perfect Miter

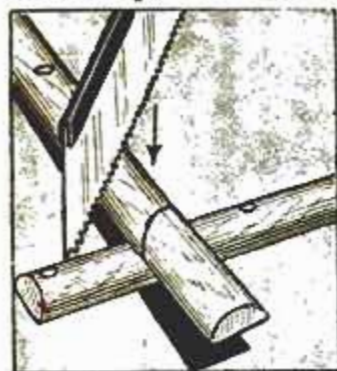

When troubled by mitered corners which do not square-up when the two angle-cut surfaces are joined together, simply overlap the two pieces at right angles to each other, tacking them temporarily

to a flat surface, and cut both at the same time. This will result in perfect mitered corners, gapless and square, and is practical for cutting moldings, screen and picture frames.

Fly Screen in Pipe Tee Prevents Clogged Sprinkler

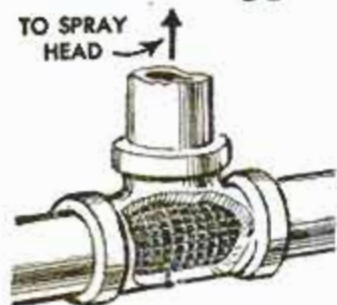

To prevent clogged spray heads in his overhead field and orchard sprinklers, which use water pumped from a stream, one fruit-grower installed a short roll of galvanized fly screen inside the pipe tee under each sprinkler-head riser. Drain plugs or caps should be provided at the end of each line so that accumulated dirt can be flushed out quickly by removing the plugs and inserting a hose.

vanized fly screen inside the pipe tee under each sprinkler-head riser. Drain plugs or caps should be provided at the end of each line so that accumulated dirt can be flushed out quickly by removing the plugs and inserting a hose.

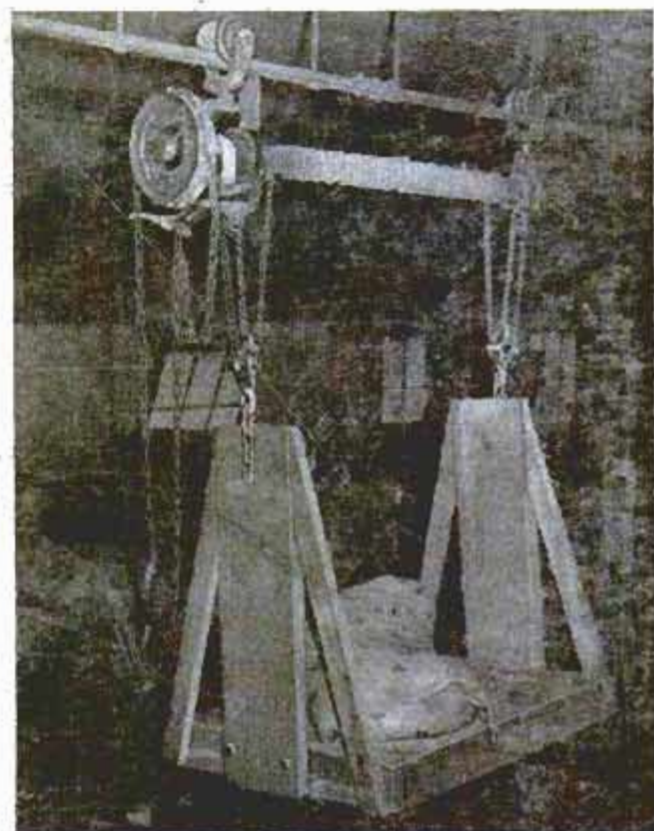

□ A light coat of household wax applied to the top of a circular-saw table will keep it free from rust and make it easier to slide wood over it.

ELECTROPLATING WITHOUT CYANIDES

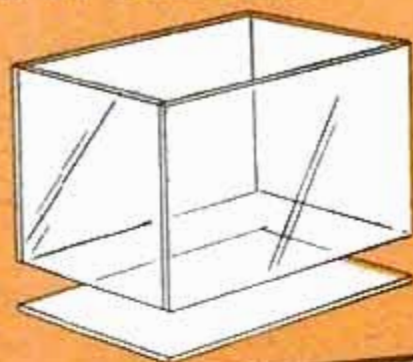
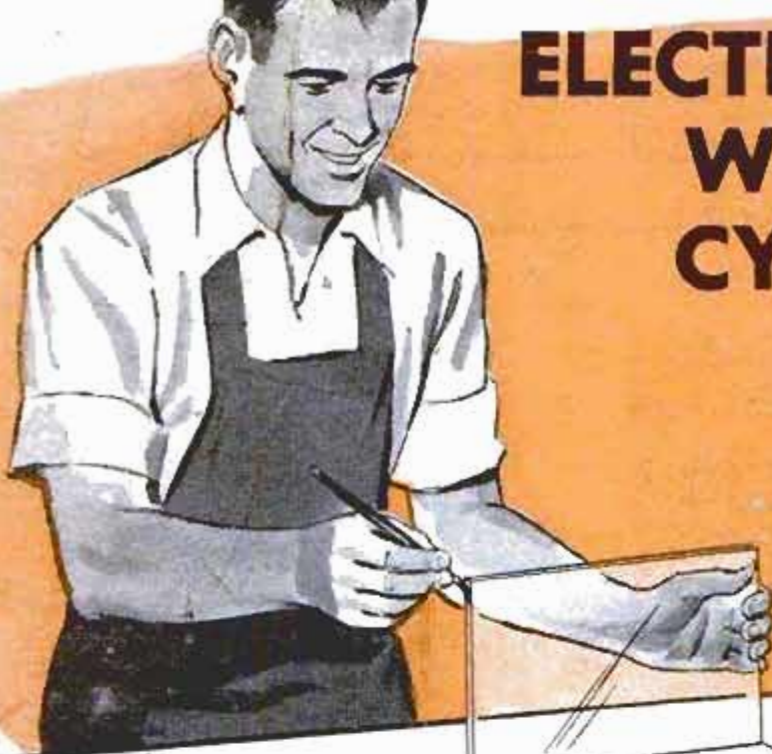

PART I

By J. B. Mullen

YOU CAN ELECTROPLATE articles of iron, steel or brass, with copper and other protective coatings, by using recently developed plating solutions made with fluoborates. Although the latter are free from the extreme hazards of cyanides, they are toxic and must be handled with care. Fluoborates come in the form of liquid concentrates, making mixing of plating solutions easier and more accurate. Most common metals, such as copper, nickel, cadmium and lead, can be deposited from fluoborate solutions.

For plating small items, old battery boxes or earthenware jars can be used for plating

tanks, also to hold acid solutions for removing rust and scale. Serviceable plating tanks also can be made from clear acrylic plastic sheets as pictured above. Cut the plastic sheets carefully so as to assure straight edges. To assemble, dip or paint the joining edges with ethylene dichloride (liquid) and then clamp the parts together. A cement made by dissolving scraps of plastic in ethylene dichloride can be used to calk the joints.

For electrical supply, a storage battery can be used with a small power rheostat to adjust the current. A voltmeter of 10-amp. range and a switch, while not essential, are helpful. The electrical circuit for plating metals is shown in Fig. 1. To

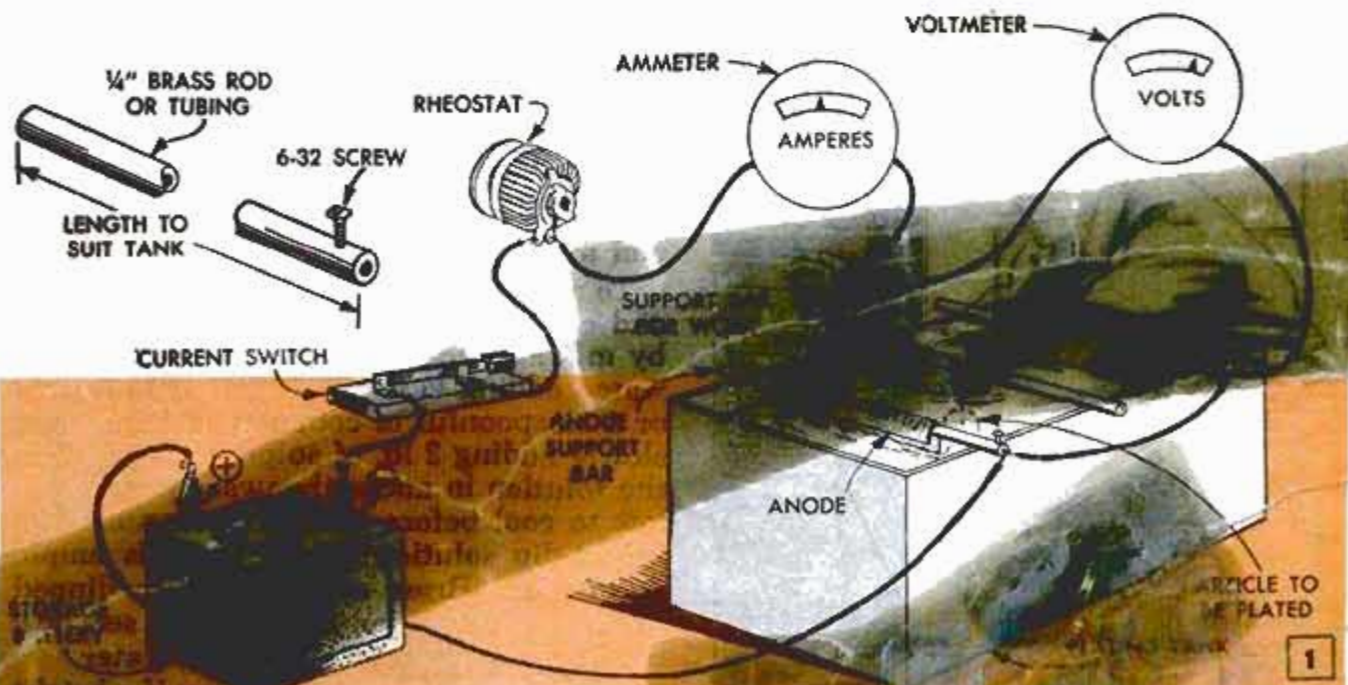

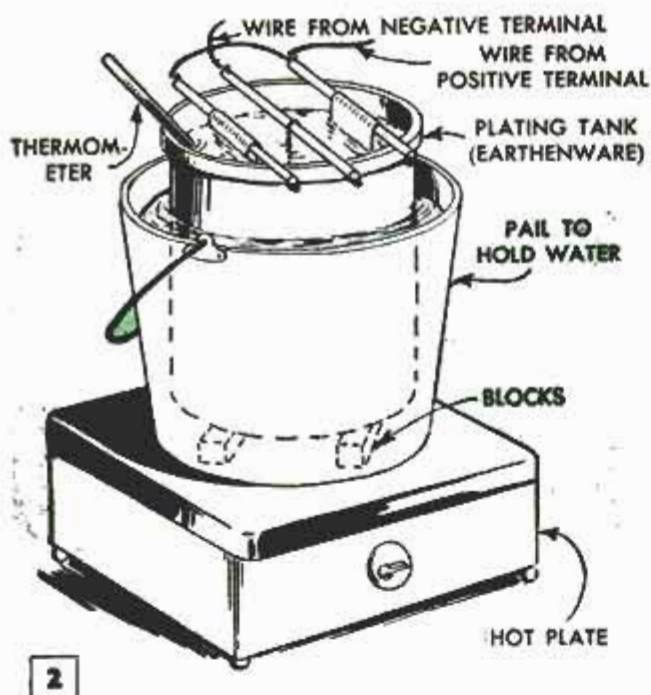

When necessary, plating solutions can be held at given temperature in water bath arranged as pictured

support the work and anodes, which are metal plates used as positive connections to the tank and as a source of the plating metal, make up several brass or copper support bars as in the upper left-hand detail, Fig. 1. For some solutions a water bath consisting of a large kettle or pan filled with water, in which the plating tank can be heated, Fig. 2, will be needed. You also will require a thermometer for reading the temperature of solutions.

Surface Preparation

Good electroplating depends on having a smooth and clean surface on the underlying

Remove grease and dirt with nonflammable solvent. Work should be done outdoors because of toxic fumes

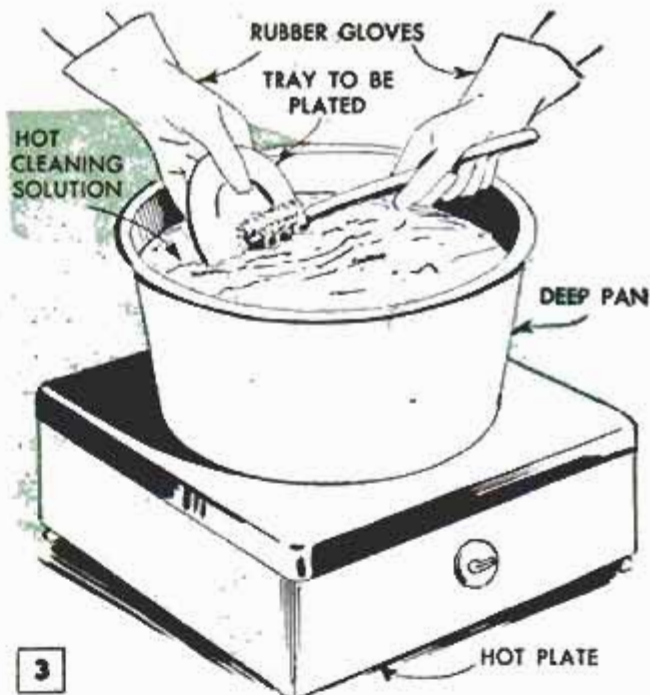
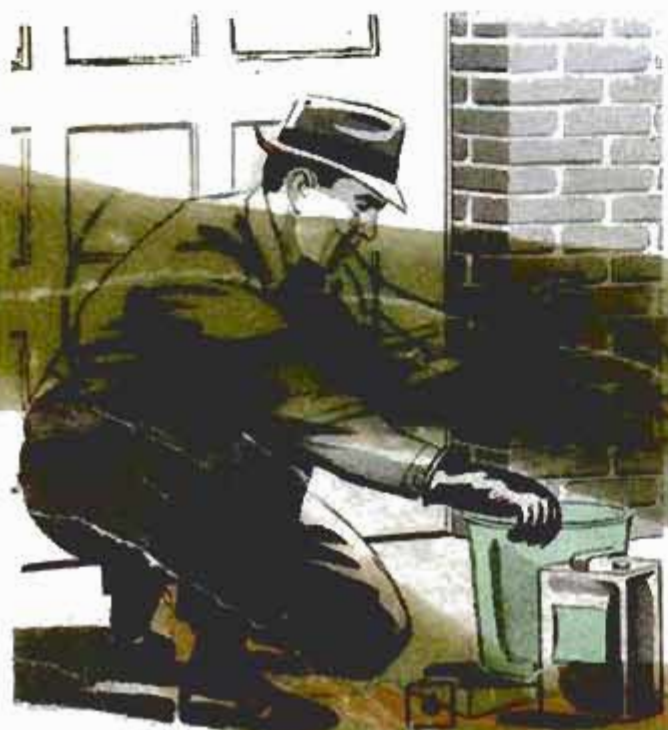

Precleaning is first step to successful electroplating. Cleaning solution should be heated before use

metal. Unless there are heavy layers of grease on the metal to be plated, begin surface preparation by scrubbing the article in a hot precleaning solution containing $\frac{1}{2}$ lb. of sodium carbonate (washing soda) or trisodium phosphate and 4 tablespoonfuls of washing compound in 1 gal. of water, Fig. 3. After washing, rinse the item in a hot solution of soap or synthetic detergent, then in hot running water. Heavy layers of grease should be removed before the precleaning operation, by degreasing with carbon tetrachloride. **This operation should be done out of doors, Fig. 4, because of the toxic vapors.**

To remove rust and scale from iron or steel, a pickling solution is made by adding $\frac{1}{2}$ pt. of sulphuric acid to $\frac{1}{2}$ gal. of water. **Add the acid slowly to the water and mix. Use the solution in an earthenware jar. Immerse the work in the pickle, Fig. 5, as long as is necessary to remove the rust entirely. Then rinse thoroughly in hot and then in cold water, Fig. 9. Acid solutions are corrosive to metals, porcelain fixtures, clothing and the skin. Wear rubber gloves and avoid splashing the solution.**

To remove scale and corrosion from brass and copper, a bright-dip solution is made by mixing 1 lb. of nitric acid with 1 qt. of water, adding $\frac{1}{4}$ fl. oz. of hydrochloric acid or 4 teaspoonful of common salt and then slowly adding 2 in. of sulphuric acid. Mix the solution in an earthenware jar and allow to cool before use. **Use the bright-dip solution in a well-ventilated area. Brass and copper may be dipped in this solution for 10 to 15 seconds, then rinsed immediately in cold water.**

Polishing usually is necessary if a bright

plated finish is desired. On articles that are comparatively clean, polishing can be done before any cleaning operation. Otherwise polish only after precleaning and pickling. Polishing is done with aluminum oxide (No. 80, coarse, to No. 220, fine), tripoli, lime and rouge. Aluminum oxide is used for preliminary polishing, the last two abrasives being suitable for producing a high luster (coloring). For medium luster use a sewed-cotton buffing wheel and for a high luster use a loose wheel. Apply polishing compound (in stick form) to the wheel while running and hold the work low on the wheel as in Fig. 6. Keep work in motion so as not to scuff the surface.

As a final preparation of the work for plating, an electrocleaning bath containing 4 oz. trisodium phosphate and $\frac{1}{2}$ cup synthetic detergent is prepared in a large can or pail. Connect the negative terminal of the battery directly to the container, Fig. 7, and suspend the work from a support bar, which is insulated from the tank by wooden blocks. Heat the solution to 180 deg. F., or higher, then connect the article to the positive side of the circuit. Adjust the rheostat to produce a vigorous bubbling action. After a minute or two, remove the work and rinse in hot and cold running water. From this point on the work should never be touched with the hands. Neither should it be allowed to dry. After electrocleaning and rinsing, water should remain on the surface of the work in an unbroken film, Fig. 8. If the film breaks over some areas, repeat the precleaning and electrocleaning processes.

Sometimes a dark film remains on the metal after electrocleaning. This can be removed from iron or steel by a quick dip in a solution of hydrochloric acid, 6 oz., in 2 qt. of water. After this operation, the work should be plated immediately without being allowed to dry.

Copper Plating

Steel parts to be copper plated are first given a copper strike (thin copper coating) in a special solution made up as in Fig. 10. Dissolve the copper sulphate in $\frac{1}{2}$ gal. of water and add sodium oxalate, which has been dissolved separately in another portion of the water. Stir the mixture while adding triethanolamine until the precipitate that has formed dissolves, then dilute with water to make 1 gal.

Connect the work as in Fig. 1 to the negative battery terminal and hang pieces of copper from the anode-support bars, the latter connected to the positive terminal. Plate at approximately $1\frac{1}{2}$ v. for 3 to 5 min. Then rinse thoroughly to remove the alkaline strike solution.

Copper fluoborate comes in the form of



FOR BRASS AND COPPER		
NITRIC ACID		1 LB.
HYDROCHLORIC ACID		$\frac{1}{4}$ FL. OZ.
WATER		1 QT.
SULPHURIC ACID		2 LB.
FOR STEEL		
SULPHURIC ACID		$\frac{1}{2}$ PINT
WATER		$\frac{1}{2}$ GAL.
NOTE—ADD ACID TO WATER		



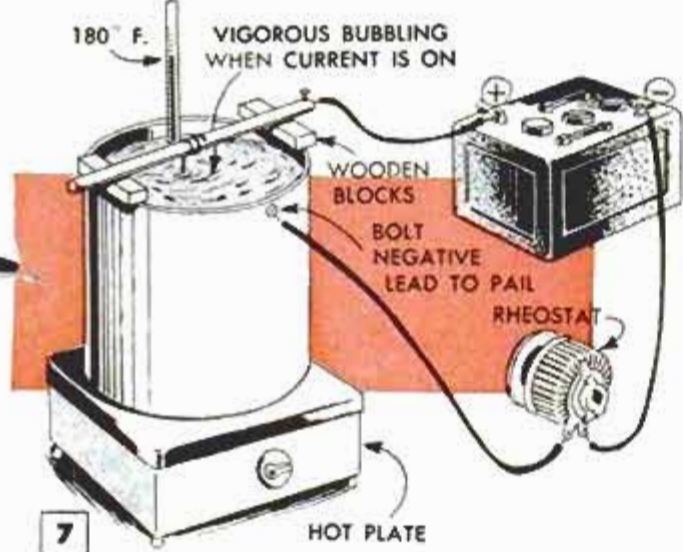

Electrocleaning is last step before plating. Work should not be handled, or dried, before plating

Importance of rinsing after each step cannot be overstressed. This can determine success or failure

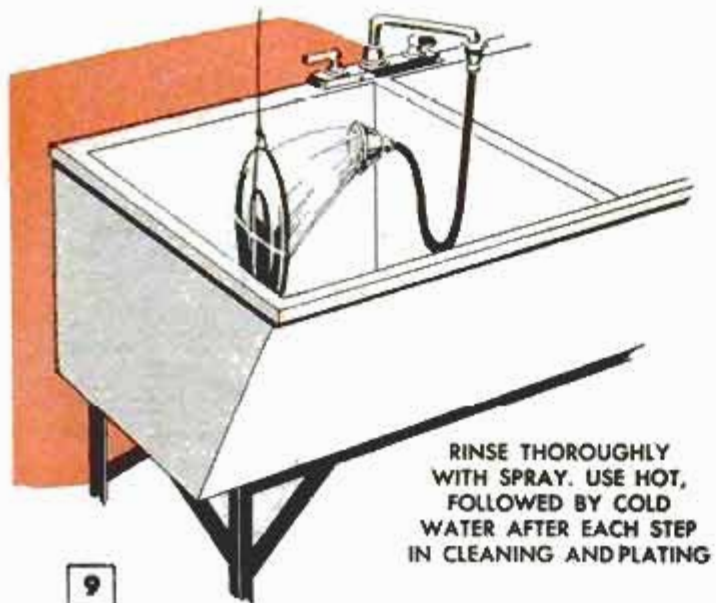

Steel parts to be copper plated are given a copper strike with solution made up as detailed below

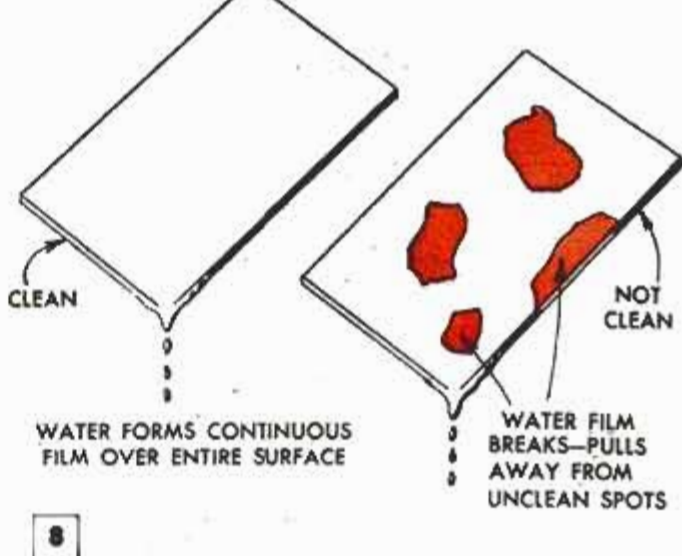
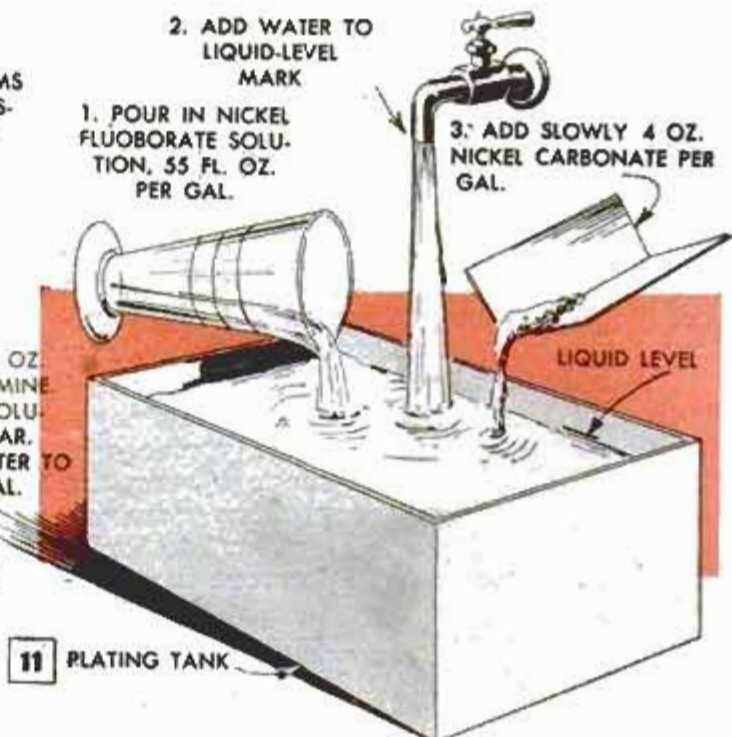

Work is chemically clean if water remains on surface in unbroken film. If film breaks, repeat processes

a concentrated solution containing 45 percent by weight of copper fluoborate. To prepare a plating solution, mix $\frac{1}{2}$ gal. of the concentrate with $\frac{1}{2}$ gal. of distilled water. Hang plates or sheets of pure copper from the anode bars, which are connected to the positive terminal of the battery as in Fig. 1. Pour the plating solution into the tank. Best results will be obtained with the solution at a temperature of 80 to 90 deg. F. It may be necessary to heat a part of the solution separately and then return it to the tank to obtain the desired temperature. Or, use the water bath, Fig. 2.

The work, properly cleaned, is then suspended from the center, or cathode-support bar. Adjust the rheostat to 4 to 6 v. and observe the copper deposit as it forms. Increase voltage slightly if the copper is slow to form, or decrease slightly if the deposit is coarse grained, or rough. Another way of controlling the deposit is to adjust the

Nickel plating follows copper plating, solution being prepared as detailed. Be sure to clean plating tank

current based on the area of the work surface. For every 10 sq. in. of surface use a current of about 1-amp. density. Thus a small tray, 8 in. long with an average width of 3 in., would have a surface area of 48 sq. in., requiring a current density of about 5 amp. At 5 amp., plating time should be about 40 min. If the work is to be nickel plated, remove from the plating solution and rinse thoroughly. Then place in the nickel solution without handling or drying. Otherwise the copper-plated item should be dried and lacquered.

Nickel Plating

A nickel-plating solution is prepared as in Fig. 11, pouring nickel fluoborate into the water, then adding 4 oz. of nickel carbonate and stirring with a wooden paddle until dissolved. Hang the work from the center, or-cathode bar, and adjust the rheostat to give 2 to 3 v. Increase or decrease voltage as required. Plating time should be about 50 min.

Chromium Plating

A chromium-plating solution is made by dissolving chromic acid, 53 oz., in sufficient water to make a total volume of 1 gal. After this has dissolved, add 2 fluid drams (8 cc.) of concentrated sulphuric acid. **Both chromic and sulphuric acids are highly corrosive; handle with extreme care.** Warm the solution to an operating temperature of 100 deg. F. Use plain steel anodes. Suspend the item to be plated from the center support bar and cover with several sheets of newspaper before turning on the current. Adjust the rheostat for about 4 v. Turn off the current after 10 to 15 sec. and note if the plate is forming. Adjust the voltage, if necessary, until plating forms. When plating begins, keep temperature and voltage constant. Plate 3 to 5 min. Then rinse, dry the work and polish with a loose cotton buffing wheel.

(To be continued)

Faulty Voltage Regulator "Shorted" Out of Circuit

As an emergency measure only, when the voltage regulator on your car fails to operate, connect a jumper wire between the armature and field poles on the generator. A third post on the generator is grounded and should not be used. Connecting of the two posts "shorts" out the regulator and produces maximum generator output, which eventually would overcharge the battery and burn out the electrical components on the car. Therefore, the car should not be driven more than a short distance with this jumper-wire arrangement.—Don Engdahl, Santa Rosa, Calif.



Coupling Handle on Tractor Plow Provides Safety Measure

A safety feature for coupling a plow to a tractor is this long handle bolted to the plow tongue. To make the handle, one end of a heavy rod is bent at a right angle for a handhold, while the other end is welded to the head of the bolt in the plow tongue. Since the operator stays on the tractor seat while coupling the plow to the tractor hitch, there is no chance of pinched fingers and the tractor remains under complete control at all times.

Multiple Baking Pans With Handle Provide Portable Parts Tray

Commercial-type baking tins, which are bound together with metal straps, are used by one farmer as handy trays for nuts, bolts and miscellaneous parts in his farm shop. Fitted with a handle, as shown in the photograph, the trays are used to carry parts for repairing the tractor in the field, fence-mending and other jobs away from the shop.

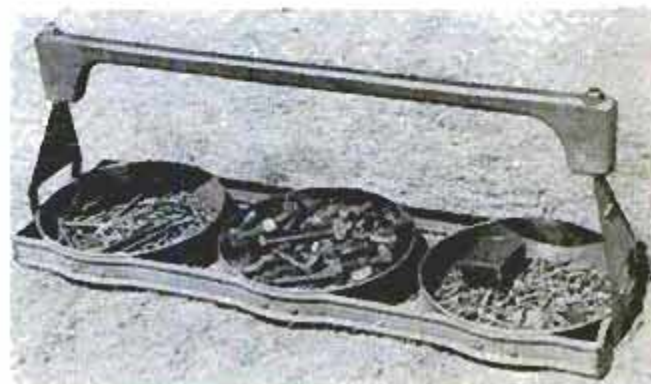

SHOPPING FOR TOOLS



PERSPECTOGRAPH simplifies and speeds up draftsman's job of transcribing plans and blueprints into perspective drawings so that parts and assemblies can be more easily visualized in appearance and relationship. Eliminates the preliminary work ordinarily required to plot a perspective drawing and work it out

in detail. Easily attached to any drawing board with thumbtacks. Consists of a calibrated sweep arm and a cylindrical chart of curves by means of which a pattern of dots is transferred from the original orthographic drawing. Connecting these dots with straight and curved lines gives a perspective of the original

Perspectograph Corp., 285 Madison Ave., New York City 17

POCKET MAGNET is fountain-pen size for convenience in handling and carrying. A swiveling handle is attached to the unbreakable plastic barrel, or case, permitting the latter to swing freely when in use. Locates hidden nails, wall studs, tacks, nails and metal chips in tires, pulls metal chips out of blind holes. Magnet exerts pull equal to 100 times its weight

Reder Mfg. Co., 3523 Martens St., Franklin Park, Ill.

MITER CLAMP is designed not only to clamp the mitered joint tightly for gluing or nailing, but also to permit "sawing down" one or more of the four joints in a mitered frame to correct a slight error in cutting the stock to 45 deg. Enables user to make perfect mitered joints on picture frames, screens and cabinet doors. Takes straight-edged stock up to 2 in. wide

Gunver Mfg. Co., Manchester, Conn.

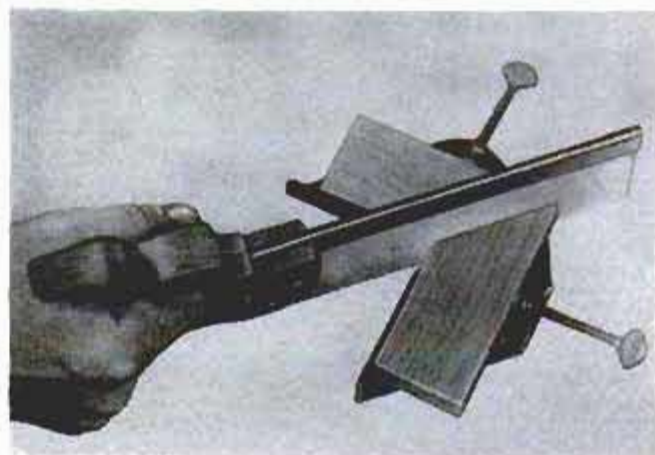
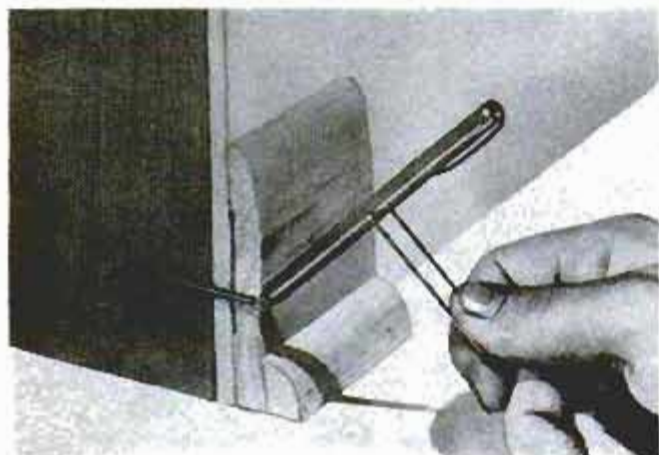

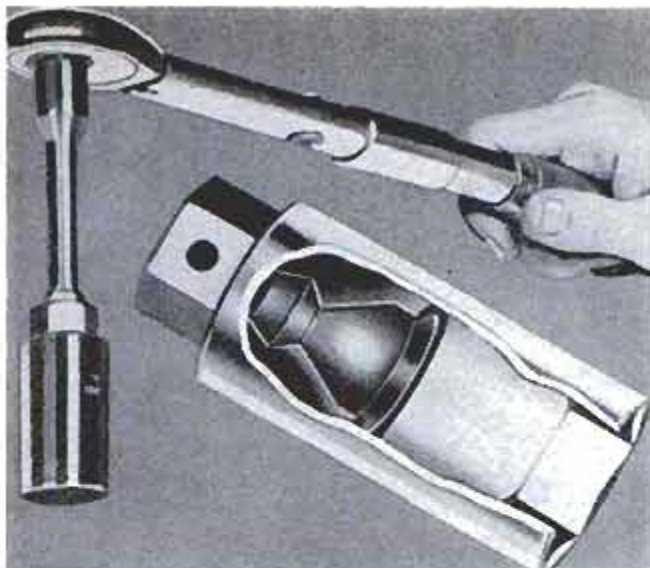

SPARK-PLUG SOCKET has a formed rubber insert which grips porcelain tip of plug and withdraws it with socket. Eliminates possibility of breakage when unscrewing plugs from deep recesses in cylinder heads
Plomb Tool Co., Los Angeles, Calif.

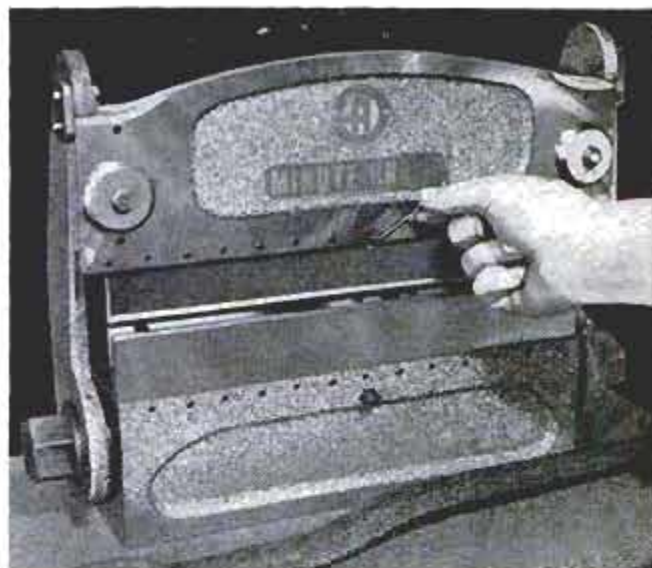

SHEET-METAL BRAKE combines a shear capable of handling sheet metal up to 14 ga. Takes stock up to 12 in. wide, develops 4½-ton pressure for hemming, bending, flattening, corrugating, boxing and shearing
Rotex Punch Co., 2350 Alvarado St., San Leandro, Calif.



SWINGING BINS are hinged to a metal bracket which is attached to the wall or tool panel over the workbench. Each bin is of clear plastic so that the contents are easily seen as in the photo at the left.

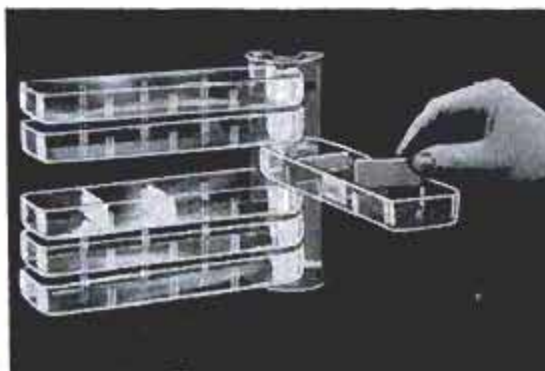

Three dividers per bin, center photo, make it possible to keep small parts separate in individual compartments. Bins swing individually as in the center and right-hand photos. Available in several sizes
Mid-Continent Hardware, P.O. Box 111, Lee's Summit, Mo.



HEIGHT GAUGE has a micrometer head which raises and lowers a series of blocks, or steps, spaced 1 in. apart. Settings within .0001 are possible throughout the range of the instrument. Comes in two heights
Brown & Sharpe Mfg. Co., Providence 1, R. I.



GUIDE FOR HAND TAP takes standard taps up to ½ in., assures straight, true thread and reduces tap breakage to minimum. Suitable for use with any tap, taper, plug or bottom type. Comes with wood holder
Griffith Tool Co., 237 E. Crescent, Elmhurst, Ill.

On the MARKET

for Do-It-Yourselfers

PAINT-AND-PLASTER mix solves the problem of what to do about those dingy, cracked walls of plaster. Repairs and redecorates walls and ceilings in one step, fills and hides cracks in plaster, dents and seams in plasterboard. Comes in 12 decorator colors

Beardon Company, St. Louis, Mo.

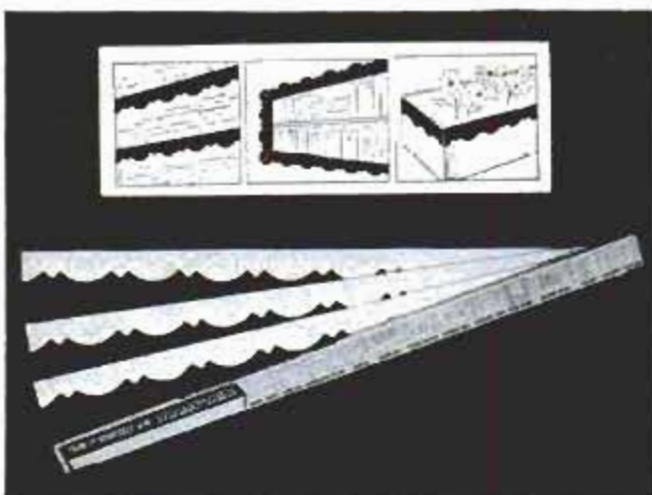

PLYWOOD TRIM KIT consists of 3 strips of birch plywood, each strip having one edge attractively scalloped. Thoroughly sanded, ready to finish with paint, or stain and varnish. Makes perfect trim for shadow box, picture frame, shelf, bookcase or room cornice

Direct Promotions, 33 W. 46th St., New York City 36

WOOD TRIM in strips of veneer thickness is now available for finishing the exposed edges of plywoods. Strip, or tape, is 1 in. wide and comes in a variety of woods to match any hardwood-faced plywood. Applied with ordinary glue. No heat or clamping required

United States Plywood Corp., 55 W. 44th St., New York City 36



COUNTERBALANCED, DOUBLE-HUNG SASH opens simultaneously at top and bottom. As lower sash is raised, upper sash lowers an equal distance. Comes as a unit ready for installation. Made of aluminum with special weather stripping and trim that snaps on

Per-Fit Products Corp., 1216 E. 52nd St., Indianapolis 5, Ind.

BASEMENT WATERPROOFER seals porous, leaky walls watertight. Available as two separate components which are mixed before application to the wall. Application is made with brush, spray or roller after wire-brushing and cleaning the masonry surface

American Metaseal Mfg. Corp., West New York, N. J.



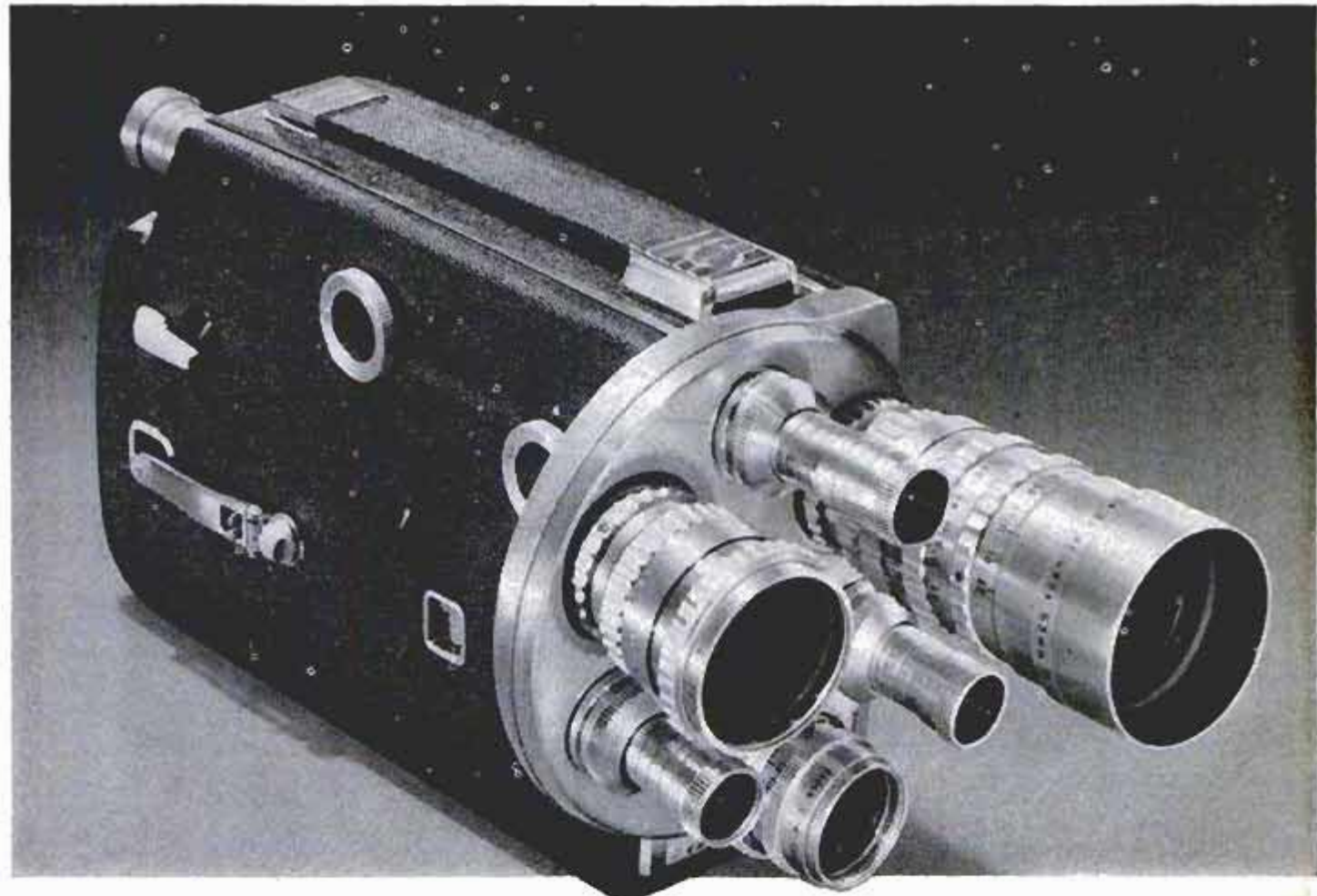

NOW IT'S HERE! THE MAGNIFICENT NEW

Cine-Kodak K-100 Turret Camera

Truly a 16mm camera built to perfection—not to price!

The K-100's turret accepts your choice of any three great Kodak Cine Ektar Lenses, 15 to 152mm, without optical interference. When you click the turret to shift from the standard lens to a wide-angle or telephoto lens, the matching viewfinder automatically clicks into correct position.

Luxury features? The K-100 is packed with them. Accepts single- or double-perforated roll film—gives you an unequalled 40-foot film run from *each winding* of its powerful spring-driven motor. Full speed range from single-frame exposures to slow motion . . . built-in exposure guide . . . precision footage meters to tell you exactly

how much film can be exposed before re-winding, how much unexposed film remains on the roll. Provision for hand crank (for producing multiple exposures, dissolves, special effects), and for attaching electric-motor drive. K-100 Turret Camera with superb Ektar II 25mm Lens and matching viewfinder, from \$315. See it soon!



Ask your dealer to show you the other 16mm and 8mm cameras in Kodak's famous family of movie-makers. Prices begin as low as \$29.95!

Ask about small down payment, easy terms

Prices include Federal Tax and are subject to change without notice

Eastman Kodak Company, Rochester 4, N. Y.

Kodak
TRADE MARK

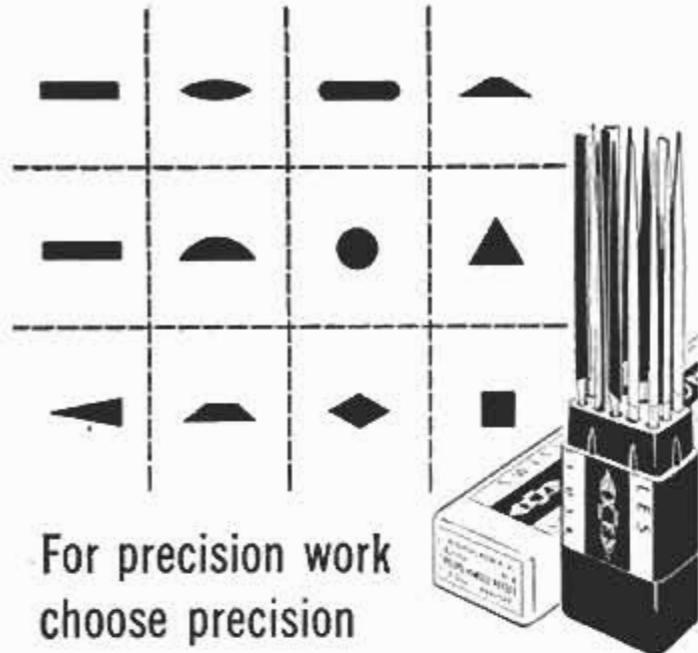

For precision work
choose precision

NICHOLSON X.F. SWISS PATTERN FILES

Jewelers . . . gunsmiths . . . die finishers . . . expert hobbyists and "old pros" . . . overwhelmingly, they prefer Swiss Patterns made by Nicholson when there's extra-precise filing to be done.

Nicholson X.F. (EXtra Fine) brand files are made to extremely exacting standards by specially-trained craftsmen. More finely tapered and usually smaller than conventional files, Nicholson Swiss Patterns are available in six degrees of fineness instead of the usual three.

There are hundreds of Nicholson Swiss Pattern shapes and sizes. Many of them are "specialists." For the discriminating home-crafter, the assortment shown here is recommended. These are the 12 most-used types of Round Handle Needle files, packaged in an attractive plastic holder to protect their finely-cut teeth. Ask for Nicholson X.F. Swiss Patterns at good hardware stores.

FREE 52-PAGE BOOK, "File Philosophy," contains invaluable information on care, choice and use of files. Write for your copy.



NICHOLSON FILE COMPANY
Providence 1, Rhode Island



NICHOLSON FILES
A FILE FOR EVERY PURPOSE

Clinic for Homemakers



As a service to our readers in solving the hundreds of problems pertaining to a home—inside or out—the editors of *Popular Mechanics* invite you to present your problems to The Clinic Editor for help and advice. Address your questions to The Clinic Editor, *Popular Mechanics Magazine*, 200 East Ontario Street, Chicago 11, Ill.

Shellac Finish

Q—Recently I acquired a very old chest of drawers. On removing the paint I found that the wood was curly maple. I was told to finish the wood with orange shellac. The shellac remained sticky for days, never really dried hard. Now I'm wondering what I did wrong.—O. G., N. H.



A—Of all the possible causes, we think the most likely one is that you used shellac which was too old. Shellac, especially that from a can which has been opened and resealed, is not always reliable after storing for a long period of time. If this guess is correct, then the only thing to do is remove the shellac with alcohol, sand the wood to remove any residue and refinish with new shellac. However, as already stated, there are other possible causes and perhaps the most likely of these is a lack of air circulation in the room where the refinishing was originally done. This condition also can cause failure of shellac finishes. Another possible cause, more remote but still a possibility, is the type of finish which was applied to the chest at the time it was made. Some of the very old finishing materials contained wax in some form. In some cases these were penetrating finishes, a residue of which might tend to affect normal hardening of subsequent finishes. In applying new shellac we would cover only a small area as a test. If the new material dries properly then it likely will be safe to refinish the chest.

Early Planting

Q—For two seasons I have planted garden seeds early and have had rather indifferent success. I've always understood that early planting was the approved procedure, the purpose being to take advantage of a cool growing season and ample early-spring moisture. Only about half the seeds I plant germinate and the resulting growth is anything but healthy. What is wrong?

—L. H., Mich.



A—Much depends on what you mean by "early planting." Much also depends on the kind and condition of the soil in the garden plot, how the seeds are planted and on the vagaries of the season

(Continued to page 208)

"WHITE RUBIES"

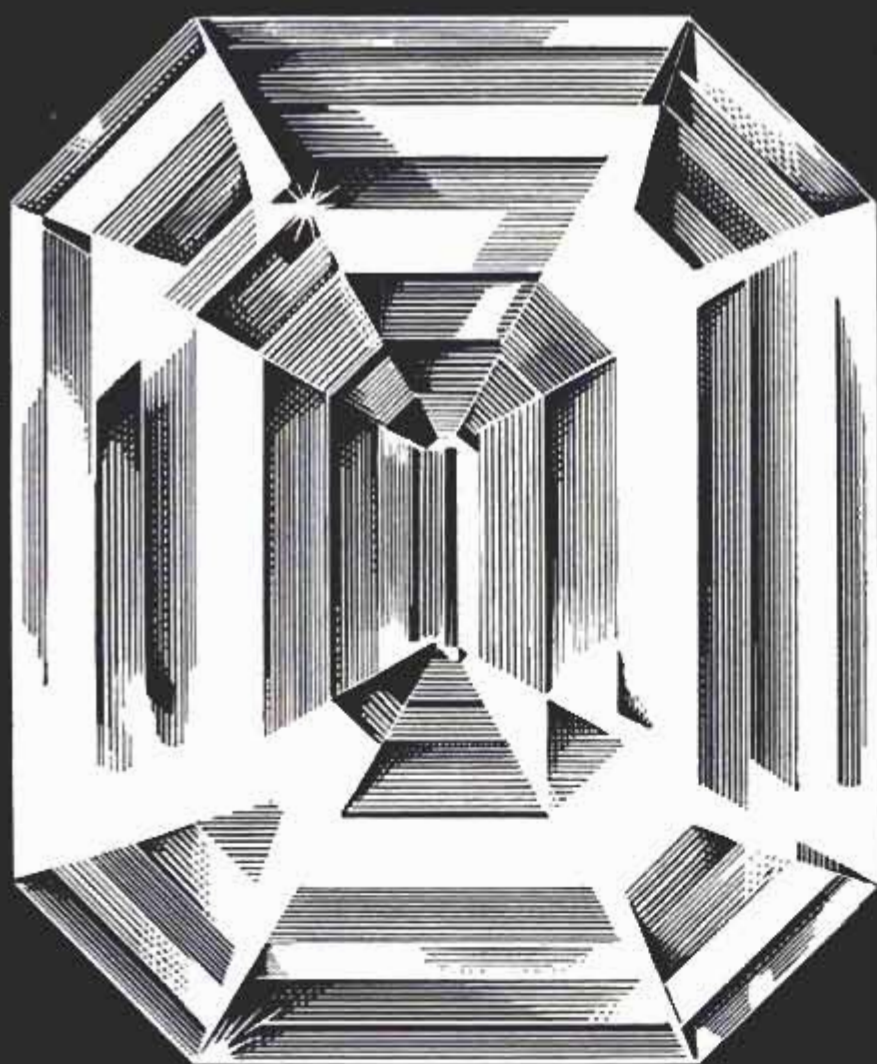

...secret
behind
the
famous
AC
HOT TIP!

Rubies and sapphires, two of nature's finest gems, are composed of corundum . . . so are AC Spark Plug Insulators.

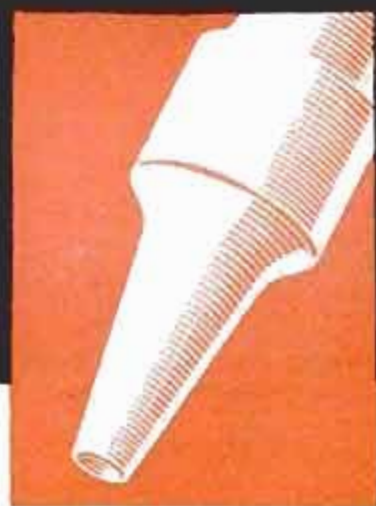

HOT TIP
Spark Plugs



AC SPARK PLUG **THE ELECTRONICS DIVISION OF GENERAL MOTORS**

And just like rubies and sapphires, AC Insulators can withstand intense heat and pressure. High-compression engines demand these qualities in a spark plug.

The gem-like qualities of corundum are ideal for the famous AC Hot Tip. This tip is deeply recessed so it heats up fast to burn off fouling carbon and oil deposits as soon as they form. The AC Hot Tip stays cleaner longer for better performance and economy.

Get the benefits of the AC Hot Tip for your car. Get a new set of AC Hot Tip Spark Plugs every 10,000 miles.



Once a
dreary attic
... now a cheerful room!



You can turn unused space into a room as beautiful as this with Gold Bond Insulation Planks and Tiles—even if carpentering is a mystery to you.

WALLS GO UP FAST because Gold Bond Insulation Planks are light, easy to handle. Place them vertically, horizontally, diagonally. Nail or staple 'em up. Interlocking edges hide the fastenings. Planks have flame-resistant finish—in ivory or in a random assortment of four harmonizing colors. They keep you warmer in winter, cooler in summer, too!

FOR THE CEILING use handsome Gold Bond Insulation Tiles. Easy to nail or staple. They absorb sound just as the Insulation Planks do.

SEE YOUR GOLD BOND DEALER NOW for the materials you need. He'll even help you with easy terms.

NATIONAL GYPSUM COMPANY
Buffalo, N. Y.



Mail the coupon today for Gold Bond "How-to-Do-It" Plan #14 ... complete illustrated instructions that show how you can build a room just as attractive as this.



MAIL THIS COUPON TODAY!

National Gypsum Co., Dept. PM 66, Buffalo 13, N. Y.
Please send me Gold Bond "How-to-Do-It" Plan #14, giving complete instructions on how to apply Gold Bond Insulation Planks and Tiles.

Name _____

Address _____

City _____ Zone _____

County _____ State _____

after planting. In your area a late frost may occur somewhere between May 1 and May 10. Although frost is only a possibility and by no means a regular seasonal occurrence, weather conditions preceding these dates are not likely always to be favorable for garden plantings. Seeds planted in heavy, wet soils in cool weather are certain to germinate slowly, if at all, and the seedlings that survive seldom attain vigorous growth, even though growing conditions later on may be favorable. Successful gardeners do not plant until the soil is sufficiently dry to work easily. Heavy, clayey soils require a longer dry-out period than do sandy, gravelly soils. Small seeds such as radish, lettuce and onion should be planted in shallow trenches and covered lightly with fine soil. Transplants such as cabbage and tomato require good growing weather and plenty of warmth. Even though they are set out late by the calendar, they usually will make up for lost time by a more rapid growth. Experienced gardeners always wait for favorable weather conditions.

Cracks in Brick

Q—My home is brick-veneer construction, about 20 years old, 1½ story with basement. Two years ago I first noticed cracks in the basement floor and foundation and lately cracks have appeared diagonally across the exterior wall at one corner above the grade. Also, the plaster is beginning to crack in a corner of one room. What could cause this defect in a house 20 years old?

—O. D., III.



A—If we can judge correctly from your description you will have to do a major repair job in order to remedy the condition permanently. Not knowing the area we can only guess the probable cause, but it seems most likely that the portion of the structure that is breaking away was built over a cinder fill and that the cinders under the foundation have deteriorated to the point where they no longer give adequate support. Of course, it is not possible to say how long the settling will continue, or to what extent the cracks will open. Perhaps it would be a good idea to test this by pointing up one of the cracks for a short distance with mortar. Mix a fairly stiff mortar and force into the crack, making sure that it adheres to both sides. The total length of the portion of the crack filled should be about 18 in. Smooth the joint carefully and then note the result over a period of two months or so. If the joint opens, that is, the mortar breaks away from the brick on one side or the other of the crack, it is reasonable to assume that settling of that portion of the wall affected is continuing. In this case it probably will be necessary to excavate, remove the footing, foundation and brick below the crack, or cracks, and rebuild, beginning with a new footing, pouring new sections of the basement wall and re-laying the bricks in that part which has broken away. However, if the test joint does not open after a lapse of time then it is just possible that pointing the cracks with mortar will effect a reasonably satisfactory repair.

Layering

Q—What is the meaning of the term layering when referring to plant propagation?—U. P., Me.

A—Well-known examples of natural plant propagation by what is known as layering are strawberries, dewberries and black raspberries. Strawberry plants send out runners each season which root in the soil adjacent to the parent plant and thereby establish a new plant, or plants, depending on the number of runners. Dewberries and raspberries root at the tips of the canes which bend naturally until the tips contact the surface of the soil. Gardeners practice simple layering by bending the canes in the late spring and covering them near the ends with soil to a depth of 2 to 4 in. In this procedure the tip must be left exposed.

DISSTON

D-23 Lightweight, Straight-back

HAND SAW

©HKP

CUTS CLEANLY!

CUTS SMOOTHLY!

ONLY
\$895

CUTS FOR A
LIFETIME!

10-to 12-pt. Disstons recommended for smoothest cuts in plywood and other well-seasoned woods

When you're cutting plywood and want a beautifully smooth finished edge, you've got to use a saw that's made for finished work.

That's a 10-, 11-, or 12-point Disston. These fine-toothed saws often make the difference between fine workmanship and an ordinary job. They are specifically designed to be used for finishing.

So if you've been trying to cut plywood or other well-seasoned woods with an 8-point saw, ask at your hardware or tool store for a Disston D-23 in 10-, 11-, or 12-point. You'll get a saw of fine tool steel, with perfectly tempered and double taper ground blade . . . a saw you'll use and treasure for a lifetime.

CARLSON STEEL TAPE RULES AND TAPES



WHITE CHIEF
(6 ft.) \$1.80

BIG CHIEF
(12 ft.) \$3.50

STAR CHIEF
(25 ft.) \$4.00

Finest quality long tapes and pocket-size rules for every purpose. From 6 feet to 100 feet. Accurate, easy-to-read. Double graduations, feet and inches. Stiff, rigid, easily-changed blades. Easy-action swing tips.

DISSTON DE LUXE CIRCULAR SAWS AND DADOS

from \$2.25 to \$22.80

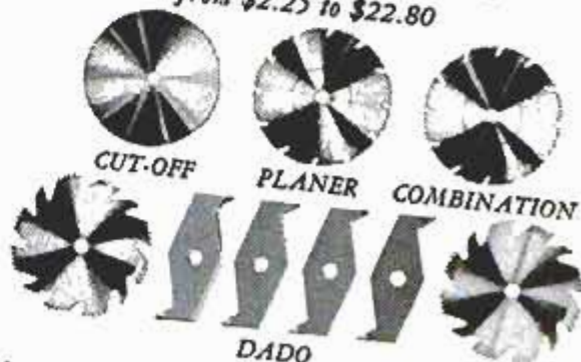

Make curting easy and accurate. Made of famous Disston steel. High finish; keen teeth; accurate fitting. Special styles to fit all makes of bench and portable electric hand saws.

FREE ILLUSTRATED BOOKLET! 64-page Disston Saw, Tool & File Manual. Tells how to choose and use tools; how to care for them. Helpful hints on wood working, metal working and selection of materials. Write today for your free copy.

ASK YOUR HARDWAREMAN
TO SHOW YOU THESE FINE DISSTON TOOLS

DISSTON

Henry DISSTON DIVISION • H. K. PORTER COMPANY, INC.
611 Tacony, Philadelphia 35, Pa.



Tropical Fish Are Fun

(Continued from page 101)

Male bettas here are usually kept in small bowls in solitary splendor. To breed them, male and female betta must be kept in a special plastic tank with a Plexiglas partition between them, until they get used to each other. One day Mr. Betta will blow masses of sticky bubbles that cover the surface. That's the egg nest. The partition is pulled out and Mr. Betta proceeds to squeeze the eggs from Mrs. Betta by wrapping himself around her. Then the male pushes the eggs up to his nest and guards them. Many tropicals blow these odd bubble nests which the male guards jealously.

In some families of tropical fish, either the male or female hatches the eggs by mouth. In one variety called the Egyptian mouthbreeder, the female does the job. As eggs hatch, the young swim out of her mouth, but for some time afterward, in times of danger, the fry dart back inside her mouth.

Still other tropicals are "live bearers," giving birth to strings of wiggly youngsters. Beginners soon learn the unhappy fact that many fish will eat their offspring unless special care is taken. Even the best aquarium hasn't the hiding places nature provides. Plastic breeding tanks called "traps"

—divided by partitions with tiny slots through which fry can swim but parents can't—are the answer if you want the fun of seeing baby tropicals grow.

Bettas aren't the only fierce fish among tropicals. One tank in John Groetzinger's aquarium bears the sinister label "Murder,"

(Continued to page 212)

Fish now are mailed in plastic bags packed in cartons. "Shot" of oxygen added to water keeps fish alive



CONTENTMENT costs LESS in a PERMABILT® home!



Any family paying \$67.00 a month rent can own a professionally planned PERMABILT home. If you have been waiting for a home of your own, a PERMABILT is the answer.

ARCHITECT DESIGNED

to give your family custom-built quality and design without custom-built cost, a PERMABILT home is bright and modern, inside and out.

Planned for spaciousness and convenience with lots of closet and storage space.

ASSEMBLE IN HOURS

Your PERMABILT home is shipped as a complete package containing everything you need. Wall panels are assembled, windows and doors installed. Even the roof trusses are assembled. Erection on your lot takes a matter of hours.

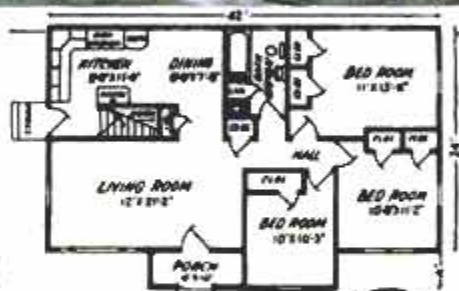

SEND FOR BEAUTIFUL COLOR CATALOG AND FLOOR PLANS . . . only 25¢

EASY TO FINANCE

All quality-approved PERMABILT homes are eligible for VA and FHA financing through your own bank or savings and loan association.



Enclosed is 25c. Please send your beautiful color catalog with specifications and floor plans.

MANUFACTURED HOMES, INC.

328 SO. KALAMAZOO AVENUE
MARSHALL, MICHIGAN

Name _____

Address _____

City _____ Zone _____ State _____

MANUFACTURED HOMES, INC.

328 SO. KALAMAZOO AVENUE
MARSHALL, MICHIGAN

AMF DeWalt® POWER SHOP makes a wall desk

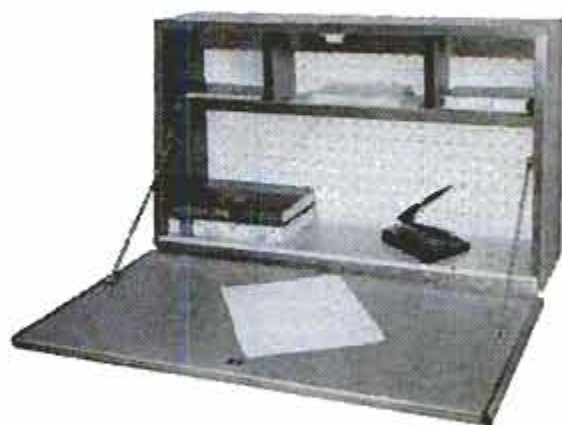
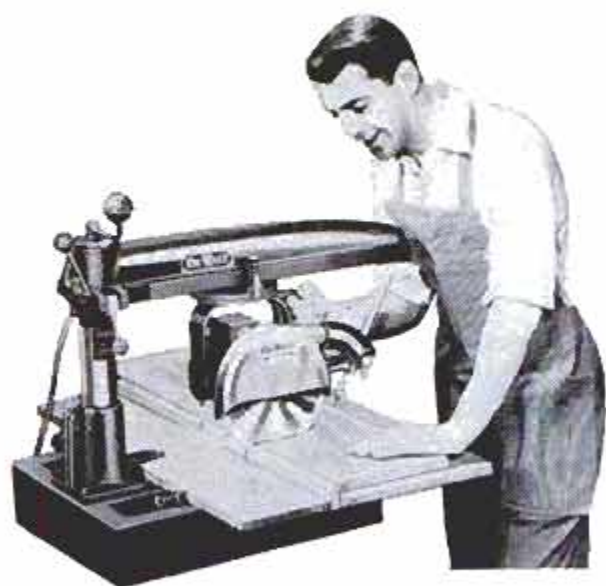

in one evening
does everything — easier, finer, safer



Simply draw saw across boards to cut to size. See your mark *and* your cut, **A**. Turn motor and taper-rip both side boards at once, **B**. Mount dado head and groove where required, **C**. Shaper head molds desk edge, **D**. And you have a smart wall desk, ready to erect!

Your big-capacity, easy-to-use DeWalt is 12 professional power tools in one—a *complete home workshop*. And it builds into workbench—uses 75% less floor space than ordinary table saws! Arm raises, lowers, swings 360°... motor and saw ride on arm, rotate 360°, tilt past 90°. DeWalt saws, sands, routs, shapes, grinds, drills, dados, surfaces, even cuts aluminum... converts to a lathe, saber saw, belt sander...

pays for itself many times over!

MB-F above— $\frac{3}{4}$ hp DeWalt-built motor, U.L. & C.S.A. Approved, 9" blade cuts 2½" deep, rips 24" wide... *just \$239 delivered*. Professional size GW-I—1½ hp motor, 10" blade cuts 3" deep, rips 26" wide... \$395.

As little as \$2.50 a week after 10% down on DeWalt's Easi-Budget Payment Plan.



DeWalt Inc., Dept. PM-56-6, Lancaster, Pa.
Subsidiary of AMERICAN MACHINE & FOUNDRY COMPANY

- Send FREE 20-PAGE DEWALT BOOKLET and name of nearest dealer.
 Send FREE STEP-BY-STEP PLANS on Wall Desk.

NAME _____

ADDRESS _____

CITY _____ ZONE _____ STATE _____



WHY SWELTER?



Enjoy...An Air-Cool House EVEN WITHOUT AIR-CONDITIONING

Of course an air conditioning unit does the best cooling job. But if you aren't ready for such an expensive improvement now... *insulate with ZONOLITE*. A Zonolite-insulated house is as much as 15° cooler in summer. Helps you enjoy wonderful, cool comfort during summer's hot spells—and *saves up to 40% on winter's fuel bills!*

INSULATE WITH ZONOLITE® DO-IT-YOURSELF IN JUST HALF-A-DAY...

Easiest of all insulations to install. Lightweight! Pours into place! Anyone can do the job in 3 or 4 hours. Zonolite vermiculite is 100% fireproof—permanent, rodent-proof, rotproof.

As low as

\$67⁰⁰

Insulates an average attic

The Only Tool You Need...
FREE at your Dealer!

See your dealer for a free estimate on how economically you can insulate *your* home with Zonolite. Then pour it...level it with the tool that's free...and you're insulated for the life of the building. That's *guaranteed in writing at dealers!* Mail coupon today for free "How-to-do-it" booklet.



ZONOLITE® INSULATING FILL



—Send for DO-IT-YOURSELF booklet—

Zonolite Company, Dept. PM66
135 So. La Salle St., Chicago 3, Ill.

Please send me free booklet HI-47 telling how I can have an air-cool home...even without air conditioning.

Name _____

Address _____

City _____ Zone _____ State _____

AT LUMBER & BUILDING SUPPLY DEALERS

Inc." In it is a shimmering group of three-inch tropicals with names like "Jack Dempsey," "flag fish" and "jewel fish." "We put the 'Murder, Inc.' label on there the day a new attendant put a black-spotted Jack Dempsey in a carton with eight neons," recalls Groetzinger. "In less than 10 seconds there was only a Jack Dempsey left."

Finny characters like these are kept in isolation tanks. But you don't have to go in for ferocity to be a tropical-fish fan. Most of the moderately priced little fellows are sociable and some are extraordinarily curious.

Amusing, for instance, are the pinkish white kissing gouramis that chase each other around the tank and hitch their mouths together. They'll continue "kissing" for a minute or more. No one knows why. And when not kissing another of its kind, a kissing gourami may try kissing its own reflection in the glass.

In a big tank in Dalwin's aquarium emporium you can see another curious fish called a headstander. He spends his life swimming around timidly with his nose pointed at the bottom of the tank as though there were a weight in it. There are tiny, silver hatchet fish, triangular in shape; blind cave fish with beautiful pearlescent bodies. One funny fellow called the archerfish eats flies and insects that have the misfortune to fly over the tank. He spits droplets of water at them, pegs them on the wing and knocks them out. They tailspin into the tank and are promptly snapped up by the archer. Ken Zinck, manager of the Westchester Aquarium, once stuck an artificial fly on a piece of paper above the archerfish tank and crowds gathered to watch the odd tropicals at target practice. "Their score was hot," says Ken. "They could shoot a droplet with a wallop at 12 inches." Every time Zinck and his assistants walked past that tank afterward, a barrage of droplets was shot at them by the archers.

Most tropicals today cost from 25 cents to a few dollars a pair, depending on breed, size and age. Few are really "rare" anymore. But you may still be exclusive if you can afford it. John and Elinor Groetzinger have a tank of slender black ghostfish that will cost you \$100 per. About four inches long, they resemble miniature eels, with two undulating fins running the length of their bellies. "They can move backward as quickly as forward without even shifting gears," John explains, "as you soon learn when you try to net one. Few are caught because they're so timid, and there's only one place they're found—an Amazon tributary, where

(Continued to page 214)

new saws that DO MORE and COST LESS

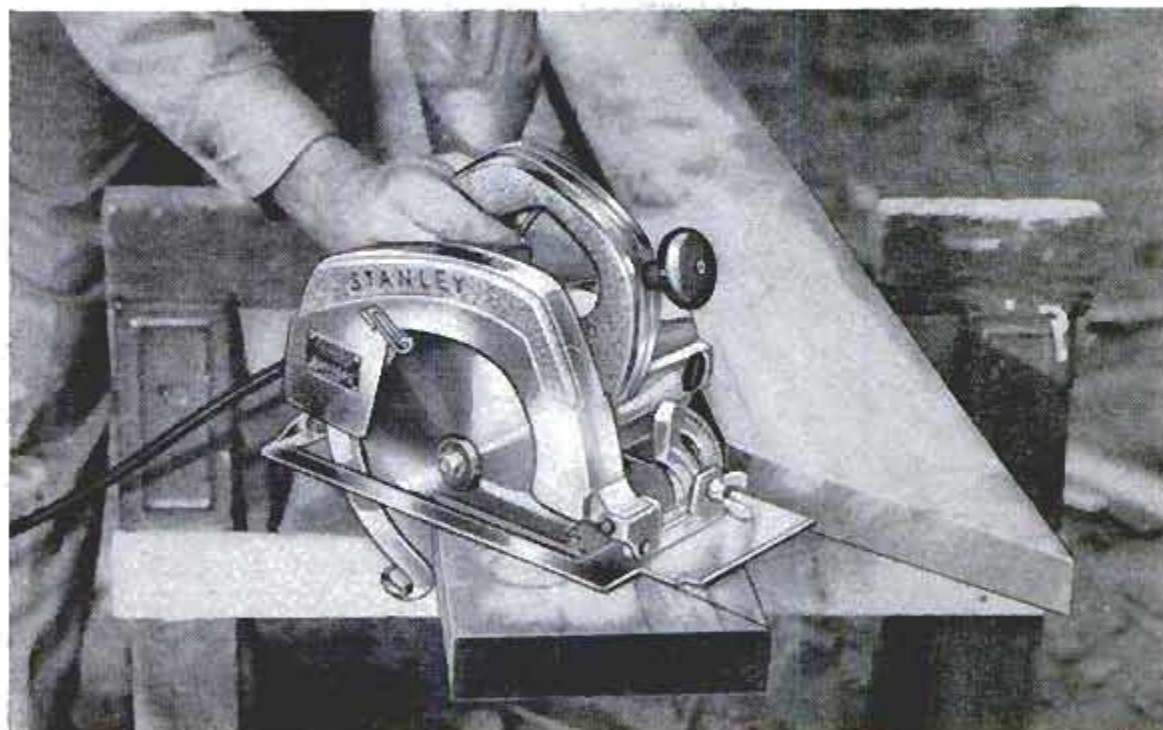

Whether you prefer a 6", 7" or 8" saw, Stanley makes them all . . . and all for heavy duty. Now at reduced prices.

6" H65 cuts 2" at 90° — 1½" at 45° and retails at \$59.95.

7" H70 at \$69.95 cuts 2¾" at 90° — 1¾" at 45°.

8" H85 at \$79.95 cuts 2⅞" at 90° — 2⅛" at 45°.

STANLEY BUILDERS SAWS . . . the finest you can buy



The "Motor Saver"
Power plus protection!

Exclusive Stanley drive protects saw motor against impact shock when blade hits nails, etc., and ensures full cutting power at all other times.

Featuring . . .



The "Free-Start" Guard
Ease of operation!

Exclusive Stanley blade guard makes starting cuts accurate and easy. Guard never sticks regardless of angle of cut . . . no "hang-up" or "drift" in starting.

Look for these fine saws. Your dealer can supply you or obtain them promptly for you. For free power tool catalog No. 400, write Stanley Electric Tools, 626 Myrtle St., New Britain, Conn.



STANLEY



**no other plier
does so many jobs
SO WELL**

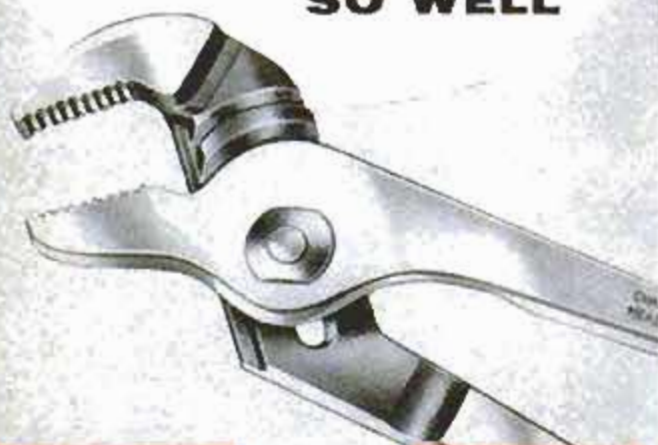

CHAN NEL LOCK

No. 420

GRIPS LIKE A PIPE WRENCH

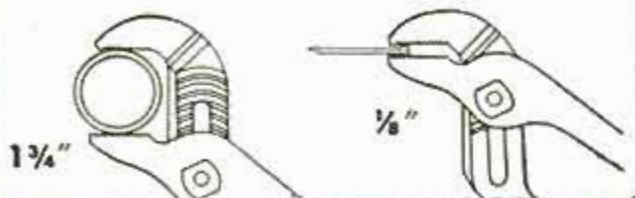

Help yourself to a Channellock No. 420 . . . the handiest plier of them all. With this handy plier, you can grip anything from a cotter pin to a 1 3/4" hex nut. And what gripping power! Just like a pipe wrench. What's more, Channellock is streamlined . . . easy to use in hard-to-get-at places. This all 'round usefulness is the reason why Channellock is the favorite plier of craftsmen everywhere. It'll be your favorite, too . . . for the same reason. Ask your hardware man for a Channellock No. 420.

BE SURE IT'S A GENUINE CHANNELLOCK



CHAMPION DEARMENT TOOL Co. MEADVILLE, PA.

natives believe they are the spirit of a murdered white man and, therefore, refuse to catch them."

Even more exclusive are the discus, or pompadour fish. A full-grown pair (each about five inches long) have a tank to themselves in Dalwin's fishery. He calls them "King and Queen of all tropicals." The timid, disk-shaped beauties have brilliant colors that change from red to orange to brown to blue or green at the discus' whim. A grown pair is worth up to \$1500; small ones about \$25 to \$45 apiece.

Another exotic fellow is an eight-inch, mottled-brown monster called a lionfish, whose spiny dorsal fin resembles a lobster's feelers. He carries a poison bringing fatal illness to anyone who touches it.

Dalwin or Groetzinger will be glad to order you a piranha—famous Amazon man-eater about 10 inches long. Swarms of these powerful-jawed fish with silver and orange scales have been known to pick a man to a skeleton in a matter of minutes. A baby will cost you \$12 to \$65; a mature one between \$75 and \$300 depending on color and size. One of these aggressive fellows at Groetzinger's has battered himself into retiring timidity from smashing against rocks when darting after live goldfish which he demolishes with a gulp.

Actually, a few dollars' worth of more genteel guppies, angels, tetras and the like can be as curious and interesting as the expensive varieties—and few people know the difference. Just for fun, Groetzinger bought some blacknose dace—prolific bait fish found in New England streams—and exhibited them at a recent trade gathering under their Latin name. "Everyone thought they were a new breed of tropical," says John. "No one thinks of local bait fish in terms of decorative fish, but some are very pretty. What's more, they keep well in home aquariums, get along well with tropicals and they're not fussy about water temperature."

Despite the easy maintenance of tropicals, experts like Dalwin and the Groetzingers stress certain rules if you don't want your fun spoiled by high mortality. Biggest mistake among amateurs is overfeeding, they'll tell you. Most fish will eat dry food only as it falls through the water. What hits bottom remains there to decay and pollute the tank. That's why a siphon or dip tube is needed to clean the bottom occasionally. And every aquarium should have a scavenger, like a catfish, in its population. Gouramis and mollies also feed on bottom leavings.

"Pile sand or gravel three inches in back, one inch in front," advises Groetzinger.

(Continued to page 216)

New Bronson Spin-King

... the only reel that
CAN'T TWIST LINE!

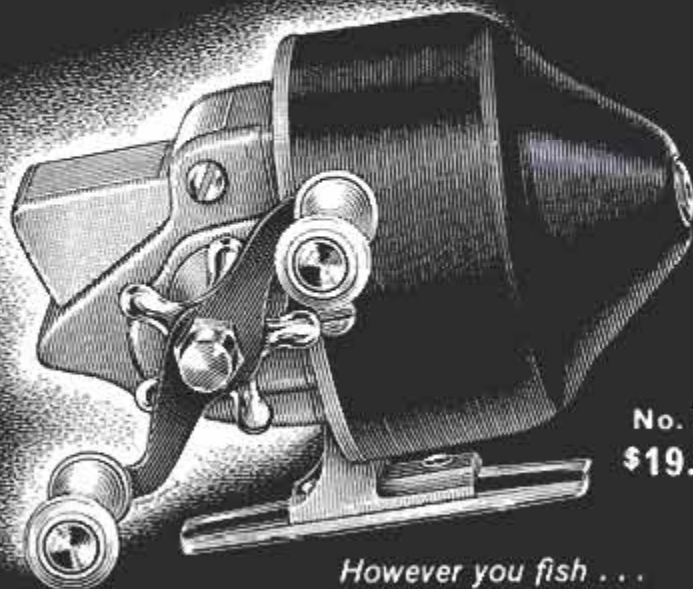

No. 700
\$19.95

However you fish ...
spin, fly or bait cast ...
a Bronson Reel makes it more fun!



Div. of Higbie Mfg. Co.



EXPLORE FOR TREASURE!

Find gold, silver, coins, jewelry, battle relics! Treasure-Metal-Mineral Detectors. M-SCOPE. Used worldwide for Treasure Hunting. Mineralights. Geiger. Scintillation Counters. Prices from \$14.75. Fully GUARANTEED. Time Payment Plan. FREE Treasure and Uranium booklets. New outfitting catalog. FISHER RESEARCH LAB., INC., Dept. PM-1, Palo Alto, Calif.

SENSATIONAL NEW HIGH SPEED DRILL MASTER

NOW turns the ordinary shop drill into HIGH SPEED DRILL. PRESS at a big saving. When DRILLMASTER is used on a 5,000 rpm drill press its top speed will be 20,000 rpm. Does the work of expensive high speed drill presses on brass, aluminum, plastics and cast iron where high speed drilling is necessary. Available for work of any size runs. Fits any 1/2" chuck, holding drills from 3/32 to #80. Shafts are heat treated and ground. Ball bearings and oil impregnated bearings and gear train are housed in cast aluminum. Precision made throughout. \$62.50 Feb. Chgo. Wt. MAIL ORDER TODAY only. ON C.O.D. ORDERS WE REQUIRE A 10% DEPOSIT. 2 =

DIRZIUS MACHINE SHOP "C", 1423-25 So. 52nd Ave., Cicero 50, Ill.

Protect your home against
power interruptions
with an...

ONAN Emergency ELECTRIC PLANT

Provides dependable stand-by electricity for heating system, pumps, freezer, lights, appliances. Keeps home safe, livable. Automatic start and stop. Find out how little it costs!

Write for Folder!

D. W. ONAN & SONS, INC.
3640 University Ave. S. E. • Minneapolis 14, Minnesota

A SIZE FOR EVERY NEED
500 to 50,000 watts.
Compact, quiet-running.
Gasoline-powered.
Priced from \$255.00



**BETTER PERFORMANCE
IN ALL KINDS OF WEATHER**

Whether it is 100 in the shade or 30 below zero, your car will start quicker and run better with a Bendix* Electric Fuel Pump. It's easy to install and costs less per mile of operation than any electric fuel pump on the market. Sold by independent garages and service stations.

*REG. U. S. PAT. OFF.



FREE: A descriptive folder is yours for the asking. Write today.

Bendix

ELECTRIC FUEL PUMP

Grand Prix Winner
ECLIPSE MACHINE DIVISION, BENDIX AVIATION CORP.
ELMIRA, N. Y.



Herb Thomas
—ace driver of NASCAR
(National Association for
Stock Car Auto Racing), says:

"We give oil filters their toughest test

—and we pick Purolator
for every make of car!"

Protect your car like the "pro's" do! Because a Purolator can trap up to 3 pounds of grit in one NASCAR race, 9 out of 10 drivers use Purolators *whichever make of car they drive!*

Purolator Micronic filters stop dirt fine as 39 millionths of an inch . . . have up to 10 times greater capacity than many oil filters.

Ask your serviceman to put in a Purolator refill every 4,000 miles—when he changes your oil. Takes only minutes. From \$1.60.

© 1956, Purolator Products, Inc., Rahway, N. J.; Toronto, Canada.

"Purolator" and "Micronic," Reg. U. S. Pat. Off.

Proved best for every make of car

PurOlator

OIL FILTERS

"This makes wastes roll forward where they're easily removed, and gives depth in back for water plants to root." An aquarium with good plants and scavengers takes care of itself, and you rarely need to change water. In fact, water change can be bad for tropicals. Experts pay a premium for "conditioned" water in which fish have lived a long time.

Depending on heat in your home, you may or may not want a thermostatically controlled heating unit that hooks to the tank side. Tropicals need 75 to 80 degrees for good health. Aeration assemblies that pump tank water through a filter and dump it back in the tank with a string of bubbles are not necessary but allow some 50 percent more fish in a tank without overcrowding. "With no aerator," Groetzinger will tell you, "the rule is two inches of fish per gallon. A five-gallon tank, with wide top to provide large air surface over the water will take eight to twelve fish. Better too few than too many."

An odd thing about almost any fish, according to Groetzinger, is that they never grow too big for a tank. A fish that grows 18 inches long in natural environment may only get two or three inches long in a tank.

The best tanks have stainless-steel frames with glass set in mastic. But painted metal is cheaper, safe and durable if the water level is kept below the metal rim.

Too much sun, you learn, is bad for tropicals. But hooded strip lamps that fit over the tank top will dramatically illuminate your fish and provide light that the plants need. Experts advise you not to use daylight-type fluorescent lamps.

A complete setup, fish and all, will cost about \$20 or \$30. This might include an inexpensive aerator, filter, heater and modest tank with breeding equipment to save some fry at least.

A relatively new wrinkle in tropicals for those who like something different is a salt-water setup—interesting because of the weird varieties of sea creatures it adds to home-aquarium populations. John and Elinor Groetzinger, enthusiastic salt-water tropical fans, predict they're the coming thing. "They take the same equipment," says John, "but instead of green plants you can have odd sea vegetation, bright coral, rocks and strange ocean-bottom creatures like starfish, queer snails and anemones that ceaselessly wave their tentacles." You need genuine ocean water, not just salt water.

More odd than the decorations are the fish—lumpy, ugly filefish with green fluorescent eyes; four-eyed butterflies, named for the black spots on their tails that look

(Continued to page 218)

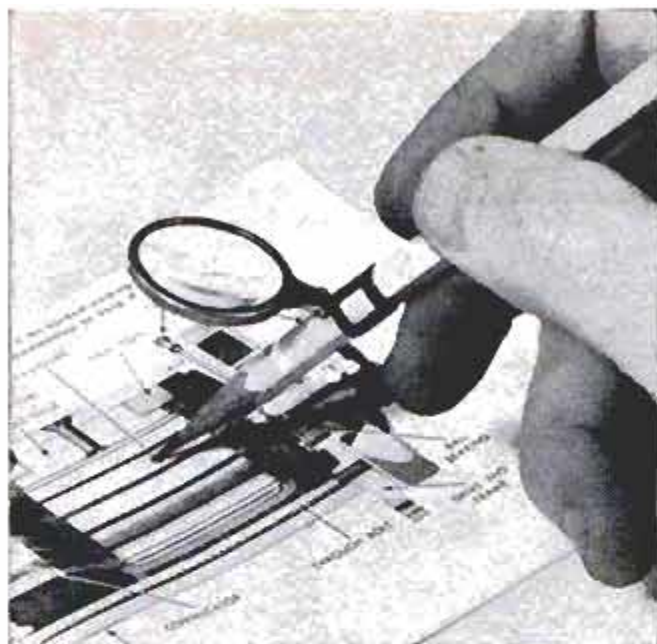

Pencil Magnifier

Artists, retouchers and draftsmen find many uses for a little magnifying glass that clamps onto a pencil or cutting tool. Used in picture retouching, cutting and etching, for silk-screen cutting, making fine drawings and cutouts, the glass shows the user an enlarged view of the section he is working on. It is also handy for looking up and writing down phone numbers.



Bell Ringer

Rudolf, family cat in a Danish home, rings the doorbell when he wants to enter. A paw pressed on a mat outside the door brings his 12-year-old master running. The boy, Aksel Peterhaensel of Odense on Funen Island, devised the feline doorbell.

Here's that new **MAGNA JOINTER**

This big Magna Jointer has all the built-in precision and features that you'd expect from the makers of SHOPSMITH®

* Exclusive *Twin-tube Mount* for bench, *Magna Power Stand*, or SHOPSMITH. Gives you *Instan-Tension*.

- ① Longest table of any 4" Jointer—28"
- ② Largest and most rigid fence—21 3/4" x 3"
- ③ Greatest depth of rabbet—3/8"+
- ④ Single knob fence control—3 auto-stops
- ⑤ Safety-taper, Micro-Adjustable Knives

Only \$49.95. Ask your dealer about Magna-Tool-Time Plan. See the new Magna Jointer demonstrated at leading hardware and department stores or any Montgomery Ward store. For free literature write Department 329-B, Magna Power Tool Corporation, Box 2808, Fort Wayne, Indiana, or Menlo Park, California.

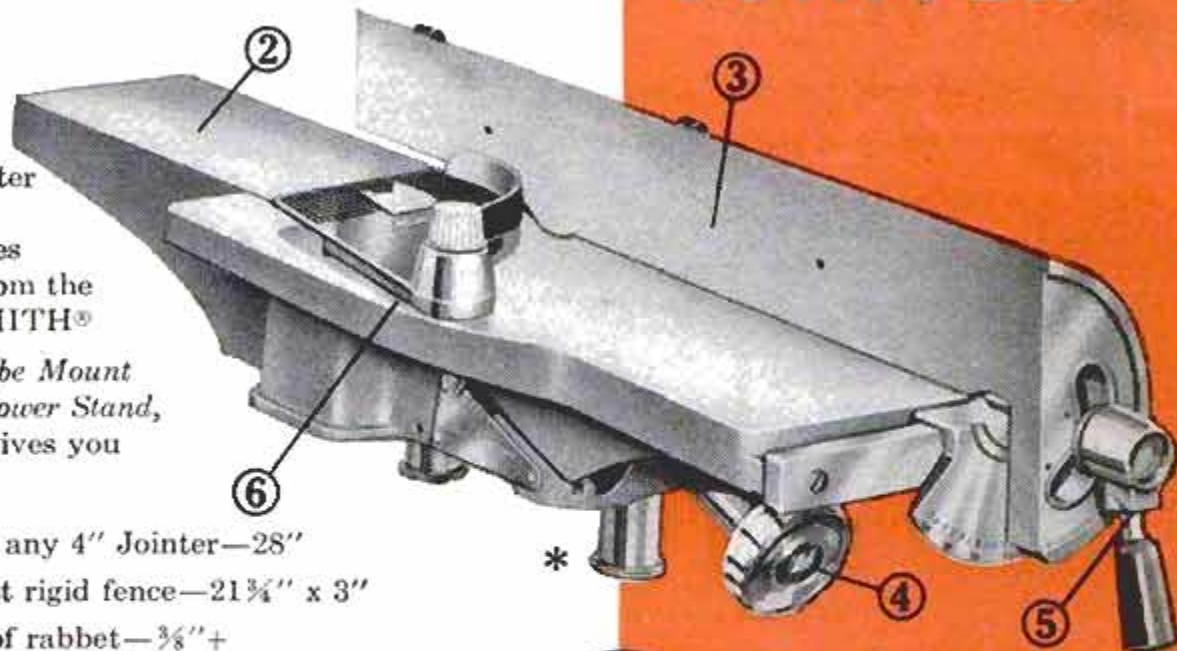

MAGNA

POWER TOOL
CORPORATION

Manufacturers of
SHOPSMITH

Looking for Something?



DOLLS- REPAIRING



FROM DOLLS TO BEAUTY SHOPS WHATEVER YOU NEED



Ads with this emblem make your shopping easier

more like eyes than the real eyes up front. It's hard to tell if the squarish fish is coming or going. "Nature's idea," explains Elinor, "was to confuse his enemies and make them attack the end that could bite back."

Some marine tropicals don't even look like fish. A yellow character called a cowfish is shaped like a one-inch square box with a protuberance at one end exactly like the head of a cow—horns and all. He has ballast tanks and goes up and down in the water like a submarine. He can spin, spiral, scoot or—if frightened—turn upside down on the surface and play possum. "When he does that," explains Groetzinger, "he thinks nobody can see him."

Marine tropicals are often more whimsical than fresh-water types. Take sea horses, for instance. When the Groetzingers first began breeding them, they kept finding dead males atop the water. "Finally," says John, "we learned why. When a lady sea horse lays eggs, she puts them in a pouch in her husband's stomach and he hatches them. During this process, the two of them romp around the tank together. One day I noticed a dancing male swim through the aerator bubbles. Instantly his pouch closed and he quit dancing. He thought he had an egg in there. That was our answer. All those males had died of frustration waiting for air bubbles in their pouches to hatch out little sea horses."

The Groetzingers solved the problem by tying a woolen thread to every male-sea-horse tail, and weighting it with a button. "This was just heavy enough to yank the pouch open now and then when the male danced around," says John. "Any air bubbles escaped and wised Mr. Sea Horse to the fact that his trouble was just gas."

A curious thing to remember is that as sea water evaporates you don't add salt water, but fresh water. The salt doesn't evaporate. If you added ocean water, you'd soon have too much salt in the tank.

Marine tropicals aren't so fussy about temperature and survive nicely at 55 to 75 degrees. They have fewer ailments but need more aeration and live food. Small sea horses eat things like brine shrimp and daphnia; bigger ones need live guppies. Since sea horses have very small mouths, they must be kept in a separate tank or other fish will eat everything before they get a mouthful.

Such odd characteristics are things you learn yourself when you go in for tropical fish. It doesn't matter whether they're fresh-water or marine types, there are still plenty of things the books won't tell. But you can be sure of one thing: you'll find these finny pets completely absorbing—capable of new tricks every day. ★ ★ ★

Thor's 7¼-inch heavy-duty saw

NEW THOR SPEEDSAW

An industrial tool...
at a home-shop price

MODEL 475... ONLY

\$64⁹⁵

This new electric Thor SpeedSaw meets a long-felt demand by contractors, woodworking plants and home workshops. It has power to handle the toughest jobs; does fast, accurate precision cutting, and costs about half what you'd expect.

Thor SpeedSaw's universal motor delivers a full 1.75 horsepower. Expert carpenters appreciate SpeedSaw's

all-ball-bearing construction, light weight (only 14½ lbs.), and easy wingnut adjustments for angle and depth of cut.

SpeedSaw's automatic telescoping blade guard affords complete protection for the user. Thor SpeedSaw is guaranteed by the world's largest manufacturer of portable power tools. SpeedWay Mfg. Co., a division of Thor Power Tool Co.



THOR POWER TOOL COMPANY, Aurora, Illinois

Branches in all principal cities

World's largest exclusive manufacturer of portable air and electric tools



Water Is Pumped a Mile High to Hawaiian Cattle Ranch

(Continued from page 104)

pressure at the pump head runs from 550 to 575 pounds per square inch. The 1½-inch pipe is not guaranteed to withstand this pressure, but there has been no breakage due to internal strain.

The Horseshoe One ranch uses a four-cycle, kerosene-burning, 12 to 13-horsepower engine weighing over a ton.

The pumps push 1600 gallons of water mountainward each hour. They can do it 24 hours a day, seven days a week.

Water Cleans Pipes

Strangely enough the brackish water keeps the galvanized line clean as a whistle. Not so the pure rainwater. During the rainy months, at 3200 feet, fresh water is collected from a small shed and flows down the line to the cattle below. It doesn't take pure water long to rust and corrode the pipe, but a week or so of brackish water from the well cleans this corrosion out.

In order to service the water system, there is a telephone at each pump rig. To safeguard the pumps, there is a low-water cutoff switch that works on the magneto and the engine is killed if the water source is cut off or lost.

As a result of the Ghyben-Herzberg lens, the cattle no longer have to be rationed water, and sometimes the people of Kona hook into the line when there is no rain to get water for particular uses. ★ ★ ★

Milwaukee Glacier

What is now Milwaukee, Wis., was buried under thousands of feet of glacial ice only 10,700 years ago. Geology professor Dr. Richard F. Flint of Yale University has obtained the evidence with carbon-14 dating methods. The last big ice push covered a region from Duluth, Minn., across the Great Lakes to Lake Champlain in New York, and advanced southward at a rate of 960 feet per year. It stopped finally at Milwaukee, and after a few hundred years began retreating. By 8200 years ago, it had receded to the vicinity of Green Bay, Wis., 170 miles north of Milwaukee, and by 6500 years ago it had melted from all the Great Lakes region. Glacial ice, Flint says, covered the area northwest of Hudson Bay 4000 years ago.

☞ Heat plus a chemical, triethylene-melamine, has checked experimental cancers growing in yolk sacs of embryonated eggs, Drs. Alfred Taylor and Roger Williams of the University of Texas have announced.



FEW DOLLARS BUILDS A BREEZE WITH EASY TO ASSEMBLE FAN KITS

SAVE UP TO 75% on WINDOW & ATTIC FANS

The New All-Purpose Fan Kits insure dependable performance as Window Fans or for Standard and Horizontal installations in attic. No additional parts needed.

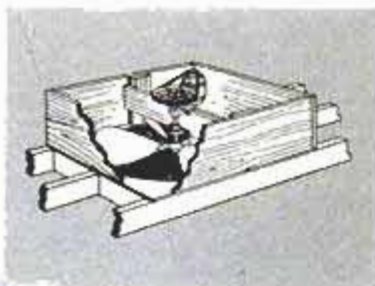

KITS OF PARTS, with step-by-step instructions, include: Aluminum fan spider, Masonite blades, Shaft, Oilite bronze bearings, collars, pulleys, belt and bolts.

No special tools or skill are required to install your own modern home cooling system . . . Invigorating, refreshing outside breezes can now cool your home at the lowest price ever. The Fan Kit, assembled with ease by thousands and sold on a money-back guarantee, is now built for window and Standard or Horizontal attic installation. Thoroughly tested for dependable performance, every kit includes all the parts you need plus complete instructions. The only additional requirements are a few pieces of lumber for fan housing and a new or used ¼ HP 1750 RPM motor.

Sizes are available for every need.

30" Fan cools average home, 6000 CFM. \$14.95
36" Fan cools larger homes, 8000 CFM. \$17.95
24" Fan cools smaller homes, 4500 CFM. \$13.95
20" Fan cools Apts., Offices, etc. 2800 CFM. \$12.95

You buy direct from Manufacturer. Orders accompanied by check or money order shipped postpaid. Deposit of \$3.00 required on C.O.D. orders. Immediate delivery. Satisfaction guaranteed. Circular Free. Dealer inquiries invited.

FAN KIT COMPANY
154-F, NO. BELVEDERE
MEMPHIS, TENN.

Why wish and wait?

...We'll ship this beautiful home complete

YOU ERECT IT YOURSELF

...at amazing savings!



THE HAWTHORNE A compact, livable floor plan. Every foot of space put to good use. No wasted building dollars—more closet space than many larger homes. House above shown with carport and planter.

Only \$2775 (Without Basement)

Most complete House "Package" anywhere. Precut and panelized—ready for easy "Build-it-Yourself" Erection. Prices subject to change without notice. Freight paid in 11 Midwestern States.

Are you among the many who wish they could have a fine, attractive home of their own? Then wait no longer because you can afford the beautiful Pagemaster "Hawthorne" right now!

Perhaps you'd like to change the floor plan. Then you help plan your new home just the way you want it. When it arrives, you erect it yourself in just days and put the \$\$s you save in construction costs right in your own pocket. All exterior walls are panelized, all openings accurately cut in. Windows and doors are hung in frames and weather-stripped as complete units, ready for you to insert in prepared openings. Pre-manufactured roof trusses come in two sections—just nail them together. No other build-it-yourself home saves you so much construction time or helps you avoid costly on-the-job mistakes. Unmatched in value, unequalled in low cost, all Pagemaster quality-built Homes are eligible for VA and FHA financing.

Send 50¢ for our full-color catalog with many exciting new homes to choose from



Pagemaster
HOMES

204 PIERCE STREET, SHAKOPEE, MINN.

"EXCLUSIVE NORTHWEST PRODUCER" of — "THE PM PRECUT HOUSE" — "PANELIZED FOR EASY ERECTION"



GENUINE ALNICO
MAGNETS

AMAZING, PERMANENT, NON-ELECTRIC, HIGHLY PRACTICAL. Conduct interesting experiments. Hundreds of uses. Retrieve valuable steel items such as guns, tackle from fresh or salt water; tools from tanks & drains. **GUARANTEED.** Try any magnet one week. Money back if you are not well-pleased.

No. M-710 Has pull of 225 lbs. on flat steel block. \$16.50
No. M-625 Has pull of 125 lbs. on flat steel block. \$9.50
No. M-575 Has pull of 75 lbs. on flat steel block. \$6.50
No. M-500 Has pull of 50 lbs. on flat steel block. \$4.50
No. M-47 Hot Pad Magnets, 10 for \$1.00. 50 for \$4.87
No. M-35 Hobbyist assortment of 8 small magnets. \$1.50

Send M.O. or check. We pay postage. Sorry no C.O.D.'s.

MIAMI MAGNET COMPANY, 3240 N.W. 27th Ave., Miami 42, Fla.

Cadillac GIVES YOU MORE



PERFORMANCE, BEAUTY, SAFETY!

Extremely rugged, with special hull contours which permit cat-quick handling and full-load safety—Cadillac boats are high-compression molded of 5 to 7-ply clear veneer. Light, fast, roomy—with rich mahogany, chromed brass hardware, walk-through seats. Write for literature on Cadillac's line of aluminum and molded plywood boats.

CADILLAC MARINE & BOAT CO.
180 Seventh Ave., Cadillac, Mich.

Speedy Sprayer

mobile paint sprayer



FREE!

Write for
"How to Spray"
Booklet and
Literature.

Choice of craftsmen for 35 years! Saves time, paint and money. Quickly gives flawless finish to walls, furniture, screens, fences and handiwork. Sprays all materials; 1/4 H.P. motor. Diaphragm principle assures clean, oil-free air. Never needs lubrication. With gun, less motor.

No. 890 Speedy Sprayer . . . \$38.50

Add wheels with Wheel Kit No. 909. Includes 6" wheels, handle, fittings. \$6.95

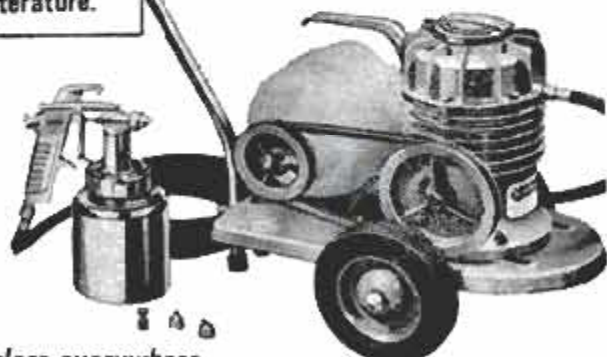

At dealers everywhere

W. R. BROWN CORPORATION
2635 N. NORMANDY AVE., CHICAGO 35, ILLINOIS

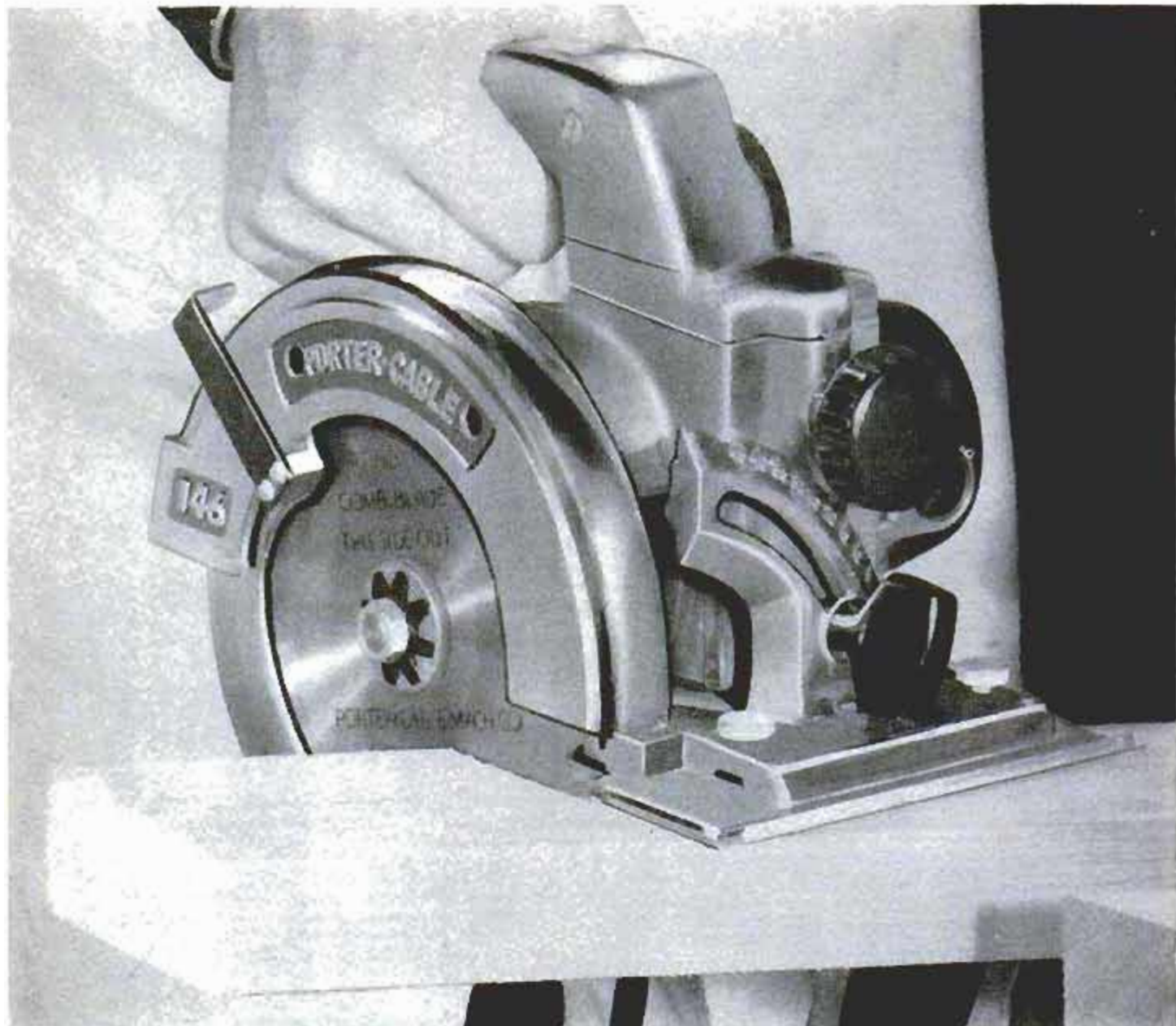

Tremendous values in these

three great new Porter-Cable saws!

From Porter-Cable's fifty years of leadership in electric tool design come these three brand new power saws . . . farther ahead than ever in design, in versatility, in solid *value*.

Model 146 is a rugged 6½" saw of full *professional capacity*—makes every cut it takes to build a house. It slices through 2" dressed lumber, even at a 45 degree angle—has a host of special features for convenience and long life. Yet it's priced at only \$69.50—and you'll find a special Introductory Offer on the opposite page that saves you \$12.00 on a complete Model 146 Kit!

If you prefer a saw with blade on the left, be

sure to see Porter-Cable's new Model 157, shown opposite—a big, husky 7¼" professional saw with exclusive Kickproof Clutch, full ball bearing construction, and many other features at only \$89.50.

Finally, there's *the world's finest professional saw*—the all-new 8½" Model 528 Speedmatic. *More speed, more power*—telescoping guard, exclusive Kickproof Clutch, calibrated depth gauge — and every conceivable feature of *quality design and construction*.

See these new professional quality saws at your Porter-Cable dealer's today—or write for full information *now*.

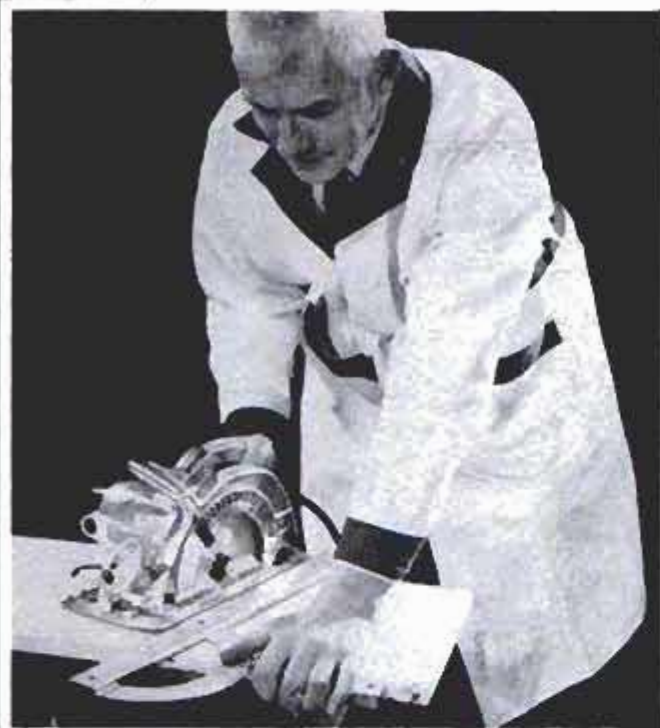

Model 157

Porter-Cable *quality* in a professional 7 $\frac{1}{4}$ " saw with blade on left. Light in weight—only 13 lbs. complete. Ball bearing construction throughout—instant depth and bevel adjustments, telescoping guard, powerful 12 amp. universal motor, exclusive Kickproof Clutch—only \$89.50. In handy kit with accessories, only \$104.50.



Model 528 Speedmatic.

World's finest professional saw. Extra speed and power for extra-heavy duty—perfect balance for easy, all-day use. 8 $\frac{1}{4}$ " blade with new telescoping guard and exclusive Porter-Cable Kickproof Clutch—new calibrated depth gauge, instant bevel adjustment, new handle design with built-in trigger switch. Full ball bearing construction for long, troublefree service. \$130—in kit form with accessories, \$145.

Special Introductory Offer on Model 146. Save \$12.00 when you buy the rugged 6 $\frac{1}{2}$ " Model 146 Saw in handy kit form. Kit includes saw, rip guide, protractor gauge for all straight or angle cut-offs, and a strong steel carrying case. Regularly \$87.75—now only \$75.75! Offer expires July 30, 1956—See your Porter-Cable dealer *now!*

Porter-Cable

Quality Electric Tools

PORTER-CABLE MACHINE COMPANY • 6146 N. Salina Street, Syracuse 8, New York
SAWS • DRILLS • SANDERS • ROUTERS • SHAPERS • PLANES
In Canada: write Porter-Cable, Ltd., Box 5049, London, Ont. Canadian prices slightly higher.

Rambler Is Small But Roomy, Say Owners

(Continued from page 111)

"My biggest surprise is the excellent ride compared to the heavy cars I have owned. It rides 100 percent better than my previous big car."—Pennsylvania salesman.

"Friends are overwhelmed at the quality of the ride."—Illinois general manager.

"Fine ride. Often when tired I pull to roadside, drop back the reclining seat and rest."—Texas retired owner.

Third best-liked feature, say Rambler owners, is its economy:

"I drive to work every day. Used to buy 18 gallons of gas a week, now I buy only 11 gallons."—Ohio labor representative.

"Gas consumption of 17 miles per gallon in city driving is outstanding. Much better than any other car I have owned."—Virginia federal worker.

"I drive only 5000 miles a year, mostly to work and the grocery. Wanted an economical car. To me, 200 horsepower is something for bull sessions only."—Ohio lithographer.

Most-Frequent Complaints

Nearly a third of the owners (31.3 percent) had no complaints to make about their 1956 Ramblers, but others did. The complaint most frequently mentioned was that the car failed to live up to its advertised gasoline mileage. It may get good mileage, but it doesn't get what the ads say it will, say 15.5 percent of the owners.

"They advertise up to 30 miles per gallon. I can't get 20 out of mine."—Oklahoma retailer.

"Fuel economy not what I was led to expect. Dealer informs me that the factory is not satisfied with mileage on early models and is replacing carburetors."—Anonymous owner.

"My '51 Rambler gave 28.6 miles per gallon at 55 miles per hour. My '53 Rambler gave 25.8 miles per gallon. My '56 gives 22.6 miles per gallon. Where is Rambler's economy going?"—California market owner.

Second most-frequent complaint was about the Rambler's dashboard design and arrangement:

"Driver has to reach too far for the cigarette lighter and has to reach under the steering wheel for ash tray."—California foreman.

"Glove compartment too small. I liked drawer style better."—Connecticut inspector.

"Knobs for heater and lights are apparently pressed on and come loose occasionally."—Pennsylvania consultant.

(Continued to page 226)

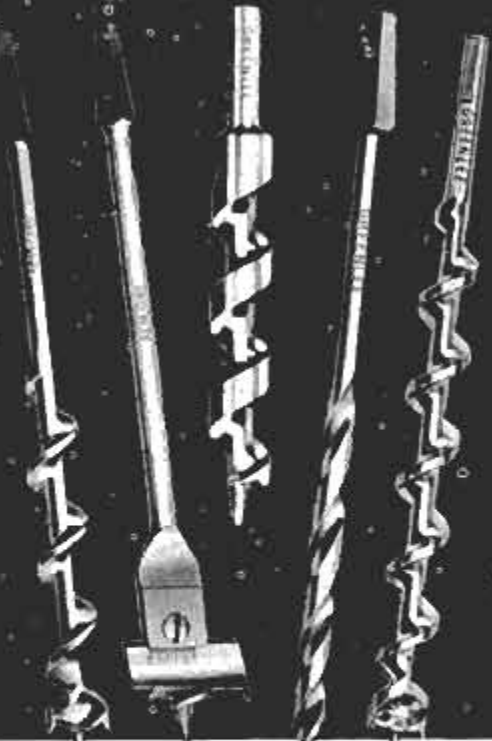

high-quality hand tools for finer workmanship

Do the job easier and better with GREENLEE tools. Auger bits, electric-drill bits, other boring tools, chisels, gouges, spiral screw drivers, push drills, and many more. All expertly made of top-quality materials for long life, fine results. At leading hardware and building supply dealers. Write for folder, Greenlee Tool Co., 2106 Columbia Avenue, Rockford, Illinois.



WEEDS CAN'T STOP YOU!

JOHNSON'S SILVER MINNOW

For Best Results Use Johnson's Pork Rind

100% Snag-proof, yet special weed-guard doesn't interfere with strikes. Casts like a bullet! Enticing action!

Send For FREE New CATALOG

LOUIS JOHNSON CO.
1549-W Deerfield Rd., Highland Park, Ill.



KING MIDGET

World's Lowest Priced Car!

NOW—32 PAGE BOOK filled with photos, drawings, specifications, records, wholesale price, and Rider Agents plan if no dealer near you. Send 25c for book, or send \$1 (refunded first order) for it plus actual operating book and service manual.

MIDGET MOTORS MFG. CO., ATHENS 1, OHIO



NOW—SHOPSMITH®
for as little as **\$3 per week**

Start enjoying SHOPSMITH now for only \$29 down, \$3 weekly. Start saving now! Savings on projects and home repairs can more than equal weekly payments. See your hardware dealer or Montgomery Ward store. Write for 2 big, free, illustrated books. SHOPSMITH, Dept. 322-B, Menlo Park, Cal., or Box 2808, Ft. Wayne, Ind.

Need an extra \$1,000, \$2,000, or more? Make it with an **IDEAL LAWNMOWER SHARPENER**

There are thousands of lawnmowers in your locality: Average \$1,000 profit per 250 mowers with customer satisfaction and repeat business assured. Provide this essential service with an Ideal® Lawnmower Sharpener, the only machine that grinds the reel to "fit" the bed knife. Compare by any standard. The Ideal, backed by 53 years of experience, costs no more. Write today for complete, free catalog.

THE FATE-ROOT-HEATH COMPANY
Dept. PM-6 Plymouth, Ohio



new Fir Plywood*

8 BOAT PLANS

only **25¢** each

PERFORMANCE TESTED
Fir Plywood Fleet
ARCHITECT DESIGNED

See your lumber dealer or use coupon below.

Large, easy-to-follow plans contain illustrated step-by-step instructions and complete bill of materials.



No. 30. 7' 9" Pram Dinghy



No. 35. 11' 3" Outboard



No. 40. 13' 4" Outboard



No. 45. 13' 9" Punt



No. 50. 15' Outboard



No. 55. 15' 11" Runabout



No. 60. 18' Day Cruiser



No. 65. 20' Cabin Cruiser

*Use Only Exterior Fir Plywood For All Marine Construction

(EXT-DFPA® Means 100% Waterproof Glue!)

EXT-DFPA®

EXT-DFPA®

Douglas Fir Plywood Association, Dept. 9, Tacoma, 2, Wash.

Please send plans checked below. I enclose 25c for each. (Good in U.S.A. only)

No. 30 No. 35 No. 40 No. 45 No. 50 No. 55 No. 60 No. 65

Name _____

Address _____

City _____ Zone _____ State _____



Finest Lightweight
Spinning Reels made in America

All American in name, performance and manufacture! H-I Spin Reels set new standards for quality, value and long, trouble-free service. Light weight—only 6 oz. . . . right- or left-hand operation, without interior adjustment . . . noiseless nylon gears, oil-less bearings . . . adjustable spool drag . . . anti-reverse button . . . handsome, long-lasting finish, with all fittings hard chrome plated.

Also a de luxe model 1903 (\$15.00) especially balanced for super performance on glass rods.

Look for 

on the tackle you buy
Rods, Reels, Lines, Lures,
for every fisherman and
every kind of fishing



Valuable Fishing Guide. Send 25¢ to
HORROCKS-IBBOTSON CO. Dept. PM-626 UTICA, N. Y.
Manufacturers of the largest line of fishing tackle in the world

SAY YOU SAW IT IN
POPULAR MECHANICS



Rotary Mower is
only one of 21 tools
. . . 5-HP Gravely Tractor does every lawn,
garden, field job easier, better! All-gear Drive,
Power Reverse. New "Power vs Drudgery"
Booklet FREE! Write today . . . and ask about
the NEW EASY PAY PLAN.

(Push-button Starter Optional Equipment)

GRAVELY
BOX 663 DUNBAR, W. VA.
FIELD-TESTED FOR 34 YEARS

"Clock is useless to driver."—Massachusetts railroad fireman.

Tied for third place on the complaint parade are two related faults of poor assembly work and water leaks (both were mentioned by 8.2 percent of the owners).

"Too quickly put together. Too many faults. Doors not watertight. Leak in fuel line. Hood does not close properly."—Indiana policeman.

"Body fits are rough and sloppy. Too much is left for dealers to do over."—North Carolina salesman.

"Water leaks around right-front door."—North Carolina housewife.

Reclining Seats

While only a small percentage of the owners state that they have slept in the Rambler's twin beds, most are enthusiastic about the reclining-seat design. Those who have slept in the bed were generally satisfied with it, although some complain that the beds are not long enough for the average-size man.

"We purchased the Rambler with a vacation in mind. We took a month's vacation in Florida. My wife and I slept in the car for 12 consecutive nights. We also like the restful reclining position of the seats."—Ohio mechanic.

"On a trip it sure is nice to put the seat back a notch."—California tileworker.

"Should eliminate the hump in the reclining seats when made up as a bed. It should be a little longer for a tall person."—California inspector.

"Some lock should hold reclining seats in place and prevent them from swinging forward on sudden stop or impact."—New York shipping director.

Like Bigger Car?

Originally, the Rambler was a chopped-off 100-inch-wheelbase two-door model that sold principally because it was a small car. Since then it has grown up and is now a 108-inch-wheelbase car less than a foot shorter than some other cars. It is built only in four-door models now. As it gets longer, it seems to become more popular. We asked the owners what they think about this trend. Most of them like it, 79.2 percent to be precise. When the figures are tabulated on the basis of previous Rambler ownership, the result is the same, but less emphatically. Among previous Rambler owners, 71.1 percent like the trend toward a larger car. Among first-time Rambler owners, the percentage of those who like the bigger car jumps to 84.6 percent. Rambler seems to appeal to more buyers in its bigger form.

(Continued to page 228)

THE ORIGINAL PACKAGED BOAT KITS

Made ONLY by *Custom-Craft*
Top Performance,
Design, Styling!
Over 70 Models
8 to 21 ft

World's largest line! Over 200
Boats: Kits, Formed-Hulls, Semi
& Custom-finished! All types: Prams
-Cruisers! Easy to build! Flying stern,
Tredonic bottom, Bulkhead construction!
Send 25¢ for KIT CATALOG
52 pages: Includes Victory Series, hardware, paint
accessories, Fiberglass! Send \$1.00 for Catalog Plus
"Boating Handbook". DEALERS-AGENTS INQUIRE

BOAT PLANS & PATTERNS Frame-Pac Kits

World's largest selection: over 200 plans, full-
size patterns, frame-pac kits! Designed strictly
for amateurs! All types: prams, kayaks, racers,
runabouts, catamarans, houseboats, cruisers -
inboard-outboard 6-40' wood-plywood-steel!
Send 25¢ for PLAN CATALOG
Catalog PLUS "Boatbuilding Handbook" \$1.00
DEPT. A CUSTOM-CRAFT - BUFFALO 7, N.Y.

NEW! Giant AUTOMOTIVE CATALOG

1956 Edition! Everything for car, truck, custom-
styled car, hot rod . . . at **LOWEST PRICES!**

SAVE UP TO 50% on all parts, accessories! Only
complete automotive buying guide . . . 75,000
items . . . 180 pages! Thousands of **hard-to-find**
parts; equipment, parts for 1920 to 1956 models;
Hollywood accessories never before offered;
hi-speed parts. Send your name and address
and 25¢ (refundable with first \$5.00 order) to:
J. C. Whitney & Co. 1917 Archer, Dept. P-6, Chicago 16, Ill.



FIND HIDDEN RICHES!

NOW - find buried treasure, gold, silver, and metal
objects, with sensational 3 1/2" locator - **GOLDAK'S**
"FIND-IT" . . . only \$49.50 complete with earphones,
batteries, instructions.



Manufacturers of metal de-
tection devices since 1933

Write for **FREE** literature
full line metal, mineral locators;
geiger and scintillation counters.

GOLDAK CO. 1542 W. Glenoaks Blvd., Glendale, Calif.

BUILD FINE GRANDFATHER CLOCK NOW

The simple sensible Red-i-Kut way as thousands have -
**SAVE HALF. SHOP TESTED PLANS "SPIRIT OF THE CEN-
TURY"** Narrow waist 83" tall or stately straight side
"SPIRIT OF AMERICA," EASY-TO-FOLLOW photopark! PLANS
tell all - plus **BROCHURE** of heavy brass weight Westminster,
tube chime, movements, gorgeous bronze-silver dials, 3/4" solid
mahogany case kits. **Send \$1.00 today - Both plans \$1.50 NOW.**
Kuempel Chime Clock Works, 28 Kuempel Bldg., Minneapolis 16, Minn.

MAGNETS

5 Assorted Size Magnets \$1.00. Powerful Pocket Magnet W/ case \$1.00.
Hot Pad Magnets - large size 8 / \$1.00. Bulletin Board Magnets 8 / \$1.00.
Slender Magnets - pencil type 2 / \$1.00. Car Compass - accurate, useful
\$1.50. Retrieving Magnets - extra power, heavy duty - 30 lb. pull \$4.00,
also 50-75-100 lb. pull.

Explore, learn Electricity, Magnetism, Electro magnets, complete
kit and instructions with 22 experiments and models . . . \$3.98
Also - Rods, discs, bars, horseshoes. **Send stamp for catalog -**
Specify your requirements - **100% SATISFACTION GUARANTEED.**
PARK MAGNETS, 266, 1557 GREENBAY RD., HIGHLAND PARK, ILL.

\$40 for 1 1/2 DAY'S SPARE TIME WORK GRINDING LAWNMOWERS

Yes, J. H. B. writes, "not bad for a 76 year
old young fellow earning \$40 for a day and
a half's work" . . . and others are making
even bigger money with the Universal
Model B Lawnmower Grinder. You, too
can make good spare or full
time profits in your own
business in your garage or
basement. We furnish
everything you need.
Write today. No cost
or obligation. Dept. M-66.



ROGERS
MANUFACTURING CO.
LINDSEY, OHIO

FREE! SPRAY-GUN PAINT STRAINER

LIMITED TIME OFFER
Mail this coupon today! Get your **FREE** strainer.

JOHNSON SERVICE COMPANY

Compressor Division, PM-6, Milwaukee 1, Wisconsin

Please send me price list and free literature describing
the Johnson Compressor line. Also send me my free
spray-gun paint strainer. No obligation.

NAME _____

STREET _____

CITY & STATE _____

JOHNSON Portable & Piston Model AIR COMPRESSORS Professional Quality at Popular Prices! for SHOP, HOME or FARM USE

MAIL TODAY!

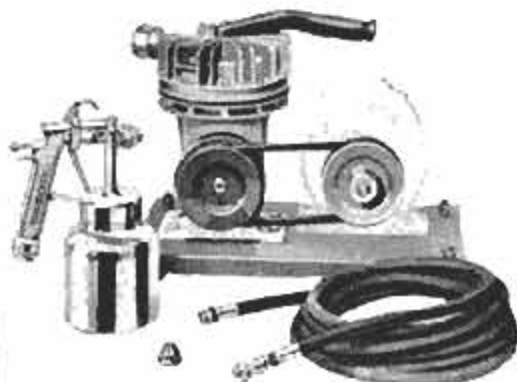

These are the same top quality compressors that deep sea divers, Army and Marine field forces depend upon! 17 different models . . . a popular priced unit for every use. **All guaranteed to deliver 100 lbs. pressure.**

For Painting, Spraying, Inflating, Lubricating, Cleaning . . . Model 1520 (illustrated) delivers more air than many models three times its size! Sealed ball bearings. No piston rings . . . no oil needed. Helps you do dozens of "everyday" jobs easier, faster, better, cheaper! Cuts down on repair bills for home, car, machinery.



Powered by Electricity, Gas Engine, 6 or 12 Volt Storage Battery. Regardless of the job, wherever you want to work, there's a Johnson Compressor to fit your exact needs!

Complete Line of Matched Accessories for Every Job. Free catalog illustrates 17 different compressors and all kinds of accessories . . . hose, spray guns, tire chucks, grease guns, mounting brackets, air gauges, blow guns, etc. For farm buildings, famous Insectospray attachment kills insects with push-button ease!



JOHNSON SERVICE COMPANY

507 E. Michigan St., Milwaukee 1, Wisc.

"Rambler was a bit small before. Now it is large enough and I hope they leave well enough alone."—New York draftsman.

"Okay if they stop now. The '56 is just right."—Michigan salesman.

"I bought it because it is now average in size. Hope they don't make it larger."—Wisconsin supervisor.

"Getting too large for me. Factory is defeating its original purpose."—Washington glassworker.

"Liked them better when they were smaller."—Pennsylvania machinist.

More Best-Liked Features

Here, in order of frequency of mention by Rambler owners, are more quotations describing best-liked features:

"Everywhere I park my car, people start touching it, walking around it and talking about it. It's a honey."—Oklahoma teacher.

"It has the highest H.T.P. of any car on the road (H.T.P. is head-turning power)." —New Jersey machine operator.

"Although styling played no part in my selection, the Rambler is distinctive. People crane their necks to look at it."—Washington, D. C., dentist.

"Has looks of a sports car."—Michigan maintenance supervisor.

"My wife is in love with the Rambler because it is easy to park."—Ohio contractor.

"People have been surprised at roominess of the interior. Small on outside, yet large inside."—Illinois laborer.

"Visibility good. No blind spots. Four front headlights very good for country driving as you can see ditches on both sides of road."—Illinois supervisor.

"Easy to handle in traffic with so much glass."—North Carolina hosiery worker.

"The only sensible car for the average family. Its 120 horsepower is enough. It cruises at 65 and 70 as well as other cars."—Ohio telephone operator.

"Good pulling power on hills despite only 120 horsepower."—Virginia supervisor.

"I like the fact that it is small."—California secretary.

"Hugs the road. Feels safe."—Tennessee tool designer.

"Best cornering car I have owned."—Pennsylvania industrial engineer.

"I like the unit body and frame."—Arizona cabinetmaker.

"Doors on this car never rattle."—Wisconsin salesman.

"Sold on antirattle feature of unit frame construction."—Michigan engineer.

"Rollbar above rear window is great safety factor."—Ohio machine operator.

"Heater gives quick heat."—Pennsylvania machinist.

"Compact layout of engine."—New Jersey machine designer.

"Easy to start at 20 below zero."—Michigan inspector.

"All-leather upholstery." — Wisconsin laborer.

"My fourth Rambler. I drive 40,000 miles a year and never had any major trouble."—California upholstery dealer.

And More Complaints

Fifth among the owners' complaints is the operation of the Hydra-Matic transmission, with 6.8 percent mentioning it. Next comes the poor quality of the radio, followed by body rattles (mostly in hardtop models). For a listing of percentages of these and other complaints turn to page 109.

Here are typical quotations describing complaints listed in order of frequency of mention by the owners:

"Hydra-Matic jerks too much when put in reverse."—Pennsylvania salesman.

"Hydra-Matic jumps out of reverse at times as you back up."—New York housewife.

"Very poor radio for price paid. Cheapest part of car."—New Hampshire owner.

"Body rattles more prevalent. Doors do not close tightly. Believe this complaint is peculiar to hardtop models."—Virginia builder.

"Paint job is very poor. Paint chipped in many places."—Connecticut accountant.

"Steering wheel too close to driver. Seat will not go back far enough."—Michigan architect.

"Should have light on Hydra-Matic indicator."—Michigan bus driver.

"Speedometer noisy, but manufacturer is supposed to replace later with plastic gear to cut out noise."—Illinois editor.

"Heater not all I thought it would be. Warm in front, rear floor cold."—Wisconsin salesman.

"Rubber hose connecting gas-filler neck and gas tank came loose on my car and 10 others delivered by my dealer. Water and debris got into tank, fuel lines and pump, causing two engine failures in traffic. Hard to take in brand-new car."—Virginia government worker.

"Window handle too far away and winds backward."—New Jersey night checker.

"Radio grille vibrates."—California communications specialist.

"Not enough clearance between body and rear tires for chains."—New Hampshire rural letter carrier.

"Have trouble with carburetor when going around right-hand turns fast."—Washington messenger.

(Continued to page 230)

Just what paste wax needed - a built-in cleaner!



Johnson's J-Wax
new Paste Wax Discovery
does the cleaning work for you!

LONG-LASTING WAX
KEEPS FRESH AND EASY
TO APPLY IN THIS
NEW
KEY-OPENING
CAN



**Start right in waxing! No extra
cleaner needed—nothing else to buy!**

Here's what you've been waiting for—a paste wax with a cleaner built right in! Johnson's new J-Wax saves you hours of pre-cleaning. J-Wax takes the dirt off for you—replaces grime with a crystal-clear coating of wax. Even the dirt you can't wash off loosens instantly and disappears as you rub on this new self-cleaning paste wax.

Then watch the high brilliant luster that comes as you buff. J-Wax sets smooth and hard—bonds itself into a long-lasting wax-tight seal. Gives your car tough wax protection it needs for any weather. And look! The colors are far brighter, truer—even the chrome glistens.

Get your car ready now for the months ahead—with J-Wax. It's the easiest, fastest way to genuine wax protection—*paste wax protection!*

Extra-Handy ... and tough all the way through!



RIDGID

the easy-to-use Bench Pipe Vise

Look at the *more* you get for your money . . . built-in pipe rest aids accurate threading, handy pipe bender . . . Long-Grip tool-steel jaws hold pipe firmly without chewing it up . . . yoke and base of special last-a-lifetime malleable . . . a bargain in quality!

Buy your RIDGID
Pipe Vise at your
Hardware Store!

RIDGID
Chain Bench
Pipe Vise—5 sizes
to 8" pipe.



The Ridge Tool Company, Elyria, Ohio, U.S.A.

"Putting shift into first gear there is always a grind even though clutch pedal is all the way down."—Illinois salesman.

There you have it, the digest of the thinking of hundreds of Rambler owners. For an engineer's analysis of the car turn to page 108. For Floyd Clymer's driving test turn to page 107. ★ ★ ★

Clymer Road Tests The 1956 Rambler

(Continued from page 107)

advantage—a more rigid rear-end assembly that assures constant alignment of rear wheels.

I found less tendency for the front end to nose-dive than most cars when the brakes are applied quickly.

Economy and high performance do not go hand in hand, but in the Rambler the owner will find a happy medium. Its economy certainly is unequalled by any other American car. The large gas tank (20 gallons) enables the Rambler to go long distances between fuel stops. Starting with a full tank, I drove 432 miles before the tank ran dry. This included city driving in Los Angeles and San Diego plus moderate highway driving on long, open stretches. The average was 21.6 miles per gallon, certainly not bad for a station wagon. Regular gas is satisfactory.

Surprising Speed

Speed was also surprising. The speedometer showed a top of 96 miles per hour, although, like most cars, the speedometer is fast by at least six percent. It is a fast highway car and surprisingly high average speeds can be maintained without undue effort or fatigue. Body rumble at high speed was slight, indicating good insulation.

Brakes are excellent. Pressure is light and smooth. There was little evidence of fading, even when descending steep hills or stopping from high speeds.

Rambler a Safe Car

In my judgment, Rambler, though smaller, is safer than many cars. The welded, unitized body-frame construction offers above-average protection in collisions. It also reduces rattles and squeaks. None developed in the test.

Rambler is the lowest-price car to offer Hydra-Matic. The test car had it. Standard transmission, with or without overdrive, is also available.

Hydra-Matic has two driving ranges. For normal use in Range 4, a kickdown for fast acceleration takes place up to 58 miles per

(Continued to page 232)

IDEAS FROM WELDWOOD



The Weldwood Question Box

Q. I want to finish off a playroom. How do I go about putting wood paneling over a concrete-block wall?

A. First make sure walls are dry and no moisture problem exists. Then put up your furring strips (1" x 2" pine)—horizontal ones every 16"—vertical ones every 4'. Vertical strips should be placed so the joints of the paneling will fall on them. Use wooden shims behind furring where needed to make all the furring strips even. To attach furring strips to concrete block, use anchor bolts or cut nails. After furring is in place, nail the paneling right to it—or better still, use Weldwood Contact Cement and avoid nail holes in the wood face. Leave about 1/8" space between bottom of panels and floor, for air circulation.

Q. Planning on painting some fir plywood. How can I keep grain from showing through?

A. That's simple. Prime the plywood with a coat of white Firzite. Firzite is specially designed to seal wood pores and help tame unsightly grain. Sand lightly, and apply finish

THIS MONTH'S PROJECT — LAWN CHAISE

Here's the way to soak up the sun in style! This form-fitting chaise is extra comfortable and so easy to build. (See coupon for Easi-Bild Pattern*.) It's a handsome addition to your lawn furniture . . . and even comes apart for easy storage or for carting to the beach. You'll find it's a good idea to build two of them . . . because they'll be in demand all summer long.

And you'll find it's an extra good idea to make your chaise with either Weldwood exterior plywood or with amazing new Weldwood Duraply®. New

Duraply is easy to work, gives you clean edges. And Duraply has a special tough facing that will save you paint. Needs no priming coat! Two coats on Duraply's super-smooth surface actually give the same coverage as 3 coats on ordinary wood. And the paint will stay new-looking longer. The overlay face is completely weatherproof, too. You'll have no fear of the rain damaging your chaise.

*T. M. Reg. Easi-Bild Pattern Co.

This Month's Hints

1. Putting an addition on the house? You can save time and trouble with Weldwood fir plywood for sheathing, sub-flooring, and roof-decking. Plywood makes a very strong and rigid structure . . . goes up fast . . . holds nails well . . .

and there's almost no waste. **2. Screws put into the edge** of a piece of plywood should be just long enough to take a 3/4" bite into the wood. Shorter screws won't hold securely enough . . . longer screws won't add much, if any, strength to the joint.

coat. Use white Firzite as an under-coat for paint or enamel. For varnish or stain finishes use clear Firzite.®

HAVE A QUESTION?

Send it to "The Weldwood Question Box," 55 West 44th St., N. Y. 36, N. Y.

\$10 for your ideas

for "This Month's Hints", if accepted for publication. (Hints must apply to some Weldwood product.) Send them to Weldwood Hint Editor, 55 West 44th St., New York 36, N. Y.



Weldwood®

A product of

United States Plywood Corporation

Weldwood—The Best Known Name in Plywood

United States Plywood Corporation, Pattern Dept.
P. O. Box 215, Pleasantville, New York

Enclosed find 35¢ for which please send me Pattern #324—Lawn Chaise. PM6-56

NAME.....

ADDRESS.....

CITY.....STATE.....

MILLERS FALLS
DYNO-MITE

1/4-inch electric drill
No. 1814
\$25.70



Here's Power and Performance that's hard to beat

If you want power — plenty of power — then you'll like Millers Falls Dyno-Mite Electric Drills. They're light, compact, perfectly balanced — and they pack a punch that's way beyond their size.

You'll like the looks of these shining beauties, too — mirror polished to glistening silver sleekness. Most of all — you'll like the rugged quality that guarantees years of trouble-free service.

Illustrated is the 1/4" No. 1814 Drill, one of the *complete* line of Dyno-Mite 1/4", 3/8" and 1/2" drills. In addition, Millers Falls offers the broadest range of attachments and accessories available today — including the remarkable, high-speed Dyno-Mite Power Bits shown with drill above. See — try — buy them at your dealer's.



Dyno-Mite Jig Saw Attachment for 1/4" electric drills. Cuts straight lines, circles, any shape. Capacity: 1 3/4" in wood, 1/2" in metal. Comes with 4 blades. No. 2140..... \$10.95



Buffing and Sanding Attachment. Fits 1/4" electric drill. Complete with 5" Rubber Pad, two 5" Sanding Discs, and a 5" Lamb's Wool Bonnet. Two speeds. No. 2120..... \$8.45

Millers Falls

**Finest Power
Tools Made**



FREE FOLDERS on the complete line of Dyno-Mite Power Tools, including the amazing new Dyno-Mite Power Workshop. Ask for them at your dealer's or write:

MILLERS FALLS COMPANY, Dept. PM-14, Greenfield, Mass.

hour if the throttle is floored. Final upshift with floored throttle takes place at about 65 miles per hour. In Range 3, desirable in traffic or hilly country, there is no upshift into high.

The Rambler engine is started by lifting up on the gearshift lever to engage the starter switch.

The car has many exclusive and excellent features. The doors have dual sponge-rubber seals around the windows, affording a water and dust-proof joint. No dust leaks appeared on dusty back roads. No water leaks resulted during a water test.

Improved performance has resulted from the overhead-valve design of the new engine. It has the smallest displacement (196.6 cubic inches) of any American car except the Studebaker Champion. Rambler does not offer a power pack.

The engine has little vibration at any speed and is extremely smooth under all conditions. Even at high speeds over desert roads or during miles of low-gear use over sandy trails no heating occurred.

The driving position is comfortable for the short or medium-height driver, but legroom is short for the six footer. The armrest is too high for the tall person. Headroom is satisfactory. Doors open and operate easily and have a solid feel. Squeeze-type door handles now operate better than on earlier models. Window cranks require only two turns to open or close the window and they turn easily. The location of the window crank, however, is too low; it should be higher on the door.

Interior Is Good

The interior is well finished. All instruments are grouped in the small panel directly in front of the driver. A full-circle horn ring is used but does not obstruct speedometer vision. The shift-lever quadrant is right in front of the driver. Heater controls are on the left side of the steering column.

A needle temperature gauge is used with warning lights for oil pressure and generator output. Two plain but practical radio dials are in the center of the cowl. Except for some spots in the desert, radio reception was good. A small, bin-type glove compartment is in the center of the dash.

The brake pedal is high in relation to the throttle and could be wider. The parking-brake lever is far forward and should be closer to the driver.

Bumpers are of moderate size with good wrap-around protection. They are practical and have no projections. The license-plate mount is in the center of the front bumper and is the first point to hit another

(Continued to page 234)

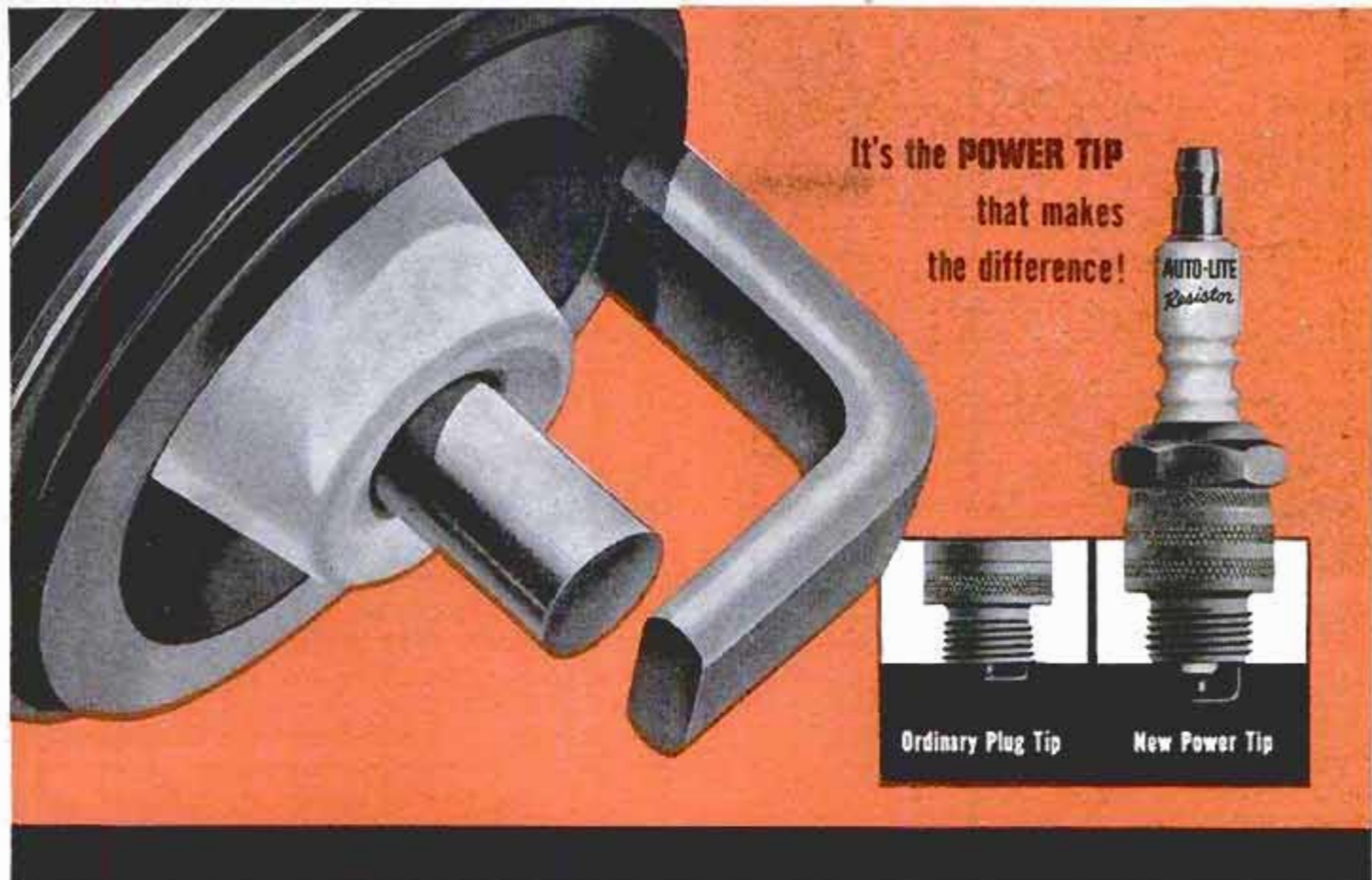

Some spark plugs are designed for low speeds . . . some spark plugs are designed for high speeds . . .

Only new **POWER TIP** "fires up" your engine at all speeds!

No more need for old-type plugs in modern engines. In the past, you had no choice but to use conventional type spark plugs in your modern overhead-valve engine. You had to choose between "hot" or "cold" plugs depending on whether your driving was mostly at *low* speeds or *high* speeds.

Now new POWER TIP—one plug for ALL speeds! Here's the difference. Projecting center electrode and ceramic tip—the **POWER TIP**—extends the spark gap in toward the center of the combustion cham-

ber. It operates *hotter* at low speed—resists fouling because deposits burn away clean. Yet the Power Tip takes advantage of richer intake gases in high-speed, wide-throttle driving—runs *cooler* and checks pre-ignition!

Available now for all these cars with overhead-valve V-8 engines using 14 mm plugs: Buick, Cadillac, Chevrolet, Chrysler, De Soto, Dodge, Plymouth, Ford, Hudson, Imperial, Lincoln, Mercury, Nash, Oldsmobile, Packard, Pontiac, Studebaker.

AUTO-LITE **RESISTOR SPARK PLUG WITH POWER TIP**

Auto-Lite manufactures over 400 products, including Spark Plugs, Batteries, Wire and Cable, and Automotive Electrical Systems . . . sold throughout the United States and Canada.

Sound your Z...expect

PICKUP FOR KEEPS

because—

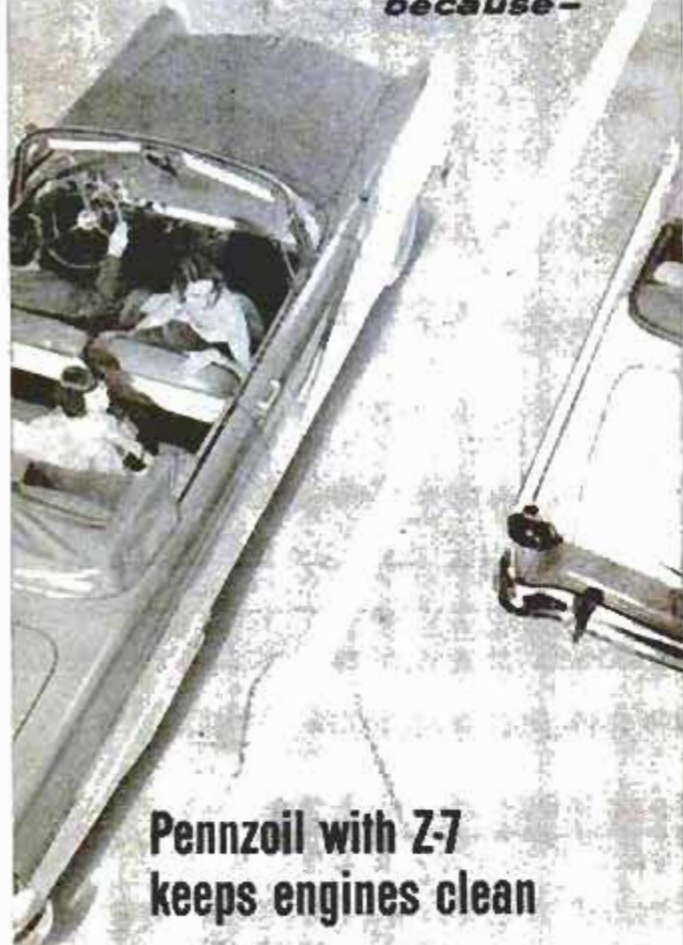

Pennzoil with Z-7 keeps engines clean

Trust your engine to Pennzoil with Z-7 and you can count on that extra burst of power when you need it! This different Pennsylvania motor oil with an all-oil body controls carbon and other deposits completely . . . prevents power-stealing knock and ping. By keeping your engine clean and smoothly responsive, it keeps horsepower unlocked—not for just a few miles after an oil change, but for keeps. To pass safely or flatten the hills, just sound your Z for Pennzoil with Z-7, The Tough-Film® oil, in the exact seasonal grade for your car!



IN EVERY STATE,
AT DEALERS WHO
care FOR YOUR CAR



MEMBER PENN. GRADE CRUDE OIL ASSN., PERMIT NO. 2, OIL CITY, PA.

bumper. Designers seem to think a thin, metal license plate needs no protection. It does, though.

Headlights are mounted within the grille, closer than on conventional designs. Smaller running lights are in the front ends of the fenders and operate whenever the headlights are on to show car width.

Rambler has a very practical rear door in its station wagon. The window cranks down into the tailgate. When the gate is lowered, there is no upper transom to obstruct loading or to bang your head on.

Vision in every direction is excellent. The short sloping hood provides a good view directly forward.

Of course, the reclining-seat and twin-bed features are continued in the new Rambler. ★ ★ ★

Talking Directory

Shoppers in a Whittier, Calif., supermarket are told where to look for grocery items by a "talking directory." When a shopper pushes one of the 96 buttons on a directory panel, a tape-recorded voice tells where the selected item is located and may add a plug for a related item or for the special of the day. Seven duplicate panels, each with a self-contained loudspeaker, are connected to a master tape recorder. A "stand by" sign on the panel lights up when someone at another location is using the system. When the unit goes into production, 10 duplicate panels each with 144 selections will be possible in one system.



Win



**3-country expense-paid
Grand Tour of Europe
for 2 in the WEPCO
wonder-trip contest**

fly via PAN AMERICAN WORLD AIRWAYS

99 OTHER PRIZES

2nd to 5th Prizes: Week's vacation for 2 in Bermuda.

Plus 95 Wepeco Product Prizes.

Nothing to Buy! Get Free Entry Blank From Your Lumber or Hardware Dealer! Contest Ends June 30th.

KANGAROO *Self Storing* COMBINATION DOOR

Only door with its own self-storage compartment. Screen or storm inserts are stored inside bottom panel, always ready for use. Rugged, extruded aluminum construction.



NEW WEPCO adjustable aluminum window awnings \$15.95 & up. Slightly higher in some areas.



DUO-MATIC 3-track, self-storing extruded aluminum combination window as low as \$15.95.



DUO-DOR extruded aluminum combination door. \$39.95, 6 standard sizes. Slightly higher in some areas.

Wepeco Products Are Sold Only At Dependable Lumber and Hardware Dealers.



the weather-proof co.

1407 East 40th Street
CLEVELAND 3, OHIO

Stops hydraulic valve lifter noise!

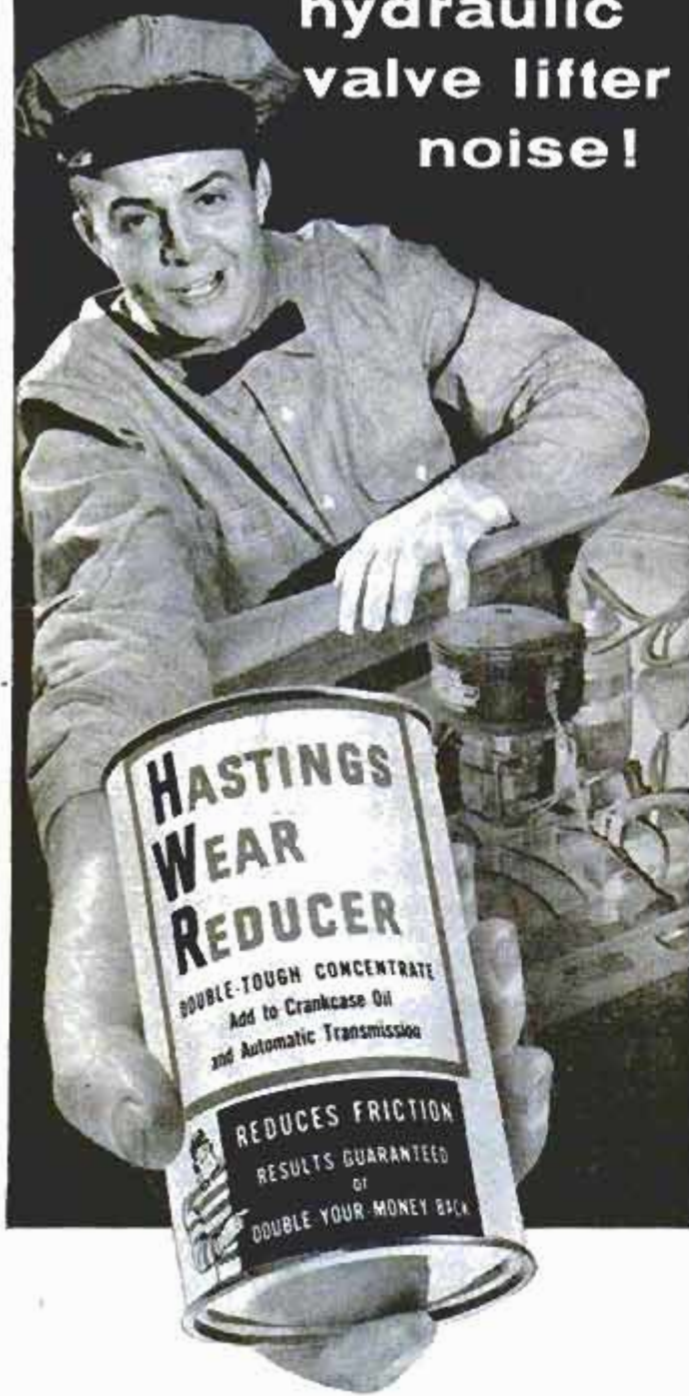

H-W-R stops hydraulic lifter noise . . . keeps your engine clean, restores power . . . gives smoother, quieter performance . . . rids automatic transmission of jar and jerk. Results guaranteed or *Double-Your-Money-Back!*

HASTINGS MANUFACTURING CO., HASTINGS, MICHIGAN

HASTINGS

Buy these Hastings Products with confidence!
H-W-R, Casite, Piston Rings
Oil Filters, Spark Plugs

Lightning Plays Queer Pranks

(Continued from page 69)

vanish or jump to another point on the line. No sensation was experienced on applying the tongue to the line[!]

"Meanwhile the cups of the anemometer, which were revolving rapidly, appeared as one solid ring of fire, from which issued a loud rushing and hissing noise. Our stone chimney was a flaming arrow. . . . On placing my hands close over the revolving cups of the anemometer, I did not discover the slightest sensation of heat, but my hands instantly became aflame. On raising them and spreading the fingers, each of them became tipped with one or more cones of light nearly three inches in length. The flames issued from my fingers with a rushing noise accompanied by a crackling sound. The wristband of my woollen shirt, as soon as it became dampened, formed a fiery ring around my arm, while my mustache was electrified so as to make a veritable lantern of my face."

Such hair-raising experiences are examples of the weird effects of St. Elmo's fire and lightning. Nature may have a chuckle or two hidden in the black depths of a thunderstorm. ★ ★ ★

Plastic Patching Stick

Heat from an ordinary clothes iron melts a plastic-metal stick which fills dents in auto fenders, wood and other materials. Two two-ounce sticks are equal to one pound of solder, and no tinning or flux is needed. The patch can be sanded, polished and painted, and will withstand heat up to 265 degrees Fahrenheit.

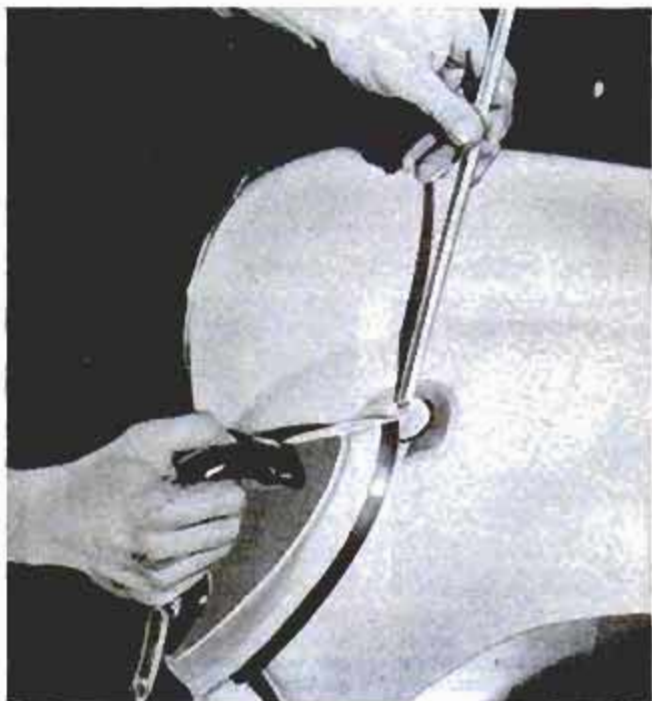

New!
Leader Material
 on
COLOR-CODED SPOOLS*



* Pat. Pend.

NEW! HANDY BUILT-IN CUTTER

25c each

Distinctive color for each line weight—no guessing. 2 to 20 lb. test Deceiver® Monofil Nylon. South Bend Tackle Co., Inc., 891 High St., South Bend 23, Ind.

South Bend
 THE BEST IN RODS · REELS · LINES · LURES

BOAT KITS 28 MODELS—8 to 19 ft.
 \$39 up—FREE FREIGHT

SAVE 2/3!

Easy-to-build MAHOGANY FRAMES—DECKS
 19' CRUISER KIT \$499.50!



SEND 10¢ for KIT CATALOG!
 Includes Hardware
 -Trailers-Fiberglass

BOAT PLANS—Patterns—Frame Kits

Craft
 Tanawanda, N. Y.

Build over 50 modern boats from large scale plans, available with FULL-SIZE patterns, new PRE-FAB frame kits! All types: prams to cruisers, 6 to 25 ft. Best buy for Amateurs! SEND 10¢ for CATALOG.

Print Your Own

Cards, Stationery, Advertising, Circulars, labels, photo and movie titles, church work, tags, etc. Save money. Sold direct from factory only. Raised printing like engraving, too.

Own a Printing Business

Print for Others. Good Profit. Have home shop. Junior press \$15; Senior \$29 up. We supply everything. Easy rules. Pays for self in short time. Write for free catalog of outfits and all details. **KELSEY PRESSES, C-37 Meriden, Conn.**

Kelsey Excelsior Presses

SAVE MONEY ON YOUR COMPRESSED AIR



buy this complete SMITH 45-P air compressor

Right for spray painters, plumbers, contractors, monument shops, tire changing trucks, maintenance shops, quarries, utilities, many other users. Delivers 45 plus cu. ft. per minute; pressure up to 150 PSI. Powered by Wisconsin 4-cyl. air-cooled engine; uses less than 1 gal. gasoline an hour! Most compact, biggest-value compressor for its capacity anywhere! Other models to 230 cfm.

write for FREE brochure

GORDON SMITH & COMPANY, Inc.
 411 College Street, Bowling Green, Ky.



Easy Does it!

EASIER EDGING WITH

\$495



ROWE'L-EZY

(Say Roll Easy)

ALL PURPOSE LAWN and GARDEN EDGERS

It's down-right easy to do a clean, fast, effortless job of edging along sidewalks, flower beds, stepping stones, trees, fences and walls with a Rowe'l-Ezy, "Rotary Lawn Shear"

The patented trouble-free shearing action combined with top-quality materials and workmanship assures you of easy edging with Rowe'l-Ezy.

Close Coupled **\$395**

Two-Wheeler **\$595**

At all Hardware Garden Supply, and Department Stores

LOOK FOR THIS LABEL IT IS YOUR GUARANTEE OF QUALITY



ROWE TOOL CO., Box 3185, Glendale, Calif.

YOU SAVE \$10 to \$20...

(smaller saws cost that much more!)

NEW! 6½" POWER SAW

with exclusive
**Automatic
SAFETY CLUTCH**
increases work life
up to 15 times!

says Fred Wiborg,
Master Carpenter
of Chicago



only **\$49.95**

This new Pet saw is packed with power . . . a husky 1 horsepower. And Pet's exclusive Automatic Safety Clutch eliminates dangerous kick-back, motor burn-outs from overloads. Increases saw life up to 15 times!

And what a price! This all-new Pet 6½" saw costs \$10 to \$20 less than other top 6½" saws!

Fred Wiborg (above) says, "I job-tested this Pet saw on the roughest, toughest work I could find . . . and it came through like a thoroughbred. Cuts a 2 x 4 at 45° in one cut! And you should see the report on it by a famous research institute. Proves that this Pet saw equals or excels any other make, *regardless of price!*"

Automation is the secret of its amazing low price—**JOB-TESTING** is the secret of its heavy duty performance. See it tomorrow for sure!

- 1 h.p. Universal ac/dc motor develops 4850 r.p.m.!
- Exclusive Tru-Guide for right, left or on-line sawing — stops guesses!
- Exclusive Automatic Safety Clutch adds up to 15 times more work life!
- Comfort-engineered Handi-Grip for easiest working angle!
- Retracting lever on automatic blade guard!
- Easy grip knobs adjust all saw positions instantly, effortlessly!

NEW!

*Those who depend
on their tools depend on*

**JOB
TESTED**



PORTABLE ELECTRIC TOOLS, INC.

Chicago 20, Illinois

6-Transistor Superhet Portable

(Continued from page 148)

settings of the i.f. transformers are fairly close to the correct i.f. frequency (455 kc.) the receiver can usually be aligned by ear. However, a noise generator, rather than an actual signal, should be used to do this. A fluorescent light or electric shaver can be used as a noise generator.

To align the set, temporarily connect a long, flexible wire to the r.f. stator lug of the tuning capacitor and throw the other end of the wire over the noise generator. With the generator on, adjust the i.f. transformer slugs, through the bottom of the chassis, for maximum noise. The receiver volume should be turned down so that a small change in noise is readily perceptible.

Tracking adjustments: Adjust the receiver for proper tracking, as follows:

1. Tighten the oscillator and r.f. trimmer capacitors (see Fig. 2) and then open each approximately one half turn.

2. Cut out the dial scale on page 146 and tape it to the chassis and speaker frame so that the tuning capacitor shaft protrudes through the hole in the scale.

3. Attach a pointer knob to the capacitor shaft so that the pointer indicates the beginning of the scale with the capacitor plates fully meshed.

4. Set the pointer to the dial number corresponding to the lowest-frequency station in your area and adjust the slug in the oscillator coil until that station is heard.

5. Rotate the tuning capacitor until the knob points to the dial number of the highest-frequency station in the area and adjust the oscillator trimmer capacitor until that station is heard. Adjust the r.f. trimmer for maximum volume of the station.

6. Repeat steps 4 and 5 until no more adjustment change is required to tune in both end-frequency stations at the correct dial settings.

Tracking test: To determine if the receiver is tracking properly at the low-frequency end of the dial, set the tuning capacitor to a frequency slightly above that of the low-frequency station, and readjust the oscillator slug until the station is heard at this new setting. If the station volume is higher at this new setting than it was at the correct one, some of the loop-antenna turns must be removed. This is done by exerting a slight pull on the white antenna lead. Remove the turns one at a time until maximum station volume is obtained when the oscillator coil is readjusted to bring in the station at the correct dial setting. Then, repeat steps 5 and 6 described under tracking adjustments.

(Continued to page 240)

Make it of Aluminum... the metal that lasts ... outdoors

It never rusts, rots or warps...



Available
in Canada

Aluminum is at its best out-of-doors. Strong and rust-proof, it stays new in looks and performance. Its light weight makes it easy to handle or move about.

And when you use Reynolds Do-It-Yourself Aluminum there are extra advantages. You work it, easily, with just woodworking tools. Most jobs are well started for you

because Do-It-Yourself Aluminum comes in pre-formed sheets (8 kinds), in tubes, bars, fittings, rods and special extruded shapes.

Use it outdoors this summer for trellises, downspout extensions, patio windscreens. In minutes you'll make driveway markers, hose or tool racks. And Do-It-Yourself Aluminum is the one material for making a screen house or screening a porch.

At hardware and lumber dealers. Call Western Union Operator 25 for the name of the one nearest you.

REYNOLDS Do-It-Yourself ALUMINUM

By the makers of Reynolds Wrap

REYNOLDS METALS COMPANY, 2494 SOUTH THIRD STREET, LOUISVILLE 1, KY.

See "FRONTIER," Reynolds exciting dramatic series, Sundays, NBC-TV



best hardware...
for hard wear
GRIFFIN
HINGES

at your hardware or
building supply store
GRIFFIN MFG. CO., ERIE, PA.

CONVERT YOUR POWER LAWN MOWER TO A "RIDING" MODEL



Ask your dealer about BREWER-CYCLE. This low-cost attachment converts your small power lawn mower to a "rider." Just detach mower handle, secure BREWER-CYCLE with nuts and bolts — start riding! Works with old or new equipment. Write for dealer name.

Brewer-Cycle
Div. Pat. No. 178,710



E. F. BREWER CO., BUTLER, WIS.

NEW!



HANDEZE Plier Grips

- PROTECT YOUR HANDS
- STRENGTHEN YOUR GRIP
- REDUCE HAND FATIGUE

Hard jobs are a snap with P&C Handeze Grips. You work faster, more efficiently. Made of smooth, comfortable blue vinyl plastic in three sizes to fit easily on practically all pliers. If you use pliers, you need P&C Handeze Grips. Buy them today!



Shop from colorful P&C tool merchandisers, in more than 10,000 stores coast to coast. Send 10c for big tool catalog.

P&C the best tools money can buy.

P & C TOOL CO.

Dept. H2, Box 5926
Portland 22, Ore.

**Bernz-O-Matic Instant-lighting
"Packaged" Propane Torch
MAKES IT EASY**

**Patch gutter leaks
in 15 minutes**



Simply wire brush or sand around the hole. Apply flux. Clean and flux underside of copper patch. Tin both patch and gutter by heating solder with Bernz-O-Matic® Torch. Then place patch over hole and heat with torch until it sweats on.

**Antique a chair
in 20 minutes**

First, burn off existing paint with Bernz-O-Matic Torch. Carefully sand. Then go over piece slowly with torch with low flame. Move flame with grain and in circles to make knots. Then cover with clear shellac.



**Repair jewelry
in 5 minutes**



Place TX-400, small soldering accessory tip on TX-10 Torch and "tin." Clean area where metal is to be joined with emery cloth. Use acid and solder with Bernz tip providing heat that "flows" solder between joints.

Making the carrying case. The carrying case can be constructed by making a frame of 1/2-in. lumber, just large enough to house the receiver, using two pieces of 1/4-in. plywood for the front and back. The receiver itself can be used as a template for determining the exact locations of the speaker and control cutouts (see Fig. 6). The two battery holders are fastened to the back cover with 1/4-in. wood screws (flathead), and a couple of flexible plastic strips are mounted on the frame to hold the loop antenna away from the speaker frame. Better drill two holes in the frame to coincide with the trimmers on the tuning capacitor since these must be readjusted for best results after the antenna is properly positioned.

A professional appearance can be given to the case by painting it, or by covering it with decorative plastic laminate. This material is available from hardware stores in many different patterns and designs. It is self-adhering to any smooth surface. For better adhesion, however, the case should be covered with a coat of varnish and the laminate applied before the varnish has completely dried.

The two screws in the top speaker holes are used to fasten the receiver securely to the cabinet. These screws can be counter-sunk in the front panel. A piece of grille cloth glued or stapled to the inside of the case, over the speaker hole, protects the speaker and adds the final touch to the finished appearance. ★ ★ ★

Garden Guide Line

Keeping your garden rows straight and edging lawns and driveways is easy with this new guide line. Two rust-resistant zinc-plated rods topped by bright-red knobs support the line. One of the knobs mounts a coil spring that keeps up to 25 feet of yellow mason's cord taut. If a hoe hits the cord it snaps back into place.

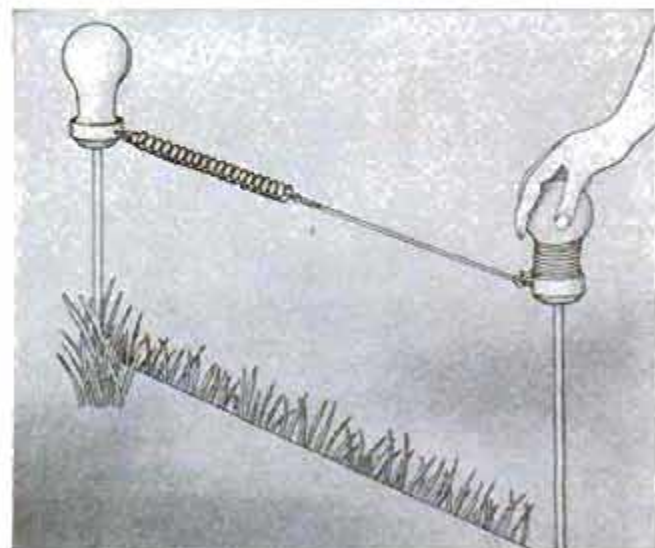

NOW SAVE \$3.41!
GET A **BERNZ O MATIC**® TX-80
UTILITY TORCH KIT



This low-priced, big value Propane Torch Kit, a \$10.90 value only \$7.49

Includes Bernz-O-Matic Torch with pencil-burner head, plus utility burner head, plus soldering tip attachment and a box of Kester solder—a regular \$10.90 value, now only \$7.49 at your hardware dealer's today. Torch alone only \$6.95.

Jobs illustrated and others are in the Bernz-O-Matic "Do-it-yourself" book. To get your free copy write:

OTTO BERNZ CO., INC.

771-6 DRIVING PARK AVENUE • ROCHESTER 13, NEW YORK

Shop by Mail and
Save!

SURPLUS & NEW MANUFACTURE EQUIPMENT

FOR HOME, FARM AND FACTORY

BRAND NEW 1 H.P. 12 Volt Electric Motor



• For electric wheel chairs (Pop. Mech. design—Mar., 1953)
• For electric golf carts
• For self-propelled scooters, children's midge-cars.

ITEM #308
Rated 1 H.P.—100 amps., 5600 R.P.M., 12 volts, D.C.—This double shaft motor of ball-bearing construction may be run on 6 volts for lower horsepower requirements—Standard 3/4" shafts, flange mountings—Dimensions: 9" x 4 1/2" x 4 1/2", Shp. wt. 19 lbs. A real value at..... **12.50** F.O.B. Chicago

GROBAN HYDRAULIC SPEED REDUCER with FINGERTIP CONTROL

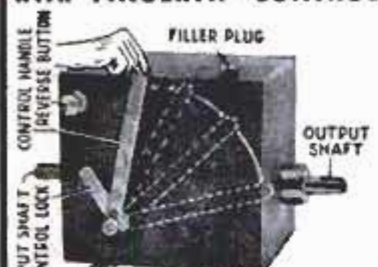

ITEM #115
FOR: • Reamer Drives • Midget Cars • Feed Mills • Canning Machines • Conveyors • Lathes • Milling Machines • Motor Boats • Cream Separators • Garden Tractors • Pumps.
Variable output speeds from 0 to input speed available by moving control handle. Locking handle maintains setting. Use input power of 1/4 to 1 1/2 H.P. Shafts 5/8" diam. Input rotation counter-clockwise facing shaft. Input speed 750 R.P.M. 7 1/2" x 7 1/2" x 1 1/2". Output rotation reversible. Shpg. wt. 31 lbs. Complete with 2 qts. of oil and full instructions. **54.50** F.O.B. Chicago

GROBAN FOUR-WAY OPEN CENTER HYDRAULIC CONTROL VALVE

ITEM #126—Four-way open center control valve, with built-in adjustable relief valve factory set at 1000 P.S.I. Spring loaded neutral position. For use with one double acting cylinder. In neutral position cylinder is locked and pump unloaded. Can be used as single unit or mounted in series. Has 3/4" pipe thread inlet and outlet, 1/2" pipe thread cylinder ports. Finger grip handle. Ship. wt. 10 1/2 lbs. AN OUTSTANDING BUY! F.O.B. Chicago **21.50**

FACTORY-TO-YOU-VALUE PORTABLE ELECTRIC LIGHT PLANTS



BRAND NEW 1956

ITEM #1008

POWER TO OPERATE:
• Electric Saw, Electric Drills, Pipe Bender.
• Refrigerator, Deep Freezer, Incubator.
• Water Pump, Radio, Lights, Air-conditioner.

COMPACT—FITS IN THE TRUNK OF YOUR CAR
1000 WATTS OUTPUT, continuous duty. 115 Volts A.C. 60 cycles, 9 amps. Powered by husky, easy starting Clinton engine. Engine and generator operate at 3600 R.P.M. for maximum efficiency at minimum weight. Both units are mounted on steel base, with heavy sheet metal belt guard. Generator is self regulating, and is equipped with outlet box containing fuse and 2 A.C. convenience receptacles. Cost only 5c an hour to operate. Dimensions: Length 20 1/2", Width 12", Height 16". Shipping wt. 100 lbs. F.O.B. Chicago..... **149.50**
700 WATT-GENERATOR SET—same as above, slightly smaller—with Briggs-Stratton Engine—Model 708—F.O.B. Chicago..... **129.50**
ITEM #2008—2000 WATTS—115 V. A. C. generator set, powered by husky, fast starting Briggs-Stratton engine. Mounted on portable steel carrying base for easy handling. — Just right for small cottage and cabins needing inexpensive 2000 Watts of electricity. Ship. Wt. 190 lbs. F.O.B. Chicago..... **295.00**

MASTER & SLAVE HYDRAULIC REMOTE CONTROL SET

ITEM #415—Designed for remote operation of controls on engines, boats, special machinery, etc. Eliminates complicated mechanical linkages, cables, pulleys, etc. The master unit connects to the slave unit with a single 1/4" tube. When master control lever is moved, slave lever follows exactly. Light, compact, aluminum alloy construction. Dim. of both units: 5 1/4" W, 9" H, 1 3/4" D. (exclusive of handle) Ship. Wt. 8 lbs. **27.50** per pair F.O.B. Chicago..... (Note — tubing not supplied)

U. S. NAVY ALL BRONZE CENTRIFUGAL PUMP

These all bronze Centrifugal Pumps are ideal for use as marine bilge pumps, circulating pumps, fire protection or irrigation, car-washing, dewatering, basement sump pumping, lawn sprinkling. Will pump water, oil, brine, gasoline, DDT and sulphur compounds. Equipped with 6" adjustable "V" pulley, 2" dia. inlet and outlet, 180 GPM capacity. Inlet and outlet take hose with 2 1/4" inside diameter. Dimensions 11" x 8" x 11".

Total head-feet	Speed	H.P.	GPM
25	3600 RPM	3	180
35	3000 RPM	1 3/4	90
20	2400 RPM	1 1/2	75

Back plate may be rotated for most convenient inlet position. Shipping weight 31 lbs. Govt. cost \$66.00. F.O.B. Chicago..... **29.50** ITEM #384

ORDER DIRECT FROM AD SATISFACTION GUARANTEED
Send Payment Or Purchase Order Today
All Phones—WEster 9-3793

FREE! — NEW CATALOG
1956 EDITION, 56 PAGES, chock-full of unsurpassed War Surplus and newly manufactured Equipment Bargains for farm, home, factory, workshop. Write letter today.

GROBAN SUPPLY CO. Dept. PM-6
1139 S. WABASH AVE., CHICAGO 5, ILL.

300 AMP. D. C. GENERATORS
IDEAL FOR WELDING GENERATOR
Type R-1. ITEM #91
rated 300 Amps.—30 Volts. Mfd. by Jack & Heintz, Government Acquisition. Cost \$389.00. Shpg. wt. 55 lbs. Dimensions: 16" x 10" x 7". Complete with instructions to connect as Welder. F.O.B. Chicago..... **35.00**

BELT DRIVEN A. C. GENERATORS

ITEM #700
Ideal for powering electric tools, oil burner, refrigerator, lights, or other appliances requiring up to 700 watts of power. 700 WATTS, 115 Volts, 60 cycles A.C. 3600 R.P.M. Compact, self-regulating generator with V Belt pulley and double outlet receptacle. Rotation counterclockwise. May be driven by tractor or auxiliary gasoline engine. Requires 2 HP minimum. Dimensions: 10" long x 8" high x 6" wide. Shipping wt. 27 lbs. F.O.B. Chicago..... **59.50**
Model 1010—1000 WATTS (Same as above) F.O.B. Chicago..... **79.50**
2000 Watt Generator..... **149.50**

DOUBLE ACTION HYDRAULIC CYLINDERS

ITEM #31C—3 1/2" bore, 11" stroke. Alloy steel cylinder wall. Micro-Honed and all steel 1 1/2" diameter piston rod. 19 1/2" overall length closed. Clevis mounting at base and shaft. Will lift 9625 lbs. with 1000 PSI Pump Pressure. Uses 3/4" tubing fittings. (Fittings to pipe thread) two 3/4" MPT @ 35c.) A \$102.00 value. Shipping weight 11 lbs. FOB Chicago... **25.00**
ITEM #16C—1 1/2" bore, 26" stroke. Will lift 1760 lbs. with 1000 lbs. pump pressure. Great for hay loaders, etc. 1" stainless steel piston rod. Postpaid... **16.95**

BERRY — HEAVY DUTY HYDRAULIC PUMP or MOTOR

ITEM #166—Use on road machinery, vibrators, paper mills, wire reels, hydraulic presses, speed control units. Ball bearing construction, balanced cam design assures high efficiency performance. When used as a pump: delivers 8 G.P.M. 1000 P.S.I., 8 H.P. At 1200 R.P.M. as a HYDRAULIC MOTOR: Rated up to 12 H. P., up to 2400 R.P.M. Standard 3/4" pipe thread ports. 3/4" shaft with keyway. Dimensions: 14 1/2" x 8" x 7". Weight 63 lbs. Regularly \$212.00. OUR SPECIAL PRICE.....ea. **59.50** F.O.B. Chicago

MONEY MEN ALL DATA FREE

THE PLASTEX Industry needs manufacturers on small scale and for big production of Lamp and Clock Stands, Art Goods and Novelties in Plastex and Marble imitation. Experience unnecessary. Lge material makes regular 10c store sellers. Rubber moulds furnished for speed production. Small investment brings good returns. We are now placing big Chain Store Orders with manufacturers. Ambitious men have chance for real prosperity. Our Free booklet will interest and benefit you.

PLASTEX INDUSTRIES, Dept. A
3400 Third Ave. New York 56, N. Y.

10" TILT/ARBOR SAW BUILD-IT-YOURSELF from GIL-BILT KITS-PLANS

Sturdy wood, steel, and aluminum construction, NEW DEPARTURE ball bearings. Capacity and performance of floor saws selling for \$150.00 and up. Plans, all metal parts in kit with 10" comb. blade **\$25.90**, less blade **\$22.95**. F.O.B. St. Louis. Detail PLANS-PATTERNS only \$1.00 postpaid.

Build-it-yourself 12" and 18" Bandsaws, 6" Belt Sander, Shaper. Simplified plans, build easily with hand tools only. Advertised and sold for 8 years, over 30,000 units in use. Money back guarantee. FREE CATALOG.

GILLIOM POWER TOOLS, Dept. 80-F, Lambert Field, St. Louis 21, Mo.

"My 6 big reasons for buying this Fiberglas Boat-Covering Kit!"*



- It'll make my boat leak-proof and dry!
- I'll be saying 'so long' to scraping, sanding, caulking—and be first in the water every spring.
- My boat'll be stronger and more rigid—more resistant to hull damage!
- It'll get a longer lease on life!
- I get resin, activator, color pigment and Fiberglas fabric all together. No shopping around!
- I'll spend less time on maintenance, more time on the water.

Over 400,000 boat owners have improved their boats this way! How about you? For covering materials, see your local marine dealer. Or, for step-by-step instructions, write me for my free boat-covering booklet and a list of kit suppliers. Charlie M., Dept. 178-F, Essex, Conn.



OWENS-CORNING
FIBERGLAS

®T.M. (Reg. U.S. Pat. Off.) Owens-Corning Fiberglas Corporation

On the Trail of the Spray

(Continued from page 81)

And, after watching this canny craftsman at work on the boat of his dreams, you know instinctively that all will be right, before he ever sets sail for the open sea.

I came upon Bob first when he was shaping up the oak keel of his sailboat, on the dirt floor of the shed. A year before he had gone into the forest nearby, selected a fine white-oak tree, 20 inches or so at the butt and 30 feet in the clear, felled it, and drawn it with his horses to the shed to dry. Now he was starting work on it. There he stood, astride the huge log, adz hung loosely between his knees, slowly chipping the round sides down to a flat surface some seven inches wide by nine inches deep. It was the kind of picture you see in a museum. But here it was 1955, and here was a very real, live person, quietly nibbling his way through inches of tough oak to form a single piece which was just one of the vast hundreds that were yet to be fitted together, before his creation could be called a boat.

How Can One Man Do It?

How could a man, who had served some eight years in the Navy and merchant marine, where he had used all the latest mechanical equipment, have the courage to undertake a task of this size with only hand tools and no outside assistance? How could he not only work the tremendous oaken timbers into their required shape, but have the strength to handle them?

I found the answers to these and many other puzzling questions when I got to know the unusual Bob Carr. Here is a man who would rather have lived 100 years ago than today. Here is a man who knows and appreciates the craftsmanship that went into our boats and sailing ships of a century ago, when America's clipper ships were the fastest and finest vessels afloat. Here is someone for whom the age of steam destroyed the most fascinating era of sail that our country has ever known.

Bob Carr is a person who revels in using the God-given strength and brains that were passed out to him some 39 years ago. He loves to figure out difficult problems connected with the building of a boat, like how to bend the four by four-inch oak timbers into the sweet curves of the hull, or how to keep a piece of 10 by 10-inch wood from checking. It takes longer to do things by the brain and brawn method, he will admit, but it produces the greatest possible satisfaction.

His only concession to modern methods

(Continued to page 244)

ELECTRIC MOTORS & KITS FOR EDUCATION AND ENTERTAINMENT

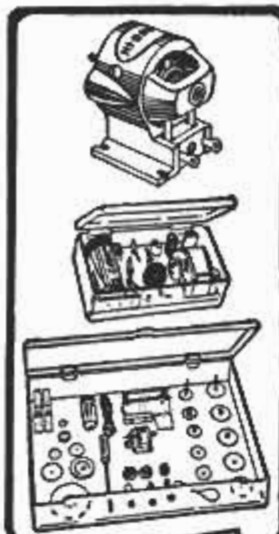

Wilson's battery-operated motors, motor kits and power application kits will keep any hobbyist busy developing new motor driven projects. A motor or kit for every purse and each is FULLY GUARANTEED. Order your selection today from list below.

- *No. 8-100 Hi Drive Motor, 3-6V \$2.50
- *No. 9-100 Same for 12V..... \$3.00
- No. 3-100 Tiny Atom Motor, 1½-3V \$2.00
- For higher voltages: \$2.50
- No. 96 Steel frame motor with gear, pinions, pulley, worm \$4.00
- *No. 3113N Tiny Atom motor assembly kit with many acc. \$3.50
- No. 1300 Small accessories kit \$1.00
- No. 3700 Large accessories kit \$3.00
- No. 4000 DeLuxe accessories kit with motor..... \$5.00
- *No. 700 Super-Power kit with motor, speed reducer, all accessories \$10.00
- No. 88 Kit of 8 pulleys—2 belts \$2.00
- No. 3000 Vari-speed gear unit \$4.00

*Item illustrated. Ask for FREE Cat. All Wilson's motors have Permanent Alnico Magnets.

Remit with order and we pay postage in U.S.A. No C.O.D. Add 3% Sales Tax for delivery in Ohio. Write Dept. PM.



For quick delivery see your local dealer — or order direct

WILSON'S OF CLEVELAND

425 Lakeside Ave., N.W. • Cleveland 13, Ohio

KAKEST MORTAR PLANE

"Amazing New Mason's Tool"

Makes it easy for amateurs to build masonry block walls. Lays smooth ribbon of mortar. Saves time and money. No waste of mortar. Send for FREE Folder.

KAKEST COMPANY Dept. PM
Carwensville, Penna.



\$13.95
Money Back Guarantee

NOW You Can DRILL, SAW, REAM, CUT ... ALL WITH ONE BIT!

Beaver's new improved Hi-Speed side cutting drill bit can be used on any electric drill, drill press, lathe, etc. Made from the finest American hi-speed steel. 3½" long, 2" side cutting section, ¼" diameter. Designed to cut steel, wood, plastic, aluminum, etc. MONEY back guaranteed. Specify types desired. All Purpose, Wood and Heavy Metal. BUY From Your Dealer or send check or money order today. Dealer inquiries invited.

BEAVER DRILL & TOOL CO., 30088 McGo Trafficway, Kansas City, Mo.



BEAVER
Hi-Speed-SAW
DRILL BITS

ONLY \$2.45 each 3 for \$7.00

Say You Saw It in Popular Mechanics

THE PAYSWELL ALL-PURPOSE

Sprayer
by
SELLCO

Compressor, Motor, Gun
... All in ONE Unit
Sprays At 50 Lbs. Pressure

- ★ paints
- ★ liquid plastics
- ★ lacquers
- ★ deodorants
- ★ liquid waxes
- ★ disinfectants
- ★ fireproofing
- ★ rust inhibitors
- ★ wood preservatives

For Further Information Write

SELLCO CORPORATION, 224 W. 7th, St. Paul, Minn.



\$49.95

Make \$20 to \$30 a Week

EXTRA MONEY



MACHINE SAW FILING PAYS UP to \$3 or \$5 an HOUR

• Turn your spare time into CASH—sharpening saws with a Foley Automatic Saw Filer pays up to \$3 or \$5 an hour. You will find you can make \$20 to \$30 a week in your spare time as a starter.

You can work in your basement or garage—no experience necessary. "The first saw I sharpened with my Foley Filer came out 100%"—writes Clarence E. Parsons. No canvassing—"I advertised in our local paper and got in 93 saws"—says M. L. Thompson. The Foley is the only machine with which you can file all hand saws, also band saws and cross-cut circular saws.

SEND FOR FREE BOOK "MONEY MAKING FACTS"

Shows how you can get business from home owners, farmers, carpenters, schools, factories, etc. With a small investment, no overhead, no stock of goods to carry, you can get right into a cash business,—and possibly later on develop into a full-time repair shop. Send coupon today for Free Book. No salesman will call.

"Each saw I filed got me 6 more and business has been picking up that way since a year ago. If it keeps up I will have to buy another Foley Saw Filer." William C. Baldwin

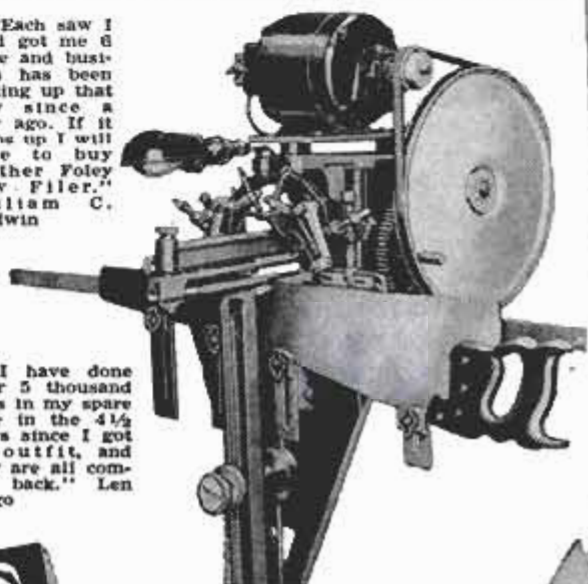

"I have done 4 or 5 thousand saws in my spare time in the 4½ years since I got the outfit, and they are all coming back." Len Crego

Send Coupon for **FREE BOOK**

FOLEY MFG. CO., 616-6 Foley Bldg. Minneapolis 18, Minnesota

Send **FREE BOOK**—"Money Making Facts"

Name _____

Address _____

He saves time and money!



He rides to work on a ...

HARLEY-DAVIDSON HUMMER

It's faster, more economical, more convenient, and more fun than driving a car or riding to work on a crowded bus!

With a Hummer, you, too, can breeze past time-wasting traffic jams... be pepped up for work or play, end parking worries.

Yes, ride America's most economical power transportation. Pay as little as \$17.00* per month... get up to 100 miles per gallon, savings of more than 75% on what the lowest priced car would cost you in terms of depreciation, and upkeep!

Why not get the facts now.

See your dealer and take a trial spin. Or, write us for free literature today.

*After minimum down payment. Includes fire, theft and collision insurance; local taxes (federal tax now off); freight and carrying charges.

HARLEY-DAVIDSON MOTOR CO.
DEPT. P, MILWAUKEE 1, WISCONSIN

was to let the sawmill rip out the planking, decking and some of the three-inch-thick oak for the boat. Everything else was cut and formed by him with his own hands. Occasionally, when he was handling some extra-heavy or bulky item, his mother would come out of the farmhouse nearby and help by holding the end of a line, or by taking up slack on a block and tackle. The rest of the time he has gone it alone.

Later I watched him working on the heavy white-oak stem piece, sided 7 inches and molded 10 inches, bringing it down to within $\frac{1}{8}$ inch of final size. It was perhaps the sturdiest stem I had ever seen in a 36-foot boat and to my eye it seemed heavier than necessary. I asked him about it. For his answer he referred me to an incident in the life of the original *Spray* which carried the identical size stem piece. "One day in the Keeling Islands," her master stated, "she got in too near shore and split a coral patch in two, without even a blemish to her oak stem." That was good enough for Bob Carr; he was making his craft just like the *Spray*.

Construction Is Conventional

Actually, the construction of *Sirius* follows conventional boat-building practice very closely. After completing the stem piece, keel and transom frame, they were set up, plumbed and fastened together with galvanized bolts. Deadwood, knees and floor timbers went in next, and the backbone of the ship was in place on the little shop floor. All the timbers were treated with rot preventive. Before bending his frames, it was necessary for Bob to build a set of 12 molds, or temporary forms, outlining the shape of the hull. These, mounted on the keel at three-foot intervals, gave the shape for the frames, which were of three by three-inch white oak, spaced one foot apart. As each was put in, it was nailed at the keel, and fastened with three bolts to the floor timbers, which in turn had been bolted to the keel. Red lead was applied generously to all fastenings. When all were in place, three longitudinal stringers of good two by six-inch Vermont white oak tied the whole vessel together longitudinally between keel and the three by four-inch sheer clamp, on the upper inside hull edges.

After the deck beams and bulwark frames had been let in, Bob started on the hull planking, cut from 20-foot lengths of $1\frac{1}{2}$ -inch-thick long-leaf yellow pine. The planks were cut from clear 14-inch-wide boards, the finished width averaging about five inches after they had been shaped to the necessary curve. Each was fastened with galvanized nails to the frames, bolted

(Continued to page 246)

8" TILT ARBOR POWER SAW

NOW ONLY

\$19⁹⁵



SOLD DIRECT FROM FACTORY-TO-YOU!

Save big money. Buy direct from manufacturer. Big 8" power saw mitres, dados, cuts compound angles, crosscuts, rips, bevels. All cast iron and steel construction. Will last a lifetime; shipping weight 30 pounds. Uses any standard 1/4 to 1/2 h.p. motor. Precision cast iron table. Blade tilts 0° to 50°. Single hand wheel controls depth 0" to 2-3/16".

WRITE FOR FREE BOOKLET

INCLUDED: Famous Simonds 8" combination blade — at no extra cost. Buy direct and save. Send check, M.O. or write for FREE BOOKLET.

AMERICAN MACHINE & TOOL CO.

ROYERSFORD 15, PA.

DITCH-WITCH TRENCHER



Portable DITCH-WITCH digs 4 1/2" or 6" clean, even ditches to 36" depth in all types of soil. Four rugged models. Complete unit — self-propelled. **OUTDIGS 8 MEN**
Write for Illustrated Literature

The CHARLES MACHINE WORKS
620 B Street Perry, Okla.

make your own *Gems* 29⁵⁰

The Gem Maker comes complete with all necessary equipment, including a super-charged diamond blade for sawing, and all wheels for grinding, shaping and polishing; also complete instructions. The complete equipment as shown, less motor and belt, for only \$29.50, f.o.b., Burlington, Wisconsin. Write today for information and literature.

B & I MANUFACTURING CO.
Dept. S Burlington, Wis.



ROAD TO RICHES

You can be the next uranium millionaire! Government guarantees huge bonus! PRI instruments from \$29.95. See your local dealer today! **FREE CATALOG!**

Write PRI, 4223 PM W. Jefferson
Los Angeles 16, California



NEW HULL AUTO COMPASS

INSTALLS, OPERATES WITH SPARKLING NEW PERFECTION

Hull—the last word in accurate, dependable auto compass performance—also offers the latest in mounting brackets, for easy, best installation in ANY car.

NEW HULL COMBINATION MOUNT

Works as **SCREW-DOWN STAND** along Lower Windshield Molding . . . **Hanging Bracket** along Upper Molding or Mirror Foot . . . **Vacuum Cup** anywhere on GLASS.



At Better Dealers Everywhere, or Write For Free Literature

HULL MFG. CO.

P. O. Box 246-D6, Warren, Ohio

FOUR-COLOR SELECTION

Beaconlite
illuminated \$6.50
Streamline
non-illuminated \$4.95

PAINT SMOOTHER, EASIER with *Brushes by Baker!*



Use Baker Brushes and paint easier, faster, better! Enjoy smoother painting, use fewer strokes, get more coverage. Next time you paint choose the right Baker Brush size most practical for the job.

learn to paint like an expert . . .



Free booklet tells "HOW TO DO A GOOD PAINT JOB." Today, send card to Baker Brush Co., Inc., 83 Grand Street, New York 13.



BRUSHES BY BAKER

AMERICA'S FINEST PAINTING TOOLS

Now! Cover plywood edges with real wood

New Flexible **Weldwood Wood-Trim**

Avoid unsightly edges in building any plywood project—tables, desks, cabinets, etc. Give them a "pro" finish with Weldwood Wood-Trim. So flexible you can beautify any edge—straight, curved, angled. In handy rolls, Wood-Trim is a cinch to apply. No clamps, nails, hot iron, etc. Just use Weldwood Contact Cement or Presto-Set® Glue.

Countless Decorating Uses!

Trim lamp shades with Wood-Trim! Decorate picture frames! Smarten coffee tables, clocks, waste baskets, etc. 8 ft. rolls 1" wide. Oak, African Mahogany, Walnut, Birch, Fir, Korina.

For perfect wood finishing jobs, use **FIRZITE** and **SATINLAC**.

Another
Weldwood
Wizard

At hardware, paint,
lumber dealers.
Write for free leaflet
to Dept. PM6-6WT.

*Trade Mark

UNITED STATES PLYWOOD CORP., Box 525, New York 46

**SUPERIOR
PERFORMANCE**



You can rely on Gerstner Chests to provide proper care for your precision tools. Free Catalog.

GERSTNER TOOL CHESTS
456 Columbia St., Dayton 7, Ohio



**MENDS
MOST ANYTHING**

"HOLDS LIKE IRON"

Used by fine furniture makers. Ideal for home and office. In ¼ oz. or 2½ oz. sizes.

at both ends, countersunk and the holes plugged. Bulwarks went in next, followed closely by the decking of 1½-inch oak and yellow pine. The transom was planked, the cabin built and the cargo hatch roughed in. Meanwhile all the spars had been formed from native spruce, each oversized in keeping with the heavy construction of the original *Spray*. The mainmast itself looked stout enough to stand if the shrouds should be carried away. And so month after month went by, each filled to the brim with careful, loving labor until now the *Sirius* has progressed to a point where she is almost ready for launching.

To have been able to fabricate a boat of this size in this workmanlike fashion speaks well for its builder. No finer ships than the *Sirius* are being built today.

Man of Many Skills

Carr is not only able to work in rough wood like the old-time craftsman, but his skills include those of an expert sailmaker, ironworker, rigger and cabinetmaker. With the same hands that swing the adz so adroitly, he has sewn two complete suits of sails for *Sirius* of number 6 and number 9 canvas, as well as a storm sail and sea anchor; and forged out the ironwork for her rigging on a small hand forge behind the barn, including the martingale, travelers, collars, wyes, chain plates, spreaders and stays. He has fabricated the beautiful steering wheel with its inlaid wood; made the pulley blocks, deadeyes, rudder, booms and masts. Each bears the imprint of the craftsman. With a lever, he moves great weights single handed. He knows how to steam-bend the stoutest oak to make it do his bidding; knows what makes one nail stay in a board, and another pull out. Instinctively he feels the proper balance in everything. He can tell you just how far the *Sirius* will heel under a strong breeze, before she brings up short, although he has never sailed in her. He knows the compass by heart; can navigate his own ship; shoot the sun and stars and plot his position anywhere in the world; knows what he is going to do if he gets into a hurricane; how to cook, and live on survival rations if he has to; reads a chart as you or I read a road map.

Perhaps, in days to come, Bob Carr, sitting at the helm of his ocean cruiser, may find himself on the selfsame course that Captain Slocum sailed with the *Spray* so many years ago. There will be one difference between the two, however. Bob is not taking along a supply of carpet tacks to spread on the deck at night, to keep inquisitive island natives from coming aboard while he sleeps.

★ ★ ★

**MORE \$ \$ \$ PER HOUR WITH
MODERN IMPROVED
LAWNMOWER SHARPENER**



Write for
free
booklet
10A

Compare
Before You Buy

Grinds All Reel
Type Mowers
Hollow Grinds or
Flat Grinds Bed Knives

Engine, oil, or gasoline
are not removed from
power mowers. Wheels,
handle and roller re-
main in place.
Modern's precision
grinding assures re-
peat business.
100% Steel Construction

Faster—Easier to
operate

NO CHANGE IN PRICE FOR OVER 10 YRS.

\$263.00 Complete with 1/2 H.P. Motor
f.o.b. Pasadena, Calif.

MODERN MFG. CO.

160 N. FAIR OAKS, PASADENA, CALIF.

NO MORE BOILING OVER

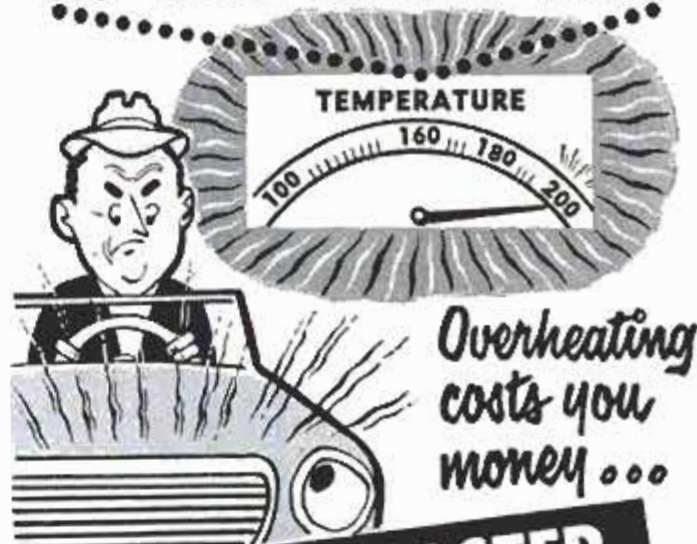

RUST MASTER
saves it for you!



NO FUSS—
NO MUSS—
JUST POUR—
NO MORE

Carb-Master
Sludg-Master
Parts Master
Leak Master

Rust Master
for Cooling Systems

- Removes Rust As You Ride
- No Overheating or Clogging
- No Draining or Flushing
- No Cores or Acids

Rust is the biggest cause of overheating. Stop costly repair bills by pouring Rustmaster into the cooling system of your car. RUSTMASTER uses an exclusive chemical action to break up rust and scale, and prevent further formation for a full year. Acid-free, non-inflammable, it's perfectly safe for new cars as well as old, even makes an excellent water pump lubricant. Next chance you have, pick some up. While you're at it, look into the Rustmaster line of master automotive products for complete engine protection:

Send for Free Descriptive Literature
Dept. PM-1 Specialties by:

PRODUCTS WORK WHILE YOU RIDE!

Rust Master
CHEMICAL CORP

MFG. CHEMISTS

50-56 CREIGHTON ST., CAMBRIDGE 40, MASS.

The silent partners of motor efficiency



Prospectors Supplies

Gold or Uranium seekers, rock hounds, mineralogists, vacationists—Send us \$1.00 for the book "URANIUM AGE" by Bill Hosokawa and receive a FREE copy of our 1956 catalog on counters, specimen kits, books, legal forms, etc.—a complete line of gold and uranium prospecting equipment. Send today!

PROSPECTORS SUPPLY COMPANY
Dept. D, 1407 17th St., Denver 2, Colorado

Exclusive Double-Bearing HEAVY-DUTY PUMPS

IRRIGATE • DRAIN • CIRCULATE • SPRAY
Up to 7,500 GPH, 3,000 GPH from 25' well. Use 1/4 to 1 HP motor. 1 1/4" inlet; 1" outlet. Stainless shaft. TYPE X—2 oilless bronze bearings. **\$10.95**
Won't rust.
TYPE XB—Ball bearing model. \$12.95
Postpaid if cash with order. Rush your order today

MONEY BACK GUARANTEE
Centrifugal and Gear Pumps in All Sizes
LABAWCO PUMPS, Belle Mead 2, N. J.



**CUT EXACT CIRCLES
CURVED PATTERNS**

"ARCO JIG-SAW"

with Circle-Cutter (up to 20" dia.) & Rip Gage fits any 1/4" drill. Has speed of 855 saws. Cuts 2x4's, plywood, metals, etc. Incl. blade. At your dealer or try it on our 10-day trial. Send check, M.O. (ppd.) C.O.D. + post.
ARROW METAL PRODUCTS CO., Dept. PM-6, 140 West Broadway, N.Y. 13, N.Y.



\$10.95

"DO IT YOURSELF"

IT'S EASY WITH

KESTER SOLDER



Soldering's really a "cinch" . . . when you use time-tested, reliable KESTER . . . available everywhere.

FREE! "Soldering Simplified" . . . 16-page how-to-solder booklet. At your dealer or write direct.

KESTER SOLDER COMPANY
4251 Wrightwood Avenue Chicago 39, Illinois

KLEINS



AID TO YOUR CRAFTSMANSHIP

These three pliers—a Klein Side Cutting Plier, Long Nose Plier and Oblique Cutting Plier—belong in every workman's kit.

They put the exclamation point after your good workmanship! For a century Klein has stood for the finest in pliers and Kleins are still the standard of comparison by which other pliers are judged.

There is a type and size of Klein Plier for every job—all famous for Klein quality "since 1857."



Your hardware store has Kleins in stock or can get them for you quickly. Look for this new display board. It shows the most popular items in the Klein line.

Mathias **KLEIN** & Sons
Established 1857 Chicago, Ill., U.S.A.
7200 McCORMICK ROAD • CHICAGO 45, ILLINOIS

Most Valuable Player ... the Catcher

(Continued from page 95)

At the instant you hear the ball bloop off the bat, reach up and remove your mask but *hang onto it*. Spot the ball in the air, then toss the mask in the opposite direction so you won't stumble over it. In going for any foul, *turn your back to the plate* and play the ball over your head, catching it at arm's length. In this way the ball will curve toward you. Never walk or run backward to catch a foul.

Another thing you'll soon sense is that right-hand batters always tend to foul an outside pitch to your right, an inside pitch to your left. Just the opposite applies to left-hand batters.

In the case of popups, run out in front of the plate but again play the ball over your head.

Yogi, Campanella and the rest emphasize one point: *Don't watch a high fly ball constantly!* If you do you'll start swaying and losing your balance.

Throwing to bases. If you can't keep the runners from advancing you'll soon be riding the bench. Let just one runner take an extra base, and that steal may also steal the game. Always be alert for the steal or the hit-and-run. In throwing to a base, take a short step forward with the left foot, skip once, then throw overhand from behind the ear and aim *inside* the bag and a foot or two off the ground. Ignore your infielders and throw for the bag. Any infielder worth his salt will arrive at the base in time to catch the ball.

Fielding bunts. I've seen many a fine defensive team get more upset over a booted bunt than a home run. The catcher must react in an eyewink. As he breaks from position his hand flicks up for his mask, but this time instead of holding it he knocks it off with a quick flip over his head. Berra, one of the finest bunt-fielders in the business, never tries to fancy-Dan a ball. He uses both hands on every bunt, stopping the ball with the mitt if necessary. If possible, try to field the ball with your body facing first base. From this position you can most easily throw to any base. But the main thing is to get your hands on the ball in a hurry.

Covering the plate. Here's where the catcher really takes a beating, and here's where every eye in the ball park is on him. The rules prevent you from blocking the base line unless you have possession of the ball. To catch a throw from the left-field side, stand just in front of the plate. To catch a peg from the right-field side, stand

(Continued to page 250)

a whole-house air conditioner only \$599

Complete two-ton
pre-wired unit.
Ductwork and
installation extra.
(Unit price higher in Canada)

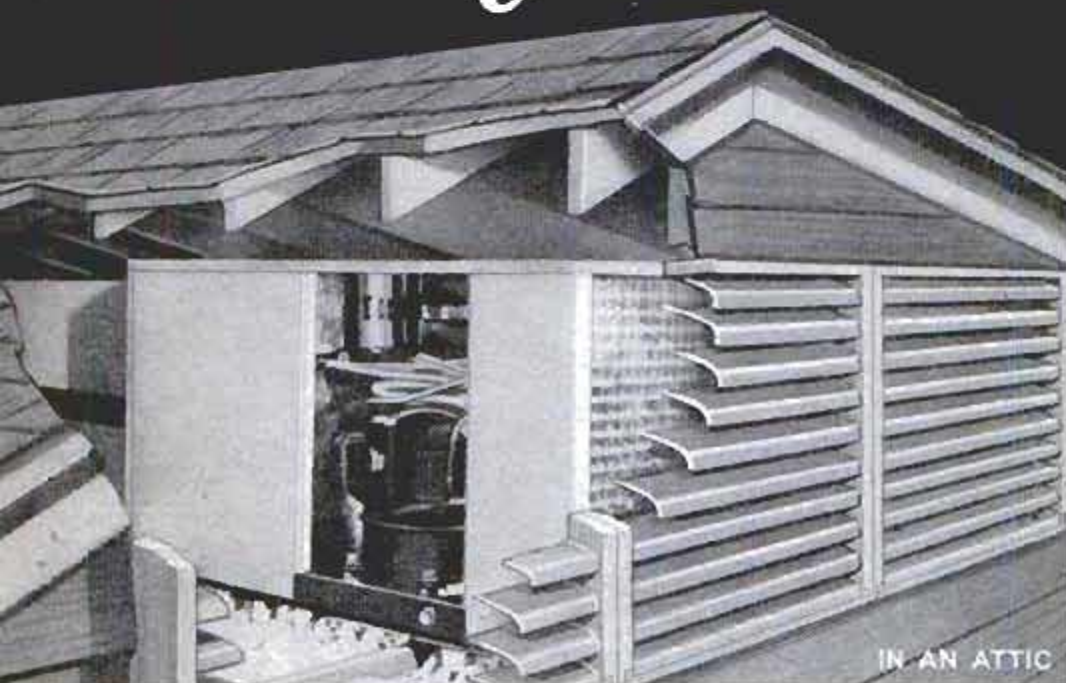

IN AN ATTIC

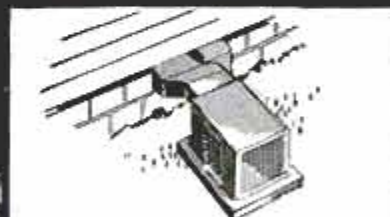

OUTSIDE OF CRAWL SPACE



ON A FLAT ROOF



IN A BASEMENT WALL

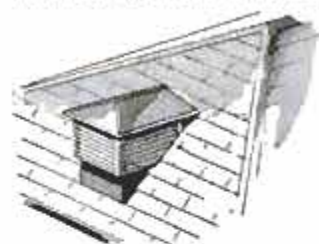

AS A HIP ROOF DORMER

No matter how your home is designed... no matter how you heat it, you can economically install the new Lennox Stowaway Air Conditioner

Lennox, leader in the development of home comfort systems since 1895, announces one of the great engineering achievements of our time—a high quality central air conditioner that costs just \$599. Unexcelled in operating economy, it actually consumes up to 40% less electric current than many other air-cooled air conditioners of the same capacity.

Any middle-income family can now enjoy and afford whole-house air conditioning with this new Lennox Stowaway unit. It requires no plumbing, no water tower, no expensive wiring; has two compressors for maximum comfort. Every style of home has a place for it—either inside or outside, upstairs or downstairs. For it's so compact that it can be neatly "stowed away" most anywhere—to cool and dehumidify the air throughout your entire home.

No matter how you heat your home, it's economical to install this amazingly quiet Lennox air conditioner. Existing ducts will do, if you heat with forced warm air. If you have hot water, steam or radiant heat, a space heater, wall heaters or floor furnace, the simplest ductwork is all you need.

Your Lennox dealer-expert will give you a free estimate on installing a Lennox Stowaway Air Conditioner, available in 2-ton, 3½-ton and 5-ton sizes.

**BUY NOW ON
EASY PAY PLAN!**

See your factory-trained Lennox dealer-expert, listed in the yellow pages of your phone directory under "Air Conditioning" or "Furnaces." He can bring you whole-house cooling today on liberal financing terms.

MORE FAMILIES BUY

LENNOX



THROUGH MORE THAN 5,600 HOME COMFORT SPECIALISTS

© 1956 Lennox Industries Inc.;
Marshalltown and Des Moines,
Ia.; Syracuse, N. Y.; Columbus,
O.; Ft. Worth, Tex.; Los Angeles,
Calif.; Salt Lake City, Utah;
Decatur, Ga. In Canada: Tor-
onto, Montreal, Calgary.

SO EASY TO USE...

SO POWERFUL..

SO DURABLE!

and



MODEL 900

Heavy duty. Out-sands, outlasts others. Exclusive "No Jumping" Multi-Motion sanding action. **\$39.95**

MODEL 504

Light. Powerful. Easiest for vertical use. America's greatest finish sander. **\$19.95**

SYNCRO SANDERS Feature the MODERN SYNCRO RECIPROCATING MOTOR

... today's greatest achievement of all electro-mechanical research! Powerful! Smooth! No cams, belts or gears. No rotating parts to wear out. No brushes to burn out. See sanders at stores. Write Syncro for Free catalog and sanding handbook.



MULTI-MOTION SYNCRO SANDERS

SYNCRO CORPORATION
DEPT. 1-A6
OXFORD, MICHIGAN, U.S.A.

WORLD'S LARGEST MANUFACTURER OF RECIPROCATING MOTORS

just outside the base line. As soon as you have possession of the ball, block the base line completely with your body far enough away from the plate to prevent a successful hook slide. Most catchers drop to one or both knees to guard the plate. If the throw is wide, about all you can do is dive for the runner. Main thing is to have the ball firmly in your hand, as the runner may come barreling in with the idea of kicking it loose. Some catchers hold the ball in the bare hand, others in the mitt. Don't forget that you needn't touch the runner with the ball—just with the hand or mitt which holds the ball.

The catcher, peering out from the "jail" of his mask, must be alert to every possible way he can help his team. If he can safely leave home plate he should back up first and third on throws to those bases. He must keep his eye on the manager for signals. He's the only player who faces his own teammates. When he makes a play he must recover instantly for the next one.

Catching today has evolved into a scientific art. Every movement of the catcher means something. The man behind the plate must combine the intelligence of a quarterback, the ruggedness of a goalie and the strategy of a coach. He's very likely the most valuable player on the team. Keep your eye on him the next time you see a ball game. You'll not only enjoy watching him, but you'll see a lot more baseball than you ever saw before. ★ ★ ★

Red Devil



PUTTY KNIVES WALL SCRAPERS SPACHTLING KNIVES

Top-quality professionally-styled at prices to suit your pocket-book. High carbon, tempered steel blades—imported hardwood or tenite handles.

FREE

How to Fix Broken Windows. Illustrated instructions on cutting and replacing window panes.

Red Devil Tools, Dept. 145

2400 Vauxhall Road, Union, N. J., U. S. A.

Please send FREE copy of "HOW TO FIX BROKEN WINDOWS."

NAME _____

ADDRESS _____

CITY _____ ZONE _____ STATE _____

1961

Slip-On Boot Cleats Anchor Fishermen

Fishermen wading on mossy rocks, slime and in fast water aren't as likely to slip with a pair of special cleats strapped to their boots. The metal alloy of the cleats clings to pores of wet rock. Special buttons dig and hold on moss and slime. Light in weight and with a flexible "hinge", the metal cleats are easy to wear, put on, take off, pack or carry.

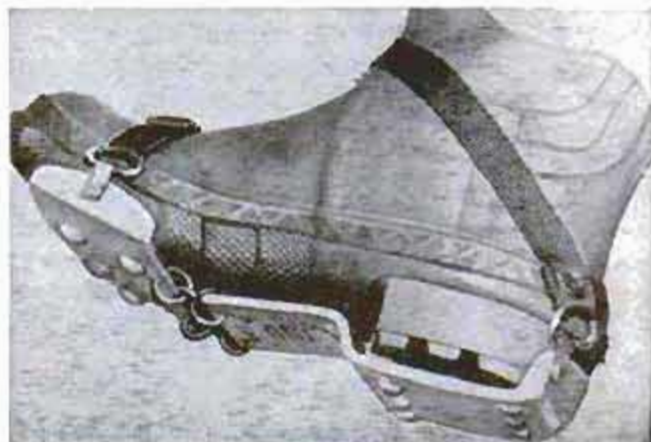

POPULAR MECHANICS

For your Ford... always specify the distributor points with the

TRIPLE LIFE!

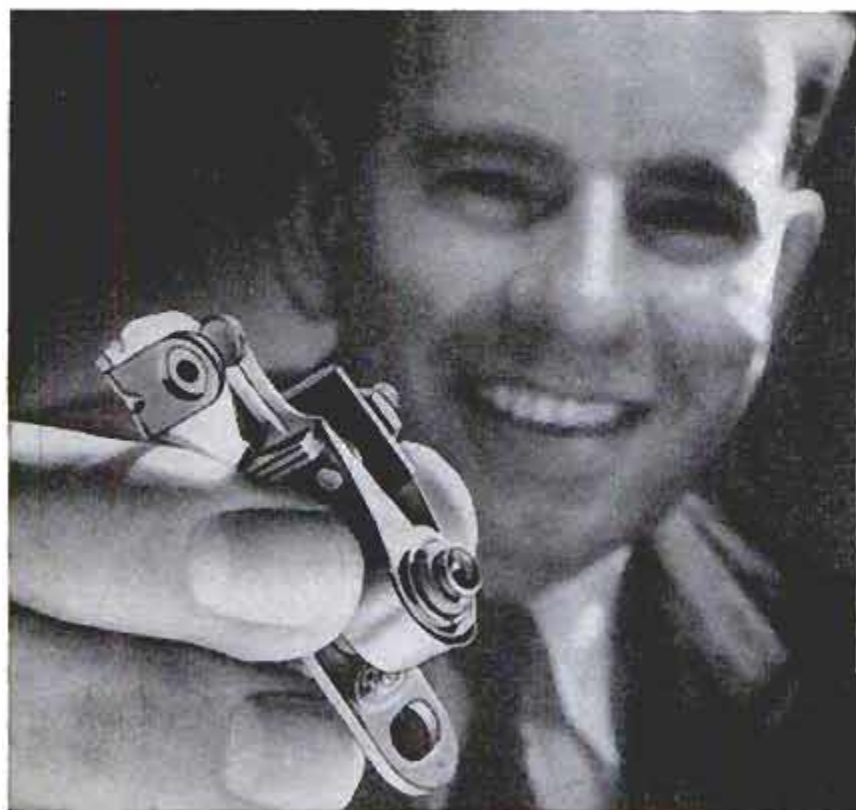

They're "ventilated"!

Contact surfaces of all Ford points have an exclusive hole-in-the-middle. This lets air surge past contact surfaces while they're operating, keeps deposits from forming, and gives points about *three* times the life!

"The unique surfaces of Genuine Ford Distributor Points are *self-cleaning*," says James Oldham, Ford's Chief Ignition Engineer. "This helps them last up to three times longer than ordinary points."

All Genuine Ford Parts are made right to last longer in your Ford!

Whenever *any* replacement will add to your Ford's performance, always make sure that you specify a Genuine Ford Part, the part that's made to Ford specifications.

For Genuine Ford Parts have to prove they can "take it" in exhaustive Ford track tests, before they're awarded the Genuine Ford label by Ford Engineering. Subjected to as much as fifty times the abuse they would normally get in actual service, you can be sure that they're made right to fit right to last *longer* in your Ford!



Keep your Ford all Ford

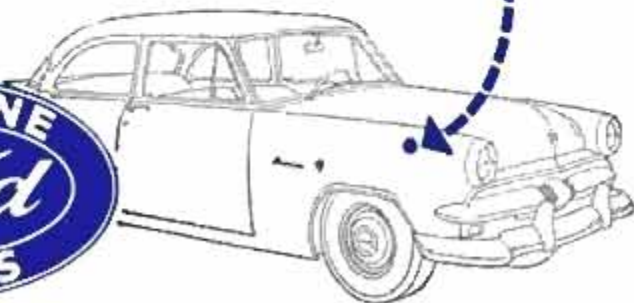

Amazing CAR POLISH Discovery! FAST as a car wash!



Now! MAC'S new Resin Coat. A long-lasting polish that's quick and easy to apply. Fast-acting Solvent Action does it...loosens surface film harmlessly while special resins produce a hard, high gloss that lasts up to 6 months. Just rub on, wipe off. Do a perfect job in minutes—not hours. Nothing like it.

"DON'T WAX IT—MAC'S-IT"
...with MAC'S RESIN COAT!

AT
YOUR
SERVICE
STATION

MAC'S SUPER GLOSS CO., INC.
Los Angeles 42, California

BE PRECISE

Say **STANLEY**

It's A Good Rule



Easy to use 8' tape rule—Model 1208W
\$1.19 at your hardware store.

Other Stanley Rules from 75¢ up, 6 ft. to 12 ft., and each in the reuseable plastic box with the magnifying lens. You'll use the rule — you'll use the box.

Write Stanley Tools, 6206 Elm St., New Britain, Conn., for free booklet on measuring tools and how to use them.

STANLEY

We Drove a Turbine Car Coast-to-Coast

(Continued from page 76)

until the engine is making 12,000 revolutions per minute. Then a relay switches the current flow and the constantly meshed starter converts itself into a generator to recharge the battery.

Now the spark shuts off. The flame is self-sustaining and the engine is running. It continues to rev up until it hits 20,000 revolutions per minute, its normal idling speed. It will now run continuously as long as fuel is pumped into the "firebox." We didn't stall the engine once on the trip. Flameouts apparently are no problem.

So far, this has taken about seven or eight seconds, roughly the same time it takes to get a piston engine running and in gear on a cold morning. Hot or cold weather makes no difference. It starts in sub-zero weather as quickly as in summer.

It is always in gear. There is no neutral, no clutch. The only shift is into reverse. We may add an "emergency low" later, but we have not needed one thus far. The engine is its own torque converter and no automatic transmission is necessary.

To drive away, you simply step on the accelerator, throwing more "coal" into the fire. A system of automatic controls keeps the engine from burning itself up. There are no limiting factors like mechanical valves to hold it back. It could run away with itself if the controls did not keep temperatures down to correct operating levels. Without these automatic controls, it would be a two-man job just to keep the engine running right. Each driver would have to have a "flight engineer" beside him watching the various dials.

In its present state of development, our gas turbine doesn't accelerate as fast from a stop as today's big V8 engines. But future engines can be as large as we want to get the desired characteristics. If you want to, you can spin the wheels by winding up the turbine against the brakes to about 35,000 revolutions per minute and then letting up the brake pedal.

The lack of friction in the engine presents another problem—the absence of engine braking. To provide an added margin of safety on the cross-country run, we put big 12-by-2½-inch brakes on the Plymouth. We will have licked any brake problems by the time the turbine engine is ready for production.

Top design speed of the experimental gas-turbine engine is 50,000 revolutions per minute (which would propel the car at about 85 miles per hour). We built the

(Continued to page 254)

Automatic Saw Set...

MAKE EXTRA PROFITS!



Set 400 teeth per minute on hand or band saws, 4 to 16 point, with the BeMaCo Automatic Saw Set. Fast, accurate, true hammer-anvil action sets teeth uniformly, eliminates tooth breakage. Used profitably by saw shops and manufacturers everywhere. Every machine positively guaranteed! Write for details—today!

Saw Machine Division 22-C

BEAVER MFG. CO.
800 ISIS AVENUE • INGLEWOOD, CALIF.

WELD **BRAZE**
SOLDER **CUT**



4WAY
ONLY \$14.75
f.o.b. factory

Acclaimed by thousands of Homeowners, Mechanics and Hobbyists as the welder of 1001 uses. Easily operated from properly wired 110 volt AC or DC line. The ideal gift with a life-long use... Order today on 10 day money back guarantee.

WELDER
Complete with Twin Carbon Arc Torch and accessories... to handle all metal-craft work.

FOUR-WAY WELDER CO., Dept. F2-F
1810 S. Federal St. • Chicago 16, Ill.

Also Eshelman TRACTORS. Riding ROTARY MOWERS. ROTARY TILLERS at amazing savings. Write for Free Literature

ESHELMAN GOLF CAR GASOLINE ENGINE

70 MILES PER GAL. GAS UP TO 20 MILES PER HR.

1/3 the cost of most other cars. Ideal for golfers, industrial plants, farms, etc. Also Child's 2 pass. Cars. Free Literature Write: ESHELMAN, Dept. MC-56, 109 Light St., Balto 2, Md. PATENTED

Shipping Points: BALTIMORE • CHICAGO • NEW YORK

NOW! It's EASY TO REMOVE STUMPS With "MAGIC" STUMP REMOVER

All you do is pour "Magic" Stump Remover—a new, quick-acting chemical compound—into hole drilled in center of stump. Wood fibres soon decompose all way to root tips, making removal easy... even for women and youngsters!

SPECIAL TRIAL OFFER: 8-oz. Can (enough for one stump)—\$1.50; 16-oz.—\$2.50; 3 lbs.—\$5.00. Send no money! Pay postman, plus postage. (Or send full amount with order for postpaid delivery.) Satisfaction Guaranteed or Money Refunded!

FREE! Generous sample of "GRO-GREEN," new liquid lawn fertilizer, with each Stump Remover order.

H. D. CAMPBELL CO. Rochelle 42, Ill.

No Digging! No Chopping! No Blasting!

EASY TO USE! Saves Time, Money!

WORN ENGINE BURNING OIL!

Reduces oil bills!
Restores compression!
Increases miles per gallon!

Forms self-lubricating seal at piston top. Inserted through spark plug holes. Used by millions of motorists. Tested and approved by motoring experts.

\$4.95 Tube for most cars

PISTON SEAL

Write for Full DETAILS

See Your Neighborhood Auto Accessory and Parts Replacement Store
TREGLOWN CO. INC., FANWOOD 82, N.J.
* TRADE MARK REGD. CANADA: 1366 GREENE AVE, MONTREAL 6 (PRICES HIGHER)

BLUEJET CHAIN

PRECISION-BUILT FOR PEAK PERFORMANCE



GUIDE LINK—Reamed rivet holes give precision fit, eliminate stretch and "chain slop" for less wear, longer service.

ROUTER—Precision ground, chrome plated high grade steel means longer life, less sharpening.

SIDE LINK—Shaped for proper sprocket fit, ample "riding" area reduces bar wear and gives smoother cutting.

RIVET—Large head plus hardened bearing surface helps maintain chain tightness, assures longer life.

See your authorized dealer or send coupon for information on BlueJet Chains

BLUEJET CHAIN CO. G46
2704 Fourth Avenue South, Seattle, Wash.

Name.....
Address.....
City.....

Say You Saw It in POPULAR MECHANICS

Holt's HAVE THE ANSWER!

REPAIR MUFFLER AND EXHAUST LEAKS in 10 min.

The plastic gas-tight seal sets hard, withstands heat and vibration. Prevents carbon monoxide gas poisoning.



\$1.69 per can

SETS LIKE A WELD—NO TOOLS NEEDED

Holt's GUN-GUM

MUFFLER SEAL

engine as a small, relatively low-power package. It will be easier to make it bigger and more powerful. Parts, like the turbine buckets, will be larger, easier to keep cool.

In the present engine, each of these buckets or blades is as small as your little fingernail. Yet each one is capable of producing about five horsepower. There are over 60 blades on the wheel, which is only about seven inches in diameter and could be slipped in your coat pocket easily. Initially, these wheels cost from \$1000 to \$1500 each. Our target cost for a 500-a-day production is \$10 a wheel.

I haven't yet mentioned the key feature of the Chrysler turbine—the feature that makes it economically feasible. This is the regenerator that transfers much of the exhaust heat to the air from the compressor, increasing efficiency tremendously.

By taking about 1000 degrees of heat from the exhaust gas and adding it to the air going into the combustion chamber, we are able to boost part-load fuel economy from something less than one mile per gallon (which it would be without a regenerator) to a figure comparable to that of a high-performance V8 with automatic transmission. At the same time, we lower exhaust temperature to under 500 degrees, which is lower than piston-engine exhaust.

A common sight at each stop on our trip was that of an unbelieving spectator holding his hand close to the exhaust outlet to prove that this "jet" doesn't shoot flame.

This exhaust is amazingly clean, too. It will create no automotive smog. There is no carbon monoxide in it and it has been hard to find unburned hydrocarbons.

Don't get the idea, though, that all our problems are solved. Many still remain.

There is need for advances in metallurgy. If we can make turbine blades that will take 3000 degrees of heat, the engine will be much more efficient. As it is now, we have to cool the gas down to about 1500 degrees to prevent the blades from burning up. Better metals or combinations of metal and ceramics will let us operate at higher temperatures. This will mean we have to pump less air for cooling, increasing engine efficiency. The goal, of course, is to take in only as much air as is needed for combustion (as does the piston engine today). Then the turbine will be far more efficient than the piston engine because of its greatly reduced friction.

In the past five years, Chrysler Research has built more than 50 automotive turbine engines. That is an insignificant total compared with the piston-engine production of even one hour. But it is enough for me to say that we are on the way—and the car of tomorrow can be turbine powered. ★ ★ ★



Dress up your car with bright, new Wizard Seat Covers . . . smart, modern design. Tough, woven Saran plastic panels with leather grain Vinalflex top cap, face trim. "Flex-Fit" Vinyl sides for guaranteed perfect fit. Smart new matrix pattern. Fully beaded. Red, blue, green. (116613) From \$20.95

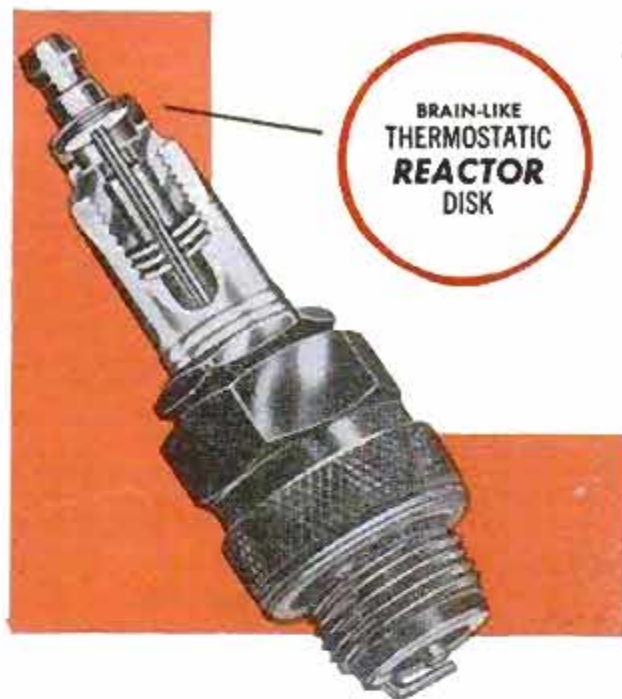

Automatic Spark Plug.

Aldor Spark Plugs have thermostatic control that automatically keeps spark gap at peak efficiency and performance. Adjusts to any heat range requirement. Ideal for modern high compression engines and premium higher octane fuels. Each, in sets (11280-8)\$1.05



Like a "tune-up"! For better engine performance the year around, add Casite to your motor oil with every oil change. Keeps engine clean. Gives you easier, faster starting... quiet, smooth power. Ideal for new cars. Pint, only (41329).....\$1.00



Portable Spotlight plugs in lighter socket... perfect for night car repairs, finding house numbers, etc. On-off switch in handle. Chrome. Powerful 4 1/2" sealed beam. 10-ft. cord. 6 volt (2L6116)\$5.85
12-volt (2LW6120)\$5.75



Car Top Carriers. Reddi-Rak all steel—completely assembled. Adjustable. Heavy webbing straps anchor to rain gutters... vacuum cups support and cushion any load.
Strong steel 45" (CS212) Pr. \$...
Hardwood 48" (CS229)Pr. \$...

"New-Condition" Your Car Now

Choose from over 4,000 guaranteed top quality parts and accessories at

Western Auto

Stores and Associate Stores



Non-slip, non-stretch, cool running! Top quality Wizard Fan Belts are guaranteed to fit. Inner core of endless rubber impregnated rayon cords. Tough rubber cushion assures efficient, peak performance. Carry a spare! (19106).....\$1.19



It cleans! It polishes! Johnson's Deep Gloss Carnu cleans as you put it on... shines to a beautiful long-lasting, mirror finish when you wipe it off! No hard rubbing. Restores deep down color. Won't harm finish. 20-oz. can (397109).....\$1.65



Wizard® "Twin-Fire" Spark Plugs... guaranteed 18,000 miles! Give top performance twice as long as single electrode plugs. (Alternate firing twin electrodes stay accurately gapped up to twice as long.) Sets of 4 or more, ea. (11070-95) 75c

NOTE: In some areas of the U. S., Hawaii, Alaska, and Mexico, prices slightly higher. Western Auto Associate Dealers own their stores, set their own prices, terms and conditions. (PM66)

... now with the **NEW**

Airguide OUTBOARD SPEEDOMETER

it's so easy
to know
how fast
you can go

The only complete portable speedometer—No tubes to connect—No holes to bore

- Designed especially for outboards. Mounted on transom near motor. Head, bracket, stabilizer and pitot all in one compact portable unit. Instantly attached and detached, easy to carry (only 1½ lbs).
- Exclusive Airguide CONTRALOG® movement permits nearly uniform graduations from top speeds down to zero for easier reading.
- Sturdily made of finest materials. Fits transoms from 12" to 20" high and up to 1¼" thick. Dial diam. 3". Choice of speed ranges 0-15, 0-30, 0-45 MPH. Other models available for permanent installation.

Made and guaranteed by
AIRGUIDE INSTRUMENT CO.
Chicago 47, Ill.

GET THEM AT YOUR DEALER'S

IT BETTER

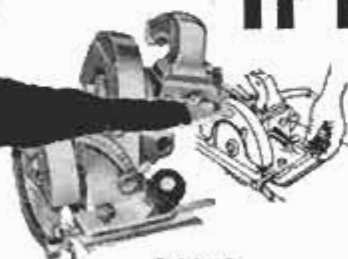

SAWS



FLAT SANDER

and MUCH FASTER



NEW
Handy to Hang or Haul
DRILL KIT



POLISHER

with SIOUX TOOLS

The Tools the Professionals Use!



WRITE FOR CATALOG



ALBERTSON & CO., INC., SIOUX CITY, IOWA, U.S.A.



Hot Seat for Sports Cars

Sports-car owners will welcome an electric heating pad that is said to keep the driver warm even in open-top cars in winter. The pad, actually a molded seat cushion, plugs into an outlet mounted on the floor directly behind or under the seat. It operates on 12 volts and is completely safe as the bare heating element could be held in the hand without injury. Using only 12 volts, there is no shock hazard. Two types are available, one a molded, bucket-type seat cushion for sports cars, the other for use on bench seats and in trucks, buses and other commercial vehicles.

Dynamometer Measures Tension

Proper tension of moving wire is maintained with a tensioning arm that mounts a dynamometer. The instrument gauges the tension on a center pulley through which the wire runs. The operator, by watching the dial, can immediately increase tension when the needle on the dial drops.

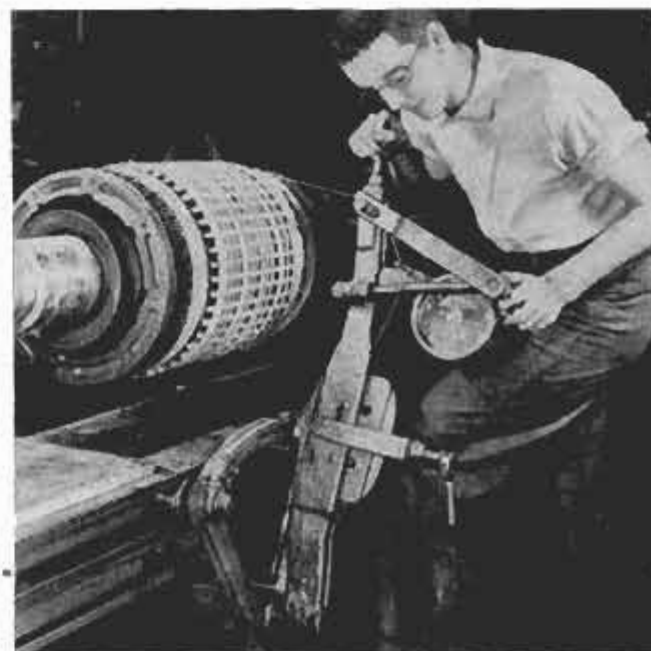

EXPERT WOOD FINISHING

made easy!

Now anyone can get a professional wood finish every time.

deft
WOOD FINISH



A clear semi-gloss interior wood finish that SEALS, PRIMES and FINISHES. Nothing else to use. *Deft dries in 30 minutes.* No thinning. A 3-coat bar top finish can be had in a few hours instead of days. Use on paneling, floors, cabinets, furniture, any interior wood surface.

See your dealer or write for free Deft booklet. D-M DESMOND'S 1826 W. 54th St., Los Angeles 62, Calif.

WHEREVER YOU DRIVE...

THIS IS A GOOD SIGN

**CARTER
CARBURETOR
SERVICE**

Wherever your automotive travels take you, you're never far from authorized Carter fuel system service. More than 25,000 Carter trained servicemen throughout the United States are authorized to display this sign. You can depend on them to give your car the same skillful, conscientious carburetor, fuel pump and fuel filter service you get from your Carter serviceman at home.

CARTER CARBURETOR
DIVISION OF **ACF** INDUSTRIES
INCORPORATED
ST. LOUIS 7, MISSOURI

DO MORE PLANING JOBS WITH LOW COST BELSAW

LOW DOWN PAYMENT EASY TERMS



Exclusive MONEY-MAKING Features: Full 12 3/4" x 6" capacity • Power feeds at 14' to 34' a minute • Provides for Grinding Knives in the Cutter-head • Attachments for Jointing, Rabbeting, Tongue, Matching, Groove. Convert low cost rough lumber into high priced stock. Easy to make flooring and popular patterns. Send Today for FREE Literature and Prices.

Belsaw Machinery Co., 2056 Field Bldg., K.C. 11, Mo.



YIPEE - A SAWHORSE IN A Jiffy

Jiffy Brackets and 2x4s are all you need. Set up and knocked down in a jiffy—no nails, screws, or bolts required. Easy to move or store. Sold by hardware and building supply stores everywhere, or order direct.

GRAND HAVEN STAMPED PRODUCTS CO., Grand Haven, Mich.

695



FREE WIN A TRACTOR FREE

WRITE FOR ENTRY BLANK NOTHING TO BUY

HEAVY OIL-PUMP BALL BEARINGS PUMPS MILLIONS OF GALS.

IRRIGATE, SPRAY, DRAIN OR FILL ANYTHING—ANYWHERE! Will not Rust—Clog—or Leak. Patented Seal. Pumps 2800 gph, 420 gph at 75' high or 1600 gph from 25' well. Six blade impeller. Threaded for pipe, 3/4" inlet, 1/2" outlet. Use 1/2 to 3/4 hp motor . . . 7500 gph 9.95 Heavier 2800 gph 8.95 Heavier 11.95

Check, MO or COD—Money Back Guarantee
FREE Literature—Comparison Charts
U. A. T. ENG. & MFG. CO. HICKSVILLE 273, NEW YORK

BUILD YOUR OWN WINDOW FAN

Save 1/2 or More
Enjoy Cool Comfort

ORDER TODAY—A factory-packed fan kit containing fan blade, self-contained bearing and shaft assembly, two pulleys, and belt, plus easy assembly instructions. You use your own 1/8 HP or larger motor and lumber for frame. Iowa Residents add 2 1/2% Sales Tax. If cash with order, we prepay shipment. If C.O.D., send 25% deposit.



Size	RPM	CFM	Price
20"	882	3990	\$12.90
24"	662	4890	\$14.90
30"	430	5880	\$17.90

Send for FREE complete Fan and Parts Catalog.

KLOPPENBORG FOUNDRY & FAN CO.

211 MARQUETTE STREET

DAVENPORT, IOWA

STOP SAGGING REARS!



with
LOW-COST

AIR LIFT PNEUMATIC SPRING BOOSTERS

Car got that "middle age spread" look? Even new cars need help for overloads of luggage, equipment or extra passengers. AIR LIFTS fit between leaf springs and frame — inflate with air to support overloads up to 1000 lbs! Perfect for vacation trips, and so easy to install. See your dealer or write for his name.

Most Models
\$20



FREE! . . . tip-packed literature on Air Lift remedies for sagging rears. Write Dept. 46.



AIR LIFT COMPANY,
LANSING, MICHIGAN

Make \$500 an Hour CASH PROFIT THE DAY YOU START!



START YOUR OWN BUSINESS AT HOME . . . SHARPEN HOUSEHOLD, GARDEN AND SHOP TOOLS IN SPARE TIME

Now you can turn spare time into Big Cash Profits with new Belsaw Sharp-All. Sharpen knives, scissors, shears, snips, ice skates, mower blades, hedge trimmers, grass whips, axes, chisels, screw drivers, scrapers and saws . . . just about any household, garden and shop tool. Your own CASH business with no inventory. No calls to make. No experience needed.

Learn how easily you can start your own spare time business. Amazing low cost easy-payment plan. Send postcard for FREE BOOK.

BELSAW SHARP-ALL CO

716 Field Bldg. Kansas City 11, Missouri

FREE BOOK

Airport Lights That Blind Birds To Be Tamed by Filters

Birds flying south on migratory flights may soon be guarded from a modern hazard—the ceilometer, an airport unit which casts a bright vertical beam of light into the air. As many as 25,000 birds have perished in one night at a single airfield as they flew into the beam. Apparently the beam blinds the birds or blunts their sense of direction, causing them to crash into the ground. Filters for the lights have been developed which screen out visible light and allow only ultraviolet light to escape. Two such filters have been tested, with good results. The Air Force is considering their use.

Rake-Hoe-Weeder

You can rake, weed or hoe with a garden tool that adjusts to three positions. The flexible steel prongs attached to the base of the aluminum handle are extended in a fan position for raking. To convert the tool into a hoe, a push button on the handle is pressed to draw the prongs together to form a solid sheet of metal, including the ends which bend hoe-fashion into the ground. In the weeding position, the prongs are not brought entirely together, leaving numerous spaces in which the stems and roots of weeds can be caught and pulled up.



NEW! **RECLAIMO**
 ELECTRICALLY HEATED **Oil RE-REFINING Filter**
 A Wm. Schwalge Product

Super-Efficient Filtration
 for TODAY'S Car-Truck-Tractor Engines
INCOMPARABLE PERFORMANCE!! RECLAIMO—
REMOVES Solids—PREVENTS Excess Water
Accumulation, Acid and Sludge Formation
—CHECKS Fuel Dilution—MAINTAINS Stable Viscosity! Keeps
 engines "young and frisky" with crankcase oil in peak lubricating
 quality at all times. **FULLY GUARANTEED.**

ENDS NEEDLESS OIL CHANGING!
NEW FEATURES: Electric Heat from generator, thermostat controlled—Dual Flow by-pass—Steel non-corrosive body—Hinged mounting bracket—Easy to install or transfer to other equipment.

JUDGE FOR YOURSELF! Each Reclaimo is sold with
 an unconditional 6 months* no-risk return privilege.

Write for folder with full details. **Wm. Schwalge,**
RECLAIMO MFG. CO., Dept. M-66, Author, Inventor,
6251 TOWNY AVE., CHICAGO 30, ILL. Pioneer in
 oil reclaiming
 since 1910.

Manifold-heated Reclaimos NOW OBSOLETE, accepted (new or used) for trade-in.

FREE New FAN—Shutter—Motor—Catalogue

Packed with the Largest Selection of Fan equipment
BUY FROM MFR. and SAVE MONEY
FANTEX AND TORRINGTON BLADE KITS

Attic Fans • Exhaust Fans • Pedestal Fans • Window Fans
 • Shutters • Motors • Tub Enclosures • Sewing Machines
 • Awnings • Home and Industry Supplies

VISIT US OR SEND FOR FREE COPY TODAY
 Attic or Window Fan Kit. Includes Steel Blade—2 Pulleys—2 Bearings—2 Collars—Shaft—Instructions—Easy assembly. Enclose Postage with order. (Wt. 7 lbs.) **\$7.95** REG. **\$15.90** PR.
DEALERS INVITED **SALE PRICE**

16" ALBIN MACHINE Dept. M, N.Y. 423 Broome St., N.Y. 13
 DETROIT, 14030 W. 6 MI. Mich. 35
 LOUISVILLE, 710 W. Market, KY.

New Black & Decker 6½" H.-D. Saw!
 Extra Capacity • Extra Safety • Extra Power
 Extra Convenience • Extra Adjustment Features!
 See your B&D dealer for demonstration. The
 Black & Decker Mfg. Co., Dept. M-66, Towson 4, Md.

ELECTRIC SELF STARTER
 for small aircooled engines up to 12 horsepower.—All kits designed
 for easy installation on lawn-mowers, garden-tractors, etc.
 Write for details regarding Dealerships and Distributorships
CHIEF INDUSTRIES, Dept. P.M., Dowagiac, Michigan

Get New 128 Page Catalog of
WOOD AND WOODWORKING
MATERIALS

WORLD'S LARGEST SELECTION—Lowest Prices
 Your buying guide for finest kiln dried domestic and
 rare imported woods, inlays, bendings, matched ply-
 wood, mouldings, ornaments, etc. Biggest selection
 of tools and hard-to-find hardware. Packed with scroll
 saw patterns, projects, wood facts and money mak-
 ing ideas. Enclose 25c (refunded on first order) to
 help pay mailing and handling costs. Write today to
CRAFTSMAN WOOD SERVICE CO.
 2729 S. Mary St., Dept. A-6, Chicago 8, Ill.

HANDY TIPS
YOU CAN USE!

1 Use AMERICAN Dripless Oil
 for best lubrication and rustproofing
 of guns, fine mechanisms and
 appliances. Runs in—won't run
 out. 29c.

2 Use DOOR-EASE Stainless Stick Lubricant
 for things that stick or squeak—doors,
 drawers, windows, zippers. Apply like a
 crayon! 15c and 39c sizes.

3 Use LOCK-EASE Graphited Lock Fluid
 to give car and other locks best year-round
 protection against freezing, sticking and
 rust. 39c.

SPECIAL OFFER!
 send \$1.00 for complete set of all
 large sizes to Dept. M-6
AGS COMPANY, Muskegon, Michigan

AGS
 PRODUCTS

"My Williams locking adjust-
 able is the most used wrench
 of the shop and at home.
 No other wrench offers
 so many features or is
 so easy to use."

NEW PATENTED LOCKING FEATURE
AT NO EXTRA COST

PUSH DOWN TO UNLOCK
PUSH UP TO LOCK

6"
 8"
 10"
 12"
 sizes

at most leading hardware stores

WILLIAMS
LOCKING ADJUSTABLE WRENCH

- No obstruction
- Structurally sound
- Positive lock
- Increased safety
- Drop-forged from selected alloy steel and heat-treated
- Rapid adjustment
- One hand operation
- No fumbling
- Chrome plated finish

THE HANDIEST WRENCH YOU'LL EVER OWN

J. H. WILLIAMS & CO., 417 Vulcan St., Buffalo, N. Y.

RIDE and MOW
 with the

SHAW DU-ALL

Model RM 24 (24" cut)
 or
 Model RM 32 (32" cut)

Biggest little mower on the market!

LOW PRICE, too. Great for estates, farm and suburban homes, parks, cemeteries, etc. Trims smartest lawn; or tallest grass, turning radius only 45 inches. Sturdy 2½ to 3 H.P. air-cooled engine. 110 volt starting motor plugs into house current (optional). RM 32 is 6 H.P.

WRITE TODAY for free folder, prices, and full details. Also walking and riding tractors, 1½ to 12 H.P.

SHAW MFG. CO. 4506 Front St., Galesburg, Kansas
 668-G6 N. 4th St., Columbus, Ohio

*Smoother casting
longer lasting
casting-spinning-squidding lines*



... Preferred
at Famous Fishing Spots

Two great names in lines... **M-I**—**FLOAT**, the famous hollow center, non-sinkable fly line... and **SKIRR**, America's No. 1 fresh or salt water line for spinning, bait casting, surf casting and squidding.

M-I unconditionally guarantees these lines to be the finest on the market today, regardless of price! Prove it for yourself, at your dealer's.

Look for 
on the tackle you buy
Rods, Reels, Lines, Lures,
for every fisherman and
every kind of fishing



Valuable Fishing Guide. Send 25¢ to
HORROCKS-IBBOTSON CO. Dept. PM-616 **UTICA, N. Y.**
Manufacturer of the largest line of fishing tackle in the world

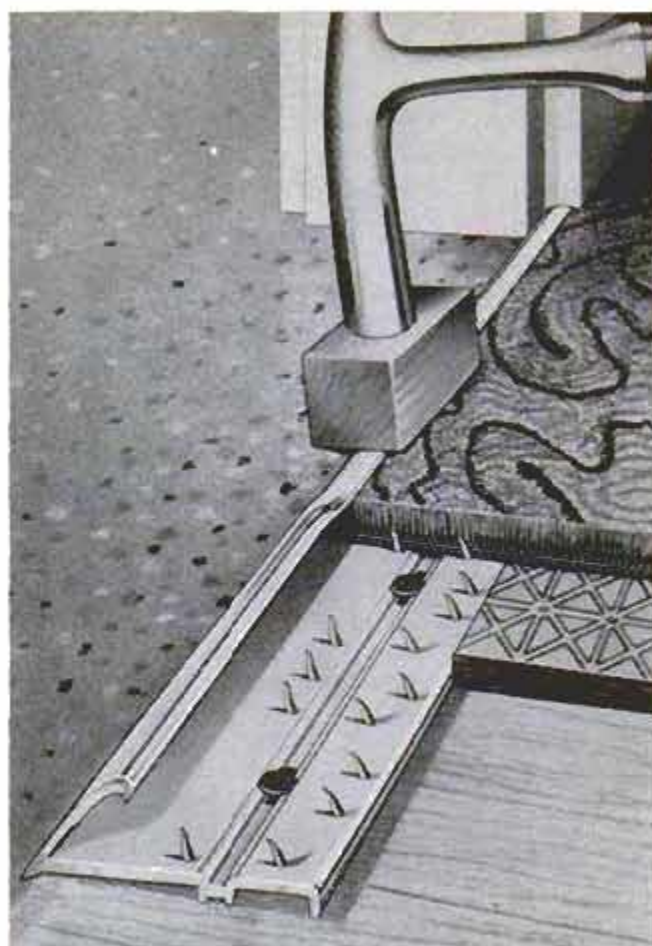

Tackless Carpet Binder

Carpet edges that do not butt against a wall can now be bound with a one-piece aluminum anchor and edge binder that requires no tacks. The edge of the carpeting is gripped by a series of sharp barbs, and a protective tap-down segment along one edge eliminates the need for stitched or "latexed" carpet edges. Slots are provided for nails that secure the anchor strip to the floor. Carpet padding is cut flush with the inner edge of the anchor strip.

Sonic Boom Outlawed in Sweden

Sonic booms have been outlawed in Sweden, as the Swedish air force issued regulations that its planes must not pierce the sonic barrier—with the resulting boom—at altitudes of less than six miles over land. The sound barrier was first cracked in Sweden in 1953 by an A-32 "Lance" jet. This fighter-bomber, now being delivered to the Swedish air force in quantity, is a two-seater with a top speed of 700 miles per hour. It's an all-weather plane capable of carrying a heavy load of rockets, bombs, guided missiles and tactical atom bombs.

Ⓜ A Japanese newspaper recently published a color photograph that was transmitted by radio from California.

INTRODUCING A NEW IDEA!!

FLUSH SLIDING DOOR HARDWARE



Now you can quickly — easily install sliding doors in your cabinets and have the doors perfectly **FLUSH** with the surface. (Ideal for built-in cabinets). No hardware will be visible and your cabinets will take on an entirely new, clean appearance.

With **MULRAY D-34 FLUSH SLIDING DOOR HARDWARE**, the doors slide on the tracks and are **FLUSH** when closed, (Fig. 1). When opening either door, the tracks automatically switch, (Fig. 2); and one door slides behind the other, (Fig. 3).

D-34 Hardware consists of 2 pr. assembled track-switch units for top and bottom of cabinet opening and instructions. (D-34 Hardware is designed for doors up to 3/4" thick and cabinet openings to 4' H. x 6' W. Tracks may be cut down to fit opening exactly).

30" inside cabinet opening—\$4.50; 36"—\$4.85; 42"—\$5.20; 48"—\$5.55; 54"—\$5.90; 60"—\$6.25

If D-34 Hardware is not available at your local Hardware Store, order direct. Send a check or M. O.

MULRAY PRODUCTS, INC.
68 FIRST STREET, NEW ROCHELLE, NEW YORK

The POWER TO STOP can save your life!

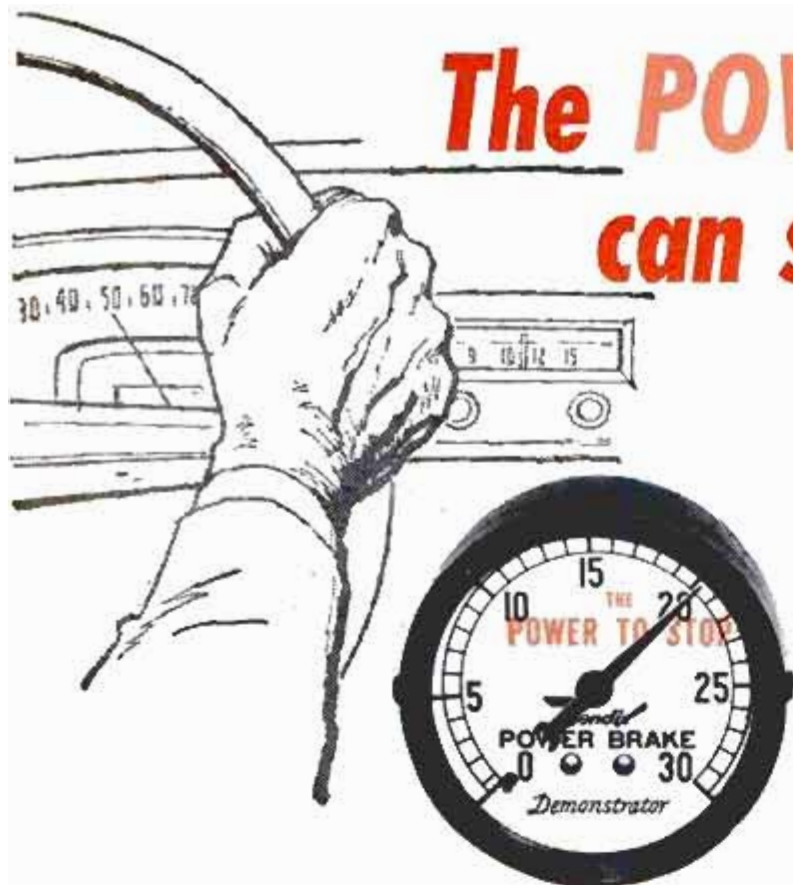

Once you've tried Bendix* Power Brakes—and marveled at the difference they make in stopping ease—you'll demand them for your present car, whatever its make. Ask for a test ride today. Car dealers, better garages, service stations and brake shops across the country have cars equipped with Bendix Power Brake Demonstrator Units. When you've seen the difference, *felt* the difference, you'll know they're the finest automotive buy on the market. And get this: Average price—about \$60 (including installation)!

*REG. U.S. PAT. OFF.

Bendix POWER BRAKES

Bendix Products Division, Bendix Aviation Corp., South Bend, Ind.



Holder for Eyeglasses

Athletes, anglers and other active people keep their glasses safely anchored with an elastic strap that goes around the back of the head. Short lengths of rubber tubing grip the stem ends of the glasses. The adjustable strap unsnaps to permit easy re-

moval. The strap was invented by a Joliet, Ill., dentist who now produces up to 50,000 per year in the basement of his home.

Backward-Facing Tractor

When engineers of a farm-implement company decided to build a fork-lift tractor, they simply modified the design of a field tractor and made the front the rear. The driver sits atop the hood and controls the fork lift mounted where the drawbar was. The tractor's high clearance and large wheels allow it to operate in mud, snow and on rough surfaces. Counterweights prevent tip-over and permit it to hoist 4000 pounds.



END TRANSMISSION FAILURES



CAUSED BY LUBRICANT LOSS

HERE'S GREAT NEWS FOR CHEVROLET AND FORD OWNERS! HERE, AT LAST, IS A WAY TO END LEAKY TRANSMISSIONS! The Davis Ball Boot seals both ends of the transmission coupling on Chevrolets; 1937 through 1954 . . . keeps dirt out, oil in, saves expensive metal parts.

For '55 and '56 Chevrolets, and Fords from '49 to '55, the Davis Ball Boot protects the factory seals against the intrusion of road grit . . . prevents failure of seals and bushings that result in lubricant loss.

Don't risk a burnt-out transmission. Don't put up with "temporary" repairs. ORDER A DAVIS BALL BOOT TODAY and END this trouble! Fits standard and automatic transmissions . . . easy to install . . . lasts for the life of your car . . . unconditionally guaranteed! (Pat. No. 2,702,996).

DAVIS BALL BOOT CO., INC., 2301 Yale St., Houston, Tex. Rush postpaid the following Davis Ball Boot:

- For 1937-1954 Chevrolet @ \$4.85 each.
- For 1955-1956 Chevrolet @ \$1.45 each.
- For 1949-1956 Ford @ \$1.45 each.
- Check Money Order Enclosed Send Literature

NAME _____

ADDRESS _____

CITY _____

STATE _____

DAVIS BALL BOOT CO., INC.
2301 YALE STREET, HOUSTON 8, TEXAS

RETAIL PRICE \$125.00
FACTORY TO YOU \$79.95

SUPERSHOP includes precision-built 8" tilting table saw, vertical and horizontal drill press, 30" lathe, sander, grinder. 100% BALL BEARING. Write for FREE catalog, full details, trial plan. Easy Pay Plan.

POWER TOOLS, INC.

184 YATES AVENUE
BELOIT, WIS.



Grips the screw!

Drives it too!

Quick-Wedge
SCREW-HOLDING
SCREWDRIVER

2" to 14" blades, 4 bit sizes
Available with shockproof
plastic covered tubing
Unconditionally guaranteed

ASK FOR IT AT YOUR DEALER

Kedman Co., 233 So. 5th W., Salt Lake City

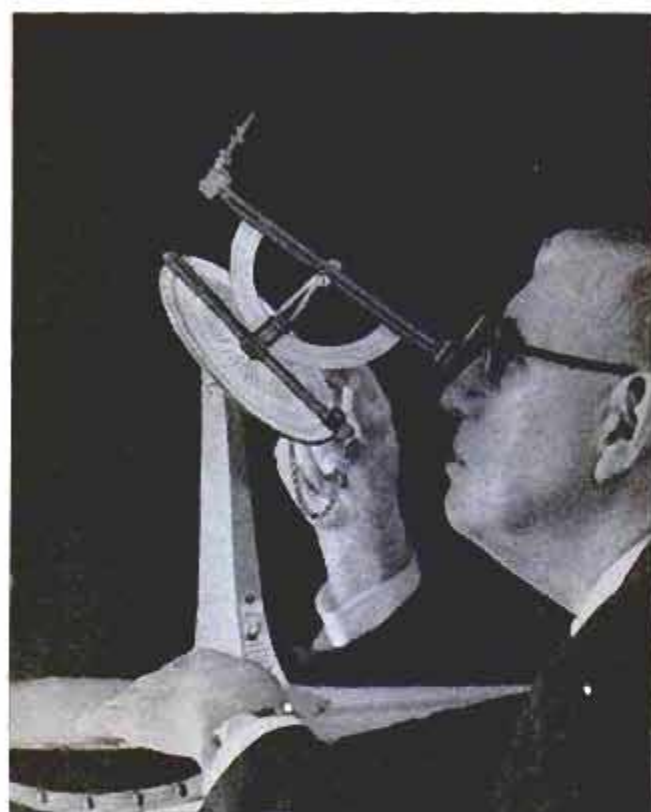

Finder Points Out Stars

Amateur astronomers with little knowledge of mathematics can find particular stars with a new instrument which does the calculations automatically. Though the astronomer doesn't do the figuring himself, the instrument makes the mathematical process clear to him as it is set to point accurately at any planet, star or cluster. The base of the instrument is installed permanently in the lawn, but the calculator and pointer can be detached and taken inside for protection. Designed for beginners, the instrument also can be used as a finder for a portable telescope.

Deaf Persons May Work With Noisy Jets

Totally deaf persons are being tested at Pensacola, Fla., to determine what effect noise may have on those who can't actually hear it, with the idea that the Navy may employ such persons to work around jet planes. The average person finds noise levels above 140 decibels intolerable. Most jets now in use create sound levels around 130 decibels, and others in the production stages will have engines producing up to 160 or 170 decibels—greater than humans can stand. The tests are designed to learn whether these sounds will produce injurious effects even if they are not heard.

Fluorescent lamps capable of flashing on and off like incandescent bulbs will soon appear in advertising display signs.

**FINISH CONCRETE OR MASONRY WALLS
WITH WALLBOARD OR WOOD PANELS—
Do It Yourself
this easy,
low-cost way!**

Just attach *Gemco Anchor Nails* (16" apart) to walls with waterproof *Tuff-Bond Adhesive*. These will hold furring strips securely in place. Then nail wallboard or wood panels to furring strips... and the job is done. It's that simple! All you need is the *Gemco Anchor Nail Kit*... at better dealers everywhere. If your dealer cannot supply you, write...

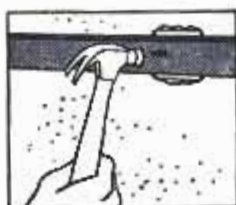
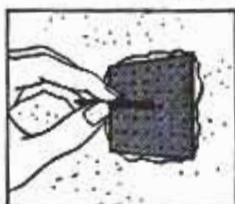

Goodloe E. Moore, Incorporated, Danville 2, Ill.

There's a **Katolight**

ELECTRIC PLANT

for every portable or standby power need.



HOME • FARM • COTTAGE
• COMMERCIAL

Katolight Portable Power Plants give you electric power anywhere... anytime. Standby Plants permit uninterrupted operation of all electrical equipment despite power failure. Extra high overload capacity, long life, dependability. Full line from 350 Watts to 75 KW and larger.

WRITE FOR
NEW FOLDER

KATOLIGHT CORPORATION, Box 891-22 Mankato, Minn.

Find HIDDEN TREASURES

GOLD, SILVER, PRECIOUS METALS with the Famous Model 27 Metal Detector. Lightweight, ultra-sensitive, low cost. None finer. Also GEIGER COUNTERS for uranium and the VIOLITE for tungsten. INFORMATION FREE

THE *Detectron* CORP.
5528 Vineland Ave., No. Hollywood, Calif.



Say You Saw It in Popular Mechanics

KEEP ALL SAWS SHARP

SUPER SAW FILER NO. 6

IT'S NEW! with Automatic DEPTH CONTROL ROLLERS

Automatically controls DEPTH—ANGLE—PITCH

Perfect bevel and angle maintained, and fool-proof depth control for all Rip, Cross-cut, and Handsaws. Precision made and calibrated for instant setting at desired angle. Can be used in any vise or clamp. Complete with file, only... \$6.50 ppd.

SAVE TIME AND \$\$\$

JOINT & SHARPEN CIRCULAR SAWS

Sensational new Super Filer No. 11 joints and sharpens both hand and circular saws 6" to 10" with all teeth the correct height, depth, pitch and bevel. Easy to use—when file hits hardened steel roller, teeth are finished. Saw runs true and smooth with no side pull. Complete with special 8" file \$9.95 ppd. "TRU-CIRCLE" saw set automatically sets teeth at 10° or more \$2.95.

SEND FOR
FREE CATALOG

Guaranteed
A. D. McBURNEY, 5908 Hollywood Blvd., Hollywood 28, Cal., Dept. A-66



Now! a full size economical

TURNER

Util-i-torch

that has hundreds of uses!

only

\$**4.99**

* propane gas



- easy to operate
- lights instantly
- down to - 30° below zero
- no pumping
- no priming
- simple to use

Now you can do hundreds of jobs quickly and easily with the TURNER "Util-i-Torch." It's light weight, compact, long burning and extremely versatile. See, try and buy this big value at your neighborhood hardware store today.



disposable cylinder

And on all the other jobs for which you've wished you owned a blow torch.

THE TURNER BRASS WORKS

SYCAMORE, ILLINOIS



NEED CONCRETE...USE SAKRETE

• It's Easy To Fix With a SAKRETE MIX. Do it in '56!

Patch It - Build It - Repair It



JUST
ADD
WATER

• For the SAKRETE 48-page booklet with photos, diagrams and instructions for "Do it yourself" cement jobs, see your building supply dealer, lumber dealer or hardware store or send 25 cents to —

SAKRETE, Inc.
P. O. Box 11, Dept. A
Cincinnati 17, Ohio

Gravel Mix —
Sand Mix —
Mortar Mix —



SAKRETE

SUPREME Versamatic REVERSIBLE SCREW DRIVER AND SPEED REDUCER



fits all
power
drills

First time ever! It REVERSES!



Drive and remove screws with Supreme Versamatic. Versamatic reduces speed 7 to 1, increases power 7-fold. Reverses with one twist. Handles even the largest screws with ease. Also for nut running (adapter furnished); tapping; and all heavy duty drilling where speed reduction is needed. Fingertip control means safe, fast work. Complete set \$14.95.

(1/2" chuck extra). At better hardware stores.

SUPREME PRODUCTS, Inc., 2222 S. Calumet, Chicago 16



Mobile Scaffold

Carpenters can drive a new mobile scaffold right up to the job. A truck and a trailer unit are manufactured. The trailer unit, unlike the truck-mounted unit, has its own chassis and can be collapsed for transport. The work platform of the units travels up and down on steel beams. Cables suspend it from pulleys at the top of the beams, and a winch driven by an electric motor regulates the cables. A generator powers the electric motor on the truck scaffold, which also mounts a bed for holding lumber. A switch mounted on a long extension cord permits control of the units from ground or scaffold. Heights up to 40 feet can be reached with the scaffolds.

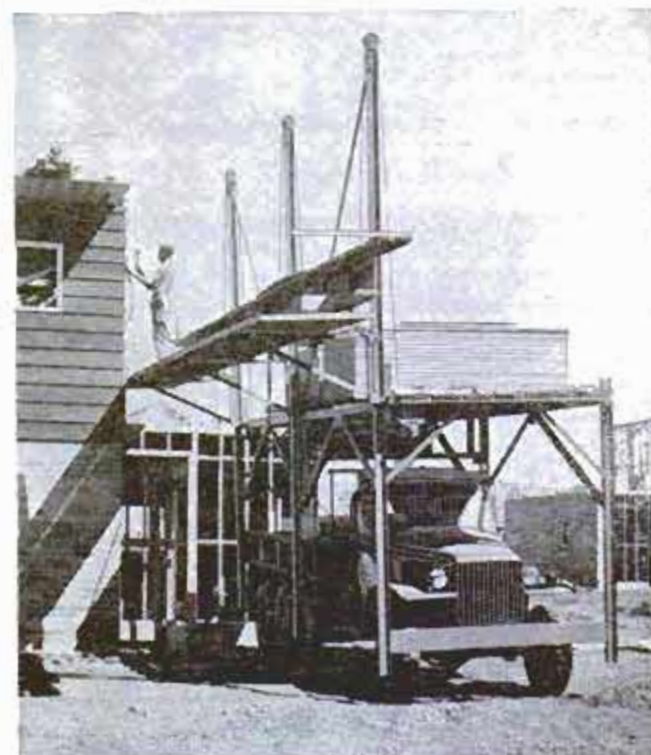

GIGANTIC
SAVE-TO-70%

MAIL SALE

WAR SURPLUS
EXCESS INVENTORY
BANKRUPT STOCK

WEED SPRAY OUTFIT

Leading make. Latest design. 5-row (17) F.T.O. tractor drive finest pump. T-jet nozzles, precision controls, gauges, hose. Complete. List \$175.00. Postpaid in U.S.A. **\$97.65**
FREE big weed spray catalog.



EXTRA SPECIAL OFFERING! GIANT ARMY BOX KITE

Order Now — only 100 Available!

Approx. size
14'x10'x3'

During war these huge kites were towed behind ships on long cables to entangle enemy aircraft—also used over London.

Made of a very strong, light silken fabric. Prefabricated light weight wood frame. Unit is shipped knocked down. Can be assembled in 15 minutes—disassembled in two!

Takes off without towing in any wind that will support ordinary small kites. **MANY USES!** Ideal for spectacular advertising. Radio-TV antenna experiments. Boys Club aviation studies, aerial photography. Can be used to pull boats. Pull on towline varies from 50 to over 100 lbs., depending on wind. Use any strong non-metallic cordage tow-line. Full instructions. Est. Gov't. Cost Over \$125. Special F.O.B. Lincoln. **\$14.21**



Weights 25 lbs!

ARMY POWER PLANTS

Marvelous buys in new condition genuine Gov't. surplus plants and generators. We pay freight on most of the units.
• 1000-w, 115-v, 60-c, \$149.50 • 2000-w, 115-v, 60-c, \$269.50 • 3000-w, 115-v, 60-c, \$299.50 • 5000-w, 115-v, 230-v, 60-c, \$497.50 • 25 kw, \$6000 plant \$2100 (FOB)
Many other bargains. Send for Free Catalog.

IRRIGATION PUMPS

New finest Navy surplus. Standard makes.
#1-2 1/2" Centrifugal, 280 gpm. Prepaid \$44.37
#2-1 1/2" Centrifugal, 140 gpm. Prepaid \$24.61
Many other pump buys. See our Catalog.

HYDRAULIC BARGAINS

Savings to 80%. Build-repair loaders, diggers, presses, etc. Valves, gauges, cylinders, etc. Marvelous values!
• Control Valve, 1 or 2 way (Specify) \$18.00
• Pump, 1000 lb. 12 gpm. \$45.50
• Cylinder, 2"x10", 3000 lb. lift. . . \$17.50
• Servo-Cylinders, 4" stroke. . . pr. \$5.95
Many other Hydraulic items—see Catalog!

Miscellaneous SPECIALS

• Navy Bomb Hoists (1000 lb. cap.) \$29.95
• Magneto Wall Telephones. \$9.95
• Surveyor's Level and Tripod. . . \$42.95
• Air Power Tree Trimmer. \$15.37
• AC-DC Power Rectifier (FOB). . . \$15.61
• Gear Head DC Motor (6, 12 volt) \$8.72
• One-Two Man Navy Rubber Boats \$27.92

SPECIAL OF THE MONTH! GOLF CAR BATTERY MOTOR



Genuine Gov't. Surplus
900 Available

Powerful gear reduction slow speed-high torque battery motor. Runs on 6 to 24 volts. Speed 150 to 300 rpm. Uses ordinary car storage battery.



BUILD MANY ITEMS—
• Self-propelled golf car
• Warehouse personnel cars
• Store lift trucks
• Electric boat or truck winch
• Garage door opener
• Invalids wheel-chair
• Farm wagon unloader
Dozens fascinating, useful, very practical applications.

SPECIFICATIONS— Consists of powerful storage-battery-type ball bearing motor with fine precision built-in gear reduction. Output shaft 3/4" diameter.

Exceptionally high torque. Will pull two men in golf car at speeds up to 7 mph. Units cost gov't. over \$200. Precision built—will last for years. Economical—require minimum battery charging.
• Order Now. Free instructions furnished. Wt. 34 lbs. Gov't. cost over \$200. Special F.O.B. Lincoln. . . **\$19.46**

ORDER FROM AD or write us for big FREE CATALOG of 1000s of items! Motors, sporting goods, hand and electric tools, watches, tarps, etc., etc. We pay freight except where stated "F.O.B."

BURDEN SALES COMPANY
808 "O" ST., LINCOLN, NEBRASKA

"SPEEDY" DRILL GRINDING GUIDE MAKE OLD DRILLS LIKE NEW...

For repointing dull and broken twist drills up to 1/2" in diameter. One piece cast Aluminum. Simple. Anyone can use it. Order yours to-day. \$1.00 post-paid.



BRASS CASTING CO.
P. O. Box 3056 Memphis 9, Tenn. **\$1.00**

IMPORTED SIERRA SPINNING REEL... \$5.95

First all-feature spinning reel ever offered at this price. Non-wear nylon drive gear (3.25:1 ratio), anti-reverse drag switch, brake knob, removable aluminum spool (holds 200 yds of monofilament line), full pick-up bail. Simple to clean and maintain. Fine aluminum with luster-black finish. 10-day unconditional money-back guarantee. \$2 deposit on C.O.D.

BARRINGER & CO.
106 Weller • Los Angeles 12, California

BRONZE FOUNDRY Schools and Home Workshops

Make your own castings of aluminum, copper, bronze, silver. Foundry sets are available in three sizes including 2400 Deg. F. blast furnaces. See advertisements in March or Apr. issues, free Circular.

KANSAS CITY SPECIALTIES CO.
P.O. Box 8022 Dept. P-6 Marysville, Kan.

SAY YOU SAW IT IN POPULAR MECHANICS

Twin-claw UTILITY BAR

Pulls Nails
STRAIGHT! Easier, Quicker!



Heavy duty TWIN-CLAW Utility Bar does the work of crowbars and wrecking bars faster, easier! Patented TWIN-CLAW wide-radius head and long 30" twin-cambered handle, pulls nails 5 times easier—without bending! "Stand-Up" Tool saves stooping. Saves your back; saves energy! Saves time, labor, materials. Sold on money back guarantee! Send cash, check, money order or C.O.D. order today. *Patent Pending

4.95 Post Paid

A & F MANUFACTURING CO.
1423 - 28th St., Dept. M SACRAMENTO, CALIF.

Also Eshelman Adult 2 Pass. SPORT & GOLF Cars 1/5 the Price of most other Cars. 70 Miles Per Gal. Free Catalog.

ESHELMAN TRACTORS LOW AS \$99

ESHELMAN TRACTORS, Tillers, Riding Rotary Mowers for Better Lawns and Gardens. Advertised in GOOD HOUSEKEEPING. Thousands of Satisfied Users. Write for Free Literature. **ESHELMAN CO., Dept. R-56, 106 Light St., Balto. 2, Md.** 2 to 8 HP

Shipping Points: BALTIMORE • CHICAGO • RENO

TAKE THE WORK... OUT OF SPRING PAINTING with a DREMEL SANDER!

Easy does it—when you use a DREMEL Straight-Line Action SANDER for all your spring refinishing projects. Why sand by hand when it's so much easier and faster with a Dremel. A welcome addition to any man's shop and a fine gift for Father's Day. Three popular models to choose from.

DREMEL Straight-Line Action SANDERS sand with-the-grain of the wood—leave no cross-grain scratches or swirl marks to spoil your finish.

IDEAL FATHER'S DAY GIFT

MODEL 53

The deluxe sander of the Dremel line. A powerful heavy-duty machine for rough and finish sanding. Pad size 3 3/8" x 7". Wt. 5 1/4 lbs. . . . **\$34.85**



MODEL 2000—This is the most popular, all-purpose sander in the field. Ideal for shop and home use. 14,400 strokes per minute. Pad size 3 1/8" x 7". Wt. 2 1/2 lbs. Model 2000 Sander Deluxe Kit with steel case. **\$24.50**

Model 2000 Sander only. **\$19.95**

MODEL B—A combination sander-polisher-massager for all-family use. Pad size 2 3/8" x 5 3/8". Wt. 2 1/2 lbs. **\$14.85**



SEE YOUR DEALER for all 3 models. If he cannot supply you, order direct on 5 day trial, money back guarantee. Remit in full and we'll ship postpaid. Or send \$2.00 now, pay postman balance plus postage and C.O.D. fee.

WRITE FOR FREE CATALOG

DREMEL MANUFACTURING CO., Dept. 116-F, Racine, Wis.

**MAKE YOUR OWN
BOLTS, BRACES,
HANGERS!**



now available
GALVANIZED!

**REDI-BOLT®
THREADED STEEL RODS**

Save repair and construction time. Just cut to length; heat and bend; add std. nuts. Seven sizes: 1/4", 5/16", 3/8", 7/16", 1/2", 5/8", and 3/4". Handy lengths of 24" and 36". Available in galvanized or blue rust-resistant finish.

Sold in Leading Hardware Stores

REDI-BOLT, Inc.

5330 Indianapolis Blvd., East Chicago, Indiana

**SAVE MONEY on SURPLUS PARTS for
MILITARY TYPE TRUCKS & JEEPS**

4 & 6 wheel drive. FREE catalog to Jeep owners. State make truck or Jeep. (New Jeep Tops, steel or canvas all models). **AMERICAN AUTO PARTS CO., Inc., 1830 Locust, Kansas City, Mo.**

Say You Saw It in Popular Mechanics

**133 PIECE SURPLUS \$2
POWER TOOL SET**

Brand New—U.S. Gov't Surplus
Once in a Lifetime Bargain on
Power Tool Accessory Set.
Guaranteed \$11.00 Retail Value
—Now Yours for only \$2.00.
A must for every homeowner,
hobbyist, craftsman and
carpenter.



12 1/2 Million Tools — Less Than 2 Cents Each
Now the famous Blue Steel Tool Co. can make this fabulous offer because they just bought out an entire U. S. Gov't. Surplus warehouse—12 1/2 million tools in all. Every single piece is absolutely and completely guaranteed to be of the first professional and industrial quality. If bought separately would cost you at least \$11.00. But now yours for only \$2.00, less than 2 cents apiece. You can use this U. S. Gov't. surplus bargain 133 tool set with any electrical drill . . . any flexible shaft . . . any grinder. And here's what you get in this guaranteed \$11.00 retail value . . . for only \$2.00. Grinding wheels—sanding cartridges and discs—steel cutters—mandrels—burnisher—mounted stones—knife edge rubber wheels, etc. You'll find thousands of uses for this set around the house, for home repairs, hobby work, tool-shop work, wood, metal and plastic hobby work. You'll use it for sanding, grinding, buffing, polishing, carving, burnishing, etching, milling, cleaning, cutting off, hole cleaning, deburring and hundreds of other jobs. You must order now to make sure you get this tool bargain of a lifetime. **Send \$2.00 and 25c for postage and handling for one 133 piece set—\$4.00 for (2) 133 piece sets or \$6.00 for (3) 133 piece sets.** Because of the large number of tools we must ask for 25c for postage and handling on all one set orders. We absorb these costs on 2 or 3 tool set orders. You will refund my money if I am not satisfied.
BLUE STEEL TOOL CO. DEPT. G-2 HARTSDALE, N. Y.

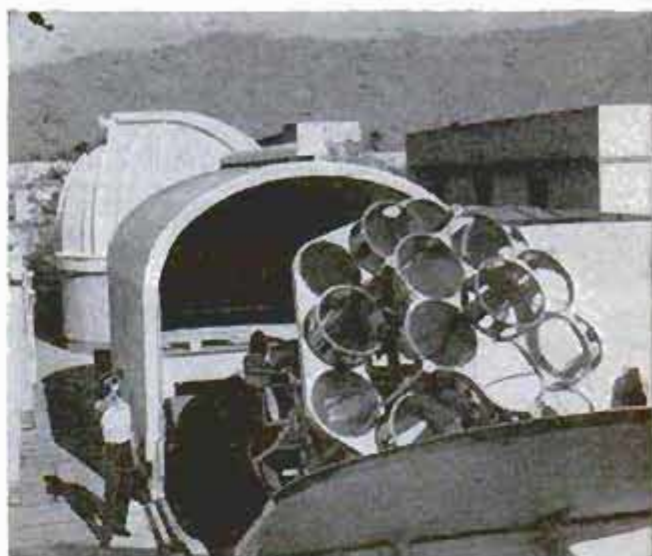
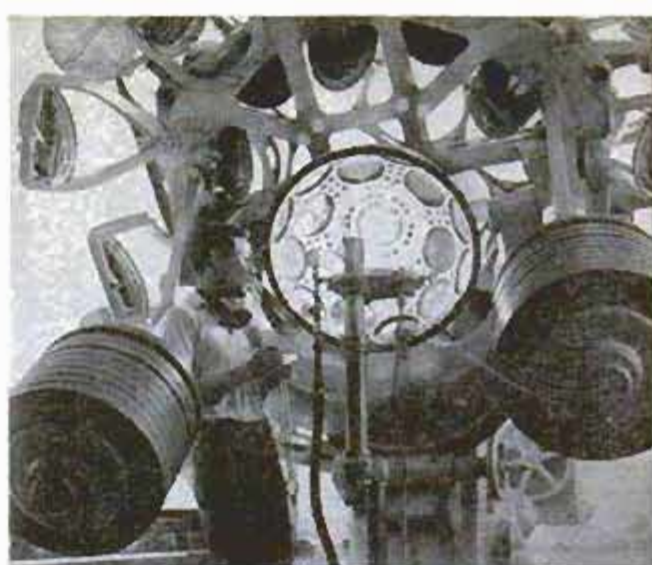

Solar Furnace

Scientists at California Institute of Technology are using a unique solar furnace to heat-test materials that may be used in the first earth satellites. Unlike most solar furnaces, which use a large concave mirror, the new furnace has an intricate system of lenses and mirrors to focus the sun's rays. There are 19 main lenses 24 inches in diameter which focus the rays onto 18 flat mirrors. These reflect the light through 19 seven-inch lenses which focus it on one pinpoint spot. The instrument, counter-balanced with heavy weights, is driven by precise motors so that it follows the sun. At the focal point the heat ranges up to 5440 degrees, half the level of the heat on the surface of the sun.

Blister Rust in White Pines

Blister rust disease in white pines, which destroyed a total of 623,000,000 board feet of saw timber in a typical year recently, has been brought under control on 17,000,000 of the 23,300,000 acres where the Forest Service is fighting it.

1/2-HP Motor SPEED REDUCER

Reduces Speed at a 20-1 Ratio

Brand New! Guaranteed! Gov. Cost \$86

Mfr'd. for Army radar equipment, this reducer is a masterpiece of design and precision workmanship. For experimental and laboratory uses . . . for building special equipment that saves valuable man hours. Ratio of 20-1 gives approximately 90-RPM with 1750 motor, direct drive; or can be belt driven to give ANY DESIRED SPEED! Use with any size motor up to 1/2-HP. Case is cast of aluminum alloy (not die cast) and has BALL BEARINGS throughout. Heavy duty, double reduction, spur gear drive built for continuous duty. Smooth, quiet running. Base to shaft is 4 1/2" high. Comes complete with couplings. Operates: conveyors, timing devices, revolving window displays and signs, tumbling equipment and machine tool drives . . . 1,001 uses!

Only \$16.50 PPD.



Order From Ad! We Pay Shipping!
ROBERTS ELECTRIC CO., Dept. PM-467, 849 W. Grand, Chicago 22, Ill.

Also Eshelman Adult 2 Pass. SPORT & GOLF Cars 1/5 the Price of most other Cars. 70 Miles Per Gal. Free Catalog.

ESHELMAN TRACTORS LOW AS \$99

For Better Lawns and Gardens investigate Eshelman Riding Rotary Mowers, Tillers, Tractors. Advertised in GOOD HOUSEKEEPING. Thousands of Satisfied Users. Free Literature Write:

ESHELMAN
Dept. M-56, 109 Light St., Balto 2, Md.

Shipping Points: BALTIMORE - CHICAGO - DENVER

POINT-O-MATIC ELECTRIC PENCIL POINTER

REG. \$19.95 NOW ONLY \$14.95 F.O.B.

Automatically and instantly points the lead of a drafting pencil to a smooth conical or wedge shaped point.

- MAGNETIC SNAP ON ABRASIVE, easy to change.
- SAVES TIME. It's electric and automatic.
- PRECISE POINT for precision drawings.
- CLEAN and MEAT for cleaner drawings.

See your office supply dealer, or write direct.
JOHNSON MFG. CO., INC., Monroeville, Indiana

URANIUM-GOLD PROSPECTING BOOKS

Uranium-Where To Find It \$1.50 How To Pan Your Own Gold \$2.50

FREE prospecting catalogue with all orders (include 10c postage per book)

THE GEIGER CENTER
1201 BROADWAY DENVER 2, COLORADO

41 SURPLUS TWIST \$2 PPD. DRILLS

LESS THAN 5c ea. For Hand or electric drills. Brand new genuine hardened carbon tool steel drills from 1/16" through 1/2". Each drill designed and tempered to give up to 1800 drillings through steel, aluminum, iron, wood, plastics. Sells in the stores for up to \$8.00.

Send check or M.O. COD plus postage. MONEY BACK GUARANTEE

SCOTT MITCHELL HOUSE, INC. Dept. X-510, 611 Broadway, New York 12, N. Y.

SET OF 3 PAINT BRUSHES \$1.29 PLUS 25c PP

SURPLUS BIG BARGAIN OFFER

All-purpose Genuine Bristle Quality Brushes for the Do-It-Yourself painting of Furniture, Walls, Woodwork, for any paint job inside or outside. Set consists of a 1", 2" and 3". Finest quality brushes vulcanized-in-rubber. All 3 actually cost less than you could pay for any one of these brushes elsewhere! Only \$1.29 plus 25c PP. (Only 3 sets to a customer.) Money Back Guarantee.

MATTHEW DAY CO., INC., Dept. PM-6, Dumont, New Jersey

BOAT PLANS-PATTERNS FRAME KITS

INBOARDS and OUTBOARDS especially for the amateur builder

SEND 40c FOR Our New Complete CATALOG

marine designs Box 568T Compton, Calif.

earn **BIG Money** arc welding

"Simplified" welding the Hobart way helps you earn hundreds of extra dollars. Get the "BIG PAY" jobs—weld, run tools, pumps, lights, etc. with these big capacity, low cost models.

WELDER Plus POWER for running tools, lights, motors

Built-in convenience features enable you to do professional work in your own shop or outside.

HOBART BROTHERS CO., BOX M-66, Troy, Ohio

AC Weld or AC Power

Air Cooled Arc Welder

now! assemble your own

ALUMINUM SCREENS

save up to **50%**

LIFETIME PROTECTION—

YET IT'S ONLY MINUTES FROM PARTS TO FINISH WITH **HOMESHIELD** easy-to-make **SCREEN KITS**

Make your work shop pay off! Assemble these maintenance-free aluminum window screens for your home, cabin, or shop and save money...make 'em for neighbors, apartment houses or businesses, and make money! It's a simple assembly job that requires no special tools.

No more repainting or repainting! Replace heavy, old-type screens or screen your new home with sparkling Homeshield screens that'll dress up your home for life. Eliminates rust and stained walls. Lightweight—install or remove in a jiffy. No ladders needed.

Kits are complete with sturdy aluminum frames, easy-to-handle Fiberglas® screening, corner locks, installation hardware—even a miter box. Sizes for full screens and sliding half screens (and storm sash, too!) Ask your department store, hardware or lumber yard dealer, or mail coupon for folder and name of nearest Homeshield distributor.

AMERICAN SCREEN PRODUCTS CO.
Dept. PMK-6, 807 N.W. 20th Street, Miami, Florida

Name.....

Street.....

City..... State.....

"PROJECTS FOR OUTDOOR LIVING"

NEW DELTA hard cover book features dozens of outdoor projects. Clear illustrations, complete bills-of-materials, easy-to-follow plans. Only \$1.00. Also get FREE folder on complete Delta Library: Delta Power Tool Division, Rockwell Mfg. Co., 502F N. Lexington Ave., Pittsburgh 8, Pa.

SAY YOU SAW IT IN POPULAR MECHANICS

Here's the window you want...

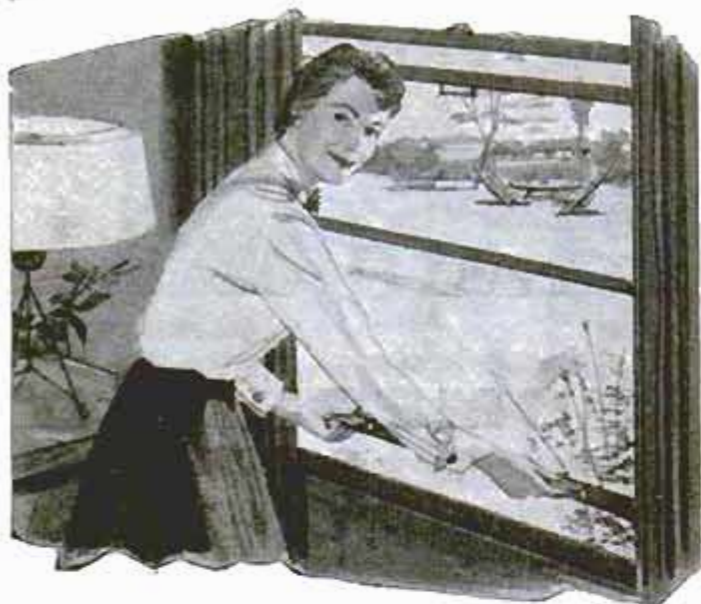

It's Truscon's Double-Hung Steel Window that *will never stick or rattle*. That's because steel will never rot, warp, swell or shrink. You buy these Truscon Series 138 Windows from your dealer *ready to install*. All hardware is factory-attached. Stainless steel weather stripping is built in. There are types and sizes for every home style —with storms and screens available, too.

HERE'S HOW TO INSTALL IT



Free book shows how to install Truscon Steel Window in frame, brick veneer, masonry and concrete block construction. Clear pictures and complete step-by-step explanation are easy to follow —with helpful tips on professional methods. Send coupon below.

**TRUSCON STEEL DIVISION
REPUBLIC STEEL
YOUNGSTOWN 1, OHIO**



**TRUSCON STEEL DIVISION,
REPUBLIC STEEL**

1126 Albert Street • Youngstown 1, Ohio
Please rush free book showing how to install
Truscon® Double-Hung Steel Windows, Series 138.

Name

Address

City Zone State

K-9693



Adhesive Floor Felt Holds All Kinds of Tile

You can lay any kind of floor tiles by simply sticking them to the surface of a new adhesive floor felt. Pressure-sensitive adhesive covers both sides. One side sticks to the floor, the other side to the tiles. The felt comes in 36-inch-wide rolls. A strip is placed face down. Slight pressure with the hand will hold the felt in place. The top side is covered by protective paper which is stripped away, a section at a time, as the tiles are pressed gently into position. The tiles get tighter as the floor is walked upon.



Now You Can Upholster Any Piece of Furniture!

Upholster—Restyle Any Piece of Furniture Yourself

John Bergen, custom furniture designer, tells and shows you how to transform old out-of-date furniture into brand new smart-looking comfortable furniture in his new book **ALL ABOUT UPHOLSTERING**.

No Experience Needed

Bergen tells you every step to follow in amazingly clear easy-to-understand step-by-step instructions and then shows you how in hundreds of big, clear drawings and photos. You read and see how to strip the old frame, install new webbing and springs, apply burlap, install stuffing and padding, fit the muslin cover and the final fabric and install trim.

Use New Materials—Methods

Now you can have furniture upholstered with foam rubber, sagless springs and other new materials that add so much to comfort and durability and are so costly when included in new furniture.

Save 50% of Usual Cost

Don't pay a small fortune for new furniture when you can make your old furniture better than new! Why pay high prices to have someone else upholster and restyle your old furniture when you can do it yourself for cost of materials alone? It's easy and it's fun.

Special Chapter on Slipcovers

Learn how to make custom-made slipcovers with professional look and fit. Find out how you can realize tremendous savings by investing a few spare-time hours and the cost of a few yards of fabrics.

7-Day Money Back Guarantee

Send for your copy of **ALL ABOUT UPHOLSTERING** today. Read and use it for 7 days. If it isn't entirely satisfactory return it for a full refund.



USE THIS HANDY ORDER COUPON

POPULAR MECHANICS PRESS, Dept. 656
200 E. Ontario St., Chicago 11, Illinois

Gentlemen:

Please send my copy of **ALL ABOUT UPHOLSTERING**. Enclosed is my remittance of \$3.50. If I am not completely satisfied with the book I will return it for a full refund after 7 days.

Name _____

Address _____

City _____ Zone _____ State _____

WAR SURPLUS AND OTHER BARGAINS SAVE UP TO 90%

DOUBLE-ACTION HYDRAULIC CYLINDERS

Oil or air operated. Ideal for shop, production machinery, hydraulic boat steering and 100's of other uses. Steel barrel, new, aircraft quality, precision-built. Extremely rugged, can stand tremendous pressures. Able to do job usually requiring cylinder 5 times its size.



ROD END BEARING: 7 3/4" length of stroke, 5 1/2" shaft, 1 1/2" bore, 13" overall. Approx. GOVT. COST \$75. New, \$5.95 ea., special, 2 for \$10.
DOUBLE SPRING LOADED: Zerk lubricated end mounting, 4" length of stroke, 9/16" shaft, 1 1/2" bore, overall length 15". Spring is removable. Approx. GOVT. COST \$75. New, \$5.95 ea., special, 2 for \$10.

PIONEER MAGNETIC COMPASS



For boats, trucks, cars. By Pioneer Instrument Co., Div. of Bendix, No. 1829-2A. Contains screw-type heading compensator, removable drawer-type compensator, screw-type horizontal compensator and spider-type compensator. All devices for elimination of errors caused by effects of magnetism. Has constant deviation corrector and course setter. Rotable dial engraved with compass card graduations. Complete with book of instructions, light and mounting screws and shock mounts. Shpg. Wt. 10 lbs. Approx. GOVT cost \$400. NEW, \$13.95.

ARC WELDER KIT \$24.95—build your own



Complete make-up package consisting of 1 Aircraft DC Generator, Electric Auto-Lite, 200-250 Amps. 24 Volt RPM from 2600 up, 1 Rheostat, 1 Giant Toggle Switch, 1 Ammeter, 1 Shunt, 0 to 240 Amps, 1 Voltmeter, 0 to 30 Volts, 1 Electrode Holder. Wiring diagram chart showing conversion of Aircraft Generator to Arc Welder. Shpg. Wt. under 100 lbs. Approx. GOVT. COST \$475. Buy of a lifetime. Like new, perfect, \$24.95.
DC Generator (only)—same as above... if purchased separately: \$12.50.

MICROMETERS Chrome plated, precision engineered, carefully tooled to give long life. All new 0-1" cap. \$2.25 ea., 1-2" cap. \$3.30.



HELIOS MAUSER-TYPE CALIPER
All hardened 1/128"-1/1000". Has expanded vernier scale for quicker, easier reading. Knurled thumb slide lock. Inside & outside measurements start from zero. Decimal equivalent embossed on reverse side of caliper. Comes complete with depth gauge slide extension. NEW. A \$49.70 value. Limited quantity—\$12.95 with leather case.

NEW! 1956 CATALOG Largest ever... just out... new low prices. Send 25c for your copy today. Prices F.O.B. Culver City unless otherwise stated. Check, cash or money order, 25% deposit for C.O.D.

AIRBORNE SALES CO., INC. DEPT. PM 656
8501 Steller Drive, Culver City, Calif

SPARE-TIME MONEYMAKING OPPORTUNITIES
READ OUR CLASSIFIED ADS
HUNDREDS OF BARGAINS AMAZING OFFERS

140-1 REDUCTION GEAR!



Make your own winches, hoists, wagon unloaders, stump pullers or fence stretcher. Sturdy Aircraft quality. Built-in (removable) 34 V. AC motor & clutch. High torque. Low speed, 1000 rpm. Bendix price \$285.00. Wght. \$17.89 F.O.B., 42". Good used \$14.88. Brand New only. **\$17.89 F.O.B. York.**
SEND DIME FOR COMPLETE CATALOG
K. GRT, Dept. P.M.S. YORK, PA.

SAY YOU SAW IT IN POPULAR MECHANICS

Make BIG MONEY Sell NAME BRAND TOOLS

Through Your Own Giant 148-Page Illustrated Wholesale Catalog. Run your OWN business.



Pocket up to 100% profit on all you sell. You make quick, easy sales because you sell only the best standard brand names. Everyone you approach is your prospect—home owners, factories, shops. Also, cash in on the profit-boosting boom in do-it-yourself. Take their orders for any and every kind of tool (hand, electric or automotive) from your special catalog. We stock over 12,000 items and ship from our giant warehouse the same day your order arrives.
Every item unconditionally guaranteed: money back without question. Build your own business selling tools from a coded catalog bearing your name and only your name on it. Profits and earnings will amaze you. For giant catalog, send \$1.00 deposit which we return on first order. DO IT NOW!

U. S. SUPPLY, Warehouse 9,
149 Church St. N. Y. C. 7, N. Y.

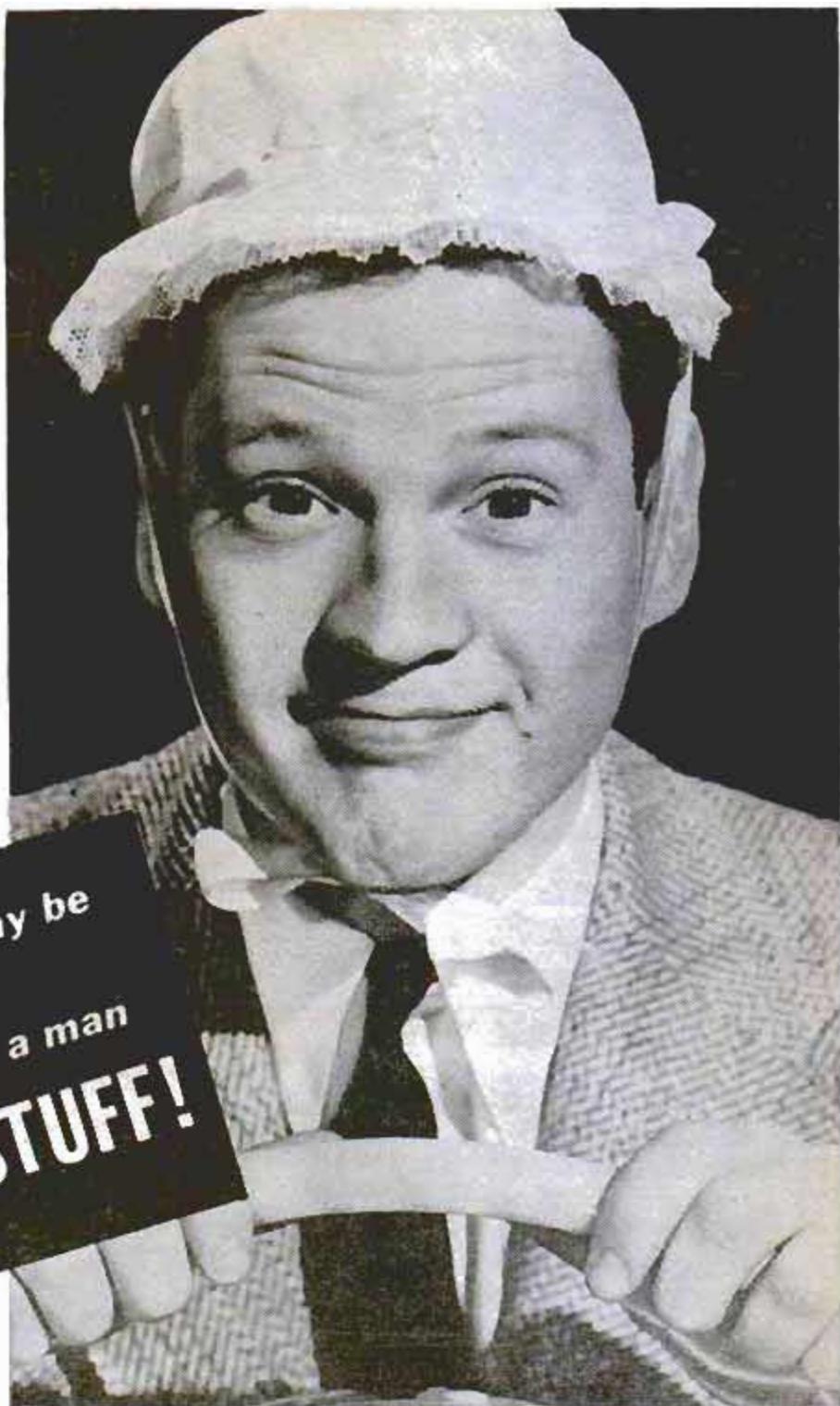

Taking chances may be
part of growing up—
But when you're a man
IT'S KID STUFF!

This fellow takes chances. He's a crazy driver.

Why? For attention! So—people will know he's around. He thinks it makes him stand out. Same as when he was a kid.

If he only knew!

His friends have him pegged—"strictly juvenile." They have an expression—"Careless driving is kid stuff." That's him.

If he only knew. He'd wise up and drive right.



An official public service message prepared by
The Advertising Council in cooperation with the
National Safety Council



A DRY BASEMENT with a DIXIE

ONLY
\$79⁵⁰

The DIXIE AIR DRYER rids your basement of musty, costly dampness. No fancy cabinet or frills—just a full size dehumidifier that keeps your basement dry as a bone. Install yourself in minutes. • Plug in and forget it.



ORDER DIRECT OR FOR FURTHER INFO WRITE DEPT. B

ADAMS EQUIPMENT, INC.

511 SOUTH JACKSON, JACKSON, MICH.

24" ATTIC FAN KIT



Easy to assemble. Belt-driven. Blade, shaft, 2 self-aligning bearings, 2 pulleys, 2 collars, and V-belt. Everything you need, except frame and 1/4-hp motor, to make your own house cooler. Send for complete list of fan parts.

ONLY
\$9.95

SAVE \$46.00

PENNA. WHOLESALE DISTRIBUTORS
104 N. 6th St., Phila. 6, Pa.

CLOSE OUT! HEAVY DUTY 6-VOLT MOTOR

ALL BRAND NEW! ORIGINAL PRICE \$16.50. Only

\$1.49
Just 1200 Left - Hurry!
A terrific buy! Oilite bearings. 1/4 inch shaft. High starting torque. Enclosed body. Perfect for car heater & defroster or any 6 volt battery operated mechanism. Send \$2. (\$1.49 plus 51c) and we'll ship postpaid on 10 day money back offer.

ILLINOIS MERCHANDISE MART, Dept. M-6, 1227 Loyola, Chicago 26, Ill.

CRESCENT TOOLS

Give Wings to Work

ASK YOUR
HARDWARE
DEALER

Wholesale! TOOLS! GUNS! CAMERAS!

AGENTS - BUY TOOLS, PHOTO EQUIP., SPORTING GOODS, JEWELRY AND THOUSANDS OTHER NATIONALLY ADVERTISED PRODUCTS AT BIG DISCOUNTS. BIG PROFITS SELLING TO OTHERS.

POSTCARD BONUS FREE COPY "THE WHOLESALE PLAN"

AMERICAN BUYERS SERVICE

HERTEL STATION, DEPT. 15, BUFFALO 16, NEW YORK

Get up to
40% off

MAKE BIG CASH PROFITS

ASSEMBLE YOUR OWN LAWN TRACTOR



NEW!
YOU CAN NOW SEED, FERTILIZE, PULL SPRAYS, GRASS, SOIL - CUT WHEELS, REMOVE STONES

When your neighbors see the fun you have mowing your lawn with RIDE-TRAC, they'll want one too. Make Big Cash Profits in your own neighborhood with our Rider Agent Plan. Complete RIDE-TRAC kit goes together quickly with wrench and screwdriver. RIDE-TRAC makes fun out of all your lawn work. Write today for details of Rider Agent discount. BELSAW RIDE-TRAC DIVISION.

556 Field Bldg., 315 Westport Rd., Kansas City 11, Mo.

FREE AMAZING NEW BOOK "HOW TO ANSWER ADS"



Never before have you seen anything like this. Tells you in simple language the correct way to answer ads. Gets you quicker replies—better results, and greater satisfaction. Will save you time and money and it's ABSOLUTELY FREE. No obligation whatever. Every reader of advertising should have this booklet. Send a postcard for your copy NOW. F. W. JOHNSON, Poplar Mechanics Magazine, Room 600-A, 204 East Ontario Street, Chicago 11, Ill.

COMPLETELY AUTOMATIC "SEA-HORSE" DIVING LUNGS

\$169 VALUE

2-TANK UNIT

99⁵⁰

COMPLETE
Approx. 2 Hours
Underwater Time



New Improved

SINGLE TANK
Outfit Complete
\$110 Value
Approx. 1 Hour
Underwater Time **\$69**

The 2-stage demand REGULATOR automatically releases air as needed; effortless breathing in any position, includes both emergency and warning device; 84 cu. ft. cap. at 2000 psi; non-return mouthpiece keeps water out of hose; adjustable harness. Full Instructions and Safety Booklet included.

SIGNED GUARANTEE OF SATISFACTION

Send Check or Money Order. If C.O.D., 25% deposit with order. WE PAY FREIGHT CHARGES ANYWHERE IN U. S. A.

Write for Literature TODAY . . . Club Inquiries Invited

DIVING INDUSTRIES Division of HONUS WAGNER CO.
813 LIBERTY AVE. DEPT. PM-6 PITTSBURGH 22, PA.

Say You Saw It in Popular Mechanics

THE KIT OF 1001 HOMESHOP USES



ONLY **\$29⁹⁵** . . . with a Ball Bearing High Speed Geared Chuck

22 PIECES

- 1 Geared Chuck Drill
- 1 Pedestal
- 9 Drill Bits (1/4" — 1/2" inch)
- 1 5" Rubber Backing Pad
- 1 6" Polishing Pad
- 6 Abrasive Disks
- 1 Paint Stirrer
- 1 Side Handle
- 1 Steel Carrying Case

This 1/4" steel, 1/2" wood drill with attachments for doing varied homeshop and maintenance work will enable anyone to do a professional job—in wood, metal or other materials. The motor is AC-DC. 25 to 60 cycle. Voltage: 2.3 amps. Free speed 2500 rpm. Full kit includes 22 pieces plus 7 ft. cord with plug and ground.

MALL TOOL COMPANY PORTABLE POWER TOOLS
GASOLINE • ELECTRIC • AIR
7805 South Chicago Ave., Chicago 19, Ill. HU-2211

POPULAR MECHANICS

FAMOUS LITTLE LIBRARY OF USEFUL INFORMATION

Complete Set
of 126 BOOKS
only \$17.95

25 BOOKS	\$3.75
12 BOOKS	\$2.00
5 BOOKS	\$1.00

SINGLE BOOK 25c

Here at amazingly low cost is the practical help and information you have always wanted. Articles in previous issues of Popular Mechanics have been classified according to subject and are now available in these handy reprint booklets.

Check titles wanted, clip ad, mail today.

HOME WORKSHOP

Power-Driven Saws—74: How to build.
Drill Presses, Plane, Grinders—79.
Sanders—80: Details on 8 machines.
Wood & Metal-Turning Lathes—81.
Filing Machine, Hack Saw, Cutoff Wheel, Shaper—82: Full details on these.
Metal Lathe Tools—101: How to build.
Workbenches and Tool Cabinets—47.
Spray Painting—94: Proper methods.
From Pattern to Casting—91: How castings are made in sand molds.
How to Use a Circular Saw—135.
Jigsaw Technique—136: How to use.
Bandsaw Know-How—137: Techniques.

HOME IMPROVEMENTS

Painting Your House Inside and Out—117.
Simple Home Improvements—104: Save money.
Building Extra Rooms in Your Attic—23: Add to the value of your home.
Basement Playrooms—24: Build an attractive playroom in your basement.
House Wiring—89: How-to-do-it.
Curing Leaky Basements—45.
Fitting Home Game Room—55.
Built-in Fixtures—78: Several.
Lower Your Fuel Cost—31: Practical kinks that will save you hundreds of dollars.
Hanging Wallpaper—38: Hints and tricks.
Bidding the Home of Insect Pests—107.
Constructing Indoor & Outdoor Fireplaces—88: Details on stone fireplaces.

CRAFTWORK • HOBBIES

Games and Puzzles—131: Have fun at home.
Model Planes You Can Build—129: Several.
Fun With Your Model Railroad—127.
How to Make Novelty Jewelry—126.
Working with Plastics—61: Novelties, etc.
25 Shelves You Can Make—64: Wall shelves, etc.
Novelties Turned on Lathe—62: Dishes, etc.
Projects in Plastics—112: How to use.
Inlay Pictures—Veneering—63.
Whittling and Wood Carving—65: Methods.
Action Toys—66: 21 easy-to-make toys.
Marionettes—113: How to make and use.
High Flying Kites—67: How to build.
Windmills & Weather Vanes—68.
Lamps in Wood, Metal, Plastic—69: Several.
Bows and Crossbows—115: How to make.
Playground Equipment—73: 8 projects.
Metal Craft—28: Simple instructions.
Weaving and Recaning—37: Full details.
Gem Cutting—42: How to cut and polish.

USING TOOLS

How to Use Your Drill Press—125.
Correct Measurements—106: How to obtain.

Tool and Saw Sharpening—92: Tricks and hints.
Technique of Using Drills and Wood Bits—90.
Successful Wood Turning—32.
How to Read Blueprints—71: Tells you how.
Metal Turning Lathe Kinks—99.
Operating a Metal Turning Lathe—100.
Heat Treating and Case Hardening—102.
Working with Glass—103: Cutting, etc.
Using Basic Tools—120: Tips and hints.

WELDING • SOLDERING

Rewinding & Servicing Electrical Motors—75: Repairing and rewinding motors.
Electrical Appliances, How to Fix—111.
Electromagnets & Solenoids—44.
Transformer Construction—41: Directions.
The Boy Electrician—43: Five projects.
Soldering & Brazing—17: Tells how to.
Arc & Spot Welders—5: How to use & build.
Build Your Own Relays—123: Instructions.
Home Burglar Alarms, Secret Locks and Time-Setting Systems—128.
Welding with Arc and Gas—134: Tips.

AUTOMOBILE BOOKS

House Trailers—121: Build it yourself.
Automobile Kinks and Shortcuts—10.
Building Trailers—Small Teardrop and Utility—27: Can be built in your spare time.
Motor-Driven Midget Car & Scooter—34.
Curing Auto Electrical Troubles—98.

BUILD A BOAT

14 Ft. Outboard Runabout—2: How to build.
Rowboats, Bicycle Boat, Small Dinghy—53.
Small Sail Boats—84: For young sailors.
Two Outboard Runabouts—85: 14 ft. & 12 ft.
Build Your Own Canoe, Kayak, Surfboard—30: Complete building details.
Fast Class-E Ice Yacht—22: Build your own.

GARDENING HELPS

Lawn and Garden Equipment—124.
Mandy Farm Implements—114: How to build.
Tractor Attachments—116.
Backyard Gardening—39: Helpful hints.
Lawn & Garden Novelties—72: Easy to build.
Trellises, Pergolas, Fences—76.
Lawn & Garden Furniture—77.
Colored Concrete Garden Furniture—6.
Farm & Garden Tractors—8: How to build.

PHOTOGRAPHY

Home Movie Equipment—118: How to use.
Photo Lighting—119: Helpful information.
Photo Enlargers—1: Complete plans.
Photo Printers & Dryer—25: Describes three.
Photo Darkroom Equipment—96.
Picture Projector, Trick & Table Top Photography—97: Tips on how to make.
Photo Kinks—98: Money-saving ideas.

FURNITURE MAKING

Furniture Upholstery and Repair—122.
Rustic Furniture—18: How to build.
Children's Room Furniture—51.
Book Ends—52: Good selection from 10 designs.
Small Tables—54: Interesting styles.
Desks—53: Many varied designs.
Smoking Stands—56: Seven designs given.
Plain & Novelty Wood Finishing—40.
Book Cases—59: Eight designs.
Magazine Racks—49: Ten attractive racks.
Clock Cases—50: Several types.
Serving Trays for Every Occasion—53.

MISCELLANEOUS

Cleaning Formulas—11: Make your own.
Re-Silvering Mirrors—70: How to do it.
How to Build a Concrete Block Machine—110: Make your own block machine.
It's Easy to Tie Knots—109.
Chemical Experiments—93: Several.
Taxidermy—9: How to mount small animals.
Log Cabins and Tourist Cottages—14.
Magic for Everybody—29: Simple tricks.
Trapping Small Animals—33: How to trap.
Training Your Dog—35: Tricks and obedience.
Small Furnaces—36: For melting copper, etc.
Electroplating with Copper, Nickel, Chromium, Lead, Zinc, Cadmium—86.
Plating Non-Metallic Objects—Plating with Gold, Silver, Alloys—87.
Telescopes—20: Design and construction.
Poultry Houses—108: How to build.
Guns & Decoys—109: Clean guns, make decoys.
For Better Business—130: Timely tips.
For Better Business—132: Saves time.
For Better Business—133: For smooth operation.

USE THIS HANDY ORDER COUPON NOW!

Popular Mechanics Press, Dept. 656
200 E. Ontario St., Chicago 11, Ill.

I enclose \$_____ (U.S. currency may be mailed if carefully wrapped) for "Little Library" booklets numbers:

25 Books	12 Books	5 Books	1 Book
\$3.75	\$2.00	\$1.00	25c

NAME _____

ADDRESS _____

CITY _____ ZONE _____ STATE _____

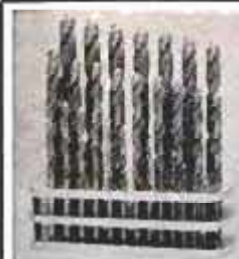

29 Piece DRILL SET

Complete with sturdy, calibrated, rustproof drill stand. Finest alloy steel drills, precision ground and hardened for use on steel, wood, plastic, etc. Designed for HIGH SPEED DRILLS. Sizes by 64ths. 1/16" to 1/2". Send check or money order, no C.O.D.'s. **\$9.95** Money back guarantee....

10 PIECE NATIONAL COARSE OR FINE THREAD CHROME-SPKED STANDARD TAP SET. Ideal for craftsman or home workshop. Sizes 6/32" to 1/2" in heavy plastic kit. **\$3.95**

PACIFIC COAST SURPLUS CO.
10203 VENICE BLVD. LOS ANGELES 34

What Every Farmer Should Know About Taking Care of Farm Animals



The Most Popular Veterinary Guide Ever Printed

This practical and helpful VETERINARY GUIDE FOR FARMERS prepares the farmer to perform many routine veterinary tasks—provides quick information that can often save the life of an animal—prevents disease in herds—saves money on the farm in a hundred different ways.

Written in plain understandable language. It covers symptoms, causes of disease and prevention, and treatment of cattle, swine, sheep, horses and poultry and warns when to call in the professional veterinarian. Names, terms and phrases made clear in a separate section. Over 100,000 copies of this book are in use on American farms. 275 pages. Fully illustrated. Only \$3.95. Order today under money-back guarantee.

POPULAR MECHANICS PRESS, Dept. PM13
200 E. Ontario St. Chicago 11, Ill.

SPARE-TIME MONEymaking OPPORTUNITIES
READ OUR CLASSIFIED ADS
HUNDREDS OF BARGAINS AMAZING OFFERS

SEND ME



every month so I am sure to see each new issue. Here's

- \$3.50 for 1 year
 \$8.00 for 3 years

name _____

address _____

city _____ zone _____ state _____

Hand this order to your newsdealer or send it to

POPULAR MECHANICS
200 East Ontario St. Chicago 11, Ill.

Mammoth 1956 Wholesale Tool Catalog

TOOL CATALOG



puts You In Business

The opportunity now awaits you to own and operate your own business on a part time or full time basis in the lucrative field of HARDWARE, APPLIANCES, BICYCLES, CAMERAS, HAND TOOLS, FANS, POWER TOOLS, MOTORS, PAINTS, etc., or BUY TOOLS FOR YOUR INDUSTRIAL OR INSTITUTIONAL USES.

Buy Nationally Advertised Tools for Resale or Industrial or Institutional Use
NO INVESTMENT REQUIRED. BUY AS YOU NEED IT. A MILLION DOLLAR INVENTORY AT YOUR FINGER TIPS.

Discount UP TO **50%**

\$1.00 refund on first purchase or refund if you are not 100% satisfied.



Every one needs tools. Meet the demands of the growing "Do-it Yourself" markets. Sell direct from the jumbo buying guide—your cost is known only to you.

JUST FILL OUT COUPON

SILVO HARDWARE CO.
Dept. PM-6
108 Market St.
Philadelphia 6, Pa.

I am enclosing \$1.00. Rush me your dealer's mammoth Catalog Today. If I am not completely satisfied with your plan, I understand that I can return the Dealer's Catalog for refund, and if I decide to order, my \$1.00 will be deductible from my first order.

NAME.....

ADDRESS.....

CITY.....ZONE.....STATE.....

Say You Saw It in Popular Mechanics

Reg. U. S. Pat. Off.



BUILD 16 RADIO

CIRCUITS AT HOME WITH THE NEW DELUXE 1956 PROGRESSIVE RADIO "EDU-KIT"

A PRACTICAL HOME RADIO COURSE only **\$19.95**

All parts, tools, instructions, punched metal chassis, printed circuit materials, electric Soldering Iron, Tester included. Unconditional Money-Back Guarantee.

PROGRESSIVE "EDU-KITS" INC.
Room 5468, 497 Union Ave., Brooklyn 11, N.Y.

MAIL COUPON OR POST CARD

Please Rush me Free Descriptive Literature concerning "EDU-KIT." Also send me Free Radio, TV, Hi-Fi Servicing Literature. No obligation.

NAME _____
ADDRESS _____

HAYES GARDEN HOSE SPRAYERS

The new, scientific way to kill insect pests and fertilize lawns



Easy as watering—no tank to lug, no lifting, no pumping—water pressure does the work. Does any garden or lawn spraying in 1/4 the time as compared with old-fashioned methods.

Patented internal metering jets in Hayes spray guns automatically mix and accurately proportion garden chemicals and water in the exact ratio recommended by chemical manufacturers for killing insects, fertilizing lawns.

That's why the Hayes—and only the Hayes—carries the approval of leading manufacturers of garden chemicals for use with their products including these well-known nationally advertised brands:

Acme • Black Leaf • Ortho • Bonide • Carac • Northrup King • Pratt • Chlordane • Crag • PMA5 • End-O-Weed • Instant Vigoro • Follum • Gro-Stuff • Weedone.

Models for every spraying need! At your hardware and nursery dealer!

Hayes Garden Sprayers—For insecticides, fungicides, leaf feeding. Available in 1 1/2, 3, 4, 6 and 12 gal. capacities. Priced from \$2.95.

Hayes Lawn Sprayers—For mass spraying of lawn moth solutions, weed killers, crabgrass killers, herbicides, liquid and soluble fertilizers. Available in 3 models. From \$3.45.

FREE! 16-page booklet on garden and lawn care. Write Dept. M.

Hayes Spray Gun Company

World's Largest Manufacturer of Garden Hose Sprayers

98 N. San Gabriel Blvd., Pasadena 8, Calif.



• New BUILD-IT-YOURSELF Window Fan Kit

20, 24 & 30" Blade Fan Part Kits, less frame

These FAN KITS provide LOW COST, high efficiency belt driven fans, for COOLING nature's way. Dynamically balanced, highly polished, completely assembled Aluminum Blade, Rubber Mounted Bearings, 3/8" Shaft, Collars, Motor and Fan Pulleys & Belt. Instructions included in factory packed carton. Complete less motor.

SHIPPED SAME DAY
Easily Assembled

20" BLADE & COMPLETE KIT, ONLY	\$12.95
24" BLADE & COMPLETE KIT, ONLY	\$15.95
30" BLADE & COMPLETE KIT, ONLY	\$19.95

(for vertical installation add \$7.50 for ball bearing assembly)

WESTINGHOUSE 1/4 H.P. Fan Motor, 110 V.-A.C. Rubber mounted SPECIAL	\$10.00
TWO SPEED 1/4 H.P. Motor, SPECIAL	\$17.50

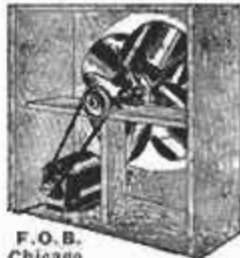

F.O.B. Chicago

C. MARSHALL SALES, 3546 W. Fullerton Av., Dept. P-6, CHICAGO 47

Works in seconds!



Loosens Rusted Bolts nuts, screws, "frozen" parts!

LIQUID WRENCH

AT HARDWARE STORES, GARAGES SERVICE STATIONS EVERYWHERE

For information write manufacturer Radiator Specialty Co., Charlotte, N. C.



ELECTRIC WELDER

AC or DC 110 Volts

The "Little Marvel" all-metal welder, 5-year written guarantee. Welds 1/8" metal or money back. Repairs tanks, tools, fenders, machine parts, etc. Complete with everything—rods, unit, eye shield, directions. \$8.95

plus 50c postage. Flame torch accessory for soldering, cutting, brazing \$3.95 complete with carbons, brass rods, flux. \$2.00 Deposit on C.O.D. 75 ampere 1/4 inch Transformer Welder \$21.95 F.O.B.

ESSAY MFG. CO., Dept. 51, Quincy 69, Mass.

\$6.95
Complete

SIMPLIFY PREVENTIVE MAINTENANCE WITH
MACHINE TOOL RECONDITIONING
& THE ART OF HAND SCRAPING (2nd printing)
SEND FOR FOLDER DESCRIBING ILLUSTRATED BOOK
MACHINE TOOL PUBLICATIONS, 382 Holly Ave., St. Paul 2, Minn.

SOUTH BEND

LATHES
DRILL PRESS
SHAPER



9" to 16-24" Lathes 14" Drill Presses 7" Bench Shaper

Write for literature—indicate machine.

SOUTH BEND LATHE, SOUTH BEND, IND.

Say You Saw It in Popular Mechanics

Enjoy the Fascinating Story of the Horseless Carriage in



Popular Mechanics

AUTO ALBUM

166 Illustrations

The most intriguing book about the automobile ever printed. It's thrilling, fascinating and informative. From the very first gasoline-propelled buggy to the cars of today and the atomic auto of the future. The first cars—the men who made them—the scrambled start and the development of the fabulous auto industry—the story of auto racing—the growth of the Nation's highways, 166 thrilling action pictures—old-time cars—racing cars—early auto advertising—automotive oddities. Roll call of names of more than 2000 autos made in the U.S. included. Ideal gift book. Cloth bound, only \$3.00 by mail. Money back if not pleased. Paper covered edition \$1.00 at newsstands.

POPULAR MECHANICS PRESS, Dept. PM14
200 East Ontario Street Chicago 11, Illinois



AMAZING CORNER CLAMP

NO. M-200

ONLY
\$1.79

NOW YOU CAN CORRECT ERRORS IN 45° MITERED CORNER CUTS!

GLUING — DOWELLING — WELDING
PICTURE FRAMES — SCREENS — FURNITURE

HERE'S a true bargain! Nothing comparable available! A quality made miter correcting corner clamp, twin screws with big 2" vise-like grip for only \$1.79. Makes your picture framing, window screening, drawers, cabinet and furniture building easier—accurate. Saves time on gluing, dowelling, welding. Holds 2 different sizes of stock at once. Fasteners can be placed through slot in back of clamp for gluing. Groove protects saw blade. Ruggedly made of heavy gage steel—Cadmium Plated. You may need 2 - 4 is better.

At your Hardware Store. Tear out this Ad as a Reminder.

Write for Data on other Gunver Tools for Craftsmen

GUNVER MFG. CO., Manchester, Conn.

GIVE THE KIDS A THRILL



CRYSTAL RADIO

3.95
NEW

Picks up standard broadcast stations without using batteries or electricity. Just plug in headset, antenna and ground wires and tune in your favorite program. You'll be amazed at the STRONG, CLEAR SIGNAL. Has a 100KC tuning range. Comes complete with Receiver, Antenna and Ground wires PLUS a 2000 ohm Headset. A GENUINE CRYSTAL RADIO SET.

SOUND POWER PHONES

Originally used by the Navy for gun control. Ideal for emergency communication because each set is "sound powered". Will operate up to 1/2 mile distance. Set includes 2 phones on chest plate, 2 headsets, approx., 35 feet of wire.

9.95
PER SET

RS 3BA MICROPHONE

Carbon type with push-to-talk button. Ideal for use where background noise is high. Can be operated with 110V drycell. Comes 6 ft., 3 conductor, shielded cable & plug.

2.49

MS-10U Signal Corps HEADSET - Low Impedance. Two earphones & band. . .

3.95

SAVE ON U-LINE MODELS

NAVY F4U CORSAIR

Has 20" wingspan - 16-1/4" length. For .099 Gas powered engines. Complete with pre-cut parts.

2.99

Famous P-51 MUSTANG - Class A

22" wing. Complete kit. . .

3.95

FREE FOLDER ON MODELS

Complete with prices and descriptions of our complete line of U-Central planes, Electric Boats, Model Gas Engines, etc. SEE our flying model of the famous F-86 SABREJET powered with a real Jet engine. Send for your copy Today.

SURPLUS HOISTS

5 TON HOIST

\$100.00 VALUE
69.95

A real heavy duty Hoist. Mfd. by the Seattle Chain & Mfg. Co. Crank operated. Has two speeds one for rapid lift - other for heavy duty. Drum size: 8-3/8" x 5" diameter. Complete with hand brake and handle.

3 TON WINCH HOIST - With crank type handle and ratchet brake. In excellent condition. Ideal for truck or jeep mounting. . . .

39.95

580.00 VALUE

HOIST

ONLY 32.50

Lifts 2500 lbs. with 24 to 1 gear ratio. Bronze worm gear drive. Has 12 ft. of 3/16" steel cable.

MOUNTING FRAME \$4.50

PORTABLE WINCH HOIST

A "swing around" type hoist. Will lift up to 1500 lbs. with 21 to 1 gear ratio. Has 12 ft. of 3/16" steel cable. 40" apr with 3" pulley. . . .

22.50

Palley's

2263 E. VERNON AVE., DEPT. PM-6
LOS ANGELES 58, CALIF.

NOW! A PROVEN FACT - SAFETY BELTS SAVE LIVES

NYLON AUTO SAFETY BELTS

MADE TO WITHSTAND A CRASH PRESSURE OF 3000 POUNDS

Meets Civil Aeronautics Standards. Approved by Police, Safety Councils, Highway Patrol, Fleet Operators, etc. Made of finest NYLON webbing and lined with Aircraft type buckle. Easily installed in any car. Special sizes for Sports Cars. Available in the following colors: Blue, Green, Gray and Maroon.

995 VAL.
ONLY 4.89 EACH

INSTALL IT IN 1/2 HOUR

SPECIFY COLOR AND ALTERNATE COLOR

5 SECONDS TO FASTEN - 1 SECOND TO UNFASTEN

3400 RPM 1/2 HP POWER SAW

COMPARES TO SAWS SELLING UP TO \$49.50 WITH A 5 1/2" BLADE

ONLY 19.98

RIPS - CROSSCUTS CUTS A FINISHED 2x4 LIKE A KNIFE THROUGH BUTTER

A rugged, professional type, adjustable saw. Will cut any angle from 0 to 45°. Has an adjustable (0 to 6") rip fence. Safety-trigger switch on handle. Full 1/2 HP Universal AC-DC. 110-120 Volt. 60 cycle motor. Weighs only 6 1/2 lbs.

PHILIPPINE MAHOAGANY LUAN PLYWOOD AT LESS THAN WHOLESALE

For Paneling Dens, Offices, etc. Use in Cabinets, Furniture, etc. Rotary cut. Both sides sanded.

Banded with finest resin adhesive. Face side unjointed. Shipped at lowest rates.

3MM (1/8") x 3 FT. x 6 FT. \$5.00 VALUE
1.79 PER SHEET

FREE SAMPLE ON REQUEST

1/4" x 4 FT. x 8 FT. 950 VAL.
4.49 PER SHEET

NEW OUTDOOR BUBBLER

CONVERT ANY OUTDOOR FAUCET TO A DRINKING FOUNTAIN

Now you can have a convenient drinking fountain in your yard or patio. Attaches directly to your regular faucet and you enjoy a cool, refreshing drink by pressing a button. DOES NOT INTERFERE with the use of your garden hose. Made of polished nickel-plated bronze and brass with a durable Shrene Plastic Bowl.

Only 3.95

AMAZING NEW DESIGN MICROSCOPE

60 to 450 POWER

Take advantage of our tremendous foreign purchase. Ideal for use by the Amateur, Scientist, Student.

- Has Triple Revolving Tower with 10X, 20X and 30X precision ground and polished lenses.
- Two interchangeable eyepieces of 6X and 7.5X with precision ground and polished lenses.
- 23x Magnifications for all purposes - 120X, 150X, 180X, 300X and 450X.
- New Patented Tub Stage with SELF CONTAINED LIGHT. No external light source is needed.
- Large substage mirror for use with external light when desirable.
- All Metal Body - precision made. Swivels through 90 degrees.
- Special hardwood case and 3 glass covers included.

FREE WITH MICROSCOPE
This sight glass measuring set contains: centimeter, millimeter, etc. Free with microscope above.

12.95

SPECIAL 12 PIECE SPORTSMAN'S KNIFE

HAS 4 1/2" BONE HANDLE

ONLY 9.95

Eliminates 12 Items from Pack or Tool Kit

Contains a regular knife, a fork, a spoon, scissors, draw knife, bone saw and fish scaler, can & bottle opener, cork screw, awl punch, screwdriver, and metal file. Mounted in a rugged bone handle.

Order From This Ad. Pay by M.O. or check. P.O.'s accepted from D&S firms. 1/3 deposit with C.O.D.'s. All Prices FOB Los Angeles, W.H.Y.

FAMOUS PALLEY MIXES



GADGET MIX - Consists of 5 pounds of Rivets, Spacers, Bolts, Screws, Gears, Wheel Bearings, Springs, Clamps, and many more. ALL for ONLY. . . **1.19**

BEARING MIX - Approximately 20 needle and Ball and Roller bearings. New and Used. Sizes: 1/2" to 4". Some of these cost the Gov't \$10 apiece. Never such a value. 5 lbs. ONLY. . . **1.59**

FILE MIX - Ten assorted Files, 4" to 12", includes 3 Vixens, half rounds saws, mills, etc., in seconds and used but in good condition. 1 Vixen alone worth our price for a tire max. \$1.10

PULLEY MIX, No. PM-1 - You'll want this one around. 10 micarta & metal pulleys ranging from 1" to 5" with ball and one piece bearings. These are aircraft pulleys, the best made with 100% of uses. A WONDERFUL BUY!!! **2.95**

NEW NYLON ROPE

Very finest quality. Lustrous white color.

SIZE Strength PRICE

1/4" Nylon 1100 lbs. 9c run ft.

3/8" Nylon 2700 lbs. 17c run ft.

1/2" NYLON 5000 lbs. 27c run ft.

11/16" Nylon 13500 lbs. 39c run ft.

15/16" Nylon 17500 lbs. 57c run ft.

1" Nylon 18000 lbs. 62c run ft.

FIBREGLAS PANELS - SAVE 40%
500,000 sq. ft. in all lengths and widths - A full range of colors. Finest quality at a big **49¢ SQ FT** saving. Free Sample -

180° OFFSET DRIVE

For use where tremendous power at low take-off RPM's is desired. 6 gears rotate on self-lubricating, hi-speed roller bearings. 85 to 1 gear ratio. Shafts are 1/4" & 3/8" dia. USED

5.95
NEW in excellent condition. . . **8.95**

UNIVERSAL JOINTS

90 to 180° UNIVERSAL

Has a heavy duty, solid cast Bronze body. Rotates from 90° to 180° as desired. Has 29/32" dia. steel shafts. Ball and socket joint.

5.95
UNIVERSAL JOINT - Same as above with cast iron body. **5.25**

In excellent condition and in many sizes and types. Listed below are a few examples.

TUBULAR SHAFT TYPE

1. 1/2" OD x 3/8" ID x 2-3/8" long **75c**

2. 5/8" OD x 1/2" ID x 2-3/16" long **75c**

3. 1" OD x 1/2" ID x 3-3/8" long **1.10**

4. 3/4" OD x 5/8" ID x 3-1/4" long **1.25**

with Neoprene Dust Cap

5. 1 1/2" OD x 3/8" ID x 2-5/16" long **.75c**

with Neoprene Dust Cap

HEAVY DUTY TUBULAR TYPE

6. 1" OD x 13/16" ID x 4-3/16" long **1.65**

7. 1-1/4" OD x 1-1/8" ID x 3-11/16" long with gimbal ring in center. **1.65**

HEAVY DUTY SOLID SHAFT

8. 1-1/4" diameter x 3-3/4" long **1.95**

9. 1 1/2" dia. (one side) x 3/8" dia. (other side) x 2-1/4" long. . . **1.35**

ORDER BY ABOVE NUMBERS - Send for FREE BOOKLET on our Full line of flex drives, universals, gears, etc.

SAVE 50% ON PALLEY HYDRAULICS

Send for our Special HYDRAULIC CATALOG SUPPLEMENT - Shows the entire line of our New Hydraulic Equipment designed especially to fill the needs of industry. Also shows our regular line of War Surplus Hydraulics such as pumps, valves, cylinders, fittings, etc. at SAVINGS UP TO 85%. Write today. It's FREE!



Save miles and minutes with an **Airguide-AUTO COMPASS**

Points the right way all the way. Neatly styled for today's smart car interiors. Fits all cars, easy to install and adjust, easy to read.

Super-power Alnico V Magnet and aircraft type compensators assure steady dependable performance under all driving conditions. Three models to choose from—

- No. 84 NON-ILLUMINATED\$5.95
- No. 85 WIRE-ILLUMINATED (by car power) 6.95
- No. 86 SELF-ILLUMINATED (with long-life self-contained flash cell) Shown below.... 6.95

CHOICE OF 5 SMART COLORS IN EACH MODEL

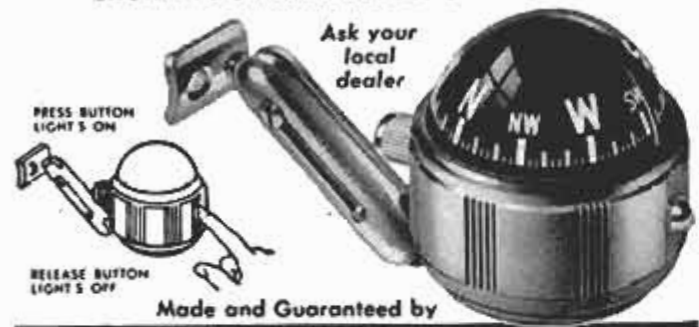

Made and Guaranteed by

AIRGUIDE INSTRUMENT CO., CHICAGO 47, ILL.

\$5000 PER DAY AND MORE

SERRATING AND SHARPENING TABLE KNIVES

SAW-KEEN PORTABLE, ELECTRIC, EASY - TO - OPERATE

Be your own boss, work anywhere, full or part time. Every restaurant, hotel, drive-in, etc., repeat customers. Serrated (saw-edged) table and steak knives in great demand. \$98.50 investment returns first week. Guaranteed. Write today for proven daily profit plan.

CUTTER-CRAFT 58-J SOUTH RAYMOND PASADENA 1, CALIF.

send for **FREE** tool catalog

SNAP-ON TOOLS CORPORATION
8062-F 28th Avenue, Kenosha, Wis.

Send me free catalog.

OCCUPATION

NAME

ADDRESS

CITYZONESTATE



A big, fact-packed catalog full of pictures and tool information . . . yours for the asking.

- Snap-on tools help you handle repair jobs faster, easier, better.
- Snap-on tools LAST . . . pay for themselves over and over.
- Used and endorsed by America's top-earning mechanics in all fields.
- Start building your Snap-on set with basic units . . . add other tools any time.



HOBBYISTS • STUDENTS • ARTISTS
ARCHITECTS • ENGINEERS • CONTRACTORS

DRAFTETTE

CUTS DRAWING TIME IN HALF

IMPROVES ACCURACY — NEATNESS

Speeds up sketches of any kind! A precision-accurate portable drafting machine that clips on any tablet, sketch pad, notebook or board up to 11" x 17". Eliminates need for ruler, protractor, T square, triangle. Compact, lightweight, made of sturdy anodized aluminum. Carry in pocket, briefcase, etc.

Last a lifetime. Order Now! Cash, Check, Money Order. **POSTPAID** **\$3.95**

Dealer, jobber inq. invited.

DAVID MILLER SALES CO. Dept. M-1, P.O. Box 572
Established 1937 Beverly Hills, California

OVERLOAD SPRINGS

\$9.95 Per Pair
Postpaid

2,000 lb. Size \$11.95

For cars and trucks. Front and rear. Gives 2,000 lbs. extra capacity for all 1/2, 3/4, and 1 ton trucks. 500 or 1,000 lbs. extra for all cars. Easily installed. Guaranteed. State make, model. Dealers wanted.

BRINKMAN MFG. CO.
2315 CLAY, DEPT. 15-J, TOPEKA, KAN.

No Leak Lamp

Test 110-600 Volts

\$2.75
\$1.50 add'l for 2 ft. leads. At dealers . . . or order direct from us. Mailed **POSTPAID**

STAR TEST-PLIERS

STAR FUSE CO., 233 Canal St., New York 13, N. Y.

STOP SLAMMING DOORS

WITH **AIREZE**

SCREEN DOOR CHECK

Positive compressed air action works every time! 2-minute installation. Cannot rust. Money back guar. At most hdw. counters, or order direct.

\$1 CANNON PRODUCTS INC.
8513 TAHOMA DRIVE, SILVER SPRING, MD.

Say You Saw It in Popular Mechanics

FIND HIDDEN PIPES • TANKS
CABLES • LOCATE WATER

NO EXPENSIVE ELECTRONIC DEVICES

Save time and money. . . . Locate before you excavate. . . . Findzit Rods pinpoint the location with remarkable accuracy. Send today.

\$5.95 PER SET POSTPAID

SATISFACTION OR MONEY BACK

FILTRATION EQUIPMENT CORP.
P.O. BOX 1331 • ROCHESTER 3, N. Y.

LESS THAN WHOLESALE

1300-1500 WATT PLANT

115v. 60 cyc. AC Push Button Start. Powered by a 3 1/2 HP. Clinton engine. Combines big output with easy portability. Provides emergency power for operating any oil burner, sump pump, freezer, television, lights, communications systems, etc. which require up to 1500 watts. (Item 22). Wt. 110 lbs. Reg. \$475 value. Factory price... **\$239.50**



1750 Watt Plant Powered by 4.5 Briggs engine. Electric starting & battery charging built-in. Factory price... **\$279.50**

MASTER-LITE 2500 Watt Plant 110/120 v. 60 cyc. AC. A powerful plant, ruggedly constructed and yet designed for easy portability. Can be started by rope or built-in 12 v. electric push button start.



Built-in winding to charge battery. Powered by a big 5.10 HP Briggs engine, complete with all accessories. Includes control box, voltmeter, and handy plug-in power receptacle. An ideal plant for permanent or stand-by service. Wt. 225 lb. Reg. price \$645.00 (Item 21) Factory Price... **\$329.50**

3500 Watt Plant Push Button Start (Item 23) 115 v. 60 cyc. AC. Similar to above, but larger and 33% more capacity. Wt. 270 lbs. Reg. \$760. Factory Price... **\$379.50**

DUAL VOLTAGE 110/220 for Item 21 or 23 -\$30 additional.

We make every type and size of light plants -Write, giving us your requirements!

SAVE

middleman profits... get **MASTER MECHANIC'S** bedrock factory prices



600-700 WATT PLANT

PUSH BUTTON START

115 v. 60 cyc. AC Powered by a rugged 2 HP. easy starting Briggs engine. No wiring necessary; just plug in and operate. Plenty of current for any oil burner, freezer, brooder, emergency lights, etc. which require up to 700 watts. Ideal for television and radios. Complete with voltmeter and built-in winding to charge 6 v. auto batteries. (Item 24) Wt. 75 lbs. Easily fits in car trunk. Be prepared if storm knocks out power lines. Regular \$275.00 value... **\$143.50**

1000-1200 Watt Plant (Item 45) same as Item 24 but larger generator and engine with 50% greater output... **\$199.50**

9 TON HYDRAULIC PRESS

A tremendously powerful hydraulic press, capable of exerting 18,000 lbs. pressure. Pays for itself many times over—straightening bent connecting rods, king pins, crankshafts, axles, link pins and bars—or pushing out frozen bearings and bushings. Developed pressure under precise control and visible at all times on accurate gauge. Complete with both large and small anvils and jigs to straighten any kind of curve or bend. (Item 46) Wt. 110 lb. Actual list price \$365. Our special close-out price... **\$69.50**



RUBBER HOSE

Synthetic Neoprene Hose—outlasts ordinary rub. 3 to 1. Reinforced with super tough cotton cord piles—yet completely flexible. Equipped with standard thread male and female fittings. Pump water for irrigation, stock tanks, home, barn, fire fighting, etc.—or pump gas and fuel oil. Volume factory prices—save more than 60%.



TERRIFIC VALUES!

Inside Dia.	Length	Price
1"	10 ft.	5.95
1 1/4"	10 ft.	8.95
1 1/4"	25 ft.	13.95
1 1/4"	50 ft.	24.75
1 1/4"	100 ft.	49.95
1 1/2"	10 ft.	10.95
1 1/2"	25 ft.	14.75
2"	10 ft.	16.50
2"	(no cord ply)	9.50
2"	(suction)	21.50
2 1/2"	(discharge)	21.75
3"	10 ft.	25.50

1 1/2" I.D. HIGH PRESSURE STEAM HOSE per ft. \$1.00

AIR HOSE Heavy duty, 1 1/4" I.D., 2 braided (150 lb. pressure) with standard couplings, 20 ft. lengths, ea. \$2.95

PAINT SPRAY MATERIAL HOSE 3/8" I.D. Synthetic Thickett inertible and neoprene covered—first made! 25 ft. lengths with standard couplings. (Item 62) each \$7.50

JET STEAM MASTER

Now, a super efficient portable steam generator that produces live steam at 100 lb. pressure in 60 seconds from a cold start! Produces large volume of high pressure steam on 2 pints of fuel oil. Instantly cleans sticky grease, dirt, rust, old paint, etc. off implements and road machinery. Pays for itself in a few weeks. Sterilizes soil. Sterilizes as it cleans—milk equipment, etc. Fully automatic—oil fired with new, built-in lifetime bronze water circulating pump. Draws water from faucet of bucket, sump and safe—anyone can use it. Built-in safety valve. Complete with 12 ft. of hi-pressure steam hose and new triple efficiency steam gun that automatically mixes in soap solution if desired. Wt. 250 lbs. Item 463. **\$329.50** Special factory price



PORTABLE LIGHT PLANTS

GIANT 2000-2500 WATT PLANT

110-120 v. 60 cyc. AC. Absolutely the best made—exclusive dynamically balanced armature; heavy windings develop up to 5000 watt overload for motor starting. Skid mounted—portable. Powered by an easy starting Briggs or Wisconsin 6 HP engine—complete with all accessories; engine easily disconnected for other uses. Big outlet box, voltmeter, no wiring necessary. Ample current for all purposes. Factory warranty. (Item 31) Wt. 210 lb. Reg. price \$585. Special at... **\$299.50** Same plant with electric self starter (Item 31a)... **\$359.50** Generator only and control box... **\$169.50** **DUAL VOLTAGE 110-220** available on any of above models for \$28.00 additional.



EXTENSION CORD

Heavy duty and very flexible. Neoprene 14-2 cable. 20 year quality. Wt. 12 lbs. (Item 185) 100 ft. Complete with rubber plug and outlet. A terrific buy at only **\$8.95**



No. 10-2 POWER CABLE. Heavy duty, very flexible, rubber covered, 50 ft. with male and female fittings. Wt. 9 lbs. (Item 592a) **\$10.45** 50 ft. without fittings (Item 592b) **\$9.45**

No. 12-2 POWER CABLE. Very flexible rubber covered, special outside shield for grounding power tools, etc. 50 ft. (Item 109) wt. 8 lbs. **\$6.95** 100 ft. (Item 200)... **\$12.95**

No. 14-8 Conductor Power Cable. heavy duty very flexible, rubber covered, with 8 contact plug & socket. Ideal for tractor-trailer connections (Item 796) 15 ft. **\$9.95**

HEATING & VENTILATING FAN

(Item 10) Easily installed in furnace pipes. Forces even heat to all rooms. Over range removes kitchen smoke and odors. Powerful, continuous duty motor, 110-120v. AC. Mount in wall or ceiling to ventilate any area. Quiet, super-efficient fan moves huge volume of air. (400 to 600 CFM).



8" Pipe, wt. 5 lb. **\$6.85**
9" Pipe, wt. 6 lb. **\$7.85**
10" Pipe, wt. 7 lb. **\$8.85**
12" Pipe, wt. 8 lb. **\$9.85**

HEAVY DUTY FAN. Semi-enclosed motor, suitable for spray booths, restaurant exhausts, poultry houses, etc. 10" Fan, wt. 8 lbs. (Item 10E) **\$11.95**
12" Fan, wt. 10 lbs. (Item 10D) **\$12.95**

CONDITIONAIRE VENTILATING FANS

Save big money installing your own exhaust fan. Efficient propeller type blade moves huge volume of air quietly and effortlessly. Heavy welded frame—pre-drilled for easy installation. Just cut opening and bolt in place. Continuous duty motors. Ideal for attics, restaurants, garages, barns, chicken houses, etc. Control manually or with thermostat.



Blade Opening	CFM	WT.	Item	Price
16"	18 1/4"	2925	10 lb.	365a \$27.95
18"	19 1/4"	3600	20 lb.	365b \$31.95
20"	21 1/4"	4100	30 lb.	365c \$39.95

Rugged, ball bearing WINCH

Sturdy ball bearing winch—super tough aluminum alloy construction. Powered by an easy starting 2 1/2 HP Briggs gas engine thru gear reduction drive—it exerts up to 3000 lbs. of terrific force for hoisting materials or pulling.



Combination gear and pulley reduction results in tremendous multiplication of engine power. Idler pulley clutch arrangement and built-in drum brake (with ratchet hand lever) enables operator to ease loads down gently and lock at any point desired. Drum handles 400 ft. of 3/8" cable or 800 ft. of 1/2" cable. Ideal for contractors, farm implement trails and unlimited other uses! (Item 795) Wt. 125 lbs. Only... **\$149.50**

HAND WINCH—Same winch with large crank handle for extra leverage and 2 speed drive. (Item 794) Wt. 60 lbs. **\$59.50**

HI-FLO Centrifugal PUMP

Completely self-priming! No foot valve required. Tremendous capacity—100 gal. per min. 1" Special Impeller enables pump to handle muddy or sandy water. Simple to operate—simply start engine and watch the water go. Powered by a rugged, easy-starting 2 HP Briggs engine. Pre-lubricated sealed bearings for years of heavy low-cost service. Big 1 1/2" Model. Item 602. Wt. 70 lbs. **\$134.50** Factory price...



2" Model (150 gal. per min.) with 2 1/2 HP engine. Item 302a. 90 lbs. Fact. Spec. \$154.50

BIG JOE Portable Pump. Exclusive impeller has 25% more capacity—handles up to 15,000 g.p.h. Self-priming after initial prime. Powerful 6 hp Briggs gas engine and big rubber-tired wheels. Wt. 280 lbs. (Item 503) **\$299.50**

MASTER AIR COMPRESSOR

COMPARE! This is the only compressor built with a **NO RUST** stainless steel tank. Safe up to 500 lbs. (Item 209) High pressure type (4 c.f.m.) Large volume of air for heavy duty service. For paint spraying, inflating truck & auto tires, greasing, sand blasting, etc. Piston type 2" bore compressor with built-in air filter. Master built with high strength alloys and precision bearings. Tank, 12"x24", 2100 cu. in. cap. Equipped with automatic switch that starts and stops motor to maintain desired pressure (up to 150 lbs.) and check valve, safety valve, gauge, shut-off valve, 20 ft. air hose and tire chuck. Beautifully balanced on ball bearing wheels and rubber tires. Don't take chances with used or surplus equipment. Our compressors are factory new and are guaranteed **SAFE**. Low factory prices. 1 1/2 HP Model (esp. 85 lbs.) Reg. \$175. (Item 209) **\$109.50** 1 1/2 HP heavy duty model, Rep.-Ind. motor & unloader switch (Item 209a) **\$129.50**



Tested up to 500 lbs. per sq. in.

Send check or M.O. Prices f.o.b. Factory. 10 day Money back guarantee. SEND 10c for... **Big 1956 Catalog**

MASTER MECHANIC MFG. CO., DEPT. 67-M

Burlington, Wis.

MASTER DC ARC WELDERS

Now! a portable rugged, industrial type welder with terrific performance, yet at a price hundreds of dollars less than you'd expect. Senior model made for years of trouble-free, continuous service. High capacity DC welding unit enables you to tackle any job with confidence—easily welds anything up to 2" plate using from 1/16" to 1/4" rods. Built-in stabilizer cooling system makes arc easy to strike and hold. Dual control rheostat provides low heat soldering, brazing and welding from 30 to 300 amps. Complete with instructions, guarantee and triple V-belt or flat pulley. Easy to hook up and easy to operate. **WELDER ONLY—DUAL CONTROL MODEL.** Same as above, but drive with your tractor, jeep or gas engine of 14 HP or more. (Item 38a.) Wt. 110 lbs. \$450 value... **\$119.50**



WELDER ONLY—STANDARD MODEL. Same as above, but with single rheostat for heavy metal welding only. (Item 38.) Wt. 110 lbs. \$400 value. Special... **\$99.75**

COMPLETE POWER MASTER (Illustrated above) powered by a 14.6 hp., air cooled Wisconsin engine. Wt. 480 lbs. (Item 280) Complete with welder coating \$1200. **\$449.50** Factory Special.

WELDING KIT Two 10 ft. leads, welding helmet, electrode holder, ground clamp. Sold only with welder at... **\$10.50**

Cast your ballot for a successful future!

256 I.C.S. COURSES



Whether you stand at a machine or sit at a desk . . . whether you're making \$75 a week or \$75 hundred a year . . . whether your interest is Power Plants or Paper Pulp, Advertising or Electronics . . . chances are I.C.S. has exactly the course you need to get ahead.

I.C.S. is not only the oldest and largest correspondence school. It also offers the most courses, 256 in all. Each one success-proved by graduates who rose to top technical and administrative positions. Chief engineers. Superintendents. Foremen. Managers. Executive assistants.

I.C.S. Courses cover bedrock facts and theory plus practical, on-the-job applications. No skimping. Texts

are prepared by leading business and industrial authorities working with I.C.S. editors and educators. They are constantly being reviewed and revised in line with current developments.

As an I.C.S. student, you study in your spare time, set your own pace. No time lost getting to class or waiting for slower students to catch up. If you wish, I.C.S. will make progress reports to your employer. You win recognition as a "comer," one who is ready to move ahead. Thousands of students report pay increases and promotions within a few months of enrollment. All graduates win the coveted, approved I.C.S. diploma.

3 FREE BOOKS! Check the subject that interests you in the coupon below. I. C. S. will rush you (1) a special book outlining your opportunities in this field, (2) the 32-page gold mine of career tips, "How to Succeed," (3) a sample I. C. S. lesson (Math.) demonstrating the famous "I. C. S. Method." "X" MARKS OPPORTUNITY.



For Real Job Security—Get an I. C. S. Diploma! I. C. S., Scranton 9, Penna. Member, National Home Study Council

INTERNATIONAL CORRESPONDENCE SCHOOLS

65TH YEAR

BOX 23626F, SCRANTON 9, PENNA.

(Partial list of 256 courses)

Without cost or obligation, send me "HOW TO SUCCEED" and the opportunity booklet about the field BEFORE which I have marked X (plus sample lesson):

- | | | | | |
|--|---|--|---|---|
| <p>ARCHITECTURE and BUILDING CONSTRUCTION</p> <ul style="list-style-type: none"> <input type="checkbox"/> Air Conditioning—Refrig. <input type="checkbox"/> Architecture <input type="checkbox"/> Architectural Interiors <input type="checkbox"/> Building Contractor <input type="checkbox"/> Building Estimator <input type="checkbox"/> Building Maintenance <input type="checkbox"/> Carpentry and Mill Work <input type="checkbox"/> Heating <input type="checkbox"/> Painting Contractor <input type="checkbox"/> Plumbing <input type="checkbox"/> Reading Arch. Blueprints <p>ART</p> <ul style="list-style-type: none"> <input type="checkbox"/> Cartooning <input type="checkbox"/> Commercial Art <input type="checkbox"/> Fashion Illustrating <input type="checkbox"/> Magazine Illustrating <input type="checkbox"/> Show Card and Sign Lettering <input type="checkbox"/> Sketching and Painting <p>AUTOMOTIVE</p> <ul style="list-style-type: none"> <input type="checkbox"/> Auto Body Rebuilding <input type="checkbox"/> Auto Elec. Technician <input type="checkbox"/> Auto-Engine Tune Up <input type="checkbox"/> Automobile Mechanic | <p>AVIATION</p> <ul style="list-style-type: none"> <input type="checkbox"/> Aeronautical Engineering Jr. <input type="checkbox"/> Aircraft & Engine Mechanic <p>BUSINESS</p> <ul style="list-style-type: none"> <input type="checkbox"/> Advertising <input type="checkbox"/> Bookkeeping and Accounting <input type="checkbox"/> Business Administration <input type="checkbox"/> Business Correspondence <input type="checkbox"/> Public Accounting <input type="checkbox"/> Creative Salesmanship <input type="checkbox"/> Federal Tax <input type="checkbox"/> Letter-writing Improvement <input type="checkbox"/> Office Management <input type="checkbox"/> Professional Secretary <input type="checkbox"/> Retail Business Management <input type="checkbox"/> Sales Management <input type="checkbox"/> Stenographic-Secretarial <input type="checkbox"/> Traffic Management <p>CHEMISTRY</p> <ul style="list-style-type: none"> <input type="checkbox"/> Analytical Chemistry <input type="checkbox"/> Chemical Engineering <input type="checkbox"/> Chem. Lab. Technician <input type="checkbox"/> General Chemistry <input type="checkbox"/> Natural Gas Prod. & Trans. <input type="checkbox"/> Petroleum Engineering <input type="checkbox"/> Plastics <input type="checkbox"/> Pulp and Paper Making | <p>CIVIL, STRUCTURAL ENGINEERING</p> <ul style="list-style-type: none"> <input type="checkbox"/> Civil Engineering <input type="checkbox"/> Construction Engineering <input type="checkbox"/> Highway Engineering <input type="checkbox"/> Reading Struct. Blueprints <input type="checkbox"/> Sanitary Engineering <input type="checkbox"/> Structural Engineering <input type="checkbox"/> Surveying and Mapping <p>DRAFTING</p> <ul style="list-style-type: none"> <input type="checkbox"/> Aircraft Drafting <input type="checkbox"/> Architectural Drafting <input type="checkbox"/> Electrical Drafting <input type="checkbox"/> Mechanical Drafting <input type="checkbox"/> Mine Surveying and Mapping <input type="checkbox"/> Plumbing Drawing and Estimating <input type="checkbox"/> Structural Drafting <p>ELECTRICAL</p> <ul style="list-style-type: none"> <input type="checkbox"/> Electrical Engineering <input type="checkbox"/> Electrical Maintenance <input type="checkbox"/> Electrician <input type="checkbox"/> Contracting <input type="checkbox"/> Lineman <p>HIGH SCHOOL</p> <ul style="list-style-type: none"> <input type="checkbox"/> Commercial <input type="checkbox"/> Good English <input type="checkbox"/> High School Subjects <input type="checkbox"/> Mathematics | <p>LEADERSHIP</p> <ul style="list-style-type: none"> <input type="checkbox"/> Foremanship <input type="checkbox"/> Industrial Supervision <input type="checkbox"/> Leadership and Organization <input type="checkbox"/> Personnel-Labor Relations <p>MECHANICAL AND SHOP</p> <ul style="list-style-type: none"> <input type="checkbox"/> Gas—Electric Welding <input type="checkbox"/> Heat Treatment <input type="checkbox"/> Metallurgy <input type="checkbox"/> Industrial Engineering <input type="checkbox"/> Industrial Instrumentation <input type="checkbox"/> Industrial Supervision <input type="checkbox"/> Internal Combustion Engines <input type="checkbox"/> Machine Design-Drafting <input type="checkbox"/> Machine Shop Inspection <input type="checkbox"/> Machine Shop Practice <input type="checkbox"/> Mechanical Engineering <input type="checkbox"/> Quality Control <input type="checkbox"/> Reading Shop Blueprints <input type="checkbox"/> Refrigeration <input type="checkbox"/> Sheet Metal Worker <input type="checkbox"/> Tool Design <input type="checkbox"/> Toolmaking <p>RADIO, TELEVISION</p> <ul style="list-style-type: none"> <input type="checkbox"/> Industrial Electronics <input type="checkbox"/> Practical Radio TV Eng'ng <input type="checkbox"/> Radio and TV Servicing <input type="checkbox"/> Radio Operating | <ul style="list-style-type: none"> <input type="checkbox"/> Television Technician <p>RAILROAD</p> <ul style="list-style-type: none"> <input type="checkbox"/> Air Brake Equipment or <input type="checkbox"/> Car Inspector <input type="checkbox"/> Diesel Engineer & Fireman <input type="checkbox"/> Section Foreman <p>STEAM AND DIESEL POWER</p> <ul style="list-style-type: none"> <input type="checkbox"/> Combustion Engineering <input type="checkbox"/> Diesel—Elec. <input type="checkbox"/> Diesel Eng's <input type="checkbox"/> Electric Light and Power <input type="checkbox"/> Stationary Fireman <input type="checkbox"/> Stationary Steam Engineering <p>TEXTILE</p> <ul style="list-style-type: none"> <input type="checkbox"/> Carding and Spinning <input type="checkbox"/> Cotton, Rayon, Woolen Mfg. <input type="checkbox"/> Finishing and Dyeing <input type="checkbox"/> Loom Fix'g <input type="checkbox"/> Textile Des'ing <input type="checkbox"/> Textile Eng'g <input type="checkbox"/> Throwing <input type="checkbox"/> Warping and Weaving <p>MISCELLANEOUS</p> <ul style="list-style-type: none"> <input type="checkbox"/> Domestic Refrigeration <input type="checkbox"/> Marine Engineering <input type="checkbox"/> Ocean Navigation <input type="checkbox"/> Professional Engineering <input type="checkbox"/> Short Story Writing <input type="checkbox"/> Telephony |
|--|---|--|---|---|

Name _____ Age _____ Home Address _____

City _____ Zone _____ State _____ Working Hours _____ A.M. to P.M. _____

Occupation _____ Canadian residents send coupon to International Correspondence Schools, Canadian, Ltd., Montreal, Canada. . . . Special tuition rates to members of the U. S. Armed Forces.

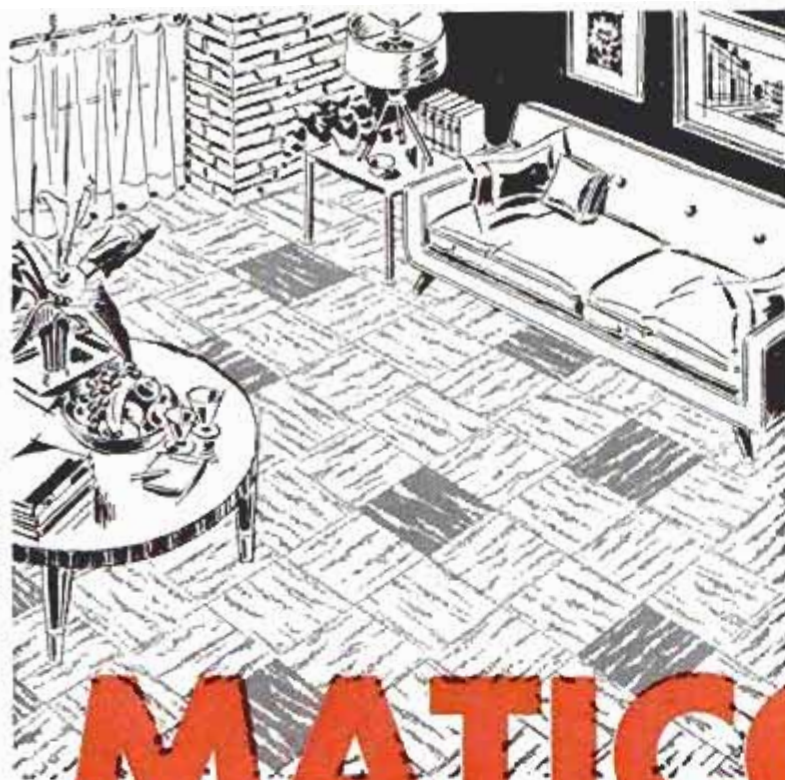

Replace your
worn-out
floors with
**BEAUTIFUL,
ECONOMICAL**

MATICO TILE FLOORING

DO-IT-YOURSELF IN JUST A FEW HOURS

Yes, you can install your own smart, easy-to-clean MATICO Tile Floor . . . free your wife from floor drudgery . . . in just a few hours. It's easy with MATICO's big, new illustrated instruction book to show you how. And you couldn't choose a more economical, durable, colorful flooring. MATICO comes in popular marbled colors, Confetti dots-of-color patterns and smart wood tones in asphalt and vinyl-asbestos tile.

CUT COSTS TOO

Save money? You bet. You save plenty by installing your own floor . . . and MATICO saves on upkeep, too, because it requires less care, lasts for years. Ask your MATICO dealer for full details today. He's listed under "floors" in the classified telephone directory. Or mail coupon for your free instruction book.



FREE

INSTRUCTION
BOOK SHOWS
YOU HOW

**MAIL COUPON
TODAY!**

MASTIC TILE CORPORATION OF AMERICA

Houston, Tex. • Joliet, Ill.
Long Beach, Calif. • Newburgh, N. Y.



Rubber • Vinyl • Asphalt Tile • Confetti • Aristoflex
Parquetry • Maticork • Cork Tile • Plastic Wall Tile

Mastic Tile Corp. of America
Dept. M2-6, Newburgh, N. Y.

Please send me full details on MATICO Tile
Flooring and FREE install-it-yourself instruc-
tion book.

NAME _____

ADDRESS _____

CITY _____ ZONE _____ STATE _____



DREAMSHIP! . . . the spectacular Lark "Sportster"! A gifted designer's concept of a hull to fittingly complement the dramatic beauty and brilliant performance of Evinrude's premier model, the fabulous new Lark. From coast to coast this is the motor being chosen for smartest runabouts of every make. See your Evinrude dealer. Look for his name under "Outboard Motors" in your phone book. Catalog free. **EVINRUDE MOTORS,** 4286 N. 27th St., Milwaukee 16, Wisconsin.

the Lark

by

Evinrude

pioneers in quiet outboard motors

